

POPULAR MECHANICS MAGAZINE

WRITTEN SO YOU CAN UNDERSTAND IT

REG'D. TRADE MARK, GREAT BRITAIN, No. 410426

REG. U.S. PAT. OFF.

See page 65



**How Owners
Rate the
'51 CADILLAC**

For the Home Owner
**How to Install
Attic Ventilating Fans**

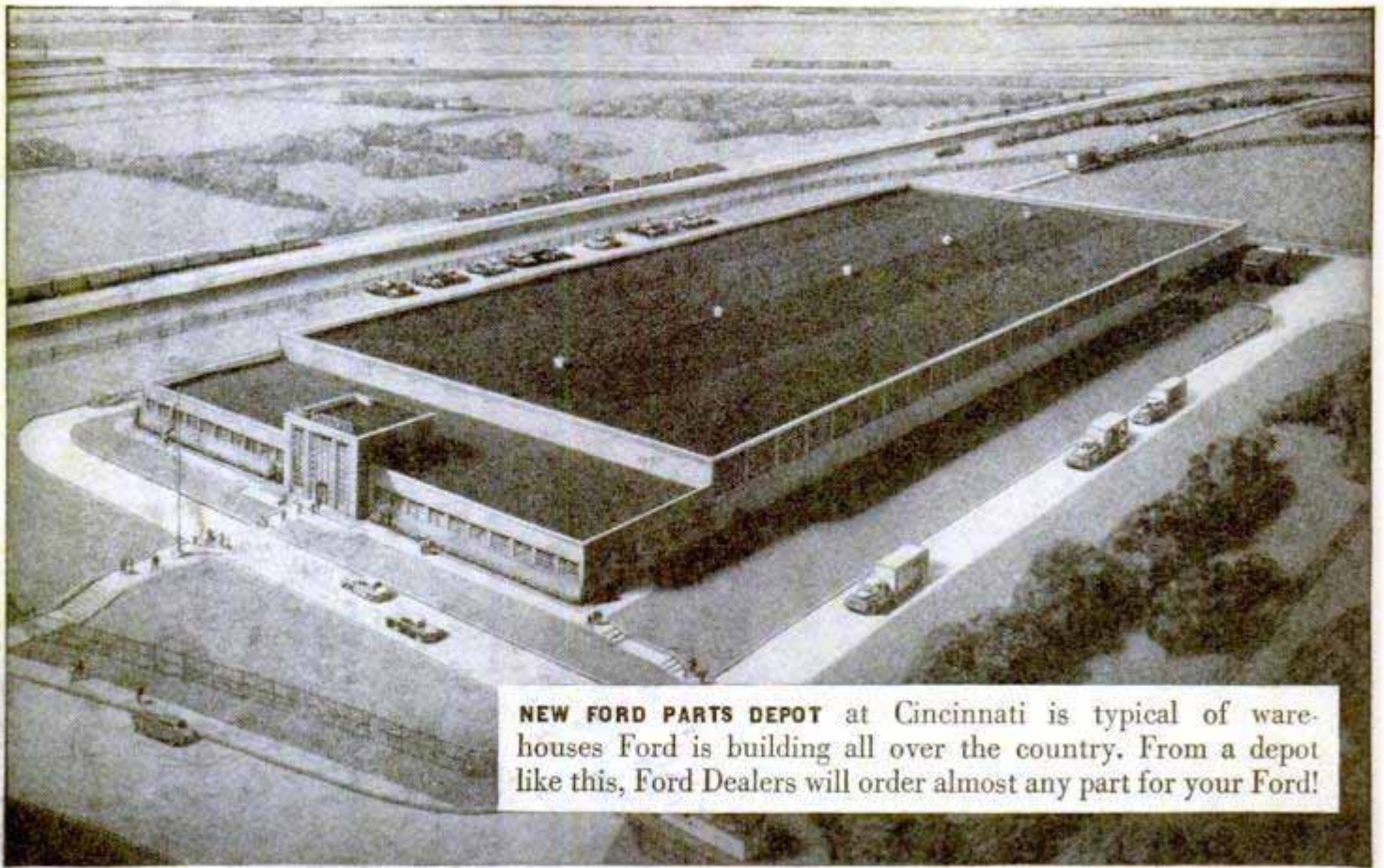

NEW FORD PARTS DEPOT at Cincinnati is typical of warehouses Ford is building all over the country. From a depot like this, Ford Dealers will order almost any part for your Ford!

TO SERVE FORD OWNERS BETTER THAN EVER!

Ford's \$500,000,000 expansion program will make Genuine Ford (FoMoCo) Parts easier to get than ever. The depot (above) is only one of ten new parts depots built or being built. Nineteen others are being expanded. This expansion program, designed to triple stock space, is part and parcel of Ford's "Look Ahead" policy to better serve Ford owners.



MADE RIGHT for Fords, Genuine Ford Parts, like this muffler, are specified by wise motorists to save time, money and trouble. They're *right* because they're duplicates of the parts in your Ford—they keep Fords *all Ford*.



FIT RIGHT in your Ford—a "must" for important parts like the Genuine Ford Carburetor above. It's typical of the parts designed by Ford engineers, to work right in your Ford . . . to keep your Ford young longer.



LAST LONGER in Fords. This sign is displayed wherever Genuine Ford Parts are sold . . . at all Ford Dealers and selected independent garages. Specify Genuine Ford Parts . . . made right . . . to fit right . . . to last longer.

KEEP YOUR FORD ALL FORD!

MAKES *Gas* FROM *Oil!*

TIMKEN
Silent Automatic

**WALL-FLAME
OIL BURNER**

**CONVERTS FUEL OIL
INTO A GAS, THEN
BURNS THE GAS WITH
AMAZING EFFICIENCY!**

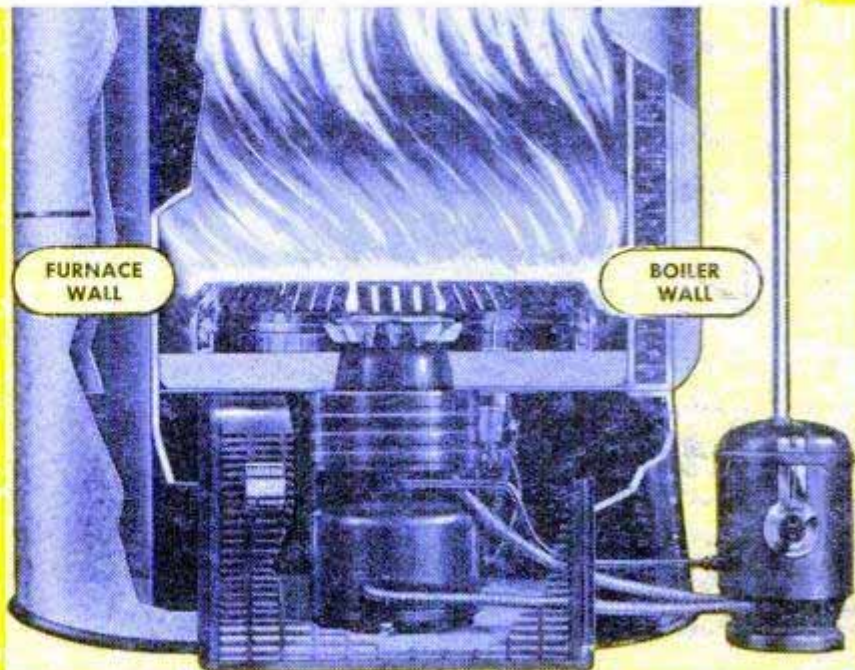

Scientific flame placement, as illustrated in the sectional view above (left side shows furnace, right side boiler), is a major factor in the extraordinary operating efficiency of the Timken Silent Automatic Wall-Flame Oil Burner, famous for fuel oil savings up to one gallon in every four used by ordinary burners.

Every useful Btu. of heat is extracted from every drop of fuel oil—thanks to the exclusive design of the Timken Silent Automatic Wall-Flame Oil Burner. This is the one and *only* type of automatic fuel burner that combines all the best features of oil heat with the clean-burning efficiency of gas heat. Your local Timken Silent Automatic Authorized Dealer will be glad

The unique chrome-steel flame rim shown at right converts fuel oil into a gas, *thus*: Oil droplets strike glowing-hot flame rim and are instantly vaporized. Resultant mixture of oil-gas and air rises through grills, is superheated, and burns with same blue color characterizing a gas flame.

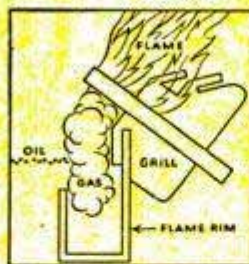

to show you operating units as well as cut-away models. See for yourself the exceptional efficiency of this advanced development in heating science; ask for free literature with detailed data for your further study. Without any obligation on your part, your Dealer will make a scientific heating survey of your home, using approved laboratory-type instruments—and give you a written guarantee of fuel oil savings if you are changing over from an ordinary burner. Examine his findings and then decide for yourself whether you can afford to remain without Timken Silent Automatic Oil Heat. *Phone him today!*—or use coupon below.

MAIL THIS COUPON TODAY FOR ILLUSTRATED LITERATURE!

Timken Silent Automatic, Jackson, Michigan
Please mail illustrated literature. I am interested in:

_____ (type of equipment)

NAME _____

STREET ADDRESS _____

CITY and STATE _____

If you are a student, please check here () for special information.



TIMKEN
Silent Automatic
HEAT

TIMKEN SILENT AUTOMATIC DIVISION
The Timken-Detroit Axle Company • Jackson, Michigan
The Timken-Detroit Axle Company of Canada, Ltd., Toronto, Ont.

TRADE MARK REGISTERED

PM-861



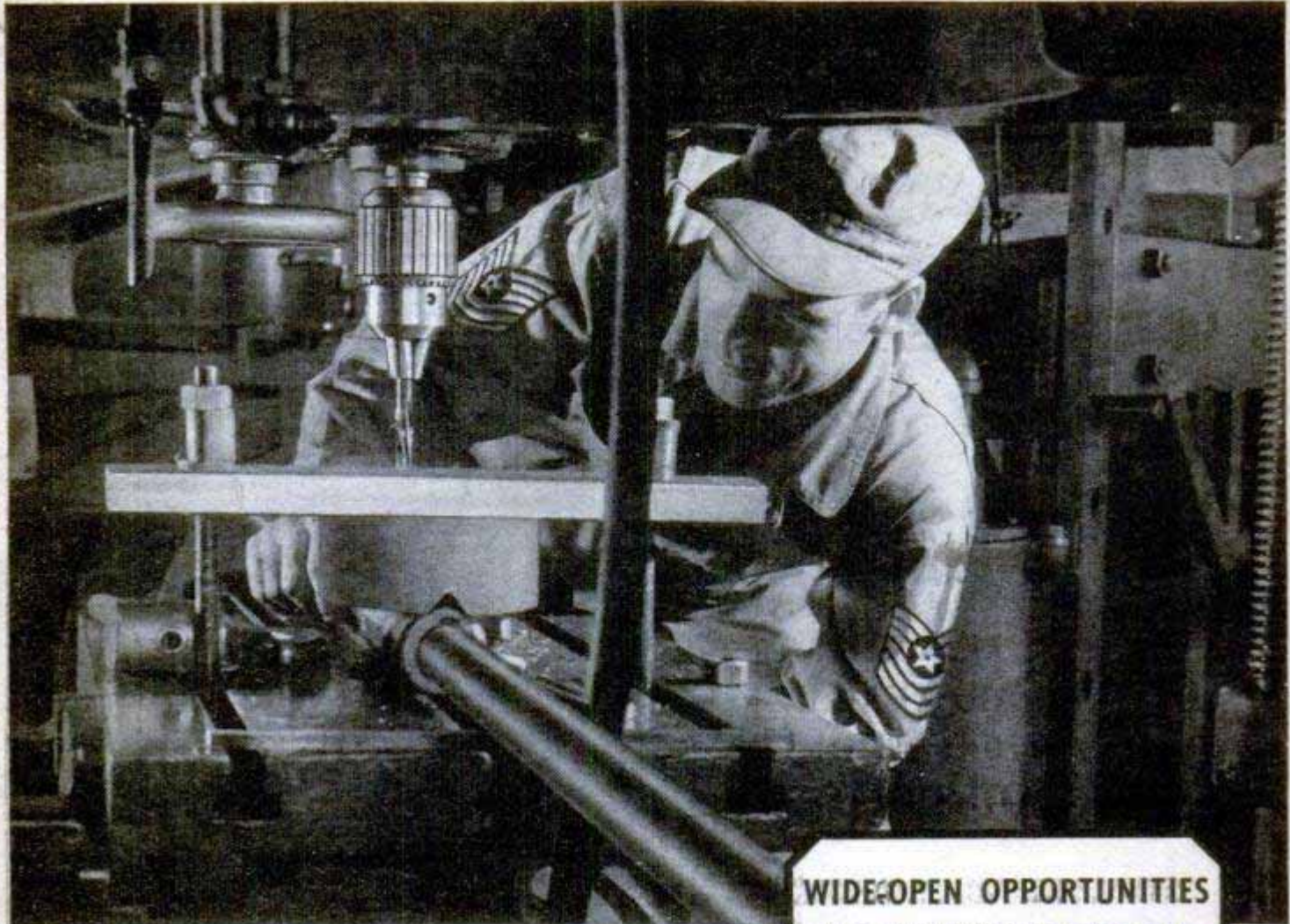

Metal Working is but one of the many technical fields in which the Air Force offers unusual opportunities today.

WHAT THE AIR FORCE OFFERS VETERANS

With Technical Training and Experience

If you are a veteran of any branch of the Armed Forces—with an essential technical skill—find out what the U. S. Air Force can offer you today!

Here are just four of the reasons why so many veterans with special skills have been moving into the Air Force:

FIRST, if qualified, you can enter the Air Force at your old grade or better, according to your present ability.

SECOND, the Air Force will tell you exactly what your initial rating and pay grade will be, before you join up.

THIRD, you will skip basic training, and be assigned initially to a nearby Air Force base.

FOURTH, today's fast-growing Air Force offers better pay, and more chances for rapid advancement, than ever before.

Hear the whole story. Tell the Air Force what you have to offer . . . ask the Air Force what it can offer you.

WIDEPEN OPPORTUNITIES FOR TRAINED VETERANS

in these and many other fields:

AIR TRAFFIC CONTROL

ARMAMENT

ENGINE MAINTENANCE

METAL WORKING

PHOTOMAPPING

RADAR

RADIO

ROCKET PROPULSION

WEATHER

Visit your U. S. Army and U. S. Air Force Recruiting Station today.



U. S. AIR FORCE

POPULAR MECHANICS

Popular Mechanics Magazine

Registered in U. S. Patent Office and Canada

H. H. WINDSOR, Founder

H. H. WINDSOR, JR., Editor and Publisher



this month's cover

IN THE EERIE light of the ocean floor the Navy's famous "frog men" cut a hole in an enemy submarine net and slip silently through toward the shore. Our cover is taken from a scene shot for a Hollywood epic. The man who masterminded the movie is Louis Witte, Hollywood's ace authority on celluloid warfare. He's created everything from the dramatic sweep of an amphibious landing to the plunk of a bullet into a tree near Shirley Temple's lovely head. For the movie about the frog men Witte shattered the air, earth and water with some 90 cases of dynamite, 500 pounds of blasting powder, 250 pounds of flash powder and two tons of TNT. "My masterpiece," Witte says, in discussing this magnificent barrage. Even the Marines consider him an authority on depicting warfare—during World War II the Corps called on him to create super-real battle effects for troop training. To see how Witte stages a modern celluloid war, turn to page 65

Published monthly by Popular Mechanics Company, 200 E. Ontario St., Chicago 11, Ill. H. H. Windsor, Jr., president; William Harrison Petridge, vice president; D. F. Windsor, vice president and secretary-treasurer; H. H. Windsor III, vice president; Clover L. Perkins, advertising manager; Alan M. Deyoe, circulation manager. Single copy in the United States and Canada, 35 cents; subscription rates in United States and possessions, Canada, Philippines and countries of the Pan-American Postal Union, 1 year \$3.50; 2 years, \$6.00; 3 years \$8.00. To all other countries add \$1.00 a year over United States prices for overseas postage. If you plan to move, notify us at least 30 days in advance so you will not miss an issue. Give both your old and new addresses. Entered as Second Class Matter, September 15, 1903 at the Post Office at Chicago, Illinois, under Act of March 3, 1879. Entered as Second Class Matter at Post Office Dept., Canada. Registered as Second Class Matter at the Post Office at Mexico, D. F., Mexico, June 20, 1950. Copyright 1951 by Popular Mechanics Company. Copyright under International Copyright Union. Copyright in France. All rights reserved under Pan-American Copyright Union. Printed in the United States of America.

AUGUST 1951

Volume 96

AUGUST 1951

Number 2

Managing Editor.....Roderick M. Grant
 Assistant Managing Editor.....Wayne Whittaker
 Shop Notes and Crafts Editor.....James R. Ward
 Radio-Television, Electronics Editor.....Frank L. Brittin
 Associate Editor, Aviation.....Aubrey O. Cookman, Jr.
 Associate Editor.....Clifford B. Hicks
 Associate Editor.....Donald R. Brooks
 Assistant Shop Notes and Crafts Editor.....Wayne C. Lecky
 Automotive Editor.....Siler Freeman
 Art Director.....Frank Beatty

Assistant Editors
 W. Clyde Lamney Arthur R. Railton Frank N. Stephany
 C. E. Mitchell Dorothy Hoffmann Carlton H. Ihde
 Eastern Editor.....Richard F. Dempewolff
 Empire State Bldg., Room 2906, New York 1, N. Y.
 Western Editor.....Thomas E. Stimson, Jr.
 302 23rd St., Santa Monica, Calif.
 Representative in Great Britain.....Douglas W. Wedderspoon
 77 Baker St., London W. 1, England
 Director, Bureau of Information.....Allan Carpenter
 200 E. Ontario St., Chicago 11

IN THIS ISSUE

Mastermind for Hollywood's Wars - - - -	65
New Land From Old - - - - -	76
What's New for Your Home - - - - -	82
Oil City Under the Sea - - - - -	86
The Farm Shop Keeps Pace - - - - -	90
It's New for the Tackle Box - - - - -	96
Owners Report on the '51 Cadillac - - - -	102
The Patients Are Pets - - - - -	113
On the Trail of the Gulf Stream - - - - -	124
A Clock for Eternity - - - - -	130
Historic Homes for Sale - - - - -	139

For the Craftsman

Money-Making Projects - - - - -	146
"Bench Build" P.M. Ranch House—Part IV - -	153
Repeating Crossbow - - - - -	165
Lakeside Tent-Cottage - - - - -	169
Keep Cool With an Attic Fan - - - - -	174
Nursery Furniture—Part II - - - - -	180
Remote Control for Gearshift Outboard - -	188
Extra Service From Your Contact Printer - -	192
Drill Press Made From Auto Parts - - - -	195
Cross-Drilling Round Work - - - - -	200
Shopping for Tools - - - - -	204
Radio-Television, Electronics - - - - -	207
Clinic for Homemakers - - - - -	218

Other items, and manufacturers of available products described, are listed on pages 12, 14 and 16

Read these interesting facts about your own automobile

Listen to what the men who build automobile engines have to say about your car. At 40 miles an hour on a smooth, level highway, 50% of your gasoline is used up to overcome engine friction. Yes, half of the power your gasoline produces never gets to the rear wheels to make your car go faster or farther or climb a steeper hill.

Friction eats a lot of gas, doesn't it?

Now just suppose you can *reduce* that friction. Then some of the power that was being used to overcome it will be *released to help* drive your car ahead.

And that's exactly what happens!

In hundreds upon hundreds of scientific Dynamometer tests using cars like yours, the average motorist got 8% more *usable* power from the same amount of gasoline after he had changed from whatever oil he had been using to Macmillan Ring-Free Motor Oil.

The minute you change to Macmillan, you'll get an increase in power and gasoline mileage. You cut down on "drag"—your gasoline "pushes" easier than before. After the second or third drain, the average motorist gets an increase in gasoline mileage of 8%!

That's because Macmillan has not only reduced engine friction but also has reduced carbon and gum deposits in the combustion chamber, on rings, valves,

and valve stems. This results in higher compression because of better piston seal—smoother operation, and less tendency for the motor to ping.

Let's figure what 8% means to you. First, it means an 8% saving on your gasoline bill—that's about 2¢ a gallon on every gallon you buy. 8% means an average of 20 extra miles on every tankful. Or, look at it this way: over a normal oil drain period, your gasoline saving is \$2.00—enough to *pay for your oil*.

And don't ever forget, it's friction that wears out motors. With Macmillan Ring-Free Motor Oil you *reduce* friction—you save on wear and repair—your motor lasts longer, runs sweeter, uses less oil. New motors stay newer longer.

You'll find Macmillan—the original carbon-removing oil—at independent garages, car dealers and service stations where you see the sign of the big red "M." Drive in, try the *OIL* that makes your *GAS* go farther.



R. S. Macmillan
President

MACMILLAN PETROLEUM CORPORATION
530 W. 6TH STREET, LOS ANGELES
50 W. 50TH, NEW YORK • 624 S. MICHIGAN, CHICAGO

P.S. If you are unable to locate a Macmillan dealer, write to me and I'll be glad to direct you to the one nearest you. R.S.M.

NEED A NEW FLOOR?

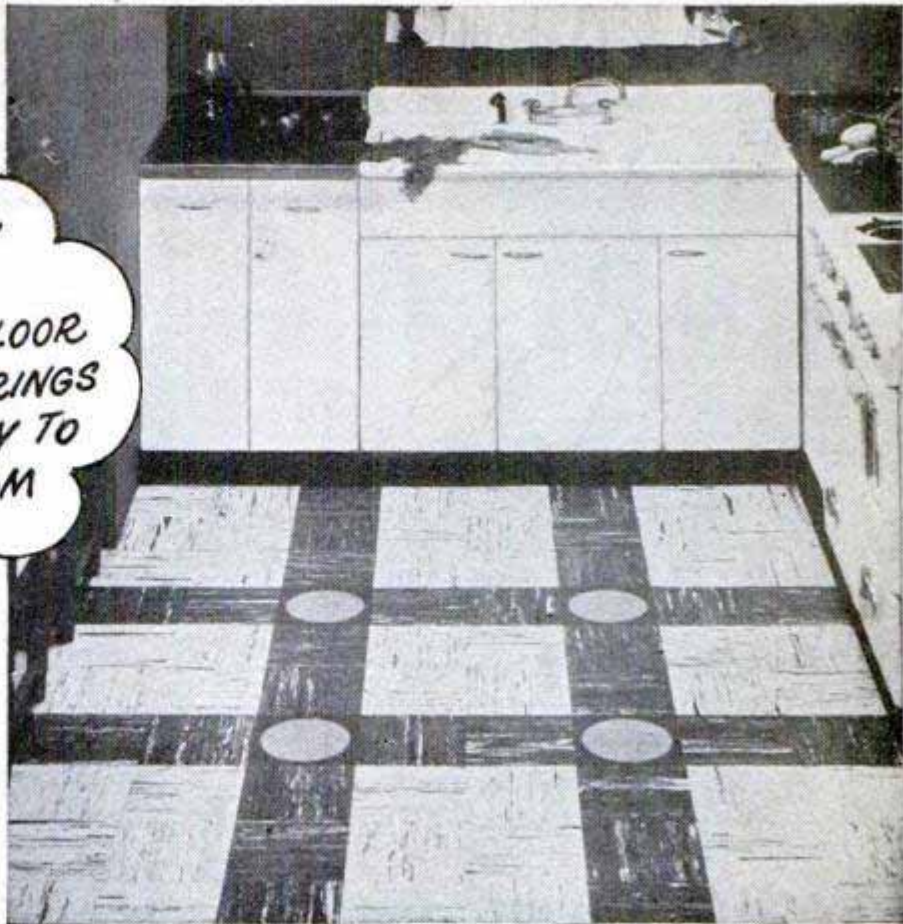

A long-lasting colorful floor like this for only \$22⁵⁰*

IT'S MONEY-SAVING FUN TO

INSTALL YOUR OWN KENTILE FLOOR

Home handymen (and women) of all ages are finding that it's so easy to lay their own Kentile Floors! The tiles go down one by one ... a few at a time or whole rooms all at once. And, as soon as it's down, the floor is ready for immediate use.

The smart, modern beauty of the 26 light bright Kentile colors lasts for the life of the floor ... colors are permanent because they go clear through to the back of each tile. And, no floor is easier to clean ... just mild soap and water plus an occasional no-rub waxing brings out all the sparkling, decorator beauty.

To find out just what it will cost you to lay a Kentile Floor in any room of your house, consult your Kentile Dealer. He's listed under FLOORING in your classified phone directory.

*Price quoted is for a 8' x 9' kitchen. Your floor may cost considerably less or slightly more depending on the colors you choose and the size of your room.



This handy
KEN-KIT gives
me all the tools
I need to do a
real workman-
like job

FREE BOOKLETS. Send for your copies of the Kentile Self-Installation Folder and the Kentile Color Line. Learn how easy it is to install your own Kentile Floor and see the 26 modern colors you can choose from. Kentile, Inc., Dept. G-2, 58 2nd Ave., Brooklyn 15, N. Y.



KENTILE®

The Asphalt Tile of
Enduring Beauty 

Freedom from Friction with PYROIL

● When you put Pyroil in your motor, you win freedom from friction, and then some. Freedom from excessive wear, breakdowns and big repair bills. Pyroil wraps a fine protective film of lubrication on cylinder walls, and pistons. That's why Pyroil gives you freedom from "dry starts" and corrosion. Pyroil "frees" your engine of gummy deposits — and keeps it clean.

The cost of Pyroil is so small, it's almost free — ask your gas station attendant. He's sure to agree—add Pyroil—add more trouble-free miles to your car.

Pyroil for Aircraft Engines

Use Aircraft Pyroil B for lubricating oil, Aircraft Pyroil A for gasoline.

GIVEN!

An attractive Pyroil metal savings bank — takes coins up to 50¢ pieces. **MOTORISTS**, it's yours for the asking — sent postage paid.



Manufactured and Guaranteed by Pyroil Company, 118 Pyroil Bldg., La Crosse, Wisconsin

Canadian Distributors: Central Purchasing Agencies, Ltd. Toronto, Ontario

PYROIL COMPANY

118 Pyroil Bldg., La Crosse, Wisconsin

I want my car to last and run properly. Please tell me more about Pyroil and how it can accomplish this for me.

Name _____

Address _____

City or Town _____ State _____



in this corner.....

THE EDITORS



THE WEATHER is hard to beat!

There are some things you can do, however, to make your home livable in a hot summer.

This month, in the Craftsman Section, you'll find a timely article on how to install attic fans that will pull the August day's heat right up from your living floors and pour it outdoors.

Next month another perennial problem is solved for you in an article telling how to defeat condensation, that eternal bugaboo of damp homes. Don't miss this September feature.

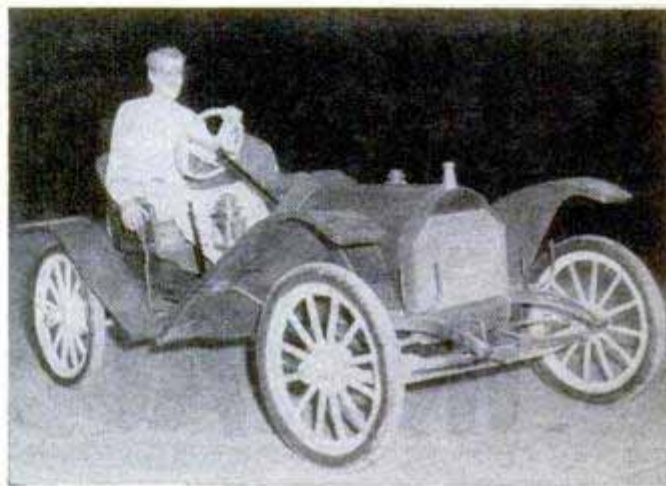

Letter to the Editor

Roger Ellis, a University of Texas student majoring in petroleum engineering, found a 1908 Hupmobile about 60 miles from Austin. A farmer had owned the car, keeping it in a dry barn where it stood the years very well. In 1918 the farmer had a small accident in it and bent a headlight, which he gave to the scrap-metal drive during World War II. The car had bad tires which he will have to get on special order; other than this, and having to reline the brakes he has done little to it. He cleaned the motor out when he first got it and has had to do little in the way of repairs. Parts are next to impossible to obtain and most of them will have to be made if he ever needs them.

He and his wife drive the car every day and it is running well. It is mainly a car to use in town, for it will only go 30 miles per hour and has a four cylinder, 20-horsepower motor. The car is a Hup 20, sports sedan seating two. It has a fan blade and

(Continued to page 8)

5 reasons why ACCOUNTANCY

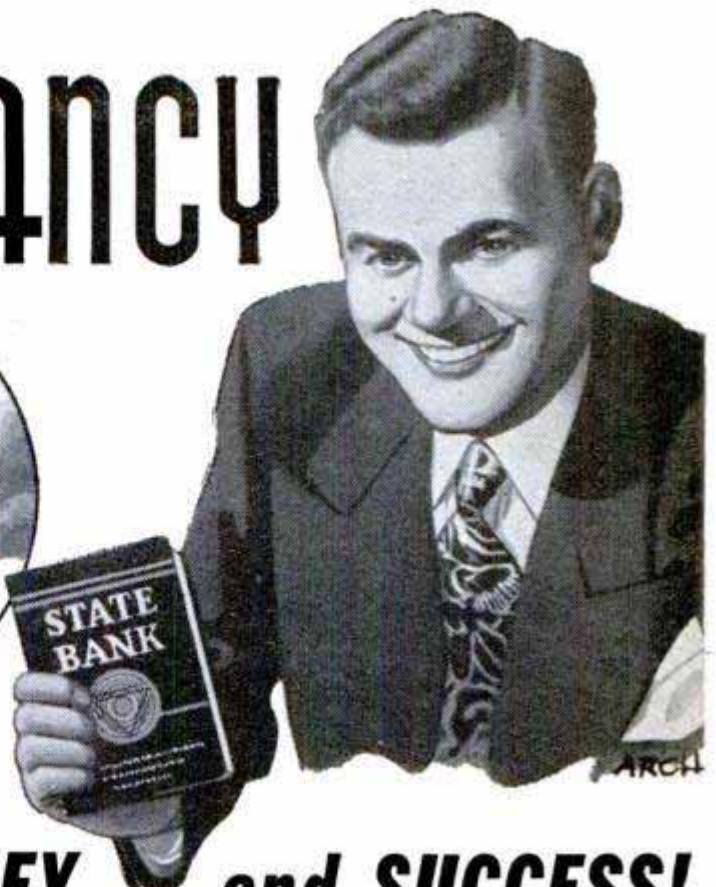
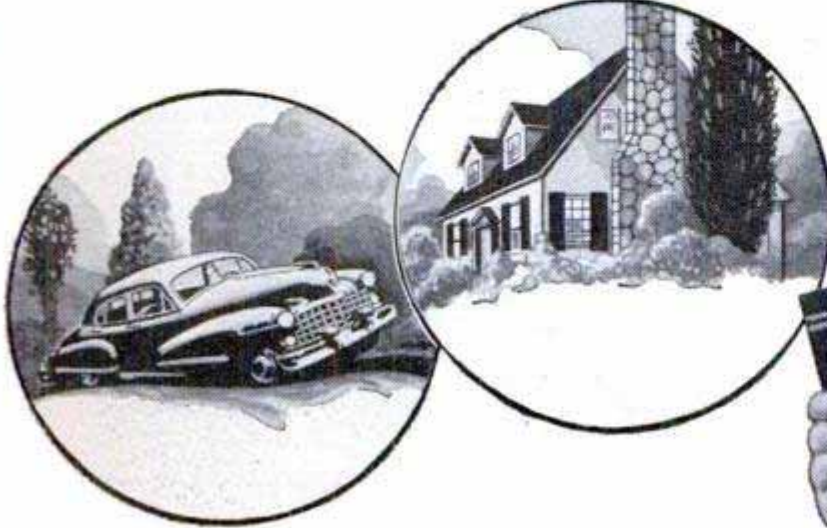

offers you MORE MONEY... and SUCCESS!

REASON #1. If you were an expert accountant right now, chances are you would find yourself among the highest-paid of all professional men and women. Even back in "depression years," surveys showed that accountants earned more on the average than men in other major professions.

REASON #2. The demand for accountants is great—everywhere. All businesses must have trained accountants to cope with ever-growing requirements. It's a profession offering wide opportunity—always—to the man who knows.

REASON #3. You can fit into any business, anywhere in the country—because accounting principles are universal. Think what this means in terms of security and independence!

REASON #4. Accountancy is open to all. Any man or woman of good intelligence, who enjoys figure work and is willing to follow LaSalle's systematic "problem method" plan, can rapidly qualify for a highly profitable, enjoyable lifetime career... and he doesn't have to finish his training before beginning to "cash in."

REASON #5. Without losing a day from your present work, you can prepare in spare hours at home, at low cost, under LaSalle's step-by-step "Problem Method" of "learning by doing." This famous plan accounts for LaSalle's remarkable record of having trained nearly 10 per cent of all Certified Public Accountants in the U. S. . . . and of having put many thousands of others into high-paying careers.

Send today for LaSalle's interesting booklets, "Accountancy, the Profession That Pays," and "Success Reports." Learn about the five great fields of opportunity . . . and LaSalle's time-tested plan for helping men and women to rapid advancement, higher income, greater prestige and professional standing. The coupon below will bring these fact-filled booklets to you—without cost or obligation—also, a free sample lesson showing LaSalle's famous "Problem Method" plan of instruction.

→ GET FREE SAMPLE LESSON ←

LASALLE
417 S. Dearborn St.,
CHICAGO 5, ILL.

**WHICH . . . ?
can help you most?**

- Accounting—Elements to C.P.A. Coaching
- Bookkeeping
- Cost Accounting
- Auditing
- Income Tax
- C.P.A. Coaching

LaSalle Extension University
— A Correspondence Institution —

Dept. 864HR, 417 S. Dearborn St., Chicago 5, Ill.

Please send me, free of all cost or obligation, a sample lesson in Accounting . . . also, your 48-page illustrated books, "Accountancy, the Profession that Pays," and "Success Reports."

Name Age

Address

City, Zone, State



Shavers Vote NEW 1951

SCHICK INJECTOR BLADES OUTSHAVE ALL OTHERS 5 TO 1

Including Our Own Old Blades!



You get
this 1951 blade
only in the **NEW
GOLD PACK!**

20 Blades Only **73¢**
12 Blades Only 49¢
6 Blades Only 25¢

IN AUTOMATIC
CARTRIDGE

HERE'S THE FULL SCORE

On Every Point
Important To Shaving:

- SMOOTHER SHAVES $5\frac{1}{2}$ to 1
- CLEANER SHAVES 5 to 1
- SAFER SHAVES 7 to 1
- FASTER SHAVES 5 to 1
- MORE SHAVES per blade nearly 2 to 1

Men in 10 cities—
nationwide—com-
pared NEW 1951
SCHICK INJECTOR
BLADES with what-
ever they had been
using. About 80% of
the men had a prefer-
ence. Of these, the
votes were in the
ratios shown above.

Special, new surgical steel!
Scalpel-sharp! Precision-
ground! And *only* these
NEW 1951 SCHICK INJECTOR
BLADES are made to fit
your injector razor perfectly!
So we guarantee this:
EITHER YOU GET THE FIN-
EST SHAVES OF YOUR LIFE—
OR YOUR MONEY BACK,
QUICK!



WORLD'S ONLY
RAZOR WITH AUTO-
MATIC BLADE
CHANGER! Get com-
plete shaving kit;
Gold-Plated Schick
Injector Razor; 12 new
Scalpel-sharp
blades; tra-
vel case. **98¢**

SCHICK INJECTOR RAZOR & BLADES

(Continued from page 6)

flywheel combined, brass lights and radiator, starts with crank, burns regular gas cut with kerosene (1-1).

He is a member of the Horseless Carriage Club, and a fellow member has given him a set of head and tail lights for it.

Nolan Borden,
Austin, Tex.

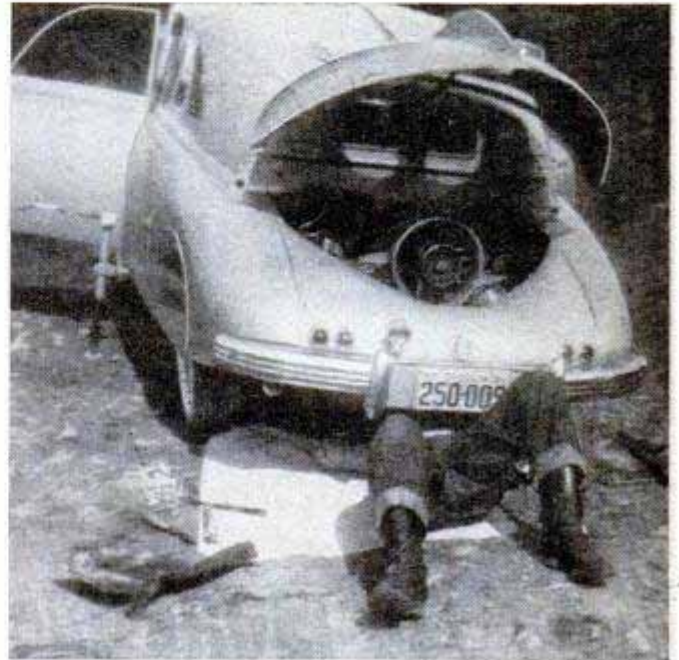

Letter to the Editor

Looking through the May Editor's Column I read the comment on the rear-engine car. I beg to differ with Mr. Cady that an engine cannot be put in the rear. Here is a picture of our 1950 Tatra with the motor in the rear . . . they have been making them for about 28 years. We haven't found any hill it has had any trouble on. There isn't an American car that can keep up to it on curves.

E. K. Wooldridge,
Enumclaw, Wash.

Letter to the Editor

While reading my favorite magazine (*Popular Mechanics*), I was very much interested in this little clipping:

"If you don't bind or store your back issues of *Popular Mechanics*, do you burn them? America's defense effort requires a vast number of paper products. Call your local Boy Scouts or veterans' organization to pick up your wastepaper."

I thought you might be interested in what I do with my magazines. As a Gray Lady of the Red Cross, I save my issues to take to the Army hospital, Fort Bragg, N. C., at which time I present them to the Korean casualties. The boys eagerly await their

(Continued to page 10)

With spare-time study, he paved a

Highway to Success



SAM P. TURNBULL
Florida Highway Engineer

From rodman in a road crew to top engineer in the Florida State Road Department — that's the spectacular story of Sam P. Turnbull.

Millions of dollars worth of highways have been constructed under his direction. He is president of the Florida Society of Professional Engineers. Though not a college man, he was nevertheless credited with the equivalent of five years of college when he entered the Army during World War II.

What is the secret of his success? Engineer Turnbull credits it to hard work and spare-

time study with the International Correspondence Schools:

"I.C.S. offers ideal training for engineers. A man can learn while he is on the job. He gains technical knowledge right along with practical experience. And I.C.S. courses are recognized nationally as among the best correspondence-type training programs in the engineering field."

Study this statement. Then mark your interest on the coupon and mail it today for full information on what I. C. S. can do for you!

INTERNATIONAL CORRESPONDENCE SCHOOLS



BOX 5505-L, SCRANTON 9, PENNA.

Without cost or obligation, please send me full particulars about the course BEFORE

which I have marked X:

- | | | | |
|---|---|---|--|
| <p>Air Conditioning and Plumbing Courses</p> <p><input type="checkbox"/> Air Conditioning
<input type="checkbox"/> Heating
<input type="checkbox"/> Refrigeration
<input type="checkbox"/> Plumbing
<input type="checkbox"/> Steam Fitting</p> <p>Chemical Courses</p> <p><input type="checkbox"/> Chemical Engineering
<input type="checkbox"/> Chemistry, Analytical
<input type="checkbox"/> Chemistry, Industrial
<input type="checkbox"/> Chemistry, Mfg. Iron & Steel
<input type="checkbox"/> Petroleum Refining
<input type="checkbox"/> Plastics
<input type="checkbox"/> Pulp and Paper Making</p> <p>Civil Engineering, Architectural and Mining Courses</p> <p><input type="checkbox"/> Architecture
<input type="checkbox"/> Architectural Drafting
<input type="checkbox"/> Bridge and Building Foreman
<input type="checkbox"/> Building Estimating
<input type="checkbox"/> Civil Engineering
<input type="checkbox"/> Coal Mining
<input type="checkbox"/> Contracting and Building
<input type="checkbox"/> Highway Engineering
<input type="checkbox"/> Lumber Dealer
<input type="checkbox"/> Reading Structural Blueprints
<input type="checkbox"/> Sanitary Engineering
<input type="checkbox"/> Structural Drafting</p> | <p><input type="checkbox"/> Structural Engineering
<input type="checkbox"/> Surveying and Mapping</p> <p>Communications Courses</p> <p><input type="checkbox"/> Electronics
<input type="checkbox"/> Practical Telephony
<input type="checkbox"/> Radio, General
<input type="checkbox"/> Radio Operating
<input type="checkbox"/> Radio Servicing
<input type="checkbox"/> Television
<input type="checkbox"/> Telegraph Engineering</p> <p>Electrical Courses</p> <p><input type="checkbox"/> Electrical Drafting
<input type="checkbox"/> Electrical Engineering
<input type="checkbox"/> Electric Light and Power
<input type="checkbox"/> Lighting Technician
<input type="checkbox"/> Practical Electrician</p> <p>Internal Combustion Engines Courses</p> <p><input type="checkbox"/> Auto Technician
<input type="checkbox"/> Diesel-Electric
<input type="checkbox"/> Diesel Engines
<input type="checkbox"/> Gas Engines
<input type="checkbox"/> Aviation
<input type="checkbox"/> Gas Engines</p> <p>Mechanical Courses</p> <p><input type="checkbox"/> Aeronautical Engineer's, Jr.
<input type="checkbox"/> Aircraft Drafting
<input type="checkbox"/> Flight Engineer
<input type="checkbox"/> Forging
<input type="checkbox"/> Foundry Work
<input type="checkbox"/> Heat Treatment of Metals
<input type="checkbox"/> Industrial Engineering
<input type="checkbox"/> Industrial Instrumentation</p> | <p><input type="checkbox"/> Industrial Metallurgy
<input type="checkbox"/> Machine Shop
<input type="checkbox"/> Mech. Drafting
<input type="checkbox"/> Mechanical Engineering
<input type="checkbox"/> Mold-Loft Work
<input type="checkbox"/> Patternmaking—Wood, Metal
<input type="checkbox"/> Reading Shop Blueprints
<input type="checkbox"/> Sheet-Metal Drafting
<input type="checkbox"/> Sheet-Metal Worker
<input type="checkbox"/> Ship Drafting
<input type="checkbox"/> Ship Fitting
<input type="checkbox"/> Ship Fitting
<input type="checkbox"/> Tool Designing
<input type="checkbox"/> Toolmaking
<input type="checkbox"/> Welding—Gas and Electric</p> <p>Railroad Courses</p> <p><input type="checkbox"/> Air Brake
<input type="checkbox"/> Car Inspector
<input type="checkbox"/> Diesel Locomotive
<input type="checkbox"/> Locomotive Engineer
<input type="checkbox"/> Locomotive Fireman
<input type="checkbox"/> Locomotive Machinist
<input type="checkbox"/> Railroad Section Foreman
<input type="checkbox"/> Steam-Diesel Loco. Eng.</p> <p>Stationary Eng'g Courses</p> <p><input type="checkbox"/> Boilermaking
<input type="checkbox"/> Combustion Engineering
<input type="checkbox"/> Engine Running
<input type="checkbox"/> Marine Engineering
<input type="checkbox"/> Power Plant Eng'g
<input type="checkbox"/> Steam Engr.</p> | <p>Textile Courses</p> <p><input type="checkbox"/> Cotton Manufacturing
<input type="checkbox"/> Loom Fixing
<input type="checkbox"/> Rayon Weaving
<input type="checkbox"/> Textile Designing
<input type="checkbox"/> Woolen Manufacturing</p> <p>Business and Academic Courses</p> <p><input type="checkbox"/> Accounting
<input type="checkbox"/> Advertising
<input type="checkbox"/> Bookkeeping
<input type="checkbox"/> Business Administration
<input type="checkbox"/> Bus. Law
<input type="checkbox"/> Bus. Correspondence
<input type="checkbox"/> Certified Public Accounting
<input type="checkbox"/> Commercial
<input type="checkbox"/> Commercial Art
<input type="checkbox"/> Cost Accounting
<input type="checkbox"/> Federal Tax
<input type="checkbox"/> Foremanship
<input type="checkbox"/> First Year College
<input type="checkbox"/> Good English
<input type="checkbox"/> High School
<input type="checkbox"/> Higher Mathematics
<input type="checkbox"/> Illustration
<input type="checkbox"/> Industrial Supervision
<input type="checkbox"/> Motor Traffic
<input type="checkbox"/> Postal Civil Service
<input type="checkbox"/> Retailing
<input type="checkbox"/> Retail Bus. Management
<input type="checkbox"/> Salesmanship
<input type="checkbox"/> Secretarial
<input type="checkbox"/> Sign Lettering
<input type="checkbox"/> Spanish
<input type="checkbox"/> Stenography
<input type="checkbox"/> Traffic Management</p> |
|---|---|---|--|

Name _____ Age _____ Home Address _____
 City _____ State _____ Working Hours _____ A.M. to _____ P.M.
 Present Position _____ Employed by _____

Special tuition rates to members of the Armed Forces. Canadian residents send coupon to International Correspondence Schools Canadian, Ltd., Montreal, Canada.

MEN! DIM that "FACE SHINE" with MENNEN



Talcum
FOR MEN!

- ★ Use Mennen Talcum after every shave and later in day to hide whiskers!
- ★ Neutral tint kills face shine . . . doesn't show!
- ★ Hammerized for extra smoothness!
- ★ Used by more men than any other men's talcum powder in the world!

GIANT SIZE . . . **55¢**
LARGE SIZE **29¢**



**U.S.
GOVERNMENT
JOBS**



**START AS HIGH
AS \$3,450.00 YEAR**

Many Early Examinations Expected. Prepare NOW!

Veterans Get Special Preference! 32-Page Civil Service Book FREE

Mail Coupon Today SURE



COUPON

Franklin Institute
Dept. X-83,
Rochester 4, N. Y.
(Not Government Controlled)

Gentlemen: Rush to me, FREE of charge, list of U. S. government big pay jobs. Send FREE 32-page book describing salaries, vacations, hours, work, etc. Tell me how to qualify for one of these jobs.

Name _____

Street _____

City _____ Age? _____

(Continued from page 8)

coming. *Popular Mechanics* is an every-time request. Our group carries to the boys homemade sandwiches, cakes, gifts, etc. I am sure that magazines may be picked up for the paper drives after the boys have finished with them. I, for one, save all of my scrap paper for the paper drives.

Mrs. C. A. Dillon,
Raleigh, N. C.



Picnic on the Roof

Marcel Desourdy, of St. Hilaire Station in the Province of Quebec, has built himself a car-top gallery on which the family can enjoy picnics or refreshments. Accessible by a ladder hung from its railing, the platform is shaded by an eight-foot-diameter umbrella. In the center is a cabinet, 16 by 20 inches, housing an icebox for cool drinks and providing a table top for glasses. Desourdy and his family and friends have enjoyed their gallery especially on holidays, election day, at horse races and football games.

\$1000 House of Molasses

George W. Rappelyea announces emphatically that anyone can build a five-room house for about \$1000. Rappelyea, of Southport, N.C., has developed a cheap building material from powdered molasses. You mix the stuff with ordinary sand and clay, then cast it into bricks, pour it like cement or trowel it like plaster. Our Eastern Editor investigated and says the stuff is nothing short of miraculous. You'll find his report next month.

WHAT **AUTO** MECHANIC Every Wants to Know

A motor vehicle is a machine of many parts, each part designed and constructed for its own special function. All good mechanics, like good doctors, should know the working theory and operation of each part and understand what causes trouble and how to remedy it.

LET AUDELS AUTO GUIDE SOLVE YOUR PROBLEMS

Every auto mechanic, helper, serviceman and operator can use a copy of AUDELS AUTOMOBILE GUIDE. The information it gives saves time, money and worry. Highly indorsed by all users. It presents the whole subject of auto mechanics from A to Z in plain language and simple terms.

This Big Practical Book gives full information with working diagrams covering the principles, construction, ignition, service and repair of modern cars, trucks and buses.

A complete Guide of 1800 pages, with over 1500 illustrations showing inside views of the working parts, with instructions for service jobs. Diesel engines, Fluid and Hydra-matic drives fully explained.

IT PAYS TO KNOW HOW TO

How to fit pistons—How to locate engine knocks—How to fit connecting rod bearings—How to service main bearings—How to recondition valves—How to time valves—How to adjust fan belts—How to adjust carburetors & chokes—How to rebuild a clutch—How to service automatic transmissions—How to service brakes—How to adjust steering gear—How to cope with ignition troubles—How to service distributors—How to time ignition—How to "tune up" an engine.

INFORMATION IN A HANDY FORM

73 INTERESTING CHAPTERS—Read this partial list of subjects on which practical information is fully given for quick reference under the headings as shown below. Ready Reference Index.

All Parts of an Automobile—Automotive Physics—The Gas Engine—Gas Engine Principles—Multi-Cylinder Engines—Horse Power—Automobile Engines—Stationary Parts—Moving Parts—Pistons—Piston Rings—Connecting Rods—Crank Shafts—Valves—Valve Gear—Cams and Cam Action—Valve Timing—Cooling Systems—Fuel Feed Systems—Dual Fuel Feed—Mixture—Carburetors—Carburetor Service—Automatic Choke—Super-Chargers—Transmissions—Special Transmissions—Fluid and Hydra-matic Drives—Clutches—Universals and Propeller Shafts

A Ready Reference

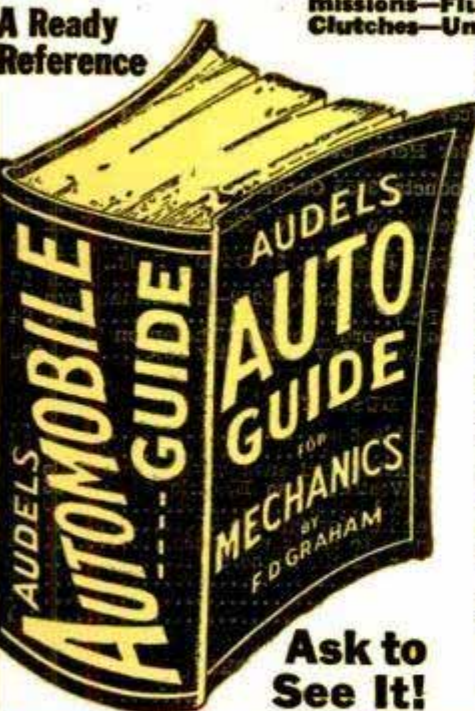

Ask to See It!

—The Differential—Rear Axles—Rear and Front Suspension—Running Gear—Brakes—Wheel Alignment—Knee Action—Steering Gear—Tires—Lubricants and Lubrication—Automotive Electricity—Ignition Systems—Magneto Ignition—Spark Plugs—Ignition Coils—Distributors—Automatic Spark Control—Ignition Timing—Generators—Starters—Generator and Starter Testing—Lighting Systems—Storage Batteries—Charging and Testing—Diesel Engines and Trouble Shooting.

7 DAYS' FREE TRIAL
TO GET THIS ASSISTANCE FOR YOURSELF SIMPLY FILL IN AND MAIL COUPON TODAY.

\$4 COMPLETE
PAY \$1 A
ONLY 1 MO.

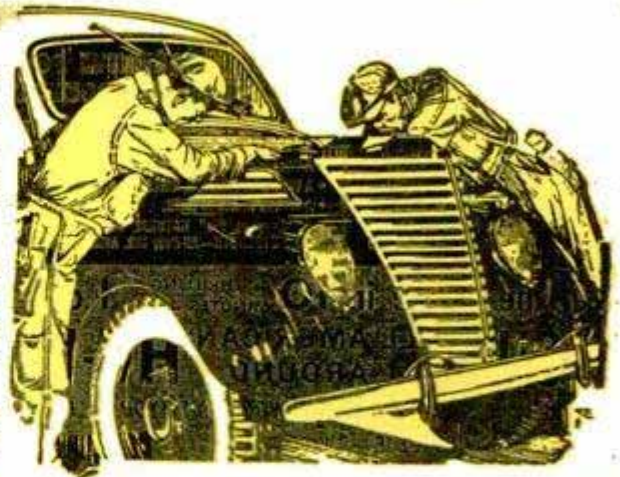

Sent on 7 Days Approval

Step up your own skill with the facts and figures of your trade. Audels Mechanics Guides contain Practical Inside Trade Information in a handy form. Fully illustrated and Easy to Understand. Highly Endorsed. Check the book you want for 7 DAYS FREE EXAMINATION. Send No Money. Nothing to pay postman.

CUT HERE MAIL ORDER

AUDEL, Publishers, 49 W. 23 St., NEW YORK 10, N. Y.

Please send me postpaid for FREE EXAMINATION books marked (x) below. If I decide to keep them I agree to mail \$1 in 7 Days on each book or set ordered and further mail \$1 monthly on each book or set until I have paid price, otherwise I will return them.

- TRUCK & TRACTOR GUIDE, 1299 Pages . . . \$ 4
- AUTOMOBILE MECHANICS GUIDE, 1800 Pages . . . 4
- DIESEL ENGINE MANUAL, 575 Pages . . . 2
- MACHINISTS HANDY BOOK, 1650 Pages . . . 4
- WELDERS GUIDE, 400 Pages . . . 1
- BLUE PRINT READING, 416 Pages . . . 2
- MATHEMATICS & CALCULATIONS, 700 Pages . . . 2
- SHEET METAL PATTERN LAYOUTS, 1100 Pages . . . 4
- SHEET METAL WORKERS HANDY BOOK, 388 Pgs. . . 1
- MECHANICAL DRAWING GUIDE, 160 Pages . . . 1
- MECHANICAL DRAWING & DESIGN, 480 Pages . . . 2
- AIRCRAFT WORKER, 240 Pages . . . 1
- TELEVISION SERVICE MANUAL, 384 Pages . . . 2
- RADIOMANS GUIDE, 914 Pages . . . 4
- ELECTRONIC DEVICES, 216 Pages . . . 2
- ELECTRIC MOTOR GUIDE, 1000 Pages . . . 4
- ELECTRIC WIRING DIAGRAMS, 272 Pages . . . 1
- ELECTRICIANS EXAMINATIONS, 250 Pages . . . 1
- ELECTRIC POWER CALCULATIONS, 425 Pages . . . 2
- HANDY BOOK OF ELECTRICITY, 1440 Pages . . . 4
- ELECTRIC DICTIONARY, 9000 Terms . . . 2
- ELECTRIC LIBRARY, 7000 Pages (12 Book Set) . . . 18
- MARINE ENGINEERS HANDY BOOK, 1258 Pgs. . . 4
- SHIPFITTERS HANDY BOOK, 250 Pages . . . 1
- REFRIGERATION & Air Conditioning, 1280 Pgs. . . 4
- MILLWRIGHTS & MECHANICS GUIDE, 1200 Pgs. . . 4
- POWER PLANT ENGINEERS GUIDE, 1500 Pages . . . 4
- ENGINEERS & FIREMANS EXAMS, 525 Pages . . . 1
- PUMPS, Hydraulics & Air Compressors, 1658 Pgs. . . 4
- ENGINEERS LIBRARY (3 Book Set) . . . 9
- MECHANICAL DICTIONARY, 950 Pages . . . 4
- GARDENERS & GROWERS GUIDES (4 Book Set) . . . 6
- CARPENTERS & BUILDERS GUIDES (4 Book Set) . . . 6
- PLUMBERS & Steamfitters Guides (4 Book Set) . . . 6
- MASONS AND BUILDERS GUIDES (4 Book Set) . . . 6
- PAINTERS & DECORATORS MANUAL, 450 Pgs. . . 2
- HOUSE HEATING GUIDE, 1000 Pages . . . 4
- OIL BURNER GUIDE, 384 Pages . . . 1

Name _____
Address _____
Occupation _____
Employed by _____ 43A

AUDEL, Publishers, 49 W. 23 St., New York 10, N. Y.

"Hey You SKINNY Bag of Bones!"



That's what the boys shouted at me ONLY A FEW WEEKS AGO... But look at me NOW, PAL... A Trophy-Winning JOWETT HE-MAN Like YOU can be SOON!

5-WAY PROGRESSIVE POWER can make YOU an ALL-AROUND WINNER

- In Civilian Life or Armed Services.
 - A Winner of Success on JOB.
 - A Winner of FRIENDS, GIRLS.
 - A Winner at ALL SPORTS.
 - A Winner of Trophies.
 - A Hero on the DANCE FLOOR.
 - A Hero at BEACH, GYM.
 - A Hero to your SWEETHEART.
 - A LEADER in any crowd.
- This "Easy as Pie" NATURAL Method gives you All-Around CHAMP STRENGTH—All-Over MR. AMERICA BUILD!

Let me Prove in 10 THIRLING MINUTES A DAY I can make YOU An ALL-AMERICAN ALL-AROUND HE-MAN FAST—OR IT WON'T COST YOU A CENT SAYS GEORGE F. JOWETT—

WORLD'S GREATEST BUILDER OF HE-MEN

YES! YOUR SUCCESS STORY can soon be like Sill's—

Now weakling wins trophy as MAGNIFICENT HE-MAN! Few weeks ago everyone picked on John... No guts to fight for his rights. TODAY everyone admires John's movie-star build—his mighty ARMS, broad BACK, heroic CHEST. His ATHLETIC ability. His ENERGY at work. His POPULARITY. How GIRLS go for him! NO! I don't care if you're 14 or 40; if you're SKINNY or flabby. Give me 10 EXCITING MINUTES to make you over in your home by the method I turned myself from a wreck into A WORLD CHAMPION.

YES! Add INCH on INCH of MIGHTY MUSCLE, to your ARMS. Deepen your CHEST. Broaden your SHOULDERS. Gain SIZE, SPEED, POWER! Become an All-American HE-MAN! A WINNER in everything you tackle—or you won't pay one cent!

DEVELOP YOUR 520 MUSCLES Gain POUNDS, INCHES fast! Friend, I travelled the world. Made a LIFETIME study of EVERY way known to build your body. Then I devised the BEST, "5-WAY PROGRESSIVE POWER", the ONLY method that builds you 5 WAYS fast Save YEARS, DOLLARS, like MANY THOUSANDS like you did. Mail Coupon NOW!

Builder of CHAMPS 4 times WINNER PERFECT MAN CONTEST



DARLING THAT BULLY WON'T PICK ON YOU AGAIN

JOE WALLOPPED ANOTHER HOMER HE'S SURE TO BE CAPTAIN NOW

JOE YOUR NEW ENERGY AND APPEARANCE SURE DO A GOOD JOB YOU EARNED YOUR PROMOTION

JOE JOWETT HE-MAN STRENGTH AND BUILD WON HIM THOSE STRIPES

How to Build A MIGHTY CHEST

How to Build A MIGHTY ARMS

How to Build A MIGHTY BACK

How to Build A MIGHTY GRIP

How to Build MIGHTY LEGS

AMAZING ALL 5 Picture-packed courses while the supply lasts—only 10c

MILLIONS SOLD at \$1 and more

FREE PHOTO BOOK of FAMOUS STRONG MEN DEPT. PM-18

JOWETT INSTITUTE OF PHYSICAL TRAINING 230 FIFTH AVENUE, NEW YORK 1, N.Y.

Dear George: Please mail to me FREE Jowett's Photo Book of Strong Men, plus all 5 HE-MAN Building Courses: 1. How to Build a Mighty Chest, 2. How to Build a Mighty Arm, 3. How to Build a Mighty Grip, 4. How to Build a Mighty Back, 5. How to Build Mighty Legs—Now all in One Volume "How to Become a Muscular He-Man" ENCLOSED FUND 10c FOR POSTAGE AND HANDLING (No C.O.D.'s).

Name Age

(Please print plainly)

Address

City Zone State

WHERE-TO-BUY-IT INDEX

Source of supply appears after items commercially available

AUTOMOTIVE

Drive-yourself test for motorists (Aetna Casualty and Surety Co., Hartford 15, Conn.)	74
Detroit listening post	81
Pedal car	85
Mechanical "traffic cop" clips to accelerator pedal (Speedminder Laboratories, Inc., Box 3496, Merchandise Mart Station, Chicago 54)	89
Brussels auto show	99
Tire-tread gauge (Pure Oil Co., 35 E. Wacker Dr., Chicago 1)	100
Lift enables one man to remove transmission (The Cleveland Pneumatic Tool Co., 3781 E. 77th St., Cleveland 5, Ohio)	100
Bug screen protects car (Parker Products, Inc., 20 N. 16th St., Minneapolis 3, Minn.)	108
Car from lawn mower	108
Nash Rambler hardtop	112
"Pigeonhole" parking lot	138

AVIATION

Two-passenger twin-rotor helicopter (McCulloch Motors Corp., 6101 W. Century Blvd., Los Angeles 45, Calif.)	71
Lockheed's handyman	72
School-made jet engine	100
Metal in engine lowers igniting point of oil	122
Helicopter saves steeplejack time	134

BOATS

Jointed oars	112
Fastest PT boat	122
Aluminum launch	122
Twin-hulled racers sail Spanish seas	136

COMMUNICATIONS

Microwaves aid power distribution	74
Private conversations now possible in fleets of radio-equipped cars	85
Mobile newspaper plant	129
Mobile broadcasting booth	138

FARM AND GARDEN

Reed harvest	84
Converter adds power to your hand mower (LeJay Mfg. Co., 2912 S. Emerson Ave., Minneapolis 8, Minn.)	89
"Fork" aerates soil (West Point Lawn Products, West Point, Pa.)	94
Double side rake windrows 16 feet of hay	95

GAMES, HOBBIES AND NOVELTIES

"Painting" with a flashlight	107
Checkers for the invalid (John H. Wheat, 345 McClelland, Pueblo, Colo.)	118
Hobbyist "grows" clam pearls in his basement	129
Paper chairs	135

HOUSE AND HOME

Phone guard (Murray Mfg. Co., 63 Rock St., Avon, Mass.)	70
Corn butterer (Elron Products, 156 W. Chicago Ave., Chicago 10)	82
Glass brush (Wallace, Davis Co., 2813 Dixwell Ave., Hamden 14, Conn.)	82
Marking kit (Identi-Kit, 1739 Townsend St., Cincinnati 23, Ohio)	82
Pants hanger (Holdapres, 9106 Woodward Ave., Detroit, Mich.)	82
Filler funnel (Speedex Co., 129 E. 159th St., South Holland, Ill.)	82
Nontip coasters (Kelcey Products, 1687 McDonald Ave., Brooklyn, N. Y.)	83
Personal tray (Alexander Hertz Co., 94-15 69th Ave., Forest Hill, N. Y.)	83
Grease brush (L. K. Products, 3855 Cardiff Ave., Culver City, Calif.)	83
Catchup dispenser (Weolite Co., 552 W. 53rd St., New York City 19)	83
Window opener (Rene-Craft Products, 21 Owen's Bldg., Wilmette, Ill.)	83
Lunch-box liner (Dutch Treat Shop, 5932-42 Germantown Ave., Philadelphia 44, Pa.)	94
Stick-on traction mats stop record slippage (Thompson Traction Mat Co., 516 Fifth Ave., New York City 18)	138

INDUSTRY

Science "factory" produces ideas	74
Air-lift "cat" cracker	80
"Give and take" chrome plating will save critical materials (Central Publicity Div., Westinghouse Electric Corp., 306 4th Ave., Pittsburgh 30, Pa.)	98
Pier with conveyor belt handles foreign ore	108
Science makes synthetic fruits to study real ones	119
Rubber processing headed for all-time record	122
Uphill river	123
Prestressed concrete footbridge	144
Rhenium rivals tungsten	230

OFFICE, SHOP AND STORE

Portable neon sign	70
Look! It's flying disks again	120
"Punchboard" sorting for accounting system (Boeckeler Instrument Co., Box 181, Tucson, Ariz.)	134

(Continued to page 14)

You Practice COMMUNICATIONS

I send you parts to build this transmitter

As part of my Communications Course you build this low power broadcasting transmitter, learn how to put a station "on the air," perform procedures demanded of Broadcast Station operators, make many tests.

This is just part of the equipment my students build. You keep all parts I send.



You Practice Radio SERVICING

on this modern radio you build with parts I send

As part of my Servicing Course, I send you the speaker, tubes, chassis, transformer, loop antenna, EVERYTHING you need to build this modern, powerful Radio Receiver! I also send parts to build many other Radio circuits. You use equipment for practical experience and to earn EXTRA money in spare time.

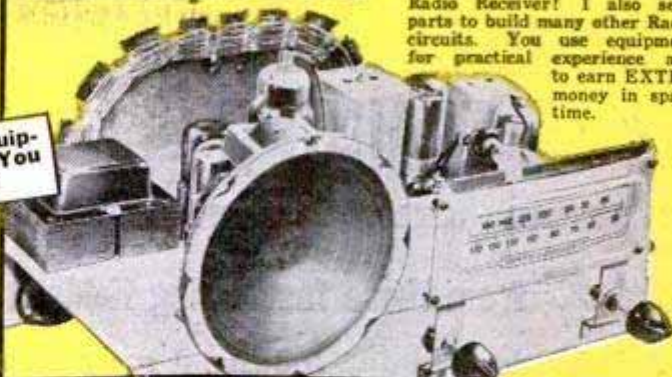

BE A RADIO-TELEVISION TECHNICIAN

NOW! Advanced Television Practice

New, special TV kits furnished to build high-definition SCOPE . . . RF OSCILLATOR with flyback power supply . . . complete TV set . . . many other units. You see pulse, tropezoidal, saw-tooth wave forms. Get valuable PRACTICAL EXPERIENCE locating and correcting TV troubles. Mail coupon for facts, pictures and prices!

I TRAINED THESE MEN

 "I have been operating my own Servicing business. In two years I did \$14,000 worth of business; net profit \$6,850. Have one full time employee, an NRI student."—PHILLIP G. BROGAN, Louisville, Ky.

 "Four years ago, I was a bookkeeper, with a hand-to-mouth salary. Now I am a Radio Engineer with a key station of the American Broadcasting Company network."—NORMAN H. WARD, Ridgefield Park, New Jersey.

 "When halfway through the NRI course, I made \$5 to \$8 a week fixing sets in my spare time. Am now selling and installing Television sets and antennas."—E. J. STREITENBERGER, New Boston, O.

 "My first job was operator with KDLR, obtained for me by your Graduate Service Dept. I am now Chief Engineer of Police Radio Station WQOX. I never hesitate to endorse NRI."—T. S. NORTON, Hamilton, Ohio.

 **EXTRA PAY IN ARMY, NAVY, AIR FORCE** 

Knowing Radio, TV, Electronics can help you get extra rank, extra prestige, more interesting duty at pay up to several times a private's base pay. You are also prepared for good Radio-TV jobs upon leaving service. Mail Coupon TODAY.

Have Your Own Business

Many N.R.I. trained men start their own Radio-Television sales and service business without capital. Let me show you how you, too, can be your own boss, have a good income from your own shop. Send coupon for FREE book now!

Tested Way to Better Pay

Learn Servicing or Communications Practice at Home in Spare Time



J. E. SMITH, President National Radio Institute

Do you want good pay, a job with a bright future and security? Would you like to have a profitable shop or store of your own? If so, find out how you can realize your ambition in the fast growing, prosperous RADIO-TELEVISION industry. Even without Television, the industry is bigger than ever before. 90 million home and auto Radios, 3100 Broadcasting Stations, expanding use of Aviation and Police Radio, Micro-wave Relay, Two-way Radio for buses, taxis, etc., are making opportunities for Servicing and Communications Technicians and FCC-Licensed Operators.

Television is TODAY'S Good Job Maker

In 1950, over 5,000,000 TV sets sold. By 1954, 25,000,000 TV sets estimated. Over 100 TV Stations now operating. Authorities predict 1,000 TV Stations. This means more jobs, good pay for qualified men all over the United States and Canada.

Many Make \$10 Extra a Week in Spare Time

Keep your job while training. Hundreds of successful RADIO-TELEVISION TECHNICIANS I trained had no previous experience, some only a grammar school education. Learn Radio-Television principles from illustrated lessons. Get PRACTICAL EXPERIENCE—build valuable multimeter—experiment with circuits common to Radio and Television. Keep all equipment. Many students make \$5, \$10 extra a week fixing neighbors' Radios in spare time. SPECIAL BOOKLETS start teaching you the day you enroll.

Send Now For 2 Books FREE—Mail Coupon

Send now for my FREE DOUBLE OFFER. You get actual Servicing lesson to show you how you learn at home. Also my 64-page book, "How to Be a Success in Radio-Television." Read what my graduates are doing, earning; see equipment you practice with at home. Send coupon in envelope or paste on postcard. J. E. SMITH, President, Dept. 1HA, National Radio Institute, Washington 9, D. C. Our 38th Year.

Good for Both—FREE

The ABC's of SERVICING

MR. J. E. SMITH, President, Dept. 1HA National Radio Institute, Washington 9, D. C.

Mail me Sample Lesson and 64-page Book about How to Win Success in Radio-Television. Both FREE. (No Salesman will call. Please write plainly.)

Name..... Age.....

Address.....

City..... Zone..... State.....

Approved for training under G. I. Bill

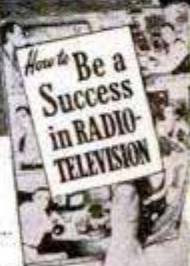

COME TO THE UNIVERSITY OF HOUSTON

FOR YOUR

TECHNICAL AND VOCATIONAL TRAINING

ONE OF AMERICA'S LARGE AND MOST MODERN UNIVERSITIES

Select from these fascinating fields

- | | |
|---|---|
| <input type="checkbox"/> Aeronautics | <input type="checkbox"/> Industrial mechanics |
| <input type="checkbox"/> Air conditioning and refrigeration | <input type="checkbox"/> Drafting |
| Automobile trades | <input type="checkbox"/> Machine shop |
| <input type="checkbox"/> Body and paint | <input type="checkbox"/> Welding |
| <input type="checkbox"/> Mechanics | <input type="checkbox"/> Woodworking |
| <input type="checkbox"/> Upholstery and trim | <input type="checkbox"/> Photography |
| <input type="checkbox"/> Diesel | <input type="checkbox"/> Radio |
| <input type="checkbox"/> Electricity | <input type="checkbox"/> Stationary Engineering |
| <input type="checkbox"/> Electronics | <input type="checkbox"/> Television |

PREPARE FOR YOUR FUTURE NOW . . . with the very latest methods and equipment, at the modern University of Houston School of Technology. For entrance: high school diploma, or over 18 and ability to profit from instruction. Beautiful campus—250 wooded acres in Houston, Texas—the city of tomorrow. Full college activities . . . sports . . . social life. Day or night, short or longer courses. Cooperative work and study programs . . . earn part of tuition and expenses with part-time job in your own career field, while you learn. Personal vocational counselling. Diploma or B.A.S. degree on completion—and job placement assistance. Sept., Feb., June semesters. G.I. approved. — V. A. on campus. Send for Free illustrated brochure now!



EZEKIEL W. CULLEN BUILDING

University of Houston, School of Technology
Dept. 181—HOUSTON 4, TEXAS

Without cost or obligation, please send me fully-illustrated brochure and full particulars. I am interested in subject marked X above.

Name Age

Address

City State

(Continued from page 12)

OUTDOOR RECREATION

Swimmer's snorkel (Von Lengerke & Antoine, 9 N. Wabash Ave., Chicago 2)	94
Fishing-leader dispenser (Weber Lifelike Fly Co., Stevens Point, Wis.)	94
Sportsmen's crossbow (Schmid & Co., 1513 N. Gardner St., Los Angeles 46, Calif.)	98
Swimmers hear music underwater in hotel pool	134

MISCELLANEOUS

Moon rocket in sections?	16
Algae factory	70
Street "stethoscope" (H. M. Beard, 810 Saxe St., Beaumont, Tex.)	70
Adhesive-cloth signs (W. H. Brady Co., Dept. 391, Chippewa Falls, Wis.)	84
Guide wheels keep ambulance on rails in Korea	85
Cyclone motorcycle	89
Prone rider sets speed mark on streamlined motorbike	89
Outdoor laboratory checks roots in sewer pipe	95
Layman's weather indicator (Swift & Anderson Co., 952 Dorchester Ave., Boston, Mass.)	98
Clothesline pumps water	107
Death of a lighthouse	109
Supersonic proving ground	110
One-handed dog snare	118
Electric-fan kit (General Electric Co., Schenectady 5, N.Y.)	118
Passengers may ride conveyor belts on New York subway	119
X-ray pictures in one minute (Polaroid Corp., Cambridge, Mass.)	224

Craftsman and Shop Notes Index

AUTOMOTIVE

Roll of canvas saves clothes when repairing car	172
Grounding tail lamps on cars	179
Battery pulled in emergency by means of end wrenches	198

FARM

Closed cabinet for milk pails and equipment utilizes large storm window as door	202
Counterbalanced rocker arm aids small motor in operating pump jack	202
Light but sturdy stand holds anvil	206

HOUSE AND HOME

Novel home-window beautifier is roller-type fabric shade	152
Minimizing egg breakage	158
Baby-food jars kept in muffin tin	158
Making-ice for picnics	158
Wedge-type door holder	158
Telescoping curtain rod substitutes for shade slat	158
Potato-chip cans store brown sugar	159
Threading bobbins	159
Playpen solves a painting problem	159
Carton simplifies cleaning after playtime	159
Flower boxes mulched with lawn clippings	159
Sandpaper on phonograph records prevents slipping while playing	160
Portable clothesline in driveway provides dry hanging area	160
Holder for slack in electric cord	186
Hardening "dusty" concrete	186
Telephone stand	187

LAWN AND GARDEN

Build this "fly in" feeding station for your feathered friends	151
Trellis legs kept from rotting by inserting in steel pipe	152
Hose-reel cart for lawn sprinkling	161
Rabbitproofing young plants	164
Overhead lattice added to small patio gives that "finished" look	179
Quickly constructed trellis	191

OFFICE, SHOP AND STORE

Tips to make looseleaf binders work better and last longer	164
Shipping tags form index tabs on looseleaf binder	168
Shop ash tray from flowerpot	168
Drawer pulls for tiny-parts bins	168
Artist's "marking gauge" holds brush to speed drawing straight lines	172
Sidewalk flag held upright with metal rings	198
Paper stapler mounted on paddle is easy to hang up	198
Cork "seats" improve thumbtacks	198
First turn off the electric current when extinguishing a burning motor	199
Rubber stamp brought up-to-date by "resetting" type	199
Making lettering pens from bamboo shoots	203
Brazing C-clamp to desk lamp provides utility shop light	206
Ordinary beam scale used for counting small stock-room parts by weight	206

(Continued to page 16)

IMPORTANT NOTICE—It is the intention of this magazine to provide its readers with information regarding the latest developments in the mechanical arts. We take no responsibility as to whether the disclosures contained in our articles are covered by patents and advise readers to investigate this subject before making, using, or selling any of the products, machines, or processes described in order to avoid possible liability for patent infringements.

INVENTORS

Learn how to protect your invention. The U. S. Patent Laws provide that any new and useful art, machine, article of manufacture, or composition of matter, or any new and useful improvement thereof, may be patented if the act of invention is involved. Therefore, every inventor with a valuable invention should take advantage of the Patent Laws and proceed for patent protection in order to safeguard his rights.

A patent gives the inventor the exclusive right to prevent others from making, using, or selling the invention claimed in the patent for a period of seventeen years.

The Patent Laws were enacted for the benefit of the inventor to give him protection for the features of his invention which are patentable. These features must be properly and concisely set forth and claimed in a formal application for patent, in order to comply with the requirements of the Patent Laws. For that reason, unless the inventor is familiar with patent matters, he should engage a competent registered patent attorney or agent to represent him. We are registered to practice before the U. S. Patent Office and are prepared to serve you in the handling of your patent matters.

A specially prepared booklet entitled "Patent Guide for the Inventor", containing detailed information with respect to patent protection and procedure, together with a "Record of Invention" form will be promptly forwarded to you without obligation upon request.

CLARENCE A. O'BRIEN & HARVEY JACOBSON

Registered Patent Attorneys

11-H DISTRICT NATIONAL BUILDING

WASHINGTON 5, D. C.

VOTE TODAY FOR THE FUTURE YOU WANT!

AMERICAN SCHOOL,
Dept. GC45, Drexel at 58th, Chicago 37, Ill.
Without obligation, please send FREE and postpaid, full particulars about the subject checked below.

- | | | |
|--|---|---|
| <input type="checkbox"/> Accounting | <input type="checkbox"/> Drafting—Building Trades | <input type="checkbox"/> Plastics Engineering |
| <input type="checkbox"/> Air Conditioning | <input type="checkbox"/> Drafting—Machine Trades | <input type="checkbox"/> Plumbing—Practical |
| <input type="checkbox"/> Architecture & Building | <input type="checkbox"/> Electrical Engineering | <input type="checkbox"/> Private Secretary |
| <input type="checkbox"/> Automotive Technician | <input type="checkbox"/> Electricity—Practical | <input type="checkbox"/> Refrigeration |
| <input type="checkbox"/> Better Farmship | <input type="checkbox"/> Electronics—Industrial | <input type="checkbox"/> Retail Merchandising |
| <input type="checkbox"/> Bookkeeping | <input type="checkbox"/> High School Courses | <input type="checkbox"/> Salesmanship—Outside |
| <input type="checkbox"/> Business Management | <input type="checkbox"/> Machine Shop Operations | <input type="checkbox"/> Sheet Metal Work |
| <input type="checkbox"/> Contracting | <input type="checkbox"/> Mathematics & Slide Rule | <input type="checkbox"/> Tool Making |
| <input type="checkbox"/> Diesel Technician | <input type="checkbox"/> Mechanical Engineering | |

NAME OCCUPATION

HOME ADDRESS AGE

CITY STATE

THIS IS YOUR BALLOT
Find the subject that interests you most and then... Check, Sign and Mail Today

• Today, choose the job you want — and prepare for it in spare time at home. Or if you are already engaged in the work you like best, start training now for quicker promotion. In hours you might otherwise waste, gain the knowledge and skill that can help you to get ahead faster, make more money, and have greater security.

Training Backed by 54 Years of Experience

For over half a century American School has helped ambitious men and women toward success by providing specialized training for commercial and technical advancement. Its study program for you has been planned by experts with years of experience in the subject you select and they will give you needed guidance every step of the way.

Don't Delay Your Start

Give serious thought to the list of training courses listed above. Pick the opportunity that interests you, check it and add your name and address. (Check more than one if you are undecided as to which appeals most.) Finally clip out and mail the "ballot" and full information will be supplied, without cost or obligation.

AMERICAN SCHOOL
DEPT. GC45, DREXEL AT 58th, CHICAGO 37, ILL.

THE SOONER YOU START, THE SOONER YOUR GOAL CAN BE REACHED

(Continued from page 14)

OUTDOOR RECREATION

Semi-pneumatic barrow wheels utilized as fenders on boat dock151
Cork disks form fishhook guards151
Greasing cap on insulated jug helps prevent sticking152
Swing seat from worn belting is safe for toddlers157
Outdoor game layout162
Extension for grease-gun fitting aids lubricating outboard motor164
Homemade picnic cooler173
Dual-pole bracket makes life easy for bank fishermen179

PHOTOGRAPHY

Waist-level finder on lensboard aids taking low-angle shots194
Tripod for table-top photography improvised from angle brackets194
Fingerprint causes overexposure194
Screw-eye thermometer holder194

TOOLS

Sleeve gauges depth of hole151
Grinding wheel on circular saw sharpens planer blades157
Gauge blocks permit accurate setting of drill-press depth stop160
Spools used as file handle168
Sturdy base for bench saw made from scrap parts180
Comb cases store small tools186
Ball bearing flares copper tubing191
U-clamp height adjustments made using "battery" of shims199
Easily installed airplane jack makes useful hydraulic press199
Steel slag "boiled" from torch tip199
Truck tires with two-part rims safely inflated on special jig203
Quick-change collet (Sutton Tool Co., Sturgis, Mich.)204
Pneumatic stapler (Powers Wire Products Co., 523 Detroit Ave., Monroe, Mich.)204
Six-in-one tool (Hoffritz For Cutlery, 551 Fifth Ave., New York City 17)204
Milling attachment for small drill press (Waterborg Machine Co., 2830 Rapids Drive, Racine, Wis.)204
Wire-tying unit (Piper Form Tie Co., 3802 N. Attu, Portland, Ore.)205
Protractor for portable electric saws (Black & Decker Mfg. Co., Towson 4, Md.)205
Drip guard (Warner Ventilator Co., La Grange, Ind.)205
Dual-purpose hand truck (Clark-Hopkins Equipment Corp., Philadelphia 23, Pa.)205
Extra socket on tool-post wrench saves time when making adjustments206

MISCELLANEOUS

A primer for asbestos shingles152
Minimizing tile breakage152
Tubing held without flattening152
Bucket-ball handgrip made with wire solder164
Quick method of restringing beads164
Gallon can provides self-feeder168
Corks aid in bending glass tubes168
Drawer knobs kept from loosening by rubber washers172
Masking tape rubbed with wax prevents ragged paint edges172
Make your chessmen nontipping172
Fumbleproof matchbox180
Swinging taillight on bicycle is easily seen by motorists186
Can key scores cardboard186
Removing broken setscrews186
Clear-plastic cylinder holds magnifying glass for viewing187
Air outlet for hot-water system198
Oil consumption of compressors lessened by making minor alterations202

Radio-Television, Electronics

Television today207
Three-speed record broadcaster plays through any set in the home208
Soldering hints for students and radio workers (Instant-heat soldering gun, Drake Electric Works, Inc., 3656 Lincoln Ave., Chicago 13)211
Antenna rotator solves TV-reception problems (Antenna rotator, American Phenolic Corp., 1830 South 54th Ave., Chicago 50)212
Self-help ideas for set owners (TV booster, Industrial Television, Lexington Ave., Clifton, N. J.)213

Moon Rocket in Sections?

Probably the first rocket to be fired toward the moon will shed pieces from itself during the trip. That's the verdict of Anthony Nerad of the General Electric Research Laboratory. He suggests that with fuels now available, the best way to make a long-distance flight would be by a rocket with sections that would drop off as the fuel in each was consumed. Hydrogen gas offers some theoretical advantages as a propellant for such a rocket, Nerad says.



How can you serve your country best?

You may serve in uniform. You may serve on the production front. But this much is sure . . . you will serve your country best if you are trained.

America needs trained men. Aircraft and engine mechanics, boilermakers, carpenters, instrument repairmen, machinists, metal workers, patternmakers, welders and other trained craftsmen. Men with the training to fill these and other skilled jobs are scarce.

Do you have the ambition and initiative necessary to get the training that will help you serve your country best? If you have, you can learn at home in your spare time from the International Correspondence Schools. Clip and mail the post paid card at right for complete, free information.



YOUR FUTURE

Air Conditioning and Plumbing

- Air Conditioning
- Heating
- Refrigeration
- Chemistry, Analytical
- Chemistry, Engineering
- Chemistry, Industrial
- Petroleum Refining Operator's
- Plastics
- Pulp and Paper Making
- Plumbing
- Steam Fitting

Civil Engineering, Architectural and Mining

- Architecture
- Architectural Drafting
- Bridge and Building Foreman
- Building Estimating
- Civil Engineering
- Concrete Engineering
- Contractor's, Building
- Highway Engineering
- House Planning
- Structural Drafting
- Structural Engineering
- Surveying and Mapping
- Coal Mining

Communications

- Electronics
- Radio, General—Operating
- Radio Servicing, Practical
- Practical Telephony
- Telegraph Engineering

Electrical

- Electrical Engineering
- Electric Light and Power
- Industrial Electrical Engineering
- Lighting Technician
- Power House

Internal Combustion Engines

- Automobile Technician
- Aviation
- Diesel Engines
- Gas Engines
- Diesel-Electric
- Flight Engineer

Mechanical

- Aircraft Drafting
- Heat Treatment of Metals
- Industrial Engineering
- Locomotive Machinist
- Foundry Work

- Mechanical Drafting
- Mechanical Engineering
- Machine Shop
- Patternmaking, Wood-Metal
- Reading Shop Blueprints
- Sheet-Metal Worker
- Ship Drafting
- Tool Designing
- Welding Engineering
- Shipfitting
- Tool Making

Railroad

- Air Brake
- Diesel Locomotive
- Locomotive Engineer
- Locomotive Fireman
- Railroad Car Repairer
- Section Foreman
- Car Inspector

Steam Engineering

- Boilermaking
- Combustion Engineering
- Engine Running
- Marine Steam Engineering
- Steam Electric
- Steam Engineering

Textile

- Cotton Manufacturing
- Loom Fixing
- Rayon Weaving
- Textile Designing
- Woolen Manufacturing

Business and Academic

- Accounting
- Bookkeeping
- Business Correspondence
- Business Management
- Certified Public Accountant
- Commercial
- Cost Accountant
- Federal Tax
- First Year College
- Foremanship
- Good English
- Illustrating
- Postal Civil Service
- Retailing
- Retail Store Management
- Salesmanship
- Traffic Management
- Advertising
- High School
- Secretarial

Name _____ Age _____
 Street and No. _____
 City _____ State _____
 Occupation _____ Working Hours _____ A.M. to _____ P.M.

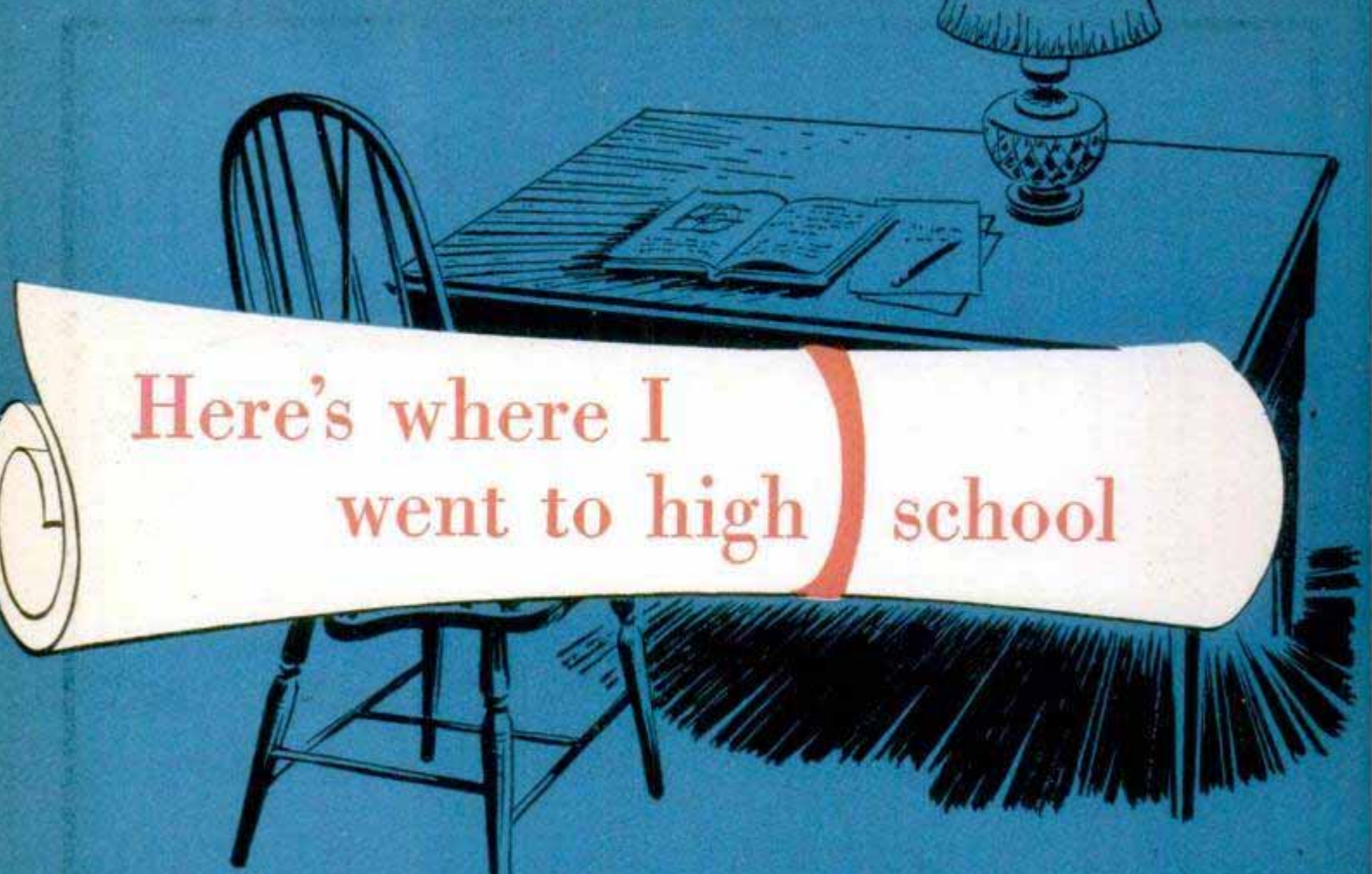

Here's where I
went to high school

No
Postage Stamp
Necessary
If Mailed in the
United States

BUSINESS REPLY CARD

FIRST CLASS PERMIT No. 1000, Sec. 34.9 P. L. & R. 1 : SCRANTON, PA.

INTERNATIONAL CORRESPONDENCE SCHOOLS

1000 WYOMING AVENUE

SCRANTON 9, PA.

Box 5506-L

Postage
Will Be Paid
by
Addressee

I'm Tim Moylan, and this is where I did my I. C. S. assignments—to get the equivalent of the high school diploma I missed out on when Uncle sent me "greetings."

The boys who stayed home and graduated got a head start. So when I was discharged, I took a job at a gas station and studied nights—got my diploma the I. C. S. way. I'm managing one of those big city pump stations now—they were looking for somebody with ambition and a high school education.

Hundreds of thousands of ex-Servicemen have bettered their jobs with the help of I. C. S. training—closed the earning gap brought by war years. As Tim Moylan puts it, "I. C. S. training puts money in your pocket." Yes, to buck today's job competition, you need the equivalent of a high school education and special skills. To get started, fill out the prepaid card at left and mail it—now!

INVENTORS

If you believe that you have an invention, you should find out how to protect it. The first step is to have a search made of the prior pertinent U. S. patents. If a report on this search indicates that the invention appears patentable you can apply for a patent, and the specifications and claims should be prepared.

The firm of **McMorrow, Berman & Davidson**, with offices in Washington, D. C., is qualified to take the necessary steps for you. We can make a preliminary search on your invention, advise you whether we think it can be patented, and prepare your application for patent.

Unless you are fully familiar with the U. S. Patent Laws, we recommend that you engage the services of a Registered Patent Attorney to protect your interests. The patent laws are *your* laws. A patent gives you the right to prevent others from making, using or selling the invention claimed in your patent for a period of 17 years.

Use these patent laws for your protection. Investigate whether your invention can be patented. If you have what you believe to be an invention, we suggest that you have this firm make a search for you.

Send for a copy of our Patent Booklet entitled "How To Protect Your Invention," containing information about patent protection and patent procedure. Along with this we will also send you an "Invention Record" form, for your use in writing down and sketching details of your invention. We will mail them promptly. No obligation. They are yours for the asking.

McMORROW, BERMAN & DAVIDSON

Registered Patent Attorneys

PATENTS • COPYRIGHTS • PATENTS

135 - X VICTOR BUILDING, WASHINGTON 1, D. C.

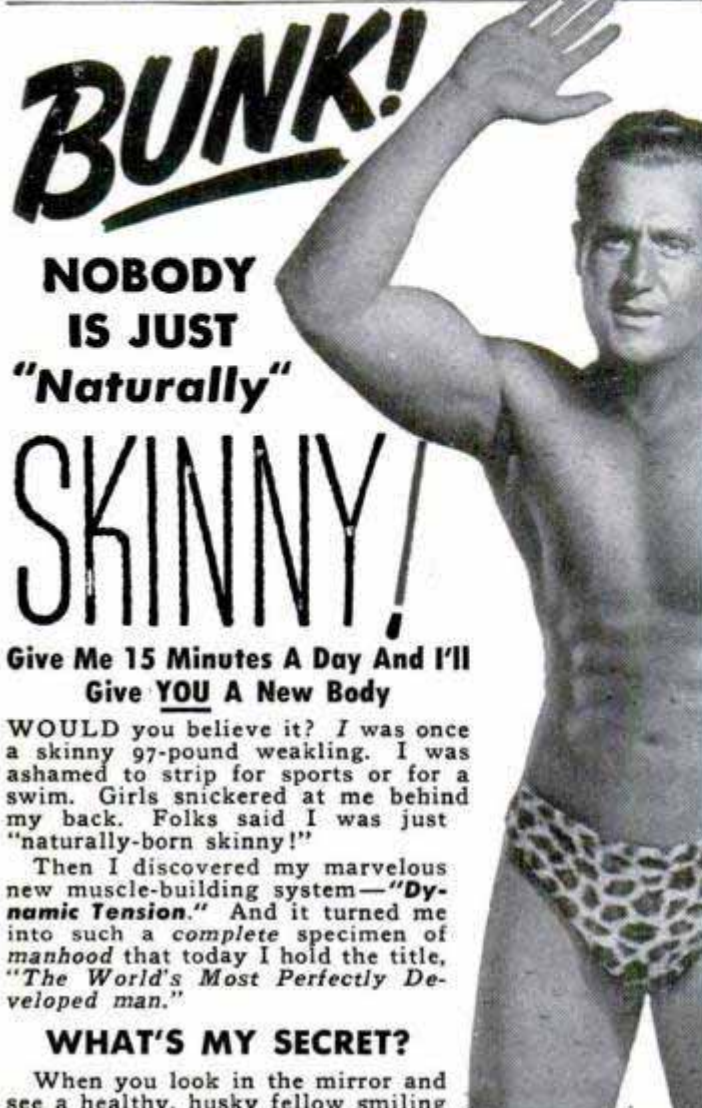
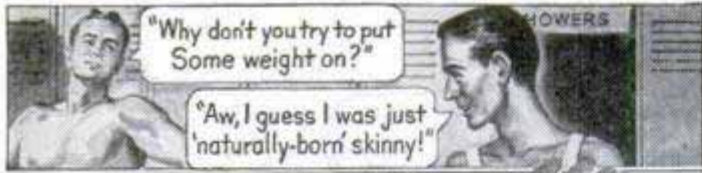

Give Me 15 Minutes A Day and I'll Give YOU A New Body

WOULD you believe it? I was once a skinny 97-pound weakling. I was ashamed to strip for sports or for a swim. Girls snickered at me behind my back. Folks said I was just "naturally-born skinny!"

Then I discovered my marvelous new muscle-building system—"Dynamic Tension." And it turned me into such a complete specimen of manhood that today I hold the title, "The World's Most Perfectly Developed man."

WHAT'S MY SECRET?

When you look in the mirror and see a healthy, husky fellow smiling back at you—then you'll be astonished at how fast "Dynamic Tension" gets results! And you'll be using the method which many great athletes use for keeping in condition—prize fighters, wrestlers, baseball and football players, etc.

"Dynamic Tension" is the easy natural method that you can practice in the privacy of your own room—just 15 minutes each day—while your scrawny chest and shoulder muscles begin to swell . . . those spindly arms and legs bulge . . . and your whole body starts to feel full of zip, self-confidence, new energy!

FREE My 48 Page Illustrated Book is Yours
— Not for \$1.00 or 10c — But FREE

Send NOW for my famous book, "Everlasting Health and Strength," 48 pages, packed from cover to cover with actual photographs, valuable advice, answers to many vital questions. Page by page it shows what I can do for YOU. This book is a real prize for any fellow who wants a better build. Yet I'll send you a copy absolutely FREE. Just glancing through it may mean the turning point in your whole life! Rush the coupon to me personally: Charles Atlas, Dept. 8H, 115 East 23rd St., New York 10, N. Y.

CHARLES ATLAS, Dept. 8H,
115 East 23rd St., New York 10, N. Y.

Send me—absolutely FREE—a copy of your famous book, "Everlasting Health and Strength"—48 pages, crammed with actual photographs, answers to vital health questions, and valuable advice to every man who wants a better build. I understand this book is mine to keep, and sending for it does not obligate me in any way.

Name.....Age.....
(Please print or write plainly)

Address.....

City.....State.....

Peace or War Business

Are YOU the Man?

... if you are honest, willing to work to enjoy success—write today for details on how to Own a Business of Your Own. No experience necessary. You can have your business operating in a very few days.

Clean and Mothproof Rugs and Upholstery

Duraclean cleans and sanitizes. Duraproof protects against moths and carpet beetles. Furnishings are serviced right "in the home" or business building.

No overhead expense. Some dealers open a shop or an office . . . others operate from their own home. Profits up to \$15 a day on EACH of your service men.

Duraclean and Duraproof are Nationally Advertised in quality magazines to create voluntary orders for you in this year 'round, lifetime business of "your own." Send now for free booklet. No obligation.

DURACLEAN CO., 1-168 Duraclean Bldg., Deerfield, Ill.

Patented Equipment

ENGINEERING DEGREE IN 27 MONTHS

INDIANA TECHNICAL COLLEGE

B. S. DEGREE. Aeronautical, Chemical, Civil, Electrical, Mechanical and Radio Engineering (inc. television), Drafting, 1-yr. Government approved for G.I.'s. Low rate. Earn board. Large industrial center. Students from 48 states, 21 countries. Demand for graduates. Enter September, December, March, June. Write for catalog, 1681 E. Washington Boulevard, Fort Wayne 2, Indiana.

You're Right!

NOBODY LIKES TO ADD & SUBTRACT FRACTIONS

Get a **Fractionator**

100% Accurate. Direct reading. Answers in Fractions and Decimal Equivalents. Handles all Engineering Fractions.

\$1.00 POSTPAID U.S.A.

Direct Mail Only Refund if not Satisfied

Chas. E. Wells • Box 25 • Montrose, Calif.

DIALS LIKE A TELEPHONE

BE A LOCKSMITH

Learn from experts at home! Age or handicap no disadvantage. Profitable profession. FREE booklet.

INSTITUTE OF LOCKSMITHING, Dept. P-21
55 Park Ave., Rutherford, N. J.

"YOU ARE UNDER ARREST!"

Help Bring Crooks to Justice Through Scientific CRIME DETECTION!

We have taught thousands this exciting, profitable, pleasant profession. Let us teach you in your own home. Learn Finger Printing, Firearms Identification, Police Photography, Secret Service Methods thoroughly, quickly, at small cost. Over 800 of all American Bureaus of Identification employ I. A. S. students or graduates. We can prepare you for this fascinating work, during spare time. Write today, stating age, for "Blue Book of Crime."

INSTITUTE OF APPLIED SCIENCE, 1920 Sunnyside Ave., Dept. 135-C, Chicago 40, Ill.

MAKE EXTRA MONEY

PLASTICS LEARN AT HOME

There are RICH OPPORTUNITIES for MEN and WOMEN with "know-how" in Plastics. Interstate's amazing new Plastics course tells and shows how to make hundreds of fast selling items out of Plastics. Gives complete training in fabrication, casting, lamination, molding, etc., in simple, easy, step-by-step language and pictures.

START A PLASTICS BUSINESS OF YOUR OWN. No other industry holds such promise for the future. You can make big money manufacturing novelties, toys, signs, etc., in your own home in spare or full time. Don't wait! Learn NOW how Interstate's Plastics Training qualifies you for success in the plastics field.

Write for FREE Information Today!

INTERSTATE TRAINING SERVICE
School of Plastics
PORTLAND 13, OREGON (Dept. 3-H)

LEARN HOW TO MAKE fast selling PLASTIC NOVELTIES FURNITURE JEWELRY SIGNS TOYS LAMPS

THESE MEN ARE GETTING PRACTICAL TRAINING IN **ELECTRICITY**

On Real:



**A.C. and D.C. MOTORS
GENERATORS
SWITCHBOARDS
CONTROLLERS
WIRING JOBS
APPLIANCES
ELECTRONIC UNITS**

(Shown at left—Instructor explaining operation and testing of a large Motor Generator in our A.C. Department.)

AND **TELEVISION-RADIO**

On Real:

**TELEVISION SETS
RADIO RECEIVERS
F.M.
(Frequency Modulation)
RECORD CHANGERS
AUTO RADIOS
PUBLIC ADDRESS Systems**

(Right—Instructor helping students check the wiring and trace circuits of television receivers.)



TRAIN QUICKLY in the Great Shops of COYNE for VITAL FIELDS

ELECTRICITY—RADIO—TELEVISION—VITAL in defense program. Trained men whether 16 or up to 50 needed. **TRAIN QUICKLY** for better rating if drafted—Vital job in industry if not.

FINANCE PLAN for non-veterans. G.I. Approved. Special plan for men of draft age.

NOT "HOME-STUDY" COURSES! At Coyne you learn on real, full-size equipment. Trained instructors show you how, then you do typical jobs yourself. We don't teach by mail.

CLIP COUPON NOW for big new illustrated Coyne book. Check whether interested in **ELECTRICITY** or **TELEVISION-RADIO** or both. No obligation; no salesman will call. Get vital facts now!

COYNE

**B. W. COOKE, Pres.
ELECTRICAL & TELEVISION-RADIO SCHOOL
An Institution not for Profit.
500 S. Paulina St., Dept. C1-72H
Chicago 12, Illinois**

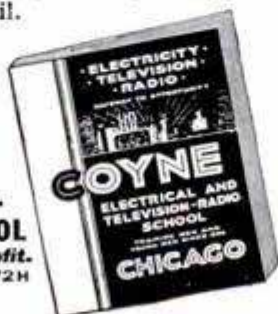

**Mail Coupon for
BIG FREE BOOK!**



**B. W. COOKE, President
COYNE ELECTRICAL &
TELEVISION-RADIO SCHOOL
500 S. Paulina St., Chicago 12, Ill. Dept. C1-72H**

Send **BIG FREE** book and details of your training offer. This does not obligate me and no salesman will call. I am interested in:

ELECTRICITY **TELEVISION-RADIO**

NAME

ADDRESS

CITY.....STATE.....

You are in demand if you can draw!



Make Money with your brush and pen! If you like to draw, sketch, or paint, take the Free Talent Test. No fee. No obligation. Mail this coupon TODAY!



ART INSTRUCTION, INC., Dept. 8131

500 S. 4th Street, Minneapolis 15, Minnesota

Please send me your FREE Talent Test.

Name _____ Age _____
 Address _____ Phone _____
 City _____ Zone _____ County _____
 State _____ Occupation _____

Learn this Profitable Profession



**IN 90 DAYS
AT HOME**

Money-Making Career Open to Men and Women, 18 to 60

Hundreds of men and women between 18 and 60 make \$10 to \$20 in a single day giving scientific Swedish Massage and Hydro-Therapy treatments. There is big demand from doctors, hospitals, sanatoriums and clubs. Graduates earn large full time incomes from these or in private practice in their own offices. Others make good money from home treatments given in spare time. Learn this interesting, money-making profession in your own home, through our home study course. Same instructors as in our nationally known resident school. You can win independence and prepare for future security by qualifying for your Diploma. Course can be completed in 3 to 4 months. Many earn while they learn. Begin your training at once.



NEW 32-PAGE BOOKLET FREE

Fill in the coupon below (please print name and address) and mail it for your FREE copy of 32-page Information Booklet. If you act at once we will include Anatomy Charts and Success Booklet which supply additional information you should have. All will be sent postage paid.

THE COLLEGE OF SWEDISH MASSAGE
 Dept. 164K, 41 E. Pearson St., Chicago 11, Illinois
 Please send me FREE and postpaid New 32-Page Illustrated Booklet, Anatomy Charts and Success Booklet at once.

Name _____ Age _____
 Address _____
 City _____ State _____

SHORTHAND in 6 Weeks at Home

Famous Speedwriting system. No signals; no symbols; no machines; uses ABC's. Easy to learn; easy to write and transcribe. Low cost. 100,000 taught by mail. For business and Civil Service. Also typing. 28th year. Write for FREE booklet to:

Speedwriting
 Dept. 1508-1, 55 W. 42 St., New York 18 (R)

RUPTURE



RELIEF...OR YOUR MONEY BACK
 Simple, easy to wear truss made by old surgical house. You risk nothing. Write for free booklet. Don't delay.

WEB TRUSS CO., Dept. M-8, Hagerstown, Md.

"It Measures As It Rolls"

ROLLER RULE

HANDY MECHANICAL PENCIL

Measures Curves and Straight Lines. Any Shape. Any Distance. Any Surface.

\$1.29
 POST PAID

Roll head over surface. Inches and fractions record accurately on "Inch-O-Meter". Excellent pencil too! Order Now!
10 Day Money Back Guarantee!
 C.O.D. (postage extra). In Calif. add 3% Sales Tax.

PENCIL SALES CO., Dept. PM8
 Room 6, 1213 E. Ocean Blvd., Long Beach, California

GET INTO A
**MONEY MAKING
TRADE—NOW!**



**L. J. ROSENKRANZ,
President**

**LET ME SEND YOU THESE
BIG FREE BOOKS!**

These Big FREE Books and Sample Lessons show how we train you. Get all the facts—send today for your choice of our valuable book on Radio-Television, or Diesel-Automotive Opportunity. Check coupon at right. No cost or obligation.

TAKE YOUR CHOICE OF
2 BIG FIELDS OF

**RADIO
TELEVISION
ELECTRONICS**

GET THE FACTS . . . MAIL COUPON TODAY

National Schools, Dept. 8-PMC
4000 South Figueroa Street
Los Angeles 37, California

Mail in envelope
or paste on
penny postal

Send me Free the book checked below and the sample lesson. I understand no salesman will call on me.

"My Future in Radio, Television & Electronics."

OR

"My Future in Diesel, Automotive & Allied Mechanics."

NAME _____ AGE _____

ADDRESS _____

CITY _____ ZONE _____ STATE _____

Use coupon to get your choice of these FREE illustrated books and actual sample lessons.

Let National Schools, of Los Angeles, a practical Technical Resident Trade School for almost 50 years, train you for today's unlimited opportunities.



**OPPORTUNITY
DIESEL
AUTOMOTIVE &
ALLIED MECHANICS**

**TODAY'S SHORTAGE OF TRAINED TECHNICIANS
CREATES BONUS OPPORTUNITY FOR YOU!**

Radio, Television, Electronics is a dominant factor in the national emergency. How well these essential services will do the big job they have been given depends upon the supply of trained men. Prepare yourself now to step into a good-paying job with a real future! New developments in color TV, guided missiles, radar, other electronics fields are only the beginning! National Schools Master Shop Method Home Training is complete—you master all phases of Radio, Television, Electronics.

**WE SEND YOU EVERYTHING YOU
NEED TO LEARN AT HOME**

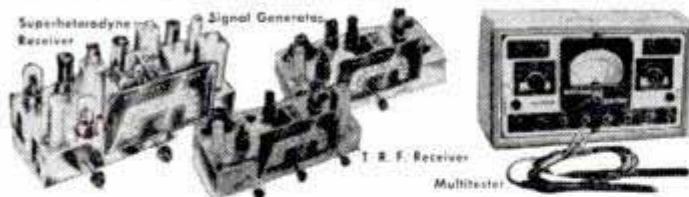

Above are some of experimental units you build with kits of standard parts we send you: Signal Generator, Audio Oscillator, T. R. F. Receiver and many other units and circuits, including a big modern Superheterodyne Receiver. We send you all the tubes and a valuable professional quality Multimeter. No extra charges. You learn by doing!

**HAVE A PROFITABLE
BUSINESS OF YOUR OWN**

National training qualifies you for your choice of many job opportunities in radio and television broadcasting, manufacturing, servicing, sales. Also installation & maintenance of laboratory electronics equipment, sound systems, police radio, and many others. You can start a good paying business of your own, as many other National Schools graduates have done!

TELEVISION TRAINING

A complete series of up-to-the-minute TV lessons is an important part of your course. They cover all phases of TV repairing, servicing and construction.



**IF YOU LIKE MECHANICS, THERE'S A BRIGHT
FUTURE FOR YOU IN DIESEL-AUTOMOTIVE!**

Trained engine mechanics are needed in increasing numbers in the Armed Forces and civilian production—everywhere that engine power is used! National Schools gives you complete training for this great industry.

**YOU GET MASTER SHOP METHOD
TRAINING RIGHT IN YOUR HOME**

With our practical home training, you learn Diesel Fuel Injection, Automotive Motor Tune-up, Diesel Engine Maintenance, General Garage Mechanics, Thermodynamics, Auto Electrical Service and all other phases. Your National Course covers Gasoline and Special Fuel Engines; Diesels, High Speed and Heavy Duty; Semi-Diesels; Allied Mechanics. Get all the facts—use the coupon above.

**WE SEND YOU TOOLS
OF YOUR TRADE**

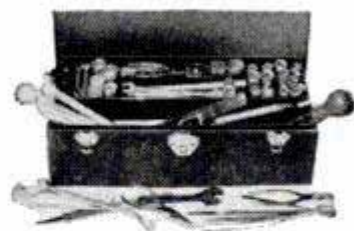

In addition to all lesson texts, Diesel Chart Manual, Spare Time Lessons, Service Manuals & other material, you receive a full kit of high-quality tools and equipment...all a part of your course.

No extra charge for this valuable kit of tools and equipment.

EARN WHILE YOU LEARN

You can earn extra money and get valuable experience in spare time. Special Spare Time Work Lessons show you how! Many National students pay for all or part of their course this easy way.

Use the coupon now to get valuable Free Book about the great Diesel-Automotive Industry and the Sample Lesson, plus full information about how we train you.

**BOTH RESIDENT
& HOME STUDY
COURSES OFFERED**

NATIONAL SCHOOLS Technical Trade Training Since 1905
Los Angeles 37, California

WHAT SECRET POWER DID THIS MAN POSSESS?



BENJAMIN FRANKLIN
(A Rosicrucian)

WHY was this man great? How does anyone—man or woman—achieve greatness? Is it not by mastery of the powers within ourselves? Know the mysterious world within you! Attune yourself to the wisdom of the ages! Grasp the inner power of your mind! Learn the secrets of a full and peaceful life!

Benjamin Franklin—like many other learned and great men and women—was a Rosicrucian. The Rosicrucians (NOT a religious organization) first came to America in 1694. Today, headquarters of the Rosicrucians send over seven million pieces of mail annually to all parts of the world. Write for YOUR FREE COPY of "The Mastery of Life"—TODAY. No obligation. No salesmen. A non-profit organization. Address: Scribe Z. V. R.

THIS BOOK FREE!

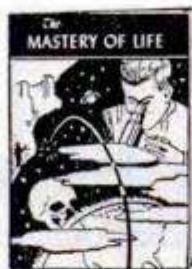

The ROSICRUCIANS

SAN JOSE • (AMORC) • CALIFORNIA

—SEND THIS COUPON—

Scribe Z.V.R.
The ROSICRUCIANS (AMORC)
San Jose, California
Please send me the free book, *The Mastery of Life*, which explains how I may learn to use my faculties and powers of mind.

Name _____

Address _____

City _____

No Experience Needed To PRINT YOUR OWN POST CARDS

The GEM STENCIL DUPLICATOR saves money... gets results quickly! Hundreds of uses for every type of business and organization. We ship the GEM complete with all supplies, Guide Board for accurate printing and 60-page Book of Ideas at the special low price of only \$8.50 (a \$15 value).

FREE TRIAL OFFER

Use the GEM FREE at our expense! SEND NO MONEY. Write and complete GEM outfit will be sent you postpaid. After ten days, send us only \$8.50 or return the GEM. You must be satisfied!

BOND EQUIPMENT CO. Dept. 48
6633 Enright • St. Louis 5, Mo.



SHINE WITHOUT 'POLISH'

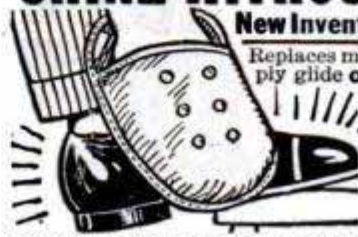

New Invention! • Sells Like Wild

Replaces messy pastes, liquids. Simply glide over shoes—and PRESTO! —you have a lustrous, long-lasting shine. No mess. No muss. No soiled hands. Clean. Handy. WORKS LIKE MAGIC! For Men's, Women's and Children's Shoes. Low priced, Lightning seller!

SAMPLES FOR TESTING Sample offer sent immediately to all who send name at once. A penny postal will do. SEND NO MONEY —just your name. KRISTEE CO., Dept. 688, AKRON 8, OHIO



GOLD-SILVER-COINS

Easily located with new Lightweight M-Scope Detector. Superior performance, lowest price, monthly payment plan.

FREE LITERATURE
FISHER RESEARCH LAB., INC.
PALO ALTO CALIF.

Rupture Troubles Ended

Advanced method has healed thousands. No leg straps, no elastic, no plasters. No pressure on hips or spine. Flexo-pad. Entirely different. Endorsed by doctors, mechanics, clerks. Very light. **INEXPENSIVE. GUARANTEED.** Write for information and trial.

SMITH MANUFACTURING COMPANY
EST'D 1893 DEPT. PM PRESTON, ONTARIO

TRY HOME STUDY WATCHMAKING

FREE Sample Lesson

Famous Sweazey System shows how to master watchmaking... expertly, quickly, successfully... right in your own home. No previous experience needed to learn one of the highest paid trades. Try it without obligation.

APPROVED RESIDENT COURSES

... in Watchmaking, Engraving, Jewelry Repair, Diamond and Stone Setting at our modern, fully-accredited resident school. Founded 1908. Write for FREE CIRCULAR.

CHICAGO SCHOOL OF WATCHMAKING
1608 N. Milwaukee Avenue Dept. 181 Chicago 47, Ill.

NOW... GET EVERYTHING YOU NEED TO LEARN AND MASTER

TELEVISION

RADIO-ELECTRONICS ...AT HOME!

Use REAL commercial-type equipment to get practical experience



Here's the REAL THING!

SET UP YOUR OWN HOME LABORATORY

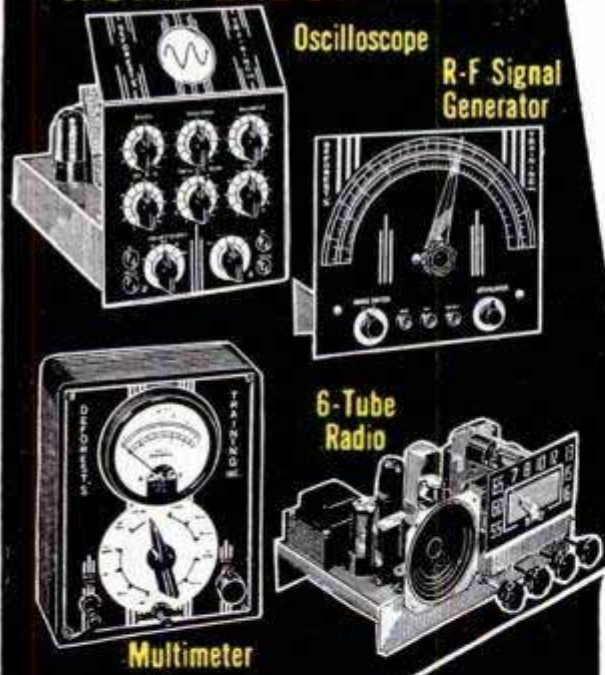

Oscilloscope
R-F Signal Generator

6-Tube Radio

Multimeter

ABOVE: Build and keep a real 16 INCH commercial TV receiver. Optional after completing regular training at slight additional cost.

D.T.I., ALONE, INCLUDES BOTH MOVIES and HOME LABORATORY In addition to easy-to-read lessons, you get the use of HOME MOVIES — an outstanding training advantage — plus 16 big shipments of Electronic parts. Perform over 300 fascinating experiments for practical experience. Build and keep real commercial-type test equipment shown at left.

MODERN LABORATORIES

If you prefer, get all your preparation in our new Chicago Training Laboratories—one of the finest of its kind. Ample instructors, modern equipment. Write for details!

MILITARY SERVICE!

If you're subject to military service, the information we have for you should prove doubly interesting. Mail coupon today.

Get BOTH of these information packed publications FREE!



HOME MOVIES

ACT NOW! MAIL COUPON TODAY!

DeFOREST'S TRAINING, INC., Dept. PM-8-H
2533 N. Ashland Ave., Chicago 14, Ill.

Without obligation, I would like your late News-Bulletin showing 89 ways to earn money in Television-Radio-Electronics ... and how I may prepare to get started in this thrilling field.

Name..... Age.....
Street..... Apt.....
City..... Zone..... State.....

De FOREST'S TRAINING, INC.
CHICAGO 14, ILLINOIS
A DeVRY INSTITUTION

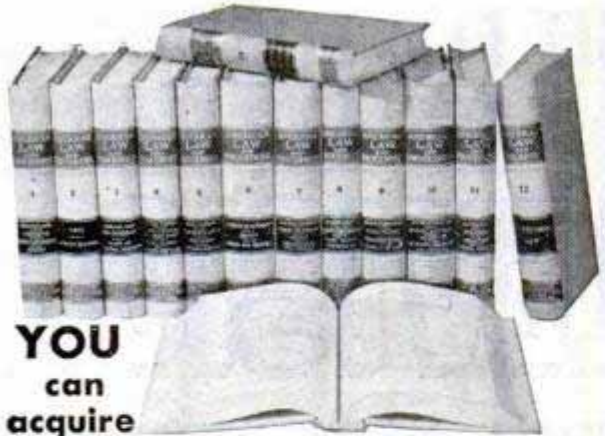

YOU
can
acquire

LAW NIGHTS AT HOME! L. L. B. DEGREE

LaSalle's famous Law Library—used as reference in many Law libraries and Law offices—has enabled thousands to master Law surprisingly fast, in spare hours at home, for business and professional advancement.

These 14 remarkable volumes, compiled by leading professors and lawyers, cover the whole basic field of Law in condensed, orderly, simplified manner.

You advance rapidly with this great library, plus special lectures furnished. We guide you step-by-step with personalized Problem Method of instruction . . . you learn by doing—handling legal problems—not by memorizing rules.

Send for two FREE 48-page booklets, "Law Training for Leadership," and "Evidence," answering questions about Law and its value to you, and telling how LaSalle Law graduates are winning rapid advancement in business and public life. Mail coupon below. No obligation.

LA SALLE EXTENSION UNIVERSITY

A Correspondence Institution

417 S. Dearborn St., Dept. 864L, Chicago 5, Ill.

Send me your two FREE booklets described above; without obligation.

Name _____ Age _____

Street _____

City, Zone & State _____

Prepare Now!

ENGINEERING

B.S. DEGREE IN 27 MONTHS

WORLD FAMED SCHOOL • ESTABLISHED 1884

Mechanical, Civil, Electrical, Chemical, Aeronautical, Radio (Television) Engineering; Business Administration and Accounting. Also 36-weeks diploma courses in Surveying and Drafting.

Personalized instruction. Accelerated courses. For ambitious earnest students. Preparatory department.

Heavy demand for Tri-State graduates; hold positions of responsibility the world over. Placement service. Serious shortage of engineers indicated for immediate future. Prepare now for the opportunities ahead. Technical training helpful in military assignments.

Extensive campus. Well equipped, new and modernized buildings; up-to-date labs. Low cost. New terms start quarterly. Enter September, January, March, June.

Write today for free catalog and special information.

TRI-STATE COLLEGE

481 COLLEGE AVENUE ANGOLA, INDIANA

Turn YOUR Spare Time Into

CASH WITH STARK FRUIT TREES

MEN—WOMEN make welcome EXTRA CASH in spare hours, evenings, weekends. Take easy orders from friends and neighbors, others for world-famous Stark Fruit Trees, Apples, Pears, Peaches, Cherries, Plums and others. Sensational quick-bearing U. S. Patent Varieties. Also amazing new Stark DWARF Fruit Trees. Enormous demand. Added income selling Stark Shrubs, Vines, Roses to home owners. Join Stark Bro's—America's largest, oldest nursery—now in our 139th year.

FREE SEND NO MONEY for GIANT SALES OUTFIT

Rush name and address today for FREE STARK MONEY-MAKING SALES OUTFIT. Everything you need, including large, full color Photo Plate Book. No experience is needed. Write at once, best selling weeks just starting.

STARK BRO'S DEPT. 5582 LOUISIANA, MO.

FORD-MERC. OWNERS STOP BURNING POINTS!

Dual Point Distributor Conversion SAVES COSTLY REPLACEMENTS! Complete kit for '49, '50, '51 Ford 8 or Mercury. Converts single point to dual point distributor using same coil and single condenser. Easily installed.

SATISFACTION GUARANTEED

- Eliminates missing • Increases Acceleration • Higher RPM • All parts stock Ford, buy anywhere. • Money Back Guarantee. Send 25¢ For Special "Custom Accessories" Catalog. Dealers Write.

EASTERN AUTO
3319 SO. GRAND AVE.
DEPT. P-8, LOS ANGELES 7, CALIF. \$2.00 deposit with C.O.D.'s.

ONLY \$7.95

Cash or C.O.D.'s.

LEARN WATCH REPAIRING

AT HOME. By our modern and original system of instruction you can learn every part of the WATCH REPAIRING TRADE AT HOME. Prepare yourself for a well-paying position or start in business after completing our course of instruction. Good watch repairers are in demand and generally earn very good salaries. For particulars apply to the WISCONSIN SCHOOL OF WATCH REPAIRING, 759 North Milwaukee St., Milwaukee 2, Wis.

A "GOOD HAND" HELPS YOU SUCCEED!

LEARN TO WRITE WELL

Handwriting quickly improves with our easy-to-understand picture lessons! Put your spare time to good use; send today for FREE BOOK, "How to Become a Good Penman", or check volumes wanted below at \$1 each: Business Writing Artistic Writing Card Writing Bird & Design Flourishing Engrossing Alphabets. COMPLETE SET \$4.50

TAMBLYN SCHOOL of PENMANSHIP
S. A. Ziller, Pres. 442 Ridge Bldg., Kansas City, Mo., USA

Beautifully written, plus special pen-point for shaded writing. **Only 10¢** OUR 53rd YEAR

FOAM RUBBER

SAVE 50%! BUY DIRECT

FOR HOME • CAR • SPORTS

16x16x1/4" . . . \$.35	14x16x1" . . . \$.90
16x16x1/2"60	18x16x1" . . . 1.10
16x16x1"95	22x20x1 1/2" . . . 2.25
24x24x1/2" . . . 1.20	22x20x2" . . . 2.95
24x24x1" . . . 1.90	22x60x1 1/2" . . . 5.95

Send for complete price list. Immediate delivery on all orders. No C.O.D.

FOAM & FABRIC WAREHOUSE
483 KENMORE BLVD., DEPT. 2, AKRON 1, O.



"We have been using your book on Auto Repair for the past year and feel like it is a third man around the shop."—F. M. Scott, Stanwood, Wash.



"Fixed motor in 30 minutes another mechanic had worked on half a day."—C. Auberry, Murfreesboro, Tenn.



"Instructions so clear, have no trouble learning anything about any car. Now working as mechanic in big plant."—S. Ordonez, San Francisco, Calif.



"So easy to understand—have done jobs with Manual I would not have attempted without it."—C. L. Vanerstrom, Hazel Park, Mich.



"I have found my MoToR Manual a wonderful help. It has put me in a position to do every job."—S. L. Sharpless, Los Angeles, Cal.

THOUSANDS OF MEN ARE RAVING ABOUT THIS GIANT GUIDE!

Now YOU Can Be a "Cracker-jack" at Auto Repairs!

BRAND-NEW
1951
EDITION!

Thousands of Easy-to-Follow Step-by-Step Pictures

Easy-Step-by-Step Instructions Show How to do ANY Job on ANY Car—from 1935 through 1951!

THOUSANDS of men are raving about MoToR's BIG NEW 1951 ILLUSTRATED AUTO REPAIR MANUAL! It enables them to do any job FASTER and better; do MORE jobs; make MORE money!

Whether it's on a 16-year-old "jalopy" or a brand-new 1951 beauty, YOU, too, can "breeze through" any repair job quickly, easily, right! Just look up the make, model, and job in the quick index—and go to it!

Everything You Need to Know to Repair Any Car!

This NEW 1951 REVISED edition has MORE REPAIR INFORMATION THAN EVER—right up to the minute! 771 big pages, 2300 "This-Is-How" pictures—clear drawings, diagrams, cut-away photos that lead you every step of the way. Over 200 "Quick-Check" charts containing more than 38,000 essential repair specifications. Over 225,000 service and repair facts. Clear, simple directions. You can't go wrong!

Any man—even a green beginner—can do a good job. If you're a top-notch mechanic, you'll find yourself tackling jobs now that you wouldn't touch before!

Earn More Money! Win Greater Prestige!

The editors of MoToR's Manual have put together the "Know-How" from over 150 Official Factory Shop Manuals; "boiled it down" into one handy book!

Includes ALL Automatic Transmissions and Semi-Automatic Transmissions. Covers the new GM Rochester Carburetor, Engines... Chokes... Carburetors... Fuel Pumps... Hydramatic Drives... Overdrives... Oil Filters... Starting Motors... Generators... Distributors... Clutches... Universals... Axles... Brakes... Steering Gears... Shock Absorbers, etc.

Valuable help in Body Service, Factory Specifications and Adjustment Tables, Tune-up Charts, Tables of Measurements and Clearances, Overhauling and Replacement Facts—AND MUCH, MUCH MORE.

Used by Armed Forces, hundreds of thousands of auto service men! YOU'LL want it, too, once you see its 771 giant pages—almost a foot high!—its 2300 close-up pictures! Try it on the following UNCONDITIONAL GUARANTEE:

Try Book for a Week FREE

Send No Money. Pay nothing to postman. Test book in your own garage or shop. It's GUARANTEED to pay for itself in 7 days. If it doesn't, just return the book, and owe nothing. You don't risk a penny. Rush coupon for your free-trial copy of this great money-saving Manual. MoToR Book Dept., Desk 18, 250 West 55th St., New York 19, N. Y.

SEND NO MONEY!
TRY BOOK FREE!
FOR A WEEK!



COVERS 800 MODELS—ALL THESE MAKES!

- Buick
- Cadillac
- Chevrolet
- Chrysler
- Crosley
- De Soto
- Dodge
- Ford
- Frazer
- Henry J.
- Hudson
- Kaiser
- Lafayette
- La Salle
- Lincoln
- Mercury
- Nash
- Nash Rambler
- Oldsmobile
- Packard
- Plymouth
- Pontiac
- Studebaker
- Terraplane
- Willys

ALSO complete tune-up adjustments for: American Bantam, Auburn, Austin, Cord, Graham, Hupmobile, Pierce Arrow, Reo.

USED BY U.S. ARMED FORCES

Same FREE 7-Day Offer on MoToR's TRUCK and TRACTOR REPAIR MANUAL

Covers EVERY job on EVERY gasoline-powered truck and farm tractor made from 1935 thru 1949! 1867 pictures, 963 big 8 1/2 x 11-inch pages, 300,000 facts. Used by Armed Forces. All types Gasoline Engines, Fuel Systems, Governors, Lubrication Systems, Ignition Systems, Starters, Generators, Clutches, Transmissions, Axles, Torque Dividers, Transfer Cases, Brakes, Steering, etc. Check proper box in coupon for free trial.

MAIL COUPON NOW FOR 7-DAY FREE TRIAL

MoToR Book Dept., Desk 18, 250 West 55th Street, New York 19, N. Y.

Rush to me at once: (Check box opposite book you want)

- MoToR's New 1951 AUTO REPAIR MANUAL. If O.K. I will remit \$1 in 7 days (plus 35c delivery charge), then \$2 monthly for 2 months, and a final payment of 96c a month later. Otherwise I will return book postpaid in 7 days. (Foreign price, remit \$8 cash with order.)
- MoToR's TRUCK AND TRACTOR REPAIR MANUAL. (Described at left.) If O.K. I will remit \$2 in 7 days, and \$2 monthly for 3 months, plus 35c delivery charge with final payment. Otherwise I will return book promptly. (Foreign price, remit \$10 cash with order.)

Print Name Age

Print Address

City & Zone No. State

SAVE 35c delivery charges by enclosing WITH COUPON check or money order for full payment of \$5.95 for Auto Repair Manual (or \$8.00 for Truck and Tractor Manual). Same 7-day return-for-refund privilege applies.

EARN MORE IN DRAFTING



More Opportunities for Employment and Promotion

"Here I am at work making good money as a draftsman. I'm glad I sent the coupon to Chicago Tech for that Free Trial Lesson and found out how easy it is to learn Drafting in spare time at home. Today I feel secure in my job because the draftsman's work comes first on any new project. And, in addition, draftsmen can't be replaced with machines. What's more, I feel I'm slated for promotion and more pay, because I see so many draftsmen advancing to high-pay jobs."

LEARN IN SPARE TIME—AT HOME! (or at the College in Chicago)

A few hours of pleasant home study every week—that's all. No interference with your present job. All the tools you need; drawing outfit included. With Chicago Tech's help, you train yourself step by step. This tested method—developed over 46 years of C.T.C. progress—prepares men quickly for good positions in industry.



FREE INFORMATION—SEND COUPON

To prove to you how easy it is to learn Drafting at home by the Chicago Tech method, we will send you this FREE TRIAL LESSON. No charge for this lesson, now or later. Fill out and mail coupon, or send post card today.

CHICAGO TECHNICAL COLLEGE

K-214 Tech Bldg., 2000 So. Michigan Ave., Chicago 16, Illinois

Mail me FREE Lesson with information about big opportunities in DRAFTING.

Name _____ Age _____

Address _____

City _____ Zone _____ State _____

SAY YOU SAW IT IN POPULAR MECHANICS

NOW REFILLS TO FIT YOUR CAR OIL FILTER —ONLY 10c!

Thanks to amazing new Adapter Plates easily installed in your oil filter!



Retlif Adapter Plates are easily, quickly installed in your present oil filter. With them you can use an ordinary toilet paper roll (cost about 10¢) as the filter element.

Actually cleans oil better, faster and at 94% less cost than regular filter elements. Proved conclusively by laboratory tests, millions of miles in service! Unconditionally guaranteed! For facts and free descriptive literature, write:

RETLIF CORPORATION
Dept. 87

1239 North Highland Avenue, Los Angeles 38, California 26

WORLD'S FASTEST BOATS!

BUILD and DRIVE your own high speed racing boat



as hundreds of others are doing! Easy to follow our simplified plans for newest types of racing craft. Large selection of full race Hydroplanes ranging from 6 ft. to 20 ft. lengths. Service, Racing, Utilities, and 3 Points. Both inboard and outboards.

SEND 25c for CATALOGUE

containing pictures and descriptions of **Champion Boats** for which plans are designed and distributed exclusively by **CHAMPION BOATS**, P. O. Box 9038, Dept. 15H, Long Beach, California, U.S.A.

NO NAILS! NO SCREWS! NO GLUE!

Selfix hooks

For Bathrooms Kitchens Closets

Hold 15 Lbs. ON TILE • GLASS PLASTER • WOOD

So Easy...Just Moisten... Press...Up in a Minute

Firm as a rock—fully tested—satisfaction guaranteed. In white, red, yellow, black, green, blue, pink. At Department, 5 and 10 or Hardware Stores—or write for address of nearest store. Selfix Products Co., Dept. L, 30 E. Adams St., Chicago 3, Ill.



"How to Make Money with Simple Cartoons"



A book everyone who likes to draw should have. It is free; no obligation. Simply address

FREE BOOK

CARTOONISTS' EXCHANGE

Dept. 98D Pleasant Hill, Ohio

WHY DON'T YOU WRITE?

Writing short stories, articles on business, sports, hobbies, travel, snop crafts, local and club activities, etc., will enable you to earn extra money. In your own home, on your own time, the New York Copy Desk Method teaches you how to write the way newspaper men learn—by writing. Our unique "Writing Aptitude Test" tells whether you possess the fundamental qualities essential to successful writing. You'll enjoy this test. Write for it, without cost or obligation.

Veterans: Course approved for Veterans' Training.

NEWSPAPER INSTITUTE OF AMERICA

SUITE 5591-M, ONE PARK AVENUE, NEW YORK 16, N. Y.

PHOTOGRAPHY



EARN BIG MONEY! PERSONAL ATTENDANCE TRAINING in News-Magazine-Fashion-Portrait-Advertising-Natural Color Photography. Splendid equipment, glamorous models. Or—our COMPLETE HOME STUDY COURSE provides you with a spare time short-cut to success.

Our 41st year. Write immediately for BIG FREE BOOK!

NEW YORK INSTITUTE OF PHOTOGRAPHY

Dept. 49, 10 West 33 St., New York 1, N. Y.

FOR BIG MEN ONLY!



SIZES

WIDTHS

10 to 16 AAA to EEE

We SPECIALIZE in large sizes only—sizes 10 to 16; widths AAA to EEE. Loungers, Wing Tips, Moccasins, Dress Oxfords, High and Low Work Shoes, House Slippers, Rubbers, Overshoes, Sox. Extra quality at popular prices. Satisfaction guaranteed. Sold by mail only. Write for FREE Catalog.

SEND FOR FREE CATALOG

KING-SIZE, Inc., 658, Brockton, Mass.
POPULAR MECHANICS

PLAY RIGHT AWAY

—even if you don't know a single note of music now!

Now it's FUN to learn piano, guitar, accordion, or any instrument you choose. No tedious scales or boring exercises. Even if you don't know a single note of music now, we'll have you playing delightful pieces RIGHT AWAY—right from your very FIRST lesson! This keeps up your interest and enthusiasm—builds up your musical skill with amazing rapidity. Soon you're able to play the pieces you and your friends love! And properly — by NOTE!

No wonder our "easy as A-B-C" method has been famous throughout the world for 53 years! No wonder 850,000 people (yes, 850,000) have turned to it as the means of making their dream of playing music come true! Don't worry about whether or not you have the "talent"—none is needed. Don't worry about "having the time" either. Learn in the spare time of your own choosing, free from the rigid schedule imposed by a teacher. And forget about the cost—it's only a few cents per lesson, including sheet music!

How often have you thought: "If only I could play!" Perhaps every time someone else occupied "the center of the stage" at a party. Or you came home exhausted and longed for some way to relax and refresh yourself. Or dreamed of meeting new friends through music. Now you CAN play. Let us SHOW you how easy it is!



FREE BOOK and Free Instruction-Sample

Mail coupon for Free Illustrated Book and free Instruction-Sample. No obligation; no salesman will call. See how easily YOU can put this wonderful accomplishment into your life! U. S. School of Music, Studio A308, Port Washington, N. Y.

U. S. School of Music, Studio A308, Port Washington, N. Y.

Please send me Free Book and free Instruction-Sample. I'm interested in playing (name instrument) _____

I do I do not—have instrument now.

Name _____ (please print)

Address _____

HERE IS THE NEW SENSATION IN LOW-COST

Truly, Cushman EAGLE is the new sensation in its field. It operates for only $\frac{3}{4}$ ¢ per mile, cruises to 50 m.p.h., gets over 75 miles per gallon. Dealer inquiries invited.

CUSHMAN MOTOR WORKS Lincoln, Nebr.



TRANSPORTATION

Cushman

EAGLE

WRITE FOR DETAILS AND SPECIFICATIONS
DEPT. 15M

LEARN MEAT CUTTING AT NATIONAL Pay After Graduation



The steady dependable trade of Meat Cutting taught easily in 8 short weeks. YOU LEARN BY DOING under actual meat market conditions in big modern school at Toledo.

For beginners or men with experience. Get a profitable store of your own. Remember, PEOPLE MUST EAT! Big pay jobs. Free employment help. Thousands of successful graduates.

Buying, cutting, percentage, pricing, advertising, selling, etc. A complete retail meat education. National School established over 25 years. Get National training NOW. Pay your tuition in easy weekly payments

after you graduate. G. I. approved. Send coupon for FREE 52 page school catalog — TODAY.

National School of Meat Cutting, Inc., Dept. 50-V, Toledo 4, Ohio

Send me your FREE school catalog on National Training at Toledo in Meat Cutting. Meat Merchandising and Self Service Meats. No obligation. No salesman will call.

Name _____

Address _____

City _____ State _____

() Check here if Veteran of World War II

9 BIG BUILDING BOOKS

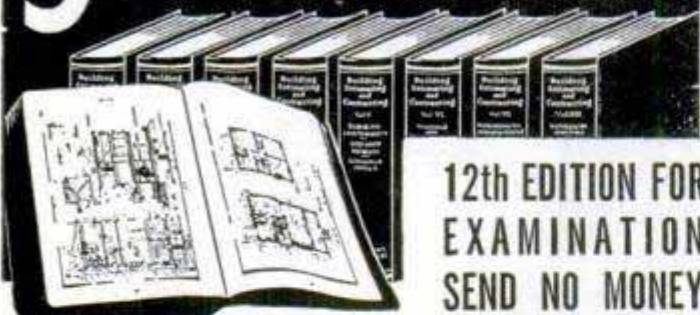

12th EDITION FOR EXAMINATION SEND NO MONEY

Learn to draw plans, estimate, be a live-wire builder, do remodeling, contracting. These 9 practical, profusely illustrated books cover subjects that will help you to get more work and make more money. Masonry, concrete forms, carpentry, steel square, roof framing, construction, plumbing, heating, painting, decorating and many other subjects. More than 4000 pages — 2750 illustrations.

BETTER JOBS — BETTER PAY UP-TO-DATE EDITION

A nationwide building boom is in full swing and trained men are needed. Big opportunities are always for **MEN WHO KNOW HOW**. These books supply quick, easily understood training and handy, permanent reference information that helps solve building problems.

Coupon Brings Nine Big Books for Examination

AMERICAN TECHNICAL SOCIETY—Publishers since 1898
Dept. GC19 Drexel at 58th Street Chicago 37, Ill.

You may ship me the Up-to-Date edition of your nine big books, "Building, Estimating and Contracting," without any obligation to buy. I will pay the delivery charges only, and if fully satisfied in ten days, I will send you \$3.00, and after that only \$4.00 a month, until the total price of only \$34.80 is paid. I am not obligated in any way unless I keep the books.

Name _____

Address _____

City _____ State _____

Please attach a letter stating your age, occupation, employer's name and address, and name and address of at least one business man as a reference. Men in service, also please give home address.



MEN OF THE HOUR are moving UP!

These men in top jobs are proving that Embry-Riddle training is your quickest, surest road to success. Complete eight-month to two-year Embry-Riddle courses to fit practical aviation industry requirements.

Investigate at once the full advantages plus career security of Embry-Riddle training. Join the Embry-Riddle Men of the Hour. Write for full information today.



Address REGISTRAR
SCHOOL OF AVIATION
DEPT. 99 MIAMI 30, FLORIDA

Please Print

NAME _____

ADDRESS _____

City _____

State _____ Age _____

Send coupon today!

I am interested in...

- A.&E. Mechanic
- Commercial Pilot
- Aeronautical Design and Technology
- A.&E. Combined Commercial Pilot
- Flying Mechanic

Check One Veteran Non-Vet.

TRAIN IN MIAMI -- AIR CAPITAL OF THE WORLD

AMAZING NEW DISCOVERY! FOR ALL CARS WITH OVERDRIVE



\$9.95 Postpaid & Installed

We enclose FREE installation certificate redeemable for cash by your garage or gas station.

The Gane-O-Matic Overdrive Control puts to work all the hidden advantages of all Ford, Mercury, Lincoln, Studebaker, Nash, Hudson, Kaiser-Frazer, Jeepster, Dodge, DeSoto and other overdrive systems. **AUTOMATIC HILLHOLDER** holds car on any slope without use of hand or foot brake. **OVERDRIVE COMPRESSION** saves gas, brakes and tires. **SIX FORWARD SPEEDS**... three each in overdrive and regular range are selected with the flick of your finger. **NO CLUTCH SHIFTING** engaged up or down without touching your clutch. **YOUR MONEY BACK IF NOT FULLY SATISFIED!** Send cash, check or money order. \$1 C.O.D. deposit. **NATIONAL AUTOMOTIVE RETAIL CORP., Dept. Y-8**
350 W. Washington Blvd., Venice, Calif.

- AUTOMATIC HILLHOLDER**
- OVERDRIVE COMPRESSION**
- 6 FORWARD SPEEDS**
- NO CLUTCH SHIFTING**

MAKE \$5 PER HOUR WITHOUT A PRINTING PRESS

PRINTING REVOLUTIONARY NEW SCREEN METHOD

PRINT colorful signs, posters, banners, fabrics, wall paper, show cards—ANYTHING! Print on any surface. NO printing press or special equipment is needed with this amazing "approved" new printing secret. **300% profit** on nearly every job. Easy to learn — **NO EXPERIENCE** or art ability necessary. Exceptional opportunity. Complete illustrated detailed plan and colorful sample **FREE**—Write.

SCREEN-PRINT COMPANY, Dept. 28
1010 So. Los Angeles St., Los Angeles 15, Calif.

FREE complete "BIG MONEY" Plan and SAMPLE!



EARN AT HOME SPARE or FULL Time

Become a Doctor of PSYCHOLOGY

Win the degree of Ps.D. Teach the secret of contentment, happiness. Solve mental worries. Experience the revelation of truth. Chartered college. Individual help. Write for **FREE** book. **COLLEGE OF UNIVERSAL TRUTH, 5153-B North Clark St., Chicago.**

LEARN MEAT CUTTING At Home — In Spare Time

Get into the vital meat industry. Concise, practical Home Training based on 25 years proven instruction methods used at National's famous resident school. Prepares you for bigger pay as Meat Cutter, Supervisor, market manager or more money in your own store. Go as rapidly as your spare time permits. Diploma. Start NOW to turn your spare hours into money. Send for **FREE** bulletin today. No obligation.

NATIONAL SCHOOL OF MEAT CUTTING, INC., Div. U-131, Toledo 4, Ohio

SHOE REPAIRING OFFERS BIG INCOME

Learn in 12 weeks to be a skilled repair man by actually working on shoes. Free big 24-page book. The only old practical school in U. S. Established 1927. Write for Big 24-page Book today.

MODERN SHOE REBUILDING SCHOOL
806 SO. FIGUERO ST., Dept. PM, LOS ANGELES 17, CALIF.

SAY YOU SAW IT IN POPULAR MECHANICS



FUN!

MAKE THIS Squirrel Lamp

Yes sir, out of a real squirrel! Also make ash-trays, book-ends, etc., using rabbits, frogs, etc. **EARN AT HOME TO MOUNT BIRDS, ANIMALS & FISH!** tan skins and make rugs. Decorate your room. **It's FUN! BIG profits in spare time!**

Free book tells how. **FREE BOOK!** Write TODAY for beautiful free book telling how to learn this fine hobby. Book is free. Contains many fine pictures. **STATE YOUR AGE.**



N.W. SCHOOL OF TAXIDERM, Dept. 2508, Omaha, Nebr.

TUBE GIVEN WITH EVERY TIRE AT NO EXTRA COST

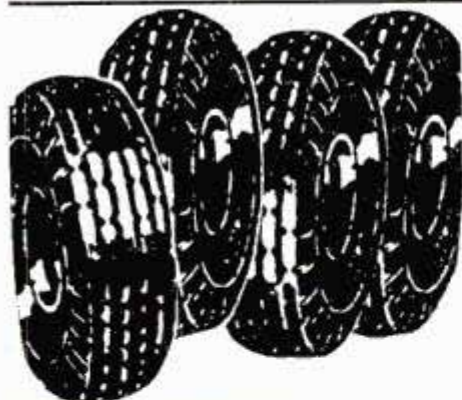

WRITTEN GUARANTEE SENT WITH EVERY TIRE YOU BUY

PLEASE NOTE: Our Tires are NOT Retreaded or Re-Capped

GOOD USED TIRES

A TRIAL OF ONE TIRE WILL CONVINCE YOU.

TUBE GIVEN WITH EACH PASSENGER & TRUCK TIRE AT NO EXTRA COST—SEND THIS AD!

If your size is not listed, write for prices. **18 YEARS AT THIS ADDRESS**

600-16	\$5.42	670-15	\$6.12	710-15	\$6.12	760-16	\$7.72
650-15	5.82	700-15	6.42	750-16	8.72	820-15	7.00
650-16	6.22	700-16	5.92	760-15	6.42	550-17	5.72



600-20	\$9.72	32x6 (8)	\$11.72	1000-20	\$18.42
680-20	9.92	32x6 (10)	14.72	1100-20	18.42
700-20	12.72	825-20	21.52	1000-22	19.52
750-20	13.92	900-20	17.72	1100-22	18.42

Thousands of tires shipped all over U.S.A. All tires shipped F.O.B. Phila. Send Check or M.O. with this ad. Dept. 2.

STANDARD 834 N. Broad St., Philadelphia 30, Pa.

Learn WOOD PRODUCTION ENGINEERING

At Home In Your Spare Time

from **THE ONLY SCHOOL OF IT'S KIND**

There are big money making opportunities in furniture drafting, production, or a furniture business of your own. You will quickly attain success through our instruction.

KLOK SPECIALIZED TRAINING

Teaches you the arts of Sketching—Drafting—Time Study—Production Scheduling—How to Operate a Successful Business of Your Own, through our Home Study Course or Resident Course at Grand Rapids.

WRITE TODAY—without obligation, for our FREE Booklet. State age, Home Study or Resident Course preference, present occupation.

JOHN H. KLOK, Pres. Woodworking Industry Training Since 1928
KLOK INSTITUTE, Louis St. N.W., Grand Rapids 2, Mich.



BE A DETECTIVE

WORK HOME or TRAVEL. Experience unnecessary. DETECTIVE Particulars FREE. Write to GEO. P. M. WAGNER, 125 W. 86th St., N. Y.

WHAM-O SPORTSMAN*



45-LB. PULL!

HITS LIKE A .22 RIFLE—KILLS RABBITS, SQUIRRELS. Powerful, silent, accurate. For hunting, target, routing pests.

Sportsman's choice sold world over!

HUNTING SLINGSHOT



Heavy duty 7" ash stock.

40 steel balls, extra rubber, target.

GUARANTEED - at dealers, or send \$1.25 to Wham-O Mfg. Co., Box 81, South Pasadena, Calif.

*Professional model of Nat'l Slingshot Assn.

Earn up to \$6,000 a year!

MORE JOBS THAN WE CAN FILL METAL TRADES BACKBONE OF INDUSTRY

Men who are mechanically inclined have a wide open field to choose employment in the Metal Trades Industry. Jobs are going begging for lack of qualified trained men. You need no previous experience to start your training at this school.

SHORT COURSES TO MEET PRESENT JOB DEMAND.

INDICATE YOUR PREFERENCE—RESIDENT or HOME STUDY TRAINING

ALLIED SCHOOL OF MECHANICAL TRADES, Inc.
1338-1340-1342 S. MICHIGAN AVENUE
408 ALLIED BUILDING, CHICAGO 5, ILL.

Write for **FREE BOOKS**
A 1c Postcard will do.

ENTER RADIO-TV
thru This Plan—

As a young man with a career to build, you may today be interested primarily in training for Radio — and perhaps for TV. But — *who knows . . .* you may some day have both the desire and opportunity to climb further and become an Electrical Engineer! Here, then, is a world-renowned educational plan that permits you to use your Radio training as a major stepping-stone to an even greater career.



IN 12 MONTHS

become a

RADIO TECHNICIAN

Train here for radio shop operator or serviceman, mobile receivers and all types of transmitters, and for supervision of service personnel. You

may then advance immediately, or at any future date, into courses described below.

IN 6 ADDITIONAL MONTHS

you become a

RADIO-TELEVISION TECHNICIAN

An additional 6-months course gives you intensive TV Technician's training — under the personal guidance so necessary in this expanding field.

ALSO... your Radio course is full credit toward the B.S. degree in ELECTRICAL ENGINEERING

The Radio course, while complete in itself, is one-third of the college program (major in Electronics—minor in Electrical Power). Further — you are guided scientifically toward specialization beyond basic engineering training.

Military, practical or prior academic training evaluated for advanced credit. Preparatory courses available. Over 2300 enrolled. Terms open October, January, April, July.

MILWAUKEE

SCHOOL of ENGINEERING

Technical Institute • College of Electrical Engineering

FREE — Write for helpful "Occupational Guidance Bulletin" and 1951 Catalog.



MILWAUKEE SCHOOL OF ENGINEERING
Dept. PM-851, 1025 Milwaukee, Milwaukee, Wis.

Without obligation, rush following: 1951 Catalog; "Occupational Guidance Bulletin" on Electrical Service Electro Technician Electrical Engineering (Power) Radio Television Electrical Engineering (Electronics) Heating Refrigeration Air Conditioning Welding.

Name.....Age.....

Address.....

City.....Zone.....State.....

Check if World War II Veteran

What Fun To Build "OLD TIMERS" On Your Vacation!

Now available—
our newest Old Timer—
The 1902 Franklin Car.



1902 Air-cooled
Franklin—\$2.50

Rain or shine—it's always a pleasure at vacation-time to build these nostalgic antique auto miniatures! Authentic, colorful, historic—and just what you want for a den or mantelpiece!

15 famous antique autos in our complete collection of these 3/4" scale model construction kits—measuring 8" to 10 1/2" in length when completed.

All parts completely pre-fabricated. Each kit comes with die-cast plastic parts, cast wheels, lights, horns, radiators, etc. History of car and easy-to-follow instructions included.

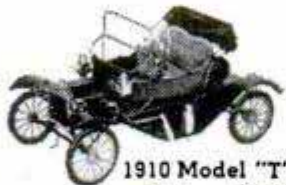

1910 Model "T"
Ford — \$2.50



1909 Stanley Steamer \$2.95

1914
Stutz Bearcat — \$3.95



1911 Maxwell \$2.50

- | | |
|-----------------------------|--------|
| 1904 Olds | \$1.95 |
| 1911 Buick | \$2.50 |
| 1903 "A" Ford | \$2.50 |
| 1909 "T" Ford | \$2.95 |
| 1903 Cadillac | \$2.50 |
| 1900 Packard | \$2.50 |
| 1903 Rambler | \$2.50 |
| 1902 Franklin | \$2.50 |
| 1910 Inter. Harvester | \$2.95 |
| 1913 Mercer Raceabout | \$3.95 |
| 1906 "Old 16" Loco..... | \$3.95 |

SEE them at your hobby, toy, or department store, or write to us. Add 25c for postage, handling. No C.O.D.'s, please.

Hudson Miniatures' "OLD TIMERS"
SCRANTON HOBBY CENTER, Dept. 14, Scranton 10, Pa.

CHOICE CAREERS await you!



Let **MASTER CHEFS** teach you the money-making art of **Fine Cooking!**

There are not enough **RESTAURANT INSTITUTE** graduates to meet the growing demand of restaurants, hotels, clubs. Train now to take these jobs! Move up rapidly to responsible, well-paid positions as master chefs, dining room managers, or own your own restaurant. Let the **RESTAURANT INSTITUTE** teach you all phases of preparing fine foods. Free scholarships available—you may be eligible! Short basic course leads to jobs paying as much as \$80 a week! Pleasant dormitory rooms, free placement. Send now for free brochure. Enrollment for fall term closes Oct. 1.

RESTAURANT INSTITUTE

393 Prospect St., New Haven, Conn.

Without obligation, please send free brochure to:

Name _____

Address _____

City _____ State _____

How to Always Have **HOT WATER**

Make Your Own Automatic Electric Water Heater
now for only

\$19.95

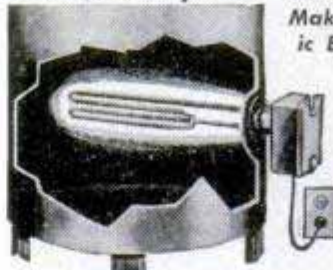

ONE YEAR GUARANTEE
Underwriters Lab. Approved
Heater

Why suffer without hot water? Enjoy lots of it to wash, bathe, shave. Heater keeps water **HOT** in your present tank. Turns **ON** when needed—shuts **OFF** when water is heated. No flue, dirt, fire! Ideal for 30-gal. tanks! Heater screws into any size boiler taps as shown. Plugs into outlet . . . 1250 w. 110 v. AC. (also 220 v. model). Install in 5 min. . . works automatically thereafter. Temperature adjustable between 120 to 180 degrees. Replaces coal, oil, gas in home, store, summer cottage, green house, farm, barn, stock tank, poultry scalding, factory. Uses only 1/4 to 1/2 electricity per gallon hot water. Why burn expensive main furnace unit for summer hot water? Send check or M.O. NOW; save postage, shipping charges. **ORDER NOW . . . TODAY. Money back in 10 days if not delighted.**

COLLOID EQUIPMENT CO., INC. Dept. PM8, 50 Church Street, New York 7, N. Y.



Free Book

Money In Hamsters

The new wonder animals from Syria. Often called Toy Bears. Delightful pets. Everyone wants them. Laboratories use thousands. Clean, odorless. Raise anywhere. NOW, spotted and golden breeds. We furnish breeders, equipment and manual of instructions. Write today for free illustrated literature.

GULF HAMSTERY 1536 BASIL ST., MOBILE 17, ALA.

LEATHERCRAFT
TEXTILE PAINTING • COPPER
TOOLING and many other crafts

PAY-OFF



Yes, these crafts "pay off" in pleasure and profit. You can do it! Everything you need in Kit Kraft's big illustrated catalog. Send 10c (credited to first order) for catalog today!

KIT KRAFT 7377 Melrose Ave., Dept. 27 Hollywood 46, California

RUPTURED?

MAGIC DOT HOLDER for MEN or WOMEN

\$1

HOLDS good with gentle pressure. No Steel. Washable. Don't show. Full price only \$1 single \$2 double. Avoid Embarrassment. Send Money with Hip measurement. Hundreds of satisfied customers. Be one yourself. Satisfaction guaranteed or money back. Rush your order today.

P. M. DOLLAR TRUSS — Box 812 — Oakland 4, Cal.

START YOUR OWN MONEY-MAKING BUSINESS

Clean upholstered furniture on customers' premises with highly efficient electric machine which is making **BIG MONEY** for others. No special skill or experience required. No shop necessary. No hauling costs. Write today for complete **FREE** information. Address:

VON SCHRADER MFG. CO., 836 PL, RACINE, WIS.

SAY YOU SAW IT IN
POPULAR MECHANICS

LAW FREE BOOK



Your **FREE** copy of "The Law-Trained Man" shows how to gain prestige and greater earnings through Blackstone home law study. All instruction material furnished including 17-volume Law Library written by 65 well-known law authorities. Lawyers, judges among our graduates. LL.B. degree. Low cost; easy terms. Write today.

BLACKSTONE COLLEGE OF LAW 225 N. Michigan Ave. Dept. 50-C, Chicago 1, Ill.
A Correspondence Institution Founded in 1890



Thrilling Work **COLORING PHOTOS**

Fascinating vocation learned at home by those with aptitude. Thrilling pastime. National method brings out life-like colors. Free booklet.

NATIONAL PHOTO COLORING SCHOOL
835 Diversey Pkwy., Dept. 135C, Chicago 14

BOAT KITS

For Home Assembly



PRAMS
\$39⁶⁰ up

8 TO 11 FT.
ALSO WITH SAILS

NEW CATALOG
MOST COMPLETE

- EVER OFFERED
- 1-BOAT KITS 26 MODELS
 - 2-MARINE HARDWARE
 - 3-MARINE ENGINES
 - 4-MARINE CONVERSIONS
 - 5-PAINTS & COLOR CHARTS



ALL ONLY 35c, SEND COIN TODAY
U-MAK-IT PRODUCTS 703P-WHITTIER ST.
New York 59, N. Y.

Learn CARPENTRY BRICK LAYING

Get into the billion dollar building trades. Learn now while opportunities are greatest. Train in our completely equipped shops under expert instructors. Enroll now. Limited classes. Resident and Home Study. Write for FREE Catalog.

MIDWEST SCHOOL OF BUILDING TRADES, Dept. PM-8
411 N. Center St. Bloomington, Ill.

REAL ESTATE

BE A BROKER

PAYS BIG! SEND FOR FREE, BIG, ILLUSTRATED CATALOG NOW! No obligation. Graduates report making substantial incomes. Start and run your own business quickly. Men, women of all ages, learn easily. Course covers Sales, Property Management, Appraising, Loans, Mortgages, and related subjects. **STUDY AT HOME** or in our classrooms in big cities. Diploma awarded. Nationally known.

WEAVER SCHOOL OF REAL ESTATE (Est. 1936)
15 E. Pershing Road Dept. PM Kansas City, Mo.

FREE BOOK TELLS HOW

TALK WELL

BEFORE SMALL & LARGE GROUPS

"EVERYBODY SPEAKS" by J. Martin Kohn shows you how you can start making talks easily, quickly without embarrassment or stage-fright. 60 Pictures show you exactly what to do. Only \$2.50 Postpaid. Will send C.O.D. You pay postage. Circular on request. 10 Day money-back guarantee.

RALSTON PUBLISHING CO.
141 Engineers Bldg., Cleveland 14, Ohio
50 Years Publishing Inspirational Books

PORTABLE GARAGE

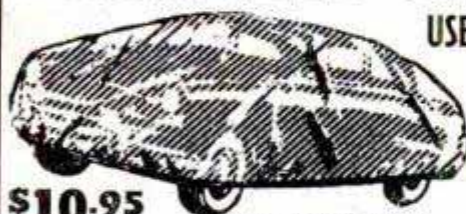

\$10.95

(Extra Heavy Gauge)

USE IT ANYWHERE!

- Goes wherever your car goes
- Takes little room
- Keeps rain, snow, dust, salt air, sun or sleet away & protects your car's finish

- Durably constructed of clear transparent — heavy gauge vinyl plastic that is long wearing and tough
- Spring-tite elasticized bottom, holds securely in all kinds of weather
- Fits all makes and models
- Direct from manufacturer
- \$10.95
- Enclose check or money order, or sent C.O.D.

DOMAR SALES CO., 480 LEXINGTON AVE.,
DEPT. GF7 — NEW YORK 17, N. Y.



Spot ANY Car Trouble IN A JIFFY!



ONLY \$100 if you decide to keep it!

Amazing New Auto "Trouble-Shooter" Helps You Find "What's Wrong" FAST!

Don't waste time and energy trying to track down auto troubles! Let this handy, indexed guide find them for you—easily, quickly. Lists 1760 specific causes of car, truck troubles; where to find them.

Helps you track down noises, knocks, misses, breakdowns. If car has fan belt noise—turn to that section; find the eight things that could cause it! Book covers engines, clutches, brakes, ignition, cooling system — all other parts of car. Includes valuable cross-section pictures. Section on automatic transmissions alone is worth more than price of book. Valuable for beginner or expert mechanic. Handy spiral binding lies open flat as you work.

Some of the 1760 Causes of Car Troubles Covered in This Guide

How to Spot 87 Automatic Transmission Troubles. 8 Causes of Connecting Rod Noise. 87 Checks for Poor High-Speed Performance or Lack of Power. 82 Causes for Engine "Misses" At All Speeds. 17 Checks for Pre-Ignition or Spark Knock. 45 Causes of Excessive Oil Consumption. 3 Ways to Spot Inoperative Engine Oil Filters. 14 Common Causes of Crankshaft Noise. 73 Checks for Clutch Troubles. 14 Piston - Noise Checks. 66 Causes of Rear-Axle Trouble. 150 Checks for Front Suspension and Steering Troubles. 81 Causes of Brake Trouble. 27 Checks for Faulty Springs and Shock Absorbers. 84 Different Types of Wheel Troubles.

TRY BOOK 7 DAYS — Money Back If Not Delighted!

Just mail coupon with \$1 each for the number of copies you want. See how much guide can mean to you as time and work saver. If not delighted, return in week for prompt refund. Mail coupon today! **MOTOR Book Dept., Box C, 250 W. 55th St., New York 19, N. Y.**

MOTOR Book Dept., Box C,
250 West 55th St., New York 19, N. Y.

Rush me on approval _____ copies of MOTOR'S work-saving TROUBLE-SHOOTER. I enclose \$1.00 for each copy ordered. Unless completely satisfied, I may return book (or books) in 7 days and my money will be promptly refunded in full.

Name _____

Address _____

City _____ Zone _____ State _____

STOP THAT OIL EATER!



GET NEW CAR PERFORMANCE WITH PISTON SEAL WITHOUT COSTLY OVERHAULING

Piston Seal—the amazing compound that forms a self expanding, pliable lubricating seal around pistons that compensates for wear. Eliminates oil burning, restores power and compression. Can be applied in a few minutes.

GOOD FOR 10,000 MILES



SIMPLY REMOVE SPARK PLUG AND SQUEEZE

SEND FOR A TUBE TODAY

\$4.95 No C.O.D.'s

Postpaid

OR WRITE FOR FURTHER INFORMATION

RICHE DISTRIBUTING CO. 1628-L Cohasset Avenue Lakewood 7, Ohio



"I'M EARNING \$300 A MONTH!"

... says Leonidas Burgoyne of Chicago, Illinois, "Expert individual instruction in the fully equipped shops of Greer Shop Training gave me the right start to get my good paying job."

GREER SHOP TRAINING ... established 1902, is one of America's largest trade schools. Over 48,000 successful graduates. You learn by tearing down, repairing and rebuilding. Day and evening classes. Mail this coupon today!

LEARN A TRADE NOW!

GREER SHOP TRAINING, Desk 211, 2230 S. Michigan Avenue, Chicago, Ill.

Gentlemen: Please send me information about trade I have checked below. (Specify if you are VET or NON-VET .

- IN OUR CHICAGO SHOPS**
- | | |
|---|--|
| <input type="checkbox"/> AUTO MECHANICS | <input type="checkbox"/> BODY, FENDER REPAIR |
| <input type="checkbox"/> DIESEL | <input type="checkbox"/> WELDING—ARC, GAS |
| <input type="checkbox"/> REFRIGERATION | <input type="checkbox"/> MACHINIST |
| | <input type="checkbox"/> PIANO TUNING |

Above courses approved for Vets and Civilians.

ALSO THE FOLLOWING HOME STUDY COURSES

- REFRIGERATION DIESEL PLASTICS

Name _____ Age _____

Address _____

City _____ State _____

GREER SHOP TRAINING

Chronograph Wrist Watch

Now Only **\$5.98**

LOWEST MARKET PRICE \$5.98



Sweep Second Hand; Precision Workmanship; Rugged Shock-resistant case; Radium hands and numerals; Leather strap. It measures distance, speed of cars, planes, horses and other moving objects. It's a time keeper, stop watch, telemeter, tachometer. **ONE YEAR WRITTEN GUARANTEE** and full operating instructions enclosed with each watch. **SEND NO MONEY.** Mail your order today. Pay postman \$5.98 plus 10% Federal tax. Total \$6.58 plus postage. Or send cash (money order or check) with your order and save postage charge.

MARDO SALES CORP., Dept. BW-1
480 Lexington Ave., New York 17, N. Y.

TASOPE PHOTO-ENGRAVING PLANTS



MATERIAL COST OF THIS CUT 1/4" SELLING PRICE \$1.00 AND UP

Establish your own profitable **PHOTO-ENGRAVING** business. Make cuts for newspapers, printers, and advertisers. Make etched name plates, plaques etc. Instructions furnished, no experience necessary. Sold direct from factory since 1931. First five hundred cuts sold locally or by mail will pay for plant and pay you well for your time. Write for **FREE** catalog. **TASOPE DEPT. PM5, AURORA, MO.**

MAKE MONEY with Bostonian SHIRTS

TAKE orders for old, reliable line finest quality dress and sport shirts. All styles ... fabrics ... colors ... sizes. Sensational **LOW PRICES.** No experience needed. **FREE** Samples of actual fabrics and big Style Kit waiting for you! Send no money, but rush name **NOW!** **BOSTONIAN MFG. CO.,** 89 Bickford St., Dept. H-40, Boston 30, Mass.



OWN YOUR OWN BUSINESS!

Repair electrical appliances of friends and neighbors. Service electrical equipment in factories, stores, etc. New Shop Method home training system. Rush name today for **FREE** BOOK and special form for getting Electronic kit, illustrated instructions on new easy payment plan. Pay us later with your **EARNINGS WHILE LEARNING.**

CHRISTY TRADES SCHOOL 4432 N. KEDZIE AVE. Dept. D-9603, CHICAGO 25

GREAT PROFITS
MAKE YOUR OWN RUBBER MOLDS

X.L. RUBBER MOLDS

will realize your great profits quickly! WRITE FOR NEW FREE CATALOG

YOU can EASILY learn to cast thousands of perfect plaques, book ends, figurines, ash trays, etc. IT'S EASY, FUN, PROFITABLE! X.L. Rubber, Pts. \$2.50; Qts. \$4.00. Special: 3 models and enough rubber for 3 molds prepaid for \$1.50.



SEND FOR FREE FACTS

PLASTIC ARTS STUDIO Address Dept. 2 3403 S. Madison St. Muncie, Ind.

Worry of

FALSE TEETH

Slipping or Irritating?

Don't be embarrassed by loose false teeth slipping, dropping or wobbling when you eat, talk or laugh. Just sprinkle a little **FASTEETH** on your plates. This pleasant powder gives a remarkable sense of added comfort and security by holding plates more firmly. No gummy, gooey, pasty taste or feeling. It's **alkaline** (non-acid). Get **FASTEETH** at any drug store.

WAR SURPLUS OPTICAL BARGAINS

35 POWER ERECTING MICROSCOPE

Amazing clarity. "All-Position" Universal mount. 3" of working space from objective to platform. Prism Erectors give you an erect image—exactly as your eye sees it. Ramsden Eyepiece permits fine precision focusing. 3-Element color corrected objective—1" diameter. Microscope body is of brass with black crackle finish. . . 6 1/2" long with base 7"x9". Easily worth \$75.00.



Stock No. 970-H. \$29.50 Postpaid
SLIDE PROJECTOR SETS Consists of all unmounted lenses you need to make the following size projectors:

- Stock #4029-H—35 mm. \$2.85 Postpaid
- Stock #4038-H—2 1/4"x2 1/4" \$3.35 Postpaid
- Stock #4039H—2 1/2"x3 1/2" \$3.35 Postpaid

SIMPLE LENS KITS —Include plainly written, illustrated booklet showing how you can build lots of optical items. Use these lenses in photography and for dozens of other uses in experimental optics, building TELESCOPES, low power Microscopes, etc.

- Stock #2-H—10 lenses. \$ 1.00 Postpaid
- Stock #5-H—45 lenses. 5.00 Postpaid
- Stock #10-H—80 lenses. 10.00 Postpaid

We Have Literally Millions of War Surplus Lenses and Prisms for Sale at Bargain Prices. Numerous Types of Instruments, Too! Write for FREE CATALOG-H

EDMUND SCIENTIFIC CORP., Barrington, N. J.
 (Formerly Edmund Salvage Co.)

Learn ACCOUNTING BOOKKEEPING

This nationally renowned school has demand for graduates in good salary positions thru Nationwide recognition and placement service. Write Department PMA today for Big 32 page Success Book to be sent to you **FREE**

Hills BUSINESS UNIVERSITY AND EXTENSION SCHOOL
 619 W. MAIN ST. OKLAHOMA CITY 2, OKLAHOMA



Free Fall Catalog

Ready August 6

Fully illustrated, 96 pages, showing Hunting Footwear, Clothing, and fifty-two other leather and canvas specialties of our own manufacture for campers and hunters.

L. L. Bean, Inc.
 266 Main St.
 Freeport, Maine

SPORTONE MUFFLERS

SANDEE TONE DURABILITY

Ford & Chevrolet.....	\$ 4.45
All other popular cars.....	5.45
V-8 Dual Sets.....	15.95
Chromed Silentips.....	2.95

(Please state make & year of car on all orders.)
SANDEE MUFFLER CO.
 5643 Carryne Place • Culver City, California

Say You Saw It in Popular Mechanics

FREE 10-DAY TRIAL

DO YOUR OWN HOUSE CARPENTRY

SAVE TIME AND MONEY This Easy Way



Every step of carpentry in and around a house is clearly explained and illustrated in this big, useful book. Shows you how to build forms for foundations, footings, walls, steps, walks — How to build sills, girder supporting posts and girders — How to figure loads for house framing — How to lay out, cut and erect floor joists — How to lay flooring — How to irame outside and inside walls, allowing for openings — How to check the plumb of studs — How to brace and sheathe up outside walls — How to erect ceiling joists — How to frame around a chimney and stair well — How to lay out rafters for a gable roof, dormer roof, porch roof — How to sheathe gable ends and rafters — How to build cornices — How to lay shingles — How to build porches and bays — How to apply siding — How to frame up inside walls — How to construct stairs — How to place trim around windows and doors — How to fit and hang sash — How to hang doors — How to make closets, shelving and built-in equipment — How to lay finished wood flooring, linoleum flooring — How to hang a set of garage doors—How to insulate.

Over 600 Illustrations Show You Just What To Do and How To Do It

If you have a hammer, saw and plans, just follow the step-by-step directions and do any house carpentry job from foundation forms to interior trim. Here, in one remarkable volume, is the practical know-how that saves you time and money on house carpentry jobs of every description. "I built my entire 5-room house myself with no other instruction except your book."—James Sidwell, Twin Falls, Idaho.

USE IT FOR TEN DAYS FREE

Don't send us a penny. Just mail coupon and get "HOUSE CARPENTRY" for 10 days FREE trial. If not delighted, send book back to us and owe nothing. If you keep it, entire cost is only \$3.98, plus few cents postage. Mail coupon below for your free-trial copy.

Send No MONEY

MAIL THIS COUPON

SIMMONS-BOARDMAN PUBLISHING CORP., PM-851
 30 Church Street, New York 7, N. Y.

Send me for 10 DAYS' FREE TRIAL, "House Carpentry and Joinery." I will either return it in 10 days and owe nothing, or send only \$3.98 (plus shipping charges) in full payment.

Name _____

Address _____

City _____ State _____

SAVE! Send \$3.98 with this coupon and we pay postage. Same return and refund privilege.

Amazing Attachment MAKES OLD REFRIGERATORS INTO MODERN Automatic Defrosters!

Thirty Million Prospects. Sell without "selling pressure" on sensational Free Trial Plan. Just plug it in and leave it. Frees women from drudgery and mess of defrosting. Saves electricity. Keeps food longer, better. Gives longer life to refrigerator. Secret "follow-up" Plan often brings five additional sales by making every user your agent. Big season now on!

SENT FREE... JUST SEND NAME!

Don't send a cent—just your name on penny postcard. We'll send you the biggest money-maker you ever got your hands on and guarantee your sales at profits as high as \$5.00 on each sale. Rush your name!

MAXILUME COMPANY, 125 West Hubbard Street, Dept. D-88, Chicago 10, Illinois

Women buying by the thousands!
 Salesmen Cleaning up on "Free Trial" Sales Plan
 Sent Free with Instructions.
 Make as high as \$5 on Every Sale!



LUFKIN X-46

actually gives
you 2 rules in 1!

FOR REGULAR MEASURING

The "double-purpose" Lufkin X-46 does the work of 2 ordinary rules—first, all regular measuring with typical Lufkin accuracy; second, with its built-in solid brass extension slide, does inside measuring of doors, windows, all other openings! Extra durable with 1/8-in. thick Wood Sections, Patented Lock Joints, Brass Strike Plates, Brass Inset End Caps and Prominent, easy-to-read Black Markings. There's an X-46 waiting for YOU . . . at your nearest Lufkin Dealer.

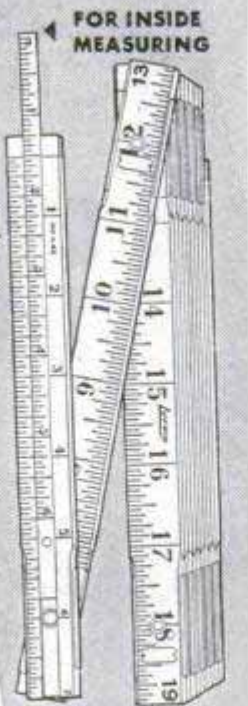

115

BUY LUFKIN

Tapes • Rules
Precision Tools

THE LUFKIN RULE CO., SAGINAW, MICHIGAN
132-138 Lafayette St., New York City • Barrie, Ont.

WAR SURPLUS AND OTHER BARGAINS



HAND MITRE

IT'S SENSATIONAL!

"It pays its way
in just one day!"

New HAND MITRE saves the carpenter - picture framer - cabinet maker and craftsman hundreds of hours . . . a "flick" of the hand and a few seconds for a precision mitre every time. The HAND MITRE will cut any desired angle. Its rugged construction will handle hard and soft wood mouldings, plastic trim, base shoe, dowels, laminated materials, rubber extrusions, leather, linoleums and asphalt tile. Made of heavy gauge stainless steel, electro polish finish. Will endure years of hard usage. Eliminate bulky mitring equipment - save valuable hours and labor. \$3.95 postpaid.



RIVET SETS

Universal type, case hardened tips. Set of dies will head up any brazier or round head rivet from 1/8" to 1/4". With adapters for air gun or hand use. All new . . . cost Government about \$27.00. Complete 15 piece set, wt., 2 lbs., \$5.00

HIGH SPEED DRILLS

All New. Fractional & numbered. Orig. Val. \$15. Nationally known brand. Asst. sizes. Set 30, \$3.50

EXTENSION DRILLS

High Speed Steel, like new. Asst'd sizes from No. 1/4 to 40. Lengths from 6" to 12". Approximately \$20 value. Set of 12 \$3.75

HIGH SPEED DRILL BITS

Like New! Original value over \$16.00. 25 assorted sizes and lengths, \$2.50



MICROMETERS

Chrome plated, precision engineered and carefully tooled to give long life. All new. 0-1" capacity . . . ea. \$2.25. 1-2" capacity . . . \$3.50.

Send check, money order or cash. 25% deposit required on COD orders. All prices FOB Culver City, California, unless otherwise stated.

Send 25c for Illustrated Catalog.

AIRBORNE SALES CO., INC. DEPT. PM 8-51
CULVER CITY, CALIF.

NOW AT LAST YOU CAN STOP BOAT LEAKS COMPLETELY WITH "SEALER 900"



An absolutely watertight seal. Being rubber it expands and contracts. Withstands all weather conditions.

Here, at last, is the answer to keeping your boat *bone dry*. No longer is there any excuse for a "wet" boat. Simply flow this synthetic rubber sealer into opened seams, let dry, and paint over. Not necessary to remove old paint.

MONEY-BACK GUARANTEE. "Sealer 900" is fully guaranteed to seal leaks on bottom, chines, transom, skeg and stem, when used as directed. Get it from your dealer now, or send \$3.60 and we'll mail a quart can to you postpaid.

Product of
MINNESOTA
MINING &
MFG. CO.

MARINE PRODUCTS, INC.
52 Commerce St. Oshkosh, Wis.

CARBURETOR TOO RICH MAKES MOTORIST TOO POOR



Car owners who are wasting money and not getting proper gas mileage due to over-rich mixtures will be pleased to learn how to save gasoline by VACU-MATING over-rich mixtures. VACU-MATIC fits all cars, trucks and tractors. It is automatic and operates on the supercharge principle. Easily installed in a few minutes.

SALESMEN WANTED! Big Profits! Send name, address on penny postcard for free particulars and how to get yours for introducing.

VACU-MATIC CO., 7617-1769 W. State St., Wauwatosa, Wis.

TRAIN Your VOICE!

RESULTS GUARANTEED
STRENGTHEN your voice this tested, scientific way. Yes—you may now be able to improve the POWER of your speaking and singing voice . . . in the privacy of your own room! Self-training lessons, mostly silent. No music required. Write TODAY for Eugene Feuchtinger's great booklet "How to Develop a Successful Voice." It's absolutely FREE! You must state your age. Booklet mailed postpaid in plain wrapper. No salesman will call. Send your name and age RIGHT NOW! Perfect Voice Institute, 210 S. Clinton St., Studio H-2, Chicago 6, Ill.

Learn CARTOONING

HAVE FUN! MAKE MONEY! Cash in on your sense of humor at HOME—BY MAIL. No experience needed to start. Write today for FREE TRIAL LESSON and full particulars. MOON Gag Cartoon School, Dept. L, Fall Creek, Wis.



COMBAT!



See over 100 drama packed pictures of GI's in Combat . . . how they fight . . . how they live . . . how they die. Send only \$1 cash or M. O. Book sent post paid. Complete satisfaction or your money refunded. Act now—supply limited.

COMBAT

P. O. Box 133

Berkeley, Calif.



Sensationally NEW for 1952!

MIDWEST TELEVISION

A Magnificent New Line of Beautiful CONSOLES and Complete CHASSIS featuring This MAMMOTH

20-Inch Rectangular PICTURE TUBE

FACTORY-TO-YOU

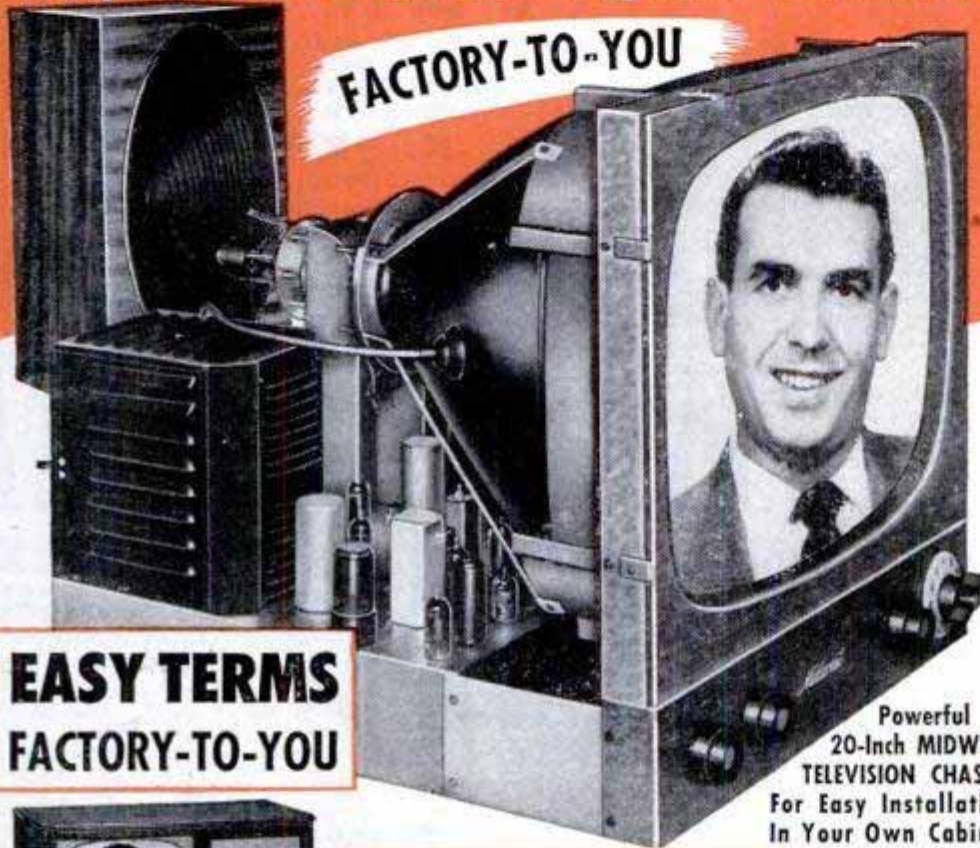

**EASY TERMS
FACTORY-TO-YOU**

Powerful
20-Inch MIDWEST
TELEVISION CHASSIS
For Easy Installation
In Your Own Cabinet

"CONSTELLATION"
20-Inch Television Console



Video Grand 20-Inch TELEVISION-RADIO- PHONOGRAPH CONSOLE

A luxurious instrument that offers the Mammoth 20-Inch Rectangular Picture Television, plus powerful AM-FM Radio, plus 3-Speed Automatic Intermix Record-Changing Phonograph in a beautiful mahogany veneer console.

Also—Powerful New 1952 World-Ranging
MIDWEST Series of RADIOS
For Beautiful Consoles and Complete Chassis

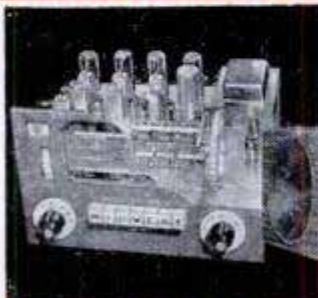

An entirely new line of radios featuring the powerful Series 16 five wave band AM-FM Radio Chassis and the magnificent Symphony Grand Radio-Phonograph with 3-Speed Automatic Intermix Record Player.

Easy Terms



WRITE or PHONE
For This NEW 1952
**FREE MIDWEST
TELEVISION
RADIO CATALOG**



If You Live In One of These Cities
Phone and Ask for Your Catalog

- NEW YORK MURRAY Hill 2-6810
- CHICAGO State 2-5600
- PITTSBURGH GRant 1-0609
- CLEVELAND PRospect 1-7450
- DETROIT WOODward 3-1233
- ST. LOUIS GRand 1161
- PHILADELPHIA LOcust 4-1035

or Send Coupon Below

• WRITE IN NAME AND ADDRESS (PLEASE PRINT) ON COUPON OR 1c POSTCARD •

MIDWEST RADIO & TELEVISION CORP.
Dept. 251, 909 BROADWAY • CINCINNATI 2, OHIO

Please send me your new FREE 1952 Catalog.

NAME _____

ADDRESS _____

CITY _____ ZONE _____ STATE _____

MIDWEST RADIO & TELEVISION CORP.
DEPT. 251, 909 BROADWAY, CINCINNATI 2, OHIO



BRAND NEW QUALITY GLASSES

Achromatic lens! Have precision ground optics, lightweight metal bodies. Moisture-Dust proofed.

Coated! Featherweight

16x50 COATED \$69.50

The ultimate in a fine binocular. Tremendous power. Featherweight (weighs only 31 ounces!) Precision made in every detail. COATED, providing sharper, brighter images. Individual focus. Objective lens is 50mm (2 inches) across!

6x30 Coated	\$27.95
7x35 Coated (center focus)	49.50
7x40 Coated (center focus)	52.50
7x50 Coated	39.50
8x30 Coated	32.50
8x40 Coated	54.50
10x30 Coated	39.50
10x50 Coated	62.00
12x50 Coated	65.00



6 POWER BINOCULAR
Now \$16⁹⁵

7 POWER — \$21.95

COATED! Pocket size—weigh only 4 oz. and 7 oz. respectively! Precision constructed PRISM binoculars. Not field glasses. Made of lightweight, durable, black and chrome metal. Achromatic lens. Genuine leather case and straps. Carry the United Seal of Quality.

15 to 40 POWER



\$29.50
COATED

SIX TELESCOPES IN ONE! American-made Wollensak telescope. Instant focusing at 15x, 20x, 30x, and 40x, etc. Turn power tube to click—no guesswork. Telescope measures 9" closed, 27" when extended. Weighs only 18 oz.! Has rustproof chrome tubes, large 40mm objective lens. All 12 optic surfaces are COATED. See 22 bullet holes clearly at 300 feet. Use also for astronomical observation. \$29.50 price includes tax and fine leather case. **UNCONDITIONALLY GUARANTEED.** Try for 20 days at our risk! If not fully satisfied, return for full refund! Cash orders rushed postpaid. On C.O.D.'s include \$2.00 deposit. Add Federal tax. Prices include handsome genuine leather case and straps.

UNITED BINOCULAR CO.

9043 S. Western Dept. CARF-2608 Chicago 20

FREE CIGARS!

To introduce you to smoothest, free-burning, easy-drawing, mild Corona DeLuxe Havana Blend Cigar you've ever smoked, we'll send a sample **FREE** of any cost or obligation. Simply PRINT name and address on Postcard. Do it TODAY! **ALLURA CIGAR CO., Dept. 152, Memphis, Tenn.**

Say You Saw It in Popular Mechanics

INVENTORS

Before you make any effort to market your invention, you should take the first steps toward proceeding for patent protection.

The usual first step is to have a search of the U. S. patent records conducted, so that I can report to you on the question of patentability.

I shall be pleased to furnish you with information relative to patent procedure, upon request from you, and this will be without any obligation on your part.

PATRICK D. BEAVERS

(Formerly RANDOLPH & BEAVERS)

Registered Patent Attorney

934 Columbian Building Washington 1, D. C.

INVENTORS

IF YOU WISH TO PROTECT YOUR INVENTION, You should take steps to protect it by a U. S. Patent. Write me for "INVENTION RECORD" form

CARL MILLER
REGISTERED PATENT ATTORNEY

WOOLWORTH BLDG., 35th FLOOR, 81A
NEW YORK CITY

INVENTORS

Whether an invention is patentable can be substantially determined by a search of the U. S. Patent records. Without obligation, write for information explaining the steps you should take to secure a patent.

JOHN N. RANDOLPH

Registered Patent Attorney

201 Columbian Building, Washington 1, D. C.



PATENTS

C. A. SNOW & CO.

REGISTERED PATENT ATTORNEYS

WRITE FOR INFORMATION TO

428 SNOW BUILDING, WASHINGTON 1, D. C.



PATENTS PATENT LAWYER

GUSTAVE MILLER
REGISTERED
PATENT ATTORNEY
81-PM WARNER BLDG.
WASHINGTON 4, D. C.

ASSOCIATE EXAMINER
U. S. PATENT OFFICE 1922-1929
Patent Attorney and Advisor
U. S. NAVY DEPT. 1930-1947
Send for
PATENT INFORMATION book
and "INVENTOR'S RECORD"
without obligation

INVENTORS

Send today for "Patent Protection for Inventors" outlining preliminary steps to take toward patent protection, also convenient "Evidence of Invention" Form.

VICTOR J. EVANS & CO.

630-J Merlin Building, Washington 6, D. C.



HURRICANE EXHAUST CUT-OUT

This specially engineered cut-out enables you to install special pipes and mufflers without removing the original muffler.

Now control your exhaust tone from a dash control button. Cut back into your original muffler in restricted areas at will. Fits all exhaust pipes from 1 3/4" to 2 1/4" size.

This cut-out is well constructed; actually strengthens exhaust pipe; made of heavy plate steel, designed for easy installation—no special tools required. Sent post-paid for only \$6.95 check or money order. Satisfaction guaranteed or your money back.

ST. LOUIS PRODUCTS CO., Box 24, Normandy 21, Mo.



FULLY GUARANTEED TIRES COST LESS!

Nationally famous FIRESTONE, GOODRICH, U.S. ROYAL, GOODYEAR, and other makes. Every tire selected and inspected for your safety.

SALE
New Tread Tires Guar. 24 Mos. (White Walls—3.00 Extra)

550x16	9.98	600x16(6)	11.98	650x20(8)	21.95	700x16(6)	16.48
550x17	9.98	650x15	11.98	640x15	10.98	710x15	12.48
600x15	9.98	650x16	12.48	670x15	11.98	760x15	13.98
600x16	9.98	650x16(6)	14.48	700x15	13.48	820x15	14.98

GOOD TIRES GUARANTEED 12 MONTHS

600x16	4.14	700x16	5.14	32x6(8)	8.84	825x20	14.24
650x16	4.54	670x15	4.74	32x6(10)	10.84	900x20	13.34
650x15	4.34	650x20	7.84	750x20(8)	8.54	1000x20	14.14
700x15	4.64	700x20(8)	8.94	750x20(10)	9.94	1100x20	16.14

AAA PREMIUM GRADE GUARANTEED 18 MONTHS

600x16	5.58	750x16(6)	8.98	600x20	9.78	825x20	18.68
650x16	5.98	820x15	7.48	650x20	10.88	900x20	18.98
650x16(6)	6.98	710x15	6.48	700x20	12.88	1000x20	19.98
650x15	5.98	550x18	5.98	32x6(8)	10.48	1000x22	21.98
700x15	6.68	500x19	5.48	32x6(10)	12.48	1100x20	20.98
700x16	6.78	780x15	6.78	750x20(8)	12.98	1100x22	21.98
700x16(6)	7.98	550x17	5.88	750x20(10)	14.98	1400x20	54.98

MILITARY AA Guaranteed 12 Months—SPECIAL

900x16	11.98	1000x20	19.98	New Tread Guar. 24 Mos.	
750x20	12.89	1100x20	21.98	600x16	10.98
				600x16(6)	11.98
				750x20	26.98

AAA GUARANTEED 18 MONTHS

900x16	14.98	750x20	16.48	Passenger Tubes—Water Tested—All Sizes	11.50
				Truck Tubes—Water Tested—All Sizes	13.95

Largest stock of used tires in the East. Thousands of satisfied customers. Write for sizes not listed.
MONEY ORDER OR CHECK WITH ORDER.
NO C.O.D.'s

PYRAMID TIRE CO.
1333-35 North 5th St.
Dept. M., Phila. 22, Pa.

Mustang
LIGHTWEIGHT \$362.20
(Fed. tax paid, at factory)

9.5 hp. 4-cycle. 3-speed. Foot-shift. Over 70 miles per gal. Over 60 m.p.h. Write for free circular.

MUSTANG, Dept. PM
635 W. Colorado, Glendale 4, Calif.

UNLIMITED GUARANTEE—PRACTICALLY WHOLESALE
17 JEWEL! Formerly \$59.00
YOU SAVE \$44.05 Our Price Only \$14.95

Worn by servicemen. Incabloc, shock & water resist precision movement. FREE 16 Day TRIAL. FREE expansion band. Send \$1 with order, bal. C.O.D. Or send \$14.95 plus tax—we pay postage!

MARYLAND DIST. Dept. 271
501 E. Balto St., Baltimore-2, Md.

Plus \$1.50 tax

WRITE FOR FREE JEWEL CATALOG!

LAW
STUDY AT HOME for Business Success and **LARGER PERSONAL EARNINGS.** 42 years expert instructions — over 114,000 students enrolled. LL.B. Degree awarded. All text material furnished. Easy payment plan. Send for **FREE BOOK** — "Law and Executive Guidance" — **NOW!**

AMERICAN EXTENSION SCHOOL OF LAW
Dept. PM-41, 646 N. Michigan Ave., Chicago 11, Ill.

NEW—Sensational! GEIGER COUNTER
"The SNOOPER"
LOW PRICE ONLY \$24.95 COMPLETE

Find a fortune in uranium with this new, super-sensitive Geiger Counter. Get one for atom bomb defense. So small it fits in the palm of the hand or in the hip pocket, and yet more sensitive than many large, expensive instruments. Weighs only 1 1/4 lbs. Uses flashlight battery. Low price includes earphone, radio active sample, instructions. Sold with ironclad moneyback guarantee.

ORDER YOURS TODAY—Send \$5.00 with order or payment in full to save C.O.D. Write for free catalog on treasure finders for gold, silver, etc. and larger, more elaborate Geiger Counters.

Dealer Inquiries Inquired **PRECISION RADIATION INSTRUMENTS**
4113 PM W. Jefferson, L. A. 16, Calif.

FREE
A NEW HOME INDUSTRY

Let us show you how extremely easy and PROFITABLE it is to make beautiful and useful things out of LIQUID PLASTICS, LIQUID MARBLE, LIQUID IVORY, LIQUID GLASS, CERAMICS, ETC. . . . as easy as pouring water out of a glass! We have started THOUSANDS of people in this fascinating and very PROFITABLE home occupation! Make novelties, jewelry, gifts, artware, toys, tools, dies, gadgets, ceramics . . . a million useful things! We supply everything—**MATERIALS, INSTRUCTIONS and BUYERS!** Send only 25c for 1. Big catalog of 300 casting materials, molds and accessories. 2. A beautiful **CASTING FREE** (to show you what you can do), and 3. Actual **INSTRUCTIONS** on how to cast and start in the **CASTING BUSINESS!** VALUABLE **MOLDS** given FREE with orders! Send 25c today — this may be the lucky coin that will start the most fascinating and profitable phase of your life.

BILLIONS for DEFENSE!

The country is preparing the greatest peace-time defensive in history . . . BILLIONS are being spent! Our liquid plastics are being used in THOUSANDS of different operations in defense work! **NO SPECIAL TOOLS OR MACHINERY REQUIRED!** Work can be done at home, garage, shop, etc. Full time or spare time, by the able and the disabled. We help you get defense work and instruct you in all the details! Send 25c for catalog (see above) and details how to take part in this tremendous defense program that offers you a grand opportunity to combine patriotism and profit!

PLASTICAST COMPANY (Dept. C)
P. O. BOX 6737 (Write to either address) P. O. BOX 987
CHICAGO 6, ILL. PALO ALTO, CALIF.

Canadian customers: send 35c for catalog and order direct from: Canadian Industrial Plastics, Ltd., 1066 1/2 W. Pender Street, Vancouver, B. C.

WONDER-PASTE
Paint Remover

The modern, easy way to strip paint, varnish, enamel, lacquer, etc. AT PAINT AND HARDWARE STORES

ART OFFERS YOU A PROFITABLE CAREER

Learn to Draw in Spare Time—at Home!
COMMERCIAL ART, DESIGNING, CARTOONING—all in one complete home study course. Trained Artists are capable of earning \$75, \$100 and more a week. No experience necessary. We teach you step by step. Our famous method has trained thousands since 1914. **TWO ART OUTFITS** included. Low tuition, easy terms. Trial Plan. **Course G.I. Approved.**

MAIL COUPON FOR FREE BOOK

WASHINGTON SCHOOL OF ART
Studio 128A, Washington 5, D. C.

Send me without obligation Free Book, "Art for Pleasure & Profit." No salesmen. (Please print).

Name Age
Street
City Zone State



For Loose Caster Guides

Remove the guide, fill the hole with a putty-like mixture of Smooth-On No. 1 Iron Cement and drive the guide back in. It will stay in place, because Smooth-On, in hardening, expands slightly and takes hold tight. Use Smooth-On for tightening other loose parts and also for stopping leaks in boilers, furnaces, piping, radiators, etc. Buy Smooth-On No. 1 in 1 3/4 oz. or larger sizes at your hardware store. If they haven't it, write us.

FREE Repair Handbook

Shows how to save time and money, making many household repairs. 40 pages. 170 pictures. Clear directions. Send today. 50 370

SMOOTH-ON

SMOOTH-ON MFG. CO., DEPT. 37H
570 Communipaw Ave., Jersey City 4, N.J.
Please send me FREE Repair Handbook

Name.....

Address.....

City..... State.....



STOP...UNEXPECTED MOTOR OVERHEATING

Easily, Quickly—

AT SMALL COST!

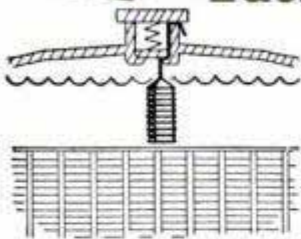

the bottom of the radiator where it is easily flushed out. You've got it—but don't know it.

Avoid—Radiator rodding expense—Valve Grinding—New Piston Rings and possibly a new motor on Autos, Trucks and Tractors. Rust and scale inside the engine's cooling system, prevents complete transference of heat to the water for dissipation, causing continuous damage.

For only \$1.95 you get insurance that gives driving satisfaction and ease of mind on your trip or local driving.

Order Today—anyone can install it in less than 3 minutes. Save needless wear and tear, plus avoidable expense.

Further information on request

Another CALLBOY Product distributed by

THOR-HAL PRODUCTS CO.
BOX 923, (Richfield Branch) MINNEAPOLIS, MINN.

BURN WATER in your CAR

with the **AMAZING OCTA-GANE "50"**
BURN WATER, ALCOHOL, OR BOTH IN YOUR CAR!



The Octa-Gane "50" is the only all bronze, "fog type," exhaust operated pressure injector on the market today. It is adjustable to burn up to one gal. of water or alcohol to every 10 gal. of gas. U. S. Agricultural Dept. scientists say "THE GASOLINE MILEAGE OF NEW HIGH COMPRESSION AUTO ENGINES CAN BE INCREASED UP TO 30% WITH ALCOHOL-WATER-GASOLINE FUELS."

Only \$24.95
postpaid
(Send \$2, balance C.O.D.)
List car make, year, & cyl.

NEWHOUSE AUTOMOTIVE INDUSTRIES, Dept. 06-8
5807 E. Beverly Blvd. Los Angeles 22, Calif.

BECOME AN EXPERT IN TRAFFIC

Traffic men earn \$4,000 to \$10,000 and up. Thousands of firms need experts on rates, tariffs, regulations. We train you thoroughly in spare time at home for executive traffic jobs. Personal training under traffic authorities. Placement counsel and help. Write for free 48-page book "Traffic Management—the Fast Growing Profession."

LASALLE Extension University, 417 So. Dearborn St.
A Correspondence Institution Dept. 8647 Chicago 5, Ill.



NEW, IMPROVED CALCULATOR FOR WOODWORKERS only 25c

Instantly gives information on lumber, nails, concrete mixes, painting materials, etc. Convenient, simple to read. Just set dial for nail specifications, to convert linear to board feet, find bit sizes for screws, compare characteristics of woods. 6" diameter heavily varnished cardboard. Send 25c, no stamps, please to Greenlee Tool Co., 2108 Columbia Avenue, Rockford, Illinois.



Save 1/2 On a NEW HOME Remodeling Repairs

— Especially for Home Owners and Amateur Builders — Don't be robbed by high labor costs. Build it yourself. Do your own modernizing, repairs. Sensational book shows how to save hundreds, thousands of dollars. Make space-saving cabinets, add a room, a new porch, install picture windows, convert attic or basement. Make your home worth more. Even small repair job will pay for book 10 times over. Order **PRACTICAL CARPENTRY** today. Big 8 1/2 x 11 in. book. 350 pages. Hundreds of pictures, plans, etc. Only \$5.60 postpaid. COD if you prefer. Money back if not satisfied. Goodheart-Willcox Co., Dept. 163, 1321 S. Michigan Ave., Chicago 5

SONG POEMS WANTED

To Be Set to Music
Send one of poems for free examination. Any subject.
PHONOGRAPH RECORDS MADE.
★ FIVE STAR MUSIC MASTERS 224 Beacon Bldg., Boston, Mass.

Say You Saw It in Popular Mechanics

the FROGMEN

We supplied most of the diving gear used in the exciting movie, "The Frogmen"—the story of Uncle Sam's UNDERWATER COMMANDOS. This same equipment is now available for civilian use in limited quantities.

- AQUA-LUNG** \$99.95
Self contained diving unit.
- ARBALETE** 24.95
Underwater spear gun.
- FRENCH DIVE MASK** 5.95
Navy type, shatter-proof glass.
- BREATHING TUBE** 2.95
Permits breathing with face underwater.
- PROPULS** 9.95
French swim fins—new design.
- FROGMENS SUIT** 37.50
Keeps diver warm & dry year round.

All equipment sold on a 10 day money-back guarantee. For additional information or where measurements are required please write to us for data. Exclusive distribution in the U.S. Merchandise sent postpaid, C.O.D.'s acceptable. In Calif. add sales tax.

U. S. DIVERS CO.
1045 Broxton Avenue, Los Angeles 24, Calif.



SACRIFICE SALE of Nationally Advertised Watches

Jet-O-Matic Full Swing SELF WINDING 24.95

Super De-Luxe Model—360° FULL-SWING AUTOMATIC. Just set it—then forget it! It winds itself as you wear it. Patented INCABLOC 17 Jewel movement of superb accuracy. WATER & SHOCK RESIST—you can drop it, bang it, even SWIM with it. 100% stainless steel screw-back. Radium Luminous Markings. Unbreakable Kleersite Crystal. Hairline sweep-second. SPLIT-SECOND calibrations for precision timing. Handsome thin case. Smart, GILT numerals & hands. CAUTION: Do not confuse with inferior 180° HALF swing automatics! Thoresen's Jet-O-Matic is 360° FULL swing. It's the "high compression" self-winder! Formerly \$75.00 NOW—24.95 plus 10% tax—total 27.45. FLEX-METAL band given!

Save 40%
to 72%

**FREE
10 DAY TRIAL**

Check watches wanted in coupon below. Remit check or money order for FAST prepaid delivery, or order COD plus postage. Try, appreciate, enjoy 10 whole days. Full price back QUICK if not delighted! **UNLIMITED GUARANTEE** Exclusive of Parts! No charge ever for skilled labor, "handling," etc. for LIFETIME of business. All THORESEN watches subjected to 11 special tests before shipment. Save with SAFETY . . . the THORESEN way!

Genuine Recipro-Register CHRONOGRAPH

The ONE and ONLY genuine Recipro-Register CHRONOGRAPH—computes speeds & distances down to 1/5th of second! INCABLOC 17 Jewel Movement resists shocks of work & play. Remembers for you while movement continues to keep time! TIMES: Races, Planes, Sports, Photography, Shop Work, Lab Experiments, Lightning, etc. AUTOMATICALLY! 3 multi-function synchronized dials. Contact clutch starts computation. Brake clutch freezes result. Also ERASE back to zero. Radium dial, hairline sweep-second, all stainless steel back, unbreakable Kleersite crystal. Don't confuse with cheap, troublesome chronographs. Every Recipro-Register Chronograph is INCABLOC equipped—subject to 11 gruelling tests before shipment! Formerly \$79.95. NOW—27.25 plus 10% tax—total: 29.98.

3 DIAL CHRONOGRAPH

Outstanding value! 3 Dials — 5 Hands! 2 Push Buttons. Both a wristwatch & chronograph. Sweep-second hand. 60 Second Dial. 45 Minute Registering Dial and 6 Hour Dial. 2 independent movements for DOUBLE use. Sturdy construction. Keeps on going while measuring speed of planes, sports, etc. NOW—7.85, plus 79c tax. Total: 8.64.



B De-Luxe 17 Jewel Gold Plate ACCURACY 14.00

MASTERPIECE of superb styling! Streamlined 14 karat Rolled Gold Plate—stainless steel back. Gilt numerals & hands, Hi-Dome crystal. Amazing accuracy! One of the smartest watches today. Formerly \$59.50. Now yours for only 14.00 plus 1.40 tax—total 15.40.

C 17 Jewel INCABLOC 14.95 WATER & SHOCK Resist

World famous INCABLOC! Radically different! 17 Jewels! You can DROP it . . . WET it . . . BANG it! Actually runs UNDER WATER! Try at our risk. De-Luxe Features: Radium-applique numerals — Stainless Steel Screw Back — SafeGuard Gasket — Sweep-second—Thin. GIVEN: Vita-Flex band. Why pay up to \$65.00? Thoresen's sacrifice price—14.95 plus 10% tax, total: 16.45.

THORESEN DIRECT SALES, Dept. 6H-300

131 WEST 33rd STREET — NEW YORK 1, N. Y.

RUSH watches checked on 10 DAY FREE TRIAL.

Remittance enclosed—send Prepaid. Send COD plus post.

A B C D E

NAME _____

ADDRESS _____

TOWN _____

STATE _____

HIGH POWER TELESCOPES



40 Power—opens to 36 inches. Precision & Polished Lenses. Ideal for Studying Stars, Plane Spotting or Interesting Pleasures. Satisfaction Guaranteed or Money Refunded.

Send Check or Money Order to
CRITERION CO., DEPT. PM 10 \$3.49
438 ASYLUM ST. HARTFORD 3, CONN. Postpaid

PITH HELMET

Genuine British Army pith helmet. Coolest, most comfortable, most practical sun helmet made. Best possible sun protection for hunters, fishermen, prospectors, mountain climbers, beachgoers. Ideal for engineers, construction workers, farmers, anyone that's outside. Perfect ventilation for cool comfort. Proven effective by the British army in Africa. Khaki covered pith cork, foil lined, leather sweatband. The perfect outdoor headgear. Specify size. Easily a \$12.50 value.



\$3.95

Aqua GOGGLES

Large glass lens. Exclusive inner vacuum lip molds to fit face. Comfortable. Permits continued use. Adjust. head strap. Natural rubber, sea green.



\$1.25

JR. GOGGLES, plastic lens. 79c

GIANT BALLOONS

Neoprene. Genuine Govt. surplus weather & target balloons. Inflates with vacuum cleaner. Great fun for yards, picnics, fairs, shows. Wonderful for advertising — attracts immediate attention.

3 FT. DIA. 6 FT. DIA. 13 FT. DIA.
39c 79c \$1.39



Postage Paid On Prepaid Orders
Calif. Res. Add Sales Tax

WAR ASSETS DIV. Volume Sales Co.

Dept. M-851, 3930 Sunset Blvd., Los Angeles 29, Calif.

GET THIS
"How to do it"
BOOK FREE!



PARTIAL LIST OF CONTENTS

- "Better Painting"
- "Refinishing Antiques"
- "A Superb Furniture Polish"
- "Protecting Tools"
- "Waterproofing"
- "Finishing Gun Stocks"

Here are 101 useful ways to use America's finest 100% pure linseed oil. Perfect for painting and the handiest item for every housewife, homeowner and farmer. Available at all stores.

EARN \$2.00 EASY

We will pay \$2.00 for each new practical idea for using Pol-mer-ik Linseed Oil, which is acceptable to our research laboratory. Write Archer Daniels Midland, 603 Roanoke Bldg., Minneapolis, Minnesota.



REPLACEMENT OR REFUND OF MONEY
Guaranteed by
Good Housekeeping
IF NOT AS ADVERTISED THEREIN

**ARCHER
Pol-mer-ik
100% PURE LINSEED OIL**

NOW! see as you drive...
how to save gas
-cut repair bills



NEW Stewart-Warner
MOTOR MINDER
quickly pays for itself in savings

You see at a glance how to keep your motor at gas-saving speed. You're warned at a glance of faulty motor performance—faulty spark plugs, valves, timing, piston rings, manifold, muffler. Same accuracy used by factory trained mechanics. All in plain sight on illuminated dial. Made by Stewart-Warner, the most trusted name in precision automotive instruments. Only \$10.95.

Ask Your Dealer Now! Or Write

Stewart-Warner

Instrument Division, Dept. N-81
 1840 Diversey Parkway • Chicago 14, Ill.

AERONAUTICAL
ENGINEERING



Design Aircraft & Components—Study with Jets & Rockets—
 Great Future—Advanced Aeronautical Subjects—World-Wide
 Enrollment—Fully Accredited—Established 1929—Approved
 for Vets—CAL-AERO grads in heavy demand.

WRITE TODAY for Special Information. PM-8

NAME _____ AGE _____
 ADDRESS _____
 CITY _____ ZONE _____ STATE _____

CAL-AERO TECHNICAL INSTITUTE
 GRAND CENTRAL AIR TERMINAL • GLENDALE 1, CALIFORNIA

Prepare Now for YOUR Tomorrow
"3 TRADES IN 1 CAREER"

Engraving • WATCH REPAIRING • Jewelry

WATCHMAKERS URGENTLY NEEDED—NOW. Investigate this life-long career . . . profitable, pleasant work, or a business of your own. Write for FREE CATALOG and information on WATCHMAKING, CHRONOGRAPHS, JEWELRY & ENGRAVING. KCSW's outstanding resident training now offered in WATCHMAKING and ENGRAVING by Home Study.

Only resident training offered under G.I. Bill.

Resident School Home Study

Name _____
 Address _____

KANSAS CITY SCHOOL OF WATCHMAKING
 1218 Admiral Blvd. — Kansas City 6, Missouri

IN HOT WEATHER

Get top-notch performance from your electric razor. In sticky, perspiry days of summer when shaving is most uncomfortable, this amazing preparation:



1. Evaporates sticky, razor-clogging perspiration.
 2. Lubricates skin for faster, more comfortable shaving.
 3. Tautens skin—"brings out" your beard for closer, better-looking shaves.
 4. Lubricates your shaver's cutting head.
- FREE! Try Lectric Shave at our expense. It is avail-

able at drugstores or toilet goods counters. Only 49¢ plus tax—enough for 80 shaves. For a generous free sample, send name, address to The J. B. Williams Co., PM-5, Glastonbury, Conn. (Offer good only in U.S.A.)

LEARN RADIO-ELECTRONICS



Train for an important job in Radio, Television and Radar—with unlimited future. Spartan resident study is backed with actual construction and operation. Write Department PM-81

SPARTAN SCHOOL of RADIO-ELECTRONICS
 MUNICIPAL AIRPORT • TULSA, OKLAHOMA

Our 412th Advertisement

REAL DIESEL ENGINE

\$2.95 • for planes, boats, midget cars
 • 7500 RPM; 1/7 HP; ht. 3 1/2"; wt. 5 oz.
 • comes completely assembled

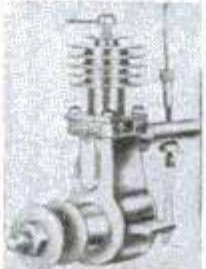

You just can't beat this price for a complete precision diesel engine! Streamlined, rugged, compact. Starts quickly, easy to install, runs for years. Fast delivery if you ORDER TODAY! Send \$2.95 plus 25¢ postage.

GOTHAM HOBBY CORP. Dept. P, 107 E. 126 St. New York 35



SILVER SOLDER TORCH & KIT \$7.50

JOINS ALL METALS PERMANENTLY

Do your own repairing. KIT includes one tube silver solder "XCEL-FLUX" paste and 10 5-in. lengths silver solder alloy. Hottest ALCOHOL TORCH known. 2700° F. flame. Operates in any position, indoors or out. Pint of special fuel included. TORCH alone with pint of special fuel \$6.50. KIT alone \$1.50. Add 25¢ on each order towards shipping charges.

AMERICAN PRODUCTS CORP., 422 S. Dearborn, Dept. 3-H, Chicago

DEPENDABLE CRAFT SUPPLIES



LEATHER CRAFT • PLASTICS • POTTERY
 CRAFT • BLOCK PRINTING • BELT CRAFT •
 TEXTILE COLORS • POWER TOOLS • WOOD
 BURNING • INSTRUCTION BOOKS • ETC.



DWINNELL CRAFT SHOP
 Dept. PM-851—Wheeling, W. Va.

SELL GOLD & SILVER WINDOW LETTERS

300% PROFIT! Fast, easy sales to stores, offices, doctors, lawyers, etc. Individual orders for merchants interested in saving \$\$\$ doing their own window lettering. Letters easily applied on glass, wood, metal with varnish-glue (not water). Won't wash off; withstands frost. Write for samples.

METALLIC SIGN CO., 430 N. Clark St., Chicago 10, Ill.



Bar Bells

Buy Direct From Factory Approved and Recommended by **\$8.95**

Karl Koberle (Foremost Ex-Army Instructor on Weight Training) up

Write for free booklet and price list.
INDEPENDENT IRON WORKS
 2416 East 23rd Street, Dept. B
 Los Angeles 58, Calif.

Learn PHOTOGRAPHY at Home

Splendid opportunities. Prepare in spare time. Practical basic training. Long-established school. Send for free book, "Opportunities in Photography." No obligation.

American School of Photography, 835 Diversey Parkway, Dept. 135C, Chicago 14, Ill.

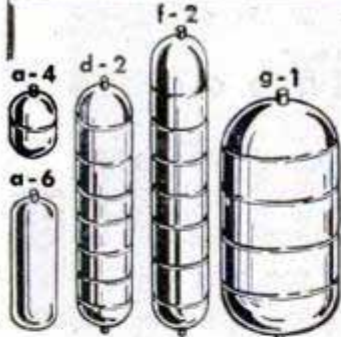

STEEL AIR TANKS

Steel pressure tanks suitable for compressors, pneumatic units, gases, hydraulics, and liquids. Rated at 500 lbs. per square inch pressure. 1/4" standard pipe thread openings on tank ends as shown.

		Size	Wt. Lbs.	Internal Volume	Price
A-4	Stainless Steel—New	7 1/2" x 5 1/4"	1 1/2	104 cu. in.	\$1.50
A-6	Carbon Steel—New	14 1/2" x 5 1/2"	3 1/4	280 cu. in.	3.50
D-2	Stainless Steel—New	24" x 6"	5	500 cu. in.	6.50
D-2A	Carbon Steel—New	24" x 6"	5	500 cu. in.	5.50
F-2	Stainless Steel—New	45" x 6"	11	1000 cu. in.	9.50
F-2A	Carbon Steel—New	45" x 6"	11	1000 cu. in.	5.50
G-1	Stainless Steel—New	24" x 12"	18	2100 cu. in.	11.50
G-1A	Stainless Steel—Used	24" x 12"	18	2100 cu. in.	7.50

Prices F.O.B. Chicago. Include approx. postage on orders paid for in advance. C.O.D. orders enclose 25%, balance sent C.O.D.

U. A. S. Corp. Dept. PM8, 5637 W. 63rd Pl. Chicago, Illinois

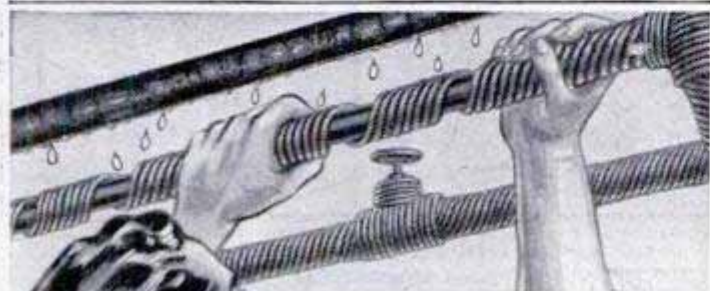

STOP DRIP

caused from condensation on cold water pipes. Turn idle basement space into play or work rooms. Keep store rooms dry. Just wrap cork-filled NoDrip Tape around



pipes and joints. Do it yourself. Clean and easy to apply. Roll covers about 10 feet of 1/2" pipe, \$1.69. Higher west of Rockies and Canada. Get at Hardware, Department Stores, or sent postpaid. Write for free circular. J. W. Mortell Co., 522 Burch St., Kankakee, Ill.



SAY YOU SAW IT IN POPULAR MECHANICS



THE MOST AMAZING OFFER IN USED TIRE HISTORY. EVERY PASSENGER TIRE **UNCONDITIONALLY GUARANTEED** plus TIRE INSURANCE FREE

10% OFF ON 2 OR MORE TIRES

Here's DOUBLE proof that we bear the loss if your tire wears out within the guarantee period or is damaged in any way (except willfully). Don't take risks: we send FREE insurance certificate PLUS written unconditional guarantee with your order.

BEST GRADE PASSENGER TIRES
UNCONDITIONAL ONE YEAR GUARANTEE plus TIRE INSURANCE FREE

600-16 \$5.59	700-16 \$7.59	700-15 \$5.59	550-16 \$5.95
600-16(6) 6.50	600-15 5.59	750-16 12.25	580-17 7.75
650-16 5.79	650-15 5.59	550-15 5.59	475-19 6.75

LO-PRESSURE TIRES FOR EASY RIDING
UNCONDITIONAL ONE YEAR GUARANTEE plus TIRE INSURANCE FREE

640-15 \$5.75	710-15 \$6.50	820-15 \$7.50	760-16 \$7.50
670-15 5.95	760-15 6.75	670-15 6.95	

MILITARY MUD AND SNOW TIRES
2 YEAR WRITTEN GUARANTEE

600-16 \$6.95	900-16 \$12.95	750-20 Reg. \$12.50, Special \$15.95
---------------	----------------	--------------------------------------

EXTRA VALUE TRUCK TIRES
2 YEAR WRITTEN GUARANTEE

600-20 \$10.75	750-20 \$14.50	825-20 \$21.50	1100-20 \$26.95
650-20 11.75	32x6(8) 11.75	900-20	1100-22 24.50
700-20 12.50	32x6(10) 12.50	(36x8) 19.50	750-20(10) 18.00
		1000-20 20.00	

MAIL ORDERS PROMPTLY FILLED. Send check or money order with this ad. 920 W. CARY ST.,

THE SAFTYRE CO.
"FOR THAT SAFE TIRE"
Dept. PM, RICHMOND, VA.

The NEW Model 50 UTILITY TESTER FOR REPAIRING ALL ELECTRICAL APPLIANCES-MOTORS

an all-around electrical trouble shooter



• Measures A.C. and D.C. Voltages, A.C. and D.C. Current, Resistances, etc.

• Will measure the current consumption while the appliance under test is in operation. The appliance or utility may be plugged directly into the front panel receptacle. A special pair of insulated clip-end leads is included for motors, etc.

• Incorporates a sensitive direct-reading resistance range which will accurately measure all resistances commonly used in electrical appliances, motors, etc. This range will enable continuity checks and tests for shorts and opens.

• Will test thermostats, radio tube filaments, bulbs, fuses, fluorescents, condensers, switches, field coils, circuit breakers, lighting systems, etc.

Handsome round cornered molded bakelite case 3 1/8" x 5 7/8" x 2 1/4". Complete with all test leads and instructions.

\$13⁹⁰

SOLD ON EASY PAYMENTS AT THE NET CASH PRICE

No interest or carrying charges added. Simply remit \$3.90 with order, pay balance, \$2.00 per month for 5 months.

SUPERIOR ELECTRONIC CO., INC.
Dept. B-24 • 227 FULTON STREET • NEW YORK 7, N. Y.

High School at Home

Many Finish in 2 Years

No classes. No time wasted going to and from school. Progress as fast as your time and abilities permit. Standard H. S. texts supplied. Thousands enroll each year in this 54-year-old school. Send for FREE descriptive booklet.

AMERICAN SCHOOL, Dept. HC45
Drexel at 58th St., Chicago 37, Ill.

Without obligation, please send FREE descriptive booklet.

Name _____

Address _____

A FASCINATING, MONEY-MAKING art career can be yours

AMERICA'S 12 MOST FAMOUS ARTISTS SHOW YOU HOW!



Write Today

FAMOUS ARTISTS COURSE

Dept. 6-V, Westport, Conn.

FREE Send book about your home study art course.

Name _____ Age _____

Street _____

City, State, Zone Number _____

Now! YOU CAN MAKE MONEY...

TURNING WORTHLESS OBJECTS INTO VALUABLE TREASURES— ... BY CERAMIZING!

HERE ARE JUST A FEW OF THE HUNDREDS OF ARTICLES THAT CAN BE TRANSFORMED BY "CERAMIZING"—INCREASED IN VALUE—OR "ETERNALIZED" AS KEEPSAKES WITH A VARI-COLORED COATING THAT HAS THE APPEARANCE OF THE FINEST KILN FIRED CHINA



Costume Jewelry from flowers, leaves, nuts, and shells.



Paper Weights, Trays, and Objects of Art from Nature.



"Ceramized" Busts, Figures from plaster, or wood carvings.



"Ceramized" Objects of glass, leather, plastics, or rubber.



"Eternalize" baby shoes, toys, and other sentimental mementoes.



"Ceramize" Baskets, Plates, Trays, and other metal objects.



Preserve sport and war trophies in sparkling simulated china.

YES—ANY MAN OR WOMAN CAN DO WORK LIKE THIS IN ONE CORNER OF THE KITCHEN OR IN ANY SPARE ROOM!

A Satisfying New Home Art Hobby Pays Up To \$5.00 AN HOUR for SPARE TIME

Amazing book tells you how

HOW to do the work—how to get customers coming to you—how to set up the simple equipment—how and where to buy the materials—what to charge—how to start in spare time—how to expand into a full time business whenever you wish. Shows you in pictures and words how to put a hard "Ceramized" finish on such things as flowers, leaves, insects, shells, wood carvings, plaster castings, busts, statues, religious figures, buttons, baskets, feathers, base balls, golf balls, mementoes of all kinds, such as, baby shoes, party and wedding favors and decorations. Operating a home "Ceramizing" business is one of greatest insurance policies a man could ask for his future. **READ ABOUT IT WITHOUT RISKING A PENNY.**

Think of turning 56 cents worth of materials into a profit of \$5.00 for just a few minutes of easily learned handiwork. Think of beautifying your own home and amazing friends with the artistic skill you can master in less than an hour of study and practice. Sounds fantastic. Yet it's absolutely true... **as you can QUICKLY PROVE to yourself.**

AN EXCITING NEW OPPORTUNITY FOR PLEASURE AND PROFIT!

Just at a time when hundreds of men and women would like to make an extra \$35.00 to \$50.00 a week in spare time home work—just at a time when hundreds would like a new outlet for expressing their artistic skills—just at a time when the country is turning to a revival of appreciation of beautiful handcrafts, the fascinating new art of "Ceramizing" is ready for you. Every step of this process can be learned in less than an hour of home practice.

The process is so simple that even a child can learn it. No knowledge of art or drawing is re-

quired. No knowledge of proportion or design is needed. You work with objects already created, or with the countless thousands of Nature's beautiful forms. You coat the object itself with a hard finish that has the appearance of kiln fired glazed china—and you apply a variety of colors. By following my simple instructions you can develop a deeply satisfying creative hobby—or you can use your hobby in spare time to make as much as \$5.00 an hour. I even show you the easy way to get others to come to you for your products.

ALL THIS INFORMATION IS FREE

The information is free. A postage stamp brings you the exact plan by which hundreds are NOW MAKING EXTRA MONEY EVERY WEEK, in an artistic creative hobby. Study my plan. See examples of the beautiful work. Read the special marketing plans that bring you such big profits. If you're not "burning up" to get started, your only loss is a 3c stamp. Read the Plan at my risk.

NO "CATCH" TO THIS OFFER DON'T SEND ME A PENNY ... Just Your Name!



Learn about this wonder "ace in the hole" business that can supply you with a good income—even when other sources fail. Learn how you can start a business in spare time—without risking job or paycheck—that can be turned into a full time business whenever you need a new source of full time income. Learn R. E. Brandell, Warner Electric Co., 1512 Jarvis Ave., Dept. 38, Chicago 26, Ill.

this Art Hobby that can lead to personal independence—an income producer that can be operated in the corner of any room in your home—in any part of the country. Scores of men and women have already started... plenty of opportunity for hundreds more. **BUT DON'T PUT IT OFF.** Send your name and address today. It may open new horizons in your life.

R. E. Brandell, Warner Electric Co. 1512 Jarvis Ave., Dept. 38, Chicago 26, Ill.

Rush complete facts on the fascinating new Home Art Hobby of "Ceramizing." Show me how I can make as high as \$5.00 an hour for spare time work at home. No charge or obligation for the information you send.

Name.....
Address.....
City..... Zone..... State.....

**WORLD'S
BEST
WANT AD
MEDIUM**

CLASSIFIED Advertisements



Advertisements in this section 85 cents per word, each insertion, minimum 10 words, payable in advance. To be inserted under proper classification, copy must be in our office the 20th of the second month preceding date of issue
F. W. Johnson, Manager, Classified Advertising
Popular Mechanics Magazine, 200 East Ontario Street, Chicago 11, Illinois

YOU'LL PROFIT

By reading and answering the classified ads in this section. Hundreds of opportunities for you to make and save money

AUTOMOBILES, MIDGET CARS

SPEED Equipment catalog 25c. Large four color stock car or racer decal or jacket emblem 50c, five for \$2.00. Jr. racing helmet \$2.00. Catalog free with orders. Frank Smith, 17-P-Watson St., Paterson 2, New Jersey. (Dealers wanted.)

SAFETY Belt for fast highway driving. Adjustable to 5'. Comfortable. Ride with safety. Quick release. Complete with fittings. \$3.00. Frank Smith, 17-P-Watson St., Paterson 2, New Jersey.

SAVE—Headquarters for California custom accessories. Buy direct from original designers. Chrome dash panels, push button door-trunk conversions, dual mufflers, lowering kits, speed equipment, chrome motor accessories. Custom catalog, 40 pages, hundred of photos—25c. Eastern Auto, 3319A South Grand, Los Angeles 7, California.

FREE "Power Handbook"—given with world's biggest speed equipment catalog showing 1000 bargains—Hollywood mufflers \$4.95, duals \$18.95, cut-outs \$6.95, dual manifolds \$12.95, racing cams \$29.00, water injectors \$6.95, lowering kits \$1.45. Custom accessories galore! Cash discounts! Send 25c. Almquist Engineering, Milford 31P, Penna. (Dealers wanted.)

LITERATURE Offered on old, new and foreign automobiles; shop manuals, engineering papers, data books, glossy photos, free motor magazines. Contact auto hobbyists everywhere. Write today; get name on free mailing list. Auto Maniacs, Inc., Stockbridge, Mich.

NEWHOUSE Presents amazing automotive information, all cars, see pages 38 and 58.

FROM Speedway to roadway! Track-proved hi-speed heads and manifolds now available for your passenger car! No special tools needed! Increase horsepower 25%! Astounding getaway! Free illustrated catalog. Speedsport, 6215P Diversey, Chicago 39.

WATER Injection. Also economy, power, methods. Free illustrated information. Neher Industries, La Verne, California.

PLYMOUTH Owners save money with big 288-page manual. Tells how to keep your Plymouth in tip-top shape; how to make repairs and recognize troubles. Hundreds of diagrams, drawings and illustrations. \$3.50 postpaid or order c.o.d. Popular Mechanics Press, 200 E. Ontario St., Chicago 11, Ill.

AUTO SUPPLIES AND EQUIPMENT

MOTORIST—Why spend money on costly repairs. Buy at lowest exchange prices. Write for catalog of reconditioned carburetors, generators, starters, fuel pumps, shock absorbers, etc. Auto Electric Service Co., 5858 Broadway, Chicago 40, Illinois.

CROSLY Engines. Factory rebuilt with cast iron block. \$124 exchange. Glenn Walraven Motors, "King of the Crosleys," Marion, Ohio.

WATER Injectors wholesale! Soups up performance—\$6.95! Almquist Engineering, Milford 34P, Pennsylvania.

SPEED Equipment. Edelbrock, Offenhauser, Navarro heads, manifolds and Winfield cams, dual ignition points. Chev. 37-51, Ford 49-50. Deepstone mufflers, headers and dual muffler sets. Send for speed information 25c. Urzi's Auto Supply, San Jose, Calif.

REMOVE Knocks, raise oil pressure. Hand operated crankshaft grinder \$3.75. Free information. L. D. McGee, 719A Cascade St., Wenatchee, Washington.

VAPOJET Helps save gas, engine wear, carbon accumulation and increase power with water-alcohol vapor injection. \$9.95 postpaid. \$1 deposit c.o.d. 30 day money-back agreement. Easily installed, free details. Agents wanted. Bantel, 757AR Venice, Los Angeles 15.

AIR Horns. Auto accessory catalog! Send postcard: John McCanna, 148-A East 40th, New York 16.

WHOLESALE Prices, automotive electric supplies. "Modern." Box 4704, Kansas City, Mo.

DON'T Look for your car after it's stolen. Automatic device will protect it even when keys are forgotten and left in car. No gadgets to remember or forget. Simple, cheap, effective. Instructions one dollar. Anderson, Washington, Illinois.

PLASTIC Weld bodies and fenders. Permanent, quick, easy. Formula and instructions \$1.00. Brownie, Arvada, Wyo.

ALSO Gives cool motors. Lachapelle's 100,000 miles treatment, \$3.00 postpaid. Ferns Products, 8120-B Walnut Dr., Los Angeles 1, Calif. (Data on request.)

PLASTIC Coated fiber auto seat covers \$11.00. All plastic \$15.00. Zebra, leopard, \$28.00. Add \$2.00 car. Ace Distr., 672 Hinsdale Street, Brooklyn 7, New York.

1951 SUPERIGNITIONITER. Starting, pep, mileage \$4.50. Barbells 200/s \$25.00. Catalog \$1.00. EG, Elmsford 1, N. Y.

CAR-Bed for all post war Studebakers except four doors. Save hundreds dollars. Absolutely no rework or expense. Complete information \$4. Ensco, Pasadena 16, California.

INCREASE! Gasoline mileage, three to five miles gallon. Guaranteed vaporizer, increases power; easier starting; \$3.50 each. Turb-O-Vane, 1024 West Vine, Stockton, Calif.

"HOW To Get 150 M.P.G." Authentic book, shows how passenger cars actually go over 100 miles per gallon on regular gasoline. Big equipment catalog, plus 32 page Economy Driving Manual, plus book—all three—50c postpaid. Newhouse Automotive, 5805 East Beverly, Los Angeles 22.

NEW Government surplus. Low voltage circuit tester in steel box cost \$202. Our price \$27.50. Will test batteries, starters, generators, voltage regulators, grounds, short circuits. Wilt Electrical Company, 7829 S. Racine Ave., Chicago 20, Ill.

CHEV. Rebuilt motors. Guaranteed like new. Lowest prices. Grossman Chev. Co., Minneapolis, Minn.

SEND For free life membership card. "Water Burners" of America, La Verne, California.

OFFENHAUSER'S New catalog available. Send 25c. Complete line of speed equipment. Offenhauser Equipment Corp., 5054-p Alhambra Ave., Los Angeles 32, California.

AUTO Parts and accessories. Briggs Automotive Engineering of Chicago, P.O.B. 3454 Merchandise Mart, Chicago 54, Ill.

NEW And used guaranteed parts for civilian and army cars and trucks. Largest stock in America. Mail orders. Pioneer Auto Wrecking Co., 734 W. 13th Ave., Denver, Colorado.

FOR Free descriptive literature on alcohol-water injection for cars, trucks, tractors write Shade, Webster, New York.

BRUSH Plating outfits connect to a battery. No tanks or shop required. Free particulars. Gunmetal Co., Avenue J, Decatur, Illinois.

1951 EDITION! It's new! It's different! Get world's largest auto accessory and parts catalog and save money. Over 50,000 items, including Hollywood accessories, hi-speed equipment, rebuilt engines, all parts and accessories for all cars and trucks. We have that hard-to-get part! Jam packed with bargains. Completely illustrated. Send 25c (refundable) J. C. Whitney, 1919 Archer, Chicago 16.

MOTORIST Save gasoline by Vacuumating overrich mixtures. Fits all cars. For free particulars write Vacuumatic, Dept. 1768, Wauwatosa, Wis.

AUTO TRAILERS

PLANS 16' Sportsman trailer, expertly prepared, ideal for craftsmen, \$2.00. Freeland Engineering, 16587 Freeland, Detroit 35, Michigan.

BUILD Your own trailer! Plans for all kinds. Illustrated catalog 10c. Jim Dandy, 125-M, Wausau, Wisconsin.

VAGABOND House trailers \$2,295.00-\$4,695.00. Tops. Otho DeWitt, Utica, Michigan.

MOTORCYCLES, BICYCLES, MOTORSCOOTERS AND SUPPLIES

WHIZZER Motorbike (all attachments) \$25; others \$5 up; Cushman motorscooter \$20; Indian motorcycle \$30; Briggs Motors \$5.00 up. Rush 25c (35c first class mail) for catalog #949 listing many other amazing bargains in motors, midget cars, motorscooters, motorbikes, etc. Associated, Box 1764-CS, Toledo, Ohio.

NEW 1951 Issue Indian, Harley, new, used parts and accessories book 15c. Boots, 1700 East University, Des Moines 16, Iowa.

REBUILT Gasoline engines \$9.00 to \$30.00. Cauffiel Motor Industries, Temperance, Michigan.

TWO Passenger Motorette midget car \$45; Servicycle \$35. Doodlebug motorscooter \$5. Cushman \$15. Motorbike \$5, less engines. Two cylinder motorwheel \$10; Briggs engines \$5 up. Four airplane type tires \$3. Mailorder only. Send 25c for new catalogue Number 42, just out listing these and hundreds of other bargains in new and used midget cars, motorscooters, homebuilders parts, plans, engines, transmissions, clutches, war surplus, etc. (35c by first class mail). Midget Motors Directory, Athens, Ohio.

U. S. Govt. surplus "45" Harley Davidson motors, complete with carburetor and generator, in running condition—\$69.50 f.o.b. Chicago. 25% deposit with order. Parts and accessory catalog 25c. Triangle, 2157 Harrison, Chicago.

WHIZZER In Schwinn bike \$20; good motorscooter (twist grips) \$22.50; midget car \$15; Shaw bicycle motor \$15. Send 25c (35c first class mail) for catalog #18 jammed with other sensational bargains in wheels, motors, clutches, motorscooters, midget cars, motorettes, motorbikes, etc. Gail, 538 Erie, Toledo, Ohio.

HARLEY-DAVIDSON parts, accessories, repair manuals on all models. 24 hour service. Authorized factory dealer. Philadelphia Harley-Davidson Company, 857 North Broad Street, Philadelphia 23, Penna.

AVIATION

PROPELLERS—For sleds, airdrive boats. Literature. Standard Aircraft, Box 387, Ft. Worth, Texas.

BULLET Raceplane. Home-built monoplane. Blueprints \$2.00. Corcraft, 81-V Elmerston, Rochester 20, N. Y.

JET Engine plans \$1.00. Make your own. Any size. Simple 2 hr. job. JWS, 500-MN, Tamarind, Fontana, Calif.

PROPELLERS, Plans, supplies for snow sleds, air boats. Catalog 20c. Banks-Maxwell, Box 3301, Ft. Worth, Texas.

ELECTRICAL SUPPLIES

LAMPS—Build own originals, parts wholesale, any amounts. Catalogue 10c. Brown Lamp Co., Box 501, Wellston, St. Louis 12, Missouri.

BE Independent, be secure, have your own profitable business—Earn \$30.00 and more a day making beautiful, fast-selling lamps at home. No equipment needed. Illustrated course teaches you quickly. Course, parts catalog, wholesale price list—only \$2. Gearon Co., Dept. 200-B8, 27 S. Desplaines, Chicago 6, Ill.

LAMP Parts bargain offer—To introduce our quick service and fine merchandise. \$10.00 brings bargain box essential lamp parts, value \$17.50. Contains sockets 16 $\frac{1}{2}$ c, harps 8 $\frac{1}{2}$ c, cords 12 $\frac{1}{2}$ c, switches 12 $\frac{1}{2}$ c, necks, couplings, nuts, etc. Not sold individually at these prices. Bargain box only. Order early, quantity limited. Expires August 31. Details and catalog 25c. Gyro Lamps, 5402P Clark, Chicago 40.

ELECTRIC Pencil: Engraves all metals \$1.50. Beyer Mfg., 10511-H Springfield, Chicago 43.

LAMPS—Had trouble finding repair parts? Your search is ended. 25c brings 64 page illustrated catalog also containing wiring charts. Gyro Lamps, 5402P Clark, Chicago 40.

SOLVE Your plug-in problems with Tapaline Multiplug. Makes 8 appliances instantly available from one outlet, in workshop, home, or office. Tough plastic sheath, 12 inches long, with 6 foot cord. Approved by (UL). Order today, only \$2.25 postpaid, or C.O.D. Satisfaction guaranteed. Circular free. Sunshine Sales, Dept. MT1, Loudonville, Ohio.

WELDING, SOLDERING, PLATING

ACETYLENE Welding outfits now \$49.00; used \$29.00; arcwelders \$46.50. Eagle Welding, Dept. PM, 5085 Broadway, Chicago 40, Illinois.

BUY Direct from factory. Welding and cutting equipment. All makes of equipment repaired. Established 1913. Box 331, Hamilton, Ohio.

MACHINERY, TOOLS, SUPPLIES

"WORK Horse" workbench deluxe; ruggedly built of hard maple with 1 $\frac{3}{4}$ " laminated top, 2 wood vices, 12 clamping blocks. Two sizes, \$69.50 and \$47.50 f.o.b. Request circular today. Trecost Co., Inc., 2 Railroad St., Fairport, N. Y.

THREADING Tools for wood dowels and holes. All sizes. Write for catalogue. Woodworkers' Tool Works, Jefferson & Quincy Sts., Chicago 6, Illinois.

WATCHMAKERS' Staking set, 50 punches, 6 stumps, \$39.50. Larger set 100 punches, 20 stumps, \$49.50. Public Sport Shops, 11 S. 16th Street, Philadelphia 2, Penna.

INSTANT Reverse single phase motors. Simple. Inexpensive. No rewinding. No special parts. Complete instructions \$1.00. Fred Tann, 23738 Ronan Ave., Wilmington, Calif.

DRILLPRESS Tool, cuts discs, holes, chamfers edges! (\$3.00 retail), special, \$1.00. Technicraft, 1156 Commonwealth, Boston 34.

FREE Cata'og. Full line hobby and light industrial power wood working tools. Guaranteed. Dealers wanted. Backus Machine Co. Chippewa Falls, Wisconsin.

MACHINES For your shop. 12" lathe \$150. 15" lathe \$280. 16" shaper \$310. Drill press; \$180. 30"x24" lathe \$940. Auto conversions and parts. Marine manifolds for all engines. Your transmission converted to marine gear, propellers, shafts, struts, couplings, etc. Everything you need for your boat. Money back guarantee. Conversion Parts Company, 278 Adams Street, Boston 22, Massachusetts.

CIRCLE Saw sharpener with grinding wheel \$8.95 fits saw table. McBurney, 319 E. Fourth, Los Angeles 13, Calif.

BIG Dollar value—Six assorted lifetime screwdrivers. Ambir handles. Shock proof. Factory surplus. Stocks limited. Worth triple. \$1.00 postpaid. Sax-On, Dept. KK-2, 3840 Fullerton, Chicago 47.

DRILL Grinder for twist drills, \$2.95. See ad on page 246.

BUILD Power machines with Kimo Plans. New York 19. Descriptives 25c (refundable).

PRECISION Tools. Immediate delivery on Starrett, Lufkin, Brown & Sharpe tools. Send for free catalog. Acme Hardware Company, 1013 W. 63rd St., Chicago 21. Fine tools for all tradesmen.

CHUCKS: Independent; Universal—threaded 1 $\frac{1}{2}$ "-8, 1"-8, 1"-10, 1"-12, or with adapter recess. The only complete line of bench lathe chucks built to heavy duty standards. Other chucks to 16" diameter. Write for quotation; free literature. No obligation. Westcott Chuck Co., 3600 Walnut, Oneida, N. Y.

FLEXIBLE Shaft tool by Fairchild for grinding, polishing, sanding, buffing, carving. Original price \$19.95. While they last! Special price \$12.95. Public Sport Shops, 11 S. 16th Street, Philadelphia 2, Penna.

BOATS, OUTBOARD MOTORS

FASTEST Boats in the world—Build now. Complete plans available for sleek three point racing hydroplanes, runabout and others. Send 25c immediately for illustrated catalogue. Champion Boats, P.O. Box 9038, Dept. 22-H, Long Beach 7, Calif.

OUTBOARD Motor parts—New, used for all makes. Send stamp for price quotation. Outboard Motor Mart, Inc., 309 Atlantic Avenue, Boston 10, Massachusetts.

MARINE Conversions for Ford and Jeep engines. Catalog 10c. Lehman Manufacturing Company, 972D Broad Street, Newark 2, New Jersey.

CONVERT Fords and Jeep to 100% marine engines with Osco's world famous Convo-Kits. Deluxe catalogue 25c (coin). Oscomotors, 3627B Lawrence, Philadelphia 40, Penna.

SAVE 2% Cost. Assemble your own boat. We furnish parts. No experience necessary. Rowboats, cruisers. Illustrated catalog 25c. Midwest Boat Company, Menomonee Falls, Wisconsin.

STEERING Wheels, windshield brackets, from \$7.95. Modern fittings, water-skis at lowest prices. Complete pre-cut plywood boats. Bargains galore. Folder 10c. Marine, Box 681, Mendota, Minnesota.

NEW, Used, rebuilt marine motors. Marine conversions, fittings. Free catalog. Stokes Marine Supply, Dept. 24, Coldwater, Michigan.

FULL Size, cut to shape boat patterns, blueprints, 7 $\frac{1}{2}$ -38 feet. Illustrated "Build a Boat" catalog, 25c (coin). "How to Build Boats" book, \$1.00. PolyWog houseboat plans \$10. Marine catalog \$1.00. Marine Specialty Mfg. Co., 3107 Detroit Ave., Cleveland 13, Ohio.

"P38 Belly tanks" steel, \$9.95. Free picture. Bucks Auto Parts, Box 89, Merced, Calif.

ENGINES, MOTORS, DYNAMOS

REBUILT Gasoline engines \$9.00 to \$30.00. Cauffiel Motor Industries, Temperance, Michigan.

WINDING Data, listing 225 motors, single and three phase, \$1.00. Motor Data Co., Box 7631, Kansas City 3, Mo.

ATHLETIC EQUIPMENT, BODY BUILDING COURSES

HANDBALANCING Self-taught, quickly. Write. Power, 923-B W. Vine St., Kalamazoo, Michigan.

SCIENTIFIC Boxing! (Dempsey, Louis and Bratton techniques). Home study course. Completely illustrated, \$1. University Publications, 615 Davis, Evanston, Illinois.

DEADLY Judo—Fiercest fighting technique. Trick knockouts. (Over 200 illustrated pictures.) Expert instructions; three volumes. Complete \$2.25. Variety House, Box 46-B Wall Station, New York 5.

SPORTING GOODS, GUNS, FISHING TACKLE, ARCHERY, TRAPPING

STEEL Fishing sinker molds. Makes seven assorted sizes. \$2.00 postpaid. Sewell Machine Works, Versailles, Ky.

CAST Iron molds for making fishermen's sinkers. Free illustrated booklet. Reading Instrument Co., Box 78, Reading, Penna.

TENTS, Camping equipment, tarpaulins, etc. Also war surplus. Low prices, free catalogue. Morsan, 10-17G 50th Ave., Long Island City 1, N. Y.

H&R .22. With holster \$20; Winchester .44 rifle \$5; .22 rifle \$10; 1828 musket \$13; arrowhead collection 70c; German officer swords \$5; pistols \$2 up. Rush 25c for catalog #509 listing many other bargains in guns (new and old), swords, relics, etc. Jefscoc, Box 1682-CS, Toledo, Ohio.

GETZEM Automatic fish hook for the one that got away. Only 60c. Lamont's, 130 Forest Ave., Fond du Lac, Wis.

PLUGCASTERS. Sensational new style of angling sent free. More and larger fish. Eljay Company, 6632 Colmar, Bell Gardens, Calif.

5000 BARGAINS, Firearms, binoculars, war relics. Catalog 50c. Smith Firearms, Runnemed, N. J.

AMMUNITION Immediately available for Lugers, Mausers, Japanese, Italian guns. Send 10c; complete list; 100 kinds. Also 8 power pocket telescope, \$5.00; cameras, microscopes, rifles, crossbows, knives. Ashton Company, 1511 North Gardner Street, Hollywood 46, California.

FISH At night with beautiful plastic lighted bobber lure. More fun. More fish. Two for \$1.00 postpaid. Glo-Lite Bobbers, Inc., 2111 Woodward, Detroit 1, Mich.

190 PROFUSELY Illustrated pages antique and modern pistols, swords, daggers, armor, etc. 50c. Robert Abels, A860 Lexington Ave., New York 21.

MOLDS, (For fisherman's sinkers, squids, jigs and lures.) Handled and hinged. Quality fishing tackle. Free catalogue. E. L. Sweet & Son, Tonawanda, New York.

TAXIDERMISTRY

MODERN Taxidermist Magazine, Greenfield Center 2, N. Y. Devoted entirely to taxidermy, photos, articles, methods. Trial year's subscription, \$1.00.

BINOCULARS, TELESCOPES, MICROSCOPES, MAGNIFIERS

SAVE 50% On new binoculars! Free catalog. Free book. "How to Select Binoculars." Write today! Bushnell's, 43-M-28 Green, Pasadena 1, California.

BINOCULAR Specialists, all makes repaired. Authorized Zeiss, Hensoldt dealer. Tele-Optics, 5514 Lawrence, Chicago 30, Illinois.

BINOCULARS, Telescopes, microscopes. Our 20th year of leadership in optical values. Bargain catalog free. Brownscope Co., 24 West Street, New York.

WAR Surplus bargains, binoculars, telescopes, sextants, millions of lenses, prisms, reticles, eyepieces, objectives, etc. Mail 10c for big "Catalog CH." Send \$1.00 for Stock CH—10-piece lens kit and big instruction booklet. Edmund Scientific Corp. (Formerly Edmund Salvage Co.), Barrington, N. J.

REFLECTING Telescope mirrors, 3", 4", 5", 6" diameters. Eyepieces, prisms, tubing. Priced right. Postcard brings plans, lists. Pfelecor Optical Co., PM-8, Sunbury, Penna.

AMAZING Prices, brand new precision binoculars, \$16.00 up. Free trial. Folder "Binocular Selecting," pricelist free. Prentiss Importers, Mercury Bldg., West Los Angeles 25, Calif.

MAKE Your 6" telescope reflector. Glass, abrasives, instructions—\$8.50. F. Cameron, Box 65, Inwood, N. Y.

REFLECTOR Telescope kits, refractors. Free illustrated bulletin. Esco Products, 911 Willow Ave., Hoboken, N. J.

GIANT Astronomical telescope with 6 ft. tripod \$15.00, f.o.b. factory. 100 power. (10,000 area magnification). Clear vision, full power guaranteed. Ready for use. Suffolk Science Service, Dept. BT, Riverhead, N. Y.

POWERFUL Astronomical telescopes easily made. Perfect lenses and instructions; 100X \$3.00; 100X and 200X \$4.00; 100X, 200X and 400X \$6.00. Full power, clear vision guaranteed. Instructions alone 10c. Suffolk Science Service, Riverhead, N. Y.

REFLECTING Telescopes, 60X, completely assembled \$25.00. Guaranteed observatory clearness. Free information. Skyscope, 475 Fifth Avenue, New York 17.

PETS—DOGS, BIRDS RABBITS, HAMSTERS, ETC.

GOLDEN Hamsters, pets and breeders \$1.00 each. Pandas, reasonably priced. Fred Battersby, 430 N. 4th St., Vineland, N. J.

NO Money needed. Raise rabbits for me. Stock furnished. Details for dime. Knickerbocker, Franklin Rd., Coventry, R. I.

SEE Gulf Hamstery ad on page 30. Shows picture of hamster.

HAMSTERS—Moneymakers. Send \$5.00 for beautiful virgin pair, cage, and illustrated instructions. Free prices. Dixie Hamstery, 502-C Trinity Lane, Nashville 7, Tenn.

BEAUTIFUL Pure white pedigreed police puppies. Ansonia Kennels, Mose, N. Dak.

RAISE Rabbits. Profitable business. Literature free. Tayco Rabbitry, Hapeville, Georgia.

GOLDEN Hamsters. Superior breeder and pet stock \$2.50 pair, \$3.75 trio. Free folio. Valley Hamstery, 734 North Milam, San Benito, Texas.

MAKE Big money! Raise Chinchilla rabbits. Cash markets supplied. Write today! Rockhill Ranch, Sellersville 15, Penna.

INCREASE Your income by raising domestic rabbits. Small space needed. Ready market for delicious meat, fur and wool. Largest magazine in the industry tells you how. \$1.50 per year. Sample 15 cents. No stamps. Small Stock Magazine, Lamoni 20, Iowa.

EARN Up to \$400 monthly raising Angora or New Zealand rabbits. Plenty markets. Particulars free. White's Rabbitry, Newark 38, Ohio.

RAISE Guinea pigs. Money makers. Booklet free. Taylors, B426A, Hapeville, Georgia.

MINK Raising information free. Complete. Lake Superior Mink Farm, Superior, EEL, Wisconsin.

A Practical beginning to successful rabbit raising. 48 page illustrated booklet. Dime. American Rabbit Breeders Association. 36 AR & CBA Bldg., Pittsburgh, Penna.

FARMS, FARM LANDS, REAL ESTATE

NEW Farm and business catalog free! Just out! Maine to Florida. Bargains from \$1000 up! West's, M-6, Pittsburgh 17, Penna.

WESTERN Ranch lands. Virgin timber. Hunting, fishing, river and highway frontage tracts. \$5 to \$10 acre full price. Easy terms. 10c (coin) brings land catalog, pictures. Pacific Lands, Box 2350-BW, Hollywood 28, Calif.

\$5.00 MONTHLY Buys 40 acres near town; price \$200; free list. Box 425-P, Carthage, Mo.

STROUT'S Farm and business catalog. 3084 bargains. 33 states. Mailed free! Buy now and save through Strout Realty, 7 So. Dearborn St., Chicago 3, Ill.

GOOD Farms — Ranches. Washington, Minnesota, Montana, Idaho, Oregon, North Dakota. Dependable crops, favorable climate. Write for literature, lists describing typical farm opportunities. Specify which state. J. W. Haw, 119 Northern Pacific Ry., St. Paul 1, Minn.

POULTRY, FARM SUPPLIES

KNOW How to raise poultry for profit. Read Poultry Industry. Every issue packed with helpful hints and practical suggestions. Latest articles on breeding, feeding and management. Subscribe now. 1 year 65c. 2 years one dollar, foreign subscriptions \$1.00 a year. Poultry Industry, Dept. P.M., 376 Boylston St., Boston 16, Mass.

EASY Ways to earn extra income are described in Money-Making Hobbies. 132 projects you can make at home and sell anywhere. 160 pages, \$2.00. Popular Mechanics Press, 200 E. Ontario St., Chicago 11, Ill.

PROFITABLE OCCUPATIONS

WANT A diesel job? Our approved, up-to-the-minute diesel training program can help you qualify for steady, big pay jobs or specialized military training. Covers diesel, tractor, heavy equipment. Easy to master. No loss of present income. Job placement advisory service. Investigate! Write for information today. Interstate Training Service, Dept. 3H, Portland 13, Oregon.

BOLIVIA Offers unlimited opportunities to wealth in mining, gold washing, coffee, tobacco growing, dairy, constructional engineering, manufacturing. Information 2 dollars airmail. Dr. Jimmy Kay, Casilla 380, Oruro, Bolivia.

TURN Your spare time into cash. Make quick-selling, highly profitable lamps — every home a prospect. No experience or special tools required. New 1951 56-page illustrated catalog shows shades, shade frames, figurines and bases, oil lamp converters, boring compounds, and dozens of similar items. Also all kinds of sockets, cords, pipes, harps, finials, bases, and hundreds of other parts — everything you need. Special 8-page section shows 6 beautiful lamps in kit form ready to assemble. You buy wholesale, sell at retail — make big profits. Hundreds doing it. You can, too. Send 25c today for catalog and wholesale price list. Refundable first order. Gearon Co., Dept. 500-B8, 27 S. Desplaines, Chicago 6, Ill.

"FROG Raising!" New book tells how! Illustrated literature free. Marlboro-A, Box 7002, New Orleans 19, Louisiana.

FOREIGN Employment construction men, building trades, helpers, office men, others, interested in foreign projects. High wages, quarters, trans. Listings of firms actively working on U. S. foreign intercontinental projects. Send \$1 for foreign construction compendium and application forms. Foreign Service Bureau, Dept. PM-8, Box 295, Metuchen, New Jersey. (Not an employment agency — no fees.)

MUSHROOMS Grown. Boxes, barrels. Instructions 50c. Spawn \$1.00. Manureless process. \$2.00. Gordons, 553 William, Winnipeg, Manitoba.

FREE Book "How to Make Money With Home Workshop" describes amazing methods used by hundreds of successful craftsmen. Tells what to make, how to sell workshop output spare time. Write at once for details. Remember it's free! Craftsman, 115-A8 Worth St., New York City.

\$3.00 HOUR! Part or full time. Service aquariums. Send 50c full instructions. Catalog. Box 47, Cathedral Station, New York 25.

GROW Mushrooms. Cellar, shed. Spare, full time. We pay \$3.00 pound. Free book. Mushrooms, 2954 Admiral Way, Seattle, Wash.

PRINT Without a printing press. Big profits! See page 28.

OWN A printing business. Good profits printing cards, stationery, etc., in spare time. Easy rules furnished. Have home shop. Send dime for illustrated printer's supply book and samples. Kelsey, Inc., T-24, Meriden, Conn.

EARN Up to \$400 monthly raising Angora or New Zealand rabbits. Plenty markets. Particulars free. White's Rabbitry, Newark 61, Ohio.

\$250 WEEK Reported! Free book, "505 Odd, Successful Businesses." Work home. Expect something odd! Pacific, Oceanside, Calif.

MAKE Flexible molds! Cast plaques, bookends, figurines! Free sample! H. Tooker, 630-M Chestnut, Hamilton, Ohio.

RESILVER Mirrors at home. Formula 25c. Ideal Service, Park Ridge 4, Illinois.

HAVE Fun! Make money! "Working With Leather" — 64-page booklet tells how. Send 25c for copy. No foreign orders. Free catalog and valuable information included. Wilder-Craft, 1039 Crosby, Chicago 10.

RAISE Pheasants on the \$100 week plan. Little capital and space can make you independent. Free details. Great Central Game Management System, Columbus 1, Kansas.

LIFETIME Income as notary public. Appointment assistance. Stationers, Helotes 50, Texas.

\$40.00 WEEKLY Made growing mushrooms, fresh, dried. Dominion patent 331583. Free spawn. North American, 169P Yonge, Toronto, Canada.

BE The Popular Mechanics representative in your neighborhood and earn big profits in your spare time. Write Popular Mechanics Magazine, Room 408M, 200 E. Ontario St., Chicago, Ill.

FOREIGN And Latin American employment. 1951 "Foreign Service Directory" gives up-to-minute facts on military and civilian construction, government jobs, major oil listings, aviation, transportation, steamship lines, mining, importers, exporters, how-when-where to apply, application forms, hot list firms hiring. \$1.00 postpaid. Global Reports, P.O. Box 883-P, Hollywood 28, Calif.

BOOKS, PERIODICALS, PICTURES POSTCARDS

WOODWORKING Ripsaw practice book by Hyler, woodworking wizard. \$1.75. Be a ripsaw expert. Hyler, 231 Rialto Building, Peoria 2, Illinois.

TWO Real illustrated Joke books with our fascinating catalog 25c. Aladdin Book Co., 210-P Fifth Ave., New York 10.

RENT Books, all kinds. Technical, non-fiction, fiction list for dime. Mohican, Fitch Ave., Poquonock Bridge, Conn.

HARD-TO-FIND Books supplied. Send wants. Pierce's, Winthrop, Iowa.

BOOKHUNTERS! Any subject, send wants! Atlantic Book Service, Lawrence Avenue, Charlestown 29, Massachusetts.

BOOKHUNTERS! All subjects. Send wants! Jaher Book Service, 620-P East 178 Street, New York 57.

MAGIC TRICKS, PUZZLES, JOKER NOVELTIES

ADVENTURES In Puzzledom — 50 fascinating, instructive puzzles, many varieties, set 1 20c. Graphic Quiz, 1063 Dwane St., So. St. Paul, Minn.

BIG Fun kit! Tricks, jokes, novelties, books. Clever and amusing. All for \$1.00. Johnson, 414 McRae, Wilmington, N. C.

PLASTIC Ventriloquist dummy with moving eyes and lips, instructions included 25c. Roalex, 32 West 39th Street, New York.

BEAUTIFUL Magic cigarette case. Fill with cigarettes, close, reopen and presto! Cigarettes have vanished. Magic case and illustrated circular, 50 cents. Royall's, 1920 Heights Boulevard, Houston, Texas.

FREE Trick and large illustrated catalog, 35c. Lerro Magic, 509 80th Street, Brooklyn 9, N. Y.

LATEST Magic for pocket, parlor, stage. Catalog 500 tricks, only 10c. Unequaled magic service for 30 years. Douglas Magicland, Dept. 1, Dallas, Texas.

WORLD'S Largest professional magic shop, keeps you in touch with latest tricks. To receive mailings, send 50c for new catalog. Holden's, M220 West 42nd St., New York.

512-PAGE Catalogue of 2500 tricks, pocket, parlor, stage. World's finest magic. Send \$1.50 for catalogue (refunded first \$6.00 order). Kanter's, M-1311 Walnut, Philadelphia 7.

PROFESSIONAL Catalog, 124 pages, 25c. Williams, 900 Plymouth, Ellwood City, Penna.

BE A magician. Large professional magic catalog of latest tricks, 35c. Ireland, C-109 North Dearborn, Chicago 2.

COINS, TOKENS, CURRENCY

OLD Money wanted. Do you know that coin collectors pay up to \$100.00 for certain U. S. cents? And high premiums for all rare coins? We buy all kinds. Send 4c for large coin folder. May mean much profit to you. Numismatic Co., Dept. 20, Fort Worth, Texas.

WANTED Rare coins. Describe fully. Samuel L. Bigford, Earville, N. Y.

35 DIFFERENT Selected coins, \$1.00. Oddehon, Box 482, St. Louis, Mo.

RARE Old coin, two wooden nickels, and "Coin Collector's" new magazine, 10c. Lawrence Brothers, Anamosa, Iowa.

JAPANESE Invasion notes for U. S. 1c to \$1000.00. Set \$2.00. Burma note and catalogue 25c. Shultz, Salt Lake 10, Utah.

FREE! Foreign coin, banknote and coin collectors illustrated catalog to approval service applicants. Send 3c postage. Tatham Coinco, Springfield 30, Mass.

GET Profit and pleasure in collecting old coins. Send 10c for 56 page illustrated coin catalog. You'll be delighted with it. Send for it now. B. Max Mehl, 370 Mehl Bldg., Fort Worth, Texas. Largest rare coin establishment in U. S. Established 50 years.

GIANT Fifty-two page illustrated price-list of coins, albums, supplies. Send dime to Ben's Coin Shop, 31 N. Clark, Chicago 2.

STAMP COLLECTING

FREE! Big "3." 3 Abyssinia, 3 Triangles, 3 Diamond shaped stamps, to new approval applicants. N. Moulblow, 740 Hegney, Bronx 56, N. Y.

SENSATIONAL! Set each Honduras, Martinique, Guadeloupe, Guiana, also \$2.-000,000 stamp, Brunel, over 100 different others. Everything 10c with approvals. Whitehead, 315P South 5th Ave., Canton, Illinois.

FREE! "Carnival" packet of midget, giant, and other "freak" stamps—yours with bargainful, temptingly-different approvals. Niagara Stamp Company, 12 Queensway, Niagara-on-the-Lake, Canada.

BOHEMIA Moravia collection free—25 different, high values, Hitler heads, pictorials—absolutely free with approvals. Viking Stamp Co., 130-ZZ Clinton St., Brooklyn 2, New York.

UNITED STATES stamps! Cheap! Catalogs. Sullivan, 115-F Endicott, St. Paul 1, Minnesota.

ARE You satisfied? If not, write us today. Ask for 1c and 2c foreign approvals. U.S. at bargain prices. References appreciated. Roseland Stamp Co., Dept. 10-B, Spring Lake, Michigan.

FASCINATING Congo idols only 10c with giant foreign approvals. Valuable premiums. Postage paid. Faith, 1339½ Westminster, Alhambra, California.

PENNY Approvals that satisfy. Neil Gronberg, Box 5441-P, Philadelphia 43, Penna.

U. S. Commemoratives—all different, 50—30c, 75—50c, 100—75c! Krick, 511 Fifth, Niagara Falls, N. Y.

FREE—Serbia, Bulgaria! Bonus approvals. Colonial, Box 326A, Passaic, N. J.

TRUMAN, Stalin stamps plus worldwide packet free to approval applicants. Conquistador, 15½ Troy Road, Schenectady 9, N. Y.

POUND Foreign mixture \$1.00, sample 25c. Book Nook, Oronoco, Minnesota.

BIG U.S. illustrated catalogue free. Stone, 45 Bromfield, Boston 8, Mass.

FREE—Complete set of famous Americans, flags, parks and presidentials to approval buyers. Send 3c for 15 of the above stamps plus full particulars. Triboro Stamp Company, 145 Nassau Street, Dept. 108, New York 38, N. Y.

KOREA, Fiji, U.P.U., Persia; free with approvals. Assured Stampco, Box 431, Miami 3, Florida.

FINE Approvals. Fast, personal service. What countries do you prefer? I'll send their stamps. Skinner, 438 Locust, Long Beach 12, California.

SURPRISE Premium free; approvals. Shonback, P.O. Box 989, San Francisco 1, California.

BARGAIN! 100 Different United States stamps—including commemoratives, airmails, only 10c to approval applicants. Sunset Stamp Co., Box 47, South Gate, Calif.

PENNY Approval bargains—Write Department PM, 1267 Tutwiler, Memphis 7, Tennessee.

70,000 STAMPS Sale. Grabbag 30c. Box, hundreds all different, blocks, sets and free gift \$1. Schollmeyer, Box 48, Brooklyn 25, N. Y.

NEED Higher wages? Not when buying our stamps. Try our books of 1,000 at 1c and 2c each, or economy U. S. approvals. Clark, Box 544P6, Muskegon, Michigan.

1000 MIXED U. S. and foreign. 25c. Monjar, Fairmount, Cincinnati 14, Ohio.

1/2c-1c APPROVALS! Bargains galore! Cole, 43-a Rinewalt, Buffalo 21, N. Y.

ROOSEVELT Set plus 25 different U. S. 10c approvals. Locust Stamp Co., Harmon-on-Hudson, N. Y.

FREE! Big United States catalog! Invaluable guide and check list. Hundreds of illustrations. Harrisco, Boston 17-W, Mass.

BEGINNER'S Collection of 500 different worldwide stamps—just 25c! "Beginners' Delight" approvals included. Niagara Stamp Company, 14 Queensway, Niagara-on-the-Lake, Canada.

FREE! Big illustrated catalog listing everything for the stamp collector. Harrisco, 202 Transit Bldg., Boston 17, Mass.

UNBELIEVABLE But true! 500 different stamps, free with bargainful beginners' approvals. Krick, 511 Fifth, Niagara Falls, N. Y.

FREE—Beautiful set diamond-shaped Costa Rica airmails sent to approval applicants. Pegasus Stamp Company, 716-M DeKalb Avenue, Brooklyn 16, N. Y.

BREAKING Up big collections, want lists invited. Private collections wanted. C. Ritchie, Watertown, S. Dak.

FLAG Stamp—Free with hydrate U. S. approvals. Wenigman, 1933 Patterson, Chicago 13.

FREE Booklet "Stamp Collecting in Ten Easy Lessons." Approvals. Redmon, Capitol Heights 1, Maryland.

TRIANGLES! Six bicolored beauties (ferocious beasts, tropical birds, etc.) With colorful approvals—only 10c! Atlas, 2830-t Eisenhower, Racine, Wisconsin.

FREE—Packet list. Many bargains. Reed, Box 980, Chicago 90, Illinois.

GIFT—Tokelau Is. complete mint to approval applicants. Deane Stamps, Box 487, Miami 35, Florida.

CHINA—100 Different 15c; 500, \$1.00. Fagan, 3408 North 41st, Milwaukee 16, Wis.

SOUVENIR Sheet free if you request approvals. Knight, Box 3770, Portland 8, Oregon.

FREE. Scott's International Album. Other big premiums. Full particulars with approvals. Raymax, 123-Z William St., New York City 38.

COMPLETE Clearance. Sensational bargain lists free. Beacon Sales, Maynard, Massachusetts.

NOVA Scotia, Prince Edward Island, Newfoundland. 20 different 45c to approval applicants. Green Co., Box 208, Toronto 1, Canada.

500 DIFFERENT 40c With approvals at wholesale to clear. K. S. Holmes, London, Canada.

50 DIFFERENT U. S. 10c. No approvals. Seidenberg, 944, Appleton, Wis.

STAMPS Wanted. Collections, duplicates, surplus stock, mint and used. Buy outright if bargain. What have you? Vanroy Shirk, Lebanon, Penna.

77 DIFFERENT United States—25c. Approvals. Utechts, 1143-D North Keeler, Chicago 51.

FREE Collection—Over 100 different stamps of world: commemoratives, animals, natives, ships, famous men, others all to approval buyers; also Scott albums, catalogs. Bell Stamp Service, Dept. S-2, Bell, Calif.

UNITED STATES approvals—Select, used or mint. Kingsbury, Woodbury, Vermont.

307 ALL Different—Only 15c! Beautiful collection: commemoratives, triangles, high values, bicolored stamps, etc. Garcelon, Calais 400, Maine.

NOTHING Free. Just good stamps reasonable. Send dime for seventy-four page catalog. Ben's Stamp Shop, 31 N. Clark, Chicago 2.

"HOW To Recognize Rare Stamps." Free book illustrated! Kenmore, Richford, H-57, Vermont.

FREE U. S. price list, postage 3c. Mark Hanna, 335 5th Ave., Pittsburgh 22, Penna.

OLD Scarce U. S. seconds on approval. Slightly defective. Bargain prices. Hernefield, Clintonhill Station, Newark 8, N. J.

FREE "Stamp Finder." Tells instantly country to which any stamp belongs. 32 pages profusely illustrated. Garcelon, Calais 17, Maine.

10,000 DIFFERENT 1c Each! Gordon Davison, Box 1019S, Manchester, N. H.

100 NETHERLANDS. All different. Beautiful assortment. 10c with approvals. Thomson's, Box 4074-P, Miami, Florida.

AMAZING Offer! 500 United States stamps—including commemoratives, airmails, high values to \$5.00. Only 10c to approval applicants! Illustrated bargain lists free. Mystic Stamp Co., Dept. 80, Camden, New York.

FIRST U. S. (1847) government reissues 5c, 10c, plus giant bargain U. S. collection—only 5c to applicants U. S. approvals. Metropolitan, Box 312G, Jackson Heights, N. Y.

10 ASSORTED U. S. Commemorative 15c. Five U. S. Air Mail 15c. 10 Famous Americans 25c. All for 50c. Ideal Stamp Shop, Box 179, Park Ridge, Illinois.

WOW! 203 All different Germany 10c! Zeppelins, semipostals, airmails, high values, etc. to new customers. Jamestown Stamp, Jamestown 512, New York.

WORLD'S Largest stamp (7½x14 inches). A real curiosity! Retail for 50c, only 3c to approval applicants. Tatham Stamp Co., Springfield 30, Mass.

UNITED STATES stamps nearly 100 years old, Roosevelt set, others, 40c value—only 5c to applicants United States approvals. Wakonda, Box 272K, Jackson Heights, N. Y.

500 STAMPS For only 10c! This mammoth value includes airmails, pictorials; stamps from strange countries, cataloging up to 25c each! Also approvals. Mystic Stamp Company, Camden 80, New York.

COLUMBIANS. Trans-Mississippi, Pan Americans, Pan Pacific, ten other different commemoratives. All 10c with your request for U. S. approvals. Moda Stamps, Box 251-X, C.S.A., New York 8.

MAGNIFIER. Big stamp magazine; first U. S. commemorative; plus unused \$5000 Foreign Legion, diamond, giant, and other worthwhile stamps. Everything free to approval buyers. Capital Stamp Company, Little Rock 2, Arkansas.

FREE! Powerful magnifying glass. Jamestown Stamp, Jamestown 202, New York.

200 DIFFERENT Including Roosevelt triangle, 5c to approval applicants. M. Avalon Stamp Company, Springfield, Mass.

OVER 1,000,000 Sold; 200 different stamps 10c with approvals. Carlton's, Tujunga, Calif.

500 EXOTIC Japan stamps—10c. Kenmore, Richford, J-57, Vermont.

750 FRANCE And colonies stamps 10c. Littleton Stamp Co., Littleton 25, N. H.

50,000 STAMP Grabbags 25c each. Anderson, 630B, Bingham, Reading, Penna.

FREE—Illustrated catalog! Kenmore, Richford, C-57, Vermont.

ANTIQUES, RELICS, INDIAN GOODS, CURIOS

ODDITIES, Antiques, relics most unusual. List 25c. Farish's, Vicksburg, Miss.

PRECIOUS STONES, MINERALS

GEMS, Cut and uncut, minerals, free price list. Warren's Minerals and Gems, P.O. Box 277, San Diego 7, Calif.

JASPER, Agate, quartz, and catalog 25c. Gemco, Elkhart Lake 1, Wisconsin.

GOLD—Genuine dust; gold bearing quartz. Specimens other earth's hidden treasures—Lead, zinc, copper, natural ores. Beautiful, complete assortment \$7.50. The Old Prospector, East Ely, Nevada.

FIND Tungsten, mercury, uranium with Mineralight. Free brochure. Write Dept. PM8, Ultra-Violet Products, South Pasadena, California.

GEMCUTTING, Silvercraft authority. Illustrated magazine tells how. Cut rocks, make jewelry. 150 ads illustrating equipment, offering gems for collectors, cutters. Postal brings literature. Lapidary Journal, Palm Desert, Calif.

GEMSTONES, Mineral specimens. Every variety. Lowest prices. Postcard brings free booklet. Plummer's, 2183C Bacon, San Diego 7, California.

HOBBIES AND COLLECTIONS

50 DIFFERENT Army embroidered patches \$1. Other bargains. Insignia Mart, 703A Broadway, New York 3, N. Y.

UNUSED Matchbook covers—100 different \$1.00 36-page catalog 25c. Charles Edelman, 1311C East 84, Cleveland 3, Ohio.

INVENTING Can be an interesting and profitable hobby. Write for complete particulars. Institute of American Inventors, Dept. 40-E 631-E St. N.W., Washington 4, D. C.

CAMERAS, PHOTO SUPPLIES

FREE Photographic bargain book packed with hundreds of sensational values in still and movie cameras, lenses and latest accessories. Super savings for you in new and used equipment. Liberal trade-in allowances, too, on your equipment. Write now for your free copy to Central Camera Company, Dept. 9H, 230 S. Wabash Ave., Chicago 4. (Photographic headquarters since 1899.)

GUMMED Photo album titles. Free samples. James Buttke, 3916 N. 6th St., Milwaukee, Wis.

PHOTOMURALS. Your negatives or ours. Catalogue 25c. Photomammoth Murals, 12048 Vanowen St., North Hollywood, Calif.

ULTRA Powerful telephoto camera easily made. Trifling cost. Objects miles away photograph close up. Carl Jamer, Box 694, Manorville, N. Y.

PHOTOCOPY Anything—Papers, books. No darkroom. 8½" x 11" complete \$6.95. Fotoflek, 8555 Plainfield Lane, Cincinnati 36, Ohio.

BASS Says: Trading cameras a national habit since 1910. Write to Bass the old "horse trader." A postcard will do. Simply say: "Bass, I have and I want. How much will you allow me?" It's fun to trade with Bass. Satisfaction guaranteed. Bass buys, sells, and trades. Bass Camera Company, Dept. AG., 179 W. Madison St., Chicago 2.

PHOTO FINISHING

GREAT News! Our famous Century jumbo oversize finishing at contact prices. Our Chicago plant, with new improved equipment, exclusive with Century, produces sensationally magnificent quality work. Any 8-exposure roll finished deluxe style only 35c. 12-exp. 50c. 16-exp. 60c. 36-exp. \$1.35. Oversize reprints 4c each. Free mailers. Send us your next order, you will be delighted with results. Century Photo Service, Box 5208, Chicago 80, Ill.

DOUBLE Size prints. 8 exposure roll 30c; 12, 45c; 16, 55c. Same day service. Send for free mailers. Emerson Photo, Box P, Emerson, N. J.

8 CONTACTS 30c, Jumbos 40c, 12—45c. Jumbo—55c. Reprints 4c, jumbos 5c. Free mailers. Western Photo, PM81, Box 298, San Francisco 1, Calif.

UNBEATABLE For quality and price. You will be surprised and pleased with the beautiful results from our celebrated jumbo oversize finishing. Low prices, same as contact. 8-exp. roll superfine finish only 35c. 12-exp. 50c. 16-exp. 60c. 36-exp. \$1.35. Oversize reprints 4c each. Send us your order, you will be delighted. Free mailers. Mailbag Film Service, Box 5440A, Chicago 80, Ill.

FAST Film service—You get dealers' prices and save up to 5c per photo. Developing and plastic-bound Super Pak album included. All prints enlarged to jumbo size. Satisfaction or money back. Write for free mailing bag and complete price list. Rochester Laboratory, Inc., Dept. M, Rochester 1, N. Y.

FREE Reload with each order of 35mm. developed and printed, \$1.50. Any 8 exp. roll 40c; 12 exp. roll 60c; 16 exp. roll 75c. Bonded prints are custom Hollywood professional quality. Why gamble? Free mailers. Bonded Photo, 1021 W. Santa Barbara, Los Angeles 37, Calif.

FILM Developed. First class work at prices you can afford. Returned same day received. 8 oversize prints 40c. 12—50c. 16—60c. Special offer, 35mm: 20 exp. 90c. 36—\$1.50, reprints 5c—Free mailers. Mail King, Dept. PM-4, Box 132, Hamden, Conn.

100 PHOTO Post cards from your negative, \$3.50; from print, \$3.95. Photo Reprint Service, 1256 Park Blvd., Camden 3, N. J.

EARN \$8.00 To \$10.00 daily with your movie projector. Write: Beverly, 10806 Glenroy, Chicago 43, Ill.

6 OR 8 Picture roll 35c, 12 or 16 picture roll 55c. Each roll printed and developed. Handy album pack. If you fail to get pictures on your film a new roll will be sent you without extra cost. Send coin with roll. No c.o.d.'s. Mailing containers sent free. DeLux Film Service, Box 1268-A, Shreveport, Louisiana.

8 OVERSIZE Snapshots from roll, 25c with this ad. Foto's, Box 8, Aurora, Illinois.

MAIL Us your films. Prompt service. 8 exposures developed and print'd 30c. Free enlargements. Foto Art Studio, Box 466, San Francisco, Calif.

16 PRINTS Or 8 jumbos from roll, 25c with this ad. S. Skrudland, River Grove, Ill.

MOTION PICTURES AND SOUND EQUIPMENT

PANCHROMATIC 8/8MM. \$1.10. 16mm. \$2.20, magazine \$1.75, processed free. Esdee, 567 Van Sicklen, Brooklyn 7, N. Y.

ADD Spice to home projection shows with colorful old-time Nickleodeon slides. 2x2. Write for free list. Nickleodeon Co., New Fieldner Bldg., Portland 5, Oregon.

FREE Movies. Thousands of subjects. Interesting. Entertaining. Fascinating. New directory—only 50c. National Cine Society, 126 Lexington, New York 16, N. Y.

ALMOST Free—With your request for Blackhawk's big 32-page catalog of film bargains—one brand new film, postpaid. (We select the title)—100' 16mm. sound, 98c; or 100' 16mm. silent, 59c; or 50' 8mm., 39c—as a special get acquainted offer. Other typical Blackhawk bargains: New 1-reel, 16mm. sound films, \$7.95 (formerly \$17.50); new 1-reel, 16mm. silents, \$2.98 (formerly \$8.75); new 1-reel 8 mm., \$1.89 (formerly \$5.50)—all first quality prints in original cartons. Used Panoram 100' 16mm. musicals—\$6.89 per dozen. Similar bargains in used features, cartoons, sports, comedies, musicals, travels. Used sound projectors—Ampros, Bell & Howells, Victors—often available low as \$129.95. Bargains in reels, cans, supplies. World's biggest stock 16mm. films—over 100,000 prints. Write today for Blackhawk's free catalog and get acquainted offer. "Sixteen's Super Market." Blackhawk Films Inc., 1202 Putnam Building, Davenport, Iowa.

16MM.-8MM. films. Royal Film Service, Passaic, New Jersey. Lists.

UNUSUAL 8-16MM. movies. Full-color projection length sample, \$1.00. Color Tru-Art slides, three samples \$1.00. Big catalog, 25c (refundable). National Film Supply, Toledo 9-H, Ohio.

5000 NEW-Used 8-16mm. silent-sound films. International, 2120 Strauss, Brooklyn 12.

8-16MM. Silent-sound films. Complete rental library. All latest subjects. Free catalogue, sample film 10c. Garden Film, 317 West 50th, New York 19.

BASS Says: Leadership since 1910 guarantees satisfaction. Finest Cine equipment: 8mm., 16mm., and 35mm., silent and sound. Write the old "horse trader." Satisfaction or your money back always! Bass Camera Company, Dept. A, 179 W. Madison St., Chicago 2.

RENT 16MM. sound films, 50c reel. Large selection; free catalog. Film Service, 128 Chestnut St., Roselle Park, N. J.

GUARANTEED Fresh 8mm. roll, magazine; 16mm. roll, magazine movie films. Color, b&w. Free catalog. ESO-S, 47th Holly, Kansas City 2, Missouri.

MOVIE Camera film: 8mm. roll \$1.50, 16mm. 100' \$3.00. Free processing. Better Films, 742 New Lots, Brooklyn, N. Y.

MUSIC AND MUSICAL INSTRUMENTS

ELECTRIC Guitars, amplifiers, wholesale. Free catalog. Carvin PM, Baldwin Park, Calif.

FOR Sale. A fine collection of old violins. Very rare. C. T. Cole, 918—13 St., Paso Robles, California.

POEMS Wanted. Broadcast consideration. Sooner Song Co., 22PM North West 8th, Oklahoma City 2.

MUSIC Composed to sacred words. Manuscripts printed. Dorby Publishers, P.O. 738, Morristown, New Jersey.

GUITAR. Master only 12 chords, play hundreds of songs. \$1. Details free. Bennett, 629 N. St. Andrews Pl., Hollywood 4, Calif.

MUSICAL Instruments, accordions, guitars, 10-day trial, free bargain list. Meyers, 454-A Michigan, Detroit 26, Michigan.

HARMONICAS, Accordions, zithers, banjos—catalog. Belanger, 51-A Talcott, Rockville, Conn.

SONGWRITERS! Send poems, songs. Music Service, 243 West 72nd St., PM, New York 23.

SWING Piano—By mail, 30 self-teaching lessons \$3. (Samples.) Phil Breton Publications, P.O. Box 1402, Omaha 8, Nebr.

POEMS Wanted for musical setting. Send poems for free examination. Five Star Music Masters, 630 Beacon Bldg., Boston, Mass.

MUSIC Arranged. Songs printed. Frank Wildt, Music Publisher, Lancaster, Penna.

POEMS Wanted to be set to music. Free examination. Send poems. McNeil, Master of Music, 510-PM S. Alexandria, Los Angeles, California.

WRITE Songs. Big money and reputation. Write for information. J. Gordon Pub. Co., 4700 South California Avenue, Chicago.

WANTED! Poems for musical settings. Write Songwriters' Service, Clifton, N. J.

SWISS Musical movements \$1.00. Catalogue 10c. Bell Music, 1610 First Avenue, New York 28, New York.

ACCORDIONS — All brands. New and used. Save 50%. Wholesale to every one. Del Principe, 307 So. Wabash, Chicago, Ill.

1951 ACCORDION — Wholesale. Free catalog. American Accordion Center, 5329 Belmont, Chicago.

YOUR Voice made loud, clear and powerful with my diaphragm exerciser. Write, inventor "Oz," Box 665, St. Louis, Mo.

RADIO AND TELEVISION

BUILDER'S "Pictorial Construction Plans," Free list. Arthur Alena, Box 24, Astoria 6, New York.

ENGINEERING Service—Radio and electrical. Henry Twillmann, R.R. #1, Chesterfield, Missouri.

RECORDERS. Wire, tape, disc. Webster, Revere, Ampro, Wilcox. Wack's, 32nd and North, Milwaukee, Wis.

AMATEUR Radio license preparation. Correspondence course. Low cost. Personal coaching. Federal Electronics Institute, 34 E. Putnam, Dept. B, Greenwich, Conn.

15 TESTED One-tube circuits 25c, including "Radiobuilder," catalog. Laboratories, 411-C Capitol Hill, Reno, Nevada.

RADIO-Television tubes —All types, standard makes. Large or small quantities. Attractive discounts. Write for lists. Electronics Supply, 1020 Broad St., Newark, N. J.

BUILD Cheap sensitive antennae, circular, rhombic, yagi. Plans 25c each. All 50c. Frieberger, Box 532, Texas City, Tex.

MAKE Simple, tubeless, batteryless, distance-getting crystal radios. Crystal and illustrated instructions 25c postpaid. Allen, 427-P, Clinton, Mo.

BUSINESS OPPORTUNITIES

CASH Backyard income! Unusual businesses! Details free. Pickett's, Florence, Kentucky.

PROFITABLE Sawfiling method. Instructions free. Zapart, 586-PM Manhattan Avenue, Brooklyn 22, New York.

TRADE Magazines help you to success. Get latest copies through our easy-to-get-acquainted service. Nearly 1200 business, professional, agricultural, automotive, educational, sport, hobby, music, writer, television, etc. List free. Commercial Engraving Publishing Co., 34C North Ritter, Indianapolis 19, Indiana.

MAN! These are hot! Make \$6.35 on every sale. Sales are really easy. New adding machines in original factory cartons you can sell for only \$12.95 and you make over 45%. They're executive model portables, precision built, fully guaranteed. Send for life-size color photo with full details. Write today to Lightning Adding Machine Co., Inc., Dept. P8, 1260 West Second St., Los Angeles 26, California.

START Home manufacturing business making cleaning compounds, soaps, insecticides, cosmetics, polishes, food flavors. No machinery. Literature free. Kemix, Park Ridge 9, Ill.

BIG Money! Spare or full time in your home. No selling! Spray new miracle finishes, plush and suede, on signs, radios, automobiles, figurines, lamps, toys, etc. Our business is booming. Help us fill huge demand. New easy Flok-Kraft methods. Material costs few pennies. You get dollars. Free samples, complete powerful money-making plan free. Write now! Coast, 1002L S. Los Angeles St., Los Angeles 15, Calif.

START Your own business on credit. Always your own boss. 1437 dealers sold \$5000 to \$28,500 in 1950; their average \$6704. We supply stocks, equipment on credit. 200 home necessities. Selling experience unnecessary to start. Wonderful opportunity to own pleasant, profitable business backed by world-wide industry. Write Rawleigh's, Dept. H-U-PPM, Freeport, Ill.

TREMENDOUS Profits, new guaranteed Cedar-Wall! Mothproofs closets, drawers, trunks forever! Laboratory approved, applied like paint. Building supply dealers, stores, contractors, housing developers buy quantities. Attractively packaged, strong sales material. Exclusive distributors, write, wire now for samples, etc. Millen Mfg., 96A Summit Ave., Brookline, Mass.

MIRROR Resilvering. Wonderful home business. Complete formula 50c. Magic two-way mirrors. You can see out—no one can look in. Formula 50c. How to make coppered mirrors, vases, glasses. Formula 50c. All three \$1.00. Nelko Chemical Service, Box 3462-MH, Chicago 54, Ill.

MONEY In new greaseless doughnuts. Start in kitchen. No smoke. Sell stores. Free recipes. M. Ray Company, 3605 South 15 Ave., Minneapolis 7, Minnesota.

MAIL Order—Strictly co-operative, unusual opportunity. Items of merit. Sample, details \$1.00. Manager, P.O. Box 757, Newark 1, N. J.

YOU Can make \$42 cash profit selling 24 religious necklaces. Miraculous, sacred heart, etc., medals encased in everlasting plexiglas. 18" gold plated chain. Gift boxed. Sample \$1.00 (Retail \$2.50) sent first class mail. Money back guarantee. Free money-making catalog. Stephen Products, 1947 Broadway, Dept. P, New York 23.

FREE Mail selling advertising book. Unique, different, hooks, punch. Carl H. Torrey, Melrose 76, Mass.

\$10 HOUR! Invisible reweaving course, including steel tool, 17 pictorial samples, material for life. \$3 complete. Details free. Walsh, 894 Main, Buffalo 2, N. Y.

EXTRA Dollars. Spinning angora wool for us. Angora House, PM, Springfield, Illinois.

HUNDREDS Of unusual moneymaking plans 25c to \$10.00. All or spare time. Catalog 25c (refundable). Charles Company, 12-BWQ, Norwood, Ohio.

DOLLARS Daily in your mails. All profit plan. Spare, full time. VeeJay, 14707M CimSta., Los Angeles 18, Calif.

MAKE Rubber stamps, repair dolls, invisible reweaving, metalize baby shoes, silver mirrors. Catalogue of "40-Ideas" free. Universal, Box 1076-A, Peoria, Ill.

LIFE-TIME Security! Manufacturing chemical specialties! Extremely profitable! Formula lists free. Thermolab, Peoria 4, Ill.

INCREDIBLE Profits of war surplus can be yours. Read the new 1951 copyrighted war surplus report. Tells how to buy direct from Government. Covers every phase of surplus dealings. Satisfaction guaranteed. Only \$2.00. S. & S. Publications, Box 1218A, Goldthwaite, Texas.

WANTED! At once! Home producers by manufacturers in our clearing house service. Become a sub-contractor, casting plastic products for these companies. Thousands of easy to make items required. Cash in at home without previous experience. For details write Plastic Service Guild, Dept. PM, 233 Condor St., E. Boston 28, Mass.

OWN A profitable business. 137 successful plans. No capital or experience. Stanko, 6215 Woodhaven, Rego Park, New York.

\$200 WEEKLY Reported! No selling. Free booklet. T. J. Surface, Roanoke 4, Virginia.

ATTENTION! "Your Phone Is Your Fortune." Tells how to turn your telephone into dollars. Send \$1.00. Sales, Box 675, Richmond, Va.

BUY Wholesale—Million articles. Supply source directory, dime. Nelko, Box 3462-DR8, Chicago 54, Ill.

HOW And where to obtain capital. Free particulars. Star Service, Wapakoneta, Ohio.

YOUR Name and address on postal will bring many local and mail business opportunities. Apex Supply, Box 165, New York 18, N. Y.

HOME Business of your own! Full time or spare time earnings up to \$500. monthly. Information free. Western B. Aircraft, Los Angeles 19.

PROFITS! Pleasure! Preserve live flowers and leaves. Rich, untapped market. Ideal home business, hobby or pastime. Easy-to-follow instructions \$1.00. Satisfaction or money back. S. Butowsky, 1918 N. 32, Philadelphia, Penna.

SEWING Machine spare and full time repairmen wanted. We train you. Income unlimited. Motors, new machines, supplies furnished. Write Taylor Service Co., Hamilton PM8, Ohio.

FORTUNE'S Favorite plan, the beginner's friend. Write Ad-Man Dankmeyer, 2831-A Guilford, Baltimore 18, Maryland.

EARTHWORMS—100 Till-O-Cast breeders \$1 postpaid. Free instructions. Mrs. Howard E. Smith, R.3, Jonesville, Mich.

MAKE Tough, durable plastic—1c pound. Makes attractive floors, walls, built-ins, roofs. Build good home, \$150.00 room. Bays Laboratory, Oklahoma City 9.

DOLL Hospital practice selftaught. \$1.25 prepaid. Box 755 Southkent Branch, Grand Rapids, Michigan.

CAREY Laboratories. Write "Carey Laboratories," 1914 Chouteau PM-8, St. Louis 3, Missouri.

TO \$35.00 Weekly. Spare time, home operated mail order business. Successful small "beginner's" plan. Everything supplied. Lynn, 5710-M Bankfield, Culver City, California.

UNPAINTED Figurines. Illustrated list. Free. Oman, 642 Broadway, St. Paul 1, Minnesota.

MAKE Chemical products at home. Profitable. Kits for home manufacturing. Literature free. Kem Products, Moriches, New York.

WHERE To buy at wholesale 100,000 articles. Free list. Also extra-income literature. Maywoode, 1133 Broadway, New York.

SELL By mail, free details, instructive booklet 25c. Manhattan House, P.O. Box 51-M, St. Albans, N. Y.

HOW To set up and run a mirror shop! Resilvering mirrors. Making chipped glass nameplates. Electroplating salts and rectifiers. John Sprinkle V60, Marion, Indiana.

EARN Spare-time dollars. "Here's How" tells how. Sample copy 25c. Associated, Box 1441-P, Des Moines, Iowa.

WATERLESS Hand cleaner. Cleans thoroughly. (No ammonia, no kerosene.) Easily prepared. Good profit. Formula \$1.00. Nelko Chemical Service, 3462-H Merchandise Mart Sta., Chicago 54, Ill.

MAKE Perfume—Catalogue free. International, 6347 Parnell-PM-8, Chicago 21, Illinois.

FREE Illustrated instructions, casting novelties. Genuine latex for molds. Major Chemical & Latex Co., 25 Allerton St., Boston 19, Mass.

INEXPENSIVE. Profitable home process for electroplating metals, mirrors, non-metals. Free booklet. Tyco Metals, Box 13231-AD, Houston 19, Texas.

BRONZE Baby shoes, complete illustrated instructions, data on tested sales plan showing how to get thousands of new prospects every month (without canvassing), everything—\$2.00. Box #1167, Saginaw, Michigan.

FIX Typewriters—Home study course quickly trains you for own business. Factory methods taught. Write: Typewriter, 8915 Corbet, Tarentum, Penna.

PRINT Without a printing press. Big profits! See page 28.

FORTUNES Made from sandwiches. New system. Equipment furnished. Dickerson Manufacturing, Drawer 30-A, Springfield, Missouri.

GROW Mushrooms. Cellar, shed. Spare, full time. We pay \$3.00 pound. Free book. Mushrooms, 2954 Admiral Way, Seattle, Wash.

GO In business for yourself part or full time. Electric steak knife serrator, patented, guaranteed. 15 seconds per knife, wide profits. Write for full information. Duro Sales, 3162 W. 159, Cleveland 11, Ohio.

FREE Literature. Your own business. Profitable permanent. Hubbard, 6 North 6th Street, Yakima, Washington.

MAKE Gifts, novelties, from sea shells, fish scales and plastics. 150 beautifully photographed designs. Secret pearlizing, bronzing, luminizing, metalizing, dyeing, tinseling processes disclosed. No tools or experience needed. Giftcrafts, Box 4550-MP, Coral Gables, Fla.

\$46 FROM Square foot plywood; jigsaw necessary. Literature free, write today. Woodarts, Bridgewater, Mass.

SPECIAL Rubber for making molds. Literature and sample free. Universal, Box 1076-A, Peoria, Ill.

EARN Up to \$400 monthly raising Angora or New Zealand rabbits. Plenty markets. Particulars free. White's Rabbitry, Newark 92, Ohio.

BOOKKEEPERS. Keep books, small firms spare time. Manual latest technique by C.P.A., \$3.00. Modern Business, Box 406, Youngstown 1, Ohio.

FREE Book "372 Unusual Worldwide Businesses." Work home (U.S.A.)! Publisher, Carlsbad, Calif.

EARN Money at home with your typewriter! Spare time! Details free. Edwards, Publisher, 3915-PM, 12th, Des Moines 13, Iowa.

ESTABLISH Profitable home mail business. Exclusive built-to-order proposition service. Everything handled for you. Booklet free. NMD Agency, Box 88-W, Dorchester 22, Mass.

MAKE Money spare or full time casting metal toys and novelties. Big wholesale and chain store demand for autos, soldiers, ashtrays, banks, etc., keeps manufacturers busy. Production moulds furnished for up to 100 and more castings per hour. No experience or special place necessary. "Cash-in" on holiday orders now being placed. Write for information and illustrations of patterns needed. Metal Cast Products Co., Dept. A, 1696 Boston Road, New York 60, N. Y.

\$250 WEEK Reported! Free book, "505 Odd, Successful Businesses." Work home. Expect something odd! Pacific, Oceanside, Calif.

START A venetian blind laundry. Profit opportunity for lifetime business. New machine method. Free booklet on request. F. C. Co., 442 N. Seneca St., Wichita 12, Kansas.

MAKE Money at home as renewal headquarters for all magazines. Liberal commissions. No experience, no capital needed. Supplies furnished. Write for free catalog. McGregor Magazine Agency, Dept. 500B, Mount Morris, Ill.

INCOME From local information. No selling. Write Neherco, La Verne, Calif.

NATURAL Molding Latex. Extra thick. Free sample. W. Wooley, 115-A Donald, Peoria, Ill.

QUICK Sign painting. Use letter patterns, avoid sloppy work, wasted time. Write for folder. John Rahn, A1330 Central, Chicago 51.

MAKE Flexible molds! Cast plaques, bookends, figurines! Free sample! H. Tooker, 630-R Chestnut, Hamilton, Ohio.

NEW Profitable home business repairing zippers. Thousands of customers waiting. No experience required. We furnish everything. Write Texas Specialty Company, 204-B Texas, Texarkana, Texas.

UNPAINTED Bookends, plaques, statues, figurines. List. Haverty Products, 822-17th St., Altoona, Penna.

EARTHWORM Breeding. Valuable bulletins on successful methods mailed free. Earthmaster System, Dept. 14, El Monte, Calif.

YOUR Own profitable home business. Preserve live flowers to last for years. New simple discovery. Enormous demand all year round. Tremendous profits! Light fascinating work. Send \$2.00 for working equipment, instructions, and valuable sales plans. Satisfaction guaranteed or money promptly refunded. Alfred Hermansen, 210 Fifth Ave., Suite 1102A, New York 10, N. Y.

START Mailorder bookshop—Everything furnished. 25c brings booklet, samples, exciting ideas. General Publications, Ossining, N. Y.

THOUSAND Articles wholesale. "Supply Source Directory" 10c. Ideal Service, Park Ridge 30, Illinois.

BE Appointed state notary public now! Details. Stationers, Helotes 50, Texas.

OPERATE Profitable mail order business. Write Walter Service, 4159-A East 112th, Cleveland 5, Ohio.

DOLLARS In personalized baby record books. Sell by mail. Use same literature we do. No-Co-Re, Oakland 6, Calif.

FABULOUS Earnings—Fascinating pastime. Growing genuine, living miniature (ming) tree. New sensational business or hobby. Astounding information free. Dwarf Gardens, Box 355B, Briggs Station, Los Angeles 48, Calif.

BRUSH Plating outfits connect to a battery. No tanks necessary. Good paying business at home plating autoparts, bathroom fixtures, bicycles, reflectors, silvering mirrors. No shop or experience required. Outfits furnished. Free booklet. Gunmetal Co., Ave. H, Decatur, Ill.

COMMERCIAL Deep frying course. Mock chicken legs, potatoes. New and proven methods. Learn about this money-making field. \$2.50 p.p. Concession, Toledo 13, Ohio.

RECAST Old batteries into new. Latest achievements. Battery Laboratories, Minneapolis.

MADE \$24,500 Using money making plans from Schemer Magazine, world's oldest mailorder publication. Box 275M, Canfield, Ohio. Year \$2.00. Sample 20c.

MINK Raising information free. Complete. Lake Superior Mink Farm. Superior, E.E.I. Wisconsin.

POPCORN And potato chip equipment. Long Eakins Company, 5160 High, Springfield 99, Ohio.

COPUBLISH Leading m.o. paper. Latest copy Mail Sale Advertiser, details, dime. Vanroy Shirk, Lebanon, Penna.

READ "Advance"—The voice of mail order. Offers money-making opportunities, sources of supply, personal guidance, etc. Issued monthly. Sample copy 25c. Yearly subscription \$2.00. Advance Publishing Company, 313 East 21st Street, Suite 450, New York 10, N. Y.

CO-PUBLISH And advertise in The Central Mail Advertiser. Sample copy 10c. Low rates. Large circulation. Bagby Printing Co., Georgetown, Ohio.

BUY It wholesale! Manufacturers, distributors offer 850,000 items. Literature free. Olsen, 1231-A East Third St., Duluth 5, Minn.

LIQUID Rubber. Make flexible molds. Free sample. Chaney, 1130 E. 16th St., Jacksonville 6, Fla.

MAILING Postcards selling repeat merchandise is profitable. Everything supplied. Details free. Gordan Publishers, Box 23, Pawtucket, R. I.

MEN—Women. Everybody likes candy. Learn to make professionally. Our 40th year. Ragsdale Candies, D5, East Orange, New Jersey.

COLORGLAZED Concrete pottery made without molds. Patented method. Cemetery products, novelties, tiles. Basement leak-sealing. Money-making projects. Booklet, details free. Men only. National Potteries Company, Grand Rapids, Minnesota.

SECURITY. \$10,000.00 yearly possible. Investigate. Boyd, 329 Fourth, Pittsburgh 22, Penna.

MONEYMAKING OPPORTUNITIES

BE An arm chair farmer. An investment of \$60 can return as much as \$500. Let the farmer do the work for you. Repeat as often as you like. Complete plan \$1. Sure-fire. Sabetha Enterprises, Box 111, Sabetha, Kansas.

FLOOR Polishing! Free new plans and ideas. Start money-making, lifetime business. Send postcard: Don McCanna, 148-A East 40th, New York 16.

NUMEROUS Money making offers free. Keena, 1312 Jefferson, Grand Rapids 7, Mich.

EARN Extra money! Spare time. Write—D'Yarmett, 245 Church, Newark, Ohio.

MAKE Money at home with "Mail Gazette." Information, 10c. Mercer, 583 Timberlake, Upper Darby, Penna.

EARN \$100.00 Weekly at home. Free details. Universal, Box 664-M, Springfield, Missouri.

\$35 WEEKLY! Home! Two hours daily! 27 unusual ways. Walsh, 894 Main St., Buffalo 2, N. Y.

"HOW To Win Contests." Detail free. Columbia Mailers, Box 644, Springdale, Conn.

MONEY Making ideas, etc. Box 297, R 1, Pekin, Illinois.

MAIL Gazette, leading mail order newspaper. Sample copy 15c. Worthwhile moneymaking opportunities included. Variety, 57-H Circuit Avenue, Newton Highlands 61, Massachusetts.

FREE "Success Plan" (worth \$2)! Describes \$10,800 business on "shoestring." free mailorder book. Treasury, 149 Storer, New Rochelle 48, New York.

WHERE To swap-buy-sell anything. Free information. Toole, 5 Bernardin Apts., Evansville, Indiana.

START Profitable home business now. Write. Vee's, Box 301-PM, Decatur, Ga.

SELL Merchandise, books, using low-cost, effective, mailing pieces! Samples, 10c! Details, free. Box 685-P, GPO, Brooklyn 1, N. Y.

GROW Mushrooms. Cellar, shed. Spare, full time. We pay \$3.00 pound. Free book. Mushrooms, 2954 Admiral Way, Seattle, Wash.

\$100-\$200 WEEKLY. No selling or manufacturing. Charge \$80 up. Each job takes 8 hours. Theodore Mahaffey, 3032 Weldon, Los Angeles 65.

FREE! Moneymaking plans galore. Wilbur Erickson, Box 141, Englishtown, New Jersey.

\$250 WEEK Reported! Free book. "505 Odd, Successful Businesses." Work home. Expect something odd! Pacific, Oceanside, Calif.

"HOW Rich Men Get That Way." Secrets to great wealth revealed in book. \$1.00. Morley Publishing Co., 425-43rd St., Sarasota, Florida.

MEXICAN Jumping beans 150% profit. Details. Mann's, 5330 No. Natoma, Chicago 31.

MAKE Money at home. 101 ideas for full or spare time earnings. Proven winners. All for 25c. Thomas F. Patrick, c/o State Farm, Pikeville, Tennessee.

"WATERLESS (Lanolin) Hand Cleaner." (Oil base.) Make, sell. No machinery. Build profitable business. Complete formula \$1.00. Ideal Service, Park Ridge 3, Ill.

DOLLARS Three ways with "Kitty-Kat" readi-cut baby shoes. Complete local and mail order plans. Write No-Co-Ro, Oakland 6-K, California.

RAISE Your business value, standing, as state notary public. Information. Stationers, Helotes 50, Texas.

PUBLISH Your own magazine. Handsome 52 page format, well edited, illustrated. Cost low as \$1.00 month. Brings you prestige, profits, 25c brings sample, details. National, Ord, Nebr.

READ Progressive Mailtrade, the magazine that tells how to make money by mail. Dime brings sample and special offer. Progressive Mailtrade, Box 357, Sheboygan, Wisconsin.

LEARN How others earn money at home! Write—A. Sizemore, 4917 Kostner, Chicago 30, Ill.

EARN Money evenings, copying and duplicating comic cartoons for advertisers. Adservice, Argyle 1, Wisconsin.

300 PROJECTS You can make in Popular Mechanics 32-page Blueprint Catalog. Send 3c stamp for copy. Popular Mechanics Press, Dept. BP, 200 East Ontario St., Chicago 11, Ill.

FORMULAS, PLANS, ETC.

UNUSUAL Formulas, recipes, one way mirror, yogurt, others. List free. Bruce, Box 341-PS, Palo Alto, Calif.

ANY Formula \$1 or refund. Dr. Paul, 11559 Kling Street, North Hollywood, Calif.

FORMULAS. Latest, best. Catalog and chemical instruction sheet 10c. (refundable). Nelko Chemical Service, 3462-F Merchandise Mart Sta., Chicago 54, Ill.

REAL Manufacturing formulas. Lists free. Cummings, Chemist, Gordon Ave., Syracuse 4, N. Y.

MAKE—Sell cleaners, soaps, polishes, flavors, cosmetics. No machinery. Formula literature free. Kemico, Park Ridge 16, Illinois.

FORMULAS. Trade secrets, for nearly everything. Catalog free. Creative Publishers, Winnetka 6, Illinois.

TESTED Formulas. Interesting descriptive booklet free. Pont, Box 635-PM, Terre Haute, Indiana.

PLASTICS

LUCITE. Plexiglas, acetate; casting, molding plastics, findings. Dye manufacturer. Quantity prices. Special bargain lots, immediate shipment. Complete catalog 10c. 25c airmailed. Gem-O'-Lite, Box 6863, North Hollywood, Calif.

HI-Profits, internally hand carved plastics, gifts—jewelry. Free catalogue. Pilot Plastics, 67-C-Fulton St., New York City 7.

NEW Liquid plastic. Clear, colors. Cast without heat. Embed flowers, insects, coins. Saw, drill, carve. Free folder, "Liquid Magic," shows fine things you can make and sell. Write today. Castolite, Dept. J-101, Woodstock, Illinois.

LUCITE. Plexiglas. Any size sheets, masked. Square foot (12 x 12) cost, 1/16", \$1.20; 1/8", \$1.40; 3/16", \$1.75; 1/4", \$2.08. Include 10% postage. Almac Plastics, 230 Fifth Ave., New York 1, N. Y.

PLASTIC. Sheets, rods, tubes, etc. Free list. Plastic Supply Co., 2901 N. Grand Blvd., St. Louis 7, Mo.

CHEMISTRY

NEW Idea chemical and apparatus outfits for home experimenting. Photo-scales, microscopes, chemicals, biological and laboratory supplies in small quantities. Catalog 25c. Established 1931. John H. Winn, 124A West 23rd Street, New York, N. Y.

ILLUSTRATED Catalog: Chemistry, mineralogy, biology, 10c. Tracey Laboratories, Evanston, Illinois.

CHEMICALS And apparatus for industrial, analytical, and private laboratories. Catalog 15c. Dept. M-50, Biological Supply Co., 1176 Mt. Hope Ave., Rochester 20, N. Y.

AGENTS WANTED

EXTRA Money reward! Free gift offers! Sell friends outstanding Christmas, all-occasion greeting cards, gift wrappings, novelties. Big profits. Bonus. Experience unnecessary. Request feature assortments for free trial approval, free samples name imprinted Christmas cards, stationery, napkins and free catalog. New England Art Publishers, North Abington 504-A, Mass.

MAKE Money with Merritt. Sell Davis air cushioned shoes, dress, work, heavy duty. Popular priced. Advance commissions. Cash bonuses. Experience unnecessary. Write to Geo. Merritt Shoe Co., C-81, Brockton, Mass.

ANYONE Can sell Hoover DuPont Nylon uniforms for beauty shops, waitresses, doctors, nurses, others. In white and colors. Exclusive styles. Top quality. Low priced. Exceptional income. Real future. Equipment free. Write fully. Hoover, Dept. P-100, New York 11, N. Y.

JUST Out! New, thrilling sensation in Christmas cards. Make big money! Show lustre foils, satins, brilliants. Amazing values bring easy orders! Christmas cards with name 50 for \$1.25 up. Also imprinted book matches, stationery, many gifts. Get 30 free samples with name; several \$1 boxes on approval. Joy Greetings, 507 N. Cardinal, Dept. K-60, St. Louis 3, Mo.

ABSOLUTELY Free! Big package actual sample fabrics and style presentation of dresses, lingerie, hosiery, etc. Take orders. Commissions big. Send no money. Melville Co., Dept. 6192, Cincinnati 25, Ohio.

NAMEPLATES For homes, offices. Free samples. Whitneys, 94 Boulevard, West Springfield, Mass.

\$200 WEEKLY. Sell outstanding silverplate, flatwear. Murphy-Yale, Meriden, Conn.

\$80 WEEKLY Making four sales daily! Sell cushioned, non-cushioned shoes. Work shoes guaranteed six months. Free outfit. Concordian Shoes, 8-C West Concord, Mass.

SHINE Shoes without "polish." New invention. Lightning seller. Shoes gleam like mirror. Samples sent on trial. Kristee 130, Akron, Ohio.

CASH In on spare time. Sell wonderful Regal Christmas cards exclusive with us. 25 sell for \$1.00. Also 50 for \$1.25. Over 150 other boxes. Free samples. Kit on approval. Regal Greetings, Dept. 92, Ferndale, Michigan.

MAKE Money fast. Sell big value Christmas and everyday card assortments to friends, others. 7 leading 21 card \$1.00 boxes. Religious, metallic, comic, secret pal cards. Gift wrappings, ribbons, scented stationery. Many gifts; rain sandals, automatic telephone pencils, totebrushes, napkins. Over 100 items. Amazing profits. Bonus plan. No experience necessary. Write today for samples on approval and special "get started" offer. Hedenkamp, 361 Broadway, Dept. PM-14, New York.

IS \$210 A week worth a penny postcard to you? Then rush card with name and address for special free trial plan that sells amazing new automatic refrigerator defroster "like hot cakes!" Write to Mr. Lewis, D-Frost-O-Matic Corp., Dept. PMC-8, 6 N. Michigan, Chicago 2, Illinois.

BEST Source for nylons. Rich Supply, 215 W. 98, New York 25.

MAKE Wedding profits. Sell invitations, napkins, matches. Samples free. Dunbar's, Middlebush 3, N. J.

EXTRA Cash—Quick, easy! Sell friends newest greeting cards. Profits to 50c per \$1.00 box. 21-card \$1.00, comic Christmas, all-occasion assortments, gift wrap ensembles, exclusive items. Experience unnecessary. Special offers. Bonus. Prompt service. Write for free samples name imprinted Christmas cards, stationery, napkins, book matches, feature assortments on approval, free catalog. Elmira Greeting Card Co., C-2209 Elmira, New York.

BEAUTIFUL Chenille flowers and novelties. Free catalogue. Midwest Supply Co., Box 2193, Casper, Wyo.

CALL On friends with sensational Christmas cards in handy assortments. Exclusive designs. Sell for \$1.00. Profit up to 50c. Also popular-priced personal Christmas cards, everyday assortments, stationery, gift items. Samples on approval. Wallace Brown, Dept. B-4, New York 10, N. Y.

BRAND New! Amazingly different and smart Christmas cards bring you big money! Take easy orders fast. Pays up to 100% cash profit. Christmas cards with name 50 for \$1.25, up. Big line. Personal stationery and book matches. Get sample assortments on approval, imprints free. Write today. North Star, 31 Glenwood, Dept. V-18, Minneapolis, Minn.

NYLON Uniforms. Immediate delivery, immediate profits. Sell to doctors, dentists, nurses, waitresses, beauticians, housewives. Free sales kit. Superior Fabrics, Dept. P-8, 3936 Market, Philadelphia 4, Penna.

BIG Profits selling Sunshine's famous exclusive Christmas cards. Tremendous values! 21 for \$1.00, holly assortment. All lined envelopes. Snow scenes, religious, gift wraps, stationery, super value imprints, 50 for \$1.25. Many more! Write for samples on approval, free imprint folders. Act now! Sunshine Art Studios, Dept. PM-8, 115 Fulton St., New York 38, N. Y.

YOUR Personal lingerie free as bonus—extra cash besides—introducing sensational Curve-Tailored idea to friends. Outfit free. World's Star, Dept. D-36, Grand Rapids, Michigan.

\$50 YOURS. Sell only 100 boxes new Xmas cards; other amazing offers. Free samples imprinted cards. Feature box assortments on approval; over 100 profitable items. Work with a national leader. Pen-'N-Brush, PM-8, 139 Duane St., New York City 13.

CASH Profits handling most attractive Christmas cards. Amazing values. Complete line. Special sample offers. Literature free. Arro, 2749 Garrison, St. Louis 6, Mo.

FREE Brush catalog for canvassers. George H. Erb & Son, Dept. M, East Greenville, Penna.

AT Last! Something new and sensational in Christmas cards. Make extra money fast! Show gorgeous satins, velours, metallics never before offered. Gets easy orders! Pays up to 100% cash profit. Free samples 30 Christmas cards with name, 50 for \$1.25 up. 80 assortments. Personalized book matches and stationery, gifts. Several \$1.00 boxes on approval. Write Puro Co., 2801 Locust, Dept. 140-K, St. Louis, Mo.

BIG Daily profits—Selling embroidered wool and cotton uniforms, initialed buckles, belts, badges, choice 3000 emblems. Free sales kit. Hook-Fast, Box 480PM, Roanoke, Virginia.

\$25 BONUS Selling tailoring! Also unclaimed bargains. Beacon, 1713 North Ashland, Chicago.

NEW Bathroom deodorizer. Hangs on wall. Banishes odors bathroom, kitchen. Lightning seller. Samples sent on trial. Kristee 131, Akron, Ohio.

DO You need money? \$35 is yours for selling only 50 boxes of our 300 Christmas card line. This can be done in a single day. Free samples. Other leading boxes on approval. Many surprise items. Experience unnecessary. Free samples personalized Christmas cards, stationery, napkins. Write today. It costs nothing to try. Cheerful Card Co., 293 White Plains, N. Y.

FACTORY Clearance—Dealer's net cost. Power mowers \$46.00 (delivered). Rotacut-PM. Excelsior Springs, Mo.

SALESMEN, Distributors, fast selling costume jewelry direct from factory. Big picture catalog, free. Pickcraft, M19 Bank, Attleboro, Massachusetts.

SELL Christmas cards, novelties, 100 different assortments. Personal cards low as 25 for \$1.00. Imperial, Dept. P, Los Angeles 13.

LOOK—Big profits, free samples. Personalized Christmas cards, personalized napkins and personalized stationery. G. M. Dunn Co., 484 Broadway, Newark, N. J.

FREE Samples, and amazing plan, giving you gorgeous dress without penny cost. Rush name today, with dress size. Harford, Dept. E-235, Cincinnati 25, Ohio.

EARN Money selling Christmas and all-occasion cards, samples on approval. Pascale Company, Irvington 57, N. J.

CHRISTMAS Cards at jobbers prices! Large selection dollar assortments 35c each in hundred lots. Imprint cards, money folders, gift cards, ornament books, pictures, etc. Make more profits selling our line! Catalog free! Three sample boxes \$1.00. Elfco, 438 North Wells, Chicago 10.

MEXICAN Feather pictures. High profit selling gift shops, etc. Adelphi, Box 57-B, Bellerose 6, N. Y.

\$3.00 AN Hour selling cushioned shoes direct. Advance commissions. Bonus. No investment. Experience unnecessary. Free outfit. Samples. Paragon Shoes, 739 Columbus, Boston, Mass.

MEXICAN Feather pictures. Sell on sight; 200% profit! Free details; sample 10c stamps. Sylviapo, Apartado 9036, Mexico City.

MAKE Money easy. Sell Christmas cards. 21 for \$1.00 and others, children's books, personalized cards and stationery, note paper, wrappings and novelties. Send for samples. Howard P. Ellis, Dept. PM-8, Pitman, N. J.

HUNDRED Blades 50c. Thousand English needles \$1.40. Free cut rate wholesale catalogue. Mills Sales Co., 901 Broadway, N. Y.

DRESSES, Used 18c; Coats \$2.00, blouses 35c. Free catalog. Crown, 164-P Monroe Street, New York.

FREE Sample nylon stocking of world's only nationally advertised hosiery line actually guaranteed against runs and snags or replaced free within guarantee period to three months! Complete line from sheerest 15 denier to heavy 70 denier service weight. All gauges. Also complete line men's fine hosiery guaranteed for one full year! Not sold in stores. Good Housekeeping Guarantee Seal. No money or experience needed. Nothing to pay now or later. Easiest and quickest sales. Just show free outfits and write orders. We deliver and collect. Advance cash plus huge bonus to 40%. Big money spare or full time. Become manager—appoint others to sell for you. Man or woman, young or old, beginner or veteran, you can earn more money than you thought possible. Everything needed given free. Rush name and address to Kendex Corp., Babylon 83, N. Y.

EVERYBODY Uses handkerchiefs; buy from leading manufacturer. Write Stan-chief, 1 Bond St., New York 12, N. Y.

ULTRA-Blue stock signs—6c, sell 35c. 1000 slogans, 7" x 11", comedy, religious, general. 15 samples, \$1.00. Lowy, 812-ML Broadway, New York 3.

GORGEOUS Christmas cards. \$50 yours selling 100 boxes. 40 with name, \$1. Personal napkins, stationery. Wrappings, novelties, gifts. Free samples. Approval box. Torres, 373 Fulton St., Brooklyn 1, N. Y.

\$50 WEEKLY Selling finest razor blades, other items. Free details. Edison, Department 274, Far Rockaway, N. Y.

BE A money maker. Use your home as magazine headquarters. Liberal commissions. No experience, no capital needed. Everything furnished. Write for free catalog. McGregor Magazine Agency, Dept. 500A, Mount Morris, Ill.

NEED Extra cash? Take orders for personal initialed belts and buckles, cap badges, tie holders, etc. Choice of 3000 emblems. Free sales kit. Hook-Fast, Box 1425PM, Providence, R. I.

PHOTO-Salesmen, agents. Sell beautiful hand colored plastic enlargements and sensational new photo compacts, rings, bracelets, lockets, etc. Collect deposit, we deliver. Profitable sideline. Send card, for free sample kit. Novel Portrait Co., 3343 North Ave., Chicago, Ill.

EXCELLENT Sideline for printing and advertising salesmen. Decalcomania name plates in small quantities. Great demand. Also, make money with our line of automobile initials and sign letters. Free samples. "Ralco" XL-Roxbury, Boston 19, Mass.

GOLD Lacquered window sign letters. Large sizes penny each. New foils. Absolutely beautiful. Free samples. Atlas, 544 W. 79th, Chicago 20.

AGENTS: Stamping names on key protectors. Sample 25c. Stamping outfits, checks, social security and name plates. Hart Mfg. Co., 303 Degraw St., Brooklyn, N. Y.

AGENTS—300% Profit selling genuine gold window letters; stores and offices. Free samples. Metallic Letter Co., 438-B North Clark, Chicago.

WANTED—Purchasing agents. No money or experience required. Write Dept. C, Purchasing Manager, 2719 Lawrence, Chicago, Ill.

SELL Big money—maker to men and women. Easy handwork makes fast-selling useful articles. Sunmade Company, Brockton 64, Mass.

EARN Big money. Cash bonus. Popular sizes and styles. Free hosiery for your family. Duratest, Dept. PM, Warren, Penna.

HIGH-GRADE SALESMEN

GO Into business for yourself. Make storekeepers' profits without storekeepers' troubles. We'll put you into business, furnish everything you need, train you, carry stock for you, without your investing one penny. We'll work to make you a success. We've done it for others. We'll do it for you if you are honest, ambitious and willing to work hard. Write. You'll hear from us at once with facts. Address, Manager, P.O. Box 335-F11, Chippewa Falls, Wis.

REPRESENTATIVES For sale of fine embossed seals. Flat and special gummed labels. Quality products. Designed for your customer's individual needs. KCS Co., 606 E. Clybourn St., Milwaukee 2, Wisconsin.

MAKE Money showing neighbors how to beautify yards with glorious flowering shrubs and trees. Quick-bearing dwarf fruit trees; world-famous Stark patented varieties produce abundant harvests champion-quality apples, pears, peaches, other fruits. Even small plots produce fruit for family-use and to sell. Beautiful sales kit free. Stark Bro's, Dept. 30182, Louisiana, Mo.

EARN Big money fast! Sell finest-quality advertising work uniforms to garages, factories, filling stations, etc. Free selling kit. Topps, Dept. 538, Rochester, Ind.

GEN. Douglas MacArthur. Just out! Sweeping sales sensation. Dramatic, up-to-minute life story; picture-packed; richly bound; 352 pages. Includes Congressional address. Big comm., profits. Write quick! Universal House, 1010-X Arch, Philadelphia, Penna.

A Fine income, your own nylons free! Show nylons, lingerie, men's socks with amazing free replacement guarantee against runs, snags, tears. Write for free sales kit. Group organizers invited. Rosalee Hosiery Co., Clifton 58, N. J.

ADVERTISING Book matches—Cash in on big demand; sell union label matches. Cuts for all businesses and political parties. Free powerhouse selling kit, low prices, protection guaranteed on repeat orders. Cash commissions. Superior Match Co., Dept. M-851, 7530 Greenwood, Chicago.

AD Matches! Sell amazing designs—20, 30, 40 and 240-light book matches. Bigger spot cash commissions; every business a prospect. Low prices for high quality. Repeats. Start without experience; men, women; full, part time. Buy nothing! Sales kit furnished. Match Corp., Dept. PM-20, Chicago 32, Illinois.

SALESMEN. Money-making sideline. Calendars and advertising specialties. Highest commissions advanced. Free new cars. Rush name. Advertising Specialties Manufacturing, Brooklyn 36, N. Y.

MAKE Money with famous, easy-selling Bostonian shirts—spare time, full time, sideline. Fabrics, outfit free. Bostonian, 89 Bickford, Dept. G-10, Boston 30, Mass.

"MARY-Mac" gas water heaters—Factory. Steady income. Permanent. McDaniel Manufacturing, 1012 Powhattan, Dallas, Texas.

NEW Jobs open in selling! Send name, address for five free issues of Opportunity Magazine's money-making guide, listing hundreds of companies who'll pay you well, full or part-time. No experience needed. Opportunity, 28 E. Jackson, Dept. 17, Chicago 4, Ill.

\$2600 NEXT 9 Weeks—Season starting. Sell calendars, specialties, matches. Prospects everywhere. Advanced commissions. Experience unnecessary. Samples free. Continental Calendar, 542-A South Dearborn, Chicago.

BIG Money taking orders. Shirts, ties, Sox, pants, jackets, sweaters, shoes, uniforms, etc. Sales equipment free. Experience unnecessary. Nimrod, 4922-AN Lincoln, Chicago.

EDUCATIONAL AND INSTRUCTION

OIL Coloring photographs can be a fascinating hobby or profitable sideline for those with artistic talent. Learn at home. Easy simplified method. Send for free booklet. National Photo Coloring School, 835 Diversey Parkway, Dept. 343C, Chicago 14, Illinois.

IT'S Fun learning a language by Linguaphone. At home, in leisure time, quickly, easily, correctly master Spanish, French, German, Russian, Asiatic—any of 29 languages through Linguaphone Conversational Method. Add to service, job, travel opportunities. Send for free book. Approved for Veterans' Training. Linguaphone Institute, 8308 Rockefeller Plaza, New York 20.

LEARN Auctioneering at home working with successful auctioneer. Revolutionary method provides classroom training in spare time. \$100.00 daily often earned by trained auctioneers. Advance Auction School, 5944 North Newark, Dept. 103, Chicago 31.

"HOW To Break and Train Horses"—A book every farmer and horseman should have. It is free; no obligation. Simply address Beery School of Horsemanship, Dept. 1108, Pleasant Hill, Ohio.

START A collection agency business. Very profitable. Quickly learned. Write Cole & Associates, Syracuse 2, N. Y.

BE A real estate broker through home study or classroom instruction. Write for free book. Weaver School of Real Estate, 15 E. Pershing Rd., Box CP-8, Kansas City 8, Missouri.

YOUR For President of your own Credit-Collection Agency. Many who answered our ads now have their names on office doors. Franklin Credit, Roanoke 7, Va.

HIGH School—No classes. Study at home. Spare time. Diploma awarded. Write for free catalog HF-11. Wayne School, 2527 N. Sheffield, Chicago 14, Ill.

STUDY For game warden, fish, park, forestry, patrol and wildlife service. Details free. Write Delmar Institute, Box 214, Whittier, Calif.

WELDING Training pays at Hobart Welding School, Box M-812, Troy Ohio. VA contract. Best equipment. Catalog free.

LEADERS persuade others. Learn persuasion! Develop charming, winning personality. Write for free descriptive booklet, "Personality That Persuades." The turning point of your life. Address "Personality That Persuades," 2911 Rivera, Wichita 16A, Kansas.

INCREDIBLE! Unprecedented! Look under "Miscellaneous"! Bijou, Box 1727-ME, Hollywood 28, California.

KEPLER'S Laws are illusions 35c. Williamsburg Station, Box 100, Brooklyn 11, N. Y.

PREPARE For civil service examination, pay for course after securing position. Write, Free School, Dept. PM-8, Kokomo, Ind.

STUDY To be a doctor of psychology or metaphysics. Obtain Ps.D., Ms.D., D.D. or Ph.D. degree. Chartered by state. Write for free book telling how. The Neotarian Fellowship, Desk 8, Pickwick Building, Kansas City 6, Missouri.

LEARN Technical metaphysics. Insure success in life. Valuable information. Canada School of Technical Metaphysics, 2532 McKenzie St., Vancouver, B.C., Can.

USED Correspondence courses and educational books bought, sold, rented. Catalog free. Educational Exchange, Summerville, Ga.

3800 USED Correspondence courses. 2 art course, \$2.95. Catalog \$1.00. EG, Elmsford 1, N. Y.

SUCCESS In business, social life, strengthen your voice! Free booklet. Perfect Voice, Studio 2H-2, 210 South Clinton, Chicago 6.

INVESTIGATOR Training. Phillips Secret Service System, 1917-B North Keneth, Chicago 39.

USED Correspondence courses and books sold and rented. Money back guarantee. Catalog free. Courses bought. Lee Mountain, Pisgah, Alabama.

MEDICAL Laboratory Technicians in great demand. We train you in your own home. Catalogue free. Imperial Technical Institute, Box 973-J, Austin, Texas.

SECRET Investigation. Experience unnecessary. Investigators particulars free. George Wagner, M 125 West 86th, New York.

BOOKKEEPERS! Increase your earnings! Operate your own simplified "dollar-a-week" bookkeeping and tax service. Full or spare time. Details free. No obligation. Ellis, Box 200, Cedar Grove, North Carolina.

HOME Study course, drugless therapy. Free literature. Institute of Drugless Therapy, Tama, Iowa.

PLAYS, STORIES, MANUSCRIPTS

MUSICAL Comedy plays, pageants. Dorby Publications, P.O. 738, Morristown, New Jersey.

WE Edit, copyright, publish books. Wetzel Publishing Co., 524 So. Spring, Los Angeles.

FREE—My talk "Column Writing That Pays." Ben Arid, 1141A-7th St., Hermosa Beach, Calif.

I Want new writers to cash checks of \$1 to \$100 offered daily. The easiest way to write for pay. No previous experience necessary. Free details. Saunders M. Cummings, 468-11 Independence Bldg., Colorado Springs, Colo.

BEGINNING Writers: Let us show you how to get \$1.00 to \$20.00 checks daily. Experience unnecessary. Details free. Herwell Company, 7016-M Euclid, Cleveland 3, Ohio.

BUSINESS SERVICE

HAVE A Chicago mail address. It's valuable to you. Schultz House, 3116 Seminary, Chicago 13.

SPECIAL SERVICES

BOOKKEEPERS Everywhere, do you have problems? We solve them for you. Business Advisory Service, 205-210 Building, Omaha, Nebraska.

ENGRAVING On nameplates, trophies, medals, etc. Folder. Ackerman, Malden-on-Hudson, N. Y.

WHAT Can I do for you in Chicago? Personal-business, purchasing, selling, legal, information, representation. Mail forwarding. Strictly on the up-and-up! We are in now way connected with any detective agency or bureau. Henry, 30 W. Washington Ave., Room 900, Chicago 2, Ill.

CONSTANTINOPLE Postmark. Letters remailed. 25c (stamps). Box 167, Istanbul, Turkey.

LETTERS Rемаiled from Canada 25c each. 6 scenic postcards \$1.00. Joseph Stan, General Delivery, Main Post Office, Hamilton, Ontario, Canada.

LETTERS Rемаiled 25c each. Hollywood view cards, 8 for \$1.00. Stadler, Box 2335, Hollywood 28, California.

CARTOONING, COMMERCIAL ART, SHOWCARD WRITING, SIGN PAINTING

"HOW To Make Money With Simple Cartoons"—A book everyone who likes to draw should have. It is free; no obligation. Simply address Cartoonists' Exchange, Dept. 98-C, Pleasant Hill, Ohio.

LEARN Sign painting, 152 lesson course. Results guaranteed. Stewart Sign Co., Box 287M, Pasadena, Calif.

TALENT Test—Information. Give age. Art, Box 8066, Dallas 5, Texas.

CHALK Talks. Laugh producing program, \$1.00. Catalog 10c. Balda The Cartoonist, Oshkosh, Wisconsin.

ADVERTISING AGENCIES, LETTER WRITERS, FOR ADVERTISERS

FREE Publicity. Products! Inventions! Newspapers, magazines, radio, T.V. Low service fee. Minkoff, 921 Downing Rd., Valley Stream, N. Y.

ADVERTISERS! Reach nearly 18,000,000 readers. 25 Sunday national key newspapers, 18 words, \$59.00. "Terrific pullers." 20 popular newspapers, \$11.50. Free booklet. Special—One inch display 2.-\$21.198 circulation, \$51.10. Newmark's Advertising Agency, (Established 1893), 217-7th Ave., New York 11.

ADS Placed in out of town newspapers and magazines. Low rates. Catalogue free. Ideas that pay. Baker Advertising Agency, Successors Ankrum Agency, 189 W. Madison, Chicago 2.

MAILING Lists: \$5.00-1000 up. Write Dixie Service, King, N. C.

24 WORDS In 50 weeklies, \$4.96. J. Darrell, 730 Hays, Jackson, Tenn.

ADVERTISE: 24 Words, 40 newspapers \$3.50. Lists free. Advertising Bureau, 10511-C Springfield, Chicago 43.

TYPEWRITERS, DUPLICATORS, OFFICE DEVICES

PRINTOMATIC Selffeeding post card printing duplicator \$15.75. Envelope addressing machines \$24.50. Pittsburgh Typewriter Company, 336-R Fourth Avenue, Pittsburgh 22, Penna.

RECONDITIONED Typewriters, printing devices, office machines, equipment. DixieGraph, King, N. Car.

RUBBER STAMPS AND OFFICE SUPPLIES

SPEED-MO Rubber stamp pads. Catalog free. Ford's Stamps, Bristol 9, Conn.

3 LINES 50c; Pads 35c; signature \$2.35. Stamp-right, Wauwatosa, Wis.

PRINTING, MULTIGRAPHING, MIMEOGRAPHING GUMMED LABELS

PRINTING, Multigraphing, mimeo-graphing. Prices free. Progressive, 270H Burkhart, Cincinnati 15, Ohio.

500 LETTERHEADS Or 6¼ envelopes \$3.90. Prices and estimates. Mullins Letter Press, Robinson, Illinois.

DISTINCTIVE Business cards reasonably priced. Samples free. Roscoe M. Heavener, Colmar, Penna.

ENVELOPES, Letterheads, statements, etc. Samples, prices. Mercury Press, Box 69, Marengo, Iowa.

BUSINESS Letterheads, stationery. Samples free. Southern Printers, Box 331, Lake Charles, La.

1000 PRINTED Cards, \$2.75. Free samples. Morey's, 629 Baker, San Francisco 17, Calif.

PRINTED Scotch tape, three lines on 2595 inch roll \$3.50. 3 rolls \$10.00. Modern Litho-Print, Jefferson City, Missouri.

JOB Printing. Free estimate. H. L. Wilson Press, New Germantown, Penna.

MIMEOGRAPHING—Reasonable. Any copy. Mailers Service, Box 606-B, Chicago 90, Ill.

TWO Color letterheads designed to order, samples 10c. Refunded. Osgood's, 1320 Prospect, New York 59.

BUSINESS Printing. Samples, prices, free. Howprint, 723-M Eunice, Webster Groves 19, Missouri.

500 VELLUM Business cards \$1.75, samples. Box 146, Brooklyn 12, N. Y.

PRINTING—5000 5¼ x 8½ Circulars \$18; 3¼ x 5½ \$8.25; folders, catalogs, everything. Garrison Press, Harrisonburg, Va.

1000 BUSINESS Cards \$2.50 prepaid. Samples free. Reliable Print Shop, 905 East Jefferson, Louisville 6, Ky.

QUALITY Printing. We specialize in publications, newspapers, tabloids. Send copy for estimate. Bagby Printing Co., Georgetown, Ohio.

SEND 10c Now for our 48 page 1951 price list—refunded first order. McCall Press, 1326 South 27th, Omaha, Nebraska.

MIMEOGRAPHING—Letters, pricelists, formulas, instructions. Lowest prices. Lem's Letter Shop, 5710 Stanton, Detroit 8.

500 ¾x2¼ FOUR Line gummed stickers 50c. Red border \$1.00. Moritz Printery, Saginaw, Mich.

PRINTING OUTFITS AND SUPPLIES

PRESSES, Type, cabinets, supplies. List for stamp. Lincoln Press Company, 220-Y Hartwell, Fall River, Mass.

SAMPLE Font type \$1.00. Literature free. Republic, 1103 W. 69th St., Chicago 21, Ill.

PRINT Your own cards, stationery, cir-culars, advertising. Save money. Simple rules. Print for others, nice profit. Raised printing like engraving too. Have home shop. Details free. Kelsey Presses, L-11, Meriden, Conn.

PRINTING Presses, type, supplies. Lists 3c. Turnbaugh Service, Loysville, Penna.

MAKE Your own printing cuts. Self-molding process. Plexirubber, Argyle 1, Wisconsin.

PATENT ATTORNEYS

INVENTORS—If you believe you have an invention, we can make a preliminary search on your invention and advise you whether we think it can be patented. Send for copy of our patent booklet "How to Protect Your Invention" and "Invention Record" form. No obligation. McMorror, Berman & Davidson, Registered Patent Attorneys, 1343 Victor Building, Washington 1, D. C.

INVENTORS—If you consider your invention to be something of importance, take steps to protect it with a United States Patent which gives you the right to exclude others from making, using and selling your invention as claimed. "Patent Protection for Inventors" outlines steps to take to secure patent protection. Mailed promptly without obligation. Victor J. Evans & Co., Merlin M. Evans, Registered Patent Attorney, 631-H Merlin Building, Washington 6, D. C.

INVENTORS: Learn how to protect your invention. Special booklet "Patent Guide for the Inventor" containing detailed information concerning patent protection and procedure together with "Record of Invention" form will be promptly forwarded to you upon request—without obligation. We are registered to practice before the U. S. Patent Office and prepared to serve you in the handling of your patent matters. Clarence A. O'Brien & Harvey Jacobson, Registered Patent Attorneys, 11A-G District National Building, Washington, D. C.

REGISTERED Patent attorney offers services. Sanders, 6430 Evans, Chicago 37, Ill.

INVENTORS: When you are satisfied that you have invented something of value write me, without obligation, for information as to what steps you should take to secure a patent. Write Patrick D. Beavers (Formerly Randolph & Beavers) Registered Patent Atty., 935 Columbian Bldg., Washington 1, D. C.

PATENTS. "Proof of Invention" folder mailed without obligation. E. E. Vrooman, Registered Patent Attorney, 507 McKim Building, Washington 5, D. C.

INVENTORS: Write for free brochure "Evidence of Invention." Labiner, World Building, New York 38.

C. A. Snow & Co.—M-427, Snow Building, Washington 1, D. C. Registered Patent Attorneys. Write for information.

INVENTORS—For "Record of Invention" form, contact Carl Miller, Registered Patent Attorney, Woolworth Building, New York.

INVENTORS: Without obligation, write for information explaining the steps you should take to secure a patent. John N. Randolph, Registered Patent Attorney, 203 Columbian Bldg., Washington 1, D. C.

PATENTS—Irving L. McCathran, 315 McLachlen Bldg., Washington 1, D. C. Registered Patent Attorney.

CANADA—Ramsay Company Registered, 273 Bank Street, Ottawa, Canada.

FOR INVENTORS

INVENTORS—If you believe you have an invention, we can make a preliminary search on your invention and advise you whether we think it can be patented. Send for copy of our Patent Booklet "How to Protect Your Invention" and "Invention Record" form. No obligation. McMorro, Berman & Davidson, Registered Patent Attorneys, 1342 Victor Building, Washington 1, D. C.

INVENTORS—This form is registered to practice before the United States Patent Office and is available to assist you in the preparation and prosecution of your patent application. "Patent Protection for Inventors" booklet containing detailed information and steps to take toward patent protection will be sent upon request. No obligation. Victor J. Evans & Co., 632-J Merlin Building, Washington 6, D. C.

INVENTORS—Need help on electronic phases of your invention? Strictly confidential consulting service. Your ideas protected. Electro Engineering Service, Box 432, Detroit 31, Michigan.

BOOKS For inventors on financing, promoting, selling inventions. Box 1434A, Amarillo, Texas.

DO You have idea or product worth promoting, manufacturing, selling? Write Bigham, Brooker, Florida.

INVENTORS: Learn how to protect your invention. Special booklet "Patent Guide for the Inventor" containing detailed information concerning patent protection and procedure together with "Record of Invention" form will be promptly forwarded to you upon request—without obligation. We are registered to practice before the U. S. Patent Office and prepared to serve you in the handling of your patent matters. Clarence A. O'Brien & Harvey Jacobson, Registered Patent Attorneys, 11A-G District National Building, Washington, D. C.

INVENTORS Booklet—"Reaching Your Invention Markets" mailed free. Patented, patent pending only. No obligation. Address, Market Contacting & Data Service, 11106-A3 Longwood, Chicago 43.

PATENT Searches \$5.00. Reports airmailed within 48 hours. Invention protection forms free. Write Miss Ann Hastings, Patent Searcher, P.O. Box 176 Washington 4, D. C.

INVENTORS: Without obligation, write for information explaining the steps you should take to secure a patent on your invention. John N. Randolph, Registered Patent Attorney, 203 Columbian Bldg., Washington 1, D. C.

CASH For your idea, 280 manufacturers need inventions, patented or unpatented. List free. Invention Bureau, 208M Clinton, Oak Park, Ill.

SEARCHES—Put your patent searches in the hands of a registered patent attorney or agent, as he qualifies to give a worthwhile patentability report. Record of invention form upon request and information on patent protection. Patrick D. Beavers, Registered Patent Attorney, 935 Columbian Bldg., Washington 1, D. C.

PATENT Searches conducted for patent attorneys and inventors \$5.00. 48-hour service. Protection forms free. Write Patent Engineering Service, 1404 New York Avenue, Washington 5, D. C.

INVENTORS. For "Record of Invention" form, contact Carl Miller, Registered Patent Attorney, Woolworth Building, New York.

PATENT Owner representative. Years of experience. Can I help you? Charles A. Scott, 773PM Garson Avenue, Rochester 9, N. Y.

INVENTORS: If you have an invention for sale, patented or unpatented, write Institute of American Inventors, Dept. 40A, 631-E St. N.W., Washington 4, D. C.

PATENT Searches \$5.00. 48-hour service. Patent copies included. Protection forms free. Write Raymond L. Smith, Patent Searcher, 410 Bond Building, Washington 5, D. C.

INVENTIONS WANTED

YOUR Ideas are worth money. Long-established manufacturer with successful record of national distribution in kitchen utensils and light-machinery seeks new products. Cash or royalty. Can assist on development and patent protection. First letter will supply details of registry protection plan to safeguard your interest on ideas submitted. Do not send sample or model until requested. Write Dept. 30, Product Division, Foley Mfg. Co., Minneapolis 18, Minn.

NEW Ideas wanted on LPG use for farm power by established, successful manufacturer with large production capacity and national sales organization. Royalty or sale basis. Send patented or patented-applied-for ideas only with full details in first letter. Box 265, Kansas City 10, Mo.

INVENTIONS Promoted. Patented or unpatented. Established 1911. Write Adam Fisher Company, 61 Enright, St. Louis, Mo.

INVENTIONS Wanted by manufacturers. Free details. Inventors Exchange-B, Hartford 1, Conn.

INVENTORS—What have you, patented, patent pending available for manufacturers? Booklet mailed free. Address: Market Contacting & Data Service, 11106-A2 Longwood, Chicago 43.

INVENTIONS Wanted. Patented or unpatented. 20 years experience promoting inventions. National Service Bureau, 3130 Meramec, St. Louis 18, Mo.

INVENTORS: Hundreds of manufacturers have requested our assistance in locating marketable new products. Complete information free. Institute of American Inventors, Dept. 40-D, 631-E St. N.W., Washington 4, D. C.

PATENTS FOR SALE

HEAT Saving oil furnace, patent applied for, outright or royalty. Langen, 170 High St., Fitchburg, Mass.

FOUR Patents on the Clayton animal trap. 811—16th Ave., Belmar, New Jersey.

MASSAGING Device for relief of headaches. Elmer Carlson, Box 102, Galva, Ill.

INVENTORS: Test the commercial value of your patented or unpatented inventions, quickly and inexpensively. Write for free information. Institute of American Inventors, Dept. 40-B, 631-E St. N.W., Washington 4, D. C.

MANUFACTURING

MODELS — Small lot manufacturing. Metals, plastics, etc. Milburn, Burlington, Kentucky.

MODELS, MODEL SUPPLIES

STEAM Engines, boilers. Catalog 25c. Anton Bohaboy, 2297 Price, Rahway 7, N. J.

BUILD Historic ship models, complete kits 50c to \$9.00. Catalog 15c. Ideal Models, 19 W. 18th, New York 11, N. Y.

SHIP Models and yacht supplies complete. Large 64 page catalogue 30c. Bill Wild's, 510 East 11 St., New York City 9.

SHIP And yacht model fittings; blueprints. Send 25c for illustrated catalog No. 26—listing hundreds of items. A. J. Fisher, 1002-1 Etowah Ave., Royal Oak, Mich.

STEAM Locomotives, 1½", 1", ¾", ½", ¼" scales. Castings, rail, steam fittings! Thorough drawings with instructions. Catalog 50c. Little Engines, Wilmington, California.

HOME CRAFTSMEN

FREE Book "Practical Painting, Wood Finishing" shows how to get professional results. Furniture finishing, workshop projects, home decorating. Complete. Modern brush and spray methods. Tricks you've never seen. It's free! Write Home Craftsman, 115-F Worth Street, New York 13.

89 FULL Size jig saw patterns of beautiful shelves, ornaments, toys, novelties. Plus "How, Where to Sell." Only \$1.00. Mastercraft 84M, 7041 Olcott, Chicago 31, Illinois.

CRAFTSMEN, Hobbyists. Universal self centering drill guide for doweling, etc. Unlimited applications. Early constructed. Complete plans \$1. L and B Tool Works, Box 514, Crete, Ill.

OUR Biggest leather and craft catalog yet! 1000's of items. Send 25c (refunded with first order). Russo Handicraft Supplies, Dept. C-7, 245 S. Spring, Los Angeles, California.

90 ALL New, full size lawn ornament and novelty patterns, up to 20" high. Only \$1.00. Mastercraft 82M, 7041 Olcott, Chicago 31, Illinois.

HOBBYISTS: Precision pliers 3½"-4½" long; imported, all purpose set of 3, cutter, longflat, roundnose \$2.95 postpaid. Nessalc, 4 East 41 St., New York 17, N. Y.

CLOSET Lining, knockdown chests. Anything in cedar. Free literature. Cedarcraft, Fayetteville, Tenn.

FORMICA Bonded to heavy fir plywood. All colors. 30" x 18" and smaller. Free details. Haswell, 719 Massachusetts Ave., Ellwood City, Penna.

LEATHERCRAFT. Everything needed by beginners, advanced hobbyists and professional leatherworkers. Largest stock of supplies in U.S. Moderate-priced tooling leathers, top quality calfskins, tools, supplies, kits. Send 10c for big catalog. J. C. Larson Co., 820 S. Tripp, Dept. 1075, Chicago 24.

MAKE Leather belts, billfolds, purses. Big catalog and genuine steerhide keyholder, 10c. Tandy Leather, Box 397C, Tulsa, Oklahoma.

COMPLETE Stocks foam rubber. All types, sizes and thicknesses. Hurry, write for price list! AMC Supply, P.O. Box 1440, Fort Worth, Texas.

80 FULL Sized patterns, lawn ornaments, toys, novelties, \$1.00. Modern Woodcraft, Saginaw, Mich.

POWER Tools, equipment, wholesale prices. Free bulletin. Homecrafters Cooperative, Grand Rapids 6, Michigan.

PROFESSIONAL Type furniture finishing and refinishing supplies. Beautiful new, complete, illustrated catalog and complete simplified instruction manual 25c. Colorall, Dept. M, 515 Cedar Lane, Teaneck, N. J.

OZARK Wood samples. Eleven varieties prepaid. \$1.50. Davis Lumber, Cabool, Missouri.

NEW Leathercraft catalogue. Pleasure and profit. New styles, belts, purses, shoes. Largest leathercraft school in U.S.A. G. I. approved. Send 10c for catalogue. Dept. PM, Apache Leather Co., 2804 E. Washington St., Phoenix, Arizona.

LEATHERCRAFT, Copper tooling, textile painting. Make spare time, profitable time. Free illustrated catalog shows everything you need. Kit Kraft, 7377 Melrose, Hollywood 46, California.

KNOCKDOWN Cedar chests. Lumber and veneers. Free price list. Giles & Kendall Company, Huntsville, Ala.

LEATHERCRAFT Bargains! Lacing. Francis Byrd, 3406 Montrose Ave., Richmond, Va.

30 **LAWN** Ornament patterns, ready cut. Full size, color indicated. \$1.00 postpaid. Lincoln Craft Studio, Farmington, Conn.

LEATHER. Tools, lacings, supplies. Free catalog. National Handicraft, 199 William St., New York 7.

MAKE IT YOURSELF

PLANS—New convenient slide away kitchen mixer cabinet. Send \$2.00. Grace Company, 2202 East Grand, Springfield, Missouri.

PLANS, Septic tank or water softener, \$1.00 each. Freeland Engineering, 16587 Freeland, Detroit 35, Michigan.

1" **DRILL** Press plans, \$2.00. Build your own machinery from salvage. Handbook, only 25c (refundable). Free details. Kenneth Reeves, Box 3357-PM, El Paso, Texas.

GRANDFATHER Clock easily built. Big savings. See ad on page 246.

BUILD Your own "tractor." Free information. Eltraco, D-I, Camptonville, California.

"**CONCRETE** Block Homes." 32 page booklet on how to build. \$1.00. H. C. Lightfoot, Civil Engineer, Richboro 1, Penna.

WATCHES, OLD GOLD, JEWELRY

WATCHMAKERS' Journal contains instructive articles for watchmakers and beginners. \$1.00 year. Sample copy 20c. Dean Co., Box 3218, Daytona Beach, Fla.

WATCHES Completely repaired; \$3.50. Guaranteed; Berkowitz, 1265 Olmstead Ave., Bronx 61, N. Y.

WATCHMAKERS', Jewelers', hobbyists', tools, supplies. Catalogue! Bengal Company, Culver City, California.

RHINESTONES Jewelry settings, cameos, sequins, beads. Catalog free. J & M Novelties, Dept. CJ-3, Griffith, Ind.

FREE Gem offer. Has diamond brilliance. Gemimports, 432 South Western, Hollywood 5, Calif.

HIGHEST Cash paid for old, broken jewelry, gold teeth, watches, silverware, diamonds, spectacles, platinum. Free information. Satisfaction guaranteed. Rose Smelting Company, 29-A East Madison, Chicago.

GEMS, Precious and semi-precious, all genuine, from world wide sources. Deal direct, no overhead, save money. Catalog 10c. Hill Co., Route 7, Salem, Oregon.

WRIST Watches, U. S. Air Corps, Waltham, 16 jewel, water and shock proof, stainless steel case, reconditioned. Value \$55.00. Special \$17.95. Public Sport Shops, 11 S. 16th Street, Philadelphia 2, Penna.

GOLD Plated jewelry supplies. Rhinestones, pearls. Illustrated catalog, only 10c. Barry's, 47-N Branford Place, Newark 2, N. J.

TOBACCO, SMOKERS' SUPPLIES

CIGARS. Fine, mild factory fresh. 10c size. Box of 50 \$3.00, two boxes \$5.00, postpaid. Check or currency. Or four trial cigars send quarter. Money back guarantee. D. Burr Cigar Factory, 5516 Easton, St. Louis, Missouri.

PIPES—Genuine Hawaiian monkey pod. Prepaid \$2.50. Royal Hawaiian Jewelers, 315 Royal Hawaiian Ave., Honolulu, T. H.

PIPE Smokers blend private aromatic tobaccos. Information free. Cozza, Pharmacist, Pequannock, N. J.

HAND Carved filtered imported briars \$1.00. Ace Dist., 672 Hinsdale St., Brooklyn 7, N. Y.

OF INTEREST TO WOMEN

MAKE Money at home sewing useful articles. Liebig Industries, Beaver Dam 10, Wisconsin.

FOR SALE—MISCELLANEOUS

RUBBER Mattresses, nationally advertised; including foundation, \$95.42. Radman's, St. Louis 1, Missouri.

PATENTED Electric cattle branding irons. Safe, economical, reasonable. Charles E. Farrar, Greenwood, Miss.

FREE Catalog! War surplus clothing. Amazing bargains. N. Y. Clothing Co., New York 29A.

COMBAT Phones, sound powered, no batteries or electricity needed. U. S. Signal Corps post secret. No parts wear out. Work to one mile. Two phones, postpaid \$3.95 pair. Wire 2c foot postpaid. Akron Army & Navy Stores, Dept. 9-PC, 4400 Sunset Blvd., Los Angeles, Calif.

ELECTRIC Fans, all types. Chrome cabinet hardware. Write Box 89, Troy, Ohio.

DRESSES, Used, 18c; coats \$2.00; blouses 35c. Free catalog. Crown, 164-PA Monroe Street, New York.

TRIPODS. All wood, solid leg with four inch circular metal head, can be threaded, 55" tall, value \$27.50—special \$6.95. Public Sport Shops, 11 S. 16th Street, Philadelphia 2, Penna.

HANDSIGHTING Levels, improved, new model, used for grading land, contouring and laying out fences, piers, roads and gardens, price \$2.50 postpaid. Public Sport Shops, 11 S. 16th Street, Philadelphia 2, Penna.

SAVE Money on army, navy and factory surplus. Write today for new 52-page illustrated catalog. Tennusa Sales Co., Dept. AE, 1451 Market, Chattanooga, Tenn.

WANTED—MISCELLANEOUS

WANTED—All types of novelties and gadgets suitable for mail order. Especially those of interest to men. Write full particulars and send samples. Standout Products, 141 North LaBrea Avenue, Los Angeles 36, California.

QUICKSILVER, Platinum, gold, diamonds, sterling, dental-jewelry-optometrist scrap. Ship or write. Wholesale Terminal, Norwood, Massachusetts.

PERSONAL

BORROW By mail. Loans \$50 to \$300 to employed men and women. Easy, quick. Completely confidential. No endorsers. Repay in convenient monthly payments. Details free in plain envelope. Give occupation. State Finance Co., 210 State Finance Bldg., Dept. B-14, Des Moines 8, Iowa.

YOUR Name, address on brass plate, 25c. DuRaney, Johnstown 1, Pennsylvania.

YOUR Letters remailed in California 25c. Also private receiving-forwarding address. Lowest rates. Shanks Mail Service, Box 3110-D, San Francisco 19, Calif.

INTERESTING Mails, 25c keeps name on mailing list three months. Bentz, Desk D/62, Chatawa, Mississippi.

VALUABLE Big mails, four months listing, 25c. Wright Publications, 2270 Hubbard, Memphis 8, Tenn.

HAIRCUT As you like it. Booklet tells how, 25c. Mastrolia, 5½AK Jane, New York City 14.

LETTERS Remailed 25c each, coin. Mail received and forwarded. Rates. McLaughlin, 369 Welch, Columbus 7, Ohio.

KNOW Yourself—Handwriting analyzed by Certified Grapho Analyst \$1.00. Box 35, Bainbridge, N. Y.

PRINT Without a printing press. Big profits! See page 28.

MYSTIFY Friends! Your letter remailed from New York City, 25c. Picture postcards, 3—25c coin. Cullen Brown, Box 893-G, Jersey City 6, N. J.

FRANCE, Germany, Switzerland remail. 3 letters \$1. Stamps free. C. Paige, Hauptpostlag, Basel 1, Switzerland.

NEW York letters remailed 25c each. Bernard Romano, 412-B East 116, New York City 29.

SALT Lake remail! 25c each. Jack's, 915-A Jefferson St., Salt Lake City 4, Utah.

MEXICAN Law practice reliably conducted. Box 1736, El Paso, Texas.

HERE'S How and where to borrow \$50.00 to \$300.00 by mail. Confidential. Free particulars. Postal Finance Company, Dept. 45, Sioux City, Iowa.

MISCELLANEOUS

TREMENDOUS Bargain—Selling out entire stock of aviation type sun glasses with leatherette case. Ridiculously low price only 90c complete. Send today. Remember special only 90c complete. R. D. Enterprises, Box 253, Portland, Maine.

FREE Catalog of clothing for big men—Waist 46-66; neck 17-22. Burns-Martin, Dept. 248; 147 Summer St., Boston 10, Mass.

MUSSOLINI'S Corpse. Actual photo (25c). Edward Koshinski, West Enterprise St., Glen Lyon, Penna.

SEEK Gold, uranium, buried treasure! Latest low cost super-sensitive equipment. Free literature. Glen Scientific, Box 151-B, Glen Ellyn, Illinois.

INCREDIBLE! Unprecedented! Become a mental superman overnight! Floor everybody! No studying! "Memoprop" does all your thinking! It's uncanny! Revolutionary! Write: Bjou, Box 1727-ME, Hollywood 28, California.

TWO Letters airmailed \$1. Errands. Information. Swords, Casilla Correo, 4342, Buenos Aires, Argentina.

WHERE To get free items. Booklet 25c. General Sales, 267 Jeffrey, Long Branch, New Jersey.

NEW Free fall catalog just off press! Farm and country real estate bargains, good pictures, many states, easy terms, many equipped, business opportunities. For special service, state requirements, desired location. United Farm Agency, 220-PM South State St., Chicago 4, Ill.

70 BIBLE Lessons, 25c. Bulletin, Box 87, Cathedral Station, New York 25.

NATIONALLY Advertised products far below wholesale. Collins Co., Forsyth, Ga.

SAVE 50% On first quality, white T-shirts—\$5.75 doz. Free catalogue of underwear and hosiery. Agents wanted. G.S. Company, 217P Centre St., New York City.

TIE-Breakers exposed. Picture puzzle contestants. Now you can win big cash prizes. Your key to fortune \$1.00. Wenograd, Box 1495, Philadelphia 5, Penna.

DRESSES, Used, 18c; coats \$2.00; blouses 35c. Free catalogue. Crown, 164-PM Monroe Street, New York 2.

SQUARE Dance instructions, thirty dances, \$1.00. Wesley Rader, 3926 Alcott, Denver 11, Colorado.

SEPTIC Tanks, outdoor toilets, cesspools cleaned, deodorized easily. Make this amazing cleaner yourself. Sell to others. Complete formula \$1. Kemiklean, Park Ridge, Ill.

MEN—I shaved 128 days, with only one single edge safety razor blade. Cost 5 cents. You can do the same. Complete instructions sent for only \$1.00. Address, Razor Blades, 1001 Montana St., El Paso, Texas. Print your name plainly.

RECEIVE Giant mails, magazines, catalogs! Three months 25c, year 50c. Waddell's Directory, 341B East 76th, New York 21.

CESSPOOL Trouble? Use Peps-It. Rejuvenates fermentation action, saves pumping costs, deodorizes, reduces masses. Costs only \$2.50. Safe. Sanitary. Free descriptive literature. Chemical Cesspool Cleaning Co., Boston 34, Mass.

GOLD, Silver, metal detectors. Geiger counters for uranium. Mineralights. Sensational new fully guaranteed models. None finer. Information free. Detectron Co., 5631 Cahuenga Blvd., North Hollywood, California.

TREASURE Finders for gold, silver and minerals. Money back guarantee, best available. Also Geiger counters for uranium prospectors, free information. Write Goldak Company, 1541 West Glenoaks, Glendale 1, Calif.

OUTDOOR Toilets, cesspools, septic tanks cleaned, deodorized with amazing new product. Just mix dry powder with water; pour into toilet. Safe, no poisons. Save digging, pumping costs. Postcard brings free details. Burson Laboratories, Dept. C-36, Chicago 22, Illinois.

"**RECEIVE** Mail." Moneymaking offers, opportunities, catalogs. Name listed 10c. Ideal Service, Park Ridge 10, Ill.

PANNING Gold lesson and catalogue. Beginners supplies, books, "maps where to go" free. Old Prospector, Box 729D1, Lodi, Calif.

TREASURE—M-Scope Geiger counters, mineral locators. Why buy something inferior when you can buy the best at a lower price? Backed by years of experience. Fully guaranteed by factory. Detects minerals, metals, gold, silver, coins. Payment plan available. Proven superior performance. Free 16 page illustrated booklet. Fisher Research Lab., Inc., Palo Alto, California.

TATTOOING Outfits, supplies. Illustrated list free. Zeiss, 728 Leslie, Rockford, Illinois.

EARN Up to \$200 month, inventing toys, games, gadgets. Write, Hendrickson, Argyle 1-A, Wisconsin.

FALSE Teeth tight, longer. Free facts. Veldent, 1439-D, Milwaukee 13, Wis.

best
white tape
made

ONLY
98¢



The new "Evans White-Tape" has everything you'll find in tapes costing over \$1.50—plus.

- snow-white blade with bold, legible, jet-black numerals and graduations. Graduated in 32nds for first 6 inches.
- sturdy die-cast case heavily chrome-plated, calibrated for quick reading inside and outside measurements.
- blade 1/2" wide made of finest high carbon steel—tempered—Bonderized—enamelled—baked.
- blade replaceable in seconds—without tools—without even opening case. And Evans replacement blades cost far less.
- every "Evans White-Tape" is unconditionally guaranteed.
- exclusive Evans automatic brake gives smoother push-pull action with absolutely no "creeping" of tape into case.
- underside is white, too. Mark with ordinary pencil, remove mark with flick of thumb.
- unheard-of low price*: 10-ft. \$1.49; 8-ft. \$1.19; 6-ft. 98¢. Prices higher in far west and Canada.

Evans

& CO. • Newark 5, N. J.

Sold only through retailers.

Makers of Evans 6-ft. Folding Rule and "Folding Yardstick"

LEOPARD SEAT COVERS
SWEEP TO SENSATIONAL NATIONAL POPULARITY



Salesmen jamming
pockets with
\$1000 bills...
TAKING ORDERS FOR
KEY
EXPERTLY
Tailored AUTO
SEAT COVERS

7
Styles

**BIG SEASON
NOW STARTING!**

You've heard of the tremendous demand for Leopard auto seat covers that built up overnight from one end of the country to the other when Cadillac introduced a new 1950 model with Leopard Seat Covers. Car owners are paying \$50.00 to \$60.00 and \$70.00... and more for covers with Leopard design. Now you can serve that eager demand at a fraction of the cost the customers expect to pay! No wonder salesmen are making money hand over fist with this sensational new Key line!

Make big money daily. Take orders from car owners everywhere. Beat all competition with covers cut to accurate

Look at These Features

- 7 STYLES—7 PRICE RANGES
- A COMPLETE LINE OF SENSATIONAL NEW DESIGNS
- FOR ALL CARS—ALL MAKES—MODELS—YEARS

patterns like the finest suit of clothes... Sleek, smooth, wrinkle-free fit adds an accent of elegance to any car... just like an original upholstery job!

RUSH NAME FOR FREE

OUTFIT Give Make, Year and Model Of Your Car Anyone working full or spare time can realize big money in this business. No need to search for prospects. **Every** car owner is one. Be the first to cash in... Make year around **STEADY PROFITS**. Don't put it off—get your Free Selling Kit at once for some real money. **ACTUAL SEAT COVERS GIVEN FREE TO PRODUCERS FOR OWN USE!** Write for full details!

KEY PRODUCTS CORP.
Dept. 4-0
800 N. Clark, Chicago 10, Ill.

PACKAGED BOAT KITS

**LARGEST CATALOG
EVER OFFERED!**

16 pages—80 construction and action photos PLUS specifications and performance data.



\$38.95 UP

COMPLETE LINE—SKIFFS, OUTBOARDS, RACERS, CRUISERS. 23 Models! Kits, Semi-finished and Custom-finished boats, hardware, paint.



Send 35c for Boat Catalog

Boat Catalog PLUS booklet on boat building, \$1.00

BOAT PATTERNS-BLUE PRINTS

Over 70 modern plans and full size patterns. Racing classes, cruisers, inboards, outboards, sail boats. By famous designers, 6' to 30'. DESIGN CATALOG 35c. Design catalog and boat building handbook, \$1.00.

MARINE MART-DEPT. 52-BUFFALO 7, N. Y.

BOYS-IT'S FREE!

See the barbs on a bee's stinger, the thousands of lenses in a fly's eye, wriggling vinegar eels and countless other marvels. Send today for exciting free book which introduces you to this amazing new world of scientific adventure.

THE PORTER CHEMICAL COMPANY
600 Prospect Ave., Hagerstown, Md.



EXTRA DOLLARS EASY

Yes, there's lots of extra money in spare time raising hamsters, particularly the new spotted hamsters. It's fascinating and it's fun, too. So clean, so odorless, can be raised in your kitchen. Get started right with Lakeview's superior breeding stock. Free shipping plan saves money.

LAKEVIEW HAMSTER COLONY
DEPT. PM, NEWFIELD, NEW JERSEY



NEW FREE BOOK ON

ALUMINUM PAINT TELLS HOW

How to Get
Better Paint
Results with
One Coat

Write for your free copy of 24-page illustrated fact-packed book, "Paint it Bright". Prepared by Alcoa experts to help you get best paint results. Absolutely free—no obligation. Write to:

ALUMINUM COMPANY OF AMERICA
1718H Gulf Building, Pittsburgh 19, Pa.

MONTH AFTER MONTH, YEAR AFTER YEAR, YOU SEE OUR AD. **REMEMBER IT'S DANGEROUS** to pay less if you want the finest (nonskid) USED tires.

GOOD YEAR **FIRESTONE**

GOODRICH, UNITED STATES, GENERAL & OTHERS, NOT RECAPS

Our policy is to select your tires so carefully, as if our very future depended on the service given by that particular tire.

FREE TUBE WITH "ALL" BLATT'S GOOD GRADE TIRES

GOOD GRADE, 16 MONTHS GOLDEN RULE GUARANTEE BOND.		FINEST GRADE, 26 MONTHS GOLDEN RULE GUARANTEE BOND	
600-16	\$4.14	700-15	\$4.54
650-16	5.42	670-15	4.74
700-16	5.04	710-15	4.94
650-15	4.44	550-17	4.64
650-20	\$7.94	650-20	8.54
32x6(8)	\$8.64	32x6(10)	9.94
900-20	13.94	1000-20	13.94

FINEST GRADE, 26 MONTHS GOLDEN RULE GUARANTEE BOND

THIS GRADE MADE THE BLATT NAME "WORLD FAMOUS".		THIS GRADE MADE THE BLATT NAME "WORLD FAMOUS".	
450-20	\$6.00	450-21	\$6.00
600-16	5.49	650-15	5.94
650-16	6.42	670-15	6.24
700-16	5.94	700-15	6.54
750-16	7.94	710-15	6.34
550-17	5.94	760-15	6.54
525-18	5.54	820-15	7.04
650-19	9.00	475-19	5.94
700-15(6)	\$10	750-16(8)	\$11
600-20	9.94	900-20	18.54
650-20	9.94	1000-20	18.54
700-20	11.94	1100-20	18.54
32x6(8)	10.54	1000-22	17.54
32x6(10)	13.92	1100-22	18.54
825-20	12.54	1200-22	22.54
825-20	22.84	1100-24	21.54

900-16	600-16	Military	750-20
Reg. \$10.94	Reg. \$6.75	Reg. 16 months	Reg. \$10.44
Super 19.94	Super 9.75	Super 30 months	Super 18.64

BLATT BLATT BLDG., GIRARD & LANCASTER AVES., DEPT. PM., PHILADELPHIA 31, PA. Send check or money order and this ad for rush shipment. We won't ship a tire we wouldn't use. The name to trust in rubber. PRICES SUBJECT TO CHANGE Shipments RUSHED Down South, Up North and Far West

Earn Big Money

WRITING ORDERS

AMAZING NYLONS

Guaranteed Against

RUNS AND SNAGS

Regardless of Cause!

The world's ONLY complete, nationally advertised nylon hosiery line actually guaranteed against runs, snags or excessive wear, **REGARDLESS OF CAUSE!** It's amazing, but true! No matter what the cause—hard use or deliberate abuse—Kendex nylons are replaced **FREE** if they run, snag or become unfit for wear within entire guarantee period! Every weight from sheerest 15 denier to heavy 70 denier—all gauges up to luxury 60 gauge—all sizes, lengths, popular shades, fancy heels, black seams—full fashioned and seamless. Nothing is missing to make sure every woman is pleased. In spite of the amazing guarantee, retail postage prepaid prices are no higher than comparable quality national brands. Should free replacement be necessary, actual cost is cut in half! How could any woman possibly resist saving money and solving her hosiery problems? **NOT SOLD IN STORES.** Men and women wanted **NOW**, spare or full time, to write orders and earn big money. You can get orders even if you never sold a thing in your life!

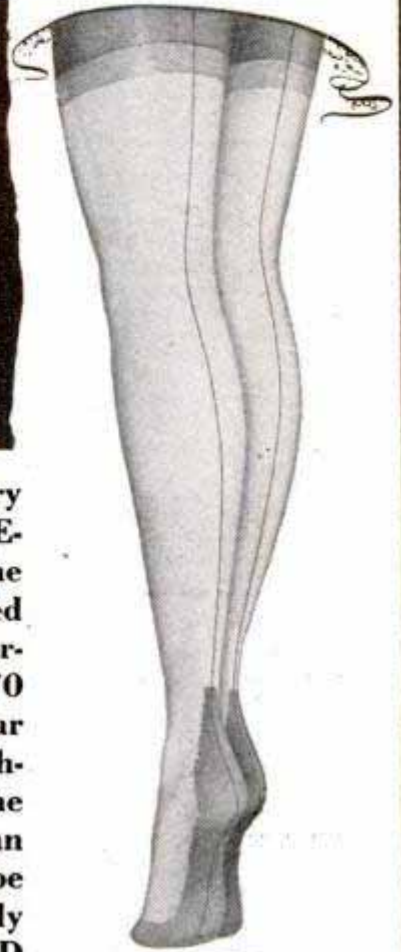

FREE SAMPLE STOCKING

Man or woman—young or old, **YOU** can easily earn steady income, spare or full time. No money or experience needed. We supply **EVERYTHING** free and set you up in business at **OUR** expense. Nothing to buy or deliver. Write orders. We deliver and collect. Big advance pay plus huge cash bonus that increases your earnings up to **40%**! Your name and address on postcard will bring you sample stocking; self-selling sales books with **FULL COLOR** illustrations; 32-page sales manual showing you easy steps to success; color cards, free "door openers" worth \$1 each but which you give away free; special plan to have others sell for you, etc., etc. You can start making money the minute you receive the complete **FREE** outfits!

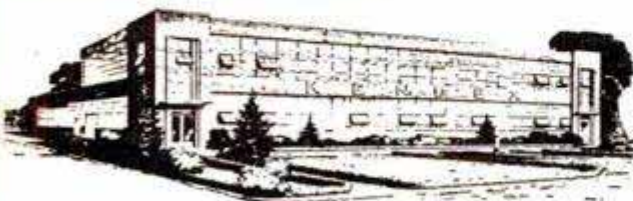

YOUR COST ONE CENT!

SEND NO MONEY. Pay nothing now or later. No obligation. Not even a promise to return outfits. Simply write your name and address on a penny postcard and mail to us. We'll immediately rush you everything you need **FREE** and postage prepaid. **WRITE TODAY!**

KENDEX CORPORATION



BABYLON 446, N. Y.

PISTON SEAL

is "Penicillin" in your AUTO ENGINE!



DON'T spend Big Money overhauling your car! Use Holt's "Piston Seal" instead! Exactly what's your trouble? Burning oil? Lacking power? Piston slap? Worn cylinders? "Piston Seal" effectively eliminates these ailments! By forming self-expanding pliable lubricating seal around the pistons, this amazing British product compensates for wear! Restores compression! Cuts oil loss! Checks piston slap! Lasts 10,000 miles! Cannot harm the finest engine; easily installed. The British call it a "Godsend!" You will, too!



It's easy!
Remove Plugs
Insert Rubber Tube
and Squeeze
That's All!

**DETAILS FREE!
WRITE TODAY!**

R. H. PHILBRICK, Dept. 62
Suite 203, 161 Aragon Ave., Coral Gables 34, Fla.
RUSH details on Piston Seal—without obligation!

NAME.....
ADDRESS.....
CITY.....STATE.....

TITANIUM Rutile MORE BRILLIANT THAN DIAMONDS

Refractive Index About 10% Higher Than Diamonds
Compare: Refractive Index of Rutile is between 2.62 and 2.90 as compared to the diamond's 2.42. Dispersion of Rutile ranges between 0.155 and 0.205 in comparison to the diamond's 0.025.



Available in 58 facet BRILLIANT, EMERALD and MARQUISE shapes @ \$10.00 per carat, postpaid—1 to 10 carats.

Unconditional 30 Day Trial — Money Back Guarantee

(Actual Photograph of Our Product)
HUDSON GEM CO., Dept. PM-6,574 5 Ave., N.Y.C., N.Y.

ENGINEERING DEGREE IN 27 MONTHS

Big Demand for Graduates

Aeronautical, Chemical, Civil, Electrical, Mechanical and Radio Engineering (including Television)

Hundreds of young men are earning engineering degrees in this recognized institution each year—continuous operation. New terms start quarterly. Many students earn a major part of their college expenses in this large industrial center.

Low tuition. Competent instruction. Thorough, intense, practical program. Modern laboratory facilities including new physics lab. and modernized wind tunnel. Individualized instruction emphasized.

Approved for Veterans. Engineering preparatory courses. Students from 48 states and 21 foreign countries. Enter September, December, March or June. Send coupon for free catalog and full information. Enroll now.

SEND COUPON TODAY

INDIANA TECHNICAL COLLEGE

581 E. Washington Boulevard
Fort Wayne 2, Indiana

Please send me free information on B.S. Engineering Degree in 27 months as checked.

- Aeronautical, Chemical, Civil, Electrical,
 Mechanical, Radio-Television

Name _____

Address _____

YOU CAN BUILD Beautiful Furniture for every room of your home

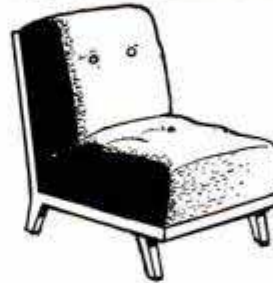

LIVING ROOM



DINING ROOM



BEDROOM



No Experience Needed
Suites for Living,
Dining and Bedroom
Exclusive Designs
Modern and
Traditional Styles
Scaled Diagrams

Now you can build beautiful furniture for every room of your home—charming, graceful furniture that will give your house an air of elegance and be the envy of your neighbors and friends.

For the Man with Few Tools and Limited Experience

Take your choice from a wastebasket to a complete suite. Choose any one of 100 beautiful articles. Start with a simple project and end up by refurbishing every room in your home. Step-by-step instructions from the Editors of *Popular Mechanics* and scaled diagrams make building easy.

Save Hundreds of Dollars

Why pay skyhigh prices for furniture when with a few evenings' spare time you can build a desk, dresser, bookshelf or even a complete suite and save as much as 67% of the cost? And the furniture you build will be even more attractive and sturdily constructed than the furniture you could buy. Several designs are exclusives by John Bergen, famous furniture designer.

160 Pages
16 Full Color Plates
Hundreds of Illustrations,
Photographs, Diagrams

Start building your furniture now. Send only \$3.00 for your copy of "100 Beautiful Pieces of Furniture You Can Build," or you can pay the postman if you prefer. Money back in five days unless you are completely satisfied.

Order on this Handy Coupon

POPULAR MECHANICS PRESS, Dept. 39
200 E. Ontario St., Chicago 11, Ill.

Gentlemen:

Send at once my copy of "100 Beautiful Pieces of Furniture You Can Build" at \$3.00. Unless it is entirely satisfactory I may return it within five days for a full refund.

NAME _____

ADDRESS _____

CITY _____ ZONE _____ STATE _____

Remittance Enclosed

Send C.O.D. (Postage Extra)

Draw This Car

Free! \$280 Art Course!

6 PRIZES! 1st: Complete \$280 Art Course; 2nd to 6th: Complete Artist's Drawing Sets.

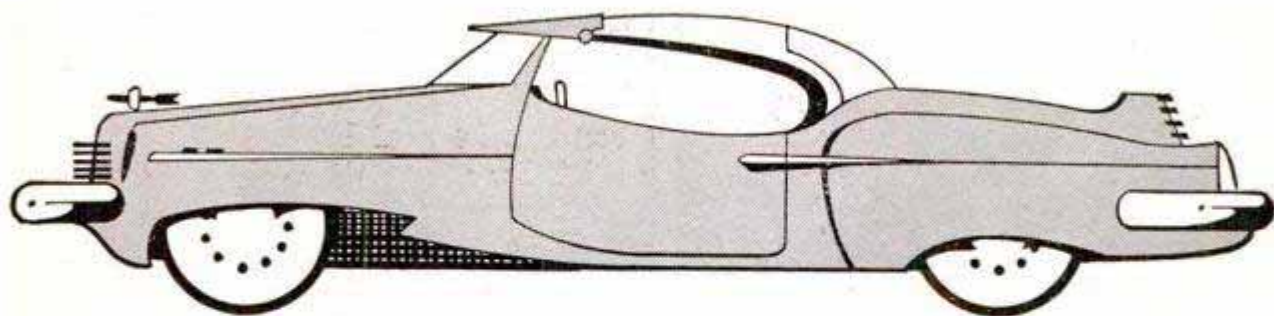

Here's your big chance, if you want to become a commercial artist, designer, or illustrator! An easy-to-try way to win FREE art training!

Whether you win or not we send you our comments on your work, if your drawing shows

promise! Trained illustrators, artists and cartoonists now making big money. Find out now if YOU have profitable art talent. You've nothing to lose—everything to gain. Start your drawing now. Mail it today.

Amateurs Only! Our students not eligible. Make copy of car 2 ins. high. Use pencil and/or pen. Omit the lettering. All drawings must be received by September 30, 1951. None returned. Winners notified.

Art Instruction, Inc.

MINNEAPOLIS • NEW YORK • CHICAGO

CHARTER MEMBER NATIONAL HOME STUDY COUNCIL

ART INSTRUCTION, INC., Dept. 8131C
500 S. 4th St., Minneapolis, Minn.

● Please enter my attached drawing in your Draw A Car Contest. (PLEASE PRINT)

Name _____ Age _____
 Address _____ Phone _____
 City _____ Zone _____ County _____
 State _____ Occupation _____

MAGIC-SCREEN INCOME PLAN OFFERS BIG MONEY, AT HOME, SPARE OR FULL TIME



Reproduce any painting, design, trade-mark, picture, printing, in full color, on any surface! Proven new method enables you to cash in on established business where Profits up to \$5.00 or more an hour are being made, right now! Examine complete Plan and equipment without risk!



Write today for free sample - Complete free details! **Send NOW!**

CALIF. ACADEMY OF SCREEN PROCESS DEPT. 28, 5100 SO VERMONT AVE., LOS ANGELES 37, CALIF.

FREE CATALOG

Over 300 books on Fishing, Hunting, Home Repairs and Improvements, Bricklaying, Welding, Home Workshop, Power Tools, Hobbies, Crafts, Home Building, Trades, Making Money at Home, Furniture Making, Woodworking, Carving, Photography, Art, Drawing, Mechanisms, Engineering, Refrigeration, Plumbing, Radio-TV, Electricity, Automobiles, Farming, Livestock, Gardening, Decorating, Painting, many, many more. Send for yours today.

POPULAR MECHANICS PRESS, 200 E. Ontario St., Chicago 11

Make Your Own LOW COST POWER TOOLS

Use Wood, Scrap, Discarded Materials—Make Practical, Proven Machines

Order today the new "Forty Power Tools You Can Make." Even though you have the older edition, get this new book with twenty brand new tools—40 in all. Make your own motorized lathe, drill press, sander, shaper, circular band, scroll and jig saws from old auto and other discarded parts. Make forty different tools following simple instructions, diagrams and photos and have an efficient, up-to-date shop. Save money, time and hard work and do a better job with low-cost power tools. Sent postpaid for only \$1.50 with order. Avoid high C. O. D. charges.

POPULAR MECHANICS PRESS
200 E. ONTARIO ST., CHICAGO 11, ILLINOIS



Your **ELECTRIC DRILL** Trims **HEDGES — SHRUBS — GRASS** with **ROTO-TRIM** DRILL ATTACHMENT

Today's Greatest Hedge Trimmer **VALUE \$10.95** Yours, Postpaid, for only **\$10.95** (Less Drill)

Keep your whole yard neatly tailored... trim hedges, shrubs, and hard-to-reach grass easily and smoothly with this new, inexpensive drill attachment. ROTO-TRIM quickly converts any 1/4" drill into an easy handling, keen-cutting Hedge Trimmer.

Quality Built throughout. Rigid steel and aluminum construction with smooth-running hardened steel gears and cam in one-piece case. Cutting blades are 10" long, of high carbon steel, heat-treated, precision ground and designed for maximum safety and efficiency.

Easy to Use! Quickly attached to drill—flats simplify chucking. Light weight and precision balance make ROTO-TRIM much easier to handle than more expensive trimmers. Handle turns blade to any angle.

Order TODAY! Don't miss this chance to get your ROTO-TRIM Hedge Trimmer Attachment while still available at today's low price of \$10.95.

UNCONDITIONAL 10-DAY MONEY BACK GUARANTEE! Send check or M. O. and we'll ship postpaid—direct from factory to you.

Dept. 851 **ROTEX COMPANY** 837 WEST DAVIS DALLAS 8, TEXAS

1951 SPEED and POWER "SOUP UP" ANY CAR

SPEED & POWER

JUST OFF THE PRESS!

LEARN HOW TO GET LIGHTNING SPEED, SUPER POWER AND BETTER MILEAGE FROM ANY CAR. CONSTRUCTION DRAWINGS SHOW HOW TO BUILD FAST STOCK CARS, CALIFORNIA ROADSTERS, 200 MPH HOT RODS.

FREE BOOK INCLUDED TELLS HOW FULL SIZED MODERN CARS ACTUALLY GO 150 MILES PER GALLON WITH REGULAR GAS.

EASY, STEP BY STEP METHODS help you save by building your own dual manifolds, superchargers, hot cams, water injectors, high compression heads and mileage devices.

50 BREATH TAKING CHAPTERS TELL ABOUT: Tuning techniques, Speed tricks, Economy secrets. Formulas for attaining racing speed and dynamic power. Includes Information On Racing Frames, Reciprocating Masses, Jet Engines, Wheel Geometry, Dynamometers. Also 34 pages with photos and diagrams cover Re-styling and Customizing all cars. Learn about dual pipes, gears, fuels, porting, relieving, lowering, balancing.

THIS GREAT 128 PAGE "SPEED & POWER HANDBOOK" . . . PLUS BIG "1951 SPEED EQUIPMENT CATALOG", listing and picturing hundreds of items . . . the finest in Hi-Performance Equipment . . . **PLUS "HOW TO GET 150 MILES PER GALLON"** . . . new book, shows how you can drive over 100 miles per gallon with your own car . . . **PLUS 44 PAGE "ECONOMY DRIVING MANUAL"** . . . explaining the theory and benefits of fuel additives, water-alcohol injection, and special equipment for internal combustion engines.

ALL 4 BOOKS . . . ONLY \$1.98 POST-PAID

NEWHOUSE AUTOMOTIVE INDUSTRIES, Dept. B-8
5805 East Beverly Blvd. Los Angeles 22, Calif.

MAKE A "Stradivarius" VIOLIN

BOOK AND PLANS ALL YOU NEED

**—For Pleasure
—For Profit
—For Your Own Use**

**You Can Do It at Little Cost!
It's Easy! It's Fun!**

Here is the "tops" of all home crafts projects. Make a violin—a replica of a famous "Strad"—the original of which sold for \$80,000.00. Joe Reid who has made hundreds of fine violins makes the job so easy—so inexpensive—in his new book "You Can Make a 'Stradivarius' Violin." You don't need any tools. Reid shows you how to make all the tools you need from old table knives, worn out files, sheet metal, etc. Eight full-size plans, 16x23 inches, folded into the book give you every detail in actual size.

Comp'ete Instructions

8 Actual Size Plans

How to Make the Tools You Need

Where to Get the Materials

You trace or work direct from actual size plans. No measurements to translate or confuse you. You see the entire violin in the plans. You read the how-to-do-it instructions in the book.

Violins Bring High Prices

Make a violin and you probably will never want to sell it. But good tone modern violins bring terrific prices, yet the materials cost comparatively little. With Reid's plans and step-by-step instructions you can make such a violin for yourself. 15 chapters guide you in selection of wood, fashioning the belly, back, sides, mold, lining, neck, scroll, purfling. Other chapters cover varnishing, finishing, stringing. Others show how to make tools and clamps at little or no cost.

**Order Book Today.
Money Back if Not Satisfied.**

Make your own violin for pleasure or profit. Get book and plans now. Clip this ad and mail with check, money order or cash for only \$3.50 or we will send C.O.D. Money back in 5 days if not satisfied.

WAR SURPLUS BARGAINS

WAR SURPLUS BARGAINS

\$500,000.00 INVENTORY for QUICK LIQUIDATION

Surplus items—hundreds of them for home, shop, factory, farm and outdoor use. New items, used items, reconditioned items—all at tremendous savings—all priced for quick sale.

Page After Page of Values

This big catalog shows page after page of amazing money saving values. Write for your copy today. Send 10c to cover postage, mailing, etc. Write today!

SEND TODAY FOR YOUR COPY 10c

STARK'S Dept. 509 So. STATE STREET PM-8 CHICAGO 5, ILLINOIS

DRIVING RELIEF! New LEFT-FOOT ACCELERATOR



Cut driving fatigue in half with Lefty! Install this new left foot accelerator yourself in 60 seconds with just a wrench—no alterations to your car are necessary. Enjoy relaxed comfort on long drives. Lefty lets you feed the gas with your left foot when you desire, relieves tension and fatigue in leg, back, and foot. Safe, positive and convenient. Swings out of way when not in use. Brings your car up to date. \$5.95 ppd. Specify year and make. No COD's please.

INVENTOR'S MARKETING LAB.
400-A De Young Bldg., 690 Market St., San Francisco, Calif.

Dealer inquiries invited.

POPULAR MECHANICS PRESS Dept. 30 200 E. Ontario St., Chicago

PLEASE SEND ME



for the time checked.

I am enclosing . . .

1 year \$3.50
2 years \$6.00

name _____
address _____
city _____ zone _____ state _____
PM-8

Hand this order to your newsdealer or send it to

POPULAR MECHANICS
200 East Ontario St. Chicago 11, Ill.

65 KW. 225 Volt D.C. DIESEL ELECTRIC GENERATING UNIT

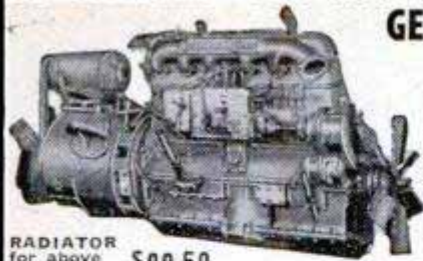

RADIATOR for above unit..... \$89.50

RECONDITIONED

Equipped with 6 cyl. DRXC Hercules DIESEL engine, 45" bore, 5 1/4" stroke, 133 H.P. at 2000 R.P.M. Complete with injector, pump, nozzles and electrical equipment. Generator attached to engine. Complete as shown.

Ea. \$1375.00
Lots of 2 ea. **\$1295.00**

Write for price on DIESEL ENGINE only.

60 HP. JEEP ENGINE

Reconditioned, tested & Guaranteed in perfect order, ready to run. **192.50**

SEND 25% CASH WITH ORDER, BALANCE C.O.D.



FOR GAS, OIL, WATER. NEW **5 GAL. CANS**

- Self locking cap.
 - Compact in size.
 - Sturdily made.
 - Floats when full.
 - 3 bar strong handle.
- 18" high, 6 1/4" thick, 13" wide.
Ea. \$2.95
Lots 12, ea. **\$275**

1951 EDITION! It's New! It's Different! Get World's Largest Auto Accessory & Parts Catalog and Save Money! Over 50,000 items including Hollywood Accessories, Hi-Speed Equipment, Rebuilt Engines, all parts & accessories for all cars & trucks. We have that Hard-To-Get Part! Jam packed with Bargains. Completely illustrated. Send 25c (refundable).

J. C. WHITNEY & CO.

1917SP ARCHER AVE. CHICAGO 16, ILL.

RADIO

ENGINEERING, Broadcasting, Television, P.M. Servicing, Electronics, Aviation, Marine & Police Radio taught thoroughly. Engineering course equivalent to 3 years' college radio work. Approved Veteran Training. Catalog free.

VALPARAISO TECHNICAL INSTITUTE, Dept. D, Valparaiso, Ind.

BOYS! MAKE YOUR OWN RADIO

Make your own simple, tubeless, batteryless Crystal Radio. SEND 25c for a GENUINE MELOMITE CRYSTAL with complete illustrated instructions for making your own set. Crystal sent postpaid with instructions and our own publication, "THE MAGIC CRYSTAL" which is full of news, diagrams, questions and answers of interest.

SEND 25c FOR YOUR CRYSTAL TODAY!

ALVA ALLEN RADIO Dept. 176 Clinton, Mo.

MASTER MIND!

Learn Short-Cut Mathematics
Juggle figures, do baffling number tricks. Make people gasp at your marvelous lightning-quick mind. Multiply 4 figures by 4 figures without using old-fashioned multiplication! Big cloth-bound volume; fully illustrated course. Includes worked-out problems, answers, etc. Sensational bargain, only \$1.95, postpaid or COD plus postage. Satisfaction guaranteed or refund. Order this amazing "Short-Cut Mathematics" today!

NELSON-HALL CO., 210 S. Clinton St. **\$1.95**
Dept. 2H-2 Chicago 6, Ill. Complete

WHY SUFFER TONGUE BITE?

These NEW pipes cost little more than the best of old-fashioned pipes. No TONGUE BITE. No DRINK. Burn to bottom on one lighting.

FREE Circular tells WHY. Send postcard to KLEENSMOK PIPE CO. 26597 Johnson City, Tenn. Pat's Pat'd.

7 JEWELS!

3 YEAR SERVICE GUARANTEE

- Shock Resist
- Radium Dial
- Sweep Sec. Hand
- Gift Boxed
- Chromed Case
- Leather Band

LADIES' WATCH \$7.95 plus 80c tax

As described above—smaller size
Money back guarantee! Order today! Sorry, no C.O.D.

ELCO PRODUCTS

Dept. PB, 166 W. Washington St., Chicago 2, Illinois



\$6.95
POST PAID
Plus 70c Tax

Learn BAKING At Home

Baking is one of America's high industries in wages. Nearly depression-proof. Thorough basic home course lays sound foundation. If you have aptitude, write for FREE BOOKLET, "Opportunities in Commercial Baking."

NATIONAL BAKING SCHOOL
835 Diversey Parkway Dept. 135C Chicago 14



PARTITION OFF AN EXTRA ROOM

Provide more usable space in your home by turning a large room into two smaller ones. For example, partition off a large double parlor into two rentable bedrooms or a small apartment. You can do it easily at low cost with Gold Bond Gypsum Wallboard. Nail the sturdy fireproof panels to a 2 x 4 framework. Seal joints with Gold Bond Tape Joint System and paint with Gold Bond Sunflex—the one hour wall paint. Or, if you prefer, Gold Bond Gypsum Wallboard takes wallpaper or texture beautifully. For further information, write Div. W, Dept. MI-81.

Available at your local Gold Bond lumber and building materials dealer

NATIONAL GYPSUM COMPANY
BUFFALO 2, NEW YORK



BRAND NEW

33 MODELS
\$14.95 up

BUSHNELL Binoculars

30 DAY FREE TRIAL

High Power BINOCULARS

Finest Precision Optics
Featherlight
Money Back Guarantee
Easy Pay Plan
Leather Case Incl'd.

Free! Catalog & Book
"How to Select Binoculars"
Dealer Inquiries Invited
Bushnell Bldg., Dept. MB28,
Pasadena 1, Calif.

AUTO SEAT COVERS

SPECIAL OFFER!

\$1.98
COUPE OR FRONT SEAT

"MIRACLE PLASTIC" Complete Set, FRONT AND REAR **3.89**

in 5 LUSTROUS COLORS
RED • BLUE • GREEN • GRAY • MAROON

Add instant class to your car! Snap-on action holds 'em tight. Color fast. No fade! No shrink! Wash with damp cloth. SEND NO MONEY! Order TODAY at our risk! Give year and make of car, 2-door, 4-door, or coupe, and color preference. Pay postman plus postage. Or send Cash. Check or Money Order and We Pay Postage! Keep 10 days—return for full refund of purchase price if not fully satisfied, but, HURRY—they'll sell like hot cakes

LEOPARD OR ZEBRA
Front Seat, 2.98
Complete Set, 4.5

YOUNG PRODUCTS
Dept. 9-C 2605 Elmhurst, Detroit 6, Mich.

- Waterproof
- Stainproof
- Greaseproof
- Won't Burn

RELIEVES PAIN OF HEADACHE · NEURALGIA NEURITIS

FAST

The way
thousands of
physicians
and dentists
recommend



Anacin® relieves headache, neuralgia, neuritis pain fast because Anacin is like a doctor's prescription—that is, Anacin contains not just one, but a combination of medically proven, active ingredients in easy-to-take tablet form. Thousands have been introduced to Anacin through their own dentist or physicians. If you have never used Anacin, try these tablets yourself for incredibly fast, long-lasting relief from pain. Don't wait. Buy Anacin today.

LOWER YOUR CAR in 30 MINUTES!

with **CLARK LOWERING BLOCKS I**
Gives any car that sleek, streamlined look! Easy to do! Everything furnished.. Adds to safety at high speeds by dropping center of gravity. Fits all makes and models. Please state.

MAKE	DROPS		
	1 1/2"	2"	3"
Chev. (except 1951)	\$3.00	\$3.50	\$5.00
All other (ex. 1951)	3.50	4.00	5.00
All 1951 models having wide springs	5.00		5.00
Special Ford & Merc. set ('32 to '48)	1.00		



Over
One
Million
in Use

Dealers
Write.

CLARK COMPANY ★ 7018 E. FIRESTONE BLVD. Dept. P-8 DOWNEY, CALIF.

NEW "PAINT PEN"

PAINT STRIPING TOOL Works like a Fountain Pen Stripes with Paint instead of Ink!

This amazing new "PAINT PEN" is a Paint Striping Tool that makes it easy to do expert striping on furniture, bikes, model planes, autos, signs, toys, linoleum, wall board, etc. Makes plain painted walls look like tile. Paint straight, curved, circular or evenly spaced parallel lines the same way a professional painter does. Simply fill Tubular Glass Paint Fountain with any color paint and wheel tip feeds paint evenly. Tips interchangeable — jaws split apart for easy cleaning. Tool complete with tip for 1-16 inch strip only \$1.00 postpaid. Other complete tools with 1-64, 1-32, 3-64, 1-16, 5-64, 3-32, 1-8 inch tips. \$1.50 ea. Extra tips, 75c each. Complete KIT with 7 tips, \$5.00. C.O.D.'s postage collect. Here's the handiest tool in your whole painter's kit. Get yours today.

DEALERS
PAINT STRIPING TOOL
packed in display cartons
of 1 doz. Fast, profitable
seller. Write for illus-
trated circular, discounts

Only
\$1.00

WENDELL MFG. CO., Dept. 38,
4234 LINCOLN AVENUE, CHICAGO 18, ILL.

Paint
STRAIGHT,
CURVED OR
PARALLEL LINES

Home Craftsmen

Just the tool you've been waiting for! New Paint Striping Tool gives "professional" results every time, yet simple and easy to use as a fountain pen. Adjustable guide keeps lines straight as an arrow. Just as easy to make curves or free hand designs. Adds new beauty and finished look to everything you paint. (Send \$1 now)

PLYMOUTH SAVE MONEY!



Learn How to Make Your
Car Run Better . . . Last
Longer . . . and Save Hundreds of Dollars!

Get this book, written especially for you, without one penny of risk and get more out of your car. Mail coupon for **MANUAL FOR PLYMOUTH OWNERS** today. When the book comes, skip through the pages and see how your investment in one of America's most popular automobiles can be even a better investment than you thought. If you don't agree, send the book back and you'll get your money back.

A Popular Mechanics Book Written Just for You

Not a re-hash of service manuals. A complete new Popular Mechanics book written for the Plymouth owner by an outstanding automotive authority with the full cooperation of Plymouth engineers and service directors. It will save you money on repairs and service; make your Plymouth last longer; give you safe, economical and trouble-free motoring. And this is true whether you take your Plymouth to a regular service station or service it at home.

Prevents Trouble. Cuts Down on Repair Bills

Nothing like this manual anywhere. It covers all phases of operation, service and maintenance. It has entire chapters on the individual parts of your Plymouth—battery, ignition, starter, generator, regulator, lighting, fuel system, engine, lubrication, gasoline qualities, cooling systems, transmission, differential, rear axle, brakes, wheel alignment, tire care, body maintenance, trouble shooting on the road, etc. It covers your Plymouth, new and older models, step by step—bumper to bumper—showing you how parts operate; what can go wrong; how repairs and adjustments should be made and how to avoid all types of troubles.

Money Back if Not Satisfied

Mail the coupon today. Send only \$3.50 or you can pay postman. Money back guarantee protects you.

Official, Authoritative, Practical Information

Written by C. E. Packer, formerly service school instructor and auto show lecturer for automobile manufacturers, Member Society of Automotive Engineers, Special Services Editor of Automobile Digest, contributor to leading magazines, author of some of the biggest selling books on Automotive subjects. Prepared with the full authority and active cooperation of the Plymouth Division of the Chrysler Corporation.

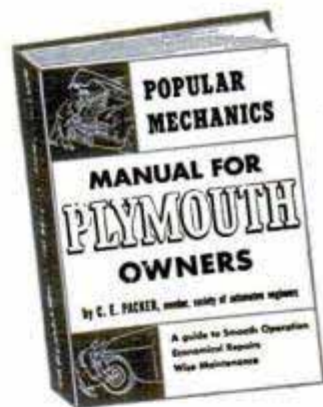

288 Pages. Hundreds of How-To-Do-It Illustrations and Diagrams

The entire book follows Popular Mechanics famous easy-to-read and easy-to-understand style. While primarily intended for the Plymouth owner, to help him get more out of his car at lower cost, it can be worth its weight in gold to the auto mechanic and service station operator who works, not only on Plymouths, but on all other makes as well, to which the information in the book can be easily applied.

Order on this Handy Coupon

POPULAR MECHANICS PRESS,
200 E. Ontario St., Chicago 11, Ill.

Send Manual for Plymouth Owners at once. If not satisfactory I will return it within 5 days and you will refund full purchase price.

Remittance for \$3.50 enclosed. Send C.O.D.

Name _____

Address _____

City _____ State _____

Now! Save Dollars on Your Gasoline Bill



—With Plain Tap Water

Yes... using nothing but tap water, the amazing HYDRO POWER INJECTOR actually saves you up to 15% on gasoline, increases your car's power as much as 25%. Developed after long years of research by Army and Navy, the HYDRO POWER INJECTOR (a product of the Hydro Power Injector Co., Denver, Colorado) increases acceleration, reduces carbon and actually prolongs engine life. Easily installed. Must be all we claim or money back. **ORDER TODAY — WRITE DEPT. PM-1. Specify if for single or double throat carburetor.**

Simple directions enclosed **\$15** ppd.
Truck Model—\$17.50 ppd.



Zumbach Motor Co.
129 W. 53 St., New York, N.Y.

TRUSS WEARERS

Here's good news! **FREE** Penny demonstrator—proves that greater safety and comfort can be yours immediately. No obligation. Send post card for details.

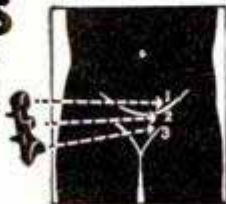

ACTIVE MAN TRUSS CO.

549 W. Randolph St., Dept. PM8, Chicago 6, Ill.

RETIRE IN FIVE YEARS!

FREE Literature and information

FISHER'S KEY CHINCHILLA EXCHANGE

1611 MONTANA AVE.,
SANTA MONICA, CALIF.



HOW TO IMPORT! FOR PROFIT AND PLEASURE

Men—women! Learn how to import at low foreign prices for your local buyers. No previous experience needed. Big profits possible, no stock investment. World-wide Import-Export business from your own home by mail order, spare—full time. (Example of money saving prices at left.) Big savings on clothes, tools, antiques, watches, china, silk, toys, etc. Get **FREE** list of imports from Europe—Orient, etc. Trade world-wide from small towns—large cities — or travel abroad. World Trade Home Course sent on five day no risk examination. Write today for **FREE** details and list. Airmail reaches us overnight. **MELLINGER CO., Exporters-Importers.**

1418-EF Westwood Blvd., Los Angeles 24, Calif.

FREE!!
LIST 1000
Bargain Imports



57¢

INSTALL A KENTILE FLOOR YOURSELF FOR Less Than

SAVE UP TO 66%
DO IT YOURSELF!

FREE!

INSTRUCTION BOOK

Tells how to plan, design, measure room, lay tiles and border, cut tiles at wall, fit to pipes, radiators, etc., prepare floors.



DO IT YOURSELF!

EASY TO DO—ECONOMICAL TOO!
Kentile can be installed on any concrete or wood floor, for a new and lasting brilliance — at savings up to 66%! **SOLID COLORS** (black, quarry red) **ONLY \$3.98. MARBLEIZED** (black, brown, heather, green) **ONLY \$4.69.** Packed 80 tiles to box (45 sq. ft.) shipped freight collect

HOME INC. TILE CENTER
8702 Georgia Avenue, Silver Spring 5, Maryland

Illustrated Catalog
Full color catalog kit, contains: 2 catalogs on asphalt tile, borders and colorful inserts for playroom, den, bath, kitchen, commercial establishments; complete booklet on how to measure rooms and make installation of Kentile. Send only 10¢ for this valuable, interesting kit.

STOP THE ITCH of ATHLETE'S FOOT

this **NEW, BETTER WAY!**

...AND Kill fungus germs, TOO!

BACTINE brings quick relief from painful foot itching. Tests prove it kills fungus germs causing over 90% of all Athlete's Foot. **BACTINE** soothes, cleanses, deodorizes and never stains.



Guaranteed by Good Housekeeping

Bactine AT ALL DRUG STORES
30c and 70c SIZES

BRAND Reg. U.S. Pat. Off.

BUILD

Stronger Models

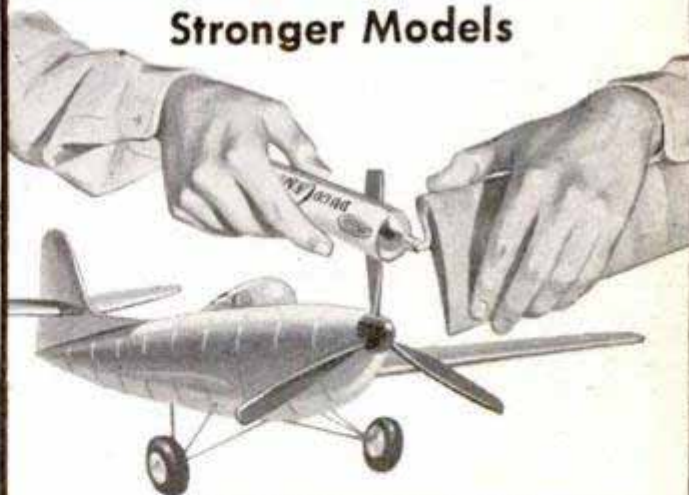

It's transparent, waterproof, flexible and durable. Get a tube today.



DU PONT DUCO CEMENT

REG. U. S. PAT. OFF.

70c CAN SAVE YOUR CAR



by "Hib"

Just a few pennies for a can of WARNER LIQUID SOLDER may save your car from ruin. You see, a radiator leak, no matter how small, may lead to overheating that can literally burn up your engine. Non-metallic WARNER LIQUID SOLDER repairs leaks quickly by depositing tiny fibers in the holes. And WARNER LIQUID SOLDER is easy to use — just shake, pour and fret no more.



WARNER-PATTERSON COMPANY
CHICAGO 5, ILLINOIS

BE YOUR OWN BOSS

Make Hundreds of \$ Spare or Full Time Work

You can make simply and cheaply

NO EXPERIENCE NEEDED

Here is the ideal business with no previous experience or large investment required and no high-priced equipment to buy. A business that will return dollars for the pennies you invest.

YOU CAN CAST ANYTHING

With *Flexible Mold Making and Ornamental Casting*, an amazing fact-packed book, you learn how you can cast practically any article in concrete, plaster, imitation marble or any other casting material using a marvelous new process. You can make ash trays, novelties, garden and lawn ornaments and hundreds of other highly profitable items that cost you but a few cents and sell for as much as \$5.00 and more. Why you can even make true-to-life full-sized busts of your neighbors and friends.

NO EXPENSIVE MOLDS TO BUY

Why buy high-priced molds from others? Learn how you can make your own molds quickly, easily and inexpensively with materials that can be used over and over. You get copyrighted formulas, complete instructions and detailed how-to-do-it photographs as well as complete sources of supply for the few inexpensive materials you need. This is the only book printed in America today that contains instructions for making profitable papier-mache casts.

MONEY BACK GUARANTEE

Start on your road to extra income and independence today. Send only \$3.00 for your copy of *Flexible Mold Making and Ornamental Casting*. Complete satisfaction guaranteed or your money refunded within seven days.

POPULAR MECHANICS PRESS, Dept. 46
200 E. ONTARIO ST., CHICAGO 11, ILL.



•• A SHOE BUSINESS IN YOUR HAND! ••

EARN \$60 WEEKLY
WITH ONLY
3 SHOE ORDERS A DAY!

Make more money with famous 30 year old company. Show complete line quality shoes for men, women, children. Commissions to \$4.00 per pair. PLUS Cash Bonus to 75c per pair. PLUS Paid Vacation! Smash hit styles with magic comfort heel-to-toe cushion are selling dynamite. No experience or investment needed.

Actual shoe samples supplied without cost. Write TODAY for full information and FREE 60 page Fall Catalog.

TANNERS SHOE CO., 851 Boston 10, Mass.

THE
BIGGEST
SELLER
IN
30 YEARS



FREE! LAFAYETTE RADIO'S NEW RADIO • TV CATALOG

Reserve your copy now! Complete with everything in TV, radio, parts, experimenters equipment, tools, sound systems, Hi-Fi, test equipment, etc. Newest parts as well as old standard lines. Mail postcard today for your value-packed, money-saving copy. RADIO WIRE TELEVISION, INC., Lafayette Radio, Dept. LH-1, 100 Sixth Ave., New York 13.



FEBRUARY DRIVE 3 TO 6 DAYS A MONTH

S	M	T	W	T	F	S
				1	2	3
4	5	6	7	8	9	10
11	12	13	14	15	16	17
18	19	20	21	22	23	24
25	26	27	28			



Gas Free!

Better performance, more power, quicker starts, faster acceleration on all cars, light trucks, tractors—any age, make or model. Amazing discovery, tested in Engineering Dept. leading U. S. University. Greatly reduces gas consumption—may actually pay for itself in cash savings. It can help you keep rolling if gas rationing comes. TEST IT 30 DAYS ON YOUR OWN CAR BEFORE DECIDING. Prove for yourself outstanding benefits of new miracle development by actual day-by-day experience on the road, TRY IT AT OUR RISK. Write or wire today for FREE details, technical explanation and 30 day Examination Request Blank. SEND NO MONEY. G. B. SCHUYLER, Dept. 48, 2804 10th St., Berkeley, Calif.

SEND ME



every month so I am sure to see each new issue. Here's

- \$3.50 for 1 year
 \$8.00 for 3 years

name _____

address _____

city _____

zone _____

state _____

PMB-8

Hand this order to your newsdealer or send it to

POPULAR MECHANICS
200 East Ontario St. Chicago 11, Ill.

TERRIFIC VALUES - SURPLUS - SAVINGS UP TO 85%

MANUFACTURERS AND JOBBERS -
Write us about your surplus items

Portable LIGHT PLANT

PUSH BUTTON START
500-700 watts 110-120 v. - 60 cyc. A.C. Powered by a sturdy dependable, easy starting, air cooled 1 3/4 hp. gas engine. No wiring necessary, just plug in and operate. Plenty of current for any oil burner, freezer, brooder, pump, emergency lights, etc. which require up to 700 watts. Ideal for Civil Defense, Fire Depts; trailers & camps. Complete with Voltmeter and built-in winding to charge 6 v. auto batteries. Wt. 85 lbs. Fully guaranteed. Be prepared if war or storm knocks out power lines. Reg. \$275.00 value.

\$143.50

\$169.95

\$199.50

(Item 24) which require up to 700 watts. Ideal for Civil Defense, Fire Depts; trailers & camps. Complete with Voltmeter and built-in winding to charge 6 v. auto batteries. Wt. 85 lbs. Fully guaranteed. Be prepared if war or storm knocks out power lines. Reg. \$275.00 value.

GIANT 2000-2500 WATT PLANT

110-120 V. 60 cyc., A.C. Absolutely the best made because its heavy windings develop up to 5000 watt overload for motor starting. Skid-mounted - portable. Powered by 5 h. p. easy starting Briggs or Wisconsin engine - complete with all accessories: engine easily disconnected for other uses. Big outlet box, voltmeter, no wiring necessary. Ample current for all purposes. Factory warranty and instructions included. Wt. 220 lbs. Reg. \$855.00. Special at

\$299.50

\$169.50

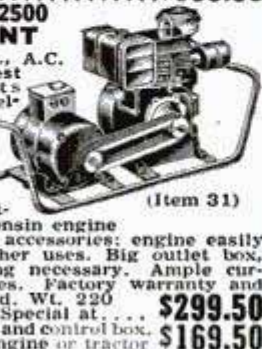

GENERATOR ONLY and control box. \$169.50

Drive it with your engine or tractor

RADIO TRANSMITTER

(Item 60) Type SCR 578, portable. Only 18 lbs. Ideal for boats, Hams, etc. Crank operated generator produces ample current to send Morse code (built-in hand key), blinker light or continuous automatic SOS. 500 KC. mck. Can be converted to power transmitter. Contains hundreds of valuable parts. Built in antennae and ground. Slightly used for training. Complete instructions and Morse code incl. Cost govt. over \$200. Terrific value.

\$18.95



GIANT BUNSEN BURNER

(Item 61) Operates equally well on gas or ordinary alcohol. Economical. 1 pt. burns for hours. Produces intense blue smokeless flame. Ideal for lab. or as emergency cooking unit. Fine for camping. Heavy brass burner with shut-off and adj. valve. Simple and safe. 5 ft. flex. hose, 1 qt. tank incl. Wt. 5 lbs. A \$15 value. Spec.

\$4.95

\$1.49

1/4" DRILL

(Item 34) Hi-power, long-life, smooth running. Alloy steel gears; built-in blower. Cutler-Hammer switch, Jacobs handle chuck. 110-120 v. AC-DC 1000-1600 rpm. Cap. 1/4" in steel. 1 year guar. Wt. 4 lbs. Terrific value at \$12.95.

38 Pc. DRILL KIT

(Item 35) Includes above illus. guar. drill, buffers, polishing, buffing, sanding discs, grinding wheels, wood bits, screw bits, wire wheels, bench stand, paint mixer, burrs. Complete in steel case. Wt. 13 lbs. 38 pc's., all highest quality. Complete kit worth \$38.50. Our

\$19.85

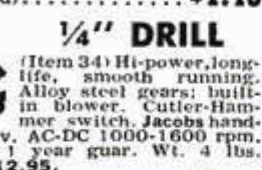
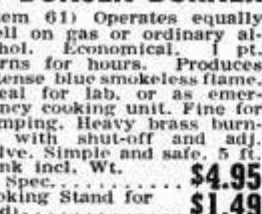

FIRE or BURGLAR ALARM

(Item 46) Completely automatic. Wind and hang anywhere. Thermostatic element sets off loud clanging bell if heat reaches 140° (setting adjust.). A fool-proof burglar or signal alarm when used with trip cord attached to door, window, invalid's bed, etc. Sturdy metal const. assures lifetime of protection. Ideal for homes, stores, whse., gar., etc. Wt. 3 lbs. Easily worth \$20. Special.

\$4.95



HEAVY DUTY ARC WELDER

(Item 38) Use as portable or shop welder. 250 amps. D.C., Senior model. Made for years of trouble-free, continuous service. Will handle light or heavy jobs. Weld up to 1/2" plate using 1/4" rods. Built-in air-cooling system. Arc is easy to strike and hold, because of specially designed arc stabilizer. Hi-to switch and dial control gives wide range of welding heats. Run welder at 2600 rpm. with tractor, jeep or 10 hp. gas engine, or 7 hp. elec. motor. Complete with instructions, guar. and double V belt on flat pulley. Wt. 110 lbs. A \$400 value at

\$99.75

\$10.50

DUAL TUBE LIFE SAVERS

(Item 54) NEW APPROVED TYPE made by Genl. Tire for Navy. Each has 2 rubber tubes for double protection. Easily inflated by mouth to 55 in. Wear one around waist as comfortable life saver. Adjustable safety buckles fit adults or children. Tie several together for raft or big luxurious mattress. Invaluable on boats or beach. Wt. 2 lbs. each. Our spec. in fraction of cost! 99c each, 6 for

\$5



HIGH PRESSURE HAND PUMP

(Item 53) Positive displacement type. Cap. 550 gph. Completely self priming. 3/4" pipe thread inlet and outlet. Use for fuel or water transfer on boats, trailers, air craft, etc. Ideal for insecticides, emerg. sump pump or as vacuum pump. Wt. 15 lbs. Govt. cost \$95. Our Special.

\$12.95

FIRE EXTINGUISHER

(Item 39) Fully charged at 1,000 lbs. P. S. L. or more) with CO2 (carbon dioxide) the proven miracle fire fighting chemical that smother's oil, gasoline and electrical fires. Play safe; keep one in your car, garage and home. Heavy ICC approved steel cylinder, valve and 3000 lb. gauge that shows available remaining pressure. REFILLABLE at nominal cost. Hose included for emergency tire inflator or air blast. Wt. 4 lbs. \$19.50 value. Special.

\$6.95

LARGE FIRE EXTINGUISHER

(Item 57) commercial size, 5 x 14 in. (275 cu. in.) heavy ICC approved steel cylinder charged at 1000 lbs. or more with CO2. Equipped with genuine Kidde Valve and Gauge to show available pressure at all times. Refillable. Hose incl. Suitable for fire depts. stores, garages, homes, etc. Wt. 18 lbs. \$42.50 value. Spec.

\$15.85

32 pc. SOCKET SET

(Item 59) Highest quality guar. non-breakable sockets made by Plomb, Snap On, etc. Complete range of 22 sockets from 1/4" thru 3/4" in 3/8" drive and 7/16" in 1/2" drive. 2 speeder handles, thru 1 1/16" 2 slide heads, double 3/4 x 1/2 in. "L" handle, reversible ratchet, 12" Phillips type screw driver and metal tool box. For professional mechanics who want the best. Wt. 14 lbs. Easily worth \$32.50. while they last.

\$15.95



RUBBER HOSE

New genuine Neoprene Hose - outlasts ordinary rubber 3 to 1. Reinforced with super tough cotton cord plies. Flexible. Easy Flo brass couplings with standard pipe threads for quick connections, included. Pump water for irrigation, stock tanks, home, barn, fire fighting, etc. Pump Gas or Fuel Oil. Save more than 60%.

(Inside Diam.) 1 1/2" 1 3/4" 1 1/2"

Length 25 ft. 40 ft. 30 ft.

Price 9.25 14.75 14.75

If specified we will send special hose for gas or oil at same prices.

AIR HOSE

(Item 11) 1/4" Diam. heavy duty, double braid, suitable for gas stations, spray painting, air tools, etc. 20 ft. with standard swivel couplings. Wt. 4 lbs. Reg. \$6.50 val., only \$2.95. Five 20 ft. lghs. (100 ft.). Wt. 20 lbs. Only \$13.75.

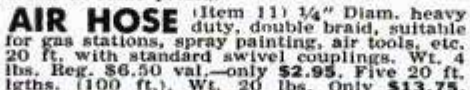

EXTENSION CORD

(Item 16) 40 ft. heavy duty, made of specially insulated No. 14 2-conductor wire. So tough that you can drive over it and yet amazingly flexible and easy to handle. Resists oil, grease or water. Extends electricity up to 400 ft. without voltage drop. Use indoors or out. Complete with heavy rubber plug and outlet. Wt. 2 1/2 lbs. Usually \$4.50 - Special 40 ft. \$1.99 Comb: 2-40 ft. and 1-20 ft. (total 100 ft.) \$4.95 100' (foot length (one piece)

\$4.95

TRENCH-LAY WIRE

(Item 51) Anaconda #10 -2 cond., for buried service to barns, outdoor lights, etc. Absolutely impervious to soil and moisture. Wt. 25 lbs. per 100 ft. Special surplus price. 100 ft. coils, 19c per ft.; 250 ft., 18c per ft.; 500 ft., 17c per ft.

HEATING & VENTILATING FAN

(Item 10) Easily installed in furnace pipes. Forces even heat to all rooms. Over range, removes kitchen smoke and odors. Powerful continuous duty motor, 110-120 V. A.C. Quiet, super efficient fan moves huge volume of air (400 to 600 c.f.m.) 8" Fan, wt. 5 lb. \$6.35; 9" Fan, wt. 6 lbs. \$7.45; 10" Fan, wt. 7 lb. \$8.45; 12" Fan, wt. 8 lbs. \$9.45.

G. M. HI-FLO PUMP

(Item 56) 210 gal. per min. Centrifugal turbine type. Unexcelled for fire-fighting, irrigation, sprinkling systems, swimming pools, drainage, fuel transfer, etc. Built by GM for the army at cost of more than \$145. Tremendous volume, will deliver 210 gpm with 5.3 hp. down to 40 gpm with 1 1/2 hp. 2 1/2" stand, pipe thr. inlet (can be reduced to 2" if desired). Twin 1 1/4" outlets, dynamically balanced, 3/4" shaft, hi-speed ball bearings. Easy fast priming. (instr. incl.) Wt. 36 lbs. Sensational value.

\$39.50

ELECTRIC HAND SAW

(Item 36) Most perfectly balanced and smoothly running saw made. Advanced design provides max. power and light weight. Easily adjusted for all angles, depth and width of cut. Comes complete with 6 1/4" comb. blade, tipping guide and 10 ft. hvy. duty cord. Built-in sawdust blower. Autom. telescoping guard. 110-120 v. AC-DC. Depth of cut 2 1/4". 1 year written guar. Wt. 12 lbs. Drastically reduced.

\$39.95

SPRAY OUTFIT

(Item 37) Twin cyl. piston type compressor direct-connected to powerful 110-120 v. AC-DC motor. Built-in air tank eliminates pulsation and provides steady flow of air at 25-30 lbs. Sprays lacquers, enamels, insecticides, etc. Does beautiful work on autos, furniture, farm equip. 1 qt. spray gun, relief valve and 10 ft. air hose incl. Full instructions and 1 year guar. Wt. 11 lbs. Regularly \$50. Spec.

\$22.95

ANGLE DRILL

(Item 23) Fits into chuck of any electric or pneumatic drill or flex. shaft. Operates at any angle in a full 360° arc. Makes possible drilling, grinding, carving, routing, etc. in close cramped quarters. Makes impossible jobs easy. Made by Kett Tool Co. Complete with built-in chuck (1/4" capacity) and adjusting key. Hardened alloy gears. Precision built for heavy duty. Lists at \$39.95 - while they last.

\$9.95

CARRY-AIR

(Item 32) Stainless steel tank - capacity 500 cu. in. at 400 lbs. press. complete with inlet and shutoff valves, press. gauge, detachable air hose, tire chuck. Fill at any service station. Carry air for tire inflation, blowing out lines, spray painting, insecticides, etc. One emergency pays back cost. Wt. 10 lbs. Worth \$20.00. Our price.

\$8.95

(Item 55) With big double tank

(1000 cu. in.) **\$11.95**

(Item 58) Tank only, 500 cu. in. (no fittings) **\$5.95**

PRESSURE SWITCH

(Item 30) Penn Electric Model 110 BPO2, best made. For pumps and air compressors. Heavy duty. Will handle up to 250 lbs. press. and up to 5 h. p. Autom. unloader valve, for easy starting. 110-220 v. A.C. or D.C. 2 pole. Wt. 5 lbs. Reg. list \$17.50. Our Spec. \$9.45.



All items brand new. Prices f.o.b. Chicago area. 10 day Money back guarantee. Send check or M. O. **MASTER MECHANIC MFG. CO., DEPT. 59 Burlington, Wis.**

Bite's Out



*The National
Joy Smoke*

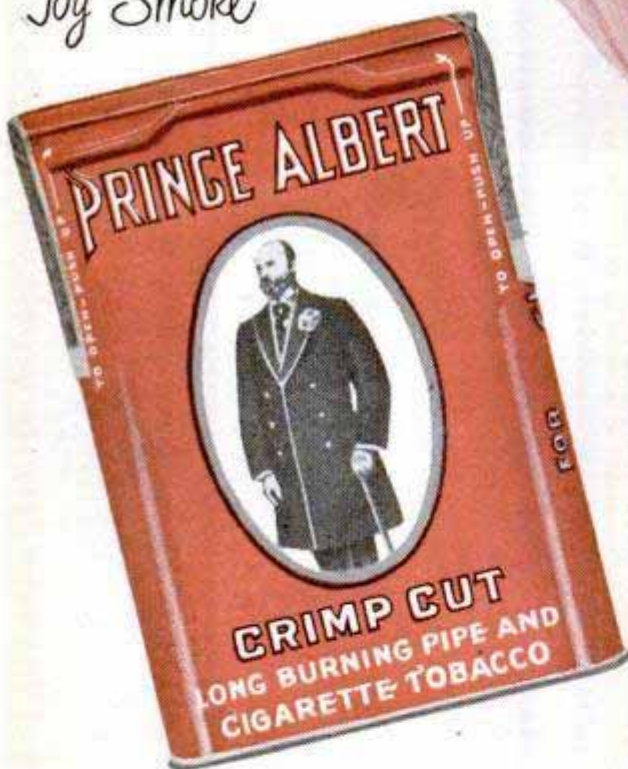

Pleasures In!

PRINCE ALBERT'S PATENTED* "NO-BITE" PROCESS MEANS REAL PIPE COMFORT

Yes! Whether you smoke a pipe or roll your own...

you'll find real smoking joy in Prince Albert's choice, rich-tasting tobacco, specially treated to insure against tongue bite. Crimp cut—and so mild, P.A.'s as big a favorite with roll-your-owners as with pipe smokers.



*Process Patented July 30, 1907

MORE MEN SMOKE

Prince Albert

THAN ANY OTHER TOBACCO

E. J. Reynolds Tobacco Co., Winston-Salem, N. C.

POPULAR AUGUST 1951 MECHANICS NO. 2

WRITTEN SO YOU CAN UNDERSTAND IT
VOL. 96



Staging 200 movie wars has skilled Lou Witte, below, in the use of props like this flame-throwing tank

Mastermind for Hollywood's WARS



By Andrew Hamilton

WHEN THE Marine Corps general spotted the machine gun, he loosed a string of profanity. "Why isn't that gun in Korea," he demanded, "instead of being used in a blankety-blank movie?" He quickly cooled off when told it was a dummy gun, run by electricity, compressed air and acetylene-gas flame.

Shirley Temple crouched against a tree in a movie about the French and Indian wars, while bullets splintered the bark around her. Film fans shivered, but she was as safe as in her Santa Monica home.

More recently the quiet waters and tropical air of the Virgin Islands churned with huge splashes, flared with bursts of flame,

blackened with towering columns of smoke and reverberated to ear-shattering explosions. It was a motion-picture crew making "The Frogmen," and a Navy officer acting as technical adviser muttered, "Just like Iwo Jima!"

The man who gets such realism onto celluloid is Louis Witte of Twentieth Century-Fox. He's Hollywood's ace authority on the arts of war, and has probably masterminded more military movies than any man in the business.

Around the studio he's commonly known as a "special effects" man. But his full title is Head of the Mechanical Effects and Arsenal Department.



For film life of General Rommel of North African fame, Witte set up the desert-bombing scene, above. Close-up water action, like that, below, from "The Frogmen," can best be shot in a reservoir on the studio lot

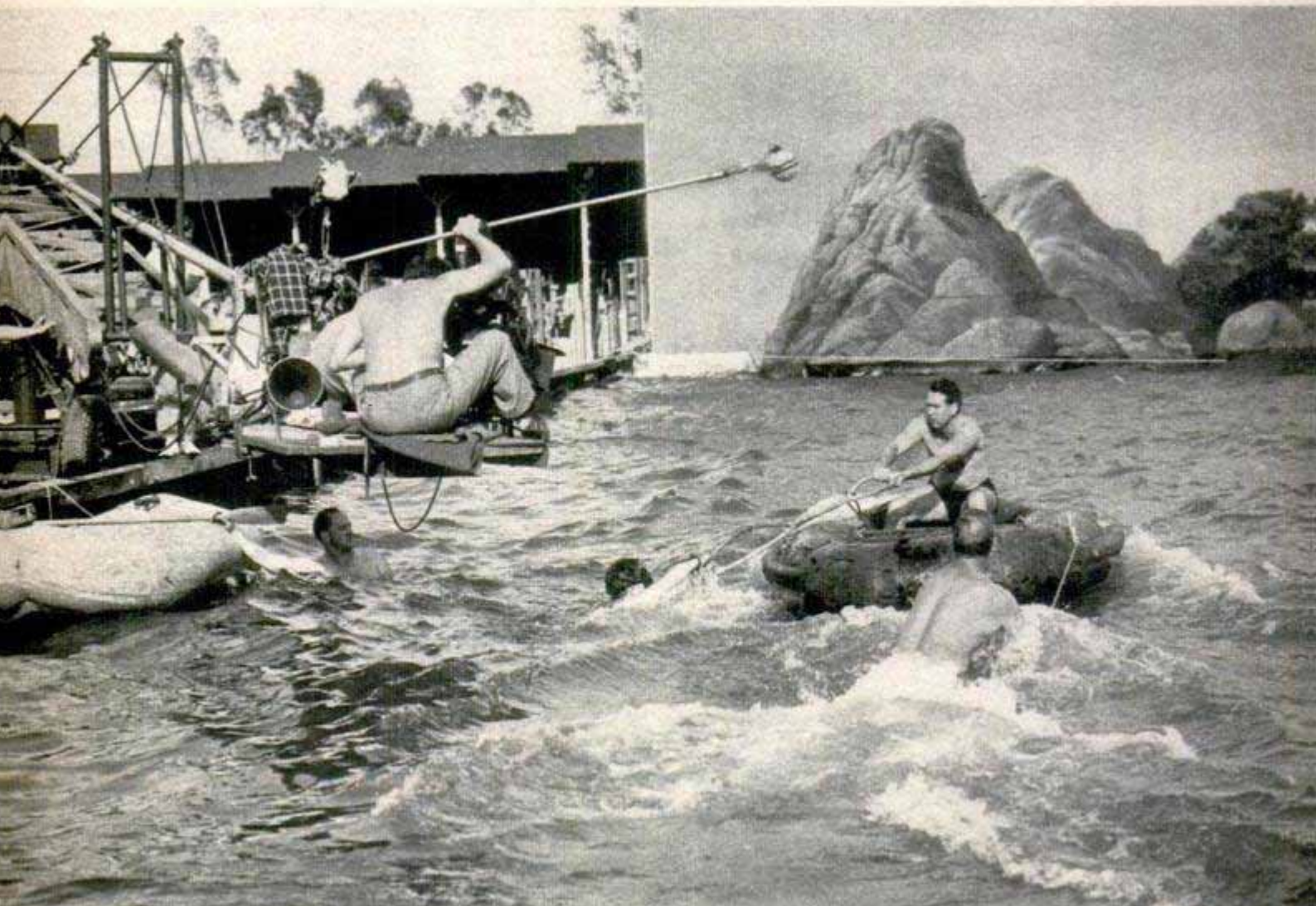

Tall and soldierly, Witte was once an engineering student at the University of Washington, fought with the Army engineers in World War I, worked for DuPont as a powder expert and came to Hollywood in 1925. His first picture was the famous "What Price Glory," and he's done more than 200 since then.

He can create the dramatic sweep of a tank charge, an amphibious landing or an artillery barrage. Or, he can give you small, intimate vignettes of war—the exploding of a hand grenade, men cowering in a foxhole, the squirt of a flame thrower.

When Witte wants to create the effect of exploding shells, he mixes dynamite, black powder and TNT with such material as chunks of cork, whiting, lamp-black, fuller's earth, black loam and magnesium flash. "That kind of an explosion is more photogenic than the real thing, and there's less chance of killing someone," he says.

Witte is also an expert on weather—rains, fogs, winds, lightning, thunder and hurricanes. He can produce a gentle, misty type of rain or a raging hurricane. Sometimes his fogs are the "pea soup" variety, sometimes the "low rollers" that swirl about your legs. He once perfumed a fog for a finicky female star and flavored another with wintergreen for a child actress. His snow scenes would fool the hardiest New Englander.

But in 26 years of creating special effects, Witte considers "The Frogmen" his greatest achievement. "It took more skill and ingenuity to make that one come off to the satisfaction of the studio and the Navy than anything I've ever done," he says.

For example, that scene filmed in the Virgin Islands—which is supposed to represent a Navy "softening up" barrage of an enemy-held seacoast before the underwater demolition teams go in to dismantle mines, booby traps and beach defenses.

Setting it up required a crew of seven special-effects men, 25 Navy frogmen and 45 natives working 12 hours a day for two weeks in picturesque Bovini Bay near St. Thomas. They used more

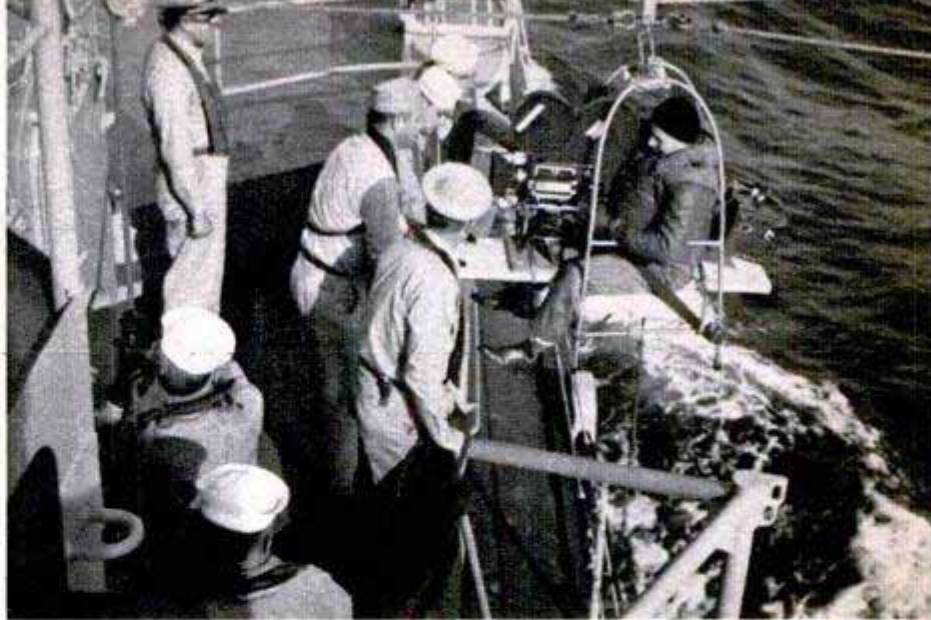

For added realism, cameraman prepares to get close-to-the-water footage from a breeches-buoy line suspended between two ships

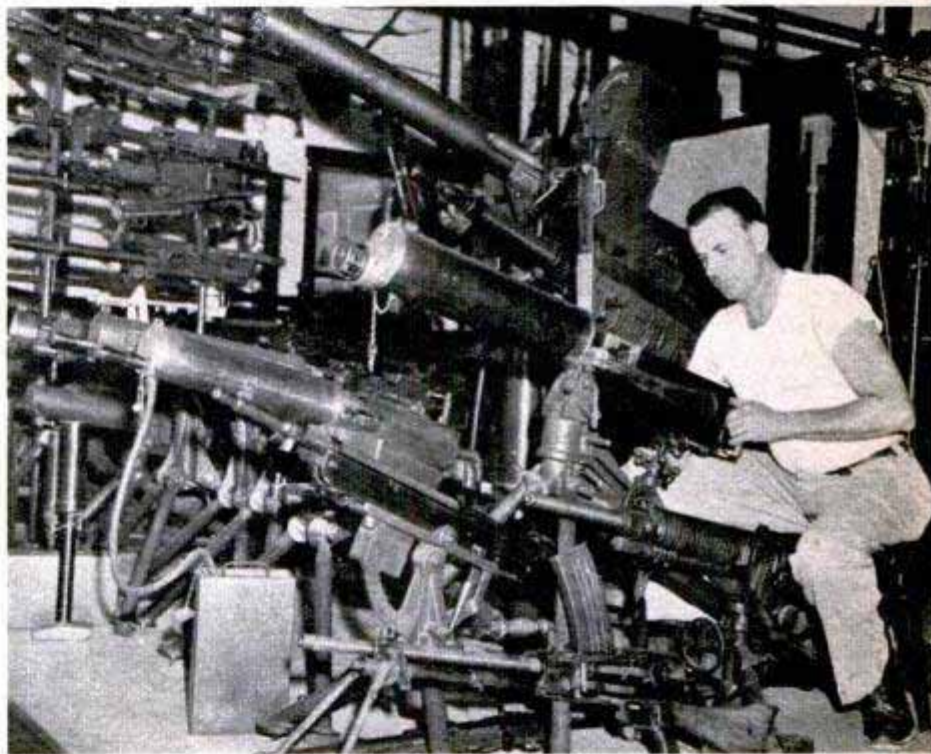

A corner of Witte's \$135,000 arsenal of 4000 guns, one of the largest collections in the world. Some of it was used to guard Los Angeles during the war. Operated hydraulically, the devices below churn and agitate water in the reservoir into wave motion

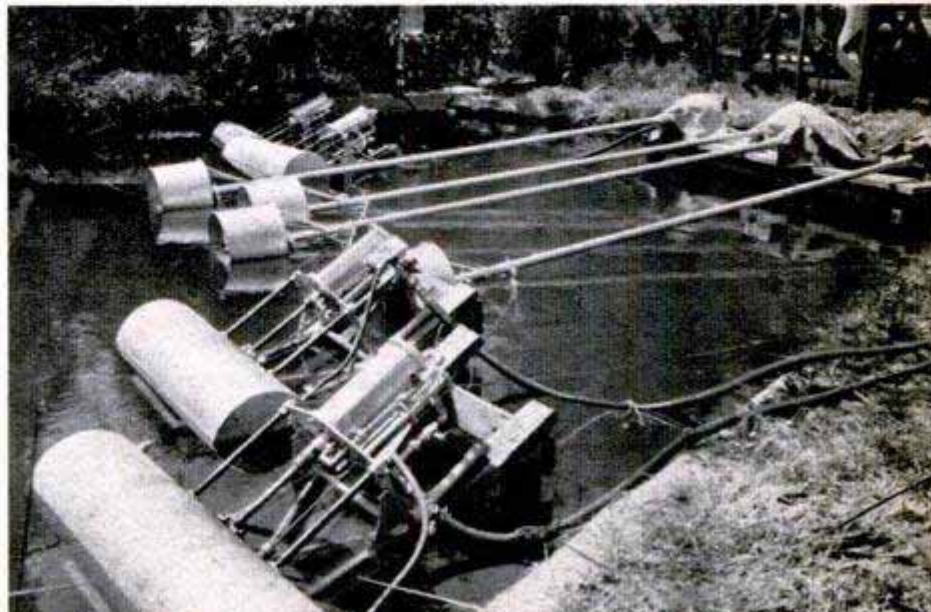

than 200,000 feet of electrical wiring (connecting individual explosions to a central control panel), 90 cases of dynamite, 500 pounds of black blasting powder, 250 pounds of flash powder, 1000 gallons of gasoline, 700 gallons of diesel oil and two tons of TNT.

The scene called "Hollywood's Biggest Boom," required thousands of man-hours to construct—yet it lasts only 62 seconds on the screen.

About 90 percent of the picture is shot on, in or under the water. For storm sequences filmed off Cape Hatteras, a unique under-seas diving bell was used. The seven-ton steel structure is, in effect, a small, under-seas studio. Two king-sized pontoons rest on the water and a steel ladder leads down to the below-water compartment, fitted with four 30-inch-square windows of inch-thick optical glass. Cameras may be aimed from these portholes.

When it was necessary for the camera to move around, though, and follow the swimmers underwater, the new Aquaflex camera was used—the first time by any motion-picture studio. It was employed both on location scenes in the Virgin Islands and in Twentieth Century-Fox's "tank" on the studio lot.

The Aquaflex is a 107-pound camera entirely independent of air supply or electric cables running to the surface. It has its own battery-powered lights and is fitted with fins and a rudder—in appearance almost like a stubby little toy submarine. One man can operate it with one hand, leaving the other free for swimming.

Sound problems were licked, too. For example, it was demonstrated for the first time that ordinary microphones could be used to record sound underwater. Regular mikes, sealed in rubber balloons with waterproof tape, were found to be five times more efficient submerged than when operated in dry air.

Nearly 100 new sounds were added to the studio library during the shooting—voices of actors through diving masks, the threshing of giant sharks, the eerie hissing of the submarine aqua-lungs worn by the actors. Also used for the first time was a gyroscope-balanced platform to keep the camera on an even keel at all times.

Although the entire crew—actors, technicians, prop men and special-effects experts—were chosen because of their swimming ability, Navy-tested precautions to prevent loss of life were rigidly observed. For example, when anyone went into the water on location, he was required to wear a sack of cupric-acetate tablets around his neck—the best known shark repellent.

In some of the close-up scenes taken in

(Continued to page 226)

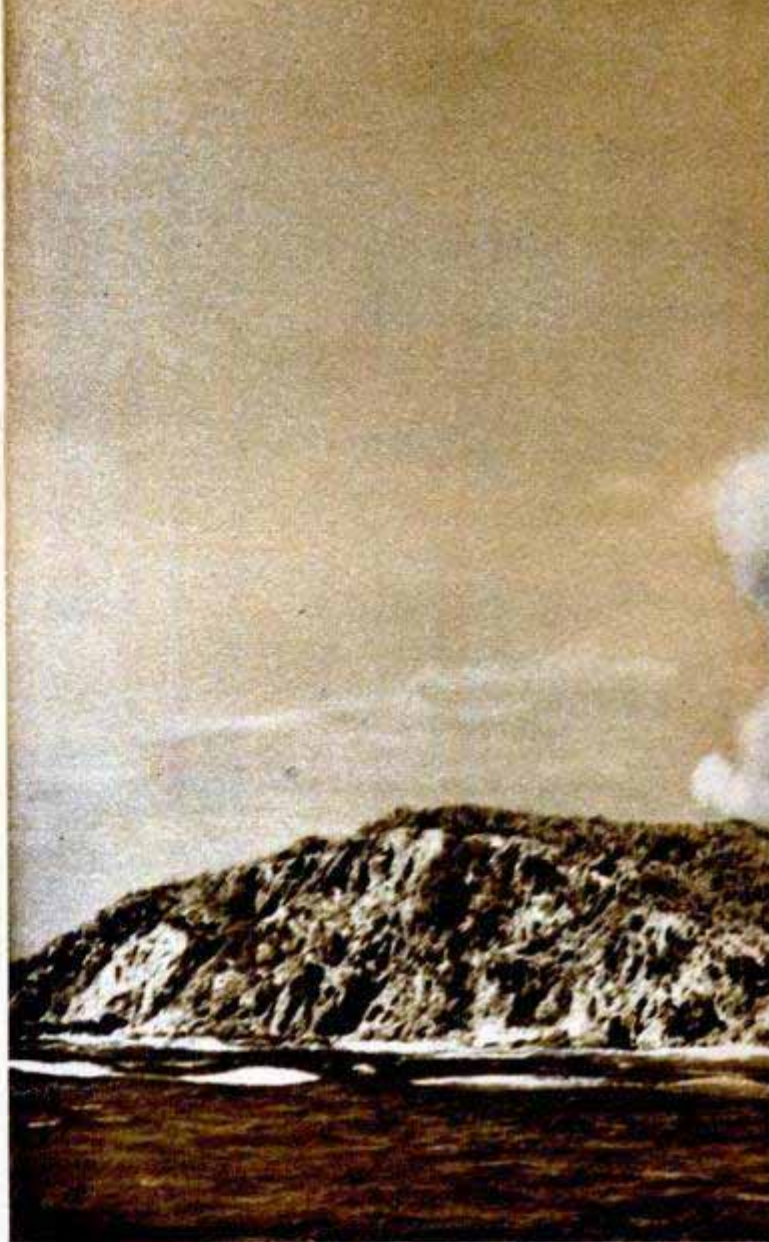

Termed "Hollywood's Biggest Boom," 1000 gallons of gasoline, 500 pounds of blasting powder and 90 cases of dynamite were used to create the explosion above

Underwater scenes in "The Frogmen," below and on the opposite page, were shot with a new submarine-shaped camera with fins and a rudder. A man can operate it with one hand, leaving the other free for swimming. Camera carries air and lighting supplies



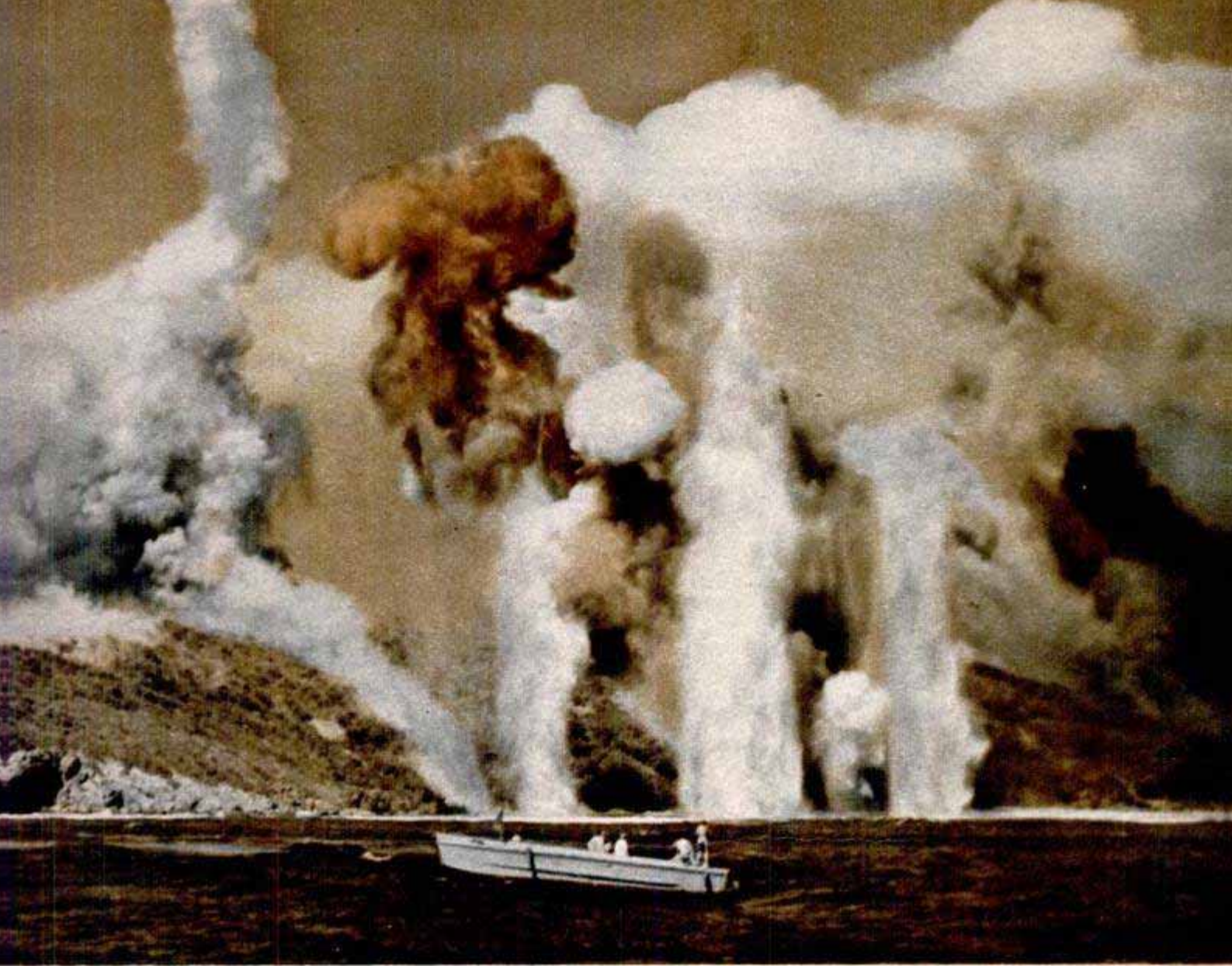



H. M. Beard, 810 Saxe St., Beaumont, Tex.

Street "Stethoscope"

With the aid of a homemade street "stethoscope," city authorities in Beaumont, Tex., are "prospecting" for 3500 water valves hidden beneath the paved streets. The lost valves are just a few inches beneath the surface. H. M. Beard, assistant superintendent of water distribution, patterned the instrument after a mine detector. He found that if the operator used a headset, the lead wire picked up electrical body discharges in sufficient quantity to affect the squeal of the detector, so he placed the headset in the instrument box and ran a stethoscope tube to it. Now the operator listens like a doctor while the instrument picks up the "pulse" of the hidden water valves.



Murray Mfg. Co., 63 Rock St., Avon, Mass.



Portable Neon Sign

Going the sandwich sign one better, a portable neon sign is the newest idea in advertising in Tokyo. The sign, powered by a small battery, will remain lighted for several hours.

Algae Factory

Algae are simple plants that provide us with the best way of capturing the sun's energy and, because of this, are often thought of as the food of the future. News that makes this possibility more likely comes from the University of Texas where a highly efficient algae-growing apparatus has been developed. For each gallon of water in the apparatus, $\frac{1}{2}$ pound of algae is produced. Under natural conditions, such as in a pond, it takes about 50,000 gallons of water to produce that much algae. Scientists expect algae to be a future source of animal food and of raw materials for the making of fats, oils and other organic materials.

Phone Guard

When a new guard is installed on a telephone, children won't interrupt phone service if they remove the receiver or play with the dial. The child can play with the telephone without actuating the dialing mechanism. The guard is slipped in place over the contact points of the receiver. Lifting the receiver will not release the points until a button is pushed. Returning the receiver to the cradle automatically locks the contact points again.

☐ Reversible bifocal glasses allow the user to rotate the lens at will to move the bifocal portion to the top.



Rising straight up, the twin-rotored helicopter, above, travels 1520 feet a minute. Its horizontal speed is 100 miles an hour

TWO-PASSENGER TWIN-ROTOR HELICOPTER

DESIGNED for relatively large production, a twin-rotor helicopter that carries two people and baggage is undergoing final flight tests in Los Angeles. It has a top speed of 100 miles per hour and a cruising range of 260 miles. The rotors use automotive-type gears and bearings. The blades are formed without rivets from simple extrusions, an economy made possible by their small size. No antitorque propeller is needed. The upholstered cockpit has standard dual controls, with instruments and switches on a pedestal in front of the two occupants.

Automotive-type gears and bearings in each rotor, below, link driveshaft to the rotors

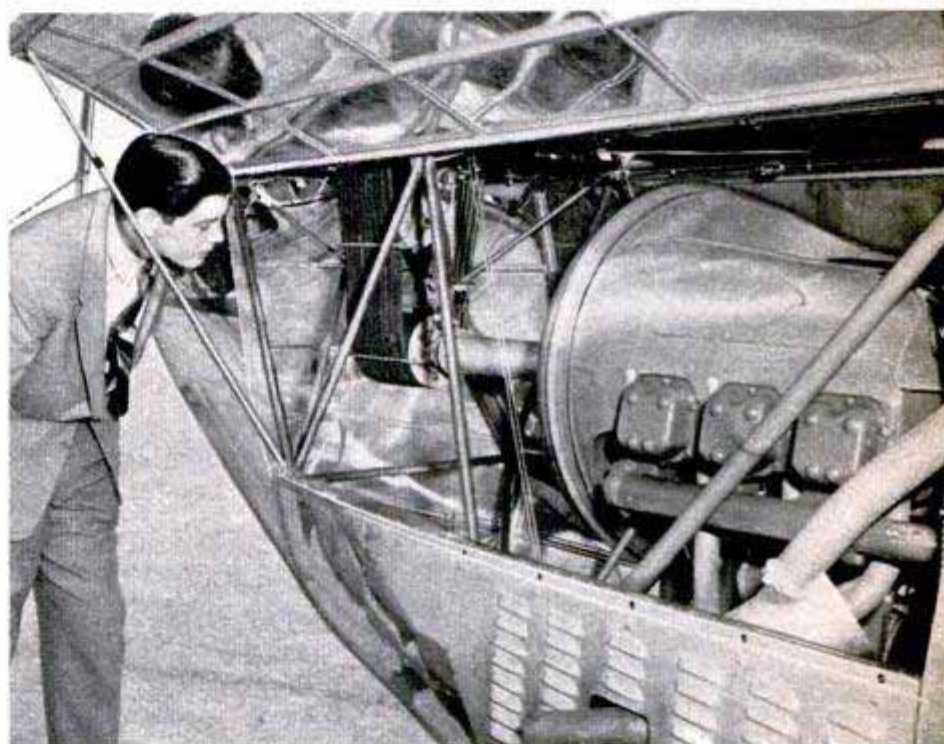

McCulloch Motors Corp., 6101 W. Century Blvd., Los Angeles, Calif.

Ten V-belts connect engine, above, to main driveshaft. Switches and instruments are on pedestal, below, between two occupants

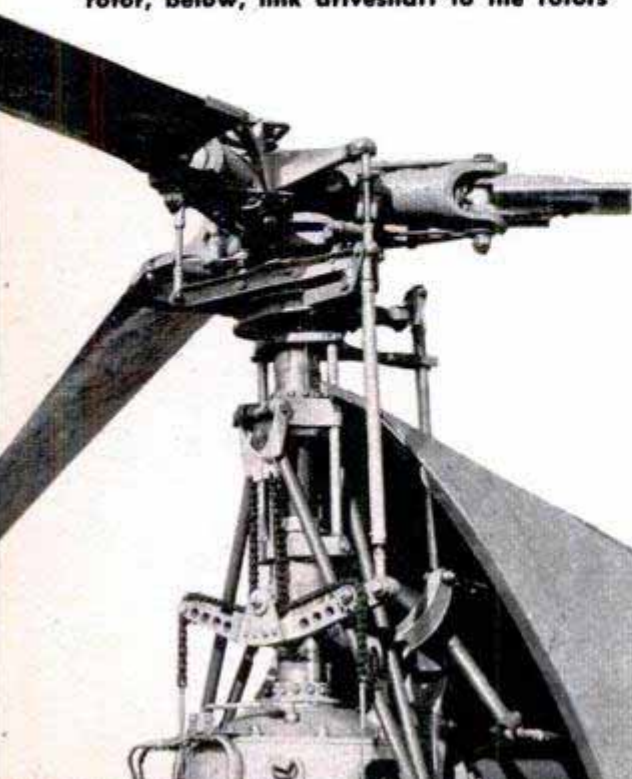

LOCKHEED'S *Handyman*

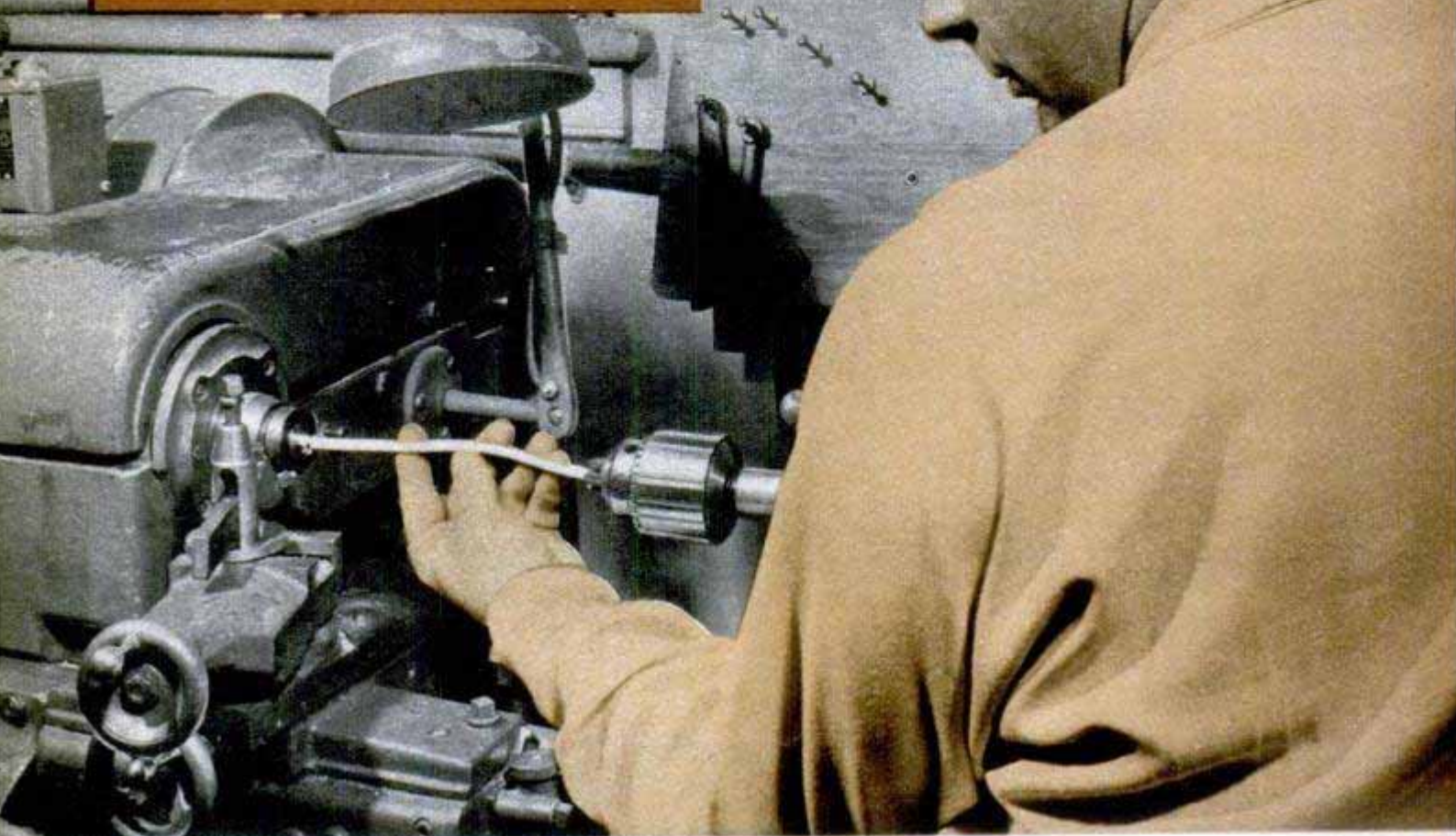

By Sam Lynch

THEY LAUGHED when Bill Shott opened his homemade electric lunch box—but none of his co-workers were surprised. In the electronics laboratory of Lockheed Aircraft, Burbank, Calif., they have learned in 15 years to expect the unusual from him.

He had cut the bottom out of a conventional lunch box and replaced it with a metal grill. Underneath he attached an insulated frame holding two Nichrome wires unwound from electric-heater elements, connected in series to reduce the heat. Inside the box, a Pyrex dish held an "entree" of beans and sausage.

At noon he plugged the container into a power outlet and enjoyed a hot meal.

Along with innumerable gadgets for his own television-repair shop, Bill has developed many ingenious time and money-saving devices for Lockheed. One is a method of threading wires through long lengths of flexible plastic tubing, commonly called "spaghetti." Hundreds of feet of it are used to protect wiring in a large plane.

Formerly, it had been a slow, tedious process to hand thread a string or thin

To hold flexible plastic "rope" to .001-inch tolerance, Bill Shott rigged up a method of feeding it, above, through a reamed-out drill rod with teeth cut on it

Shott has a hot meal at noontime by plugging in an electric lunch box he made from a conventional container. The dish is Pyrex. "Danger" label is a gag



"pull" wire into 30 to 40 feet of tubing and threading longer lengths had been impractical. Bill devised an air gun that, in a few seconds, blows a string through as much as 100 feet of tubing.

Another device of his is appreciated by workers who have to crimp any quantity of lugs onto electric wires. Previously, it was done with special pliers. Bill, nursing tired hands, sawed off the head of the pliers, drilled a hole in each jaw to which he attached a coiled spring to hold them open, and then welded a bolt to the bottom jaw so that it could be bolted into the hole where the stationary set in an air-operated rivet gun is usually mounted. Onto the top jaw of the pliers he welded a small round plate (head off a bolt) against which the movable set in the rivet gun squeezes. Now air pressure squeezes the lugs on.

When Bill came to Lockheed, it was frequently necessary to change the voltage of battery carts from 12 to 24 volts. This meant unbolting several bus bars. Bill devised a throw switch to do it. Then he noticed that some generator-control boxes in Hudson bombers were defective, necessitating removal for repair. So Bill built a test board to determine quickly, before installing a box, whether it was defective, and if so, what part was at fault.

On another production line, when four feet of insulation had to be hand-stripped from thermocouple wires in each plane, taking up to 10 minutes and often damaging the wires, he drilled a hole in a Micarta block the size of the covered wires. He inserted a razor blade the depth of the insulation in the hole and, as fast as he could pull the wires through, stripped them without a scratch.

During the war Bill was concerned over

Air gun for blowing string through long lengths of plastic tubing. String will later pull wire through

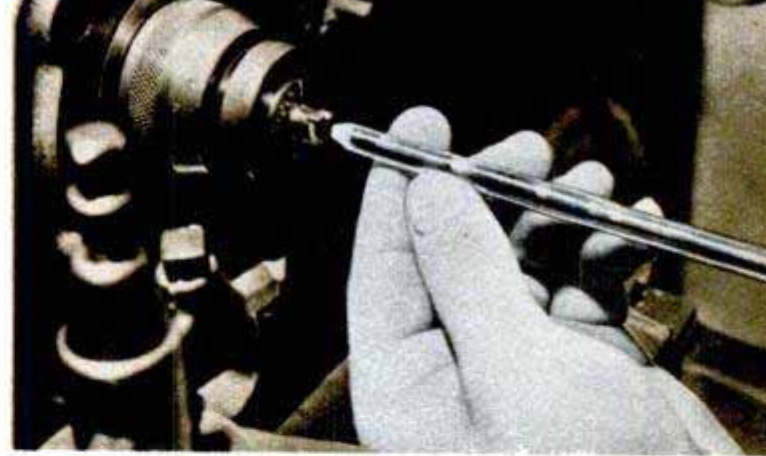
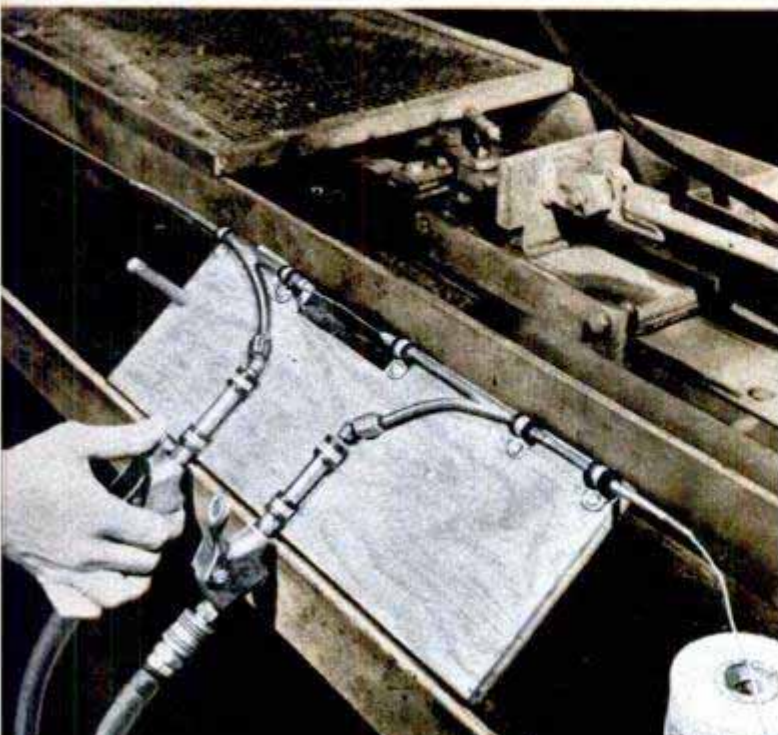

Close-up of flexible plastic tubing being fed through reamed-out drill rod for an ultrafine "shaving" job

punctures in precious tires, caused by packing-case nails lying around overcrowded freight terminals. Using rejected aircraft solenoids and generators, he devised a magnetic bar, attached it to a tractor and drove it around the hangars and warehouses picking up the nails.

In the laboratory he was handed a piece of semiflexible plastic rod and asked to shave it down to a slightly smaller diameter. It was to be used as the core of a tiny coil and had to be within .001 inch of a certain diameter. Bill realized that shaving what amounted to plastic "rope" in a lathe would be impossible, let alone keeping it to a tolerance of .001. So he took a short piece of drill bar, reamed a hole in it the exact size desired, cut teeth in the remaining "shell" and, mounting it in a lathe chuck, fed the plastic rod through it as it turned slowly.

On his last birthday, Bill's wife clipped his horoscope from the paper. It read: "Your mind teems with all sorts of new ideas for improving duties."

Replacing pliers, another timesaver devised by the "Lockheed handyman" crimps lugs onto electric wires

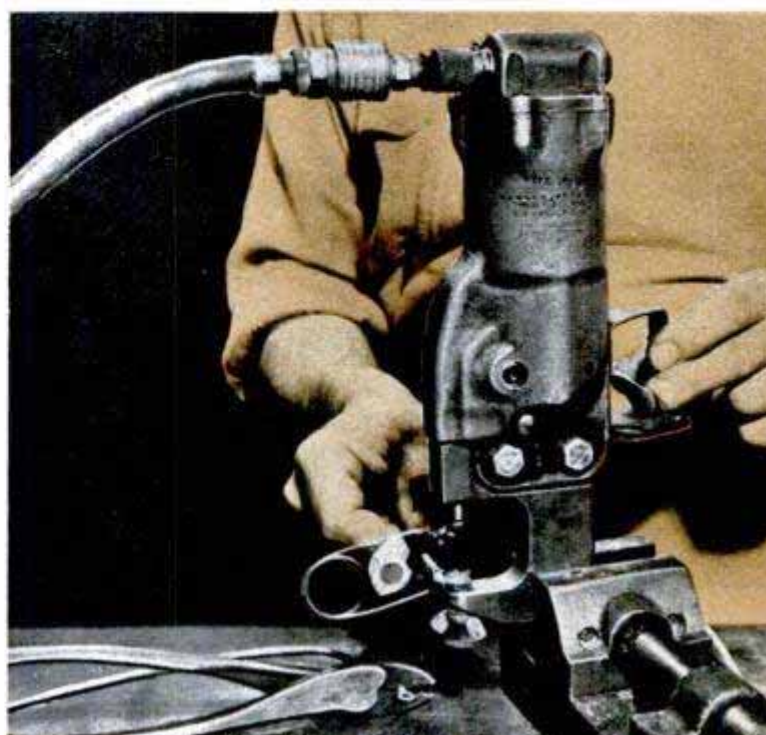

SCIENCE "FACTORY" PRODUCES IDEAS

GONE ARE THE DAYS when basic scientific research can be done while sitting under an apple tree (like Newton) or while lounging in a bathtub (like Archimedes). Science has grown too complex for that. Today, the scientist requires complicated and expensive equipment to carry on his work of probing the unknown.

Providing such facilities are the Research Institutes of the University of Chicago. These institutes are idea "factories" where scientists explore the unknown, seeking basic knowledge. America, far ahead in applied sciences, depended on Europe for most basic science before World War II. Today, this dependency is being eliminated by scientists like those in the institutes.

Three broad fields of study are included: 1. Nuclear studies; 2. Radiobiology and biophysics; and 3. Metals. The University hopes to add others in the future.

The nuclear-physics program is the largest privately supported research program in the field today. The research is nonsecret and devoted to peacetime applications.

Appropriately, the institute buildings are across the street from the west stand of Stagg Field where, on Dec. 2, 1942, the first controlled chain reaction was accomplished in deepest secrecy. Many scientists who took part in this epoch-making experiment are continuing their research on more peaceful matters at the institutes. Included are such outstanding men as Enrico Fermi, designer of the Stagg Field pile, Harold C. Urey, discoverer of heavy water and James Franck, photosynthesis expert, all of whom are Nobel prize winners.

Cost of the institute buildings and equipment is about \$11,000,000, of which the biggest chunk was for the synchro-cyclotron, a \$2,500,000 atom smasher. A major part of the cost of this machine was paid by the Office of Naval Research. The buildings, covering a block, have complete facilities for research, including built-in systems to provide steam, hot and cold water, gas, compressed air and vacuum to each lab. Special precautions were taken, such as a battery of 86 blowers, to remove dangerous gases from the buildings.

Operating costs are paid in part by industrial concerns that are listed as sponsors. The companies receive no direct help from the institutes (no tests or product experimentation, that is) but contribute because they know that a continued expansion of basic knowledge is essential in our industrial world.



Aetna Casualty and Surety Co., Hartford, Conn.

Drive-Yourself Test For Motorists

In three minutes, an unprejudiced test machine decides whether or not you are a good automobile driver. The driver, seated behind a conventional steering wheel, sees a series of traffic situations projected on a screen in front of him. The film accurately simulates what he might see when actually operating his car. During the test the driver must jam on his brakes, steer around road barriers, slow down to avoid a truck, use a turn indicator, sound the horn for a careless pedestrian and avoid speeding. When the three-minute drive is over, the machine dispenses a report card that rates the driver for each situation.

Microwaves Aid Power Distribution

Microwaves are carrying messages to aid in the smooth distribution of electric power through the Pacific Northwest. The Bonneville Power Administration has over 200 miles of microwave circuits in operation and expects to have at least 1400 miles within five years. The microwaves are reflected and beamed from one station to another. Up to 20 or more simultaneous conversations can be carried over the same radio waves. The communications system is used to keep the load dispatcher apprised of load conditions, to send instrument readings and to tell within seconds the exact location of a power breakdown. The circuits are not affected by weather conditions such as heavy snow and ice.



Above, using the scanning technique of television, an electron-gun X-ray device being developed at the institutes gets brighter pictures with less exposure

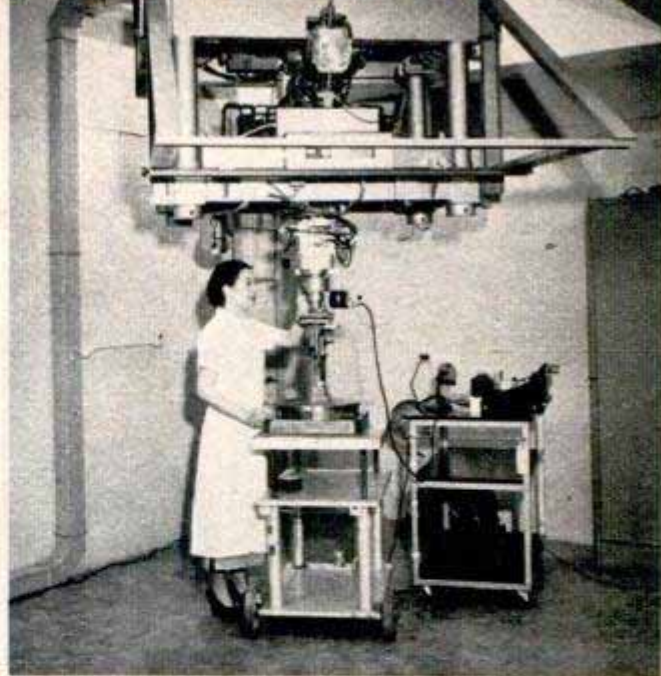

Above, right, the beam from a huge two-million-volt accelerator is aimed at a part of a live cell only 1/12,000 inch square with this precise apparatus

Right, under construction at the institutes is the kevatron, oldest type of atom smasher, with which scientists produce fission in the lighter elements



Below, pride of the University is the 450-million-volt synchro-cyclotron, most powerful atom smasher known. It produces a beam of the mysterious mesons

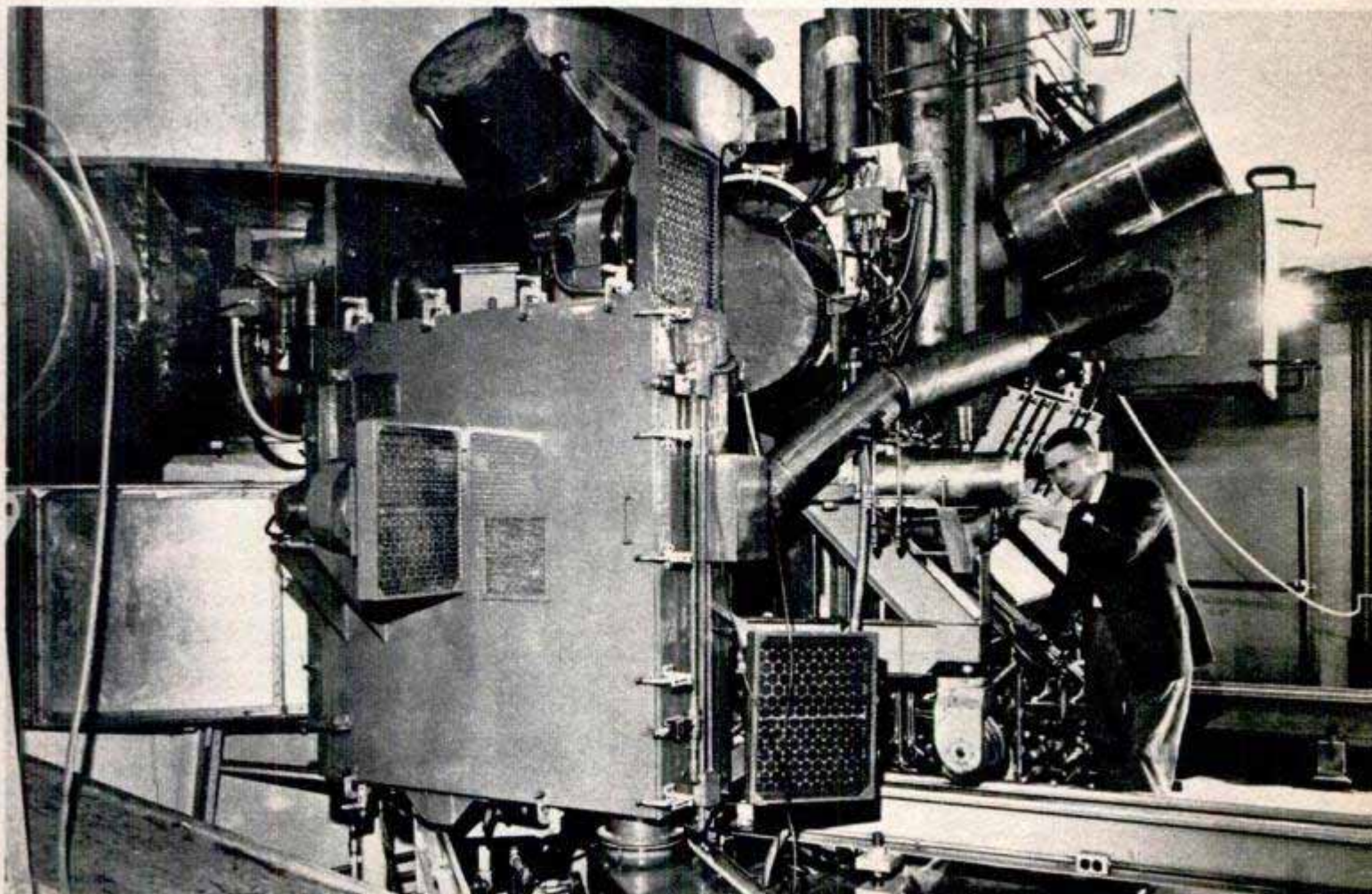

NEW LAND FROM OLD

Legends

1. Chunks of dirt and debris removed
2. Cane washer
3. Clean cane moves off for processing
4. Waste water
5. Pump house
6. Tub breaks velocity of water
7. Clear water overflows
8. Mud settles in basin
9. Rake arms scoop mud to center of basin
10. Suction returns mud to pump house
11. Mud is pumped through five-inch pipe
12. Dike of sugar leaves
13. Reclaimed soil settles on coral flat

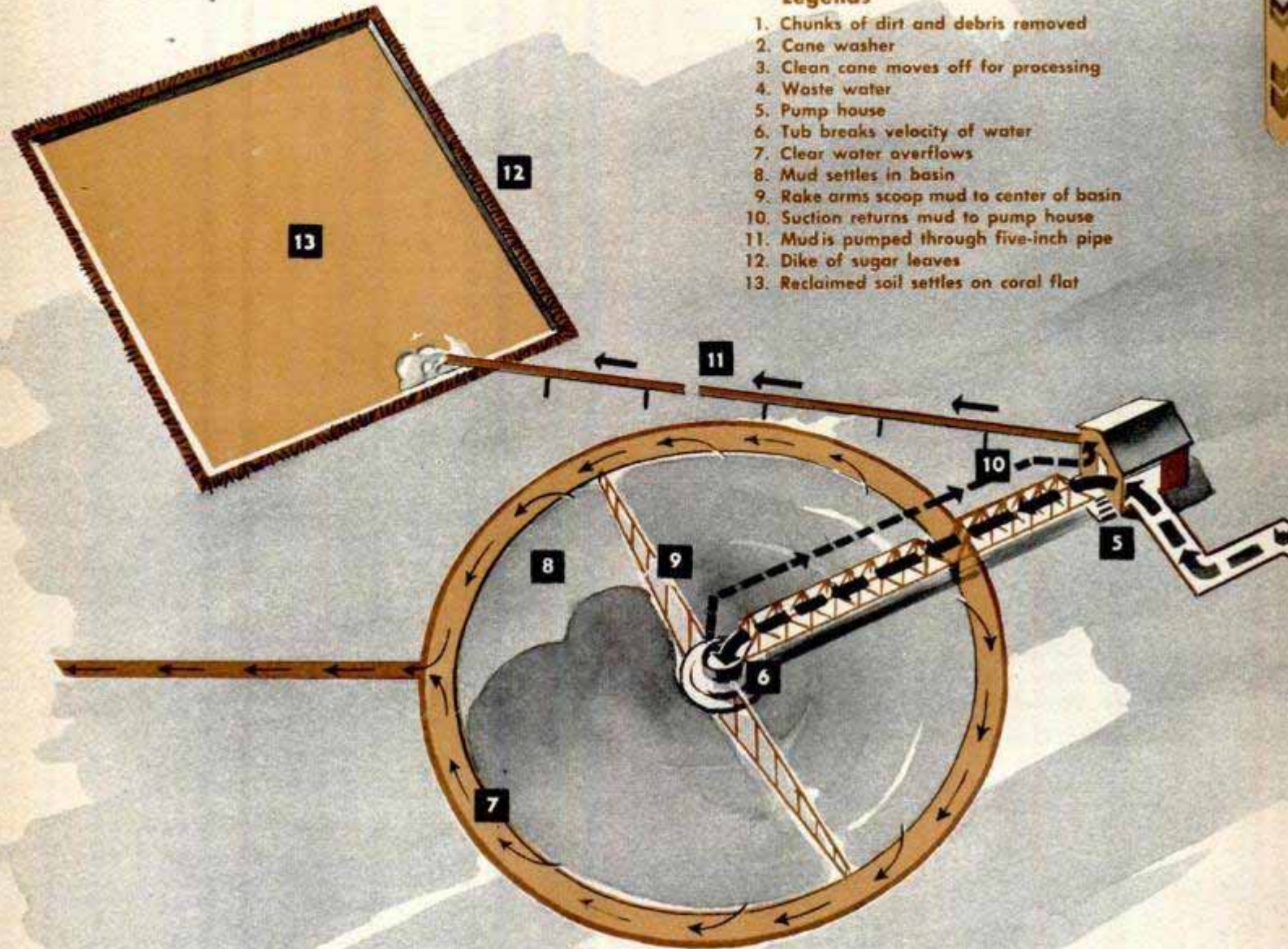

BEFORE: Nothing can grow on the hard-packed white coral flats. The land is useless for agriculture

TREATMENT: Water laden with rich silt pours out across the flat. The result is mud two feet deep

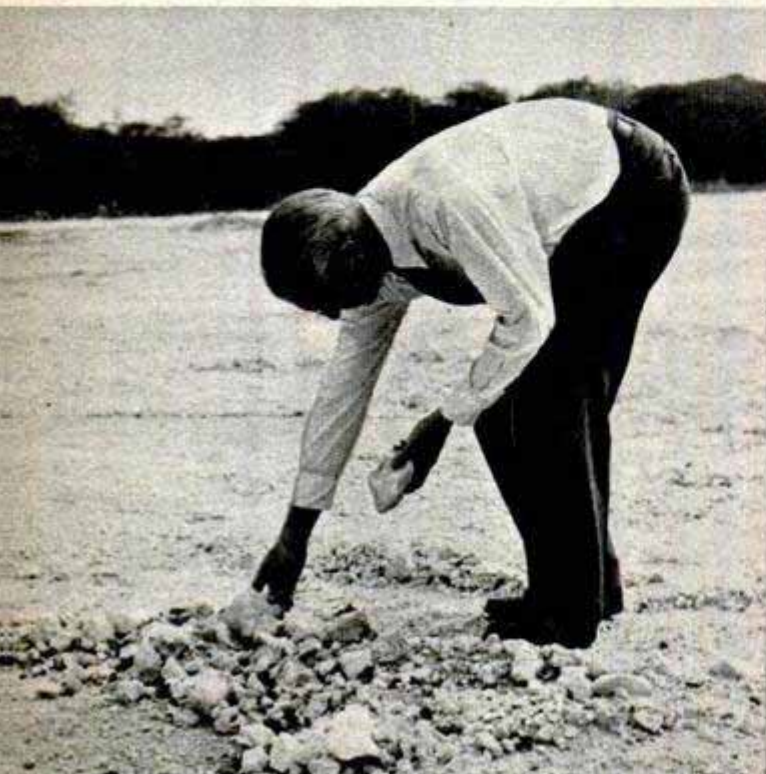

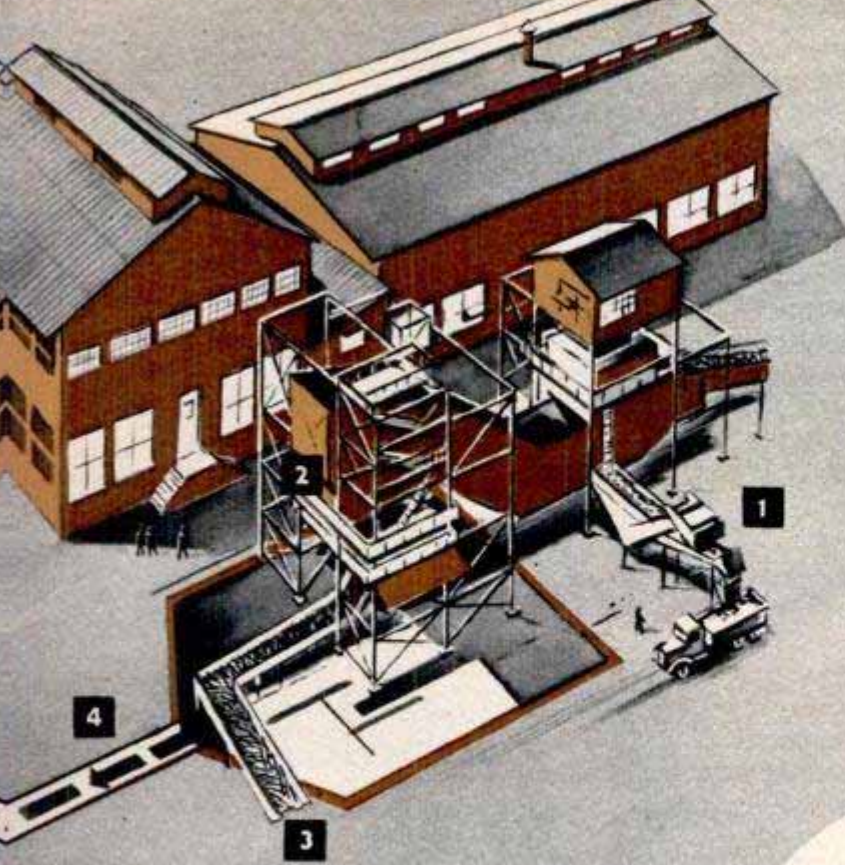

but a white coral reef where not even weeds would grow. Now look at it.”

All this is possible through a new and novel, but somewhat expensive, machine called a Hydroseparator being used on several Hawaiian plantations. So well has Ewa's \$125,000 Hydroseparator worked, however, that Frank is looking forward to converting another 300 acres of once useless coral land. At about 30 acres a year it will take 10 years to complete the job.

Land reclamation in Hawaii, however, happened almost accidentally.

In Hawaiian cane fields, virtually every phase of operation from planting to harvesting is done mechanically. Instead of hand-cutting, as in most parts of the world, weird mechanical harvesters of various types are used.

Unfortunately, these mechanical contrivances, not being human, couldn't distinguish between cane, earth or rock. So, a lot of trash as well as cane was sent to the mill.

In recent years, plantations have built huge washers to clean the cane before processing. These washers resemble large Escalators—the cane moves up the “escalators” and is continually washed. The water washes off the rich red dirt which has stuck to the cane stalks; the large boulders, rocks and trash are removed elsewhere in the washer. A mill like Ewa uses about eight to ten million gallons of water each working day just to wash the cane—enough to supply a city of 100,000 people!

The dirty mill-waste water then either ran off to sea and was lost forever, or was

By Richard M. Botts

IN HAWAII, sugar men like big Frank Wiley, superintendent of Honolulu's huge Ewa Sugar Plantation, are performing land-reclamation miracles that have the experts gasping. They're getting soil out of water!

At Ewa, for instance, Frank points with pride to a new field of young cane tossing saucily in the trade wind. “Just a few months ago,” he tells you, “this was nothing

AFTER: At left of trash dike is a new field ready for planting. At right, muddy field is not yet dry

HARVEST: Here's young cane growing on the brand-new field. Equipment yields 30 new acres every year





With basin dry, blades of a rake arm can be seen. They scoop the mud to the center of the big basin

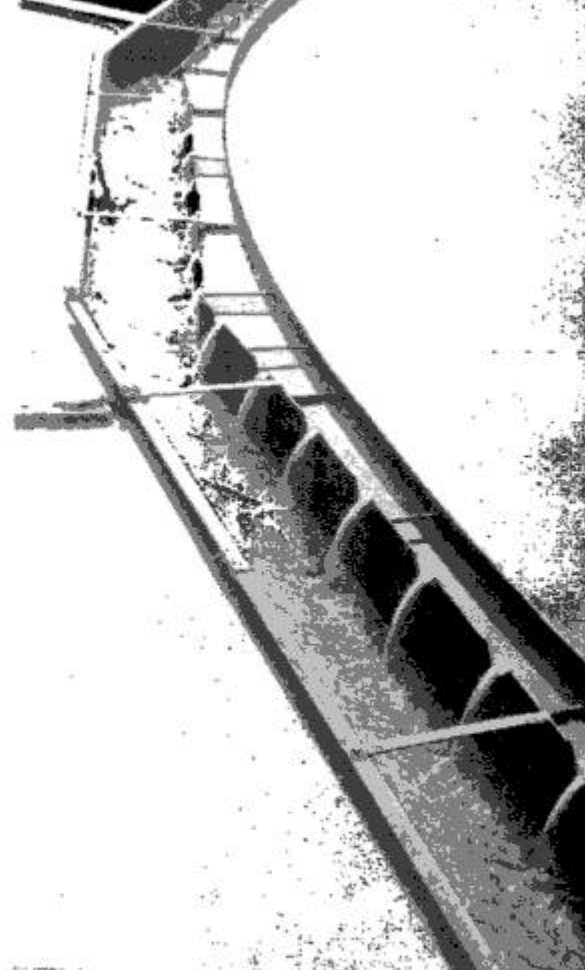

Clear water, with mud settled out, overflows around rim of basin, is used to irrigate the cane fields

used for irrigating the near-by cane fields.

When the plantation used the water for irrigation, they found the system soon clogged so heavily with sediment that the water would not flow properly. This was due to the high silt content in the water after washing the cane. The plantation had to send men continually to the fields to clean out the irrigation system, which resulted in large added expense each year. And when you see miles and miles of tall waving sugar cane that has to be irrigated, you get some idea of the plantation-men's problems.

Some years ago Frank Wiley tried to alleviate this problem by building a U-shaped settling basin which allowed some of the mud to settle, and the free water to drain off into the irrigation system. Unfortunately, this didn't work too well. The basin soon became clogged with mud and could only be dredged out when the mill stopped work over week ends. This was costly and the slimy mud which was hauled away in the trucks dripped all over the roads, causing a traffic hazard. And the water used to irrigate the fields still contained sediment and continued to clog the irrigation system—but not so quickly as previously.

Frank decided to tackle the problem of cleaning the mill waste water with Allan Duvall, engineering representative of The Dorr Co., of Stamford, Conn., a firm special-

izing in machines to remove solids in water.

The first step was to build a pilot plant which they operated for months. The final result was that they not only created silt-free irrigation water with their Hydroseparator machine, but they found they could build about 30 to 50 acre-feet of new land each year from soil reclaimed from the mill waste water.

Frank Wiley recalls the final findings of the work with considerable amusement today.

"The fact that we could produce siltfree water was proven and easy to understand," says Frank. "But I began to wonder if the owners of our plantation wouldn't seriously doubt my sanity if I also announced that I proposed to put 30 acres of new land through a five-inch pipe each year. So, in the report to the owners, we stressed the point that the Hydroseparator could easily and cheaply create siltfree water which would end the troubles in the irrigation system."

These figures were enough to convince the owners that the machine would save its cost in a very few years, so Frank and his engineers went ahead with work on the Hydroseparator.

The engineers first constructed a large bowl-shaped basin in the earth about 150 feet in diameter and 13 feet deep at the center. This was constructed for a high

enough water level so the clear water would flow, by gravity, into the irrigation system. In the center of this bowl is a round center pier and on this a turntable-like structure. Attached to the pier are large rake arms that extend 60 feet out from the center of the basin.

As the waste water leaves the cane washer it flows by gravity through an open cement canal and then by overhead pipe, attached to a steel truss, to the center of the basin. Here the water pours into a center "feed well" which is nothing more than a huge steel tub with holes in it. This breaks the velocity of the water and allows it to remain still while the dirt settles out.

In use, the rake arms turn slowly. It takes about 15 minutes for each rake to complete a revolution. It takes about three hours for the water to pass through the basin. By that time the dirt has settled out. The cleaned water overflows into the V-notched circular flume, which runs around the outer side of the basin, and flows down this flume by gravity to the irrigation system for the cane fields.

In the meantime, the muddy slime has settled to the bottom. The rake blades slowly scoop this slime along the bottom of the basin. As each revolution proceeds, the outer blade on one rake passes the slime along to the path of the next inside rake blade on the following arm until the slime reaches the center.

Here a suction pipe draws the slime away as the rakes bring it to bottom center. This pipe reaches out under the basin from suction sludge pumps in a pump house just outside the basin. The pumps deliver the settled slime into a sludge tank.

Not all the suspended matter in the dirty cane-washer water sinks. Some of it floats. So this is skimmed off the basin and it too goes into the pump-house sludge tank. From the sludge tank there is a continuous feed into high-pressure centrifugal pumps.

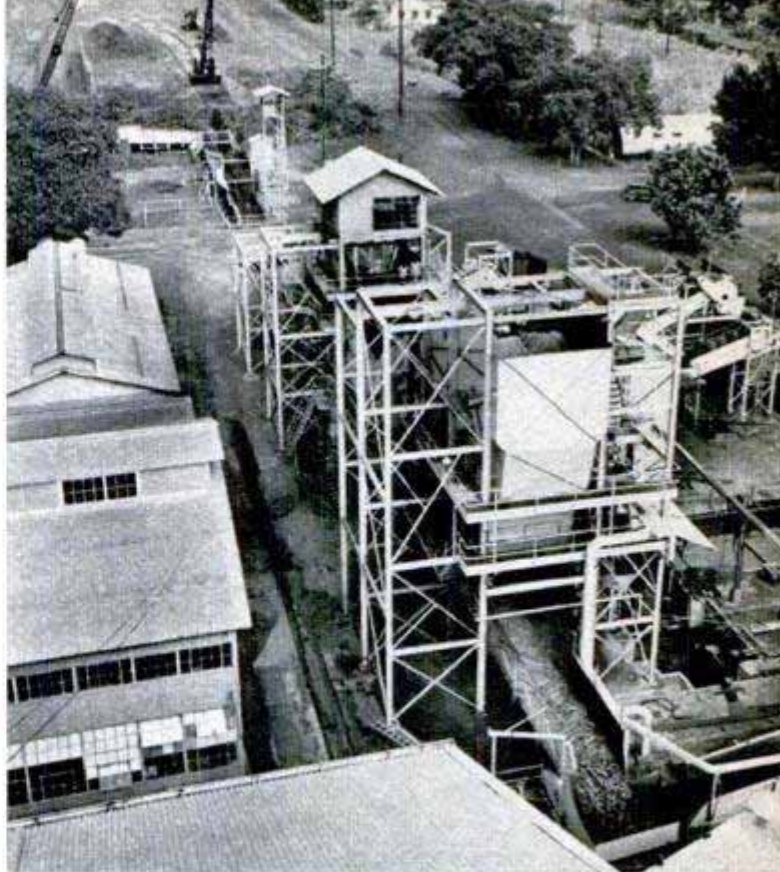

Ten million gallons of water flow through washer daily. Cane moves in one end, emerges clean at other

From the pump house the reclaimed soil is now pumped by five-inch pipe to the coral flats about two miles away. When the mud has dried it takes on a curious color. The top of the new land looks almost fuzzy—as if an earthquake had occurred—for some of it is the light chewed-up part of the cane stalk. Below this are layers of good earth—a mixture of topsoil from various fields. Beneath this is a little sand. When the area is filled to a depth of about two feet and dried up, it is plowed. It is then a rich brown color, and a new field is ready to grow new cane.

As a Bureau of Soil Conservation man puts it: "This is really a fabulous project—erosion in reverse."

Unit 150 feet in diameter separates earth from the water. Earth builds new fields, water irrigates the old

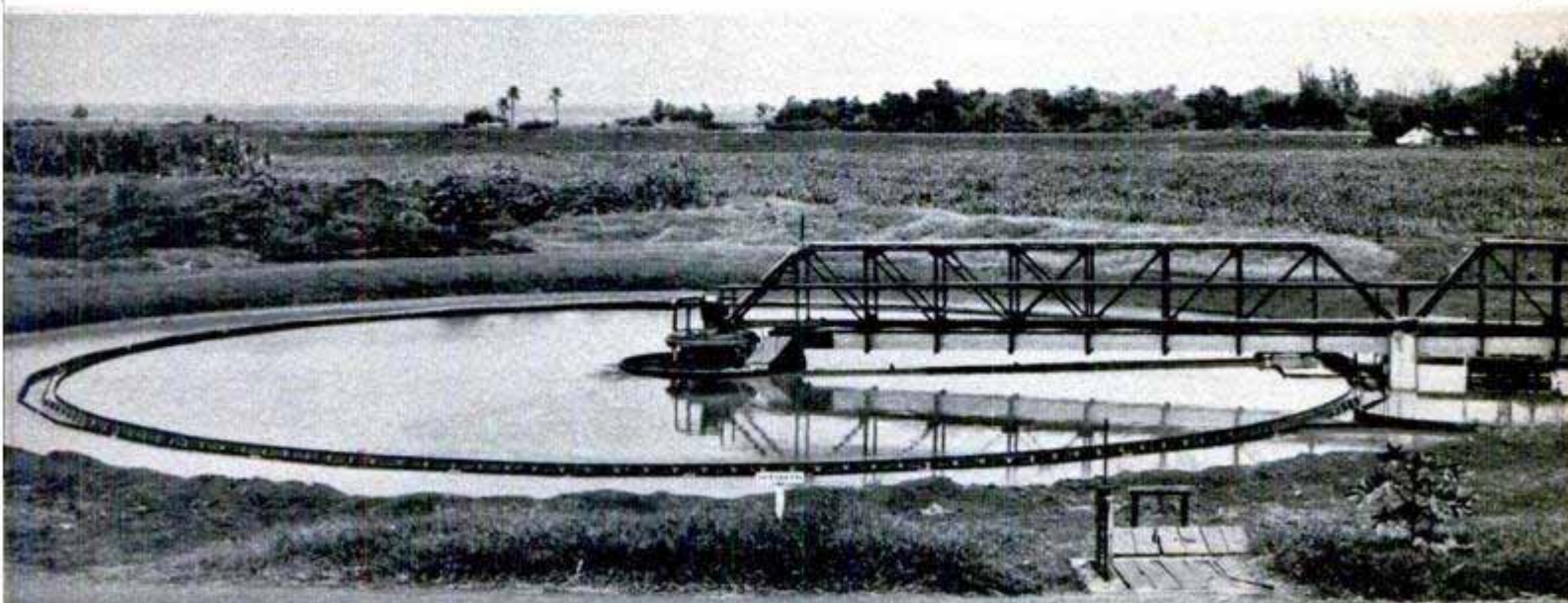

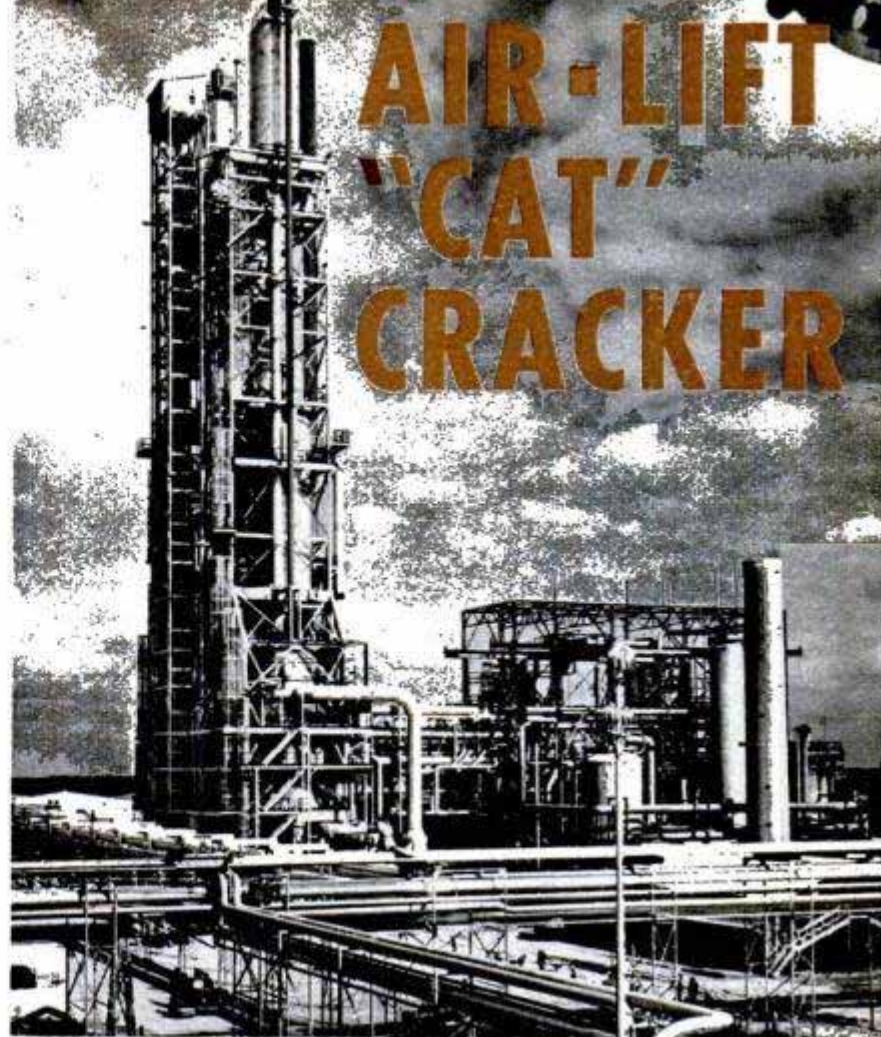
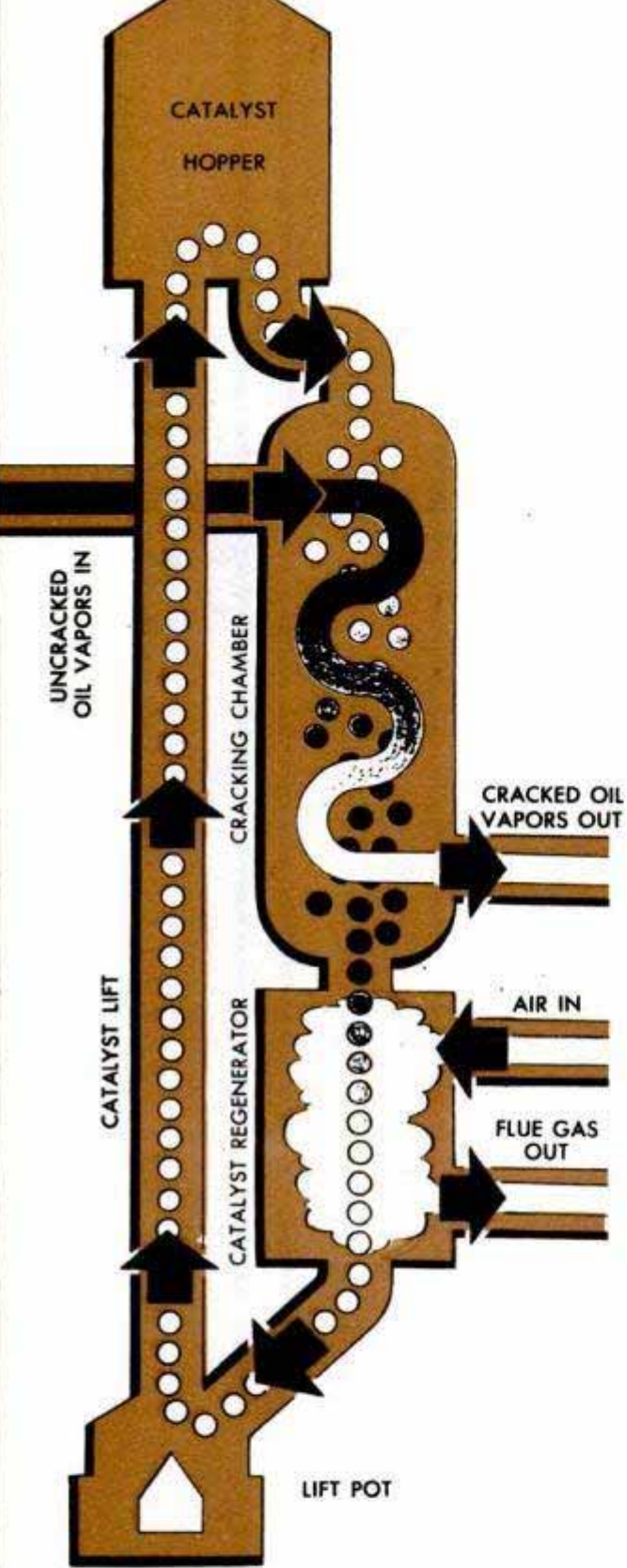

AIR-LIFT "CAT" CRACKER

First of the air-lift crackers is operating at Beaumont, Tex.

LIKE THE daring young man on the trapeze, beads of catalyst "fly through the air with the greatest of ease" to produce 50 percent more high-octane gasoline. In use at the Magnolia Refinery, Beaumont, Tex., the air-lift process eliminates shutdowns for catalyst recharging. Beads are continuously recharged as they pass through the regenerator portion of the cycle. The beads are caught in an air flow at the base of the unit and carried to the hopper at the top. From there they fall through the cracking chamber to the regenerator where the air lift picks them up to swirl them to the top again. Uncracked oil vapors flow around the beads in the cracking chamber. The process is called modified, air-lift Thermoform "cat" cracking.

Left, explanation of process. Below, one man runs the cracker

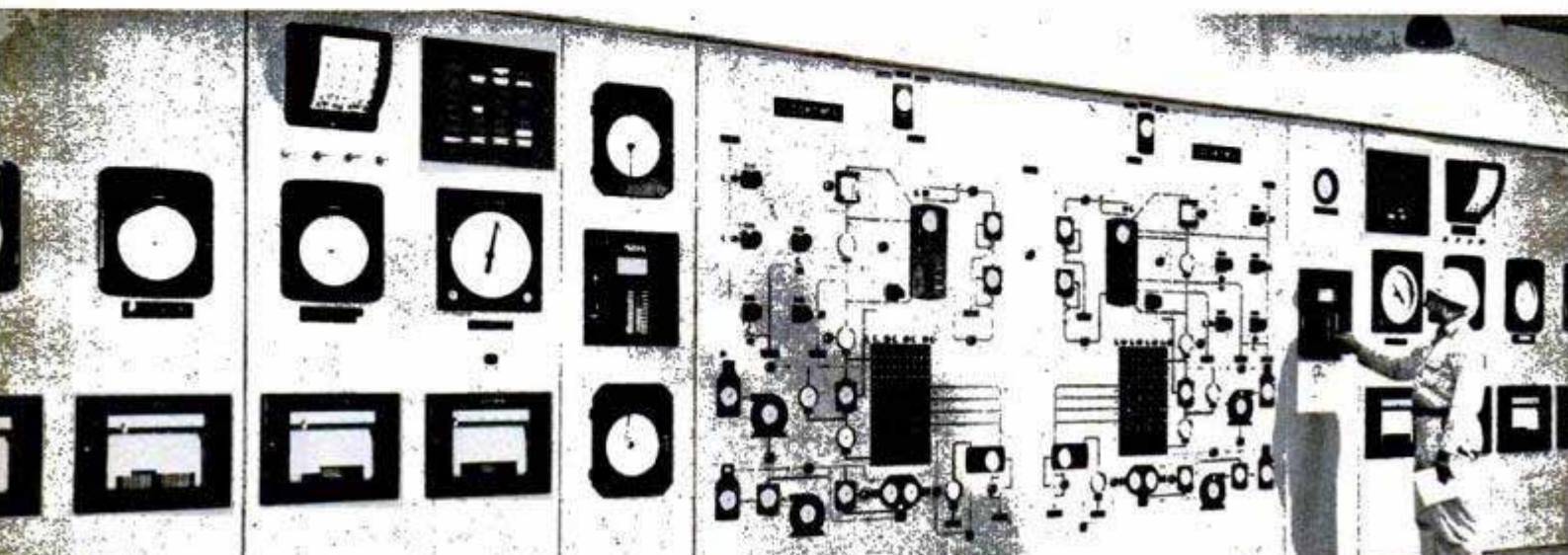



Detroit Listening Post

By Siler Freeman

UNLESS the National Production Authority changes its mind about allowing the automobile industry to come out with new models for 1952, the ranks of the small-car producers will be swelled by at least one new candidate.

From all indications, Willys-Overland is about to return to the passenger-car field with a small-wheelbase car of new design. The car, which has been completed for some time, will be larger than its two competitors, the Nash Rambler and the Henry J, which are both on 100-inch wheelbases, but smaller than the popular triumvirate of Ford-Chevrolet-Plymouth.

The new Willys will be on a 108-inch wheelbase. It will be more customized than the Henry J but less decked out with a standard accessory group than the Rambler. Unlike the latter, it will be brought out in the closed models first.

Willys-Overland has been in Washington to ask for a better percentage of the automotive steel than it was allotted under the third-quarter setup for the industry. It was given only one percent, at the bottom of the list of passenger-car makers. The tooling for the car is said to be completed and all Willys needs to go ahead with its plans is the green signal on steel.

The Willys passenger car has been a dream of Barney Roos, executive vice-president, for many years. Roos is a great advocate of the light car as the ideal transportation for the masses. He believes the time is ripe for launching his theory, with gas prices, taxes and the cost of living all soaring.

Another potential for this market is Nash's real small car, the NXI. The company, which flashed it before the public more than a year ago, conducted a unique survey to test public reaction to a two-passenger car with a lightweight engine. The idea has not been abandoned.

Nash has several different ideas which it is testing in this field. The original NXI has been lengthened and broadened somewhat. The thinking now is of a car which can seat three and will have about an 85-inch wheelbase. The 18-horsepower power

plant has been definitely supplanted by a 40-horsepower. But whether it still remains at the \$1000 price level at which the company was shooting is hard to say.

General Motors Research Laboratory, which devotes about 50 percent of its varied interests to engines, is now engaged in intensive research on paint finishes. A process is being developed that will help keep the shiny finish on automobiles from "chalking" indefinitely.

The answer is not found in silicone polishes or waxes, according to Ralph J. Wirshing, head of the research-chemistry section. His experiments have been going for 11 years, but it was not until recently that Wirshing saw real progress.

GM's experimenters went from Chile to Miami to find the answer to chalking. They evolved a new theory that a reducing action, not oxidation, causes finishes to deteriorate. This knowledge, said Wirshing, literally forces finishes to fade in a hurry and should aid chemists in trying new formulae to retard dulling of luster.

GM is still interested in engine research. C. L. McCuen, head of the laboratories, revealed recently his engineers are planning a gas-turbine engine to develop around 300 horsepower. The gas turbines, which are now used primarily in aircraft, develop over 5000 horsepower.

McCuen explains the engine is not designed for automotive use. It will be tested in a Greyhound bus "just to see what it can do." McCuen does not see a gas-turbine engine for passenger cars in any foreseeable future, nor a diesel for that matter. But GM is missing no bets and its program of continuing research takes in gas turbines.

Effortless operation of motor cars is still the objective of the industry. Gears are being shifted automatically, and steering is being aided dramatically by a hydraulic device which is going to be extended in use by the end of the year. Next year, air brakes may make their bow in the passenger-car field. One company is trying out a power brake coupled with the engine. Very little pressure on the brake pedal brings the car to an immediate halt.

WHAT'S NEW For Your Home

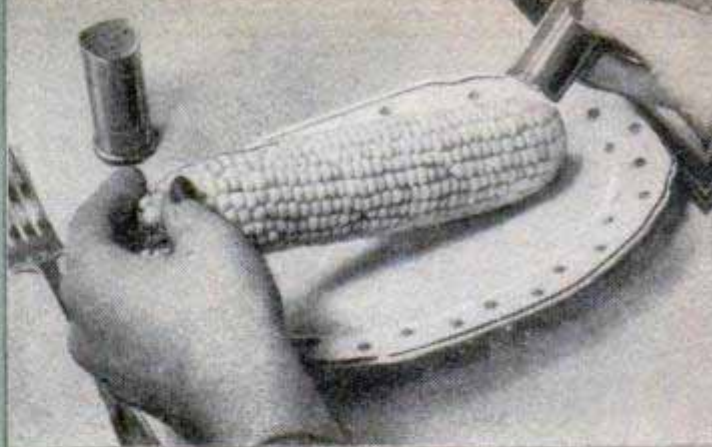

Elron Products, 156 W. Chicago Ave., Chicago 10
CORN BUTTERER eliminates balancing butter on a hot knife! Simply put butter into cylinder, press plunger and spread butter evenly on corn

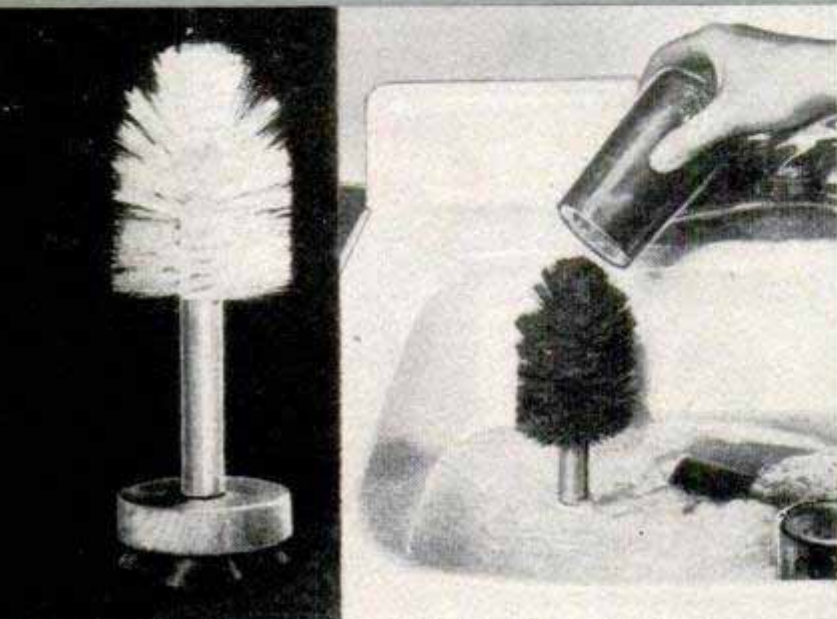

The Wallace, Davis Co., 2813 Dixwell Ave., Hamden 14, Conn.
GLASS BRUSH is held vertically in the sink by a set of suction cups on its base. You slip the glass over the brush, twist it back and forth and it's clean

MARKING KIT is a quick means of labeling personal articles, including tools and equipment. The permanent fluid can be used on fabrics, leather, wood and metal
Identi-Kit, 1739 Townsend St., Cincinnati 23, Ohio

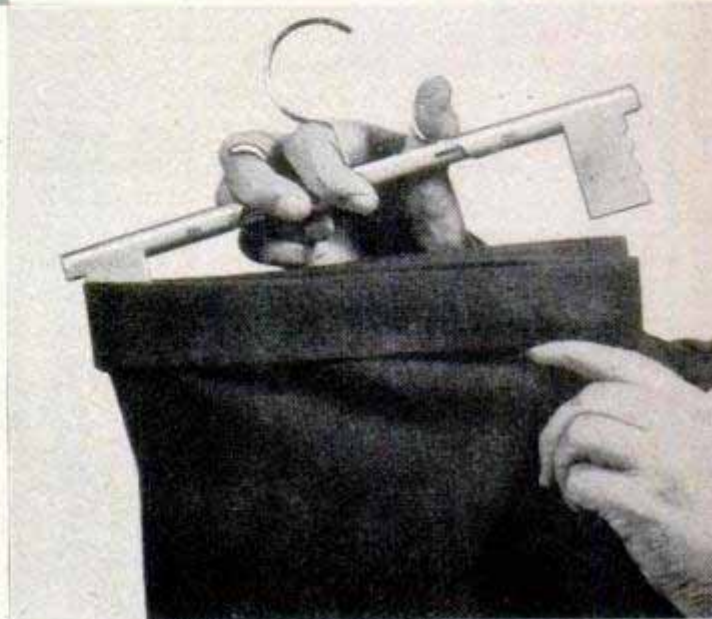

Holdapres, 9106 Woodward Ave., Detroit, Mich.
PANTS HANGER slips inside the trouser legs and expands by spring pressure to hold both the press and the trousers. It is of all-metal construction

FILLER FUNNEL guides food into freezer packages, keeping tops of bags clean for tighter seal. It's used with jars, too, and it stores in small space
The Speedex Co., 129 East 159th St., South Holland, Ill.



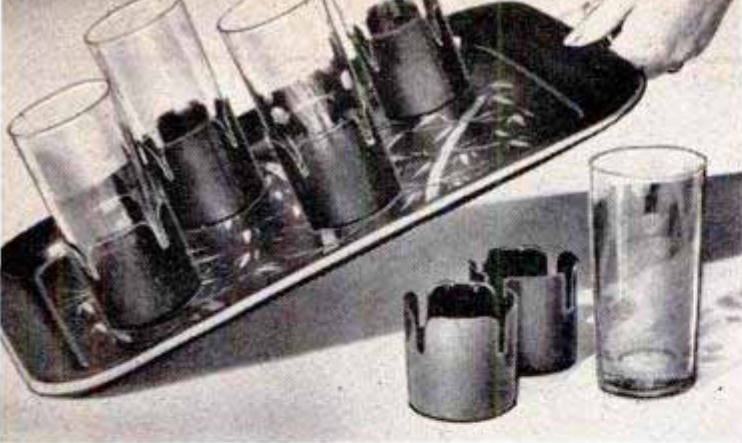

Kelcey Products, 1687 McDonald Ave., Brooklyn, N.Y.

NONTIP COASTERS work like magic. Magnets concealed in plastic coasters cling to metal tray and hold glasses upright even when tray is tipped



Alexander Hertz Co., 94-15 69th Ave., Forest Hills, N.Y.

PERSONAL TRAY for the man of the house mounts on the closet door and has sections for coins, glasses, pen and pencil, keys and other pocket-filling items

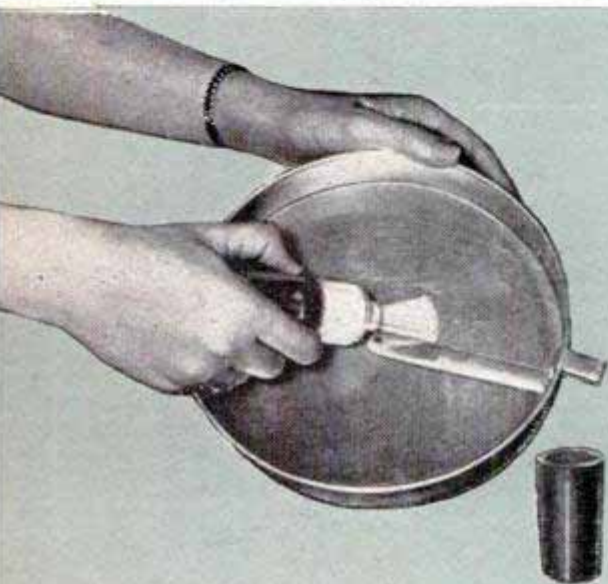

GREASE BRUSH spreads shortening, butter or oil over pans, waffle irons and food. There's no mess and you cut waste, too. The grease is placed inside the plastic handle and the cap screwed on. This forces the grease into the vegetable-fiber bristles. Used at room temperature, it flows smoothly from bristles to pan

CATCHUP DISPENSER ends bottle pounding. You press button, catchup flows smoothly from nozzle. It is also used with mayonnaise, mustard and icing
Weolite Co., 552 W. 53rd St., New York City, 19

WINDOW OPENER saws stuck windows free with its double edges of saw teeth. Whether window is warped, swollen or paint-stuck, the tool will cut it loose
Rene-Craft Products, 21 Owen's Building, Wilmette, Ill.

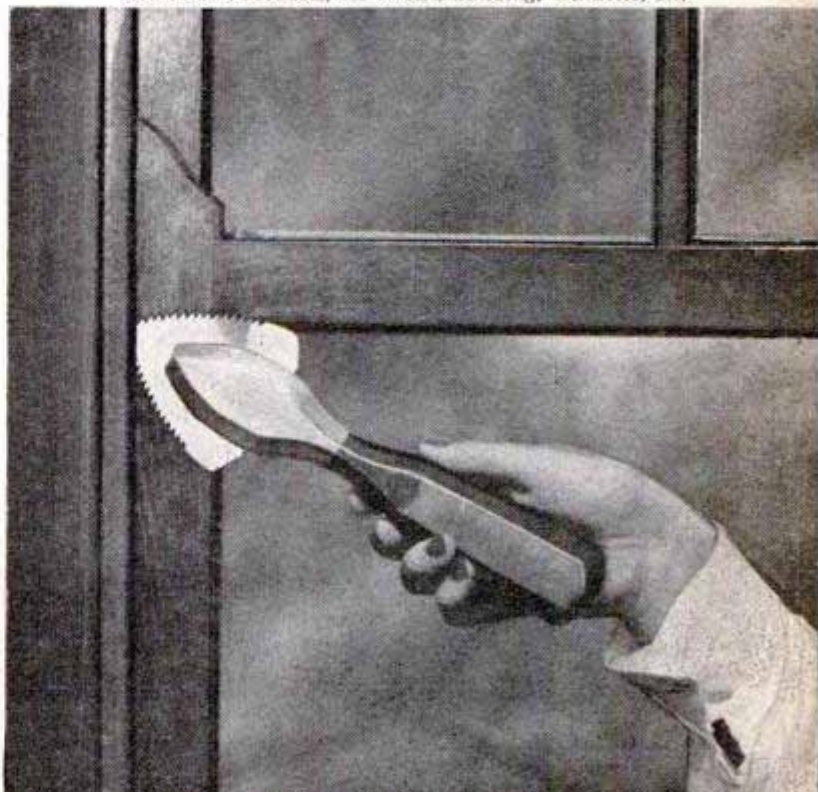
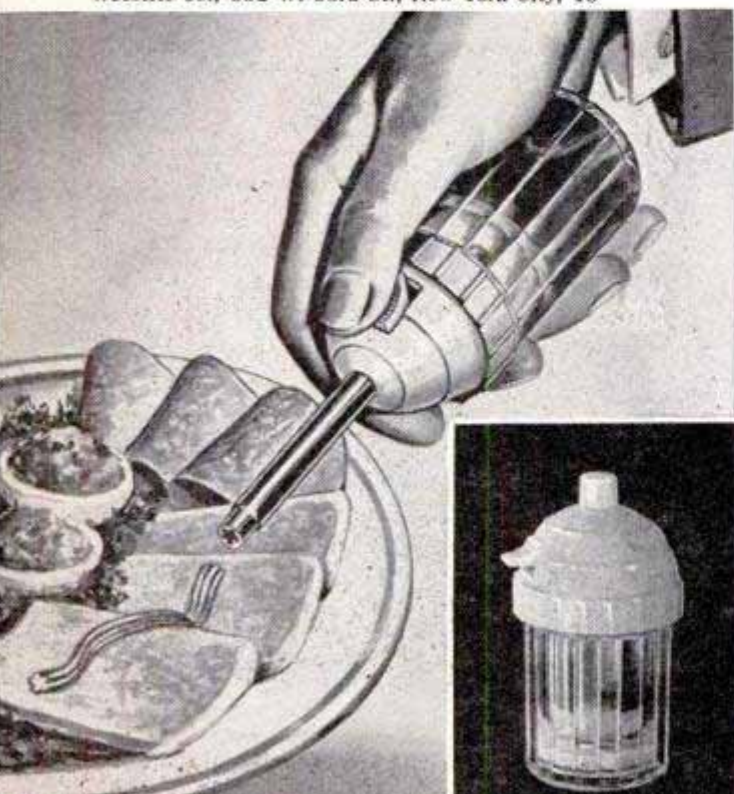



Reed Harvest

In Berlin, Germany, reapers harvest their crops in the dead of winter on the frozen surface of Havel Lake. The crop consists of frozen reeds that grow straight and tall in the lake. A large scythe, attached to a pair of runners, is pushed over the ice by the worker, cutting the reeds off a few inches above the ice. The reeds are then dried and fastened together by wire to form a strong mat, which is used as awnings, fences or even as insulating walls or roofs of small huts.

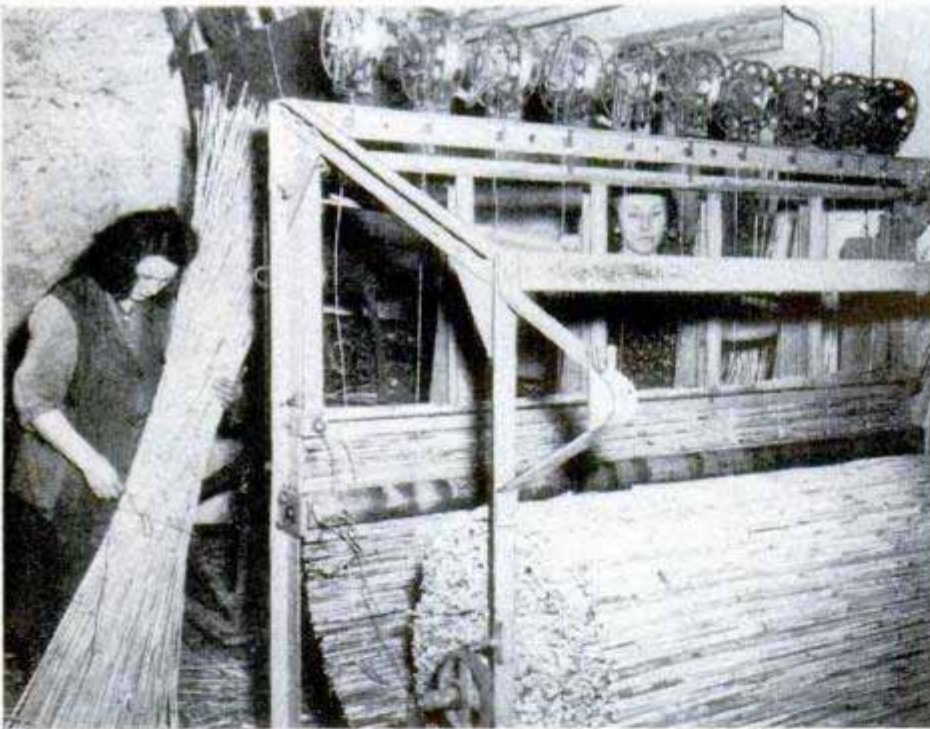

Adhesive-Cloth Signs

Signs printed on cotton cloth with a self-adhesive backing will stick to glass, metal, wood or masonry. A silicone plastic coating protects the extra-strength cloth from dirt, grime, grease and weather, permitting indoor or outdoor applications.

Our defense effort requires thousands of products made from wastepaper. Don't throw it away. Your local Boy Scouts or some other civic organization will pick up your wastepaper, sell it and use the money for a good cause.



W. H. Brady Company, Chippewa Falls, Wis.
POPULAR MECHANICS

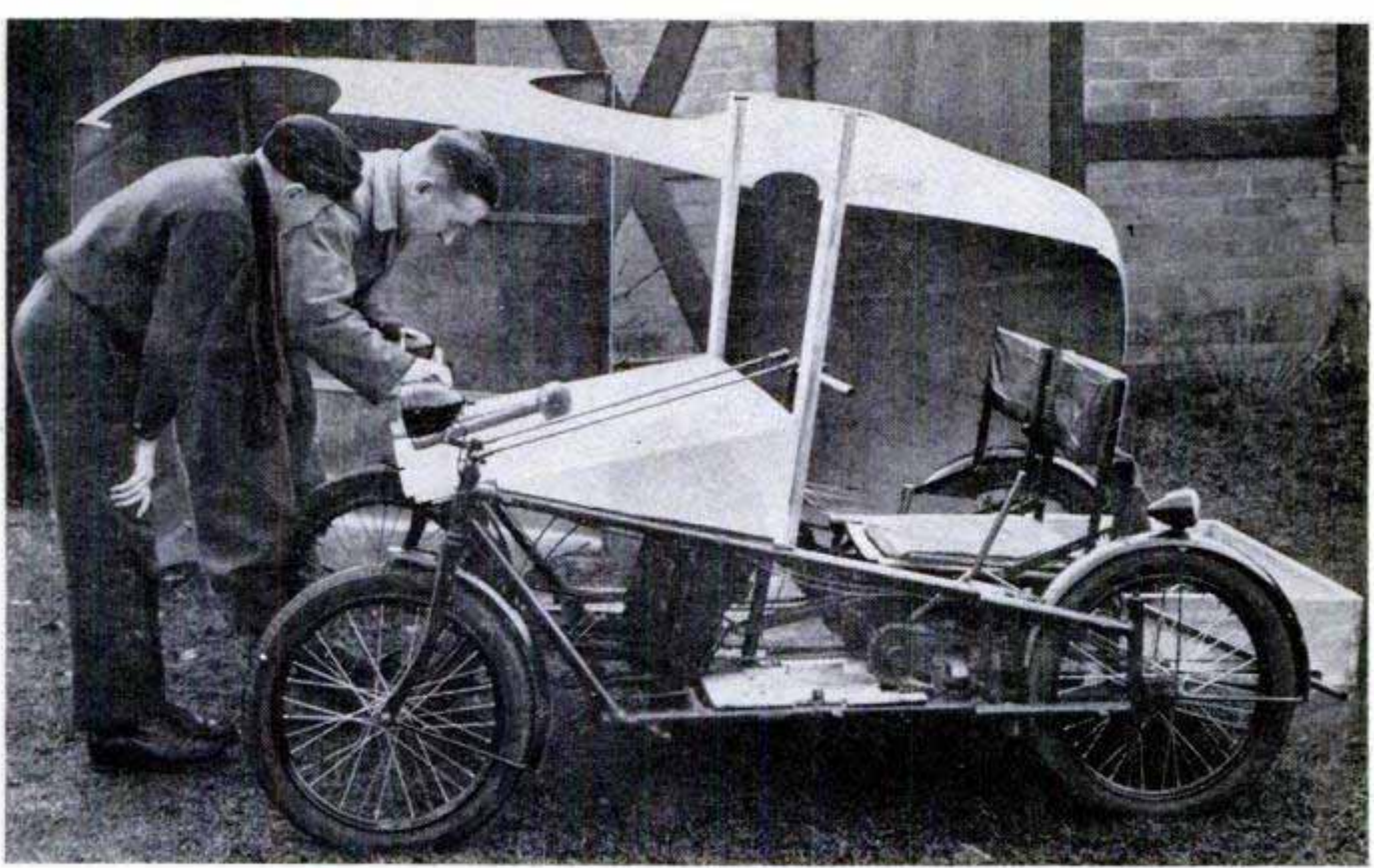

Pedal Car

"Driverpower," not horsepower, moves a small vehicle developed in Berlin. The driver and his passenger pump four pedals

with their feet to move the vehicle along the street. A chain drive transmits the pedal motion to the two rear wheels. According to the inventor, it takes less energy to pedal the vehicle than a bicycle.

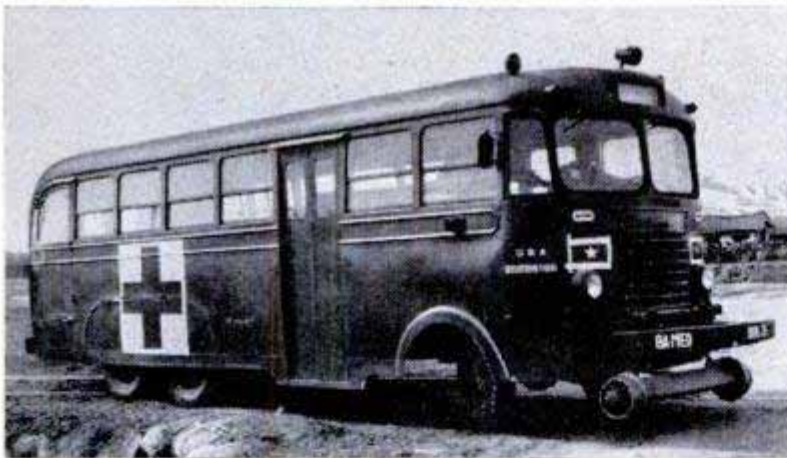

Guide Wheels Keep Ambulance on Rails in Korea

Transporting wounded over rough Korean roads is a slow and uncomfortable operation, so mechanics of the 765th Transportation Railroad Shop Battalion adapted a van for rail driving. Auxiliary guide

wheels, retracted when the van operates on the road, keep the wheels of the van on the tracks. Driving over the rails is a lot more comfortable for the wounded men than the bumpy ride over Korean roads.

Private Conversations Now Possible in Fleets of Radio-Equipped Cars

Individual drivers can be singled out for messages and replies with an all-electronic radio-communications system developed by General Electric. At present all drivers in a fleet equipped with two-way radio hear all messages from the dispatcher and all "talk back" conversations, many of which

are of no interest to most drivers. The new system is for two-way communication involving large numbers of radio-equipped vehicles, such as taxicabs, fire engines and police cars. By pushing buttons the dispatcher can talk to a single driver, to a group of drivers or to all cars at once.

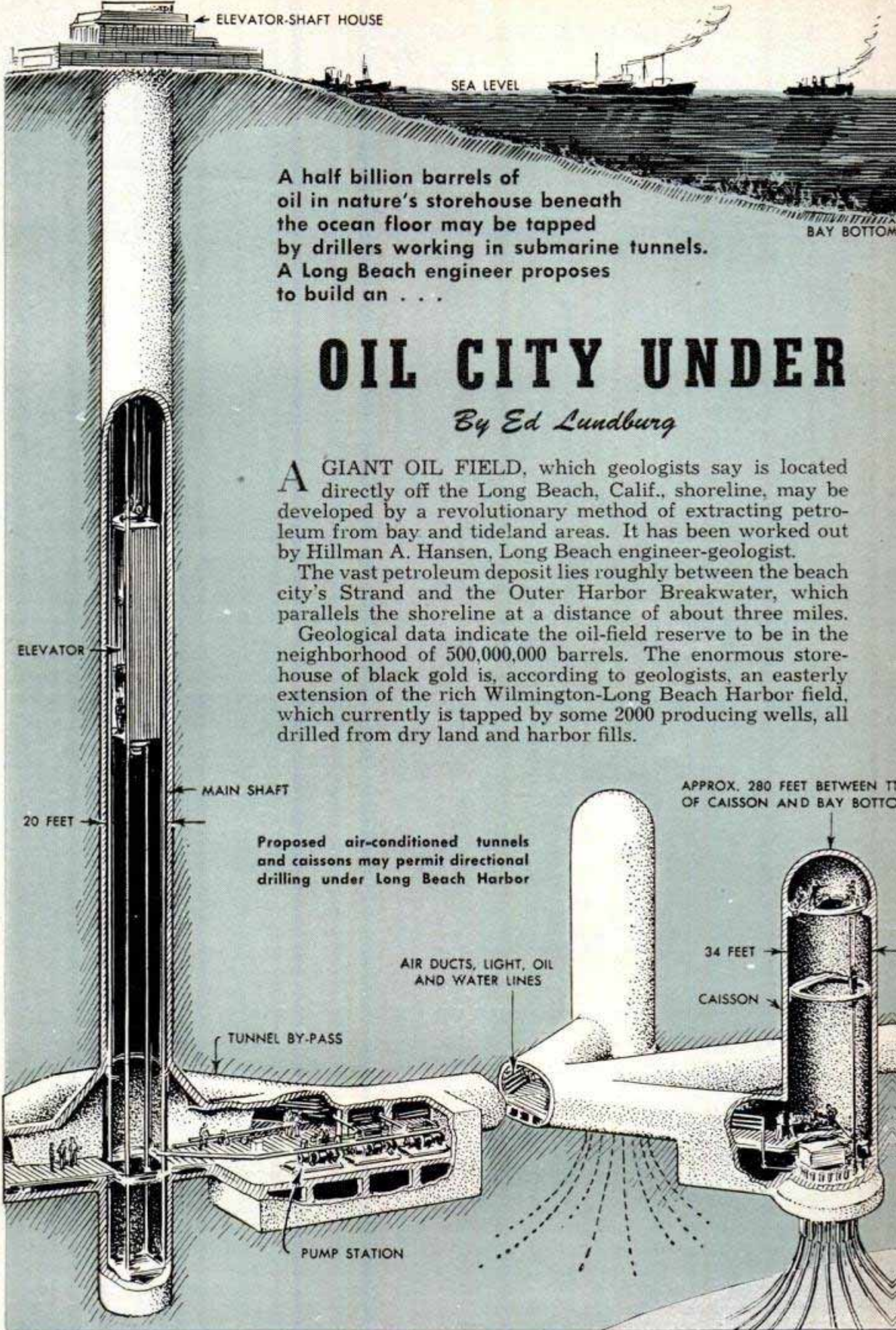

ELEVATOR-SHAFT HOUSE

SEA LEVEL

BAY BOTTOM

A half billion barrels of oil in nature's storehouse beneath the ocean floor may be tapped by drillers working in submarine tunnels. A Long Beach engineer proposes to build an . . .

OIL CITY UNDER

By Ed Lundburg

A GIANT OIL FIELD, which geologists say is located directly off the Long Beach, Calif., shoreline, may be developed by a revolutionary method of extracting petroleum from bay and tideland areas. It has been worked out by Hillman A. Hansen, Long Beach engineer-geologist.

The vast petroleum deposit lies roughly between the beach city's Strand and the Outer Harbor Breakwater, which parallels the shoreline at a distance of about three miles.

Geological data indicate the oil-field reserve to be in the neighborhood of 500,000,000 barrels. The enormous storehouse of black gold is, according to geologists, an easterly extension of the rich Wilmington-Long Beach Harbor field, which currently is tapped by some 2000 producing wells, all drilled from dry land and harbor fills.

ELEVATOR

MAIN SHAFT

20 FEET

Proposed air-conditioned tunnels and caissons may permit directional drilling under Long Beach Harbor

APPROX. 280 FEET BETWEEN TOP OF CAISSON AND BAY BOTTOM

AIR DUCTS, LIGHT, OIL AND WATER LINES

34 FEET

CAISSON

TUNNEL BY-PASS

PUMP STATION



Maintenance man descends steps to check an underground producing oil well at Long Beach, Calif.

THE SEA

The unprecedented method of developing oil fields which lie beneath water involves the use of a technique familiar to mining engineers. The plan envisions sinking a vertical shaft into the earth to a depth of 400 feet below the bottom of the bay. From this depth, a network of tunnels, conforming to a predetermined pattern, would be driven laterally.

Drifting out from each side of the subway tunnels would be short access tunnels leading into caissons constructed of steel and concrete. The caissons, 34 feet in diameter and 120 feet high, would provide necessary

room for installation of standard oil-well drilling equipment. Each caisson would accommodate the drilling of 20 wells in an adjacent 100 acres of "field," as projected downward from the surface of the harbor waters. The wells would be whipstocked (an oil-field term for directional drilling) so that each would draw upon five acres of the projected oil-producing area.

The master plan calls for construction of about 50 of the subterranean caissons.

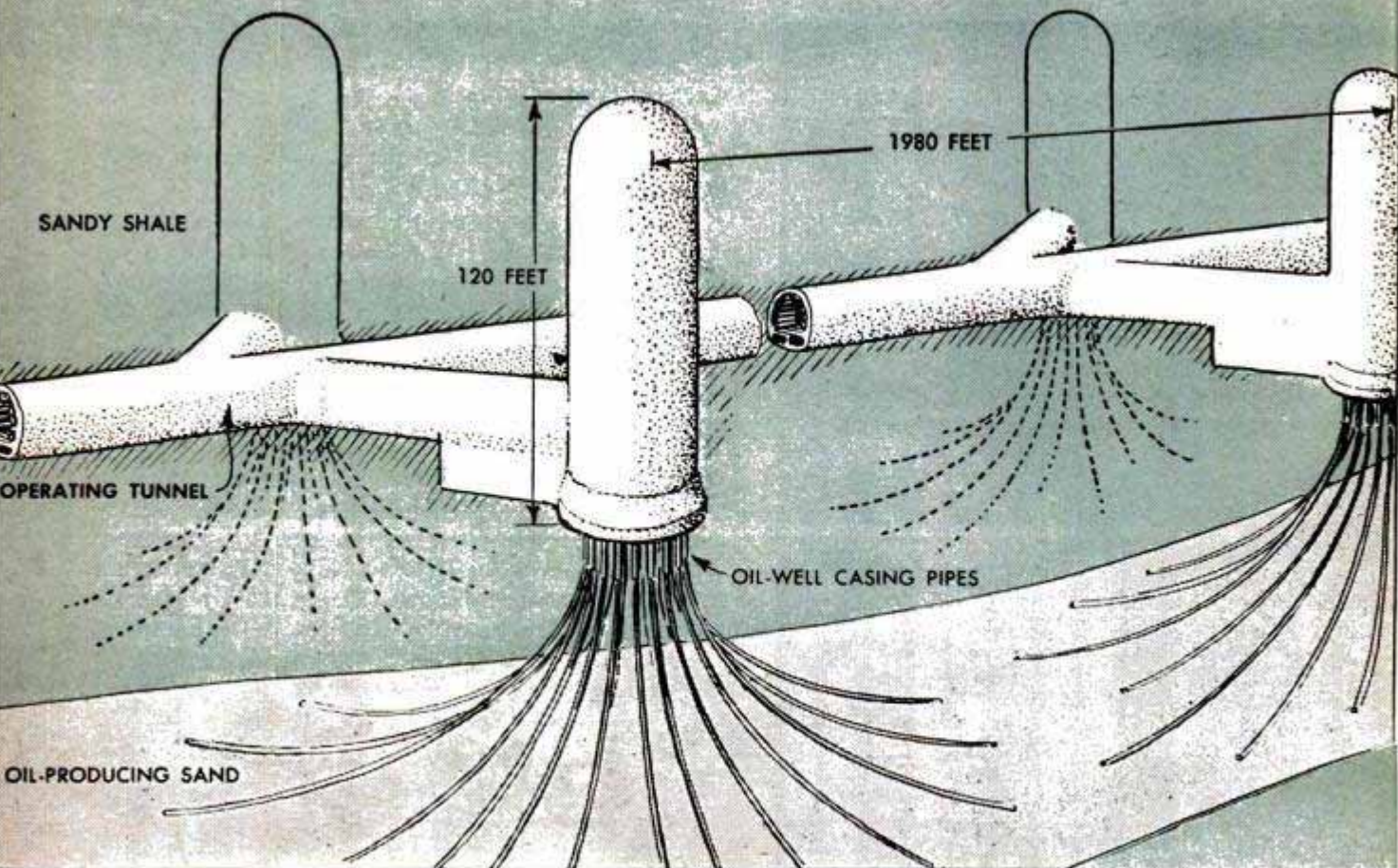

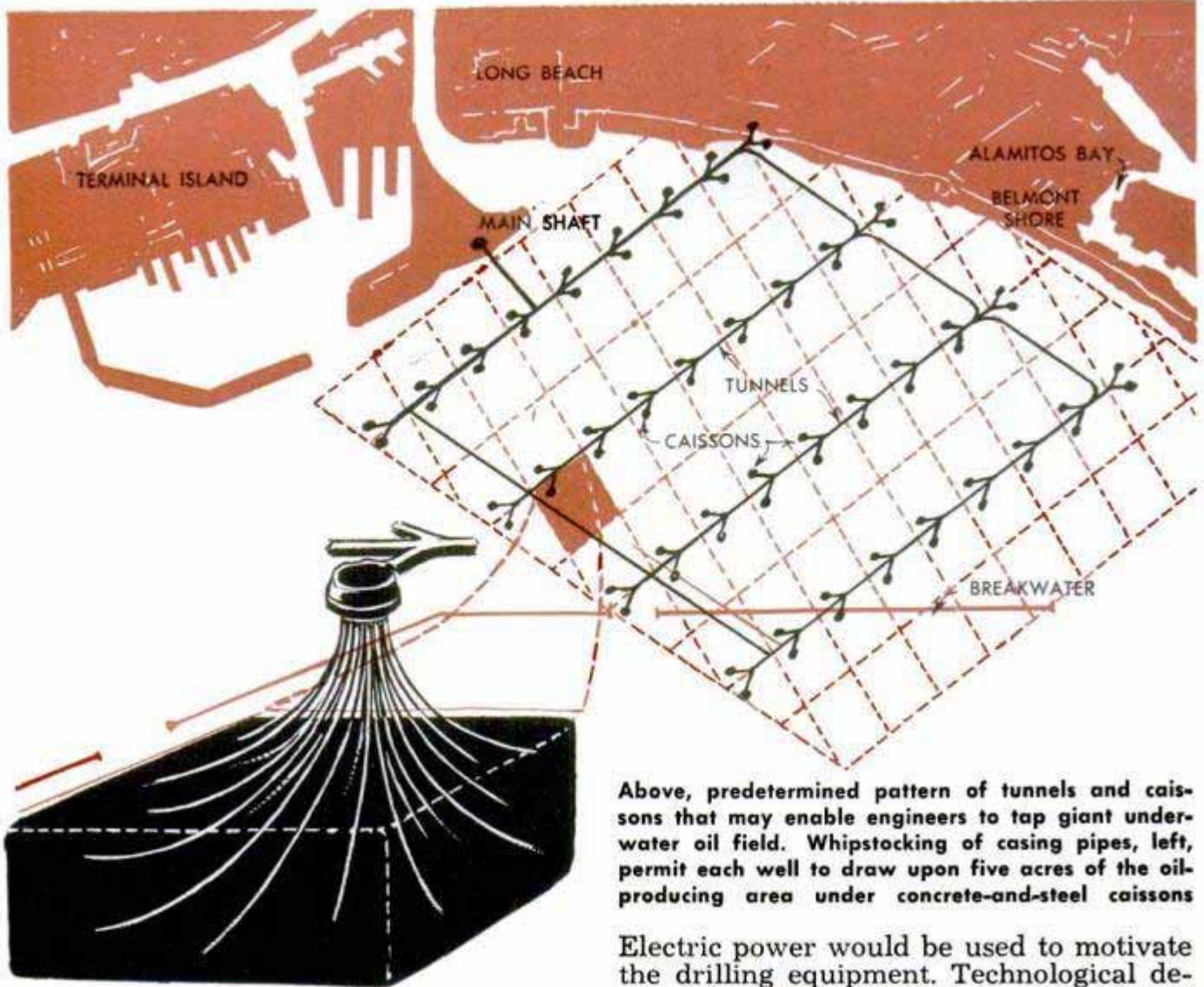

Below, heavy installation on top of an active oil well indicates high gas pressure in producing sands

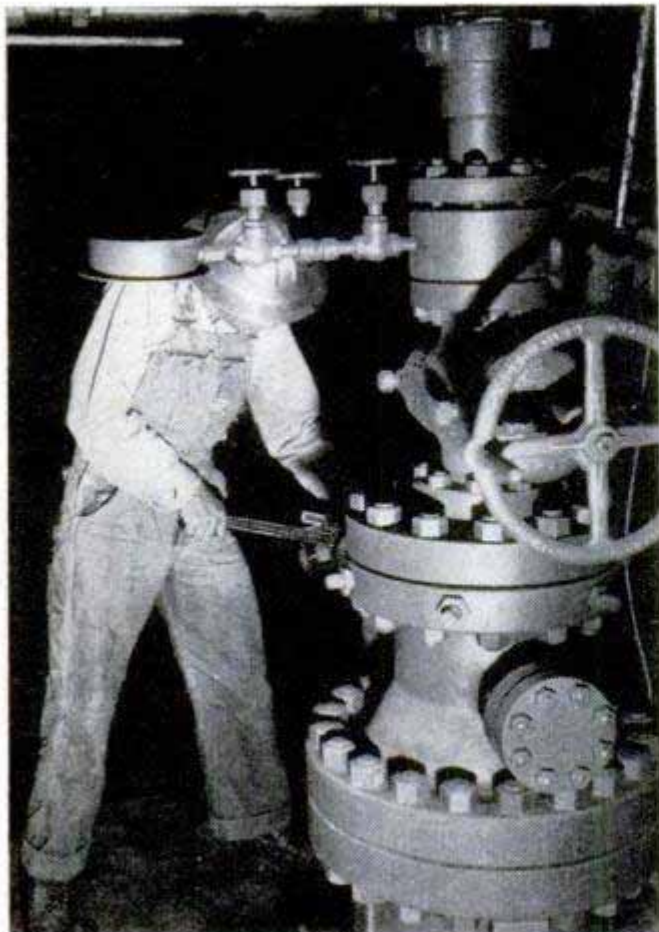

Above, predetermined pattern of tunnels and caissons that may enable engineers to tap giant underwater oil field. Whipstocking of casing pipes, left, permit each well to draw upon five acres of the oil-producing area under concrete-and-steel caissons

Electric power would be used to motivate the drilling equipment. Technological developments, such as the modern shutoff valves and sparkproof electric motors like those used on seagoing tankers, make the tunnel-and-caisson method of underwater oil-field development both safe and practical, engineers claim.

Military experts have studied Hansen's tunnel-and-caisson method and expressed interest in its bombproof aspects.

Two other suggested methods of drilling the Long Beach offshore field have also been advanced. These are (1) constructing a series of concrete islands which would dot the bay with drill sites, and (2) attaching "blisters" (drill sites) to the existing offshore breakwater.

While the proposed island-platform plan would meet the engineering needs of the drilling problem, the plan is presently prohibited by state law on the grounds that it would constitute obstructions to commerce and navigation within the port. Experts agree that the Outer Harbor Breakwater would be a suitable base for anchoring drill sites, but point out that it would permit too limited development of the oil field.

Meanwhile, Hansen continues his study into the problem of drilling bay and tideland oil fields, firmly convinced that he has come up with the logical answer in tunnels and caissons.



Cyclone Motorcycle Breaks Speed Record

Streamlined beyond recognition, a German motorcycle zoomed along the super-highway from Munich to Nuernberg at a record-smashing speed of 180 miles an hour. Wilhelm Hertz, 39-year-old speed enthusiast, drove the racer. The former record, set in 1937, was 173.5 miles an hour.

Converter Adds Power To Your Hand Mower

Any hand mower can be converted into a power mower in five minutes by replacing its handle with a self-driven power unit. The small tractor is a single-wheel unit and is installed by tightening four bolts. Maneuverability with the converted power mower is greater than many ready-made power mowers, according to the manufacturer. It even backs up, something that many standard power mowers cannot do. The unit can be purchased with or without a motor. It is designed for use with either gasoline or electric motors.

LeJay Mfg. Co., 2912 South Emerson Ave., Minneapolis 8, Minn.



Prone Rider Sets Speed Mark On Streamlined Motorbike

Riding prone on a streamlined motorbike, E. Dotterweich of Germany set a new world speed record on a highway near Munich. His time was 48.9 miles per hour. Pamarozzi, an Italian racer, held the previous record of 45.3 miles an hour.

Mechanical "Traffic Cop" Clips to Accelerator Pedal

Quickly attached to the accelerator pedal, a calibrated speed control helps the driver maintain a steady, safe speed of his own choosing. The device, made of spring steel, can be set at any speed. When the pedal is depressed to that speed level, the spring speed control strikes the floor board. To make the car go faster, the motorist has to push against the spring and thus has to make a conscious effort at overspeeding. Another feature of the control is that it provides a restful stop for the accelerator foot at cruising speed. When fast acceleration is needed, or when more power is needed to climb a hill, the driver simply applies extra pressure to depress the pedal.

Speedminder Laboratories, Inc., Box 3496,
Merchandise Mart Station, Chicago 54



THE FARM SHOP

KEEPS PACE

By Rafe Gibbs

BETWEEN the sounds of hammering, we heard a baby's cry. We were in the machine shop of Gene Hagedorn, young wheat farmer of Latah County in Idaho. And there was no baby to be seen.

Then we heard the cry again. It came from the speaker of an intercommunication set perched on a stand above the shop's workbench.

Hagedorn stopped hammering and grinned:

"My wife had to run into town and I'm baby tending today along with tractor repairing. That was Eddie you heard—just waking up from his nap. The intercom in the house is near his crib. Guess I'll have to go down to the house and pick him up. He's getting louder."

Today the farm is a highly mechanized establishment. It used to be merely grand-

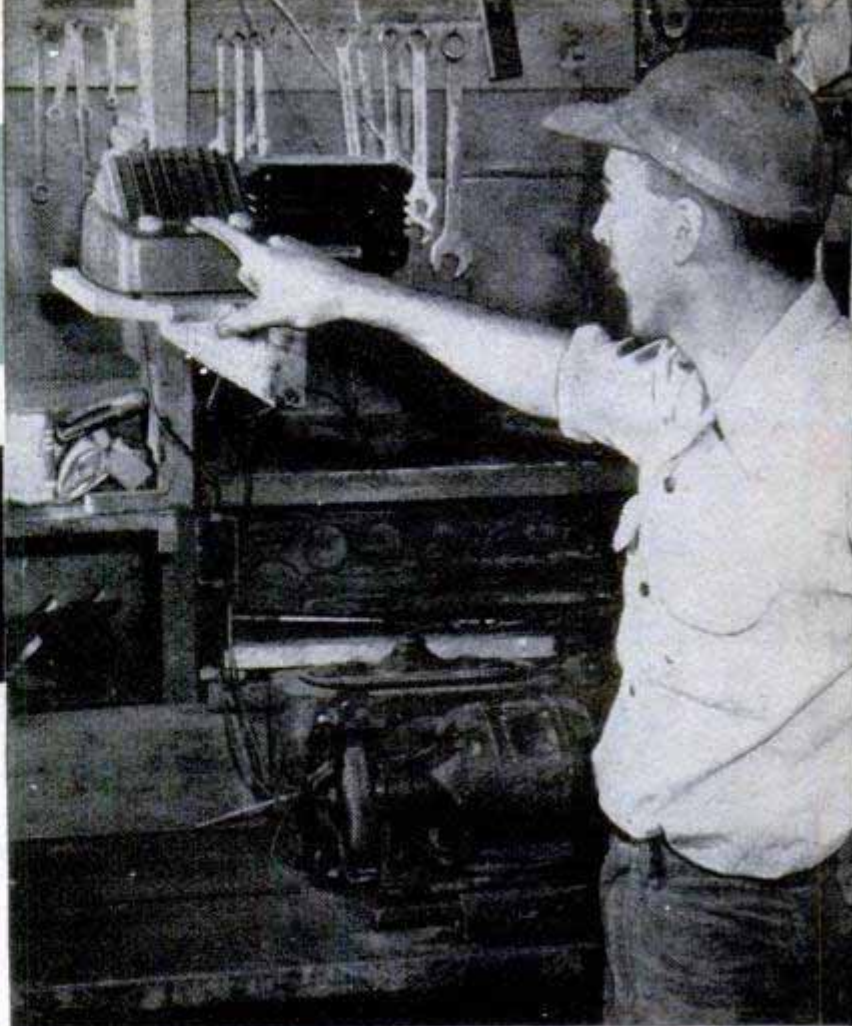

That old dinner bell of yesterday's farm is gone—replaced by an intercom system, like the one at Gene Hagedorn's place

pa's wrists swelling. Now it's the milking machine ceasing to function. A horse would develop a collar sore and would be turned out to pasture to be replaced by another. Now a shaft on the tractor cracks and farm work ceases until it is repaired. Too many things go wrong for a farmer to be running to town for repairs. So efficiency-minded farmers like Hagedorn are setting up shops in the barnyard.

Over at Genesee, Idaho, we visited the farm shop of John Luedke. He recently equipped it with fluorescent lights.

"They cast fewer shadows," he said. "And shadows are no help when you're trying to get a quick grip on a bolt."

Originally, Luedke's shop was equipped with nothing but 110-volt leads and he had trouble with heavy-duty power equipment stalling.

Farmer's war-surplus lubricator keeps his equipment rolling. It is electric so he powers it with a small gas engine for field use

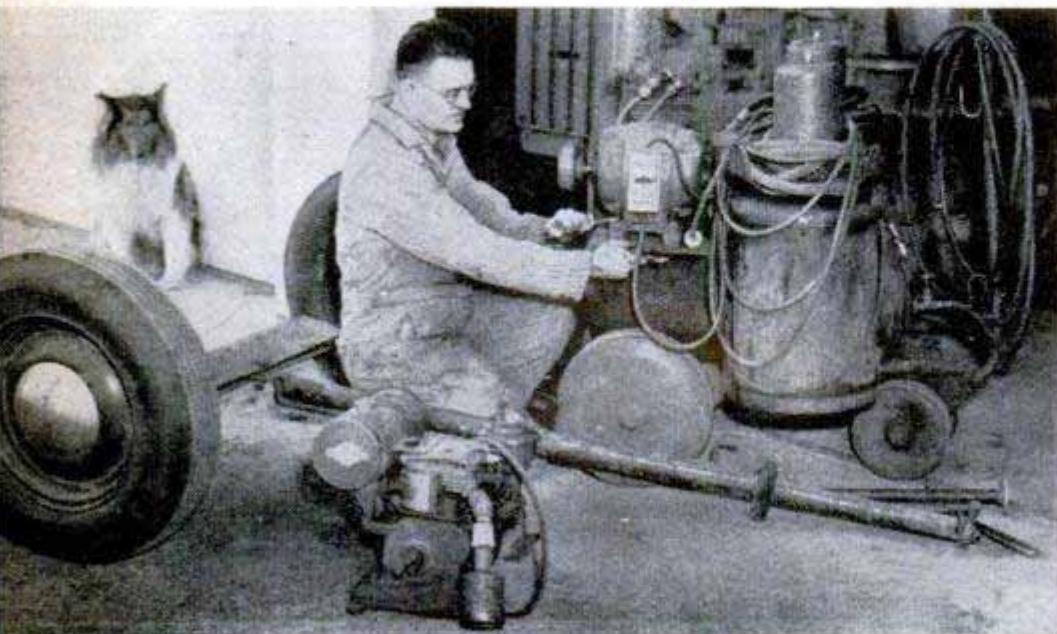

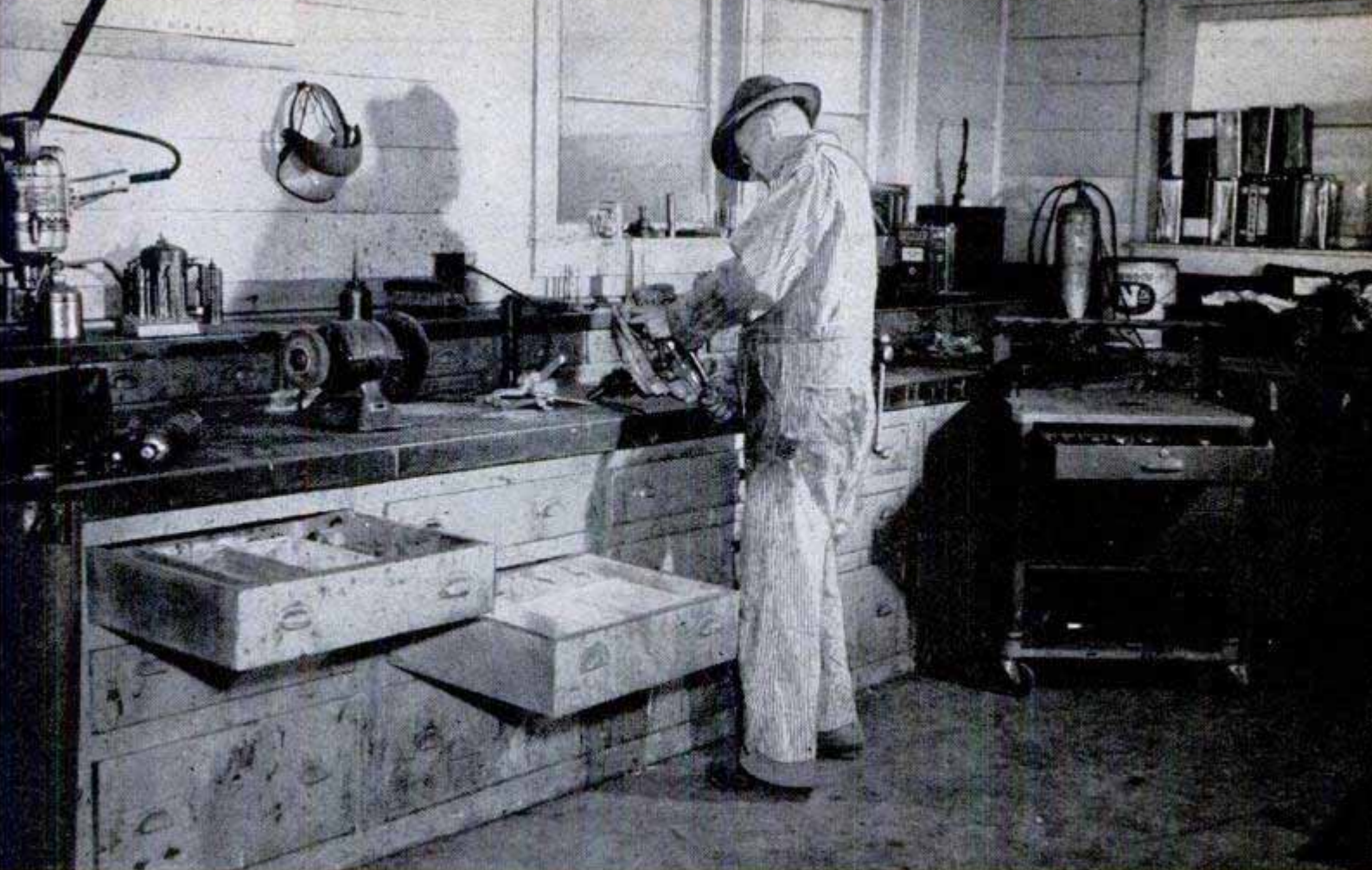

Drawers partitioned for different types of tools are more efficient than wall tool racks, says farmer Luedke

Now he has installed 230-volt branch circuits for all his permanently installed equipment and has no more trouble.

We have seen shops where farmers have hung their tools on nails, then outlined them with crayon or paint for ready identification of position. We have seen walls covered with racks, walls with clips for the tools. But Luedke doesn't go along with these ideas.

"I've installed drawers—lots of drawers," he said. "There are drawers for hammers, drawers for wrenches, pliers and welding tools. They make it easy to find a tool, easy to toss it back."

Keeping the right-sized bolt quick at hand is equally important.

"I was wasting too much time in my farm shop hunting bolts," said Melvin Hattan, Moscow, Idaho, farmer, "so I built shelving and labeled all compartments with sizes."

When Hattan completed the shelving, he spent almost two days sorting bolts from his bolt box, then gave up and bought new bolts already grouped to size. Some day—whenever he gets time—he will complete the digging in the bolt box.

The University of Idaho has conducted

Made of parts salvaged from the scrap pile, a welding cart saves Clarence Steelsmith time and energy

extensive studies on the farm shop. William H. Knight, farm-electrification project director, provided these special tips:

1. A portable $\frac{1}{2}$ to $\frac{3}{4}$ -horsepower electric motor with a four-step pulley and V-belt can be used both inside and outside the shop for many seasonal or short-time jobs such as grinding, buzz sawing, elevating grain or hay and similar jobs.

2. An anchor hook installed flush with the floor near the rear-center of the shop is valuable for snaking in heavy machinery.

3. A pressure line running from the

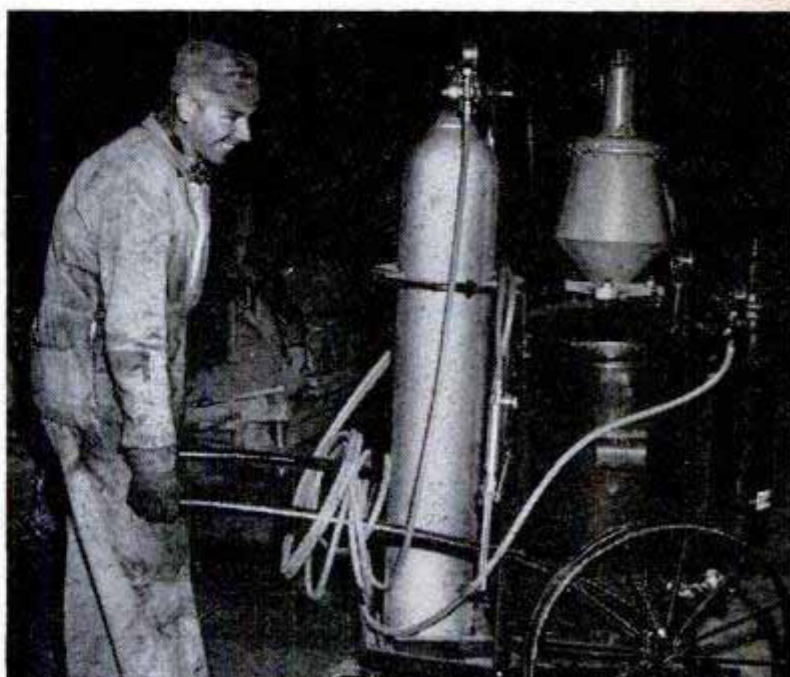

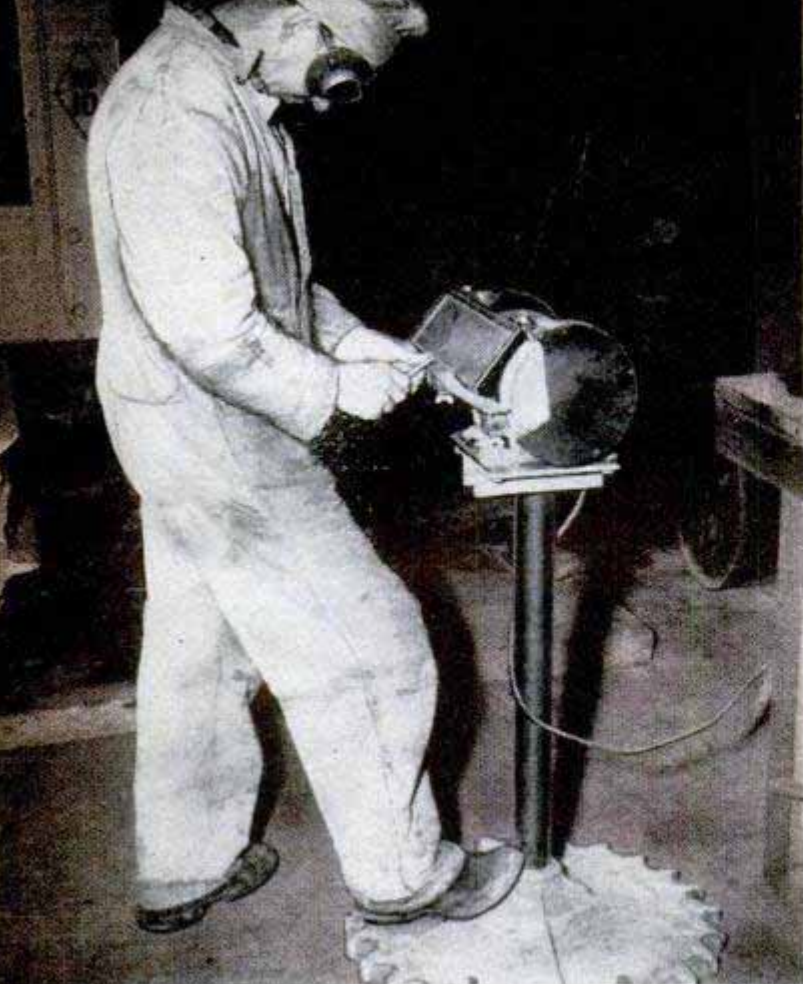

Steady but movable is the grinder base made with a discarded tractor sprocket wheel and a short pipe



One western farmer found a dust-covered lathe in an old blacksmith shop and put it to work on his farm

compressor to the workbench area will prove of value for spraying and cleaning.

4. If you have a center crane track and a small door, you can project the crane track outside for five or six feet (like a hay-barn track) for lifting heavy machinery.

Knight is a strong believer, however, in getting the right-sized door—and shop—in the first place. For the small truck gardener or orchardist, a shop 16 by 26 or 18 by 30 feet is probably big enough. But the farmer

with heavy acreage and corresponding equipment usually needs a shop perhaps 24 by 36 or 26 by 42 feet. The rule is that it should be at least big enough to handle the largest equipment on the farm.

That's how the door size is determined, too. Snowbelt farmers need a big door if they want to work on their combine in December.

Sufficient working room is also important from the safety angle. Actually, we

have yet to see a farm shop with too much room, although we visited a big one on the farm of the Steelsmith brothers, Laurence and Clarence, of Troy, Idaho.

They had converted a 32 by 60 foot abandoned horse barn into a shop; knocked out the stanchions and uprights, bolstered the haymow floor with trusses. The haymow itself was converted into a storage room for parts and equipment.

Experts in farm-shop techniques at the University of Idaho say this storage unit with sliding doors is ideal for small parts

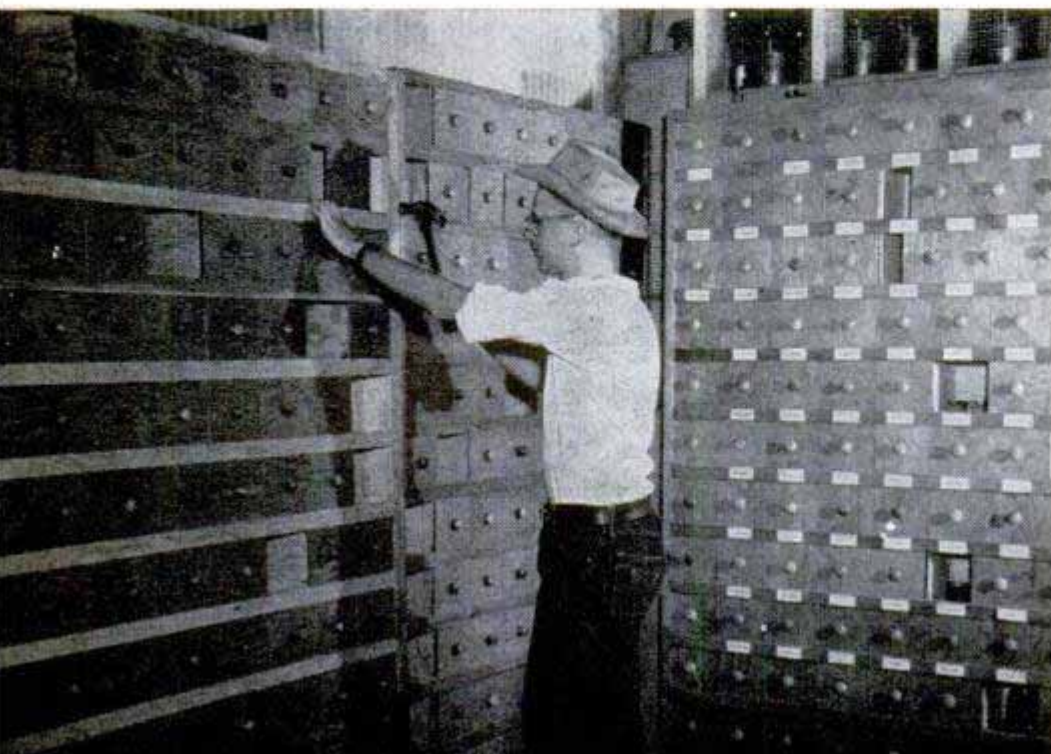

"We can work on a variety of equipment at one time without backing into a torch or grinder," said Laurence.

Good lighting is essential. Over in Washington, near Pullman, Carl Boyd has a shop with windows on the back and sides with just enough free space for shelving. Natural light is good—even on a cloudy day.

Many farmers are realizing that light-colored walls are as important in the shop as in the home. Drab, unpainted interiors are giving way to white walls.

If fluorescent lights such as in Luedke's shop are not used, one incandescent ceiling light of at least 100 watts should be provided for each 200 square feet of floor. In addition, there should be at least a 100-watt light over each piece of fixed equipment—drill press, lathe and welding table. Every eight feet of work bench calls for another 100-watt light.

In wiring the shop, consult a local wiring contractor or power-company farm representative. But here is an important tip—wire adequately, leaving room for expansion. Fundamental rules stressed by the University of Idaho farm-electrification experts are:

1. Plan special branch circuits for lighting only. Use no wire smaller than No. 12.

2. Plan special branch circuits for convenience outlets only. Use no wire smaller than No. 12.

3. Allow no more than 10 outlets per circuit.

4. Keep circuits as short as possible; otherwise use larger wires.

5. Plan special 230-volt branch circuits for all permanently installed motors over ½ horsepower, and for appliances of 1000 watts and over.

6. A special welder circuit of two No. 6 wires and one No. 8 wire on 230 volts is satisfactory for farm welders of 180-ampere capacity.

7. Allow a double convenience outlet for each six feet of bench length and one for each permanently placed piece of equipment less than ½ horsepower.

University researchers have found that where a line shaft is used to drive several machines, approximately 50 percent of the horsepower of the motor is lost to friction. Individual motors increase efficiency.

Then there's the matter of comfort in the shop—summer and winter. For summer cooling and for exhausting smoke and odors, a 12-inch ventilating fan, placed above the windows at the end of the shop, is almost indispensable. For heating, the 50-gallon drum-type stove is popular.

Commented Hattan:

"Guess my stove is the most important piece of equipment in the shop. I would hate to go through a summer of farming without a winter of shop work."

When Hugh Vandemark, Washington farmer, made his nonwobbling grinder, he used a brake drum for the shield





Dutch Treat Shop, 5932 Germantown Ave., Philadelphia 44, Pa.

Lunch-Box Liner

For the breadwinner of the family there's a new plastic lunch-box liner which permits him to carry "soupy" salads and vegetables as well as sandwiches and fruit. The liner will fit any standard-size lunch box. Two of the three compartments are airtight and spillproof, while the third is designed for sandwiches and other large items.

Swimmers' Snorkel

Swimmers, as well as submarines, can now use a snorkel breathing device to lengthen the time they can spend underwater. Made of clear plastic, the tube has a shaped mouthpiece and an exhaust valve.

Von Lengerke & Antoine, 9 N. Wabash Ave., Chicago 2

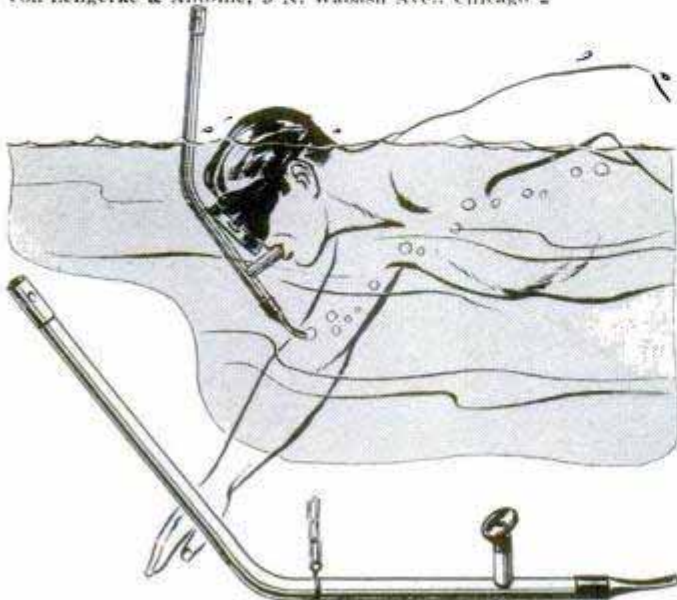

West Point Lawn Products, West Point, Pa.

"Fork" Aerates Soil

To provide better absorption of water, plant food or fertilizer, a forklike device digs up cores of soil and breaks them as they are pulled from the ground. The unit, which is designed for use on small lawns or for spot treatment of larger areas, permits reseeding of limited sections without digging up the complete lawn.

Fishing-Leader Dispenser Has Built-In Cutters

Nylon fishing leader now is marketed on a convenient dispensing spool with built-in cutters. The dispenser, made of aluminum, is two inches in diameter. Before the leader is cut, the line is snubbed under a clamp on the spool to prevent the remainder of the coil from unwinding.

Weber Lifelike Fly Co., Stevens Point, Wis.

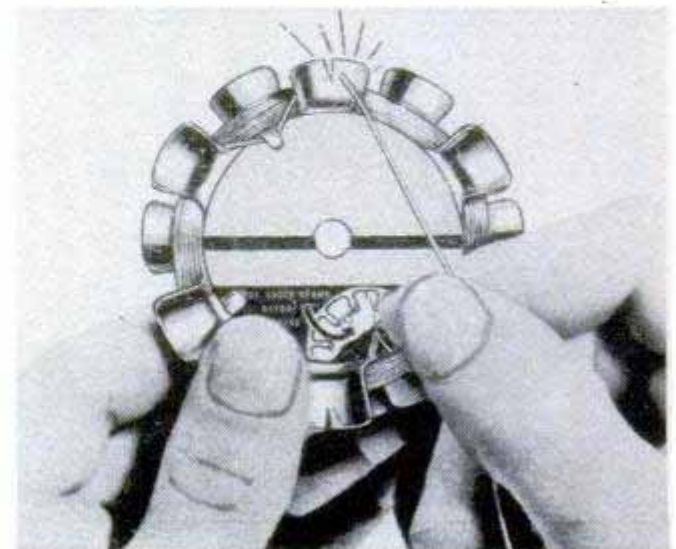

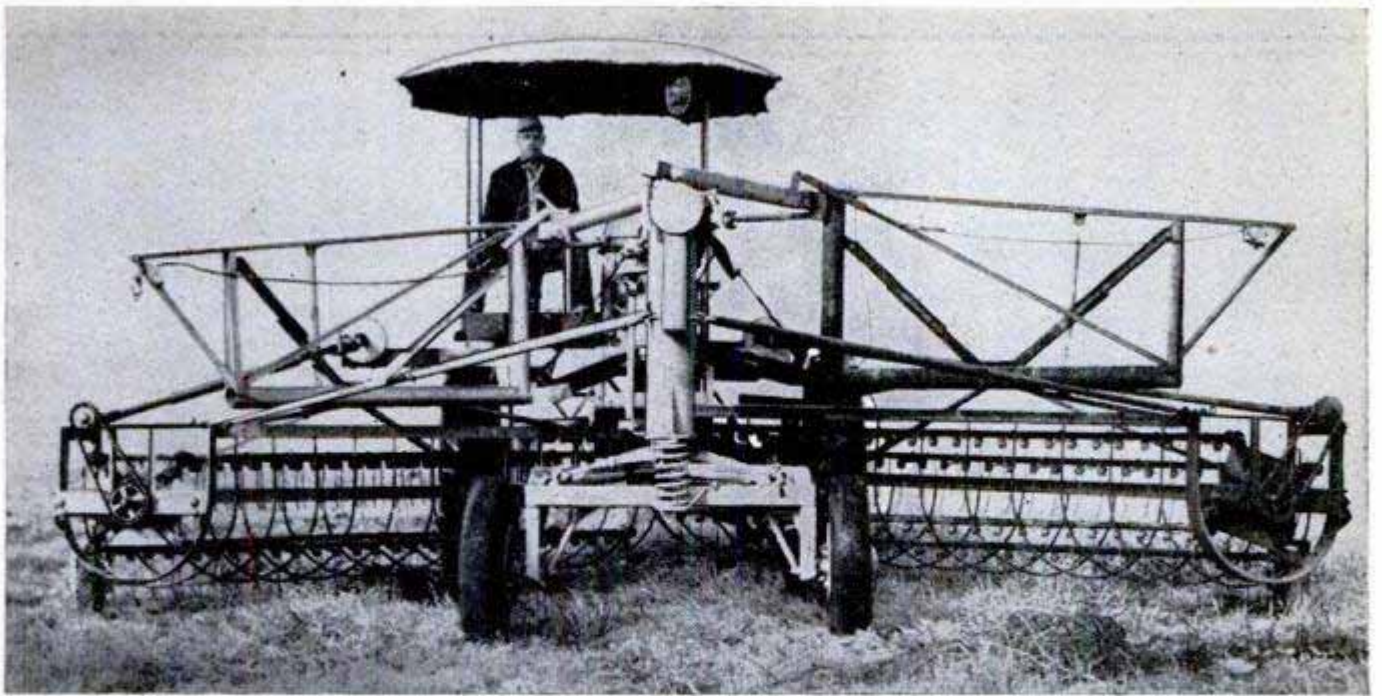

Head-on view of the double side rake ready to go to work. The hay is drawn in to the center and piled between the wheels by the two rakes. Below, the rakes retract for highway travel

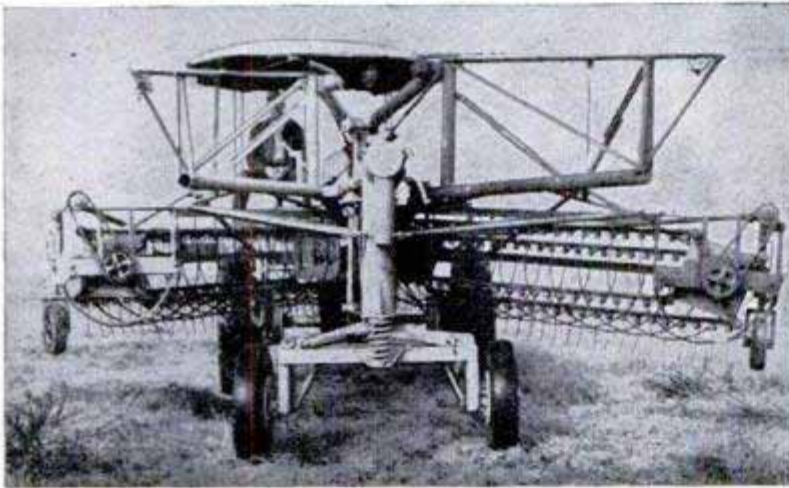

Double Side Rake Windrows 16 Feet of Hay

Windrowing about twice as much hay as the conventional rake, a double side rake enables one man to work 45 acres in eight hours. A hydraulic lift raises the two rakes to decrease the width of the machine for travel on the highway. Power is furnished by a Model-A Ford truck engine mounted on the driver's platform. Both rakes and wheels are driven by chains. The two rakes pile hay between the wheels. The machine was built by Jay Clark of Modesto, Calif.

Outdoor Laboratory Checks Roots in Sewer Pipe

What causes tree-root tendrils to penetrate and clog home sewer pipe? Technicians are seeking the answer to that question in a unique outdoor laboratory at Manville, N. J. Various types of sewer pipe are installed in a concrete basin which is filled with sand. Trees with aggressive roots are planted in the basin. It has previously been assumed that roots would enter crevices in pipes even though no moisture were present. The research indicates, however, that roots enter sewer pipe only where water has leaked out.

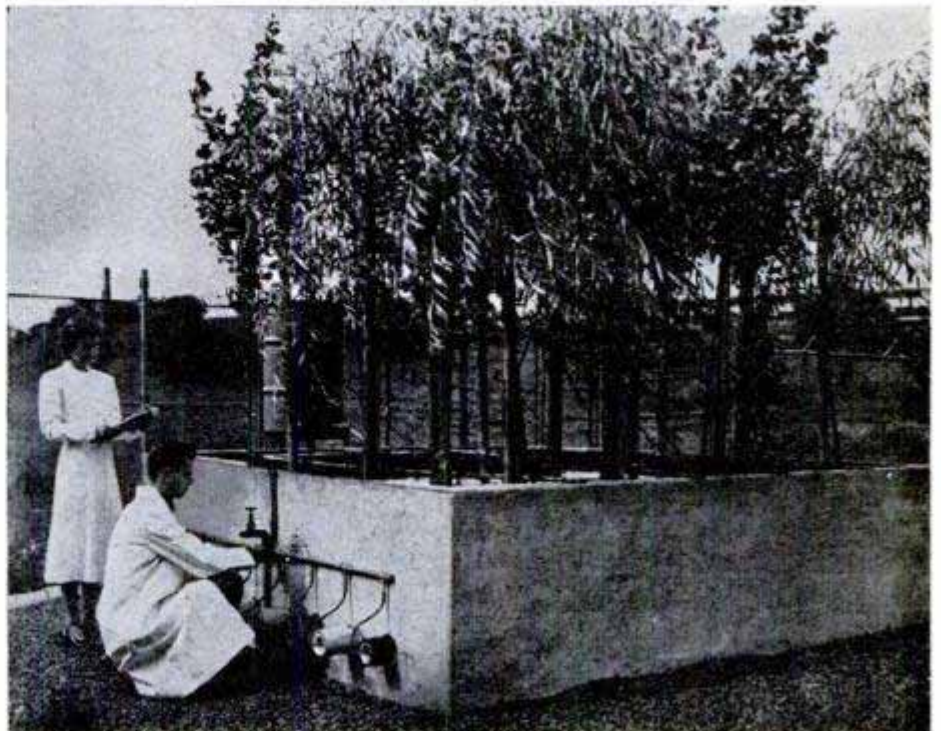

IT'S NEW

For Your Tackle Box



1. Plastic oxygen generator hangs on the side of a live-bait bucket and diffuses oxygen through the water to keep minnows alive. One "charge" of fluid generates oxygen for 90 hours

2. Interchangeable spools on a new reel permit the angler to use the same equipment for spinning, casting, fly fishing. Different types of line are carried ready to use on various spools

3. Lure made of a flexible material looks, feels and moves like a live minnow. The transparent fins, soft body wriggle as lure moves in water

4. Container made of Tenite plastic permits angler to cast live bait without injuring it. There's a bobber on one end, trap door on the other. When the container strikes the water, door opens and bait sinks to desired depth

5. Wiggly artificial worm looks and feels like the real article, yet even milady won't mind baiting her own hook. It's made of a flexible material that won't get stiff in the water

6. Double lure increases the angler's chances of catching fish. The twin minnows both wobble, their tails spinning, as the lure is retrieved

7. Two hooks connected with spring-wire yoke are baited together. When the fish strikes, the yoke slides down the leader and the hooks spring apart to give a double grip in fish's mouth

8. Transparent-plastic minnow bucket collapses to pocket-size, yet holds 6½ quarts of water. When a tube at the top is inflated, bucket can't sink

9. One-cell flashlight clamps to any fishing rod, signals a strike. After the cast, the line is slipped into a clip. When the fish bites, flashlight comes on, line springs out of the clip

Minn-Oxy Inc., 3105 E. 42nd St., Minneapolis, Minn.

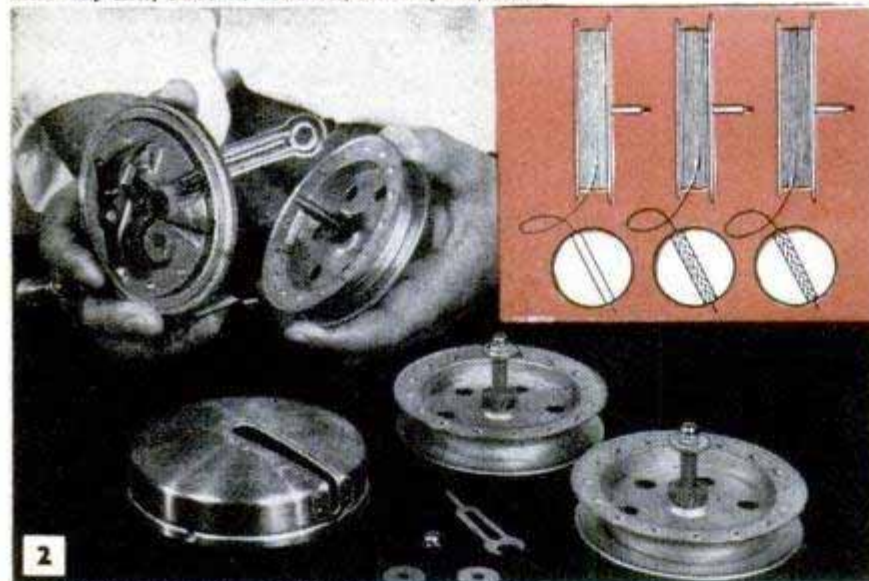

Magic Fishing Reel Co., 3500 Walnut, Denver, Colo.

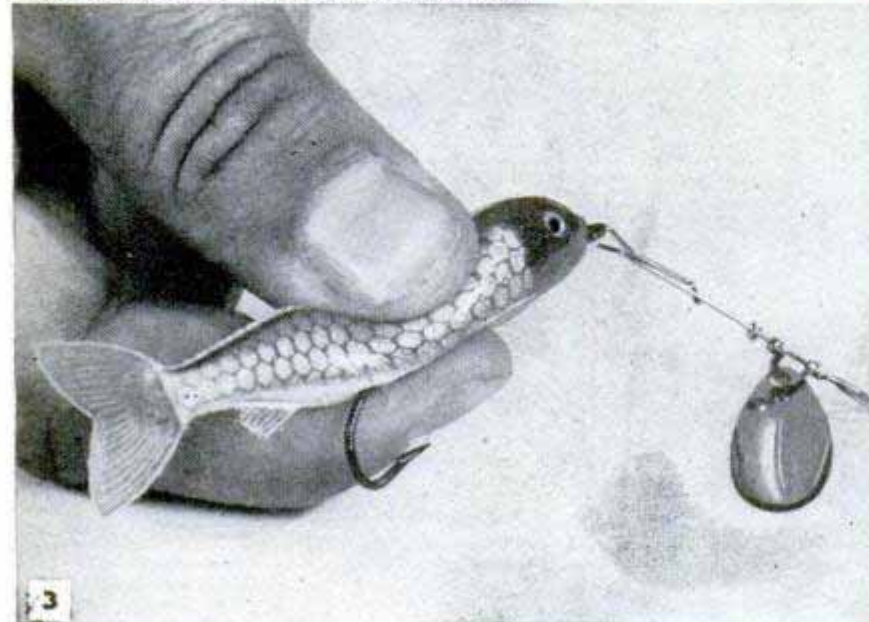

Lif-Lik Lure Co., 3814 Independence Ave., Kansas City, Mo.

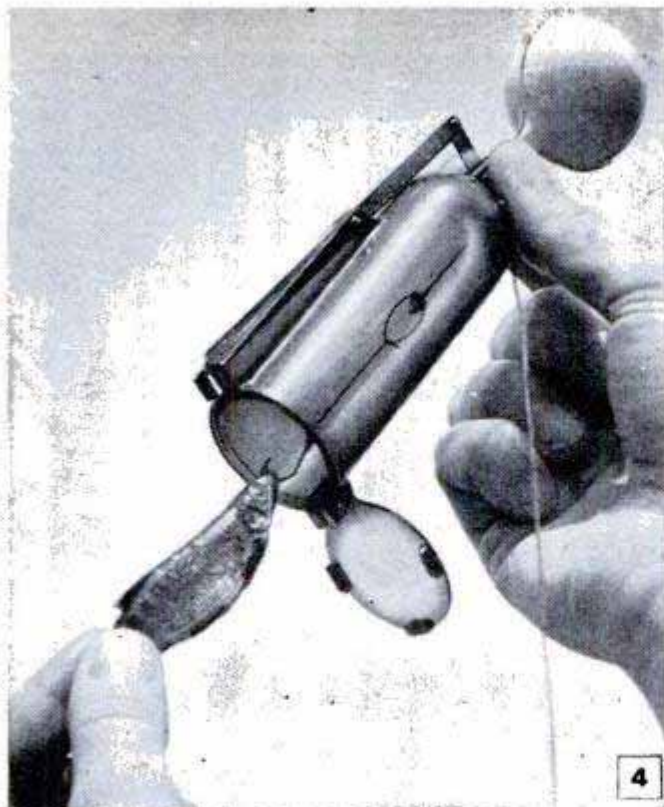

Mackenzie Tool & Engineering Co., 88 Andrew St., Springfield, Mass.

4



5

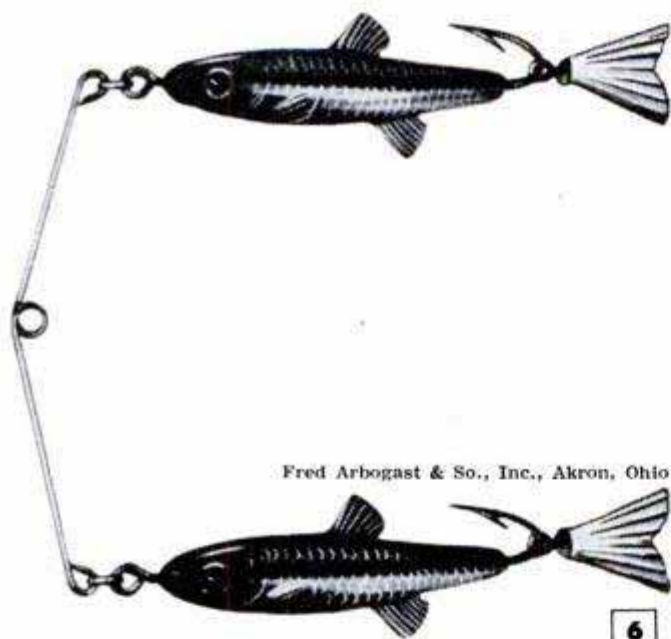

Fred Arbogast & So., Inc., Akron, Ohio

6



Creme Lure Co., 1005 E. Tallmadge Ave., Akron, Ohio

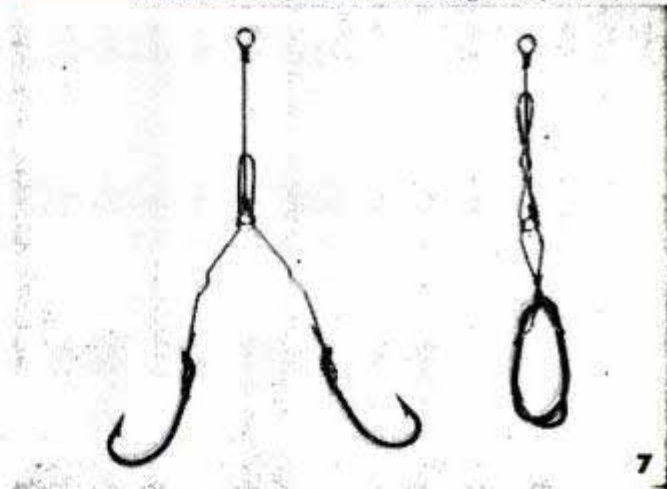

7

Scientific Research Co., 1618 N. Vancouver Ave., Portland 12, Ore.



8

Walco Products, 2300 W. 49th St., Chicago 9



9

Fish-O-Matic Manufacturing Co., 19 Railroad Ave., Kingston, N.Y.

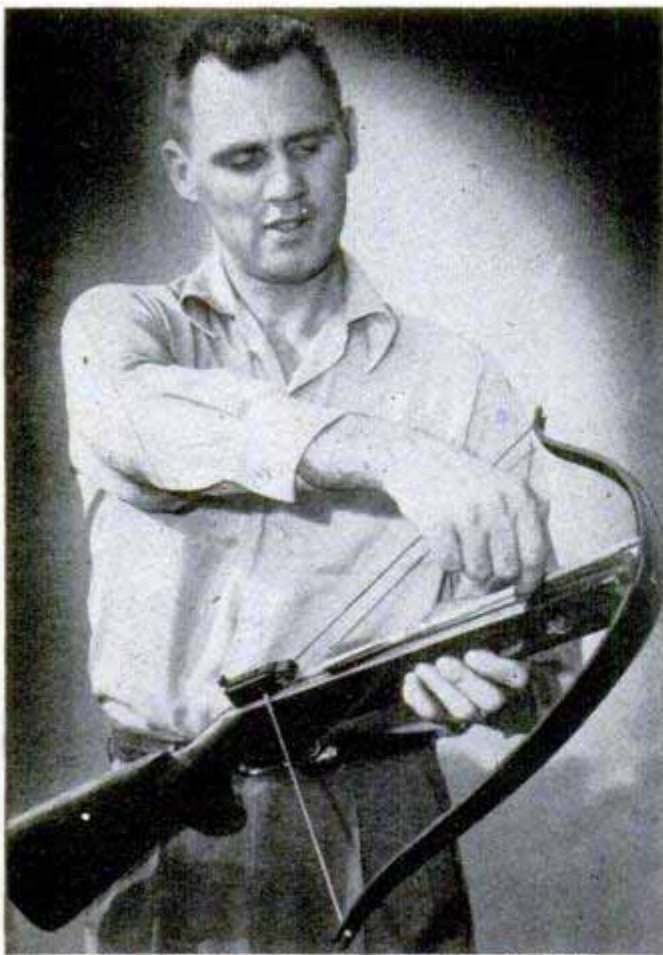

Schmid & Co., 1513 N. Gardner St., Los Angeles 46, Calif.

Sportsmen's Crossbow

Sportsmen who like to hunt with a bow and arrow will find a 20th-century version of the ancient crossbow a dependable and accurate weapon. The hunter's model has a 125-pound-pull bow that is accurate up to 100 yards. A target version of the crossbow has a 75-pound pull and is designed for back-yard bowmen. The stock, shaped like those on rifles, is equipped with an accurate sight that provides height and windage adjustments. Either bow can be used with the same stock, thus providing an all-purpose crossbow for archery fans.

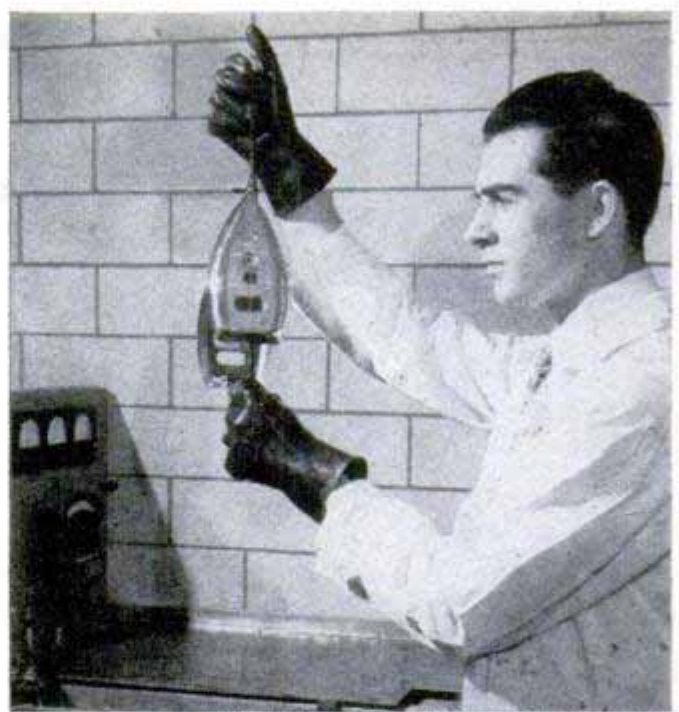

Westinghouse Electric Corp., Pittsburgh, Pa.

"Give and Take" Chrome Plating Will Save Critical Materials

New automobiles and appliances may continue to gleam with shiny chrome despite defense demands for critical nickel because of a new process for metal plating. The technique, called periodic reverse plating, permits the use of a copper layer beneath the chrome, eliminating all nickel in many appliances. In parts where the use of nickel is allowed, as in car bumpers, an extremely thin layer of nickel is added to the copper layer, affording additional nickel saving. Key feature of the system, developed by Westinghouse, is an electrical "back stroke" that alternately deposits metal then takes some of it away until a smooth surface is achieved. This removes inferior metal deposits, providing a sound plating of superior brightness and strength with a minimum of critical metals.



Swift and Anderson Co., 952 Dorchester Ave., Boston, Mass.

Layman's Weather Indicator

No scientific knowledge is needed to predict the weather 12 to 24 hours in advance with the aid of a stiff-paper dialing device. The user dials the current barometric pressure reading to a marker below the prevailing wind direction. The arrow on a smaller inside dial is then lined up with these two values and three forecast code letters appear in a window on the card. Final selection of the appropriate code letter of the three is based on whether the barometer has been rising, steady or falling.

Ⓛ During periods of peak production, the U. S. aluminum industry consumes more electricity each day than a city of 60,000 homes normally uses in an entire year.

BRUSSELS AUTO SHOW

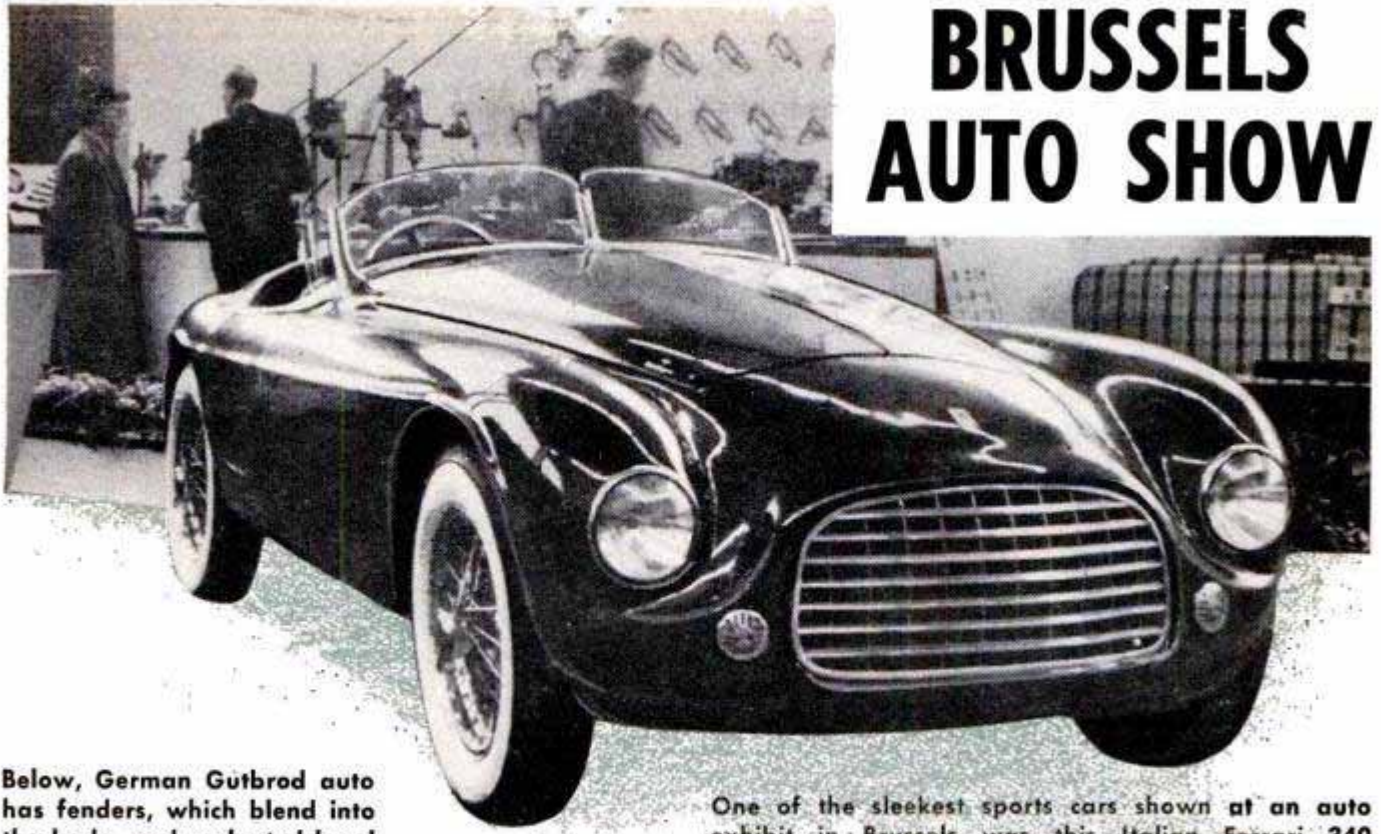

Below, German Gutbrod auto has fenders, which blend into the body, and a slanted hood

One of the sleekest sports cars shown at an auto exhibit in Brussels was this Italian Ferrari 340



Hood and front end of this German Taunus auto are similar in appearance to our Ford of a few years ago

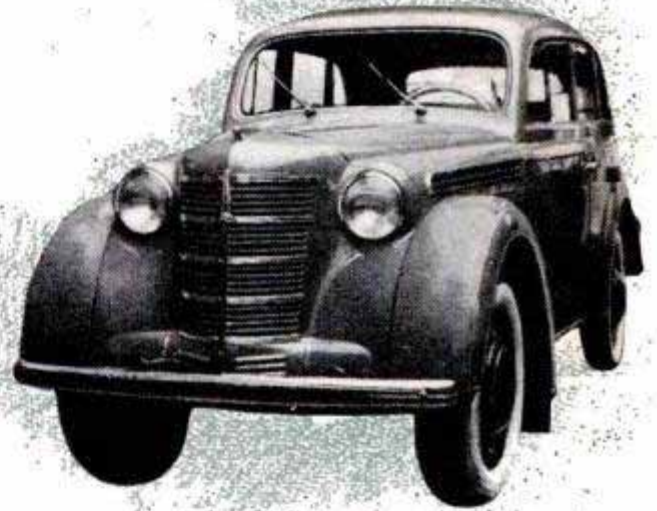

Russian six-seater Moskitch sedan has protruding fenders with no running board. It sells for about \$1043

Below, here's a scale model of the Ford Vedette. It shows American influence in hood and grille design

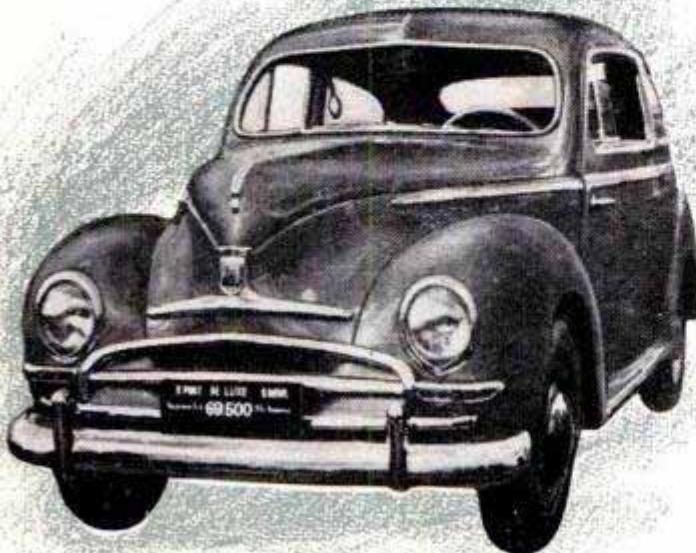

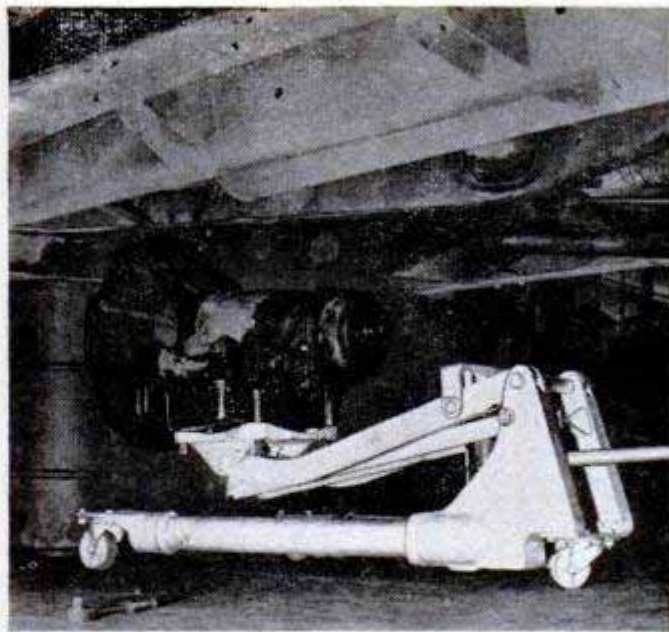
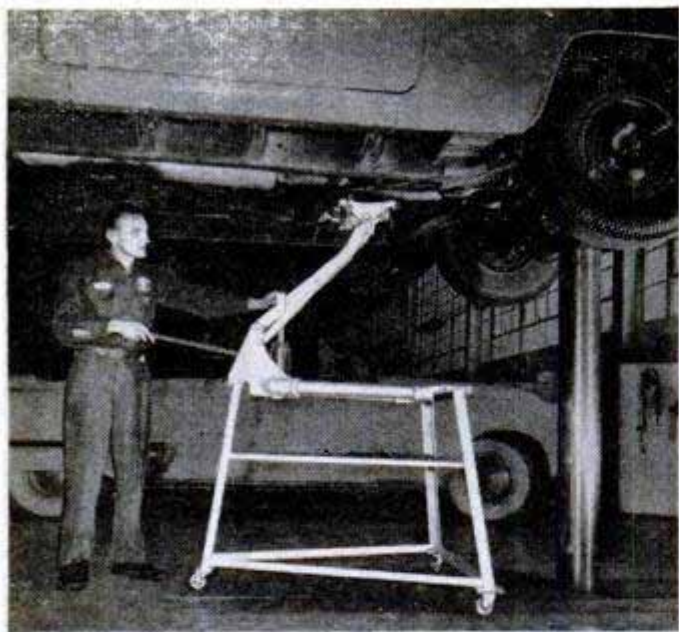

The Cleveland Pneumatic Tool Co., 3781 E. 77th St., Cleveland 5, Ohio

Lift Enables One Man to Remove Transmission

With a capacity of 1500 pounds, a tilting-cradle lift handles transmissions, motors, axles and other heavy automotive parts during major repair jobs. Powered by any standard five-ton hydraulic jack, the lift

is mounted on casters so it can be rolled around the shop. With it, one man can remove or install major parts. A stand for the lift raises it to 70 inches, high enough for the mechanic to work under the car.

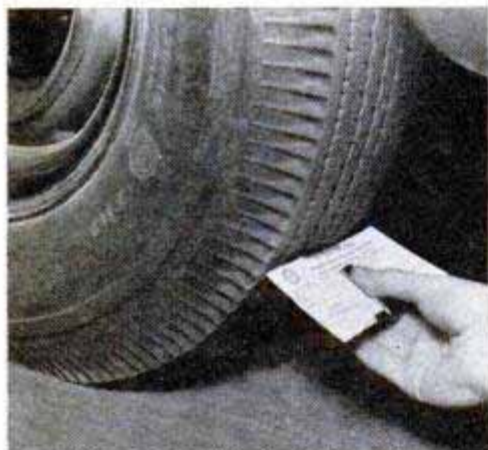

Pure Oil Co., 35 East Wacker Drive, Chicago 1



Tire-Tread Gauge

Service-station attendants keep an accurate record of their customers' tires with a measuring device that records tread thickness on a card. A metal finger is pushed into the tire groove and then the marker arm is depressed to punch the card, automatically recording tread thickness.

School-Made Jet Engine

Starting by modifying a supercharger from a wartime fighter, Northrop Aeronautical Institute students have built a jet engine that can power a light plane in the 200 to 300-mile-an-hour range. Weighing 168 pounds, it is believed to be the first four-burner type ever built. The engine develops an estimated 320 pounds of static thrust.

☐ About 50 tons of aluminum are used in the construction of a single B-36 bomber.

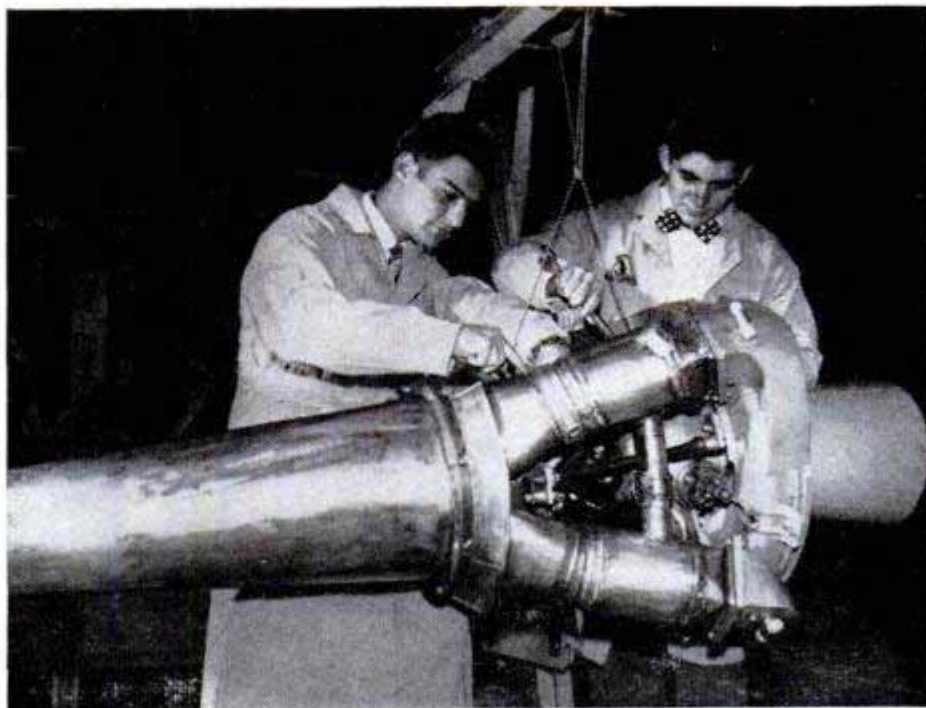

50th Anniversary

\$5,000

What does America mean to you?**Answer that question with a photograph
and win one of these big prizes!****American
Way of Life****PHOTO CONTEST****prizes**

	Black and White	Color
1st Prize	\$1,000	\$1,000
2nd Prize	\$ 500	\$ 500
3rd Prize	\$ 300	\$ 300
4th Prize	\$ 100	\$ 100
5th Prize	\$ 100	\$ 100
6th Prize	\$ 100	\$ 100
7th Prize	\$ 100	\$ 100
8th Prize	\$ 100	\$ 100
16 Prizes—Black and White Only	\$ 25 each	

rules

1. The "American Way of Life" photo contest is open to all persons except employees of Popular Mechanics Company and their families.

2. There will be a Black-and-White Competition and a Color Competition with separate prizes in each. Hand-tinted prints are not eligible.

3. Photographs must illustrate your own conception of the "American Way of Life," but the subject you pick can be in any field — industry, agriculture, government or any other. You may see it in a country store, a view, a man at work, a city street or a thousand places. Winners will be selected on (a) how well the picture illustrates the "American Way of Life" and (b) its all-around photographic excellence.

4. All entries must be postmarked not later than midnight, September 1, 1951, and must have been taken between April 1, 1951, and September 1, 1951. No entry fee is required and there is no limitation on the number of entries you may submit. Data sheet, giving information listed at the bottom of this page, must be attached securely to the back of each entry. When submitting transparencies, attach data sheet to the top of the transparent sleeve.

5. All prints and transparencies will be held until after winners are announced in the 50th Anniversary Issue of Popular Mechanics, January 1952. Non-winning prints and transparencies will be returned as soon as possible thereafter, provided that a self-addressed and stamped envelope is enclosed with the entries.

6. Black-and-white prints must be no smaller than 8 by 10 inches and no larger than 11 by 14 inches and must be mailed flat and unmounted. Color prints submitted must be 5 by 7 inches or larger. Color transparencies must be 2¼ by 2¼ inches or larger.

7. All prize-winning photographs become the exclusive property of Popular Mechanics Company. Original negatives of prize-winning prints must be submitted upon request.

8. Judges will be selected by the editors of Popular Mechanics Magazine. Their decisions will be final. In case of ties, duplicate prizes will be awarded.

9. Mail all entries to PHOTO CONTEST, POPULAR MECHANICS, 210 East Ontario St., Chicago 11, Ill.

10. Popular Mechanics Company will use all reasonable care in handling entries, but it can assume no responsibility for loss or damage of any entry.

**Attach to each photograph
the following information:**

- | | | | |
|-------------------|---------------|------------------|----------------|
| 1. Your name | 4. Subject | 7. Shutter speed | 10. Film |
| 2. Street | 5. When taken | 8. Lighting | 11. Lens stop |
| 3. Town and state | 6. Camera | 9. Where taken | 12. Other data |

The OWNERS REPORT on

The true test of an automobile begins when the owner takes the wheel. This is another report from owners of 1951 cars who answered questionnaires sent by Popular Mechanics to 1000 Cadillac owners from coast to coast

By Floyd Clymer

This enthusiastic Cadillac owner tells Floyd Clymer he gets 19 miles per gallon on his '51

Typical questionnaire filled out by an Indiana owner agrees with big majority in the survey

The average was 17.9 m.p.g.

97% in survey are happy with Hydra-Matic

Only a few complaints like this one

He agrees with 82% in Poll

THE POPULAR MECHANICS MOTOR SURVEY
AS CONDUCTED BY FLOYD CLYMER

I am the owner of a 1951 Cadillac. Model: 61 62 60 Special 75
I have owned it about 3 months. Speedometer mileage is 1612 mi

I use only regular gasoline - I use premium (high test) gasoline Gulf + Shell
My approximate gas mileage in the city is 13 MPG; in country, 17 MPG

I CHANGE OIL every 1000 miles; I ADD OIL - one quart every _____ miles.

How does the car handle on the road? Excellent Average Unsatisfactory
Maneuverability seems to be: Very good Average Poor
Acceleration is: Outstanding Satisfactory Too high Too low
Curb and road clearance is: Satisfactory Too high Too low

Why did you buy a Cadillac? Because I believe they are the best

What features about the car do you especially like? Automobile built. The American that it shifts gears with - also the body lines are good. Also good seats.

Do you like the length of wheelbase? Just right Too long Too short
Do you like Cadillac's HYDRA-MATIC DRIVE? Yes BODY STYLING? Yes
VISIBILITY? Fair FIN-TYPE REAR FENDERS? good INST. PANEL? good

What is your opinion of the new overhead-valve-V8 engine? Very good

What do you dislike about the car? The front seat is a little high causing me to rest down in front seat to get good visibility.

Have you ever owned a Cadillac before? Yes No If so, how many? one

Would you buy another Cadillac? Yes Possibly No
Do you secure good dealer service? Yes Fair No
How would you rate your new Cadillac? Excellent Good Average Poor

GENERAL INFORMATION

What type of engine would you prefer in your car of the future? In-line V-type
Cylinders: 6 8 Overhead Valves: Side Overhead Like it or now
Based on my present experience, I want my next car equipped with: Standard transmission
Overdrive Cadillac Hydra-Matic Drive Other type of automatic transmission
Please state reasons: I've owned approx 25 to 30 different cars and this is the best.

Do you like the new low-pressure, super-cushion tires? Yes No How much more? _____ lbs.

Do you carry the recommended pressure? Yes No

Please check all answer boxes (✓).

Your name will be held in strict confidence.

My Name: _____
Address: _____
City & State: _____
Occupation: Sandwich Shop's owner

(Use other side for additional remarks.)

Please mail promptly to:
FLOYD CLYMER
1268 SO. ALVARADO ST.
LOS ANGELES 6, CALIF.

Best shifting and driving car of them all.

the '51 CADILLAC



MORE PEOPLE are driving Cadillacs today than ever before and here are some of the reasons gleaned from *Popular Mechanics'* nationwide survey of '51 owners: Performance. Dependability. Beauty. Pride of ownership.

Eighty-two percent rated their cars as excellent (when given a choice of excellent, good, average or poor), and 90 percent said they will buy another Cadillac. One man added on the end of this line "unless I go broke." Like scores of other owners, a junior executive from Grand Island, Neb., says he enjoys "the distinction of owning a Cadillac" and "the courteous service I receive."

Although most Cadillac owners do not profess to know much of what goes on under the hood of a car, they are highly critical of its performance. They demand perfection in operation, servicing repairs and guarantees.

Some are dubious about the new overhead-valve engine. They seem to prefer the old faithful side-valve V-8 which, although it had less power and gave less gasoline mileage, was considerably more quiet. A surprising proportion of owners (79 percent) have owned Cadillacs previously; 26 percent have owned five or more. One man had owned 20.

Ninety-eight percent of all who answered the survey desired automatic transmission; because they said the Cadillac Hydra-Matic functions so smoothly, 97 percent would want Hydra-Matic on their next car.

A great majority of Cadillac owners are very well satisfied, and either neglected to mention any dislikes on their questionnaires or simply wrote, "No dislikes."

Some objected to the slow steering ratio

ECONOMY TEST

1951 Cadillac 62 Coupe de Ville
with Hydra-Matic Drive
MILES PER GALLON

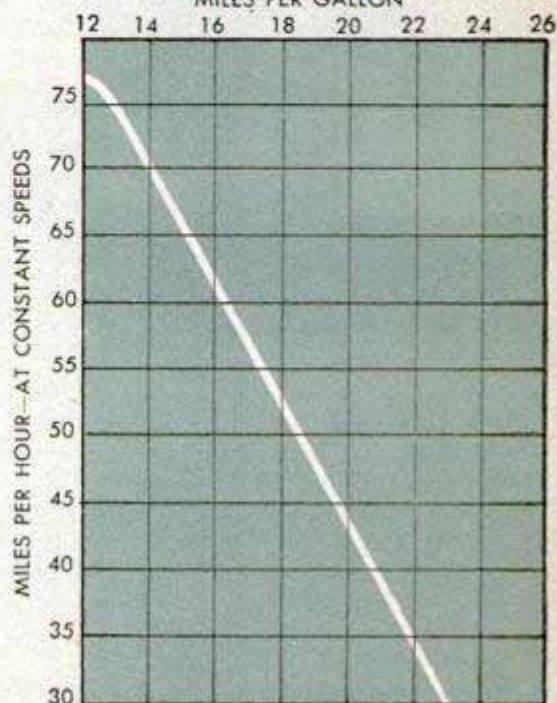

Below, Clymer gives the Coupe de Ville used in his test a workout on steep hill in Los Angeles

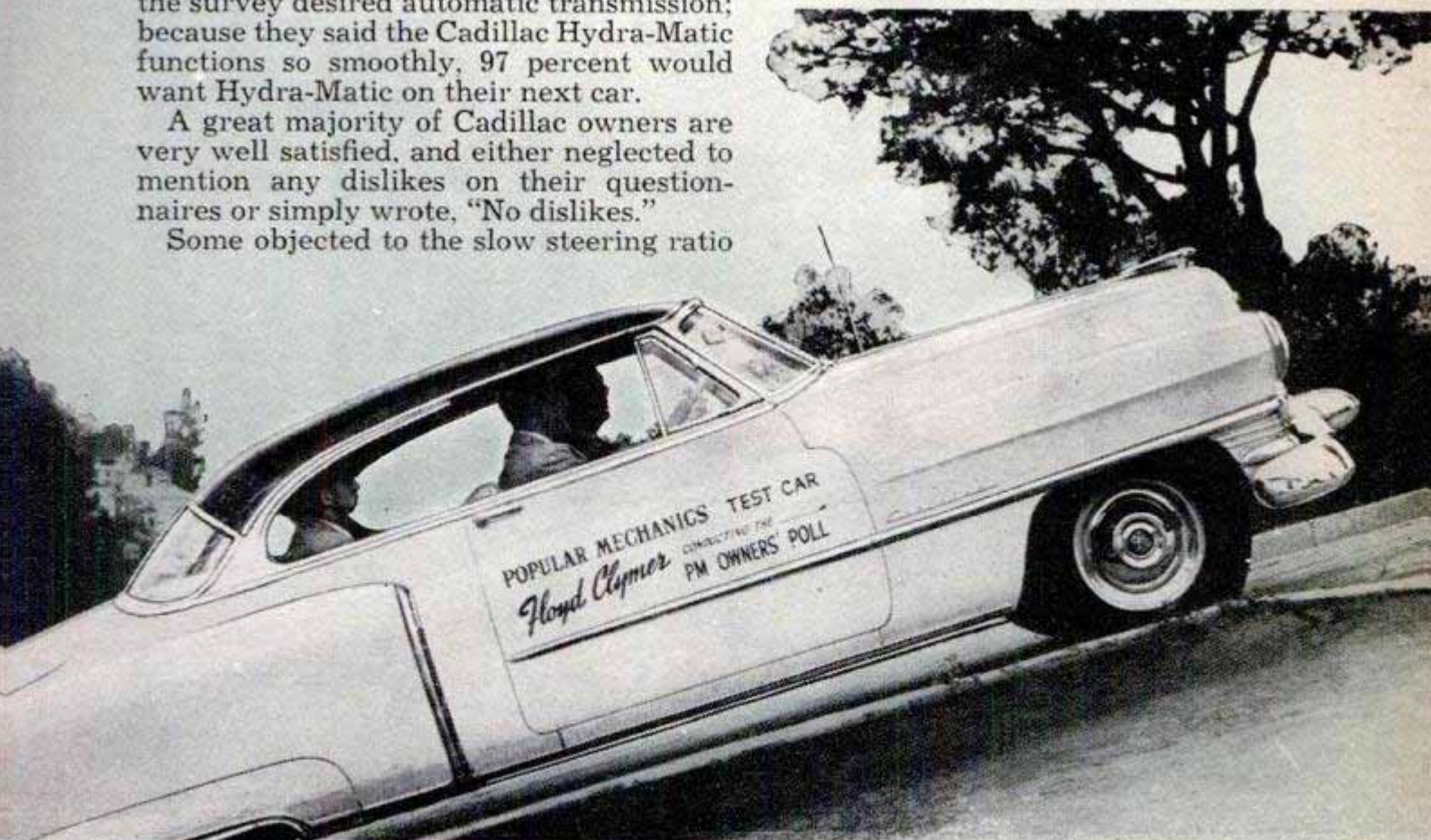



"For size and horsepower," Clymer reports, "the Cadillac high-compression engine undoubtedly is one of the world's best and, for the size and the weight of the car, the gasoline mileage is remarkable . . . the engine weighs only 60 pounds more than many V-8s in the lighter cars"

1951 CADILLAC 62 COUPE DE VILLE WITH HYDRA-MATIC DRIVE



Ninety-two percent of the owners polled in survey rated the '51 Cadillac's acceleration either "outstanding" or "very good." These figures explain why

Percentages from P. M. Poll

Owners of Series 62	70%
61	18%
60 Special	11%
Average gasoline mileage (in country).....	17.9 m.p.g.
Average gasoline mileage (in city).....	14.0 m.p.g.
Use premium gas	98%
Use regular gas	2%
Change oil	99%
Average mileage for change of oil.....	1591
Add oil (and also change periodically).....	6%
Average mileage for adding oil	1144
Maneuverability excellent	88%
average	11%
unsatisfactory	1%
Acceleration outstanding	56%
very good	36%
average	8%
Road clearance satisfactory	95%
too low	4%
too high	1%
Wheelbase just right	92%
too long	5%
too short	3%

FEATURES

Owners who like Hydra-Matic Drive	97%
Owners who like the body styling	94%
Owners who like the fin-type rear fenders.....	92%
Owners who like the visibility offered	93%
Owners who like the interior finish.....	85%

(These percentages are based on the fact that some owners commented on more than one feature.)

OWNERS' RATING OF CAR

Excellent	82%
Good	14%
Average	3%
Poor	1%

GENERAL INFORMATION

Prefer V-type engine	98%
Prefer in-line engine	2%
Prefer eight cylinders.....	99%
Prefer six cylinders	1%
Prefer overhead-valve system	89%
Prefer side-valve arrangement	11%
Prefer automatic transmission.....	98%
Prefer standard transmission with overdrive.....	2%
Prefer Hydra-Matic Drive	97%*

*(The above figure means 97% of the 98% preferring automatic transmissions.)

Prefer makes other than Hydra-Matic	3%
Owners who like low-pressure tires.....	92%
Previous Cadillac owners	79%
Will buy another Cadillac	90%
Might buy another Cadillac	7%
Will not buy another Cadillac	3%
Dealer service good	73%
average	19%
poor	8%

Most frequent objections:

location of rear-view mirror, slow steering ratio, driver's seat position.

(too much movement of the wheel) and complained of the difficulty in parking and turning with low-pressure tires. Some complained of the front-seat adjustment and sitting position, and some wanted more headroom in the rear seat.

In answer to the question "What features about the car do you especially like?" the reply of a retired Oklahoma City, Okla., man was typical. He said, "All of them." One other fairly prevalent reaction was that of a milling-company owner in Kenilworth, Ill., who said he bought a Cadillac because of "previous satisfactory service and family tradition."

A Kentucky physician said he bought one "in answer to prayer!"

An Indianapolis sales manager complained strongly about the doors. They are entirely too hard to close, he said, remarking that the person sitting on the right side has a tough job slamming the door while sitting in the seat.

An Air Force officer in San Antonio, Tex., said "I feel like I'm driving a truck or tractor when I'm behind the wheel of a '51 Cadillac," but commended the new overhead-valve V-8 engine as "a step in the right direction needed a long, long time in engine development for the future."

A Short Hills, N. J., securities trader bewailed the fact that, being six feet three, he knocks his hat off every time he gets in the car. But a manufacturing printer of Atlanta, Ga., likes Cadillac so well he buys one every year and "keeps two always."

One of the minor complaints of a few owners is that the rear-view mirror is too large and obstructs the vision at times. But a large percentage had high praise for the car's ease in handling. A food-company official of Omaha, Neb., commented that his Cadillac 62 "has plenty of power, gives a smooth, quiet ride and handles fine in mountains."

An Oklahoma City, Okla., statistician was disappointed because "you have to look twice to tell whether the car is a Chevrolet or a Cadillac; one should expect something more for the money than a big Chevrolet."

A soft-drink dealer in Jackson, Tenn., should make the Cadillac people happy with his comment that "it costs less to operate and less to own." An enthusiastic res-



From a standing start the Cadillac Coupe de Ville tested by Clymer topped this 500-yard, 32-percent grade hill at 23 miles per hour

taurant owner in New Castle, Ind., stated: "I've owned approximately 25 or 30 cars and this is the smoothest shifting and driving car of them all." From a Baltimore, Md., bakery proprietor came the compliment that "This car is classed as the best. It seems to be the goal of every car owner. Besides this, to me there is no finer-looking car made."

The general opinion of the Cadillac Hydra-Matic drive was summed up by an automotive machinist in Mobile, Ala., who said: "I think Hydra-Matic gives you longer engine life and less transmission trouble." Many owners reflected this sentiment in much the same words.

A manufacturers' agent in Birmingham, Mich., was among several owners who said they bought a Cadillac because it was the choice of their wives. Daughters also influenced the choice occasionally.

A retired Palm Beach, Fla., man said: "I believe Cadillac is the buy today for all the car you get. A Cadillac 15 years ago cost around \$4000 and was not near the car of today. You had to have the car overhauled after driving it 35,000 miles—not today, if given care at all and regular service every 1000 miles."

A Michigan businessman had his own safety in mind when he said one of the best

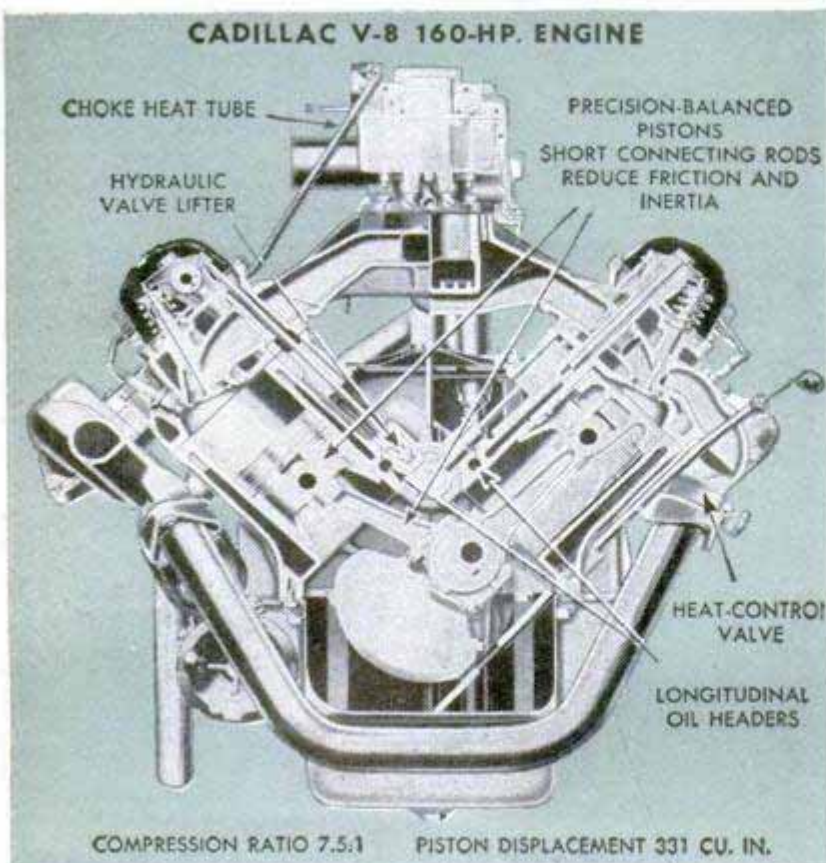
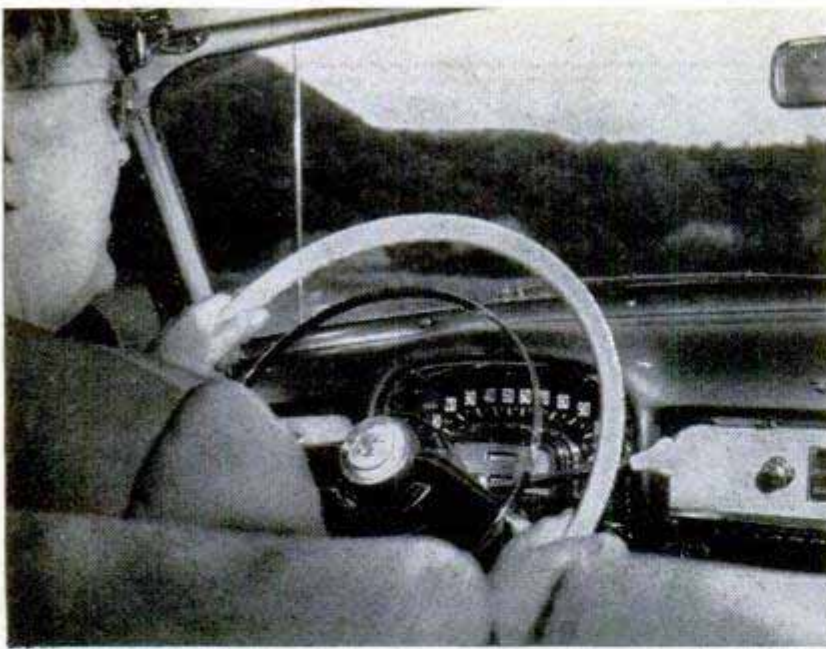

Clymer at the wheel agrees with the 93 percent who like Cadillac's visibility. Center, he inspects master control that operates all windows from driver's seat

features he liked about the car was its weight "when hit by another." An Orlando, Fla., man pointed out that the hood no longer locks from the inside and that the air horns, battery or other under-hood equipment can be stolen. He liked the previous inside hood lock better.

Although 73 percent of the owners replying in the poll said they receive good dealer service, an Omaha, Neb., sales executive was one of a few who noted that "an overcrowded garage services local Cadillacs." A San Antonio, Tex., man said he got good dealer service, but that it was "too expensive . . . that goes with a Cadillac, I guess."

The new low-pressure, super-cushion tires were generally popular, but one impression came from an Indianapolis man who likes them "For riding, yes; for steering, no." Most owners agreed that they give a better ride. (92 percent like them, yet 36 percent exceed the recommended pressure by an average of three pounds.)

Here is a comment from a Spokane, Wash., executive: "I like the 1951 Cadillac very much. It should, however, have a top gear ratio of about 3.7:1. The car is sluggish in acceleration and power at speeds up to 35 miles per hour with the higher gear ratio. The steering is so slow that it is dangerous at high speeds when a sudden change of direction is necessary. The big tires give too much sidesway on curves . . . Brakes should be stronger and motor should develop at least 25 or 35 more horsepower. Valve springs should be stronger to prevent fadeout at high speeds. But I like the dependability, comfort, driver's position, quietness and quality throughout."

A Florida physician said he likes the overhead-valve V-8 engine, but suggested that it be made more powerful so that regular gas could be used. (We can't have high-powered engines

(Continued to page 232)

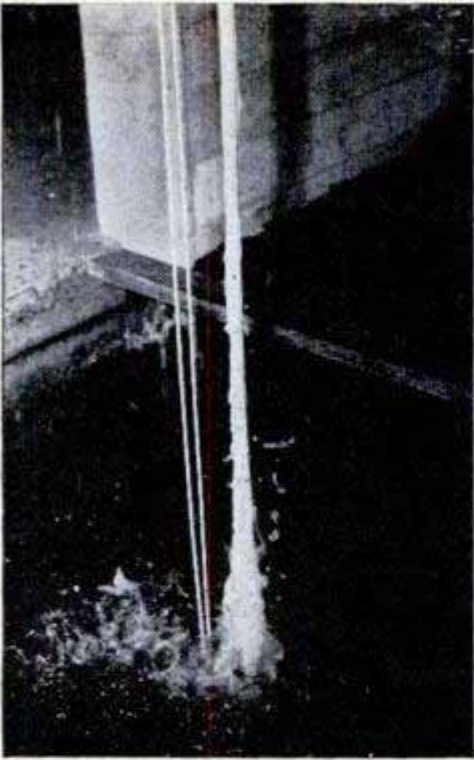

Clothesline Pumps Water

With a clothesline, two pulleys and a small electric motor, engineers at the University of Illinois are pumping water by the bucketful. The rope pump lifts 12 gallons of water a distance of 25 feet every minute, a job that would do credit to a pump costing several hundred dollars. The rope is doubled around the pulleys so two strands are rising while two others move downward. The water clings to the upbound ropes and splashes off at the top pulley.

The bottom pulley, weighted by a piece of scrap iron, simply is dropped into the water. The engineers came across the idea in an old book on hydraulics, didn't think much of it, but decided to investigate it anyway. They were amazed at their success. They feel the idea could be of considerable interest to farmers, soldiers or anyone else who might need a single pump that could be improvised from materials found almost anywhere. They see no reason why the rope pump can't raise water considerably higher than 25 feet.

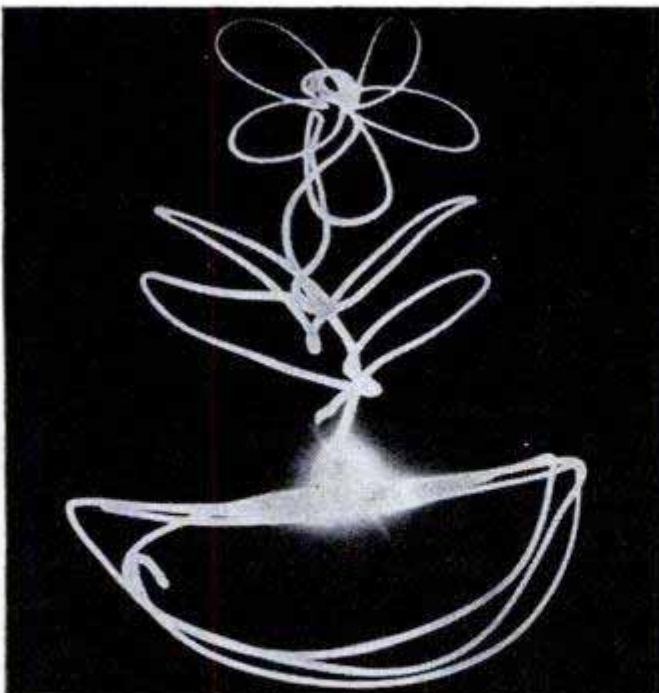

"Painting" With a Flashlight

Using the air as his canvas, George Daly, a Vermont illustrator, "paints" unusual sketches with a pencil flashlight. By setting

his camera for a time exposure, he captures the sketch on photographic film. Each sketch is made in four or five seconds and is, of course, made by a continuous stroke of the flashlight.



Car From Lawn Mower

Larry Melear's grass may not get cut this summer, but the neighborhood kids will have a lot of fun. Melear, of Atlanta, Ga., decided last winter to convert his power mower into a miniature car. Now—no mower, but a car that runs 16 hours on a gallon of gas. The frame and body are made of wood. The motor is connected to the rear wheels by a series of chains and gears and operates through a friction belt. The harder a pedal is pushed the tighter the belt is pulled to make the car go faster. The car has a top speed of 15 miles per hour and can carry an 800-pound load.

Pier With Conveyor Belt Handles Foreign Ore

More than 2000 tons of foreign ore can be unloaded from ships and reloaded on railroad cars each hour at a new \$5,000,000 pier in Baltimore, Md. The pier, built by the Baltimore and Ohio Railroad, is the first specially designed to handle foreign ores, which are being imported in increasing quantities to offset the depletion of domestic ores. Six hundred and fifty feet long, the pier has two unloading machines on movable towers. The ore is scooped out of the ship's hold by huge 15-ton buckets and deposited into bins which feed it onto a conveyor belt. The belt carries the ore to a scale house where it is weighed and then dumped into waiting railroad cars. The rubber belt is 1812 feet long and weighs 45,000 pounds. It travels 400 feet per minute.

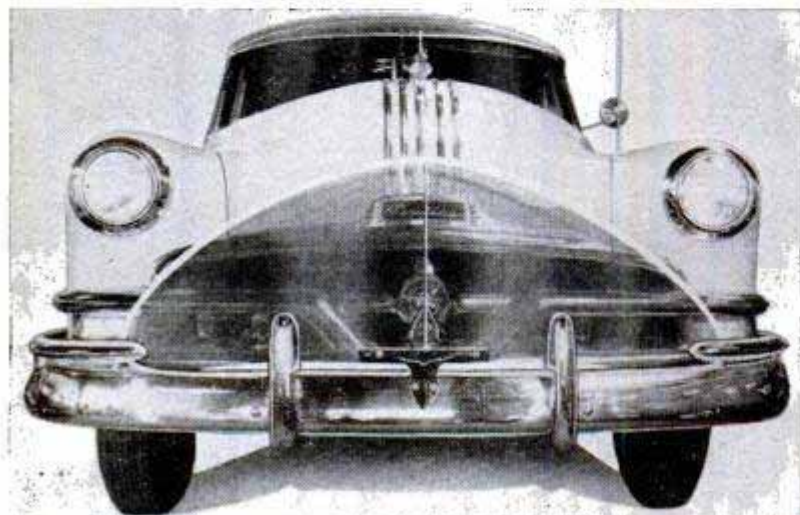

Bug Screen Protects Car

Mounted on the front bumper, a plastic screen keeps bugs from clogging radiator pores and marring grille finishes. Quickly installed, the screen is wide enough to protect the entire grille from damage by flying stones and gravel. Being plastic, the screening will not rust or bulge and requires no upkeep.

☐ A one-shot vaccine capable of giving dogs lasting immunity against distemper is now available.

DEATH OF A LIGHTHOUSE

WHEN demolition workers, assigned to tear down the Ponquogue Lighthouse on Long Island, found it would be unsafe to use dynamite, they felled the tall structure as if it were a huge tree. Along one side of the lighthouse they cut a hole six feet high, shoring up the building with timbers. Then logs and brush were packed into the hole, soaked with gasoline and ignited. When the timbers burned through, the lighthouse toppled in exactly the right direction.

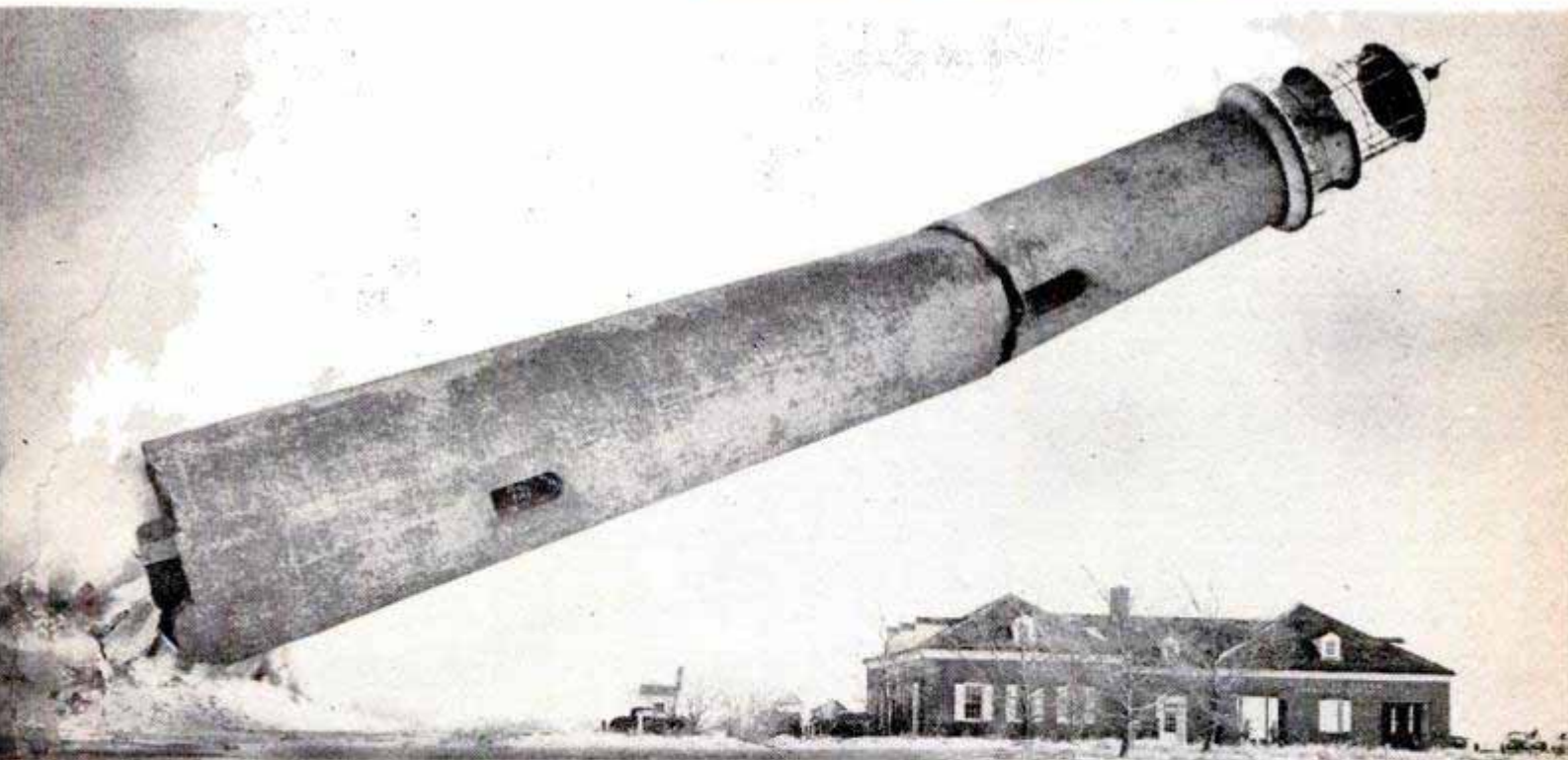
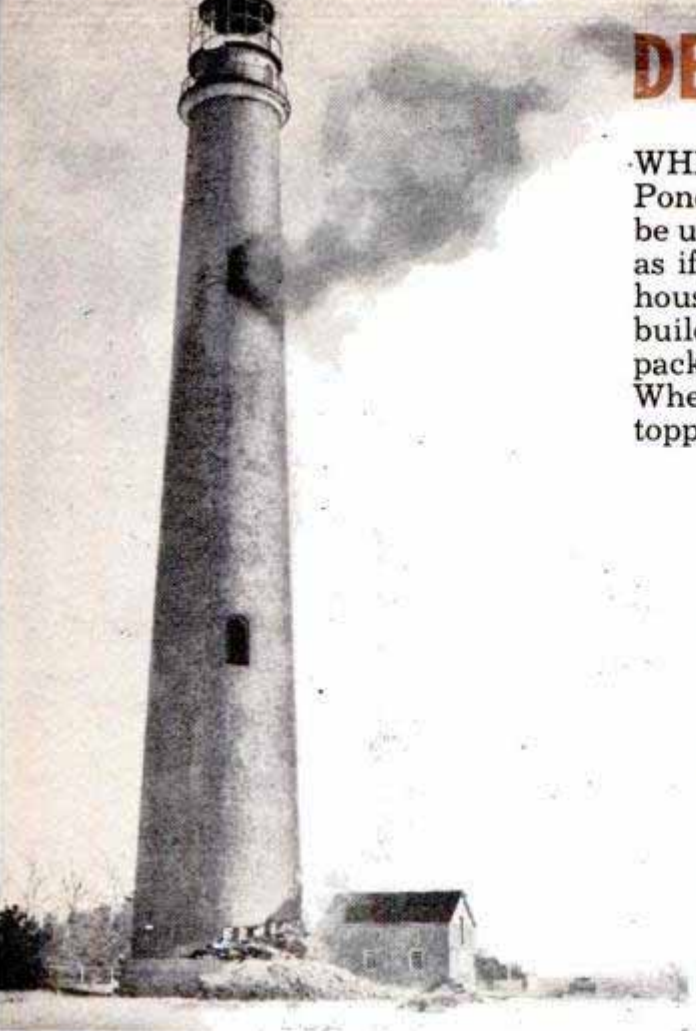

Top, smoke from the burning timbers pours from window of the doomed 135-foot structure

Top, right, members of a demolition crew pour gasoline on logs in the hole cut in the base

Above, down she goes! Line of fall had to be carefully planned because of near-by buildings

Right, all that was left of the unwanted lighthouse was a long line of broken masonry



SUPERSONIC PROVING GROUND

ROCKET-POWERED models fired out over the Atlantic from an island off Virginia's coast are helping determine the best shapes for tomorrow's airplanes. Some fly as high as 100,000 feet and as fast as 40 miles a minute before plunging into the water a few miles from shore. These experiments in aerodynamic behavior are conducted by the National Advisory Committee for Aeronautics with models 4 to 12 feet long that are preset to roll, dive, climb and turn like an airplane. Though the models are lost, their records are not. Radar tracks them and provides a running record of their velocities. The latter is obtained through Doppler velocity radar, using two large saucer-shaped antennas that are side by side and move as a unit. Continuous radio waves from the transmitter antenna are reflected back from the model to the receiver antenna, with the increasing time interval of their return revealing the model's speed. Additional data comes from tiny electronic telemeter instruments within the model which relay back 10 different kinds of flight information to be used in designing high-speed aircraft and missiles.

Air is pushed through the NACA's supersonic pressure tunnel at Hampton, Va., at a rate of 860,000 cubic feet per minute by the rotor shown below. It weighs 55 tons

Final checks are made on a rocket-powered model, below, before a firing at the island test station

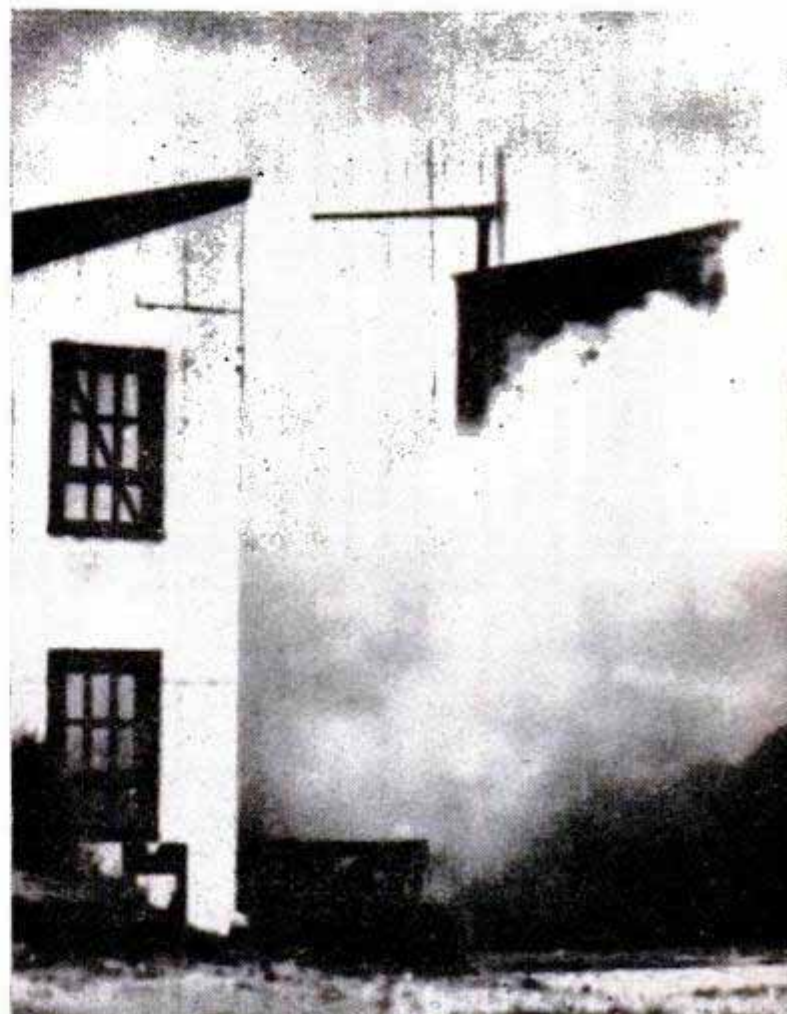
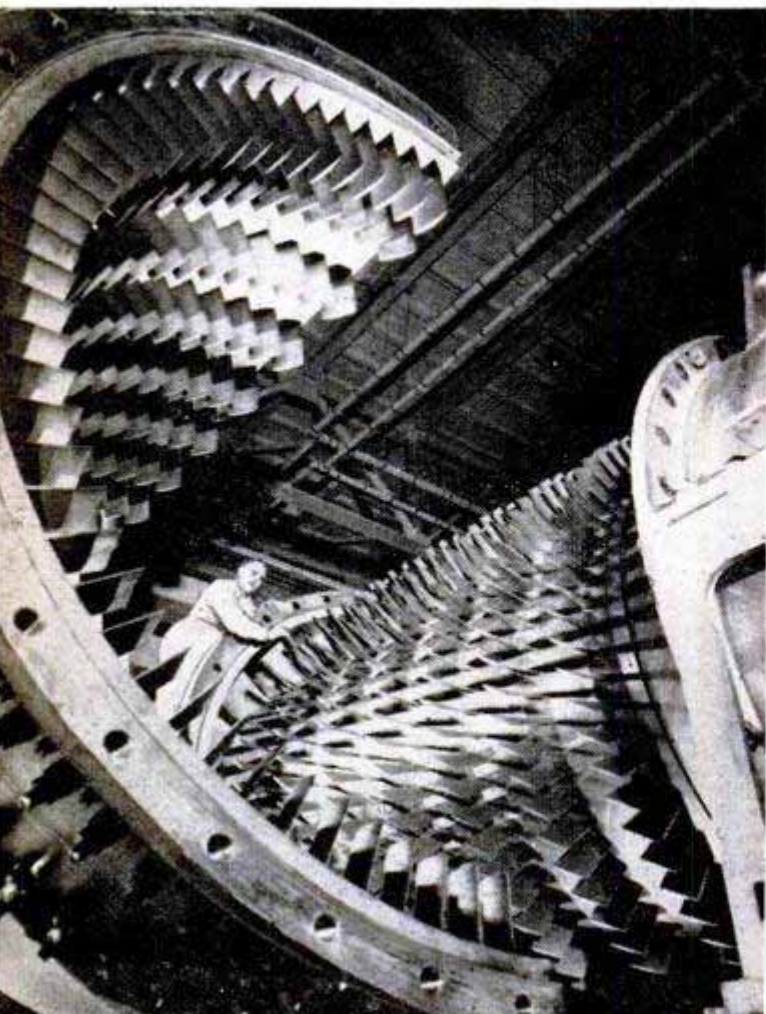
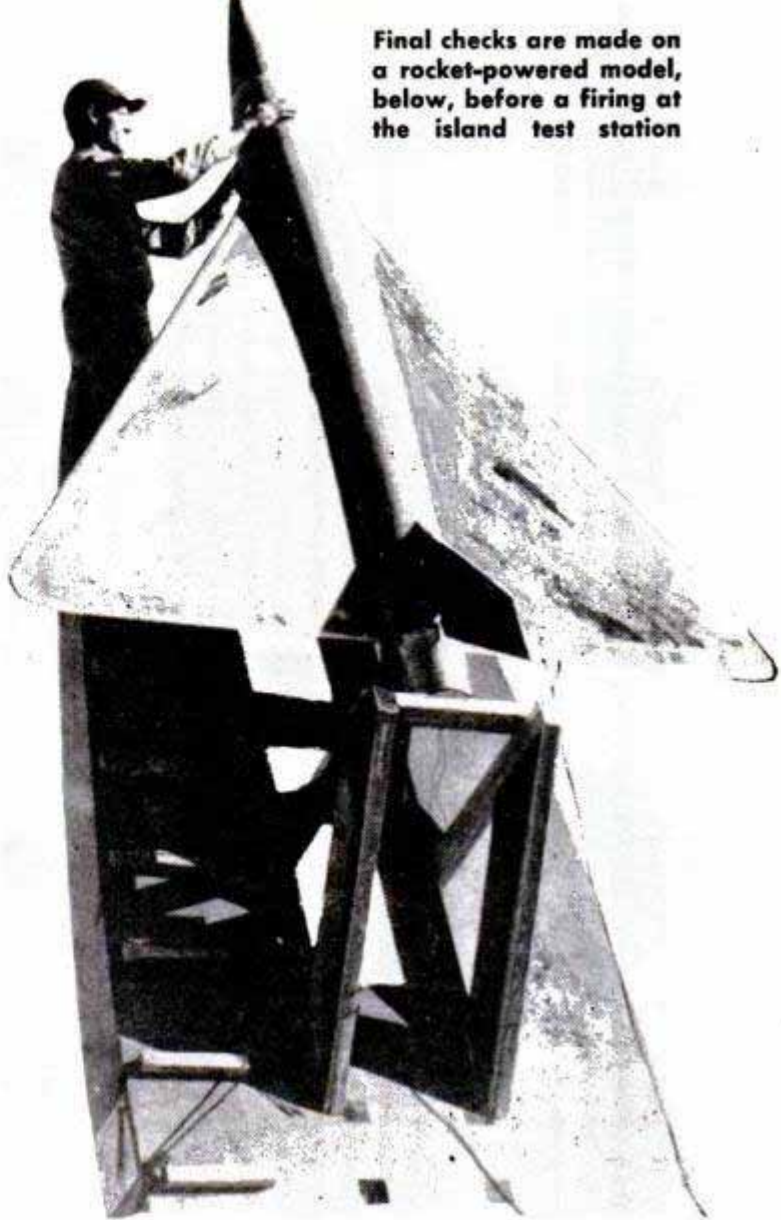

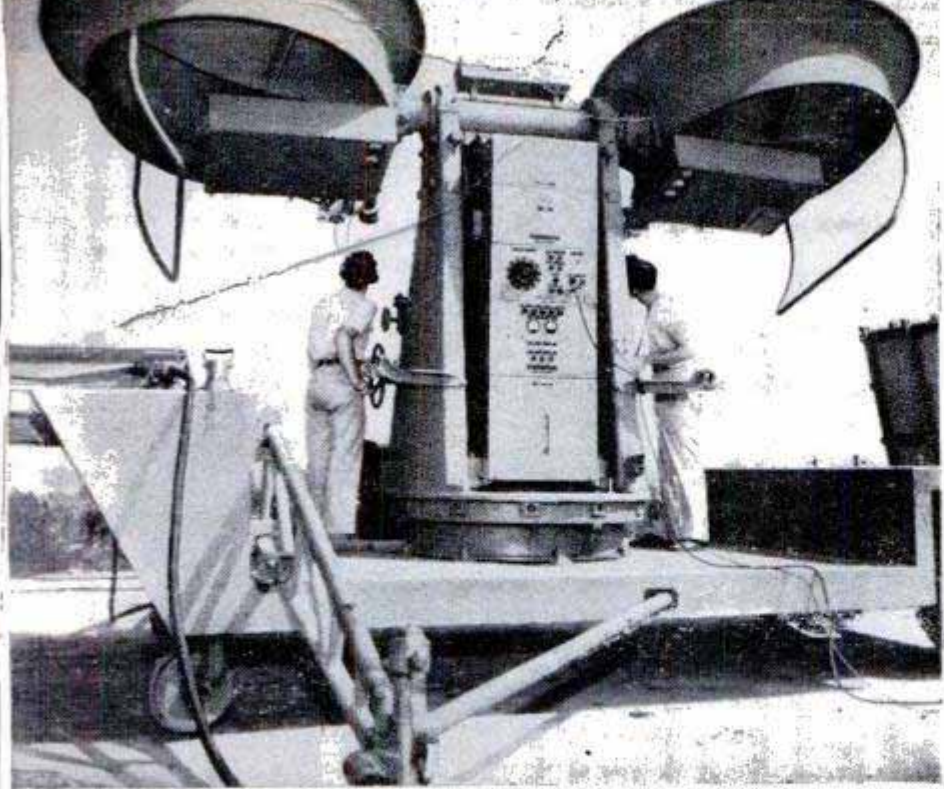

Operators aim the Doppler velocity radar, left, at a flying model. Continuous waves from one antenna are reflected back to the other from the model, with the intervening time indicating the object's flight speed

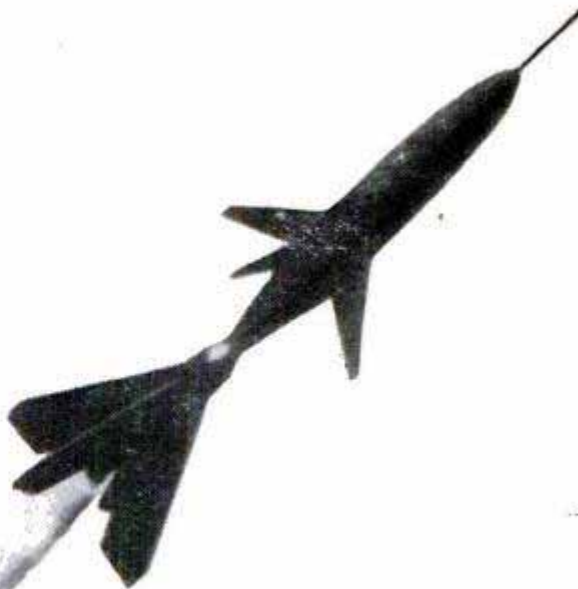

With a rocket-booster unit at the rear, a Tiamat missile, above, speeds out over the ocean for a two-minute test flight

Graphic information about the turbulence behind each wing tip is provided by a wire grid with white wool tufts, placed in wind tunnel behind a delta-wing shape

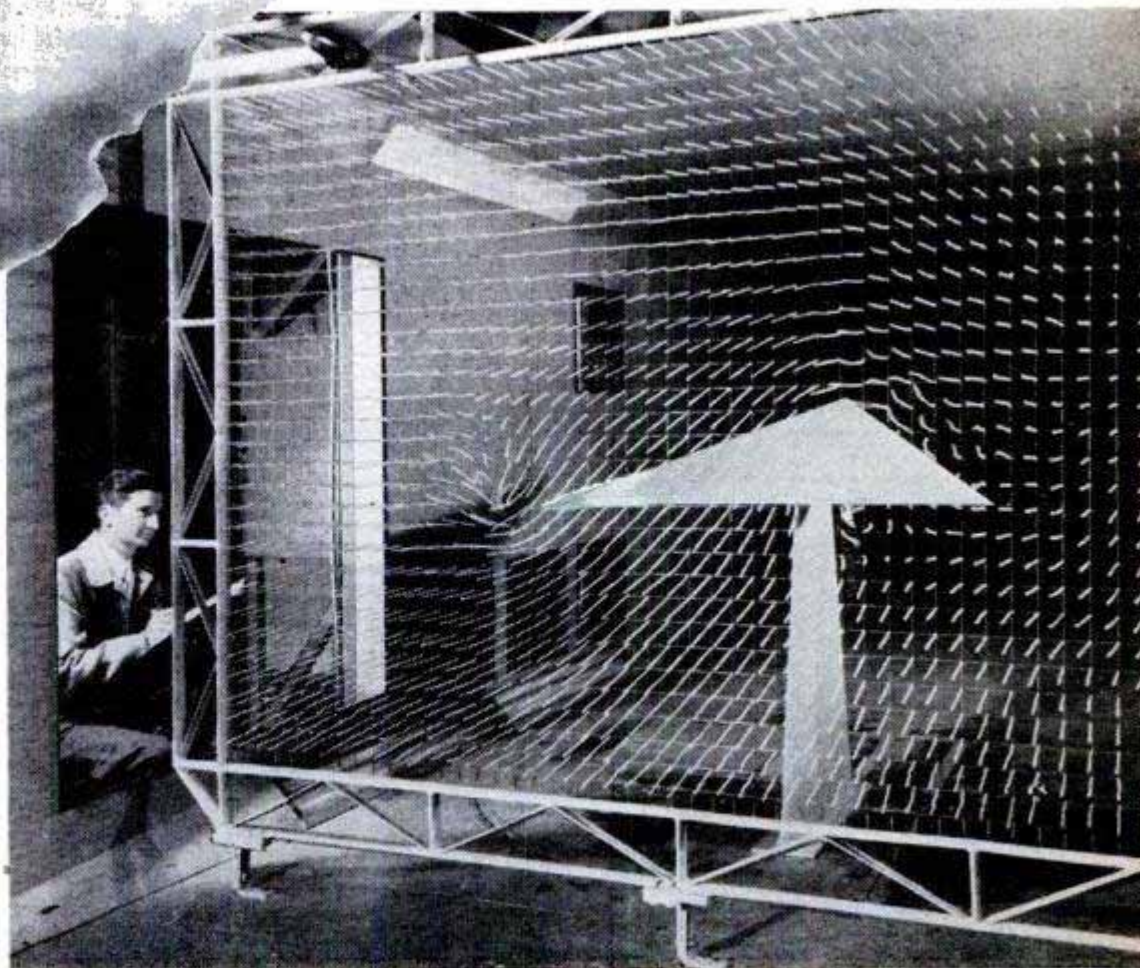



Nash Rambler Hardtop

Nash has brought out its candidate for hardtop honors in the Rambler. It calls the addition the Country Club, and like the others in that styling has a steel top and full-vision windows that drop into the sides. This is the fourth model that Nash has introduced in the Rambler line. Like the convertible, which was the first of the Rambler line, the hardtop will have complete accessories, including radio, clock, directional signals, custom upholstery and trim and Nash's famed Weather Eye, as standard equipment. The Country Club will have an L-head, six-cylinder engine. The windshield is one piece and curved. The luggage compartment offers 14½ cubic feet of space. The body is unitized, with body and frame welded together. It has sweeping front to rear fender lines, a low hood for

Latest addition to the Nash Rambler line is the Country Club, a hardtop model. A one-piece windshield and "wrap around" rear windows give wide visibility. Below, roomy luggage compartment

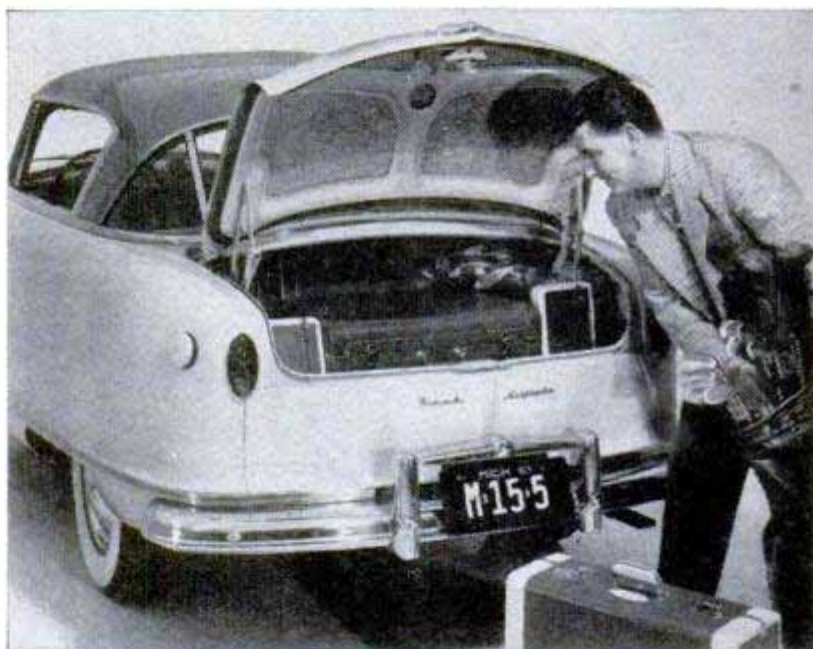

better visibility and a low center of gravity. Overdrive is offered as optional equipment. Two-tone colors are available.



Jointed Oars

Jointed oars designed by Manuel Lopez Dafonte of Ferrol, Spain, permit the user to face the direction he is rowing. Boatmen using the conventional straight oar in the usual manner have their backs to the direction of travel.

☐ A paper-pulp plant located in Algeria soon will start processing the bark of eucalyptus trees into high-grade paper, book paper and newsprint.

THE PATIENTS ARE PETS

... in this ultramodern hospital, where neurotic cats and movie stars, expectant poodles and alligators with ulcers bring their troubles. A dog's life is not bad!

By Clifford B. Hicks

Surgery at Speyer is as serious, as delicate as surgery at any hospital for humans. Sterile equipment is the finest

Who's hurt the most—the boy or his dog? Mongrels and thoroughbreds get the same treatment, regardless of owner's ability to pay for the top-notch care

Richard Averill Smith photos



THEY'VE CURED a monkey with the city jitters and a neurotic cat that would eat only if it heard a certain tune played on the harmonica. They've stopped the nose-bleed of a tiny hamster and restored the health of a punch-drunk kitten that sneaked too much Christmas eggnog.

White-garbed doctors at the Speyer Hospital for Animals wouldn't bat an eye if you dragged a kangaroo with a sore pocket into the waiting room. They'd diagnose the trouble, then probably prescribe such modern drugs as penicillin and aureomycin for your ailing marsupial.

The New York hospital has a phenomenal record. In its 40-year history it has treated more than a million animals, from alligators to ocelots, and restored an amazingly high percentage of them to health. No animal in distress ever has been turned away from Speyer. A millionaire's poodle and a stray mongrel get exactly the same treatment—the finest in the world, according to some authorities on veterinary medicine. The equipment at Speyer would do credit to an up-to-date hospital for human beings; dogs and cats, squirrels and rats get the works, from oxygen tents to X-rays, fluoroscopes and pretty nurses.

Each year, about 25,000 animals of all





Big collar for Tabby; a huge ruff keeps this cat from licking its wounds, thereby infecting them

sizes and species check into Speyer and are treated in the clinic or assigned "bed" space for an indefinite stay.

"We'd treat a sick horse if we could find one," says Mrs. H. Thomas Richardson, assistant director of the hospital. To prove her point she'll take you to the basement where, sure enough, there's a stall waiting for a sick horse. Hasn't been occupied for many a moon, but someday an ailing equine will "sign" in, and his bed will be waiting.

Dr. James R. Kinney, director, and his staff of six assistant veterinaries perform some 4000 operations each year. About 450 of these operations are classified as major surgery, and an unusually high percentage of the patients pull through. Doctor Kinney continually warns that the hospital can't perform miracles, but he is nationally known for his uncanny ability to diagnose and successfully treat ailments in animals.

Modern oxygen tent frequently saves patients that might otherwise be lost



Under his guidance, Speyer has made such an outstanding record that the State Department's Voice of America recently broadcast a description of the hospital and its work to more than 2,000,000 people in Europe.

There are seven vets and 45 attendants on the staff, and each is guided by the same basic belief. Doctor Kinney puts it into words: "To many people—especially the poor, young and old—a pet isn't a luxury but a necessity. In many cases, a pet is the only comfort in a person's life."

The wealthy New York suburbanite pays a flat \$2.00 to have his blue-blood poodle treated in the Speyer clinic, \$2.50 a day for a bed in the hospital. The ragged little boy living in New York's worst slum district doesn't pay a penny if his pup needs the same treatment. In both cases, the ailing animal is given a warm welcome, assigned a spotless, individual cage with a sterile blanket on the floor, fed the best food and given treatment as fine as any amount of money could buy. A whopping 60 percent of the animals which check into the hospital are given free care.

Speyer's sparkling equipment would impress the most sophisticated of poodles. Purifiers wash germs from the air to prevent contagion. The hospital has its own laundry for sterilizing the bedding of the patients and the clothing of the attendants. Special operating tables are designed specifically for animals, and the dispensary is filled with the latest antibiotics. If you read the patients' record cards, fastened to their beds, you'd find many being treated with aureomycin, penicillin and chloromycetin.

Manhattan's traffic is rough on dogs' legs, and Speyer is full of pups and kittens with broken bones. The bones are set in novel splints—metal loops of various sizes which fit up over the hip of a dog or cat. The loop binds the bone, keeping it straight while it mends, and at the same time serves as a crutch so Rover or Tabby can walk. Many of the patients sport fluffy collars—ruffs designed to keep the ailing animals from licking wounds and thereby infecting them.

Doctor Kinney and his staff have a personal interest in each animal, for they know you can't measure the affection between a human being and his pet. For many months a shriveled man, so old he

might have been Father Time's own grandfather, brought his great Dane to the hospital for treatment. Actually, the great Dane brought the man to Speyer, for the huge animal literally jerked the old-timer up the steps and into the waiting room. Despite the finest treatment, the dog eventually died, and members of the staff were heard to murmur that in this particular case there was one redeeming feature—at least the old man wouldn't be dragged along the streets of Manhattan by an animal twice his weight. The following week, though, the old man came flying through the door again, this time jerked on the leash of a great Dane much larger than the former pet.

Caesarians are common at the hospital. Some of the other ailments frequently diagnosed and treated include tumors, cancer, tuberculosis, odd breaks in bones, distemper and skin diseases. Doctor Kinney and his six able assistants operate daily to remove an amazing variety of items from the pet's stomachs. They have recovered, intact, a roll of paper money, bones, safety pins (open and closed), handkerchiefs, stockings, stones, peach pits, rubber toys, a threaded needle, keys and rings. One big dog swallowed a large drinking glass without breaking it; another registered at the hospital, hiccuping from the twitch of a metal spring 10 inches long in its stomach. Not long ago a dog was suspected of harboring a valuable diamond ring, but Doctor Kinney conclusively proved the animal wasn't the culprit.

The hospital has an international flavor. In the waiting room, placards carry instructions in five languages on how to handle animals to avoid contagion. Though most of his patients are from the New York area, Doctor Kinney has treated animals from the southern and western states, Canada, Cuba and Puerto Rico. One dog traveled all the way from Africa for treatment, and the daily mail usually brings an inquiry from Central or South America, England, India or China, requesting advice. Servicemen, sometimes forbidden to keep pets, have sent animals to Speyer from all over the world, and the hospital has found a good home for



Here's how Speyer attendants recommend giving your dog a bath: First put ring of ointment around eyes to prevent infection



Plain soap flakes are best for the bath. Dog's paws should be scrubbed well, but not his face—he'll take care of that himself



Rinse is the most important step of the bath. If even a speck of soap remains on the dog's skin, an irritation may develop

In the final step at Speyer, hot air from a blower dries the dog. Towel will do just as thorough a job if owner is careful

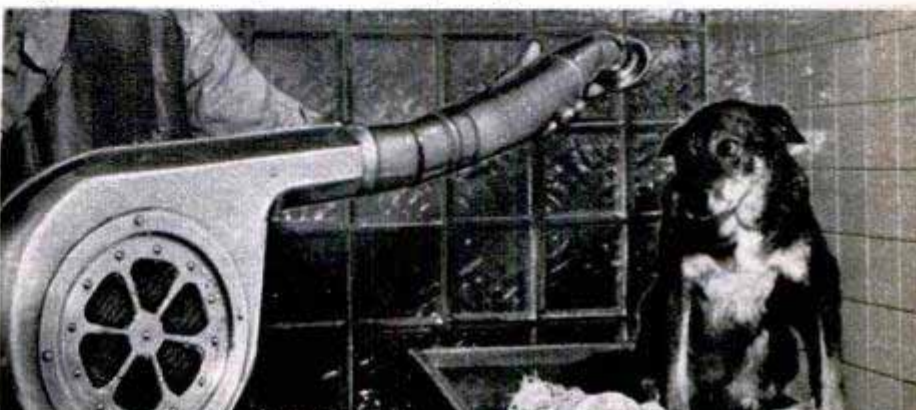

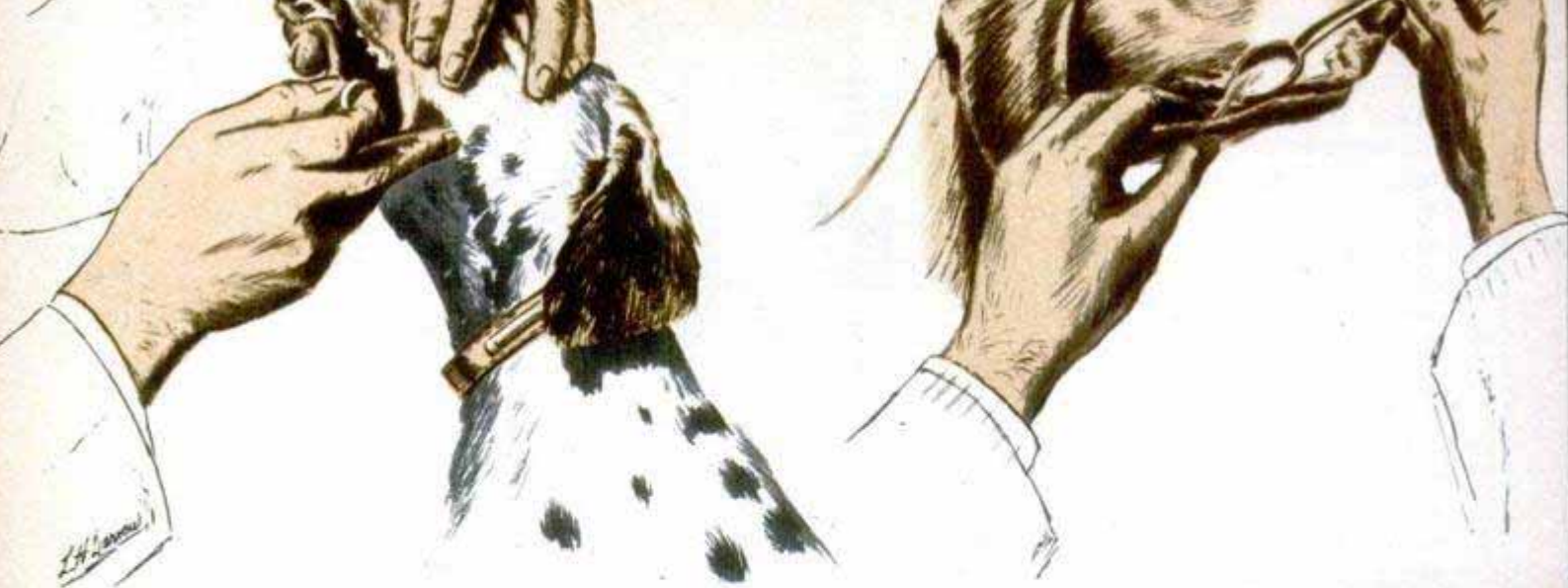

To give pet a pill, squeeze jaws open, then place pill as far back on tongue as possible. To administer liquid medicine, merely pull out the lower lip to form a funnel and pour in the medicine with a spoon

every one of them. Free service is extended any Seeing-Eye dog. Also, there's no charge for firehouse mascots, and Mrs. Richardson figures the hospital has treated about every smoky Dalmatian along the East Coast.

The pride of the hospital is its gleaming new \$40,000 distemper ward. About 2000 cases of distemper are brought to the hospital annually. According to Doctor Kinney, it now is known definitely that the villain which causes distemper is a virus. Distemper can flare like a runaway fire through any group of animals. Any animal suspected of harboring the disease is hustled into a private elevator at Speyer and whisked to the top floor where the new ward is located. There it is immediately as-

signed to one of 61 roomy cages. The walls of the cages are made of glossy ceramic tile, and the bars across the top and front are stainless steel. Fluorescent lights and Venetian blinds cast a soft light across the big ward. The terrazzo floors are coved to eliminate corners that might hide infection. Attendants' uniforms and the pads are washed in the ward's own laundry, and food is prepared in a separate kitchen. Actually, it's a hospital within a hospital.

According to Doctor Kinney, the best treatment yet developed for distemper includes the use of aureomycin, sulfa, penicillin, terramycin and biologics, together with intravenous feedings to build up the animal's strength.

Spotless new distemper ward is a hospital within a hospital, has its own kitchen, laundry, private elevator

Richard Averill Smith photo



Odd animals with odd ailments frequently pop up at Speyer. The staff has taught a beakless parrot to eat. No one knows where a certain stray monkey came from—when it was brought in, burns were found on its feet. A wild possum was picked up in Long Island, of all places, and taken immediately to Speyer. Hamsters, alligators, squirrels, marmosets, pigeons, white rats and chinchillas all have been restored to health. A duck with a leg injury was put back on its feet.

Probably no institution in existence has treated so many famous animals. The fawn which starred in the movie "The Yearling," stayed at the hospital for several days, complete with its own green carpet. A tiny marmoset named "Skippy," mascot of a TV program, was successfully treated for abscesses under the eyes. Two white mice that had been mascots of the cast of "Two Blind Mice," ended up at Speyer, where Mrs. Mouse gave birth to a family.

You can find famous people prowling the corridors of Speyer, too. A good many worried celebrities bring in their pets for treatment. Fannie Hurst, Eva LeGallienne and Russel Crouse have nervously paced the halls. Leon Janney brought his dachshund to the hospital—a maternity case—and Lillian Gish brought a dog that was suffering from a tumor. Lilli Palmer, playing the part of a witch on Broadway, came to Speyer to find a Siamese cat to perform in the production.

The hospital itself made one animal famous. The New York Women's League for Animals owns Speyer, and will do almost any wacky stunt to raise the \$150,000 required to operate the hospital annually. A

(Continued to page 228)



Modern X-ray and fluoroscope instruments are available to help the doctors diagnose animal ailments
Richard Averill Smith photo



Metal-hoop splint binds broken leg and also acts as a crutch. Below, famous animals often come to Speyer. Here Dr. Kinney meets fawn, star of "The Yearling"

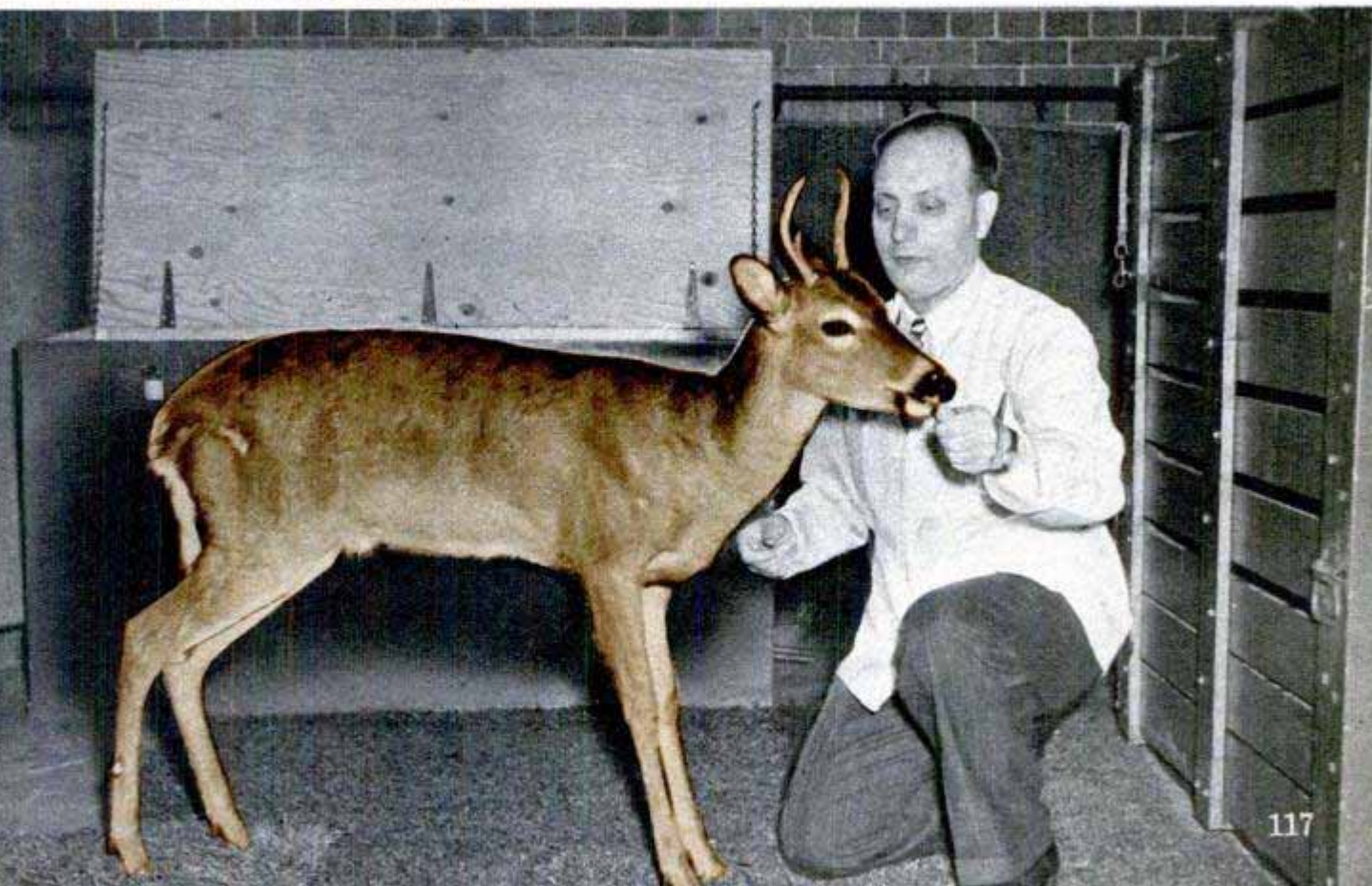

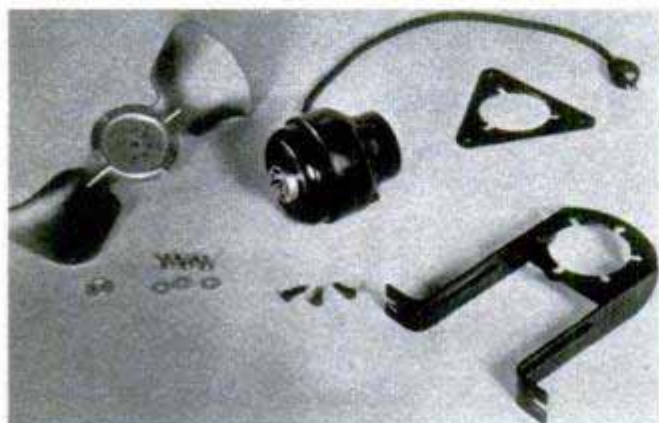

General Electric Co., Schenectady 5, N. Y.

Electric-Fan Kit

You can assemble an electric fan yourself with a new kit that contains the necessary parts. The fan is designed for permanent installation in kitchens, attics or farm buildings. Included in the kit are the motor, 10-inch blade and two mounting brackets. The fan is capable of moving about 360 cubic feet of air per minute.



One-Handed Dog Snare

Dogcatchers are protected from vicious animals by a one-handed snare that holds the dog in a rubber-covered noose at a safe distance. The snare is composed of a hollow metal rod with a rubber-covered piano-wire loop. When open, the noose has a 12-inch diameter. By touching the trigger on the handle, the warden releases a spring which retracts the loop to fit snugly around the animal's neck. The noose does not hurt the animal, says Mayor F. Edward Bier-tuempfel of Union, N. J., who invented it.

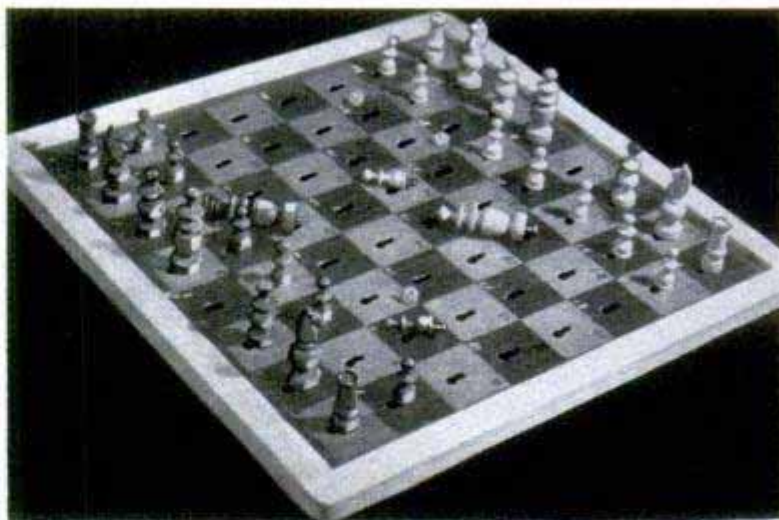
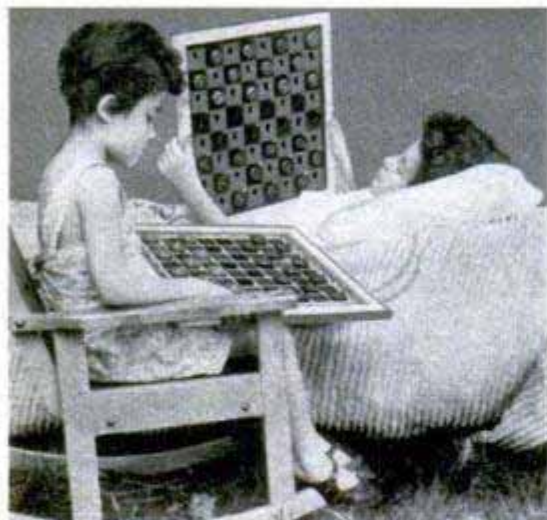

John H. Wheat, 345 McClelland, Pueblo, Colo.

Checkers for the Invalid

Checkers or chess can be played by invalids and blind persons with slotted boards that hold the pieces in place. Each square is numbered with raised numerals so the

blind can identify them. The black pieces have one flattened side for identification by touch. The key slots hold the pieces in place even though the board is tilted as it would have to be when used by many bed-ridden persons.

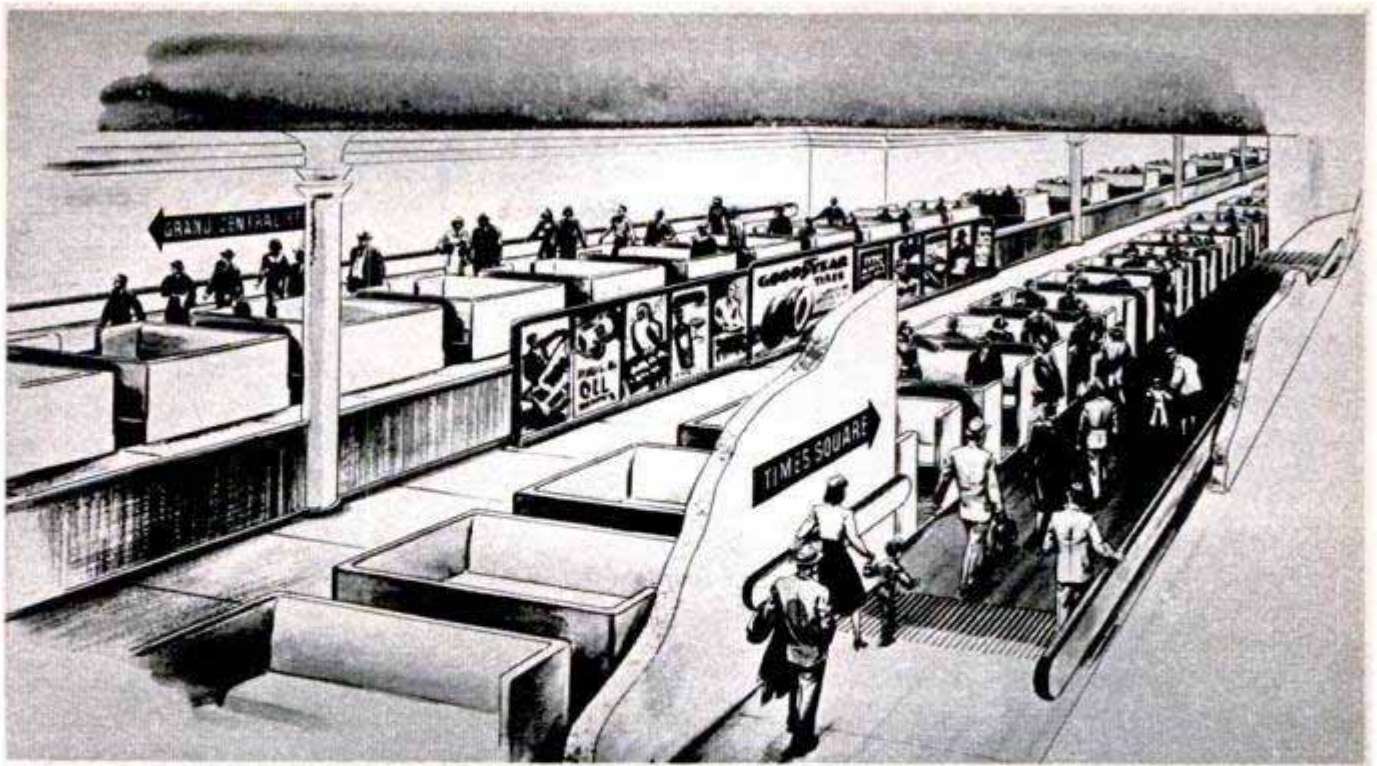

There's no waiting for a car here. Shown with the tops and doors removed for clarity, the cars roll past the moving platform continuously. Below, a plan view of the turnaround and the banks of accelerating wheels

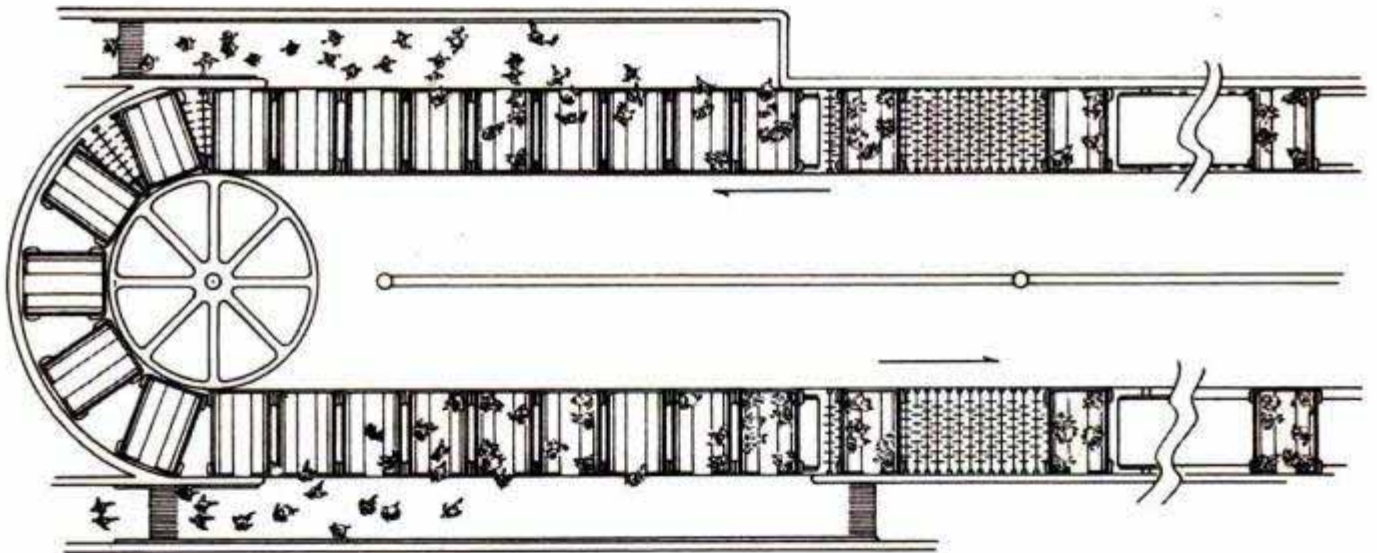

Passengers May Ride Conveyor Belts on New York Subway

Capable of hauling 32,000 passengers an hour in each direction, a conveyor-belt subway system has been proposed as an efficient replacement for the present shuttle between Times Square and Grand Central Station in New York. The system, unlike previously suggested moving sidewalks, would use moving platforms for loading and unloading and small, closely spaced cars. These passenger cars ride on an end-

less track of conveyor belts and rubber-tired banks of accelerator wheels. Passengers walk on a loading platform that moves at the same speed as the stream of cars. Twenty-five cars pass the platform each minute. Once past the platform, the cars move over banks of accelerator wheels which speed them up and carry them to another conveyor belt that moves them along at 15 miles an hour.

Science Makes Synthetic Foods to Study Real Ones

Chemists at the University of Delaware have created synthetic fruits and vegetables, not for eating but for experiments with dried foods. Real fruits and vegetables are so complex that the role played by their various materials can't be isolated,

so chemists have combined pure cellulose, fruit acids, salts, sugars and pectins to form simulated foods with natural texture and appearance. Their research has proved that pectins are most important in swelling the dried product when it is heated with water.

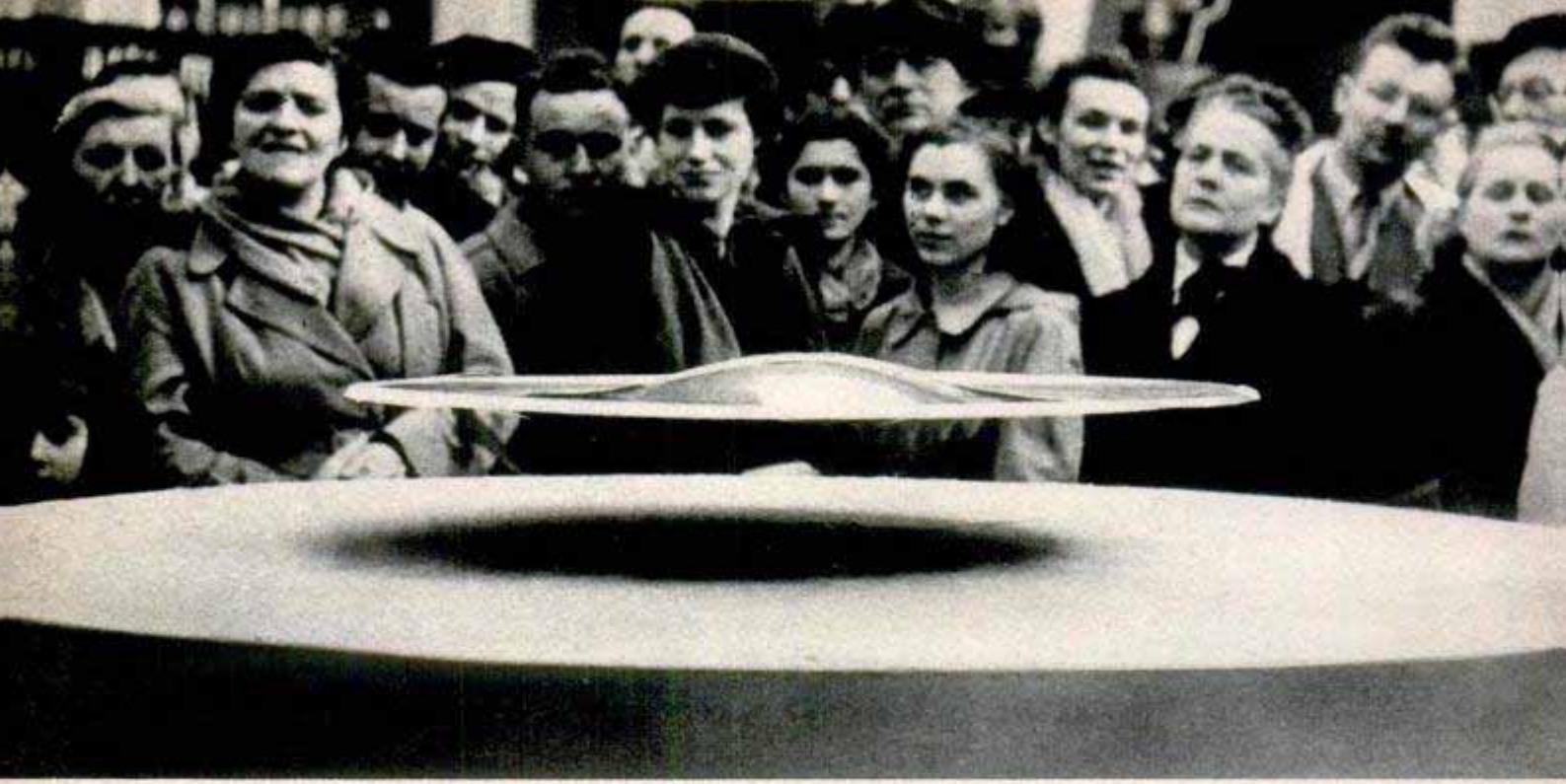

You don't believe it? These Parisians seem skeptical, too. The metal plate is actually floating in the air

PARIS has its flying saucer, but it is called "The Magic Plate." It is a two-pound aluminum disk that floats in air without apparent support.

It moves up and down. It rotates. It lifts an ornate chandelier with bulbs burning continuously as it spins. If such trickery doesn't prove that the plate is magic, it will fry eggs to a golden brown with nothing between it and the table but air!

LOOK! IT'S

Actually, of course, it is no more "magical" than the magic of electricity and the phenomenon of induction.

Below the plate, concealed in the table, are two concentric coils. The inner coil sets

Left, it takes all these controls to make the plate perform by regulating the current entering the coils

Below, inside the table or pedestal above which the plate hovers is a complex maze of metal and wiring

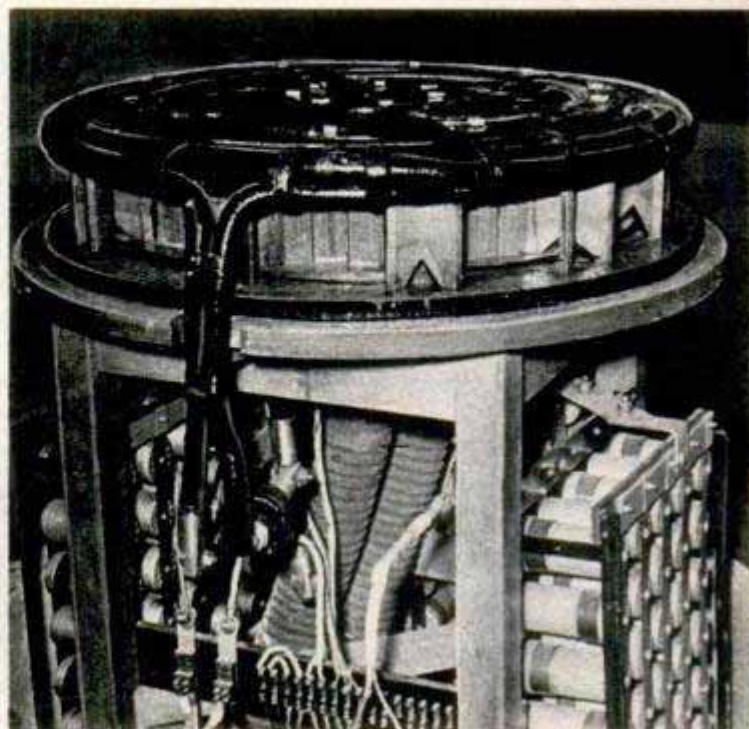
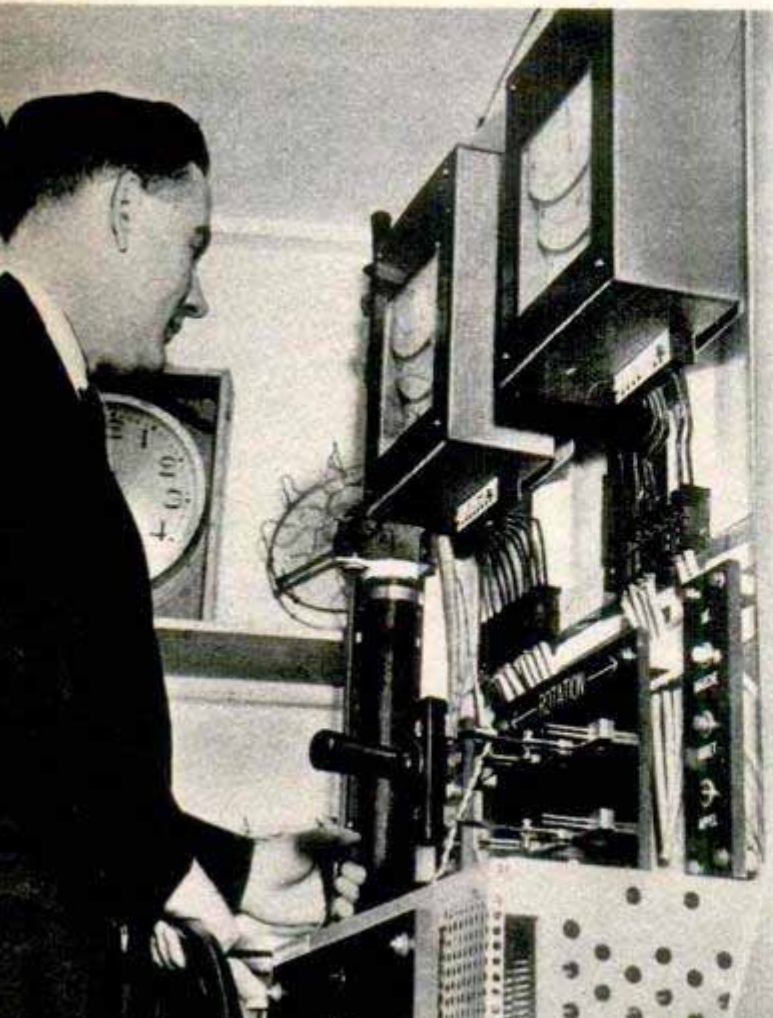



Like your eggs fried lightly? These are so light they fly! Magnetic fields heat plate enough to fry the eggs

FLYING DISKS AGAIN!

up a magnetic field that repels the tray, forcing it into the air. To keep the tray from slipping sideways out of the lifting field, a large outer coil is used. This develops a conical field, tapering toward the top, to keep the plate centered.

A third field makes the disk rotate. Four coils create it. Once the tray starts spinning, it does so for a long period even after the rotation coils are turned off because

the drag of friction is almost nonexistent.

The chandelier weighs one pound. Its bulbs are lighted by induced current. The aluminum tray gets hotter than an ordinary electric iron, providing ample heat for egg frying.

What's it all for? It is strictly a stunt used in Parisian store windows to attract customers and impress them with the magic of electricity.

Best trick the "magical" plate does is to rotate a chandelier in air, its bulbs burning by induced current





British Aluminum Co. photo

Aluminum Launch

Made entirely of aluminum-magnesium alloy, a 60-foot launch has a draft of only two feet nine inches. The launch was built in England for the Pakistan government, which will use it to survey estuaries. The craft has a speed of 12 knots and can travel

1500 miles on the fuel it carries. Twin diesels power the launch. A unique system was used in constructing the craft. The skin of the boat was laid out flat with the longitudinal framing attached. Then the skin was bent up into shape, which stressed it in two directions to give the craft exceptional strength.



Fastest PT Boat

Speed tests of a new motor torpedo boat made of aluminum show it is the fastest craft of its kind that Navy officials have

found. Figures for the tests have not been released. The aluminum boat, with an overall length of 105 feet, is considerably larger than its predecessors. It was designed and built at Philadelphia Navy Yard.

Rubber Processing Headed for All-Time Record

You'll be watching 2½ tons of rubber flying the next time you see a B-36 overhead. This is one of the growing new uses, the B. F. Goodrich Company points out, that this year may result in the industry processing an all-time record 1,260,000 tons

of man-made and crude rubber. About 600,000 tons last year went into automobile and tire manufacture, the big users, and nearly 80,000,000 pounds are annually made into garden hose. Girdles and golf balls account for more than 10,000,000 pounds yearly.

Metal in Engine Lowers Igniting Point of Oil

In seeking more fireproof lubricating oils for jet engines, University of Cincinnati chemists found that the catalytic effect of

metals used may lower the igniting point. The research is being done for the National Advisory Committee for Aeronautics.

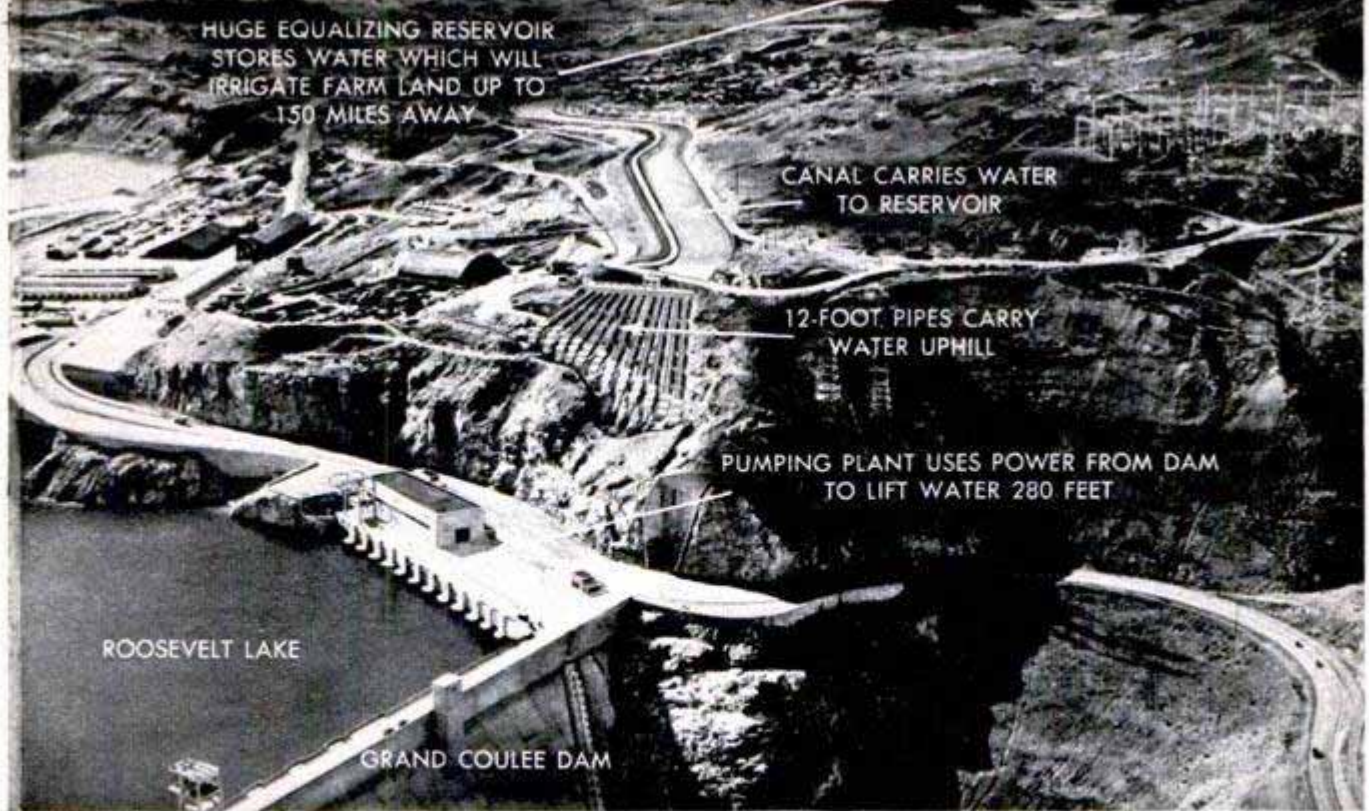

Bureau of Reclamation photos

Water from dam generates power, which in turn raises water up the cliff to irrigate farm land 150 miles away

UPHILL RIVER

"OPERATION BOOTSTRAP" at Grand Coulee Dam is scheduled to start this summer. Power generated at the dam will be used to drive enormous pumps which will lift a river of water 280 feet up the face of a cliff on the Columbia River. From there the water will be distributed to irrigate a million acres of farm land, some of it 150 miles away. Each of the 12 giant pumps has a capacity of a billion gallons of water a day, enough for all the people of New York City. This year, all the canals, siphons and gates of the distribution system will be tested and primed. Actual irrigation will start in the spring of 1952.

Above, left, sectional view shows how water from behind dam is drawn into pumps, then forced uphill. Below, left, 12-foot pipes carry water to top of cliff. Below, power flows to top of dam through large tubes

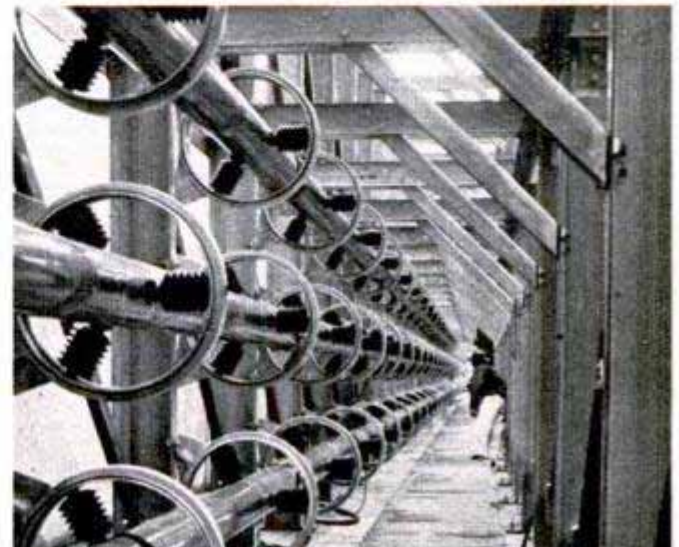
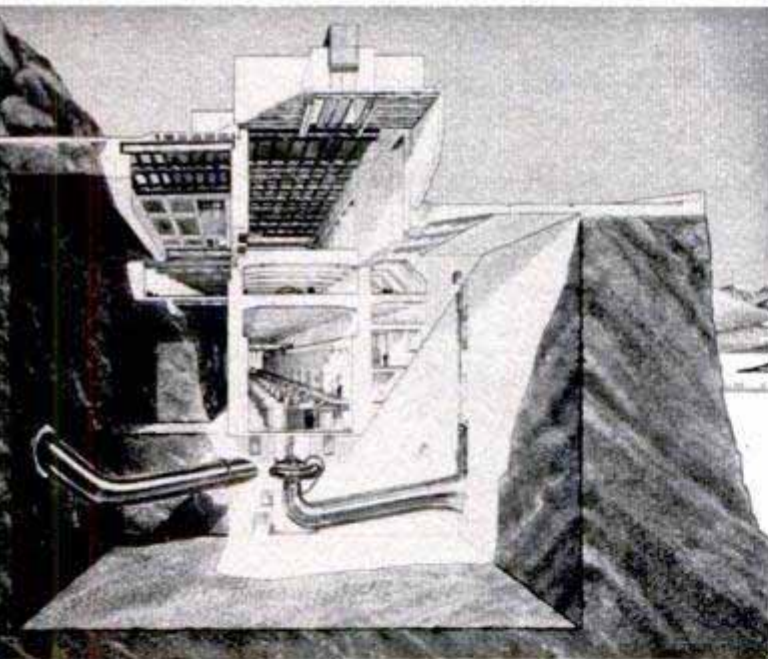

OUT ON THE tossing North Atlantic last summer, a fleet of small ships seemed to be zigzagging aimlessly like a bunch of kids looking for a lost penny on a ball field. If you'd passed them on a liner, your curiosity might have been aroused by one of them, at least. She was a 142-foot ketch, and might have been under full sail or, even more perplexing, hove-to and rolling deep in a trough of the Atlantic swell.

The ship was the research vessel, *Atlantis*, out of Woods Hole Oceanographic Institution in Massachusetts. Standing off her, at about 100-mile intervals were the *Caryn*, the institution's 96-foot ketch; *Albatross III* of the U. S. Fish and Wildlife Service; the U. S. ships, *Rehoboth* and *San Pueblo*; and a Canadian craft. Using a new combination of loran, to get accurate bearings every half hour, and a tricky underwater thermometer known as a bathythermograph, which instantly measures

changes in ocean temperature as deep as 900 feet, this little fleet was tracking down the baffling meanders of the Gulf Stream over vast areas with pin-point accuracy never before possible.

From the ships, new recording echosounders bounced sound waves off the ocean bottom. By measuring the time lag between sound and echo, scientists could chart contours of the sea's floor, locating undersea mountain ranges and valleys that might affect the course taken by the Gulf Stream.

And there's a new underwater coring device which drills 60 feet into the ocean floor to bring up samples of sediment layers laid down a million years or more ago. These samples will tell scientists much about the world's history but, even more important, will reveal the great climate cycles that the earth has undergone since the beginning of time—a possible clue to the climate cycles

Photos From
Jan Hahn

By
Richard F. Dempewolf

Research vessel, *Caryn*, heaves to on the swelling Atlantic while her crew makes underwater tests to find exact rim of the meandering Gulf Stream

ON THE TRAIL OF

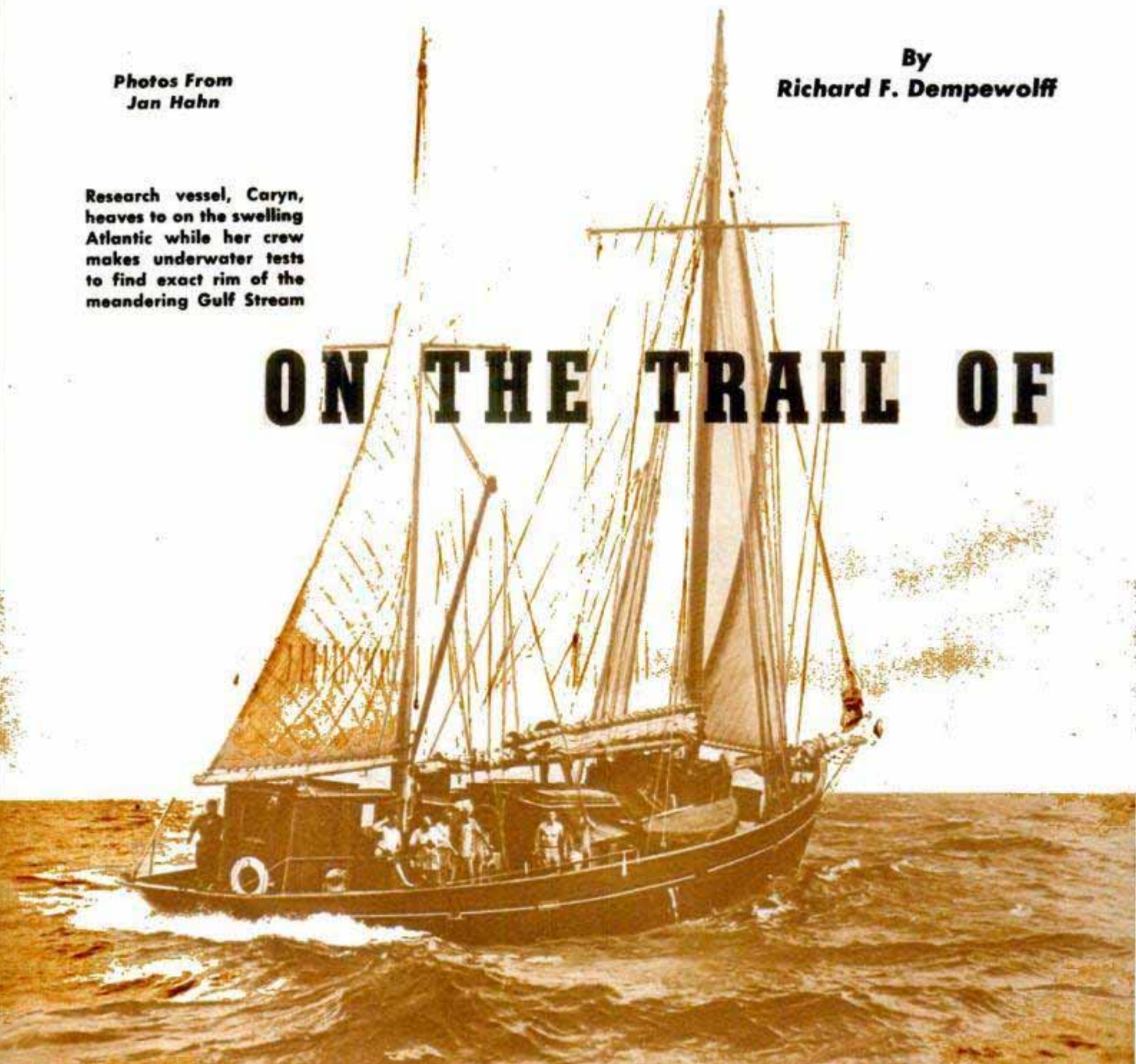

we may expect at sometime in the future.

All this work is part of a far-reaching project aimed at solving mysteries the oceans have kept locked for eons in their green depths. Besides the Woods Hole groups and government agencies, laboratory ships of Scripps Institution of Oceanography at the University of California, Yale's Bingham Oceanographic Laboratory, oceanographic laboratories of the University of Washington, the Marine Laboratory of Miami University, and Chesapeake Bay Institute of Johns Hopkins University, also are out helping pry the lid from the oceans' secrets. Several loran-equipped oil tankers, which ply the Gulf Stream route, are contributing by reporting records of the currents they follow.

Whimsies of the ocean currents have long puzzled scientists. "We know that currents like the Gulf Stream shift around, meander, break off to form eddies," says Dr. Arnold Arons, top physicist at Woods Hole. "We want to find out why."

Ships depend more and more on rigid timetables. It costs \$1000 a day to operate a big tanker or freighter. If skippers knew that by moving starboard or port a mile or two they could pick up a four or five-mile-an-hour boost, instead of bucking a similar current from a backlash or eddy, millions of wasted hours and dollars could be saved each year. Radio and communications are affected by weather, generated in large part by air masses passing over large warm

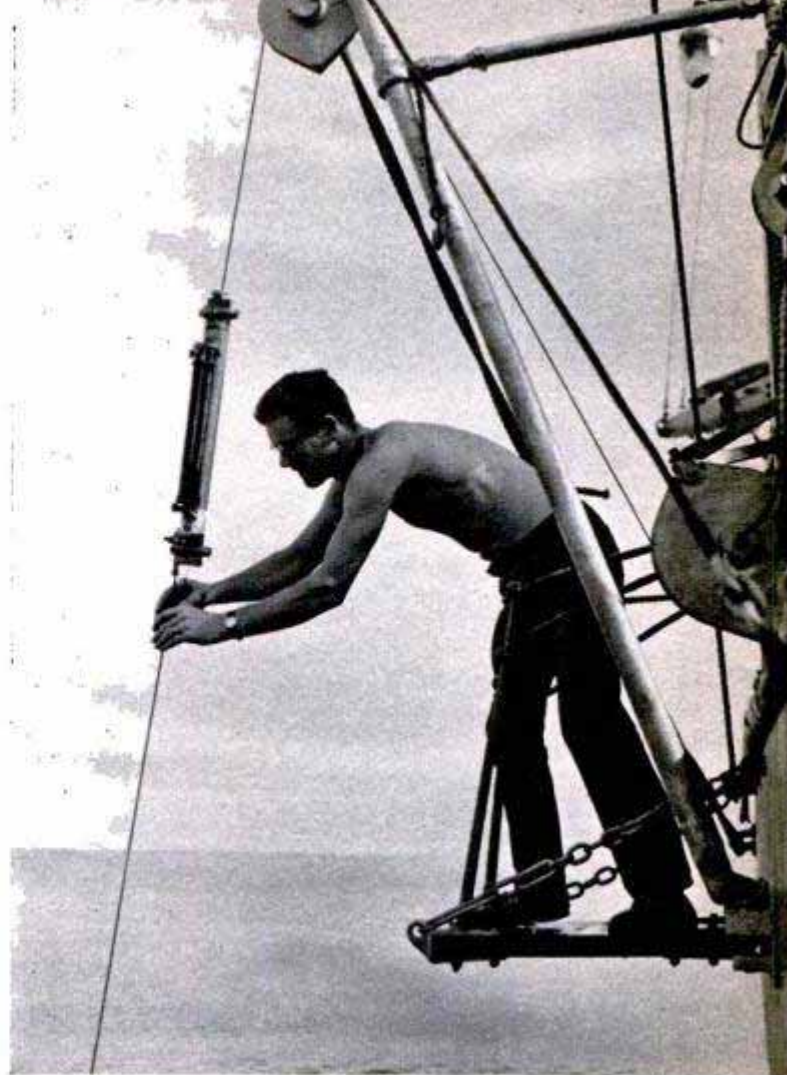

Crewman takes a reading from an Ekman current meter. Propeller tells speed of flow, pellets in bottom of the instrument indicate direction of the current

THE GULF STREAM

World's basic currents flow clockwise in Northern Hemisphere, counterclockwise in Southern Hemisphere

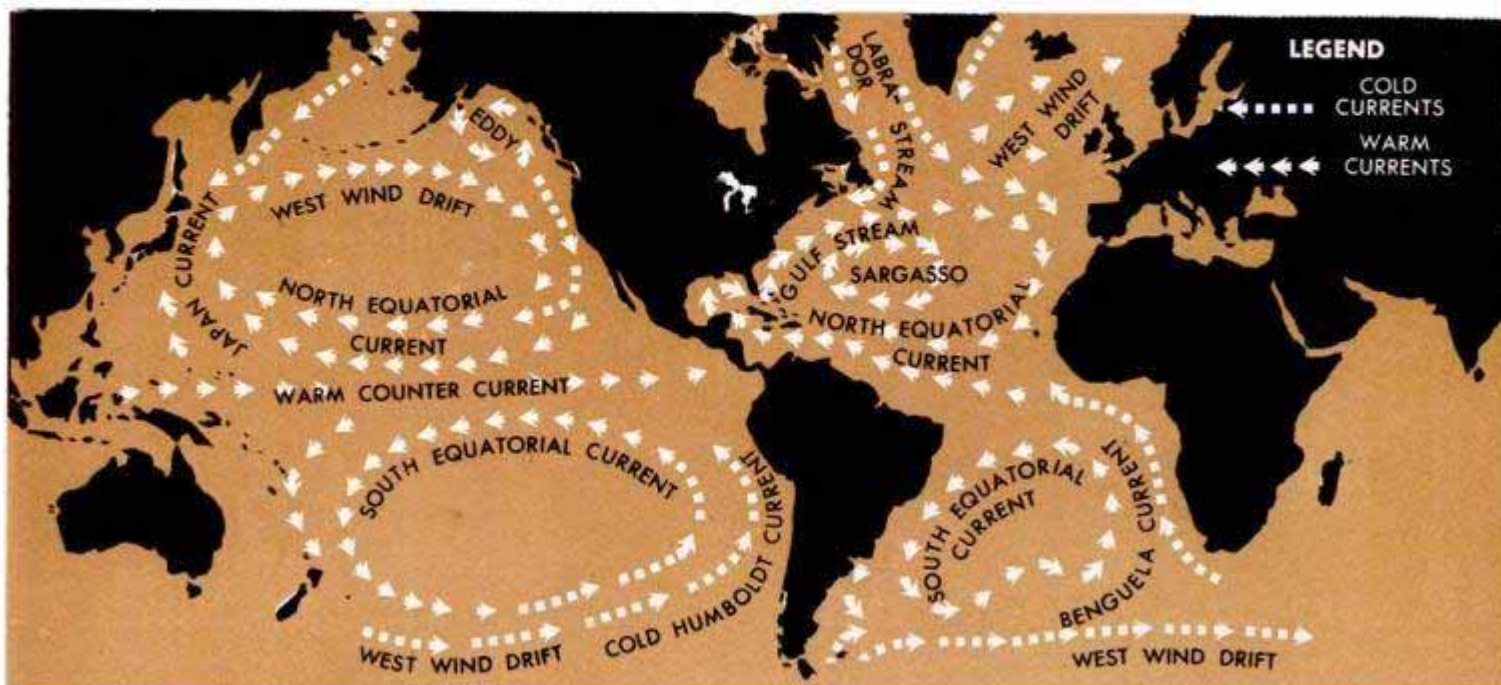



Balloon carries aloft a psychograph, shown above, which measures wet and dry-bulb temperatures of air. These readings, with others from planes and underwater instruments, will tell the heat exchange between water and air

or cold areas of sea surface carried by the currents.

One of the big things that may come out of oceanographic research in the next 10 years is a tremendous advance in long-range weather forecasting—important not only to mariners and airmen, but to the farmer raising potatoes in Idaho. "Seventy-eight percent of the atmosphere borders on the ocean," explains Woods Hole meteorologist, Dr. Bernard Haurwitz, "and is affected by the exchange of heat, moisture and salt particles between its lower layers and the ocean surfaces—which makes the seas the biggest weather breeders on the globe."

In all of these projects, a complete knowledge of ocean currents plays a big part.

Each of the seven seas has currents that revolve slowly around it like the rim of a monstrous wheel. What keeps the currents turning? Winds, for one thing. But the currents are also spun by the rotating earth, which makes them flow clockwise in the Northern Hemisphere and counterclockwise in the Southern Hemisphere. Each of these ocean currents is

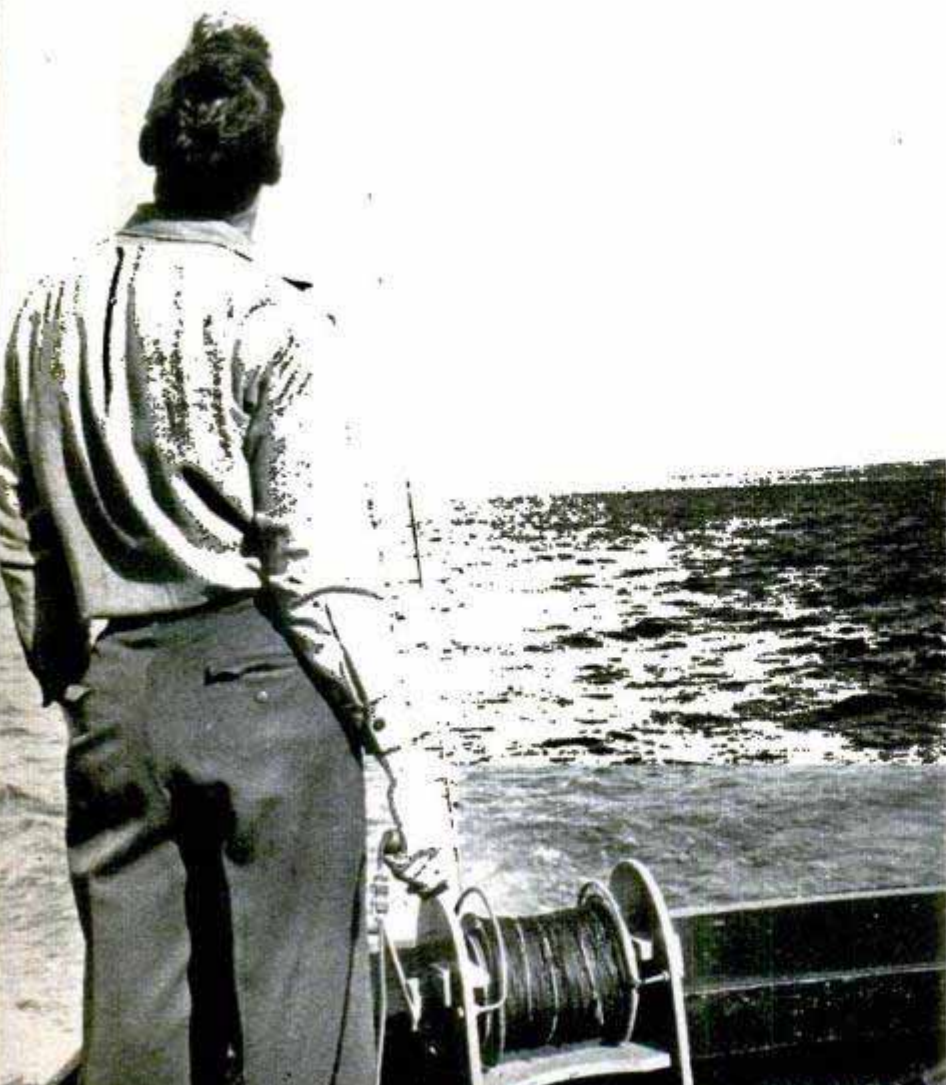

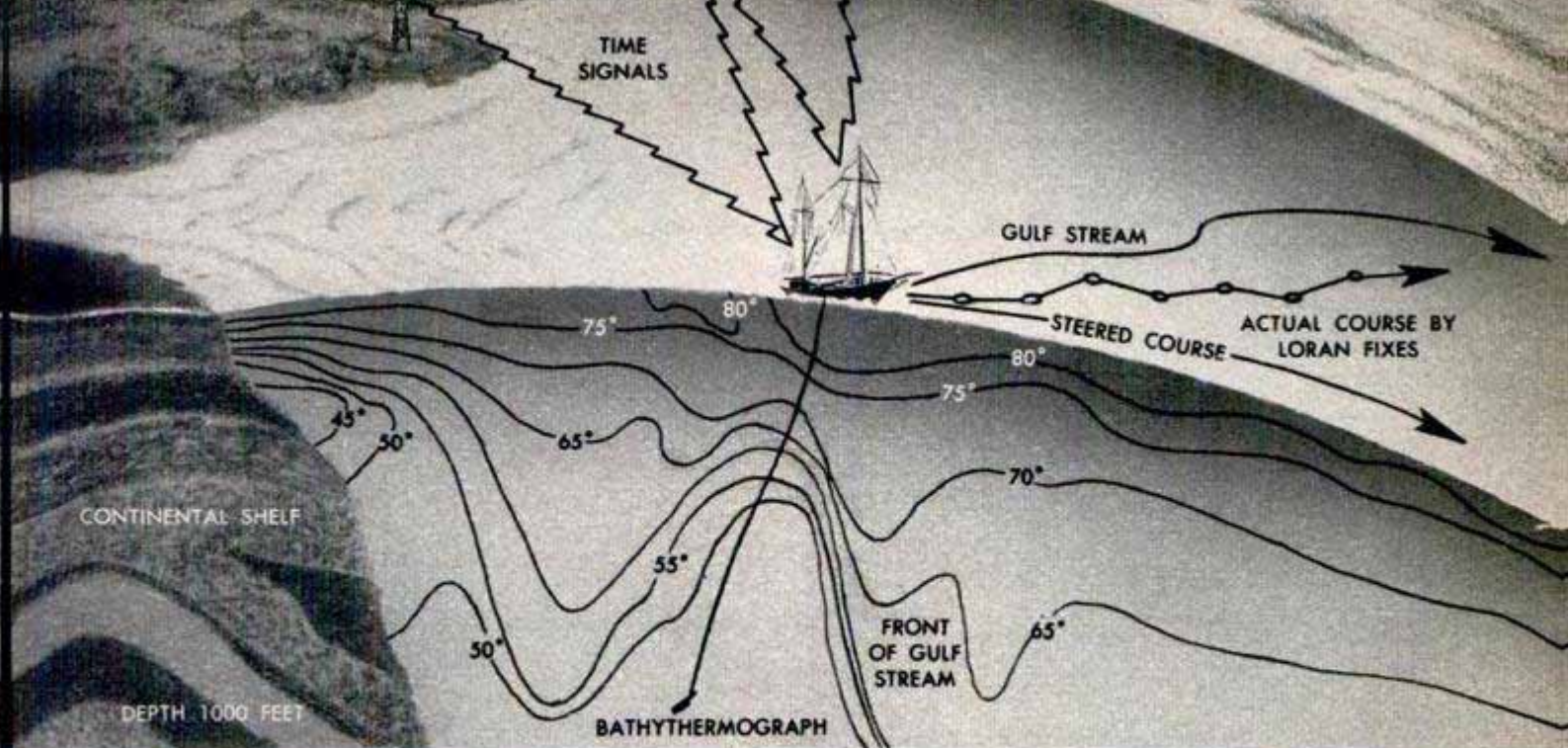

deflected by continental shores, submarine topography, local winds and weather to form its own peculiar pattern of eddies and streamers. To complicate matters, tropical suns warm these currents, and arctic fridgidity cools them. This creates vertical currents that turn the revolving oceans over and over.

Here's how it works in our familiar North Atlantic: The big spinning water wheel is made up of the North Equatorial Current moving eastward from the Canary Islands, which Columbus rode on his voyage to America. It swings up toward the Caribbean Sea as the Florida Current and is swept northward into the Gulf Stream to become a rushing torrent larger than 10 Mississippi squeezed through the narrow strait between Cuba and the Keys. Here, the currents have created a huge and ancient 1000-mile eddy—the Sargasso Sea.

The familiar Gulf Stream flows northward along the Continental Shelf, becoming the West Wind Drift as the turning earth presses it eastward, carrying temperate weather to western Europe and coasting down the shore to become the Canaries Drift and start all over again.

Up in the northern latitudes, cooled in the Arctic "refrigerator," the water becomes dense and heavy. Hence it sinks below the surface and slowly creeps southward along the primeval ocean-bottom ooze toward the Equator, where it rises again, as surface water is warmed by the sun, and flows back north with the currents.

The persistence and steadiness of these currents are something to reckon with in any ocean study. Oceanographers tell incredible tales about them. In a 1900 hurricane, the coffin of actor Charles Coghland

Aided by loran fixes, vessel plots edge of Gulf Stream. Profile of temperatures helps indicate current's front

Deck of the Atlantis is loaded with electronic gear. Underwater measurements are read on dials topside

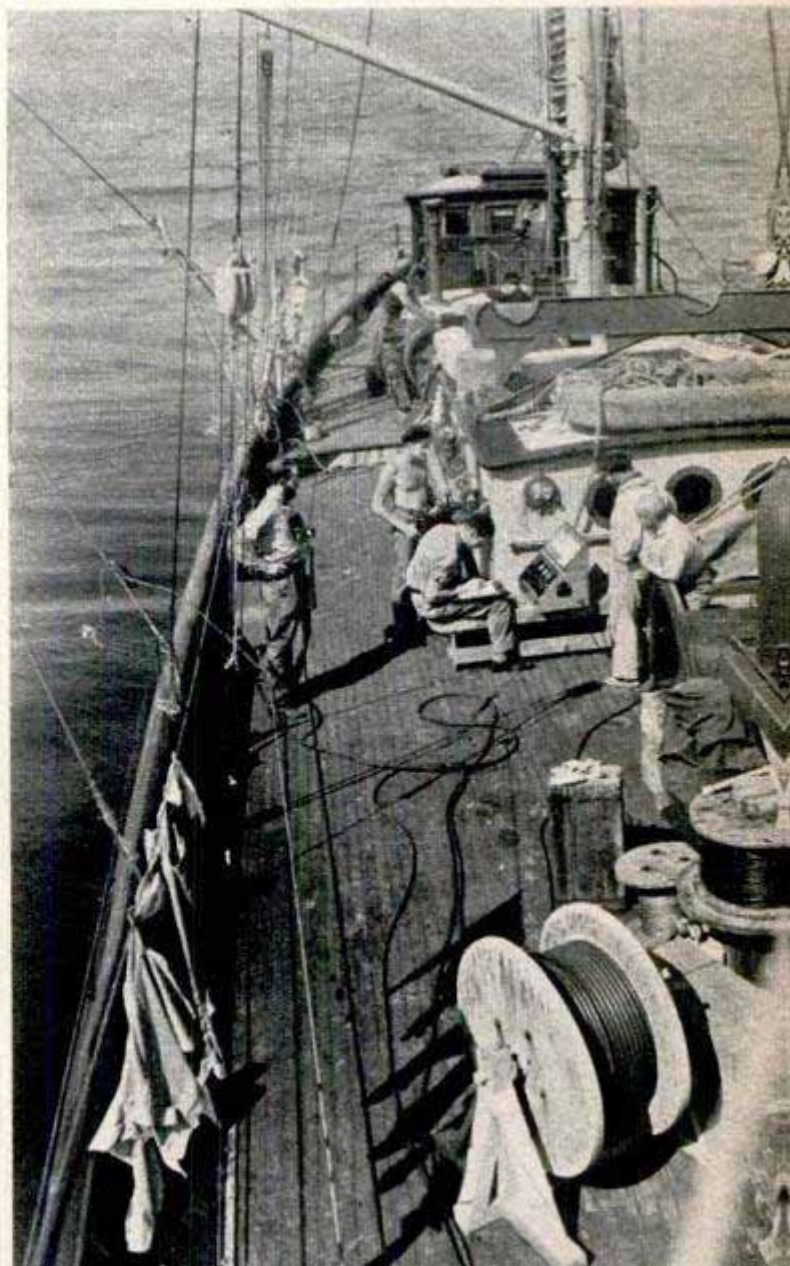



By measuring heat exchange between water surface and air, scientists hope to forecast fog conditions

Gulf Stream shifts constantly. Lines show its edge on various dates. Heavy line shows stream last summer

was swept off a ship near Galveston, Tex., drifted into the Gulf Stream and wound up in the Gulf of St. Lawrence, 2000 miles away. In another case, a test bottle, cast adrift at Nova Scotia, landed in Australia after following the Gulf Stream to Europe, down the coast with the Canaries Drift. Then, probably swept by a storm into the South Equatorial Current, it was caught up in the Brazil Current, traveled the South Atlantic counterclockwise currents around to Cape Horn, where it was snatched away by the Antarctic West Wind Drift and carried to its final port.

How these currents affect the lives of men is clearly seen in the record. In 1930, a microorganism attacked and killed all the eel grass along the Florida coast. Geese and other fowl that inhabited the grass died off. Within two years, the microbe had been carried north by the Gulf Stream, destroying the grass and taking a toll in birds all the way up to Nova Scotia and, moved eastward by the West Wind Drift, wrought its damage in northern Europe as well. With the grass gone, banks of land in England's sheltered waterways slumped into the sea, killing off other vegetation as well.

Even more startling is the periodic disaster that occurs in Peru. Here, the Humboldt Current of the South Pacific sweeps north along the west coast of South America, carrying icy Antarctic water rich in organic matter. This supports many fish,

(Continued to page 216)

THE GULF STREAM

- 1 MAY 1-7, 1946
- 2 MAY 24-26, 1946
- 3 JUNE 13-15, 1947
- 4 JUNE 27-JULY 6, 1947
- 5 NOV. 1948
- 6 NOV. 1948
- 7 JAN. 1949

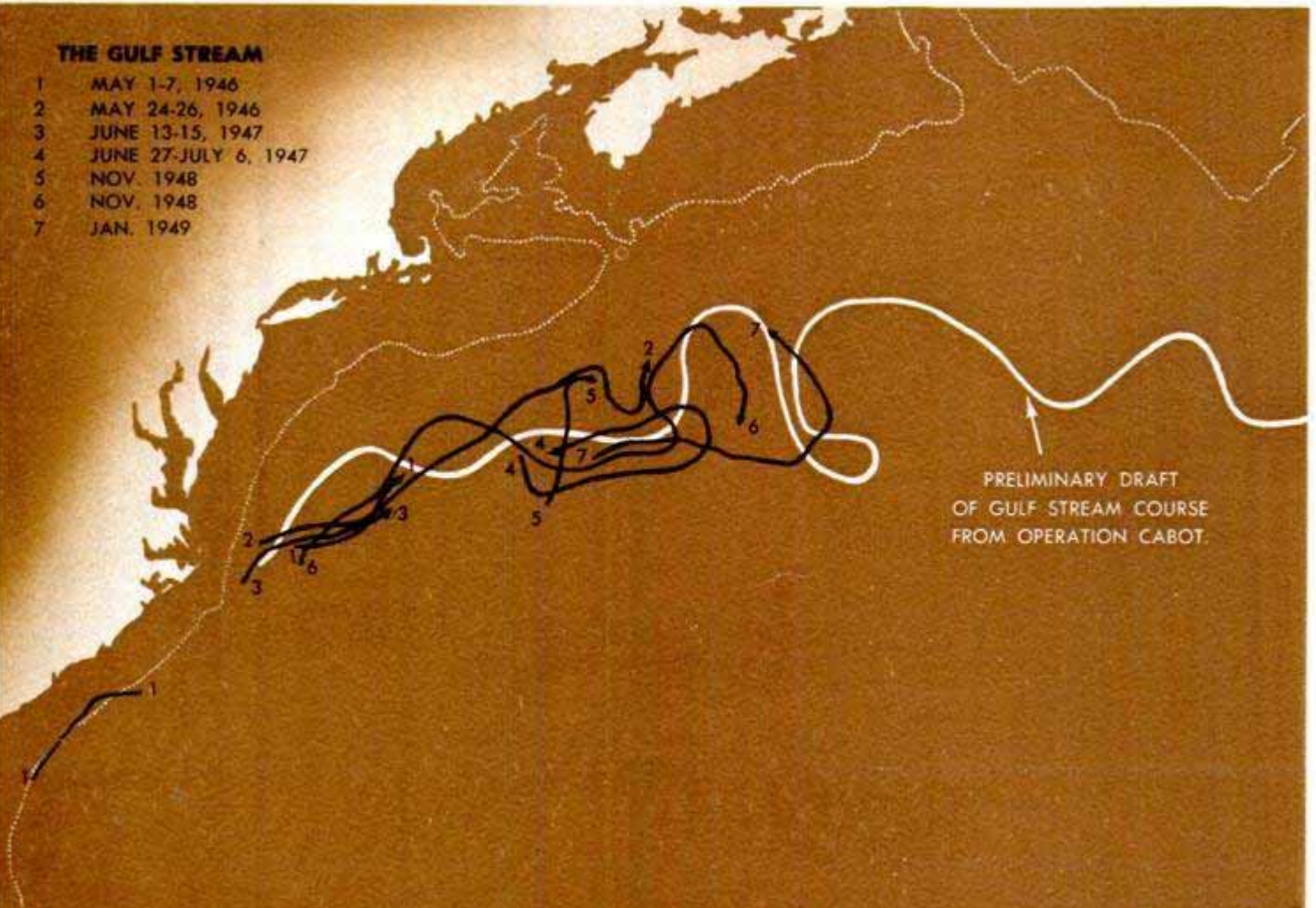

PRELIMINARY DRAFT
OF GULF STREAM COURSE
FROM OPERATION CABOT.

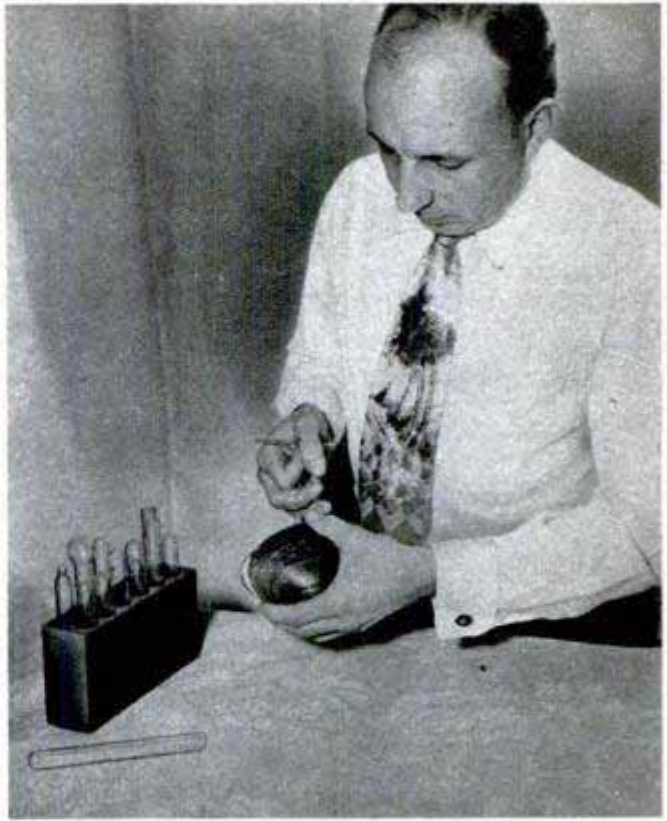

Top, Heckenkamp siphons water from a clam jar to check it for foreign matter. Just below he finds a pearl in clam shell. Right, he uses instrument similar to hypodermic needle to inject sand particles into a clam

Hobbyist "Grows" Clam Pearls in His Basement

In the basement of his home, Andrew C. Heckenkamp raises beautiful pearls. Furthermore, he "grows" them in fresh-water clams instead of in oysters. Heckenkamp, president of the St. Louis Aquarium Society, developed the pearl-producing process himself. He first opens the clams with electrical impulses; he discovered early in his hobby that clams which are pried open usually die. Into the opened clam he injects sandlike particles with an instrument re-

sembling a hypodermic needle. It takes four or five years for the clam to develop the pearl and during this period it must be tended frequently or it will die. The water is chemically treated, and parasitic leeches must be removed from the younger clams from time to time. In a two-month period recently, Heckenkamp "seeded" 50 to 60 small clams. If all goes well he'll have a harvest of pearls in another four or five years.

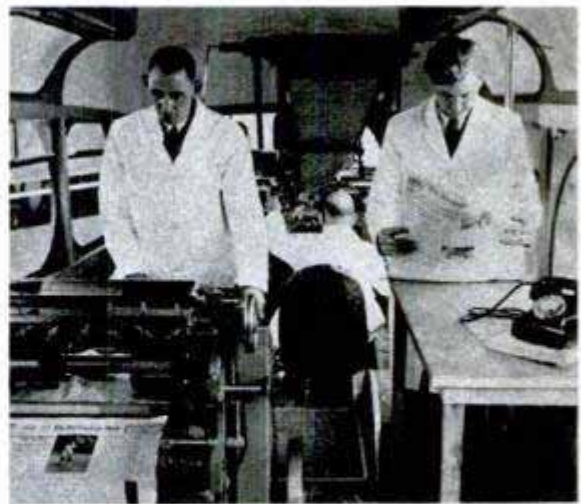

Mobile Newspaper Plant

Last minute news is furnished out-of-town readers of the Birmingham (England) Post & Mail by a mobile printing plant. It produces late editions of the newspaper at points of distribution. What at first glance

appears to be a luxurious motor coach actually contains all the facilities for printing. It has a Linotype machine, Teletype, radio photo transmitter, small press, photographic darkroom and two generators to operate the equipment. The chassis was specially built by Wilsdon & Co., Ltd., Birmingham.

Jens Olsen, a little Danish craftsman — you'd have taken him for Santa Claus — died before he finished the incredible task he set for himself. His countrymen have completed his life's work for him—

A CLOCK FOR ETERNITY

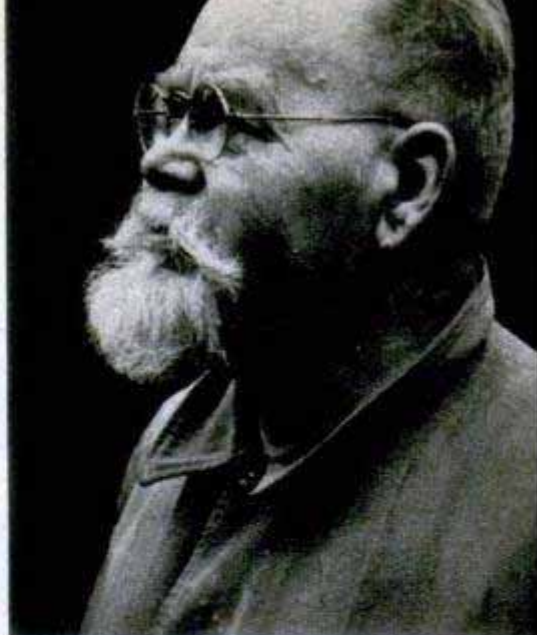

By Kai Norredam

Timepiece of the solar system is being installed for exhibit in the Town Hall in Copenhagen, Denmark

Copyright by Nordisk Pressefoto

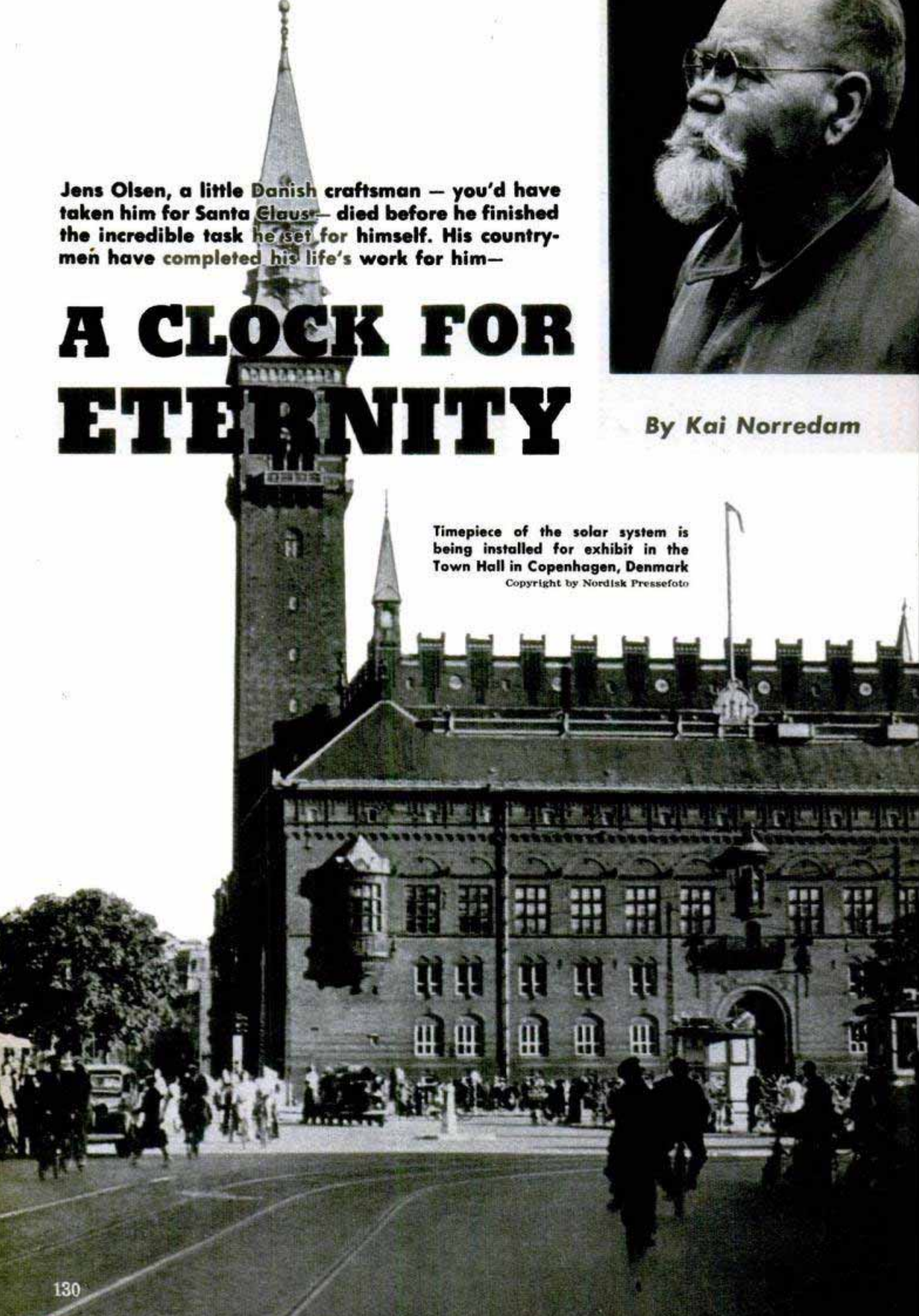

LATE THIS YEAR a new clock will start ticking away in the old Town Hall at Copenhagen, Denmark. It is not an ordinary clock, for this is a timepiece built for eternity, a mechanism that will keep an accurate record of the time throughout the solar system, a clock we expect to tick away for three or four thousand years.

The maze of gears and shafts in our clock is so accurate that the pointer showing the eclipses of the sun and moon makes one revolution in precisely 6798.36152 days!

The clock is a finer timepiece than even the famous astronomical clock at Strasbourg, according to engineers and astronomers who have studied it. It is the lifework of Jens Olsen, a locksmith's apprentice who died shortly before the clock was finished.

Olsen was born nearly 80 years ago. When his journeyman's probation as a locksmith was completed, he strapped a knapsack on his back and started wandering throughout Europe. In every town he studied the old clocks and read every book in the local library on the subject of timekeeping. He was determined to make the finest clock in history.

In 1902 Olsen returned to Denmark and, between odd jobs, worked on the plans for his masterpiece. For 30 years he toiled over

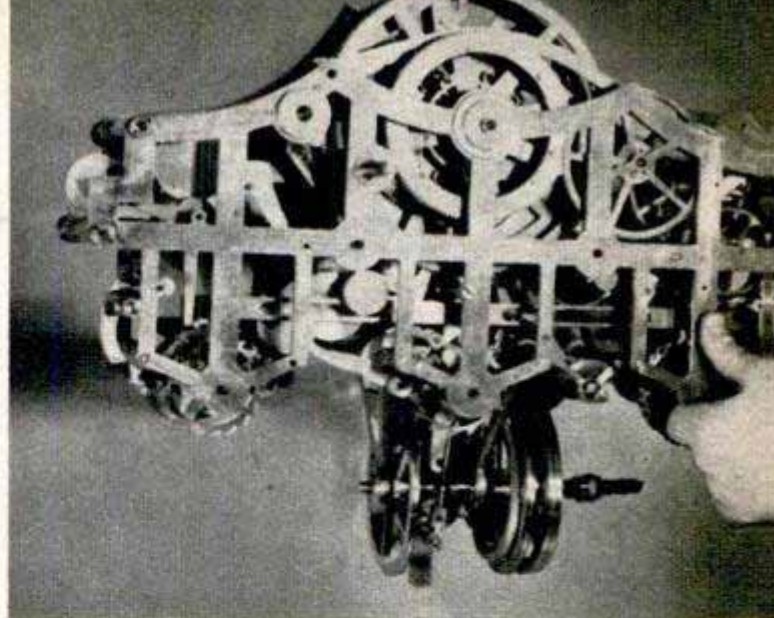

Main calendar mechanism functions only on New Year's Eve when it sets movable feasts and calendar for year. The calendar period lasts 570,000 years

Below, though not yet completed, clock will have a face with multiple dials. They indicate: 1—Time equation. 2—True solar time. 3—Local time. 4—Time around the world. 5—Sunrise, sunset. 6—Gregorian calendar. 7—Mean time. 8—Sidereal time. 9—Sunday letter. 10—Epect. 11—Golden number. 12—Indiction. 13—Lunar cycle. 14—Main calendar. 15—The sky. 16—Stars and movement of the pole of the sky. 17—Sun, moon. 18—Planetary system. 19—The Julian period

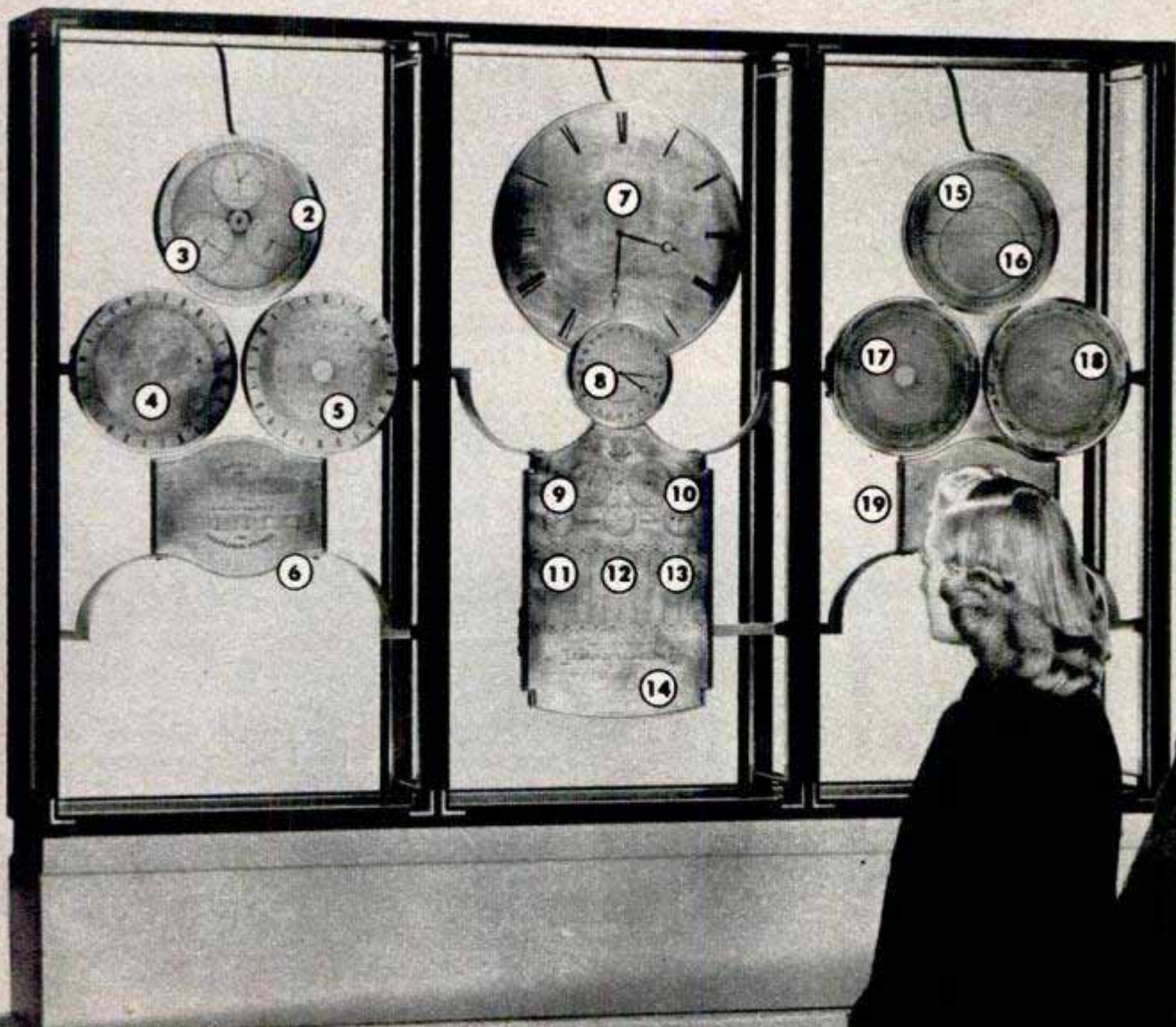

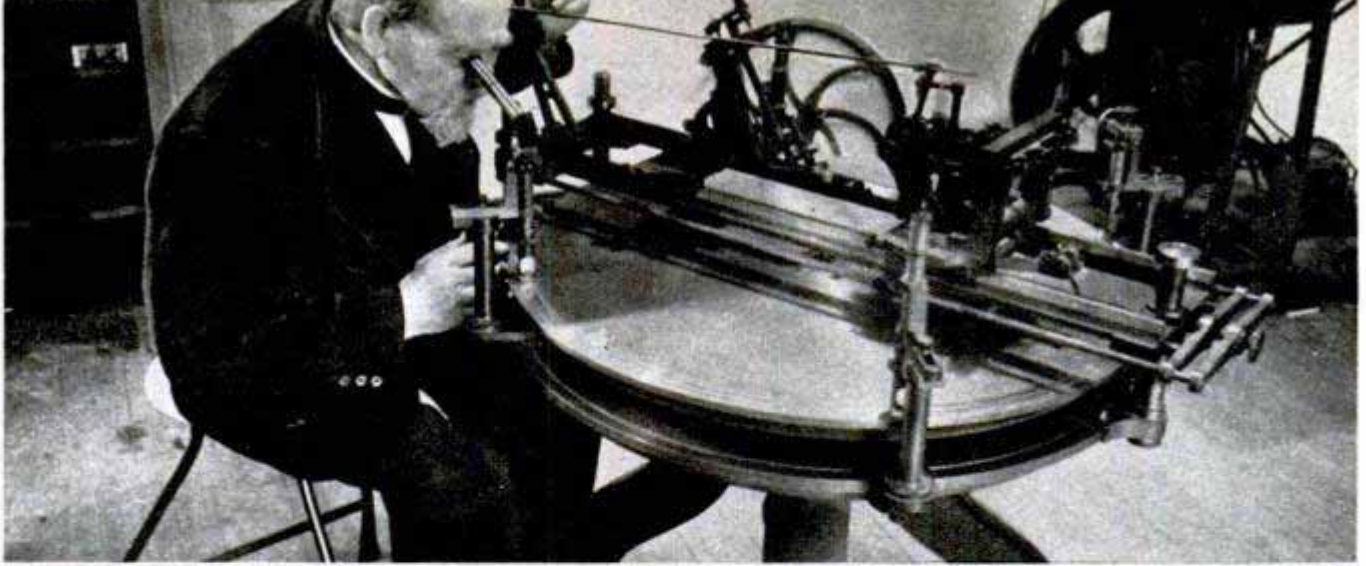

Copyright by Nordisk Pressefoto

Jens Olsen spent a lifetime on the intricate clock. Here he works at an instrument for dividing a circle

drawings of the mechanism. Then in 1935, the drawings were completed and he already had constructed some of the clock's thousands of intricate parts. An article in a scientific journal, in which he described the astronomical clock in detail, astonished the astronomers. Immediately a committee was set up to back the construction of the clock, and an excellent engineer appointed as an aid to Olsen.

For 16 years the work has gone forward on the clock. Not long ago Olsen died. But the important element of his work, the drawings which had been traced for a lifetime, remained. Now our clock is complete except for the details of mounting it.

Once it starts ticking away the centuries, here is what the face of the clock will tell:

1. Standard Central-European time.
2. Mean solar time, true solar time and sidereal time for the locality where the clock is erected; also the difference between mean and true solar time.

On the sun-and-moon dial, the small globes on the pointers illustrate the eclipses as they occur

3. Mean solar time at different longitudes.
4. The times when certain stars rise and set, and when they cross the meridian.
5. The precession, and the extent to which this influences the rising and setting of the stars.
6. The time when the sun passes the meridian; sunrise; sunset.
7. The phases of the moon.
8. The geocentric longitudes of the moon and sun.
9. The longitude of the lunar nodal line and the time of future eclipses of the moon and sun.
10. The longitude of the lunar line of apsides (line coinciding with the axis of the moon's orbit).
11. The varying distances of the great planets from the sun.
12. A fully automatic Gregorian calendar that, on every New Year's Eve at 0.00 hours, calculates all the chronological elements of the calendar, such as: the

Here's the mechanism which calculates solar and lunar eclipses, transmits movement to globes on pointers

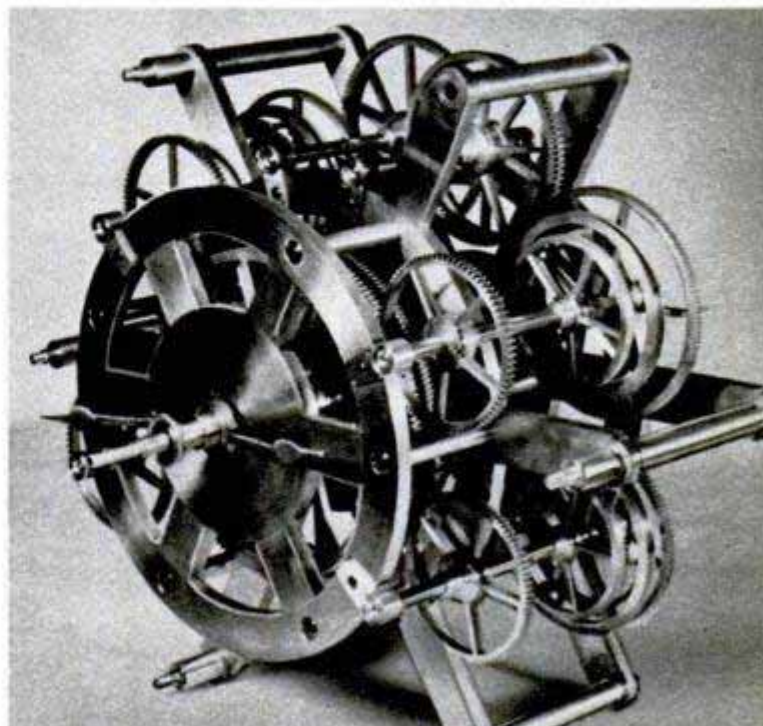
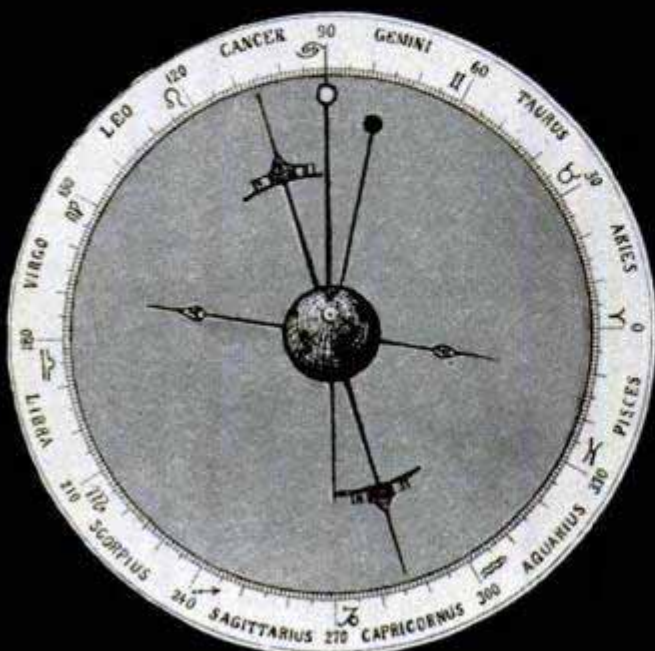

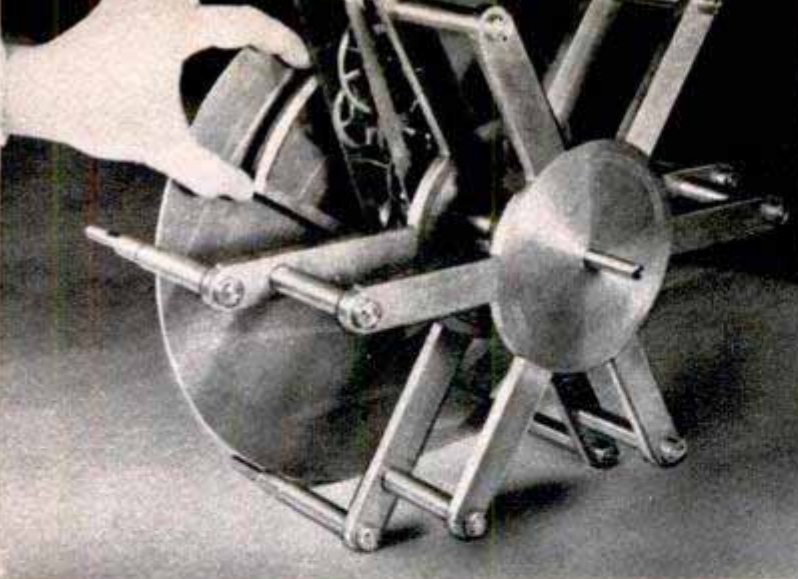

In next 3000 years, mechanism for planetary movements will move only the distance between fingers

cycle of the sun (a period of 28 years); the Roman indiction (a fiscal period of 15 years reckoned originally by the Romans); the golden number (after each period of 19 years, the new and full moons return on the same days of the month as before); the epact (the excess of solar over lunar year); the Sunday—or Dominical—Letter (days of the month on which the Sundays fall during each year of the cycle); the weekdays and holidays of future years.

13. The year, the day of the week, the date, the month and the number of the day in the Julian period of 7980 years.

Several astronomical clocks have been constructed in the past. The finest is the clock in Strasbourg, justly famous throughout the world. It is far surpassed, however, by Jens Olsen's clock in astronomical exactness. The calendar is much superior in the Danish clock, and what is of great importance to the observer, the astronomical phenomena are so clearly presented as to be readily seen and understood by everyone.

The clock is mounted on a green granite base and enclosed in a large glass case. The mechanism cannot stand the slightest vibration so it is necessary that the foundation go deep into the earth to the firm under-soil. Warm, dry air is let through the case, thereby creating slight pressure inside and preventing the entrance of dust.

The timepiece is made of 12 independent mechanisms; they are, however, mutually connected by axles or gearing, or by a steel band.

Just beneath the ordinary clock dials is a smaller dial which shows sidereal time in hours, minutes and seconds. Sidereal time

(Continued to page 230)

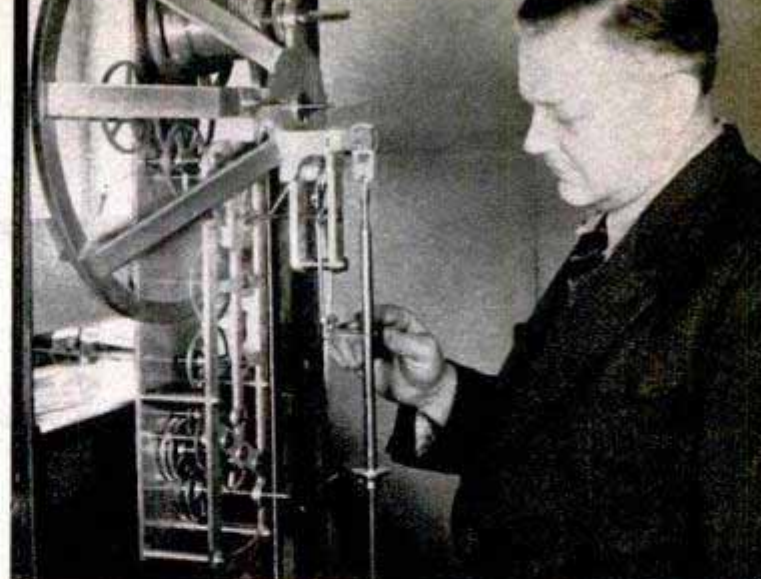

Technician examines the main works which show the mean time and sidereal time, govern the other works

Otto Mortensen, the skilled clockmaker who took over after Olsen's death, checks some of the delicate parts
Copyright by Nordisk Pressefoto

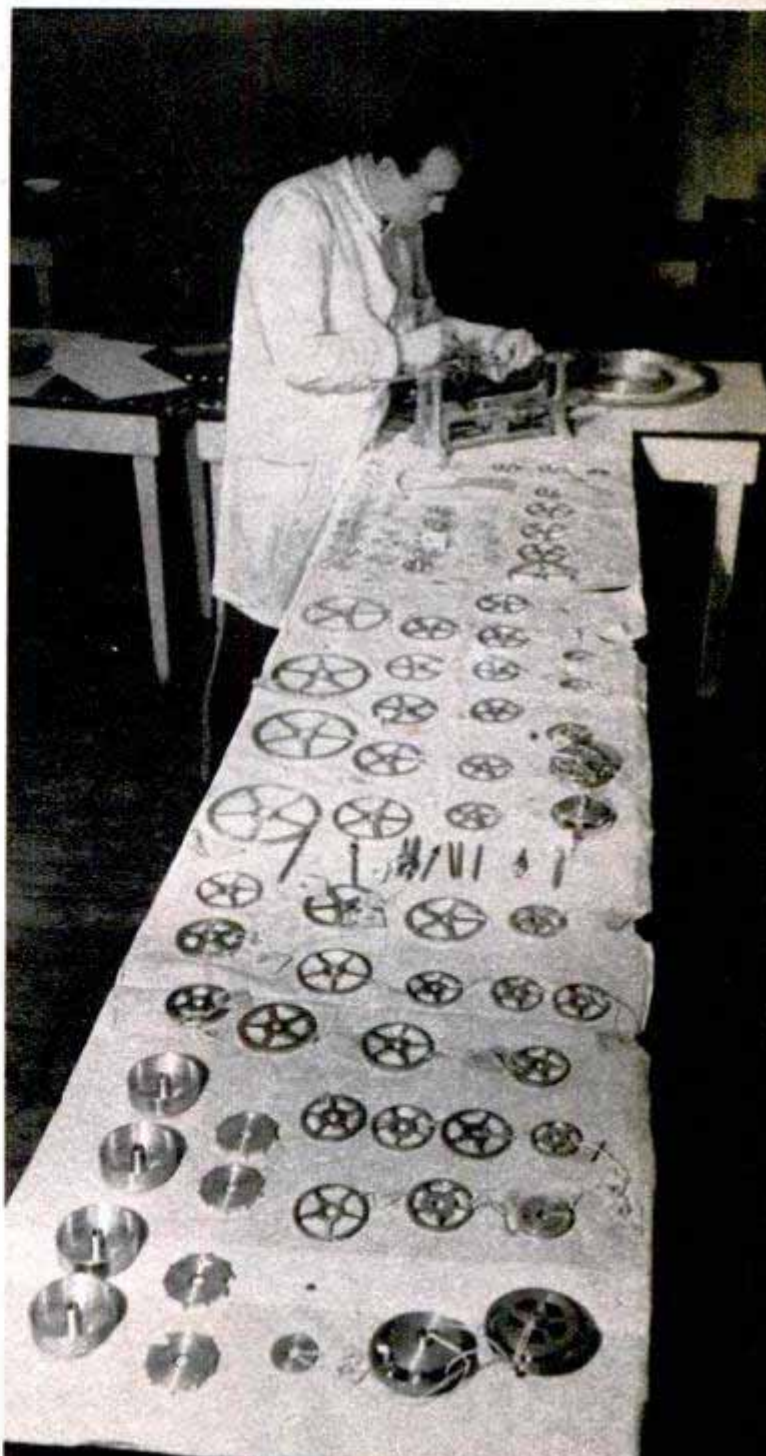



Swimmers Hear Music Underwater in Hotel Pool

If you like music while you swim, you'll enjoy swimming at the Beverly-Wilshire Hotel in Beverly Hills, Calif. There, the swimming pool is wired for sound. A special underwater speaker, suspended in the

water, enables underwater swimmers to hear the music in any part of the pool. The speakers are so powerful that they will blow themselves apart if removed from the water while in use.



Helicopter Saves Steeplejack Time

By using a helicopter as a "sky hook," a Boston steeplejack made his rigging ready for painting a smokestack in less than 30 minutes. To accomplish the same job with the lashed-on ladders usually used would have required a day and a half. The steeplejack was flown by helicopter to the top of the stack. He simply leaned out, dropped his staging hook over the chimney edge and played out the rigging. Returning to the ground, he hooked up his swinging chair and went to work.

☐ Wastepaper is needed for America's defense. Don't throw it away.

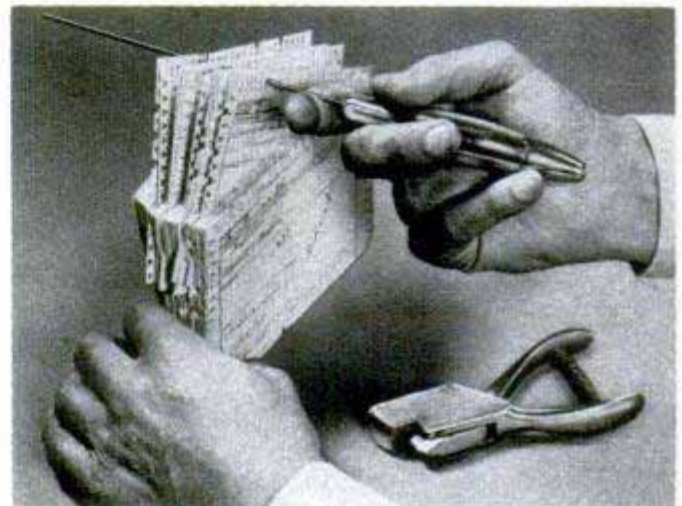

Boeckeler Instrument Co., Box 181, Tucson, Ariz.

"Punchboard" Sorting For Accounting System

Holes punched along the margins of a filing card provide a speedy sorting system that does inexpensively what complex machines do in large-scale operations. To record certain data for future reference, a particular hole is punched open to the edge on all cards in the category being recorded. That hole is not punched open on cards not in the category. Then when you want to pick out the cards in that grouping, you slide a spindle through the correct holes and lift up the cards. Those cards with opened holes drop out and the sorting is accomplished.

Sources of available products described in this issue are listed in the WHERE-TO-FIND-IT LIST, which is available to readers without charge from the Bureau of Information, Popular Mechanics Magazine, 200 East Ontario Street, Chicago 11, Ill.



Crude foundation consists of wood frame covered with rabbit wire. Paper pulp will give it attractive lines



Wire mesh was used as foundation on this chair. Student covers frame with paper strips soaked in paste



Finished chair, under construction at top, is strong and comfortable

Paper Chairs

OLD NEWSPAPERS have been converted into durable chairs by students at Southern Illinois University. The idea came from Kenneth Ervin, art instructor, who decided chairs would be a good subject for a contour-designing project by his students. Plastic would have been too expensive as the basic material, so Ervin and his students turned to paper. Some of the students made chair frames of wood, then wrapped them with rabbit wire and added the paper pulp for modernistic lines. Others used only wire as the base. Later they discovered that the paper alone could be made extremely durable, eliminating the need for any kind of base. The newspaper simply is mixed with flour or wheat paste until it forms a pulp, then is molded to the desired shape. The finished chairs are as strong as most conventional types.

Paper chairs can be produced cheaply in infinite designs, are attractive enough for living room or porch



TWIN-HULLED RACERS SAIL SPANISH SEAS



Catamaran-type sailboat balances on one hull, making sharp turn in demonstration off the coast of Spain

SAILING enthusiasts off the coast of Spain are adding new thrills to an ancient maritime sport with a boat that is a cross between a catamaran and a sailboat. A one-man boat, it is noted for its speed and maneuverability. The boat has no keel or centerboard and can navigate in shallow water; in fact, it can be sailed right up on a beach. It makes sharp turns on one pontoon and makes a complete reversal of di-

rection in a jiffy by sinking one end and pulling the forward section around with a rope. The craft is built of lightweight wood (scarce in Spain) and weighs only 187 pounds. The favorite model with Spanish fans is 18½ feet long, 3 feet 4 inches wide and has a mast height of 21½ feet. Its pontoonlike twin hulls have a height of only 1 foot 10 inches. There are 140 square feet of canvas in the sail.

With ropes taut, sailor shows fine balance of the boat. Right, pulling boat around for change of direction is accomplished by hoisting of prow

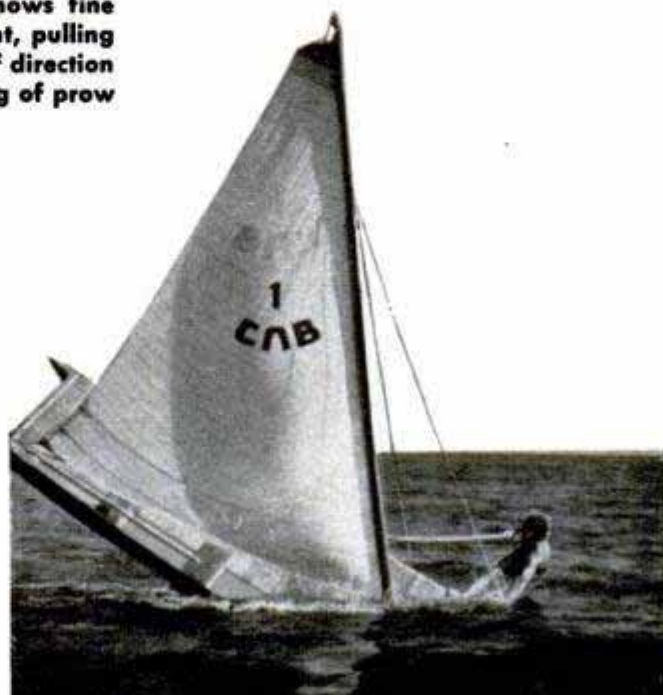
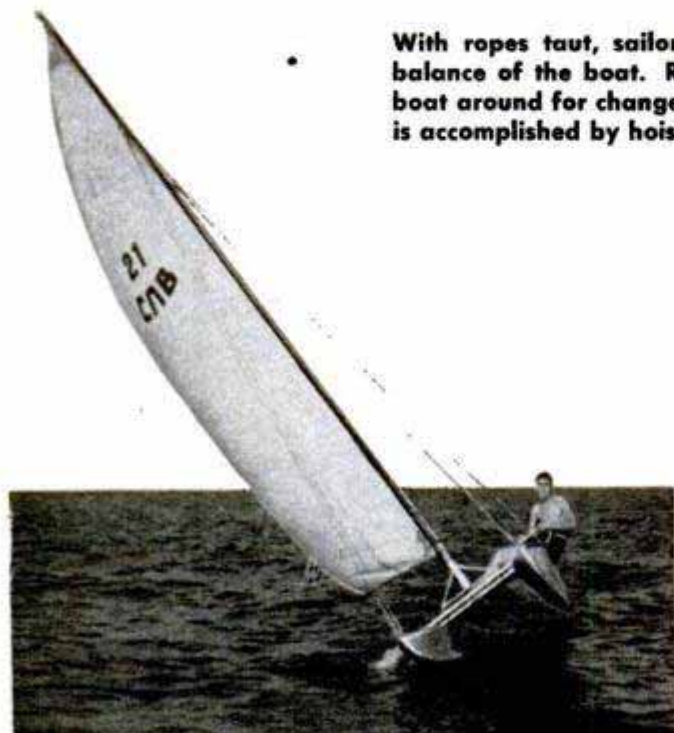

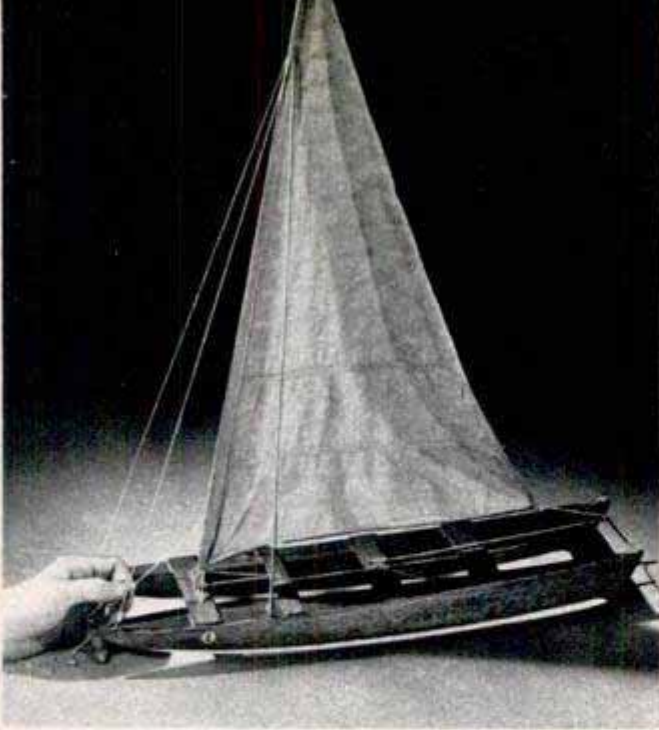

Small model of Spanish catamaran shows the cross-pieces used by catlike sailors to climb over boat



This picture (says its builder) is just to prove that the twin-hulled Spanish racer will sail on even keel



Expert sailor shows that it only takes one hand to maneuver the vessel while it makes a turn on one hull. Below, getting under way for a Mediterranean race under auspices of Spanish Federation of Nautical Clubs

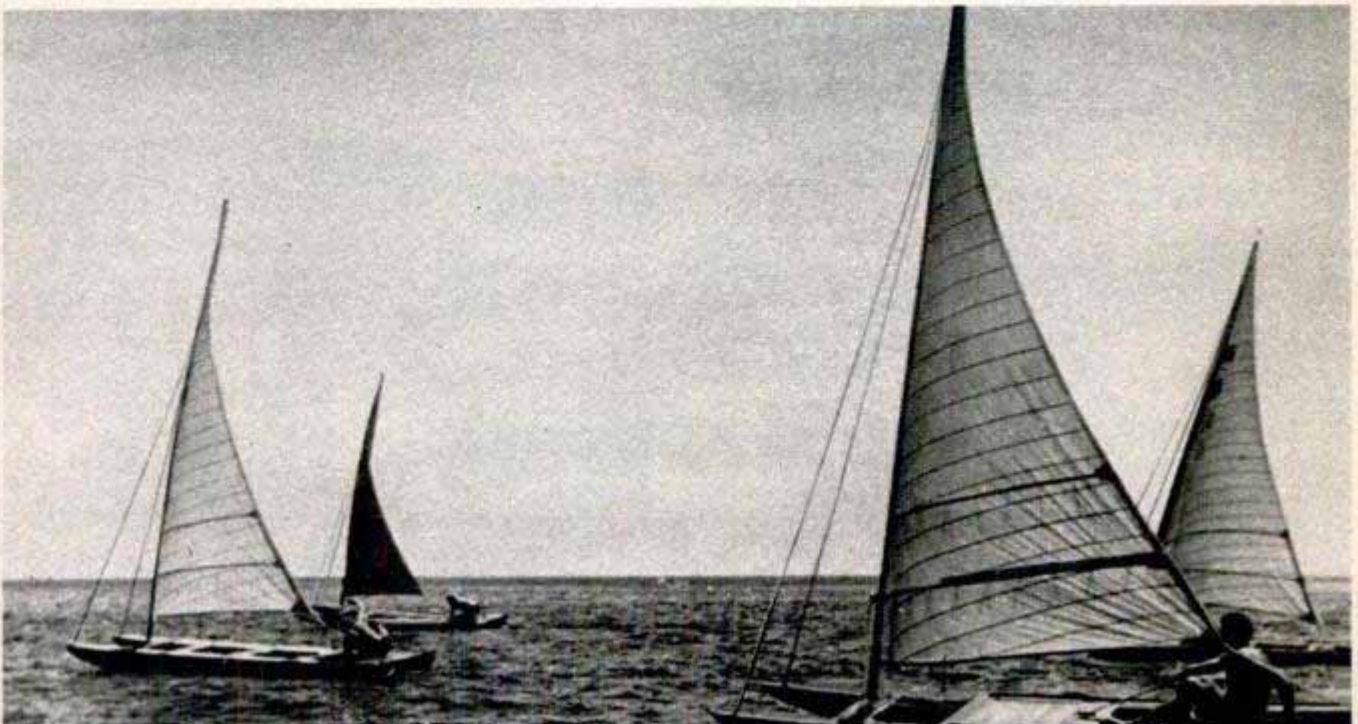

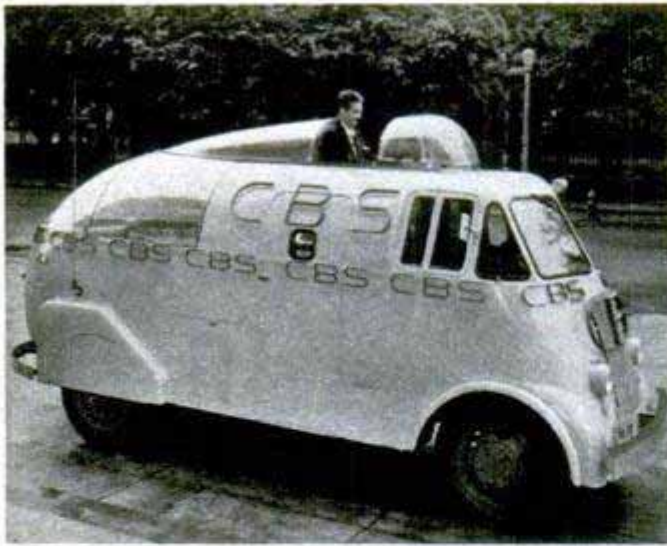

Mobile Broadcasting Booth

Radio reporters and commentators view news events at firsthand from the weather-proof press box built on a truck chassis for the Columbia Broadcasting System. As many as four commentators can broadcast simultaneously from the observation plat-

form at the rear of the truck. The Plexiglas windows provide full vision on three sides. A plastic bubble atop the truck gives full forward vision. The truck has a high-frequency transmitter powered by its own generator. It has a range of 35 miles from the home station and can tie into telephone cables for longer transmission.



"Pigeonhole" Parking Lot

Four times as many cars are parked in a Spokane, Wash., parking lot with a rampless garage in which cars are delivered to parking stalls by elevator. The customer drives up to a receiving stall. A platform reaches out, lifts the car onto the elevator which rolls along a track between the two parking racks. The elevator lifts the car to the desired level and rolls it into the parking stall. The unit parks a car in the most distant stall in 60 seconds!

Stick-On Traction Mats Stop Record Slippage

Warped phonograph records are played without distortion of sound due to slippage when traction mats are applied to the record labels. Provided with an adhesive backing, the mat has a semicircular cut-out to permit reading the label. In addition to keeping the record spinning at the correct speed, the mats also act as cushions to prevent damage and noise when the record is dropped by the changer mechanism.



☐ American household refrigerators are being produced in Brazil for the first time.

Thompson Traction Mat Co., 516 Fifth Ave., New York City 18

POPULAR MECHANICS

HISTORIC HOMES FOR SALE

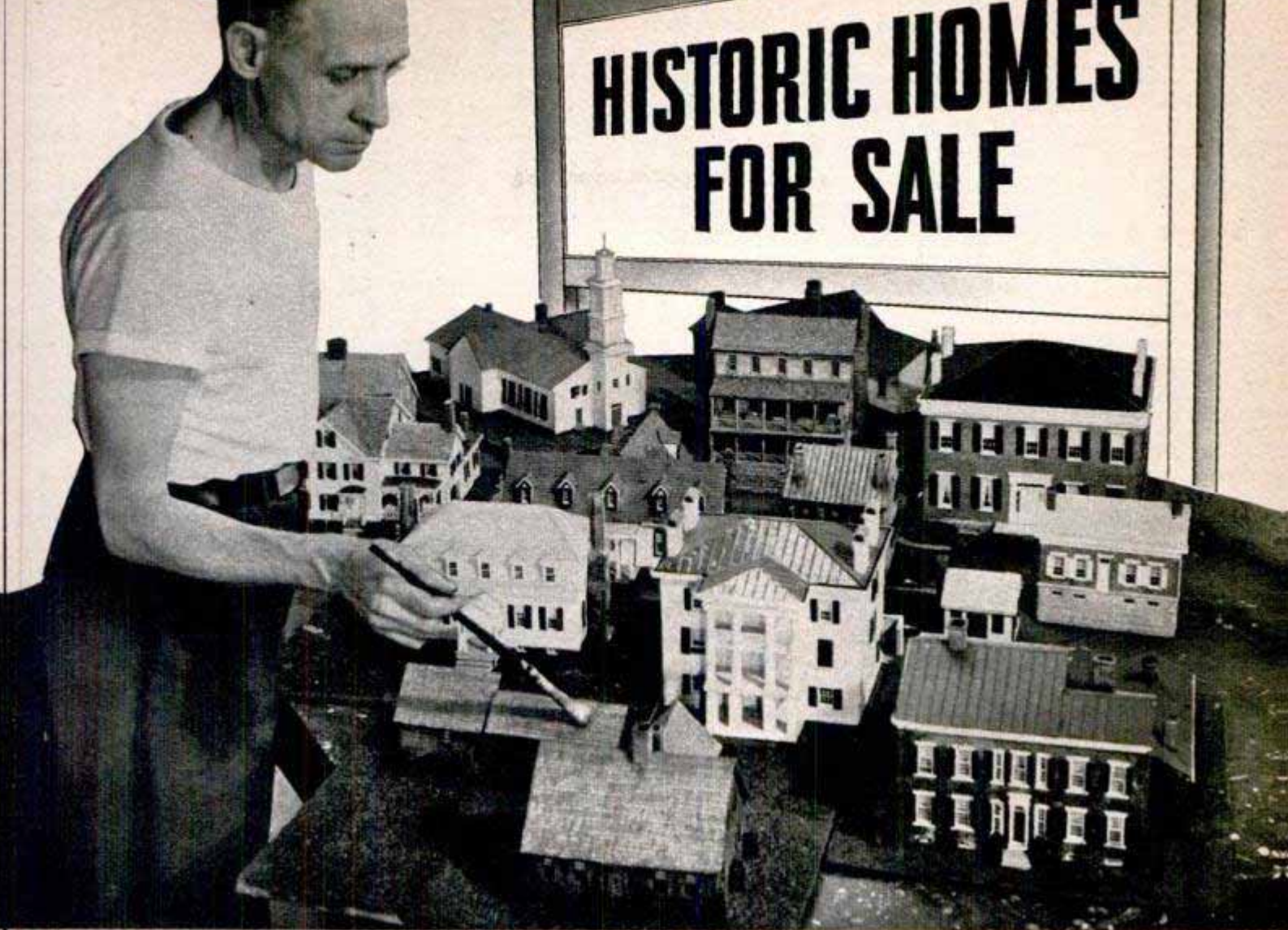

L. L. Tucker photo

Hutton and some of his models. Impressive, four-columned building in center is Woodrow Wilson's birthplace

By Ross L. Holman

EVERYBODY'S BUILDING new houses these days, but Fred Hutton has put a double twist in the house-building business—he builds old houses and builds them right on his workbench! He can do this

because the houses he builds are scale models of historic shrines. Begun as a hobby, this unusual activity has been paying the grocery bills for the Nashville, Tenn., craftsman for many years.

To make his model of Mount Vernon, Hutton measured and photographed every important detail of the original
Howard Bryan photo



Fred didn't intend it that way. But when his baby "Mount Vernons," "Hermitages" and other miniature reproductions became so realistically like the originals as to make other history fans want them, the money he got out of them enabled him to devote his entire time to his hobby.

It usually takes Fred five to eight weeks to complete a single model like Andrew Jackson's Hermitage, Woodrow Wilson's birthplace at Staunton, Va., General Grant's home and others like it. He is such a rabid perfectionist in every detail that his models duplicate the original buildings even down to the weatherbeaten texture of the shingles on the roof or the weatherboarding on the walls.

If he can get blueprints or the building plans for an historic structure, his reproductions come much easier. He is able to secure a few of these from the Library of Congress and other places.

But when he modeled Mount Vernon he found there were no building plans of it in existence. So he made several trips to the George Washington mansion and cased it, down to the last detail. He photographed it from several angles, took exact measurements of every door, window, floor, window blind and dormer in order to reconstruct every part to his scale of $\frac{3}{16}$ inch to the foot. He even measured the lap of the shingles over each other to get the proportionate lap on his model.

It ordinarily takes many thousands of individually placed pieces to construct each model completely. After documenting Mount Vernon thoroughly Fred went back home. Six weeks and 10,000 pieces later he had a miniature likeness of the Washington home with which George himself couldn't have found any fault. Many of his other models have had to be laboriously



worked out in research like Mount Vernon because no building plans were available.

Naturally, assembling a multithousand-piece building in baby size is a whale of a job requiring infinite patience. Among other things, Fred applies each tiny model shingle one at a time. Most of the wooden parts of each historic building such as shingles, weatherboarding and floors are reproduced in the model with artist paper secured from an artist-supply shop. This paper is cut in strips of right width and length for the part to be duplicated. Three or more strips of such paper glued together make a rigid plank, studding, rafters or what have you.



Many of the tools used by Hutton are surgical instruments. He often has to use a magnifying glass in his work

Below, the model-home maker grinds up a brick from the original building and mixes the dust into the paint to give his model the texture of the original

Left, when he has applied the paint and brick-dust mixture to the different parts of the building, he presses a mold into it, making it look like bricks

L. L. Tucker photos

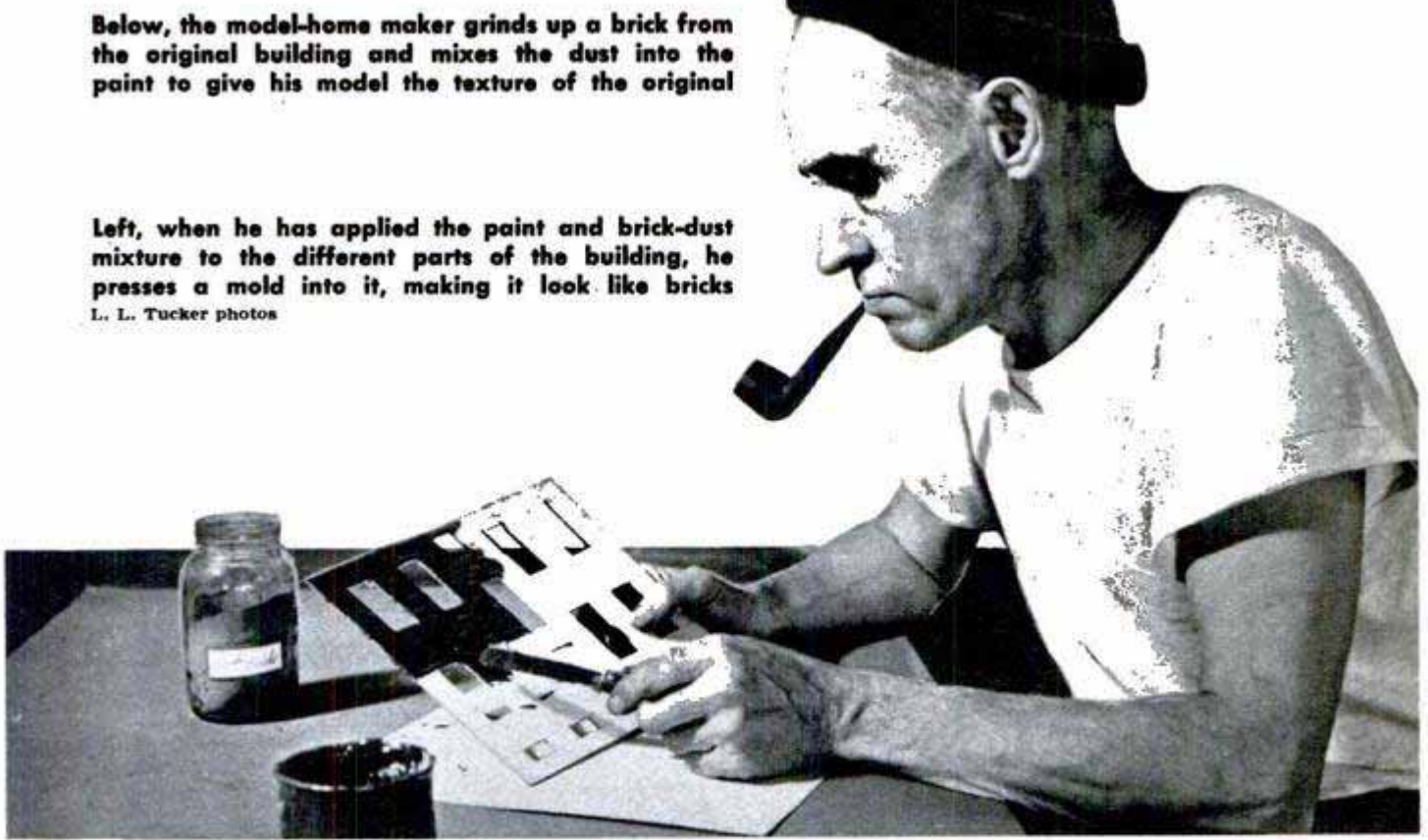

The shingles, however, are cut from a single strip to the tiny scale size.

Fred makes the model roof and covers it with a cardboard sheeting. Then he spreads a thread of glue across the roof to which he sticks his first row of shingles, one at a time. He picks up each shingle with a pointed instrument and sticks it in place on the glue in shingle-row formation. Each succeeding row of shingles is applied in similar manner and it usually requires a little more than a day to shingle an entire model structure. To get the correct weatherbeaten texture on shingles or weatherboarding, Fred

Although most of the work is done by hand, there is need for power tools. Here, he turns a porch column

uses an artist's paint—burnt umber or ocher.

Other materials used in his models are plaster, poster board, white-pine wood and some metals. When he reproduces a brick structure like The Hermitage near Nashville, or My Old Kentucky Home at Bardstown, Ky., he insists on getting the exact brick texture of the original. To do this, he obtains a brick from the original structure, powders it thoroughly and sifts the brick dust through a silk sieve. The sifted powder is mixed with a matching paint and this mixture is spread over the model. While

Naturally, the power saw is small—it has to be to cut the "boards" that are used in model construction

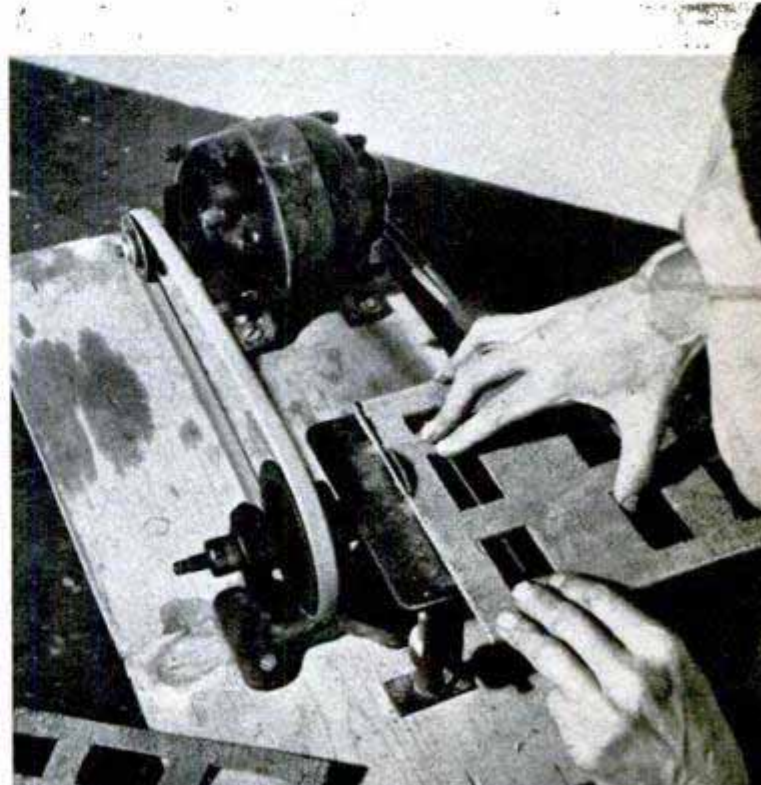
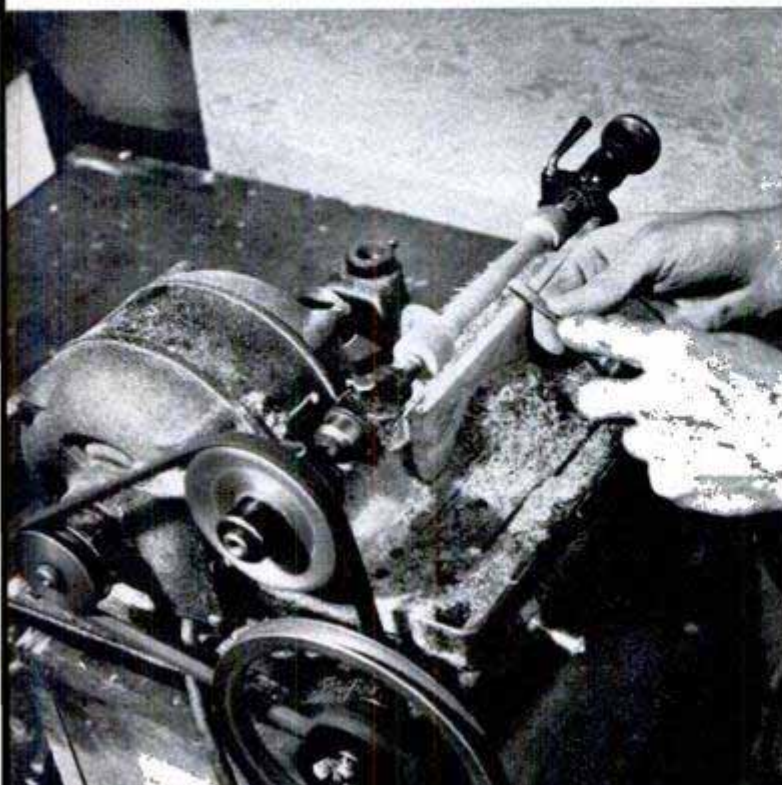

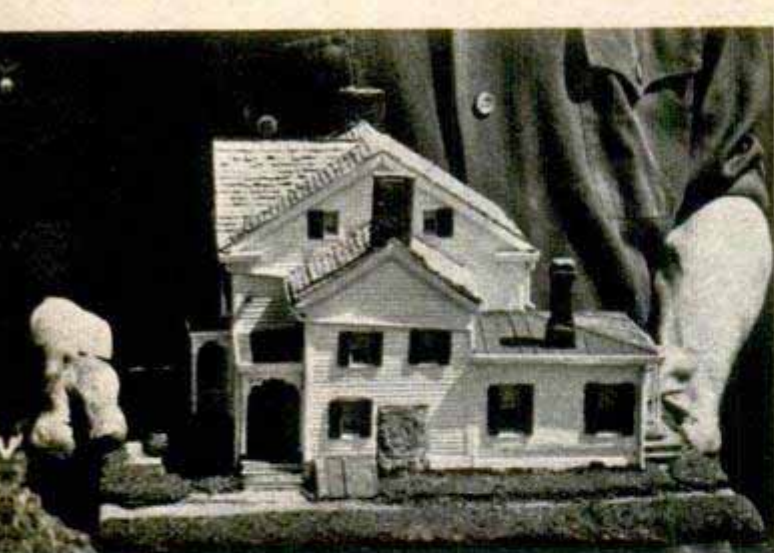

There's a real American look about the model of the house in which President Grover Cleveland was born

this paint is still soft he presses against it a brick-outline mold which leaves the walls with a realistic brick-surface effect.

To shape out the difficult or ornamental parts of a building, Fred uses delicate surgical and dental precision tools. In addition, he has a tiny motor-driven saw to cut out the small wooden pieces. When he got ready to make the porch columns for *The Hermitage*, he made a little jig with which he turned out the 5½-inch pieces. He has tiny vises and other miniature model tools.

The work of cutting out porch railing, ornamental molding and other small pieces is tedious. Some of the parts are so small they have to be tooled under a large magnifying glass. For example, an old-time window blind sized to a ⅜-inch-per-foot scale is small enough in the first place. But when each blind has 15 or 20 different slats to be put in place, one by one, to correspond with

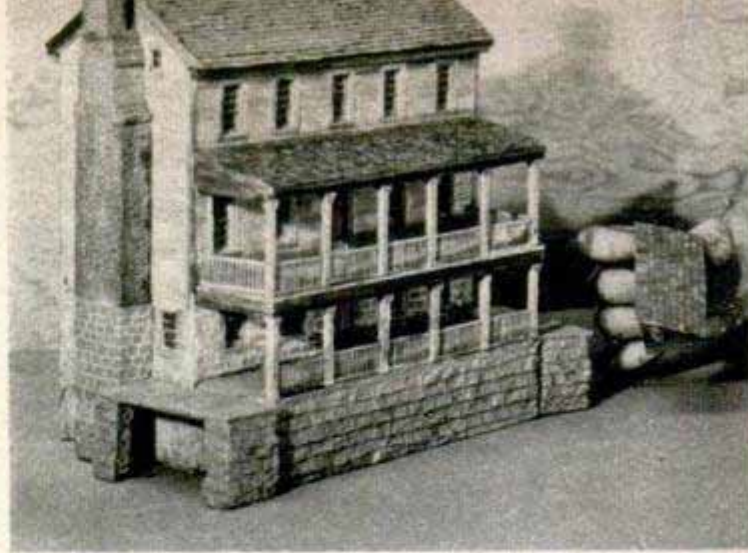

Another example of an architectural style common in early America is Chisholm Tavern, Knoxville, Tenn.

the number and scale-size of the original, it requires the utmost skill and patience.

Fred has in his shop collection a scale model of an old Spanish mission building built by Indian labor in Solvang, Calif., in the 18th century. The walls of the original are five feet thick. But the feature that created the biggest problem was reconstructing the mission's clay-tile roof of varicolored tiles. He solved this by using split soda straws painted in the same hues of browns, reds and greens as in the original. These were cut into the tiny model-tile lengths and put into place on the roof. Soda straws are also used for guttering on many models.

In his collection are scale models of antebellum and colonial homes that date back almost to the time when a man by the name of Columbus discovered there was something west of Europe besides ocean water.

Even the shrubbery and landscaping look real around *The Hermitage*, home of Andrew Jackson near Nashville
John Lipscomb photo

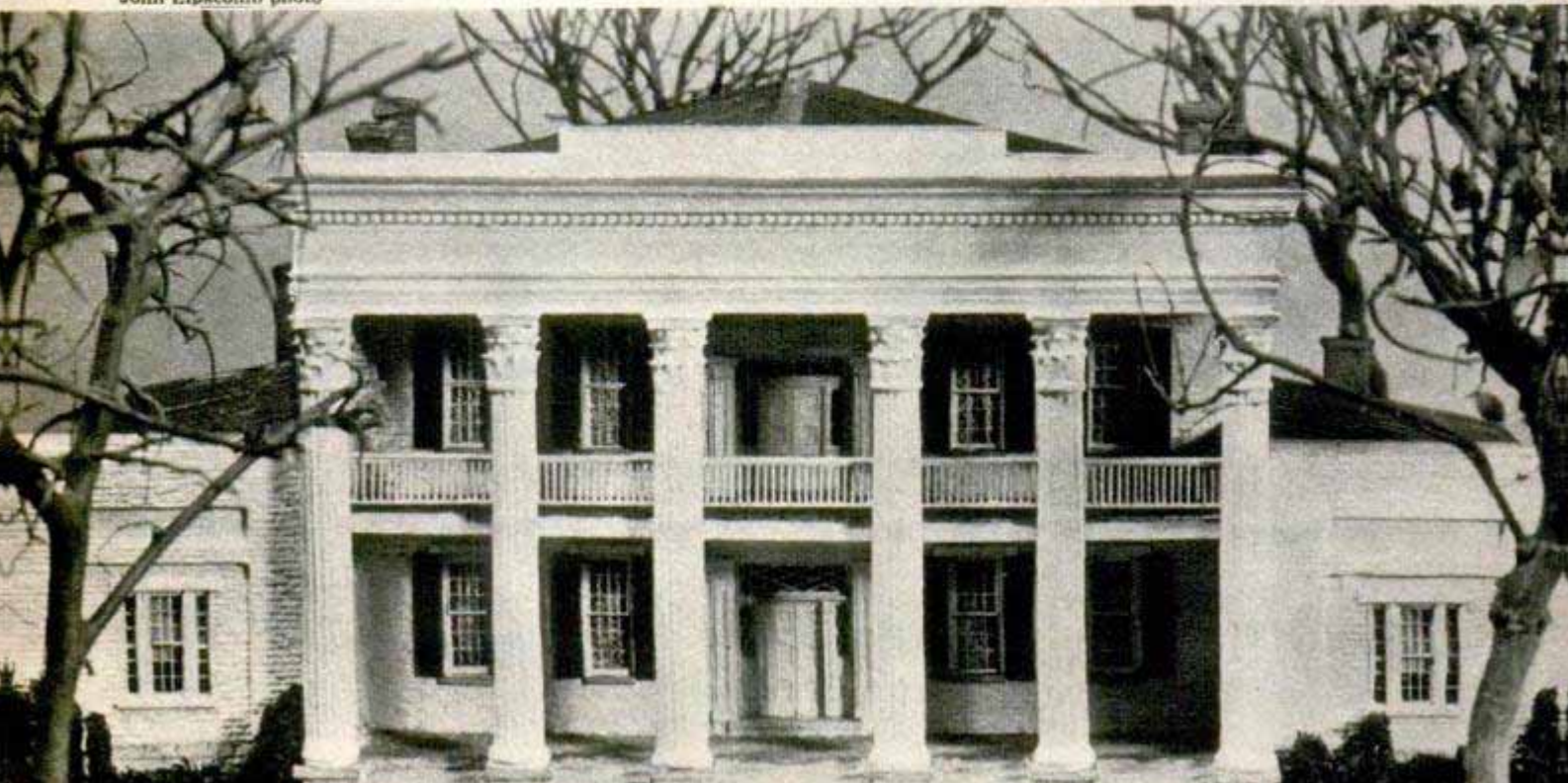

Among the reproductions are Uncle Sam's Plantation Home at Convent, La., Woodlawn Plantation, St. Charles Parish, La., and Crosskeys Tavern between Shelbyville and Louisville, Ky. These three structures were destroyed years ago and Hutton's scale models were made from the building plans. Another destroyed historic building of which he made a model is the James K. Polk home at Nashville. Still other reproductions are Edison's birthplace, the house at Greenbush, Mass., that inspired "The Old Oaken Bucket," the home in which U. S. Grant was living when he was called to command the Union troops in the Civil War, the house at Appomattox, Va., in which Lee surrendered, the Mary Washington home in Fredericksburg, Va., the house at Yorktown, Pa., in which Cornwallis surrendered to Washington, and the St. John's church at Richmond in which Patrick Henry uttered his immortal "Liberty or Death" sentiments. The models are fastened to a wooden base and some even have reproductions of the shrubbery, which is accomplished with pieces of sponge dyed a foliage green.

Fred's insistence on exacting similarity has aroused the admiration of the history minded world. A former executive of the New York World's Fair said no exhibit at the fair approached the intricate detail of Hutton's work. This perfectionist concern has created an outside demand for his models he didn't anticipate. Right now he is creating miniature model exhibits for the Tennessee Historic Association and other historic societies. He is making other model exhibits for the Children's Museum at Nashville. The National Council of Churches of Christ in America gave him an order for three buildings symbolizing the

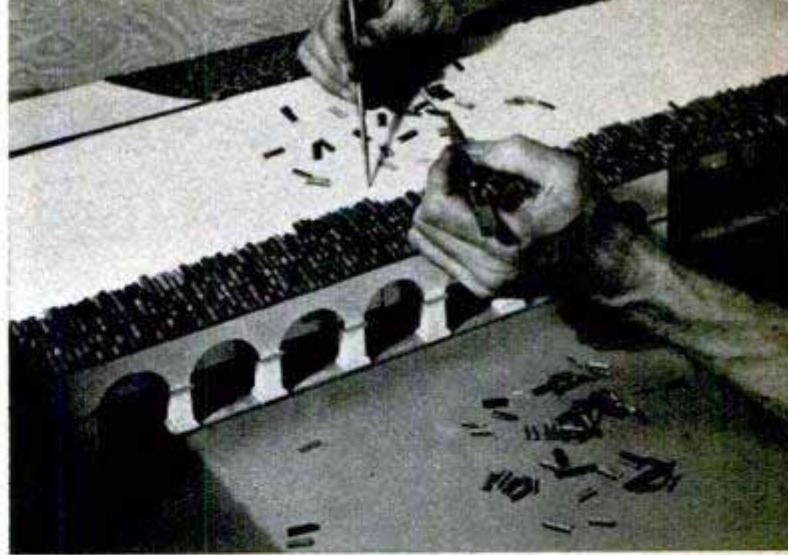

Patience is needed here! Hutton cuts up soda straws and glues them down individually to form a tile roof

tie-in between church, school and home. The Memphis Home-Builders' Association, made up of Memphis building-supply dealers, is paying him handsomely to display at its annual exhibit a number of old homes and churches. Contractors and building-trade interests are dickering with him for historic re-creations.

Recently, he has taken up the study of sculpture and is now shaping out men, horses and other animal life contemporary with the architecture he is reproducing. In the back of his head is a plan to reproduce in models enough old-time buildings to show every change of architecture in the nation's history. Since different sections of the country have had architectural designs that differ from each other, he would like to have scale-model reproductions of at least three shrines in every one of the 48 states.

A lot of work? Of course, but that won't bother Hutton. It's a hobby with him—a hobby that pays the grocery bill.

One of Hutton's best is the pre-Civil War home in Memphis. Each detail is realistic, including the bricks in the walls
L. L. Tucker photos

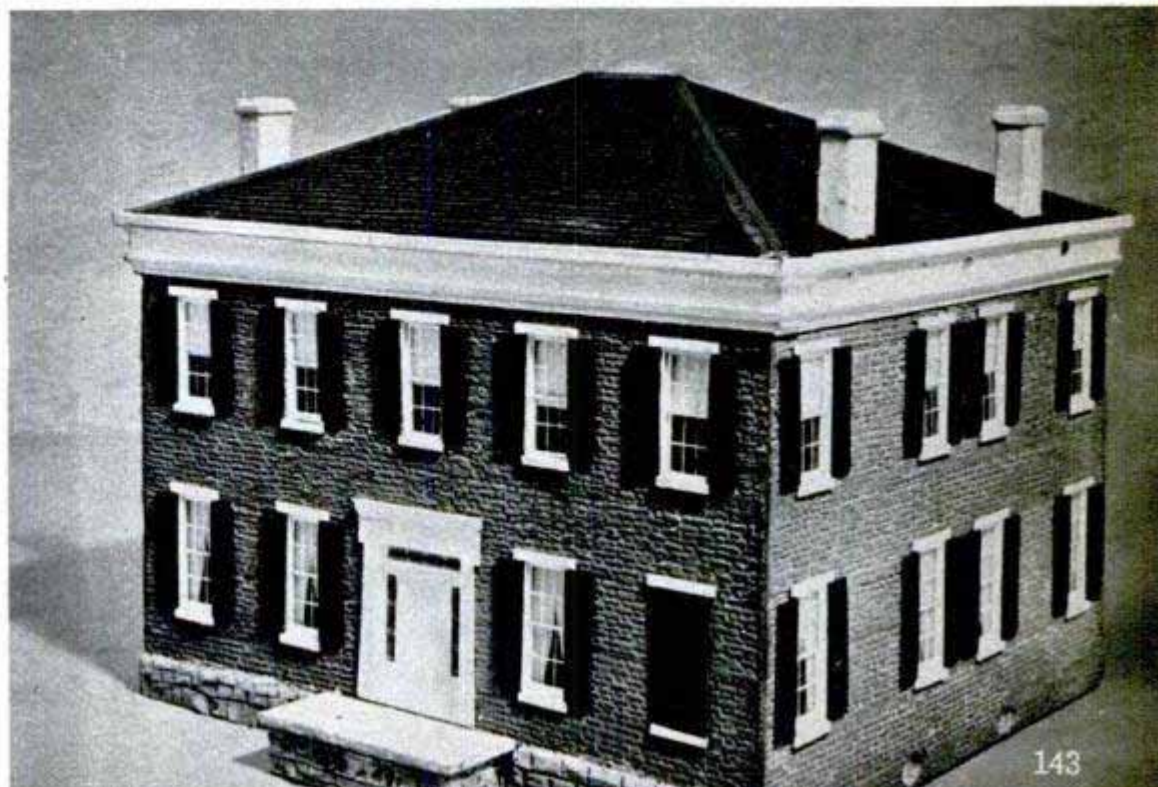

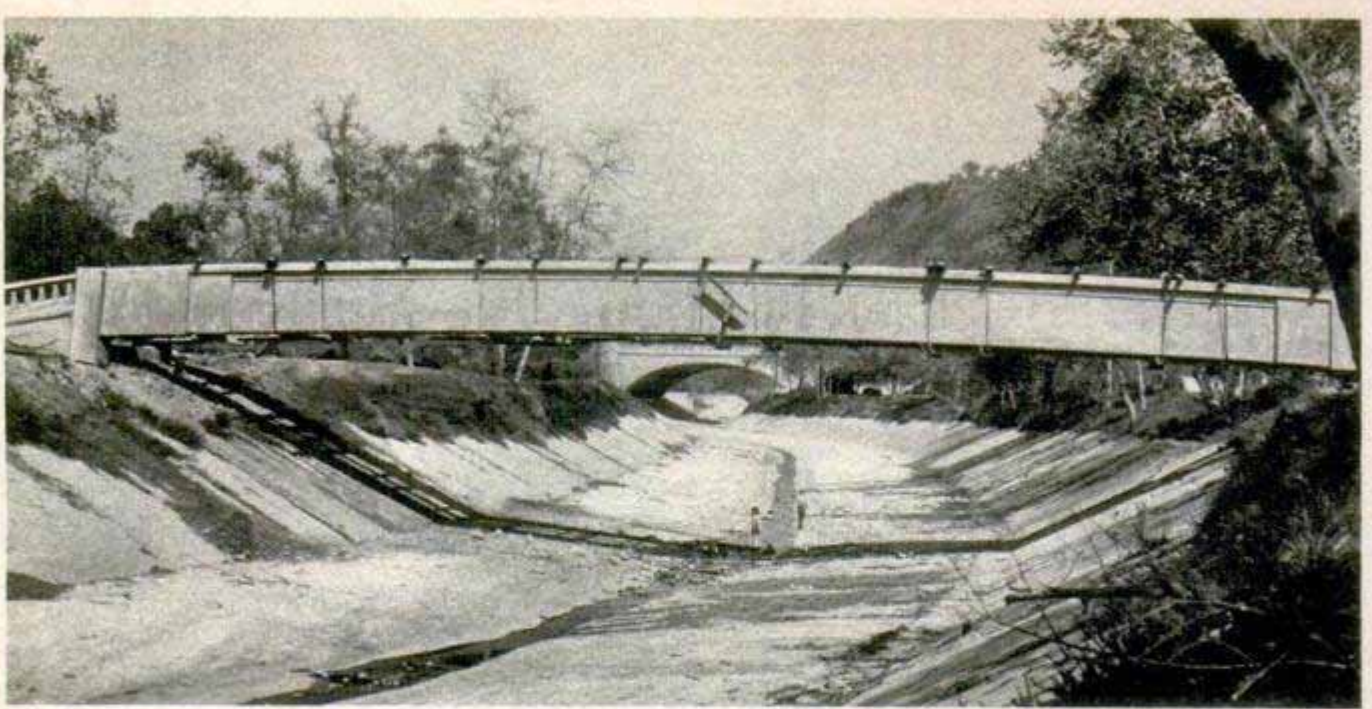

Taut wires inside girders strengthen bridge in the same way a row of books can be lifted by pressing on ends

Cranes pick up graceful girder and swing it into place. Wires have been installed and placed under tension

PRESTRESSED CONCRETE FOOTBRIDGE

Spanning a channel in Los Angeles is a graceful little footbridge, built with a new construction technique applicable to larger structures. During construction, steel wires were pulled taut through holes in each hardened concrete girder. The wires strengthen the bridge by holding it under tension.

Concrete cap conceals wires anchored at end of girder. Method may be applied to larger buildings

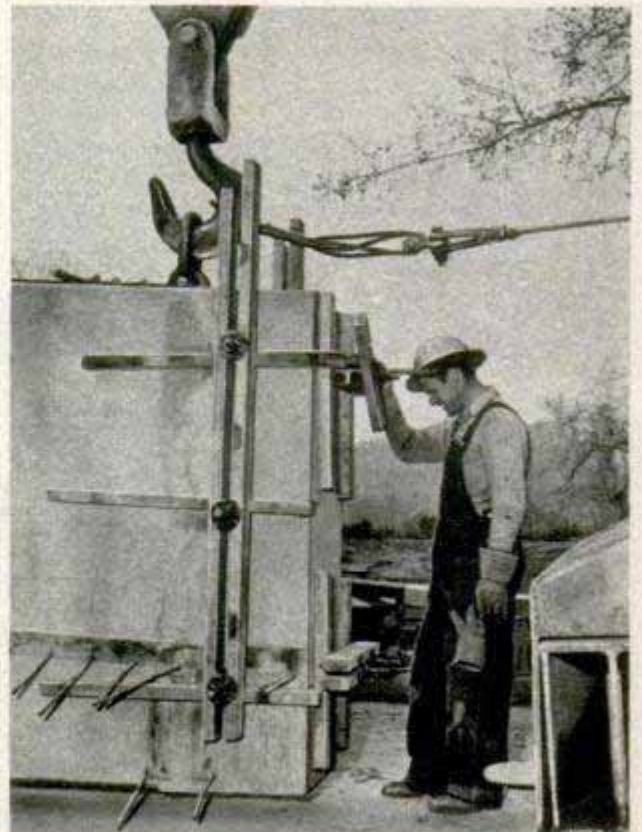

the

POPULAR
MECHANICS

CRAFTSMAN

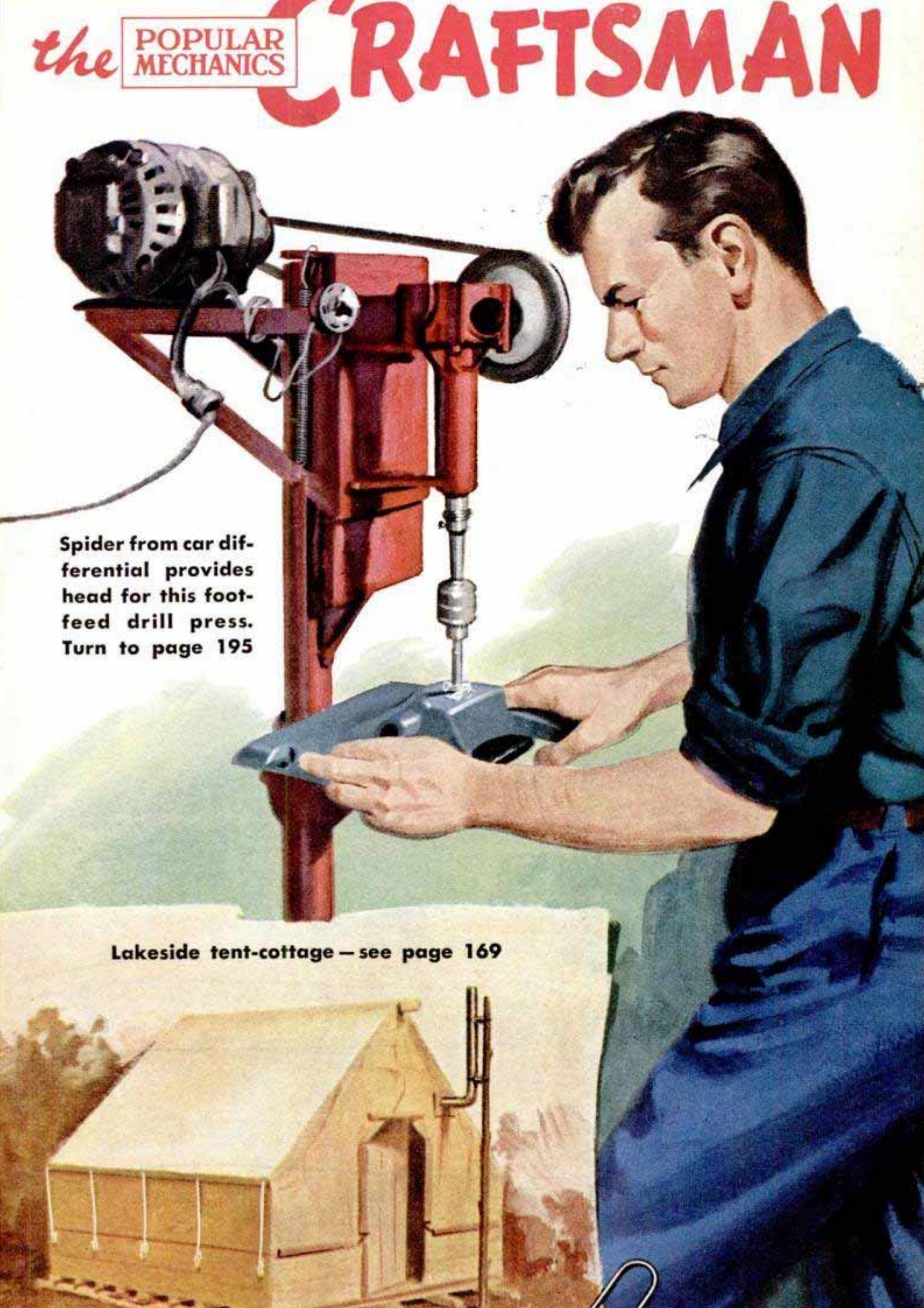

Spider from car differential provides head for this foot-feed drill press. Turn to page 195

Lakeside tent-cottage — see page 169





Money-Making

PM color photos by Paul T. Hutchinson

If it's spare-time income you are after, producing colorful novelties from paper plates and preserving mementos in liquid plastics are two good home enterprises that will set you up in business. Small outlay and inexpensive materials make business prosper with low overhead

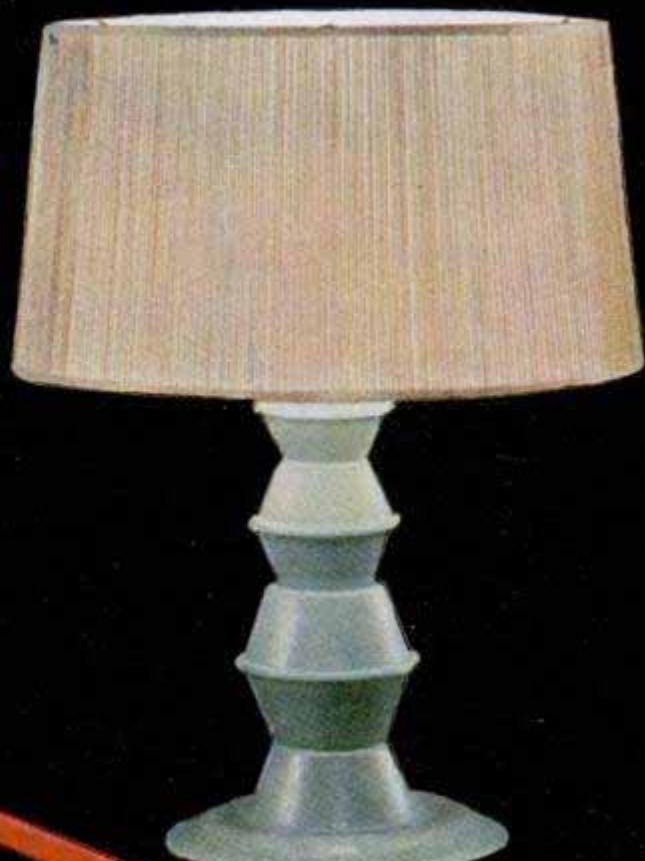

PROJECTS

FEW HAVE LOOKED upon the common paper plate as worth-while craft material, but Albert Belanger of Alton, Ill., an expert in craftwork development, has applied his ingenuity to transform these lowly picnic items into attractive and useful articles, some of which are pictured on the opposite page. Stiffened by gluing together several thicknesses and then painting, the molded-paper plates make novel, durable projects that are practically as solid as if they were made of wood. The items shown at the left and detailed on page 149 should serve to get you started in this profitable hobby and offer suggestions for other good sellers of your own design. Possibilities are limited only by your imagination and ingenuity and you'll be surprised at the number of different projects that can be made by combining plates and cups of varying sizes and shapes.

Some of the projects shown can be made from paper plates of the kind sold in dime stores. Others require standard cups and shapes that can be ordered from manufacturers of fiber products. There are two types of molded-paper products, one being rather porous, while the other is fairly hard. Usually, two thicknesses of the hard type are sufficient to give the desired stiffness. The porous variety requires as many as three or four layers. The new plastic-type glues have been found to give best results, and the work should be clamped or, at least, weighted to keep the work flat and straight while the glue dries. Before the paper is painted, all rough places are sanded smooth. One prime coat of lacquer,

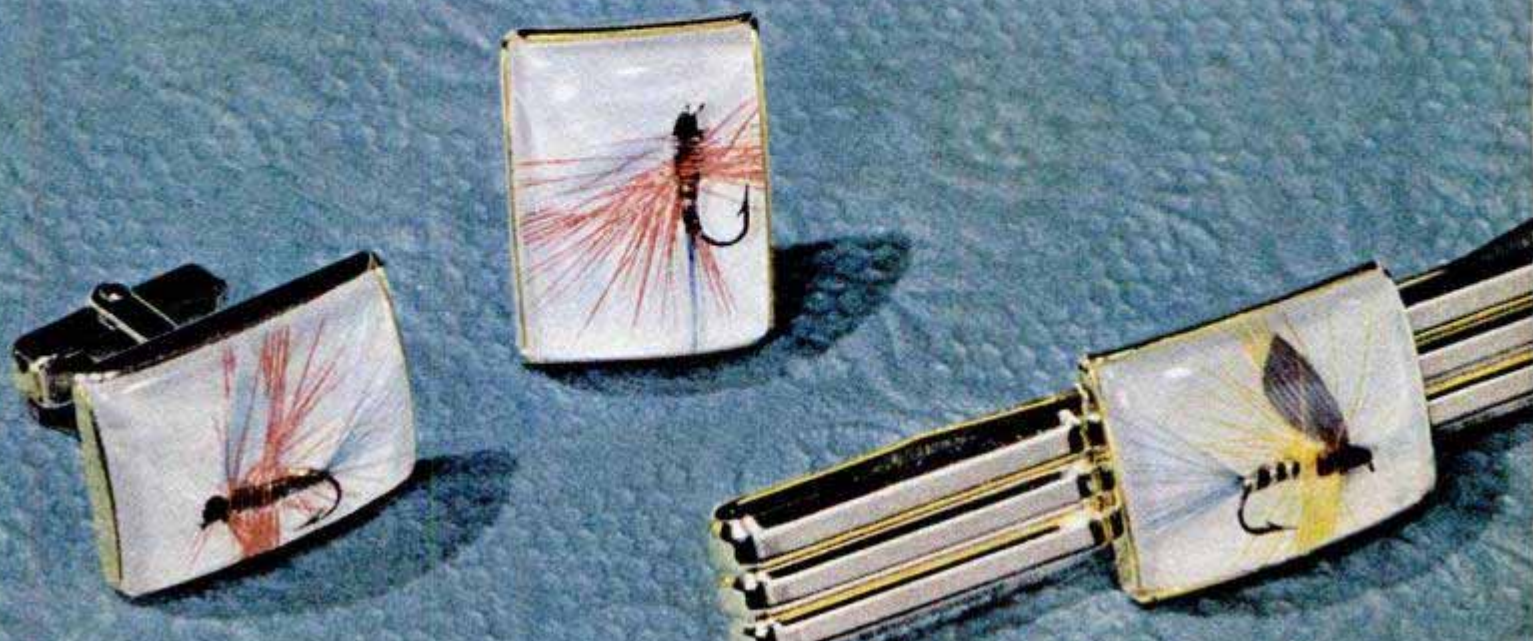
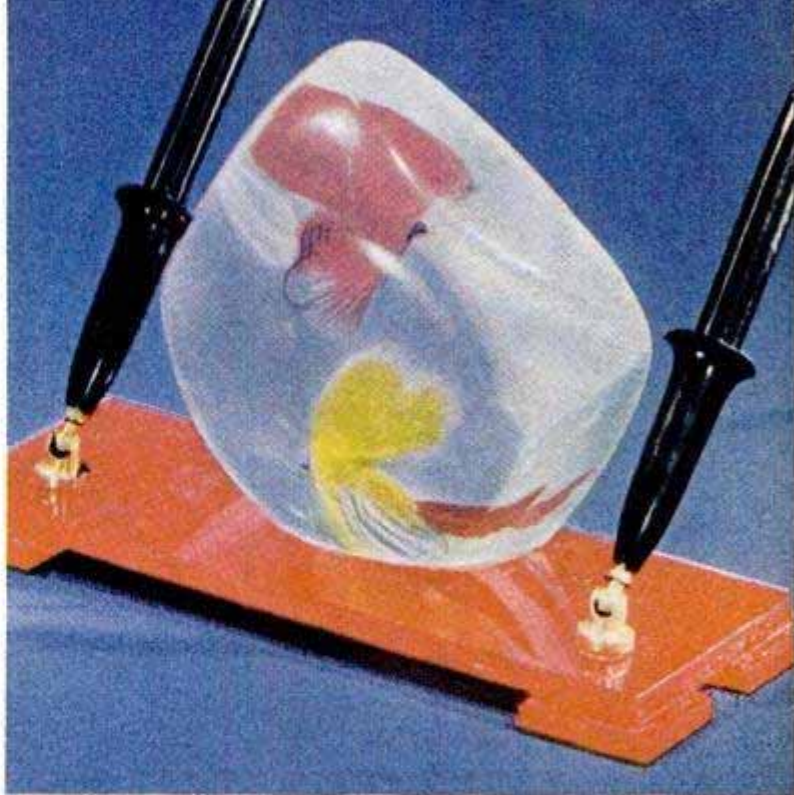

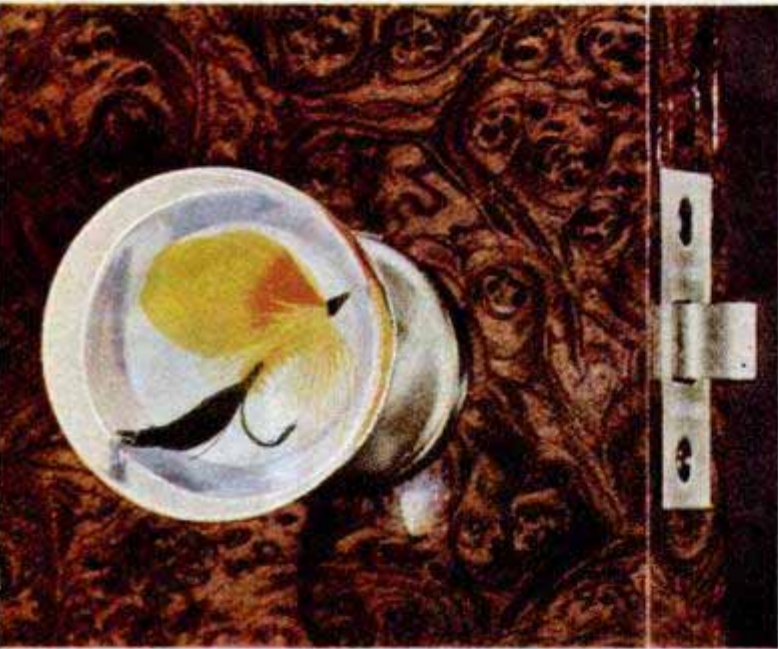

followed by an enamel undercoater and a final coat of enamel, gives a satisfactory finish. The drawings on the facing page, which are self-explanatory, show how most of the sample projects are made. Note how the fixture pipe in the lamp base is centered in the ends of each section with a wooden disk and supported with wooden spacer blocks, which are inserted inside the sections before the latter are glued together. The body of the toy wagon is made of four tray-shaped containers of the type in which meat is sold, while the wheels are built up from molded-paper hot pads.

The second money-making idea consists of preserving mementos and keepsakes by casting them in liquid plastics. Like the bronzing of baby shoes, this hobby offers real opportunities for extra cash, as nearly everyone is a potential customer. For example, a fresh flower from a bride's bouquet or other memorable occasion can be

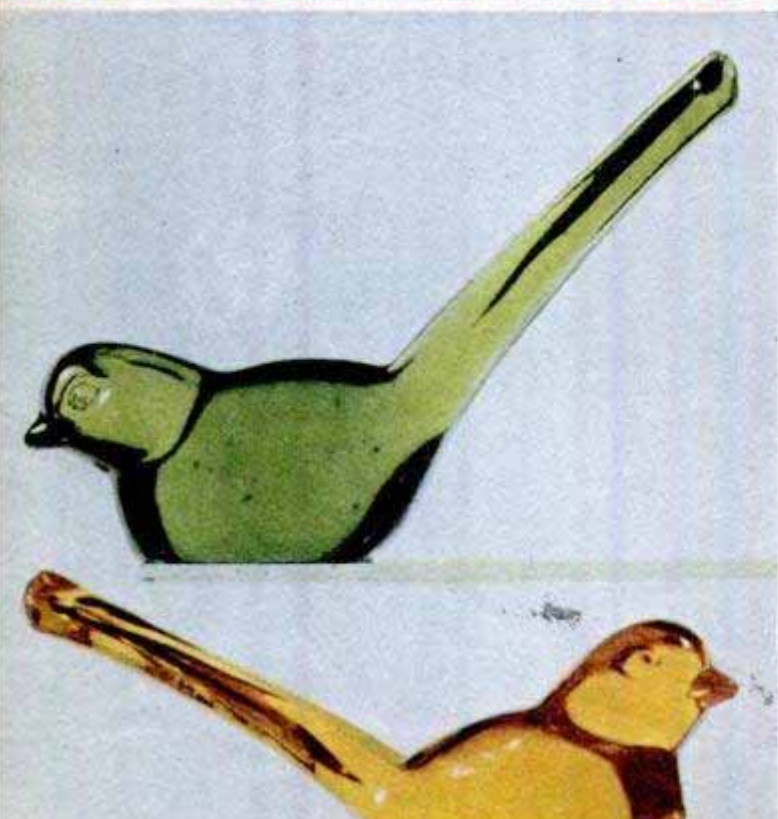

Chinese Temp Base

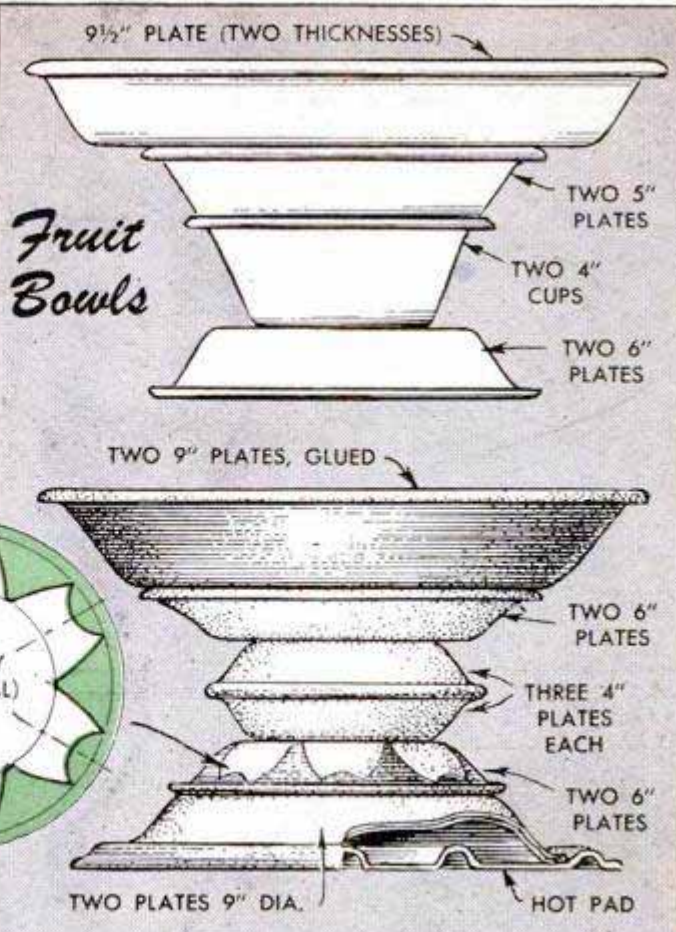
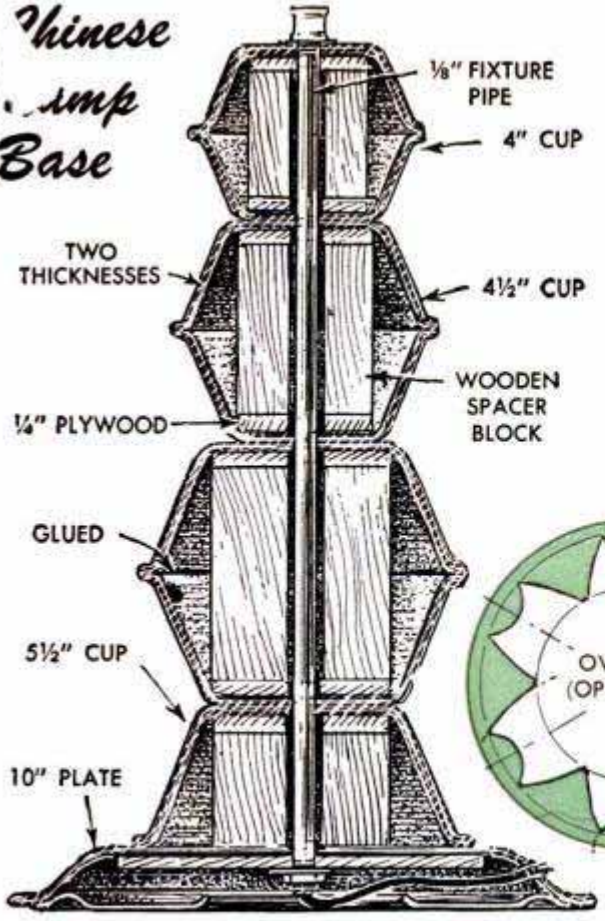
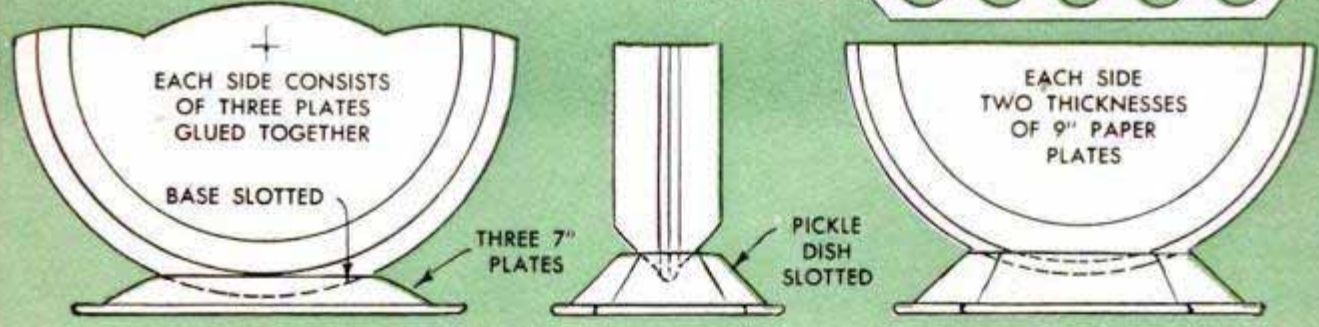
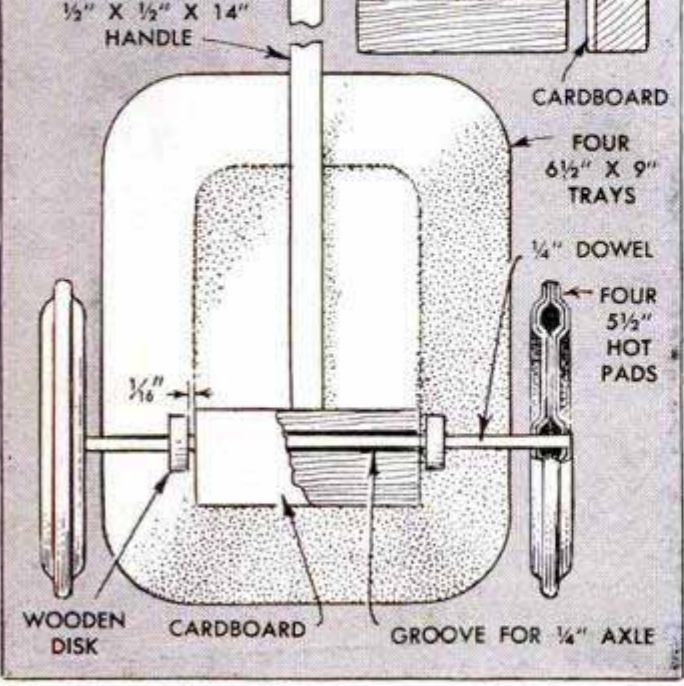

Table Centerpieces



Toy Wagon



Serving Tray

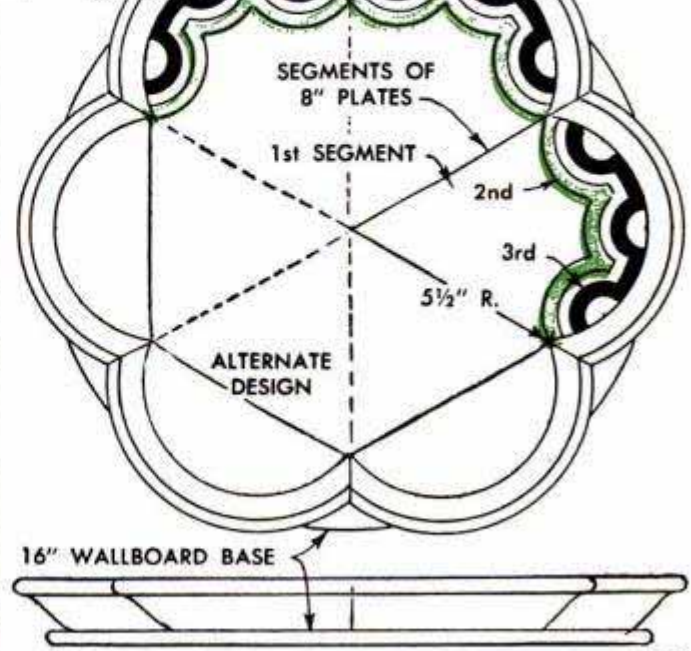

CASTING WITH LIQUID PLASTIC



1st
POUR $\frac{2}{3}$ OF ESTIMATED
AMOUNT OF PLASTIC RE-
QUIRED INTO GLASS CUP



2nd
ADD FEW DROPS OF
CATALYST (HARDENER)
AND STIR 1 MIN.



3rd
POUR MIXTURE INTO
MOLD AND ALLOW TO
STAND UNTIL IT JELLS



4th
PLACE OBJECT TO BE
EMBEDDED ON TOP OF
THE JELLED PLASTIC



5th
FILL REMAINDER OF MOLD
WITH LIQUID PLASTIC AND
LET STAND UNTIL FIRM

6th
PLACE IN OVEN FOR
30 MIN. AT 150° F.



7th
INVERT MOLD AND GIVE
SHARP RAP ON TABLE TO
REMOVE THE CASTING

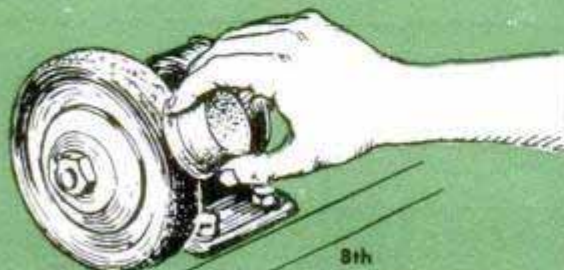

8th
SAND FACE OF CAST-
ING FLAT AND BUFF
ON WHEEL CHARGED
WITH JEWELERS' ROUGE

encased in a plastic paperweight to become a daily reminder. And, what mother wouldn't be thrilled to have baby's first photo or a lock of hair preserved? Rare coins, lodge emblems and prized medals are other items that can be set in plastic for safekeeping. Unlike pressing a flower, embedding a blossom in plastic preserves its coloring and makes it look as if it were suspended, thus retaining its third-dimensional quality. The examples pictured are only a few of the many possibilities. The little night lamp, shown at the top of page 148, transmits light from below through the edge of a cast-plastic upright to illuminate an embedded floral spray. The doorknob pictured on the same page is a unique example of how the door to a trophy room or den can be fitted with a knob in which a colorful bass fly has been embedded.

As its name implies, liquid casting plastic comes ready prepared in liquid form and is poured cold. Until recently, the art of casting the transparent plastics was limited to such common molds as dishes, glasses, cups, ash trays, etc., as the material could not be cast satisfactorily in rubber molds. Now, thanks to the Plasticast Company, makers of liquid casting plastics, a wide selection of inexpensive glass-lined molds is available to the hobbyist. In these, the plastics can be cast in a variety of forms, such as doorknobs, coasters, cabinet knobs, wall-switch plates, picture frames, etc.

The basic steps in casting liquid plastics are illustrated at the left, and take you through the steps of making a doorknob. Obviously, if you are not embedding an object, for example the birds shown on page 148, the mold can be filled in one operation, thus eliminating steps four and five. Occasionally, it is desirable to make two-color castings. In this case, the second portion of the plastic can be colored by adding a few drops of dye, using either a transparent dye or one that is somewhat opaque to produce a background for the embedded object. Unless the top surface of the casting is to be exposed, such as the doorknob, the casting requires no additional finishing, when removed from the glass-lined mold, as the highly polished surfaces already possess the appearance of glass. However, if the top of the casting is to be exposed, the surface can be easily sanded off flat and buffed to match the rest of the polished surfaces, as shown in step eight. The finished knob is finally cemented to a tapered plastic base piece which is drilled and fitted with a setscrew for attaching it to the lock. When earrings, lapel buttons and other pieces of costume jewelry are cast, the plastics can be easily drilled for attaching eyelets, clips, etc. In fact, the material can be worked much the same as hardwood.

Semipneumatic Barrow Wheels Utilized as Fenders on Boat Dock

Boatmen who wish to equip their docks with fenders that will prevent damage to their boats when docking, will find two or three barrow wheels excellent for the purpose. The wheels are provided with long bolts to act as axles, which extend through holes bored vertically in the stringer of the dock. Hung in this manner, clearance is left below the stringer so that the wheels will turn.

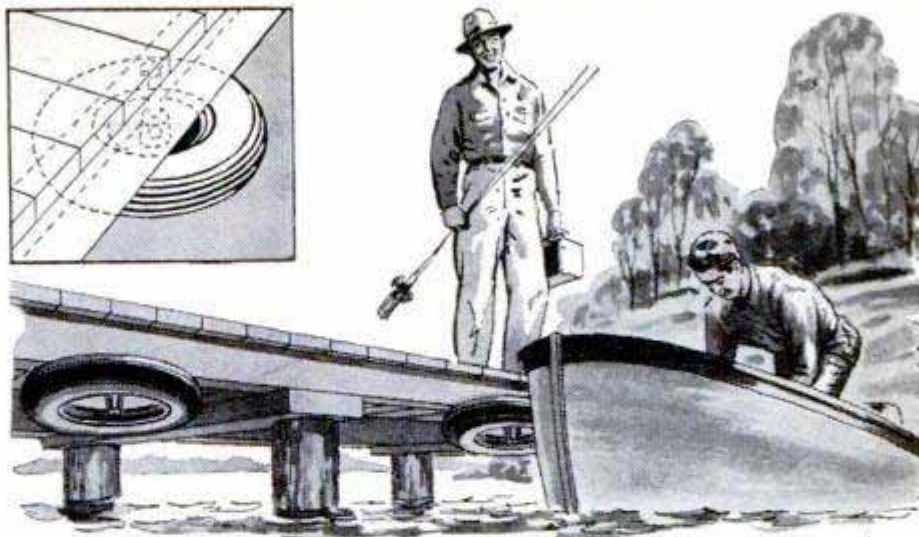

Build This "Fly In" Feeding Station for Your Feathered Friends

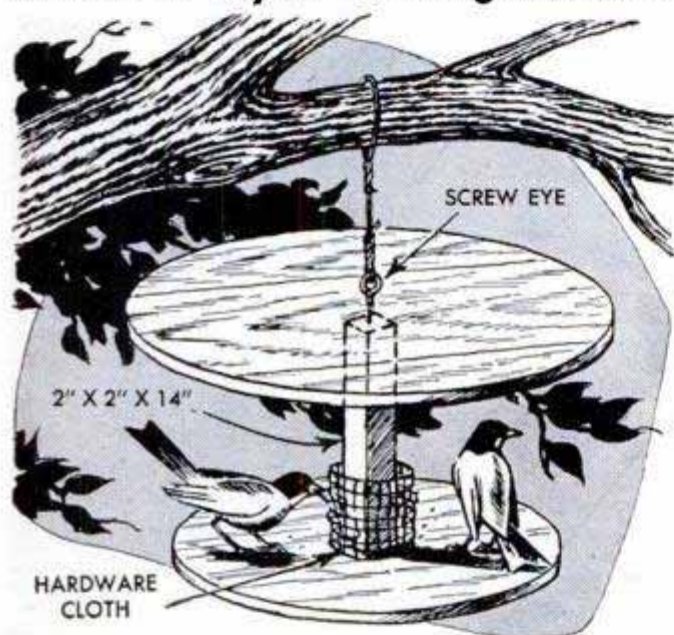

Here is a suitable feeding station for birds which can be made quickly and easily from scrap materials. The wooden bottom and top are built up from odd pieces and screwed to the ends of a 14-in. length of 2 x 2-in. stock. A screw eye, which is turned into the center of the top disk, is threaded with a length of wire to provide a means of hanging the feeding station. A piece of hardware cloth, wrapped loosely around the center post, serves as a holder for suet or other food.—L. G. Gibson, Oakton, Va.

Sleeve Gauges Depth of Hole

When using an electric drill, there is often need of some method to control the depth of the hole being drilled. A wooden stop for this purpose was devised by one man who wanted to drill holes in the windshield pillar of his car without damaging the electric wires located therein. A short, 1 x 1-in. wooden block was drilled through the center lengthwise and then cut to a length about $\frac{1}{4}$ in. shorter than the portion of the drill exposed from the drill chuck. Slipped over the drill, the block acted as a stop between the face of the work and the drill chuck to limit the depth of the hole.

Cork Disks Form Fishhook Guards

To guard against possible injury from treble hooks carried loosely in the tackle box, one fisherman uses a cork disk, which is notched on one side, to slip over the shank of the hooks. The points are embedded in the cork. For small treble hooks the cork disk in a beverage-bottle cap is just the right size.

For larger units, cut the disks from $\frac{1}{8}$ -in. sheet cork or from large cork stoppers of the type used in gallon jugs.

William B. Eagan, Louisville, Ky.

☐ The next time you prune thorny bushes, use a spring-type clothespin to grasp the cut branch and discard it, thus protecting your hands from painful scratches.

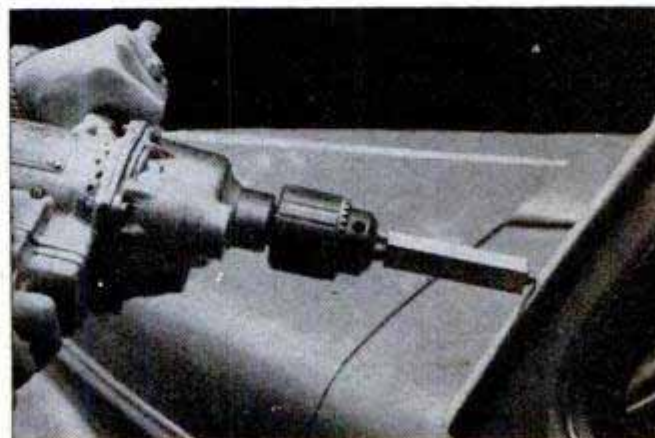

Novel Home-Window Beautifier Is Roller-Type Fabric Shade



A unique way to gain a pleasing effect in the windows of your home is by replacing the window-shade material with a colorful fabric. The expense is small. Perhaps some material left over from recently made draperies can be used, in which case each shade will match the draperies exactly. To convert a shade, first remove the old material from the shade, leaving it intact so that it can be used as a pattern for cutting the fabric. Cut the fabric a little oversized to allow room for a hem at each edge. The hem at the bottom should be large enough to permit inserting the wooden slat from the old shade. Attach the fabric to the roller with small tacks and transfer the pull cord.

Ervin L. Strayhorn, Beebe, Ark.

Trellis Legs Kept From Rotting By Inserting in Steel Pipe

When the legs of garden trellises are embedded in the ground without protection, they will rot in a comparatively short time, making it necessary to repair or replace

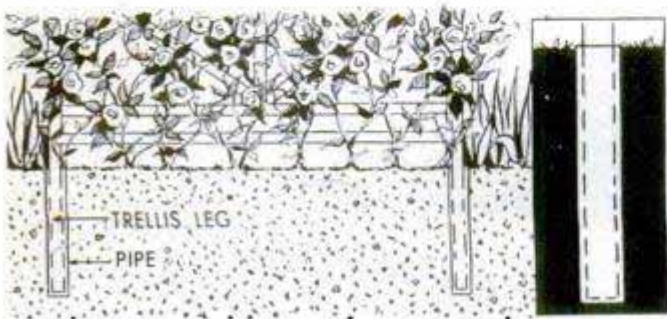

them. To prevent this deterioration, cover the portions of the legs that will be below ground level with a roofing tar or other waterproofing compound, and insert the legs into lengths of steel pipe before setting them in the ground.

J. Rosenberg, New York City.

Greasing Cap on Insulated Jug Helps Prevent Sticking

Instead of fretting and straining to remove the screw cap from an insulated jug the next time you are on a picnic or other outing, spread a little fresh lard or salad oil on the threads before the cap is put in place. It will then come off easily. However, don't forget to wash the cap because the lard or oil may become rancid before the jug is used again.

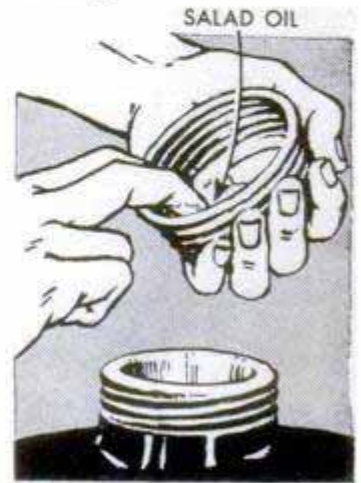

Paul Will, Chicago.

A Primer for Asbestos Shingles

Paint can be made to spread evenly on asbestos shingles if they are first primed with a mixture of spar varnish, 1 part, to exterior primer, 4 parts. Mix the solution thoroughly before using. Be sure to use no more than one part varnish. Otherwise, the result will be a surface too glossy to provide a good bond for the finish paint.

D. B. Owens, Toledo, Ohio.

Minimizing Tile Breakage

Truckers, or others who handle sewer or well tile, will find that breakage can be minimized by slipping a section cut from an inner tube over the ends of each tile section. Easily put on and removed, the "rubber bands" act as insulators for the tile at points that are most likely to be chipped.

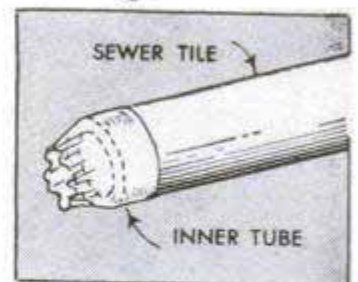

Tubing Held Without Flattening

A short length of copper tubing can be held for sawing, without danger of being crushed, by chucking one end of the tubing in an auger brace. The brace is then clamped in a vise.

"Bench Build"

POPULAR
MECHANICS

RANCH HOUSE

EDITOR'S NOTE: Now that Tom Riley has told you how he devoted his full time to building the P.M. Ranch House, this concluding article explains how the same house can be erected in a minimum of spare time by prefabricating most of it indoors during winter days in readiness for spring

Part IV

By Tom Riley

TIME, more than any other factor, is probably the most critical "item" facing the man who attempts to build a home himself. Discounting the time lost due to bad weather, the man who spends every free moment, week ends, plus vacation time, does exceptionally well if he gets his home under cover during the normal building season. Realizing that those who can devote their full time to building a home are comparatively few, the Craft Editors of *Popular Mechanics* suggested to John J. Whelan, noted architect who designed the P.M. Ranch House, that he keep the week-end carpenter in mind when planning the home. Accordingly, he designed the home so that a good part of it could be prefabricated indoors during winter months to help save precious time on the building site. Starting out with a floor plan of 4-ft. interior module, architect Whelan adapted it to his famous "bench build" system of construction which has had wide use on the West Coast and in

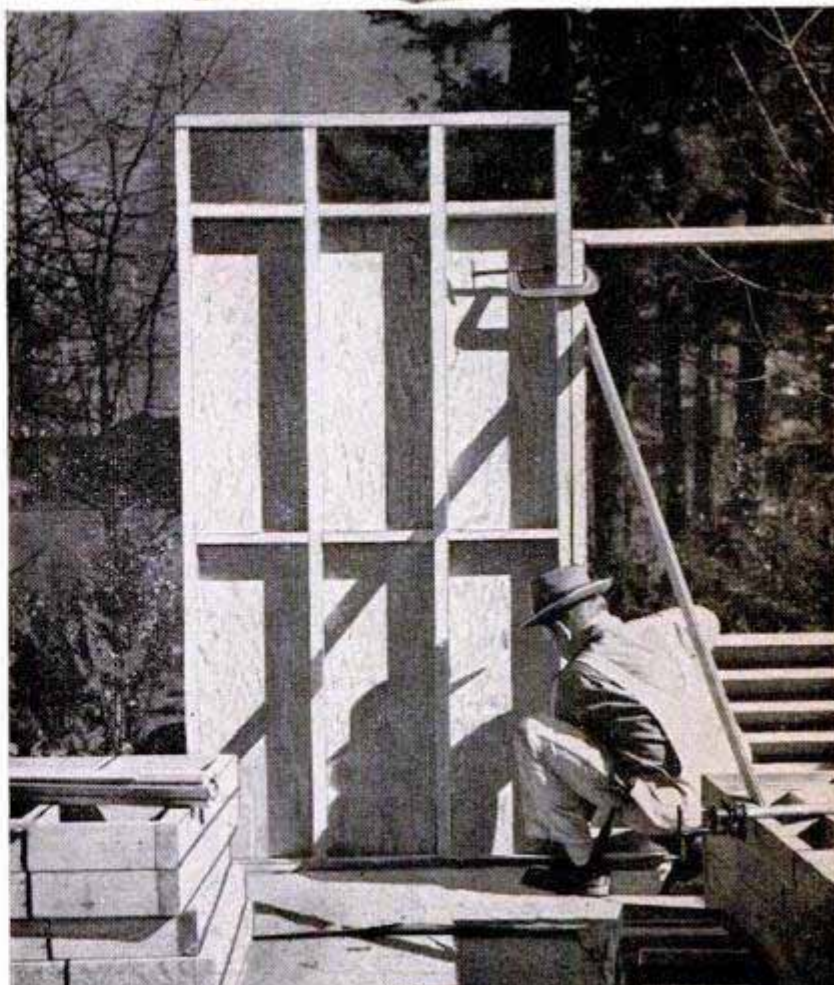
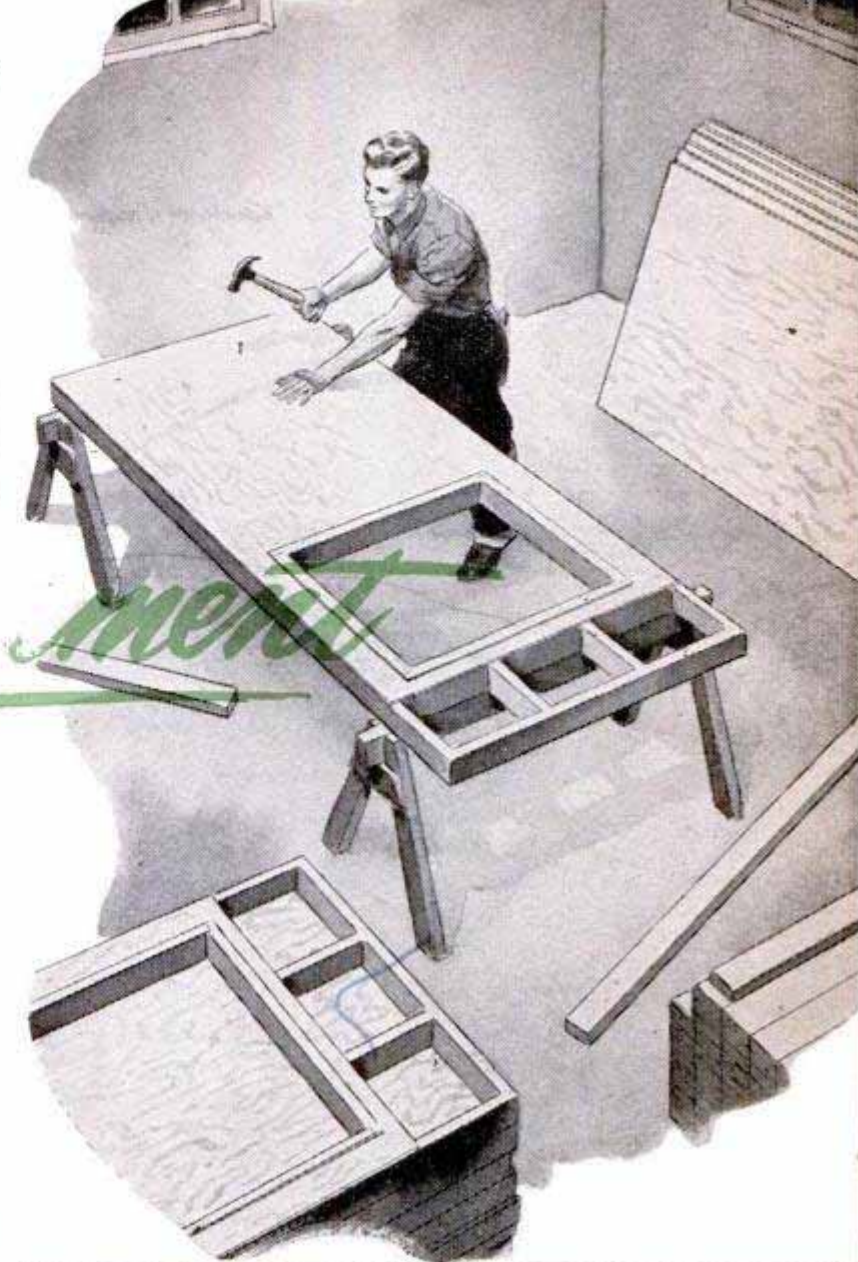
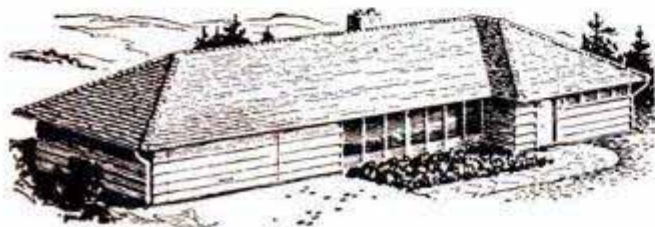

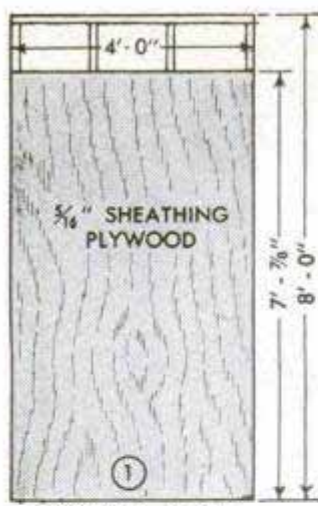

EXTERIOR — SOLID PANEL



BEDROOM-WINDOW PANEL

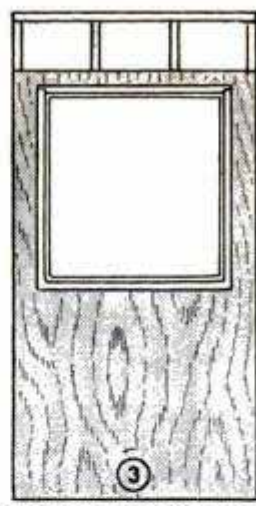

KITCHEN-UTILITY-GARAGE WINDOW PANEL

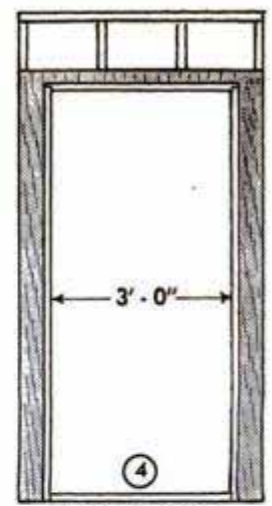

FRONT-DOOR PANEL

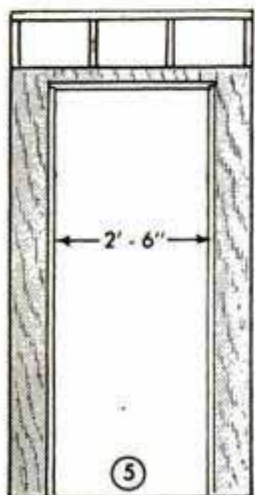

REAR-DOOR PANEL



FRONT SIDE OF SOLID PANEL

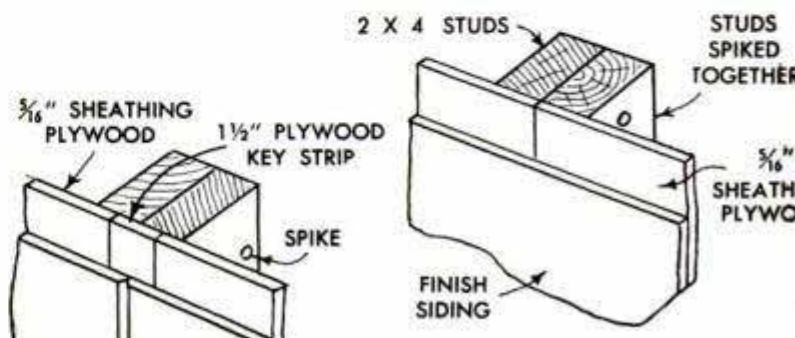

Two methods of joining sections. When both sheathed and sided, key strip between sections seals joint to make it both weather tight and secure

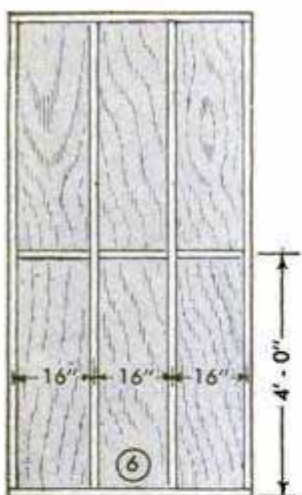

REAR SIDE OF — SOLID PANEL

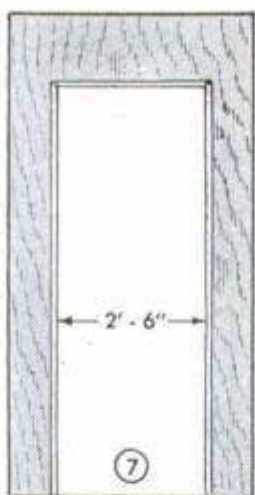

DOOR PANEL, 4' WIDE

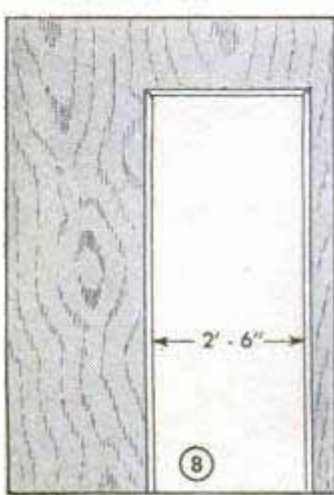

5'-6" DOOR PANEL

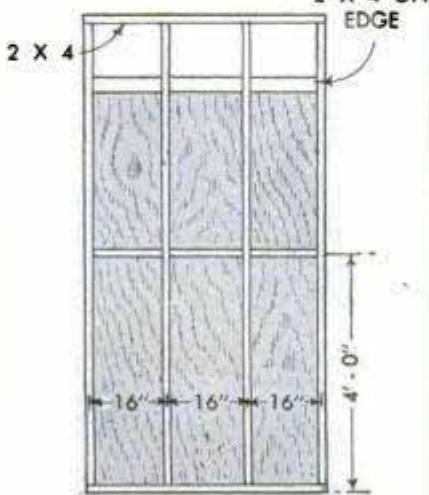

REAR SIDE OF SOLID EXTERIOR PANEL

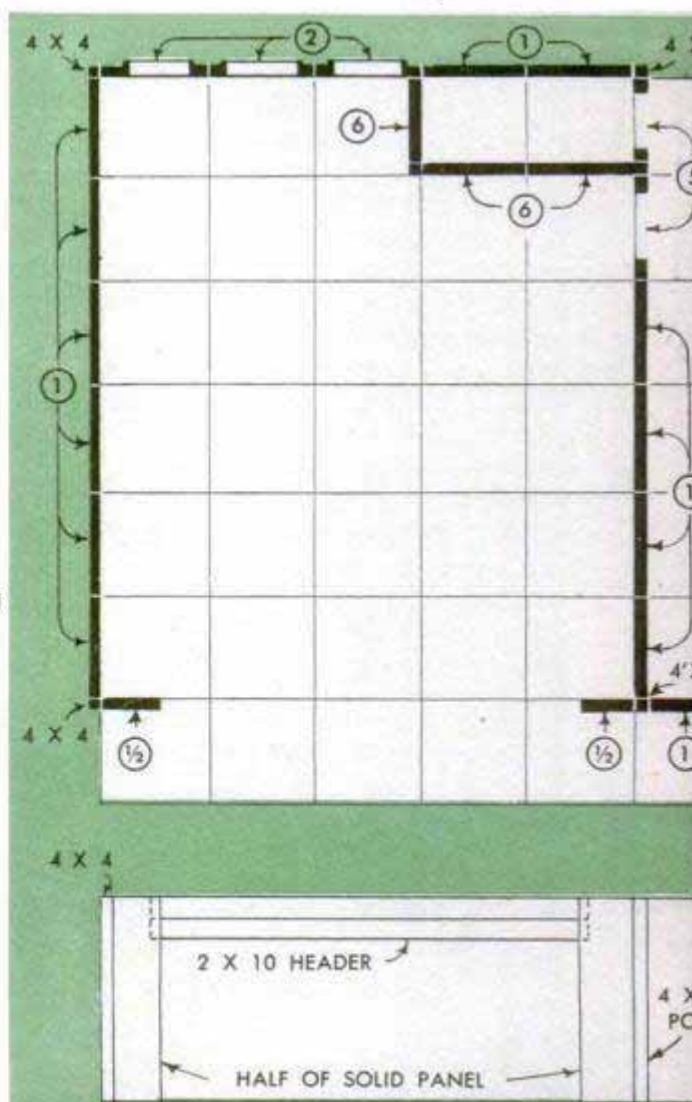

Alaska. Making use of standard 4 x 8-ft. sheets of plywood, both interior and exterior walls are prefabricated in individual 4-ft. sections, standardized in size and shape to permit them to be mass-produced with common tools in the basement or garage. The sections can be merely sheathed, which is sufficient to enclose the house, or they can be completely finished with siding and door or window frames. Thus, during the winter, all the wall sections can be assembled and the roof trusses put together and then stored until spring. With this much of your house ready-built, early spring week ends can be devoted to pouring the foundation and laying the subfloor in the same way as described in Part I. Then, your summer vacation can be spent in setting the wall sections and roof trusses in place and completing the finished roof. In this way, you'll have your home fully enclosed and protected before cold weather arrives. Only 69 wall sections are required, including garage and breezeway, and these can be stored in a single-car garage or outdoors along with the roof trusses until ready for use. If limited space does not permit assembling the long roof trusses at home, at least the various parts can be pre-cut and assembled later at the site. Renting a small trailer will solve the problem of transporting the sections to your lot or

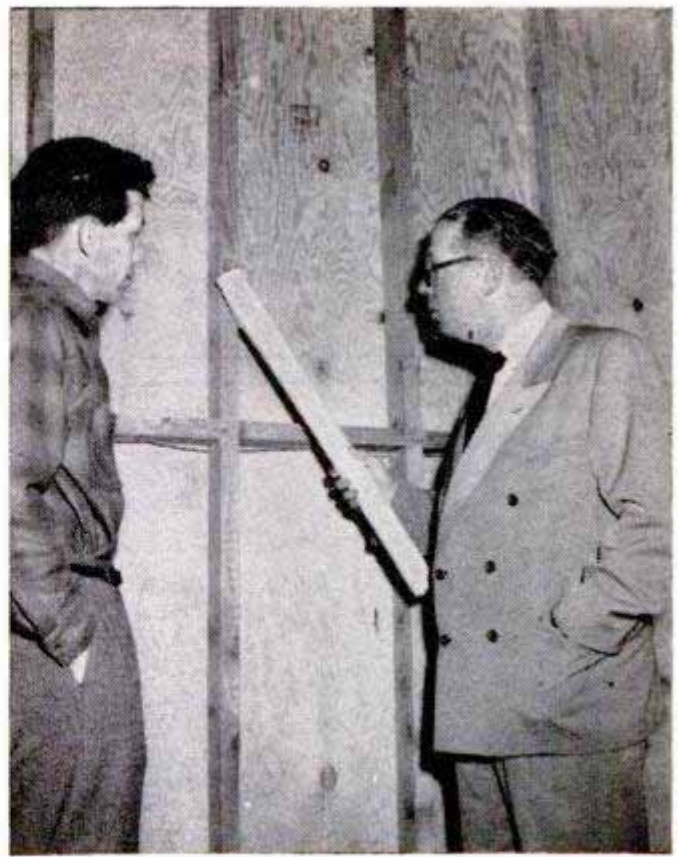

Here, architect Whelan who fathered the bench-built prefab system, points out to Tom Riley how walls of his ranch house could be easily built up of individual sections, preassembled before trucking to the building site to save construction time on the job. Permits getting house under cover in minimum of time

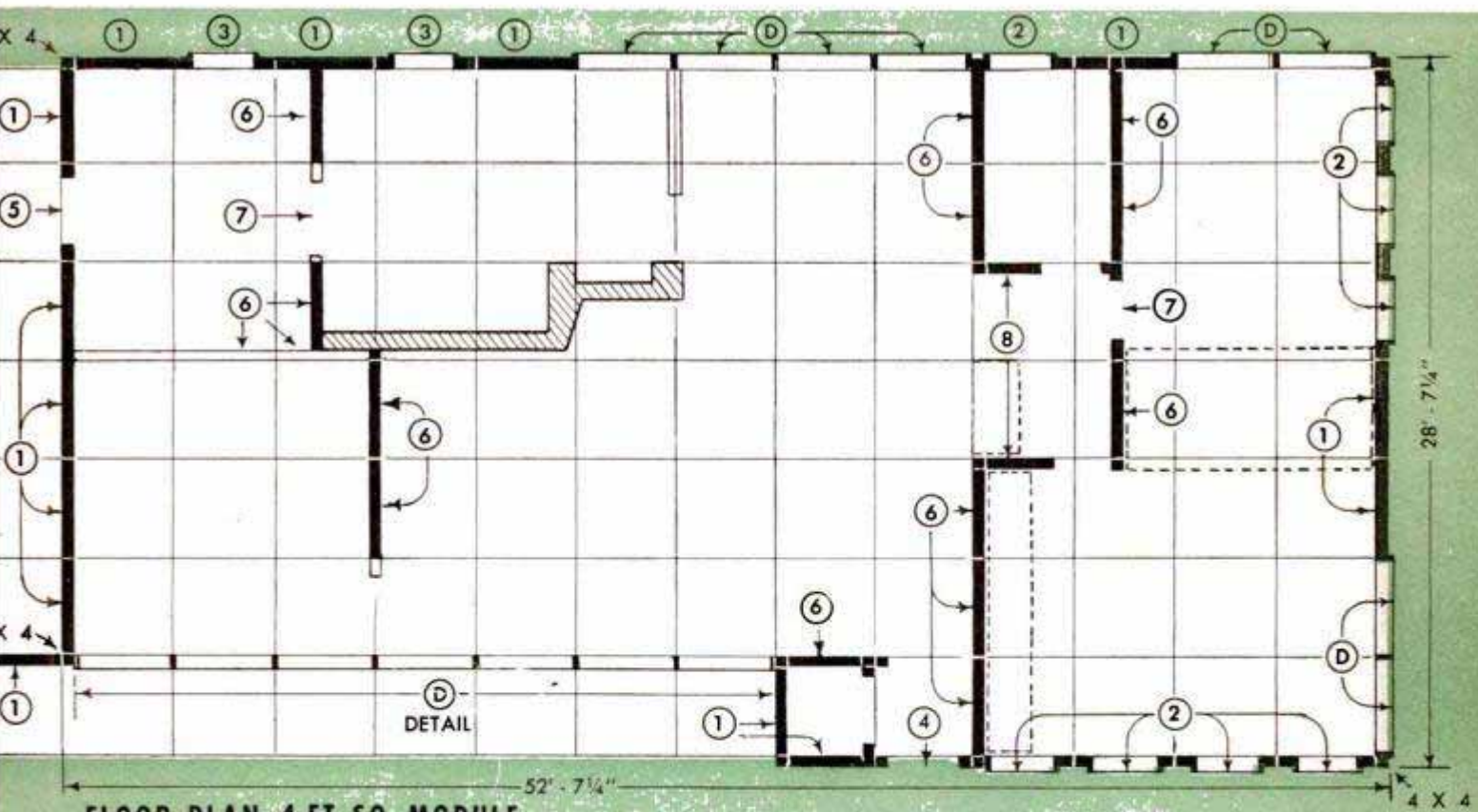

FLOOR PLAN, 4-FT.-SQ. MODULE

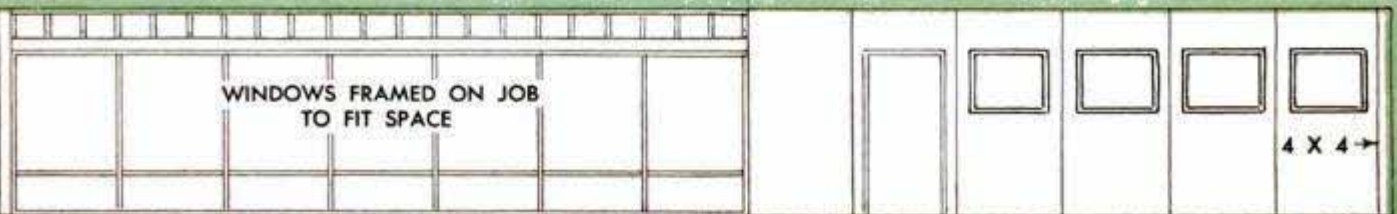

ELEVATION VIEW OF ASSEMBLED BENCH-BUILT WALL (FINISH SIDING NOT SHOWN)

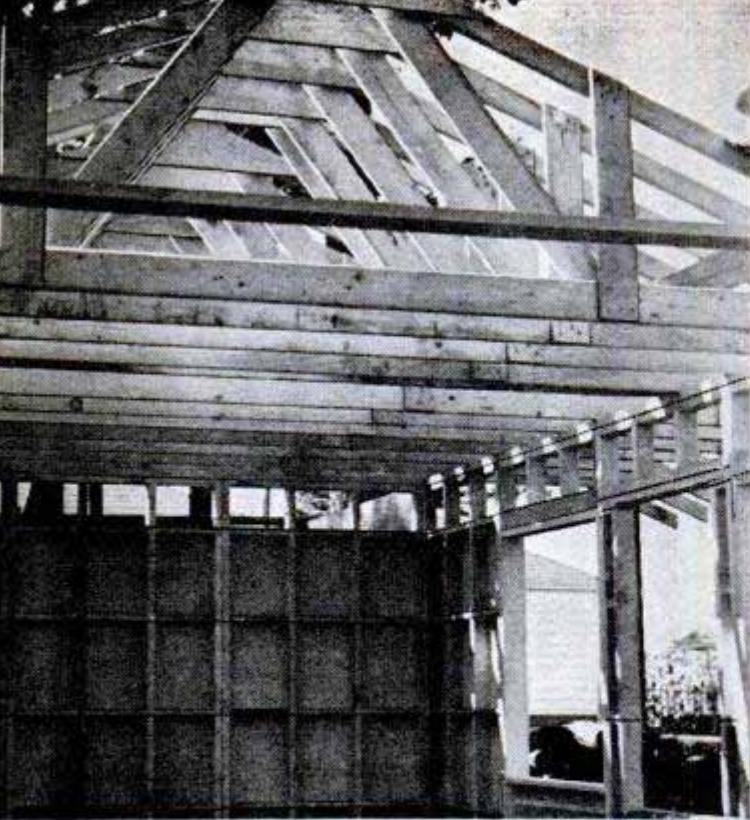

Same type of roof trusses as used in original construction speed framing of prefabbed home and help save time when erecting the roof

you can hire this done. If the sections must be stored outside, cover them with roofing paper or tarps.

The inner framing of the wall sections is equal in strength to that of standard construction. A study of the keyed floor plan will show the location of each section in relation to the modular plan and from it you can determine the number of each particular section required. If the wall sections are covered with sheathing only, the sections are joined together at the site by

John J. Whelan, architect, right, explains his "bench build" construction to James R. Ward, P.M. Craft Editor, as Tom Riley, builder, looks on

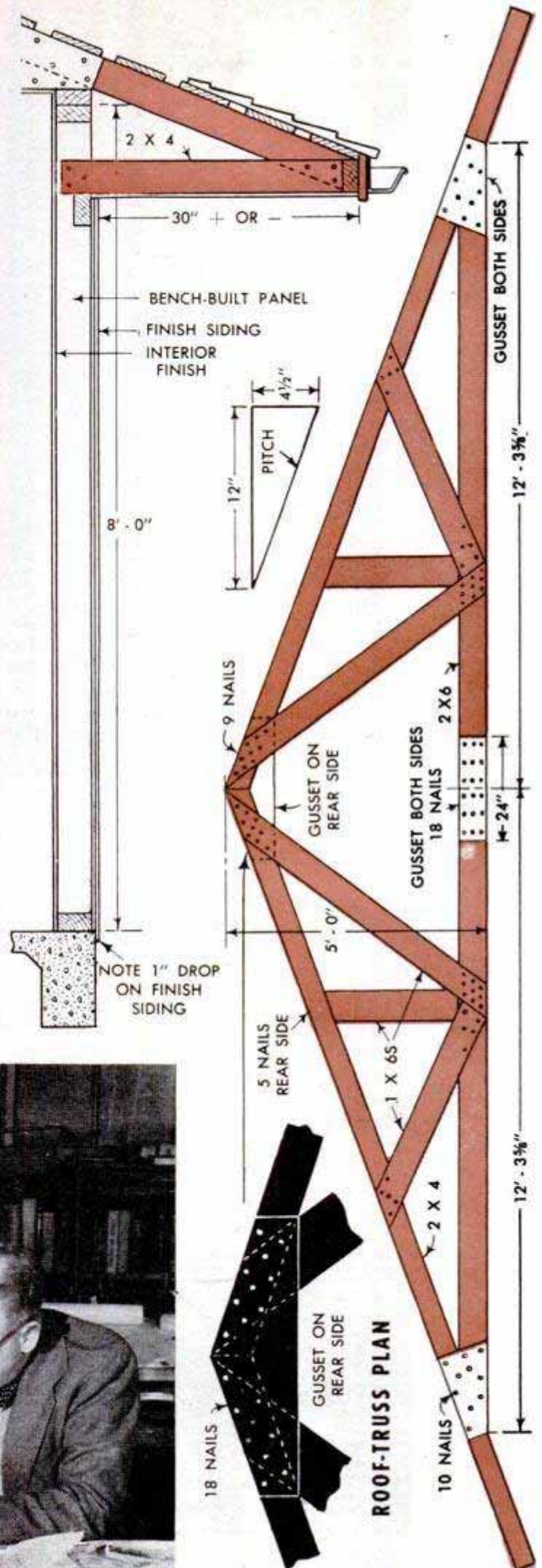
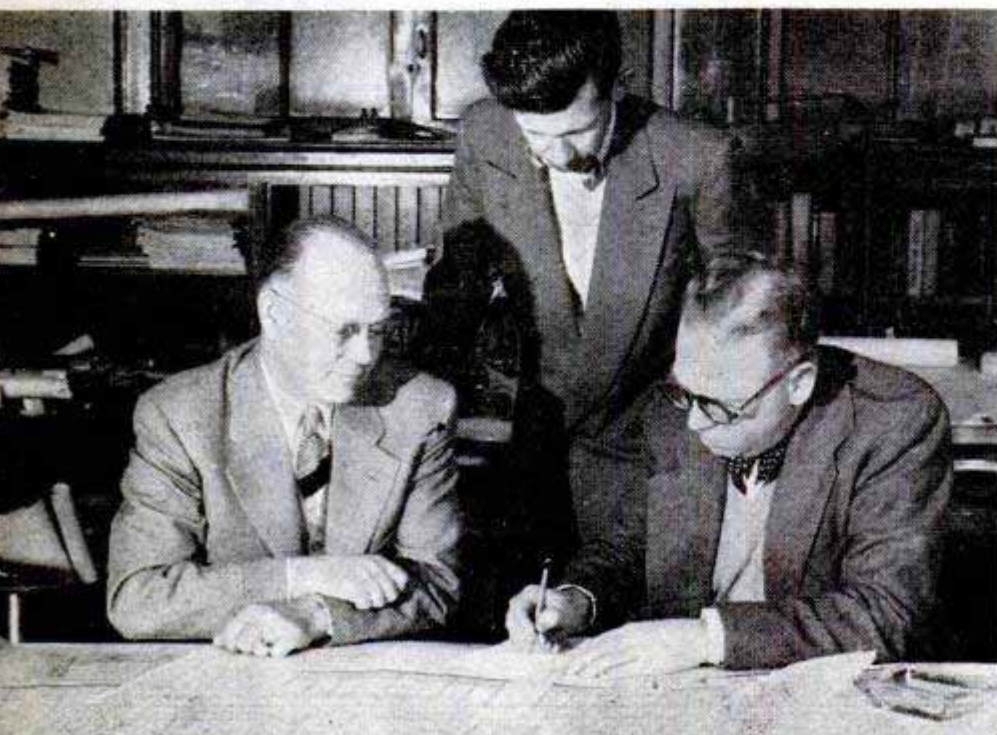

merely spiking abutting edges with 16d nails. However, if you plan to completely finish the sections in the basement, a 1½-in.-wide strip is ripped off the edge of each plywood sheet beforehand and then the plywood sheet is centered as shown in the detail on page 154. The 1½-in. waste strip is later used as a key to form a weather-tight joint. Each section is spiked to the subfloor as you would in conventional framing. Standard ¾-in. exterior-grade plywood, used vertically to cover the panels, makes an excellent siding material. When this is used, either 1-in. batten strips can be nailed over the joints, or as a second method, each plywood panel can be scored vertically on the outside face to simulate planking. Another material that can be used is 1 x 8-in. redwood, rerun at the mill with a shiplap edge. Rabbeted to the proper depth, seven boards placed edge to edge will measure exactly 48 in., the width of a single wall section. Assembly of the roof trusses is detailed in the drawings at the left. Note how the overhang of the roof is tied to the wall sections by resting the 2 x 4 soffit-framing members on the built-in headers of the sections and spiking them to the face of the studding members. The 2 x 6 frames for the large louver-type windows, labeled D in the keyed floor plan, are of the same construction as described in Part II. It's best to frame these in place right on the job, although the louver sections can be made ready beforehand. From here on, facing the walls on the inside with plywood and completing the rest of the construction is done in the same manner as previously described in the May, June and July issues of the magazine.

The End

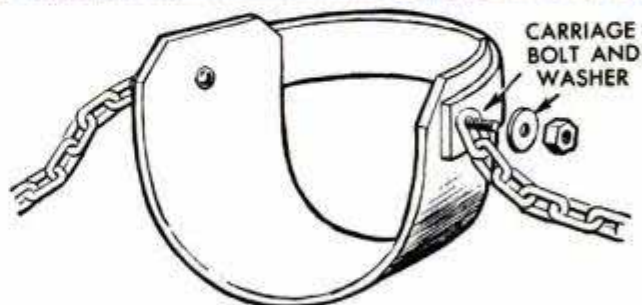

Swing Seat From Worn Belting Is Safe for Toddlers

A safe and comfortable swing seat for toddlers can be made from scraps of heavy belting material and two bolts with washers and nuts. The seat and backrest, which are cut from the belting, are joined by a single bolt on each side. The lengths of chain, from which the seat is suspended, are slipped over the same bolts before the nuts are turned onto the threads. If desired, a "double seater" can be made by bolting two swings together and using three lengths of chain to hang them. After the nuts are drawn tight, peen over or upset the ends of the bolts so the nuts cannot work loose and allow the chains to slip off.

Grinding Wheel on Circular Saw Sharpens Planer Blades

Mounting a high-speed grinding wheel on the arbor of a circular saw provides a convenient setup for sharpening jointer-planer blades. After replacing the saw-table insert with a piece of plywood slotted

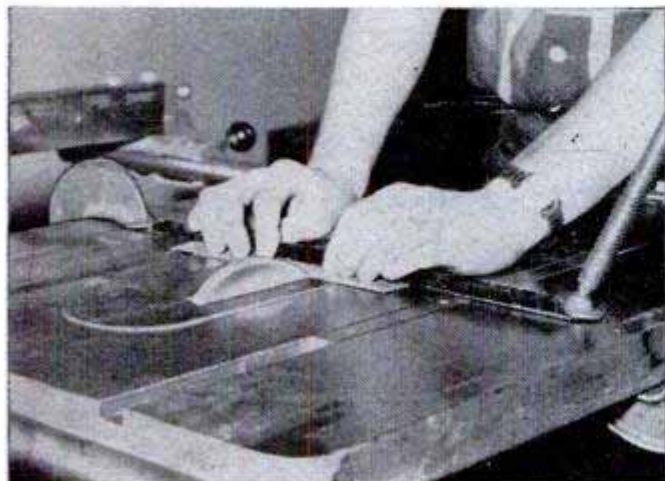

to fit over the grinding wheel, clamp a straightedge to the table perpendicular to the face of the wheel. The straightedge will serve as a fence for moving the planer blade back and forth while grinding. By adjusting the straightedge and raising or lowering the saw table, the blade can be ground to the desired bevel. For planing average stock, it is recommended that the face of the bevel be twice as wide as the thickness of the blade. As the grinding proceeds, move the straightedge forward slightly by tapping it at the points where it is clamped to the table. *Caution:* Be sure that the indicated speed of the grinding wheel is at least as great as the speed of the saw, and that the wheel is properly bushed.

Melvin Ham, Choteau, Mont.

☞ To clean tufted leather furniture, use a soft paintbrush dipped in warm castor oil.

★ Solving HOME

3 REFRIGERATOR STUNTS

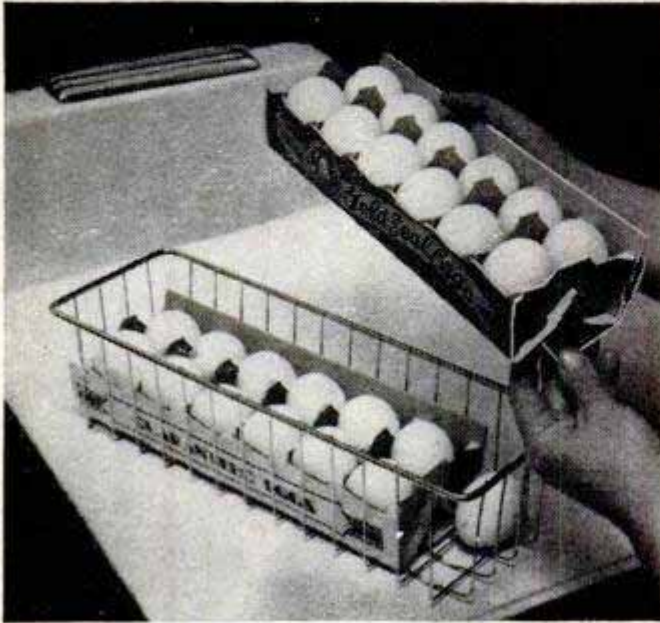

DANGER OF BREAKING EGGS stored in a wire basket is minimized by leaving the eggs in their carton and simply folding the cover back and under the carton

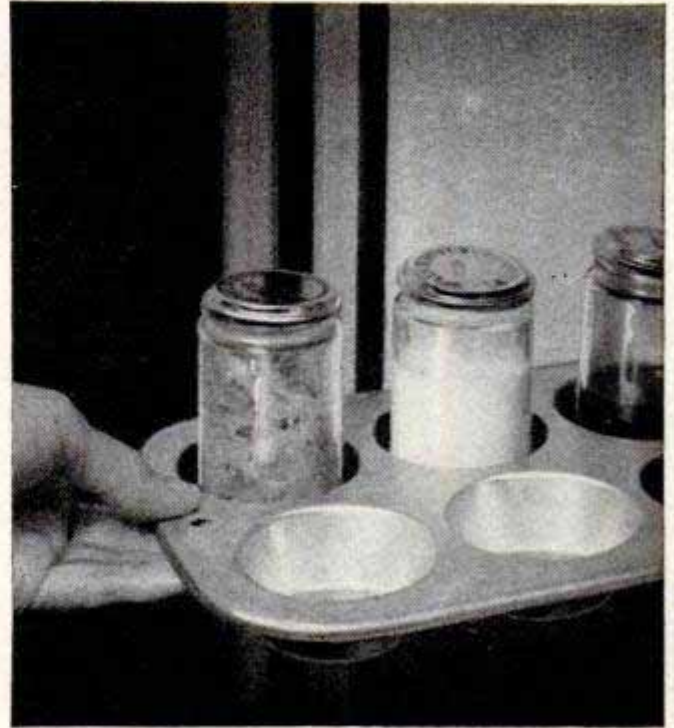

THERE'S NO SEARCHING through the refrigerator for partially used jars of baby food if the jars are set upright in compartments of an ordinary muffin tin



NONDRIP ICE for cooling picnic foods and beverages is made by freezing water in milk cartons. Top is sealed, and ice is left in carton which retains the water

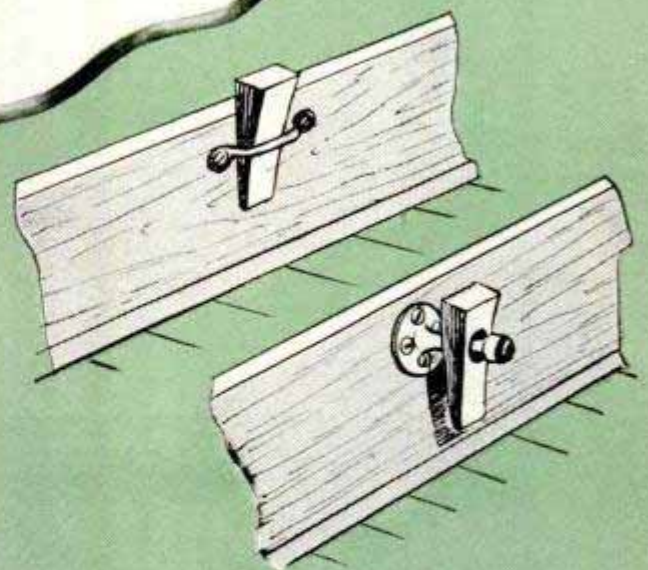
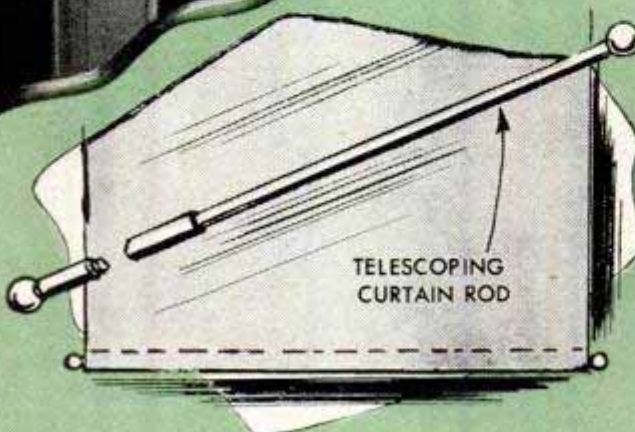

WEDGE-TYPE DOOR HOLDER, above, won't be mislaid if placed in rack formed by sash lift, or drilled to fit over the doorstep. Left, telescoping curtain rod comes in handy to replace broken window-shade slat. The rod is adjusted and the sections are taped together

PROBLEMS

POTATO-CHIP CANS are just the thing for storing brown sugar to prevent caking, or silverware to keep it from tarnishing. Pieces of silverware are wrapped individually in tissue paper before packing in can. Lid may be sealed with cellulose tape



TO SAVE REMOVING SPOOL from spindle when threading bobbins with different-colored thread, just place a tumbler over spool, as above. Below, while painting your home, a playpen can be used to keep painting supplies out of reach of small children

CLEANING UP SCRAPS from paper-doll cutouts or children's sewing kits is easy if the youngster sits in a tray cut from a large carton, as above. Mulching flower boxes with lawn clippings, below, keeps mud from splattering adjacent window panes

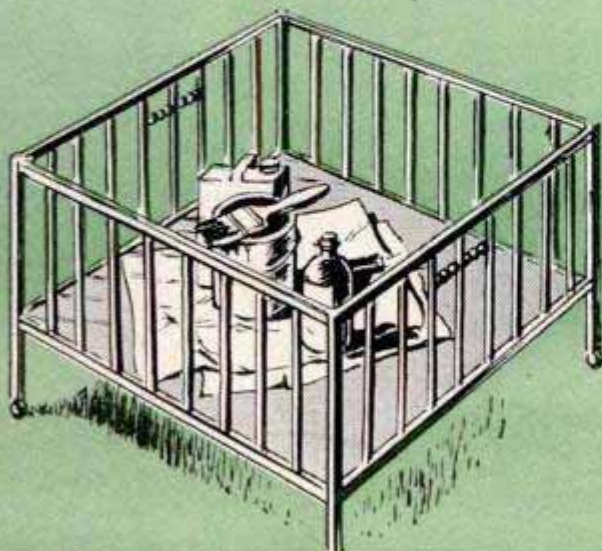

Gauge Blocks Permit Accurate Setting of Drill-Press Depth Stop

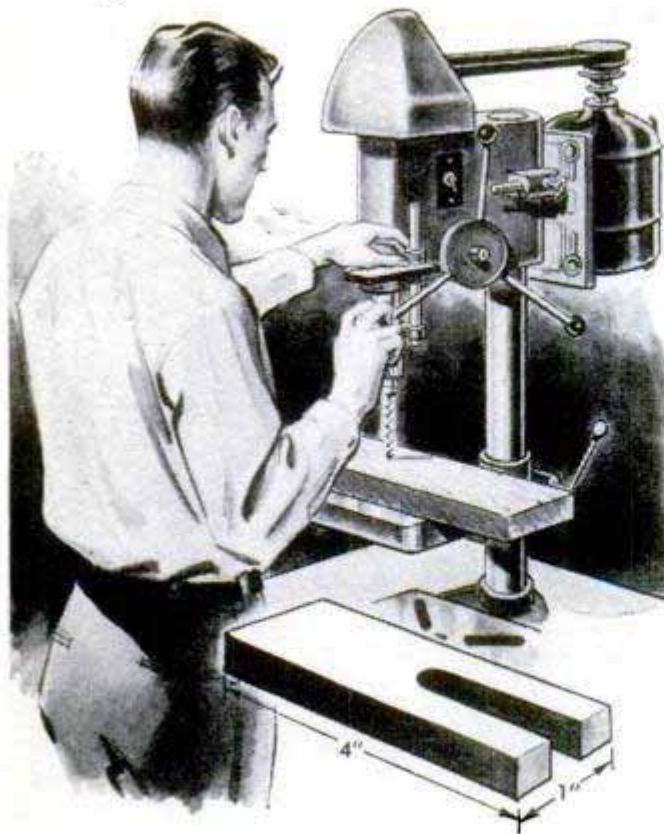

On some small drill presses the depth-stop rod is not graduated and, because of this, settings for repetitive depth drilling and countersinking are often rather difficult to make with the accuracy required. One home craftsman solved this problem by making a number of stops from hardwood strips of varying thicknesses. The thickness determines the depth of the hole. The strips are 1 in. wide and 4 in. long and each is slotted half its length from one end, the slot being just wide enough to permit slipping the stop over the stop rod. In use, the knurled stop nuts are run up on the rod to clear, the bit is brought down until the cutting edges touch the work and the wooden stop is slipped over the stop rod. Then the knurled nuts are run down against the stop and tightened. This will limit the downward travel of the quill, or sleeve, to a distance equal to the thickness of the stop. If desired, several stops can be drilled and stored conveniently together on a bolt in the manner of blades on a feeler gauge.

R. L. MacLean, High Bank, P.E.I., Can.

Sandpaper on Phonograph Records Prevents Slipping While Playing

Playing one lightweight phonograph record on top of another record on the turntable sometimes results in sound distortion. This is due to a lack of traction between the records which allows the lower record to turn faster than the one being played. Suf-

ficient traction can be furnished by cementing a $\frac{1}{4}$ -in. square of 2/0 sandpaper near the edge of each record label. When stacking the records to be played, alternate the positions of the squares.

Jack H. Lewis, Willow Run, Mich.

Portable Clothesline in Driveway Provides Dry Hanging Area

A portable clothesline, which can be set up quickly on a concrete driveway, will be appreciated by the housewife who finds on some washdays that she has to walk in the mud in order to hang up the clothes. An added advantage is that the garage can be used to support one end of the line. A short length of pipe is threaded on one end and embedded in the center of the drive to serve as a socket for holding a T-shaped pole. The pole is made from three lengths of pipe, which are simply turned into a tee. One end of each clothesline is attached to the cross member of the pole while the other end is formed into a small loop which can be slipped on and off a screw hook driven into the garage. Note in the detail that the concrete around the socket is countersunk. This is to permit the threaded end of the socket to be capped when not in use, but remain flush with the surface of the drive. A metal pin, driven transversely through holes drilled in the socket, engages slots cut in the end of the pole to keep the pole from turning. The pole is easily taken down. The lines are unhooked from

the screw hooks, wound together and the complete unit stored in the garage or basement.

Thomas P. Ramirez, Fond du Lac, Wis.

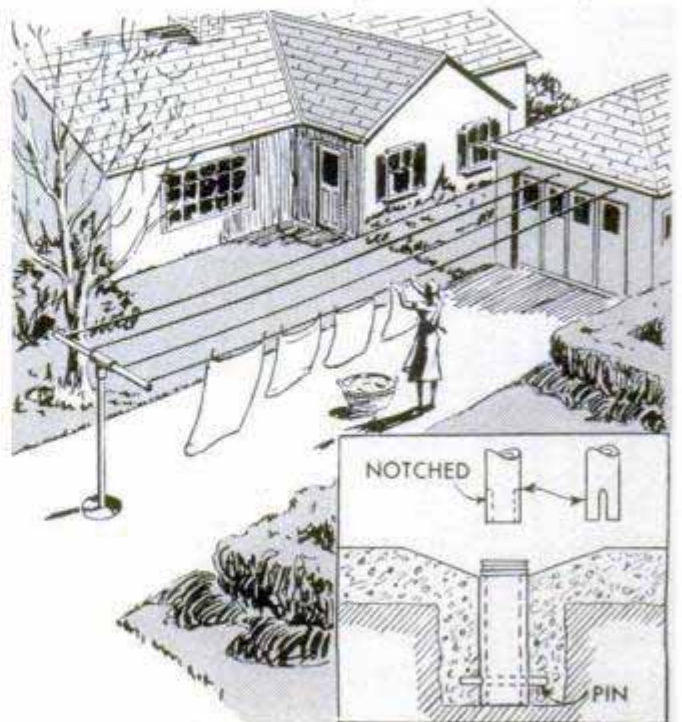

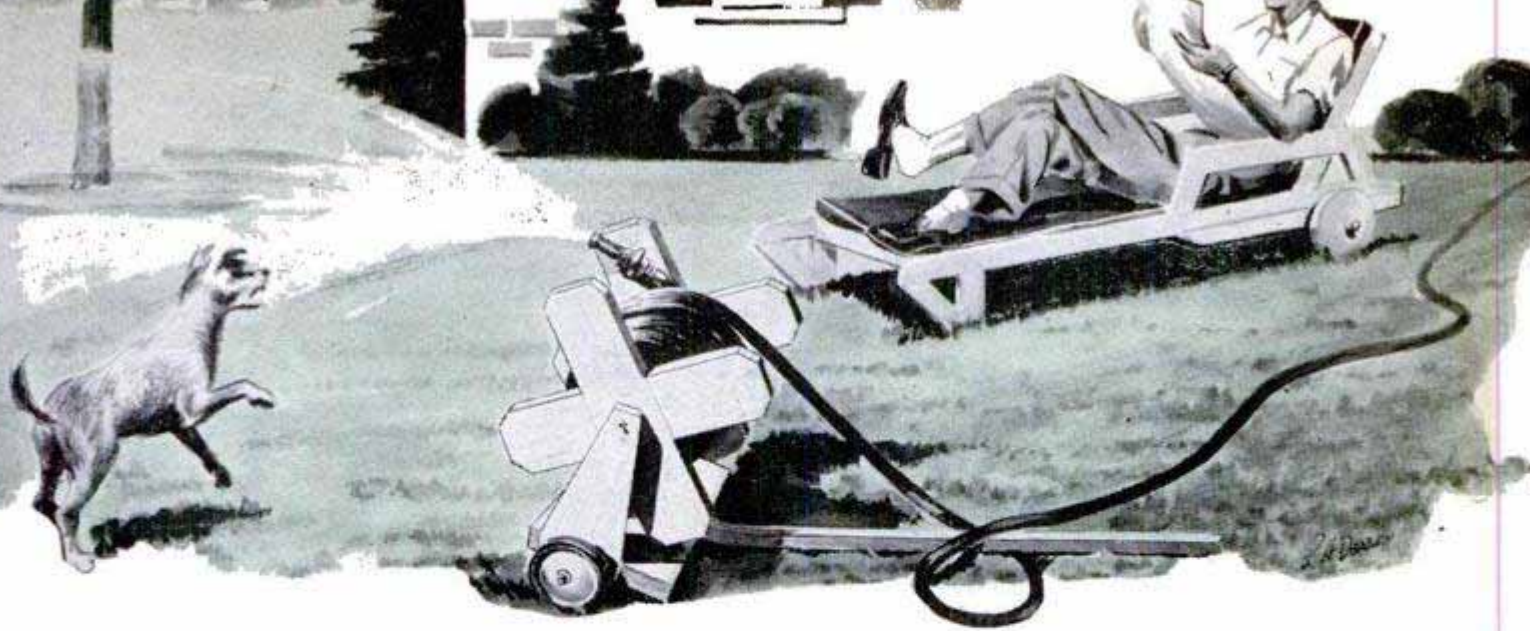

Hose-Reel Cart for Lawn Sprinkling

By Dick Hutchinson

WHY DRAG a heavy hose over the lawn when you can build a combination reel-cart that provides storage facilities and the convenience of a wheeled sprinkler head in a single unit? The cart wheels and axle may be purchased or adapted from a discarded stroller and the reel, cart frame and handle can be made from scrap stock. Each end of the reel is formed from two pieces half-lapped at the center, joined with brass screws and center-drilled for the reel shaft. If desired, 1 x 4-in. stock can be used for these parts. The reel drum consists of six

strips, or staves, of $\frac{1}{2}$, $\frac{5}{8}$ or $\frac{3}{4}$ -in. stock joined to hexagon blocks with screws or nails. In assembling, the hex blocks are first center-drilled and screwed to the half-lapped ends. Then the strips are attached. As dimensioned below, the reel will accommodate 50 ft. of hose. The reel supports are notched into the bottom board as shown and are attached with nails or screws. The handle, or tongue, is notched over the edge of the bottom board and attached by means of a flat-steel strip fastened with a staggered line of screws.

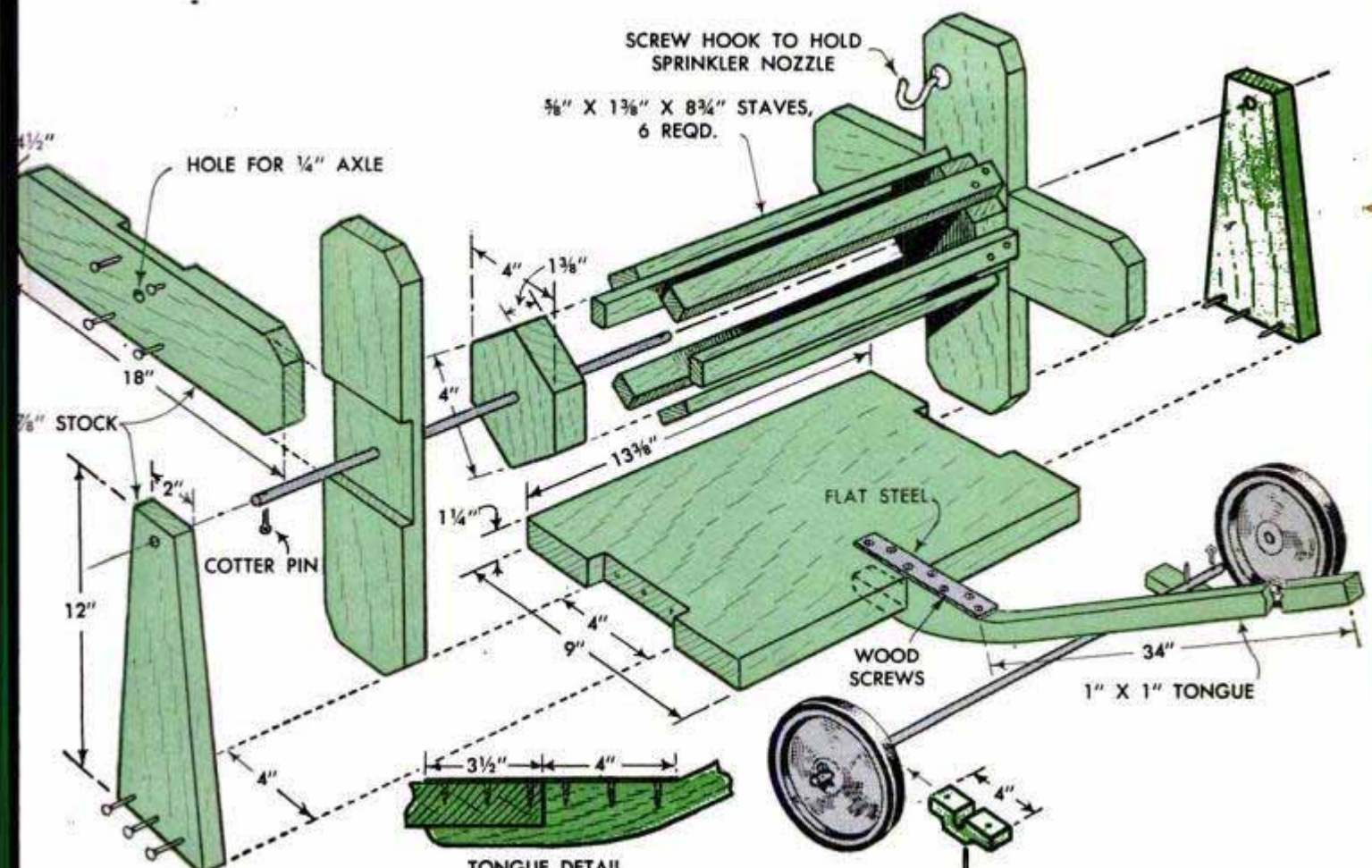

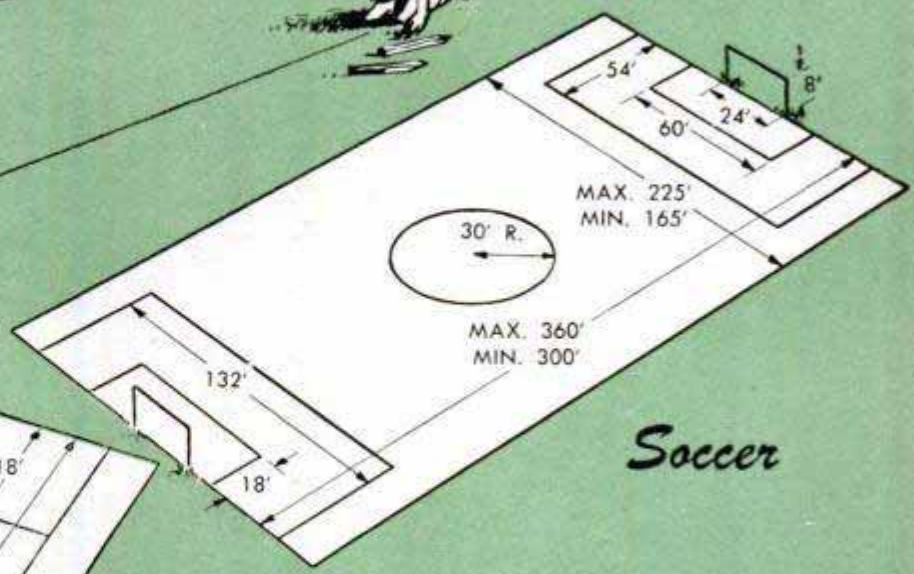
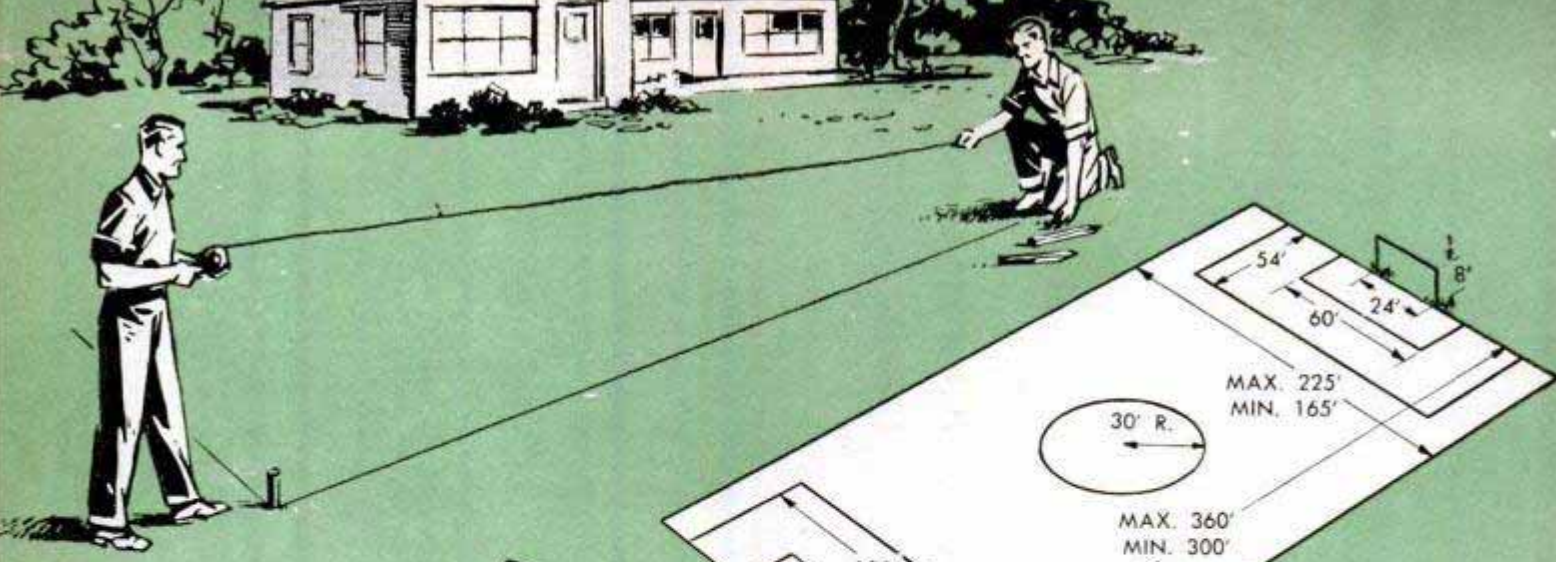

Lawn Tennis

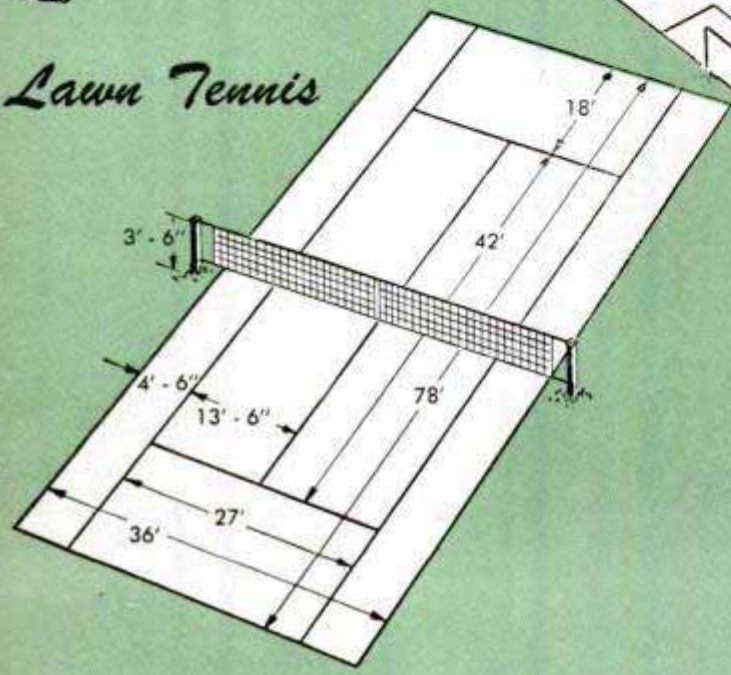

Soccer

OUTDOOR

NO DOUBT you have wondered how large the playing court should be for a particular outdoor game. To make sure that the court is regulation size, dimensions are given here for laying out several popular games. The letters R and B in the corners of the shuffleboard court stand for red and black and designate the playing positions of opponents when playing doubles. The regulation court requires a very smooth concrete playing surface which generally is waxed, although, if necessary, the court can be laid out on a driveway. Over-all size of the horseshoe court should measure 10 x 50 ft., and the outside wickets of a croquet court are placed 7 ft. in from the boundary lines.

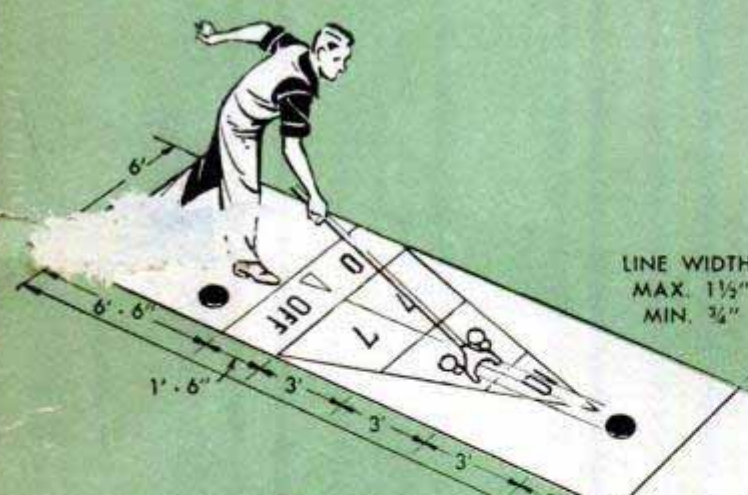

LINE WIDTH:
MAX. 1 1/2"
MIN. 3/4"

CROSS SECTION

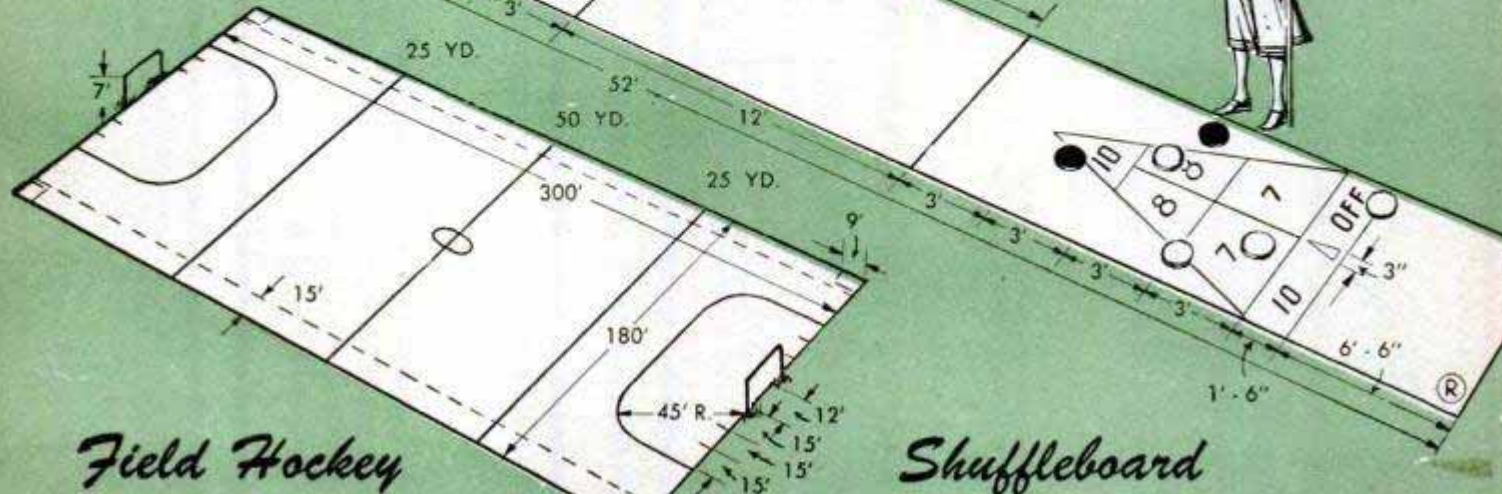
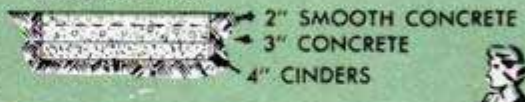

Field Hockey

Shuffleboard

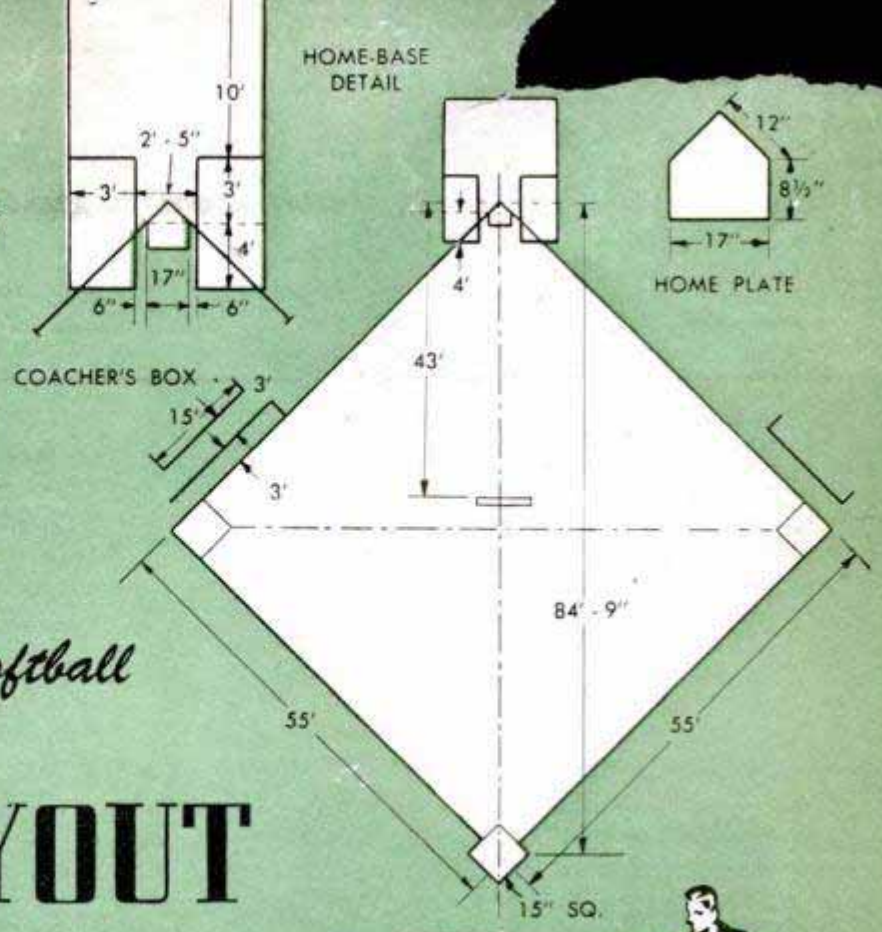
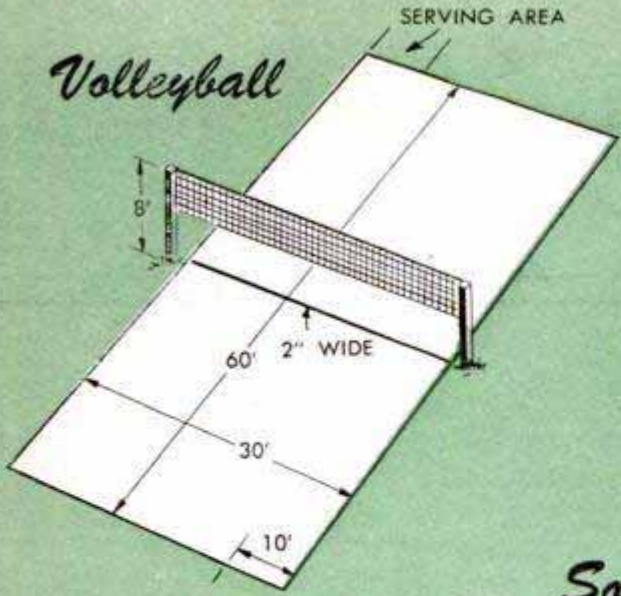

GAME LAYOUT

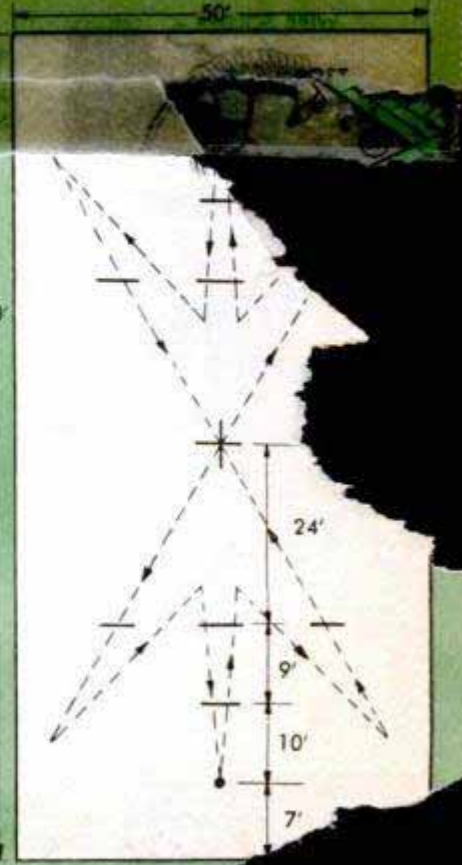
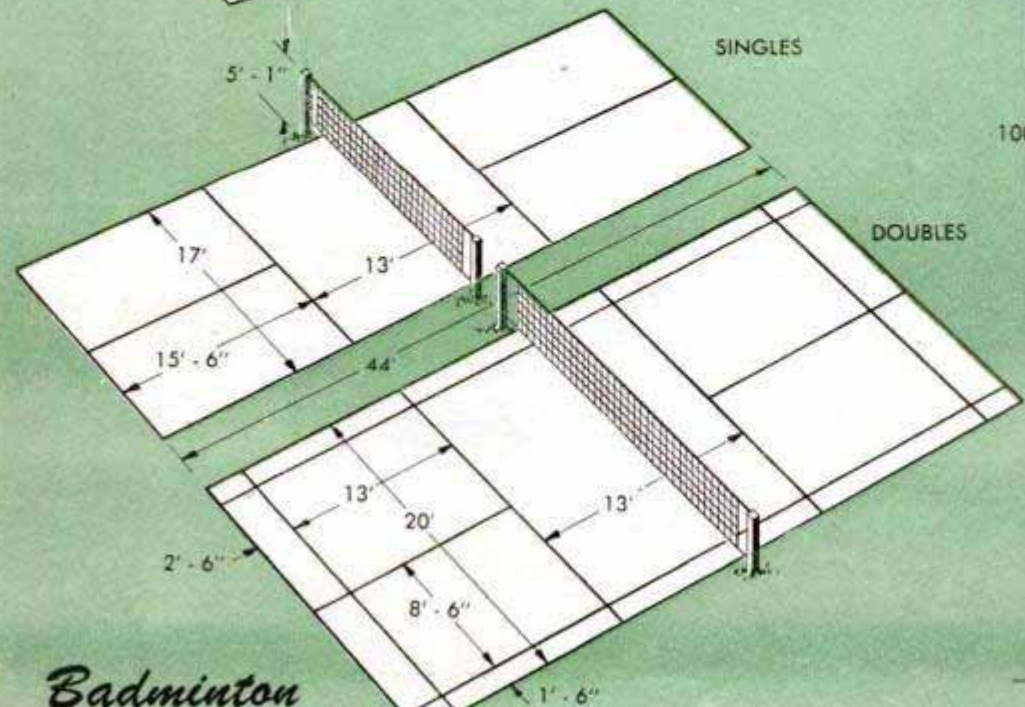
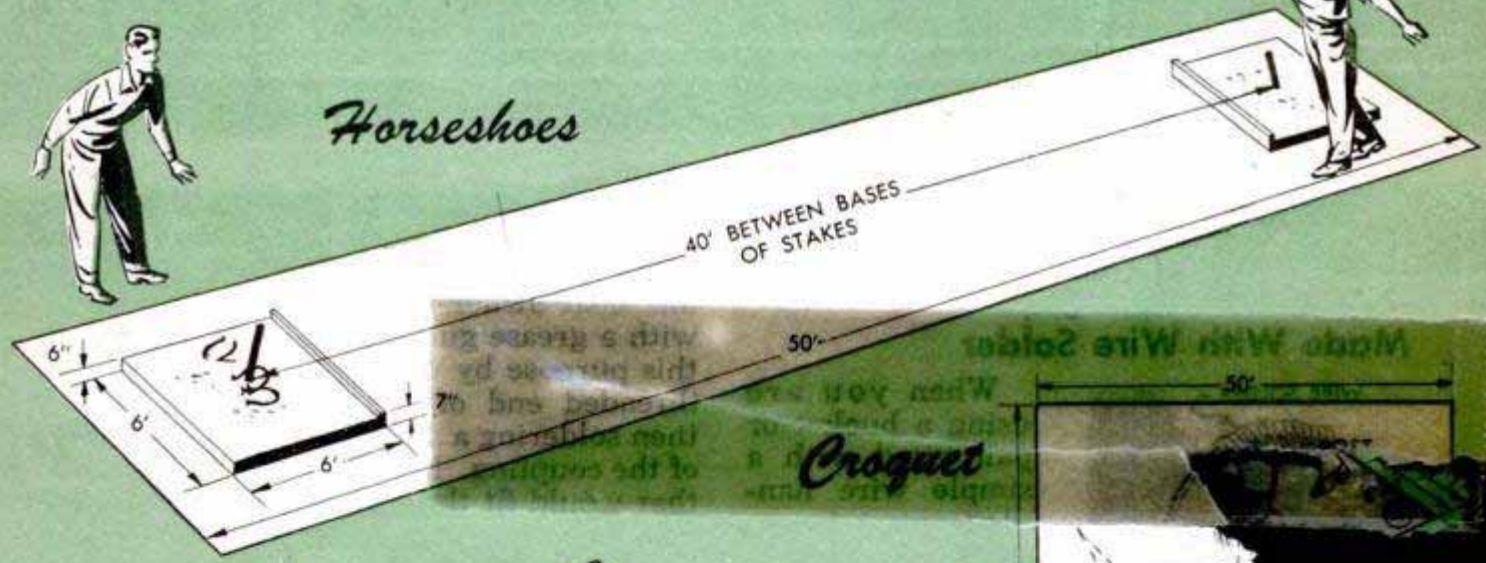

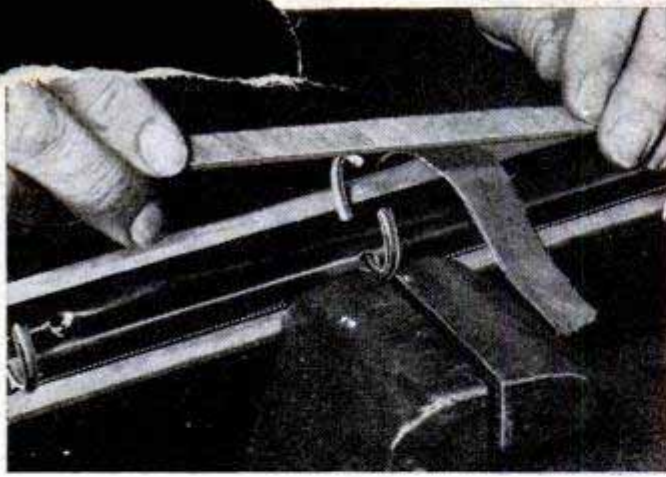

Tips to Make Looseleaf Binders Work Better and Last Longer

Sharp burrs, sometimes found on the rings of looseleaf binders, can be removed by touching them lightly with a file. Follow by rubbing with fine emery cloth to smooth out the file marks, and sheets will turn smoothly on the rings without tearing. The cover of a looseleaf binder can be protected by a Manila-paper jacket, attached in the same manner as the jacket on a book. Leather covers should be given frequent treatment with saddle soap and a high-quality oil. When opening a three-ring binder, pull only on the two parts of the center ring, as opening the rings from the ends may spring the mechanism. Overloading a binder will keep the rings from closing all the way, with the result that sheets are sometimes lost.

Bucket-Bail Handgrip Made With Wire Solder

When you are using a bucket or pail fitted with a simple wire handle to carry heavy loads, you can prevent the bail from injuring your hand by providing a larger grip. Such a grip can be made quickly by merely wrapping the bail with wire solder, using one or two layers to get the desired size. When the job is finished and you have no further use for the pail, the solder can be removed and kept for its regular purpose.

G. E. Hendrickson, Argyle, Wis.

☐ To avoid cracking the cylinder block, allow your car engine to cool off for a half hour or so after overheating before you add water to the cooling system.

Quick Method of Restringing Beads

If you have a worn strand of beads, try this easy method of restringing them. With a needle, pull the new thread through the old one, as in the upper detail. Use a thread that is twice as long as the old thread, pulling it through far enough to double it. Then, restring the beads by sliding them from the single thread to the doubled one. Naturally, the size of the holes in the beads determines whether this method can be used.

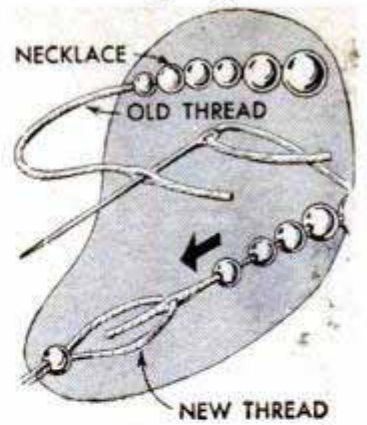

Rabbitproofing Young Plants

Dry lime sprinkled on tender plants will protect them from damage by rabbits. Use a discarded flour sifter for uniform distribution with a minimum of waste. It should be remembered that continued use of lime, for more than one season, will tend to "sweeten" acid soils.

Clara Goldammer, Newport, Ark.

Extension for Grease-Gun Fitting Aids Lubricating Outboard Motor

Finding it difficult to lubricate the propeller gears on his outboard motor by squeezing grease directly from the tube, one boat owner does a more efficient job with a grease gun. He adapted the gun to this purpose by turning a coupling on the threaded end of an Alemite fitting, and then soldering a small bolt to the other end of the coupling. For this, he selected a bolt that would fit the tapped hole in the gear housing, and drilled the bolt lengthwise through the center. The head of the bolt was ground to fit inside the threaded hole in the coupling. In use, the extension simply serves as a reducer to adapt the Alemite fitting to the lubrication hole in the gear housing.—E. G. Pilcher, Rochester, N. Y.

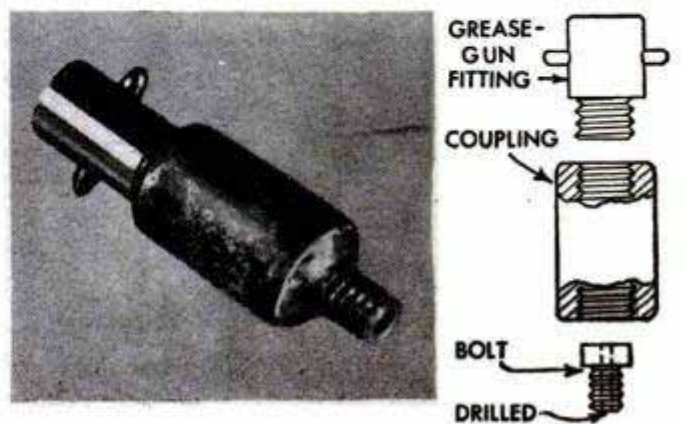

REPEATING CROSSBOW

By Austin H. Phelps



THIS REPEATING CROSSBOW has all the handling characteristics of a fine repeating rifle of the slide-action type. In the hands of an experienced crossbowman it will deliver five shots in five seconds with near-rifle accuracy over ranges up to 40 yards. The steel-pointed arrows, or quarrels, as they are correctly called, are loaded from the top into a magazine just as are the cartridges in a bolt-action rifle. After loading, the bow is cocked by a slide, and the quarrel is fired by pressing a trigger which releases the bowstring. Nocking of the five quarrels in the magazine is done automatically by the repeating mechanism as shown in the lower detail in Fig. 3. The two-piece barrel, Figs. 1 and 2, has a square bore, the groove being cut to full

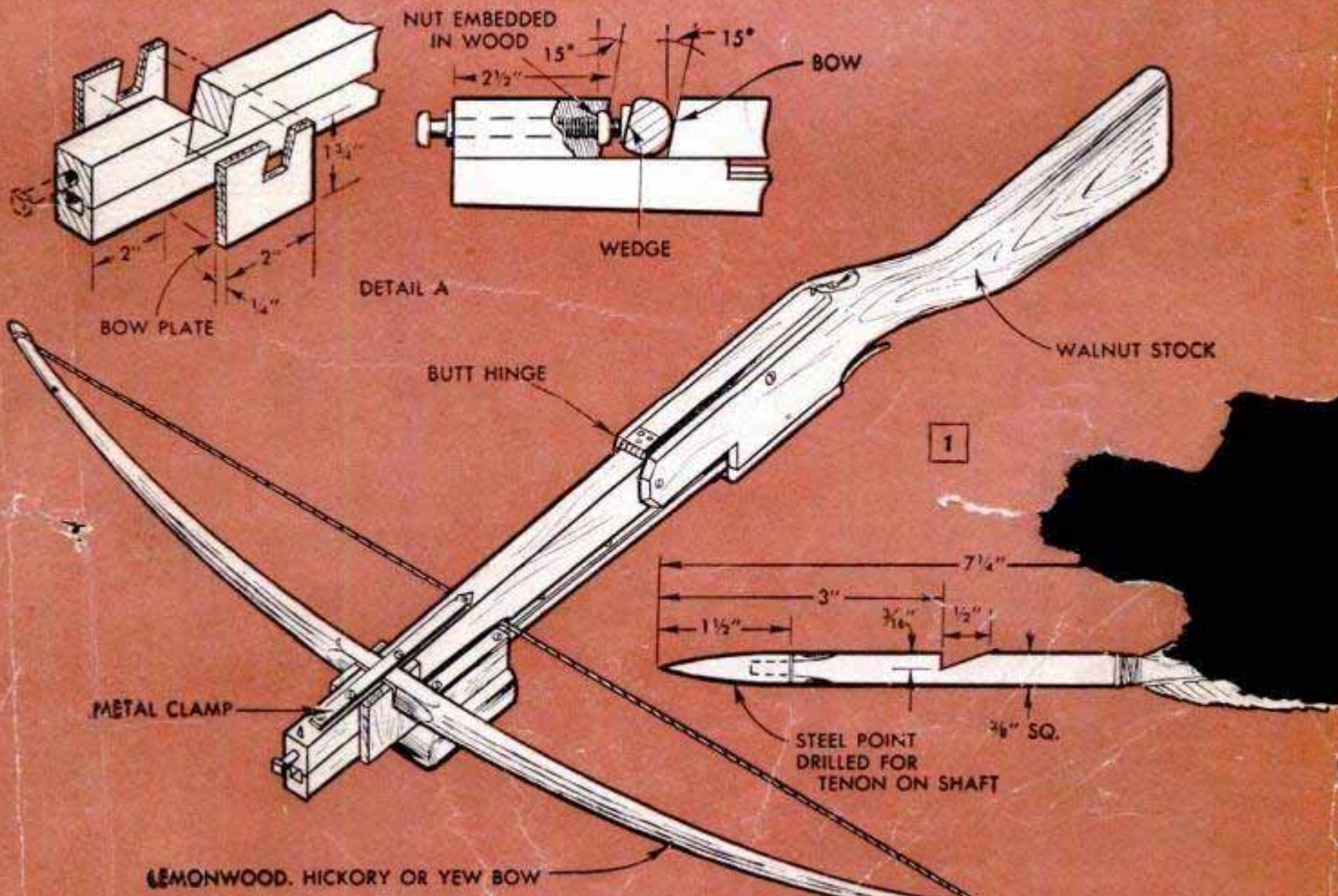

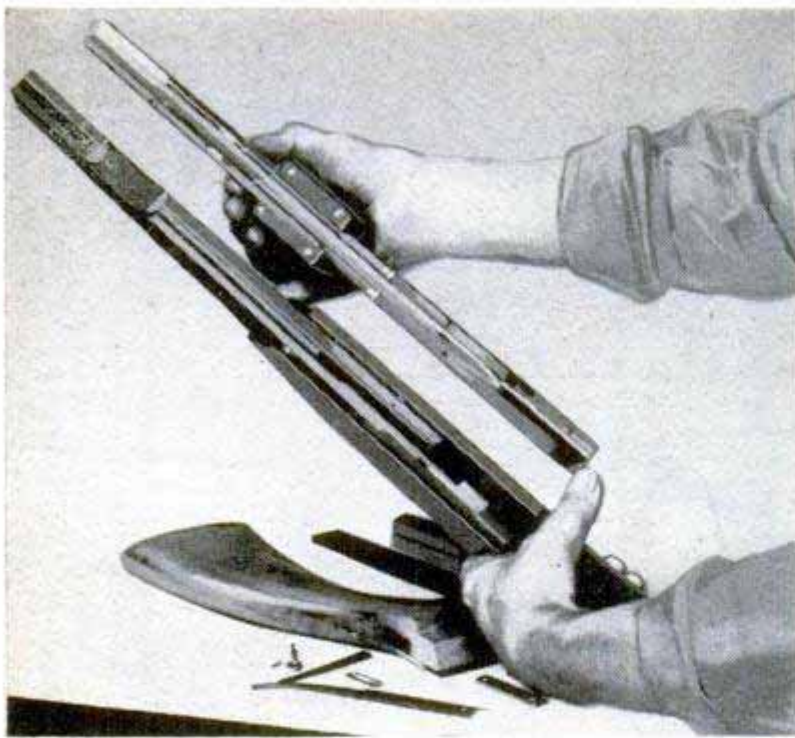

An assembly view of the two-piece barrel showing the pump slide, brass runners, and the top barrel in position. Stock should be handmade to specifications that fit individual user in the same way as a rifle or shotgun stock. Use hardwood for all parts

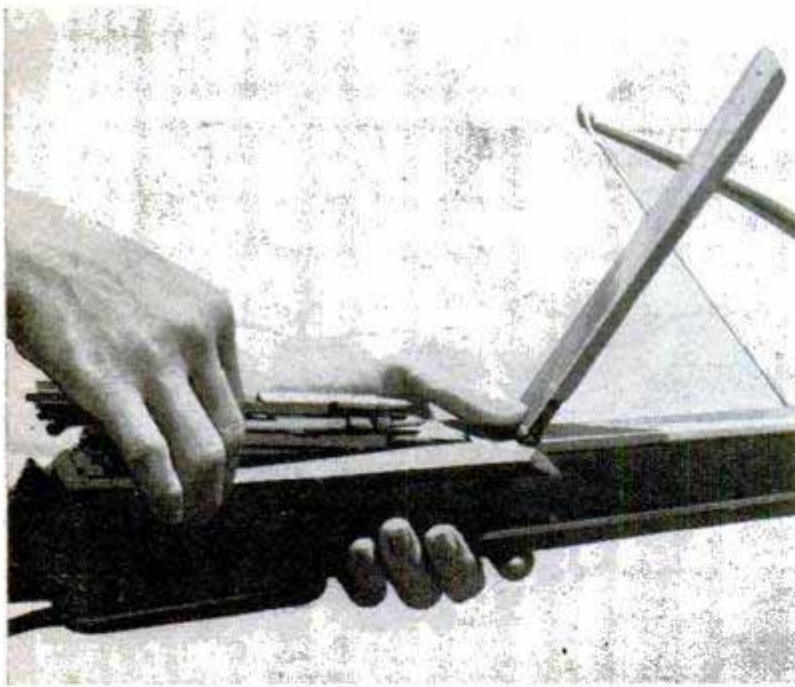

Above, this repeating crossbow is loaded just like a bolt-action rifle, five quarrels being placed in the box magazine at one time. Below, note the trim lines of the finished job. If desired, you can install either open or peep sights on the barrel

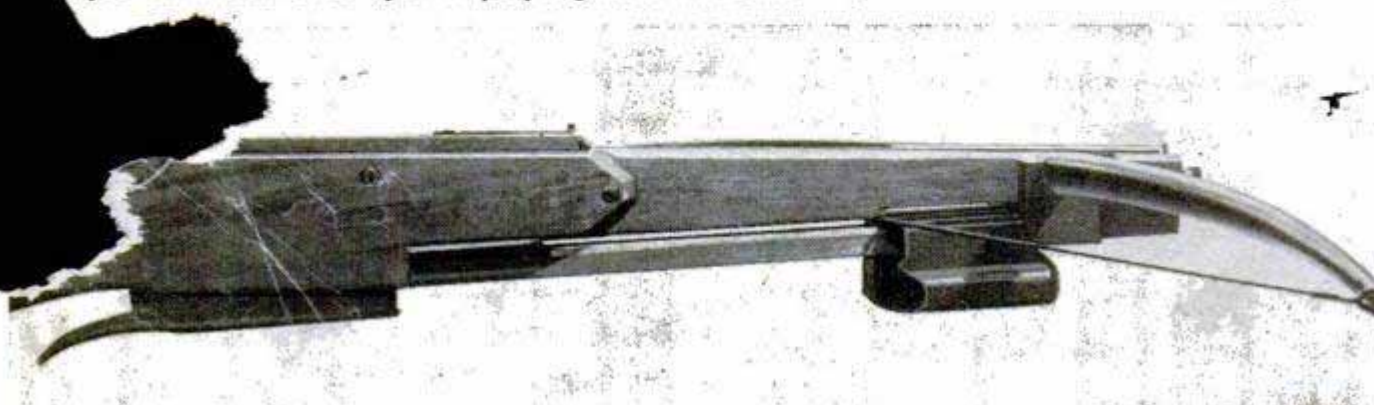

depth in both halves. Then parts of both halves are cut away so that when assembled there will be an offset slot for the bowstring as in the lower detail in Fig. 2. Brass runners, fitted with $3\frac{1}{2}$ -in. brass strips soldered edgewise to them, are screwed to the lower barrel as in the center left-hand detail in Fig. 2. Care must be taken to space the runner strips so that the inner edges are exactly flush with the inner edges of the magazine liners. After making a trial assembly, it may be necessary to file the slanting ends of the $3\frac{1}{2}$ -in. strips or the underside of the upper barrel to permit free passage of the bowstring through the offset slot. The purpose of the offset in the slot is to force the bowstring upward sufficiently to release it from the notch in the quarrel, permitting the latter to enter the bore in free flight.

In making the stock, it's a good idea to copy a rifle or shotgun stock that fits you and has a grip and tang shaped to your liking. Bandsaw the wood to the rough outline of the stock selected, then finish to contour with wood rasps and sandpaper. Care must be used in cutting and finishing the magazine slot in the stock, as the magazine liners must be spaced accurately so that the quarrels drop freely into firing position, Fig. 3. The inner rear corners of the liners are rounded to a smooth curve. To assure free movement of the quarrel in firing position, it may also be necessary to round the inner corners of the brass runners. The pump slide, Fig. 2, engages the bowstring as in Fig. 1 when in the forward position. Overhanging brass strips, which are screwed to the guide blocks, Fig. 2, ride on the brass runners. In cocking, the slide is drawn back as far as it will go and the forward end is pulled

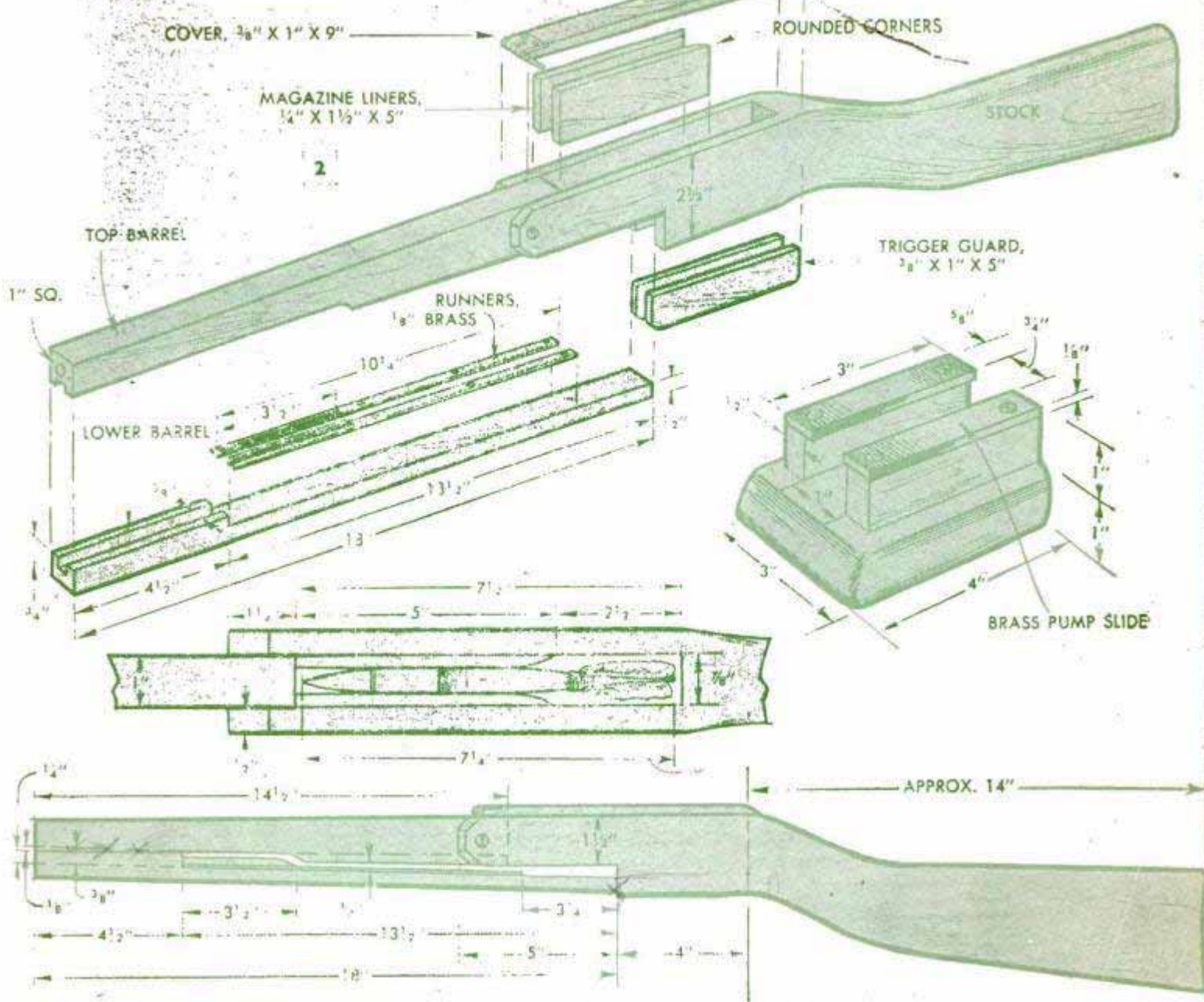

down slightly so that the ends of the brass strips on the slide engage the ends of the runners. This movement locks the slide in firing position and a groove cut across the rear end of the slide engages the trigger sear, as shown by dotted lines in the lower detail, Fig. 3. Simultaneously, the bowstring passes between the first and second quarrels, and the lower quarrel is automatically nocked ready for firing. Provide a hinged cover for the magazine and a trigger guard. Then fit a lemonwood bow of 30 to 50-lbs. pull, using bow plates and a clamp made as in the upper details in Fig. 1. Although the dimensions of the quarrels in Fig. 1 specify that the shaft shall be $\frac{3}{8}$ -in. square, it is best to finish the shaft slightly under this dimension to allow correct clearance. Practice quarrels should be blunt pointed.

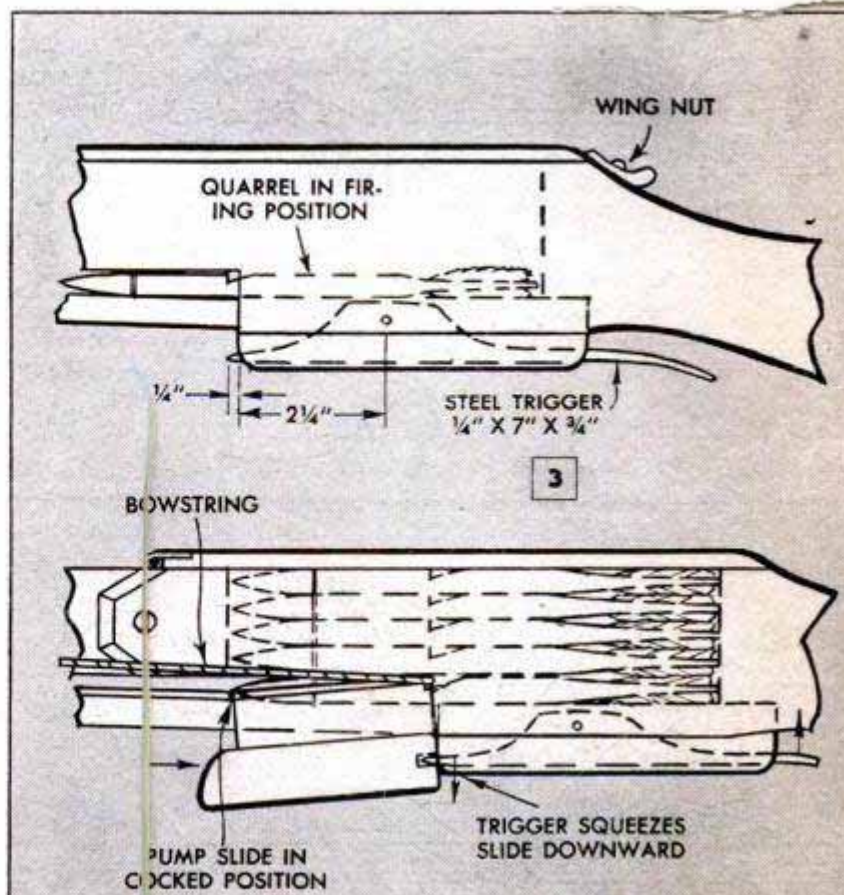

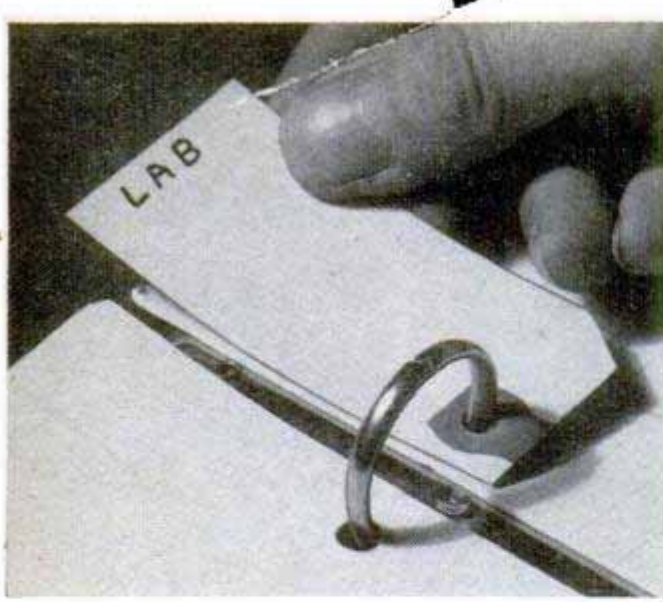

Shipping Tags Form Index Tabs On Looseleaf Binder

Tabs for indexing looseleaf binders can be made from shipping tags. These are cut to the size and shape indicated, and slipped over one of the rings to project beyond the pages of the binder. A drop of mucilage or a piece of cellulose tape will stick the tab to one of the pages, keeping it from turning on the ring where it cannot be seen when the folder is closed.

Corks Aid in Bending Glass Tubes

The inexperienced person who has to bend a glass tube can do a better job if he slips a couple of corks over the ends of the tube as indicated.

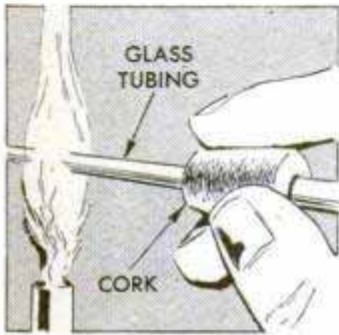

The corks will serve as finger grips and also as protection against the hot glass, thus permitting the fingers to be placed close to the desired bend in the tube. The corks will also enable you to bend

the glass right in the flame and, consequently, shape it accurately.

Ralph Ellison, Alum Creek, W. Va.

Drawer Pulls for Tiny-Parts Bins

Inverted and screwed to the sides of hanging tool cabinets, drawer pulls of the type which is formed like a half cup make convenient bins for storing small parts, such as nails, screws, etc. If the pulls are attached in such a position that the contents cannot be seen, staple a sample part beside each bin.—George Kapitan, Bronx, N. Y.

Spools Used as File Handle

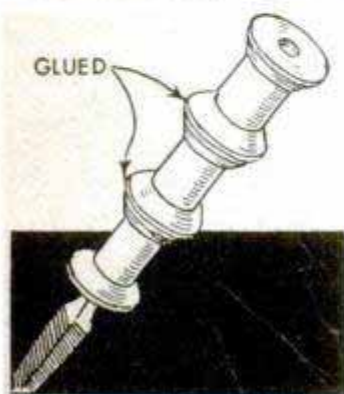

Thread spools, glued end to end, form an excellent file handle. To attach, press the tang of the file into one of the spools. The spool flanges will provide a convenient handgrip.—Fred Cornelius, El Paso, Tex.

Shop Ash Tray From Flowerpot

When smoking at your workbench where there is danger of a fire being started by smoldering butts or by matches dropped in sawdust or wood shavings, use this "snuffer" ash tray improvised from a flowerpot and saucer. Inverted and placed in the saucer, the flowerpot quickly smothers glowing cigarettes and matches.



Gallon Can Provides Self-Feeder

A rectangular-shaped, 1-gal. can is easily converted into a convenient self-feeder for a pet rabbit or other small animal. Cut across the width of the can at a point about 3 in. from the bottom, extending the cut approximately halfway around each corner. Then, push the side of the can inward above the cut and pull outward the portion below the cut to form a pocket, as shown in the photograph. Tape the edges of the opening to prevent injury to the pet. If desired, the top of the feeder can be cut off and fitted with a wooden lid, thus making the feeder easier to load.

Bill Dugovich, Tacoma, Wash.

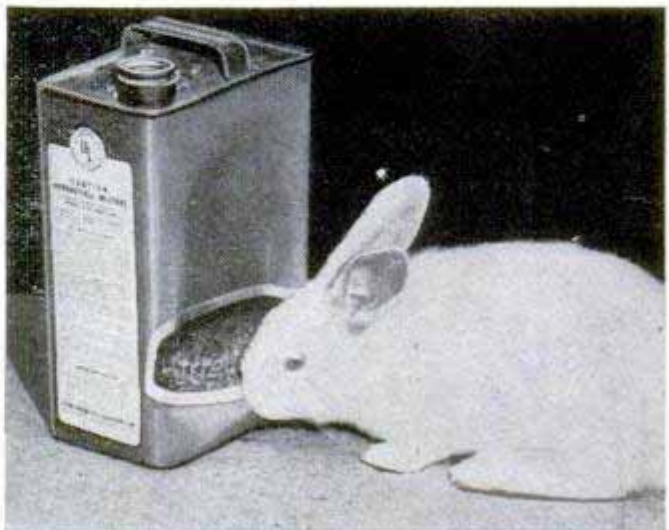

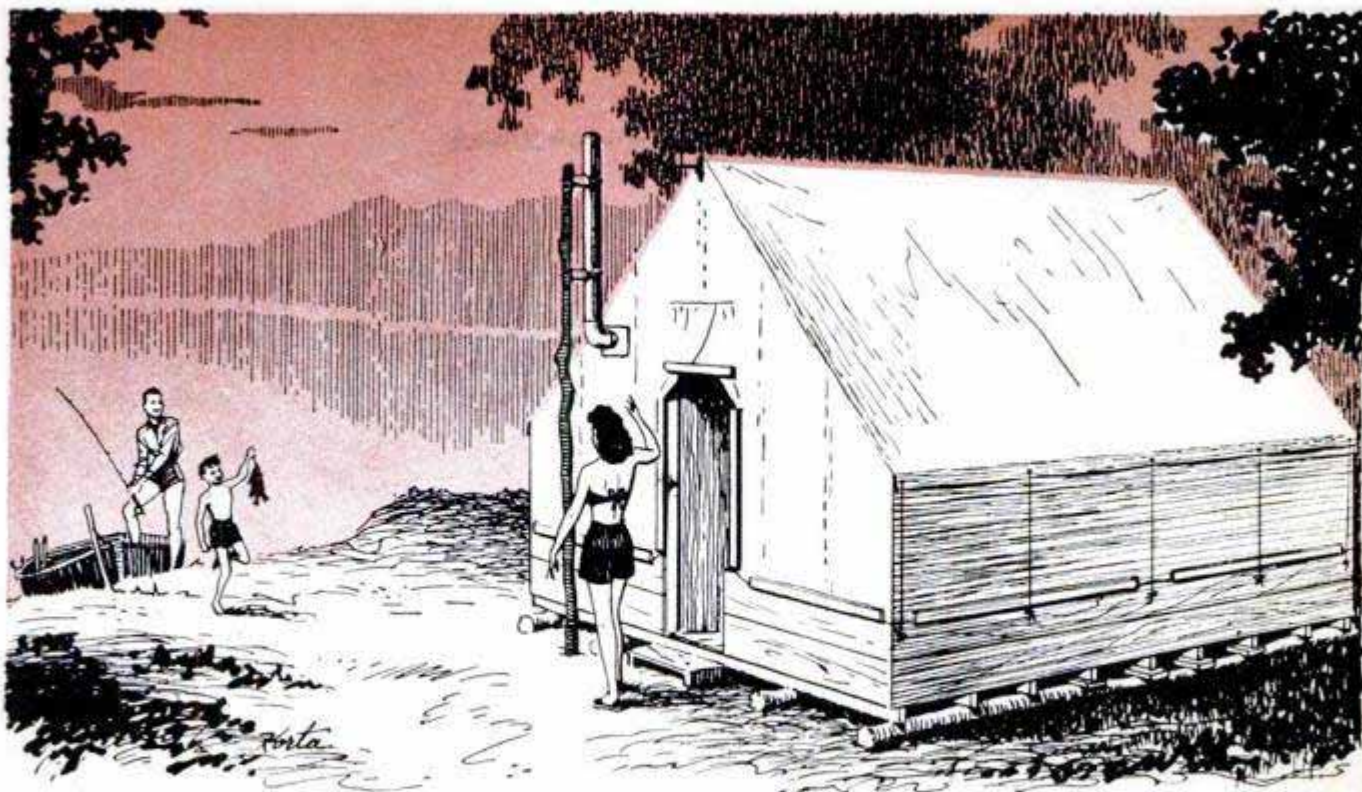

LAKESIDE TENT-COTTAGE

By Rafe Gibbs

DESIGNED at the suggestion of forest rangers by Horace F. Ralph of the U. S. Forest Service, this tent-cottage meets the requirements of hunters, fishermen and vacationists who like to set up comfortable living quarters beyond the trailside at a fraction of the cost of a permanent camp or summer home. It provides a warm, dry room in cold, stormy weather and the braced roof framing and half-height wooden walls give the structure exceptional resistance to high winds.

First, the floor is built on the desired site as in Fig. 1, by nailing floor joists across log sills, or sleepers. Spacing of the joists should be 16 in. on centers and they should be shimmed with blocks or wedges where necessary to bring the top edges flush. Although the specifications call for 1 x 12-in. floor boards to be laid with butted joints, you can use 1 x 6-in. tongue-and-groove flooring if desired. In placing the joists and laying the floor, be sure to dimension the latter 1 in. less in width and length than the floor size of the wall tent you are to use as a covering for the framing, Fig. 2. Figure the height of the corner posts by adding the height of the 1 x 12-in. siding, two boards high (about 23¼ in.) to the height of the tent walls, allowing for a 3-in. overlap so that the fabric wall can be fastened with cleats as in Fig. 3. Cut the corner posts and the center studs to the same length. Toenail the four corner posts and

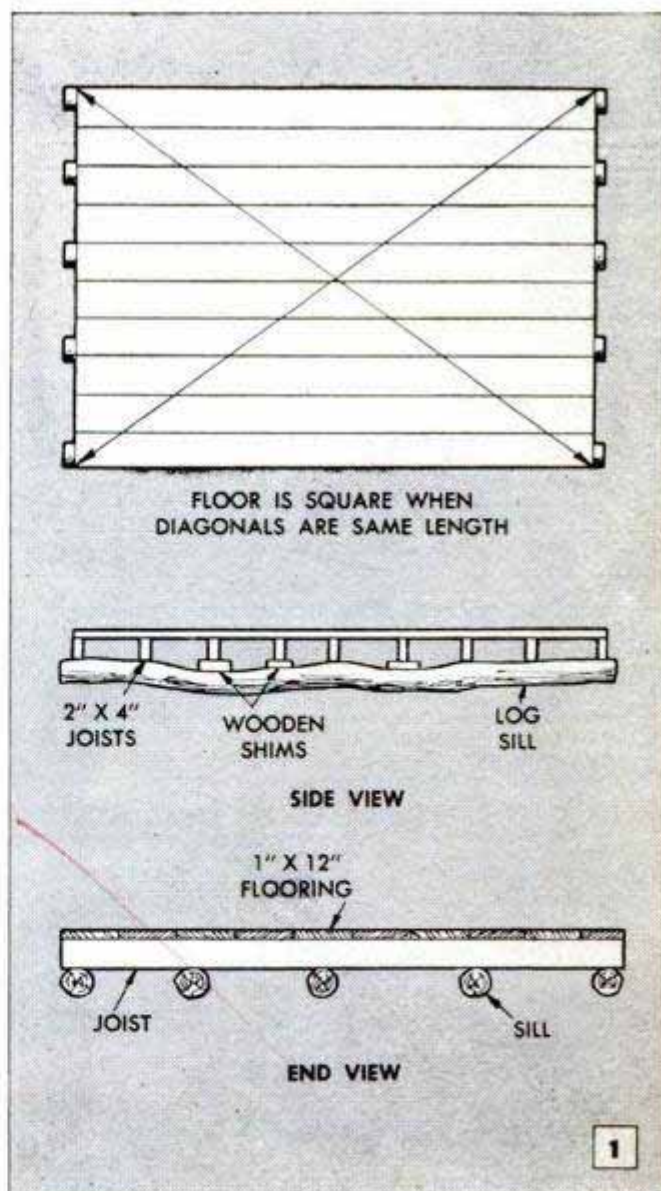

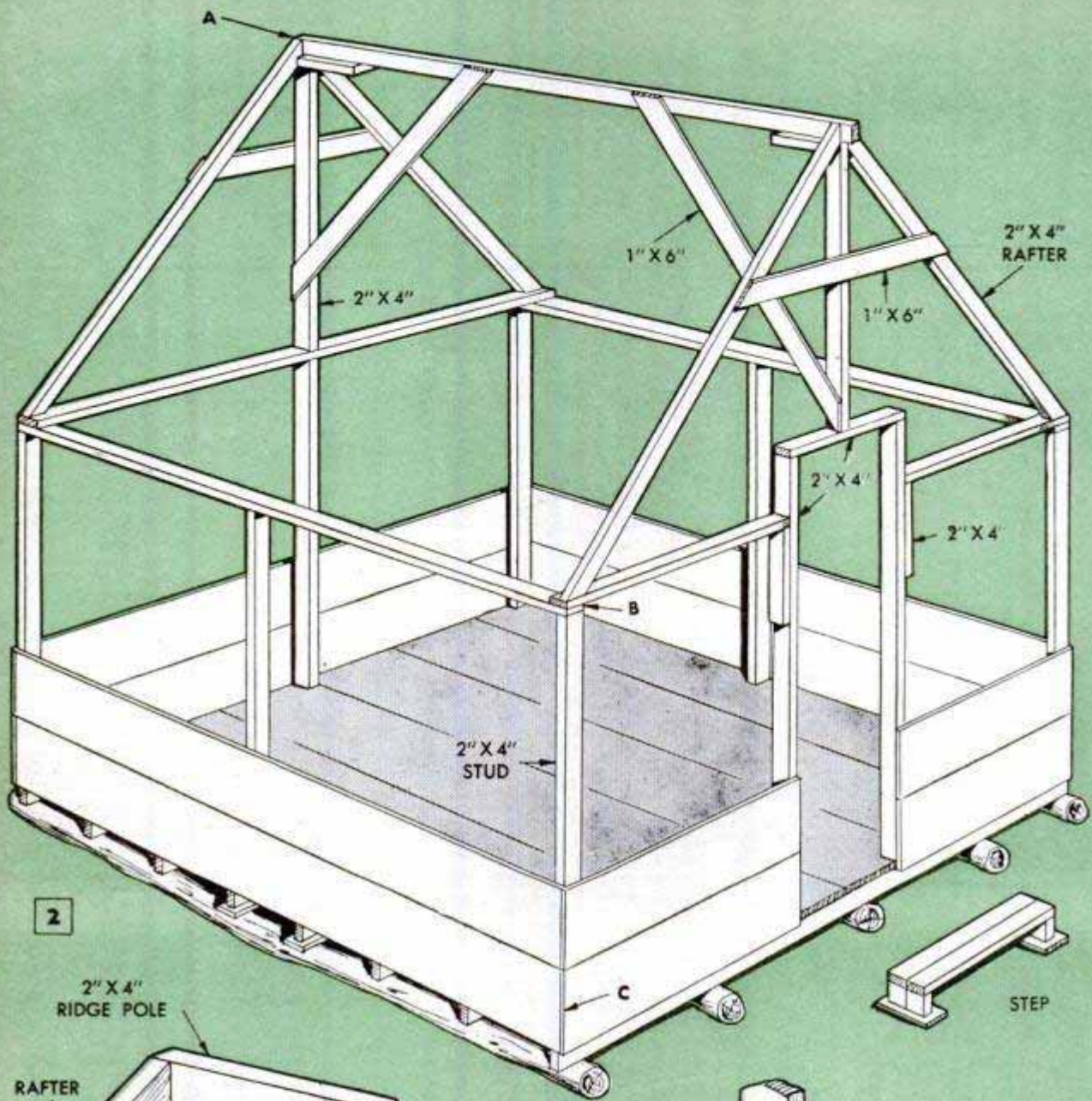

2

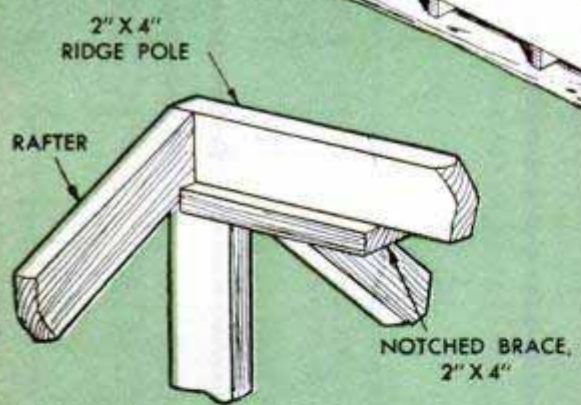

DETAIL A

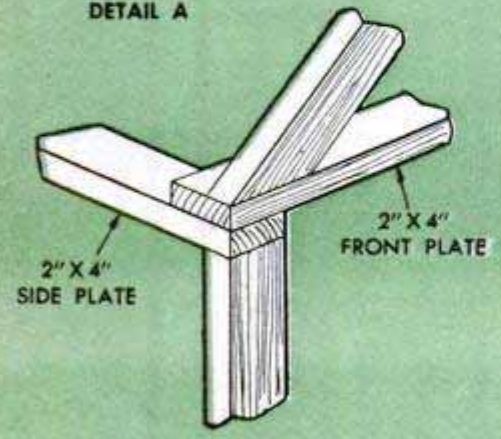

DETAIL B

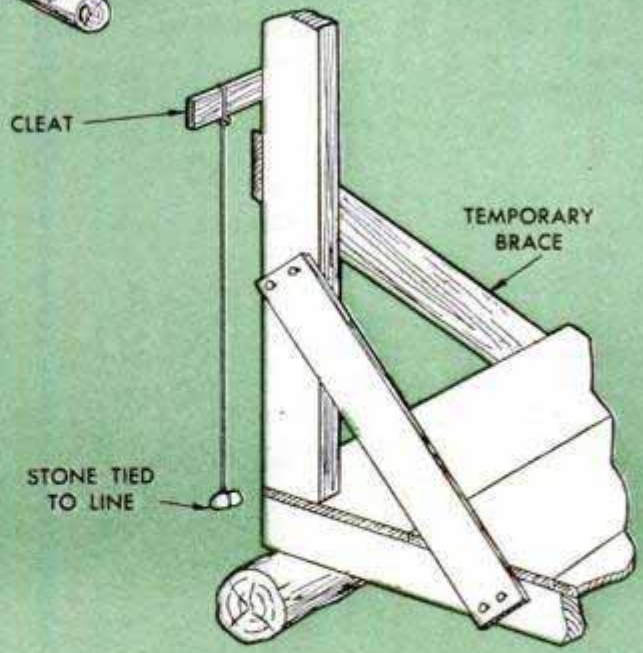

DETAIL C

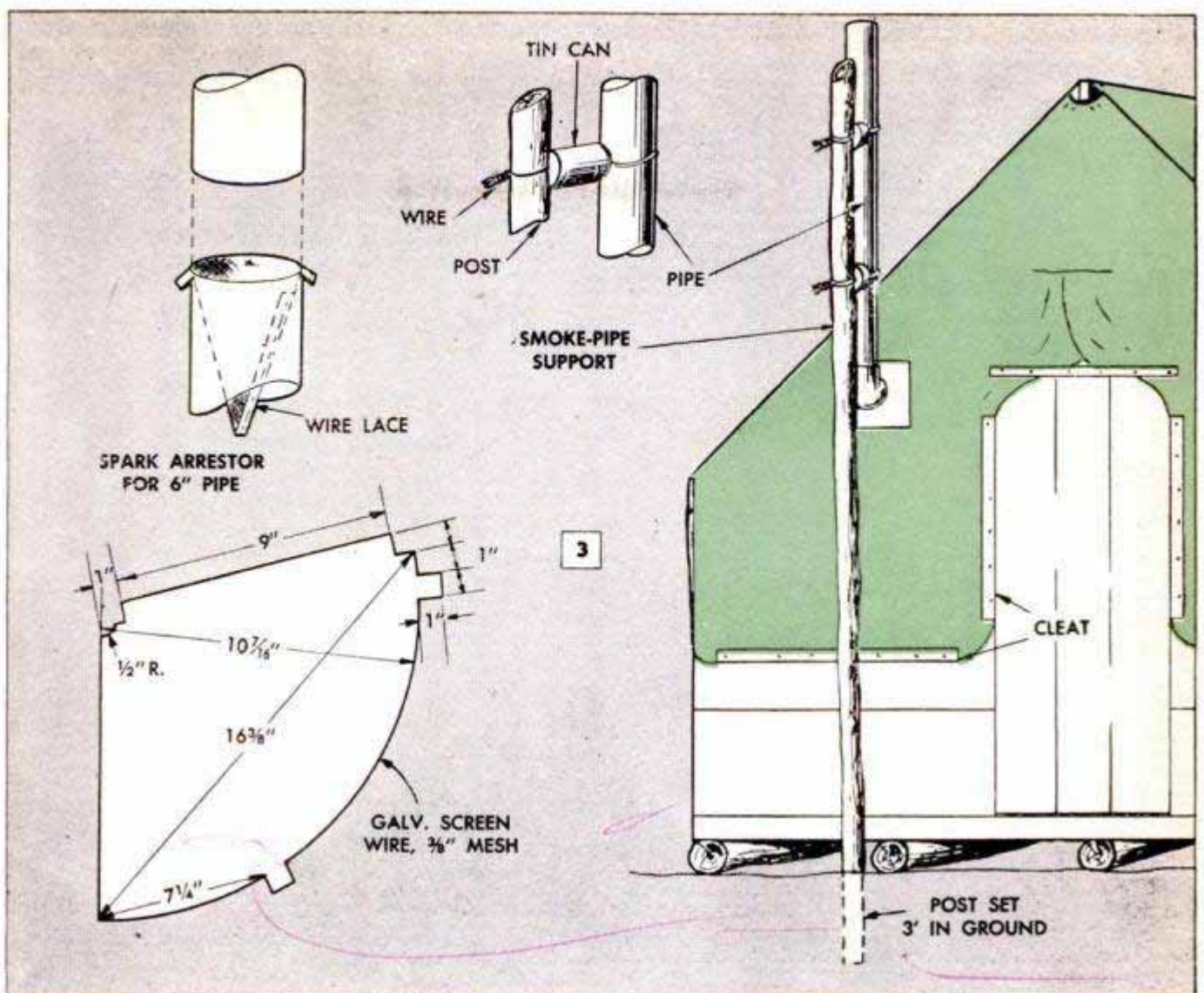

plumb and brace them as in detail C, Fig. 2. If no level is available, use a weighted cord as shown. After plumbing the corner posts, nail the side plates in position first, and then install the middle studs. Now, tie the side frames by nailing the back plate and stud in place. The doorframe is 30 in. wide and 78 in. high, inside measurements. Install the uprights, which serve as jambs, and tie the top ends with a header as shown in Fig. 2. Then nail false studs to the inner faces of the uprights to support the ends of the divided front plate. Toenail the ridge-pole supports in place and brace them temporarily. Set the ridge pole in position, toenail it to the supports and then nail the diagonal braces in place. Cut the rafters to fit at the lower ends as in detail B, Fig. 2, and at the upper ends as in detail A. Nail them in place at the upper and lower ends. Now, note the position of the notched braces in detail A. These braces are designed to strengthen the whole roof structure and should be carefully fitted. One end of each brace is notched, or slotted, to fit tightly over the upper end of the ridge-pole support and butt against the rafters. In this position it serves as a three-way nailing block, as it is nailed to the bottom edge of the ridge pole, and also to the up-

per end of the support from both sides. Finally, nails are driven through the rafters near the lower edges and into the butting ends of the brace. If a tent larger than 10 x 12-ft. floor area is used, install four additional rafters, two on each side. Draw the tent over the framework and fasten the side walls with cleats.

If desired, you can hang a conventional door to swing inward, or make one by cleating boards together to build up to the required width. If the room is to be heated, a smoke pipe is installed and supported by a post as in Fig. 3. The pipe is attached to the post by means of metal spacers made from tin cans in the manner detailed. For your own safety, as well as to prevent forest fires, the pipe must be fitted with a spark arrestor. This is made from galv. screen in the cone shape detailed in Fig. 3, and is installed in the inverted position in the pipe at the first joint below the upper end. Place the stove or heater in a shallow box filled with dry sand. Install a turn damper in the pipe between the stove and the first elbow of the smoke pipe. To protect the tent wall from the hot smoke pipe, install an asbestos flange, or thimble, in an opening cut in the canvas about 8 to 10 in. below the lower edge of the rafter.

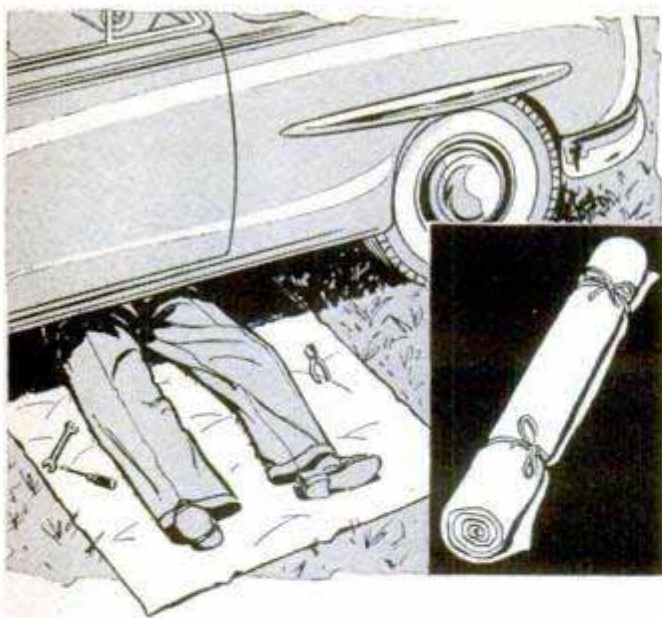

Roll of Canvas Saves Clothes When Repairing Car

A piece of ordinary canvas, rolled up and carried in the luggage compartment of your car, will come in handy should it become necessary to crawl under the car in order to make some unexpected repair. Besides protecting your clothes, the canvas provides a measure of comfort to a generally uncomfortable job.

Artist's "Marking Gauge" Holds Brush to Speed Drawing Straight Lines

Used in the same way as a carpenter's marking gauge, this handy tool makes it possible to draw fine lines with an artist's brush quickly and easily. To use the tool, the guide pin is simply held against a straightedge, as shown, and the brush held to draw the line parallel to the straightedge. The guide pin is made from an 8d finishing nail, the head being cut off and the point filed round. It is fitted in a hole drilled in a plastic or light, metal block and held by a setscrew. A second hole, drilled adjacent to the guide pin, is countersunk to accommodate brushes of various sizes. In use, the brushes are pressed into the hole and the guide pin is set to the necessary length.

L. W. Mitchell, St. Clair Shores, Mich.

Make Your Chessmen Nontipping

To keep chessmen from tipping and rolling on the board, cement a metal washer to the bottom of each piece. Then cement a felt disk to the washer to keep it from scratching the board.

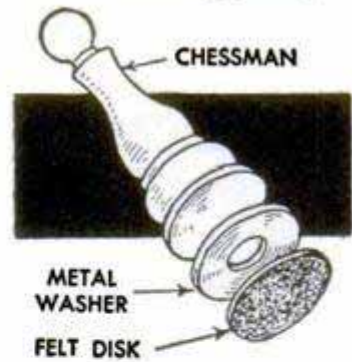

Masking Tape Rubbed With Wax Prevents Ragged Paint Edges

One disadvantage in the use of masking tape to paint straight edges is bridging—the formation of a bridge of paint between the work and the edge of the tape. This usually necessitates removing the tape before the paint is dry in order to avoid pulling chips of paint from the edge of the work. However, bridging can be prevented by rubbing the edge of the tape with a piece of wax or a candle before using. As the paint will not stick to the waxed edge, the tape can be removed at any time and will leave a clean edge.

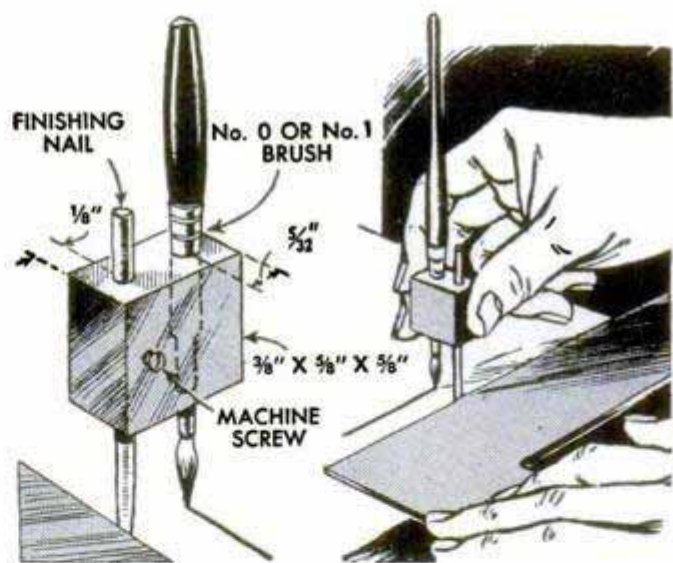

Drawer Knobs Kept From Loosening by Rubber Washers

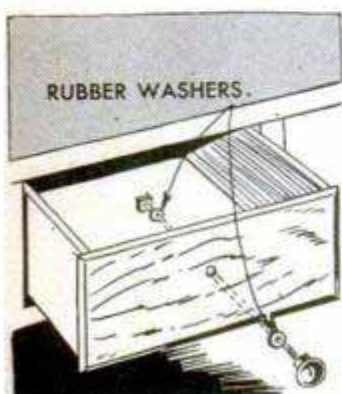

When you have a drawer knob of the type that is attached either with a bolt or a screw and cannot keep it tight, use a couple of rubber washers as illustrated. Remove the knob and place one washer on the outside.

Then push the knob in position and place a second washer on the inside. Tighten the screw or nut, whichever is used, and you will have no further trouble.

Victor Lamoy, Upper Jay, N. Y.

☐ If you are inexperienced at staining, always test the stain at hand on a piece of scrap wood of the same kind that you plan to finish. Also, remember that the same stains made by different manufacturers are not always the same color.



Homemade Picnic Cooler

Reliable cold storage for foods and beverages solves a major picnic problem. This food-storage unit is simply a box within a box, the outer one being made of plywood and the inner one of galvanized sheet metal. The 4-in. space between the walls and bottoms of the boxes is packed with Vermiculite, a granular-type insulating material. Sides, ends and top of outer box are of $\frac{1}{2}$ -in. plywood. Bottom is an open frame, half-lapped at corners and covered with hardboard. Cut ends of metal box with rivet tabs and, after riveting, solder the joints. Make metal ice container in the same manner and provide a tight-fitting metal cover

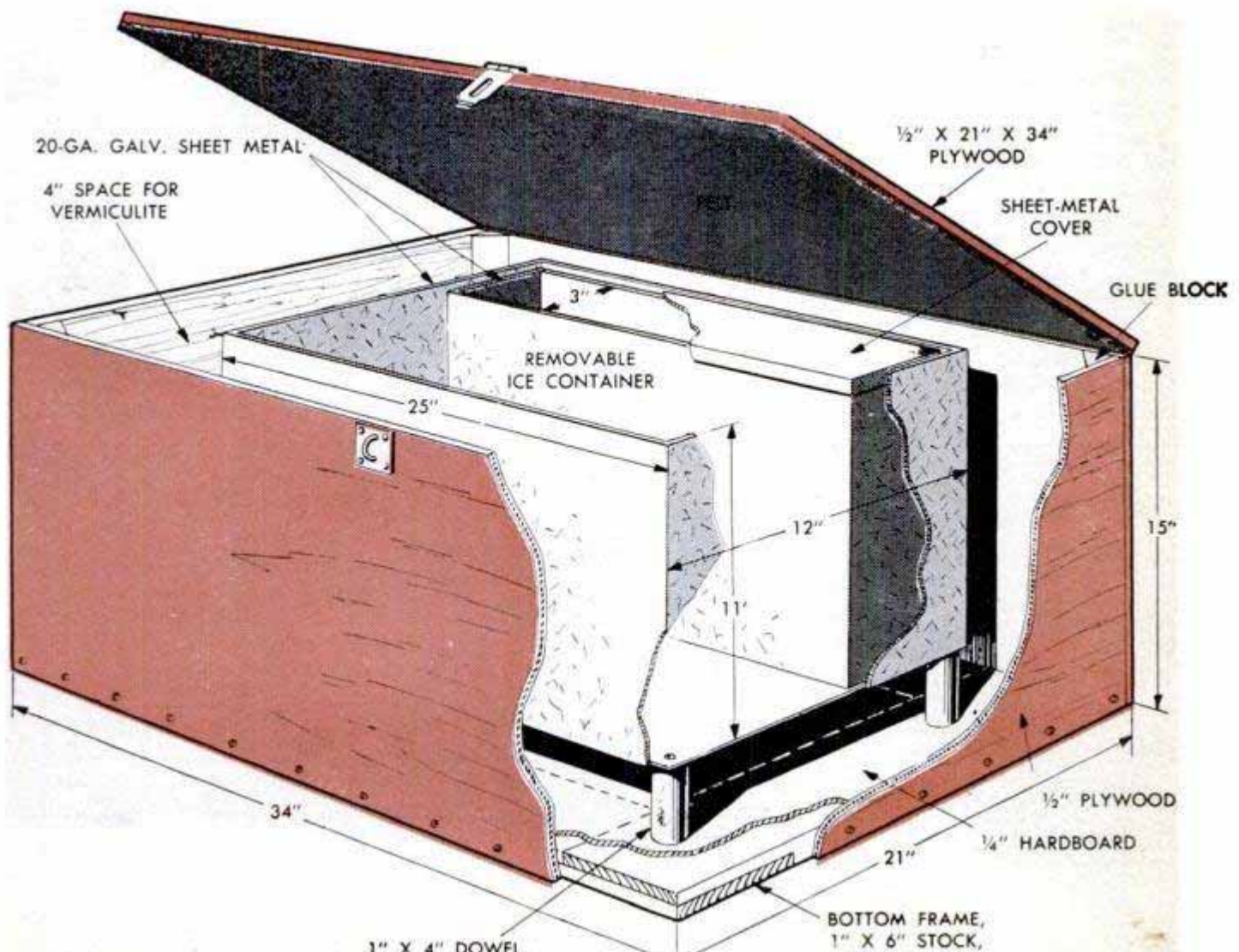

KEEP COOL

By Stanley Schuler

QUICK relief from hot-weather discomfort can be had by reducing excessive temperatures in your home with an attic fan. The operating principle of this unit is simple: At the end of a hot summer day the outside temperature drops 10 to 20 degs. at nightfall, but the walls and roof of the house prevent escape of warm air accumulated during the day. Air in the closed attic that has been heated to a high temperature continues to radiate heat to the rooms below until well into the early morning hours. An attic fan removes this stifling, heated air from the attic and from the rooms below and replaces it with fresh, cool air from outside. The high rate of air exchange carries away accumulated heat from the walls, furniture, draperies and linens, thereby reducing the temperature in the entire home. How the attic fan cools the home so rapidly and efficiently is shown graphically on the typical floor plan at the left, the directional arrows indicating movement of air through open windows to a centrally located ceiling grille, or louver. The air is drawn through the grille and exhausted through the attic louvers. As long as the fan is in operation there will be a slow movement of air in all the rooms, and cool air drawn into the house in this manner through windows and screen doors will gradually equalize inside and



Photo courtesy Hunter Fan & Ventilating Co.

After installing the vertical-discharge fan in the ceiling opening, check belt tension and all electrical connections

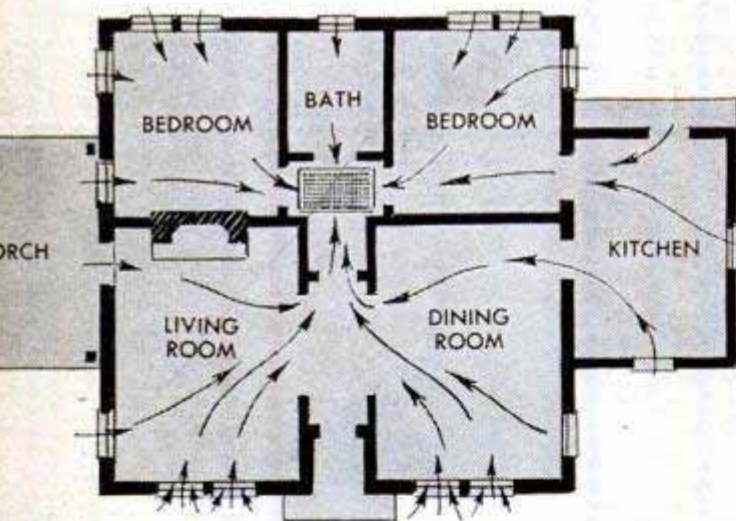

Locate ceiling opening in a hallway or in one corner of the room nearest the center of the house. Finish the opening to the edges with new plaster before framing

When framing the ceiling opening, check carefully to make sure it will be of the size recommended by the manufacturer of the fan. Make required allowances

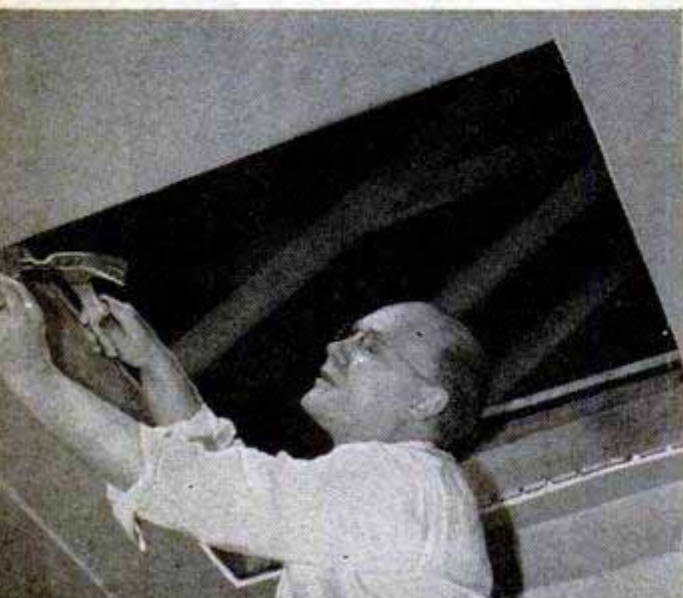

With an Attic Fan

outside temperatures. However, effective use of the attic fan is not limited to the early hours of the night. It can be turned on at intervals during hot, sultry days to exhaust heated air from the attic and maintain a more comfortable temperature in the living areas of the house.

In general, manufacturers of attic fans supply two basic types as packaged units. One is designed to exhaust air vertically in a low attic, the other is designed to discharge air from a plenum chamber or directly through an attic louver. The vertical-discharge fan is installed in a framed opening cut in the ceiling of a hallway. Photos below and on the opposite page show the method of installing this unit. It will operate efficiently with a minimum of attic headroom. Often this is the only type of installation that can be made in ranch-type homes and in 1½-story structures where most of the attic space is utilized for rooms.

The size of the fan selected depends primarily on where you live. The map at the right shows those areas in the central, western and southern states where a 1-minute air change is generally recommended. In the northern states a 1½-minute change is usually considered sufficient. In computing the size of the fan required, determine the floor area of all the rooms in the house and multiply the total by the ceiling height. Then divide this result by the rate of air exchange required. For example, if the cubic volume of the house is 10,000 cu. ft., and you live in an area requiring a 1½-minute air change, divide the cubic volume by 1½ to determine the capacity of the fan.

After the opening is framed, it is lined with a resilient, sound-deadening material so that slight vibrations are not transmitted to the framing members

If a 1-minute air change is necessary then you would install a fan rated at 10,000 c.f.m. When computing the cubic volume of the house it usually is not necessary to include clothes closets, pantries, or other small dead-storage spaces. These values assume that the fan or the grille will be located centrally, such as in a short hallway or in a corner of the room nearest the center of the house. There are two other important computations to make before installing the fan. The first is the minimum gross area of the exhaust opening and the second is the grille and louver size. If you purchase the grille unit with the fan, the size has already been computed by the manufacturer and the unit is installed in an opening in the ceiling as in the photo at the left. If you make your own louver, or grille, as in the details on page 176, then it will be necessary to compute the net free areas of both as in the tables on page 177.

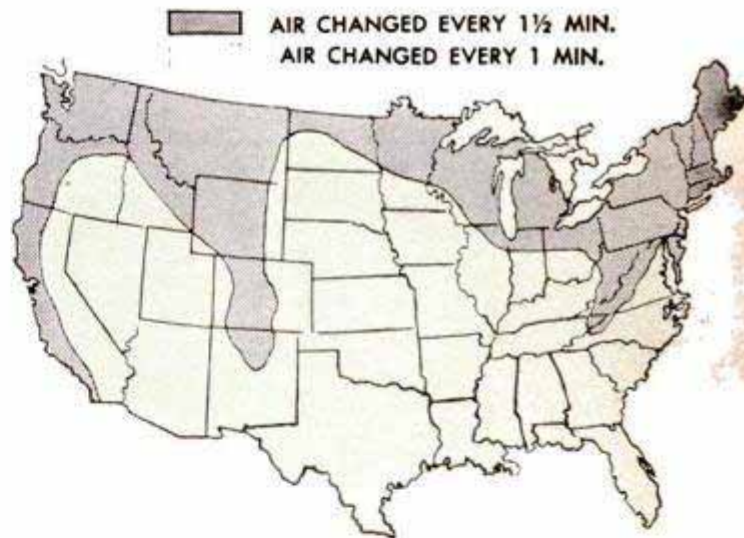

Above, map shows areas where 1 and 1½-minute air changes are required. Below, the fan unit is lifted into the attic through the rough ceiling opening

Photos courtesy American Blower Corp.

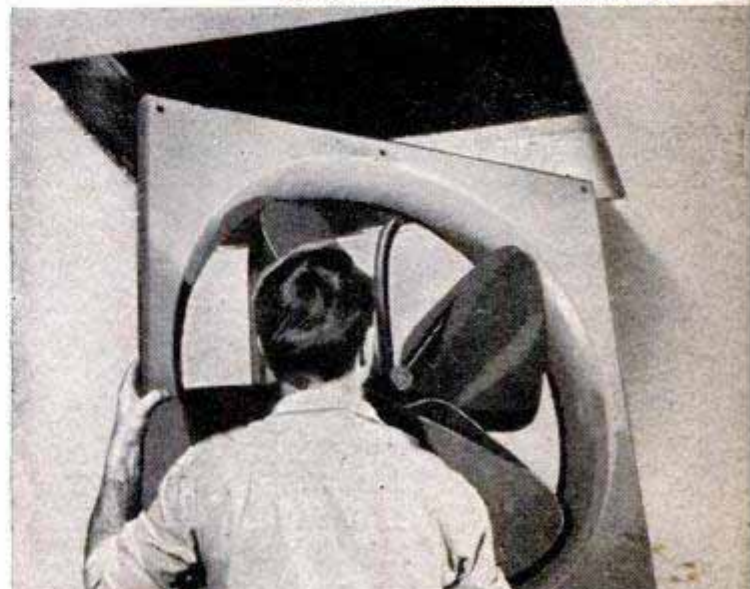

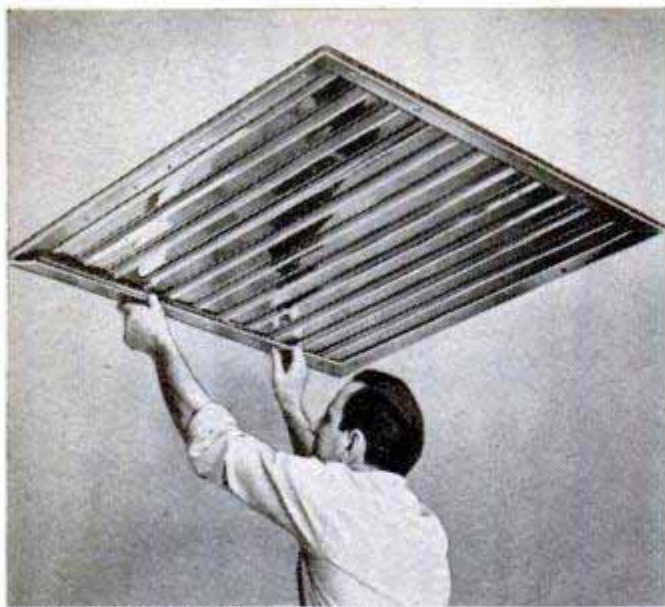

Photos courtesy American Blower Corp.

The last step is the installation of the metal louver, or grille, in the ceiling. In this type of installation, the metal shutters open and close automatically

In computing louver and grille areas, use the lower table on page 177 which makes it easy to determine the required size. In the table, the values under the heading "gross grille area" are based on the assumption that the wooden grille provides a net free opening of approximately 80 percent, while the average metal grille has a net free opening of about 65 percent. Although you can build a suitable ceiling grille, as in the lower right-hand details A and B on this page, you'll save a lot of time and extra work by purchasing this unit ready-made to fit your fan. The metal shutters open and close automatically as the fan is started and stopped. This type of ceiling grille is recommended for use with all vertical-discharge installations. Although a 14-mesh screen is specified in the upper right-hand detail of an exhaust louver, instructions usually call for 1/2-in. mesh screening over exhaust openings.

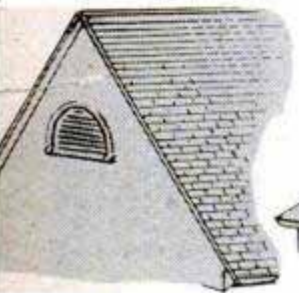

HALF-ROUND LOUVER

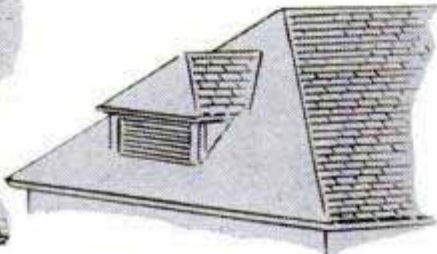

LOUVER IN HIP DORMER

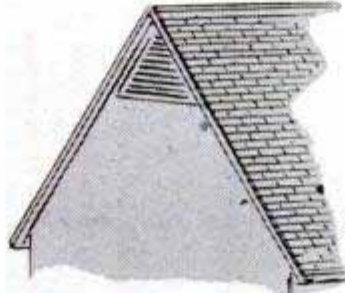

GABLE-END LOUVER

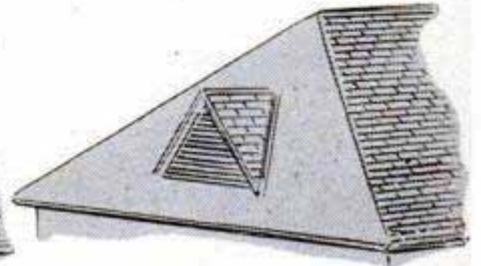

GABLE-ROOF DORMER

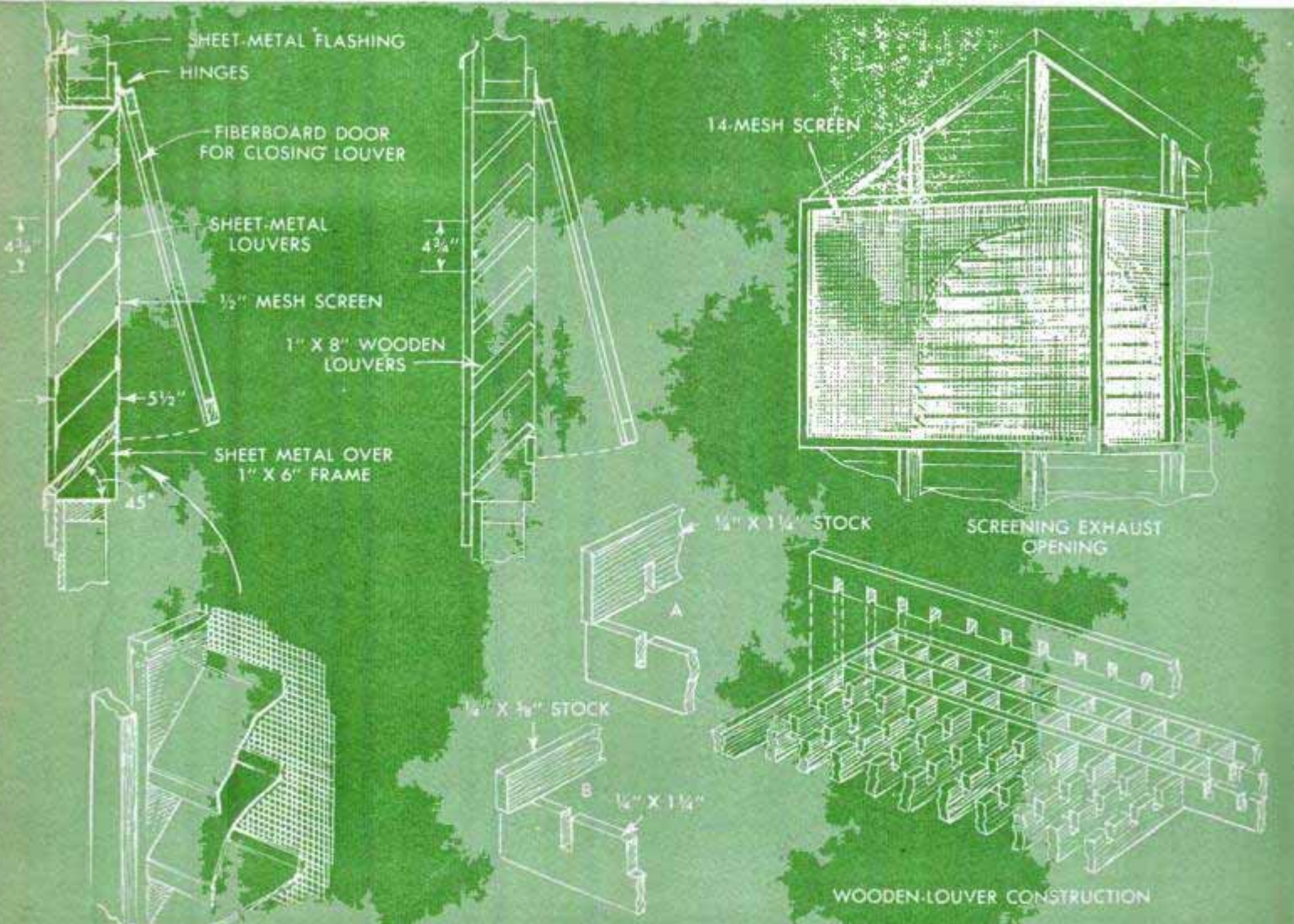

WOODEN-LOUVER CONSTRUCTION

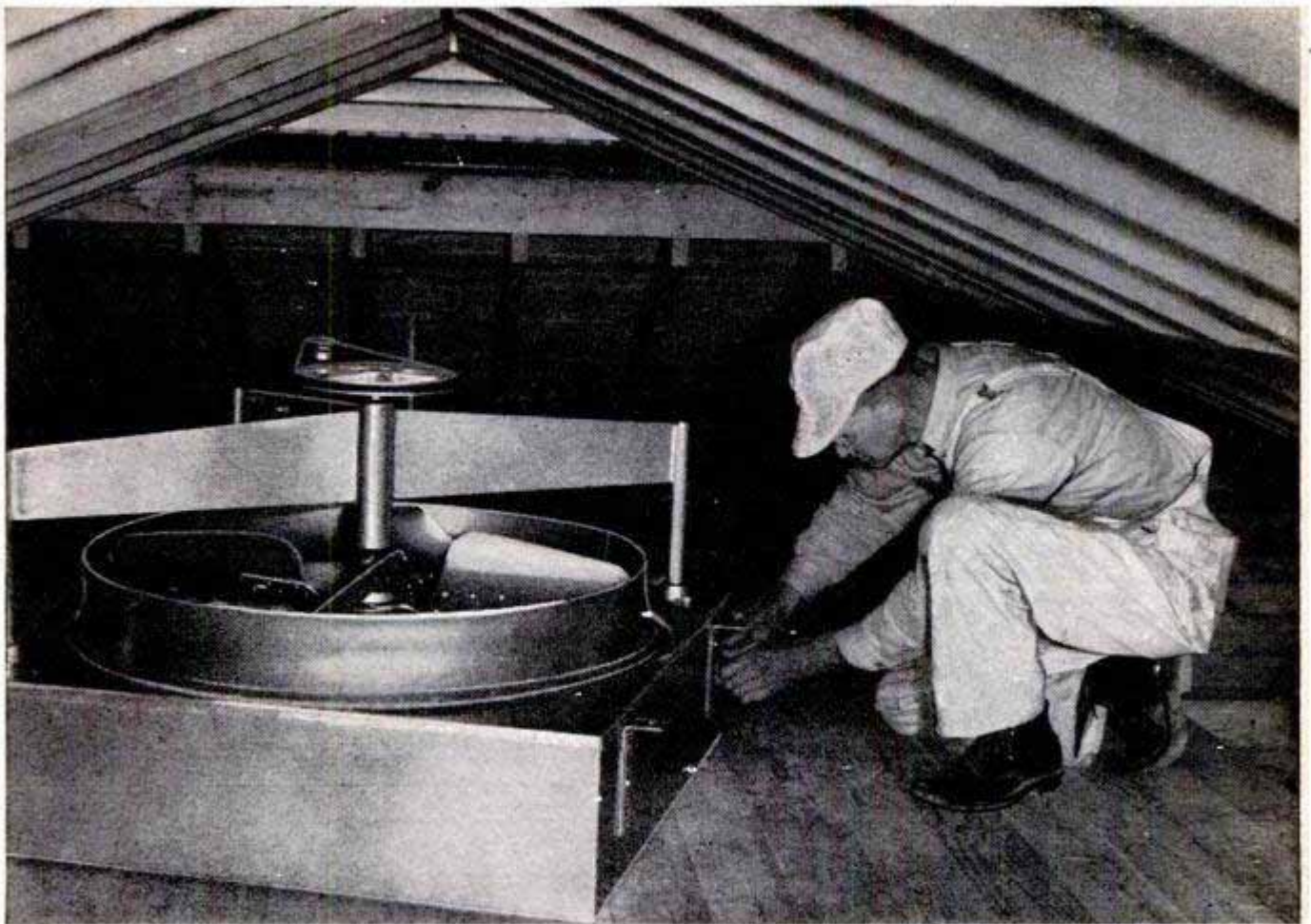

Photos courtesy Hunter Fan & Ventilating Co.

The vertical-discharge fan is designed for installation in low attics. It will operate in only 30 in. of headroom

MINIMUM GROSS AREAS OF EXHAUST OPENINGS

AREAS	1-MINUTE AIR CHANGE	1½-MINUTE AIR CHANGE
Wood louvers backed with ½-inch wire mesh	Not less than 1/40 of gross floor area	Not less than 1/60 of gross floor area
Metal louvers backed with ½-inch wire mesh	Not less than 1/50 of gross floor area	Not less than 1/90 of gross floor area
Plain openings, such as those in soffits, backed with ½-inch wire mesh	Not less than 1/65 of gross floor area	Not less than 1/100 of gross floor area

GRILLE AND LOUVER SIZES

Fan capacity CFM	Net grille, or louver, area Sq. Ft.	Gross grille area Sq. Ft.		Gross louver area Sq. Ft.	
		Wood grille	Metal grille	Wood louver	Metal louver
4000	5.3	6.7	8.1	10.6	7.6
5000	6.7	8.3	10.3	13.4	9.5
6000	8.0	10.0	12.3	16.0	10.4
7000	9.3	11.7	14.3	18.6	13.3
8000	10.7	13.3	16.5	21.4	15.2
9000	12.0	15.0	18.5	24.0	17.1
10000	13.3	16.7	20.0	26.6	19.0
11000	14.7	18.3	22.6	29.4	20.9
12000	16.0	20.0	24.6	32.0	22.8
13000	17.3	21.7	26.6	34.6	24.7
14000	18.7	23.3	28.8	37.4	26.7
15000	20.0	25.0	30.8	40.0	28.6
16000	21.3	26.7	32.8	42.6	30.5
17000	22.7	28.3	34.9	45.4	32.3
18000	24.0	30.0	36.9	48.0	34.3

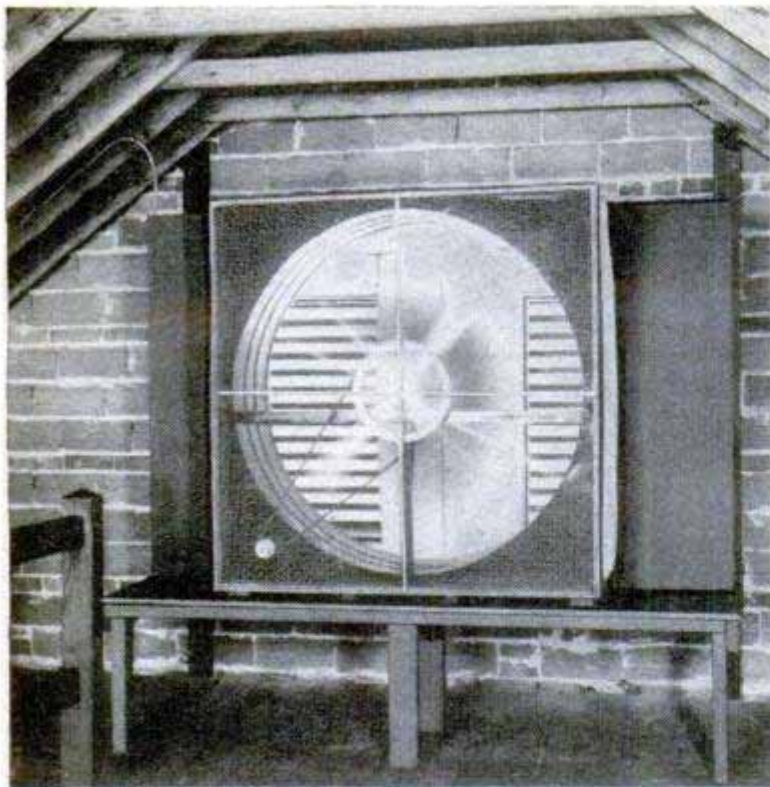
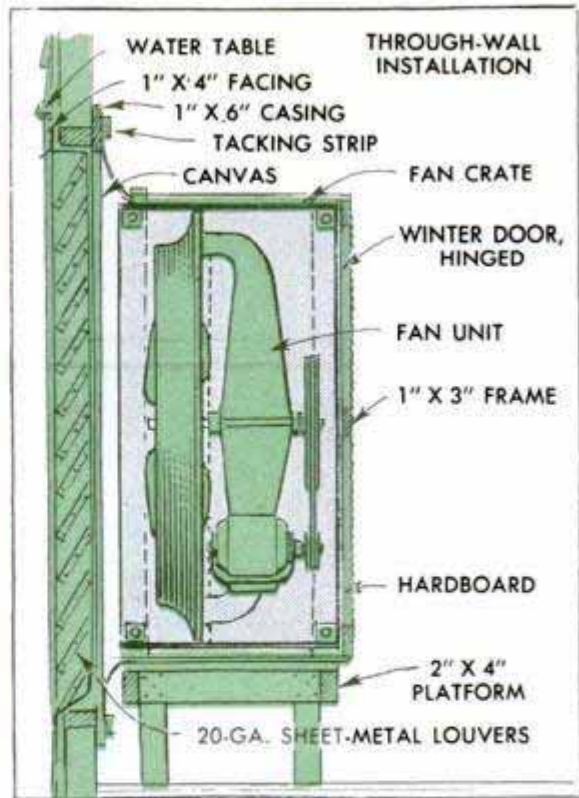

Photo courtesy Emerson Elect. Mfg. Co.



When installing the metal grille with shutters, it is essential to follow the manufacturer's directions in all details. Be sure that the opening is cut to the correct size and is framed according to the instructions for installation of both the grille and fan. Often it is necessary to shim the metal frame of the grille at several points to prevent twisting, which might cause the shutters to bind and prevent them from opening fully. Although every attic will offer

Photo courtesy Hunter Fan & Ventilating Co.



an individual installation problem, it is essential that the vertical-discharge fan be placed on its resilient mountings in such a way that no part of the frame touches the framing in the opening. For quiet operation the unit must "float" on the mountings. When installed in unheated attics in cold climates, the automatic ceiling grille does not always provide sufficient protection against infiltration of cold air and some arrangement must be made for closing the opening. Some owners cut insulation batts to fit over the ceiling shutter. These batts are removed in the spring and kept in the attic for easy replacement.

The gable, or through-wall, installation of the type pictured and detailed above is a popular unit. Usually the louver is homemade, the louver shutters being made of metal or wood, and the fan is installed to discharge horizontally as in the detail. In this installation the fan and its shipping crate are supported on a low platform and connected to the louver opening by means of a canvas bellows. The fan mounting should be cushioned on a piece of softboard or rubber pads, and the opening to the fan should be screened with $\frac{1}{2}$ -in. wire mesh. Provision must also be made for closing the opening during the cold winter months. Where possible, locate the louver on the side or end of the building opposite the prevailing winds. The center details on page 176 suggest several different types of attic-louver installations. As a rule, attic fans are controlled by a manual switch conveniently located in a room or hall as in the photo at the left. If desired, an automatic time switch can be installed.

Overhead Lattice Added to Small Patio Gives That "Finished" Look

If you have a small patio between your house and garage, an overhead lattice will often give it that added improvement for which homeowners constantly strive. The photo shows such a lattice which, in this case, was built to finish off the space formed by the sides of a house, breezeway and garage. Lengths of 2 x 4s were used in assembling the lattice. The openings are 18 in. square. All joints were half-lapped with the exception of those in the outside frame. It is advisable to assemble the entire lattice on a flat surface, such as a driveway, after which it is lifted into position. Use a length of pipe or 2 x 4 to support the lattice while it is being nailed in place.

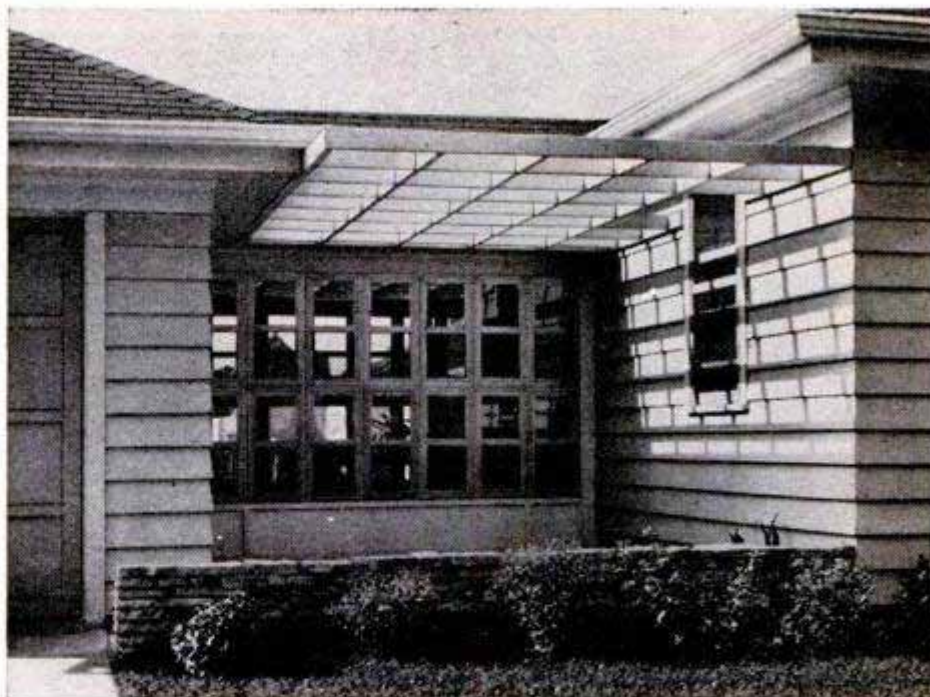

Blocks can be used under the post for slight adjustments in height.

Don Brooks, Lombard, Ill.

Dual-Pole Bracket Makes Life Easy for Bank Fishermen

Fishermen who like to use set poles when fishing from the banks of streams or farm ponds will appreciate this handy bracket, or holder, for two poles. In this case, bait-casting rods are pictured, but the bracket can be made for bamboo poles as well. The holder is a welded job, using $\frac{3}{8}$ -in. mild-

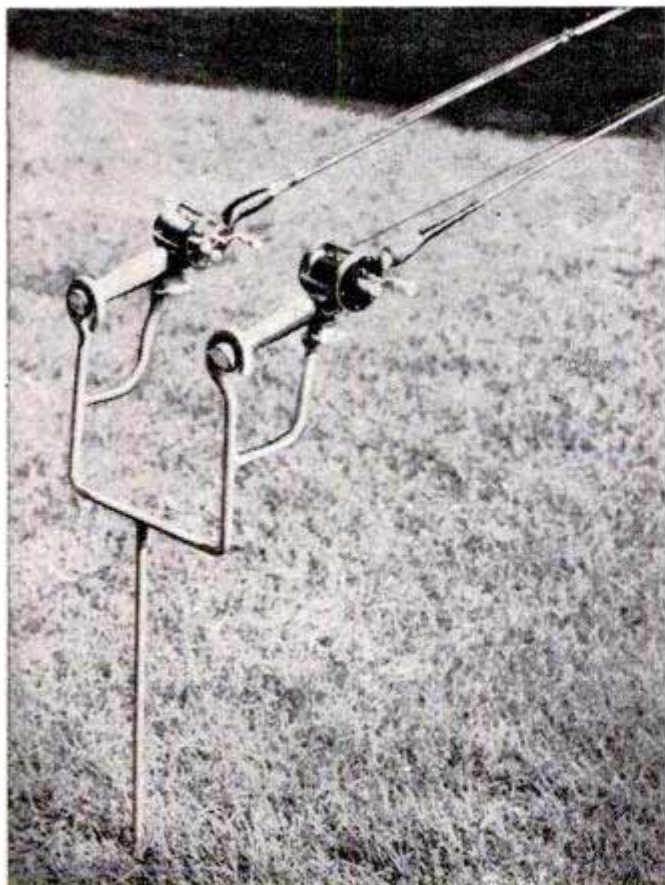

steel rods for the various parts. The lower end of the vertical member is sharpened to form a stake which is easily forced into the ground. A U-shaped member, having eyes formed at the ends, is welded to the stake to form a yoke. The eyes should be just large enough for easy insertion of the butt ends of the rod grips. Then supporting arms are welded to the arms of the yoke. U-shaped members of $\frac{1}{8}$ x $\frac{3}{4}$ -in. flat steel are welded to the top ends of the supporting arms to form seats for the rods. These seats, or clips, support the rod at a point opposite the reel seat and prevent it from twisting or sliding forward when a fish is hooked.

Grounding Tail Lamps on Cars

On older cars where tail lamps are bolted to the rear fenders, rust and dirt accumulated in the joint between the bracket and fender often prevent grounding of the lamp circuit. The joint can be cleaned and the ground renewed simply by driving a thin metal washer between the bracket and fender. Both sides of the washer should be indented with a punch to form slight projections on the metal which will cut through the corrosion.

E. T. Gunderson, Jr., Humboldt, Iowa.

Wads of cotton packed in the finger tips of rubber gloves will keep fingernails from tearing through the rubber.

NURSERY

Part II

CONTINUING the series on nursery furniture styled by John Bergen, details are presented for building a playpen, desk-toy cabinet, chair, toy chest and night lamp. The playpen is completely enclosed with plastic screen wire and features a hinged top which folds flat against the back of the playpen. Both the front and back sections of the playpen are assembled by fastening the top and bottom rails of each section to a center upright and then joining the ends of the rails to 1 $\frac{3}{4}$ -in.-sq. corner posts, all the joints being doweled and glued. Note that a handrail is installed between the corner posts approximately 12 in. from the top. Each end section of the playpen consists of two screened panels pivoted to the corner posts and hinged together at the center to permit folding. Hinges are improvised from common L-braces, angle brackets and mending plates. The hinged panels are locked in the open position by flat-steel latches. These are notched near one end to engage roundheaded screws driven partially into the panel frames. The hinged panels are locked in the open position by flat-steel latches. These are notched near one end to engage roundheaded screws driven partially into the panel frames. The $\frac{1}{2}$ -in.-plywood bottom rests on cleats screwed along the lower rails of the front and back sections. The over-all height of the side panels is 37 $\frac{3}{4}$ in., the corner posts extending 2 in. below them.

The desk-toy cabinet is made entirely of

Sturdy Base for Bench Saw Made From Scrap Parts

One craftsman made a sturdy base for his bench saw by utilizing the base from a discarded cream separator and a wheel taken from an old mowing machine. The cream-separator base was inverted and attached to the wheel with a single large bolt run through the hub of the wheel. Holes in the separator base that had formerly been used to anchor the machine were utilized for bolting the saw in place.

Fumbleproof Matchbox

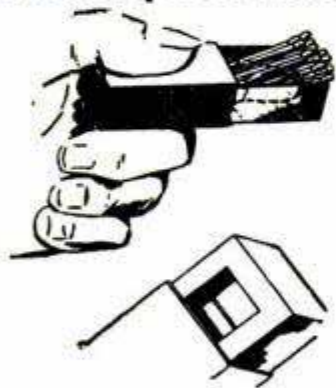

Cutting a hole in the drawer of a penny-size matchbox makes it possible to raise the matches out of the box with the finger tip so that one match can be removed without having to fumble for it. If cut ap-

proximately $\frac{3}{4}$ in. square in the center of the drawer, the hole will not be large enough to permit the matches to fall through.—E. Binderwald, Riverton, N. J.

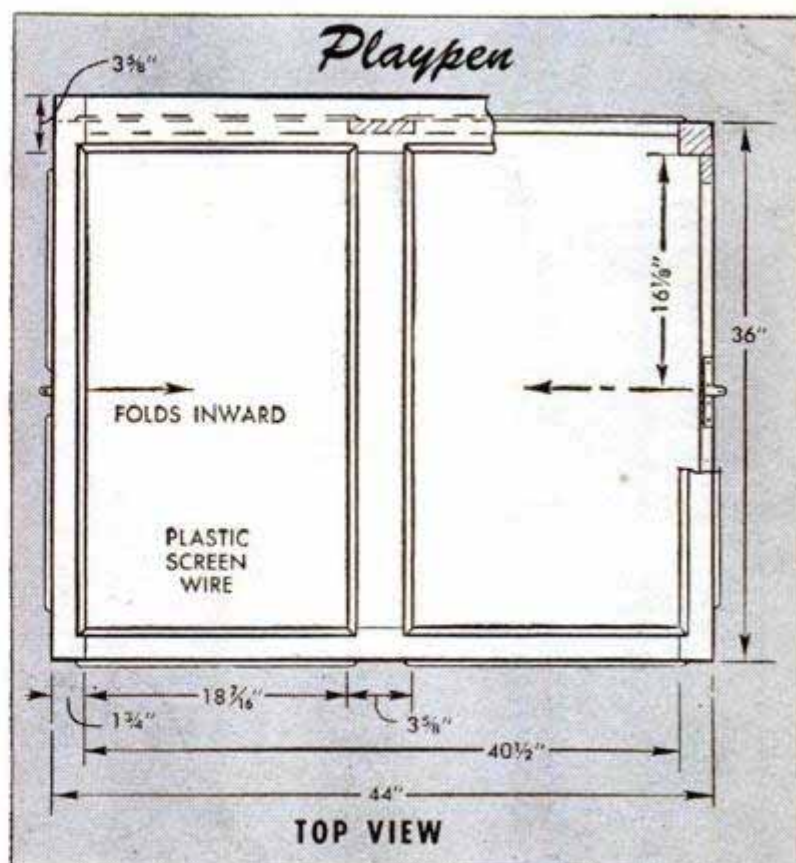

TOP VIEW

FURNITURE

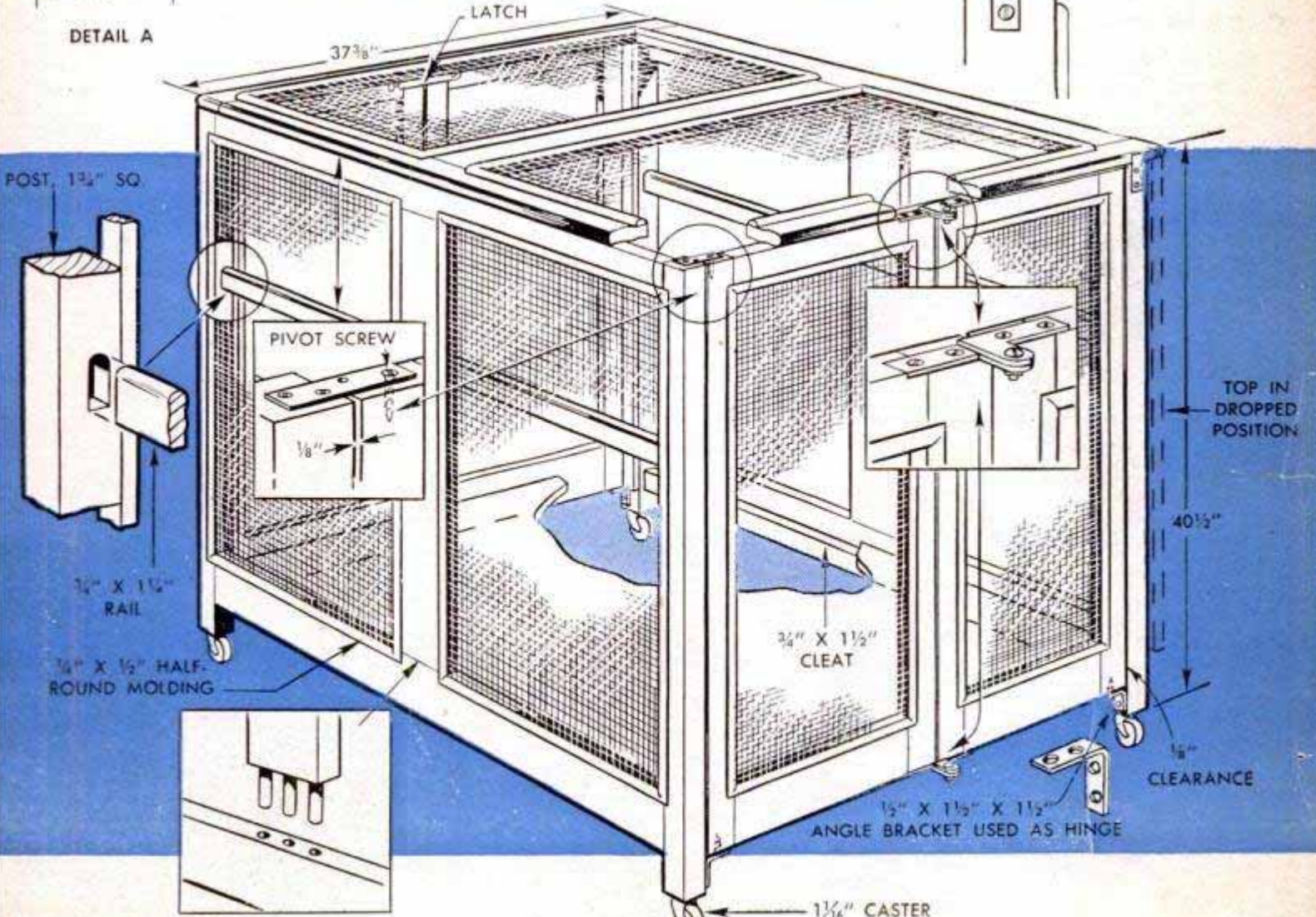
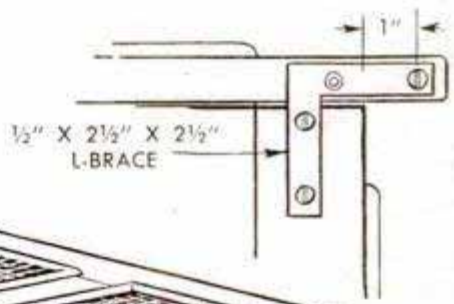
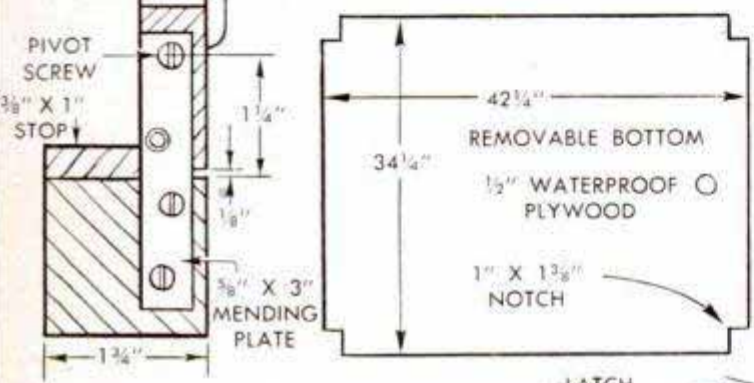
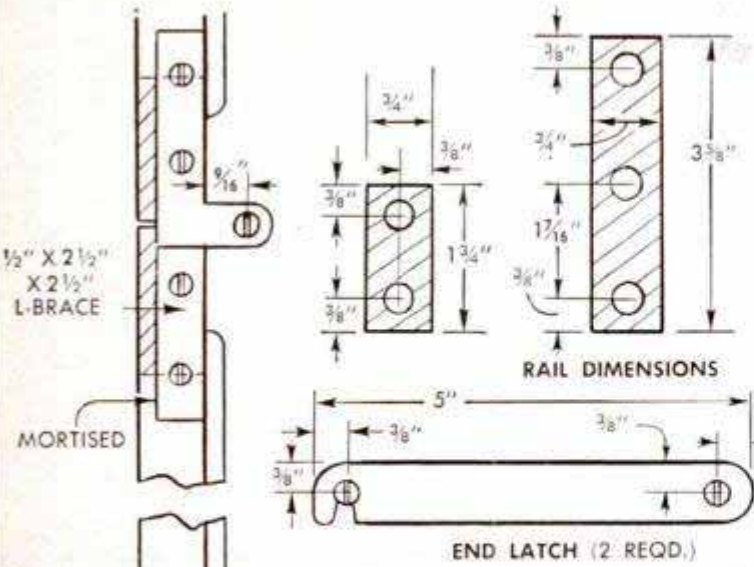
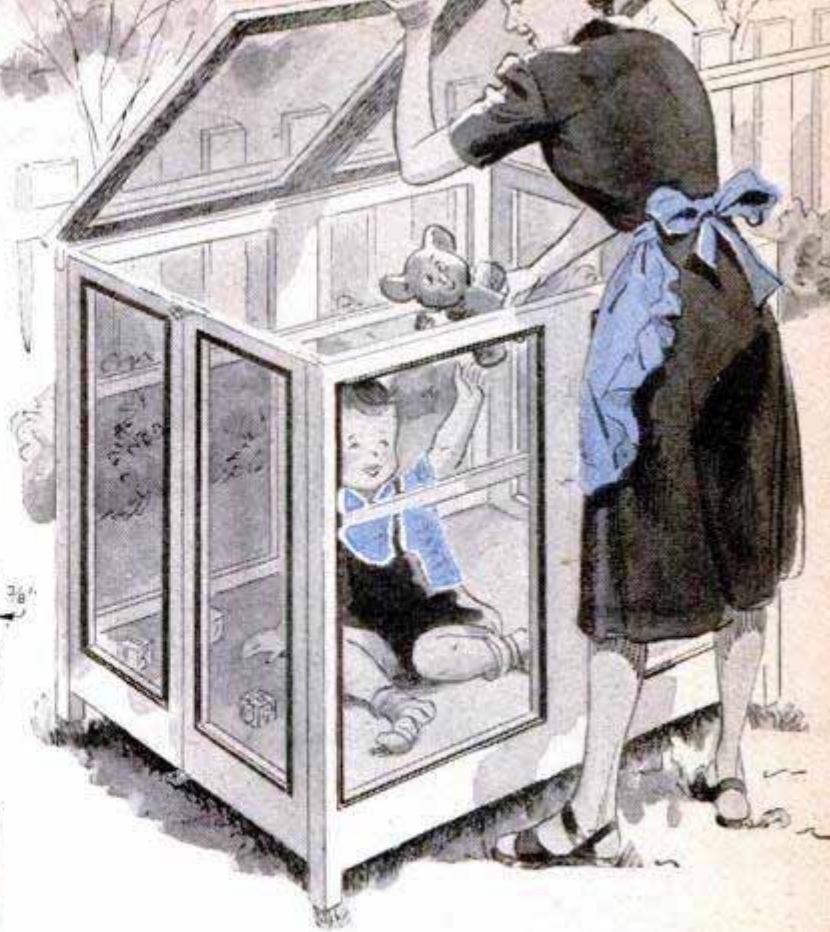

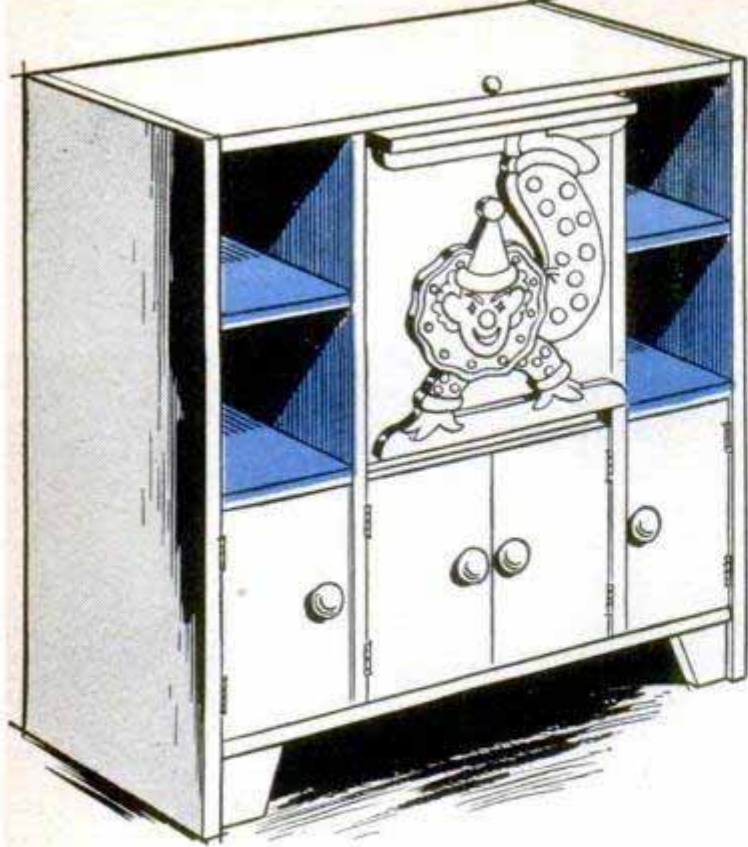

3/4-in. plywood except for the back panel which is of 1/4-in. hardboard. Construction is unusually simple, the edges of the shelves and top being tenoned to fit matching grooves in the sides and partitions. The drop leaf, detailed below, is hinged to the center half and supported in the open position by a large clown jigsawed from 3/4-in. plywood. The clown is hinged to a 3/4 x 1 3/4-in. cleat mounted along the front edge of the drop leaf. A standard drop-leaf support locks the clown cutout at right angles to the leaf, and when the leaf is in the up, or closed, position the cutout folds flat to form a decorative overlay on the front of the cabinet.

Splayed legs and a novel jigsawed back distinguish the sturdy desk chair. The seat

Desk-toy Cabinet

The drop-leaf table is held in closed position with metal or hardwood pin detailed at the right. The pin engages a hole drilled in the front edge of the leaf and is pulled upward by means of a ball-shaped wooden knob in order to disengage leaf

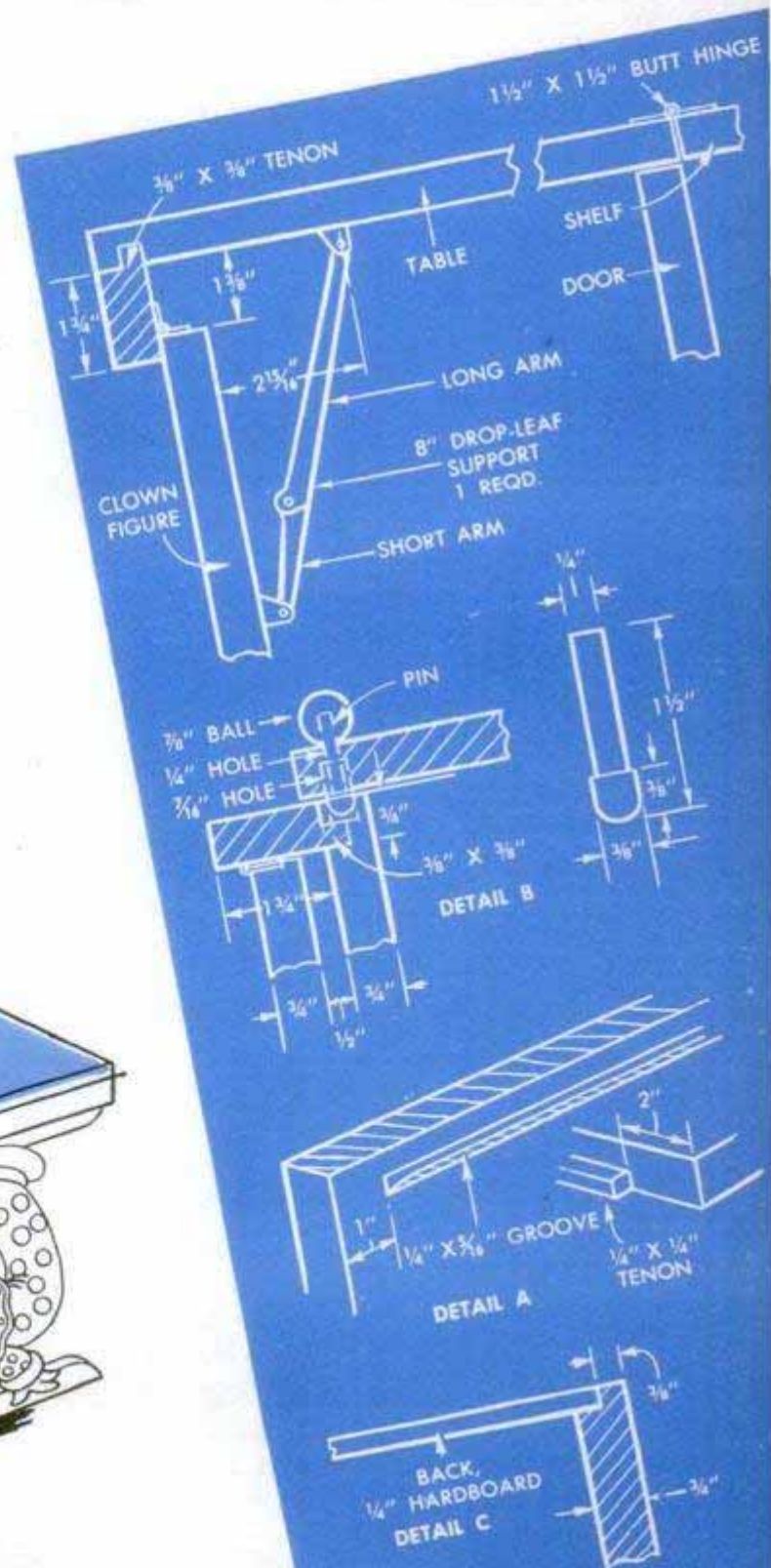
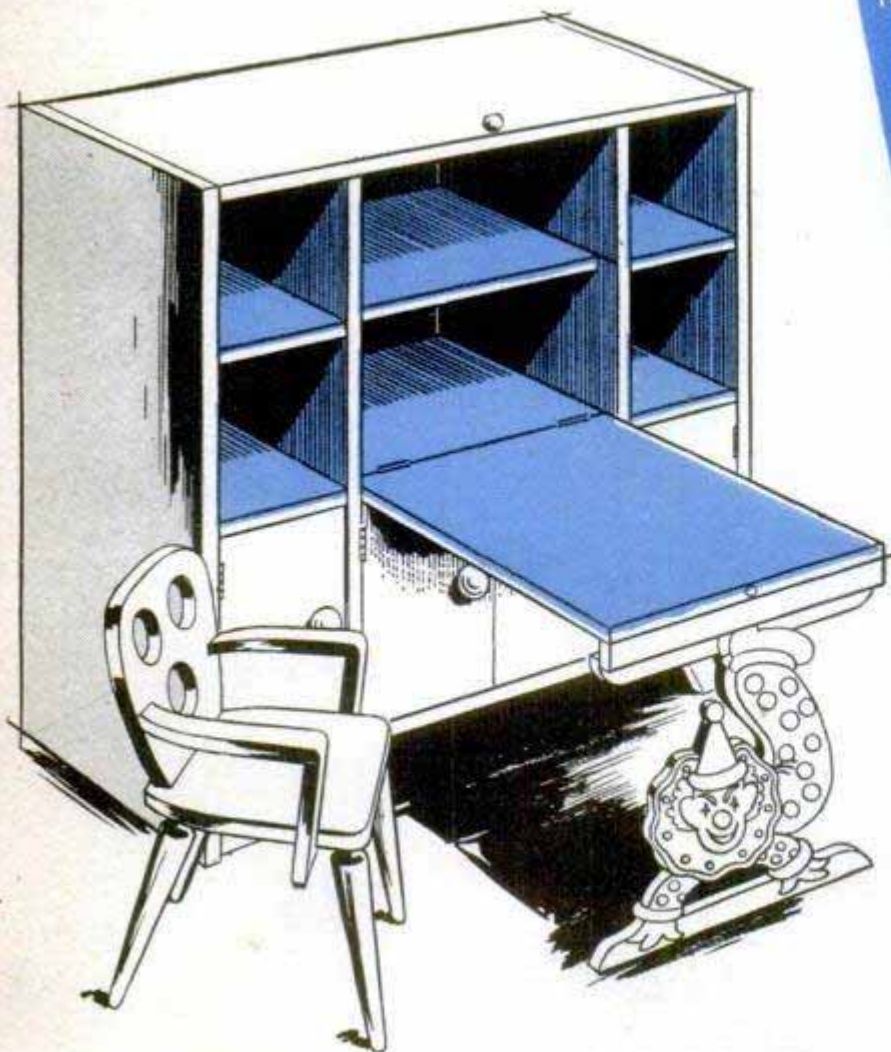

and back are of $\frac{3}{4}$ -in. plywood, the back being tenoned and glued in a blind groove plowed in the seat. Note that the ends of the tenon are relished, or cut back, to fit in the groove. Three holes are jigsawed in the back, as in the upper detail, and four holes are bored through the seat to receive the tenons turned on the splayed legs. The chair arms are doweled and glued to the supports which, in turn, are doweled to the ends of a crosspiece. The crosspiece

is screwed to the underside of the seat, the top edge of the crosspiece being beveled to fit the slant of the seat.

With its plastic-upholstered lid, the handy toy chest also serves as a window seat or bench. Two removable trays comprise the upper portion of the chest, and facilitate storing small items which otherwise would be "lost" in the bottom of the chest. Front,

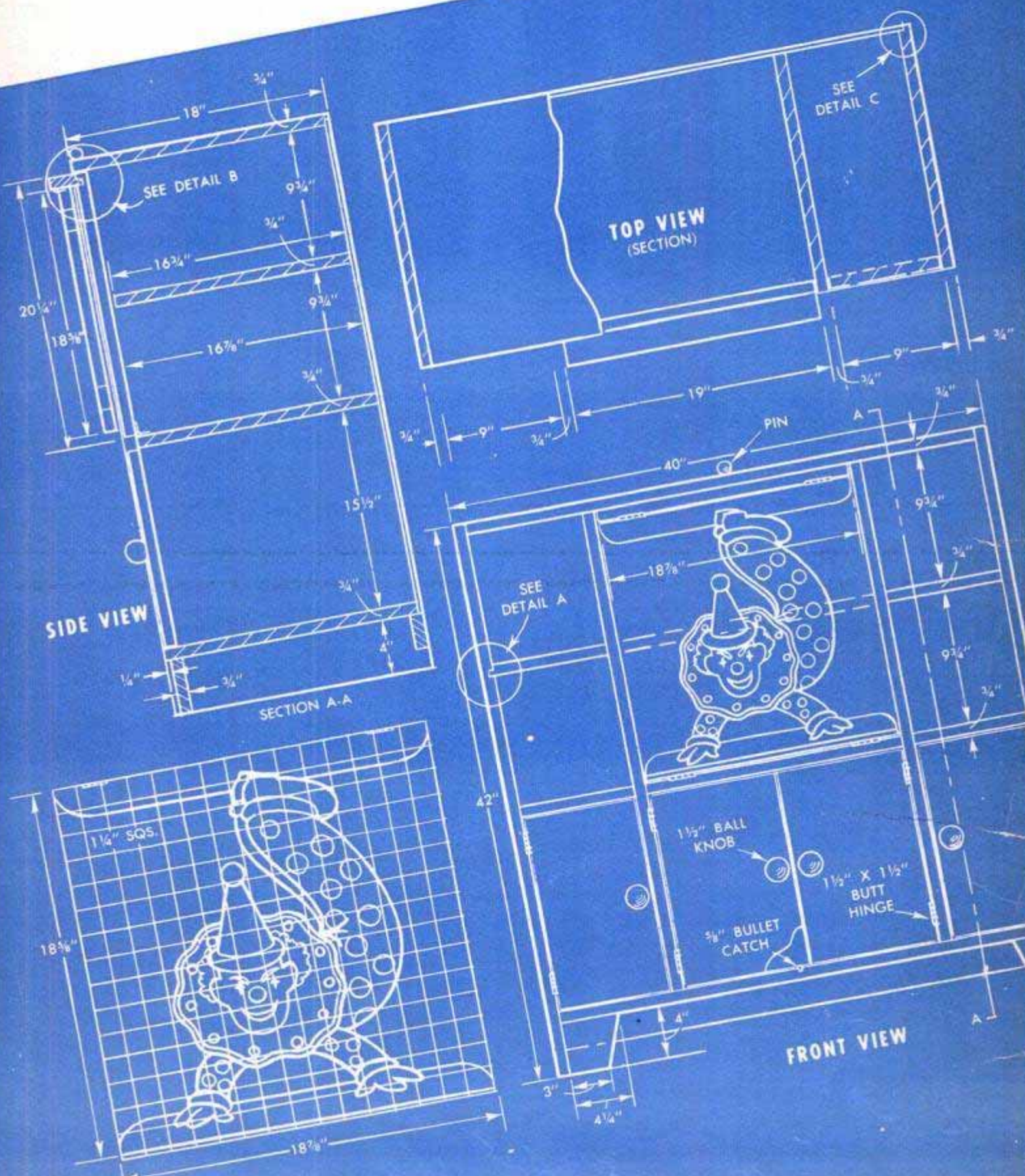

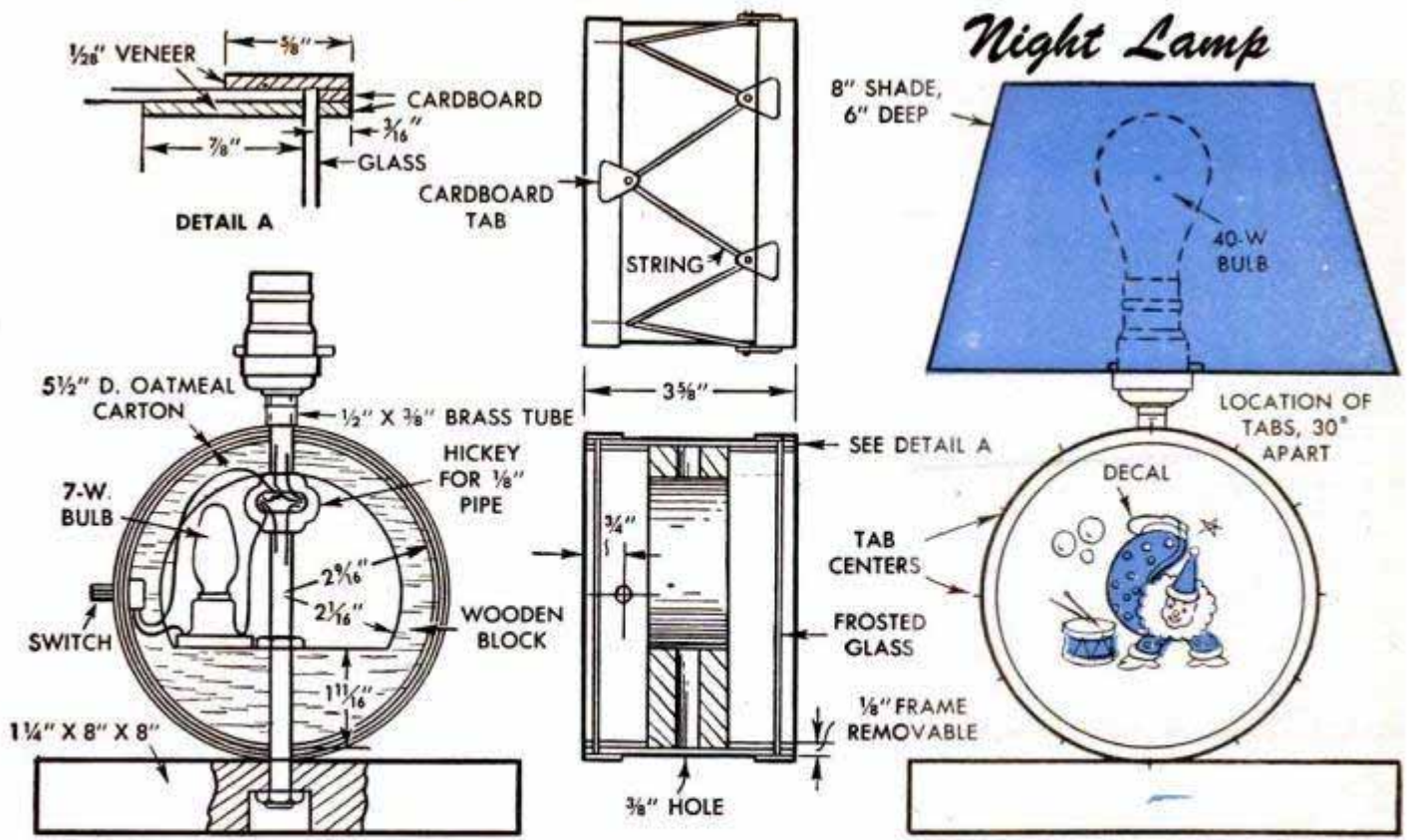

A drum-shaped base decorated with a phosphorescent decal retains the circus motif in this little night lamp. The drum shell is made from a cardboard cylinder, such as a section cut from an oatmeal carton, which is reinforced with a wooden block about 1 1/4 in. thick. Disks of frosted glass form the "heads" of the drum. These are held in place with spacer rings of 1/28-in. veneer on inside and laminated-cardboard frames on outside. The frames fit inside strips of veneer which form the rims of the drum. A threaded fixture pipe extends through the bottom of the drum to permit attaching an 8-in.-square wooden block. Lamp is wired as in the left-hand detail, the base block being drilled from the center hole to one side to provide an outlet for the lamp cord

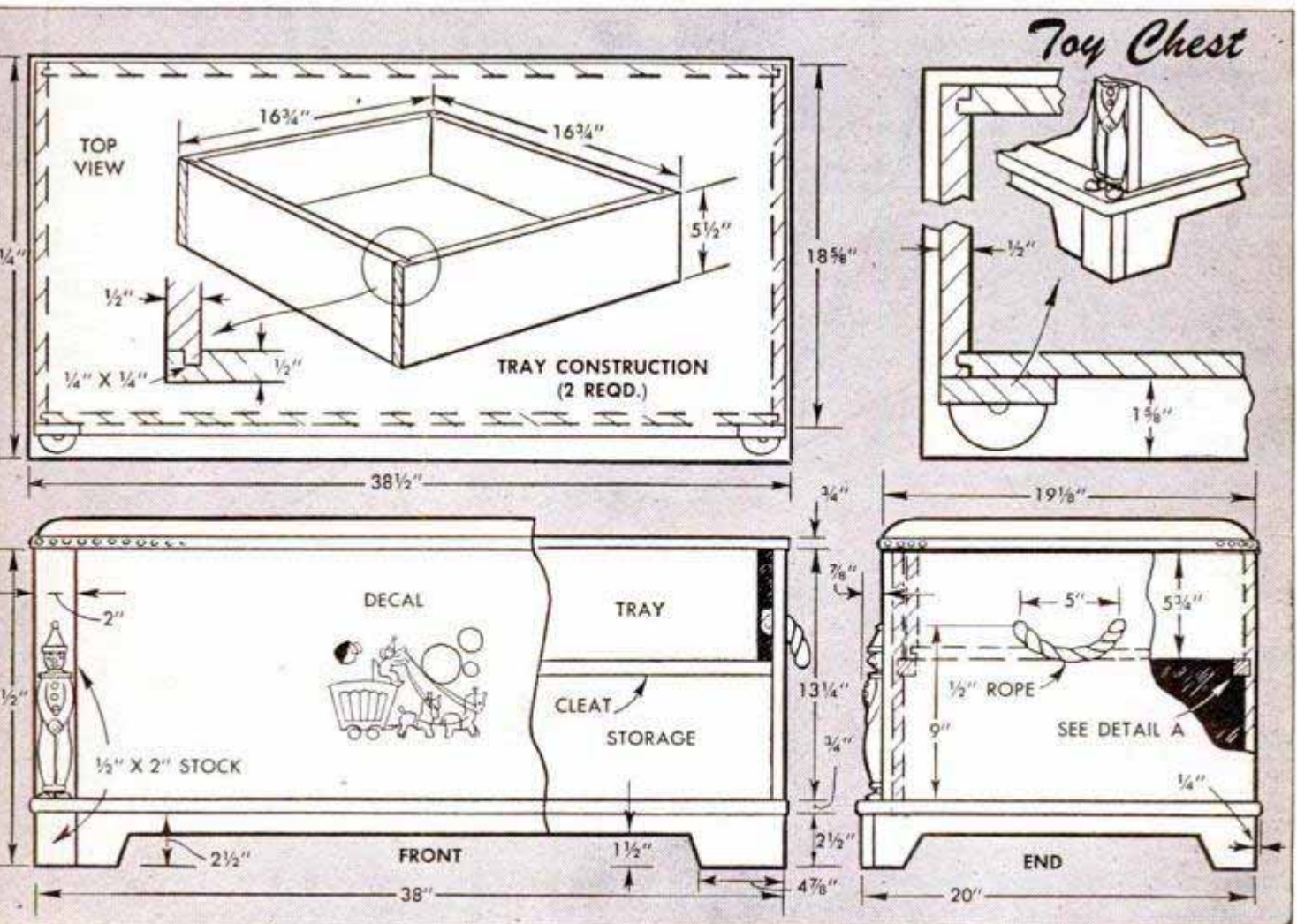

Swinging Taillight on Bicycle Is Easily Seen by Motorists

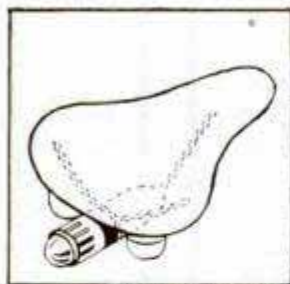

To make the taillight on your bicycle attract attention of oncoming motorists, suspend it with small chains from the bicycle seat where it will swing back and forth in constant motion. The light in the detail is a two-cell unit that works in the same way as a flashlight, but any type light can be used. Three short lengths of small chain are attached to the sides and rear end of the light, and are bolted to the underside of the seat in the positions shown. The chains should be short enough to keep the light from striking any part of the seat.

R. Galuzzo, Chicago.

Holder for Slack in Electric Cord



A useful device, on which excess slack in an electric cord is wound and held, can be made from a $\frac{1}{8}$ x 1 x 6-in. length of pressed board or heavy cardboard. Drill a $\frac{5}{16}$ -in. hole, $\frac{1}{2}$ in. from each end and cut a slot from each hole to the end of the board. The surplus cord is wound on the holder and held by slipping the cord through the slots.

Removing Broken Setscrews

Removing a broken socket-head setscrew, or one on which the socket has been deformed, can be a real poser, especially if the screw is in a hard-to-get-at place. One way of doing the job is with a screwdriver. Drive the screwdriver lightly into the

socket and, placing a drop or two of penetrating oil on the head of the screw, turn the screwdriver bit with a small wrench. Another way is to select a socket-setscrew wrench of a larger size than the screw socket and grind a taper on the hex end. Then drive the tapered end lightly into the deformed screw socket until it fits tightly. Still another method that often works is to place a pin punch against the screw socket and upset it slightly by striking the punch with a hammer. This method usually will reform the socket sufficiently so that the screw can be turned out with the regular wrench. If the head of the screw is broken or chipped but still projects slightly above the tapped hole, it generally is possible to slot the broken end of the screw and remove it with a screwdriver.

LeRoy T. Rice, Syracuse, N. Y.

Comb Cases Store Small Tools

Pocket-comb cases make handy holders for small tools such as rulers, pencils or scribers. Tack the cases to the wall where the tools to be held will be kept convenient.



Hardening "Dusty" Concrete

If you have a concrete floor in your home that always seems "dusty," chances are that the condition can be corrected by hardening the surface of the floor with a zinc sulphate solution. Mix powdered zinc sulphate, 3 lbs., to water, 1 gal., and pour the mixture over the floor. Then scrub vigorously with a stiff brush but don't remove the solution. Instead, let it dry thoroughly, and then sweep the floor clean.

Can Key Scores Cardboard

Hobbyists who work with cardboard will find this tool useful for making press scores in cardboard so that it can be folded without breaking. The small key used to open most vacuum-packed, tin containers is force-fitted into a hole drilled in the end of a short length of $\frac{1}{2}$ -in. dowel. If a key is not readily available, a substitute can be made from a piece of stiff wire.

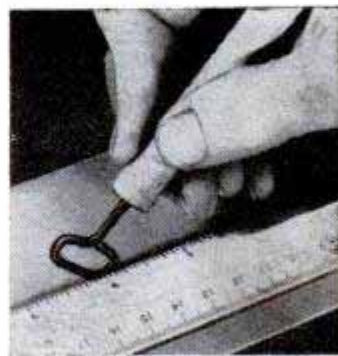

Telephone Stand

By James F. Casey



ATTRACTIVE design and day-to-day utility are features of this cabinet telephone stand. The partitioned drawer provides space for receipts as well as a phone-number file and, if desired, the top edge of the partition can be V-grooved and notched to serve as a pencil holder. Use $\frac{1}{4}$ -in. solid stock for exposed parts and $\frac{1}{4}$ -in. plywood for the drawer bottom, sides and back. The curved drawer front is bandsawed from $1\frac{1}{2}$ -in. stock, a cross-hatched detail below, giving the curve pattern for the drawer front and the forward ends of the top and bottom members of the cabinet. Strips of matching wood, $\frac{1}{4}$ in. square, are glued to the top to hold the telephone in place. Finish with varnish or enamel.

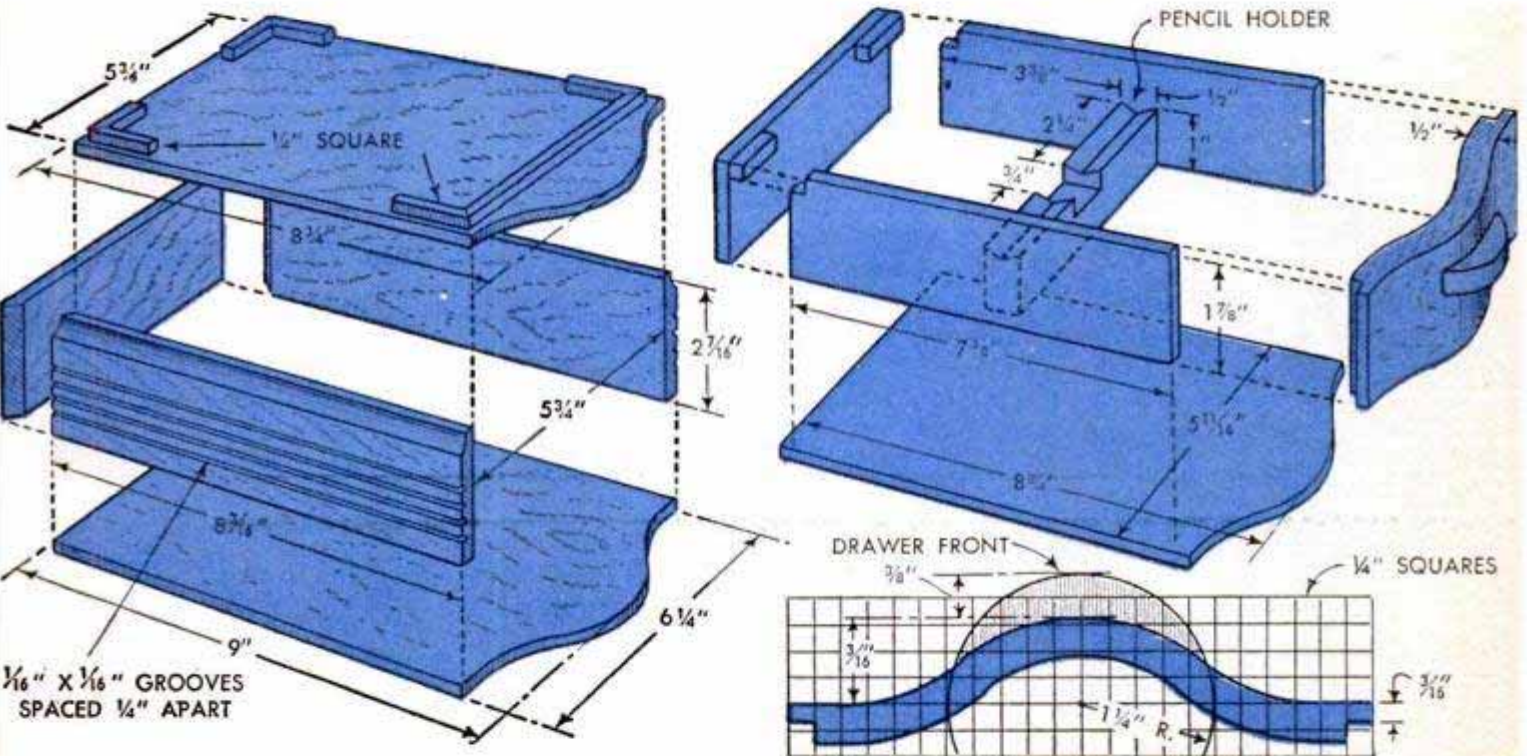

Clear-Plastic Cylinder Holds Magnifying Glass for Viewing

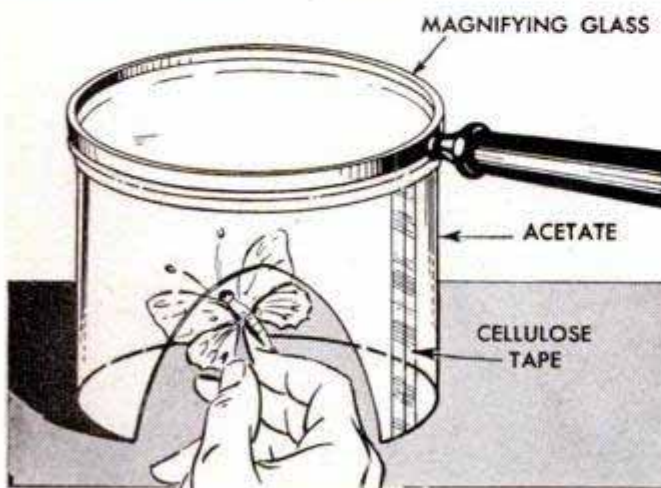

Butterfly collectors, or other hobbyists who collect small items that are usually viewed with a magnifying glass, will find this clear-plastic holder very convenient. It provides a steady support for the glass, thus leaving both hands free to handle the specimens, and the transparent sides allow unobstructed lighting of the object being viewed. To make the holder, bend a thin sheet of plastic to form a cylinder that just fits within the rim of the magnifying glass, joining the butting edges of the strip with cellulose tape. Then cut an opening in the holder, as shown, and set the glass on the top edge.—Ed Packer, Chicago.



REMOTE CONTROL *for* GEARSHIFT OUTBOARD

By Clinton R. Hull

NOW YOU CAN fit your gearshift outboard motor with a remote control that gives you the safety, maneuverability, and smoothness of operation formerly enjoyed only by inboard boat owners. The principal features of the control units, designed by Joe Carver of Costa Mesa, Calif., are ease of construction, adaptability and positive action. Both the gearshift and throttle-control mechanisms operate without takeup or drag, a feature of importance in the control of high-speed craft. Both controls are mounted on the conventional outboard steering-wheel unit, such as the Kainer wheel. The designs of the control-support brackets that mount on the motor are quite easily changed to adapt them for use with various types of outboard motors and shift mechanisms.

On most small boats of the runabout type, somewhat better balance will be obtained

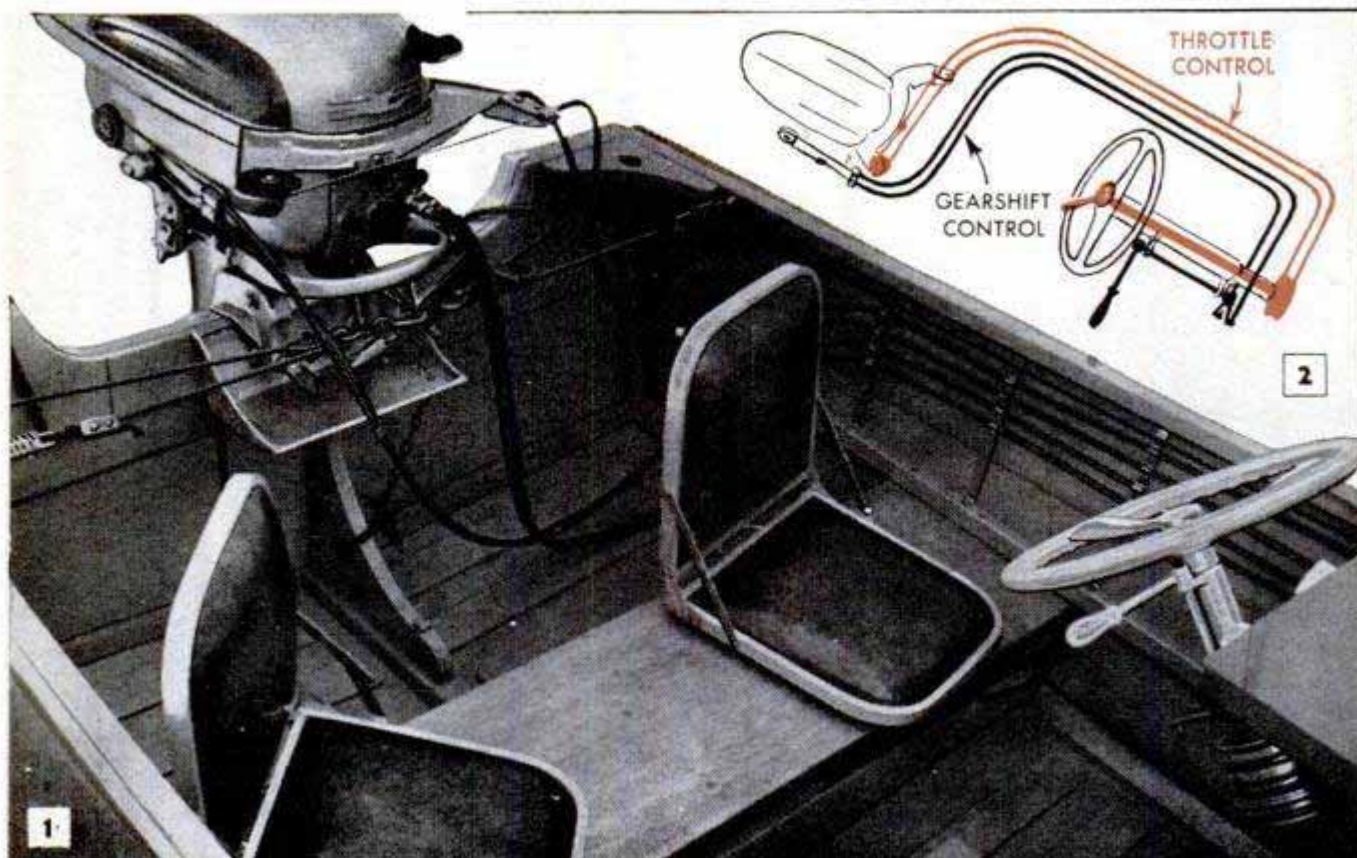



by mounting the steering wheel on a cowl aft of midships as in Fig. 1. In this case, the cowl and deck are open at the center to permit easy passage to the forward cockpit. The left-hand (port) section of the built-in cowl provides a support for the steering-wheel-and-control assembly and the space under the starboard section is utilized for storing an extra fuel tank. Figs. 1 and 2 show how the steering cables and the Bowden wires controlling the gearshift and throttle are placed along one side of the boat. The cables and wires are attached by means of special cable and casing clamps to metal straps which are screwed to the inwales and seat risers. The parts which are added to the standard steering-wheel unit are detailed in Fig. 5 and shown in place in Figs. 3 and 4. Parts A, B, D and F are aluminum castings. If you wish, you can make the wooden patterns and have the castings made at a local

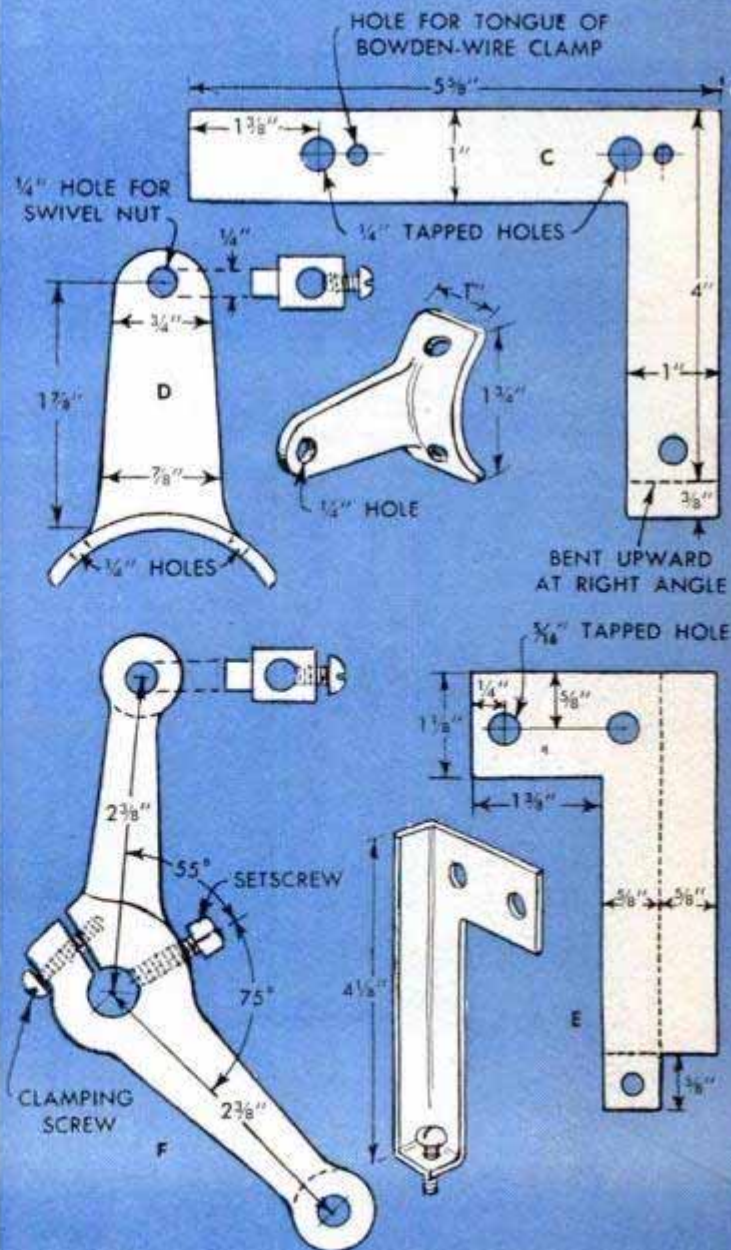
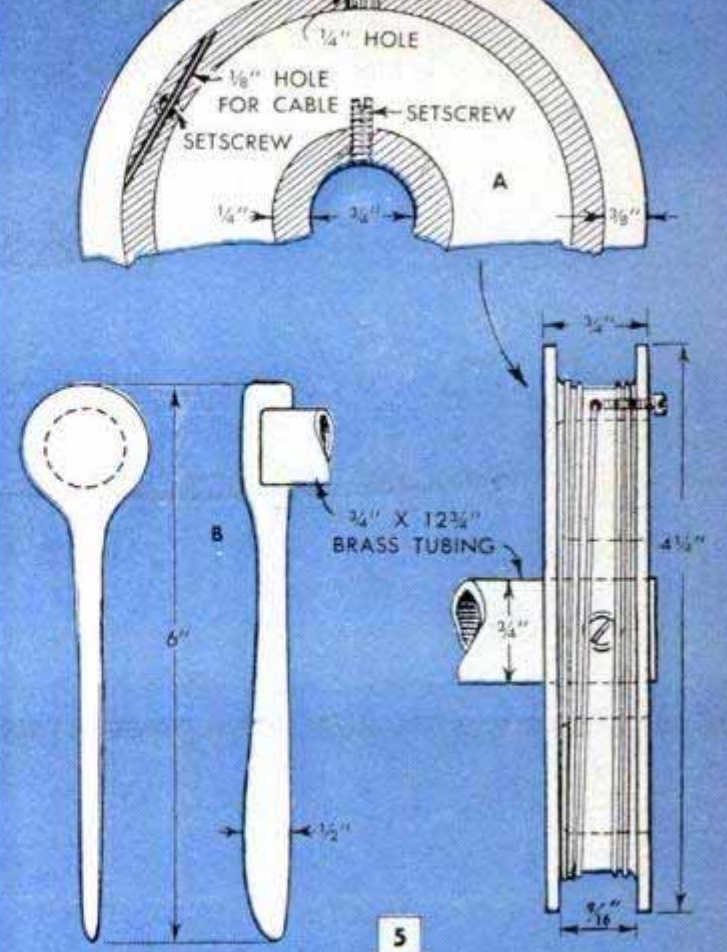
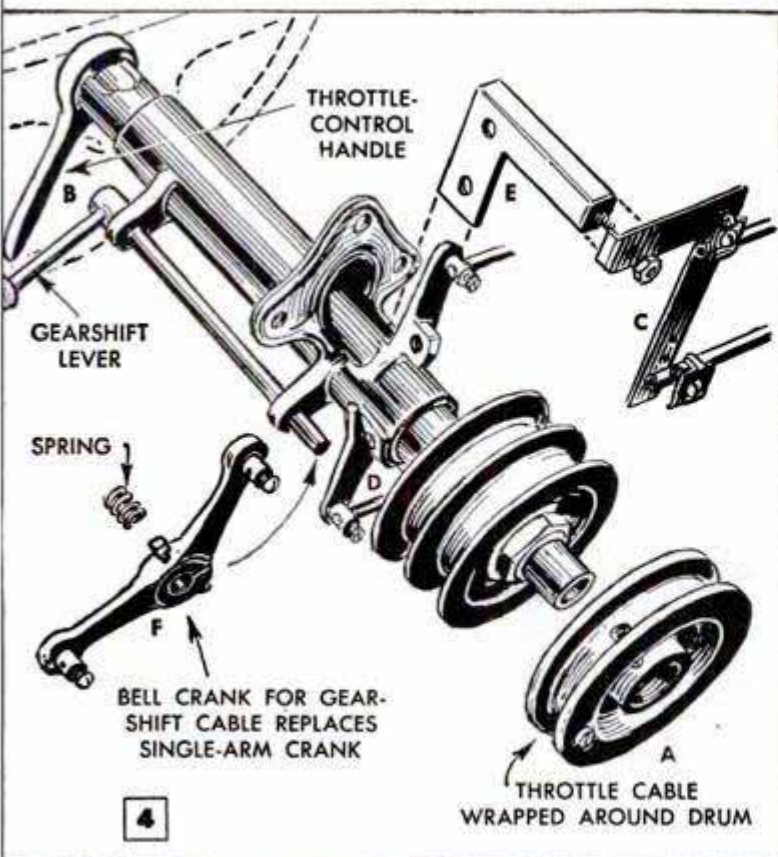

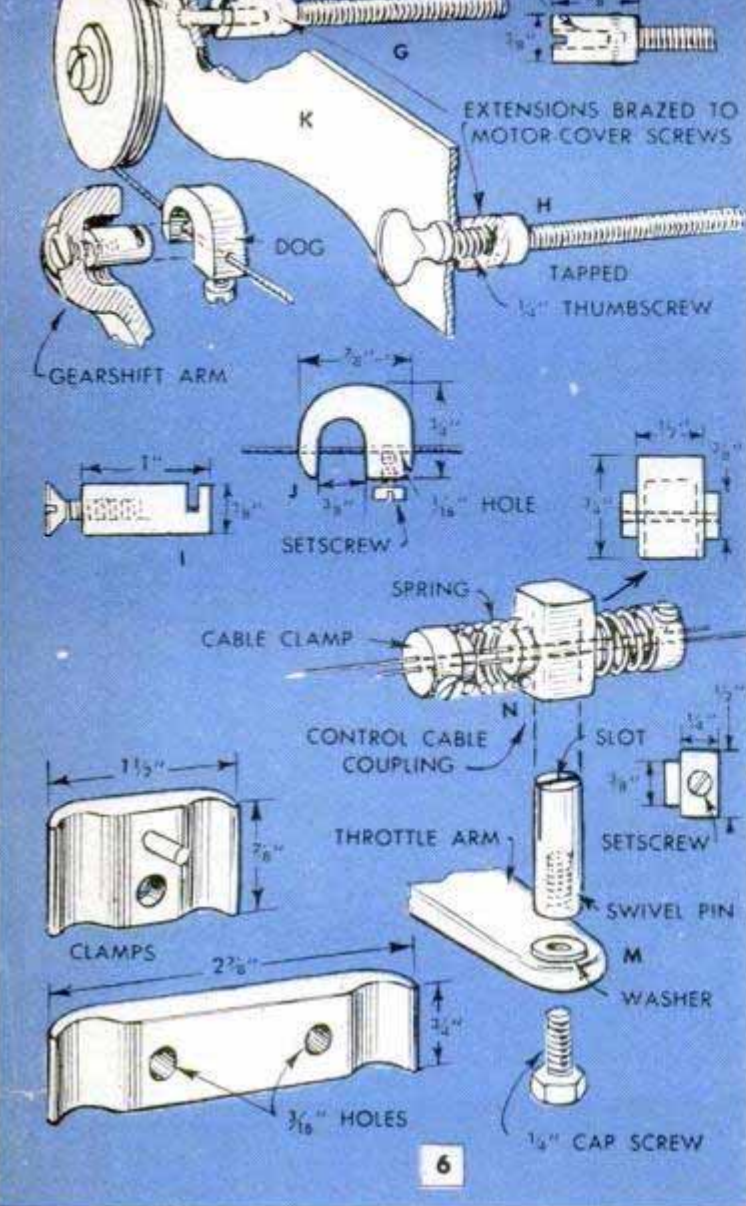

foundry, or castings can be obtained from the designer at a nominal cost. The special parts C and E, which form the bracket supporting the Bowden-wire throttle control, are made from sheet metal. Note especially the location of the holes for the Bowden-wire clamps on part C, Fig. 5, and the position of the parts C and E in Figs. 3 and 4. The drum on which the throttle-control wires are wound is actuated by the throttle-control handle, B. Both parts are attached to a brass tube which passes through the steering column, Figs. 4 and 5, and forms the throttle-control shaft. When assembling the throttle control on the Kainer steering unit, the brass pin which passes through the original drum and steering column is removed to permit passage of the tubular throttle shaft. Two 10-32 machine screws replace the pin.

Figs. 6 and 7 detail the parts of the gearshift and throttle-control brackets, while Fig. 8 shows the parts in their relative positions on the motor. First, note the construction of the mounting screws, G and H, in Figs. 6 and 8. These are brass studs with 3/8-in. extensions brazed on. One extension is drilled lengthwise to take a 1/8-in. pin; the other is drilled and tapped for a thumbscrew. This arrangement makes possible the easy removal of the bracket, K, when the motor is removed from the boat. Although not shown, it will be necessary in some applications to provide the studs, or screws, with jam nuts. The pulley is mount-

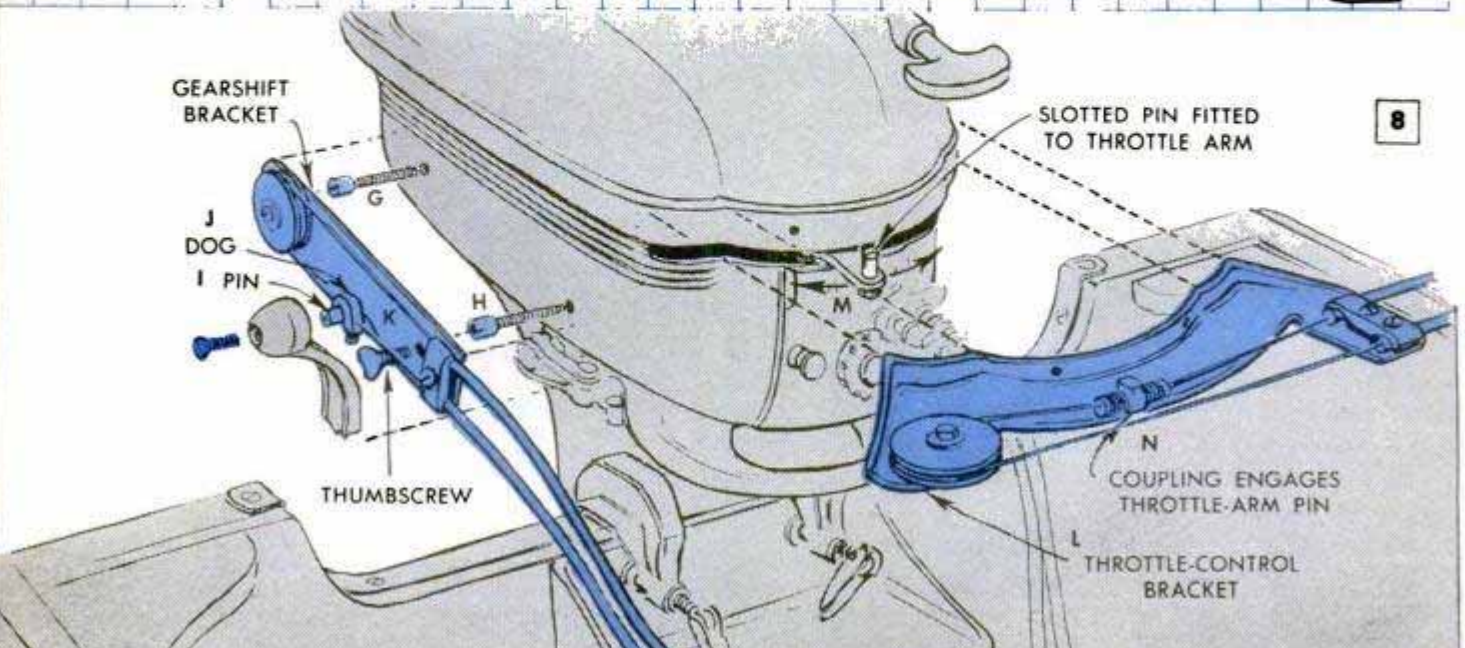
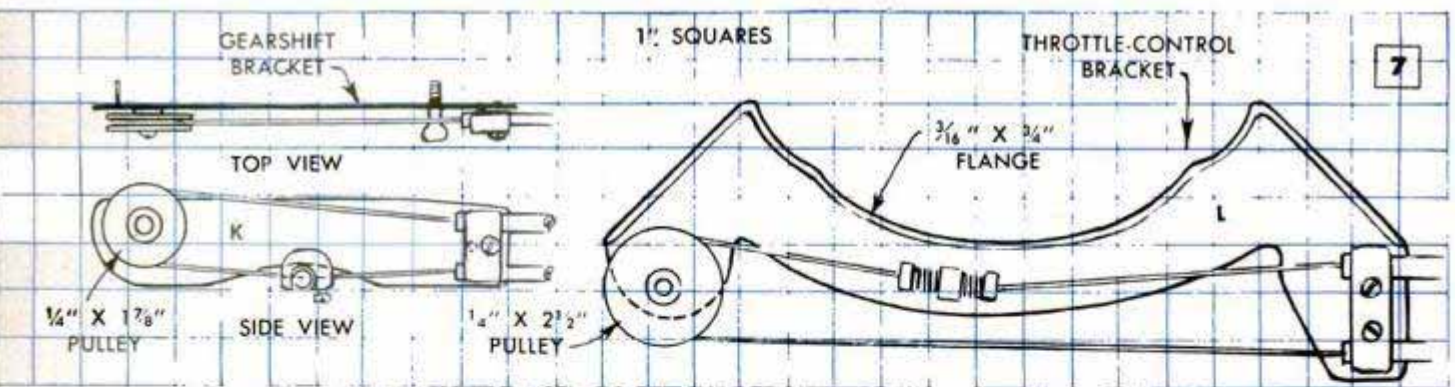

ed on a shouldered brass spindle, not detailed, which is center-drilled and tapped for a machine screw. The shouldered end of the spindle is threaded to turn into a tapped hole in the bracket, K. Turning a nut onto the projecting threaded end holds the spindle firmly. After the pulley is placed on the spindle it is held in position by a machine screw and washer as shown. The same construction is used when assembling the pulley on the throttle-control bracket. Both pulleys are turned from aluminum to the diameters given in Fig. 7. The dog, J, parts of the cable coupling, N, and the swivel pin, M, should be made from brass or bronze, preferably the latter. Note that the swivel pin is slotted at the upper end to provide clearance for the ends of the Bowden control wires, or cables. The clamps are shouldered to provide spring seats. Note also that the wire from the right, Fig. 6, passes through the first clamp, through the swivel block and through the second clamp in which it is held with a setscrew. The second wire is inserted from the left, passes through the left-hand clamp, through the swivel block and the end is held in the right-hand clamp by means of the setscrew. This arrangement places the springs under compression, giving necessary flexibility to the control. There's one more important detail in the assembly of the coupling: The slotted pin, M, must swivel on the throttle arm and, to assure this, use a cap screw that will bottom in the tapped hole without drawing the parts tightly together. If necessary, file the end of the cap screw. The casing clamps for both controls are easily made by filing the parts from brass or aluminum to the size and shape required. Rubber-lined casing clamps are available from marine-hardware dealers. The throttle-control bracket, L, Figs. 7 and 8, is cast aluminum, and, as detailed in Fig. 7, is adaptable to only one type of outboard motor. Minor changes will have to be made in the wooden pattern if the bracket casting is to fit other types of motors. Of course, it also is practical to make the bracket from 1/4-in. aluminum and support it by means of L-brackets fastened to the motor housing with thumbscrews. After the units have been installed, some adjustment may be necessary to assure that they operate properly. It should be remembered that all fastenings and parts must be of corrosion-resistant metals such as brass, bronze or aluminum. Galvanized parts are the second-best choice. When checking the units after assembly, be sure that the parts operate freely throughout the entire range of movement. A tight pulley or a sharp bend in the control wires may cause binding at some point. This fault should be corrected before the units are placed in service.



Quickly Constructed Trellis

Because of the simplicity of its design, this sturdy trellis can be built in only a few minutes. It is particularly suited to climbing roses planted near a house, garage or other building. The three upright members are lengths of 1 x 2-in. stock which are clamped together and drilled at 8-in. intervals to receive the 1/2-in.-dowel cross members. The lower ends of the uprights are set into the ground, while the upper ends are attached with angle brackets to the overhang of the roof.

Ball Bearing Flares Copper Tubing

Copper tubing can be flared by using a ball bearing slightly larger than the inside diameter of the tube. Simply lay the bearing on the end of the tube and tap it gently with a hammer until the desired degree of flare is obtained.

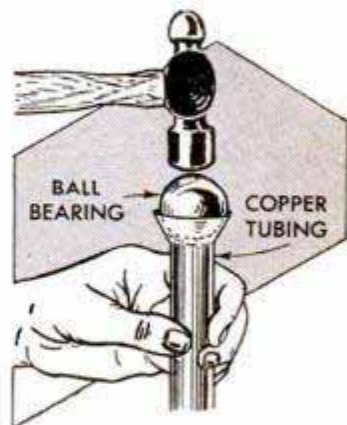

☞ When you take a bathing cap out of storage, rub it with a mixture consisting of a small amount of household ammonia and soapy water. This will make the rubber pliable so that there is less danger of it splitting when placed on your head.



Photos by Irwin Nord

It's easy to adapt your contact printer to serve as a retouching stand, copy easel and negative viewer

Extra Service from YOUR CONTACT PRINTER

By Alan R. Harris

BY MAKING a few simple changes in the electrical circuit and adding controlling switches, a rheostat and a low-wattage lamp, your contact printer can be used for retouching, copy easel for transparencies, tracing easel, light box for register of bas-reliefs, and as an accessory for solarizing negatives and prints. The changes also improve the efficiency of the printer, as fast projection papers and slow negative materials may be used in contact printing. Nearly all print-control operations in connection with enlarging are possible.

As you will see in the wiring diagram on the opposite page, a rheostat of 2000 to 3000-ohm capacity is placed in the printing-light circuit to control light intensity when using high-speed printing papers. As the regular printing light is not suited to printing at very low intensities, a 6 or 8-watt bulb is located in a socket directly under the center of the printing glass, and between the glass and the regular printing light. A separate switch makes it possible to select either of the lights, and an on-off switch is wired into the circuit as an auxiliary to the regular platen switch. The

on-off switch is used for making very short exposures on fast papers and it also is especially useful when two or more units are being registered on the printing glass. After register has been attained, the platen is lowered and locked in position before making the exposure with the on-off switch.

Additional switches, 6 or 8-watt lamp and rheostat are installed in the printer to increase versatility



The lower photo on the opposite page pictures the extra electrical units which are added to the regular printing-box circuit, and the photo at the right shows these units in place in the printing box. Note also from the wiring diagram that one switch shunts current past all other controls directly to the regular printing light. Using this circuit, the light comes to full intensity and remains on until the switch is turned to the off position. With the printing light controlled by this switch, the platen can be lowered and locked, and the box used as a retouching easel, for dodging with a soft pencil, as a negative or transparency viewer and for vignetting, diffusing, or other methods of print control.

Before installing the new wiring and switches, remove all the old wiring. Locate the switches and rheostat on the front of the box as in the lower right-hand photo. Then bring in the wiring and make the necessary connections. When installing the wiring inside the box make sure that no wires pass underneath the printing glass in a position to cast a shadow either from direct or reflected light. Before plugging in the new circuit, check all connections carefully, as a short may seriously damage the rheostat. It's also important to check the box in the darkroom for light leaks. Plug the box into the darkroom circuit, close the platen and switch on the printing light. Examine the box thoroughly for leaks, especially around the newly installed switches and rheostat. On some metal printing boxes it may be necessary to install switches and wiring leads with rubber washers and grommets to prevent leaks. Also on some types of boxes it is possible to install an opal glass between the printing glass and the light source to provide even more uniform light distribution. The printing bulb should be of the frosted type, but the small bulb should be clear.

The printing light can be controlled with a separate on-off switch for retouching or negative viewing

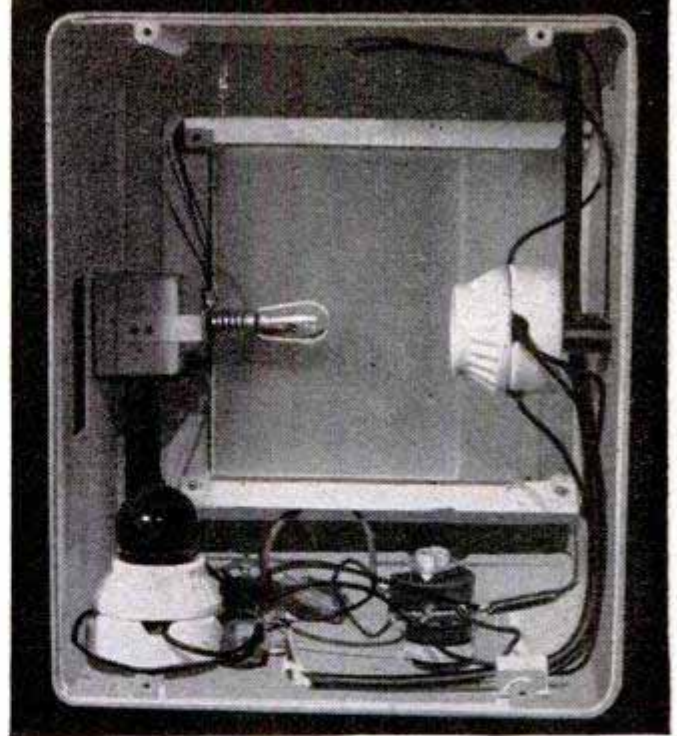

A 6 or 8-watt clear bulb is placed between the printing light and glass for printing at low intensities

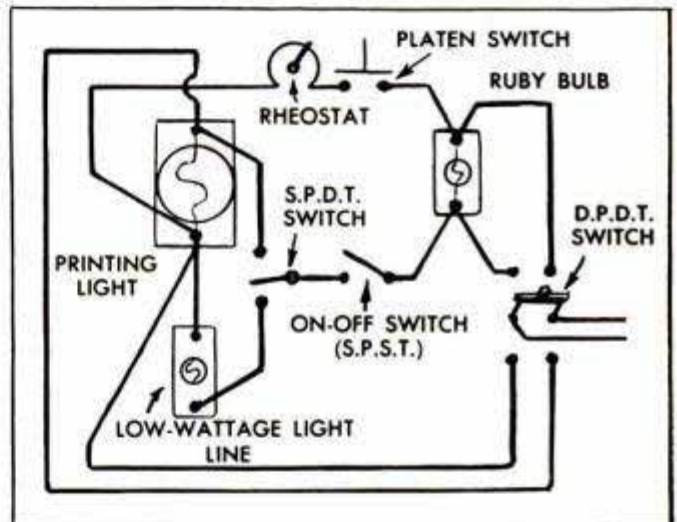

This wiring diagram shows how the switches and rheostat control the electrical circuit to the three lights

Front of printing box is used as a panel for installing controls. After the installation, test box for light leaks



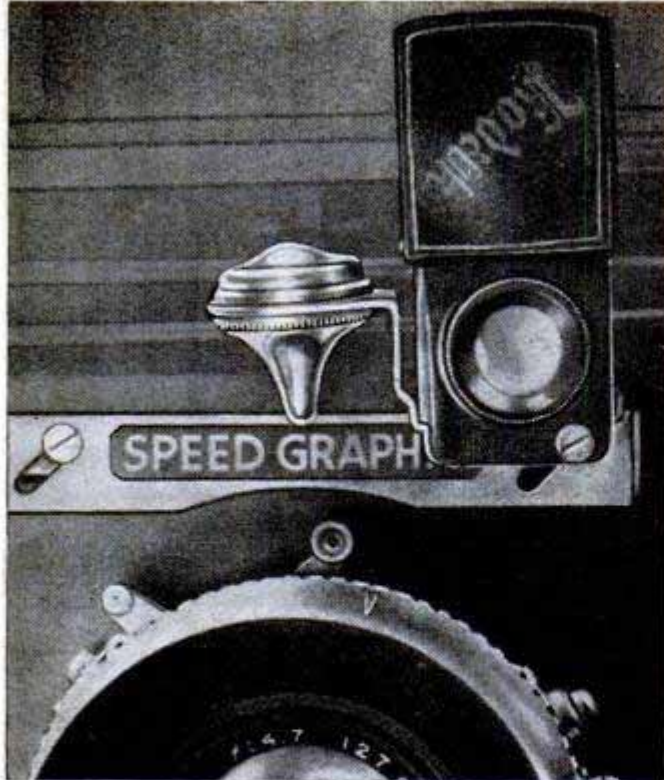

Screw-Eye Thermometer Holder

When not in use, a stirring-rod thermometer can be stored safely and conveniently in a screw eye, which has been turned into the edge of an overhead shelf. If desired, the inside surface of the opening in the



screw eye can be padded by applying several thicknesses of adhesive tape. This will prevent the possibility of the thermometer being broken when dropped into place in the holder.

Waist-Level Finder on Lensboard Aids Taking Low-Angle Shots

One photographer finds that it is more convenient to shoot from the hip and take low-angle shots if a waist-level view finder is mounted on the lensboard of his press-type camera. He simply fastened a waist-level finder to his Speed Graphic with one of the screws that holds the lensboard slide lock.—Julian A. Belin, Bronx, N. Y.

Tripod for Table-Top Photography Improvised From Angle Brackets

Just the thing for table-top shots, this little tripod is formed by bolting together three angle brackets. A single $\frac{1}{4}$ -20 stove bolt is passed through the outer hole in one arm of each bracket, and a nut, used to hold the brackets in place, is left loose enough to permit the tripod to be folded for carrying in the coat pocket. A second nut, turned on the bolt, locks the camera on the tripod.

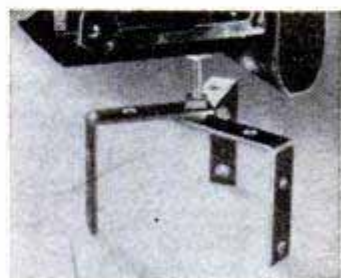

David Findlay, Brooklyn, N. Y.

Fingerprint Causes Overexposure

If you occasionally find a negative with bright areas that are fuzzy, though the image is sharp, look for a large fingerprint or grease smudge on the lens. A lens soiled in this fashion will pass the sharp image but will cause the brighter areas to receive more exposure and will give an effect similar to that produced by halation.

Popular Mechanics Book Shop

POWER TOOLS AND HOW TO USE THEM

To get the most from your home-workshop power tools, it is necessary to know how to use them and the various types of operations that can be performed on them. In this book, Mr. Lammey, who is an assistant Crafts Editor of *Popular Mechanics Magazine*, not only tells what can be done with each tool, but illustrates the various operations. No matter whether you have only one tool or a complete shop, the book will pay for itself on just one of your projects. Send \$2.50 and it will be delivered to your door.

MOTORIST'S FIX-IT BOOK

By enabling you to make just one small repair or adjustment on your car, this book will

return its price of \$2.00 to you. Hundreds of such repairs are given so that you can keep your car operating at top efficiency and thus save money on gas and oil and increase your motoring pleasure.

RADIO-TV AND ELECTRONICS HANDBOOK

If you are like most owners of TV sets—dislike being without your set while it is being adjusted or repaired—this book will enable you not only to make some minor repairs and adjustments, but it also will help you to keep your set in top condition so that you get a good picture. It will also assist you in determining the causes of many major ailments that should be handled by your repairman. Price \$2.50.

All books available from Popular Mechanics Book Dept., 206 East Ontario Street, Chicago 11

DRILL PRESS *made from auto parts*

By L. H. Houck *X-246*

UNUSUAL simplicity of design and construction are features of this inexpensive drill press that will appeal to craftsmen and shop mechanics who like to make their own power tools. The spindle is motor driven through bevel gears adapted from an auto-differential spider, and is actuated by foot feed only, no hand feed being provided. This feature eliminates most of the accurate machine work which otherwise would be necessary. The motor, motor bracket and drill head lower as a unit and the head is returned to the original position by a tension spring.

Details below show the construction of the base and the lower end of the column. The steel base plate should be large enough for mounting the treadle supports in the position shown. The construction of these parts will be clear from the details and notes, which give the important dimensions. Likewise, details on page 197 show the construction of the combined slide and motor support, the spindle assembly and the drill table. First, note the part A, below, and also part A on page 197. The part labeled A in both details is the long treadle link between the treadle arm and the drill head. The lower end of the link is attached to the treadle arm by a U-shaped clamp,

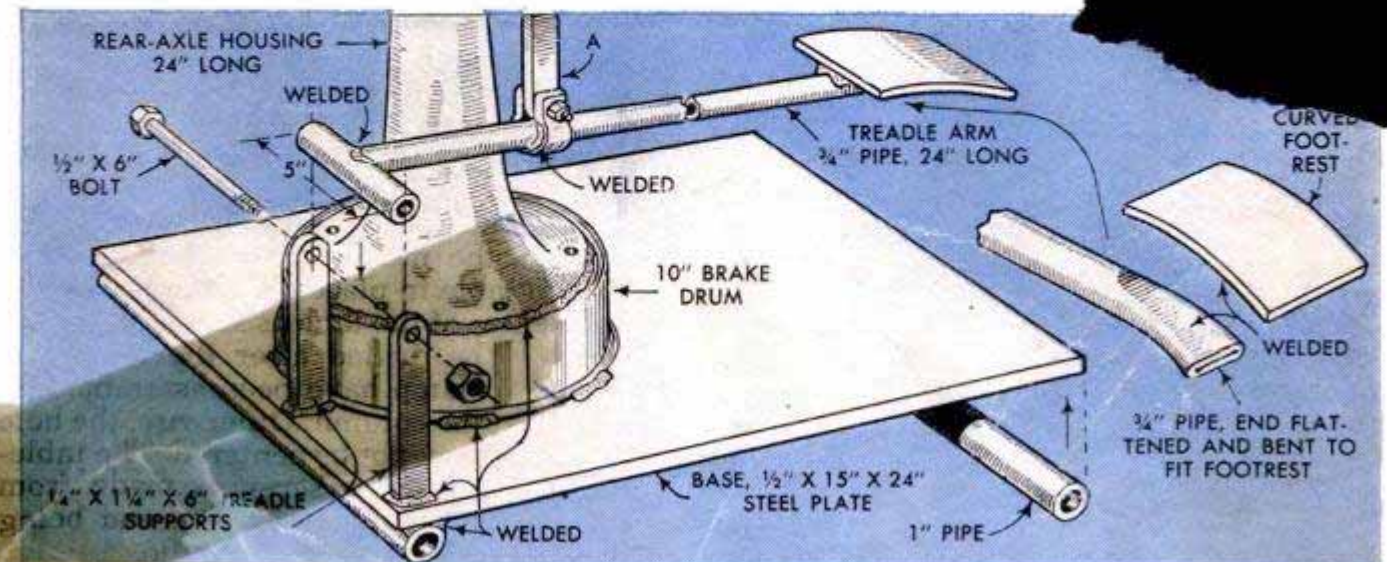
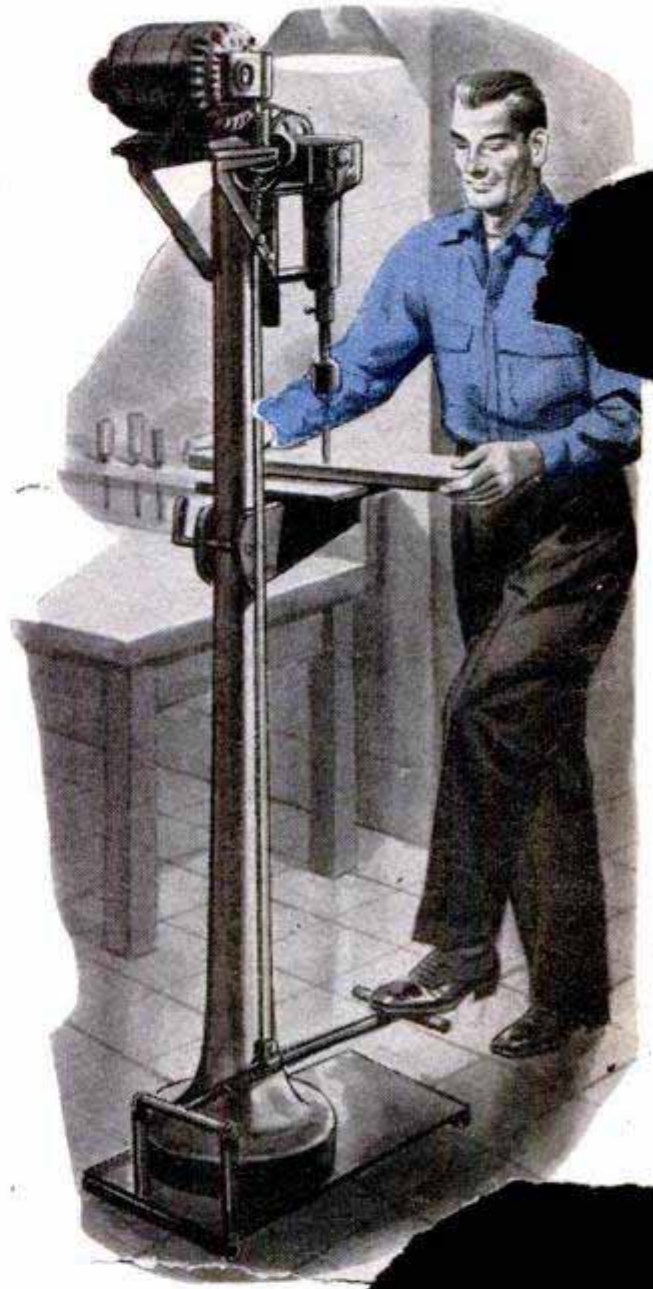

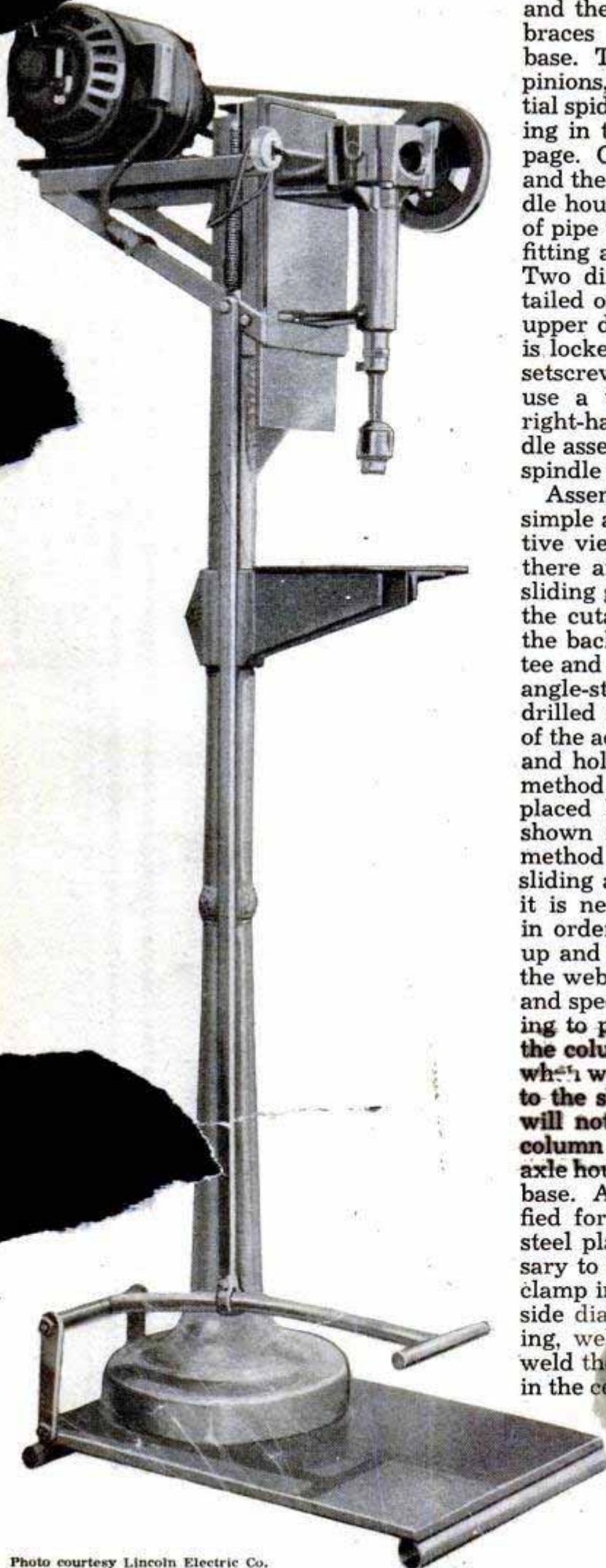
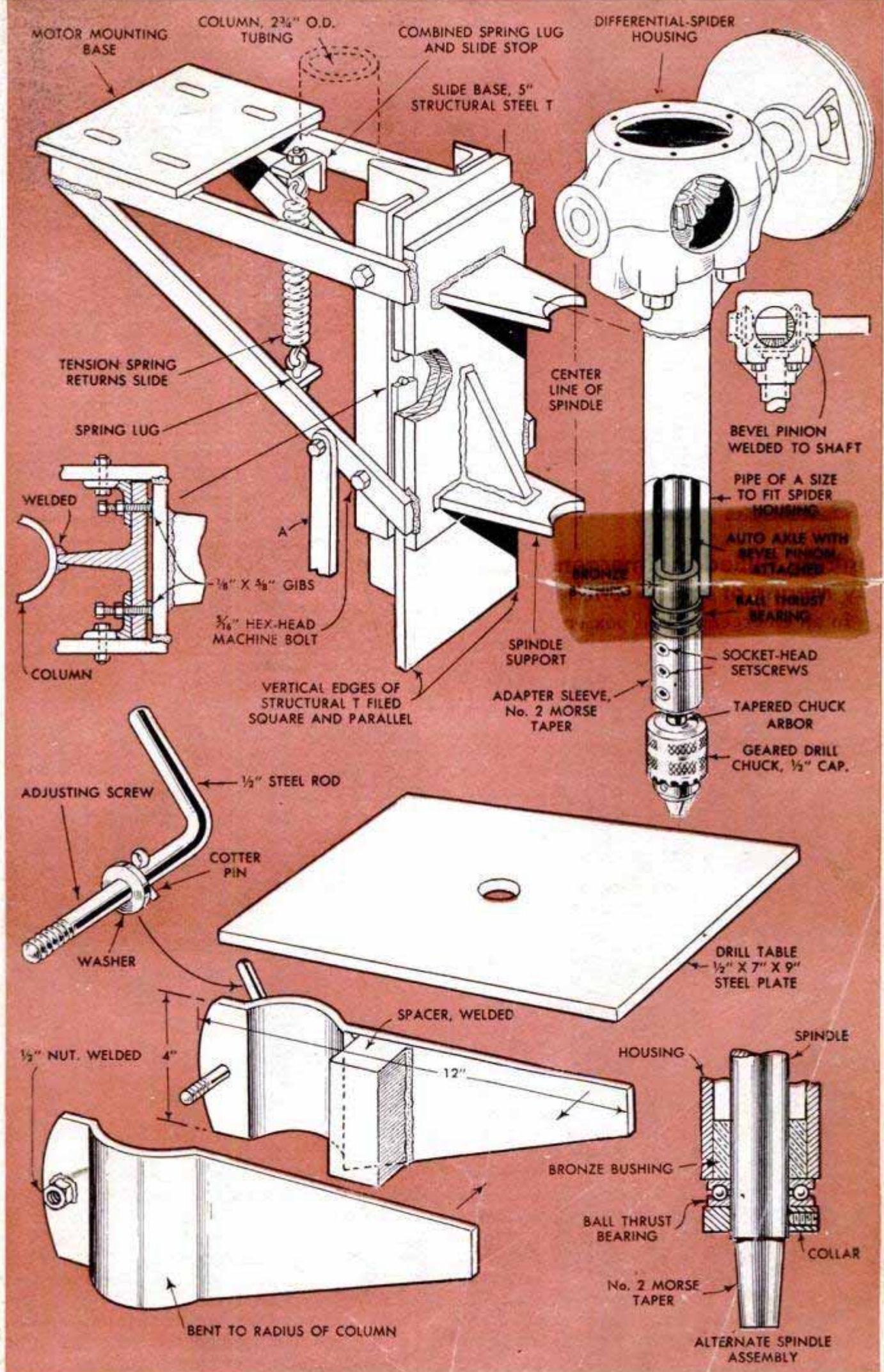

Photo courtesy Lincoln Electric Co.

and the upper end is bolted to one of the braces supporting the motor mounting base. The spindle is driven by two bevel pinions, which are taken from the differential spider, and mounted in the spider housing in the manner shown on the opposite page. One pinion is welded to the spindle and the other to the pulley shaft. The spindle housing is formed by welding a length of pipe to the spider housing as shown, and fitting a bronze bushing at the lower end. Two different spindle assemblies are detailed on the opposite page, the one in the upper detail using a tapered sleeve which is locked on the end of the spindle with a setscrew. On this spindle it is necessary to use a tapered chuck arbor. The lower right-hand detail shows an alternate spindle assembly in which the lower end of the spindle itself is tapered.

Assembly of the sliding drill head is quite simple and is clearly shown in the perspective view. However, it will be noted that there are two methods of assembling the sliding gibs. By the first method, shown in the cutaway perspective, the gibs ride on the back face of each leg of the structural tee and are placed between the tee and the angle-steel guides. Two blind holes are drilled in each gib and the threaded ends of the adjusting setscrews enter these holes and hold the gibs in place. In the second method of mounting the slide, the gibs are placed between the slide and the tee as shown in the sectional view. This latter method results in an exceptionally smooth sliding action but has one disadvantage as it is necessary to slot the leg of the tee in order to permit the setscrews to move up and down with the head. In any case, the web of the tee is welded to the column and special care must be taken while welding to position it parallel with the axis of the column. **The same care must be taken when welding the spindle-support brackets to the sliding head as, otherwise, the drill will not run true.** The lower end of the column is welded to the upper end of the axle housing which forms a part of the floor base. Although $\frac{1}{2}$ -in. steel plate is specified for the drill table, $\frac{3}{8}$ or even $\frac{1}{4}$ -in. steel plate may be used. It will be necessary to heat the two members of the table clamp in order to bend them to fit the outside diameter of the column. After bending, weld the members to a spacer, then weld the table in place. Although the hole in the center of the table is shown, it should be drilled after the table and clamp have been assembled on the column. Otherwise, the hole may not be centered. The table-adjusting screw is made from $\frac{1}{2}$ -in. steel rod, one end being bent to form a handle.





Battery Pulled in Emergency by Means of End Wrenches

In an emergency, two box end wrenches can be used to lift a battery out of a car. The wrenches should be just large enough to fit snugly over the terminals of the battery. In lifting, hold the wrenches at such an angle that they will wedge against the terminals in the same manner as a regular battery puller. Letting the handles touch, while in contact with the terminals, will, of course, short the circuit.

Sidewalk Flag Held Upright With Metal Rings

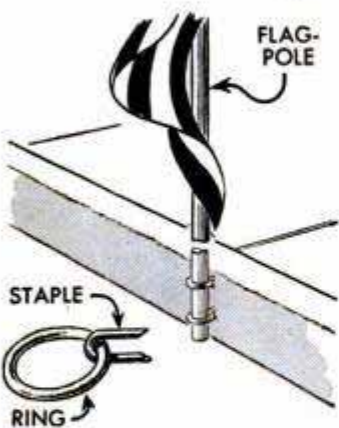

Instead of the usual dirt-catching socket in a sidewalk for supporting a flag, one store owner had large staples and rings placed in the edge of the sidewalk as indicated. Holes, drilled in the curb, were fitted with lead anchor shields to receive the staples.

The rings support the flag just as rigidly as a socket and, when not in use, fold down close to the walk out of the way.

Two squares of sandpaper tacked to the edge of a drawing board come in handy—one for sharpening pencils, and the other one for cleaning erasers.

Paper Stapler Mounted on Paddle Is Easy to Hang Up

To keep his stapler conveniently at hand, yet out of the way, one shipping clerk mounted it on a paddle-shaped base. He drilled a hole in the base so that it could be hung from a nail on the wall above his desk. The stapler is convenient to use when mounted on a paddle, and is not likely to be knocked off the packing bench or thrown carelessly into a drawer.



The stapler is convenient to use when mounted on a paddle, and is not likely to be knocked off the packing bench or thrown carelessly into a drawer.

Cork "Seats" Improve Thumbtacks

Thin drawing paper, especially tracing paper, which has a tendency to tear away from thumbtacks, can be held firmly in place by using tacks having thin, cork pads under the heads. Cut slightly oversized from small cork stoppers, the pads are simply pushed over the points of the tacks.

Richard Hanscom, Elmhurst, Ill.

Air Outlet for Hot-Water System

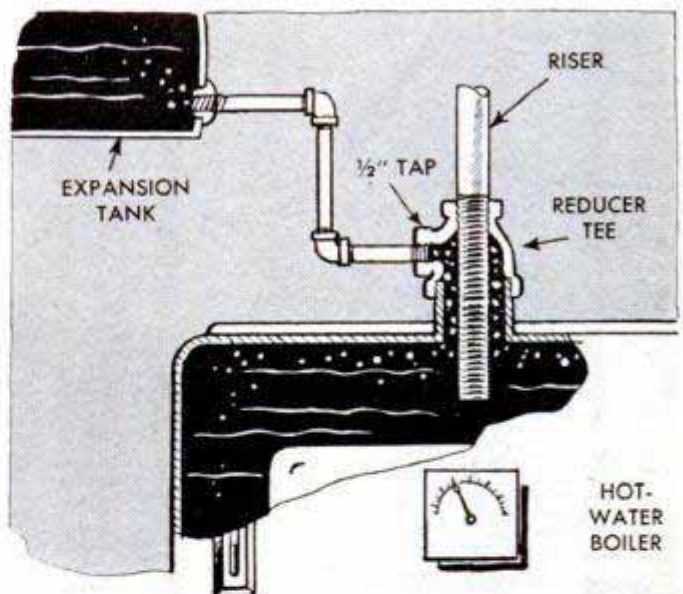

If you have had trouble eliminating air in water-heating systems, try this hook-up. Instead of connecting the water line to the boiler with the usual reducer, use a reducer tee having a side opening to take 1/2-in. pipe. By running a line from the side of the tee to the expansion tank, and turning the riser far enough to extend several inches into the boiler—but not far enough to contact the second section of the boiler—air bubbles by-pass the riser and enter the tank.

Gerald D. Wickham, Iowa Falls, Iowa.

U-Clamp Height Adjustments Made Using "Battery" of Shims

When clamping irregularly shaped work on the drill-press table or other machine, and the clamps used are the older-type

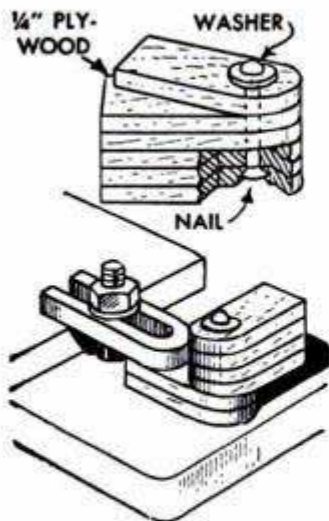

U-shaped clamps — sometimes called "horseshoe" clamps—it's handy to have adjustable shims which can be set to the correct height under the heel of the clamp. The shims can be built up as a unit by stacking several thicknesses of 1/4-in. plywood and sawing to size and contour on a bandsaw. Drill

a hole through the stack near the rounded end for a rivet. Countersink the head of the rivet in the lower shim so that it will clear the table surface and peen the rivet loosely so that the separate leaves of the shim, or pad, will swing sidewise easily. In use, place the work, locate the clamp and simply slide the pad under the heel. It will adjust automatically to the correct height, as excess leaves of the pad will swing sidewise when the battery is pushed against the heel of the clamp.

Clifford T. Bower, London, England.

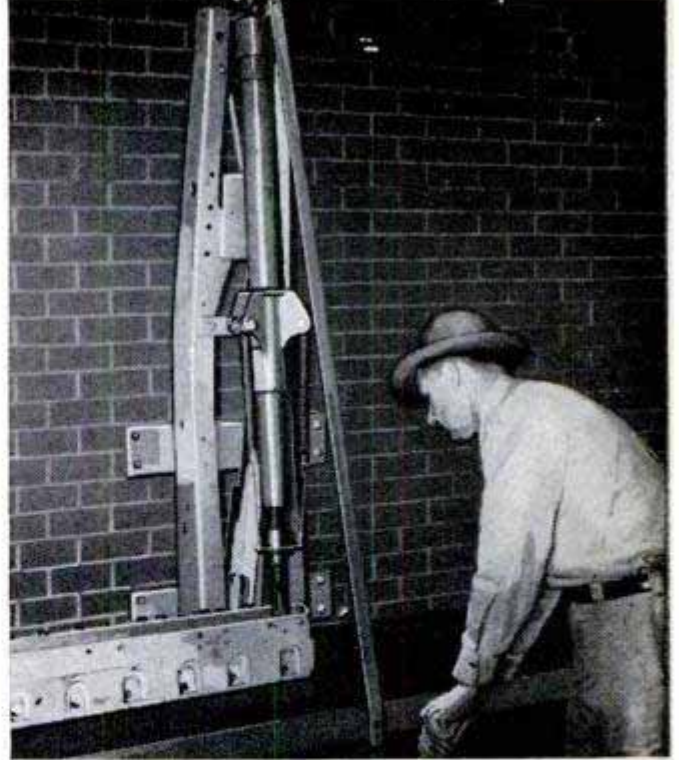

Easily Installed Airplane Jack Makes Useful Hydraulic Press

An airplane jack, mounted on the wall as shown, makes an effective hydraulic press in this mechanic's shop. This particular jack is used primarily for installing new valve seats in overhead-valve cylinder heads. However, such a jack can be readily adapted for use on various other pressing jobs often called for in the shop.

L. H. Houck, Jefferson City, Mo.

First Turn Off the Electric Current When Extinguishing a Burning Motor

Suppose an electric motor in your shop should suddenly burst into flames? Your first thought should be to turn off the current at the main switch. Turning the motor switch is not sufficient. Then use your fire extinguisher — you should have one for

such an emergency, filled with carbon tetrachloride or carbon dioxide. If you do not have one, smother the fire with a blanket, tarpaulin or other heavy cloth. Having neither extinguisher nor the cloth, cover the motor with dirt, sand or ashes.

Rubber Stamp Brought Up-to-Date by "Resetting" Type

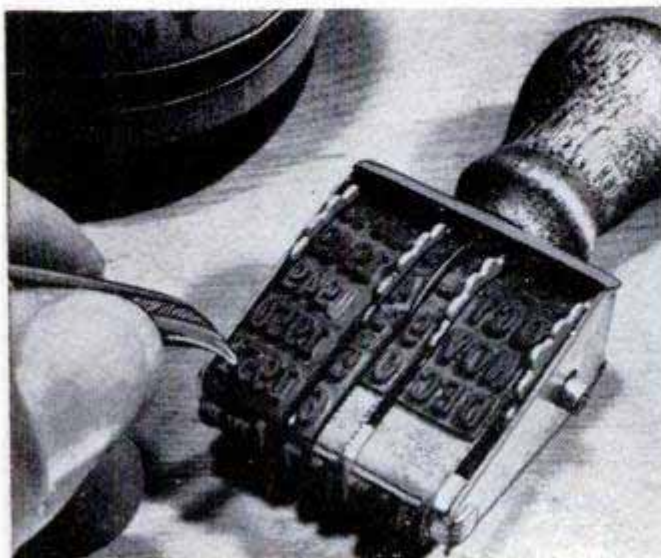

If your date stamp has become "dated," you can change 1950 to 1951, for example, by replacing the "0" in 1950 with a "1" cut from 1949. Cut off the number with a razor blade and "transplant" it by cementing in place, being careful to align it perfectly with the other numbers.

Louis Hockman, Sherman Oaks, Calif.

Steel Slag "Boiled" From Torch Tip

The opening in a brass acetylene-torch tip can be cleaned of slag metal, or even a chip of a steel drill or cleaner, by boiling the tip in an alum solution. Use a heat-resistant container and as much alum as a quart of boiling water will dissolve.

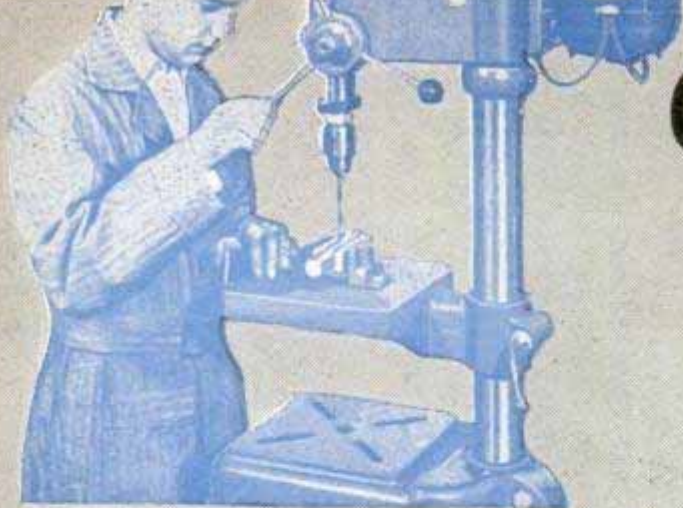

CROSS-DRILLING ROUND WORK

There's no trick to drilling transverse holes through round stock or the walls of tubing if you make use of these simple jigs and fixtures

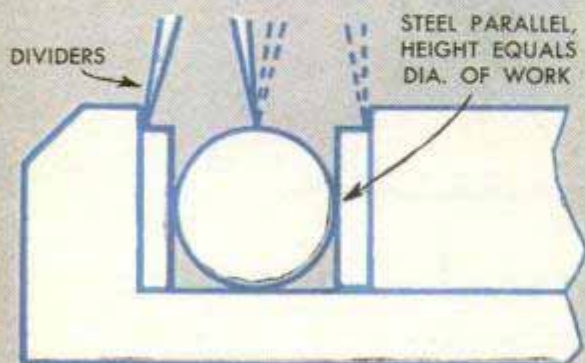

To locate center, clamp work in drill-press vise between steel parallels. Set the dividers for the estimated center and scribe two lines along work, using vise jaws as straightedges

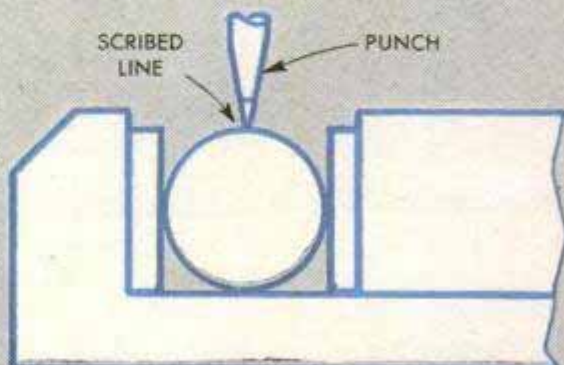

Then use a prick punch to mark the point to be drilled. Tap punch into the scribed line or, if two distinct lines were scribed by dividers, center the punch mark between them

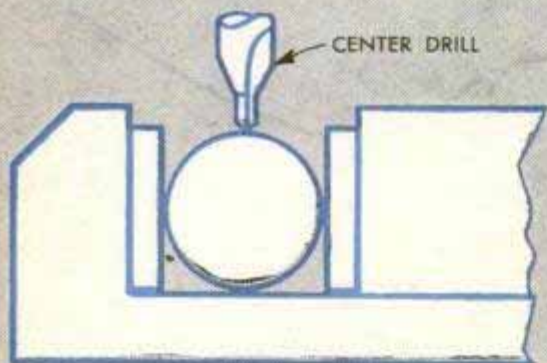

After enlarging the prick-punch mark with a center punch, start the hole with a center drill, which is carefully aligned with the indentation that was formed by the center punch

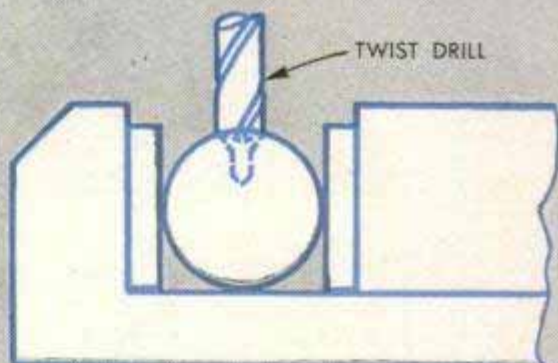

Hole of desired size now can be bored with a twist drill. Tapered hole formed by the center drill will accurately pilot the twist drill, eliminating the danger of drill runout

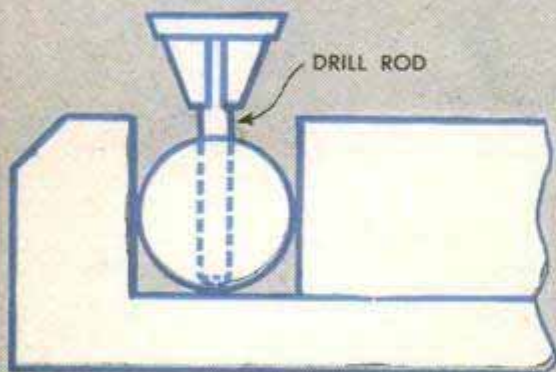

A length of drill rod chucked in the drill press can be used to align a hole in cross-drilled work to permit accurate reaming. Rod should be a fairly snug fit in the hole

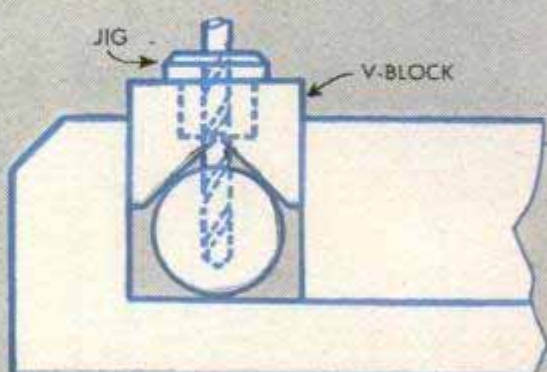

Another way to center round work for cross-drilling is to use a drill jig inserted in an ordinary V-block. The block is held firmly against work and clamped in drill-press vise

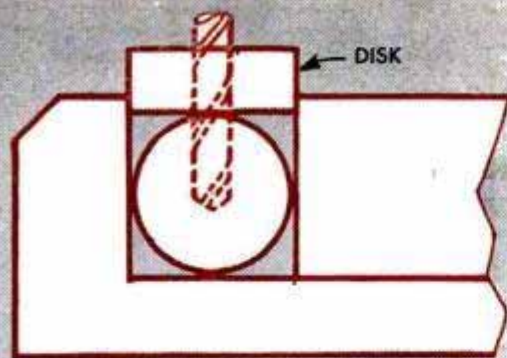

For precision drilling, turn a metal disk to exact diameter of the work, and drill center with a bit of same size to be used for cross-drilling. Clamp disk in drill-press vise over work to guide drill

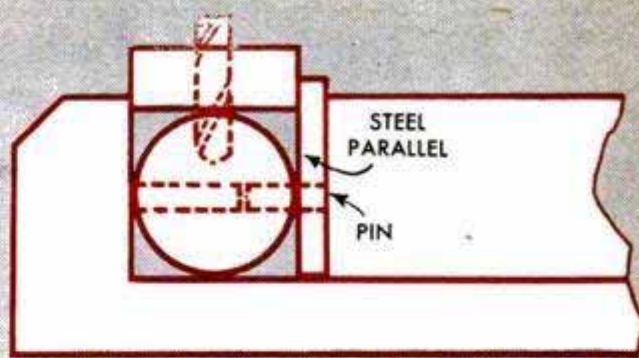

To bore at right angles to previously drilled hole, rivet pin in flat-steel parallel to align with original hole. Then clamp the work in vise with pin inserted in hole, drilling the second hole with jig as before

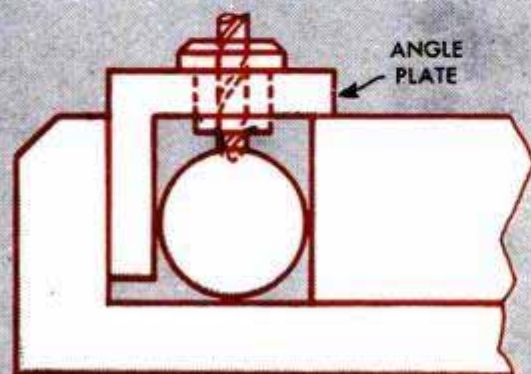

Cast-iron angle plate, accurately machined and fitted with drill jigs of various sizes, can be used to cross-drill work of specific diameter. A flat-steel packing adapts jig to take work of smaller diameter

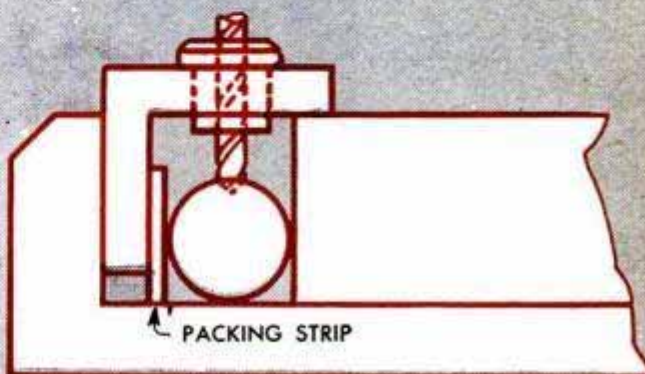

Flat-steel packing is inserted between work and face of angle plate. Thickness of packing must be exactly half the difference between the diameter of the work and the diameter for which the plate was designed

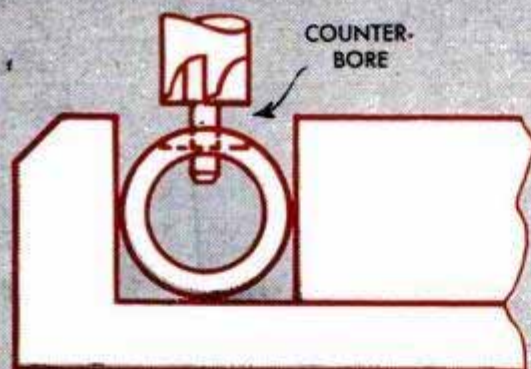

Large-diameter holes in round stock or tubing are drilled best with a counterbore of the type shown, hole for guide pin being drilled first. Use a good cutting oil, medium drill-press speed and light feed

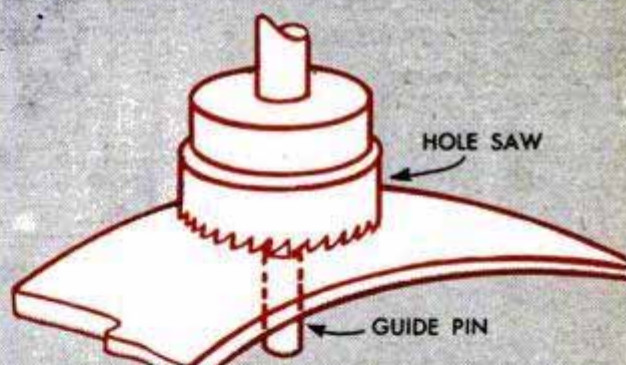

A hole saw can be used for cutting large holes in large-diameter, thin-wall tubing. If saw has guide pin instead of bit, drill pilot hole for pin. Use medium speed and flood the work with cutting oil

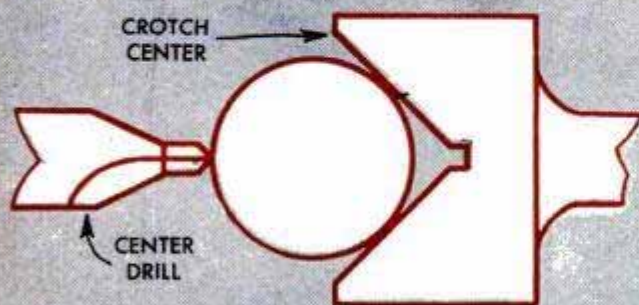

Crotch center of metal lathe automatically aligns work for cross-drilling. Start with center drill to avoid runout, operate at medium speed and feed slowly. Follow with a twist drill of the desired diameter

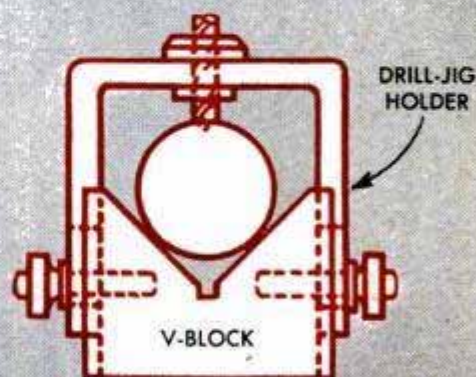

V-block with adjustable drill-jig holder quickly centers round work of various diameters. Holder is slotted for vertical adjustment and is locked in place with thumb nuts turned on threaded studs in V-block

Closed Cabinet for Milk Pails and Equipment Utilizes Large Storm Window as Door

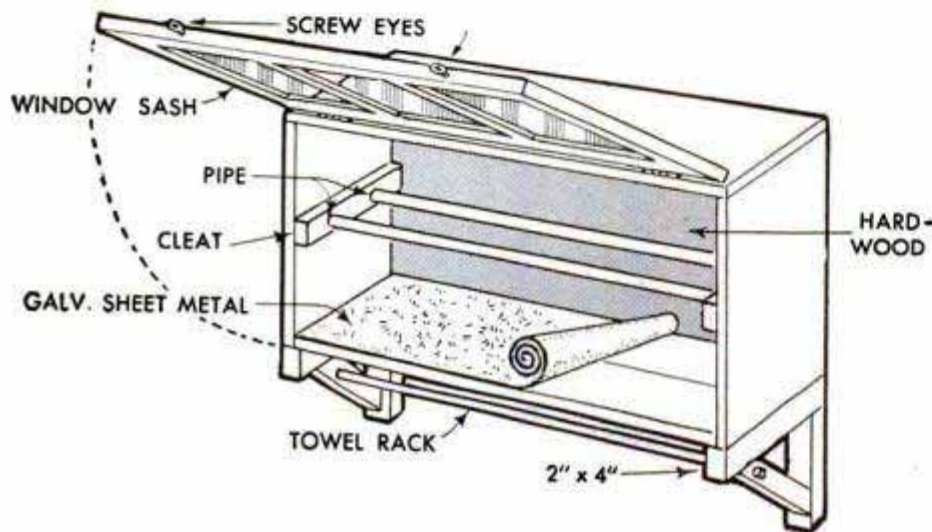
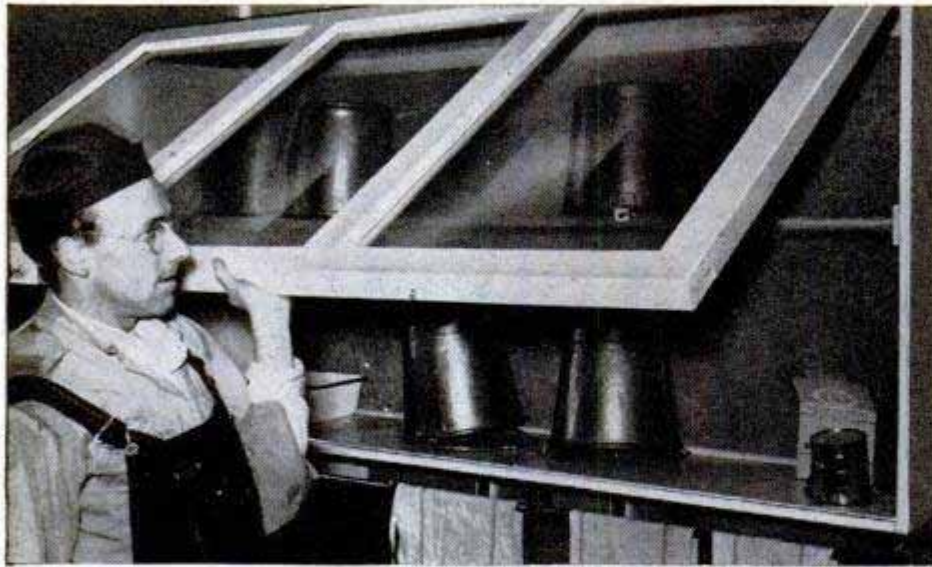

A closed cabinet in the milk barn is a handy aid in keeping pails and other milking equipment free from dust and insects. The one shown was made from $\frac{3}{4}$ x 12-in. stock, for the sides, top and bottom, and a hardwood panel for the back. It was provided with a door by utilizing a large storm window. The latter was hinged from the top and is held open by overhead hooks that engage screw eyes turned into the bottom edge of the door. Wooden cleats, attached to the inner sides of the cabinet, support a "shelf" of two steel pipes on which recently washed milk pails are drained. The bottom shelf was covered with galvanized sheet metal to catch the drainage water and provide for easy cleaning. The cabinet is mounted on brackets assembled from 2 x 4s, as shown. A wooden dowel is attached between the brackets to serve as a rack for hand towels.

Oil Consumption of Compressors Lessened by Making Minor Alterations

Oil consumption of compressors can be reduced considerably by means of this kink. The lower oil ring is removed from the piston and six or eight $\frac{1}{8}$ -in. grooves are ground about .01 in. deep at equal intervals across the bottom surface of the ring. Then, a similar number of $\frac{1}{8}$ -in. holes

are drilled at an angle in the bottom of the ring groove and through the piston walls, the holes being spaced to register with the grooves in the ring. Thus, oil is permitted to pass into the skirt of the piston and drop back into the crankcase.

B. E. Wilder, Chicago Heights, Ill.

Counterbalanced Rocker Arm Aids Small Motor in Operating Pump Jack

By counterbalancing the long, heavy pump shaft with a simple rocker arm and a counterweight, this deep-well pump is operated with a small motor. The rocker arm is pivoted near the center to an upright member, and is linked to the pump jack at one end and to the counterweight at the other end. Weight of the counterbalance should equal approximately in pounds the pull of the pump rod on the upstroke.

☞ To prevent nuts from becoming locked on bolts by rust, dip the threads of the bolt in shellac and turn the nut onto the bolt before the shellac has had time to dry.

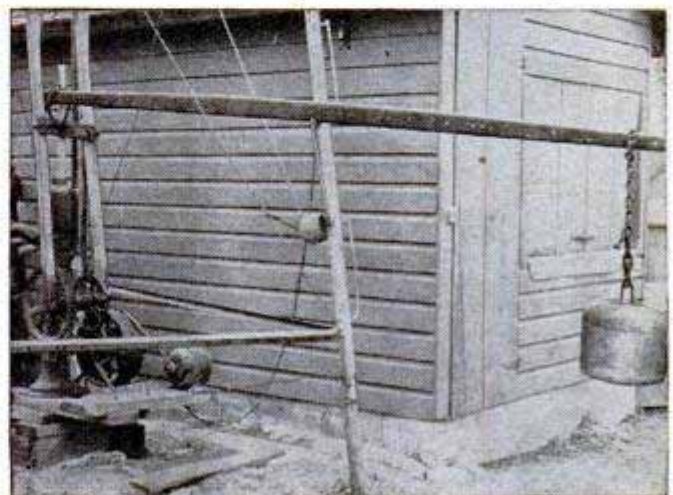

Making Lettering Pens From Bamboo Shoots

Finding reed pens especially helpful in executing scroll or Old English-type lettering, many letter artists make their own from bamboo shoots. These are available at most florist shops and, for ordinary sized lettering, should be no larger than $\frac{3}{8}$ in. or smaller than $\frac{1}{4}$ in. in diameter. The shoots are cut to lengths that will be suited to the individual user. Follow the diagrams at the right, which show steps for making each pen. Start the first cut, diagram A, $\frac{7}{8}$ in. from the end of the reed and make it a little over half the diameter of the reed in depth. Make the diagonal cut across the end of the reed, B, to conform to the angle at which the user will hold the pen. If the user is left-handed, the diagonal will, of course, be cut in the direction opposite that shown. The tiny hole in the reed is made to check the length of the split made in the reed. Therefore, the hole is made first, with a small drill or the point of a knife, and the split is started at that point. The dotted line in diagram C is a side view of the cuts made on each side of the reed that will determine the width of the tip and, thus, the width of vertical lines made by the pen. The bevel shown on the end of the tip will govern the

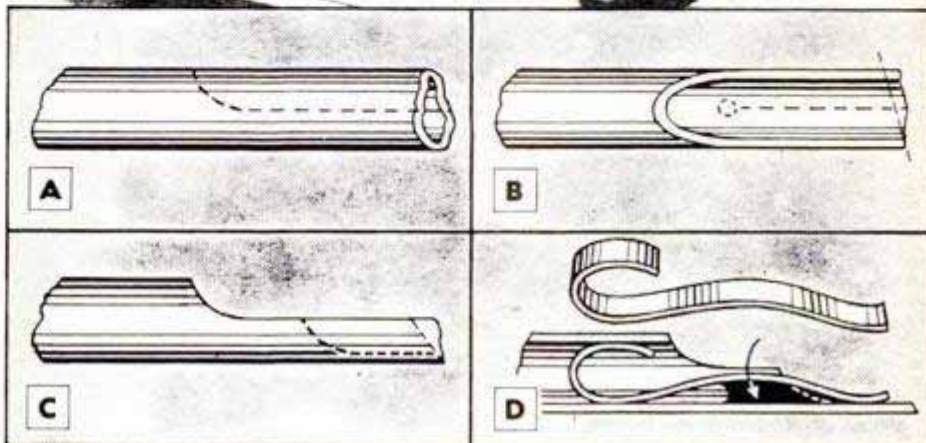
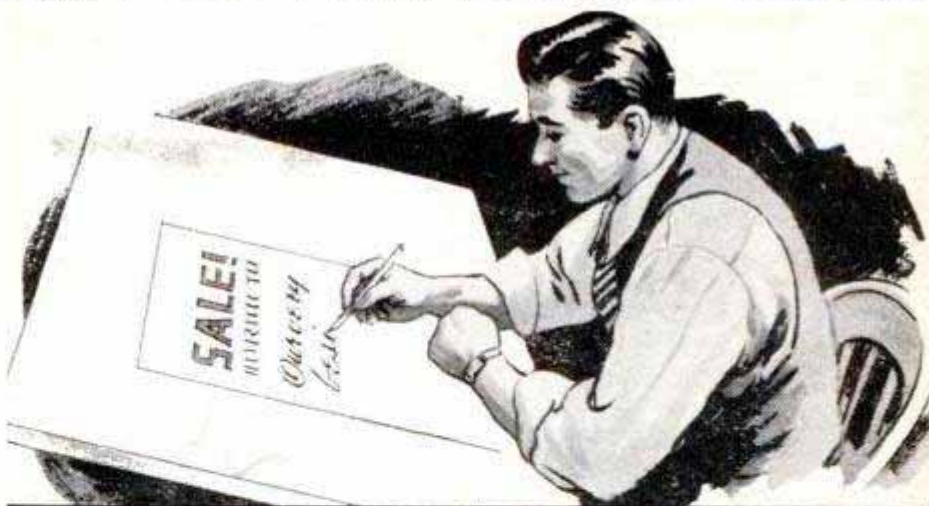

thickness of lines made with side strokes of the pen. Both the width of the tip and the bevel can be varied with different pens as desired. Next, all sharp edges of the pen should be broken by sanding very lightly with fine sandpaper. Finally, diagram D, a short length of flat, spring steel, about $\frac{1}{16}$ in. wide—the mainspring out of a watch will be fine—is heated over an open flame, bent to the shape shown and inserted in the pen to provide an ink reservoir.

Truck Tires With Two-Part Rims Safely Inflated on Special Jig

The danger involved when inflating some truck tires—that is, the possibility that the outer ring on certain types of rims may be



blown off to injure someone when the tire is expanded—was completely eliminated by one Nebraska garage owner. A special jig was made on which the tire is mounted, and which holds the outer ring of the rim intact while the tire is being inflated. Utilizing scrap parts from the junk pile, a cone-shaped base, of a size to engage the inside diameter of the rim, as shown in the photograph, was welded together. A large bolt was welded to extend vertically from the center of the base. A length of channel steel was drilled at the center and, in use, is slipped over the bolt where it spans and is held against the outer surface of the rim by turning a nut onto the bolt. The latter is welded to a short length of steel rod. This makes it a simple matter either to tighten or to remove the nut.

SHOPPING

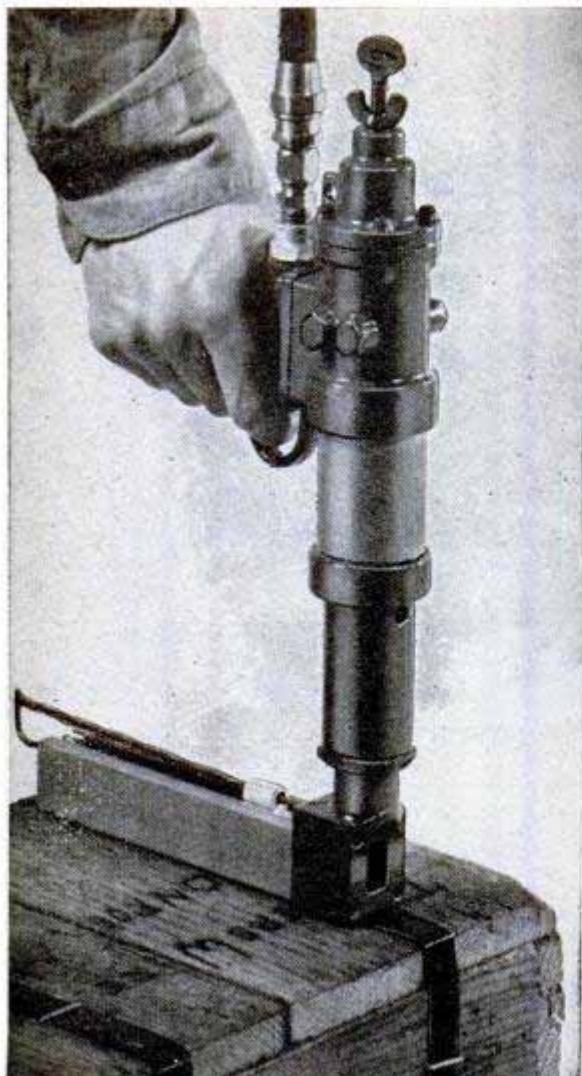

Powers Wire Products Co., 523 Detroit Ave., Monroe, Mich.

PNEUMATIC STAPLER eliminates fatigue and assures uniform stapling of steel box banding or wire strapping at a speed unequaled by handwork. Drives a 13/16-in. staple over flat-steel banding, but also is available for 3/8-in. banding or wire strapping. Attaches to airline



Sutton Tool Co., Sturgis, Mich.

QUICK-CHANGE COLLET is fitted with interchangeable pads which can be changed without removing the collet from the machine. Bearing surfaces of the pads are diamond-serrated to withstand both horizontal and rotating thrusts of the work and are held in place by a special mechanism which entirely eliminates looseness and scoring of the work



Hoffritz For Cutlery, 551 Fifth Ave., New York City 17

SIX-IN-ONE tool combines a hatchet, hammer, pliers, wire cutter, screwdriver and nail puller in one easily handled unit. The screwdriver bit is forged on one handle, the nail puller on the other. Both parts serve as a handle for the pliers, hammer and hatchet, a knurled section on each of the handles providing a firm grip

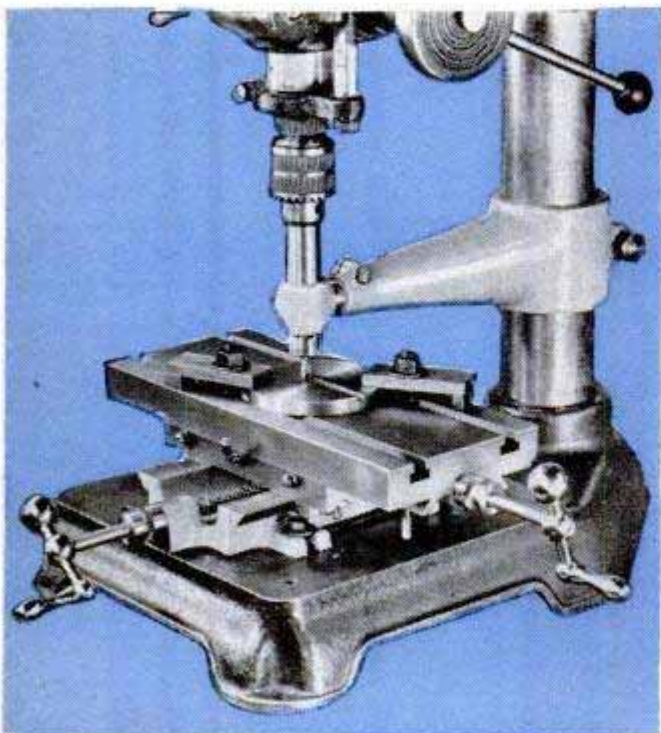

Waterborg Machine Co., 2830 Rapids Drive, Racine, Wis.

MILLING ATTACHMENT for small drill press fits any light bench-type machine. Unit consists of a compound slide which is bolted to the drill-press table, and a support arm which clamps to the drill-press column. Outer end of the arm carries the milling-cutter spindle in a bronze bushing, thus relieving stress on chuck

FOR TOOLS

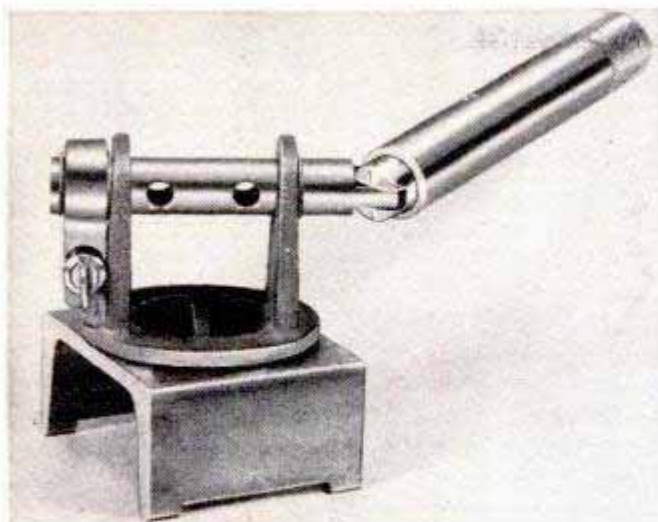

Piper Form Tie Co., 3802 N. Attu, Portland, Ore.

WIRE-TYING UNIT speeds erection of concrete forms by enabling the operator to tie the ends of the supporting wires automatically. Wires are drawn to a uniform tension and the tie is made simply by turning the handle of the unit. After the tie has been completed, the tool is easily removed from the work

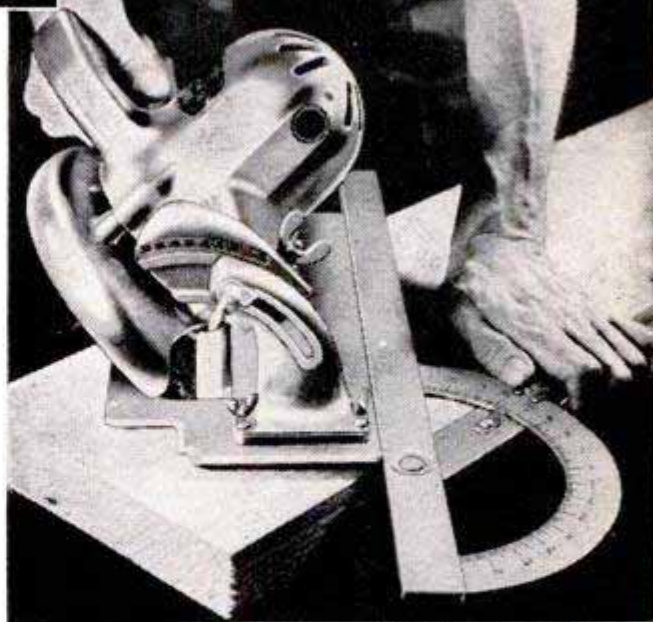

Black & Decker Mfg. Co., Towson 4, Md.

PROTRACTOR for use with portable electric saws enables operator to make all angle cuts with the accuracy of a tilting-arbor table saw. Unit consists of two straightedges and a calibrated segment. One straightedge slides along the edge of the work while the other, set at the desired angle, guides the saw

DRIP GUARD fits any paint roller and effectively solves the problem of dripping paint and spotted walls. Made of sheet metal with an enamel finish, the guard attaches to the handle of the roller by means of a clamp. Bottom of guard is curved to the contour of the roller so that it retains paint drops

Warner Ventilator Co., La Grange, Ind.



DUAL-PURPOSE HAND TRUCK is fitted with a hydraulic hoist for lifting and stacking heavy cartons and barrels from ground level. Lifting capacity is 500 lbs. and maximum lifting height is 54 in. The load platform measures 19 x 22 in. and the front edge of the platform is flush with the floor when fully lowered



Clark-Hopkins Equipment Corp., Philadelphia 23, Pa.

AUGUST 1951

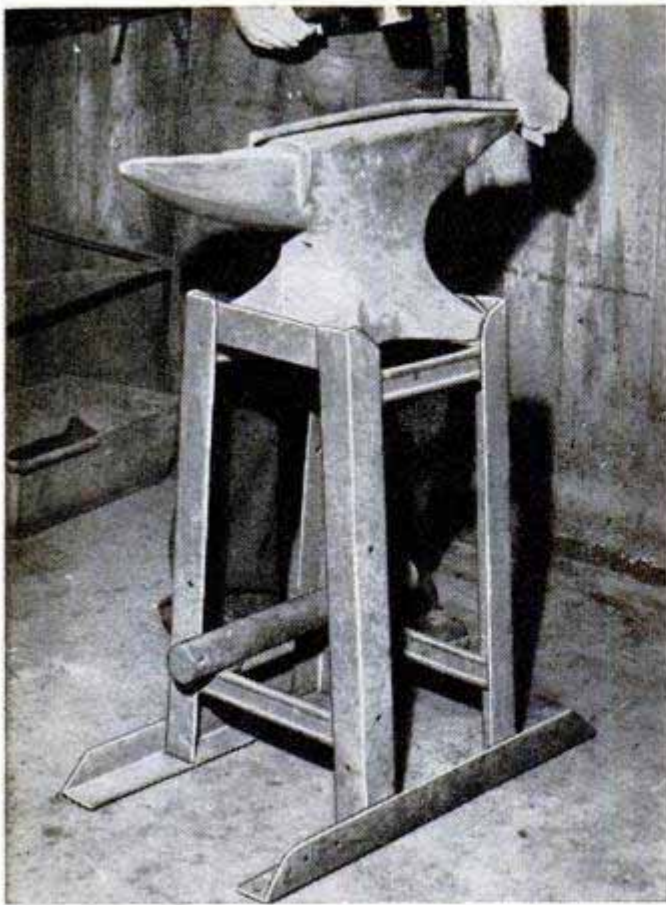

Light But Sturdy Stand Holds Anvil

Rather than use the usual section cut from a log, or other makeshift type of stand for his anvil, one farmer built a stand from heavy angle steel that is not only sturdy and exceptionally rigid, but fireproof as well. Each pair of legs is slanted, or splayed, in one direction as will be noted from the illustration. An angle-steel foot welded to each pair of legs prevents tipping sidewise. Short pieces of channel, with their ends welded into the corners of the angle legs near the upper and lower ends, form braces. The length of these braces must be determined by the size of the anvil base, which is supported on two rails made from steel angle and welded to the legs in an inverted position. The projecting sides of the legs form stops which prevent the anvil base from slipping sidewise.

A. M. Wettach, Mt. Pleasant, Iowa.

Extra Socket on Tool-Post Wrench Saves Time Making Adjustments

When doing specialized lathe work that necessitates frequent changing of the tools and shifting of the toolholder, this combination wrench saves considerable time.

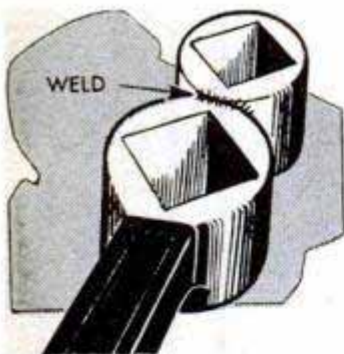

It's made by cutting off the square socket on the toolholder wrench and welding it to the side of the socket head on the tool-post wrench. In this way, the one wrench can be

used for shifting the tool post and adjusting the tool bit in the holder, thus eliminating the loss of time when using the separate wrenches ordinarily supplied.

M/Sgt. James R. Wood, Seattle, Wash.

Brazing C-Clamp to Desk Lamp Provides Utility Shop Light

Needing a special shop light that would be readily portable and could be clamped to power tools or a drafting board, one craftsman removed the flexible arm, or gooseneck, from the base of an ordinary desk lamp and brazed it to a small C-clamp.

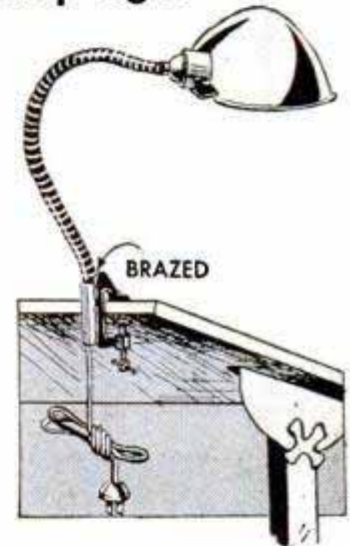

Before brazing, the lamp cord must be removed to prevent damage to the insulation. To remove the cord, unscrew the bulb and shade and disassemble the socket. Attach the end of the cord to a length of fine wire and pull the cord back out of the flexible arm, leaving the wire in the arm. Then after the brazing is completed, the cord is drawn into place by means of the wire.

Warren Norcross, Philadelphia, Pa.

Ordinary Beam Scale Used for Counting Small Stock-Room Parts by Weight

Where an occasional request to count out quantities of small identical parts does not warrant investing in a regular counting scale, a beam-type balance scale can be used as a substitute. Noting the balance ratio of the particular scale, for example, 50 to 1 (1 lb. of weight on the counterpoise equals 50 lbs. on the platform), one of the parts to be counted is placed on the counterpoise instead of the regular weight. Then

the parts are placed on the platform. Thus, when the weight of the parts brings the scales to the balancing point, the number of parts should equal the balancing ratio of the scales, which would be 50 pieces in the example given.

Robert G. Murphy, Stillwater, Minn.

☐ Dirt packed in cap-screw holes is often the cause of gaskets repeatedly blowing.

TELEVISION TODAY

PERHAPS the first television receiver to be installed in a private car was demonstrated recently by William M. MacDonald, Jr., in Chicago. It is a custom-built permanent installation and features a Zenith television set with a 12½-in. screen. The viewing screen is built into the back of the front seat solely for the entertainment of the passengers as illustrated in photo A. In this position, it does not disturb, or distract, the driver any more than the usual radio receiver located on the instrument board. The entire chassis is shock-mounted in the trunk of the car on a specially built platform as shown in photo C. In this location, it is easy to service, and there is plenty of room for the battery-operated power units.

The antenna is mounted on the trunk cover of the car as shown in photo B, and it is operated with an electrically driven rotor for directional beaming to receive any desired TV station within range. A complete control panel for the TV receiver is mounted on the armrest of the rear seat to permit convenient remote control of the picture and sound. This car, in addition to its television receiver, is also equipped with two telephones.

A practical joke that turned into a useful idea occurred at the General Electric Supply Corporation during last year's World Series. Company workers watching the telecast of the series were mystified when they saw a player apparently head for third base after smacking a liner to the outfield. They saw runners score from what appeared to be first base. The TV-service manager for the company had purposely reversed the coil controlling the horizontal reception of the televised image so that everything came out in reverse. It furnished a lot of laughs for the company workers, but it means much more now to Bob McKenna of Rochester, N. Y., who sees his television through a mirror attached to the top of his iron lung at the Strong Memorial Hospital. As in the practical joke, the TV image is reversed, but the mirror shown in photo D reverses it again, affording McKenna a true image adjusted to his line of sight. He now watches television steadily from early afternoon until midnight. American Legion posts are sponsoring this and similar installations.

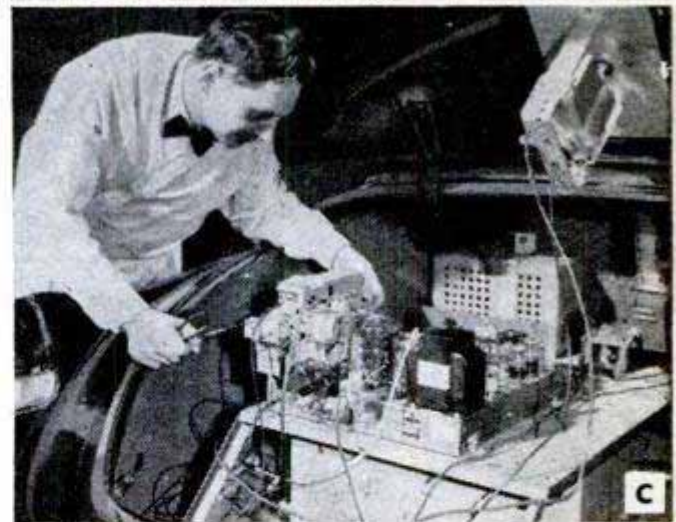

THREE-SPEED RECORD BROADCASTER



THIS HIGH-QUALITY "wireless" record player will mystify your friends as it is really an efficient "miniature broadcasting station." It employs a special oscillator circuit which provides nearly 100-percent modulation from the amplifier tube, a feature definitely not found in phono oscillators of the past. This means that you can now play phonograph records through your radio receiver with greatly improved quality of reproduction without the necessity of a direct connection to the radio set itself, as illustrated in photos A and D.

With the short built-in antenna indicated in photo B, broadcasts can be made up to 10 ft. with plenty of signal strength, and up to 20 ft. with acceptable signal strength. With the addition of about 20 ft. of external wire added to the built-in antenna, a range of from 20 to 30 ft. can be covered easily. The two-tube oscillator unit and three-speed record player operate from any 110-120-volt, 60-cycle a.c. line. Photos B, C, D and E show various views of the completed unit which is housed in the homemade case detailed in Fig. 2. The schematic circuit diagram appears in Fig. 1. The chassis base is standard miniature open-end aluminum type that is available from radio parts houses for about 50 cents. It is mounted in one corner of the plywood case by means of two 6-32 ornamental-head machine screws, 1 in. long, in the position shown in photo F. The size of the cutout for mounting the phono motor in the cabinet, Fig. 2, will depend upon the make of the three-speed phono motor used. Each manufacturer supplies a paper template for the mounting hole required for his particular product. The phono motor used was an Alliance model JPT8 three-speed type, which is listed in parts-house catalogues for about \$6.50.

The selenium rectifier for the oscillator unit can be either a Mallory 6S75 or a Federal No. 1003A, the latter being preferred for this particular circuit. A 6C4 amplifier tube is used to modulate one of the grids of a 50C5 oscillator tube. A standard Meissner oscillator coil, No. 14-1040, is employed. (Lugs 3 and 6 are wide-spaced for terminal identification. See Fig. 1.) The 6C4 tube amplifies the weak signals from the crystal pickup. The three-speed phonograph turntable plays any standard 78-r.p.m. record, as well as the new 33 $\frac{1}{3}$ -r.p.m. long-playing records and 45-r.p.m. miniature records. The pickup uses a universal stylus having a .002-in.-dia. point so that it may be used with any type record without changing needles. It is the Shure model 901U.

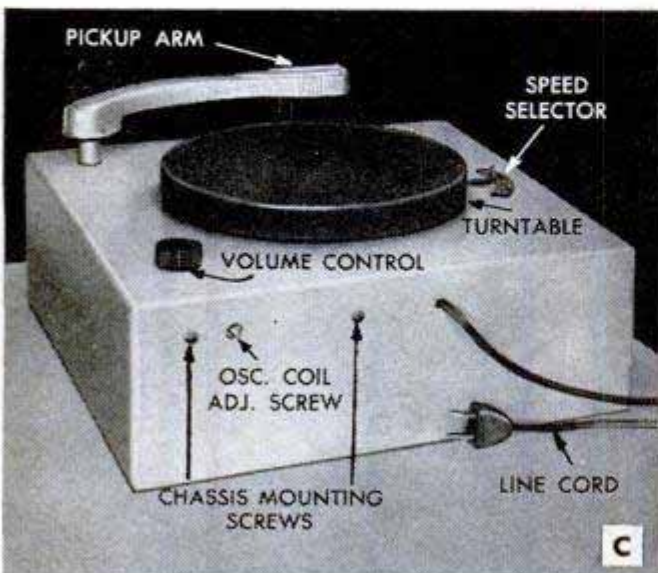
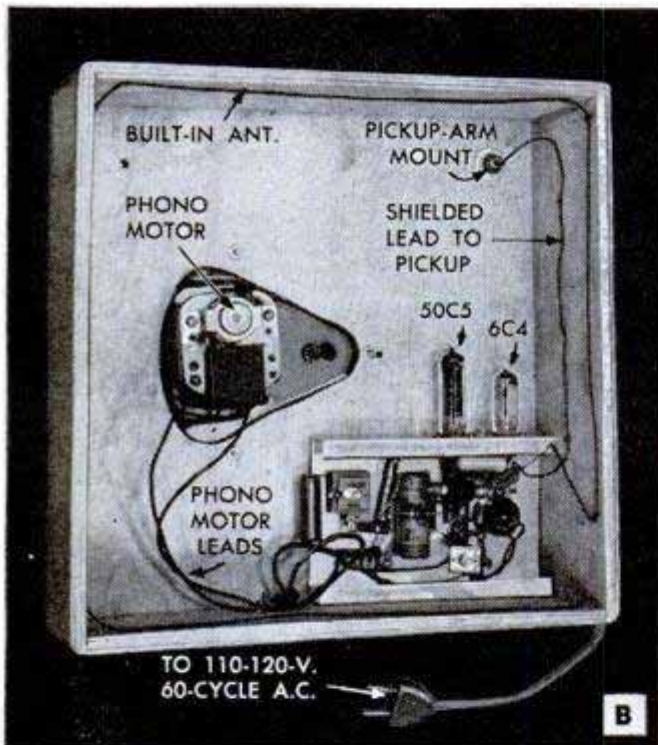

PLAYS THROUGH ANY SET IN THE HOME

The actual layout of parts on the oscillator chassis, photo F, is not critical. The volume control R1, which includes the on-off switch, has its shaft protruding through the top of the plywood case. A hole is also provided on the side of the case to permit the adjustment of the oscillator-coil tuning-slug screw. The tube-socket holes in the side of the chassis base are $\frac{5}{8}$ in. in diameter and may be made with either a tapered reamer or a $\frac{5}{8}$ -in. socket punch.

The power-line leads for the phono motor and line cord are connected to a terminal strip which has three insulated lugs. Looking at photo F, the line cord connects to the center and left-hand terminals. One of the phono-motor leads also connects to the left-hand terminal. The other one is on the right-hand terminal. The center and right-hand terminals are connected to the switch on volume control R1. Leads to R7 and R8 are also connected to the right-hand terminal. The two final connections on the left-hand terminal are the end of condenser C1 and a lead run over to common ground on the insulated two-lug terminal strip at the left of the volume control. The opposite end of C1 goes to chassis ground on the top of the selenium-rectifier chassis-mounting screw. The rectifier positive and negative lugs are out at the side.

Final adjustment is very simple and, once made, may be left that way indefinitely. The oscillator is tuned both by means of the small mica trimmer condenser C6, and the iron-core slug inside the oscillator coil. Turn on the unit with the switch on the volume control. This also starts the phono motor. Then allow three or four minutes

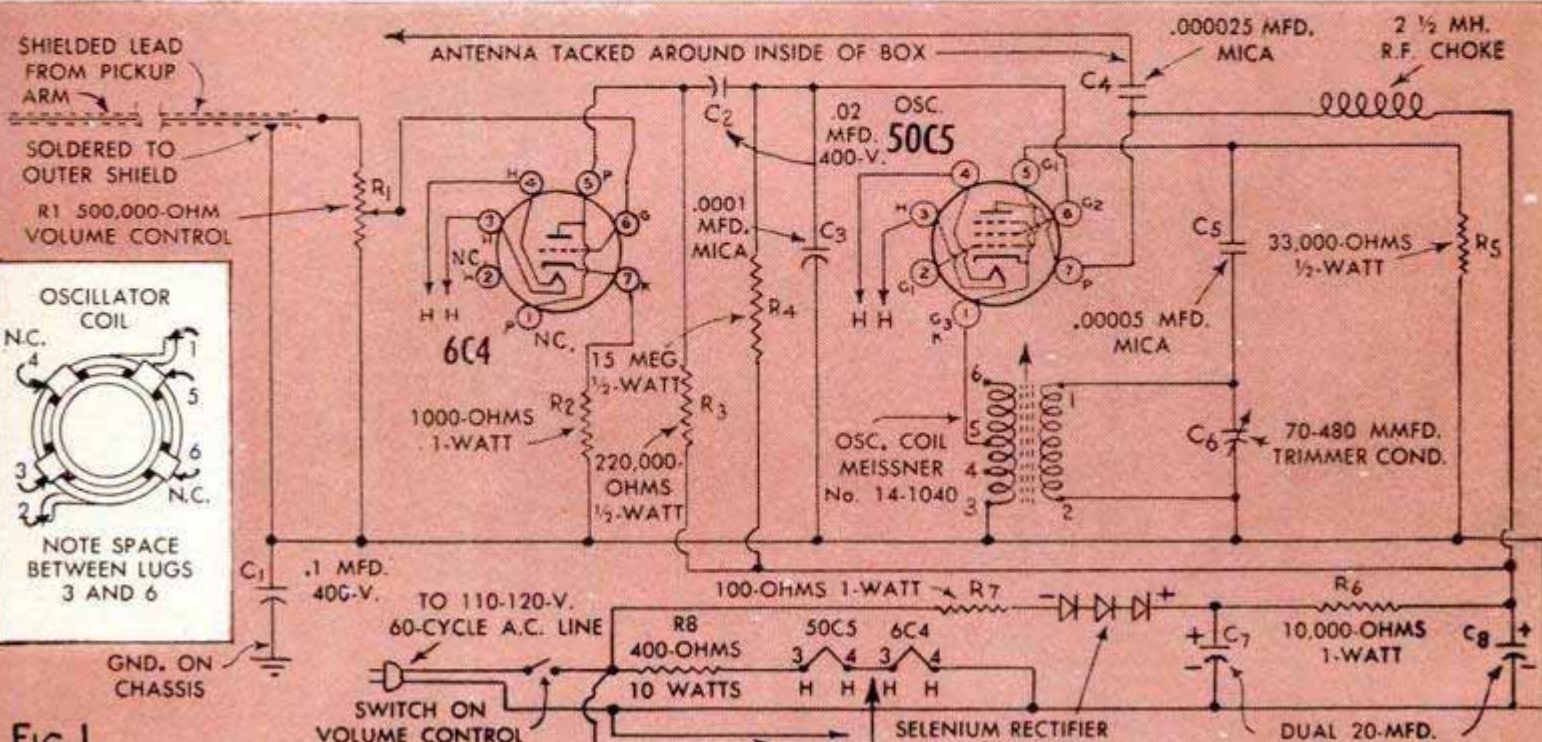

Fig. 1

for a warmup. Now tune in your home radio set to a spot on the dial where no broadcast stations are received. Go back to the record-broadcaster unit and adjust the trimmer condenser C6 with a small screwdriver to where you hear a quiet spot without crackling or hissing in your radio. You will identify the presence of your record-

broadcaster carrier signal when these noises stop. Now put a record on the turntable and set it to playing. Following this, for precise adjustment to the exact frequency on your radio set, adjust the oscillator-coil screw until maximum volume and clarity are obtained. The volume control R1 permits setting at the proper playing level for the various kinds of records. See that the speed selector is set at the proper speed for the type of record you are playing. The proper setting of the volume control is the highest setting which does not introduce distortion. It is always better to advance the volume control on the radio receiver rather than the volume control on the record broadcaster in order to prevent distortion. Too high a volume-control setting in the phono-oscillator unit will result in impaired reproduction quality. This unit is not designed for use with a microphone. It is intended for record-playing purposes only. Detailed student material list R-402 is available from Popular Mechanics Radio and Electronics department upon receipt of ordinary postage.

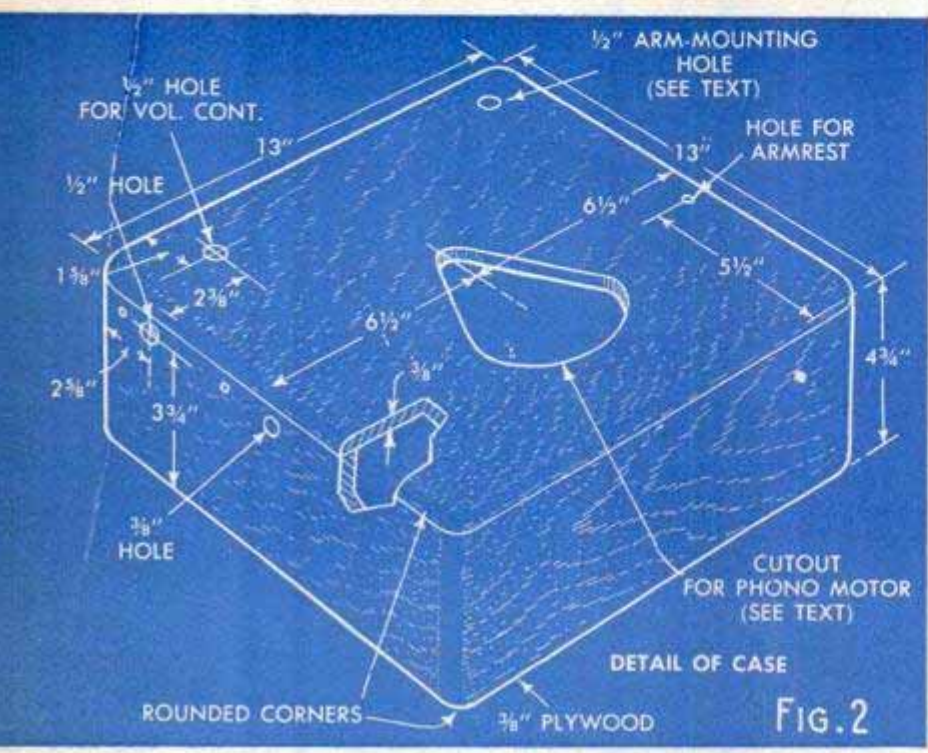
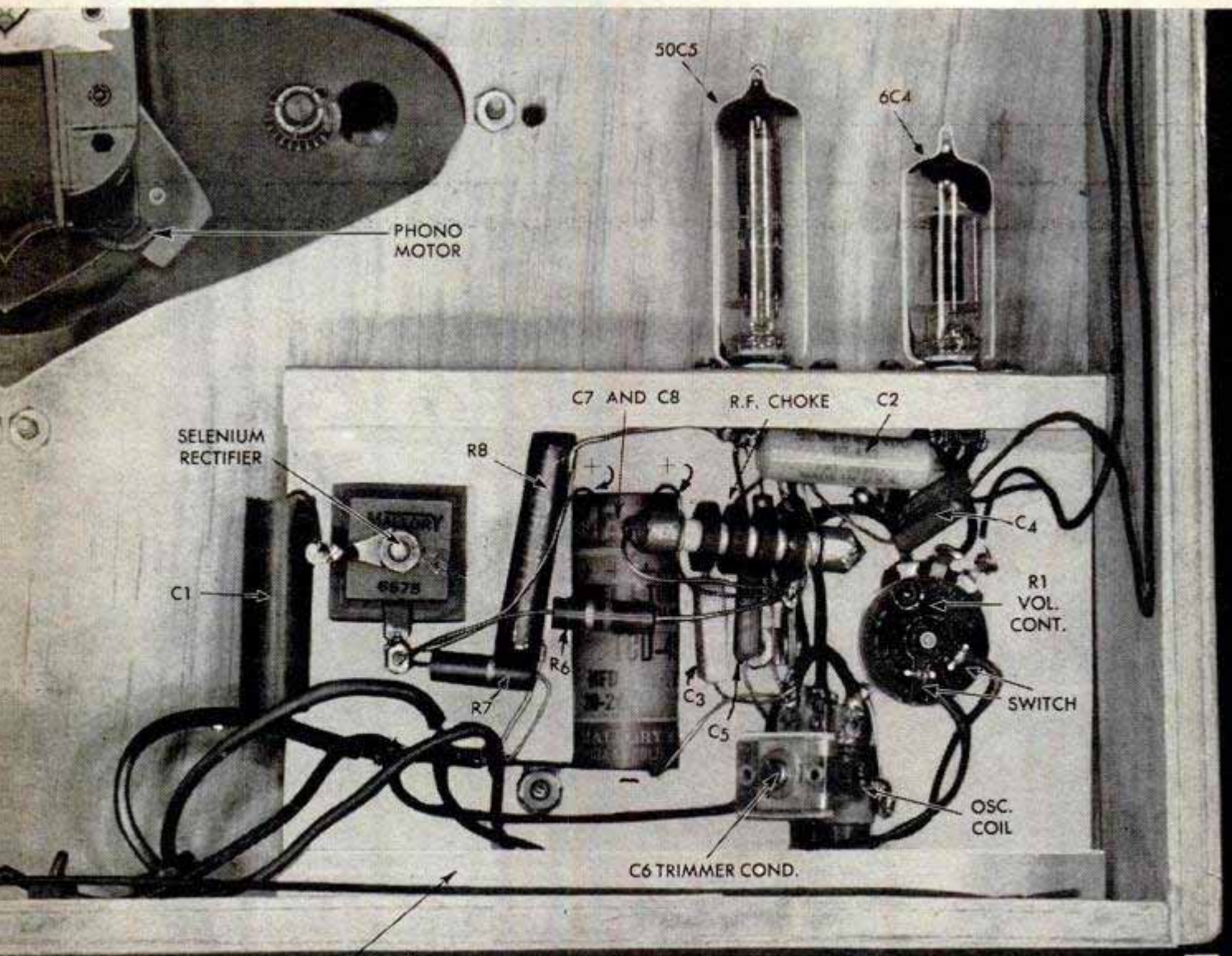

FIG. 2



CHASSIS BASE

← OSC. COIL

SOLDERING HINTS FOR STUDENTS AND RADIO WORKERS

POORLY soldered connections account for a large percentage of troubles in student units. Servicemen and factory workers always strive to improve their soldering technique. Soldering is a basic technique in many arts, but it is especially important in radio and electronics. The novice may wonder why it is necessary to solder a connection that can be made easily by twisting two wires together. When such connections are exposed to air for some time, the wires will oxidize and form a high-resistance joint. Furthermore, a mechanical bond, no matter how well it is made, will work loose under vibration.

Photo A shows a radio worker testing a soldered connection by giving it a sharp pull with a pair of long-nose pliers. Soldering irons should be suitable for the type of work being done. Soldering guns of the type shown in photo B supply instant heat and are great timesavers. The tiny variety illustrated in photo C is ideal for delicate work. Never use acid flux, or acid-core solder for radio, TV or electronic circuits; always employ a good grade of rosin-core wire solder.

The eight soldering hints illustrated in the sketches appeared in one of the DuMont Laboratories' pamphlets intended for use by their workers and assembly inspectors to insure a high standard of assembly wiring and soldering. Fig. 1 shows the correct way to hold the soldering iron to transfer maximum heat to the surface to be soldered. Figs. 2 and 3 show the proper application of solder when soldering a wire to a horizontal terminal (Fig. 2) and a vertical terminal (Fig. 3). Applied in this manner, a smooth layer of solder will merge with the terminal. Fig. 4 shows improper edge placement of the soldering tip; the correct position for this type of vertical terminal is illustrated in Fig. 5. Always apply the solder directly to the heated surfaces as in Fig. 7, and not to the iron as in Fig. 6. When shaping flexible resistor leads for making soldered connections, do not make sharp bends, for the reason illustrated in Fig. 8.

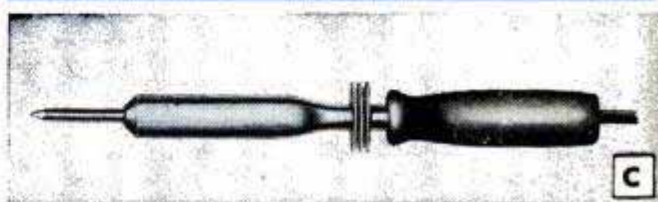
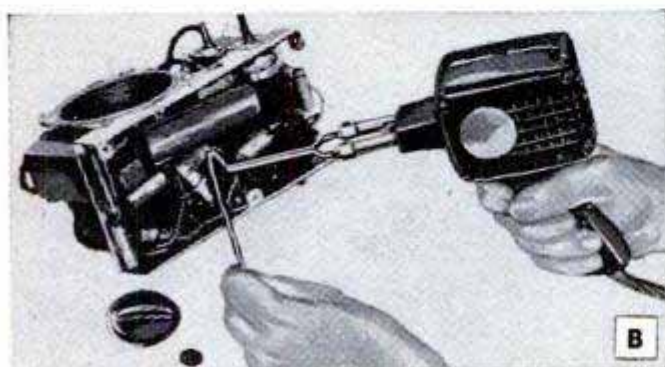
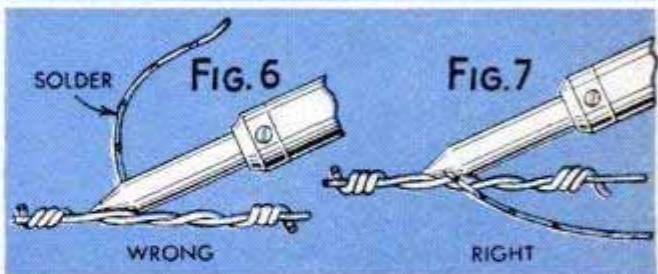
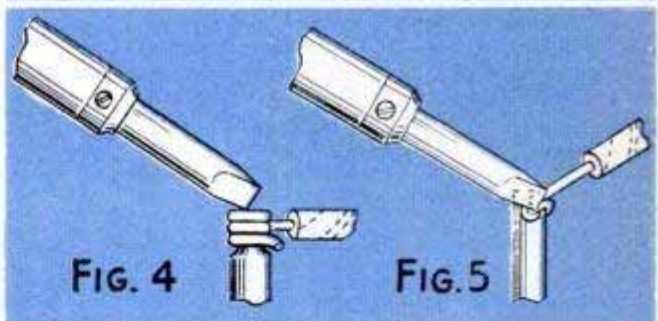
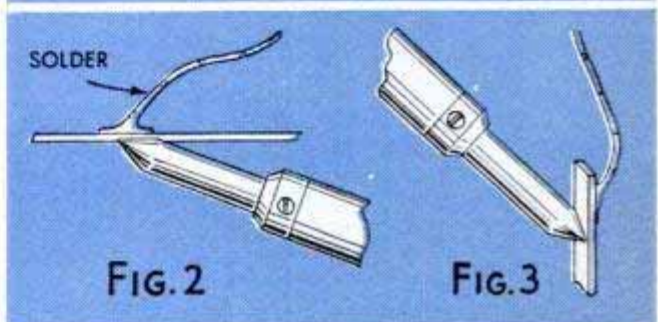
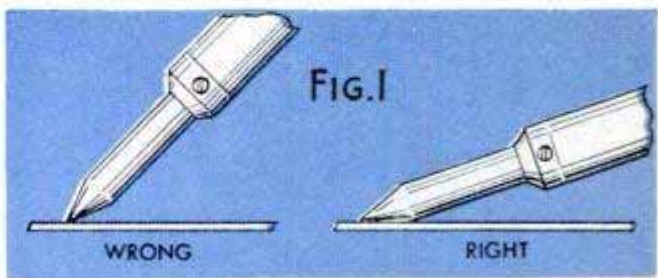
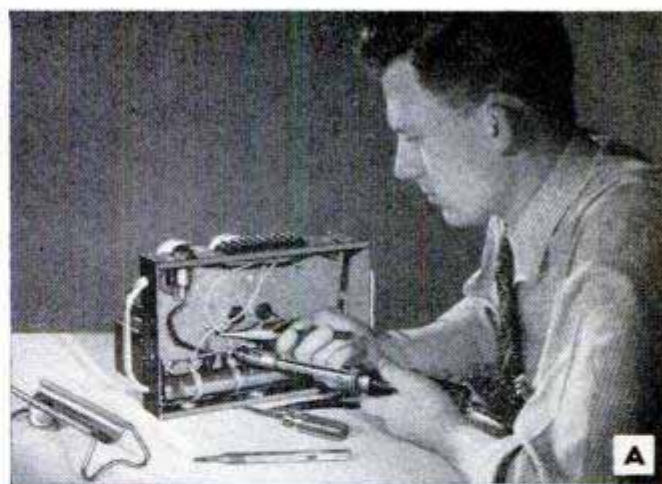



New, inexpensive slide projector

Kodaslide Merit Projector, only \$24.50; carrying case, extra. The big news about this projector is the new, improved slide-feeding mechanism. You insert slides in top of projector—thus no jarring or moving of instrument. Large-sized lamphouse of unique, new design assures efficient cooling to keep slides flat. Built-in elevating mechanism for angles up to 10 degrees. Other features: (1) Lumenized Kodak Projection Ektanon Lens, 5-inch $f/3.5$; (2) ready access to optical system for cleaning; (3) powerful 150-watt lamp.

Color Show



Think of shooting and showing your own personal pictures in glorious full color with Kodachrome Film! It's one of the biggest thrills in photography. On these pages you see some of the latest equipment and accessories now offered for projecting and viewing the color

Fine, ultra-thrifty "miniature"

The value-packed Kodak Pony 828 Camera makes superb color slides on Kodachrome Film; sharp black-and-white negatives; also gorgeous Kodacolor snapshots. Kodak Anaston $f/4.5$ Lumenized Lens; Kodak Flash 200 Shutter with built-in "synch"; body shutter release. Takes 8-exposure rolls. Only \$32; similar "Pony" 135 for 35mm. films, \$36.75. Field cases for both models also available.

slides you get, and for displaying color prints and enlargements made from them.

Your dealer will be glad to answer any questions you may have regarding picture taking in color—and to help you choose the right Kodak equipment for getting the most out of color photography. Visit him soon.

Projects images up to 7 feet wide

Kodaslide Projector, Model 2A, is compact and efficient—costs only \$49.50, with Kodak Projection Ektanon Lens, 5-inch $f/3.5$; with 7½-inch $f/4$ lens, \$59.50. Slide carrier accepts two transparencies. All optics are Lumenized. 150-watt lamp. You can tilt projector up to 10 degrees. Made of die-cast metal with gray finish. You'll find this model ideal for large home gatherings.

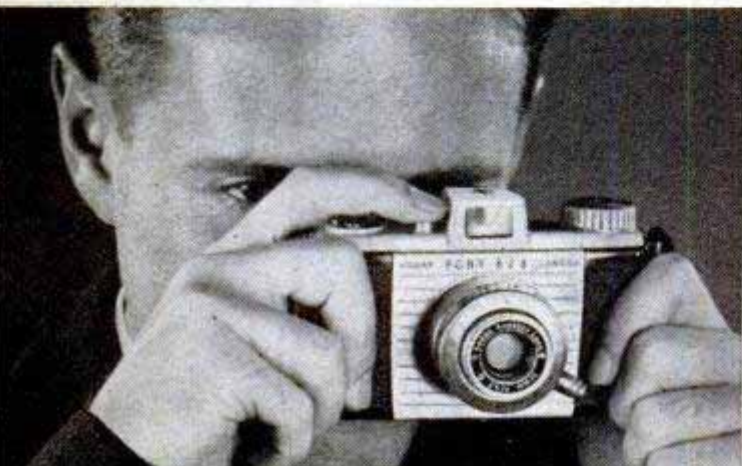

**Budget-priced
table viewer**

Kodaslide Table Viewer, 4X, combines projector and screen in one compact unit. Here's the *practical, effortless* way to show color slides, enlarged more than four times, to a small group of friends. With the "4X" there's no longer any need to rearrange furniture, no dimming of lights. Just plug it in and you're ready for a color show. Because of the handy on-and-off switch on the eight-foot cord, you can leave the viewer plugged into a wall socket when not in use. Attractively styled to blend with room furnishings. Price, \$49.50. Accessory carrying case, extra.

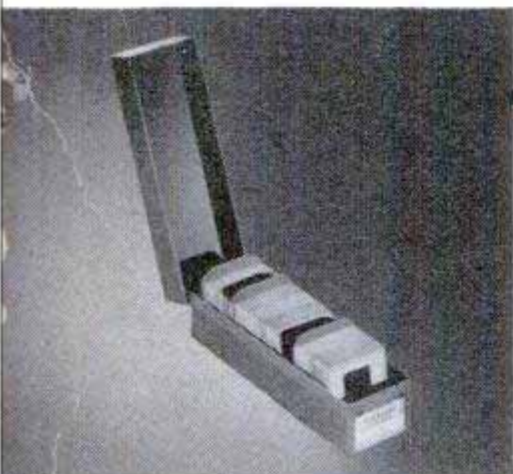

Protect precious slides—Inexpensive metal Kodaslide File Box holds 150 cardboard or 53 glass slides—keeps them organized. \$1.50.

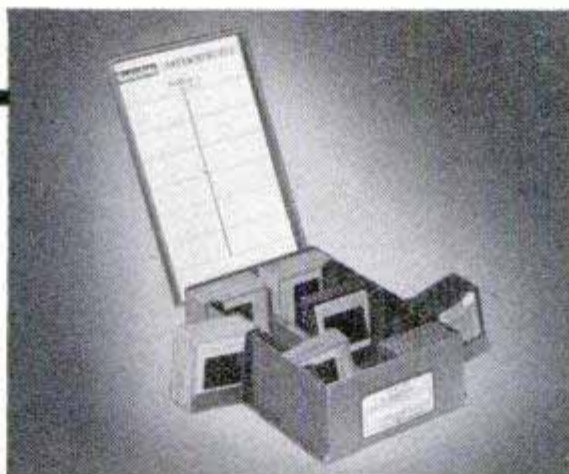

De Luxe file—Kodaslide Compartment File has 12 swing-out compartments, for 240 cardboard or 96 glass slides. Contains handy index inside cover for listing slides by subject. \$3.75.

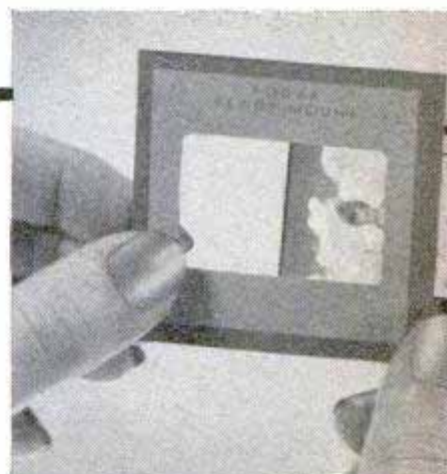

Ready-Mounts—Mount Kodachrome transparencies at home with Kodak Ready-Mounts (cardboard). Box of 50, \$1.75 (35mm. or Bantam).

Share your color prints—For Kodachrome Prints: A, Kodachrome Print Wallets. For Kodachrome or Kodacolor Prints and Enlargements: B, Kodak Color Print Albums; C, Kodak Color Print Mounts. For Kodachrome or Kodacolor Prints: D, Kodak Color Print Folders. Protect your Kodak color prints and enlargements, and make it easy to share your enjoyment of them with family and friends. Prices start at 10¢.

Prices subject to change without notice and include Federal Tax where applicable. Consult your dealer.

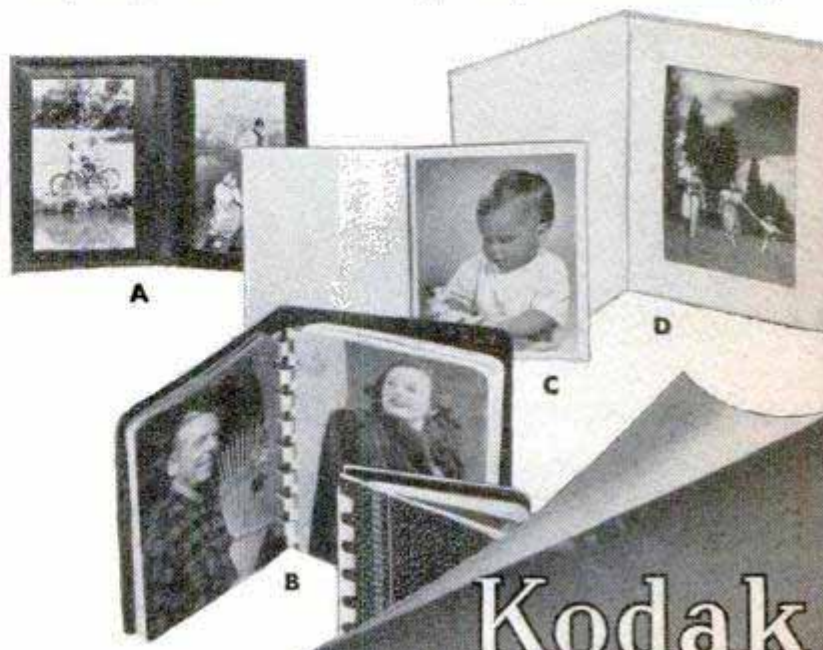

Kodak

ANTENNA ROTATOR SOLVES TV-RECEPTION PROBLEMS

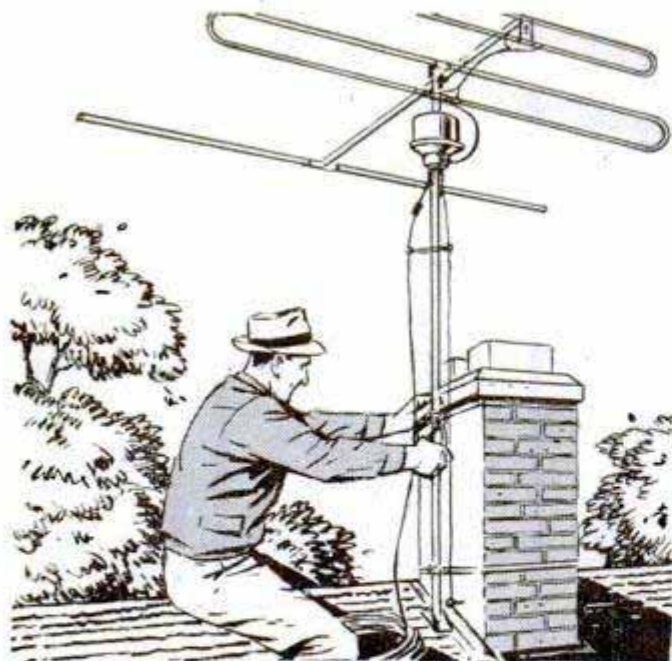

TRANSMITTED at ultra-high frequencies, TV sight and sound signals are reflected like light from the surfaces of buildings in crowded localities, and these reflected signals result in ghost images. This condition usually demands a highly directional receiving antenna that will give sharp discrimination to reject unwanted signals. These ghosts are often received on several stations, making it necessary in some locations to employ more than one TV antenna, or a rotating device like the one illustrated that will turn the directional antenna to favor the desired station.

In areas where there are several TV-transmitting stations located in widely separated directions from the set-owner's home, a means for rotating the antenna is obviously desirable. Early antenna-rotating devices in many cases were of the hand-operated, homemade variety. These have now been replaced with highly efficient motor-driven rotator units operated by remote control from direction-indicating control boxes located near the receivers.

The motor-driven antenna rotator and control-box units are easy to install. One of the new assemblies is illustrated in photos A, B and C. It is designed to rotate in one direction only, and it is claimed to have greater power and higher torque than is usually available in reversible motors. The attractive remote-control unit is shown in photo A. A handy card for logging stations slips into a slot in the front of the control unit as will be noted in the inset photo. A close-up of the rotator-unit assembly appears in photo B. The three-wire rotator-control cable connects to the terminal board on the underside of the automatic-control unit as illustrated in photo C. To operate the device, you merely switch the power on and then set the pointer to the desired antenna direction. When the pre-determined direction is reached, rotation stops automatically.

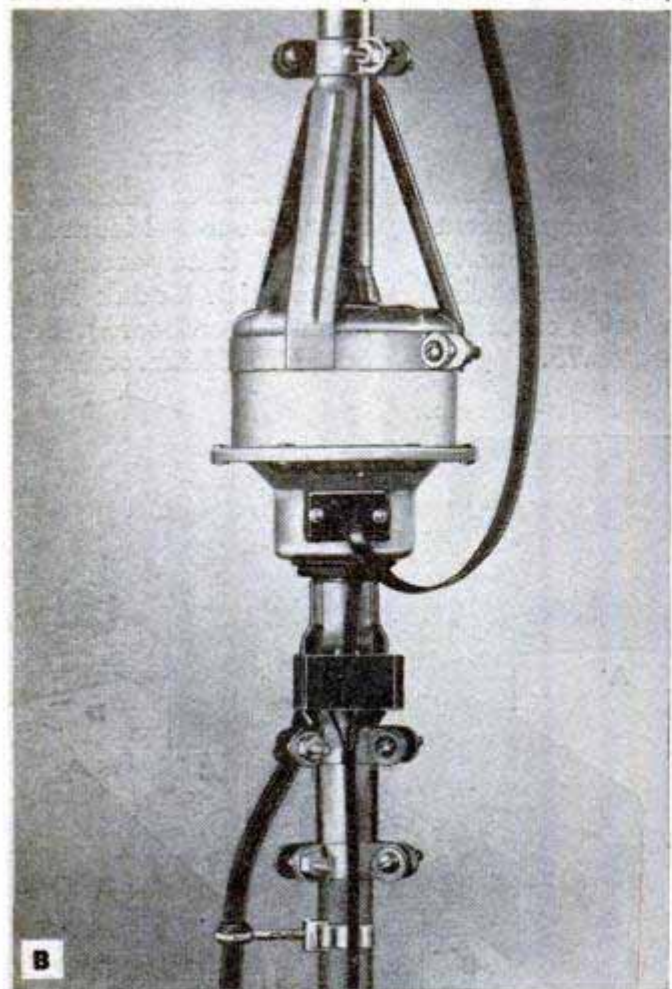
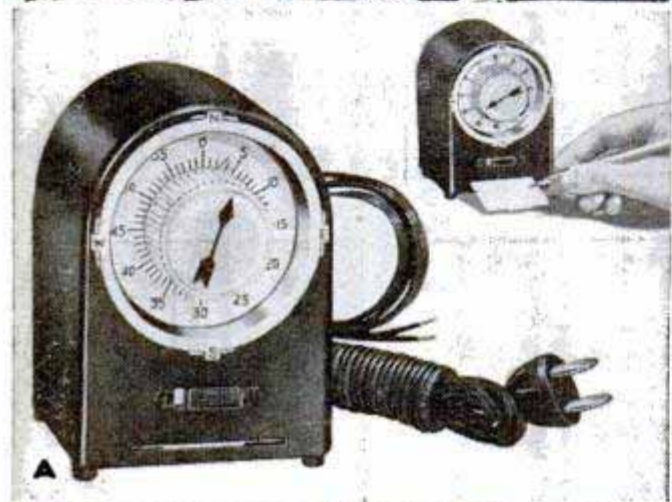



SELF-HELP IDEAS FOR SET OWNERS

A—Many set owners using large extension speakers can take a tip from this serviceman, who houses his test speaker in a storage cabinet under his workbench. The same idea can be applied to closet doors, kitchen cabinets and recreation-room walls.

B—If you are in a fringe area or need a TV-FM booster for better reception, here is one that is fully automatic. You can hang it on the back of the TV set where it is out of sight, and forget about it, as it is automatically tuned by normal operation of the set.

C—You can check your a.c. record-player speeds with a 15-cent stroboscope card and a small neon lamp.

D—A window screen will serve as a temporary antenna for radios that normally use an external wire.

E and F—How a sideboard can be used to house a bass-reflex (10-in. speaker) enclosure 11½ in. deep, 20 in. wide, 26 in. high. The rectangular hole in E is 3½ x 7½ in. Inside lining is carpet padding.

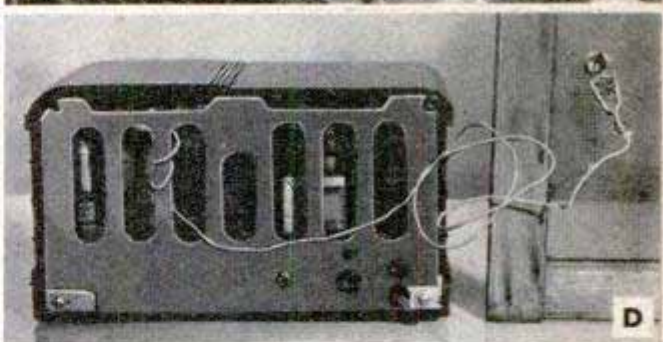



Care and Feeding of Engines

BY S. P. CORP

COOL BEARINGS IN SUMMER HEAT

Lubrication of front wheel bearings every 10,000 miles is sometimes neglected with sad consequences. It's not a hard chore to remove a front wheel, clean, grease and replace—but remember these points. Have a new inner oil seal and new cotter pin for replacement. Clean the bearings with gasoline and allow to dry but **DON'T** spin a dry bearing. Inspect bearings and cups for chipping, flat spots or for overheating—indicated by a dark blue ball or roller. Work about a tablespoon of wheel bearing lubricant into each bearing with your fingers.

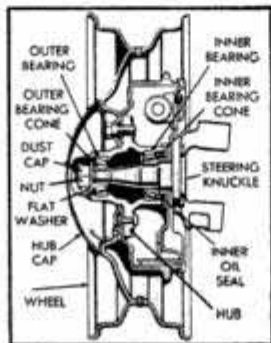

Tighten nut till you feel a binding on wheel rotation, then turn one revolution to seat bearing and back off wheel nut until bearings are slightly loose. Retighten nut until looseness is just removed. Install your new cotter pin.

CLEANING AIR CLEANERS

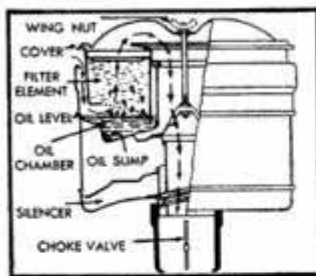

Oil bath air cleaners need service every 5000 miles, others every 2000 miles. If used on dusty roads, clean them twice as often. Oil should be replaced with SAE50 for hot weather and a lighter oil for winter. A dry cleaner unit should be plunged up and down in clean gasoline or kerosene,

taking care not to wet the felt at the top of the cover.

IF YOUR CAR DRINKS TOO MUCH

An engine that uses too much oil needs new Sealed Power piston rings. The Sealed Power MD-50 Steel Oil Ring does the world's best job of oil control, even in badly tapered and out-of-round bores. Your dealer has Sealed Power Rings or can get them for you. They save gas, save oil, restore original power to your engine and lengthen its life. A postal to "Sealed Power, Dept. G-8, Muskegon, Mich." will bring you free a helpful book, "7 Ways to Save Oil."



On the Trail of the Gulf Stream

(Continued from page 128)

which, in turn, support the multitudes of Antarctic birds like guanayes, pelicans and penguins. They are able to survive only because the Humboldt Current is chilly enough to sustain them. The birds, in turn, help support the Chileans and Peruvians with their production of guano—a world-famous source of nitrate for fertilizer.

But every few years, a warm, tropical current from somewhere sneaks in and heats up the Humboldt, kills the fish and raises Cain with the birds. Last time it happened, the coasts were littered for hundreds of miles with millions of guanayes that had died of starvation.

To find out what causes these shifts in the currents, what the effects may be, and perhaps how they may be forecast, is one of the big reasons scientists at Woods Hole and other oceanographic institutions are forever out scouring the seas.

Currents in the ocean have different temperature and salt content from the water around them. It is by measuring these that scientists can tack their ships in and out of a current, follow its edge and track it down.

Until recently, the surest way to follow a current was to compute its temperature and salinity every 20 to 60 miles, then figure how it would have to be running to set up such a pattern—a tedious job. The ship would heave to. A man would lean perilously over the dipping side and lower a series of Nansen bottles on a long cable into the water. The bottles, fitted with thermometers, would test the temperature and salinity at different levels.

Now, loran provides accurate positions at any interval. And a rapid temperature-measuring device—the bathythermograph—which looks like a bazooka shell, is simply lowered every 30 minutes. On a glass slide coated with skunk oil (because it won't wash off in the water) the bathythermograph makes a running record of temperatures as deep as 900 feet while the ship is under way.

Over the side of the pitching ships, scientists also lower their direct-current meter—a propeller with a long fin on it which acts like a weather vane and keeps the propeller facing into the current. The current turns the propeller, and from the number of revolutions, scientists can compute the speed of flowing water.

Already, out of recent surveys, oceanographers have learned that the Gulf Stream is not a broad, steady "river in the ocean." At its swiftest part, between Hatteras and the Grand Banks, it is 10 to 15 miles wide,

(Continued to page 222)

Yogi Berra SAYS

"I add water
only 3 times
a year"

PREST-O-LITE HI-LEVEL BATTERY...



Yogi Berra, most colorful catcher in baseball and star clutch-hitter for the New York Yankees, finds Prest-O-Lite Hi-Level has over 3 times the liquid reserve of ordinary batteries—goes 3 times as long without adding water.

needs water only 3 times a year

IN NORMAL CAR USE

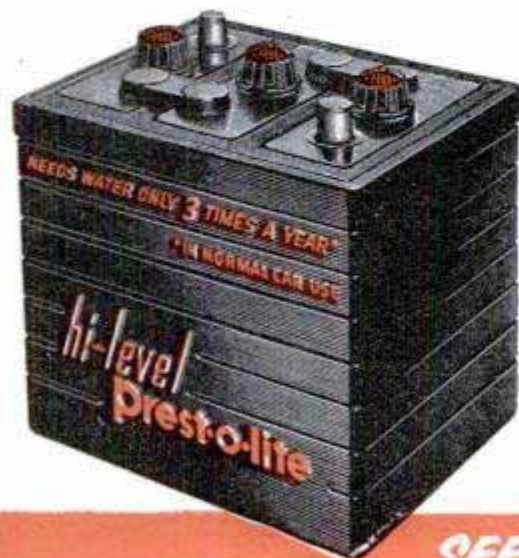

INSTALL a Prest-O-Lite Hi-Level Battery in your car and enjoy the comfort and convenience of this new principle of battery design. The Hi-Level Battery needs water only 3 times a year in normal car use and because of its advanced engineering design, it lasts longer, in tests conducted according to accepted life cycle standards. For quick starts and dependable service, see your Prest-O-Lite Dealer.

PREST-O-LITE BATTERY COMPANY, INC.
Toledo 1

Ohio

SEE YOUR PREST-O-LITE DEALER TODAY



Just Like Magic

for making or mending
— these amazing
Wizards with Wood

Handy with your hands? Have your own workshop? Like to do odd jobs? You'll bless the day you discover the magical results you can obtain with Firzite, Satinlac and Weldwood Glue. At hardware, paint and lumber dealers. And mail coupon for free leaflets,

A MUST for Finishing Fir Plywood



Tame that wild grain with FIRZITE. Virtually prevents grain raise or checking... readies the surface satin-smooth for paint, stain or enamel. (For blond, pickled, or tinted effects on soft or hard woods, use White Firzite).

FIRZITE*

Newer than Shellac or Varnish



Pints, Quarts,
Gallons

For "natural wood" finishes on furniture, panelling or woodwork, there's nothing like Satinlac. Brings out natural grain and color beauty of any plywood or solid wood. Avoids that "built-up" look; will not turn yellow or darken with age. "Water-clear," easy to brush or spray, dries ready for next coat in 2 or 3 hours.

SATINLAC*

Glue That's Stronger than Wood



To make things or fix things, use Weldwood Glue for all wood-to-wood bonds. Makes joints stronger than the wood itself. Mixes easily with water. Stain-free, rot-proof... highly water-resistant!

WELDWOOD® PLASTIC RESIN GLUE

*Trade Marks

United States Plywood Corporation,
Dept. 290, 55 West 44th St., New York 18, N.Y.

Send me free leaflets on Weldwood Glue, Firzite and Satinlac.

NAME _____

ADDRESS _____

Clinic for Homemakers

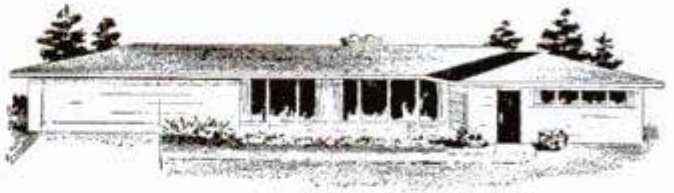

As a service to our readers in solving the hundreds of problems pertaining to a home—inside or out—the editors of *Popular Mechanics* invite you to present your problems to The Clinic Editor for help and advice. Address your questions to The Clinic Editor, *Popular Mechanics Magazine*, 200 East Ontario Street, Chicago 11, Ill.



Hanging Gutters

Q—In planning to replace the gutters on my house I've encountered the question of whether to hang them level or slant them toward the downspouts. The gutters are 30 ft. long, without any offsets, and are of the half-round type. Which should I do, slant them, or hang them level?—T.B., Kans.

A—Although it's a common practice to pitch gutters to the downspouts, especially half-round gutters, it also is recommended that gutters be installed level on certain types of architecture. This recommendation applies particularly to box-type gutters and also to wooden gutters of various types. Half-round gutters are more apt to sag slightly at one, or several, points along the length, and for this reason alone it generally is recommended that they be installed with a pitch toward the downspout ranging from $\frac{1}{4}$ to $\frac{1}{2}$ in. for each 10-ft. length. For short runs up to 20 ft. total length, pitch the run $\frac{1}{2}$ in. Longer runs up to 30 ft. on a single downspout should be pitched not more than a total of 1 in. for the full run, as otherwise the gutter will tend to overflow at the lower end during heavy rainstorms. On a long run such as you have, it's a good idea to place hangers every 30 in. throughout the length, instead of the 36-in. spacing usually recommended. Use 5-in. gutter, as the 4-in. width is entirely too small for a 30-ft. continuous run.

Waterproofing a Porch Deck

Q—What should I use to waterproof a porch deck that is covered with matched flooring and roll roofing? Apparently the roll roofing will not withstand being walked on, as the deck leaks already in several places. Is there any way of sealing the joints in the floor boards to make the deck waterproof?—S.R., Kans.

A—It is not clear from your letter whether you are referring to new or old construction. Assuming that you are describing a fault in new construction, we would not consider it practical to attempt to waterproof the deck by filling the joints between the floor boards. Rather we would suggest that you apply a covering of canvas of a grade made especially for this purpose. Remove the roll roofing and sweep the flooring clean. Plane off raised edges of the individual boards and renail any that are warped. Fill open cracks between the boards with calking compound. If the flooring is old and in rather bad condition generally, it will be necessary to cover it with $\frac{3}{8}$ -in. outdoor plywood. A newer

(Continued to page 220)

Make
the Whole
Country
Your
Vacation
Land!

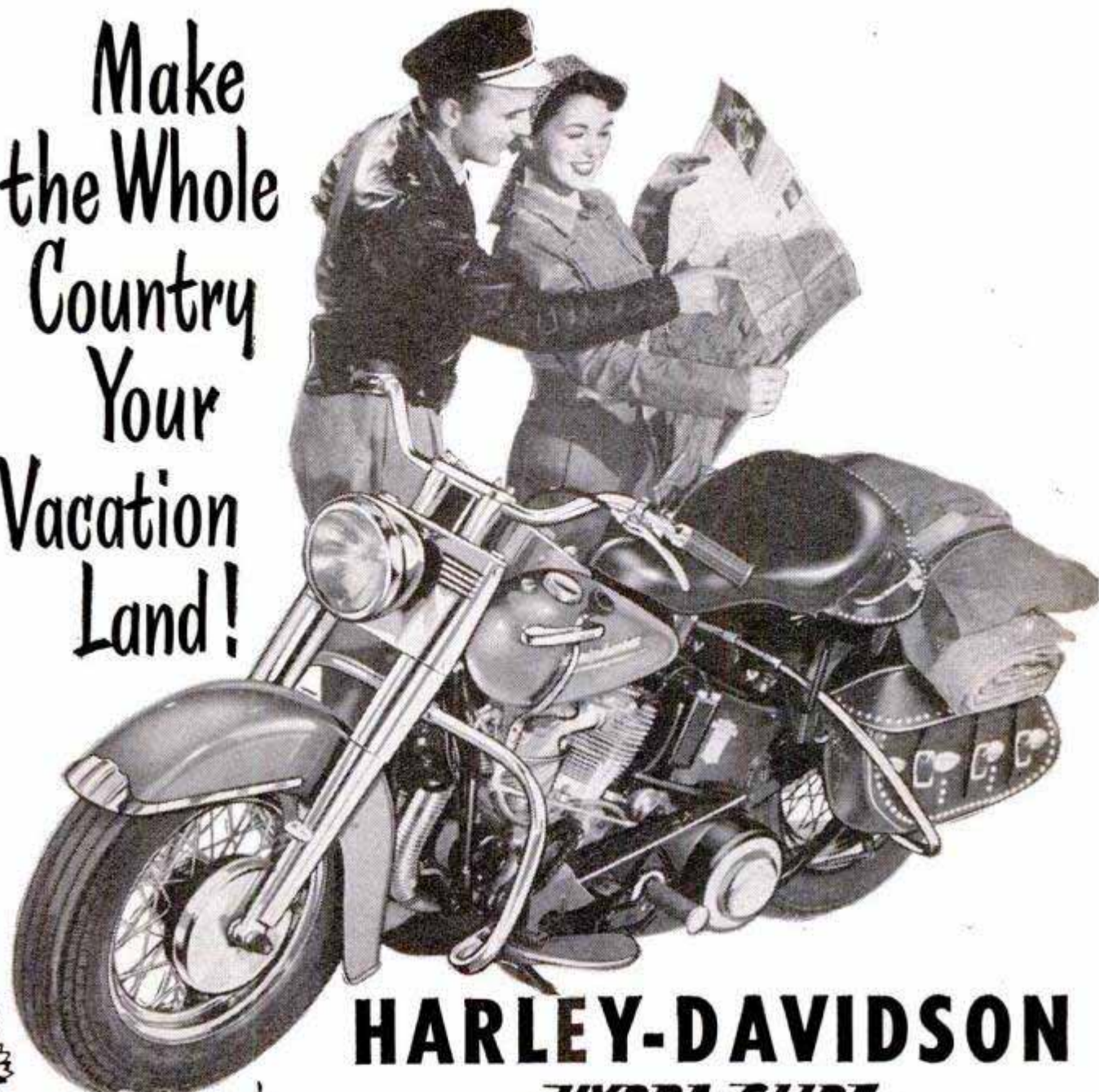

HARLEY-DAVIDSON *HYDRA-GLIDE*®

SEE America the scenic, low-cost way — on a Harley-Davidson Hydra-Glide! You'll enjoy a new kind of vacation — an economical and fun-packed tour, with picturesque back-country roads and towns, breath-taking mountain trails, hidden lakes and out-of-way resort regions offering thrilling new adventures and good times. You'll ride swiftly and comfortably, too . . . float along like a breeze! Even on longest trips you'll hardly know you're traveling. Plan now for a thrilling vacation. See your dealer today.



MAIL COUPON NOW

HARLEY-DAVIDSON MOTOR CO., Dept. P, Milwaukee 1, Wisconsin

Name.....

Address.....

City..... State.....

Send me free copy of ENTHUSIAST Magazine filled with motorcycle action pictures and stories; also literature on new models.



DEALERS WANTED: A few franchises available for the full line of famous Big Twins and the 125 Model. Write today.

How to make files last longer

STEEL is the national security program's most essential material. Its conservation is everybody's concern—and duty. In files, steel can be either saved or wasted . . . saved, firstly, by buying *good* files (they consume no more steel than poorly made, short-lived ones); secondly, by proper use and care of files. Here are a few rules:



DON'T

throw files around carelessly—say, on top of one another. Scuffs, blunts, chips teeth.



DO

keep files clean—tap frequently on wood to loosen chips; also brush with file "card."



DO

use The right file for the job. Different metals ruin wrong files.



DON'T

let files rust or fill up with dirt. Corrodes and dulls teeth.



DON'T

put heavy pressure on forward file stroke; nor "drag" file back under needless pressure.

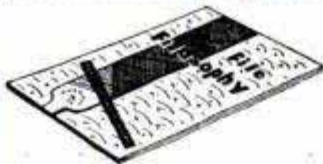

DO

send for "File Philosophy"—best book on kinds, use and care of files you ever saw. FREE.

Using files properly is up to you. Making good files is up to us. There are none more carefully shaped, accurately cut, properly hardened—none longer-lasting than Nicholson and Black Diamond brands. The hardware dealer who sells them is reliable in helping you select the files you need.

NICHOLSON FILE CO.
22 Acorn St., Providence 1, R. I.
(In Canada, Port Hope, Ont.)



NICHOLSON FILES

FOR EVERY PURPOSE

(Continued from page 218)

floor in reasonably good condition will do, if treated as described. Apply a coat of lead-and-oil paint and allow to dry. Then coat the surface with white-lead paste, or heavy white-lead paint, applying the paste or paint in a strip only as wide as the canvas, and at the low side of the porch deck. Press or roll the canvas strip in place. Then coat another area of equal width and length and lay the second strip of canvas, allowing for a 4-in. lap. Continue this same procedure until the deck is covered. Then tack the edges and laps with copper tacks spaced about 1 in. apart. After drying, paint the canvas with two coats of deck paint.

'Sweating' Stovepipe

Q—I have an oil-burning space heater in my combination garage-workshop. The vent pipe passes through the ceiling and runs horizontally to a chimney at the end of the building. Length of the horizontal run is about 12 ft. In cold weather, water drips from the pipe joints along the horizontal run, causing the pipe to rust out in one season. Where does the water come from and what can I do to remedy the trouble?—E.F., Mass.



A—One of the products of the combustion of concentrated fuels is water vapor. Heat from the horizontal run of vent pipe is quickly dissipated in the cold attic of the building. This lowers the temperature of the pipe to the dew point and causes the vapor in the waste gases to condense on the cold metal. Sometimes it is possible to correct the trouble by adjusting the gravity damper, or draft control, to permit more heat to escape to the vent pipe. While this lowers the efficiency of the heater and raises fuel consumption, it often proves effective in preventing the objectionable condensation in the pipe. A better way, where space permits, is to slant the horizontal run of pipe 15 deg., or more, from the elbow to the chimney. This inclining of the vent pipe generally increases the velocity of the gases sufficiently to minimize condensation to the point where it is no longer troublesome.

Mildew in Closet

Q—Clothing mildews in our clothes closets every summer. The closets have single-panel swinging doors and it is not possible to leave them open because of the wall space they take up in small rooms. What causes the mildew, and what can we do to remedy the condition?—A.P., Ore.



A—Lack of ventilation and high humidity cause this trouble and the problem of ventilating a closet is not simple. Leaving the door open might alleviate the condition to some extent but still would not cure the basic cause, which is the presence of high humidity in the air throughout the house. One thing that sometimes proves to be a help is the installation of a shutter door. These are now available to fit doorframes of various standard sizes. The shutter door would permit the circulation of air, even when kept closed and might prove a remedy for your trouble. Air the garments frequently in bright sunlight and, when placing them on hangers, space them individually so that air can circulate around each one. Regular use of an electric dehumidifier will reduce humidity to the point where it no longer is a cause of the trouble you describe. Of course, this unit is rather expensive.

NO OTHER SPARK PLUG CAN MATCH THIS RECORD!

CHAMPIONS

SCORE 21ST VICTORY IN INDIANAPOLIS "500"

Proof of their unequalled performance
and dependability in the most grueling test
of automotive equipment.



1951 winner, Lee Wallard, and 2nd, 3rd,
4th and 5th drivers use Champion Spark
Plugs! Wallard sets new record of 126.244
m.p.h.! All Champion users report
perfect performance!



FOLLOW THE EXPERTS . . .
Use the spark plugs champions use!



JOHNNY PARSONS
Winner 1950
124.002 m.p.h.
(345 mile race)



GEORGE ROBSON
Winner 1946
114.82 m.p.h.



MAURI ROSE
Co-winner 1941
115.117 m.p.h.



FLOYD DAVIS
Co-winner 1941
115.117 m.p.h.



WILBUR SHAW
Winner 1940
114.277 m.p.h.
Winner 1937
113.580 m.p.h.



FLOYD ROBERTS
Winner 1938
117.2 m.p.h.



LOUIS MEYER
Winner 1928
99.482 m.p.h.
Winner 1933
102.162 m.p.h.
Winner 1936
109.069 m.p.h.



KELLY PETILLO
Winner 1935
106.24 m.p.h.



BILL CUMMINGS
Winner 1934
104.863 m.p.h.



FRED FRAME
Winner 1932
104.144 m.p.h.



LOU SCHNEIDER
Winner 1931
96.629 m.p.h.



BILLY ARNOLD
Winner 1930
100.448 m.p.h.



RAY KEECH
Winner 1929
97.585 m.p.h.



GEORGE SOUDERS
Winner 1927
97.545 m.p.h.



FRANK LOCKHART
Winner 1926
95.904 m.p.h.



PETER DE PAOLO
Winner 1925
101.13 m.p.h.



JOE BOYER
Co-winner 1924
98.23 m.p.h.



L. L. CORUM
Co-winner 1924
98.23 m.p.h.



TOMMY MILTON
Winner 1921
89.62 m.p.h.

CHAMPION SPARK PLUG COMPANY, TOLEDO 1, OHIO

SWITCH TO

MILD

KENTUCKY CLUB

The Thoroughbred
of
Pipe Tobaccos



Get Fine Pipes at Worth-while

Savings—You bet it pays to switch to Kentucky Club. It's the thoroughbred of pipe tobaccos—choice white Burley specially blended to give you a mild, smooth smoke with grand taste and aroma. In addition, every package of Kentucky Club contains a valuable Dividend Coupon. Save these Coupons and get your choice of fine pipes at *big savings*. Beautiful pipes of imported briar made by expert craftsmen. 14 shapes. Do these two things today. Buy your first tin of Kentucky Club.

Mail coupon for free catalog.



FREE

Illustrated catalog showing Kentucky Club Dividend pipes and other premiums.

Mail Pouch Tobacco Co., Dept. 45
Wheeling, West Virginia

Please send—free—Kentucky Club Catalog.

Name.....

Street.....

City.....State.....

some 6000 feet deep, flowing at a rate of four to six miles an hour. Between Hatteras and the Grand Banks, it starts spreading and weaving like a big snake, looping into large meanders which break off and form eddies—some of them hundreds of miles across. It's by getting on the wrong edge of one of those eddies that a ship captain, thinking he's following the stream, can actually be bucking a stiff current.

A brand-new current-measuring device, developed at Woods Hole, may be the answer for tomorrow's navigators who want to know how they're faring. Called a geomagnetic electrokinetograph, it uses the earth's magnetic field as a navigational reference—instead of fixed points on land. Thus, instantaneous and accurate position fixes can be made and, with a minimum of figuring, a navigator can tell whether his ship is being shoved along or pushed back by an ocean current.

On most voyages, Woods Hole scientists make frequent weather observations. Little by little they are gathering data to show what happens to air coming in contact with the varied surfaces of sea.

To find out if salt particles ever get into the air to become fog, cloud and raindrop nuclei, the institution's Alfred Woodcock devised a gadget that looks like a mammoth comb. The instrument is carried aloft by planes, circling from almost sea level to heights of 9000 feet. Any salt particles in the air adhere to the comb spikes for examination later.

So far Woodcock has found large salt particles in cloud formations high above the seas. How did they get there? "Picked off the whitecaps by wind," says Woodcock, "and carried aloft. Bacteria from the ocean, and other organisms get up there the same way."

The meteorologists believe that they may be on the trail of a real weather breeding phenomenon.

These men lose no chance to find out more about their discovery. If salt nuclei gather raindrops, then you should be able to find them in rainstorms. They decided to test a hurricane and see. Recently, Woodcock got word of a hurricane moving in on Florida. He flew down immediately. Though his plane was headed for Miami, Woodcock was forced to get out at Jacksonville, where the plane was grounded. He took a train—which was forced to call it quits at Daytona. The meteorologist grabbed a cab, paid the driver \$37 and told him to "just drive south." They made it to Cape Canaveral. There the cab was creeping across a causeway at Cocoa when the wind hit it as it came around a jetty. "It

(Continued to page 224)



SINCLAIR RESEARCH LABORATORIES—nine buildings containing the most modern testing equipment known—have contributed many of today's most important developments in petroleum products, production and

refining. Under the Sinclair Plan, the available capacity of these great laboratories is being turned over to work on the promising ideas of independent inventors who have no such facilities within their reach.

An Offer of Research Facilities To Inventive Americans Who Need Them

The Sinclair Plan is opening up the Company's great laboratories to every American who has an idea for a better petroleum product

INVENTIVE Americans are often at a loss today. Not because of any lack of ideas, but because of a need for large and expensive facilities to find out if and how their ideas work.

This was no obstacle in our earlier days. The Wright Brothers designed their first airplane with the help of a foot-square homemade "wind box"—and the plane flew.

In contrast, the man with a new idea in airplane design today often needs a supersonic wind tunnel costing millions.

In short, science and invention have become so complex that a man with an idea for a better product often needs the assistance of an army of specialists and millions worth of equipment to prove his idea has value.

Within the petroleum field, the Sinclair Plan now offers to provide that assistance.

Under this Plan, Sinclair is opening up its great research laboratories at Harvey, Illinois, to independent inventors who have sufficiently good ideas for better petroleum products or for new applications of petroleum products.

If you have an idea of this kind, you are invited to submit it to the Sinclair Research Laboratories, with the provision that each idea must first be protected, in your own interest, by a patent application, or a patent.

The inventor's idea remains his own property

If the directors of the laboratories select your idea for development, they will make, in most cases, a very simple arrangement with you: In return for the laboratories'

investment of time, facilities, money and personnel, Sinclair will receive the privilege of using the idea for its own companies, free from royalties. This in no way hinders the inventor from selling his idea to any of the hundreds of other oil companies for whatever he can get. Under the Plan, Sinclair has *no control* over the inventor's sale of his idea to others, and has *no participation* in any of the inventor's profits through such dealings. Moreover, it is a competitive characteristic of the oil business that the new products adopted by one company are almost invariably adopted by the whole industry. This means that the very fact of his agreement with Sinclair should open up to the inventor commercial opportunities which might otherwise be hard to find.

How to proceed: Instructions on how to submit ideas under the Sinclair Plan are contained in an Inventor's Booklet available on request. Write to: W. M. Flowers, Executive Vice-President, Sinclair Research Laboratories, Inc., 630 Fifth Avenue, New York 20, N. Y. for your copy.

IMPORTANT: *Please do not send in any ideas until you have sent for and received the instructions.*

SINCLAIR

A Great Name in Oil

For SMOOTHER
MOTORING

INSIST ON
BOWES



DEPENDABLE
SPARK
PLUGS

*Here's
Why—*

★ **Every Bowes Plug is Individually Tested**—tested at higher voltage than is ever encountered in your car.

★ **Oversize Special Alloy Electrode . . .** welded construction assures positive connection.

★ **Extra Large Ground Electrode** assures longer life for plug.

★ **Husky Aluminum Oxide Type Insulator** assures against porosity—sure proof against shorting.

★ **One-Piece, Leak-Proof Construction.**

★ **Patented Engine Gasket Retainer Ring** assures better contact and better heat transfer.

BOWES PLUGS

are tailored to YOUR car's motor

If your favorite SERVICE STATION does not handle Bowes Spark Plugs, write us direct for further information.

BOWES "SEAL FAST" CORPORATION
INDIANAPOLIS 7, INDIANA

blew the cab clear across the road," recalls Woodcock, "and the driver would not go another inch."

Dragging his equipment with him, the meteorologist scrambled to a near-by lighthouse, where he sat at a porthole taking hurricane rain samples for several days. They contained enough salt particles to make him a happy man.

With a more complete knowledge of how the cauldrons and refrigerators of the seven seas brew up weather, and how the mighty currents carry their weather-breeding stews to different parts of the world, some meteorologists are hopeful that eventually they may be able to predict changes in climate and weather long before they occur. Columbus Iselin, senior oceanographer of the Woods Hole Oceanographic Institution, points out, "Ocean circulation is much like air circulation, but slower. A week in the ocean is apparently equal to a day in the air so far as circulation is concerned."

And out of it all may come the answer to why the whole world is getting warmer—as it seems to be doing. Are the warm, shifting currents of the Gulf Stream the reason why Greenland Eskimos are eating, as a main diet, codfish, never found in those northern waters before 1900; and why great cracks are splitting Greenland's ice dome, and melting it away to reveal Norse cemeteries 900 years old? Ice is also receding from Antarctica's giant refrigerator in several places; some small glaciers in Lapland have disappeared and one has lost 30 feet in height since 1902; snow-capped mountains in East Africa are growing green bonnets; and one Alaskan glacier has receded a full 18 miles in 35 years.

Is the answer in the ocean? Oceanographers won't even talk about it. They're too busy trying to explain the ocean's behavior. If they get the key to that puzzle, they'll move on to open the next door.

X-Ray Pictures in One Minute Without a Darkroom

With a new medical apparatus weighing only 50 pounds, X-ray pictures can be taken and developed in one minute without a darkroom. The X-ray equipment is designed for field use and may provide quick examination of wounded men. The film is developed inside the apparatus. After the X-ray exposure is made, a pod containing developer and fixer is ruptured. The jelly-like contents flow over the sensitized film. This produces a positive image measuring 10 by 11 inches. The equipment was developed by the Polaroid Corporation of Cambridge, Mass., and Picker X-Ray Corporation of Cleveland, Ohio.

Stucco Spraying Can Be Your Opportunity



You can build a profitable, lifetime business with Colorcrete. Large waiting market. Work is easy and interesting. Moderate investment; high return. Large waiting market. Full instructions and liberal co-operation.

Sprayed-On Beauty

Colorcrete is modern beauty treatment for masonry surfaces—exterior and interior. Fuses to concrete, stucco, etc. Applied by air pressure. Range of many smart colors. Proven by 20 years of use on all kinds of buildings.

Write or wire for Opportunity Book.

COLORCRETE INDUSTRIES, INC.

570 Ottawa Ave.,
Holland, Mich.



MONEY for MEN ALL DATA FREE

THE PLASTEX Industry needs manufacturers on small scale and for big production of Lamp and Clock Stands, Art Goods and Novelties in Plastex and Marble imitation. Experience unnecessary. 1/2¢ material makes regular 10¢ store sellers. Rubber moulds furnished for speed production. Small investment brings good returns. We are now placing big Chain Store Orders with manufacturers. Ambitious men have chance for real prosperity. Our Free booklet will interest and benefit you.

PLASTEX INDUSTRIES, Dept. A
3400 Third Ave. New York 56, N. Y.

BETTER PERFORMANCE FOR OUTBOARD MOTORS



Enjoy more speed, smoother performance, greater carrying capacity by equipping your motor with the Michigan propeller recommended for your particular motor and type of boat used.

Write for FREE copy of 1951 catalog — "Outboarder's Bible" covers all motors old and new. Describes the "Aqua-Jet," super speed wheel for racing runabouts. For finer inboard performance investigate our "Aqua-Master." Write NOW! Michigan Wheel Co., Dept. 1-1 Grand Rapids 3, Michigan.



EARN EXTRA DOLLARS

IDEAL LAWNMOWER SHARPENER

Saves work, saves time, helps you earn extra dollars! Sharpens hand, power mowers without disassembling. Complete shop in one machine — equipped with Bed Knife Grinder and "lapping-in" Reconditioner. Home owners, parks, clubs, cemeteries pay good money for efficient sharpening; get your share!

WRITE NOW FOR FREE CATALOG

THE FATE-ROOT-HEATH CO., Dept. 1-3, Plymouth, Ohio

POINTERS FOR HOME PAINTERS



How to get smoother paint jobs . . . longer service from brushes



When finishing rough surfaces, work in the first coat to cover all cavities. Then brush the second coat on with smooth, even strokes.



Apply varnish and enamel finishes with a full brush, allowing the paint to flow on. Always use as few strokes as possible for the job.



Clean brushes in thinner after daily use. Suspend brush in thinner overnight. Bristle tips should not touch bottom of can. Work out thinner before painting again.



When you store brushes for long periods, clean thoroughly and wrap securely in manner shown here. Brushes stay in better condition when they're kept in shape.

For best results use NYLON PAINT BRUSHES

Job after job, you'll get best results with a well-tipped nylon paint brush. Durable Du Pont nylon bristles don't break off, even on roughest surfaces. They last 3 to 5 times longer than ordinary bristles . . . paint smoother . . . are clean and sanitary. Nylon paint brushes are made by leading manufacturers in all types and sizes. Look for the word NYLON on the handle.



Better Things for Better Living
... through Chemistry

The best brushes have
DU PONT NYLON BRISTLES

NEW

**POWERFUL
COMPACT
RUGGED
SAFE**

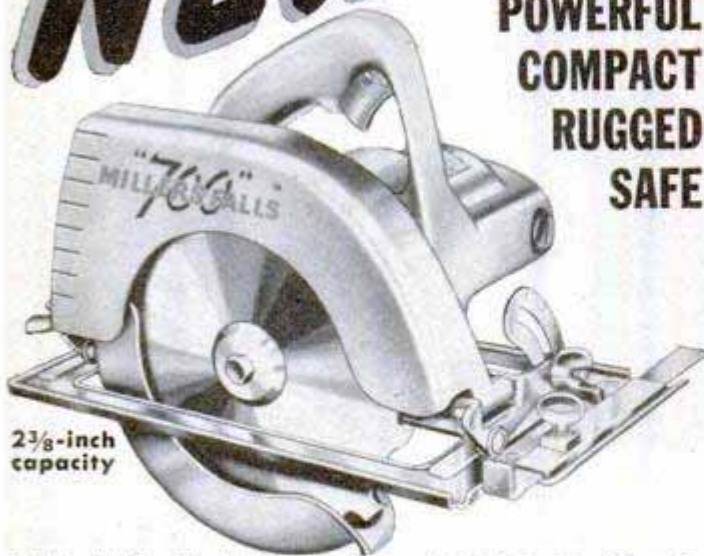

2 $\frac{3}{8}$ -inch
capacity

MILLERS FALLS 7-inch Electric Saw

**The smallest saw that will make
45° mitre cuts on finished 2" lumber**

It's light (weighs only 11 lbs.), compact and easy to control — yet it gives you ample capacity for 90% of all sawing jobs. A full $\frac{1}{2}$ h.p., driven through precision-cut helical gears, provides plenty of power for fast ripping or cross-cutting in hard or soft woods. Using abrasive discs, it cuts metals, concrete, tile, etc. Quick, simple adjustments for depth (2 $\frac{3}{8}$ " to $\frac{3}{4}$ ") and angle (90° to 45°). Extra rigid steel base with adjustable ripping guide. Fully guarded saw and instant trigger switch control assure maximum safety. Ruggedly built with ball bearings throughout for long-lived service. Complete with enameled steel carrying case. Ideal for construction, farm and maintenance work. Write for full details.

MILLERS FALLS COMPANY • GREENFIELD, MASS.



The Mark of Superiority

Mastermind for Hollywood's Wars

(Continued from page 68)

the studio's tank, Witte directed the operation of giant wind-making machines, huge drums that created waves, and pots that produced clouds of billowing smoke. As he hand-signalized the various effects, he was almost like Arturo Toscanini conducting a symphony orchestra.

When the script called for a deadly stream of machine-gun bullets to cut through the water, Witte's experts laid submerged pipe. Blasts of magnetically controlled compressed air simulated the bullets. (This is how the Shirley Temple scene was shot.) When an actor was bloodied, a broken capsule spread a gruesome red dye.

Witte's skill at creating movie magic brought him to the attention of the Marine Corps during World War II. At Camp Pendleton, the big Marine Corps training base near San Diego, he helped to create realistic battle effects for troop training and set up a camouflage school.

Witte is also manager of one of the largest private arsenals in the country, located in the old Tom Mix stables on the Twentieth Century-Fox lot. Consisting of some 4000 guns, ranging from duelling pistols to six-foot-high machine guns, its worth has been estimated at \$135,000.

Some of these guns were once actually used to guard the West Coast. It was during those bleak and tense days of December 1941 when nobody knew where the Jap fleet was. The commandant at Fort MacArthur, Los Angeles' main military base, learned of Witte's guns and got in touch with him.

"We need any machine guns you've got—in a hurry!" he ordered. A studio crew hustled 15 Vickers, Thompson, Lewis and Browning guns to Fort MacArthur. For several months, until the Army sent additional equipment, they guarded the Los Angeles airport.

Witte feels that Hollywood has come a long way in the making of war pictures—both from the viewpoint of safety for the actors, and authenticity.

"When we made 'What Price Glory,' we just put a lot of dynamite in the ground and touched her off. Explosion and smoke were enough, and if it looked something like a battlefield scene we were lucky."

"But it's harder to convince today's audiences. A lot of young men saw the real thing since 1941 and you can't fool them. Television and newsreels are also sharpening up the public's eye for the genuine article. That's why we went to such great lengths in 'The Frogmen' to make it technically flawless."

DRY OUT DAMP WORKSHOPS!



Amazing little Fedders Electric Dehumidifier dries damp rooms without messy chemicals! Plugs in like a radio, removes up to 3 gals. of moisture from the air every 24 hours. Stops damage from rust, mildew, rot, warp. Protects tools,

wood, guns, luggage, furniture, linens. Compact and portable. No service worries. Runs for a few pennies a day. Write today for details on 5-day FREE home trial offer. Fedders-Quigan Corp., Dept. PM-2, Buffalo 7, New York.

fedders

A GREAT NAME
IN COMFORT

Make Money
SELLING
Eshelman
Kulti-Mowers
and DOING
GARDEN
WORK

PLOWS
CULTIVATES
HARROWS
HAULS
SPRAYS
SAWS
DOZER
MOWS
CUTS
ROLLS
RAKES

ESHELMAN

low as
\$95
PLUS
TOOLS
& RE-
VERSE

FOR BETTER
LAWNS
and
GARDENS
also POWER MOWERS
and RIDING TRACTORS
Women can operate it.

11/2-3-6 H.P.
Free Catalog. Write
ESHELMAN CO.,
Dept. 196, 119 Light
St., Balto. 2, Md.

SAW SHARPENER



Table model, gums and sharpens rip saws, combination saws & cut-off saws. Ideal for "Skill-saw" blades. Cap. 4" to 20" diam. Complete with 1/4 h.p. motor & 1 grinding wheel & cord — \$64 f.o.b. Portland. Shipping weight, 63#. SEND FOR FREE LITERATURE.

P. T. HOBBS MACHINERY
8375 N. Interstate, Dept. PM-57, Portland 17, Ore.

WARN HUB CAP MAKES 2 JEEPS OUT OF 1



\$20.00

Prepaid
U.S., Canada

Ends front wheel drag on 4-wheel drive Willys Station Wagons, Pick-ups and Jeeps

Saves gas up to 5 miles per gallon, tire wear, front axles, increases speed and power. Stops shimmy—front wheels coast out of gear! 4-wheel drive handles, performs, climbs like 2-wheel. Install or remove WARN HUB CAPS in 10 minutes. Polished aluminum, guaranteed. Rush check, M.O., or C.O.D. Write for circular.

WARN MFG. CO. - 1625 Third Ave., Seattle 1, Wash.

ELECTRICITY Anywhere

FOR PORTABLE, EMERGENCY OR HOME USE

ONAN Electric Plants generate 110-volt, 60-cycle current for homes, farms, cabins and resorts beyond the highline. Lightweight, portable plants cut costs, speed work for contractors. Standby plants protect units against power failure. 400 to 55,000 watts. Gasoline or Diesel-powered. Priced from \$219.00.

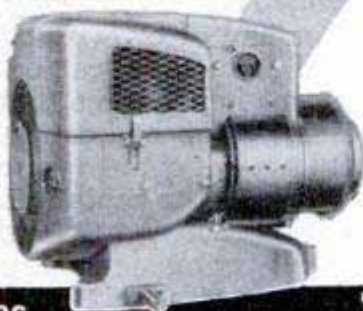

WRITE FOR CATALOG

D. W. ONAN & SONS INC.

5848 UNIVERSITY AVE., MINNEAPOLIS 14, MINN.

Mechanics, farmers, small
builders, service businesses:

**ELECTRIC
HOME-UTILITY
TOOLS**

**Put More Power in your
Manpower!**

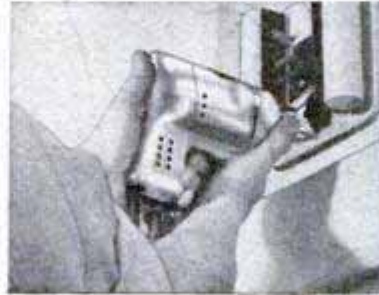

HOME-UTILITY 1/4" DRILL (\$22.95) drives twist drills, masonry drills, wood augers, wire brushes, grinding wheels, sanding discs, buffing wheels. Powered by a quality B&D-built universal motor. Saves hours in numerous jobs.



HOME-UTILITY 1/2" DRILL (\$44.95) drives twist drills to 1/2" diam. in steel, wood augers to 1" diam. in hardwood, Hole Saws to 3" diam. in any material a hacksaw will cut. Makes ideal drill press in Home-Utility Bench Stand.

**Save You Time, Labor and
Materials on Scores of Jobs!**

Whether you build, install or repair, Home-Utility Electric Drills fit your needs to a "T"! They are speedy, versatile, easy to handle, designed for trouble-free service. Quality-built by BLACK & DECKER, world's largest Portable Electric Tool maker. Operate on AC or DC. Over a million sold. And when you buy and use these popular-priced Home-Utility Drills, you release production tools for defense plants where their heavy-duty capacity is vitally needed!

See your hardware, appliance, building supply or implement dealer for a demonstration of the performance and quality features of Home-Utility Electric Drills!

Products of HOME-UTILITY Div.,
BLACK & DECKER Mfg. Co., Dept. H8M, Towson 4, Md.

**ELECTRIC
HOME-UTILITY
TOOLS**

DRILLS • LECTRO-SAWS • SANDER-POLISHERS

SELF-CONTROL STARTS HERE



and to restore

CAR PERFORMANCE

OIL-CONTROL STARTS HERE

To stop oil-pumping, replace worn engine connecting rod bearings

Control is always important. A roving eye can lead to trouble—so can worn engine bearings!

Worn connecting rod and main bearings cause oil-pumping. Excess oil reaches combustion chambers, burns to performance-stealing carbon on spark plugs, valves, pistons and rings. *Performance goes up in smoke!*

Worn engine bearings are a *major cause* of oil-pumping. Give new piston rings a chance to do their own job—replace worn bearings at the same time. Genuine Federal-Mogul bearings are *engineered* for the job of oil-control. *Ask your mechanic!*

FEDERAL-MOGUL SERVICE

(Division of Federal-Mogul Corporation)

DETROIT 13, MICHIGAN



CONTROL OIL-PUMPING

WHERE IT STARTS—REPLACE WITH

FEDERAL-MOGUL

OIL CONTROL

BEARINGS



The Patients Are Pets

(Continued from page 117)

few years ago someone came up with the suggestion the League auction off a race horse at the annual ball in the Plaza Hotel. A race horse promptly was procured. Getting it through the revolving door at the Plaza was an engineering problem, but the auction brought in \$15,729.10 and a tremendous splash of publicity. Even the new owner was happy—the horse became a fairly consistent winner at tracks in the East.

The handling of pets is a science at Speyer. The attendants, who know every trick of the trade, offer a few suggestions on handling household pets. First of all, they say, a dog owner who gives his dog a bath can do more harm than good—if he doesn't watch his step. To prepare the pup, say the Speyer experts, put boric-acid ointment, yellow mercuric oxide or castor oil around his eyes so soap won't irritate them.

Plain soap flakes are best for the bath, they say. Be sure you wash between the toes where dirt collects and cuts frequently become infected. Don't wash the dog's face, as he'll take care of that himself. And most important of all, use enough rinse water. If even a speck of soap remains, a skin irritation may result.

Over a period of years Speyer experts have administered tons of pills to animals. Here's the way they suggest giving a dog a pill so he won't spit it back out. First, apply gentle pressure far back on the upper jaw, forcing the lips against the teeth. Hold the pill between the forefinger and middle finger of the right hand, so it will be ready to slip into the mouth. When the dog opens his jaws, insert the pill and push it as far back to the root of the tongue as possible. Once there, the dog's esophagus should automatically swallow the pill and the animal won't choke. But if the dog doesn't seem to be swallowing the pill, Doctor Kinney says, massage his throat for a few seconds in a downward direction. This will eliminate any tendency to regurgitate the pill.

Even the New York police occasionally call on Speyer for help. Not long ago startled passers-by saw a big, black paddy wagon squeal to a stop at the hospital door. A squad of brawny cops proceeded to unload 16 boxes of cat, each miaowing in a different key. Seems that the Police Athletic Association had conducted a very successful pet-cat contest for children, but when it was over the captain found 16 cats roaming the station house, left behind by their small-fry masters. He made a desperate call to Speyer, where the felines were housed until diligent research turned up every one of the owners.

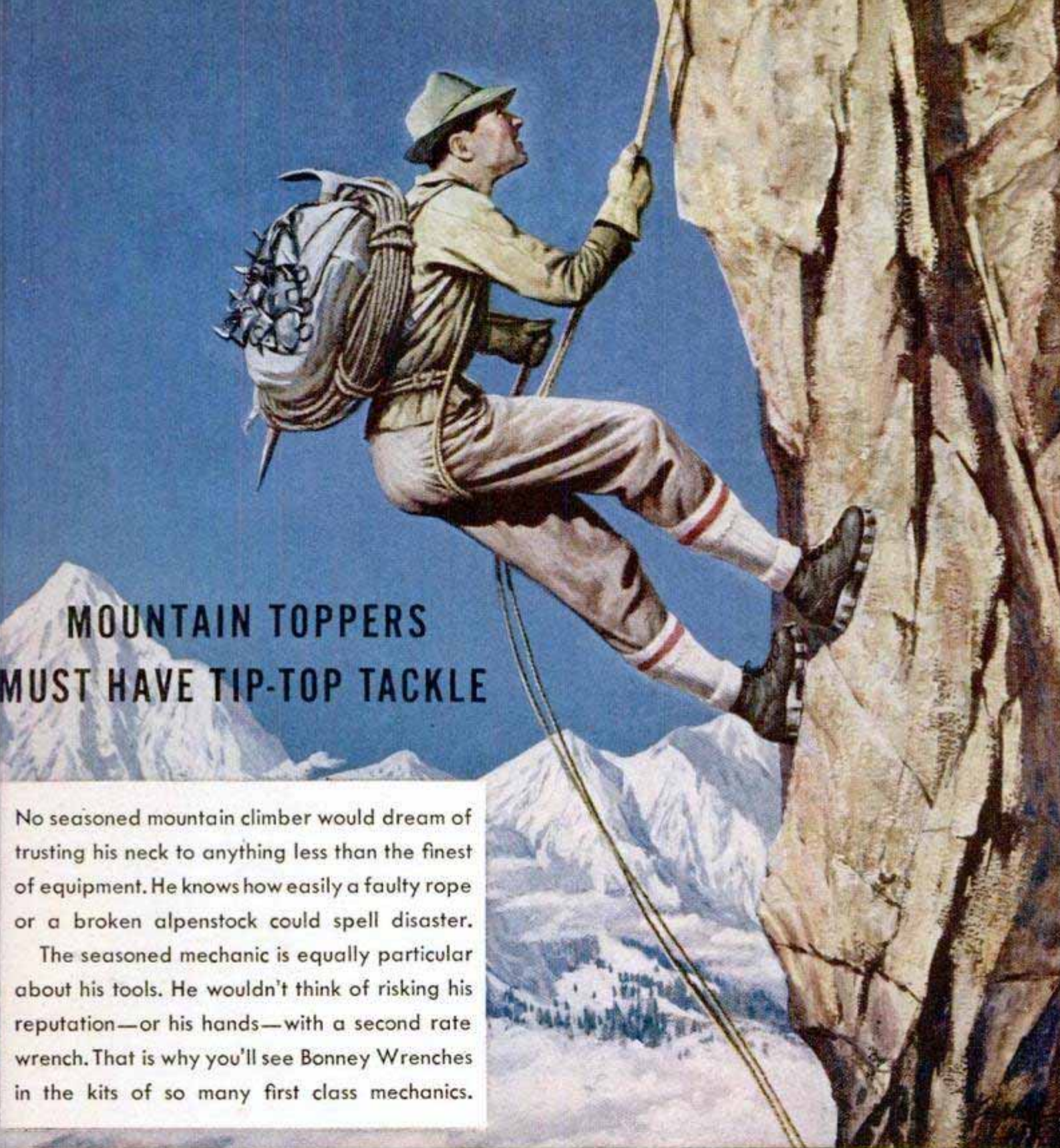

MOUNTAIN TOPPERS MUST HAVE TIP-TOP TACKLE

No seasoned mountain climber would dream of trusting his neck to anything less than the finest of equipment. He knows how easily a faulty rope or a broken alpenstock could spell disaster.

The seasoned mechanic is equally particular about his tools. He wouldn't think of risking his reputation—or his hands—with a second rate wrench. That is why you'll see Bonney Wrenches in the kits of so many first class mechanics.

This is one of a series of spirited sporting scenes (in full color, without advertising) available on request. Write for your free set today.

"CHEAP TOOLS ARE FOR CHUMPS". So says the good mechanic. And the best recommendation for Bonney Wrenches is the kind of men who use them.

As thousands of good mechanics can testify, for lightness, strength, balance and precision, you can't beat a Bonney.



NOW—a new easy way to wash your car

DU PONT CAR WASH

**makes the job
no job at all!**



It's a synthetic detergent... not a soap!

Here's the fastest, easiest way of washing a car! Just put a little DU PONT CAR WASH into a half pail of water, and you'll get the ideal car-washing solution, with an abundance of foam. Then, *swish, swish* . . . it

cleans away grease, oil, without harm to finish or tires. No need to use a chamois. After a good rinsing, your car drains dry and bright... *without streaks or spots.* Try DU PONT CAR WASH next time and take life easy!

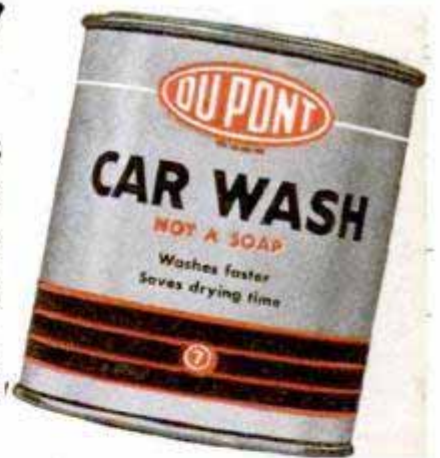

DU PONT NO. 7 POLISH—gives a "super" shine with much less rubbing. Contains "stroke-saving" methyl cellulose. Works wonders on *all* car finishes!



DU PONT SPEEDY WAX—made especially for *new* cars—and those fairly new. Cleans and wax-polishes in one easy step. Produces a dry, brilliant lustre.



DU PONT TAR REMOVER—a safe, easy way to remove tar, road oil, and tree sap from your car. Will not soften, discolor or dull the finish.



DU PONT CHROME POLISH—cleans and polishes bumpers and chrome fittings quickly and safely. Excellent also for nickel, brass, copper, and stainless steel.

DU PONT

REG. U. S. PAT. OFF.

BETTER THINGS FOR BETTER LIVING... THROUGH CHEMISTRY

GROBANS' WAR SURPLUS SPECIALS

ALL BRAND NEW FULLY GUARANTEED

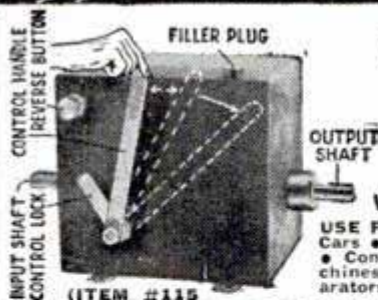

HYDRAULIC SPEED REDUCER

with FINGERTIP CONTROL

USE FOR: • Reamer Drives • Midget Cars • Feed Mills • Canning Machines • Conveyors • Lathes • Milling Machines • Motor Boats • Cream Separators • Garden Tractors • Pumps

Variable output speeds ranging from 0 to input speed now available. Merely move control handle until desired speed is attained. Then turn locking handle to maintain the setting. Internal relief valves prevent overloading. Use input power of 1/4 to 1 1/2 H.P. This Westinghouse-Oil Gear Unit converted to commercial use from 40 MM anti-aircraft traversing mechanisms consists of a variable displacement hydraulic pump feeding a fixed displacement hydraulic motor. These components are contained in a crackle-finish steel oil reservoir (capacity 2 qts.). Adjustable relief valves set at factory for 100 inch pounds of torque may be reset up to 180 inch pounds. Independent reverse control allows full output power and speed selection in either direction of rotation. Both input and output shafts measure 5/8" diam. include keyway. Input rotation is counter-clockwise facing shaft. Recommended input speeds not to exceed 750 R.P.M. Over-all dimensions 7 1/2" x 7 1/2" x 11 1/2". Gov't. acquisition cost, \$428.00 Shipping weight 31 lbs. Complete with 2 qts. of oil and full instructions. F.O.B. Chicago

54.50

BYRON-JACKSON "PUP"

\$3800.00 value

CENTRIFUGAL PUMP UNIT

COMPLETE WITH FULL ENGINE AND PUMP INSTRUCTIONS

2 STAGE MODEL "PUP" PUMP DRIVEN BY AN 8 CYLINDER MODEL C-36 CHRYSLER INDUSTRIAL ENGINE. ENGINE SPEED 2400 RPM — 100 H.P. 600 GPM AT 175 PSI — PARALLEL CONNECTION 300 GPM AT 375 PSI — SERIES CONNECTION

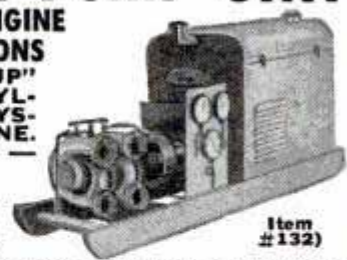

Item #132

IDEAL FOR: Pick-up, Gathering, Fire Fighting, Salt Water Disposal, Sprinklers, Irrigation, Dewatering, Construction, etc.

These skid-mounted Pumping Units are standard production models with parts and service readily available. Designed for a wide range of operating conditions particularly where wide variation in head and capacity are required. Twin suction and discharge ports are cast on the same side and so arranged that external piping is interchangeable for either parallel or series pumping applications. Overall dimensions, 114" L x 29" W x 62" H. Weight 2480 lbs. Now, complete with operating instructions and performance data. F.O.B. Chicago

1495.00

AIRCRAFT QUALITY HYDRAULIC CYLINDERS

Large supply of new labor-saving, economical hydraulic equipment in many types and sizes. Use these positive, highly efficient smooth pressure hydraulics on presses, arbors, lifts, loaders, power control, positioning, brakes, plastic dies, luto frame alignment, etc., etc.

ITEM #70—Purrolator hydraulic oil filter. Permanent element type. 3/8" female pipe thread ports. Capacity 16 gallons per minute. A \$13.00 value.

Now, postpaid **4.95**

ITEM #4—All steel double action hydraulic cylinder. 1 1/2" bore, 27 1/2" stroke. Clevis mounting. Will lift 1000 lbs. with 1000 P.S.I. line pressure. Perfect for positioning and feeding movements.

Now, postpaid **4.95**

ITEM #127—Double acting hydraulic cylinder, 1" bore, 1" stroke, 1/2" diam. shaft, 1/4" tubing thread ports. Over-all length closed—6 1/2". Clevis mounting at both ends. Perfect for clamping and feeding. Postpaid **5.95**

ITEM #33C—Double action hydraulic cylinder, 1 1/2" bore, 4 1/2" stroke. Clevis mountings at both ends. Uses 1/4" pipe fittings. Postpaid **8.95**



(Item #42)

ITEM #16C—Double acting hydraulic cylinder, 1 1/2" bore, 26" stroke. Will lift 1760 lbs. with 1000 PSI line pressure. Weight 8 lbs. A \$55.00 value.

Now Only, Postpaid **16.95**

ITEM #103—Double acting hydraulic cylinder, 2 1/2" bore, 17" stroke. Clevis mounting. Will lift 4900 lbs. with 1000 PSI line pressure. 1 1/4" diam. shaft, 3/8" tubing thread ports. Overall length closed 28"

Shpg. wt. 11 lbs. F.O.B. Chicago. **21.50**

ITEM #31C—Double action hydraulic cylinder, 3 1/2" bore, 11" stroke. Aluminum alloy cylinder wall and all steel 1 1/8" piston rod. Clevis mounting at base and shaft. 19 1/2" overall length closed. Will lift 9625 lbs. using 1000 PSI from Logan Heavy Duty Hydraulic Pump. Uses 3/8" tubing fittings. Value \$102.00. Shipping wt. 11 lbs.

F.O.B. Chicago **22.50**

ITEM #6—Double action hydraulic cylinder, 3" bore, 24" stroke. Will lift 7070 lbs. with 1000 PSI line pressure. Steel barrel, 1 1/8" stainless steel shaft. Gov't. acq. cost \$176.00. Shpg. wt. 26 lbs. F.O.B. Chicago. **28.00**

ITEM #42—Double action hydraulic cylinder, 4" bore, 18" stroke. Rated lift capacity with 1000 PSI line pressure is 12,500 lbs. Ship. wt. 30 lbs. F.O.B. Chicago. An Excellent Buy for. **32.50**

GENERAL MOTORS — ALLISON

BRAND NEW

CENTRIFUGAL PUMP

200 GALLONS PER MINUTE

- For Draining Basements • Fire-Fighting • Irrigation • Fuel Transfer • Swimming Pools
- Home Water Systems • Dewatering

This General Motors-Allison Centrifugal Pump—designed for use on U. S. Air Force Mustang fighters, now converted for commercial, home, and industrial high volume pumping applications. Inlet, 2 1/2" standard pipe thread, twin outlets with 1 1/4" pipe thread, ball bearing supported 3/4" shaft. Easy, fast simple priming. Rotation, counter-clockwise facing shaft. Shipping wt. 35 lbs.

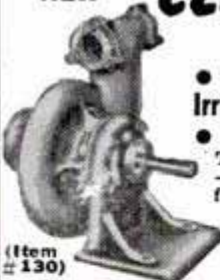

(Item #130)

Suction Lift	Head Pressure	Gal. Per Min.	H.P.	R.P.M.
10'	75'	260	6.0	3500
10'	65'	200	5.2	3500
10'	80'	40	1.5	2500
10'	50'	140	5.0	3500
10'	30'	100	3.0	2500

Gov't. acq. cost \$145.00. F.O.B. Chicago. Now Only **39.50**

NEW! STATIONARY OR PORTABLE

DC Arc Welder

250 AMPS. MODEL 252 (ITEM #65)

For Any Welding Job, Light or Heavy STOP COSTLY REPAIR BILLS, WELD IT YOURSELF AND SAVE

Only one or two jobs will pay for entire welder. Designed for many years of trouble-free service. This precision-engineered Direct Current ELECTRIC ARC WELDER is offered at but a fraction of its original value. It can be mounted permanently or easily transported for portable use. Does the job instantly where and when you need it. Has dial type rheostat for easy pinpoint control and a high-low range switch. Run welder at 2500 RPM from drive pulley or power take-off of tractor, a 7 1/2 HP electric motor or a 10 HP gas engine. Use 1 1/2" belts or flat belt (on pulley). Price includes double V or flat belt pulley and instruction book. Shpg. wt. 107 lbs. F.O.B. Chicago. **99.50**



Now at a fraction of its value

DIRECT CURRENT GENERATORS



For welders, plating, truck and marine use, D.C. appliances, lights, etc. Aircraft quality—lifetime grease sealed ball bearings. Heavy duty.

Item #131—Brand new Electric Auto-Lite 12 volt Direct Current electric generators, rated 18 amps. Complete with blower and pulley. Use for trucks, tractors, boats, battery chargers, etc. Part No. GEF-4805A. In original sealed U. S. Army cartons. \$40.00 value. Shpg. wt. 27 lbs. F.O.B. Chicago. Now Only **15.00**

Item #90—Type P-1, rated 200 Amps.—28 Volts, 2500 RPM. Mfd. by General Electric, Ford, Delco-Remy and Westinghouse. Gov't. Acq. Cost \$300.00. Shpg. wt. 53 lbs. F.O.B. Chicago. **22.50**

Item #91—Type R-1, rated 300 Amps.—30 Volts. Mfd. by Jack & Heintz. Gov't. Acq. Cost \$380.00. Shpg. wt. 59 lbs. F.O.B. Chicago. Each individually packed in wooden box **35.00**

FREE: NEW 48-PAGE CATALOG: Chuck-full of unsurpassed War Surplus Bargains for the shop, home, farm and factory, including Generators, Motors, Pumps, Hydraulics and Welders at far below cost-prices. Write for yours today!

Vickers HYDRAULIC PUMP



(Item #39)

PISTON TYPE

Ideal for use with hydraulic cylinders and valves

described in this page ad, Vickers constant displacement piston type pump delivers .507 cubic inches per revolution, 8 gallons per minute at 3750 RPM, 1000 PSI. Has 1/2" diam. shaft, 3/4" 18 thread inlet and outlet ports. Rotation—clockwise. Postpaid **19.90**

HYDRAULIC CONTROL VALVE



(Item #26)

Four-way control valve for use with two hydraulic double-action cylinders.

Each cylinder may be operated independently of the other or in conjunction with the other. Oil may be locked in any of the cylinders to hold the piston at any required position. Ship. wt. 8 lbs. A \$60.00 value. **12.95** postpaid

ORDER DIRECT FROM AD — SEND PAYMENT OR PURCHASE ORDER TODAY — SATISFACTION GUARANTEED

GROBAN SUPPLY CO. 1139 SO. WABASH AVE., CHICAGO 5, ILL. DEPT. PM-8

LATEST MODELS! LOWEST PRICES!

BRAND NEW MERCHANDISE

16x50 mm SUPER-POWER

This unit is the Most Powerful commercially available—standard—practical Binocular. COAT-ED, Center-Focus, only 28 oz. weight, it is a unique development we are proud to offer. In fine case with straps.

\$67.50 plus 20% Fed. Tax (total \$81.00)



7x50 mm PRISM BINOCULAR

Imported from U.S. Zone abroad. Finest Ground and Color Corrected Lenses. Inter-pupillary adjustment. Eye focus. Light weight: This model features greatest light transmission; very wide field, Night Glass, Naval Model. With handsome case and 2 straps.

\$28.00 plus 20% Fed. Tax (total \$33.60)

SUPER-POWERED HUGE STEREOPRISMS, 10x50 mm

Same fine manufacture as above 7x50mm's but 43% more powerful. In fine case with neck and shoulder straps.

\$55.00 plus 20% Fed. Tax. (total — \$66.00)

8x30 mm GERMAN

This is a REAL BUY. These are genuine GERMAN, Coated, Center-Focus Binoculars made in Germany. They have great optical precision and are but 10½ oz. in weight, Magnesium. In hand made leather case with straps. Similar glasses on the market at very high prices.

\$36.00 plus 20% Fed. Tax (total — \$43.20)



6x15 mm PRECISION PRISM BINOCULAR—COATED

This is the same nation-wide famous tiny precision model sold so widely at much higher prices. Eye-width adjustment—individual eye focus adjustment. 370 foot field at 1,000 yards (leather case & neck cord).

\$19.50 plus 20% Fed. Tax (total—\$23.40)



30x to 70x FRENCH POCKET MICROSCOPE

Both lower side adjustment and upper tube extension to increase power. Exceptionally critical instrument. \$4.95

20x40x60 POCKET MICROSCOPE

This model has high light clarity, very powerful, lower knurled adjustment knob. Unusual buy in this Power and quality \$3.95



200 POWER MICROSCOPE

Newly imported from France. Highly ground and polished precision lenses. With 2 directional French Mirror. In box including 5 prepared slides complete. \$12.95

25 POWER ALUMINUM POCKET MICROSCOPE WITH CLIP. REG. \$2.50. SPECIAL FOR THE YOUNG SON 99c

1,500 POWER MEDICAL MICROSCOPE

This is the finest instrument we handle. It is in every way comparable to domestic makes selling for \$495.00. Complete with tools, oil for immersion, 3 objectives: 10x, 40x & 100x oil immersion. Eye pieces are 5x, 8x, 15x Huygenian. X & Y mechanical stage. Abbe 1.2 condenser. In hardwood chest with lock and Key, etc. \$250.00



80 POWER MICROSCOPE

Precision, Polished Lenses. Ideal Instrument for Nature Study, Botany, Mineralogy, etc. With prepared slide in box complete. \$6.75

8X Wollensak Explorer Telescope. Ideal for the boy. \$8.75



GENUINE WOLLENSAK TELESCOPE

Adjustable Powers, 15x, 20x, 25x, 30x, 35x, 40x. Fully coated lenses throughout. The finest telescope we can offer. In Leather Case \$29.50

10-DAY TRIAL UNCONDITIONAL MONEY-BACK GUARANTEE

SAVE MONEY—NO CATALOGUES OR TIME PAYMENTS. Each item is a real investment in education and practical lifetime use and pleasure. Add 75c P.P. & Hdq. Federal Tax on Binoculars only. Send check or M.O. C.O.D.—you pay postage. Please send Mail Orders to nearest office. For reference apply to your bank.

STANLEY OPTICAL CO.

MAIL ORDER DEPT. PM-8, 574 5th AVE., N.Y.C. 19, N.Y.
Mid-West Branch Office, 30 W. Washington St., Chicago 2, Illinois

A Clock for Eternity

(Continued from page 133)

—or stellar time—has an interesting explanation. It is brought about by the fact that, while the earth rotates 365 times about its own axis in relation to the sun during a mean year, it will, during the same period, rotate 366 times in relation to a fixed star. It follows that a sidereal day is 3 minutes 56.666 seconds shorter than a solar day. The hands showing sidereal time and mean time are driven by the same mechanism. They are connected by a transmission which consists of three pairs of wheels with different cogs, the sizes of which are calculated so exactly that during 300 years there will be a deviation of only 0.4 second in sidereal time.

Two special hands on the sun-and-moon mechanism have peculiar, bowed extensions which show the eclipses. Another dial shows the courses of the planets. The dial consists of eight movable rings, each of which represents a planet and rotates with a speed corresponding to that of the planet. The planet nearest the sun, Mercury, goes around its orbit in 88 days, whereas Neptune, which is farthest from the sun, takes no less than 165 years to go once around its orbit.

Jens Olsen completed a model of the clock and a new set of construction plans in 1943. The plans consisted of 46 sheets with 14 diagrams and 214 detail drawings, all done in six copies which, for the sake of safety, were kept in different places throughout the country. The clock cost \$150,000 to build, a sum that was realized through contributions, small and large, from an immensely interested public which, through the press, also took an active part in the discussion of the clock's site of erection and its artistic embellishments.

It is the clock of all Denmark, of all the solar system.

Rhenium Rivals Tungsten

Because it has a longer life than wolfram (tungsten), a little-known metal called rhenium may become increasingly important in high-temperature alloys and in electronics. Its only known production now is at the University of Tennessee. Originally the metal is in a flue dust obtained in the processing of molybdenum sulphide, a by-product of Arizona copper sulphide. Rhenium's melting point is 3100 degrees Centigrade, about the same as wolfram, and it has a higher electron emission than that metal. A dark gray to black powder, samples of the now-limited supply have been sold to research labs at \$900 a pound.

"New-Engine" Your Car Now For As Little As \$16 Down

(TERMS VARY BY AREA AND MAKE OF CAR)

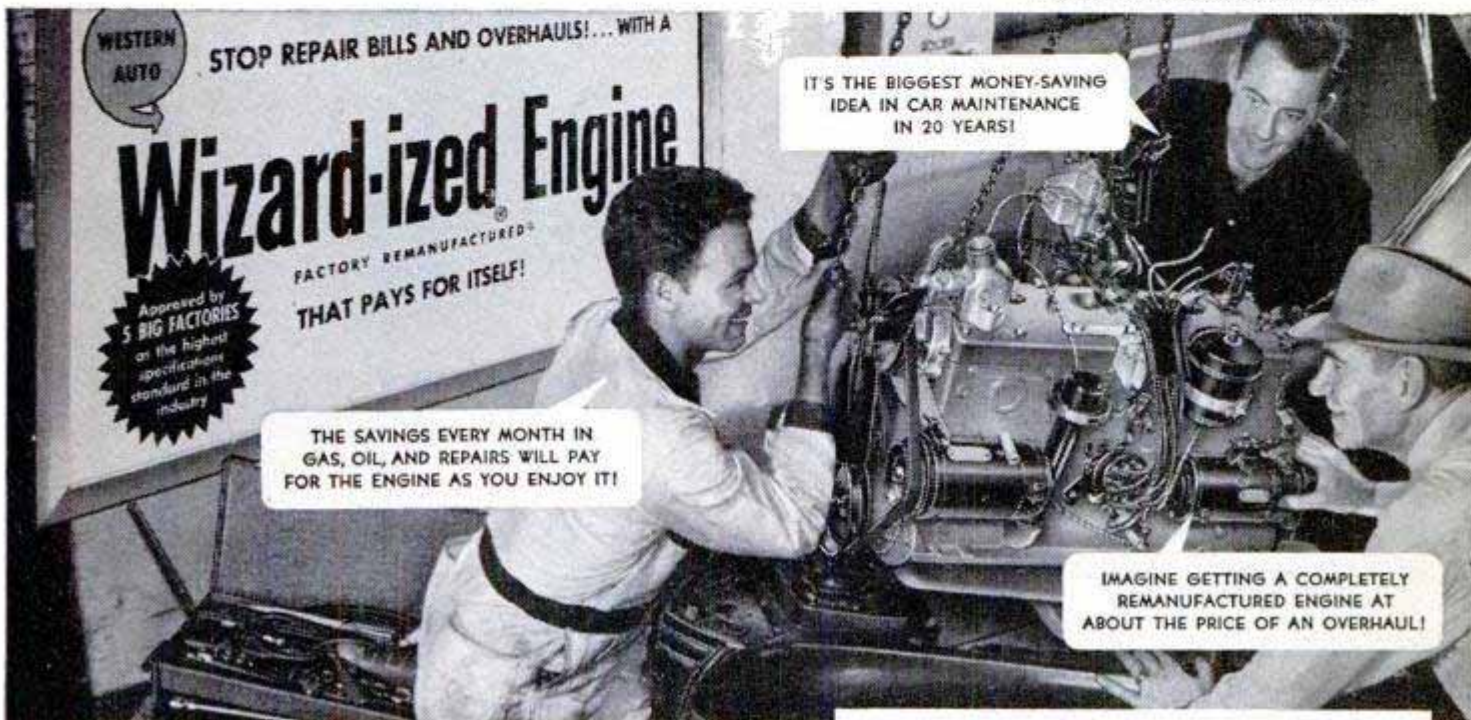

WESTERN
AUTO

STOP REPAIR BILLS AND OVERHAULS! ... WITH A

Wizard-ized Engine

FACTORY REMANUFACTURED
THAT PAYS FOR ITSELF!

Approved by
5 BIG FACTORIES
at the highest
specifications
standard in the
industry

IT'S THE BIGGEST MONEY-SAVING
IDEA IN CAR MAINTENANCE
IN 20 YEARS!

THE SAVINGS EVERY MONTH IN
GAS, OIL, AND REPAIRS WILL PAY
FOR THE ENGINE AS YOU ENJOY IT!

IMAGINE GETTING A COMPLETELY
REMANUFACTURED ENGINE AT
ABOUT THE PRICE OF AN OVERHAUL!

***Your easy, low-cost solution for "tired" Chevrolets, Fords, Plymouths, Pontiacs, Dodges, and other popular makes. Wizard-ized Engines are fully remanufactured in 5 large factories (not just shops or garages). Engine accessories are used from old engine, or may be replaced new.**

Get Another 50,000 Miles or More from Your Car With a WIZARD-IZED ENGINE That Pays for Itself!

Thousands have discovered this easy new way to end costly repair bills—simply by replacing their old engines with low-cost Western Auto Wizard-ized Engines . . .

No other engine—no overhaul job—can give you more power-packed miles at so little cost! And, you get . . .

The same engine guarantee that comes with a new car—plus a free 500-mile service inspection of our installation. Every Wizard-ized Engine gets a . . .

Complete factory inspection and then a final test run. Our installations made by trained mechanics in fully equipped garages. And, this new car power is yours for . . .

Half the cost of a new engine. You're paying for it in gas, oil, repairs . . . why not enjoy it now? For . . .

Less than 1/2¢ per mile, you get years of new miles without paying the high cost of a new car. Don't wait . . .

See your Western Auto man tomorrow . . . find out about his guaranteed trade-in allowance for your old engine! ➔

Why You Can Have Confidence in a WIZARD-IZED ENGINE!

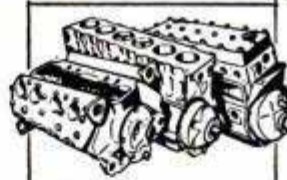

1. Not just "rebuilt," but completely remanufactured—using selected original factory block.

2. Typical BRAND NEW top quality parts in Wizard-ized Engines. All other parts fully remanufactured.

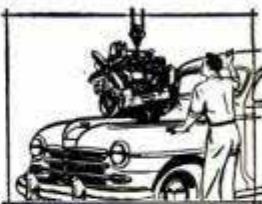

3. New car engine guarantee . . . by America's largest group of auto supply stores (over 3000).

4. Backed by a fifty million dollar firm with 25 million customers, proof of dependability!

EASY TERMS AS LOW AS \$300
Terms vary by area and make of car **3** weekly

Wizard-ized Engines

FACTORY REMANUFACTURED*

Sold Only By **WESTERN AUTO**
STORES & ASSOCIATE STORES

The Engine You Can Buy with New Car Confidence!

NOTE: Western Auto Associate dealers own their own stores and set their own prices. Terms and conditions quoted are recommended, and subject to variance. © 1951, Western Auto Supply Co., K. C., Mo. 04913

Here's why Cars that WASTE OIL
are headed for

PREMATURE OLD AGE

INSIDE FACTS

OIL WASTE is your warning that in your engine rocking their pistons are wearing out cylinder walls.

This FREE BOOKLET brings you facts

ON EXCESSIVE OIL CONSUMPTION

FORM MER-301 PRINTED IN U.S.A.

...every car owner should know about the 10 ways worn piston rings cause premature old age in engines. Learn why oil pumping is the danger signal WRITE POSTCARD TO RAMSEY CORPORATION, Dept. 3764, St. Louis 8, Mo.

RAMCO RE-POWERING

with 10,000 Mile (or 1 Year) Guaranteed
Piston Rings actually
CURBS WEAR



Ramco's
"NO-GAP"
Spiro-Seal steel section on the 10-Up oil ring develops a special compensating action that minimizes friction on the power stroke. Then, as the piston rises in cylinder, Spiro-Seal lessens its contact thus insuring adequate wall lubrication for exceptionally long life. This is one of many Ramco originations which make possible the control of oil in worn engines through STABILIZATION rather than pressure. See your repair shop displaying the RE-POWERING Sign... or write for free booklet. Send postcard to Ramsey Corporation, Dept. 3764, St. Louis 8, Missouri.

5572

The Owners Report On the '51 Cadillac

(Continued from page 106)

with high compression and regular gas—they don't go well together.)

A Nashville, Tenn., dentist was uncertain about the engine, saying: "Right now I can't get used to the odd noise it makes; I guess it is supposed to sound like that." A Bristol, Tenn., building-materials salesman said he likes the engine fine, "but with a few more miles the valves probably will start sticking like the '49 and '50 models." (This skeptical owner, we think, is going to have a pleasant surprise.)

1951 CADILLAC SPECIFICATIONS

ENGINE

Type.....	V-8, OHV
Bore and stroke.....	3-13/16 in. x 3 5/8 in.
Piston displacement.....	331 cu. in.
Horsepower.....	160
Compression ratio.....	7.5:1
Transmission.....	Hydra-Matic, 4-speed automatic 61-11/16 in.

GENERAL

	Series 61	Series 62	Series 60
Weight (4-door sedan).....	3827 lbs.*	3983 lbs.	4155 lbs.
Wheelbase.....	122 in.	126 in.	130 in.
Tread, front.....	59 in.	59 in.	59 in.
Tread, rear.....	63 in.	63 in.	63 in.
Height.....	61-11/16 in.	62-11/16 in.	62-11/16 in.
Over-all width.....	80 1/8 in.	80 1/8 in.	80 1/8 in.
Over-all length.....	211 1/2 in.	215 1/2 in.	224 1/2 in.

Interior Dimensions (4-door sedan)

Front-seat width.....	63 7/8 in.	63 1/2 in.	63 1/2 in.
Rear-seat width.....	64 5/8 in.	64 1/2 in.	64 1/2 in.
Leg room, front.....	43 1/2 in.	44 3/8 in.	43 5/8 in.
Leg room, rear.....	40-13/16 in.	41-15/16 in.	41-15/16 in.
Headroom, front.....	35-13/16 in.	35 1/2 in.	35 1/2 in.
Headroom, rear.....	35 1/8 in.	36 in.	36 in.
Tire size.....	8.00x15	8.00x15	8.00x15
Recommended tire pressure	24 lbs.	24 lbs.	24 lbs.
Road clearance.....	8.34 in.	8.34 in.	8.34 in.
Turning radius (outside bumper sweep).....	22 ft.	22.5 ft.	23 ft.
Steering wheel, lock to lock	4 1/2 turns	4 1/2 turns	4 1/2 turns
Steering ratio.....	21.3:1	21.3:1	21.3:1

CAPACITIES

Oil.....5 qts. Water.....18 qts. Gasoline.....20 gal.

*On Series 61, add 90 lbs. to weight figures for cars equipped with Hydra-Matic transmission.

A Milwaukee, Wis., executive remarked that he had "a sloppy engine for the first 5000 miles, but after that it is perfect." He also commented that the lack of air conditioning makes the windows steam up. (This didn't happen in my test car.)

A few owners complained of rattles and overhead-valve noise, but these constituted a small minority.

Perhaps the most frequent comment in the entire survey was on the 1951 Cadillac's "ease of driving." Most owners seem to think it is the easiest car they have ever driven on the highway. Ninety-eight percent prefer the V-8 engine as their choice of design, and 89 percent think overhead valves are best.

(Continued to page 234)



THE MOST

Versatile TOOL

ON YOUR BENCH!

CHANNELLOCK PLIERS

Made only by CHAMPION DEARMENT

In almost any job you can think of—Pliers are necessary—and Channellock pliers are the best you can buy. Whether you are working on your car, electrical repairs, plumbing work or just tightening nuts and bolts Channellock pliers do it better.

And remember, Only Champion DeArment makes Channellock—More than 3/4 of a Century of experience in producing highest quality tools. Send for Catalog D15—today.

CHAMPION DEARMENT TOOL CO.
Meadville, Pa.

Channellock pliers are listed in the Yellow Pages of most Telephone Directories

under "Tools"



ONLY Champion DeArment makes

CHAN NEL LOCK

TRADE MARK REG.

U. S. PATENT OFFICE



BETTER TOOL VALUES!

SEND FOR NEW FREE CATALOG

INDESTRO TOOLS



Ready Soon—Brand New Mechanic's Catalog of Low-Cost, Long-Service Indestro Tools. Full of photographs and detailed descriptions of regular or special tools your dealer can supply for home workshop or professional use.

Tells how to select good tools and why you get Better Value when you select Indestro Tools—for in-

stance, all sockets "Hot Broached" to make them wear longer.

Offers you big values in Tool Sets, from 5-pc Punch and Chisel Sets to 114-pc DeLuxe Workshop Sets. Reserve your copy of this Dollar-Saving Pocket-Size Tool Catalog.



FILL OUT AND MAIL NOW FOR FREE COPY

Send to INDESTRO MANUFACTURING CORP.
2649 N. Kildare at Schubert, Chicago 39, Ill.

Write your name and address in margin space

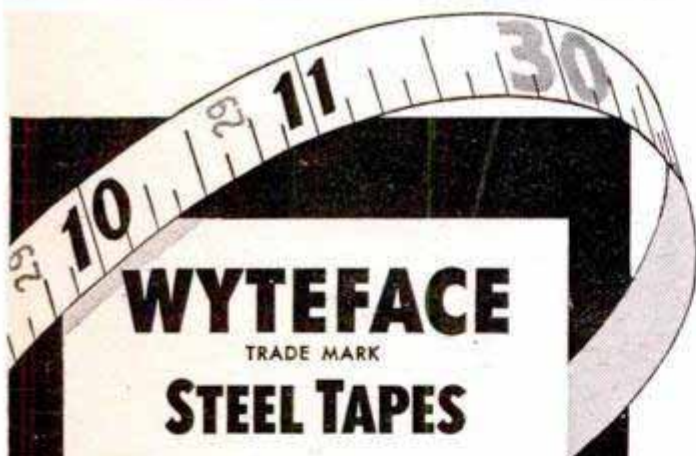

WYTEFACE TRADE MARK STEEL TAPES

No squinting, no guessing when you use WYTEFACE Steel Tapes. Jet black markings (foot numbers in red) on a white background. Easier to read in any light. Faster, more accurate measurements. Rust-resisting, hard to kink, simple to clean.

Protected by U. S. Patent 2,089,209



"I'll take the WHITE one every time!"

KEUFFEL & ESSER CO.

Snap-on

Blue-Point

BENCH GRINDERS

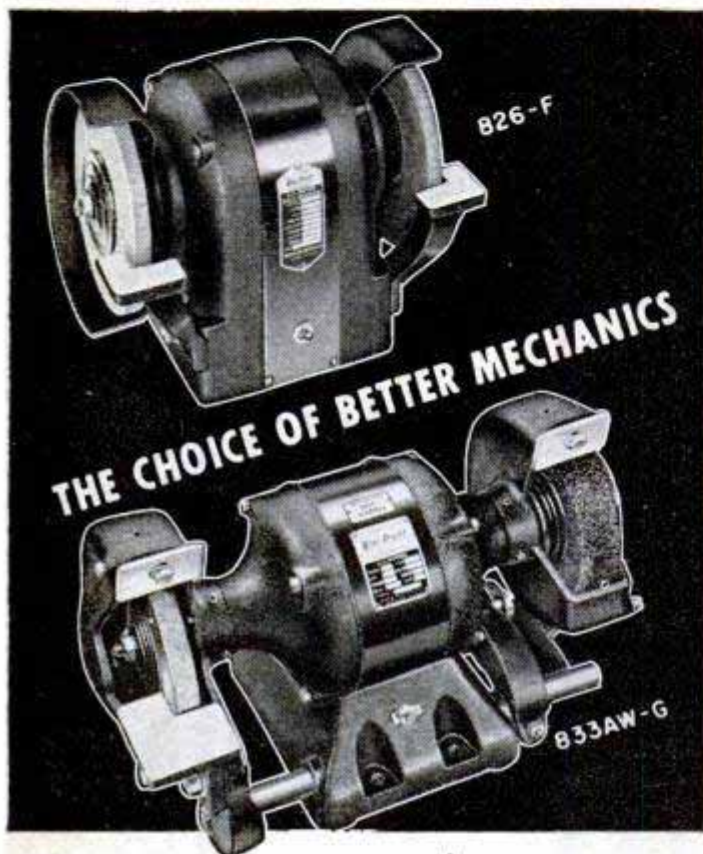

IT'S BLUE-POINT for the finest grinder performance you've ever enjoyed! Blue-Point Bench Grinders are amply powered and exceptionally smooth—ruggedly built—designed in every detail for handy, time-saving operation! Complete range of models, $\frac{1}{4}$ to 1 H.P. Never sold in stores—buy direct from factory (or from Snap-on factory branch in larger cities). Complete details in free Snap-on catalog—write for it today!

Compare **THESE FEATURES**

- Motor completely enclosed, protected.
- Oversize ball bearings throughout.
- Induction run motor develops less heat in windings.
- Bell-type design provides full clearance.
- Large wheel guards—sturdy tool rests.
- Heavy base, "rubber footed," gives vibrationless mounting.

SNAP-ON TOOLS CORPORATION

8062-H 28th Ave.
Kenosha, Wisconsin

*Snap-on is the Trademark of Snap-on Tools Corporation.



And now for my own test of the '51: I drove the new Cadillac approximately 2900 miles from the factory in Detroit to Indianapolis, then over Route 36 through St. Joseph, Mo., to Denver, and on to Albuquerque, N. Mex., then on Route 66 to Los Angeles, and then some additional mileage in Southern California.

The test included 75 miles of back-road testing in New Mexico over dirt roads, some covered with dust and gravel.

When I left the Cadillac factory I was given the standard instructions. One thing that intrigued me . . . I was told by the young chap who delivered the talk that no break-in period is necessary for the Cadillac engine. "Drive it as fast as you want to as soon as you want to," he said. This was music to my ears, for I have long felt that slow driving when new is unnecessary.

Cadillac's roadability and ease of riding compares favorably with any car manufactured in the world, and is far superior to most other makes. The 160-horsepower, overhead-valve engine packs a lot of dynamite and the acceleration is terrific.

My maximum speedometer reading (on long, open stretches) was 107 miles an hour. Like all speedometers on modern cars, I found a variation of about five percent on the high side. The instrument panel is easy to read and the speedometer figures go up to 110 miles per hour. On a long, straight stretch a good Cadillac driver can keep the needle somewhere between 100 and 110 if he so chooses.

Cadillac's Hydra-Matic transmission (four forward speeds) is smooth and shifts with little effort. One feature I do not like about Hydra-Matic is the lack of a parking-lever position in the shift arrangement. There also is some creeping when standing with the lever in Drive or Low position. The high gear ratio (3.37:1 in fourth) enables the Cadillac driver to cruise at extremely high speeds with no apparent strain on the engine and with little effort on the part of the driver. Eighty-five and 90 miles an hour can be reached with almost no effort or strain.

For the length and weight of the car, it handles very well on corners. The springing is very soft—in fact, a little too soft to suit me when cornering at high speed. The ease of steering is apparent; however, it takes a lot of turning of the wheel to set the wheels exactly where you want them. I would prefer a quicker-acting steering wheel. It must be remembered, however, that to secure easy steering with our large, fat, present-day supercushion tires we must have a lot of wheel movement.

The driving position in the Coupe de

(Continued to page 236)

MILLER ROTARY HI-SPEED COPE-SAW DRILL-BIT IT DRILLS IT SAWS IT REAMS

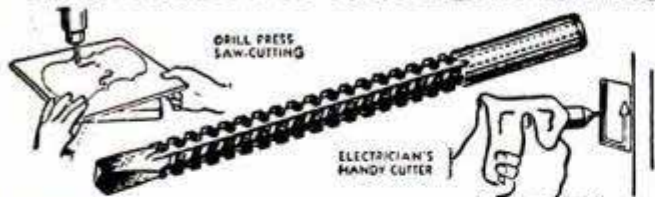

DRILL, SAW, REAM metal, pipe, wood, plastic, Transite, etc. Use with any electric drill, slow drill press, lathe or milling machine. Drills own starting hole—upper part of bit is used to cut, saw or ream circles, ovals, squares or scrolls. Easy to operate. Ideal for carpenters, mechanics, electricians, plumbers, hobbyists, many others. Abrasive resistant, high speed steel. Flutes ground from solid. Will withstand severe continuous use without breaking. Resharpener at no charge. Takes place of up to \$50 in tools. 1/2" diameter, 2" cutting sections, total length 3 1/2". Also available specially designed for wood or metal and in 2 3/8" and 1 3/4" lengths. Write for details. Specify all-purpose bit. Shipped same day. Money-back guarantee. Dealer inquiries invited.

SEND CASH CHECK OR MONEY ORDER
Manufactured and distributed by:
INTERNATIONAL TWIST DRILL CORP.
624 Wyandotte, Rm. 632, Kansas City 6, Mo.

only
\$3.95
POST PAID

Polish-Aire

Versatile home-appliance, hobby tool



Precision built for versatility...

an all-round handy tool for home hobbyists as well as for housecleaning. Scrubs and polishes any type of floor in a 10-inch path, snug to baseboards, into corners. Speedy and child-easy to operate. Half the price you'd expect... and Guaranteed!

1. Polishes cars quickly with no muscle effort.

2. High speed 1/4" drill for wood and metal.

3. Easily converted for all purpose grinding.

4. As an easily operated sander for floors, furniture and hobby shop work.

works
for
you

in
all
these
ways

Polish-Aire

With a **USA** logo
please send me facts about POLISH-AIRE.

Interstate
ENGINEERING CORP.
EL SEGUNDO, CALIF.

NAME _____
ADDRESS _____
CITY _____ STATE _____

Save Time!!! Save Money!!! SEND FOR THIS BIG, NEW Woodworkers Catalog No. 18

ONLY
15c

New low prices...great selection of fine domestic and imported woods...bargains in hard to get supplies--144 pages of items and ideas for woodworkers. Quick delivery on mahogany, walnut, maple, cherry, poplar, oak, red cedar, and others properly seasoned, kiln dried. Send 15c for your copy--TODAY. Dept. A-8



RAFTSMAN WOOD SERVICE CO.

2729 S. MARY STREET-CHICAGO 8, ILLINOIS

SHOPMASTER POWER TOOLS

Only
\$47.95

Each
Complete,
less motor



Now you can get Shopmaster quality in power tools specially designed for the smaller home workshop, operating on a limited budget. Efficiently designed, they contain features found only on the highest priced tools.



Write for catalog on complete line of Shopmaster Tools.



SHOPMASTER, INC.

1214 Third St. S.

Minneapolis 15, Minn.

LISTEN TO THAT ENGINE

Hummmmm!



CASITE KEEPS IT TUNED

You can feel the difference after a Casite treatment. In just a few minutes, you get that keener, smoother performance you've been looking for. Casite frees sticky valves and rings, lets the engine breathe, lets the power zoom through. Casite actually guarantees Better and Smoother Motor Performance or Double-Your-Money-Back.

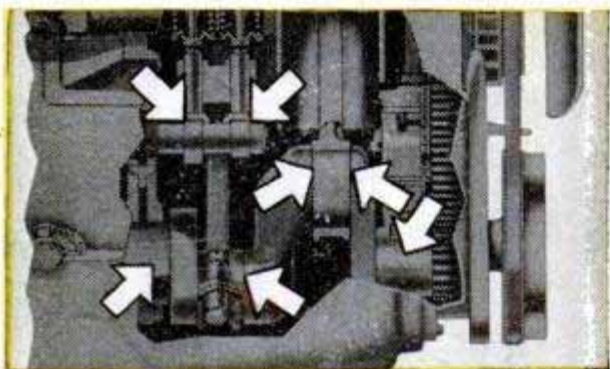

CASITE KEEPS IT YOUNG

Casite protects your engine, too—by speeding lubrication. When you first start your car, the oil is "cold" and slow—can't get around fast enough to protect vital working parts. Casite makes that slow oil move fast—speeds the flow of No. 10 oil 20.6% at 75° F., more when the engine is colder—greatly reducing start-up wear. Casite gets enough oil to the right places at the right time—to give you longer engine life, to cut those big repair bills.

Get Casite today from your garage, service station or car-dealer.

CASITE DIV. • HASTINGS MFG. CO. • Box F—HASTINGS, MICH.

Casite Division, Hastings Ltd., Toronto

CASITE • drou • PISTON RINGS • SPARK PLUGS • OIL FILTERS



FREE!

Write for your free copy of "Facts of Engine Life," or ask your service man.

Ville I tested is fairly comfortable, although there could be more space between the steering wheel and the left door—and a large man needs more room for arm movement than is provided. Likewise, there is not too much leg room for a tall driver.

I found Cadillac's brakes to be very good, with little evidence of fading even when used at high speeds or on mountain roads.

The brake-pedal pressure is light and the operation is especially smooth. I would prefer a wider brake pedal, inasmuch as the clutch pedal is eliminated.

The hand brake operates easily and the operating lever is well located at the left side. A feature I like is when the hand brake is applied, there is an indicator on the instrument board that reads "Brake" when the ignition is turned on.

The ventilating system is one of the finest that I ever have used, and entry of cool or hot air is controlled by two separate levers. There is, of course, a blower to help circulation of either hot or cold air.

The foot-controlled de luxe radio which I had on my test car (offered as optional equipment) is unique in that touching a foot button brings in the desired station.

The choke is automatic. During my 2900-mile test, there was no evidence of overheating at any time, and no water was added during the test period.

The oil level remained unchanged and no oil was added after the first oil change at 700 miles.

Another feature that was a part of all speedometers a few years ago and which has apparently been forgotten by most of today's manufacturers still is remembered by Cadillac. I refer to the trip-mileage indicator which, of course, can be instantly reset to measure the exact mileage of any set distance.

The push-button doors are quite heavy and it takes considerable pressure or slamming to close them. I think easier door closing would be an improvement.

The body is, of course, the well-built Fisher which has been used on all General Motors cars for years. The body is solid, and with the exception of one small squeak in the door for about 500 miles, there were no rattles or squeaks of any kind. Incidentally, I ran into a hard rainstorm for about 400 miles and no water leaked in at the windows or windshield. I have found in the testing of a large number of postwar cars that a surprising percentage of many makes of cars do leak water at some point, and many bodies are not dustproof.

Vision is far above average, with the one-piece curved windshield and narrow corner posts. Vision directly in front of the hood

(Continued to page 238)

NOW - A FLUSHING TOILET and SEWAGE DISPOSAL UNIT

Easily Installed

**IN RURAL HOMES, TRAILER HOMES
AND SUMMER COTTAGES . . .**

This modern McPherson flush-type toilet with its sewage processing feature grinds, liquifies and aerates fully all sewage for quick absorption into the soil thru an inexpensive sub-surface irrigation system. Real expensive plumbing installations are no longer necessary with this entirely new water-driven sewage disposer. Because of the ease of installation and operation the McPherson Disposal Flush-Type Toilet is standard equipment in thousands of House Trailers in use today.

The McPherson is a full size aluminum toilet chrome plated. It automatically ventilates and is equipped with the famous 'Healthguard' valve that even a child can operate. It is frost proof.

Satisfaction guaranteed or your money back.

NO CHEMICALS - NO SEPTIC TANKS

Write Today for FREE Catalog

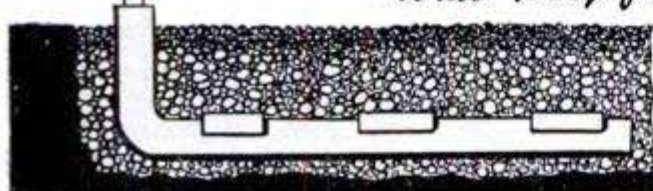

New
**HEALTHGUARD
VALVE**

**APPROVED BY THE
AMERICAN SOCIETY OF
SANITARY ENGINEERS**



McPHERSON, INC.

7450 N. Milwaukee Chicago 31, Ill.

FILE your own SAWS . . . easy!



A SPEEDCOR TOOL!

Do expert saw filing without experience. Keep your hand saws extra sharp, true-cutting. Easy to use. Money back guarantee. Cash with order, prepaid. (COD postage extra.)

**COMPLETE
\$2.95
WITH FILE**

THE SPEED CORP. PM-8
512 N.E. 73 Ave., Portland, Oregon

300 Power Import MICROSCOPE Laboratory Model

\$14.95

POSTPAID

Triple revolving turret holds 100 power, 200 power and 300 power lenses! No frills, just excellent optical qualities, delicate adjustment, solid construction. Its quality and price astounded biology instructors. A lifetime bargain for students, schools, labs, research, amateurs. *Anyone can now own one.* (Performance cannot be duplicated for \$75.00)

FEATURES: Fine micro adjustment, adjustable plano substage mirror. Dovetail hardwood case included free. If you are not amazed by its quality, send it back in two weeks. Your money refunded immediately. Send \$5.00 deposit if you wish C.O.D. or send check. **\$14.95 ppd.** cash or money order for . . .

**SQUIRREL CAGE
BLOWER with MOTOR**
for Heating, Ventilating, Air Circulation
Continuous duty—runs on 110 volt, just plug in wall socket—blows like a tornado

- Kitchen ventilator (complete room air change in few minutes)
- Photo dark room (sucks fumes out)
- Workshop (sucks dust out)
- Drying purposes
- Hot rooms (circulates air)
- Controlled draft for furnaces

\$9.95

LISTS TODAY FOR \$29.50

WE PAY POSTAGE!

Free illustrated catalog sent free or included with your order
AKRON ARMY & NAVY STORES
DEPT. 7-P, 4400 SUNSET BLVD., LOS ANGELES, CALIF.

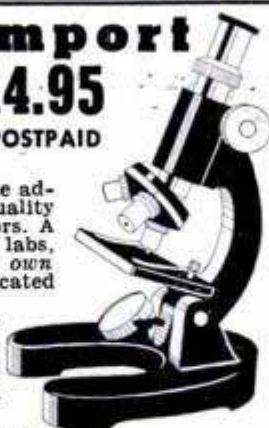

Start a Business in Your Backyard



Earn **BIG MONEY**
MAKING
BUILDING BLOCKS

**General Concrete Vibrator
BLOCK MACHINE**
CAPACITY 1000 BLOCKS A DAY

only \$218 LESS MOTOR
F.O.B. PLANT

SHIPPING WEIGHT 400 LBS.



Here is a business you can start on small capital—in your own backyard—that earns 100 to 150% profit, with unlimited opportunities. Make concrete or cinder blocks. Millions used for homes, factories, public buildings, garages. Sell all you make to building trade. Do it with a General—and you're headed for success.

1000 BLOCKS A DAY

The General is a high speed, power-driven block machine at amazingly low cost. Rugged all-steel construction. Simple to operate indoors or outdoors. Makes superior 3 core type block meeting all code requirements. Produces up to 1000 blocks per day. Full operating instructions and mixing formulas supplied. Write for FREE details.

Dealer inquiries invited

GENERAL ENGINES CO.

DEPT. M-81 • 307 HUNTER ST. • GLOUCESTER, N. J.

Includes floor plans for 6 beautiful, easy to build concrete block bungalows. Shows ways to save money. How to lay blocks, lay out building lines, mix concrete, build steps, porches and concrete floors. Mail coupon at once with \$1.

*Wonderful
Book Written
& Illustrated
by Experts*

**HOW TO
BUILD
YOUR OWN
CONCRETE
BLOCK
HOME**
Only \$1 Prepaid

Name.....
Address.....
City..... Zone .. State.....

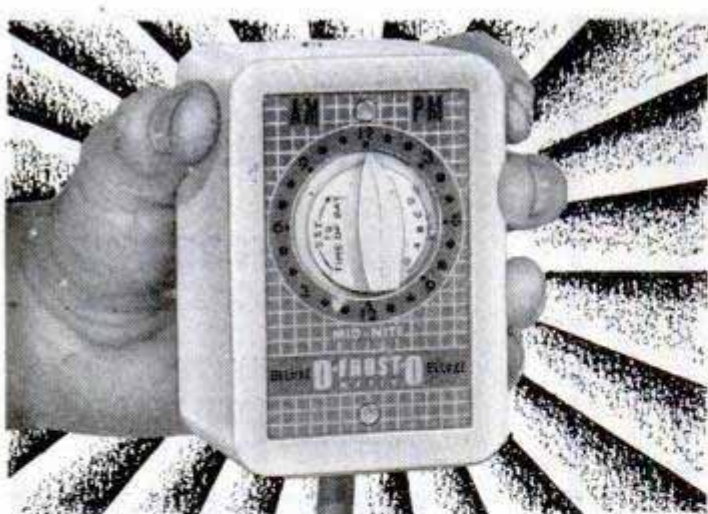

AMAZING INVENTION EXCITES MILLIONS!

Owners of electric refrigerators are excited about an amazing invention that automatically defrosts these "ice boxes" every night, without mess, work, or attention.

The tremendous demand for this Patented invention, the D-Frost-O-Matic, is creating big-money-making opportunities for men and women. They use a FREE TRIAL plan that assures sales in three out of five homes.

They earn up to \$210.00 a week just spending a few hours a day plugging in units on a Free Trial basis.

FIRST VERNIER GEAR USED IN A TIME CONTROL

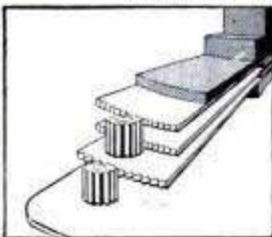

Never before has a Vernier gear been used in an automatic control of this type. The unit is greatly simplified, and gives trouble-free service for years. Designed by Carl Broken, member of the Society of Industrial Designers.

Independent Laboratory Test Makes Selling Easy

Tests by the famous U. S. Testing Company, Inc.* proved the D-Frost-O-Matic saves 20% of electricity, saves excess wear on refrigerators, and keeps food fresh and appetizing for longer. The Free Trial plan is making up to \$210.00 an evening for men and women who sell in spare time, with far larger sums for full time.



If you would like to make a great deal of money mail the coupon below right now, for the D-Frost-O-Matic FREE TRIAL plan.

SEND COUPON NOW!

Mr. Sidney Lewis
D-Frost-O-Matic Corp.
6 N. Michigan Ave., Dept. PM-8
Chicago 2, Ill.

Please RUSH your GUARANTEED PROFIT and FREE TRIAL plans, with the U. S. Testing Company's report on the new Patented D-Frost-O-Matic.

Name _____

Address _____

Town _____ State _____

*Test No. E-2059

would be improved some if the hood sloped a little more in front.

The trunk space varies on different models, but is ample. The rear-deck lid is counterbalanced and ease of opening is a nice feature, although it takes a little too much pressure or slamming to close it easily.

The ignition switch is easily controlled by the right hand, and by turning the switch to the extreme right, the starter is placed in operation.

The car I tested had the automatically controlled door windows. A master switch operated by the driver controls all four windows and there are individual switches for both right and left doors and rear windows, which the passenger can operate. Owners I interviewed reported very little trouble with the automatic-window unit.

For its size and horsepower (160), the Cadillac high-compression engine undoubtedly is one of the world's best and, for the size and weight of the car, the gasoline mileage is remarkable. While the car is heavy, actually the engine weighs only about 60 pounds more than many V-8 engines used in lighter cars.

Owners reported excellent economy with an average of 17.9 in country driving and 14 in the city.

In the 1951 Mobilgas Economy Run a Cadillac 62 averaged 21.539 miles per gallon when driven at an average speed of 40.329 miles per hour from Los Angeles to the Grand Canyon, Ariz., and return.

In Cadillac's high-compression engine (7.5:1) I found that premium gasoline is best to use. (An amazingly high percentage of the owners who replied to our poll reported the use of premium gasoline.)

From the days of the lowly chain-driven, single-cylinder "chugger" to the luxurious 1951 V-8, Cadillac never has built a really poor car. Nor since early days have they been a poor-man's car. However, in 1906 Cadillac, with its single-cylinder model at \$750, was hardly competition for Henry Ford's massive 6-cylinder Model K at \$2650.

Soon after that Cadillac started its climb to dominate the high-priced class, while Ford went on to mass-produce low-priced automobiles.

Even as early as 1909 Cadillac craftsmanship was evident when four Cadillac cars were sent to England, then dismantled and all parts mixed up, then selected at random for reassembly. This was to demonstrate precision, interchangeability of parts, and uniformity of Cadillac workmanship—and for this demonstration Cadillac brought to the United States for the first time England's famed Dewar Trophy.

Cadillac engineers take continued pride in perpetuating the Cadillac tradition.

NOTHING LIKE IT AT THE PRICE for POWERFUL, FAST CUTTING PRODUCTION

Model 2000 — with straight-line reciprocating action that guarantees scratch-free surfaces—is a fast-cutting production sander for heavy-duty craft and woodworking projects — for hobby work, refinishing and redecorating. It gives you the added stroke and power required for furniture and cabinet making, boat building or refinishing, resurfacing large areas, sanding plastics, leather, etc. Great for building operations such as woodwork, dry wall joints, siding and other exteriors. Also does a superb wax-polishing job! Buy it, try it, compare Model 2000 with any competitive electric sander. You be the judge!

ONLY
\$24.50

WITH STEEL
CARRYING CASE
AND COMPLETE
ACCESSORIES

14,400
Sanding
Strokes
Per
Minute

New DREMEL Electric
MODEL 2000
SANDER • POLISHER



21
SQUARE INCHES
OF SANDING SURFACE!

WHERE TO BUY DREMEL SANDERS

If your dealer can't supply, send full remittance for postpaid shipment. Or send only \$2. and pay postman balance plus postage and C.O.D. fee. Money back if not delighted after 5 days' trial.



DREMEL MFG. CO., Dept. 111-H, RACINE, WIS.

OUTSTANDING Model 2000 FEATURES

- 21 sq. in. sanding surface
- weighs only 5 lbs.
- easy one hand operation—just guide it
- only 2 moving parts
- requires no oiling
- cam-type holder permits 10-second paper change
- dust-proof, fool-proof, fully guaranteed
- over-all size 3 1/8" x 4 1/2" x 7"
- operates on 110-120 v. 60 cycle, A.C.



LIGHTER CAPACITY MODEL "A" FOR ALL HOUSEHOLD SANDING-POLISHING JOBS

Housewives, homeowners, hobbyists go for Model "A". Over a quarter-million now in use! Perfect for all household sanding, polishing, refinishing. Also a soothing massager. Only 2 1/2 lbs.; sanding pad 2 1/4" x 5 1/2". Same construction features as larger Model. With 6 sheets sandpaper, sheepskin, felt pad... Only **\$14.85**

BEFORE YOU BUY ANY
SANDER
COMPARE!
BE SURE YOU WILL GET
A SCRATCH-FREE FINISH

ROTARY
Action
About 50%
cross-grain
motion



ORBITAL
Action
Partial
cross-grain
motion



ARC
Action
100%
cross-grain
motion

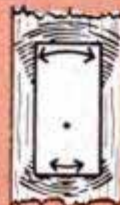

DREMEL
Reciprocal
Action
100%
WITH
THE
GRAIN
motion
for
scratch-free
finishes

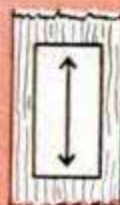

NOW—40 different CUTS with AMAZING, NEW *Warren*



DADO SAWING WASHERS
On Your Saw Blade
Just dial widths to cut
parallel grooves perfectly
smooth. No warp, vibration

or trick screws. Strengthens blade, perfect balance.
GUARANTEED! At your dealer's or order
direct. Give arbor size—1/2", 3/8", 3/4", 1".

ONLY
\$4.95
PER
SET

Send for free booklet
WARREN WASHERS COMPANY
70 Medbury, Detroit 2, Michigan

TOOLS AT WHOLESALE

DIRECT FROM FACTORY
Full line of top quality, fully
guaranteed, chrome, factory-new
mechanics hand tools. You save
HALF REGULAR PRICE
for tools of this quality. Our
Permanent Price Protection Plan
guarantees you wholesale prices.

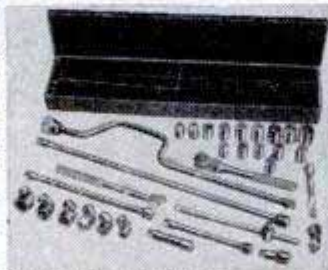

WRITE TODAY FOR FREE CATALOG

MECHANICS CO-OP

Dept. A OAKLAND 8, CALIFORNIA

Make \$20 to \$30 a Week EXTRA MONEY!

With the high prices of food, clothing and everything else, just think what you could do with extra money every week! Turn your spare time into CASH—sharpening saws with a Foley Automatic Saw Filer pays up to \$2 or \$3 an hour. Start in your basement or garage—no experience necessary. "The first saw I sharpened with my Foley Filer came out 100%"—writes Clarence E. Parsons. No canvassing—"I advertised in our local paper and got in 93 saws"—says M. L. Thompson. With a Foley you can file all hand saws, also band and cross-cut circular saws.

FREE BOOK Shows How to Start

It explains how you can get business from home owners, farmers, carpenters, schools, factories, etc. "I get work from 20 to 30 miles away"—says Charles H. Smith. Free Book, "Independence After 40," tells how to start. Send coupon today—no salesman will call.



SEND COUPON FOR FREE BOOK

FOLEY MFG. CO. 816-I FOLEY BLDG.,
MINNEAPOLIS 18, MINN.

Send FREE BOOK—"Independence After 40."

Name _____

Address _____

Never be without power!

FAIRBANKS-MORSE GENERATING SETS

Fairbanks-Morse
1800 Watt
A.C. Generator



Even though storms, accidents or calamities cut off your power supply, you can still have plenty of power to operate lights, utilities, tools etc., if you install a Fairbanks-Morse stand-by generating set—*now!*

Fairbanks-Morse Generating Sets are available in capacities from 600 to 35,000 watts, A.C. or D.C., with manual, remote or automatic starting. There are sizes for all shops, filling stations, garages, farms, homes, stores, and other businesses. For complete details, see your local Fairbanks-Morse dealer, or write Fairbanks, Morse & Co., Chicago 5, Ill.



FAIRBANKS-MORSE,

a name worth remembering

BRIKCRETE



Local Manufacturing of this Modern Masonry Has High Earning Power

Several hundred territories are being opened up for local Brikcrete manufacture by men of vision and aggressiveness. Brikcrete ties in with today's huge building program. Makes possible better construction at lower cost. Truly better than brick; actually cheaper than lumber. Combines strength, safety, insulation value, colorful beauty that fits today's styling.

Brikcrete is made in locally owned plants, using local materials and local labor. That's why high quality and low price still permit a 100% to 150% mark-up. We supply complete equipment; easy terms if required. Generous cooperation. Exclusive manufacturing privileges in protected territory. Write for information.

Brikcrete Associates, Inc.
4679 Division Ave. S
Grand Rapids 8, Mich.



AMAZING TOOL BARGAINS!

ALL BRAND NEW MERCHANDISE

12 MINIATURE CUTTERS \$1.00

FOR CUTTING WOOD, PLASTIC, or METAL



POST-PAID
IN U.S.A.
Actual size, Asst. shapes on 3/32" shank. For die makers, home workshop, etc.

12 MOUNTED WHEELS and points on 1/8" Mandrel.



For grinding on plastic, wood, soft and hard metals. Regular \$8.40. List Val. ONLY \$2.95

SCHUPACK SUPPLY CO., 7331 Cottage Grove, Dept. M-21, Chicago 19, Ill. (Illustrated Bargain Catalog Free)



BUILD YOUR OWN MACHINE TOOLS CASTINGS-DRAWINGS



Catalog with complete construction drawings of this bench milling machine or six inch shaper 25 cents per set postpaid or send one dollar for drawings of shaper, three millers and three lathes. Refund on castings order.

POOTATUCK CORPORATION, 100 Sammis Pl., Stratford, Conn.

VARIABLE SPEED HYDRAULIC POWER TRANSMISSION



It has Infinite Speeds 0 to 550. Reverse. Automatic Overload Protection; Adjustable Torque up to 180 inch pounds. 5/8" Input and Output Shafts. It will handle 1/4 to 1 1/2 H.P. Motor. Case measures 7 1/2" long 7" high 6 1/2" wide. VALUE OVER \$300. 5 H.P. Input Wt. 25#. On C.O.D. Orders we require a 10% only Fob. Chicago

\$54.50

DIRZIUS MACHINE SHOP "E" 1423-25 So. 52nd Ave., Cicero 50, Ill.



FREE...

16-pg., illus. book about SHOPSMITH—America's largest-selling power tool. Send for a copy!



SHOPSMITH, Dept. 166-B

12819 COIT ROAD, CLEVELAND 8, OHIO



OWN A Printing Business

Cards, Tickets, Stationery, etc. Good profit in spare time. PRINT YOUR OWN greeting cards, movie titles, church work, etc. Save money. Easy rules supplied. Raised printing like engraving too. Have home shop. Sold direct from factory only. Pays for itself in short time. Write for free catalog of outfits, and all details. KELSEY PRESSES, 0-37, MERIDEN, CONNECTICUT

2 DRILLS in 1

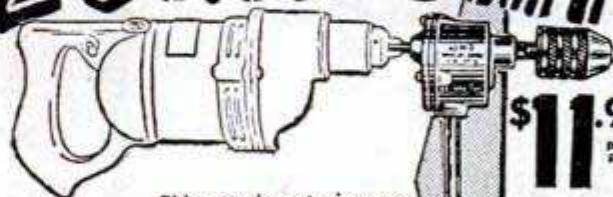

\$11.95
post paid

This attachment gives you two drills in one. It converts any 1/4 inch electric drill to 1/2 inch capacity. Reduction gears reduce the drill speed 5 to 1, the average speed of a 1/2 inch drill, and thereby increases the power. Absolutely indispensable for all shop work and home craftsmen.

Send check or Money Order
Satisfaction guaranteed

Order yours now

G. M. CO. MANUFACTURING, INC.
1308 43rd AVE.
LONG ISLAND CITY 1, NEW YORK

Here's Your Best Work-Saving Buy...

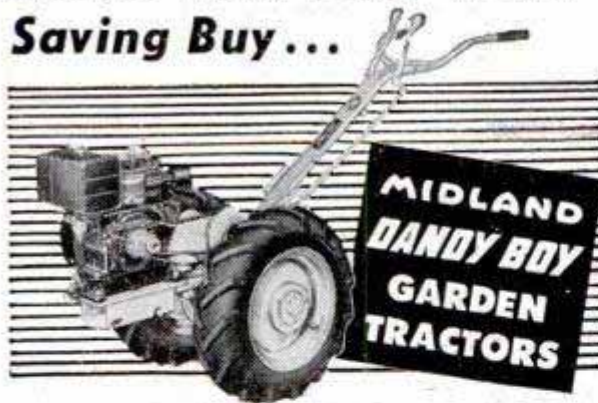

The power-unit that works the year 'round, DANDY BOY does a time-and-labor-saving job of discing, seeding, cultivating. Then in spare moments it takes on the task of lawn mowing, power spraying, cutting weeds, hauling supplies, sawing wood, mulching leaves, plowing snow or many others. More than pays its way EVERY season of the year. See your friendly DANDY BOY dealer for a demonstration, or write.

THE MIDLAND CO.

Dept. PM-8, South Milwaukee, Wis.
Builders of Farm and Garden Implements Since 1911

**WELD
BRAZE, SOLDER,
and CUT**

ONLY \$1475 F.O.B. complete!

EASILY... QUICKLY!

No experience needed. Follow simple instructions, weld on iron, steel, bronze, brass, aluminum, and other metals. Plugs into any properly wired 110 volt A.C. or D.C. line. Make or save time and money doing repair work for yourself and others. Repair men, farmers, tinsmiths, home and auto owners, hobbyists, etc., say FOUR-WAY pays for itself over and over. Order today or send for Free details.



ORDER NOW 10 DAY TRIAL

FOUR-WAY WELDER COMPANY, Dept. F2-HB
2326 So. Michigan Ave. • Chicago 16, Illinois

NU-WAY HEAVY DUTY CUTTING UNIT
with Timken Roller Bearings

PRICE \$16.50
WHY PAY MORE

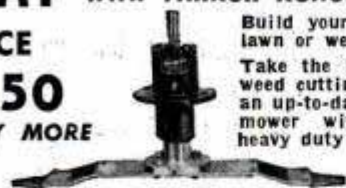

Build your own rotary type lawn or weed cutter. Take the hard work out of weed cutting. Build yourself an up-to-date weed and lawn mower with the Nu-Way heavy duty unit.

Write for Free Circular—We Supply Cutting Unit Complete
TRACTOR-LITE MFG. CO., Spirit Lake, Iowa

BeMaCo Dependable

AUTOMATIC SAW SET

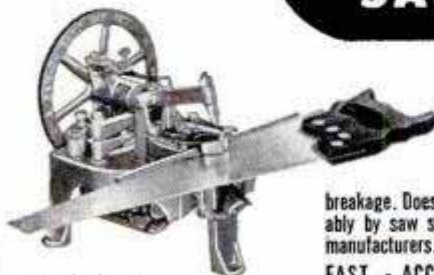

Sets 400 teeth per minute on hand or band saws 4 to 16 point. Hammer and anvil action sets teeth accurately and uniformly... No tooth breakage. Does a perfect job. Used profitably by saw shops everywhere and saw manufacturers. Every machine guaranteed!

FAST - ACCURATE - DEPENDABLE

★ INCREASES PROFITS

BEAVER MFG. CO.

Saw Machine Div. #7M
800 SO. ISIS AVE. • INGLEWOOD, CALIF.

CARTER



FUEL PUMPS

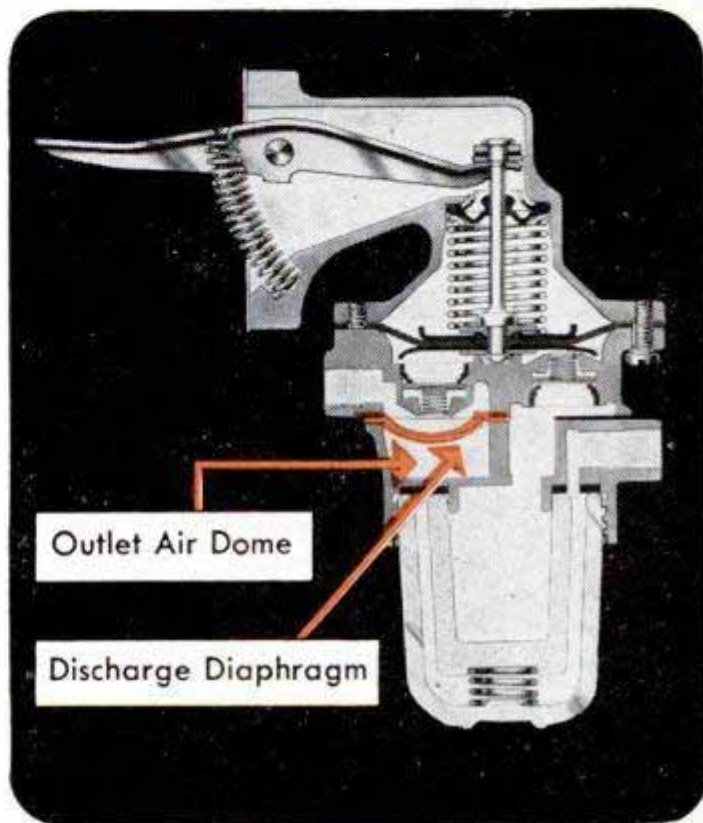

Assure Steady, Non-Pulsating Fuel Flow

See your garage, car dealer or service station for a

LIBERAL TRADE-IN ALLOWANCE

on your old pump.

The discharge diaphragm seals and maintains the outlet air dome—thus assuring a steady, non-pulsating fuel flow.

... another reason for replacing your old pump with an advance-design Carter.

CARTER CARBURETOR CORPORATION

St. Louis 7, Missouri

Division of American Car and Foundry Company



EVERY ELECTRIC DRILL A PORTABLE SAW

JOIN THE THOUSANDS who
SAVE WORK — SAVE TIME
and do the job BETTER with

"ARCO-SAW" (Over 100,000 Sold)

AT
BETTER
HARDWARE
STORES
EVERYWHERE

9.95

No. 444
"ARCO-
SAW"

"ARCO
SAW"

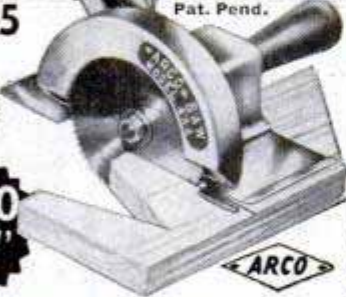

Pat. Pend.

CAN BE USED
WITH ONE HAND!
Any 1/4" or 3/8"
Drill a Powerful
Saw in ONE
MINUTE

"ARCO-SAW" is
a rugged tool with
right angle gear
drive (no clumsy,
dangerous, direct
drive with drill
sideways). Works
like a high priced
Portable Saw.

CUTS 1-5/16", or 2x4 by turning over

ONLY ARCO GIVES YOU ALL THESE FEATURES: Safety-yoke
assures rigid connection and absolute safety—Visual guide and
wide shoe-plate for straight, square cuts—Big handle affords
firm grip for two-hand operation—Precision one-piece gear box
—Self-lubricating lifetime bearings.

NOW AVAILABLE! No. 445 "ARCO-SAW"
11.50 for DEPTH & BEVEL CUTS



Has All Features Listed Above Plus:
Depth gage with graduated adjust-
ment from 0 to 1 1/4" depth (for
grooves, dados, scoring), Bevel gage
with graduated adjustment from 0
to 45° bevel (for dovetails, bevels),
Rip gage with sideways adjustment
(for accurate width molding, strips),
Visual guide with adjustment to
follow lines on both straight and
bevel cutting.

- NO. 444 "ARCO-SAW", complete with 4-inch
"HYCARBON" CROSSCUT BLADE (less drill)... \$9.95
NO. 445 "ARCO-SAW", complete with Depth-Bevel-Rip Gage
and 4-inch ARCO "HYCARBON"
CROSSCUT BLADE (less drill)..... \$11.50
NO. 444G DEPTH-BEVEL-RIP GAGE, Easily attaches
to any No. 444 "ARCO-SAW" to convert it to a
No. 445 "ARCO-SAW"..... \$1.95
"HYCARBON" REPLACEMENT BLADES—4-inch
Crosscut or 4-inch Combination..... \$2.00

90-DAY FACTORY GUARANTEE

ORDER TODAY at your dealer or send us check or M.O. (Post-
paid). C.O.D.'s—Postage extra. Ask for literature of other tools.

UNCONDITIONAL 10-DAY
MONEY BACK GUARANTEE

DEALERS—Write for
nearest jobber.

ARROW METAL PRODUCTS CO.

DEPT. PM-8, 140 WEST BROADWAY, NEW YORK 13, N. Y.

New POWER MOWER



FREE Building Instructions
Write For Them

Amazing invention makes whirl-blade
mower pull and steer itself as well
as cut grass and weeds. Convert
your mower or build a complete
mower with screw-
driver & pliers. Send
name and address. 1c
postcard will do.

PULLS
ITSELF,
STEERS
ITSELF

Convert Your Mower
Or Build A New One

T & H Mfg. Co., Dept. MPC-8, 811 E. 31 St., Kans. City, Mo.



Spindle—Platform—Wheels—Fork—Handles—Driving & Steering Parts
All parts available—kit or separately.

SOUTH
BEND

LATHES
DRILL PRESS
SHAPER



9" to 16-24" Lathes 14" Drill Presses 7" Bench Shaper

Write for literature—indicate machine.
SOUTH BEND LATHE, SOUTH BEND, IND.



Learn Welding quickly...easily!

— Earn
BIG
MONEY
Enroll NOW!

Whether you take a defense welding job
or start your own shop, there's plenty of big
money ahead for you as a trained welder.
Learn now in this modern, non-profit school.
Thorough training, best equipment, experi-
enced instructors. Complete or partial
courses. Write today.

HOBART Trade School, Box M-81, Troy, Ohio



Gerstner TOOL CHESTS

are "Champion" Quality chests. Free catalog
for Machinists and Toolmakers.

GERSTNER TOOL CHESTS
451 COLUMBIA ST. DAYTON 7, OHIO



Clark EXPANSIVE BIT

CUTS BETTER • COSTS LESS!

Accurate, fast; cuts smooth holes in
hard or soft wood. Chrome van-
adium steel blades, all chrome
body. No. 250, 1/2" - 1 1/2", \$1.89; No.
251, 3/8" - 3", \$2.19. GUARANTEED.
At your dealer or write Dept. PM-8

ROBERT H. CLARK COMPANY • Beverly Hills, California

SAVE THREE WAYS WITH A NEW Cushman

WRITE
FOR FOLDER
AND PRICES
DEPT. 16M



Get the big three Cushman economies—low purchase price,
low operating cost, low maintenance. Ride the Cushman
scooter to work, school or shop. Less than a penny per mile
to operate. Dealer inquiries invited.

CUSHMAN MOTOR WORKS Lincoln, Nebr.

New MOTOR BARGAINS for Home, Farm & Industry



- New General Electric 1/2 H.P. In-
duction Type 3450 RPM 110 V. 60
cy. 1 Ph. A. C. Motor. #GEH-5. Fob. \$23.50
New General Electric 1/2 H.P. Cap/
Ind. Ball Brg. 1750 RPM, double
1/2" shaft. 110 V. 60 cy. 1 Ph. \$29.75
1 Ph. A. C. Motor. #GE-17. Fob. \$34.50
New General Electric 3/4 H.P. Cap/Ind. Ball Brg. 1750
RPM, double 1/2" shaft. 110 V. 60 Cy. 1 Ph. \$52.00
A. C. Motor. #GE-75. Fob. \$75.00
New Dayton 1 H.P. Heavy Duty. Cap or Repulsion In-
duction. 3450 RPM, 110/220 V. 60 Cy.,
1 Ph. A. C. Motor. #EH-1. Fob. \$97.00
Same as above, 2 H.P. 220-V. 3450 RPM
#EH-20. Only. Fob. \$75.00
Same as above 3 H.P. 220-V. 3450 RPM,
#EH-30. Only. Fob. \$97.00

MOTOR and FAN BLADE COMBINATIONS

BUILD WINDOW FANS, EVAPORATIVE COOLERS, EXHAUST FANS

—With these Efficient Combinations

Set #	Blade Size	H.P.	Blade Price	Guard Price	Motor Price	Combination Motor Guard & Blade
FC-10	10 inch	1/60	\$1.25	\$1.75	\$ 4.50	\$ 7.50
FC-12	12 inch	1/40	\$1.50	\$2.00	\$ 6.50	\$10.00
FC-16	16 inch	1/20	\$2.25	\$2.75	\$ 8.50	\$13.50
FC-18	18 inch	1/15	\$3.75	\$3.75	\$10.00	\$17.50

All above items shipped PREPAID. Motors or parts can be bought separately...

ALL SIZES of motors have extended thru bolts for mounting.
Write for FAN CIRCULAR: listing Blades, Guards, Motors, All Sizes
for building your own Attic Fan, Window Fan or Room Cooler.

C. MARSHALL SALES, 3546 W. Fullerton Av., Dept. P-8, Chicago 47

SURPLUS MACHINE SHOP TOOLS AT PRICES YOU CAN AFFORD

High Speed Straight Shank Drills

SET 1R 30 Selected H. S. Straight Shank Drills from 1/8" to 1 1/2". Mixed new and used — 1/3 new. Drill flute length up to 7". \$15 Value. **\$2.95** only.

SET 2R 10 Different Size H. S. Straight Shank Jobber Length Drills, 1/4" to 1 1/2" (shank same dia. as drill). \$25 Value, only. **\$3.95**

HIGH SPEED DRILLS

1/4" to 1/2" with 1/4" Shanks
1/2" to 1" with 1/2" Shanks

SET 3R 6 Different Size H. S. Drills, 1/4" to 1 1/2" all with 1/4" shanks. **\$3.50**

SET 4R 10 of above. **\$4.95**
Set 3R and 4R will fit any 1/4" drill.

SET 5R 5 Different Size H. S. Drills, 1/2" to 1" with 1/2" shanks. **\$6.95**

SET 6R 10 Different Size H. S. Drills, 1/2" to 1" with 1/2" shanks. **\$12.95**
These H. S. precision drills with 1/2" shanks can be used in a 1/2" electric drill or a 1/2" capacity lathe or drill press.

1/4" DRILL GRINDING WHEEL KIT
10 First Quality, 1/4" arbor Grinding Wheels, all grits and sizes from 5/8" to 1 1/4" dia. and 1/2" to 1 1/2" thick, all which fit machined mandrel pictured. Mandrel will fit any 1/4" stone you now have. 10 stones plus mandrel, only. **\$1.95**
20 stones as above, plus mandrel. **\$3.79**

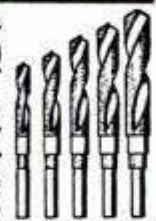

HIGH SPEED STRAIGHT SHANK CHUCKING REAMERS

SET 7R 20 Different Size High Speed Straight Shank Chucking Reamers up to 1 1/2". Priced at only. **\$7.95**

SET 8R 10 Different Size High Speed Straight Shank Chucking Reamers from 1/2" to 1 1/4". Priced at only. **\$9.95**

SET 9R 15 Different Size High Speed Straight Shank Chucking Reamers from 1/4" to 1". Priced at only. **\$6.95**

OXYGEN OR AIR TANK WITH REGULATOR

Volume 104 Cu. In. Maximum pressure capacity 500 lbs. Complete with regulator assembly; 500 lb. pres. gauge; belt clamp. Excellent for breathing apparatus; compressors; small welders, etc. **\$3.95**

GASKET PASTE one lb. tin excellent for automotive pan gaskets, etc. Dis. on quantity. Only. **98c**

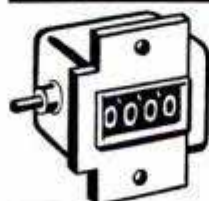

NEW VEEDER ROOT COUNTER

4-digit clock-wise rotation type. **\$1.89**
3-digit clock-wise rotation type. **\$1.49**
Discount on large quantity available

Money-Back Guarantee—All Mdse. Mixture of New and Reconditioned Tools Unless Specified Brand New—All Orders (Except Those Specified F.O.B. Tulsa) Are Shipped Post Paid, saving you up to 25% on total delivered cost.

Write for Free Catalog Describing Thousands of Bargain Cutting Tools.

T & T TOOL 221 W. SECOND TULSA, OKLA.

HIGH SPEED MORSE TAPER SHANK DRILLS

SET 10R 15 Different Size High Speed Morse Taper Shank Drills up to 9/16" with No. 1 and 2 tapers. \$50 Value. Priced at only. **\$6.49**

SET 11R 20 Different Size High Speed Morse Taper Shank Drills from 1/4" to 1". \$70 Value. Priced at only. **\$12.95**

SET 12R 10 Different Size High Speed Morse Taper Shank Drills from 1/2" to 1 1/4". \$50 Value. Priced at only. **\$9.95**

SET 13R 8 Different Size High Speed Morse Taper Shank Drills from 1" to 2" with No. 3, 4, and 5 tapers. \$125 Value. Priced at only. **\$29.95**

HIGH SPEED HAND TAPS

SET 14R 8 Different Size High Speed Standard Thread Hand Taps up to 3/4" including 2 std. High Speed Pipe Taps. **\$2.95**

6 SLITTING SAWS with MANDREL

SET 15R 6 Different Size High Speed Slitting Saws, 2 3/4" dia. x 1" arbor. Thickness from .040 to .071. Cuts wood, aluminum, brass, steel, etc. PLUS SPECIAL MANDREL which enables use of saws in 1/4" or 1/2" elec. drill. \$25 Value. Only. **\$4.95**

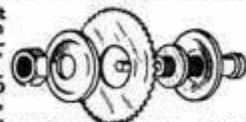

MODERN LAWN MOWER SHARPENER

FOR LAWN MOWER SHOPS FIX-IT SHOPS

GOLF COURSES • PARKS
101 OTHER JOBS

Sharpens All Reel Type Mowers • Hand, Power or Gang • 10 to 20 Minutes • No Dismantling • No Extra Attachments Needed. All reel type mowers, from 5-inch edgers to 36-inch power mowers, are quickly sharpened to extreme ends of both left and right twist blades.

ORDER NOW
Immediate Delivery.

Handle, wheels, roller and motor remain in place when sharpening is in process. Bed knife is sharpened in same brackets. Grinding head rides on five ball bearing races. Easy to operate. Also sharpens chisels, jointer knives, planer blades. Big profit maker. Own your own business. Send Today for FREE Illustrated Bulletin No. 10-C. Prices Subject to Change Without Notice.

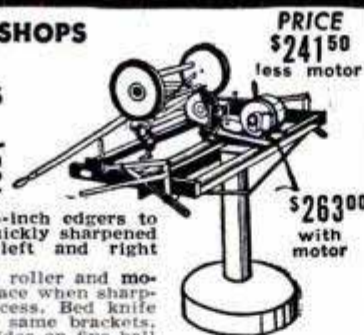

PRICE \$241.50 less motor

\$263.00 with motor

MODERN MFG. CO. 160 N. FAIR OAKS AVE PASADENA, CALIFORNIA

SAY YOU SAW IT IN POPULAR MECHANICS

Amazing New

FOLEY Power SAW SETTER

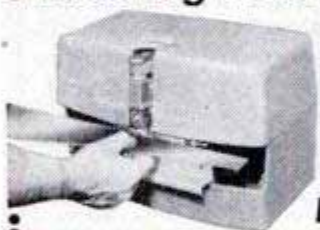

For hand and band saws

A perfect set on 26" hand saw in 32 seconds

The new Foley Automatic Power Setter with exclusive "Twin Hammer" action has two hammers (one for each side of saw) operating from a single spring, insuring utmost accuracy. ONCE through turns out a perfectly set, true-cutting saw. Relieves eye-strain, no tooth breakage. Sets all hand saws (with handles left on) and band saws from 4 to 16 points per inch. 1-year Guarantee. **FREE—Foley Price Guide** of actual 1951 saw sharpening charges. A valuable help to any saw repair shop. Write for it today, also Foley Setter circular. No salesman will call.

FOLEY MFG. CO., 875-1 Foley Bldg., Minneapolis 18, Minn.

PISTON TYPE COMPRESSOR



EASY PROFIT IN PAINT SPRAYING

Paints walls, ceilings, screens, furniture and machinery faster, better. All complete as shown less motor. Carry anywhere. Fully guaranteed. Could be used with 1/4 H.P. motor or less. Price \$35.00 less motor F.O.B. Chicago. \$5.00 deposit balance C.O.D. or see your dealer. With motor \$55.00.

IDEAL AUTOMATIC PUMP CO., Dept. P.M.8
801 W. Washington Blvd. Chicago 7, Ill.

MAKE MONEY SAVE MONEY BUY SUPERSHOP

15 DAY TRIAL

GRINDER
SANDER
30" LATHE
HORIZONTAL DRILL PRESS

Retail Price \$125.00 — **\$79.95**
FACTORY TO YOU

SUPERSHOP offers you a lifetime of power tool pleasure and profit. 100% ball bearing. RUGGED. Accurate. Big capacity. 15 day FREE trial. Money back guarantee. Mail postcard for FREE catalog. Buy on easy pay plan.

POWER TOOLS, INC. 126 YATES AVENUE BELOIT, WISCONSIN

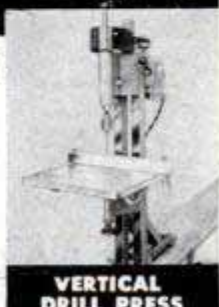

VERTICAL DRILL PRESS

P&C Hot Forged Tools Stay on the job Longer!

Really tough jobs—in industry or at home—prove that special analysis alloy steel and scientific heat treating make P&C tools last longer. More than 300 P&C tools are easier and faster in everyday use or on special jobs.

Ask your hardware dealer for the P&C tools you need; he will recommend them.

Write for the new folder on P&C tools—"the BEST tools money can buy."

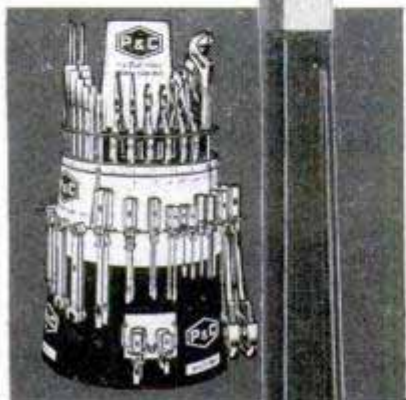

P&C HAND FORGED TOOL CO.
Portland 22, Oregon

BRAND NEW

30 DAY FREE TRIAL

High Power
BINOCULARS

Finest Precision Optics
Featherlight
Money Back Guarantee
Easy Pay Plan
Leather Case Incld.
Free! Catalog & Book
"How to Select Binoculars"
Dealer Inquiries Invited
Bushnell Bldg., Dept. MA-28
Pasadena 1, Calif.

33 MODELS
\$14.95
up

BUSHNELL Binoculars

FREE GUIDE "How to Select Binoculars"

NAME _____ CITY _____
ADDRESS _____ STATE _____

AUTOMATIC RETOOTHER

MAKES NEW PROFITS

Cuts new teeth in 50 seconds—any size 4 to 16 points. Old teeth fall off as chips. Easy to operate. A perfect job.

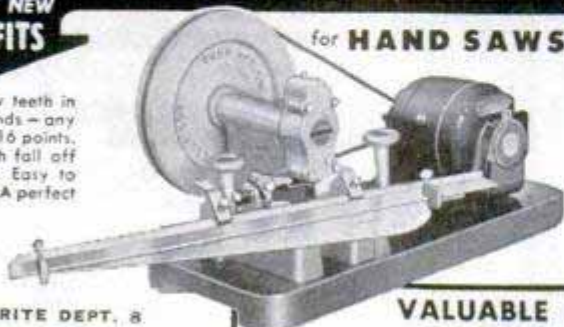

WRITE DEPT. 8

BURR MFG. CO.
8933 VENICE BLVD.
LOS ANGELES 34, CALIFORNIA

VALUABLE BOOK

25¢

Order Burr's Blue Book of Coast to Coast prices for saw shop services

BUILD YOUR OWN POWER TOOLS—TILT/ARBOR SAW

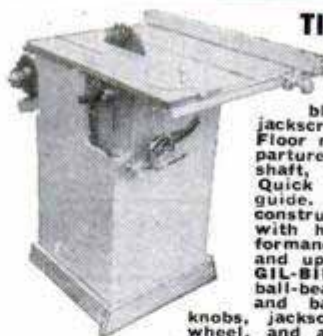

TILT/ARBOR SAW

• 27x28 in. table stays level. Blade tilts full 45 degrees. • 10 in. blade cuts 3 1/4 in. deep. Jackscrew depth adjustment. • Floor model, 34 in. table height. • New Departure ball bearing arbor, 3/4 in. precision shaft, ready to run, 5/8 in. bore blades. • Quick positioning, self-aligning rip fence guide. • Sturdy wood, steel and aluminum construction. • No machining—build easily with hand tools only. • Capacity and performance of floor saws selling for \$150.00 and up!

GIL-BILT Metal Parts Kit, includes Plans, ball-bearing arbor, cast aluminum miter gauge and bar, rip fence guide, machined lock knobs, jackscrew mechanism with 4 1/2 in. hand-wheel, and all other metal parts including every screw, bolt, nut and washer (less blade) \$20.95
Same Kit with 10" combination blade..... 24.90
Same Kit with 8" combination blade..... 23.90

If not satisfied, return Kits in 10 days for refund of purchase price.

(Prices include postage up to 600 miles)

GIL-BILT Step-by-Step pictorial plans (No blue-print reading required), full scale patterns, actual photographs for above **10" TILT-ARBOR SAW, 12" BAND SAW, BELT SANDER, 8" TILT/TABLE SAW \$1.00** each, postpaid anywhere in the world. ALL 4 Plans for \$3.00, or write for FREE descriptive catalog.

COMPLETE PLANS only \$1.00 EACH

GILLIOM POWER TOOLS P. O. Box 1-PH, Lambert Field, St. Louis 21, Missouri

TRAVEL LIGHT (hearted) with a HULL AUTOMOBILE COMPASS



THIS HANDSOME, accurate instrument—mounted on divider strip or top moulding of one-piece windshields—gives you the happy assurance that you're still headed right after every turn on strange roads or city streets. . . . Write for local dealer's name, free literature.

"SURE DIRECTIONS WITHOUT STOPPING"

HULL MFG. CO.

P. O. Box 246-D8 Warren, Ohio

Beaconlite '695
Illuminated
STREAMLINE '495
Standard (not Inc.)

POWER TOOLS WORK BEST when they're oiled, polished, rust-free. For lathes, drills, saws, etc.—get and use



Ever-Ready OIL

ELECTRIC MOTOR BARGAINS!



1/2 HP 1750 RPM **1975** 3/4 HP 1750 RPM **3250**
1 HP 3450 RPM **\$39.00**

Every Motor Fully Guaranteed

Heavy Duty Repulsion Induction and Capacitor Types, 110-220 Volts, 60-cycle, Single-phase. Standard Makes (G. E., Wagner, Leiland, Westinghouse, etc.). Rush your order TODAY—large stock of motors—1 & 3 phase. 32-v. direct current bargains. Prices f.o.b. **ROBERTS ELECTRIC CO., 849 W. Grand, Dept. 7, Chicago**

WOODWORKING VISE



for amateurs and professionals
USE UPRIGHT — FLAT — AT ANY ANGLE
MAIL CARD FOR FREE FOLDER TODAY
THE WILL-BURT CO., Dept. PM-8, Orrville, Ohio

40 PAGES OF TOOL "KNOW HOW"—ONLY 25¢

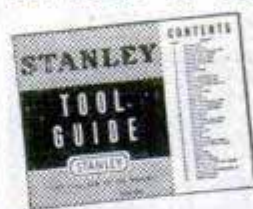

Stanley Tool Guide contains full information on how to use all common hand tools. Invaluable to beginners, helpful to experienced craftsmen. Send 25c today to Stanley Tools, 381A Elm St., New Britain, Connecticut.

Say You Saw It in POPULAR MECHANICS

MAKE BIG MONEY!

Be a floor surfacing contractor and sand both new and old floors. Sanders are easy to operate and better still, you're your own boss. Write for latest "tell-all" booklet entitled "Opportunities in Floor Surfacing", enclosing 25 cents in coin or stamps to cover handling.



AMERICAN

FLOOR SURFACING MACHINE CO.
525 So. St. Clair Street - Toledo 2, Ohio

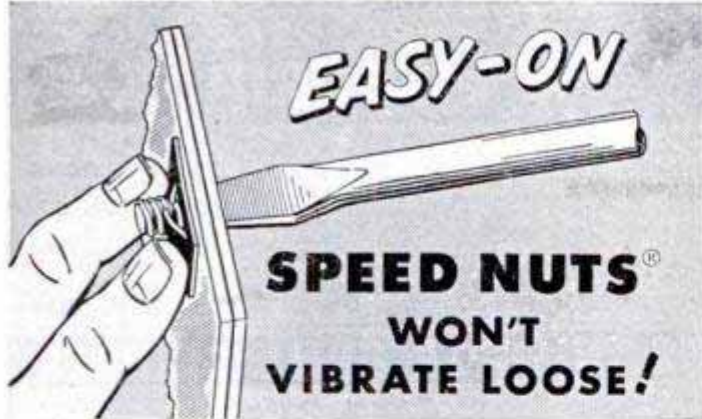

EASY-ON

**SPEED NUTS®
WON'T
VIBRATE LOOSE!**

NOW in handy kit for home use

The most practical fastener you can have around the house! Replaces threaded nuts and lock washers. Hundreds of repair and hobby uses on toys, equipment, etc. Kit contains over 100 parts—SPEED NUTS and matching screws in popular sizes. Price: only \$1.00. Send check or cash to Tinnerman Products, Inc., Dept. 13, Box 6688, Cleveland 1, Ohio.



ALL NEW 1951 KING MIDGET AUTO

World's Lowest Priced 2 Passenger Car

Drive it for 75c per week. Amazing performance. Surprising comfort. All steel construction. Full accessories, top and heater. Ready to run or assemble it with our bolt together parts. Rider agents wanted, earn your car Free. Send 25c for detailed literature or \$1 (refunded first order) for actual assembly book and service manual filled with photos, drawings, specifications, etc.



MIDGET MOTORS MFG. CO.,
ATHENS 1, OHIO

Genuine MAHOGANY Wood

Large Batch \$1.00 Postpaid. Other Usable Scrap Bargains Postpaid
Sample 25c — Price List 3c

S. R. MARKS CO., Dept. C-8, Montgomery 5, Ala.

1951 BUZZ MASTER

8 MODELS — \$99 up

More cutting — "Tomorrow's BUZZ MASTER Today!" See the de luxe riding model. Nothing else like it. Made by the oldest firm in the business—now in our 47th year. Many special features used only on Ottawa Saws. Write today for FREE DETAILS. OTTAWA MFG. CO., 1-127 Brush Ave., OTTAWA, KANS.



NOTE
THIRD
WHEEL

**MAKE
Big
MONEY
WITH THE**

**Universal
LAWN MOWER
GRINDER!**

Enjoy a profitable lawn mower sharpening business of your own. No previous experience needed. Place a hand or power mower on the UNIVERSAL GRINDER. With only ONE SET-UP you quickly grind the stationary blade and all the reel blades to proper clearance WITHOUT REMOVING A SINGLE BLADE from the mower.

PROOF
G. Spurlock, of Arkansas, writes: "I have my Universal Grinder two months and made a net profit of \$227.00".
C. E. Hardy of Miss, writes, "I am doing a fine business with the Universal Grinder. I spent 40c for a newspaper ad and have done nearly \$500.00 of business." Write today for FREE FACTS about Big Profits in Lawn Mower Sharpening.
DEPT. M-81
ROGERS MFG. CO., LINDSEY, OHIO



**SEND
FOR IT!**

**1951 ALLIED
RADIO & TV CATALOG**

free!

**COMPLETE
UP-TO-DATE
EVERYTHING
IN RADIO & TV
AT LOWEST
PRICES!**



**212 PAGES
OF VALUES**

**Everything for
Experimenters, Builders,
Amateurs, Servicemen,
Engineers and Soundmen..**

Save money on every Radio and TV need! Get the big 212-page 1951 ALLIED Catalog featuring the world's largest stocks of top-quality equipment at low, money-saving prices! See the latest TV releases, home radios, radio-phonos, Amateur equipment, P.A. systems and Hi-Fidelity Custom Sound, recorders, test instruments, builders' kits—plus thousands of parts, tools, books and diagrams. Get more for your money from the World's Largest Radio Supply House. Send today for your FREE 1951 ALLIED Catalog!



**TV, HOME RADIOS
& RADIO-PHONOS**



**SERVICE SUPPLIES
BUILDERS' SUPPLIES**



AMATEUR GEAR



**P.A. SYSTEMS
RECORDERS**

**free
CATALOG
Send For It!**

ALLIED RADIO

ALLIED RADIO CORP., Dept. 5-H-1
833 W. Jackson Blvd., Chicago 7, Ill.

Rush FREE 212-Page Catalog No. 126

Name _____

Address _____

City _____ Zone _____ State _____

ABSORB DAMPNESS!

In Basements, Closets, etc.
with the
**SOLVAY
AIR-DRYETTE, JR.**
and
Solvay Calcium Chloride

Absorbs moisture—the cause of rust, warping, mildew in workshops, darkrooms, closets, play-rooms, storage rooms, vaults. Built to last for years. Big capacity. Works fast, absorbs up to 3 1/2 qts. per day. Compact, inexpensive, clean, safe, odorless. Thousands in use. Write for booklet and name of your nearest dealer. Not available on Pacific Coast. Dept. 89-8, SOLVAY SALES DIVISION, Allied Chemical & Dye Corporation, 40 Rector St., N. Y. 6, N. Y.



MACHINE SHOP EQUIPMENT

The No. 49 edition of the famous Center Tool Co. Catalog is now ready! Every workshop owner should have a copy. 240 pages full of illustrations, descriptions, and prices of the latest tools made by best known manufacturers in U. S. You pay the cost of printing—50c. We refund your 50c with your first order of \$10.00 or more. Prompt delivery on most tools. Send check or money order today!

CENTER TOOL CO.

153 Centre Street, Dept. C, New York 13

REMODEL... Kitchens-Bathrooms



Do it yourself with easy-to-install MARLITE Wall Panels

It's easy to modernize old walls and ceilings with plastic-finished Marlite panels. Beautiful Marlite never needs redecorating, cleans with a damp cloth. Big panels 5/32" thick and 4' wide, lengths to 12', go up fast over any wall. Cut and fit with ordinary carpenter tools. 63 color and pattern combinations at your lumber store now!

MARSH WALL PRODUCTS, INC., Dept. 842, DOVER, OHIO
Subsidiary of Masonite Corporation

Write for FREE
"How-to-do-it"
instructions and
Color Folder

Marlitz
PLASTIC-FINISHED
WALL and CEILING PANELS

EASY AS 1-2-3 VISE-GRIP WRENCH

Now, VISE-GRIP makes short work of every job from the largest to the smallest! LOCKS with more than Ton Grip! Can't slip. Turns stubborn nuts, screws, broken studs. Holds anything. Whether you use it for electrical, plumbing or car repairs, it makes every job a cinch! With cutter—No. 7W, 7", \$2.25; No. 10W, 10", \$2.60. Without cutter—No. 7C, 7", \$1.95; No. 10C, 10", \$2.25. No. 7, 7", \$1.85; No. 10, 10", \$2.15.
Order From Your Dealer.



LOCKS
with
TON-GRIP

PETERSEN MFG. CO., Dept. P-8, DeWitt, Nebr.

NONE BETTER! SUPER DRILL GRINDER



Sharpens round shank drills from 3/32" to 1/2" in diameter, up to 6" long. Grinds old drills like new in 4 different point angles, using hand or power grinding wheels. Money-back guarantee.

Price only \$2.95

At Dealers or Postpaid

CRANDALL MFG. CO. 1512 W. Slauson, Dept. FA-58, Los Angeles 44, Calif.

DRAINS Cellars, Laundry Tubs; CIRCULATES Oil; IRRIGATES Gardens

Original "Type P" Pump has 2400 GPH capacity. 360 GPH 75' high, or 1500 GPH from 25' well. Use any 1/8 to 1/2 HP motor. DOES NOT CLOG.

Only \$6.95 postpaid if cash with order. (West of Mississippi, add 50c.)

SATISFACTION GUARANTEED OR MONEY BACK!

\$6.95



LABAWCO PUMPS, BELLE MEAD 7, N. J.

MARCOT KEY MACHINE



MARCOT No. 8 KEY MACHINE.
less motor
Auto Code Book and Depth Keys... \$110.00
75 Dz. Popular Key Blanks... 12.50
Set — Key File, Follow-Through Rods, Lock Picks, Bit Key Gauge, Thimble, Pins, Springs... 10.50
"Locksmith Trade Books"... 6.75
How to Open Locks without Keys or Picks; Secret of Locksmithing; How to Make Keys by the Impression Method; Master Key Systems.

TOTAL COST... \$199.75

A. J. MARCOTTE CO., 1200 N. Kedzie Ave., Dept. PM, Chicago 51, Ill.

BUILD FINE GRANDFATHER CLOCK NOW

The simple sensible Red-i-Kut way as thousands have—SAVE HALF. SHOP TESTED PLANS "SPIRIT OF THE CENTURY" Narrow waist 83" tall or stately straight side "SPIRIT OF AMERICA." EASY-TO-FOLLOW photopack PLANS tell all — plus BROCHURE of heavy brass weight Westminster tube chime, movements, gorgeous dials, 3/4" solid mahogany case kits. Send \$1.00 today — Both Plans \$1.50 NOW.

KUEMPEL CHIME CLOCK CO., #4 Kuempel Bldg., Minneapolis 16, Minn.

\$1995



DOUBLE POWER SANDER

READY! New Syngro amazes with double power for sanding, polishing, yet lightweight for vertical, overhead work! Exclusive Double-Arc Motion! 14,400 strokes a minute! With built-in Fractional Horsepower Reactance

Electric Motor, \$19.95 at dealers or postpaid from

SYNGRO, Dept. D-81, OXFORD, MICHIGAN

SYNGRO
ELECTRIC SANDER



ELECTRIC WELDER

AC or DC 110 Volts

"The Little Marvel" All-Metal welder. 5-year written guarantee. Welds 1/8" thick metal or money back. Repairs tanks, tools, fenders, machine parts, etc. Comes complete with everything—rods, unit, eye shield, and direct-ons. We also make a welder for 16 to 22 gauge metal... \$3.95 complete. On C.O.D., postage extra.

\$6.45
Complete

ESSAY MFG. CO., Inc., Dept. 51, Quincy 69, Mass.

WAR BARGAINS
Over 200 terrific
SURPLUS ALSO FACTORY SURPLUS VALUES!
SEND FOR FREE catalog
SIoux FALLS SURPLUS STORE
SIoux FALLS, S. DAK.



**CAPE COD CHAIRS
TRELLISES • ARBORS
DUTCH WINDMILLS**

Chairs style B-C-A PLANS 50c Ea., all 3 only \$1.00. 12 different trellis designs PLAN of all 12 only 50c. Authentic 40" high Dutch Windmill Detailed PLAN only 75c. Unique 40" high Light-house having copper lantern, ideal for garden or on lake shore of summer home. Large detailed PLAN 75c.

SPECIAL ALL PLANS ABOVE \$3.00 VALUE ONLY \$2.50
SEND 10c for catalogue of many fine projects.
Dept. P31
CRAFTSMAN'S MODEL CO. DELAFIELD, WISCONSIN



**FREE CATALOG
OF HARD-TO-GET TOOLS!**

Free pocket-size catalog chockful of hard-to-find, power-driven, time-saving tools! Powerful new electric drills... and dozens of accessories for vice, drill, drill press, circle saw and lathe—for sawing, sanding, polishing, grinding, drilling, mortising, wood-shaping, etc.! Every tool illustrated. A word to the wise—write for your free copy today!

BERTRAM M. ENGINEERING AND SUPPLY CO.
3125 HARRISON ST. KANSAS CITY, MO.

Build your own JET ENGINE!



Order these plans today

1. JET PROPELLED BICYCLE. Assemble your own. Photo and instructions, \$1.00.
2. HOW TO MAKE EXPERIMENTAL JET ENGINES. Seven sheets drawings with information and instructions \$2.95.
3. BOTH OF ABOVE in one order \$3.75. SEND NO MONEY. Order both at once \$3.75 C.O.D. in USA plus c.o.d. postage. Send check or Money Order and we pay postage. Get other information too. Rush Order.

J. HOUSTON MAUPIN, Dept. 55, Tipp City, Ohio

BRUSH PLATING OUTFITS

for re-plating articles in the home and shop. No tanks necessary. Free particulars.

GUNMETAL CO., AVE. M, DECATUR, ILLINOIS

Ready for you NOW-Deltagram Vol. 4
THREE WHOLE YEARS OF FUN-AND-PROFIT IDEAS... Sturdy cloth binding: **ONLY \$3.75** WRITE FOR IT



DELTA POWER TOOL DIVISION
Rockwell MANUFACTURING COMPANY
803H E. VIENNA AVE. • MILWAUKEE 1, WISCONSIN

CASH IN YOUR SPARE TIME



BIG MONEY IN OWN BUSINESS
YOU CAN MAKE UP TO \$40 A DAY sharpening and setting circular saws for factories, builders, lumber yards -- with **NEW BELSAW COMPLETE CIRCULAR SAW SHOP.** LOW COST, Sharpens 4 to 5 saws per hour, no experience needed, complete instructions. Send today for **FREE** Catalog.

BELSAW MACHINERY CO

3703 Field Bldg. Kansas City 2, Mo.



STARRETT "Tools and Rules" BOOK

Describes and illustrates the precision methods skilled mechanics use. Only one dime. Write Dept. AP.

THE L. S. STARRETT CO., Athol, Mass., U. S. A.

HELPFUL BOOKS

Send post card asking for **FREE** catalog

Popular Mechanics Press, 200 E. Ontario, Dept. 601, Chicago 11

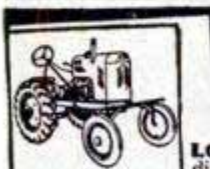

SAVE TIME, WORK, MONEY!

**SHAW
"DU-ALL"**

and "PEPPY PAL" TRACTORS

LOW FACTORY PRICES Buy direct or through your dealer.

FREE Illustrated folders giving complete details, price lists—write today.

4508 Front St., Galesburg, Kans.
6686 North 4th St., Columbus, O.



**SHAW
MFG. CO.**

**What Home Improvements
Are You Planning?**

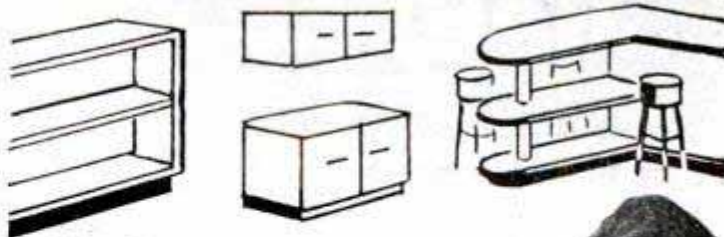

**Atlas-POWER KING
Tools Will Save You
Time and Money!**



8" Tilt/Arbor SAW

**NEW
4" Jointer-Planer**

Whatever you have in mind to add to the comfort and livability of your home, these Power King tools will save you hours of time and many dollars. The 8" Tilt/Arbor saw gives you big cutting capacity at low cost. The new 4" jointer-planer adds that "professional-quality" look to all your projects. New **FREE** tool catalog—send the coupon.



**40th YEAR
Atlas**

**DEPENDABLE
QUALITY TOOLS**



ATLAS PRESS CO., 835 N. Pitcher St., Kalamazoo, Mich.
Please send the new Power King catalog.

Name _____

Address _____

City, State _____

A Toolshop in Your Hand

HANDEE®

tool of 1001 Uses

**FINEST IN POWER TOOLS
Plus 51 Accessories**

Complete . . . designed for every hobbyist and mechanic! Grind, drill, polish, carve, sand, saw, etc. Packs plenty of power in the 25,000 r.p.m. motor, with approved 7-segment commutator. Handsome fitted steel carrying case.

Complete, with liberal 10-day money back trial offer **\$27.50**
with 7 accessories . . . **\$19.95**



HANDEE WORKSHOP

**Tornado-Powered
with NEW HANDEE "85"**

Versatile, with 41 accessories . . . suitable for shop or home use. For novice or expert . . . precision routing, molding cuts. HANDEE "85" a production wizard . . . automatically air-cooled, pin-point accuracy. Sensational power! Complete, packed in handsome case **\$29.95**



Chicago Wheel & Mfg. Co., Dept. PM
1101 West Monroe St., Chicago 7, Ill.

PARTS FOR MILITARY TRUCKS

FOR JEEP, DODGE, CHEV., GMC, STUDEBAKER, 4 WHEEL DRIVE AND 6 WHEEL DRIVE. ALSO PARTS CATALOG. WRITE

American AUTO PARTS CO. INC.

1830 LOCUST—DEPT. PM
KANSAS CITY, MISSOURI

Cut SAW FILING time in half with the

FOLEY SAW RETOOTHER



Don't waste time filing tough old hand saws with irregular, broken teeth. Put them through the Foley Power Retoother and cut a perfect set of new teeth in less than 1 minute. The Foley saves you extra time because it takes saws with handles on. Cuts 20 sizes of teeth

from 4 to 16 points per inch on both rip and cross-cut saws, either straight or crowned. Simple adjustments, no eye-strain. **FREE—Foley Price Guide** of 1951 saw sharpening charges. A valuable chart of actual prices. Send coupon today. No salesman will call.

**FOLEY MFG. CO., 870-1 FOLEY BLDG.,
MINNEAPOLIS 18, MINN.**
Send FREE Price Guide and Foley Retoother circular.

Name _____

Address _____

ALNICO MAGNETS LIFT 175-lb.

AMAZING PERMANENT MAGNETS — WILL NOT WEAKEN! NON-ELECTRIC. Retrieve guns, tackle, tools and other steel items from lake, river, plating tanks, drains or other hard-to-reach spots. Recover drills, taps, etc. from floor sweepings. Clear alley of harmful tacks, nails. Many other uses listed. Pays for itself quickly. **GUARANTEED:** Try any magnet one week. Money refunded if you are not well-pleased. Cat. No. 675 (Has pull of 175 lbs. on a flat steel block) \$10.50
Cat. No. 650 (150 lb. pull) \$8.50 Cat. No. 530 (30 lb. pull) \$3.00
Cat. No. 550 (50 lb. pull) \$4.00 Send M.O. or check. We pay postage.
Cat. No. 17 (14 lb. pull) \$1.50
Cat. No. 30—Hobbyist assortment of six medium magnets \$1.50

MIAMI MAGNET CO.

3240 N.W. 27th Ave., Aviation Bldg. No. 43, Miami, Florida

WAR EQUIPMENT MAIL SALE!

Gigantic Summer Sale, War Surplus,
Excess Inventory Bargains

- Air Conditioners and Tanks
- Arc Welders A-C and D-C
- Water Pumps, Valves, etc.
- Wire Recorders, home and office
- Farm Weed Spray Outfits

Send Card For Bargain Listings.

BURDEN SALES COMPANY

810 "O" St., LINCOLN, NEBR.

Speed up office work! General Electric Dictator transcribes—plays back. Use for inventory work, taking orders, dictation, etc. Records can be used over and over.

Special Price **\$29.50**
PP

make your own Gems 29.50 F.O.B.

All necessary lapidary equipment is furnished, including a super-charged diamond blade for sawing, and all wheels for grinding, shaping and polishing; also complete instructions. The complete equipment as shown, less motor and belt, for only \$29.50, f.o.b., Burlington, Wisconsin. Write today for information and literature.

B&I MANUFACTURING CO.
Dept. S Burlington, Wis.

AXLE ASSEMBLIES

MODEL 1UCO
Ideal axles for farm implements, carts and trailers of all kinds

\$61.56 Less Tires
F.O.B. Factory

Solid steel construction with springs and saddles—U-bolts and shackles—spring bolts and brackets—hubs and bearings and 15" or 16" Wheels—shipped complete, ready for use

HAMMER BLOW TOOL COMPANY Wausau 13H, Wisconsin

HOBBYISTS! SHOPMEN! Special ONLY \$54.50

PALMGREN "HOBB-E" Rotary, Index, Milling Table

Ideal for Model Parts or Shop Work

Mill-Grind-Drill-Index-Route curved or straight-Rabbit and Mortise on drill press or lathe. 8" Table, 4" Cross Feed, 360° Rotation, Accurately Graduated. Bolts to table. Order NOW! SAVE \$100. Only \$54.50. Less Rotary Feed \$42.75. Write for "HOBB-E" Tool Circular.

CHICAGO TOOL AND ENGINEERING CO.
8365 South Chicago Ave. Chicago 17, Ill.



CIRCULAR SAWS

USE YOUR OWN saw table. Sharpen combination, rip and hollow ground saws from 6" to 10". Makes hand filing obsolete. Saws last twice as long . . . and stay round . . . with correct tooth bevel . . . for cleaner work.

ONLY \$8.95 includes \$3.00 grinding wheel & instructions. At dealers or postpaid. Guaranteed.

"Tru-Circle" Automatic Saw Set. Sets teeth at 10° or more. Only \$2.95. At dealers or postpaid.

A. D. McBurney, 317 E. 4th St., Los Angeles 14, Calif., Dept. A-8

SAY YOU SAW IT IN
POPULAR MECHANICS

MARVEL Mystery Oil

- Frees Sticky Valves
- Stops Hydraulic Valve Clatter

Buy it at your favorite gas station



Wellworth AIR COMPRESSOR

For Farm and Home Workshop

Compressor has 2" bore, 1 3/4" stroke, 2.8 cfm up to 150 lb. pressure. Motor required: 1/4 h.p. at 100 lbs.; 1/2 h.p. at 125 lbs.; 3/4 h.p. at 150 lbs. or equivalent gas engine. V-belt drive, intake muffler and cleaner, bronze bearings, splash lubrication. Wt. 16 lbs. Replacement parts always available. **\$20.50**

COMPLETE OUTFIT. Compressor, pressure tank, air gauge, air chuck, 20 ft. hose, pop valve, copper tubing with 4 brass flared fittings for connecting compressor to tank, 4-way cross and 3 nipples. **COMPLETE OUTFIT, wt. 30 lbs. \$32.45**
Equipment less compressor **\$12.45**
Tank only. **\$6.25**

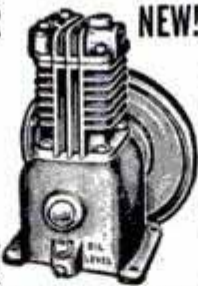

\$32.45

All Brand New Equipment

Wisconsin GAS ENGINES

at a big saving!

BRAND NEW
Model A.B., 2.5 to 3.4 H.P., 2 1/2" bore, 2 3/4" stroke, 13.5 cu. in. Wt. 60 lbs. List Price, \$90.00. **\$76.00**
Special Price...
Model A.K., 3.5 to 4.7 H.P., 2 3/8" bore, 2 3/4" stroke, 17.8 cu. in. Wt. 70 lbs. List Price \$160.50. **\$86.50**
Special Price....

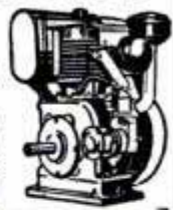

"Wellworth" BLOWER BARGAIN



BRAND NEW
Quiet operating. Double wheel inlet, double width blower. For heating, ventilating, cooling, all washing, exhausting and forced draft. **DIMENSIONS:** 10" wheel; outlet 13 1/2" x 11 3/4"; inlet 8 3/4". Height 19"; Width 18"; Depth 16 1/2"; C.F.M., 1/4" S.P. 1600; outlet vel. 1575; wt. 45 lbs. **BLOWER LESS MOTOR AND DRIVE... \$27.50**

with belt and variable speed pulleys **\$2.50** extra. (Motor required. 1/4 h.p.)

LIGHT PLANTS
5 KW. \$2200 Value

\$895.00

GENERATORS
500 and 2000 Watts

AIR REGULATOR and EXTRACTOR

1/4" Air Regulator, Gauge and filter. Wt. 5 lbs.

BRAND NEW \$8.95

Regulator and Gauge only.... **\$5.95**

Air Filter only..... **\$3.25**



Red Seal Continental Gas Engine

BRAND NEW. 1 1/2 HP with 6 to 1 reduction gear. Operates at 450 R.P.M. For lawn mowers, scooters, garden tractors, pumps, compressors, generators, etc. List Price \$79.50. Shipping weight 54 lbs.

SPECIAL PRICE.. \$47.50
(BRAND NEW)



WELLWORTH V-BELT CLUTCH



Takes starting load off engines or motors. When speed is reached, a flip of handle shifts clutch from idling to driving position. Handles "A" belts, 2.35" pitch diameter, 5/8" bore. Ideal for use with lawn mowers, garden tractors, home workshop motors, etc. 3 1/4" long. Safe, easy to mount, sealed bronze bearings, positive action. Shpg. wt. 3 lbs. **\$7.50**
BUSHING FOR 1/2" SHAFT, 15c

BRAND NEW SAME CLUTCH FURNISHED WITH 3/4" BORE \$8.50

PRICES F.O.B. CHICAGO. MONEY BACK GUARANTEE. SEND CHECK OR MONEY ORDER TODAY. PROMPT SHIPMENT. WRITE FOR CATALOG. SEND 10c FOR POSTAGE

AIR TANK & ACCESSORIES

Air receiver, stainless steel, Brand New, 6"x24", 400 lb. test. Ideal for carrying on trucks, autos and wherever compressed air is needed. Equipped with 500 lb. combination air gauge and inflation valve with core for retaining pressure in tank; tire chuck, 3 ft. high test air hose. Ship. Wt. 12 lbs. Complete outfit. **\$7.95**
Tank only, Wt. 7 lbs. **\$6.25**



WELLWORTH TRADING CO. 1831 S. STATE ST., DEPT. D-8, CHICAGO 16, ILL.

Make Your Own POWER LAWN MOWER
with this DRIVE CUTTER ASSEMBLY
Constructed for those who desire to build their own mower or to replace your old cutter assembly. Complete with 18" blade and double ball bearing drive, only. **\$12.95**
Add 50c to cover handling & shipping. No COD's

Special: COMPLETE POWER MOWER
just add electric motor or gas engine, 18" cut. fob. KC **\$44.95**
WRITE FOR DESCRIPTIVE CATALOGUE
ATLAS EQUIPMENT CO., Dept. PM8
229 SW BLVD. KANSAS CITY, MO.

D. C. ARC WELDER
\$300 VALUE - ONLY \$97.50

200 Amperes Continuous Duty. Up to 250 amps. Intermittent duty. Easily mounted on your tractor. Welding range from 0-up by dial type control. 1-yr. guarantee with money back 10-day trial period. Write for FREE literature. OR send 35c for PLAN "Build Your Welder from Aircraft Generator." Write today.
LEJAY MFG.
847 LeJay Bldg., Minneapolis 8, Minn.

HELPFUL BOOKS
Send post card asking for FREE catalog
Popular Mechanics Press, 200 E. Ontario, Dept. 601, Chicago 11

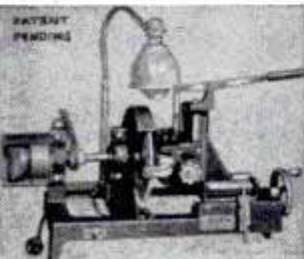

Start a NEW BUSINESS!
or Add to your present Repair Business
SHARPEN DULL PIPE WRENCHES
PIPE TAPS & DIES
"GUM" CIRCULAR SAWS
Write for Information
J. C. MOORE INDUSTRIES
BOX M 276 FREDONIA, PA.

POSTPAID ANYWHERE IN U.S.A. WE FURNISH ALL MACHINED METAL PARTS, EVERY SCREW, NUT, BOLT, WASHER, AND COMPLETE PLANS FOR THIS...
BIG 10" POWER SAW
\$10.95 FULL REFUND IF LESS GUARD NOT SATISFIED & WOOD IN 10 DAYS
COMPLETE PLANS 10c
MARCUS-POLLAK
DEPT. N, ROYERSFORD, PA.

ASSEMBLE IT YOURSELF WITH SIMPLE HOUSEHOLD TOOLS!

MAKE YOUR OWN!
WITH
GRIFFIN LEATHERCRAFT KITS
Best assortment of tools, materials in U.S.A.! Send 25c for 116-page catalog. (money refunded first order)
GRIFFIN CRAFT SUPPLIES
SINCE 1924
5626-A Telegraph Ave., Oakland 9, Calif

584 Page Novelty Catalog Now Ready!
Rush Coupon **584 Pages; 7500 Amazing Novelties**
Send 10c for mammoth new catalog of 7500 novelties. (Each copy costs us over 50c-10c helps pay postage.) More fascinating than World's Fair. Thousands of things you never knew existed—newer where to get. Includes novelties, tricks, jokes, live animals & pets, scientific supplies, den novelties, hobby supplies, planes & boats, looms, magic, unusual seeds, gadget time savers, camera & optical goods, movies, projectors, lucky jewelry, religious novelties, telegraph sets, magnets, disguises, easy musical instruments, stamps, coins, puzzles, fortune tellers, radios, experimental sets, auto & bike accessories, Western belts & wearing apparel, telescopes, magnifiers, compasses, banks, smokers' gadgets, artists' supplies, printing sets, engines & motors, electric shockers, knives, billfolds, weird articles, archery, swimming helps, 1000 fascinating books, games, locks, live chameleons, barometers, rings, watches, charms, imported novelties, exercisers, money savers, handy tools, Indian novelties, etc., etc., etc. Jammed & packed with sensational funmakers & useful articles. Big catalog—over 1 inch thick. 6 color cover. Rush Coupon to Johnson Smith & Co.
— RUSH — THIS — COUPON —
Johnson Smith & Co., Dept. 385, Detroit 7, Mich.
Here's My 10c. Send Big Catalog to:
Name & Address _____

SAVE OVER 50% ON THESE BRAND NEW WAR SURPLUS POWER UNITS



BE PREPARED for any emergency!

LIGHT PLANT BUYERS—
in emergency telephone collect—unit shipped same day!
5 KW Plant, 120 volts, 60 cycle AC. List today \$1910.00. Used \$675.00
NEW. Your price only **\$895.00**

BARGAIN SPECIALS!!

Ball-bearing Arbor... \$ 6.95
Alarm Siren or Horn... 15.45
Mercury Heat Control... 6.95
Barn Ventilator... 69.50
Electric Hot Water Heater, 10 gal... 24.95
Hot Rod Supercharger... 31.00
NEW 2 1/2 HP Briggs & Stratton AP Lists at \$103... \$69

2500 Watt, AC, 110 volts, 60 cycle, Slightly used but reconditioned and fully guaranteed ONLY... \$295.00
NEW, same as above... \$345.00
Plants built in 1951... \$426.00
3000 Watt, 110-220 volts, with AUTOMATIC battery starter... \$465.00
300 Watt, Reg. \$145, Now... \$99.00
750 Watt... \$232.00
1000 Watt AC... \$248.00
3000 Watt DC Contractor's PORTABLE. Rubber tired wheels, 5 to 7 HP gas engine, Used like new \$220.; New... \$279.00
7500 Watt 4 cyl. engine; New... \$995.00
10,000 Watt Used \$1195.00; New... \$1495.00
25,000 Watt Used \$1995.00; New... \$2495.00
35,000 Watt Diesel, Rebuilt \$2995.00
50,000 Watt Diesel, New \$5900.00

Electric MOTORS AC & DC 50% off list!
Single and three phase. 1/4 to 100 HP. GUARANTEED.

HEAVY DUTY, all purpose WINCH

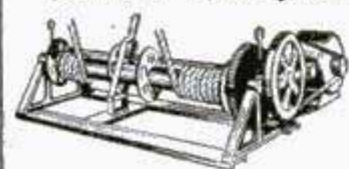

For — CONTRACTORS, BOATS, FARMERS, TRUCKS, LOGGERS, ETC.
Multiply your pulling, hoisting power tenfold. Can be driven by hand, gas, electric, or tractor take off, 10 to 1 ratio; double drum for reverse. Manufactured by Bronner, Wgt. 280 lbs. List price \$119.95. Our price... **\$49.50**

Below are just a few of the many items we have in stock at sensationally low prices:
Pumps Air Tanks Fire Pumps Gear Reducer
Grinders Drop Cords Saws Clutches
Air Compressors Generators Winches Motors

Write today for free catalog. Thousands of \$3 saving buys.
C & H ELECTRIC Co.
434 W. JUNEAU AVE.
MILWAUKEE 3, WISCONSIN

Buy the Mechanic's FIRST Choice

...EMPIRE LEVELS

For Home, Farm, all Trades



See Empire Levels at your dealer, or write for free booklet "Choice and Care of your Level."
Empire No. 151 Aluminum Level; Adjustable vial cases, twin levels, plumbs, 45° vials — 24" — \$7.50.

EMPIRE TOOLS MFG. COMPANY
10930 West Potter Rd., Dept. PM., Milwaukee 13, Wis.

CALENDAR WATCH

CHRONOGRAPH & STOP WATCH

Only **8.95** + 10% TAX

31-Day Automatic Calendar
A precision timepiece and chronograph at an unusual low price. Imported Swiss jeweled movement, Radium Glow 1" dial, red sweep-second hand, shock resistant case, metal expansion wristband. 1 Year Guarantee, 10-day Free Trial. Choice of white, black dial.



GAYLORD DEPT. PH-7, Fifth & Hamilton, Pittsburgh 6, Pa.
Send... Watches @ 8.95 + 90¢ tax. Enclose Check, Money Order, Send C.O.D. Print name, address & dial color in margin.

NEW! OIL BURNER

CHEAP! SWEEPING THE COUNTRY!

SALESMEN BIG MONEY

SLIPS INTO ANY COAL RANGE, STOVE OR FURNACE. Amazing quick, intense heat. By finger-tip control. Cheaper than coal. No more shoveling coal or ashes. SENT ON TRIAL. Prove it pays for itself quickly by what it saves. \$1 bonus for testing. We'll let you try one in your own home for one month. Write for details today. Northwest Mfg. Co., 360-K Main, Mitchell, S. Dak.

CRAFTSMAN

REG. U.S. PAT. OFF.

HAND and POWER TOOLS

Famous for fine quality... precision performance... lower price! Buy them NOW... at Sears convenient Retail Stores... located in principal cities throughout the United States.

SEARS, ROEBUCK and CO.

BIG LEATHER & CRAFT CATALOG!

1000's of items for Leathercraft, Textile Painting, Copper Tooling, Kits, Projects, Tools, Supplies, Etc. Send 25¢ (refunded with 1st order) to:
RUSSO HANDICRAFT SUPPLIES Dept. CD-2, 245 S. SPRING, LOS ANGELES 12, CALIF.

BUILD YOUR OWN FAN

One-piece cast aluminum propellers for cooling and ventilating

Size	Polished	Unpolished	Bore
15	\$3.00	\$4.00	\$2.50
18	3.75	5.00	3.00
20	4.00	5.50	3.25
24	4.50	6.50	4.00

Write for pamphlet on larger fan blades, wire guards, fan bases, shutters, pillow blocks, exhaust fan frames, etc. Shipped prepaid if money accompanies order. Dealers write for discount.
KLOPPENBORG ALUMINUM FDY., Dept. PM-551, Davenport, Iowa

MAGNETS

OF ALL TYPES—10c UP
AMAZINGLY POWERFUL!
1/2 lb. magnet lifts 25 lbs. \$1.95.
Cur Lender, 1 lb. magnet lifts 40 lbs. \$2.95. New alloy—will not weaken! Useful for lifting valuables from tanks, lakes, or rivers easily! 7 small magnets \$1.25 with list of many shop and home uses. Satisfaction guaranteed.
R. EYRICH, 1219 W. WEINCKE AVE., MILWAUKEE, WIS.

SHEET METAL BRAKES

Forms angles, flanges and Pittsburgh locks. 26 gauge steel, heavier aluminum, Cam locking. Portable, can be bolted to bench, or clamped to edge of truck. All steel, reinforced.
Shipped Exp. Coll. 30" size, Wt. 54 lbs., \$26.50. 36", Wt. 66 lbs., \$31.00. 48", Wt. 100 lbs., \$45.00. Floor mountings, portable, 32" high, 30 lbs. \$7.00
12" BRAKE. Fits in vise to form difficult compound bends, up to 20 gauge steel. Not illustrated. \$12.50 PP.
5" Wide Pliers forms locks... \$2.50
24" CURVE FORMER, 2 roll, 16 gauge, 2" to 2" dia. \$10.00 P.P.
IRON BENDER, 1/4x2", capacity, 10 parts. All steel... \$10.00 P.P.
Immediate Delivery. Order direct, cash or C.O.D. or send for folder.
VYKE BRAKE CO., P-1116 So. 27th St., Omaha 5, Nebr.

LAWN ORNAMENT-NOVELTY PATTERNS

28 Lawn Ornament Patterns, 25¢. Other Patterns; 15-20" high; Dutch Girl, Dutch Boy, Pirate, Bull Terrier, Mexican Girl, Mexican Boy, Dwarf, Penguin, Flower Girl, 10¢ each. 25 Novelty Patterns, 30¢. All 62 Full Size Patterns, \$1.00 Postpaid.
Strother Pattern Service, Dept. CK-8, Box 126, Belington, W. Va.

Say You Saw It in POPULAR MECHANICS

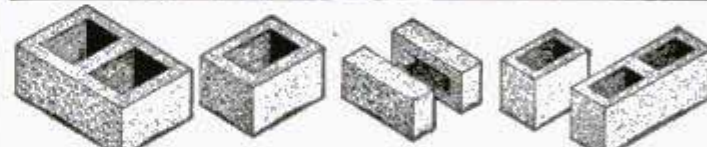

Make Concrete Blocks and Bricks

New superior method makes square, true, easy-to-lay units which will pass any building code. Small investment, high production, big profits. One \$30.00 machine will make four 5"x8"x12" blocks per minute—1000 per day. Pays for itself in a few days. Sell blocks or save 2/3 building cost by making and laying your own.

POST CARD BRINGS FREE FOLDER

Economy Manufacturing Company
Dept. P Stone Mountain, Georgia

FOAM RUBBER

In Slabs, Sheet stock & moulded, pre-formed Cushions, Mattresses & Pads Use it for upholstering, beds, pillows, nooks, chairs, sofas, patio & yard furniture, auto seats, boat deck pads, etc! Priced FAR BELOW current market!

CORED STOCK - Smooth one side, "cored" on other side to give max. resilience & reduce weight. Ideal for chairs, cots, beds, bunks,

thick-pw. sq. ft.	thick-pw. sq. ft.
1"..... .80	3"..... \$1.70
1 1/2"..... 1.10	4"..... 3.00
2"..... 1.50	4 1/2"..... 3.14

SLAB STOCK - Smooth both sides. A solid but spongy material. Use for pads or shock-absorbing layer pads.

thick-pw. sq. ft.	per sq. ft.
1/4".....	-.50
1/2".....	-.50
3/8".....	-.38
3/4".....	-.75
1".....	1.00
1-1/4".....	\$1.25

Pulleys will cut the Slab or Cored Sheet stock to your needs. However all pieces must be rectangular or square in shape of least 1 sq. ft. or larger.

TOPPER PADS	Price
60" x 25" x 1 1/4".....	\$7.95
25" x 60" x 1 1/4".....	\$8.95
25" x 65" x 2".....	\$9.95

SEAT PADS	Price
17 1/2" x 20-1/4" x 2".....	\$2.39
21" x 19 1/2" x 2".....	\$3.75
18" x 22 1/2" x 4 1/2".....	\$6.49
35" x 17 1/2" x 4 1/2".....	\$12.89

MATTRESSES

Size... 54" x 74" x 4-1/2" .. \$83.95
Some as above with durable patterned cover, 3/4 length zipper... \$93.95
Bunk Bed size...
74" x 27" x 4 1/2" .. \$41.95

FOAM RUBBER PILLOWS
Retains shape and stays clean. Covered with fine patterned ticking.
15" x 24" **Only 5.95**

Fisherman's BAROMETER

This Barometer tells you when fish are biting. Veteran fishermen swear it's right 94 times in 100. Easy to read... foretells local weather accurately. Pocket size (3 1/2") with detailed instructions. For altitudes up to 7000 ft. Handsome carrying case included. This is a real must for the fisherman. Now ONLY... **8.15**

NEW AUTO ALTIMETER

Has a fine grade Taylor Barometric movement. Range from 1000 ft. BELOW sea-level to 10,000 ft. ABOVE in 1000 ft. divisions. Instantaneous adjustments... Easy mounting. Guaranteed 5 years. A \$10.00 value... **8.95**

SAVE 85% on WAR SURPLUS

1951 CATALOG
ILLUSTRATED 200 PAGES
1000's of Money Saving Bargains in Camping and Outdoor Equipment, Clothing, Photo Supplies, Binoculars, Tools, Machinery & many, many more. Send only 50¢ TODAY!
(we will refund it on your first order amounting to \$1.00 or more)

PALLEY SUPPLY COMPANY
6321 SAN FERNANDO RD.
Dept. PMB, GLENDALE 1, CALIF.

SAVE UP TO 85% IN WAR SURPLUS

GADGETEERS HEAVEN SPECIAL!

STATIONARY or PORTABLE D.C. ARC WELDER
300 AMPS CONTINUOUS
350-400 AMPS INTERMITTANT
For light or heavy duty work. Will easily handle welding up to 1/2" plate. Made to operate continuously, giving years of trouble-free service. Built around that famous B-29 (R-1) generator incorporating many features no other generator has. Unit includes pulley reactor output controls, Hi-lo switches & rheostat. All assembled on heavy steel frame and easily adapted to mounting on Jeep or Tractor for portability & power supply. Can be run on 7 1/2 HP electric or 10 HP gas motor. Generator alone cost Gov't \$400! NOW ONLY **9750**



MICROPHONE

Telephone type, highly sensitive with excellent clarity. This was the Signal Corps favorite. An ideal instrument for the radio "ham" and professional recording studio, broadcasting, home recording, public address, etc. A sensational buy! Complete with cord and plug... **2.69**

EXACTOR HYDRAULIC REMOTE CONTROL MASTER & SLAVE

Consists of two units. Designed to operate controls on boats, machinery, engines, motors, etc., without need for rods, cables, pulleys, etc. When connected with 1/2" tubing & filled with oil they act as a precision, remote controller. When Master handle is moved, Slave arm responds in exact motion. Range is 0 to 90 degrees. **4250**
Combination Master & Slave for an extra **2125**
control on bridge or stern.

BARGAINS IN SLEEPING BAGS

100% KAPOK FILLED BAG - a real treasure for hiker or camper. Special heavy duty, water repellent outer cover... filled with 3 lbs. imported Kapok... Has 100" zipper down side and across bottom. Large head flap makes dust cover to keep bag dry and clean when rolled up. Large air mattress pocket. Zip to another bag for double-up sleeping...
Wt. 7 lbs. Size 34" x 78" .. **16.95**

MUMMY TYPE BAG Has an outer cover of forest green, water repellent, balloon cloth. Filled with 15% Duck Down and 85% Chicken Feathers. Closes with 3/4 length zipper. NEW Size is 34" by 77" .. **15.95**

RUBBER BOATS

Ideal for fishing or fun! Safe... Lightweight, Re-conditioned & ready! Easy to pack and carry. Complete with carrying case.
1 MAN with **14.95** 4 & 5 MAN **29.95**
7 MAN **42.50** Oars **2.95** PR. Pump **3.95** EA.

MAE WEST PNEUMATIC LIFEJACKET

A MUST for the Fisherman and Boat Owner. Why Take Chances? BE SAFE! Have one for each person aboard. Easily inflated by mouth or sparklette bottle charge. **2.49**

SWIM FLIPPERS

Top quality rubber. No pebble tread bottom. Adj. heel strap... Re-inforced for strength. Vented for air & drainage. Ideal for diving and swimming.
Med. & Small **7.95** Large **8.95**

DIVING MASK

Soft rubber mask fits over eyes. Heavy duty glass shield. Adj. headband.
Jr. **2.59** Ad. **2.69** W. **3.95**

FISHING SPEAR

Corrosion resistant. Ideal for spear fishing. 11" long with barbed end. Dia. of socket 1" 3 for \$1.19 **49.95**

WADING SUIT

Makes surf and stream fishing a pleasure! Made of rubberized canvas with vulcanized seams. Has inner air pockets to give buoyancy and balance in deep water. The rubber gloves & half length boots are vulcanized to sleeves and pants legs.
Sizes - Small, Med., Lge. **6.95**

NYLON FISHLINE

STRONG - LIGHTWEIGHT - NYLON FISHING LINE. ROT-PROOF and WATERPROOF... Especially treated for strength and long life. ON SPOOLS.
1500 ft. 10 lb. \$1.59
1000 ft. 25 lb. \$1.80
750 ft. 45 lb. \$3.29
750 ft. 50 lb. \$3.50
300 ft. 72 lb. Braided \$3.79

THAT SENSATIONAL GSAP 16mm MOVIE CAMERA

Has semi-telephoto, 1-3/8" (35mm) lens with yellow filter - 3 shutter speeds - for normal; (16 frames); semi-slow motion; (32 frames); slow motion; (64 frames) per second. Uses any standard Eastman film magazine or Type "G" AAF magazine. Takes Black & White or Full Color pictures. Operates on 24V (dry cell batteries) & requires no light conversion for hand use.
Cost Gov't \$735.00. NOW ONLY **27.95**

Photo TRIPOD Has Friction Lock, single control head, Precision machined body, and hardwood legs. The legs extend approx. 6 ft. Head tilts freely and is quickly locked. Only **7.95**

Genuine ARMY AIR FORCES SUNGLASSES

HERE'S THE REAL M.C.O.Y!
Optically ground & polished Glare-free, PUR-O-RAY lenses. Guaranteed free of all distortion. Made to meet Gov't specifications. Lenses are Air Force Brown or Green. Ideal for smog fog or haze penetration. Frames are either nickel silver or 14K gold finish. Pearloid sweat bar and pads... Handsome belt loop case. A \$17.50 val. **3.95**

NAVY Sealed Beam LAMP

U. S. Navy, Portable type. Has Pistol Grip and aiming sight. Makes an ideal search, spot or emergency light for your auto, boat, farm, etc.
12V. light - 4" lens **3.29**
24V light - 5" lens **3.79**
Set of 3 filters - red, green, amber... (specify type lamp) **99¢**

NAVIGATORS LAMP

A handy light for desk, work bench... chart table... engine room, etc. Can be used on 6-12-24-110 Volt by changing bulbs. 3 ft. shaft has 4 joints to adjust position... **3.29**

U.S. NAVY BATTLE LANTERN

A powerful lamp complete with two 1 1/2 V. dry cell batteries... size: 7" x 7" x 4". **4.29**

ANGLE SCOPE

A precision, panoramic periscope. Revolving head type. Contains lenses & prisms of very finest quality & can be used in photo, job & shop work. Included are 2-90 degree prisms, 1, 3" dove prism, a 1" achromatic, objective & a 3/8" eyepiece. Can be used separately or in combinations. **5.95**

20 inch TANK TELESCOPES

3 Power... \$4.95 - 20 Power... \$8.95

Aviators (AN-6530) Waterproof & Drip Proof GENUINE GOGGLES

Rubber or chamois covered frame. Clear or Green GROUND LENSES are inter-changeable. Adjustable nose bar. Ideal for flying, motor cycling, etc. **2.19**

GO-1 GOGGLE KIT

NEW! U.S. Navy - Has soft sponge rubber frame. 4 Polaroid lenses. 2 green, 1 red, 1 clear. Perfect for racing, cycling, etc. **89¢**

LARGEST FIRM OF ITS TYPE IN THE WORLD

Order from this ad. All sales final. Prices F.O.B. Glendale. Pay by M.O. or check, P.O.'s accepted from D&B firms. 1/2 deposit with C.O.D.'s.

**FITS THE HAND
FITS THE WORK
FITS THE BELT**



This tag says
"PRETESTED"
It guarantees that each individual tool tested 100% satisfactorily before it left the factory.

This Plier
is made of
CRESTOLOY
STEEL
and has tested
100%
satisfactorily

● Here's one of the finest tools ever to bear the Crescent name. It's an improved, easier-to-use CRESTOLOY Round Nose Lineman's Pliers... streamlined for better handling, better work and easier carrying in the belt. Forged from special "Crestoloy" steel, it's two ounces lighter, yet just as strong as the heavier conventional model. Its cutting edges are carefully hand-honed to provide lasting sharpness. The milled teeth in the nose assure a non-slip grip on wire or other work. The handles fit the hand "like a glove."

No. 2150
Crestoloy 8" Lineman's Pliers. Available also with insulated handles.

CRESCENT TOOL COMPANY, JAMESTOWN, N. Y.

"Crescent" is our trade-mark, registered in the United States and abroad, for wrenches and other tools. Sold by leading distributors and retailers everywhere and made only by Crescent Tool Company, Jamestown, N. Y.

CRESCENT TOOLS
Give Wings to Work

*Sign of the Artisan
Symbol of Excellence*



Printed by Popular Mechanics Company, Chicago, Ill., U. S. A.

POPULAR MECHANICS

readers know that they get smoother performance and quick starts when worn-out spark plugs are replaced with

AUTO-LITE SPARK PLUGS

THESE three world-famous Ignition Engineered Auto-Lite Spark Plugs have been selected as original factory equipment on millions of America's finest cars, trucks and tractors.

- **Auto-Lite Resistor Spark Plugs** offer greater gas savings plus benefits found only in automotive type spark plugs with built-in resistors.
- **Auto-Lite Standard Spark Plugs** offer unsurpassed quality and unbeatable performance.
- **Auto-Lite Transport Spark Plugs** are especially suited to rugged farm, truck, bus service and give lowest cost per mile of spark plug operation.

See your Auto-Lite Spark Plug Dealer today, because "You're Always Right With Auto-Lite."

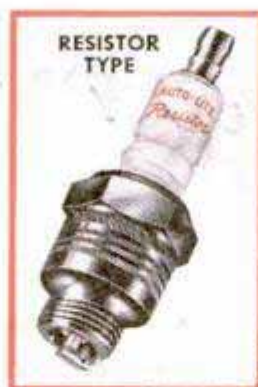

Auto-Lite Spark Plugs—Patented U.S.A.

TUNE IN "SUSPENSE!"... CBS TELEVISION TUESDAYS





Paul Hesse photo

Decorative and other specifications subject to change without notice.

See and drive this 120-horsepower wonder car!

Great new Studebaker Commander V-8

New type V-8 engine! Spectacular zip and pep!
Best gas mileage of any 8 in Mobilgas Economy Run!*

Surprisingly low in price!

*Overdrive, optional at extra cost, was used.

SEE THE TOP VALUE OF THE TOP 4 LOWEST PRICE CARS...THRIFTY STUDEBAKER CHAMPION

©1951, The Studebaker Corporation, South Bend 27, Indiana, U.S.A.