

ANC



# POPULAR MECHANICS

## MAGAZINE

YOU CAN UNDERSTAND IT

REG'D TRADE MARK GREAT

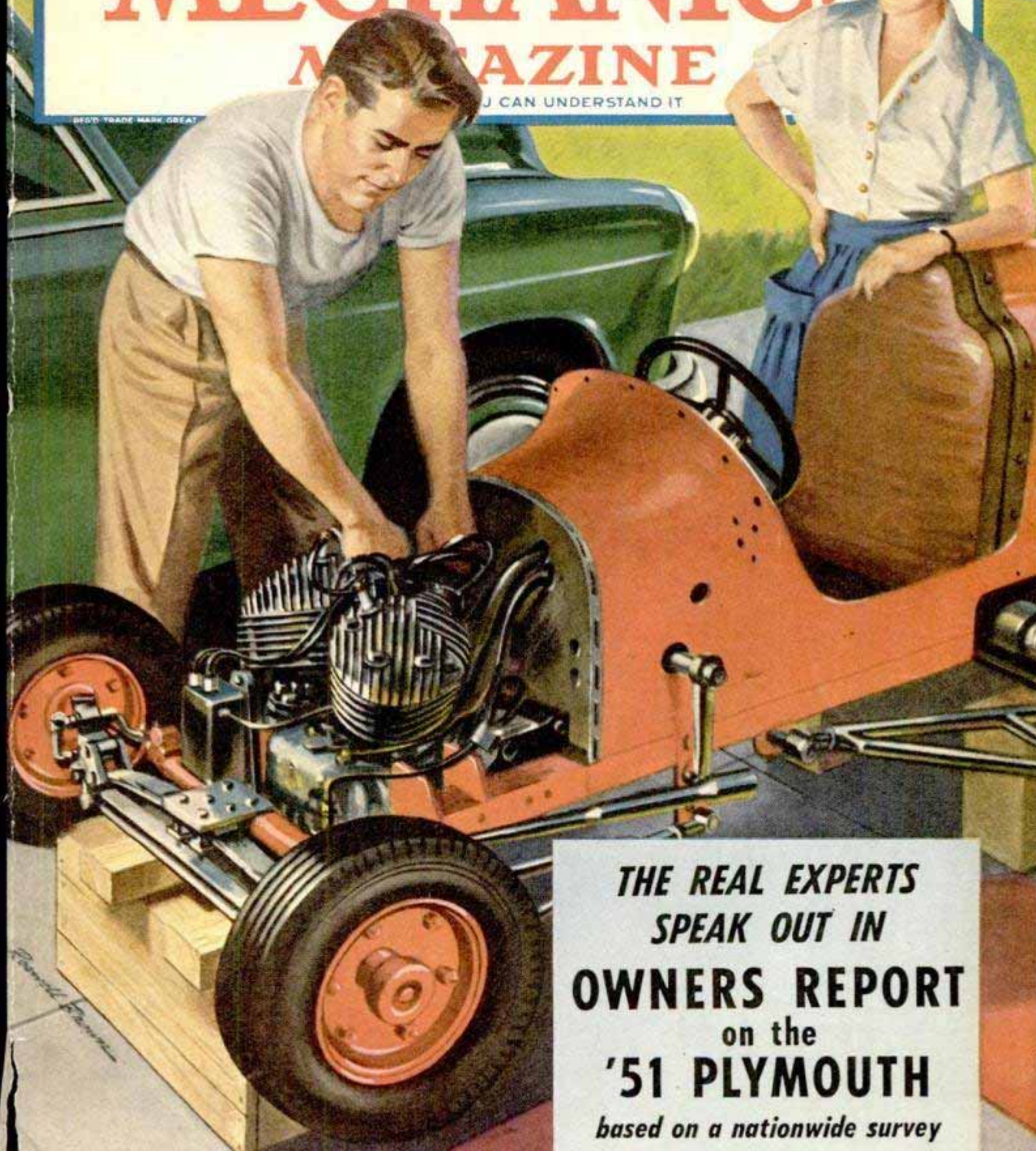

**THE REAL EXPERTS  
SPEAK OUT IN  
OWNERS REPORT**  
on the  
**'51 PLYMOUTH**  
*based on a nationwide survey*

ALSO

**How to Build This Midget Racer**

**A rust-clogged radiator overheats,  
causes trouble and expense**

**CLEAN  
OUT  
RUST**

with

**DU PONT Cooling System CLEANSER**



You can prevent engine overheating by cleaning out rust, scale and scum in the cooling system. Just pour in a can of DU PONT CLEANSER, run

the engine for 30 minutes or more, then drain. It's easy to do, cleans thoroughly and safely. No reverse flushing is required.



**KEEP OUT RUST WITH**

**DU PONT  
Acid and Rust  
INHIBITOR**



After cleaning, you can keep your radiator free from rust all season by pouring in DU PONT ACID AND RUST INHIBITOR. It retards rust and keeps out acid.

**PREVENT LEAKS WITH**

**DU PONT  
Cooling System  
SEALER**



You can stop leaks quickly and securely—and help prevent leaks in the future—by pouring in DU PONT COOLING SYSTEM SEALER. It won't clog the radiator.

**DU PONT**

REG. U. S. PAT. OFF.

**BETTER THINGS FOR BETTER LIVING . . . THROUGH CHEMISTRY**

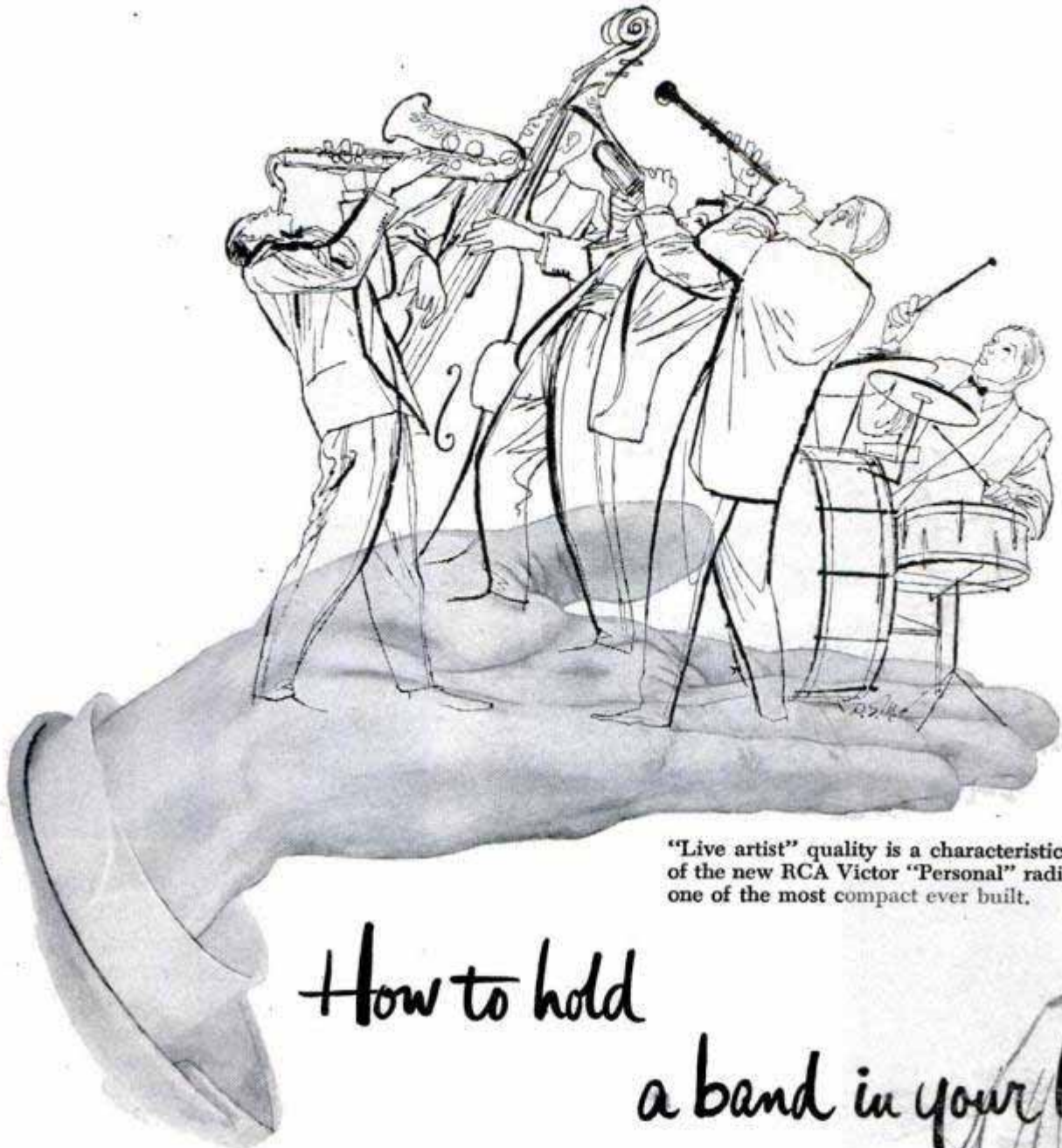

"Live artist" quality is a characteristic of the new RCA Victor "Personal" radio, one of the most compact ever built.

# How to hold a band in your hand!

Tune in this new RCA Victor "Personal" radio—no bigger than a book. From it pour the full tones of any orchestra—so full of "living presence"—that it's like holding a band in your hand.

This instrument grows directly from research at RCA Laboratories. Scientists and engineers here perfected highly efficient circuits and electron tubes—powered by miniature RCA Batteries. Its built-in antenna gives peak per-

formance at home or "on the road." Its miniature loudspeaker offers fine acoustical performance in minimum space.

Development of this handsome portable radio, weighing less than 4 pounds, is another example of RCA research and engineering at work for you. Result: a totally new satisfaction from a small "Personal" radio.

\* \* \*

See the latest wonders of radio, television and electronics at RCA Exhibition Hall, 36 West 49th Street, N. Y. Admission is free. Radio Corporation of America, RCA Building, Radio City, New York 20, N. Y.



For another example of how RCA Research works for you, see the new RCA Victor "Personal" radio today. Model B411—at your local RCA Victor dealer's.



**RADIO CORPORATION of AMERICA**  
*World Leader in Radio — First in Television*





# It tells how you talk

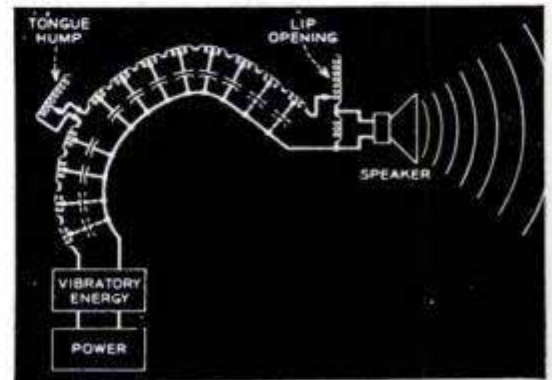
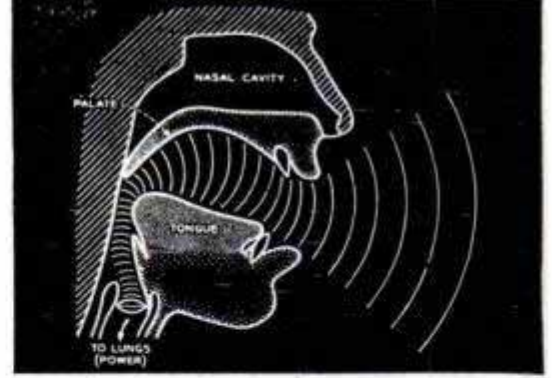

*The machine at the left is saying "Ah!" It's the new electrical vocal system developed at Bell Laboratories. Top sketch shows human vocal system also saying "Ah!" The electrical model is sketched below it. Energy source at bottom of "tract" can emit a buzz sound, like vocal cord tone, or the hiss sound of a whisper.*

No one else speaks exactly like you. Each of us uses different tones to say the same words. To study and measure *how* we make speech, acoustic scientists of Bell Telephone Laboratories built a model of the vocal system.

Electric waves copy those of the vocal cords, electric elements simulate the vocal tract, and, by adjustments, vowels and consonants are produced at pitches imitating a man's or woman's voice.

Using this electrical system, telephone scientists will be able the better to measure the properties of people's voices. Knowing more about speech they can find better and cheaper ways to transmit it.

This is another step in the research at Bell Telephone Laboratories which pioneered the exact knowledge of speech. Past work in the field is important in today's fine telephone service. Still deeper understanding is essential in planning for tomorrow.

**BELL TELEPHONE LABORATORIES**

Exploring and inventing, devising and perfecting, for continued improvements and economies in telephone service



# Popular Mechanics Magazine

Registered in U. S. Patent Office and Canada

H. H. WINDSOR, *Founder*

H. H. WINDSOR, JR., *Editor and Publisher*

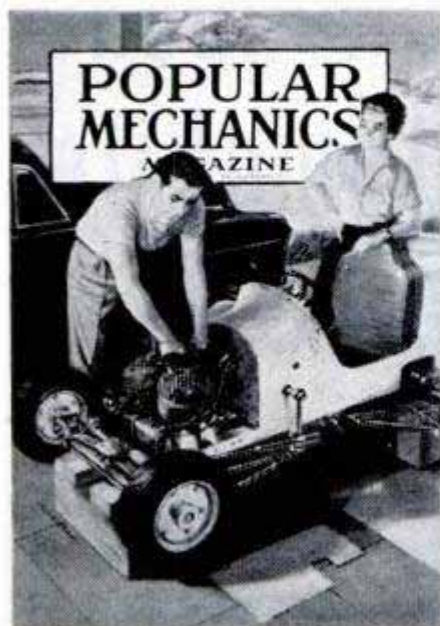

## this month's cover

JUST FINISHED and ready to zip around a "popcorn bowl" is this "TQ" midget racer. In our June 1950 issue, we published a feature on the little racers, which were inspired by kids' sidewalk autos. Three months after the article appeared, the Three-Quarter Midget Racing Association was bogged down with more than 3000 inquiries, most of them requesting plans for building one of the little cars. A reply starts on page 201, where you'll find step-by-step instructions complete with photos and exploded diagrams. Our TQ was designed for back-yard machinists. It's easy to build and most of the parts are standard—you can find them at an auto cemetery. A motorcycle engine serves as power plant. TQ races first were held on the West Coast but the sport is migrating east at top speed. Don't underestimate the midgets—a well-built TQ racer, after delicate tuneup, will snarl around the track at 100 miles an hour

Published monthly by Popular Mechanics Company, 200 E. Ontario St., Chicago 11, Ill. H. H. Windsor, Jr., president; William Harrison Petridge, vice president; D. F. Windsor, vice president and secretary-treasurer; Clover L. Perkins, advertising manager; Alan M. Deyoe, circulation manager. Single copy in the United States and Canada, 35 cents; subscription rates in United States and possessions, Canada, Philippines and countries of the Pan-American Postal Union, 1 year \$3.50; 2 years, \$6.00; 3 years \$8.00. To all other countries add \$1.00 a year over United States prices for overseas postage. If you plan to move, notify us at least 30 days in advance so you will not miss an issue. Give both your old and new addresses.

Entered as Second Class Matter, September 15, 1903, at the Post Office at Chicago, Illinois, under Act of March 3, 1879. Entered as Second Class Matter at Post Office Dept., Canada. Registered as Second Class Matter at the Post Office at Mexico, D. F., Mexico, June 20, 1950.

Copyright 1951 by Popular Mechanics Company. Copyright under International Copyright Union. Copyright in France. All rights reserved under Pan-American Copyright Union. Printed in the United States of America.

JULY 1951

Volume 96

JULY 1951

Number 7

Managing Editor.....Roderick M. Grant  
 Assistant Managing Editor.....Wayne Whittaker  
 Shop Notes and Crafts Editor.....James R. Ward  
 Radio-Television, Electronics Editor.....Frank L. Brittin  
 Associate Editor, Aviation.....Aubrey O. Cookman, Jr.  
 Associate Editor.....Clifford B. Hicks  
 Associate Editor.....Donald R. Brooks  
 Assistant Shop Notes and Crafts Editor.....Wayne C. Leckey  
 Automotive Editor.....Siler Freeman  
 Art Director.....Frank Beatty

### Assistant Editors

W. Clyde Lammy                      Arthur R. Railton                      Frank N. Stephany  
 H. H. Windsor III                      C. E. Mitchell                      Dorothy Hoffmann

Eastern Editor.....Richard F. Dempewolff  
 Empire State Bldg., Room 2906, New York 1, N. Y.

Western Editor.....Thomas E. Stimson, Jr.  
 302 23rd St., Santa Monica, Calif.

Representative in Great Britain.....Douglas W. Wedderspoon  
 77 Baker St., London W. 1, England

Director, Bureau of Information.....Allan Carpenter  
 200 E. Ontario St., Chicago 11

## IN THIS ISSUE

<b>Slo-Mo-Shun Leads the Pack</b>	<b>65</b>
<b>"Co-op" Village in the Woods</b>	<b>72</b>
<b>Miniatures From Butterfly Wings</b>	<b>80</b>
<b>TNT Clinic</b>	<b>88</b>
<b>The Owners Report on the '51 Plymouth</b>	<b>94</b>
<b>What's New for Your Home</b>	<b>104</b>
<b>Fire Bombs Blaze a Trail of War</b>	<b>108</b>
<b>The Lost Rivers Return</b>	<b>117</b>
<b>France Rearms</b>	<b>128</b>
<b>Pioneering the Hells Canyon Dam</b>	<b>134</b>
<b>New York's Waterfront Lumberjack</b>	<b>139</b>
<b>Mystery of the Spinning Dust</b>	<b>144</b>

## For the Craftsman

<b>Build Your Own Nursery Furniture—Part I</b>	<b>150</b>
<b>How I Built the P.M. Ranch House—Part III</b>	<b>162</b>
<b>A Good Paint Job on Concrete</b>	<b>168</b>
<b>Build This 20-Ft. Trimaran</b>	<b>174</b>
<b>Pour Your Own Driveway</b>	<b>182</b>
<b>Servicing the Carburetor</b>	<b>189</b>
<b>How to Make a Power Hacksaw</b>	<b>197</b>
<b>"TQ"—A Speedy Midget Racer</b>	<b>201</b>
<b>Shopping for Tools</b>	<b>208</b>
<b>Radio-Television, Electronics</b>	<b>211</b>
<b>Clinic for Homemakers</b>	<b>220</b>

Other items, and manufacturers of available products described, are listed on pages 12, 14 and 16

# Here is something you don't know about your own automobile

Let's say you're driving your car on a level road at 40 miles per hour. Do you know that *half* the power generated by your motor never reaches the rear wheels; doesn't help your car go farther or faster or climb a steeper hill?

And do you know why? Because automotive engineers have proved that 50% of that motor's power is used to overcome *engine friction*.

Therefore any lubricating oil which further *reduces* this engine friction can't help but deliver the same power with *less* gasoline.

That's exactly what Macmillan Ring-Free Motor Oil does. And we don't just think it's true—we *know* it's true. Here's how we proved it beyond question:

There is a machine called the Dynamometer. It is a scientific way to measure the power an engine delivers to the rear wheels. Cars of all makes, models and ages—cars that had been using *every* nationally known brand of motor oil—were used in this nation-wide test. Hundreds and hundreds of them. And what was the result?

After the oil in these cars had been changed to Macmillan, *the same power was developed with an average of 8% less gasoline*.

The minute you change to Macmillan, you'll get an increase in power and gasoline mileage. You cut down on "drag"—your gasoline "pushes" easier than before. After the second or third drain, the average motorist gets an increase in gasoline mileage of 8%! That's because Macmillan

has not only reduced engine friction but also has reduced carbon and gum deposits in the combustion chamber, on rings, valves, and valve stems. This results in higher compression because of better piston seal—smoother operation, and less tendency for the motor to ping.

That means, at an average price of 25¢ per gallon, you can save 2¢ on every gallon of *gas*—simply by changing your motor *oil*.

That's a big saving— isn't it? Yet it's small when you realize *how much more* you save in repair bills. Because: The less friction, the less wear and tear on your car. New motors stay newer longer.

You can't laugh off proof like that—proof that makes dollars-and-sense! Especially when, on top of all this, Macmillan Oil actually *removes carbon from your motor*—cleans your motor as you drive.

Ask for this fine motor oil at any one of the independent service stations, garages and car dealers where you see the sign of the big red "M." It means Money in your pocket, Mileage in your car. Try the *OIL* that makes your *GAS* go farther.

  
President

MACMILLAN PETROLEUM CORPORATION  
530 W. 6TH STREET, LOS ANGELES  
50 W. 50TH, NEW YORK • 624 S. MICHIGAN, CHICAGO

P.S. If you are unable to locate a Macmillan dealer, write to me and I'll be glad to direct you to the *one* nearest you. R.S.M.

# You'll see more, go farther, spend less riding a HARLEY-DAVIDSON *HYDRA-GLIDE*®

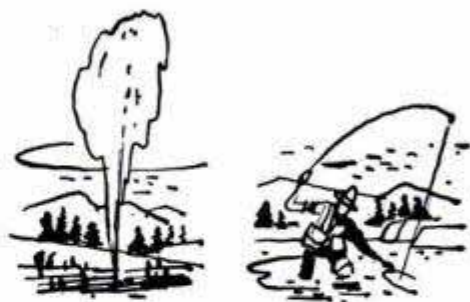

IT'S like nothing else in this world . . . that "out in the open" feeling you get on a Harley-Davidson Hydra-Glide. Nothing to obstruct your view; nothing but the great outdoors all around you . . . and the feel of the wind, song of birds, fragrance of roadside flowers blending with the soft purr of surging power beneath you! You get around easier, too . . . see out-of-way places, hidden scenic splendors, vacation regions so hard to reach by train or bus. You travel comfortably, too, go miles farther in a day without tiring. At trip's end you've seen more, spent less, had more fun! This year give yourself a new vacation treat . . . a thrill-packed tour on a Harley-Davidson Hydra-Glide! See your dealer today.

HARLEY-DAVIDSON MOTOR CO., Dept. P, Milwaukee 1, Wisconsin

Name.....

Address.....

City..... State.....

Send me free copy of ENTHUSIAST Magazine filled with motorcycle action pictures and stories; also literature on new models.

**DEALERS WANTED: A few franchises available for the full line of famous Big Twins and the 125 Model. Write today.**

"Thanks,  
Mister  
for

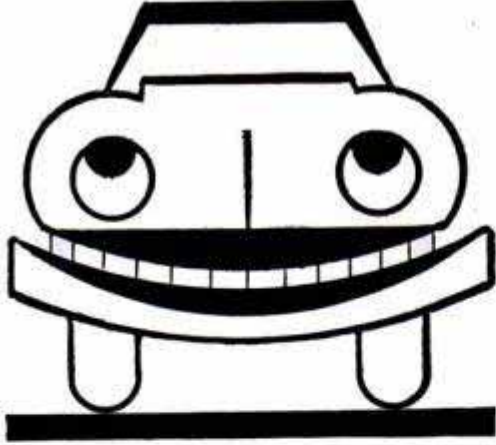

# PYROIL"

If your motor could talk it would say, "Thanks, Mister for giving me Pyroil. It makes me feel so good inside. It keeps my vital parts so slick, smooth and friction-free.\* Best of all, it keeps me young, alive and full of 'go'. And that means that you and I, Mister, will be driving around together a lot longer—a lot better.

"So when you hear me 'hum' inside, you know it's just my way of saying, Thanks, Mister for Pyroil — for adding miles to *your* car."

\*Because Pyroil gives oil the property of clinging to metal surfaces, assuring minimum wear due to friction.

### Pyroil for Aircraft Engines

Use Aircraft Pyroil B for lubricating oil, Aircraft Pyroil A for gasoline.

### GIVEN!

An attractive Pyroil metal savings bank — takes coins up to 50¢ pieces. **MOTORISTS**, it's yours for the asking — sent postage paid.



Manufactured and Guaranteed by  
Pyroil Company, 117 Pyroil Bldg.,  
La Crosse, Wisconsin

Canadian Distributors:  
Central Purchasing Agencies, Ltd.  
Toronto, Ontario

**PYROIL COMPANY**  
117 Pyroil Bldg., La Crosse, Wisconsin

I want my car to last and run properly. Please tell me more about Pyroil and how it can accomplish this for me.

Name \_\_\_\_\_

Address \_\_\_\_\_

City or Town \_\_\_\_\_ State \_\_\_\_\_



in this corner.....

## THE EDITORS



LT. CMDR. ARTHUR L. SCHOENI, author of "Fire Bombs Blaze a Trail of War" on page 108, is the globe-trotting editor of Naval Aviation News—"official bullhorn," he says, "of Navy men who wear wings." Schoeni was born in Illinois 38 years ago but lived in Oregon and Washington from the time he was seven, and was bureau manager for the United Press at Salem, Portland, Olympia and Seattle for a number of years. His career with Naval Aviation News began at the outset of World War II. Since then he has flown a crisscross pattern across all the Naval districts in just about every type of plane the Navy uses, digging up stories about everything from nuts and bolts to the latest carrier jets. A tall, blond, Viking type with a nose for news, he may be found in Guantanamo, Cuba, one week, Pearl Harbor the next, and back in the Pentagon a few days later, grinding out a sheaf of reports for his magazine. He's also a photographic expert. His gripping story in this issue on the effective use of napalm bombs in Korea is his second for *Popular Mechanics*.

### Letter to the Editor

While the undersigned was going through the August 1950 issue of your esteemed magazine he was very much pleased to find

(Continued to page 8)





To the man who wants to enjoy  
**an ACCOUNTANT'S CAREER**



**IF** you're that man, here's something that will interest you.

Not a magic formula—not a get-rich-quick scheme—but something more substantial, more practical.

Of course, you need something more than just the desire to be an accountant. You've got to pay the price—be willing to study earnestly, thoroughly.

Still, wouldn't it be worth your while to sacrifice some of your leisure in favor of interesting home study—over a comparatively brief period? Always provided that the rewards were good—a salary of \$4,000 to \$10,000?

An accountant's duties are interesting, varied and of real worth to his employers. He has *standing!*

Do you feel that such things aren't for you? Well, don't be too sure. Very possibly they *can* be!

Why not, like so many before you, investigate LaSalle's modern Problem Method of training for an accountancy position?

Just suppose you were permitted to work in a large accounting house under the personal supervision of an expert accountant. Suppose, with his aid, you studied accounting principles and solved problems day by day—easy ones at first—then more difficult ones. If you could do this—and could turn to him for advice as the problems became complex—soon you'd master them all.

That's the training you follow in principle under the LaSalle Problem Method.

You cover accountancy from the basic Principles right up through Accountancy Systems and Income Tax Procedure. Then you add C. P. A. Training and prepare for the C. P. A. examinations.

As you go along, you absorb the principles of Auditing, Cost Accounting, Business Law, Statistical Control, Organization, Management and Finance.

Your progress is as speedy as you care to make it—depending on your own eagerness to learn and the time you spend in study.

Will recognition come? The only answer, as you know, is that success *does* come to the man who is really *trained*. It's possible your employers will notice your improvement in a very few weeks or months. Indeed, many LaSalle graduates have paid for their training—with increased earnings—before they have completed it! For accountants, who are trained in organization and management, are the executives of the future.

**Write For This Free Book**

For your own good, don't put off investigation of *all* the facts. Write for our free 48-page book, "Accountancy, The Profession That Pays." It'll prove that accountancy offers brilliant futures to those who aren't afraid of serious home study. We'll also include "Ten Years' Promotion in One"—a book which has helped many men. Send us the coupon *now*.

**LASALLE EXTENSION  
 CHICAGO 5, ILL.**

Over 3200 Certified  
 Public Accountants among  
 LaSalle alumni

- Other LaSalle Opportunities**
- Higher Accountancy
  - C.P.A. Coaching
  - Bookkeeping
  - Law: LL.B. Degree
  - Business Management
  - Salesmanship
  - Traffic Management
  - Foremanship
  - Industr'l Management
  - Stenotypy  
 (Machine Shorthand)

**LASALLE EXTENSION UNIVERSITY  
 A CORRESPONDENCE INSTITUTION**

417 S. Dearborn St. Dept. 764 HR Chicago 5, Ill.

I want to be an accountant. Send me without obligation, "Accountancy, the Profession that Pays"—also "Ten Years' Promotion in One."

Name.....Age.....  
 Address.....  
 City, Zone & State.....





# MEN OF THE HOUR

## are moving UP!

Thousands of Embry-Riddle trained engineers, mechanics, specialists and pilots are making rapid strides in today's booming aviation industry.

These men in the top jobs are undeniably proving that thorough, practical Embry-Riddle training is by far your quickest, surest road to success in aviation. Complete eight-month to two-year Embry-Riddle courses are tailored to practical aviation industry requirements.

The latest, most modern equipment (including jet engines), the finest instructors, the most complete aviation school campus anywhere, are all yours at Embry-Riddle.

If you are now a high school student, a graduate or a veteran, investigate at once the full advantages and tremendous career security of Embry-Riddle training.

If military service interrupts your studies, you're still a long way ahead of the crowd.

Join the Embry-Riddle Men of the Hour. Write for full information today.

### 4 Keys to Success!

#### AIRCRAFT & ENGINE MECHANICS

Our C.A.A.-approved school has a quarter-century aviation training experience. Learn fast with modern equipment, including jet... live aircraft, airline-size hangars.

#### A & E COMBINED WITH COMMERCIAL

Embry-Riddle training gives you unusual dual pilot-engineering ability.

#### AERONAUTICAL DESIGN AND TECHNOLOGY

Embry-Riddle's accelerated 26-mo. Aeronautical Design and Technology Course provides finest training available.

#### COMMERCIAL PILOT

Benefit from our experience with 30,000 students... best instructors and aircraft, year-'round flying weather.



**Embry-Riddle**  
International  
SCHOOL OF AVIATION  
MIAMI 30, FLORIDA

CLASSES BEGINNING NOW -- SEND COUPON TODAY!

Dean of Enrollments -- Dept 99  
Embry-Riddle School of Aviation  
MIAMI 30, FLORIDA  
Please Print

NAME \_\_\_\_\_  
ADDRESS \_\_\_\_\_  
City \_\_\_\_\_  
State \_\_\_\_\_ Age \_\_\_\_\_

I am interested in...

A.&E. Mechanic  
 Commercial Pilot  
 Aeronautical Design and Technology  
 A.&E. Combined with Commercial Pilot  
 Flying Mechanic

Check  Veteran  
One  Non-Veteran

TRAIN IN MIAMI--AIR CAPITAL OF THE WORLD

that it contained a big treasure of useful information about easy spare-time cottage industries.

The one that attracted us most is a handloom on page 70 . . . Being producers of cotton, we are keenly interested and would like to know if you can arrange its export on a commercial scale . . . Our government is encouraging such cottage industries.

We are also keenly interested in a similar machine which could produce 20 single, and 40 single cotton yarns. If any of your readers can help us in this, we shall be very grateful.

Saiyid Hadi Husain Rizvi,  
Shirkat-Ul-Kasibin, Importers,  
Wood Street, P.O. Box 1006,  
Karachi 2, Pakistan.

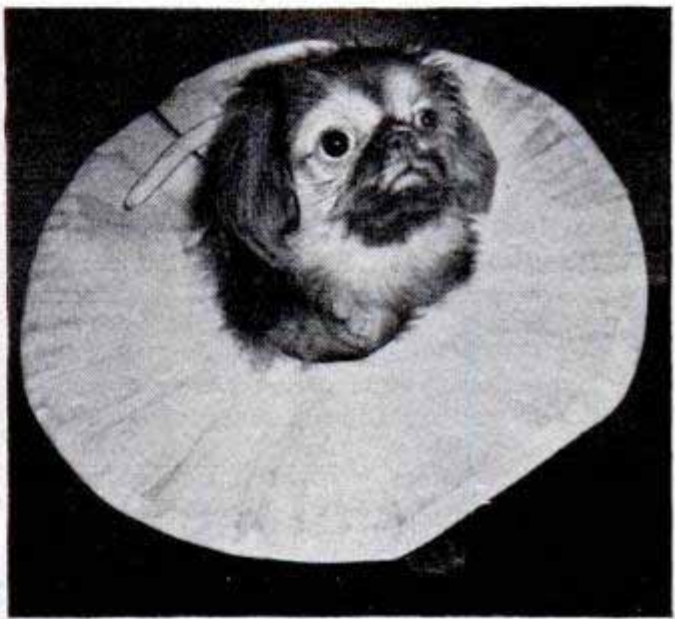

### Prima Donna in an Elizabethan Ruff?

No, this is somebody's darling, a Pekingese on sick leave—one of the principals in the story next month of New York's Speyer Hospital for Animals, where every year are treated some 25,000 pets and strays, monkeys with city jitters, alligators with the itch, movie stars like the Yearling and cats with an appetite for glass. If you like animals, don't miss it!

### Letter to the Editor

Just picked up my monthly copy of *Popular Mechanics* at the newsstand. May I congratulate you on the fine article on the *Popular Mechanics* Ranch House.

It is certainly a beauty, and very well arranged.

Yours very truly,  
Robert L. Moulton,  
Ottawa, Ill.

(Continued to page 10)

# NOW!



Industry needs *trained* men—needs them NOW!

Can you qualify for the premium jobs that are open to trained draftsmen, machinists, technicians?

You can, if you start preparing yourself immediately. And the International Correspondence Schools can help you.

Just mark and mail the coupon below. We'll rush you full information about practical, easy-to-understand I. C. S. Courses—courses being used by many defense industries to train their own workers.

The time for action is NOW!

## INTERNATIONAL CORRESPONDENCE SCHOOLS



BOX 5503-L, SCRANTON 9, PENNA.

Without cost or obligation, please send me full particulars about the course BEFORE which I have marked X:

- |   |  |   |   |
|---|--|---|---|
| <p><b>Air Conditioning and Plumbing Courses</b></p> <ul style="list-style-type: none"> <li><input type="checkbox"/> Air Conditioning</li> <li><input type="checkbox"/> Heating</li> <li><input type="checkbox"/> Refrigeration</li> </ul> <p><b>Chemical Courses</b></p> <ul style="list-style-type: none"> <li><input type="checkbox"/> Chemical Engineering</li> <li><input type="checkbox"/> Chemistry, Analytical</li> <li><input type="checkbox"/> Chemistry, Industrial</li> <li><input type="checkbox"/> Chemistry, Mfg. Iron &amp; Steel</li> <li><input type="checkbox"/> Petroleum Refining</li> <li><input type="checkbox"/> Pulp and Paper Making</li> </ul> <p><b>Civil Engineering, Architectural and Mining Courses</b></p> <ul style="list-style-type: none"> <li><input type="checkbox"/> Architecture</li> <li><input type="checkbox"/> Architectural Drafting</li> <li><input type="checkbox"/> Bridge and Building Foreman</li> <li><input type="checkbox"/> Building Estimating</li> <li><input type="checkbox"/> Civil Engineering</li> <li><input type="checkbox"/> Coal Mining</li> <li><input type="checkbox"/> Contracting and Building</li> <li><input type="checkbox"/> Highway Engineering</li> <li><input type="checkbox"/> Lumber Dealer</li> <li><input type="checkbox"/> Reading Structural Blueprints</li> <li><input type="checkbox"/> Sanitary Engineering</li> <li><input type="checkbox"/> Structural Drafting</li> </ul> | <ul style="list-style-type: none"> <li><input type="checkbox"/> Structural Engineering</li> <li><input type="checkbox"/> Surveying and Mapping</li> </ul> <p><b>Communications Courses</b></p> <ul style="list-style-type: none"> <li><input type="checkbox"/> Electronics</li> <li><input type="checkbox"/> Practical Telephony</li> <li><input type="checkbox"/> Radio, General</li> <li><input type="checkbox"/> Radio Servicing</li> <li><input type="checkbox"/> Telegraph Engineering</li> </ul> <p><b>Electrical Courses</b></p> <ul style="list-style-type: none"> <li><input type="checkbox"/> Electrical Drafting</li> <li><input type="checkbox"/> Electrical Engineering</li> <li><input type="checkbox"/> Electric Light and Power</li> <li><input type="checkbox"/> Lighting Technician</li> <li><input type="checkbox"/> Practical Electrician</li> </ul> <p><b>Internal Combustion Engines Courses</b></p> <ul style="list-style-type: none"> <li><input type="checkbox"/> Auto Technician</li> <li><input type="checkbox"/> Diesel-Electric</li> <li><input type="checkbox"/> Diesel Engines</li> </ul> <p><b>Mechanical Courses</b></p> <ul style="list-style-type: none"> <li><input type="checkbox"/> Aeronautical Engineer's, Jr.</li> <li><input type="checkbox"/> Aircraft Drafting</li> <li><input type="checkbox"/> Forging</li> <li><input type="checkbox"/> Heat Treatment of Metals</li> <li><input type="checkbox"/> Industrial Engineering</li> <li><input type="checkbox"/> Industrial Instrumentation</li> </ul> | <ul style="list-style-type: none"> <li><input type="checkbox"/> Industrial Metallurgy</li> <li><input type="checkbox"/> Machine Shop</li> <li><input type="checkbox"/> Mechanical Engineering</li> <li><input type="checkbox"/> Mold-Loft Work</li> <li><input type="checkbox"/> Patternmaking—Wood, Metal</li> <li><input type="checkbox"/> Reading Shop Blueprints</li> <li><input type="checkbox"/> Sheet-Metal Drafting</li> <li><input type="checkbox"/> Sheet-Metal Worker</li> <li><input type="checkbox"/> Ship Drafting</li> <li><input type="checkbox"/> Tool Designing</li> <li><input type="checkbox"/> Toolmaking</li> <li><input type="checkbox"/> Welding—Gas and Electric</li> </ul> <p><b>Railroad Courses</b></p> <ul style="list-style-type: none"> <li><input type="checkbox"/> Air Brake</li> <li><input type="checkbox"/> Diesel Locomotive</li> <li><input type="checkbox"/> Locomotive Engineer</li> <li><input type="checkbox"/> Locomotive Fireman</li> <li><input type="checkbox"/> Locomotive Machinist</li> <li><input type="checkbox"/> Railroad Section Foreman</li> <li><input type="checkbox"/> Steam-Diesel Loco. Eng.</li> </ul> <p><b>Stationary Eng'g Courses</b></p> <ul style="list-style-type: none"> <li><input type="checkbox"/> Boilermaking</li> <li><input type="checkbox"/> Combustion Engineering</li> <li><input type="checkbox"/> Engine Running</li> <li><input type="checkbox"/> Marine Engineering</li> <li><input type="checkbox"/> Power Plant Eng'g</li> </ul> | <ul style="list-style-type: none"> <li><input type="checkbox"/> Mech. Drafting</li> <li><input type="checkbox"/> Ship Fitting</li> </ul> <p><b>Textile Courses</b></p> <ul style="list-style-type: none"> <li><input type="checkbox"/> Cotton Manufacturing</li> <li><input type="checkbox"/> Loom Fixing</li> <li><input type="checkbox"/> Textile Designing</li> <li><input type="checkbox"/> Woolen Manufacturing</li> <li><input type="checkbox"/> Rayon Weaving</li> </ul> <p><b>Business and Academic Courses</b></p> <ul style="list-style-type: none"> <li><input type="checkbox"/> Accounting</li> <li><input type="checkbox"/> Bookkeeping</li> <li><input type="checkbox"/> Business Administration</li> <li><input type="checkbox"/> Bus. Correspondence</li> <li><input type="checkbox"/> Certified Public Accounting</li> <li><input type="checkbox"/> Commercial</li> <li><input type="checkbox"/> Cost Accounting</li> <li><input type="checkbox"/> Federal Tax</li> <li><input type="checkbox"/> Foremanship</li> <li><input type="checkbox"/> Good English</li> <li><input type="checkbox"/> Higher Mathematics</li> <li><input type="checkbox"/> Industrial Supervision</li> <li><input type="checkbox"/> Motor Traffic</li> <li><input type="checkbox"/> Retailing</li> <li><input type="checkbox"/> Salesmanship</li> <li><input type="checkbox"/> Sign Lettering</li> <li><input type="checkbox"/> Spanish</li> <li><input type="checkbox"/> Traffic Management</li> <li><input type="checkbox"/> Advertising</li> <li><input type="checkbox"/> Bus. Law</li> <li><input type="checkbox"/> Commercial Art</li> <li><input type="checkbox"/> First Year College</li> <li><input type="checkbox"/> French</li> <li><input type="checkbox"/> High School</li> <li><input type="checkbox"/> Illustration</li> <li><input type="checkbox"/> Postal Civil Service</li> <li><input type="checkbox"/> Retail Bus. Management</li> <li><input type="checkbox"/> Secretarial</li> <li><input type="checkbox"/> Stenography</li> </ul> |
|---|--|---|---|

Name \_\_\_\_\_ Age \_\_\_\_\_ Home Address \_\_\_\_\_

City \_\_\_\_\_ State \_\_\_\_\_ Working Hours \_\_\_\_\_ A.M. to \_\_\_\_\_ P.M.

Present Position \_\_\_\_\_ Employed by \_\_\_\_\_

Length of Service \_\_\_\_\_  
in World War II \_\_\_\_\_

Enrollment under G.I. Bill approved for World War II Veterans. Special tuition rates to members of the Armed Forces.  
Canadian residents send coupon to International Correspondence Schools Canadian, Ltd., Montreal, Canada.

# VOTE TODAY

## FOR THE FUTURE YOU WANT!

AMERICAN SCHOOL, Dept. GB45, Drexel at 58th, Chicago 37, Ill.  
Without obligation, please send FREE and postpaid, full particulars about the subject checked below.

- |  |   |   |
|--|---|---|
| <input type="checkbox"/> Accounting              | <input type="checkbox"/> Drafting—Building Trades | <input type="checkbox"/> Plastics Engineering |
| <input type="checkbox"/> Air Conditioning        | <input type="checkbox"/> Drafting—Machine Trades  | <input type="checkbox"/> Plumbing—Practical   |
| <input type="checkbox"/> Architecture & Building | <input type="checkbox"/> Electrical Engineering   | <input type="checkbox"/> Private Secretary    |
| <input type="checkbox"/> Automotive Technician   | <input type="checkbox"/> Electricity—Practical    | <input type="checkbox"/> Refrigeration        |
| <input type="checkbox"/> Better Foremanship      | <input type="checkbox"/> Electronics—Industrial   | <input type="checkbox"/> Retail Merchandising |
| <input type="checkbox"/> Bookkeeping             | <input type="checkbox"/> High School Courses      | <input type="checkbox"/> Salesmanship—Outside |
| <input type="checkbox"/> Business Management     | <input type="checkbox"/> Machine Shop Operations  | <input type="checkbox"/> Sheet Metal Work     |
| <input type="checkbox"/> Contracting             | <input type="checkbox"/> Mathematics & Slide Rule | <input type="checkbox"/> Tool Making          |
| <input type="checkbox"/> Diesel Technician       | <input type="checkbox"/> Mechanical Engineering   |   |

OCCUPATION .....  
 NAME ..... AGE .....  
 HOME ADDRESS .....  
 CITY ..... STATE .....

### THIS IS YOUR BALLOT

Find the subject that interests you most and then... Check, Sign and Mail Today

• Today, choose the job you want — and prepare for it in spare time at home. Or if you are already engaged in the work you like best, start training now for quicker promotion. In hours you might otherwise waste, gain the knowledge and skill that can help you to get ahead faster, make more money, and have greater security.

#### Training Backed by 54 Years of Experience

For over half a century American School has helped ambitious men and women toward success by providing specialized training for commercial and technical advancement. Its study program for you has been planned by experts with years of experience in the subject you select and they will give you needed guidance every step of the way.

#### Don't Delay Your Start

Give serious thought to the list of training courses listed above. Pick the opportunity that interests you, check it and add your name and address. (Check more than one if you are undecided as to which appeals most.) Finally clip out and mail the "ballot" and full information will be supplied, without cost or obligation.

AMERICAN SCHOOL  
DEPT. GB45, DREXEL AT 58th, CHICAGO 37, ILL.

THE SOONER YOU START, THE SOONER YOUR GOAL CAN BE REACHED



Nesco, Inc., 270 N. 12th, Milwaukee, Wis.

### The New Shape in Pails

Maybe it's habit, but we've been using round pails for a few hundred years. Now a Milwaukee manufacturer introduces an oval pail for which a number of advantages are cited. The new shape accommodates wide sponge-rubber mops more readily, its narrow base fits more snugly on stair treads, and it pours and carries more easily.

### Sorry, Our Mistake

Through a typographical error the manufacturer of a nonjamming zipper with a release mechanism was shown in our May issue, page 104, as "Zee Zipper." The correct name is Kee Zipper Co., 350 Fifth Ave., New York City 1.

### Letter to the Editor

Inasmuch as I am a constant reader of your magazine I, obviously, like it. However, the automobile articles by Floyd Clymer are the best ever. We "lay people" need such data and information as he gives out and will look forward each month to the car covered therein. Thanks.

Lincoln Holland, Jr.,  
3365 Glendale Blvd.,  
Los Angeles, Calif.

### Oysters Opened With Nothing

Nothing is used to open oysters in a new process — at least, very close to nothing! The tight-shelled mollusks are dumped into a vacuum chamber from which the air is removed. In a short time, the oysters are yawning their shells wide open. Air is allowed to rush back into the chamber. The sudden-pressure change kills the oysters by tearing the shell-contracting muscles and the meat is easily removed.

# WHAT Every AUTO MECHANIC Wants to Know

A motor vehicle is a machine of many parts, each part designed and constructed for its own special function.

All good mechanics, like good doctors, should know the working theory and operation of each part and understand what causes trouble and how to remedy it.

## LET AUDELS AUTO GUIDE SOLVE YOUR PROBLEMS

Every auto mechanic, helper, serviceman and operator can use a copy of AUDELS AUTOMOBILE GUIDE. The information it gives saves time, money and worry. Highly indorsed by all users. It presents the whole subject of auto mechanics from A to Z in plain language and simple terms.

This Big Practical Book gives full information with working diagrams covering the principles, construction, ignition, service and repair of modern cars, trucks and buses.

A complete Guide of 1800 pages, with over 1500 illustrations showing inside views of the working parts, with instructions for service jobs. Diesel engines, Fluid and Hydra-matic drives fully explained.

### IT PAYS TO KNOW HOW TO

How to fit pistons—How to locate engine knocks—How to fit connecting rod bearings—How to service main bearings—How to re-condition valves—How to time valves—How to adjust fan belts—How to adjust carburetors & chokes—How to rebuild a clutch—How to service automatic transmissions—How to service brakes—How to adjust steering gear—How to cope with ignition troubles—How to service distributors—How to time ignition—How to "tune up" an engine.

### INFORMATION IN A HANDY FORM

73 INTERESTING CHAPTERS—Read this partial list of subjects on which practical information is fully given for quick reference under the headings as shown below. Ready Reference Index.

All Parts of an Automobile—Automotive Physics—The Gas Engine—Gas Engine Principles—Multi-Cylinder Engines—Horse Power—Automobile Engines—Stationary Parts—Moving Parts—Pistons—Piston Rings—Connecting Rods—Crank Shafts—Valves—Valve Gear—Cams and Cam Action—Valve Timing—Cooling Systems—Fuel Feed Systems—Dual Fuel Feed—Mixture—Carburetors—Carburetor Service—Automatic Choke—Super-Chargers—Transmissions—Special Transmissions—Fluid and Hydra-matic Drives—Clutches—Universals and Propeller Shafts

A Ready Reference

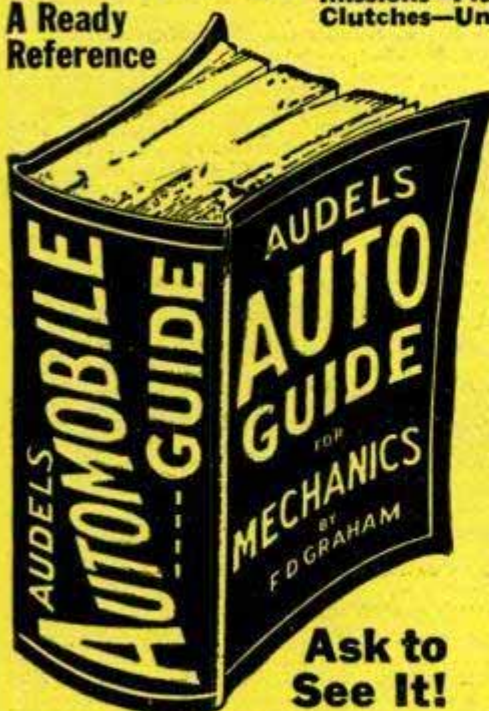

—The Differential—Rear Axles—Rear and Front Suspension—Running Gear—Brakes—Wheel Alignment—Knee Action—Steering Gear—Tires—Lubricants and Lubrication—Automotive Electricity—Ignition Systems—Magneto Ignition—Spark Plugs—Ignition Coils—Distributors—Automatic Spark Control—Ignition Timing—Generators—Starters—Generator and Starter Testing—Lighting Systems—Storage Batteries—Charging and Testing—Diesel Engines and Trouble Shooting.

**7 DAYS' FREE TRIAL**  
TO GET THIS ASSISTANCE FOR YOURSELF SIMPLY FILL IN AND MAIL COUPON TODAY.

**\$4 COMPLETE PAY \$1 A ONLY 1 MO.**



### Sent on 7 Days Approval

Step up your own skill with the facts and figures of your trade. Audels Mechanics Guides contain Practical Inside Trade Information in a handy form. Fully illustrated and Easy to Understand. Highly Endorsed. Check the book you want for 7 DAYS FREE EXAMINATION. Send No Money. Nothing to pay postman.

## ---CUT HERE--- MAIL ORDER

AUDEL, Publishers, 49 W. 23 St., NEW YORK 10, N. Y.

Please send me postpaid for FREE EXAMINATION books marked \* below. If I decide to keep them I agree to mail \$1 in 7 Days on each book or set ordered and further mail \$1 monthly on each book or set until I have paid price, otherwise I will return them.

- TRUCK & TRACTOR GUIDE, 1299 Pages \$ 4
- AUTOMOBILE MECHANICS GUIDE, 1800 Pages 4
- DIESEL ENGINE MANUAL, 575 Pages 2
- MACHINISTS HANDY BOOK, 1650 Pages 4
- WELDERS GUIDE, 400 Pages 1
- BLUE PRINT READING, 416 Pages 2
- MATHEMATICS & CALCULATIONS, 700 Pages 2
- SHEET METAL PATTERN LAYOUTS, 1100 Pages 4
- SHEET METAL WORKERS HANDY BOOK, 388 Pgs. 1
- MECHANICAL DRAWING GUIDE, 160 Pages 1
- MECHANICAL DRAWING & DESIGN, 480 Pages 2
- AIRCRAFT WORKER, 240 Pages 1
- TELEVISION SERVICE MANUAL, 384 Pages 2
- RADIOMANS GUIDE, 914 Pages 4
- ELECTRONIC DEVICES, 216 Pages 2
- ELECTRIC MOTOR GUIDE, 1000 Pages 4
- ELECTRIC WIRING DIAGRAMS, 272 Pages 1
- ELECTRICIANS EXAMINATIONS, 250 Pages 1
- ELECTRIC POWER CALCULATIONS, 425 Pages 2
- HANDY BOOK OF ELECTRICITY, 1440 Pages 4
- ELECTRIC DICTIONARY, 9000 Terms 2
- ELECTRIC LIBRARY, 7000 Pages (12 Book Set) 18
- MARINE ENGINEERS HANDY BOOK, 1258 Pgs. 4
- SHIPFITTERS HANDY BOOK, 250 Pages 1
- REFRIGERATION & Air Conditioning, 1280 Pgs. 4
- MILLWRIGHTS & MECHANICS GUIDE, 1200 Pgs. 4
- POWER PLANT ENGINEERS GUIDE, 1500 Pages 4
- ENGINEERS & FIREMANS EXAMS, 525 Pages 1
- PUMPS, Hydraulics & Air Compressors, 1658 Pgs. 4
- ENGINEERS LIBRARY (3 Book Set) 9
- MECHANICAL DICTIONARY, 950 Pages 4
- GARDENERS & GROWERS GUIDES (4 Book Set) 6
- CARPENTERS & BUILDERS GUIDES (4 Book Set) 6
- PLUMBERS & Steamfitters Guides (4 Book Set) 6
- MASONS AND BUILDERS GUIDES (4 Book Set) 6
- PAINTERS & DECORATORS MANUAL, 450 Pgs. 2
- HOUSE HEATING GUIDE, 1000 Pages 4
- OIL BURNER GUIDE, 384 Pages 1

Name \_\_\_\_\_  
Address \_\_\_\_\_  
Occupation \_\_\_\_\_  
Employed by \_\_\_\_\_

AUDEL, Publishers, 49 W. 23 St., New York 10, N. Y.

# Don't Forget!

## PROTO means PROfessional TOols!

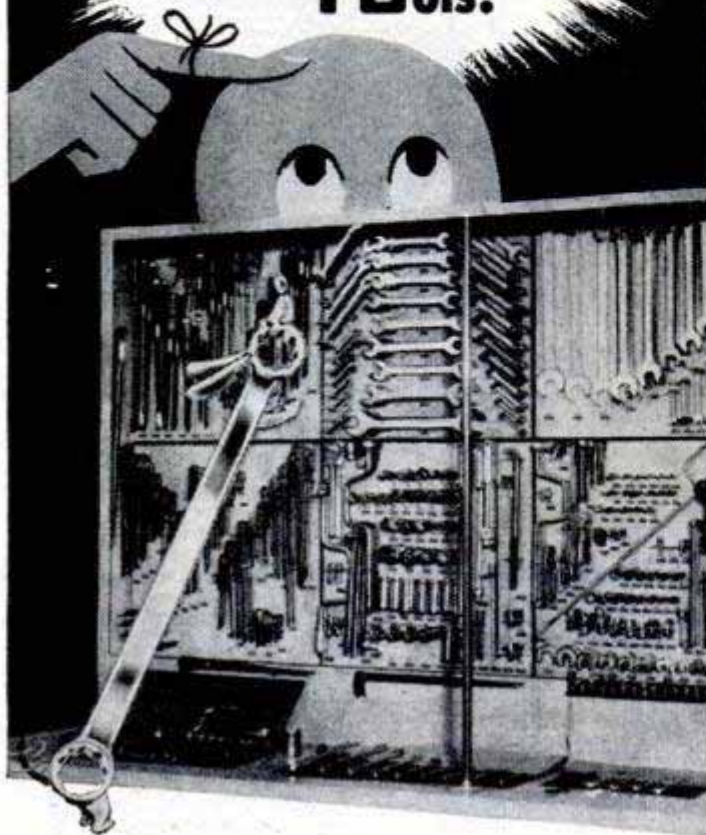

Like professional users, you can point with pride to your PROTO tools. And, like our Wrenchund, you'll sit up and take notice when you see that each tool does your work faster, safer and better. Modern designs? You bet! Special steels? Toughest yet! How to buy? One or a set! See your PROTO dealer.

Send 10¢ for 68-page catalog to

**PLOMB TOOL COMPANY**  
2255H Santa Fe Ave., Los Angeles 54, Calif.

### TOOLAGRAM



PROTO adjustable wrenches are forged from fine alloy steel. The lower jaw design fully seats both square and hex nuts, preventing slippage. Sizes—4"–20".

5183

# PROTO TOOLS

REG. U. S.  
PAT. OFF.

LOS ANGELES

MADE  
IN U. S. A.

Source of supply appears after items commercially available

#### AUTOMOTIVE

What, no electric iron?	78
Detroit listening post	86
Liquid seals engine parts against moisture (Elektrik Seal Laboratories, 161 W. Elm St., Chicago 10)	107
German auto salon	114
Oil gauge and viewer show motorist oil sample (Oil-Eye Corp., Winona, Minn.)	116
Gasoline-tank sealer (R.A. Shannon & Co., 5792 Oster St., Pontiac, Mich.)	126
Dimmers for night driving (Bruce Industries, Atwater St., Plantsville, Conn.)	138

#### AVIATION

Pilot will see own plane and others near airport on television	71
Twenty-man umbrella raft	84
Back-tilting seat protects air passenger in crash	116
Pilot escape simplified	132
Inflated rubber bags lift damaged airplane	146

#### BOATS

Rubber compound seals boats (Marine Products, Inc., 166 N. Main St., Oshkosh, Wis.)	71
Fast ferry "wings" along at 35 knots	93
Folding boat has two detachable wheels for highway travel (Ozarka, Inc., Woodstock, Ill.)	143

#### HOUSE AND HOME

The new shape in pails (Nesco, Inc., 270 North 12th St., Milwaukee, Wis.)	10
Plastic plants (Plastic Plants Co., 210 St. Clair Ave., N.W., Cleveland, Ohio)	79
Wind controls chimney vent cap (Tesco, Inc., 110 S. Norfolk, Tulsa, Okla.)	92
Picture heater (Electrofilm Corp., 7116 Laurel Canyon Blvd., North Hollywood, Calif.)	104
Ventilating window (Lilly-Vent, Inc., 7692 S.E. Powell Blvd., Portland, Ore.)	104
Hook-on strainer (Sunset Sales Corp., 1001 North Vermont, Hollywood 29, Calif.)	104
Clam shucker (Hoffritz for Cutlery, 551 Fifth Ave., New York City 17)	104
Button gauge (John Dritz & Sons, 1115 Broadway, New York City 10)	105
Air circulator (W. W. Welch Co., 439 Race St., Cincinnati, Ohio)	105
Portable mixer (Rowe Industries, Inc., Sag Harbor, Long Island, N. Y.)	105
Pressing sponge (David Traum Co., Inc., 11 East 26th St., New York City 10)	105
Drying frames (Queen Mfg. Co., 4227 Lake St., Chicago 24)	105
Metalized window curtain aids in A-bomb protection (Strategic Products, Inc., 600 S. Michigan Blvd., Chicago 11)	122
Cedar-chest scent (Thrifty Products Co., Box 371, GPO, Brooklyn 1, N. Y.)	138
Cuckoo clocks in kit form imported from Germany (J. F. Reich, Quivira Lake, Kansas City 3, Kans.)	142
Drive-in metal clip holds shelves (Asa D. Scott Industries, Inc., 1028 E. 63rd St., Chicago 37)	147
Air freshener (Vita-Aire Div., Hydro Aire Corp., Waukesha, Wis.)	248

#### INDUSTRY

Interlocking construction block (Precision Building System, Inc., Canton, Ohio)	87
Rubber "chain" drive (U. S. Rubber Co., 7300 Keystone St., Tacony, Philadelphia 35, Pa.)	102
Seismic lab on wheels	103
Electric-wheeled tractor (R. G. LeTourneau, Inc., Peoria, Ill.)	106
Oil-well instrument charts slant of underground formations (Carter Oil Company, 1133 N. Lewis, Tulsa, Okla.)	122
Macaroni-making process shapes hollow propellers	123
Locomotives stop rolling but don't stop working	123
Pavement saw (Joy Mfg. Co., Henry W. Oliver Bldg., Pittsburgh 22, Pa.)	132
"Three o'clock" welding process (Lincoln Electric Co., 12818 Coit Road, Cleveland 1, Ohio)	133
"Breathing package"	143
Tank-car laundry	148

#### LAWN AND GARDEN

Lawn seeder (R. Krasberg & Sons Mfg. Co., 2501 Homer St., Chicago 47)	107
Self-cleaning rake (Arthur Paul Sales, Box 495, Green Bay, Wis.)	132
Portable greenhouse (Old Copper Mine Farms, Inc., Dept. P1, Warrenton, N. J.)	147

#### MILITARY

Army "grows" roads in Pacific	16
Robot antiaircraft gunner	71
Foxhole digger	138
Blackout tape (Century Coating Co., Whitestone, L. I., N. Y.)	146

#### MODELS AND NOVELTIES

Thimble drome (L. M. Cox Mfg. Co., Box 476, Santa Ana, Calif.)	113
Railroad in an English garden	124
Mailbox "hangs" on a chain	133
Miniature bagpipe	133
Midget fluid-drive tractor	142

(Continued to page 14)

# BE A SUCCESS AS A RADIO-TELEVISION TECHNICIAN

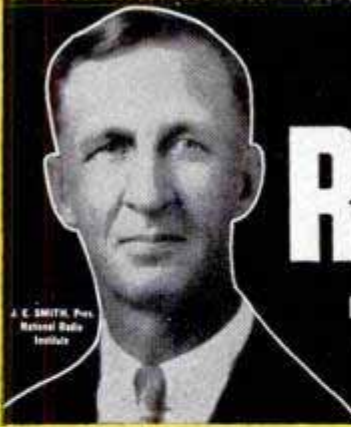

J. E. SMITH, Pres. National Radio Institute

2 FREE BOOKS SHOW HOW MAIL COUPON

America's Fast Growing Industry Offers You

Available to VETERANS under G. I. Bill

## 1. EXTRA MONEY IN SPARE TIME

Many students make \$5, \$10 a week extra fixing neighbors' Radios in spare time while learning. The day you enroll I start sending you SPECIAL BOOKLETS to show you how to do this. Tester you build with parts I send helps you service sets. All equipment is yours to keep.

## 2. GOOD PAY JOB

Your next step is a good job installing and servicing Radio-Television sets or becoming boss of your own Radio-Television sales and service shop or getting a good job in a Broadcasting Station. Today there are over 90,000,000 home and auto Radios. 3100 Broadcasting Stations are on the air. Aviation and Police Radio, Micro-Wave Relay, Two-Way Radio are all expanding, making more and better opportunities for servicing and communication technicians and FCC licensed operators.

## 3. BRIGHT FUTURE

And think of the opportunities in Television! In 1950 over 5,000,000 Television sets were sold. By 1954 authorities estimate 25,000,000 Television sets will be in use. Over 100 Television Stations are now operating, with experts predicting 1,000. Now is the time to get in line for success and a bright future in America's fast-growing industry. Be a Radio-Television Technician. Mail coupon for Lesson and Book—FREE.

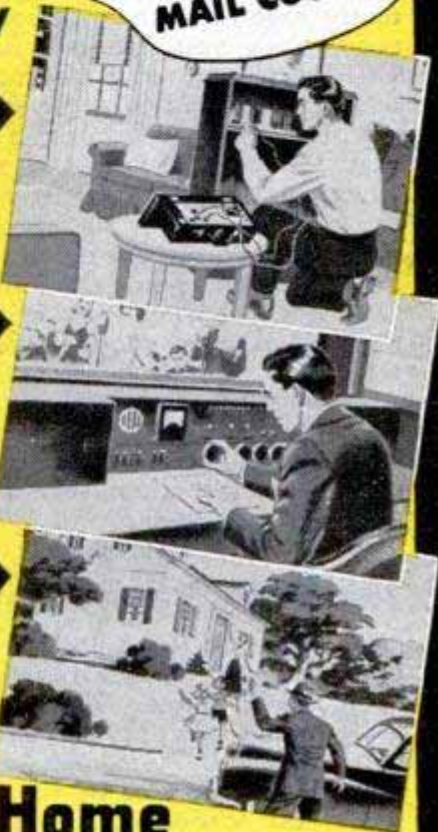

### I TRAINED THESE MEN

- Shop Specializes in Television.** "Have my own shop. Am authorized serviceman for 5 large manufacturers, do servicing for 7 dealers. N. R. I. enabled me to build enviable reputation." P. MILLER, Maumee, Ohio.
- NRI Graduate Doubles Salary.** "Am with Station WKBO as transmitter operator. More than doubled salary since starting in Radio full time. N. R. I. has been helpful to me." A. HERR, New Cumberland, Pa.
- \$10 Week in Spare Time.** "Before finishing course, I earned as much as \$10 a week in Radio servicing in spare time. I recommend N. R. I. to everyone who shows interest in Radio." S. J. PETRUFF, Miami, Florida.
- Gets First Job Through N.R.I.** "My first job was operator with KDLK, obtained for me by your Graduate Service Dept. I am now Chief Eng. of Police Radio Station WQOX." T. S. NORTON, Hamilton, Ohio.

## I Will Train You at Home

Read How You Practice Servicing or Communications with Many Kits of Parts You Get!



I send you many valuable Kits of parts for PRACTICAL EXPERIENCE. They "bring to life" theory you learn in my illustrated texts. As part of my Servicing Course, you build a complete, powerful Radio Receiver, a Multi-tester useful in earning extra spare time money, AM and FM Signal Generator, etc. In my Communications Course, you assemble a low-power Broadcasting Transmitter that shows you how to put a station "on the air," a Wavemeter, etc. This and other equipment I send you, is yours to keep.

**NOW! Advanced Television Practice**

New, special TV kits furnished to build high-definition SCOPE . . . RF OSCILLATOR with flyback power supply . . . complete TV set . . . many other units. You see pulse, trapezoidal, saw-tooth wave forms. Get valuable PRACTICAL EXPERIENCE locating and correcting TV troubles. Mail coupon for facts, pictures and prices!

Keep your job while training at home. Hundreds I've trained are successful RADIO-TELEVISION TECHNICIANS. Most had no previous experience; many no more than grammar school education. Learn Radio-Television principles from illustrated lessons. Get PRACTICAL EXPERIENCE—build valuable Electronic Multitester for conducting tests; also practice servicing Radios or operating Transmitters—experiment with circuits common to Radio and Television. At left is just part of the equipment my students build with many kits of parts I furnish. All equipment is yours to keep. Many students make \$5, \$10 a week extra fixing neighbors' Radios in spare time.

#### Mail Coupon For 2 Books FREE

Act Now! Send for my FREE DOUBLE OFFER. Coupon entitles you to actual lesson on Servicing; shows how you learn Radio-Television at home. You'll also receive my 64-page book, "How to Be a Success in Radio-Television." You'll read what my graduates are doing, earning; see photos of equipment you practice with at home. Send coupon in envelope or paste on postal.

J. E. SMITH, Pres., Dept. 1GA, National Radio Institute, Washington 9, D. C. . . . Our 38th year.

### Good for Both—FREE

Mr. J. E. SMITH, President, Dept. 1GA, National Radio Institute, Washington 9, D. C. Mail me Sample Lesson and 64-page Book about How to Win Success in Radio-Television. Both FREE. (No salesman will call. Please write plainly.)

Name \_\_\_\_\_ Age \_\_\_\_\_  
 Address \_\_\_\_\_  
 City \_\_\_\_\_ Zone \_\_\_\_\_ State \_\_\_\_\_  
 Check if Veteran Approved Under G. I. Bill





## THOUGHTS HAVE WINGS

### You Can Influence Others With Your Thinking

TRY IT SOME TIME. Concentrate intently upon another person seated in a room with you, without his noticing it. Observe him gradually become restless and finally turn and look in your direction. Simple—yet it is a *positive demonstration* that thought generates a mental energy which can be projected from your mind to the consciousness of another. Do you realize how much of your success and happiness in life depend upon your influencing others? Is it not important to you to have others understand your point of view—to be receptive to your proposals?

How many times have you wished there were some way you could impress another favorably—*get across to him or her your ideas?* That thoughts can be transmitted, received, and understood by others is *now* scientifically demonstrable.

### This FREE Book Points the Way

The tales of miraculous accomplishments of mind by the ancients are now known to be fact—not fable. The method whereby these things can be **INTENTIONALLY**, not accidentally, accomplished has been a secret long cherished by the Rosicrucians—one of the schools of ancient wisdom existing throughout the world. Write for the free copy of the fascinating sealed book, "THE MASTERY OF LIFE," which explains how you may receive this unique wisdom and benefit by its application. Address: Scribe Z. S. K.

## The ROSICRUCIANS

San Jose, (AMORC) California

### USE THIS COUPON

Scribe Z. S. K.  
The Rosicrucians  
San Jose, California

I am sincerely interested in an intelligent method of attaining a mastership of life. Send me without obligation, your FREE Book which explains how I may receive and use your age-old method.

Name.....  
Address.....  
City.....

### OFFICE, SHOP AND STORE

High-speed facsimile .....	126
Lighted "road map" in office building.....	127
Budget protector helps shoppers.....	142
File-card conveyor operated by pedals (Remington Rand, Inc., 315 Fourth Ave., New York City 10).....	143

### OUTDOOR RECREATION

Rubber tape (Central States Industrial Supply Co., Terminal Tower, Cleveland, Ohio) .....	79
"Snowball" ride .....	92
Plastic mask for gridders.....	127

### MISCELLANEOUS

America "weighs" its land resources.....	70
Sagebrush shredder (J. I. Case Co., Racine, Wis.).....	78
Borings from trunk reveal tree's age.....	79
Farm wastes grow wonder drugs.....	87
Volunteer life guards patrol Aussie beaches.....	100
Flippy trains for "I.Q." test.....	102
Pneumatic panning of movie scenes (Grover Photo Co., 201 1/2 E. Broadway, Glendale, Calif.).....	107
"Strait jacket" for liquid ozone.....	107
Vertical table holds book for bedridden patients.....	113
Helium-3 solidified for the first time.....	123
Fish-foed fisherman .....	127
White leather stays white.....	132
Self-tightening hose clamp (Corbin Hose Clamp Div., American Hardware Corp., New Britain, Conn.).....	133
Water "sanitizer" .....	138
TV microscope .....	146
Frozen pollen .....	147
Merry-go-round for bulls .....	148
Potent antimalaria drug .....	248

## Craftsman and Shop Notes Index

### DRAFTING AND LAYOUT

Abrasive strip on T-square prevents slipping.....	157
Cork insert in drawing board safely supports compass.....	160
Calibration on wooden scale kept clean with tape.....	167
Lamp shade and glass pane provide setup for tracing.....	181
Builder's blueprints held flat with screen-door catches.....	200

### FARM

Milking-machine extension cord travels on overhead line....	200
Ice discourages broody hens.....	207
Water trough for young calves.....	210

### FIXTURES

Molding clamped to edge grain with improvised fixture.....	157
Soldering-iron heat conserved with steel-pipe holder.....	160
Conduit-clamp toolholders .....	186
Support for long gutter lengths permits installation by one man .....	188
"Rocker" mount for oil drum permits easy pouring.....	200
Welding table has open-grid top.....	207

### HOBBIES AND NOVELTIES

Railings for model buildings from cotter pins and solder....	161
Personalized paper doll from child's own photo.....	173
Decorative plywood rack holds fly swatters.....	187
Slip poured through paper spout.....	181

### HOUSE AND HOME

Picnic sugar kept dry.....	158
Net bags used to store bath toys.....	158
Moth balls inserted in coat hanger.....	158
Automatic meat baster.....	158
Wristwatch holder for desk.....	159
Cleaning gilt picture frames.....	159
Aluminum foil saves ironing time.....	159
Replacing Venetian-blind cord.....	159
Applying DDT .....	159
Protecting dressing-table top.....	159
Sun lamp bleaches scorched fabric.....	159
Worn linoleum renewed.....	159
Cornstarch removes grease spots.....	159
Easy way to hang curtains.....	159
Cleaning Venetian blinds.....	159
Powder puff used to apply varnish.....	159
Stair rail made slideproof by spiral wire wrapping.....	160
Sponge cuts down soap waste.....	173
Convenient rack for kitchen towels has three swinging arms..	193

### MOTORS

Electric motors started manually.....	160
File aids adjusting carburetor on engine too hot to handle....	160
Stationary-engine muffler.....	210

(Continued to page 16)

**IMPORTANT NOTICE**—It is the intention of this magazine to provide its readers with information regarding the latest developments in the mechanical arts. We take no responsibility as to whether the disclosures contained in our articles are covered by patents and advise readers to investigate this subject before making, using, or selling any of the products, machines, or processes described in order to avoid possible liability for patent infringements.



# INVENTORS

**L**earn how to protect your invention. The U. S. Patent Laws provide that any new and useful art, machine, article of manufacture, or composition of matter, or any new and useful improvement thereof, may be patented if the act of invention is involved. Therefore, every inventor with a valuable invention should take advantage of the Patent Laws and proceed for patent protection in order to safeguard his rights.

A patent gives the inventor the exclusive right to prevent others from making, using, or selling the invention claimed in the patent for a period of seventeen years.

The Patent Laws were enacted for the benefit of the inventor to give him protection for the features of his invention which are patentable. These features must be properly and concisely set forth and claimed in a formal application for patent, in order to comply with the requirements of the Patent Laws. For that reason, unless the inventor is familiar with patent matters, he should engage a competent registered patent attorney or agent to represent him. We are registered to practice before the U. S. Patent Office and are prepared to serve you in the handling of your patent matters.

A specially prepared booklet entitled "Patent Guide for the Inventor", containing detailed information with respect to patent protection and procedure, together with a "Record of Invention" form will be promptly forwarded to you without obligation upon request.

---

**CLARENCE A. O'BRIEN & HARVEY JACOBSON**

*Registered Patent Attorneys*

**11-G DISTRICT NATIONAL BUILDING**

**WASHINGTON 5, D. C.**

# Immediate Comfort And Relief for You with **RUPTURE-EASER**

(A PIPER BRACE PRODUCT)

for MEN, WOMEN and CHILDREN

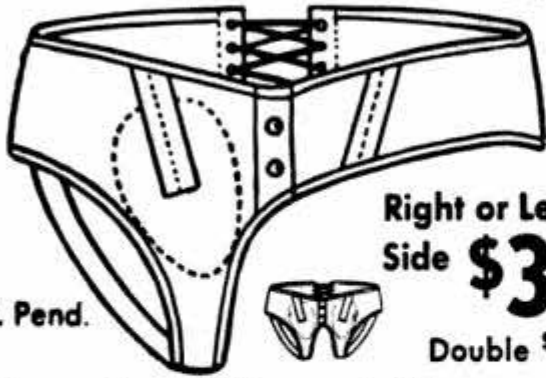

Pat. Pend.

Right or Left  
Side **\$3.95**  
Double **\$4.95**

A strong, form fitting washable support designed to give you relief and comfort. Adjustable back-lacing and adjustable leg straps. Snaps up in front. Soft flat groin pad—**NO STEEL OR LEATHER BANDS.** Unexcelled for comfort, **INVISIBLE UNDER LIGHT CLOTHING.** Washable. Also used as after operation support.

● **THE MOST EFFECTIVE HERNIA SUPPORT.**

Thousands of people who have tried old-fashioned, expensive devices turn to Rupture-Easer for new comfort.

● **RUPTURE-EASER IS SANITARY.**

Can be washed without harm to fabric—you never offend when you wear Rupture-Easer.

● **NO FITTING REQUIRED.**

Just measure around the lowest part of the abdomen and specify right or left side or double.

**Over 250,000 Grateful Users**

**R. C. of Corvallis, Oregon, Air Mails:** "Send me another Rupture-Easer so I will have one to change off with. It is enabling me to work at top speed at my press machine 8 hours a day."

**M. S. of Anderson, Ind., thanks us and says:** "It is one of the finest things I have ever worn and has made my life worth living. It has given me untold ease and comfort."

**O. B. R. of Boston:** "Send me another . . . I wish to say to everyone who suffers as I did, 'Oh what relief I have found from its help!'"

**Blessed Relief Day and Night—You can sleep in it—you can work in it—you can bathe in it.**



**10-DAY TRIAL OFFER.**

Money-back guarantee if you don't get relief.

**PIPER BRACE CO., DEPT. PM-71**  
811 Wyandotte, Kansas City 6, Mo.

**Piper Brace Company, Dept. Dept. PM-71**

811 Wyandotte, Kansas City 6, Mo.

Please send my RUPTURE-EASER by return mail.

Right Side  \$3.95 Measure around lowest part of  
Left Side  \$3.95 my abdomen  
Double  \$4.95 is ..... INCHES.

(Note: Be sure to give Size and Side when ordering.)

We Prepay Postage except on C.O.D.'s.

Enclosed is:  Money Order  Check for \$\_\_\_\_\_  Send C.O.D.

Name.....

Address.....

City and State.....

**RUSH THIS COUPON NOW!**

(Continued from page 14)  
**PAINTING AND REFINISHING**

Helpful hints on varnishing.....	161
Nail polish "mix" fills cracks.....	173
Newly painted chairs "shod" to protect floors.....	186
Valuable advice from master craftsman on refinishing antiques.....	187

**PHOTOGRAPHY**

Economically constructed camera-lens shade specially designed for indoor photography.....	194
"Quick-rinse" solution saves time when removing hypo.....	194
Crinkled section of metal-foil paper softens harsh shadows on subject.....	194
Tripod carrier.....	195
Bulk-film can serves as dispenser for loading 35-mm. cartridges.....	196
Negatives placed in business envelope are pressed flat with heavy book.....	196

**RECREATION**

Fish kept fresh in this homemade cold box.....	161
Coating of insulating material restores old vacuum jug.....	167
Folding backrest on boat seats.....	188

**TOOLS**

Saw-blade armature tool.....	173
Roofing-paper seams sealed with castor "roller".....	181
Pliers used as emergency calipers.....	186
Rivet set smooths screwheads.....	193
Stops clamped to hacksaw blade control depth of cut.....	200
Jet-spray brush (Tucker Mfg. Co., 305 First St., S.W., Cedar Rapids, Iowa).....	208
Ball-type universal wrench sockets (Plomb Tool Co., Los Angeles 54, Calif.).....	208
Vest-pocket tachometer (Verdell Instrument Sales Co., Box 212, Burbank, Calif.).....	208
Periphery press holder (M. E. Cunningham Co., 83 E. Carson St., Pittsburgh 19, Pa.).....	208
Radial saw motor (DeWalt, Inc., Lancaster, Pa.).....	209
Punch press (Kenco Mfg. Co., 5211 Anaheim-Telegraph Blvd., Los Angeles, Calif.).....	209
Adjustable drill jig (Mathewson Machine Works, Inc., 2 Hancock St., North Quincy 71, Mass.).....	209
Hollow masonry drill (Tilden Tool Mfg. Co., 1144 W. Washington Blvd., Chicago).....	209
Easily made machinist's jack.....	210

**MISCELLANEOUS**

Oilcan doubles as glue applicator.....	157
Applying friction tape in restricted places.....	167
Driving tacks in tight places.....	173
Improvised repair of bicycle chain.....	173
Trailer lights made dependable by improving contacts of ground circuit.....	181
Tips on cutting glass.....	186
Small mechanisms lubricated by "hypodermic" grease gun.....	186
Holding machine screws in vise when cutting with hacksaw.....	188
Removing calcimine from walls.....	188
Bobby pin taped to paste bottle serves as brush holder.....	188
Sediment filter on auto fuel line improvised from T-fitting and screen.....	210
Renewing bolt threads.....	210

**Radio-Television, Electronics**

Television in the home (Combination weather vane and TV antenna, Zenith Mfg. Co., 6001 Dickens Ave., Chicago 39; TV glare filter, Vernon Robbins, E-Z-C TV Filter Co., Paynesville, Minn.).....	211
Safety-first service hints for TV set owners.....	212
Radio and electronics today (Portable amplifier, Leslie Products Co., 12002 Lansing Ave., Leslie, Mich.; multiple outlet box, Sun Radio and Electronics Co., 122 Duane St., New York City; metal detector, RCA Victor, Camden, N. J.; three-way portable radio, General Electric Co., Syracuse, N. Y.).....	216

**Army "Grows" Roads in Pacific**

Some roads built by U. S. Army Engineers in the Pacific have to be fed until they are strong enough to do their job. On islands where there is no rock aggregate, the road builders lay the base course with coral taken from the sea. The coral is fragile and too easily pulverized to make a good roadbed when first taken from the water. To remedy this, the engineers have to spray the live organisms with a salt solution several times daily for six weeks so they will keep growing and knit themselves into a firm surface.

# INVENTORS

If you believe that you have an invention, you should find out how to protect it. The first step is to have a search made of the prior pertinent U. S. patents. If a report on this search indicates that the invention appears patentable you can apply for a patent, and the specifications and claims should be prepared.

The firm of McMorrow, Berman & Davidson, with offices in Washington, D. C., is qualified to take the necessary steps for you. We can make a preliminary search on your invention, advise you whether we think it can be patented, and prepare your application for patent.

Unless you are fully familiar with the U. S. Patent Laws, we recommend that you engage the services of a Registered Patent Attorney to protect your interests. The patent laws are *your* laws. A patent gives you the right to prevent others from making, using or selling the invention claimed in your patent for a period of 17 years.

Use these patent laws for your protection. Investigate whether your invention can be patented. If you have what you believe to be an invention, we suggest that you have this firm make a search for you.

*Send for a copy of our Patent Booklet entitled "How To Protect Your Invention," containing information about patent protection and patent procedure. Along with this we will also send you an "Invention Record" form, for your use in writing down and sketching details of your invention. We will mail them promptly. No obligation. They are yours for the asking.*

**McMORROW, BERMAN & DAVIDSON**

*Registered Patent Attorneys*

**PATENTS • COPYRIGHTS • PATENTS**

**135 - W VICTOR BUILDING, WASHINGTON 1, D. C.**

# Will You Let Me PROVE I Can Make YOU a New Man?

LET ME START SHOWING RESULTS FOR YOU



I COULD fill this whole magazine with enthusiastic reports from OTHERS. But what you want to know is— "What can Atlas do for ME?"

## 15 MINUTES A DAY

Just give me 15 minutes of your spare time daily. That's all I ask. And even in that short time I'll start giving RESULTS. And it will be the kind of RESULTS that you (and anyone else) can SEE, FEEL, MEASURE with a tape.

I myself was once a 97-pound weakling—sickly, half-alive. Then I discovered "Dynamic Tension." And I won the title, "The World's Most Perfectly Developed Man!"

"Dynamic Tension" has done so much for other fellows that I simply ask you to let me prove that it can make a New Man of YOU—that it can start new inches of power pushing out your chest—build up your shoulders to champion huskiness—put new, hard, firm muscles on your biceps—make those stomach muscles of yours hard ridges!

**FREE—My Illustrated Book is Yours — Not for \$1.00 or 10c — But FREE**

Send for my book, "Everlasting Health and Strength," 48 pages, packed with actual photos, valuable advice. A real prize for any fellow who wants a better build... but yours FREE! Rush coupon to me personally: Charles Atlas, Dept. 8G, 115 East 23rd St., New York 10, N.Y.



**CHARLES ATLAS, Dept. 8G, 115 East 23rd St., New York 10, N. Y.**

Send me—absolutely FREE—your famous book, "Everlasting Health and Strength"—48 pages, crammed with photos, answers to vital questions, valuable advice. I understand book is mine to keep, and sending for it does not obligate me in any way.

Name \_\_\_\_\_ Age \_\_\_\_\_  
 (Please print or write plainly)  
 Address \_\_\_\_\_  
 City \_\_\_\_\_ State \_\_\_\_\_

TUBE GIVEN WITH EVERY TIRE AT NO EXTRA COST

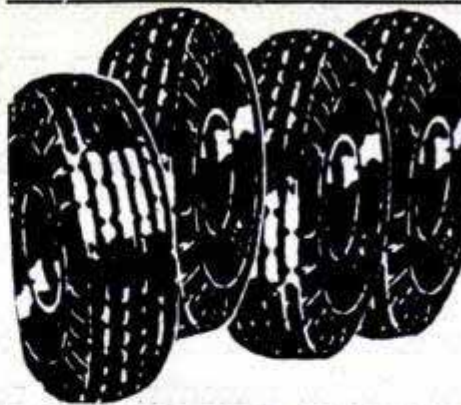

WRITTEN GUARANTEE SENT WITH EVERY TIRE YOU BUY

PLEASE NOTE: Our Tires are NOT Re-Treaded or Re-Capped

GOOD USED TIRES

A TRIAL OF ONE TIRE WILL CONVINCE YOU.

TUBE GIVEN WITH EACH PASSENGER & TRUCK TIRE AT NO EXTRA COST—SEND THIS AD!

If your size is not listed, write for prices. 17 YEARS AT THIS ADDRESS

600-16	\$5.92	670-15	\$6.12	710-15	\$6.82	760-16	\$7.72
650-16	5.82	700-15	6.42	750-16	8.72	820-15	8.52
650-16	6.22	700-16	7.22	760-15	8.72	850-17	5.72

600-20	\$9.72	32x6(8)	\$11.72	1000-20	\$22.52
650-20	10.52	32x6(10)	14.72	1100-20	22.52
700-20	12.72	825-20	21.52	1000-22	19.52
750-20	13.92	900-20	17.72	1100-22	20.42

Thousands of tires shipped all over U.S.A. All tires shipped F.O.B. Phila. Send Check or M.O. with this ad. Dept. 2.

**STANDARD 834 N. Broad St., Philadelphia 30, Pa.**

## Learn WOOD PRODUCTION ENGINEERING

At Home In Your Spare Time

from THE ONLY SCHOOL OF ITS KIND

**Veterans**  
 You must enroll in training before July 1st to get it free under the G. I. Bill. Act Now!

Prepare now for a top pay position in the furniture and woodworking industry... with KLOK SPECIALIZED TRAINING. Teaches you the arts of Sketching—Drafting—Time Study—Production Scheduling in our Home Study Course or Resident Course at Grand Rapids.

FREE Booklet



**WRITE TODAY**—for FREE Booklet. State age, veteran, non-veteran, Home Study or Resident Course preference, occupation.

JOHN H. KLOK, Pres. Woodworking Industry Training Since 1928  
**KLOK INSTITUTE, E. Louis St. N.W., Grand Rapids 2, Mich.**

## LEARN WATCH REPAIRING



**AT HOME.** By our modern and original system of instruction you can learn every part of the WATCH REPAIRING TRADE AT HOME. Prepare yourself for a well-paying position or start in business after completing our course of instruction. Good watch repairers are in demand and generally earn very good salaries. For particulars apply to the WISCONSIN SCHOOL OF WATCH REPAIRING, 759 North Milwaukee St., Milwaukee 2, Wis.

## RADIO ENGINEERING, Broadcasting, Television, FM, Servicing, Electronics, Aviation, Marine & Police Radio taught thoroughly.

Engineering course equivalent to 3 years' college radio work. Approved Veteran Training. Catalog free.  
**VALPARAISO TECHNICAL INSTITUTE, Dept. D, Valparaiso, Ind.**

Say You Saw It in Popular Mechanics

## HAVE FUN!

with Your Own OUTDOOR FIREPLACE

It's easy to build yourself! Just add masonry—to your choice of design—around one of these all-metal units and you have an outdoor fireplace that works right. Costs less! A true recreation spot—for family or guests—right in your own yard. Everyone loves to cook and eat outdoors! Choice of sizes and accessories available. See your dealer, or send



56 Pages

DESIGN BOOK



WRITE FOR COPY TODAY



check or money order  
 Model OF-28 Only \$20.95  
 Size 21"x26"x13½"

FULL OF IDEAS

THE MAJESTIC COMPANY  
 367 Erie Street, Huntington, Indiana

# Like father... like son

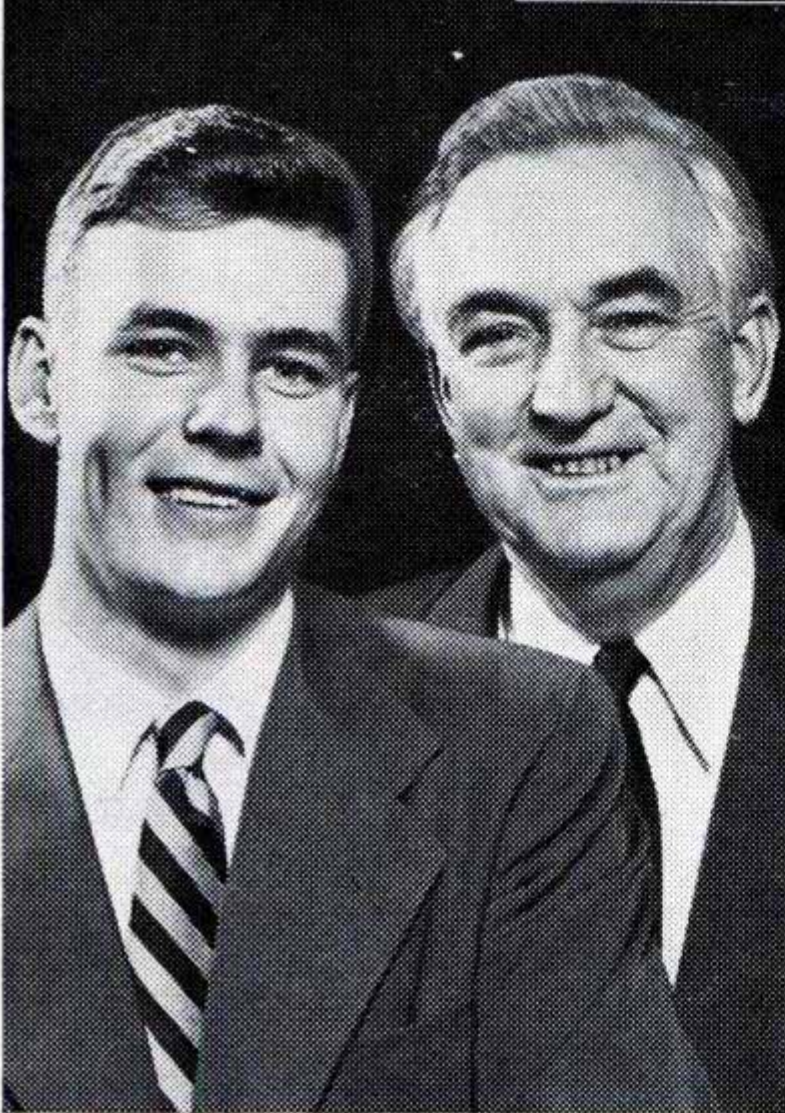

*This story actually happened. The man's name has been changed and this is not his photograph, but the facts are true.*

**DON SHOLL** Senior is Production Superintendent with a radio firm. Don Sholl Junior is at college.

Don Sholl Senior started his climb to the top with an I. C. S. course in Mechanical Engineering. Don Sholl Junior started his I. C. S. studies while still in high school. Both men agree that, for sound practical training, you can't beat I. C. S. Yes, they're I. C. S. boosters. Like father . . . like son.

It's remarkable how many of the men who go places are on the I. C. S. rolls. And that's your cue to fill out the coupon *today!*

## INTERNATIONAL CORRESPONDENCE SCHOOLS



BOX 5504-L, SCRANTON 9, PENNA.

Without cost or obligation, please send me full particulars about the course BEFORE which I have marked X:

- |  |   |  |   |  |
|--|---|--|---|--|
| <p><b>Business and Academic Courses</b></p> <ul style="list-style-type: none"> <li><input type="checkbox"/> Accounting</li> <li><input type="checkbox"/> Bookkeeping</li> <li><input type="checkbox"/> Business Administration</li> <li><input type="checkbox"/> Bus. Correspondence</li> <li><input type="checkbox"/> Certified Public Accounting</li> <li><input type="checkbox"/> Commercial</li> <li><input type="checkbox"/> Cost Accounting</li> <li><input type="checkbox"/> Federal Tax</li> <li><input type="checkbox"/> First Year College</li> <li><input type="checkbox"/> Foremanship</li> <li><input type="checkbox"/> Good English</li> <li><input type="checkbox"/> Higher Mathematics</li> <li><input type="checkbox"/> Industrial Supervision</li> <li><input type="checkbox"/> Motor Traffic</li> <li><input type="checkbox"/> Retailing</li> <li><input type="checkbox"/> Salesmanship</li> <li><input type="checkbox"/> Sign Lettering</li> <li><input type="checkbox"/> Spanish</li> <li><input type="checkbox"/> Typing</li> <li><b>Air Conditioning and Plumbing Courses</b></li> <li><input type="checkbox"/> Air Conditioning</li> <li><input type="checkbox"/> Heating</li> <li><input type="checkbox"/> Refrigeration</li> </ul> | <p><input type="checkbox"/> Advertising</p> <p><input type="checkbox"/> Bus. Law</p> <p><input type="checkbox"/> Commercial Art</p> <p><input type="checkbox"/> French</p> <p><input type="checkbox"/> High School</p> <p><input type="checkbox"/> Illustration</p> <p><input type="checkbox"/> Postal Civil Service</p> <p><input type="checkbox"/> Retail Bus. Management</p> <p><input type="checkbox"/> Secretarial</p> <p><input type="checkbox"/> Stenography</p> <p><input type="checkbox"/> Traffic Management</p> <p><input type="checkbox"/> Plumbing</p> <p><input type="checkbox"/> Steam Fitting</p> | <p><b>Chemical Courses</b></p> <ul style="list-style-type: none"> <li><input type="checkbox"/> Chemical Engineering</li> <li><input type="checkbox"/> Chemistry, Analytical</li> <li><input type="checkbox"/> Chemistry, Industrial</li> <li><input type="checkbox"/> Chemistry, Mfg. Iron &amp; Steel</li> <li><input type="checkbox"/> Petroleum Refining</li> <li><input type="checkbox"/> Plastics</li> <li><input type="checkbox"/> Pulp and Paper Making</li> <li><b>Civil Engineering, Architectural and Mining Courses</b></li> <li><input type="checkbox"/> Architecture</li> <li><input type="checkbox"/> Architectural Drafting</li> <li><input type="checkbox"/> Building Estimating</li> <li><input type="checkbox"/> Civil Engineering</li> <li><input type="checkbox"/> Contracting and Building</li> <li><input type="checkbox"/> Coal Mining</li> <li><input type="checkbox"/> Highway Engineering</li> <li><input type="checkbox"/> Lumber Dealer</li> <li><input type="checkbox"/> Reading Structural Blueprints</li> <li><input type="checkbox"/> Sanitary Engineering</li> <li><input type="checkbox"/> Structural Drafting</li> <li><input type="checkbox"/> Structural Engineering</li> <li><input type="checkbox"/> Surveying and Mapping</li> <li><b>Communications Courses</b></li> <li><input type="checkbox"/> Electronics</li> <li><input type="checkbox"/> Prac. FM and Television</li> <li><input type="checkbox"/> Prac. Telephony</li> <li><input type="checkbox"/> Radio, General</li> <li><input type="checkbox"/> Radio Engineering</li> <li><input type="checkbox"/> Radio Operating</li> <li><input type="checkbox"/> Radio Servicing</li> <li><input type="checkbox"/> Telegraph Engineering</li> </ul> | <p><b>Electrical Courses</b></p> <ul style="list-style-type: none"> <li><input type="checkbox"/> Electrical Drafting</li> <li><input type="checkbox"/> Electrical Engineering</li> <li><input type="checkbox"/> Electric Light and Power</li> <li><input type="checkbox"/> Lighting Technician</li> <li><input type="checkbox"/> Practical Electrician</li> <li><input type="checkbox"/> Power House Electric</li> <li><input type="checkbox"/> Ship Electrician</li> <li><b>Internal Combustion Engines Courses</b></li> <li><input type="checkbox"/> Auto Technician</li> <li><input type="checkbox"/> Diesel-Electric</li> <li><input type="checkbox"/> Diesel Engines</li> <li><input type="checkbox"/> Aviation</li> <li><input type="checkbox"/> Gas Engines</li> <li><b>Mechanical Courses</b></li> <li><input type="checkbox"/> Aeronautical Engineer's, Jr.</li> <li><input type="checkbox"/> Aircraft Drafting</li> <li><input type="checkbox"/> Forging</li> <li><input type="checkbox"/> Foundry Work</li> <li><input type="checkbox"/> Heat Treatment of Metals</li> <li><input type="checkbox"/> Industrial Engineering</li> <li><input type="checkbox"/> Industrial Instrumentation</li> <li><input type="checkbox"/> Industrial Metallurgy</li> <li><input type="checkbox"/> Machine Shop</li> <li><input type="checkbox"/> Machine Shop Inspection</li> <li><input type="checkbox"/> Mechanical Drafting</li> <li><input type="checkbox"/> Mechanical Engineering</li> </ul> | <ul style="list-style-type: none"> <li><input type="checkbox"/> Mold-Loft Work</li> <li><input type="checkbox"/> Patternmaking—Wood, Metal</li> <li><input type="checkbox"/> Reading Shop Blueprints</li> <li><input type="checkbox"/> Sheet-Metal Drafting</li> <li><input type="checkbox"/> Sheet-Metal Worker</li> <li><input type="checkbox"/> Ship Drafting</li> <li><input type="checkbox"/> Ship Fitting</li> <li><input type="checkbox"/> Tool Designing</li> <li><input type="checkbox"/> Toolmaking</li> <li><input type="checkbox"/> Welding—Gas and Electric</li> <li><b>Railroad Courses</b></li> <li><input type="checkbox"/> Air Brake</li> <li><input type="checkbox"/> Diesel Locomotive</li> <li><input type="checkbox"/> Locomotive Engineer</li> <li><input type="checkbox"/> Locomotive Fireman</li> <li><input type="checkbox"/> Locomotive Machinist</li> <li><input type="checkbox"/> Railroad Section Foreman</li> <li><input type="checkbox"/> Steam and Diesel Loco. Eng.</li> <li><b>Stationary Engineering Courses</b></li> <li><input type="checkbox"/> Boilermaking</li> <li><input type="checkbox"/> Combust. Engrg.</li> <li><input type="checkbox"/> Engine Running</li> <li><input type="checkbox"/> Marine Engineering</li> <li><input type="checkbox"/> Power Plant Engr.</li> <li><input type="checkbox"/> Steam Engineer</li> <li><b>Textile Courses</b></li> <li><input type="checkbox"/> Cotton Manufacturing</li> <li><input type="checkbox"/> Loom Fixing</li> <li><input type="checkbox"/> Rayon Weaving</li> <li><input type="checkbox"/> Textile Designing</li> <li><input type="checkbox"/> Woolen Manufacturing</li> </ul> |
|--|---|--|---|--|

Name \_\_\_\_\_ Age \_\_\_\_\_ Home Address \_\_\_\_\_

City \_\_\_\_\_ State \_\_\_\_\_ Working Hours \_\_\_\_\_ A.M. to \_\_\_\_\_ P.M.

Present Position \_\_\_\_\_ Employed by \_\_\_\_\_

Length of Service in World War II \_\_\_\_\_ Enrollment under G.I. Bill approved for World War II Veterans. Special tuition rates to members of the Armed Forces. Canadian residents send coupon to International Correspondence Schools Canadian, Ltd., Montreal, Canada.

# "Hey You SKINNY Bag of Bones!"



That's what the boys shouted at me ONLY A FEW WEEKS AGO . . . But look at me NOW, PAL . . . A Trophy-Winning JOWETT HE-MAN Like YOU can be SOON!

## 5-WAY PROGRESSIVE POWER can make YOU an ALL-AROUND WINNER

- In Civilian Life or Armed Services.
  - A Winner of Success on IOB.
  - A Winner of FRIENDS, GIRLS.
  - A Winner at ALL SPORTS.
  - A Winner of Trophies.
  - A Hero on the DANCE FLOOR.
  - A Hero at BEACH, GYM.
  - A Hero to your SWEETHEART.
  - A LEADER in any crowd.
- This "Easy as Pie" NATURAL Method gives you All-Around CHAMP STRENGTH—All Over MR. AMERICA BUILD!

Let me Prove in 10 THIRLLING MINUTES A DAY I can make YOU An ALL-AMERICAN ALL-AROUND HE-MAN FAST—OR IT WON'T COST YOU A CENT

SAYS GEORGE F. JOWETT—

WORLD'S GREATEST BUILDER OF HE-MEN

## YES! YOUR SUCCESS STORY can soon be like Sill's—

How weakling wins trophy as MAGNIFICENT HE-MAN! Few weeks ago everyone picked on John . . . No guts to fight for his rights. TODAY everyone admires John's movie-star build—his mighty ARMS, broad BACK, heroic CHEST. His ATHLETIC ability. His ENERGY at work. His POPULARITY. How GIRLS go for him! NO! I don't care if you're 14 or 40; if you're SKINNY or flabby. Give me 10 EXCITING MINUTES to make you over in your home by the method I turned myself from a wreck into A WORLD CHAMPION.

YES! Add INCH in INCH of MIGHTY MUSCLE to your ARMS. Deepen your CHEST. Broaden your SHOULDERS. Gain SIZE, SPEED, POWER! Become an All-American HE-MAN! A WINNER in everything you tackle—or you won't pay one cent!

DEVELOP YOUR 520 MUSCLES Gain POUNDS, INCHES fast! Friend, I travelled the world. Made a LIFETIME study of EVERY way known to build your body. Then I devised the BEST, "5-WAY PROGRESSIVE POWER", the ONLY method that builds you 5 WAYS fast Save YEARS, DOLLARS, like MANY THOUSANDS like you did. Mail Coupon NOW!

Builder of CHAMPS 4 times WINNER PERFECT MAN CONTEST

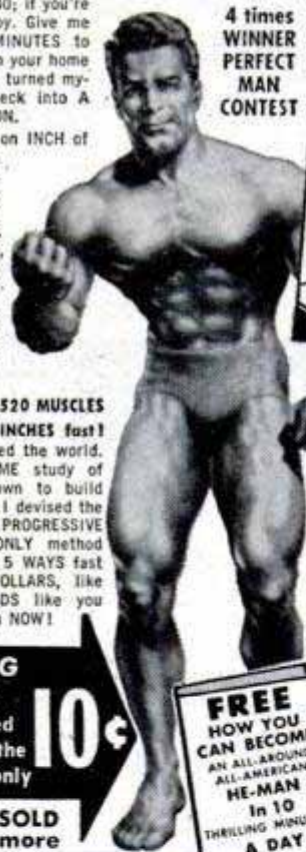

AMAZING ALL 5 Picture-packed courses while the supply lasts—only 10¢

MILLIONS SOLD at \$1 and more

FREE PHOTO BOOK of FAMOUS STRONG MEN

DEPT. PM-17

"Jowett Courses greatest in World for Building All-Around HE-MEN."  
—R. F. Kelley  
Physical Director

JOWETT INSTITUTE OF PHYSICAL TRAINING  
230 FIFTH AVENUE, NEW YORK 1, N. Y.

Dear George: Please mail to me FREE Jowett's Photo Book of Strong Men, plus all 5 HE-MAN Building Courses: 1. How to Build a Mighty Chest. 2. How to Build a Mighty Arm. 3. How to Build a Mighty Grip. 4. How to Build a Mighty Back. 5. How to Build Mighty Legs—Now all in One Volume "How to Become a Muscular He-Man" ENCLOSED FIND 10¢ FOR POSTAGE AND HANDLING (No C.O.D.'s).

Name \_\_\_\_\_ Age \_\_\_\_\_  
(Please print plainly)  
Address \_\_\_\_\_  
City \_\_\_\_\_ Zone \_\_\_\_\_ State \_\_\_\_\_

# COMBAT!

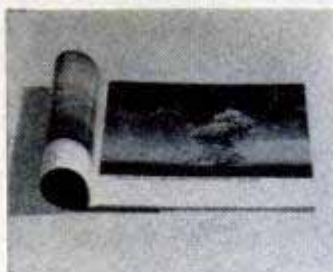

See over 100 drama packed pictures of GI's in Combat . . . how they fight . . . how they live . . . how they die. Send only \$1 cash or M. O. Book sent post paid. Complete satisfaction or your money refunded. Act now—supply limited.

## COMBAT

P. O. Box 133

Berkeley, Calif.

MAKE \$5 PER HOUR WITHOUT A PRINTING PRESS  
**PRINTING** REVOLUTIONARY NEW SCREEN METHOD  
FREE complete "BIG MONEY" Plan and SAMPLE!

PRINT colorful signs, posters, banners, fabrics, wall paper, show cards—ANYTHING! Print on any surface. NO printing press or special equipment is needed with this amazing "approved" new printing secret. 300% profit on nearly every job. Easy to learn—NO EXPERIENCE or art ability necessary. Exceptional opportunity. Complete illustrated detailed plan and colorful sample FREE—Write:

SCREEN-PRINT COMPANY, Dept. 27  
1010 So. Los Angeles St., Los Angeles 15, Calif.



## STAMMERER?

New booklet, "Stammering, and How to Stop It," sent free to any stammerer upon request. Write today. BENJAMIN N. BOGUE, Dept. 514, Circle Tower, Indianapolis 4, Ind.

GET THIS FREE BOOK!

## ENGINEERING DEGREE IN 27 MONTHS

INDIANA TECHNICAL COLLEGE

B. S. DEGREE. Aeronautical, Chemical, Civil, Electrical, Mechanical and Radio Engineering (inc. television). Drafting, 1-yr. Government approved for G.I.'s. Low rate. Earn board. Large industrial center. Students from 48 states, 21 countries. Demand for graduates. Enter September, December, March, June. Write for catalog. 1671 E. Washington Boulevard, Fort Wayne 2, Indiana.



## SILVER SOLDER TORCH & KIT \$6

JOINS ALL METALS PERMANENTLY  
Do your own repairing. KIT includes one tube silver solder "XCEL-FLUX" paste and 10 5-in. lengths silver solder alloy. Hottest ALCOHOL TORCH known. 2700° F. flame. Operates in any position, indoors or out. Torch alone \$5.50. KIT alone \$1.50. Add 25¢ on each order towards shipping charges. AMERICAN PRODUCTS CORP., 422 S. Dearborn, Dept. 3-G, Chicago

## Say You Saw It in Popular Mechanics

MAKE EXTRA MONEY PLASTICS LEARN AT HOME



LEARN HOW TO MAKE fast selling PLASTIC NOVELTIES FURNITURE JEWELRY SIGNS TOYS LAMPS

There are RICH OPPORTUNITIES for MEN and WOMEN with "know-how" in Plastics. Interstate's amazing new Plastics course tells and shows how to make hundreds of fast selling items out of Plastics. Gives complete training in fabrication, casting, lamination, molding, etc., in simple, easy, step-by-step language and pictures. START A PLASTICS BUSINESS OF YOUR OWN. No other industry holds such promise for the future. You can make big money manufacturing novelties, toys, signs, etc., in your own home in spare or full time. Don't wait! Learn NOW how Interstate's Plastics Training qualifies you for success in the plastics field.

Write for FREE Information Today!

INTERSTATE TRAINING SERVICE

School of Plastics  
PORTLAND 13, OREGON

(Dept. 3-6)

# LEARN ELECTRICITY OR TELEVISION-RADIO

ON REAL EQUIPMENT  
IN THE GREAT SHOPS  
OF **COYNE**

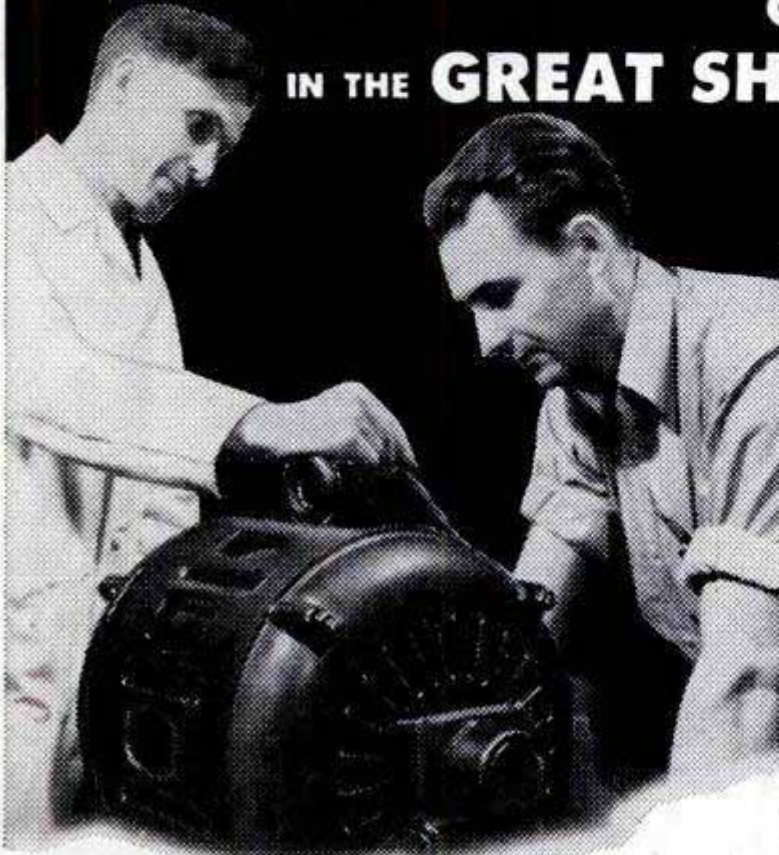

## ELECTRICITY-

The Power Behind Our Defense Program

A great opportunity field and vital to Defense. Thousands of trained Electrical men needed in good jobs with a real future when the emergency is over. Why be satisfied with a "no future" job? Get Free Book that tells how thousands have prepared quickly for a good job with a real future in Electricity at Coyne.

### TRAIN QUICKLY AT COYNE FOR VITAL FIELDS

ELECTRICITY—RADIO—TELEVISION—VITAL in Industry and Armed Forces. TRAIN QUICKLY at Coyne for better rating, if drafted—vital job in Industry, if not. Trained men whether 16 or up to 50 needed. Many men with physical handicaps can qualify. Prepare now for steady, well paid, essential jobs in A FIELD THAT ALSO OFFERS A REAL FUTURE WHEN THE EMERGENCY IS OVER.

#### Not "Home-Study"

We do not teach by mail. All training is given in our Great Training Shops in Chicago, plus necessary theory. No advanced education or previous experience needed.

#### START NOW—PAY LATER

Enroll now, pay most of tuition later. If you need part-time work to help out with living expenses while at Coyne, we'll help you get it. G.I. approved.



**1** You are TOLD the how and why of each job.



**2** You're shown how to do typical jobs by trained instructors.



**3** You DO practical job YOURSELF on equipment.

## TELEVISION-RADIO

Plays a Vital Role in Nation's Defense

The tremendous growth of this new field is almost unbelievable. New stations are rapidly bringing television to all parts of the country. RADIO and TELEVISION applications are vital to our Defense Program. Unusual opportunities to get in on ground floor of this vital field that also offers a world of opportunities for a real future when the emergency is over. Train quickly on actual equipment at Coyne by practical-technical methods. Get big Free Book today.

### Mail Coupon for Big FREE BOOK

Whether you prefer Electricity or Television-Radio, train on actual equipment, at Coyne. We have a Big, fully illustrated book we'll send you if you will indicate below which course you are interested in. Fill in and mail coupon TODAY. Paste it on a penny postcard if you wish. Complete details will come by return mail. No salesman will call.

**B. W. Cooke, President**  
**COYNE ELECTRICAL & TELEVISION-RADIO SCHOOL**  
An Institution not for Profit  
500 S. Paulina St., Chicago, 12  
Dept. B1-72H



**B. W. COOKE, President**  
**COYNE ELECTRICAL & TELEVISION-RADIO SCHOOL**  
500 S. Paulina St., Chicago 12  
Dept. B1-72H

Send your BIG FREE BOOK and details of your training offer. This does not obligate me and no salesman will call. I am interested in

ELECTRICITY     TELEVISION-RADIO

NAME.....

ADDRESS.....

CITY.....STATE.....

# Learn this Profitable Profession



**IN 90 DAYS AT HOME**

## Money-Making Career Open to Men and Women, 18 to 60

Hundreds of men and women between 18 and 60 make \$10 to \$20 in a single day giving scientific Swedish Massage and Hydro-Therapy treatments. There is big demand from doctors, hospitals, sanatoriums and clubs. Graduates earn large full time incomes from these or in private practice in their own offices. Others make good money from home treatments given in spare time. Learn this interesting, money-making profession in your own home, through our home study course. Same instructors as in our nationally known resident school. You can win independence and prepare for future security by qualifying for your Diploma. Course can be completed in 3 to 4 months. Many earn while they learn. Begin your training at once.



### NEW 32-PAGE BOOKLET FREE

Fill in the coupon below (please print name and address) and mail it for your FREE copy of 32-page Information Booklet. If you act at once we will include Anatomy Charts and Success Booklet which supply additional information you should have. All will be sent postage paid.

**THE COLLEGE OF SWEDISH MASSAGE**  
Dept. 164H, 41 E. Pearson St., Chicago 11, Illinois  
Please send me FREE and postpaid New 32-Page Illustrated Booklet, Anatomy Charts and Success Booklet at once.

Name \_\_\_\_\_ Age \_\_\_\_\_  
Address \_\_\_\_\_  
City \_\_\_\_\_ State \_\_\_\_\_

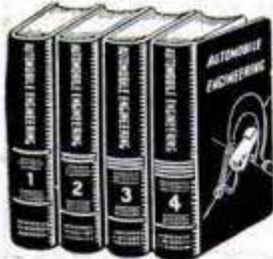

# AUTO BOOKS ON APPROVAL

**SEND NO MONEY.** Just mail the coupon for a complete set of 4 Big, Thick Auto Books. 20th Edition. Over 2700 Pages! Whether you are a mechanic or helper, expert or apprentice, auto owner or driver, take immediate advantage of this FREE EXAMINATION OFFER.

### MAKE GOOD MONEY NOW HOLD A PERMANENT JOB

America wants its automobiles kept in good repair. Men with "know how" are in demand, at big pay. These books will help you get and hold an important job, or give you a chance to go into business for yourself now or later. Any man who half tries to improve himself can learn auto servicing and repairing by this quick reference method. Use the JIFFY INDEX to find easily understood answer to any auto problem. These wonder books prepared by eleven of America's great automobile engineers. Many hundreds of valuable illustrations. Send the coupon TODAY.

**[A year's consulting privileges with our engineers now given with these books without extra charge.]**  
Publishers Since 1898

### CAN YOU FIX IT?

These wonder books tell step by step HOW to make difficult repairs and adjustments, how to keep a car at maximum efficiency, including latest improvements in car design and operation. Engine troubles and how to correct them well covered.

**AMERICAN TECHNICAL SOCIETY, Dept. AB19**  
Drexel Ave. at 58th St., Chicago 37, Ill.

I would like to examine your 4-Volume Set of Auto Books. I will pay the delivery charges only, but if I choose I may return them express collect. If after 10 days' use I prefer to keep them, I will send you \$3 and pay the balance at the rate of only \$4 a month until \$24.50 has been paid. Include consulting service as offered above.

Name \_\_\_\_\_  
Address \_\_\_\_\_  
City \_\_\_\_\_ State \_\_\_\_\_  
Please attach letter stating age, occupation, employer's name and address and name and address of at least one business man as reference. Men in service, also please give home address.

## OIL FILTER REFILLS... 10c



Here's News! Ordinary toilet paper makes an ideal oil filter. Laboratory tests prove it cleans oil faster and better than popular makes of filter elements. All you need is a simple set of RETLIF ADAPTER PLATES... and you can start using ordinary toilet paper rolls in your present oil filter. For proof and descriptive literature, send name and address to:

**RETLIF CORPORATION, Dept. 84**  
1239 No. Highland Ave., Los Angeles 38, Calif.

## SHORTHAND IN

Famous Speedwriting system. No signs; no symbols; no machines. Uses ABC's. Easy to learn, write, transcribe. Low cost. 100,000 taught by mail. Also typing. 28th year. Write for FREE booklet to:



Dept. 1507-1  
55 W. 42 St., N. Y. 18, N. Y.

**6 WEEKS AT HOME**

## "YOU ARE UNDER ARREST!"



### Help Bring Crooks to Justice Through Scientific CRIME DETECTION!

We have taught thousands this exciting, profitable, pleasant profession. Let us teach you in your own home. Learn Fingerprinting, Firearms Identification, Police Photography, Secret Service Methods thoroughly, quickly, at small cost. Over 800 of all American Bureaus of Identification employ I. A. S. students or graduates. We can prepare you for this fascinating work, during spare time. Write today, stating age, for "Blue Book of Crime."

**INSTITUTE OF APPLIED SCIENCE, 1920 Sunnyside Ave., Dept. 135-B, Chicago 40, Ill.**



## WARN HUB CAP MAKES 2 JEEPS OUT OF 1

\$20.00  
Prepaid U.S., Canada

Ends front wheel drag on 4-wheel drive Willys Station Wagons, Pick-ups and Jeeps

Saves gas up to 5 miles per gallon, tire wear, front axles, increases speed and power. Stops shimmy—front wheels coast out of gear! 4-wheel drive handles, performs, climbs like 2-wheel. Install or remove WARN HUB CAPS in 10 minutes. Polished aluminum, guaranteed. Rush check, M.O., or C.O.D. Write for circular.  
**WARN MFG. CO. - 1625 Third Ave., Seattle 1, Wash.**



## LEARN MEAT CUTTING At Home - In Spare Time

Get into the vital meat industry. Concise, practical Home Training based on 25 years proven instruction methods used at National's famous resident school. Prepares you for bigger pay as Meat Cutter, Supervisor, market manager or more money in your own store. Go as rapidly as your spare time permits. Diploma. Start NOW to turn your spare hours into money. Send for FREE bulletin today. No obligation.

**NATIONAL SCHOOL OF MEAT CUTTING, INC., Div. U-130, Toledo 4, Ohio**

## "How to Make Money with Simple Cartoons"



A book everyone who likes to draw should have. It is free; no obligation. Simply address **FREE BOOK**

**CARTOONISTS' EXCHANGE**  
Dept. 97 Pleasant Hill, Ohio

## Learn BAKING At Home

Baking is one of America's high industries in wages. Nearly depression-proof. Thorough basic home course lays sound foundation. If you have aptitude, write for FREE BOOKLET, "Opportunities in Commercial Baking."

**NATIONAL BAKING SCHOOL**  
835 Diversey Parkway Dept. 1358 Chicago 14







# Learn RADIO

## TELEVISION, ELECTRONICS

by

## SHOP METHOD HOME TRAINING

Let NATIONAL SCHOOLS, of Los Angeles, a practical Technical Resident Trade School for almost 50 years, train you for today's unlimited opportunities.

You receive all parts, including tubes, for building this fine, modern Superheterodyne Receiver. This and other valuable standard equipment becomes your property.

*these two FREE books will tell you how*



WE BRING  
NATIONAL  
SCHOOLS TO YOU!

### GOOD JOBS AWAIT THE TRAINED RADIO TECHNICIAN

You are needed in the great modern Radio, Television and Electronics industry! Trained technicians are in constant and growing demand at excellent pay—in Broadcasting, Communications, Television, Radar, Research Laboratories, Home Radio Service, etc. National Schools Master Shop Method Home Study Course, with newly added lessons and equipment, can train you in your spare time, right in your own home, for these exciting opportunities. Our method has been proved by the remarkable success of National Schools-trained men all over the world.

#### You Learn by Building Equipment with Standard Radio Parts We Send You

Your National Schools Course includes not only basic theory, but practical training as well—you learn by doing. We send you complete standard equipment of professional quality for building various experimental and test units. You advance step by step until you are able to build the modern superheterodyne receiver shown above, which is yours to keep and enjoy. You perform more than 100 experiments—build many types of circuits, signal generator, low power radio transmitter, audio oscillator, and other units. The Free Books shown above tell you more about it—send for them today!



#### NOW! NEW PROFESSIONAL MULTITESTER INCLUDED



This versatile testing instrument is portable and complete with test leads. Simple to operate, accurate and dependable. You will be able to quickly locate trouble and adjust the most delicate circuits. You can use the Multitester at home or on service calls. It is designed to measure AC and DC volts, current resistance and decibels. You will be proud to own and use this valuable professional instrument.

GET THE DETAILS - SEND THE COUPON →

#### Lessons and Instruction Material Are Up-to-date, Practical, Interesting

National Schools Master Shop Method Home Training gives you basic and advanced instruction in all phases of Radio, Television and Electronics. Each lesson is made easy to understand by numerous illustrations and diagrams. All instruction material has been developed and tested in our own shops and laboratories, under the supervision of our own engineers and instructors. A free sample lesson is yours upon request—use the coupon below.

**TELEVISION TRAINING** A complete series of up-to-the-minute Television lessons is an integral part of your course, covering all phases of Television repairing, servicing and construction.

Here are just a few of the interesting facts you learn with the **FREE SAMPLE LESSON**

1. How radio receivers operate.
2. How the antenna circuit is constructed.
3. Converting signal currents into sound.
4. How the R-F transformer handles the signal.
5. How the tuning circuit functions.
6. The Radio "bands."

**VETERANS  
HURRY!  
ACT NOW!  
G. I. BILL  
expires July 25**

### NATIONAL SCHOOLS

LOS ANGELES 37, CALIFORNIA EST. 1905



#### MAIL OPPORTUNITY COUPON FOR QUICK ACTION

National Schools, Dept. 7-PM  
4000 South Figueroa Street  
Los Angeles 37, California

(Mail in envelope or  
paste on penny postcard.)

Mail me FREE the book "Your Future in Radio-Television" and the sample lesson of your course. I understand no salesman will call on me.

NAME \_\_\_\_\_ AGE \_\_\_\_\_

ADDRESS \_\_\_\_\_

CITY \_\_\_\_\_ ZONE \_\_\_\_\_ STATE \_\_\_\_\_

Check here if veteran of World War II

# C. T. C. TRAINING IN DRAFTING

**PREPARES FOR PROMOTION  
MORE MONEY  
SUCCESS**

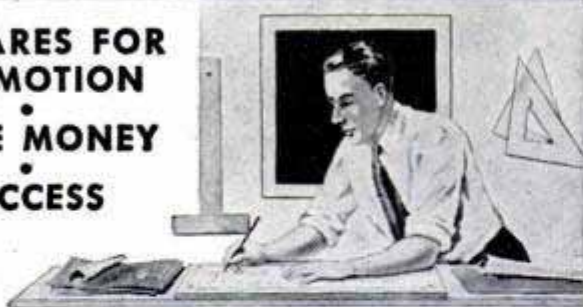

"Here I am at work making good money as a draftsman. I'm glad I sent the coupon to Chicago Tech for that Free Trial Lesson and found out how easy it is to learn Drafting in spare time at home. Today, I feel secure in my job. What's more, I feel I'm slated for promotion and more pay."

**LEARN IN SPARE TIME—AT HOME!**  
(or at the College in Chicago)

A few hours of pleasant home study every week—that's all. All the tools you need; drawing outfit included. This tested method—developed over 46 years of C.T.C. progress—prepares men quickly for good positions in industry.



**FREE INFORMATION — SEND COUPON**  
To prove to you how easy it is to learn Drafting at home, we will send you this **FREE TRIAL LESSON**. Mail coupon or send post card today.

## CHICAGO TECHNICAL COLLEGE

H-214 Tech Bldg., 2000 So. Michigan Ave.  
Chicago 16, Illinois

Mail me **FREE** Lesson with information about big opportunities in **DRAFTING**.

Name \_\_\_\_\_ Age \_\_\_\_\_

Address \_\_\_\_\_

City \_\_\_\_\_ Zone \_\_\_\_\_ State \_\_\_\_\_

## Prepare Now! ENGINEERING B.S. DEGREE IN 27 MONTHS

WORLD FAMED SCHOOL • ESTABLISHED 1884

**Mechanical, Civil, Electrical, Chemical, Aeronautical, Radio (Television) Engineering; Business Administration and Accounting.** Also 36-weeks diploma courses in Surveying and Drafting.

**Personalized instruction.** Accelerated courses. For ambitious earnest students. Preparatory department.

**Heavy demand for Tri-State graduates;** hold positions of responsibility the world over. Placement service. Serious shortage of engineers indicated for immediate future. Prepare now for the opportunities ahead. Technical training helpful in military assignments.

**Extensive campus.** Well equipped, new and modernized buildings; up-to-date labs. Low cost. New terms start quarterly. Enter September, January, March, June.

Write today for free catalog and special information.

## TRI-STATE COLLEGE

471 COLLEGE AVENUE — ANGOLA, INDIANA

# FUN!



## MAKE THIS Squirrel Lamp

Yes sir, out of a real squirrel! Also make ash-trays, book-ends, etc., using rabbits, frogs, etc. **LEARN AT HOME TO MOUNT BIRDS, ANIMALS & FISH;** tan skins and make rugs. Decorate your room.

**It's FUN! BIG profits in spare time!**

Free book tells how.  
**FREE BOOK!** Write TODAY for beautiful free book telling how to learn this fine hobby. Book is free. Contains many fine pictures. **STATE YOUR AGE.**



N.W. SCHOOL OF TAXIDERMRY, Dept. 2507, Omaha, Nebr.

## WHAM-O SPORTSMAN\*

\$1.25 45-LB. PULL!

HITS LIKE A .22 RIFLE—KILLS RABBITS, SQUIRRELS.

Powerful, silent, accurate.

For hunting, target, routing pests.

Sportsman's choice sold world over!

## HUNTING SLINGSHOT

Heavy duty 7" ash stock.

40 steel balls, extra rubber, target.

**GUARANTEED**—at dealers, or send \$1.25 to

Wham-O Mfg. Co., Box 8T, South Pasadena, Calif.

\*Professional model of Nat'l Slingshot Assn.

# WATCHMAKING

Learn at home • **FREE** sample lesson

## CHICAGO SCHOOL OF WATCHMAKING

1608 N. Milwaukee Avenue Dept. 171 Chicago 47, Ill.

## CHAPMAN CHINCHILLAS

The originator of the first Chinchilla Farm in the United States. For information on purchasing the finest, selected breeding stock of these aristocratic animals that were virtually trapped to extinction write or visit—

**Established 1919 Chapman Chinchilla Farm**  
"P. O. BOX 221" 4957 West 104th Street  
Inglewood, California

## TASOPE PHOTO-ENGRAVING PLANTS



Establish your own profitable **PHOTO-ENGRAVING** business. Make cuts for newspapers, printers, and advertisers. Make etched name plates, plaques, etc. Instructions furnished, no experience necessary. Sold direct from factory since 1931. First five hundred cuts sold locally or by mail will pay for plant and pay you well for your time. Write for **FREE** catalog.

MATERIAL COST OF THIS CUT 3/4" SELLING PRICE \$1.00 AND UP

**TASOPE DEPT. PM5, AURORA, MO.**

## LEFAX POCKET SIZE TECHNICAL DATA BOOKS \$1. EACH

Printed on loose leaf, six hole, 6 3/4" x 3 3/4" bond paper, each book contains about 140 pages of technical data, presenting condensed, accurate and essential data for the student, engineer, technical worker and business man.

- |                    |                  |                    |
|--------------------|------------------|--------------------|
| Architecture       | Building Constr. | Piping Data        |
| Home Heating       | Radio            | Surveying Tables   |
| Illumination       | Television & FM  | Trig-Log Tables    |
| Electrician's Data | Electricity, AC  | Metallurgy         |
| Builder's Data     | Electricity, DC  | Analytic Chem.     |
| Lumber Data        | AC Motors and    | Highway Eng.       |
| Air Conditioning   | Generators       | Mech. of Materials |
| General Math.      | Transformers,    | Pwr. Trans. Mach.  |
| Math. Tables       | Relays, Meters   | Thermodyn. Tbls.   |
| Physics            | Hydraulics       | & Charts           |
| Chemical Tables    | Surveying        | Phys. & Thermo-    |
| Metals             | Mech. Drawing    | dyn. Data          |
| Gen. Chemistry     | Machine Design.  | Phys. & Org. Chem. |
| Reinf. Concrete    | Machinists' Data |                    |

Write for **FREE** catalogs (over 2000 listings). See for yourself how helpful **LEFAX** can be to you. Send \$1 for each book, (or \$5 for any six books listed above) to

**LEFAX DEPT. PM-8 PHILADELPHIA 7, PA.**

NOW...GET EVERYTHING YOU  
NEED TO LEARN AND MASTER

# TELEVISION

**RADIO-ELECTRONICS**  
**...AT HOME!**

Use **REAL** commercial-type equip-  
ment to get practical experience

Your future deserves and needs every advantage you can give it! That's why you owe it to yourself to find out about one of the most **COMPLETE**, practical and effective ways now available to prepare **AT HOME** for America's billion dollar opportunity field of **TELEVISION-RADIO-ELECTRONICS**. See how you may get and keep the same type of basic training equipment used in one of the nation's finest training laboratories... how you may get real **STARTING HELP** toward a good job or your own business in Television-Radio-Electronics. Mail the coupon today for complete facts — including 89 ways to earn money in this thrilling, newer field.

Here's the **REAL THING!**

**SET UP YOUR OWN HOME LABORATORY**



Oscilloscope

R-F Signal Generator

6-Tube Radio

Multimeter

**HOME MOVIES**

**ABOVE:** Build and keep a real 16 INCH commercial TV receiver. Optional after completing regular training at slight additional cost.

**D.T.I., ALONE, INCLUDES BOTH MOVIES and HOME LABORATORY** — in addition to easy-to-read lessons, you get the use of **HOME MOVIES** — an outstanding training advantage — plus 16 big shipments of Electronic parts. Perform over 300 fascinating experiments for practical experience. Build and keep real commercial-type test equipment shown at left.

Get **BOTH** of these information packed publications **FREE!**

**MODERN LABORATORIES**

If you prefer, get all your preparation in our new Chicago Training Laboratories—one of the finest of its kind. Ample instructors, modern equipment. Write for details!

**MILITARY SERVICE!**

If you're subject to military service, the information we have for you should prove doubly interesting. Mail coupon today.



**ACT NOW! MAIL COUPON TODAY!**

DeFOREST'S TRAINING, INC., Dept. PM-7-H  
2533 N. Ashland Ave., Chicago 14, Ill.

Without obligation, I would like your late News-Bulletin showing 89 ways to earn money in Television-Radio-Electronics... and how I may prepare to get started in this thrilling field.

Name..... Age.....  
Street..... Apt.....  
City..... Zone..... State.....

**De FOREST'S TRAINING, INC.**  
CHICAGO 14, ILLINOIS  
A De VRY INSTITUTION

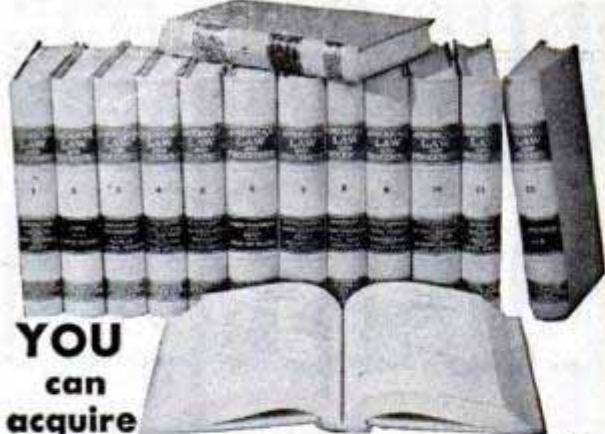

**YOU  
can  
acquire**

**LAW NIGHTS AT HOME!  
L. B. DEGREE**

LaSalle's famous Law Library—used as reference in many Law libraries and Law offices—has enabled thousands to master Law surprisingly fast, in spare hours at home, for business and professional advancement.

These 14 remarkable volumes, compiled by leading professors and lawyers, cover the whole basic field of Law in condensed, orderly, simplified manner.

You advance rapidly with this great library, plus special lectures furnished. We guide you step-by-step with personalized Problem Method of instruction . . . you learn by doing—handling legal problems—not by memorizing rules.

Send for two FREE 48-page booklets, "Law Training for Leadership," and "Evidence," answering questions about Law and its value to you, and telling how LaSalle Law graduates are winning rapid advancement in business and public life. Mail coupon below. No obligation.

**LA SALLE EXTENSION UNIVERSITY**

*A Correspondence Institution*

417 S. Dearborn St., Dept. 764L, Chicago 5, ILL.

Send me your two FREE booklets described above, without obligation.

Name.....Age.....

Street.....

City, Zone & State.....

**ENGINEERING DEGREE IN  
27 MONTHS**

**Big Demand for Graduates**

**Aeronautical, Chemical, Civil, Electrical, Mechanical and Radio Engineering (including Television)**

Hundreds of young men are earning engineering degrees in this recognized institution each year—continuous operation. New terms start quarterly. Many students earn a major part of their college expenses in this large industrial center.

Low tuition. Competent instruction. Thorough, intense, practical program. Modern laboratory facilities including new physics lab. and modernized wind tunnel. Individualized instruction emphasized.

Approved for Veterans. Engineering preparatory courses. Students from 48 states and 21 foreign countries. Enter September, December, March or June. Send coupon for free catalog and full information. Enroll now.

**SEND COUPON TODAY**

**INDIANA TECHNICAL COLLEGE**

571 E. Washington Boulevard  
Fort Wayne 2, Indiana

Please send me free information on B.S. Engineering Degree in 27 months as checked.

Aeronautical,  Chemical,  Civil,  Electrical,  
 Mechanical,  Radio-Television

Name.....

Address.....

**NEW!**

**POLARVISION SAFETY LIGHT**



A revolutionary new light discovery recently released for civilian use.

**STOP  
HEADLIGHT GLARE**

Fits All Cars & Trucks

FOR SAFETY AND COMFORTABLE DRIVING

The Amazing "Ergon Glass Lens" is an integral part of the Polarvision Light. It produces a Black Light (barely visible to the eye) which Counteracts oncoming headlights, street lights, etc. without interfering with your visibility. Easy to install above windshield—beautiful accessory. Light encased in high grade chrome holder. Works off car's central lighting circuit. Limited Supply. Complete (Including \$6.95 all parts)

Send cash, check, or money order. Guaranteed

Electronic Development Company, Dept. B7, Los Angeles 34, Calif.



Free Book

**Money In Hamsters**

The new wonder animals from Syria. Often called Toy Bears. Delightful pets. Everyone wants them. Laboratories use thousands. Clean, odorless. Raise anywhere. NOW, spotted and golden breeds. We furnish breeders, equipment and manual of instructions. Write today for free illustrated literature.

**GULF HAMSTERY** 1536 BASIL ST., MOBILE 17, ALA.

**Learn ACCOUNTING  
BOOKKEEPING**

This nationally renowned school has demand for graduates in good salary positions thru Nationwide recognition and placement service. Write Department PMZ today for Big 32 page Success Book to be sent to you **FREE**

**Hills BUSINESS UNIVERSITY AND  
EXTENSION SCHOOL**  
619 W. MAIN ST. OKLAHOMA CITY 2, OKLAHOMA

**TRAIN in Our SHOPS -**

in AIR CONDITIONING, REFRIGERATION, ELECTRICITY, MAJOR APPLIANCES, AUTOMOTIVE MECHANICS, BODY and FENDER REBUILDING

*If interested write or wire*

**COMMERCIAL TRADES INSTITUTE Inc. of Ala.**

200 S. 20th ST.  
BIRMINGHAM, ALA.

254 IVY ST. N.E.  
ATLANTA, GA.

VETERANS ASK ABOUT G I TRAINING

**\$100 STOPS METAL RUST**

**DUK-KOTE Sheds Water — Seals**

**Metal Surfaces** Protect auto chrome, other metals from rusting. Actually displaces water. Forms dry, non-oily, TOUGH film. Brush, spray or wipe on protection. Gives highly polished film to cars. For tools, mowers, implements, bicycles, toys, etc. Stops snow, ice from sticking to plows, shovels. One coat lasts 6 months. Harmless to paint, easily removed.

**THE THOMAS COMPANY**

Chemical Coatings Division 1645 Hennepin Minneapolis, Minn.



Agents write for free premium catalog. Order today.



**START YOUR OWN  
ELECTRICAL APPLIANCE  
REPAIR BUSINESS**

Repair electrical appliances of friends and neighbors. Service electrical equipment in factories, stores, etc. Work full or part time! New Shop Method home-training system. Rush name today for **FREE BOOK** and special form for getting Electronic Kit, Valuable Heating Element Kits, Advisory Service and Illustrated Instructions on new easy-payment plan. Pay later from **EARNINGS WHILE LEARNING**. Rush name today.

**CHRISTY TRADES SCHOOL**  
4432 N. Kedzie, Dept. D-9503, Chicago 25

# HOW TO FIX ANY PART OF ANY CAR

USED BY U. S. ARMED FORCES

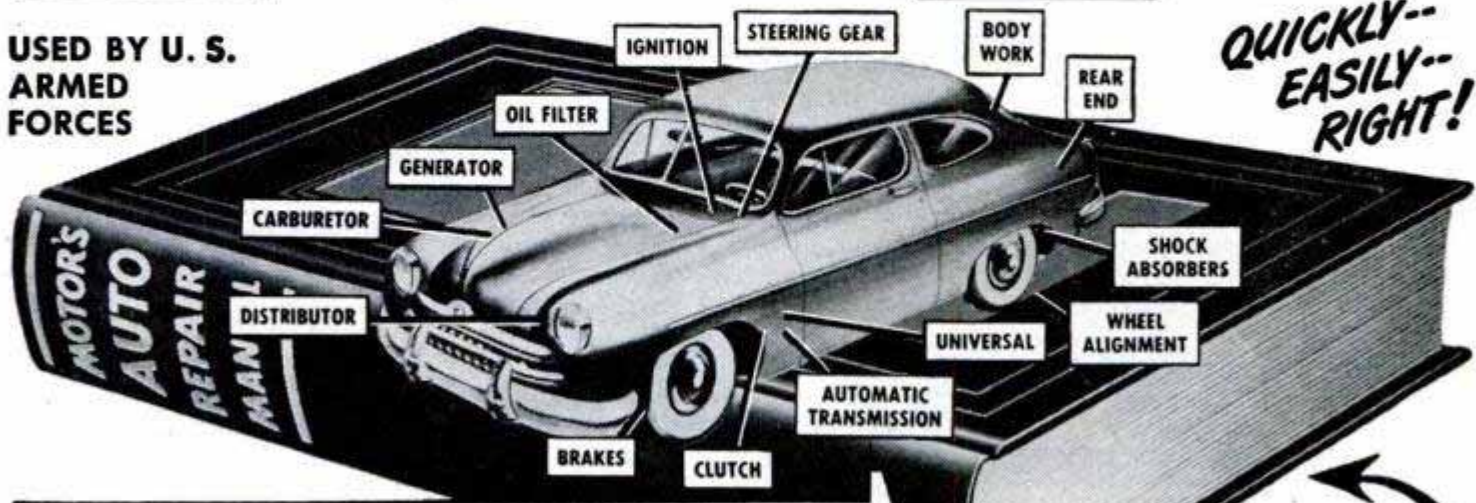

QUICKLY--EASILY--RIGHT!

**NOW—Whether You're a Beginner or an Expert Mechanic —You Can "Breeze Through" ANY AUTO REPAIR JOB! MoToR's BRAND-NEW 1951 AUTO REPAIR MANUAL Shows You HOW—With 2300 PICTURES AND SIMPLE STEP-BY-STEP INSTRUCTIONS.**

**Free 7-DAY TRIAL**  
Return and Pay Nothing If Not Satisfied!

## COVERS EVERY JOB ON EVERY CAR BUILT FROM 1935 THRU 1951

**Y**ES, it's easy as A-B-C to do any "fix-it" job on any car whether it's a simple carburetor adjustment or a complete overhaul. Just look up the job in the index of MoToR's New AUTO REPAIR MANUAL. Turn to pages covering job. Follow the clear, illustrated step-by-step instructions. Presto—the job is done!

No guesswork! MoToR's Manual takes nothing for granted. Tells you where to start. What tools to use. Then it leads you easily and quickly through the entire operation!

### Same FREE Offer On MoToR's Truck and Tractor Manual

Covers EVERY job on EVERY popular make gasoline truck, tractor made from 1936 thru 1949. FREE 7-Day Trial. Check proper box in coupon.

short-cuts that will amaze you. No wonder this guide is used by the U. S. Army and Navy! No wonder hundreds of thousands of men call it the "Auto Repair Mans' Bible"!

### Meat of Over 150 Official Shop Manuals

Engineers from every automobile plant in America worked out these time-saving procedures for their own motor car line. Now the editors of MoToR have gathered together this wealth of "Know-How" from over 150 Official Factory Shop Manuals, "boiled it down" into crystal-clear terms in one handy indexed book!

### Covers 800 Models—All These Makes

- |           |           |              |
|-----------|-----------|--------------|
| Buick     | Henry J.  | Nash Rambler |
| Cadillac  | Mudson    | Oldsmobile   |
| Chevrolet | Kaiser    | Packard      |
| Crosley   | Lafayette | Plymouth     |
| De Soto   | La Salle  | Pontiac      |
| Dodge     | Lincoln   | Studebaker   |
| Ford      | Mercury   | Terraplane   |
| Frazer    | Nash      | Willys       |
- ALSO tune-up adjustments for others.



Many Letters of Praise from Users  
"MoToR's Manual paid for itself on the first 2 jobs, and saved me valuable time by eliminating guesswork."  
—W. SCHROP, Ohio.

He Does Job in 30 Min.—Fixed motor another mechanic had worked on half a day. With your Manual I did it in 30 minutes.  
—C. AUBERRY, Tenn.



Over TWO THOUSAND Pictures! So Complete, So Simple, You CAN'T Go Wrong!

NEW REVISED 1951 Edition covers everything you need to know to repair 800 car models. 771 giant pages, 2300 "This-Is-How" pictures. Over 200 "Quick-Check" charts—more than 38,000 essential repair specifications. Over 225,000 service and repair facts. Instructions and pictures are so clear you can't go wrong!

Even a green beginner mechanic can do a good job with this giant manual before him. And if you're a top-notch mechanic, you'll find

### Try Book FREE 7 Days

SEND NO MONEY! Just mail coupon! When the postman brings book, pay him nothing. First, make it show you what it's got! Unless you agree this is the greatest time-saver and work-saver you've ever seen—return book in 7 days and pay nothing. Mail coupon today! Address: **MoToR Book Dept., Desk 17, 250 West 55th St., New York 19, N. Y.**

## MAIL COUPON NOW FOR 7-DAY FREE TRIAL

MoToR BOOK DEPT.

Desk 17, 250 W. 55th St., New York 19, N. Y.

Rush to me at once (check box opposite book you want):

MoToR's NEW AUTO REPAIR MANUAL. If O.K., I will remit \$1 in 7 days (plus 35c delivery charges), \$2 monthly for 2 months and a final payment of 95c one month after that. Otherwise I will return the book postpaid in 7 days. (Foreign price, remit \$8 cash with order.)

MoToR's TRUCK & TRACTOR REPAIR MANUAL. If O. K., I will remit \$2 in 7 days, and \$2 monthly for 3 months, plus 35c delivery charges with final payment. Otherwise I will return book postpaid in 7 days. (Foreign price, remit \$10 cash with order.)

Print Name.....Age.....

Address.....

City.....State.....

Check box and save 35c shipping charge by enclosing WITH coupon entire payment of \$5.95 for Auto Repair Manual (or \$8 for Truck and Tractor Repair Manual.) Same 7-day return-refund privilege applies.

YOU CAN BECOME AN AVIATION

*Expert...*  
EARN MORE — ADVANCE FASTER  
WITH **SPARTAN** TRAINING



Airlines and Manufacturers of aircraft, engines, instruments and accessories are spending thousands of dollars advertising for trained men. Personnel Managers, from the nation's leading companies, visit SPARTAN regularly to interview students. The demand far exceeds the supply. You can train — in a few short months, — for a job offering high wages, finest working conditions and security. Graduates from SPARTAN — THE UNIVERSITY OF AVIATION — are always in demand and advance faster. *Let us show you what former students of SPARTAN are now doing. Write for complete information — without obligation.*

## SPARTAN

SCHOOL OF AERONAUTICS  
TULSA, OKLAHOMA

### MAIL COUPON TODAY

Spartan School of Aeronautics  
Tulsa, Oklahoma Dept. PM-71

Please send me complete information on: Course \_\_\_\_\_

Name \_\_\_\_\_ Age \_\_\_\_\_

Street \_\_\_\_\_

City \_\_\_\_\_ State \_\_\_\_\_



"I'M EARNING \$300 A MONTH!"

... says Leonidas Burgoyne of Chicago, Illinois, "Expert individual instruction in the fully equipped shops of Greer Shop Training gave me the right start to get my good paying job."

GREER SHOP TRAINING... established 1902, is one of America's largest trade schools. Over 48,000 successful graduates. You learn by tearing down, repairing and rebuilding. Day and evening classes. Mail this coupon today!

## LEARN A TRADE NOW!

GREER SHOP TRAINING, Desk 211, 2230 S. Michigan Avenue, Chicago, Ill.

Gentlemen: Please send me information about trade I have checked below. (Specify if you are VET  or NON-VET .

- IN OUR CHICAGO SHOPS
- |   |  |
|---|--|
| <input type="checkbox"/> AUTO MECHANICS | <input type="checkbox"/> BODY, FENDER REPAIR |
| <input type="checkbox"/> DIESEL         | <input type="checkbox"/> WELDING—ARC, GAS    |
| <input type="checkbox"/> REFRIGERATION  | <input type="checkbox"/> MACHINIST           |
|   | <input type="checkbox"/> PIANO TUNING        |
- Above courses approved for Vets and Civilians.

### ALSO THE FOLLOWING HOME STUDY COURSES

- |  |                                 |                                   |
|--|---------------------------------|-----------------------------------|
| <input type="checkbox"/> REFRIGERATION | <input type="checkbox"/> DIESEL | <input type="checkbox"/> PLASTICS |
|--|---------------------------------|-----------------------------------|

Name \_\_\_\_\_ Age \_\_\_\_\_

Address \_\_\_\_\_

City \_\_\_\_\_ State \_\_\_\_\_

## GREER SHOP TRAINING



READ ABOUT TRAILERS  
BEFORE YOU BUY

## TRAILER TOPICS MAGAZINE

Brings you the latest in Trailer Coaches—Equipment—Accessories—Trailer Trips—Trailer Parks and many other interesting features at only—\$3.00 for 2 years.

(6 month trial subscription \$1.00)

Send your subscription to

TRAILER TOPICS MAGAZINE, (Room 1518)  
28 EAST JACKSON BLVD. CHICAGO 4, ILL.

## Learn PHOTOGRAPHY

There's big money in PHOTOGRAPHY—and an action-packed career for you. Our HOME STUDY COURSE is your spare-time SHORT CUT TO SUCCESS! Or, if you wish—PERSONAL ATTENDANCE TRAINING at our famous New York School is available. G. I. APPROVED. Our 41st year. Write immediately for big FREE BOOK!

NEW YORK INSTITUTE OF PHOTOGRAPHY

Dept. "49," 10 West 33 Street, New York 1, N.Y.



## GOLD-SILVER-COINS

Easily located with new Lightweight M-Scope Detector. Superior performance, lowest price, monthly payment plan.

FREE LITERATURE

FISHER RESEARCH LAB., INC.  
PALO ALTO CALIF.

## LAW FREE BOOK



Your FREE copy of "The Law-Trained Man" shows how to gain prestige and greater earnings through Blackstone home law study. All instruction material furnished including 17-volume Law Library written by 65 well-known law authorities. Lawyers, judges among our graduates. LL.B. degree. Low cost; easy terms. Write today.

BLACKSTONE COLLEGE OF LAW 225 N. Michigan Ave.  
Dept. 50-B, Chicago 1, Ill.  
A Correspondence Institution Founded in 1890



## SPORTONE MUFFLERS

- |                             |         |
|-----------------------------|---------|
| Ford & Chevrolet.....       | \$ 4.45 |
| All other popular cars..... | 5.45    |
| V-8 Dual Sets.....          | 15.95   |
| Chromed Silentips.....      | 2.95    |
- (Please state make & year of car on all orders.)

SANDÉE MUFFLER CO.  
5643 Corryne Place • Culver City, California

## MAKE EXTRA MONEY

EVERY BUSINESS EVERYWHERE  
USES UNION LABEL BOOK MATCHES

No experience needed to earn big daily commissions. Be a direct factory representative of the world's largest exclusive UNION LABEL Book Match manufacturer. Prospects everywhere. Feature Glamour Girls, Hillbillies, scenics and dozens of other styles—Double Books—Jumbo Books—nearly 100 color combinations. New, bigger portfolio makes this fastest selling line a real profit maker for you. Write TODAY for full details.



## SUPERIOR MATCH CO.

Dept. MD-751, 7528 S. Greenwood Ave., Chicago 19, Ill.  
WEST COAST SALESMEN, write BOX 1087, SAN JOSE, CALIF.

# GET INTO AUTOMOTIVE DIESEL AND ALLIED MECHANICS

by Shop Method Home Training

**JOBS LIKE THESE ARE OPEN  
TO YOU AS A TRAINED ENGINE  
MECHANIC...CHOOSE THE  
FIELD YOU LIKE BEST!**

## Get complete training

Diesel Fuel Injection  
Automotive Motor Tune-up  
Diesel Engine Maintenance  
General Garage Mechanics  
Agricultural Implements

Auto Engine Rebuilding • Auto Elec. Service  
Public Utilities • Parts Dealers  
Bus & Truck Lines • Industrial Maintenance  
Contracting & Excavating  
Business of Your Own  
**AND MANY other similar openings**

With our practical Master Shop-Method Home Training, you study at home in your spare time. You receive Spare Time Work Lessons, which show you how to earn while you learn...for extra money and experience. You Learn by DOING.

### YOU RECEIVE AND KEEP ALL THIS MATERIAL:

Basic Lesson Texts	Engine Service Manuals
Diesel Installation Operation—Maintenance	Engine Repair Drive Systems
Diesel Chart Manual	Diesel Electric Power
Spare Time Lessons	Thermodynamics

### TOOLS AND EQUIPMENT

**INVESTIGATE!  
SECURE FULL  
INFORMATION**

**WE GIVE  
YOU TOOLS  
OF YOUR  
TRADE**

JULY 1951

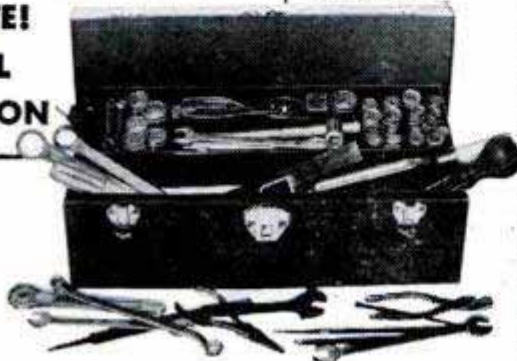

**Master  
All  
Phases!**



Get Master Shop-Method Home Training from an Established Resident School with its own Training Shops and Laboratories—and almost 50 years of Successful Experience in Training Men.

### We Bring National Schools To You

National Schools trains you for all opportunities in the dynamic, fast-growing Automotive-Diesel and Allied Industries. You get complete training for this great Industry.

Thousands upon thousands of autos, trucks, tractors, ships, trains, farms and factories are dependent upon engine power! Trained engine mechanics are needed in the Armed Forces as well as in civilian production. This huge field needs trained men for servicing, repairing, installing, operating and manufacturing equipment. The pay is good, the future excellent! National Schools offers you a practical, all-embracing Automotive-Diesel Mechanics Course that qualifies you for your choice of many good jobs.

Your National Course covers Gasoline and Special Fuel Engines; Diesels, High Speed and Heavy Duty; Semi-Diesels; Allied Mechanics.

**BOTH RESIDENT  
AND  
HOME STUDY  
COURSES  
OFFERED**

AUTOMOTIVE

DIESEL

ALLIED MECHANICS

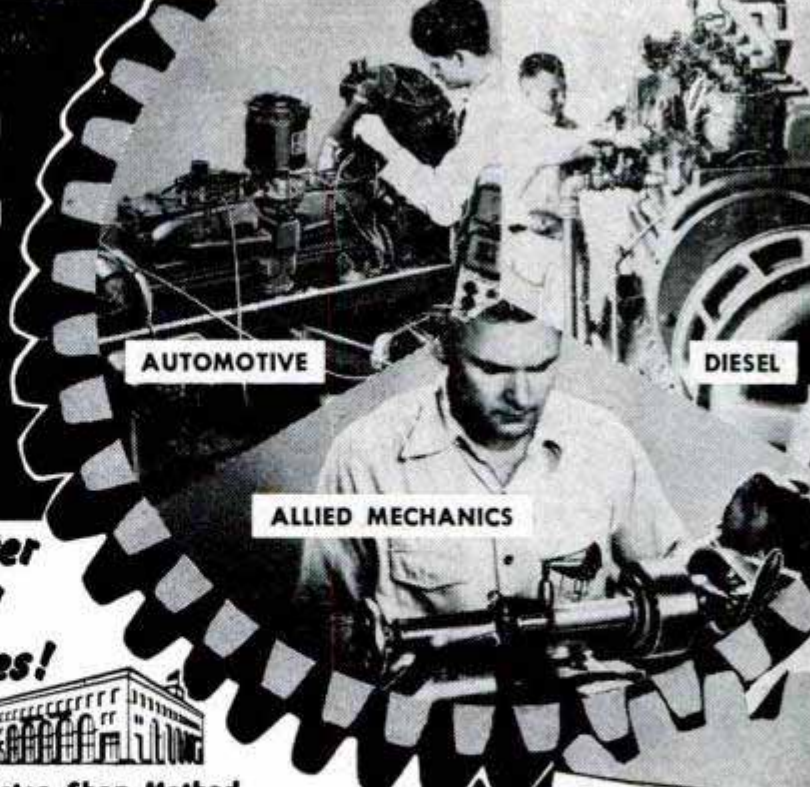

### These Two FREE Books Show You How

Send today for National Schools' new, illustrated Book of Opportunity in Automotive, Diesel and Allied Mechanics, and an actual sample lesson. No cost—no obligation. Use the coupon now—we'll answer by return airmail.

**VETERANS  
HURRY!  
ACT NOW!  
G. I. BILL  
expires July 25**

**NATIONAL SCHOOLS** LOS ANGELES 37 CALIFORNIA  
TECHNICAL TRADE TRAINING SINCE 1905  
**FIND OUT NOW...MAIL COUPON TODAY**

NATIONAL SCHOOLS, Dept. 7-PMD (Mail in envelope  
4000 South Figueroa Street or paste on  
Los Angeles 37, California penny postcard)  
Mail me FREE the book, YOUR FUTURE IN AUTO-  
MOTIVE-DIESEL MECHANICS, together with the  
Sample Lesson. I understand I may keep and use  
the information with no obligation.

NAME \_\_\_\_\_ AGE \_\_\_\_\_

ADDRESS \_\_\_\_\_

CITY \_\_\_\_\_ ZONE \_\_\_\_\_ STATE \_\_\_\_\_

Check here if Veteran of World War II

# LOOK! Amazing New Gem Discovery

## More Brilliant Than a Diamond!



Write today for the **FREE** illustrated booklet that tells the full story of the latest miracle of science—the story of a glorious jewel discovered in the laboratories of one of the world's largest corporations. Read all about the Kenya Gem that so closely resembles a diamond that only an expert can tell the difference.

### More Fire! More Brilliance!

Yes, this marvelous gem has more brilliance, more fire and a more dazzling display of color than the finest diamond of equal size. You can own an unmounted Kenya gem for only \$27 (1 carat) to \$120 (4 carats); also men's distinctive rings and ladies' fashionable rings and earrings in 14K gold set with expertly cut Kenya gems.

### EASY PAYMENT TERMS

### The Cinderella of Science

Kenya gems are the discovery you read about in Reader's Digest, Time, Sat. Eve. Post and other magazines, "the only thing on earth more brilliant than a diamond." It is a true gem, crystallized by science instead of nature.



Copyright 1951  
Kenya Gem Corp.

Write Today or Send Coupon  
for **FREE** Illustrated Booklet

**KENYA GEM CORPORATION, Dept. 287**  
Philadelphia 44, Pa.

### Mail This **FREE** Coupon Today

Kenya Gem Corporation, Dept. 287, Philadelphia 44, Pa.  
Please send me, without obligation, the **FREE** illustrated booklet telling all about Kenya Gems.

Name.....  
Address.....  
City..... State.....

Say You Saw It in *Popular Mechanics*

## MIDWEST

Presents its **NEW 1951**

### Line of TELEVISION and RADIOS

Mammoth  
**19 1/2**  
INCH  
PICTURE  
TUBE

**EASY TERMS**

### 30 DAYS TRIAL

Don't buy any radio or television receiver until you've seen the new 1951 Midwest line — it's the finest in 31 years.

### FACTORY-TO-YOU

SEND THIS COUPON ON 1c POST CARD FOR NEW 1951 **FREE 4 COLOR MIDWEST CATALOG**

**MIDWEST RADIO & TELEVISION CORP.**

Dept. 25-P, 909 Broadway, Cincinnati 2, Ohio

NAME.....

ADDRESS.....

CITY..... ZONE..... STATE.....

## I need 500 Men to wear **SAMPLE SUITS!**



### Pay No Money — Send No Money!

My plan is amazing! Just take a few easy orders for my sensational values in made-to-measure suits. Get your own suits **WITHOUT A PENNY COST** and make money too! Men can't resist the outstanding style, long wear and low price of my made-to-measure suits. You need no experience. Spare time pays big profits. Rush name and address today for complete details, big **FREE SAMPLE OUTFIT** contains more than 100 actual woolen samples, style illustrations, etc. Write today!

**PIONEER TAILORING CO., Dept. V-1116**  
Congress & Throop St., Chicago 7, Illinois

## FORD-MERC. OWNERS STOP BURNING POINTS!

Dual Point Distributor Conversion **SAVES COSTLY REPLACEMENTS!** Complete kit for '49, '50, '51 Ford 8 or Mercury. Converts single point to dual point distributor using same coil and single condenser. Easily installed.



### SATISFACTION GUARANTEED

• Eliminates missing • Increases Acceleration • Higher RPM • All parts stock Ford, buy anywhere. • Money Back Guarantee. Send 25¢ For Special "Custom Accessories" Catalog. Dealers Write.

### EASTERN AUTO

3319 SO. GRAND AVE. DEPT. P-7, LOS ANGELES 7, CALIF. \$2.00 deposit with C.O.D.'s.

**ONLY \$7.95**

## MAKE EXTRA MONEY!



### SELL QUICK-BEARING NEW FRUIT TREES

**GORGEOUS FLOWERING SHRUBS, ORNAMENTALS, ROSES** Get **FREE** Sales Kit—make money fast demonstrating world-famous Stark Patented Apple, Pear, Peach and other fruit trees, Grapes and Berries. Gorgeous flowering shrubs, roses, ornamentals sell fast to home owners. Sensational hardy, Quick Bearing new varieties. Enormous demand for small farms, home yards, etc. No experience needed. Rush your name for Giant Kit and Color Plate Book — **FREE**. **STARK BRO'S, DEPT. 5572, LOUISIANA, MISSOURI**

## WHY DON'T YOU WRITE?

Writing short stories, articles on business, sports, hobbies, travel, shop crafts, local and club activities, etc., will enable you to earn extra money. In your own home, on your own time, the New York Copy Desk Method teaches you how to write the way newspaper men learn—by writing. Our unique "Writing Aptitude Test" tells whether you possess the fundamental qualities essential to successful writing. You'll enjoy this test. Write for it, without cost or obligation.

**Veterans: Course approved for Veterans' Training.**

**NEWSPAPER INSTITUTE OF AMERICA**  
SUITE 5591-L, ONE PARK AVENUE, NEW YORK 16, N. Y.

## HIGH POWER TELESCOPES



40 Power—opens to 36 inches. Precision & Polished Lenses. Ideal for Studying Stars, Plane Spotting or Interesting Pleasures. Satisfaction Guaranteed or Money Refunded.

Send Check or Money Order to **CRITERION CO., DEPT. PM9 \$3.49**  
438 ASYLUM ST. HARTFORD 3, CONN. Postpaid

"It Measures As It Rolls"

## ROLLER RULE

HANDY MECHANICAL PENCIL

Measures Curves and Straight Lines. Any Shape. Any Distance. Any Surface.

\$1.29

POST PAID

Roll head over surface. Inches and fractions record accurately on "Inch-O-Meter". Excellent pencil too! Order Now! **10 Day Money Back Guarantee!** C.O.D. (postage extra). In Calif. add 3% Sales Tax.

**PENCIL SALES CO., Dept. PM7**

Room 6, 1213 E. Ocean Blvd., Long Beach, California



# Excellent Opportunities

## IN TEXAS

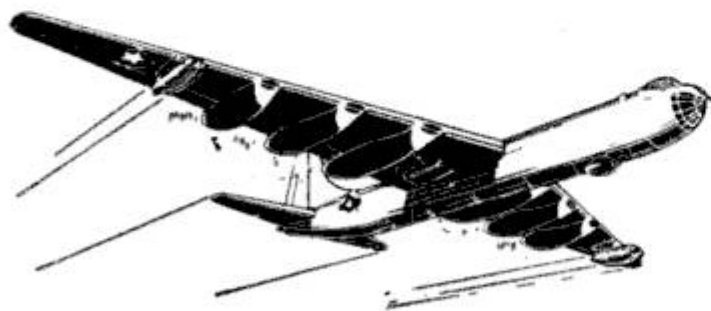

- INDUSTRIAL ENGINEERS
- AERONAUTICAL ENGINEERS
- DESIGN ENGINEERS
- TOOL AND DIE MAKERS
- TOOL DESIGNERS
- MACHINE TOOL OPERATORS
- TEMPLATE MAKERS
- FORM BLOCK MAKERS
- SHEET METAL WORKERS

You may be qualified to fill one of these exceptional openings at Consolidated Vultee Aircraft Corporation's Fort Worth Division.

You'll like the working conditions in this air-conditioned plant — world's largest integrated aircraft factory — where B-36 bombers are in development and production. Other extremely interesting but highly classified projects for the Air Force also offer challenging work.

And you'll like living in friendly, bustling Fort Worth — fastest growing city in the Southwest. Tremendous industrial expansion now under way. Healthful climate. Unexcelled schools. One acre of recreational space for every 26 citizens.

### **MEN OVER 18**

*with mechanical training or experience also needed for less skilled jobs.*

*Men subject to immediate induction into military service need not apply.*

If you are interested in a well-paying position with one of America's oldest and best-known aircraft companies, write today for application blank to

Dept. 3-1

Consolidated Vultee Aircraft Corporation  
Fort Worth, Texas

## **CONVAIR**

Consolidated Vultee Aircraft Corporation

San Diego

Fort Worth

# Easy-to-Build "OLD TIMERS"

Recapture Memories of Early Auto Days!



DURING your idle hours in the "good old summertime" turn to "Old Timers" for the fun of building these famous gas huggies of yesteryear! Authentic in detail, colorful, historic—each of these 3/4" scale models are the delight of collectors' and hobbyists!

ALL parts are completely pre-fabricated. Each of our 15 "Old Timers" miniatures comes with die-cast plastic parts, cast wheels, lights, horns, radiators, and easy-to-follow instructions.

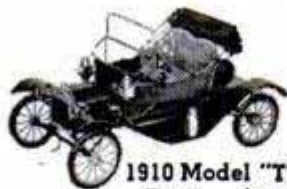

1910 Model "T"  
Ford — \$2.50



1909 Stanley  
Steamer — \$2.95



1914  
Stutz Bearcat — \$3.95



1911 Maxwell \$2.50

- |                          |        |
|--------------------------|--------|
| 1904 Olds .....          | \$1.95 |
| 1911 Buick .....         | \$2.50 |
| 1903 "A" Ford .....      | \$2.50 |
| 1909 "T" Ford .....      | \$2.95 |
| 1903 Cadillac .....      | \$2.50 |
| 1900 Packard .....       | \$2.50 |
| 1903 Rambler .....       | \$2.50 |
| 1902 Franklin .....      | \$2.50 |
| 1910 Inter. Harvester... | \$2.95 |
| 1913 Mercer Raceabout    | \$3.95 |
| 1906 "Old 16" Loco.....  | \$3.95 |

SEE them at your hobby, toy, or department store, or write to us. Add 25c for postage, handling. No C.O.D.'s, please.

Hudson Miniatures' "OLD TIMERS"  
SCRANTON HOBBY CENTER, Dept. 14, Scranton 10, Pa.

# SALESMEN JAM POCKETS WITH \$10 BILLS



Taking orders for **KEY** expertly tailored auto seat covers  
The "LEOPARD" selling sensation of the year

## BIG SEASON NOW STARTING!

Tremendous demand for Leopard auto seat covers built up overnight when Cadillac introduced a new 1950 model with Leopard Seat Covers. Car owners are paying \$50.00, \$60.00 and \$70.00 and more for car seat covers with Leopard design. Now you can serve that eager demand at a fraction of the cost your customers would expect to pay! Salesmen making money hand over fist.

### 7 STYLES

7 Price Ranges. A full line in addition to the leopard. Woven fiber. Woven Saran Plastic.

**FREE!**  
SALES KIT

Take orders from car owners everywhere. Year around income! A line of covers cut to accurate patterns like the finest suit of clothes. Add an accent of elegance to any car... just like an original upholstery job! Full or spare time, you can realize big money in this business. Every car owner a prospect. Be the first in your territory to cash in. Get your free selling kit at once for some real money.

ACTUAL SEAT COVERS GIVEN FREE TO PRODUCERS FOR OWN USE! Write for full details TODAY!

**KEY PRODUCTS CORP.**  
800 N. Clark St., Dept. 4-M, Chicago 10, Ill.

# Ships & Sailing

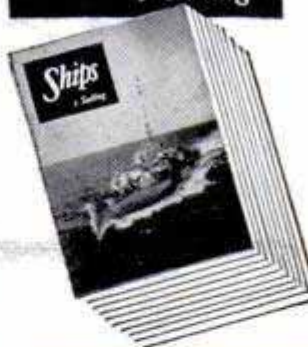

# Enjoy a Year of "Salty" Reading

Almost as good as an ocean cruise — a year's voyage with the exciting new magazine, SHIPS & SAILING. Each issue is loaded to the hatches with fascinating illustrations, stories of famed small boat passages, tramp steamer and ocean liner cruises, salty yarns, charts, adventure, port stories and a model ship-building section. Send \$5.00, check or money order, for year's subscription. Your money back after 2 issues if not more than satisfied! Send remittance today to Kalmbach Publishing Company, Dept. 1555, Milwaukee 3, Wis.

THE MAGAZINE THAT BRINGS THE SEA TO YOU

# Learn CARPENTRY BRICK LAYING

Get into the billion dollar building trades. Learn now while opportunities are greatest. Train in our completely equipped shops under expert instructors. G.I. Approved. Enroll now. Limited classes. Write for FREE Catalog.  
**MIDWEST SCHOOL OF BUILDING TRADES, Dept. PM-7**  
411 N. Center St. Bloomington, Ill.

# BE A DETECTIVE

WORK HOME or TRAVEL. Experience unnecessary.  
**DETECTIVE** Particulars FREE. Write to  
**GEO. P. M. WAGNER, 125 W. 86th St., N. Y.**

# MAKE MONEY with Bostonian SHIRTS

TAKE orders for old, reliable line finest quality dress and sport shirts. All styles... fabrics... colors... sizes. Sensational LOW PRICES. No experience needed. FREE Samples of actual fabrics and big Style Kit waiting for you! Send no money, but rush name NOW! **BOSTONIAN MFG. CO.**  
89 Bickford St., Dept. G-40, Boston 30, Mass.



# Learn Welding quickly...easily!



Whether you take a defense welding job or start your own shop, there's plenty of big money ahead for you as a trained weldor. Learn now in this modern, non-profit school. Thorough training, best equipment, experienced instructors. Complete or partial courses. Write today.

**HOBART Trade School, Box M-71, Troy, Ohio**



\$500,000.00 INVENTORY  
for QUICK LIQUIDATION

Surplus items—hundreds of them for home, shop, factory, farm and outdoor use. New items, used items, reconditioned items—all at tremendous savings—all priced for quick sale.

Page After Page of Values

This big catalog shows page after page of amazing money saving values. Write for your copy today. Send 10c to cover postage, mailing, etc. Write today!

SEND TODAY FOR YOUR COPY

**10c**

**STARK'S** Dept. PM-7 509 So. STATE STREET CHICAGO 5, ILLINOIS

# IMAGINE THEIR JOY when they found they could play this easy-as-ABC way!



**LEARNED QUICKLY AT HOME**  
 "I didn't dream I could actually learn to play without a teacher. Now, when I play for people they hardly believe that I learned to play so well in so short a time."  
 \*H.C.S., Calif.



**PLAYS AT DANCES**  
 "Your lessons have been most satisfactory. I can play all of the popular songs. I have earned money playing at dances."  
 \*E.N.J., New York.



**PLAYS ON RADIO**  
 "I can't keep from telling you that I have a good position playing from KTHS, Hot Springs, Ark., every morning."  
 \*J. S., Okla.

## What Instrument Would You Like to Play?

JUST name your instrument and we'll show you how you can learn to play it—quickly, easily, in spare time at home. Never mind if you don't know one note of music from another—don't worry about "special talent." And forget all you've ever heard about music being hard to learn.

The truth of the matter is that *thousands now play who never thought they could!* Yes, men and women everywhere have discovered this amazingly easy way to learn music at home.



Now they are enjoying the thrilling satisfaction of playing the piano, violin, guitar, saxophone or other favorite instruments. Some of them are playing in orchestras and over the radio; others are teaching music, making money in spare or full time. And thousands are having the time of their lives playing for their own enjoyment and the entertainment of their friends.

No tedious study and practice, no tiresome exercises. You learn to play by

playing—start right in with the melody of a simple tune! It takes only a few minutes a day; the cost is trifling. Does it sound too good to be true? Mail the coupon and get the **FREE PROOF!**

### SEND FOR FREE PROOF

Fascinating illustrated booklet answers all your questions; free Print and Picture Sample shows how method works. If interested, just mail coupon. U. S. School of Music, Studio 77, Port Washington, N. Y. 53rd Successful Year.

\*Actual pupils' names on request. Pictures by professional models.

### FREE! Print and Picture Sample

U. S. School of Music, Studio 77, Port Washington, N. Y. Please send me Free Booklet and Print and Picture Sample. I would like to play instrument checked below.

- |                 |                 |                   |
|-----------------|-----------------|-------------------|
| Piano           | Saxophone       | Modern Elementary |
| Guitar          | Trumpet, Cornet | Harmony           |
| Hawaiian Guitar | Organ           | Mandolin          |
| Violin          | Tenor Banjo     | Practical Finger  |
| Piano Accordion | Clarinet        | Control           |

Name \_\_\_\_\_ Have You Instrument? \_\_\_\_\_  
 Address \_\_\_\_\_  
 City \_\_\_\_\_ State \_\_\_\_\_

Save 2c—Stick Coupon on Penny Postcard

## HERE IS THE NEW SENSATION IN LOW-COST TRANSPORTATION

Truly, Cushman EAGLE is the new sensation in its field. It operates for only  $\frac{3}{4}$ ¢ per mile, cruises to 50 m.p.h., gets over 75 miles per gallon. Dealer inquiries invited.



*Cushman*

**EAGLE**

WRITE FOR DETAILS AND SPECIFICATIONS DEPT. 13-M

**CUSHMAN MOTOR WORKS Lincoln, Nebr.**

## LEARN MEAT CUTTING AT NATIONAL Pay After Graduation



The steady dependable trade of Meat Cutting taught easily in 8 short weeks. YOU LEARN BY DOING under actual meat market conditions in big modern school at Toledo.

For beginners or men with experience. Get a profitable store of your own. Remember, PEOPLE MUST EAT! Big pay jobs. Free employment help. Thousands of successful graduates.

Buying, cutting, percentage, pricing, advertising, selling, etc. A complete retail meat education. National School established over 25 years. Get National training NOW. Pay your tuition in easy weekly payments

after you graduate. G. I. approved. Send coupon for FREE 52 page school catalog — TODAY.

National School of Meat Cutting, Inc., Dept. 50-U, Toledo 4, Ohio

Send me your FREE school catalog on National Training at Toledo in Meat Cutting, Meat Merchandising and Self Service Meats. No obligation. No salesman will call.

Name \_\_\_\_\_  
 Address \_\_\_\_\_  
 City \_\_\_\_\_ State \_\_\_\_\_  
 ( ) Check here if Veteran of World War II

# TURN YOUR CAR INTO A COMFORTABLE BED

You Can  
MAKE CONVERSION  
QUICKLY & EASILY  
With Complete  
CAR BED KIT

SEAT GOES BACK  
AT THE DROP  
OF A LATCH

Ideal for  
HUNTERS, FISHERS  
VACATIONERS and  
ON OVERNIGHT  
TRIPS

Use your auto as private sleeping car and save money; rest in solid comfort.



WORKS ON ALL  
2 and 4-DOOR  
SEDANS  
CLUB COUPES &  
CONVERTIBLES  
Dealer Inquiries  
Invited

GUARANTEED TO WORK OR YOUR MONEY BACK

ONLY  
**13.95**  
for complete kit  
and  
instructions

NO INSTALLATION CHARGES!—  
With Car Bed kit and instructions you do converting yourself in your spare time. Give make, model and whether 2 or 4-door. ACT NOW! Shipped postpaid. Send check or money order.

**AUTO BED COMPANY**  
305 East 6th St. Panama City, Fla.

**GET**  
A  
Government  
JOB!

START AS HIGH  
AS \$3,450.00 YEAR

Many early Examinations Expected. Prepare NOW! Veterans Get Special Preference! 32-Page Civil Service Book FREE

**Franklin Institute**  
Dept. W-83,  
Rochester 4, N. Y.  
(Not Gov't Controlled)

Gentlemen: Rush to me FREE of charge, list of U. S. government big pay jobs. Send FREE 32-page book describing salaries, vacations, hours, work, etc. Tell me how to qualify for one of these jobs.

Mail Coupon Today SURE

Name \_\_\_\_\_  
Street \_\_\_\_\_  
City \_\_\_\_\_ Age? \_\_\_\_\_

# new, easy way to.. STRIPE with PAINT

Do Perfect Paint Striping at Home with New Kind of PAINT STRIPING TOOL

This Master Painters' Striping Tool makes it easy to do expert striping on furniture, bikes, model planes, autos, signs, toys, linoleum, wall board, etc. Makes plain, painted walls look like tile. Paint straight lines... curved... circular or evenly spaced parallel lines the same way a professional painter does. Simply fill Tubular-Glass Paint Fountain with any color paint and wheel tip feeds paint evenly. Tips interchangeable—jaws split apart for easy cleaning. Tool complete with tips for 1-16 in. stripe only \$1.00 postpaid. Other complete tools with 1-64, 1-32, 3-64, 6-64, 3-32, 1-8 inch tips, \$1.50 ea. Extra tips — 75c each.



**\$1 ONLY**  
POSTPAID  
ATTENTION  
Home Craftsmen  
and Hobbyists

**DEALERS**  
Paint  
Striping Tool  
packed in attractive display cartons of 1 doz. Each, profitable seller. Write for illus. circular, discounts.

Just the tool you've been waiting for! New PAINT STRIPING tool gives "professional" results every time, yet simple and easy to use as a fountain pen. Adjustable guide keeps lines straight as an arrow. Just as easy to make curves or free hand designs. Adds new beauty and finished look to everything you paint. Send dollar today.

WENDELL MFG. CO., 4234 N. Lincoln Ave., Dept. 37, Chicago 18, Ill.

## BE A LOCKSMITH

Learn from experts at home! Age or handicap no disadvantage. Profitable profession. FREE booklet. INSTITUTE OF LOCKSMITHING, Dept. P-20, 55 Park Ave., Rutherford, N. J.

## REAL ESTATE

BE A BROKER

PAYS BIG! SEND FOR FREE, BIG, ILLUSTRATED CATALOG NOW! No obligation. Graduates report making substantial incomes. Start and run your own business quickly. Men, women of all ages, learn easily. Course covers Sales, Property Management, Appraising, Loans, Mortgages, and related subjects. STUDY AT HOME or in our classrooms in big cities. Diploma awarded. Nationally known.

**WEAVER SCHOOL OF REAL ESTATE (Est. 1936)**  
15 E. Pershing Road Dept. PM Kansas City, Mo.

FREE BOOK TELLS HOW

## INVENTORS

Send today for "Patent Protection for Inventors" outlining preliminary steps to take toward patent protection, also convenient "Evidence of Invention" Form.

**VICTOR J. EVANS & CO.**  
630-H Merlin Building, Washington 6, D.C.

## CARTOONING

HAVE FUN! MAKE MONEY! Cash in on your sense of humor AT HOME—BY MAIL! No experience needed to start. Write today FOR FREE TRIAL LESSON and full particulars.

Moon Gag Cartoon School, Dept. K, Fall Creek, Wis.

## Save Fingers with

### Steel-Grip Finger Guards

Lower Your Hand Protection Cost

Hundreds of factories save time and injuries by protecting workers with Steel-Grip Open End Finger Guards. For handling rough, sharp articles, buffing, grinding, sanding, and punch press work, hundreds of other jobs. Protect fingers or thumbs, front or back, from cuts, abrasions or blisters. Various designs in leathers and other materials: elastic web back for snug, cool, comfortable fit. Sizes for men and women. Send 10c for sample. Catalog of Safety Apparel Free.

**INDUSTRIAL GLOVES CO.**  
A Corporation  
1416 Garfield St., Danville, Ill.  
(In Canada, Safety Supply Co., Toronto)

**Steel-Grip INDUSTRIAL Safety Apparel**  
Famous Industrial Safeguards Since 1910

**\$350** IN A SINGLE WEEK **GROSS**



**IN MY OWN BUSINESS**

**Some Make More, Some Less . . . Start This Business for YOUR OWN**

**George Held earned \$350 in one week with**

**ELECTRIC UPHOLSTERY CLEANER**

● Here's YOUR chance to start a money-making, year-'round business of your own and make the success you've dreamed about. R. O. Donnelly took in \$40 in seven hours. O. W. Ware landed a \$750 hotel job and made a fine profit. J. S. Corbit grossed \$279.50 his first month. P. D. Ash cleaned 23 auto seats at \$5 each in one week. And so it goes. Homes, hotels, offices, clubs, all places where furniture is used, offer you big profit possibilities. Auto seats and interiors, also.

**NO SHOP OR OFFICE NECESSARY**

You clean furniture on customers' premises. No hauling costs. No high rents. Supplies are in-

**FREE BOOK! MAIL COUPON**

**VON SCHRADER MFG. CO.**  
736 PL., Racine, Wisconsin

Send at once (no obligation) your FREE booklet containing information about your Electric Upholstery Cleaner and how I can own my own permanent, profitable business.

Name \_\_\_\_\_  
Address \_\_\_\_\_  
City \_\_\_\_\_ Zone \_\_\_\_\_ State \_\_\_\_\_

expensive and you operate, at low cost, from your home. What you take in is mostly profit. Surely YOU will want to investigate an opportunity like that — right away. Own your own business. Be your own boss. If you are ambitious, honest and courteous, we will help you to start and succeed.

**FULL INFORMATION FREE MAIL COUPON TODAY**

Send the coupon or write for Furniture Cleaner Booklet. It tells all about this electric cleaner—how to start YOUR business—how to make a profitable success. Don't delay. It's your BIG opportunity.



**MAIL COUPON TO**

**VON SCHRADER MFG. CO., 736 PL., RACINE, WIS.**

**Amazing Attachment MAKES OLD REFRIGERATORS INTO MODERN Automatic Defrosters!**

Thirty Million Prospects. Sell without "selling pressure" on sensational Free Trial Plan. Just plug it in and leave it. Frees women from drudgery and mess of defrosting. Saves electricity. Keeps food longer, better. Gives longer life to refrigerator. Secret "follow-up" Plan often brings five additional sales by making every user your agent. Big season now on!

**SENT FREE... JUST SEND NAME!**  
Don't send a cent—just your name on penny postcard. We'll send you the biggest money-maker you ever got your hands on and guarantee your sales at profits as high as \$5.00 on each sale. Rush your name!

**MAXILUME COMPANY, 125 West Hubbard Street, Dept. D-87, Chicago 10, Illinois**

**Women buying by the thousands!**

Salesmen Cleaning up on "Free Trial" Sales Plan Sent Free with Instructions.

Make as high as \$5 on Every Sale!



**DRAW for MONEY... Be an ARTIST!**



**Trained Artists are Capable of Earning \$75, \$85 and MORE a WEEK!**

YOU CAN learn to draw at home in your spare time the well-known WSA way. COMMERCIAL ART, DESIGNING, CARTOONING all in ONE complete course. No previous Art experience necessary—we teach you step-by-step. Prepare for a fascinating hobby and profitable career. Good art jobs await artists in advertising, television, publishing, etc. For 37 years WSA graduates have been making good—WHY NOT YOU? Low cost—easy monthly terms.



**VETERANS! G. I. Bill Deadline is in July '51 — Enroll now! Write for FREE BOOK, "Art for Pleasure and Profit," fully describes course and commercial opportunities for you. See how quickly, easily you can get started. TWO ART OUTFITS included with training.**

**MAIL COUPON TODAY. NO SALESMEN WILL CALL**

**WASHINGTON SCHOOL OF ART, Studio 127A, Washington 5, D. C.**

Please send details and your Free Book, "Art for Pleasure and Profit." (Please print.)

Name \_\_\_\_\_ Age \_\_\_\_\_  
Street \_\_\_\_\_  
City \_\_\_\_\_ Zone \_\_\_\_\_ State \_\_\_\_\_  
 I am entitled to training under "G.I." Bill. Rush me details!

# FREE



## A NEW HOME INDUSTRY



Let us show you how extremely easy and PROFITABLE it is to make beautiful and useful things out of LIQUID PLASTICS, LIQUID MARBLE, LIQUID IVORY, LIQUID GLASS, CERAMICS, ETC. . . . as easy as pouring water out of a glass! We have started THOUSANDS of people in this fascinating and very PROFITABLE home occupation! Make novelties, jewelry, gifts, artware, toys, tools, dies, gadgets, ceramics . . . a million useful things! We supply everything—MATERIALS, INSTRUCTIONS and BUYERS! Send only 25c for 1. Big catalog of 300 casting materials, molds and accessories. 2. A beautiful CASTING FREE to show you what you can do, and 3. Actual CASTING INSTRUCTIONS on how to cast and start in the CASTING BUSINESS! VALUABLE MOLDS given FREE with orders! Send 25c today — this may be the lucky coin that will start the most fascinating and profitable phase of your life.

# BILLIONS for DEFENSE!



The country is preparing the greatest peace-time defensive in history . . . BILLIONS are being spent! Our liquid plastics are being used in THOUSANDS of different operations in defense work! NO SPECIAL TOOLS OR MACHINERY REQUIRED! Work can be done at home, garage, shop, etc. Full time or spare time, by the able and the disabled. We help you get defense work and instruct you in all the details! Send 25c for catalog (see above) and details how to take part in this tremendous defense program that offers you a grand opportunity to combine patriotism and profit!

### PLASTICAST COMPANY (Dept. C)

P. O. BOX 6737 (Write to either address) P. O. BOX 987  
CHICAGO 6, ILL. PALO ALTO, CALIF.  
Canadian customers: send 35c for catalog and order direct from;  
Canadian Industrial Plastics, Ltd., 1056½ W. Pender Street,  
Vancouver, B. C.

# INVENTORS

Before you make any effort to market your invention, you should take the first steps toward proceeding for patent protection.

The usual first step is to have a search of the U. S. patent records conducted, so that I can report to you on the question of patentability.

I shall be pleased to furnish you with information relative to patent procedure, upon request from you, and this will be without any obligation on your part.

## PATRICK D. BEAVERS

(Formerly RANDOLPH & BEAVERS)  
Registered Patent Attorney

934 Columbian Building Washington 1, D. C.

# Wheels Wheels



# Wheels Wheels

- 5" Disc Wheel 5/8" Tire 5/16" or 3/8" sleeve . . . . .30c ea.
  - 6" Disc Wheel 5/8" Tire 5/16" or 3/8" sleeve . . . . .35c ea.
  - 7" Disc Wheel 3/4" Tire 3/16" sleeve . . . . .45c ea.
  - 8" Disc Wheel 1 1/4" Tire 1/2" sleeve . . . . .70c ea.
  - 7" Disc Wheel 1" Tire 1/2" ball bearing . . . . .80c ea.
  - 8" Disc Wheel 1 1/4" Tire 1/2" ball bearing . . . . .1.00 ea.
  - 8" Disc Wheel 2" semi-pneum. T. 1/2" B.B. . . . .1.35 ea.
  - 10" Disc Wheel 1.75 semi-pneum. T. 1/2" B.B. . . . .1.50 ea.
  - 12" Disc Wheel 1.75 semi-pneum. T. 1/2" B.B. . . . .1.85 ea.
- Above wheel prices includes hub cap.  
Plus Postage, 20%. C.O.D.'s accepted.

### UNITED WHEEL STAMPING CO.

2756 W. 115th STREET PM-7 CHICAGO 43, ILLINOIS

# PATENTS PATENT LAWYER

## GUSTAVE MILLER

REGISTERED  
PATENT ATTORNEY

71-PM WARNER BLDG.  
WASHINGTON 4, D. C.

ASSOCIATE EXAMINER  
U. S. PATENT OFFICE 1922-1929

Patent Attorney and Advisor  
U. S. NAVY DEPT. 1930-1947

Send for  
PATENT INFORMATION book  
and "INVENTOR'S RECORD" without obligation

# PATENTS

## C. A. SNOW & CO.

REGISTERED PATENT ATTORNEYS  
WRITE FOR INFORMATION TO  
428 SNOW BUILDING, WASHINGTON 1, D. C.

# INVENTORS

Whether an invention is patentable can be substantially determined by a search of the U. S. Patent records. Without obligation, write for information explaining the steps you should take to secure a patent.

## JOHN N. RANDOLPH

Registered Patent Attorney

201 Columbian Building, Washington 1, D. C.

### INVENTORS! IDEA PEOPLE!

send for FREE FOLDER—explains new kind of valuable service that helps you GUARD YOUR IDEAS as low as \$3 per yr.

We are not lawyers.  
IDEA SAFEGUARD CO.  
511-5th Ave., N. Y. 17, N. Y.

### SHOE REPAIRING OFFERS BIG INCOME

Learn in 12 weeks to be a skilled repair man by actually working on shoes. Free big 24-page book. The only old practical school in U. S. Established 1927.

MODERN SHOE REBUILDING SCHOOL  
806 SO. FIGUERO ST., LOS ANGELES 17, CALIF

# INVENTORS

IF YOU WISH TO PROTECT YOUR INVENTION, You should take steps to protect it by a U. S. Patent. Write me for "INVENTION RECORD" form

**CARL MILLER**  
REGISTERED PATENT ATTORNEY

WOOLWORTH BLDG., 35th FLOOR, 71A  
NEW YORK CITY

- Experience in the aircraft field is not necessary.
- Your own experience in mechanical and structural design and layout can be applied to Aircraft Work.
- Special opportunities now available to electrical draftsmen.

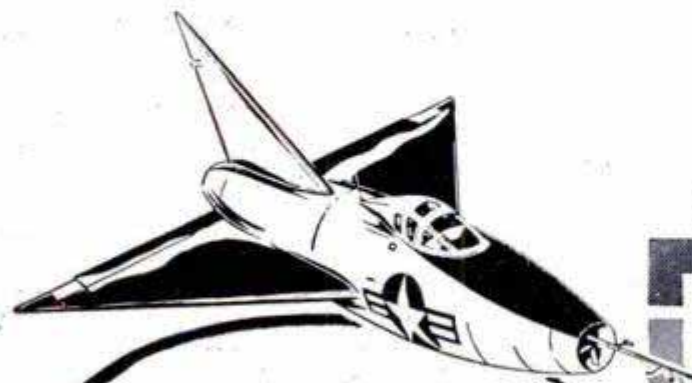

# DRAFTSMEN ENGINEERS

Work in California for  
**CONVAIR**  
(Consolidated Vultee Aircraft Corporation)

Send coupon now for **FREE** information.

Mr. H. T. Brooks, Engineering Department P.M.  
Convaair, 3302 Pacific Hiway, San Diego, California  
Please send me **FREE** booklets describing the Convaair Opportunity for me and my Convaair Application Form.

My name \_\_\_\_\_  
Occupation \_\_\_\_\_  
Address \_\_\_\_\_  
City \_\_\_\_\_ State \_\_\_\_\_

**LIVING:** San Diego offers you and your family incomparable living. Cool, clean, dry climate. It offers you a new way of life — pleasant, refreshing, happy.

*Earn up to \$6,000 a year!*

**MORE JOBS THAN WE CAN FILL**

**METAL TRADES BACKBONE OF INDUSTRY**

Men who are mechanically inclined have a wide open field to choose employment in the Metal Trades Industry. Jobs are going begging for lack of qualified trained men. You need no previous experience to start your training at this school.

**SHORT COURSES TO MEET PRESENT JOB DEMAND.**      **INDICATE YOUR PREFERENCE—RESIDENT or HOME STUDY TRAINING**

ALLIED SCHOOL OF MECHANICAL TRADES, Inc.      Write for **FREE BOOKS**  
1338-1340-1342 S. MICHIGAN AVENUE      A 1c Postcard will do.  
407 ALLIED BUILDING, CHICAGO 5, ILL.

## AUTO SEAT COVERS

to fit all makes and years!

*Leopard Seat Covers*

**Only \$2.98**

- Choice of full front and rear seat covers or split front seat
  - Leopard skin effect on colorful plastic
  - Water-proof and stain proof
  - Comfortable and Cool
  - Easy to attach—no pins necessary
- You must be satisfied or Money Back! Front or rear seat only \$2.98 each or FULL SET for \$5.00. Order now. Enclose payment or pay postman plus postal charges. Specify whether split or solid front seat.
- DOMAR SALES CO., Dept. CF-4**  
480 Lexington Ave., New York 17, N. Y.

## PISTON SEAL

is "Penicillin" in your AUTO ENGINE!



**DON'T** spend Big Money overhauling your car! Use Holt's "Piston Seal" instead! Exactly what's your trouble? Burning oil? Lacking power? Piston slap? Worn cylinders? "Piston Seal" effectively eliminates these ailments! By forming self-expanding pliable lubricating seal around the pistons, this amazing British product compensates for wear! Restores compression! Cuts oil loss! Checks piston slap! Lasts 10,000 miles! Cannot harm the finest engine; easily installed. The British call it a "Godsend!" You will, too!



**DETAILS FREE!  
WRITE TODAY!**

**R. H. PHILBRICK, Dept. 61**  
**Drawer 4590, Coral Gables 34, Fla.**  
RUSH details on Piston Seal—without obligation!

NAME.....  
ADDRESS.....  
CITY..... STATE.....

# Become an ELECTRICAL ENGINEER

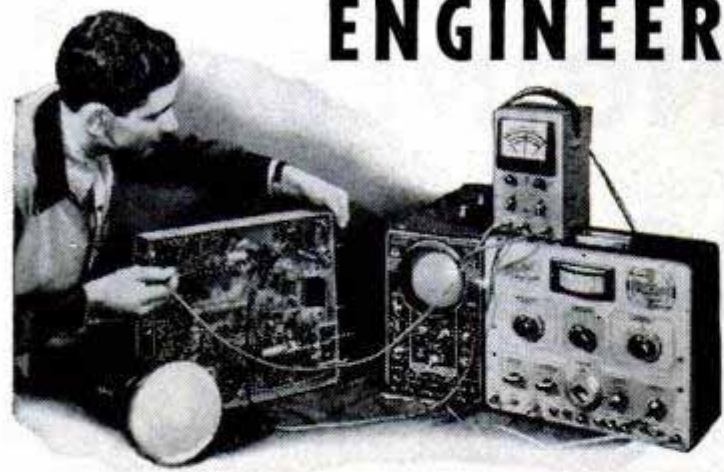

## Major in Power or Electronics ... B. S. Degree in 36 Months

Important advantages are yours at this nonprofit institution of higher learning. Through optional year-round study, a *valuable year is saved* by gaining your B. S. degree in 36 months. Further—you are guided scientifically toward specialization for design and research, manufacturing and production—or engineering sales and management.

- Choose the Course That Interests You Most
- SERVICE**  
6 Months
- Electricity
  - Welding
  - Refrigeration
  - Heating
- TECHNICIAN**  
12 to 18 Months
- Radio and Television
  - Electronics
  - Electrical Power
  - Welding
  - Air Conditioning
- ENGINEERING**  
36 Months
- Electrical Engineering — B. S. Degree Major in Electrical Power or Electronics

## A Radio-Television Technician's Certificate can be yours in 18 months

Under this school's **proven plan** you can become a Radio Technician in 12 months — or a Television Technician in 6 additional months. Courses are complete in themselves, and can be applied as **one-third** of the electrical engineering course.

**Practical, Military or Academic Training** will be evaluated for advanced credit.

**Faculty of specialists.** Over 2,300 annually enrolled. 35,000 former students from 48 states and 23 overseas countries.

# MILWAUKEE SCHOOL of ENGINEERING

Terms open July, Oct., Jan., April

Write for free 110-page catalog, 48-page pictorial booklet "Your Career" and "Occupational Guidance" Bulletins

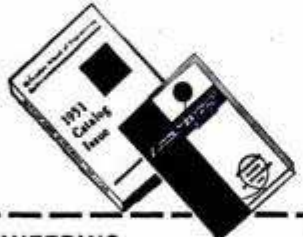

MILWAUKEE SCHOOL OF ENGINEERING  
Department PM 751, 1020 N. Broadway, Milwaukee, Wis.  
Without obligation send catalog and "Your Career" bulletin plus "Occupational Guidance Bulletin" and details on course in

NAME \_\_\_\_\_ AGE \_\_\_\_\_  
ADDRESS \_\_\_\_\_  
CITY \_\_\_\_\_ ZONE \_\_\_\_\_ STATE \_\_\_\_\_  
 Check if World War II Veteran

## PUP TENT

FULL SIZE GI PATTERN — ONE-PIECE HEAVY GAUGE PLASTIC

Full size 5'x7' 2-man tent. Complete with GI Poles, pins & tie-down cords. Attractive outdoor colors. Waterproof, mildew proof, dry. (Boy Scouts, churches, clubs 10% Discount on 6 or more). FREE carrying bag for easy packing

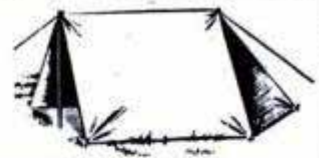

\$5.95

## Aqua GOGGLES

Large glass lens. Exclusive inner vacuum lip molds to fit face. Comfortable. Permits continued use. Adjustable head strap. Natural rubber, sea green. For pool, ocean, lake or river.



\$1.25

JR. GOGGLES, plastic lens..... 79c



## GIANT BALLOONS

Neoprene. Genuine Govt. surplus. Used as weather & target balloons. Inflates with vacuum cleaner. Great fun for yards, picnics, fairs, shows. Wonderful for advertising, attracts immediate attention.

3 FT. DIA. 6 FT. DIA. 13 FT. DIA.  
39c 79c \$1.39

Postage Paid On Prepaid Orders  
Calif. Res. Add Sales Tax

## WAR ASSETS DIV.

Volume Sales Co.  
Dept. M-751, 3930 Sunset Blvd., Los Angeles 29, Calif.

## OWN a Business

Clean and Mothproof rugs and upholstery "in the home." Patented equipment. No shop needed. Duraclean dealer's gross profits up to \$15 a day on EACH serviceman. These Nationally Advertised services create repeat customers. Easy to learn. Quickly established. Easy terms. Send today for FREE Booklet — Full details.

**DURACLEAN CO.,** 1-167 DURACLEAN BLDG. DEERFIELD, ILL.

## ARTISTS MAKE MONEY

Do you like to draw? Send name, address, age and occupation for FREE ART TEST, to find out your ability.

**ART INSTRUCTION, Inc.** 7131 ART INSTRUCTION BLDG. MINNEAPOLIS 15, MINNESOTA

## Mustang LIGHTWEIGHT

\$362.20  
(Fed. tax paid, at factory)

9.5 hp. 4-cycle. 3-speed. Foot-shift. Over 70 miles per gal. Over 60 m.p.h. Write for free circular.

**MUSTANG, Dept. PM**  
635 W. Colorado, Glendale 4, Calif.

## AMAZING NEW DISCOVERY!

### FOR ALL CARS WITH OVERDRIVE

**\$9.95** Postpaid & Installed

We enclose FREE installation certificate redeemable for cash by your garage or gas station.

The Gane-O-Matic Overdrive Control puts to work all the hidden advantages of all Ford, Mercury, Lincoln, Studebaker, Nash, Hudson, Kaiser-Frazer, Jeepster, Dodge, DeSoto and other overdrive systems. **AUTOMATIC HILLHOLDER** holds car on any slope without use of hand or foot brake. **OVERDRIVE COMPRESSION** saves gas, brakes and tires. **SIX FORWARD SPEEDS** . . . three each in overdrive and regular range are selected with the flick of your finger. **NO CLUTCH SHIFTING** enjoyed up or down without touching your clutch.

**YOUR MONEY BACK IF NOT FULLY SATISFIED!**  
Send cash, check or money order. \$1 C.O.D. deposit

**NATIONAL AUTOMOTIVE RETAIL CORP., Dept. Y-7**  
350 W. Washington Blvd., Venice, Calif.

**AUTOMATIC HILLHOLDER**

**OVERDRIVE COMPRESSION**

**6 FORWARD SPEEDS**

**NO CLUTCH SHIFTING**



# SACRIFICE SALE of Nationally Advertised Watches

## Jet-O-Matic Full Swing SELF WINDING 24.95

Super De-Luxe Model—360° FULL-SWING AUTOMATIC. Just set it—then forget it! It winds itself as you wear it. Patented INCABLOC 17 Jewel movement of superb accuracy. WATER & SHOCK RESIST—you can drop it, bang it, even SWIM with it! 100% stainless steel screw-back. Radium Luminous Markings. Unbreakable Kieersite Crystal. Hairline sweep-second. SPLIT-SECOND calibrations for precision timing. Handsome thin case. Smart, GILT numerals & hands. CAUTION: Do not confuse with inferior 180° HALF swing automatics! Thoresen's Jet-O-Matic is 360° FULL swing. It's the "high compression" self-winder! Formerly \$75.00. NOW—24.95 plus 10% tax—total 27.45. FLEX-METAL band given!



Save 40% TO 72%

**FREE  
10 DAY TRIAL**

Check watches wanted in coupon below. Remit check or money order for FAST prepaid delivery, or order COD plus postage. Try, appraise, enjoy 10 whole days. Full price back QUICK if not delighted! **UNLIMITED GUARANTEE** Exclusive of Parts! No charge ever for skilled labor, "handling," etc. for LIFETIME of business. All THORESEN watches subjected to 11 special tests before shipment. Save with SAFETY . . . the THORESEN way!

## B De-Luxe 17 Jewel Gold Plate ACCURACY 14.00

MASTERPIECE of superb styling! Streamlined 14 karat Rolled Gold Plate—stainless steel back. Gilt numerals & hands. Hi-Dome crystal. Amazing accuracy! One of the smartest watches today. Formerly \$59.50. Now yours for only 14.00 plus 1.40 tax—total 15.40.

## C 17 Jewel INCABLOC 14.95 WATER & SHOCK Resist

World famous INCABLOC! Radically different! 17 Jewels! You can DROP it. WET it. BANG it! Actually runs UNDER WATER! Try at our risk. De-Luxe Features: Radium-applique numerals — Stainless Steel Screw Back — Safe-Guard Gasket — Sweep-second—Thin. GIVEN: Vita-Flex band. Why pay up to \$65.00? Thoresen's sacrifice price—14.95 plus 10% tax, total: 16.45.

## Genuine Recipro-Register CHRONOGRAPH

The ONE and ONLY genuine Recipro-Register CHRONOGRAPH—computes speeds & distances down to 1/5th of second! INCABLOC 17 Jewel Movement resists shocks of work & play. Remembers for you while movement continues to keep time! TIMES: Races, Planes, Sports, Photography, Shop Work, Lab Experiments, Lightning, etc. AUTOMATICALLY! 3 multi-function synchronized dials. Contact clutch starts computation. Brake clutch freezes result. Also ERASES back to zero. Radium dial, hairline sweep-second, all stainless steel back, unbreakable Kieersite crystal. Don't confuse with cheap, troublesome chronographs. Every Recipro-Register Chronograph is INCABLOC equipped—subject to 11 gruelling tests before shipment! Formerly \$79.95. NOW—27.25 plus 10% tax—total: 29.98.



## 3 DIAL CHRONOGRAPH

Outstanding value! 3 Dials — 5 Hands! 2 Push Buttons. Both a wristwatch & chronograph. Sweep-second hand. 60 Second Dial. 45 Minute Registering Dial and 6 Hour Dial. 2 independent movements for DOUBLE use. Sturdy construction. Keeps on going while measuring speed of planes, sports, etc. NOW—7.85, plus 79c tax. Total: 8.64.

\$7.85

THORESEN DIRECT SALES, Dept. 6G-300  
131 WEST 33rd STREET — NEW YORK 1, N. Y.

RUSH watches checked on 10 DAY FREE TRIAL.  
Remittance enclosed—send Prepaid.  Send COD plus post.

A  B  C  D  E   
NAME \_\_\_\_\_  
ADDRESS \_\_\_\_\_  
TOWN \_\_\_\_\_ STATE \_\_\_\_\_

## FREE . . . .

I will show you how you can make \$200 or more per week . . . with just 13 words. Write for this new proven sales aid now. Terrific money-maker!!! Amazing new plastic signs and letters that stick to glass without tape, glue or suction. Just press on!!! Washable, almost indestructible. Write today.

## CLAYTER CORPORATION

65 WEST 39th ST., N. Y. C.

DEPT. PM-7



## BE A TILE SETTER

Earn VERY high wages. IN YOUR HOME you can learn professional tile-setting—in a few weeks of spare time. One day's wages more than pays for the course. Big demand. Send for free details now!

AMERICAN INSTITUTE OF TILE SETTING  
PO Box 1845 Wilshire-LaBrea Station, Dept. PM7, Los Angeles 36, Calif.

SAY YOU SAW IT IN  
POPULAR MECHANICS

## WANT TO Write Stories

FREE LESSON  
shows how you  
learn at home  
Articles  
Mysteries?



The demand for writers is creating great new opportunities and it's not as hard to succeed as you may imagine. At home, you may learn fiction writing, best basis for all fields; short stories, radio & TV, articles, business items. Palmer training is endorsed by famous authors, scores of successful graduates. Complete instruction, professional coaching. FREE book and lesson show how you may enjoy an ideal part-time or full-time career. Write TODAY (no salesman will call). Approved for veterans: advise if eligible.

PALMER INSTITUTE OF AUTHORSHIP, Since 1917  
1680 N. Sycamore, Hollywood 28, Calif., Desk T-71

## No Experience Needed To PRINT YOUR OWN POST CARDS

The GEM STENCIL DUPLICATOR saves money . . . gets results quickly! Hundreds of uses for every type of business and organization. We ship the GEM complete with all supplies, Guide Board for accurate printing and 60-page Book of Ideas at the special low price of only \$8.50 (a \$15 value).



## FREE TRIAL OFFER

Our 21st Year  
Use the GEM FREE at our expense! SEND NO MONEY. Write and complete GEM outfit will be sent you postpaid. After ten days, send us only \$8.50 or return the GEM. You must be satisfied!

BOND EQUIPMENT CO. Dept. 48  
6633 Enright • St. Louis 5, Mo.

Combined Experience and

**NOW FOR THE FIRST TIME**

# KNOW HOW of World's BEST AUTO MECHANICS

## AUTO Repair Kinks



by Bill Toboldt  
Editor  
Motor Service Magazine  
Only \$3.00  
Postpaid to Your Home

### ZIP THRU Auto Repair Jobs

Bill Toboldt's AUTO REPAIR KINKS, the entirely new and different guide to "doctoring up" ailing autos, describes hundreds of out-of-the-ordinary but practical time and money-saving repair kinks that have helped auto mechanics out of tough spots . . . tells how to Step Up Speed, Power; Save Fuel, Cure High Oil Consumption, Trouble Shoot Engine Knocks, Service Cooling Systems . . . brings you the combined experience and KNOW HOW of World's Best Auto Mechanics. Also, complete Mechanical and Tune-Up Specifications 1938-1950 models on: Buick, Chrysler, Dodge, Hudson, Mercury, Packard, Studebaker, Cadillac, Crosley, Ford, Kaiser, Nash, Plymouth, Willys, Chevrolet, DeSoto, Frazer, Lincoln, Olds, Pontiac.

SEND NO MONEY. Simply clip this ad and mail with name and address. If not pleased return in 5 days and pay nothing. If you keep book, send only \$3.00 plus 25c for postage and handling.

Goodheart-Willcox Co., Dept. 162, 1321 S. Michigan Ave., Chicago 5

NOTE: You can save 25c by including remittance with order. (Three \$1 bills will be okay.) Same return privilege.

## AERONAUTICAL ENGINEERING



Design Aircraft & Components—Study with Jets & Rockets—Great Future—Advanced Aeronautical Subjects—World-Wide Enrollment—Fully Accredited—Established 1929—Approved for Vets—CAL-AERO grads in heavy demand.  
WRITE TODAY for Special Information. PM-7

NAME \_\_\_\_\_ AGE \_\_\_\_\_  
ADDRESS \_\_\_\_\_  
CITY \_\_\_\_\_ ZONE \_\_\_\_\_ STATE \_\_\_\_\_

**CAL-AERO TECHNICAL INSTITUTE**  
GRAND CENTRAL AIR TERMINAL • GLENDALE 1, CALIFORNIA

## High School at Home

### Many Finish in 2 Years

No classes. No time wasted going to and from school. Progress as fast as your time and abilities permit. Standard H. S. texts supplied. Thousands enroll each year in this 54-year-old school. Send for FREE descriptive booklet.

**AMERICAN SCHOOL, Dept. HB45**  
Drexel at 58th St., Chicago 37, Ill.  
Without obligation, please send FREE descriptive booklet.  
Name \_\_\_\_\_  
Address \_\_\_\_\_

## WAR SURPLUS OPTICAL BARGAINS

**MAKE A MICROSCOPE** Get wonderful results. Own an instrument worth many times the cost to you. Simply convert a U. S. Govt. Rifle scope (Govt. cost over \$65.00). It's easy! We show you how. No machining required. Get up to 40 Power. Scope we furnish is used but good condition . . . sent complete with extra lenses and direction sheet. Stock #959-H . . . \$7.90 Postpaid

**10 POWER SPOTTING SCOPE**—A WONDERFUL BUY! Pocket-Size! Complete with tripod and swivel head. Only 5 1/2" long—8 1/2" high on tripod. Adapted from Army telescope and worth many times our price. Has prism erecting system, achromatic objective, Ramsden Eye-Piece. Lenses low reflection coated. Stock #955-H . . . \$14.95 Postpaid

**SLIDE PROJECTOR SETS** Consists of all unmounted lenses you need to make the following size projectors:  
Stock #4029-H—35 mm. . . . . \$2.85 Postpaid  
Stock #4038-H—2 1/4" x 2 1/4" . . . . . \$3.35 Postpaid  
Stock #4039-H—2 1/2" x 3 1/2" . . . . . \$3.35 Postpaid

**SIMPLE LENS KITS**—Include plainly written, illustrated booklet showing how you can build lots of optical items. Use these lenses in photography and for dozens of other uses in experimental optics, building TELESCOPES, low power Microscopes, etc.  
Stock #2-H—10 lenses . . . . . \$ 1.00 Postpaid  
Stock #5-H—45 lenses . . . . . 5.00 Postpaid  
Stock #10-H—80 lenses . . . . . 10.00 Postpaid

We Have Literally Millions of War Surplus Lenses and Prisms for Sale at Bargain Prices. Numerous Types of Instruments, Too! Write for FREE CATALOG-H

**EDMUND SCIENTIFIC CORP., Barrington, N. J.**  
(Formerly Edmund Salvage Co.)

## Bar Bells

Buy Direct From Factory \$8.95 up  
Approved and Recommended by Karl Koberle (Foremost Ex-Army Instructor on Weight Training).  
Write for free booklet and price list.  
**INDEPENDENT IRON WORKS**  
2416 East 23rd Street, Dept. B  
Los Angeles 58, Calif.

## NEW! "WIGGLE" GETS BIG FISH HULA DIVER

**POSITIVE CONTROL OF DEPTH AND ACTION**  
New big lip and rear paddle for amazing results. Ideal open-water 5/8 oz. lure for deep-feeding game fish. \$1.25 at your dealer.

**FRED ARBOGAST & Co., Inc., 2267 W. North St., Akron 3, Ohio**

**FREE** WRITE TODAY FOR BIG FREE 1951 ARBOGAST COLOR CATALOG—FULL OF PICTURES OF CATCHES

## WEAR THE MASCOT OF THE SPEEDWAY DRIVERS!

"LADY LUCK" in Three Colors

7" Felt Jacket Emblems . . . . . 50c  
10" Felt Jacket Emblems . . . . . \$1.00  
Decals— .15c Stickers— .15c  
"T" Shirts With Design . . . . . \$1.50

No C.O.D.'s, Please  
Complete Catalog of Popular Emblems, including Club items, Racing Novelties, Garments, Decals, Special Emblems: 25c

**EMBLEMS MADE TO YOUR ORDER**  
**STYLIZED EMBLEM COMPANY**  
1356-P N. Western Ave., Los Angeles 27, Calif.

## MAKE MORE MONEY • HAVE MORE SECURITY BE A CAMERA REPAIRMAN

Camera repair offers ambitious men interesting, well paying, secure careers. We teach you with practical "on the spot" training. Other courses include: Portrait, Commercial, and Natural Color Photography - retouching - air brush technique. Tools furnished with courses.  
G.I. Approved • Free Job Placement • Housing accom. secured

**GERMAIN** WRITE FOR FREE BOOKLET PM  
SCHOOL OF PHOTOGRAPHY 225 B'way, N. Y. C. 7  
"The School of Personalized Instruction"

## Say You Saw It in POPULAR MECHANICS

## SHINE WITHOUT 'POLISH'

New Invention! • Sells Like Wild

Replaces messy pastes, liquids. Simply glide over shoes—and PRESTO!—you have a lustrous, long-lasting shine. No mess. No muss. No soiled hands. Clean. Handy. **WORKS LIKE MAGIC!** For Men's, Women's and Children's Shoes. Low priced, Lightning seller!

**SAMPLES FOR TESTING** Sample offer sent immediately to all who send name at once. A penny postal will do. **SEND NO MONEY**—just your name. **KRISTEE CO., 688 Bar Street, AKRON, OHIO**

## BOAT KITS

*Easy To Build*

**PRAMS**  
\$39<sup>60</sup> up  
8 TO 11 FT.  
ALSO WITH SAILS  
26

**NEW CATALOG**  
MOST COMPLETE  
EVER OFFERED

**MODELS**  
KAYAKS  
DINGHIES  
ROWBOATS  
RUNABOUTS  
OUTBOARDS  
INBOARDS  
CABIN  
CRUISERS

1-BOAT KITS 26 MODELS  
2-MARINE HARDWARE  
3-MARINE ENGINES  
4-MARINE CONVERSIONS  
5-PAINTS & COLOR CHARTS

**U-MAK-IT PRODUCTS**

▶ All Only 35c. SEND COIN TODAY  
703P-WHITTIER ST.  
New York 59, N. Y.

## CARBURETOR TOO RICH MAKES MOTORIST TOO POOR

Car owners who are wasting money and not getting proper gas mileage due to over-rich mixtures will be pleased to learn how to save gasoline by VACU-MATING over-rich mixtures. VACU-MATIC fits all cars, trucks and tractors. It is automatic and operates on the supercharge principle. Easily installed in a few minutes.

**SALESMEN WANTED!** Big Profits! Send name, address on penny postcard for free particulars and how to get yours for introducing.

VACU-MATIC CO., 7617-1772 W. State St., Wauwatosa, Wis.

## A "GOOD HAND" HELPS YOU SUCCEED! LEARN TO WRITE WELL

*Your Name*  
beautifully written, plus special pen-point for shaded writing.  
Only 10¢

Handwriting quickly improves with our easy-to-understand picture lessons! Put your spare time to good use; send today for  FREE BOOK, "How to Become a Good Penman", or check volumes wanted below at \$1 each:  Business Writing  Artistic Writing  Card Writing  Bird & Design Flourishing  Engrossing Alphabets. COMPLETE SET \$4.50

**TAMBLYN SCHOOL of PENMANSHIP**  
S. A. Ziller, Pres. 442 Ridge Bldg., Kansas City, Mo., USA

**COURTESY LIGHT**  
For All Makes of Cars  
State Year and Make

FOR SAFETY **\$3.00** pr.  
and CONVENIENCE.

**QUIK CLAMP MFG. CO.**  
702 Evergreen, S. E. Grand Rapids, Michigan

## The ORIGINAL "LITTLE GIANT" GAME HOIST

**A Must For Hunters!**

Be ready to handle that big deer, elk, bear, or moose with the original pocket game hoist. This little hoist will lift and swing up to 500 pounds with ease.

Kit is comprised of 2 double aluminum pulleys weighing only 3 ounces each, and 30 feet of manila rope. (Equipped with 30 feet of 800# NYLON test rope, \$1.40 extra.)

The "Little Giant" is ideal for those heavy lifting jobs around the home and home workshop. Try it!

**DEALERS' INQUIRIES INVITED**  
**ANDY SORENSEN**  
2362 S. Rosemead Blvd., Rosemead, Calif.

Complete Kit **\$4.95** post paid (No C.O.D.'s, please)

# MEN!

# DIM that

# "FACE SHINE"

with **MENNEN** *Talcum*

**FOR MEN**

- ★ Pat on Mennen Talcum after your shave and later in the day to hide whiskers!
- ★ Neutral tint kills face shine... yet doesn't show itself!
- ★ Mennen Talcum is Hammerized for extra smoothness!
- ★ Used by more men than any other men's talcum powder in the world!

**GIANT SIZE FOR ECONOMY... 55¢**  
**LARGE SIZE... 29¢**

*Say You Saw It in Popular Mechanics*

## Not Just 1—Nor 2—But 3 SURE WAYS TO SECURE • YOUR FUTURE •

**VETERANS**

CROSS THE DATE LINE TO

(1) WATCHMAKING & CHRONOGRAPH REPAIRING  
(2) ENGRAVING  
(3) JEWELRY—STONE SETTING

**"3 HIGH PAYING TRADES IN 1 CAREER"**

- Trades that are always in demand.
- Trades that offer outstanding possibilities to YOU right now.
- 3 WIDE FIELDS OF OPPORTUNITY: (1) Defense work or the Armed Forces, where Watchmakers are given preference; (2) High Paying Jobs in the Trade or industry; (3) A Business of your own. Small communities offer unlimited opportunities.

**LEARN THESE 3 HIGH-PAYING TRADES AT KCSW, NATIONALLY RECOGNIZED FOR ITS THOROUGH TRAINING IN ALL THREE.**

*Resident School GI Approved.*

Home Study Courses in Watchmaking and Engraving only.  
 Resident School  Home Study Course

Name \_\_\_\_\_  
Address \_\_\_\_\_

**KANSAS CITY SCHOOL OF WATCHMAKING**  
1218 Admiral Blvd. — Kansas City 6, Missouri

# TERRIFIC VALUES - SURPLUS - SAVINGS UP TO 85%

MANUFACTURERS AND JOBBERS - Write us about your surplus items

## Portable LIGHT PLANT

**PUSH BUTTON START**  
500-700 watts 110-120 v. - 60 cyc. A.C. Powered by a sturdy dependable, easy starting, air cooled 1 3/4 hp. gas engine. No wiring necessary, just plug in and operate. Plenty of current for any oil burner, freezer, brooder, pump, emergency lights, etc. which require up to 700 watts. Ideal for Civil Defense, Fire Depts., trailers & camps. Complete with Voltmeter and built-in winding to charge 6 v. auto batteries. Wt. 85 lbs. Fully guaranteed. Be prepared if war or storm knocks out power lines.

(Item 24)

Reg. \$275.00 value. **\$143.50**  
700-800 Watt Plant (Item 44) same as Item 24, but larger generator. **\$169.95**  
1000-1200 Watt Plant (Item 45) same as Item 24, but larger generator & engine. **\$199.50**

## GIANT 2000-2500 WATT PLANT

110-120 V. 60 cyc., A.C. Absolutely the best made because its heavy windings develop up to 5000 watt overload for motor starting. Skid-mounted - portable. Powered by 5 h. p. easy starting Briggs or Wisconsin engine - complete with all accessories; engine easily disconnected for other uses. Big outlet box, voltmeter, no wiring necessary. Ample current for all purposes. Factory warranty and instructions included. Wt. 220 lbs. Reg. \$585.00. Special at... **\$299.50**  
**GENERATOR ONLY** and control box. **\$169.50**  
Drive it with your engine or tractor

## 1/2" DRILL

(Item 33) Deluxe model - powerful, smooth running, precision built. Handles toughest jobs. Cutler-Hammer switch, Jacobs key chuck, 110-120 v. AC-DC 900-450 rpm. Alum. alloy case for high strength and easy handling. Built-in blower assures cool operation. Cap. 1/2" in steel. One year written guar. Wt. 11 lbs. Should be \$65. Special... **\$34.50**



## 1/4" DRILL

(Item 34) Hi-power, long-life, smooth running. Alloy steel gears; built-in blower. Cutler-Hammer switch, Jacobs hand-chuck. 110-120 v. AC-DC 1000-1600 rpm. Cap. 1/4" in steel. 1 year guar. Wt. 4 lbs. Terrific value at **\$12.95**.

## 38 Pc. DRILL KIT

(Item 35) Includes above illus. guar. drill, buffers, polishing bonnet, sanding discs, grinding wheels, wood bits, steel bits, wire wheels, bench stand, paint mixer, burrs. Complete in heavy steel case. Wt. 13 lbs. 38 pc's., all highest quality. Complete kit worth \$38.50. Our **\$19.85** Spec. only...



## FIRE or BURGLAR ALARM

(Item 46) Completely automatic. Wind and hang anywhere. Thermostatic element sets off loud clanging bell if heat reaches 140° (setting adjustable). A fool-proof burglar or signal alarm when used with trip cord attached to door, window, invalid's bed, etc. Sturdy metal constr. assures lifetime of protection. Ideal for homes, stores, whse., gar. etc. Wt. 3 lbs. Easily worth \$20. Special... **\$4.95**

## PARTS WASHER

(Item 20) Store gas or carbon tet. in 5 gal. safety can. Valve releases just the right amount into washing compartment. Parts are washed and drained on a "fishing" screen - no fishing for parts. Eliminates fire-danger, waste, spillage, evaporation. Wt. 14 lbs. Reg. \$19.50 - Special... **\$5.95**



## HYDRAULIC HOSE

High pressure, heavy duty, complete with swivel fittings. Pipe thread connections. Ideal for farm equip., bulldozers, grease guns, airbrakes, etc. Any length. Minimum \$1 per ft. **INSIDE DIAMETER:** 1/4" 50c per ft. 3/8" 60c, 1/2" 80c, 5/8" 90c.



## HEAVY DUTY ARC WELDER

(Item 38) Use as portable or shop welder. 250 amps. D.C., Senior model. Made for years of trouble-free, continuous service. Will handle light or heavy jobs. Weld up to 1/2" plate using 1/4" rods. Built-in air-cooling system. Arc is easy to strike and hold, because of specially designed arc stabilizer. Hi-lo switch and dial control gives wide range of welding heats. Run welder at 2600 rpm. with tractor, jeep or 10 hp. gas engine, or 7 hp. elec. motor. Complete with instructions, guar. and double V belt or flat pulley. Wt. 110 lbs. A \$400 value at... **\$99.75**  
**WELDING KIT.** Two 10 ft. leads, welding helmet, electrode holder, ground clamp. Sold only with welder at... **\$10.50**



## DUAL TUBE LIFE SAVERS

(Item 54) **NEW IMPROVED TYPE** made by Genl. Tire for Navy. Each has 2 rubber tubes for double protection. Easily inflated by mouth to 55 in. Wear one around waist as comfortable life saver. Adjustable safety buckles fit adults or children. Tie several together for raft or big luxurious mattress. Invaluable on boats or beach. Wt. 2 lbs. each. Our spec. (a fraction of cost) **99c each, 6 for... \$5**

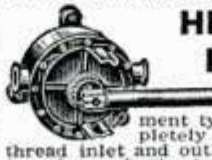

## HIGH PRESSURE HAND PUMP

(Item 53) Positive displacement type. Cap. 550 gph. Completely self priming. 3/4" pipe thread inlet and outlet. Use for fuel or water transfer on boats, trailers, air craft, etc. Ideal for insecticides, emerg. sump pump or as vacuum pump. Wt. 15 lbs. Govt. **\$12.95** cost \$95. Our Special...



## FIRE EXTINGUISHER

(Item 39) Fully charged (at 1,000 lbs. P. S. I. or more) with CO2 (carbon dioxide), the proven miracle fire fighting chemical that smothers oil, gasoline and electrical fires. Play safe; keep one in your car, garage and home. Heavy ICC approved steel cylinder, valve and 300 lb. gauge that show available remaining pressure. **REFILLABLE** at nominal cost. Hose included for emergency tire inflator or air blast. Wt. 4 lbs. **\$19.50** value. Special... **\$6.95**

**LARGE FIRE EXTINGUISHER** (Item 57) size, 5 x 14 in. (275 cu. in.) heavy ICC approved steel cylinder charged at 1000 lbs. or more with CO2. Equipped with genuine Kidde Valve and Gauge to show available pressure at all times. Refillable. Hose incl. Suitable for fire depts., stores, garages, homes, **\$15.85** etc. Wt. 18 lbs. \$42.50 value. Spec...

## 32 pc. SOCKET SET

(Item 59) Highest quality guar. non-breakable sockets made by Piomb, Snap On, etc. Complete range of 22 sockets from 1/4" thru 3/4" in 3/8" drive and 7/16" thru 1-1/16" in 1/2" drive. 2 speeder handles. 2 extensions, 2 slide heads, double 3/8 x 1/2 in. "L" handle, reversible ratchet, 12" Phillips type screw driver and metal tool box. For professional mechanics who want the best. Wt. 13 lbs. Easily worth \$32.50, while they last... **\$15.95**



## RUBBER HOSE



New genuine Neoprene Hose - outlasts ordinary rubber 3 to 1. Reinforced with super tough cotton cord plies. Flexible. Easy Flo brass couplings with standard pipe threads for quick connections. Included. Pump water for irrigation, stock tanks, home, barn, fire fighting, etc. Pump Gas or Fuel Oil. Save more than 60%.

## TERRIFIC VALUES!

(Inside Diam.) 1 1/4" 1 1/4" 1 1/2"  
Length 25 ft. 40 ft. 30 ft.  
Price 9.25 14.75 14.75  
If specified we will send special hose for gas or oil at same prices.

**AIR HOSE** (Item 11) 1/4" Diam. heavy duty, double braid, suitable for gas stations, spray painting, air tools, etc. 20 ft. with standard swivel couplings. Wt. 4 lbs. Reg. \$6.50 val. - only **\$2.95** Five 20 ft. lghs. (100 ft.). Wt. 20 lbs. Only **\$13.75**.



## EXTENSION CORD

(Item 16) 40 ft. heavy duty, made of specially insulated No. 14 2-conductor wire. So tough that you can drive over it and yet amazingly flexible and easy to handle. Resists oil, grease or water. Extends electricity up to 400 ft. without voltage drop. Use indoors or out. Complete with heavy rubber plug and outlet. Wt. 2 1/2 lbs. Usually \$4.50 - Special 40 ft. **\$1.99** Comb: 2-40 ft. and 1-20 ft. (total 100 ft.) **\$4.95** 100 foot length (one piece) **\$4.85**  
**WIRE ONLY.** (Item 50) No fittings, 100 ft. **\$4.00**

**TRENCH-LAY WIRE.** (Item 51) Anaconda #10 - 2 cond., for buried service to barns, outdoor lights, etc. Absolutely impervious to soil and moisture. Wt. 25 lbs. per 100 ft. Special surplus price, 100 ft. coils, 19c per ft.; 250 ft., 18c per ft.; 500 ft., 17c per ft.

## G. M. HI-FLO PUMP

(Item 56) 210 gal. per min. Centrifugal turbine type. Unexcelled for fire-fighting, irrigation, sprinkling systems, swimming pools, drainage, fuel transfer, etc. Built by GM for the army at cost of more than \$145. Tremendous volume, will deliver 210 gpm with 5.3 hp. down to 40 gpm with 1 1/2 hp. 2 1/2" stand. pipe thr. inlet (can be reduced to 2" if desired). Twin 1 1/4" outlets, dynamically balanced, 3/4" shaft, hi-speed ball bearings. Easy fast priming. (instr. incl.) Wt. 36 lbs. **\$39.50**  
Sensational value...



## ELECTRIC HAND SAW

(Item 36) Most perfectly balanced and smoothest running saw made. Advanced design provides max. power and light weight. Easily adjusted for all angles, depth and width of cut. Comes complete with 6 1/2" comb. blade, ripping guide and 10 ft. heavy duty cord. Built-in saw-dust blower. Autom. telescoping guard. 110-120 v. AC-DC. Depth of cut 2 1/8". 1 year written guar. Wt. 12 lbs. **\$39.95**  
Draastically reduced...



## SPRAY OUTFIT

(Item 37) Twin cyl. piston type compressor direct-connected to powerful 110-120 v. AC-DC motor. Built-in air tank eliminates pulsation and provides steady flow of air at 25-30 lbs. Sprays lacquers, enamels, insecticides, etc. Does beautiful work on autos, furniture, farm equip. 1 qt. spray gun, relief valve and 10 ft. air hose incl. Full instructions and 1 year guar. Wt. 11 lbs. **\$22.95** Regularly \$50. Spec...



## ANGLE DRILL

(Item 23) Fits into chuck of any electric or pneumatic drill or flex. shaft. Operates at any angle in a full 360° arc. Makes possible drilling, grinding, carving, routing, etc. in close cramped quarters. Makes impossible jobs easy. Made by Kett Tool Co. Complete with built-in chuck (1/4" capacity) and adjusting key. Hardened alloy gears. Precision built for heavy duty. Lists at \$39.95 - while they last... **\$9.95**



## HEATING & VENTILATING FAN

(Item 10) Easily installed in furnace pipes. Forces even heat to all rooms. Over range, removes kitchen smoke and odors. Powerful continuous duty motor, 110-120 V. A.C. Quiet, super efficient fan moves huge volume of air (400 to 600 c.f.m.) 12" Fan, wt. 5 lb. **\$6.35**; 9" Fan, wt. 3 lbs. **\$7.45**; 10" Fan, wt. 7 lb. **\$8.45**; 12" Fan, wt. 8 lbs. **\$9.45**.



## CARRY-AIR

(Item 32) Stainless steel tank - capacity 500 cu. in. at 40 lbs. press. complete with inlet and shut-off valves, press. gauge, detachable air hose, tire chuck. Fill at any service station. Carry air for tire inflation, blowing out lines, spray painting, insecticides, etc. One emergency pays back cost. Wt. 10 lbs. Worth \$20.00. Our price... **\$8.95**  
(Item 55) With big double tank (1000 cu. in.)... **\$11.95**  
(Item 58) Tank only, 500 cu. in. (no fittings)... **\$5.95**



## PRESSURE SWITCH

(Item 30) Penn Electric Model 110 BPO2, best made. For pumps and air compressors. Heavy duty. Will handle up to 250 lbs. press. and up to 5 h. p. Autom. unloader valve, for easy starting. 110-220 v. A.C. or D.C. 2 pole. Wt. 3 lbs. Reg. list \$17.50. Our Spec. **\$9.45**



All items brand new. Prices f.o.b. Chicago area. 10 day Money back guarantee. Send check or M. O. **MASTER MECHANIC MFG. CO., DEPT. 54** Burlington, Wis.

**WORLD'S  
BEST  
WANT AD  
MEDIUM**

# CLASSIFIED Advertisements



Advertisements in this section 85 cents per word, each insertion, minimum 10 words, payable in advance. To be inserted under proper classification, copy must be in our office the 20th of the second month preceding date of issue  
F. W. Johnson, Manager, Classified Advertising  
Popular Mechanics Magazine, 200 East Ontario Street, Chicago 11, Illinois

## YOU'LL PROFIT

By reading and answering the classified ads in this section. Hundreds of opportunities for you to make and save money

### AUTOMOBILES, MIDGET CARS

**CALIFORNIA** Custom accessory headquarters. Buy direct from original designers and save. Chrome dash panels, push button door-trunk conversions, chrome motor accessories, lowering kits, speed dress-up equipment. 1951 catalog. 40 pages, hundreds of photos—25c. Eastern Auto, 3319A South Grand, Los Angeles 7, California.

**MOTORISTS**—Save gas with proven automatic alcohol-water injector! Only \$5.95! Free literature. Vaporizer Company, Box 7033D, Los Angeles 37, Calif.

**PLYMOUTH** Owners save money with big 288-page manual. Tells how to keep your Plymouth in tip-top shape; how to make repairs and recognize troubles. Hundreds of diagrams, drawings and illustrations. \$3.50 postpaid or order c.o.d. Popular Mechanics Press, 200 E. Ontario St., Chicago 11, Ill.

**BIGGEST** Racing and hot rod catalog in world, just out! Lowest prices. Hollywood mufflers \$4.50, duals \$15.90, chrome megaphones \$1.55, dual manifolds \$9.95, racing cams \$29, heads \$23.50, water injectors \$12.95, superchargers, bargains! Free power calculator included. 25c coin or stamps. Almqvist Engineering, Milford 13P, Pennsylvania. (Dealers wanted.)

**STOP** Headlight glare with new Polar-vision light! See page 26.

**FROM** Speedway to roadway! Track-proved hi-speed heads and manifolds now available for your passenger car! No special tools needed! Increase horsepower 25%! Astounding getaway! Free illustrated catalog. Speedsport, 6215P Diversey, Chicago 39.

**WATER** Injection. Also economy, power, methods. Free illustrated information. Neher Industries, La Verne, California.

### AUTO SUPPLIES AND EQUIPMENT

**CAR-Bed** for all post war Studebakers except four doors. Save hundreds dollars. Absolutely no rework or expense. Complete information \$4. Enasco, Pasadena 16, California.

**SHATTERPROOF** Glass! Factory savings! Write requirements. Cooper's, 3124 Lawrence, Chicago 25.

**LEARN** Starter, generator, regulator rebuilding. Introductory manual \$1. Parts catalog 10c. Modern Supplies, Box 4704, Kansas City, Mo.

**LEFT** Foot dual accelerator. Step on the gas with either foot with equal ease. \$7.20 postage prepaid. Fits all cars and guaranteed for life of car. Dealers and distributors inquiries also invited. R. V. Lehner Mfg., Ness City, Kansas.

**INCREASE!** Gasoline mileage, three to five miles gallon. Guaranteed vaporizer, increases power; easier starting; \$3.50 each. Turb-O-Vane, 1024 West Vine, Stockton, Calif.

**"HOW To Get 150 M.P.G."** Authentic book, shows how passenger cars actually go over 100 miles per gallon on regular gasoline. Big equipment catalog, plus 32 page Economy Driving Manual, plus book—all three—50c postpaid. Newhouse Automotive, 5805 East Beverly, Los Angeles 22.

**GARAGEMEN:** Generator and magneto tester, literature free. Abbott Supply, Quincy, Illinois.

**DON'T** Look for your car after it's stolen. Automatic device will protect it even when keys are forgotten and left in car. No gadgets to remember or forget. Simple, easy, cheap. Instructions, one dollar. Anderson, Washington, Illinois.

**FLATTEN** The hills. Lachapelle's 100,000 miles motor and motor fuel treatment (patented). \$3.00 postpaid. Ferns Products, 8120-B Walnut Dr., Los Angeles 1, Calif. (Data on request.)

**GOVERNORS** And butterflies for auto or any gasoline driven engine. Candee-Smith, P.O. Box 612, Riverside, Calif.

**VAPOJET** Helps save gas, engine wear, carbon accumulation and increase power with water-alcohol vapor injection. \$9.95 postpaid. \$1 deposit c.o.d. 30 day money-back agreement. Easily installed. Free details. Agents wanted. Bantel, 757-AN Venice, Los Angeles 15.

**MOTORIST** Save gasoline by Vacuumating overrich mixtures. Fits all cars. For free particulars write Vacuumatic, Dept. 1771, Wauwatosa, Wis.

**SPARK** Plugs; reconditioned. (Champions, Autolites.) New appearance, 10,000 mile guarantee. Trial dozen \$2.00. Ten dozen \$17.00. Prepaid. Best Reconditioning, 315E 107th, New York 29.

**"CAR** Care Check Chart," simplified servicing guide and record, assures worthwhile savings. \$1.00. Car Care Club, 218A Gifford, Syracuse 4, N. Y.

**SCISSORS** Jack—Heavy duty. Safe and easy operating. Five foot folding handle. \$4.69 complete, f.o.b. Cleveland, Ohio. Dealer inquiries invited. Grothe Manufacturing Company, 9002 Madison Avenue, Cleveland 2, Ohio, U.S.A.

**JEEP** Governors—New and complete with bracket pulley belt and control. Regular \$29.50 value. Our price, only \$19.80 prepaid. Rieke Equipment Co., 3201 Merriam Blvd., Kansas City, Kans.

**NEW** Hub cap guards eliminate loss of hub caps while driving. Prevent theft. Fit most popular cars. Takes but a few minutes to attach them yourself or by serviceman. Send \$1.00 for 5 wheel set. Satisfaction guaranteed. Security Mfg. Co., 144 West 27th, New York 1, N. Y.

**STOP** Headlight glare with new Polar-vision light! See page 26.

**NEW** Government surplus. Low voltage circuit tester in steel box cost \$202. Our price \$27.50. Will test batteries, starters, generators, voltage regulators, grounds, short circuits. Wilt Electrical Company, 7829 S. Racine Ave., Chicago 20, Ill.

**CHEV.** Rebuilt motors. Guaranteed like new. Lowest prices. Grossman Chev. Co., Minneapolis, Minn.

**SEND** For free life membership card. "Water Burners" of America, La Verne, California.

**OFFENHAUSER'S** New catalog available. Send 25c. Complete line of speed equipment. Offenhauser Equipment Corp., 5054-p Alhambra Ave., Los Angeles 32, California.

**AUTO** Parts and accessories. Briggs Automotive Engineering of Chicago, P.O. B. 3454 Merchandise Mart, Chicago 54, Ill.

**FOR** Free descriptive literature on alcohol-water injection for cars, trucks, tractors write Shade, Webster, New York.

**NEW** And used guaranteed parts for civilian and army cars and trucks. Largest stock in America. Mail orders. Pioneer Auto Wrecking Co., 734 W. 13th Ave., Denver, Colorado.

**BUICK** Parts—Enjoy new-car pep and power in your old Buick. Same day service from world's largest stock of new (not rebuilt) Buick parts and engines. Ship anywhere. Write today. Robertson Buick Co., 1001 S. Wabash Ave., Chicago 5, Ill.

**BRUSH** Plating outfits connect to a battery. No tanks or shop required. Free particulars. Gunmetal Co., Avenue J, Decatur, Illinois.

**1951 EDITION!** It's new! It's different! Get world's largest auto accessory and parts catalog and save money. Over 50,000 items, including Hollywood accessories, hi-speed equipment, rebuilt engines, all parts and accessories for all cars and trucks. We have that hard-to-get part! Jam packed with bargains. Completely illustrated. Send 25c (refundable). J. C. Whitney, 1919 Archer, Chicago 16.

### AUTO TRAILERS

**PLANS** 16' Sportsman trailer, expertly prepared, ideal for craftsmen, \$2.00. Freeland Engineering, 16587 Freeland, Detroit 35, Michigan.

**BUILD** Your own trailer! Plans for all kinds. Illustrated catalog 10c. Jim Dandy, 125-M. Wausau, Wisconsin.

### MOTORCYCLES, BICYCLES, MOTORSCOOTERS AND SUPPLIES

**TWO** Passenger Motorette midget car \$45; Servicycle \$35. Doodlebug motorscooter \$5, Cushman \$15, Motorbike \$5, less engines. Two cylinder motorwheel \$10; Briggs engines \$5 up. Four airplane type tires \$3. Mailorder only. Send 25c for new catalogue Number 42, just out listing these and hundreds of other bargains in new and used midget cars, motorscooters, homebuilders parts, plans, engines, transmissions, clutches, war surplus, etc. (35c by first class mail). Midget Motors Directory, Athens, Ohio.

**MOTORCYCLE** Magazine—Worldwide coverage. Yearly subscription \$2.00. Sample 20c. Motorcycle News, 5424-A Sawyer, Chicago 25.

**MOTORCYCLE** Pistons, parts, new, used. Harley, Indian, Henderson. List and wings pin 25c. Ballak, 811 N. 9th, St. Louis 1, Missouri.

**NEW** 1951 Issue Harley, Indian, new, used parts book, 15c. Boots, 1700 East University, Des Moines 16, Iowa.

**WHIZZER** Motorbike (all attachments) \$25; others \$5 up; Cushman motorscooter \$20; Indian motorcycle \$30; midget car \$35. Rush 25c (35c first class mail) for catalog #948 listing many other amazing bargains in motors, midget cars, motorscooters, motorbikes, etc. Associated, Box 1764-CS, Toledo, Ohio.

**U. S. Govt.** surplus "45" Harley Davidson motors, complete with carburetor and generator, in running condition—\$69.50 f.o.b. Chicago. 25% deposit with order. Parts and accessory catalog 25c. Triangle, 2157 Harrison, Chicago.

**WHIZZER** in Schwinn bike \$40; good motor scooter (twist grips) \$22.50; midget car \$15; Shaw bicycle motor \$15. Send 25c (35c first class mail) for catalog #18 jammed with other sensational bargains in wheels, motors, clutches, motor scooters, midget cars, motorettes, motorbikes, etc. Gail, 538 Erie, Toledo, Ohio.

**RECONDITIONED** Motorcycles and motors. Chromium accessories. Complete stock Indian parts. Expert rebuilding. Fast service. Indian Motorcycle Sales, Kansas City 1, Mo.

**HARLEY-Davidson** parts, accessories, repair manuals on all models. 24 hour service. Authorized factory dealer. Philadelphia Harley-Davidson Company, 857 North Broad Street, Philadelphia 23, Penna.

**HARLEY-Davidsons**—All models and prices. Genuine late and old model supplies. Expert service. Send 25c for bulletin. Knuth's, 1753 Muskego, Milwaukee, Wis.

## AVIATION

**PROPELLERS**, Plans, supplies for snow sleighs, air boats. Catalog 20c. Banks-Maxwell, Box 3301, Ft. Worth, Texas.

## BATTERIES, GENERATORS

**REAL Edison** batteries. Long unconditional guarantee. 37 to 600 ampere sizes. Free interesting literature. Hawley Smith Co., Croton Falls 1, New York.

## ELECTRICAL SUPPLIES

**LAMPS**—Build own originals, parts wholesale, any amounts. Catalogue 10c. Brown Lamp Co., Box 501, Wellston, St. Louis 12, Missouri.

**BE Independent**, be secure, have your own profitable business—Earn \$20.00 and more a day making beautiful, fast-selling lamps at home. No equipment needed. Illustrated course teaches you quickly. Course, parts catalog, wholesale price list—only \$2. Gearon Co., Dept. 200-B7, 27 S. Desplaines, Chicago 6, Ill.

**ELECTRIC Pencil**: Engraves all metals \$1.50. Beyer Mfg., 10511-H Springfield, Chicago 43.

**FREE**—New catalog. Bargains in welders, motors, generators, surplus equipment. Or, build your own kits—save. LeJay Company, Minneapolis, Minnesota.

**LAMPS**—Had trouble finding repair parts? Your search is ended. 25c brings 64 page illustrated catalog also containing wiring charts. Gyro Lamps, 5402P Clark, Chicago 40.

## WELDING, SOLDERING, PLATING

**DO Better** welding, burning; double tip life. Wypo tip cleaners, world's finest. Set of 12 clean 27 drill sizes, \$1.95 postpaid. Fesociates, Bell, Calif.

**DEFENSE** Welding jobs pay. Welders needed. Train quickly. VA contract. Hobart Welding School, Box M-714, Troy, Ohio.

**ACETYLENE** Welding outfits new \$49.00; used \$29.00; arcwelders \$46.50. Eagle Welding, Dept. PM, 5085 Broadway, Chicago 40, Illinois.

**BUY Direct** from factory. Welding and cutting equipment. All makes of equipment repaired. Established 1913. Box 331, Hamilton, Ohio.

## MACHINERY, TOOLS, SUPPLIES

**PRECISION** Tools. Immediate delivery on Starrett, Lufkin, Brown & Sharpe tools. Send for free catalog. Acme Hardware Company, 1013 W. 63rd St., Chicago 21. Fine tools for all tradesmen.

**CHUCKS**: Independent; Universal—threaded 1½"-8, 1"-8, 1"-10, 1"-12, or with adapter recess. The only complete line of bench lathe chucks built to heavy duty standards. Other chucks to 16" diameter. Write for quotation; free literature. No obligation. Westcott Chuck Co., 3600 Walnut, Oneida, N. Y.

**FLEXIBLE** Shaft tool by Fairchild for grinding, polishing, sanding, buffing, carving. Original price \$19.95. While they last! Special price \$12.95. Public Sport Shops, 11 S. 18th Street, Philadelphia 2, Penna.

## BOATS, OUTBOARD MOTORS

**FASTEST** Boats in the world—Build now. Complete plans available for sleek three point racing hydroplanes, runabout and others. Send 25c immediately for illustrated catalogue. Champion Boats, P.O. Box 9038, Dept. 22-G, Long Beach 7, Calif.

**AUTO** Conversions and parts. Marine manifolds for all engines. Your transmission converted to marine gear, propellers, shafts, struts, couplings, etc. Everything you need for your boat. Money back guarantee. Conversion Parts Company, 278 Adams Street, Boston 22, Massachusetts.

**MARINE** Conversions for Ford and Jeep engines. Catalog 10c. Lehman Manufacturing Company, 972D Broad Street, Newark 2, New Jersey.

**CONVERT** Fords and Jeep to 100% marine engines with Osco's world famous Convo-Kits. Deluxe catalogue 25c (coin). Oscomotors, 3627B Lawrence, Philadelphia 40, Penna.

**SAVE ¾ Cost**. Assemble your own boat. We furnish parts. No experience necessary. Rowboats, cruisers. Illustrated catalog 25c. Midwest Boat Company, Menomonee Falls, Wisconsin.

**FREE** illustrated folder and literature describing Sea Craft, famous 25 ft. cabin cruiser you can build yourself. Sleeps four people, fully seaworthy, cruises at 15 knots with converted auto engine. Complete with galley, fresh water tank, sink, toilet, and spacious cabin interior. Save hundreds of dollars—use Popular Mechanics blueprints and step-by-step instructions. Popular Mechanics Press, Dept. BP, 200 E. Ontario St., Chicago 11, Illinois.

**STEERING** Wheels, windshield brackets, from \$7.95. Modern fittings, water-skis at lowest prices. Complete pre-cut plywood boats. Bargains galore. Folder 10c. Marine, Box 681, Mendota, Minnesota.

**BOAT** Trailer winches. Brass. 1636 Bonnie Brae, Houston, Texas.

**OUTBOARD** Motor parts; new, used. For all makes. Save money. Outboard Motor Mart, 309 Atlantic Avenue, Boston 10, Mass.

**NEW**, Used, rebuilt marine motors. Marine conversions, fittings. Free catalog. Stokes Marine Supply, Dept. 24, Coldwater, Michigan.

**FULL** Size, cut to shape boat patterns, blueprints, 7½"-38 feet. Illustrated "Build a Boat" catalog, 25c (coin). "How to Build Boats" book, \$1.00. PolyWog houseboat plans \$10. Marine catalog \$1.00. Marine Specialty Mfg. Co., 3107 Detroit Ave., Cleveland 13, Ohio.

"P38 Bely tanks," steel, \$9.95. Free picture. Bucks Auto Parts, Box 89, Merced, Calif.

**BOAT** Kits: Outboards, inboards, hydroplanes, sail. Easy to assemble. Minimum expense. Catalog, specifications, prices, 25c. Brooks Boat Company, Carrollton, PM, Michigan.

## ENGINES, MOTORS, DYNAMOS

**WINDING** Data, listing 225 motors, single and three phase, \$1.00. Motor Data Co., Box 7631, Kansas City 3, Mo.

## ATHLETIC EQUIPMENT, BODY BUILDING COURSES

**STRENGTH** With stretchers. Super cable course. Natural rubber expanders. Free information. Write Comborep, 79 Oakland Terr., Newark 6, N. J.

**BE Strong** and muscular, the enjoyable way, by hand balancing. Complete course \$1. "Hand Balancing," 512 S. Church, East Point, Georgia.

**DEADLY** Judo—Fiercest fighting technique. Trick knockouts. (Over 200 illustrated pictures.) Expert instructions; three volumes. Complete \$2.25. Variety House, Box 46-B Wall Station, New York 5.

**BARBELLS**. Exercise equipment. Courses. Free booklet. Good Barbell Co., Reading, Penna.

## SPORTING GOODS, GUNS, FISHING TACKLE, ARCHERY, TRAPPING

**TENTS**, New, complete; 5x7 wall, \$11.95; 7x7, \$14.95; 2-man jungle, floor, zippers on door and netting, fabric, \$13.95; nylon \$19.95; sleeping bag, wool, \$4.49; jungle hammock, \$5.95. Catalogue. Mor-San Sales, 10-17G 50th Ave., Long Island City 1, N. Y.

**CROSSBOWS**: Practical for hunting or fishing. Accurate. Dept. 4, Schmid & Co., 1513 Gardner St., Los Angeles, Calif.

**5000 BARGAINS**, Firearms, binoculars, war relics. Catalog 50c. Smith Firearms, Rummene, N. J.

**AMMUNITION** Immediately available for Lugers, Mausers, Japanese, Italian guns. Send 10c; complete list; 100 kinds. Also 8 power pocket telescope, \$5.00; cameras, microscopes, rifles, crossbows, knives. Ashton Company, 1511 North Gardner Street, Hollywood 46, California.

**FISH** At night with beautiful plastic lighted bobber lure. More fun. More fish. Two for \$1.00 postpaid. Glo-Lite Bobbers, Inc., 2111 Woodward, Detroit 1, Mich.

**190 PROFUSELY** illustrated pages antique and modern pistols, swords, daggers, armor, etc. 50c. Robert Abels, A860 Lexington Ave., New York 21.

**TENTS** (pup, pyramidal, wall, umbrella, nylon mountain, etc.); camping equipment (cots, sleeping bags, blankets, rugsacks, hammocks, ponchos, etc.); tarpaulins. Low prices; free 60 page catalogue. Morsan, 10-17G 50th Ave., Long Island City 1, N. Y.

**MOLDS**, (For fisherman's sinkers, squids, jigs and lures.) Handled and hinged. Quality fishing tackle. Free catalogue. E. L. Sweet & Son, Tonawanda, New York.

## TAXIDERMISTRY

**MODERN** Taxidermist Magazine, Greenfield Center 2, N. Y. Devoted entirely to taxidermy, photos, articles, methods. Trial year's subscription, \$1.00.

## BINOCULARS, TELESCOPES, MICROSCOPES, MAGNIFIERS

**SAVE 50%** On new binoculars! Free catalogue. Free book, "How to Select Binoculars." Write today! Bushnell's, 43-M27 Green, Pasadena 1, California.

**AMAZING** Prices, brand new precision binoculars, \$16.00 up. Free trial. Folder "Binocular Selecting," pricelist free. Prentiss Importers, Mercury Bldg., West Los Angeles 25, Calif.

**WAR** Surplus bargains, binoculars, telescopes, sextants, millions of lenses, prisms, reticles, eyepieces, objectives, etc. Mail 10c for big "Catalog CH." Send \$1.00 for instruction booklet. Edmund Scientific Corp. (Formerly Edmund Salvage Co.), Barrington, N. J.

**MAKE** Your 6" telescope reflector. Glass, abrasives, instructions—\$8.50. F. Cameron, Box 65, Inwood, N. Y.

**BINOCULARS**, Telescopes, watches, guns. Buy, sell, trade. Schweer's, Donnellson, Iowa.

**REFLECTOR** Telescope kits, refractors. Free illustrated bulletin. Esco Products, 911 Willow Ave., Hoboken, N. J.

**POWERFUL** Astronomical telescopes easily made. Perfect lenses and instructions; 100X \$3.00; 100X and 200X \$4.00; 100X, 200X and 400X \$6.00. Full power, clear vision guaranteed. Instructions alone 10c. Suffolk Science Service, Riverhead, N. Y.

**TELESCOPES**, Binoculars, microscopes, big bargain catalog free. Brownscope Company, 24 West 45th Street, New York.

**ASTRONOMICAL** Telescopes, binoculars, microscopes, bought, sold, repaired. Books. Lists 10c. Rasmussen-Reece, Amsterdam, N. Y.

**GIANT** Astronomical telescope with 6 ft. tripod \$15.00, f.o.b. factory. 100 power. (10,000 area magnification). Clear vision, full power guaranteed. Ready for use. Suffolk Science Service, Dept. BT, Riverhead, N. Y.

**REFLECTING** Telescopes, 60X, completely assembled \$25.00. Guaranteed observatory clearness. Free information. Skyscope, 475 Fifth Avenue, New York 17.

## PETS—DOGS, BIRDS, RABBITS, HAMSTERS, ETC.

**HAMSTERS**—Moneymakers. Send \$5.00 for beautiful virgin pair, cage, and illustrated instructions. Free prices. Dixie Hamstery, 502-C Trinity Lane, Nashville 7, Tenn.

**BEAUTIFUL** Pure white pedigreed police puppies. Ansonia Kennels, Mose, N. Dak.

**RABBIT** Market bulletin free. Rabbit Federation, 200-P Burrell Bldg., San Jose, Calif.

**FAMOUS Angoras!** Giant Chinchillas! World's most profitable rabbits. Finest pedigree, heavy-producing, prize-winners. Catalog free. P. M. Grinsteeds, Edwardsville, Illinois.

SEE Gulf Hamstery ad on page 26. Shows picture of hamster.

**BOXERS, St. Bernards, Hof Kennels,** 5136 Cascade Rd. S.E., Grand Rapids 6, Mich.

**RAISE Rabbits.** Profitable business. Literature free. Tayco Rabbitry, Hapeville, Georgia.

**GOLDEN Hamsters.** Superior breeder and pet stock \$2.50 pair, \$3.75 trio. Free folio. Valley Hamstery, 734 North Milam, San Benito, Texas.

**BEST Hamsters.** Lowest prices. Pair \$3.00. Free illustrated folder. Lakeview Hamster Colony, Newfield, N. J.

**MAKE Big money!** Raise Chinchilla rabbits. Cash markets supplied. Write today! Rockhill Ranch, Sellersville 15, Penna.

**INCREASE Your income** by raising domestic rabbits. Small space needed. Ready market for delicious meat, fur and wool. Largest magazine in the industry tells you how. \$1.50 per year. Sample 15 cents. No stamps. Small Stock Magazine, Lamoni 20, Iowa.

**EARN Up to \$400 monthly** raising Angora or New Zealand rabbits. Plenty markets. Particulars free. White's Rabbitry, Newark 38, Ohio.

**RAISE Guinea pigs.** Money makers. Booklet free. Taylors, B426A, Hapeville, Georgia.

**MINK Raising information free.** Complete. Lake Superior Mink Farm, Superior, EEL, Wisconsin.

**A Practical beginning to successful rabbit raising.** 48 page illustrated booklet. Dime. American Rabbit Breeders Association. 36 AR & CBA Bldg., Pittsburgh, Penna.

### FARMS, FARM LANDS, REAL ESTATE

**OREGON Coast gas station,** Highway 101. Draft calls owner. E. McDonald, Arch Cape, Oregon.

**SUMMER List stock farms, ranches,** Owen Farm Agency, Conway, Arkansas.

**NEW Summer farm and business catalog free!** Just out! Maine to Florida. Bargains from \$1000 up! West's, M-5, Pittsburgh 17, Penna.

**\$5.00 MONTHLY Buys 40 acres** near town; price \$200; free list. Box 425-P, Carthage, Mo.

**BIG Free summer catalog!** Farm and country real estate bargains, good pictures, many states, easy terms, many equipped, business opportunities. For special service, state requirements, desired location. United Farm Agency, 220-PM South State St., Chicago 4, Ill.

**GOVERNMENT And state ranch,** timber, hunting and fishing lands in California, Oregon and Washington at \$1 to \$5 per acre. 10c (coin) brings circulars. Pacific Lands, Box 2350-PM, Hollywood 28, California.

**40 ACRE Tracts,** good land, \$600, \$10 down, \$10 monthly. Richard Stewart, Inverness, Florida.

**STROUT'S Farm and business catalog.** 3084 bargains. 33 states. Mailed free! Buy now and save through Strout Realty, 7 So. Dearborn St., Chicago 3, Ill.

**GOOD Farms - Ranches,** Washington, Minnesota, Montana, Idaho, Oregon, North Dakota. Dependable crops, favorable climate. Write for literature, lists describing typical farm opportunities. Specify which state. J. W. Haw, 119 Northern Pacific Ry., St. Paul 1, Minn.

**GOVERNMENT Lands \$2.00 acre up.** Information all states twenty-five cents. National Tax Service, 901-A Majestic Bldg., Detroit.

### POULTRY, FARM SUPPLIES

**KNOW How to raise poultry for profit.** Read Poultry Industry. Every issue packed with helpful hints and practical suggestions. Latest articles on breeding, feeding and management. Subscribe now. 1 year 65c. 2 years one dollar, foreign subscriptions \$1.00 a year. Poultry Industry, Dept. P.M., 376 Boylston St., Boston 16, Mass.

**BABY Chicks \$10.00 per 100 c.o.d.** New Hampshire, Barred Rocks, White Rocks and heavy assorted. Prices at hatchery. A. F. Hockman, R7, Bellefonte, Penna.

### PROFITABLE OCCUPATIONS

**WANT A diesel job?** Our approved, up-to-the-minute diesel training program can help you qualify for steady, big pay jobs or specialized military training. Covers diesel, tractor, heavy equipment. Easy to master. No loss of present income. Job placement advisory service. Investigate! Write for information today. Interstate Training Service, Dept. 3G, Portland 13, Oregon.

**EARN Up to \$400 monthly** raising Angora or New Zealand rabbits. Plenty markets. Particulars free. White's Rabbitry, Newark 61, Ohio.

**FREE Book "How to Make Money With Home Workshop"** describes amazing methods used by hundreds of successful craftsmen. Tells what to make, how to sell workshop output spare time. Write at once for details. Remember it's free! Craftsman, 115-A7 Worth St., New York City.

**FOREIGN Employment construction men,** building trades, helpers, office men, others, interested in foreign projects. High wages, quarters, trans. Listings of firms actively working on U. S. foreign intercontinental projects. Send \$1 for foreign construction compendium and application forms. Foreign Service Bureau, Dept. PM-7, Box 295, Metuchen, New Jersey. (Not an employment agency—no fees.)

**TURN Your spare time into cash.** Make quick-selling, highly profitable lamps—every home a prospect. No experience or special tools required. New 1951 56-page illustrated catalog shows shades, shade frames, figurines and bases, oil lamp converters, boring compounds, and dozens of similar items. Also all kinds of sockets, cords, pipes, harps, finials, bases, and hundreds of other parts—everything you need. Special 8-page section shows 6 beautiful lamps in kit form ready to assemble. You buy wholesale, sell at retail—make big profits. Hundreds doing it. You can, too. Send 25c today for catalog and wholesale price list. Refundable first order. Gearon Co., Dept. 500-B7, 27 S. Desplaines, Chicago 6, Ill.

**MUSHROOMS Grown.** Boxes, barrels. Instructions 50c. Spawn \$1.00. Manure-less process. \$2.00. Gordons, 553 William, Winnipeg, Manitoba.

**DEFENSE Welding jobs pay.** Welders needed. Train quickly. VA contract. Hobart Welding School, Box M-713, Troy, Ohio.

**\$250 WEEK Reported!** Free book, "505 Odd, Successful Businesses." Work home. Expect something odd! Pacific, Oceanside, Calif.

**GROW Mushrooms.** Cellar, shed, and outdoors. Spare, full time. Spawn replaced free. We pay \$3.00 pound. We paid O. Babbitt \$4,165.00. Send \$2.00 for general information book. Washington Mushroom Ind., Dept. 111, 2954 Admiral Way, Seattle, Wash.

**PRINT Without a printing press.** Big profits! See page 20.

**MAKE Flexible molds!** Cast plaques, bookends, figurines! Free sample! H. Tooker, 630-M Chestnut, Hamilton, Ohio.

**RESILVER Mirrors at home.** Formula 25c. Ideal Service, Park Ridge 4, Illinois.

**HAVE Fun! Make money!** "Working With Leather"—64-page booklet tells how. Send 25c for copy. No foreign orders. Free catalog and valuable information included. Wilder-Craft, 1039 Crosby, Chicago 10.

**RAISE Pheasants on the \$100 week plan.** Little capital and space can make you independent. Free details. Great Central Game Management System, Columbus 1, Kansas.

**LIFETIME Income as notary public.** Appointment assistance. Stationers, Helotes 50, Texas.

**\$40.00 WEEKLY Made growing mushrooms,** fresh, dried. Dominion patent 331583. Free spawn. North American, 169P Yonge, Toronto, Canada.

**BE The Popular Mechanics representative** in your neighborhood and earn big profits in your spare time. Write Popular Mechanics Magazine, Room 408M, 200 E. Ontario St., Chicago, Ill.

**FOREIGN and Latin American employment.** 1951 "Foreign Service Directory" gives up-to-minute facts on military and civilian construction, government jobs, major oil listings, aviation, transportation, steamship lines, mining, importers, exporters, how-when-where to apply, application forms, hot list firms hiring. \$1.00 postpaid. Global Reports, P.O. Box 883-P, Hollywood 28, Calif.

**ALASKA - America's frontier.** \$1.00 brings 1951 business directory, large government map giving up-to-date construction projects, current employment information, homestead and highway facts; hunting, fishing, game rules; firm's hiring and application forms. Alaska Opportunist, P.O. Box 883-P, Hollywood 28, Calif.

### BOOKS, PERIODICALS, PICTURES POSTCARDS

**POCKET Books—Western, mystery, romance;** 10 for \$1 postpaid. Record Shop, 920 North Kansas Ave., Topeka, Kansas.

**HOW-To-do-it books on every subject.** Written in Popular Mechanics' famous easy-to-understand style and profusely illustrated. Subjects include workshop planning and practices, projects, hobbies, household repairs, motoring, outdoor sports, photography, home building, and many others. Also booklets on specific topics. Write for free illustrated catalog. Popular Mechanics Press, 200 E. Ontario St., Chicago 11, Ill.

**HARD-To-Find Books supplied.** Send wants. Pierce's, Winthrop, Iowa.

**HARD-To-find books, send wants.** Green, Box 6761, Los Angeles 22, Calif.

**BOOKHUNTERS! Any subject, send wants!** Atlantic Book Service, Lawrence Avenue, Charlestown 29, Massachusetts.

**BOOKHUNTERS! All subjects. Send wants!** Jaher Book Service, 620-P East 178 Street, New York 57.

### MAGIC TRICKS, PUZZLES, JOKER NOVELTIES

**SPECIAL Catalog plus new trick—25c.** Town House, 1377 Union, St. Louis, Mo.

**VENTRILOQUISM Taught.** 3c stamp brings particulars. Smith, 801 Bigelow, Peoria 5, Ill.

**SHOCKING Bubble dancer, 50c.** Free lists. Tupler, 64 W. Randolph, Chicago.

**PLASTIC Ventriloquist dummy with instructions 50c.** Smokers, 34 West 39th St., New York City.

**FREE Trick and large illustrated catalog, 35c.** Lerro Magic, 509 80th Street, Brooklyn 9, N. Y.

**LATEST Magic for pocket, parlor, stage.** Catalog 500 tricks, only 10c. Unequaled magic service for 30 years. Douglas Magicland, Dept. 1, Dallas, Texas.

**WORLD'S Largest professional magic shop,** keeps you in touch with latest tricks. To receive mailings, send 50c for new catalog. Holden's, M220 West 42nd St., New York.

**512-PAGE Catalogue of 2500 tricks,** pocket, parlor, stage. World's finest magic. Send \$1.50 for catalogue (refunded first \$6.00 order). Kanter's, M-1311 Walnut, Philadelphia 7.

**16 CARD Tricks and catalog 25c.** Sterling Magic, Royal Oak, Mich.

**PROFESSIONAL Catalog, 124 pages, 25c.** Williams, 900 Plymouth, Ellwood City, Penna.

**BE A magician.** Large professional magic catalog of latest tricks, 35c. Ireland, C-109 North Dearborn, Chicago 2.

### COINS, TOKENS, CURRENCY

**WANTED 1894-S Dime, pay \$500.00.** Certain 1913 nickel \$1,000.00, 1901-S quarter \$10.00 — \$150.00, hundreds of others. Complete catalogue 25c. Worthy Coin Corporation, D-317, Boston 8, Massachusetts.

**FOREIGN Bills 10 diff. 15c.** Foreign coins 10 diff. 25c. Lists. O. Arnold, Macon, Mo.

**OLD Money wanted.** Will pay fifty dollars for nickel of 1913 with liberty head (not buffalo). We pay cash premiums for all rare coins. Send 4c for large coin folder. May mean much profit to you. Numismatic Co., Dept. 20, Fort Worth, Texas.

**1 COIN, 2 Wooden nickels, 3 notes and coin collector's new magazine 10c.** Lawrence Brothers, Anamosa, Iowa.

**WANTED Rare coins.** Describe fully. Samuel Bigford, Earville, N. Y.

**COINS Wanted, will pay up to \$2000 for certain coins, send 25c for catalogue.** Burton's, 111 So. Third, Columbus, Ohio.

**FREE! Foreign coin, banknote and coin collectors illustrated catalog to approval service applicants.** Send 3c postage. Tatham Coinco, Springfield 30, Mass.

GET Profit and pleasure in collecting old coins. Send 10c for 56 page illustrated coin catalog. You'll be delighted with it. Send for it now. B. Max Mehl, 370 Mehl Bldg., Fort Worth, Texas. Largest rare coin establishment in U. S. Established 50 years.

JAPANESE Invasion notes. 1c to \$1,000.00, \$2.00. Burma note and catalogue 25c. Shultz, Salt Lake City 10, Utah.

100 COINS And bills, \$1.00. Oddehon, Box 482, St. Louis, Mo.

GIANT Fifty-two page illustrated price-list of coins, albums, supplies. Send dime to Ben's Coin Shop, 31 N. Clark, Chicago 2.

### STAMP COLLECTING

GET Scott's new popular stamp catalog! Makes collecting more fun. Covers all countries. 1,250 pages, thousands of illustrations, handsome flexible cover. Simplified edition of standard catalog. Only \$3.00. If your dealer cannot supply, order from Scott Publications, Inc., 1 West 47th St., New York City 19.

FREE! Blindfold, Breadfruit, Calypso, Moravian Hitler, Nile, Ruanda, other curious stamps. Exciting approvals included. Mitchell, Box 923-h, Portland, Maine.

PAY Check gone? Are you paying too much for approvals? Try our books of 1,000. Priced at 1c and 2c each. Reference appreciated. Roseland Stamp Co., Dept. 10-A, Spring Lake, Michigan.

STAMP Magazine! Copy free! "Stamp Post," South Catalina, Pasadena, Calif.

BARGAIN! 100 Different United States stamps—including commemoratives, airmails, only 10c to approval applicants. Sunset Stamp Co., Box 47, South Gate, Calif.

TRIANGLES! Six bicolored beauties (ferocious beasts, tropical birds, etc.) With colorful approvals—only 10c! Atlas, 2830-t Eisenhower, Racine, Wisconsin.

FINE Approvals. Fast, personal service. What countries do you prefer? I'll send their stamps. Skinner, 438 Locust, Long Beach 12, California.

U. S.—50 Different, 10c! Big bargain list included. Breck, 10516 Clifton, Cleveland 2, Ohio.

ROOSEVELT With six fingers, scarce error; free with approvals. Super Stamps, Box 687, Hollywood, Florida.

FLAG Stamp—Free with hygrade U. S. approvals. Wenigman, 1933 Patterson, Chicago 13.

50%-75% DISCOUNTS! Approvals from 33,000 collection—1/2c up! Schur, Box 252, Buffalo 12, N. Y.

POUND Stamps containing thousands \$1.00. Longacre Shop, 108 West 42nd, New York 18.

FREE! Big Liberian beauty, new Borneo pictorial, gorgeous Sarawak, Brunel canoe, Zanzibar sultan, assortment U. S. commemoratives, and over 100 others! Everything free to approval applicants. Krick, 511 Fifth, Niagara Falls, N. Y.

SOUVENIR Sheet free if you request approvals. Knight, Box 3770, Portland 8, Oregon.

FREE—Complete set of famous Americans, flags, parks and presidentials to approval buyers. Send 3c for 15c of the above stamps plus full particulars. Triboro Stamp Company, 145 Nassau Street, Dept. 107, New York 38, N. Y.

FREE! Jumbo, Pigmy, Diamond, other strange stamps—yours for requesting "Bargain Approvals." Niagara Stamps, Niagara-on-the-Lake 11, Canada.

FREE—Goldcoast, Nigeria! Bonus approvals. Colonial, Box 28A Rutherford, N. J.

1/2c-1c APPROVALS! Bargains galore! Cole, 43-a Rinewalt, Buffalo 21, N. Y.

GERMANY B218-29, Warplanes, destroyers, Paratroopers, machinegunners; free with approvals. William Deems, Ravenswood, West Virginia.

ROOSEVELT Set plus 25 different U. S. 10c. approvals. Locust Stamp Co., Box 390T, Peekskill, N. Y.

FREE. Scott's International Album. Other big premiums. Full particulars with approvals. Raymax, 123-Z William St., New York City 38.

COMPLETE Clearance. Sensational bargain lists free. Beacon Sales, Maynard, Massachusetts.

ONLY serious collectors: airmails \$2.00, receive superb assortment Morocco pictorials. Free list. You will never regret it! Idap, 26 Hollande, Tangier, Morocco.

SWASTIKAS! Leipzigs! "Osterreich" on Hitler! 3 complete mint sets—10c! Approvals. Billingslea, Gilmer 4, Tex.

FORMOSA, Manchukuo, Mongolia, others, 30 oriental stamps! Rare! Only 3c. Approvals. Concord, 429-E, Beeville, Texas.

NOVA Scotia, Prince Edward Island, Newfoundland, 20 different 45c to approval applicants. Green Co., Box 208, Toronto 1, Canada.

MOZAMBIQUE Triangulars, unused set 10c with approvals. Vargo Stamps, 6044 South Fairfield, Chicago 29, Illinois.

BIG U. S. illustrated catalog free. Stone, 45 Bromfield, Boston 8, Mass.

SOUVENIR, Columbian World's Fair ticket, with big illustrated catalog 10c. "Stamps By Mail," 109 N. Dearborn, Chicago 2.

U. S. Collectors—Write today for free material. Eagle Stamp Co., 2221-A Romine, Pittsburgh 26, Penna.

500 FOREIGN Free with dollar packet. Book Nook, Oronoco, Minn.

IS Your hobby too expensive? Are high prices keeping your collection on the shelf? Try our 1c and 2c foreign approvals in books of 1000, or U. S. at bargain prices. Clark, Box 544P5, Muskegon, Michigan.

500 DIFFERENT 40c With approvals at wholesale to clear. K. S. Holmes, London, Canada.

STAMP Cleaning service. We will clean your stamps on paper. Write for details. Ray & Ray's Service, 5310 50th Street, Maspeth, L. I., N. Y.

50 DIFFERENT U. S. 10c. No approvals. Seidenberg, 944, Appleton, Wis.

FREE! \$10,000 Airmail! Philippines! Fezzan! Uruguay! Approvals. Keating, 2520-P Boulevard, Jersey City 4, New Jersey.

"GOYA Nude" set (Catalogs 55c) 15c with approvals. Royal Stamp Company, Tamaqua, Penna.

STAMPS Wanted. Collections, duplicates, surplus stock, mint and used. Buy outright if bargain. What have you? Vanroy Shirk, Lebanon, Penna.

77 DIFFERENT United States—25c. Approvals. Utechts, 1143-D North Keeler, Chicago 51.

FREE Hinges. With 25 large different Mexican airmails, only 60 cents. Robert Boger, 3401 Oakmont Ave., Philadelphia 36, Penna.

FREE Collection—Over 100 different stamps of world: commemoratives, animals, natives, ships, famous men, others all to approval buyers; also Scott albums, catalogs. Bell Stamp Service, Dept. S-2, Bell, Calif.

UNITED States approvals—Select, used or mint. Kingsbury, Woodbury, Vermont.

307 ALL Different—Only 15c! Beautiful collection: commemoratives, triangles, high values, bicolored stamps, etc. Garcelon, Calais 400, Maine.

UNITED States approvals complete coverage, fine quality, attractive prices. Seminole Stamps, Box 1138-P, Coral Gables, Florida.

NOTHING Free. Just good stamps reasonable. Send dime for seventy-four page catalog. Ben's Stamp Shop, 31 N. Clark, Chicago 2.

FREE! United States—Germany Occupation stamps. Approvals. Stampco, #987, Albany 2, New York.

"HOW To Recognize Rare Stamps." Free book illustrated! Kenmore, Richford, H-57, Vermont.

FREE U. S. price list, postage 3c. Mark Hanna, 335 5th Ave., Pittsburgh 22, Penna.

OLD Scarce U. S. seconds on approval. Slightly defective. Bargain prices. Herfield, Clintonhill Station, Newark 8, N. J.

FREE Supply list. Penny approvals on request. Reed, Box 980, Chicago 90, Illinois.

FREE "Stamp Finder." Tells instantly country to which any stamp belongs. 32 pages profusely illustrated. Garcelon, Calais 17, Maine.

10,000 DIFFERENT 1c Each! Gordon Davison, Box 1019S, Manchester, N. H.

100 NETHERLANDS. All different. Beautiful assortment. 10c with approvals. Thomson's, Box 4074-P, Miami, Florida.

AMAZING Offer! 500 United States stamps—including commemoratives, airmails, high values to \$5.00. Only 10c to approval applicants! Illustrated bargain lists free. Mystic Stamp Co., Dept. 80, Camden, New York.

FIRST U. S. (1847) government reissues 5c, 10c, plus giant bargain U. S. collection—only 5c to applicants U. S. approvals. Metropolitan, Box 312G, Jackson Heights, N. Y.

10 ASSORTED U. S. Commemorative 15c. Five U. S. Air Mail 15c. 10 Famous Americans 25c. All for 50c. Ideal Stamp Shop, Box 179, Park Ridge, Illinois.

WOW! 203 All different Germany 10c! Zeppelins, semipostals, airmails, high values, etc. to new customers. Jamestown Stamp, Jamestown 512, New York.

WORLD'S Largest stamp (7 1/2 x 14 inches). A real curiosity! Retail for 50c, only 3c to approval applicants. Tatham Stamp Co., Springfield 30, Mass.

UNITED States stamps nearly 100 years old. Roosevelt set, others, 40c value—only 5c to applicants United States approvals. Wakonda, Box 272K, Jackson Heights, N. Y.

500 STAMPS For only 10c! This mammoth value includes airmails, pictorials; stamps from strange countries, cataloging up to 25c each! Also approvals. Mystic Stamp Company, Camden 80, New York.

COLUMBIANS, Trans-Mississippi, Pan Americans, Pan Pacific, ten other different commemoratives. All 10c with your request for U.S. approvals. Moda Stamps, Box 251-X, C.S.A., New York 8.

MAGNIFIER, Big stamp magazine; first U. S. commemorative; plus unused \$5000 Foreign Legion, diamond, giant, and other worthwhile stamps. Everything free to approval buyers. Capital Stamp Company, Little Rock 2, Arkansas.

FREE! Powerful magnifying glass. Jamestown Stamp, Jamestown 202, New York.

200 DIFFERENT Including Roosevelt triangle, 5c to approval applicants. M. Avalon Stamp Company, Springfield, Mass.

OVER 1,000,000 Sold; 200 different stamps 10c with approvals. Carlton's, Tujunga, Calif.

500 EXOTIC Japan stamps—10c. Kenmore, Richford, J-57, Vermont.

750 FRANCE And colonies stamps 10c. Littleton Stamp Co., Littleton 25, N. H.

50,000 STAMP Grabbags 25c each. Anderson, 630B, Bingaman, Reading, Penna.

FREE—Illustrated catalog! Kenmore, Richford, C-57, Vermont.

UNHEARD OF! Scarce Liberian pictorials. Catalog value \$1.75. Only 5c to approval applicants. Capital Stamp Co., Box 621, Silver Spring, Md.

### ANTIQUES, RELICS, INDIAN GOODS, CURIOS

EIGHT Fine arrowheads \$1.00. Catalog free. Nirscher's, 111 South 31st, Belleville, Illinois.

4 FINE Ancient Indian arrowheads \$1.00. Fine tomahawks \$2.00, \$3.00. List free. Lear's, Glenwood, Arkansas.

ODDITIES, Antiques, relics most unusual. List 25c. Parish's, Vicksburg, Miss.

### PRECIOUS STONES, MINERALS

JASPER, Agate, quartz, catalogue, 25c. Gemco, Elkhart Lake, Wisconsin. Best prices.

MINERAL Specimens, rough and cut gems. Lowest prices. Free price list. Warren's Minerals & Gems, P.O. Box 277, San Diego 7, Calif.

GOLD! "Panned" from California's fabulous gold country. Show your friends authentic gold dust. Generous sample. Send \$2.00. Whiskey Diggings Prospector, 712 Plumas Street, Yuba City, California.

GEMCUTTING, Silvercraft authority. Illustrated magazine tells how. Cut rocks, make jewelry. 150 ads illustrating equipment, offering gems for collectors, cutters. Postal brings literature. Lapidary Journal, Palm Desert, Calif.

GEMS—Mined, brilliant. Cut like a diamond Sample 25c. Money back guarantee. List free. Importers, 432 South Western, Hollywood 5, California.

GEMSTONES, Mineral specimens. Every variety. Lowest prices. Postcard brings free booklet. Plummer's, 2183C Bacon, San Diego 7, California.



## HOBBIES AND COLLECTIONS

**GOLDEN Hamsters**, experienced producer. Let me serve you. Woodworth Hamsters, Glendora, Calif.

**WANTED** Old cigarette cards. Write Charles Bray, East Bangor, Penna.

**COLLECTOR** Wants old barbershop shaving mugs with owner's name and occupational or sporting design. Minimum \$7.00 each. Describe fully. Evans, Box 412, Lenexa, Kansas.

**UNUSED** Matchbook covers—100 different \$1.00 36-page catalog 25c. Charles Edelman, 1311C East 84, Cleveland 3, Ohio.

**INVENTING** Can be an interesting and profitable hobby. Write for complete particulars. Institute of American Inventors, Dept. 40-E 631-E St. N.W., Washington 4, D. C.

## CAMERAS, PHOTO SUPPLIES

**FREE** Photo catalogs, cameras, supplies. Rock bottom prices. Trades welcomed. Mogull's, (Dept. P.M.) 112 West 48th, New York 19, N. Y.

**PHOTOMURALS**. Your negatives or ours. Catalogue 25c. Photomammoth Murals, 12048 Vanowen St., North Hollywood, Calif.

**ADD Spice** to home projection shows with colorful old-time Nickleodeon slides. 2x2. Write for free list. Nickleodeon Co., New Fleidner Bldg., Portland 5, Oregon.

**PHOTOMURALS**. Your negatives or ours. Catalogue 25c. Photomammoth Murals, 12048 Vanowen St., North Hollywood, Calif.

**ULTRA** Powerful telephoto camera easily made. Trifling cost. Objects miles away photograph close up. Carl Jamer, Box 694, Manorville, N. Y.

**BUY** Photographic supplies wholesale. Free catalog. Expert camera repairing. Capitol Photo Supplies, 2428 Guadalupe, Dept. 5, Austin, Texas.

**FREE** Photographic bargain book packed with hundreds of sensational values in still and movie cameras, lenses and latest accessories. Super savings for you in new and used equipment. Liberal trade-in allowances, too, on your equipment. Write now for your free copy to Central Camera Company, Dept. 9D, 230 S. Wabash Ave., Chicago 4. (Photographic headquarters since 1899.)

**PHOTOCOPY** Anything—Papers, books. No darkroom. 8½" x 11" complete \$6.95. Potoflek, 8555 Plainfield Lane, Cincinnati 36, Ohio.

**BASS** Says: Trading cameras a national habit since 1910. Write to Bass the old "horse trader." A postcard will do. Simply say: "Bass, I have and I want. How much will you allow me?" It's fun to trade with Bass. Satisfaction guaranteed. Bass buys, sells, and trades. Bass Camera Company, Dept. AG., 179 W. Madison St., Chicago 2.

## MOTION PICTURES AND SOUND EQUIPMENT

**ALMOST** Free—With your request for Blackhawk's big 32-page catalog of film bargains—one brand new film, postpaid. (We select the title)—100' 16mm. sound, 98c; or 100' 16mm. silent, 59c; or 50' 8mm., 39c—as a special get acquainted offer. Other typical Blackhawk bargains: New 1-reel, 16mm. sound films, \$7.95 (formerly \$17.50); new 1-reel, 16mm. silents, \$2.98 (formerly \$8.75); new 1-reel 8 mm., \$1.89 (formerly \$5.50)—all first quality prints in original cartons. Used Panoram 100' 16mm. musicals—\$6.89 per dozen. Similar bargains in used features, cartoons, sports, comedies, musicals, travels. Used sound projectors—Ampros, Bell & Howells, Victors—often available low as \$129.95. Bargains in reels, cans, supplies. World's biggest stock 16mm. films—over 100,000 prints. Write today for Blackhawk's free catalog and get acquainted offer. "Sixteen's Super Market." Blackhawk Films Inc., 1201 Putnam Building, Davenport, Iowa.

**THE** World's greatest story. "Entire Life of Christ;" 8mm., 16mm. Sound and silent. Rent or purchase. Hemenway Film, 33 F Melrose Street, Boston 16, Mass.

**FREE** Movie catalogs. Wonderful values. 8, 16, 35mm., sound-silent projectors, cameras, film, lenses, accessories. Trades welcomed. Mogull's, (Dept. NP), 112 W. 48th, New York 19.

**16MM.-8MM.** films. Royal Film Service, Passaic, New Jersey. Lists.

**NOW!** Sound for your 8 and 16 mm. movie projection. Add interest by recording titles, voices and background music. Send for complete details free. Lake Erie Electronics, 9048 Ridgewood Dr., Cleveland 29, Ohio.

**UNUSUAL** 8-16MM. movies. Full-color projection length sample, \$1.00. Color Tru-Art slides, three samples \$1.00. Big catalog, 25c (refundable). National Film Supply, Toledo 9-H, Ohio.

**EARN** \$8.00 To \$10.00 daily with your movie projector! Write: Beverly, 10806 Glenroy, Chicago 43, Ill.

**5000** NEW-Used 8-16mm. silent-sound films. International, 2120 Strauss, Brooklyn 12.

**FREE** Movies "Hundreds of Subjects." Interesting. Entertaining, fascinating. Latest Directory only 50c. National Cine Society, 126 Lexington Ave., New York 16, N. Y.

**8-16MM.** Silent-sound films. Complete rental library. All latest subjects. Free catalogue, sample film 10c. Garden Film, 317 West 50th, New York 19.

**BASS** Says: Leadership since 1910 guarantees satisfaction. Finest Cine equipment: 8mm., 16mm., and 35mm., silent and sound. Write the old "horse trader." Satisfaction or your money back always! Bass Camera Company, Dept. A, 179 W. Madison St., Chicago 2.

**RENT** 16MM. sound films, 50c reel. Large selection; free catalog. Film Service, 128 Chestnut St., Roselle Park, N. J.

**LEARN** Professional motion picture technique at home. Free catalog. Motion Picture Institute, Birmingham 4, Mich.

**GUARANTEED** Fresh 8mm. roll, magazine; 16mm. roll, magazine movie films. Color, b&w. Free catalog. ESO-S, 47th Holly, Kansas City 2, Missouri.

**MOVIE** Camera film: 8mm. roll \$1.50, 16mm. 100' \$3.00. Free processing. Better Films, 742 New Lots, Brooklyn, N. Y.

## PHOTO FINISHING

**QUALITY** Enlargements by professionals. Special 3 8x10 D. W. sepi, \$2.00. Marchion Photo Service, Fostoria, Ohio.

**8 CONTACTS** 30c, Jumbos 40c, 12-45c, jumbos, 55c. Reprints 4c, jumbos 5c. Free mailers. Western Photo, PM71, Box 298, San Francisco 1, Calif.

**8 ALBUM** Prints (oversize) 40c, 12-60c, 16-80c. Fast service. O'Henry Photo Service, Box 2458, Greensboro, N. C.

**6 OR 8** Picture roll 35c, 12 or 16 picture roll 55c. Each roll printed and developed. Handy album pack. If you fail to get pictures on your film a new roll will be sent you without extra cost. Send coin with roll. No c.o.d.'s. Mailing containers sent free. DeLuxe Film Service, Box 1268-A, Shreveport, Louisiana.

**8 OVERSIZE** Snapshots from roll, 25c with this ad. Foto's, Box 8, Aurora, Illinois.

**MAIL** Us your films. Prompt service. 8 exposures developed and printed 30c. Free enlargements. Foto Art Studio, Box 406, San Francisco, Calif.

**16 PRINTS** Or 8 jumbos from roll, 25c with this ad. S. Skrudland, River Grove, Ill.

## MUSIC AND MUSICAL INSTRUMENTS

**LEARN** Guitar Hollywood way. Short new method. Play songs immediately. Only \$1. Carey Bennett, 629 N. St. Andrews Place, Hollywood 4, Calif.

**SONGWRITERS!** Send poems, songs. Music Service, 243 West 72nd St., PM, New York 23.

**CHORDS!** The "Kord-Key" Guide. All chords. All keys. This amazingly simple device shows all the chords in all the keys. No note reading required. Shows how to play in any key. May be used with any instrument. Only \$1.00 brings you a "Kord-Key" Guide. Creative Harmony, Box 3366A, Glendale 1, Calif.

**VOICE** Secrets of famous tenor. \$1.00. Box 864, Hollywood, California.

**SWING** Piano—By mail. 30 self-teaching lessons \$3. (Samples.) Phil Breton Publications, P.O. Box 1402, Omaha 8, Nebr.

**POEMS** Wanted for musical setting. Send poems for free examination. Five Star Music Masters, 630 Beacon Bldg., Boston, Mass.

**SONGWRITERS** Service. Newark Publications, GPO Box 1226, Syracuse, New York.

**ELECTRIC** Guitars, amplifiers, save 50%. Free literature. Carvin PM, Baldwin Park, Calif.

**MUSIC** Arranged. Songs printed. Frank Wildt, Music Publisher, Lancaster, Penna.

**POEMS** Wanted. Broadcast consideration. Sooner Song Co., 22-PM Northwest 8th, Oklahoma City 2.

**SWISS** Musical movements \$1.00. Catalogue 10c. Bell Music, 1610 First Avenue, New York 28, New York.

**ACCORDIONS** — All brands. New and used. Save 50%. Wholesale to every one. Del Principe, 307 So. Wabash, Chicago, Ill.

**1951 ACCORDIONS** — Wholesale. Free catalog. American Accordion Center, 5329 Belmont, Chicago.

**YOUR** Voice made loud, clear and powerful with my diaphragm exerciser. Write. Inventor "Oz," 34V, Box 665, St. Louis, Mo.

**POEMS** Wanted to be set to music. Free examination. Send poems. McNeil, Master of Music, 510-PM S. Alexandria, Los Angeles, California.

**WRITE** Songs. Big money and reputation. Write for information. J. Gordon Pub. Co., 4700 South California Avenue, Chicago.

**WANTED!** Poems for musical settings. Write Songwriters' Service, Clifton, N. J.

## RADIO AND TELEVISION

**FREE**—Completely new 1951 radio, television and electronic buyer's guide. Page after page of the very latest available supplies of guaranteed quality at today's lowest prices. Thousands of super-values in Hi-Fi units, recorders, television and radios, phonos, sound equipment, testers, tubes, kits, parts and books. Big stocks for immediate shipment. Send for it now! Concord Radio Corp., Dept. LG-51, 901 W. Jackson, Chicago 7, Illinois.

**ANYONE** Can build this simple inexpensive radio controlled door closer or it will operate any electrical device from your car. Build, sell, install two-thirds under all competitors. Pictorial illustration with complete material list and diagram. 35c. Apco, 1553 Plainfield, Grand Rapids, Mich.

**AMATEUR** Radio operator license preparation. Correspondence course. Low cost. Personal coaching. Federal Electronics Institute, 45 E. Putnam, Dept. B., Greenwich, Conn.

**RADIO** Tubes, surplus radio equipment, bargains. Ask for list. Kay Electronics, Box 25, Hollis, New York.

**"LOUDEST"** Crystal, catwhisker, radio plans, catalogue: 25c. Amorose, Route Four, Richmond, Virginia.

**RHOMBIC** TV antenna outperforms all other types, power gains of 100 for extreme fringe area, reception drawings, complete instructions for 24 sizes \$1.50. R. Buchan, WOTJF, Bricelyn, Minnesota.

**PICTORIAL** Instructions. Midget radio, all-purpose tester. Code, crystal sets, 25c. Arthur Alena, Wall Street Station, Box 271, New York 5.

**FREE** 1951 Catalog—Radio, television and electronic supplies. Hundreds of super values in sound equipment, record changers, Hi-Fi units, TV tubes, antennas. Big stock. Fastest service in the West. Wholesale Television and Radio Supply Company, Dept. PM7, 408 Market Street, San Francisco, Calif.

**MAKE** Simple, tubeless, batteryless, distance-getting crystal radios. Crystal and illustrated instructions 25c postpaid. Allen, 427-P, Clinton, Mo.

## BUSINESS OPPORTUNITIES

**START** Your own business on credit. Always your own boss. 1437 dealers sold \$5000 to \$28,500 in 1950; their average \$8704. We supply stocks, equipment on credit. 200 home necessities. Selling experience unnecessary to start. Wonderful opportunity to own pleasant, profitable business backed by world-wide industry. Write Rawleigh's, Dept. G-U-PPM, Freeport, Ill.

**HUGE** Profits up to 150%. Internally carved Lucite costume jewelry, carded and boxed. Send \$1.00 sample and list. Goshen Plastics, Goshen, N. Y.

**OPPORTUNITIES** Galore! Business plans, mail-order schemes, factful information. Free literature! Lightway Service, 3121-E North Hamlin, Chicago 18, Ill.

**INVISIBLE Reweaving.** Men - women. Home course sent on five-day no-risk examination. \$5 hour possible spare or full time. Reweave burns, tears, moth-holes like new at home. Free details. Skill-Weave, 1418-CC Westwood, Los Angeles 24, California.

**SOAPMAKING**—Profitable home business. 20 complete formulas, \$1.00. Soap substitutes, complete collection \$1.00. Waterless hand cleaner (no ammonia—no kerosene) \$1.00. All for \$2.00. Nelko Chemical Service, 3462-SM Merchandise Mart Sta., Chicago 54, Ill.

**OPERATE** Profitable mailorder business. Particulars free. George Lenhoff, Lincoln 8, Nebraska.

**REVOLUTIONARY** Conception of public bookkeeping! \$5.00 hourly. Simple instructions. Full, spare time. Systems, shortcuts, obtaining clients. Auditax, 10775-P Tabor, Los Angeles 34.

**FREE Literature.** Your own business. Profitable permanent. Hubbard, 6 North 6th Street, Yakima, Washington.

**WOULD** You like a better income? \$20.00 to \$50.00 per day? We show you how to cover the exterior of any building—new or old, wood masonry or concrete—with a lasting and beautiful composition finish. Simulate brick or stone, or do stucco work in any pleasing color or combination of shades. Results are amazing in beauty and coloring. Opportunities everywhere. This is your opportunity. Don't pass it up. Complete directions and formulas, \$10.00. Garwood Construction Co., Blackwell, Okla.

**MAKE** Gifts, novelties, from sea shells, fish scales and plastics. 150 beautifully photographed designs. Secret pearlizing, bronzing, luminizing, metalizing, dyeing, tinseling processes disclosed. No tools or experience needed. Giftcrafts, Box 4550-MP, Coral Gables, Fla.

**START** Home manufacturing business making cleaning compounds, soaps, insecticides, cosmetics, polishes, food flavors. No machinery. Literature free. Kemix, Park Ridge 8, Ill.

**BIG Money!** Spare or full time in your home. No selling! Spray new miracle finishes, plush and suede, on signs, radios, automobiles, figurines, lamps, toys, etc. Our business is booming. Help us fill huge demand. New easy Plok-Kraft methods. Material costs few pennies. You get dollars. Free samples, complete powerful money-making plan free. Write now! Coast, 1002K S. Los Angeles St., Los Angeles 15, Calif.

**MORE** Money in closeouts. Pricelist free. Metro, 60 South Street, Boston 11, Mass.

**MIRROR** Resilvering. Wonderful home business. Complete formula 50c. Magic two-way mirrors. You can see out—no one can look in. Formula 50c. How to make coppered mirrors, vases, glasses. Formula 50c. All three \$1.00. Nelko Chemical Service, Box 3462-MG, Chicago 54, Ill.

**\$46 FROM** Square foot plywood; jigsaw necessary. Literature free, write today. Woodarts, Bridgewater, Mass.

**MAKE** Perfumes, write, "Carey Laboratories," 1914 Chouteau PM-7, St. Louis 3, Missouri.

**TRADE** Magazines help you to success. Get latest copies through our easy-to-get-acquainted service. Nearly 1200 business, professional, agricultural, automotive, educational, sport, hobby, music, writer, television, etc. List free. Commercial Engraving Publishing Co., 34C North Ritter, Indianapolis 19, Indiana.

**MAKE** Tough, durable plastic—1c pound. Makes attractive floors, walls, built-ins, roofs. Build good home, \$150.00 room. Bays Laboratory, Oklahoma City 9.

**MAN!** These are hot! Make \$6.35 on every sale. Sales are really easy. New adding machines in original factory cartons you can sell for only \$12.95 and you make over 45%. They're executive model portables, precision built, fully guaranteed. Send for life-size color photo with full details. Write today to Lightning Adding Machine Co., Inc., Dept. P-7, 1260 West Second St., Los Angeles 26, Calif.

**SPECIAL** Rubber for making molds. Literature and sample free. Universal, Box 1076-A, Peoria, Ill.

**\$10 HOUR!** Complete invisible reweaving course, including everlasting equipment and supplies \$3. Details free. Walsh, 894 Main, Buffalo 2, N. Y.

**AMAZING** New, formulas. Dr. Hertzstein, 511 Thomas, Grand Rapids, Mich.

**PROFITABLE** New sawing method. Zapart, 586-PM Manhattan Avenue, Brooklyn 22, New York.

**MAIL** Order strictly co-operative, unusual opportunity. Items of merit. Sample details \$1.00. Manager, P.O. Box 757, Newark, N. J.

**EARN** Up to \$400 monthly raising Angora or New Zealand rabbits. Plenty markets. Particulars free. White's Rabbitry, Newark 92, Ohio.

**BOOKKEEPERS.** Keep books, small firms spare time. Manual latest technique by C.P.A., \$3.00. Modern Business, Box 406, Youngstown 1, Ohio.

**BE** Your own boss. 137 successful business plans. Full, spare time. No capital, experience or canvassing. Free details. Stanko, 6215 Woodhaven, Rego Park, New York.

**LEARN** Invisible reweaving, repair dolls, make rubber stamps, repair sewing machines. Catalogue of "40 Ideas" free. Universal, Box 1076-A, Peoria, Ill.

**FIX** Typewriters—Home study course quickly trains you for own business. Factory methods taught. Write: Typewriter Repair, 7915 Corbet, Tarentum, Penna.

**FREE** Book "372 Unusual Worldwide Businesses." Work home (U.S.A.)! Publisher, Carlsbad, Calif.

**WHITE'S** Comb vendor. Real money-maker. Buy one. Convince yourself. 865 Grace Street, Elgin, Illinois.

**DOLLARS** Daily in mail. All profit plan. Free details. Veejay, Box 14707-M, Cimarron Sta., Los Angeles 18, Calif.

**EARN** Money at home with your typewriter! Spare time! Details free. Edwards, Publisher, 3915-PM, 12th, Des Moines 13, Iowa.

**ESTABLISH** Your own business. Free information. Arrow Press, Box 933, Buffalo, N. Y.

**MAKE** Money spare or full time casting metal toys and novelties. Big wholesale and chain store demand for autos, soldiers, ashtrays, banks, etc., keeps manufacturers busy. Production moulds furnished for up to 100 and more castings per hour. No experience or special place necessary. "Cash-in" on holiday orders now being placed. Write for information and illustrations of patterns needed. Metal Cast Products Co., Dept. A, 1696 Boston Road, New York 60, N. Y.

**TIN-Cans.** Turn them into cash. Nine methods. Instructions 50c. Charles Co., 12-BWP, Norwood, Ohio.

**HOW** To set up and run a mirror shop! Resilvering mirrors. Making chipped glass nameplates. Electroplating salts and rectifiers. John Sprinkle V60, Marion, Ind.

**GROW** Mushrooms. Cellar, shed, and outdoors. Spare, full time. Spawn replaced free. We pay \$3.00 pound. We paid O. Babbitt \$4,165.00. Send \$2.00 for general information book. Washington Mushroom Ind., Dept. 125, 2954 Admiral Way, Seattle, Wash.

**\$250 WEEK** Reported! Free book, "505 Odd, Successful Businesses." Work home. Expect something odd! Pacific, Oceanside, Calif.

**INDIAN** Carpets; arts, crafts; postage stamps; etc., available. Viegas, Post Box 1477, Bombay, (India).

**MAKE** Sell perfume. Home business opportunity. 2 popular fragrances, blender, base, bottles, labels, instruction folio. \$18 retail value—\$2.00. Genmerco, Box 142-P, Dorchester 24, Mass.

**SEWING** Machine spare and full time repairmen wanted. We train you. Income unlimited. Motors, new machines, supplies furnished. Write Taylor Service Co., Hamilton PM7, Ohio.

**PRINT** Without a printing press. Big profits! See page 20.

**PROFITABLE** Mailorder business. Free details. Paley, 3519-M Charles, Cincinnati 8, Ohio.

**MAKE** Perfume and cosmetics—Instructions free. "International," 6347 Parnell-PM-7, Chicago 21, Illinois.

**TO** \$35.00 Weekly. Spare time, home operated mail order business. Successful small "beginner's" plan. Everything supplied. Lynn, 5710-M Bankfield, Culver City, California.

**YOUR** Name and address on postal will bring many local and mail business opportunities. Apex Supply, Box 165, New York 18, N. Y.

**WHERE** To buy at wholesale 100,000 articles. Free list. Maywoode, 1133 Broadway, New York.

**NEW** Exceptionally profitable plans—ideas for home operated mail business. Rush name. Miller, 1772-P Carlyon Road, East Cleveland 12, Ohio.

**FREE** Illustrated instructions, casting novelties. Genuine latex for molds. Major Latex & Chemical Co., 25 Allerton St., Boston 19, Mass.

**ESTABLISH** Profitable home mail business. Exclusive built-to-order proposition service. Everything handled for you. Booklet free. NMD Agency, Box 88-W, Dorchester 22, Mass.

**ELECTROPLATE** Metals, mirrors, non-metals. Inexpensive, profitable home process. Free booklet. Tyco Metals, Box 13231-T, Houston 19, Texas.

**START** A venetian blind laundry. Profit opportunity for lifetime business. New machine method. Free booklet on request. F. C. Co., 442 N. Seneca St., Wichita 12, Kansas.

**MAKE** Money at home as renewal headquarters for all magazines. Liberal commissions. No experience, no capital needed. Supplies furnished. Write for free catalog. McGregor Magazine Agency, Dept. 500B, Mount Morris, Ill.

**SELL** By mail, free details. Instructive booklet 25c. Manhattan House, Box 50-M, New York 28, N. Y.

**INCOME** From local information. No selling. Write Neherco, La Verne, Calif.

**NATURAL** Molding Latex. Extra thick. Free sample. W. Wooley, 115-A Donald, Peoria, Ill.

**QUICK** Sign painting. Use letter patterns, avoid sloppy work, wasted time. Write for folder. John Rahn, A1330 Central, Chicago 51.

**BOOKKEEPERS** Earn \$100.00 weekly operating simplified "Bookkeeping-Tax Service." Details free. Universal, Box 664-M, Springfield, Mo.

**BIG** Time earnings selling popular repeat-order merchandise by mail from your home. Everything furnished. Spalding, 254-P Taylor Blvd., Millbrae, Calif.

**MAKE** Flexible molds! Cast plaques, bookends, figurines! Free sample! H. Tooker, 630-R Chestnut, Hamilton, Ohio.

**A** Business in your own home! Our chemicals, plus free water and cheap "grocery store" materials can bring you over \$500 monthly earnings. Plans and formulas free. Western B Aircraft, Los Angeles 19.

**BUY** Wholesale—Million articles. Supply source directory, dime. Nelko, Box 3462-DR, Chicago 54, Ill.

**LIQUID** Marble—Colorful, glossy! Molded, brushed, sprayed! Cast novelties, statuary, colored tiles. Flexible molds. Composition floors. Particulars free. Marbleizing Service, Edwardsville, Illinois.

**NEED** Money? Stop wishing! Do something! Free information. E. L. Glodfelter, Box 23, Loganville, Penna.

**NEW** Profitable home business repairing zippers. Thousands of customers waiting. No experience required. We furnish everything. Write Texas Specialty Company, 204-B Texas, Texarkana, Texas.

**UNPAINTED** Bookends, plaques, statues, figurines. List. Haverly Products, 822-17th St., Altoona, Penna.

**EARTHWORM** Breeding. Valuable bulletins on successful methods mailed free. Earthmaster System, Dept. 14, El Monte, Calif.

**YOUR** Own profitable home business. Preserve live flowers to last for years. New simple discovery. Enormous demand all year 'round. Tremendous profits! Light fascinating work. Send \$2.00 for working equipment, instructions, and valuable sales plans. Satisfaction guaranteed or money promptly refunded. Alfred Hermansen, 210 Fifth Ave., Suite 1102A, New York 10, N. Y.

**WANTED!** Home producers by manufacturers in our clearing house service. Become a sub-contractor, casting plastic products for these companies. Thousands of easy to make items required. Cash in at home without previous experience. For details write Plastic Service Guild, Dept. PM, 233 Condon St., E. Boston 28, Mass.

**START** Mailorder bookshop—Everything furnished. 25c brings booklet, samples, exciting ideas. General Publications, Ossining, N. Y.

**THOUSAND** Articles wholesale. "Supply Source Directory" 10c. Ideal Service, Park Ridge 30, Illinois.

**BE** Appointed state notary public now! Details. Stationers, Helotes 50, Texas.

OF EARLY Profitable man or business. Write Walter Service, 4159-A East 112th, Cleveland 5, Ohio.

**DOLLARS** In personalized baby record books. Sell by mail. Use same literature we do. No-Co-Ro, Oakland 6, Calif.

**FABULOUS Earnings**—Fascinating pastime. Growing genuine, living miniature (ming) tree. New sensational business or hobby. Astounding information free. Dwarf Gardens, Box 355B, Briggs Station, Los Angeles 48, Calif.

**BRUSH** Plating outfits connect to a battery. No tanks necessary. Good paying business at home plating autoparts, bathroom fixtures, bicycles, reflectors, silvering mirrors. No shop or experience required. Outfits furnished. Free booklet. Gunmetal Co., Ave. H, Decatur, Ill.

**COMMERCIAL** Deep frying course. Mock chicken legs, potatoes. New and proven methods. Learn about this money-making field. \$2.50 p.p. Concession, Toledo 13, Ohio.

**OWN** A printing business. Good profit printing cards, stationery, etc. in spare time. Easy rules furnished. Have home shop. Send dime for complete printer's supply book and samples. Kelsey, Inc., Z-24, Meriden, Conn.

**RECAST** Old batteries into new. Latest achievements. Battery Laboratories, Minneapolis.

**MADE** \$24,500 Using money making plans from Schemer Magazine, world's oldest mailorder publication. Box 275M, Canfield, Ohio. Year \$2.00. Sample 20c.

**MINK** Raising information free. Complete. Lake Superior Mink Farm. Superior, EEL, Wisconsin.

**POPCORN** And potato chip equipment. Long Eakins Company, 5160 High, Springfield 99, Ohio.

**COPUBLISH** Leading m.o. paper. Latest copy Mail Sale Advertiser, details, dime. Vanroy Shirk, Lebanon, Penna.

**READ "Advance"**—The voice of mail order. Offers money-making opportunities, sources of supply, personal guidance, etc. Issued monthly. Sample copy 25c. Yearly subscription \$2.00. Advance Publishing Company, 313 East 21st Street, Suite 450, New York 10, N. Y.

**CO-PUBLISH** And advertise in The Central Mail Advertiser. Sample copy 10c. Low rates. Large circulation. Bagby Printing Co., Georgetown, Ohio.

**BUY** It wholesale! Manufacturers, distributors offer 850,000 items. Literature free. Olsen, 1231-A East Third St., Duluth 5, Minn.

**LIQUID** Rubber. Make flexible molds. Free sample. Chaney, 1130 E. 16th St., Jacksonville 6, Fla.

**MAILING** Postcards selling repeat merchandise is profitable. Everything supplied. Details free. Gordan Publishers, Box 23, Pawtucket, R. I.

**MEN**—Women. Everybody likes candy. Learn to make professionally. Our 40th year. Ragsdale Candies, D5, East Orange, New Jersey.

**COLORGLAZED** Concrete pottery made without molds. Patented method. Cemetery products, novelties, tiles. Basement leak-sealing. Money-making projects. Booklet, details free. Men only. National Potteries Company, Grand Rapids, Minnesota.

**MONEY** In new greaseless doughnuts. Start in kitchen. No smoke. Sell stores. Free recipes. M. Ray Company, 3605 South 15 Ave., Minneapolis 7, Minnesota.

### **MONEYMAKING OPPORTUNITIES**

**FREE!** Moneymaking plans galore. Wilbur Erickson, Box 141, Englishtown, New Jersey.

**ONE** Way mirror, picture transfer, other profitable formulas. List free. Bruce, Box 341-PM, Palo Alto, Calif.

**\$35 WEEKLY!** Home! Two hours daily! 27 amazingly unusual ways! Walsh, 894 Main, Buffalo 2, N. Y.

**EASY** Ways to earn extra income are described in Money-Making Hobbies. 132 projects you can make at home and sell anywhere. 160 pages, \$2.00. Popular Mechanics Press, 200 E. Ontario St., Chicago 11, Ill.

**CONVERT** Burnt out light bulbs into an item needed and wanted in every home. Nearly all profit. Copyrighted instructions \$1.00. Or write for details. Fred A. Lewis, Box 104, Kensington Sta., Brooklyn, N. Y.

**100,000 MONEY-Making** ideas. World's greatest collection. Catalog 25c. Cummings, 1321 Arch, Philadelphia 7M, Penna.

**ACTIVE** The making is fascinating, profitable! Detailed manual explains everything: casting, dipping, scenting, coloring, marketing! Price only \$1.00. Full return privileges. Candle Craft, Sylvan Lake, Mundelein, Illinois.

**\$250 WEEK** Reported! Free book. "505 Odd, Successful Businesses." Work home. Expect something odd! Pacific, Oceanside, Calif.

**GROW** Mushrooms. Cellar, shed, and outdoors. Spare, full time. Spawn replaced free. We pay \$3.00 pound. We paid O. Babbitt \$4,165.00. Send \$2.00 for general information book. Washington Mushroom Ind., Dept. 108, 2954 Admiral Way, Seattle, Wash.

**"HOW Rich Men Get That Way."** Secrets to great wealth revealed in book. \$1.00. Morley Publishing Co., 425-43rd St., Sarasota, Florida.

**CONTEST** Fortunes! How and where to win your share! Stamp. National Contest Bulletin, Box 2685-P, Miami 16, Fla.

**MAKE** Backyard profits! Unusual opportunities! Details free. Pickett's, Florence, Kentucky.

**MEXICAN** Jumping beans 150% profit. Details. Mann's, 5330 No. Natoma, Chicago 31.

**WANT** To sail merchant ships? Outstanding wages to \$400.00. Beginners \$220.00 monthly. Only \$3.00 delivers bargain. American Seamans Guide, 545 5th Ave., New York City.

**MAKE** Money at home. 101 ideas for full or spare time earnings. Proven winners. All for 25c. Thomas F. Patrick, c/o State Farm, Pikeville, Tennessee.

**"WATERLESS** (Lanolin) Hand Cleaner." (Oil base.) Make, sell. No machinery. Build profitable business. Complete formula \$1.00. Ideal Service, Park Ridge 3, Ill.

**DOLLARS** Three ways with "Kitty-Kat" ready-cut baby shoes. Complete local and mail order plans. Write No-Co-Ro, Oakland 6-K, California.

**RAISE** Your business value, standing, as state notary public. Information. Stationers. Helotes 50, Texas.

**PUBLISH** Your own magazine. Handsome 52 page format, well edited, illustrated. Cost low as \$1.00 month. Brings you prestige, profits. 25c brings sample, details. National, Ord, Nebr.

**READ** Progressive Mailtrade, the magazine that tells how to make money by mail. Dime brings sample and special offer. Progressive Mailtrade, Box 357, Sheboygan, Wisconsin.

**LEARN** How others earn money at home! Write—A. Sizemore, 4917 Kostner, Chicago 30, Ill.

**EARN** Money evenings, copying and duplicating comic cartoons for advertisers. Adservice, Argyle 1, Wisconsin.

### **FORMULAS, PLANS, ETC.**

**10,000** FORMULAS, Processes, trade secrets, etc. 900 pages, \$3.98 postpaid. K. Paulin, Loudonville, Ohio.

**ANY** Formula \$1 or refund. Dr. Paul, 11559 Kling Street, North Hollywood, Calif.

**FREE** Formula literature. Popular fast-selling products. Flashy label designs. Majestic, 530½ S. Main, Elkhart, Indiana.

**FORMULAS.** Latest, best. Catalog and chemical instruction sheet 10c, (refundable). Nelko Chemical Service, 3462-F Merchandise Mart Sta., Chicago 54, Ill.

**REAL** Manufacturing formulas. Lists free. Cummings, Chemist, Gordon Ave., Syracuse 4, N. Y.

**MAKE**—Sell cleaners, soaps, polishes, flavors, cosmetics. No machinery. Formula literature free. Kemico, Park Ridge 16, Illinois.

**FORMULAS.** Trade secrets, for nearly everything. Catalog free. Creative Publishers, Winnetka 6, Illinois.

**TESTED** Formulas. Interesting descriptive booklet free. Pont, Box 635-PM, Terre Haute, Indiana.

### **PLASTICS**

**NEW** Liquid plastic. Clear, colors. Cast without heat. Embed flowers, insects, coins. Saw, drill, carve. Free folder, "Liquid Magic," shows fine things you can make and sell. Write today. Castolite, Dept. H-101, Woodstock, Illinois.

**PLASTIC** Consulting services to small businesses. 65 East Rich Street, Columbus 15, Ohio.

**MAKED** Square root (12 x 12) cost, 1/16", \$1.20; 1/8", \$1.40; 3/16", \$1.75; 1/4", \$2.08. Include 10% postage. Almac Plastics, 230 Fifth Ave., New York 1, N. Y.

**PLASTICS**—This catalog is your bible. Wholesale, retail quantities. Lucite, plexiglas, acetate, sheets, rods, tubes. Casting, molding plastics. Dye manufacturer. Internal carving supplies. Findings, supplies. Catalog, 10c. 25c airmail. Gem-O-Lite, Box 6862, North Hollywood, Calif.

**PLASTIC.** Sheets, rods, tubes, etc. Free list. Plastic Supply Co., 2901 N. Grand Blvd., St. Louis 7, Mo.

### **CHEMISTRY**

**CHEMICALS.** Materials. List 10c. Welch Laboratories, Box 1831, Long Beach, Calif.

**NEW** Idea chemical and apparatus outfits for home experimenting. Photo-scales, microscopes, chemicals, biological and laboratory supplies in small quantities. Catalog 25c. Established 1931. John H. Winn, 124A West 23rd Street, New York, N. Y.

**ILLUSTRATED** Catalog: Chemistry, mineralogy, biology. 10c. Tracey Laboratories, Evanston, Illinois.

**CHEMICALS** And apparatus for industrial, analytical, and private laboratories. Catalog 15c. Dept. M-50. Biological Supply Co., 1176 Mt. Hope Ave., Rochester 20, N. Y.

### **AGENTS WANTED**

**MAKE** Extra money quickly! Take easy orders from friends for outstanding Christmas, all-occasion greeting cards, gift wrappings, novelties. Big profits. Bonus. Experience unnecessary. Request feature assortments on approval, free samples name imprinted Christmas cards, stationery, napkins and free catalog. New England Art Publishers, North Abington 503-C, Mass.

**EVERYBODY** Uses handkerchiefs; buy from leading manufacturer. Write Stan-chief, 1 Bond St., New York 12, N. Y.

**DO** You need money? \$35.00 is yours for selling only 50 boxes of our 300 Christmas card line. This can be done in a single day. Free samples. Other leading boxes on approval. Many surprise items. Experience unnecessary. Free samples personalized Christmas cards, stationery, napkins. Write today. It costs nothing to try. Cheerful Card Co., 255 White Plains, N. Y.

**SHINE** Shoes without "polish." New invention. Lightning seller. Shoes gleam like mirror. Samples sent on trial. Kristee 128, Akron, Ohio.

**JUST** Out! New, thrilling sensation in Christmas cards. Make big money! Show lustre foils, satins, brilliants. Amazing values bring easy orders! Christmas cards with name 50 for \$1.25 up. Also imprinted book matches, stationery, many gifts. Get 30 free samples with name; several \$1 boxes on approval. Joy Greetings, 507 N. Cardinal, Dept. J-60, St. Louis 3, Mo.

**FREE** Samples, and amazing plan, giving you gorgeous dress without penny cost. Rush name today, with dress size. Harford, Dept. E-135, Cincinnati 25, Ohio.

**BRAND** New! Amazingly different and smart Christmas cards bring you big money! Take easy orders fast. Pays up to 100% cash profit. Christmas cards with name 50 for \$1.25, up. Big line. Personal stationery and book matches. Get sample assortments on approval, imprints free. Write today. North Star, 31 Glenwood, Dept. T-18, Minneapolis, Minn.

**DISTRIBUTORS!** Automotive product! Tremendous profits! Needed by millions! Northlaker, Peoria 4, Illinois.

**AT** Last! Something new and sensational in Christmas cards. Make extra money fast! Show gorgeous satins, velours, metallics never before offered. Gets easy orders! Pays up to 100% cash profit. Free samples 30 Christmas cards with name, 50 for \$1.25 up. 80 assortments. Personalized book matches and stationery, gifts. Several \$1.00 boxes on approval. Write Puro Co., 2801 Locust, Dept. 140-J, St. Louis, Mo.

**NYLON** Uniforms. Immediate delivery. Immediate profits. Sell to doctors, dentists, nurses, waitresses, beauticians, housewives. Free sales kit. Superior Fabrics, Dept. P-7, 3936 Market, Philadelphia 4, Penna.

**BIG Profits** selling Sunshine's famous exclusive Christmas cards. Tremendous values! 21 for \$1.00, holly assortment. All lined envelopes. Snow scenes, religious, gift wraps, stationery, super value imprints, 50 for \$1.25. Many more! Write for samples on approval, free imprint folders. Act now! Sunshine Art Studios, Dept. PM-7, 115 Fulton St., New York 38, N. Y.

**BUY Direct.** Extra profit. Power mowers—\$46.00 (delivered). Rotacut-PM, Excelsior Springs, Mo.

**ABSOLUTELY Free!** Big package actual sample fabrics and style presentation of dresses, lingerie, hosiery, etc. Take orders. Commissions big. Send no money. Melville Co., Dept. 6135, Cincinnati 25, Ohio.

**BUY Wholesale** thousands nationally advertised products at big discount. Sent free "The Wholesale Plan." American Buyers' Service, 629-P Linden, Buffalo, New York.

**MAKE Money fast.** Sell big value Christmas and everyday card assortments to friends, others. 7 leading 21 card \$1.00 boxes. Religious, metallic, comic, secret pal cards. Gift wrappings, ribbons, scented stationery. Many gifts—rain sandals, automatic telephone pencils, totebrushes, napkins. Over 100 items. Amazing profits. Bonus plan. No experience necessary. Write today for samples on approval and special "get started" offer. Hedenkamp, 361 Broadway, Dept. PM-13, New York.

**CALL** On friends with sensational Christmas cards in handy assortments. Exclusive designs. Sell for \$1.00. Profit up to 50c. Also popular-priced personal Christmas cards, everyday assortments, stationery, gift items. Samples on approval. Wallace Brown, Dept. A-4, New York 10, N. Y.

**ANYONE** Can sell Hoover DuPont Nylon uniforms for beauty shops, waitresses, doctors, nurses, others. In white and colors. Exclusive styles. Top quality. Low priced. Exceptional income. Real future. Equipment free. Write fully. Hoover, Dept. N-100, New York 11, N. Y.

**CALENDARS,** Advertising novelties, matches. All styles, including religious, varnished, 12 sheet, girls. Hundreds of advertising novelties, book matches, etc. Fleming Calendar Co., 6539 Cottage Grove, Chicago 37, Ill.

**MAKE** Wedding profits. Sell invitations, napkins, matches. Samples free. Dunbar's, Middlebush 3, N. J.

**IS \$210** A week worth a penny postcard to you? Then rush card with name and address for special free trial plan that sells amazing new automatic refrigerator defroster "like hot cakes!" Write to Mr. Lewis, D-Frost-O-Matic Corp., Dept. PMC-7, 6 N. Michigan, Chicago 2, Illinois.

**CASH** In on spare time. Sell wonderful Regal Christmas cards exclusive with us. 25 sell for \$1.00. Also 50 for \$1.25. Over 150 other boxes. Free samples. Kit on approval. Regal Greetings, Dept. 29, Ferndale, Michigan.

**NEW Bathroom** deodorizer. Hangs on wall. Banishes odors bathroom, kitchen. Lightning seller. Samples sent on trial. Kristee 129, Akron, Ohio.

**SPANISH** Wonderful novelties, cigarette, matches, vanity, cases with typical bull-fight drawings, etc. From one to thirty dollars each. Big profits selling. Write: Jove, Lista 3, Madrid, Spain.

**EXTRA Cash—quick, easy!** Sell friends newest greeting cards. Profits to 50c per \$1.00 box. 21-card \$1.00, comic, Christmas, all-occasion assortments, gift wrap ensembles, exclusive items. Experience unnecessary. Special offers. Bonus. Prompt service. Write for free samples name imprinted Christmas cards, stationery, napkins, book matches, feature assortments on approval. Free catalog. Elmira Greeting Card Co., C-2109 Elmira, New York.

**EXTRA Money!** Big profits selling Christmas cards in spare time. Extraordinary variety name imprinted items, all-occasion assortments, gift wraps, novelties. Experience unnecessary. Free samples personalized Christmas cards, stationery, napkins, matches, etc. Write today. Senrab Co., 129 No. Warren St., Syracuse, N. Y.

**YOU** Can easily make \$27.50 a day selling 50 outstanding Christmas boxes. Up to 100% profit. 40 for \$1.00. Imprinted cards, napkins, stationery; also deluxe lines. Write for free Christmas gift cards, and big money-making catalog. Best-selling assortments on approval. Fannour Corp., 200 Fifth Ave., Dept. JX6, New York 10.

**FREE Sample** nylon stocking of world's only nationally advertised hosiery line actually guaranteed against runs and snags or replaced free within guarantee period to three months! Complete line from sheerest 15 denier to heavy 70 denier service weight. All gauges. Also complete line men's fine hosiery guaranteed for one full year! Not sold in stores. Good Housekeeping Guarantee Seal. No money or experience needed. Nothing to pay now or later. Easiest and quickest sales. Just show free outfits and write orders. We deliver and collect. Advance cash plus huge bonus to 40%. Big money spare or full time. Become manager—appoint others to sell for you. Man or woman, young or old, beginner or veteran, you can earn more money than you thought possible. Everything needed given free. Rush name and address to Kendex Corp., Babylon 73, N. Y.

**HUNDRED Blades** 50c. Thousand English needles \$1.20. Free cutrate wholesale catalogue. Mills Sales, 901 Broadway, New York.

**MEXICAN Feather** pictures. Sell on sight; 200% profit! Free details; sample 10c stamps. Sylvia PN, Apartado 9036, Mexico City.

**PAINTS—All kinds.** 65c gallon up. Private label. Big profits. Certified Products, Louisville, Ky.

**MAKE Money** easy. Sell Christmas cards. 21 for \$1.00 and others, children's books, personalized cards and stationery, note paper, wrappings and novelties. Send for samples. Howard P. Ellis, Dept. PM-7, Pitman, N. J.

**YOUR Personal** lingerie free as bonus—extra cash besides—introducing sensational Curve-Tailored idea to friends. Outfit free. World's Star, Dept. C-36, Grand Rapids, Michigan.

**DRESSES, 18c;** Coats \$2.00, blouses 35c. Free catalog. Crown, 164-P Monroe Street, New York.

**MEXICAN Feather** pictures. High profit selling gift shops, etc. Adelphi, Box 57-B, Bellerose 6, N. Y.

**BRUSHES** And plastics. Direct factory prices. Large profits. Send for catalogue. Concord, 635 E. 137th St., New York City 54.

**LADIES' Garters, hankies.** Samples 10c. P. Holday, 85-06 96 St., Woodhaven, N. Y.

**ULTRA-Blue** stock signs—6c, sell 35c. 1000 slogans, 7" x 11", comedy, religious, general. 15 samples, \$1.00. Lowy, 812-ML Broadway, New York 3.

**TWENTY** Comical illustrated signs, \$1.00. Sebastian, 5138 Cahuenga, North Hollywood, Calif.

**GORGEOUS** Christmas cards. \$50 yours selling 100 boxes. 40 with name, \$1. Personal napkins, stationery. Wrappings, novelties, gifts. Free samples. Approval box. Torres, 373 Fulton St., Brooklyn 1, N. Y.

**FERTO-Pot,** plant eats pot, and lawn-seeded Ferto-Soil, for patching or building new lawns. Commission 33 $\frac{1}{3}$ %. Allen Co., Pittstown 2, N. J.

**EASY Sales—Big profits!** Miracle advertising signs, re-usable. Sticks like magic to smooth surfaces without glue, tape; leaves no marks. Free samples, details. The Ad-Stik Co., Dept. PM-2, 5850 Centre Ave., Pittsburgh 6, Penna.

**\$50 YOURS.** Sell only 100 boxes new Xmas cards; other amazing offers. Free samples imprinted cards. Feature box assortments on approval; over 100 profitable items. Work with a national leader. Pen-'N-Brush, PM-7, 139 Duane St., New York City 13.

**IF Your town** has parking meters you can sell 39c auto dash coinholder by the thousands. 120% profit. Coinholder Products, Evanston, Illinois.

**\$50 WEEKLY** Selling finest razor blades, other items. Free details. Edison, Department 274, Far Rockaway, N. Y.

**NYLONS!** Amazing get rich quick, 100% bonus offering. Essential Products Co., 210 5th Ave., New York City.

**STOP Searching!** Learn how to select the best products to sell. Free details. Pelham, Box 512, Dallas, Texas.

**BE A money** maker. Use your home as magazine headquarters. Liberal commissions. No experience, no capital needed. Everything furnished. Write for free catalog. McGregor Magazine Agency, Dept. 500A, Mount Morris, Ill.

**NEED Extra** cash? Take orders for personal initialed belts and buckles, cap badges, tie holders, etc. Choice of 3000 emblems. Free sales kit. Hook-Fast, Box 1425PM, Providence, R. I.

**LOOK! Big profits—Free samples.** Personalized napkins. G. M. Dunn Co., 484 Broadway, Newark, N. J.

**SELL Greeting cards—Big profits! Quick sales!** Catalog free! Ellico, 432 North Wells, Chicago 10.

**PHOTO-Salesmen, agents.** Sell beautiful hand colored plastic enlargements and sensational new photo compacts, rings, bracelets, lockets, etc. Collect deposit, we deliver. Profitable sideline. Send card, for free sample kit. Novel Portrait Co., 3343 North Ave., Chicago, Ill.

**EXCELLENT Sideline** for printing and advertising salesmen. Decalomania name plates in small quantities. Great demand. Also, make money with our line of automobile initials and sign letters. Free samples. "Ralco" XL-Roxbury, Boston 19, Mass.

**JEWELRY** Factory desires salesmen, distributors, jobbers. Pickcraft, 19 Bank Street, Attleboro, Mass.

**GOLD Lacquered** window sign letters. Large sizes penny each. New foils. Absolutely beautiful. Free samples. Atlas, 544 W. 79th, Chicago 20.

**AGENTS:** Stamping names on key protectors. Sample 25c. Stamping outfits, checks, social security and name plates. Hart Mfg. Co., 303 Degraw St., Brooklyn, N. Y.

**AGENTS—300% Profit** selling genuine gold window letters; stores and offices. Free samples. Metallic Letter Co., 438-B North Clark, Chicago.

**WANTED—Purchasing agents.** No money or experience required. Write Dept. C, Purchasing Manager, 2719 Lawrence, Chicago, Ill.

**SELL** Big money-maker to men and women. Easy handwork makes fast-selling useful articles. Sunmade Company, Brockton 64, Mass.

#### HIGH-GRADE SALESMEN

**MAKE Money** showing neighbors how to beautify yards with glorious flowering shrubs and trees. Quick-bearing dwarf fruit trees; world-famous Stark patented varieties produce abundant harvests champion-quality apples, pears, peaches, other fruits. Even small plots produce fruit for family-use and to sell. Beautiful sales kit free. Stark Bro's, Dept. 30172, Louisiana, Mo.

**GET** Into the paint business; liberal commission; complete line; competitive prices. Dunkel Paint Manufacturing Co., 2046 Belle Ave., St. Louis 21, Missouri.

**EARN Big money fast!** Sell finest-quality advertising work uniforms to garages, factories, filling stations, etc. Free selling kit. Topps, Dept. 537, Rochester, Ind.

**SALESMEN.** Money-making sideline. Calendars and advertising specialties. Highest commissions advanced. Free new cars. Rush name. Advertising Specialties Manufacturing, Brooklyn 36, N. Y.

**MAN** To earn \$85 week and up. Long needed invention. Advertised Colliers and Post. Free sample outfit, no investment. Full or part time. Exclusive territory. Write Red Comet, Inc., 988 Littleton, Colo.

**MAKE Money** with famous, easy-selling Bostonian shirts—spare time, full time, sideline. Fabrics, outfit free. Bostonian, 89 Bickford, Dept. G-10, Boston 30, Mass.

**AUTOMOTIVE** Chemicals every motorist uses. Sell service stations, garages. Liberal profit margins. Welmaid, 1737 N. Campbell, Chicago.

**AD Matches!** Sell amazing designs—20, 30, 40 and 240-light book matches. Bigger spot cash commissions; every business a prospect. Low prices for high quality. Repeats. Start without experience; men, women; full, part time. Buy nothing! Sales kit furnished. Match Corp., Dept. PM-19, Chicago 32, Illinois.

**SELL** Our waterproofings, floor mastic, cement hardener, etc. (30 items) to maintenance men, building owners, contractors. Can start part time. Commission. Territory. Write Haynes Products Co., Desk 6, Omaha 3, Nebr.

**"MARY-Mac"** gas water heaters—Factory. Steady income. Permanent. McDaniel Manufacturing, 1012 Powhattan, Dallas, Texas.

**NEW Jobs** open in selling! Send name, address for five free issues of Opportunity Magazine's money-making guide. Listing hundreds of companies who'll pay you well, full or part-time. No experience needed. Opportunity, 28 E. Jackson, Dept. 17, Chicago 4, Ill.

\$2650 NEXT 9 Weeks—Season starting. Sell calendars, specialties, matches. Prospects everywhere. Advanced commissions. Experience unnecessary. Samples free. Continental Calendar, 542-A South Dearborn, Chicago.

BIG Money taking orders. Shirts, ties, Sox, pants, jackets, sweaters, shoes, uniforms, etc. Sales equipment free. Experience unnecessary. Nimrod, 4922-AN Lincoln, Chicago.

### EDUCATIONAL AND INSTRUCTION

IT'S Fun learning a language by Linguaphone. At home, in leisure time, quickly, easily, correctly master Spanish, French, German, Russian, Asiatic—any of 29 languages through Linguaphone Conversational Method. Add to service, job, travel opportunities. Send for free book. Approved for Veterans' Training. Linguaphone Institute, 8307 Rockefeller Plaza, New York 20.

"HOW To Break and Train Horses"—A book every farmer and horseman should have. It is free; no obligation. Simply address Beery School of Horsemanship, Dept. 1107, Pleasant Hill, Ohio.

YOU For president of your own credit-collection business. Many who answered our ads now have their names on office doors. Franklin Credit, Roanoke 7, Va.

BE A real estate broker through home study or classroom instruction. Write for free book. Weaver School of Real Estate, 15 E. Pershing Rd., Box CP-7, Kansas City 8, Missouri.

WANT U. S. gov't job? Men—women. 49,000 Emergency Program jobs open! Start high as \$66.34 week. Qualify now! Experience usually unnecessary. Free 40-page book shows jobs, salaries, sample tests. Write today. Franklin Institute, Dept. X-24, Rochester, N. Y.

START A collection agency business. Very profitable. Quickly learned. Write Cole & Associates, Syracuse 2, N. Y.

MIDLAND Linotype school. Charles City, Iowa. Civilian, veteran courses. Free placement.

BECOME A Doctor of Psychology or Metaphysics. Teach secret of contentment, happiness. Win degree of Ps.D. or Ms.D. Solve mental worries. Free book. College of Universal Truth, 5153-C North Clark, Chicago.

STUDY To be a doctor of psychology or metaphysics. Obtain Ps.D., Ms.D., D.D. or Ph.D. degree. Chartered by state. Write for free book telling how. The Neotarian Fellowship, Desk 8, Dwight Building, Kansas City 6, Missouri.

USED Correspondence courses and educational books, bought, sold. Rented. Catalog free. Educational Exchange, Summer-ville, Ga.

DEFENSE Welding jobs pay. Welders needed. Train quickly. VA contract. Hobart Welding School, Box M-712, Troy, Ohio.

WANT A commission or rating in the armed forces? Particulars free. Cramwell Publications, XB-7, Adams, Massachusetts.

HIGH School—No classes. Study at home. Spare time. Diploma awarded. Write for free catalog HF-10. Wayne School, 2527 N. Sheffield, Chicago 14, Ill.

LEARN Technical metaphysics. Insure success in life. Valuable information. Canada School of Technical Metaphysics, 2532 McKenzie St., Vancouver, B. C., Canada.

INCREDIBLE! Unprecedented! Look under "Miscellaneous"! Bijou, Box 1727-MD, Hollywood 28, California.

EARN While you learn. Day or night classes. Thorough courses in: automobile mechanics, diesel mechanics, motor tune-up, auto body and fender, welding, etc. Living accommodations. Veterans may earn \$210 to \$290 per month while in school including subsistence. Fully accredited to train veterans. Thirty-two years' experience training men. Nashville Technical College, Dept. #256, Y.M.C.A. Bldg., Nashville 3, Tennessee.

KEPLER'S Laws are illusions 35c. Williamsburg Station, Box 100, Brooklyn 11, New York.

INVESTIGATORS Trained, men-women, learn fascinating profession. Spare time study. Big pay. Folders free. Investigator, Box 490, Times Square Station, New York 18, N. Y.

LEARN Linotype (machine typesetting). Good pay, steady work. Booklet "X" free. N. Y. Mergenthaler Linotype School, 244 West 23rd, New York.

EARN \$10,000 Annually! Learners \$2,700. Unlimited opportunities in Merchant Marine. Instruction-Employment Manual \$1.00. Refundable. Titan Company, 45 Clinton St., Newark 2, N. J.

INVESTIGATOR Training. Phillips Secret Service System, 1917-B North Kenneth, Chicago 39.

USED Correspondence courses and books sold and rented. Money back guarantee. Catalog free. Courses bought. Lee Mountain, Pisgah, Alabama.

MEDICAL Laboratory Technicians in great demand. We train you in your own home. Catalogue free. Imperial Technical Institute, Box 973-J, Austin, Texas.

SECRET Investigation. Experience unnecessary. Investigators particulars free. George Wagner, M 125 West 86th, New York.

BOOKKEEPERS! Increase your earnings! Operate your own simplified "dollar-a-week" bookkeeping and tax service. Full or spare time. Details free. No obligation. Ellis, Box 200, Cedar Grove, North Carolina.

HOME Study course, drugless therapy. Free literature. Institute of Drugless Therapy, Tama, Iowa.

### PLAYS, STORIES, MANUSCRIPTS

I Want new writers to cash checks of \$1 to \$100 offered daily. The easiest way to write for pay. No previous experience necessary. Free details. Saunders M. Cummings, 468-11 Independence Bldg., Colorado Springs, Colo.

BEGINNING Writers: Let us show you how to get \$1.00 to \$20.00 checks daily. Experience unnecessary. Details free. Herwell Company, 7016-M Euclid, Cleveland 3, Ohio.

### BUSINESS SERVICE

HAVE A Chicago mail address. It's valuable to you. About \$1.00 monthly. Information free. Schultz House, 3116 Seminary, Chicago 13.

### SPECIAL SERVICES

SPAIN—Letters remailed 25c. reairmailed two dollar bill, anything. Jove, Lista 3, Madrid.

LETTERS Rемаiled 25c each. Hollywood view cards, 8 for \$1.00. Stadler, Box 2335, Hollywood 28, California.

### CARTOONING, COMMERCIAL ART, SHOWCARD WRITING, SIGN PAINTING

TALENT Test—Information. Give age. Art, Box 8066, Dallas 5, Texas.

LEARN Sign painting. 152 lesson course. Results guaranteed. Stewart Sign Co., Box 287M, Pasadena, Calif.

CHALK Talks. Laugh producing program. \$1.00. Catalog 10c. Balda The Cartoonist, Oshkosh, Wisconsin.

### ADVERTISING AGENCIES, LETTER WRITERS, FOR ADVERTISERS

ADVERTISERS! Reach nearly 18,000,000 readers. 25 Sunday national key newspapers, 18 words, \$59.00. "Terrific pullers," 20 popular newspapers, \$11.50. Free booklet. Special—One inch display 2-, 821,198 circulation, \$51.10. Newmark's Advertising Agency, (Established 1893), 217-7th Ave., New York 11.

ADS Placed in out of town newspapers and magazines. Low rates. Catalogue free. Ideas that pay. Baker Advertising Agency, Successors Ankrum Agency, 189 W. Madison, Chicago 2.

MAILING Lists; \$5.00-1000 up. Write Dixie Service, King, N. C.

24 WORDS In 50 weeklies, \$4.96. J. Darrell, 730 Hays, Jackson, Tenn.

ADVERTISE: 24 Words, 40 newspapers \$3.50. Lists free. Advertising Bureau, 10511-C Springfield, Chicago 43.

### TYPEWRITERS, DUPLICATORS, OFFICE DEVICES

PRINTOMATIC Selffeeding post card printing duplicator \$15.75. Envelope addressing machines \$24.50. Pittsburgh Typewriter Company, 336-R Fourth Avenue, Pittsburgh 22, Penna.

USABLE Sample photographic duplicator stencil. 25c. Smith Company, Halfwaytree-23, Jamaica, B. W. I.

AUTO-MATIC Feed-in-ink dynagraph prints postcard to letter size \$39.50. Discount to distributors. Dansen Company, Hopkins, Minn.

RECONDITIONED Typewriters, printing devices, office machines, equipment. Dixie Graph, King, N. Car.

### RUBBER STAMPS AND OFFICE SUPPLIES

THREE Line rubber stamp, mounted on neat moulding, 50 cents; six \$2.50. Anderson, Box 855, Mountain Home, Tenn.

CHROMIUM Mount stamps. Catalog free. Williams, Box 648-M, Plainfield 13, N. J.

RUBBER Stamps. Literature free. Lee-Vall Press, Box 1242, Indianapolis 23, Indiana.

### PRINTING, MULTIGRAPHING, MIMEOGRAPHING GUMMED LABELS

ENVELOPES, Letterheads, statements, etc. Samples, prices. Mercury Press, Box 69, Marengo, Iowa.

NEED Printing? Get my samples, prices. Gooch, 202PM, Hernando, Miss.

PRINTING. Sincere service. Send your copy for free estimate. Bixler, 752 Benson, Frankfort, Kentucky.

1000 EMBOSSD Business cards \$2.98. Ortiz, 1050 Fox Street, New York.

BUSINESS Letterheads, stationery. Samples free. Southern Printers, Box 331, Lake Charles, Louisiana.

LETTERHEAD Special, July only. 8½ x 11 Hammermill, prepaid. Model Press, 96 Brown St., Johnson City, N. Y.

125 LETTERHEADS, Full size, and 125 envelopes, \$2.00 postpaid. Maywood Publishing Co., 1133 Broadway, New York.

1000 2-COLOR Business cards \$4.75. Samples. Feole, 2718 East 58th Street, Huntington Park, Calif.

PRINTING—5000 5½ x 8½ Circulars \$18; 3¼ x 5½ \$8.25; folders, catalogs, everything. Garrison Press, Harrisonburg, Va.

KOLOR-Kraft mimeographing, distinctively different. 100 8½x11 \$1.50. Box 237B, Madison, Minnesota.

1000 BUSINESS Cards \$2.50 prepaid. Samples free. Reliable Print Shop, 905 East Jefferson, Louisville 6, Ky.

QUALITY Printing. We specialize in publications, newspapers, tabloids. Send copy for estimate. Bagby Printing Co., Georgetown, Ohio.

SEND 10c Now for our 48 page 1951 price list—refunded first order. McCall Press, 1326 South 27th, Omaha, Nebraska.

MIMEOGRAPHING—Letters, price lists, formulas, instructions. Lowest prices. Lem's Letter Shop, 5710 Stanton, Detroit 8.

500 ¾x2¼ FOUR Line gummed stickers 50c. Red border \$1.00. Moritz Printery, Saginaw, Mich.

MIMEOGRAPHING—Reasonable. Any copy. Mailers Service, Box 606-T, Chicago 90, Ill.

### PRINTING OUTFITS AND SUPPLIES

PRESSES, Type, cabinets, supplies. List for stamp. Lincoln Press Company, 220-X Hartwell, Fall River, Mass.

PRESSES, Bought, sold, list 3c. Exchange, 212 Curtis, Meriden, Conn.

OFFSET Plates—Multilith or Davidson \$2.50 postpaid. Overnight service. Send original copy. Lewis Graphic, Box 446, N. Tonawanda, N. Y.

PRINT Your own cards, stationery, circulars, advertising. Save money. Simple rules. Print for others, nice profit. Raised printing like engraving too. Have home shop. Details free. Kelsey Presses, L-11, Meriden, Conn.

PRINTING Presses, type, supplies. Lists 3c. Turnbaugh Service, Loysville, Penna.

MAKE Your own printing cuts. Self-molding process. Plexirubber, Argyle 1, Wisconsin.

## PATENT ATTORNEYS

**INVENTORS**—If you believe you have an invention, we can make a preliminary search on your invention and advise you whether we think it can be patented. Send for copy of our patent booklet "How to Protect Your Invention" and "Invention Record" form. No obligation. Mc Morrow, Berman & Davidson, Registered Patent Attorneys, 1341 Victor Building, Washington 1, D. C.

**INVENTORS**—If you consider your invention to be something of importance, take steps to protect it with a United States Patent which gives you the right to exclude others from making, using and selling your invention as claimed. "Patent Protection for Inventors" outlines steps to take to secure patent protection. Mailed promptly without obligation. Victor J. Evans & Co., Merlin M. Evans, Registered Patent Attorney, 631-H Merlin Building, Washington 6, D. C.

**INVENTORS**: Learn how to protect your invention. Special booklet "Patent Guide for the Inventor" containing detailed information concerning patent protection and procedure together with "Record of Invention" form will be promptly forwarded to you upon request—without obligation. We are registered to practice before the U. S. Patent Office and prepared to serve you in the handling of your patent matters. Clarence A. O'Brien & Harvey Jacobson, Registered Patent Attorneys, 11A-G District National Building, Washington, D. C.

"INVENTOR'S Guide" free. Frank P. Ledermann, Registered Patent Attorney, 154 Nassau Street, New York.

**INVENTORS**: When you are satisfied that you have invented something of value write me, without obligation, for information as to what steps you should take to secure a patent. Write Patrick D. Beavers (Formerly Randolph & Beavers) Registered Patent Atty., 935 Columbian Bldg., Washington 1, D. C.

**PATENTS**. "Proof of Invention" folder mailed without obligation. E. E. Vrooman, Registered Patent Attorney, 507 McKim Building, Washington 5, D. C.

**INVENTORS**: Write for free brochure "Evidence of Invention." Labiner, World Building, New York 38.

C. A. Snow & Co.—M-427, Snow Building, Washington 1, D. C. Registered Patent Attorneys. Write for information.

**INVENTORS**—For "Record of Invention" form, contact Carl Miller, Registered Patent Attorney, Woolworth Building, New York.

**INVENTORS**: Without obligation, write for information explaining the steps you should take to secure a patent. John N. Randolph, Registered Patent Attorney, 203 Columbian Bldg., Washington 1, D. C.

**PATENTS**—Irving L. McCathran, 315 McLachlen Bldg., Washington 1, D. C. Registered Patent Attorney.

**CANADA**—Ramsay Company Registered, 273 Bank Street, Ottawa, Canada.

**REGISTERED** Patent attorney offers services. Sanders, 6430 Evans, Chicago 37, Ill.

## FOR INVENTORS

**INVENTORS**—This form is registered to practice before the United States Patent Office and is available to assist you in the preparation and prosecution of your patent application. "Patent Protection for Inventors" booklet containing detailed information and steps to take toward patent protection will be sent upon request. No obligation. Victor J. Evans & Co., 632-H Merlin Building, Washington 6, D. C.

**PATENT** Searches, \$5.00, including patent copies. Accurate reports. Free protection forms, 48 hour service. Patent Service Institute, 945-A Pennsylvania Avenue, Washington 4, D. C.

**INVENTORS**: Learn how to protect your invention. Special booklet "Patent Guide for the Inventor" containing detailed information concerning patent protection and procedure together with "Record of Invention" form will be promptly forwarded to you upon request—without obligation. We are registered to practice before the U. S. Patent Office and prepared to serve you in the handling of your patent matters. Clarence A. O'Brien & Harvey Jacobson, Registered Patent Attorneys, 11A-G District National Building, Washington, D. C.

**INVENTORS**—If you believe you have an invention, we can make a preliminary search on your invention and advise you whether we think it can be patented. Send for copy of our patent booklet "How to Protect Your Invention" and "Invention Record" form. No obligation. Mc Morrow, Berman & Davidson, Registered Patent Attorneys, 134-Z Victor Building, Washington 1, D. C.

**FINANCING**, Patenting, promoting inventions. Free details. Technical Service, Box 1434A, Amarillo, Texas.

**CASH** In on your ideas! Learn which inventions are profitable: how to sell or finance and market your invention. Send only \$2.50 for the big 144-page book "Money From Ideas," a primer on inventions and patents by a real, successful inventor. Popular Mechanics Press, 200 E. Ontario St., Chicago 11, Ill.

**INVENTORS** Booklet—"Reaching Your Invention Markets;" mailed free. Patented, patent pending only. No obligation. Address, Market Contacting & Data Service, 11106-A3 Longwood, Chicago 43.

**HAVE** You a small patentable product for industrial and/or consumer use? If you do contact us immediately. We are a large metal parts manufacturing company. Disclosures at inventor's risk. Replies will be held confidential. Write to Mr. W. E. Frazier, Room 1821, 123 S. Broad St., Philadelphia 9, Penna.

**PATENT** Searches \$5.00. Reports airmailed within 48 hours. Invention protection forms free. Write Miss Ann Hastings, Patent Searcher, P.O. Box 176 Washington 4, D. C.

**INVENTORS**: Without obligation, write for information explaining the steps you should take to secure a patent on your invention. John N. Randolph, Registered Patent Attorney, 202 Columbian Bldg., Washington 1, D. C.

**CASH** For your idea, 280 manufacturers need inventions, patented or unpatented. List free. Invention Bureau, 208M Clinton, Oak Park, Ill.

**SEARCHES**—Put your patent searches in the hands of a registered patent attorney or agent, as he qualifies to give a worthwhile patentability report. Record of invention form upon request and information on patent protection. Patrick D. Beavers, Registered Patent Attorney, 936 Columbian Bldg., Washington 1, D. C.

**PATENT** Searches conducted for patent attorneys and inventors \$5.00. 48-hour service. Protection forms free. Write Patent Engineering Service, 1404 New York Avenue, Washington 5, D. C.

**INVENTORS**. For "Record of Invention" form, contact Carl Miller, Registered Patent Attorney, Woolworth Building, New York.

**PATENT** Owner representative. Years of experience. Can I help you? Charles A. Scott, 773PM Garson Avenue, Rochester 9, N. Y.

**INVENTORS**: If you have an invention for sale, patented or unpatented, write Institute of American Inventors, Dept. 40A, 631-E St. N.W., Washington 4, D. C.

**PATENT** Searches \$5.00. 48-hour service. Patent copies included. Protection forms free. Write Raymond L. Smith, Patent Searcher, 410 Bond Building, Washington 5, D. C.

## INVENTIONS WANTED

**TOY** Ideas wanted on royalty basis. We paid one inventor \$65,000 in 1950. Revell Toys, Inc., 212 N. Western, Los Angeles 4, Calif.

**INVENTIONS** Wanted by manufacturers. Free details. Inventors Exchange-B, Hartford 1, Conn.

**INVENTORS**—What have you, patented, patent pending available for manufacturers? Booklet mailed free. Address: Market Contacting & Data Service, 11106-A2 Longwood, Chicago 43.

**INVENTIONS** Wanted. Patented or unpatented. 20 years experience promoting inventions. National Service Bureau, 3130 Meramec, St. Louis 18, Mo.

**INVENTORS**: Hundreds of manufacturers have requested our assistance in locating marketable new products. Complete information free. Institute of American Inventors, Dept. 40-D, 631-E St. N.W., Washington 4, D. C.

**INVENTIONS** Promoted. Patented or unpatented. Write Adam Fisher Company, 61 Enright, St. Louis, Mo.

## PATENTS FOR SALE

**PATENT** Pending. Screen hanger. Out-right or royalty. Norman Plume, 950 Harlan Ave., St. Louis 15, Mo.

**ATTRACTIVE** Amusement machine, coin operated. Patented. David Connerly, Rt. 1, Pasco, Wash.

**INVENTORS**: Test the commercial value of your patented or unpatented inventions, quickly and inexpensively. Write for free information. Institute of American Inventors, Dept. 40-B, 631-E St. N.W., Washington 4, D. C.

## MANUFACTURING

**MODELS**—Small lot manufacturing. Metals, plastics, etc. Milburn, Burlington, Kentucky.

## MODELS, MODEL SUPPLIES

**AUTHENTIC** Model kits of frontier covered wagon, stage coach, chuck wagon, surrey, horses.  $\frac{1}{2}$ " scale. Folder 10c. Sample buckboard \$1.00. C. Tontz, Elsinore, Calif.

**BUILD** Historic ship models, complete kits 50c to \$9.00. Catalog 15c. Ideal Models, 19 W. 18th, New York 11, N. Y.

**SHIP** Models and yacht supplies complete. Large 64-page catalogue 30c. Bill Wild's, 510 East 11 St., New York City 9.

**DESIGN**, Model making and manufacturing facilities offered to inventors. Aactron, P.O. Box 2722, Cleveland 11, Ohio.

**SHIP** And yacht model fittings; blueprints. Send 25c for illustrated catalog No. 26—listing hundreds of items. A. J. Fisher, 1002-1 Etowah Ave., Royal Oak, Mich.

**STEAM** Locomotives,  $1\frac{1}{2}$ ", 1",  $3\frac{1}{4}$ ",  $\frac{1}{2}$ " scales. Castings, rail, steam fittings! Thorough drawings with instructions. Catalog 50c. Little Engines, Wilmington, California.

## HOME CRAFTSMEN

**MAKE** Leather belts, billfolds, purses. Big catalog and genuine steerhide keyholder, 10c. Tandy Leather, Box 397C, Tulsa, Oklahoma.

**OIL** Painting—Learn easiest way, new method. 3 dimension demonstrators, take apart to show how. G. Watts, 25 Pullman, Kenmore 17, N. Y.

**90 ALL** New, full size lawn ornament and novelty patterns, up to 20" high. Only \$1.00. Mastercraft 72M, 7041 Olcott, Chicago 31, Illinois.

**FOAM** Rubber. Complete stocks. Send for price list. AMC Supply, P.O. Box 1440, Fort Worth, Texas.

**89 FULL** Size jig saw patterns of beautiful shelves, ornaments, toys, novelties. Plus "How, Where to Sell." Only \$1.00. Mastercraft 74M, 7041 Olcott, Chicago 31, Illinois.

**PROFESSIONAL** Type furniture finishing and refinishing supplies. Beautiful new, complete, illustrated catalog and complete simplified instruction manual 25c. Colorall, Dept. M, 515 Cedar Lane, Teaneck, N. J.

**OUR** Biggest leather and craft catalog yet! 1000's of items. Send 25c (refunded with first order). Russo Handicraft Supplies, Dept. C-6, 245 S. Spring, Los Angeles, California.

**OZARK** Wood samples. Eleven varieties prepaid. \$1.50. Davis Lumber, Cabool, Missouri.

**CHAIR** Cane. Splints. Rush. Reeds. Instructions, catalogue 25c. Complete Seat Weaving book \$1.15. Fogarty's Craftshop, Troy, N. Y.

**NEW** Leathercraft catalogue. Pleasure and profit. New styles, belts, purses, shoes. Largest leathercraft school in U.S.A. G. I. approved. Send 10c for catalogue. Dept. PM. Apache Leather Co., 2804 E. Washington St., Phoenix, Arizona.

**KNOCKDOWN** Cedar chests. Lumber and veneers. Free price list. Giles & Kendall Company, Huntsville, Ala.

**LEATHERCRAFT** Bargains! Lacing. Francis Byrd, 3406 Montrose Ave., Richmond, Va.

**30 LAWN** Ornament patterns, ready cut. Full size, color indicated. \$1.00 postpaid. Lincoln Craft Studio, Farmington, Conn.

**LEATHERCRAFT**, Copper tooling, textile painting. Make spare time, profitable time. Free illustrated catalog shows everything you need. Kit Kraft, 7377 Melrose, Hollywood 46, California.

LEATHER, Tools, lacings, supplies. Free catalog. National Handicraft, 199 William St., New York 7.

### MAKE IT YOURSELF

**HOMES** You can build for \$4500 to \$7046. Books that take you through every step. Popular Mechanics Famous Concrete Block House, \$2.00. Your Home and How to Build It Yourself, \$3.00. Also full-sized builder's plans for each home at nominal price. Popular Mechanics Press, 200 E. Ontario St., Chicago 11, Ill.

**300 PROJECTS** You can make in Popular Mechanics 32-page Blueprint Catalog. Send 3c stamp for copy. Popular Mechanics Press, Dept. BP, 200 East Ontario St., Chicago 11, Ill.

**BEAT** High costs. Build production machinery from salvage with easy Kimo Plans, New York 19. Descriptive handbook 25c (refundable).

**RANCH** Home, five rooms, concrete block. Complete building plans \$1.00, instructions included. Watkins, Box 881, Columbus 16, Ohio.

**HOBBYISTS:** Precision pliers 3½"-4½" long; imported, all purpose set of 3, cutter, longflat, roundnose \$2.95 postpaid. Nessalc, 4 East 41 St., New York 17, N. Y.

**TELEVISION**—Antenna, powerful at 50 miles. Make it yourself for pennies in minutes. Complete instructions and illustration. \$1.00 cash or money order. Ralph Fischbach, 513 S. Kendall St., Aurora, Ill.

**GRANDFATHER** Clock easily built. Big savings. See ad on page 227.

**BUILD** Your own "tractor." Free information. Eltraco, D-I, Camptonville, California.

**PLANS,** Septic tank, or water softener, \$1.00 each. Freeland Engineering, 16587 Freeland, Detroit 35, Michigan.

**"CONCRETE** Block Homes." 32 page booklet on how to build. \$1.00. H. C. Lightfoot, Civil Engineer, Richboro 1, Penna.

**BUILD** Your own concrete blockmaker. Easy. Inexpensive. Motor or hand. Make block per minute. Write. O. Lee, Mountain View, Okla.

### WATCHES, OLD GOLD, JEWELRY

**GEMS,** Precious and semi-precious, all genuine, from world wide sources. Deal direct, no overhead, save money. Catalog 10c. Hill Co., Route 7, Salem, Oregon.

**WATCHMAKERS'** Tools, materials, supplies, watches. Catalog. Gales, Box 1000, Chicago 90, Ill.

**RHINESTONES,** Jewelry settings, cameos, sequins, beads. Catalog free. J & M Novelties, Dept. CH-3, Griffith, Ind.

**HIGHEST** Prices paid for old gold, silver, platinum, diamonds, watches, gold teeth, spectacles. Cash immediately. Goods returned if offer unsatisfactory. Government licensed. United Smelting Works, (The Old Reliable), 39-B South State, Chicago 3.

**CERTIFIED** Watch repairing, complete overhaul; defective parts replaced; year guarantee; \$7.95. Write for free mailing carton. Insured. United Watchmakers, 515 Columbia, Lafayette, Indiana.

**WATCHMAKERS',** Jewelers', hobbyists' tools, supplies. Catalogue! Bengal Company, Culver City, California.

**WRIST** Watches, U. S. Air Corps, Waltham, 16 jewel, water and shock proof, stainless steel case, reconditioned. Value \$55.00. Special \$17.95. Public Sport Shops, 11 S. 16th Street, Philadelphia 2, Penna.

**DIAMONDS** Lowest wholesale prices. Airmail for full information. Joachim Goldenstein Diamond Club, Antwerp, Belgium.

**HIGHEST** Cash paid for old, broken jewelry, gold teeth, watches, silverware, diamonds, spectacles, platinum. Free information. Satisfaction guaranteed. Government licensed. Rose Smelting Company, 29-A East Madison, Chicago.

**GOLD** Plated jewelry supplies, Rhinestones, pearls. Illustrated catalog, only 10c. Barry's, 47-N Branford Place, Newark 2, N. J.

### OF INTEREST TO WOMEN

**MAKE** Money at home sewing useful articles. Liebig Industries, Beaver Dam 10, Wisconsin.

### FOR SALE—MISCELLANEOUS

**SAVE** Money. Chrome cabinet hardware, hinges, pulls, friction catches. Write Box 89, Troy, Ohio.

**FREE** Catalog! War surplus clothing. Amazing bargains. N. Y. Clothing Co., New York 29A.

**DRESSES** 18c; Coats \$2.00; blouses 35c. Free catalog. Crown, 164-PA Monroe Street, New York.

**TRIPODS,** All wood, solid leg with four inch circular metal head, can be threaded, 55" tall, value \$27.50—special \$6.95. Public Sport Shops, 11 S. 16th Street, Philadelphia 2, Penna.

**HANDSIGHTING** Levels, improved, new model, used for grading land, contouring and laying out fences, piers, roads and gardens, price \$2.50 postpaid. Public Sport Shops, 11 S. 16th Street, Philadelphia 2, Penna.

**SAVE** Money on army, navy and factory surplus. Write today for new 52-page illustrated catalog. Tennusa Sales Co., Dept. AE, 1451 Market, Chattanooga, Tenn.

### WANTED—MISCELLANEOUS

**QUICKSILVER,** Platinum, gold, diamonds, sterling, dental-jewelry-optometrist scrap. Ship or write. Wholesale Terminal, Norwood, Massachusetts.

**SCRAP** Mercury (quicksilver) tantalum, bismuth, tungsten. Metallurgical Products Company, Established 1909, 35th & Moore Sts., Philadelphia 45, Penna.

**100,000 ARTICLES** Wanted! Free information. Toole, #5 Bernardin Apts., Evansville, Indiana.

**SCRAP** Platinum—Any shape or form. Will pay, at present, \$75 per troy oz. (Price subject to market conditions). Metallurgical Products Company, Est. 1909, 35th & Moore Sts., Philadelphia 45, Penna.

### PERSONAL

**LETTERS** Retailed 25c each. Fooling your friends is fun. Edward Nadell, Box 345, Los Angeles 53, Calif.

**LETTERS** Retailed 25c each. J. Foster, 830 Terry, Cincinnati 5, Ohio.

**NEW** York postmark! Letters 25c each, confidential. Romano, 412b East 116 Street, New York City 29.

**LETTERS** Retailed 25c each. Business or personal. Replies forwarded. Confidential. McLaughlin, 369 Welch, Columbus 7, Ohio.

**SALT** Lake remail! 25c each. Jack's, 915-A Jefferson St., Salt Lake City 4, Utah.

**HAIRCUT** As you like it. Booklet tells how. 25c. Mastrolia, 5½-AH Jane, New York City 14.

**MEXICAN** Law practice reliably conducted. Box 1736, El Paso, Texas.

**RUPTURED?** Positive comfort, no understraps, no steel, no elastic. Write Smith Manufacturing Co., Preston, Ont.

**BORROW** By mail. Loans \$50 to \$300 to employed men and women. Easy, quick. Completely confidential. No endorsers. Repay in convenient monthly payments. Details free in plain envelope. Give occupation. State Finance Co., 210 State Finance Bldg., Dept. A-14, Des Moines 8, Iowa.

**PRINT** Without a printing press. Big profits! See page 20.

**LETTERS** Retailed from San Francisco 25c each. 6 scenic postcards \$1.00. Martin, Box 414, Alameda, California.

**"HOW** Can I find out?" You can! Information discreetly developed. Any matter, person, problem, anywhere. Worldwide. Officially licensed, bonded service. Established 1922. Reasonable. Confidential. William Herman, 170 Broadway, New York.

**MEXICAN** Law. General practice. Attorney, 1203 Arizona St., El Paso, Texas.

**HERE'S** How and where to borrow \$50.00 to \$300.00 by mail. Confidential. Free particulars. Postal Finance Company, Dept. 45, Sioux City, Iowa.

### MISCELLANEOUS

**SQUARE** Dance instructions, thirty dances, \$1.00. Wesley Rader, 3926 Alcott, Denver 11, Colorado.

**INTERESTING** Mails, 25c keeps name on mailing list three months. Bentz, Desk D/48, Chatawa, Mississippi.

**70** BIBLE Lessons, 25c. Bulletin, Box 87, Cathedral Station, New York 25.

**SEPTIC** Tanks, outdoor toilets, cesspools cleaned, deodorized easily. Make this amazing cleaner yourself. Sell to others. Complete formula \$1. Kemiklean, Park Ridge, Ill.

**DRESSES** 18c; Coats \$2.00; blouses 35c. Free catalogue. Crown, 164-PM Monroe Street, New York 2.

**WORRY,** Bill, worry. Learn to collect your own accounts. Twelve written letters. Price 50c. Columbia Malters, Box 644, Springdale, Connecticut.

**FLORIDA** Souvenir. Lucky charm horse shoe nail ring. Silver plated \$1.00, plain 50 cents. Post Office Box 14, Gulf Breeze, Florida.

**ORIENTAL.** Original, beautiful design, rich colors. Silk table cloth 32" x 32" excl. fringes. Send seven dollars reg'd., dispatch immediately reg'd., with specifications oriental items. Orders welcomed all countries, same conditions. Sindelar, Cruz 14, Tangier, Morocco.

**MEN**—I shaved 128 days, with only one single edge safety razor blade. Cost 5 cents. You can do the same. Complete instructions sent for only \$1.00. Address, Razor Blades, 1001 Montana St., El Paso, Texas. Print your name plainly.

**TREASURE** Searchers' newest electronic methods and search procedures explained, simplified, compared, in exclusive, informative, manual just published. Includes two new land and water electronic metal detector construction plans. Special introductory offer \$1.00. Cue Detectors, 1935 Whitman, Butte, Mont.

**INCREDIBLE!** Unprecedented! Become a mental superman overnight! Floor everybody! No studying! "Memoprop" does all your thinking! It's uncanny! Revolutionary! Write: Bijou, Box 1727-MD, Hollywood 28, California.

**BARBER** Tools of all kinds. Bought, sold and traded. Stanley Tafilaw, Licensed Dealer, 2158 North California Ave., Chicago 47, Illinois.

**RECEIVE** Giant mails, magazines, catalogs! Three months 25c, year 50c. Waddell's Directory, 341B East 76th, New York 21.

**CESSPOOL** Trouble? Use Peps-It. Rejuvenates fermentation action, saves pumping costs, deodorizes, reduces masses. Costs only \$2.50. Safe. Sanitary. Free descriptive literature. Chemical Cesspool Cleaning Co., Boston 34, Mass.

**SEEK** Gold, uranium, buried treasure! Latest low cost super-sensitive equipment. Free literature. Glen Scientific, Box 151-B, Glen Ellyn, Illinois.

**GOLD,** Silver, metal detectors, Geiger counters for uranium. Mineralights. Sensational new fully guaranteed models. None finer. Information free. Detectron Co., 5631 Cahuenga Blvd., North Hollywood, California.

**TREASURE** Finders for gold, silver and minerals. Money back guarantee, best available. Also Geiger counters for uranium prospectors, free information. Write Goldak Company, 1541 West Glenoaks, Glendale 1, Calif.

**OUTDOOR** Toilets, cesspools, septic tanks cleaned, deodorized with amazing new product. Just mix dry powder with water; pour into toilet. Safe, no poisons. Save digging, pumping costs. Postcard brings free details. Burson Laboratories, Dept. C-36, Chicago 22, Illinois.

**"RECEIVE** Mail." Moneymaking offers, opportunities, catalogs. Name listed 10c. Ideal Service, Park Ridge 10, Ill.

**PANNING** Gold lesson and catalogue. Beginners supplies, books, "maps where to go" free. Old Prospector, Box 729D1, Lodi, Calif.

**TREASURE**—M-Scope Geiger counters, mineral locators. Why buy something inferior when you can buy the best at a lower price? Backed by years of experience. Fully guaranteed by factory. Detects minerals, metals, gold, silver, coins. Payment plan available. Proven superior performance. Free 16 page illustrated booklet. Fisher Research Lab., Inc., Palo Alto, California.

**TATTOOING** Outfits, supplies. Illustrated list free. Zeiss, 728 Leslie, Rockford, Illinois.

**YOUR** Leather jacket renovated expertly. Free circular. Berlew Mfg. Co., Dept. 8, Freeport, N. Y.

**EARN** Up to \$200 month, inventing toys, games, gadgets. Write. Hendrickson, Argyle 1-A, Wisconsin.

# SPEED & POWER

## "SOUP UP" ANY CAR



Direct from the California dry lake testing grounds... comes authentic, proven information on how to get lightning speed, super power and better mileage from any car! Illustrations and construction drawings show how to build fast stock cars, California Roadsters and 225 M.P.H. Hot Rods.

**Easy, Step By Step Methods** help you save by building your own dual manifolds, superchargers, hot cams, water injectors, high compression heads and mileage devices.

**50 BREATH TAKING CHAPTERS TELL ABOUT:** Turning techniques, Speed tricks, Economy secrets, Ingenious formulas for attaining racing speed and dynamic power. Includes information on: Racing Frames, Reciprocating Masses, Jet Engines, Wheel Dynamometers. Also Re-styling and Customizing all cars. Learn about dual pipes, gears, fuels, porting, relieving, lowering and balancing.

**THIS GREAT NEW BOOK... PLUS "1951 SPEED EQUIPMENT CATALOG," PLUS "WATER INJECTION," PLUS "150 M.P.G. BOOK"—ALL 4 ITEMS \$1.98** post paid

## BUBBLE GOGGLES



Scientifically developed to eliminate distortion, and give safe, dust-proof, glare-proof service, these **DOUBLE-BUBBLE GOGGLES** are tops for all hot rod, sport car and motorcycle drivers. They are ideal for over-glasses wear, cannot blow off and are so light and comfortable you forget you have them on.

**\$1.25 Per Pair**

**NEWHOUSE AUTOMOTIVE INDUSTRIES, Dept. B-7**  
5807 East Beverly Blvd. Los Angeles 22, Calif.

## DRIVING RELIEF! New LEFT-FOOT ACCELERATOR



Cut driving fatigue in half with Lefty! Install this new left foot accelerator yourself in 60 seconds with just a wrench—no alterations to your car are necessary. Enjoy relaxed comfort on long drives, Lefty lets you feed the gas with your left foot when you desire, relieves tension and fatigue in leg, back, and foot. Safe, positive and convenient. Swings out of way when not in use. Brings your car up to date. \$5. ppd. Specify year and make. No COD's please.

**INVENTOR'S MARKETING LAB,**  
400 De Young Bldg., 690 Market St., San Francisco, Calif.

Dealer inquiries invited.

## MODEL BUILDERS!

### You can get this New O & R 1951 CATALOG!

Model Aircraft Engines • Marine Engines • Model Racers • Glow Plugs • Fuels • Accessories

**MAIL THIS COUPON TODAY!**

**OHLSSON & RICE, INC. Dept. PM**  
3344 Emery St., Los Angeles 23, Calif.

Please RUSH \_\_\_\_\_ copies of the NEW 1951 O&R Catalog at 15c each for which I am enclosing \_\_\_\_\_ in stamps or coins to cover handling and mailing.

Name \_\_\_\_\_  
Address \_\_\_\_\_  
City \_\_\_\_\_ Zone \_\_\_\_\_ State \_\_\_\_\_

# WORLD'S FASTEST BOATS!

**BUILD and DRIVE your own high speed racing boat** as hundreds of others are doing! Easy to follow our simplified plans for newest types of racing craft. Large selection of full race Hydroplanes ranging from 6 ft. to 20 ft. lengths. Service, Racing, Utilities, and 3 Points. Both inboard and outboards.

**SEND 25c for CATALOGUE** containing pictures and descriptions of **Champion Boats** for which plans are designed and distributed exclusively by **CHAMPION BOATS, P. O. Box 9038, Dept. 15G, Long Beach, California, U.S.A.**



## RUPTURED?

### MAGIC DOT HOLDER for MEN or WOMEN \$1

HOLDS good with gentle pressure. No Steel. Washable. Don't show. Full price only \$1 single \$2 double. Avoid Embarrassment. Send Money with Hip measurement. Hundreds of satisfied customers. Be one yourself. Satisfaction guaranteed or money back. Rush your order today.

**P. M. DOLLAR TRUSS — Box 812 — Oakland 4, Cal.**

## Say You Saw It in Popular Mechanics

# LAW

**STUDY AT HOME** for Business Success and **LARGER PERSONAL EARNINGS.** 42 years expert instructions — over 114,000 students enrolled. LL.B. Degree awarded. All text material furnished. Easy payment plan. Send for **FREE BOOK** — "Law and Executive Guidance" — NOW!

**AMERICAN EXTENSION SCHOOL OF LAW**  
Dept. PM-40, 646 N. Michigan Ave., Chicago 11, Ill.

## LOCKSMITHING & Key Making

**PRACTICAL UP-TO-DATE COURSE—ONLY \$4.95**

Easy-to-learn modern information for self-instruction. How to work on locks, de-code, make master-keys, repair, install, service, etc. For every handyman, home owner, carpenter, mechanic, service station operator, fix-it shop, hardware dealer, gunsmith. 53 plain illustrated lessons. **FULL PRICE ONLY \$4.95. SEND NO MONEY.** Just pay postman plus C.O.D. postage. Or send \$4.95 with order, we'll ship postpaid. Satisfaction guaranteed or refund.

**NELSON-HALL CO., 210 S. Clinton St., Dept. G-2, Chicago 6, Ill.**

**UNLIMITED GUARANTEE—PRACTICALLY WHOLESAL**

## 17 JEWEL! Formerly \$59.00

**YOU SAVE \$44.05 Our Price Only \$14.95**

Worn by servicemen. Incabloc, shock & water resist precision movement. **FREE 10 Day TRIAL. FREE expansion band.** Send \$1 with order, bal. C.O.D. Or send \$14.95 plus tax—we pay postage!

**MARYLAND DIST. Dept. 267**  
501 E. Balto St., Baltimore-2, Md. Plus \$1.50 tax

**WRITE FOR FREE JEWEL CATALOG!**



## SAVE \$50 ON GASOLINE PER YEAR

patent pending

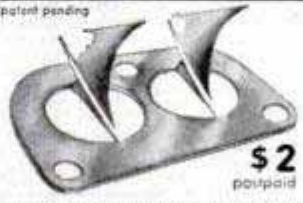

**TURBO-DYNE** — Designed by carburetion engineers to give: **BETTER MILEAGE — MORE POWER AND PICK-UP — EASIER STARTING**

**TURBO-DYNE** creates a violent vortex action that swirls and atomizes the mixture of fuel and air as it leaves the carburetor. This enables complete combustion and an even distribution of the fuel to each cylinder, which results in greater volumetric and engine efficiency. The result—**MORE MILEAGE, POWER AND PICK-UP** for each drop of fuel consumed. Quickly installed between carburetor and manifold. No moving parts. Lasts forever. Satisfaction guaranteed! Models for all cars. Send make and year of car with \$2.00 to:

**WHOLESALE DIE CO., Dept. T-2, 604 S. Marengo, Alhambra, Calif.**

**\$2** postpaid



# Earn Big Money

## WRITING ORDERS

# AMAZING NYLONS

*Guaranteed Against*  
**RUNS AND SNAGS**

*Regardless of Cause!*

The world's ONLY complete, nationally advertised nylon hosiery line actually guaranteed against runs, snags or excessive wear, REGARDLESS OF CAUSE! It's amazing, but true! No matter what the cause—hard use or deliberate abuse—Kendex nylons are replaced FREE if they run, snag or become unfit for wear within entire guarantee period! Every weight from sheerest 15 denier to heavy 70 denier—all gauges up to luxury 60 gauge—all sizes, lengths, popular shades, fancy heels, black seams—full fashioned and seamless. Nothing is missing to make sure every woman is pleased. In spite of the amazing guarantee, retail postage prepaid prices are no higher than comparable quality national brands. Should free replacement be necessary, actual cost is cut in half! How could any woman possibly resist saving money and solving her hosiery problems? NOT SOLD IN STORES. Men and women wanted NOW, spare or full time, to write orders and earn big money. You can get orders even if you never sold a thing in your life!



# FREE SAMPLE STOCKING

Man or woman—young or old, YOU can easily earn steady income, spare or full time. No money or experience needed. We supply EVERYTHING free and set you up in business at OUR expense. Nothing to buy or deliver. Write orders. We deliver and collect. Big advance pay plus huge cash bonus that increases your earnings up to 40%! Your name and address on postcard will bring you sample stocking; self-selling sales books with FULL COLOR illustrations; 32-page sales manual showing you easy steps to success; color cards, free "door openers" worth \$1 each but which you give away free; special plan to have others sell for you, etc., etc. You can start making money the minute you receive the complete FREE outfits!

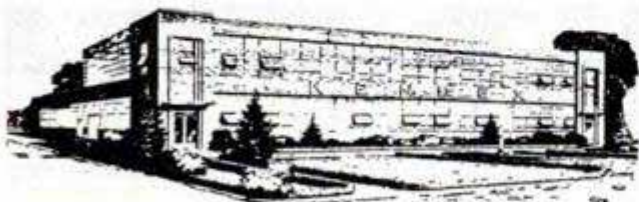

**YOUR COST ONE CENT!**

SEND NO MONEY. Pay nothing now or later. No obligation. Not even a promise to return outfits. Simply write your name and address on a penny postcard and mail to us. We'll immediately rush you everything you need FREE and postage prepaid. WRITE TODAY!

**KENDEX CORPORATION**



**BABYLON 346, N. Y.**

LEARN..

# "CERAMIZING"

THE NEW HOME ART HOBBY  
TURNING WORTHLESS OBJECTS  
into VALUABLE TREASURES

**\$5 AN HOUR PROFIT**  
Creating Things of Beauty



**Amazing Book Tells You**

How to do the work—what to decorate—what materials you need—where to buy them cheaply—how to get customers coming—what to charge—how to start a business in spare time without risking job or paycheck that can lead to future independence. You read all this without risking any money at all. Just send name.

Think of learning an artistic hobby in just a few minutes of instruction. Think of turning just 50¢ worth of material into an art object so beautiful that it brings you \$5.00 an hour for your spare time. Sounds fantastic—yet it's true—as you can easily prove without risking a cent of money. I have ready to mail to you a complete set of instructions so easy to follow that a child can learn this fascinating new art. Within an hour you can be "Ceramizing." The very first day you can create things of beauty from Nature's countless masterpieces of design, such as leaves, flowers, twigs, stones and shells. Preserve and beautify keepsakes such as Baby Shoes—turn 10 cent store products into art objects worth five to ten times their cost—restore and rebeautify hundreds of household articles for yourself and friends.

**FREE Pay Me Nothing for this Information**  
This fascinating home hobby is used by many as a means of steady extra income. Fun for the whole family—and money besides. Read the entire plan—all instructions—at my risk. **DON'T SEND MONEY—JUST YOUR NAME FOR COMPLETE DETAILS FREE.** Address **R. E. Brandell, WARNER ELECTRIC 1512 JARVIS AVE., DEPT. 37, CHICAGO 26, ILL.**

**R. E. Brandell, WARNER ELECTRIC, Dept. 37**  
1512 Jarvis Ave., Chicago 26, Illinois

Please rush complete facts showing how I can start "Ceramizing" business at home for pleasure or profit. No charge. No obligation. All FREE.

NAME \_\_\_\_\_  
ADDRESS \_\_\_\_\_  
CITY \_\_\_\_\_ ZONE \_\_\_\_\_ STATE \_\_\_\_\_

**YES! SEND**



directly  
to my door  
every month

I am enclosing

- \$3.50 for 1 year
- \$8.00 for 3 years

name \_\_\_\_\_  
address \_\_\_\_\_  
city \_\_\_\_\_ zone \_\_\_\_\_ state \_\_\_\_\_  
PMA-7

Hand this order to your newsdealer or send it to

**POPULAR MECHANICS**  
200 East Ontario St. Chicago 11, Ill.

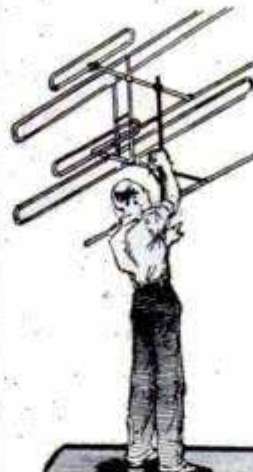

Here is the Book  
Eagerly Awaited  
by Millions  
of Popular Mechanics Readers  
**RADIO-TV**  
and  
**ELECTRONICS**  
Handbook

**Timely Information**

Covers the field of electronics as it applies to everyday life. Radio, television and other electronic devices are fully explained. Here is practical money-making and money-saving information.

**For Set Owners, Amateurs, Students**

If you own a radio or TV set, are an amateur radio fan or a student, you will find the information you need to know in the fact-packed contents of this new book.

**Build Radios, Amplifiers and Electronic Devices**

For a fascinating hobby, build your own radios, transmitters, etc. Find out how you can become a "ham" and join ranks with thousands of other radio fans all over the world.

**Partial Contents**

How to Solder, Simple Radio Repairs, Auto Radio Service Hints, How to Care for Your Record Player, Television in the Home, How to Install TV and FM Antenna Systems, How to build: Progressive Sets, Portable Sets, and other radio and electronic devices.

**160 Pages**  
**566 Photos, Drawings and Diagrams**  
by Frank L. Brittin, Senior Member  
Institute of Radio Engineers  
Radio-TV and Electronics Editor  
Popular Mechanics Magazine

Here is everything you have ever wanted to know about radio, television and electronics written by a man who millions have followed faithfully through the pages of Popular Mechanics Magazine. You need no previous experience or knowledge to understand and make use of the information contained in the text.

**Prevent Trouble —  
Cut Down Repair Bills**

If you own a television set or a radio you can use this book to save yourself money. Learn how to select television receivers; how to install and adjust TV antenna systems; how to adjust and tune your TV receiver. Find out how you can make many of your own radio repairs and eliminate unnecessary service calls.

**Satisfaction Guaranteed**

Mail the coupon now. Send only \$2.50 or you can pay the postman. Money back within five days unless you are completely satisfied.



Pictorial and schematic diagrams, complete material lists, glossaries of common radio and TV terms and color codes included.

*Order on this Handy Coupon*

**POPULAR MECHANICS PRESS, Dept. 38**  
200 E. Ontario St., Chicago 11, Ill.

Send at once my copy of Radio-TV and Electronics. Unless it is entirely satisfactory I may return it within five days for a full refund.

NAME \_\_\_\_\_  
ADDRESS \_\_\_\_\_  
CITY \_\_\_\_\_ ZONE \_\_\_\_\_ STATE \_\_\_\_\_

Remittance for \$2.50 enclosed

Send C.O.D. (Postage extra)

# NEW MYSTERY FISH-BOWL



AMAZING

Specially priced at only **2.98**

WHAT KEEPS THE WATER IN THE LOOP?



- ▶ IT'S NEW — IT'S DIFFERENT
- ▶ BEAUTIFULLY MOLDED PLASTIC GYM FISH SWIM THROUGH MAGIC LOOP
- ▶ DECORATES END TABLES, BOOKCASES, ETC.

What keeps the water in the loop? Amaze and mystify your friends with this sensational new "mystery" fish-bowl molded from clear durable plastic with a scientific tube loop. Fill it with approximately 1/2 gallon of water as per our secret instructions, then insert two or three of your pet goldfish. You'll watch them for hours and hours as they frisk and frolic through the loop. The perfect compliment to any room. Decorates end-tables, bookcases, etc. Makes a wonderful gift. **SEND NO MONEY.** (C.O.D. you pay postage. Remit with order, we pay postage.)

**RUSH YOUR ORDER TODAY!**

**NOVELTY MART • 59 East 8th Street; Dept. PM-7, New York 3, N.Y.**

## MAGIC-SCREEN INCOME PLAN OFFERS BIG MONEY, AT HOME, SPARE OR FULL TIME



Reproduce any painting, design, trade-mark, picture, printing, in full color, on any surface! Proven new method enables you to cash in on *established* business where Profits up to \$5.00 or more an hour are being made, *right now!* Examine complete Plan and equipment without risk!



Write today for free sample — Complete free details! **Send NOW!**  
**CALIF. ACADEMY OF SCREEN PROCESS DEPT. 27, 5100 SO. VERMONT AVE., LOS ANGELES 37, CALIF.**

### WHY SUFFER TONGUE BITE?



These **NEW** pipes cost little more than the best of old-fashioned pipes. No **TONGUE BITE.** No **DRINK.** Burn to bottom on one lighting. **FREE** Circular tells **WHY.** Send postcard to **KLEENSMOK PIPE CO., 3597 Johnson City, Tenn. Pat. & P. d.**

FEBRUARY						
S	M	T	W	T	F	S
				1	2	3
4	5	6	7	8	9	10
11	12	13	14	15	16	17
18	19	20	21	22	23	24
25	26	27	28			

### DRIVE 3 TO 6 DAYS A MONTH



**Gas Free!**

Amazing discovery, tested in Engineering Dept. of leading U. S. University, reduces gasoline consumption as much as 20%—gives you up to 6 days a month **gas free driving**—may actually **pay for itself** in cash savings. Also better performance, more power, quicker starts, faster acceleration, on all cars, light trucks, tractors—any age, make or model. It can help keep you rolling if emergency gas restrictions come.

**TEST IT 30 DAYS ON YOUR OWN CAR BEFORE DECIDING**  
 No one can appreciate the astounding benefits of this new miracle development without actual day-by-day experience on the road—so we want you to try it for **30 days** on your own car at our risk. Write or wire today for complete **FREE** details, technical explanation and 30-Day Examination Request Blank.

**SEND NO MONEY**

**G. B. SCHUYLER, Dept. 47**  
 1665 Mission St. San Francisco 3, Calif.

### BRAND NEW 30 DAY FREE TRIAL



### High Power BINOCULARS

Finest Precision Optics  
 Featherlight  
 Money Back Guarantee  
 Easy Pay Plan  
 Leather Case Incl'd.  
**Free! Catalog & Book "How to Select Binoculars"**  
 Dealer Inquiries Invited  
 Bushnell Bldg., Dept. M-27  
 Pasadena 1, Calif.

33 MODELS \$14.95 up  
**BUSHNELL Binoculars**

**FREE GUIDE "How to Select Binoculars"**

NAME \_\_\_\_\_ CITY \_\_\_\_\_

ADDRESS \_\_\_\_\_ STATE \_\_\_\_\_

# WHY NOT SAVE GAS?

Be Prepared If Rationing Returns



1/2 Million Use Ganes

**BOOK GIVEN FREE TO ALL WHO TRY GANE NEEDLES**

GANES REPLACE CARBURETOR IDLING ADJUSTMENT SCREW  
Install Ganes in a few minutes on all cars



HOW TO GET 150 MILES PER GAL

10 DAY FREE TRIAL IN YOUR CAR

- TEST FOR
- ✓ BETTER MILEAGE
  - ✓ EASIER STARTING
  - ✓ FASTER PICKUP
  - ✓ BETTER IDLING

MANY GANE USERS REPORT UP TO 25% MORE MILEAGE AND ALL-AROUND BETTER PERFORMANCE . . . but don't take our word for it . . . see for yourself! Test Ganes in your car for 10 days AT OUR EXPENSE. Then, compare your mileage and performance and, if fully satisfied, pay only \$1.50 per needle (8 cylinder cars use 2). If not satisfied, simply return them and owe nothing . . . fair enough? Since authorities differ on the merits of Ganes, and some users report no improvement, TRY BEFORE YOU BUY!

ALSO FREE... Auto Economy Manual—SENT ABSOLUTELY FREE TO ALL WHO TRY GANE NEEDLES, tells how to save fuel, tires and brakes; how to obtain more speed, power and better performance from any car. Also introduces many new, ingenious auto economy products.

WRITE TODAY! ENCLOSE NO MONEY! PAY POSTMAN NOTHING!

List your name, address, make and year of car, no. of cylinders and make of carburetor if known. YOUR TWO FREE BOOKS AND GANE NEEDLES WILL BE SENT IMMEDIATELY.

NATIONAL AUTOMOTIVE RETAIL CORP., Dept. J-7  
350 W. Washington Blvd., Venice, California

# New Car?



# No, New Shocks

Don't buy a new car just to get a new car ride. Save your money and get new shock absorbers instead. It's thrifter and easier than you think to replace old, rough riding shock absorbers with new smooth riding MONROE Hydraulics.

Send 10¢ FOR INSTRUCTIONS ON HOW TO INSTALL SHOCK ABSORBERS

One thin dime brings you our A B C Manual and other valuable information on shock absorber installation and service . . . tells which shocks fit your car, takes you step by step over everything you need to know.

MONROE SHOCK ABSORBERS are Standard Equipment on more makes of new cars than any other brand.



MONROE AUTO EQUIPMENT COMPANY, MONROE, MICH.

# PAY RAISING—EXTRA MONEY BOOKS

Use these books to prepare for a better job — bigger pay — to start a profitable spare time or full time business of your own, improve your home, or start a hobby. Popular Mechanics specializes in supplying outstanding self-help books on many subjects. Send for our FREE catalog.

- Outdoor Sports Manual
- Hunters, Fishermen, Trappers, Campers, Archers, Boatmen, here is your book! . . . \$2.00
- Shop Notes Library . . . \$2.00
- 5 Vols.—1951, 50, 49, 48, 47 (No Dup. Matter) . . . \$3.98
- Shop Notes 1951 . . . \$1.00
- Money From Ideas. Patent and sell your invention. . . \$2.50
- Photo Handbook
- An entirely new and different book from our Popular Photo Guide. It's a complete guide to better pictures and dark-room technique, and features dozens of handy gadgets you can make yourself. . . \$2.00
- Automatic Transmissions Simplified. How to locate trouble, service all types. . . \$4.00
- Dyke's Auto Encyclopedia (World's Greatest Auto Book) New 1950 Edition. . . \$7.50
- Garden Book
- Build own trellises, lawn furniture, fireplaces, ornaments, etc. . . \$1.50
- Diving, Cutting and Welding in Underwater Salvage Operations. Only book of its kind . . . \$2.00
- Picture Framing
- Modern methods for making and painting picture frames. Fully illustrated. . . \$2.75
- Radio-TV and Electronics Handbook. How to service radio and TV sets; build receivers, phonographs, portables, student sets, etc. . . \$2.50
- Money Making Hobbies. 132 ways to make money. . . \$2.00
- 210 Deluxe Small Homes \$1.00
- Trailer Coaches by Kuna. Complete information for construction of trailers. . . \$1.50
- Concrete Handbook
- New book on using concrete around home, garden, farm . . . \$2.00
- Veterinary Guide for Farmers by Stamm. What every farmer should know about taking care of farm animals. 288 information packed pages with more than 150 big illustrations. Covers ailments of cattle, hogs, sheep, horses, etc. . . \$3.50
- Welding, Brazing and Soldering 1950 Ed. How to build your own equipment and how to use it effectively. . . \$1.75
- Modern Electric and Gas Refrigeration. New 1950 Ed. Includes sealed units — home freezers . . . \$5.00
- Complete Book of Home Repair and Improvements. Radio's famous "Fix-It" book. Everything about repairing and improving your home. Cloth Ed. \$2.98; Deluxe Binding \$3.98
- You Can Make A "Stradivarius" Violin. Instructions. 8 full scale plans . . . \$3.50
- Oil Burner Handbook . . . \$2.50
- 23 Boats You Can Build. Rowboats, canoes, sailboats, 25 foot cabin cruiser. Working diagrams, material lists. \$2.00
- House Wiring (No. 89) . . . \$2.50
- Turn Scrap Into Money
- Convert old auto generators into motors, welders, etc. . . \$1.00
- Popular Mechanics Farm Manual
- Packed with practical ideas and usable information that can easily be worth hundreds of dollars to every farm family and to homeowners everywhere. Send for free descriptive folder giving complete contents! . . . \$3.00
- Woodworking for Everybody . . . \$2.75
- Sheet Metal Work . . . \$3.00
- Tool and Saw Sharpening (No. 92) . . . \$2.50
- Forging Practice . . . \$1.50
- Action Toys (No. 66)
- Plans for 21 easy-to-make toys . . . \$2.50
- Foundry Work . . . \$2.25
- Pattern Making
- Wood, metal. . . \$2.25
- Forty Power Tools
- Build own saw, drill, lathe, sander, etc., from scraps — save money. . . \$1.50
- Carpentry
- The Young Craftsman
- Over 450 things boys can make . . . \$2.00
- Five Acres and Independence
- How to make money on small farm . . . \$2.50
- Your Home and How to Build It Yourself. Step-by-step construction of the famous Popular Mechanics house. Wonderfully illustrated. . . \$3.00
- Manual for Plymouth Car Owners
- How to get the most from your Plymouth and save on repair bills . . . \$3.50
- 100 Beautiful Pieces of Furniture You Can Build. Complete suites for living room, dining room, bedroom shown in brilliant color. Exclusive styles by John Bergen. Working diagrams . . . \$3.00
- Motorist's Handbook
- Popular Mechanics scores again. A 160 page guide to automotive happiness. \$2.00
- Planning Your Home Workshop
- How to use every inch of space. Build cabinets, benches, etc. How to wire . . . \$2.50
- What to Make for Children
- Junior tough on toys? Build him playthings that will last. . . \$2.00
- LeJay Manual of Homemade Electric Equipment. How to construct 50 items that are scarce and valuable. . . \$1.50
- How to Estimate for the Building Trades: Material and labor costs for masonry, plumbing, electricity, carpentry, heating, hardware, painting, etc. 629 pages. . . \$5.50
- Auto Racing—6th Edition. \$2.00
- Tool Making . . . \$4.00
- Tool Design . . . \$4.50
- Plumbing Installation & Repair . . . \$2.00
- Ropp's Calculator
- Figuring Made Easy . . . 75c
- Slide Rule Simplified . . . \$2.75
- Drake's Refrigeration Service Manual . . . \$2.00
- Power Tools and How to Use Them: Tools to start with; tools to add; how to use them and where to buy them. \$2.50
- America's Best Low Cost Homes
- 125 popular practical designs . . . \$1.00
- Toys You Can Make of Wood . . . \$2.50
- A.B.C. of Poultry Raising . . . \$2.50
- Lawn Furniture
- Make attractive sturdy lawn furniture with Popular Mechanics big plans. Save over 50% of the usual cost. Four plans . . . \$2.00
- Furniture Joinery . . . \$2.00
- Essentials of Upholstery . . . \$3.25
- The Frog Industry by Hannaca. Covers every phase of frog farming; shows you how to make big money. Full of valuable information about this fascinating, profitable industry . . . \$3.00
- Home Haircutting Made Easy by Mercla. Instructions for cutting your family's hair. \$1.00

## MAIL THIS COUPON TODAY

Check the books you want, write your name and address below, and mail this advertisement with money order or check. Outside U. S. A. include 15% additional for shipping charges. Books selected will be mailed promptly on our "money back if you're not entirely satisfied" guarantee.

Name \_\_\_\_\_

Address \_\_\_\_\_

City \_\_\_\_\_ State \_\_\_\_\_

Mail to POPULAR MECHANICS PRESS  
DEPT. 700 — 200 EAST ONTARIO ST., CHICAGO 11, ILL.

DON'T MISS THIS AND  
THE NEXT 3 PAGES!

Read All About 40 Famous

How • To • Do • It

Books

from the Presses of  
Popular Mechanics



*Fifty Years of  
Book Publishing Service  
to Information-Seeking  
America*

On the next three pages are  
described and pictured forty  
POPULAR MECHANICS BOOKS

prepared by authoritative and able writers under the supervision  
of POPULAR MECHANICS EDITORS.

When he founded POPULAR MECHANICS MAGAZINE a half century ago, Mr. H. H. Windsor, Sr., began the publication of practical, down-to-earth HOW-TO-DO-IT books. Since then Popular Mechanics has continued to feature the publication of books of this type. Each book is prepared on the same practical foundation as is the magazine, under its famous slogan — WRITTEN SO YOU CAN UNDERSTAND IT. All texts are backed up with pictures, plans and diagrams that make every point unusually clear, even for those with little or no familiarity with the subject.

POPULAR MECHANICS BOOKS are abreast of the times, covering the latest inventions and developments. They describe methods and materials; explain processes and procedures; provide short cuts and easier ways of doing time-honored jobs and specifically serve the needs of INFORMATION-SEEKING AMERICA with actual HOW-TO-DO-IT information and instruction. They save time and effort and save and make money for millions of users of all ages and from all walks of life.

Please turn the page. You, too, will no doubt find the answers to your problems, or perhaps, find greater enjoyment of your interests in POPULAR MECHANICS HOW-TO-DO-IT BOOKS.

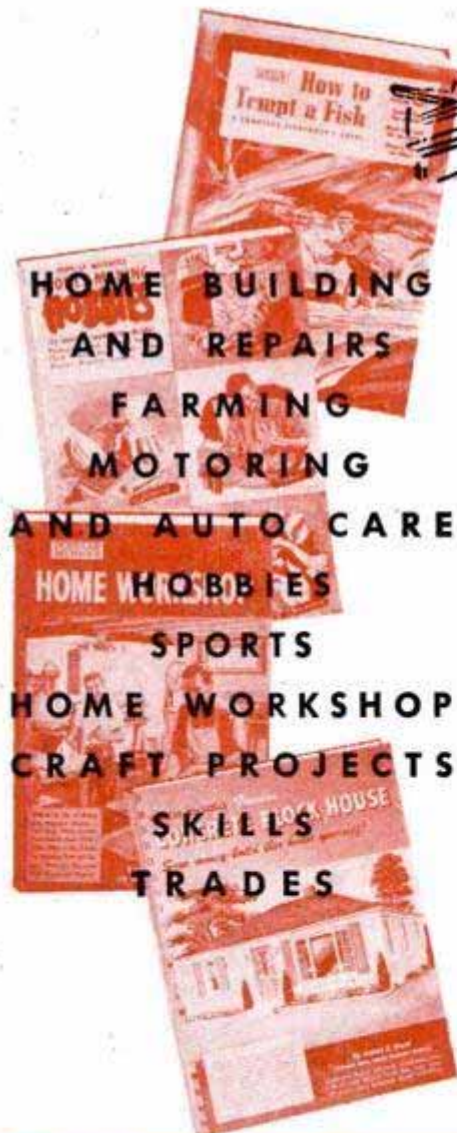

POPULAR MECHANICS PRESS • Chicago

# Popular Mechanics

## HOW • TO • DO • IT BOOKS

HOME BUILDING AND MAINTENANCE • FARMING • BETTER JOBS • SKILLS  
HOME WORKSHOP • HOBBIES • AUTO CARE • PASTIMES • ETC.

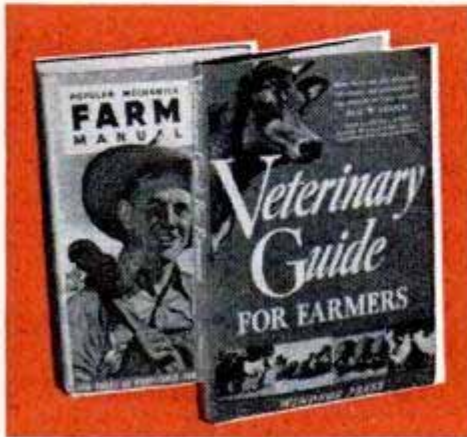

Two books endorsed by leading agriculturists, County Agents, Vo-Ag teachers and others.



### FARMING • FARM ANIMALS

**FARM MANUAL** Hundreds of practical articles and ideas for everyday use on the farm for making implements and equipment, maintaining the home, farm workshop, live stock and poultry, vegetable storage and processing and many other farm hints and kinks. Saves time, labor and money. **\$3.00**

**VETERINARY GUIDE FOR FARMERS** What every farmer should know about taking care of his farm animals and performing many veterinary tasks himself. Covers symptoms, causes of disease and prevention and treatment of cattle, swine, sheep, horses and poultry. Illustrated. **\$3.50**

### HOME MAINTENANCE

**LAWN AND GARDEN** For every home owner, with practical instruction based on proven methods for landscaping and growing fine lawns and gardens. 176 pages. Illus. **\$2.50**

**HOW TO PAINT** By Sam Brown. Covers all types of paint application. Illustrated **\$2.50**

**CONCRETE HANDBOOK** Shows how you can do many practical and ornamental concrete jobs yourself. Illustrated. **\$2.00**

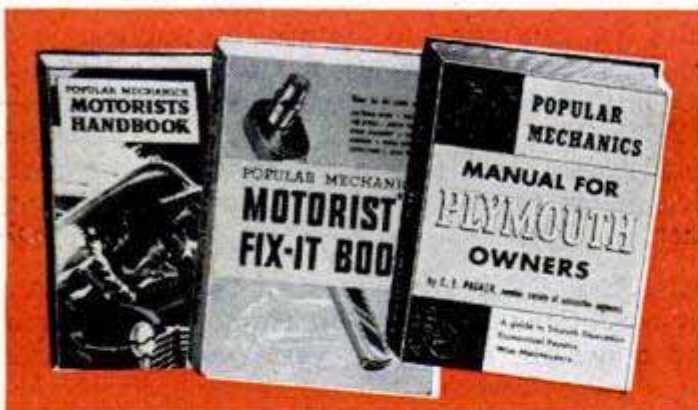

### HELP FOR CAR OWNERS, MECHANICS

**MOTORIST'S HANDBOOK** 535 practical articles of helpful information that can easily save you hundreds of dollars every year, make your car run better and look better too. Covers models 1940-1950. Illus. **\$2.00**

**MANUAL FOR PLYMOUTH OWNERS** Get the most out of your car investment. Covers the Plymouth from bumper to bumper—explains how parts operate, what can go wrong, what repairs are necessary, how to avoid trouble. Illustrated. **\$3.50**

**MOTORIST'S FIX-IT BOOK** Simplified instruction for car owners. Can easily save hundreds of dollars every year. Illustrated. **\$2.00**



### OUTDOORS AND SPORTS BOOKS

#### HOW TO TEMPT A FISH

Section by Joe Godfrey, Jr., world famous authority. A lifetime of valuable fishing information in a single book. 20 pages of best fish lures in actual colors. 525 illustrations. **\$2.00**



**OUTDOOR SPORTS MANUAL** Over 200 helpful articles for the hunter, trapper, fisherman, camper, archer and boatman. 334 illustrations. **\$2.00**

**23 BOATS YOU CAN BUILD** Plans, building instructions and material requirements for 23 different boats that anyone can build at home. Over 500 pictures. **\$2.00**



# HOME BUILDING

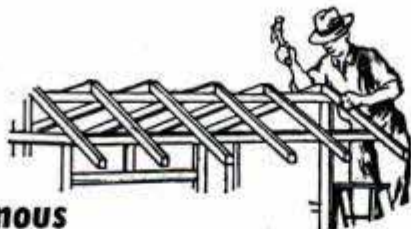

**Popular Mechanics Famous "Build-It-Yourself" Books that Save Over One-Half Home Building Costs**

**YOUR HOME AND HOW TO BUILD IT YOURSELF** Hundreds of amateur builders have built this home with the aid of this book. Typical 6-room Colonial home with garage, breezeway and basement. Can be built by any man handy with tools. Many pictures in actual colors. \$3.00

## CONCRETE BLOCK HOUSE

Built in many localities by amateur builders, complete with plumbing, electrical wiring and heating for less than \$3650. Five good sized rooms and ideal for family of four. Half of book is pictures and diagrams. \$2.00

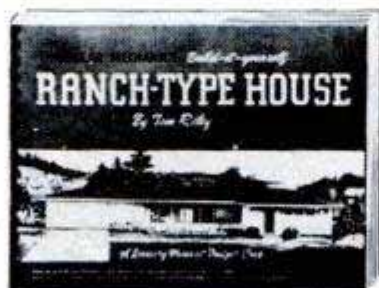

\$5.00



## RANCH HOUSE BOOK

Ready Sept. 1.

Exciting new ranch type house, finished inside and out with plywood. Fully insulated. Can be built in two easy stages by amateur. Five rooms with bath and utility room and car port, about \$7450. Added garage, breezeway and third bedroom, about \$2500. Heating, wiring, equipment included. Designed by famous West Coast architect. Plenty of pictures. \$3.50

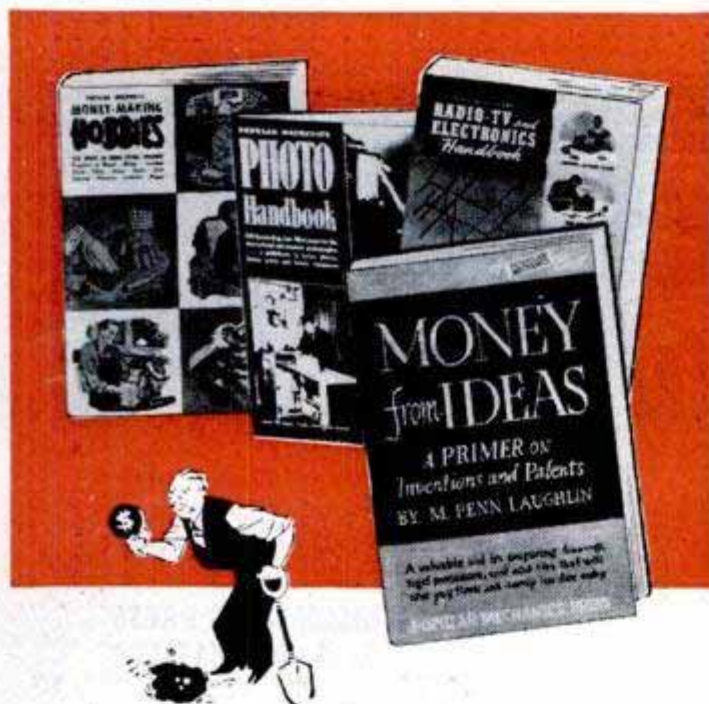

## HOBBIES, PROFITABLE IDEAS

**RADIO, TV AND ELECTRONICS HANDBOOK** by Popular Mechanics Electronics Editor. A book for set owners, experimenters, students, experienced men. 566 illustrations. \$2.50

**MONEY-MAKING HOBBIES** Tells how to have fun and make hobbies pay their own way and a profit. 132 different things. \$2.00

**PHOTO HANDBOOK** Better pictures. Gadgets you can make. Proven darkroom helps. Camera tricks. 465 illustrations. \$2.00

**MONEY FROM IDEAS** A practical book for every man with an active inventive mind who believes he has ideas that can be patented. \$2.50

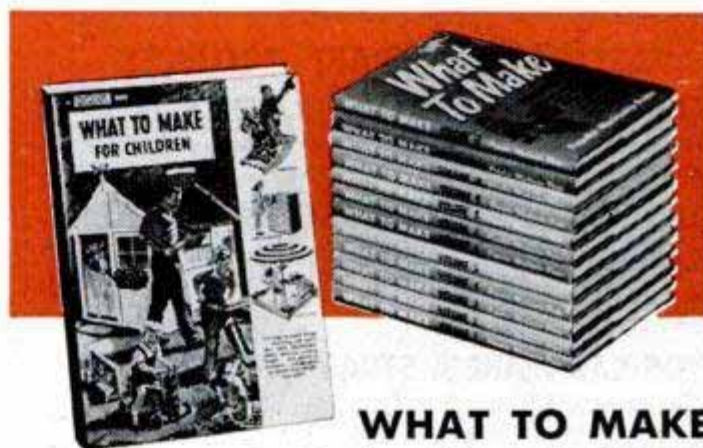

## WHAT TO MAKE

**WHAT TO MAKE** Now 12 volumes. An annual selection of craftsman projects such as furniture, toys, games, gifts, etc. More than 3000 different projects in the 12 volume set. Fully illustrated. Each volume \$1.75. Set of 12 volumes. \$18.00

**WHAT TO MAKE FOR CHILDREN** 175 things dad and mother and other members of the family can make for the young folks at home. Fully illustrated. \$2.00



## EDUCATIONAL BOOKS FOR BOYS

**YOUNG CRAFTSMAN** Over 450 different projects for boys of all ages. Brings out the inherent creativeness in every boy and stimulates imagination. More than 1100 illustrations. \$2.00

**BOY MECHANIC** Hundreds of things a boy can make at home at little or no cost. Detailed plans and hundreds of pictures. Teaches boys to think and work with their hands, making such things as autos, boats, models, games and craftwork. \$2.00

**Home Workshop Books • Projects for Home Craftsmen and Handy Order Blank on NEXT PAGE**

# HOME WORKSHOP and CRAFT BOOKS for FUN and PROFIT

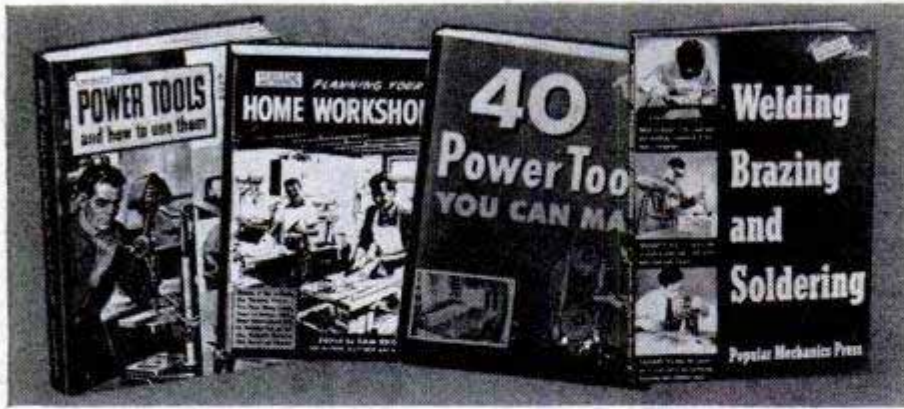

**PRACTICAL, HELPFUL INFORMATION FOR THE HOME WORKSHOP FAN**



Here is a selection of books that lead the field in all-time popularity. Nothing else like them. Superbly Illustrated.

**POWER TOOLS AND HOW TO USE THEM** A practical guide to the selection and operation of home workshop machines. Includes exciting projects in many materials. **\$2.50**

**40 POWER TOOLS YOU CAN MAKE** Tells how to make tools from scrap and discarded materials at small cost. New edition with added tools. **\$1.50**

**WELDING, BRAZING AND SOLDERING** Shows you your own equipment and use it effectively on jobs of all kinds. 1950 edition. **\$1.75**

**PLANNING YOUR HOME WORKSHOP** Edited by Sam Brown. Tells how to set up a shop on a limited budget and get the most out of it in fun and efficiency. **\$2.50**

## FASCINATING CRAFT PROJECTS

**CHRISTMAS HANDBOOK** A wonderful collection of Ideas, Gifts, Decorations, Toys—You can make at home. Informative and practical. Illustrated. **\$2.00**

**100 BEAUTIFUL PIECES OF FURNITURE YOU CAN BUILD** Scale drawings and instructions for living, dining and bedroom suites and occasional furniture. Plates in actual colors. 320 illustrations. **\$3.00**

**YOU CAN MAKE A STRADIVARIUS VIOLIN** Complete instructions and 8 full size plans. Tells where to get materials and how to make your own tools. Illustrated. **\$3.50**



## Handy Order Form

MAIL TO POPULAR MECHANICS PRESS OR ORDER FROM YOUR BOOKSELLER

### POPULAR MECHANICS PRESS

Dept. 80, 200 East Ontario Street, Chicago 11

#### Check Titles Wanted

- |  |        |   |       |
|--|--------|---|-------|
| <input type="checkbox"/> Boy Mechanic                              | \$2.00 | <input type="checkbox"/> Planning Your Home Workshop            | 2.50  |
| <input type="checkbox"/> Christmas Handbook                        | 2.00   | <input type="checkbox"/> Power Tools and How to Use Them        | 2.50  |
| <input type="checkbox"/> Concrete Block House                      | 2.00   | <input type="checkbox"/> Radio, TV and Electronics Handbook     | 2.50  |
| <input type="checkbox"/> Concrete Handbook                         | 2.00   | <input type="checkbox"/> Ranch Type House Book                  | 3.50  |
| <input type="checkbox"/> Farm Manual                               | 3.00   | <input type="checkbox"/> 23 Boats You Can Build                 | 2.00  |
| <input type="checkbox"/> Forty Power Tools You Can Make            | 1.50   | <input type="checkbox"/> Veterinary Guide for Farmers           | 3.50  |
| <input type="checkbox"/> How to Paint                              | 2.50   | <input type="checkbox"/> Welding, Brazing, Soldering            | 1.75  |
| <input type="checkbox"/> How to Tempt a Fish                       | 2.00   | <input type="checkbox"/> What to Make, Volume                   | 1.75  |
| <input type="checkbox"/> Lawn and Garden                           | 2.50   | <input type="checkbox"/> What to Make, 12 Volume Set            | 18.00 |
| <input type="checkbox"/> Manual for Plymouth Owners                | 3.50   | <input type="checkbox"/> What to Make for Children              | 2.00  |
| <input type="checkbox"/> Money From Ideas                          | 2.50   | <input type="checkbox"/> You Can Make a Stradivarius Violin     | 3.50  |
| <input type="checkbox"/> Money Making Hobbies                      | 2.00   | <input type="checkbox"/> Young Craftsman                        | 2.00  |
| <input type="checkbox"/> Motorist's Fix-It Book                    | 2.00   | <input type="checkbox"/> Your Home and How to Build It Yourself | 3.00  |
| <input type="checkbox"/> Motorists Handbook                        | 2.00   |   |       |
| <input type="checkbox"/> One Hundred Beautiful Pieces of Furniture | 3.00   |   |       |
| <input type="checkbox"/> Outdoor Sports Manual                     | 2.00   |   |       |
| <input type="checkbox"/> Photo Handbook                            | 2.00   |   |       |

Enclosed is remittance for \$\_\_\_\_\_ for which please send postpaid. Popular Mechanics Books as checked to the left. (Orders for \$2.00 or more may be sent COD, postage and charges extra.)

**MONEY BACK IF NOT SATISFIED**

Name \_\_\_\_\_

Address \_\_\_\_\_

Postal Zone \_\_\_\_\_

City \_\_\_\_\_ State \_\_\_\_\_



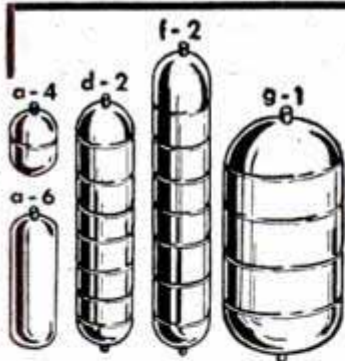

# STEEL AIR TANKS

Steel pressure tanks suitable for compressors, pneumatic units, gases, hydraulics, and liquids. Rated at 500 lbs. per square inch pressure. 1/4" standard pipe thread openings on tank ends as shown.

		Size	Wt. Lbs.	Internal Volume	Price
A-4	Stainless Steel—New	7 1/2"x5 1/4"	1 1/2	104 cu. in.	\$1.50
A-6	Carbon Steel—New	14 1/2"x5 1/2"	3 1/4	280 cu. in.	3.50
D-2	Stainless Steel—New	24"x6"	5	500 cu. in.	6.50
D-2A	Carbon Steel—New	24"x6"	5	500 cu. in.	5.50
F-2	Stainless Steel—New	45"x6"	11	1000 cu. in.	9.50
F-2A	Carbon Steel—New	45"x6"	11	1000 cu. in.	5.50
G-1	Stainless Steel—New	24"x12"	18	2100 cu. in.	11.50
G-1A	Stainless Steel—Used	24"x12"	18	2100 cu. in.	7.50

Prices F.O.B. Chicago. Include approx. postage on orders paid for in advance. C.O.D. orders enclose 25%, balance sent C.O.D.

**U. A. S. Corp.** Dept. PM7, 5637 W. 63rd Pl. Chicago, Illinois

TRAIN



## Your VOICE!

**RESULTS GUARANTEED**  
STRENGTHEN your voice this tested, scientific way. Yes—you may now be able to improve the POWER of your speaking and singing voice... in the privacy of your own room! Self-training lessons, mostly silent. No music required. Write TODAY for Eugene Feuchtinger's great booklet "How to Develop a Successful Voice." It's absolutely FREE! You must state your age. Booklet mailed postpaid in plain wrapper. No salesman will call. Send your name and age RIGHT NOW! Perfect Voice Institute, 210 S. Clinton St., Studio G-2, Chicago 6, Ill.

## HELPFUL BOOKS

Send post card asking for FREE catalog  
Popular Mechanics Press, 200 E. Ontario, Dept. 601, Chicago 11

## BIG LEATHER & CRAFT CATALOG!

1000's of items for Leathercraft, Textile Painting, Copper Tooling, Kits, Projects, Tools, Supplies, Etc. Send 25c (refunded with 1st order) to:

**RUSSO HANDICRAFT SUPPLIES** Dept. CD-1, 245 S. SPRING, LOS ANGELES 12, CALIF.

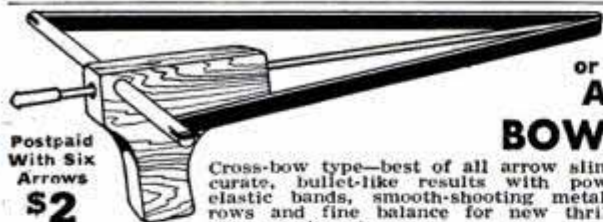

SMALL GAME OR TARGET ARROW BOW-GUN

Cross-bow type—best of all arrow slingshots. Accurate, bullet-like results with powerful live-elastic bands, smooth-shooting metal-tipped arrows and fine balance for new thrill at small game or target.

Postpaid With Six Arrows \$2

Extra Arrows Ten For \$1

**BOW-GUN CO.**

Box 25H West End Station, Colorado Springs, Colo.

## ★ ★ ★ ★ ★ SONG POEMS WANTED

To Be Set to Music  
Send one of poems for free examination. Any subject. PHONOGRAPH RECORDS MADE.

★ FIVE STAR MUSIC MASTERS 224 Beacon Bldg., Boston, Mass.

## MOVIE SUPPLIES

SURPLUS AND OTHER BARGAINS ALL FULLY GUARANTEED

9" 225mm F/5.0 AAF Ctd. Super 16mm Tele-Lenses in "C" mount. Only \$59.50  
5 1/2" 142mm F/2.9 Tele. Ctd. Only \$69.50  
16mm 50 Ft. Mag. movie film. \$1.75 ea.  
16mm 50 Ft. Mag. color film. \$4.75 ea.  
16mm x 100 Ft. rolls pan. Weston 50 \$3.50 ea.

PLEASE ADD APPROX. POSTAGE. WRITE FOR COMPLETE LIST  
**CENTURY PHOTO SUPPLY CO., Dept. MC**  
5733 CAHUENGA BLVD. NO. HOLLYWOOD, CALIF.

## Learn PHOTOGRAPHY at Home

Splendid opportunities. Prepare in spare time. Practical basic training. Long-established school. Send for free book, "Opportunities in Photography." No obligation.

American School of Photography, 835 Diversey Parkway, Dept. 135B, Chicago 14, Ill.

# WANTED!

## MEN AND WOMEN TO EARN SPARE TIME MONEY

Many Popular Mechanics neighborhood representatives are making extra cash for easy, after-hours work. A few more are needed.

For details, write:

**POPULAR MECHANICS**  
ROOM 408  
200 E. ONTARIO STREET  
CHICAGO 11, ILLINOIS

MONTH AFTER MONTH, YEAR AFTER YEAR, YOU SEE OUR AD. REMEMBER IT'S DANGEROUS to pay less if you want the finest (nonskid) USED tires.

**GOOD YEAR Firestone**

GOODRICH, UNITED STATES, GENERAL & OTHERS, NOT RECAPS

Our policy is to select your tires so carefully, as if our very future depended on the service given by that particular tire.

FREE TUBE WITH "ALL" BLATT'S GOOD GRADE TIRES

GOOD GRADE, 16 MONTHS	GOLDEN RULE	GUARANTEE BOND.
600-16 \$4.14	700-15 \$4.54	650-20 \$7.94
650-16 \$5.42	670-15 4.74	700-20 8.34
700-16 5.04	710-15 4.94	750-20 8.64
650-15 4.44	550-17 4.64	825-20 15.92

FINEST GRADE, 26 MONTHS GOLDEN RULE GUARANTEE BOND THIS GRADE MADE THE BLATT NAME "WORLD FAMOUS".

450-20 \$6.00	450-21 \$6.00	700-15(6) \$10	750-16(8) \$1
600-16 5.49	650-15 5.94	600-20 9.94	800-20 18.54
650-16 6.42	670-15 6.24	650-20 9.94	1000-20 18.54
700-16 5.94	700-15 6.54	700-20 11.94	1100-20 18.54
750-16 7.94	710-15 6.34	32x6(8) 10.54	1000-22 17.54
550-17 5.94	760-15 6.54	32x6(10) 13.92	1100-22 18.54
525-18 5.54	820-15 7.04	750-20 12.54	1200-22 22.54
650-19 9.00	475-19 5.94	825-20 22.84	1100-24 21.54

900-16 Reg. \$10.94	600-16 Reg. \$6.75	Military Reg. 16 months	750-20 Reg. \$10.44
Super 19.94	Super 9.75	Super 30 months	Super 18.64

**BLATT** BLATT BLDG., GIRARD & LANCASTER AVES., DEPT. PM., PHILADELPHIA 31, PA.

Send check or money order and this ad for rush shipment. We won't ship a tire we wouldn't use. The name to trust in rubber. PRICES SUBJECT TO CHANGE. Shipments RUSHED Down South, Up North and Far West

## A FASCINATING, MONEY-MAKING art career can be yours

AMERICA'S 12 MOST FAMOUS ARTISTS SHOW YOU HOW!



Write Today  
**FAMOUS ARTISTS COURSE**  
Dept. 6-U, Westport, Conn.

FREE Send book about your home study art course.

Name \_\_\_\_\_ Age \_\_\_\_\_  
Street \_\_\_\_\_  
City, State, Zone Number \_\_\_\_\_



Optional HiPressure spring packed with each Chrome Oil Stopper for positive oil control even in badly worn engines.

Plated with Solid Chrome

**Now!** The greatest advance in piston ring history! **PERFECT CIRCLE'S**

# 2 IN 1 CHROME PISTON RING SET

**Doubles the life of cylinders, pistons and rings**

**IT'S TRUE!** Perfect Circle's 2-in-1 Chrome Set is actually *two sets in one*, because . . .

**First**—two expander springs, Normal and HiPressure, are packed with every Chrome Oil Stopper . . . giving mechanics a choice of pressures to assure positive oil control regardless of cylinder condition.

**Second**—the protection of solid chrome plating against wear, on

**BOTH** top compression and oil rings, *more than doubles* the life of cylinders, pistons and rings!

**Whether cylinders** are slightly or badly worn, tapered or straight, round or out-of-round, it gives positive oil control with sustained power for thousands of extra miles.

**Ask your Doctor of Motors**—your favorite mechanic—to install the 2-in-1 Chrome Set in your car.



**Perfect Circle** *The Most Honored Name*

Churning the waters white this summer is a flotilla of sensational speedsters racing toward a new world record of 200 miles an hour, and . . .



## *Slo-Mo-Shun* LEADS THE PACK

*By Thomas E. Stinson, Jr.*

*Photos by Kent Hitchcock*

**I**F SOME steel-nerved power-boat driver has the courage to hold his throttle wide open for a full 30 seconds this year, there's a chance that a brand new world record for speed across the water will be made.

Today, half a dozen of America's blue-chip sportsmen have their eyes fixed on the terrific speed of 200 miles per hour, a figure that was fantastically out of reach a few years ago. No one expects to drive a boat that fast in 1951 but several men are building boats that, on paper at least, can be driven at 175 miles per hour. They hope to prove it this summer.

Ostensibly, the boats are being groomed for the Gold Cup race that is scheduled for August 4 on Lake Washington, Seattle. Actually, if a challenger finds in trial runs that his boat is capable of 175 miles per hour, he'll burn up the wires arranging for an official crack at the record.

The reason for this sudden competition is that an almost unknown boat of unique design, Slo-Mo-Shun IV, last year set a new world record of 160.32 miles per hour. It added almost 20 miles per hour to the record 141.74 miles per hour Sir Malcolm Campbell made in his Blue Bird II in England in 1939.

Blue Bird was a costly creation, designed

and built solely to capture the world speed record. Slo-Mo-Shun, on the other hand, is suitable for closed-course racing as well as for speed dashes. Stanley S. Sayres of Seattle, its owner, uses it almost like a family runabout. All of the new contenders for the world championship are being designed along the same general lines of Slo-Mo-Shun's hull.

One of the secrets of Slo-Mo-Shun's speed is that Sayres and his designer, Ted O. Jones, found a way to prevent the hull from rising completely out of water at high speed and becoming unmanageable.

Most modern racing hulls are of the so-called three-point hydroplane design. At high speed they rise up out of the water and rest on only three points: the two outboard sponsons and the stern. The trouble is that three-point hulls are too perfect, aerodynamically. There's a tendency for the bow to swing up and flip the boat over on its back. Too, rudder control is almost completely lost when the boat is literally flying through the air.

These drawbacks were avoided in Slo-Mo-Shun by providing an inverted pyramidal step under the bow, to serve as a fourth point of suspension. It acts partly like an air spoiler in the tunnel between the two



Hurricane IV of Hollywood, one of the fastest, will have a flatter, skinnier hull in next month's competition



Slo-Mo-Shun, foreground above, lost this race to My Sweetie when terrific pounding of water broke her shaft  
Guy Lombardo's Tempo VI "flying" on her propeller. She was one of the first big boats to copy smaller hydros



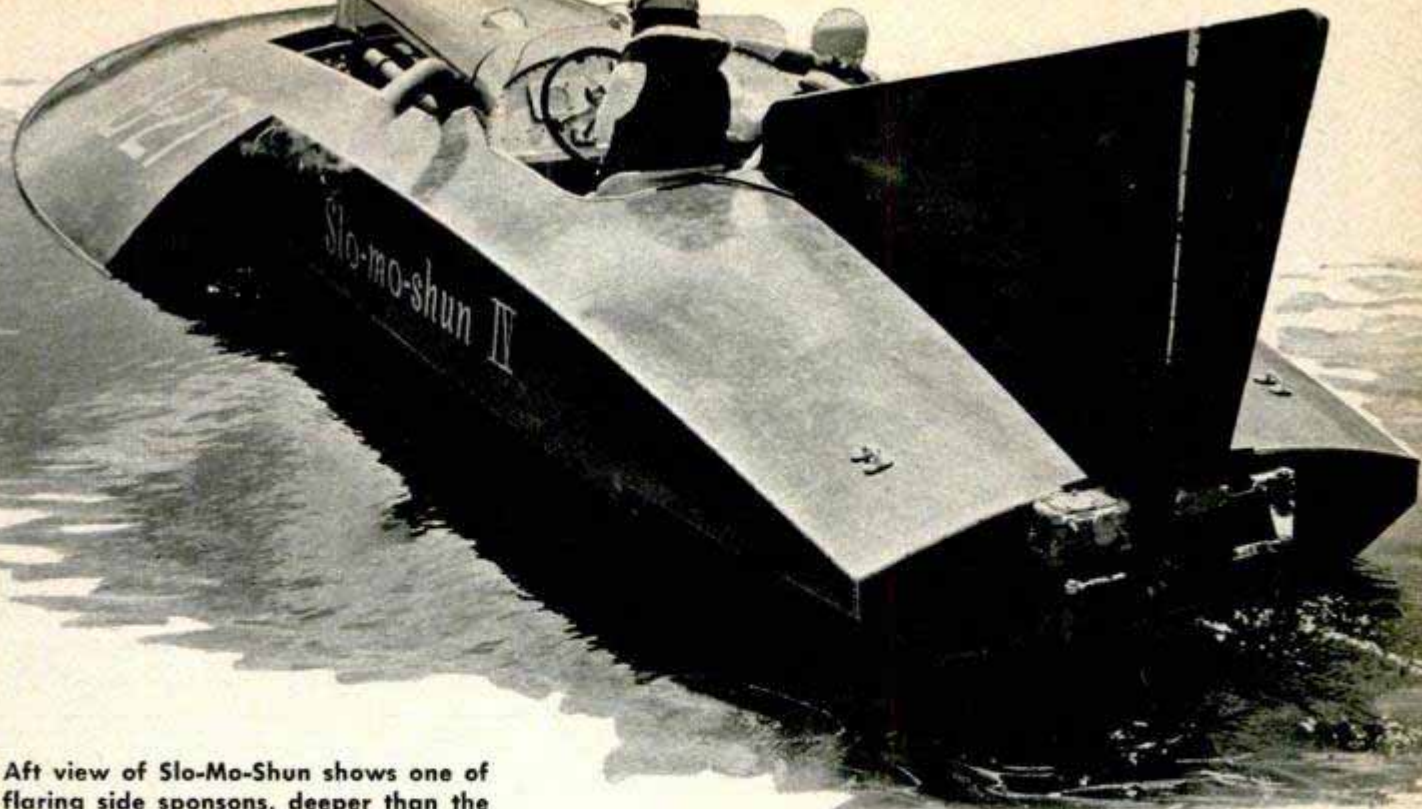

Aft view of Slo-Mo-Shun shows one of flaring side sponsons, deeper than the main portion of the hull, on which the boat rests when moving at high speed

sponsons. The resulting drag holds down the bow and there's no tendency for the boat to do a backward somersault. In rough water, the pyramidal bow plane flattens and spreads the water surface so that the boat is safe at speeds at which the ordinary hydroplane would run wild or pound itself to pieces.

Slo-Mo-Shun rides so high that only one of the blades of its special \$500 two-bladed propeller is in the water at a time. The boat leaves behind it a "rooster tail" of spray that is thrown high in the air and hangs for a quarter of a mile behind the boat. Slo-Mo-Shun's 1500-horsepower Allison aircraft engine drives the propeller, through gears, at about 10,000 revolutions per minute. The step-up gearbox is bolted directly to the rear of the engine, permit-

ting the use of a short, straight, drive shaft instead of the customary transfer drive from the bow. The deep steel rudder is mounted off center so that it moves in undisturbed water instead of in the frothy wake of the propeller.

The fastest boat in the world is 28 feet long and has a beam of 11 feet 5 inches. The plywood hull has a ½-inch-thick bottom that is sheathed in part with thin dural plating as a protection against floating debris. Unused portions of the hull are packed with foam plastic for flotation in case of a smash-up. The boat weighs 4300 pounds. To stabilize the hull and offset the effect of engine torque, Slo-Mo-Shun uses a large air fin at the stern. The fin is simply a stabilizer and isn't used for steering.

Most of the boats being built or modified

Horace Dodge is rebuilding My Sweetie's hull to make her a more dangerous challenger for 1951 Gold Cup

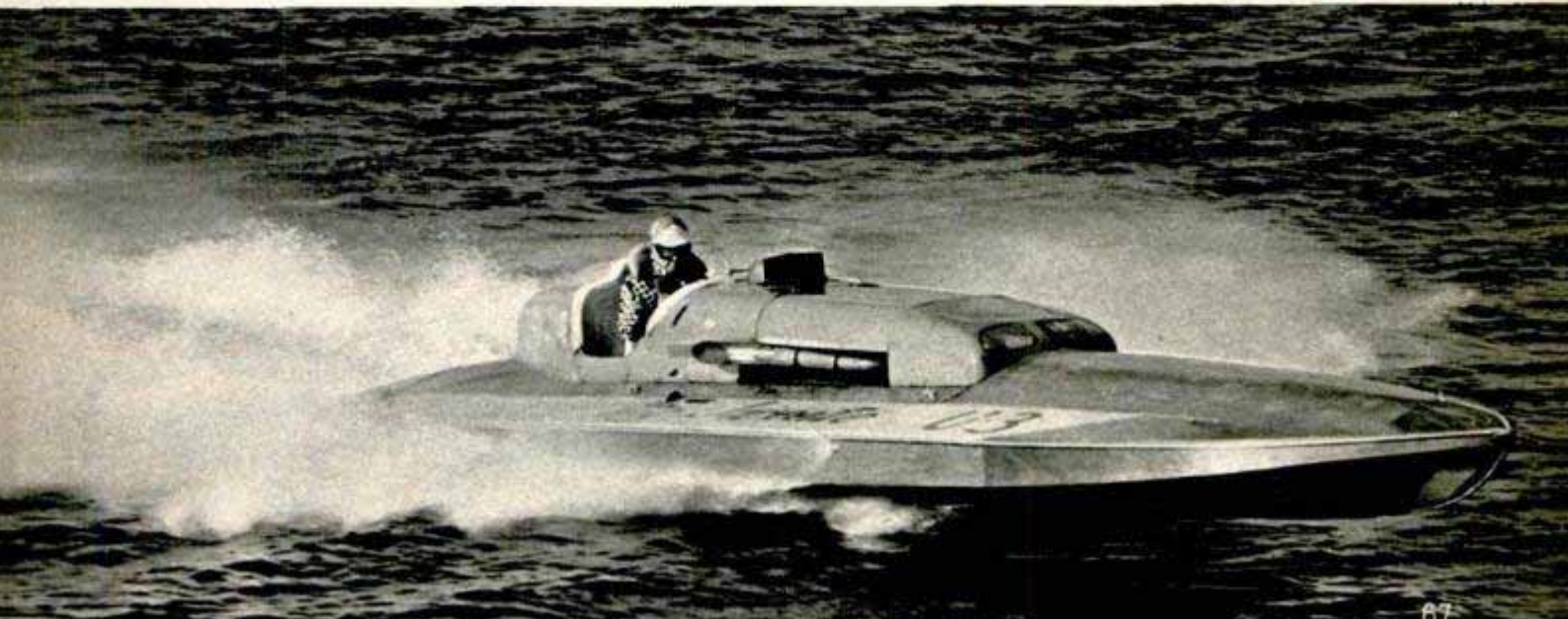

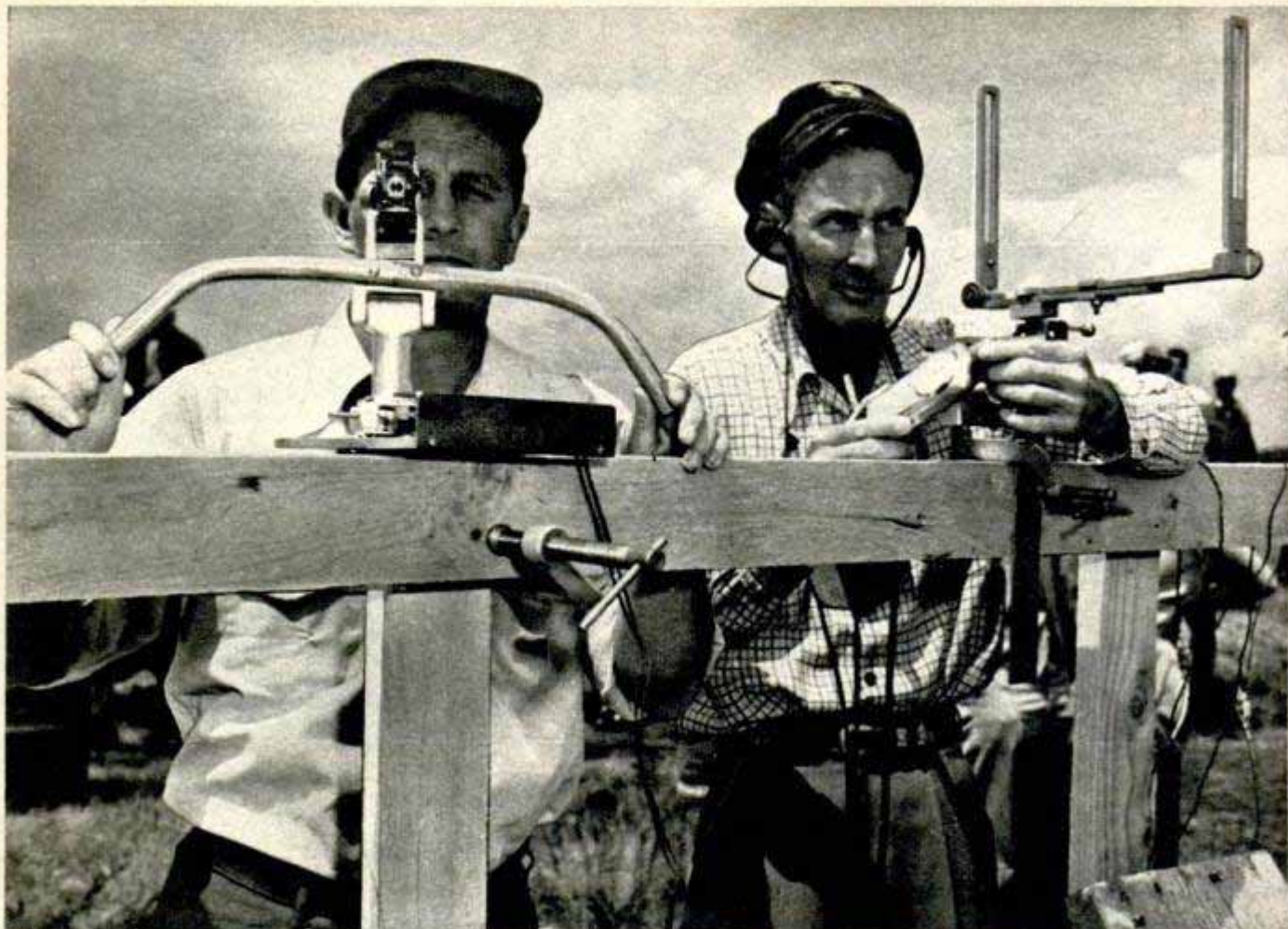

Special long-distance instruments on the beach clock the racing boats over the measured-mile lake course

this year will use a spoiler system, but there are several other ways to prevent a hull from becoming completely airborne.

Morlan Visel of Hollywood, whose Hurricane IV has been held back by control difficulties, plans to use a hinged airfoil attached to the forward deck. Adjusted from the cockpit, it is expected to hold the nose down to any degree desired, allowing the souped-up Allison power plant to deliver full power to the propeller.

Some such balancing arrangement is to be incorporated in the boats Dan Arena of

Mount Clemens, Mich., is building for various owners. Each boat will have the entire mechanical installation mounted on a pair of side rails secured to the hull with several sturdy, quick-change fasteners. The whole assembly can be lifted from the hull as a unit and replaced with a similar package in a matter of minutes. Two or more power plants for the same hull are expensive but the idea will save valuable time when testing different combinations of power and gear ratios.

The Arena-built boats are 30 feet long,



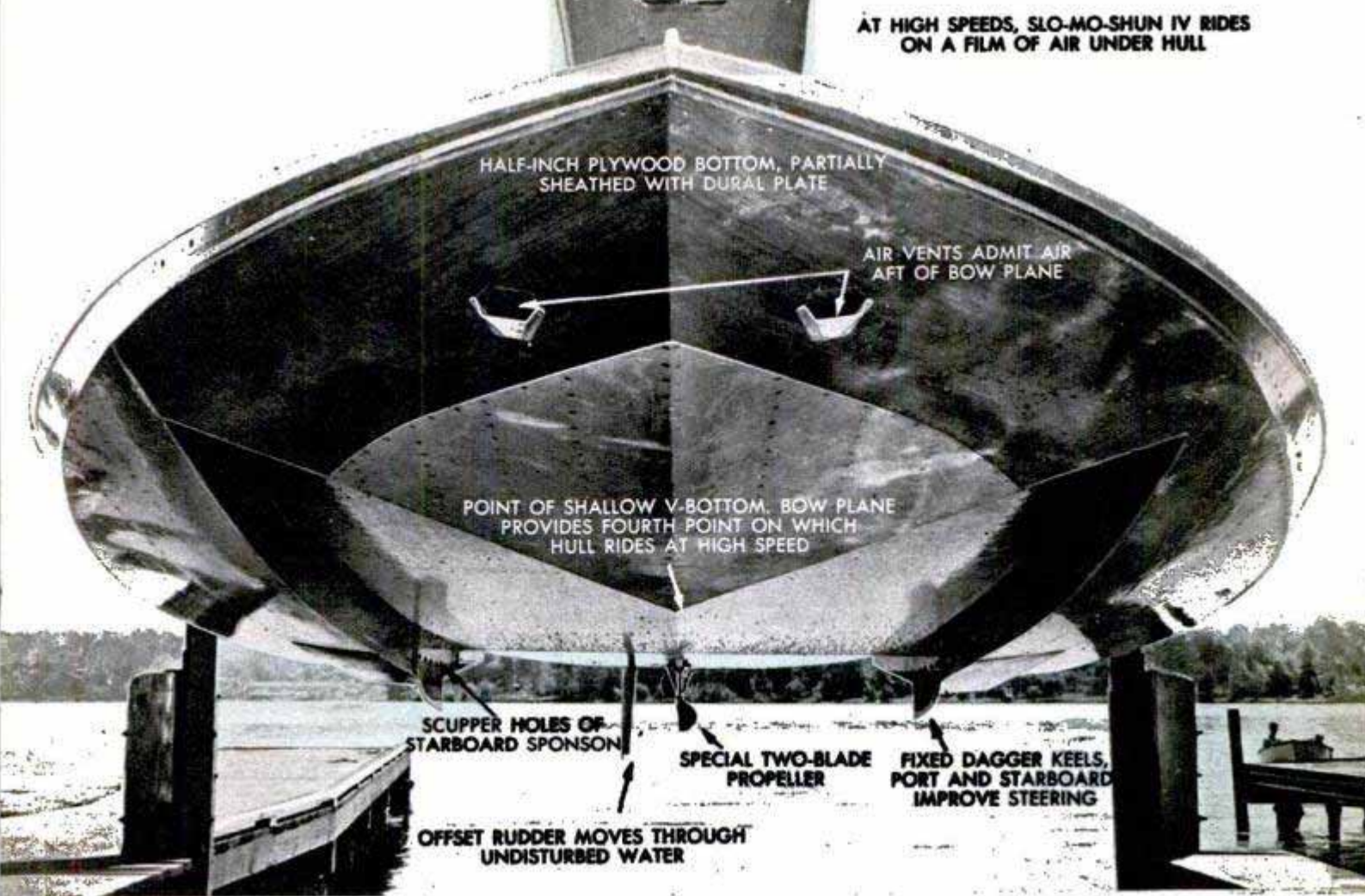

Looking up under the bow reveals shallow pyramid that provides Slo-Mo-Shun's vital fourth suspension point

have amidship sponsons, are planked with mahogany plywood, weigh 4200 pounds and are powered with single Allison 1710s.

Any boats that prove fast enough in the trial runs can be expected to try for a new world record. Others that will be in the race for a record include Such Crust II of Detroit, whose Allison engine has been replaced with a Rolls Royce of greater power, and Horace Dodge's My Sweetie, powered with an Allison and sporting a rebuilt hull for greater speed.

One dark horse in the race for a new

record is Henry Kaiser, whose engineers have been working for two years on Aluminum I, an unlimited hydroplane of Gold Cup capabilities. Also in the background is Kaiser's Hot Metal, a gigantic all-metal racing creation powered with a double Allison. This boat was built with the hope of setting a new world record at such a high speed that the mark wouldn't be threatened for years.

Meanwhile, Stan Sayres is ready to try again if Slo-Mo-Shun's present record is beaten. He had some throttle left when he was clocked at an average of 160 miles per hour and the belief is that the boat is capable of 20 more miles per hour.

The final factor for more speed on the water is the strength of drive shafts and propellers. Slo-Mo-Shun has already thrown several propellers and even after only two passes along a mile-long course at record speed a brand new propeller usually shows fracture lines close to the hub. When propellers are built that can withstand the terrific impact of slamming into the water at high speed, and when drive shafts can be beefed up so that they don't twist off, speeds up to 200 miles per hour on the water may be attained.

With a "rooster tail" spray of water rising 50 feet in her wake, Slo-Mo-Shun churns along to a new world record of 160.325 miles an hour—240 feet a second!



*power  
Gold Cup class*

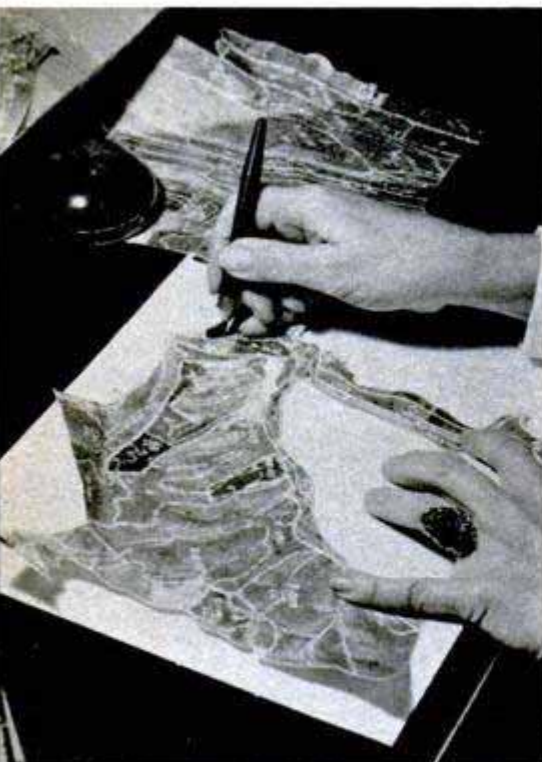

U. S. Department of Agriculture photos  
**Dozens of land parcels, varying in shape and classification, are cut from each small area-survey map**

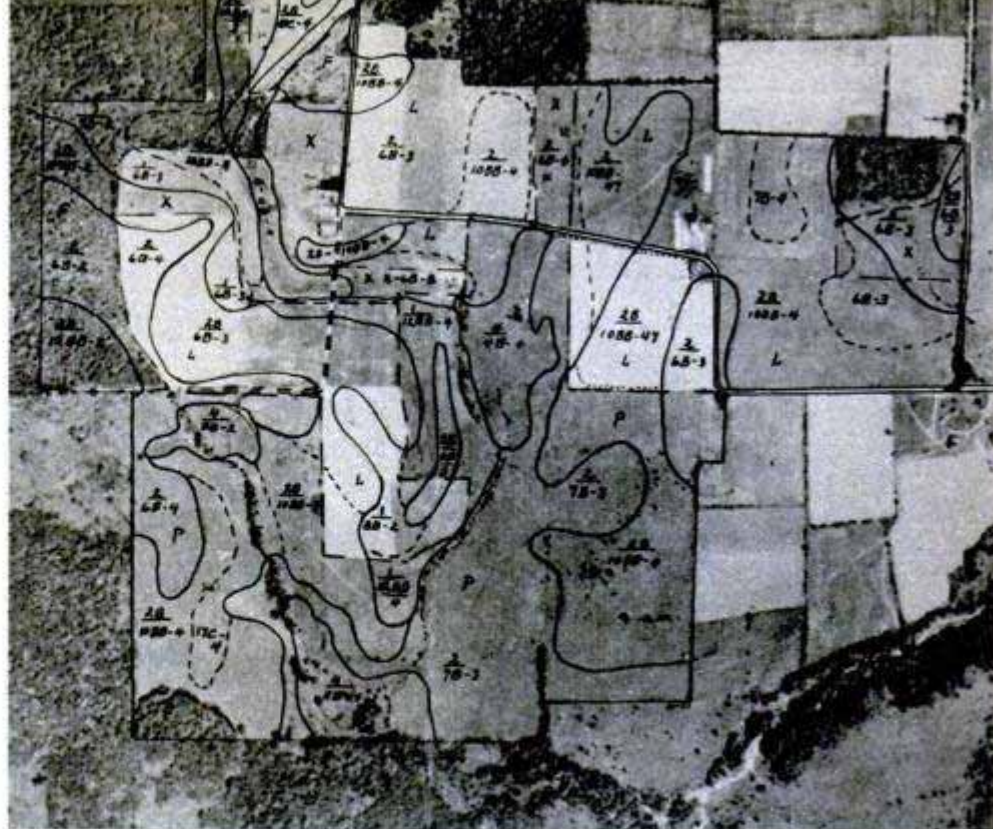

### LAND USE CAPABILITY MAP

This map prepared by		Owner <u>Willard Spicer</u> Phone _____
<b>U. S. DEPARTMENT OF AGRICULTURE          SOIL CONSERVATION SERVICE</b> M. H. Bennett Chief Austin L. Patrick Regional Conservator		Address <u>Apalachin, New York</u> Township <u>Omega</u>
		Operator <u>Same</u> Phone _____
cooperating with		Address _____ Township _____
<b>SOIL CONSERVATION DISTRICT</b>		Plan No. <u>301</u> Acres <u>300</u> Scale, App. 1"=660'
Omega, New York		Photo No. <u>AJ-51-28</u> Surveyor _____
Region I - Northeastern Region		Location of farm <u>1 1/2 mi. So. of Hiawatha Cabins</u> <u>on Route 17 between Omega &amp; Apalachin</u>

Right, as step one in "weighing" land, a soil-survey chart is superimposed on map of same area

# AMERICA "WEIGHS" ITS LAND RESOURCES

TO PLAN FOOD and fiber production, the United States can now literally "weigh" its basic stock in trade—a billion and a quarter acres of farm land. To do it the Soil Conservation Service has devised a new, faster way to inventory the hundreds of soil types, varying degrees of erosion and slope, and the many climatic and human factors involved. The method's basic principle is that an acre of land on one map should weigh the same as an acre on another map. After soil surveys are plotted on

standard-scale photo maps, cartographers using sharp instruments cut out the land parcels, jigsaw-puzzle fashion, and segregate similar kinds in separate envelopes. Each envelope's contents are weighed on fine analytical balances and, from the known weight per unit, the total area of similar land is calculated. Adjustments are made for variations in paper manufacture and weight, for differences in topography and minor scale deviations in aerial photo maps. In one of the two techniques now

used most commonly for land inventory, a transparent grid is laid over the map and the area of the parcels computed by counting squares and by interpolation. In the other, a stylus is moved completely around the perimeter of each plot and the area read from an indicator. Comparisons indicate the new method is never less than 99 percent accurate.

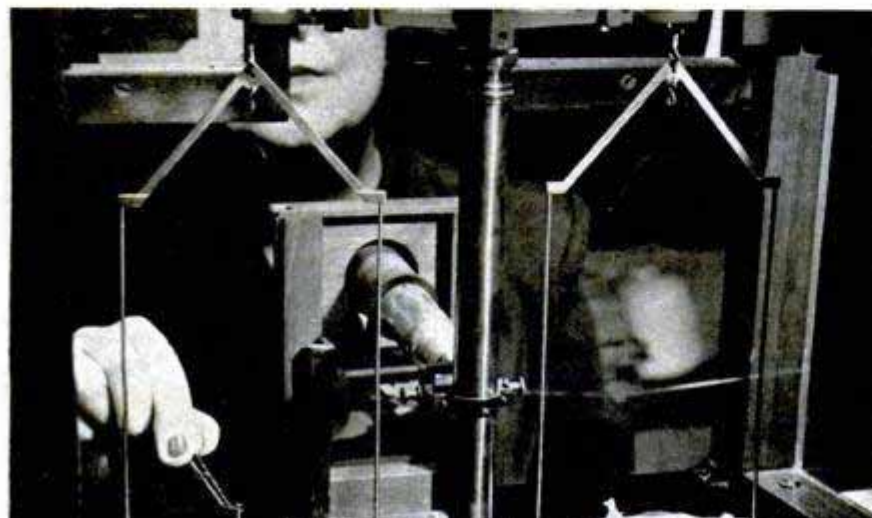

Analytical balances weigh the tiny cut-out map pieces, each classified as to its possible agricultural usage



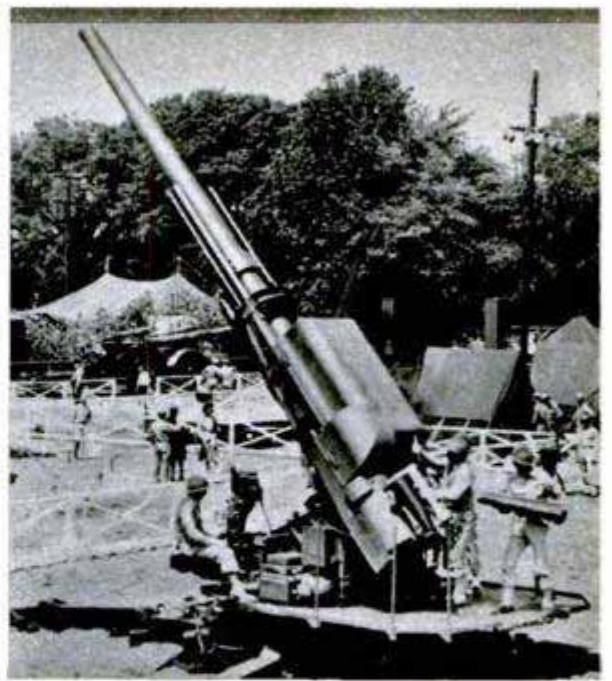
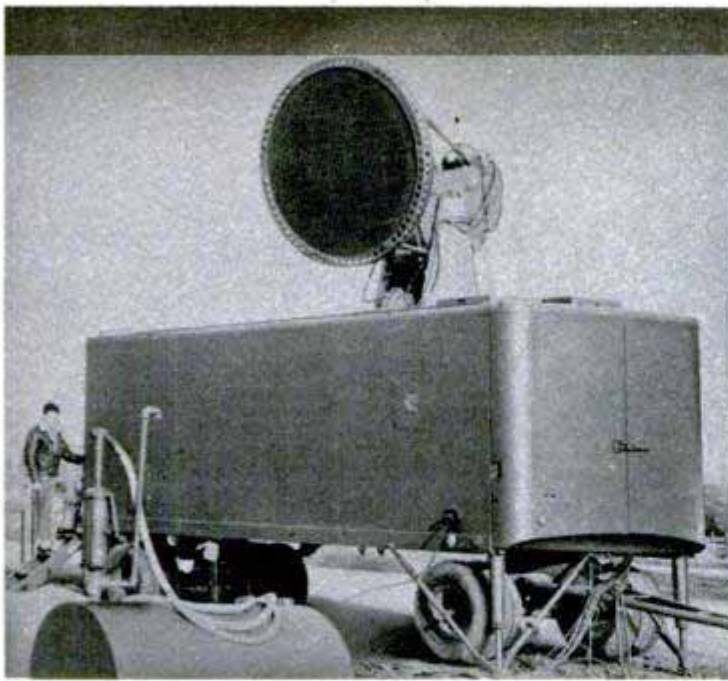

## Robot Antiaircraft Gunner

Antiaircraft guns are automatically aimed by a new fire-control system far more effective than the method used during World War II. The system, developed by Bell Telephone Laboratories, is a maze of wires, resistances, switches and vacuum tubes. It is an outgrowth of the earlier

computer, which tracked a hostile plane, calculated the wind velocity, muzzle velocity of the shells, temperature and similar factors, and then aimed the guns. The new fire-control system, adaptable to firing either 90-mm. or 120-mm. batteries, operates on the same general principle but assembles more information about the hostile craft and works more quickly and accurately.

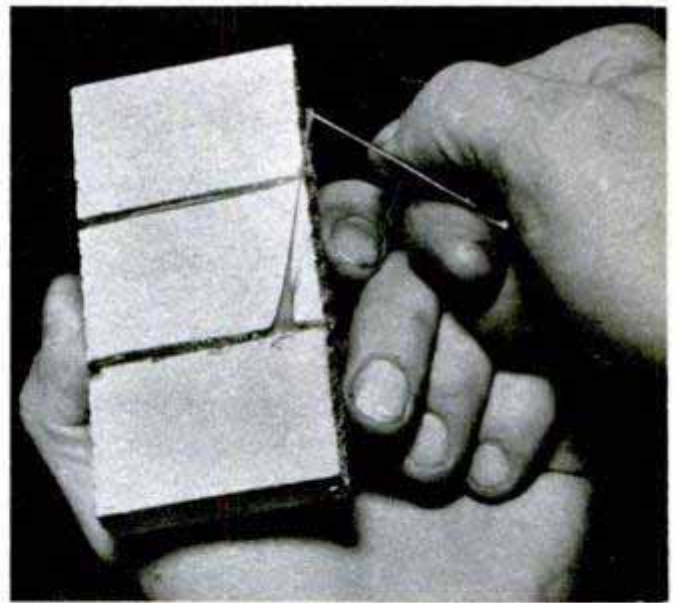

Marine Products, Inc., 166 N. Main St., Oshkosh, Wis.

## Rubber Compound Seals Boats

Boat seams can be sealed against leaks with a new compound made by homogenizing cured-synthetic rubber into a water suspension. The sealer is a heavy white

liquid, applied either by painting it on the surface with a brush or by flowing it from the spout of an oilcan. It adheres to wood, metal, glass and clean painted surfaces. The rubber compound also can be thinned and used to cement down canvas decks.

## Pilot Will See Own Plane and Others Near Airport on Television

Using a device invented by Douglas H. Ewing of Westmont, N. J., pilots will see on television whatever is on the screen of the ground-based, sky-scanning radar of the nearest airport. A pilot's own plane

and others in the area will appear as "pips," or light points, on the screen. The radar system will also include distance-measuring equipment to indicate a plane's proximity to the ground station.



Plot plan shows how roads wind around the circular lots in Usonia. Right, famed architect Wright laid out plot plan with a compass, passes judgment on each home to be built

Fugitives from the city, these suburbanites put their piggy banks together to build a . . .



Cosmo Sileo photo

**"CO-OP"**

# VILLAGE in

*By Clifford B. Hicks*

WHEN ARCHITECT Frank Lloyd Wright was a young man he had, as you might guess, an unconventional idea. It was his own conception of a modern community, which he called Usonia.

Many years later, a successful young engineer named David Henken also had an idea. His was quite conventional. He wanted to build a home for his family.

Through a fortunate accident, Henken's idea smacked head-on into Wright's. The collision produced, not just a home for Henken, but perhaps the most unusual community in America.

It's a village that meanders all over a wooded, hilly tract near New York City. Its modern homes boast

Inexpensive concrete blocks form a pleasing pattern on one of the Usonia homes designed by Theodore Bower

Jack Holmes photo

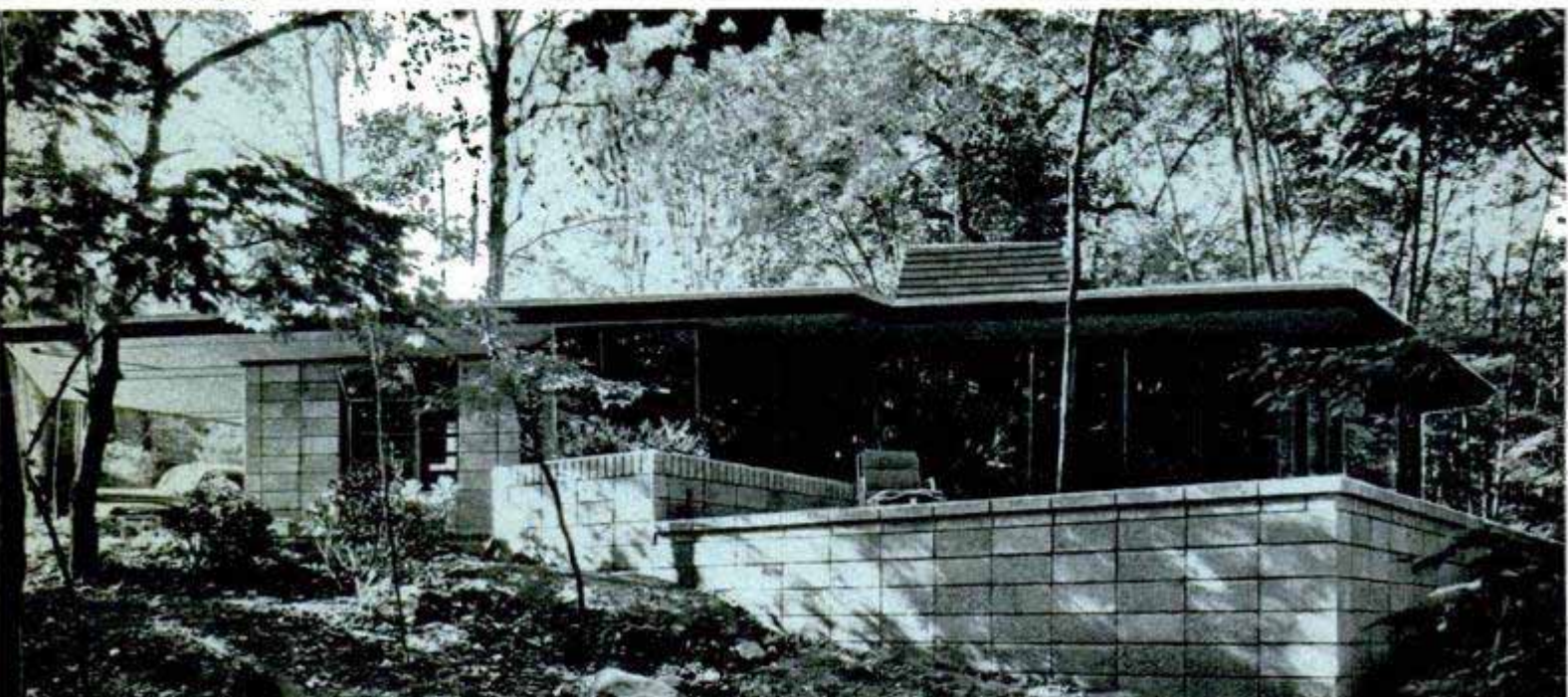

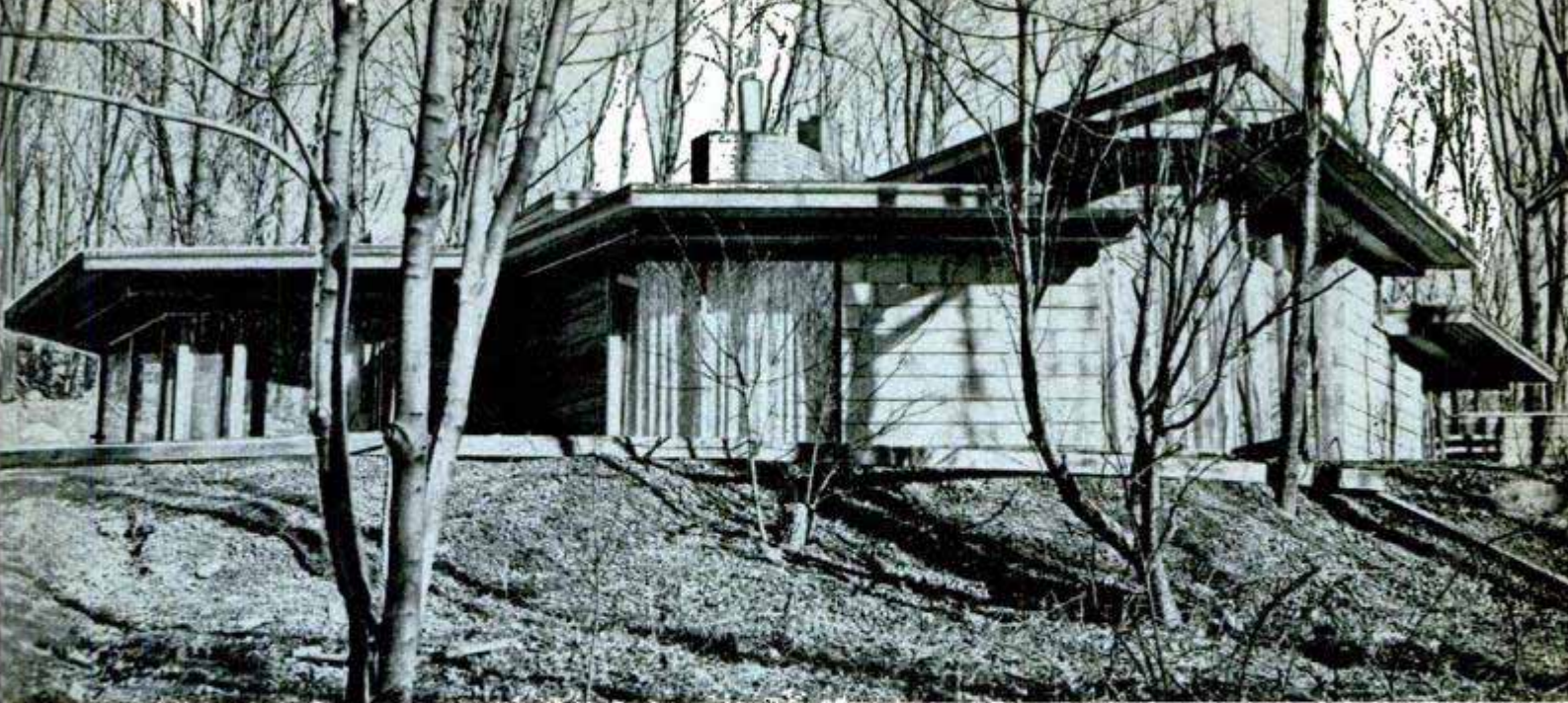

Walter A. Slattery photo

Most of the homes are low and solar-oriented. Roof trellises on this home by Henken will be covered with vines

# the WOODS

such unconventional features as circular lots, round and triangular rooms, flower gardens that creep through the walls and roofs so low that the kids use them as playgrounds.

In translating the two ideas into reality, the bearded young Henken has, at various times, found himself working as a butcher, serving an apprenticeship under Wright, pleading with mortgage companies, tracing lost persons, laboring as a stonemason and persuading an assortment of businessmen and office workers to forsake their cash registers and typewriters in order to do palm-blistering work on their own homes.

Henken says he wouldn't do it again for a million dollars. On the other hand, he wouldn't take a million dollars for his experience in helping build the community, which soon will have assets listed at just about that figure.

The homes are so unusual that a conventional contractor would throw up his hands at sight of the first elevation. If you visited Usonia today you'd probably find Henken on one of the building sites showing the workmen how to pour a concrete bathtub right into the foundation, or build a fireplace that will draw with an almighty roar.

Each home has a personality of its own that seems to wrap itself right around its family. There are some features, though, that are common to virtually all the buildings. The first is a minus factor—you won't find a basement, attic, dormer or guillotine window in Usonia. All the homes are built on a concrete slab, with radiant-heating pipes buried in the floor. The houses are solar-oriented to welcome the warmth of

the sun in the winter and lock it out in the summer. (In zero weather, on a sunny day, Henken can work in his shirt sleeves at his drawing board with the door standing wide open less than five feet away.) The houses are designed with as few solid partitions as possible, massive fireplaces, cantilever roofs, broad terraces and sweeping expanses of glass.

Henken's own home is nestled against the side of a hill, partially buried so the winter winds swirl across the roof instead of blowing against the house. So far, the designer has completed one level of an eventual three-unit home. Above the present unit, higher up on the hill, will be his studio,

Heavy vertical slats permit Mrs. Henken to see the play area, yet they close off kitchen from living area

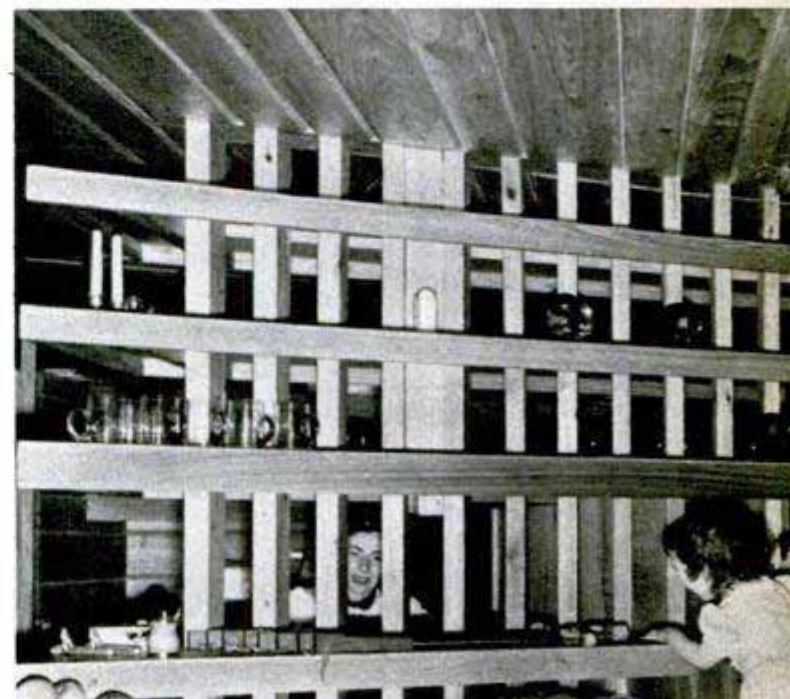



Two full walls of the living room are plate glass. Overhang passes sunlight in winter but not in the summer

connected with the central unit by a covered corridor. Below the present home he'll build a bedroom unit with the roof just the level of today's floor. Henken plans to sod the roof of the bedroom unit; then from the living room, his family can walk straight out onto a broad green terrace. Actually, they'll be standing over the bedroom ceiling.

Inside the present house you can't find a rectangular room anywhere. In fact, you can't seem to find a room at all, for partitions are so subtle they don't appear to be walls. As you walk through the living area, you suddenly find yourself in a little play area for children. Standing there, you are on the edge of the dining area, which apparently melts into the kitchen. Yet from the living room, the kitchen is screened from your view by thick vertical slats, set at an angle like a huge Venetian blind tipped on end. The slats form a strangely efficient wall, for they deny guests the sight

of the kitchen, yet they permit Mrs. Henken in the kitchen to hear clearly anything said in the living area and thus to participate in what's going on. She can peer right through the slats, though, at the children's play area a few feet away.

The Henken house is its own furniture and conversely the furniture forms part of the house. Bookcases are partitions, and the back of the sofa is a slanted wall. The attractive sofas in the living area roll out on wheels and convert into spare beds. A long table stretches along the living area, then turns at an abrupt angle around the corner and into the dining space, where it serves as the dining table. But—watch, now—where it turns the corner the two parts are joined by a V-shaped slot. If Mrs. Henken is entertaining quite a number of guests, she merely shoves the dining section of the table out so it joins the other section to form a long straight table which closes off the kitchen. From here she can

Some roofs are so low children can play on them. Tricky foundation lines call for new construction techniques





serve a full meal to guests buffet-style.

The roof is cut into "butterfly" sections, one on top of another, to shed light into the heart of the house. When he designed the kitchen as the core of the building, Henken thought he'd have to install a mechanical ventilating system. As soon as he moved in he discovered that the clerestory windows above the kitchen effectively carry out the heat and cooking odors. As he says—and he's modest about it—"the whole house seems to breath."

Shelves are built into closet doors, the bathtub is poured into the concrete floor slab and a flower garden flows from the terrace outside, through the plate-glass doors, and into the living area. The garden is watered by a perforated tube buried in the soil.

This wasn't at all the house Henken had in mind when he decided to build. At that time, in 1940, he was doodling with a pencil and discussing his ideas with several friends who wanted their own homes, too. Very few had enough money even to walk through the door of a real-estate office. Eventually, the men and their wives formed a cooperative, pooled their piggy-bank savings and started tossing \$10 per family into a cooperative kitty each week.

One day quite by accident Henken strolled through the Museum of Modern Art, which was sponsoring a Frank Lloyd Wright exhibit. The show included a model of Wright's "Broadacre City," his still-imaginary Usonia. The young engineer was so impressed that he wrote the famous architect of the cooperative's plans. Would Wright be willing to help? Yes, Wright would be willing to help.

Not long afterward a slightly dazed Henken suddenly discovered that he had given up his job, sold all his belongings and moved with his family to Taliesin, Wright's home at Spring Green, Wis., where he now was an apprentice-architect to Wright. For two

Cantilever concrete terrace is ideal for summer living. Tilted roof yields extra light inside the home



Odd two-part table in Henken's house can be angled either way or set in a straight line as buffet table

Henken shows how wall of concrete-block house tilts in at base. Rain drips off, won't penetrate mortar





Sawtooth wall gives each bedroom a door leading out to patio, double window for view in two directions

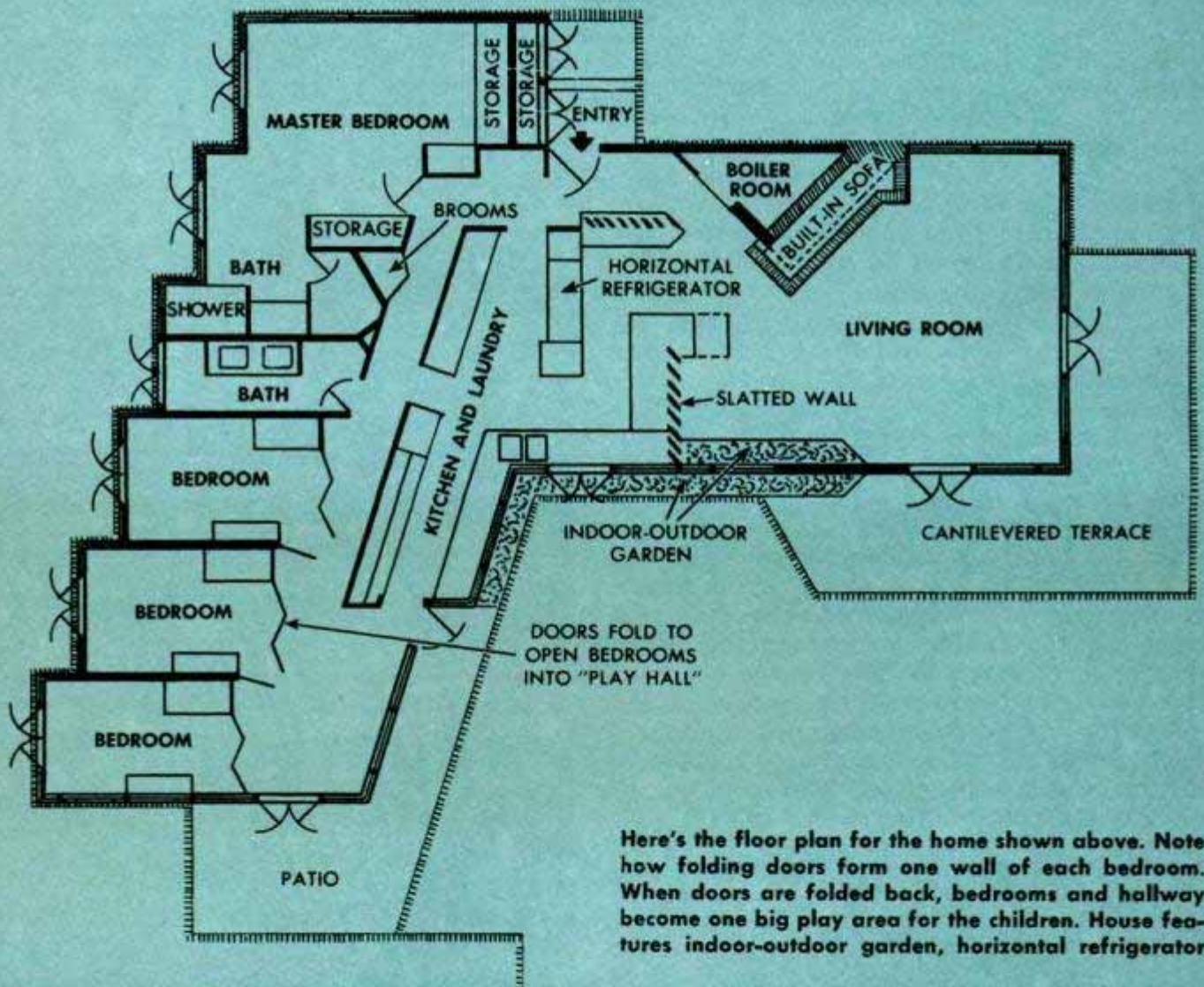

Here's the floor plan for the home shown above. Note how folding doors form one wall of each bedroom. When doors are folded back, bedrooms and hallway become one big play area for the children. House features indoor-outdoor garden, horizontal refrigerator

years he studied under the master. At the apprentice school he served as chief electrician and assistant butcher. During this period he and Wright made broad plans for bringing Usonia to fruition. Wright agreed to design five of the proposed 50 homes himself, to approve plans for the others and to design several community buildings.

By the time Henken returned to New York, the cooperative had accumulated

enough capital to search for a site. The members finally settled like homing pigeons on a tract in Westchester County, 29 miles north of New York. The title to the tract wasn't clear, and the Usonians ran up against one woman who didn't want to be served a court order. She just plain disappeared. Finally with the aid of detectives, Henken found her, oddly enough, in the maid's linen closet of a distant hotel, and



Built-in faucet waters a living-room garden that flows through glass wall from a garden outside



L-shaped living-dining area has fireplace at inside corner of ell. You can visit right through the fireplace

served her the court order. "Mysterious as a movie thriller," says Henken. Eventually, the title was cleared, and the cooperative had possession of a 93-acre tract.

Wright visited the site, then laid out the plot plan with a simplicity typical of the man. He merely picked up a compass and, on a map of the plot, drew perfect circles, tangent to each other. A Usonian's lot consists of a circle 217½ feet in diameter. Each homeowner has, touching his property, three neighbors and three community lots. All the land wedges between the circles are held by the community, too—perfect spots for playgrounds.

Usonia's winding roads skirt right around the edges of these circles or traverse the community lots. The roads are purposely laid out to foil the speed demon. Try to drive through Usonia at more than 15 miles per hour and you'll find yourself wrapped around one of the huge trees.

Just next door to Henken — if you can consider several hundred feet of wooded hillside next door — is the house he built for his father. Its principal feature is a roughly L-shaped living and dining area, with a huge fireplace at the inside corner of the ell. The fireplace has no lower support — it's suspended from above. A guest seated at one end of the ell can "look around the corner" at everyone seated in the other section. Actually, he's looking directly through the fireplace.

Most of the Henken-designed houses are built of oiled cypress. There's no expensive decoration or maintenance — all the homeowner needs for upkeep and appearance is a can of wax.

Another Usonia home is made of inexpensive concrete block. One difficulty sometimes attributed to concrete block is water

penetration. This problem was solved by overhanging each course of block slightly, so the whole exterior wall "tips" slightly outward at the top. Rain striking a block runs down it, then drips off the edge instead of penetrating the mortar.

The most unusual home in Usonia is one that Wright designed. It's a round house set on a circular lot, and it seems to grow right out of the highest ridge in Usonia. Each element of the house is a circle or arc, from the big disk-slab roof to the carport that resembles a gigantic modernistic mushroom.

Most of the homes in Usonia fall in the \$15,000 to \$30,000 bracket, though Wright's circular house was tagged at \$75,000. Henken has designed 10 homes for the community. Aaron Resnick, another member of the group, has designed seven. Usonia now has 15 houses completed, another 15 underway and eventually there will be 50 homes scattered across the wooded hills, leaving nearly half of the 93-acre tract for community use.

Five years ago, after they acquired title to the tract, the Usonians unsuccessfully sought an investment company that would grant them a cooperative mortgage. Finally, they decided to build what they could with the funds at hand and provide much of the labor themselves. Savings accounts were withdrawn, piggy banks robbed. Fifteen homes have been built in Usonia by scraping up the pennies.

But Henken and his associates finally have come to terms with a progressive investment company. Homes now going up in Usonia have outside financial backing. Here's the way the plan works:

You decide to build a home. Perhaps you

(Continued to page 226)

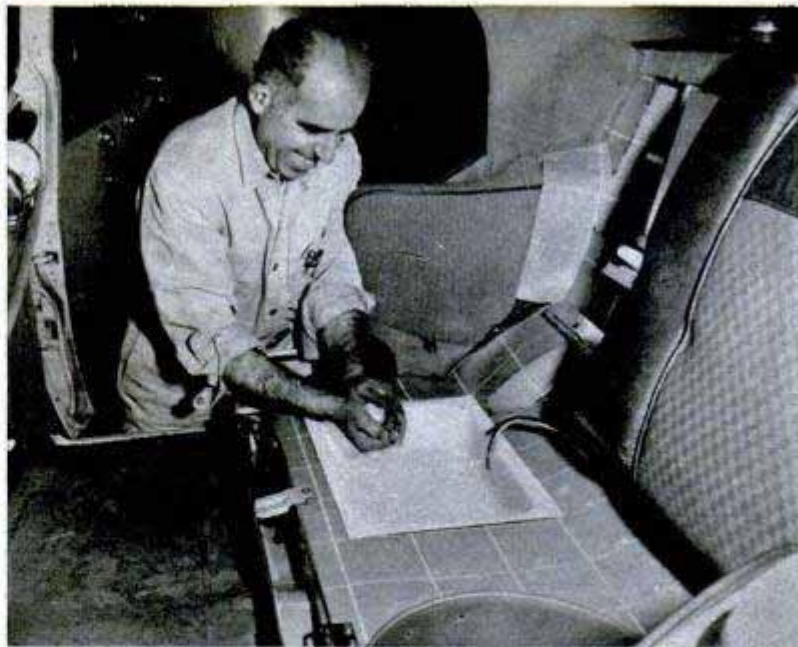

## What, No Electric Iron?

Remember the San Diego automobile equipped with shower bath, barbecue and soda fountain that was described in the January 1951 issue of *Popular Mechanics*? Louis Mattar, the owner, is still busy adding more fixtures to his rolling home. Now he has an electric washing machine and wringer, lavatory, mirror, electric shaving outlet and medicine cabinet all concealed behind and under the rear seat cushions. The lavatory has hot and cold running water, and the washing machine has a special overhead motor and head. A converter provides 110-volt alternating current from the car battery for the equipment.

Left, Mattar has a shave in "bathroom" section of his auto. Above, lavatory is concealed under rear cushion. Below, there's even an electric washing machine and wringer in the palatial car

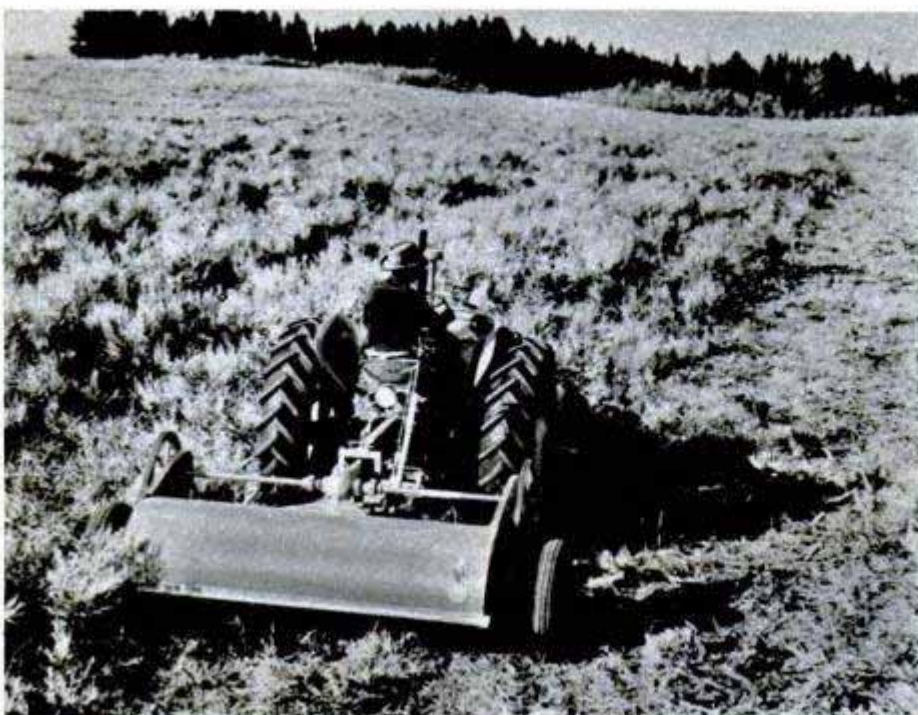
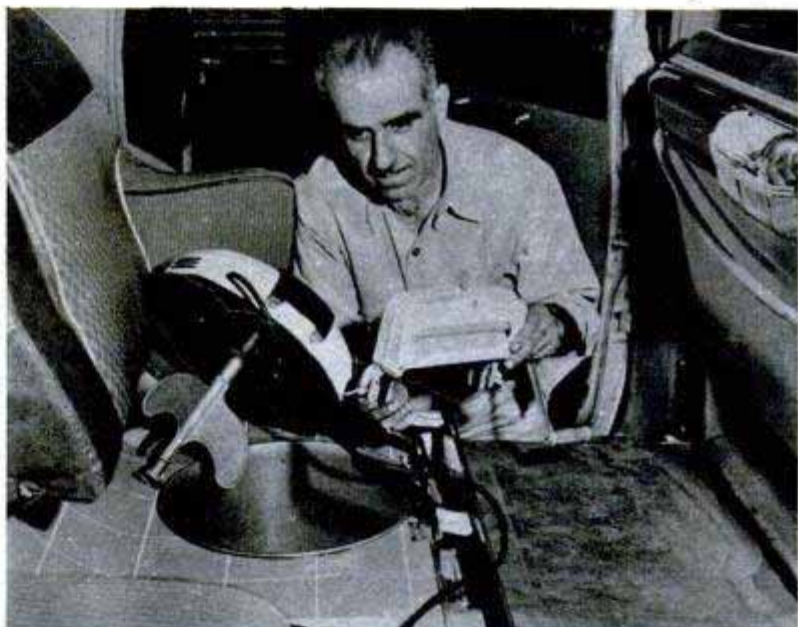

## Sagebrush Shredder

Western ranchers expect big things of a stalk shredder that was designed to chop down cornstalks, but has proved it can tear apart bothersome sagebrush. Some 12,000,000 acres of sageland in the West could be turned into grassland if the brush could be kept down. The shredder has an 80-inch rotor shaft that whirls 42 chains around 1400 times a minute. Attached to each chain are two steel hammers. The 84 hammers deliver a total of 18,000 blows a minute per foot of ground.





## Plastic Plants

Real enough in appearance to fool the eye of any but the most discerning, plastic plants provide attractive floral decorations that require no attention other than an occasional dusting. These plants, made of Ameran plastisol, are not affected by heat

Plastic Plants Co., 210 St. Clair Ave., N.W., Cleveland, Ohio up to 175 degrees Fahrenheit and are fire repellent and completely washable. Available in a wide color range, the plastic eliminates the fire hazard of previous artificial foliages. Leaf and stem structure of such decorative plants as Chinese evergreen, Philodendron and Caladium are reproduced by the manufacturer.

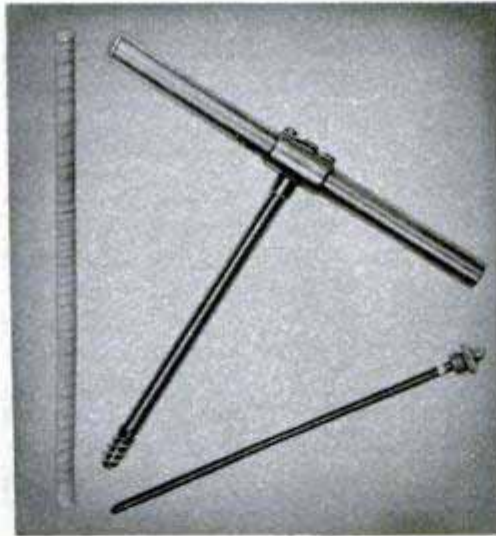

## Borings From Trunk Reveal Tree's Age

Using a special borer, foresters can extract a core of wood whose annual rings indicate the tree's age. Essentially a hollow auger, it bores to the trunk's center and forces the wood into a tube from which it is removed by an extractor rod. The hole either fills with pitch or it can be plugged with tar, leaving the tree unaffected.

## Rubber-Tape Wrapping Gives Handles Nonslip Surface

Wound around the handles of golf clubs, tennis rackets and tools, a new rubber tape provides a nonslip gripping surface. The strip of rubber can be installed without the aid of tools. It simply is wrapped around the handle and sealed in place. An overlapping flange prevents the grip from working loose. The rubber strip will be manufactured in various styles for sports equipment and hand tools.

Ⓞ Diesel-electric locomotives sometimes are operated a half million miles between major overhauls.



# Miniatures BUTTERFLY

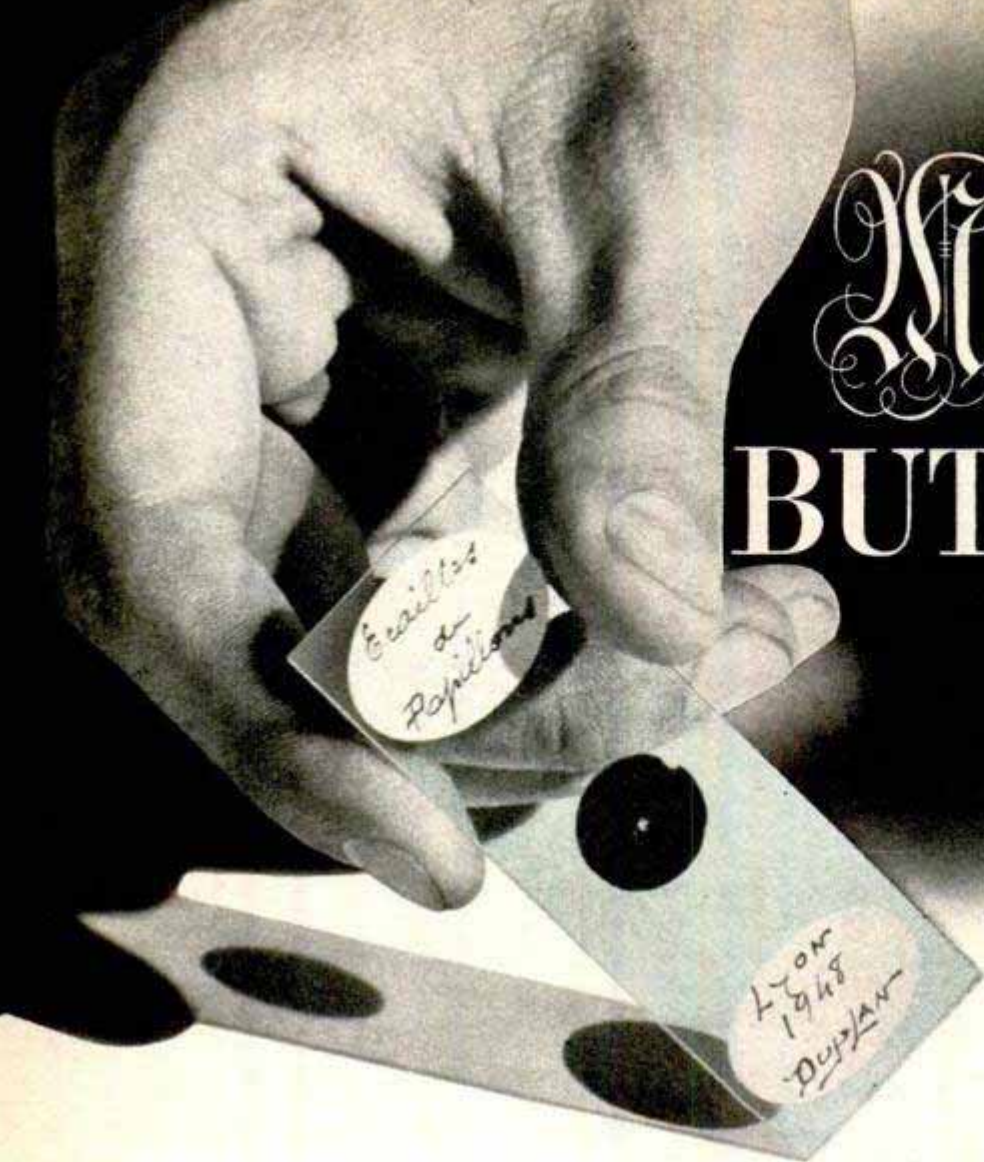

See the tiny spot on the microscope slide? It's about  $\frac{4}{100}$  inch in diameter and it's a complete painting, shimmering with breathtaking colors

Duplan's micromanipulator "gears down" the movements of his hands. The "brush" is a pig's eyelash!

Viewed under a microscope, butterfly scales look much like the scales of a fish. They are Duplan's "paint!"

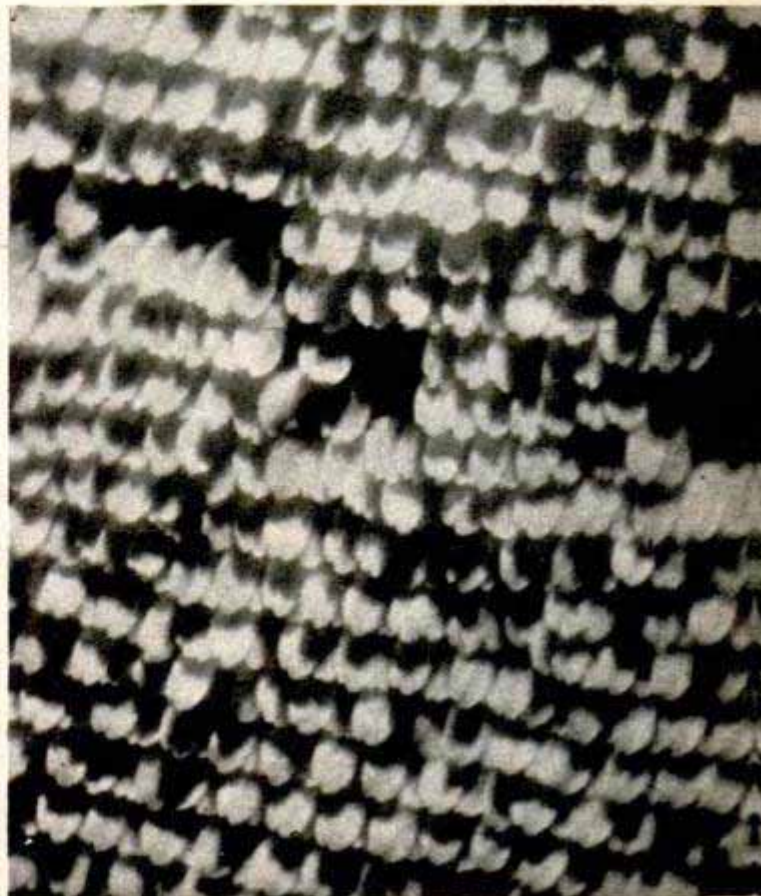

# From WINGS



Photos by Edouard Mouriquand

**N**OT MANY PEOPLE know that butterfly wings have scales almost identical with those on a fish. Even fewer ever bothered to examine these scales under a microscope. And Anatole Duplan probably is the only living artist who uses the tiny scales as "paint" in drawing his pictures.

You can't see one of Duplan's works of art with the naked eye—it's only a spot on a glass slide. But put the slide under a microscope and the picture comes to life in shimmering colors that can be duplicated only by the sun glowing on a butterfly wing.

That fine dust you may have noticed on your fingers after handling a butterfly or moth actually is the scales from the wings. Duplan, 75 years old and a resident of Lyons, France, sorts these scales according to shape, color and size and keeps them in small glass bottles for convenience. Ready for a new painting, he puts a drop of transparent glue on a microscope slide and starts mounting each scale in place.

The best instrument he has found for handling the scales is—no kidding—a pig's eyelash. It is the finest yet strongest manipulator he has discovered. Duplan has designed a micromanipulator which "gears down" the movements of his hands. He

Here are two of Duplan's colorful paintings. Actually they are the size of the spot shown on opposite page

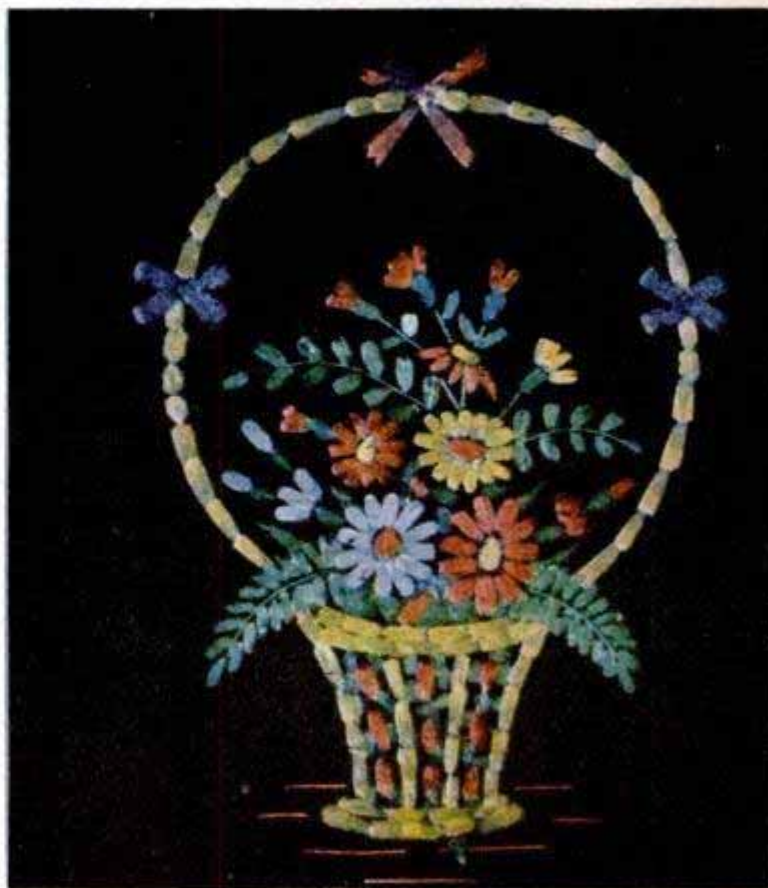



Most of Duplan's masterpieces show flowers or birds. Each petal, leaf or wing feather is an individual butterfly scale. Antennae from the butterfly form stems and other lines in the paintings. A drop of glue holds the particles together



looks through a microscope at the glass slide, moving a handle to which the pig's eyelash is fastened. A major movement of his hand produces only a tiny movement of the bristle. With the other hand Duplan manipulates a lever which moves the glass slide.

Each scale is picked up by the pig's eyelash and placed dull side upward on the glass according to the planned design. It takes Duplan 12 to 15 hours to complete a painting, which must be done at one sitting.

A finished painting is warmed in an oven to dry the glue, then mounted on a black background which brings out the brilliant colors of the scales. The completed picture measures about  $\frac{1}{100}$  inch in diameter.

Duplan also uses butterfly antennae to form lines in his paintings—flower stalks and background details. Most of his pictures show flowers, birds and insects.

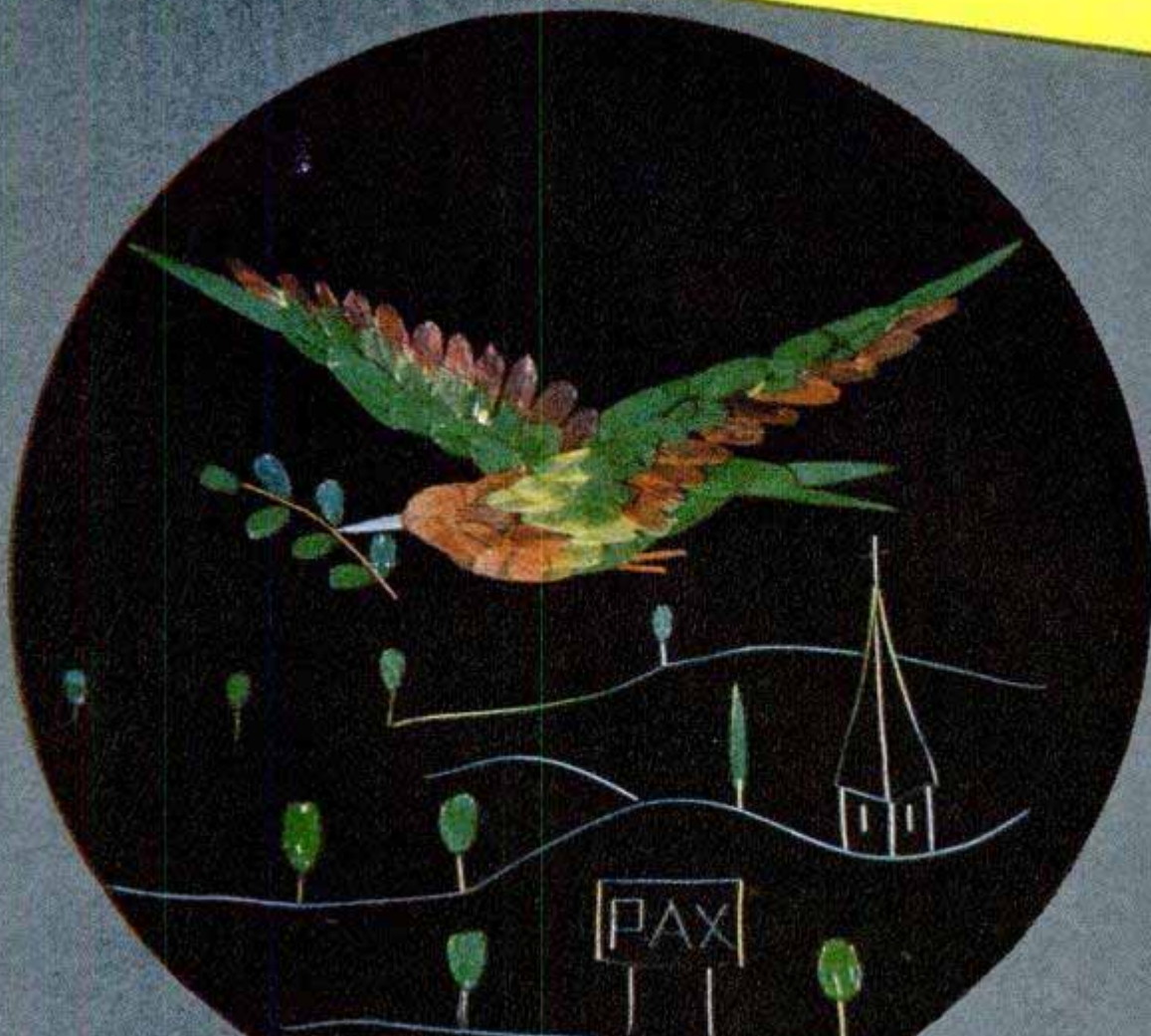
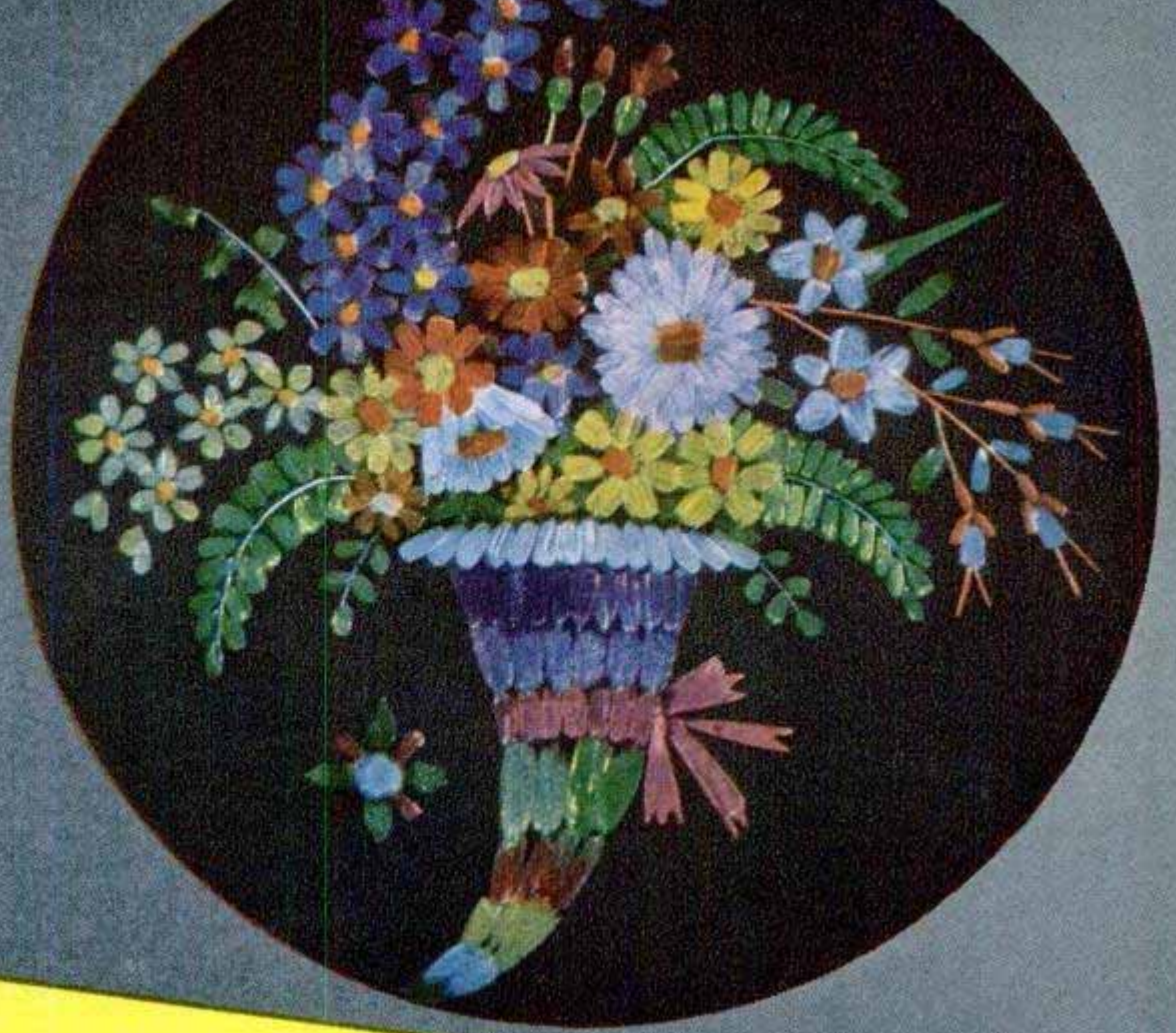



Twenty men can float to safety in a new Air Force life raft. It has survived 60-mile-an-hour winds in tests



Air Materiel Command photos

In bad weather the canopy's sides can be pulled down for protection. A drain on top traps water for drinking

## 20-Man Umbrella Raft

**W**EIGHING only 49 pounds, but capable of supporting 5000, the Air Force's new 20-man life raft looks like a floating circus tent. It can be tossed from a plane and inflated in one minute. A 25-foot lanyard attached to the raft packet is hooked inside the ditched plane before the packet is thrown overboard. After 10 feet of line has played out, the raft automatically inflates and can be pulled over to the plane's door. To simplify boarding, three feet of the perimeter remain uninflated until all are aboard, when a crewman blows up that section with a hand pump. The basic raft is made from two rubberized-nylon flotation tubes with a floor in between. There is no danger that it can inflate upside down in the water since both sides are identical. Each tube can independently support 20 men and if one is damaged an equalizer valve can be shut off, saving the remaining tube. An inflatable center bubble under the raft supports its floor eight inches above the water. The protective canopy, which is held up by a mast and side supports, is dyed a high-visibility color on one side and the other is sea-blue to aid downed airmen in camouflaging their craft in unfriendly waters. A drain in the canopy helps trap rainwater for drinking. A container attached to the raft holds the hand pump, repair tools, pliers, oars, bailing buckets, anchor, day and night distress signals, rations, first-aid kits, sea-water desalting and distilling equipment, fishing gear, sun-protective ointment and other emergency supplies. A new-type mattress floor, still in the experimental stage, is expected to give the craft

rigidity and better insulation. Four hundred of the rafts, which were developed by the Aero Medical Laboratory at Wright-Patterson Air Force Base, are being built for the Military Air Transport Service. The complete unit makes a compact 18 by 36-inch bundle.

Weighing 49 pounds, the entire 20-man raft unit folds into a compact 18 by 36-inch bundle





# Detroit Listening Post

*By Siler Freeman*

**N**OW THAT the auto manufacturers have definitely established the V-8 high-compression engine in a permanent niche, attention is being focused on the combustion chamber as offering possibilities for research and development towards the ultimate aim of more miles per gallon of gasoline. In other words, the "mechanical octanes" the designers are able to build into power plants to compensate for chemical octanes that the defense program is taking out of the present-day fuels center around the shape of the combustion chambers.

Chrysler, proud of its new V-8 engine which uses regular rather than premium fuel, has talked freely about its oddly shaped combustion chamber which enables it to get 180 horsepower with a 7.5-to-1 compression ratio. The chamber is hemispherical, with a lateral overhead-valve arrangement. The old Liberty engine used a hemispherical combustion chamber, too.

Now, General Motors has come out with what it calls the 19XX experimental engine. It is designed primarily for the Cadillac, has a displacement of only 287 cubic inches against Chrysler's 331.1, and a compression ratio of 12 to 1.

Being an experimental engine, it is not being shown as a rival to Chrysler's Firepower. However, it offers possibilities which C. L. McCuen, director of General Motors' Research Laboratories, believes are limitless. It can be enlarged slightly in

British-built Consul imported by Ford for sale in the U. S. saves scarce materials as well as gasoline



displacement to give as much as 207 horsepower or trimmed down to a smaller, compact unit that could avail itself of fuels of 95-octane rating, only recently available around the country, at 10-to-1 compression ratio with tremendous saving in fuel. The horsepower at 10 to 1 could be around 180.

What is the secret of this new engine which follows the lead set back in 1947 by C. F. (Boss) Kettering's six-in-line, 12-to-1 engine? It is in the combustion chamber—but McCuen is not ready to reveal it.

Although Cadillac has its eye on the new power plant, it will not change its present V-8 160-horsepower, 7.5-to-1 engine for 1952. It doesn't need to, says Don E. Ahrens, general manager of the division. It is still the most economical engine in its price class and weight. The combustion chamber might have been adapted to the present engine were it not for the tooling situation in the defense picture. Now it is a long-range possibility, perhaps for the 1953 models which Ahrens hopes to build. He is the only one in the industry with optimism enough even to mention 1953 possibilities.

But, there is something much nearer to the motoring public than the 19XX engine. That is a new Hydra-Matic transmission which is almost as much a part of the new power plant as the combustion chamber. It's "teamed" with the engine.

It is called a "dual range" Hydra-Matic. By changing the valving but without add-

General Motors' experimental 19XX engine is a V-8 with 12-to-1 compression and designed for Cadillac

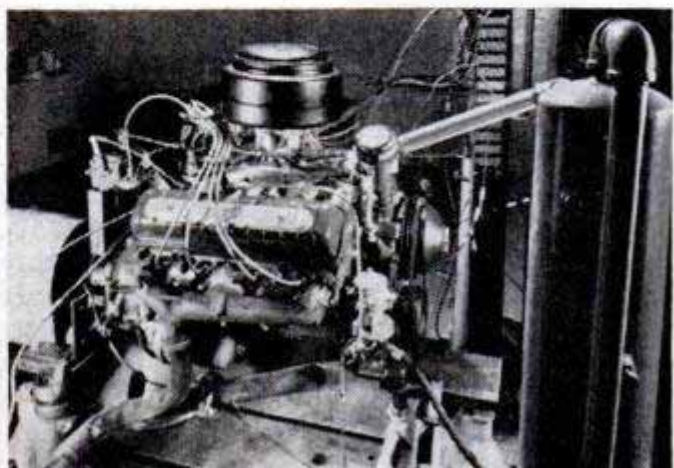



ing any gears, the Detroit Transmission division of GM has put a "third" driving range into the transmission for city or mountain driving. It gives more positive control, added power and economy at the disposal of the driver, without disturbing the smoothness and ease of handling. The new driving range takes the place of the "low" which penalizes in economy for added power it gives.

The dual-range Hydra-Matic is headed for the 1952 Cadillac, combined with the present 7.5-to-1 engine. It is not the rumored combination of Hydra-Matic and torque converter. That development is still some time off, according to Fred Arnold, chief engineer of Cadillac.

The new DeSoto engine is well on its way, too. This is a modification of the Chrysler V-8 Firepower. It will have about 130 horsepower instead of the 180, because of reduced bore and some minor changes in valving.

Plymouth is reported testing a new engine for future use. Probably not for its 1952 models. Plymouth, now the heaviest of the Big Three lower-priced cars, can reduce many pounds if it decides to get some new components. Dodge also has a new engine in the works, but the confusion about tooling may delay it.

Meanwhile, this month should show the start of the expected drop in car production, and the rest of the year will show a much lower level than the first six months. The Controlled Materials Plan, which is expected to corner at least 50 percent of available materials, will leave the automobile companies in the position of hunters, each seeking its own game.

Two new hardtops should be making their appearance this month. Nash's long-awaited Rambler "convertible convertible" will be out later and Hudson will have its entry ready for the dealers, too. This will just about round out the list of passenger-car manufacturers in that field.

Ford's announcement that it is importing the British-built Consul for sale in this country has revived some thinking that dwindling materials can be stretched by concentrating on lighter and smaller cars. Ford and Chevrolet are reported taking another look at the postwar light cars which they finally rejected because the cost factor didn't leave too much of a margin between present models and the new ones.

Inquiries by customers on mileage are causing some concern. Many believe gas rationing may still be imposed with other controls. Traditionally, the small car has not found favor with American motorists. But they would rather drive a small car than have a big one in the garage for lack of gas coupons.



Precision Building System, Inc., Canton, Ohio

### Canal Fulton, Ohio

## Interlocking Construction Block

Strong, plumb walls can be built without skilled labor with new construction blocks which interlock. The blocks can be made from a variety of aggregates including slag, pumice and cinders. Each block has a tapered shoulder on the top surface and a recessed section on the bottom. Steel reinforcing rods can be installed in the wall, depending upon the strength required. Grout is injected through holes in the block, forming a seal around each unit. On the outer surface of the wall, only the thin line between blocks can be seen, but on the inside the proper grooves are filled with grout to bind the blocks together.

## Farm Wastes Grow Wonder Drugs

Farm waste products are valuable sources of materials in which to grow antibiotic molds, the lifesaving wonder drugs. Farmers can feed the antibiotics to poultry and swine, making them grow faster and reach the market sooner. These wonder drugs can also be used in farm-related operations. Citrus fruit is protected from molding, lumber from fungi and milk from spoiling caused by microorganisms.

☐ According to Einstein's theory that a body radiating light is losing mass, General Electric scientists say the sun loses about 4,620,000 tons per second. However, its mass being over two billion billion billion tons, it would take 150,000,000,000 years at the present rate for the sun to be reduced by one percent of its mass.

# TNT

# CLINIC

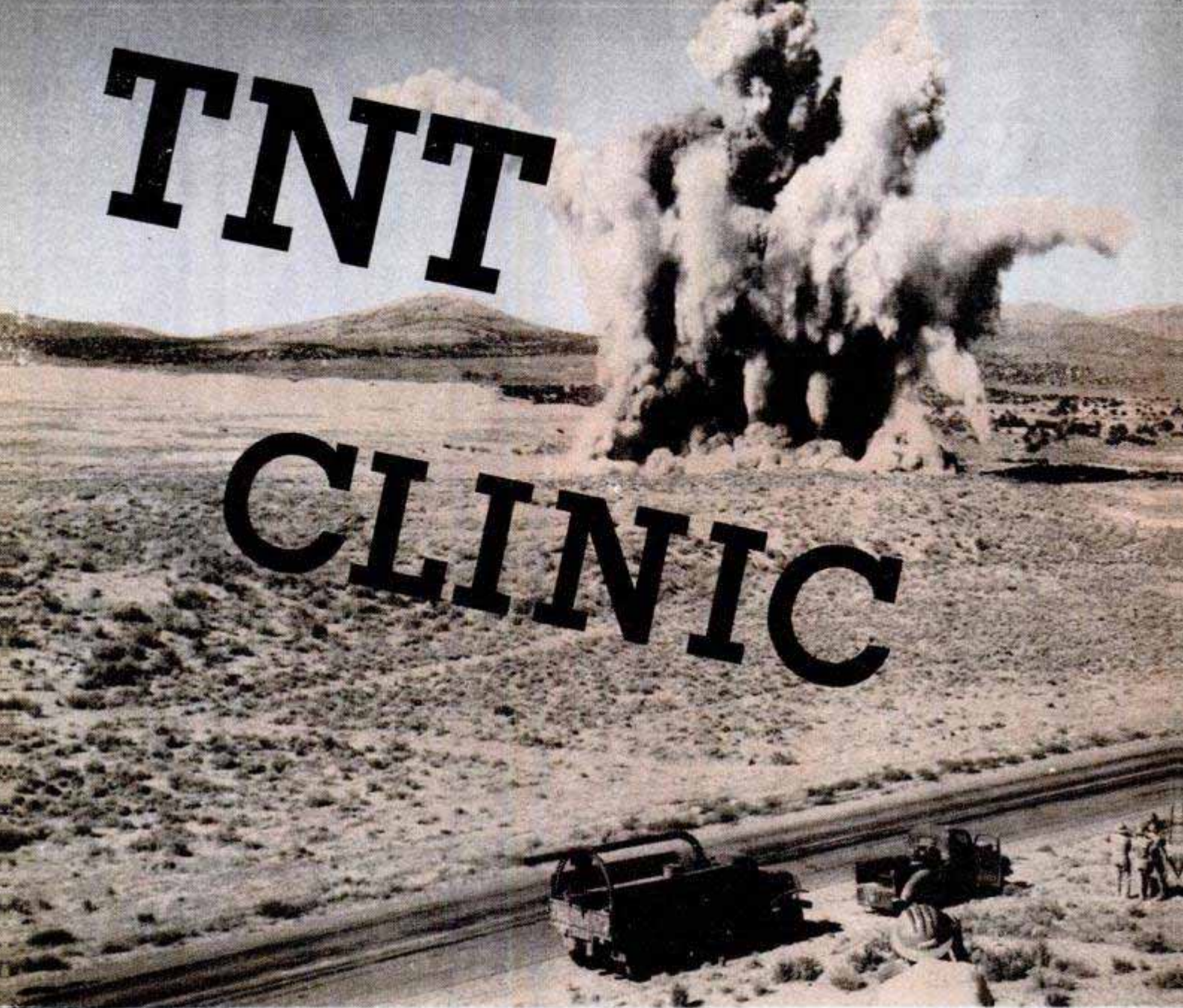

Army engineers explode huge charge of TNT in Utah, duplicating in miniature the explosion of an atom bomb. Below, these instruments will check the shock



**By Ewart Thomas**

A THICK COLUMN of earth erupts from the desert floor five miles from your observation point, shoots straight up for hundreds of feet, then blossoms into a giant mushroom cloud. From its base, a low fog of dust rolls out in all directions.

Some 25 seconds later the single heavy report of the explosion reaches your ears.

What you've just witnessed was a scale

RECORDING TRAILER  
UNDER HEAVY TIMBERS

CABLES CARRY INFORMATION TO TRAILERS



REINFORCED-CONCRETE  
TARGET STRUCTURES



model of the underground explosion of an atom bomb.

The blast was caused by 160 tons of buried TNT and was the largest deliberate detonation of an ordinary high explosive ever attempted. It was part of the Underground Explosion Tests being conducted by the U. S. Army Corps of Engineers on a portion of Dugway Proving Grounds near Salt Lake City.

By mathematical formula, the blast rep-

resented a certain small percentage of the full power of one of America's newest atomic weapons.

The explosion cloud was still high in the air when the pilot of a DC-3, that had been cruising near by, whipped his plane around in a tight turn and flew directly into the dust and smoke. Automatic samplers on the plane's wing collected samples of the airborne dust, and other instruments measured different conditions in the cloud.

Meanwhile, half a dozen Jeeps were racing toward the smoking crater so scientists could attend to the numerous instruments that had automatically recorded the effects of the blast on the buried targets.

Unlike a true atomic explosion there was no radiation effect, and yet radioactivity had played a certain small part in the test. To simulate flying debris, the scientists had buried a number of artificial rocks in the earth above the charge of trinitrotoluene. These rocks, consisting of concrete shapes, would hurtle through the air when the explosion occurred and most of them would bury themselves when they landed. Each block contained a small amount of radioactive tracer element so scientists carrying Geiger counters would be able to find them.

The United States knows exactly what happens when an A-bomb explodes in the air, and scientists have measured the shock and contamination from an underwater atomic burst. Today, we need to know the effect of an underground explosion such as would occur if a big guided missile with an atomic war head plunged into a target area.

We need to know how deeply a vital communications center or a military headquarters needs to be buried to survive such a blast. Contrariwise, it is important to know what damage an atom bomb that plunges to earth would do to the buried water and sewage pipes and other public utility lines of an enemy city.

To find out, at least one atom bomb is being exploded underground at a site unannounced. At the same time, the Corps of

Diagram shows how various target structures were clustered around 160 tons of TNT for man's largest deliberate detonation of an ordinary high explosive

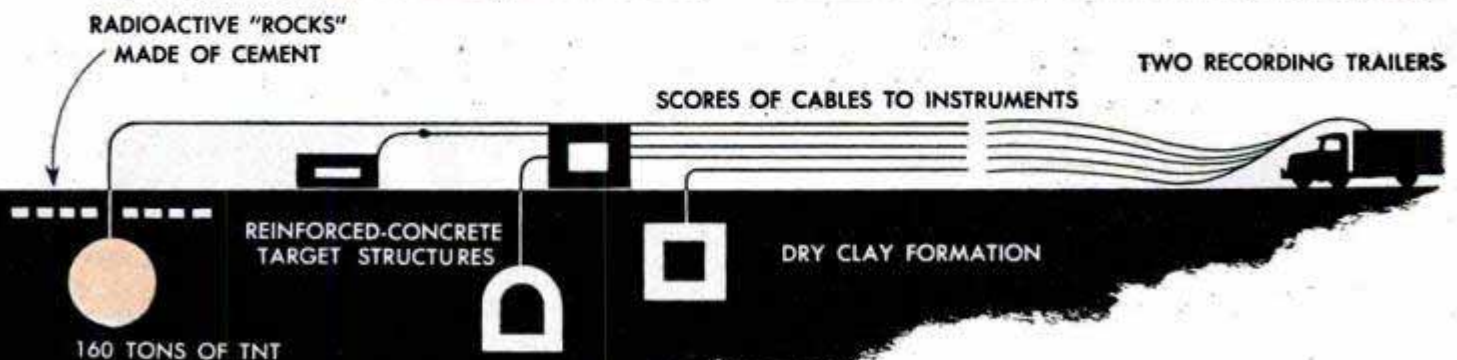

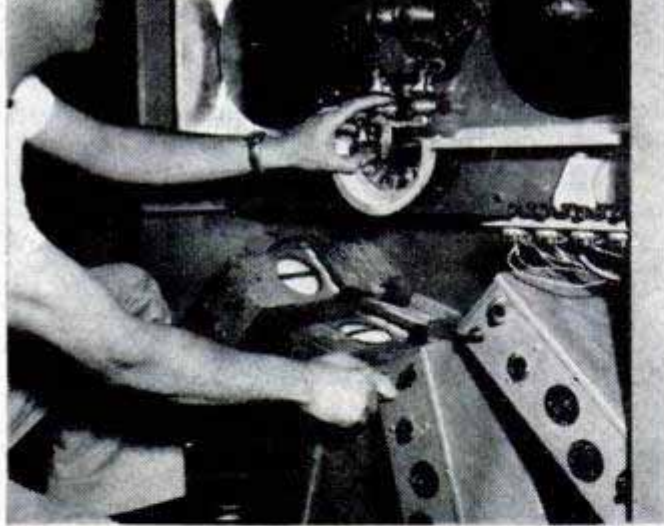

**Apparatus records readings from the test instruments, which measure various forces imposed on the targets**

**Cables run from buried instruments to the recording trailer which is dug in and covered with heavy beams**

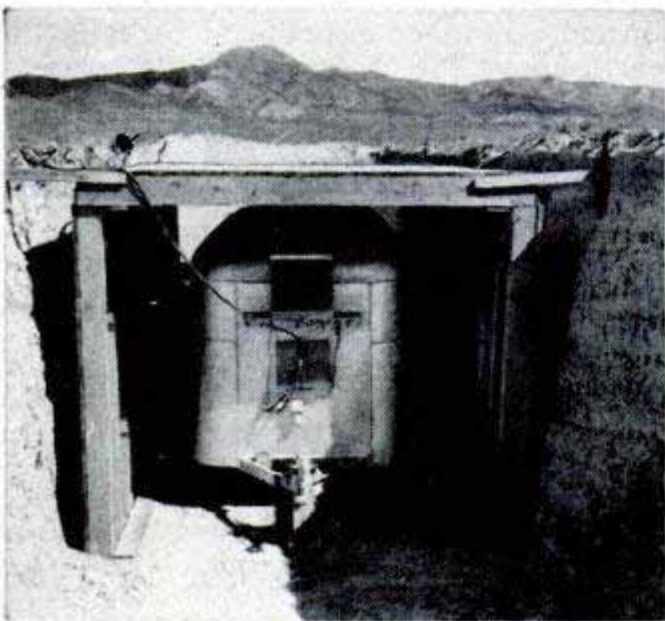

Engineers is making scores of laboratory-size tests that involve enormous amounts of TNT.

From their tremendous but, by comparison, pygmy explosions, the engineers will be able to calculate just what destruction an A-bomb would do to a certain target, of a certain strength, at a certain depth, at a certain distance from the impact point, in a certain kind of earth or rock. This wide array of information will have both offensive and defensive value.

It's a multimillion dollar program that was started in 1947, dropped for a time, then resumed in a hurry when world conditions deteriorated. The whole study is so complex that various agencies are participating in it under the liaison of the Corps of Engineers, including the Coast & Geodetic Survey, U. S. Bureau of Mines, the Air Force Weather Service, Colorado School of Mines, Stanford Research Institute, Engineering Research Institute and heavy-construction contractors.

The scientific staff includes Dr. Arthur Casagrande, soil mechanics specialist; Prof. John B. Wilbur of M.I.T., structural designer; and Dr. C. W. Lampson of Aberdeen Proving Grounds, who made the blast measurements at Bikini. The tests are being conducted under the supervision of Lieut. Col. C. C. Haug, District Engineer for the Corps of Engineers, and C. W. McGregor, project engineer at the Corps' Salt Lake City office.

To obtain data on damage to structures

**Numerous cameras record the explosions. One at left rotates to follow and photograph the huge dust cloud**





**Bulldozer excavates a huge cave which will be one "target" of a mammoth TNT charge exploded above it**

in dry sand, dry clay and wet clay, the Corps is using portions of White Sage Flats at Dugway, where these soils occur. To measure the transmission of shock in sandstone, the engineers will fire enormous charges in that medium near Castle Dale, Utah. To learn damage-distance ratios in granite, the engineers are to set off blasts in a granite mountain near Grand Junction, Colo. Locations of the experiments were determined after test holes had been drilled at many locations in a search for suitable sites.

Some of the explosions involve only 320 pounds of TNT and the effects are measured only by instruments. The so-called half-scale shots in which 40,000 pounds of TNT are detonated, and the full-scale shots involving 320,000 pounds of TNT (the scale is a geometrical progression) involve months of preparation.

In sandstone or granite, the "targets" may be the rooms and passageways of a tunnel system that is excavated out of the rock. In soil, reinforced-concrete target structures are built both above and below the surface to a scale in relation to each other and the size of the blast.

A major job all in itself is to excavate the big charge hole so that the 100-pound blocks of TNT that make up the charge can be placed at the correct distance from the surface. The hole is backfilled with earth after the loading.

Meanwhile, the targets are being built at measured distances from the charge hole. Some are small concrete shelters and shapes, some may be as large as a two-story building. If one of the latter is to be

a buried target, it's first necessary to excavate the hole that will contain the structure, set up the wooden forms and install the reinforcing steel, then pour the concrete. Various mixes of concrete are used for different targets, and all aggregates are measured twice to insure perfect mixes.

Instruments are attached to each target and other devices are buried in the earth

(Continued to page 240)

**TNT can't be exploded until the powder expert plugs in this "safety link" which he carries in his pocket**

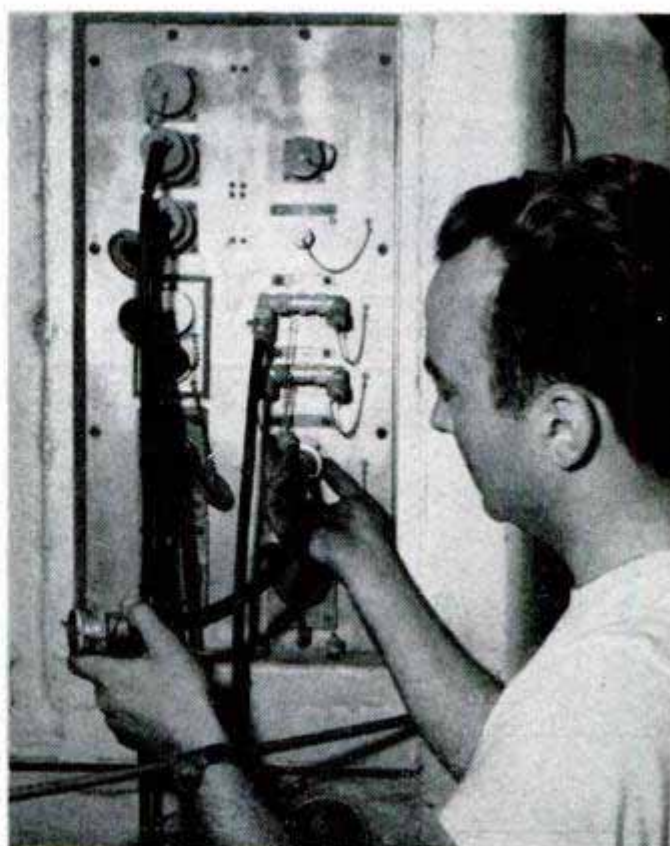

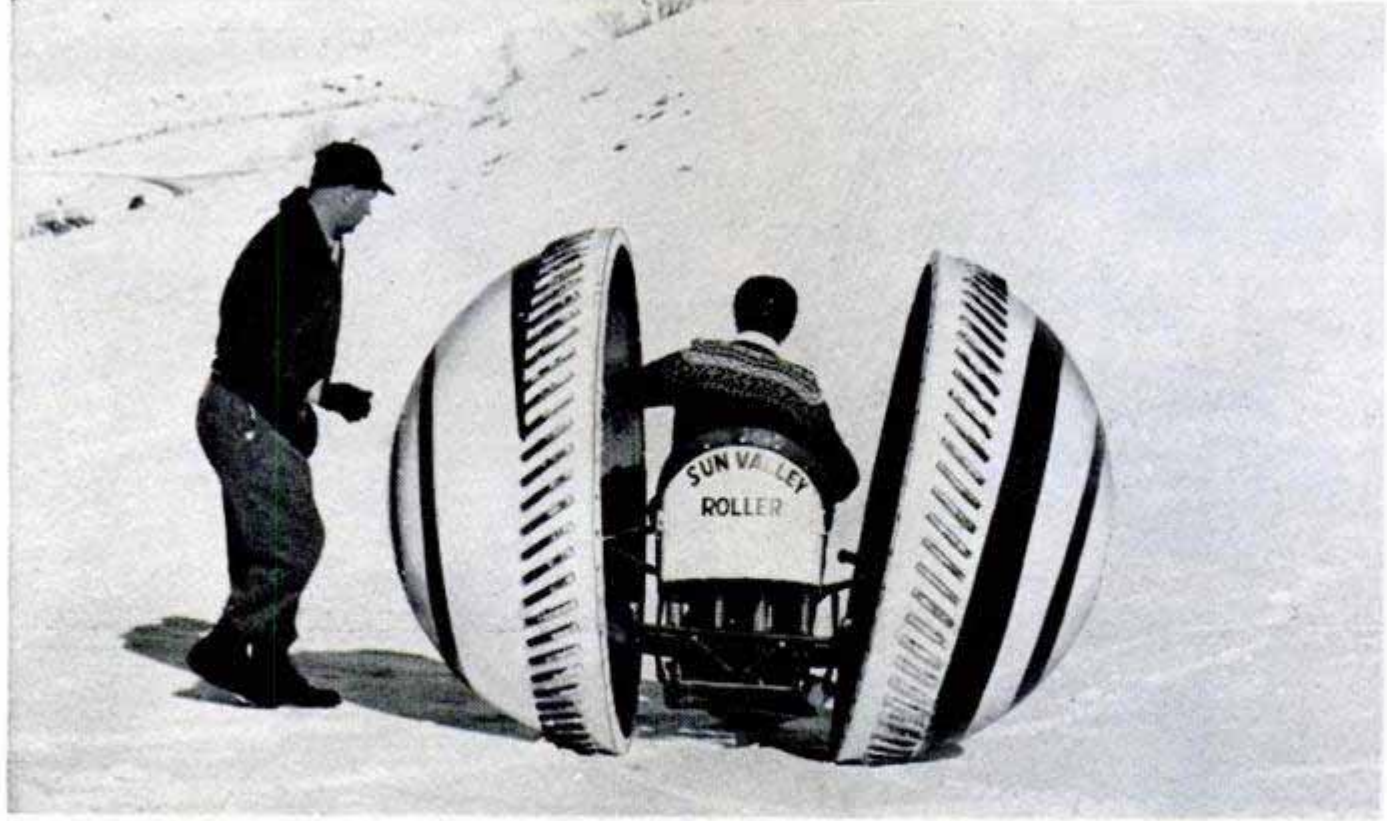

## "Snowball" Ride

Flanked by two semispherical wheels, a nonskier can have fun rushing down wintry slopes in a new "mechanical snowball." The rider's seat between the five-foot aluminum

wheels is stabilized by a skid-pan in front. Individual wheel brakes on the handle bars control the steering. The complete vehicle weighs 400 pounds. According to the inventor, the vehicle has a counterpart which may be suitable for military use.

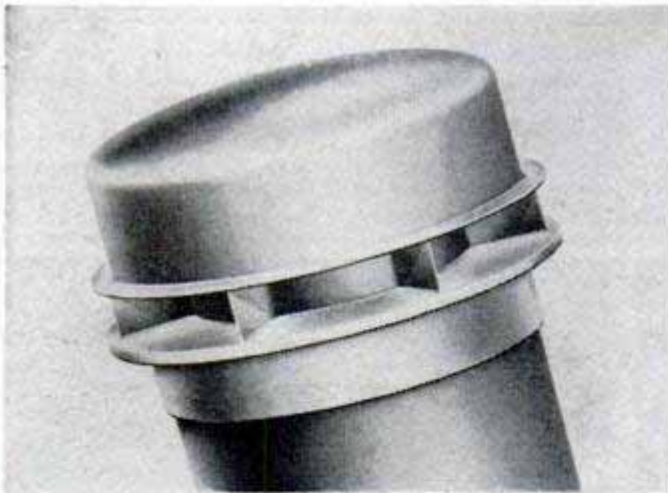

## Wind Controls Chimney Vent Cap

Regardless of wind speed, a new chimney vent cap maintains a balanced furnace draft. Made of aluminum, the vent cap is press fitted into the round vent pipe. The wind builds up pressure between vanes on one side of the cap, while creating a low-pressure zone on the opposite side. The draft through the chimney is channeled up and under the cap, where the high and low-pressure zones balance each other to maintain a normal draft. The cap is designed to give only a slight draft increase with any greatly increased wind velocity.

Below, left, vent operates with only eight inches of clearance above chimney. Center, wind creates high-pressure zone on one side of vent, balancing suction on opposite side. Right, cap makes the vent rainproof

Tesco Inc., 110 S. Norfolk, Tulsa, Okla.

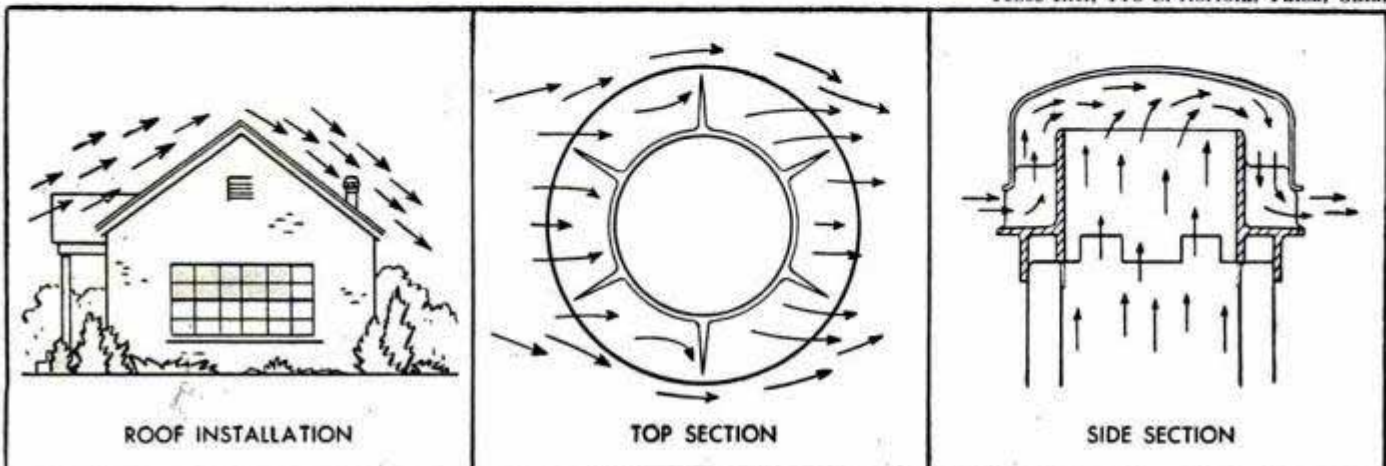



Spray stirred up by the "wings" hides the evidence, but the hull of this boat is almost entirely out of water

## Fast Ferry "Wings" Along at 35 Knots

WITH 80 passengers aboard, a 56-foot Swedish ferry boat literally takes wings to skim along at 35 knots or 40 miles an hour. Built of light metal, the craft is said to be the fastest passenger boat in the world.

Stopped or moving slowly, the boat looks like any luxurious cabin cruiser. But when its 600-horsepower Junkers diesel engine opens up, the boat is lifted out of the water by a curved bear-plane amidships and a pair of horizontal gliding planes located under the bow.

The semicircular bear-plane acts like an

airplane wing. A higher pressure develops on the underside than on the topside, forcing it upward until the hull is out of water. With its greatly decreased resistance, the boat makes 35 knots and does it economically — fuel cost being about 10 cents a mile. Maneuverability is good even in rough seas and the boat leaves little wake. It hits top speed in seven seconds. Two 60-horsepower marine engines drive it at slow speeds. The Junkers takes over at six knots, driving the ferry through a single propeller mounted in the center of the bear-plane.

Ocean-bottom view of the speedster and its wings. Smaller sketches show how boat planes at fast speeds

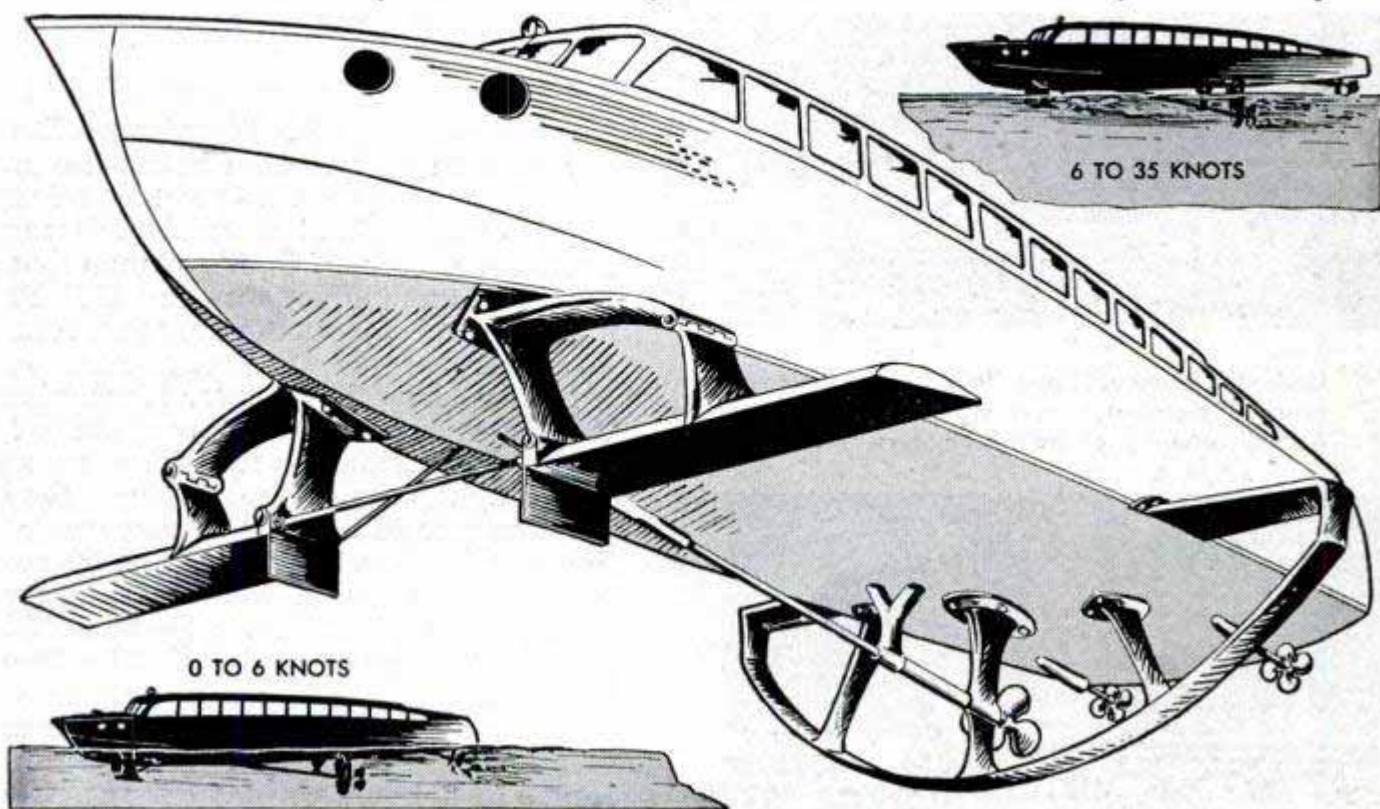

# THE OWNERS REPORT ON

*I practically live in my car*

*Comfortable as a chair*

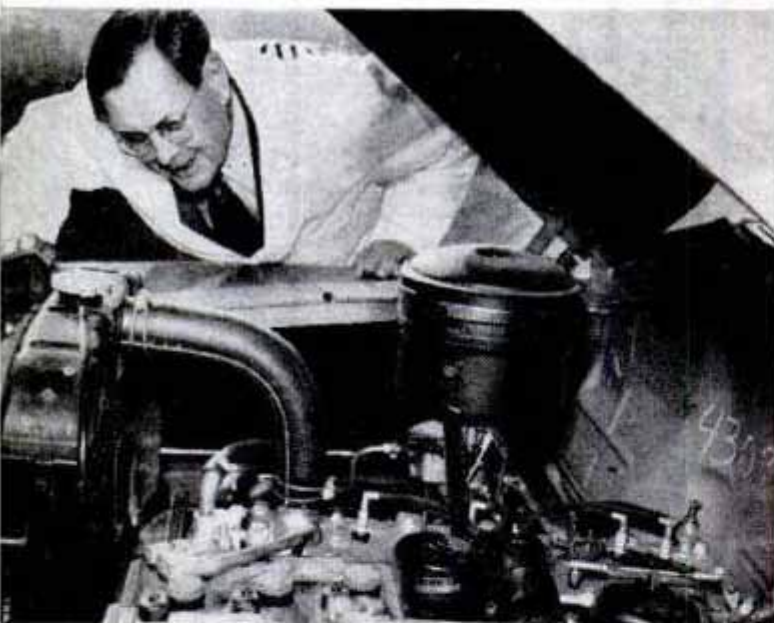

Under the Plymouth hood Floyd Clymer finds weather-proofed distributor and wires, accessible battery. Below, cutaway of built-in by-pass cooling system



**The true test of an automobile begins when the owner takes the wheel. This is another report from owners of 1951 cars who answered questionnaires sent by Popular Mechanics to 1000 Plymouth owners from coast to coast**

*By Floyd Clymer*

**W**HEN a boulevard cowboy (did you ever ride a taxi in Washington, D. C.?) agrees with an Alabama housewife and a busy Denver doctor, a traveling salesman from Nashville and a rural mail carrier from Charleston, S. C., it's a cinch that the object of their affections—the 1951 Plymouth—must have outstanding and versatile characteristics.

In answering the *Popular Mechanics* national survey of 1000 owners of 1951 Plymouths, the Washington taxi driver says that for his dough the Plymouth gives "the best performance of any car in taxi use." The Selma, Ala., housewife likes the Plymouth because "it is so easy to drive and very smart looking for a low-priced car. I love that large rear-view glass." The Denver doctor says: "What this doctor orders is a Plymouth." The Nashville salesman says: "I practically live in my car, spending at least 5 to 12 hours per day driving. Conse-



# THE '51 PLYMOUTH

*Noisy windshield wipers*

## THE POPULAR MECHANICS MOTOR SURVEY AS CONDUCTED BY FLOYD CLYMER

I am the owner of a 1951 Plymouth. Model: Club 216 Cranbrook P23  
I have owned it about 3 months. Speedometer mileage is now 3000  
I use only regular gasoline  - I use premium (high test) gasoline  BOTH  
I GET THE SAME PERFORMANCE - HI TEST ELIMINATES KNOCK.  
My approximate gas mileage in the city is 18 MPG; in country, 23 MPG.  
AT 55 MPH  
I CHANGE OIL  every 1500 miles; I ADD OIL  - one quart every \_\_\_\_\_ miles.  
FILTER 8000 miles

How does the car handle on the road? THE '51 PLYMOUTH IS BETTER THAN ANY  
Maneuverability seems to be: Excellent  Average  Unsatisfactory   
Acceleration is: Outstanding  Very Good  Fair  Poor   
Curb and road clearance is: Satisfactory  Too high  Too low

Why did you buy a Plymouth? ECONOMY, COMFORT, BETTER DRIVING QUALITIES, AMPLE  
What features about the car do you especially like? AUTOMATIC CHOKE, GOOD VISIBILITY, POWER  
ORIFLOW SHOCKS, SEATS (JUST LIKE A COMFORTABLE CHAIR AT HOME) BRAKES

Do you like Plymouth's Safety-Flow Ride? YES; electric windshield wipers? NO  
New-type brakes? YES; New interior? YES; Visibility? YES  
What is your opinion of the new body styling? ALRIGHT - LOW HOOD IS EXCELLENT  
REAR COULD STAND IMPROVING -  
If you own the 111-inch wheelbase model, how do you like it? SEE OTHER MODEL!

What do you dislike about the car? ONLY ONE - KEEPING DOWN RATTLES AROUND STEERING  
Have you ever owned a Plymouth before? YES If so, how many? FIVE  
RADIO HEATER, GLOVE COMPARTMENT - I'VE HAD THIS TROUBLE WITH ALL PLYMOUTHS

Would you buy another Plymouth? Yes  Possibly  No   
Do you secure good dealer service? Yes  Fair  No   
SUBAR MOTOR CO, WHITMIRE SC, IS THE BEST IN THIS AREA.  
How would you rate your new Plymouth? Excellent  Good  Average  Poor   
AFTER OWNING ONE PLYMOUTH - OTHER CARS DRIVE LIKE EARLY MODELS.

### GENERAL INFORMATION

What type of engine would you prefer in your car of the future? In-line  V-type   
Cylinders: 6  8  Valves: Side  Overhead   
Based on my present experience, I want my next car equipped with: Standard Trans.   
Overdrive  Chrysler Fluid Drive  Other type of automatic transmission   
Please state reasons: ELIMINATES LEAK AND GEAR SHIFTING - SEE OTHER SHUT #2  
Do you like the new low-pressure, super-cushion tires? YES How much more? 28 lbs.  
Do you carry recommended pressure? Yes  No  THIS PRACTICE PRODUCES MUCH LONGER TIRE LIFE.

Please check answer boxes (  ). Your reply will be held in strict confidence.  
Please mail promptly to:  
FLOYD CLYMER  
1268 SO. ALVARADO ST.  
LOS ANGELES 6, CALIF.  
My Name: \_\_\_\_\_  
Address: \_\_\_\_\_  
City & State: WHITMIRE, S.C.

Typical questionnaire shows owner's enthusiastic response to the survey

quently, I want the most comfortable and maneuverable car for the money. I found that Plymouth far exceeded my expectations and I would advise anyone spending less than \$2500 for a car to buy a Plymouth." The Charlestonian mail carrier reports: "I've owned seven Plymouths in 23 years and covered a rural route for many years under adverse road and weather conditions. The Plymouth always was my choice and that's why I bought a '51."

Don't rush to the conclusion that the entire survey was just one big fat orchid for the '51 Plymouth. There were complaints

about that new single-speed electric windshield wiper, lack of overdrive, body styling and occasional rattles. Nobody kicked about Plymouth not having an automatic transmission and one owner seemed to speak for a majority when he wrote: "I like to shift gears rather than to pay the difference." Seventy-seven percent either preferred standard transmission or standard with overdrive.

Visibility and Plymouth's new Safti-Flow ride carried off the honors. (I heartily approve; those new Oriflow shock absorbers really do a job of smoothing out the

bumps.) Economy is another factor frequently mentioned in various answers throughout the questionnaires. The owners like the mileage they get on regular gasoline (used by 71 percent) and they like the oil economy and low maintenance costs in general.

Maneuverability was rated excellent by 86 percent. The most popular model is the Cranbrook, which showed an ownership in our survey of 78 percent.

"Maneuverability appeals to me," wrote one Alabama owner, "the foam-rubber cushions give floating ride; electric windshield wipers are very good." And from

**Plymouth owners like these bolted-on fenders which definitely reduce repair costs in case of accident**

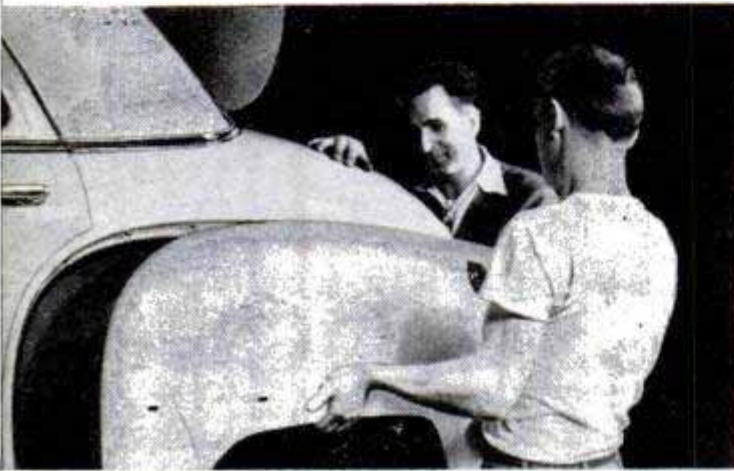

Omaha: "My Plymouth handles perfectly with little strain or effort required in driving. Appearance is now good, and the new hood design broke the former boxy look." A Grand Island, Nebr., owner says: "By far more for your money than 8 out of 10 cars on the road regardless of price. The engine is certainly powerful enough to handle overdrive easily and give more economy. The heater is no good in traffic." (He did not elaborate on the latter.)

One owner said his car is tops in "invisibility." (Too bad Houdini is not around!)

A woman from Jackson, Miss., praised her Plymouth's smooth gearshift and the chair-height seats. (By my tape measure the vertical distance from seat to roof, measured at a point 18 inches from car center line, is 36 inches for both front and rear seats on the four-door sedan.)

Although a great majority of the owners drive the 118½-inch wheelbase Cranbrook and Cambridge models, the 111-inch Concorde and Suburbans also have their fans. A Concord owner from Birmingham writes: "It takes to the road like the bigger cars, and I like the new body styling and much improved visibility." The owner of a Suburban in Greensboro, N. C., reports: "Design is far superior to any station wagon, and I like the 111-inch wheelbase which makes it easy to park." This opinion

## Percentages from P. M. Poll

Owners of Cranbrook models.....	78%
Owners of Cambridge models.....	15%
Owners of Concord models.....	7%
Average gasoline mileage (in country).....	20.1 m.p.g.
Average gasoline mileage (in city).....	16.9 m.p.g.
Use regular gas.....	71%
Use premium gas.....	29%
Change oil.....	98%
Average mileage for change of oil.....	1405
Add oil (also change periodically).....	11%
Average mileage for adding oil.....	916
Maneuverability excellent.....	86%
average.....	13%
unsatisfactory.....	1%
Acceleration outstanding.....	19%
very good.....	72%
average.....	8%
poor.....	1%
Road clearance satisfactory.....	89%
too high.....	0
too low.....	11%

### BEST-LIKED FEATURES

Safty-Flow ride.....	97%
Body styling excellent.....	84%
average.....	12%
poor.....	4%
Interior finish.....	94%
New brakes.....	95%
Visibility.....	98%

Electric windshield wipers.....	79%
---------------------------------	-----

(These percentages are based on the fact that some owners mentioned more than one feature.)

### OWNERS RATING OF CAR

Excellent or good.....	88%
Average.....	11%
Poor.....	1%

### GENERAL INFORMATION

Prefer in-line engine.....	66%
Prefer V-type engine.....	34%
Prefer six cylinders.....	63%
Prefer eight cylinders.....	37%
Prefer side-valve arrangement.....	57%
Prefer overhead-valve system.....	43%
Prefer standard transmission with overdrive.....	40%
standard transmission only.....	37%
automatic transmission.....	23%
Prefer Fluid-Matic Drive (Chrysler).....	55%
(55% of the 23% preferring automatic transmission.)	
Prefer makes other than Fluid-Matic Drive.....	45%
Like low-pressure tires.....	84%
Previous Plymouth owners.....	68%
Will or might buy another Plymouth.....	98%
Will not buy another Plymouth.....	2%
Dealer service good.....	70%
average.....	21%
poor.....	9%

### Most frequent objections:

Single-speed windshield wipers, no overdrive unit available, body styling.

is echoed by a major at Robbins Air Force Base, Ga., who adds that he likes "the lack of expensive and unnecessary gadgets."

The minority that "voted" against the electric windshield wipers did not pull any punches. "I think the Plymouth's new windshield wipers are terrible," wrote a man from New Jersey. "They're noisy." Several suggested that the windshield wiper should have at least two speeds.

The owner of a Cranbrook club coupe from Whitmire, S. C., says: "I like the automatic choke, good visibility, Oriflow shocks, the seats which are as comfortable as a chair at home and the wonderful brakes . . . Having owned five Plymouths, I think Plymouth is the best buy for the money, but think that overdrive should be offered as optional equipment for better gas economy. I witnessed the 500-mile Darlington stockcar race and the boy from Long Beach, Calif., really did burn up the track averaging 76 miles per hour, beating all other stockcars entered—that test should prove that Plymouth is the best buy for anybody's money." (During the last few years Plymouth cars have won many important stockcar races.)

A Kentucky owner says: "My Plymouth handles better than any car I have ever owned, regardless of weight. I like the comfort for the passengers . . . My dealer



Over rough back roads the '51 Plymouth's new Ori-flow shock absorbers got high rating from Clymer

REBOUND STROKE



COMPRESSION STROKE



### Acceleration Chart

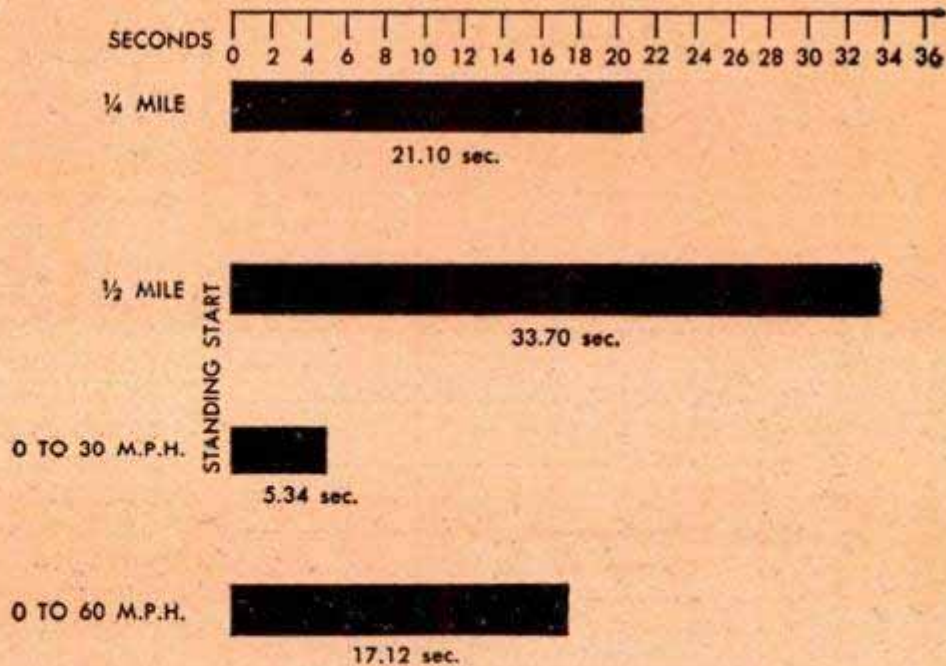

Top Speed (by speedometer)..... 93-94 m.p.h.  
Actual Top Speed, about 4% less (speedometer variation).

Oriflow shock absorber — as piston travels upward fluid passes to lower end through passages in cylinder. Also, check valve in base lifts off its seat to permit fluid in reservoir to flow into lower end

Acceleration tests made by Floyd Clymer show excellent performance of the '51 Plymouth and back up the high rating of 91 percent (outstanding or very good) given the car's acceleration in the owners' survey



High and wide windshield gives fine visibility which pleased 98 percent of owners in the nation-wide survey

is long on promises and short on performance when it comes to service."

A glance at the percentage chart will show that a great majority approve of Plymouth's styling. There were remarks, however, from an articulate minority such as: "Don't like it, but is a definite improvement over 1949 and 1950 models." "I do not care for the boxy rear end." "Too-conservative boxlike construction . . . but an improvement over old models." A Navy lieutenant from Gainesville, Fla., wrote: "Plymouth has a square appearance that gives the interior room, which I like."

### Economy Test

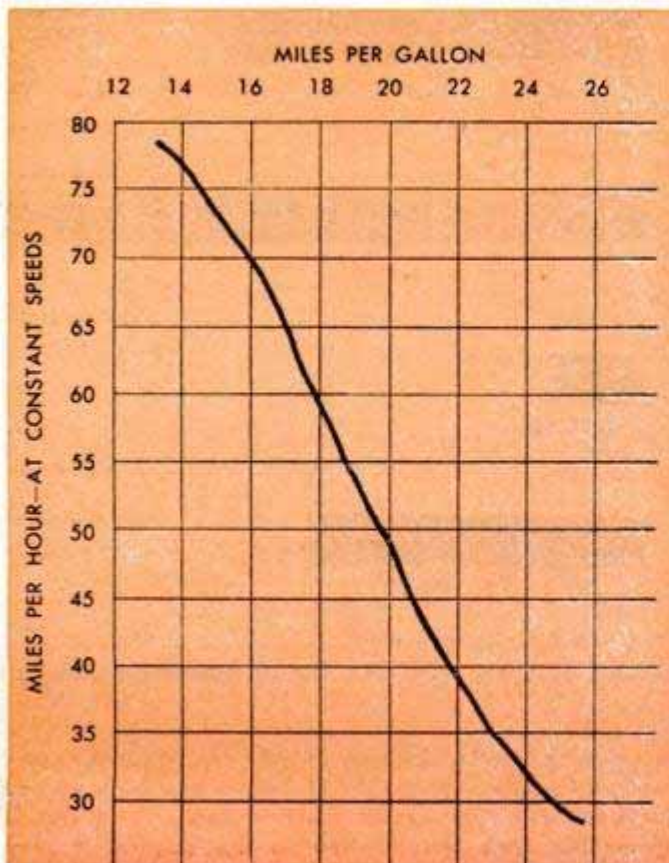

A traveling salesman from Orangeburg, S. C., thinks that the low-pressure tires on his Plymouth are fine for ordinary driving, but for a traveling salesman, the tread wears out much faster than the standard-size tires. (It's the same story on all cars.) He thinks the 1951 model has more vibration and rattles than the other two previous Plymouth cars he has owned.

A Massachusetts owner thinks the car is beautiful and has a modern look without going to extremes, is very comfortable and retains all the fine qualities for which Plymouth cars are famous. A Ft. Smith, Ark., doctor says the car is easy to handle in traffic and not too tiresome on the road. He bought a Plymouth because his father has driven his 1941 Plymouth more than 150,000 miles and still is driving it everyday. He thinks the new shock absorbers make too much noise.

A Columbia, S. C., owner likes the body styling, but thinks the rear deck and rear-deck lock could be improved. He said he went back to Plymouth with the conventional transmission after owning other makes of cars with automatic transmissions. A Fayetteville, Ark., owner says the Plymouth has big-car features and is the neatest looking car on the road, but overdrive would be desirable as it saves fuel with less strain on the engine. An enthusiastic Jackson, Miss., owner wrote that he drove one Plymouth 75,000 miles in 11 years under various conditions and it gave maximum service at minimum cost, plus the fact that it was easy to handle when it was old and worn. "It is a pleasure to recommend Plymouth and naturally, when I bought a 1951 car, it was a Plymouth," he said.

A Jackson, Tenn., owner, writes: "I was  
(Continued to page 242)

**\$5,000****American  
Way of Life  
PHOTO CONTEST****What does America mean to you?****Answer that question with a photograph  
and win one of these big prizes!****prizes**

	<b>Black and White</b>	<b>Color</b>
<b>1st Prize</b> .....	<b>\$1,000</b>	<b>\$1,000</b>
<b>2nd Prize</b> .....	<b>\$ 500</b>	<b>\$ 500</b>
<b>3rd Prize</b> .....	<b>\$ 300</b>	<b>\$ 300</b>
<b>4th Prize</b> .....	<b>\$ 100</b>	<b>\$ 100</b>
<b>5th Prize</b> .....	<b>\$ 100</b>	<b>\$ 100</b>
<b>6th Prize</b> .....	<b>\$ 100</b>	<b>\$ 100</b>
<b>7th Prize</b> .....	<b>\$ 100</b>	<b>\$ 100</b>
<b>8th Prize</b> .....	<b>\$ 100</b>	<b>\$ 100</b>
<b>16 Prizes—Black and White Only</b> .....	<b>\$ 25 each</b>	

**rules**

1. The "American Way of Life" photo contest is open to all persons except employees of Popular Mechanics Company and their families.

2. There will be a Black-and-White Competition and a Color Competition with separate prizes in each. Hand-tinted prints are not eligible.

3. Photographs must illustrate your own conception of the "American Way of Life," but the subject you pick can be in any field — industry, agriculture, government or any other. You may see it in a country store, a view, a man at work, a city street or a thousand places. Winners will be selected on (a) how well the picture illustrates the "American Way of Life" and (b) its all-around photographic excellence.

4. All entries must be postmarked not later than midnight, September 1, 1951, and must have been taken between April 1, 1951, and September 1, 1951. No entry fee is required and there is no limitation on the number of entries you may submit. Data sheet, giving information listed at the bottom of this page, must be attached securely to the back of each entry. When submitting transparencies, attach data sheet to the top of the transparent sleeve.

5. All prints and transparencies will be held until after winners are announced in the 50th Anniversary Issue of Popular Mechanics, January 1952. Non-winning prints and transparencies will be returned as soon as possible thereafter, provided that a self-addressed and stamped envelope is enclosed with the entries.

6. Black-and-white prints must be no smaller than 8 by 10 inches and no larger than 11 by 14 inches and must be mailed flat and unmounted. Color prints submitted must be 5 by 7 inches or larger. Color transparencies must be 2¼ by 2¼ inches or larger.

7. All prize-winning photographs become the exclusive property of Popular Mechanics Company. Original negatives of prize-winning prints must be submitted upon request.

8. Judges will be selected by the editors of Popular Mechanics Magazine. Their decisions will be final. In case of ties, duplicate prizes will be awarded.

9. Mail all entries to PHOTO CONTEST, POPULAR MECHANICS, 210 East Ontario St., Chicago 11, Ill.

10. Popular Mechanics Company will use all reasonable care in handling entries, but it can assume no responsibility for loss or damage of any entry.

**Attach to each photograph  
the following information:**

- |                   |               |                  |                |
|-------------------|---------------|------------------|----------------|
| 1. Your name      | 4. Subject    | 7. Shutter speed | 10. Film       |
| 2. Street         | 5. When taken | 8. Lighting      | 11. Lens stop  |
| 3. Town and state | 6. Camera     | 9. Where taken   | 12. Other data |

# VOLUNTEER LIFE GUARDS PATROL AUSSIE BEACHES



Unsinkable surfboat, above, plows through a stormy sea on a rescue attempt. Loudspeaker system, right, directs surfers into safe zones. While other crew members man the reel and pay out the line, below, a guard dons rescue belt and rushes to enter surf

SAVING LIVES along the beaches of Australia's 12,000 miles of coastline is no job for weaklings. It is a rugged combination of sport, arduous training and humanitarian — often hazardous — effort that pays off only in satisfaction. The beach patrols are handled by 8000 active



members of the Surf Life Saving Association of Australia, assigned to protect bathers at some 160 clubs. Five thousand additional reserve members, no longer fit to battle with the currents and breakers of the raging Pacific Ocean, handle administrative work at the clubs. Australian beaches are not unusually dangerous, but storms or very heavy gales sometimes shift sand bars, causing strong cross-currents ready to sweep the unwary bather seaward. It is then that volunteer lifeguards, who save nearly 4000 swimmers yearly, have their hands full. Recruits for the patrols must first swim a quarter of a mile in under 7½ minutes, then take instruction in physiology and the signals that are used between surfboats and swimmers. After passing an examination on the classwork, the recruit has to take his place on a six-man rescue squad and demonstrate his ability to handle each place in turn. Mock rescues by the patrols are a big feature of Australian surf carnivals.



With a line attached to his body, top, guard moves through line of breakers toward distressed swimmer. Holding victim, right, guard is slowly hauled in by crew on shore. Below, resuscitation rocker gently but effectively expels water from swimmer's lungs

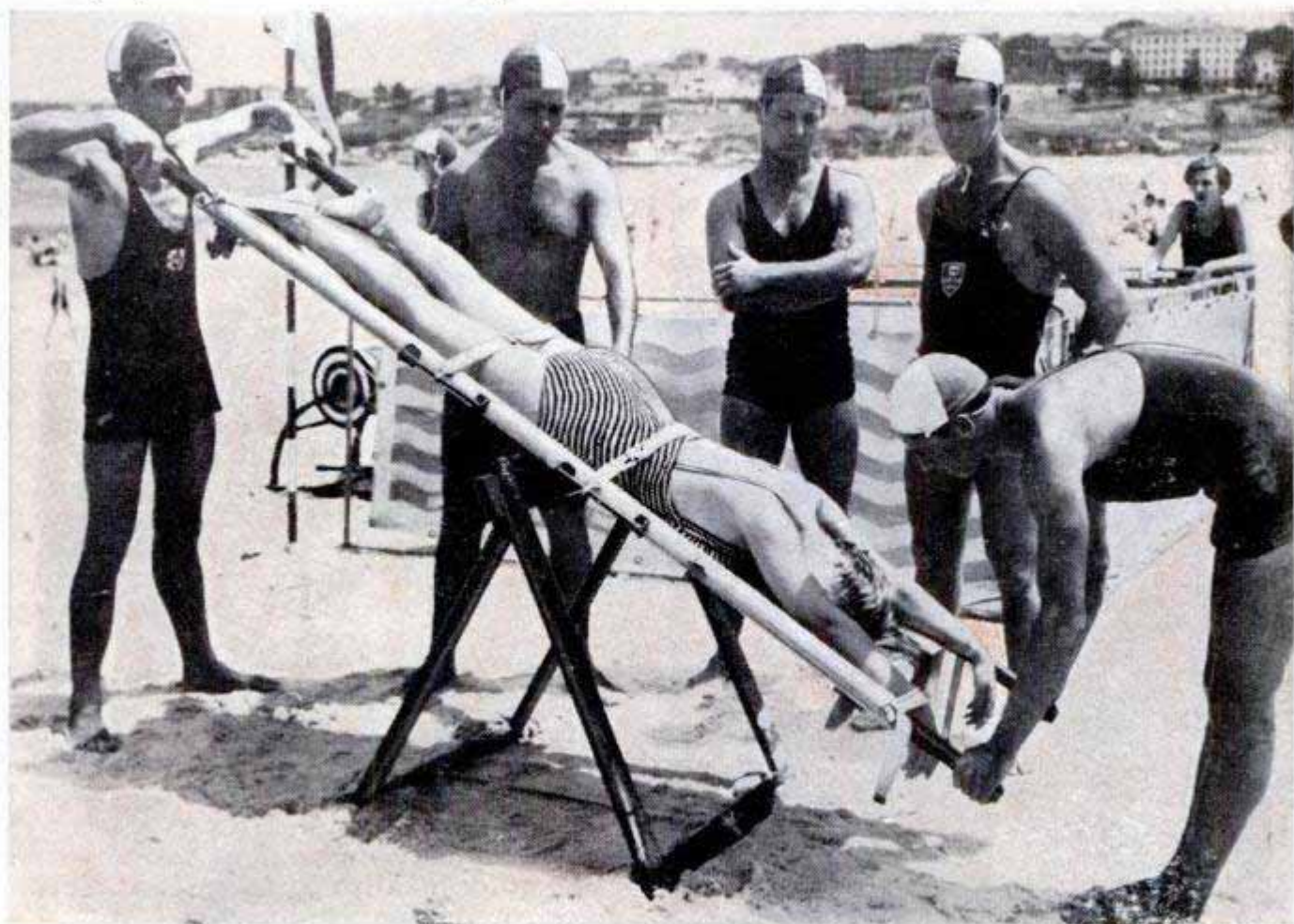

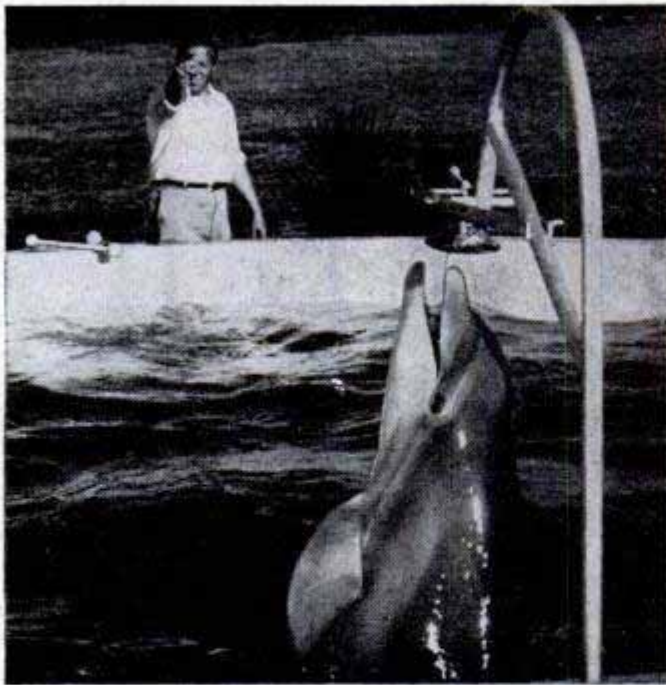

Reaching high out of the water to ring a bell, above, is Skippy's "I'm hungry" signal to his trainer. Leaping through a hoop and retrieving sticks, right, earns the six-foot dolphin extra between-meal delicacies

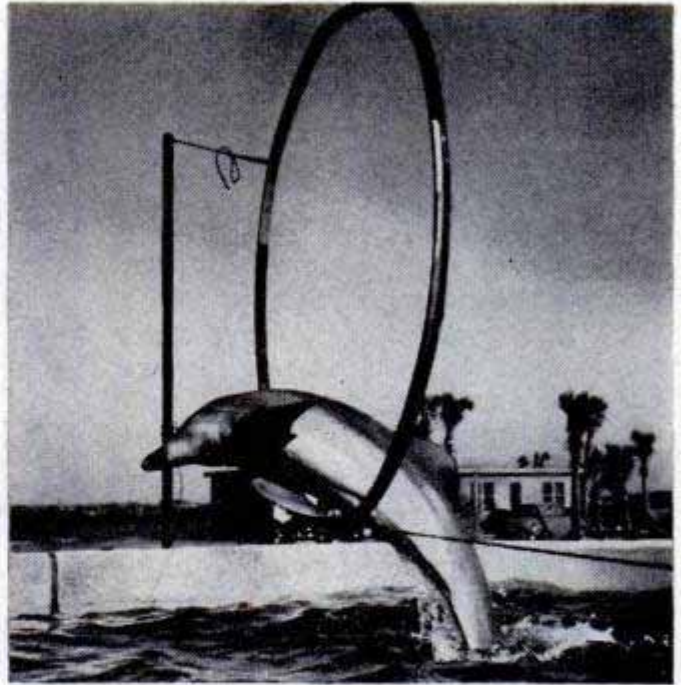

## Flippy Trains for "I.Q." Test

In experiments to test the intelligence of porpoises, a six-foot-long deep-water thinker at Marine Studios, St. Augustine, Fla., has been taught to roll over at his trainer's command, retrieve sticks, catch balls and leap three feet out of the water and through a hoop. As a reward for scholarly achievements, Flippy, a bottlenosed gray dolphin, gets between-meal snacks from trainer Adolf Frohn. Flippy has also been taught to ring a bell suspended over the side of the tank when he decides it is time for a regular feeding of his favorite "brain food"—fish.



U. S. Rubber Co., 7300 Keystone St., Tacony, Philadelphia 35, Pa.

## Rubber "Chain" Drive

Precision timing and nonslip power transmission are provided by a rubber and fabric belt that has regularly spaced rubber teeth around its inner surface. The pulleys have grooves in which the teeth engage, providing a positive, nonslip transmission of power. The belt will attain speeds up to 16,000 feet a minute and is said to operate more quietly than precision gears running in an oil bath. Another advantage of the new belt is that it won't stretch. Thus it operates on fixed centers without takeup adjustments. It has already replaced flat belts, V-belts, chain drives and gears in many applications ranging from automobile fans to electric typewriters.

☐ In an emergency not long ago a trawler came into a Scottish port with its diesel engines running on fish-liver oil.





Rear car is the laboratory, interior details shown below. Other car carries geophones, stakes and explosives

## Seismic Lab on Wheels

MORE THAN divining rods are needed to spot oil fields and so scientists at Stanford Research Institute take their laboratory with them when they go a hunting oil. Two cars are packed with equipment ranging from a 24-channel amplifier-recorder and dynamite charges for seismic mapping to built-in wastebaskets emptied through an exterior slot. Both front doors in one car contain tanks of distilled water, complete with faucets. The car serves as a photo darkroom. With a crew of seven men, the two cars can complete four line miles of seismic study a day, more than twice that accomplished by four standard trucks and nine men using conventional methods.

Also in the rear seat of the lab car are tanks for developing seismic records. Windows are blacked out

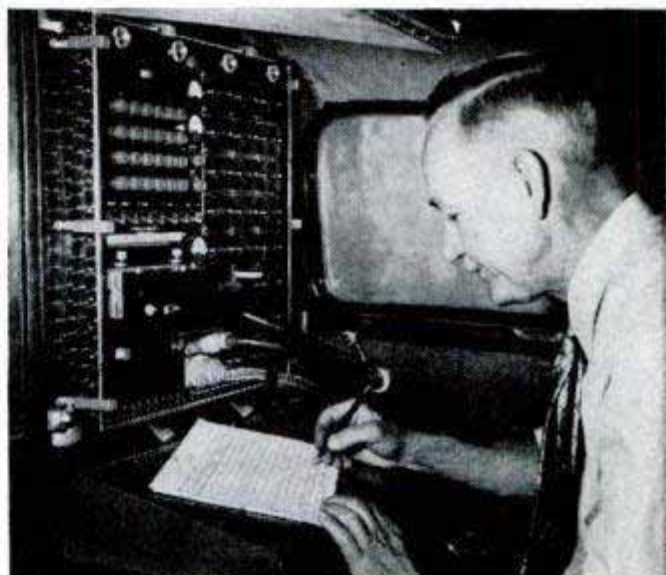

In rear of lab car is amplifier panel that records the echoes of explosions from the underground strata

Water is stored in door (note faucet at bottom). Rear body panel is wastebasket with emptying door at left





Electrofilm Corp., 7116 Laurel Canyon Blvd., North Hollywood, Calif.

**PICTURE HEATER** is actually a radiant-heating panel that provides extra heat where needed as in the nursery or office. The whole surface radiates heat

# WHAT'S NEW *For Your Home*

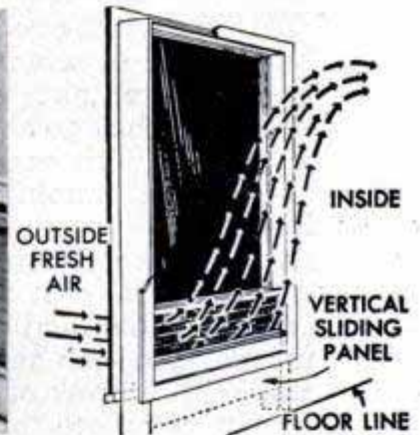
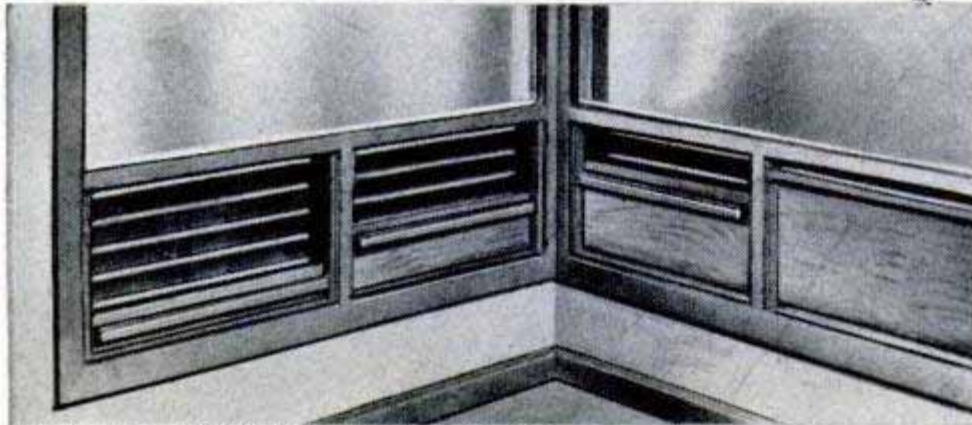

Lilly-Vent, Inc., 7962 S.E. Powell Blvd., Portland, Ore.

**VENTILATING WINDOW** can be sealed tightly with double sash yet its sliding panels below glass allow full, draft-free ventilation. Panels slide vertically and do not interfere with the draperies or furniture placement

**HOOK-ON STRAINER**, held on pan with a spring, lets you drain contents with no danger of scalding  
Sunset Sales Corp., 1001 North Vermont, Hollywood 29, Calif.

**CLAM SHUCKER** opens the most stubborn clams yet doesn't cut meat. Healthful juice is caught in tray  
Hoffritz for Cutlery, 551 Fifth Ave., New York City 17

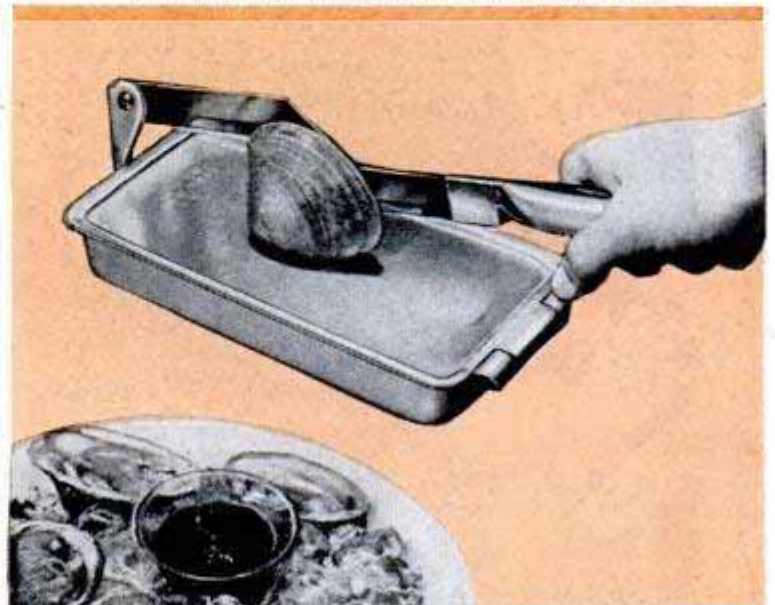
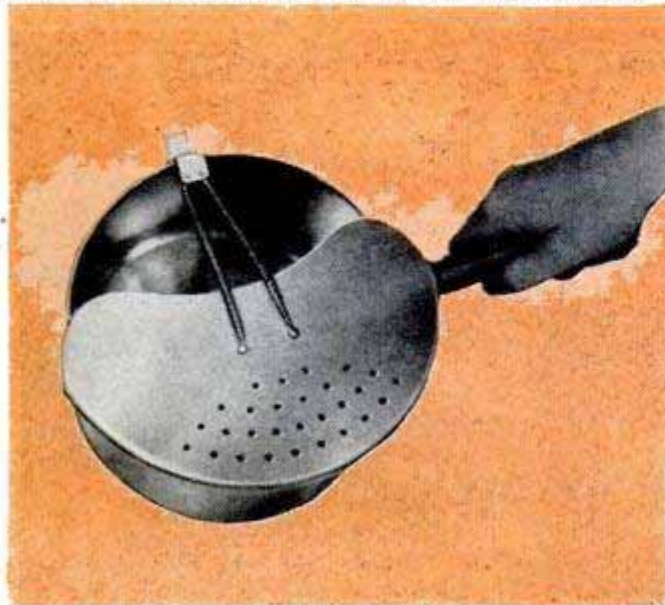

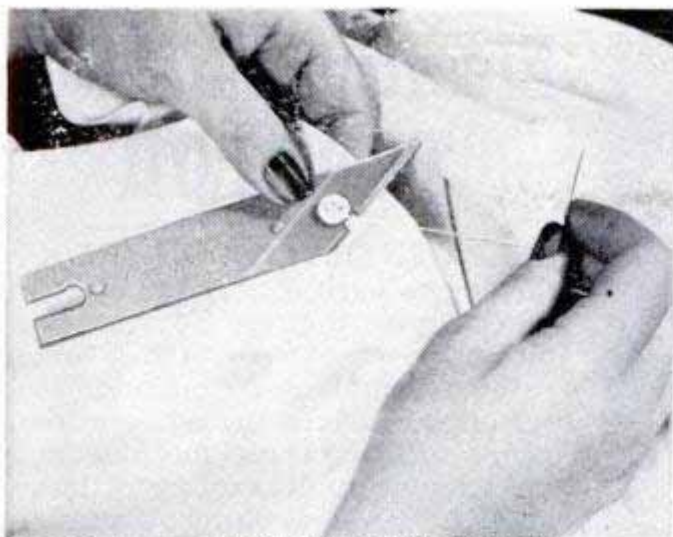

John Dritz & Sons, 1115 Broadway, New York City 10

**BUTTON GAUGE** holds button away from fabric to form correct shank on either large or small buttons

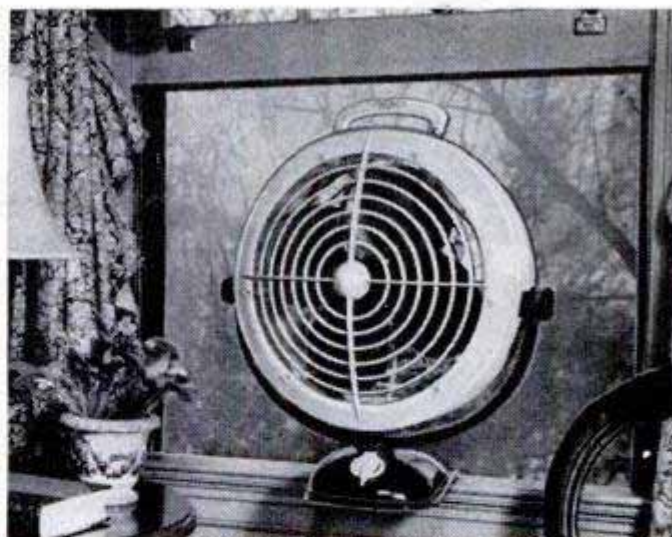

W. W. Welch Co., 439 Race St., Cincinnati, Ohio

**AIR CIRCULATOR** has nonslip base plate to mount on any window for use as intake or exhaust fan



Rowe Industries, Inc., Sag Harbor, Long Island, N. Y.

**PORTABLE MIXER** is electric, but it uses flashlight batteries. Made of plastic, it weighs only 12 ounces



David Traum Co., Inc., 11 East 26th St., New York City 10

**PRESSING SPONGE** dampens fabric evenly without mess. Water from the top reservoir moistens sponge

**DRYING FRAMES** that prevent shrinkage of socks, sweaters and gloves are nonrusting because their steel cores are coated with a smooth, nonsnagging Vinylite plastic. Being adjustable, they will fit various sizes  
Queen Mfg. Co., 4227 Lake St., Chicago 24

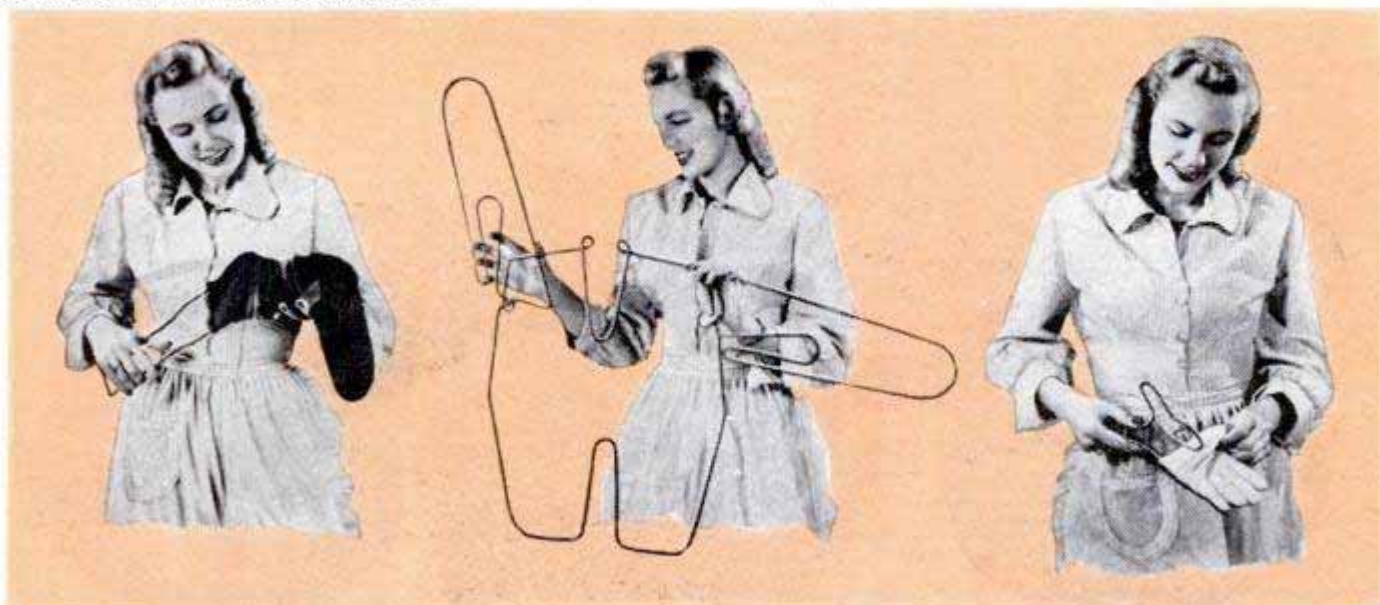

# Electric-Wheeled TRACTOR

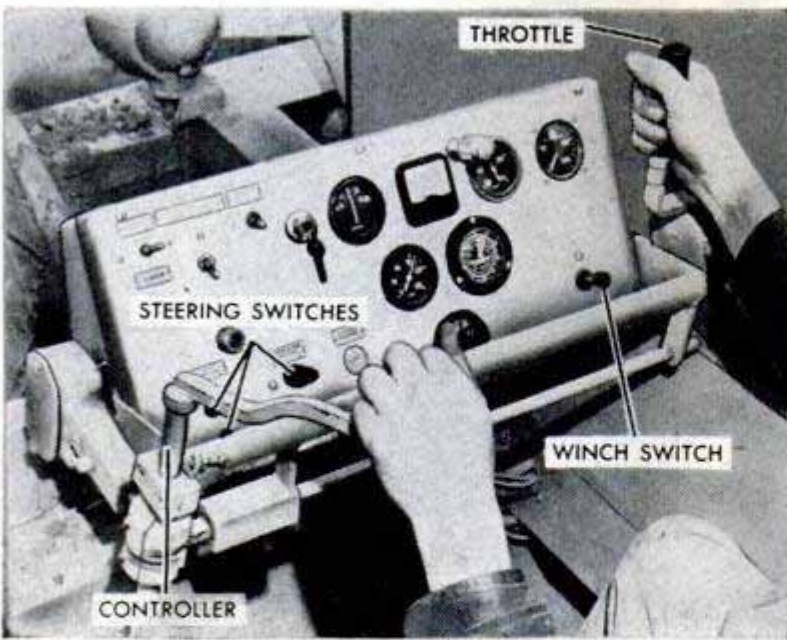

R. G. LeTourneau Inc., Peoria, Ill.

SELF-GENERATED CURRENT flowing to each of its four electric wheels gives the new Tournatow a pulling power of more than 16 times its own weight. A six-cylinder diesel engine drives the a.c. and d.c. generators powering the machine, built for ground-handling of large aircraft. It has no clutch, transmission or differential. The current goes through flexible wires directly to motors in the wheels, eliminating the need for the customary final drive gears and shafts, universal joints, hydraulic-braking system and other mechanical gearing and linkages.

Steering switches, upper left, guide the Tournatow. For short turns, below left, front and rear wheels steer in opposite directions. For oblique movement all turn same way

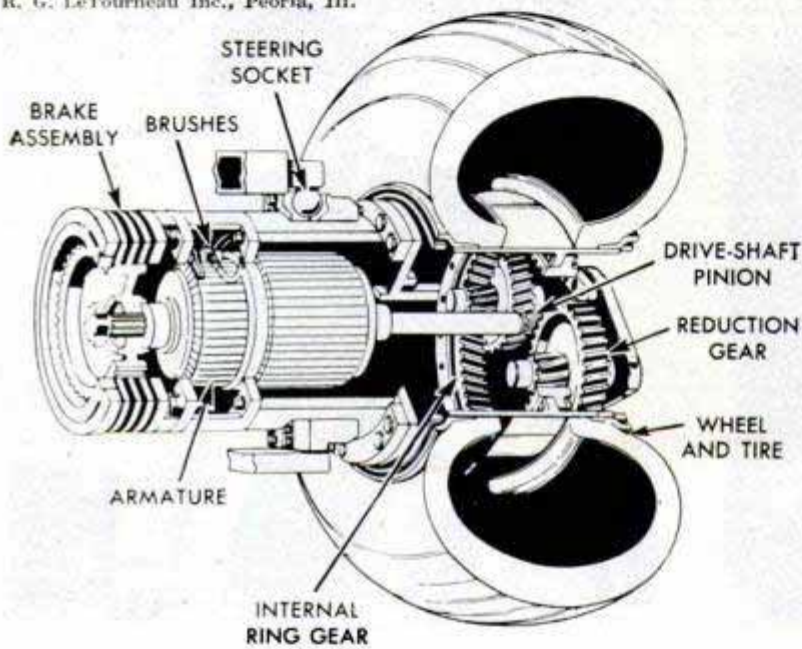

CUTAWAY DRAWING OF ELECTRIC WHEEL

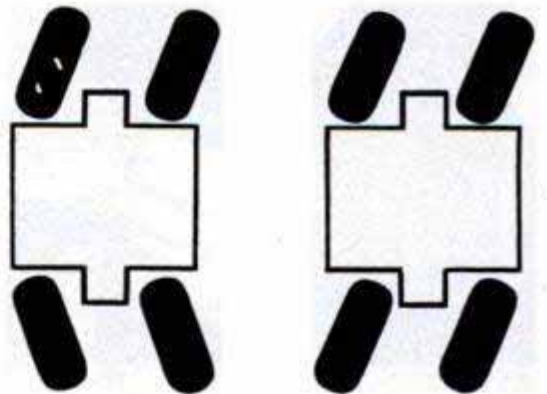

Each wheel of the Tournatow, below, has a gear arrangement in its assembly. Machine can pull 40,000 lbs.

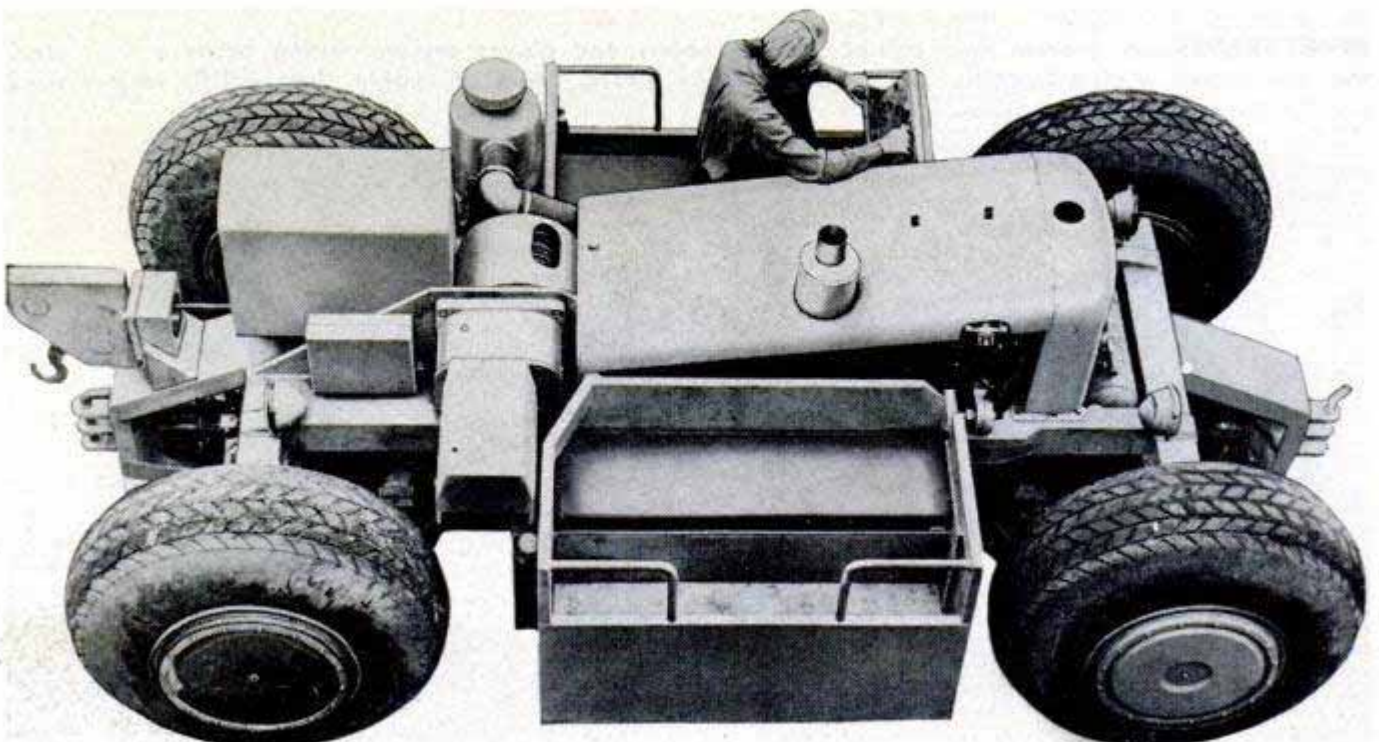



R. Krasberg & Sons Mfg. Co., 2501 Homer Street, Chicago 47

### Lawn Seeder

Lawns are seeded uniformly by a hand-held tool resembling a flour sifter. The seed is stored in a cylindrical hopper and the seeder is held in one hand with the thumb on a release lever. When the lever is pressed, the seeds pass through an opening into a fan mechanism which is operated by turning a crank with the other hand. The seed sprays out in front of the operator in a semicircular pattern. The tool also can be used to spread dry fertilizer and dry weed killer. The hopper holds a full pound of grass seed.

### "Strait Jacket" for Liquid Ozone

Scientists of Armour Research Foundation have succeeded in "taming" liquid ozone, a beautiful dark-blue substance that previously has been dangerous to handle. Liquid ozone can be used as a fuel to power rockets. It also can be decomposed directly into oxygen for submarines and high-altitude airplanes. In industrial applications it is used to purify water and air, and as a bleach. Ozone is made by bombarding oxygen with high-speed electrons. The scientists found that they could make the liquid behave by removing various thermal, mechanical, electrical and chemical influences. When these influences are present, the material is highly explosive.

Sources of available products described in this issue are listed on pages 12, 14 and 16. Sources of further information on other articles are listed in the WHERE-TO-FIND-IT LIST, which is available to readers without charge. Just send a postcard to Bureau of Information, Popular Mechanics Magazine, 200 East Ontario Street, Chicago 11, Illinois

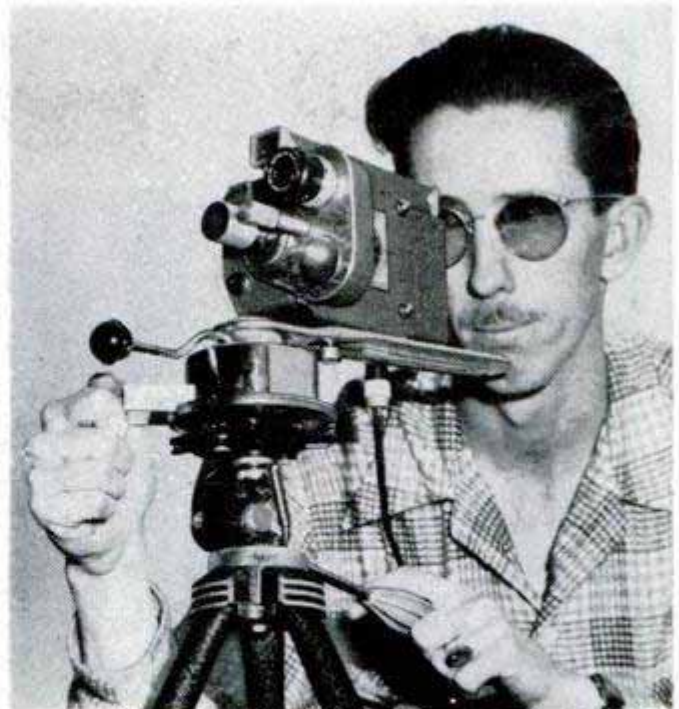

Grover Photo Co., 2011½ E. Broadway, Glendale, Calif.

### Pneumatic Panning Of Movie Scenes

Smooth panning of scenery or groups is done automatically by a movie-camera tripod head that operates on air pressure and can be adjusted to various speeds. Air is stored in a cylinder by turning the head mechanism in the direction opposite to the desired panning. The camera automatically swings back when a release valve is opened.

### Liquid Seals Engine Parts

Moisture is prevented from reaching the ignition system of a car by a heavy liquid which is brushed on all electrical contacts. It is available in a kit which also contains a brush and two treated washers for the battery posts. After the compound is applied, a stream of water can be played over the distributor, coil, spark plugs or battery without affecting the starting of the engine. In industrial applications it is applied to electric motors which in tests have successfully been run under water.

Elektrik Seal Laboratories, 161 W. Elm St., Chicago 10

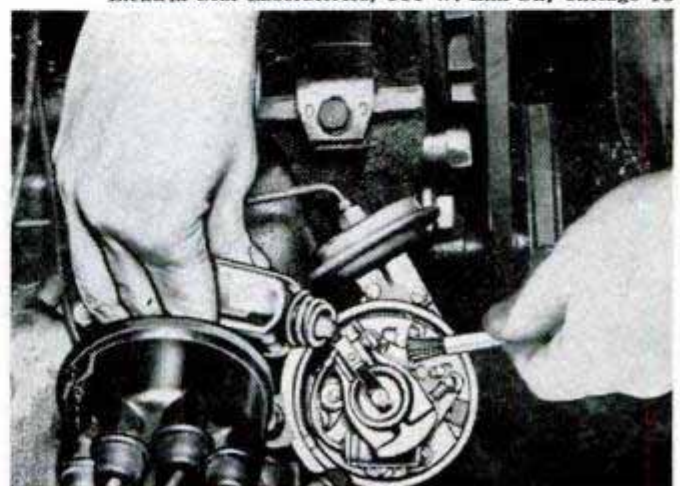

# FIRE BOMBS

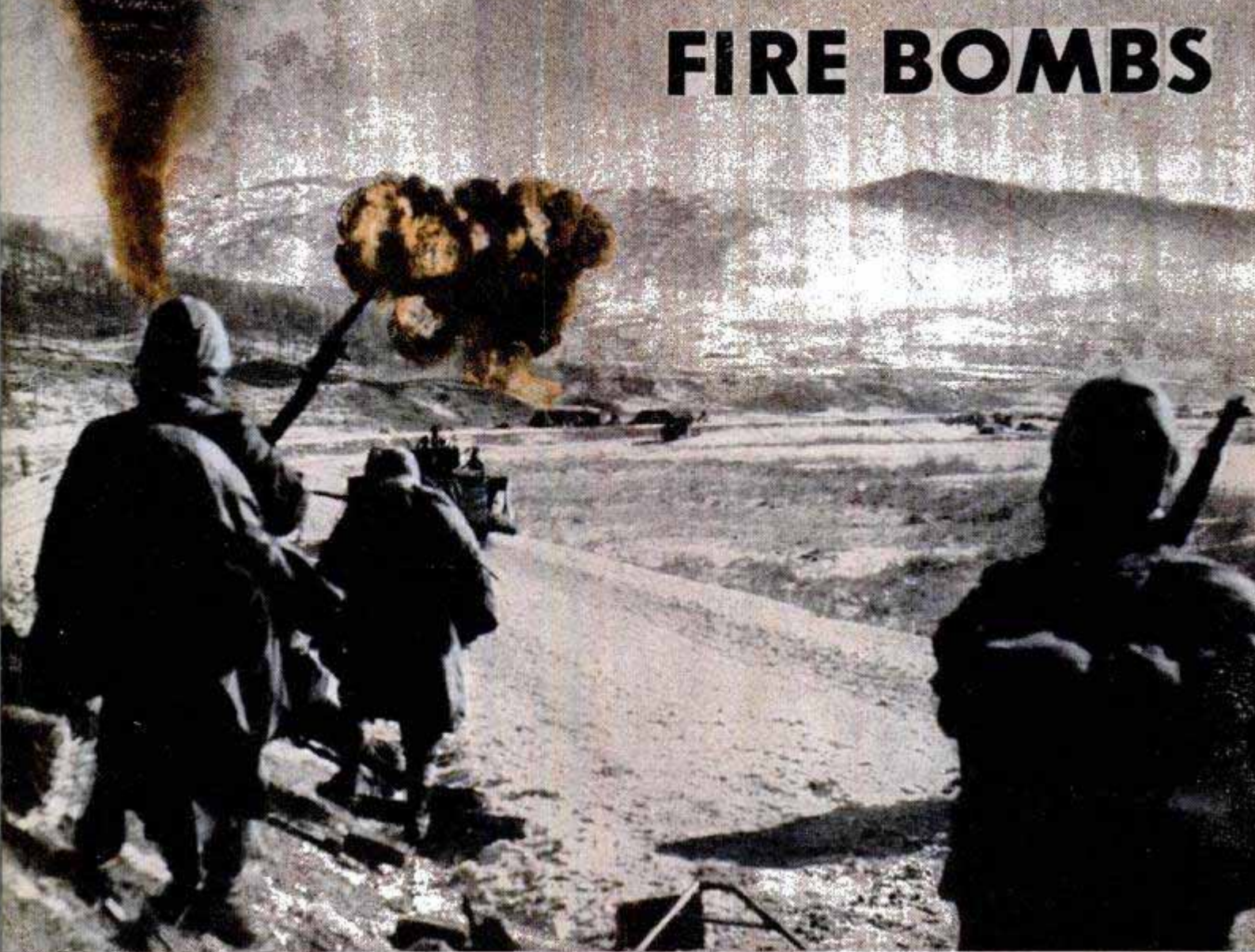

U. S. Marine Corps photo

Billowing smoke reveals where flyers flushed enemy from hillsides with napalm during advance in Korea

South Korean funnels napalm powder into gasoline. It takes from 9 to 21 pounds to fill a belly tank

U. S. Air Force photo



By Lt. Comdr. Arthur L. Schoeni

**M**ARINE fighter planes, sweeping a Korean battlefield for targets, saw a large number of Communist troops rush into a short railroad tunnel to escape their strafing.

Swooping down almost to the mouth of the tunnel, one deadeye pilot dropped a 150-gallon tankful of napalm right into it. Huge flames swept the length of the tunnel and burst out the other end, instantly killing every man inside.

Fighter-bombers in another area were trying to knock out a Communist tank. Their 20-mm. cannon shells bounced ineffectually off the thick armor plate. Another plane loosed a string of five-inch "Holy Moses" rockets against the speeding tank. Hitting a 25-mile-an-hour target going at right angles to a 400-mile-an-hour plane calls for expert marksmanship and these rockets missed.

Another pilot dived to the attack. Pulling out of his dive a few hundred feet above and ahead of the tank, he dropped his napalm-filled belly tank. Though not a direct hit, the huge burst of flaming gasoline

# BLAZE A TRAIL OF WAR



Six 110-gallon tanks of jellied gasoline add a destructive note to the appearance of this Air Force F-80

swallowed up the tank, searing its occupants and exploding their ammunition.

It is small wonder that the Communists call them "hell bombs." Pilot after pilot returning from the war zone has sworn that he would rather have a couple of droppable belly tanks filled with jellied gasoline than any other weapons—bombs, rockets or cannon.

Fire bombs have really come into their own in the Korean war. Every kind of target has fallen prey to them—troops, tanks, buildings, railroads, ammunition

dumps and even snipers in foxholes. Enemy troops fear napalm more than anything else thrown at them. One out of every four bombs dropped by Navy and Marine flyers was a napalm fire bomb. The Air Force reportedly used up 2,000,000 pounds of napalm powder the first five months of the Korean war.

Every war sees new weapons come to the fore and new uses discovered for old ones. Napalm is one of the old weapons that has risen to its highest popularity. It was used with good success against the Japanese on

With the "Y" of the tracks as an aiming point, a pilot skipbombed fiery blossoms on three enemy trains

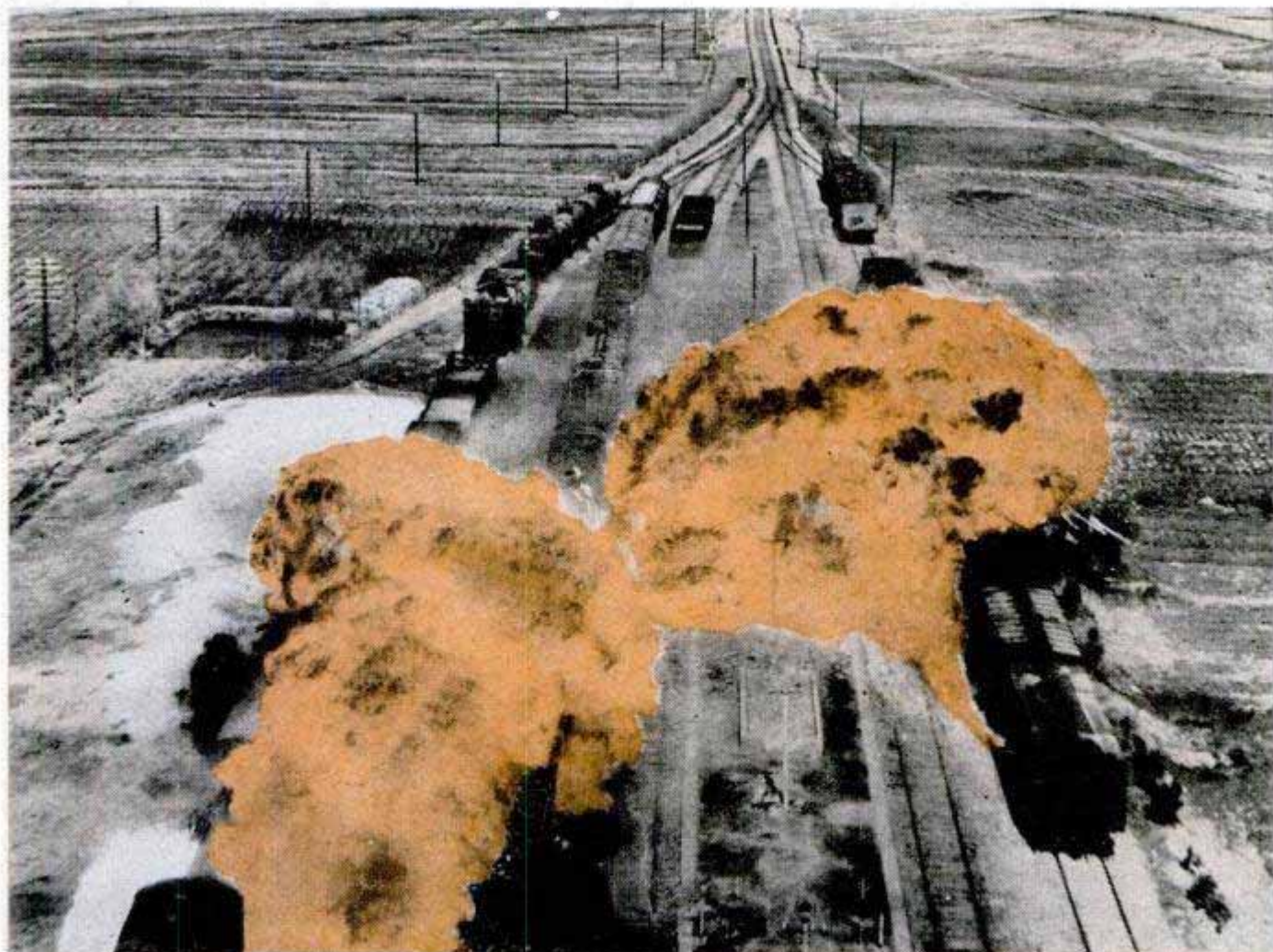



Losing no time between strikes, two Marines mix jellied gasoline while men in background change a tire

Peleliu, Iwo Jima and Okinawa. Thousands of napalm fire bombs were dropped on Japanese cities, burning many of them almost to the ground. Thinned versions of napalm are used in flame throwers that are employed by U. S. ground troops

against dug-in troops in caves and bunkers. Despite its widespread use, few persons know just what napalm is. Early in World War II scientists tried mixing gasoline with rubber. The Japanese captured all rubber supplies, so other substances were tried to

Just prior to "delivery," an ordnanceman on a U. S. carrier installs the igniter in a napalm belly tank  
U. S. Navy photo





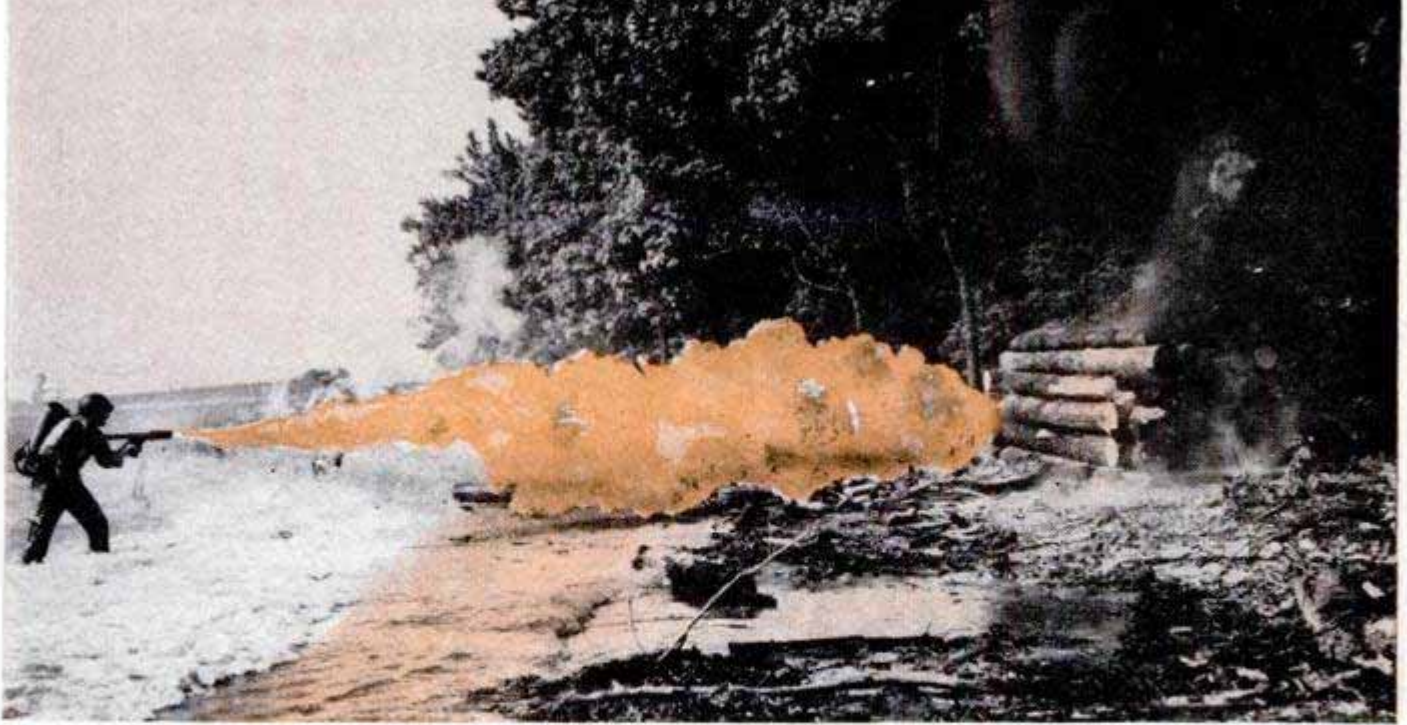

**At a rehearsal for combat, a Marine at the Quantico, Va., training base, sprays napalm from a flame thrower**

slow down the flash explosion of gasoline and make it cling. They hit the jackpot by combining aluminum naphthenate with aluminum soaps of coconut fatty acids.

What they got was a thick, gooey liquid that exploded with an atom-bomb-like swoosh, spreading fire over an area half as big as a football field when a 150-gallon belly tankful was dropped. An off-white granular powder, newest formulas for napalm include about 65 percent oleic acid,

30 percent coconut fatty acids and 5 percent naphthenic acid.

On the day before a fire-bomb raid, ground crewmen or ordnancemen on an aircraft carrier mix the gasoline and napalm powder in big drums or sometimes directly into the plane's tanks. Standing overnight, it forms the gel so feared by any troops who have seen its fearful effects. Contact detonation fuses in the mouth of the tank set it on fire when it hits a target.

**Fire-filled smoke roars from a North Korean barracks, devastated by napalm dropped at its rear entrance**





One-hundred-pounder dropped by Air Force plane, in circle, shoots a tongue of flame to its target—the tank

Near-misses are as good as a hit. Jet pilots with their tremendous speed try to drop the tanks of napalm 50 yards or more short of the target, skipbombing it so the flames spew forward and envelop the tank or enemy troops. This 1500 pounds of liquid fire death will cover an area about 250 feet long and 80 feet wide. You don't have to get hits with that kind of weapon. Personnel within 30 feet of the flames usually are suffocated by the burst.

North Korean tankmen at first ignored attacking United Nations planes until napalm bombs began destroying them right and left. Man has always feared fire and the huge mushrooms of fiery gasoline soon took their toll of tanks, thatched villages, railroad trains and columns of trucks.

Skyraiders and Corsairs from a Navy carrier caught 280 trucks racing reinforcements to beleaguered Communist troops.

(Continued to page 236)



Above, following drop shown at the top of the page, the fire catches and black smoke boils up from the target. The smoke clears and reveals, below, a tank completely gutted by fire and the 1500-degree heat



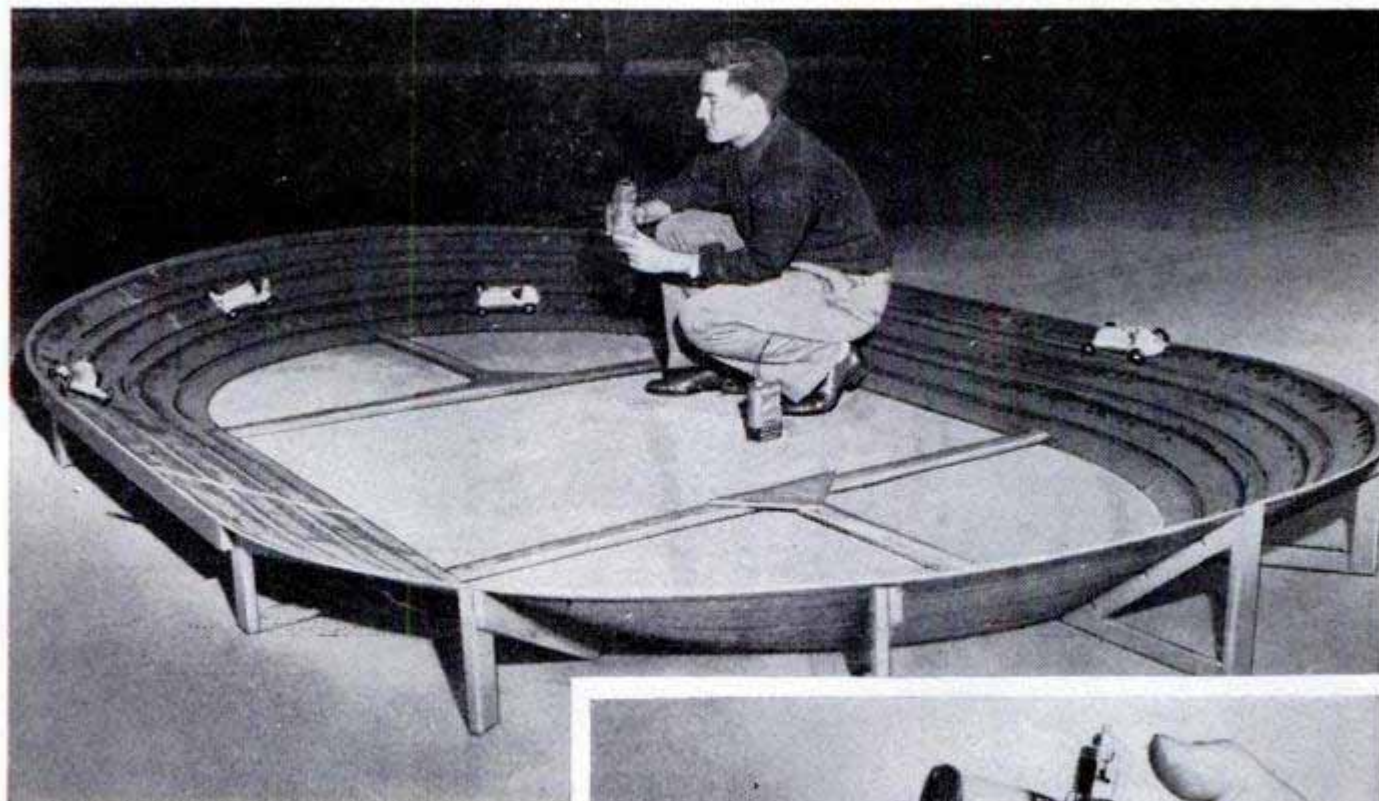

L. M. Cox Mfg. Co., Box 476, Santa Ana, Calif.

Racers whine around the back-yard track. Right, power unit has 39 tiny parts. Cable instead of guide pin in track holds one car

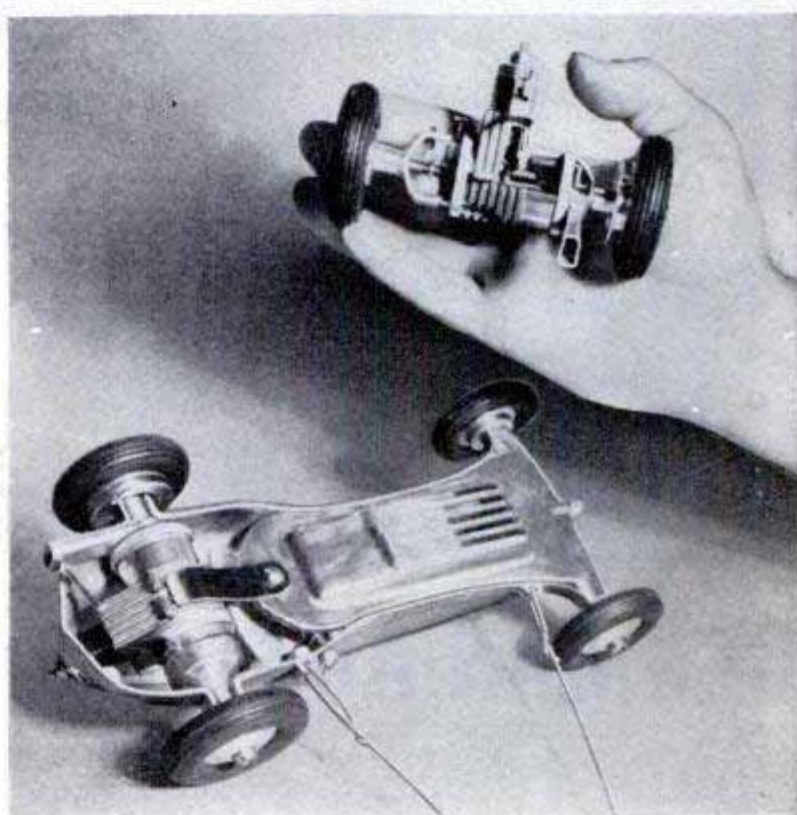

## Thimble Drome

For model racing-car fans, miniature racers now zip around a pint-size track small enough to be erected in a garage or back yard. The muffler design on the little cars cuts the whine of the racing motor down to a minimum. The six-piece prefabricated track has a hardboard surface. A guide pin on the car is inserted through one of four slots on the track to keep the midget racing along its own lane. Speeds up to 75 miles an hour are possible.

## Vertical Table Holds Book for Bedridden Patients



Patients who are unable to sit up in bed entertain themselves more easily with an overhead table that clamps to the head of the bed. The table is supported by an arm that has a counterbalancing spring to assist the patient in raising the table out of the way. Between the two legs of the table is a reversible panel that serves as the table surface. One side has clamps for holding a book or magazine. The opposite side has a mirror and plastic pockets for toilet articles. If desired, the panel can be replaced with an art board, weaving frame or some other recreational article.

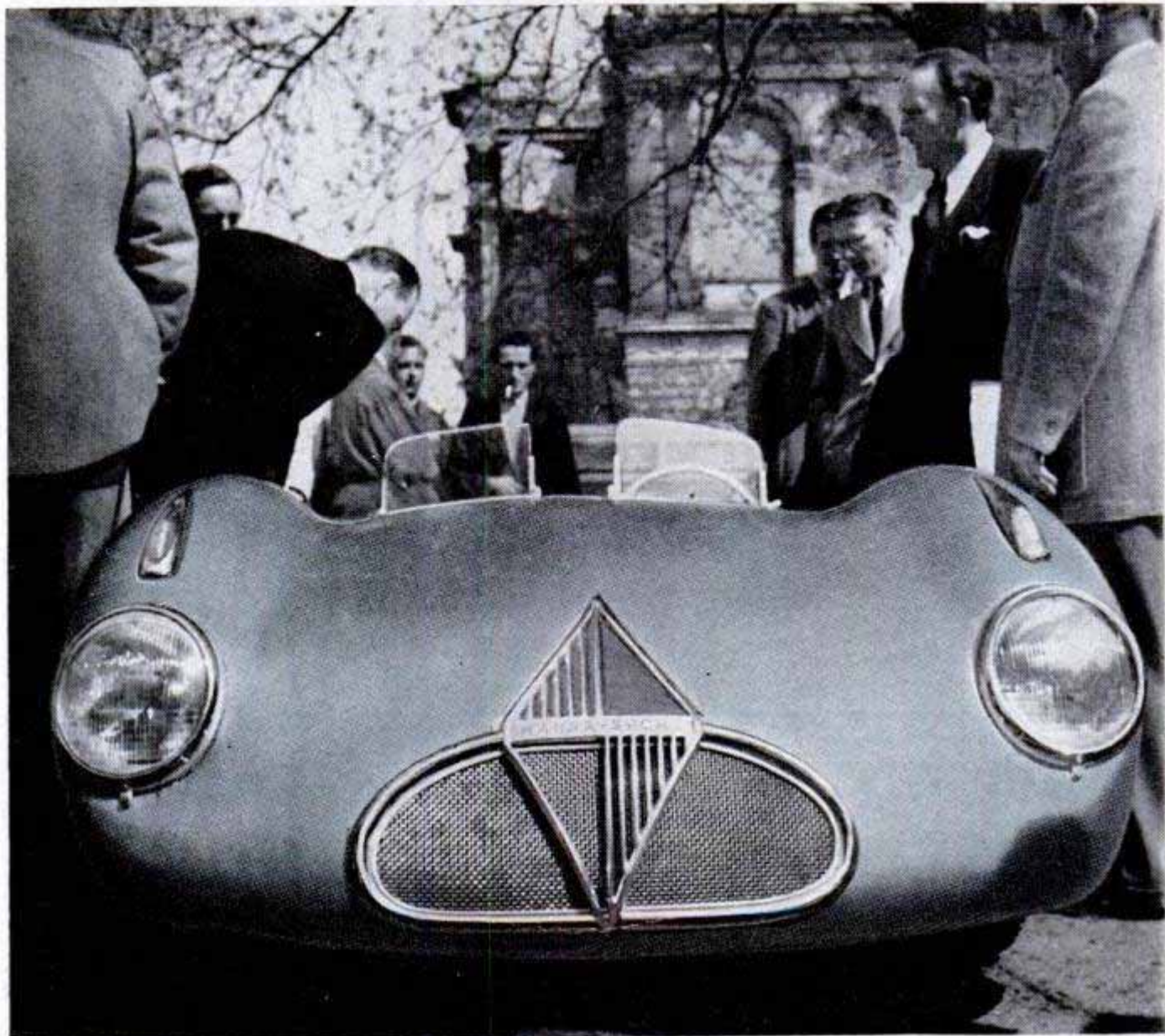

## GERMAN AUTO SALON

Popular at the first German auto show in 13 years was a Hansa Sport. A two-seater, it can go 140 m.p.h.

Selling for about \$4000, the BMW 501 sedan, right, is the first car designed by a new plant at Munich. It has a 60-horsepower, six-cylinder engine and is scheduled for production early in '52



Among famous makes on display at the exhibit was Mercedes, with the sleek cabriolet shown at left

Powered by a one-cylinder engine over its single rear wheel, the Fulda Mobile sells for \$593

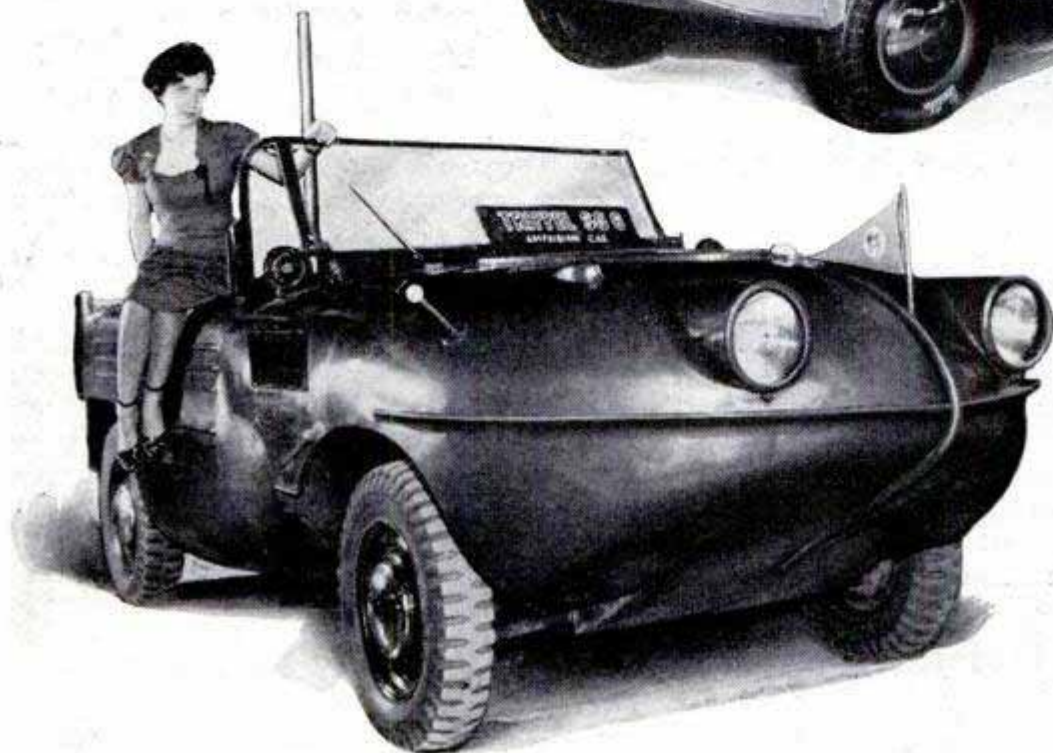

Land or water travel is possible with the Trippel SG 6. A lever alongside the driver switches the power to a propeller in rear

Small-car enthusiasts were drawn to the Partner. A front-wheel-drive sedan, it is priced at \$1375



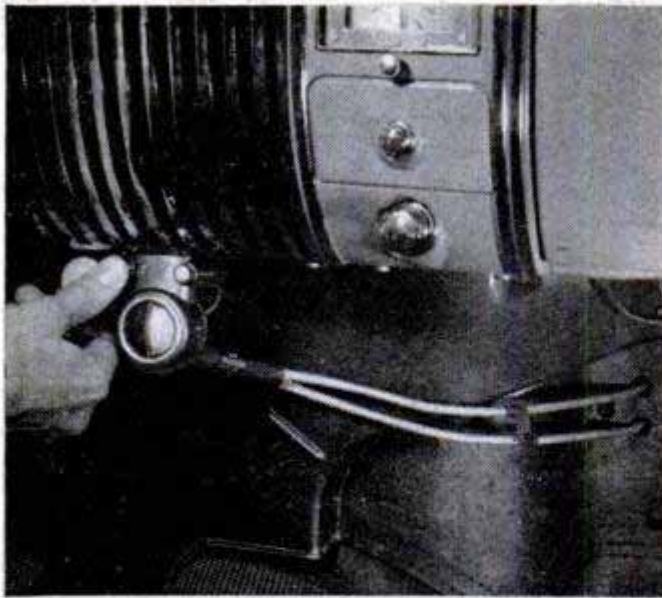

Oil from transmission flows through left half of the transparent bubble when dashboard button is pressed

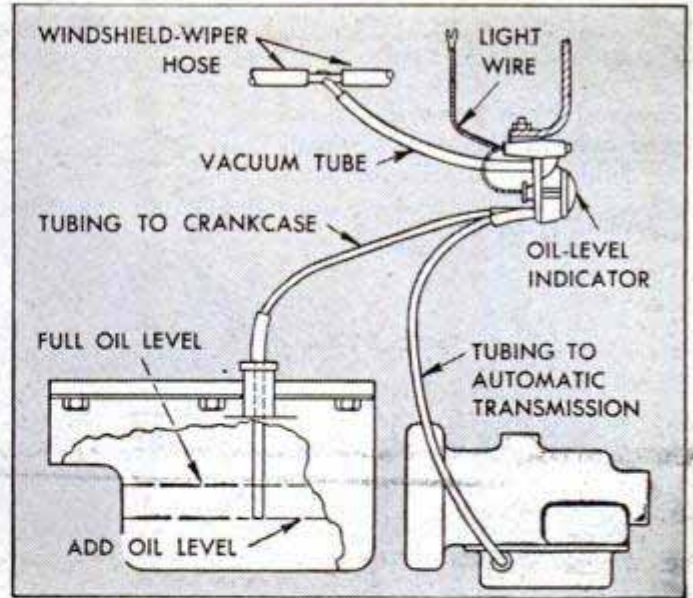

Oil-Eye Corp., Winona, Minn.

Diagram of installation. Dash indicator shows amount and condition of both crankcase and transmission oil

## Oil Gauge and Viewer Show Motorist Oil Sample

Mounted on the dashboard, an oil-level indicator shows the motorist when his oil is low and when it is dirty enough to require changing. Suction from the intake manifold draws a sample of the oil from the crankcase into a round plastic bubble behind which a small light burns. For cars with automatic transmissions, the bubble

is divided into two sections to permit checking levels of both crankcase and transmission oils. The installation is permanent and eliminates the need for the dip stick. By inspecting the oil with the light behind it, the motorist can tell when his oil-filter cartridge and oil should be changed. The indicator can be installed on marine engines.

## Back-Tilting Seat Protects Passenger in Crash

Airplane passengers are tilted safely backward by a new hammock-type seat if a crash occurs. In straight-in crashes at low speeds deaths are sometimes caused by the upper part of the body jack-knifing forward on impact and striking the seat ahead. The seat designed by Jess B. Bennett, a Braniff Airways executive, uses the inertia of the plane to put the passenger in a crouched, feet-first position in the line of crash. Springs beneath the seat further cushion the shock. Rests folding down and supporting the head also help to make passengers more comfortable.

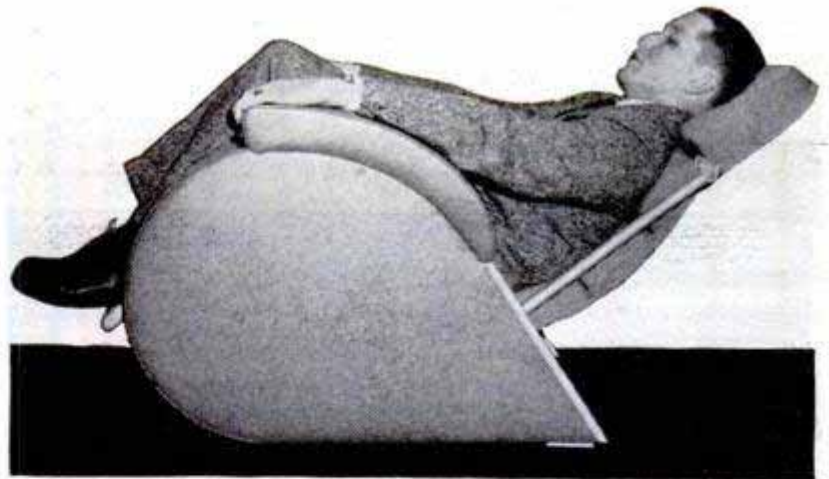

Resting position, above, of Bennett hammock-type seat. Sketches show how an impact tilts passenger backward, since his center of gravity is always lower than the front part of the seat



# THE LOST RIVERS RETURN

*By Rafe Gibbs*

**T**HE INDIANS were wrong when they lamented years ago: "Evil spirits deep in ground. They hold waters that have disappeared captive. Never return them to let the desert bloom."

The red men referred to four major streams that tumble out of Idaho's mountains with much promise, then gradually vanish among the sands. But disappearing Big Lost River, Little Lost River, Beaver Creek and Birch Creek—collectively known as the Lost Rivers—are now being released from their underground prisons through the ingenuity of the white man. And the dusty, gray desert lands are being made green with rich crops of beans, potatoes, sugar beets, wheat, barley and clover.

Already, about 13,000 acres north of Rupert, Idaho, are being irrigated by the underground water. Eventually, more than 100,000 acres will come under the system.

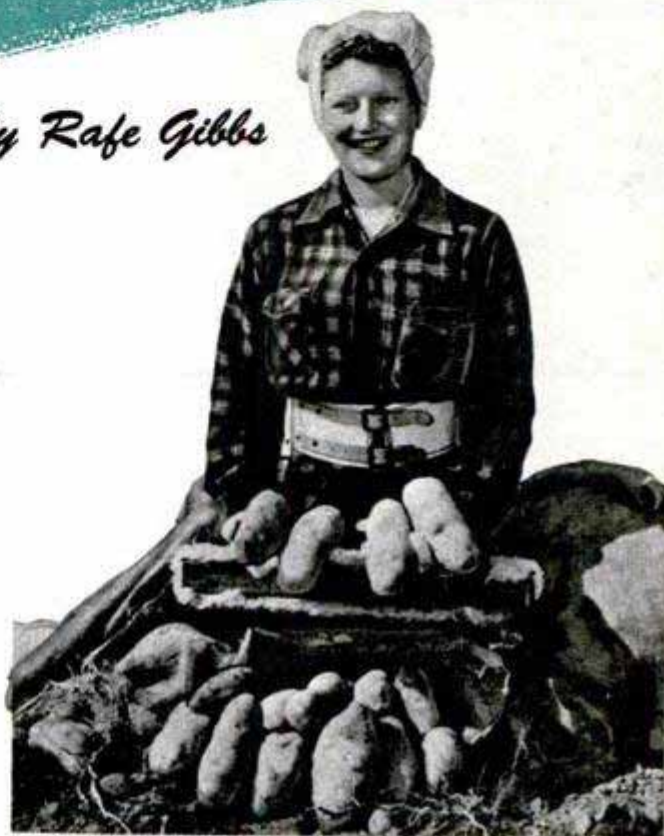

Big smiles reflect big harvests in the Lost Rivers area. So far, huge potatoes are the principal crop. Below, water pumped from the wells is cool and clear

Bureau of Reclamation photos

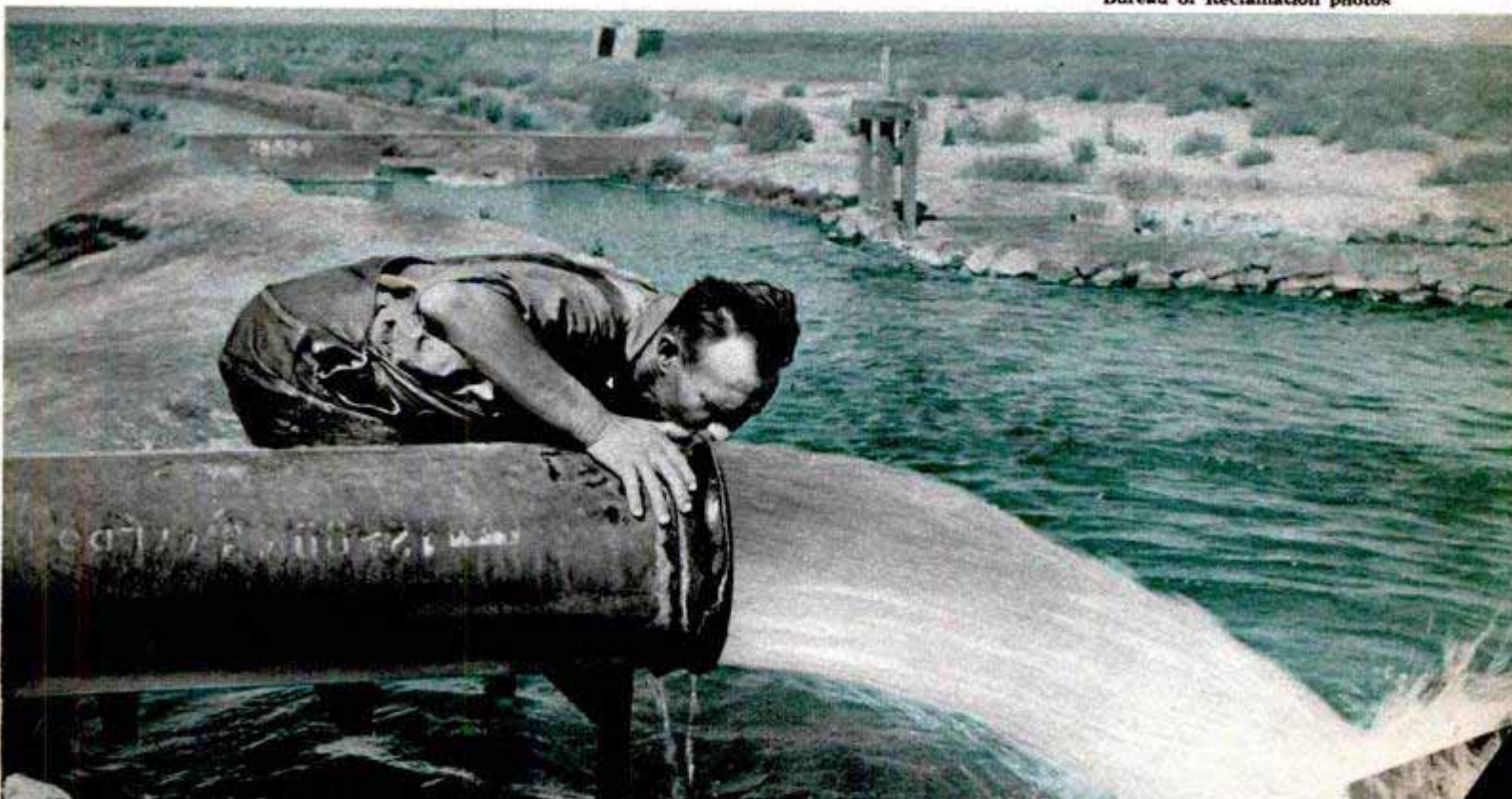

The story of what is happening in the Snake River Valley today goes back many years—perhaps a million. In that long-ago yesterday, the Snake River Valley was a pretty hot place. Molten lava spewed from huge volcanoes, crept across the land and shoved rivers aside. Even the mighty Snake River, which runs west across southern Idaho, was moved many miles to the south. Puckishly, the lava twisted Big Lost River, flowing south, so that it reversed its course and started flowing back north.

“This sort of thing,” says Raymond L. Nace of the United States Geological Survey at Boise, “continued for thousands of years. Lava piled up in some areas maybe 20,000 feet high. As the lava rose, the earth sank. Net result was the formation of a sort of shallow bowl. Outside the rim of this bowl flows the Snake River. Inside are the Lost Rivers, all dressed up with good water and no place to go except down.”

Big Lost River, Little Lost River, Beaver Creek and Birch Creek formerly found their way to the sea via the Snake. But the lava barriers trapped them. Meanwhile,

**White-gold strike!** A new well tapping the Lost Rivers is brought in by a drilling crew. Irrigation by well is easy to control—water can be turned off any time

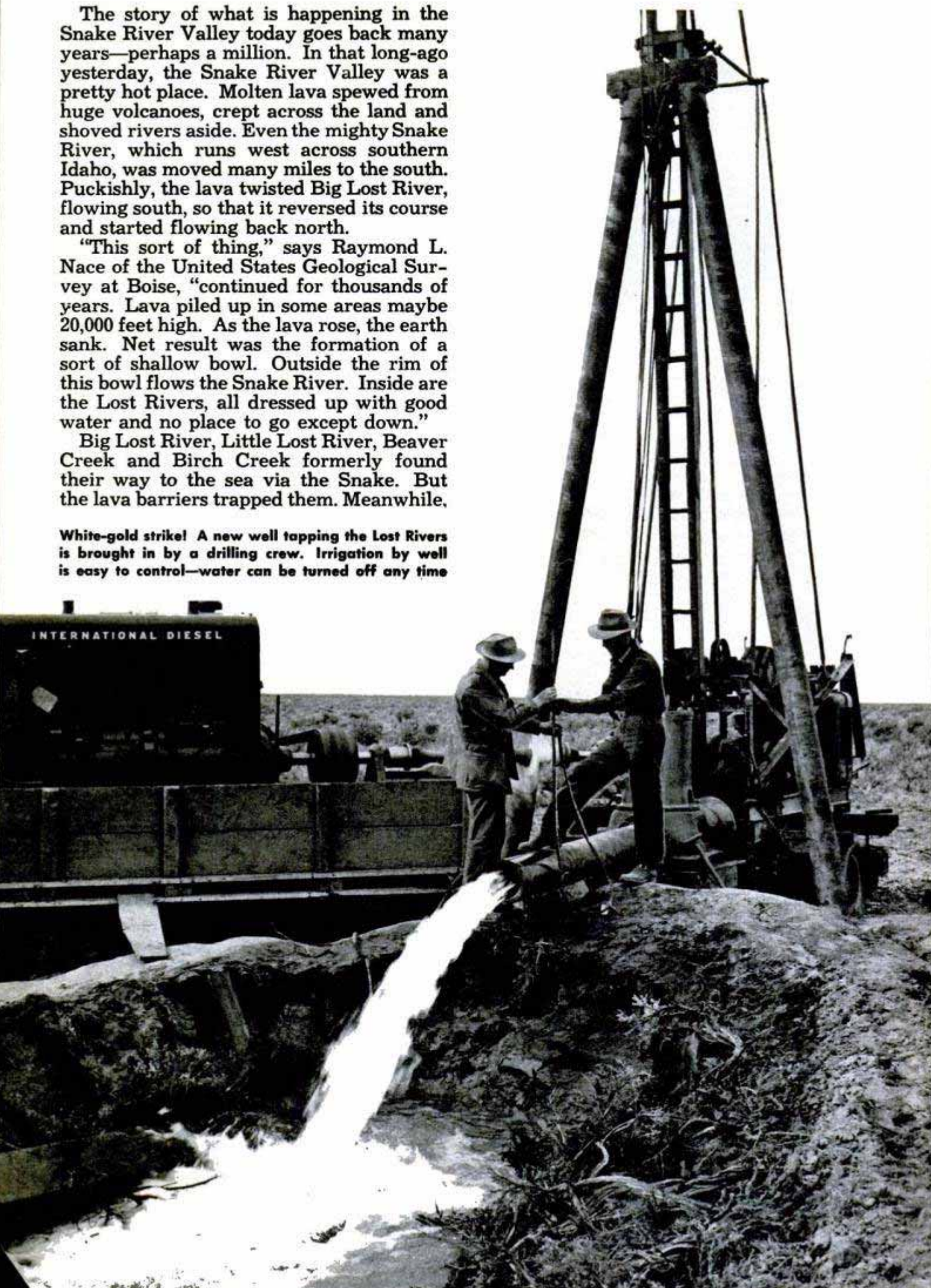



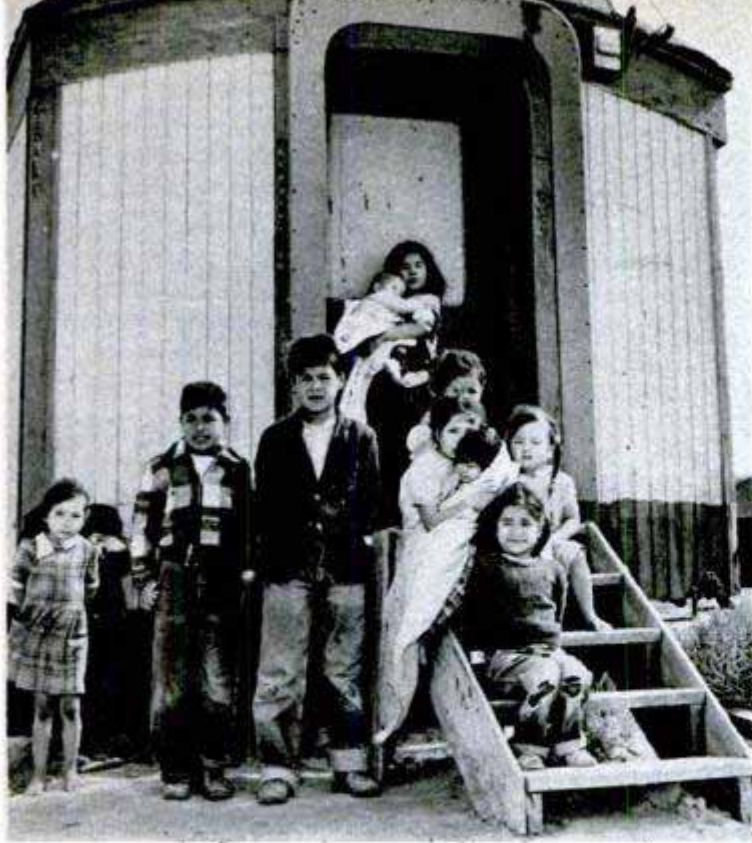

Water is brought in faster than homes. Harvesters live in rail cars and tents until houses can be built

as the lava cooled, cracks formed. And the Lost Rivers, fed by melting glaciers, carried down from the mountains great deposits of sand and gravel. Then into the lava cracks, into the sand and gravel, the Lost Rivers began to disappear.

The Indians thought there was no outlet at all for the Lost Rivers, but, explains Nace, geologists of recent times found that some of the waters from the vanished streams were actually getting to the Snake by gushing out with other waters in the Thousand Springs of the Hagerman Valley near Twin Falls. The Indians, however, are not to be discredited entirely, for a large share of the water that sinks into the earth each year just stays sunk.

"Many people today have the idea that big rivers are flowing underground," says Nace. "This is not true. There is a lot of water, but it is in a vast webwork of small channels formed by cracks and extinct volcanoes."

Pioneers suffered from thirst in pushing wagon trains over the interwoven reservoirs of water. The crackling dry sagebrush gave no indication of water below.

It was only a few years ago that serious thought was given to tapping the Lost Rivers for irrigation. One day in 1947 Julian Clawson, owner of several thousand acres of sagebrush and jackrabbits, got to wondering about the Lost Rivers. Would wells gush forth big enough flows to irrigate the land? The soil itself was good.

Clawson sank a well. The drill went down 200 feet . . . 300 . . . 400 . . . then water.



Instruments at observation wells keep a close check on water level. So far it hasn't fallen appreciably

More water than Clawson had dared dream there would be—a flow of 4000 gallons a minute. Sinking the hole cost about \$5600, and the pump and 300-horsepower motor \$12,000. Just getting a good look at that first water cost about \$17,600, but already the gamble is paying big dividends.

Recently, 160 farmers, bankers and businessmen toured the area and stopped to drink from Clawson's "pioneer" well. The water was soft, cold and sparkling clear.

The Bureau of Reclamation saw in the return of the Lost Rivers a possible answer to the query that never ceases to come in the mail: "Where can a man get homestead land?"

Detailed surveys were made and test wells sunk. Findings looked good. Then the wheels, from offices in Washington to sagebrush land in Idaho, began to turn fast. An \$11,395,000 project designed to pay out over a long period of years through water-service charges was established. The development area, known officially as the North Side Pumping Division of the Minidoka Project, covers 77,650 acres, and will in the years to come bring under irrigation 600 new farms. Thirteen thousand of the acres will be irrigated by water channeled from the Snake, but the major share—64,000 acres—will be brought into production with wells reaching down to find the waters of the Lost Rivers.

"As soon as major blocks of land have water, they will be opened to homesteaders," says Boyd Walters, bureau engineer at the project. "The homesteads will be



Farmer, who leases the land, siphons water from an irrigation pool. Area will be opened to homesteaders

plotted to average about 100 acres each."

Several bureau irrigation wells were put into operation during 1950, but the land they serve was leased for two years, with options for three more. At the end of the five years, the leased land goes back into the homestead pools together with all of the developments.

Meanwhile, private landowners are busy drilling wells. The activity smacks of an oil boom, with white gold replacing the

black. Today, there are more than 34 bureaus and private wells in operation.

Says Larry Robinson, editor of the Minidoka County News at Rupert: "Business is good and getting better by the well."

Word of the project traveled with the speed of its disturbed jackrabbits, and up from Shafter, Calif., came James Camp, son of the founder of S.A. Camp Farms, Inc., one of the biggest agriculture firms in California. Camp promptly bought for the corporation at \$106,000 a total of 6000 acres—land that only a few years ago could hardly raise an eyebrow of interest.

"We expect to have 20 wells pumping water in 1951 and a large share of the land under sprinkler irrigation," says Camp. He adds that the firm plans to spend \$400,000 in improvements. Eventually, it will erect storage cellars, warehouses and processing plants in Rupert.

Convinced of the soundness of the project, the Idaho Power Company has invested more than \$500,000 in supplying the necessary electricity. This includes a huge new substation.

But how long can the sinking of wells go on? The Bureau of Reclamation is keeping a close watch on the water level. Scattered over the project, the bureau has four wells merely for observation of the water supply, and will soon add a fifth observation well. No water is pumped out of the observation wells, but there is a copper float on the water surface of each. A copper wire from the float reaches up to the wheel of a recording device. Any drop in the water level is shown on a graph, but so far there has been no appreciable decline in the water supply. A close check is also being kept

Here's sagebrush as far as a man can see, but soon this land, too, will be irrigated by the Lost Rivers

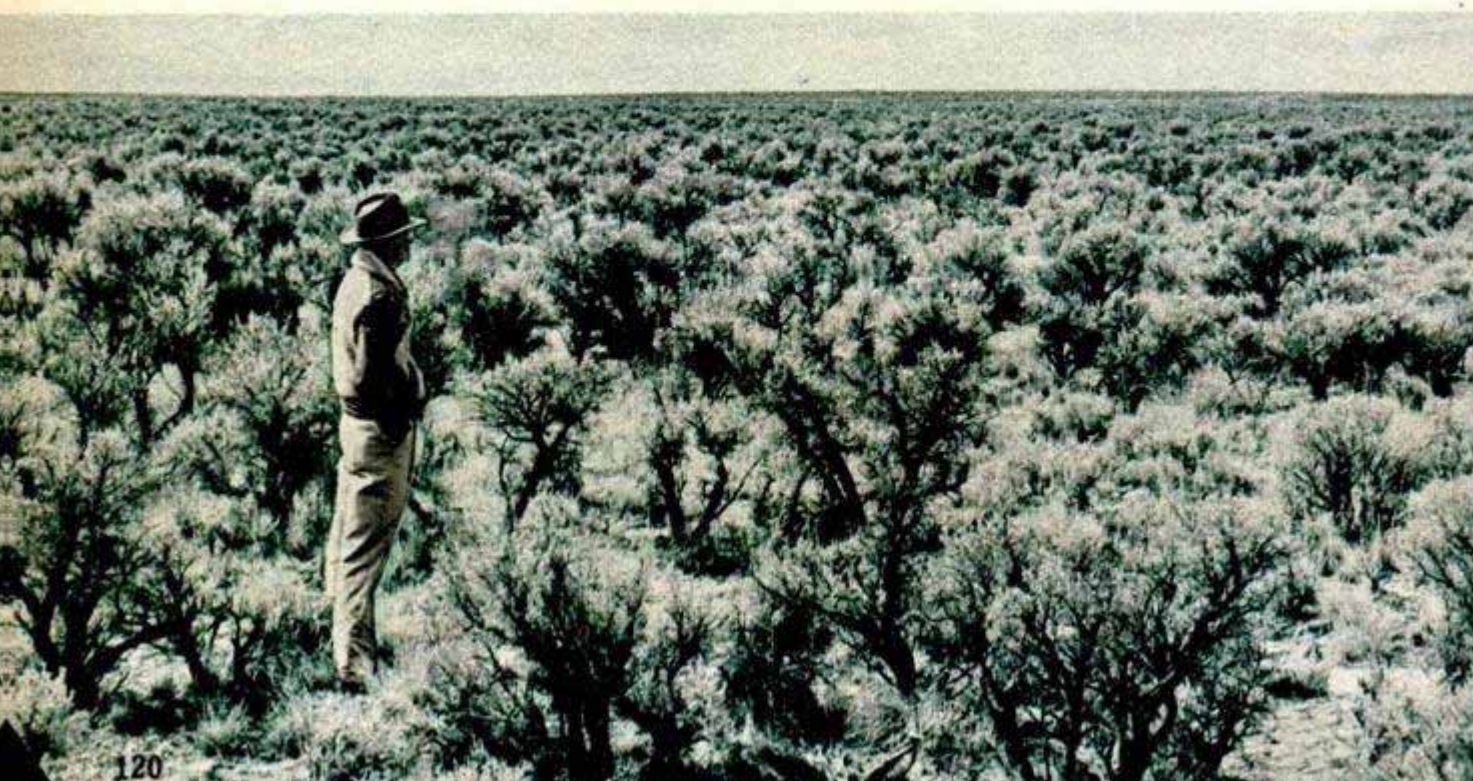

on the Thousand Springs flow at Twin Falls. The effect on the water supply there has also been negligible.

"Besides the water from the Lost Rivers, the underground reservoirs are getting considerable water from the Snake — secondhand," says geologist Nace. "Vast amounts of water are taken from the Snake to irrigate other areas. Only about 50 percent of this water is used up by plants and evaporation. The other 50 percent goes into the ground, and a considerable amount works its way to the hidden reservoirs. Some of the unused irrigation water also comes back out through the Thousand Springs. Much of the water pumped out by the new wells will go back into the ground to be pumped out again, or to gush from the springs."

The wells in the North Side area average only about 190 feet in depth, making for reasonably cheap pumping. Electric pumps, from 100 to 450 horsepower, bring water to the surface in varying amounts up to 5000 gallons a minute. The wells are spaced about  $\frac{3}{4}$  mile apart.

Right now the area is a lonesome-looking land because the farms are ahead of the homes. On bureau-developed land leased to farmers there is no inclination to erect substantial buildings because the land will soon have to go back into the homesteading pools. The private owners generally haven't gotten around to building, either. Too busy clearing and working the land. Some farmers are living in tents. Ancient railroad cars have been parked out in the wide-open spaces to provide shelter for harvest workers.

Typical of the new settlers is 27-year-old Blaine Hodges. A former infantry staff

(Continued to page 218)

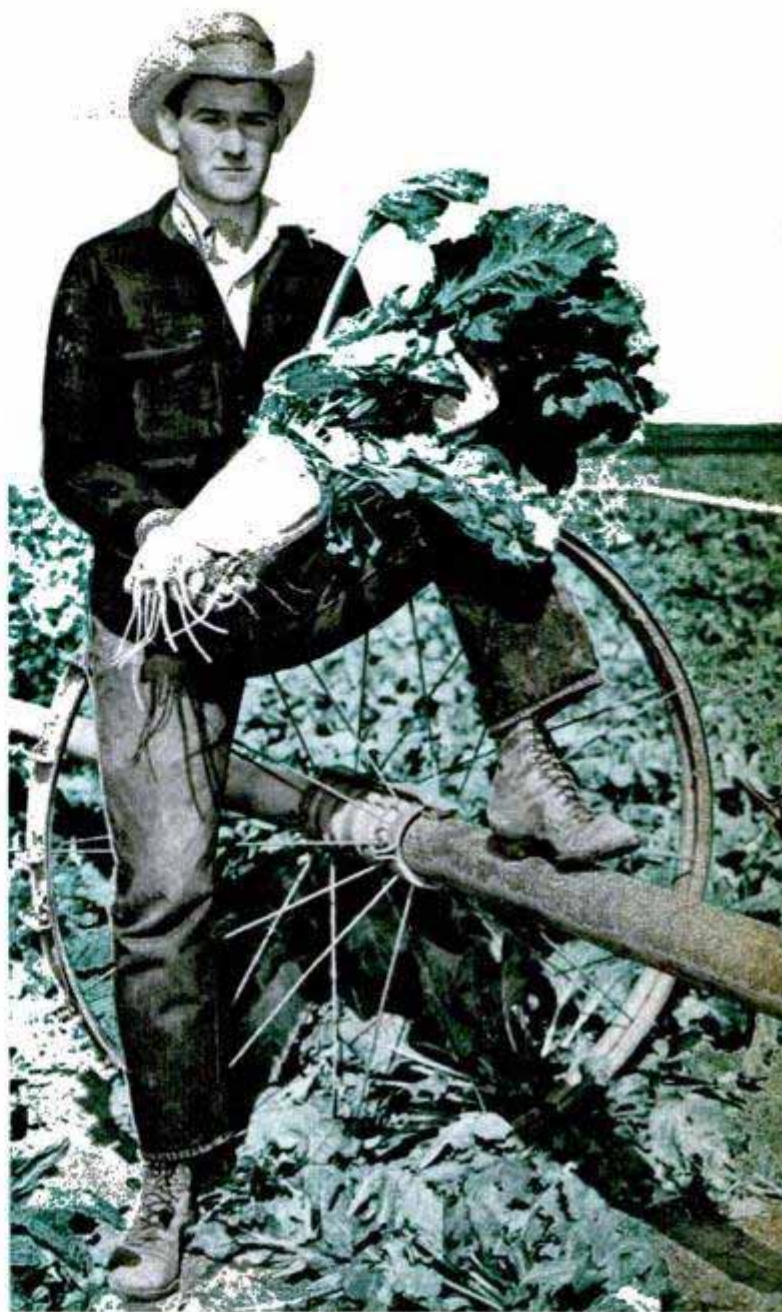

Irrigated land is fertile, produces fine crops. Farmer holds a typical sugar beet. Below, opening a dike, a farmer releases water that once flowed underground

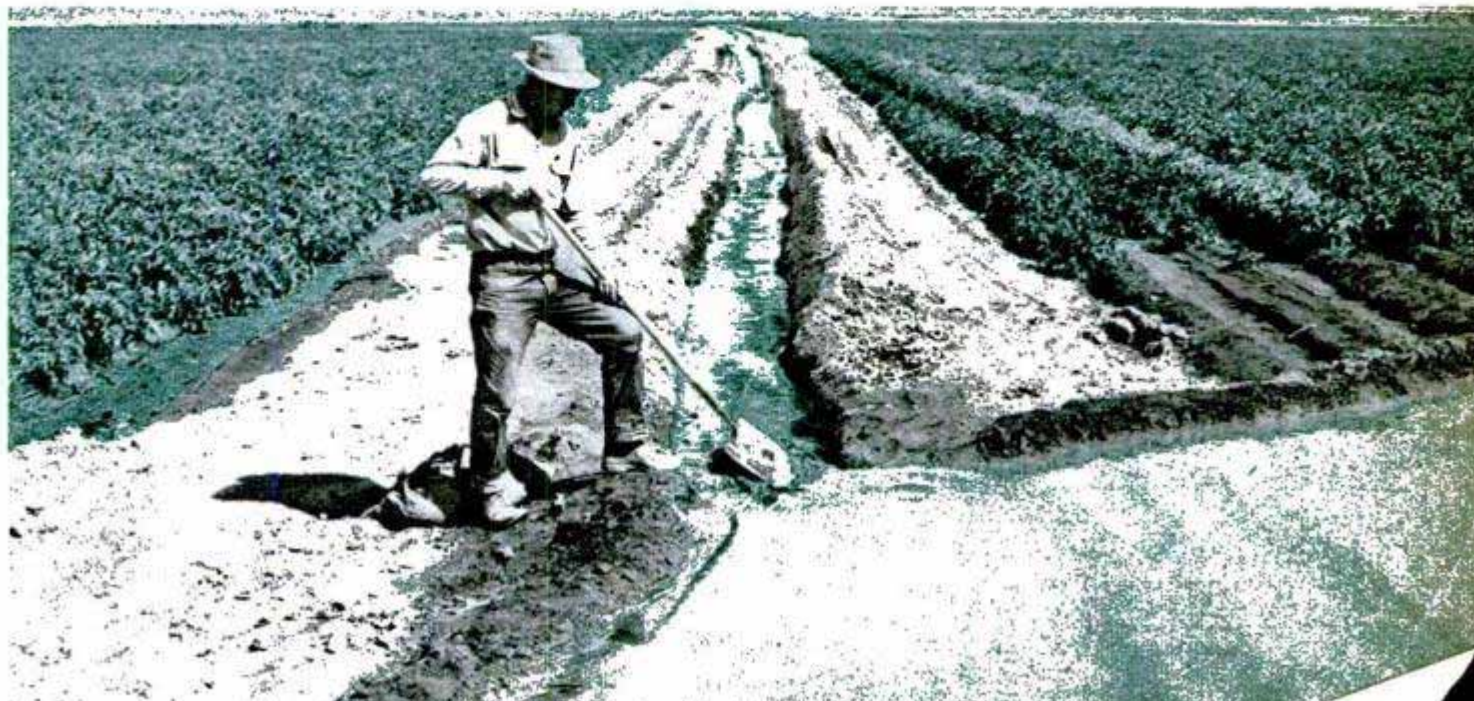

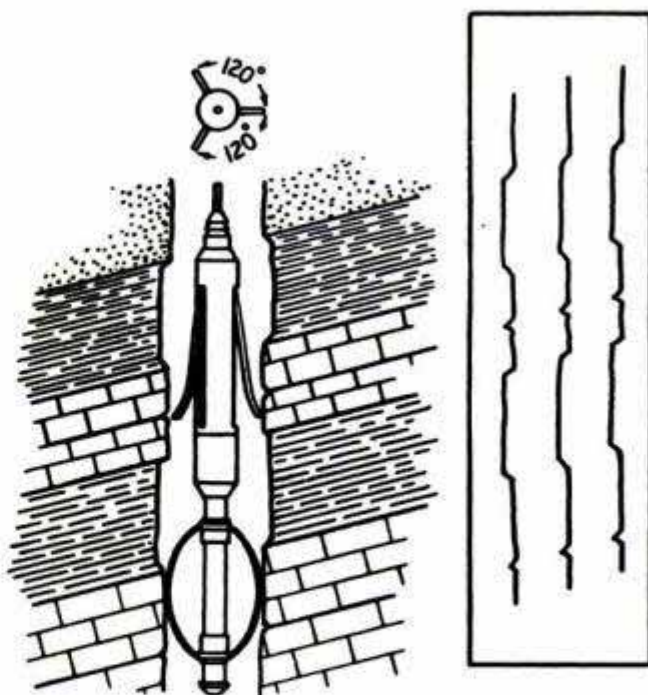

Carter Oil Company, Tulsa, Okla.

Three prongs project from instrument. Diagram shows how they "map" sides of hole to draw three profiles

## Oil-Well Instrument Charts Slant of Underground Formations

Just a few years ago the oil-well driller who had nothing to show for his work but a dry hole was faced with a problem: in which direction should he move to drill the next hole? What he really wanted to know was which way the underground earth and rock formations slanted, so he could strike the oil closer to the surface. An instrument developed by the Carter Oil Company probes the dry hole to tell him

which way to move. The instrument is dropped to the bottom of the hole, then pulled back up. Three prongs press against the sides of the hole, probing the rock and earth grooves and projections. An automatic instrument records the "feel" of each prong, drawing a profile of that side of the hole. By comparing the three profiles, a trained man can determine the slant of the underground formations.

## Metalized Window Curtain Aids in A-Bomb Protection

Heavy canvas window curtains, specially treated, are designed to give partial protection from the effects of an A-bomb blast. The curtains are metalized with aluminum and lead. They will help protect persons inside a building from flying glass, radioactive dust and flash burns, according to the manufacturer. They are said to be effective at distances beyond 2600 feet of the explosion. When not in use, the curtain rolls against the upper part of the casement like a window shade.

☐ If all the known supplies of coal, oil and wood in the world were burned at a rate liberating heat equal to that received from the sun, it would take a little more than three days to exhaust all this fuel, and less than an hour to exhaust all known nuclear fuel.

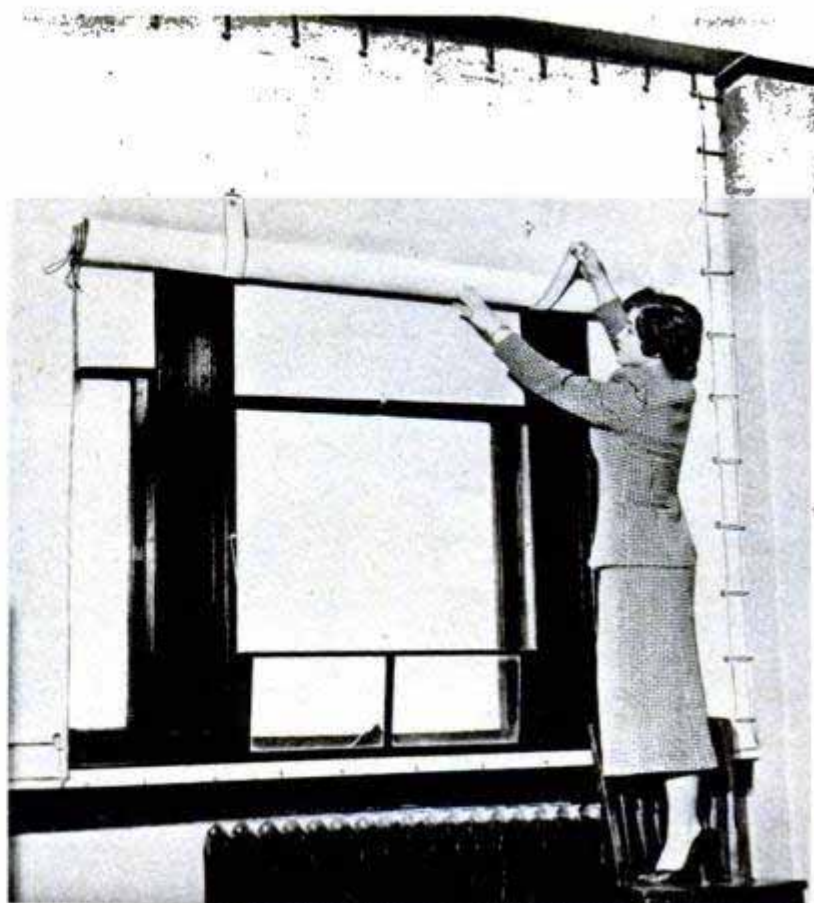

Strategic Products, Inc., 600 S. Michigan Blvd., Chicago 11

## Macaroni-Making Process Shapes Hollow Propellers

Materials and time are saved by a new extrusion process for forming hollow-steel propeller blades. Though much more complex, it resembles the method used in making macaroni. A squat, solid cylinder of steel, weighing 400 pounds, is heated in a bath of molten salt until it is glowing red. The billet is then shaped by a press into a 10-foot-long, 200-pound hollow tube with tapered walls. Another press flattens it out and the propeller is finished. The Curtiss-Wright Corporation developed the new technique with the U. S. Air Force. Forty percent more man hours and nearly twice as much steel was required to make the same propeller in two parts.

## Helium-3 Solidified For the First Time

Helium-3, a rare form, has been solidified for the first time by a combination of extreme cooling and high pressure. Liquid helium-3, unlike all other liquids except helium-4, cannot be frozen simply by cooling it. Pressure is also required. In order to solidify the helium-3, scientists at the Argonne National Laboratory cooled it to 457 degrees

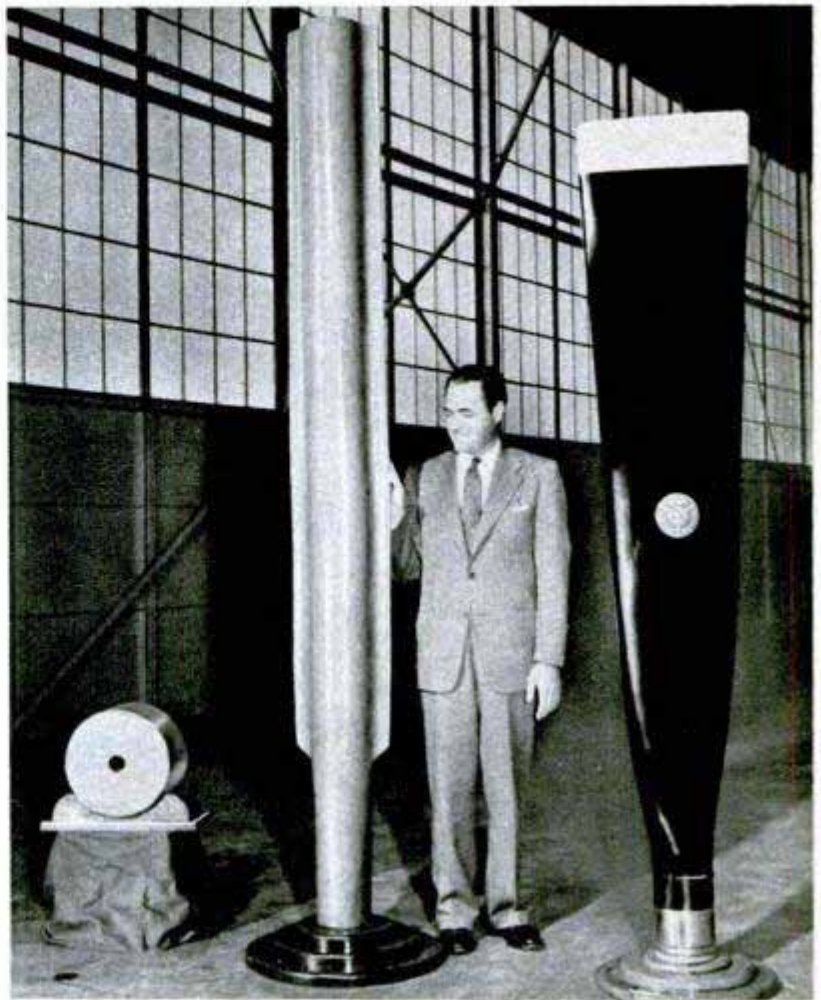

below zero and then subjected it to a pressure of 600 pounds per square inch. The quantity of helium-3, an extremely rare material, used in this experiment weighed less than one thousandth of an ounce.

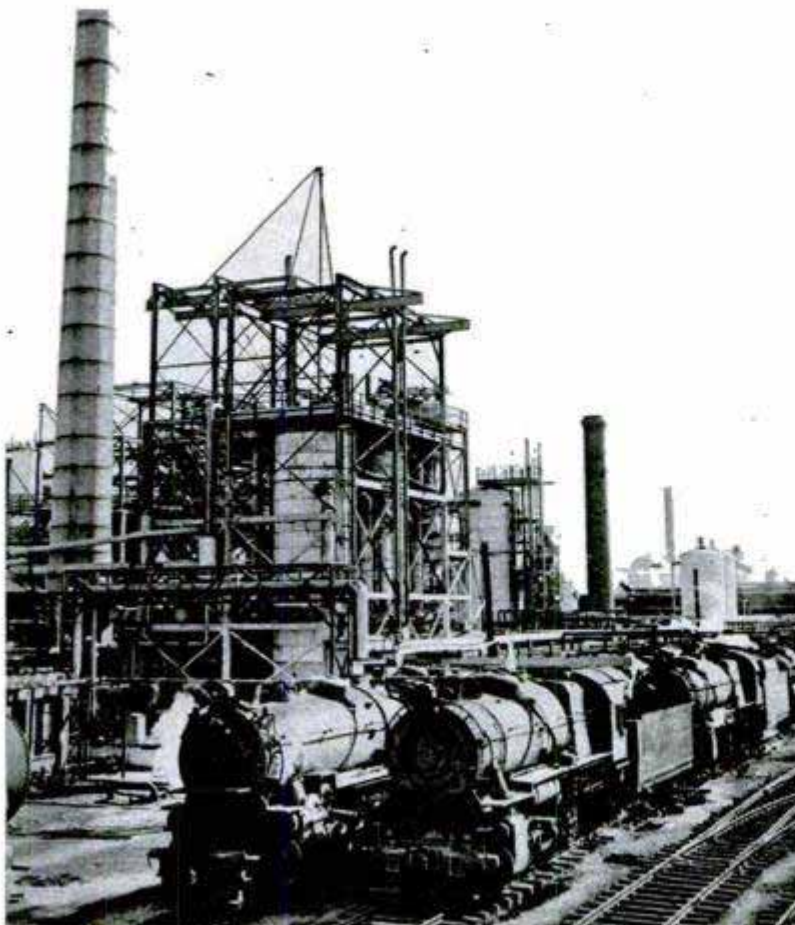

## Locomotives Stop Rolling But Don't Stop Working

When the Sun Oil Company needed thousands of pounds of additional steam to produce a rush order of high-octane gasoline, it turned to the railroads for help. Twelve retired locomotives from the Pennsylvania and the Reading railroads were rushed to the refinery and fired up. Steam from the locomotive boilers was piped into the main line of the refinery steam system. Appropriately enough, the locomotives were adapted to burn a gas which is a waste product of the refinery.

Sources of available products described in this issue are indexed on pages 12, 14 and 16. Sources of further information on other articles are listed in the WHERE-TO-FIND-IT LIST, which is available to readers without charge from Bureau of Information, Popular Mechanics, 200 E. Ontario St., Chicago 11

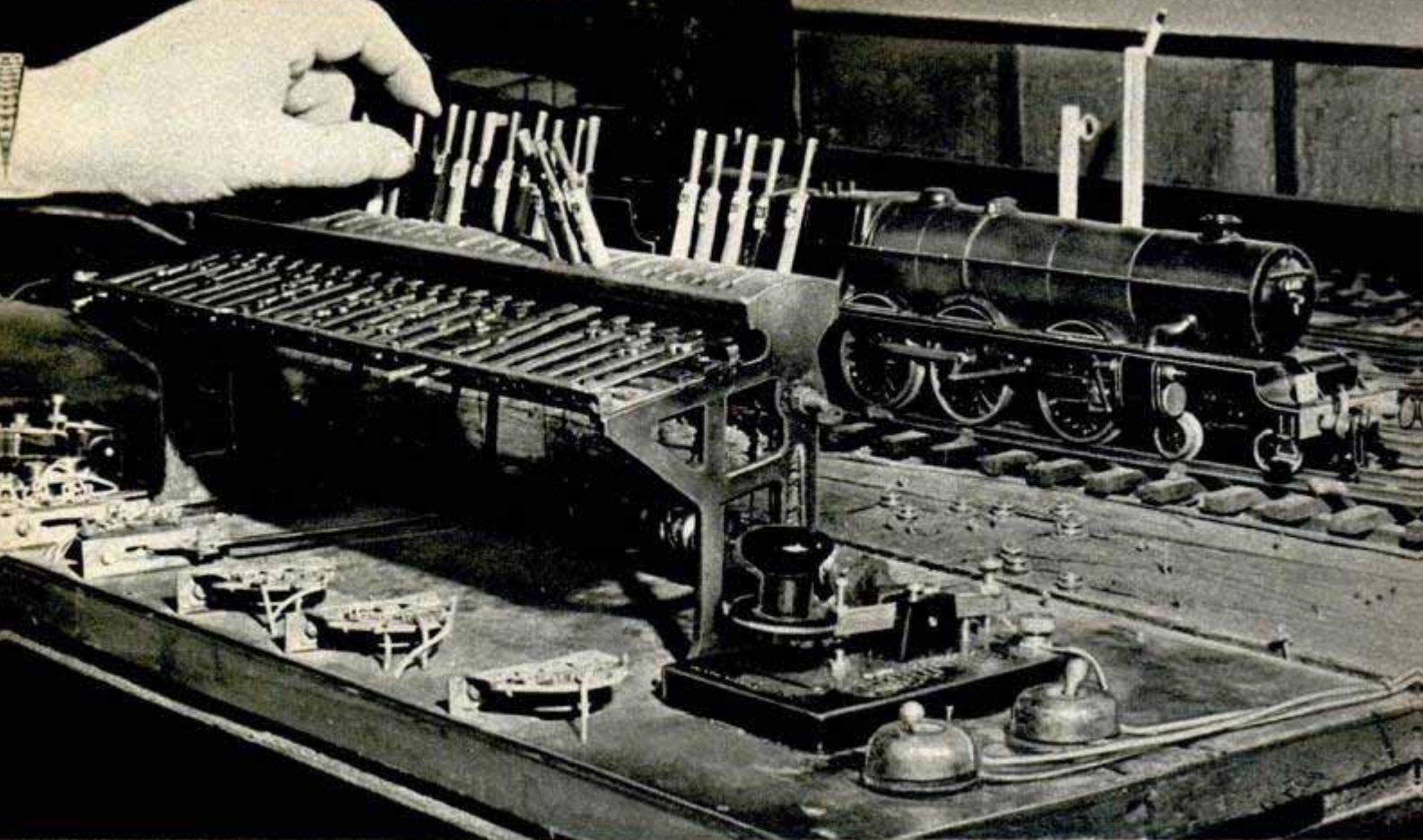

At Glovers Lane Signal Box, the lever frame and interlocking signals are operated exactly like the real thing

# *Railroad* IN AN ENGLISH GARDEN

All stations are named after villages in Sussex. A club member operates the signals at Charlwood North

Michael Sellars is a railroader by trade, but he still devotes his leisure to operations at Rusper

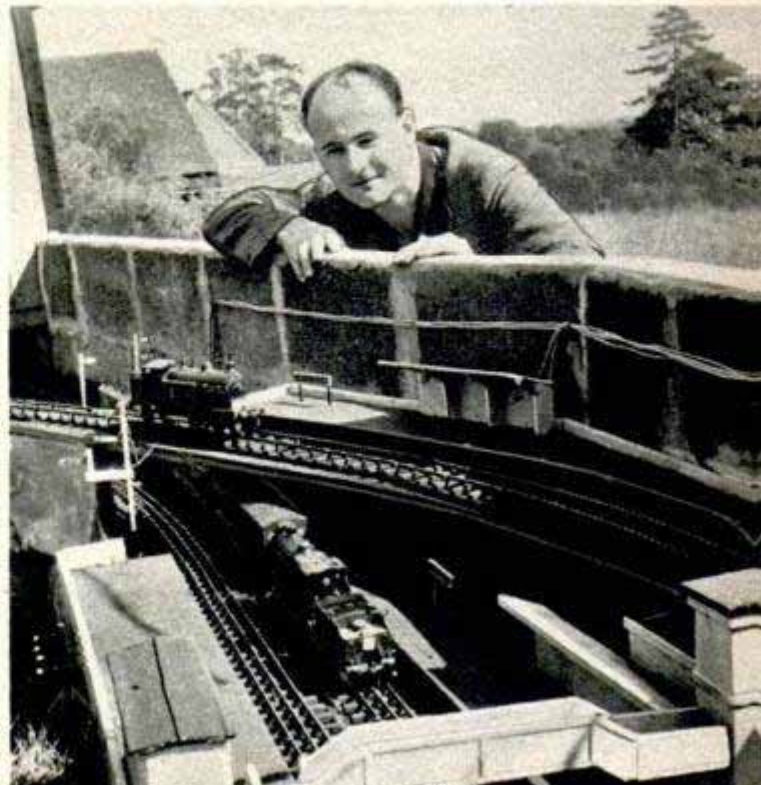
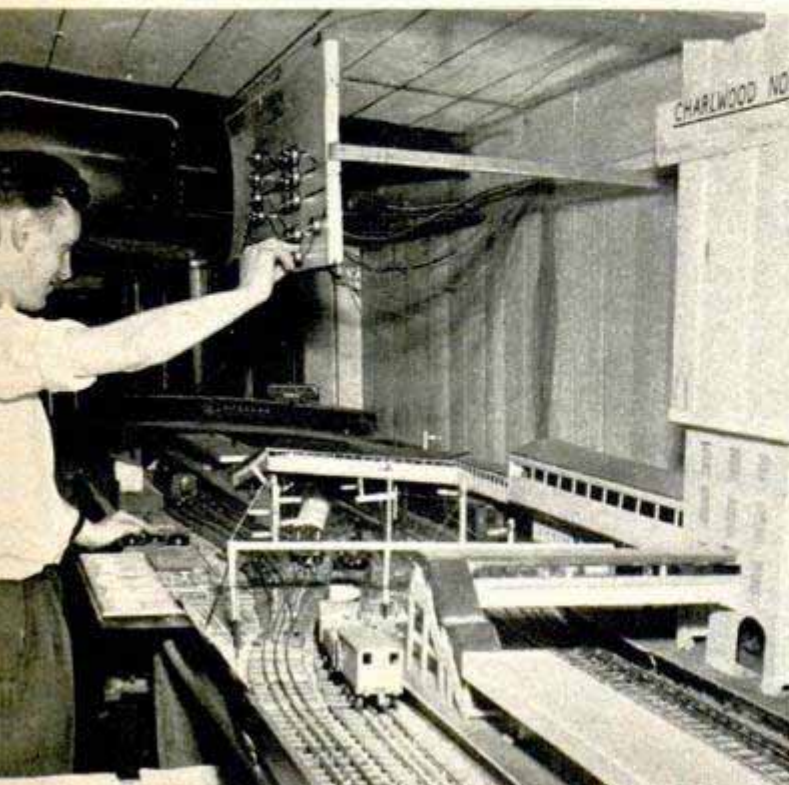

**M**OST KIDS want to be locomotive engineers when they grow up and British youngsters are no exception. Christopher Morgan of Sussex, England, was one lad whose occupation seemed certain to be railroading. At 12, he knew as much about the old London, Brighton and South Coast Railway as a British Casey Jones. But, as with most of us, somewhere along life's right-of-way, he was sidetracked, becoming a stock broker.

Unable to separate himself completely from his boyhood ambition, Morgan has, for the past 30 years, been devoting his spare time to railroading—scaled down to fit his three-acre garden. His model layout is so complicated it requires a staff of 20 to operate it!

These rail fans are members of the Ruser Railway Club, formed in 1935 to operate Morgan's equipment realistically. Trains run on a strict schedule in compliance with the rules of the British National Railways. All regulations, including safety requirements, are obeyed. The Ruser Railway consists of 100 controls, 250 signals, 45 locomotives, 240 coaches and freight cars, 15 stations, 5 freight yards and 10 marshalling yards.

About 25 fans belong to the club. A third of them are professionals, being employees of the British Railways. The others are "laymen," whose boyhood dreams like Morgan's somehow had been shunted onto a siding.



Christopher Morgan, namesake and grandson of the founder of the club, helps his father check a train through a station

Below, left, a member of the club looks through the five-foot Tilgate Tunnel along the branch-line approach to Glovers Wood

If it were not for the figure in the background, it would be easy to think this a stretch of track on the British Railways

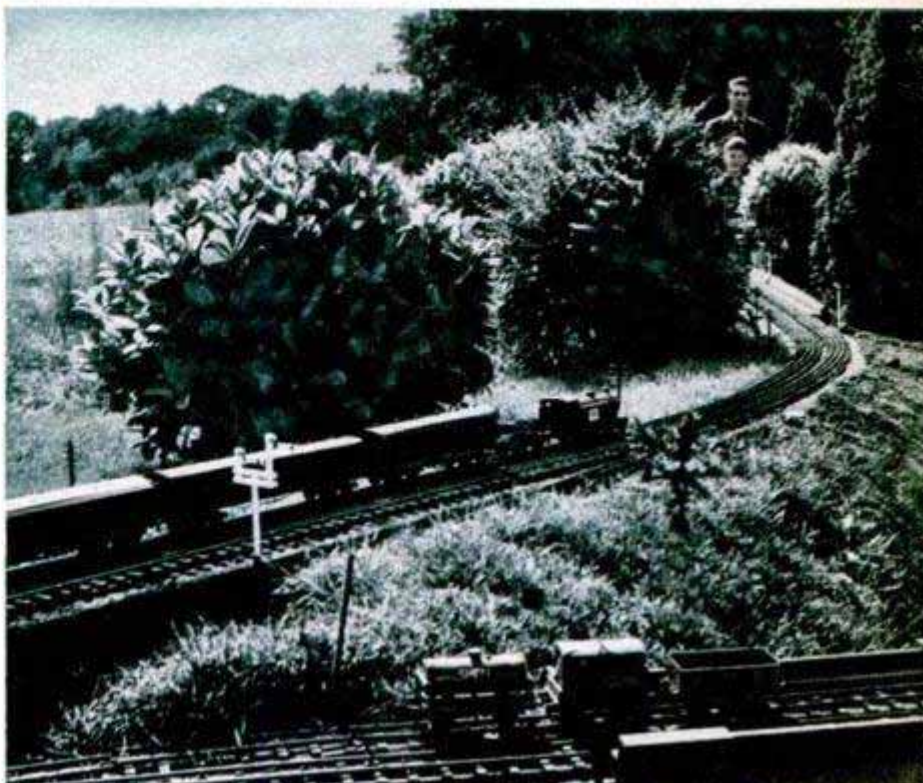
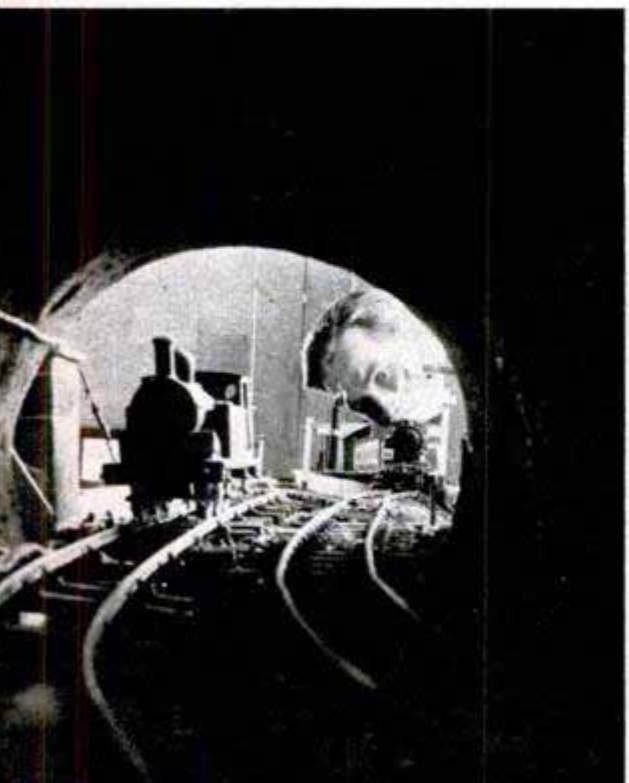



## High-Speed Facsimile

As many as 180,000 words of printed matter can be transmitted and recorded within one hour through a new high-speed facsimile system. Photos and diagrams also can be transmitted to any distant point and recorded without photographic, chemical or drying equipment. The system, developed by Western Union, uses either radio beams or communications wires as a means of transmission. The sending operator slips the printed material into a transparent cylinder and closes the endgate of the cylinder. This starts the cylinder spinning at 1800 revolutions per minute, and a photocell acting with a pin point of light scans the material. At the receiving end, needlelike instruments "print" a copy of the material on a dry recording paper. At the conclusion

Above, right, printed material is slipped into cylinder to start the transmission. Left, at receiver, image is printed on paper and ejected from machine. Below, equipment for transmission



of the message an automatic signal causes a knife to cut the facsimile copy from the roll of dry recording paper.



## Gasoline-Tank Sealer

Leaks in automobile gasoline tanks and radiators can be plugged by a new sealing compound without draining or removing them from the car. The sealer, a thick liquid that is nearly transparent, is held against the leak with an applicator for two or three minutes, or until it sets sufficiently to withstand the pressure of liquid in the tank or radiator. It also can be used to repair leaks in flexible lines, water pipes, battery cases and around windshields and windows in cars and homes.

Ⓞ Scrap metals are vital to defense as about one fifth of the tin used in the United States annually is salvaged from scrap.





## Fish-Food Fisherman

In Chicago, there is a fisherman who fishes so other fish can eat. His catch consists of tiny organisms, actually fresh-water crustaceans, he calls "fleas," and hairlike worms, known as Tubifex. The fisherman,



Leo Zetek, sells these marine animals to tropical-fish fanciers, who feed them to their pampered pets. To keep the worms and fleas alive during the time they are in captivity, Zetek has a small air compressor in his station wagon that aerates the water as he drives.

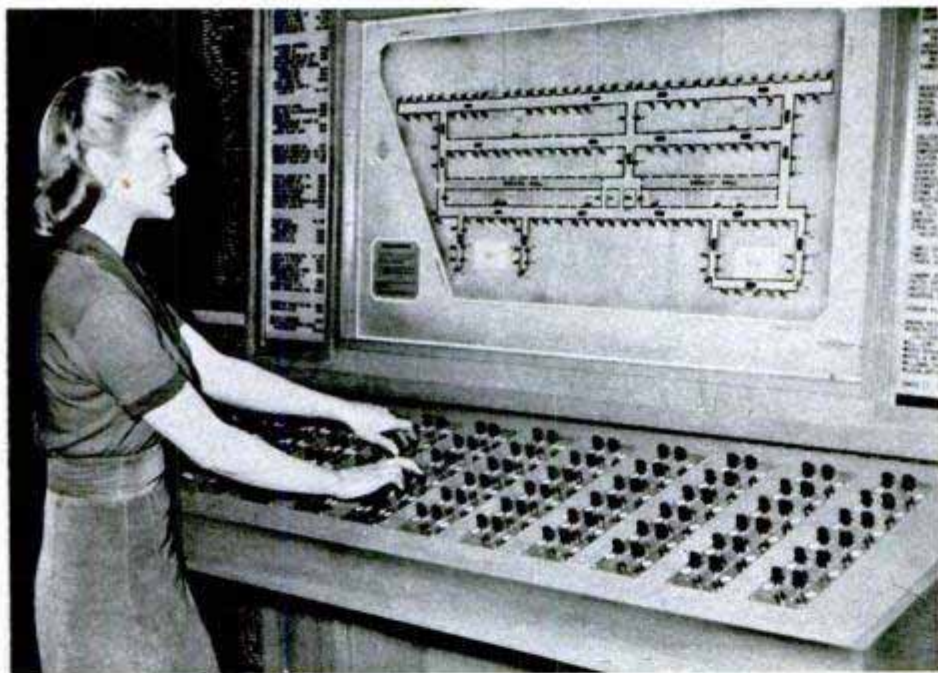

## Lighted "Road Map" In Office Building

Strangers trying to find a showroom in Chicago's Merchandise Mart quickly learn the shortest route by "inquiring" at an illuminated floor plan. There are 150 lights on the floor plan, each representing a showroom. Lighted arrows point the most direct route to the desired showroom. This device, called the Magic Board, is now being tested on the 15th floor of the building, which has 93 acres of floor space.

## Plastic Mask for Gridders

Football players are protected against facial injury, or the aggravation of old injuries, by a new plastic mask. Use of a transparent material instead of metal to guard the nose permits increased vision. A resilient padding on the inside of the protective mask cushions the player's face against impact.

¶If you don't bind or store your back issues of *Popular Mechanics*, do you burn them? America's defense effort requires a vast number of paper products. Call your local Boy Scouts or veterans organization to pick up your wastepaper.

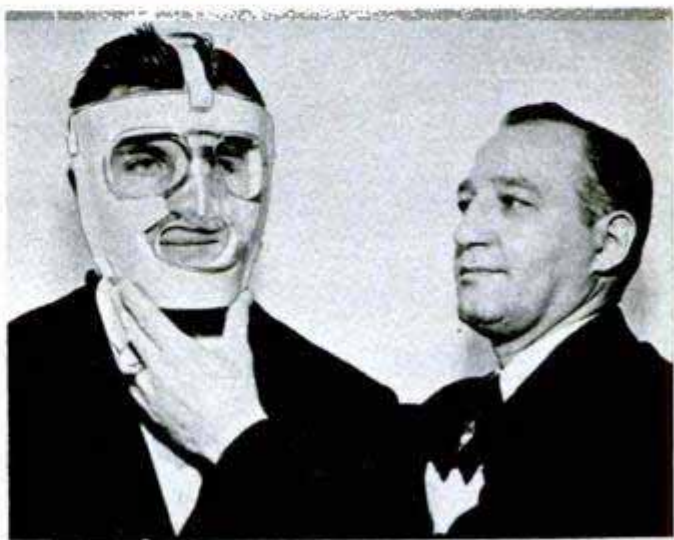

# FRANCE



Weighing under nine pounds, the French-designed bazooka can penetrate 11 inches and is effective up to 300 yards

STARTING with almost nothing at the close of World War II, France has worked steadily to restore an armament industry that is now beginning to produce some of the world's finest military equipment. Outstanding are her SE 2410 Grognard, a jet fighter-bomber of near sonic speed not yet in volume production, an armored reconnaissance vehicle with tractor treads that are lowered for cross-country travel and an antitank grenade fired from a rifle. They are pictured and described with other key French developments on these four pages



Nine miles is the maximum firing range of a self-propelled howitzer, below, which has a 20-degree firing angle. Most of the new weapons went through field testing at the military proving grounds near Bourges



Infantrymen will soon be working with an antitank grenade, above, that is fired from an ordinary rifle

# REARMS



Swept-back wings and a bullet-shaped fuselage identify the SE 2410 Grognard. Direction of the plane is controlled by moving handgrips on the pilot's armrests



Ground view of fighter-bomber shows large air intake for jet engines to rear of canopy. It is slowed down after landing by a ribbon-type parachute



Maneuverability has been emphasized in the 50-ton tank. It has a 3.9-inch gun, two machine guns and travels 30 m.p.h.



Resembling its American counterpart, the 75-mm. recoilless weapon for airborne troops weighs 150 pounds



Answering demands for greater speed in armored equipment, the 13-ton Panhard, left, has a high of 70 m.p.h. The tractor-tread wheels in middle are lowered for cross-country travel

Sturdy and fast, the one-ton Hotchkiss ammunition carrier can be parachuted down with airborne soldiers





For light, multipurpose uses, the Delahaye automobile firm is making a French version of the famous Jeep



Firing a 28-pound projectile, the Brandt mortar at left has a firing rate of 10 rounds per minute. It is capable of lobbing shells (below) 4½ miles



Armored reconnaissance model of Hotchkiss carrier operates effectively over rough ground and through water





Air Materiel Command photo

## Pilot Escape Simplified

One disconnect assembly will free fighter pilots in the future from the maze of wires that joins him to his plane and its equipment. Previously, there were four separate leads—to the G-suit hose, ear-phone and microphone wires for the radio headset and an oxygen-supply lead — to disconnect before the pilot could trigger his ejection seat for escape. The four leads are now combined in a 30-inch-long rubber cable that is separated from the plane when the seat lever is triggered.

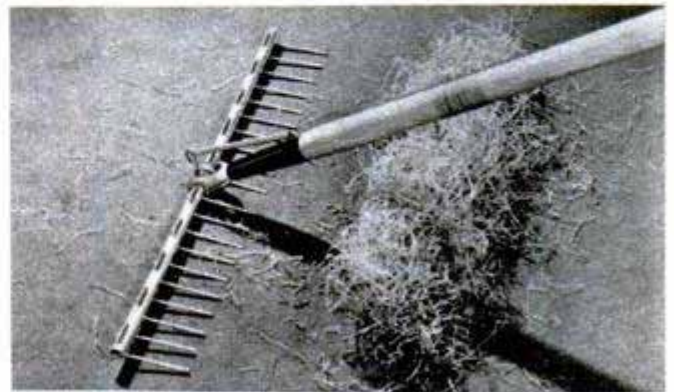
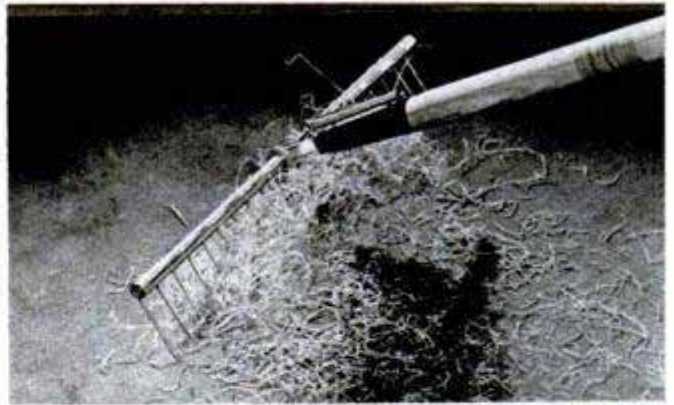

Arthur Paul Sales, Box 495, Green Bay, Wis.

## Self-Cleaning Rake

Leaves and grass slip off the tines of a self-cleaning rake when the handle is pushed forward. The head of the rake, which can move in one direction, is held in place by a spring. When the rake is pushed forward, overcoming the pull of the spring, the tines swing down parallel with the ground and the leaves or grass slide off. The rake is 20 inches wide.

## White Leather Stays White

White leather that will never darken with age or exposure to sunlight is produced with plastic tanning agents called melamine resins. Leathers so tanned are white all the way through and, therefore, remain white. Conventional chrome-tanned leathers tend to have a bluish color which has to be bleached on the surface.



## Pavement Saw

Three times as fast as the pneumatic drill and many times quieter, a pavement power saw slices through concrete or asphalt at speeds up to four feet a minute. Its two large blades carry tungsten-carbide-tipped bits. They cut slits 18 to 54 inches apart, depending on the width of the trench desired. They cut 15 inches deep in almost any pavement.

Joy Mfg. Co., Henry W. Oliver Bldg., Pittsburgh 22, Pa.

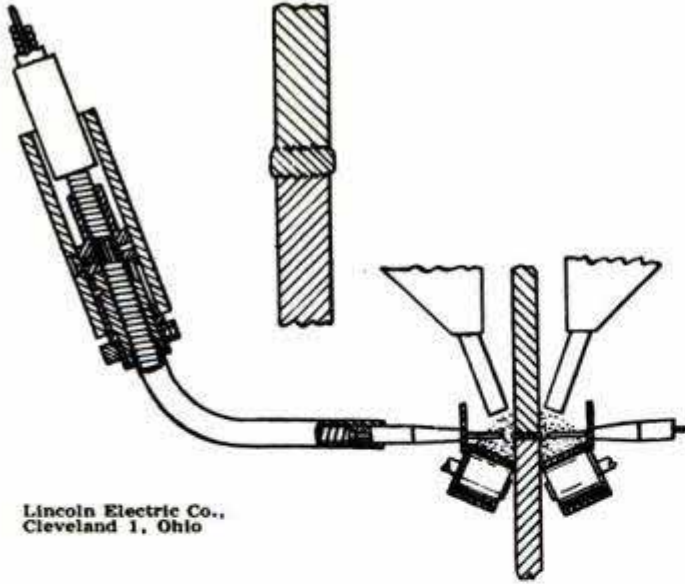

Lincoln Electric Co.,  
Cleveland 1, Ohio

### "Three O'Clock" Welding Process

Automatic arc welding on both sides of the joint can be made simultaneously with a new process that cuts actual arc time by about 50 percent. Eliminating the necessity for down-hand welding, the process permits welding in any position from flat to vertical, the joint being horizontal. Called "three o'clock" welding, the process reduces costs by cutting the amount of current required, by using less flux and electrode and by cutting labor costs.

### Mailbox "Hangs" on a Chain

As strong as a solid iron pipe, a novel mailbox support seen along Route 21, north of Charlotte, N.C., is formed by a welded link chain. The chain, shaped at a right angle, holds the mailbox from above. A short length of chain serves as a brace across the angle.

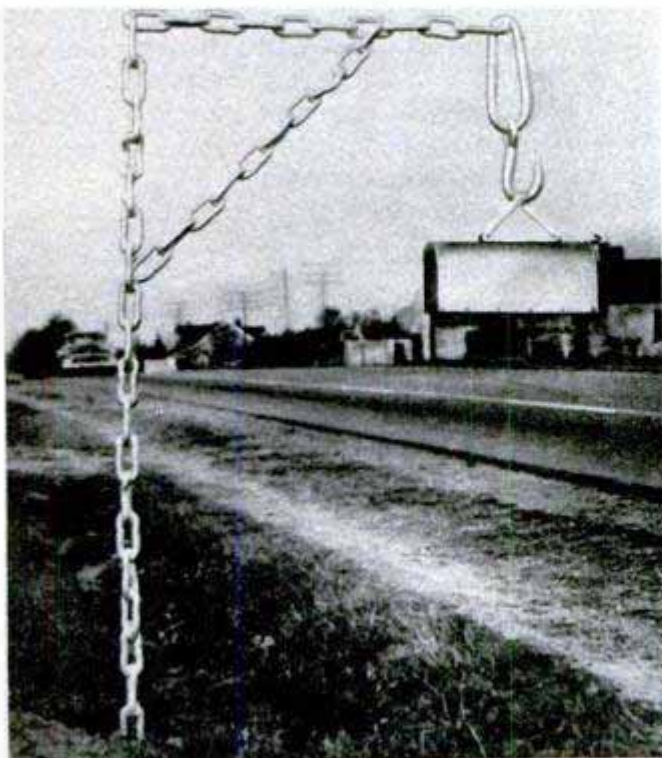

JULY 1951



### Miniature Bagpipe

One quarter the size of the Scotch instrument and weighing only nine ounces, an all-plastic bagpipe is being made by the Magnus Harmonica Corp., Newark, N. J. A simplified "chanter" — the eight-hole, oboelike part of the bagpipe which produces the melody—makes the miniature instrument easier to learn to play. The bag is made from Vinylite sheeting and the other parts are molded from Bakelite styrene plastics. It can be kept clean with a damp cloth and soap and water will not harm the reeds.

### Self-Tightening Hose Clamp

Exerting uniform pressure all the way around, a ring-type hose clamp tightens itself automatically by spring action. The clamp, formed from a piece of round stock, is installed by squeezing the ends with pliers. When the clamp is in place, it is released and the ends spread apart, tightening the ring around the hose. It can be disconnected quickly and reused.

Corbin Hose Clamp Div., American Hardware Corp.,  
New Britain, Conn.



133



# *Pioneering the* **HELLS CANYON DAM**

Drilling into the river bed from this barge anchored in midstream, engineers measure the depth of bedrock

You can't drive to the dam site. One way to get to it is by rubber boat down the swift-flowing stream  
U. S. Bureau of Reclamation photos

*By Andrew Hamilton*

**T**HEY SAY a surveyor has to be part monkey, part mountain goat, part pack mule. But if you're working for the Bureau of Reclamation in rugged Hells Canyon on the Idaho-Oregon border, "it also helps to be a little squirrely in the head—otherwise you'd never have taken the job!"

Bureau engineers are studying the results of a seven-man surveying job begun last summer—a preliminary topographic examination of the middle Snake River in preparation for building the world's highest dam.

Under the direction of Ivan Tuescher, en-

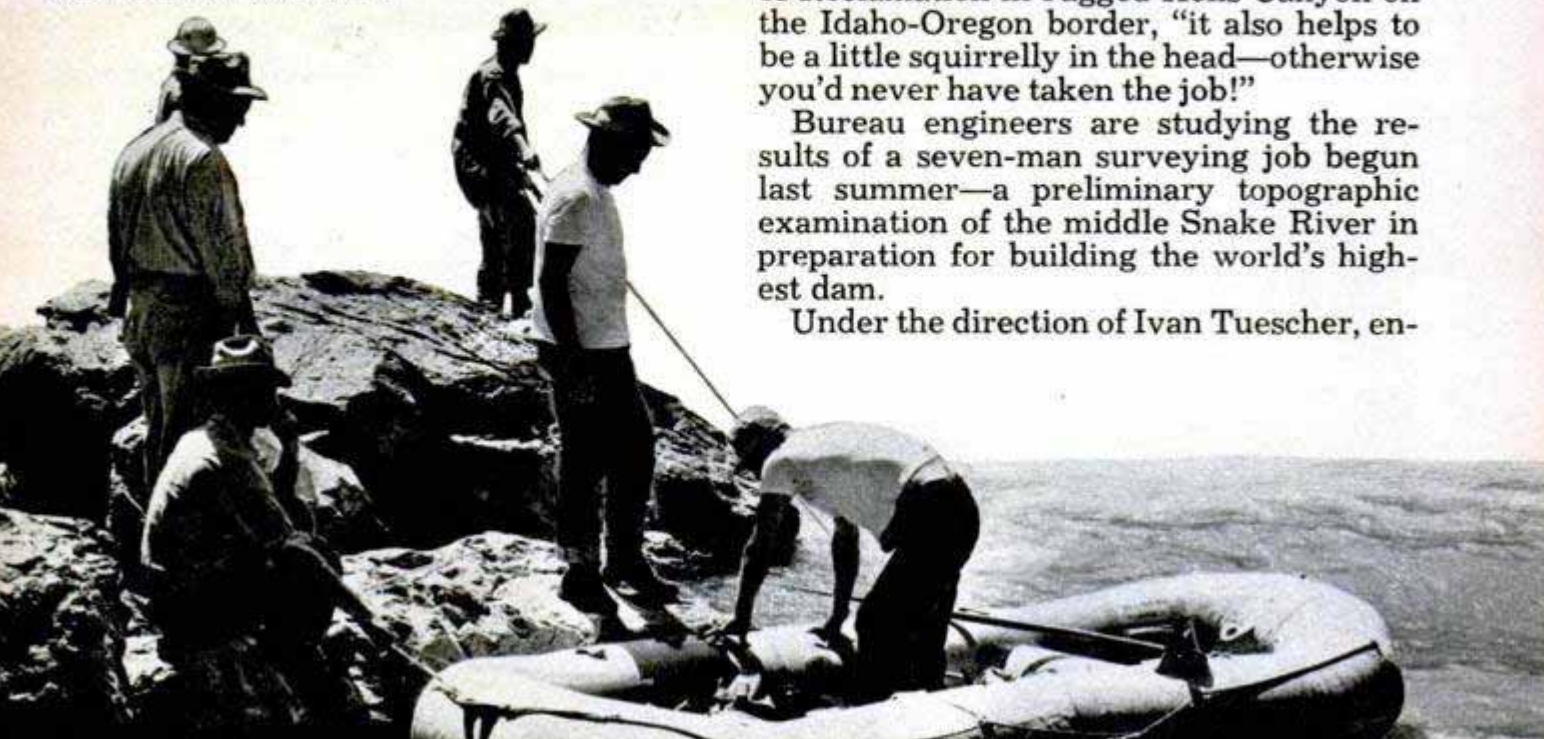



gineer-in-charge, the Bureau of Reclamation surveyors risked their lives daily to explore what is probably America's greatest remaining dam site.

The proposed concrete giant in Hells Canyon will be 742 feet tall, 16 feet higher than the Hoover Dam. It will create a lake 93 miles long and generate 1,400,000 kilowatts, some 688,000 kilowatts being generated at the dam and the remainder downstream. The dam will provide flood control, improve navigation and make accessible some good hunting and fishing territory.

What makes the job so tough is that Hells Canyon lies in one of our most primitive wilderness areas. Between the Seven Devils Mountains of Idaho and the Wallowa Mountains of Oregon, the river entrenches itself in the Grand Canyon of the Snake. It is a region of wild, breathtaking beauty.

At present there is only a single route into this area of primitive splendor and isolation. It's a one-way, 20-mile road from Homestead, Ore. to Eagle Bar. Strewn with boulders, jagged with basalt fragments and filled with chuck holes, it represents tortuous travel for even the most experienced driver. Eagle Bar is the jumping-off place for the Bureau of Reclamation surveyors—from there on, it's travel by horseback, boat or foot. Transits, stadia rods and other equipment have to be raised and lowered by ropes in many places.

To date no serious injuries have been suffered by the surveying party. Once,

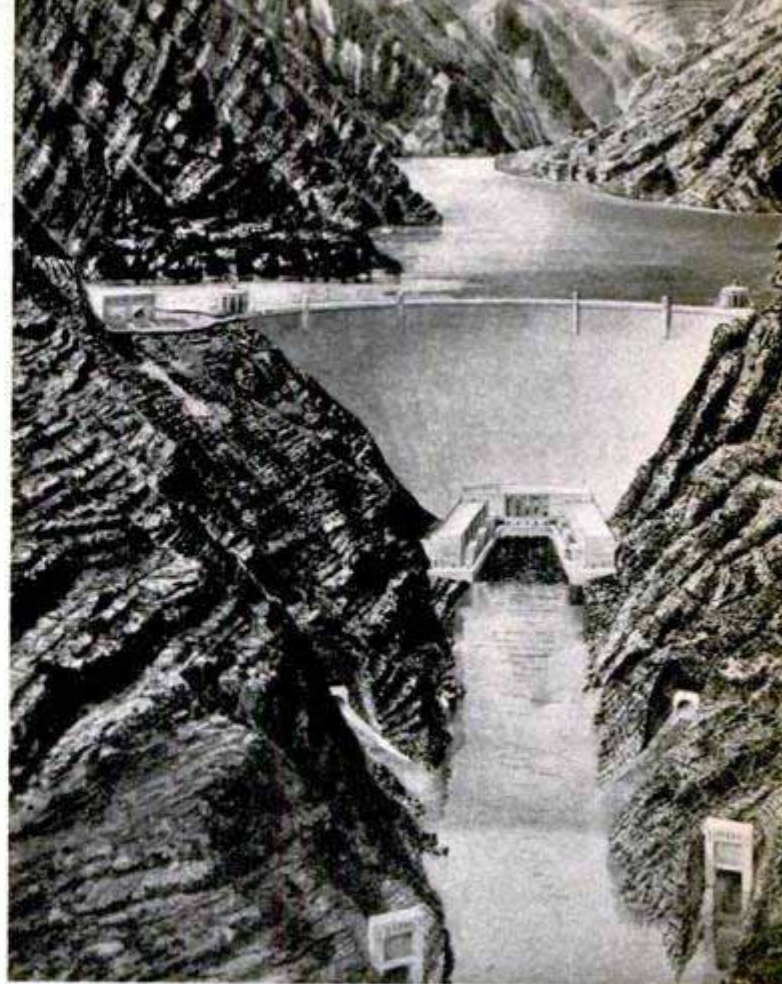

Here is what Hells Canyon Dam will look like if and when it is completed, according to the present plan

Hells Canyon is one of our finest undeveloped dam sites with volcanic-rock slopes that would serve as walls to retain about 4,400,000 acre-feet of water

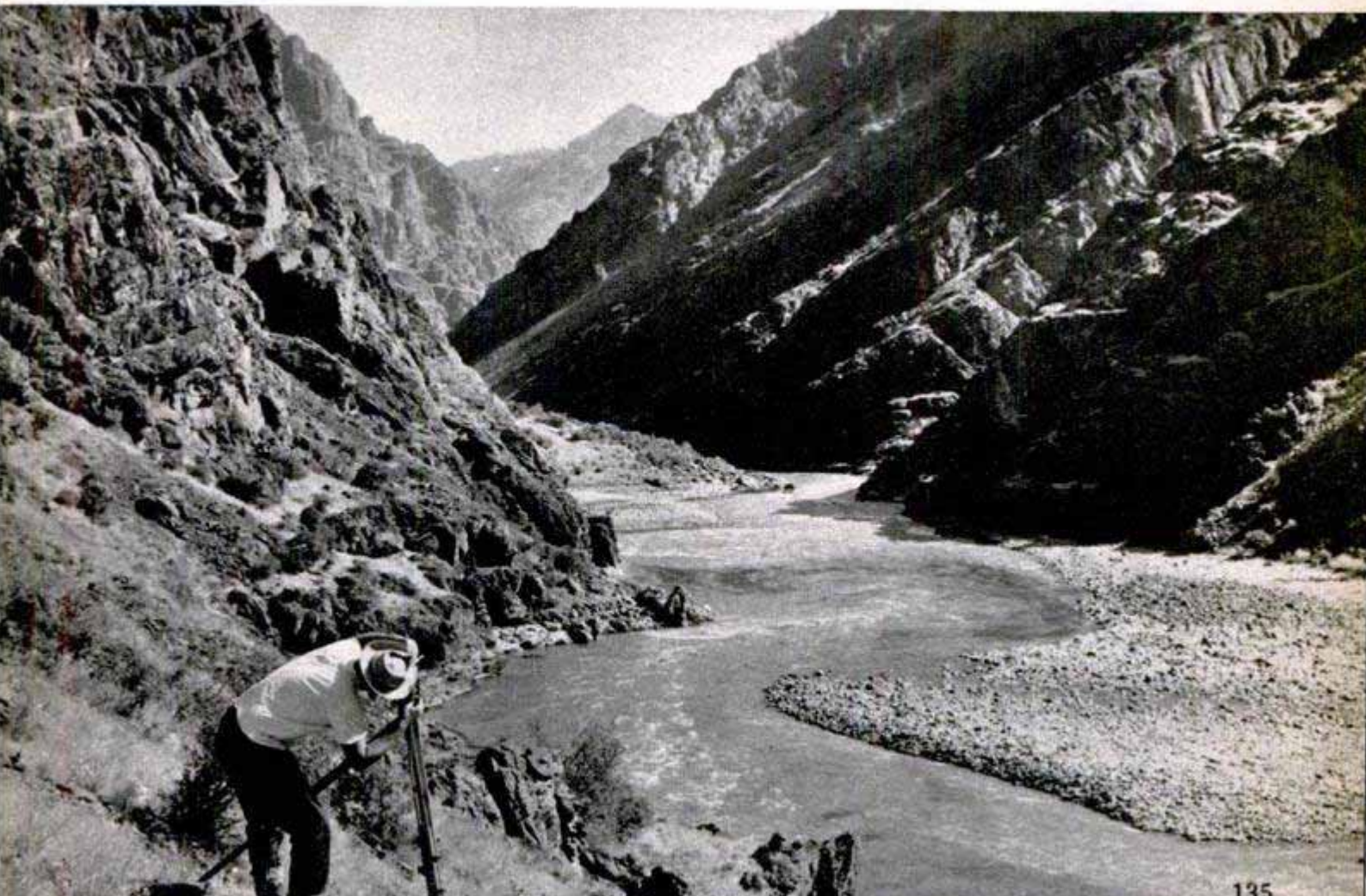

however, Phil Merritt of the Bureau of Reclamation's Regional Office was pinned to the canyon wall by a two-ton rock while on a photo assignment.

"If I'd been alone, it would have been curtains," he says. "I was really stuck."

Surveyors on the scene lifted the rock away.

In this well-named Hells Canyon, slithering rattlesnakes are an ever-present danger. Last summer 19 deadly brutes were killed and scores of others were seen and

heard by the crew. Not quite so lethal but plenty annoying is the poison oak which is liberally sprinkled throughout the area.

"And if that weren't enough, there's the midday heat," said Tuescher, who said the thermometer in summer months averages 110 degrees, sometimes hits 117.

Hells Canyon—a 7900-foot gorge, deeper than the Grand Canyon of the Colorado—has long baffled explorers. It thwarted an attempt by Lewis and Clark to pass through its turbulent and churning waters. The John Jacob Astor expedition lost three men and a fourth went mad trying to ride the rough Snake through this gorge.

Since then, one of the few persons who have attempted to master the man-killing canyon is Kyle McGrady, better known as "The Mailman of Hells Canyon." Twice a week he pilots his flat-bottom, 60-foot boat 100 miles upstream from Lewiston. Even he doesn't go all the way, stopping at Johnson's Bar. Bureau of Reclamation surveyors have been among the few ever to lick the terrain of Hells Canyon. To do it, they've had to operate like an expedition pushing into unexplored country. Their camps are similar to hunting or fishing camps in the deep woods. The surveyors cook their own food over wood fires and sleep in sleeping bags. All supplies are brought in by horseback or boat.

During off-hours, says Tuescher, there's some of the best fishing in the United States: sturgeon fishing. Largest taken so far is a 200-pounder. And on hot summer days, the cool, green water of the Snake makes an unbeatable swimming hole.

Are they mountain climbers or surveyors? They're both, being two of the Bureau of Reclamation crew that has surveyed the site. Map inset, below, shows proposed location of the giant dam

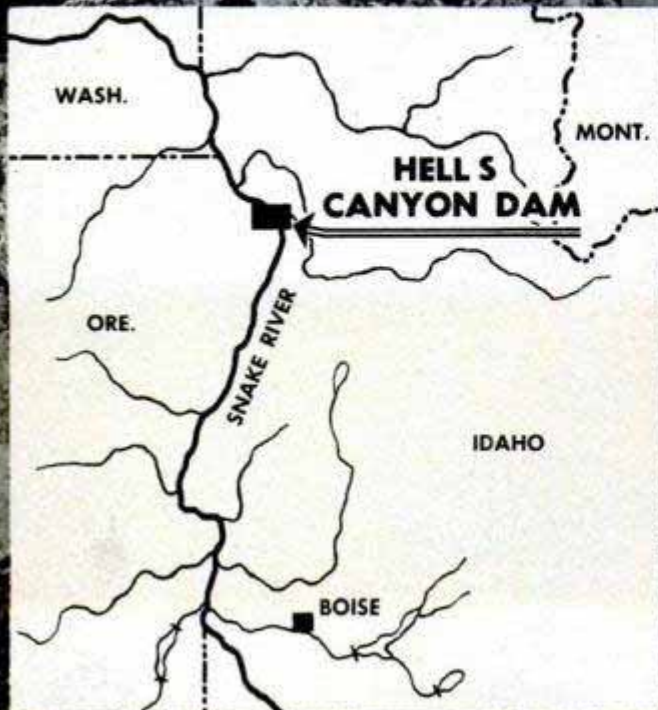
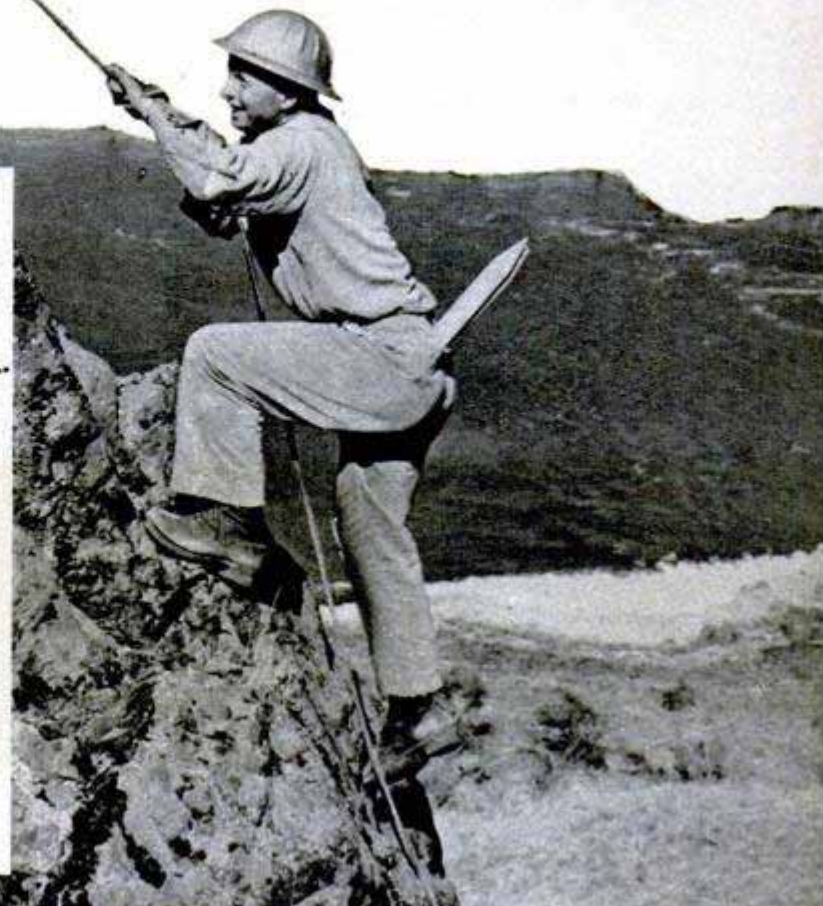
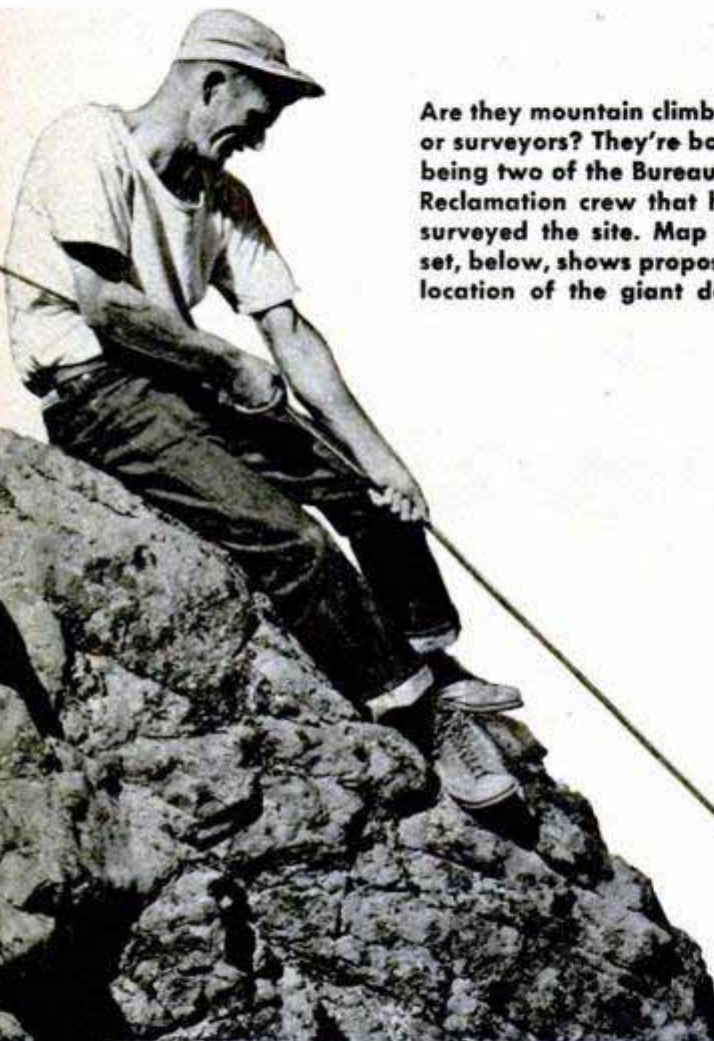



Hells Canyon may be rough, but it does provide fine sports facilities, as proved by a 100-pound sturgeon

If Congress authorizes the dam in Hells Canyon gorge, it will require six or seven years to complete and the labor of some 5000 men at peak of construction.

According to H. T. Nelson, Regional Director of the Bureau of Reclamation, the dam will be a concrete arch-gravity type structure, depending upon its weight and the support of its abutments to resist the pressure of impounded water. As lofty as a 70-story building, it will be 674 feet thick at its base, tapering to 45 feet at the crest.

Hells Canyon Dam will be the tallest dam in the world and third largest. In height, it will surpass Hoover Dam (726 feet), Shasta Dam (602 feet), Hungry Horse Dam (564 feet) and Grand Coulee Dam (550 feet). In size, (6,200,000 cubic yards) it will be exceeded only by the Grand Coulee Dam in Washington and by the Shasta Dam located in California.

Preliminary surveys have shown that the physical quality of rock at the dam site is excellent and suitable for a dam of any height. It is of volcanic origin—dense, hard, fine-grained, resistant to weathering and of high crushing strength.

Test drilling has disclosed that the thickness of the overburden in the river channel will not exceed 100 feet. Test holes are drilled through a hole in the bottom of a

barge anchored by cables in midstream.

During construction, two tunnels—each 50 feet in diameter—must be driven through the rock walls on either side of the river to divert the flow. These tunnels will be 4275 feet long on the Oregon side and 4720 feet long on the Idaho side.

Approximately 813,000 cubic yards of earth, gravel and sand will have to be excavated to expose bedrock and abutments. Another 1,611,000 cubic yards of hard rock will have to be gouged out of the tunnels and sides.

Surveyors are laying out possible routes for a heavy-duty highway and a railroad—to deliver cement, lumber, construction machinery to the site—as well as secondary roads to keep traffic circulating. Access from both the Oregon and Idaho side will be provided.

Hells Canyon Dam will create a long, narrow reservoir 93 miles along the Oregon-Idaho boundary. Maximum depth of this lake will be 627 feet. It will cover an area of 39 square miles and hold in storage some 4,400,000 acre-feet of water.

“Cost of building the dam, exclusive of electric-transmission systems, would be \$357,000,000,” according to Regional Director Nelson. “The entire investment, however, including interest, would be returned through the sale of power except allocations to power and flood control.”

He listed these ways in which it would benefit the Northwest:

(1) Increased electric power is vital to this part of the country.

(2) In the upper Snake River basin and adjacent areas lie the greatest phosphate resources in the United States. The combination of electric power and phosphate minerals will mean cheap fertilizer for the West.

(3) Although irrigation by diversion from Hells Canyon reservoir is not possible, it will reduce floods in the lower reaches of the Snake and the Columbia.

(4) Power revenues will make possible the building of valuable irrigation projects.

(5) The Hells Canyon reservoir will improve navigation on the Columbia and the Snake.

(6) The presence of a large body of water in an area of wild, rugged beauty will afford recreational opportunities, expected to attract 300,000 to 500,000 vacationists annually.

“When the Hells Canyon Dam is built, the undertaking will rank as one of our greatest engineering feats,” Nelson said.

But there will be seven surveyors and a handful of engineers who will be able to tell their grandchildren: “Shucks, I was in there in '50 and '51—Hells Canyon was really 'hell' in those days!”

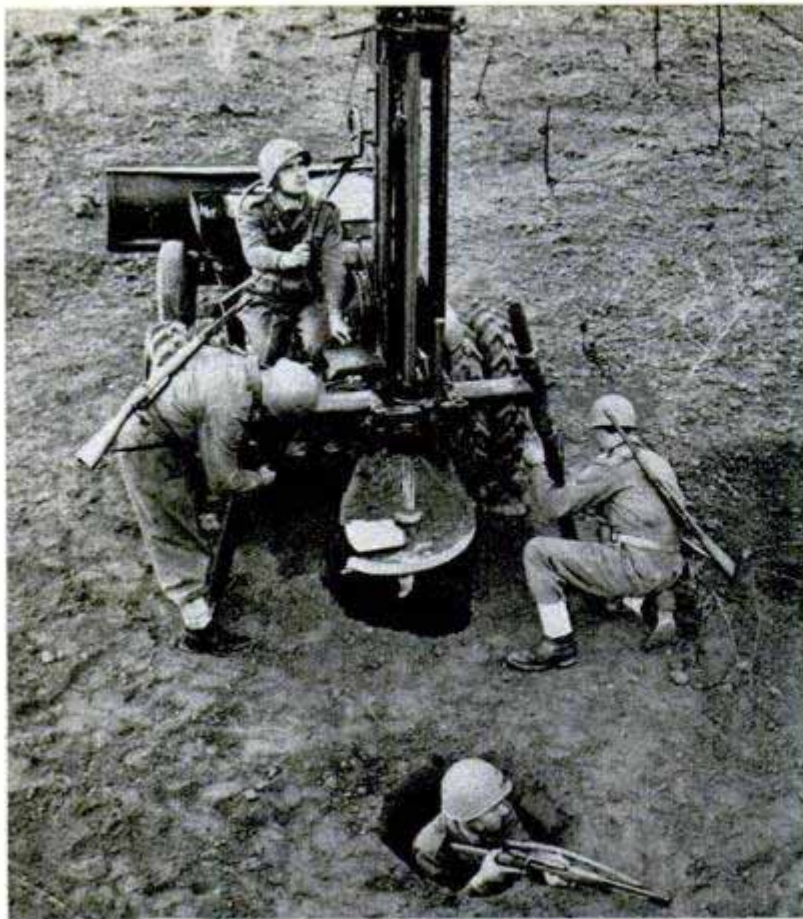

### Foxhole Digger

Life is easier for the Italian soldier these days. His army has developed a mechanical foxhole digger. The machine's big auger can drill a neat foxhole as deep as eight feet within two minutes. The digger was developed to aid in quick construction of strong defensive positions.

### Cedar-Chest Scent Can Be Painted on Walls

You can now paint the fresh, clean odor of cedar on the walls of any closet. A new chemical compound made with pulverized red cedar, concentrated oils and various other chemicals does the trick. Sold in powder form, it is mixed with water and painted or sprayed on any surface. It dries to a coat three times as hard as plaster and is mothproof and fireproof, according to its distributor, Thrifty Products Co., Box 371, Brooklyn 1, N.Y.

### Dimmers for Night Driving

Small shades, worn like spectacles, protect the eyes of a motorist from glare while driving at night. The shades are offset to the left, and are designed to shield only the pupils of the eyes from bright lights without obstructing the field of vision. When glare bothers the motorist, he merely lowers his head slightly to move the shields between his eyes and the light.

Bruce Industries, Plantsville, Conn.



### Water "Sanitizer"

Sluggish, contaminated water is purified by a new 12-pound "sanitizer," which turns out 50 quarts of crystal-clear liquid per hour. The purifier, which looks like a small pump, draws impure water through a circular filter and then passes it through a special earth powder. This renders the bacteria in the water harmless, according to the manufacturer.





"Timber!" Working in boats, these lumberjacks cut timber, but it doesn't fall — it's hauled up by crane

## ***New York's WATERFRONT LUMBERJACK***

Going over the side of the barge, the diver picks up the pneumatic saw with which he'll cut off the piling underwater. It has two reciprocating blades

**By Richard F. Dempewolff**

**M**OST OF US don't think of lower New York City's waterfront in terms of valuable stands of potential saw timber. But lumberman Richard J. Power does. Driving down the West Side overhead highway, he waves a mackinawed arm in the general direction of Wall Street.

"Some nice 90-foot pine timber waiting to be plucked down there," he says. "And west of the Empire State Building, we'll pass about a half-million board feet of real good oak. There's some first-rate yellow pine over near Hoboken, too."

Meanwhile, he points out a huge "catamaran" laden with 85-foot pine logs, slowly weaving through ferries, freighters and barges across the North River. It's on its way to his Burma Road Lumber Company sawmill on the Jersey side right behind the Statue of Liberty.





Salvaged piling is dragged off the ungainly "catamaran" by a winch and hauled up on the beach at the sawmill

Power, of course, isn't talking about beautiful stands of green timber such as you'd find in the Northwest. His is a salvage operation. Eight years ago while working at various shipping points for the War Production Board, Power, a graduate forester of Syracuse University, noticed stacks of discarded piling from waterfront piers, which New York continually dismantles to make room for new ones. The logs, ranging from 65 to 85 feet long, were either hauled off and burned, or left to rot in some out-of-the-way place.

"I did some investigating and learned a few things," Power says. "In spite of what you've heard, salt water doesn't rot wood. It preserves it. Only the section of the piling exposed to air by the rise and fall of the tide rots away. The rest is almost invariably first-rate timber."

The average pier has about 1000 piles, running 14 to 20 inches across at the butt. An 85-foot log of such dimension will yield about 500 feet of saw timber. The average New York pier has a life of approximately 40 years, so there's a steady dismantling process going on around the harbor.

Power estimates a potential of 650,500,000 feet of big timber (multiply by 500 to get saw timber) in the North River alone. That doesn't count the endless piers that stretch around the other side of Manhattan and along the shores of Brooklyn, Staten Island and New Jersey.

Convinced that the wood was good and that there was enough to supply a sawmill, Power talked pier owners into letting him take their worn-out piling. He would save them expense by hauling it away.

Handling the monster logs is a man-size

job. The tops of the piling, about 8 feet long, jut from the water like pins in a cushion. What you see is splintered, water-logged and rotted. But the 65 or 75 feet underwater is good timber, sound as a nut.

The cable from a floating crane is lashed to a pile. Sometimes the piles pop right out of the bottom, but occasionally they refuse to budge. Then they have to be sawed off at the base. A diver is lowered to the river floor, carrying an air-powered underwater power saw. About four feet long and weighing 15 pounds, it is operated by pneumatic cylinders that pump two parallel blades back and forth with an opposing motion.

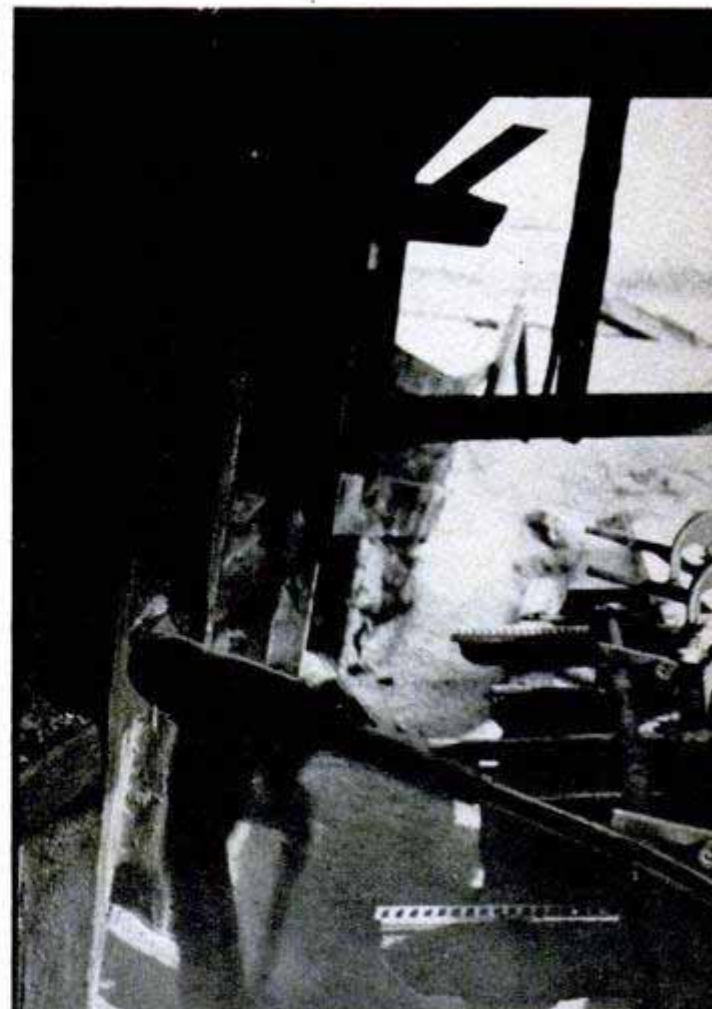

After a few months of drying out, the logs are run through the sawmill. The first step is edging as the round pilings are trimmed square on all four sides

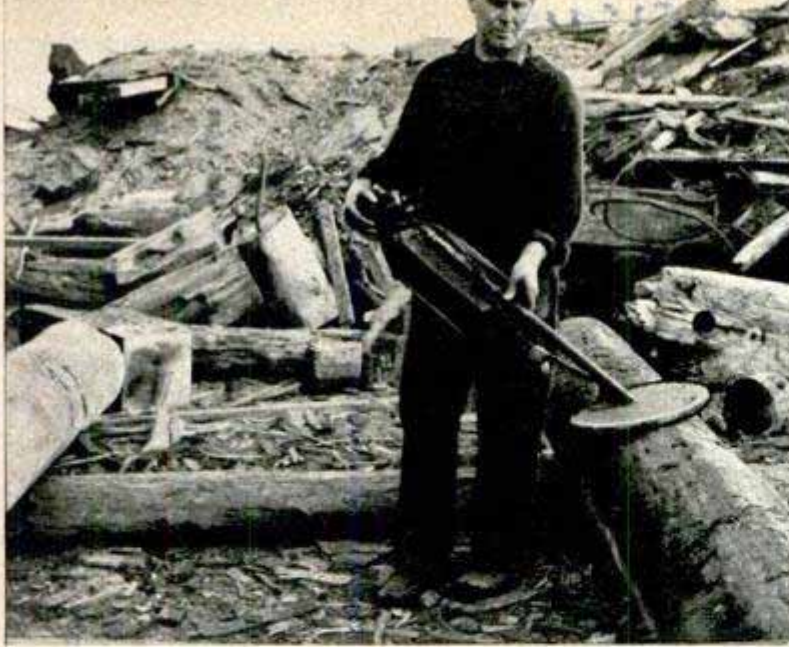

War-surplus mine detectors spot spikes in the logs. If not removed, these spikes can ruin the saw blade

The saw chews through a 20-inch pile in seconds.

The diver has to move slowly through the knee-deep harbor muck to the stubborn pile, avoiding deep pockets of silt that might suck him down. Recently, one diver sank up to his shoulders in this muck. Suction was so great that no amount of tugging from above would free him. Lines and hooks were lowered, but he couldn't be budged. Rescue divers went down with shovels and were nearly trapped themselves. Finally, the problem was solved when a diver took a fire hose below, opened

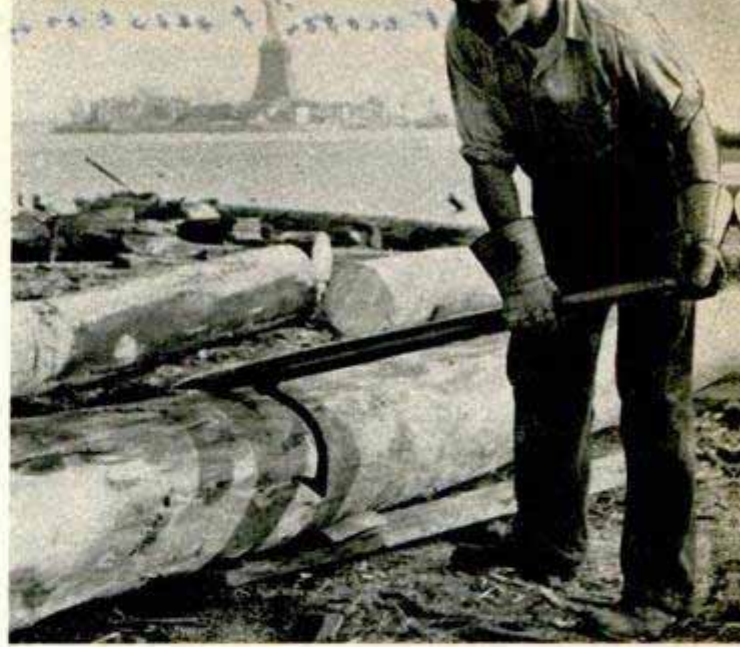

Yes, that's the Statue of Liberty! And that's not a model posing. He's a real, city-dwelling lumberjack

up the high-pressure stream and blasted the muck away from the trapped man. In a few minutes, the diver popped to the surface none the worse for his experience.

When the crane lifts the pile, it is swung around and stacked on a waiting catamaran, or "cat." How this odd craft got its name no one seems to know. It is not a catamaran at all, but merely a large raft made of heavy timbers lashed together. A strong rail along each side holds in the load. It looks like a country bridge that broke loose from its moorings and was swept down the river.

(Continued to page 218)

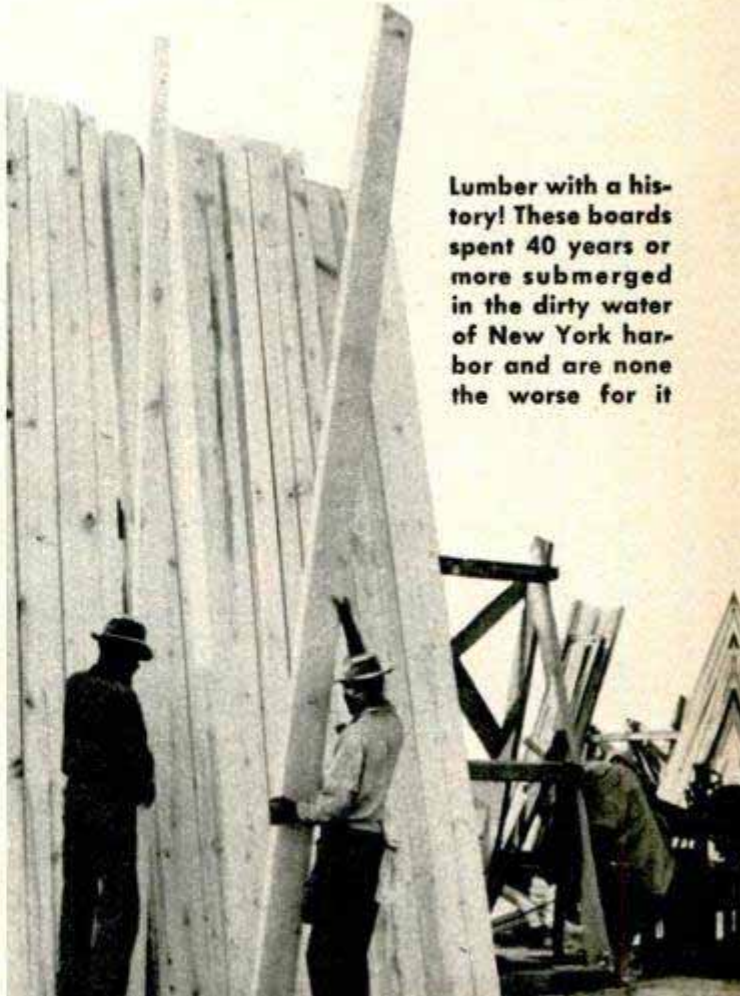
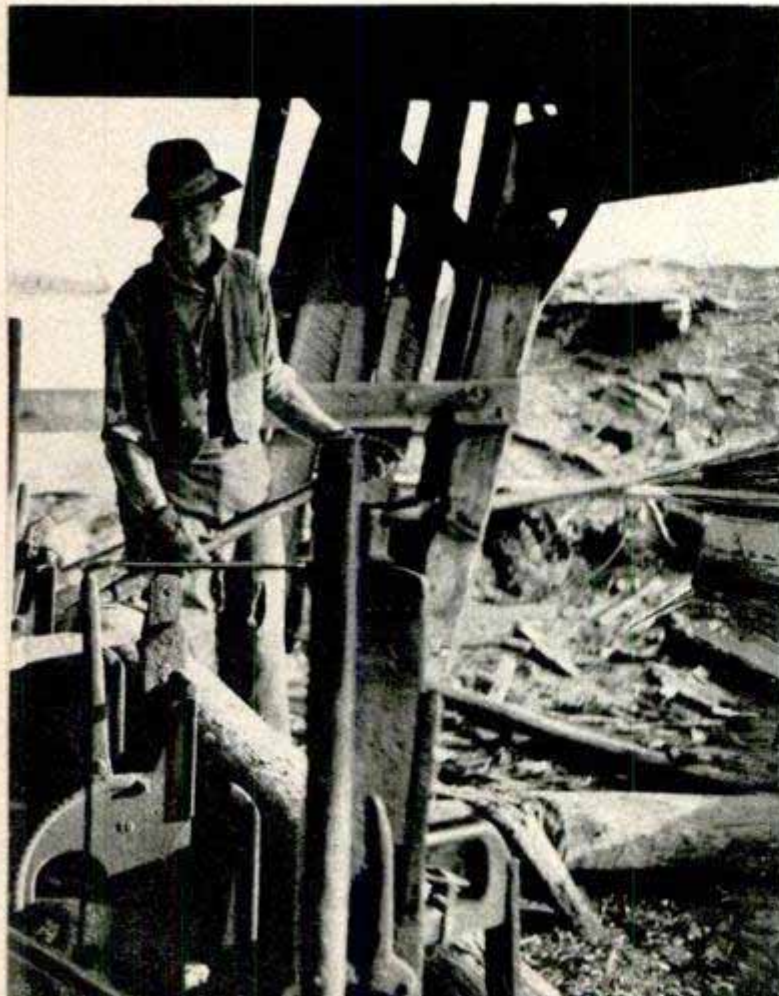

Lumber with a history! These boards spent 40 years or more submerged in the dirty water of New York harbor and are none the worse for it



### Budget Protector Helps Shoppers

Shoppers are protected from the embarrassment of having more groceries in the shopping cart than money in the pocket-book by an adding machine that is attached to the cart handle. As the shopper dials the price of each item on the machine, a running total is displayed, keeping her aware of the exact value of the items she has selected in the store.



### Midget Fluid-Drive Tractor

Young Dwight Lohrenz of Long Beach, Calif., is the proud owner of a tractor strong enough to pull several wagonloads of small-fry passengers. Built by Dwight's father, the vehicle is slow and safe. The steering wheel, soft-rubber tires and several other parts came from a plane. Power is supplied by a four-cycle gasoline engine, which spins a shaft under the chassis. A fluid drive taken from the gun turret of an airplane connects the shaft with another chain which turns the rear wheels. When Dwight pushes down the little accelerator, the fluid drive eases the vehicle into motion.

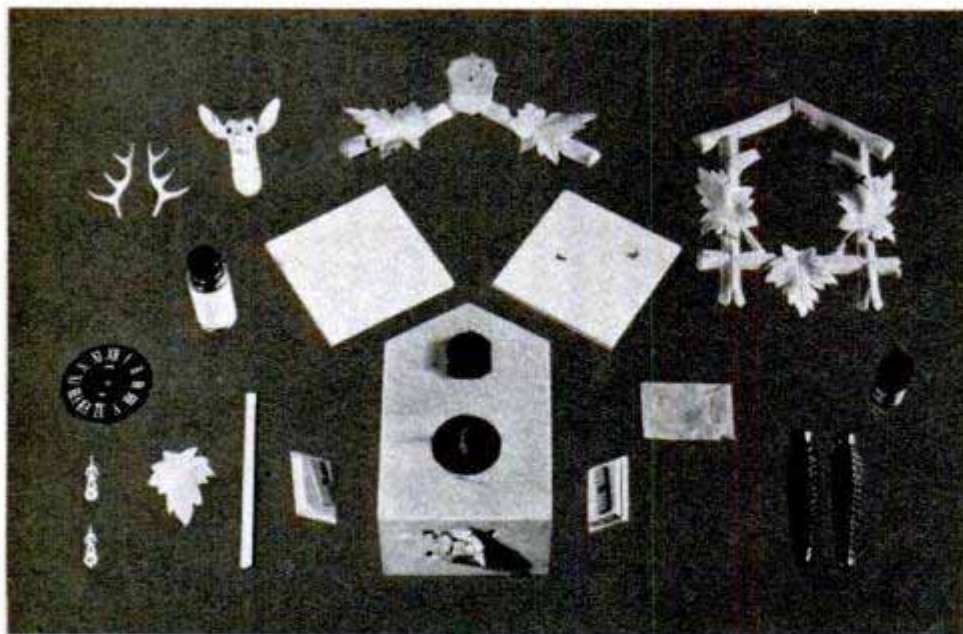

J. F. Reich, Quivira Lake, Kansas City 3, Kans.

### Cuckoo Clocks in Kit Form Imported From Germany

You can assemble your own cuckoo clock in one evening from a kit, imported from Germany, at considerable saving over the assembled cost. This saving is possible

mostly because of lowered import duties and luxury taxes. The brass works comes mounted in place ready to run. Assembly is limited to the case and its decorations.



## File-Card Conveyor Operated by Pedals

Card files are carried directly to the operator by a chain-driven office filing system. The operator sits behind the unit, which looks like a large desk. She moves trays of file cards across the unit in either direction by operating two foot pedals. In one office, where three of the units were installed, a single operator was able to handle over half a million cards.



Remington Rand, Inc., 315 Fourth Ave., New York City 10

## "Breathing" Package

Shipment of live lobsters to any part of the country can be done economically by lining the packages with a transparent plastic film, according to scientists of the Goodyear Tire & Rubber Co. The plastic film allows just the right

amount of oxygen to enter the package to keep the lobsters alive. The shellfish are packed in layers of seaweed and the whole container is refrigerated.

## Folding Boat Has Two Detachable Wheels for Highway Travel

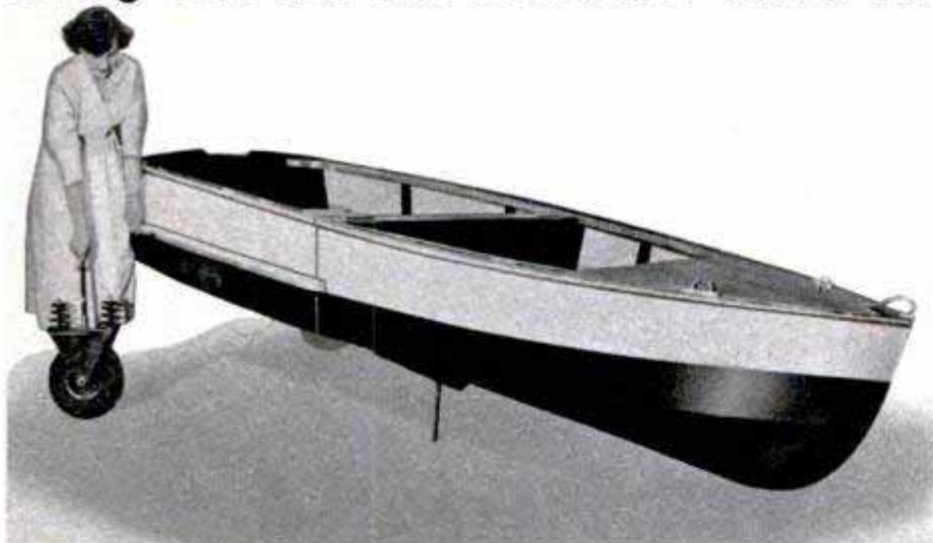

Two easily removable wheels form the running gear for a folding boat that requires no trailer for over-the-road hauling. The wheels can be put on or taken off while the boat is in the water. Hinged amidships, the 12-foot boat consists of two separate watertight sections, bow and stern. An added feature is ease of storage. The hinge comes apart to allow you to separate the boat in two sections for storing.

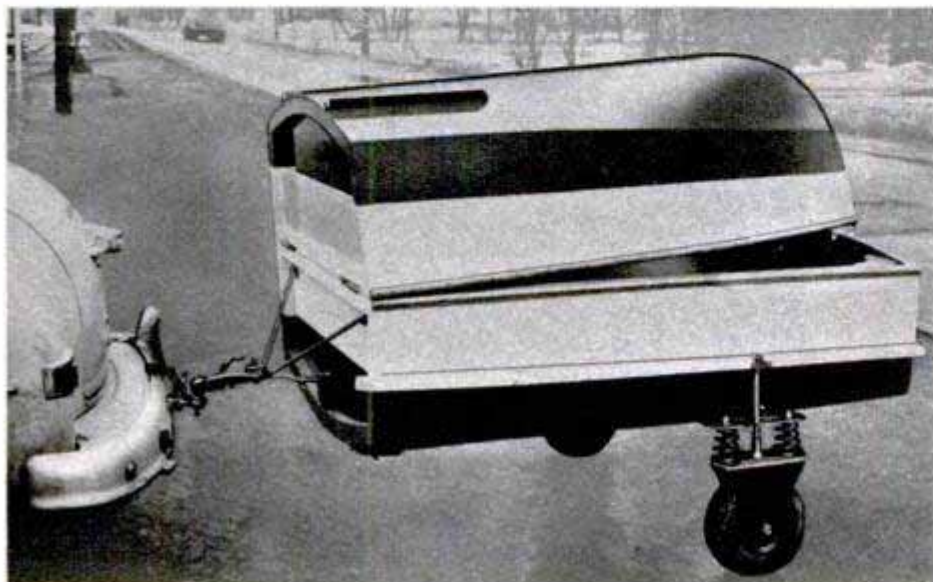

Above, a dry-run demonstration of how wheels are removed with the boat floating in the water. Left, folded for highway travel

Sources of available products described in this issue are indexed on pages 12, 14 and 16. Sources of further information are listed in the WHERE-TO-FIND-IT LIST, which is available from the Bureau of Information, Popular Mechanics Magazine, 200 East Ontario Street, Chicago 11

# MYSTERY of the SPINNING DUST

**T**HERE'S a new riddle for the world of science to solve—the mystery of why tiny particles of dust begin dancing along definite paths when they are exposed to the sunlight.

A Viennese physicist, Felix Ehrenhaft, discovered the new phenomenon of physics when he placed dust particles in a glass flask, created a vacuum in the flask and then placed it in the sun's rays. The particles began revolving along regular paths—particular planes in relation to the light. They continued to move as long as they were in the sunlight; a cloud crossing the sun immediately stopped the gyrations. Each particle seemed to follow not only an elliptical path, but also to revolve around its own axis. An obvious comparison is the earth itself, which moves around the sun while spinning on its axis.

How can this motion be explained? Not by air currents created by the heat of the sun, for the particles move in a vacuum. The movement so far has not been related to known physical laws, and suggests that a new force may have been discovered.

Ehrenhaft has his own theory. He believes the motion is due to a force possibly purely magnetic and existing separately from the electrical forces of the universe. So far, most other physicists won't accept this theory on the scanty evidence, but admit that the discovery is of importance.

The scientist now is photographing the patterns made by the dust in the hope of accumulating new information.



What makes them spin? Graphite particles, exposed to sunlight, make beautiful spiral rotations in vacuum



Weird patterns are made by various particles of dust. Some remain on single plane, others follow elliptical, rotating courses. Below, two dust specks, rotating in opposite directions, also revolve on their own axes

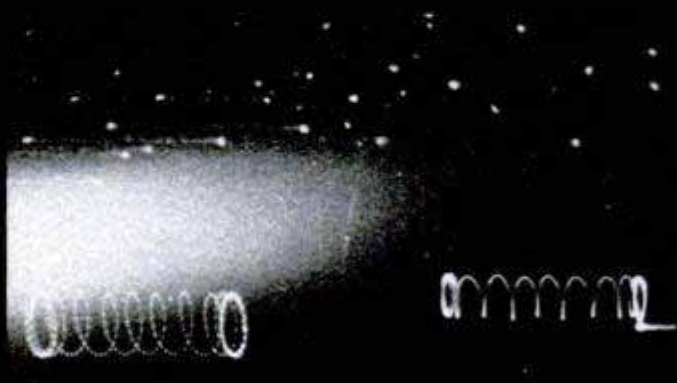

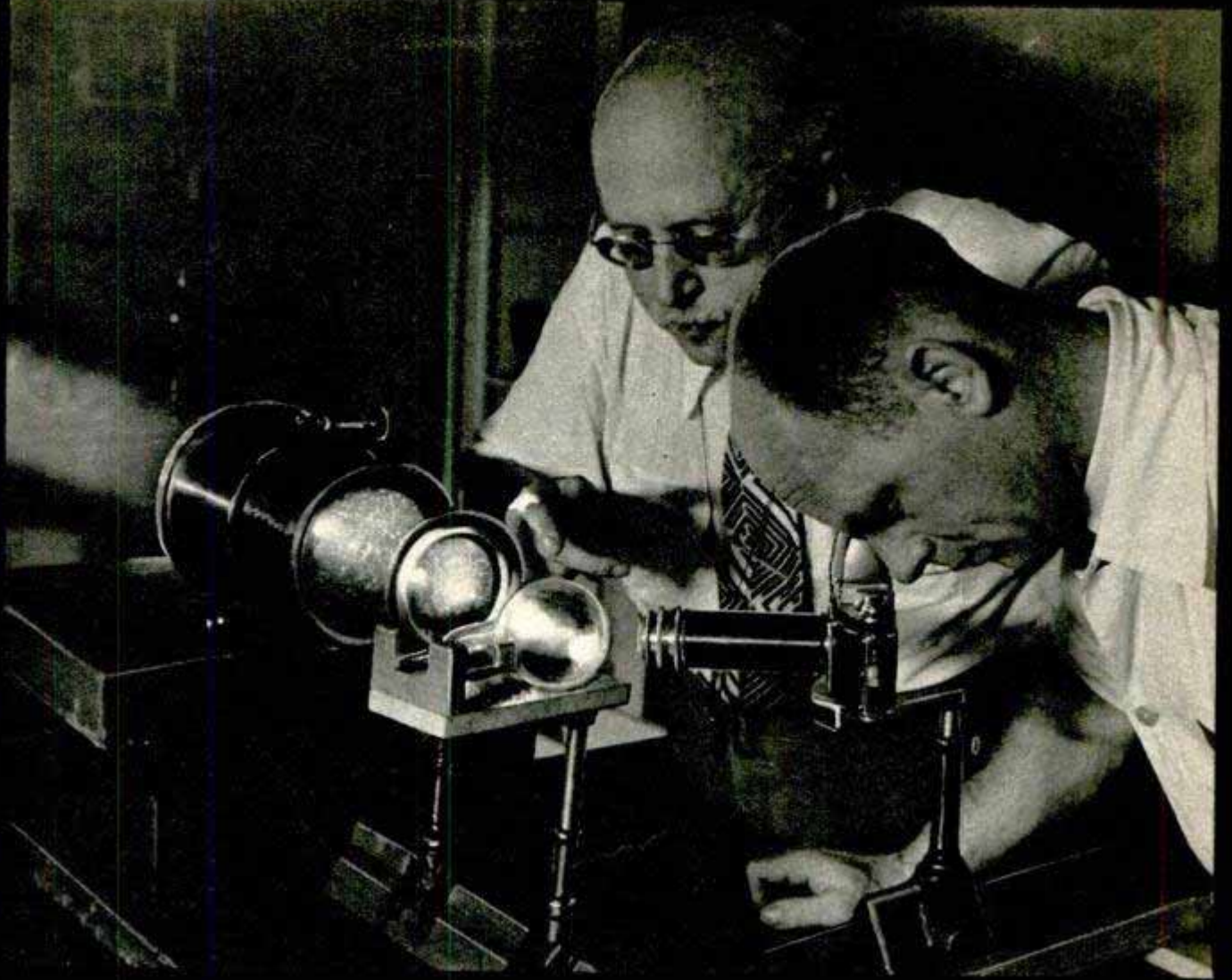

To make the photographs, sunlight is focused through lenses into the vacuum flask which holds the dust particles. Almost immediately the dust begins to spin, and a camera with an enlarging lens takes pictures at  $1/5$  to  $1/10$  second. Below, "pearly" appearance proves dust spins on own axis as it makes a larger pattern

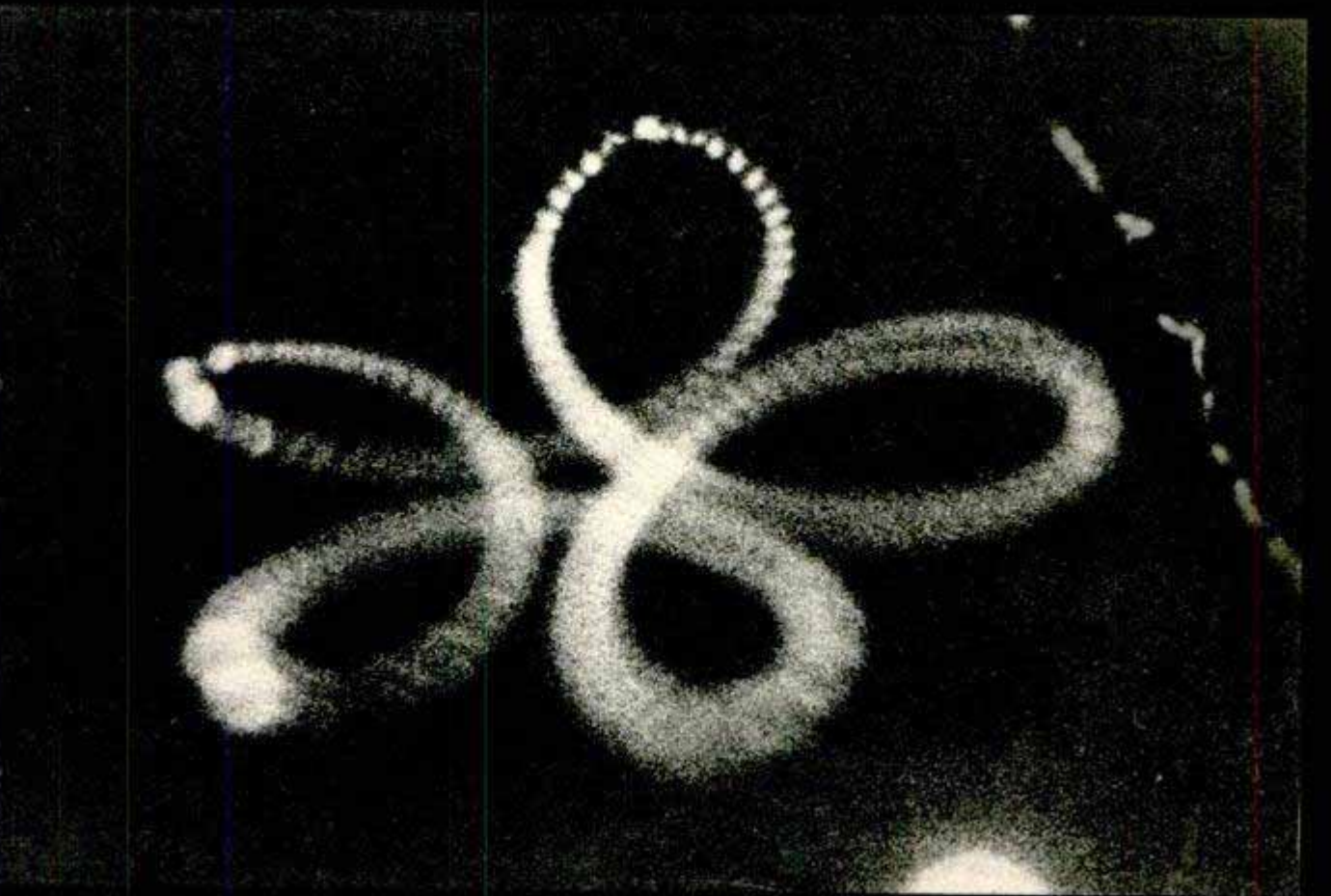



## Inflated Rubber Bags Lift Damaged Airplane

In aircraft accidents where the undercarriage has been damaged or completely sheared away, inflatable rubber bags are being used to lift the airplane for salvage

operations. The strong rubber bags distribute the lifting force and prevent further damage to wings or fuselage. Some lifting devices add to the damage.

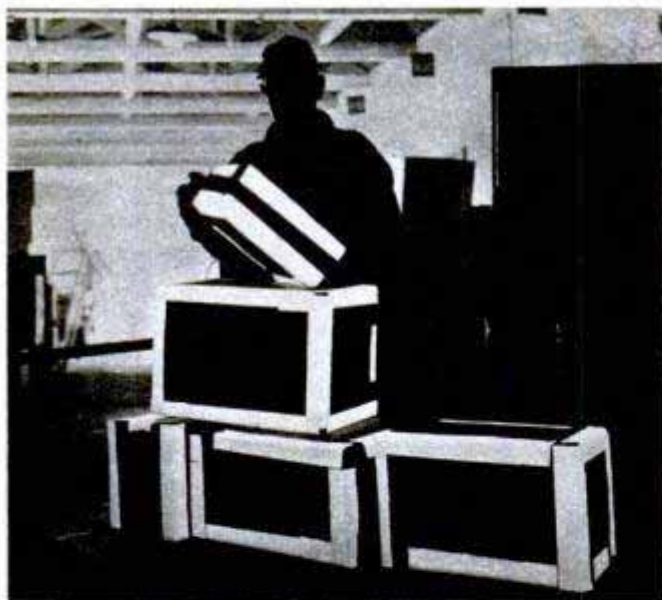

Century Coating Co., Whitestone, Long Island, N.Y.

## Blackout Tape

Easily seen in the dark from a distance of several feet, a luminescent packaging tape is being tested for possible use by the armed services. The tape not only seals the containers, but also outlines the shapes, preventing accidents in dimly lit warehouses. The Army is testing it for use as identification markers for equipment and material that will be handled under blackout conditions.

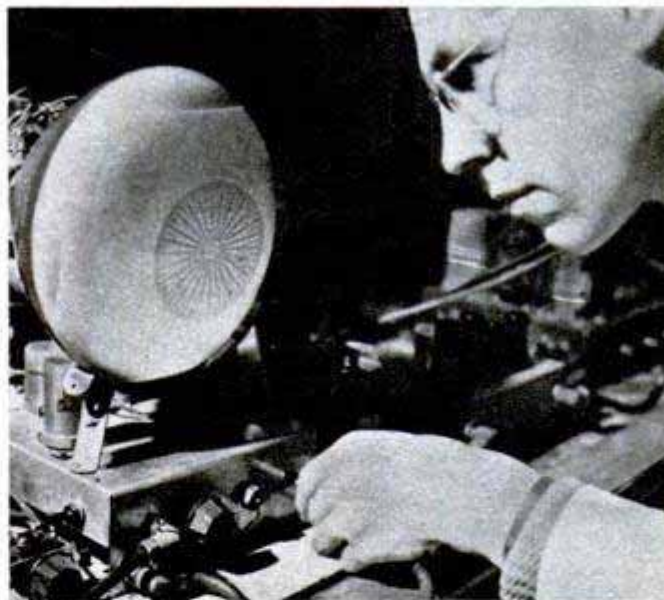

## TV Microscope Magnifies Up to 25,000 Times

Dr. Frank Roberts, a Scots electronics engineer in Britain, is doing microscopic work with the help of television. He has designed a television microscope that is said to magnify up to 25,000 times, and is especially suitable for observation of living tissues. British sources report that the microscope is being used to count and sort the number of cells in the human brain.



## Portable Greenhouse

Gardeners can grow their favorite plants or flowers the year 'round in a miniature greenhouse that can be moved even when it is in use. The greenhouse has a thermo-



Old Copper Mine Farms, Inc., Dept. P1, Warrenton, N.J.

statically controlled heating system, underground irrigation, electric lights and automatic ventilation. It is 16 inches wide and 32 inches long. Spring flowers can be grown in the greenhouse even when the little structure is surrounded by snow.



Asa D. Scott Industries Inc., 1028 E. 63rd St., Chicago 37

## Drive-In Metal Clip Holds Shelves

To make a shelf, all you have to do is pound a few metal clips into the vertical support, slip a piece of plywood into the clips and the shelf is up. The clips, made of hardened steel, are driven like a nail and are designed to take  $\frac{1}{4}$ -inch plywood. Other uses for the clips include supports for drawer dividers and no-draft window ventilators.

Two regions in the interior of western Java have been completely freed of malaria by treatment of the population with Aralen, a new antimalarial synthetic drug.



U. S. Dept. of Agriculture photo

## Frozen Pollen

Bee-collected apple pollen can be quick-frozen, stored for a year and used successfully for artificial pollination of blossoms during the next season. Such pollen has not been used extensively in artificial pollination because it loses its viability. However, it now can be stored for a year if necessary. Pollen is collected by a screen trap that scrapes the pellets from the legs of the bees as they pass through the screen into the hive. As much as two pounds of pollen are collected in a day from one colony by this trap. The process was developed by scientists of the University of California at Davis.

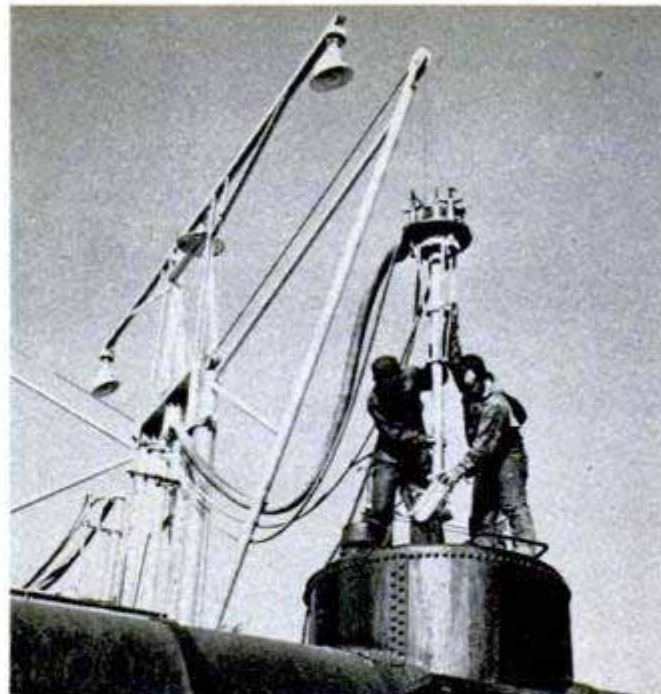
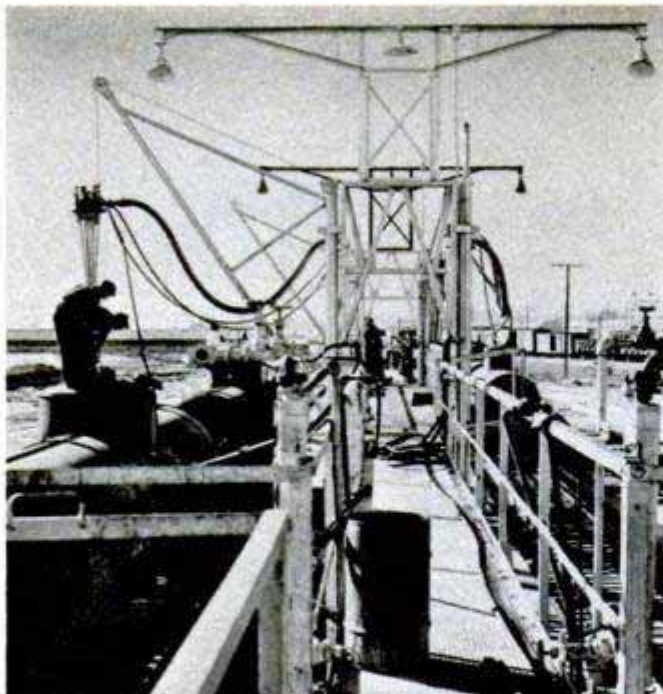

## Tank-Car Laundry

Molasses and gasoline don't mix—at least, not without spoiling each of them—and that's why the Santa Fe Railway's new car-cleaning plant is so important. An average of 12 cars per eight-hour shift can be cleaned internally so thoroughly that they can be loaded with any type of load without contamination from previous cargo. This laundry reduces the need for using certain

cars for one type of load exclusively. The cleaning plant consists of four machines, each equipped with a high-velocity nozzle that turns as it operates. All cars are given a preliminary rinse of about 1500 gallons of clean hot water. Then 1500 gallons of a hot detergent solution are forced into the car through rotating nozzles at 190 pounds pressure. A final rinse of cold water completes the operation. The laundry is located at Vernon, Calif., a suburb of Los Angeles.

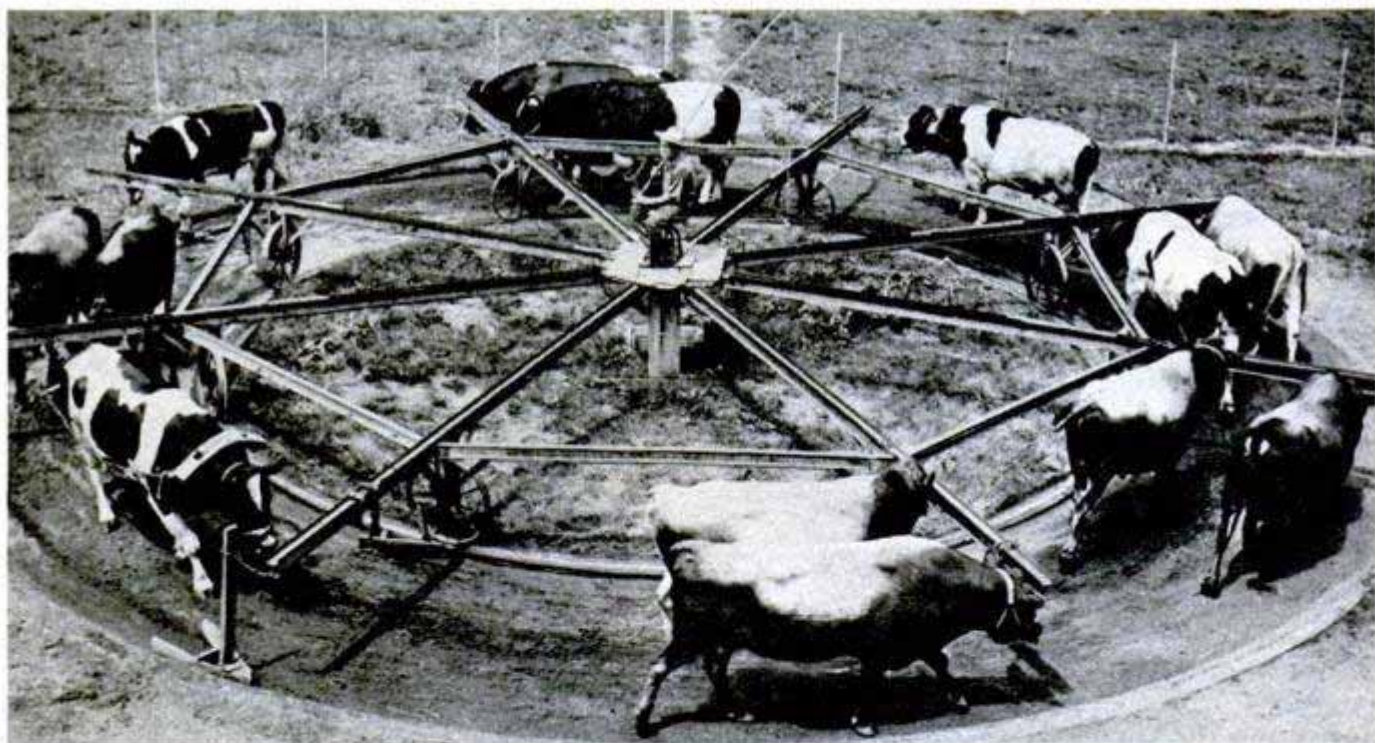

## Merry-Go-Round for Bulls

Bulls "play" on a merry-go-round of their own at the research center of the U. S. Department of Agriculture in Beltsville, Md. The merry-go-round was built to exercise the bulls daily. The bulls are hitched to metal beams which are connected with

each other and with a post in the center. Eight wheels attached to the beams ride a circular track beneath the merry-go-round.

☐ Automobile-accident deaths and injuries in the nation took a sharp jump last year over 1949, according to figures released by The Travelers Insurance Companies.

the

POPULAR  
MECHANICS

# CRAFTSMAN

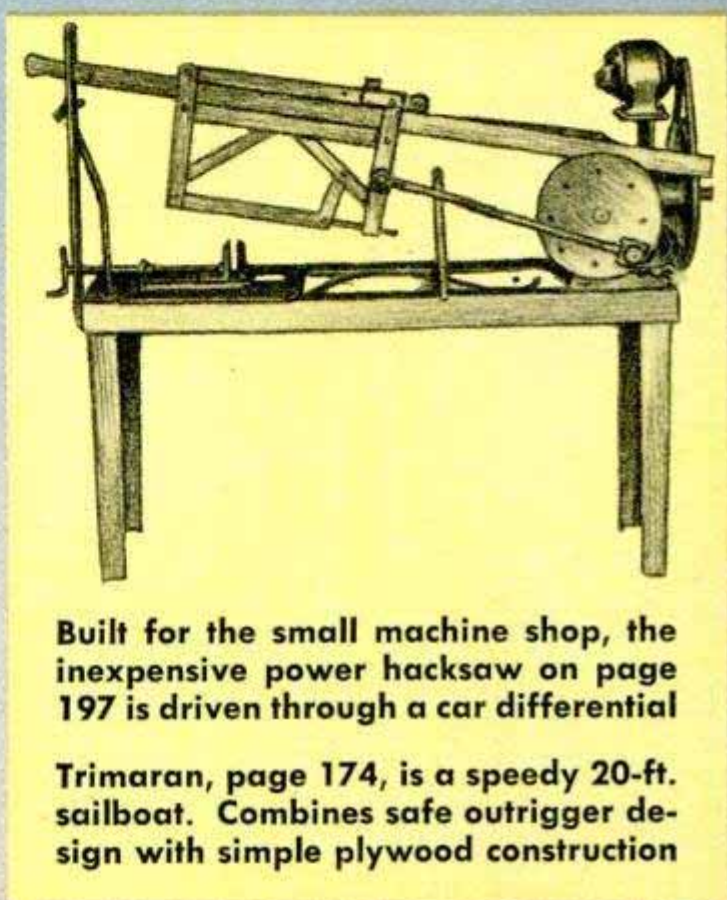

Built for the small machine shop, the inexpensive power hacksaw on page 197 is driven through a car differential

Trimaran, page 174, is a speedy 20-ft. sailboat. Combines safe outrigger design with simple plywood construction



# Build your own NURSERY FURNITURE

## Part I

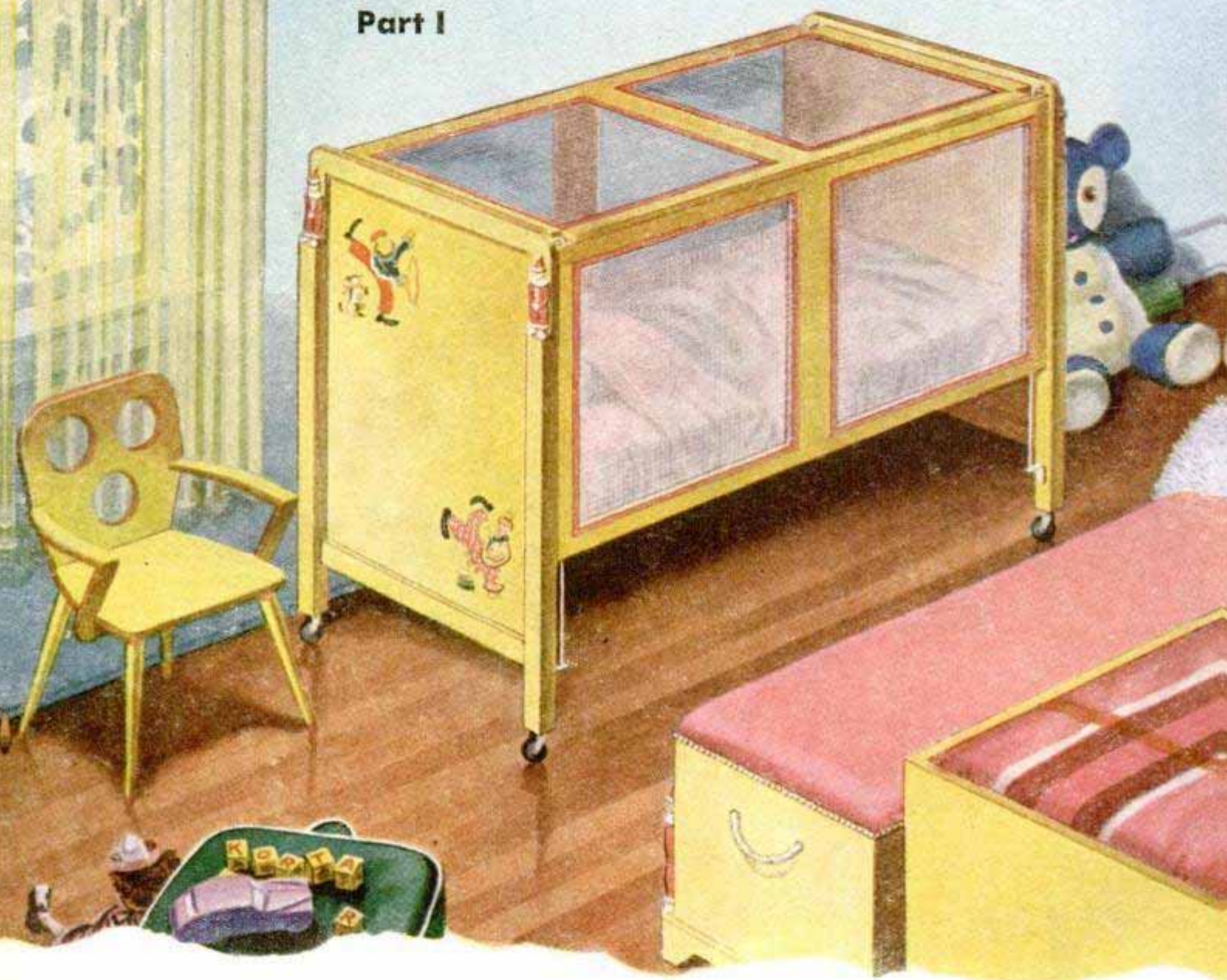

**F**EELING a need for functional improvement in run-of-the-mill nursery furniture, the editors of *Popular Mechanics* commissioned furniture-designer John Bergen to work up something new and different, stressing comfort, safety and maximum utility. At first glance, this attractive nursery ensemble looks much like other matching sets of juvenile furniture. But a second glance will reveal its many practical features—ideas that simplify baby care and provide extra storage space for clothes and toys. These features are incorporated in a gay circus design with plain lines that make cleaning a pleasure and construction easy. Take the baby bath, for instance. Standing in the corner, it blends right in with the

other two pieces of the sectional unit—the desk-toy cabinet and the wardrobe chest. However, when opened, the bath becomes an efficient unit with towel bars, generous diaper storage and a built-in electric heater to remove the chill from the vicinity of the bathtub and dressing table. Note that the three sectional pieces are made the same height for easy rearrangement to suit the room in which they are used.

You don't have to build all the pieces pictured, as each has its own individual merits and will be a welcome addition to any nursery. For example, you can start with the crib and bath. Then add the wardrobe chest and playpen next. As toys accumulate, you'll want the toy chest, and later the



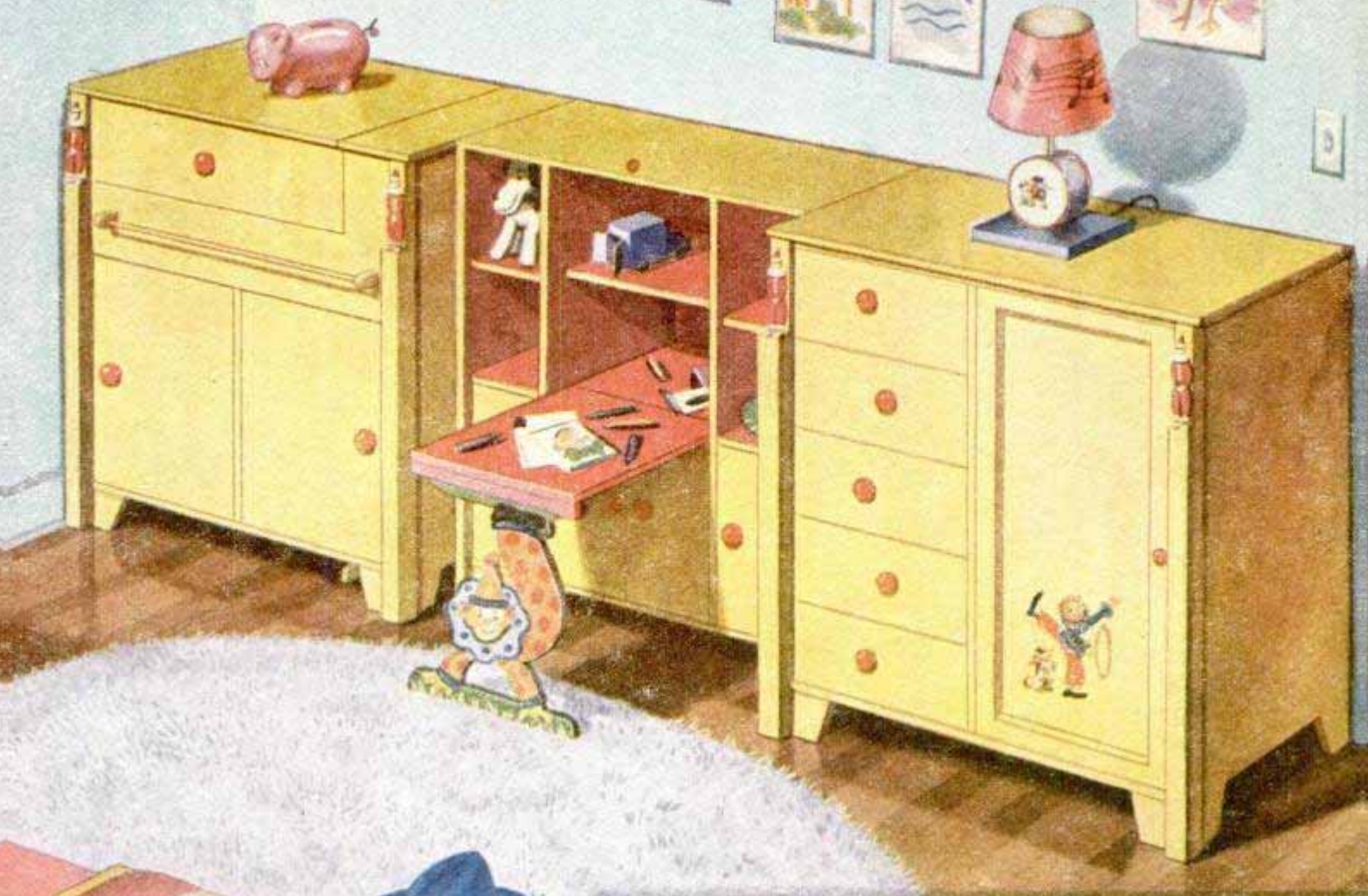

Featuring built-in design with a circus motif, this handsome 10-piece nursery set attains new heights in practical juvenile furniture



desk-toy cabinet and chair, followed in a few years by the youth bed with additional built-in drawer space. With the youth bed for the first baby, the complete nursery will handle a second addition to the family without even changing the arrangement of the room.

Both the crib and the collapsible playpen are completely enclosed with plastic screen wire to afford maximum protection. On warm summer days, the playpen can be set up on the porch or in the yard without fear of insect bites, the raised floor keeping baby well off the ground. The plastic-upholstered



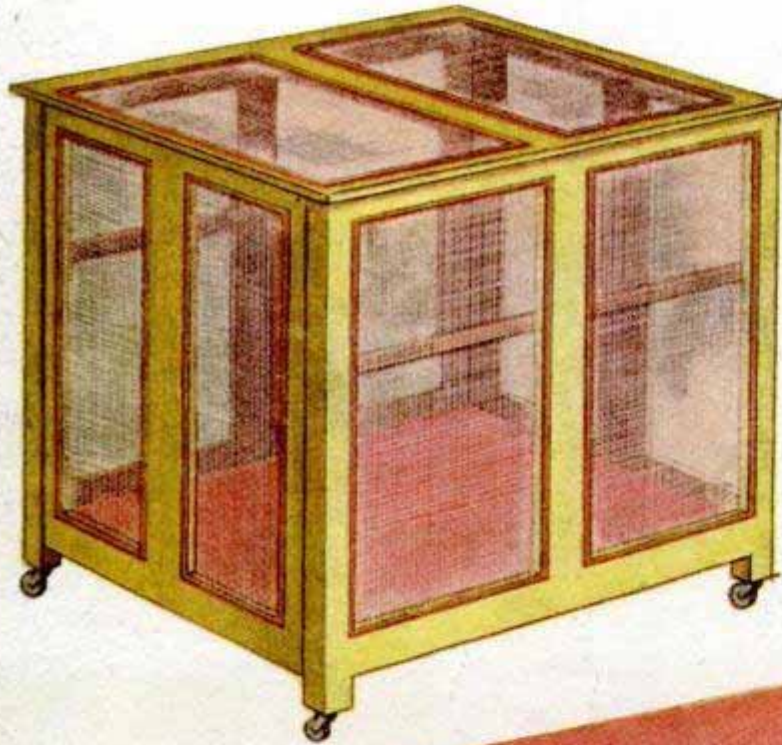

toy chest, the baby bath and the wardrobe chest are all decorated with lively decals and "carved" clowns made from split turnings. The fold-away desk is hinged to the toy cabinet. The jigsawed clown, which serves as the pedestal for the top, becomes an attractive frontpiece for the cabinet when the desk is closed. A modern splayed-leg chair forms a companion piece for the desk. The set of furniture is rounded out with the novel little drum lamp and a combination floor lamp-bench-costumer made to look like a pair of giraffes. The desk-toy cabinet and chair, toy chest, playpen



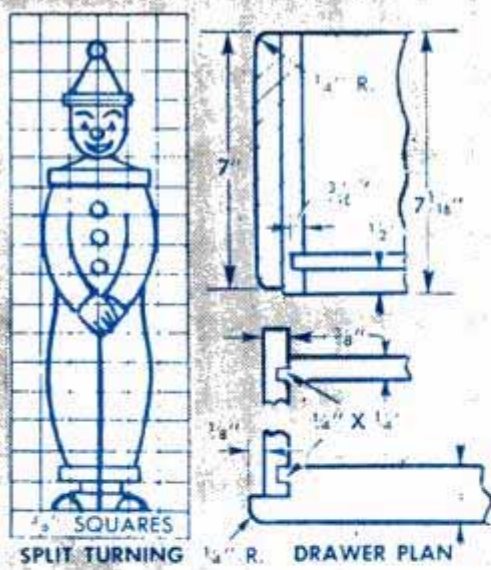

*Wardrobe chest*

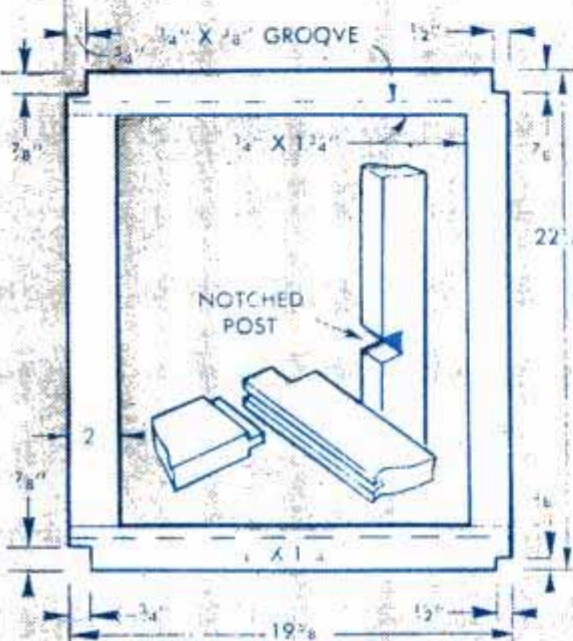
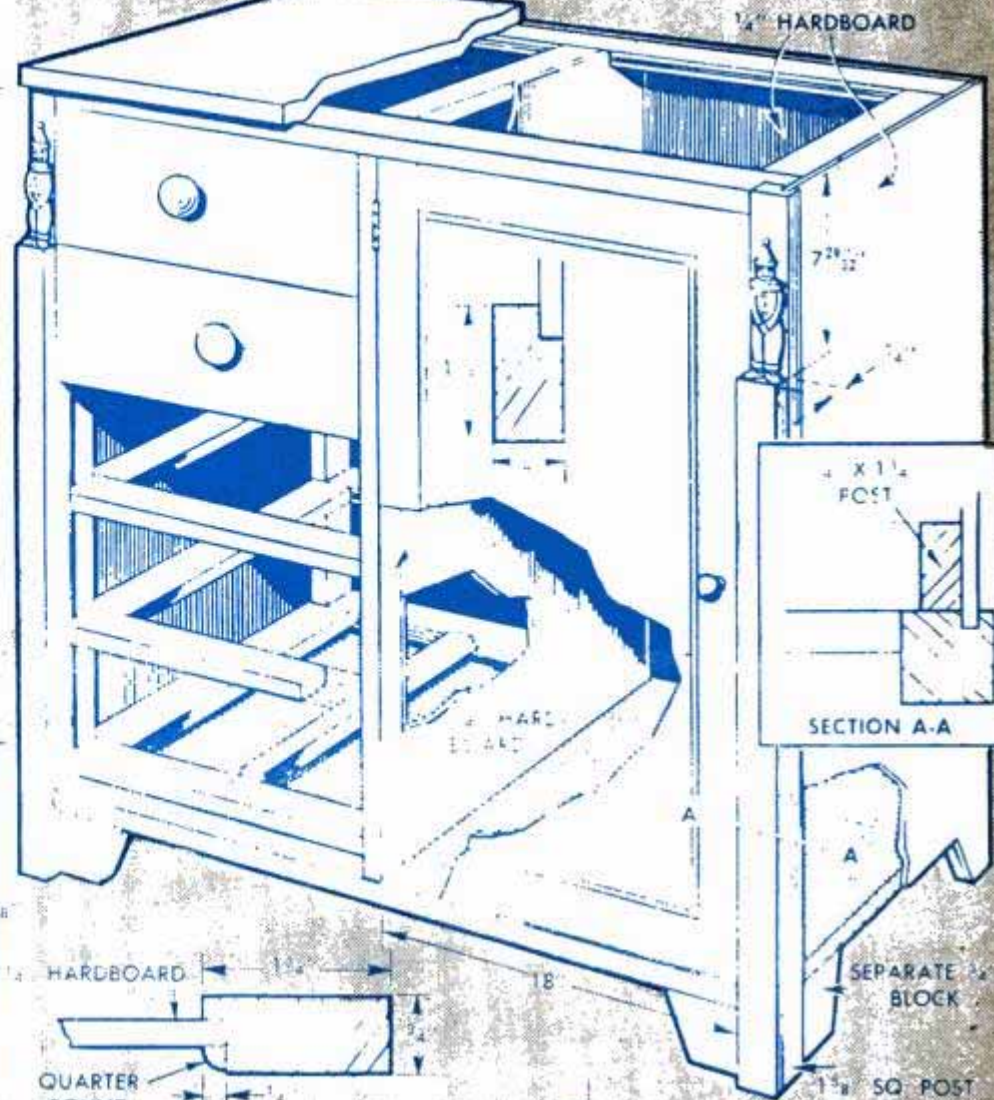

**DRAWER-RAIL FRAME**  
16 REQD.

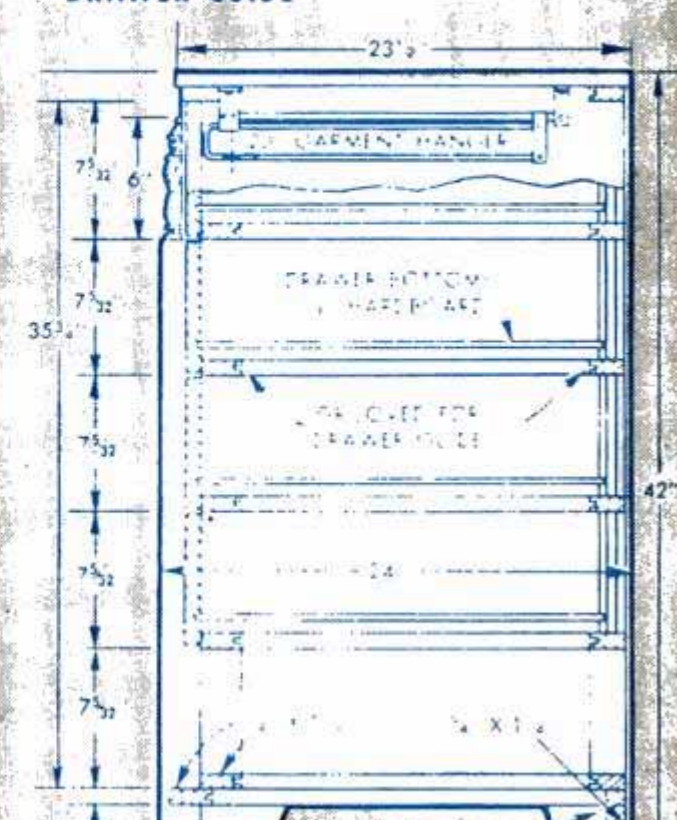
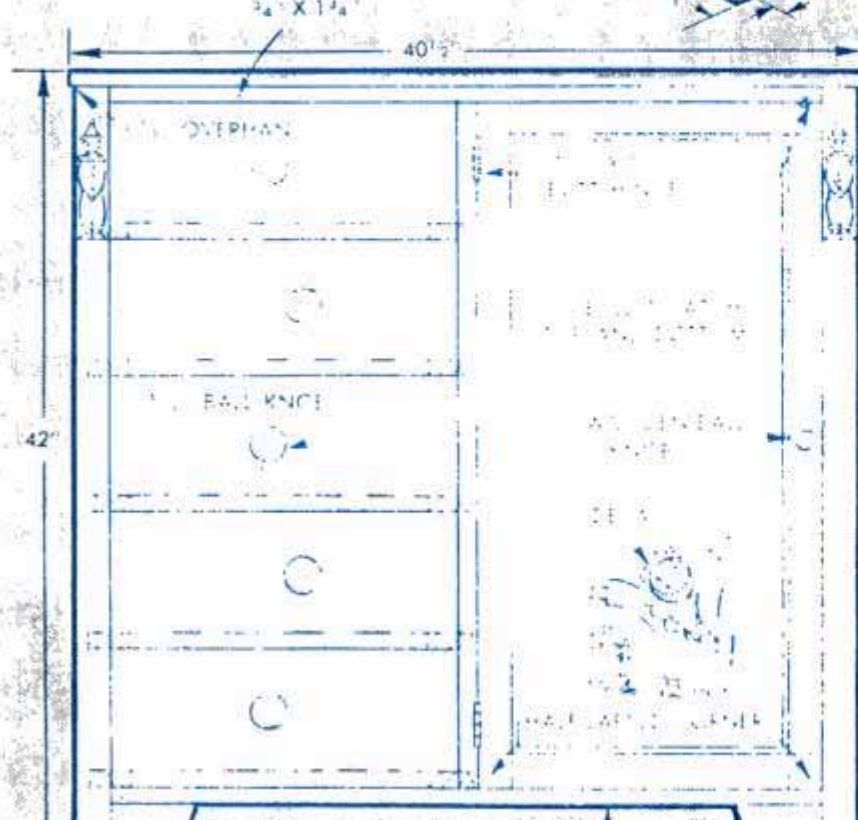
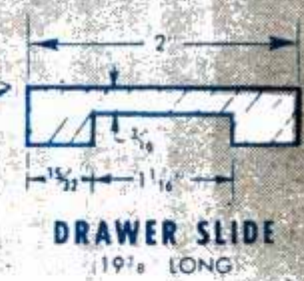
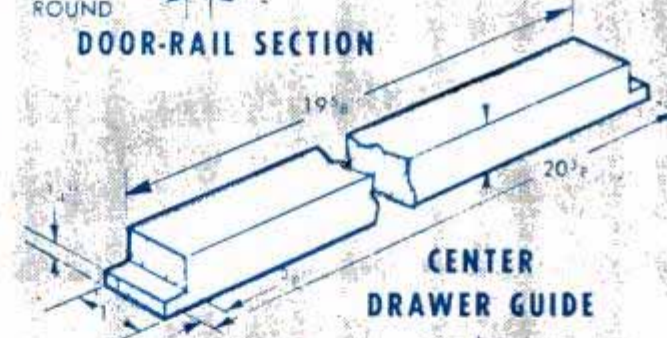
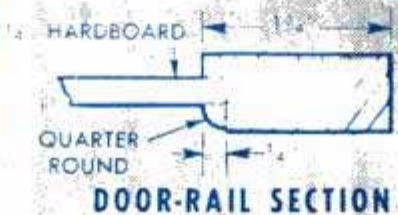

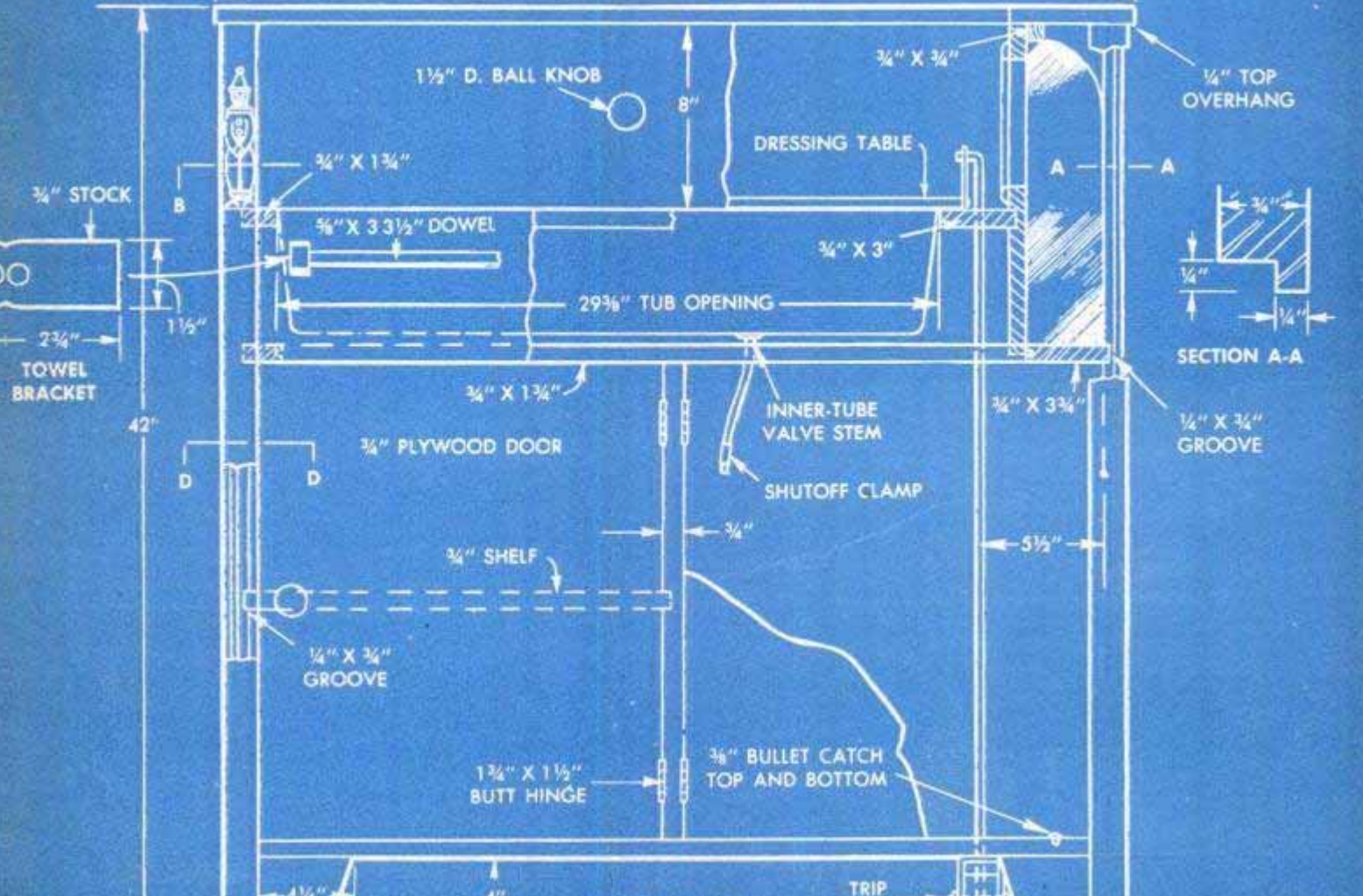
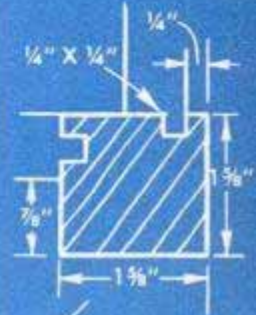
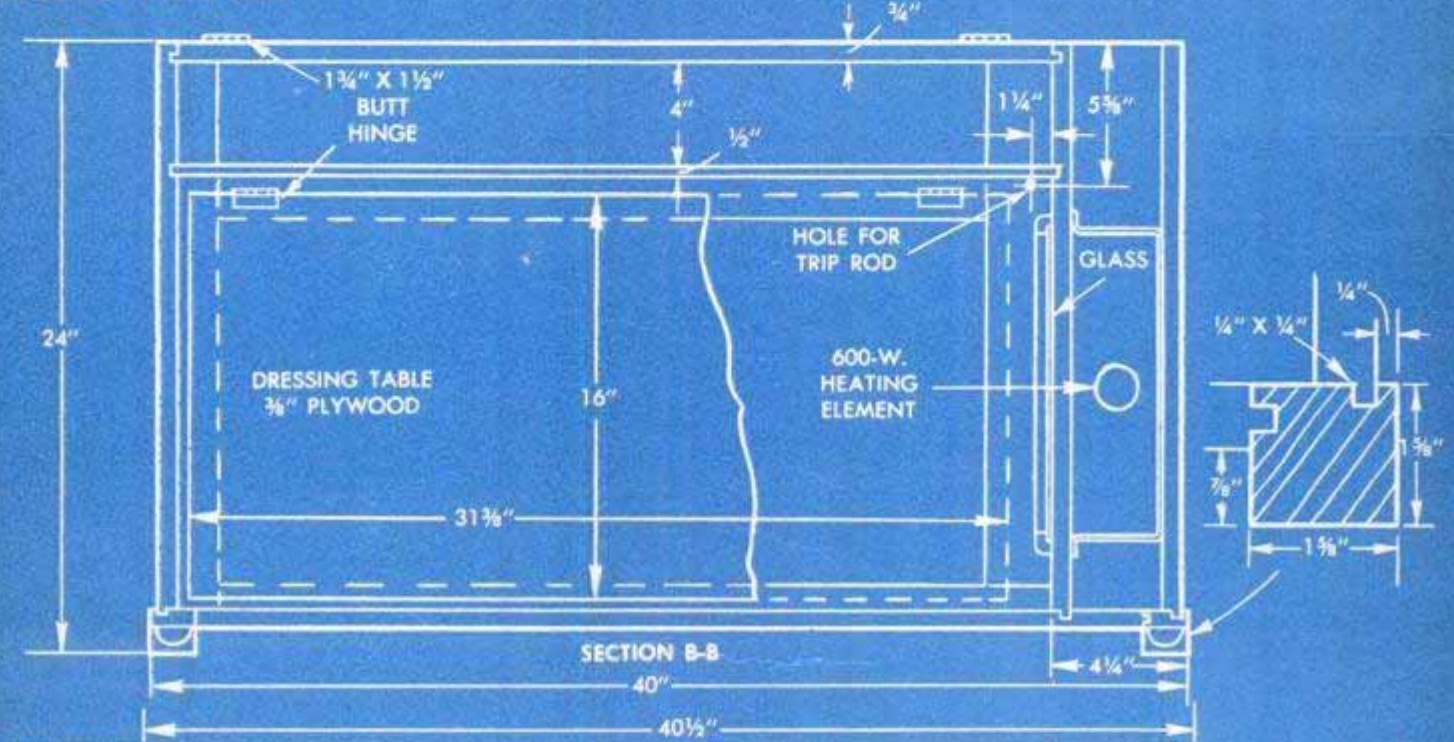
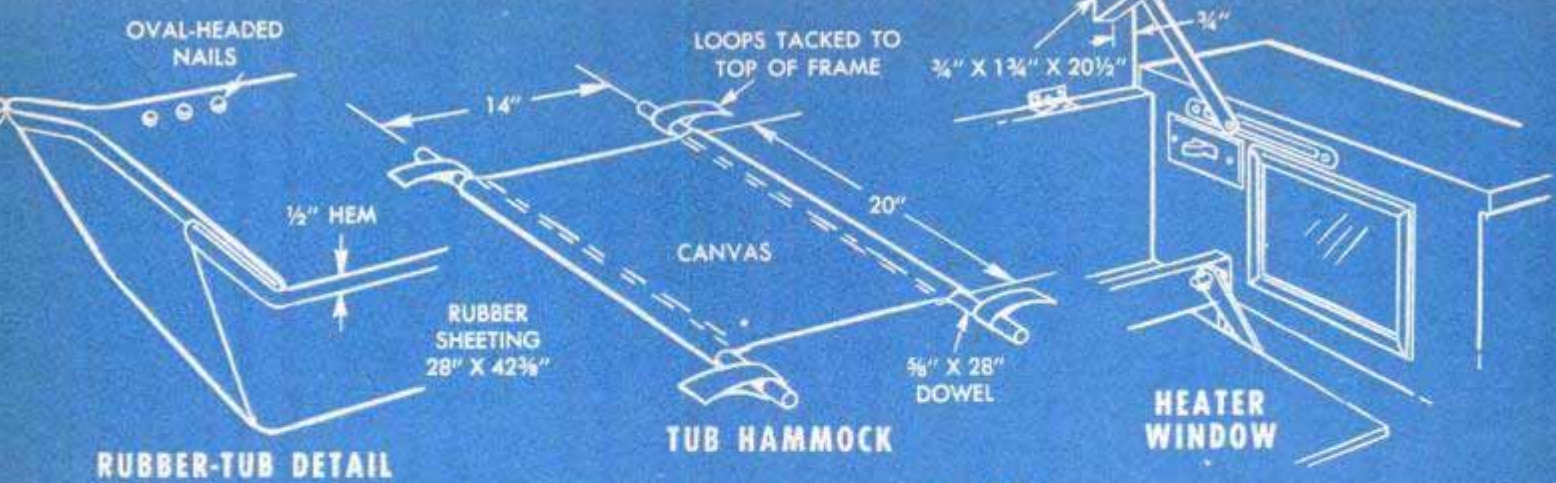

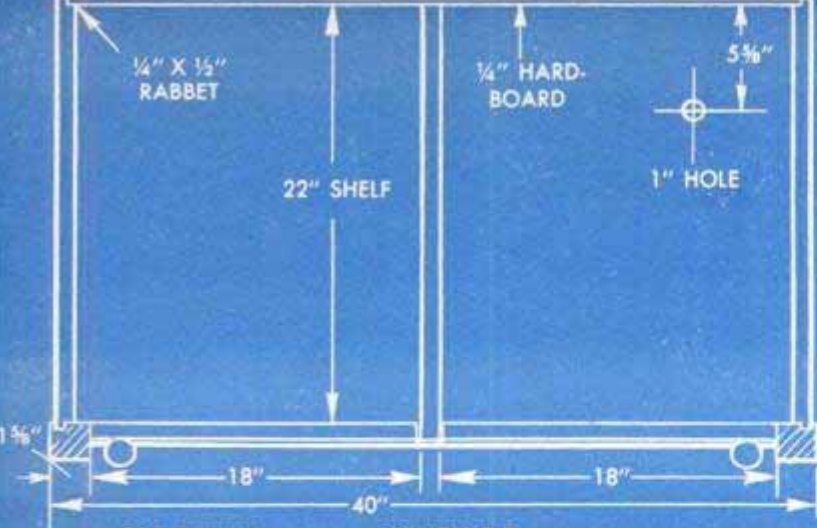

*Baby bath*

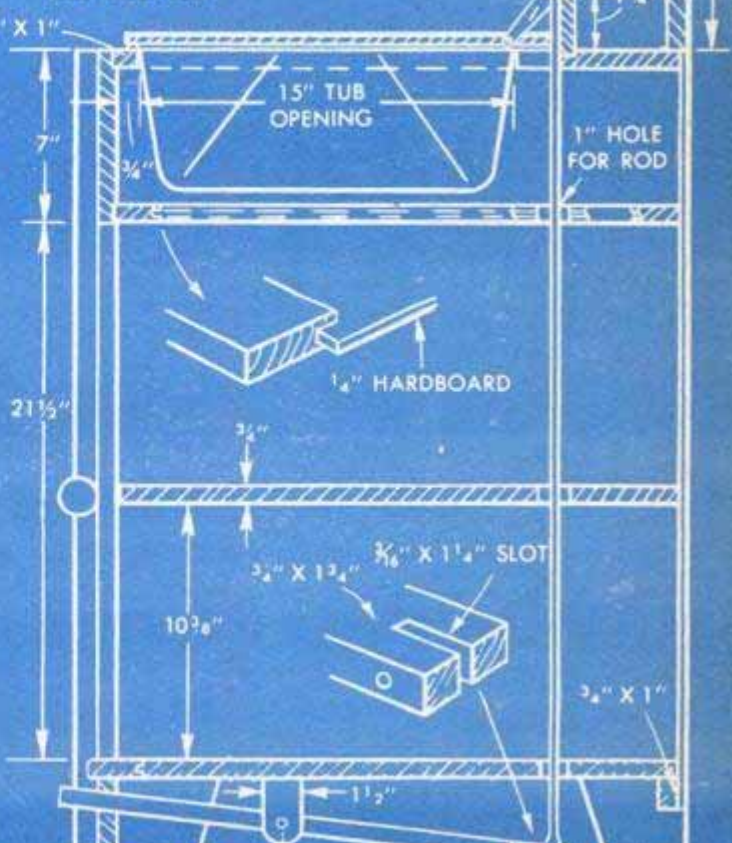
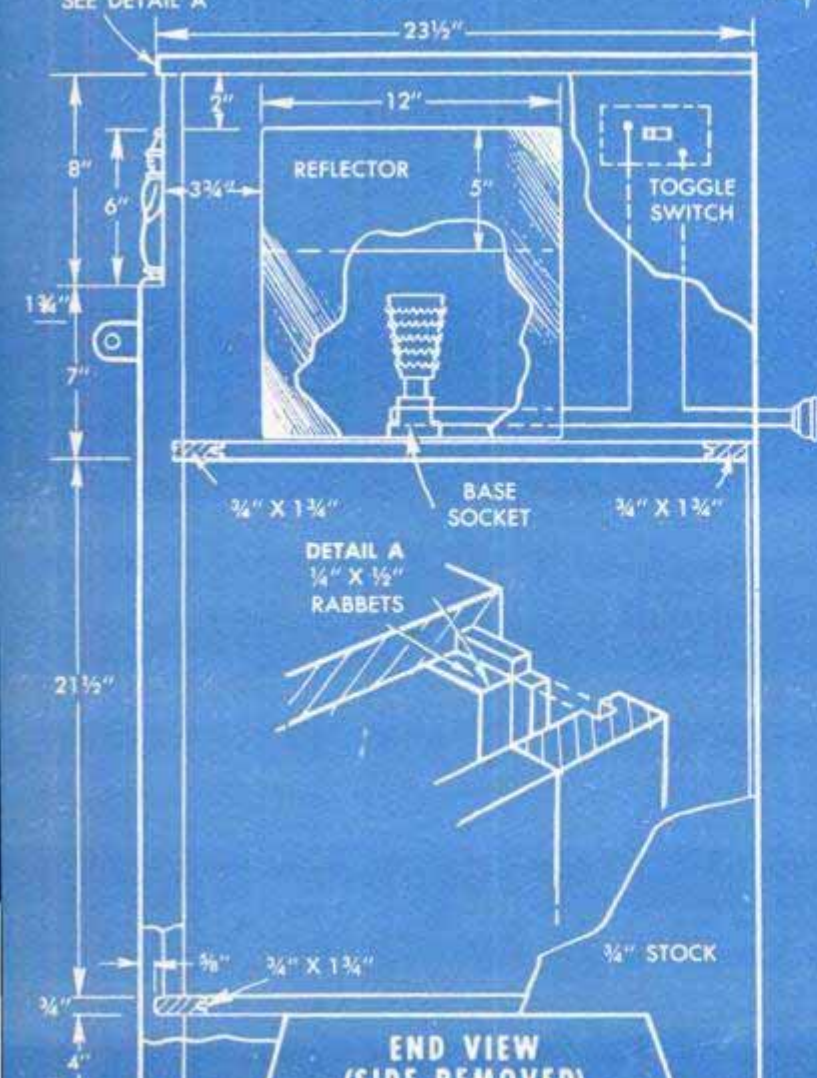
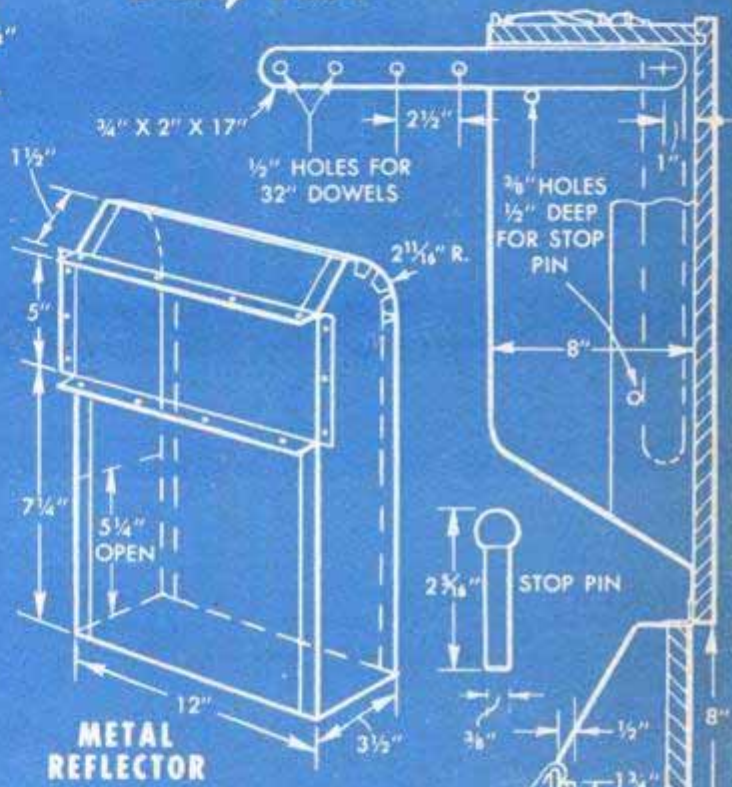
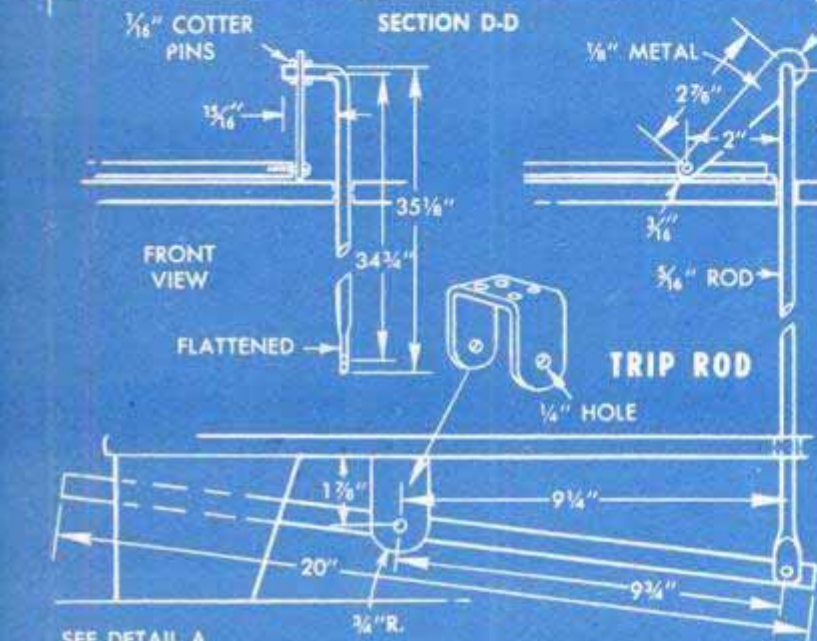

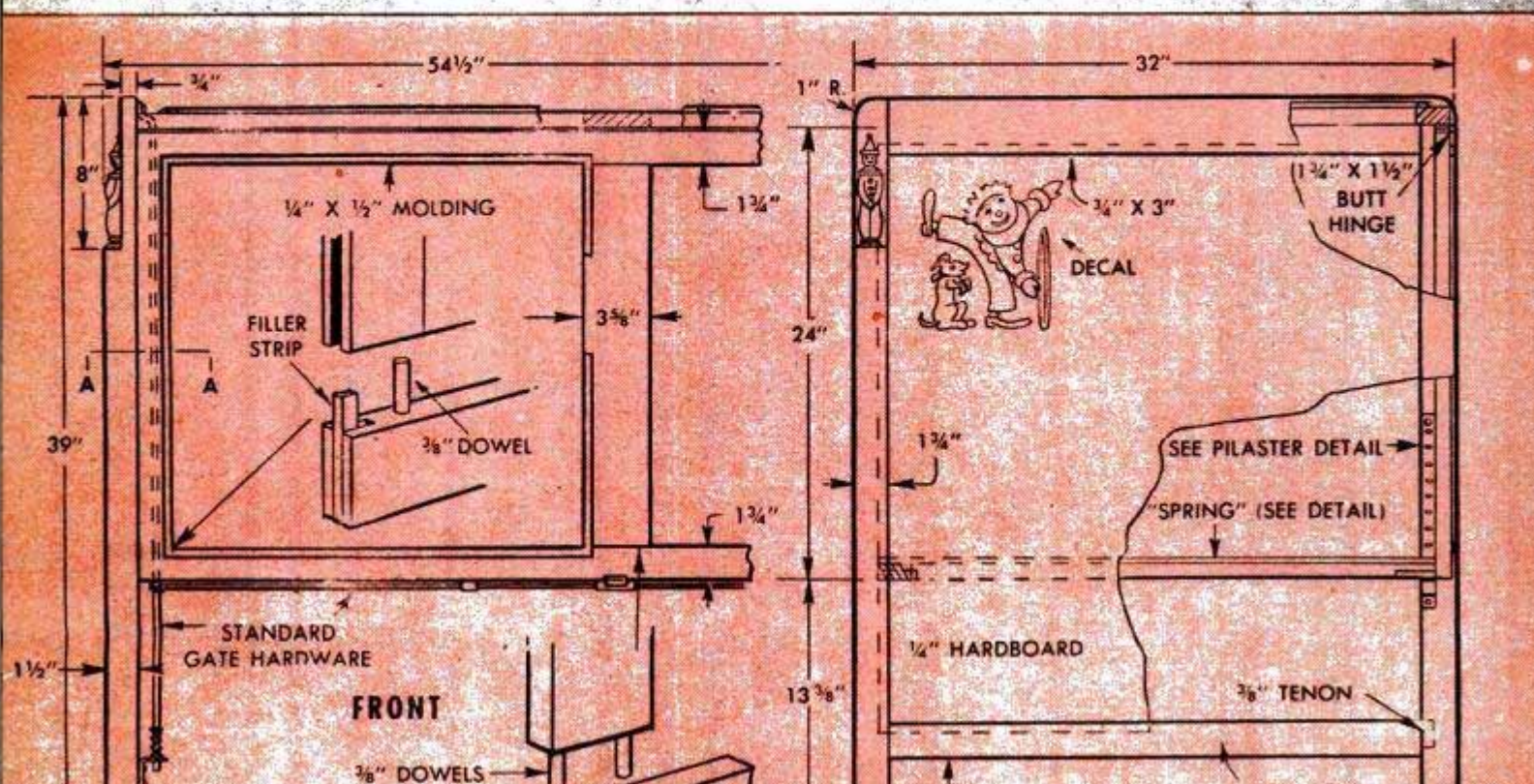
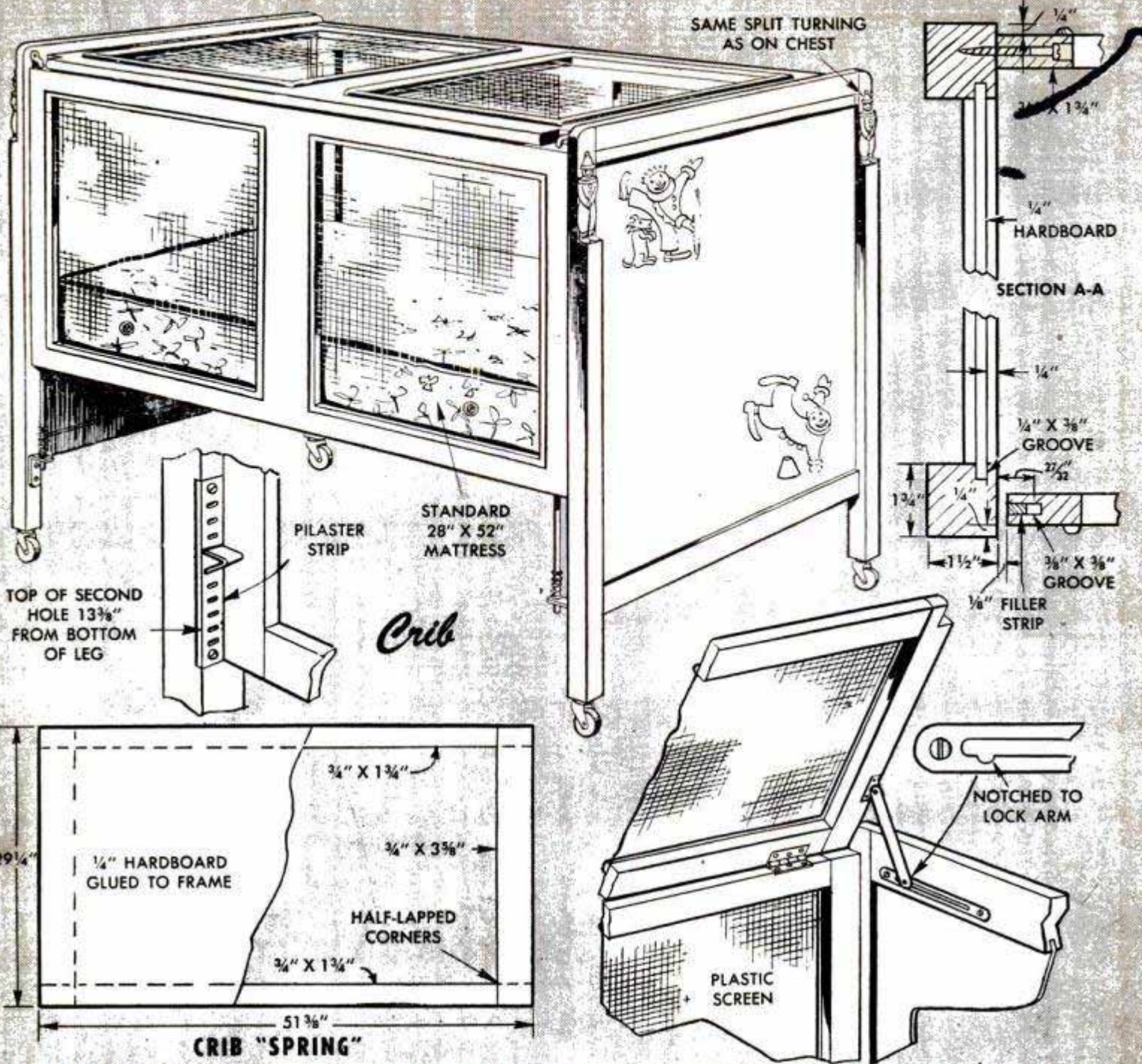

and drum lamp will be described in Part II, while the youth bed and the giraffe lamp-costumer will be detailed in Part III.

Construction of the pieces is evident from the details, pine frame members, 1/4-in.-hardboard panels and 3/4-in. plywood being used throughout. Hardwood is used for the drawer guides and slides. Note in the baby-bath details that the right-hand section of the cabinet houses an electric heating element. Heat from the coil is reflected against a glass panel at the foot of the bathtub. As the sheet-metal reflector will become quite hot, it is advisable to cement sheet asbestos to the outer surfaces of the reflector to insulate it from the wooden cabinet. A canvas tub hammock, stretched between dowels, is supported over the tub by canvas loops. A foot-operated trip lever is used to raise the plywood dressing table. A hardboard panel separates the tub from the diaper-storage compartment. Except for the ball-type door and drawer pulls, which are wood turnings, standard hardware is used throughout. If desired, stay arms for the bath and crib tops can be improvised from sheet steel as shown in the crib detail, and a crib "spring" can be made by gluing a hardboard panel to a wooden frame. A pilaster strip of the type used for adjustable shelves is mounted on each post of the crib to allow the mattress and spring to be raised or lowered for convenience in handling the baby. Finish all the furniture with nontoxic paints and be sure to use plastic rather than copper screen wire on the crib and playpen.

(To be continued)

## Abrasive Strip on T-Square Prevents Slipping

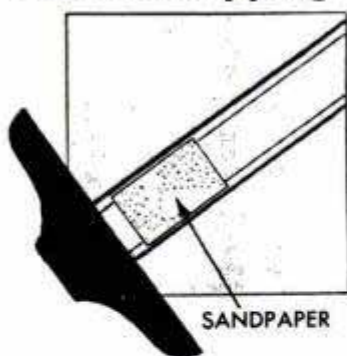

Anyone who has considerable use for a T-square in his work will find this kink very helpful. It consists of merely cementing a strip of fine sandpaper to the underside of the square, just below the head as shown. The paper should be applied with the sanded surface outward. In use, the abrasive surface helps prevent the square from slipping on the drawing board. You will find that it will require considerably less pressure, or gripping, to keep your square in position.

Benj. Nielsen, Aurora, Neb.

☞ To remove onion odor from your hands, rub them thoroughly with dry mustard and then wash with soap and water.

## Molding Clamped to Edge Grain With Improved Fixture

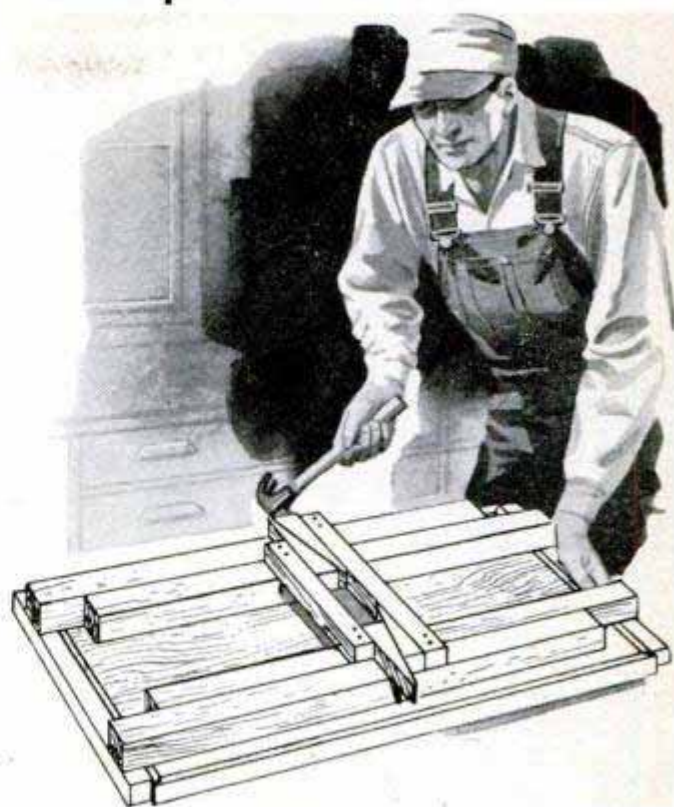

Recently I wanted to edge-glue molding to the ends of a plywood table top to cover the laminations. But not having any bar clamps, I was at a loss for a means of clamping the strips in place. To solve the problem, I built this wooden clamping fixture, consisting of two U-shaped units, one being made to slide inside the other. It is fitted with jaws of 1 x 2-in. stock, which overhang the edges of the table top, and a pair of cleats. Clamping pressure is brought to bear against the molding by merely driving four wedges between the cleats at the center of the fixture. I spaced the cleats to allow for the thickness of the molding plus about one half the width of the wedges, so that a positive wedging action would be had. As only a light clamping pressure was required to hold the strips, the cleats were simply nailed in place, making it easy to shift them to suit work of various sizes. While I used pieces of 1 x 2 and 2 x 2-in. stock, the fixture can be made of any available stock.—Evan Wright, Topeka, Kans.

## Oilcan Doubles as Glue Applicator

The usual trouble involved in applying glue in deep holes and grooves can be avoided by means of an ordinary oilcan. Warmed glue is poured into the can and applied to the work through the spout in the same manner as oil. Between applications, the can should be kept in a pan of hot water in order to keep the glue workable. The can should be washed out with hot water immediately after each gluing job, with particular care being taken to clean the spout.



**PICNIC SUGAR** is kept dry and is easily dispensed if it is carried in a cardboard container of the type in which table salt is packaged. Folding metal spout on top of container permits pouring sugar without spilling

**NET BAGS**, in which potatoes, onions or oranges are sold, are just the thing for storing children's bath toys. Bag can be hung from a clothesline or bathroom hook where it is out of the way, and toys will air-dry quickly



# Solving HOME PROBLEMS

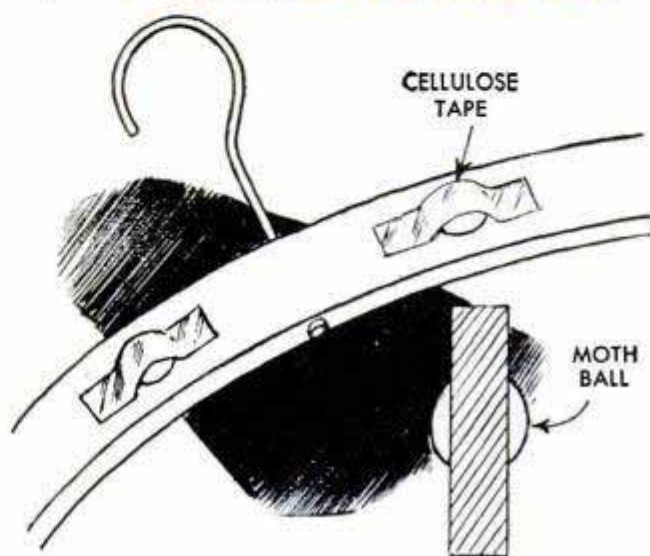

**MOTH BALLS** will stay right with a wooden coat hanger if they are pressed in two or three holes drilled near the top of the hanger. Hold moth balls in place with strips of tape so they will not fall from holes when their size decreases

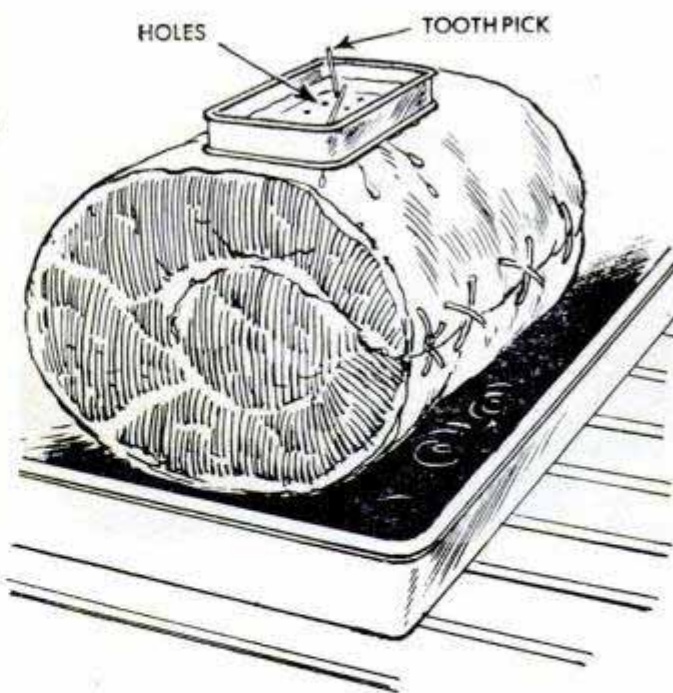

**AUTOMATIC MEAT BASTER** is improvised from empty sardine can. Several holes punched in bottom of the can allow meat juices to trickle slowly over the roast. It may be necessary to anchor the can to the roast with a couple of toothpicks





**WRISTWATCH HOLDER** for desk or bedside table is had by placing the watch in a cellulose-tape dispenser. Insert the watch between the sides of the dispenser, as shown above, and adjust to the angle at which the face is most readily seen

**GILT PICTURE FRAMES** can be cleaned quickly by "painting" with a half-and-half mixture of household ammonia and alcohol. After 15 to 20 min., brush with water and stand frame on edge to dry. Don't use solution on gold-leaf frames



**IRONING TIME** is shortened by placing a sheet of aluminum foil over ironing-board pad. As top of garment is ironed, foil smooths out wrinkles on underside, thus eliminating need for ironing both sides

**TO REPLACE** a Venetian-blind cord, just tape the new cord to the end of the old one. In this way, the cord can be pulled through the holes in the slats and over the pulleys as the old cord is removed

**APPLYING DDT** solution to screens can be done without getting the chemical on your hands. Fill bottle with the insecticide, and press a piece of sponge in the neck of the bottle to serve as an applicator

**PROTECT DRESSING-TABLE** top from spilled perfume and cologne by placing a sheet of aluminum foil under dresser scarf. Foil keeps spilled liquids from soaking through to finish and simplifies wiping them up

**USE A SUN LAMP** to "bleach" the darkened areas from scorched fabric. Moisten the damaged portion with water and hold under lamp until fabric regains normal appearance. Repeat moistening if necessary

**WORN PORTIONS** of linoleum can be renewed by painting to form a simulated throw rug. Cover a rectangular area with base color of linoleum to conceal worn spots and finish with a dark-colored border

**CORNSTARCH** removes grease spots from clothing. Make a paste by mixing starch and cleaning fluid, spread thickly over spot, feathering the edges, and allow to dry. Then brush off with clean, soft cloth

**WHEN HANGING CURTAINS** or draperies, cover end of curtain rod with a finger cut from worn rubber glove. The rubber guard will prevent the end of the rod from snagging and possibly tearing the material

**CLEANING VENETIAN BLINDS** with a soft chamois results in a fast, lint-free job. The chamois should be soaked in a solution of household detergent and warm water, and wrung nearly dry before using

**A NEW POWDER PUFF** provides an excellent "brush" for applying plastic-base linoleum varnish. The puff will spread the varnish smoothly, or can be used to pat the surface for attaining a matte finish

## Cork Insert in Drawing Board Safely Supports Compass

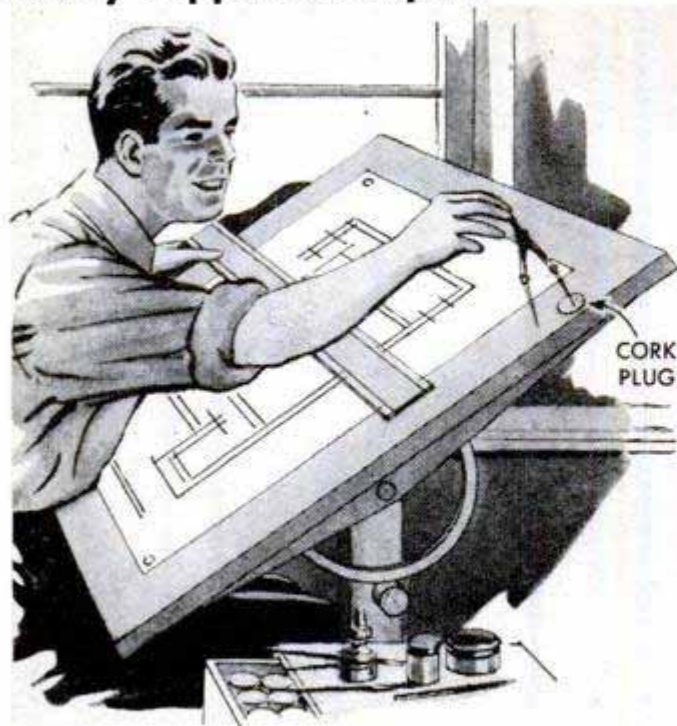

Although a compass used at a drafting, or drawing, table can be kept readily at hand by sticking it upright in the board, such a practice usually results in roughening the surface of the board and often bending the point of the compass. However, by boring a hole in the drawing board and plugging it with an ordinary cork, a place can be provided in which a compass can be stuck and held without danger of damage either to the board or the compass.

G. E. Hendrickson, Argyle, Wis.

## Soldering-Iron Heat Conserved With Steel-Pipe Holder

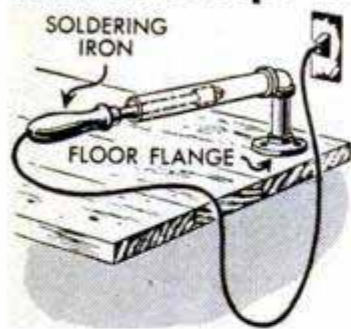

A soldering-iron holder made from pipe and fittings will retain the heat of the iron while holding it safely above the top of the workbench. A short nipple is screwed loosely into a floor flange

so that a length of pipe, connected to the nipple with an elbow, may be swung out of the way when not in use. The pipe should be just large enough to receive the tip of the soldering iron.

## Electric Motors Started Manually

Even though the starting winding of a repulsion-induction motor has burned out, the motor still can be used if it is started by spinning the shaft manually and turning on the switch while the shaft is rotating.

A motor in this condition often can be purchased at a considerable saving, and is satisfactory for driving a disk sander, grinder or other tool which allows the shaft to be spun by hand. The motor will run in the direction in which the shaft is rotated. It is best to mount a switch on or near the motor so it can be turned on quickly. However, the switch should not be turned on until the shaft is rotating.

Alfred D. Beavin, Fair Haven, Vt.

## Stair Rail Made Slideproof By Spiral Wire Wrapping

Wrapping outside stair rails with lengths of wire will discourage children from the dangerous practice of sliding down such rails. Ordinary stovepipe wire or baling wire is wrapped spirally around the entire length of the rail, allowing 3 or 4 inches between the turns. The wire is then fastened to the posts at both ends of the rail.

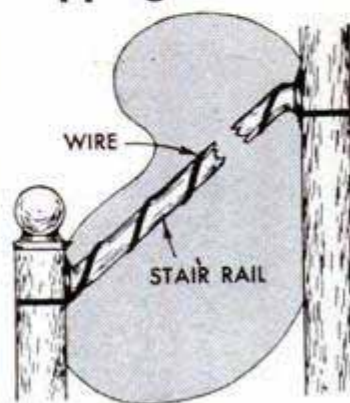

Harry Wandrus, Milwaukee, Wis.

## File Aids Adjusting Carburetor On Engine Too Hot to Handle

Surrounded by hot surfaces as well as a maze of control wires and rods, the adjusting screw of a carburetor is not always easy to reach. This is especially true on some power lawn mowers. However, a coarse file, held against the knurl of the adjusting screw and used in the manner of a rack and pinion, can be used to get the job done without burning the fingers.

Ed Packer, Chicago.

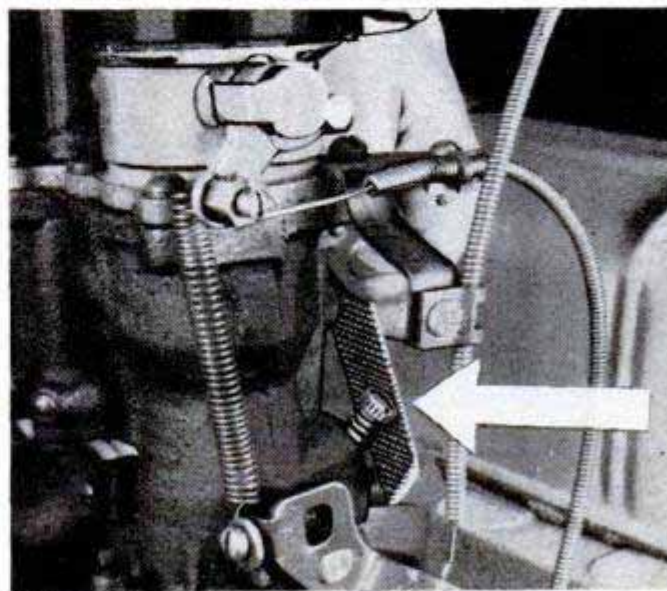

# Fish Kept Fresh in This Homemade Cold Box

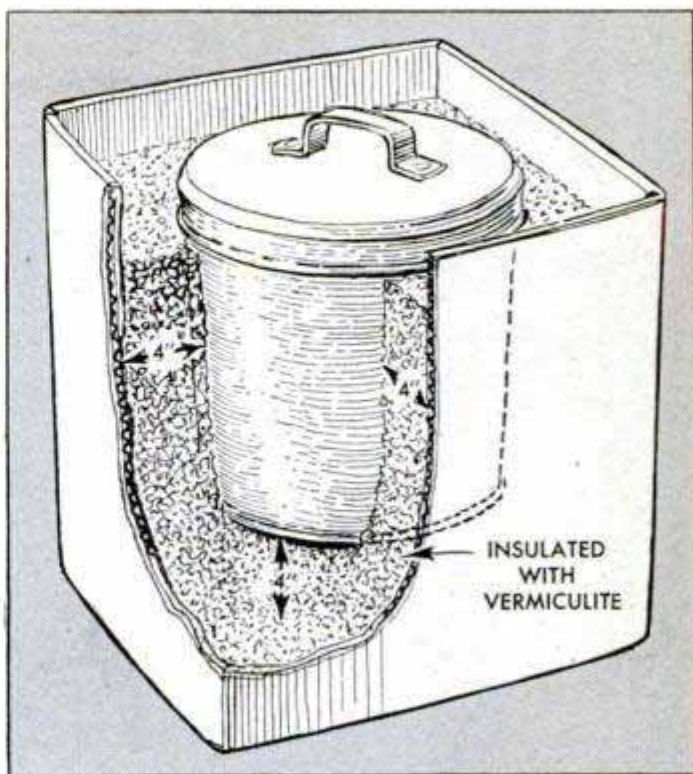

Here's something to remember when you go on your next fishing trip. According to the Zonolite Company, processors of Vermiculite, a mica-like insulation, newly caught fish will keep fresh for three days when packed in ice and stored in a box filled with this insulating material. Just pack the fish in a covered container with ice chips or cubes. Then pour Vermiculite into a cardboard box to a depth of about 4 in., set the container in the center and pour the insulating material into the area around it. Vermiculite will maintain a

freezing temperature for at least three full days. You also can accomplish the same thing by using Dry-Ice instead of natural or artificial ice. Wrap Dry-Ice in a cloth folded once or twice and place the bundle in the bottom of the container. Then pack the fish in the container with moss or other similar material and insulate in the same way. Use a box that will fit in your car trunk in case you wish to transport the catch. *Caution:* Do not handle Dry-Ice with bare hands and be careful not to inhale the fumes when ventilation is poor.

## Railings for Model Buildings From Cotter Pins and Solder

When making railings for use around model-railroad stations and for other model work where true scale is not important, cotter pins and wire solder are ideal for

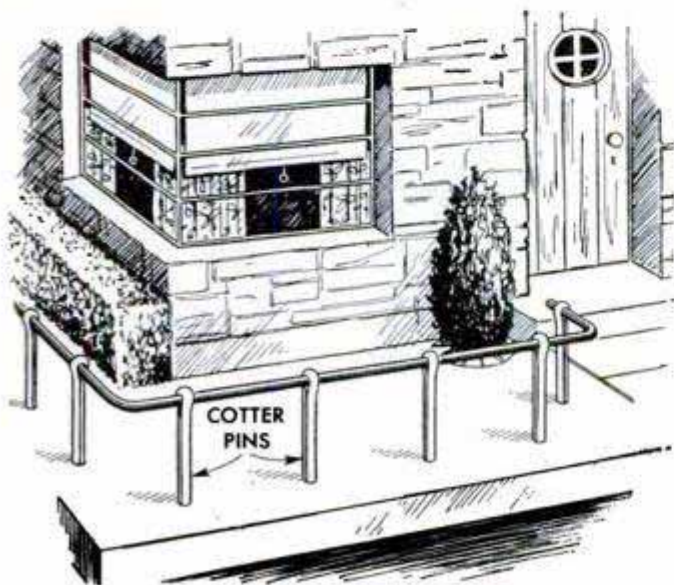

the job. The cotter pins are used for the posts and the solder is used for the railing itself. Holes drilled in the base, which supports the railings, take the cotter pins. In assembling, spring the cotter pins before putting them into the holes so that they will fit tightly. The solder should be bent and inserted through the heads of the pins before the latter are put in place. However, if you have fairly long runs of posts in a straight line, the solder can be inserted after the posts have been put into position.

## Helpful Hints on Varnishing

Before starting to varnish floors or woodwork, be sure there is no dust either on the wood or in the air. It is best to do the job when the furnace is not in operation. Varnish should be applied with smooth, light strokes and plenty of time should be allowed for it to dry.

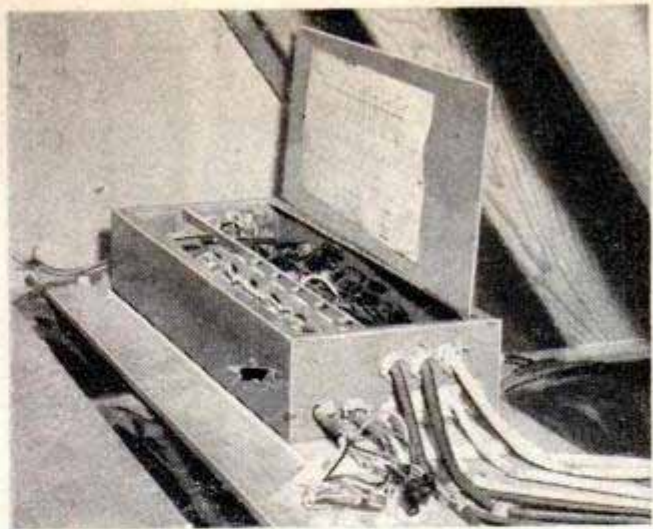
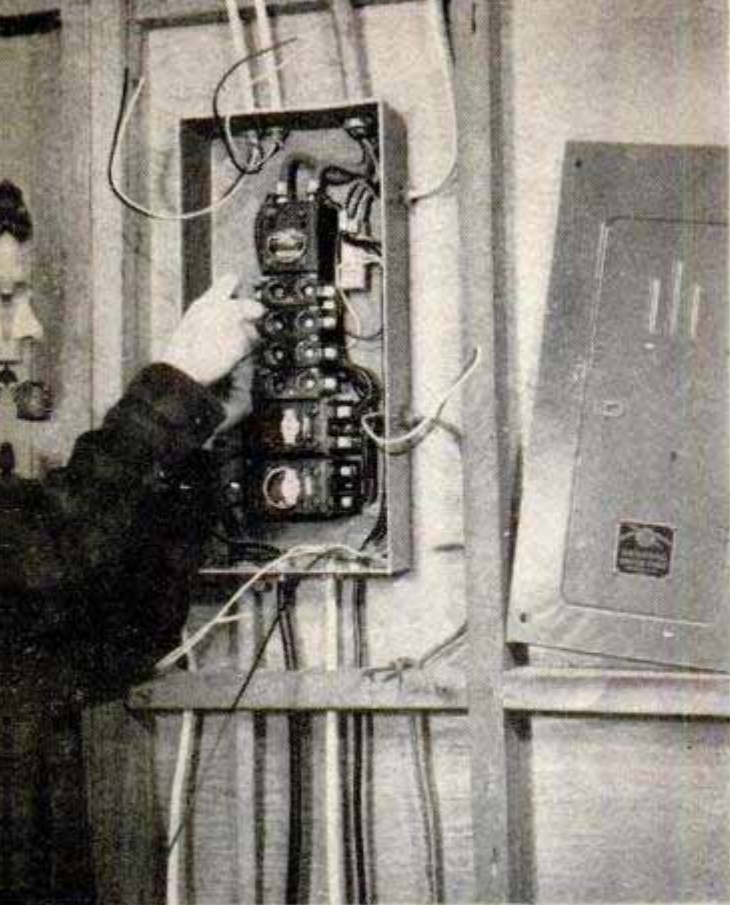

The box which houses the relays used in low-voltage wiring system is located in a central spot in the attic where it is easily accessible. Control box can be purchased assembled or you can wire it yourself

## How I Built

### PART III

By Tom Riley

I used a new-type service-entrance box which has three "pull outs" and eight ordinary fuses to handle the electric range, automatic washer, clothes drier, dishwasher, etc. The diagram below shows a typical wiring example of low-voltage, touch-plate system

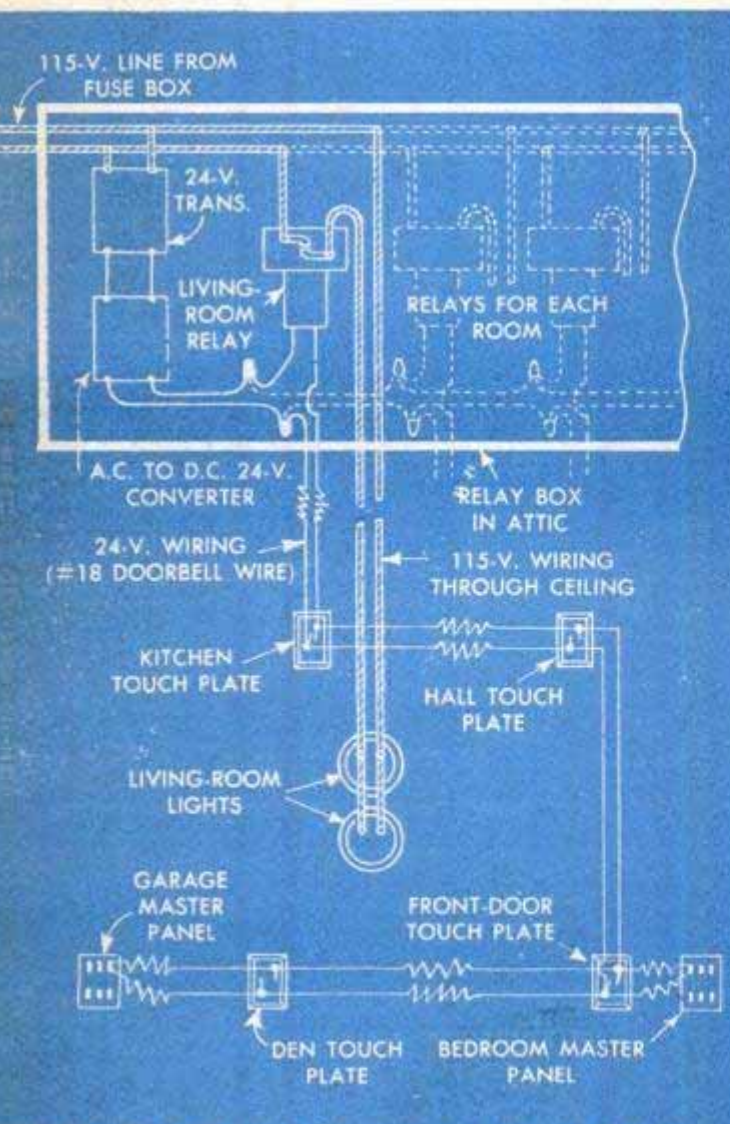

WITH MY ranch house fully enclosed and the heating and plumbing installed, as described last month, I next tackled the wiring. If your local building code authorizes installation of the new touch-plate or low-voltage system, I highly recommend using it. Not only is it far less

Using a stapler, which we rented, Vinita found that installing blanket insulation actually was fun, and one of the jobs that she could easily take over completely

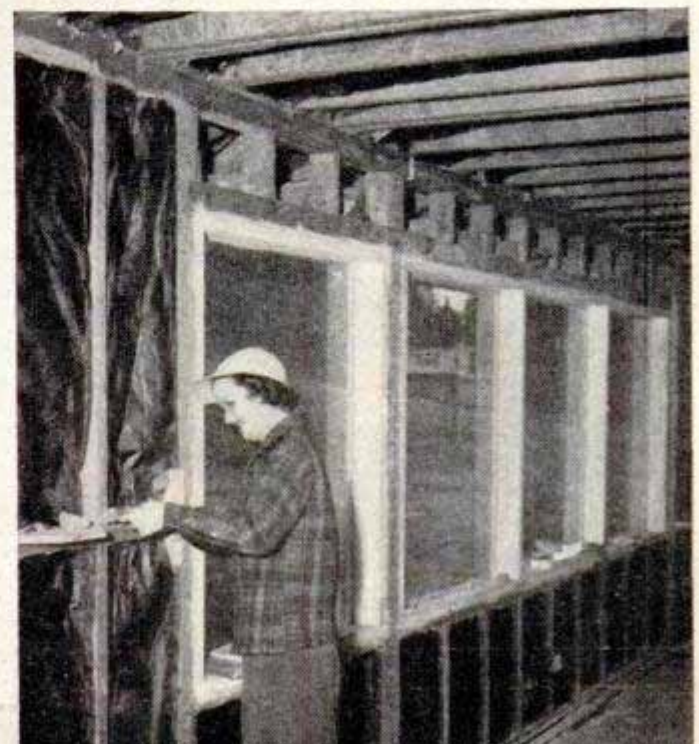

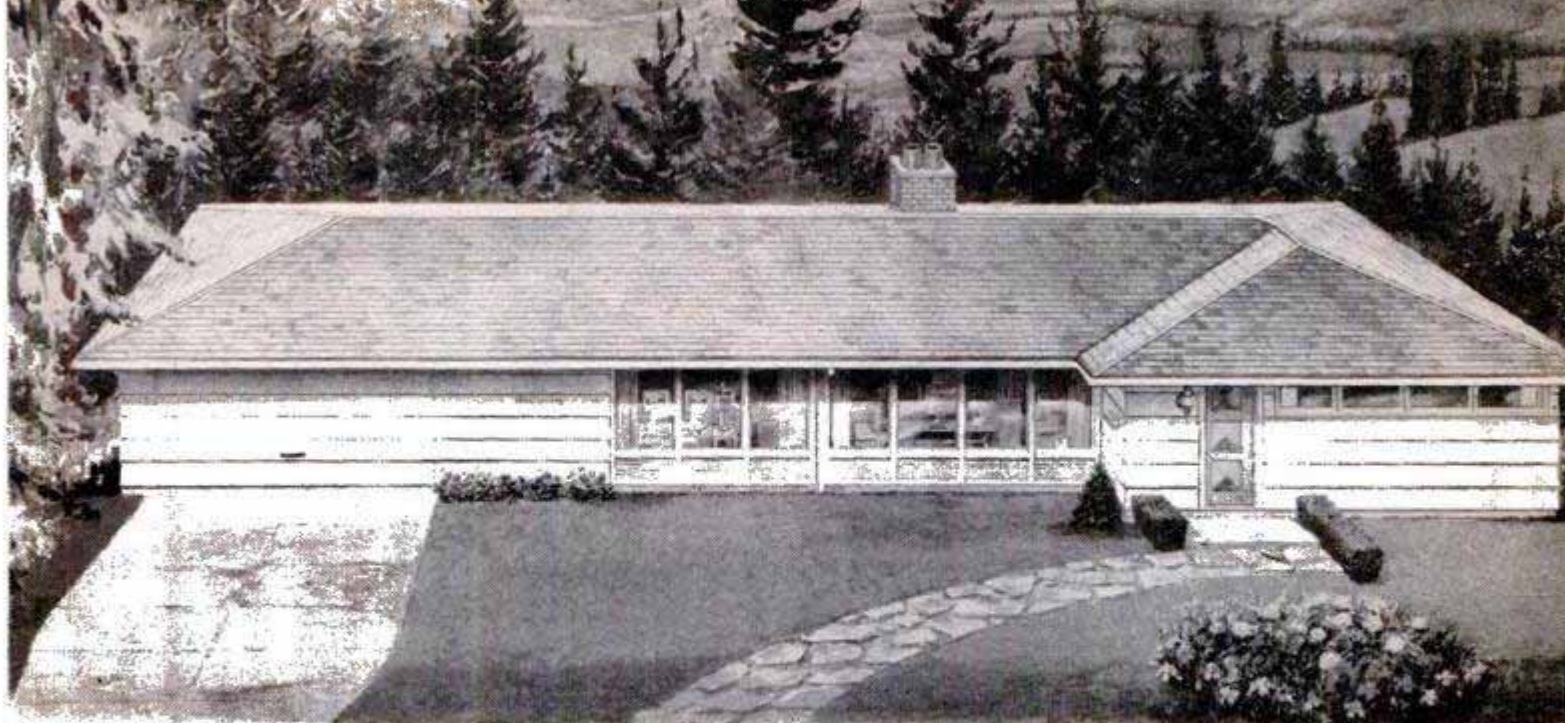

# *the* **POPULAR MECHANICS** *Ranch House*

expensive than the common 115-volt a.c. system, but it is made to order for the amateur electrician. The touch-plate system is the modern way of switching the lights in your home by means of relays which are housed in a metal box in the attic. One relay is provided for each room and the touch plates are merely push-button switches, a type similar to your doorbell button. Briefly, to wire the low-voltage system, you run ordinary 115-volt wiring to all base and

Right, the work of "tiling" the plywood for the ceilings went fast with a portable router. Below, furring strips nailed to the joists carry the plywood sheets

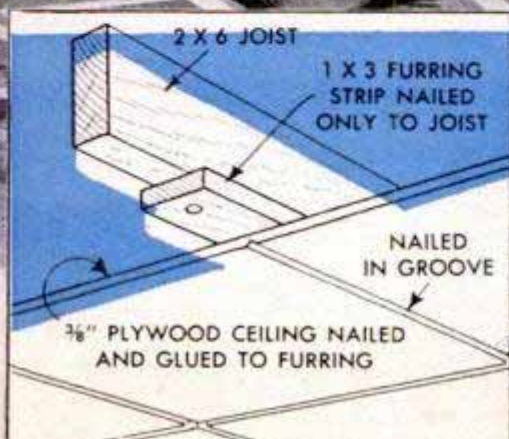
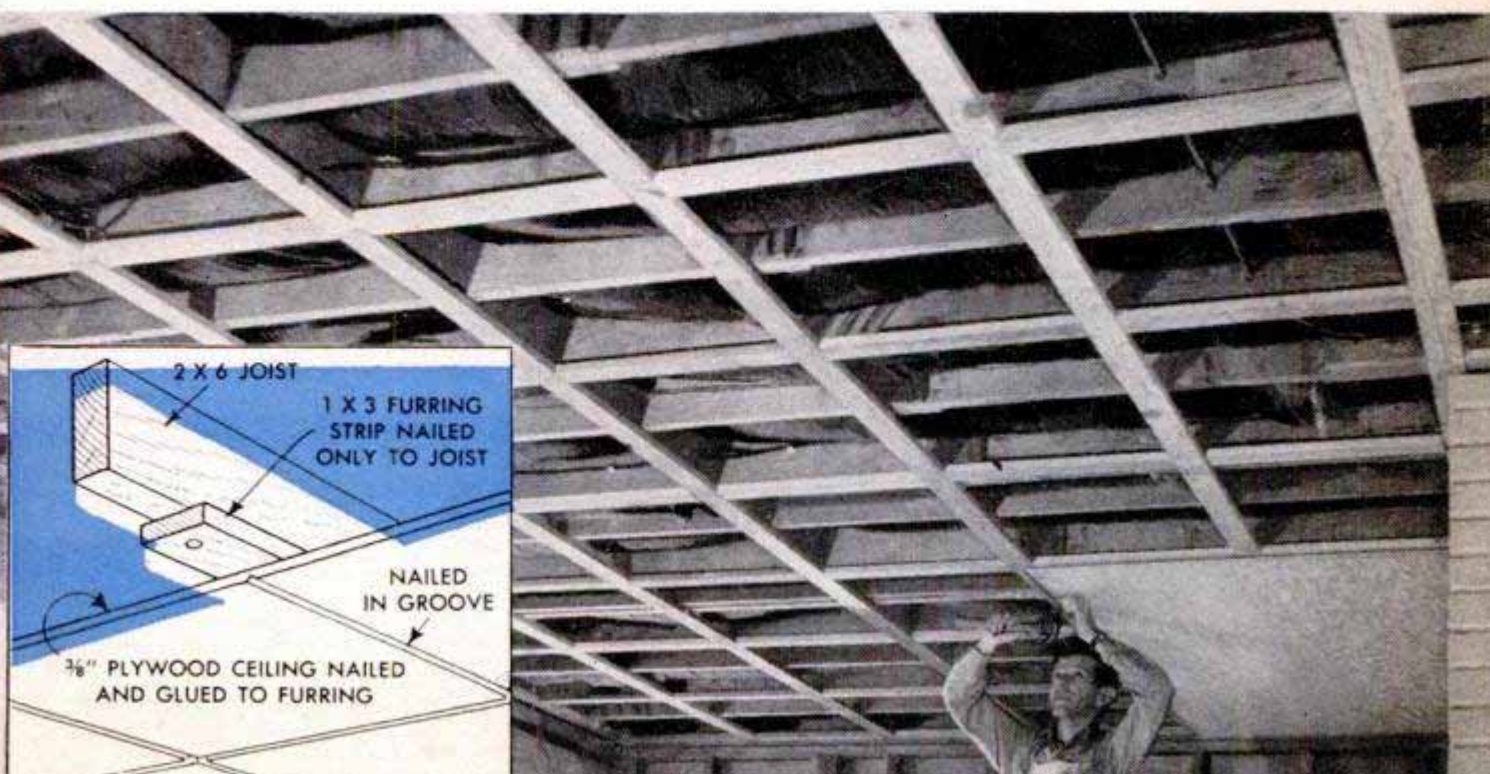
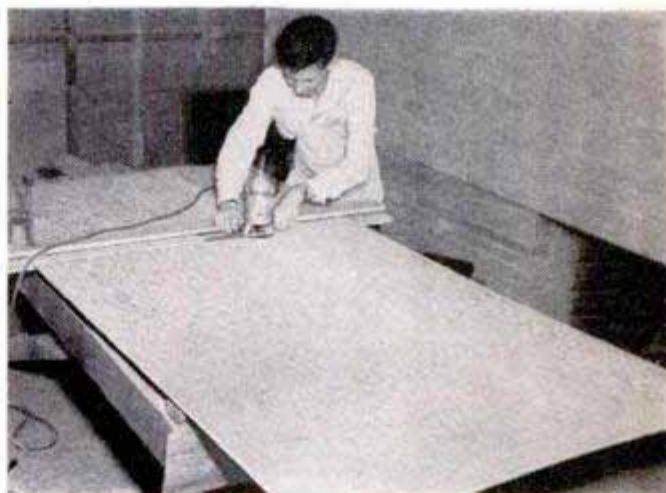



Norman Chapman, my helper, found that a ceiling horse to support the plywood let him concentrate on nailing. Detail at the right shows how to make one

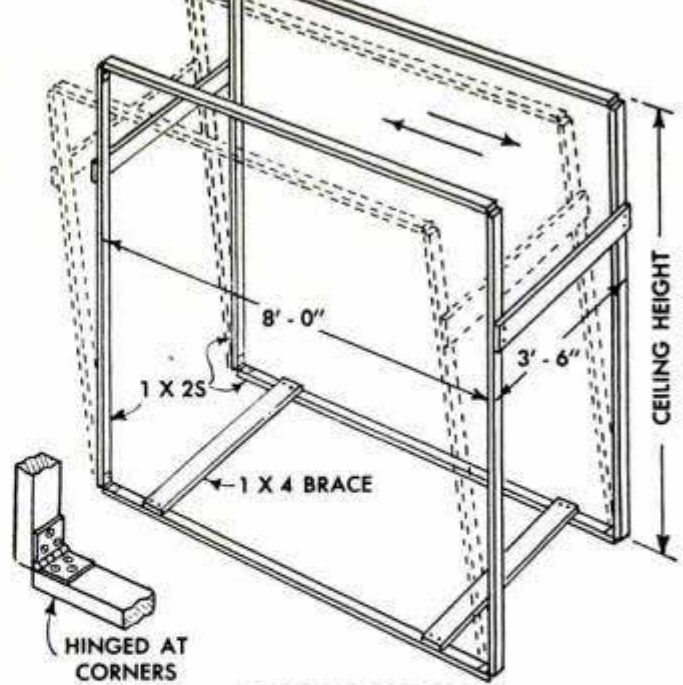

**CEILING HORSE**

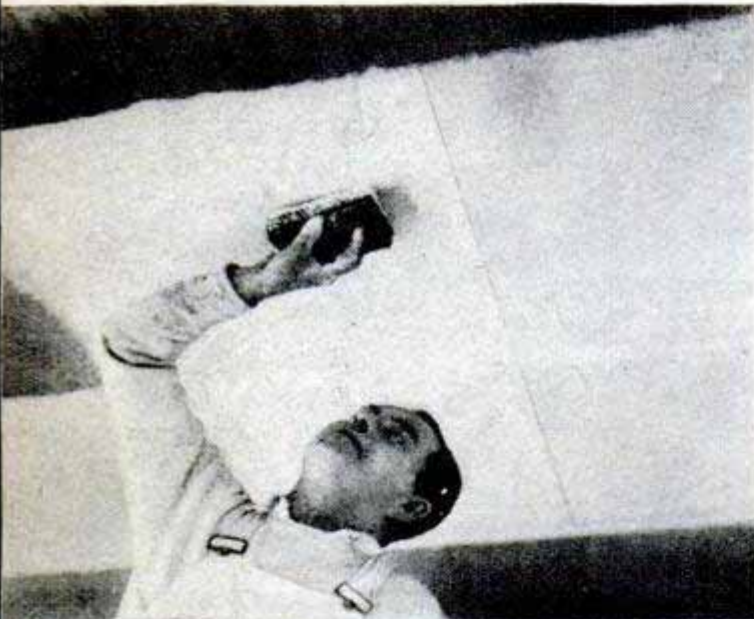

Above, the ceilings were finished with a thick coat of texture paint, stippled with a flat sponge. Below, walnut-faced plywood on one wall of the living room gives pleasing contrast to vertical-grain fir paneling



ceiling outlets in the usual way. However, from the ceiling outlets to the wall switches light bell wire is used, requiring only two wires instead of three or four-wire cables as in ordinary wiring. Thus, you can see what a saving is had by eliminating long runs of armored cable or conduit as well as the extra cost of metal switch boxes. In addition, there's a safety factor that makes the low-voltage system especially desirable in the bathroom and laundry. With only 24 volts at the switch, the chance of getting a shock is remote. A double touch plate at the entrance to each room permits you to light your way from one room to another by merely touching both buttons, which simultaneously turns on the light ahead and turns off the one behind you. Limited magazine space does not permit explaining the wiring in detail but it will be fully explained in the book that I am preparing.

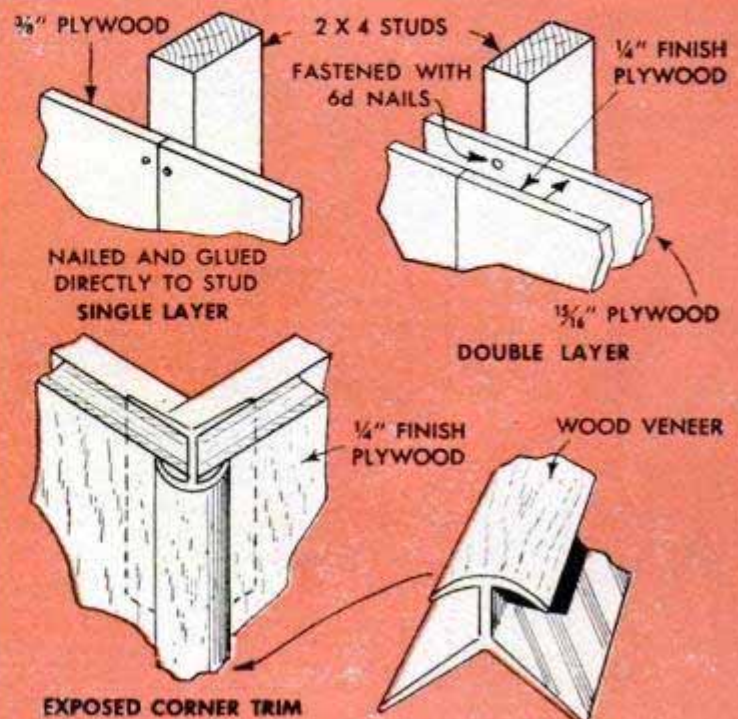

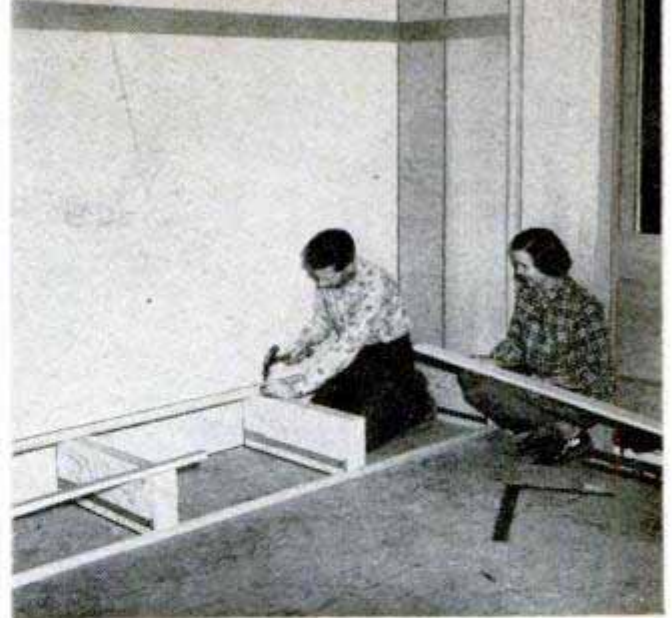
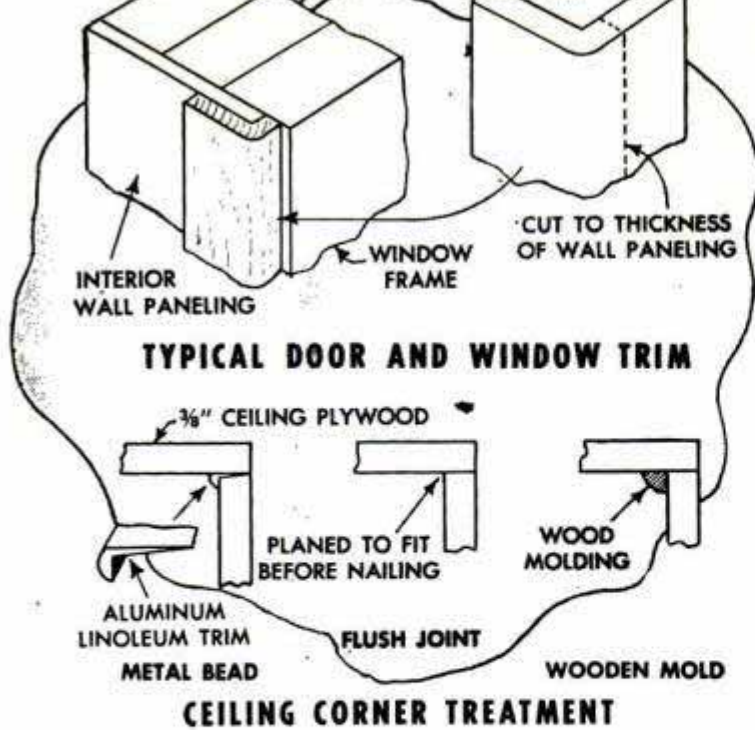

Here I'm starting the framework for the built-in wardrobe closets which divide the two bedrooms. Two chests plus three drawers provide spacious storage

With the wiring in place, I was ready to begin paneling the ceilings with plywood. While there are many ways of treating them, I followed architect Whelan's suggestion of installing a "quiet" ceiling in which ordinary 4 x 8-ft. sheets of 3/8-in.-thick fir plywood are scored in a 24 x 32-in. tile pattern. Clamping a straightedge to the work permitted cutting the shallow "mortar" grooves with a portable electric router. However, they also can be cut on a bench saw. To attach the sheets, I first nailed 1 x 3-in. furring strips to the ceiling joists, both crosswise and lengthwise, following the same 24 x 32-in. tile spacing. Then I coated the furring strips for each panel with casein glue, raised the sheets in place with the aid of a homemade "horse," and nailed through the grooves in the plywood and into the furring. Thus, when completed, the ceiling becomes one solid panel of glued plywood, with little

chance of the joints opening, as any possible contraction in the house framing takes place between the furring strips and the joists. The ceilings were finished with a thick coat of texture paint. This was applied to one panel at a time and immediately stippled with a flat cellulose sponge, after which a matchstick was used to clean out the mortar grooves. The result looks like a plastered job.

Although the interior walls can be treated in a number of ways and with a variety of different materials, I used plywood throughout. In covering the walls of the living room, bath and kitchen, I used the double-layer method, first nailing 5/16-in. unsanded sheathing plywood (Plyscord) to the studs and then gluing and nailing a finish layer of 1/4-in. plywood to the sub-layer. Besides providing an exceptionally strong wall, this method is an economical

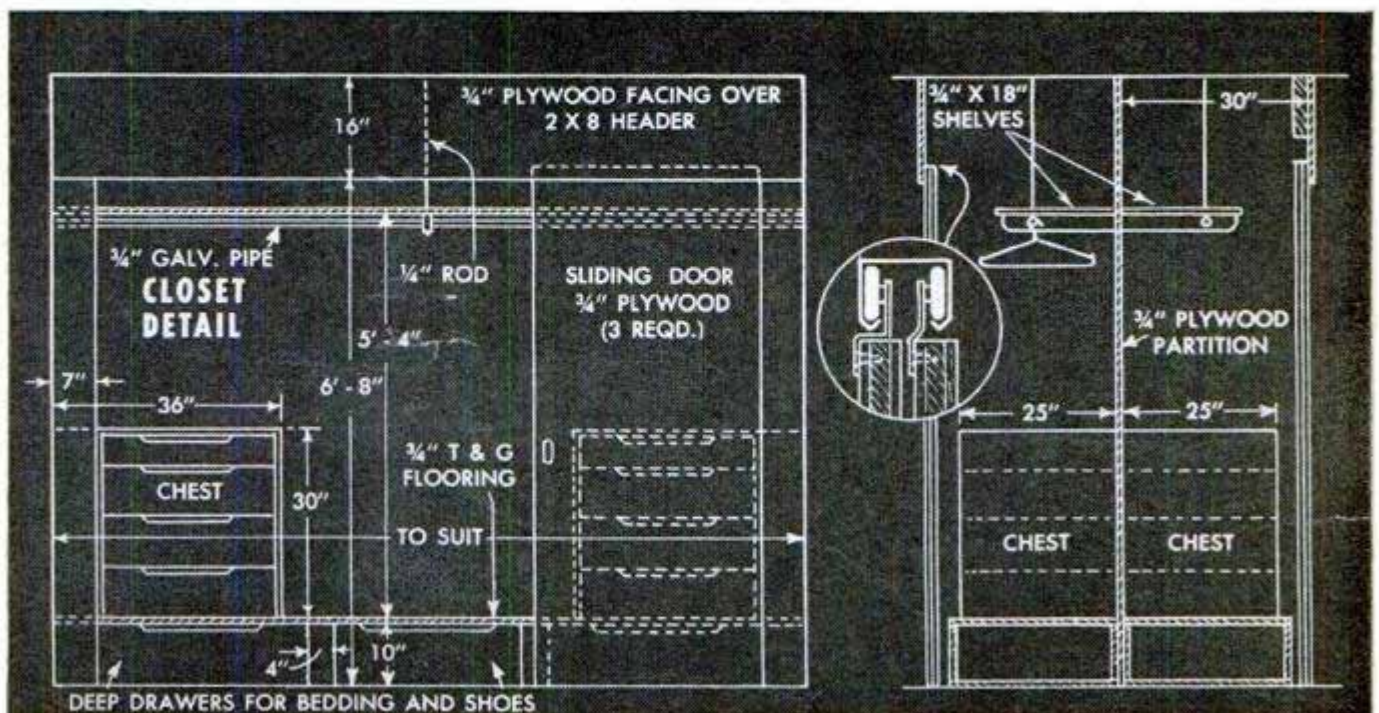

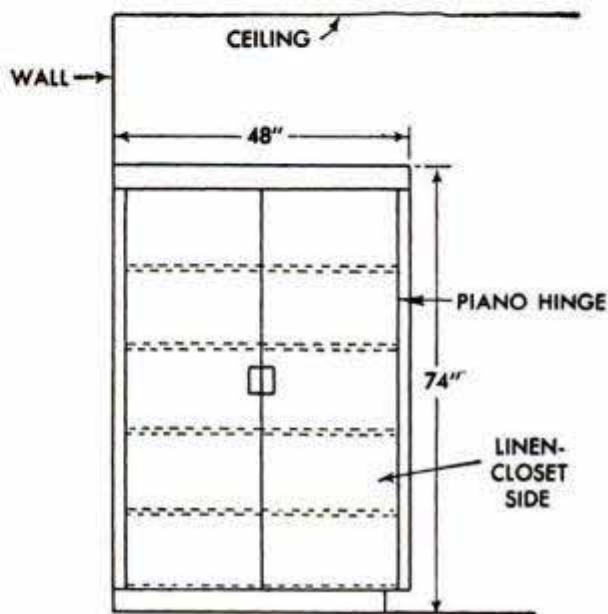
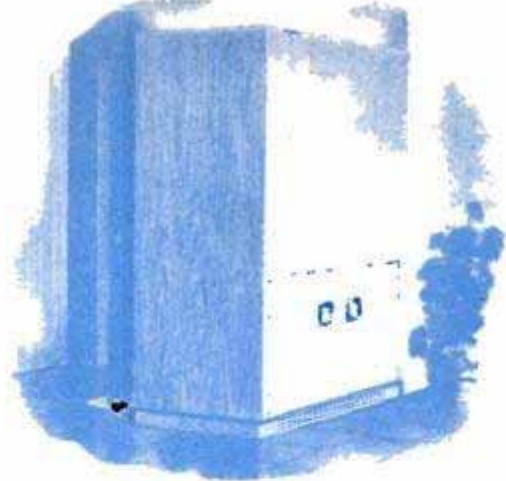
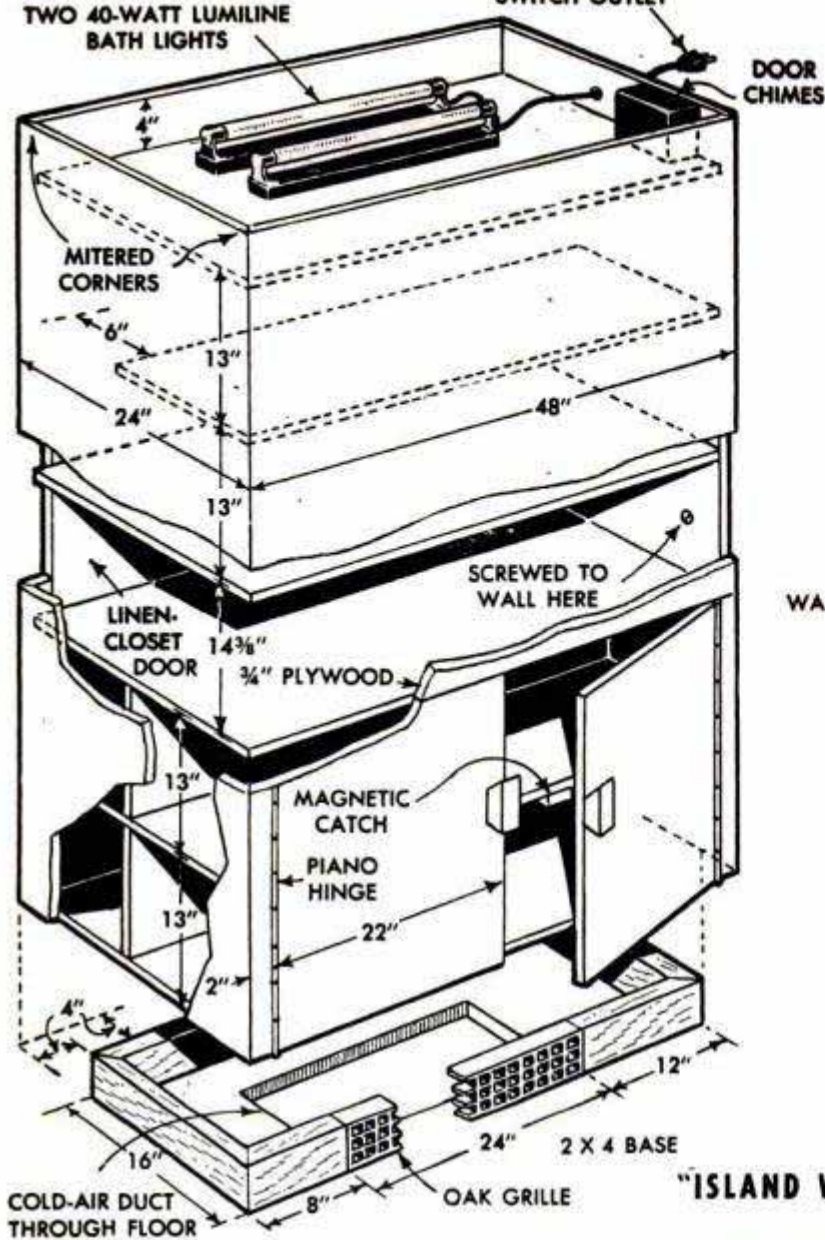

**"ISLAND WALL" LINEN CLOSET**

This drawing shows how the island-wall linen closet is built of plywood. Note that front side provides miscellaneous storage and recessed top hides indirect lighting fixture. Cabinet sets over a cold-air duct

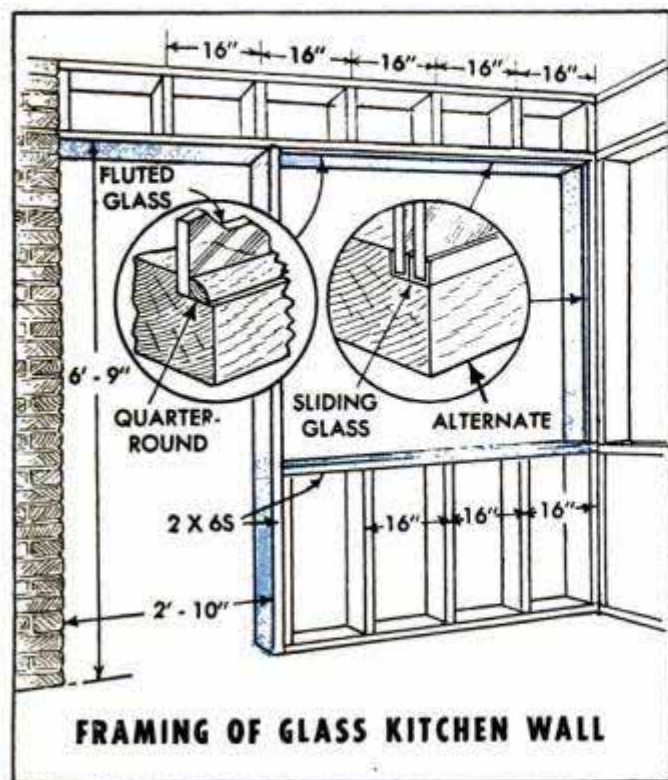

one as well because only a 1/4-in. thickness of the more expensive plywoods is needed. In the bathroom and kitchen I used vertical-grain fir plywood for the facing layer as it provides a smooth, excellent painting surface. Architect Whelan suggested paneling one wall of the living room with walnut plywood, finished natural, to contrast with the walls of vertical-grain fir, stained a warm brown. As the bedroom walls were to be papered with grass cloth, only one layer of plywood was used, this being common 3/8-in. fir glued and nailed directly to the studs. After setting the nailheads, Vinita filled them as well as the joints with Swedish putty. I selected a new embossed-type plywood, called Plyweave, for three walls of the den. This attractive plywood is produced by rolling ordinary fir plywood under heat and pressure to give a wavy leather-like texture. I finished these walls with a gray glazing paint, while facing the remaining wall of common 3/8-in. fir plywood with 1/16-in. cork tile glued in place. Common 3/8-in. plywood was used in the utility room and painted.

With the walls completed, I next went to work building the wardrobe closets which form the wall between the bedrooms, the



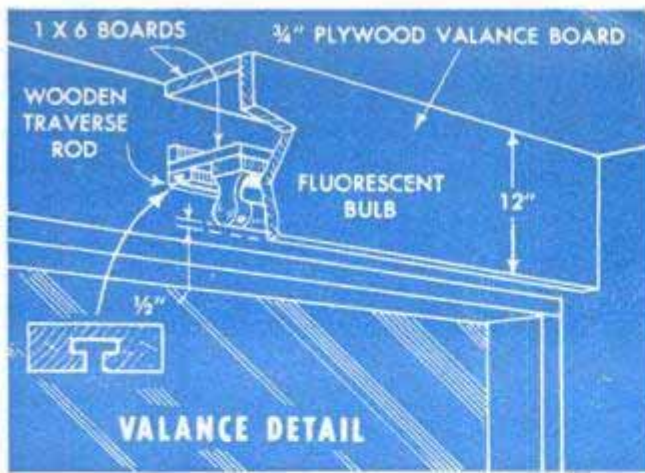

One of the final steps is the dual-purpose valance boards over the large windows in the living room and dining area. Here, Vinita gives me a hand in nailing the shelf which supports fluorescent bulbs



island linen cabinet and the glass partition between the kitchen-dining area. Then I concentrated on the cabinets for the kitchen. I used standard metal drawer units and simply faced the fronts with  $\frac{3}{4}$ -in. oak plywood. The metal units make an exceptionally neat job and are ideal for the amateur carpenter who lacks the ability to do finished cabinetwork. Except for two accordion doors which are suggested for the doorways of the den and kitchen, all others are standard flush-type doors,  $1\frac{3}{8}$  in. thick. The type of floor to use is a matter of choice. I used cork tile throughout the house. Vinita helped me install the drapery valances across the living-room and dining-area windows. As shown, they serve a dual purpose of concealing the traverse drapery rod and housing fluorescent fixtures which flood the drapes with soft indirect light.

Next month, a concluding article will explain how you can "bench build" the walls and roof trusses of this ranch house indoors during the winter, and have them ready to truck to your building site the following spring.

## Calibration/ on Wooden Scale Kept Clean With Tape

Artists, and others who use a wooden scale, can keep the calibration marks and figures clean and legible by covering them with tape when the scale is new. Cellulose tape should be used for this purpose, and will last indefinitely if it is carefully applied and its entire surface pressed firmly in contact with the scale. When it is necessary to renew the tape, be sure all adhesive has been removed from the scale before applying new tape.

H. Drouyn, Montreal, Can.

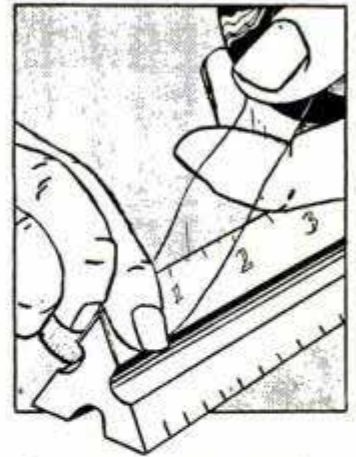

## Coating of Insulating Material Restores Old Vacuum Jug

A quart or gallon vacuum jug that has seen many camping trips and picnics is likely to lose much of its insulating effectiveness as a result of rusting of the outer container or dampening of the original insulation. In either case, the jug can be restored to usefulness by painting the outside with insulating material of the type generally used to keep cold-water pipes from sweating. After thoroughly cleaning the outside of the jug and removing all traces of rust, apply several coats of the insulating material, being careful to keep the material away from the cap threads and the spigot.

## Applying Friction Tape In Restricted Places

The next time you have to wrap a wire or some other object with friction tape, where only one hand can be used for the job, try the following: Unroll the necessary length of tape and reroll it tightly in reverse upon itself, that is, with the sticky side out. With the tape rolled in this manner, you can apply it in a restricted place by using the thumb and fingers in the way indicated in the sketch.

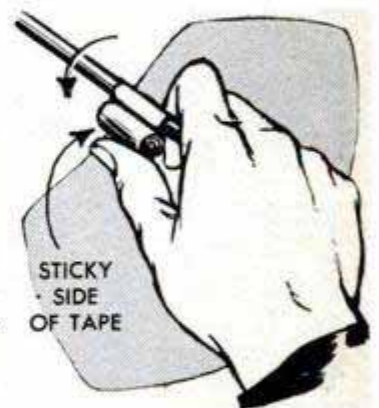

John M. White, State College, N. Mex.



## Cement Paint

IS LEAST EXPENSIVE WALL FINISH BUT TAKES MORE TIME TO APPLY AND CAN ONLY BE USED FOR WORK NEVER BEFORE PAINTED. NOT SUITED FOR FLOORS. APPLY WITH A BRISTLE WALL BRUSH AND WORK IT INTO PORES OF CEMENT WITH A SCRUB BRUSH IF NECESSARY. PATCH CRACKS WITH STIFF PASTE MADE FROM THE MASONRY PAINT ITSELF

GOOD ANCHOR IS OBTAINED ON BARE CONCRETE SURFACE

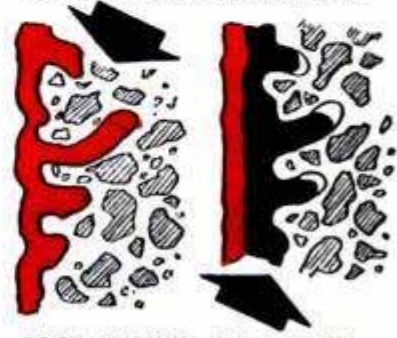

POOR ANCHOR IS OBTAINED ON SURFACE PAINTED BEFORE



1 WATER-MIX TO STIFF PASTE



2 MORE WATER AND HAND MIXING



3 STRAIN THROUGH SCREENING

# A Good Paint

By Sam Brown

PERFECTLY dry concrete above grade can be coated with almost any type of oil-base or water-soluble paint. Below grade where the material is in contact with moist earth, the moisture absorbed by ordinary concrete releases lime, which is destructive to common oil-base paints. All good concrete paints, properly applied, resist the action of water and chemicals activated in the presence of moisture. No special skills are required for correct application of masonry paints. You can do the job yourself from start to finish.

**Cement paint:** Cement paint, as it is commonly called, consists of approximately 85 percent cement and 15 percent pigments, which make it flow smoothly and spread uniformly. Finely ground cement paints brush and cover better than those which are coarsely ground

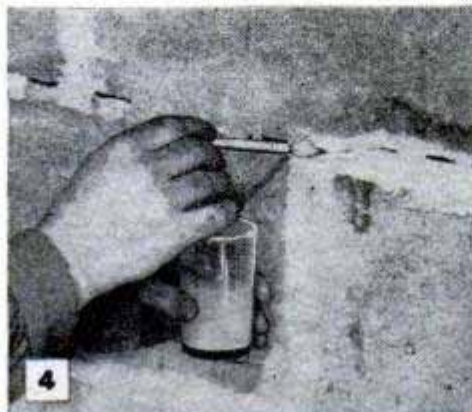

4 SLUSH CRACKS WITH PAINT



5 FILL CRACKS WITH PASTE



# Job on CONCRETE

**Rubber Base**  
IS IDEAL FINISH FOR ALL CON-  
CRETE JOBS INSIDE OR OUT

and, of course, are much more expensive. However, the cheaper, coarser grades are just as serviceable on rough walls. Nearly all cement paints depend on mechanical anchorage and bond best to an unpainted surface. For this reason, they are not generally recommended for use over surfaces which have been previously painted. Nor are they suitable for use on concrete floors, as the film is far too brittle for application over a troweled surface. See the data on masonry paints in Fig. 14.

**Patching cracks:** Cement paint is just the thing for patching masonry walls. First, mix the paint powder to a stiff paste as in Fig. 1. Then place a small quantity in a tumbler and thin with water to the consistency of milk. Brush this thin mixture into the cracks with a small brush to form a bonding coat, Fig. 4. Follow immediately with the stiff paste,



ROOF BRUSH IS HANDY FOR OUTDOOR PAINT APPLICATION



CURE PATCHES WITH WATER



KEEP THE PAINT WET



GIVE CURE THE RUB TEST



applying with a putty knife or a small trowel as in Fig. 5. For filling large cracks or patches over  $\frac{1}{4}$  in. wide, mix sand, 2 parts, and cement-paint powder, 2 parts, with just enough water to form a putty. After applying, allow the patch to surface-dry until it no longer appears wet at any point. Then spray or brush with water, Fig. 6, keeping the area of the patch wet for a couple of hours. When particles will no longer rub off the surface, the patch is sufficiently cured to permit drying without further wetting.

**Mixing cement paint:** Begin by making a stiff paste, and then add small quantities of water by stages, working out the lumps as in Fig. 2. Wear rubber gloves to prevent paint materials from coming in contact with the bare skin. A somewhat smoother paint can be made by straining the mixture through fine screen wire as in Fig. 3.

**Application:** After patching the walls wherever necessary, allow the surfaces 24 hrs. to dry. Then spray water on the entire surface to be painted, Fig. 9, and let it soak in before spraying a second time. Continue spraying until the wall is uniformly wet, then allow it to dry until no wetness shows on the surface. While the wall is drying mix the paint to the proper consistency for application. Use a shallow container so that you can dip the brush to the bottom each time. Have a paddle handy for stirring the mixture because the pigment settles fast. On the average porous-masonry wall, application should be done with a scrub brush, scrubbed in immediately with a scrub brush, and then tipped off with the bristle brush. In some cases the scrubbing operation will be unnecessary. On walls of cinder block, apply a first coat consisting of equal parts of clean, sharp sand and paint powder mixed with water to the consistency of thick cream. Brush out with a scrub brush to leave a rough surface for the second coat.



**Curing cement paint:** The paint will reach its initial set in  $1\frac{1}{2}$  to 2 hrs. after application. After it loses surface wetness and appears flat, wet the surface with a spray gun, Fig. 7, or a fine spray from the garden hose. Keep the surface wet for at least two hours to assure complete curing. When the wet coat finally resists rubbing off with the finger, it will be safe to allow it to dry.

REMOVE WHITWASH AND CALCIMINE WITH HOT WATER. USE 20-PERCENT SOLUTION MURIATIC ACID FOR WATER-RESIN PAINT



**What to do about old paint:** Although manufacturers do not recommend the application of cement paints over surfaces which have been previously painted, it is possible to remove old finishes such as whitewash and calcimine and provide a surface to which the new coating will bond. Scrubbing the surface with hot water, Fig. 10, will remove calcimine and common whitewash and most of the resin paints will yield to a 20-percent solution of muriatic acid. **Caution:** Handle muriatic-acid solutions with extreme care. The acid, either whole or in solution, is a violent poison, the fumes are toxic and its action is caustic. Wear rubber gloves and protect your eyes from spatters. Destroy all unused portions of both acid and solution. In addition to removing certain paints, the muri-

A CAN OF LYE (13 OZ.) WITH 1-GAL. HOT WATER WILL REMOVE OIL PAINT, WEAR RUBBER GLOVES. RINSE JOB WELL

## Rubber-Base Masonry Paint

DRIES FLAT AND IS INTENDED FOR WALL USE, NOT FOR FLOORS. CAN BE USED INSIDE OR OUT, ON BARE CONCRETE OR OVER OLD PAINT. GOOD FOR ASBESTOS SHINGLES. THE BRUSHES MUST BE CLEANED WITH SPECIAL THINNER PROVIDED

atic-acid solution will etch the wall surface slightly, making a good base for new cement paint. After using the acid, hose the wall to remove residues. Removing oil-base paints from any masonry surface is a tedious job, and at best it will take a lot of elbow grease to get the paint off the rough surface after softening with a remover. A good remover for paint on a masonry surface can be made by dissolving a 13-oz. can of lye in 1 gal. of hot water, Fig. 11. Use the same precautions in handling a lye solution as outlined for muriatic-acid solutions. Apply the lye solution to the wall with a large cloth swab and remove the softened paint film with a wire brush. If old oil-base paints are in good condition, it is recommended that the wall be repainted with this same type of paint. Neither the muriatic-acid nor lye solutions will touch rubber-base paints. When the walls are coated with this kind of paint, the best thing to do is smooth the rough spots with sandpaper and apply a fresh coat.

**Rubber-base wall paints:** Apply rubber-base masonry paints to walls with a brush, Fig. 12, as most of them are too heavy to spray successfully. A second coat of rubber-base paint will soften the first coat so, if a second coat is required,



## Quick Data ON 5 CONCRETE PAINTS

14 KIND OF PAINT	WHERE USED	APPLICATION	COVERAGE		GENERAL FEATURES
			FIRST COAT	SECOND COAT	
<b>CEMENT PAINT</b> Powder form for mixing with water. Tints and white	Any porous masonry wall surface not previously painted: brick, concrete, cement stucco, cinder block. Not for floors	Stiff-bristle brush. Wall must be damp and paint sprayed with water after obtaining its initial set. Sand is added for cinder block	10 to 15 sq. ft. per lb. 75 to 125 sq. ft. per gal. (8 lbs. powder makes 1 gal. of paint)	15 to 25 sq. ft. per lb. 125-200 sq. ft. per gal.	Inexpensive. Excellent for cinder block and very porous concrete. Dries flat. Too brittle for floors. Can be sprayed only with agitating equipment. Suitable for new work after 10 days
<b>RUBBER-BASE FLOOR PAINT</b> Ready-mixed. Several colors, black, white	Especially for concrete floors. Works best on bare concrete but can be used over old paint	Brush or spray. Dries in 2-4 hrs. to touch but needs 24-hr. dry for second coat or service	About 300 sq. ft. per gal. on average surface	About 400 sq. ft. per gal.	Most expensive of concrete paints. Hardens dusty floors. Dries semi-gloss. Also suitable for wood. Free flowing, easy to brush. Second coat will pick up first coat unless thoroughly dry
<b>RUBBER-BASE MASONRY PAINT</b> Ready-mixed. Tints and black, white	Especially for walls, inside or out, on bare concrete or over old paint	Heavier than R.B. floor paint and needs thinning for spray application. Wall must be dry. One coat covers	About 250 sq. ft. per gal.	About 350 sq. ft. per gal.	Too expensive as first coat for cinder block. Needs 24 hrs. to dry for recoat, although dry to touch in 2 hrs. Flat finish. Good for asbestos shingles
<b>OIL-BASE MASONRY PAINT</b> Ready-mixed. Several colors, black and white	All masonry surfaces. Also is good general paint wherever flat finish is suitable	Brush or spray. Some products require primer coat	About 250 sq. ft. per gal.	350 to 600 sq. ft. per gal.	Has tung-oil base which resists lime better than linseed oil but not as good as rubber base. May be flat or gloss depending on make. House paint with tung oil is equivalent
<b>EXTERIOR RESIN EMULSION</b> Paste form mixes with water. Tints and white	Bare or painted masonry inside or out except floors. Do not use where mildew is present	Brush or spray. Second coat should be applied 8-12 hrs. after first. Not proof against rain for 12 hrs.	About 300 sq. ft. per gal. of paste	400 to 450 sq. ft. per gal. of paste	Inexpensive. This is a breather-type paint and does not water-proof nor resist passage of water. Becomes translucent when wet. OK for new work after 30 days. Dries flat

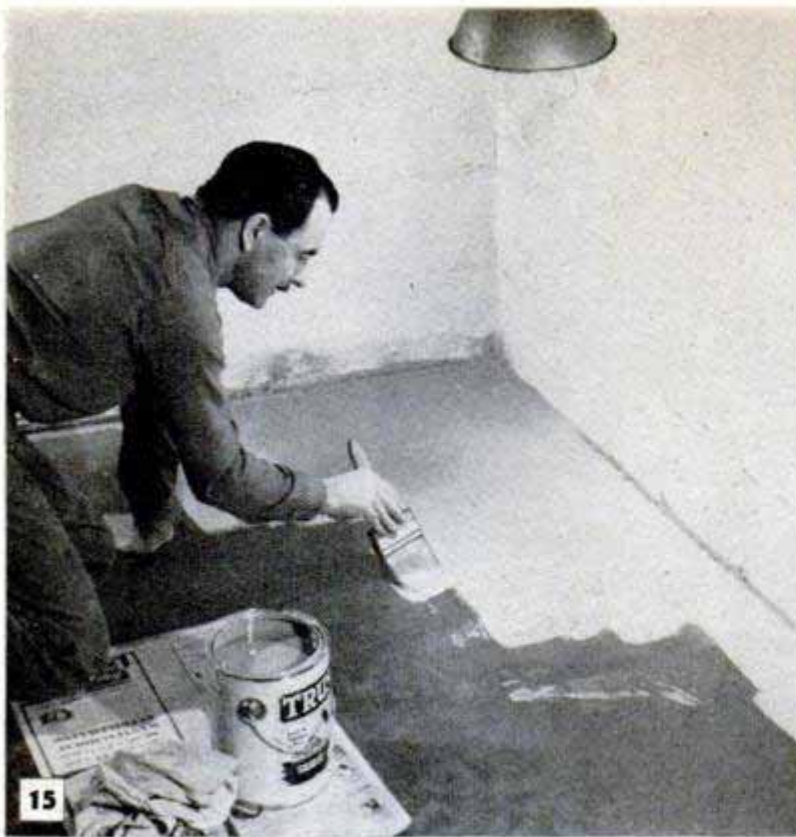

### *Rubber-Base Paint*

IS TOPS FOR FLOORS. IT HARDENS SOFT CONCRETE. ALL SOAPY OR SLICK FLOORS SHOULD BE ETCHED WITH A 10 PERCENT SOLUTION OF MURIATIC ACID. RINSE WITH WATER



EXTEND FLOOR COLOR UP WALL



WATCH OUT FOR DAMP PATCHES

allow the first coat to dry at least 24 hrs. Even then it may pick up here and there if it is brushed too much. There's no need to worry about laps, or precise, uniform brushing technique, as rubber-base masonry paints work easily and dry without showing any minor irregularities. Clean the brush in the paint thinner, Fig. 13.

**Rubber-base concrete-floor paints:** If the floor is troweled very smooth, or if there are embedded soap residues around the laundry tubs, the surface should be cleaned and then etched with a 10 to 20-percent solution of muriatic acid. Remember the precautions already outlined. Handle acid solutions with care! A gallon of the solution will cover about 100 sq. ft. Apply with an old broom, scrubbing it on to get a uniform caustic action. Permit the solution to "work" for 10 to 15 minutes, then hose it off thoroughly. After etching the floor, allow it to dry at least 48 hrs. Drying of lingering wet spots can be hastened with a heat lamp, Fig. 17. Rubber-base floor paint is somewhat thinner and can be sprayed successfully, Fig. 16, although you will find it works well with a brush, Fig. 15. On two-coat work allow plenty of drying time between coats as the second coat will soften the first if it is applied too soon. Brush as little as possible when applying one coat over another. A simple and attractive trim is obtained by running the floor color about 6 in. up on the wall, Fig. 16. If you are us-

ing a spray gun, cut the colors to a sharp line by means of masking tape as shown. Using a brush, you can cut to a pencil line quite easily by carefully stroking the brush tip to the line freehand.

**Oil-base masonry paint:** This is similar to ordinary exterior house paint except that it usually is a flat paint and contains a high percentage of tung oil or other liquid vehicle which will resist the action of lime and other water-soluble salts often contained in masonry and activated in the presence of moisture. It is suitable for outdoor use, and comes in attractive colors. Recommendations for applications vary, so be sure to follow the manufacturer's instructions in detail.

**Exterior resin-emulsion paints:** An excellent, inexpensive, exterior finish for masonry, this type of paint comes generally in paste form. It is mixed with water and applied with brush or spray.

**Hardeners and waterproofer:** If your basement floor is "dusting" and you don't want to paint it, a penetrating liquid hardener is available which is simple to apply and very durable. Just follow the instructions on the container. It also is available in crystal form to be dissolved in water. A waterproofer made especially for concrete floors also is available as a clear, penetrating liquid which does not change the original color of the floor. When applying it, follow instructions in detail.

## Saw-Blade Armature Tool



Ground from a piece of hacksaw blade, this handy tool can be used to do four different jobs when working on armatures. Note that one end is sharpened for cutting paper and notched for cleaning slots, while the other end is curved

for tucking. A fairly deep notch for scraping wire is cut in one edge.

Charles Wesley Shutt, Alma, Mich.

## Sponge Cuts Down Soap Waste

Wasteful accumulation of soap in soap dishes, which do not drain properly, can be prevented by using a pad of cellulose sponge to catch the drainage from wet bars of soap. Cut from a larger sponge to fit the bottom of the soap dish, the little pads keep the dishes clean and the bars dry at all times. The drainage of soap caught in a sponge can be utilized by moistening the sponge and using it to wash the sink or bathtub. — P. Tallerico, Bethlehem, Pa.

## Driving Tacks in Tight Places

Did you ever try to drive a tack in a corner or recess where it is difficult to reach with two fingers? It's a neat trick—if you can do it—but here's a simpler and easier way: Place a drop of glue on the head of a large nail and stick the tack firmly to the nailhead. You also can use a small steel rod in the same manner. With either method, the tack can be placed exactly where you want it



and driven into the work by tapping the pointed end of the nail, or the end of the rod, lightly with a hammer.

Harry W. Poor, Tamworth, N. H.

## Nail Polish "Mix" Fills Cracks

To repair a nick or crack in painted furniture, mix a small quantity of talcum powder with colorless fingernail polish to a spreading consistency. Fill the crack and smooth evenly. This will harden and form a plastic which makes a very neat mending job. Stain with aniline dye.

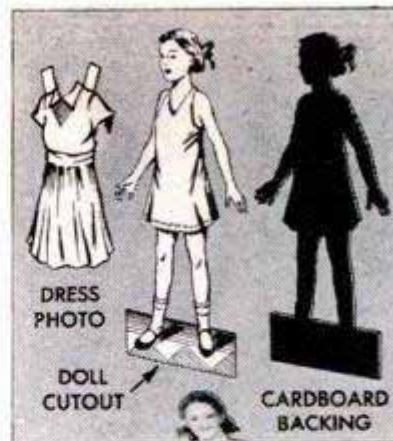

## Personalized Paper Doll From Child's Own Photo

Almost any little girl is sure to enjoy playing with paper dolls which are actually miniature cutouts of herself. Giving this personal touch to such toys and making them himself was the idea of one photographer who, of course, used his own daughter as the model. The actual job was easy. He photographed the girl several times in the same pose, but dressed differently each time. One of the prints was then cemented to a piece of fairly heavy cardboard and the figure was cut out to serve as the doll. The other photos were cemented to lighter cardboard and only the clothes were cut out. Note that small tabs, which fold and hook onto the doll, were left protruding from the dress, and that stock was left around the doll's feet to serve as a base.

Elma Waltner, Hurley, S. D.

## Improved Repair of Bicycle Chain

The link pins of most bicycle chains are held in place by small washers which fit into grooves at each end of the pins. However, when one of these washers is lost, it need not be replaced in order to repair the chain. Instead, just peen the end of the pin as shown, being careful to avoid bending it.

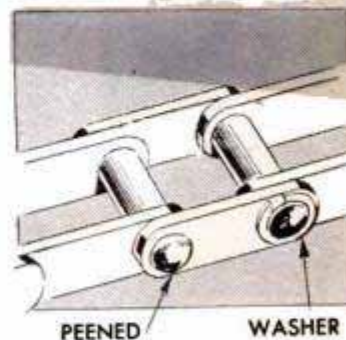

Ross S. Neureuther, Buffalo, N. Y.

# Build this 20-ft. <sup>8</sup>

By J. Julius Fanta

DESIGNED by Commodore Victor Tchetchet of the International Multihulled Boat Racing Association, Trimaran combines the thrills of a conventional sailboat with an exceptional rate of speed, maximum safety and unusual ease of handling. In a spanking wind, the sleek hull with its outriggers skims over the water at speeds as high as 22 m.p.h., and in a hardly perceptible breeze, when other sailboats are without steerageway, she moves along at a surprising speed. Capsizing is next to impossible because of the buoyancy of the outrigger pontoons. Even a wind approaching gale force would be more likely to blow out the sail or snap the mast than capsize the craft. But, while the rugged construction and "3 hull" design permit Trimaran to withstand high winds and heavy seas in an emergency, it must be remembered that she still is a small boat and sailing should be confined to protected waters.

The main hull and pontoons are built by covering wooden frames, spaced 12 in. apart, with  $\frac{1}{4}$ -in. waterproof plywood. First, make the 20 frames for the hull to the dimensions given in the table of offsets, Fig. 2. Join the frame members with waterproof glue and



Above, stern view of Trimaran shows wooden bracket just aft of cockpit. This permits emergency mounting of outboard motor on starboard side of center hull

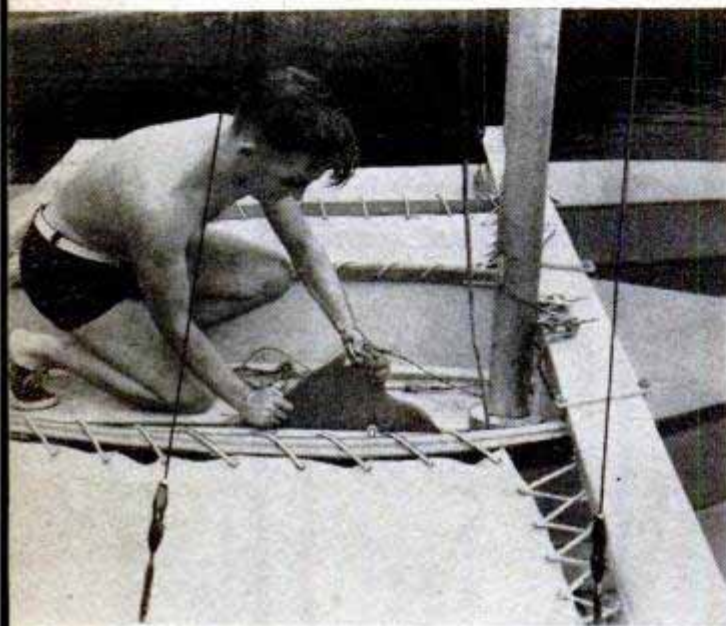

Raising the plywood centerboard, above, cuts draft of main hull to a few inches. Below, lightweight aluminum boom is easy to handle when hoisting mainsail. Note cable stays anchored to cockpit supports

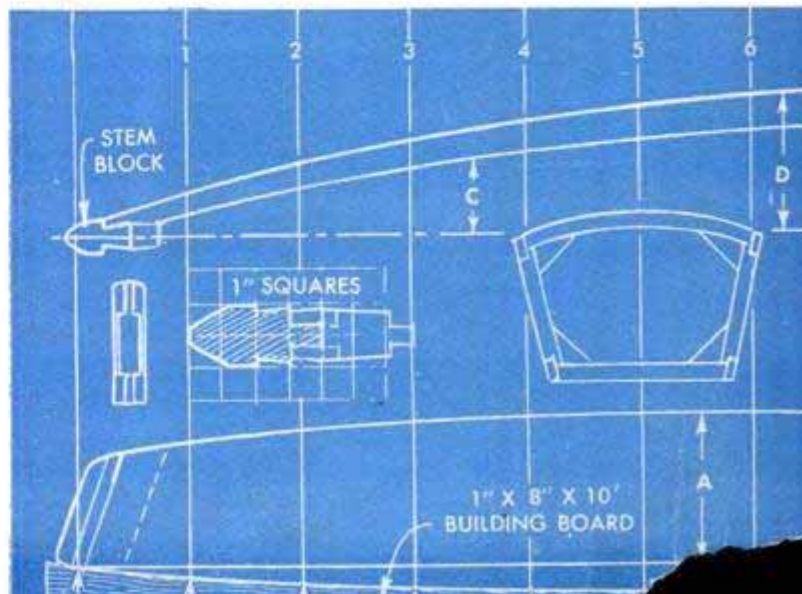
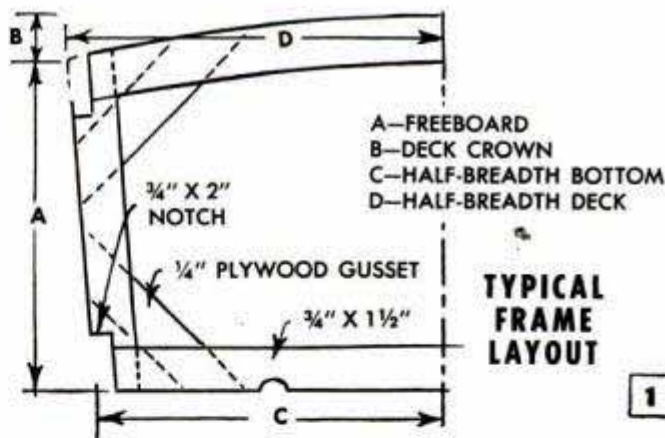
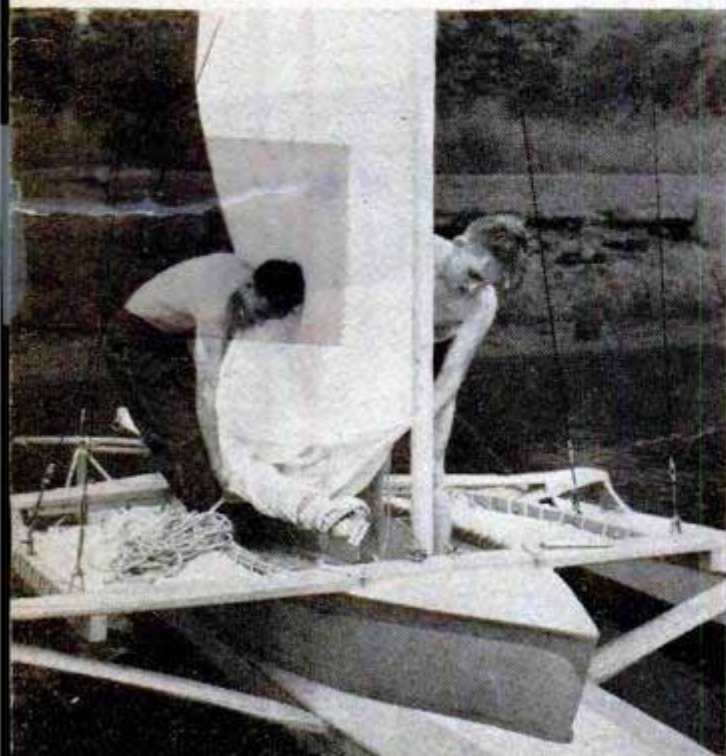



# TRIMARAN

reinforce them with plywood gussets, which are glued and nailed to the faces of adjacent members, as in Fig. 1. When building Trimaran, use monel-metal screw-type nails throughout. Note that five frames, stations 8 to 12, must be made in two parts to permit installing the centerboard trunk. Fig. 4 shows how these particular frames are put together.

After assembling all the hull frames, make a building board from 1 x 8-in. stock, cutting the contour of the top edge of the board to conform with the profile view, Fig. 3. Support the building board on sawhorses, Fig. 4, and temporarily nail the frames in position on the board, spacing them 1 ft. apart on centers. Assemble and install the centerboard trunk, as in the upper details. Then glue and nail the chine and sheer battens in the notches cut in the corners of the frames. Fair the chines and sheers into the stem and stern blocks, planing the battens flush with the frame surfaces. The centerboard trunk is made up of two pieces of 1/4-in. plywood mounted on two oak up-rights. A 1-in.-sq. cleat along each side of the trunk 1/2 in. from the bottom edge provides a surface for bolting and gluing the plywood bottom around the trunk. Cotton calking laid in glue on adjacent sides of the cleat between the bottom and the trunk assures a watertight joint.

To plank the hull, cut the plywood for



2

**TABLE OF OFFSETS**

MAIN HULL (DIMENSIONS IN INCHES)

STATIONS	1	2	3	4	5	6	7	8	9	10	11	12	13	14	15	16	17	18	19	20
HALF BREADTHS FOR BOTTOM	2 1/4	4 3/4	6 3/4	8 3/4	9 3/4	10 3/4	11 1/2	11 1/2	12	12	12	12	12	11 1/2	11 1/2	11 1/2	10 3/4	10	9 3/4	8 3/4
HALF BREADTHS FOR DECK	4	7 1/4	10	12 1/2	13 1/2	14 1/4	14 3/4	15	15	14 3/4	14 1/2	14 1/4	13 3/4	13 3/4	12 1/2	11 3/4	11	10	9 3/4	8 3/4
FREEBOARD	13 1/4	14 3/8	15	15 1/2	15 3/4	15 3/4	15 3/4	15 1/2	15 1/4	15	14 7/8	14 1/2	14	13 3/4	12 3/4	11 1/4	9 3/4	7 3/4	5 3/4	2 1/2
DECK CROWN	1	1 3/4	2 3/8	2 3/4	3	3	3	3	2 3/4	2 3/4	2 1/2	2 1/4	2	1 3/4	1 3/4	1 1/2	1 1/2	1 1/2	1 1/2	1 1/2

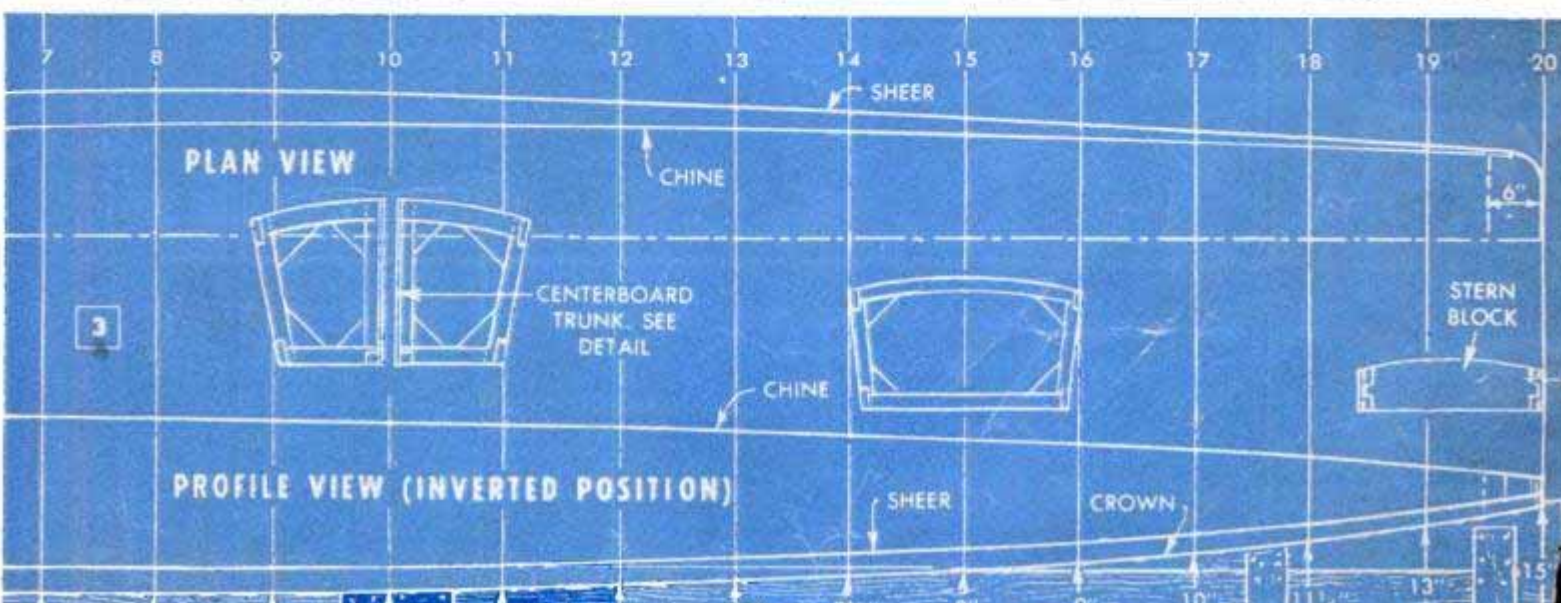

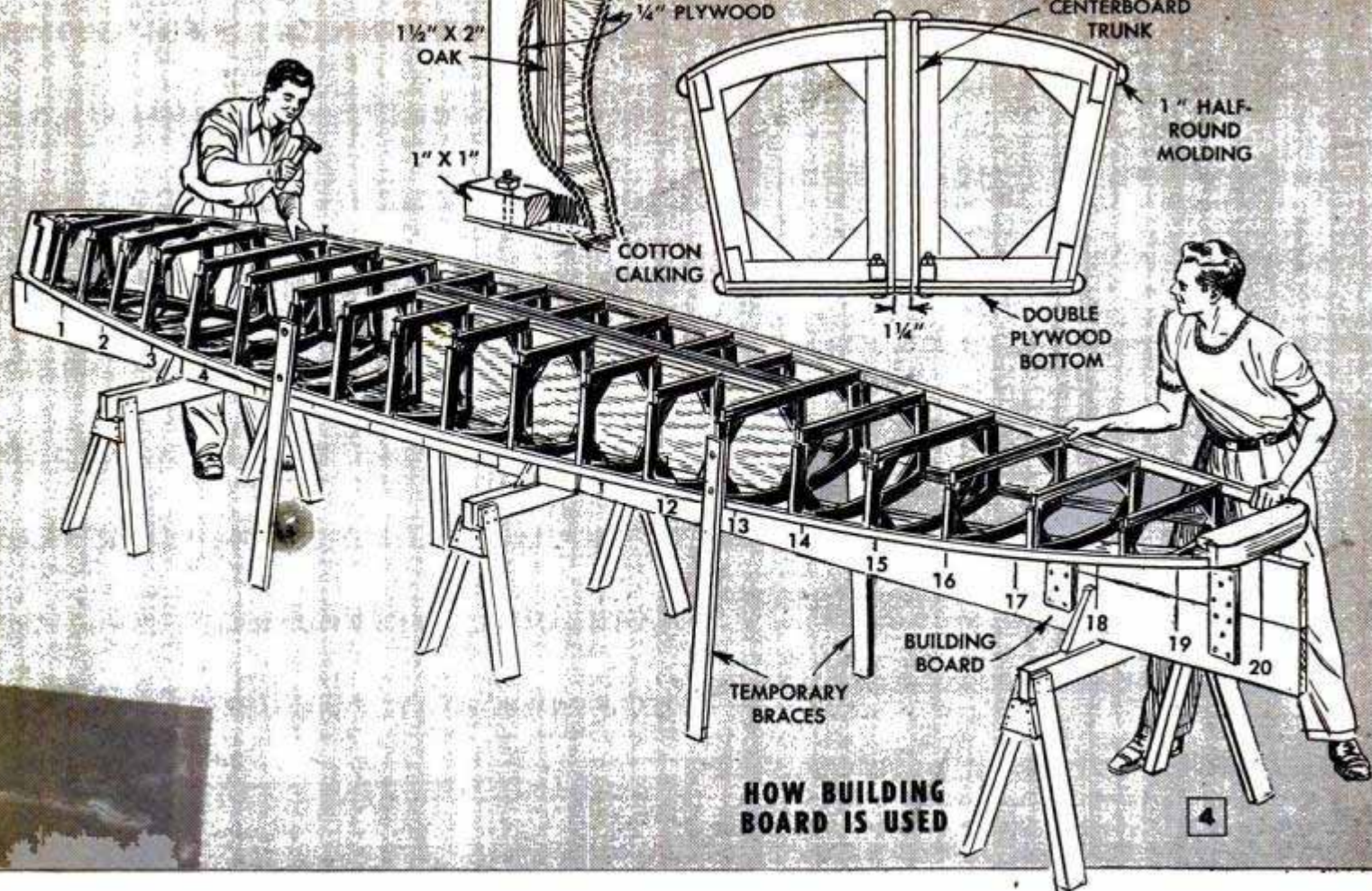

**HOW BUILDING BOARD IS USED**

the sides slightly oversize. Coat contacting surfaces of the chines and frames with waterproof (marine) glue and fasten the plywood in place with monel nails spaced 2 in. apart. Then clamp the plywood to the chines and frames. When the glue has dried, cut off the overhanging edges of the plywood and plane flush with the battens. The bottom is covered with two layers of 1/4-in. plywood, the pieces being cut a little oversize and slotted where they fit over the centerboard trunk. To assure watertight joints along the chines and around the trunk opening, cotton tape is laid in a thick coating of marine glue which is applied to all contacting surfaces. Then the plywood is laid in the glue and nailed as before. The second layer of plywood is merely glued to

the first one. When planking the boat, you can add strength by making sure that the plywood joints on opposite sides of the hull fall on different frames. The deck is covered with one layer of 1/4-in. plywood bent over the crown. After the deck is in place, the edges of the plywood are trimmed flush with the sides and the joints are covered with 1-in. half-round molding.

Construction of the main hull is completed by adding the cockpit, the sides of which are glued and nailed to a curved chine fastened directly to the plywood deck, Figs. 8 and 9. A series of holes, drilled near the deck line in the aft portions of the cockpit sides, provides a self-bailing feature to drain off spray. Both fore and aft sections of the cockpit are covered with plywood.

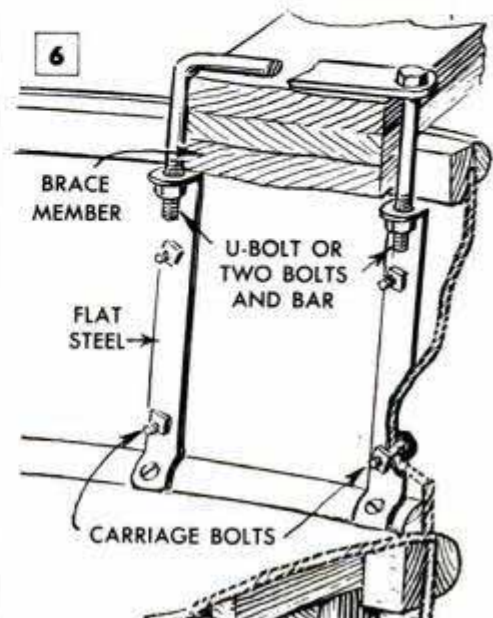
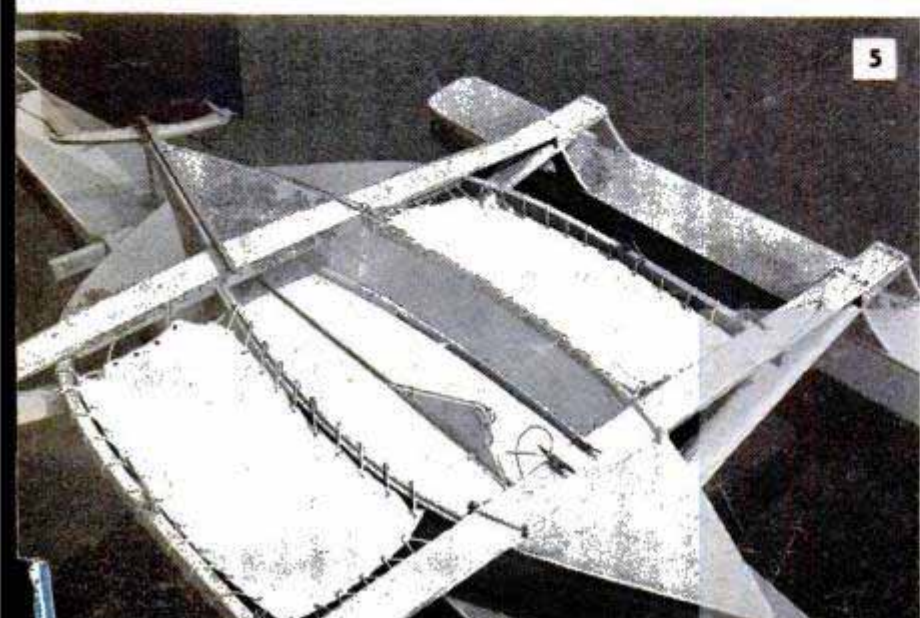

Construction of the two pontoons is similar to that of the main hull. See the table of offsets, Fig. 10, for the dimensions and Figs. 11 and 17 for the plan and profile views. As the corners of the pontoon frames are square, they can be assembled quickly in a jig made by nailing two boards to the floor or bench top at right angles to each other. Note in Fig. 21 how the pontoons are reinforced at the points where the crossbeam hangers are attached. The frames are left open at the corners for  $\frac{3}{4}$ -in.-sq. chines, parts being joined only by the plywood gussets. The frames are assembled on a building board which is cut to dimensions given in the table of offsets opposite the heading, "rise of chine floor to bottom." The  $\frac{1}{4}$ -in.-plywood sides can be beveled and glued and nailed together at the stem, or stem blocks can be used. Install one deck plate amidships in each pontoon and two deck plates in the main hull.

The curved cockpit-seat supports are laminated by gluing together three strips of  $\frac{3}{4} \times 3$ -in. spruce. Make a full-sized pattern from dimensions given in Fig. 8 and bend supports in a jig formed by wood.

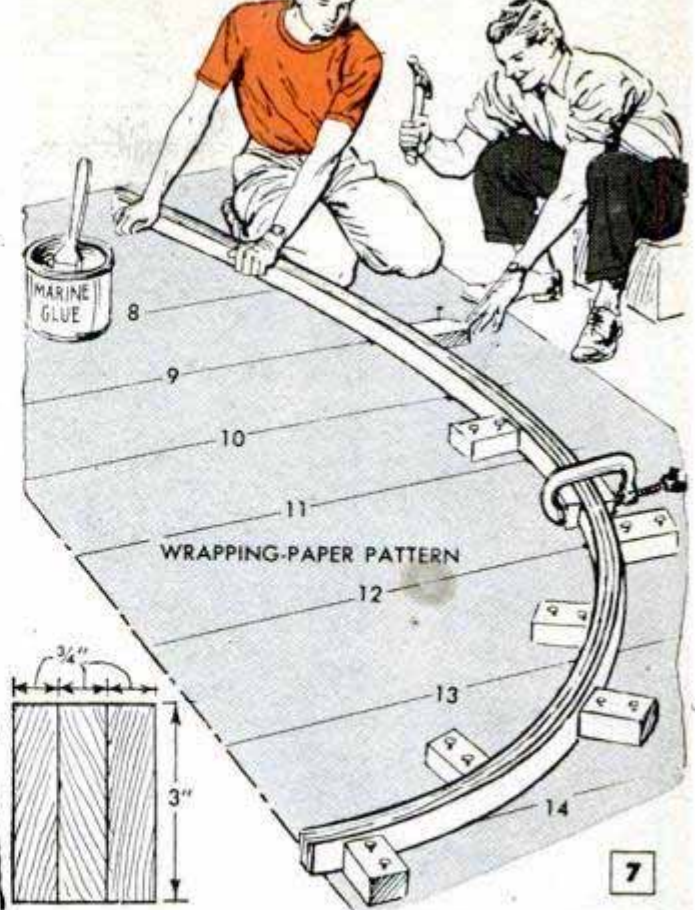

LAMINATING COCKPIT SUPPORT

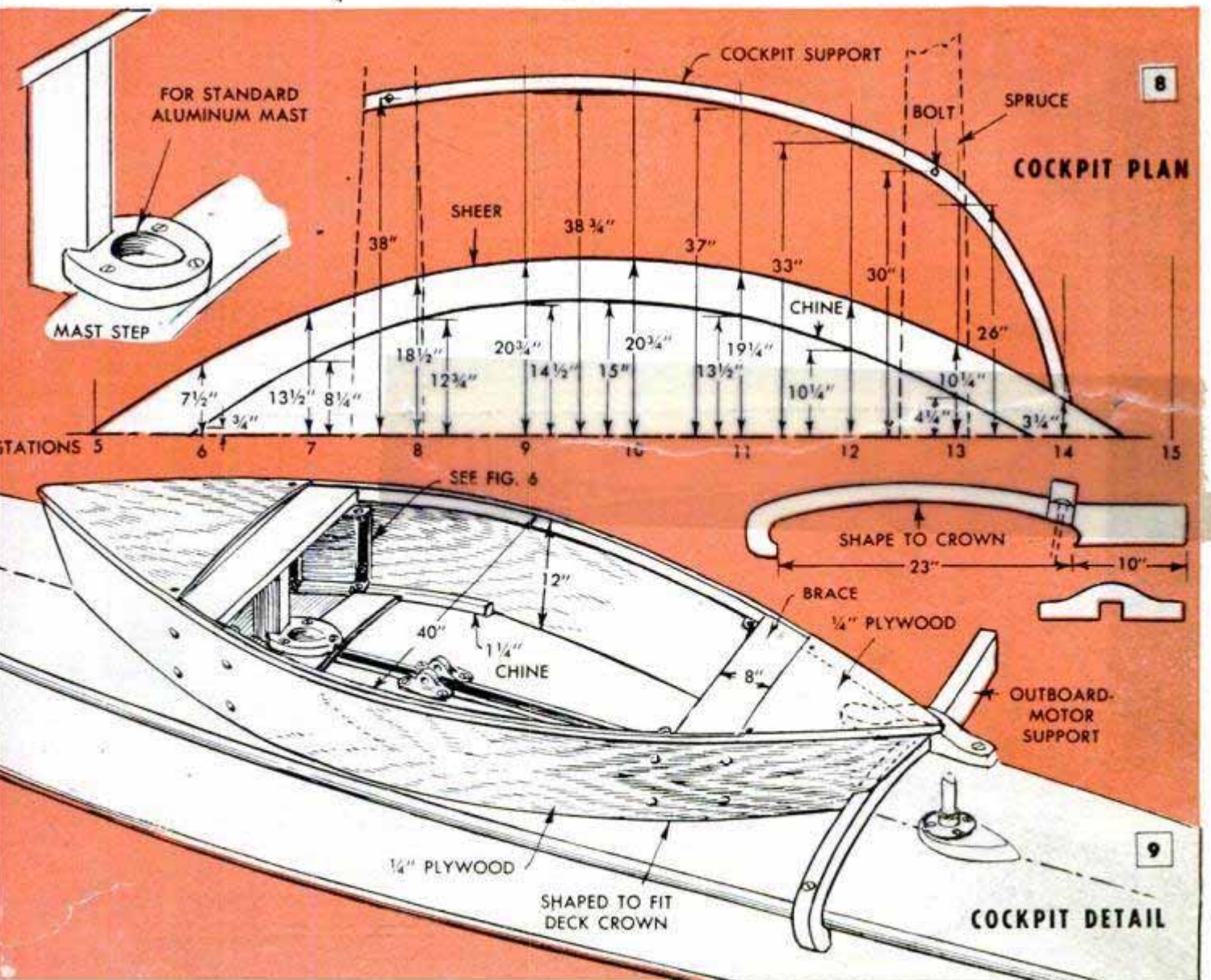

10 TABLE OF OFFSETS FOR PONTOONS (DIMENSIONS IN INCHES)

STATION	1	2	3	4	5	6	7	8	9	10	11	12	13	14
TO INNER SIDE BOTTOM AND DECK	1 1/8	1 7/8	2 5/8	3 3/8	3 3/4	4 1/4	4 1/2	4 7/8	4 7/8	4 7/8	4 7/8	4 7/8	4 7/8	4 7/8
TO OUTER SIDE BOTTOM AND DECK	2 1/4	4 1/8	5 1/4	6	6 1/4	6 1/2	6 1/2	6 1/2	6 1/4	6 1/4	6	6	6	6
FREEBOARD	6 7/8	9 1/4	11 1/8	11 1/4	11 1/4	11 1/8	10 1/2	9 3/4	8 3/8	6 7/8	4 3/8	4 1/8	2 1/4	3/4
RISE OF CHINE FLOOR TO BOTTOM	6 1/2	4 1/4	2 1/2	1 3/4	3/4	1/2	1/4	0						

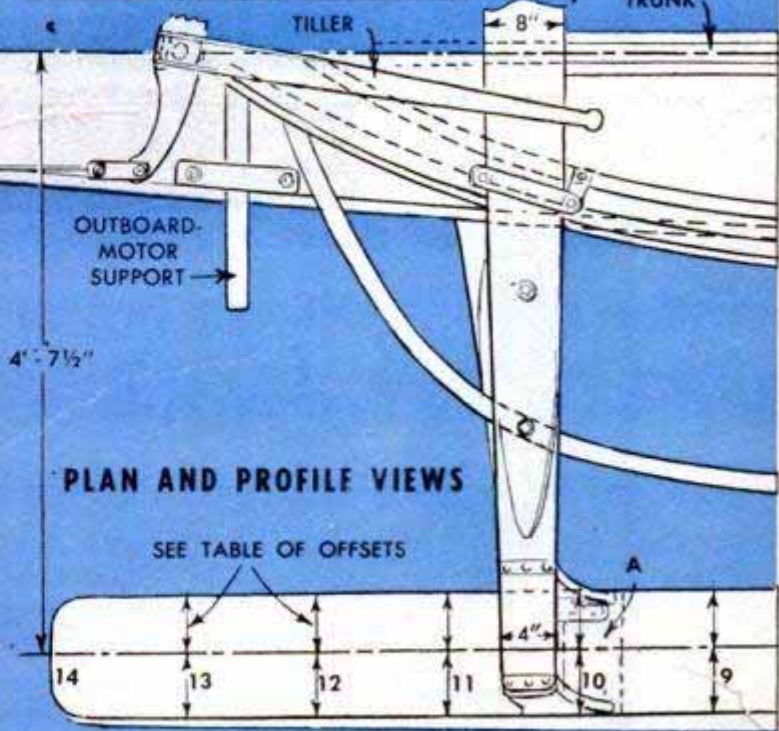
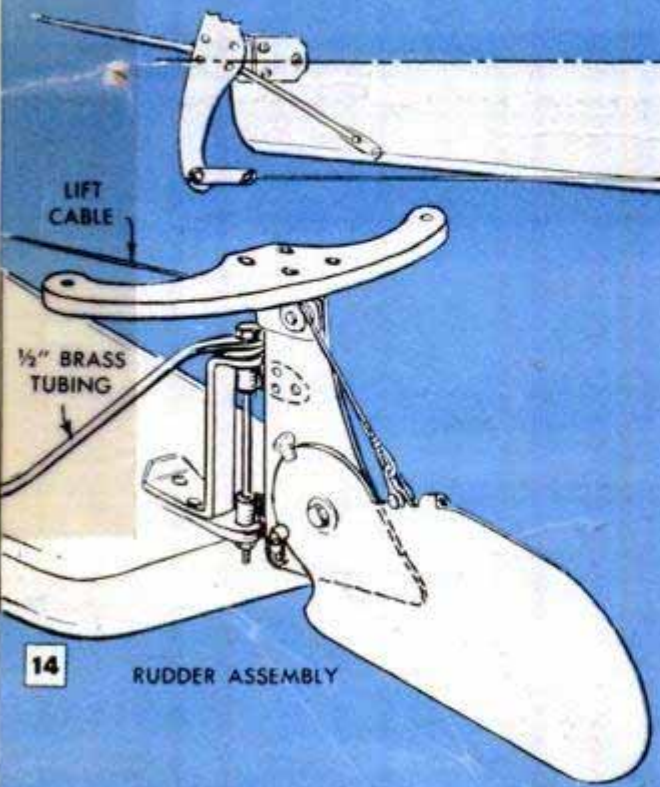
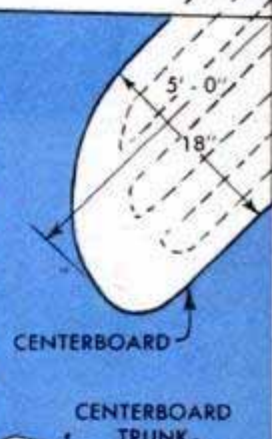
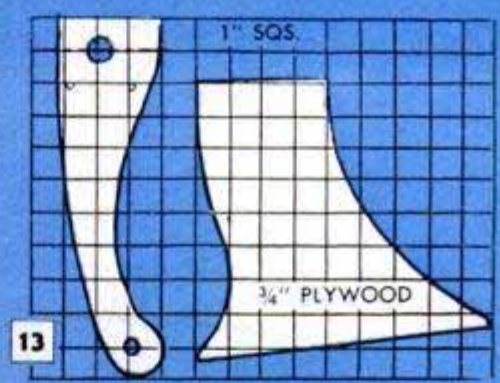
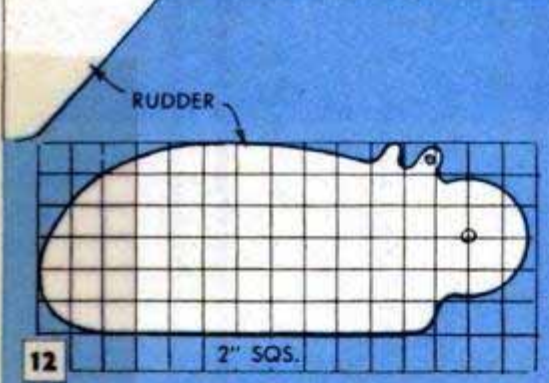
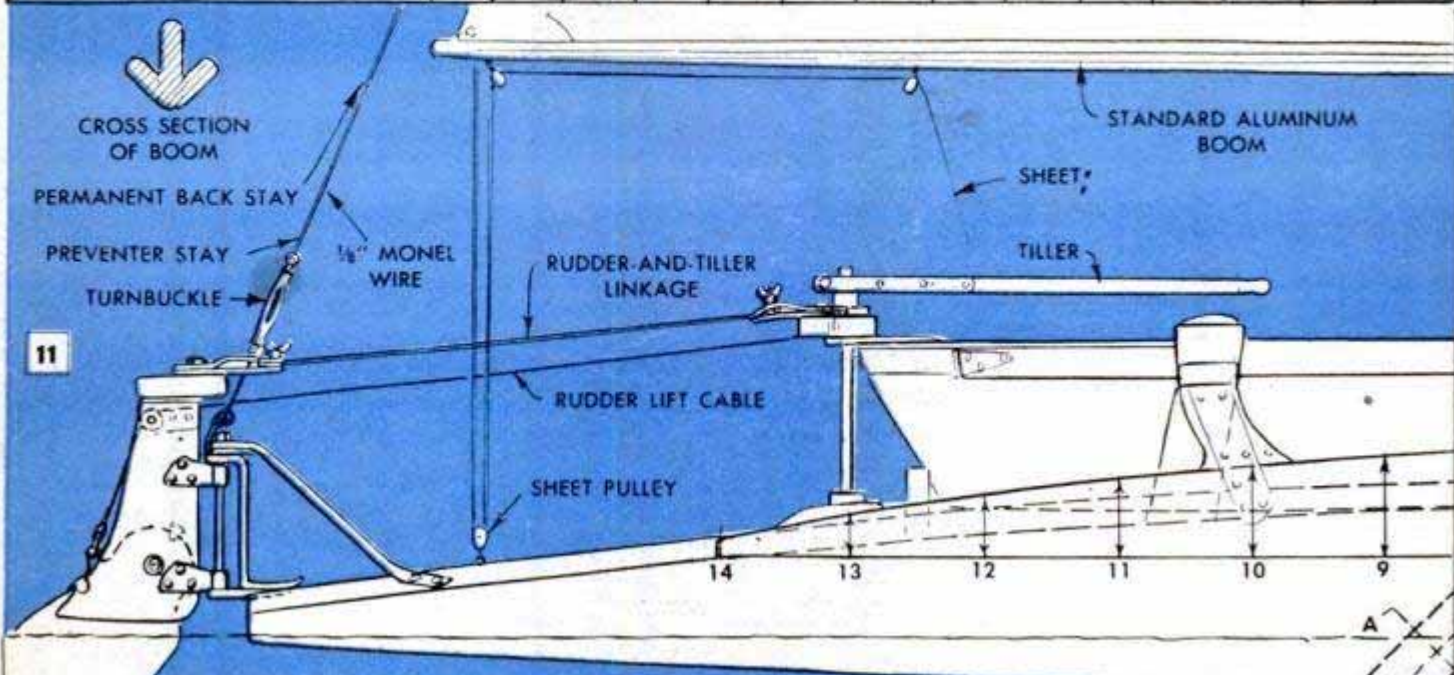

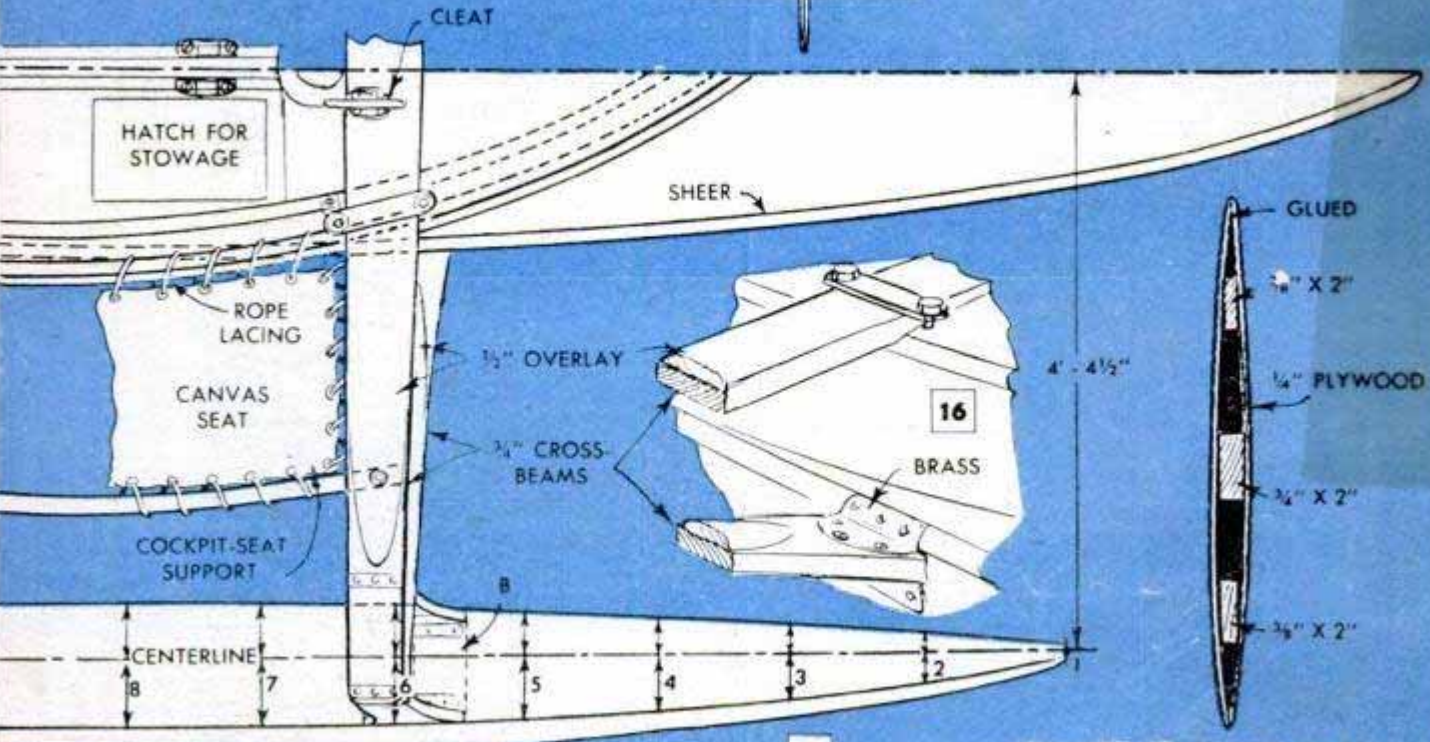
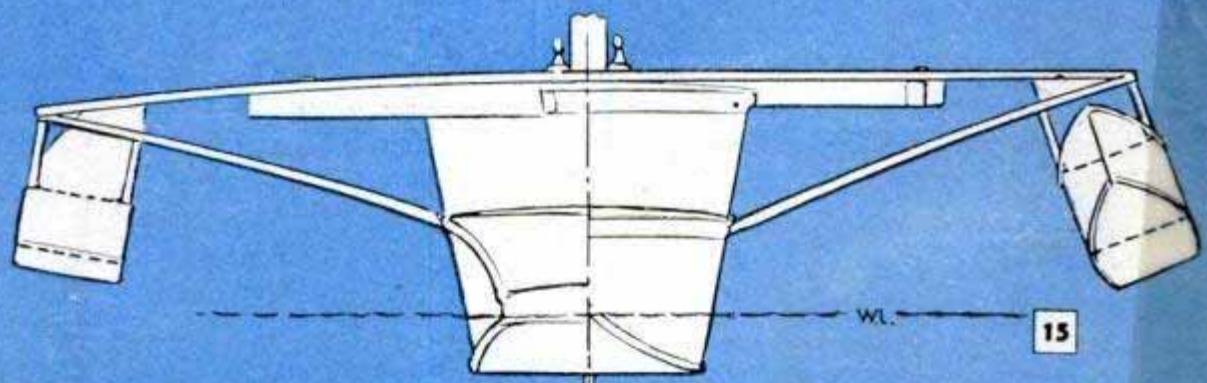
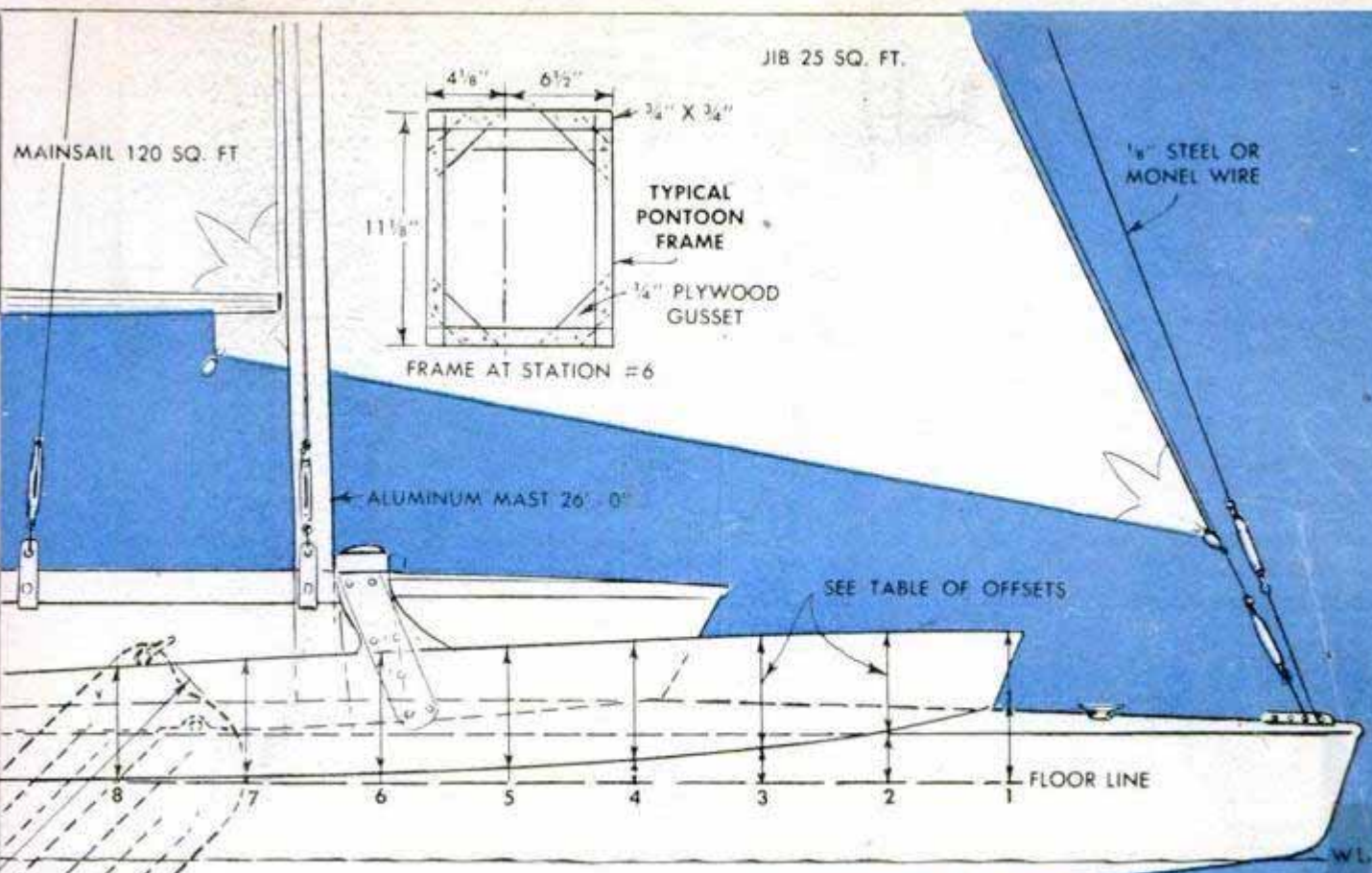

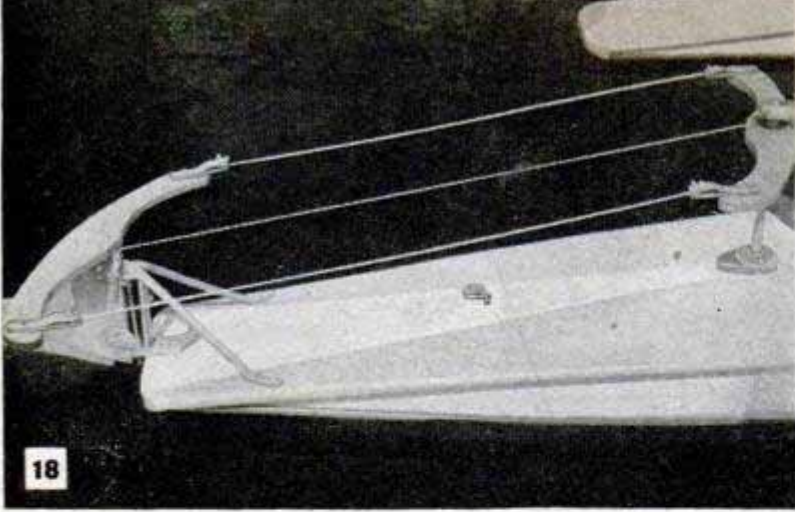
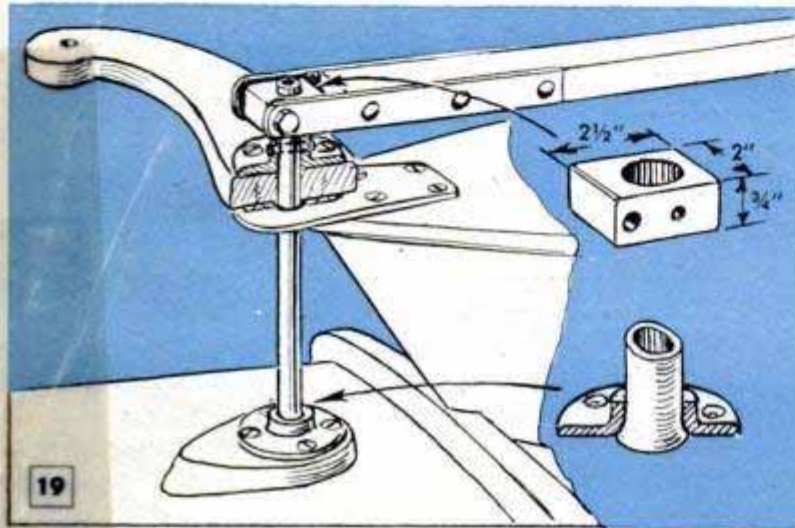

Photo above illustrates a typical steering assembly. Folding rudder is raised or lowered from the cockpit with the cable which is visible midway between the rudder-and-tiller linkage



tacking wooden blocks to the floor as in Fig. 7. Install the pontoon crossbeams as shown in Figs. 6, 15, 16 and 17, and bolt each cockpit-seat support to the underside of the upper crossbeam members, fastening the inner end of the support to the side of the cockpit with screws and glue. Fig. 5 pictures the pontoons and cockpit completely assembled with the canvas seats laced in place. The rope lacing is passed over the cockpit gunwales and through holes drilled in the sides. At the crossbeams, the rope is passed through notched cleats which are screwed to the undersides of the beams.

The centerboard is made as shown in Fig. 11 and the right-hand detail of Fig. 17. Edges of the plywood sides are glued and nailed together all around. After assembly, the upper end of the centerboard is drilled for a pivot bolt and hoisting shackle. The mast step is installed directly over a frame fore of the centerboard trunk, as in Figs. 8 and 9.

The folding rudder can be cut from galvanized steel or 1/2-in. plywood as in the squared pattern, Fig. 12. The steering arms for both rudder and tiller ends of the link-

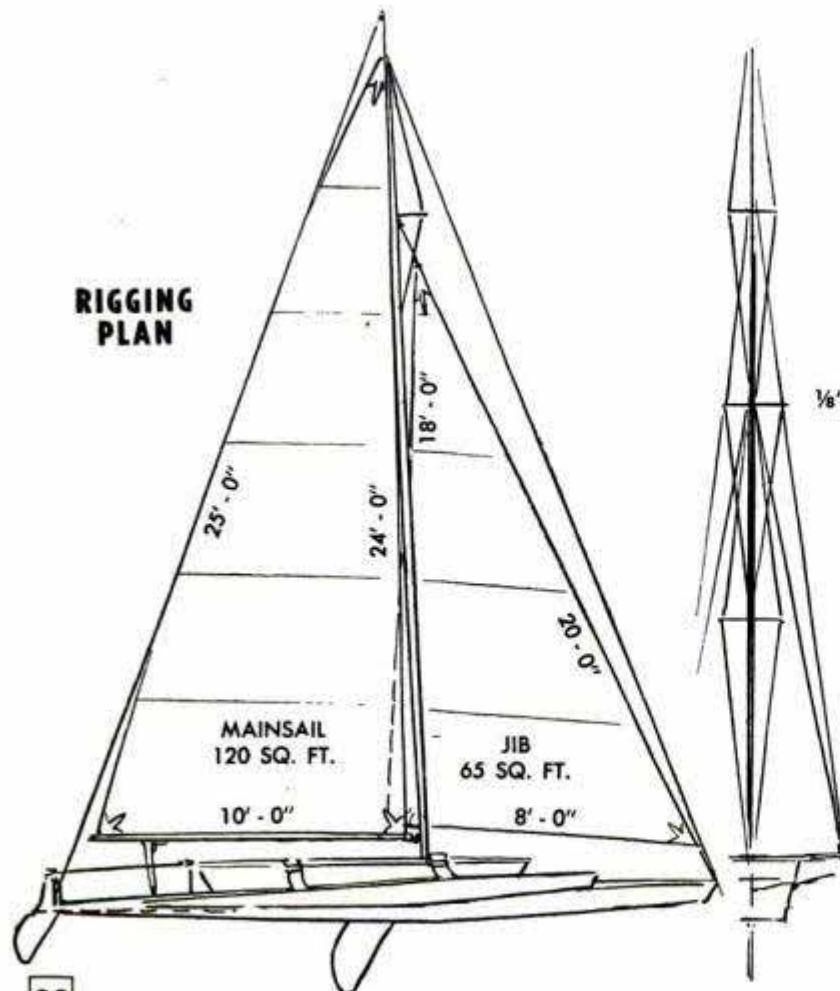

### HOW PONTOONS ARE ATTACHED

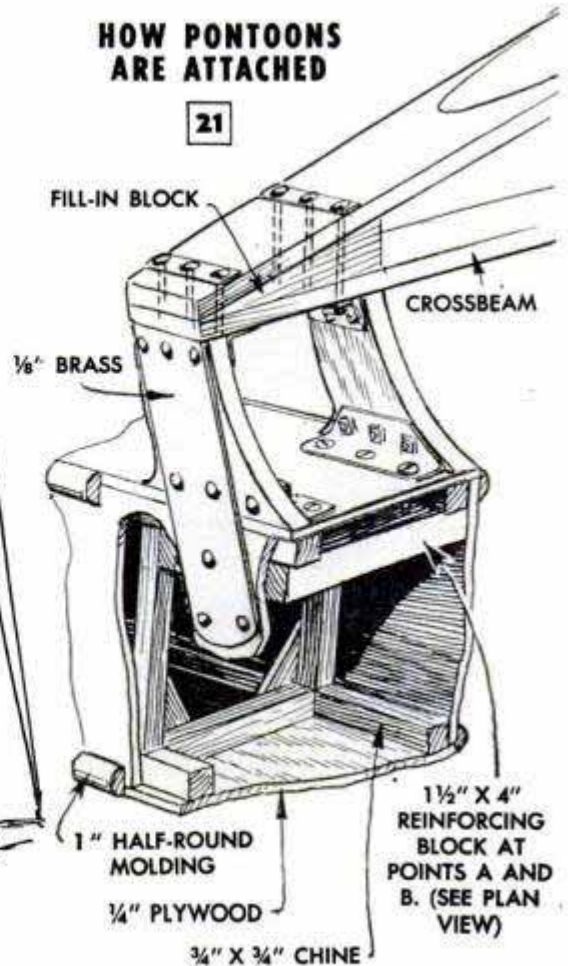

age are cut as in Fig. 13, which also gives the pattern for the 3/4-in.-plywood pontoon hangers. The rudder is assembled and then mounted on the hull with a brass bracket braced with tubing, Figs. 11 and 14. The rudder-and-tiller assembly is pictured in Fig. 18. The tiller arm is pivoted on a length of brass tubing as in Fig. 19, the lower end of the tubing being flared to lock it in a brass flange. Note that the tubing is pinned to a pivot block at the top and to a brass flange just below the block. The tiller itself is bolted to the pivot block and the flange is screwed to the top of the tiller arm, as indicated.

All wooden surfaces of Trimaran should be sanded smooth before painting, and then a copper-base wood preservative applied. Follow the preservative with two or three coats of marine paint in the desired color and apply antifouling bottom paint to the area below the waterline.

Fig. 20 shows the general rigging plan and sail sizes. A standard 26-ft. aluminum mast may be used, or one can be made of Sitka spruce. A pear-shaped cross section is recommended for the wooden mast, tapering from 3 in. at the top to 5 in. at the middle and then to 4 in. at the step.

### Lamp Shade and Glass Pane Provide Setup for Tracing

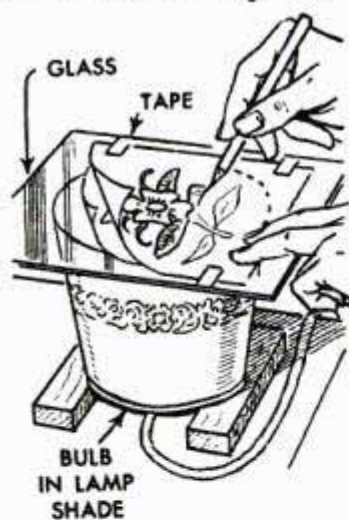

A small lamp shade and a pane of glass can be used to good advantage in tracing drawings or photos. Invert the shade and place it over a light bulb, resting the edges of the shade on blocks as shown. Place the glass on top of the shade. In use, the drawing to be traced is

taped to the glass and transparent or ordinary bond paper is placed over it. With the light on, the lines of the pattern can easily be seen through the paper.

### Trailer Lights Made Dependable by Improving Contacts of Ground Circuit

Trailer owners, who are unable to get dependable operation of the running lights and taillights, will find that the cause is often a loose contact in the ground circuit. The trailer hitch should be kept free of excess grease and rust if it is the only circuit contact between the chassis of the car and that of the trailer. However, a more positive contact can be provided by means

### Roofing-Paper Seams Sealed With Caster "Roller"



Needing a tool to press down the edges of newly laid roofing paper to insure waterproof seams, one homeowner improvised a roller from a furniture caster and a broom handle. The shank of the caster was simply fitted in a hole drilled in the end of the handle, the latter being long enough to permit rolling the seams from a standing position.

### Slip Poured Through Paper Spout

If you get things all messy while trying to pour slip from a container into a mold when making ceramics, use a simple pouring spout cut from heavy paper. Make the spout 2 or 3 in. wide and clamp it to the jar with a strong rubber band. When the pouring is done, just remove and discard the spout.



Hallie H. Holt, Springfield, Ill.

of two heavy wires, one attached to each chassis. A plug on one wire and a socket on the other provides for connecting the wires at the time the trailer is hitched to the car. Each running light, instead of being grounded to the body of the trailer, as is usual, should be connected directly to the trailer chassis by a heavy wire.

Frank H. Tooker, Lakehurst, N. J.

# POUR YOUR OWN

## TYPICAL FULL-WIDTH DRIVEWAYS

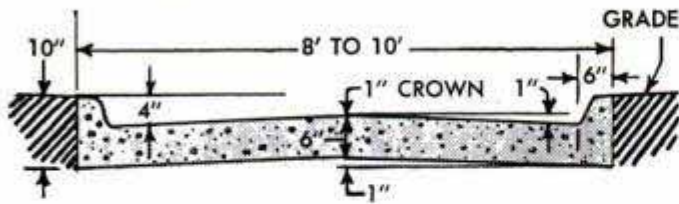

CONVEX SURFACE WITH CURBS

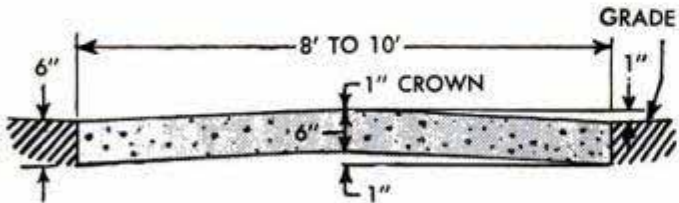

CONVEX SURFACE WITHOUT CURBS

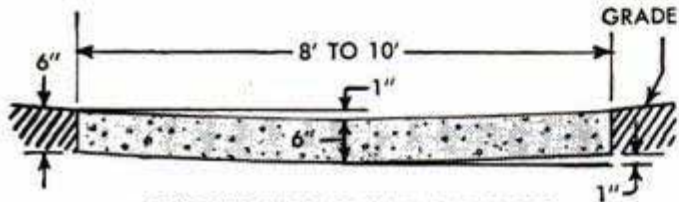

CONCAVE SURFACE WITHOUT CURBS

## TYPICAL TWO-STRIP DRIVEWAYS

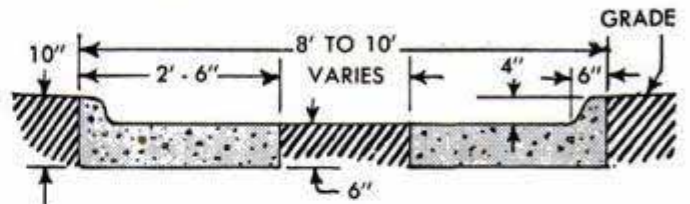

CURBS ON OUTSIDE

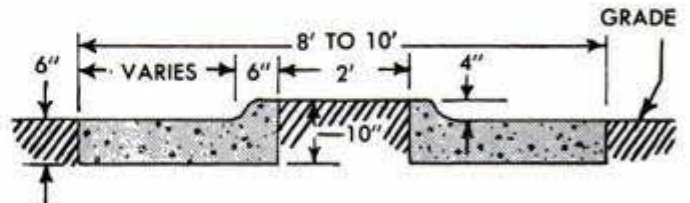

CURBS ON INSIDE

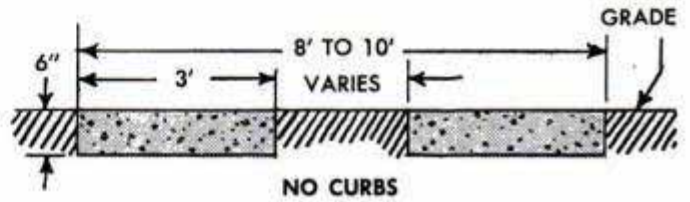

NO CURBS

An edging tool is used in the joints between the concrete and the side forms. The tool rounds the corners of the concrete so they will not chip when the forms are removed

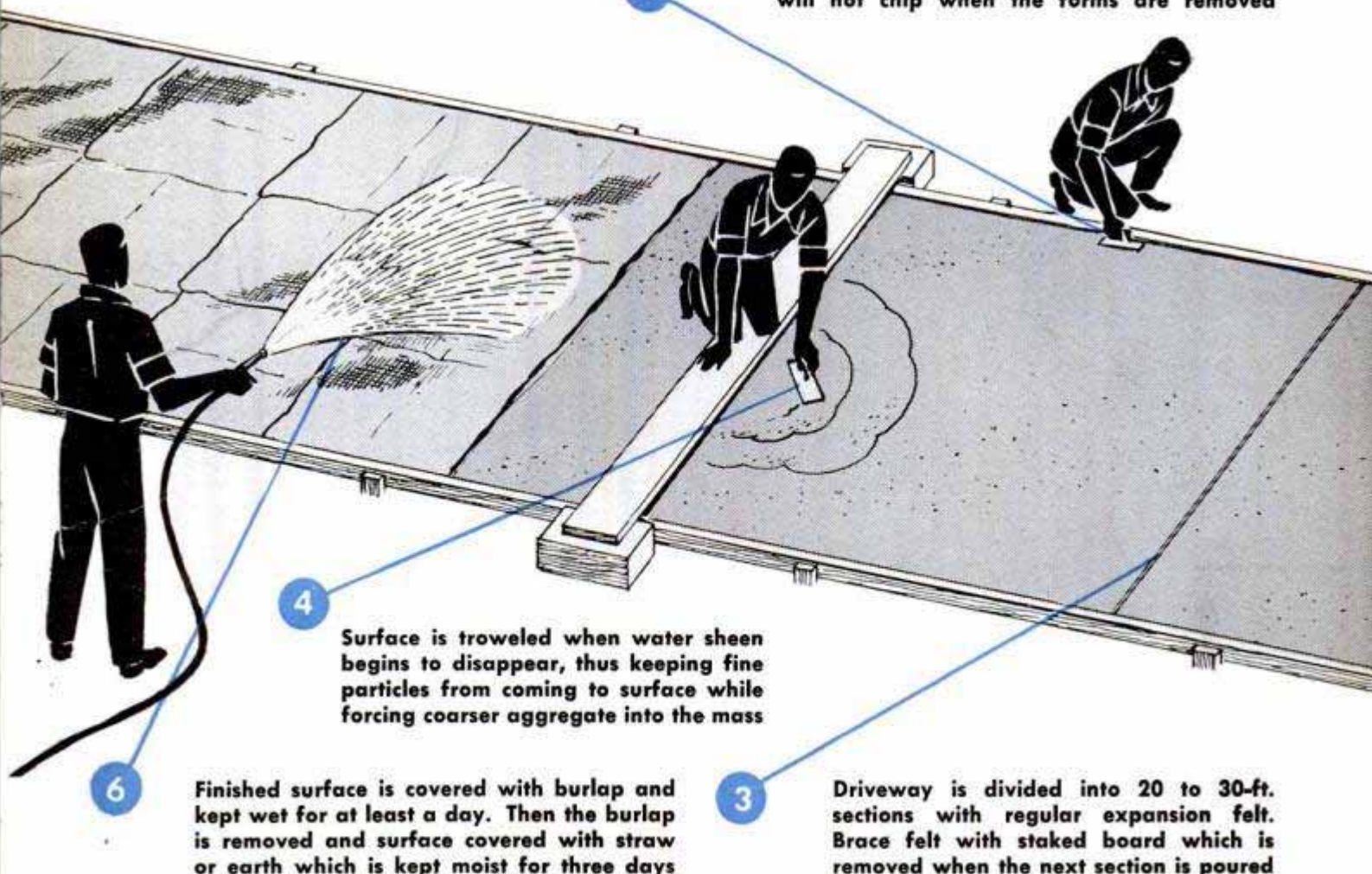

5

4

Surface is troweled when water sheen begins to disappear, thus keeping fine particles from coming to surface while forcing coarser aggregate into the mass

6

Finished surface is covered with burlap and kept wet for at least a day. Then the burlap is removed and surface covered with straw or earth which is kept moist for three days

3

Driveway is divided into 20 to 30-ft. sections with regular expansion felt. Brace felt with staked board which is removed when the next section is poured



# DRIVEWAY

By Raymond Schuessler

**N**OW THAT ready-mixed concrete is available in many communities, pouring a concrete driveway is no longer the herculean job that only a work horse would try. The backbreaking labor of feeding a mixer, wheeling the heavy grout and cleaning up the ensuing mess has been eliminated, thus bringing the job easily within the capabilities of the average homeowner. A ready-mix truck will back into the excavation and pour the concrete right into the forms. Because of the controlled methods of mixing, ready-mixed concrete also is likely to give you a far better job than if you had mixed it yourself.

The details at the left show typical full-width and two-strip driveways with convex or concave surfaces to assure proper drainage. The one selected should be determined by the load carried, drainage requirements and your personal preferences. If the drive is subjected to fairly heavy traffic, the full-width pavement will stand up longer. However, the two-strip drive will prove satisfactory where only occasional usage is involved. Note that a 6-in. layer of concrete is recommended on all types. Although this thickness is not necessary for passenger cars, it is required to



If ready-mixed service is not available in your community, your next best bet is a rented mixer. With the aid of a friend or two to keep the job moving, you won't be caught short when it comes to troweling

**2** Next, concrete is spread evenly with a strike board which is worked sideways. The lower edge of the board is cut to form desired contour on the driveway surface

**1** Ready-mixed concrete can be trucked right into your driveway forms and poured just where you want it. Worked to the top of the forms, the concrete is spaded thoroughly

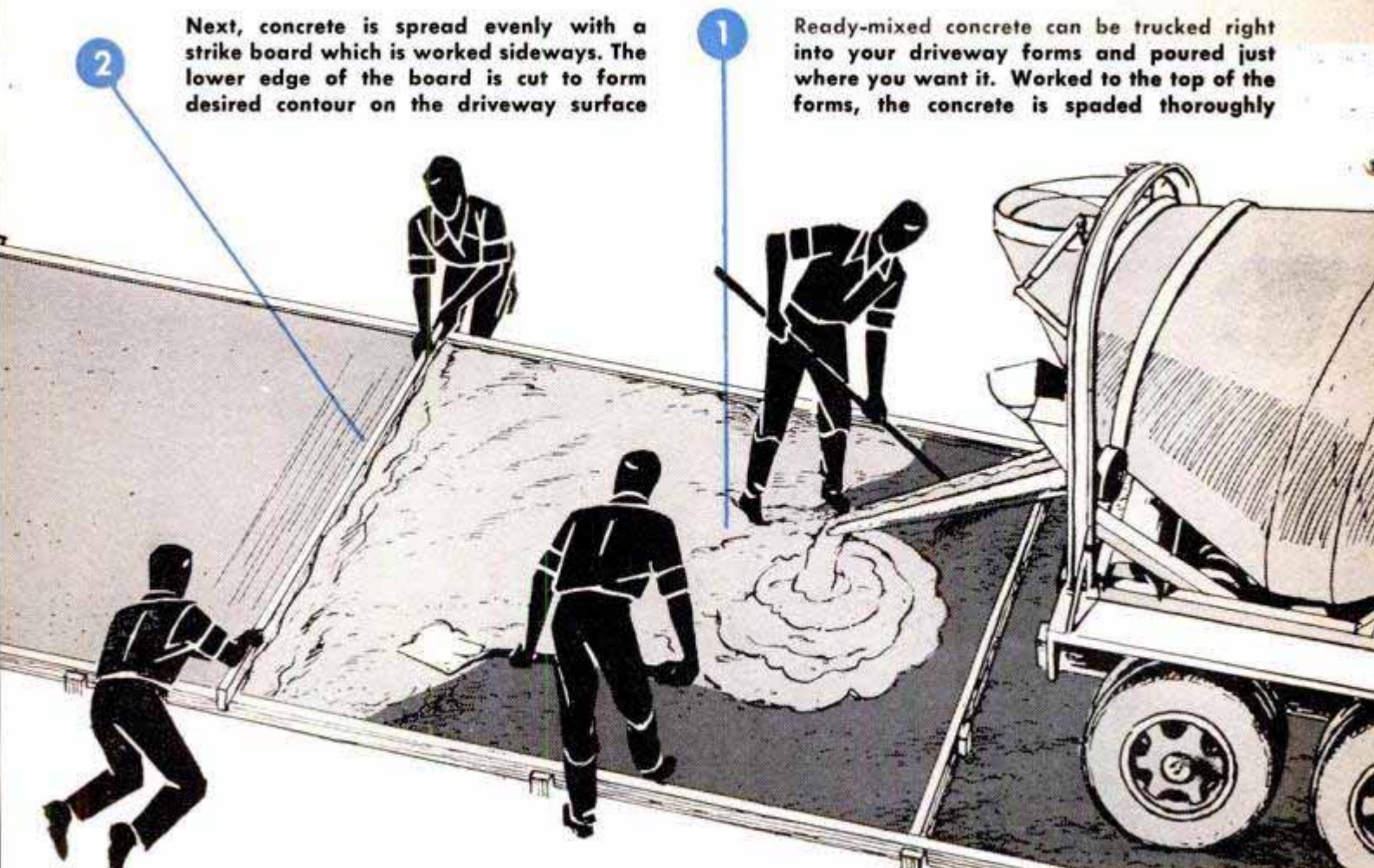



In making  $\frac{1}{2}$ -bag batch of 1 :  $2\frac{1}{4}$  : 3 mix, measure  $2\frac{1}{2}$  gal. of water into pail and mark level on inside. Then pail can be refilled with garden hose, as above, for adding just the right amount of water to the mix

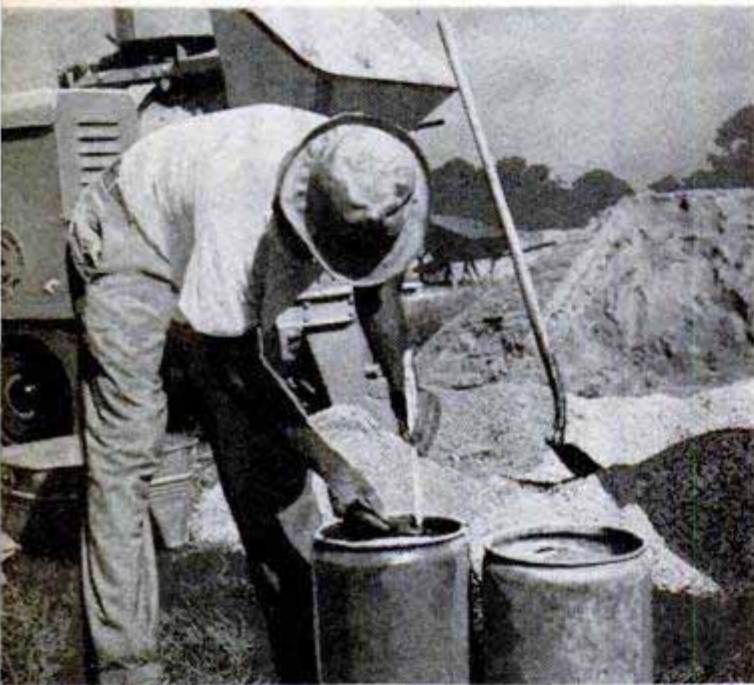

For  $\frac{1}{2}$ -bag mixes, a bag of portland cement can be divided equally by using two pails of the same size. With a ruler, measure from the rim to the top of the cement to be sure that the level is the same in both pails. Then mark one for use as a measure



carry safely the weight of coal and other delivery trucks.

The first step in building the driveway is to stake out the proposed boundaries. Connect the stakes with string and drive the car over the route, just as you would after the driveway is poured, making any necessary adjustments in width and radius of curves. Sometimes it is easier to lay out curved driveways by driving the car over the desired path and then placing the stakes to conform with the route which was taken by the car.

The grade should be as slight as possible, as steep grades tend to be slippery and, in some cases, contribute to obstructing the driver's view of the sidewalk and street. Grades of more than 25 percent offer two additional problems. The underside of the car is likely to scrape the pavement at the top of the grade, while either the front or rear bumper of the car may scrape at the bottom of the grade. Sloping drives should be built straight, as it is difficult to handle a car down a curved incline, especially when backing.

After laying out the driveway, excavate deep enough to retain a depth of at least 6 in. after tamping. To assure uniform bearing power, remove all soft, yielding material, loose rocks and boulders from the

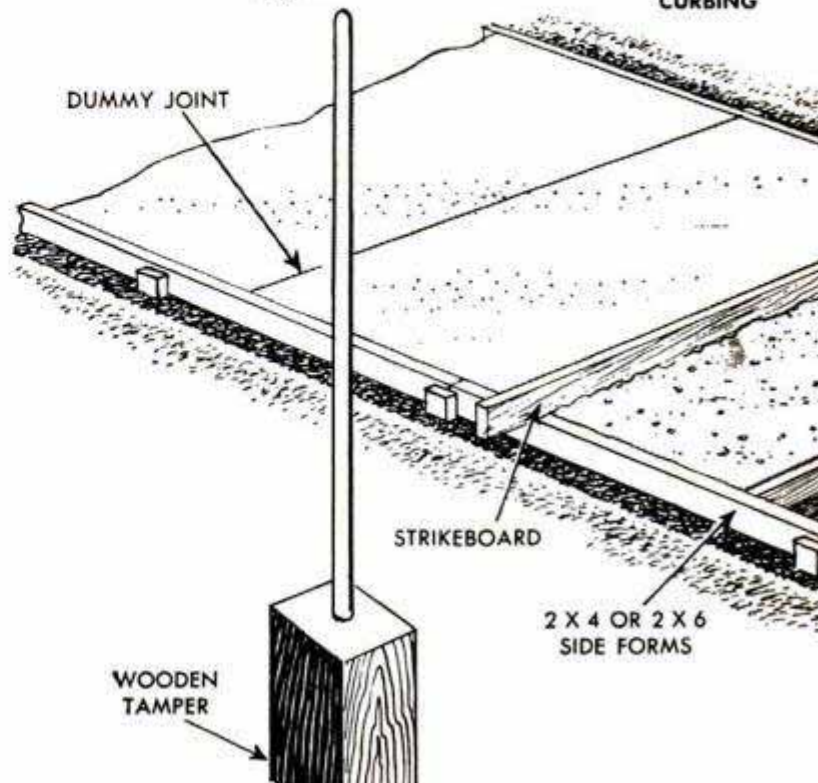
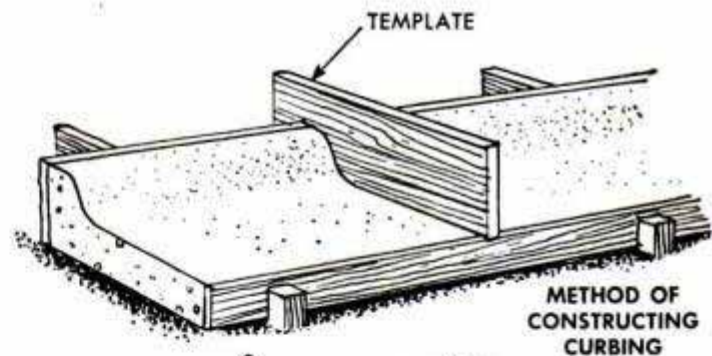

bottom of the excavation. Be sure that the bottom, or subgrade, is well compacted by tamping thoroughly before pouring the concrete, as settling will result in cracking of the driveway. On ground that has recently been filled, it is best to postpone pouring the driveway for a year or more.

If you are unable to buy expansion felt, a similar joint can be made by placing greased boards crosswise between the side forms at 20 to 30-ft. intervals to form expansion joints. The boards are removed as soon as the concrete hardens sufficiently to retain its shape, and the openings are filled with roofing asphalt, or tar. Sand is sprinkled over the tops of the joints.

When the concrete is poured, it is spaded or tamped to assure consolidation and prevent honeycombing. As concrete usually must be poured and compacted within 30 min. after mixing in order to obtain maximum strength, it is a good idea to have two or more workers present to handle a truckload of ready-mixed concrete.

If ready-mixed service is not available and you must mix the concrete with a rented mixer, use a 1:2¼:3 mix; that is, cement, 1 part, sand, 2¼ parts, and gravel, 3 parts. To estimate the quantities of material needed, figure that 1 bag of cement contains 1 cu. ft., and that 1 ton of aggregate (gravel or sand) contains roughly 22 cu. ft. This, of course, will vary, and more accurate data can be obtained from your dealer.

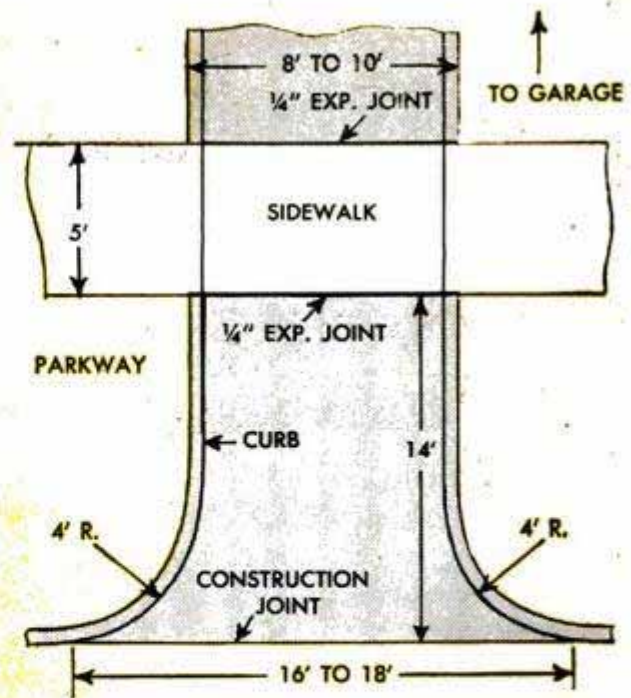
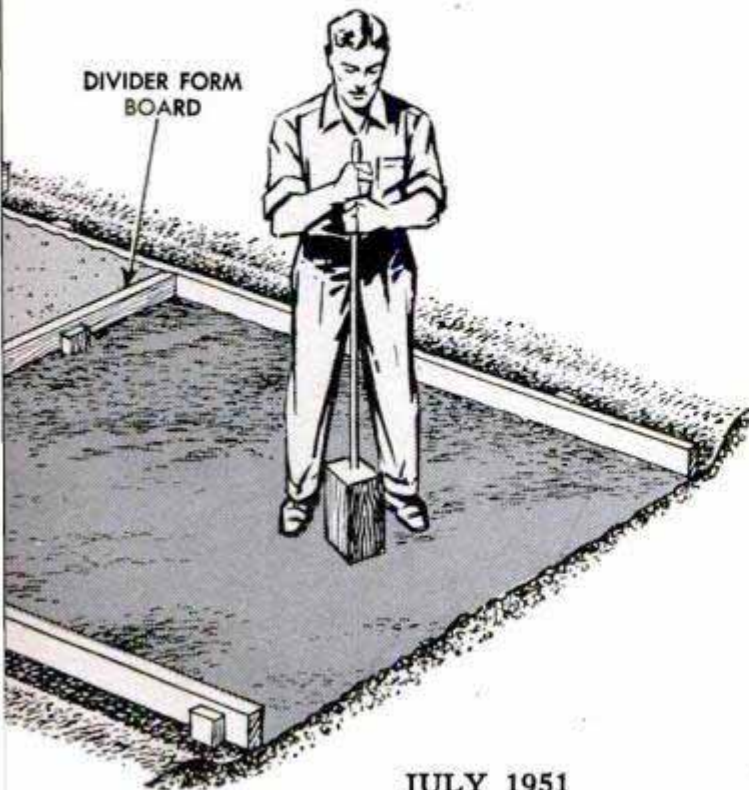
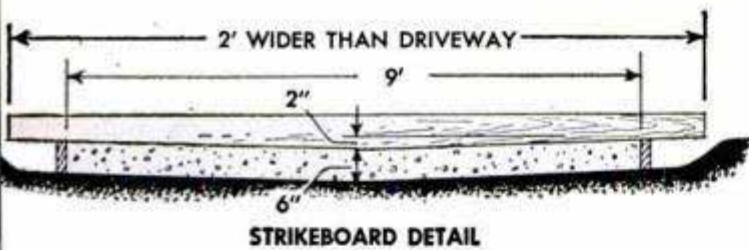

TYPICAL DRIVEWAY FOR NARROW LOT, 30' STREET AND 14' PARKWAY

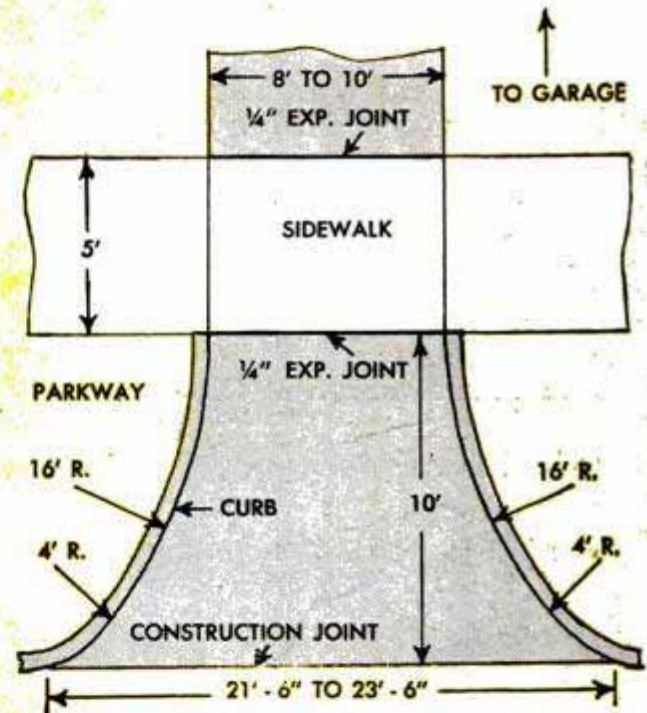

TYPICAL DRIVEWAY FOR 24' STREET AND 10' PARKWAY

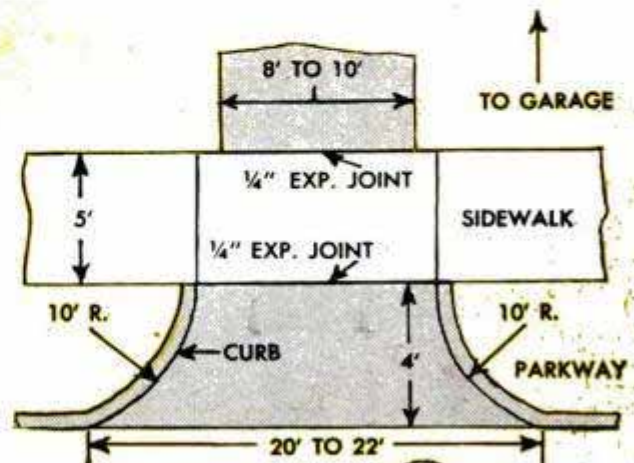

TYPICAL DRIVEWAY FOR 28' STREET AND 4' PARKWAY

## Conduit-Clamp Toolholders

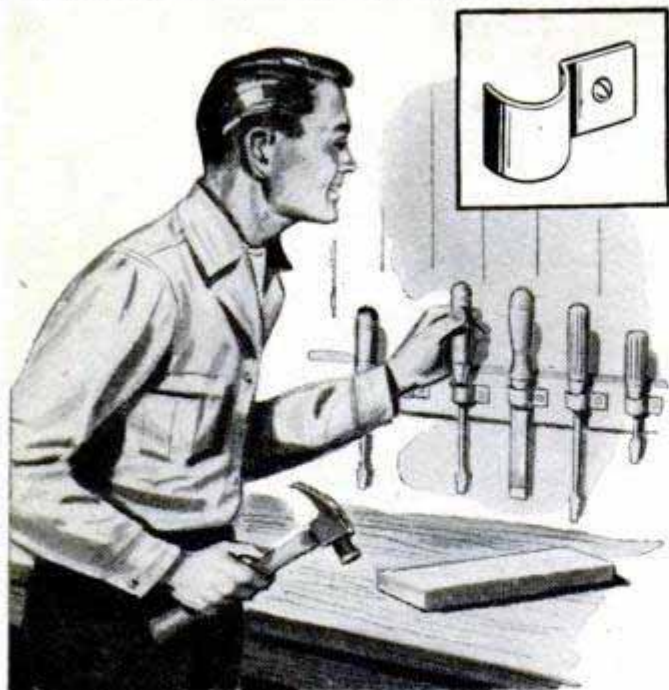

Craftsmen, wishing to arrange a group of small hand tools in neat rows on a wall panel, will find that metal conduit clamps, or cable straps, make excellent individual holders for the tools. Before attaching the clamps, the positions of the tools in each row should be determined by laying them out on a strip of  $\frac{3}{4}$ -in. stock, spacing them as desired and marking the locations of the clamps. Then screw the clamps to the strip and screw or nail the strip horizontally to the panel, as shown.

Arthur Trauffer, McClelland, Iowa.

## Pliers Used as Emergency Calipers

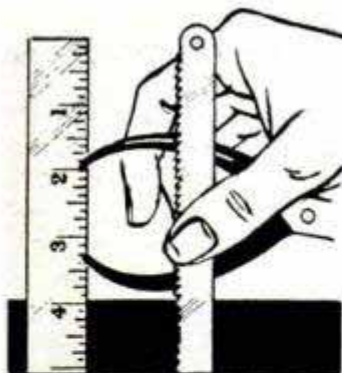

Where measurements are not too critical, a pair of ordinary pliers and a hacksaw blade can be used as emergency calipers. To use them, space the ends of the plier handles by means of a scale and then hold the hacksaw blade across them as indicated to aid in holding the set. The teeth of the blade when held firmly against the handles will help keep the handles in position.

B. F. Borsody, Arlington, Va.

## Tips on Cutting Glass

Don't attempt to use a thin, metal straightedge, such as a carpenter's square, when cutting glass. Instead, use a wooden yardstick that is thick enough to provide a substantial edge against which the glass cutter can be held. However, before using

it, check the yardstick to make sure that it is straight, and cover the underside with masking tape to prevent its slipping on the glass. In cutting the glass, lay it on a flat surface which has been padded with a piece of carpeting material or several thicknesses of burlap. Guides for cutting curved lines can be made from wallboard or  $\frac{1}{4}$ -in. stock. The pattern to be cut can best be seen if it is first drawn on paper and then placed under the glass. Cutting lines should end about  $\frac{1}{16}$  in. from the edge of the glass, as running the cutter off the glass will usually chip the edge. Don't go over a line, with the cutter, once it has been cut. Professional glass cutters will tell you that this is the quickest way to dull the cutter.

## Small Mechanisms Lubricated By "Hypodermic" Grease Gun

The difficult problem of getting lubricant into the bearings of small mechanisms, such as fishing reels, can be solved by using a hypodermic needle to apply the lubricant. These needles are available in various sizes and are ideal for the job as they apply the lubricant with considerable force, thus assuring that all surfaces of the bearing will be covered. In filling the "gun" remove the needle and slip a piece of spaghetti tubing over the nipple of the syringe. After filling the syringe, replace the needle. Use of the spaghetti tubing is necessary because the opening in the needle is too small to permit drawing the lubricant into the syringe. After use, the syringe should be cleaned with gasoline.

C. Thomas, Joplin, Mo.



## Newly Painted Chairs "Shod" To Protect Floors

Newly painted chairs, although they seem to be dry, will sometimes leave marks on floors. This is caused by extra thicknesses of paint which have collected on the bottom edges of the legs. To avoid these marks, attach a wax-paper "shoe" to each of the legs. Simply fashion small cups from wax paper and place them over the ends of the legs. Then wrap the upper portion of the paper with string or rubber bands to hold the shoes tightly to the legs.

Sid Corlin, Chicago.

# Decorative Plywood Rack Holds Fly Swatters

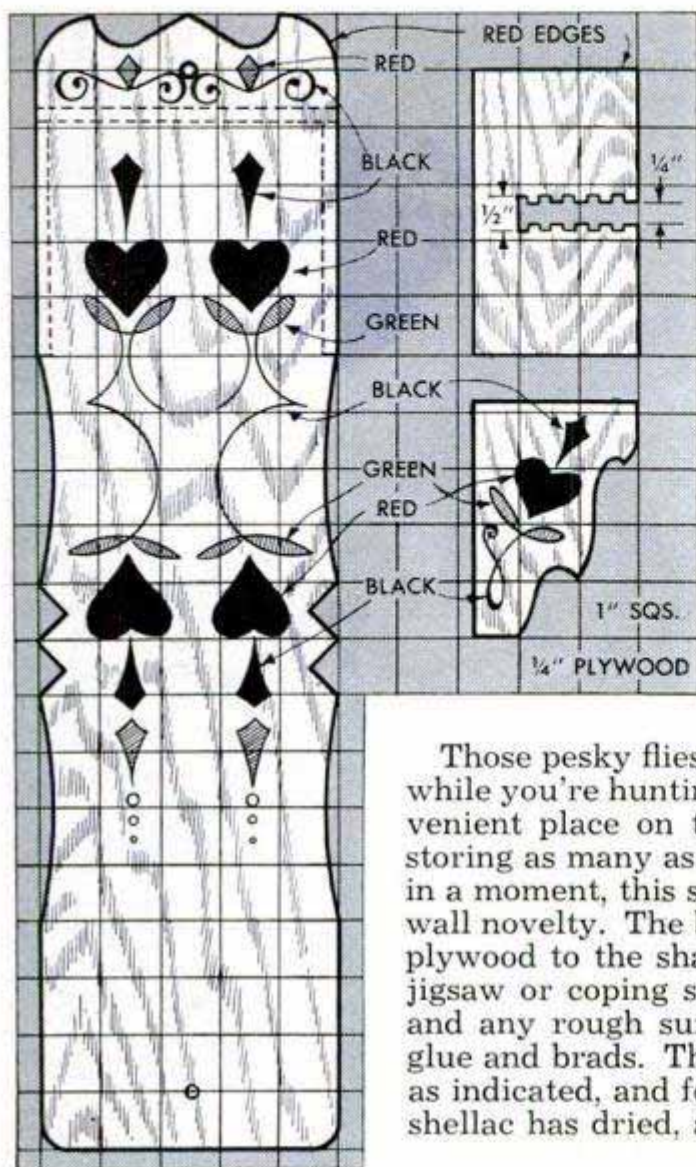

Those pesky flies won't have time to hide among the curtains while you're hunting for the fly swatter, if you keep it in a convenient place on the kitchen or pantry wall. In addition to storing as many as five fly swatters where they can be reached in a moment, this scrolled plywood rack provides an attractive wall novelty. The back, side braces and top are cut from  $\frac{1}{4}$ -in. plywood to the shapes shown on the squared patterns. Use a jigsaw or coping saw to cut out the members, sand all edges and any rough surfaces smooth, and assemble the rack with glue and brads. Then paint the designs with show-card colors, as indicated, and follow with a coat of clear shellac. When the shellac has dried, apply a coat of clear varnish to the rack.

Roberta L. Fairall, La Crescenta, Calif.

## Valuable Advice From Master Craftsman on Refinishing Antiques

A master craftsman, wise in the ways of refinishing antiques to the smoothness of old ivory and with a gleaming, rich luster, gave me the following tips: First, clean the work with a good paint and varnish remover, using a cheap brush to apply a generous coat over a small area. Let the remover stand about 15 min. and, without wiping it off, apply a second coat. Then mix a gallon of warm water with a cup of household ammonia and use the mixture with a stiff-bristled brush to scour the treated surface. Dip a rough cloth (an old towel is excellent) into the ammonia water and wipe the area. Rinse at once with clear water, removing all traces of ammonia and the work should be good and clean. Remember to clean only a small area at a time, for if varnish remover is applied over too large an area, it will harden into a cement-like finish. Should that happen, apply more remover—several coats, 15 min. apart—until you can wipe the surface clean. Before further refinishing is done, make any nec-

essary repairs to the work. Then sand with 1/0 or 2/0 garnet or sandpaper until very smooth. Wipe clean and apply the first coat of shellac, using a 4-lb. cut. Thin a pint of shellac with a pint of denatured alcohol. Use orange shellac on dark woods, such as mahogany, cherry and walnut, and white shellac on the lighter woods. Using a pure bristle brush, apply two coats of shellac with the grain of the wood, allowing 4 or 5 hrs. between coats. Between succeeding coats, allow 24 to 48 hrs. drying time. Sand after each coat using 6/0 or 7/0 garnet paper. Never apply shellac in damp or humid weather, and if the shellac gums up on the sandpaper, allow more drying time. When you have built up the desired number of coats, mix 3 heaping tablespoonfuls of fine pumice with paraffin oil to attain a creamy mixture. Then dip a pad of 000 steel wool in the mixture and rub the work briskly with the grain. When finished, wipe the surface with a soft cloth. Repeat this process twice.—Ray Wilkie, Lexington, Ky.



## Support for Long Gutter Lengths Permits Installation by One Man

This adjustable support holds one end of a new length of gutter while you fasten the hanger at the opposite end. It's just the thing for bungalow and ranch-type homes where the gutters are at a uniform height. Use 1 x 4s for the upright and the angle bracket at the top end. Nail a crosspiece to the lower end of the upright and brace it as shown. If you require height adjustment, drill a row of equally spaced holes near the top end of the upright as well as in the angle-brace member, joining these parts with bolts and wing nuts. In use, the horizontal brace rests against the house.

Arthur W. Nelson, Kansas City, Mo.

## Bobby Pin Taped to Paste Bottle Serves as Brush Holder

Occasional use of library paste usually necessitates looking for the paste brush which easily becomes misplaced. One user solved this problem by taping a bobby pin to the bottle so that the hollow metal handle of the brush could be slipped over the pin as indicated. There is sufficient grip in the pin to prevent the brush from becoming dislodged.—John J. Rea, Urbana, Ill.



## Holding Machine Screws in Vise When Cutting With Hacksaw

When it is necessary to shorten a small machine screw or stove bolt, or make a stud by cutting off the head of the screw, turn a nut on the threaded end so that the screw can be gripped in the vise without damaging the threads. Run the nut back close to the point where the screw is to be cut, lock in the vise as in the detail and then insert a screwdriver

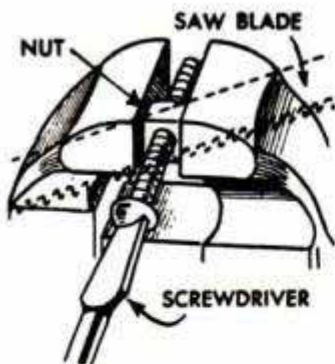

in the slot as shown to prevent the screw from turning while sawing.

Frederico Strasser, Santiago, Chile.

## Removing Calcimine From Walls

To remove calcimine, soak it thoroughly with a wet brush, or pat it with a very wet cloth. Usually, a thorough soaking will permit the calcimine to be rubbed off with a cloth or sponge. It is best to clean only a small area at a time. If a hardener has been used in the calcimine, such as alum, you may have to use a putty knife to scrape it off after soaking it.

Colorless fingernail polish is a good substitute for lacquer on small jobs.

## Folding Backrest on Boat Seats

Mindful of the comfort of his guests, one boatman fitted the seats of his boat with folding backs, which were supported by ropes equipped to snap into eyebolts attached to the gunwales. The backs were cut from  $\frac{3}{8}$ -in. marine plywood, rounded at the upper corners and strengthened by two strips of hardwood screwed near the top and bottom edges. Loose-pin butt hinges were used to attach the back to the seats. In this way the backs were easily removed by un-snapping the support rope and pulling the hinge pins. The backs were finished in the natural color of the wood with a special primer and two coats of spar varnish.

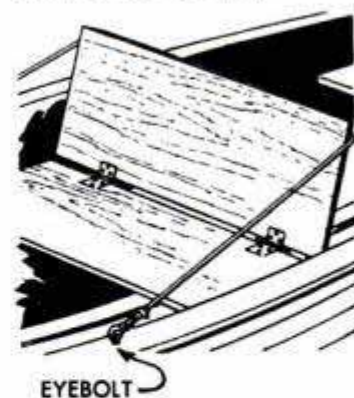

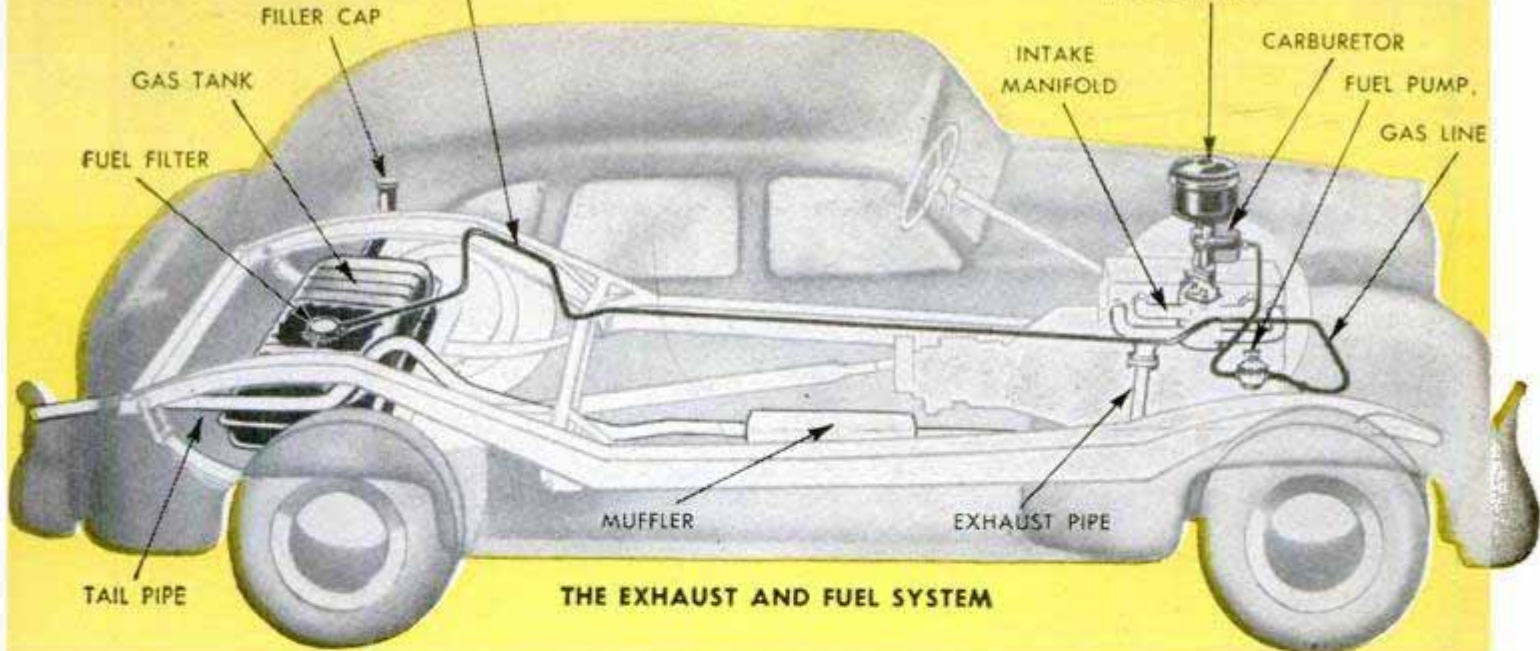

# Serviceing the CARBURETOR

By Ed Packer

**F**REQUENTLY a thorough cleaning of the carburetor alone will make an old car run like new. Accumulations of dirt and gum probably result in more carburetor troubles than any other single cause, and periodic cleaning and adjusting of the unit will give you easier starting, snappier acceleration and greatly improved gas mileage for both summer and winter driving. Anyone can take apart, clean and reassemble a carburetor, but to avoid damaging certain of the delicate parts of the unit, you should acquire the "mechanic's touch" and handle everything as if it were made of glass.

A reliable check of carburetor performance before and after servicing can be had by the use of a vacuum gauge, Fig. 1. When the engine is idling, the vacuum gauge, which is installed between the carburetor and the engine as in Fig. 1, will give its highest reading, normally between 18 and 21 divisions on the dial. This reading will be lower at high altitudes. The uniformity of the reading is the important thing in this test. Anything that causes the engine speed to vary will cause the gauge pointer to swing back and forth with the variation in speed. Although this variation in the gauge reading can indicate other mechanical faults, one of the most common causes is a rich fuel mixture. When a mechanic sees the wavering pointer on the vacuum gauge, he immediately thinks of the most likely causes. In a new car there's

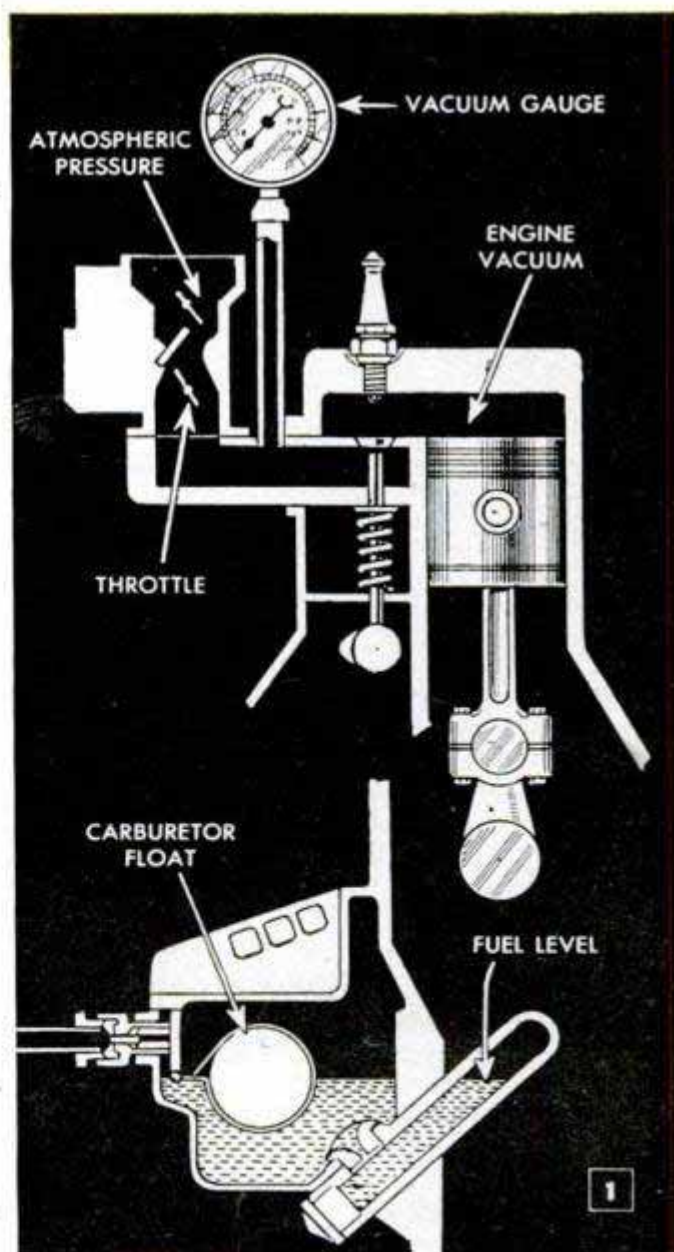

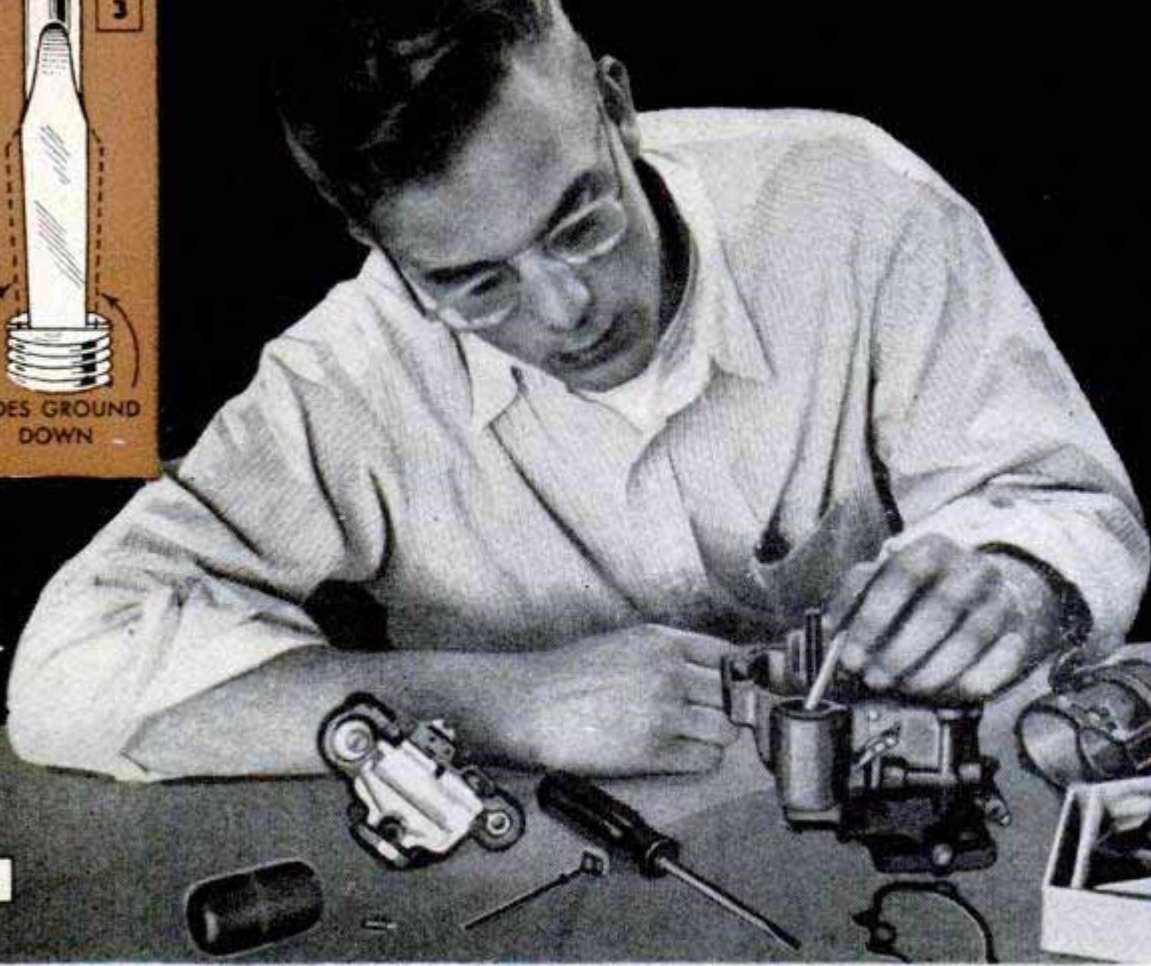

2

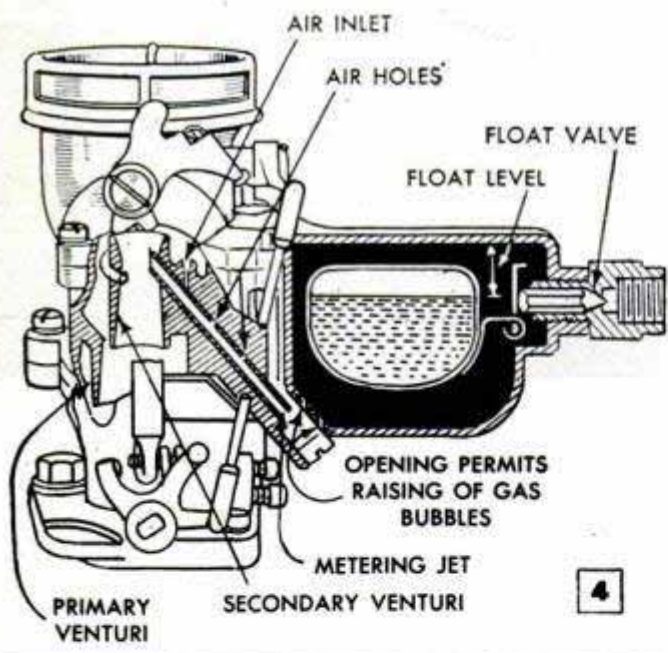

a good chance that the trouble is due to a clogged air cleaner. In an older car the mechanic thinks of a bit of dirt or gum in carburetor jets, and, more rarely, the float sticking, or not properly adjusted. Perhaps a needle valve has been damaged by turning it in too tightly. Sometimes the air holes in the metering jet are clogged with gum and dirt, Fig. 4. These are among the more common causes of a rich fuel mixture and a rough engine.

In carburetor diagnosis, one thing to keep in mind is the age of the car, both in years and miles. In older cars the float level will change gradually because of wear in the parts and, in time, looseness reaches a point where raw fuel is discharged into the air stream in ever increasing quantities. The lower detail in Fig. 1 and detail A in Fig. 8 show more clearly what happens. While

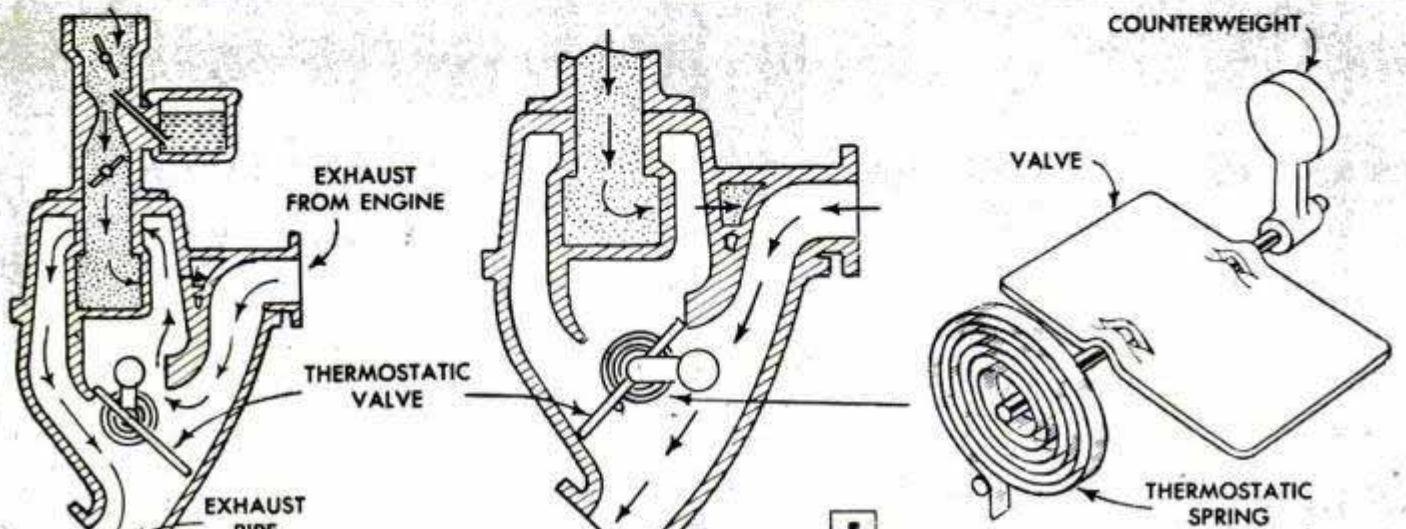



atmospheric pressure pushes down on the gasoline in the float chamber, detail A in Fig. 8, manifold vacuum drops the pressure at the restriction of the air horn, or venturi, to about 8 lbs. Difference in pressure forces the fuel through the main jet and into the air stream. As the fuel level rises as a result of wear in the float, more and more fuel is discharged into the main jet. When the throttle is closed, another set of fuel passages provides the idling mixture. These are shown in the simplified detail B, Fig. 8. Fuel is drawn from the bowl through the idle tube, or jet, and is mixed with air which enters through a small bleed opening. The air-fuel mixture then passes into the idle discharge ports, one of which is provided with an idle-adjusting screw, as shown in Fig. 9.

When the engine and carburetor are in good operating condition, adjusting idling speed and fuel mixture is simple, even though some engines are more sensitive to changes in the adjustments than others. First, turn the speed screw inward to speed up the engine, or outward to slow it, until the desired idling speed is obtained. Next, the mixture screw is turned in very slowly and by stages until the engine begins to roll and lose power. Then back the screw (counterclockwise) until the engine smooths out and idles steadily. If the carburetor is clean and otherwise in good condition, the engine will respond almost instantly to sudden, hard acceleration and will return to idling speed smoothly when the throttle is closed. However, if the float is high, or if dirt and gum have restricted passageways, turning the idling screw in or out may make little difference in the performance of the engine. Under sudden acceleration it is likely to lag through a "flat spot" and pop back violently through the carburetor. When idling, the speed generally varies and the engine rolls from side to side on its mountings. Under these conditions it also is likely that the accelerator pump, detail C in Fig. 8, is defective. This generally is the case if there is a flat spot

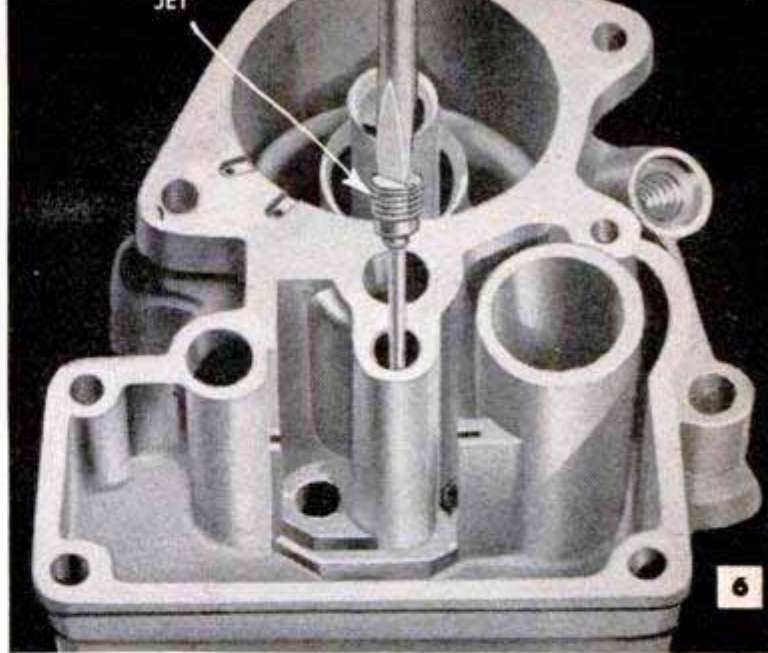

If examination of parts of the low-speed jet turns up evidence of undue wear or corrosion, they should be replaced. Be careful when installing the jet not to turn the retainer down too tightly and damage threads

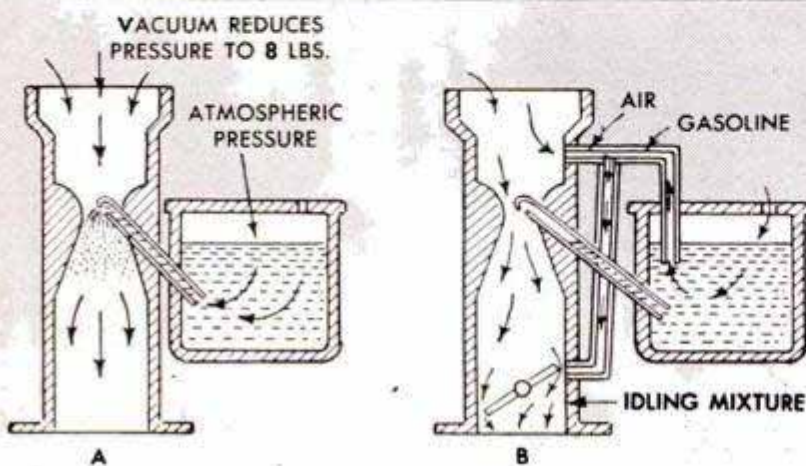
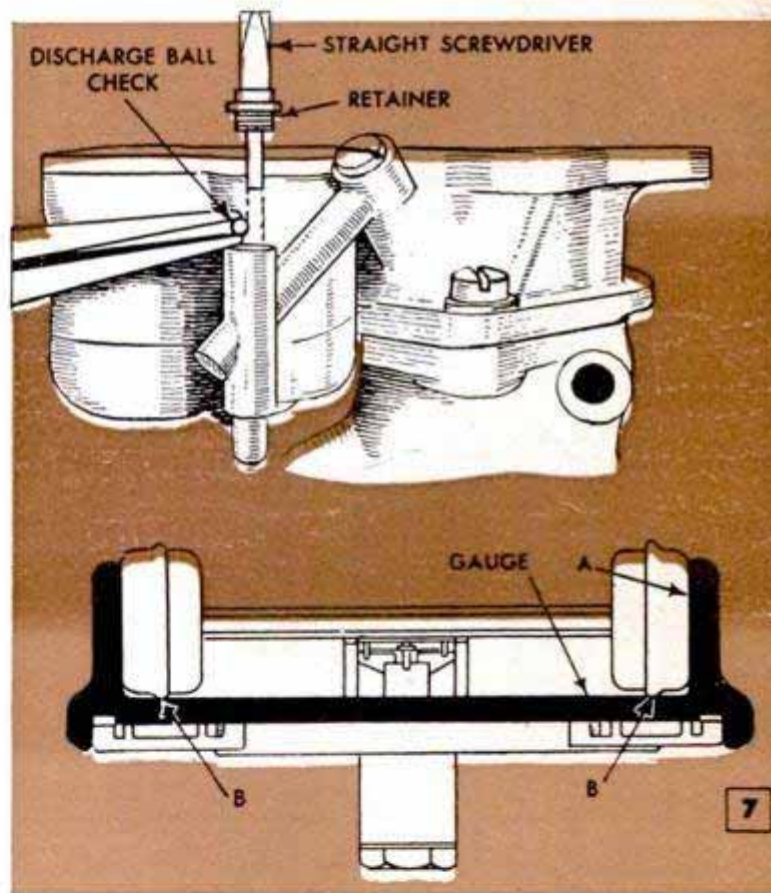

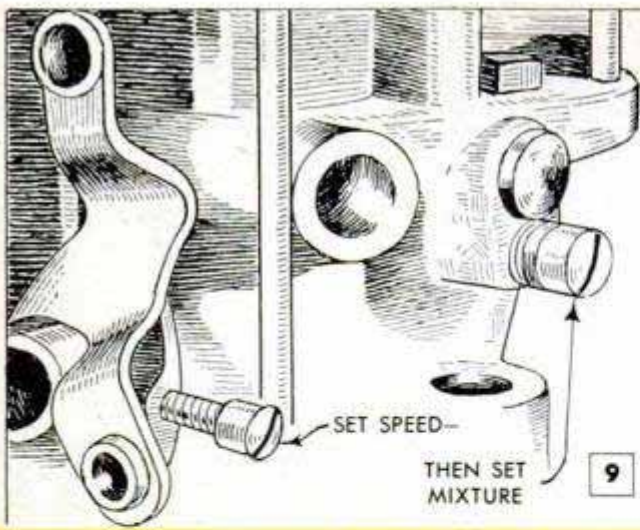

VACUUM PISTON AND LINK ASSEMBLY

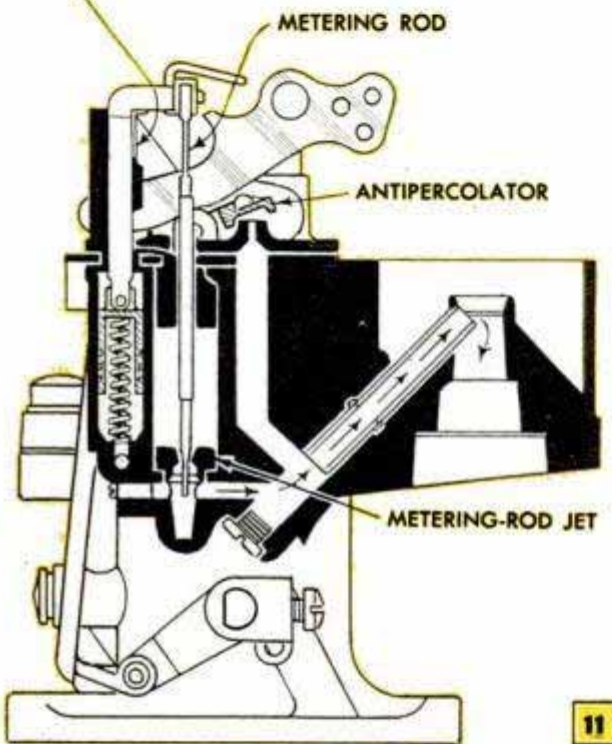
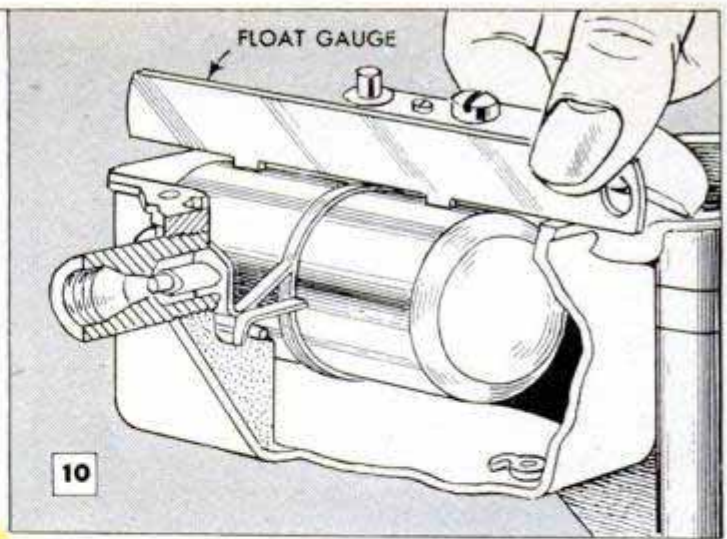

in the acceleration cycle above idling speed.

To remove the carburetor, first disconnect the ground cable from the battery. Then wash away accumulated oil and dirt from the choke and throttle controls and also the mounting flange, using white gasoline or other suitable solvent. Remove the air cleaner and, if it is of the oil-bath type, be sure to place it upright on a table top or other level surface until you are ready to clean it. Disconnect the throttle and choke rods and remove the cap screws holding the carburetor on the mounting flange. Remove the gasket carefully so that no part of it falls into the intake manifold. Fold a cloth and press it tightly into the open end of the manifold to prevent the entrance of dirt and other particles. Place the carburetor on a large clean sheet of paper on a table top as in Fig. 2, and then grind down a screwdriver blade, as in Fig. 3, so that you can reach into tapped holes and remove

retainers and other small parts without damaging the threads. As parts are removed, place them in order so that they are easily reassembled. Apply penetrating oil, or better still, lacquer thinner, to parts that refuse to loosen under moderate pressure of the screwdriver. To make an accurate check of the float level, Fig. 4, it is best to use a float gauge. Check the floats in twin-bowl carburetors with a gauge of the type shown in the lower detail in Fig. 7. This gauge usually has two arms, A, which indicate the recommended heights of the floats, B. For single-bowl carburetors, the gauge usually is of the type shown in Fig. 10. In any case, use a gauge specifically designed for the carburetor at hand. Often it is possible to adjust the float by bending the float arm slightly but, before doing this, remove the valve and examine it carefully for defects. If the valve seat is corroded or if the point of the plunger is ringed, the parts should be replaced. The same is true of the low-speed jet, Fig. 6, and the discharge ball check, upper detail in Fig. 7. Many manufacturers supply replacement kits which include retainers, jets, accelerator pump, gaskets, and parts of the throttle and choke controls. It is recommended that in carburetor servicing these units be installed to replace parts that have become worn or damaged. After removing all the parts, the carburetor body should be given a thorough cleaning with lacquer solvent (thinner), which will remove the accumulated gums and dirt. Pour the solvent into a container and place the carburetor body in the liquid, allowing it to remain immersed for about one hour. Cover the container during this time to prevent rapid evaporation of the contents. *Caution:* Lacquer solvent is highly flammable and volatile. Remember the fire hazard, and also avoid inhaling the fumes. After cleaning with solvent, remove the carburetor body and blow out all the passages with compressed air. A bicycle pump will provide sufficient air pressure for this job. Clean

small parts by placing them in a fine-mesh wire strainer and shaking them lightly in the solvent. Never use a sharp-pointed tool or a wire to clean the passages in the carburetor or jets. The jets are calibrated to precise dimensions and any enlargement of the openings or scoring of the seats will affect the operation of the carburetor. Be especially careful when assembling jets and ball valves to make certain that dust and fine abrasive particles do not find their way into the seats and openings. Be sure that all retainers are installed with the proper gaskets. After installing the float, check the level to be sure that it agrees with the float level specified for that particular carburetor. Likewise, carburetor manufacturers provide specific recommendations for setting the metering rod and the antipercolator mechanisms, Fig. 11, as well as the automatic choke. These recommendations will vary for different makes and types of carburetors, so it's a good idea to have this information at hand for the carburetor you are servicing.

After the carburetor has been cleaned, checked and reassembled, replace it on the manifold, using the proper gasket, and drawing the mounting screws down uniformly. Connect choke and throttle controls and the fuel line. Then disassemble the air cleaner and clean it thoroughly before replacing.

Start the engine and while it is warming up, note carefully the action of the heat-control mechanism, Fig. 5. When the engine is cold, the valve is closed as in the left-hand detail and the hot exhaust gases are deflected upward and around the intake manifold. As the engine manifold warms to operating temperature, the thermostatic spring gradually loses tension, permitting the valve to open as in the center detail. Proper operation of the valve mechanism is essential as it provides a means of shortening the warm-up period and thereby reduces fuel consumption and crankcase dilution. Other points to check at the time of servicing the carburetor are the tension of the foot accelerator spring and the setting of the fast idle. On some carburetors, the fast-idle mechanism requires no adjustment, but on others there is a recommended clearance between the throttle-lever adjusting screw and its bearing point, usually a dimple on the carburetor casting. A weak spring on the accelerator permits movement of the pedal when driving over rough roads or pavement and causes the accelerator to discharge excess fuel into the air stream at the carburetor venturi. This defect should be eliminated by renewal of the spring. Occasionally, this defect alone accounts for unusually low gas mileage and unsatisfactory operation of the engine.

## Convenient Rack for Kitchen Towels Has Three Swinging Arms

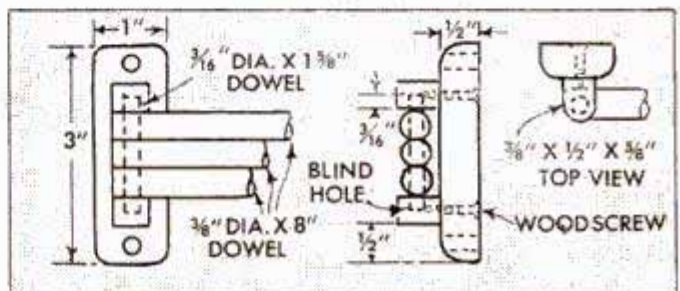

This small towel rack, the arms of which can be swung out of the way when not in use, serves as a convenient kitchen rack for drying dishcloths and towels. It can be constructed from a few scraps of 1/2-in. stock, three 8-in. lengths of 3/8-in. dowel, and a short length of 3/16-in. dowel. The corners of the base piece are rounded with sandpaper and 1/8-in. holes are drilled at the indicated positions. Blind holes in the hinge arms receive the ends of the 3/16-in. pivot pin. The holes in the 3/8-in. dowels are drilled 1/4 in. from the ends. All joints should be glued and the hinge arms fastened with flat-headed screws.

## Rivet Set Smooths Screwheads

In using a file to remove burrs from round headed screws, which have been damaged in setting, scratches from the file are often accidentally made on the work. This damage can be avoided by flattening the burrs with an ordinary rivet set instead of removing them with a file.

Simply place the set over the head of the screw as illustrated in the drawing and then tap the set lightly with a hammer.

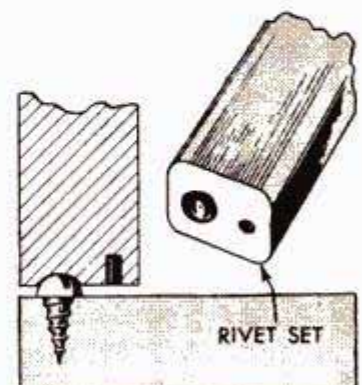

## Economically Constructed Camera-Lens Shade Specially Designed for Indoor Photography

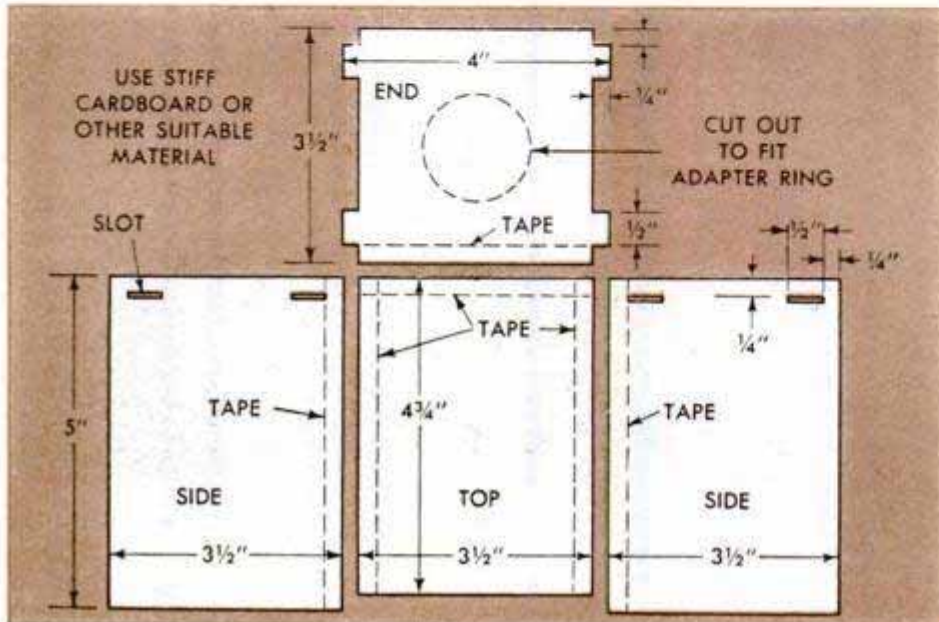
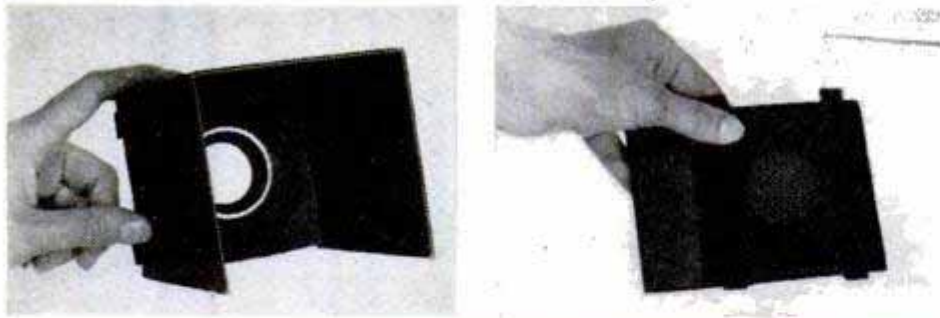

Made from heavy cardboard, such as salon mountboard, this shade is designed for the particular purpose of protecting the camera lens from floodlights placed in unusual positions. The dimensions of the shade in the detail were taken from a Kodak 620 but, of course, can be altered to fit any camera. Bear in mind that the sides and top of the shade must be out of range of the lens. The hole in the endpiece should be just large enough to admit the retaining piece of a lens adapter, as the shade is held to the camera by the two parts of the ring which grip the cardboard between them. When assembling the pieces, leave a slight space between the taped edges so they will not bind when the shade is folded. Finish the shade in dull black, using opaque water color.

## "Quick-Rinse" Solution Saves Time When Removing Hypo

When you need prints or negatives in a hurry, use a quick-rinse solution to wash away the hypo. With this solution, the work can be done in about 10 minutes instead of the hour usually necessary to do a thorough job of washing in a running-water bath. To make the solution, drop a few potassium-permanganate crystals in a container of water—just enough crystals to bring the solution to a light pink color. After pouring some of the solution in a tray, remove the prints or negatives from the hypo,

rinse them briefly in fresh water and place them in the solution. As soon as the pink color disappears from the solution, remove the contents from the tray. Then repeat with fresh trayfuls of solution until the pink color no longer disappears, and finish by rinsing the prints or negatives in fresh water. Care should be taken to keep the solution weak, as potassium permanganate is a powerful reducing agent in strong concentration.

Martin S. Dworkin, New York City.

## Crinkled Section of Metal-Foil Paper Softens Harsh Shadows on Subject

A sheet of metal foil, which has been crumpled into a ball and unfolded again, can be used as a reflector to soften harsh shadows on a subject. Hang or prop the foil in an upright position as close as possible to the subject but still out of camera range. For portraits, use several widths of foil pinned to a large piece of cardboard.

Hugh Lineback, Stillwater, Okla.

☐ A useful stand for holding a magnifying glass when doing retouching work can be made from a gooseneck-type desk lamp. Simply remove the light fixture and tape the magnifying glass in its place.

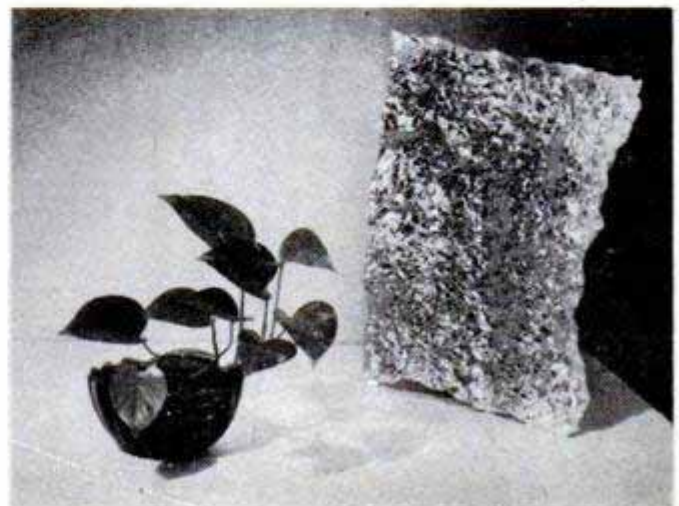

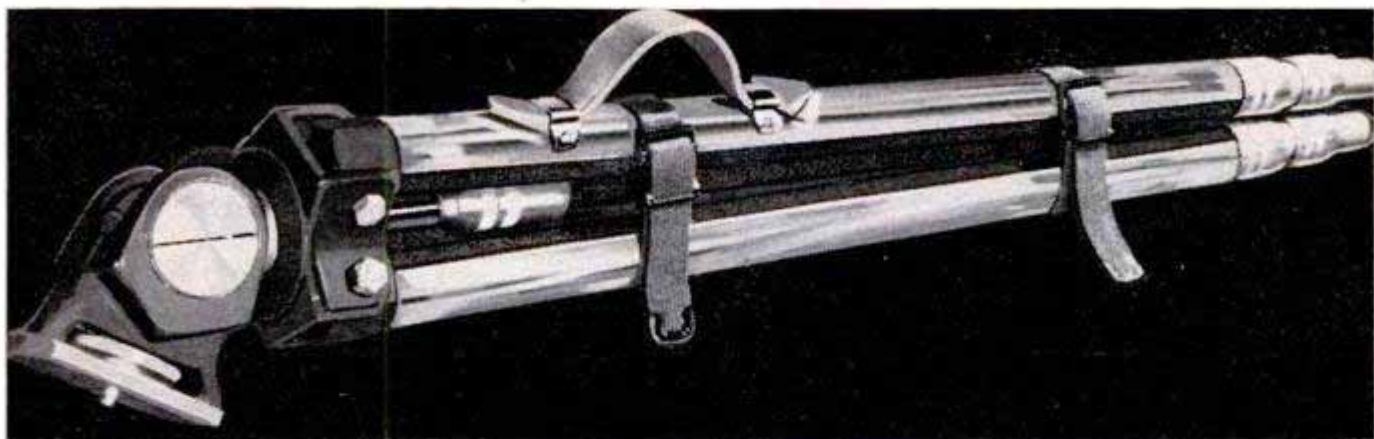

# TRIPOD CARRIER

By M. G. Winterton

AMATEUR and professional photographers will see at once the advantages of this carrier for camera tripods of the type having tubular telescoping legs. It's been specially designed to protect the tripod legs from being dented and is quickly placed in carrying position on the tripod or folded into a compact bundle when not in use. As will be seen in the two photos at the right, the carrier consists of three semicircular members attached to 12-in. lengths of cotton webbing (luggage straps) fitted with friction buckles. The semicircular members, which serve as guards, are made by cutting two pieces of plastic or aluminum tubing in half lengthwise. Measure the tripod and cut the pieces to exact length. Then space the pieces and cement or rivet the straps in place. Two sheet-metal strap guides of the type sold by luggage dealers are attached to one member with countersunk screws to hold the leather carrying handle in place. The handle can be purchased ready-made or cut from a piece of sole leather.



Plastic or aluminum tubes cut in half lengthwise fit over the tripod legs and protect the thin metal from being dented or otherwise damaged when tripod is carried folded or placed in car with other equipment

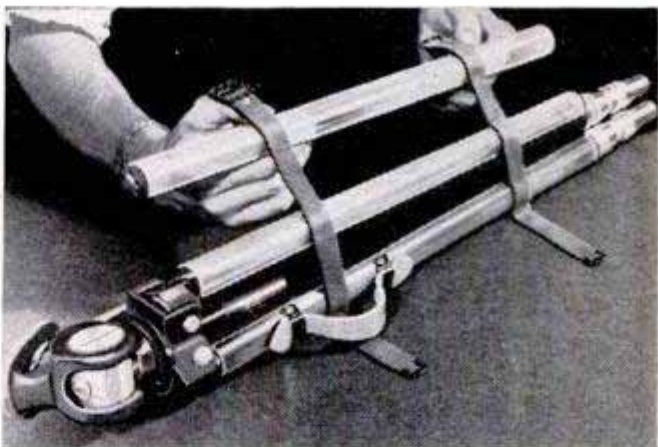

Above, cotton-webbing straps of the type used on luggage are cemented or riveted to the guards. Below, carrier folds into a small, neat bundle when not in use. Note that it is provided with a leather handle

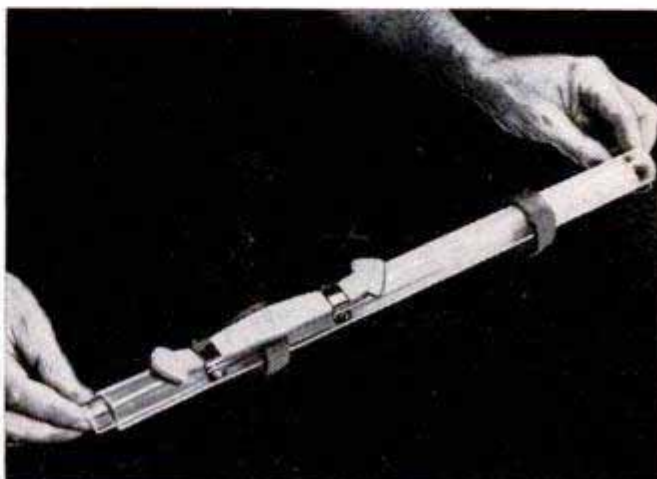
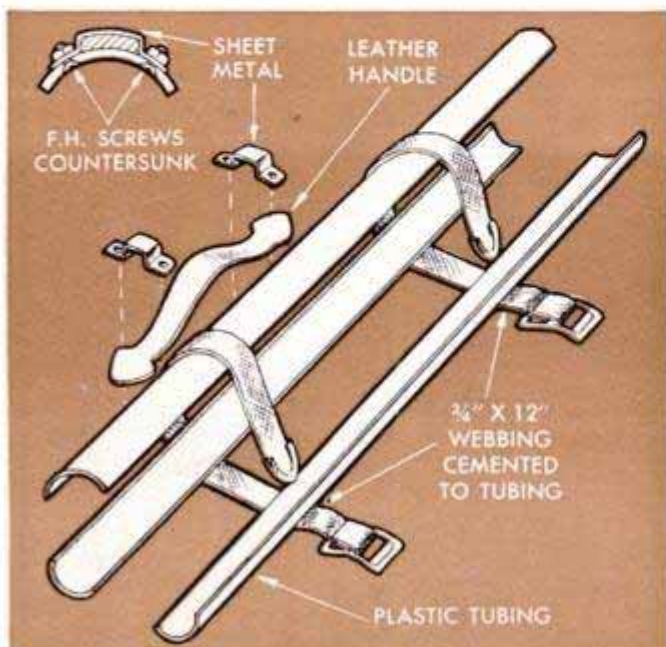

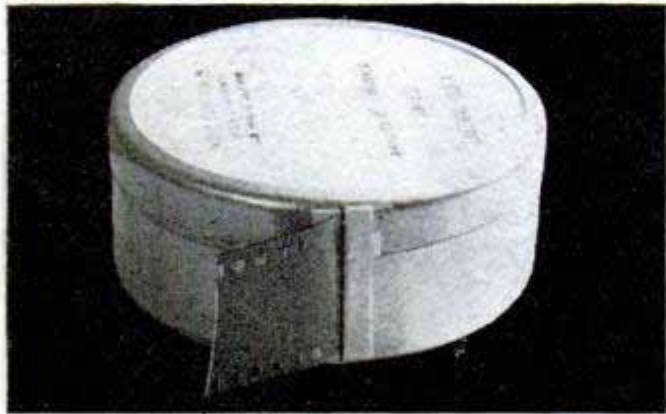
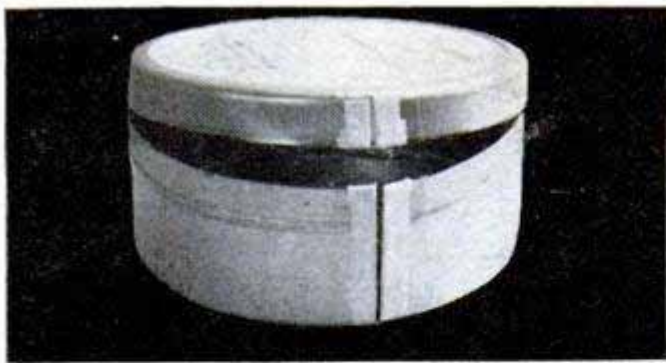

## Bulk-Film Can Serves as Dispenser For Loading 35-mm. Cartridges

If you are one of the many camera fans who buy 35-mm. bulk film and load their own cartridges, you can make the job a lot easier by converting the metal container into a light-tight dispenser. Resembling the cartridge itself, the dispenser permits attaching the film to the cartridge spool in daylight and offers the added advantage of allowing the actual loading operation, which is done in total darkness, to be accomplished without touching the film. The dispenser is made by cutting a  $\frac{1}{8}$ -in. slot in the rim of the lid and side of the can. The edges of the metal are covered with adhesive tape, after which felt or plush material is cemented over the tape. With the film placed in the can and the end protruding through the slot, the lid is sealed with adhesive tape and the dispenser stored in a lightproof drawer or box.—Virginia M. Schwarting, Oak Terrace, Minn.

## Negatives Placed in Business Envelope Are Pressed Flat With Heavy Book

Preferring to work with flat negatives, one photographer presses roll film before printing. As soon as the negatives have dried after developing, the film is cut into strips to fit an ordinary business envelope. Then the strips are placed in the envelope and weighted with a book. The film is left in the envelope and under continuous pressure until needed for printing. Thus the negatives are protected from scratches and kept free of dust and at the same time are flattened for easier handling.

Robert Hertzberg, Jackson Heights, N.Y.

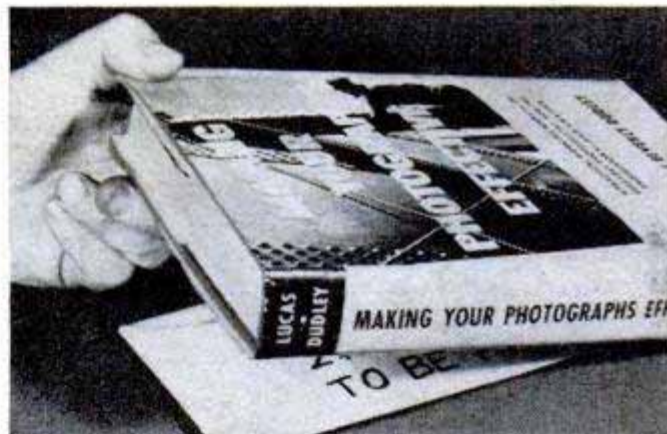

## Popular Mechanics Book Shop

### Veterinary Guide for Farmers

Every person who owns livestock, or who is interested in animal husbandry, should have this book. It will not only enable you to save the lives of high-priced animals and reduce veterinary bills, but it also will provide a vast source of self-instruction for the student veterinarian. Although the first edition contained 288 pages of almost priceless information, the second edition, now available, has two additional chapters on diagnosis and injection, plus an expanded chapter on hog cholera. Its price of \$3.50 is, in most cases, less than the cost of one visit of a veterinarian.

### What to Make With Concrete

If you own your home, live on a farm, or do construction work, this book will enable you to do many concrete jobs yourself and save cost of labor. For example, there is a long

article telling how to use, mix and pour concrete; another on repairing a leaky basement; one on making a concrete-block machine and one describing how to put in a sewage-disposal system for rural homes. In addition to these, there are hundreds of projects on making sidewalks, driveways, etc. The saving on just one simple concrete job will more than equal the price of \$2.00 for this book.

### Welding, Brazing and Soldering

Packed from cover to cover with information helpful to the welder, as well as to the inexperienced man, this book will enable you to do many jobs that often prove to be puzzlers. For the beginner, it shows how to do welding, brazing and soldering jobs, and even how to build some of the equipment. It is a must for anyone having this kind of work to do. Home-owners will find it ideal for those odd jobs of repairing. The book is priced at only \$1.75.

Books available from Popular Mechanics Book Dept., 204 East Ontario Street, Chicago 11

60 Bower  
Tools

S.N. 53187

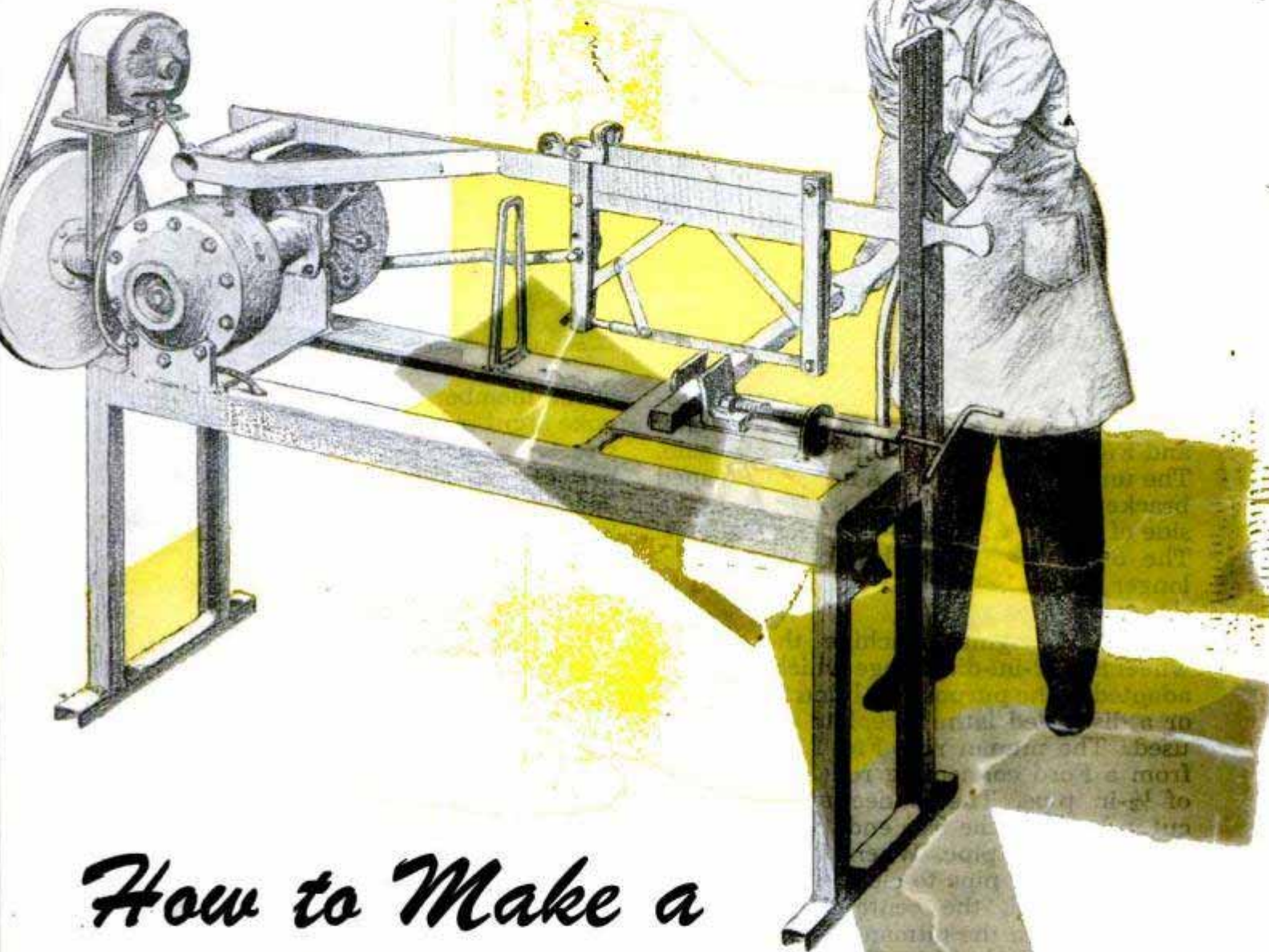

## How to Make a **POWER HACKSAW**

By **L. H. Houck**

**B**Y UTILIZING stock materials, a car differential and other odds and ends, you can easily duplicate this heavy-duty power hacksaw. It's a big, husky machine capable of handling heavy shop work, as well as light jobs where accuracy is required. It uses standard 14-in. power-hacksaw blades and operates with a 10-in. stroke at a speed of 100 strokes per minute. The sturdy floor-type base is of all-welded construction and is 14 in. wide, 28½ in. high and 54 in. long. The top rails of the base are cut from 3-in. steel angles, mitered at the ends

and welded to form a rectangular frame. Legs and foot pieces are of 2½-in. steel channel.

The right-angle reduction drive utilizes a Model-A Ford differential and a part of one axle housing. The opposite housing is cut off at the bell, or flare. If desired, a steel plate can be welded over the opening. The differential spider is locked by welding. Both the drive shaft and the housing are shortened, but the exact length is not given as it is determined to some extent by the type of motor used and the size of the

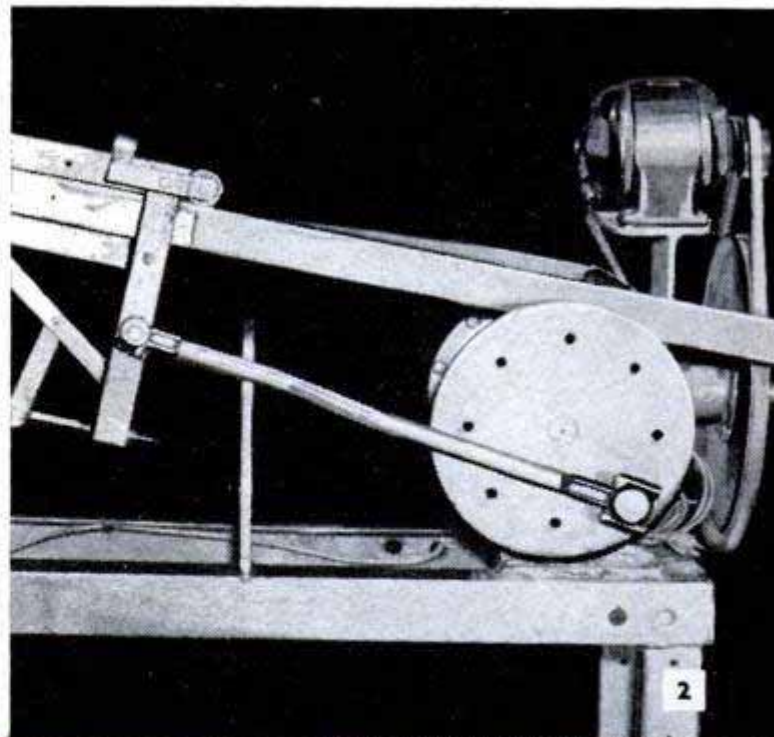
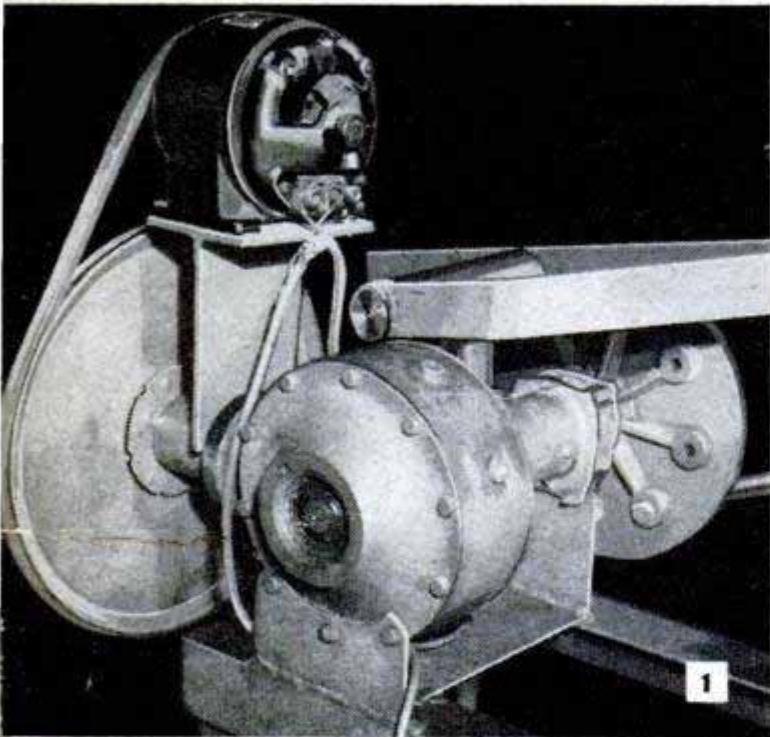

Photos courtesy Lincoln Electric Co.

motor stand required. Fig. 1 shows the completed drive unit from the differential end, and Fig. 2 shows it from the opposite side. The unit is supported in a heavy U-shaped bracket, one leg of which is bolted to the side of the differential housing as in Fig. 1. The other leg of the bracket is a little longer and is bolted to a flange welded to the axle housing.

On the original machine the pitman wheel is a 12-in.-dia. flange which has been adapted to the purpose. A blind pipe flange or a discarded lathe faceplate also can be used. The pitman rod, Fig. 2, is built up from a Ford connecting rod and a length of  $\frac{1}{2}$ -in. pipe. The connecting rod is first cut in half and the free ends are welded to the ends of the pipe. When the offset bend is made in the pipe to clear the rim of the pitman wheel, the center-to-center distance between the pitman bearings should be approximately 25 in. The crank pin for the large end of the pitman is made by turning and shouldering a short piece of cold-rolled steel shafting. The small end of the crank pin is threaded and the large end is center-drilled and tapped for a machine screw. In assembling, the shouldered end of the pin is inserted in a hole drilled in the pitman wheel and a nut is tightened on the threaded end to hold the pin permanently in place. The pitman bearing is held on the pin by means of a flange cut from  $\frac{1}{8}$ -in. flat steel and center-drilled to take the machine screw which is turned into the tapped end of the pin. On the original machine, the small end of the pitman pivots on a wrist pin (Ford) which is welded to the saw frame. The arrangement detailed in Fig. 5 also can be used.

The slide, Fig. 5, is 63 in. long and is cut from  $\frac{7}{16}$  x  $1\frac{1}{2}$ -in. cold-rolled stock. The

offset member which forms the pivoted yoke is cut from stock of the same sectional size. A 6-in. length of  $\frac{1}{2}$ -in. pipe welded between the arms of the yoke forms the bearing. The pivot pin is made by shouldering an 8-in. length of  $\frac{3}{4}$ -in. steel shafting and drilling the small end transversely for a cotter pin, as in the lower detail, Fig. 4. The free end of the slide is held in alignment by means of a guide which is shown in the illustration on page 197. This consists of two 30-in. lengths of  $\frac{1}{4}$  x 2-in. flat steel spaced  $\frac{5}{16}$  in. apart and having the lower ends welded to the frame as shown. The top ends are joined by welding a cross-bar of  $\frac{1}{2}$  x  $\frac{1}{2}$ -in. stock to both members.

The saw frame, Fig. 5, has two unique features. One is the use of a spring-loaded roller at the rear end of the saw frame which helps to equalize the strain on the blade as the frame changes direction at the end of the stroke. The other is the variable distance between the parallel guides indicated by the dimension  $1\frac{1}{16}$  in Fig. 5. This dimension refers to the variable space between the guides and has no dimension lines. Variability is achieved simply by drilling the holes in the top ends of the uprights slightly oversize, so that the bolts can be loosened and the guides adjusted to compensate for wear. Although identified as a roller bearing in Fig. 5, the roller can be any suitable ball bearing mounted in a simple fixture consisting of two flat-steel yokes welded together at right angles. The vertical yoke is fitted with a short coil spring which bears on the upper guide, Fig. 2. Note in Fig. 5 that the front uprights of the frame have offset bends at the lower ends, but that the rear uprights are straight. When the frame is assembled the space between the offset bends is just sufficient to



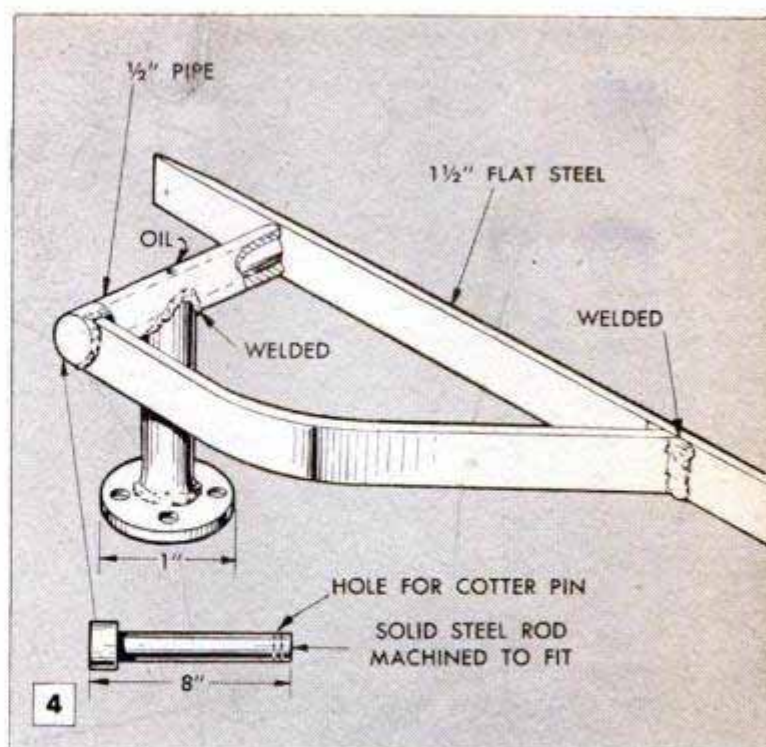
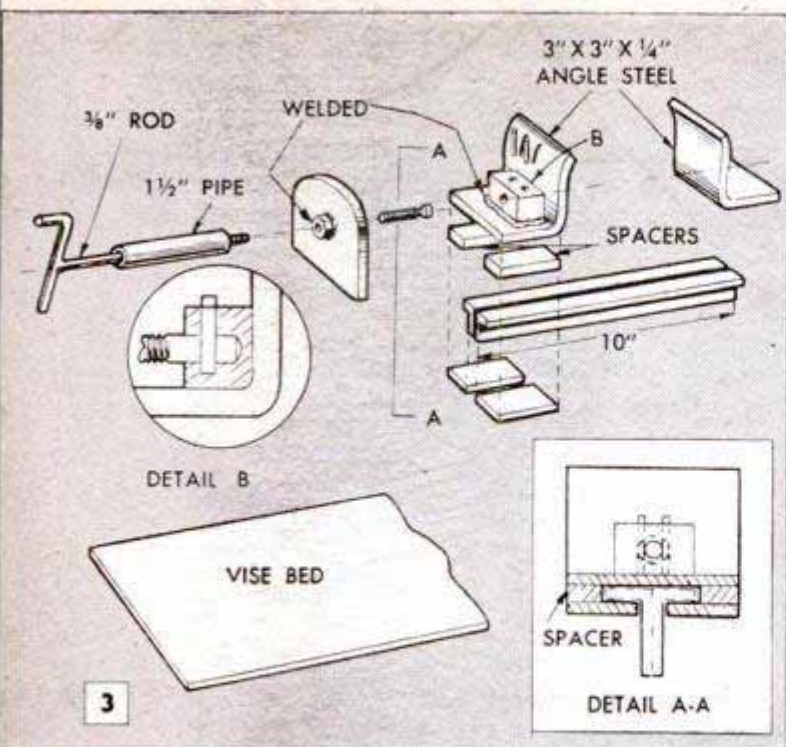

permit insertion of the saw blade. The rear end of the blade is supported by a yoke attached to a threaded rod fitted with a wing nut and washer. After attaching the forward end of the blade to the frame, the opposite end is raised so that the hole in the end registers with a hole in the angle support which is riveted to one of the braces. Then the arms of the yoke are placed over the blade and support and a pin is inserted through the holes in the three members. Finally, the yoke is pulled upward until the threaded rod fits between the straight ends of the frame uprights. Then the wing nut is tightened onto the washer to bring the blade under tension. The rear end of the frame with the blade locked in position is shown in Fig. 2.

Construction of the vise is detailed in Fig. 3. Sectional details A and B show clearly how the slide and the movable jaw are assembled from small pieces of angle and flat steel. Note that in Fig. 3 the vise screw, which is built up from  $\frac{3}{8}$ -in. steel rod, is shown broken for clarity. The finished vise is welded to a bed plate. This, in turn, is welded to the base of the machine. Drive with a  $\frac{1}{4}$ -hp., 1725-r.p.m. motor, using a 3-in. motor pulley and a 15-in. pulley on the reduction gear. As the final finishing step, weld a stop to the horizontal member of the base about midway between the vise and the gear to prevent the slide and saw frame from dropping when the blade cuts through the work. Use a length of steel channel or a bent rod for the stop.

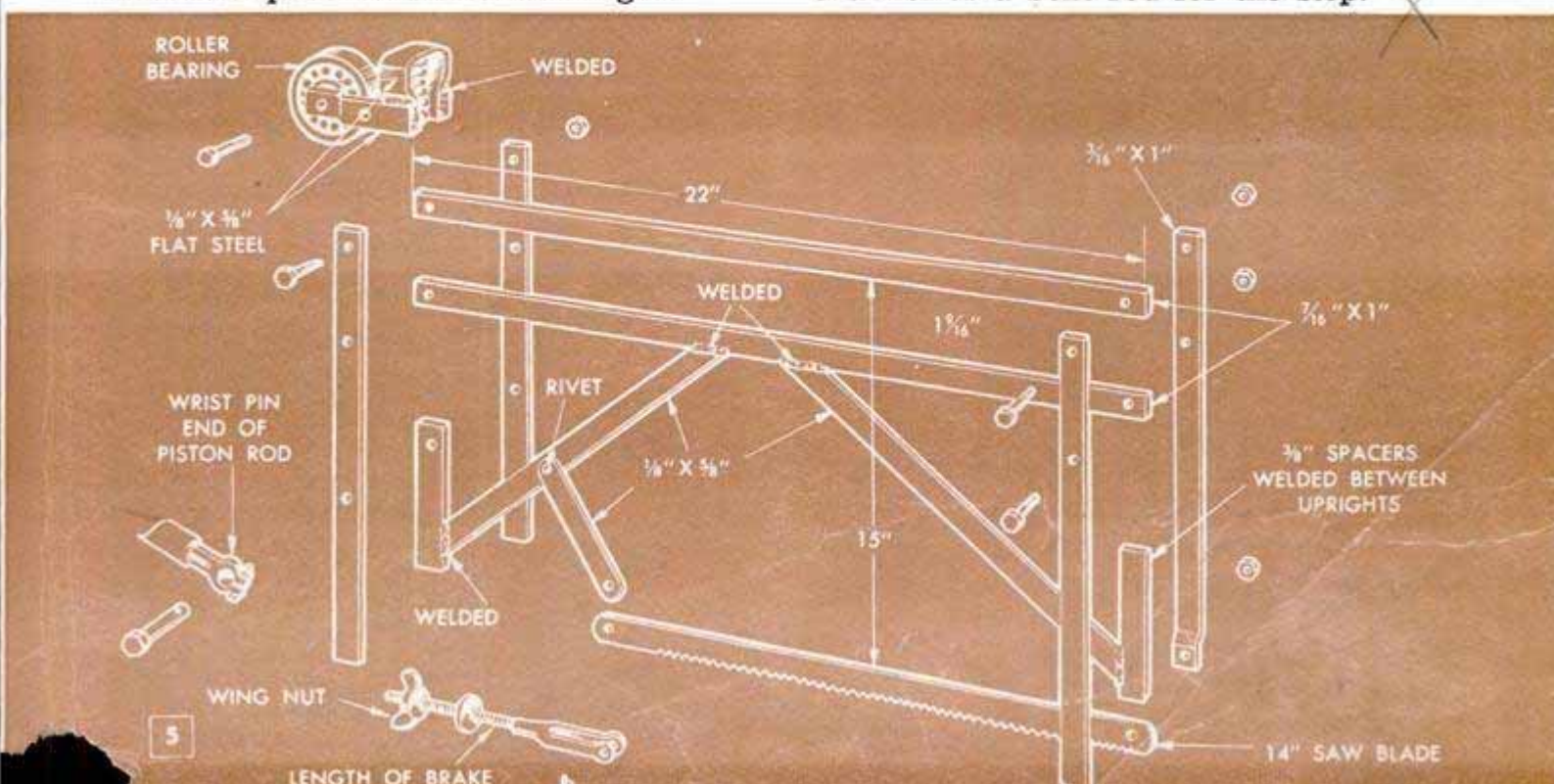

## "Rocker" Mount for Oil Drum Permits Easy Pouring



Pouring oil or gasoline from a large drum into a small vessel is no trouble at all with the aid of a "rocker" mount such as the one illustrated. Mounted on the rocker, the drum can be tilted easily to any position. In an upright position, the drum takes up little space and prevents the possibility of leakage from the spout. The rocker is built in the fashion of a sled with the runners being made of 2 x 12-in. planks, each cut at an angle from one corner to a point near the center. These are bridged by a 1 x 4-in. crosspiece at the top and a 1 x 12-in. board at the bottom. The stop, a 2 x 4 nailed on edge across the bottom of the rocker, is braced by lengths of 1 x 3. A length of heavy wire is used to lash the drum to the rocker.—E. V. Reyner, Townsend, Mont.

## Stops Clamped to Hacksaw Blade Control Depth of Cut

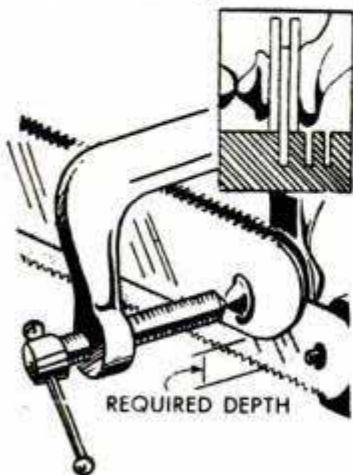

With no milling machine available, the job of removing material from a 1/2-in.-square bar of steel to a depth of 1/8 in. to form a shoulder can be a real poser, especially if the job must be done accurately. One mechanic turned the trick by clamping two hacksaw

blades to the blade in the hacksaw frame with the teeth up as shown. The inverted blades were adjusted to serve as stops so that the regular blade would cut to a uni-

form depth of 1/8 in. as required. Then a series of cuts were made in the waste, the cuts being spaced 1/8 in. apart from the end of the bar to the shoulder. This operation removed almost half of the waste to a uniform depth, making it easy to finish up accurately with a file without rounding the flat surface even slightly.

Arthur F. Hird, Worcester, Mass.

## Builder's Blueprints Held Flat With Screen-Door Catches

Builder's large blueprints are always troublesome to hold when unrolled for study on a table top. Dispensing with the usual weights, tacks and strips, one builder attached screen-door

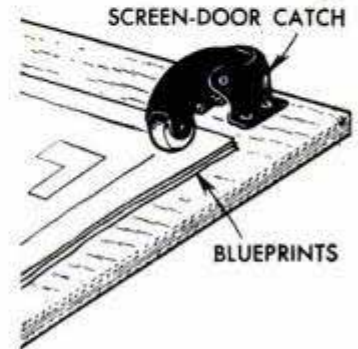

catches of the spring type to the corners of the blueprint study table. When unrolled, the corners of the blueprints are placed under the catches, which hold them flat and smooth for convenient reading.

Victor H. Lamoy, Upper Jay, N. Y.

## Milking-Machine Extension Cord Travels on Overhead Line

A long extension cord, run through shower-curtain hooks that are hung on an overhead wire, can be extended the entire length of a milk barn to supply constant power to a milking machine. At equally spaced intervals, the cord is pressed into the narrow part of the hooks where it is gripped and held securely. When not in use, the cord is easily slid to one end of the line. The overhead wire, about No. 9, is strung from eyebolts at each end of the barn and is equipped with turnbuckles for taking up slack when necessary.

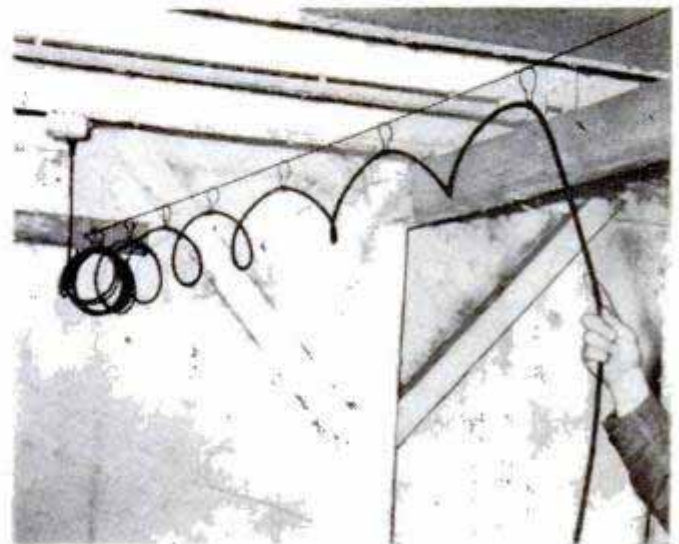



X517

# "TQ"—A SPEEDY MIDGET RACER

By Thomas E. Stinson, Jr.

WTM 53

Powered by a two-cylinder motorcycle engine, pint-sized "TQ" performs spectacularly on one-sixth and one-eighth mile dirt tracks

ACCORDING to Jerry Wright, President of TQMRA, the Three-Quarter Midget Racing Association, this little Three-Quarter racer has been purposely chosen from among several similar types because it is the easiest to build from parts which are readily available. The specifications meet all TQMRA track requirements for maximum engine displacement, wheelbase, tread and weight. Engine classifications, based on stock-motorcycle engines are: flathead, 45 cu. in.; two-cam, 30.50 cu. in.; single, 34 cu. in. and two-cycle, 30.50 cu. in.

Building "TQ" is mostly a cut-and-try job from start to finish, but it's

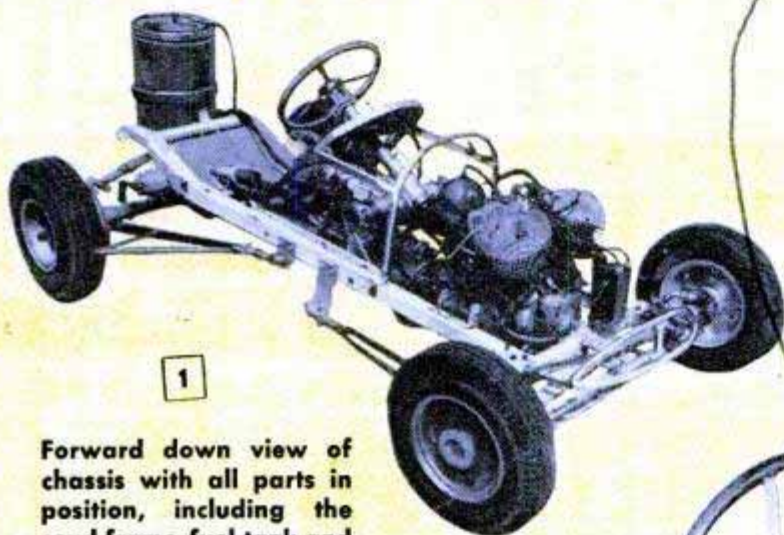

1

Forward down view of chassis with all parts in position, including the cowl frame, fuel tank and sheet-metal seat bottom. Belly pan is not shown

14543 Longworth Ave.  
Norwalk, Calif

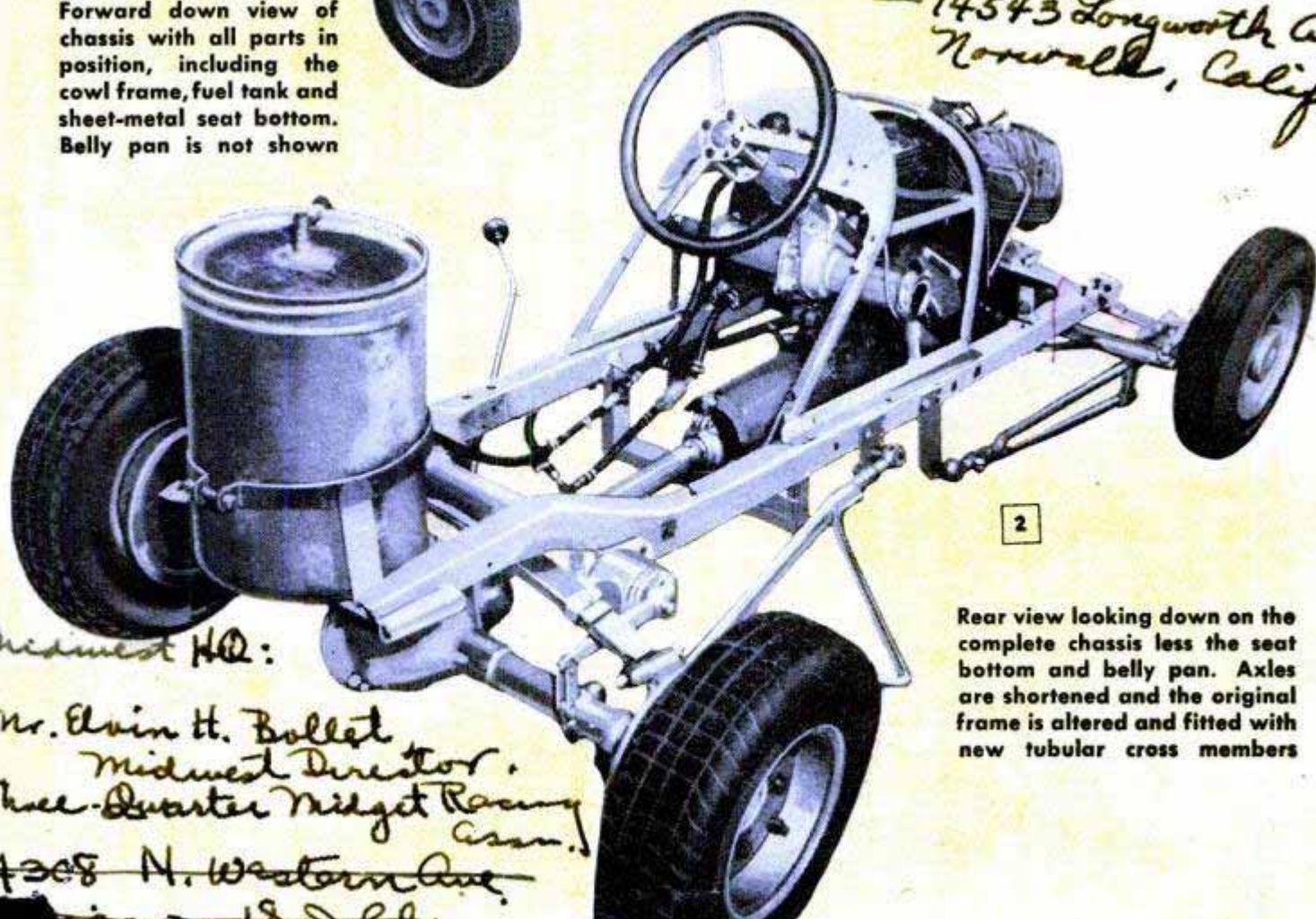

2

Rear view looking down on the complete chassis less the seat bottom and belly pan. Axles are shortened and the original frame is altered and fitted with new tubular cross members

Midwest HQ:

Mr. Elvin H. Bollet  
Midwest Director,  
Three-Quarter Midget Racing  
Assn.  
4308 N. Western Ave.  
Chicago, Ill.

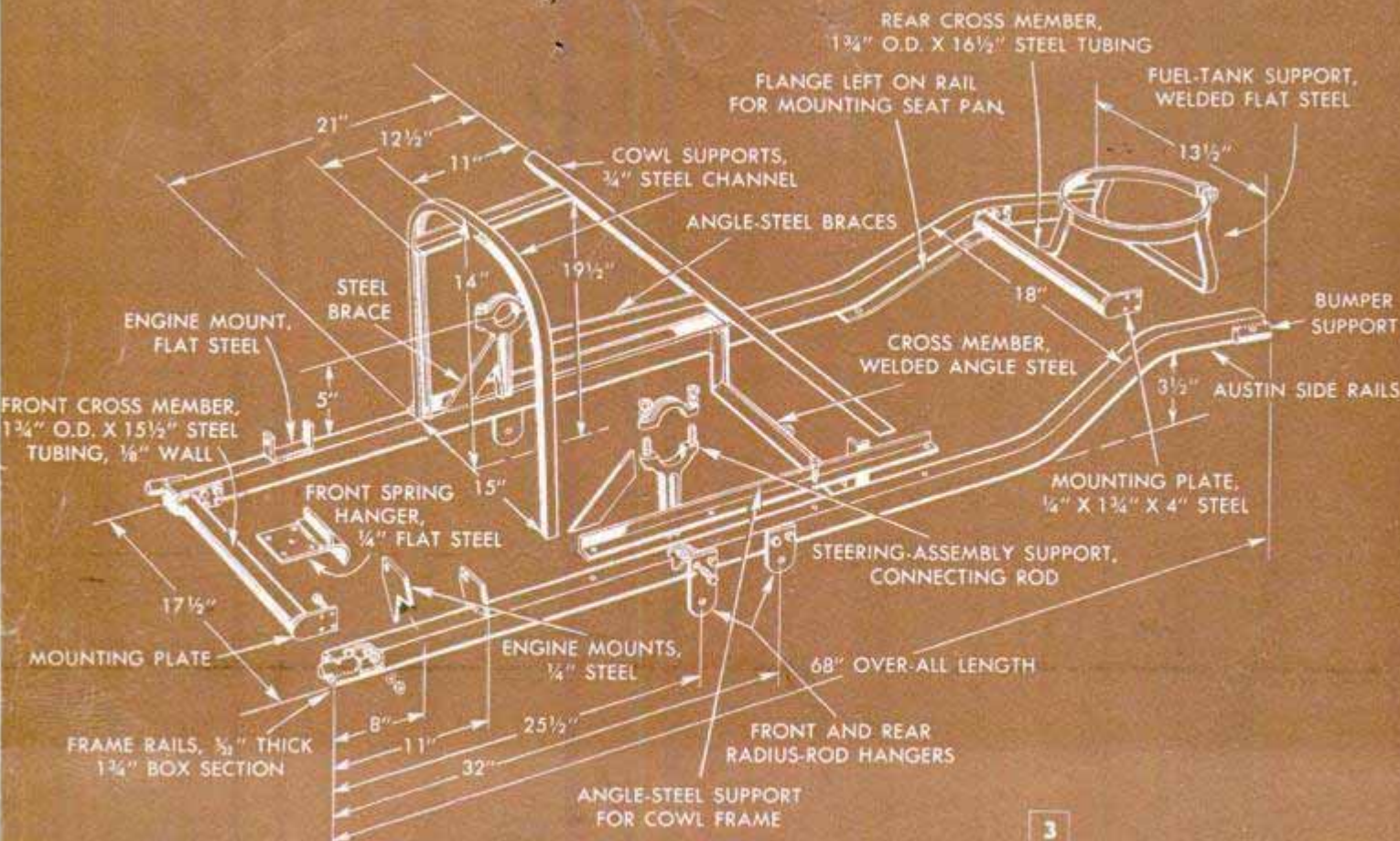

made somewhat easier by the latitude allowed in the tread and wheelbase, and also in the permissible weight variation. The wheelbase, Fig. 4, B, may range from 54 to 60 in. and the tread, Fig. 4, A, from 32 to 40 in. The total weight of the car ready for the track must not be less than 350 lbs., or more than 650 lbs. These are the specifications for the TQ-class racer and the allowable variations must not be exceeded.

The chassis, Figs. 1 and 2, is assembled mostly from American Austin car parts, but a number of parts from the Crosley car may be employed, including the frame. However, parts of the Austin car are somewhat more adaptable. You'll require the car frame, springs, radius rods, rear axle, transmission, drive shaft, drag link and wheel hubs, all in good condition. Only the side members of the Austin frame are used. Cross members and bolt lugs are removed and new, shorter cross members of steel tubing are substituted, Fig. 3. Note that

steel mounting pads, or plates, are welded to both ends of each cross member. Fig. 3 also shows a center cross member of angle steel in place. Neither this member, nor the rear tubular cross member is installed until the work on the chassis has progressed further. In all construction details, dimensions of the parts, which indicate length and sectional size, are only approximate. Because of the nature of the assembly, and the fact that even stock parts must be altered to suit, considerable hand fitting will be necessary at the time of installation.

Now, with the rear cross member temporarily bolted in place, make and fit the cowl frame, Figs. 3, 5 and 6. The vertical member, or bow, is made by heating and bending 3/4-in. steel channel to a radius of approximately 7 1/2 in. Cut off the legs to give the bow a height of 14 in. The slanting bow, which forms the forward edge of the cockpit, is bent to a radius of about 9 1/2 in., and the lower ends of the bows are welded

The tread, dimension A, can range from 32 to 40 in., measured from center to center of the tires. Wheelbase, dimension B, can be varied from 54 to 60 in. Total weight not less than 350, nor more than 650 lbs.

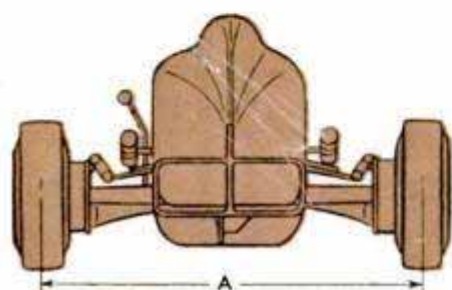

4

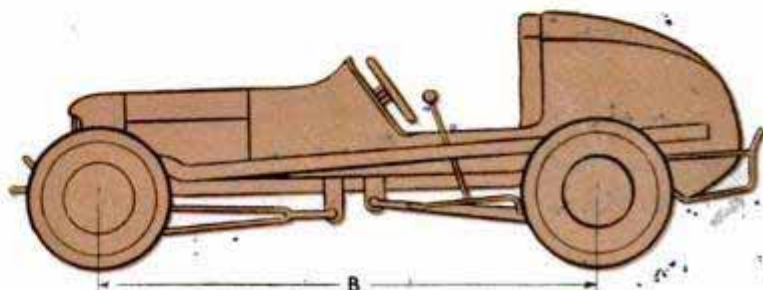

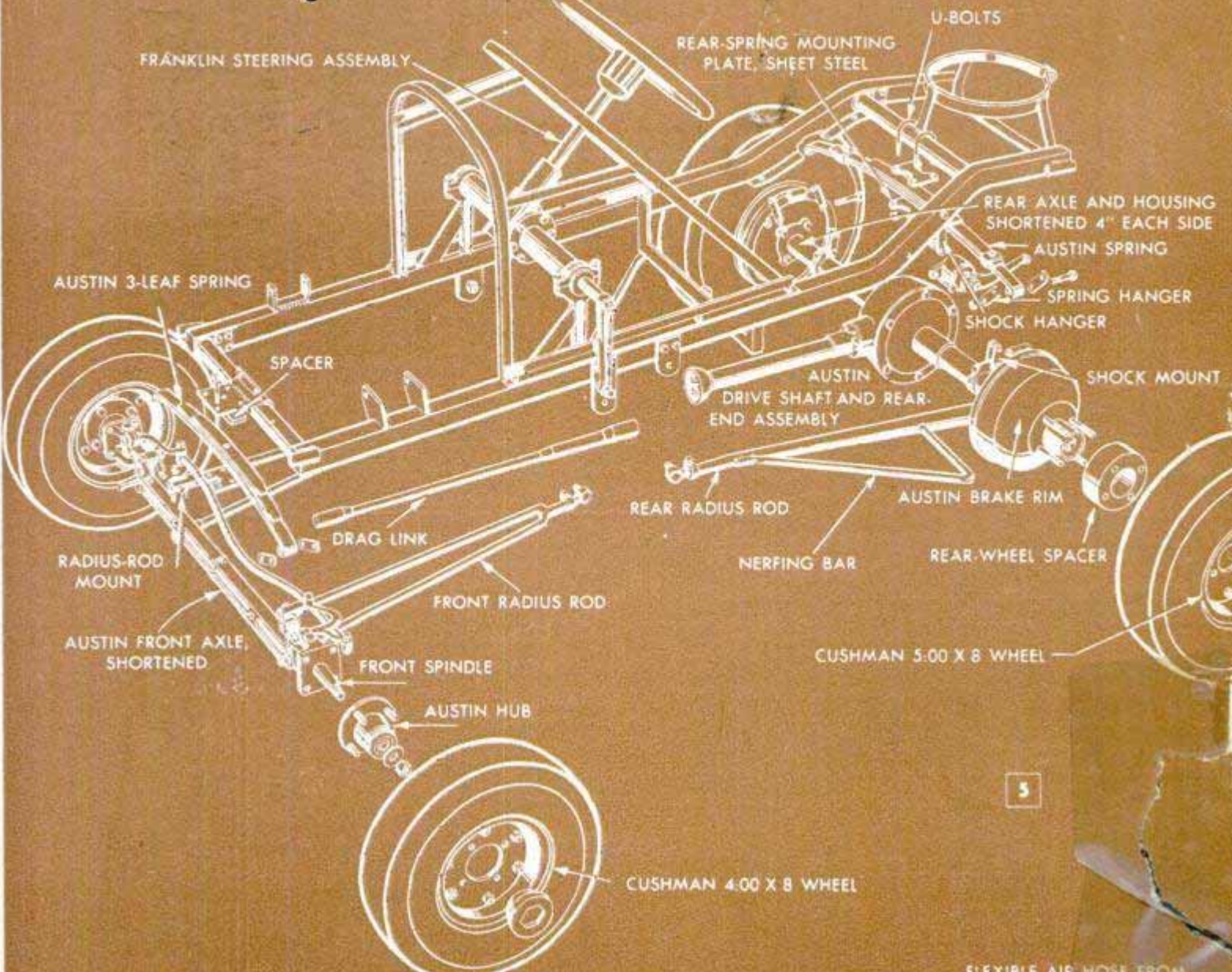

5

FLEXIBLE AIR HOSE FROM HAND PUMP, NOT REQUIRED IF FUEL PUMP IS USED

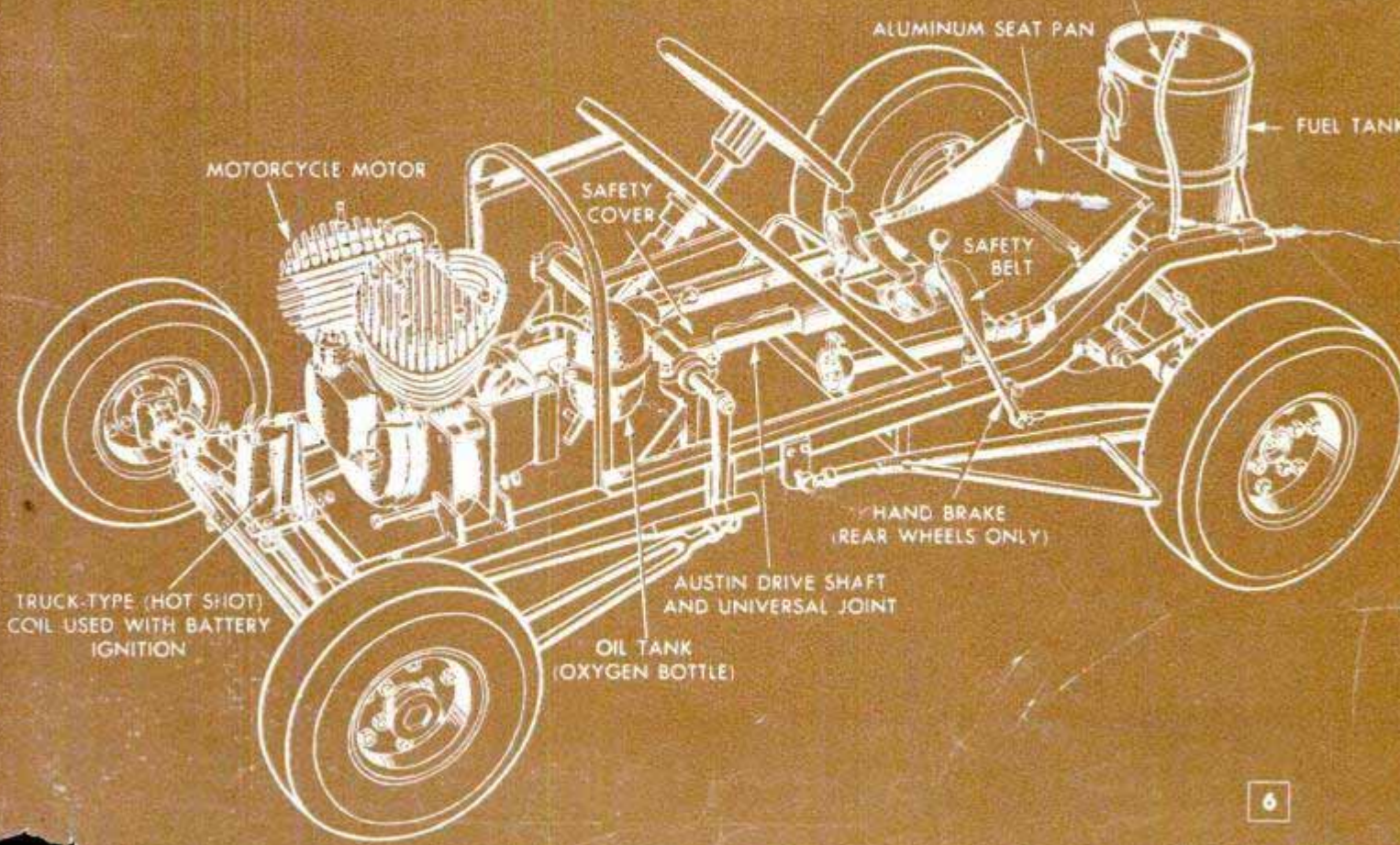

6

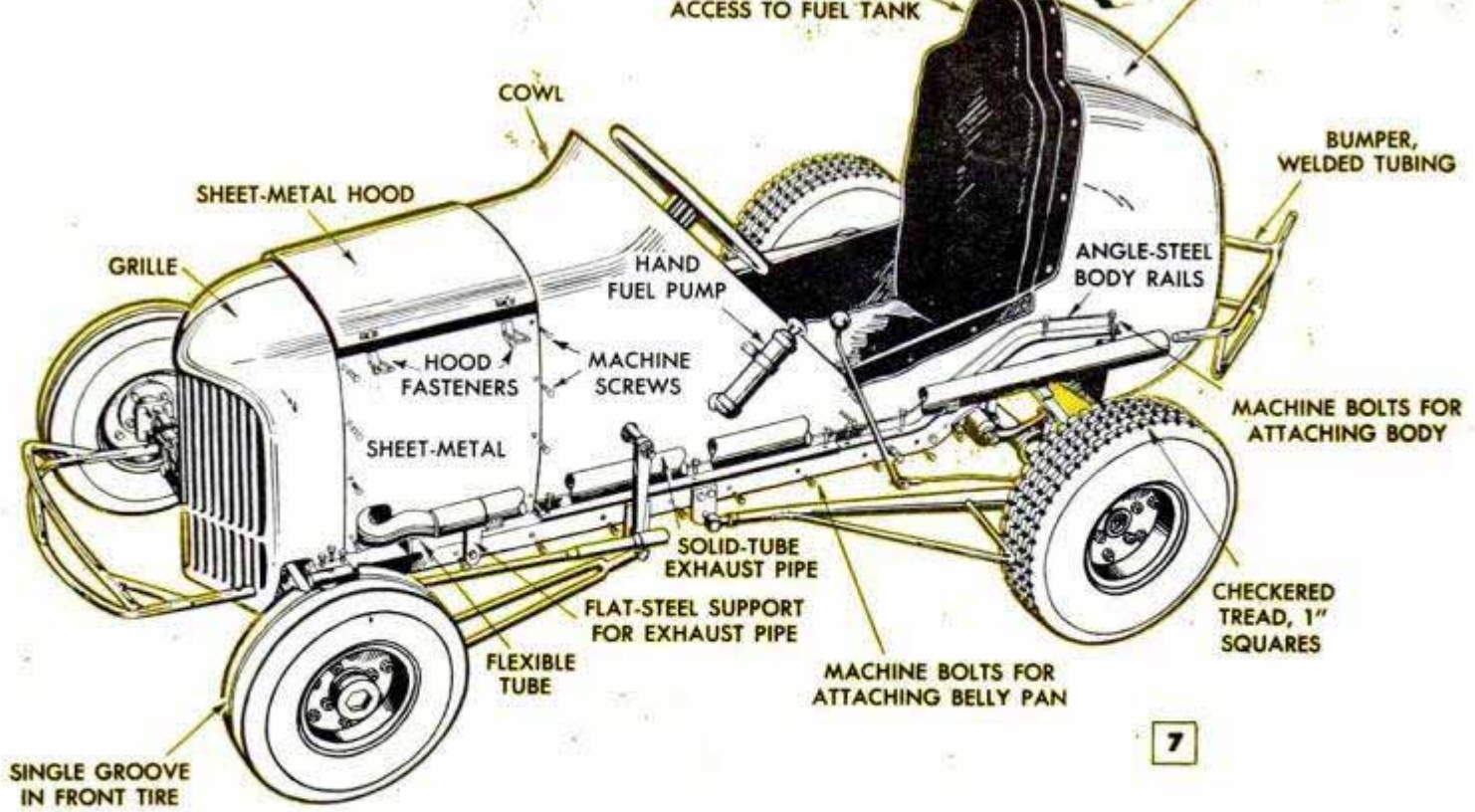

7

to the angle-steel supports which are bolted to the frame. Angle-steel braces are welded in to join the two bows near the top. Don't bolt the cowl frame in place until the steering gear has been installed and the engine located in the frame.

The Cushman 5:00 x 8 wheels won't fit over the brake drum of the Austin axle, nor will the mounting holes in the wheels fit the studs of the axle hub. Because of this, it will be necessary to run welds over the original holes and drill new ones. Steel spacers, 1 in. thick, are turned down to fit inside the wheel rims and are bored and drilled to fit over the mounting studs and the hub, Fig. 5. After these parts have been made and fitted, disassemble the axle, cut out a 4-in. section from each housing between the brake-drum mounting flange and the bell end and reweld. This step should reduce the tread to the 40-in. maximum allowed by the racing rules. Next, cut each axle to the required length, retaper, key and thread the end. Then weld the differential gears together to provide a locked rear end. Assemble the axle ready for mounting on the frame. Next, assemble the front wheels on the hubs and measure the amount to be cut from the front axle. After cutting out a section and rewelding, reinforce the axle by welding a piece of  $\frac{1}{2}$  x 1-in. steel, 6 in. long, to the axle web.

The front-spring hanger, or perhaps more properly, mounting pad, is made from  $\frac{1}{4}$ -in. flat steel with one end heated and bent to the same radius as that of the tubular cross member to which it is welded. The short length of steel angle welded to the top of the pad serves as a mounting lug for the hot-shot-coil holder, Fig. 6. Four clearance holes for  $\frac{5}{16}$ -in. machine bolts are drilled near the corners of the

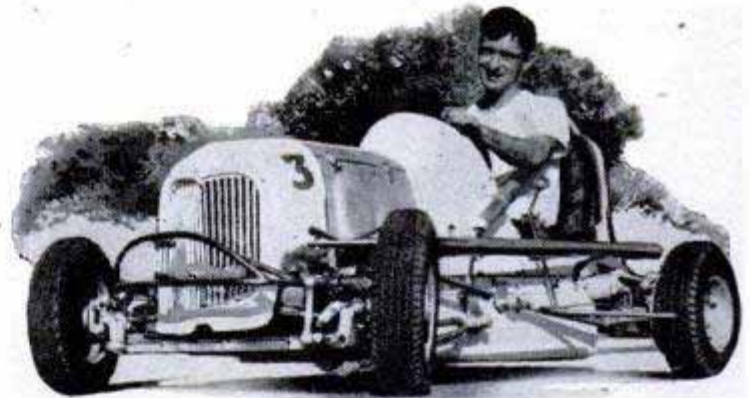

8

Above, low, racy lines of the finished car. Below, minimum ground clearance is essential

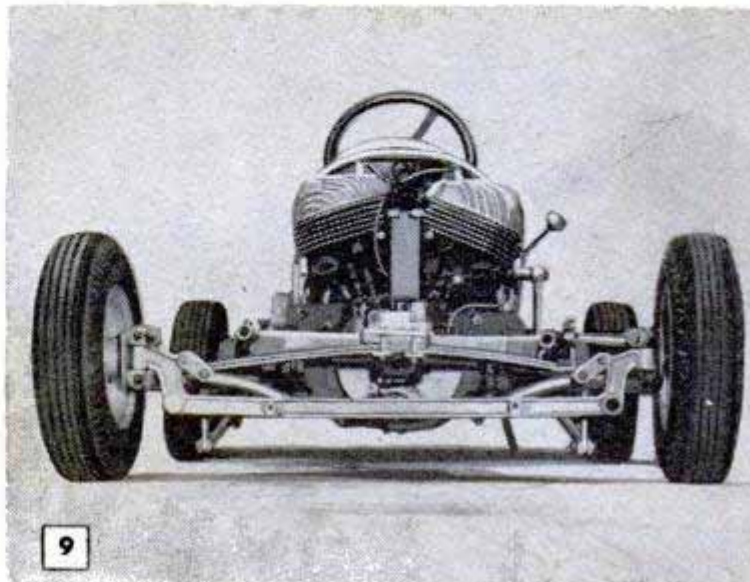

9

mounting pad and the clamping plate, and a fifth hole large enough to admit the hex nut on the spring-assembly bolt is center-drilled through the clamping plate, and also through the spacer, Figs. 5 and 9, to admit the head of the bolt. The rear spring is mounted between a pair of  $\frac{1}{4}$  x  $3\frac{1}{2}$  x 4-in. steel plates shaped and drilled for U-bolts which clamp over the rear tubular cross member, Fig. 5. The upper plate is welded to the tubular cross member. It will be necessary to shorten the main leaves of the front and rear springs and form new eyes. Use three leaves in the front spring and four or five in the rear spring. The original spring perches on the front axle are used but, because of the manner of mounting the rear spring, it will be necessary to provide new perches. Generally, the original spring hangers, or shackles, can be used. Shock absorbers from a 1940 Ford car are mounted on steel brackets welded to the frame approximately at the center of the kickup, or bend, near the rear of the frame. The shock arms are shackled to special lugs fitted to the rear-axle housings, Fig. 5.

At this stage the front and rear radius rods and the steering gear can be fitted in place. Dimensions in Fig. 3 locate the mounting lugs for the radius rods. Flat-steel mounts for the yoke ends of the front radius rods are welded to the front axle and nerfing bars are welded to the rear rods before assembly. Although you can use either an Austin or Crosley steering gear, the Franklin gear specified in Fig. 5 is preferred because of its quick action. The gear is fitted with housings cut from  $1\frac{1}{2}$ -in. O.D. steel tubing and brazed to each side of the gear case, Fig. 5. The steering unit is supported by a pair of Ford connecting rods. The pin end of each rod is cut off and the

rod is then welded and braced to the chassis frame as in Fig. 3, with the big end up. The type of steering wheel used is optional with the builder. Both the steering tie rod and drag link must be shortened.

The engine mounting brackets, Figs. 3, 5 and 6, must be adapted to the type of engine used. Because of this, neither the size nor the location of the brackets on the frame is given. Usually, it is best to install the drive shaft and transmission before locating the engine. Remove intermediate gears from the transmission, but leave the jackshaft and its sliding gear in place. A simple in-and-out gearbox is all that is required for racing, as no clutch is used. Cut down the Austin drive shaft and fit the shaft and universal to the rear of the transmission. The rear end of the transmission and drive shaft are supported on a U-shaped bracket made from several short lengths of steel angle welded together to form the required shape. This bracket will be seen in Figs. 2, 3, 5 and 10. Where the engine is rigidly connected to the transmission, Fig. 13, a supporting bracket for the forward end is not necessary. However, if a universal is used between the engine and transmission as in Fig. 12, then it will be necessary to provide a U-shaped bracket which can be bolted to the engine crankcase and to the forward end of the transmission. Some experienced drivers prefer the rigid connection between the engine and transmission as they say it reduces frictional losses. In either case, the connection between the engine crankshaft and the transmission shaft is made in the same way. The drive sprocket supplied with the engine is removed and welded to a  $\frac{1}{4}$ -in. steel disk which has been centerbored to clear the nut that holds the sprocket on the crankshaft.

**Fuel and air lines are made from copper tubing and encased in rubber hose to prevent vibration and leaks**

**Although magneto ignition can be used, battery ignition is recommended by nearly all good drivers**

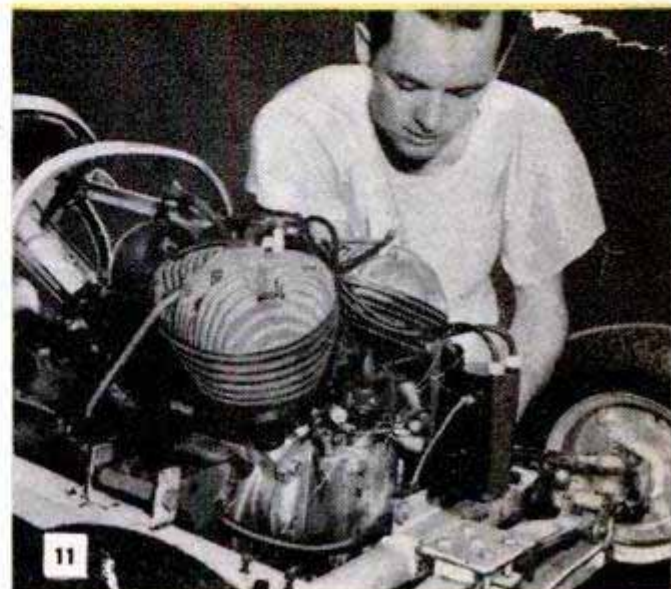
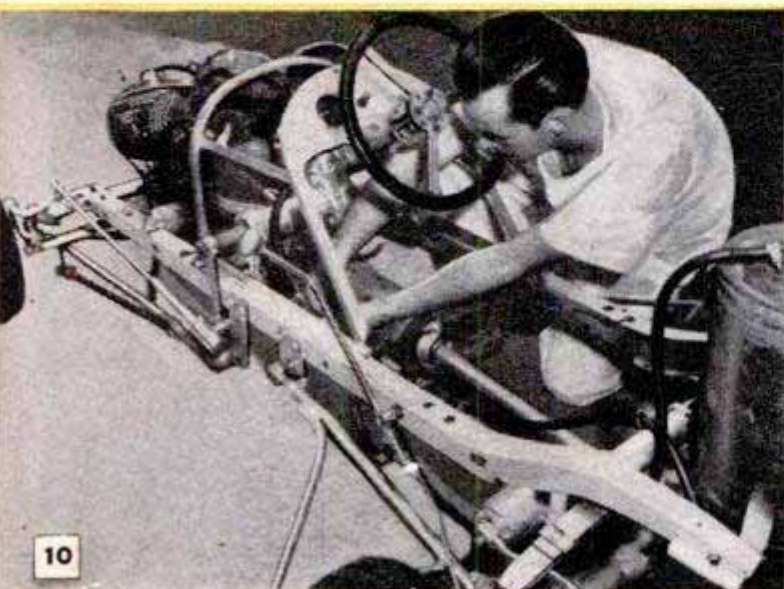

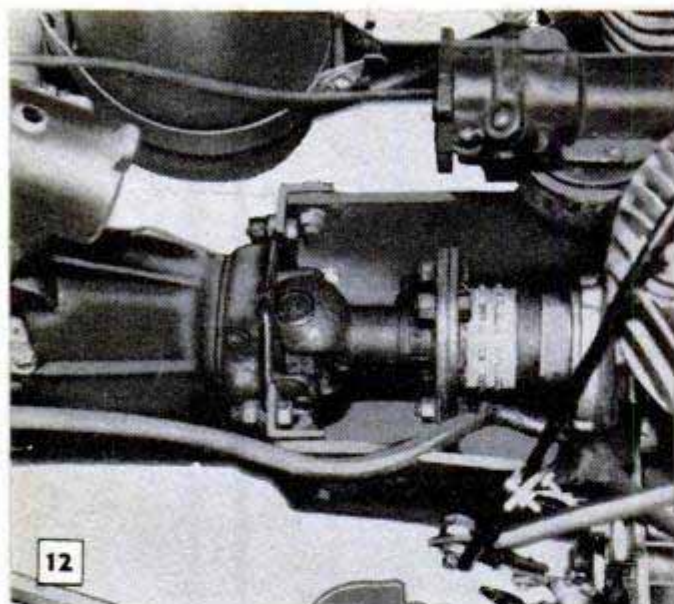

Equally spaced holes for machine screws are drilled concentrically near the edge of the disk as in Fig. 13. This disk is now used as a jig to drill holes through a second disk on the same spacing. The latter is then welded to the squared end of the transmission shaft. To assure that it is centered on the shaft, turn a recess into one side of the disk to a depth of  $\frac{1}{16}$  in. The diameter of the recess should be slightly oversize to admit the shaft in an easy fit. Then run a fillet weld all the way around the shaft. Final alignment of the parts should be carefully checked before the engine is bolted permanently in place on its mounting brackets.

At this stage the chassis is practically complete. There remain only the fuel tank, hand brake, bumpers, engine oil tank and the cowl frame, which is not yet bolted in place. The fuel tank should be of three-

gallon capacity with the filler cap located on the side, near the top, as in Fig. 6. It can be made from 18-ga. sheet metal, or, in some cases, a suitable tank can be improvised from an existing container, such as an oxygen tank. An air hose, Fig. 6, is connected to the top of the tank when a hand pump, Fig. 7, is used. Install a baffle plate vertically in the fuel tank to assure that fuel will reach the outlet when the car is making a high-speed turn. The lower edge of the baffle should be at least 2 in. above the bottom of the tank. A pattern of  $\frac{1}{8}$ -in. holes is punched in the baffle, the hole pattern covering approximately half its area. The fuel line from the tank to the carburetor is  $\frac{3}{8}$ -in. copper tubing which is encased in snug-fitting rubber hose to dampen vibration and protect the metal at points where it is attached to the frame.

Although many drivers may prefer to use the magneto ignition with which the engine comes equipped, battery ignition generally is recommended by experienced TQ drivers. A Willard Austin battery is just the right size to fit under the driver's seat where it is supported on brackets attached to the frame. Remove the magneto from the engine and close the opening with a steel plate bolted to the magneto mounting flange. With battery ignition you use a truck-type coil, and an Autopulse fuel pump can be substituted for the hand pump shown in Fig. 7. The pump should be adjusted to provide 3 lbs. of pressure. Motorcycle engines of the types classified are of the dry-sump type and require an external oil-supply tank. Although any oiltight, 2-qt. container may be used, a 2-qt. oxygen bottle fitted with flex-type oil lines is just

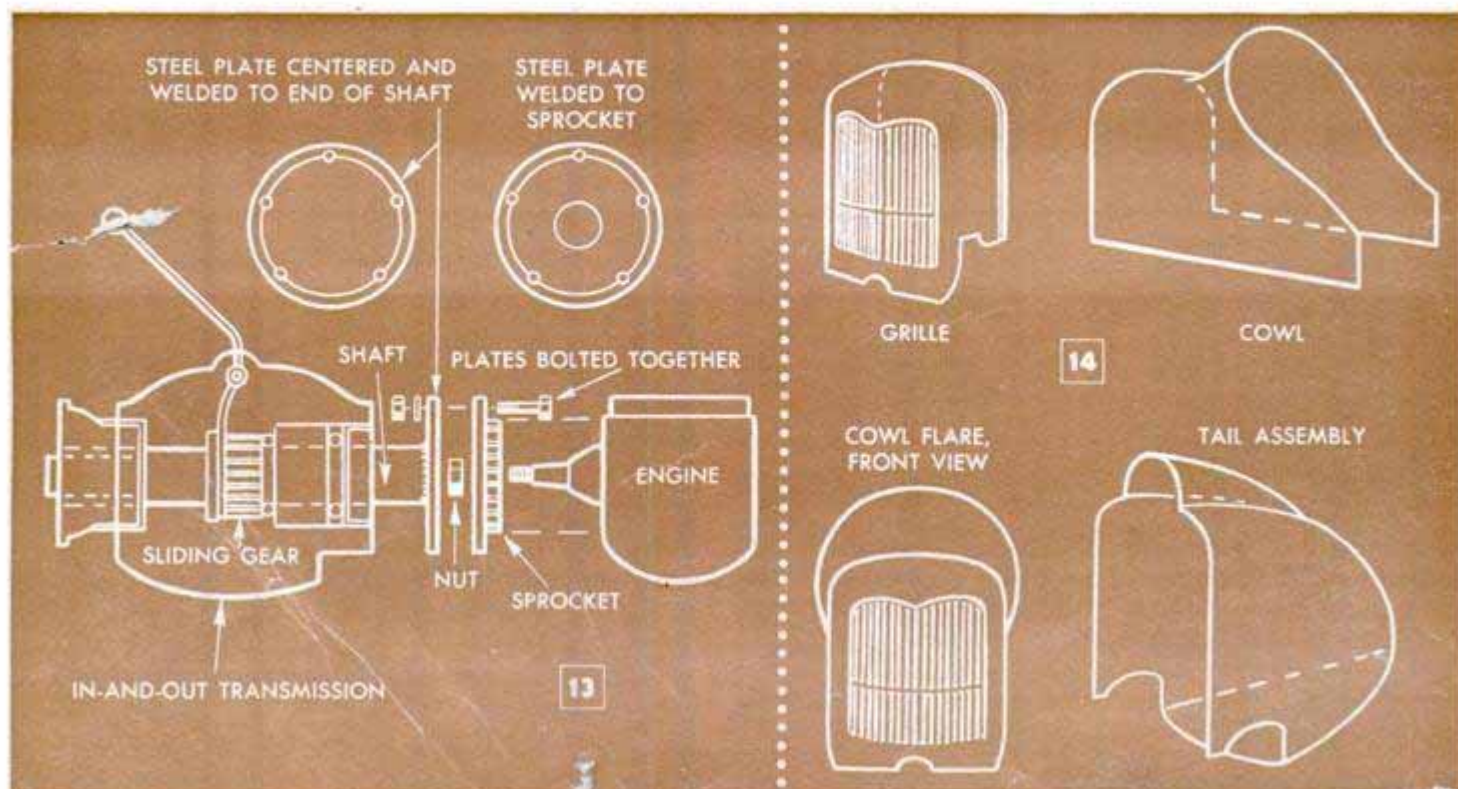



the thing for this purpose. It is mounted in a bracket attached to the fire wall as in Figs. 6, 10 and 11. Bumpers designed as in Figs. 7 and 8, are made from 1-in. steel tubing, welded for strength and rigidity. The rear bumper is especially designed with a vertical member which makes it easy to push the car with another when starting. If desired, the front and rear bumpers and the nerfing bars may be chrome plated. The free ends of the bumpers are inserted in sleeves welded to the frame members at the front and rear. They are held in place with setscrews to permit removal in case of damage. As the final step on the chassis, note that the treads of the rear wheels are checkered to give a lug-type tread, Fig. 7. This work should be done by a tire-repair shop. The hand brake, Figs. 2, 6 and 10, operates on only one rear wheel.

Construction details of the sheet-metal body have been left almost entirely to the builder. Figs. 7 and 14 will give a good idea of the shape and proportional size of the various sheet-metal parts. The grille is taken from a 1936 Plymouth car and cut down to the required size. A removable hood and side panels are cut from 16-ga. sheet metal and bent to the required shape. The curve of the cowl and the flare at the top edge are formed by cutting six equally spaced V-notches in the edge of the metal to a depth of about 2½ in. After bending, triangular pieces cut from metal of the same gauge are welded into the notches. After welding and forming the cowl, the welds are ground flush. The cowl is attached to the cowl frame with machine screws. An instrument panel, Fig. 10, is cut from ⅛-in. aluminum to fit the curve of the cowl frame. It is fitted with an oil-pressure gauge, temperature gauge, ignition switch (battery ignition), tachometer and an air-pressure gauge calibrated to 40 lbs., if a hand-operated fuel pump is used. Before the tail assembly is installed, a roll-over bar of 2-in. steel tubing is bolted to the chassis frame just back of the driver's seat. It is enclosed by the tail assembly. The rounded side panels of the tail are made from the right and left rear-fender skirts of a 1940 Buick car. The rear ends of the skirts are welded together and the open vee at the top is rounded over with two halves of a Willys headlamp fairing. The seat pan and belly pan are simple sheet-metal jobs. Have the seat upholstered by a professional workman. Extend the exhaust manifold, if necessary, and fit a solid-tube exhaust pipe leading all the way to the rear of the car.

☐ To prevent your airbrush hose from tangling, wrap it with a wire coil of the type used on telephone and clothes-iron cords.



### Welding Table Has Open-Grid Top

Because of the open-grid construction of the top, this welding table is easily kept clean and small parts are more readily held in position for welding. The light weight of the table makes it easy to move about and the telescoping column provides an adjustment for height. The top is made by welding the ends of ½-in. steel rods to 1¼-in. steel angles. The table top is then welded to a pipe flange which screws onto the upper end of the telescoping column. The lower half of the column is welded to three pieces of steel angle, arranged at the time of welding to form an X-shaped base. The base is then braced to the column by steel rods welded to the column and separate angles as pictured.

L. H. Houck, Jefferson City, Mo.

### Ice Discourages Broody Hens

Here is a novel trick that one poultry raiser claims is the quickest and easiest way to discourage a hen from brooding. Simply place several ice cubes under her while she is sitting on the nest. Usually, a couple of treatments are sufficient to discourage even the most stubborn bird from brooding.

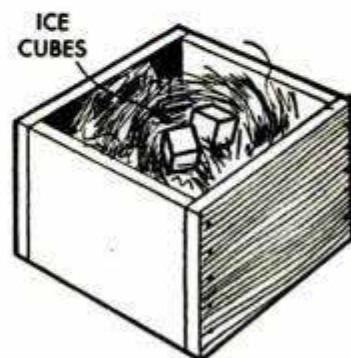

John Krill, North Lima, Ohio.

# SHOPPING

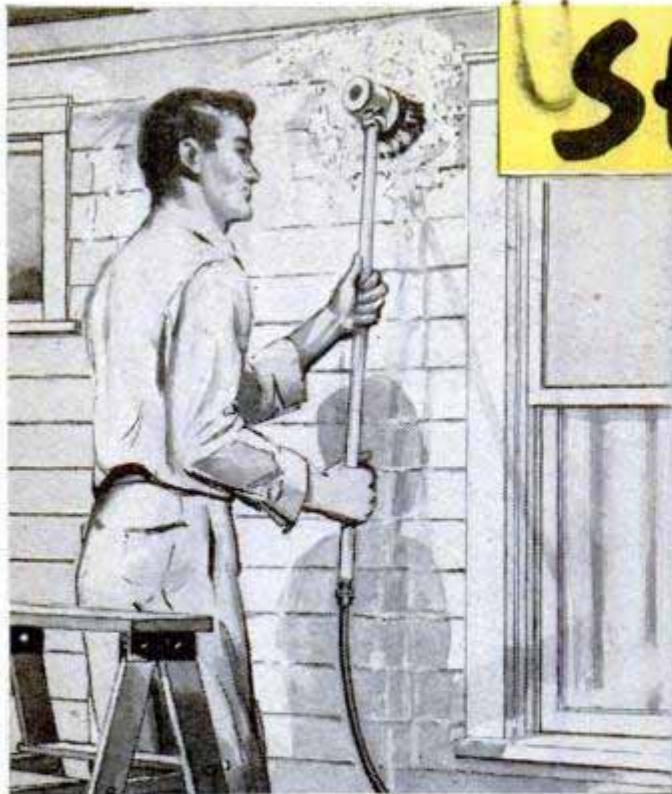

Tucker Mfg. Co., 305 First St., S.W., Cedar Rapids, Iowa



**JET-SPRAY BRUSH** offers a new idea in house and car washers. Designed with a screw-top cup to hold a supply of concentrated detergent tablets, a sudsing action is provided to dislodge embedded dirt. Opening a shut-off lever directs water into the detergent cup where it enters as a fine jet spray and slowly dissolves and feeds the solution to the brush. With the lever turned to the left, the water flows directly to the brush to flush or rinse the suds-covered surface. Washer comes equipped with a telescoping handle that is fitted with a 7-ft. length of lightweight rubber hose for connecting to any conventional garden hose

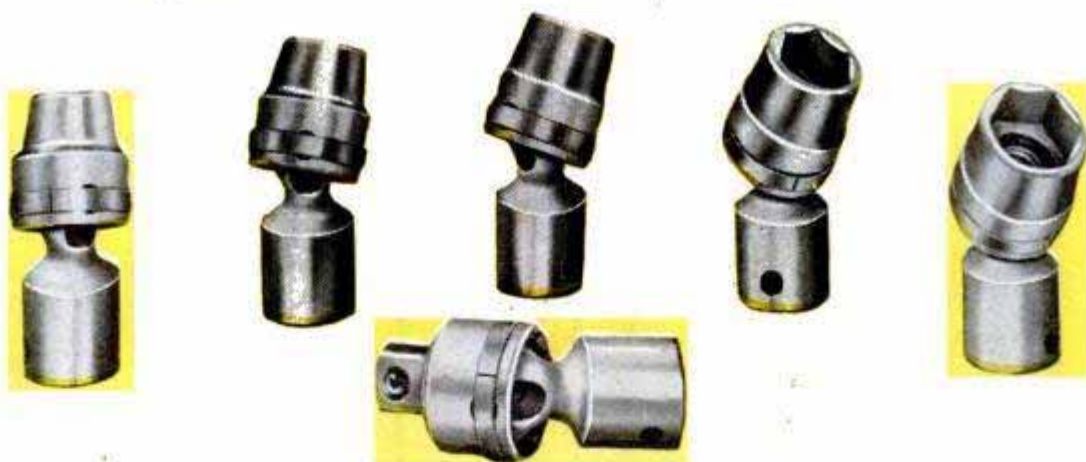

Plomb Tool Co., Los Angeles 54, Calif.

**BALL-TYPE UNIVERSAL WRENCH SOCKETS** employ a new ball coupling superior in action and wearing qualities to ordinary block-type universal. Sockets operate smoothly at all angles, have no "dead spots" common to the ordinary universal. Designed for impact wrench

◀ **VEST-POCKET TACHOMETER** not much larger than a fountain pen is handy for checking speed of rotating machine parts. Reads up to 15,000 r.p.m. directly on body of instrument. Can be used in spots wholly inaccessible to larger units

Verdell Instrument Sales Co.,  
P. O. Box 212, Burbank, Calif.

**PERIPHERY PRESS HOLDER** is custom-made for each job, the radius, size and number of type characters being determined by piece to be stamped. Made with shank size for any press, the holder is designed to use straight-sided type



M. E. Cunningham Co., 83 E. Carson St., Pittsburgh 19, Pa.

# FOR TOOLS

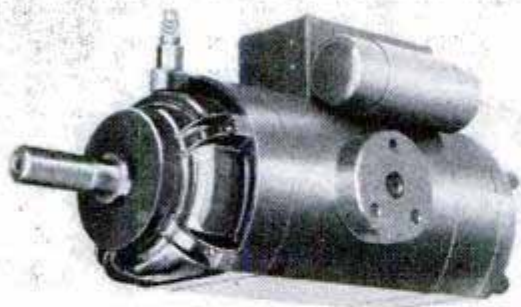

DeWalt, Inc., Lancaster, Pa.

**RADIAL SAW MOTOR** is now designed with special frame which permits full utilization of cutting capacity of blades. The new motor frame is flat across the bottom, increasing the cutting capacity of the standard saw blade about 40 percent. Motor is totally enclosed, fan-cooled and is of direct-drive design with no gears



Kenco Mfg. Co., 5211 Anaheim-Telegraph Blvd., Los Angeles, Calif.

**PUNCH PRESS** of four-ton capacity has several features new to punch presses of this size. The throat is deeper than average, 12¾ in., and the frame weighs 400 lbs. A specially engineered clutch drive replaces the regular slot in the crankshaft. This feature was worked out with the purpose of strengthening the one-piece shaft by eliminating a deep milling cut. Press is adjustable for single or continuous ramming

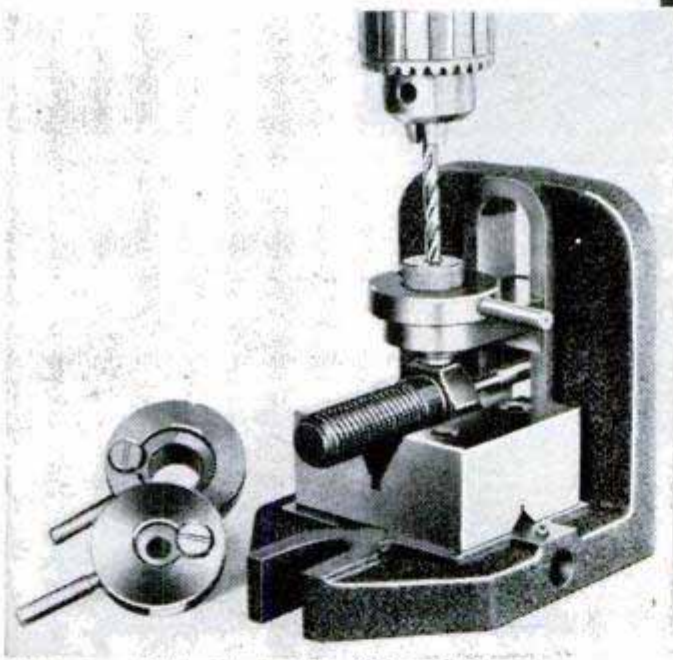

Mathewson Machine Works, Inc., 2 Hancock St., North Quincy 71, Mass.

**ADJUSTABLE DRILL JIG** reduces layout and drilling time on small lots of round stock from ¼ to 2 in. in diameter and on hex stock and cap screws from ¼ to 1 in. Hardened V-block has 90-deg. vee on one face for round stock and 60-deg. vee on other face for hex stock and cap screws. Supplied with sleeves for slip bushings of standard outside diameters. Drilling holes for cotter pins, setscrews, drive pins are typical jobs

**HOLLOW MASONRY DRILL** has carbide cutters in the perimeter of the drill head to cut reinforcing rods, glass or stones embedded in the concrete. Drills in poured concrete as fast as 6 in. per minute. Spiral grooves, or flutes, on the body of the drill carry dust out of the hole. Cuts only on the perimeter of the circle, like a plug cutter for wood. Small and medium sizes can be operated by portable electric drill. Operates quietly and with a minimum of vibration. Available from stock in sizes from 3/16 to 4-in. dia.

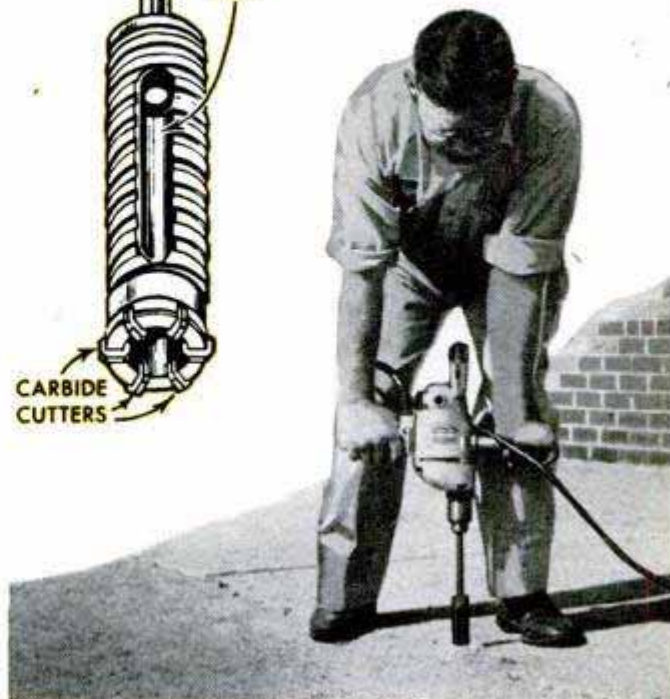
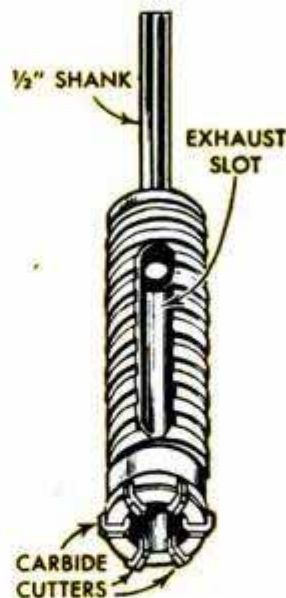

Tilden Tool Mfg. Co., 1144 W. Washington Blvd., Chicago

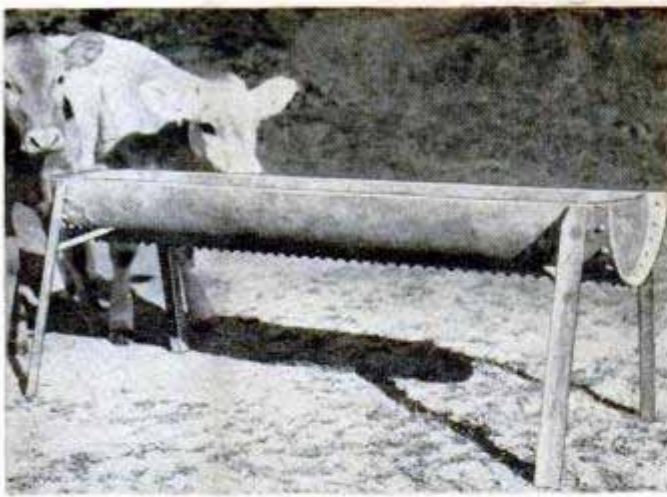

## Water Troughs for Young Calves

One discarded hot-water tank, cut in half, makes two watering troughs for calves, or other young livestock having access to a creep. Angle-steel legs are welded at the corners of the trough and braces to each leg are welded in place as shown. Troughs also may be used for feeding dry feeds without waste. Welding the tank halves together end to end and attaching shorter skids makes an excellent nontip feeder for sheep or hogs which is easily transported from place to place.

A. M. Wettach, Mt. Pleasant, Iowa.

## Sediment Filter on Auto Fuel Line Improvised From T-Fitting and Screen

Often needed on autos not having filter screens at the fuel-pump inlet or carburetor, a gas-line filter can be made from a  $\frac{3}{8}$ -in. pipe tee. The bottom opening of the tee is fitted with an ordinary plug. Then, a piece of filter screen is soldered into the shape of a finger and inserted in the tee where the edges of the open end are wedged against the inner surface of the tee with a brass ring. The ring is backed into the opening by a brass bushing to which is attached a flexible coupling. The coupling leads to the carburetor. A second bushing at the other end of the tee connects the line leading to the fuel tank. In some instances, the fitting on the fuel line is a female type, un-

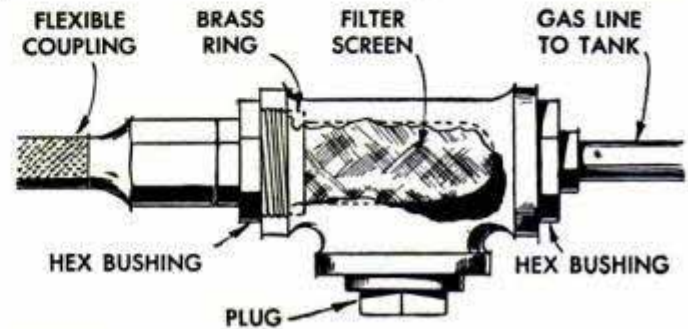

like the one shown. If so, a coupling must be added to the connection. In use, sediment from the gasoline is caught in front of the "finger" filter and can be removed by unscrewing the plug at the bottom of the tee.

George J. Link, Centerville, Ind.

## Stationary-Engine Muffler

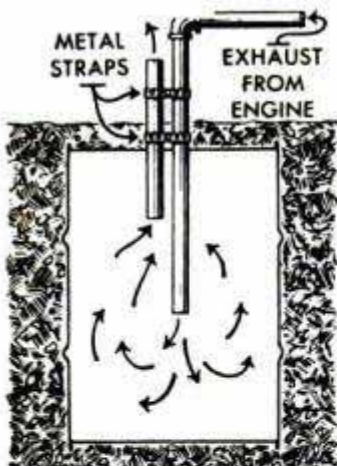

A competent muffler for the small engine of an electric light plant, or other stationary engine, can be made from an oil drum, or length of a large-diameter cement pipe buried in the ground a few inches below the surface as shown. When tile is used, the upper

end must be capped. The exhaust pipe from the engine is run into the top of the barrel, or tile, to extend several inches into it. A second pipe is placed next to this one and held with metal strips as indicated. When an oil drum is used, it may be possible to screw the pipes into a couple of end bungs instead of strapping them together.

Clinton R. Hull, Costa Mesa, Calif.

☐ Artists or writers who illustrate their articles will find dictionaries a source of inspiration for picture material.

## Easily Made Machinist's Jack

An ordinary pipe reducer and a bolt can easily be converted to use as a machinist's jack. All that is necessary is to rethread the bolt to screw into the small end of the reducer. Jacks of various sizes can be made by simply using bolts of different lengths. For accuracy, it may be necessary to true up the large end of a reducer so that it will rest squarely on a machine table.

Warren L. Miles, Providence, R.I.

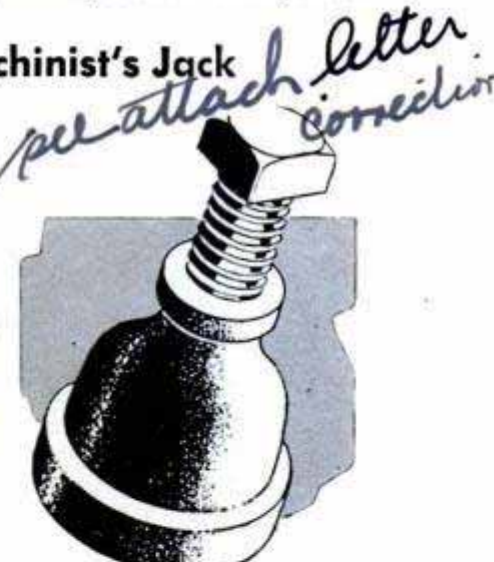

## Renewing Bolt Threads

The threads on bolts can be quickly and efficiently renewed by use of a thread die and a wrench. Clamp the die in a vise and turn the bolt into it, using a speed wrench. If the bolt head is slotted, turn it with a screwdriver bit in a brace.

## Television in the Home

WHY MISS interesting TV programs when you have work to do in other parts of the house? One set owner solved this problem in his own home workshop by building an attractive cart to house his table-model TV receiver, as illustrated in photo A. The cart was constructed from ordinary pine lumber and finished in silver gray to blend with general furnishings. Realizing that the outside TV antenna gives the best reception, he installed plug-in outlets to the roof antenna in various rooms. Several types of suitable twin-lead connectors are available.

If you do not live too far from TV-broadcasting stations, you can make an efficient attic antenna installation by suspending the TV antenna upside-down from a cross brace as illustrated in photo B. The 2 x 4 clamp detailed in the inset sketch permits proper rotation to orient the antenna for the stations.

Various types of TV-picture filters have been designed to remove glare and relieve eyestrain, but the one shown in photo C is unique in that a special variety of nylon cloth, or gauze, is employed as the filtering element.

The combination weather vane and TV antenna illustrated in photo D is both artistic and effective. It consists of the vane which is topped with a "witch" on a broomstick. Below is an inline type of TV antenna designed for both the high and low bands.

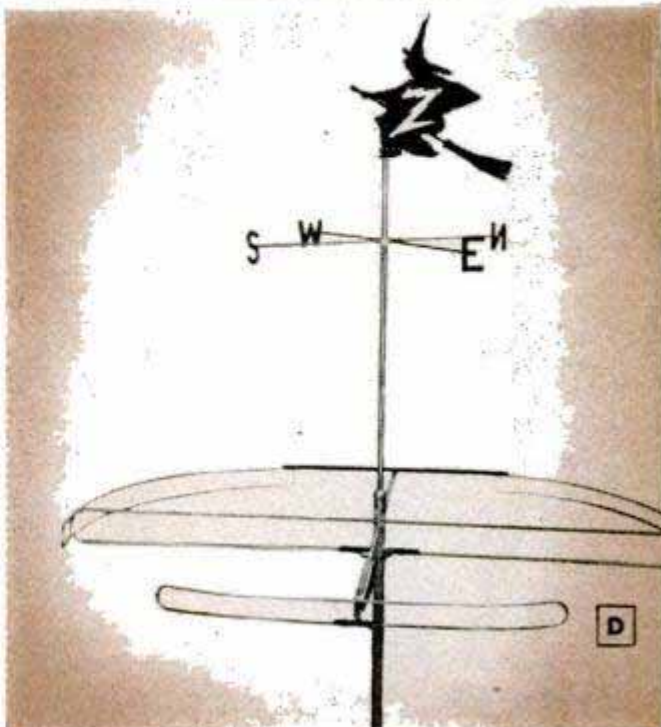
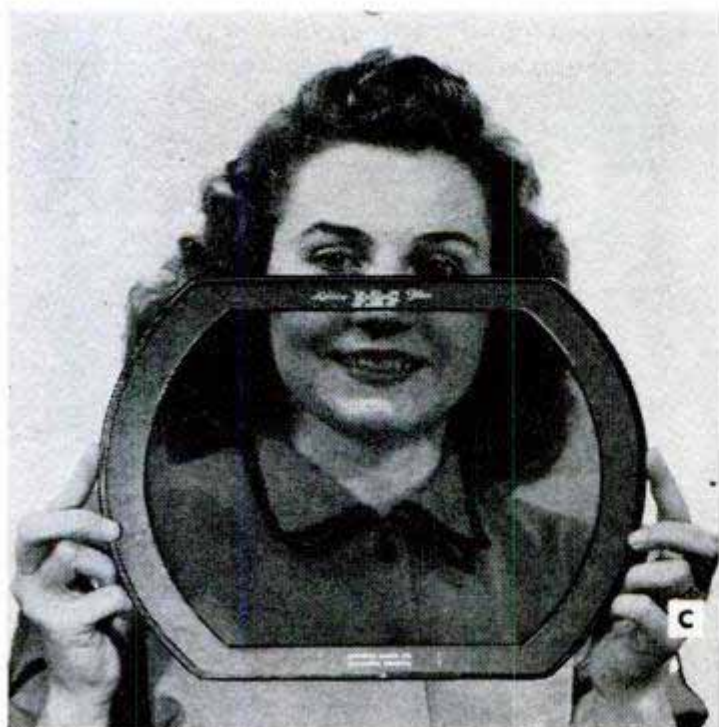
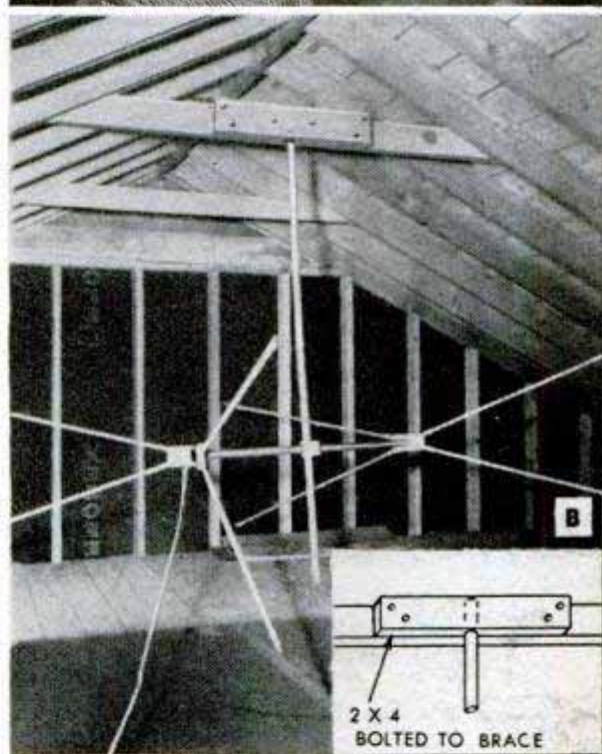

# SAFETY-FIRST SERVICE

By Frank L. Brittin

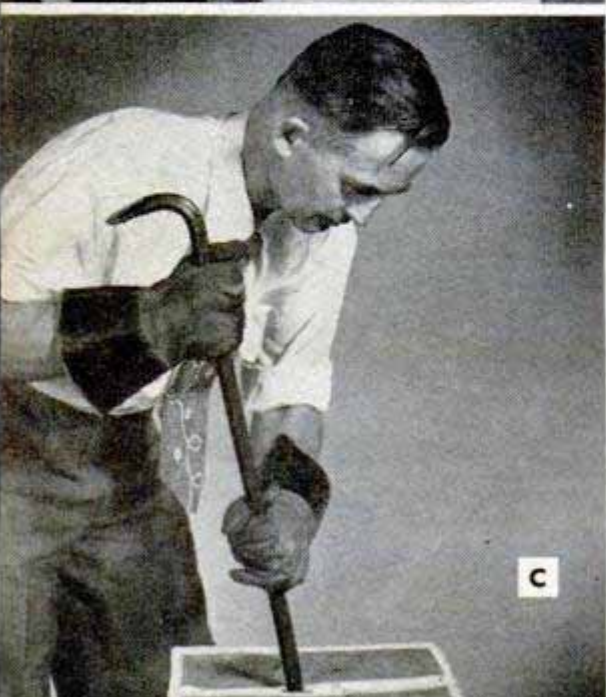

THERE ARE a number of good common-sense reasons why you should call your television serviceman if you know nothing about the inside of your TV receiver. However, many unnecessary calls are made by television servicemen every day. This is becoming a problem, as trained TV service personnel are rapidly being absorbed by the war effort. A surprising number of service calls are actually made for a reason that is always embarrassing to the set owner. The serviceman arrives after several unavoidable delays, and frantic phone calls, to find that the power cord of the receiver is not plugged into the wall socket. When the owner tried to turn the set on it was "dead." Perhaps the wife or maid accidentally disconnected it when cleaning the room or rearranging the furniture.

These unnecessary service calls cost money because no busy serviceman can make them for nothing. The serious angle involved is the plight of the TV set owner who really needs service. He has to wait and miss important programs while the serviceman is plugging in your set, or hooking up the lead-in from the antenna that came loose because the children knocked it off while chasing the dog. You can do this safely yourself and save money by making a simple inspection around the cabinet or console before calling the serviceman.

It is quite possible that we may even have to help ourselves further in the near future if we wish to avoid missing our favorite TV programs. Of course, many television set owners have had no experience with TV circuits and would not understand a block, or schematic circuit diagram, if they had one. On the other hand, a large number of TV set owners have frequently replaced tubes successfully in their AM and FM receivers by means of the simple tube-substitution method, first carefully marking the tube-socket locations to identify each tube type. There is no reason why these owners cannot replace defective tubes in their TV receivers safely if they take a little time to learn a few very important safety-first rules that apply to all television sets. If

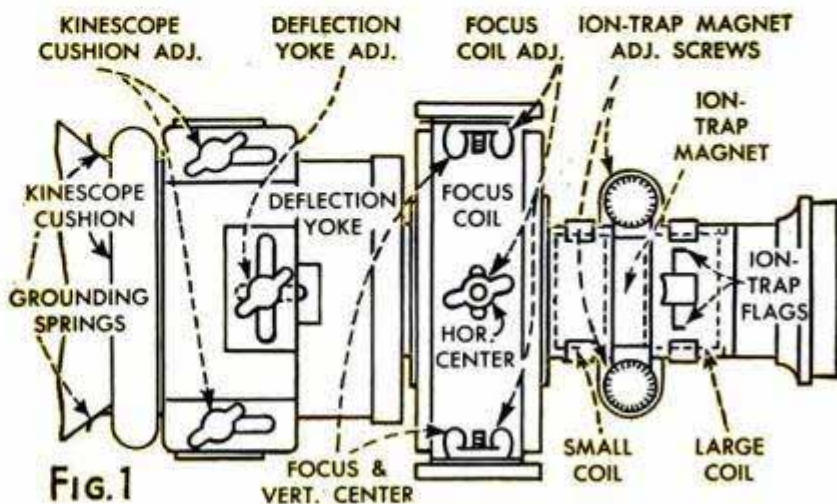

# HINTS FOR TV SET OWNERS .....

you do not have a service manual that gives the tube-layout chart for your TV set, you can obtain one from the dealer or manufacturer, or you can get one of the Howard W. Sams Television-Tube Location Guides for \$1.50 from any of the large radio-parts houses. This tube-replacement guide contains 218 charts covering the various tube locations, and their functions, in TV receivers produced by 56 manufacturers. These charts provide a means for quickly locating all tube positions in any of their television sets. Become familiar with the tube layout and controls of your particular TV set before attempting to make any tube replacements.

A television receiver is really two receivers in one. It has four or five times as many tubes as your radio receiver and, in addition, it employs a large picture tube. Replacement TV tubes and parts will continue to be available in limited supply to set owners from the large radio-parts houses just as radio-receiver tubes and parts were during the last war.

There are certain safety-first precautions that must be taken when working with any type of AM, FM or television receiver, or, in fact, with any electrical device operated from power lines. This is especially true with television receivers that employ two power supplies. One is a special high-voltage supply used for accelerating the electron beam in the picture tube. This may be any voltage from 5000 up to 20,000 volts, or more. Luckily the amperage is quite low, but it can give you a dangerous shock. The other power supply is the low-voltage B-supply, which is usually only about 350 volts. But it is really more vicious than the high-voltage supply as it normally delivers a considerably higher current. Knowing this, you can realize why the manufacturer and serviceman warn you about removing

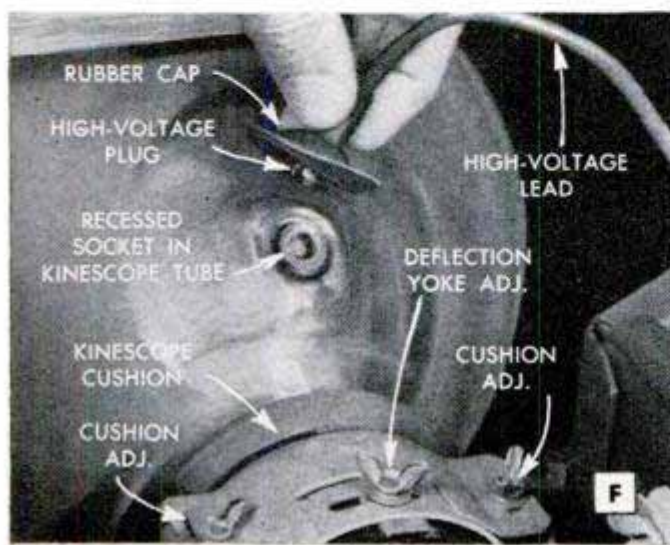

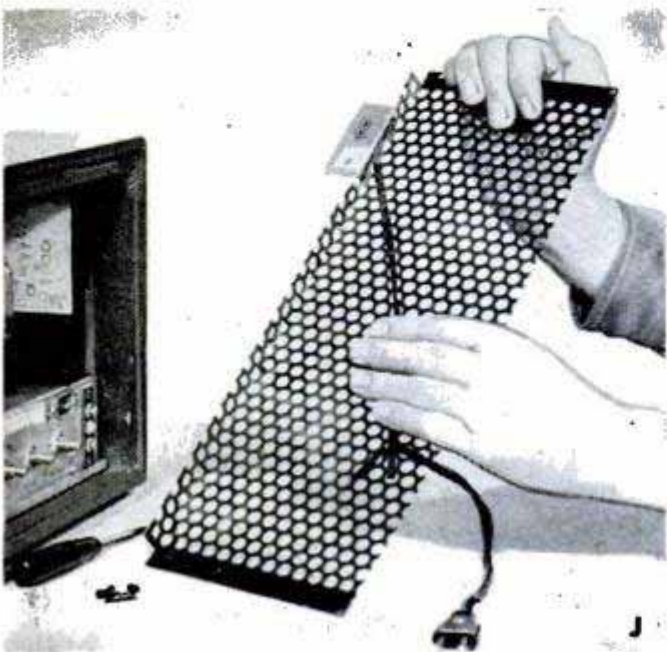

the back from your TV set even though they provide it with interlocking switches. However, you can do this if you turn off the set first, and then disconnect the power cord and wait several minutes for the condensers in the power-supply section to discharge. After removing the top cover, there are two other precautions that must be taken before you can safely handle the interior components of the TV receiver. First remove the high-voltage plug from its recessed socket in the picture tube, as illustrated in photo F, and discharge it against the metal chassis as shown in photo G. This will bleed off any charge that might still be in the condensers. The second precaution is to use a short insulated test lead between the black outer coating on the picture tube and the high-voltage plug, or chassis, to remove any possible surface charge. This is especially necessary if your picture tube is one of the glass electromagnetic types that have an outer and inner coating of conducting material which acts as a condenser for the high-voltage supply. A shock from this coating might be slight, but enough to make you drop the tube when you are removing it from the set. The socket is disconnected as shown in photo E. The picture tube is a large mass of glass that must be handled with extreme care. A high vacuum exists within the tube. Therefore, if the tube should be broken, it will collapse upon itself, causing an "implosion" (instead of an explosion). The glass will fly all over the room and could possibly damage your eyes. This is a dangerous feature that you did not have to contend with in replacing tubes in your old radio receivers. The obvious safety-first measure is always to wear protective goggles of the ordinary plastic type used in workshops and a pair of heavy gloves when handling your TV picture tube, as illustrated in pho-

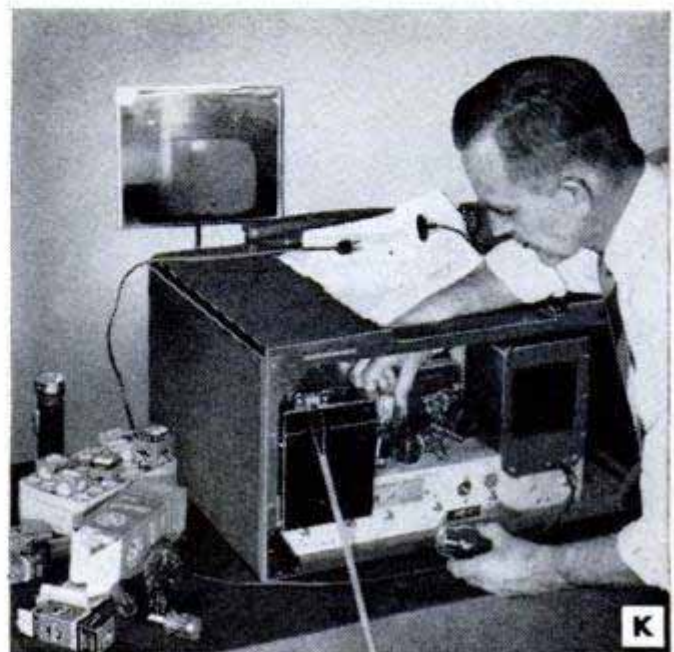



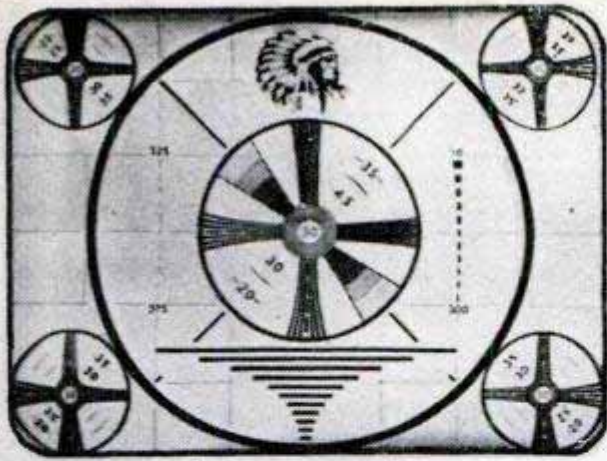

L

tos A, B and D. Always seal up the old tube in the carton that the new picture tube came in. Then take it out in the backyard and, for safety reasons, destroy the old tube with a crowbar, as illustrated in photo C. When handling TV picture tubes take great care not to scratch or knock them against any hard surface. Do your TV tube replacing in a room by yourself when there are no "small fry" around who might get hurt.

All TV picture tubes become defective and useless in time and must be replaced. As this tube is expensive, and the most difficult one to handle in making replacements, we will deal with it first. You will know that your picture tube is becoming defective when it acts as follows: When you turn the set on, the picture is dim and then gradually brightens; dimness becomes progressive as the tube loses emission; when advancing the contrast control, the picture goes negative (like a photo negative), and when restored to normal it is still dim, and nothing can be done with the controls to make the picture brighter. Under these conditions it is quite possible that you need a new "kinnie," as the picture tube is called in the serviceman's vernacular. A yellow spot on the face of the tube does not necessarily indicate that the tube is going bad. In about 50 percent of all TV sets now in use, the picture tube can be removed without taking the chassis out of the cabinet. This is done with a short Phillips screwdriver by removing the front panel that holds the protective glass plate, photo H. While you have the front off, clean this glass plate with a preparation sold by TV supply houses. Always handle the picture tube by the front end, as shown, never by the fragile neck. When removing the socket as illustrated in photo E, check the position of the tube as related to the recessed high-voltage socket and the ion-trap

(Continued to page 228)



M

## More Trouble-Shooting Hints

- 1**—A normal picture test pattern should look like the one in photo L. It should be in sharp focus with good contrast between the black and white picture elements with intermediate shades of gray. The steady image should completely fill the raster
- 2**—If the pattern, or picture, disappears and there are horizontal bars across the screen, adjust horizontal hold control, or look for defective tubes in the horizontal synchronizing section. For their location, check the tube-replacement guide sheet
- 3**—If screen is blank and sound is normal, check the horizontal amplifier tubes and high-voltage oscillator tubes. May indicate short in H.V. supply
- 4**—If there is only a vertical line on the screen, check the tubes in the horizontal sweep circuit
- 5**—If the picture folds over horizontally, always look for a defective damper tube 5V4, or 6W4
- 6**—If a picture is long and narrow, adjust width control, or look for a defective horizontal osc. and discharge tube; or horizontal output tube
- 7**—If there is only a white horizontal line in the center of the screen, look for a defective vertical oscillator or amplifier tube, 12AU7 or 6AQ5
- 8**—If picture is of improper height, reset vertical size control, or check for a defective vertical oscillator or amplifier tube, as is indicated above
- 9**—If the picture is unevenly proportioned, look for a defective vertical amplifier tube (6AQ5)
- 10**—If there is no picture, but the raster is bright and the sound is distorted and weak, the antenna is either disconnected or the lead-in is shorted
- 11**—If the picture is weak and sound is normal, the antenna is not oriented in the proper direction. The same holds true if picture is snowy or hazy
- 12**—If ghost in picture, but sound is normal, the antenna is improperly located or badly oriented. Although there is no remedy for signal reflections from near-by obstructions or buildings, the effect can be minimized by changing the location of the antenna on the roof until the best position is found. In crowded localities keep the antenna close to the roof; a resistor in the lead-in at the antenna sometimes helps to reduce strength of the unwanted reflected signals as a last resort
- 13**—If the picture jumps, and the sound is noisy, a loose connection in the antenna system is indicated. The lead-in may be shorting against house

# Radio and Electronics Today



**A**—Weighing only 12 pounds, this portable public-address amplifier enables the operator to speak in a normal voice to a large group in the field, factory or auditorium. The director or coach is no longer tied down to a platform mike or limited to areas where electric current is available. The unit measures  $5\frac{7}{8} \times 8\frac{1}{2} \times 11\frac{3}{4}$  in., and it is powered with a 2-volt rechargeable 25-amp. battery. The output from a class-B amplifier is 2 watts.

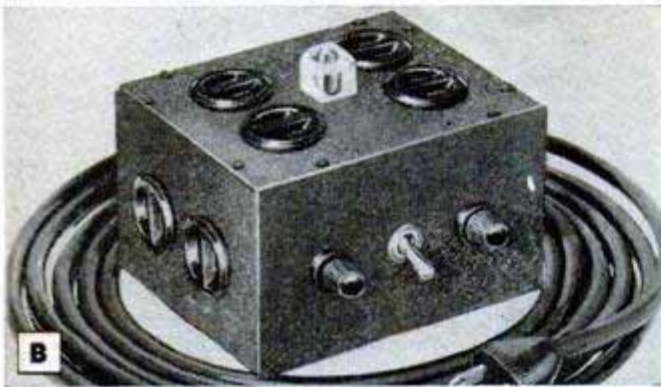

**B**—Perhaps one of the handiest units in any radio shop, laboratory, photo studio or home workshop is a multiple-outlet box. The compact unit illustrated makes possible the plugging in of eight standard Edison line-cord plugs from one outlet. A neon pilot light indicates power is on.

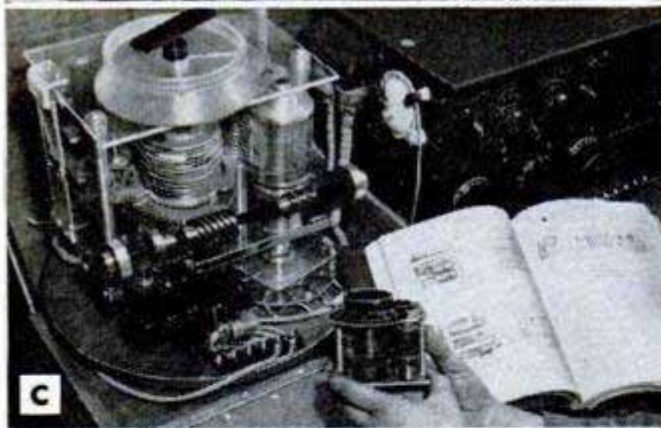

**C**—One of the most interesting training aids at the Air Force's Training Aids Wing, located at the Chanute Air Force Base, is a working model of an automatic transmitter tuning head 10 times the size of the actual unit in the student's hand. The unit automatically tunes 11 separate radio frequencies and is standard equipment on all large bombers and cargo planes. Having students watch the large model in operation saves technicians hundreds of words of instruction.



**D**—Electronic metal detector, used by a nationally known advertising service organization, screens mail received in box-top and soap-wrapper premium promotions to be sure that no coin has escaped the sorters, and that no sender will be disappointed.



**E**—One of the new portable radio receivers that weighs only about 5 pounds operates on a.c.-d.c. or AB dry-cell battery, and is small enough to pack in a suitcase. Other features include "sunburst" dial for easy tuning, built-in antenna, large speaker and a dry-plate selenium rectifier.



**GET DRAMATIC SKIES  
WITHOUT CHANGING OTHER TONES**

A Kodak Pola-Screen can change a vacation snapshot into a prize-winning photograph. Fit one on *your* camera. For color and black-and-white. Accessory Pola-Screen Viewer slips over handle—"previews" the varying sky tones you can obtain. Pola-Screens, from \$6.50. Viewer, \$6.50.

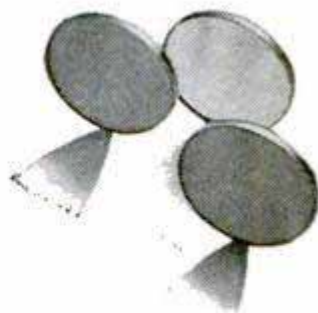

**KODAK FILTERS  
ADD LIFE...**

**SPARKLE... EMPHASIS**

Kodak Wratten Filters utilize dyes of great purity, for accurately controlled light transmission. More than 100 varieties—such as *X1*, a green filter for natural flesh tones... *A*, a red for striking landscapes... *K2*, yellow, to emphasize clouds. And to warm up *color* shots, use a Kodak Skylight Filter for mountain and marine scenes and pictures taken in open-shade. In series sizes, to fit most cameras, from \$1.60.

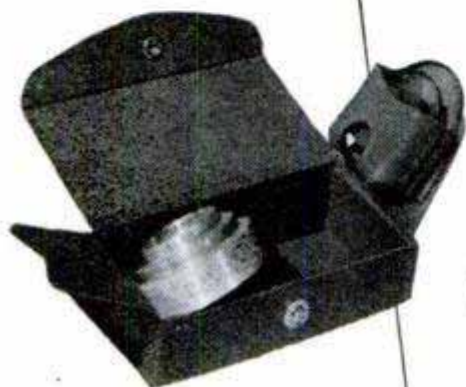

**KEEP YOUR FILTERS  
PROTECTED AND READY  
FOR ACTION**

Kodak Combination Filter Case has two compartments. Kodak Adapter Ring, filter, and Lens Hood fit in one compartment—3 filters in the second. From \$4.

**GIVE YOUR  
VACATION  
"SNAPS" THAT  
EXPERT TOUCH**

**ADAPTER KITS PERMIT KODAK TOURIST AND REFLEX  
CAMERAS TO USE KODACHROME FILM**



The Kodak Tourist Adapter Kit, (\$14.50—left) for Tourist Cameras with *f/4.5* and *f/6.3* lenses, offers a variety of picture sizes— $2\frac{1}{4} \times 3\frac{1}{4}$ ;  $2\frac{1}{4} \times 2\frac{1}{4}$ ;  $1\frac{5}{8} \times 2\frac{1}{4}$ . Also adapts cameras for 2 x 2-inch Kodachrome slides. The Kodak 828 Adapter for Kodak Reflex Cameras (\$5—right) permits use of 828-size films, including Kodachrome. Each kit consists of back-frame masks, view-finder masks, and special spool baskets.

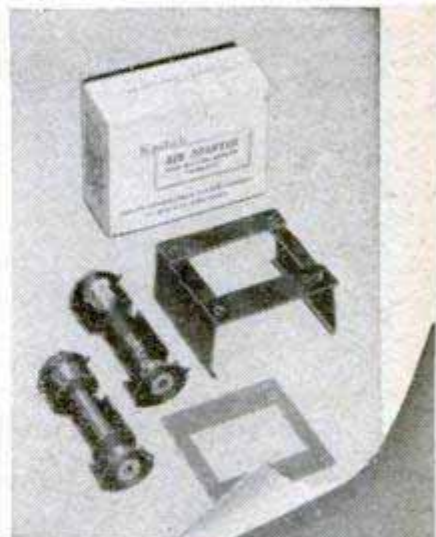

*Prices are subject to change without notice  
and include Federal Tax where applicable*

Be sure to see all these Kodak accessories at your Kodak dealer's

**Kodak**  
TRADE-MARK

EASTMAN KODAK COMPANY, ROCHESTER 4, N. Y.

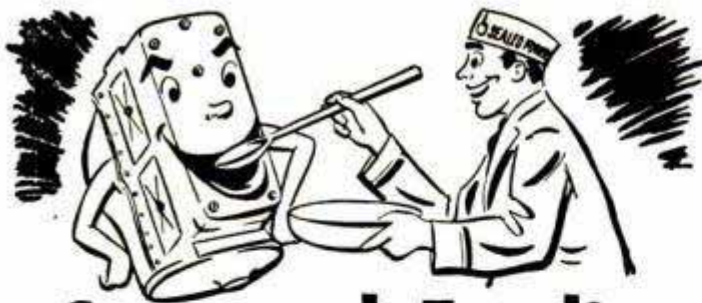

# Care and Feeding of Engines

BY S. P. CORP

## HOW TO EVALUATE VALVES

When compression reading shows faulty valves, inspect valve stem for peening. If bottom is peened, remove burrs with a fine file before attempting to pull stem through guide. Always identify valve with its own guide, for convenience in replacing.



PITTED VALVE FACE

card valve if it is warped or between head and stem, or if stem is bent.

Pitted or grooved valves are caused by blow-by at the exhaust valve. Reface them with a wet refacer after checking manufacturer's manual for correct angle. Be sure resurfacers is O. K., and that you have enough metal for resurfacing. Otherwise you are wasting your time!

Clean valve by buffing on electric brush if possible, or scrape carbon off with knife, then brush with a soft wire brush.

Look for pitting, grooving, cracking, burning, and guttering on valve head. Dis-



GROOVED VALVE FACE

## SHOCKING SUGGESTION

If your car is hard to steer at high speeds, if it pitches excessively on turns, or if it just plain rides hard, take a look at your shock absorbers. This is one item of car maintenance that is likely to be neglected.

Take hold alternately of each end of each bumper and try to bounce the car up and down rapidly. Then watch movement of car as you let go. If it keeps on bouncing before coming to rest, your shock absorber on that corner is not controlling spring movement. Repeat this on all four corners.

To remove shock absorber for testing, remove upper and lower holding nut from the rubber bushing on the studs. Now clamp the shock absorber in a vise by lower end, with upper end straight up. Pump it up and down for full length of travel. If it sticks or is hard to pull or if there is no resistance, it is leaking by the valves and should be replaced.

## WHEN YOU RE-RING...

Don't use less than the best! Use Sealed Power Piston Rings—the best rings built! MD-50 Steel Oil Ring, the only ring with the Full-Flow Spring, controls oil even in badly tapered and out-of-round bores. Sealed Power rings are used as original equipment by manufacturers of more than 80% of all passenger cars! For triple wear, use Sealed Power Chrome-Faced Rings. Write for free booklet, "7 Ways to Save Oil." It may save you real money. Just address a postal card to Sealed Power, Dept. G-7, Muskegon, Michigan.

## New York's Waterfront Lumberjack

(Continued from page 141)

When it has 100 or so logs on its back, the cat sinks into the water with only a few inches of its rails showing. Towed by a tug, it crawls across the harbor. As the cat nears the Jersey shore where Power's sawmill is located, men in calked boots pole her in until she runs aground.

The logs are rolled across the shore by lumberjacks with peavies and piled up to spend a few months drying out after their 40-year bath. Then, well-seasoned, they are ready for the mill. Unlike timber fresh from the forests, pier pilings have acquired a few souvenirs of civilization like foot-long steel spikes buried deep in the grain.

When the big saw hits one of these hidden spikes, the air is full of saw-tooth shrapnel in a split second.

After this had happened a few times, Power decided he'd had enough. Now, before a log enters the mill, lumberjacks scoot over it with war-surplus mine detectors. Any metal in the pile is located and extracted before processing begins.

There's not much of the old pier piling left when the boys at Burma Road get through with it. First, big framing timbers are cut. Softwood piling becomes boards. Hardwood makes truck-body stakes. The mill also turns out pallets for warehouses and docks. Waste pieces of lumber are fashioned into surveyors' stakes and wedges for chocking freight on railroad flatcars. Short butts are split into cordwood. Even the trimmed slabs are sold for kindling.

## The Lost Rivers Return

(Continued from page 121)

sergeant, he had been farming his grandfather's land over Preston way, but thought he would like a crack at the rich new land being opened up. He put in a bid to rent 153 acres of bureau land—\$5.05 an acre the first year and \$12.18 the second year, with an option to rent the land for three more years.

With plow and tractor, Hodges tore into the sagebrush on the rented land. He raked the cut brush into windrows, burned it, and then replowed the land, harrowed and leveled it. Seven hundred pounds of commercial fertilizer per acre were added as an assist to nature.

"I invested about \$18 an acre before I planted the first seed, but I'm coming out all right despite the current low price of potatoes," reports Hodges. "I will hate to leave the land in five years. Hope I get a homestead."

(Continued to page 224)

# The inside story of your battery- See how it works!

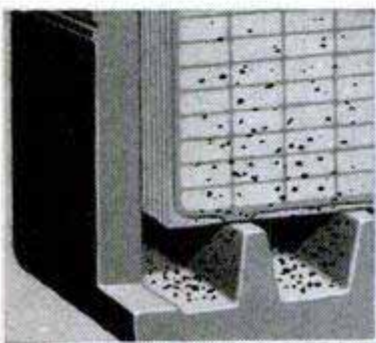

1 In ordinary batteries, small particles keep flaking off positive plates, so ordinary design batteries must have large sediment wells at bottom of case to hold these particles.



2 If sediment wells in ordinary design batteries aren't big enough to hold flaking particles from positive cells, particles pile up and short circuit cells, causing cell failure.

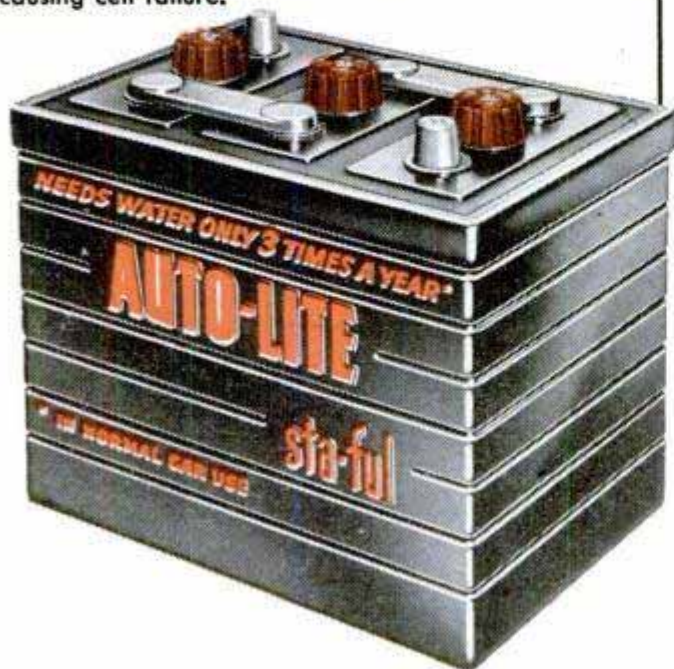

3 In the Auto-Lite "Sta-ful" Battery, every positive plate has a Fibre-glass retaining mat protecting it and holding the active materials in place to reduce shedding and flaking.

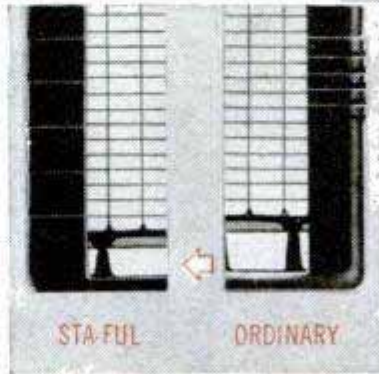
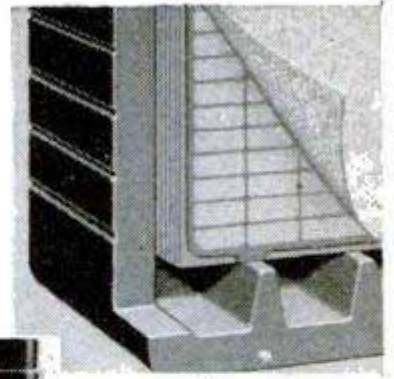

4 Side-by-side view shows that the "Sta-ful" Battery doesn't need all the extra space at bottom as ordinary design batteries do. So extra space in "Sta-ful" Battery is moved to top where . . .

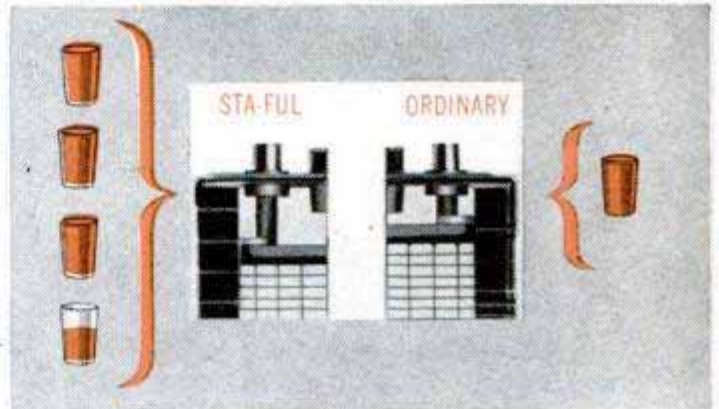

5 . . . extra space can be used to hold more battery electrolyte, giving room for over 3 times the liquid reserve in the "Sta-ful" as in ordinary batteries. That's why the "Sta-ful" needs water only 3 times a year in normal car use. "Sta-ful" Batteries give longer life, too, in tests conducted according to minimum life cycle standards.

**AUTO-LITE BATTERY CORPORATION**

Toledo 1

Ohio

*Auto-lite sta-ful*  
*...needs water*  
*only 3 times a year*

IN NORMAL CAR USE

**YOU CAN TELL  
A GOOD  
ELECTRIC DRILL  
BY ITS CHUCK**



**JACOBS**

**If it's a JACOBS  
It bears the name... look for it!**

**Jacobs Plain Bearing Key Chuck...** the most widely used drill chuck in the world. You can trust the tool that has one.

**Jacobs Rubber-Flex Hex-Key Chucks** on home workshop power tools prove that their makers put quality first.



**Jacobs Rubber-Flex Hand-Tite Chuck.** One-piece RUBBER-FLEX jaw assembly holds tools true and tight. No loose jaws or springs.



**IF IT'S A**

**JACOBS**

**IT HOLDS**

The Jacobs Manufacturing Company  
West Hartford 10, Connecticut

*Clinic for*



*Homemakers*

**Water-White Lacquer**

**Q** — What is the meaning of the term "water white" which often is used in describing certain types, or grades, of lacquer and varnish? In other words, if I'm directed to use water-white lacquer, what kind of finish is produced? Does it contain a pigment or a color? Also, what is a nonraising lacquer and for what purpose is it commonly used?—G.S., S.C.



**A**—In general, the term "water white" describes extreme paleness in either varnish or lacquer. If a water-white lacquer is applied to bare wood the change in reflective properties (color) of the wood will be hardly noticeable after the finish is dry. However, in ordinary practice, this finish is applied over surfaces which have been stained, filled and sealed, and it is desirable that the stain colors be changed as little as possible by the top (final) coat. It often is specified as a top coat over light finishes such as blond and the new light-gray stain colors. Metal lacquers which are used as a protective coating on brass and copper are sometimes described as water-white. The term is more generally applied to lacquer than to varnish. Nonraising lacquers contain slow-acting solvents which permit them to be applied over paints, varnishes and enamels.

**Choosing Wall Tile**

**Q**—I'm trying to decide what type of wall tile to use in my kitchen above and in back of a cabinet sink. The color I want comes only in the plastic tile but I'm a little doubtful about the durability of this material as the tiles are light and thin. Which should I use, plastic or aluminum tile or a hardboard scored to represent tile? Also, I want the tile to extend to the floor back of the sink. Is it advisable to move the sink out from the wall? — A.T., Calif.



**A**—So far as durability and attractiveness are concerned, there is little choice between the three types of tile. All are good quality, easy to clean, and placement is comparatively simple if the manufacturer's instructions are followed in detail. On some walls the scored hardboards may be a little more difficult to handle, especially for the individual. However, this disadvantage is offset by the large size of the scored sheet, making it unnecessary to locate each tile individually. Where it is

(Continued to page 222)

# Proved better

on 5,000,000 cars!

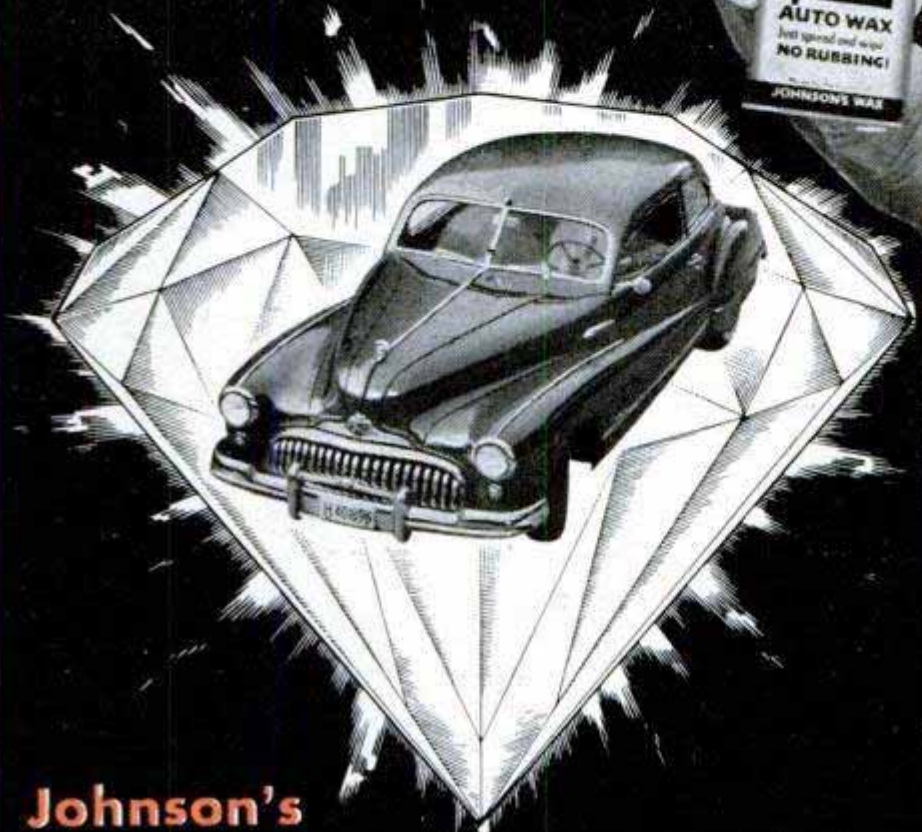

Johnson's

# Car-Plate

gives a lasting "diamond shine" in 20 minutes!

**New no-rub way to wax!** Waxing a car used to mean hours of the hardest kind of rubbing. Now it's a 20-minute take-it-easy job!

And Johnson's Car-Plate not only saves you time and work . . . it actually gives your car a tougher, brighter, longer-lasting wax protection!

More than 5 million car owners have proved it since Reader's Digest published an article describing this sensational chemical discovery.

Get Johnson's Car-Plate at your service station or regular wax dealer's. Just spread it on the clean finish of your car...let it dry...and wipe lightly. That's all it takes to wax your car to a "diamond shine"!

A 10-oz. can of Car-Plate does any car twice . . . and costs only \$1.00. Today's the day to try it.

"Johnson's", "Car-Plate" and "Carnu" are the trademarks of S. C. Johnson & Son, Inc. © S. C. Johnson & Son, Inc., Racine, Wis., 1951

### How to clean before you wax

Wax should always be applied to a CLEAN car. The finish should be free of road film and decomposed paint. For this reason it is important that you clean your car thoroughly before applying Car-Plate. For quick, easy cleaning, Johnson's Carnu is recommended. It does the job fast and safely — leaves a perfect surface for a sparkling Car-Plate finish.



# PEEL OFF PAINT WITH KLEAN-STRIP

**Amazing new-type remover  
is fast, safe, easy-to-use**

Klean-Strip changes any finish into loose, wrinkled film. Use only a brush or putty-knife to peel off all layers of the old finish at one time.

Klean-Strip leaves the surface clean, smooth and dry. No sticky mess to wash off, no waxy residue to scrape. And Klean-Strip is absolutely safe: will neither burn nor explode.

Klean-Strip is brand new . . . not like any paint remover you've ever used. Takes all the danger and drudgery out of refinishing. Buy Klean-Strip whenever you buy paint. Available at better paint, hardware and department stores, everywhere.

Product of  
W. M. BARR & CO.  
2352 S. Lauderdale  
Memphis, Tennessee



**New! No-Wash!  
Non-Inflammable!**

**This book can  
save you \$300**



**FREE** 16-page, illustrated book  
about SHOPSMITH—America's  
largest-selling power tool.

EVER dream of owning a fully equipped, professional quality, power workshop? Then you'll want a copy of the SHOPSMITH book. It tells how you can have your dream-shop at a fraction the cost and in a fraction the space—a multi-purpose shop that outperforms power equipment worth \$500. Even if you already own power tools, you'll find this book interesting and worth-while. It's packed with info and photos, details and specifications, new wood-working tricks made possible by exclusive SHOPSMITH features. Send for it today!

## SHOPSMITH

Dept. 164-B, at factory nearest you:  
12819 Coit Road, Cleveland 8, Ohio, OR  
417 Montgomery Street, San Francisco 4, Calif.

Please send me a free copy of the SHOPSMITH book.

Name \_\_\_\_\_  
Address \_\_\_\_\_  
City \_\_\_\_\_ State \_\_\_\_\_

(Continued from page 220)

necessary to cut the sheet, just make sure that it is cut with square corners so that the scorings will register. Then spread the cement, level the top edge of the sheet, press it tightly into contact with the cement and there you are. The individual tiles require a little more care when starting the first course. Once this has been accomplished properly, the rest is easy. The problem is to keep the succeeding courses level and the joints in register vertically and horizontally. If you move your sink outward from the wall a distance equal to the thickness of the tile plus the cement, the plumbing will have to be moved an equal distance so that all pipe joints will be in line in the new location. Unless you are experienced in this job, better consult your plumber. However, we do not ordinarily recommend running tile to the floor back of a cabinet sink which has already been installed, as usually the cabinet is attached to the wall in some manner. This makes it a rather costly and difficult job to change the position of the pipes and pipe connections both above and below the floor. We think you will find the job satisfactory if you simply bring the tile down to the sink drainboard.

### Garage Floor

*Q—I'm planning to build my own two-car garage but I'm undecided whether to use a slab floor and bolt the sills of the building to it, or pour foundation footings and walls and then pour the floor separately over a cinder fill. The slab floor is cheaper and easier to pour. Which should I use? — B.T., Tenn.*



*A—You can use either type of floor, the choice depending to some extent on the type of building and also on the provisions of the local municipal building codes. Some building codes do not permit two-car garages to be built on slab-type concrete floors. Specifications will vary, of course, but in general the slab-type floor should be at least 4 in., and preferably 5 in. thick, consisting of a grout coat and finish coat totaling 5 or 6 in. in thickness. The slab is poured over a 5-in. tamped-gravel fill. Never use cinders under a concrete floor, as they disintegrate in time when exposed to dampness and cause the floor to crack as a result of unequal stresses. The above brief specifications assume that the building is of average frame construction and that the slab floor will be located where there is adequate drainage. Sills of the building should be attached to bolts embedded in the concrete not more than 36 in. apart.*

### Dry Cleaning

*Q—I would like to dry-clean work clothing such as overalls, coveralls, shop coats, etc., as these garments are difficult to handle in a washing machine of the type having a wringer. What kind of a cleaner should I use for this purpose, benzine, naphtha, or what? — R.M., Neb.*

*A—Ordinarily, we do not recommend the use of benzine, naphtha, carbon tetrachloride or similar solvents for household purposes because of fire or health hazards, or both. With the exception of carbon tet, which is nonflammable, nearly all other common solvents, such as benzine and naphtha, are highly flammable, hazardous to use as household cleaners or solvents and are definitely dangerous to use for dry-cleaning fabrics because of the possibility of ignition from static electricity. Although nonflammable under these conditions, carbon tet gives off heavy fumes which are dangerously toxic, even in moderate concentrations such as might occur in a room or basement where there is inadequate ventilation. However, you can use the carbon tet if you do the cleaning outdoors and when there is a moderate breeze to prevent concentration of the fumes. It's a good idea to protect the hands with rubber gloves. Carbon tet which is kept for reuse should be stored in a tightly closed container.*



For a Carefree Holiday  
Enjoy Dependable Motoring

with

**CHAMPION**

Spark Plugs

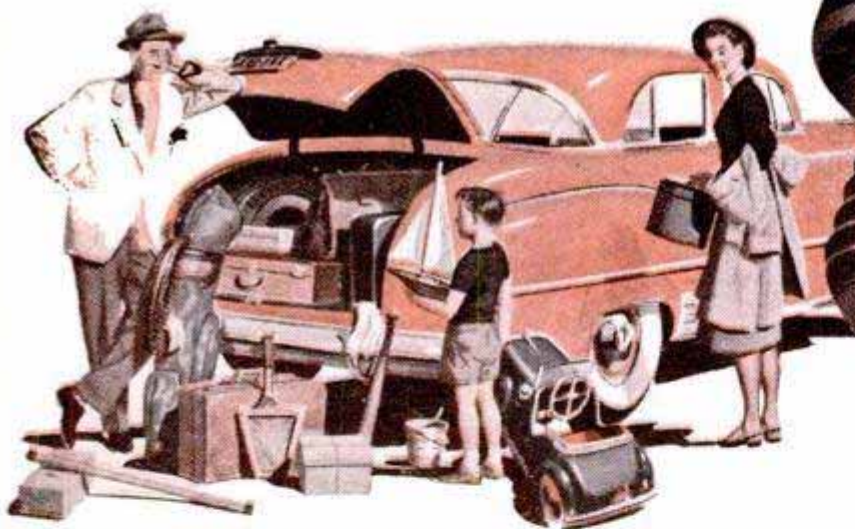
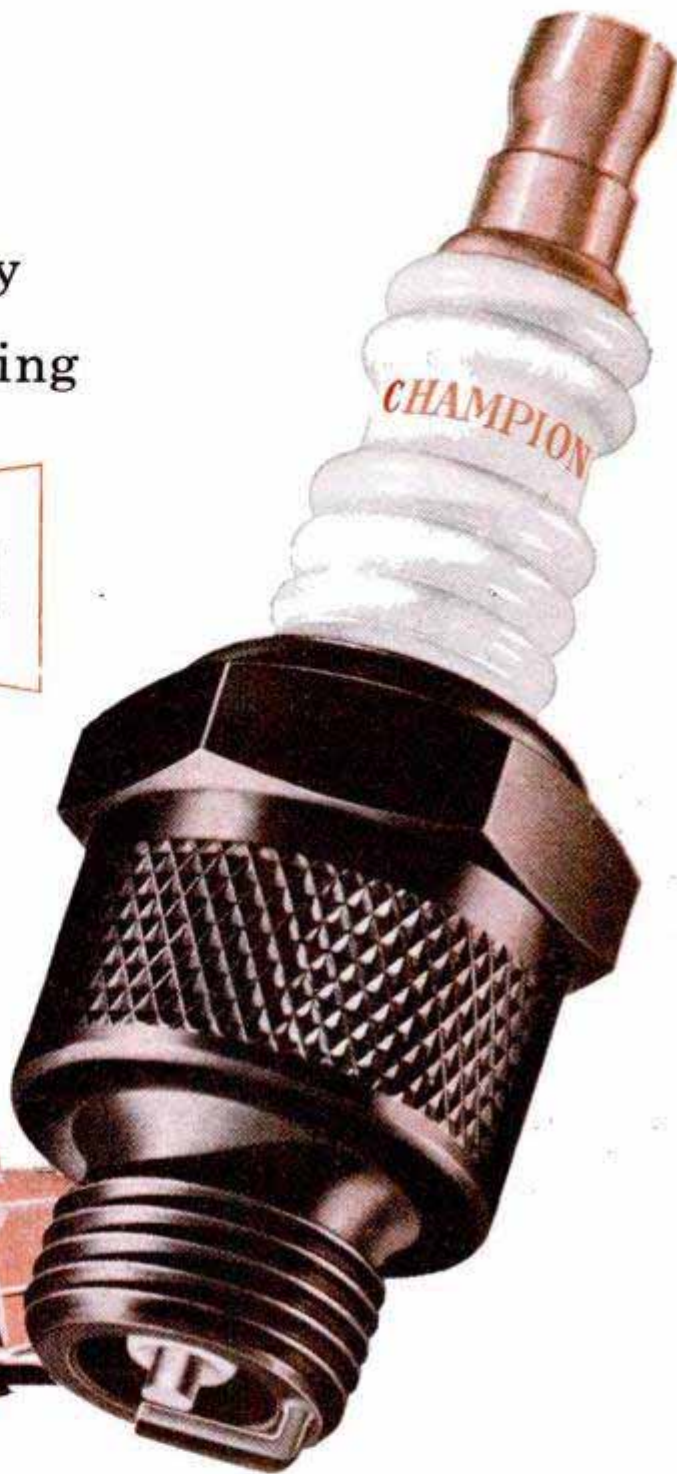

**BE A CHAMPION DRIVER**—Wave Goodbye to Spark Plug Troubles!



It's vacation time—time to leave all care behind! For carefree engine performance, start out with brand new Champion Spark Plugs!

You need carefree performance in boat engines, too. In 1950 nearly every boat-racing champion used dependable Champion Spark Plugs!

When the American public places its stamp of approval on a product you can be sure of its top quality, value and dependability.

CHAMPION SPARK PLUG COMPANY, TOLEDO 1, OHIO

GRINDS • CARVES • ENGRAVES  
DRILLS • ROUTS • SHARPENS

## DREMEL *Electric* MOTO-TOOL

FASTEST MOST POWERFUL TOOL  
OF ITS KIND . . . 27,000 R.P.M.

Most practical tool a man can own—more powerful than any similar tool you can buy. Works well in wood, plastics, and metal. For home maintenance jobs you'll wonder how you got along without it. For model making it's a must. And for general shop operations it saves time and money. Compare it, try it, buy it. You be the judge!

### Check These Important Features

- Oilless sealed bearings • Dynamically balanced armature • Shockproof, Bakelite housing • Dust-filtered air cooling system • Sturdy 110-120 V., A.C.-D.C. motor • Wt. only 13 oz. • A precision tool widely used in industry for many years.



MOTO-TOOL No. 2  
(with 1 emery wheel point)

\$16.50



MOTO-TOOL KIT No. 2  
With 23 Accessories  
(High-Speed Steel Cutters,  
Grinding Wheels, Polishers)

\$23.50



**WHERE TO BUY DREMEL TOOLS.** Dremel Tools are sold everywhere. If your dealer cannot supply you, send remittance in full and we will ship postpaid. Or send only \$2, and pay postman balance plus postage and fee. Money back if not delighted after 5 days' trial.

DREMEL MFG. CO., Dept. 111-G, RACINE, WIS.

## Paper Pattern Simplifies Building GARAGE DOOR



**SAVE MONEY . . . BUILD YOUR OWN GARAGE DOOR.** With Easi-Build\* — Build It Yourself Pattern No. 86 you can build either a single or double Garage Door for less than 1/2 present costs. Pattern tells what materials to buy, where and when each is used. No special tools or skill required. Even though you haven't used tools in years, you'll be amazed to see how easily and economically you can build a professional looking door by following the simplified step-by-step procedure outlined in this pattern.

With "Stanley's" new Garage Door Set, you can install the Swing-Up-Hardware using only hand tools. Ask your dealer for Simplified Directions for installing Stanley Swing-Up Hardware and Easi-Build Garage Door Patterns — or send 50¢ for pattern No. 86 direct to:

**EASI-BUILD PATTERN COMPANY**  
Dept. ST, Pleasantville, N. Y.

\*TRADE MARK REG. U. S. PAT. OFF. — Easi-Build Pattern Co.

The lava soil on Hodges' rented acres did itself proud during 1950 — produced 310 sacks of potatoes to the acre. The average in near-by areas that have long been under irrigation is about 200 sacks to the acre.

Hodges adds that his potatoes were "running 42 percent to 10-ounce bakers and above." Any potato man will tell you that's mighty good.

"Potatoes need controlled water, and you really get it with the well system," says Hodges. "Besides potatoes, barley and wheat, I raised 14 acres of seed peas this year, and got 45 bushels to the acre."

Afton Isom is another veteran—a former AAF major—who has rented bureau land complete with well. Like Hodges, he thinks the well system is excellent for potatoes.

"Cool growing conditions are required, and the well water helps supply them," explains Isom. "The water comes out of the ground at about 55 degrees Fahrenheit, and does a good job of cooling the surface soil." Isom also reports he's been able to irrigate more acres with less water than he'd use under the natural-flow system, because he can stop the water when not needed. With natural flow, a man has to use the water when he can get it—not necessarily when he needs it.

"In irrigating 39 acres with natural flow over by Bear River I used an average of four cubic feet of water per second," says Isom. "Here I irrigate 70 acres with an average of only 2 1/2 cubic feet per second."

It isn't all roses blooming on the project, however. Newel Baker started clearing sagebrush from 640 acres of new private land in the fall of 1949. In working out the brush, he got the soil too fine. Then the next year, with the crops in, the wind blew — no trees to stop it.

"Blew 50 acres of beet seed out of the ground," says Baker. "A lot of my fertilizer was gone with the wind, too."

Baker reseeded the 50 acres to potatoes. Then 90 of 110 acres of beans froze. More reseeded to potatoes. Ten acres of peas also froze. Potatoes again. About that time the price of potatoes went way down.

"But the potatoes yielded 340 sacks to the acre, and prospects for the future look brighter," says Baker. "I have two wells with connecting pumps on them, four miles of aluminum pipe and 2 1/2 miles of black pipe for my sprinkler system. I can turn the water off and on just when I want it. Farming with a wrench has farming with a shovel beat all hollow. I don't have large ditches all over the place, and machinery is easily moved. I can plant my crops in mile-long rows. This makes for efficient harvesting as well as planting. The first year was the hardest—I hope!"



## MARFAK MADE HIS CAR RIDE SO CUSHIONY HE'S SPOILED



Want "cushiony" driving for 1,000 miles or more? Get *Marfak* chassis lubrication! *Marfak* is specially compounded to resist squeeze-out and jar-out when the going's rough. It resists wash-out when road water splashes. That's why that "cushiony" ride lasts and lasts! For *Marfak* lubrication, see your Texaco Dealer, *the best friend your car ever had.*



**THE TEXAS COMPANY**  
**TEXACO DEALERS IN ALL 48 STATES**

*Texaco Products are also distributed in Canada and in Latin America*

**CAULK THOSE CRACKS**

**WITH Nu-CAULK**

**SPEED LOAD**



Seal out drafts, dust, around windows and doors

Here's the easy way to caulk your home. Just slip a handy Speed Load into the caulk gun and you're ready. It's the fastest, most economical way to apply the world's finest caulk compound.



USE **Nu-Glaze** INSTEAD OF PUTTY



Macklanburg-Duncan Co., Okla. City, Okla.

BUY THROUGH YOUR LOCAL HARDWARE, LUMBER OR BUILDING SUPPLY DEALER



For **CRACKS** in Concrete

Don't let cracks, widened seams, shallow holes in your concrete basement or garage floor cause you trouble! Fill them with Smooth-On No. 7B Quick Floor Patch Cement. Finish level with surrounding surface. The repair hardens in a few hours and is then ready for use. Ask for Smooth-On No. 7B Quick Floor Patch by name and number, in 1-, 5-, 20- or 100-lb. sizes. If your hardware store hasn't it, write us.



**FREE 7B LEAFLET and SMOOTH-ON HANDBOOK**

Leaflet shows how to use No. 7B. Handbook shows time-saving, money-saving home repairs you can make with other Smooth-On Cements—leaks stopped, cracks sealed, loose parts made tight. 40 pages. 170 pictures. Write us for both—FREE—today.

SMOOTH-ON MFG. CO., Dept. 37C  
570 Communipaw Ave., Jersey City 4, N. J.



Do it with **SMOOTH-ON** QUICK FLOOR PATCH CEMENT

## "Co-op" Village in the Woods

(Continued from page 77)

are attracted to Usonia, and finally apply for membership. You then discover that you must have 40 percent of the estimated value of your completed home in cash. (Usonians, remember, had been building up their own kitty for years.) The Usonians take a vote on admitting you to membership, and each family has one vote regardless of its investment. Only one factor is considered in the vote: Will the personalities in your family be congenial with those in the rest of the community?

If you are accepted, you are shown the plot plan, and you have your choice of any of the remaining lots which have not been set aside as community property. You then choose an architect from a panel of nine men approved by the cooperative. By the time the architect sits down to his drawing board he's as close to you as a shadow, for he wants to come up with a functional home, tailor-made to the exact needs of your family. The completed plans are shipped off to Wright for approval. From then on, you're probably in for a lot of blood, sweat and blisters, for you'll likely want to do some of the work yourself to cut down building costs.

The title of the completed home remains with the cooperative because the mortgage was granted to the corporation. You are granted unconditional right-of-occupancy for 99 years. If you should ever desire to move, you "sell" your home and withdraw a sum from the corporation scaled to your total investment.

Usonians claim a good many advantages for their cooperative living. In the first place, every Usonian pitches in to help fellow members build their homes. The cooperative has assembled innumerable facts on the members — all for the purpose of making life more enjoyable. For example, the Usonian historian knows that five persons are interested in handball, 15 play chess, and that Lucy Resnick was born November 1, 1941. Incidentally, when November 1 rolls around, Lucy will receive a nice gift from the entire cooperative. Each family chips into a birthday fund, believing that such projects foster the community feeling among the children.

The kids themselves are tickled pink. They frequently chase deer off their front "lawns," and every young Usonian has a pet of some kind. Most of the children show a basic interest in architecture, piling up boards or sticks into houses of their own, in shapes no city-bred child could imagine. The biggest problem, parents find, is getting

(Continued to page 228)



**GRAVELLY**  
makes tough  
jobs **EASY!**



5-HP Gravelly Tractor powers 20 tools—does every lawn, garden, field job *easier, better!* All-gear drive, Reverse. "Power vs Drudgery" Booklet FREE. Write for it today!

GRAVELLY MOTOR PLOW & CULTIVATOR CO.  
BOX 763 DUNBAR, W. VA.

**FIELD-TESTED FOR 30 YEARS**

**EVEREST & JENNINGS WHEEL CHAIRS**  
*for Smoothest Performance*



Special 8" Caster  
**UNIVERSAL**

Outdoors or in, Everest & Jennings Wheel Chairs handle with ease! They fold for travel, work or play. Attractive, light and strong. All welded joints. *Folds to 10 inches.*

See your dealer or write for catalog

**EVEREST & JENNINGS**

761 N. Highland Ave., Los Angeles 38, Calif.



**BUILD FINE GRANDFATHER CLOCK NOW**

The simple sensible Red-i-Kut way as thousands have—**SAVE HALF. SHOP TESTED PLANS "SPIRIT OF THE CENTURY"** Narrow waist 83" tall or stately straight side **"SPIRIT OF AMERICA."** **EASY-TO-FOLLOW photoparkt PLANS** tell all — plus **BROCHURE** of heavy brass weight Westminster, tube chime, movements, *gorgeous* dials, 3/4" solid mahogany case kits. **Send \$1.00 today — Both Plans \$1.50 NOW.**

**KUEMPEL CHIME CLOCK CO., 4 Kumpel Bldg., Minneapolis 16, Minn.**

Say You Saw It in Popular Mechanics

**STOPS LEAKS PERMANENTLY**

Cut your fixture replacement, water and fuel bills with Economy Renewable Seats. Make economical, permanent repairs quickly and easily with the Junior Kit (illus.). Repair bathroom, kitchen and laundry fixtures. Everything you need included in steel box. This is a natural for the "Fixit" shops—get extra income from making permanent repairs on your customers' faucets.

Senior Master Kit also available—repairs faucets and valves up to 1" pipe. Write for illustrated circular and prices.

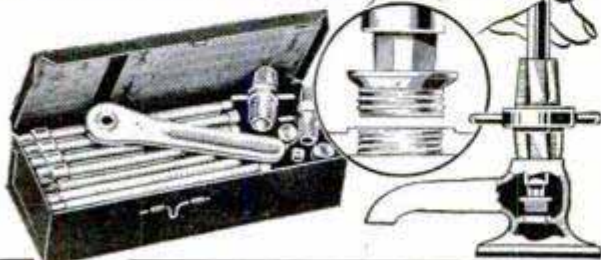

**ECONOMY VALVE SEAT CO.**

1430 N. Keating Ave.

Chicago, Ill.

**FOR SURE  
QUICK STARTS**

**INSIST ON  
BOWES**



*Corrodeless*  
**TERMINAL**

**Battery Cables**



Most battery cable trouble starts at the terminal because of corrosion or bad fit. Bowes "Seal Fast" battery cable terminals positively will not corrode. They are specially engineered, tailored to fit the posts snugly, assuring longer cable life and full power from your battery. Stop battery cable trouble before it begins. For sure, positive starts insist on Bowes "Corrodeless Terminal" Battery Cables—then you'll get all the power your battery is designed to give you.

**BOWES**

**DEPENDABLE**

**SPARK PLUGS**

*Assure*

**SMOOTHER  
MOTORING**

There is a Bowes Spark Plug specially designed for your car! Oversize Special Alloy Electrode—with welded construction for positive connection assures longer life. One-piece, leakproof construction.

Every Bowes Plug is individually tested to assure complete motoring efficiency. **INSIST on BOWES SPARK PLUGS FOR SMOOTHER MOTORING.**



**BOWES "SEAL FAST" CORPORATION**

INDIANAPOLIS 7, INDIANA



The **COASTER BRAKE**  
with  
**SELF-ALIGNING  
BRAKE SHOES**



**Ride  
a Bike  
it's  
Fun!**

Self-aligning brake shoes give quicker stops, longer life, easier pedaling. It's another Bendix feature that makes the Bendix\* Coaster Brake the outstanding performer in its field. Your dealer will put on the brake you want—so just say "Bendix Coaster Brake." \*REG. U.S. PAT. OFF.

**DOUBLE THE FUN  
WITH A  BENDIX  
COASTER BRAKE**

ECLIPSE MACHINE DIVISION of  
Elmira, New York



**Start a Business in Your Backyard**



Earn **BIG MONEY**  
MAKING  
**BUILDING BLOCKS**

**General Concrete Vibrator  
BLOCK MACHINE**  
CAPACITY 1000 BLOCKS A DAY

only **\$218** LESS MOTOR  
F.O.B. PLANT  
SHIPPING WEIGHT 400 LBS.



**HOW TO  
BUILD  
YOUR OWN  
CONCRETE  
BLOCK  
HOME**  
Only 7 Prepaid

Here is a business you can start on small capital—in your own backyard—that earns 100 to 150% profit, with unlimited opportunities. Make concrete or cinder blocks. Millions used for homes, factories, public buildings, garages. Sell all you make to building trade. Do it with a General—and you're headed for success.

**1000 BLOCKS A DAY**

The General is a high speed, power-driven block machine at amazingly low cost. Rugged all-steel construction. Simple to operate indoors or outdoors. Makes superior 3 core type block meeting all code requirements. Produces up to 1000 blocks per day. Full operating instructions and mixing formulas supplied. Write for FREE details. Dealer inquiries invited.

**GENERAL ENGINES CO.**

DEPT. M-71 • 307 HUNTER ST. • GLOUCESTER, N. J.

Includes floor plans for 6 beautiful, easy to build concrete block bungalows. Shows ways to save money. How to lay blocks, lay out building lines, mix concrete, build steps, porches and concrete floors. Mail coupon at once with \$1.

Name.....  
Address.....  
City..... Zone... State.....

the children to school—the kids frequently are waylaid by some wonder of nature more fascinating than multiplication tables.

The cooperative owns major power tools which any member may use. It buys oil for the oil burners in large quantities, thereby obtaining lower rates. It will carry a member for a while if he has had a streak of bad luck financially.

Eventually, the cooperative hopes to have a hobby shop, a theater, community food lockers, a demonstration farm with live animals for the children, a community house, a ski slope and a swimming pool. Though these projects will require money, much of the work will be done by the Usonians, whose hands already are calloused by work on their own homes.

Visitors are flocking to Usonia, and it has become a mecca for architectural students. Occasionally, a very irate young couple will show up on the winding roads. Seems that a few years ago, before the cooperative bought the land, the wooded hillside was a widely known lovers' lane. One young man, accompanied by his lady-love, was especially indignant because he couldn't even find the popcorn vendor, a peddler who once did a rushing business where Usonia's unique homes now stand.

**Safety-First Service Hints  
For TV Set Owners**

(Continued from page 215)

magnet. Refer to the pictorial diagram, Fig. 1, to identify the components that fit over the neck of the picture tube. The deflection yoke and focus coil remain in position, but the ion-trap magnet must be loosened and removed before the tube is withdrawn. Before removing the ion-trap, note its position and mark it with a pencil or crayon, with an arrow pointing towards the front end of the tube. This is important as it must go back on the new tube in the same position.

To install the new tube, insert it so that the neck goes through the deflection yoke and the focus coil easily without forcing. You have, of course, purchased a tube of the same type as the old one and it should go in easily. If it sticks do not force it, merely re-align the focus coil and deflection yoke to remove the trouble. Do not put any pressure on the fragile neck; support the weight of the tube entirely by the front end and then slide it into position, and slip on the ion-trap magnet. Keep your hands off the coated portion on the sloping neck of the tube, as moisture of the hands may cause the tube to arc internally. When the

(Continued to page 230)

**MAKE MONEY  
SAVE MONEY  
BUY  
SUPERSHOP**

**15 DAY  
TRIAL**

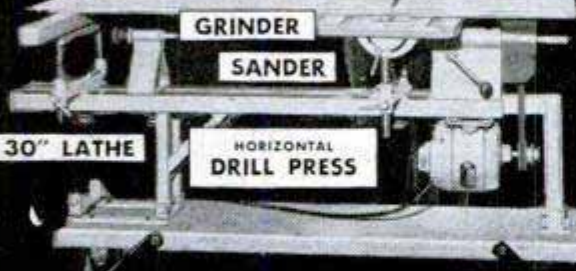

**BUY SMART — \$79.95**  
FACTORY TO YOU

SUPERSHOP offers you a lifetime of power tool pleasure and profit. 100% ball bearing. RUGGED. Accurate. Big capacity. 15 day FREE trial. Money back guarantee. Mail postcard for FREE catalog. Buy on easy pay plan.

**POWER TOOLS, INC.** 125 YATES AVENUE  
BELOIT, WISCONSIN

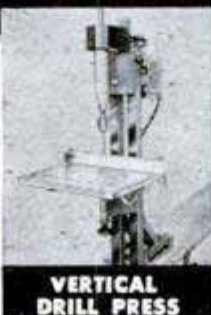

**VERTICAL  
DRILL PRESS**

**ALL NEW 1951 KING MIDGET AUTO**

**World's Lowest Priced 2 Passenger Car**

Drive it for 75c per week. Amazing performance. Surprising comfort. All steel construction. Full accessories, top and heater. Ready to run or assemble it with our bolt together parts. Rider agents wanted. Earn your car free. Send 25c for detailed literature or \$1 (refunded first order) for actual assembly book and service manual filled with photos, drawings, specifications, etc.



**MIDGET MOTORS MFG. CO.,**  
ATHENS 1, OHIO

**CRESCENT TOOLS**  
*Give Wings to Work*

ASK YOUR  
HARDWARE  
DEALER

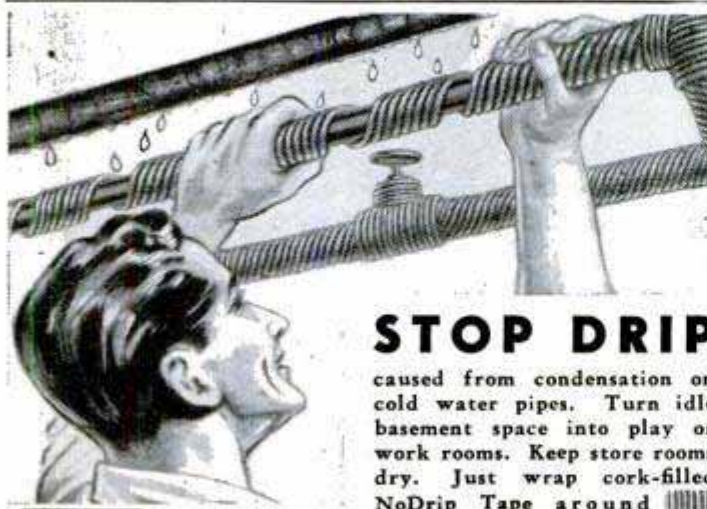

**STOP DRIP**

caused from condensation on cold water pipes. Turn idle basement space into play or work rooms. Keep store rooms dry. Just wrap cork-filled

**NoDrip  
TAPE**

NoDrip Tape around pipes and joints. Do it yourself. Clean and easy to apply. Roll covers about 10 feet of 1/2" pipe, \$1.69. Higher west of Rockies and Canada. Get at Hardware, Department Stores, or sent postpaid. Write for free circular. J. W. Mortell Co., 522 Burch St., Kankakee, Ill.



**More Hours  
of Listening  
Enjoyment**

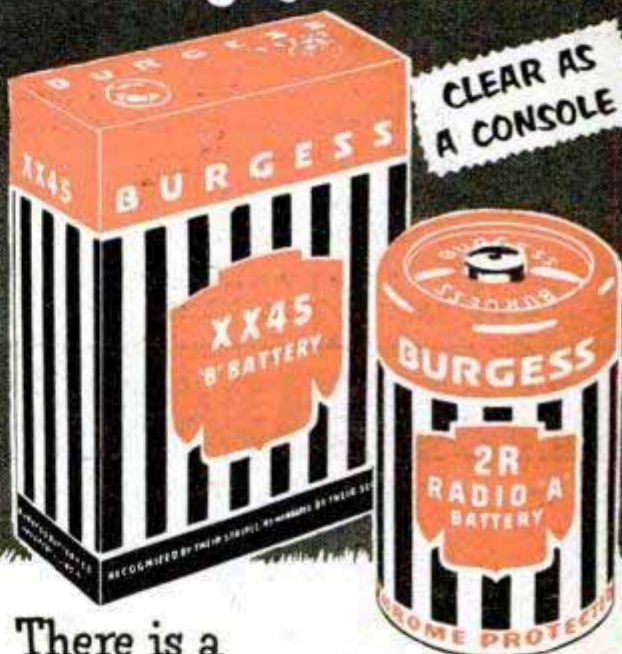

There is a  
**BURGESS BATTERY**

**MADE FOR YOUR PORTABLE RADIO**

Yes, you'll enjoy more hours of console-like performance from your portable radio with Chrome Protected Burgess Batteries on the job. Only Burgess offers this exclusive development that curbs power loss—checks internal action in the battery when your radio is turned off. Try Burgess for more hours of static-free listening ... buy Burgess and *bear* the difference!

**BURGESS  
BATTERIES**

**BURGESS BATTERY COMPANY**  
FREEPORT, ILLINOIS • Niagara Falls, Can.

**WANT QUICK  
RELIEF FROM  
SUMMER HEAT?**

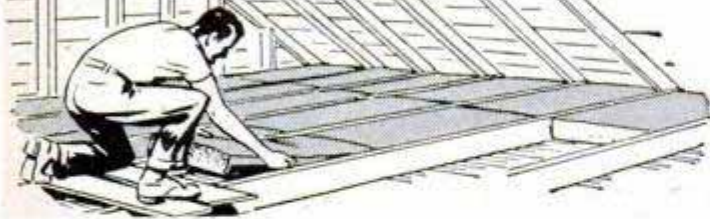

**Y**OU can beat the hot weather by insulating your attic with Gold Bond Sealed Blankets or Enclosed Batts made of fireproof Rock Wool. Lightweight and easy-to-handle, they come in standard widths, fit snugly between attic floor joists or roof rafters. Keeps summer heat out, furnace heat in...pays for itself in fuel savings. Get Gold Bond Rock Wool Enclosed Batts in 2 ft. and 4 ft. lengths. Sealed Blankets are 8 ft. long. Be sure they're "full-thick"—and be sure they're Gold Bond for best results. Write for free booklet to Div. Y, Dept. PM-71.

*Available at your local Gold Bond  
lumber and building materials dealer!*

**NATIONAL GYPSUM COMPANY  
BUFFALO 2, NEW YORK**

# REPAIRS

**Furniture, Toys,  
Luggage, Dishes**



It's transparent, waterproof,  
flexible and durable.  
Get a tube  
today.



**DU PONT**  
REG. U. S. PAT. OFF.  
**DU CO CEMENT**

tube is in position connect the socket, and insert the high-voltage plug in the recessed socket in the top side of the tube. The final position of the tube will be determined by means of the ion-trap flags. As you look at the electronic-gun structure in the neck of the tube, you will see that the second cylinder from the base inside the glass neck is provided with two small metal flags. The tube must be installed so that the two flags can be viewed from above when looking down on the tube neck. When the tube is pushed into place, the base of the tube should protrude about 2 in. beyond the focus coil, in most installations.

Next, adjust the ion-trap magnet on the neck of the tube. In some early models, the ion-trap magnet was an electromagnet containing two coils. If this is the type you have, place it on the tube with the large coil directly over the ion-trap flags. If you have an ion-trap employing permanent magnets, it goes on in the same way with the larger magnet directly over the ion-trap flags. Clean off any finger marks on the tube face and front safety glass, and re-install the cabinet front carefully. When properly adjusted, no force should be necessary. The centering slides should hold the tube face securely. With the front panel in place, slip the tube forward against the front panel. Next, slide the picture-tube cushion firmly against the flare of the tube and tighten the adjustment wing screws, shown in Fig. 1.

If it is necessary to remove the chassis from the cabinet in order to replace the picture tube, it is a simple matter. You merely pull off the control knobs on the front and remove several bolts on the underside of the cabinet and slide the chassis out. The picture tube in this case will usually be supported by a frame fastened to the chassis base. Use all of the same safety-first precautions in exactly the same order as previously outlined. In some cases the picture tube will be mounted in a separate frame independent of the chassis.

Now that you have installed the new picture tube, and have the set in the cabinet, you are ready to carry out the final adjustment of the ion-trap magnet. Although you may think that you have placed the ion-trap in the proper position, it probably will require a further adjustment. To find out, replace the back on the cabinet and connect the power cord and the antenna. You may get no picture, or it may not completely fill the raster (pattern of scanning lines on the face of the picture tube) in all corners. This means that you must either call a serviceman, or adjust the ion-trap yourself through the top of the cabinet

(Continued to page 232)



# First line of defense AGAINST ENGINE WEAR



Install a Marvel Oiler for proper and controlled feeding to critical upper cylinder areas. Visible supply in 1-qt. glass container.

Write for free information—Dept. 119

**BE  
ENGINE-WISE  
—MARVELIZE  
NOW!**

- Prevents high compression ping
- Prevents internal motor rust
- Provides ring seal
- Prevents carbon formation
- Frees sticky valves

Use in Marvel Oiler, gas tank, or as a crank case additive



**EMEROL MANUFACTURING CO., INC.**  
242 WEST 69TH ST., NEW YORK 23, N. Y.

**MONEY for MEN ALL DATA FREE**

THE PLASTEX Industry needs manufacturers on small scale and for big production of Lamp and Clock Stands, Art Goods and Novelties in Plastex and Marble Imitation. Experience unnecessary. 1/2c material makes regular 10c store sellers. Rubber molds furnished for speed production. Small investment brings good returns. We are now placing big Chain Store Orders with manufacturers. Ambitious men have chance for real prosperity. Our Free booklet will interest and benefit you.

**PLASTEX INDUSTRIES, Dept. A**  
3400 Third Ave. New York 56, N. Y.

**BUILD ARC WELDER FROM OLD GENERATOR**

For Light or Heavy Work. 75-200 amps. No previous experience needed. Complete PLANS and valuable Catalog 35c. Send today.

**LEJAY MANUFACTURING CO.**  
1347 LeJay Bldg., Minneapolis 8, Minn.

**ELECTRICITY Anywhere**

FOR PORTABLE, EMERGENCY OR HOME USE

ONAN Electric Plants generate 110-volt, 60-cycle current for homes, farms, cabins and resorts beyond the highline. Lightweight, portable plants cut costs, speed work for contractors. Standby plants protect units against power failure. 400 to 55,000 watts. Gasoline or Diesel-powered. Priced from \$219.00.

WRITE FOR CATALOG

**D. W. ONAN & SONS INC.**  
5847 ROYALSTON AVE. • MINNEAPOLIS 5, MINN.

**PISTON TYPE COMPRESSOR**

**EASY PROFIT IN PAINT SPRAYING**

Paints walls, ceilings, screens, furniture and machinery faster, better. All complete as shown less motor. Carry anywhere. Fully guaranteed. Could be used with 1/4 H.P. motor or less. Price \$35.00 less motor F.O.B. Chicago. \$5.00 deposit balance C.O.D. or see your dealer. With motor \$55.00.

**IDEAL AUTOMATIC PUMP CO., Dept. P.M.8**  
801 W. Washington Blvd. Chicago 7, Ill.

**BRAND NEW.** Quality glasses. Achromatic lens! Have precision ground optics, lightweight metal bodies, Moisture-Dust proofed.

**COATED! FEATHERWEIGHT**  
16x50 COATED **\$69.50**

The ultimate in a fine binocular. Tremendous power. Featherweight (weighs only 31 ounces!). Precision made in every detail. COATED providing sharper, brighter images. Individual focus. Objective lens is 50mm (2 inches) across!

6x30 Coated	\$27.95
7x35 Coated (center focus)	49.50
7x40 Coated (center focus)	52.50
7x50 Coated	36.00
8x30 Coated	32.50
8x40 Coated	54.50
10x30 Coated	39.50
10x50 Coated	62.00
12x50 Coated	65.00

**SIX TELESCOPES IN ONE!**

15 to 40 POWER **\$29.50**  
COATED

American made Wollensack telescope. Instant focusing at 15x, at 20x, 30x and 40x, etc. Turn power tube to click—no guess work. Telescope measures 9" closed, 27" when extended. Weighs only 18 oz.! Has rust proof chrome tubes, large 40 MM objective lens. All 12 optic surfaces are COATED. See .22 bullet holes clearly at 300 feet. Use also for astronomical observation. \$29.50 price includes tax and fine leather case.

**UNCONDITIONALLY GUARANTEED.** Try for 20 days at our risk! If not fully satisfied return for full refund! Cash orders rushed postpaid. On C.O.D.'s include \$2.00 deposit. Add Federal tax. Prices include handsome genuine leather case and straps.

**UNITED BINOCULAR CO.**  
9043 S. Western Dept. ARF-2508 Chicago 20

FOR HOME-UTILITY ELECTRIC TOOLS. Quality-built by  
BLACK & DECKER, world's largest Portable  
Electric Tool maker. Powerful,  
accurate, easy to handle.

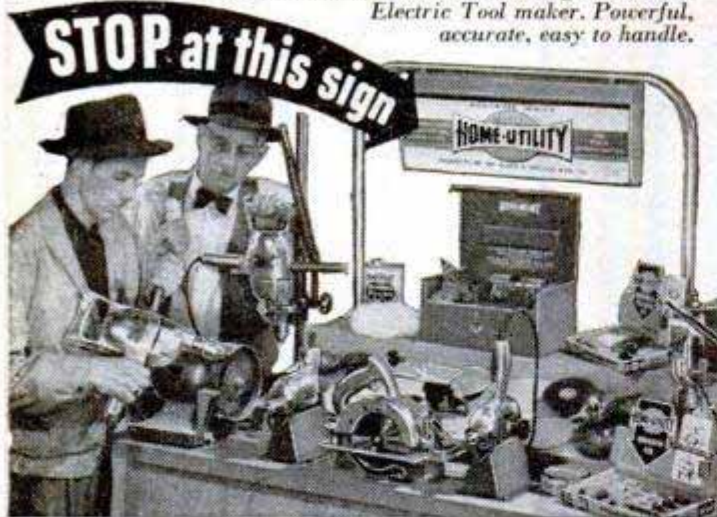

## Home-Utility Tools save you man-hours and materials

► *Mechanics, farmers, small builders, service businesses:* Home-Utility Tools put more power in your manpower—speed up drilling, sanding, sawing, grinding, polishing, many other jobs!

They do faster work to cut man-hours on any job—do better work to cut waste of materials. And when you use popular-priced Home-Utility Tools—*specially designed for your type of service*—you release production tools for defense plants where their heavy-duty capacity is vitally needed.

Stop at your hardware, appliance, building supply, implement or department store for a demonstration. Products of HOME-UTILITY Div., BLACK & DECKER Mfg. Co., Dept. H7M, Towson 4, Md.



**ELECTRIC**  
**HOME-UTILITY**  
**TOOLS**

1/4"-1/2" Drills • Lectro-Saws • Sander-Polishers • Bench Grinders

with the current on, so that you can see the picture in order to determine the proper adjustment of the trap. This is attained when you obtain maximum pattern or picture brilliancy and have the raster completely filled. The writer does not wish to imply that this is a safe thing for all TV set owners to do. However, there is no danger if the ion-trap adjustment is made without touching any other internal part of the set. A good safety-first precaution is to keep one hand behind you, and never stand on a basement floor or on any other damp floor when making adjustments in any high-voltage apparatus. Also never do it near cold-water pipes, or any grounded metal. The writer has followed these safety-first rules in handling high-voltage power supplies in radio transmitters for years. To make the final adjustment of the ion-trap, turn the brightness control fully on, and the contrast control completely off. Loosen the trap and move it forward and backward and, at the same time, rotate it slightly around the neck of the picture tube until you see the brightest full raster on the tube. Then tighten the ion-trap adjustment screws to hold it in place. When working behind the set, use a mirror in front, as illustrated in photo M, to view the picture, or tuning pattern, photo L. A further ion-trap adjustment may be made by reducing the brilliance of the brightness control until the raster is just slightly above average brilliancy. Then adjust the focus control on the rear of the set chassis until the trace lines on the raster are clearly shown. Now readjust the ion trap for maximum raster brilliancy. Final adjustment can be made with the brightness control set at the brightest level of brilliancy so that the best line focus can be maintained. Finally, fasten the trap in position and replace the top on the cabinet. Now you are all set to tune in programs.

The safest way for the owner to replace smaller defective tubes in his TV receiver is to disconnect it from the wall socket, go through the safety steps previously outlined, and then remove the tubes one by one, marking the identifying tube numbers clearly on the chassis base near each socket. Some tubes pull out easily and others may have a retainer flange that must be pressed together to release the tube. Be careful not to bend the prongs when removing and inserting the tubes, especially the miniature types. Wrap the tubes individually and take them to the nearest tube dealer for checking. The experienced set owner will do what most servicemen do—provide duplicate tubes for testing by the substitution method as illustrated in photos

(Continued to page 234)

# GROBANS WAR SURPLUS BARGAINS

BRAND NEW - UNCONDITIONALLY GUARANTEED

## GENERAL MOTORS - ALLISON

BRAND NEW

### CENTRIFUGAL PUMP

200 GALLONS PER MINUTE

- For Draining Basements • Fire-Fighting • Irrigation • Fuel Transfer • Swimming Pools
- Home Water Systems • Dewatering

This General Motors-Allison Centrifugal Pump—designed for use on U. S. Air Force Mustang fighters, now converted for commercial, home, and industrial high volume pumping applications. Inlet, 2 1/2" standard pipe thread, twin outlets with 1 1/4" pipe thread, ball bearing supported 3/4" shaft. Easy, fast simple priming. Rotation, counter-clockwise facing shaft. Shipping wt. 35 lbs.

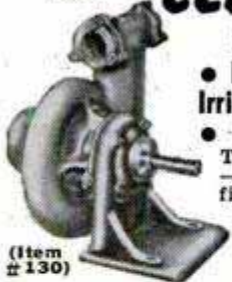

(Item #130)

Suction Lift	Head Pressure	Gal. Per Min.	H.P.	R.P.M.
10'	75'	260	6.0	3500
10'	65'	200	5.2	3500
10'	80'	40	1.5	2500
10'	50'	140	5.0	3500
10'	30'	100	3.0	2500

Gov't. acq. cost \$145.00  
F.O.B. Chicago Now Only **39.50**

## CENTRIFUGAL PUMP UNIT

\$3800.00 value

COMPLETE WITH FULL ENGINE AND PUMP INSTRUCTIONS

2 STAGE MODEL "PUP" PUMP DRIVEN BY AN 8 CYLINDER MODEL C-36 CHRYSLER INDUSTRIAL ENGINE. ENGINE SPEED 2400 RPM — 100 H.P.  
600 GPM AT 175 PSI — PARALLEL CONNECTION  
300 GPM AT 375 PSI — SERIES CONNECTION

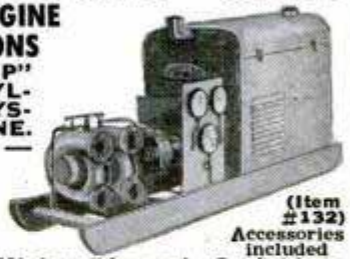

(Item #132)

IDEAL FOR: Pick-up, Gathering, Fire Fighting, Salt Water Disposal, Sprinklers, Irrigation, Dewatering, Construction, etc.

These skid-mounted Pumping Units are standard production models with parts and service readily available. Designed for a wide range of operating conditions particularly where wide variation in head and capacity are required. Twin suction and discharge ports are cast on the same side and so arranged that external piping is interchangeable for either parallel or series pumping applications. Overall dimensions, 114" L x 29" W x 62" H. Weight 2480 lbs. Now, complete with full priming equipment, operating instructions and performance data. F.O.B. Chicago

**1495.00**

## NEW! STATIONARY OR PORTABLE

### D.C. Arc Welder

250 AMPS. MODEL 252 (ITEM #65)

For Any Welding Job, Light or Heavy STOP COSTLY REPAIR BILLS, WELD IT YOURSELF AND SAVE



Only one or two jobs will pay for entire welder. Designed for many years of trouble-free service. This precision-engineered Direct Current ELECTRIC ARC WELDER is offered at but a fraction of its original value. It can be mounted permanently or easily transported for portable use. Does the job instantly where and when you need it. Has dial type rheostat for easy pinpoint control and a high-low range switch. Run welder at 2500 RPM from drive pulley or power take-off of tractor, a 7 1/2 HP electric motor or a 10 HP gas engine. Use two V belts or flat belt (on pulley). Price includes double V or flat belt pulley and instruction book. Shpg. wt. 107 lbs. F.O.B. Chicago.

Now at a fraction of its value

**99.50**

## DIRECT CURRENT GENERATORS



For welders, plating, truck and marine use, D.C. appliances, lights, etc. Aircraft quality—lifetime grease sealed ball bearings. Heavy duty.

- Item #131—Brand new Electric Auto-Lite 12 volt Direct Current electric generators, rated 18 amps. Complete with blower and pulley. Use for trucks, tractors, boats, battery chargers, etc. Part No. GEF-4805A. In original sealed U. S. Army cartons. \$40.00 value. Shpg. wt. 27 lbs. **15.00**
- F.O.B. Chicago. Now Only.
- Item #90—Type P-1, rated 200 Amps.—28 Volts, 2500 RPM. Mfd. by General Electric, Ford, Delco-Remy and Westinghouse. Gov't. Acq. Cost \$300.00. Shpg. wt. 70 lbs. **22.50**
- F.O.B. Chicago.
- Item #91—Type R-1, rated 300 Amps.—30 Volts. Mfd. by Jack & Heinz. Gov't. Acq. Cost \$380.00. Shpg. wt. 70 lbs. **35.00**
- F.O.B. Chicago. Each individually packed in wooden box

## LOGAN HEAVY DUTY HYDRAULIC PUMP or MOTOR

For operating hydraulic cylinders and hydraulic motors on tractors, bull-dozers, construction machinery, lift trucks, industrial applications, etc. Delivers 10 GPM at 600 RPM at 1000 PSI using 6 HP. Has a 3/8" inlet, 1/2" outlet, 3/4" shaft with flat and keyway for direct or pulley drive. For greater capacity tap out ports to 3/4" for 16 gallons per minute. Has flange with 4 bolt holes for convenient mounting. Ship. wt. 22 lbs. Overall dimen.: 7" L x 5 1/2" H x 5 1/2" W. A \$105.00 value FOR ONLY **22.50**



(ITEM #78)

## HYDRAULIC CONTROL VALVE

Four-way control valve for use with two hydraulic double-action cylinders. Each cylinder may be operated independently of the other or in conjunction with the other. Oil may be locked in any of the cylinders to hold the piston at any required position. Ship. wt. 6 lbs. A \$60.00 value. **12.95**



ITEM #26

## Hydraulic Cylinders—Air or Oil

Large supply of new labor-saving, economical hydraulic equipment in many types and sizes. Use these positive, highly efficient smooth pressure hydraulics on presses, arbors, lifts, loaders, power control, positioning, brakes, plastic dies, auto frame alignment, etc., etc.

- ITEM #70—Purulator hydraulic oil filter. Permanent element type. 3/4" female pipe thread ports. Capacity 16 gallons per minute. A \$13.00 value. Now postpaid. **4.95**
- ITEM #4—All steel double action hydraulic cylinder. 1 1/2" bore, 2 1/8" stroke. Clevis mounting. Will lift 1000 lbs. with 1000 P.S.I. line pressure. Perfect for positioning and feeding movements. **4.95**
- Shpg. wt. 4 lbs. Postpaid.
- ITEM #127—Double acting hydraulic cylinder, 1" bore, 1" stroke, 1/2" diam. shaft, 1/4" tubing thread ports. Over-all length closed—6 1/2". Clevis mounting at both ends. Perfect for clamping and feeding. Postpaid. **5.95**
- (Item #42)
- ITEM #33C—Double action hydraulic cylinder, 1 1/2" bore, 3 1/2" stroke. Clevis mountings at both ends. Uses 1/2" pipe fittings. **8.95**
- Postpaid.
- ITEM #16—Double acting hydraulic cylinder, 1 1/2" bore, 2" stroke. Will lift 1760 lbs. with 1000 PSI line pressure. Weight 8 lbs. A \$55.00 value. **16.95**
- Now Only Postpaid.
- ITEM #103—Double acting hydraulic cylinder, 2 1/2" bore, 1 7/8" stroke. Clevis mounting. Will lift 4900 lbs. with 1000 PSI line pressure. 1 1/4" diam. shaft. 3/8" tubing thread ports. Overall length closed 28". **21.50**
- Shpg. wt. 11 lbs. F.O.B. Chicago.
- ITEM #31C—Double action hydraulic cylinder, 3 1/2" bore, 1 1/2" stroke. Aluminum alloy cylinder wall and all steel 1 1/2" clevis mounting at base and shaft. 1 9/16" overall length closed. Will lift 9625 lbs. using 1000 PSI from Logan Heavy Duty Hydraulic Pump. Uses 3/4" tubing fittings. Value \$102.00. Shipping wt. 11 lbs. F.O.B. Chicago. **22.50**
- ITEM #6—Double action hydraulic cylinder, 3" bore, 24" stroke, will lift 7070 lbs. with 1000 PSI line pressure. Steel barrel. 1 1/4" stainless steel shaft. Gov't. acq. cost \$176.00. Shpg. wt. 26 lbs. F.O.B. Chicago. **28.00**
- ITEM #42—Double action hydraulic cylinder, 4" bore, 18" stroke. Rated lift capacity with 1000 PSI line pressure is 12,500 lbs. Ship. wt. 30 lbs. F.O.B. Chicago **32.50**
- An Excellent Buy for.



**FREE: NEW 48-PAGE CATALOG** Chuck-full of War Surplus Bargains for the farm, home, factory and workshop, at far-below-cost prices. Send for yours today!

## HYDRAULIC SPEED REDUCER with FINGERTIP CONTROL

USE FOR: • Reamer Drives • Midget Cars • Feed Mills • Canning Machines • Conveyors • Lathes • Milling Machines • Motor Boats • Cream Separators • Garden Tractors • Pumps

Variable output speeds ranging from 0 to input speed now available. Merely move control handle until desired speed is attained. Then turn locking handle to maintain the setting. Internal relief valves prevent overloading. Use input power of 1/4 to 1 1/2 H.P.

This Westinghouse-Oil Gear Unit converted to commercial use from 40 MM anti-aircraft traversing mechanisms consists of a variable displacement hydraulic pump feeding a fixed displacement hydraulic motor. These components are contained in a crackle-finish steel oil reservoir (capacity 2 qts.). Adjustable relief valves set at factory for 100 inch pounds of torque may be reset up to 180 inch pounds. Independent reverse control allows full output power and speed selection in either direction of rotation.

Both input and output shafts measure 5/8" diam., include keyway. Input rotation is counter-clockwise facing shaft. Recommended input speeds not to exceed 750 R.P.M. Over-all dimensions 7 1/2" x 7 1/2" x 11 1/2". Gov't. acquisition cost, \$428.00 Shipping weight 31 lbs. Complete with 2 qts. of oil and full instructions. F.O.B. Chicago **54.50**

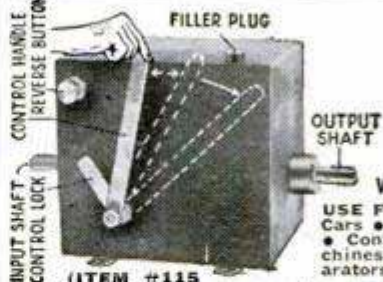

(ITEM #115)

ORDER DIRECT FROM AD — SEND PAYMENT OR PURCHASE ORDER TODAY — SATISFACTION GUARANTEED

**GROBAN SUPPLY CO.** 1139 SO. WABASH AVE., CHICAGO 5, ILL. DEPT. PM-7

K and M. The first tubes to suspect are the rectifiers in the separate metal "doghouse" on the chassis. This has a removable cover. Never be tempted to make coil-slug adjustments or any other screwdriver adjustments while working inside your set. Such adjustments require the use of expensive test instruments that you will find nowhere except in the serviceman's shop or manufacturer's laboratory. The tube-location chart for your TV set will indicate the functions of the various tubes employed in your particular receiver. The high-voltage rectifiers may be 1X2 or 1B3; the 5U4 and 6W4 are commonly used low-voltage rectifiers. Always check these power tubes. The 5V4, or 6W4-GT, is a damper tube and one to suspect. Other tubes to suspect are the 6BG6-G, or a 6BQ6, 6SN7, or, in fact, any of the many tubes in your set, the locations of which are identified on your tube-location chart. When changing these tubes in your TV set keep the picture tube covered with a small blanket or heavy towel as shown in photo K. Note that the high-voltage plug has been removed from the tube and that the power-line cord is also temporarily disconnected. This is safety-first in action. Also provide a flashlight. Do not poke around in dark corners and disturb other tubes.

Photo I illustrates a simple method of marking the original adjusting-screw positions of the various nonoperating controls on the back of the TV set chassis. This can be done with a soft crayon and it is important as any adjustment of these controls should be very slight, and the controls should be immediately returned to their original positions if not effective. Many TV sets have perforated metal back covers which, when removed as illustrated in photo J, automatically disconnect the line cord from the set chassis. These covers are often bent or otherwise damaged. If bent, straighten and make sure that the line-plug mounted on the cover makes good contact in its chassis socket when replaced.

**FIND OUT** how to select, install and maintain the most efficient TV antenna system for your particular location. Learn the importance of installing TV lightning arrestors, and how you can do it yourself. TV set owners, and prospective owners, will find this information together with pictorial TV set-tuning instructions giving picture defects and corrections, using both test patterns and picture images, in Popular Mechanics RADIO-TV and ELECTRONICS HANDBOOK. This "written so you can understand it" book is today's guide for millions of radio and television set owners, students and experimenters. Now available from your bookstore, or direct from Popular Mechanics Press, 200 East Ontario St., Chicago 11, Ill. Price \$2.50

# Speedy Sprayer

**Heavy duty all-purpose paint sprayer for  
Hobbyists, Mechanics, Home Owners who  
demand superior performance and results!**

**SPEEDY SPRAYER 890**

Delivers 2 cu. ft. per minute, clean, oil-free air at 30-40 lbs. pressure. Operated by any 1/4 h.p. motor. Never needs oiling. Complete outfit—gun, valves, nozzles, air hose, less motor.

**Free**  
**\$3250**

Here's a real "professional" spray outfit that paints anything from a house to a toy! In addition, Speedy Sprayer handles any material—enamel, varnish, lacquer, calcimine, insecticide, etc. Speedy Sprayer saves time and money, too. Does any job in *minutes* instead of hours... makes paint go further. It's the favorite sprayer whose dependability is proven by 20 years of usage. At hardware, paint, lumber or auto supply dealers.



**W. R. BROWN CORPORATION**  
**CHICAGO 39, ILL.**  
*Specialists in Portable Sprayers for Over 20 Years!*

W. R. Brown Corporation  
5717 Armitage Ave., Chicago 39, Ill.  
Free Booklet "How to Spray". Also Speedy  
Sprayer literature.

Name \_\_\_\_\_

Address \_\_\_\_\_

City \_\_\_\_\_

State \_\_\_\_\_

# New-Engine Performance at about half the cost!

● Exchange your worn engine for an **Authorized Reconditioned Ford Engine**—and save nearly half the cost of a new engine! Completely rebuilt by a **Ford-Authorized Reconditioner** . . . over 175 brand new or fully reconditioned parts!

**NEW CAMSHAFT GEARS**

**NEW PISTONS AND PINS**

**NEW CONNECTING  
ROD BEARINGS**

**NEW CRANKSHAFT  
BEARINGS**

**CYLINDERS REBORED**  
to Authorized  
Reconditioner's exacting standards

**T**HINK OF IT! New-engine acceleration and power! New-engine economy! All at about half the cost of a new engine!

Save time. Save money. Enjoy trouble-free driving—see your Ford Dealer or independent garage *right now!* Ask about the low down payment, easy terms, one-day installation.

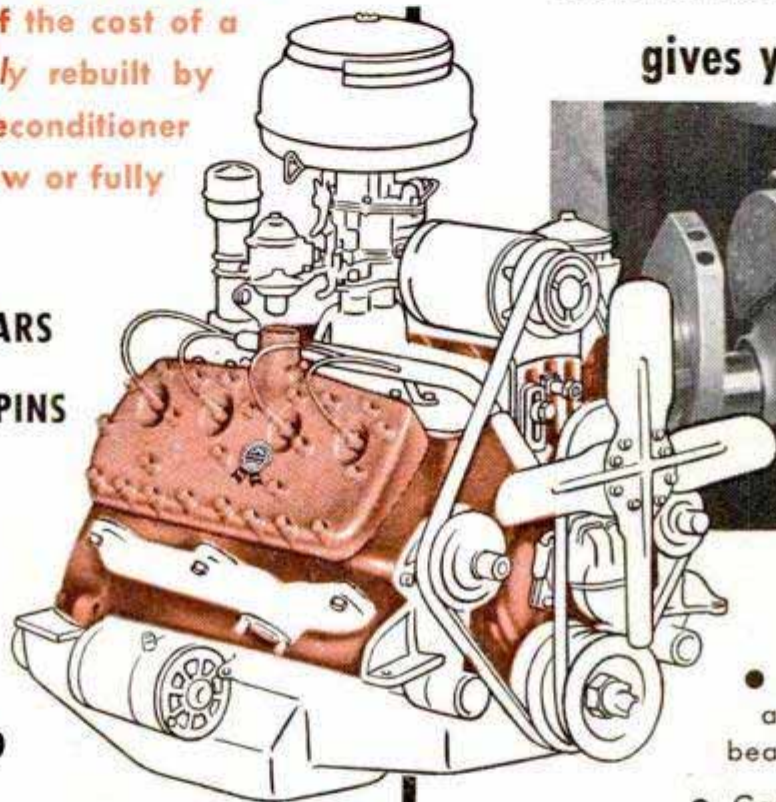

An Authorized  
**Reconditioned Ford Engine**  
gives you all this:

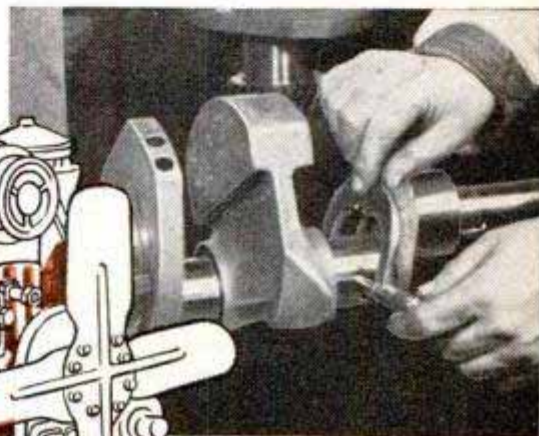

● Crankshaft reground and polished, new main bearings.

● Genuine Ford Parts—new or completely reconditioned.

● Parts precision-fitted and tested to high Reconditioner's standards.

● Costs only a few dollars more than a ring and rebores job.

● Backed by Reconditioner's guarantee against any defects in workmanship or material for 4,000 miles or 90 days, whichever occurs first.

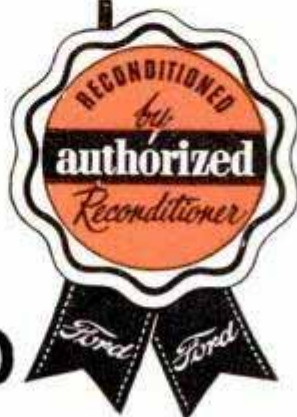

Look for this emblem—it's your guarantee that you're getting an **Authorized Reconditioned Ford Engine** with **Genuine Ford Parts**.

Keep your **FORD** all **FORD**

# FREE BOOK! ➔

**YOU, TOO, CAN  
START A  
\$40 A DAY  
BUSINESS  
IN YOUR  
SPARE TIME!**



Andy Phillips says, "My BELSAW CIRCULAR SAW SHOP gives me BIG PROFITS at LOW expense... I can run 35 to 40 saws in an 8-hour day... That makes me \$40 cash."



You can start this REPEAT CASH business in your own home or garage, while you are working at your regular job. Easy to operate, no experience needed. "Pays for itself from just 65 saw jobs." — Harvey Jensen.

For as little as \$15 down payment, you can get your BELSAW CIRCULAR SAW SHOP rushed to you.

You can make \$4 to \$5 an hour in your SPARE TIME sharpening and setting CIRCULAR SAWS for builders, lumber yards, factories... No Extra Equipment needed, no canvassing... send postcard for your Free Copy of "Life Time Security" today.

**BELSAW MACHINERY CO**

3001 Field Building

Kansas City 2, Mo.

## STOP THAT OIL EATER!



GET NEW CAR PERFORMANCE WITH  
**PISTON SEAL**  
WITHOUT COSTLY OVERHAULING

Piston Seal—the amazing compound that forms a self expanding, pliable lubricating seal around pistons that compensates for wear. Eliminates oil burning, restores power and compression. Can be applied in a few minutes.

**GOOD FOR 10,000 MILES**



**SIMPLY REMOVE  
SPARK PLUG AND SQUEEZE**

SEND FOR  
A TUBE TODAY

**\$4.95** No C.O.D.'s

Postpaid

OR WRITE FOR FURTHER INFORMATION

**RICHIE DISTRIBUTING CO.** 1628-M Cohasset Avenue  
Lakewood 7, Ohio

## Fire Bombs Blaze a Trail of War

(Continued from page 112)

So much napalm and high explosives were dumped on their heads that only 50 escaped when darkness came.

Marines of the Blacksheep squadron saw enemy troops hiding in caves in a deep canyon. Maj. Kenneth Ruesser, the strike leader, got permission to give them the napalm treatment but it took some expert piloting to hit the target. He and Capt. Charles Graber flew in so low Ruesser's napalm bomb would not arm (the fuse isn't supposed to operate unless the bomb has traveled 150 feet through the air after release). Graber made another sweep of the canyon and ignited the spewed napalm gel with tracer bullets.

The planes made life so dangerous for Communist troops in many areas that they took to moving their troops and convoys at night. They would push their tanks and trucks right into thatched huts during the day for camouflage. Soon orders went out to Navy planes to burn down villages known to harbor these vehicles. Ammunition dumps make prime targets for napalm's far-flung damage, the shells going up in one huge explosion. Pilots have to keep their distance to escape the flying shrapnel.

Another favorite tactic against North Korean rolling stock was used by pilots who were lucky enough to catch a train on a curve. Dropping their napalm bombs on the inside of the curve, they could splatter the whole train. A couple of Marine pilots played a cat-and-mouse game with one Korean trainman near Wonsan. The engineer pulled his train into a tunnel before the planes could napalm it.

Each time he would try to pull out, they would dive in and strafe it. Finally, they hid behind a hill and the train pulled completely out of the tunnel. The harrassing planes zipped in, one pilot hitting the front end and the other the rear with their "hell bombs." The train was hors de combat.

Marine Lt. James McCleery destroyed four enemy tanks with one napalm bomb. He had to. It was the only weapon he had left. Unexpectedly coming upon a cluster of four tanks, McCleery put his Corsair into a dive and released the napalm tank. It landed right in the middle of his target. Infantrymen moving in two days later reported all four tanks were completely burned out.

Communists who could withstand artillery shelling, rockets and machine gunning would leave their entrenchments and flee when fire bombs were dropped in their

(Continued to page 238)

# REMOVE PAINT THE PAINTER'S WAY



Take the painter's short-cut—avoid hard scraping and sanding. Apply Wonder-Paste to the toughest paint, enamel, varnish, etc., and it soon becomes a soggy mass, easily stripped off with a putty knife! Leaves surface smooth and clean, ready for a new coat. America's largest selling remover—find out why! At better dealers everywhere.

Write for leaflet

## WONDER-PASTE

Wilson-Imperial Company, 119 Chestnut Street, Newark 5, N. J.

# POWER MOWERS

NO  
ADVANCE  
IN  
PRICE

## Powerful — Streamlined

Complete with Maytag, Power Products or Briggs-Stratton Engine—18" rotary tool-steel, fully guarded blades—cast aluminum body. Cuts grass and weeds, wet or dry—does all trimming—chops grass into fine mulch, eliminating raking. Send check with order, or specify C.O.D.

Write for free information

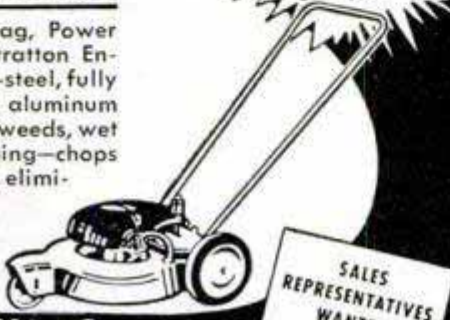

SALES  
REPRESENTATIVES  
WANTED

## HARTMAN Corp.

1100 SOUTH KIRKWOOD ROAD • ST. LOUIS COUNTY 22, MO.

# FIBERGLAS\* for your boat



\* T. M. REG.

## LOW COST EASY APPLICATION

Give your boat a permanent all-weather surface in just 4 hours! Easy to apply. Once on, lasts for years, cuts upkeep cost to minimum.

WRITE TODAY for free literature and low prices

**THALCO** Dept. K, 3417 W. 8th St., L. A., Calif.

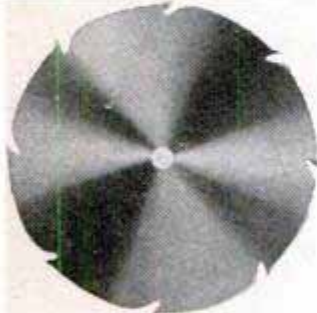

# NEW - SAFETY - CUT - SAW - BLADES DIRECT - FROM - MANUFACTURER - BY - MAIL

These sensational new blades with only 8 TEETH are made of first quality nickel chrome steel. Will crosscut and rip with NO KICK-BACK! Greater safety. Smoother cutting. Longer life. TAKES LESS POWER. Less danger of cracking.

## COMPARE PRICES

6 inch \$3.60	7 inch \$4.69
8 inch 4.89	10 inch 6.09

## MONEY-BACK GUARANTEE

1/2 - 5/8 - 3/4 arbor holes  
Also for portable saws

ADD SALES TAX IN CALIFORNIA

— WE PAY POSTAGE

SEND CHECK OR MONEY-ORDER TO:

**WESTERN SAW MANUFACTURERS, Inc.**

1842 WEST WASHINGTON BLVD.  
LOS ANGELES 7, CALIFORNIA

JULY 1951

# SAVE OVER 50%

ON THESE BRAND NEW  
WAR SURPLUS POWER UNITS



BE PREPARED  
for any emergency!

## LIGHT PLANT BUYERS—

in emergency telephone collect—unit shipped same day!  
5 KW Plant, 120 volts, 60 cycle AC. List today \$1910.00. Used \$675.00 NEW. Your price only **\$895.00**

## BARGAIN SPECIALS!!

Ball-bearing Arbor... \$ 6.95	2500 Watt, AC, 110 volts, 60 cycle. Slightly used but reconditioned and fully guaranteed ONLY... \$295.00
Alarm Siren or Horn... 15.45	NEW, same as above... \$345.00
Mercury Heat Control... 6.95	Plants built in 1951... \$426.00
Barn Ventilator... 69.50	Same plant 110-220 volts, AUTOMATIC battery starter... \$465.00
Electric Hot Water Heater, 10 gal... 24.95	300 Watt, Reg. \$145, Now \$ 99.00
Hot Rod Supercharger 31.00	750 Watt... \$232.00
NEW 2 1/2 HP Briggs & Stratton AP Lists at \$103... \$69	1000 Watt AC... \$248.00
	3000 Watt DC Contractor's PORTABLE, Rubber tired wheels, 5 to 7 HP gas engine. Used like new \$220.; New... \$279.00
	7500 Watt 4 cyl. engine; New... \$995.00
	10,000 Watt Used \$1195.00; New... \$1495.00
	25,000 Watt Used \$1995.00; New... \$2495.00
	35,000 Watt Diesel, Rebuilt \$2995.00
	50,000 Watt Diesel, New \$5900.00

## HEAVY DUTY, all purpose WINCH

For — CONTRACTORS, BOATS, FARMERS, TRUCKS, LOGGERS, ETC.

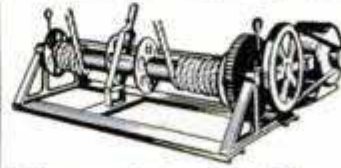

Multiply your pulling, hoisting power tenfold. Can be driven by hand, gas, electric, or tractor take off, 10 to 1 ratio; double drum for reverse. Manufactured by Brenner. Wgt. 280 lbs. List price \$119.95. Our price... **\$49.50**

Below are just a few of the many items we have in stock at sensationally low prices:

Pumps	Air Tanks	Fire Pumps	Gear Reducer
Grinders	Drop Cords	Saws	Clutches
Air Compressors	Generators	Winches	Motors

Write today for free catalog. Thousands of \$8 saving buys.

## C & H ELECTRIC Co.

434 W. JUNEAU AVE.  
MILWAUKEE 3, WISCONSIN

# MODERN LAWN MOWER SHARPENER

## FOR LAWN MOWER SHOPS FIX-IT SHOPS

GOLF COURSES • PARKS  
101 OTHER JOBS

Sharpens All Reel Type Mowers • Hand, Power or Gang • 10 to 20 Minutes • No Dismantling • No Extra Attachments Needed.

All reel type mowers, from 5-inch edgers to 36-inch power mowers, are quickly sharpened to extreme ends of both left and right twist blades.

## ORDER NOW

Immediate Delivery

Handle, wheels, roller and motor remain in place when sharpening is in process. Bed knife is sharpened in same brackets. Grinding head rides on five ball bearing races. Easy to operate. Also sharpens chisels, joiner knives, planer blades. Big profit maker. Own your own business. Send Today for FREE Illustrated Bulletin No. 10-C  
Prices Subject to Change Without Notice

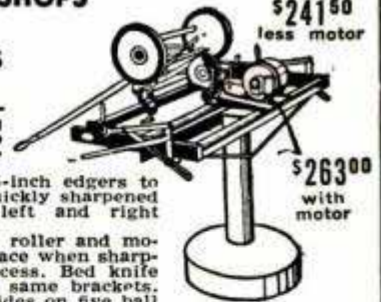

PRICE \$241.50 less motor

\$263.00 with motor

**MODERN MFG. CO.** 160 N. FAIR OAKS AVE.  
PASADENA 1, CALIFORNIA

## POINTERS FOR HOME PAINTERS

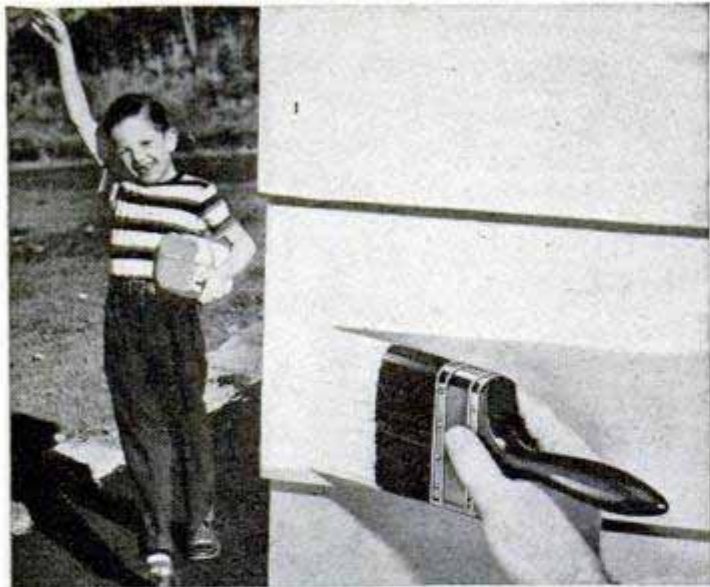

### How you can get smoother painting ... longer life from your brushes



In painting wood surfaces, work with the grain and paint last strokes of each brushful back into the portion of surface previously coated.

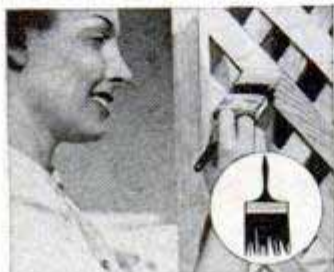

Painting edgewise on narrow surfaces with large brush causes "fingering" (inset), ruins brush. Use small brush, one designed for the job.



For overnight cleaning, pour thinner on brush and work out paint on newspaper. Then use stick or paint scraper to squeeze out paint, suspend brush in thinner.



For storage, clean brush thoroughly with thinner, then scrub bristles with warm water and cleanser. Rinse in clear water, comb bristles and wrap in paper and store.

### For best results use NYLON PAINT BRUSHES

Job after job, you'll get best results with a nylon paint brush. Durable Du Pont nylon bristles don't break off, even on roughest surfaces. They last 3 to 5 times longer than ordinary bristles... paint smoother... are clean and sanitary. Nylon paint brushes are made by leading manufacturers in all types and sizes. Look for the word NYLON on the handle.



Better Things for Better Living  
... through Chemistry

The best brushes have  
**DU PONT NYLON  
BRISTLES**

vicinity. Four F-51s spotted several groups of 50 or more North Koreans along a ridge. A couple of napalm bombs chased them into near-by buildings. When they came in for another run on the "sitting duck" targets, white flags were flying.

The planes radioed to ground troops and the Koreans were captured, while planes buzzed overhead to see that things went all right. Another pilot reported he captured 12 North Koreans by threatening them with napalm while flying past them at 250 miles per hour, without firing a shot.

Although napalm bombs are extremely cheap to make and easy to use, they have their weaker points, too. Napalm powder has a great thirst for moisture and storage is difficult in humid climates. Temperature affects the rate of jelling—during the winter months the Navy had to add other chemicals so the powder would mix faster with the gasoline. Percentage of napalm varies from 6 to 13 percent and from 9 to 21 pounds go into a tankful.

Flame throwers have been used to some extent, although probably not so much as against the Japanese, who had a habit of holing up in caves and knocking off our troops. During World War II, the U. S. tried to develop an airborne flame thrower. It mounted a 200-gallon tank of napalm in the bomb bay of a light bomber which was to swoop down and spray troops. It was felt that the plane was too vulnerable to ground fire and the idea was abandoned.

Because the jar of a carrier landing might set off the napalm fuse or knock the tank off its pylons, Navy and Marine pilots were ordered either to drop their napalm before landing back aboard or else land at some shore air strip and have it removed.

Although thousands of planes have flown over battle areas with napalm tanks slung under them, only one report of a tank being hit by gunfire has been reported generally. An F-51 Mustang took a hit in its napalm tank but the pilot jettisoned it before the plane was destroyed.

In the frozen Chosin reservoir area, where Marine ground troops fought their way out of a Chinese trap, a couple of Marine fighter pilots, Capt. W. W. Hazlett and 1st Lt. W. E. Jennings, were circling the freezing Leathernecks below. They noticed a spurt of flame and then another on the hillside below them.

Getting in radio contact with the ground leader, they asked if there was any trouble and whether they could help straighten out any little things.

"Naw," came the laconic reply. "A couple of the boys are having trouble building a fire. They're trying to light it with their flame throwers."



# WHAT LASTS FOREVER?

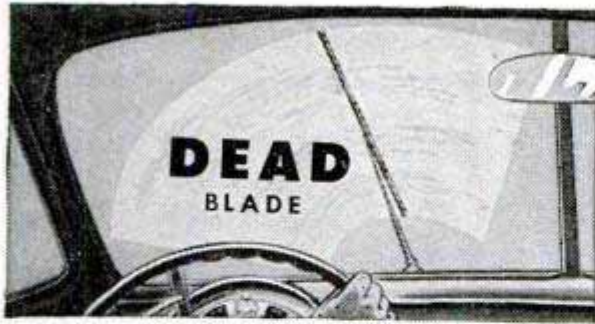

**THIS DEAD BLADE** still looks new but it blurs rain, smears muck, streaks glass. DEAD blades make dead drivers!

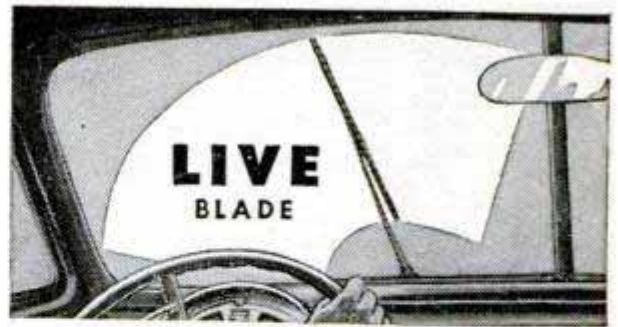

**THIS LIVE ANCO BLADE** wipes clean, clears rain, clears road muck . . . lets you SEE. Protects your loved ones.

**WHAT LASTS FOREVER?** Nothing does. This is especially true with Windshield Wiper Blades—even though made of finest natural rubber. Corrosive windshield film, wind burn and hot sun BAKE the life out of wiper blades, often in six months or less. DEAD blades cause dangerous windshield smear. DEAD blades make dead drivers. Make sure your car has live, new windshield wipers.

## Change Your Wiper Blades

Next time you buy gas, change to LIVE,

**NEW ANCO BLADES . . . RAIN-MASTER** for Flat windshields . . . **CLEAR-FLEX** for Flat or Curved windshields. They fit all cars—wipe quicker and cleaner than any other blades.

**Mr. Dealer:** Anco Wiper Motors give lots more power, lots less stall. Controlled wiping arc prevents blade slap. Six models only . . . COMPLETE replacement for ALL Cable Linkage, Bar Linkage, and Direct Drive original equipment vacuum wiper motors.

**THE ANDERSON COMPANY**  
GARY, INDIANA

## Ball-Bearing SPEED WHEELS



JUVENILE WHEELS (No bearing, solid tires)	
4" . . . . .40c	6" . . . . .65c
5" . . . . .45c	7" . . . . .75c
(Semi-pneumatic tire, ball bearing)	
8 x 1.25 . . .1.85	10 x 1.25 . .2.20
8 x 1.75 . . .1.95	10 x 1.75 . .2.30
8 x 2 . . . . .2.20	10 x 2.00 . .2.65
12 x 1.75 . .3.45	
INDUSTRIAL WHEELS	
Lug Base, Semi-Pneumatic tire	
5 x 1.75 . . .3.65	10 x 2.00 . .6.10
6 x 2 SW . .3.45	10 x 2.75 . .5.15
6 x 2.00 . .4.00	12 x 2.00 . .6.90
8 x 2.00 . .5.20	12 x 3.00 . .9.20
8 x 2.50 . .5.40	16 x 4.00 .15.15
Smooth Base, Pneumatic tire and tube	
8 x 3.00 . .11.00	12 x 4.00 .12.10
10 x 2.75 . .6.80	4.00 x 8 . .13.10
10 x 3.50 .10.55	14 x 4.50 .13.40

Dealers, Jobbers, and Manufacturers! Our new prices will interest you.

No c.o.d. orders. Prices F.O.B. our plant.  
**JIM BROWN TOY COMPANY**  
1093 HOME AVENUE AKRON 10, OHIO

## AUTOMATIC RETOOTH

MAKES NEW PROFITS

Cuts new teeth in 50 seconds—any size 4 to 16 points. Old teeth fall off as chips. Easy to operate. A perfect job.



for HAND SAWS

WRITE DEPT. 7  
**BURR MFG. CO.**  
8933 VENICE BLVD.  
LOS ANGELES 34, CALIFORNIA

**25¢**

VALUABLE BOOK

Order Burr's Blue Book of Coast to Coast prices for saw shop services.

## The NEW Model 50 UTILITY TESTER FOR REPAIRING ALL ELECTRICAL APPLIANCES-MOTORS

an all-around electrical trouble shooter

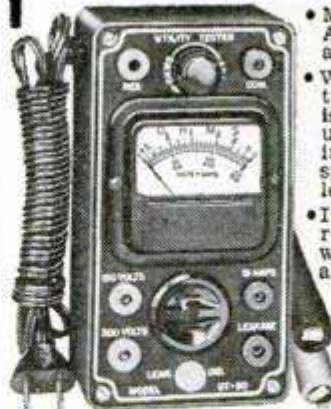

- Measures A.C. and D.C. Voltages, A.C. and D.C. Current, Resistances, etc.
- Will measure the current consumption while the appliance under test is in operation. The appliance or utility may be plugged directly into the front panel receptacle. A special pair of insulated clip-end leads is included for motors, etc.
- Incorporates a sensitive direct-reading resistance range which will accurately measure all resistances commonly used in electrical appliances, motors, etc. This range will enable continuity checks and tests for shorts and opens.
- Will test thermostats, radio tube filaments, bulbs, fuses, fluorescents, condensers, switches, field coils, circuit breakers, lighting systems, etc.

Handsome round cornered molded bakelite case 3 1/8" x 5 7/8" x 2 1/4". Complete with all test leads and instructions.

**\$13.90**

**SOLD ON EASY PAYMENTS AT THE NET CASH PRICE**

No interest or carrying charges added. Simply remit \$3.90 with order, pay balance, \$2.00 per month for 5 months.

**SUPERIOR ELECTRONIC CO., INC.**  
Dept. B-16 • 227 FULTON STREET • NEW YORK 7, N. Y.

# HANDEE®

tool of 1001 Uses



## FINEST IN POWER TOOLS PLUS 51 ACCESSORIES

Complete . . . designed for every hobbyist and mechanic! Grind, drill, polish, carve, sand, saw, etc. Packs plenty of power in the 25,000 r.p.m. motor, with approved 7-segment commutator. Handsome fitted steel carrying case.

Complete, with liberal 10-day money back trial offer . . . . . **\$27.50**

with 7 accessories . . . **\$19.95**

## HANDEE WORKSHOP

### "Tornado-Powered" with NEW HANDEE "85"

Versatile, with 41 accessories . . . suitable for shop or home use. For novice or expert . . . precision routing, molding cuts. HANDEE "85" a production wizard . . . automatically air-cooled, pin-point accuracy. Sensational power!

Complete, packed in handsome case,

**\$29.95**

**FREE! New 64-page Manual**

Chicago Wheel & Mfg. Co., Dept. PM

1101 West Monroe St.

Chicago 7, Ill.

## TAKE IT EASIER THIS YEAR WITH A

**MIDLAND  
DANDY BOY  
GARDEN TRACTOR**

You save yourself a lot of effort when you add Midland DANDY BOY garden tractor and implements to your work force. It's a working marvel that doubles at lawn mowing, field mowing, spraying, pumping, sawing, snow plowing, cultivating, and a lot of other tasks. THREE models, 2, 3, 5 H.P. give you power and performance for any job — all year. Ask your dealer how a Midland DANDY BOY can pay you a profit this year. Write Dept. PM7 for descriptive folders and name of dealer near you.

## THE MIDLAND CO.

1200 Rawson Avenue • South Milwaukee, Wis.  
Builders of Farm and Garden Implements Since 1911

## TNT Clinic

(Continued from page 91)

itself at various distances from the charge hole. Often a buried target is re-excavated after a blast has been set off so the damage and movement indicated by the instruments can be confirmed by actual inspection and measurements.

The effects that are measured include acceleration of the shock wave, pressure, velocity and strain and displacement. This information is recorded automatically by cathode-ray cameras and magnetic gauges located in three instrument trailers that are parked in the explosion area.

One trailer, close to the charge hole, is practically buried in the earth for protection. It is left untended during the time of the blast. Two other trailers nearly a mile away are protected by overhead structures of heavy timbers and sheet metal. Technicians who are stationed inside this pair of trailers are rocked as if they were in a heavy earthquake when a big blast goes off.

Firing a half-scale or full-scale shot is no casual affair. In addition to the danger there's too much work involved to permit a chance of error at the last minute. Thus, formal radio warnings and a backward count precede the blast to alert everyone concerned, just as a large experimental rocket is launched or a true atom bomb is exploded experimentally.

An hour ahead of time the technical crew stages a dry run to rehearse the sequence of events and to make sure that all electrical circuits are operating. Then a 30-minute warning is issued by radio and shortly a parade of cars streams off across the desert from the blast area to the observation point. A red flag goes up when the last person outside of the firing crew has left.

The powder expert in charge of the blast descends by a manhole into the charge hole, attaches his blasting caps to the wires that will fire them, and then hurries by Jeep to the distant trailer from which the TNT will be exploded. His last task before entering the trailer is to plug in a "safety link" of cable that he carries with him and that helps to complete the firing circuit.

A two-minute warning goes out by radio to alert the distant camera stations and the aircraft pilot, and other warnings are issued at one-minute and at 30-second periods. At 15 seconds the backward radio count begins: "Fifteen, fourteen, thirteen, twelve . . ." At "six" the firing button inside the trailer is pushed.

The firing button operates a rotary switch that automatically turns on the film drive motors of the recording apparatus,

(Continued to page 242)

# OPPORTUNITY

for Shop Men  
with Sales Ability

## BE A CUTTING TOOL SPECIALIST!

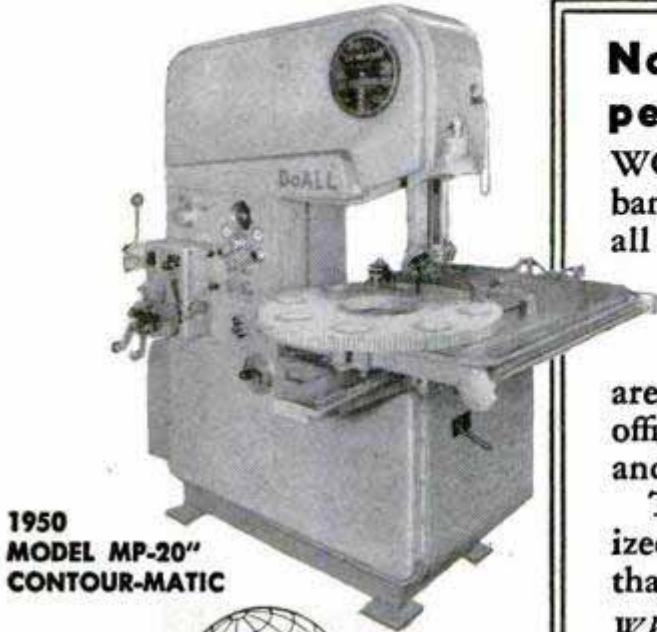

1950  
MODEL MP-20"  
CONTOUR-MATIC

**National organization offers you permanent position with good pay**

WORLD'S largest manufacturer and distributor of band sawing machines, blades, surface grinders and all around toolroom and manufacturers' needs.

Have openings for men with machine shop experience or for mechanical engineers to sell a complete line of cutting tools. Our products are sold by product demonstration. Sales-service offices in every major city in the U.S.A., Mexico and Canada.

The men selected will be given 5 weeks' specialized training with pay — plus a protected territory that is now bringing in a good income.

*When answering indicate territory preferred. Also include complete resume of experience with recent snapshot.*

**THE DoALL CO., 254 N. LAUREL AVE., DES PLAINES, ILL.**

### SURPLUS MACHINE SHOP TOOLS AT PRICES YOU CAN AFFORD

**NEW MOTOR** 1/2 H.P. 24-volt A.C. or D.C. 22 amp. 6000 RPM. Mfgd. by Delco. 3/8" shaft. Can be used on 12 or 36 volts. . . . . **\$4.95**

**HIGH SPEED STRAIGHT SHANK DRILLS**  
**SET** 10 Different Size H. S. Straight Shank Jobber Length Drills, 1/4" to 5/8". \$25 Value. Priced at only. . . . . **\$4.49**

**HIGH SPEED DRILLS**  
1/2" to 1" with 1/2" Shanks

**SET** 5 Different Size H.S. Drills, 1/2" to 1", all with 1/2" Shanks. . . . . **\$6.95**

**SET** 10 Different Size H. S. Drills, 1/2" to 1" all with 1/2" Shanks. . . . . **\$12.95**

These H. S. precision drills can be used in a 1/2" electric drill or a 1/2" capacity lathe or drill press.

Money-Back Guarantee — All Mdse. Mixture of New and Reconditioned Tools Unless Specified Brand New — All Orders (Except Those Specified F.O.B. Tulsa) Are Shipped Post Paid, saving you up to 25% on total delivered cost. Write for Free Catalog Describing Thousands of Bargain Cutting Tools.



**HIGH SPEED MORSE TAPER SHANK DRILLS**

**SET** 15 Different Size High Speed Morse Taper Shank Drills up to 9/16" with No. 1 and 2 tapers. \$50.00 value. Priced at only. . . . . **\$6.49**

**SET** 20 Different Size High Speed Morse Taper Shank Drills from 1/4" to 1". \$70.00 Value. Priced at only. . . . . **\$12.95**

**SET** 10 Different Size High Speed Morse Taper Shank Drills from 1/2" to 1 1/4". \$50.00 Value. Priced at only. . . . . **\$9.95**

**SET** 8 Different Size High Speed Morse Taper Shank Drills from 1" to 2" with No. 3, 4 and 5 tapers. \$125 Value. Priced at only. . . . . **\$29.95**

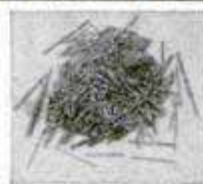

**DRILL BIT MIX**

Over 300 pcs. (2 lbs.) of used High Speed Drill Bits up to 1/4". Some require sharpening.

Ideal for pin punches, drift pins, etc. Less than 1c ea. **\$2.98**

**SLITTING SAWS WITH MANDREL**

**SET** 6 Different Size High Speed Slitting Saws, 2 3/4" dia. x 1" arbor. Thickness from .040 to .071. Cuts wood, aluminum, brass, steel, etc. Plus special mandrel which enables use of saws in 1/4" or 1/2" elec. drill. \$25 Value. Only. . . . . **\$4.95**

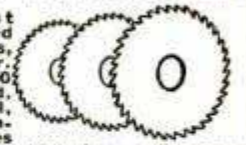

**T & T TOOL 221 W. SECOND TULSA, OKLA.**

### New MOTOR BARGAINS for Home, Farm & Industry



New General Electric 1/2 H.P. Induction Type 3450 RPM 110 V. 60 cy. 1 ph. A. C. Motor. #GEH-5. Fob. . . . . **\$23.50**  
New General Electric 1/2 H.P. Cap/Ind. Ball Brg. 1750 RPM, double 1/2" shaft. 110 V. 60 cy. 1 Ph. #GE-17. Fob. . . . . **\$29.75**  
New General Electric 3/4 H.P. Cap/Ind. Ball Brg. 1750 RPM, double 1/2" shaft. 110 V. 60 Cy. 1 Ph. #GE-75. Fob. . . . . **\$34.50**  
New Dayton 1 H.P. Heavy Duty, Repulsion Induction, 3450 RPM, 110/220 V. 60 Cy., 1 Ph. #EH-1. Fob. . . . . **\$52.00**  
Same as above, 2 H.P. 220-V. 3450 RPM #EH-20. . . . . **\$75.00**  
Same as above 3 H.P. 220-V. 3450 RPM, #EH-30. . . . . **\$97.00**

### MOTOR and FAN BLADE COMBINATIONS BUILD WINDOW FANS, EVAPORATIVE COOLERS, EXHAUST FANS —With these Efficient Combinations

Set #	Blade Size	H.P.	Blade Price	Guard Price	Motor Price	Combination Motor Guard & Blade
FC-10	10 inch	1/60	\$1.25	\$1.75	\$ 4.50	\$ 7.50
FC-12	12 inch	1/40	\$1.50	\$2.00	\$ 6.50	\$10.00
FC-16	16 inch	1/20	\$2.25	\$2.75	\$ 8.50	\$13.50
FC-18	18 inch	1/6	\$3.75	\$3.75	\$10.00	\$17.50

All above items shipped PREPAID. Motors or parts can be bought separately . . . 10", 12" & 16" size motors have extended thru bolts for mounting. 18" motor has solid base.

Write for FAN CIRCULAR: listing Blades, Guards, Motors, All Sizes for building your own Attic Fan, Window Fan or Room Cooler. **C. MARSHALL SALES, 3546 W. Fullerton Av., Dept. P-7, Chicago 47**

# P & D VOLTAGE REGULATOR

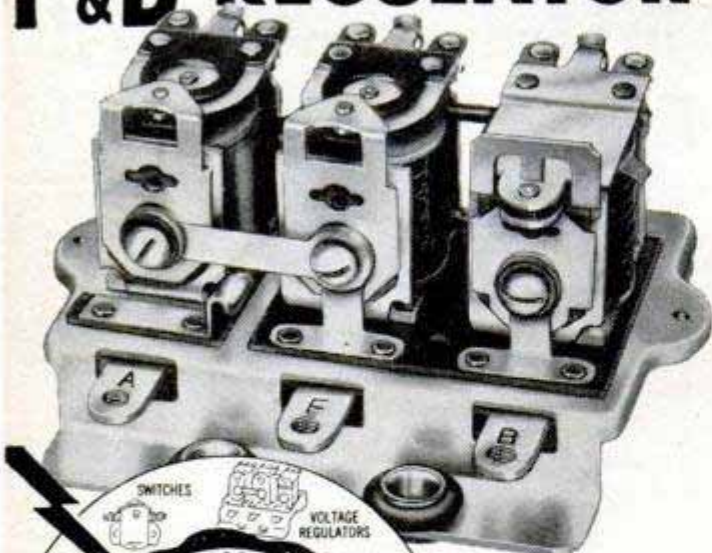

Integral contact points of rare metals alloyed and combined in pairs for maximum efficiency, service. Minimum pitting, burning, oxidation. Sensitivity of response to varying demands of battery. "Care will save your car."

**P. & D. Manufacturing Co.**

19-02 Steinway St., Long Island City 5, N. Y.

*Made*

**\$900  
IN SPARE TIME**

"I did very well last year with my Foley equipment, about 950 saws and 240 lawn mowers, in my spare time. About \$900 for me."—Leo H. Mix.

You can make up to \$2 or \$3 an hour in Spare Time. With a Foley Automatic Saw Filer you can file hand, band and circular saws better than the most expert hand filer. Cash business—no canvassing. No eyestrain, no experience needed.

**FREE BOOK "INDEPENDENCE AFTER 40"**

shows just how you can start at home in spare time, with small investment, no overhead—and develop into a full-time repair shop. Send coupon today for this practical plan. No salesman will call.



**SEND COUPON FOR FREE BOOK**

**FOLEY MFG. CO.** 716-1 FOLEY BLDG., MINNEAPOLIS 18, MINN.

Send FREE BOOK—"Independence After 40."



Name \_\_\_\_\_  
Address \_\_\_\_\_

switches on the cathode-ray oscilloscopes, starts up the high-speed cameras that will record the ground rise and the movement of aboveground targets, and makes a calibration signal that is recorded on the films. Its last job is to trip a mercury switch, and the switch completes the circuit that detonates the caps in the charge hole and explodes the TNT.

The tests aren't being made to learn the effects of atomic weapons alone; the information being acquired can be related to any size of detonation. In World War II, the Air Force sometimes pulverized a target with many times the amount of explosives needed to do the job, and sometimes they had to return to a very strong target again and again with increasingly heavier bomb loads. Data obtained from the Underground Explosion Tests should make it possible for an aerial task force to carry the precise amount of explosives needed to demolish a particular target.

The same information will be useful in building strong defensive structures, particularly those that are buried under the ground.

In the words of one Corps of Engineers spokesman, the tests are being conducted "to establish criteria for the design of sub-surface structures and tunnels to resist underground explosions produced by known or projected types of bombs and missiles."

## The Owners Report On the '51 Plymouth

(Continued from page 98)

tired of other low-priced cars. My car has a poor paint job, otherwise it is O.K."

Of all the owners reporting, there seems to be universal agreement that Plymouth is an easy-handling, economical, practical car with good vision, maneuverability and excellent brakes. Apparently, the single-speed windshield wipers and the fact that no overdrive is available as optional equipment seem to cause the most criticism. A few complained of squeaky brakes. A very small percentage complained of poor assembly and minor rattles.

Sixty-eight percent of those reporting were previous Plymouth owners, which goes to show that Plymouth owners repeat time and again.

I drove our Plymouth test car approximately 1000 miles from Los Angeles to San Diego and across to Phoenix, Ariz., and returned to Los Angeles through the heat of the Imperial Valley and the Salton Sea route through Riverside. The trip covered all kinds of roads, some mountainous and

(Continued to page 244)

# BUILD YOUR OWN POWER TOOLS - TILT/ARBOR SAW

## Exclusive GIL-BILT Build-If-Yourself Features

- No machining—build easily with hand tools only
- No blueprint reading—step-by-step pictorial plans, full scale patterns, actual photographs
- Sturdy wood, aluminum, and steel construction
- Capacity and performance of commercial saws selling for \$60 and up

**BANDSAW**

**BELT SANDER**

**SAVE \$50. OR MORE**

## GIL-BILT 10-INCH TILTING ARBOR SAW



- 27x28 in. table, 13 1/2 in. capacity in front of blade
- 10 in. blade cuts 3 1/4 in. deep, tilts full 45 degrees
- Floor model 34" high, table always stays level

- New Departure ball bearing arbor, 3/4" precision shaft turned down for 5/8" bore blades, alum. housing, shipped ready to run
- Jackscrew and 4 1/2 in. dia. handwheel lowers and raises blade
- Cast aluminum miter gauge and self-aligning rip fence guide

GIL-BILT Metal Parts Kit includes Plans, ball bearing arbor, miter gauge and bar, rip fence guide, dado insert, lock knobs, jack screw mechanism and handwheel, and all other metal parts (less blade)..... \$20.95  
Same Kit with 10" Combination Blade \$24.90  
Same Kit with 8" Combination Blade \$23.90

## GIL-BILT 12-INCH BAND SAW

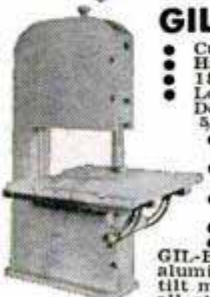

- Cuts to center of 24 inch circle
- Handles stock up to 8 inch thick
- 18x18 inch table tilts 45 degrees
- Lower wheel and drive pulley runs on sealed New Departure Ball Bearings: Upper wheel runs on two 5/8" bore Oilite Bronze bearings.
- Upper wheel tension and tilt mechanism of cast aluminum, completely assembled.
- Upper and lower blade guides. Each has ball thrust bearing, self-lub bronze jaws
- Rigid cast aluminum wheels fully machined ready-to-install. Heavy rubber tires.
- Uses standard 78 inch blades up to 3/4 in. wide.
- Fully enclosed mechanism for utmost safety.

GIL-BILT Metal Parts Kit includes Plans, rubber tires, aluminum wheels, 1/2 in. blade, ball bearing spindle, tilt mechanism, blade guides, table tilt segments, and all other metal parts..... \$20.95

Return Kits in 10 days for refund if not satisfied. (Prices include postage within 600 miles. Over 600 add 5%)

Also available—Plans and Parts Kit for Belt Sander and 8" Tilt/Arbor Saw. Order Plans at \$1.00 each—Send postpaid anywhere in the world or write for FREE descriptive catalog.

**GILLIOM POWER TOOLS** P. O. Box 1-PG, Lambert Field St. Louis 21, Missouri

# CRAFTSMAN

## HAND and POWER TOOLS

Famous for fine quality... precision performance... lower price! Buy them NOW... at Sears convenient Retail Stores... located in principal cities throughout the United States.

**SEARS, ROEBUCK and CO.**



Ask Your Hardware Store for  
**FULLER'S**  
Unbreakable Amber Handle  
**SCREW DRIVERS**

America's most popular line of moderately-priced screw drivers! Wide range of sizes.  
**FULLER TOOL COMPANY, Inc.**  
911 Faile St. New York 59  
World's largest makers of Amber-Handle Tools

## FREE BOOK PROVES WEEDS ARE A BLESSING!



**ROTO-ETTE**  
U.S. Pat. Off.

By Ed Robinson, author of famous "Have-More" Plan! Tells how revolutionary, new Roto-Miller attachment for Roto-Ette makes weeds a blessing, by chopping and mixing them in to improve soil instead of yanking them out to waste away on surface! Shows how Roto-Ette prepares garden for planting—and then cultivates without change of attachment! How it Power Composts! Also Power Lawn Making and Mowing, Scything, Wood Sawing, Snow Plowing—countless other garden and farm jobs with quick-change, low-cost attachments! Just send 10 cents (postage, handling) for big, illustrated FREE BOOK by return mail! Proves revolutionary Roto-Ette is by far the best buy in whole power-gardening field! Rototiller, Inc., Dept. 207, Troy, N. Y. (Some choice dealerships still open. Please write if interested.)

# Genius begins with good tools...



Michael Angelo once said,

"Genius begins with good tools." Take a tip from a master,

choose the tools you use with care and reap a bonus of extra pleasure from your hobby, your everyday work.

For simplified all-purpose measuring see the versatile TUFBOY at your local hardware outlet today. Examine its rugged chrome case, spring steel, push-pull blade. Available in satin or Brite-Blade finish. Satin: 6 ft., \$1.60; 8 ft., \$2.00; 10 ft., \$2.25. (Ask about the handy decimal equivalent chart now printed on every TUFBOY.)

If not available locally, clip this ad and forward with remittance to Dept. P-7.

# MASTER

MASTER RULE MFG. CO. INC. Middletown New York  
WOOD AND STEEL TAPE RULES

## Now HI-SPEED (OPE-SAW) DRILL-BIT

IT DRILLS IT SAWS IT REAMS  
..YOUR CHOICE OF 3 TYPES - 3 LENGTHS

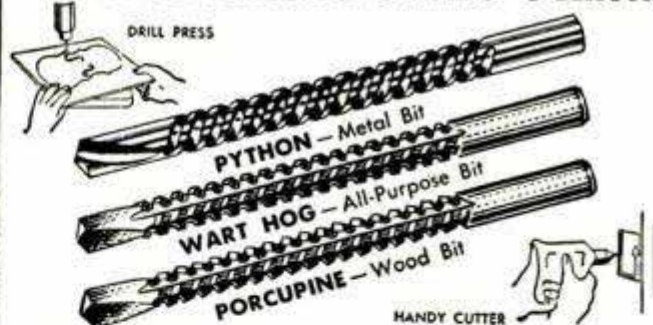

**DRILL, SAW, REAM**—Metal, pipe, wood, plastic, transite, etc. Use with any electric drill, slow drill press, lathe or milling machine. Drills own starting hole—upper part of bit is used to cut, saw or ream circles, ovals, squares or scrolls. Easy to operate. Ideal for carpenters, mechanics, electricians, plumbers, hobbyists, many others. Abrasive resistant, high speed steel. Flutes ground from solid. Withstands severe continuous use without breaking. Takes place of up to \$50 in other tools. Resharpened at no charge. Each type made in three lengths—Conventional 3 1/2" with 2" cutting section, Junior 2 1/2" with 1" cutting section, Router (no drill point) 1 1/2" with 1" cutting section. Specify length and type. Send cash, check or money order. Shipped post paid. Money back guarantee.

CONVENTIONAL LENGTH BITS	Each \$3.95	— Any 3 \$11.50
JUNIOR LENGTH BITS	Each \$2.95	— Any 3 \$8.50
ROUTER LENGTH BITS	Each \$1.95	— Any 3 \$5.50
SETS WITH ONE CONVENTIONAL, ONE JUNIOR AND ONE ROUTER	\$8.50	SPECIFY PYTHON, WART HOG OR PORCUPINE

**MILLER ROTARY**  
HI-SPEED (OPE-SAW) DRILL-BIT  
IT SAWS & CUTS IT REAMS

DEALER INQUIRIES ARE INVITED

**INTERNATIONAL TWIST DRILL CORP.**  
624 Wyandotte Room 631 Kansas City 6, Mo.

**SEND  
FOR IT!**

# 1951 ALLIED RADIO & TV CATALOG

**free!**

**COMPLETE  
UP-TO-DATE  
EVERYTHING  
IN RADIO & TV  
AT LOWEST  
PRICES!**



**212 PAGES  
OF VALUES**

**Everything for  
Experimenters, Builders,  
Amateurs, Servicemen,  
Engineers and Soundmen..**

Save money on every Radio and TV need! Get the big 212-page 1951 ALLIED Catalog featuring the world's largest stocks of top-quality equipment at low, money-saving prices! See the latest TV releases, home radios, radio-phonos, Amateur equipment, P.A. systems and Hi-Fidelity Custom Sound, recorders, test instruments, builders' kits—plus thousands of parts, tools, books and diagrams. Get more for your money from the World's Largest Radio Supply House. Send today for your FREE 1951 ALLIED Catalog!



**TV, HOME RADIOS  
& RADIO-PHONOS**



**SERVICE SUPPLIES  
BUILDERS' SUPPLIES**



**AMATEUR GEAR**



**P.A. SYSTEMS  
RECORDERS**

**free  
CATALOG  
Send For It!**

## ALLIED RADIO

ALLIED RADIO CORP., Dept. 5-G-1  
833 W. Jackson Blvd., Chicago 7, Ill.

Rush FREE 212-Page Catalog No. 126

Name \_\_\_\_\_

Address \_\_\_\_\_

City \_\_\_\_\_ Zone \_\_\_\_\_ State \_\_\_\_\_

winding, others long and smooth. I went into the back-roads country for about 100 miles over rough, sandy and winding roads that were little more than trails in some places.

The ride is excellent and Plymouth's new shock absorbers, which they call Oriflow, do a good job. They give excellent stability on corners, and the pitching effect seems to be practically eliminated. It is surprising how you can drop off a smooth paved section into a rough detour at high speed and find that the new Plymouth hugs the road and takes the bumps and chuckholes with little required change in driving technique. This is a tremendous safety factor.

The car has good power and the acceleration is excellent. Personally, I would like



Combination ignition key and starter on Plymouth is handily placed to the right of steering column

to see an overdrive as optional equipment. I like the steering of the new Plymouth better than most cars. It is fairly quick and positive. The driving position in the new Plymouth is very good. The seat is high enough and there is no cramping in the legs. Indeed, there is a lot of headroom for both driver and passengers.

Plymouth's hydraulic brakes in the 1951 models are up to par as usual. Plymouth brakes have consistently been good throughout the years. The operation of the brake pedal is soft and there was no tendency for the brakes to fade even when used at high speeds. A couple of squeaks developed for short distances and then went away; otherwise, I'd give the brakes a 100-percent rating.

The electric windshield wipers definitely have some advantages. Regardless of the

(Continued to page 246)



**THE MOST**

**Versatile TOOL**

**ON YOUR BENCH!**

**CHANNELLOCK PLIERS**

*Made only by* CHAMPION DEARMENT

In almost any job you can think of—Pliers are necessary—and Channellock pliers are the best you can buy. Whether you are working on your car, electrical repairs, plumbing work or just tightening nuts and bolts Channellock pliers do it better.

And remember, Only Champion DeArment makes Channellock—More than 3/4 of a Century of experience in producing highest quality tools. Send for Catalog D15—today.

**CHAMPION DEARMENT TOOL CO.**  
Meadville, Pa.

Channellock pliers are listed in the Yellow Pages of most Telephone Directories

under "Tools"

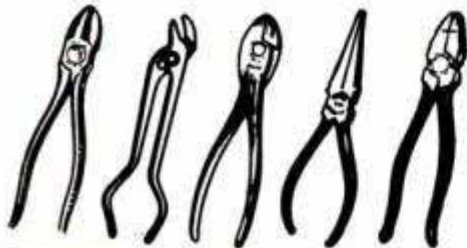

ONLY Champion DeArment makes

**CHAN NEL LOCK**

TRADE MARK REG.

U. S. PATENT OFFICE



**The Modern PLASTIC for lasting Home Repairs**

PERMANENTLY mends cracks or holes in wood, tile, stone or plaster. Sticks and stays put—Does not chip, shrink or fall out. Easy to use. Economical. Mold it, chisel it, polish or paint it. If unobtainable from your lumber, paint or hardware dealer, the big 4-lb. can will be sent you post-paid (in U.S.) for only \$1.15. Full money-back guarantee, order now.

**DONALD DURHAM CO.**  
Box 804-S, Des Moines, Iowa

**Say You Saw It in Popular Mechanics**

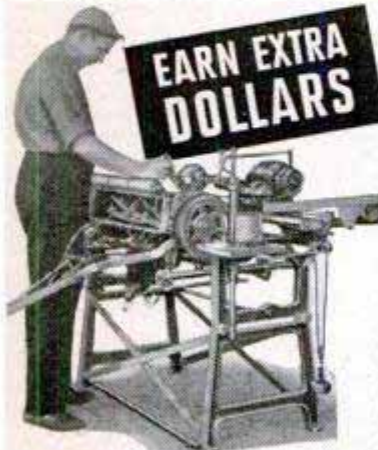

**IDEAL LAWNMOWER SHARPENER**

Saves work, saves time, helps you earn extra dollars! Sharpens hand, power mowers without disassembling. Complete shop in one machine — equipped with Bed Knife Grinder and "lapping-in" Reconditioner. Home owners, parks, clubs, cemeteries pay good money for efficient sharpening; get your share!

WRITE NOW FOR FREE CATALOG

**THE FATE-ROOT-HEATH CO., Dept. I-3, Plymouth, Ohio**

**a "Must" for every mechanic**  
**FREE, NEW CATALOG of those**

*"doggone good"*

**DURO-CHROME TOOLS**



Makers of Nationally Advertised DURO Power Tools

Soon to be released—a new Duro-Chrome Mechanic's catalog. Crammed with pictures and detailed descriptions of the latest ideas in tools. Shows the right

Duro-Chrome Quality Tool for every mechanic's needs, PLUS hard-to-find and "special job" tools your dealer has or can get for you.

Explains why Duro-Chrome Tools have been preferred by professional shop men for over 30 years. Tells what to look for in picking good tools; how Duro puts

Extra quality into every tool; for example, gets 25% more wear on Sockets, by exclusive Hot Broaching process.

Shows Duro-Chrome Tool Sets from 5-pc Punch and Chisel Sets up to 114-pc DeLuxe Workshops Sets. Reserve your copy of this "cyclopedia" of fine tools.

5399 R

**USE THIS COUPON NOW TO GET FREE COPY**

**SEND IT TO DURO METAL PRODUCTS COMPANY**

2649 N. Kildare Avenue, Chicago, Ill.

*Write your name and address in margin space*

# SHOPMASTER POWER TOOLS

Only  
**\$47.95**

Each  
Complete,  
less motor

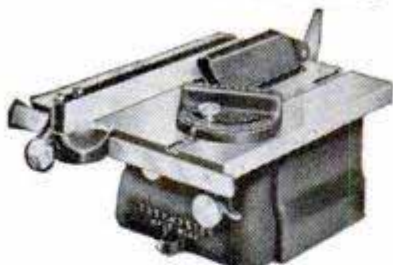

Now you can get Shopmaster quality in power tools specially designed for the smaller home workshop, operating on a limited budget. Efficiently designed, they contain features found only on the highest priced tools.

Write for catalog on complete line of Shopmaster Tools.



## SHOPMASTER, INC.

1214 Third St. S.

Minneapolis 15, Minn.

### SET-UP - KNOCKDOWN SAWHORSE with *Jiffy* BRACKETS



No nails or bolts . . . use 2x4's for legs, 2x4 or wider for crossbar. Easy to move, saves storage space. Buy at hardware or building material dealers, or direct.

GRAND HAVEN STAMPED PRODUCTS CO., Grand Haven, Mich.

## STOP...UNEXPECTED MOTOR OVERHEATING

Easily, Quickly—

AT SMALL COST!

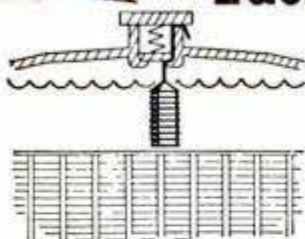

Protecto Plate not only prevents rust and scale accumulation but loosens the previous accumulation and makes hard and rusty water, soft and crystal clear. Rust and scale go to

the bottom of the radiator where it is easily flushed out. You've got it—but don't know it.

**Avoid**—Radiator rodding expense—Valve Grinding—New Piston Rings and possibly a new motor on Autos, Trucks and Tractors. Rust and scale inside the engine's cooling system, prevents complete transference of heat to the water for dissipation, causing continuous damage.

**For only \$1.95** you get insurance that gives driving satisfaction and ease of mind on your trip or local driving.

**Order Today**—anyone can install it in less than 3 minutes. Save needless wear and tear, plus avoidable expense.

Further information on request

Another CALLBOY Product distributed by

## THOR-HAL PRODUCTS CO.

BOX 923, (Richfield Branch) MINNEAPOLIS, MINN.

steepness of the hill or the throttle opening, the wipers operate at a constant speed. My only objection is that at times I'd like to have the wipers operate at a slower speed. Certainly, the new electric wipers are positive and sure. They are a bit noisy in operation.

The instrument panel, I think, is attractive and the various gauges and indicators are easy to read.

The choke is automatic. The shifting of

### 1951 PLYMOUTH SPECIFICATIONS

#### ENGINE

Type.....6-cyl. L-head, in-line  
Bore and stroke.....3¼ in. x 4¾ in.  
Piston displacement.....217.8 cu. in.  
Brake horsepower.....97  
Compression ratio.....7.0 to 1  
Transmission.....3-speed conventional

#### GENERAL

	Cranbrook and Cambridge 4-dr.	Concord 2-dr.
Weight—		
Cranbrook.....	3109 lbs.	2969 lbs.
Cambridge.....	3104 lbs.	
Wheelbase.....	118½ in.	111 in.
Tread, front.....	55½ in.	55½ in.
Tread, rear.....	58⅞ in.	58⅞ in.
Height.....	64¾ in.	62¾ in.
Over-all width.....	73¾ in.	73 in.
Over-all length.....	193¾ in.	188¾ in.
<i>Inside Dimensions</i>		
Front-seat width.....	55 in.	54¾ in.
Rear-seat width.....	57 in.	49 in.
Legroom, front.....	40¾ in.	40¾ in.
Legroom, rear.....	42½ in.	37¾ in.
Headroom, front.....	36 in.	35½ in.
Headroom, rear.....	36 in.	36½ in.
Tire size.....	6.70 x 15	6.40 x 15
Recommended		
tire pressure.....	24 lbs.	24 lbs.
Road clearance.....	8 in.	7½ in.
Turning radius.....	Left—19 ft. 4 in. Right—19 ft. 8 in.	18 ft. 6 in. (R & L)
Steering wheel,		
lock to lock.....	4¼ turns	4¼ turns
Steering ratio.....	18.2 to 1	18.2 to 1

#### CAPACITIES

Oil.....5 qts.  
Water.....13 qts.  
Gasoline.....17 gal.

gears is easy, as the lever is quite long and there is, of course, good leverage.

The clutch pedal operates with very light pressure. Visibility is excellent and I especially like the quick-action windup of the windows.

The shortness and forward slope of the 1951 Plymouth hood gives excellent road vision within a few feet of the driver's seat. This undoubtedly is a safety feature and is good when parking.

There is ample space in the trunk, and the lid is counterbalanced. The operation of the lever and the locking arrangement, I think, could be improved.

The body has a solid feel and the assembly is above average. Plymouth has removable fenders, and they are not integral

(Continued to page 250)



## HERMETICALLY SEALED PUMPS



Made of Solid Brass—Fully Guaranteed  
**ONLY \$16.00** Will operate completely submerged or in 1" of liquid. No oiling or servicing necessary.

Nickel plated and rubber mounted—gives longer life and eliminates vibration. Three foot neoprene leads.  
 110 volt, 60 cycle, AC only.  
 Shipping Wt. 5 lbs.  
**LARGER MODELS AVAILABLE**

Mod. No.	1 Ft.	3 Ft.	G.P.H. Delivery			Price	
			6 Ft.	Outlet	Height	Dia.	
MH-90	152	130	90	3/8"	5"	4"	\$16.00

If your Dealer unable to supply—send cash with order direct to us—we'll ship prepaid.

**THOMAS BECKETT & CO., INC.** 2001 WILLOWBROOK DR. DALLAS, TEXAS



## CAPE COD CHAIRS TRELLISES • ARBORS DUTCH WINDMILLS

Chairs style B-C-A PLANS 50c Ea., all 3 only \$1.00. 12 different trellis designs PLAN of all 12 only 50c. Authentic 40" high Dutch Windmill Detailed PLAN only 75c. Unique 40" high Light-house having copper lantern, ideal for garden or on lake shore of summer home. Large detailed PLAN 75c.

**SPECIAL ALL PLANS ABOVE \$3.00 VALUE ONLY \$2.50**  
 SEND 10c for catalogue of many fine projects.  
 Dept. P30  
**CRAFTSMAN'S MODEL CO. DELAFIELD, WISCONSIN**

## SOUTH BEND

LATHES  
 DRILL PRESS  
 SHAPER



9" to 16-24" Lathes      14" Drill Presses      7" Bench Shaper

Write for literature—indicate machine.  
**SOUTH BEND LATHE, SOUTH BEND, IND.**

## BRUSH PLATING OUTFITS

for re-plating articles in the home and shop. No tanks necessary. Free particulars.

**GUNMETAL CO., AVE. M, DECATUR, ILLINOIS**

## DEPENDABLE CRAFT SUPPLIES

WRITE FOR CATALOG  
 SINCE 1928

LEATHER CRAFT • PLASTICS • POTTERY CRAFT • BLOCK PRINTING • BELT CRAFT • TEXTILE COLORS • POWER TOOLS • WOOD BURNING • INSTRUCTION BOOKS • ETC.

**DWINNELL CRAFT SHOP**  
 Dept. PM-751—Wheeling, W. Va.



## ASSEMBLE YOUR OWN MOWER

**\$79.95**  
 F.O.B. WICHITA

**SAVE 40%**  
 INCLUDES NEW 1 1/2 - 2 HP VERTICAL ENGINE AND ALL PARTS

### CAST ALUMINUM BASE

This is a modernized streamlined and nicely finished product. Two-tone baked enamel. Full 20" cut, hardened steel, one-piece cutting blade with safety clutch. Ball bearing, large size rubber-tired wheels.

**CUTS TALL GRASS**  
 will mow to carpet smoothness tall coarse grass, cuts close to fence.

OVER 12,000 SATISFIED USERS

Price Complete Satisfaction Guaranteed

Cash With Order or Money Refunded

**NEFF EQUIPMENT CO.**  
 510 PETROLEUM BLDG., WICHITA, KAN.



## EVERY ELECTRIC DRILL A PORTABLE SAW

JOIN THE THOUSANDS who  
**SAVE WORK — SAVE TIME**  
 and do the job **BETTER** with

**"ARCO-SAW"** (Over 100,000 Sold)

AT BETTER HARDWARE STORES EVERYWHERE

**9.95**

No. 444 "ARCO-SAW"

**'ARCO SAW'**

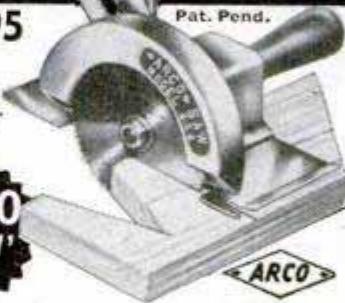

PAT. PEND.  
**CAN BE USED WITH ONE HAND!**  
 Any 1/4" or 3/8" Drill a Powerful Saw in ONE MINUTE

"ARCO-SAW" is a rugged tool with right angle gear drive (no clumsy, dangerous, direct drive with drill sideways). Works like a high priced Portable Saw.

**CUTS 1-5/16"**, or 2x4 by turning over

ONLY ARCO GIVES YOU ALL THESE FEATURES: Safety-yoke assures rigid connection and absolute safety—Visual guide and wide shoe-plate for straight, square cuts—Big handle affords firm grip for two-hand operation—Precision one-piece gear box—Self-lubricating lifetime bearings.

**NOW AVAILABLE! No. 445 "ARCO-SAW" 11.50 for DEPTH & BEVEL CUTS**

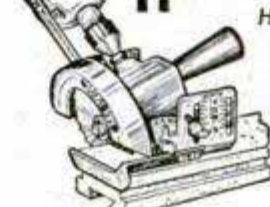

Has All Features Listed Above Plus:  
 Depth gage with graduated adjustment from 0 to 1 1/4" depth (for grooves, dados, scoring). Bevel gage with graduated adjustment from 0 to 45° bevel (for dovetails, bevels). Rip gage with sideways adjustment (for accurate width molding, strips). Visual guide with adjustment to follow lines on both straight and bevel cutting.

No. 444 "ARCO-SAW", complete with 4-inch "HYCARBON" CROSSCUT BLADE (less drill)..... **\$9.95**

No. 445 "ARCO-SAW", complete with Depth-Bevel-Rip Gage and 4-inch ARCO "HYCARBON" CROSSCUT BLADE (less drill)..... **\$11.50**

No. 444G DEPTH-BEVEL-RIP GAGE. Easily attaches to any No. 444 "ARCO-SAW" to convert it to a No. 445 "ARCO-SAW"..... **\$1.95**

"HYCARBON" REPLACEMENT BLADES—4-inch Crosscut or 4-inch Combination..... **\$2.00**

**90-DAY FACTORY GUARANTEE**

ORDER TODAY at your dealer or send us check or M.O. (Post-paid). C.O.D.'s—Postage extra. Ask for literature of other tools.  
**UNCONDITIONAL 10-DAY MONEY BACK GUARANTEE** DEALERS—Write for nearest jobber.

## ARROW METAL PRODUCTS CO.

DEPT. PM-7, 140 WEST BROADWAY, NEW YORK 13, N. Y.



## STARRETT "Tools and Rules" BOOK

Describes and illustrates the precision methods skilled mechanics use. Only one dime. Write Dept. AP.

THE L. S. STARRETT CO., Athol, Mass., U. S. A.



## earn BIG PROFITS

### Sharpening Hand Saws

Cut new teeth in a jiffy with **FOLEY POWER RETOOTHER**

You can earn a good spare-time income in the saw repair business. The Foley Saw Retooter cuts brand new teeth right over old ones without removing saw handle,—and saves you HALF your filing time. Takes all hand saws 4 to 16 points per inch. Relieves eye-strain. No experience needed.

FREE—Foley Price Guide of 1951 saw sharpening charges. A valuable chart of actual prices. Send coupon today. No salesman will call.

**FOLEY MFG. CO., 770-1 FOLEY BLDG., Send FREE Price Guide and Foley Retooter circular.**

Name \_\_\_\_\_  
 Address \_\_\_\_\_

# Crosman

## "CO<sub>2</sub> POWERED" GUNS



**POWER  
WITHOUT POWDER  
WITHOUT PUMPING**

Expert or beginner, you'll get a thrill without a "kick" shooting these amazing guns. Safe to shoot indoors or out, thanks to Crosman's "no-ricochet" type Super-Pells. Available in .177 and .22 cal. models. See them at your Crosman dealer's. Write for literature.

CROSMAN ARMS CO., Inc., ROCHESTER 20, N.Y.

Amazing New

## FOLEY Power SAW SETTER



For hand and band saws

A perfect set on 26" hand saw in 32 seconds

The new Foley Automatic Power Setter with exclusive "Twin Hammer" action has two hammers (one for each side of saw) operating from a single spring, insuring utmost accuracy. ONCE through turns out a perfectly set, true-cutting saw. Relieves eye-strain, no tooth breakage. Sets all hand saws (with handles left on) and band saws from 4 to 16 points per inch. 1-year Guarantee.

FREE—Foley Price Guide of actual 1951 saw sharpening charges. A valuable help to any saw repair shop. Write for it today, also Foley Setter circular. No salesman will call.

FOLEY MFG. CO., 775-1 Foley Bldg., Minneapolis 18, Minn.

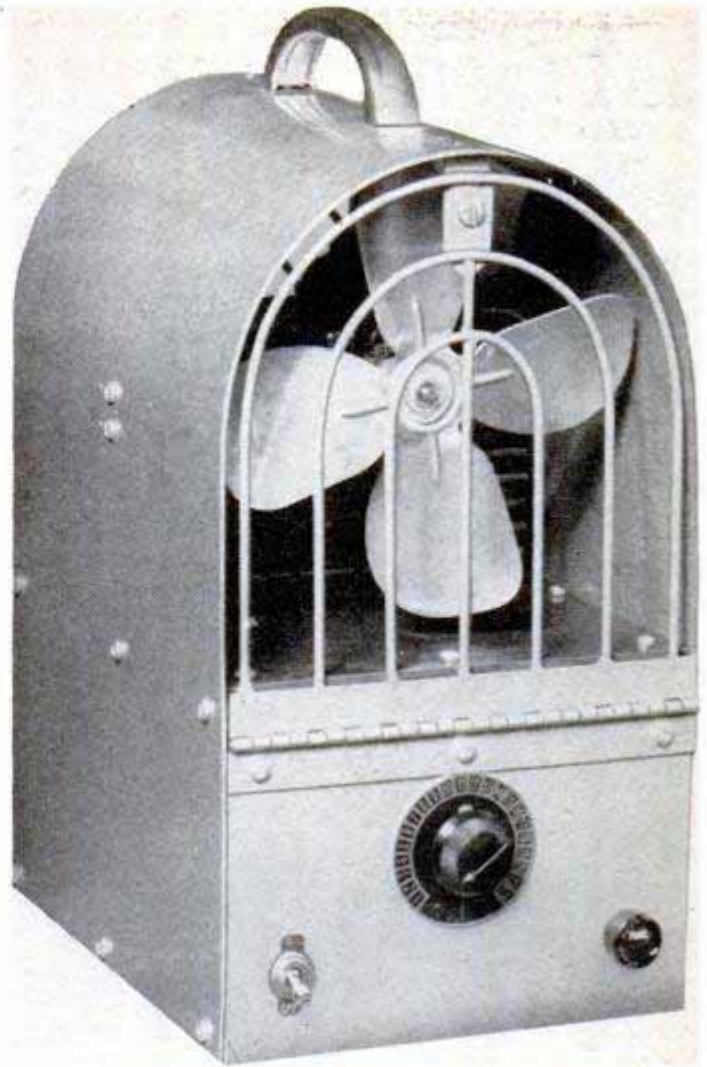

Vita-Aire Division, Hydro-Aire Corp., Waukesha, Wis.

## Air Freshener

Room air is freshened by a new ultraviolet-ray unit that has a built-in electric fan. The fan pulls air through the ultraviolet field, where it is ionized. The resulting discharge oxidizes smoke particles, cooking odors and gases to purify the air, according to the manufacturer. The air freshener also tends to destroy bacteria and germs, and prevent the formation of mold.

## Potent Antimalaria Drug

Still in an experimental stage, an anti-malarial drug has been announced which is so powerful a single ounce would treat an average patient for five to ten years. The drug is said to be a thousand times as potent as quinine. It is synthesized at low cost from readily available raw materials by the Wellcome Research Laboratories, Tuckahoe, N. Y. The drug is of the suppressive type, which means it will not cure but would control the disease. Malaria now afflicts about a half-billion persons throughout the world. In many areas the standards of living are so low quinine and atabrine are too costly for constant treatment.

☐ Three out of four traffic accidents happen in clear weather on dry roads.

BEAUTIFIES natural wood, pine paneling

POLISHES furniture, woodwork

IMPROVES paint jobs

PROTECTS wood and metal surfaces

THE BEST BUY FOR EVERY HOME

**101 HANDY HOME USES!**  
Every home, every workshop, needs Pol-mer-ik BOILED Linseed Oil. Available at all stores. Free folder tells you how to use it. Write Dept. 603 . . .  
ARCHER-DANIELS-MIDLAND CO., Minneapolis 2, Minn.

# PACKAGED BOAT KITS

**LARGEST CATALOG  
EVER OFFERED!**

16 pages—80 construction and action photos PLUS specifications and performance data.



**\$38.95 UP**

**COMPLETE LINE — SKIFFS, OUT-BOARDS, RACERS, CRUISERS.**  
23 Models! Kits, Semi-finished and Custom-finished boats, hardware, paint.

Send 35c for Boat Catalog

Boat Catalog PLUS booklet on boat building, \$1.00

## BOAT PATTERNS—BLUE PRINTS

Over 70 modern plans and full size patterns. Racing classes, cruisers, inboards, outboards, sail boats. By famous designers, 6' to 30'. DESIGN CATALOG 35c. Design catalog and boat building handbook, \$1.00.

**MARINE MART—DEPT. 52—BUFFALO 7, N. Y.**

**NEW!**

# TIRE—TUBE—WHEEL

*Complete!*

Includes: choice of "balloon" or "heavy-duty" tread 10 1/2"x4" 6-ply tire (standard, replaceable); tube; and choice of 3 wheels:  
For slow-moving dollies, barrows, small tractors, etc.:

- A. Pressed steel wheel, 5/8" dia. oilite bearing . . . . . \$8.95
- B. Pressed steel wheel, 3/4" dia. oilite bearing . . . . . \$8.95
- C. Cast aluminum wheel, 1" Timken roller bearing . . . . . \$12.95

All prices freight prepaid. 5% discount on 4 or more units. Immediate delivery. Send check or M.O. — no C.O.D.'s.

**CRAFT, INC., Dept. PM-7, 6671 Telegraph Road, Los Angeles 22, Calif.**

## BUILD HEAVY DUTY MACHINES

**SAVE UP TO 90%**— You can build, using our practical, easy-to-read plans, all kinds of machines, for home, farm or shop — scooters, portable sawmills, metal working machines, concrete machinery of all kinds, printing equipment, woodworking machines, midget autos, dish washers, farm equipment, freezers, tractors.

**FREE CATALOG HANDBOOK**  
183 SETS OF PLANS  
VALUABLE INFORMATION

**NICHOLS EQUIPMENT COMPANY**  
D-11 PURVIS, MISS.

## make your own Gems 29<sup>50</sup>

F.O.B.

All necessary lapidary equipment is furnished, including a super-charged diamond blade for sawing, and all wheels for grinding, shaping and polishing; also complete instructions. The complete equipment as shown, less motor and belt, for only \$29.50, f.o.b., Burlington, Wisconsin. Write today for information and literature.

**B&I MANUFACTURING CO.**  
Dept. S Burlington, Wis.

## Build your own SMITH Compressor

Operates spray guns, rock drills, tampers, paving breakers, sandblasting . . . Uses only 1 gallon of gas an hour!

Save Money—build your own Smith Air Compressor! Famous the world over! Capacity 60 cu. ft.; pressure up to 100 lbs. per sq. inch. Just order the Smith Compressor Head and Accessories with complete instructions for assembling. All you need is a Ford Motor and shop facilities. Head equipped with high speed compressor valves; automatic unloading and idling.

**Write for complete information!**  
**GORDON SMITH & COMPANY, Inc.**  
410 College Street • Bowling Green, Ky.

# RELIEVES HEADACHE NEURALGIA NEURITIS PAIN

# FAST



**Here's Why . . .**

Anacin® is like a doctor's prescription. That is, Anacin contains not one but a combination of medically proved active ingredients. Anacin is specially compounded to give **FAST, LONG LASTING** relief. Don't wait. Buy Anacin today.

## HOBBYISTS! SHOPMEN! *Special* ONLY \$54.50

**PALMGREN "HOBB-E" Rotary, Index, Milling Table**  
*Ideal for Model Parts or Shop Work*  
Mill-Grind-Drill-Index-Route curved or straight-Rabbit and Mortise on drill press or lathe. 8" Table, 4" Cross Feed, 360° Rotation, Accurately Graduated. Bolts to table. Order NOW! SAVE \$100. Only \$54.50. Less Rotary Feed \$42.75. Write for "HOBB-E" Tool Circular. CHICAGO TOOL and ENGINEERING CO. 8365 South Chicago Ave. Chicago 17, Ill.

## WAR SURPLUS AND OTHER BARGAINS

### DRILL GRINDER

All New. \$2.80 each.

Sharpens round, square or tapered drills up to 6" long. Even an amateur mechanic can get a new, factory finish on a drill in 25 seconds. New protractor feature gives every drill sharpening angle, with 5 convenient angles already marked off. Usable with hand or power stone. A brand new development, manufactured by Ten Eyck. Shipped postpaid.

### RIVET SETS

Universal type, case hardened tips. Set of dies will head up any brazier or round head rivet from 1/8" to 1/4". With adapters for air gun or hand use. All new . . . cost Government about \$27.00. Complete 15 piece set, wt., 2 lbs., \$5.00

<h3>HIGH SPEED DRILLS</h3> <p>All New. Fractional &amp; numbered. Orig. Val. \$15. Nationally known brand. Astd. sizes. Set 30, \$3.50</p>	<h3>EXTENSION DRILLS</h3> <p>High Speed Steel, like new. Ass'd sizes from No. 1/4 to 40. Lengths from 6" to 12". Approximately \$20 value. Set of 12 . . . . . \$3.75</p>
--	---

**HIGH SPEED DRILL BITS**  
Like New! Original value over \$16.00. 25 assorted sizes and lengths, \$2.00

### MICROMETERS

Chrome plated, precision engineered and carefully tooled to give long life. All new.  
0-1" capacity . . . ea. \$2.25. 1-2" capacity \$3.50.

Send check, money order or cash. 25% deposit required on COD orders. All prices FOB Culver City, California, unless otherwise stated.

Send 25c for Illustrated Catalog.  
**AIRBORNE SALES CO., INC.** DEPT. PM 7-51 CULVER CITY, CALIF.

# Running HOT WATER in a Jiffy! from any COLD WATER FAUCET

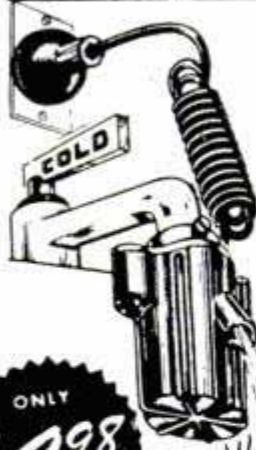

With Jet Instant Hot Water Heater you can get Continuous Hot Water from your Cold Water Faucet when you want it! No Waiting - No Fussing with Fires or Boilers. The Faucet Regulates Temperature. The Jet Heater attaches to most faucets easily. No Tools needed. You can get Hot Water Anywhere! In Summer Cottages, Cabins, Kitchen, Basement, Garage, Office or Factory - On the Farm or Barn wherever a cold water faucet and an electrical outlet are handy.

ONLY  
**\$4.98**

8 Foot U. L. cord

- Check THESE FEATURES:**
- No Moving Parts to Wear Out.
  - Operates on AC or DC current.
  - Constructed of Chrome Steel and Porcelain
  - Measures 2 3/4" x 3 3/4" - Stores away easily.
  - Fits any Standard sized faucet.
  - Comes with 8 Ft. U. L. Approved cord.
  - Attaches quickly - without tools.
  - Costs only few cents to operate.
  - Full Factory Guarantee against defects.
  - Money Back Guarantee if JET does not deliver hot water instantly.

The Jet Heater is Factory Guaranteed. Satisfaction assured or money refunded. Send cash, check or money order for \$4.98 or order C.O.D. enclosing \$1.00 Deposit, balance plus postage on del. very. Order today. **SUCCESS PRODUCTS, 224 South 3rd Street, Dept. HW3—Brooklyn 11, N. Y.**

## AUTOSCOPE

### the STETHOSCOPE

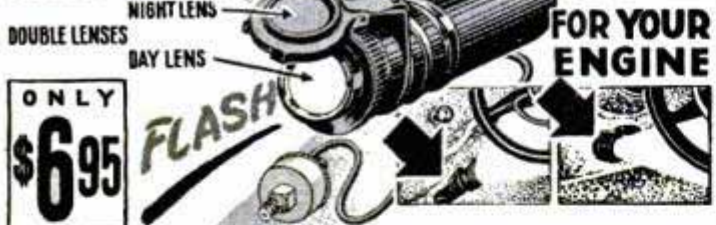

## GET MORE MILES PER GALLON!

And peak performance too! **AUTOSCOPE** does it through "Acceleration Control," the method used by experts. **AUTOSCOPE**, the precision vacuum "analyzer", **FLASHES** a light when you waste gas by pushing your accelerator down too hard. **BLINKS** and warns when you develop engine trouble—defective plugs, burnt valves, etc.

Attractive, compact, easily installed in any car or truck; no drilling. Operates visibly day or night, no confusing dials, no taking eyes off road, ideal for women drivers too.

**AUTOSCOPE** intrigues you — constantly reminds you to drive economically—keeps your car in top condition. Mail orders filled promptly, so send for yours **TODAY**.

Dealerships available. Free details.

**UNIPRODUCTS CORPORATION, Dept. A-1  
59 Park Avenue, New York 16, N. Y.**

RUSH \_\_\_\_\_ **AUTOSCOPES** @ \$6.95 ea., ppd.  
RUSH ( ) **FREE DETAILS**

NAME \_\_\_\_\_

ADDRESS \_\_\_\_\_

CITY \_\_\_\_\_ STATE \_\_\_\_\_

parts of the body. They are bolted on and in the event of damage the fenders can be removed easily for repair or replacement. This is a desirable feature which has saved owners a lot of money.

The Plymouth engine is mounted in rubber, of course. Plymouth's design called "Floating Power" pioneered rubber engine mountings. The engine is balanced on its center of weight and rests on live rubber cushions which undoubtedly does cut vibration and prolong the life of the chassis and body.

The ignition switch is conveniently operated by the right hand. You simply turn the key and the engine starts. No button to push or pull. It's a clever idea and I like it.

This year, Plymouth has a waterproof distributor. The neoprene ignition cables are water and oil-resistant. This eliminates missing or ignition failure if you are in a bad rainstorm, run through deep water on the highway or go through puddles.

Another improvement is the greater output of the new generator. The increased capacity gives a reserve charging rate far beyond normal needs. This is an improvement that will be appreciated by Plymouth car owners who reside in regions where cold weather presents a starting problem.

In my test, I found the Plymouth to be easy on gasoline. My economy report appears elsewhere in this article. I found regular gasoline to be satisfactory for use in the '51 Plymouth. (And so did 78 percent of the owners reporting.)

On long stretches the car cruised nicely at 75 to 80 miles an hour. It would do 85 miles per hour easily. Top speed by speedometer was around 93 miles per hour. Like most speedometers on all cars I've tested, the reading was fast, but the variation was not so much as in some other makes. I found the speedometer to be about four percent fast.

Plymouth engineers have incorporated some worth-while improvements in their latest, and to my mind this is the finest Plymouth ever offered by the Chrysler Corporation.

## Blood-Vessel Bank

Arteries and veins for operations can now be drawn from a blood-vessel bank operated by New York Hospital, Cornell Medical Center and Bellevue Hospital, New York. They come from deceased patients whose relatives permit an autopsy to be made. The graft most commonly taken for the bank is the aorta, a large artery leading directly from the heart.

## 65 KW. 225 Volt D.C. DIESEL ELECTRIC GENERATING UNIT

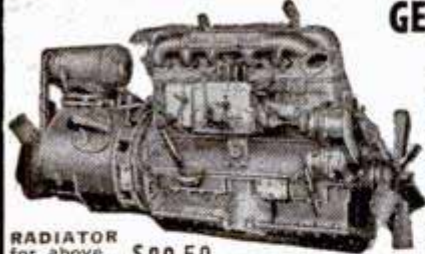

RADIATOR for above unit..... \$89.50

### RECONDITIONED

Equipped with 6 cyl. DRXC Hercules DIESEL engine, 45 1/2" bore, 5 1/4" stroke, 133 H.P. at 2000 R.P.M. Complete with injector, pump, nozzles and electrical equipment. Generator attached to engine. Complete as shown.

Ea. \$1375.00  
Lots of 2 \$1295.00  
ea. ....

Write for price on DIESEL ENGINE only.

60 HP. Jeep Engine Reconditioned, tested & Guaranteed in perfect order, ready to run. \$192.50

SEND 25% CASH WITH ORDER, BALANCE C.O.D.

1951 EDITION! It's New! It's Different! Get World's Largest Auto Accessory & Parts Catalog and Save Money! Over 50,000 items including Hollywood Accessories, Hi-Speed Equipment, Rebuilt Engines, all parts & accessories for all cars & trucks. We have that Hard-To-Get Part! Jam packed with Bargains. Completely illustrated. Send 25c (refundable).

**J. C. WHITNEY & CO.**

1917SP ARCHER AVE. CHICAGO 16, ILL.



EASY AS 1-2-3

**VISE-GRIP** WRENCH

Now, VISE-GRIP makes short work of every job from the largest to the smallest! LOCKS with more than Ton Grip! Can't slip. Turns stubborn nuts, screws, broken studs. Holds anything. Whether you use it for electrical, plumbing or car repairs, it makes every job a cinch! With cutter—No. 7W, 7", \$2.25; No. 10W, 10", \$2.60. Without cutter—No. 7C, 7", \$1.95; No. 10C, 10", \$2.25. No. 7, 7", \$1.85; No. 10, 10", \$2.15.

Order From Your Dealer.  
**PETERSEN MFG. CO., Dept. P-7, DeWitt, Nebr.**

## Make Your Own POWER LAWN MOWER

with this DRIVE CUTTER ASSEMBLY

Constructed for those who desire to build their own mower or to replace your old cutter assembly. Complete with 18" blade and double ball bearing drive, only.

Add 50c to cover handling & shipping. No COD's

**ATLAS EQUIPMENT CO., Dept. PM7**  
229 SW BLVD. KANSAS CITY, MO.

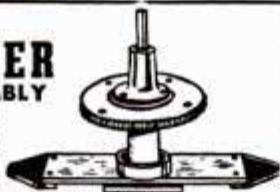

## EVINRUDE Catalog Free

Write today for big full-color catalog of complete Evinrude line—the right motor for every boat! 5 models, 1.5 to 25 certified H.P. 2 models with Gearshift and Cruis-a-Day Tank. Thrilling new Big Twin—a 30 miler that trolls, handles like a small motor! Write for your copy today—address

**EVINRUDE MOTORS**  
4707 N. 27th St., Milwaukee 16, Wis.

## NOW—40 different CUTS with AMAZING, NEW



**Warren**

**DADO SAWING WASHERS**  
On Your Saw Blade

Just dial widths to cut parallel grooves perfectly smooth. No warp, vibration

or trick screws. Strengthens blade, perfect balance. **GUARANTEED!** At your dealer's or order direct. Give arbor size—1/2", 3/8", 3/4", 1".

Send for free booklet

**WARREN WASHERS COMPANY**  
70 Medbury, Detroit 2, Michigan

**ONLY \$4.95 PER SET**

# USE YOUR ATTIC

## Install the PRECISION folding stairway YOURSELF



Fits all ceilings. Just saw the hole in your ceiling—frame the hole with 2x6's, nail the stairway in place and cut off the stairway at the calibrated ceiling height. The Precision Stairway is simple and easy to operate. No springs, actuated by counterweights, it's perfectly balanced, raising or lowering easily with one hand. Composition safety treads on steps. Insulated door panel. Requires no attic space. Made of No. 1 kiln dried poplar with cast brass hinges, heavy cast aluminum rocker arms and brackets. Approved by F.H.A. everywhere

See your local lumber dealer or write direct today.

Manufactured by

**PRECISION PARTS CORP.**  
Nashville 7, Tennessee

SAY YOU SAW IT IN POPULAR MECHANICS

## MAKE MONEY POLISHING FLOORS . . .



You can when you have your own Floor Polishing & Maintenance Service. Write for free plans and ideas on how you can easily get started in this money-making business. Send a postcard to:

**McCANNA SUPPLY CO., 148-F East 40 Street, New York 16, N.Y.**

**FIX IT or FASTEN IT**  
*Better and Faster!*

**NEW TINNEMAN**  
*Speed Nut*

**TINKER KIT**



**SPEED NUT**—the one-piece, self-locking, vibration-proof fastener—famous throughout industry... **NOW READY FOR HOME USE!** Handy assortment of 10 popular sizes of SPEED NUTS and matching screws. Over 100 home repair and hobbycraft uses. Once on—they stay on! Replace threaded nuts and lock washers.

**ONLY \$1.00**  
POSTAGE INCLUDED  
SEND CASH OR CHECK—NO STAMPS

**TINNEMAN PRODUCTS, INC.**  
DEPARTMENT 13 • CLEVELAND 1, OHIO

# Double YOUR FUN Double Your "Production"

## with Atlas POWER KING TOOLS



You make and do more things—get more fun from woodworking—with low-cost Power King tools! Send today for this big free catalog. Gives you complete information on every tool—shows every feature which helps you do better, more professional work, and contains many helpful shop hints. Send a postcard today.

**40th YEAR**  
*Atlas* **ATLAS PRESS CO.**  
735 N. Pitcher St. • Kalamazoo, Mich.  
DEPENDABLE QUALITY TOOLS

### NEW—Sensational! GEIGER COUNTER



**"The SNOOPER"**  
LOW PRICE **\$24.95**  
ONLY  
COMPLETE

Find a fortune in uranium with this new, super-sensitive Geiger Counter. Get one for atom bomb defense. So small it fits in the palm of the hand or in the hip pocket, and yet more sensitive than many large, expensive instruments. Weighs only 1 1/4 lbs. Uses flashlight battery. Low price includes earphone, radio active sample, instructions. Sold with ironclad moneyback guarantee.

**ORDER YOURS TODAY**—Send \$5.00 with order or payment in full to save C.O.D. Write for free catalog on treasure finders for gold, silver, etc. and larger, more elaborate Geiger Counters.

Dealer Inquiries Invited **PRECISION RADIATION INSTRUMENTS**  
4113 PM W. Jefferson, L.A. 16, Calif.

## MAKE Big MONEY WITH THE Universal LAWN MOWER GRINDER!

Enjoy a profitable lawn mower sharpening business of your own. No previous experience needed. Place a hand or power mower on the UNIVERSAL GRINDER. With only ONE SET-UP you quickly grind the stationary blade and all the reel blades to proper clearance WITHOUT REMOVING A SINGLE BLADE from the mower.

**PROOF**  
G. Spurlock, of Arkansas, writes: "I have my Universal Grinder two months and made a net profit of \$227.00".  
C. E. Hardy of Missa, writes: "I am doing a fine business with the Universal Grinder. I spent 40c for a newspaper ad and have done nearly \$500.00 of business." Write today for FREE FACTS about Big Profits in Lawn Mower Sharpening.  
**ROGERS MFG. CO., DEPT. M-71, LINDSEY, OHIO**



Marmot, Ltd., Letchworth, Herts, England

### Collapsible Buggy

Mothers who live in upstairs apartments will welcome a collapsible buggy which is being made in England. The wheels and chassis detach from the body and fold into a compact unit. The body can be taken upstairs and used as a crib if desired.

### Metal Recovered From Smoke

Scientists are constantly finding valuable materials in strange places. Now, they've discovered worthwhile amounts of germanium, an important but little-known metal, in the dust that collects in British smokestacks. Some of the coal mined in England contains germanium and, when the coal is burned, deposits of germanium compounds collect in the flues. An economical recovery process has been developed by the research laboratory of the General Electric Company in London by which it is expected that about 2000 tons of germanium will eventually be recovered annually. Germanium is becoming increasingly important in the field of electronics and may some day replace vacuum tubes as rectifiers in radios.

Ⓞ Cigarette-lighter "flints" aren't made of real flint, but of an alloy, usually of the metal cerium with smaller amounts of other metals, which generates a shower of sparks when struck.

# 2 DRILLS in 1



This attachment gives you two drills in one. It converts any 1/4 inch electric drill to 1/2 inch capacity. Reduction gears reduce the drill speed 5 to 1, the average speed of a 1/2 inch drill, and thereby increases the power. Absolutely indispensable for all shop work and home craftsmen.

**\$11.95** post paid

Send check or Money Order

Satisfaction guaranteed

Order yours now

**G. M. CO. MANUFACTURING, INC.**  
1308 43rd AVE.  
LONG ISLAND CITY 1, NEW YORK



Your **ELECTRIC DRILL** Trims **HEDGES — SHRUBS — GRASS** with **ROTO-TRIM** DRILL ATTACHMENT

FITS ANY 1/4" DRILL

Today's Greatest Hedge Trimmer **VALUE \$10.95** (Less Drill)  
Yours, Postpaid, for only **\$10.95**

Keep your whole yard neatly tailored... trim hedges, shrubs, and hard-to-reach grass easily and smoothly with this new, inexpensive drill attachment. ROTO-TRIM quickly converts any 1/4" drill into an easy handling, keen-cutting Hedge Trimmer.

**Quality Built throughout.** Rigid steel and aluminum construction with smooth-running hardened steel gears and cam in one-piece case. Cutting blades are 10" long, of high carbon steel, heat-treated, precision ground and designed for maximum safety and efficiency.

**Easy to Use!** Quickly attached to drill—flats simplify chucking. Light weight and precision balance make ROTO-TRIM much easier to handle than more expensive trimmers. Handle turns blade to any angle.

**Order TODAY!** Don't miss this chance to get your ROTO-TRIM Hedge Trimmer Attachment while still available at today's low price of \$10.95.

**UNCONDITIONAL 10-DAY MONEY BACK GUARANTEE!** Send check or M. O. and we'll ship postpaid—direct from factory to you.

Dept. **ROTEX COMPANY** 837 WEST DAVIS DALLAS 8, TEXAS 751

## GRIND YOUR OWN

### CIRCULAR SAWS

USE YOUR OWN saw table. Sharpen combination, rip and hollow ground saws from 6" to 10". Makes hand filing obsolete. Saws last twice as long... and stay round... with correct tooth bevel... for cleaner work. **JIG ONLY \$8.95** with \$3.00 grinding wheel & instructions. At dealers or postpaid. Guaranteed.

"Tru-Circle" Automatic Saw Set Sets teeth at 10° or more. Only **\$2.95**. At dealers or postpaid.



A. D. McBurney, 317 E. 4th St., Los Angeles 14, Calif., Dept. A-7



**Snap-on Tools**  
THE CHOICE OF BETTER MECHANICS

4000 fine tools, available direct from factory to user. Snap-on catalog free—send for it today.

**Snap-on Tools Corporation**  
8062-G 28th Ave., Kenosha, Wis.

## Start a NEW BUSINESS!

or Add to your present Repair Business

### SHARPEN DULL PIPE WRENCHES

PIPE TAPS & DIES  
"GUM" CIRCULAR SAWS

Write for Information

**J. C. MOORE INDUSTRIES**  
BOX M 276 FREDONIA, PA.



## VARIABLE SPEED

HYDRAULIC POWER TRANSMISSION

It has Infinite Speeds 0 to 550. Reverse. Automatic Overload Protection: Adjustable Torque up to 180 inch pounds. 5/8" input and Output Shafts. It will handle 1/4" to 1 1/2" H.P. Motor. Case measures 7 1/2" long 7" high, 8 1/2" wide. **VALUE OVER \$54.50**

25¢. On C.O.D. Orders we require a 10% only Deposit. Feb. Chicago

**DIRZIUS MACHINE SHOP "D" 1423-25 So. 52nd Ave., Cicero 50, Ill.**



Save Time!!! Save Money!!!  
SEND FOR THIS BIG, NEW

## Woodworkers Catalog No. 18

ONLY **15c** New low prices...great selection of fine domestic and imported woods...bargains in hard to get supplies--144 pages of items and ideas for woodworkers. Quick delivery on mahogany, walnut, maple, cherry, poplar, oak, red cedar, and others properly seasoned, kiln dried. Send 15c for your copy--TODAY.



**RAFTSMAN WOOD SERVICE CO.**  
2729 S. MARY STREET-CHICAGO 8, ILLINOIS

## Sensational New Type ADJUSTABLE FLY CUTTER

for wood, metal, plastic, leather, gaskets, etc.

**Vernier adjustment! Lifetime!**

**Heavy, rigid construction!**

Capacity	Post.Pd.	Capacity	Post.Pd.
4 1/2" (single bit)	\$4	10" (single bit)	\$6
6 1/2" (single bit)	\$4.50	6 1/2" (double bit)	\$6.50

18% tungsten high speed tool bits

Check or Money Order. No C.O.D.'s

**BRITISH OVERSEAS MART Inc., Dept. M-7**  
300 4th AVE. NEW YORK 10, N.Y.

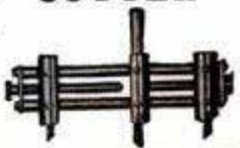

## DRY OUT DAMP WORKSHOPS!



Amazing little Fedders Electric Dehumidifier dries damp rooms without messy chemicals! Plugs in like a radio, removes up to 3 gals. of moisture from the air every 24 hours. Stops damage from rust, mildew, rot, warp. Protects tools, wood, guns, luggage, furniture, linens. Compact and portable. No service worries. Runs for a few pennies a day. Write today for details on 5-day FREE home trial offer. Fedders-Quigan Corp., Dept. PM-1, Buffalo 7, New York.

**fedders** A GREAT NAME IN COMFORT

# Make Ur-Own ROTARY TYPE POWER MOWER

**THIS IS NOT A KIT**

**\$44.95**



But A Complete Mower Assembled As Illustrated  
**Model 50M KEEN MOWER.** Add your electric motor or gas engine. Concealed blade for safety, 3 cutting heights, 1½" to 3½". Ball bearing rubber tired wheels. 18" cut. Cuts to within ½" of sidewalk. Weight 48 lbs. America's Greatest Power Mower Value. Order Now. Shipped F.O.B., K.C. **\$44.95**

Send check or money order  
 Write for FREE Folder for information on "Make Ur-Own" and other models with gasoline engines or electric motors.

**ATLAS KEEN MOWER**  
 KANSAS CITY, MO.

229 S. W. BLVD.

Dept. PM7

## AMAZING TOOL BARGAINS!

ALL BRAND NEW MERCHANDISE

**12 MINIATURE CUTTERS \$1.00**  
 FOR CUTTING WOOD, PLASTIC, or METAL



POST-PAID  
 IN U.S.A.  
 Actual size. Asst. shapes on 3/32" shank. For die makers, home workshop, etc.

**12 MOUNTED WHEELS** and points on 1/8" Mandrel. For grinding on plastic, wood, soft and hard metals. Regular \$8.40 List Val. ONLY **\$2.95**



SCHUPACK SUPPLY CO., 7331 Cottage Grove, Dept. M-20, Chicago 19, Ill.  
 (Illustrated Bargain Catalog Free)

## DO MORE PLANING JOBS WITH LOW-COST BELSAW \$215.00

**AMAZING 12¼-IN. PLANER Does All Ordinary Planing Mill Jobs.** Provides attachments for Jointing, Rabbeting, Tongue, Groove, Matching, 12¼ x 6-in. capacity, 3-knife solid round all-steel cutterhead. Power feeds at 24 feet per minute, 42 cuts per inch. Provides for full line of accessory attachments—Grind and Joint knives IN THE CUTTERHEAD WITHOUT REMOVING. **FREE BOOK**

**BELSAW MACHINERY CO**  
 1018 Field Bldg., 315 Westport Rd., Kansas City 2, Mo.

## CALENDAR WATCH CHRONOGRAPH & STOP WATCH

Only **8.95** + 10% TAX

**31-Day Automatic Calendar**  
 A precision timepiece and chronograph at an unusual low price. Imported Swiss jeweled movement, Radium Glow 1" dial, red sweep-second hand, shock resistant case, metal expansion wristband. 1 Year Guarantee, 10-day Free Trial. Choice of white, black dial.



**GAYLORD** DEPT. PG-7, Fifth & Hamilton, Pittsburgh 6, Pa.

Send..... Watches @ 8.95 + 90¢ tax. Enclose  Check,  Money Order,  Send C.O.D. Print name, address & dial color in margin.



Peerless Roll Leaf Co. Inc., Union City, N. J.

## Playing-Card Monogram Machine

In four minutes, two decks of playing cards are monogrammed by a machine that impresses roll leaf on the cards. No skill is required to operate the machine as everything except loading is automatic. The roll leaf comes in gold, silver and colors and requires no drying time.

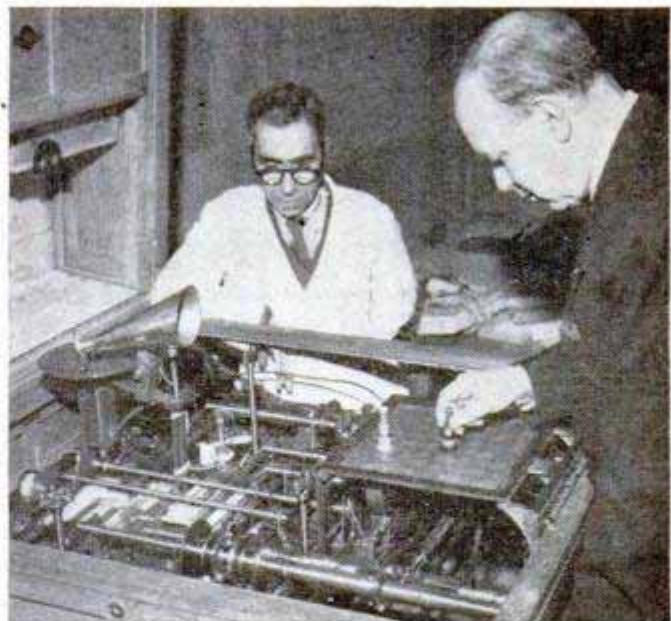

## Mechanical Chess Opponent

Chess fans can play solitaire against a machine that never makes a mistake. Invented by a Spaniard, the machine teaches perfect chess techniques. Whenever an error is made in play, a light flashes on automatically.





## BARGAIN! BRAND NEW! SPINNER!

only \$47<sup>95</sup> Save \$34<sup>55</sup> REG. \$82.50  
7-in. disc

**While They Last — Direct From Manufacturer**  
Uses 7-in. or 9-in. disc—Sands, grinds, wire brushes, etc. Makes tough jobs easy. 3/4 h.p., Heavy Duty Motor. 10-day, money-back guarantee. No C.O.D. Send check or M.O. TODAY—while they last! Californians add 2% State Sales Tax

**HOLT MFG. CO.** 651 20th Street Oakland 12, Calif. | 272 Badger Avenue Newark 8, New Jersey



## MAKE YOUR OWN!

WITH

**GRIFFIN LEATHERCRAFT KITS**  
Best assortment of tools, materials in U.S.A.! Send 25¢ for 116-page catalog. (money refunded first order)

**GRIFFIN CRAFT SUPPLIES**  
SINCE 1924  
5626-A Telegraph Ave., Oakland 9, Calif



## How to Get Better Paint Jobs!

Send for free illustrated 24-page booklet—tells how to buy and apply right aluminum paint for all jobs around the house. We don't make paint, but prepared this booklet to help you get better results with aluminum paint. Write for free book "Paint it Bright!".

**ALUMINUM COMPANY OF AMERICA,**  
171 8G Gulf Building, Pittsburgh 19, Pa.

## SHEET METAL BRAKES

Forms angles, flanges and Pittsburgh locks. 26 gauge steel, heavier aluminum. Cam locking. Portable, can be bolted to bench, or clamped to edge of truck. All steel, reinforced.

Shipped Exp. Coll. 30" size, Wt. 34 lbs., \$26.50, 36" Wt. 43 lbs. \$31.00, 48" Wt. 100 lbs. \$45.00. Floor mountings, portable, 32" high, 30 lbs. \$7.00 12" BRAKE. Fits in vise to form difficult compound bends, up to 20 gauge steel. Not illustrated. . . . . \$12.50 PP. 5" Wide Pliers forms locks, "S" slips, etc.

**IRON BENDER.** 1/4x2" capacity. 9 parts. All steel. . . . . \$10.00 P.P. Immediate Delivery. Order direct, cash or C.O.D. or send for folder.

**VYKE BRAKE CO., P-1116 So. 27th St., Omaha 5, Nebr.**



30"—36"—48"

## MAKE BIG MONEY!

Be a floor surfacing contractor and sand both new and old floors. Sanders are easy to operate and better still, you're your own boss. Write for latest "sell-off" booklet entitled "Opportunities in Floor Surfacing", enclosing 25 cents in coin or stamps to cover handling.

**AMERICAN**  
FLOOR SURFACING MACHINE CO.  
525 So. St. Clair Street • Toledo 3, Ohio



## WAR EQUIPMENT MAIL SALE!

Gigantic Summer Sale, War Surplus, Excess Inventory Bargains

- Air Conditioners and Tanks
- Arc Welders A-C and D-C
- Water Pumps, Valves, etc.
- Wire Recorders, home and office
- Farm Weed Spray Outfits

Send Card For Bargain Listings.

**BURDEN SALES COMPANY**  
809 "O" St., LINCOLN, NEBR.

Do your own professional quality nickel-plating with simplified Jewell Thermo-Nickel-plating process. Non-electric. Many advantages. Users enthusiastic. Ideal for machinists, hobbyists, mfgs., tool and die makers, etc. WRITE!

## NU-WAY HEAVY DUTY CUTTING UNIT

with Timken Roller Bearings

**PRICE \$16.50**  
WHY PAY MORE

Build your own rotary type lawn or weed cutter. Take the hard work out of weed cutting. Build yourself an up-to-date weed and lawn mower with the Nu-Way heavy duty unit.

Write for Free Circular—We Supply Cutting Unit Complete

**TRACTOR-LITE MFG. CO., Spirit Lake, Iowa**



## A HOLLOW GROUND Hand Saw

World's First and Only Saw Blade That Has Maximum Clearance WHERE YOU NEED IT MOST!

The ONLY BLADE with full clearance in the WORKING AREA

Patent Pending

For the easiest, fastest, smoothest sawing action known, get a hollow ground saw!

**FREE** Valuable tips on easier sawing, and hints on saw care. New folder shows amazing advantages of hollow ground hand saws over ordinary taper-ground saws. Send for free copy today.

**THEY COST NO MORE!**  
Sold thru dealers only

**The LARSAN Mfg. Co.** 673—17th Ave., Columbus 3, Ohio



## SAY YOU SAW IT IN POPULAR MECHANICS

## HOLD-E-ZEE

THE ORIGINAL AUTOMATIC GRIP SCREWDRIVERS

FIRST CHOICE OF SKILLED CRAFTSMEN

Models for All Types of Screws

Pat'd.

At Leading Dealers Everywhere

Gripper Recedes into Handle

Upson Bros., Inc. Rochester 14, N. Y.



## ELECTRIC MOTOR BARGAINS!

1/4 HP	1750 RPM 110 Volt 60 Cy. Split Phase Type . . . . .	\$8.50
1/2 HP	3450 RPM 110 Volt 60 Cy. Capacitor Type . . . . .	22.50
3/4 HP	1750 RPM 110-220 V 60 Cy. Repulsion Induction. . . . .	34.75
3/4 HP	3450 RPM 110-220 V 60 Cy. Repulsion Induction. . . . .	34.50
1 HP	3450 RPM 110-220 V 60 Cy. Repulsion Induction. . . . .	39.00
1 1/2 HP	3450 RPM 110-220 V 60 Cy. Repulsion Induction. . . . .	47.50

Every Motor Fully Guaranteed. ALL PRICES F.O.B. Write for 32-volt Bargain List.

## 1/3 HP ROPER PUMP UNIT

Original cost \$133.00 **\$59.50**  
Our Price F.O.B. only

Will handle any liquid from water to heavy lubricating oils—for permanent installation or can be used as a portable unit for irrigation, weed spraying, etc. This is not to be confused with ordinary units sold for light duty and intermittent work. **ROPER IS THE NAME IN PUMPS.** Unit is powered by heavy duty Repulsion Induction—1/3 HP Leland—110-220 Volt—60 Cy.—Single Phase motor. Pump will handle up to 300 gallons per hour. 22' suction lift—120' head possible—60' head at 30 lb. pressure—self priming—1/2" inlet; 1/2" outlet—wt. 60 lbs. All new and fully guaranteed.

**ROBERTS ELECTRIC COMPANY, 849 W. Grand, Dept. 5, Chicago**



# New easy-to-follow PROJECT SHEETS



Don't miss this great offer. Send in your dime now to Rogers Isinglass and Glue Company, Gloucester, Mass.

FREE! A brand-new series of Rogers' valuable woodworking plans. These simplified instructions tell you how to make your own tables, bookcases, chairs, etc.

Send 10c today and we will send you a bottle of Rogers famous liquid fish glue plus a complete set of these free plans. Rogers glue has a ton of strength in every drop! Ask for Rogers at your local Hardware Store.



## IN HOT WEATHER

Get top-notch performance from your electric razor. In sticky, perspiry days of summer when shaving is most uncomfortable, this amazing preparation:

1. Evaporates sticky, razor-clogging perspiration.
2. Lubricates skin for faster, more comfortable shaving.
3. Tautens skin—"brings out" your beard for closer, better-looking shaves.
4. Lubricates your shaver's cutting head.

FREE! Try Lectric Shave at our expense. It is avail-



able at drugstores or toilet goods counters. Only 49¢ plus tax—enough for 80 shaves. For a generous free sample, send name, address to The J. B. Williams Co., PM-4, Glastonbury, Conn. (Offer good only in U.S.A.)



Seal-Dri Sportswear Co., Rockford, Ill.

## Portable Duck Blind

Hunters can carry a new duck blind with them wherever they go and pitch it in a few seconds. The blind is made of camouflaged canvas and weighs 4½ pounds, complete with a single stake and two curved aluminum rods which shape the canvas into a cylinder, with enough room inside for a dog and a stove. The hunter wears a shawl-type canvas hood which gives him freedom to move when he stands to shoot. Two of the units can be snapped together to form a larger blind for two hunters.

## Water Blasting Cleans Metals

Ordinary water in which fine abrasive dust is suspended produces high finishes on metal products when sprayed under high pressure. The abrasives, some being finer than talcum powder, remove minute amounts of metal from the surface, leaving it clean and with an attractive appearance. Actually, the surface is pitted with millions of microscopic "pockets." On working surfaces, these hold oil and improve the operation of the part, according to the Hydro-Finish Division of Pangborn Corp., Hagerstown, Md.

☐ Rattlesnakes, which are attacked by cancer just like humans, are aiding New Mexico University scientists in a study of abnormal cell growth.

## WELD BRAZE, SOLDER, and CUT

ONLY \$14.75 F.O.B. complete! EASILY... QUICKLY!

No experience needed. Follow simple instructions, weld on iron, steel, bronze, brass, aluminum, and other metals. Plugs into any properly wired 110 volt A.C. or D.C. line. Make or save time and money doing repair work for yourself and others. Repair men, farmers, tinsmiths, home and auto owners, hobbyists, etc., say FOUR-WAY pays for itself over and over. Order today or send for Free details.

FOUR-WAY WELDER COMPANY, Dept. F2-GB 2326 So. Michigan Ave. • Chicago 16, Illinois



ORDER NOW 10 DAY TRIAL

SAY YOU SAW IT IN POPULAR MECHANICS

## POWER MOWERS & KITS FREE PLANS



Build your own quality mower with our LOW COST KITS, Parts, Engines. Free Plans guide you. 3 and 4 Wheel Kits, complete. Parts precision finished, ready to use. Write TODAY for Free Plans, Low Prices, Parts List and Guarantee.

### 3-WHEEL KIT NO. T-800



America's Finest Power Mowers completely assembled in 3 and 4 wheel models. Belt or direct drive. 18" and 20" sizes. Nationally known make engine optional. Latest improved features, sturdy construction and money back guarantee fully described in color folder. Write today.

▼ TRIANGLE MANUFACTURING CO., Dept. M-8, Fort Scott, Kansas

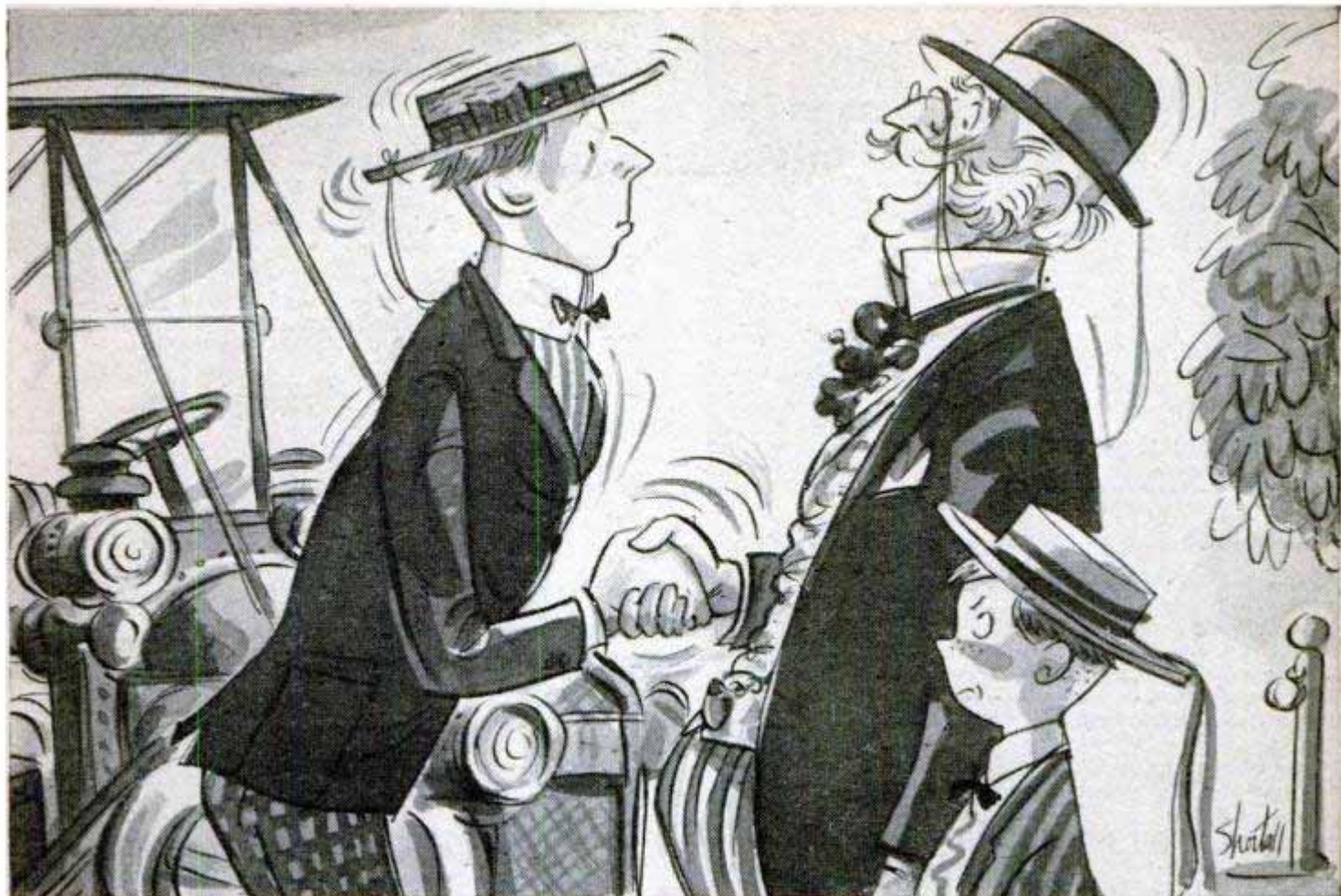

## WAS GRANDPA **CORNY**?

When I was young, grandpa was so embarrassing...

If anyone questioned his pet brands, he'd take it as a personal insult.

Once, when an old crony made some slurring remarks about grandpa's favorite brand of pipe tobacco, he refused to speak to the man for two years.

But he was most embarrassing about that car of his. He'd bought it back in 1919...and from that day on, he took full credit for everything about it.

Whenever he saw another car of the same make, he'd go up to the owner like the fellow was a long-lost brother. He'd button-hole perfect strangers, and practically kiss 'em!

To a small boy it was agony... could anything be *cornier*?

As I grew older, I began to see that having brand names you could look for and *trust*, wasn't a bad idea at that.

Maybe it is "corny" to think of familiar brands as old friends...

But it's good to know exactly what you're getting. It's reassuring to realize that most manufacturers of brand name products spend money for research and quality control to make their brands live up to their name.

They know the best way to make money is to make *friends!*

Every day thousands of these brands are fiercely competing for your friendship...trying to give you *more and more value and quality.*

If value, and better products, and better living are "corn," let's have more of it.

As you study the ads in these pages, remember...brand names are names of friends you can *count on!*

**Whenever you buy—  
demand the brand you want**

*Brand Names Foundation*  
INCORPORATED

A non-profit educational foundation  
37 WEST 57 STREET, NEW YORK 19, N. Y.

\$10.95



**NOW!**

**Trim that hedge with your electric drill and the BULL HEDGE TRIMMER**

Just chuck the Bull Hedge Trimmer in your 1/4" electric drill, and you've got a "power mower" that does all the work for you! The shuttle action of the 9" hardened high carbon steel blade clips any hedge cleanly... quickly... more evenly than you can do by hand. Also ideal for trimming grass around walls, house, trees, shrubs, etc. Blade can be turned to any angle. Light, easy to carry. No vibration. Order yours now — and avoid that hot, unpleasant hand work this summer and every summer from now on! Complete, ready to chuck in your drill, \$10.95.

Send cash, check, or money order today to  
**BERTRAM L. ENGINEERING & SUPPLY CO.**  
3125 HARRISON KANSAS CITY, MO.

**LOWER YOUR CAR in 30 MINUTES!**

with **CLARK LOWERING BLOCKS!**  
Gives any car that sleek, streamlined look! Easy to do! Everything furnished. Adds to safety at high speeds by dropping center of gravity. Fits all makes and models. Please state.

MAKE	DROPS		
	1 1/2"	2"	3"
Chev. (except 1951)	\$3.00	\$3.50	\$5.00
All other (ex. 1951)	3.50	4.00	5.00
All 1951 models having wide springs	5.00		5.00
Special Ford & Merc. set ('32 to '48)	1.00		

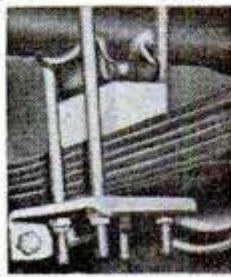

Over One Million In Use  
Dealers Write.

**CLARK COMPANY** 7018 E. FIRESTONE BLVD. Dept. P-7, DOWNEY, CALIF.

Say You Saw It in

**POPULAR MECHANICS**

**SAW SHARPENER**



Table model, gums and sharpens rip saws, combination saws & cut-off saws. Ideal for "Skill-saw" blades. Cap. 4" to 20" diam. Complete with 1/4 h.p. motor & 1 grinding wheel & cord — \$64 f.o.b. Portland. Shipping weight, 63#. SEND FOR FREE LITERATURE.

**P. T. HOBBS MACHINERY**  
8375 N. Interstate, Dept. PM-56, Portland 17, Ore.

**MAGNETS OF ALL TYPES—10c UP**  
AMAZINGLY POWERFUL!  
1/2 lb. magnet lifts 25 lbs. \$1.95.  
Our Leader, 1 lb. magnet lifts 40 lbs. \$2.95. New alloy—will not weaken!  
Useful for lifting valuables from tanks, lakes, or rivers easily! 7 small magnets \$1.25 with list of many shop and home uses. Satisfaction guaranteed.  
**R. EYRICH, 1219 W. MEINECKE AVE., MILWAUKEE, WIS.**

SAVE TIME, WORK, MONEY!

**SHAW "DU-ALL"**  
and "PEPPY PAL" TRACTORS

LOW FACTORY PRICES Buy direct or through your dealer.  
FREE Illustrated folders giving complete details, price lists—write today.

**SHAW MFG. CO.**  
4507 Front St., Galesburg, Kans.  
6686 North 4th St., Columbus, O.

**PARTS FOR MILITARY TRUCKS**  
FOR JEEP, DODGE, CHEV., GMC, STUDEBAKER, 4 WHEEL DRIVE AND 6 WHEEL DRIVE. ALSO PARTS CATALOG. WRITE

**American AUTO PARTS CO. INC.**  
1830 LOCUST—DEPT. PM  
KANSAS CITY, MISSOURI

**JULY IS OIL FILTER CHECK MONTH**

Keep your car's motor oil cleaner, your engine running sweeter, your repair bills lower. Install a clean, new

**PUROLATOR Micronic\* REFILL**

Only \$1.38 to \$3.00 (depending on make of car)

\*Reg. U. S. Pat. Off.



**AGENTS 300% Profit SIGN LETTERS**

For Store Fronts and Office Windows. Anyone can put them on. Free samples. Liberal Offer to General Agents.

**METALLIC LETTER CO., 430 N. Clark, Chicago 10**

**BUILD YOUR OWN FAN**



One-piece cast aluminum propellers for cooling and ventilating

Size Inches	Polished		Unpolished		Bore Inches
	2 Blade	3 Blade	2 Blade	3 Blade	
15	\$3.00	\$4.00	\$2.50	\$3.00	1/2, 5/8, 3/4
18	3.75	5.00	3.00	4.00	1/2, 5/8, 3/4
20	4.00	5.50	3.25	4.50	1/2, 5/8, 3/4
24	4.50	6.50	4.00	5.50	1/2, 5/8, 3/4

Write for pamphlet on larger fan blades, wire guards, fan bases, shutters, pillow blocks, exhaust fan frames, etc. Shipped prepaid if money accompanies order. Dealers write for discount.

**KLOPPENBORG ALUMINUM FDY., Dept. PM-551, Davenport, Iowa**

**LIQUID MARBLE** COMPOSITION FLOORS FLEXIBLE MOLDS  
MOLD novelties, Statuary, Art Goods in Flexible Plastic Molds; 5c

Mold, Brush, Trowel, Spray It! material makes \$1 seller. Make Marbleized floors, Tile Walls. Colorful, glossy, amazing! Easily learned; start in garage or basement. Particulars free.  
**MARBLEIZING SERVICE, Dept. 10-F, Edwardsville, Ill.**



Our 402nd Advertisement  
**REAL DIESEL ENGINE**

**\$2.95**

- for planes, boats, midget cars
- 7500 RPM; 1/7 HP; ht. 3 1/2"; wt. 5 oz.
- comes completely assembled

You just can't beat this price for a complete precision diesel engine! Streamlined, rugged, compact. Starts quickly, easy to install, runs for years. Fast delivery if you ORDER TODAY! Send \$2.95 plus 25c postage.

**GOTHAM HOBBY CORP. Dept. P. 107 E. 126 St. New York 35**

**Print Your Own**

Cards, stationery, circulars, tags, labels, photo and movie titles, advertising, etc. Save money. **Print for Others, Good Profit!** easy rules sent. Raised Printing like Engraving, too. Sold direct from factory only. Write for free catalog of outfits and all details. **KELSEY PRESSES, M-37, Meriden, Conn.**

**EXTRA INCOME THE YEAR 'ROUND**

Earn additional income and have fun at the same time! Popular Mechanics **MONEY MAKING HOBBIES** shows you how to make 132 different projects at home in your spare time! Complete instructions with over 600 illustrations, photographs, drawings and diagrams. Projects for everyone regardless of experience. Excellent resale value. State making your hobby pay a profit by ordering a copy of **MONEY MAKING HOBBIES** today from **\$2.00**  
**POPULAR MECHANICS PRESS**  
200 E. Ontario Street Chicago 11



**EARN BIG MONEY SINGING PROFESSIONALLY**

Learn how you can make thousands of dollars singing... on the radio... stage... screen... in the movies!

Now you can learn the secrets of famous singing stars who earn hundreds of thousands of dollars each year. Learn what has helped them hit the top and then use the same secrets and hints to become a famous singing star yourself. This famous book contains special words of advice from Jack Owens, Burl Ives, Kate Smith and a host of other nationally known vocalists. Learn how you can develop your voice, how to interpret, how to use a microphone, personality techniques and hundreds of other little known professional facts about singing. **Your Guide to Successful Singing** is written by Eugene Gamber, well-known critic and singer. It contains a special large-sized guidance chart, beautifully lithographed and suitable for framing. Send for your copy today on ironclad 7 day money-back guarantee. Only \$2.95 postpaid or order C.O.D. if you prefer. Mail order to



**WINDSOR PRESS, 200 East Ontario St., Chicago 11, Ill.**

## MARCOT KEY MACHINE



MARCOT No. 8 KEY MACHINE, less motor.....\$110.00  
 Auto Code Book and Depth Keys.....12.50  
 75 Dz. Popular Key Blanks.....60.00  
 Set — Key File, Follow-Through Rods, Lock Picks, Bit Key Gauge, Thimble, Pins, Springs.....10.50  
 "Locksmith Trade Books".....6.75  
 How to Open Locks without Keys or Picks; Secret of Locksmithing; How to Make Keys by the Impression Method; Master Key Systems.

Immediate Delivery

A. J. MARCOTTE CO., 1200 N. Kedzie Ave., Dept. PM, Chicago 51, Ill.

## Build your own JET ENGINE!



Order these plans today

1. JET PROPELLED BICYCLE. Assemble your own. Photo and instructions, \$1.00.  
 2. HOW TO MAKE EXPERIMENTAL JET ENGINES. Seven sheets drawings with information and instructions \$2.95.  
 3. BOTH OF ABOVE in one order \$3.75. SEND NO MONEY. Order both at once \$3.75 C.O.D. In USA plus c.o.d. postage. Send check or Money Order and we pay postage. Get other information too. Rush Order.

J. HOUSTON MAUPIN, Dept. 55, Tipp City, Ohio

## Clark EXPANSIVE BIT



CUTS BETTER • COSTS LESS!

Accurate, fast; cuts smooth holes in hard or soft wood. Chrome vanadium steel blades, all chrome body. No. 250, 1/2" - 1 1/2", \$1.89; No. 251, 3/8" - 3", \$2.19. GUARANTEED. At your dealer or write Dept. PM-7

ROBERT H. CLARK COMPANY • Beverly Hills, California

**GREAT PROFITS**

MAKE YOUR OWN RUBBER MOLDS

Make your own rubber molds quickly, cheaply with X.L. RUBBER. Cast thousands of perfect figurines, book ends, plaques, ornaments, ash trays, etc. **GREAT PROFITS!** Write for NEW Catalog.

X.L. Rubber, Pts. \$2.50; Qts. \$4.00; Models and enough rubber for 3 molds \$1.50 postpaid.

SEND FOR FREE FACTS

**PLASTIC ARTS STUDIO** Dept. 2, 3403 S. MADISON ST., Muncie, Ind.

POSTPAID ANYWHERE IN U.S.A. WE FURNISH ALL MACHINED METAL PARTS, EVERY SCREW, NUT, BOLT, WASHER, AND COMPLETE PLANS FOR THIS...

### BIG 10" POWER SAW

**\$10.95** FULL REFUND IF LESS GUARD NOT SATISFIED & WOOD IN 10 DAYS

COMPLETE PLANS 10c

**MARCUS-POLLAK**  
 DEPT. N, ROYERSFORD, PA.

ASSEMBLE IT YOURSELF WITH SIMPLE HOUSEHOLD TOOLS!

### DRAINS Cellars, Laundry Tubs; CIRCULATES Oil; IRRIGATES Gardens

Original "Type P" Pump has 2400 GPH capacity. 360 GPH 75' high, or 1500 GPH from 25' well. Use any 1/8 to 1/2 HP motor. DOES NOT CLOG.

Only \$6.95 postpaid if cash with order. (West of Mississippi, add 50c.)

SATISFACTION GUARANTEED OR MONEY BACK!

**\$6.95**

LABAWCO PUMPS, BELLE MEAD 7, N. J.

### LAWN ORNAMENT-NOVELTY PATTERNS

28 Lawn Ornament Patterns, 25c. Other Patterns: 15-20" high; Dutch Girl, Dutch Boy, Pirate, Bull Terrier, Mexican Girl, Mexican Boy, Dwarf, Penguin, Flower Girl, 10c each. 25 Novelty Patterns, 30c. All 62 Full Size Patterns, \$1.00 Postpaid.

Strother Pattern Service, Dept. CH-8, Box 128, Belington, W. Va.

### PROPANE GAS ON YOUR CAR—TRUCK OR TRACTOR

SEND \$1.00 for booklet of details and special prices on equipment.

ORDER NOW

LPG PRODUCTS Dept. PM-7 KEARNEY, NEBR.

## SAVE UP TO 85% IN WAR SURPLUS



Here it is! The **FAMOUS G.S.A.P. 16 mm MOVIE CAMERA**

- Semi-Telephoto Lens
- Three Shutter Speeds
- Continuous Exposures
- Magazine Loading.
- Takes B & W or Color

That famous "gun camera" used by the Navy & USAF. Now adaptable to hand use for professional or amateur movies. Has a 1-3/8" (35mm) lens with built-in exposure guide & shade. Adjustable for 3 shutter speeds—16, 32 & 64 frames per second. Uses regular Eastman magazines (50 ft). Requires no winding, no film threading. Operates on 24 volt dry cell batteries. View-finder not included. Requires slight conversion for hand use. Conversion diagram furnished free.

**VIEW FINDER** Especially designed & calibrated for this camera. Contains optically ground & polished lenses. **2795**  
**895**

**CAMERA BATTERY BOX**  
 Custom made to take single cell flashlight batteries to provide 24 volt power for operation of GSAP Camera. **329**

**CONVERTED CAMERA** READY TO USE!  
 Complete with positive, optical view-finder, micro-switch & battery boxes. Beautiful finish. **4495**

**16mm FILM** In Genuine Eastman magazines. 50 feet of fresh, Black & White film. Can be used in GSAP and some standard 16mm, magazine type cameras. Price includes processing in our own plant. **225**

### Photo TRIPOD

With Friction-Lock, single control head. Precision machined body & leg hinges are made of dural. Highly polished to a gleaming finish. Extendable legs are of special hardwood in natural finish. Can be extended to approx., 6 ft. Head tilts freely and is quickly locked into position by handle control. Ideal for large or small cameras, telescopes, etc. **795**

### PORTABLE FLOOD-SPOT LITE

Has adjustable ball & socket swivel head, long rubber covered cord and wall plug. All-purpose — indoor photography, Hoodlights, baby or large spot, personal bed reading, work bench, garage, etc.

Lamp alone.....139  
 5" spot reflector }  
 9" Parabolic reflector... } 109

### PROJECTION LENS

1.9" Ideal for your enlarger. Specially suited to 35mm negs. — Clear — super-sharp. Excellent condition, very fine quality, 4 element lens in precision aluminum housing. 3" focal length. **495**

### U.S. AIR CORPS GENUINE SUN GLASSES

6BASE

Here is the real McCoy! 6 Base — fine quality, Glare-Free, PUR-O-RAY lenses, optically ground & polished. Guaranteed free of all distortion. These fine glasses are made to meet the most rigid Gov't specifications. Lenses are AAF brown or green, specially developed for the USAF. Frames are either nickel silver or 24K gold plated finish with Pearlized sweat bar and pads. Protect your eyes from glare! Don't miss this \$12.50 VALUE!

Complete with leatherette belt case..... **395**

**PALLEY SUPPLY CO.** Order from this Ad. All sales final. All Prices F.O.B. Los Angeles. Pay by M.O. or Check. P.O.'s Accepted from D & B firms. 1/2 deposit with C.O.D.'s

Dept. PM-7, 6321 SAN FERNANDO RD. GLENDALE 1, CALIFORNIA

For safe summer driving,  
keep your radiator  
free of **SCRUM**\*



by "Hib"

\*Clogging accumulation of scale, rust and oil muck in cooling system

Hot summer days mean extra work for the cooling system. Be sure to protect the engine by keeping the system free of clogging SCRUM (scale, rust and oil muck). Just pour in a can of Warner Cooling System Protector and relax. Warner Cooling System Protector helps prevent the formation of SCRUM—keeps the water circulating efficiently — all summer long.



WARNER-PATTERSON COMPANY  
CHICAGO 5, ILLINOIS

**INSTALL IT YOURSELF**

**KITCHEN VENTILATION  
ATTIC COOLING**

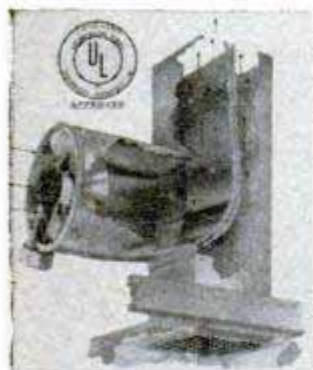

Flip a switch and the patented ATTIFAN removes kitchen smoke, steam and odors and at the same time discharges hot attic air. Keeps your rooms approximately 20° cooler. Freshens up the whole house. Fully efficient design assures noiseless operation. Firesafe because motor and blade are mounted remote from grease

laden airstream. Uses no more current than the average light bulb. Easy to install — instructions with each unit. Shipped assembled—ready to go. You'd pay as much for a comparable quality kitchen fan alone . . . only \$39.95 f. o. b. Remit in full with order and we prepay shipping, or send \$5 deposit and we ship C. O. D. at \$34.95 balance plus modest postage cost *Money Back Guarantee*. Immediate Delivery. ORDER NOW ATTIFAN, 1388 Fairfax Drive, San Bernardino, California.

**\$39.95 Assembled, complete**  
D<sup>R</sup> ER INQUIRIES INVITED

**ATTIFAN**

**BRIKCRETE**



**Local Manufacturing  
of this Modern Masonry  
Has High Earning Power**

Several hundred territories are being opened up for local Brikrete manufacture by men of vision and aggressiveness. Brikrete ties in with today's huge building program. Makes possible better construction at lower cost. Truly better than brick; actually cheaper than lumber. Combines strength, safety, insulation value, colorful beauty that fits today's styling.

Brikrete is made in locally owned plants, using local materials and local labor. That's why high quality and low

price still permit a 100% to 150% mark-up. We supply complete equipment; easy terms if required. Generous co-operation. Exclusive manufacturing privileges in protected territory. Write for information.

Brikrete Associates, Inc.  
4679 Division Ave. S  
Grand Rapids 8, Mich.



**BULL DOG JACKS**

Makes parking or hitching trailers and heavy farm implements an easy, one-man job



Model  
No. 60-F  
Only \$15.75  
Post Paid  
(when paid  
in advance)

All steel construction—heavy duty ball bearing swivel action . . . raise and lower with crank . . . complete with bracket, ready to install

**HAMMER BLOW TOOL COMPANY**

Wausau 13G Wisconsin

**SURE DIRECTIONS WITHOUT STOPPING**



**HULL** AUTOMOBILE  
COMPASS

The Name HULL Guarantees  
Accuracy, Dependability.  
Write for local dealer's name,  
free literature

**HULL MFG. CO.**

P. O. Box 246-D7 Warren, Ohio

Beaconlite \$6.95  
Illuminated  
STREAMLINE \$4.95  
standard (not this)

**LUMITE**

SARAN SCREENING

\*Registered Trade-mark

**GUARANTEED RUSTPROOF!**

**New POWER MOWER**



**FREE** Building Instructions  
Write For Them

Amazing invention makes whirl-blade mower pull and steer itself as well as cut grass and weeds. Convert your mower or build a complete mower with screw-driver & pliers. Send name and address. 1c postcard will do.

**PULLS  
ITSELF,  
STEERS  
ITSELF**

Convert Your Mower  
Or Build A New One

T & H Mfg. Co., Dept. MPC-7 811 E. 31 St., Kans. City, Mo.



Spindle—Platform—Wheels—Fork—Handles—Driving & Steering Parts  
All parts available—kit or separately.

POPULAR MECHANICS



## WELLWORTH Air Compressor

For Farm and Home Workshop

Compressor has 2" bore, 1 3/4" stroke, 2.8 cfm up to 150 lb. pressure. Motor required: 1/4 h.p. at 100 lbs.; 1/2 h.p. at 125 lbs.; 3/4 h.p. at 150 lbs. or equivalent gas engine. V-belt drive, intake muffler and cleaner, bronze bearings, splash lubrication. Wt. 16 lbs. Replacement parts always available. **\$20.50**

**COMPLETE OUTFIT.** Compressor, pressure tank, air gauge, air chuck, 20 ft. hose, pop valve, copper tubing with 4 brass flared fittings for connecting compressor to tank, 4-way cross and 3 nipples. **COMPLETE OUTFIT, wt. 30 lbs. \$32.45**

Equipment less compressor **\$12.45**  
Tank only. **\$6.25**



NEW!

## LIGHT PLANTS

5 KW

\$2200 Value

**\$895.00**

GENERATORS

500 and 2000 Watts

## Wisconsin GAS ENGINES at a big saving!

BRAND NEW

Model A.B., 2.5 to 3.4 H.P., 2 1/2" bore, 2 3/4" stroke, 13.5 cu. in. Wt. 60 lbs.

List Price, \$90.00. Special Price... **\$76.00**

Model A.K., 3.5 to 4.7 H.P., 2 7/8" bore, 2 3/4" stroke, 17.8 cu. in. Wt. 70 lbs.

List Price, \$160.50. Special Price... **\$86.50**

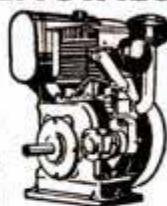

### AIR REGULATOR and EXTRACTOR

1/4" Air Regulator. Gauge and filter. Wt. 3 lbs.

BRAND NEW! **\$8.95**

Regulator and Gauge only... **\$5.95**  
Air Filter only... **\$3.25**



## RED SEAL CONTINENTAL GAS ENGINE

BRAND NEW. 1 1/2 HP with 6 to 1 reduction gear. Operates at 450 R.P.M. For lawn mowers, scooters, garden tractors, pumps, compressors, generators, etc. List Price \$79.50. Shipping weight 54 lbs. **SPECIAL PRICE \$47.50**



## WELLWORTH V-BELT CLUTCH



Takes starting load off engines or motors. When speed is reached, a flip of handle shifts clutch from idling to driving position. Handles "A" belts, 2.35" pitch diameter, 5/8" bore. Ideal for use with lawn mowers, garden tractors, home workshop motors, etc. 3 1/4" long. Safe, easy to mount, sealed bronze bearings, positive action. **\$7.50**

Shpg. wt. 3 lbs. **BUSHING FOR 1/2" SHAFT, 15c**  
Brand New! Same clutch furnished with 3/4" bore. **\$8.50**

WRITE FOR CATALOG SEND 10c FOR POSTAGE

PRICES F.O.B. CHICAGO. MONEY BACK GUARANTEE. SEND CHECK OR MONEY ORDER TODAY. PROMPT SHIPMENT.

**WELLWORTH TRADING CO.** 1831 S. STATE ST., DEPT. D-7, CHICAGO 16, ILL.

## SAVE THREE WAYS WITH A NEW Cushman

WRITE FOR FOLDER AND PRICES DEPT. 14-M



Get the big three Cushman economies—low purchase price, low operating cost, low maintenance. Ride the Cushman scooter to work, school or shop. Less than a penny per mile to operate. Dealer inquiries invited.

**CUSHMAN MOTOR WORKS Lincoln, Nebr.**

## B & I VARI-SPEED

This variable speed transmission provides approx. 3 1/2 to 1 speed ratio. Speed ratio lever can be fixed in any operating position. Brass bearings with grease cup lubrication. Ideal for power tools where immediate variable speed is desired. speeds changed while unit is in operation.

Order today **\$8.95** post-paid only  
B & I MFG. CO., BURLINGTON, WISCONSIN

## Have fun, save money by making things yourself • Delta's wonderful "How To Do It" Books will aid you

ASK YOUR DELTA DEALER

**DELTA MILWAUKEE** **DELTA POWER TOOL DIVISION**  
**Rockwell MANUFACTURING COMPANY**  
8036 E. VIENNA AVE. • MILWAUKEE 1, WISCONSIN

## Gerstner TOOL CHESTS

Rugged, long-lasting chests for Machinists and Toolmakers. Free Catalog.

## GERSTNER TOOL CHESTS

451 COLUMBIA ST. DAYTON 7, OHIO

## NEW, IMPROVED CALCULATOR FOR WOODWORKERS only 25c

Instantly gives information on lumber, nails, concrete mixes, painting materials, etc. Convenient, simple to read. Just set dial for nail specifications, to convert linear to board feet, find bit sizes for screws, compare characteristics of woods. 6" diameter heavily varnished cardboard. Send 25c, no stamps, please to Greenlee Tool Co., 2107 Columbia Avenue, Rockford, Illinois.



## Genuine MAHOGANY Wood

Large Batch \$1.00 Postpaid. Other Usable Scrap Bargains Postpaid Sample 25c — Price List 3c

## 1951 BUZZ MASTER

8 MODELS — \$99 up

More cutting — "Tomorrow's BUZZ MASTER Today!" See the de luxe riding model. Nothing else like it. Made by the oldest firm in the business—now in our 47th year. Many special features used only on Ottawa Saws. Write today for FREE DETAILS. **OTTAWA MFG. CO., 1-127 Brush Ave., OTTAWA, KANS.**

## 584 Page Novelty Catalog Now Ready!

Rush Coupon **584 Pages; 7500 Amazing Novelties**  
Send 10c for mammoth new catalog of 7500 novelties. (Each copy costs us over 50c—10c helps pay postage.) More fascinating than World's Fair, Thousands of things you never knew existed—never knew where to get. Includes novelties, tricks, jokes, live animals & pets, scientific supplies, den novelties, hobby supplies, planes & boats, looms, magic, unusual seeds, gadget time savers, camera & optical goods, movies, projectors, lucky jewelry, religious novelties, telegraph sets, magnets, disguises, easy musical instruments, stamps, coins, puzzles, fortune tellers, radios, experimental sets, auto & bike accessories, Western belts & wearing apparel, telescopes, magnifiers, compasses, barks, smokers' gadgets, artists' supplies, printing sets, engines & motors, electric shockers, knives, billfolds, weird articles, archery, swimming helps, 1000 fascinating books, games, locks, live chameleons, barometers, rings, watches, charms, imported novelties, exercisers, money savers, handy tools, Indian novelties, etc., etc. Jammed & packed with sensational funmakers & useful articles. Big catalog—over 1 inch thick. 6 color cover. Rush Coupon to Johnson Smith & Co.

**Johnson Smith & Co., Dept. 384, Detroit 7, Mich.**  
Here's My 10c. Send Big Catalog to:

Name & Address \_\_\_\_\_

**PLEASE  
SEND ME**



for the  
time checked.  
I am enclosing . . .

1 year \$3.50  
2 years \$6.00

name \_\_\_\_\_  
address \_\_\_\_\_  
city \_\_\_\_\_ zone \_\_\_\_\_ state \_\_\_\_\_  
PM-7

Hand this order to your newsdealer or send it to

**POPULAR MECHANICS**  
200 East Ontario St. Chicago 11, Ill.

**Bet You Don't Know  
This About Advertising**  
*by Susan*

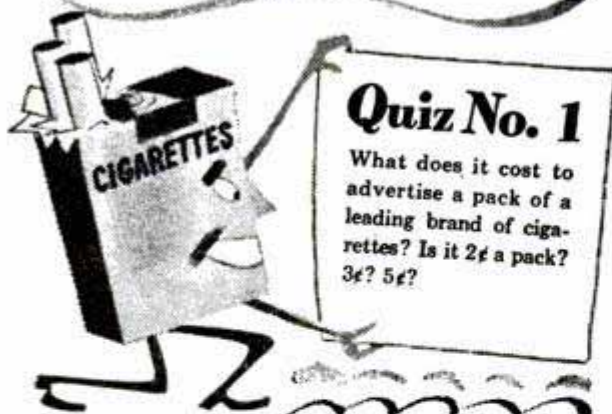

**Quiz No. 1**  
What does it cost to  
advertise a pack of a  
leading brand of ciga-  
rettes? Is it 2¢ a pack?  
3¢? 5¢?

**Answer:** It costs less than 1/2¢ a  
pack to advertise the big brands of cigarettes.  
That's only half the story. Advertising  
lowers your cost two ways:

*Cuts the selling costs. And by helping make  
mass production possible, lowers the produc-  
tion costs, too.*

So advertising saves you many times that  
1/2¢ per pack.

**VACATION TRIPS FREE  
FROM NEEDLESS EXPENSE  
SAVE GAS AND...**



See your DEALER or  
SEND \$2.00 NOW  
we pay postage.  
C.O.D. Charge extra.  
Give CAR, YEAR and if  
Regular, Overdrive or  
Automatic Shift.  
DO YOUR BIT — CONSERVE OUR DEFENSE RESOURCES.

make driving easier with  
**SPEED-MINDER**  
the NEW inexpensive STABILIZER SPRING  
that clips to your accelerator pedal  
It eases foot pressure, stops jerky ac-  
celeration, costly engine racing and  
thoughtless over-speeding. Driving at  
any desired top cruising rate it be-  
comes a foot rest maintaining steady  
speeds that greatly increase gasoline  
mileage. Fits all cars and trucks—Full  
instructions—No tools needed. 10 day  
money-back guarantee.

**SPEED-MINDER LABORATORIES, INC.**  
Lock Box 3496, Merchandise Mart Station,  
CHICAGO 54, ILLINOIS

*Say You Saw It in*  
**POPULAR MECHANICS**



**AMAZING PERMANENT MAGNETS — WILL NOT WEAKEN! NON-ELECTRIC.** Retrieve guns, tackle, tools and other steel items from lake, river, plating tanks, drains or other hard-to-reach spots. Recover drills, taps, etc. from floor sweepings. Clear alley of harmful tacks, nails. Many other uses listed. Pays for itself quickly. **GUARANTEED:** Try any magnet one week. Money refunded if you are not well-pleased.  
Cat. No. 675 (Has pull of 175 lbs. on a flat steel block) . . . \$10.50  
Cat. No. 650 (150 lb. pull) \$8.50 Cat. No. 600 (100 lb. pull) \$6.50  
Cat. No. 550 ( 50 lb. pull) \$4.00 Cat. No. 530 ( 30 lb. pull) \$3.00  
Cat. No. 17 ( 14 lb. pull) \$1.50 Send M.O. or check. We pay postage.  
Cat. No. 30—Hobbyist assortment of six medium magnets . . . \$1.50

**MIAMI MAGNET CO.,**  
3240 N.W. 27th Ave., Aviation Bldg. No. 43, Miami, Florida

**TITANIUM Rutile** MORE BRILLIANT  
THAN DIAMONDS  
Refractive Index about 10% Higher Than Diamonds  
Compare: Refractive Index of Rutile is between 2.62 and 2.90 as  
compared to the diamond's 2.42. Dispersion of Rutile ranges be-  
tween 0.155 and 0.205 in comparison to the diamond's 0.025.



Available in 38 facet BRIL-  
LIANT, EMERALD and MAR-  
QUISE shapes @ \$10.00  
per carat, postpaid—1 to 10  
carats.

Unconditional 30 Day  
Trial — Money Back  
Guarantee

**HUDSON GEM CO., Dept. PM-5, 574 5 Ave., N.Y.C., N.Y.**

**YOU'LL CATCH BIGGER FISH**

and have more fun catching them after you read  
Popular Mechanics **HOW TO TEMPT A FISH.** Here  
is the experience of veteran guides and fishermen  
brought to you for hours of enjoyable reading. Many  
pages of brilliant full color kodachrome plates.  
Covers every phase and style of fishing—even tells  
where to find the big ones and what baits to use.  
Hundreds of kinks and tips to make every trip more  
enjoyable. Endorsed by leading sportsmen through-  
out the country. 128 pages. 525 illus.



**POPULAR MECHANICS PRESS \$2.00**  
200 E. Ontario Street, Chicago 11

**Now Available  
FROM YOUR NEWS DEALER**



**NEW 1952 EDITION**

Each year Popular Mechanics publishes  
four famous books—*Home Kinks, Use-  
ful Ideas, Shop Notes and What to  
Make.* This year, one of these volumes  
is being published every three months  
to bring you wonderful practical in-  
formation throughout the year. Now—  
*Useful Ideas* is ready. It's chock-full  
of time and money saving ideas for  
you. Get your copy at your newsstand  
today for only 35c, or order direct. Be  
on the look-out for *Shop Notes* in Au-  
gust and *What to Make* in October.

**POPULAR MECHANICS PRESS**  
200 E. Ontario St., Chicago 11, Ill.



**HYDRAULIC CYLINDER SPECIAL**  
 Gives 20,000 lb. thrust (push pull) using 1500 PSI line pressure as obtained from our hyd. pumps. Or will produce 40,000 lb. thrust with 3,000 lb. line pressure. CAN ALSO BE OPERATED ON LOW PRESSURE AIR SYSTEMS. 4" Bore, 1 1/2" dia. piston shaft, 18" stroke, length 30 1/2". Equipped with ball bearing loaded clevis type mounting and swivel type high pressure steel pipe bracket for easy use. Ideal for road, farm & shop machinery, presses, etc. Cost Gov't \$390.00 **2995**

We carry the World's Largest Supply of Special Hydraulic Equipment featuring over 20,000 Cylinders in 61 Sizes and Types. Can also supply all accessories such as Pumps, Valves, Tanks, Hose and Fittings. Write for information.

**No. 3 HYDRAULIC CYLINDER**  
 Double action. Bore is 1", Shaft 1/2". Has a stroke of 2 1/2" to 4". Stroke can be adjusted with internal sleeve stops. Overall length is 8 1/2". Will take 1500 lbs. continuous duty, 3000 lbs. intermittent. Will lift or push to 1100 lbs. **575**

**No. 9-E HYDRAULIC CYLINDER**  
 Double action cylinder. Has a bore of 1-3/8" and shaft of 1". Stroke is 9". Overall length 15 1/2". Built for 1500 lbs. continuous duty, 3000 lbs. intermittent. Will lift or push up to 2300 lbs. . . . Can be adapted to hundreds of uses **975**

**FOUR WAY VALVE**  
 V-2B Poppet type. Valve shuts off at neutral position. Has 3/8" A.C. Tube Ports - 9/16 - 20 thread. Will stand 1500 PSI **675**

**V-17** - Poppet type, pressure balanced Has piston with built-in relief valve to limit cylinder strokes. Inlet and outlet ports have 1/2" std. pipe ports. 1/2" A.C. tube to cyl. (1/4" x 18 thread) **975**

**STRATO POWER PUMP**  
 With built-in variable flow control valve in head. Positive displacement piston type. Displaces .450 cu. in. per revolution. 2 gal. per min. cap. at 1500 RPM at 1250 PSI. Pressure limit, 1250 PSI continuous, 1400 PSI for 15 sec. Operates at 3750 RPM, intermittent maximum 4500 RPM. Rotates in either direction without adjustment **1950**

**GEROTER TYPE PUMP**  
 Logan Geroter type. For operating hydraulic systems on trucks, tractors, etc. Delivers 8 GPM at 1200 RPM at 1000 PSI with 5 H.P. Can also be used as Hydraulic fluid motor. 3/8" std. pipe ports, 1/2" splined shaft for pulley or direct attachment. 5 1/2" dia., 7" long. Used but condition guaranteed. **1950**

**VT-1 VICKERS HYDRAULIC Transmission**  
 Self contained, 2 H.P., constant torque at all speeds with variable volume reversible, piston pump (controlled by outside lever) supplying piston hydraulic motor. Automatic pressure, dash pot for smooth control. Power output RPM - 0 to 1/3 input RPM in both directions. Input RPM 1800 continuous, 4000 intermittent. Dash pot can be removed for greater RPM. Ideal for lathes, duplicator or set-up on mills, conveyors, small cars, drives, gears, etc. **3250**  
**4" SPLINE SHAFTS** for input & power take-off **250**

**NOW! MAKE YOUR OWN ARC WELDER!**  
 Here's a real buy! Finest precision built R-1 Generators, used on B-29's, cost the Government approximately \$400.00. Gives from 300 to 400 amps at 27 volts. Ideal for all welding, light and heavy up to 5/8" thickness. FREE complete instructions for conversion of this generator to welding unit. **2795**

**Other AIRCRAFT GENERATORS**  
 P-1 27 Volts 200 Amps **1595** E-5A 12 to 15 Volts 50 Amps **1295**  
 1273-1A 27 Volts 75 Amps **1595** 03 27 Volts 100 Amps **2500**

**NEW! GEAR HEAD MOTOR**  
 GHM-607 - Originally designed to drive large Aircraft Tow-Target reels. . . . Powered by 24 V DC, 95 Amp., compound wound motor. Rated at 2 H.P. Turns 4,200 RPM and is geared down to 136 RPM at the power take-off shaft. 60 foot pound torque at take-off. Power drive is 3/4" female adaption. Unit has magnetic clutch for instant stop control. Comes complete with operating switches and control box. **3750**

**SAVE UP TO 85% ON WAR SURPLUS ILLUSTRATED 1951 - 200 PAGE CATALOG**  
**1000'S OF BARGAINS! WRITE TODAY!**  
 JUST OFF THE PRESSES!! Packed with BARGAINS IN NEW & SURPLUS merchandise at UNHEARD OF LOW PRICES!! Items of interest to the Mechanic, Housewife, Farmer, Pilot, Manufacturer, Outdoorsman, Sportsman, etc. SAVINGS UP TO 85% in Clothing, Hand & Power Tools, Housewares, Metals, Rubber, Plastics, Machinery and Hydraulic Supplies such as Cylinders, Valves, Pumps, Motors, Fitting, etc. Send only 50¢ for your copy TODAY!! We'll refund it on your first order for \$1.00 or more.

**ELECTRIC MOTORS**  
**LEAR ELECTRIC MOTOR.** 24 volt, 6 amps, series wound reversible motor with overload clutch. Motor turns 11,000 R.P.M. Has 11 to 1 gear reduction box turning 1000 R.P.M. at take-off. Adaptable to flex or rigid drive. Limit switch box. Size 10" x 4". **5795**

**SAMSELL MOTOR**  
 27 volts, 16 amps, 1/5 H.P. reversible, series wound on motor. 3800 R.P.M., shaft 9/32" diameter. 12-spline. 4-1/8" x 2-3/8". **395**

**GEAR HEAD MOTOR**  
 Heavy Duty G.E. Gear Head Motor. 1 1/2 H.P., 24 volt DC, 125 amp reversible motor will drive reduction gear box unit 44.5 to 1, resulting in 168 R.P.M. at 5/8" diameter take-off shaft. Motor contains electro magnetic break. **495**

**UNIT COMPLETE 1095 MOTOR 495**  
**GEAR BOX ALONE 795**  
 No. 500 - New 1/2 H.P. - 27 Volt, D.C.-A.C. This motor can be readily adapted to deliver up to 1/2 H.P. on 110 Volts, A.C. by the simple method of rearranging armature brush-leads. Free diagram with each order. A sensational value **595**

No. 500-A - Converted to 110 Volts-A.C. Equipped with plug and 3/4 ft. Heavy duty cord **849**  
**GEAR BOX - VTG-1 - 90° - bevel gear 1 1/2 to 1 reduction. A life-time value . . . . . 395**  
 Size: 7" x 6" **395**  
 Has lever control for engaging & disengaging positive clutch. Dust proof housing, pre-lubricated bearings. . . . Can be adapted to Vickers Transmission.

**ELECTRIC ACTUATOR**  
 Hundreds of uses for any mechanical device needing controlled 2-way action. Opens, closes, raises or lowers doors, windows, gates, valves.  
**CTU-2** Foote linear actuator. 24 Volt, A.C. or D.C., 8500 R.P.M., 1/6 H.P. - Series wound motor. 4 1/2" stroke in 13 1/2 seconds. Compression and tension loads up to 750 lbs. Adjustable micro-switch for limits of travel. Overall length retracted 11" **695**

**TWO HEAT SOLDERING IRON**  
 This is really TWO IRONS IN ONE!! A control button in handle selects 150 or 300 watt heat. Full size iron for light & hvy work. Removable, solid copper tip. Complete with cord & tip. **495**

**D. C. METERS**  
**AMMETERS**  
 - 30-0-30+ **395**  
 - 60-0-60+  
 - 120-0-120+  
 0-120-0-240  
 0-300  
 Any above ammeters, **Only 495**

**VOLT METERS**  
 0-30 **495**  
**COMBINATION VOLT AMMETERS**  
 30 V. - 30 AMP.  
 30 V. - 60 AMP. **Only 495**

**PIANO HINGE**  
 Overall - - Width - - Length - Price ea.  
 1 1/2" - (5/8" side) - 72" alum. - \$1.00  
 2" - (1" side) - 9" alum. - \$1.75  
 3 1/2" - (1 1/2" side) - 54" st. steel - \$1.69  
**BRASS HINGE - 1 1/4" (5/8" side .040 thick) Any length at . . . per ft. .29**

**PALLEY FAMOUS MIXES!!** Prepared especially for the HOME CRAFTSMAN, HOBBYIST, INVENTOR, GADGETEER or SHOP MECHANIC.  
**GADGET MIX** - Rivets, Spacers, Bolts, Screws, Gears, Wheel bearings, Springs and Clamps. No. 106, 5 lbs. **1.19**

**BEARING MIX, No. 170A.** Approx. 20 needle, Ball & Roller Bearings, New & Used. Sizes 1/2" to 4" Some of these cost Gov't \$10 a piece. Never such a value! 5 lbs. ONLY **1.59**

**HINGE MIX, No. 170H.** 12 pairs of Strap and butt hinges, Hasps, 1" x 1" to 7/8" x 10" in length and 8" strap. 2 lbs. **1.09**

**ABRASIVE AND GRINDING WHEEL MIX** - 50 pieces including honing stone, pencil rolls, wheels, etc. A sharp value. No. 170AG **99c**

**SPRING MIX, No. 206** - Torsion, Compression & Tension Springs. Ass'd. sizes. A treasure trove for emergencies. Scores of springs. 5 lbs. for ONLY **1.69**

**RIVET MIX - 3 POUNDS** - Consisting of sizes from 1/4" to 3" long in many diameters & alloys **1.19**

**FILE MIX** - Ten assorted Files - 4" to 12". Includes Vixens, half rounds, mills, bastards, etc. - in seconds and used but good condition. 1 Vixen alone is worth our price for entire mix. **99c**

**PULLEY MIX** - You'll want this one around. 10 micarta & metal pulleys ranging from 1" to 5" with ball and one piece bearings. These are aircraft pulleys, the best made - with hundreds of uses. A WONDERFUL BUY! **2.95**

**SCREW MIX** - 5 lbs., including assortment of wood and machine screws. Many sizes. Save dollars and always have plenty of screws on hand. **1.39**

**NUT MIX NM-1-3 lbs.** approx. 500 nut. Anchor, Lock, Castle, Hex, Elastic Stop Nuts, etc. You'll always have plenty of Nuts in the shop. NM-1 **1.39**

**SUPER COMBO MIX** - No. SC2. Here's a real bargain. All ten above mixes for ONLY **12.95**

**AIRCRAFT CABLE**  
 Rust resistant, alloyed steel. Extra flexible. Pre-formed, 7 x 19 strand. On reels.  
 1/16" - 4 1/2 ft. | 5/32" - 7 1/2 ft.  
 5/64" - 5 ft. | 1/4" - 12 1/2 ft.  
 3/32" - 5 1/2 ft. | 9/32" - 15 ft.  
 1/8" - 7 ft. | 5/16" - 16 1/2 ft.  
 7/32" - 10 1/2 ft. | 3/8" - 18 ft.  
 1/2" - 20 ft.  
 Special 1/16" cable, 18 ft. long with turnbuckle ends **99c**

**Stainless Steel Cable** - Pre-formed  
 1/16" - 6 ft. | 5/32" - 20 ft.  
 3/32" - 14 ft. | 1/4" - 26 ft.  
**Bronze Cable** - Not Pre-formed  
 1/16" - 5 ft. | 3/16" - 23 ft.  
 1/4" - 17 ft. | 1/2" - 38 ft.

**Electronic Transmissn. Gear Train**  
 GT-1 - approx. 50 Bronze Spur & Pinion Gears, 3/8" to 4" dia., 5 sets of 7 cluster gears, 2 complete worm and worm gear drive sets, 40 N.D. ball bearings 1/2" to 1 1/2" dia., watch springs, bushings, posts, face plates, housings, micro switches 2 miniature controlled clutches, etc. . . . Gears in multiple size and sequence identical teeth ratio, giving 100's of gear reduction combinations. **849**  
 Wt. 19 lbs. **849**

Order from this ad. All sales final. Prices F.O.B. Glendale. Pay by M.O. or check. P.O.'s accepted from D&B firms. 1/2 deposit with C.O.D.'s.

**PALLEY SUPPLY CO**  
 6321 SAN FERNANDO RD.  
 Dept. PM7 GLENDALE 1, CALIF.

**LARGEST FIRM OF ITS TYPE IN THE WORLD**

# You Fly to Work

## IN THE U.S. ARMY AIRBORNE!

That's how the Airborne gets there "fustest with the mostest" . . . on the wings of huge transports carrying the finest fighting men in the U. S. Army.

They rate this praise, too. Each one is a volunteer. Each one has had a full course of basic training. Each one has been polished to perfection in an Army jump school. When they mount that transport, they're ready to go!

There's always room in the Airborne for more young men who can measure up to the mark. Men who want the finest, toughest training a soldier can get. Men who will wear the Airborne Insigne with honor. Men who want to "Fly to Work."

Find out—*today*—if you can qualify for the most select fighting force of all—the U. S. Army Airborne.

*Paratroopers boarding plane for practice jumps under combat conditions.*



GET FULL DETAILS ABOUT THE U. S. ARMY AIRBORNE AT YOUR NEAREST U. S. ARMY AND U. S. AIR FORCE RECRUITING STATION—WITHOUT DELAY.



# U. S. ARMY

### THE MARK OF A MAN!

The paratrooper's wings of the U. S. Army Airborne are the mark of a man! Those who wear this distinctive insigne belong to the finest fighting outfit in the world.





## TOUGH...but oh so gentle

**TOUGH ON OIL-PUMPING • GENTLE ON CYLINDER WALLS**

Using too much oil? Chances are, your piston rings are worn-out and they're not only wasting oil, they're wasting power—and causing needless engine wear.

Fortunately, worn-out piston rings can be replaced economically, but the more you delay the more you pay.

At the first sign of oil-pumping, replace your rings with Hastings piston rings. They're engineered for replacement service exclusively. They *stop* oil-pumping, *check* cylinder wear, *restore* engine performance. It's the best money you can spend on your car.

**HASTINGS MANUFACTURING COMPANY • HASTINGS, MICHIGAN**  
Hastings Ltd., Toronto

Keep your car out of the **DANGER ZONE**

Ask your motor service man for a Danger Zone check-up. Write for the free Hastings Danger Zone Booklet which shows you how to save money on engine repairs. Address Dept. P.



# HASTINGS

**STEEL-VENT PISTON RINGS**

After all the Mildness Tests,  
**CAMEL'S LEAD  
 IN POPULARITY  
 GREATEST IN 25 YEARS!**

Latest Published Figures Show  
 Camels h-



Why did  
you change  
 to Camels,  
**PAUL LUKAS?**



WITH CAMELS—  
 EVERY PUFF'S A PLEASURE! CAMELS  
 HAVE A RICH FLAVOR THAT PLEASES  
 MY TASTE—AND A MILDNESS THAT  
 AGREES WITH MY THROAT!

R. J. Reynolds  
 Tobacco Co.,  
 Winston-Salem, N. C.

**PAUL LUKAS** has delighted millions on stage, screen, TV. He says, "There's no room for throat irritation in my business and Camels agree with my throat!"

The smokers of America have made many tests for cigarette mildness. The quick tests. The trick tests. And the *thorough* Camel 30-Day Test. After all the testing, Camel has its biggest lead in 25 years!

Make your own 30-Day Camel Test. Prove to yourself, in your "T-Zone", that Camels have a full, rich flavor—and a mildness that agrees with your throat.



Noted throat specialists report on 30-day Mildness Tests:

**Not one single case  
 of throat irritation  
 due to smoking  
 CAMELS!**

*Make your own 30-Day Camel  
 Mildness Test and see why!*

Yes, these were the findings of noted throat specialists after a total of 2,470 weekly examinations of the throats of hundreds of men and women who smoked Camels—and only Camels—for 30 consecutive days.