

POPULAR MECHANICS

MAGAZINE

WRITTEN SO YOU CAN UNDERSTAND IT

REG. TRADE MARK GREAT BRITAIN NO. 40424

REG. U.S. PAT. OFF.

Timer for Champions
Page 88



Korta

**How Owners
Rate the
'51
CHEVROLET!**

Read the report of
the real experts
page 94

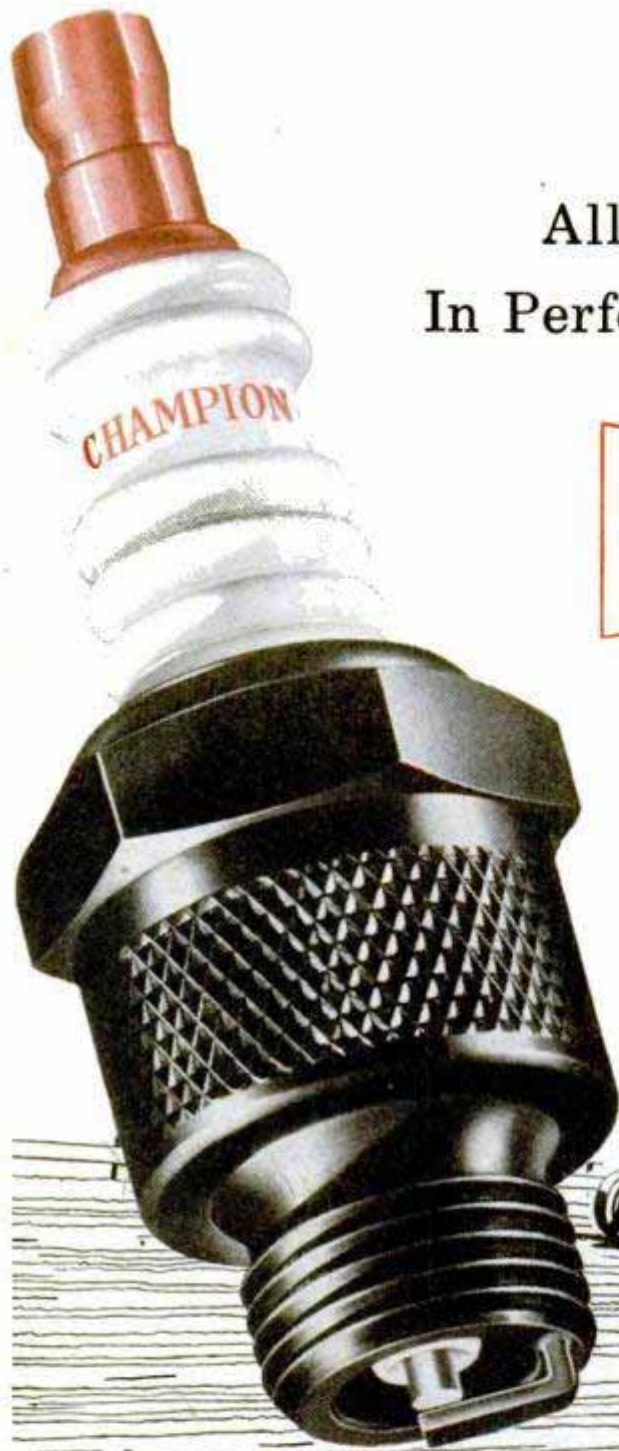

All That The Name Implies
In Performance and Dependability...

CHAMPION

Spark Plugs

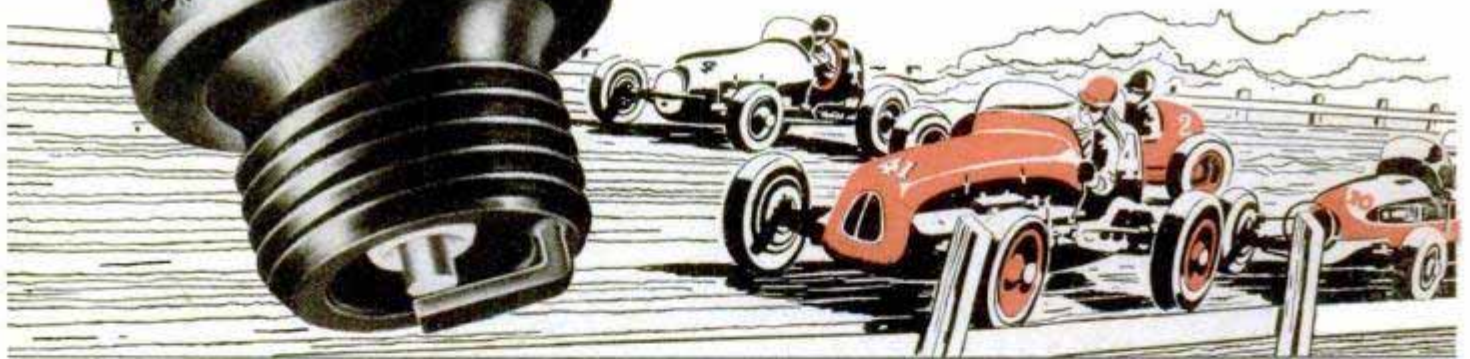

BE A CHAMPION DRIVER

... Go by the records that prove Champions best!



It's a significant fact that more racing champions use Champion Spark Plugs than all other makes combined. It proves Champions are better for every engine!



More airlines and truck fleets use Champions, too. This proves you can't beat them for economy, performance and dependability. Insist on Champions for *your* car!



On the strength of Champion's performance record in their own cars, American motorists have made it their favorite spark plug for more than a quarter century!

CHAMPION SPARK PLUG COMPANY, TOLEDO 1, OHIO

Listen to the CHAMPION ROLL CALL . . . Harry Wismer's fast sportscast every Friday night, over the ABC network

None Finer!



MODEL GCT—For all types and sizes of furnaces and boilers.

New
TIMKEN
Silent Automatic
GAS CONVERSION BURNER

Every famous, *proved* feature of gas heat engineering—that's what you'll find in this new, attractively-styled Timken Silent Automatic Gas Conversion Burner!

The illustration at left shows how efficiently and economically this advanced-designed *wall-flame* burner blankets the heat absorbing surfaces—in both boilers and furnaces. The one, large flame port is clog-proof—assuring dependable operation always. The air supply is adjustable to produce exactly the *right* gas-air mixture for the type of gas used. Listed by the American Gas Association, this efficient burner has every needed safety device. Mail the coupon below for information on the more than 93 models of Timken Silent Automatic heating equipment for oil, gas and coal.

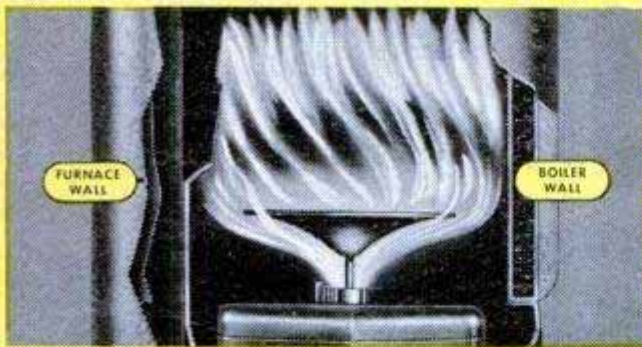

Showing wall application of burner flame against furnace wall (left) and boiler wall (right).

MAIL THIS COUPON TODAY FOR ILLUSTRATED LITERATURE!

Timken Silent Automatic, Jackson, Michigan
 Please mail illustrated literature. I am interested in:

_____ (type of equipment)

NAME _____

STREET ADDRESS _____

CITY and STATE _____

If you are a student, please check here () for special information.



TIMKEN
Silent Automatic
HEAT

TIMKEN SILENT AUTOMATIC DIVISION
 The Timken-Detroit Axle Company • Jackson, Michigan
 The Timken-Detroit Axle Company of Canada, Ltd., Toronto, Ont.



TRADE MARK REGISTERED

PM-661



The Big Boost

FOR HIGH SCHOOL GRADUATES!

High school graduates volunteering for the U. S. Army . . . and applying for Army technical schools when basic training is completed . . . are men who know how to get the big boost toward the future.

Men of the U. S. Army . . . like these Engineers . . . take pride in the outfit they serve, and in themselves. They want to get ahead in the world.

There is no better way than in your fast-growing Army, where technical skills are needed . . . where technical skills are

taught in the finest of training schools.

Get the details about how you can enlist and apply for technical training leading to a man's job in the building Engineers . . . the slugging Armor . . . the long-punching Artillery . . . the seven-league-booted Airborne . . . the "queen of battle" Infantry. Inquire today.

**Visit your nearest U.S. Army
and U.S. Air Force Recruiting
Station . . . today!**



U. S. ARMY

THE MARK OF A MAN!

The building Engineers of your U. S. Army wear this insigne. It is the mark of a man!

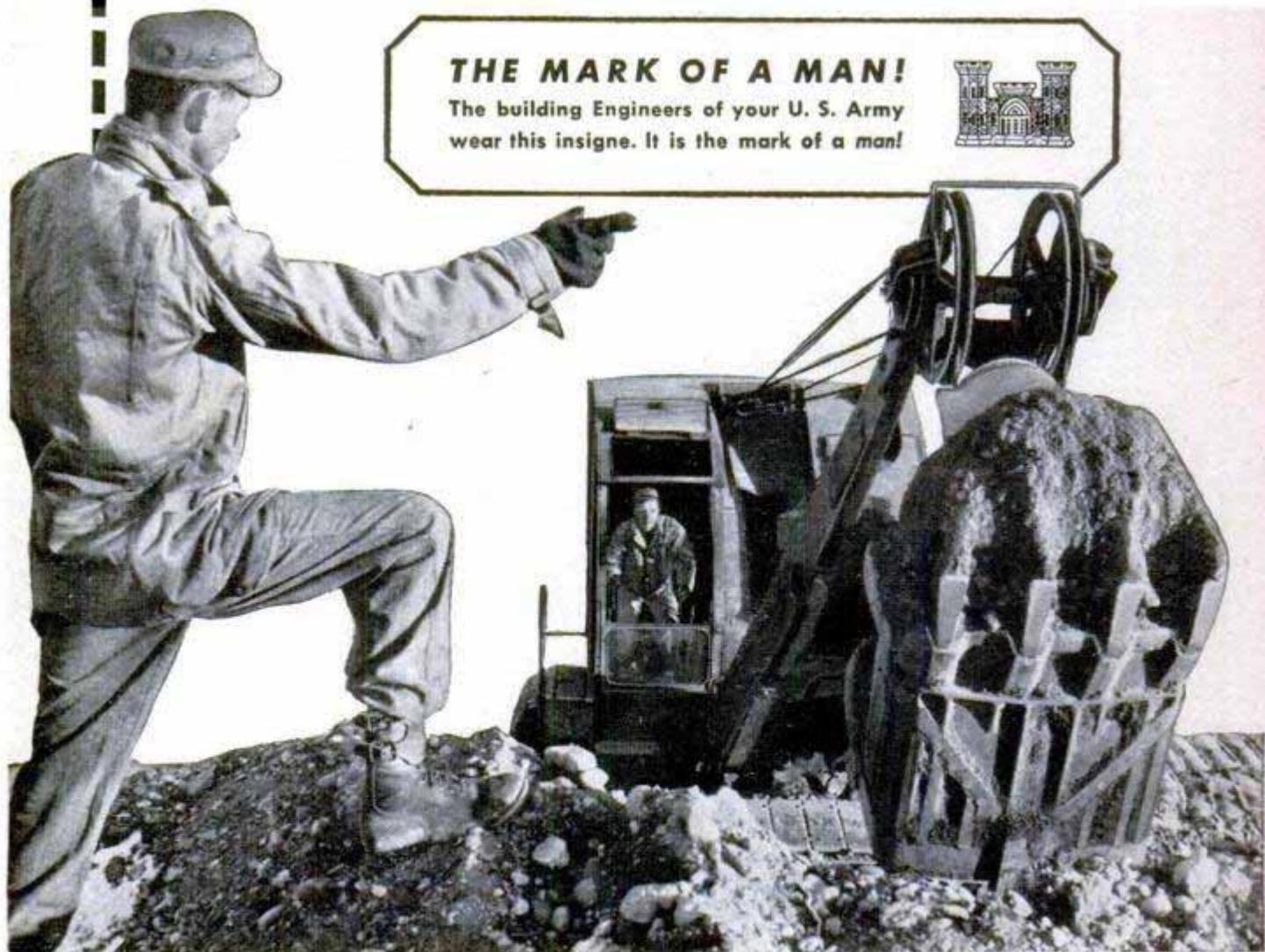

Popular Mechanics Magazine

Registered in U. S. Patent Office and Canada

H. H. WINDSOR, Founder

H. H. WINDSOR, JR., Editor and Publisher



Volume 95 JUNE 1951 Number 6

Managing Editor.....Roderick M. Grant
 Assistant Managing Editor.....Wayne Whittaker
 Shop Notes and Crafts Editor.....James R. Ward
 Radio-Television, Electronics Editor.....Frank L. Brittin
 Associate Editor, Aviation.....Aubrey O. Cookman, Jr.
 Associate Editor.....Clifford B. Hicks
 Associate Editor.....Donald R. Brooks
 Assistant Shop Notes and Crafts Editor.....Wayne C. Lecky
 Automotive Editor.....Siler Freeman
 Art Director.....Frank Beatty

Assistant Editors
 W. Clyde Lammy Arthur R. Railton Frank N. Stephany
 H. H. Windsor III C. E. Mitchell Dorothy Hoffmann
 Eastern Editor.....Richard F. Dempewolf
 Empire State Bldg., Room 2906, New York 1, N. Y.
 Western Editor.....Thomas E. Stimson, Jr.
 302 23rd St., Santa Monica, Calif.
 Representative in Great Britain.....Douglas W. Wedderspoon
 77 Baker St., London W. 1, England
 Director, Bureau of Information.....Allan Carpenter
 200 E. Ontario St., Chicago 11

this month's cover

THAT RACER streaking through the speed trap is just one of 38,000 high-speed vehicles clocked by a super-precise man named Otto Crocker. In his 10-year career as a timer, Crocker has officiated at the setting of 80 world records by speedboats, aircraft and autos. Mr. Split-Second, working in a world of high speed, has been forced to shred time to bits. The three-dial timer is his latest instrument, so precise it can clock objects along a course only 12 inches long or record a transcontinental speed dash. The instrument still has a slight error, Crocker admits—it gains 23/1000 second every 24 hours, or about the blink of an eye once a day. Crocker has witnessed a good many speed thrills in his career. There's the boat that spun crazily into a full barrel-roll, and the speed car that stood a driver on his head at 200 miles an hour. Crocker races through his own thrilling story beginning on page 88

Published monthly by Popular Mechanics Company, 200 E. Ontario St., Chicago 11, Ill. H. H. Windsor, Jr., president; William Harrison Petridge, vice president; D. P. Windsor, vice president and secretary-treasurer; Clover L. Perkins, advertising manager; Alan M. Deyoe, circulation manager. Single copy in the United States and Canada, 35 cents; subscription rates in United States and possessions, Canada, Philippines and countries of the Pan-American Postal Union, 1 year \$3.50; 2 years, \$6.00; 3 years \$8.00. To all other countries add \$1.00 a year over United States prices for overseas postage. If you plan to move, notify us at least 30 days in advance so you will not miss an issue. Give both your old and new addresses.
 Entered as Second Class Matter, September 15, 1903, at the Post Office at Chicago, Illinois, under Act of March 3, 1879. Entered as Second Class Matter at Post Office Dept., Canada. Registered as Second Class Matter at the Post Office at Mexico, D. F., Mexico, June 20, 1950.
 Copyright 1951 by Popular Mechanics Company. Copyright under International Copyright Union. Copyright in France. All rights reserved under Pan-American Copyright Union. Printed in the United States of America.

IN THIS ISSUE

Fill 'er Up With LPG - - - - -	65
The Frozen-Fish Factory Goes to Sea - - -	72
Masterpieces in Crystal - - - - -	81
I Time the Champions - - - - -	88
The Owners Report on the '51 Chevrolet - -	94
What's New for Your Home - - - - -	102
Adobe Goes Modern - - - - -	112
There's a New World in Textiles - - - -	120
Water Bronco - - - - -	128
There's No Age Limit for Mountain Climbers -	134
The Navy Films a Blast - - - - -	140
Revival in the Wheat Fields - - - - -	144

For the Craftsman

"Paddle Your Own Canoe" Safely - - - -	150
How I Built the P.M. Ranch House—Part 2 -	158
Soft Water Works for You - - - - -	170
Staining Is Easy With Brush or Spray - - -	178
Cleaning the Auto Interior - - - - -	186
Projector Cabinet Doubles as End Table - -	192
True Up Your Lathe for Precision - - - -	195
How to Build a 15-Ton Hydraulic Press - -	200
Shopping for Tools - - - - -	208
Radio-Television, Electronics - - - - -	211
Clinic for Homemakers - - - - -	220

Other items, and manufacturers of available products described, are listed on pages 12, 14 and 16

An extra 20 miles on every tankful of gasoline you buy

If you're interested in getting an average of 20 extra miles — yes, 20 extra miles — on every tankful of gasoline, you'll be interested in the following facts:

At 40 miles an hour on a smooth, level highway, half of your gasoline — 50% of it — is used up just to overcome engine friction. That's what the automotive engineers have found. And that's why it's so important for you to realize that if you can *reduce* engine friction, you're bound to get better gas mileage.

You see, by reducing friction, you simply release *some* of the power that was being used to overcome it. So naturally your car goes faster or farther or climbs a steeper hill on the *same amount of gasoline*.

Let's examine the facts!

Hundreds upon hundreds of cars like yours were scientifically tested on a Dynamometer — the industry's accepted measure of power. The results show that the average motorist got 8% more power from the same amount of gasoline after he had changed from whatever brand of oil he had been using to Macmillan Ring-Free Motor Oil.

The minute you change to Macmillan, you'll get an increase in power and gasoline mileage. You cut down on "drag"—your gasoline "pushes" easier than before. After your second or third drain, you'll get an average increase in gasoline mileage of 8%!

That's because Macmillan has not only

reduced engine friction but also has reduced carbon and gum deposits in the combustion chamber, on rings, valves, and valve stems. This results in higher compression because of better piston seal — smoother operation, and less tendency for the motor to ping.

Let's see what 8% means to you. 8% of 25¢ a gallon for gasoline is a 2¢ saving on every gallon you buy! Or, if you're now getting average mileage, an 8% *increase* means an *extra* 20 miles from every tankful.

And don't forget the long-range saving — it's friction that wears out motors. With Macmillan, you *reduce* friction — you save on wear and repair — your motor lasts longer, runs sweeter, uses less oil. New engines stay newer longer.

You'll find Macmillan — the original carbon-removing oil — at car dealers, garages, and independent service stations where you see the sign of the big red "M." Drive in, try Macmillan, the *OIL* that makes your *GAS* go farther.

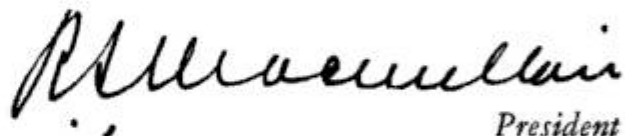

R. Macmillan
President

MACMILLAN PETROLEUM CORPORATION
530 W. 6TH STREET, LOS ANGELES
50 W. 50TH, NEW YORK • 624 S. MICHIGAN, CHICAGO

P.S. If you are unable to locate a Macmillan dealer, write to me and I'll be glad to direct you to the one nearest you. R.S.M.

**WE TREAT 'EM
ROUGH,
TO MAKE 'EM
BETTER!**

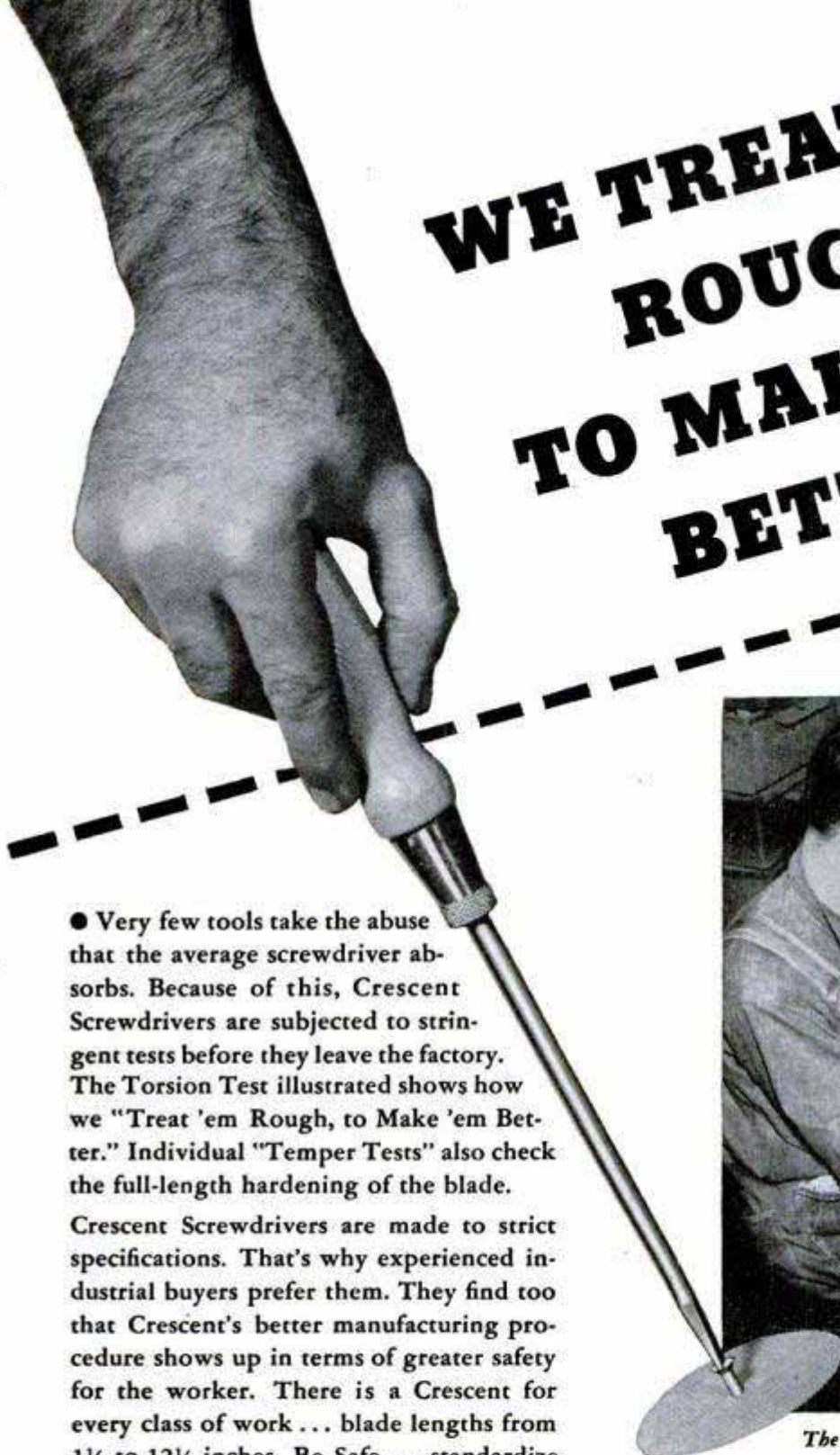

● Very few tools take the abuse that the average screwdriver absorbs. Because of this, Crescent Screwdrivers are subjected to stringent tests before they leave the factory. The Torsion Test illustrated shows how we "Treat 'em Rough, to Make 'em Better." Individual "Temper Tests" also check the full-length hardening of the blade.

Crescent Screwdrivers are made to strict specifications. That's why experienced industrial buyers prefer them. They find too that Crescent's better manufacturing procedure shows up in terms of greater safety for the worker. There is a Crescent for every class of work . . . blade lengths from 1½ to 12½ inches. Be Safe . . . standardize on these fully-guaranteed Crescent Tools.



The Torsion Test to which every Crescent screwdriver blade is subjected before assembly

CRESCENT TOOL COMPANY, JAMESTOWN, N. Y.

"Crescent" is our trade-mark, registered in the United States and abroad, for wrenches and other tools. Sold by leading distributors and retailers everywhere and made only by Crescent Tool Company, Jamestown, N. Y.

CRESCENT TOOLS

Give Wings to Work

*Sign of the Artisan
Symbol of Excellence*



Extra!

- MILES ● PROTECTION
- LUBRICATION ● COMFORT

IN Pyroil

- When you take the family for a joy ride—it will be full of joy and not "annoy", if you remember to add Pyroil first. Pyroil assures you a smooth, trouble-free ride, because Pyroil contains the "extra" special property of causing oil to adhere to metal surfaces. This provides a protective film of lubrication on metal parts. Added miles of summertime driving, add extra wear, extra exposure, extra friction on piston and cylinder surfaces. Pyroil adds extra protection, extra lubrication, extra miles to your car — extra driving comfort for your family and YOU.

Your gas station attendant has Pyroil. Add Pyroil — add more joyful miles to your car.

Pyroil for Aircraft Engines

Use Aircraft Pyroil B for lubricating oil, Aircraft Pyroil A for gasoline.

GIVEN! An attractive Pyroil metal savings bank — takes coins up to 50c pieces. **MOTORISTS**, it's yours for the asking—sent postage paid.



Manufactured and Guaranteed by
Pyroil Company, 116 Pyroil Bldg.
La Crosse, Wisconsin

Canadian Distributors:
Central Purchasing Agencies, Ltd.
Toronto, Ontario

PYROIL COMPANY

116 Pyroil Bldg., La Crosse, Wisconsin

I want my car to last and run properly. Please tell me more about Pyroil and how it can accomplish this for me.

Name _____

Address _____

City or Town _____ State _____



in this corner.....

THE EDITORS



THERE'S A NEW \$3000 pot o' gold awaiting photographers. *Popular Mechanics* announces its big Fiftieth Anniversary Photo Contest in this issue. A \$500 U. S. Defense Bond will go to the top entry in each of two divisions—black and white, and color. Entries will be judged on how well they illustrate the theme, "The Spirit of America." Even snapshots can win big money in this contest. You'll find the rules on page 111.



Smart Postmen!

Ask your postman where he'd deliver a letter addressed to "Written So You Can Understand It, U. S. A." and, if he's as smart as some postmen, he'll tell you: 200 East Ontario Street, Chicago 11, Ill.

Our mail bag the other day brought a letter from a Canadian reader in Beaupre, P. Q., with that simple and perfectly clear address. Naturally, it came through without delay.

For the last 50 years, come next January, that famous slogan has appeared on the face of *Popular Mechanics*, but this is the first time, to our knowledge, that it has served as a street and city address. H. H. Windsor, Sr., founder of the magazine, devised the slogan to introduce the first magazine that brought science, mechanics and crafts "down to earth," clearly and concisely interpreted for every reader.

Here Comes the Press!

News photographers and reporters in movies and life are always tearing back to the office with a story for the next edition. That's in the blood of journalists. At the University of Miami, student journalists have set a speed record that professional newsmen will envy. Combining the speed of the Polaroid Land camera and the speed

(Continued to page 8)

Let me send You FREE PROOF that you can become an expert **ACCOUNTANT... BOOKKEEPER** **OR C.P.A.**

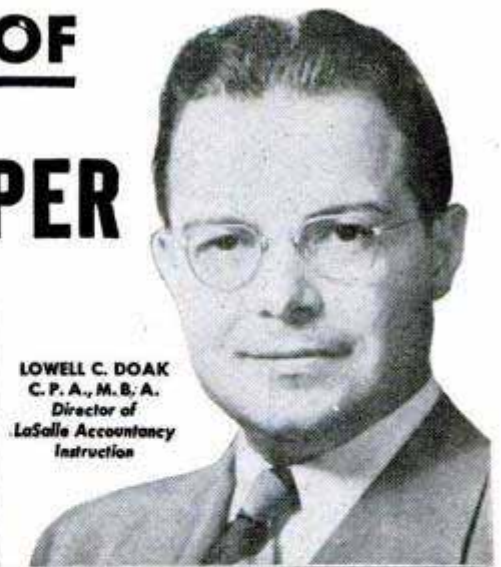

LOWELL C. DOAK
C. P. A., M. B. A.
Director of
LaSalle Accountancy
Instruction

FREE SAMPLE LESSON

I offer you this free sample lesson so that you can prove to yourself that you CAN master Accountancy—quickly, thoroughly—in spare time at home.

You will see exactly how LaSalle's famous "Problem Method" works... how you are led step-by-step through actual accounting work—learning by doing and not by study of theory alone. First you tackle easy problems, then more difficult ones—until soon you master them all. And at every step you have the close personal guidance of LaSalle's large staff of C.P.A. instructors.

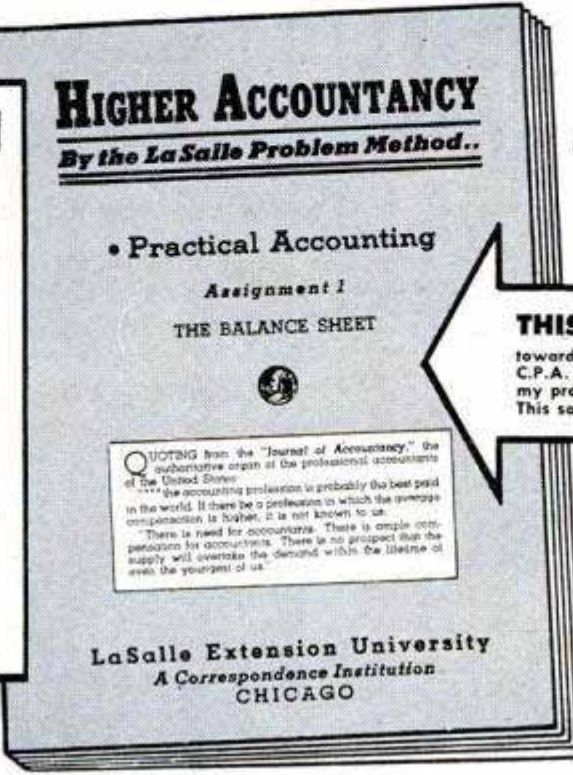

THIS SAME LESSON STARTED ME

toward a well-paid public accounting career—and my C.P.A. degree. I knew nothing of accounting before—yet my progress was rapid—my earning power climbed fast. This sample lesson will show you why.

If you have been envying the high incomes and good jobs enjoyed by thousands of men and women Accountants today... incomes ranging from \$4,000 to \$10,000 and more per year... why not launch such a career for yourself?

Do you doubt that you can?

Then let me send you—without cost or obligation—the same Lesson Number One with which LaSalle has started several hundred thousand

men and women toward successful accounting careers. I want you to see for yourself how this remarkable method, originated by LaSalle, makes Accountancy simple, interesting, practical, and certain... how it leads you step-by-step to a complete mastery of Accounting—and on up to the coveted degree, of Certified Public Accountant if you so aspire.

It doesn't matter whether you've had previous bookkeeping experience, or whether you don't know a debit from a credit. Whether you wish to qualify as an expert bookkeeper, advanced accountant, cost accountant, auditor, government accountant, income tax specialist, or public accountant... you'll find in LaSalle's Problem Method the exact plan to prepare you rapidly and inexpensively—in spare hours at home—without losing a day from your present job.

So right now, today... if you are an adult, employed, and earnestly ambitious for rapid advancement in this highest-paying of all professions... send your name and address to me on the coupon below. I'll send the free sample lesson—plus our 48-page book outlining today's career opportunities and how you can qualify for them. A coupon like this has started many thousands toward greater success. It can do the same for you. Mail it today!

**Nearly 10%
of all C.P.A.'s
in the U.S. have
been trained by the
LaSalle Problem
Method**

GOOD-PAY JOBS IN 5 BIG FIELDS

If you were an expert accountant right now, chances are you would find yourself among the highest-paid of all professional men and women. Surveys show that accountants earn more than those in other major professions.

There are five big fields of opportunity open to Accountancy-trained men and women... opportunities that are wide open and highly inviting, offering maximum income and job security in good times or bad. And under LaSalle's "Problem Method" you can start earning while still learning—either in spare-time or full-time employment... or in business for yourself with no capital required.

Get the latest information by sending for our 48-page book, "Accountancy, the Profession That Pays"... plus free sample lesson. The coupon at right will bring both to you without cost or obligation. LaSalle Extension, 417 S. Dearborn St., Chicago 5, Ill.

Clip Coupon... Mail TODAY!

LaSalle Extension University... A Correspondence Institution
Dept. 664H, 417 S. Dearborn Street, Chicago 5, Illinois

YES, MR. DOAK, I want to see how LaSalle's "Problem Method" works... how I can qualify for high-pay Accountancy positions. Also, send your 48-page book, "Accountancy, the Profession That Pays"... all without cost or obligation.

Name..... Age.....
Street Address.....
City, Zone & State.....
Present Position.....



Embry-Riddle MEN OF THE HOUR



are moving UP!

Thousands of Embry-Riddle trained engineers, mechanics, specialists and pilots are making rapid strides in today's booming aviation industry.

These men in the top jobs are undeniably proving that thorough, practical Embry-Riddle training is by far your quickest, surest road to success in aviation. Complete eight-month to two-year Embry-Riddle courses are tailored to practical aviation industry requirements.

The latest, most modern equipment (including jet engines), the finest instructors, the most complete aviation school campus anywhere, are all yours at Embry-Riddle.

If you are now a high school student, a graduate or a veteran, investigate at once the full advantages and tremendous career security of Embry-Riddle training.

If military service interrupts your studies, you're still a long way ahead of the crowd.

Join the Embry-Riddle Men of the Hour. Write for full information today.

4 Keys to Success!

AIRCRAFT & ENGINE MECHANICS

Our C.A.A.-approved school has a quarter-century aviation training experience. Learn fast with modern equipment, including jet... live aircraft, airline-size hangars.

A & E COMBINED WITH COMMERCIAL

Embry-Riddle *combination* training gives you unusual *dual* pilot-engineering ability.

AERONAUTICAL DESIGN AND TECHNOLOGY

Embry-Riddle's accelerated 26-mo. Aeronautical Design and Technology Course provides finest training available.

COMMERCIAL PILOT

Benefit from our experience with 30,000 students... best instructors and aircraft, year-round flying weather.



Embry-Riddle

International
SCHOOL OF AVIATION

MIAMI 30, FLORIDA

CLASSES BEGINNING NOW -- SEND COUPON TODAY!

Dean of Enrollments -- Dept 99
Embry-Riddle School of Aviation
MIAMI 30, FLORIDA
Please Print

NAME _____

ADDRESS _____

City _____

State _____ Age _____

I am interested in...

- A.&E. Mechanic
 Commercial Pilot
 Aeronautical Design and Technology
 A.&E. Combined with Commercial Pilot
 Flying Mechanic

Check Veteran
Our Non-Veteran

TRAIN IN MIAMI--AIR CAPITAL OF THE WORLD

(Continued from page 6)

of facsimile printing, the students published a photograph of a man making a speech while the speech was still being made! And it wasn't a long speech either. Total time from the moment the picture was taken until it was on the facsimile receivers was three minutes — 180 seconds. The photographer snapped the picture, developed it as he ran to the office, put it on the facsimile transmitter and it was instantly printed all over the campus. Metropolitan papers, please copy!

Letter to the Editor

... I read the article your two boys wrote in the October 1948 issue about their Alaska trip, drove up there last summer and found their information more valuable and correct than any other I had read ...

Leslie Faus,
206 W. 70th St.,
Chicago 21.



Letter to the Editor

I enjoyed reading the article "I Rode the Airlift to the Orient" by Richard F. Dempevolff very much, as I was a civilian employee with the Eighth Army in Tokyo and made the return trip from Tokyo General Hospital to Walter Reed General Hospital in October 1949 under similar conditions ... We changed crews at Kwajalein, and I noticed that it didn't take very long to gain

(Continued to page 10)

HOW TO IMPRESS THE BOSS

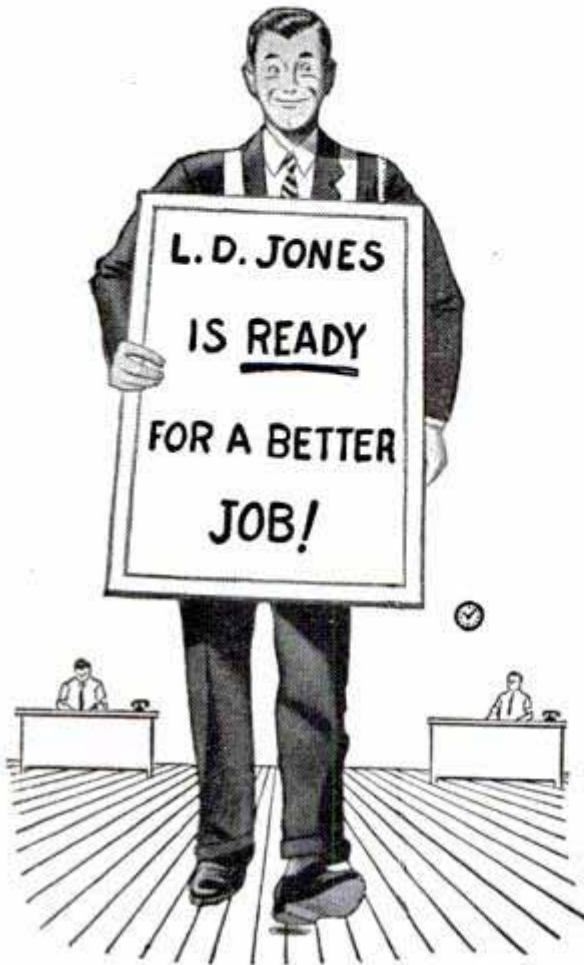

Suppose you do prepare for advancement in your spare time. Can you be sure news of it will reach the right ears? Will your boss be impressed?

I. C. S. regularly reports the progress of its students to their employers, regularly receives letters expressing appreciation of this service.

Typical of the many letters is one from an executive of a well-known oil company: "We want to thank you for your progress report on the above-named employee. It may interest you to know that he is being promoted, effective immediately."*

YOU want your employer to know that you are ready for promotion. YOU want your training recognized and rewarded. Then act now to obtain that training. Sound, practical I. C. S. Courses cover more than 400 business and technical subjects. The coupon brings full information.

*Name furnished on request.

INTERNATIONAL CORRESPONDENCE SCHOOLS



BOX 5501-L, SCRANTON 9, PENNA.

Without cost or obligation, please send me full particulars about the course BEFORE which I have marked X:

- | | | | |
|---|--|---|--|
| <p>Business and Academic Courses</p> <ul style="list-style-type: none"> <input type="checkbox"/> Accounting <input type="checkbox"/> Bookkeeping <input type="checkbox"/> Business Administration <input type="checkbox"/> Bus. Correspondence <input type="checkbox"/> Certified Public Accounting <input type="checkbox"/> Commercial <input type="checkbox"/> Cost Accounting <input type="checkbox"/> Federal Tax <input type="checkbox"/> First Year College <input type="checkbox"/> Foremanship <input type="checkbox"/> Good English <input type="checkbox"/> Higher Mathematics <input type="checkbox"/> Industrial Supervision <input type="checkbox"/> Motor Traffic <input type="checkbox"/> Retailing <input type="checkbox"/> Salesmanship <input type="checkbox"/> Sign Lettering <input type="checkbox"/> Spanish <input type="checkbox"/> Typing <p>Air Conditioning and Plumbing Courses</p> <ul style="list-style-type: none"> <input type="checkbox"/> Air Conditioning <input type="checkbox"/> Heating <input type="checkbox"/> Refrigeration | <p>Chemical Courses</p> <ul style="list-style-type: none"> <input type="checkbox"/> Chemical Engineering <input type="checkbox"/> Chemistry, Analytical <input type="checkbox"/> Chemistry, Industrial <input type="checkbox"/> Chemistry, Mfg. Iron & Steel <input type="checkbox"/> Petroleum Refining <input type="checkbox"/> Pulp and Paper Making <p>Civil Engineering, Architectural and Mining Courses</p> <ul style="list-style-type: none"> <input type="checkbox"/> Architecture <input type="checkbox"/> Building Estimating <input type="checkbox"/> Civil Engineering <input type="checkbox"/> Contracting and Building <input type="checkbox"/> Highway Engineering <input type="checkbox"/> Lumber Dealer <input type="checkbox"/> Reading Structural Blueprints <input type="checkbox"/> Sanitary Engineering <input type="checkbox"/> Structural Drafting <input type="checkbox"/> Structural Engineering <input type="checkbox"/> Surveying and Mapping <p>Communications Courses</p> <ul style="list-style-type: none"> <input type="checkbox"/> Electronics <input type="checkbox"/> Prac. FM and Television <input type="checkbox"/> Prac. Telephony <input type="checkbox"/> Radio, General <input type="checkbox"/> Telegraph Engineering | <p>Electrical Courses</p> <ul style="list-style-type: none"> <input type="checkbox"/> Electrical Drafting <input type="checkbox"/> Electrical Engineering <input type="checkbox"/> Electric Light and Power <input type="checkbox"/> Lighting Technician <input type="checkbox"/> Practical Electrician <input type="checkbox"/> Power House Electric <input type="checkbox"/> Ship Electrician <p>Internal Combustion Engines Courses</p> <ul style="list-style-type: none"> <input type="checkbox"/> Auto Technician <input type="checkbox"/> Diesel-Electric <input type="checkbox"/> Diesel Engines <p>Mechanical Courses</p> <ul style="list-style-type: none"> <input type="checkbox"/> Aeronautical Engineer's, Jr. <input type="checkbox"/> Aircraft Drafting <input type="checkbox"/> Forging <input type="checkbox"/> Heat Treatment of Metals <input type="checkbox"/> Industrial Engineering <input type="checkbox"/> Industrial Instrumentation <input type="checkbox"/> Industrial Metallurgy <input type="checkbox"/> Machine Shop <input type="checkbox"/> Machine Shop Inspection <input type="checkbox"/> Mechanical Drafting <input type="checkbox"/> Mechanical Engineering | <p><input type="checkbox"/> Mold-Loft Work</p> <p>Railroad Courses</p> <ul style="list-style-type: none"> <input type="checkbox"/> Air Brake <input type="checkbox"/> Diesel Locomotive <input type="checkbox"/> Locomotive Engineer <input type="checkbox"/> Locomotive Fireman <input type="checkbox"/> Locomotive Machinist <input type="checkbox"/> Railroad Section Foreman <input type="checkbox"/> Steam and Diesel Loco. Eng. <p>Stationary Engineering Courses</p> <ul style="list-style-type: none"> <input type="checkbox"/> Boilermaking <input type="checkbox"/> Combust. Engrg. <input type="checkbox"/> Marine Engineering <input type="checkbox"/> Power Plant Engr. <p>Textile Courses</p> <ul style="list-style-type: none"> <input type="checkbox"/> Cotton Manufacturing <input type="checkbox"/> Rayon Weaving <input type="checkbox"/> Woolen Manufacturing |
|---|--|---|--|

Name _____ Age _____ Home Address _____

City _____ State _____ Working Hours _____ A.M. to _____ P.M.

Present Position _____ Employed by _____

Length of Service in World War II _____ Enrollment under G.I. Bill approved for World War II Veterans. Special tuition rates to members of the Armed Forces. Canadian residents send coupon to International Correspondence Schools Canadian, Ltd., Montreal, Canada.

"YOU'VE GOT A CHICKEN ON YOUR SHOULDER, COLONEL - BUT HE USES MENNEN SKIN BRACER!"



THE
AFTER-SHAVE
LOTION WITH THE

*He-Man Aroma
That "WOWS"
the Ladies!*

You'll Like Its Refreshing,
"Wake-Up" Tingle!

Helps Heal Tiny Razor Nicks, Too!

Keep Presentable Longer!
CLEANER, SMOOTHER SHAVES

with

No Burning! No Stinging!

MORE DOCTORS Who Specialize in Skin Care USE
MENNEN BRUSHLESS Than All Other Brands Combined!



(Continued from page 8)

altitude, so I asked the sergeant, "What's the rush?" He explained that the pilot had flown the Berlin airlift, was used to heavy loads and probably thought he had a load of supplies rather than a light load of 18 passengers . . .

Enclosed picture which I took while in Japan [shows] a Japanese Shinto clergyman at the summit of Mount Fujiyama. He wears white since Mount Fuji is sacred; it is also clean. In August 1948 he was around 70 years of age, had climbed Mount Fuji 67 times and his greatest ambition was to climb it 100 times before death.

Luther A. Middleton, Jr.,
V. A. Hospital,
Oteen, N. C.

Letter to the Editor

As an avid car enthusiast I would like to take this opportunity to commend both you and P.M. on your new feature by Floyd Clymer. I have been following Mr. Clymer's articles for many years and must say that you couldn't have made a better choice.

I heartily agree that one test driver cannot give as full an account of a car as can the compiled report of many owners. That is the real test. May I extend my best wishes and good luck to you, and P.M.

Hal Kolb,
The Travelers Broadcasting
Service Corp.,
Hartford 15, Conn.

Letter to the Editor

Your February 1951 issue of *Popular Mechanics* carries a very good story on Fritz Abplanalp, a woodcarver from these Islands.

I think it is unfortunate that his real connection here in the Islands was not mentioned in the article. He is working full time for The Kamehameha Schools, and has under his charge several classes of woodcarving students, old and young. He is at present on sabbatical leave from the schools and living in Carmel, Calif., but will return in September.

Col. Harold W. Kent,
President,
The Kamehameha Schools,
Honolulu, Hawaii.

☞ An ingenious barber at Kirkburton, Huddersfield, Yorks, England, has installed a traffic-light system for the convenience of his customers. The red light indicates "Shop Full," the amber "Won't Keep You Long," and the green "Come Inside."

WHAT Every AUTO MECHANIC Wants to Know

A motor vehicle is a machine of many parts, each part designed and constructed for its own special function. All good mechanics, like good doctors, should know the working theory and operation of each part and understand what causes trouble and how to remedy it.

LET AUDELS AUTO GUIDE SOLVE YOUR PROBLEMS

Every auto mechanic, helper, serviceman and operator can use a copy of AUDELS AUTOMOBILE GUIDE. The information it gives saves time, money and worry. Highly indorsed by all users. It presents the whole subject of auto mechanics from A to Z in plain language and simple terms.

This Big Practical Book gives full information with working diagrams covering the principles, construction, ignition, service and repair of modern cars, trucks and buses.

A complete Guide of 1800 pages, with over 1500 illustrations showing inside views of the working parts, with instructions for service jobs. Diesel engines, Fluid and Hydra-matic drives fully explained.

IT PAYS TO KNOW HOW TO

How to fit pistons—How to locate engine knocks—How to fit connecting rod bearings—How to service main bearings—How to recondition valves—How to time valves—How to adjust fan belts—How to adjust carburetors & chokes—How to rebuild a clutch—How to service automatic transmissions—How to service brakes—How to adjust steering gear—How to cope with ignition troubles—How to service distributors—How to time ignition—How to "tune up" an engine.

INFORMATION IN A HANDY FORM

73 INTERESTING CHAPTERS—Read this partial list of subjects on which practical information is fully given for quick reference under the headings as shown below. Ready Reference Index.

All Parts of an Automobile—Automotive Physics—The Gas Engine—Gas Engine Principles—Multi-Cylinder Engines—Horse Power—Automobile Engines—Stationary Parts—Moving Parts—Pistons—Piston Rings—Connecting Rods—Crank Shafts—Valves—Valve Gear—Cams and Cam Action—Valve Timing—Cooling Systems—Fuel Feed Systems—Dual Fuel Feed—Mixture—Carburetors—Carburetor Service—Automatic Choke—Super-Chargers—Transmissions—Special Transmissions—Fluid and Hydra-matic Drives—Clutches—Universals and Propeller Shafts

A Ready Reference

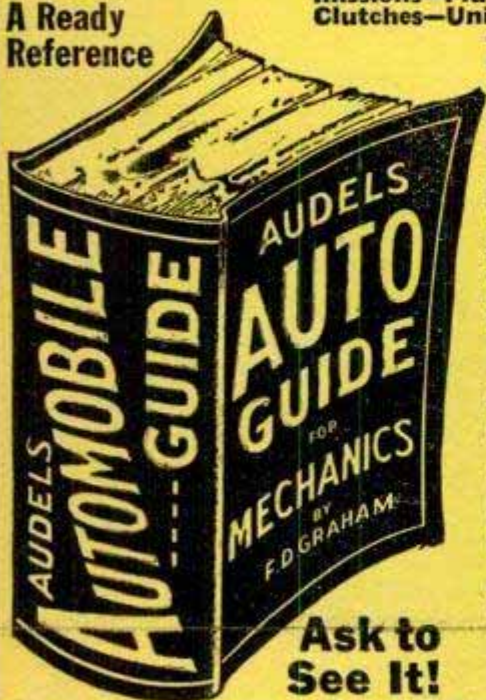

—The Differential—Rear Axles—Rear and Front Suspension—Running Gear—Brakes—Wheel Alignment—Knee Action—Steering Gear—Tires—Lubricants and Lubrication—Automotive Electricity—Ignition Systems—Magneto Ignition—Spark Plugs—Ignition Coils—Distributors—Automatic Spark Control—Ignition Timing—Generators—Starters—Generator and Starter Testing—Lighting Systems—Storage Batteries—Charging and Testing—Diesel Engines and Trouble Shooting.

7 DAYS' FREE TRIAL
TO GET THIS ASSISTANCE FOR YOURSELF SIMPLY FILL IN AND MAIL COUPON TODAY.

\$4 COMPLETE
PAY \$1 A
ONLY 1 MO.



Sent on 7 Days Approval

Step up your own skill with the facts and figures of your trade. Audels Mechanics Guides contain Practical Inside Trade Information in a handy form. Fully illustrated and Easy to Understand. Highly Endorsed. Check the book you want for 7 DAYS FREE EXAMINATION. Send No Money. Nothing to pay postman.

CUT HERE MAIL ORDER

AUDEL, Publishers, 49 W. 23 St., NEW YORK 10, N. Y.

Please send me postpaid for FREE EXAMINATION books marked (x) below. If I decide to keep them I agree to mail \$1 in 7 Days on each book or set ordered and further mail \$1 monthly on each book or set until I have paid price, otherwise I will return them.

- TRUCK & TRACTOR GUIDE, 1299 Pages . . . \$ 4
- AUTOMOBILE MECHANICS GUIDE, 1800 Pages . . . 4
- DIESEL ENGINE MANUAL, 575 Pages . . . 2
- MACHINISTS HANDY BOOK, 1650 Pages . . . 4
- WELDERS GUIDE, 400 Pages . . . 1
- BLUE PRINT READING, 416 Pages . . . 2
- MATHEMATICS & CALCULATIONS, 700 Pages . . . 2
- SHEET METAL PATTERN LAYOUTS, 1100 Pages . . . 4
- SHEET METAL WORKERS HANDY BOOK, 388 Pgs. . . 1
- MECHANICAL DRAWING GUIDE, 160 Pages . . . 1
- MECHANICAL DRAWING & DESIGN, 480 Pages . . . 2
- AIRCRAFT WORKER, 240 Pages . . . 1
- TELEVISION SERVICE MANUAL, 384 Pages . . . 2
- RADIOMANS GUIDE, 914 Pages . . . 4
- ELECTRONIC DEVICES, 216 Pages . . . 2
- ELECTRIC MOTOR GUIDE, 1000 Pages . . . 4
- ELECTRIC WIRING DIAGRAMS, 272 Pages . . . 1
- ELECTRICIANS EXAMINATIONS, 250 Pages . . . 1
- ELECTRIC POWER CALCULATIONS, 425 Pages . . . 2
- HANDY BOOK OF ELECTRICITY, 1440 Pages . . . 4
- ELECTRIC DICTIONARY, 9000 Terms . . . 2
- ELECTRIC LIBRARY, 7000 Pages (12 Book Set) 18
- MARINE ENGINEERS HANDY BOOK, 1258 Pgs. . . 4
- SHIPFITTERS HANDY BOOK, 250 Pages . . . 1
- REFRIGERATION & Air Conditioning, 1280 Pgs. . . 4
- MILLWRIGHTS & MECHANICS GUIDE, 1200 Pgs. . . 4
- POWER PLANT ENGINEERS GUIDE, 1500 Pages . . . 4
- ENGINEERS & FIREMANS EXAMS, 525 Pages . . . 1
- PUMPS, Hydraulics & Air Compressors, 1658 Pgs. . . 4
- ENGINEERS LIBRARY (3 Book Set) . . . 9
- MECHANICAL DICTIONARY, 950 Pages . . . 4
- GARDENERS & GROWERS GUIDES (4 Book Set) . . . 6
- CARPENTERS & BUILDERS GUIDES (4 Book Set) . . . 6
- PLUMBERS & Steamfitters Guides (4 Book Set) . . . 6
- MASONS AND BUILDERS GUIDES (4 Book Set) . . . 6
- PAINTERS & DECORATORS MANUAL, 450 Pgs. . . 2
- HOUSE HEATING GUIDE, 1000 Pages . . . 4
- OIL BURNER GUIDE, 384 Pages . . . 1

Name _____
Address _____
Occupation _____
Employed by _____ 36A

AUDEL, Publishers, 49 W. 23 St., New York 10, N. Y.

Shavers Pick New "Gold Pack"

SCHICK INJECTOR

BLADES 5 TO 1*

Over All Others

Including Our Own Old Blades!

WORLD'S ONLY RAZOR THAT MAKES SUCH AMAZING RESULTS POSSIBLE

Now in this Complete Kit

- New Gold-Plated Razor
- 12 "Gold Pack" Blades
- New Handy Travel Case

ALL FOR ONLY
98¢



Only NEW 1951 SCHICK INJECTOR BLADES are ground to fit your injector razor perfectly! New surgical steel! Scalpel-sharp! So we guarantee this: EITHER YOU GET THE FINEST SHAVES OF YOUR LIFE—OR YOUR MONEY BACK, QUICK!

***HERE'S THE FULL SCORE!**

- on every point important to shaving!
- | | |
|------------------------------|------------|
| SMOOTHER SHAVES | 5 1/2 to 1 |
| CLEANER SHAVES | 5 to 1 |
| SAFER SHAVES | 7 to 1 |
| FASTER SHAVES | 5 to 1 |
| MORE SHAVES per blade nearly | 2 to 1 |

Men in 10 cities—nationwide—compared New 1951 Schick Injector Blades with whatever they had been using. About 80% of the men had a preference. Of these, the votes were in the ratios shown above.

©1951 Eversharp Inc., 350 Fifth Ave., N. Y. C.

SCHICK INJECTOR RAZOR & BLADES

World's Only Razor with Automatic Blade Changer

WHERE-TO-BUY-IT INDEX

Source of supply appears after items commercially available

AUTOMOTIVE

Flywheel bus	80
Detroit listening post	87
Heat dome for car's manifold (Manifold Hot Spot Corp., 612 N. Michigan Ave., Chicago 11)	93
Rochester designs own speedster	93
Traction clamp for tires (Lantz Mfg. Co., Inc., Valparaiso, Ind.)	100
Degasser valve eliminates bus fumes	108
Body repair jack has 3000-pound punch (Keysco Mfg. Co., 1250 E. 12th St., Oakland 6, Calif.)	117
Handmade sport car is knee-high to owner	118
Three-wheel truck	138
Racy sports car made in U.S.A.	139
Traffic-light "timer" (The Main Flo-Control Traffic Light, Inc., 956 Robert St., Jackson, Mich.)	143

AVIATION

Flying "manure spreader"	101
Fiberglas "sound blotters" deaden roar of test engines	104
Cartridge starter for jets	118
Door-level truck for cargo planes (Crimasco Mfg., Div., Truog-Nichols, Inc., 1730 Oak St., Kansas City, Mo.)	118

FARM AND GARDEN

Triple-duty garden tool (Langtot, Inc., 32 E. 4th St., New York City 3)	69
Stubble cleaner (Blazer Mfg. Co., Mountain Lake, Minn.)	70
Outboard motor sprays trees (Atco Motor Mowers, 67 Broad St., New York City 4)	104
Cropland in peril	105
Electric calf dehorner (Lenk Mfg. Co., 30-38 Cummington St., Boston 15, Mass.)	119

HOBBIES AND MODELS

Tom Thumb beachhead	79
German-built "Housefly" airplane model	119
Portraits in wood	142

HOUSE AND HOME

Photo murals (R-C-S Studios, 123 N. Wacker Dr., Chicago 6)	102
Water filter (Ogden Filter Co., 4214 Santa Monica Blvd., Los Angeles 27, Calif.)	102
Vacuum lid (C & S Engineering Co., Woodside, Calif.)	102
Place mats (Hedwin Corp., 1525 W. 41st St., Baltimore 11, Md.)	102
Spring hinge (Sta-Kov Corp., 4536 Vernon Blvd., Long Island City 1, N. Y.)	103
Decals for fabrics (The Meyercord Co., 5323 W. Lake St., Chicago 44)	103
Humidifier for breadbox (Moist-Sure Products, Box 3870, Merchandise Mart Sta., Chicago 54)	103
Neat pleats (Hide-A-Brush Container Co., Brook, Ind.)	103
News rack (Simplicity Tool Co., 2850 N. Mississippi, Portland, Ore.)	103
Wall tree (Midwest Metal Products, Inc., 315 Westport Rd., Kansas City 2, Mo.)	103
School for handy housewives	106
Hand knitting machine (Ainslie Knitting Machine Co., Inc., 740-750 Grand St., Brooklyn 11, N. Y.)	108
Electrified curtains	119
Factory-built houses (B. D. Homes Co., Martin City, Mo.)	126

INDUSTRY

Soluble coffee crystals (Holiday Brands, Boston, Mass.)	70
Concentrated fresh milk reduces container cost (Sealtest Research Laboratories, Oakdale, L. I., N. Y.)	80
High-riding sugar cane	109
Truck tilter	110
Arsenic—just a "pinch"—makes lead alloys stronger	117
Concrete "grows" into tall elevators	131
Tight belt on trees may increase seeding	133
Tobacco processor	133
Oil and gas reserves at new high	143
Concrete "set" in winter with infrared lamps	147
Precast layers form building	148

OFFICE, SHOP AND STORE

Rubber brush cleans typewriter type without liquid (Defiance Sales Corp., 72-78 Spring St., New York City 12)	71
Pop-up file for slides (Westerlind Products, 1000 E. Walnut St., Pasadena 4, Calif.)	101
Shop-made space heater	108
Paper operates electric stapler (The Staplex Co., 30 Church St., New York City 7)	132
Typewriter rings judge page length (L. C. Smith & Corona Typewriters, Inc., 3200 Smith Bldg., Syracuse 1, N. Y.)	132
Nonreflecting glass forms showroom walls	143

RECREATION

Hollow log for birling	69
Mobile spotlights for night golf	71
Automatic setter pulls bowled-over pins through alley floor (Automatic Bowling Enterprises, Inc., 5227 Sepulveda Blvd., Van Nuys, Calif.)	78

(Continued to page 14)

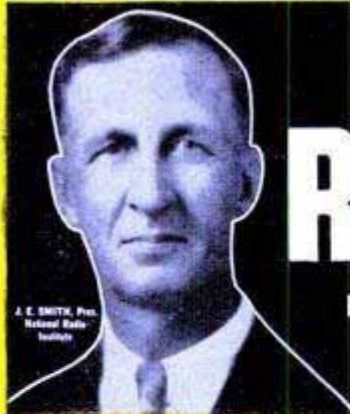

BE A SUCCESS AS A RADIO-TELEVISION TECHNICIAN

2 FREE BOOKS
SHOW HOW
MAIL COUPON

America's Fast Growing Industry Offers You

Available to
VETERANS
under G. I. Bill

I TRAINED THESE MEN



Shop Specializes in Television. "Have my own shop. Am authorized serviceman for 5 large manufacturers, do servicing for 7 dealers. N. R. I. enabled me to build enviable reputation." P. MILLER, Maumee, Ohio.

NRI Graduate Doubles Salary. "Am with Station WKBO as transmitter operator. More than doubled salary since starting in Radio full time. N. R. I. has been helpful to me." A. HERR, New Cumberland, Pa.



\$10 Week in Spare Time. "Before finishing course, I earned as much as \$10 a week in Radio servicing in spare time. I recommend N. R. I. to everyone who shows interest in Radio." S. J. PETRUFF, Miami, Florida.

Gets First Job Through N.R.I. "My first job was operator with KDLR, obtained for me by your Graduate Service Dept. I am now Chief Eng. of Police Radio Station WQOX." T. S. NOTTON, Hamilton, Ohio.



1. EXTRA MONEY IN SPARE TIME

Many students make \$5, \$10 a week extra fixing neighbors' Radios in spare time while learning. The day you enroll I start sending you SPECIAL BOOKLETS to show you how to do this. Tester you build with parts I send helps you service sets. All equipment is yours to keep.

2. GOOD PAY JOB

Your next step is a good job installing and servicing Radio-Television sets or becoming boss of your own Radio-Television sales and service shop or getting a good job in a Broadcasting Station. Today there are over 90,000,000 home and auto Radios. 3100 Broadcasting Stations are on the air. Aviation and Police Radio, Micro-Wave Relay, Two-Way Radio are all expanding, making more and better opportunities for servicing and communication technicians and FCC licensed operators.

3. BRIGHT FUTURE

And think of the opportunities in Television! In 1950 over 5,000,000 Television sets were sold. By 1954 authorities estimate 25,000,000 Television sets will be in use. Over 100 Television Stations are now operating, with experts predicting 1,000. Now is the time to get in line for success and a bright future in America's fast-growing industry. Be a Radio-Television Technician. Mail coupon for Lesson and Book—FREE.

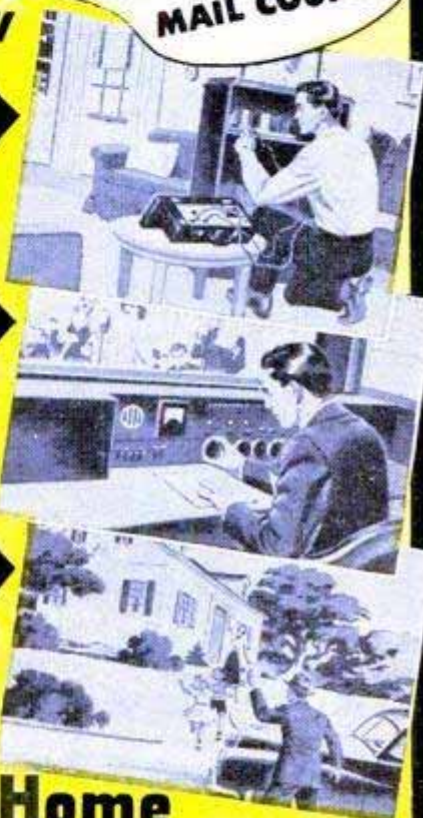

I Will Train You at Home Read How You Practice Servicing or Communications with Many Kits of Parts You Get!

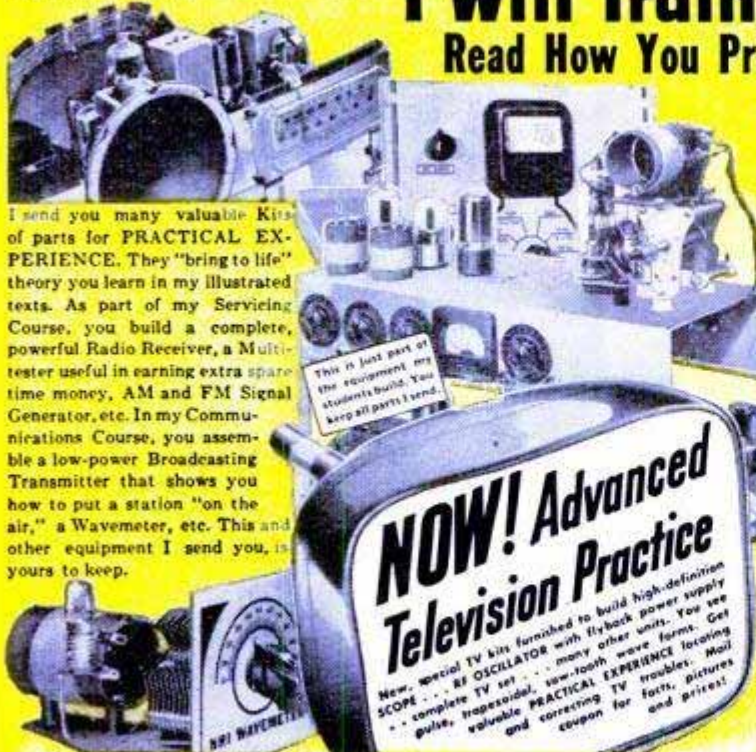

I send you many valuable Kits of parts for PRACTICAL EXPERIENCE. They "bring to life" theory you learn in my illustrated texts. As part of my Servicing Course, you build a complete, powerful Radio Receiver, a Multi-tester useful in earning extra spare time money, AM and FM Signal Generator, etc. In my Communications Course, you assemble a low-power Broadcasting Transmitter that shows you how to put a station "on the air," a Wavemeter, etc. This and other equipment I send you, is yours to keep.

This is just part of the equipment my students build. You keep all parts I send.

**NOW! Advanced
Television Practice**

New, special TV kits furnished to build high-definition SCOPE... RF OSCILLATOR with flyback power supply... complete TV set... many other units. You see pulse, trapezoidal, saw-tooth wave forms. Get valuable PRACTICAL EXPERIENCE locating and correcting TV troubles. Mail coupon for parts, pictures and price list.

Keep your job while training at home. Hundreds I've trained are successful RADIO-TELEVISION TECHNICIANS. Most had no previous experience; many no more than grammar school education. Learn Radio-Television principles from illustrated lessons. Get PRACTICAL EXPERIENCE—build valuable Electronic Multimeter for conducting tests; also practice servicing Radios or operating Transmitters—experiment with circuits common to Radio and Television. At left is just part of the equipment my students build with many kits of parts I furnish. All equipment is yours to keep. Many students make \$5, \$10 a week extra fixing neighbors' Radios in spare time.

Mail Coupon For 2 Books FREE

Act Now! Send for my FREE DOUBLE OFFER. Coupon entitles you to actual lesson on Servicing; shows how you learn Radio-Television at home. You'll also receive my 64-page book, "How to Be a Success in Radio-Television." You'll read what my graduates are doing, earning; see photos of equipment you practice with at home. Send coupon in envelope or paste on postal.

The ABC's of
SERVICING

How to Be a
Success
in RADIO-
TELEVISION

Good for Both—FREE

Mr. J. E. SMITH, President, Dept. 1FA
National Radio Institute, Washington 9, D. C.

Mail me Sample Lesson and 64-page Book about How to Win Success in Radio-Television. Both FREE. (No salesman will call. Please write plainly.)

Name..... Age.....

Address.....

City..... Zone..... State.....

Check if Veteran Approved Under G. I. Bill

LEARN! LEARN! LEARN! LEARN!

WELDING

Prepare for a good job in this High-Pay, Essential Trade

Get This
Up-To-Date
ENCYCLOPEDIA
Of Welding
Information

Covers all types of
gas, electric weld-
ing—heat treating
and metal cutting.

New 1951 edition
of this famous
Encyclopedia by
Althouse & Turn-
quist

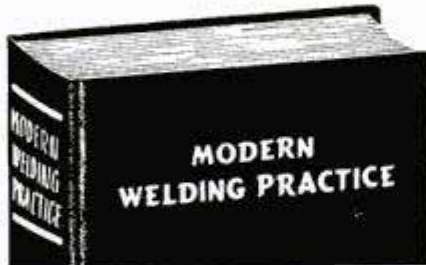

1951 Edition includes informa-
tion on latest developments in
Submerged Arc and Inert Gas
Welding, Arc-Oxygen Cutting,
Underwater Cutting and Weld-
ing, Stud Welding, Sprayed
Hard Surfacing, Welding Tool
and Die Steel, Powder and Flux
Cutting of High Alloy Steels.
Over 500 Pages. Price \$5.00.

Modern Welding Practice....\$5.00	Automotive Service
Auto Repair Kinks	Management5.00
Combined experience and KNOW-HOW of World's Best Mechanics.....3.00	MODERN Electric & Gas Refrigeration. Covers sealed units, home freezers.....5.00
Automatic Transmissions Simplified (covers all types including new Fordomatic)4.00	House Wiring3.00
DYKE'S Auto Encyclopedia (new 22nd edition).....7.50	D. C. Power Wiring.....4.00
Auto Body & Fender Repairs. Includes frame straighten- ing (new 1951 edition)....3.50	A. C. Power Wiring.....4.00
Dyke's Carburetor Book.....3.50	Plumbing & Pipe Fitting.....2.50
	Sheet Metal Layout.....3.50
	Storage Battery Simplified...3.00
	Bailey's Handbook for En- gineers & Firemen.....2.00
	Airplane Welding.....3.50

SEND NO MONEY

Use this ad as your order blank. Check titles wanted, clip and mail. Pay postman on delivery. If remittance is sent with order we will ship postpaid. Either way—your MONEY BACK if not satisfied.

GOODHEART-WILCOX CO., INC.

Dept. 161 1321 S. MICHIGAN AVE. CHICAGO 5

MAKE EXTRA
MONEY

PLASTICS

LEARN
AT HOME

LEARN HOW
TO MAKE
fast selling
PLASTIC
NOVELTIES
FURNITURE
JEWELRY
SIGNS
TOYS
LAMPS

There are RICH OPPORTUNITIES for MEN and WOMEN with "know-how" in Plastics. Interstate's amazing new Plastics course tells and shows how to make hundreds of fast selling items out of Plastics. Gives complete training in fabrication, casting, lamination, molding, etc., in simple, easy, step-by-step language and pictures.

START A PLASTICS BUSINESS OF YOUR OWN. No other industry holds such promise for the future. You can make big money manufacturing novelties, toys, signs, etc., in your own home in spare or full time. Don't wait! Learn NOW how Interstate's Plastics Training qualifies you for success in the plastics field.

Write for FREE Information Today!

INTERSTATE TRAINING SERVICE

School of Plastics
PORTLAND 13, OREGON

(Dept. 3-F)

(Continued from page 12)

Plug protector (Hollingsworth Mfg. Co., Marshalltown, Iowa)	93
Anchor control for small boats (Thoss Mfg. Co., 206 W. Third St., North Manchester, Ind.)	100
Sighting tee (Gerrits Bros., Appleton, Wis.)	100
Fishing "rod" five inches long (Trailside Mercantile Co., 532 Thatcher Rd., River Forest, Ill.)	100
Folding-practice aid	101
Plastic hip "boots" (Seal-Dri Sportswear Co., 2514 Kilburn Ave., Rockford, Ill.)	101
Remote controls for outboards (Scott-Atwater Mfg. Co., Inc., 2901 E. Hennepin Ave., Minneapolis 13, Minn.)	108
Robot caddy	109

MISCELLANEOUS

Atomproof camera	70
"Otter" goes anywhere	99
Speed control for locomotives is traffic cop of the rails	99
Mixing ball creates "out-of-this-world" colors	99
Bureau raps battery aids	105
Glass soldered to metal	105
Shock "breather" helps polio victims	105
Vegetable "blood" may save lives	109
Mechanical cougher for polio victims	110
Hot lab's "cell block"	116
Convertible railroad coach has rollaway top	117
TV teaches photography	119
Scientist seeks solution to mystery of liquids	126
Long-distance appraisal of snow's water content	127
Radio telescope	127
Worm listener	133
Underwater power mower	138
Ship's telegraph records orders	138
Parachuted lifeboats are radio-guided to survivors	139
Headset aids blind minister	240

Craftsman and Shop Notes Index

AUTOMOBILES

Cardboard matchbook cover quiets "shorted" horn	155
Backfiring motor clears carburetor jet in emergency	156
Stopping car-door rattle	168
Simple tool removes carbon	176

BOATS

Rowboat chines trimmed to guard against scuffing	156
Outboard-motor steering arm made quickly removable	184
Boat "crutches"	185
Outboard gas-tank cap permits refueling while motor runs	188

ELECTRICAL

Claw hammer removes insulation from electrical wires	168
Brass bolts and cotter pins provide plug-in jacks	174
Pet white mouse put to work fishing wire through conduit	210

FARM AND GARDEN

Barrel serves as fence post on rocky ground	168
Double-duty lawn chair	169
Folding tomato rack	177
Large cloth gathers baby chicks	198
Build a better farm gate	199
Counterbalanced dairy-barn gate	203
Movable hayrack saves feed	204
Twin cupolas on granary save time when storing grain	206
Self-feeder type granary hopper saves labor in barn	207
Small hog rings used to join lengths of woven-wire fencing	207
Concrete feeding floor between two corncribs	207
Stone sled for moving boulders improvised from auto tire	210

HOUSE AND HOME

Summer treatment for fireplace	155
Strong sewing thread	157
Easier way to wax floors	166
Garbage-can cover held in place	166
Moving a refrigerator	166
Marking burned-out light bulbs	166
Canned meat cut neatly	167
Flies kept away from screen door	167
Renewing bristles of kitchen brush	167
Notes to the milkman	167
Wall protector for light switch provides snapshot frame	176
Flexible floor mat for laundry	184
"Beacon" helps visiting friends locate your home at night	187

MODELS AND NOVELTIES

Glass-topped end table serves as home display case	174
Inlaid walnut bowl	175
Palette coffee table	189

OFFICE, SHOP AND STORE

Rubber-stamp renewed by cleaning with dry toothbrush	185
Ink "flowing" checked by pencil-lead film	204
Index file for magazine articles	204

(Continued to page 16)

INVENTORS

Learn how to protect your invention. The U. S. Patent Laws provide that any new and useful art, machine, article of manufacture, or composition of matter, or any new and useful improvement thereof, may be patented if the act of invention is involved. Therefore, every inventor with a valuable invention should take advantage of the Patent Laws and proceed for patent protection in order to safeguard his rights.

A patent gives the inventor the exclusive right to prevent others from making, using, or selling the invention claimed in the patent for a period of seventeen years.

The Patent Laws were enacted for the benefit of the inventor to give him protection for the features of his invention which are patentable. These features must be properly and concisely set forth and claimed in a formal application for patent, in order to comply with the requirements of the Patent Laws. For that reason, unless the inventor is familiar with patent matters, he should engage a competent registered patent attorney or agent to represent him. We are registered to practice before the U. S. Patent Office and are prepared to serve you in the handling of your patent matters.

A specially prepared booklet entitled "Patent Guide for the Inventor", containing detailed information with respect to patent protection and procedure, together with a "Record of Invention" form will be promptly forwarded to you without obligation upon request.

CLARENCE A. O'BRIEN & HARVEY JACOBSON

Registered Patent Attorneys

11-F DISTRICT NATIONAL BUILDING

WASHINGTON 5, D. C.



CAN LEAD TO A BETTER JOB IN BUSINESS or INDUSTRY

You can take subjects which have Real Job Value and still earn graduation!

• This is *your* opportunity to make completion of high school *work* for you. Your AMERICAN SCHOOL home study course can include high school subjects closely related to your present job or the kind of work you want to do later. You can qualify for high school course diploma and benefit from course subjects that will aid greatly in winning promotions.

50 Job Help Subjects from Which to Choose

Our FREE, 44-page book of detailed information lists 100 high school subjects, of which 29 are technical and 21 are commercial. Whether you work in a shop, factory, garage or office you will find subjects of practical benefit in your climb toward better jobs at better pay. Some of these are Blueprint Reading, Mechanical and Machine Drawing, Tool Making, Foundry Work, Automotive subjects, Electricity—and Bookkeeping, Accounting, Secretarial Practice, Salesmanship.

Turn Spare Time Into Money

During more than 50 years American School has helped thousands to reach higher job goals by profitable use of spare time at home—and it can help *you*. Others have prepared for college entrance. If you have not completed high school, check that subject on the coupon below, add your name and address and mail it *right now*. Or if you are a high school graduate and are ambitious to succeed in the vocation of your choice, check that subject. Your coupon will bring you the book of information, without obligation of any kind. Mail it *now*.

AMERICAN SCHOOL

DEPT. GA-45, DREXEL AT 58th, CHICAGO 37

PRACTICAL, EFFECTIVE HOME - STUDY TRAINING SINCE 1897

Take This First Easy Step

CHECK, CLIP AND MAIL COUPON NOW

AMERICAN SCHOOL, Dept. GA-45, Drexel at 58th, Chicago 37, Ill.
Without obligation, please send me FREE information on training course checked below.

- | | | |
|---|--|--|
| <input type="checkbox"/> HIGH SCHOOL COURSES | <input type="checkbox"/> Bookkeeping | <input type="checkbox"/> Plastics Engr. |
| <input type="checkbox"/> Accounting | <input type="checkbox"/> Business Mngmt. | <input type="checkbox"/> Plumbing—Pract. |
| <input type="checkbox"/> Air Conditioning | <input type="checkbox"/> Contracting | <input type="checkbox"/> Private Secretary |
| <input type="checkbox"/> Architecture & Building | <input type="checkbox"/> Diesel Engr. | <input type="checkbox"/> Radio Operating & Servicing |
| <input type="checkbox"/> Automotive Engr. | <input type="checkbox"/> Drafting & Design | <input type="checkbox"/> Railway Training |
| <input type="checkbox"/> Aviation—Practical | <input type="checkbox"/> Electrical Engr. | <input type="checkbox"/> Refrigeration |
| <input type="checkbox"/> Aviation Drafting & Design | <input type="checkbox"/> Electricity—Pract. | <input type="checkbox"/> Sheet Metal |
| <input type="checkbox"/> Better Forem'nship | <input type="checkbox"/> Electronics, Indus. | <input type="checkbox"/> Pattern Drafting |
| | <input type="checkbox"/> Machine Shop Operations | <input type="checkbox"/> Shop Management |
| | <input type="checkbox"/> Mechanical Engr. | <input type="checkbox"/> Tool Making |

Name _____ Occupation _____
Address _____ Age _____
City & Zone _____ State _____

(Continued from page 14)

Parallel lines at special angles inked directly from T-square...207
Tips on typewriter care...210
Handy date-stamp holder formed by bottle-cap lifter...210

PAINT AND PAINTING

Paint bucket hung on ladder rung steadied by device made from bail...156
Open-type saltcellars provide handy paint-mixing cups for artists...165
Paper disk prevents paint skin...187
Portable paint sprayer...205

PHOTOGRAPHY

Electronic timing unit built in card-file box...190
Ferrotyped prints dried quickly by mounting plates on heater...190
Shadowless stills taken using only one light...190
Extra photoflood reflector improvised from sheet of aluminum foil...190
Detergent improves negatives...190
Photographic spotlight stand made from pipe and fittings...191
Foot switch for photo enlarger has hacksaw-blade pedal...191
Camera rigged for self-portraits with string and C-clamp...192
Solution eliminates drying rings...192
T-fitting makes mixing faucet...192
Vignetting projection prints by use of cardboard cutout...194
Improving your photo trimmer...194
Photographer labels albums with novel name plate...194

TOOLS

Electrically powered peening hammer saves time when embossing metal...157
Line scribed on grinder tool rest serves as drill-sharpening guide...157
Nail "corkscrew" flares tubing...168
Thumbtack used as pivot to cut circles on jigsaw...184
Drill press used to tap thin metal...187
"Popping" of torch welding tip prevented by countersinking flame hole...188
Increasing reamer capacity...198
Length of small coil spring used to clean out tubing...198
Identifying feeler-gauge blades...204
Motor-driven sickle grinder (Lantz Mfg. Co., Valparaiso, Ind.)...208
Self-retracting tape rule (Master Rule Mfg. Co., 40 Mulberry St., Middletown, N. Y.)...208
Self-locking nuts (Grip Nuts Co., 308-T S. Michigan Ave., Chicago)...208
New welder's shield (Industrial Products Co., Philadelphia 33, Pa.)...208
Direct-reading vacuum gauge (Hastings Instrument Co., Inc., Hampton, Va.)...209
Midget hand-operated hoist (Coffing Hoist Co., Danville, Ill.)...209
Electric soldering iron (Palmer Mfg. Co., 57-16 37th Ave., Woodside, L. I., N. Y.)...209
All-metal level (Simplex Level Co., Detroit 7, Mich.)...209
Automatic pencil-scriber does fine layout work...210

MISCELLANEOUS

Cement spread from flexible tube through saw-slot in cap...155
Foil-lined gluepot cleaned easily...155
Wedge blocks between two window screens stretch wire tightly for mounting...156
Adjustable "leg" for trailer provided by auto jack...168
Punctured spice can filled with powder charges chalk line quickly...174
Pipe cap removes barrel bung...174
Cement keeps gasket from slipping...176
Small coil spring separates groups of keys on chain...176
Patching a leaky swimming pool...184
Rubber "torch" starts campfire...184
Glass jar provides minnow trap...184
Sturdy trailer hitch for dump truck welded from scrap-iron pieces...188
Emergency gate latch...198
Gas-welding discoloration prevented by smoke film...198
Jackscrew supported firmly on discarded brake drum...198
Making carborundum pastel board...203
Ordinary fuse wire doubles as plastic thread for checking bearing clearance...203
Stacks of corrugated roofing lifted safely with C-clamp...204
Pipe lengths welded to bumper hold warning flags...204

Radio-Television, Electronics

Television today (Remote-control selector, Zenith Radio Corp., 6001 W. Dickens Ave., Chicago 39; console-table TV set, Motorola, Inc., 4545 Augusta Blvd., Chicago 51; children's TV chair, Krimstock Bros., 112 N. Ninth, Philadelphia, Pa.; portable TV-transmitting unit, RCA Laboratories Div., RCA, Princeton, N. J.)...211
Low-cost receivers for junior builders...212
How to build a bass-reflex enclosure...215
Emergency replacement batteries for portable receivers...216

IMPORTANT NOTICE—It is the intention of this magazine to provide its readers with information regarding the latest developments in the mechanical arts. We take no responsibility as to whether the disclosures contained in our articles are covered by patents and advise readers to investigate this subject before making, using, or selling any of the products, machines, or processes described in order to avoid possible liability for patent infringements.

INVENTORS

If you believe that you have an invention, you should find out how to protect it. The first step is to have a search made of the prior pertinent U. S. patents. If a report on this search indicates that the invention appears patentable you can apply for a patent, and the specifications and claims should be prepared.

The firm of McMorrow, Berman & Davidson, with offices in Washington, D. C., is qualified to take the necessary steps for you. We can make a preliminary search on your invention, advise you whether we think it can be patented, and prepare your application for patent.

Unless you are fully familiar with the U. S. Patent Laws, we recommend that you engage the services of a Registered Patent Attorney to protect your interests. The patent laws are *your* laws. A patent gives you the right to prevent others from making, using or selling the invention claimed in your patent for a period of 17 years.

Use these patent laws for your protection. Investigate whether your invention can be patented. If you have what you believe to be an invention, we suggest that you have this firm make a search for you.

Send for a copy of our Patent Booklet entitled "How To Protect Your Invention," containing information about patent protection and patent procedure. Along with this we will also send you an "Invention Record" form, for your use in writing down and sketching details of your invention. We will mail them promptly. No obligation. They are yours for the asking.

McMORROW, BERMAN & DAVIDSON

Registered Patent Attorneys

PATENTS • COPYRIGHTS • PATENTS

135-V VICTOR BUILDING, WASHINGTON 1, D. C.

KNOWLEDGE
THAT HAS
ENDURED WITH THE
PYRAMIDS

A SECRET METHOD FOR THE MASTERY OF LIFE

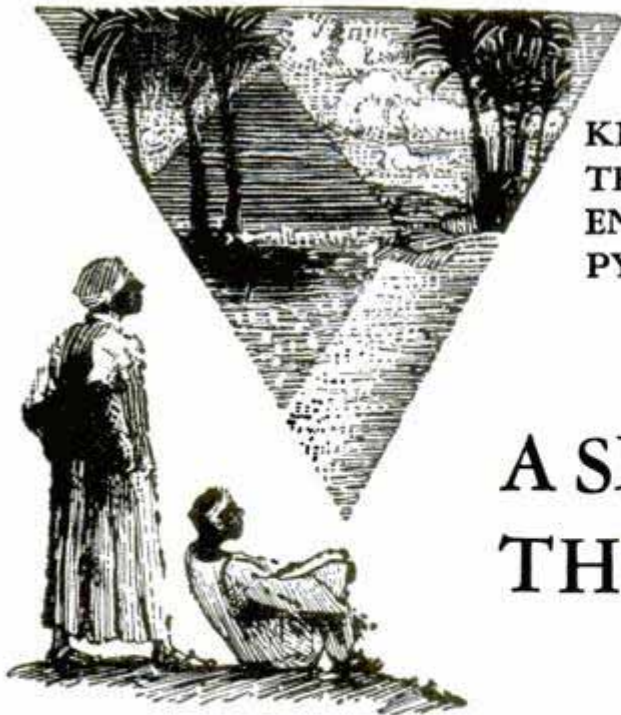

WHENCE came the knowledge that built the Pyramids and the mighty Temples of the Pharaohs? Civilization began in the Nile Valley centuries ago. Where did its first builders acquire their astounding wisdom that started man on his upward climb? Beginning with naught they overcame nature's forces and gave the world its first sciences and arts. Did their knowledge come from a race now submerged beneath the sea, or were they touched with Infinite inspiration? From what concealed source came the wisdom that produced such characters as Amenhotep IV, Leonardo da Vinci, Isaac Newton, and a host of others?

Today it is known that they discovered and learned to interpret certain *Secret Methods* for the development of their inner power of mind. They learned to command the inner forces within their own beings, and to master life. This secret art of living has been preserved and handed down throughout the ages. Today it is extended to those who dare to use its profound principles to meet and solve the problems of life in these complex times.

This Sealed Book—FREE

Has life brought you that personal satisfaction, the sense of achievement and happiness that you desire? If not, it is your duty to yourself to learn about this rational method of applying natural laws for the mastery of life. To the thoughtful person it is obvious that everyone cannot be entrusted with an intimate knowledge of the mysteries of life, for everyone is not capable of properly using it. But if you are one of those possessed of a true desire to forge ahead and wish to make use of the subtle influences of life, the Rosicrucians (not a religious organization) will send you *A Sealed Book* of explanation without obligation. This *Sealed Book* tells how you, in the privacy of your own home, without interference with your personal affairs or manner of living, may receive these secret teachings. Not weird or strange practices, but a rational application of the basic laws of life. Use the coupon, and obtain your complimentary copy.

The ROSICRUCIANS

SAN JOSE

(AMORC)

CALIFORNIA



AMENHOTEP IV
Founder of Egypt's
Mystery Schools

Use this
coupon for
FREE
copy of book

SCRIBE Z.A.J.
The Rosicrucians (AMORC)
San Jose, California

Please send free copy of Sealed Book
which I shall read as directed.

NAME.....

ADDRESS.....

CITY.....

This story actually happened. The man's name has been changed and this is not his photograph, but the facts are true.

"How do I feel about being Superintendent?"

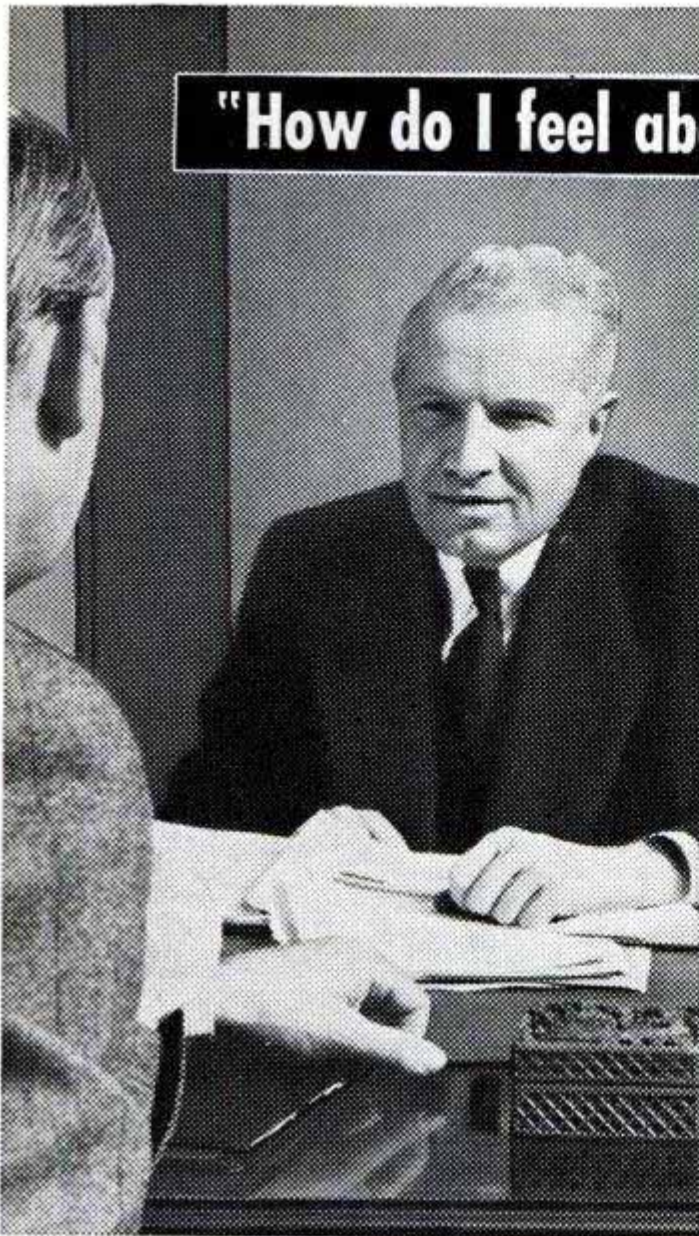

Well, that story begins in Scotland . . ."

"I was an apprentice lad in a big machine shop. Just one among many. But I was ambitious and I was studying with I. C. S. Well, one day the shop started buzzing . . . the Superintendent had come in! I should explain that this was very unusual. To even an expert machinist, the Superintendent was as distant as the Deity. But I saw him walk in, with his derby hat and high collar and cravat. And as he came he asked, 'Where is Tom McDermott?' Well, that was me. And he walked right up to me and said, 'Are you the lad who's studying with the I. C. S.?' I just nodded — for I couldn't say a word. Then he laid his hand on my shoulder and said, 'Lad, stay with it . . . for if you do I prophesy that some day you will be Superintendent!' Well, today here in America I am Superintendent of a big machine shop . . . and maybe that story will give you some idea of how I feel about it."

In the files of I. C. S., stories like this are fairly common. Some day your story may be there. If you start today by filling out the coupon.

INTERNATIONAL CORRESPONDENCE SCHOOLS



BOX 5502-L, SCRANTON 9, PENNA.

Without cost or obligation, please send me full particulars about the course BEFORE which I have marked X:

- | | | | |
|---|--|--|---|
| <p>Air Conditioning and Plumbing Courses</p> <ul style="list-style-type: none"> <input type="checkbox"/> Air Conditioning <input type="checkbox"/> Heating <input type="checkbox"/> Refrigeration <p>Chemical Courses</p> <ul style="list-style-type: none"> <input type="checkbox"/> Chemical Engineering <input type="checkbox"/> Chemistry, Analytical <input type="checkbox"/> Chemistry, Industrial <input type="checkbox"/> Chemistry, Mfg. Iron & Steel <input type="checkbox"/> Petroleum Refining <input type="checkbox"/> Pulp and Paper Making <p>Civil Engineering, Architectural and Mining Courses</p> <ul style="list-style-type: none"> <input type="checkbox"/> Architecture <input type="checkbox"/> Architectural Drafting <input type="checkbox"/> Bridge and Building Foreman <input type="checkbox"/> Building Estimating <input type="checkbox"/> Civil Engineering <input type="checkbox"/> Coal Mining <input type="checkbox"/> Contracting and Building <input type="checkbox"/> Highway Engineering <input type="checkbox"/> Lumber Dealer <input type="checkbox"/> Reading Structural Blueprints <input type="checkbox"/> Sanitary Engineering <input type="checkbox"/> Structural Drafting | <ul style="list-style-type: none"> <input type="checkbox"/> Plumbing <input type="checkbox"/> Steam Fitting <p>Structural Engineering</p> <ul style="list-style-type: none"> <input type="checkbox"/> Structural Engineering <input type="checkbox"/> Surveying and Mapping <p>Communications Courses</p> <ul style="list-style-type: none"> <input type="checkbox"/> Electronics <input type="checkbox"/> Practical Telephony <input type="checkbox"/> Radio, General <input type="checkbox"/> Radio Servicing <input type="checkbox"/> Telegraph Engineering <p>Electrical Courses</p> <ul style="list-style-type: none"> <input type="checkbox"/> Radio Operating <input type="checkbox"/> Radio Servicing <input type="checkbox"/> Television <input type="checkbox"/> Electrical Drafting <input type="checkbox"/> Electrical Engineering <input type="checkbox"/> Electric Light and Power <input type="checkbox"/> Lighting Technician <input type="checkbox"/> Practical Electrician <p>Internal Combustion Engines Courses</p> <ul style="list-style-type: none"> <input type="checkbox"/> Auto Technician <input type="checkbox"/> Diesel-Electric <input type="checkbox"/> Diesel Engines <p>Mechanical Courses</p> <ul style="list-style-type: none"> <input type="checkbox"/> Aeronautical Engineer's, Jr. <input type="checkbox"/> Aircraft Drafting <input type="checkbox"/> Forging <input type="checkbox"/> Heat Treatment of Metals <input type="checkbox"/> Industrial Engineering <input type="checkbox"/> Industrial Instrumentation | <ul style="list-style-type: none"> <input type="checkbox"/> Mech. Drafting <input type="checkbox"/> Machine Shop <input type="checkbox"/> Mechanical Engineering <input type="checkbox"/> Mold-Loft Work <input type="checkbox"/> Patternmaking—Wood, Metal <input type="checkbox"/> Reading Shop Blueprints <input type="checkbox"/> Sheet-Metal Drafting <input type="checkbox"/> Sheet-Metal Worker <input type="checkbox"/> Ship Drafting <input type="checkbox"/> Tool Designing <input type="checkbox"/> Toolmaking <input type="checkbox"/> Welding—Gas and Electric <p>Railroad Courses</p> <ul style="list-style-type: none"> <input type="checkbox"/> Air Brake <input type="checkbox"/> Diesel Locomotive <input type="checkbox"/> Locomotive Engineer <input type="checkbox"/> Locomotive Fireman <input type="checkbox"/> Locomotive Machinist <input type="checkbox"/> Railroad Section Foreman <input type="checkbox"/> Steam-Diesel Loco. Eng. <p>Stationary Eng'r'g Courses</p> <ul style="list-style-type: none"> <input type="checkbox"/> Boilermaking <input type="checkbox"/> Combustion Engineering <input type="checkbox"/> Engine Running <input type="checkbox"/> Marine Engineering <input type="checkbox"/> Power Plant Eng'r'g | <p>Textile Courses</p> <ul style="list-style-type: none"> <input type="checkbox"/> Cotton Manufacturing <input type="checkbox"/> Loom Fixing <input type="checkbox"/> Textile Designing <input type="checkbox"/> Rayon Weaving <input type="checkbox"/> Woolen Manufacturing <p>Business and Academic Courses</p> <ul style="list-style-type: none"> <input type="checkbox"/> Accounting <input type="checkbox"/> Bookkeeping <input type="checkbox"/> Business Administration <input type="checkbox"/> Bus. Correspondence <input type="checkbox"/> Certified Public Accounting <input type="checkbox"/> Commercial <input type="checkbox"/> Cost Accounting <input type="checkbox"/> Federal Tax <input type="checkbox"/> Foremanship <input type="checkbox"/> Good English <input type="checkbox"/> Higher Mathematics <input type="checkbox"/> Industrial Supervision <input type="checkbox"/> Motor Traffic <input type="checkbox"/> Retailing <input type="checkbox"/> Salesmanship <input type="checkbox"/> Sign Lettering <input type="checkbox"/> Spanish <input type="checkbox"/> Advertising <input type="checkbox"/> Bus. Law <input type="checkbox"/> Commercial Art <input type="checkbox"/> Commercial <input type="checkbox"/> First Year College <input type="checkbox"/> French <input type="checkbox"/> High School <input type="checkbox"/> Illustration <input type="checkbox"/> Postal Civil Service <input type="checkbox"/> Retail Bus. Management <input type="checkbox"/> Secretarial <input type="checkbox"/> Stenography <input type="checkbox"/> Traffic Management |
|---|--|--|---|

Name _____ Age _____ Home Address _____
 City _____ State _____ Working Hours _____ A.M. to _____ P.M.
 Present Position _____ Employed by _____

Length of Service in World War II _____ Enrollment under G.I. Bill approved for World War II Veterans. Special tuition rates to members of the Armed Forces. Canadian residents send coupon to International Correspondence Schools Canadian, Ltd., Montreal, Canada.

"Hey You SKINNY Bag of Bones!"

That's what the boys shouted at me ONLY A FEW WEEKS AGO . . . But look at me NOW, PAL . . . A Trophy-Winning JOWETT HE-MAN Like YOU can be SOON!



Your Name on it.

YES! John Sill
like millions, mailed me 10¢ and a coupon like the one below YOU MAIL NOW!

5-WAY PROGRESSIVE POWER can make YOU an ALL-AROUND WINNER

- In Civilian Life or Armed Services.
- A Winner of Success on IOB.
- A Winner of FRIENDS, GIRLS.
- A Winner at ALL SPORTS.
- This "Easy as Pie" NATURAL Method gives you All-Around CHAMP STRENGTH—All Over MR. AMERICA BUILD!
- A Winner of Trophies.
- A Hero on the DANCE FLOOR.
- A Hero at BEACH, GYM.
- A Hero to your SWEETHEART.
- A LEADER in any crowd.

Let me Prove in 10 THRILLING MINUTES A DAY I can make

YOU An ALL-AMERICAN HE-MAN

FAST—OR IT WON'T COST YOU A CENT

SAYS GEORGE F. JOWETT—

WORLD'S GREATEST BUILDER OF HE-MEN

YES! YOUR SUCCESS STORY can soon be like Sill's—

How weakling wins trophy as MAGNIFICENT HE-MAN! Few weeks ago everyone picked on John . . . No guts to fight for his rights. TODAY everyone admires John's movie-star build—his mighty ARMS, broad BACK, heroic CHEST, His ATHLETIC ability. His ENERGY at work. His POPULARITY. How GIRLS go for him! NO! I don't care if you're 14 or 40; if you're SKINNY or flabby. Give me 10 EXCITING MINUTES to make you over in your home by the method I turned myself from a wreck into A WORLD CHAMPION.

Builder of CHAMPS

4 times WINNER PERFECT MAN CONTEST

YES! Add INCH on INCH of MIGHTY MUSCLE to your ARMS. Deepen your CHEST. Broaden your SHOULDERS. Gain SIZE, SPEED, POWER! Become an All-American HE-MAN! A WINNER in everything you tackle—or you won't pay one cent!

DEVELOP YOUR 520 MUSCLES

Gain POUNDS, INCHES fast! Friend, I traveled the world. Made a LIFETIME study of EVERY way known to build your body. Then I devised the BEST, "5-WAY PROGRESSIVE POWER", the ONLY method that builds you 5 WAYS fast Save YEARS, DOLLARS, like MANY THOUSANDS like you did. Mail Coupon NOW!

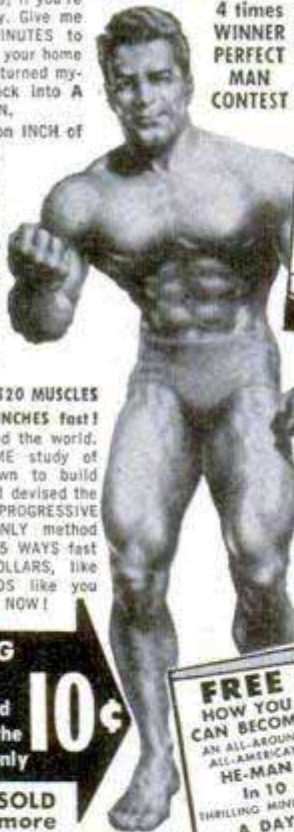

AMAZING ALL 5 Picture-packed courses while the supply lasts—only **10¢**

MILLIONS SOLD at \$1 and more

FREE PHOTO BOOK of FAMOUS STRONG MEN

DEPT. PM-16

"Jowett Courses greatest in World for Building All-Around HE-MEN."
—R. F. Kelley
Physical Director

JOWETT INSTITUTE OF PHYSICAL TRAINING
230 FIFTH AVENUE, NEW YORK 1, N. Y.

Dear George: Please mail to me FREE Jowett's Photo Book of Strong Men, plus all 5 HE-MAN Building Courses: 1. How to Build a Mighty Chest. 2. How to Build a Mighty Arm. 3. How to Build a Mighty Grip. 4. How to Build a Mighty Back. 5. How to Build Mighty Legs—Now all in One Volume "How to Become a Muscular He-Man" ENCLOSED FIND 10¢ FOR POSTAGE AND HANDLING (No C.O.D.'s).

Name Age

Address

City Zone State

NEW! POLARVISION SAFETY LIGHT

A revolutionary new light discovery recently released for civilian use.

STOP HEADLIGHT GLARE

FOR SAFETY AND COMFORTABLE DRIVING

The Amazing "Ergon Glass Lens" is an integral part of the Polarvision Light. It produces a Black Light (barely visible to the eye) which Counteracts oncoming headlights, street lights, etc. without interfering with your visibility. Easy to install above windshield—beautiful accessory. Light encased in high grade chrome holder. Works off car's central lighting circuit. Limited Supply. Complete (Including all parts) **\$6.95**

Send cash, check, or money order. Guaranteed

Electronic Development Company, Dept. 86, Los Angeles 34, Calif.

Do FALSE TEETH Rock, Slide or Slip?

FASTEETH, an improved powder to be sprinkled on upper or lower plates, holds false teeth more firmly in place. Do not slide, slip or rock. No gummy, gooey, pasty taste or feeling. FASTEETH is alkaline (non-acid). Does not sour. Checks "plate odor" (denture breath). Get FASTEETH at any drug store.

LEARN WATCH REPAIRING

AT HOME. By our modern and original system of instruction you can learn every part of the WATCH REPAIRING TRADE AT HOME. Prepare yourself for a well-paying position or start in business after completing our course of instruction. Good watch repairers are in demand and generally earn very good salaries. For particulars apply to the WISCONSIN SCHOOL OF WATCH REPAIRING. 759 North Milwaukee St., Milwaukee 2, Wis.

REAL ESTATE BE A BROKER

PAYS BIG! SEND FOR FREE, BIG, ILLUSTRATED CATALOG NOW! No obligation. Graduates report making substantial incomes. Start and run your own business quickly. Men, women of all ages, learn easily. Course covers Sales, Property Management, Appraising, Loans, Mortgages, and related subjects. STUDY AT HOME or in our classrooms in big cities. Diploma awarded. G.I. approved. Nationally known.

WEAVER SCHOOL OF REAL ESTATE (Est. 1936)
15 E. Pershing Road Dept. PM Kansas City, Mo.

FREE BOOK TELLS HOW

BE A DETECTIVE

WORK HOME or TRAVEL. Experience unnecessary. DETECTIVE Particulars FREE. Write to GEO. P. M. WAGNER, 125 W. 86th St., N. Y.

FUN!

MAKE THIS Squirrel Lamp

Yes sir, out of a real squirrel! Also make ash-trays, bookends, etc., using rabbits, frogs, etc. LEARN AT HOME TO MOUNT BIRDS, ANIMALS & FISH; tan skins and make rugs. Decorate your room. It's FUN! BIG profits in spare time!

Free book tells how.

FREE BOOK! Write TODAY for beautiful free book telling how to learn this fun hobby. Book is free. Contains many fine pictures. STATE YOUR AGE.

N.W. SCHOOL OF TAXIDERMY, Dept. 2506, Omaha, Nebr.

Prepare in our
Big Training
Shops for these

GREAT OPPORTUNITY FIELDS!



This big fire-proof building is occupied entirely by Coyne.

TRAINED YOUNG AND OLDER MEN — VITALLY NEEDED IN NATION'S GIANT DEFENSE PROGRAM

Where do you fit in today's gigantic Defense Program and Industrial expansion? Trained young and older men will play an important part in vital fields. Electricity and Television-Radio are essential to our Defense Program in both Industry and Armed Forces. Don't wait to be assigned to a dull, low pay, no future job. Get training and be ready to pick one of many job opportunities or get a better rating if drafted. Today it's not how young or how old you are that counts, but how prepared you are for jobs that demand skilled men. So, whether you are 16 or up to 50 you are needed. Qualify now for:

1. BETTER RATING, HIGHER PAY IF DRAFTED.
2. A VITAL JOB IN INDUSTRY, IF NOT IN DRAFT.

NOT "HOME-STUDY" COURSES

Our famous Television-Radio Practical-Technical method gives you practical experience on a massive outlay of equipment. Not by correspondence, but actual shop work plus necessary technical training. You are trained right here in the great Coyne shops that have been training men and young men for over 50 years.

LARGEST, OLDEST, BEST EQUIPPED SCHOOL OF ITS KIND IN THE U.S.

TELEVISION-RADIO

A great opportunity field and vital to Defense. Here at COYNE you're retrained for Construction, Testing, Trouble-Shooting on Radio, Public Address, Sound Units. Training includes FM, Television Installations, Servicing, etc. Many Coyne trained men in good jobs or own well paying Television-Radio businesses of their own.

ELECTRICITY

INCLUDING INDUSTRIAL ELECTRONICS

The Power behind the entire Defense Program. Big future in Power Plant Work, Motors, Armature Winding, Home and Factory Wiring, Appliances, Refrigeration, Maintenance, Illumination, etc. Lifetime job service to Coyne graduates. Send for BIG FREE BOOK.



Mail Coupon for Big FREE Book!

Whether you prefer Television-Radio or Electricity, train on actual equipment at Coyne. We will send you a Big, fully Illustrated Book, indicate below, which course interests you most. No salesman will call. Mail coupon TODAY.



START NOW—PAY LATER

Don't let lack of money hold you back. You can finance most of your tuition and pay for it later, in easy monthly payments. Special plan for men of draft age. We'll help you get part time work, if you need it, to help pay living costs while at Coyne.

G. I. APPROVED

B. W. COOKE, President

COYNE

ELECTRICAL AND TELEVISION-RADIO SCHOOL

An Institution not for Profit

500 So. Paulina St., Dept. A1-72H, Chicago 12, ILL.

B. W. Cooke, President
COYNE ELECTRICAL AND TELEVISION-
RADIO SCHOOL, 500 S. Paulina St.
Dept. A1-72H, Chicago 12, Ill.

Send me your Big Free book, and details of your special plan for men of draft age. I am interested in field checked below. This does not obligate me.

TELEVISION-RADIO ELECTRICITY

NAME.....

ADDRESS.....

CITY..... STATE.....

SHAVES A WEEK'S
GROWTH SLICK
AS ONE DAY'S



Only
\$15.95



Whisker® THE SHAVER

THAT CONVINCED THE BARBERS

Many Barbers use a *Whisker* to shave themselves and recommend it to customers. *Whisker's* refined hair-clipper action and .002" thin blade removes 1 to 7 day beards clean and close. Fast ... 14,400 strokes per minute. Quiet ... operates on 110 v., 60 cycle AC. No TV or radio interference. Women like *Whisker*, too, for safely removing superfluous hair on legs and under arms. Get *Whisker* at your Barber or Dealer.

ELECTRO TOOL CORPORATION
DEPT. W521-F • RACINE, WISCONSIN

See your Barber or Dealer. If he cannot supply you,
USE THIS COUPON TO ORDER

ELECTRO TOOL CORP., Dept. W521-F, Racine, Wis.

Enclosed find \$15.95 (check or money order).
Send *Whisker* POSTPAID.

Enclosed find \$5. Send *Whisker* C.O.D.
I'll pay postman balance plus postage.

Name _____

Address _____

City _____ Zo. _____ State _____

**High School
at Home**

Many Finish in 2 Years

No classes. No time wasted going to and from school. Progress as fast as your time and abilities permit. Standard H. S. texts supplied. Thousands enroll each year in this 54-year-old school. Send for FREE descriptive booklet.

AMERICAN SCHOOL, Dept. H-A45
Drexel at 58th St., Chicago 37, Ill.

Without obligation, please send FREE descriptive booklet.

Name _____

Address _____

POWER MOWERS & KITS

FREE PLANS

LOW FACTORY
PRICES DIRECT
TO YOU

3 & 4
Wheel
Model



4
Wheel
Direct
Drive

Build your own quality mower with our LOW COST KITS. Parts, Engines. Free Plans guide you. 3 and 4 Wheel Kits, complete. Parts precision finished, ready to use. Write TODAY for Free Plans, Low Prices, Parts List and Guarantee.

3-WHEEL KIT NO. T-800



America's Finest Power Mowers completely assembled in 3 and 4 wheel models. Belt or direct drive, 18" and 20" sizes. Nationally known make engine optional. Latest improved features, sturdy construction and money back guarantee fully described in color folder. Write today.

▼ **TRIANGLE MANUFACTURING CO., Dept. M-7, Fort Scott, Kansas**

MONEY for MEN ALL FREE

THE PLASTEX Industry needs manufacturers on small scale and for big production of Lamp and Clock Stands, Art Goods and Novelties in Plastex and Marble imitation. Experience unnecessary. 1/2¢ material makes regular 10¢ store sellers. Rubber moulds furnished for speed production. Small investment brings good returns. We are now placing big Chain Store Orders with manufacturers. Ambitious men have chance for real prosperity. Our Free booklet will interest and benefit you.

PLASTEX INDUSTRIES, Dept. A
3400 Third Ave. New York 56, N. Y.



GOLD-SILVER-COINS

Easily located with new Lightweight M-Scope Detector. Superior performance, lowest price, monthly payment plan.

FREE LITERATURE

FISHER RESEARCH LAB., INC.
PALO ALTO CALIF.



Free Book

Money In Hamsters

The new wonder animals from Syria. Often called Toy Bears. Delightful pets. Everyone wants them. Laboratories use thousands. Clean, odorless. Raise anywhere. NOW, spotted and golden breeds. We furnish breeders, equipment and manual of instructions. Write today for free illustrated literature.

GULF HAMSTERY 1536 BASIL ST., MOBILE 17, ALA.

A "GOOD HAND" HELPS YOU SUCCEED!
LEARN TO WRITE WELL

Handwriting quickly improves with our easy-to-understand picture lessons! Put your spare time to good use; send today for FREE BOOK, "How to Become a Good Penman", or check volumes wanted below at \$1 each: Business Writing Artistic Writing Card Writing Bird & Design Flourishing Engrossing Alphabets. COMPLETE SET \$4.50

TAMBLYN SCHOOL of PENMANSHIP
S. A. Ziller, Pres. 442 Ridge Bldg., Kansas City, Mo., USA

SAY YOU SAW IT IN POPULAR MECHANICS

MAKE EXTRA MONEY

**EVERY BUSINESS EVERYWHERE
USES UNION LABEL BOOK MATCHES**

No experience needed to earn big daily commissions. Be a direct factory representative of the world's largest exclusive UNION LABEL Book Match manufacturer. Prospects everywhere. Feature Glamour Girls, Hillbillies, scenics and dozens of other styles—Double Books—Jumbo Books—nearly 100 color combinations. New, bigger portfolio makes this fastest selling line a real profit maker for you. Write TODAY for full details.



SUPERIOR MATCH CO.

Dept. MD-651, 7528 S. Greenwood Ave., Chicago 19, Ill.
WEST COAST SALESMEN, write BOX 1087, SAN JOSE, CALIF.

GET INTO

RADIO-TELEVISION

ELECTRONICS By

Shop-Method Home Training

GOOD JOBS AWAIT THE TRAINED RADIO-TV TECHNICIAN

There is a place for you in the great Radio-Television-Electronics industry when you are trained as National Schools will train you at home!

Trained technicians are in growing demand at good pay—in manufacturing, broadcasting, television, communications, radar, research laboratories, home Radio-TV service, and other branches of the field. National Schools Master Shop-Method Home Training, with newly added lessons and equipment, trains you in your spare time, right in your own home, for these fascinating opportunities. OUR METHOD IS PROVED BY THE SUCCESS OF NATIONAL SCHOOLS TRAINED MEN, ALL OVER THE WORLD, SINCE 1905.

EARN WHILE YOU LEARN

Many National students pay for all or part of their training with spare time earnings. We'll show you how you can do the same! Early in your training, you receive "Spare-time Work" Lessons which will enable you to earn extra money servicing neighbors' and friends' Radio and Television receivers, appliances, etc.



Signal Generator

T. R. F. Receiver

Audio Oscillator

National Schools Training Is All-Embracing

National Schools prepares you for your choice of many job opportunities. Thousands of home, portable, and auto radios are being sold daily—more than ever before. Television is sweeping the country, too. Co-axial cables now under construction will soon bring Television to every city, town, and farm! National Schools' complete training program qualifies you in all fields. Read this partial list of opportunities for trained technicians:

- Business of Your Own • Broadcasting
- Radio Manufacturing, Sales, Service • Telecasting
- Television Manufacturing, Sales, Service
- Laboratories: Installation, Maintenance of Electronic Equipment
- Electrolysis, Call Systems
- Garages: Auto Radio Sales, Service
- Sound Systems and Telephone Companies, Engineering Firms
- Theatre Sound Systems, Police Radio
- And scores of other good jobs in many related fields.

TELEVISION TRAINING

A complete series of up-to-the-minute Television lessons is an important part of your course. They cover all phases of Television repairing, servicing and construction. The same lesson texts used by resident students in our own modern and complete Television broadcast studios, laboratories and classrooms!

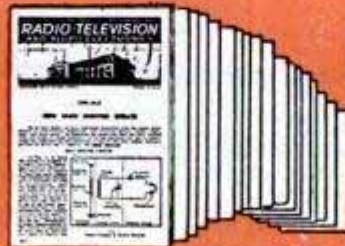

MASTER ALL PHASES!



Get Master Shop-Method Home Training from an Established Practical Resident School with its own Training Shops, Laboratories, and Studios—and almost 50 Years of Successful Experience in Training Ambitious Men.

We Bring National Schools To You



You also receive this Multitester

LEARN BY DOING

You receive and keep all the modern equipment shown above, including tubes and valuable, professional quality Multitester. No extra charges. You build the fine Superheterodyne Receiver with parts we send you.

FREE! These 2 Free Books give you all the facts. Send today for National Schools' new, illustrated Book of Opportunity in Radio-Television-

Electronics, and an actual Sample Lesson. No cost—no obligation. Use the coupon now—we'll answer by return airmail.

APPROVED FOR VETERANS AND NON-VETERANS
Check coupon below

Both Resident & Home Study Courses offered



NATIONAL SCHOOLS

LOS ANGELES 37, CALIF. • EST. 1905

FIND OUT NOW... MAIL COUPON TODAY

National Schools, Dept. 6-PM
4000 South Figueroa Street
Los Angeles 37, California

Mail in envelope or paste on penny postal.

Send me your FREE book "Your Future in Radio" and the sample lesson of your course. I understand no salesman will call on me.

NAME _____ AGE _____
 ADDRESS _____
 CITY _____ ZONE _____ STATE _____
 Check here if Veteran of World War II

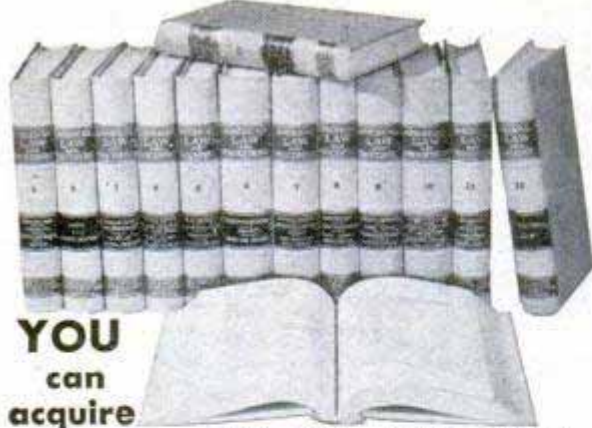

YOU
can
acquire

LAW NIGHTS AT HOME!
L. L. B. DEGREE

LaSalle's famous Law Library—used as reference in many Law libraries and Law offices—has enabled thousands to master Law surprisingly fast, in spare hours at home, for business and professional advancement.

These 14 remarkable volumes, compiled by leading professors and lawyers, cover the whole basic field of Law in condensed, orderly, simplified manner.

You advance rapidly with this great library, plus special lectures furnished. We guide you step-by-step with personalized Problem Method of instruction . . . you learn by doing—handling legal problems—not by memorizing rules.

Send for two FREE 48-page booklets, "Law Training for Leadership," and "Evidence," answering questions about Law and its value to you, and telling how LaSalle Law graduates are winning rapid advancement in business and public life. Mail coupon below. No obligation.

LA SALLE EXTENSION UNIVERSITY
A Correspondence Institution

417 S. Dearborn St., Dept. 664L, Chicago 5, ILL.

Send me your two FREE booklets described above, without obligation.

Name..... Age.....
Street.....
City, Zone & State.....

ENGINEERING DEGREE IN 27 MONTHS

Big Demand for Graduates

Aeronautical, Chemical, Civil, Electrical, Mechanical and Radio Engineering (including Television)

Hundreds of young men are earning engineering degrees in this recognized institution each year—continuous operation. New terms start quarterly. Many students earn a major part of their college expenses in this large industrial center.

Low tuition. Competent instruction. Thorough, intense, practical program. Modern laboratory facilities including new physics lab. and modernized wind tunnel. Individualized instruction emphasized.

Approved for Veterans. Engineering preparatory courses. Students from 48 states and 21 foreign countries. Enter June, September, December or March. Send coupon for free catalog and full information. Enroll now.

SEND COUPON TODAY

INDIANA TECHNICAL COLLEGE

561 E. Washington Boulevard
Fort Wayne 2, Indiana

Please send me free information on B.S. Engineering Degree in 27 months as checked.

- Aeronautical, Chemical, Civil, Electrical,
 Mechanical, Radio-Television

Name.....
Address.....

Listen to this Record!

Speak **FRENCH SPANISH**



RUSSIAN • GERMAN • ITALIAN
BRAZILIAN • JAPANESE

BIG OPPORTUNITIES await Americans who speak languages. Learn as a child learns—"by listening." The **CORTINA METHOD**, famous for 69 years, teaches you, right at home, to speak like a native!



FREE BOOK The "Cortina Short-Cut" describes this amazing method and **FREE TRIAL** offer. **WRITE TODAY.** State language interested in. Also if Veteran.

CORTINA ACADEMY Dept. 646
105 W. 40TH ST. NEW YORK 18, N.Y.

Learn **PHOTOGRAPHY**

There's big money in **PHOTOGRAPHY**—and an action-packed career for you. Our **HOME STUDY COURSE** is your spare-time **SHORT CUT TO SUCCESS!** Or, if you wish—**PERSONAL ATTENDANCE TRAINING** at our famous New York School is available with subsistence under the G. I. Bill. Our 41st year. Write immediately!

NEW YORK INSTITUTE OF PHOTOGRAPHY

Dept. "49," 10 West 33 Street, New York 1, N.Y.

Our 392nd Advertisement

REAL DIESEL ENGINE

\$2.95

- for planes, boats, midget cars
- 7500 RPM; 1/7 HP; ht. 3 1/2"; wt. 5 oz.
- comes completely assembled

You just can't beat this price for a complete precision diesel engine! Streamlined, rugged, compact. Starts quickly, easy to install, runs for years. Fast delivery if you **ORDER TODAY!** Send \$2.95 plus 25c postage.

GOTHAM HOBBY CORP. Dept. P. 107 E. 126 St. New York 35

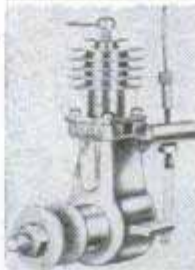

Learn **ACCOUNTING BOOKKEEPING**

This nationally renowned school has demand for graduates in good salary positions thru Nationwide recognition and placement service. Write Department PMY today for Big 32 page Success Book to be sent to you **FREE**



Hills BUSINESS UNIVERSITY AND EXTENSION SCHOOL
619 W. MAIN ST. OKLAHOMA CITY 2, OKLAHOMA

Rupture Troubles Ended

Advanced method has healed thousands. No leg straps, no elastic, no plasters. No pressure on hips or spine. Flexo-pad. Entirely different. Endorsed by doctors, mechanics, clerks. Very light. **INEXPENSIVE. GUARANTEED.** Write for information and trial.

SMITH MANUFACTURING COMPANY

EST'D 1893 DEPT. PM PRESTON, ONTARIO

CASH-IN ON YOUR IDEAS

Reputable manufacturers look to us for new inventions, patented, un-patented ideas. Get the "Inventor's Guide." Gives step by step helpful instructions, before going to the expense of patents, how to develop, protect, make money from inventions. Carefully prepared from long experience. Send 50c. Free list of needed products, record of invention form.

INVENTORS CREATIVE SERVICE
DEPT. PM 354 SO. SPRING ST. L. A., CALIF.

SAY YOU SAW IT IN POPULAR MECHANICS

Learn **BAKING At Home**

Baking is one of America's high industries in wages. Nearly depression-proof. Thorough basic home course lays sound foundation. If you have aptitude, write for **FREE BOOKLET**, "Opportunities in Commercial Baking."

NATIONAL BAKING SCHOOL
835 Diversey Pkwy. Dept. 135A Chicago 14



NOW... GET EVERYTHING YOU
NEED TO LEARN AND MASTER

TELEVISION

RADIO-ELECTRONICS
...AT HOME!

Use REAL commercial-type equip-
ment to get practical experience

Your future deserves and needs every advantage you can give it! That's why you owe it to yourself to find out about one of the most COMPLETE, practical and effective ways now available to prepare AT HOME for America's billion dollar opportunity field of TELEVISION-RADIO-ELECTRONICS. See how you may get and keep the same type of basic training equipment used in one of the nation's finest training laboratories... how you may get real STARTING HELP toward a good job or your own business in Television-Radio-Electronics. Mail the coupon today for complete facts — including 89 ways to earn money in this thrilling, newer field.

ABOVE: Build and keep a real 16 INCH commercial TV receiver. Optional after completing regular training at slight additional cost.

D.T.I., ALONE, INCLUDES BOTH MOVIES and HOME LABORATORY. In addition to easy-to-read lessons, you get the use of HOME MOVIES — an outstanding training advantage — plus 16 big shipments of Electronic parts. Perform over 300 fascinating experiments for practical experience. Build and keep real commercial-type test equipment shown at left.

MODERN LABORATORIES

If you prefer, get all your preparation in our new Chicago Training Laboratories—one of the finest of its kind. Ample instructors, modern equipment. Write for details!

MILITARY SERVICE!

If you're subject to military service, the information we have for you should prove doubly interesting. Mail coupon today.

Get BOTH of these information packed publications FREE!



ACT NOW! MAIL COUPON TODAY!

DeFOREST'S TRAINING, INC., Dept. PM-6-H
2533 N. Ashland Ave., Chicago 14, Ill.

Without obligation, I would like your late News-Bulletin showing 89 ways to earn money in Television-Radio-Electronics... and how I may prepare to get started in this thrilling field.

Name..... Age.....
Street..... Apt.....
City..... Zone..... State.....



Here's the REAL THING!

SET UP YOUR OWN HOME LABORATORY

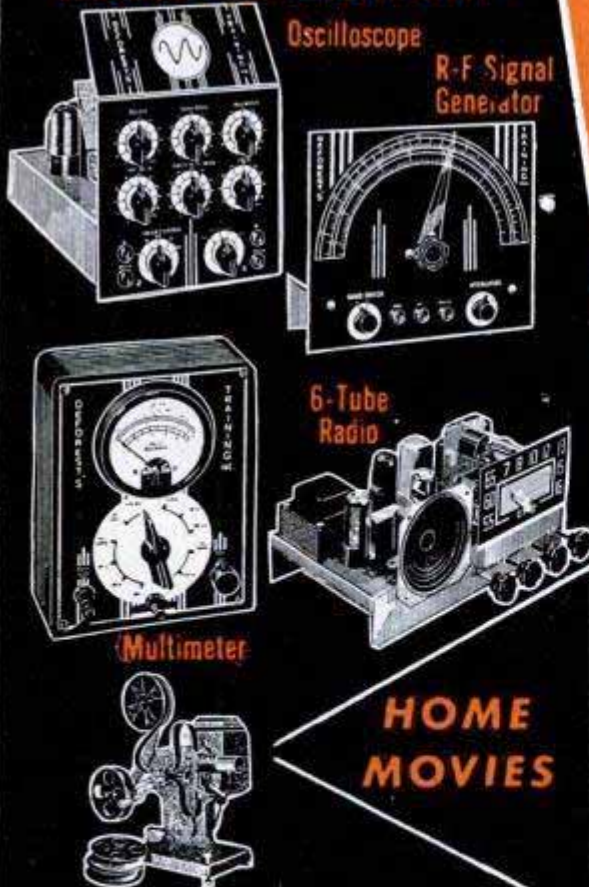

Oscilloscope

R-F Signal Generator

6-Tube Radio

Multimeter

HOME MOVIES

De FOREST'S TRAINING, INC.
CHICAGO 14, ILLINOIS
A De VRY INSTITUTION

Become an ELECTRICAL ENGINEER

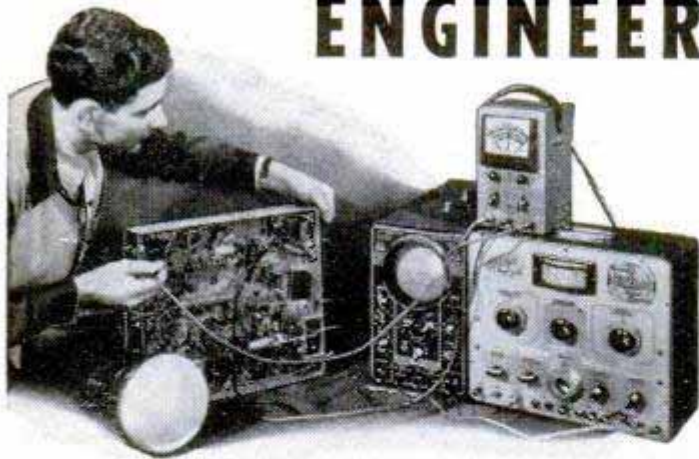

Major in Power or Electronics ... B. S. Degree in 36 Months

Important advantages are yours at this nonprofit institution of higher learning. Through optional year-round study, a valuable year is saved by gaining your B. S. degree in 36 months. Further—you are guided scientifically toward specialization for design and research, manufacturing and production—or engineering sales and management.

Choose the Course
That Interests You Most

SERVICE

- 6 Months
- Electricity
 - Welding
 - Refrigeration
 - Heating

TECHNICIAN

- 12 to 18 Months
- Radio and Television
 - Electronics
 - Electrical Power
 - Welding
 - Air Conditioning

ENGINEERING

- 36 Months
- Electrical Engineering — B. S. Degree
 - Major in Electrical Power or Electronics

A Radio-Television Technician's Certificate can be yours in 18 months

Under this school's proven plan you can become a Radio Technician in 12 months — or a Television Technician in 6 additional months. Courses are complete in themselves, and can be applied as one-third of the electrical engineering course.

Practical, Military or Academic Training will be evaluated for advanced credit.

Faculty of specialists. Over 2,300 annually enrolled. 35,000 former students from 48 states and 23 overseas countries.

MILWAUKEE SCHOOL of ENGINEERING

Terms open July, Oct.,
Jan., April

Write for free 110-page catalog, 48-page pictorial booklet "Your Career" and "Occupational Guidance" Bulletins

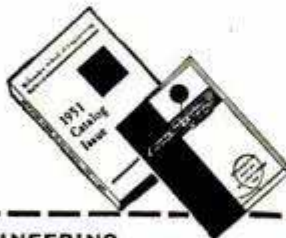

MILWAUKEE SCHOOL OF ENGINEERING
Department PM 651, 1020 N. Broadway, Milwaukee, Wis.
Without obligation send catalog and "Your Career" bulletin plus "Occupational Guidance Bulletin" and details on course in

NAME _____ AGE _____
ADDRESS _____
CITY _____ ZONE _____ STATE _____
 Check if World War-II Veteran

I need 500 Men to wear SAMPLE SUITS!



Pay No Money — Send No Money!

My plan is amazing! Just take a few easy orders for my sensational values in made-to-measure suits. Get your own suits WITHOUT A PENNY COST and make money too! Men can't resist the outstanding style, long wear and low price of my made-to-measure suits. You need no experience. Spare time pays big profits. Rush name and address today for complete details, big FREE SAMPLE OUT-FIT contains more than 100 actual woolen samples, style illustrations, etc. Write today!

PIONEER TAILORING CO., Dept. U-1116
Congress & Throop St., Chicago 7, Illinois

Learn CARPENTRY BRICK LAYING

Get into the billion dollar building trades. Learn now while opportunities are greatest. Train in our completely equipped shops under expert instructors. G.I. Approved. Enroll now. Limited classes. Write for FREE Catalog.

MIDWEST SCHOOL OF BUILDING TRADES, Dept. PM-6

411 N. Center St.

Bloomington, Ill.

BE A TILE SETTER

SIMPLE, EASY TO LEARN AT HOME! Very high pay. Great and growing demand. Light, interesting work. Even as a side line you may earn \$75.00 or more a week. Send for details TODAY!

AMERICAN INSTITUTE OF TILE SETTING

PO Box 1845 Wilshire-LaBrea Station, Dept. PM6, Los Angeles 36, Calif.



BOYS! MAKE YOUR OWN RADIO

Make your own simple, tubeless, batteryless Crystal Radio. SEND 25c for a GENUINE MELOMITE CRYSTAL with complete illustrated instructions for making your own set. Crystal sent postpaid with instructions and our own publication, "THE MAGIC CRYSTAL" which is full of news, diagrams, questions and answers of interest.

SEND 25c FOR YOUR CRYSTAL TODAY!

ALVA ALLEN RADIO Dept. 170 Clinton, Mo.



CARTOON SCHOOL

ONLY SCHOOL TEACHING CARTOONING EXCLUSIVELY Billy Hon nationally known cartoonist director. Draw comic strips, gag cartoons, editorials, sports, commercial cartoons and caricaturing. Cartoonists needed for television. Approved for Vets.

2921 Beverly Blvd. BILLY HON Los Angeles 4, Calif.

RUPTURE



RELIEF...OR YOUR MONEY BACK

Simple, easy to wear truss made by old surgical house. You risk nothing. Write for free booklet. Don't delay.

WEB TRUSS CO., Dept. M-6, Hagerstown, Md.

FOG MACHINE KILLS—

Flies, Mosquitos, other Bugs!

A simple, easy-to-install attachment for your car, power lawn mower or any other gas engine throws out a dense fog that is sure death to insect pests over large areas.

BUILD IT YOURSELF . . . \$1.00

Yes, for only one dollar we will send you complete plans for building this amazing fog machine, plus formulas for low cost insecticide. Total cost for all necessary materials ridiculously low. Free your home, garden, camp site, etc., from bothersome insects. Send \$1.00 TODAY to:

GULF PRODUCTS, Box 525M, Bradenton, Fla.

PAINT STRIPING TOOL

Works Like a Fountain Pen
Stripes with PAINT instead of INK!

New Master Painters' STRIPING TOOL makes it easy to do expert striping on furniture, bikes, model planes, autos, signs, linoleum, toys, wall board, etc. Makes plain, painted walls look like tile. Paint straight lines, curved, circular or evenly spaced parallel lines the same way a professional painter does. Simply fill Tubular Glass Paint Fountain with any color paint & wheel tip feeds paint evenly. Tips interchangeable — jaws split apart for easy cleaning. Tool complete with tip for 1-16 in. stripe only \$1 postpaid. Other complete tools with 1-64, 1-32, 3-64, 1-16, 5-64, 3-32, 1-8 in. tips. \$1.50 ea. Extra tips, 75c. Complete kit with tool and 7 tips, \$5.00. Handiest tool in painter's kit. Get it now. C.O.D.'s postage collect.

\$1.00
POST PAID

POST PAID

POST PAID

POST PAID

POST PAID

POST PAID

POST PAID

POST PAID

POST PAID

POST PAID

POST PAID

POST PAID

POST PAID

POST PAID

POST PAID

POST PAID

POST PAID

POST PAID

POST PAID

POST PAID

POST PAID

POST PAID

POST PAID

POST PAID

POST PAID

POST PAID

POST PAID

POST PAID

POST PAID

POST PAID

POST PAID

POST PAID

POST PAID

POST PAID

POST PAID

POST PAID

POST PAID

POST PAID

POST PAID

DEALERS
Paint Striping Tool
Packed in attractive Display Cartons of one dozen. Fast, profitable seller. Write for illustrated circular, discounts.

Thumb and Finger Rests.
Easy to Guide Tool

Guide Keeps Lines Straight
Knurled Wheel Distributes Paint

WENDELL MFG. CO.
4234 N. Lincoln Avenue
Dept. 36, Chicago 18, Illinois
Paints Curved, Circular or Straight Lines



NOW ANY AUTO REPAIR JOB

CAN BE A
"Push-Over" for You!

IN LESS TIME —
WITH LESS WORK —
AND MORE PROFITS!

Used by
U. S. Army
and Navy

NOW, tackle anything from carburetor to rear end on ANY car built from 1935 thru 1951. Fix it quick, easy, right the FIRST time! Just look up make, model, and job in quick index of MoToR's brand-new 1951 Edition AUTO REPAIR MANUAL. Clear, illustrated instructions—you just can't go wrong! 7-DAY FREE TRIAL!

Earn More Money! Win Prestige!
Boiled down in one BIG handy 771-page book — the complete "dope" from 150 Official Factory Manuals. 225,000 service, repair, tune-up facts, 38,000 essential dimensions! Covers 800 car models. Includes ALL automatic transmissions, ALL new carburetors. 2300 cut-away photos, diagrams, charts show what the clear text tells. Used by Army, Navy, Tech Schools, thousands of auto-repairmen. Makes every operation so easy, you'll tackle jobs you wouldn't think of doing before. You'll win added prestige, more money!

SEND NO MONEY

Mail coupon—without money! When book arrives—make it show you what it's got! Unless you agree it's the greatest time and work saver you've ever seen—return it in 7 days, pay nothing. Mail coupon NOW! MoToR Book Department, Desk 16, 250 West 55th Street, New York 19, N. Y.



Covers 800 Models — All These Makes

Buick	La Salle
Cadillac	Lincoln
Chevrolet	Mercury
Chrysler	Nash
Crosley	Nash Rambler
De Soto	Oldsmobile
Dodge	Packard
Ford	Plymouth
Frazier	Pontiac
Henry J.	Studebaker
Hudson	Terraplane
Kaiser	Willys
Lafayette	Willys

Also complete tune-up adjustments on Auburn, Cord, Reo, others.

Same FREE Offer On MoToR's Truck and Tractor Manual

Covers EVERY job on EVERY popular make gasoline truck, tractor made from 1936 thru 1949. FREE 7-day Trial. Check proper box in coupon



MAIL COUPON NOW FOR 7-DAY FREE TRIAL

MoToR BOOK DEPT.
Desk 16, 250 W. 55th St., New York 19, N. Y.
Rush to me at once (check box opposite book you want):

MoToR's New AUTO REPAIR MANUAL. If O.K., I will remit \$1 in 7 days (plus 35c delivery charges). \$2 monthly for 2 months and a final payment of 95c one month after that. Otherwise I will return the book postpaid in 7 days. (Foreign price, remit \$8 cash with order.)

MoToR's TRUCK & TRACTOR REPAIR MANUAL. If O.K., I will remit \$2 in 7 days, and \$2 monthly for 3 months, plus 35c delivery charges with final payment. Otherwise I will return book postpaid in 7 days. (Foreign price, remit \$10 cash with order.)

Print Name.....Age

Address

City.....State

Check box and save 35c delivery charge by enclosing WITH coupon entire payment of \$5.95 for Auto Repair Manual (or \$8 for Truck and Tractor Repair Manual.) Same 7-day return-refund privilege applies.

IS \$21000 A WEEK Worth a Penny Post Card?

Then RUSH postcard with name and address. Get FREE details of amazing full-and-spate-time PROFITS made by ambitious men handling new Automatic Defroster for refrigerators on FREE TRIAL basis. Learn how housewives hand you big profits when you just plug in the D-Frost-O-Matic to end defrosting mess forever. Send card for Special Offer TODAY.

D-FROST-O-MATIC

Dept. PM-6
6 N. Mich. Ave.
Chicago, Ill.

LEARN RADIO-ELECTRONICS



Train for an important job in Radio, Television and Radar—with unlimited future. Spartan resident study is backed with actual construction and operation. Write Department PM-61

SPARTAN SCHOOL of RADIO-ELECTRONICS
MUNICIPAL AIRPORT • TULSA, OKLAHOMA

GLUE INJECTOR COMPLETE WITH DRILL

Drill in handle makes a tiny hole in heart of joint — plunger forces glue through hollow tip and hole into and around joint under great pressure. Mends furniture and toys quickly, cleanly and without disassembly. Model Worker's Dream. Satisfaction guaranteed. \$1.50 PPD. Sorry no COD's.

ARTCRAFT PRODUCTS CO., Box 876, CLEVELAND 22, OHIO

OIL FILTER REFILLS... 10c



Filters Oil the full length of the Pack

10,000 Sq. In. of Filtering Surface

Plates Last Indefinitely

Here's News! Ordinary toilet paper makes an ideal oil filter. Laboratory tests prove it cleans oil faster and better than popular makes of filter elements. All you need is a simple set of RETLIF ADAPTER PLATES... and you can start using ordinary toilet paper rolls in your present oil filter. For proof and descriptive literature, send name and address to:

RETLIF CORPORATION, Dept. 81
1239 No. Highland Ave., Los Angeles 38, Calif.

EARN MORE IN DRAFTING



More Opportunities for Employment and Promotion

"Here I am at work making good money as a draftsman. I'm glad I sent the coupon to Chicago Tech for that Free Trial Lesson and found out how easy it is to learn Drafting in spare time at home. Today I feel secure in my job because the draftsman's work comes first on any new project. And, in addition, draftsmen can't be replaced with machines. What's more, I feel I'm slated for promotion and more pay, because I see so many draftsmen advancing to high-pay jobs."

LEARN IN SPARE TIME—AT HOME! (or at the College in Chicago)

A few hours of pleasant home study every week—that's all. No interference with your present job. All the tools you need; drawing outfit included. With Chicago Tech's help, you train yourself step by step. This tested method—developed over 46 years of C.T.C. progress—prepares men quickly for good positions in industry.



FREE INFORMATION—SEND COUPON

To prove to you how easy it is to learn Drafting at home by the Chicago Tech method, we will send you this FREE TRIAL LESSON. No charge for this lesson, now or later. Fill out and mail coupon, or send post card today.

CHICAGO TECHNICAL COLLEGE

G-214 Tech Bldg., 2000 So. Michigan Ave., Chicago 16, Illinois

Mail me FREE Lesson with information about big opportunities in DRAFTING.

Name _____ Age _____

Address _____

City _____ Zone _____ State _____

YOURS to make and KEEP!
This Footstool — Boudoir CHAIR and Lawson Chair!



LEARN UPHOLSTERING



For More Pay—More Profit—OR as a Hobby!

Upholstering needs more trained men for good, steady jobs! Now you can prepare for a better paying position—or your own business—with this practical home training course—by an accredited, established school, largest of its kind in the country!

YOU LEARN WITH REAL EQUIPMENT—YOU BUILD REAL FURNITURE—YOU GET A COMPLETE TOOL KIT & ALL MATERIALS. ALL AT NO EXTRA COST!

FREE! Big, illustrated brochure, sample lessons and details of "PAY AS YOU LEARN" plan. No obligation.

SEND THE COUPON TODAY!

FIELD SCHOOL OF UPHOLSTERY, DEPT. 06

39 West 19th Street, New York 11, N. Y.

Rush FREE illustrated brochure, sample lessons and details of "PAY AS YOU LEARN PLAN."

Name _____ Age _____

Address _____

City _____ Zone _____ State _____

Check if Veteran of World War II

CHRONOGRAPH WRIST WATCH \$7.90

Plus Tax



Lifetime Guarantee

(EXCLUSIVE OF PARTS)

3 DIALS—5 HANDS—2 BUTTONS

Multi-purpose watch that measures distance, speed, time, moving objects. Used as Stop Watch or Timepiece. Has Sweep-Second Hand for full 60 Second count. Second Dial records up to 45 minutes. Third Dial then records up to 6 hours. Seconds—Minutes—Hours, all recorded automatically.

INDEPENDENT MOVEMENTS

For sportsmen, professional men and women—time-keeper works when other hands and dials are stopped—separate movements permit dual use at same time.

RUGGED CONSTRUCTION

Precision workmanship and shock resistant features are added to enhance the value of this watch. Sold everywhere for as high as \$17.00. Our low introductory price is only \$7.90 plus tax. (Gold Plated \$12.95) Send check or money order and we prepay postage. Or sent C.O.D. plus charges. LIMITED STOCK!

MARDO SALES CORP., 480 Lexington Ave., Dt. W-13, New York 17, N. Y.

LEARN MEAT CUTTING At Home—In Spare Time



Get into the vital meat industry. Concise, practical Home Training based on 35 years proven instruction methods used at National's famous resident school. Prepares you for bigger pay as Meat Cutter, Supervisor, market manager or more money in your own store. Go as rapidly as your spare time permits. Diploma. Start NOW to turn your spare hours into money. Send for FREE bulletin today. No obligation.

NATIONAL SCHOOL OF MEAT CUTTING, INC., Div. U-129, Toledo 4, Ohio

SHORTHAND IN

Famous Speedwriting system. No signs; no symbols; no machines. Uses ABC's. Easy to learn, write, transcribe. Low cost. 100,000 taught by mail. Also typing. 28th year. Write for FREE booklet to:

Speedwriting
Dept. 1506-1
55 W. 42 St., N. Y. 18, N. Y.

6
WEEKS
AT HOME

LEARN AT HOME LOCKSMITHING

YOU CAN MAKE GOOD PROFITS ALL YEAR ROUND IN FULL OR SPARE TIME!

Locksmiths are always in big demand! Age is no disadvantage in this respected, permanent field. Learn how to make keys, fix locks, make duplicates, etc. Practical, illustrated lessons by experts show you how! All materials and special tools supplied. Send for FREE booklet.

INSTITUTE OF LOCKSMITHING
Dept. P-19 55 Park Ave., Rutherford, N. J.
Licensed & Approved by State of New Jersey

RADIO ENGINEERING, Broadcasting, Television, FM, Servicing, Electronics, Aviation, Marine & Police Radio taught thoroughly. Engineering course equivalent to 3 years' college radio work. Approved Veteran Training. Catalog free.
VALPARAISO TECHNICAL INSTITUTE, Dept. D, Valparaiso, Ind.

Say You Saw It in Popular Mechanics

ELECTRIFY your SEWING MACHINE

NEW LOW PRICE!
\$12.50 1 YR. GUARANTEE

Buy direct from manufacturer and save! Kit comes fully wired, installed in a jiffy. Fits all machines! You get these all-new parts:

- Motor & Bracket
- AC-DC 115v 60c
- Multi-speed foot control
- Cord set & block
- Easy instructions
- Steel pulley & belt

FREE . . . reg. \$2.95 chrome SEWLITE given with every kit.
10 DAY FREE TRIAL — ORDER NOW!
Send no money, pay COD or send money order and we'll pay postage. Please state whether wheel on your machine turns toward you or away from you. Shipping wt. 6 lbs.

SENIOR SEWING MACHINE CO.
1046 BEDFORD AVENUE Dept. PM-26 Brooklyn 5, N. Y.

GET INTO AUTOMOTIVE DIESEL AND ALLIED MECHANICS

by Shop Method Home Training

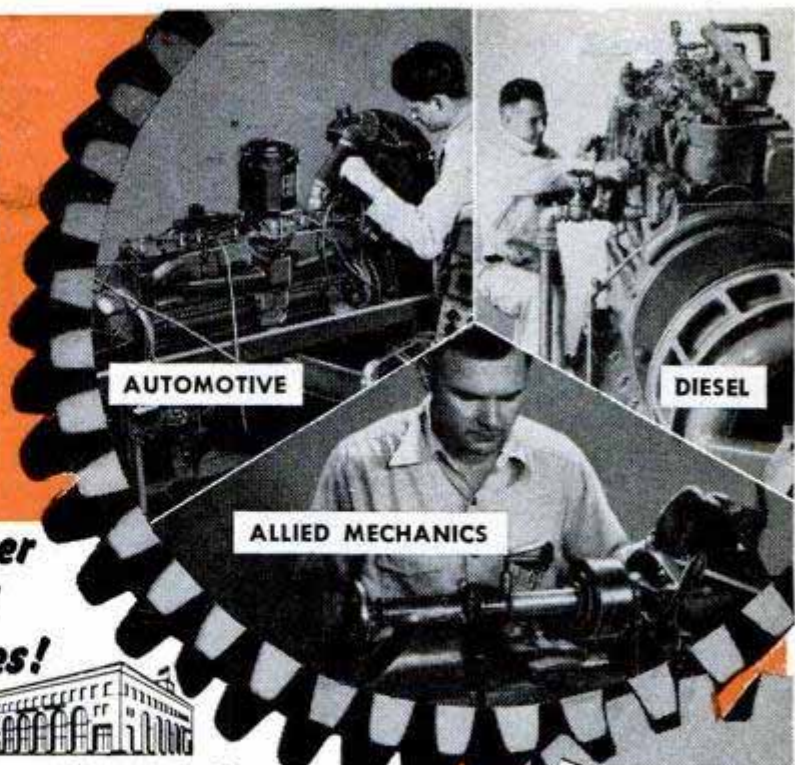

JOBS LIKE THESE ARE OPEN TO YOU AS A TRAINED ENGINE MECHANIC... CHOOSE THE FIELD YOU LIKE BEST!

Master All Phases!



Get Master Shop-Method Home Training from an Established Resident School with its own Training Shops and Laboratories—and almost 50 years of Successful Experience in Training Men.

We Bring National Schools To You
National Schools trains you for all opportunities in the dynamic, fast-growing Automotive-Diesel and Allied Industries. You get complete training for this great Industry.

Thousands upon thousands of autos, trucks, tractors, ships, trains, farms and factories are dependent upon engine power! Trained engine mechanics are needed in the Armed Forces as well as in civilian production. This huge field needs trained men for servicing, repairing, installing, operating and manufacturing equipment. The pay is good, the future excellent! National Schools offers you a practical, all-embracing Automotive-Diesel Mechanics Course that qualifies you for your choice of many good jobs.

Your National Course covers Gasoline and Special Fuel Engines; Diesels, High Speed and Heavy Duty; Semi-Diesels; Allied Mechanics.

BOTH RESIDENT AND HOME STUDY COURSES OFFERED

APPROVED FOR VETERANS AND NON-VETERANS
Check Coupon Below

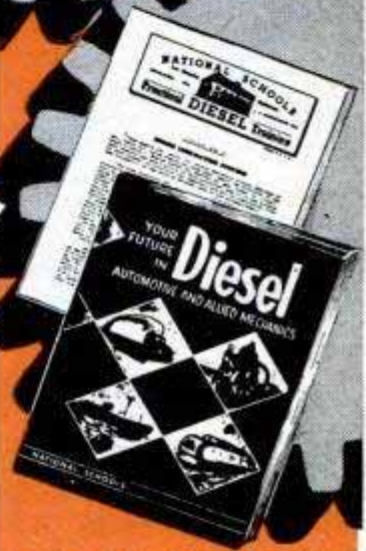

These Two FREE Books Show You How

Send today for National Schools' new, illustrated Book of Opportunity in Automotive, Diesel and Allied Mechanics, and an actual sample lesson. No cost—no obligation. Use the coupon now — we'll answer by return airmail.

Get complete training

- Diesel Fuel Injection
- Automotive Motor Tune-up
- Diesel Engine Maintenance
- General Garage Mechanics
- Agricultural Implements

- Auto Engine Rebuilding • Auto Elec. Service
- Public Utilities • Parts Dealers
- Bus & Truck Lines • Industrial Maintenance
- Contracting & Excavating
- Business of Your Own
- AND MANY other similar openings

EARN WHILE YOU LEARN!

With our practical Master Shop-Method Home Training, you study at home in your spare time. You receive Spare Time Work Lessons, which show you how to earn while you learn... for extra money and experience. You Learn by DOING.

YOU RECEIVE AND KEEP ALL THIS MATERIAL:

- | | |
|-----------------------|------------------------|
| Basic Lesson Texts | Engine Service Manuals |
| Diesel Installation | Engine Repair |
| Operation—Maintenance | Drive Systems |
| Diesel Chart Manual | Diesel Electric Power |
| Spare Time Lessons | Thermodynamics |

TOOLS AND EQUIPMENT

**INVESTIGATE!
SECURE FULL
INFORMATION**

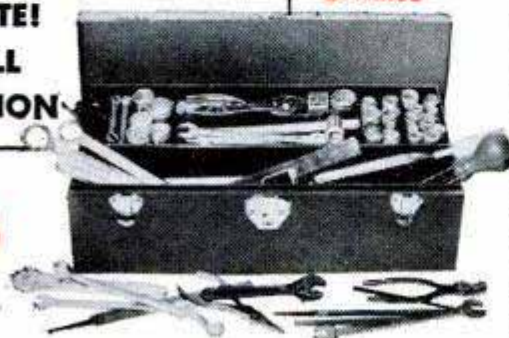

WE GIVE YOU TOOLS OF YOUR TRADE

NATIONAL SCHOOLS LOS ANGELES 37 CALIFORNIA
TECHNICAL TRADE TRAINING SINCE 1905

FIND OUT NOW...MAIL COUPON TODAY

NATIONAL SCHOOLS, Dept. 6-PMD (Mail in envelope or paste on penny postcard)
4000 South Figueroa Street
Los Angeles 37, California
Mail me FREE the book, YOUR FUTURE IN AUTOMOTIVE-DIESEL MECHANICS, together with the Sample Lesson. I understand I may keep and use the information with no obligation.

NAME _____ AGE _____
ADDRESS _____
CITY _____ ZONE _____ STATE _____
 Check here if Veteran of World War II

Give "OLD TIMERS"

They're Perfect for FATHER'S DAY Gifts!

How thrilled he will be with these authentic, fascinating 1/4" scale models of these favorite antique autos! What fun he will have assembling these nostalgic miniatures! And, what pride he will have in showing them to friends—or decorating his desk or den with them!



1909 STANLEY STEAMER \$2.95

We show only a few of the 15 famous vintage cars of yesteryear in our collection — each perfectly detailed and completely pre-fabricated. Comes with die-cast plastic parts, cast wheels, lights, horns, radiators, and easy-to-follow instructions. Which of the 15 models will you give to your Dad?



1911 MAXWELL \$2.50



1910 MODEL "T" FORD \$2.50

1904 Olds	\$1.95
1911 Buick	2.50
1903 "A" Ford	2.50
1909 "T" Ford	2.95
1903 Cadillac	2.50
1900 Packard	2.50
1903 Rambler	2.50
1910 Internat. Harvester	2.95
1913 Mercer	3.95
1906 "Old 16" Locomobile	3.95
1914 Stutz Bearcat	3.95
1902 Franklin	2.50

SEE them at your hobby, toy, or department store, or write to us Add 25c for postage and handling; no C. O. D.'s, please

Hudson Miniatures' "OLD TIMERS"

SCRANTON HOBBY CENTER, Dept. 14, Scranton 10, Pa.

NEW OPPORTUNITIES for WELDING TECHNICIANS

An immediate need exists for properly trained WELDING TECHNICIANS — men who have more than practical welding experience — to fill laboratory, experimental, supervisory, estimating, sales and managerial positions.

Take your place in the ever-increasing, essential Metal Fabrication Industries!

"Welding as a Career", a new bulletin, describes the many job opportunities for you in the rapidly expanding Welding Industries. Write for it today. It's FREE.

MILWAUKEE

SCHOOL of ENGINEERING

Welding Institute
College of Electrical Engineering

MILWAUKEE SCHOOL OF ENGINEERING
PM-651W, 1020 N. Broadway, Milwaukee, Wis.

Without obligation, mail "Welding as a Career" manual to

Name.....Age.....

Address.....

City.....Zone...State.....

Check if World War II Veteran

Other bulletins: Radio-Television, Refrigeration,

Heating, Air Conditioning, Electrical Power

(Electrical Engineering, B. S. Degree, Major in

Electronics or Power.) 1951 Catalog.

"Your Career", an illustrated bulletin.



GO PLACES
LEARN ANOTHER LANGUAGE
Linguaphone METHOD
by World's Standard
IN 20 MINUTES A DAY

FRENCH
SPANISH
GERMAN
RUSSIAN
- any of 29 Languages

Are you letting interesting job, travel, armed services and cultural opportunities pass you by because you speak only one tongue? Learn at home — any of 29 languages, including the Oriental — quickly, easily by the one and only LINGUAPHONE CONVERSATIONAL METHOD. You listen—you learn—you understand—you SPEAK. World-wide educational endorsement; over a million delighted home-study students. FREE BOOK gives fascinating facts. Write TODAY!

Approved for VETERANS' Training
LINGUAPHONE INSTITUTE
143-06 Rockefeller Plaza, New York 20, N. Y.

LAW FREE BOOK

Your FREE copy of "The Law-Trained Man" shows how to gain prestige and greater earnings through Blackstone home law study. All instruction material furnished including 17-volume Law Library written by 65 well-known law authorities. Lawyers, judges among our graduates. LL.B. degree. Low cost; easy terms. Write today.

BLACKSTONE COLLEGE OF LAW 225 N. Michigan Ave.
Dept. 50-A, Chicago 1, Ill.
A Correspondence Institution Founded in 1890

WHY DON'T YOU WRITE?

Writing short stories, articles on business, sports, hobbies, travel, gardening, local and club activities, etc., will enable you to earn extra money. In your own home, on your own time, the New York Copy Desk Method teaches you how to write the way newspaper men learn—by writing. Our unique "Writing Aptitude Test" tells whether you possess the fundamental qualities essential to successful writing. You'll enjoy this test. Write for it, without cost or obligation.

Veterans: Course approved for Veterans' Training.

NEWSPAPER INSTITUTE OF AMERICA
SUITE 5591-H, ONE PARK AVENUE, NEW YORK 16, N. Y.

"How to Make Money with Simple Cartoons"
A book everyone who likes to draw should have. It is free; no obligation. Simply address **FREE BOOK**
CARTOONISTS' EXCHANGE
Dept. 96-D Pleasant Hill, Ohio

EASY TO LEARN CODE

Learn or increase speed with an Instructograph — the Radio-Telegraph Code Teacher that takes the place of an operator-instructor and enables anyone to master code without further assistance. Available tapes from beginners alphabet to typical messages on all subjects. Speed range 5 to 40 WPM. Always ready—no GRM. Thousands have "acquired the code" with the Instructograph System. Write today for convenient rental and purchase plans.

INSTRUCTOGRAPH COMPANY
4701-V Sheridan Road, Chicago 40, Illinois

START YOUR OWN ELECTRICAL APPLIANCE REPAIR BUSINESS
Repair electrical appliances of friends and neighbors. Service electrical equipment in factories, stores, etc. Work full or part time! New Shop Method home-training system. Rush name today for **FREE BOOK** and special form for getting Electronic Kit, Valuable Heating Element Kits, Advisory Service and Illustrated Instructions on new easy-payment plan. Pay later from **EARNINGS WHILE LEARNING**. Rush name today.
CHRISTY TRADES SCHOOL
4432 N. Kedzie, Dept. D-9403, Chicago 25

\$200 GROSS IN MY FIRST WEEK!



Some Make More, Some Less... Start This Business for YOUR OWN

Would YOU like to own a permanent, year-round business in which it is possible to take in as much as \$200 gross the first week, as did L. A. Eagles? R. E. Traynor says, "I made \$62 gross in one day." R. R. Newlin reports, "I have averaged \$173 gross per week." Others report gross from \$100 per week to \$12,000 per year.

Surely YOU will want to investigate a golden opportunity like that. You need not have any special skill or experience, but if you are ambitious, honest and courteous, we will help you to start and succeed in YOUR OWN money-making business where net profits are high.

No Shop Necessary

Our Electric Rug Washer cleans rugs and carpets like new right on the customer's floor. This quick, thorough and highly efficient method removes dirt and grime, thus restoring the natural, fresh beauty of floor coverings. Anyone can do it. Rugs and carpets are not harmed.

There are hundreds of possible customers in YOUR vicinity. Most of them have several rugs needing regular cleaning. To get a quick start,

shampoo a few rugs or carpets. These customers tell their friends and soon you should have an independent, prosperous business, and you should be able to keep it growing. Send the coupon RIGHT NOW for booklet that explains everything.

Every Machine Guaranteed and Easy to Own

You take no risk. These wonderful, fully guaranteed machines have been used and endorsed by largest hotels, railroads—also used by U. S. Government. Many individuals have built up successful businesses that made big profits. Mail the coupon TODAY and we will send complete information, including how to start and succeed in YOUR business without a large investment. Don't delay your BIG opportunity. Send the coupon AT ONCE.



FREE BOOK! MAIL COUPON

VON SCHRADER MFG. CO.
610 PL., Racine, Wis.

Send at once (no obligation) your FREE booklet containing information about your Electric Rug Washer and how I can own my own permanent profitable business.

Name _____

Address _____

City _____ (Zone) _____ State _____

MAIL COUPON TO

VON SCHRADER MFG. CO., 610 PL., RACINE, WIS.

HERE IS THE NEW SENSATION IN LOW-COST TRANSPORTATION

Truly, Cushman EAGLE is the new sensation in its field. It operates for only $\frac{3}{4}$ ¢ per mile, cruises to 50 m.p.h., gets over 75 miles per gallon. Dealer inquiries invited.



Cushman

EAGLE

WRITE FOR DETAILS AND SPECIFICATIONS
DEPT. 12-M

CUSHMAN MOTOR WORKS Lincoln, Nebr.

LEARN MEAT CUTTING AT NATIONAL

Pay After Graduation



The steady dependable trade of Meat Cutting taught easily in 8 short weeks. YOU LEARN BY DOING under actual meat market conditions in big modern school at Toledo.

For beginners or men with experience. Get a profitable store of your own. Remember, PEOPLE MUST EAT! Big pay jobs. Free employment help. Thousands of successful graduates.

Buying, cutting, percentage, pricing, advertising, selling, etc. A complete retail meat education. National School established over 25 years. Get National training NOW. Pay your tuition in easy weekly payments

after you graduate. G. I. approved. Send coupon for FREE 52 page school catalog — TODAY.

National School of Meat Cutting, Inc., Dept. 50-T, Toledo 4, Ohio

Send me your FREE school catalog on National Training at Toledo in Meat Cutting, Meat Merchandising and Self Service Meats. No obligation. No salesman will call.

Name _____

Address _____

City _____ State _____

() Check here if Veteran of World War II

INVENTORS

If you consider your invention to be something of importance, you may take steps to protect it with a U. S. Patent which gives you the right to exclude others from making, using and selling your invention as claimed.

In such case, your first step will probably be to have a search made of pertinent prior U. S. patents, so that we may report to you on the question of patentability.

We shall be glad to send you promptly and without obligation, an instructive booklet, "Patent Protection for Inventors", which was prepared to give inventors detailed information and steps to take toward patent protection—also our convenient "Evidence of Invention" form. Use address below.

VICTOR J. EVANS & Co. *Merlin M. Evans*
REGISTERED PATENT ATTORNEY
630-G MERLIN BUILDING, WASHINGTON 6, D.C.

PATENTS

COPYRIGHTS



10 SHELF PLANS

ACTUAL SIZE, easily built, beautiful wall shelf plans, ready to trace on lumber for cutting out. Corner and wall racks with 1 to 3 shelves. Stores charge as high as \$75.00 for these shelves. Make money selling them. PLUS BONUS of 48 other novel cutouts, Dutch Boys, Girls, Toys, etc. PLUS FREE HOBBY BOOK. Send only \$1.00 to **CRAFTERS OF PINE DUNES** (formerly Jackson Studio) 106 Poplar St., Oostburg, Wisconsin

\$1.00

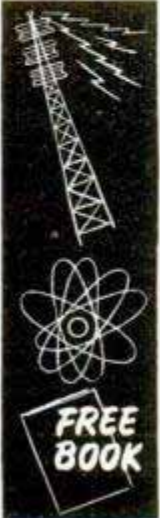

LEARN TELEVISION RADIO-ELECTRONICS

Learn in your home. Then earn BIG PAY and SECURITY. Tremendous growth has made more jobs than there are trained men! NOW is the time to get into this essential, NEW, RICH field of OPPORTUNITY. FREE placement service. SEND FOR FREE, BIG ILLUSTRATED CATALOG.

MAIL TODAY —————

I want complete information on how to succeed in Television, Radio, and Electronics. This does not obligate me in any way.

NAME _____

ADDRESS _____

CITY _____ STATE _____

CENTRAL RADIO & TELEVISION SCHOOLS
Dept. B-6, 1644 Wyandotte, Kansas City, Mo.

FREE BOOK

AUTO SEAT COVERS

to fit all makes and years!

Only **\$2.98**



- Choice of full front and rear seat covers or split front seat
- Leopard skin effect on colorful plastic
- Water-proof and stain proof
- Comfortable and Cool
- Easy to attach—no pins necessary

You must be satisfied or Money Back! Front or rear seat only \$2.98 each or FULL SET for \$5.00. Order now. Enclose payment or pay postman plus postal charges. Specify whether split or solid front seat.

DOMAR SALES CO., Dept. A-2
480 Lexington Ave., New York 17, N. Y.

"YOU ARE UNDER ARREST!"

Help Bring Crooks to Justice Through Scientific **CRIME DETECTION!**



We have taught thousands this exciting, profitable, pleasant profession. Let us teach you in your own home. Learn Fingerprinting, Firearms Identification, Police Photography, Secret Service Methods thoroughly, quickly, at small cost. Over 800 of all American Bureaus of Identification employ I. A. S. students or graduates. We can prepare you for this fascinating work during spare time. Write today, stating age, for "Blue Book of Crime."

INSTITUTE OF APPLIED SCIENCE, 1920 Sunnyside Ave., Dept. 135-A, Chicago 40, Ill.

Become a Doctor of PSYCHOLOGY

Win the degree of Ps.D. Teach the secret of contentment, happiness. Solve mental worries. Experience the revelation of truth. Chartered college. Individual help. Write for FREE book. **COLLEGE OF UNIVERSAL TRUTH, 5153-B North Clark St., Chicago.**

Find HIDDEN TREASURES



GEIGER COUNTERS for Uranium Detection. (see at left). **TREASURE DETECTORS** for gold, silver, etc. Lightweight, ultra sensitive. None finer at ANY PRICE. Information FREE.

Detection Co.
5631 Cahvonga, No. Hollywood, Calif.

STAMMERER?

New booklet, "Stammering, and How to Stop It," sent free to any stammerer upon request. Write today. **BENJAMIN N. BOGUE, Dept. 514, Circle Tower, Indianapolis 4, Ind.**

GET THIS FREE BOOK!

RAISE RABBITS, HAMSTERS, Cavies & Chinchillas FOR FUR and BREEDING PURPOSES

Big Demand - Steady Income - From a Growing and **PROFITABLE INDUSTRY**

START A PAYING BUSINESS TODAY

Small space required, a ready market, descriptive folder and magazine 10¢. Book - RAISING SMALL STOCK and Magazine 25¢. All the above and magazine (Monthly) for one year \$1.00

Small Stock Farmer, Holmes Park 1, Mo., HAMSTER.

SAY YOU SAW IT IN POPULAR MECHANICS



MAGIC "ZIP" TOOL

FOR AUTOIST, HANDYMAN

New Triple Bit 3-in-1 screwdriver with interchangeable bits. Insert bit into handle . . . and out zips new bit. Contains 9/32" flat, 3/16" flat and #2 Phillips Star bits. A must for home, shop, auto. Ideal gift. Not sold in stores. 10-day money back guarantee. Reg. \$4.50 value.

FREE! tube of Dixon's Microfyne Powdered Graphite for locks, hinges, etc. included. Special **\$2** post-paid

ARROTT SALES CO. PO BOX 9520 PHILA. 24, PA.



WOULDN'T TAKE \$1000 FOR COURSE

"The lessons are so simple that anyone can understand them. I have learned to play by note in a little more than a month. I wouldn't take a thousand dollars for my course." *S. E. A., Kansas City, Mo.



PLAYS ON RADIO

"I can't keep from telling you that I have a good position playing from KTHS, Hot Springs, Ark., every morning."

*J. S., Okla.



PLAYS AT DANCES

"The Piano course I'm taking is the 3rd course with your school. Previously I took Saxophone and Clarinet. Since then I've played a lot of dance jobs."

*E.A., Lake View, Iowa

THOUSANDS NOW PLAY who never thought they could!

You, too, can play any instrument by this EASY A-B-C METHOD

YOU think it's difficult to learn music? That's what thousands of others have thought! Just like you, they longed to play some instrument. But they denied themselves the pleasure — because they thought it took months and years of tedious study to learn.

And then they made an amazing discovery! They learned about a wonderful way to learn music at home — without a private teacher — without tedious study — and in a surprisingly short time. They wrote to the U. S. School of Music about this remarkable short cut method. A free print and picture sample actually showed them how easy it was to learn.

The result? Over 950,000 people have studied music at home this simple, A-B-C way. They have found the key to good times, popularity and profit.

And that's what you can do right now. Simply mail the coupon. Get the proof that you, too, can learn to play your favorite instrument — quickly, easily, in spare time at home. Just read the fascinating illustrated booklet — examine the print and picture sample. Tear out

the coupon now, before you turn the page. Instruments supplied when needed, cash or credit. U. S. School of Music, 76 Brunswick Bldg., New York 10, N. Y. 53rd year. (Established 1898.)

*Actual names on request. Pictures by professional models.

FREE! Print and Picture Sample

U. S. School of Music, 76 Brunswick Bldg., New York 10, N. Y.

I am interested in music study, particularly in the instrument indicated below. Please send me your free booklet, "How to Learn Music at Home" and your Print and Picture Sample. (Do you have instrument?.....)

Piano	Piano Accordion	Reed Organ	Clarinet
Guitar	Saxophone	Tenor Banjo	Trombone
Violin	Trumpet, Cornet	Ukulele	Other Instrument

Name..... (PLEASE PRINT)

Street.....

City..... State.....

Check here if under 16 years of age.

SAVE 2c — Stick coupon on penny postcard

GET FASCINATING NEW FREE PROFIT PLAN



Tired of monotonous, low-pay jobs — of working for the other fellow? Tap rich profits in huge NEW field. Have your own lifetime business — earn REAL money —

say goodbye forever to time clocks bosses! Become part of tremendous expanding industry — yet work right at home!

LEARN IN A FEW DAYS THROUGH PROVED, TESTED METHODS

to start earning more money with this amazing MIRACLE finish — gives a velvety, luxurious surface to radios, lamps, toys, signs, store displays,

figurines, auto dashboards — hundreds of items. FREE PROFIT PLAN offers everything you need to start at once. Fill out coupon, mail today.

SEND NO MONEY. I WANT YOU TO EXAMINE EVERYTHING WITHOUT RISKING A CENT.

BIG DEMAND FOR NEW MIRACLE FINISH. We show you every step. Filling huge year-round demand...easy to understand instructions tell you how. Earn up to \$5 an hour spare — full time. A few cents' worth of materials — brings you dollars!

GRASP THIS OPPORTUNITY TODAY. It's too good to miss... Fill out coupon, mail today. Get FREE sample, FREE plan, big IDEA booklet. No salesman will call! Do it NOW... be first in your community to cash in on this huge new market!

COAST INDUSTRIES Dept. 26, 1004 S. Los Angeles Street Los Angeles 15, California.

INVESTIGATE TODAY!

USE COUPON FOR FREE SAMPLE

COAST INDUSTRIES Dept. 26
1004 S. Los Angeles Str., Los Angeles 15, Calif.
Gentlemen: Please rush me all details FREE



NAME.....
STREET.....
CITY..... STATE.....

PROFIT UP TO \$500 PER HOUR

★ GET ON "UNCLE SAM'S" PAYROLL ★

START AS HIGH AS \$3,450.00 A YEAR

**MEN — WOMEN
EMERGENCY PROGRAM CREATING
THOUSANDS OF ADDITIONAL JOBS!**

Mail Clerks and Carriers, Rural Carriers, Stenographer-Typists, Clerks, Messengers, and many others.

40-page book on Civil Service FREE

Mail Coupon TODAY
ACT NOW

JUNE 1951

FRANKLIN INSTITUTE (Not Government Controlled)
Dept. T-83, Rochester, N. Y.

Sirs: Rush to me, without charge, copy of 40-page book, "How to Get a U. S. Government Job," list of positions, and full particulars telling how to qualify for them.

Name.....

Street.....

City..... Age?.....



HERE'S YOUR CHANCE!
BIG MONEY
IN DRAFTING

LEARN IN SPARE TIME AT HOME

Gain Drafting and Blue Printing training in your spare time. Both professions command big earnings. Before production starts plans must be drawn. Blue print reading is essential in every shop and on every construction job.

Clear Understandable Training

Offered by CTS who have trained thousands of men thru correspondence and having them learn by working with their hands. You are sent professional drafting instruments, a drafting table, study manuals, etc. . . . Learn by making actual drawings.

Big Money . . . Advancement Opportunities
 Offered trained draftsmen. It is light, pleasant work, paying big salaries. Drafting is the stepping stone to top managerial jobs. It is work that stimulates the mind . . . Keeps one interested.

A Business of Your Own

Either as an independent drafting firm or as the operating head of a business firm producing products you created.

MAIL THIS COUPON TODAY

CHRISTY TRADES SCHOOL, Dept. DB-1003
 4432 N. Kedzie Ave., Chicago 25.
 Mail me at once your big FREE book on Drafting and Blueprinting. Tell me how your Home Training and Professional Drafting Instruments, Drafting Table, Drafting Equipment, etc. can be had on a PAY AS YOU LEARN plan.

Name _____ Age _____
 Address _____ City _____ State _____

ASK FOR FREE CATALOG



MAKE GOOD MONEY in

Television Servicing

TV is expanding—and it pays big!

Get this brand-new, complete handbook for sure-fire working knowledge of TV installation, maintenance and trouble-shooting. Tells you step-by-step procedures for audio IF alignment, video IF alignment, aligning RF amplifiers, mixers, oscillators, etc. All possible defects classified for ready reference, thoroughly analyzed to show what is wrong and why . . . and what to do to correct the defect. No mathematical knowledge needed! Practical, authoritative, up-to-the-minute, the perfect handbook for set owners, trainees, and repairmen.

USE IT 10 DAYS FREE

Coupon below brings you "Television Servicing" on FREE trial for 10 days, without obligation. Mail it NOW.

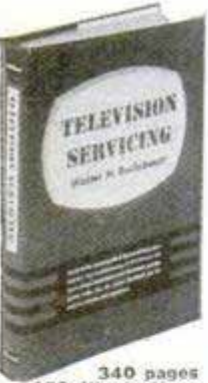

Symptoms of defective operation easily recognized, quickly corrected by illustrations, diagrams and how-to-do-it facts in this new book.

PRENTICE-HALL, Inc., Dept. M-PM-651
 70 Fifth Avenue, New York 11, N. Y.
 Send me, for 10 DAYS' FREE TRIAL, "Television Servicing." I will return it in ten days and pay nothing—or keep it and send \$1.35 down (plus postage) and \$2 monthly for 2 months.

NAME _____
 ADDRESS _____
 CITY _____ STATE _____

SAVE! Send \$5.35 with this coupon, and we'll pay postage and packing.

Ships
e Sailing



Enjoy a Year of "Salty" Reading

Almost as good as an ocean cruise—a year's voyage with the exciting new magazine, SHIPS & SAILING. Each issue is loaded to the hatches with fascinating illustrations, stories of famed small boat passages, tramp steamer and ocean liner cruises, salty yarns, charts, adventure, port stories and a model ship-building section. Send \$5.00, check or money order, for year's subscription. Your money back after 2 issues if not more than satisfied! Send remittance today to Kalmbach Publishing Company, Dept. 1554, Milwaukee 3, Wis.

THE MAGAZINE THAT BRINGS THE SEA TO YOU

WHAM-O SPORTSMAN*

\$1.25 PER PAIR

45-LB. PULL!

HITS LIKE A .22 RIFLE—KILLS RABBITS, SQUIRRELS. Powerful, silent, accurate. For hunting, target, routing pests.

Sportsman's choice sold world over!

HUNTING SLINGSHOT



Heavy duty 7" ash stock. 40 steel balls, extra rubber, target. GUARANTEED—at dealers, or send \$1.25 to Whom-O Mfg. Co., Box 1, South Pasadena, Calif. *Professional model of Nat'l Slingshot Assn.

JITTERBUG • CATCHES MORE FISH

The old favorite. Noisy surface bait. World's best hooker—day or night. Gurgling, paddling action of the double-lobed lip makes fish strike hard. At your dealer 5/8 oz. or 3/8 oz. \$1.25. Musky size \$2.00.



FRED ARBOGAST & Co., Inc., 2246 W. North St., Akron 3, Ohio

FREE WRITE TODAY FOR BIG FREE 1951 ARBOGAST COLOR CATALOG—FULL OF PICTURES OF CATCHES

Learn CARTOONING

HAVE FUN! MAKE MONEY! Cash in on your sense of humor at HOME—BY MAIL. No experience needed to start. Write today for FREE TRIAL LESSON and full particulars.



MOON Gag Cartoon School, Dept. J, Fall Creek, Wis.

Bar Bells



Buy Direct From Factory Approved and Recommended by Karl Koberle (Foremost Ex-Army Instructor on Weight Training). **\$8.95** up

Write for free booklet and price list. **INDEPENDENT IRON WORKS**
 2416 East 23rd Street, Dept. B
 Los Angeles 58, Calif.



\$500,000.00 INVENTORY for QUICK LIQUIDATION

Surplus items—hundreds of them for home, shop, factory, farm and outdoor use. New items, used items, reconditioned items—all at tremendous savings—all priced for quick sale.

Page After Page of Values

This big catalog shows page after page of amazing money saving values. Write for your copy today. Send 10c to cover postage, mailing, etc. Write today!

SEND TODAY FOR YOUR COPY **10c**

STARK'S Dept. 509 So. STATE STREET PM-6 CHICAGO 5, ILLINOIS

DRIVING RELIEF! New LEFT-FOOT ACCELERATOR

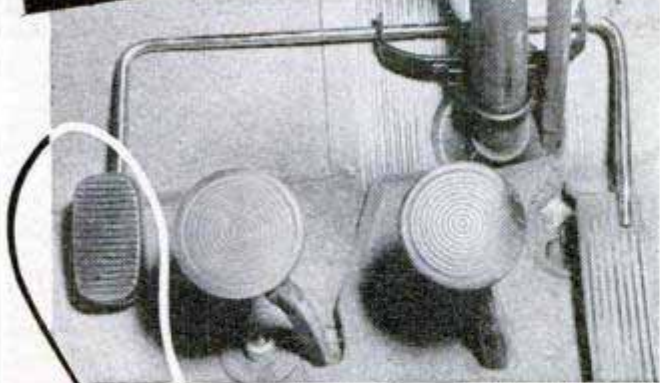

Dealer inquiries invited.

Cut driving fatigue in half with Lefty! Install this new left foot accelerator yourself in 60 seconds with just a wrench—no alterations to your car are necessary. Enjoy relaxed comfort on long drives. Lefty lets you feed the gas with your left foot when you desire, relieves tension and fatigue in leg, back, and foot. Safe, positive and convenient. Swings out of way when not in use. Brings your car up to date. \$5. ppd. Specify year and make. No COD's please.

INVENTOR'S MARKETING LAB.
1210-D De Young Bldg., 690 Market St., San Francisco, Calif.

WOULD YOU \$400 PER MONTH INTEREST YOU?



EARN UP TO \$400 A MONTH raising Angora or New Zealand White Rabbits. Good markets for wool, pelts and meat. Particulars free.

WHITE'S RABBITRY, Newark 10, Ohio.

WANT TO Write Stories FREE LESSON shows how you learn at home



Articles? Mysteries?

The demand for writers is creating great new opportunities and it's not as hard to succeed as you may imagine. At home, you may learn fiction writing, best basis for all fields; short stories, radio & TV, articles, business items. Palmer training is endorsed by famous authors, scores of successful graduates. Complete instruction, professional coaching. FREE book and lesson show how you may enjoy an ideal part-time or full-time career. Write TODAY (no salesman will call). Approved for veterans: advise if eligible.

PALMER INSTITUTE OF AUTHORSHIP, Since 1917
1680 N. Sycamore, Hollywood 28, Calif., Desk T-61



FULLY GUARANTEED TIRES COST LESS!

Nationally famous FIRESTONE, GOODRICH, U.S. ROYAL, GOODYEAR, and other makes. Every tire selected and inspected for your safety.

NEW TREAD TIRES GUARANTEED 24 MONTHS										
S	550x16	9.98	600x16(6)	11.98	650x20(8)	21.95	700x16(6)	16.48		
A	550x17	9.98	650x15	11.98	640x15	10.98	710x15	12.98		
L	600x15	9.98	650x16	12.48	670x15	11.98	760x15	13.98		
E	600x16	9.98	650x16(6)	14.48	700x15	13.48	820x15	14.98		
GOOD TIRES GUARANTEED 12 MONTHS										
S	600x16	4.14	700x16	5.14	32x6(8)	8.84	825x20	14.24		
A	650x16	4.54	670x15	4.74	32x6(10)	10.84	900x20	13.34		
L	650x15	4.34	650x20	7.84	750x20(8)	8.54	1000x20	14.14		
E	700x15	4.64	700x20(8)	8.94	750x20(10)	9.94	1100x20	16.14		
AAA PREMIUM GRADE GUARANTEED 18 MONTHS										
S	600x16	5.58	710x15	6.48	650x20	10.8P	825x20	17.68		
A	650x16	5.9P	550x18	5.98	700x20	12.88	900x20	18.98		
L	650x15	5.98	500x19	5.48	32x6(8)	10.48	1000x20	19.98		
E	700x15	6.6P	760x15	6.78	32x6(10)	12.48	1100x20	20.98		
	700x16	6.78	550x17	5.88	750x20(8)	12.98	1100x22	21.98		
	820x15	7.48	600x20	9.78	750x20(10)	14.9P	1400x20	54.98		

MILITARY AA Guaranteed 12 Months—
SPECIAL 900x16 11.98 1000x20 19.9P
750x20 12.89 1100x20 21.98

AAA GUARANTEED 18 MONTHS
900x16 14.98 • 750x20 16.48
Passenger Tubes—Water Tested—All Sizes . . . \$1.50
Truck Tubes—Water Tested—All Sizes . . . \$4.95

Largest stock of used tires in the East. Thousands of satisfied customers. Write for sizes not listed.
MONEY ORDER OR CHECK WITH ORDER.
NO C.O.D.'s

PYRAMID TIRE CO.
1333-35 North 5th St.
Dept. M., Phila. 22, Pa.

PENNA'S LARGEST STOCK

PENNA'S LARGEST STOCK

HOME OWNERS! LEARN and SAVE, BEGINNER! REPAIR or BUILD TRADE EXPERT! with these practical books.

CONCRETE BLOCK BUILDING

Concrete Block Construction for Home and Farm by Dalzell & Townsend. No need for any previous building experience to build that garage, summer home or milk house with concrete blocks. This practical guide shows every step from how-to-plan to how-to-build with one of the most plentiful and economical building materials known to man. Over a hundred pictures and cutaway diagrams show exactly what to do and what not to do. Tells how to place corner block, how to make foundations easy, how to paint for special purposes. A picture story of everything in building any type of structure with concrete blocks, easily and cheaply. 216 pages. Profusely illustrated. Use handy free trial coupon below. \$2.75

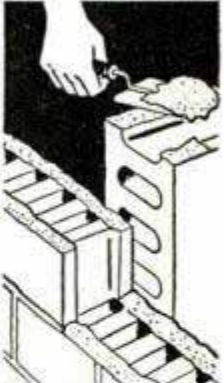

CARPENTRY FOR EVERYONE



Carpentry by Gilbert A. Townsend. A clear explanation of modern carpentry construction including framing, roof constructions, general carpentry work, exterior and interior finish of buildings, building forms and working drawings, and farm buildings. Covers everything you need to know about lumber, tools, joints and splices, floors, stairs, partitions, rafters, etc. Gives short cuts and tricks used by the master carpenter. Easy-to-understand, 504 pages, 580 illus. \$2.50. Use no-risk coupon below.

INSTALL & REPAIR YOUR OWN PLUMBING

How to Design and Install Plumbing by A. J. Matthias, Jr. A guide that fits the needs of the beginner yet so complete that even the master plumber can pick up some new tricks of the trade. Contains hundreds of illustrations, full-size blueprints, specifications and instructive details for septic tanks, storm drainage, soil pipe, water supply, fixtures, traps, drains, pumps, etc. An outstanding feature is complete design and installation of plumbing in a modern six-room, two-bath residence. 349 illustrations, 442 pages. \$3.50. Use free-trial coupon below.



IT'S EASY TO REMODEL!



How to Remodel a House by Dalzell and Townsend. With this practical, easy-to-understand book, crammed with clear explanations and illustrative examples, you can remodel any house and save thousands of dollars. Learn to plan the remodeling of rooms by a method that's like playing with blocks! Tells how to read architectural plans, shows structural details, covers stairs, insulation, bathrooms, kitchens, heating and air conditioning, etc. Sixteen full-size blueprints. 505 pages, 350 illustrations. \$5.00. Mail no-risk coupon below!

MAIL THIS NO-RISK COUPON! DON'T DELAY!

American Technical Society 819
848 E. 58th Street, Chicago 37, Illinois
Please rush me the following How-to-Do-It-Books I am checking below. If I'm not convinced that these books will help me save many thousands of dollars by building and planning myself, I may return the books within 10 days and receive full and immediate refund.

- CONCRETE BLOCK CONSTRUCTION FOR HOME AND FARM\$2.75
- CARPENTRY 2.50
- HOW TO DESIGN AND INSTALL PLUMBING.... 3.50
- HOW TO REMODEL A HOUSE..... 5.00

Print Name _____
Address _____
City & Zone _____ State _____
 I enclose _____ in full payment. Ship prepaid.
 Ship C.O.D. for _____ plus postage and C.O.D.

SPEED & POWER

HANDBOOK for all cars

1951
**SPEED
and
POWER**

From
**THE ONLY SCHOOL
OF IT'S KIND**

DIRECT FROM THE CALIFORNIA DRY LAKE TESTING GROUNDS . . . COMES AUTHENTIC, PROVEN INFORMATION ON HOW TO GET LIGHTNING SPEED, SUPER POWER AND BETTER MILEAGE FROM ANY CAR! Illustrations and construction drawings show how to build fast stock cars, California Roadsters and 225 M.P.H. Hot Rods.

Easy, Step By Step Methods help you save by building your own dual manifolds, superchargers, hot cams, water injectors, high compression heads and mileage devices.

50 BREATH TAKING CHAPTERS TELL ABOUT: Turning techniques, Speed tricks, Economy secrets. Ingenious formulas for attaining racing speed and dynamic power. Includes information on: Racing Frames, Reciprocating Masses, Jet Engines, Wheel Geometry, Dynamometers. Also Re-styling and Customizing all cars. Learn about dual pipes, gears, fuels, porting, relieving, lowering and balancing.

This Great New Book . . . Plus "1951 Speed Equipment Catalog", Plus "Water Injection" Plus "150 M.P.G. Book"—ALL 4 ITEMS **\$1.98** post-paid

HOW to obtain
**150
Miles Per Gallon**

From
**THE ONLY SCHOOL
OF IT'S KIND**

GET 150 MILES PER GALLON

WITH YOUR OWN CAR

Full sized modern cars actually get over 100 miles per gallon with regular gas. This sensational book tells you how and suggests amazing economy methods. Send only 50c for book, "How to Obtain 150 M.P.G." . . . plus our big 1951 Speed Equipment catalog Both Books listing and picturing hundreds of automotive items. **50c Postpaid**

NEWHOUSE AUTOMOTIVE INDUSTRIES
Dept. B-6, 5807 East Beverly Blvd., Los Angeles 22, Calif.

WAR SURPLUS OPTICAL BARGAINS

MAKE A MICROSCOPE Get wonderful results. Own an instrument worth many times the cost to you. Simply convert a U. S. Govt. Rifle scope (Govt. cost over \$65.00). It's easy! We show you how. No machining required. Get up to 40 Power. Scope we furnish is used but good condition . . . sent complete with extra lenses and direction sheet.

Stock #959-H **\$7.90 Postpaid**

10 POWER SPOTTING SCOPE —A WONDERFUL BUY! Pocket size! Complete with tripod and swivel head. Only 5 1/2" long—8 1/2" high on tripod. Adapted from Army telescope and worth many times our price. Has prism erecting system, achromatic objective, Ramsden Eye-Piece. Lenses low reflection coated.

Stock #955-H **\$14.95 Postpaid**

SLIDE PROJECTOR SETS Consists of all unmounted lenses you need to make the following size projectors:

Stock #4029-H—35 mm. **\$2.85 Postpaid**
 Stock #4038-H—2 1/4" x 2 1/4" **\$3.35 Postpaid**
 Stock #4039H—2 1/4" x 3 1/4" **\$3.35 Postpaid**

SIMPLE LENS KITS —Include plainly written, illustrated booklet showing how you can build lots of optical items. Use these lenses in photography and for dozens of other uses in experimental optics, building TELESCOPES, low power Microscopes, etc.

Stock # 2-H—10 lenses **\$ 1.00 Postpaid**
 Stock # 5-H—45 lenses **5.00 Postpaid**
 Stock # 10-H—80 lenses **10.00 Postpaid**

We Have Literally Millions of War Surplus Lenses and Prisms for Sale at Bargain Prices. Numerous Types of Instruments. Too! Write for FREE CATALOG-H

EDMUND SCIENTIFIC CORP., Barrington, N. J.
(Formerly Edmund Salvage Co.)

INVENTORS

Before you make any effort to market your invention, you should take the first steps toward proceeding for patent protection.

The usual first step is to have a search of the U. S. patent records conducted, so that I can report to you on the question of patentability.

I shall be pleased to furnish you with information relative to patent procedure, upon request from you, and this will be without any obligation on your part.

PATRICK D. BEAVERS

(Formerly RANDOLPH & BEAVERS)
Registered Patent Attorney
934 Columbian Building Washington 1, D. C.

Learn WOOD PRODUCTION ENGINEERING

At Home In Your Spare Time

Veterans
You must enroll in training before July 1st to get it free under the G. I. Bill. Act Now!

NON-VETERANS
Money Back Trial Offer

From
**THE ONLY SCHOOL
OF IT'S KIND**

FREE Booklet

STEPPING STONES

Prepare now for a top pay position in the furniture and woodworking industry . . . with KLOK SPECIALIZED TRAINING. Teaches you the arts of Sketching—Drafting—Rod Making—Time Study—Cost-Production Scheduling in our Home Study Course or Resident Course at Grand Rapids. An aid to hobbyists . . . to the successful operation of your own shop.

WRITE TODAY— for FREE Booklet that gives you ALL the fascinating facts. State age, veteran, non-veteran, Home Study or Resident Course preference, occupation.

JOHN H. KLOK, Pres. Woodworking Industry Training Since 1928
KLOK INSTITUTE, E, Louis St. N.W., Grand Rapids 2, Mich.

MAKE MONEY RAISE Pedigreed RABBITS FOR US!

Grinstead's Famous ANGORAS, GIANT CHINCHILLAS and NEW ZEALANDS (World's Most Profitable Rabbits) We buy ALL you raise—ALL the time! Write today for FREE INSTRUCTIONS, Illustrated Literature, and Prices.

GRINSTEAD FARMS, Dept. 70, Edwardsville, Ill.

PATENTS PATENT LAWYER

GUSTAVE MILLER

REGISTERED PATENT ATTORNEY
61-PM WARNER BLDG.
WASHINGTON 4, D. C.

ASSOCIATE EXAMINER
U. S. PATENT OFFICE 1922-1929
Patent Attorney and Advisor
U. S. NAVY DEPT. 1930-1947

Send for
PATENT INFORMATION book
and "INVENTOR'S RECORD"
without obligation

WATCHMAKING

Learn at home • FREE sample lesson

CHICAGO SCHOOL OF WATCHMAKING

1608 N. Milwaukee Avenue Dept. 161 Chicago 47, Ill.

INVENTORS

Whether an invention is patentable can be substantially determined by a search of the U. S. Patent records. Without obligation, write for information explaining the steps you should take to secure a patent.

JOHN N. RANDOLPH

Registered Patent Attorney
201 Columbian Building, Washington 1, D. C.

PATENTS

C. A. SNOW & CO.

REGISTERED PATENT ATTORNEYS

WRITE FOR INFORMATION TO

428 SNOW BUILDING, WASHINGTON 1, D. C.

SAY YOU SAW IT IN POPULAR MECHANICS

INVENTORS

IF YOU WISH TO PROTECT YOUR INVENTION, You should take steps to protect it by a U. S. Patent. Write me for "INVENTION RECORD" form

CARL MILLER

REGISTERED PATENT ATTORNEY
WOOLWORTH BLDG., 35th FLOOR, 61A
NEW YORK CITY

LET ME PROVE I Can Make YOU a New Man!



Charles Atlas—winner of title "World's Most Perfectly Developed Man"

I'VE done it for thousands of other fellows. Let me prove I can add solid inches of handsome, rippling muscles to YOUR arms, legs, shoulders, back . . . make you an outstanding specimen of strength and self-confidence. My secret of "Dynamic Tension" does it in just 15 minutes a day. You'll be amazed at the results and so will your friends.

**SEND FOR MY
FREE BOOK**

48 pages packed with valuable advice, actual photographs of fellows who became new men almost overnight . . . with "Dynamic Tension." Book can mean turning point of your life. It's yours—ABSOLUTELY FREE! Send for it TODAY. Address me personally: CHARLES ATLAS, Dept. 8F, 115 East 23rd St., N. Y.



5 INCHES OF
NEW MUSCLE

"My arms increased 1 1/2"; chest 2 1/2"; forearm 3/4".
C. S., W. Va.
"Have put 3 1/2" on chest (normal) and 2 1/2" (expanded)."
F. S., N. Y.

New Advertising Machine Prints Post Cards

FREE LEARN HOW thousands of business men, in every line, boost sales in spite of conditions—with ads printed on postcards by amazing new patented **CARDMASTER** advertising machine. Low price, sold direct. Guaranteed 5 years. **SEND NAME** for **FREE** illustrated book, new money-making ideas and complete, unique advertising plans.



Cardmaster Co., 1920 Sunnyside, Dept. 136, Chicago 40, Ill.

Limit—2 to a Customer!



WORLD'S TINIEST LIGHTER SMALLER THAN A POSTAGE STAMP

Covered with Genuine Reptile, Personalized with Your Initial! Everyone will gasp with amazement when they see you use this imported lighter! Smaller than a postage stamp, but NOT A TOY! Built like a fine watch. Covered with genuine Reptile leather—then personalized with your initial in gleaming chrome! Uses regular fuel and flints. Will last a lifetime! **SEND NO MONEY!**

Rush name, address and initial. Pay postman only \$1.25 (\$1.00 for plain Lighter) plus 35c postage on delivery. Or send only \$1.00 with order and save 25c initial charge and 35c postage. Money back in 10 days. **DRESDEN ART WORKS, Dept. 286, 169 W. Madison St., Chicago 2, Ill.**

MONTH AFTER MONTH, YEAR AFTER YEAR, YOU SEE OUR AD.

REMEMBER IT'S DANGEROUS to pay less if you want the finest matched **GOOD YEAR** tires.

GOOD YEAR Firestone
GOODRICH, UNITED STATES, GENERAL & OTHERS, NOT RECAPS

Our policy is to select your tires so carefully, as if our very future depended on the service given by that particular tire.

FREE TUBE WITH "ALL" BLATT'S GOOD GRADE TIRES			
GOOD GRADE, 18 MONTHS GOLDEN RULE GUARANTEE BOND.			
600-16	\$4.14	700-15	\$4.54
650-16	5.42	670-15	4.74
700-16	5.04	710-15	4.94
650-15	4.44	550-17	4.64
600-20	\$7.94	650-20	8.54
700-20	8.54	750-20	8.64
825-20	15.92	900-20	13.94
1000-20	13.94		

FINEST GRADE, 26 MONTHS GOLDEN RULE GUARANTEE BOND
THIS GRADE MADE THE BLATT NAME "WORLD FAMOUS".

FINEST MATCHED TIRES		FINEST MATCHED TRUCK TIRES	
600-16	\$5.49	650-15	\$5.94
650-16	6.42	670-15	6.24
700-16	5.94	700-15	6.54
750-16	7.94	710-15	6.34
550-17	5.94	760-15	6.54
525-18	5.54	820-15	7.04
700-17	10.00	475-19	5.94
600-20	\$9.94	650-20	9.94
700-20	11.94	750-20	11.94
825-20	15.94	900-20	13.94
900-20	13.94	1000-20	13.94

900-16	750x16	Military	750-20
Reg. \$10.94	Reg. \$14.44	Reg. 16 months	Reg. \$10.44
Super 19.94	Super 18.74	Super 30 months	Super 18.64

BLATT BLATT BLDG., GIRARD & LANCASTER AVES., DEPT. PM., PHILADELPHIA 31, PA.
Send check or money order and this ad for rush shipment. We won't ship a tire we wouldn't use. The name to trust in rubber. PRICES SUBJECT TO CHANGE.
Shipments RUSHED Down South, Up North and Far West

Throw Away NICOTINE*

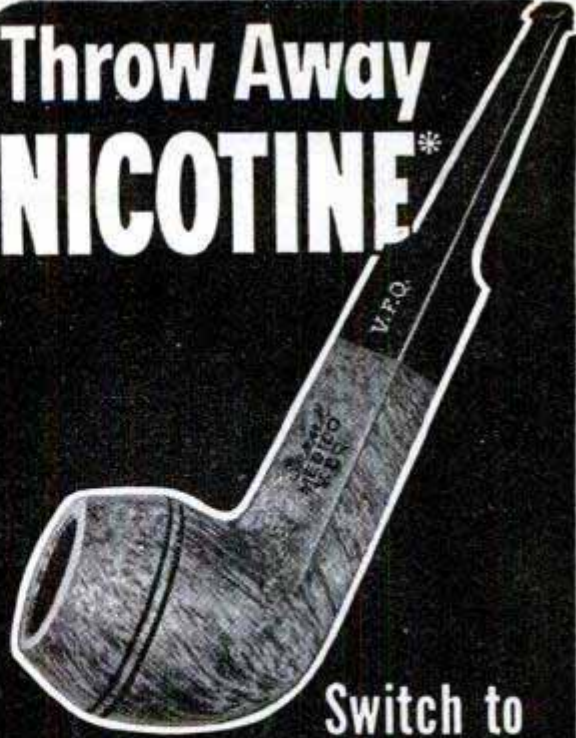

Switch to

MEDICO FILTER PIPES



* When filter turns brown—in Medico Pipes or Cigarette Holders—throw it away, with the nicotine, juices, flakes and tars it has trapped. Insert fresh filter for cooler, cleaner, dryer, sweeter smoking.

MEDICO V.F.Q.
(Very Fine Quality)
Pipes of fine selected imported briar.
With 10 filters — \$2

MEDICO MEDALIST
Just Introduced! Pipes of the choicest imported briar.
Splendid value—\$1.50

Wide variety of styles and sizes.
Write S. M. Frank & Co., N. Y., for Booklet M

MEDICO CIGARETTE HOLDERS—\$1

A FASCINATING, MONEY-MAKING art career can be yours

AMERICA'S 12 MOST FAMOUS
ARTISTS SHOW YOU HOW!



Write Today
FAMOUS ARTISTS COURSE
Dept. 6-T, Westport, Conn.

FREE Send book about your home study art course.

Name _____ Age _____

Street _____

City, State, Zone Number _____

FREE

A NEW HOME INDUSTRY



Let us show you how extremely easy and PROFITABLE it is to make beautiful and useful things out of LIQUID PLASTICS, LIQUID MARBLE, LIQUID IVORY, LIQUID GLASS, CERAMICS, ETC. . . . as easy as pouring water out of a glass! We have started THOUSANDS of people in this fascinating and very PROFITABLE home occupation! Make novelties, jewelry, gifts, artware, toys, tools, dies, gadgets, ceramics . . . a million useful things! We supply everything—MATERIALS, INSTRUCTIONS and BUYERS! Send only 25c for 1. Big catalog of 300 casting materials, molds and accessories. 2. A beautiful CASTING FREE (to show you what you can do), and 3. Actual INSTRUCTIONS on how to cast and start in the CASTING BUSINESS! VALUABLE MOLDS given FREE with orders! Send 25c today — this may be the lucky coin that will start the most fascinating and profitable phase of your life.



BILLIONS for DEFENSE!



The country is preparing the greatest peace-time defensive in history . . . BILLIONS are being spent! Our liquid plastics are being used in THOUSANDS of different operations in defense work! NO SPECIAL TOOLS OR MACHINERY REQUIRED! Work can be done at home, garage, shop, etc. Full time or spare time, by the able and the disabled. We help you get defense work and instruct you in all the details! Send 25c for catalog (see above) and details how to take part in this tremendous defense program that offers you a grand opportunity to combine patriotism and profit!

PLASTICAST COMPANY (Dept. C)

P. O. BOX 6737 (Write to P. O. BOX 987
CHICAGO 6, ILL. either address) PALO ALTO, CALIF.
CANADIAN CUSTOMERS, please order directly from:
CANADIAN INDUSTRIAL PLASTICS, LTD., 1056 1/2 Pen-
der West, Vancouver, B. C.

NOW—A JET-POWER PROFESSIONAL NOZZLE AT A HOME-USE PRICE

Soft mist or jet power. ELKAY delivers every water pressure needed around every home and shop. Yet it costs no more than old-fashioned 1-pattern nozzles!

\$1.89



Easy to use! Efficient! Expensive-looking! Effective! Precision made from light-weight, rust-proof Zamac alloy, the ELKAY is a professional nozzle in everything but price. With any water pressure—with any garden hose—one ELKAY puts every possible span and spray at your finger-tips!

ELKAY for gardening: Controlled irrigation (success secret of commercial growers) with a flick of your thumb. Every pressure from soft mist to sharp jet.

ELKAY for home care: Cleans exterior walls, cures new cement and stucco, cuts away mortar over-laps, cleans grease, grime, saw-dust from garage and shop.

ELKAY for car care: Washes windows and body with less water. Cuts mud from chassis and fender wells. Cleans car top quickly without climbing or reaching.

ELKAY for fire safety: POWERFUL ELKAY JET REACHES A TWO-STORY ROOF WITH QUICK-QUENCHING VOLUME—TO GIVE YOUR HOME A "FIRE HOSE" PROTECTION WITH A "GARDEN HOSE"!

Albin guarantees to refund your money if you're not satisfied.

\$1.89 postpaid (postage extra on C.O.D.'s)

Albin OF CALIFORNIA, Room 66
1401-55 West 8th Street
Los Angeles 17, California



Improved Americanized

JUDO

"THE BIGGER THEY ARE—
THE HARDER THEY FALL!"

Two Big Books Clearly Illustrated. Over
1200 Show-How Photos. Many New Holds!
71 Complete Lessons.

Protect yourself and others. Size and strength mean nothing. Knowledge and skill enable you to master any situation even against biggest bullies and armed thugs. Illustrations showing each hold from start to finish. Complete satisfaction guaranteed or your money refunded.

NOW VOL. I & VOL. II \$5.00 pp'd.

or **\$3.50 ea.** \$1.00 deposit with C.O.D.'s.

No C.O.D.'s outside U.S.A.

IMPROVED JUDO, INC. Dept. PM-6, P.O. Box 7355,
Sta. L, Los Angeles, Calif.



**10 DAY
FREE
TRIAL!**

BECOME AN EXPERT IN

TRAFFIC

Traffic men earn \$4,000 to \$10,000 and up. Thousands of firms need experts on rates, tariffs, regulations. We train you thoroughly in spare time at home for executive traffic jobs. Personal training under traffic authorities. Placement counsel and help. Write for free 48-page book "Traffic Management—the Fast Growing Profession."

LASALLE Extension University, 417 So. Dearborn St.
A Correspondence Institution Dept. 6647 Chicago 5, Ill.

Watch Repairing Pays Big Money Learn at home



Watchmakers in great demand. Train step-by-step under experts. We furnish all tools and 15 jewel watch and practice movement. Turn spare time into cash. 10 easy lessons. A licensed school. Low cost. Send for FREE book today.

ILLINOIS SCHOOL OF WATCH REPAIRING
2870 Elston Ave., Dept. PM61, Chicago 18, Ill.

CHAPMAN CHINCHILLAS

The originator of the first Chinchilla Farm in the United States. For information on purchasing the finest, selected breeding stock of these aristocratic animals that were virtually trapped to extinction write or visit—

Established 1919 Chapman Chinchilla Farm
"P. O. BOX 221" 4957 West 104th Street
Inglewood, California

WANT \$10,000?

Earn the govern- Super Sensitive P.R.I.
ment bonus. Locate Uranium with a GEIGER COUNTER

Also get one for Atom Bomb Defense!

Find gold, silver, and other valuable ores with a P.R.I. Treasure Locator. World's finest instruments. FREE catalog. Write!

PRECISION RADIATION INSTRUMENTS

4113PM W. Jefferson, Los Angeles 16, Cal.

Dealer Inquiries
Invited



SAY YOU SAW IT IN POPULAR MECHANICS

"It Measures As It Rolls"

ROLLER RULE

HANDY MECHANICAL PENCIL

Measures Curves and Straight
Lines. Any Shape. Any
Distance. Any
Surface.

\$1.29
POST
PAID

Roll head over surface.
Inches and fractions record
accurately on "Inch-O-Meter".
Excellent pencil too! Order Now!
10 Day Money Back Guarantee!
C.O.D. (postage extra). In Calif. add
3% Sales Tax.

PENCIL SALES CO., Dept. PM6
Room 6, 1213 E. Ocean Blvd., Long Beach, California



8 POWER
30 mm
Only

\$9.95

9 x 50
Only

\$17.95

prepaid
(C.O.D., \$2 deposit)

PRISMASCOPE

Prismatic Telescope

*TRY 5 DAYS!

Money back if you don't agree it's the greatest optical value ever.

CASE included without extra charge. Tough, long-wearing. Limited quantity—get in your order while cases last!



*YOU TRY IT!



* Use this great NEW PRISMATIC MONOCULAR to appreciate its unbelievable clarity, brilliance, terrific power! 5 of the finest lenses, plus 2 prisms made for binoculars retailing to \$150, bring objects miles away right up close. Marvelous for touring, nature study, hunting or other use demanding exacting performance. Same results as binocular, but for one eye. Adjustable eyepiece permits razor-sharp focus—huge objective of tremendous light gathering power provides super brilliancy from dawn to dark. AS PURCHASED BY U. S. GOV'T.!

WORTH MANY TIMES PRICE ASKED

Only DuMaurier master craftsmanship with 35 years experience in optical manufacturing, plus a fortunate purchase, make low price possible. Slight irregularities in some elements are so compensated that every glass is unconditionally guaranteed. Don't buy miniature makeshifts when now, at this amazingly low price, you can have the power-packed results that only a large precision glass can give. Handy neck lanyard included Free. 8x30, 3 3/8" high, 6 1/2 oz., \$9.95; 9x50, 6 1/2" high, 10 oz., \$17.95.

DU MAURIER CO., Dept. 206, Elmira, N. Y.

CARBURETOR TOO RICH MAKES MOTORIST TOO POOR



Car owners who are wasting money and not getting proper gas mileage due to over-rich mixtures will be pleased to learn how to save gasoline by VACU-MATING over-rich mixtures. VACU-MATIC fits all cars, trucks and tractors. It is automatic and operates on the supercharge principle. Easily installed in a few minutes.

SALESMEN WANTED! Big Profits! Send name, address on penny postcard for free particulars and how to get yours for introducing.

VACU-MATIC CO., 7617-1762 W. State St., Wauwatosa, Wis.

Prepare Now! ENGINEERING B.S. DEGREE IN 27 MONTHS WORLD FAMED SCHOOL - ESTABLISHED 1884

Mechanical, Civil, Electrical, Chemical, Aeronautical, Radio (Television) Engineering; Business Administration and Accounting. Also 36-weeks diploma courses in Surveying and Drafting.

Personalized instruction. Accelerated courses. For ambitious earnest students. Preparatory department. Approved for veterans.

Heavy demand for Tri-State graduates; hold positions of responsibility the world over. Placement service. Serious shortage of engineers indicated for immediate future. Prepare now for the unlimited opportunities ahead. Technical training helpful in military assignments.

VETERANS: You may still obtain training and a college degree at Tri-State College under present G.I. Bill. Last opportunity for new students to enroll is Summer Quarter, June 11, 1951.

Extensive campus. Well equipped, new and modernized buildings; up-to-date labs. Low cost. New terms start quarterly. Enter June, September, January, March.

Write today for free catalog and special information.

TRI-STATE COLLEGE
461 COLLEGE AVENUE ANGOLA, INDIANA

Yes, More Brilliant Than a Diamond!



Amazing New Discovery

Write today for the FREE illustrated booklet that tells the full story of the latest miracle of science—the story of a glorious jewel discovered in the laboratories of one of the world's largest corporations. Read all about the Kenya Gem that so closely resembles a diamond that only an expert can tell the difference.

More Fire! More Brilliance!

Yes, this marvelous gem has more brilliance, more fire and a more dazzling display of color than the finest diamond of equal size. You can own an unmounted Kenya gem for only \$27 (1 carat) to \$120 (4 carats); also men's distinctive rings and ladies' fashionable rings and earrings in 14K gold set with expertly cut Kenya gems. **EASY PAYMENT TERMS.**

The Cinderella of Science

Kenya gems are the sensational discovery you read about in Reader's Digest, Sat. Eve. Post and other magazines, "the only thing on earth more brilliant than a diamond." It is a true gem, crystallized by science instead of nature.



Copyright 1950
Kenya Gem Corp.

Write Today or Send Coupon
for FREE Illustrated Booklet

**KENYA GEM CORPORATION, Dept. 286
Philadelphia 44, Pa.**

Mail This FREE Coupon Today

Kenya Gem Corporation, Dept. 286, Philadelphia 44, Pa.

Please send me, without obligation, the FREE illustrated booklet telling all about Kenya Gems.

Name

Address

City State

Learn this Profitable Profession



IN 90 DAYS AT HOME

Money-Making Career Open to Men and Women, 18 to 60

Hundreds of men and women between 18 and 60 make \$10 to \$20 in a single day giving scientific Swedish Massage and Hydro-Therapy treatments. There is big demand from doctors, hospitals, sanatoriums and clubs. Graduates earn large full time incomes from these or in private practice in their own offices. Others make good money from home treatments given in spare time. Learn this interesting, money-making profession in your own home, through our home study course. Same instructors as in our nationally known resident school. You can win independence and prepare for future security by qualifying for your Diploma. Course can be completed in 3 to 4 months. Many earn while they learn. Begin your training at once.



NEW 32-PAGE BOOKLET FREE

Fill in the coupon below (please print name and address) and mail it for your FREE copy of 32-page Information Booklet. If you act at once we will include Anatomy Charts and Success Booklet which supply additional information you should have. All will be sent postage paid.

THE COLLEGE OF SWEDISH MASSAGE
Dept. 164G, 41 E. Pearson St., Chicago 11, Illinois
Please send me FREE and postpaid New 32-Page Illustrated Booklet, Anatomy Charts and Success Booklet at once.

Name _____ Age _____

Address _____

City _____ State _____

MAKE YOUR PASTIME PROFITABLE with this handy welder

Be the welder repairman in your neighborhood

Shortages mean more repair work to keep household equipment going. Cash in now on many money-making opportunities to fix car bodies, garden tools, toys and hundreds of other items with this easy-to-use, low priced Lincoln arc welder.

"LINCWELDER 60"



WELDS • CUTS • SOLDERS • BRAZES • CHARGES BATTERIES

- Comes complete with full instructions.
- Approved by Underwriters Laboratories.
- Operates from 115 volt grounded circuit. (No. 12 wire fused for 20 amps.)

ORDER YOUR WELDER NOW

Fill out and mail to
THE LINCOLN ELECTRIC COMPANY
Dept. 193
Cleveland 1, Ohio

- Ship me the "Lincwelder 60" with accessories \$48.00. (Including headshield, electrodes, carbons, electrode holder, ground clamp and cable). Arc Torch \$6.25 extra.
 Battery Charging Attachment \$10.00 extra.
Enclosed is check money order.

Send me free bulletin on the new "Lincwelder 60."

Name _____

Address _____

City _____ State _____ 193

EVERY MAN NEEDS A

16" x 24"

GARDNER All-Purpose SQUARE

\$2.00

POSTPAID WITH INSTRUCTION BOOKLET

Complete with RAFTER FRAMING Table, Brace Measure, Essex Board Measure, Octagon (8) square scale. Graduation 8ths, 10ths, 12ths, 16ths. Jet Black rust-resistant finish. Characters and figures deeply etched into metal, filled in with contrasting white for easy reading. One piece, non-weld, steel. Accuracy guaranteed. More than 1,000,000 Gardner squares in use today — standard with better carpenters.

A FOUR DOLLAR VALUE FOR ONLY \$2.00 POSTPAID. Money-back guarantee. Prompt delivery.

GARDNER MFG. CO.

1619 PLYMOUTH AVENUE

MINNEAPOLIS 11, MINN.

8-inch Plastic STEERING WHEELS

For Soap Box Racers..Toy Autos.. only Car Bikes.. and other vehicles **\$1.95**

8-inch compression molded plastic steering wheels, with heavy steel insert, knurled on one end to keep wheel from working loose, and hole through other end for securing unit to 7/8" steering shaft. Black in color \$1.95 postpaid. Send check or money-order Immediate delivery



Junior-Pro Products Co. 3206 Morganford Rd., St. Louis 16, Mo.

ENGINEERING DEGREE IN 27 MONTHS

INDIANA TECHNICAL COLLEGE

B. S. DEGREE. Aeronautical, Chemical, Civil, Electrical, Mechanical and Radio Engineering (inc. television). Drafting. 1-yr. Government approved for G.I.'s. Low rate. Earn board. Large industrial center. Students from 48 states, 21 countries. Demand for graduates. Enter June, September, December, March. Write for catalog, 1661 E. Washington Boulevard, Fort Wayne 2, Indiana.

HIGH POWER TELESCOPES



40 Power—opens to 36 inches. Precision & Polished Lenses. Ideal for Studying Stars, Plane Spotting or Interesting Pleasures. Satisfaction Guaranteed or Money Refunded.

Send Check or Money Order to
CRITERION CO., DEPT. PM8
438 ASYLUM ST. HARTFORD 3, CONN.

\$3.49
Postpaid

TASOPE PHOTO-ENGRAVING PLANTS



Establish your own profitable PHOTO-ENGRAVING business. Make cuts for newspapers, printers, and advertisers. Make etched name plates, plaques etc. Instructions furnished, no experience necessary. Sold direct from factory since 1931. First five hundred cuts sold locally or by mail will pay for plant and pay you well for your time. Write for FREE catalog.

TASOPE DEPT. PM5, AURORA, MO.

V-PLEX AUTOMATIC TRANSMISSION CLUTCHES

for... POWER LAWNMOWERS, MOTOR SCOOTERS, GARDEN TRACTORS, MOTORBIKES, ETC.



The Way to transmit Power Smoothly

V-PLEX CLUTCHES automatically tighten drive belt as throttle is opened, eliminate belt slippage, cut wear, permit idling engine. Easily installed on any gas engine; practically indestructible. Fit 1/2, 5/8, 3/4" drive shafts. See dealer or write.

SEND POSTCARD FOR FOLDER

MFG. BY V-PLEX CLUTCH DIVISION
LIGHT INSPECTION CAR WORKS — HAGERSTOWN, INDIANA

LIFETIME STOP-WATCH, CHRONOGRAPH CALENDAR WATCH

CALENDAR Plus Tachometer & Telemeter

STOP

START

WINDER

Reg. Price \$12.95
Special Limited Offer
\$7.95
includes Steel Expansion Band
add 10% Fed. Tax (80c)

Mechanically changes dates daily at midnight.
Jewelled Movement • Radium Glow Dial • Red Sweep
Second Hand • Shock Resistant Case • Unbreakable Crystal

GUARANTEED for one year
Automatic
31 day Calendar

Here is an outstanding, accurate, precision Swiss imported watch never before sold at this unbelievable low price. Ideal for Sportsmen, Scouts, Engineers, Broadcasting Producers and Announcers, Doctors, Navigators, etc. No C.O.D.'s please.

BERKSHIRE'S

368 N. La Cienega Blvd., Los Angeles 48, Calif.

Earn up to \$6,000 a year!

MORE JOBS THAN WE CAN FILL

METAL TRADES BACKBONE OF INDUSTRY

Men who are mechanically inclined have a wide open field to choose employment in the Metal Trades Industry. Jobs are going begging for lack of qualified trained men. You need no previous experience to start your training at this school.

SHORT COURSES TO MEET PRESENT JOB DEMAND.

INDICATE YOUR PREFERENCE—RESIDENT or HOME STUDY TRAINING

ALLIED SCHOOL OF MECHANICAL TRADES, Inc. Write for FREE BOOKS
1338-1340-1342 S. MICHIGAN AVENUE
406 ALLIED BUILDING, CHICAGO 5, ILL. A 1c Postcard will do.

OUT OF PAWN

SAVE UP TO 50% AND MORE

Approx. 1/2 Carat \$95 Tax Incl. \$200 Value

GENUINE DIAMONDS

SAVE ON DIAMONDS FROM ESTATES, BANKS AND UNREDEEMED PLEDGES

MONEY BACK GUARANTEE

SEND FOR FREE ILLUSTRATED Catalog

All diamonds reset in brand new modern mountings. Values from \$10.00 to \$10,000.

Our Ref.—Your own bank or any mercantile agency.

BERMAN'S DIAMOND LOAN BANK
DEPT. P—BERMAN BLDG., BALTO. 1, MD.

SAVE \$\$\$ ON

MAINTENANCE COSTS ... GAS ... OIL
GET MORE POWER, PERFORMANCE
FROM YOUR CAR...TRUCK...BUS!

AUTO-VAC AIR MASTER

CARS
TRUCKS
BUSES

PAT. PENDING

INSTALL IT YOURSELF...DIRECTLY INTO INTAKE MANIFOLD

When coasting is done against the motor, when gears are shifted, or when coming to a stop, the motor builds up excess vacuum that is harmful and produces waste. As the motor decelerates, excessive, wasteful, negative pull is built up. This pull sucks oil off the top of the cylinder walls drawing gasoline through the idling jet. The mixture lies in the firing chamber and smolders as though in a coke oven. This causes carbon to form! It cannot possibly burn as long as the motor is operating on a deceleration basis and the butterfly of the carburetor is closed.



When the butterfly is again opened, the gasoline does explode but cannot explode cleanly because it is not a combustible mixture. Some of this gasoline runs down into the oil and causes costly oil dilution. Discharged smoke and choking fumes at the foot of a hill or in traffic are visible evidence of the ill-effects produced. While automotive manufacturers have recognized this hazard and have tried to combat it with specially built equipment the AUTO-VAC AIR MASTER is the first and only piece of equipment that has successfully eliminated it. Any time the motor exceeds an idling vacuum the AUTO-VAC AIR MASTER meters a proper amount of air for the gasoline in the manifold. By so doing the AUTO-VAC AIR MASTER completely eliminates all excess negative pull in the combustion chamber of the motor.

SMOKE IS A WARNING! Excess vacuum develops in every gasoline motor whenever it is forced to turn over faster than normal idling speed with closed throttle. Oil is thinned, carbon is formed, black smoke and fumes are emitted when the motor returns to normal operation. AUTO-VAC AIR MASTER overcomes all this.



LASTING RESULTS! With the AIR MASTER, spark plugs and valves remain clean and carbon free, even after thousands of miles. Oil dilution is greatly reduced, providing smoother, more efficient operation and longer life with far less maintenance costs and repair "tie-ups."



SUBSTANTIAL SAVINGS! The AUTO-VAC AIR MASTER will pay for itself over and over through lower maintenance costs and fuel savings. Fleet operators have reported savings of up to 50% in oil consumption, 15% in gasoline consumption and great reductions in general maintenance costs. AIR MASTERS are pleasing thousands from coast to coast! Car owners are realizing more driving pleasure and greater operating economy than they ever believed possible.

See illustrated story on page 151 in May issue of Popular Mechanics

Complete instructions with every unit. Simple to install in any car, truck or bus.

GUARANTEED AGAINST DEFECTIVE MATERIALS AND WORKMANSHIP Only \$1500 Post Paid

ORDER TODAY! PROMPT DELIVERY!

Be sure to send make, model and year of vehicle.

AUTO-VAC SALES COMPANY
OFFICES: 605 HOTEL DYKMAN BLDG., MINNEAPOLIS 2, MINN.

LOOK! MAKE BIG EARNINGS EASILY! BE FIRST!
Become an AUTO-VAC Agent in your community. Write for discount information. Every car, truck or bus needs an AUTO-VAC AIR MASTER.

WANTED MEN AND WOMEN!
TO MAKE MONEY AT HOME—Full or Spare Time

Pearlizing baby shoes, figurines, novelties, household items, etc. Big demand, help us supply it. FREE PLAN. \$25 per day easily possible.

Write **PEARL ART STUDIO, 7216 Bear Ave., BELL, CALIF.**

Completed Popular Mechanics Ranch Type House and exact scale pictorial room and suggested furnishing layout. To right of dotted line is BASIC HOUSE. Expansion to the left. Designed for easy building in two convenient steps.



Basic house includes living room, dining area, two bedrooms, kitchen, bath, utility room and car port. Can be built for about \$5000.

More than 100,000 families have built their own homes in the past few years, doing all of the work, or most of it themselves. Right now, one of every five homes being built is at least partially owner-built. This proves that you too, if you can use hammer and saw, can build your own home and save more than one-half of the cost.

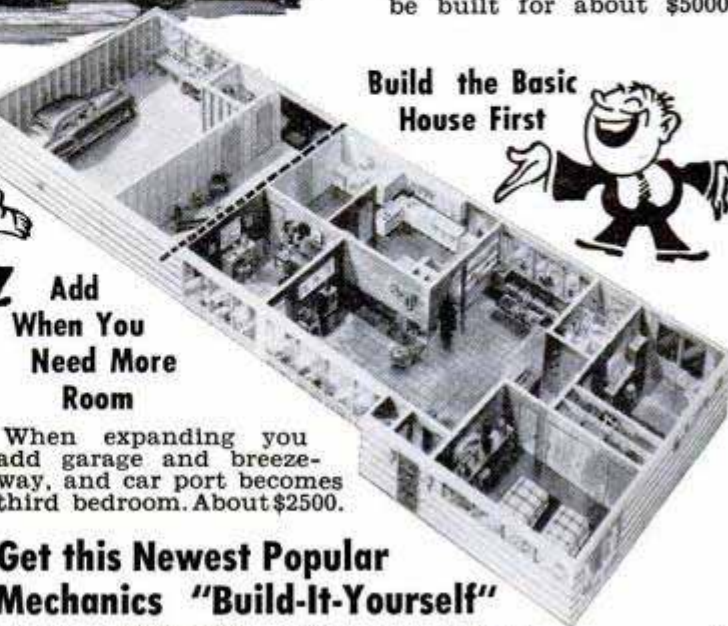

Build the Basic House First



Add When You Need More Room

When expanding you add garage and breezeway, and car port becomes third bedroom. About \$2500.

Get this Newest Popular Mechanics "Build-It-Yourself" Book and Building Plans and Save Many Thousands of Dollars

Book gives complete step by step instruction in simple language. Hundreds of pictures, actual photos and diagrams, showing every phase of construction, guide you from start to finish. Ten working size blueprints give floor plans, elevations, notes on construction, framing, lumber list, specifications, plumbing and wiring diagrams.

Read How and See How — Simplified Instruction

You read "how-to-do-it" in the book. You see how it looks in actual pictures. You follow the plans for dimensions and details. You make use of labor-saving kinks and special methods developed especially for the project.

No Previous Building Experience Required

Any ordinary handy man, using only simple tools, can build this house with little or no assistance and enjoy every

part of it. And at the same time, save in labor costs, more than he spends for material.

Reserve Book and Plans Now

Don't take chances on being disappointed. Reserve your RANCH TYPE HOUSE BOOK AND PLANS now for shipment September 1. So many advance orders have already been placed that it soon will be impossible to fill these from the first printing. The serious paper shortage may delay a second printing indefinitely. See special combination book and plans offer below. Mail coupon today.

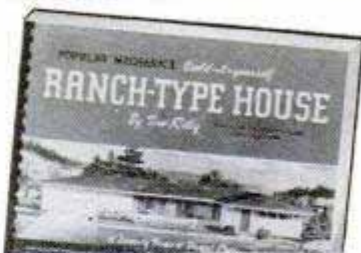

Build this Popular Mechanics RANCH HOUSE Yourself! Save Over One-Half

Beat the High Cost of Home Owning It's Easier Than You Think

Here is a dream home that can become a reality without too much worry about money. Build this beautiful Ranch Type Home yourself. Simply follow the Popular Mechanics RANCH TYPE HOUSE BOOK AND PLANS. You can save \$7,000 to \$10,000 and have one of the most desired homes of these times. You can build it all now—or part of it—and add garage, breezeway and another bedroom later on without affecting the basic house.

Modern Design • Fully Finished • All-Season Build this Home Anywhere and Save

Designed for Popular Mechanics by John F. Whelan, famous West Coast architect and designer of homes and entire villages. It's a year 'round house, 81 feet long and 29 feet wide. Fully insulated. Finished outside and inside with durable plywood and requires no plastering. Brick "island wall" and big fireplace in living room. Heating, unique ventilating system and latest development in electric wiring included. A dream home that can easily come true and a home that can grow with the family.

Reduced size illustrations from book. Building roof truss on floor for easy construction. Mrs. Tom Riley, Portland, Oregon, shingles the roof on her Popular Mechanics Ranch Type House



Use This Handy Order Coupon

POPULAR MECHANICS PRESS, Dept. 70
200 East Ontario St., Chicago 11, Ill.

I enclose remittance for \$_____. Reserve my copy of the Ranch Type House Book and Plans checked below.

- | | |
|--|---------|
| <input type="checkbox"/> Ranch Type House Book | \$ 3.50 |
| <input type="checkbox"/> Set of 10 Blueprints | 13.50 |
| <input type="checkbox"/> Book and Blueprints | 15.00 |
| <input type="checkbox"/> Duplicate Set of Blueprints | 5.00 |

Name _____

Address _____

City _____ Zone _____ State _____

**WORLD'S
BEST
WANT AD
MEDIUM**

CLASSIFIED Advertisements



Advertisements in this section 85 cents per word, each insertion, minimum 10 words, payable in advance. To be inserted under proper classification, copy must be in our office the 20th of the second month preceding date of issue
F. W. Johnson, Manager, Classified Advertising
Popular Mechanics Magazine, 200 East Ontario Street, Chicago 11, Illinois

YOU'LL PROFIT

By reading and answering the classified ads in this section. Hundreds of opportunities for you to make and save money

AUTOMOBILES, MIDGET CARS

MODERN Chassis. New book. Complete information on suspensions, steering, shocks, brakes, weight distribution. Contains data for owners modern cars, sports cars, stocks, hot rods, specials \$2.00—Modern Automatic Transmissions and Torque Converters, information all latest automatics \$2.00—Specials, Sports Cars, Hot Rods of the World Book \$1.50—Sports Car Engine \$1.50—Speed from Sports Car \$2.00—Souping the Stock Car Engine \$2.00—Ford Owners Handbook \$1.50—Chevrolet Owners Handbook \$1.50—Historical American Horse Drawn Vehicle Book \$2.00—Mexican Road Race Book \$2.00—A. Clymer, 1268 S. Alvarado, Los Angeles 6, Calif.

MECHANICS, Collectors, hobbyists: Non-profit organization offers literature on old and new cars; shop manuals, engineering papers, data books, free motor magazines. Contact auto nuts everywhere. Write today; get your name on free mailing list. Auto Maniacs, Inc., Stockbridge, Mich.

MOTORISTS—Get rocket performance with famous alcohol-water injection. Only .59¢! Free literature. Vaporizer Company, Box 7033W, Station G, Los Angeles, Calif.

SILENCE Overhead-valves, attachments unnecessary, \$2.00. Derderian, 542, Sandston, Va.

STOP Headlight glare with new Polar-vision light! See page 20.

"HOW To get 150 M.P.G." Authentic book, shows how passenger cars actually go over 100 miles per gallon on regular gasoline. Big equipment catalogue, plus 32 page Economy Driving Manual, plus book—all three 50¢ postpaid. Newhouse Automotive, 5805-B East Beverly, Los Angeles 22.

NEWHOUSE Presents amazing automotive information, all cars, see page 36.

ATTENTION! Ford owners. Model A, B and T parts. Model A Motors, Unionville, Conn.

47 **WHIZZER** Motorbike engine \$7; Briggs engine \$5; Maytag \$4. Motorette \$25, midget car \$25, less engines. Four balloon tires \$3. Mailorder only. Send 25¢ for new catalogue number 41, just out, listing these and hundreds of other bargains in new and used midget cars, motor-scooters, homebuilders parts, plans, transmissions, clutches, engines, war surplus, etc. (35¢ by first class mail). Midget Motors Directory, Athens, Ohio.

BIGGEST Racing and hot rod catalog in world, just out! Lowest prices. Hollywood mufflers \$4.50, duals \$15.90, chrome megaphones \$1.55, dual manifolds \$9.95, racing cams \$29, heads \$23.50, water injectors \$12.95, superchargers, bargains! Free power calculator included. 25¢ coin or stamps. Alquist Engineering, Milford 43P, Pennsylvania. (Dealers wanted.)

SMITHYS Mufflers for all automobiles. Free list. Buck's Auto Parts, Box 1296H, Merced, California.

CALIFORNIA Custom accessory headquarters. Buy direct from original designers and save. Chrome dash panels, push button door, trunk conversions, chrome motor accessories, lowering kits, speed-dress-up equipment. 1951 catalog, 40 pages, hundreds of photos—25¢. Eastern Auto, 3319A South Grand, Los Angeles 7, Calif.

WATER Injection. Also economy, power, methods. Free illustrated information. Neher Industries, La Verne, California.

FROM Speedway to roadway! Track-proved hi-speed heads and manifolds now available for your passenger car! No special tools needed! Increase horsepower 25%! Astounding getaway! Free illustrated catalog. Speedsport, 6215P Diversey, Chicago 39.

AUTO SUPPLIES AND EQUIPMENT

OIL Drain-O-Matic drains crankcase by remote control. Change your own oil and save money. Easily installed. Low price \$3.95 postage prepaid. Money back guarantee of satisfaction. 10 days trial. State make of car. Olinger Engineering Co., Box 646, Bloomington, Illinois.

NEW Government surplus. Low voltage circuit tester in steel box cost \$202. Our price \$27.50. Will test batteries, starters, generators, voltage regulators, grounds, short circuits. Wilt Electrical Company, 7829 S. Racine Ave., Chicago 20, Ill.

AUTO Conversions and parts. Marine manifolds for all engines. Your transmission converted to marine gear, propellers, shafts, struts, couplings, etc. Everything you need for your boat. Money back guarantee. Conversion Parts Company, 278 Adams Street, Boston 22, Massachusetts.

CHEV. Rebuilt motors. Guaranteed like new. Lowest prices. Grossman Chev. Co., Minneapolis, Minn.

GARAGEMEN: Generator and magneto tester, literature free. Abbott Supply, Quincy, Illinois.

INCREASE! Gasoline mileage three to five miles gallon; guaranteed vaporizer increases power; easier starting. \$3.50 each. Turb-O-Vane, 1024 West Vine, Stockton, Calif.

LACHAPPELLE'S 100,000 Miles motor and motor fuel treatment (patented). Puts bearings on the pistons. Only \$3.00 postpaid. Ferns Products, 8120-B Walnut Dr., Los Angeles 1, Calif. (Data on request.)

AUTO Trouble light. Plugs into cigarette lighter. 12 foot extension cord. \$1.20 postpaid. Trademart, Dept. 4, Box 97, Oakland Gardens Station, Flushing, N. Y.

SEND For free life membership card. "Water Burners" of America, La Verne, California.

VAPOJET Helps save gas, engine wear, carbon accumulation and increase power with water-alcohol vapor injection. \$9.95 postpaid. \$1 deposit c.o.d. 30 day money-back agreement. Easily installed. Free details. Agents wanted. Bantel, 757-AK Venice, Los Angeles 15.

ELECTROPLATE Metals, non-metals. Tyco electro-plater. Portable. Inexpensive. Free booklet. Tyco Metals, Box 13231-AM, Houston 19, Texas.

STOP Headlight glare with new Polar-vision light! See page 20.

CARBURETOR Too rich makes motorist too poor. New invention saves gas "Vacuumating." For free particulars, sample offer, write Vacuumatic, Dept. 8, Wauwatosa, Wis.

1951 **SUPERIGNITIONITER:** Starting; pep; mileage. \$4.50. EG MFG, Elmsford, N. Y.

OFFENHAUSER'S New catalog available. Send 25¢. Complete line of speed equipment. Offenhauser Equipment Corp., 5054-p Alhambra Ave., Los Angeles 32, California.

SENSATIONAL Information by Newhouse for all car owners. Page 36.

MOTORISTS Vacuumizer improves performance, economy, power. Protects valves. Easily installed. Inexpensive. Free Literature. Auto-Vacumizer Co., Box 357P, Granville, Ill.

NEW And used guaranteed parts for civilian and army cars and trucks. Largest stock in America. Mail orders. Pioneer Auto Wrecking Co., 734 W. 13th Ave., Denver, Colorado.

BUICK Parts—Enjoy new-car pep and power in your old Buick. Same day service from world's largest stock of new (not rebuilt) Buick parts and engines. Ship anywhere. Write today. Robertson Buick Co., 1001 S. Washburn Ave., Chicago 5, Ill.

AUTO Parts and accessories. Briggs Automotive Engineering of Chicago, P.O.B. 3454 Merchandise Mart, Chicago 54, Ill.

FOR Free descriptive literature on alcohol-water injection for cars, trucks, tractors write Shade, Webster, New York.

BRUSH Plating outfits connect to a battery. No tanks or shop required. Free particulars. Gunmetal Co., Avenue J, Decatur, Illinois.

1951 **EDITION!** It's new! It's different! Get world's largest auto accessory and parts catalog and save money. Over 50,000 items, including Hollywood accessories, hi-speed equipment, rebuilt engines, all parts and accessories for all cars and trucks. We have that hard-to-get part! Jam packed with bargains. Completely illustrated. Send 25¢ (refundable). J. C. Whitney, 1919 Archer, Chicago 16.

AUTO TRAILERS

PLANS—16'-Trailer, expertly prepared, easy to build, \$2.00. Freeland Engineering, 16587 Freeland, Detroit 35, Michigan.

BUILD Your own trailer! Plans for all kinds. Illustrated catalog 10¢. Jim Dandy, 125-M, Wausau, Wisconsin.

MOTORCYCLES, BICYCLES, MOTORSCOOTERS AND SUPPLIES

WHIZZER Motorbike (all attachments) \$25; others \$5 up; Cushman motorscooter \$20; Indian motorcycle \$30; midget car \$35. Rush 25¢ (35¢ first class mail) for catalog #948 listing many other amazing bargains in motors, midget cars, motorscooters, motorbikes, etc. Associated, Box 1764-CS, Toledo, Ohio.

U. S. Govt. surplus "45" Harley Davidson motors, complete with carburetor and generator, in running condition—\$69.50 f.o.b. Chicago. 25% deposit with order. Parts and accessory catalog 25¢. Triangle, 2157 Harrison, Chicago.

WHIZZER In Schwinn bike \$20; good motorscooter (twist grips) \$22.50; midget car \$15; Shaw bicycle motor \$15. Send 25¢ (35¢ first class mail) for catalog #18 jammed with other sensational bargains in wheels, motors, clutches, motorscooters, midget cars, motorettes, motorbikes, etc. Gail, 538 Erie, Toledo, Ohio.

RECONDITIONED Motorcycles and motors. Chromium accessories. Complete stock Indian parts. Expert rebuilding. Past service. Indian Motorcycle Sales, Kansas City 1, Mo.

INDIAN, Harley parts and accessories handbook, 15c. Bootz, 1700 East University, Des Moines 16, Iowa.

HARLEY-Davidson parts, accessories, repair manuals on all models. 24 hour service. Authorized factory dealer. Philadelphia Harley-Davidson Company, 857 North Broad Street, Philadelphia 23, Penna.

HARLEY-Davidsons—All models and prices. Genuine late and old model supplies. Expert service. Send 25c for bulletin. Knuth's, 1753 Muskego, Milwaukee, Wis.

AVIATION

PROPELLERS, Plans, supplies for snow sleighs, air boats. Catalog 20c. Banks-Maxwell, Box 3301, Ft. Worth, Texas.

LIGHT Planes. Design, build yourself. Large manual \$2.00. Circular illustrates plans, motors, 20c. Craftsmann Books, Box 1153, Milwaukee 1, Wis.

PROPELLERS—For sleds, airdrive boats. Literature. Standard Aircraft, Box 387, Ft. Worth, Texas.

BATTERIES, GENERATORS

REAL Edison batteries. Long unconditional guarantee. 37 to 600 ampere sizes. Free interesting literature. Hawley Smith Co., Croton Falls 1, New York.

ELECTRICAL SUPPLIES

ELECTRIC Pencil: Engraves all metals \$1.50. Beyer Mfg., 10511-H Springfield, Chicago 43.

BE Independent, be secure, have your own profitable business—Earn \$20.00 and more a day making beautiful, fast-selling lamps at home. No equipment needed. Illustrated course teaches you quickly. Course, parts catalog, wholesale price list—only \$2. Gearon Co., Dept. 200-B6, 27 S. Desplaines, Chicago 6, Ill.

FREE—New catalog. Bargains in welders, motors, generators, surplus equipment. Or, build your own kits—save. LeJay Company, Minneapolis, Minnesota.

LAMPS—Had trouble finding repair parts? Your search is ended. 25c brings 64 page illustrated catalog also containing wiring charts. Gyro Lamps, 5402P Clark, Chicago 40.

MAKE Big profits rebuilding automobile generators. Introductory Manual \$1.00. "Modern," Box 4704, Kansas City, Mo.

LAMPS—Build own originals, parts wholesale, any amounts. Catalogue 10c. Brown Lamp Co., Box 501, Wellston, St. Louis 12, Missouri.

ELECTRICAL Pencil—Writes, engraves all metals. \$2.95. Reb Industries, Elmhurst, Illinois.

WELDING, SOLDERING, PLATING

DEFENSE Welding jobs pay. Welders needed. Train quickly. VA contract. Hobart Welding School, Box M-614, Troy, Ohio.

ACETYLENE Welding outfits, new \$49.00; used \$29.00; arcwelders \$46.50. Eagle Welding, Dept. PM, 5085 Broadway, Chicago 40, Ill.

BUY Direct from factory. Welding and cutting equipment. All makes of equipment repaired. Established 1913. Box 331, Hamilton, Ohio.

RADIATOR Repairing books, supplies, equipment, gasoline torch. Write. Curfman Co., Maryville, Mo.

MACHINERY, TOOLS, SUPPLIES

WATCH Makers lathe, gov't surplus, complete with motor, foot pedal and chuck. Value \$225.00, like new, \$87.50. Public Sport Shops, 11 S. 16th Street, Philadelphia 2, Penna.

MACHINE Tools, industrial equipment bought, sold. Berg Machinery, 1529 N. Broadway, St. Louis, Mo.

FLEXIBLE Shaft tool by Fairchild for grinding, polishing, sanding, buffing, carving. Original price \$19.95. While they last! Special price \$12.95. Public Sport Shops, 11 S. 16th Street, Philadelphia 2, Penna.

DRILL And reamer booklet. 32 pages know how, plus time saving tap selector, plus tool catalog, all for 25c. Refunded on first order. Barclay Co., Box 883, Plainfield 8, New Jersey.

STAMPING Sets, 37 steel dies, both letters and figures. Government surplus, for marking metals, wood, leathers. $\frac{1}{8}$ " for home workshops, garages, gunsmiths, machine shops. Exceptional value, satisfaction guaranteed. \$2.98 postpaid. Numrich Arms, Dept. P.M., Mamaroneck, N. Y.

CHUCK Adapters, $1\frac{1}{2}$ "—8 threaded hole 5" o.d., semi-finished \$2.50 each. W. J. Carnahan, Box 35, Arlington, N. J.

DRILL Grinder for twist drills, \$2.95. See ad on page 260.

FREE Catalog. Full line hobby and light industrial power wood working tools. Guaranteed. Dealers wanted. Backus Machine Co., Chippewa Falls, Wisconsin.

GOVERNORS And butterflies for autos or any gasoline-driven engine. Candee-Smith, P.O. Box 612, Riverside, California.

CHUCKS: Independent; Universal—threaded $1\frac{1}{2}$ "-8, 1"-8, 1"-10, 1"-12, or with adapter recess. The only complete line of bench lathe chucks built to heavy duty standards. Other chucks to 16" diameter. Write for quotation; free literature. No obligation. Westcott Chuck Co., 3600 Walnut, Oneida, N. Y.

POWER Tools. Build your own with Lewis castings. Save up to 80%. Complete castings, material and blueprints supplied for 23 woodworking and metalworking tools. Illustrated brochure, 10c. Write today. Lewis Machine Tool Co., 3217 Union Pacific Avenue, Dept. M, Los Angeles 23, Calif.

BOATS, OUTBOARD MOTORS

BUILDING A boat? Save money on hard-to-get items. Send for free catalog. Ozarka, Inc., 66 Borden Lane, Woodstock, Ill.

BOAT Plans, patterns, kits, Rowboats, outboards, inboards, cruisers. Descriptive literature and 24 page illustrated book on boat construction 30c postpaid. Germain Boat Company, West Saginaw 3, Mich.

STEERING Wheels, windshield brackets, from \$7.95. Modern fittings, water-skis at lowest prices. Complete pre-cut plywood boats. Bargains galore. Folder 10c. Marine, Box 681, Mendota, Minnesota.

FASTEST Boats in the world—Build now. Complete plans available for sleek three point racing hydroplanes, runabout and others. Send 25c immediately for illustrated catalogue. Champion Boats, P.O. Box 9038, Dept. 22-F, Long Beach 7, Calif.

RACING Outboard boats. Van Pelt water scooters very top in speed! Consistent winners. Circular. Van Pelt Boat Co., Spring Lake 2, Mich.

BOAT Trailer winches. Brass. 1636 Bonnie Brae, Houston, Texas.

MAKE Boat pump. Use beer cans. Great little worker. Plan 25c coin. R. F. Schwitzer, Harrison, N. J.

SAVE $\frac{3}{4}$ Cost. Assemble your own boat. We furnish parts. No experience necessary. Rowboats, cruisers. Illustrated catalog 25c. Midwest Boat Company, Menomonee Falls, Wisconsin.

OUTBOARD Motor parts; new, used. For all makes. Save money. Outboard Motor Mart, 309 Atlantic Avenue, Boston 10, Mass.

BOAT Kits: Outboards, inboards, hydroplanes, sail. A cinch to assemble. Minimum expense. Catalog, specifications, prices. 25c. Brooks Boat Company, Carrollton, PM, Michigan.

MARINE Conversions for Ford and Jeep engines. Catalog 10c. Lehman Manufacturing Company, Department D, Newark 2, New Jersey.

NEW. Used, rebuilt marine motors. Marine conversions, fittings. Free catalog. Stokes Marine Supply, Dept. 24, Coldwater, Michigan.

FULL Size, cut to shape boat patterns, blueprints, $7\frac{1}{2}$ -38 feet. Illustrated "Build a Boat" catalog, 25c (coin). "How to Build Boats" book, \$1.00. PolyWog houseboat plans \$10. Marine catalog \$1.00. Marine Specialty Mfg. Co., 3107 Detroit Ave., Cleveland 13, Ohio.

"P38 Belly tanks," steel, \$9.95. Free picture. Bucks Auto Parts, Box 89, Merced, Calif.

ENGINES, MOTORS, DYNAMOS

MOTOR Winders, free bulletins. Winding and testing equipment. Motor Industries, Quincy, Illinois.

WINDING Data, listing 225 motors, single and three phase, \$1.00. Motor Data Co., Box 7631, Kansas City 3, Mo.

ATHLETIC EQUIPMENT, BODY BUILDING COURSES

STRENGTH With stretchers. Super cable course. Natural rubber expanders. Free information. Write Comborep, 79 Oakland Terr., Newark 6, N. J.

BARBELLS. Exercise equipment. Courses. Free booklet. Good Barbell Co., Reading, Penna.

MASSIVE Proportions; barbells; \$7.00 course catalog, \$1.00. EG, Elmsford, N. Y.

GAIN Weight! 4 exercises to increase weight. Complete \$1.00. Body Builders, 36 Nevada Street, Winthrop, Mass.

DEADLY Judo—Fiercest fighting technique. Trick knockouts. (Over 200 illustrated pictures.) Expert instructions; three volumes. Complete \$2.25. Variety House, Box 46-B Wall Station, New York 5.

SPORTING GOODS, GUNS, FISHING TACKLE, ARCHERY, TRAPPING

5000 BARGAINS, Firearms, binoculars, war relics. Catalog 50c. Smith Firearms, Runnemed, N. J.

NEW Engineered Richardson "BluGlas" rod. At last a glass rod with the kind of action you want where you want it. Has the tip action you need for casting of light lures and the backbone in the butt end to set the hook. Will not fade in color. Find out why the new engineered Richardson "BluGlas" will give you more rod for the money. Write for free catalog. Richardson Rod & Reel Company, 3166 North Sawyer Ave., Chicago 18, Illinois.

H&R .22, With holster \$20; Winchester .44 rifle \$5; .22 rifle \$10; 1828 musket \$13; arrowhead collection 70c; German officer swords \$5; pistols \$2 up. Rush 25c for catalog #509 listing many other bargains in guns (new and old), swords, relics, etc. Jefesco, Box 1682-CS, Toledo, Ohio.

FISH At night with beautiful plastic lighted bobber lure. More fun. More fish. Two for \$1.00 postpaid. Glo-Lite Bobbers, Inc., 2111 Woodward, Detroit 1, Mich.

190 PROFUSELY Illustrated pages antique and modern pistols, swords, daggers, armor, etc. 50c. Robert Abels, A860 Lexington Ave., New York 21.

ARCHERS. Make your own bow. Instructions 35c (coin). Coggiola, 4761 Broadway, New York City.

TENTS (pup, pyramidal, wall, umbrella, nylon mountain, etc.); camping equipment (cots, sleeping bags, blankets, rugsacks, hammocks, ponchos, etc.); tarpaulins. Low prices; free 60 page catalogue. Morsan, 10-17G 50th Ave., Long Island City 1, N. Y.

MOLDS. (For fisherman's sinkers, squids, jigs and lures.) Handled and hinged. Quality fishing tackle. Free catalogue. E. L. Sweet & Son, Tonawanda, New York.

AMMUNITION Immediately available for Lugers, Mausers, Mannlichers, Japs, Italian guns. Send 10c complete list 100 kinds plus imported shotguns, rifles, pistols, cameras, microscopes. Ashton Company, 1511 Gardner, Hollywood 46, Calif.

FISHERMEN—Make your own sinkers with our molds. Free illustrated booklet. Reading Instrument Co., Box 78, Reading, Penna.

TAXIDERMY

LEARN Fish taxidermy, small cost, details free. Pledger, Box 984, Memphis, Tennessee.

MODERN Taxidermist Magazine, Greenfield Center 2, N. Y. Devoted entirely to taxidermy, photos, articles, methods. Trial year's subscription, \$1.00.

BINOCULARS, TELESCOPES, MICROSCOPES, MAGNIFIERS

SAVE 50% On new binoculars! Free catalog. Free book. "How to Select Binoculars." Write today! Bushnell's, 43-M26 Green, Pasadena 1, California.

FINEST Astronomical telescope made for little as \$6.00. Send 30c know-how instructions. Ross, 70 West Broadway, New York 7.

BINOCULARS, Telescopes, watches, guns. Buy, sell, trade. Schweer's, Donnellson, Iowa.

WAR Surplus bargains, binoculars, telescopes, sextants, millions of lenses, prisms, reticles, eyepieces, objectives, etc. Mail 10c for big "Catalog CH." Send \$1.00 for Stock CH—10-piece lens kit and big instruction booklet. Edmund Scientific Corp. (Formerly Edmund Salvage Co.), Barrington, N. J.

AMAZING Prices, brand new precision binoculars \$21.50 upward. Free trial. Folder, "Binocular Selecting," pricelist free. Prentiss Importers, Mercury Building, West Los Angeles 25, Calif.

REFLECTOR Telescope kits, refractors. Free illustrated bulletin. Esco Products, 911 Willow Ave., Hoboken, N. J.

6" TELESCOPE Reflector kit, instructions, \$8.50 plus postage. Aluminizing, F. Cameron, Box 65, Inwood, N. Y.

POWERFUL Astronomical telescopes easily made. Perfect lenses and instructions; 100X \$3.00; 100X and 200X \$4.00; 100X, 200X and 400X \$6.00. Full power, clear vision guaranteed. Instructions alone 10c. Suffolk Science Service, Riverhead, N. Y.

TELESCOPES, Binoculars, microscopes, big bargain catalog free. Brownscope Company, 24 West 45th Street, New York.

ASTRONOMICAL Telescopes, binoculars, microscopes, bought, sold, repaired. Books. Lists 10c. Rasmussen-Reece, Amsterdam, N. Y.

GIANT Astronomical telescope with 6 ft. tripod \$15.00, f.o.b. factory. 100 power. (10,000 area magnification). Clear vision, full power guaranteed. Ready for use. Suffolk Science Service, Dept. BT, Riverhead, N. Y.

REFLECTING Telescopes, 60X, completely assembled \$25.00. Guaranteed observatory clearness. Free information. Skyscope, 475 Fifth Avenue, New York 17.

PETS—DOGS, BIRDS RABBITS, HAMSTERS, ETC.

BOXERS, St. Bernards, Hof Kennels, 5136 Cascade Rd. S.E., Grand Rapids 6, Mich.

NATURALISTS Catalog 10c. Chameleons 45c. Turtle 45c. Quivira Specialties, Topeka 51, Kansas.

RAISE Rabbits. Profitable business. Literature free. Tayco Rabbitry, Hapeville, Georgia.

SCOTCH Collies, pups like "Lassie," shipped anywhere. Lyle Tiegen, Kenyon, Minn.

BEAUTIFUL Pure white pedigreed police puppies. Ansonia Kennels, Mose, N. Dak.

READ Our display advertisement on page 32. Small Stock Farmer.

SEE Gulf Hamstery ad on page 22. Shows picture of hamster.

GOLDEN Hamsters. Superior breeder and pet stock \$2.50 pair, \$3.75 trio. Free folio. Valley Hamstery, 734 North Milam, San Benito, Texas.

BEST Hamsters. Lowest prices. Pair \$3.00. Free illustrated folder. Lakeview Hamster Colony, Newfield, N. J.

MAKE Big money! Raise Chinchilla rabbits. Cash markets supplied. Write today! Rockhill Ranch, Sellersville 15, Penna.

RAISE Rabbits. I furnish stock. You pay later from profits. Send 35 cents for market information, housing, plan of furnishing starting stock. Johnson, Box 694, Kansas City 12, Mo.

INCREASE Your income by raising domestic rabbits. Small space needed. Ready market for delicious meat, fur and wool. Largest magazine in the industry tells you how. \$1.50 per year. Sample 15 cents. No stamps. Small Stock Magazine, Lamoni 20, Iowa.

EARN Up to \$400 monthly raising Angora or New Zealand rabbits. Plenty markets. Particulars free. White's Rabbitry, Newark 38, Ohio.

RAISE Guinea pigs. Money makers. Booklet free. Taylors, B426A, Hapeville, Georgia.

MINK Raising information free. Complete. Lake Superior Mink Farm, Superior, E.E1, Wisconsin.

A Practical beginning to successful rabbit raising. 48 page illustrated booklet. Dime. American Rabbit Breeders Association. 36 AR & CBA Bldg., Pittsburgh, Penna.

FARMS, FARM LANDS, REAL ESTATE

NEW Summer farm and business catalog free! Just out! Maine to Florida. Bargains from \$1000 up! West's, M-4, Pittsburgh 17, Penna.

\$4.50 PER Acre Missouri-Oklahoma land. Large, small tracts; cash, payments. New free list, maps. Frederick Calvert, (Owner), Winter Haven, Florida.

BIG Free summer catalog! Farm and country real estate bargains, good pictures, many states, easy terms, many equipped, business opportunities. For special service, state requirements, desired location. United Farm Agency, 220-PM South State St., Chicago 4, Ill.

EQUIPPED Ranches "Land of Opportunity." Owen Farm Agency, Conway, Ark.

STROUT'S Farm and business catalog. 3084 bargains, 33 states. Mailed free! Buy now and save through Strout Realty, 7 So. Dearborn St., Chicago 3, Ill.

\$5.00 MONTHLY Buys 40 acres near town; price \$200; free list. Box 425-P, Carthage, Mo.

GOOD Farms—Ranches. Washington, Minnesota, Montana, Idaho, Oregon, North Dakota. Dependable crops, favorable climate. Write for literature, lists describing typical farm opportunities. Specify which state. J. W. Haw, 119 Northern Pacific Ry., St. Paul 1, Minn.

GOVERNMENT Lands \$2.00 acre up. Information all states twenty-five cents. National Tax Service, 901-A Majestic Bldg., Detroit.

PLANTS, SEEDS, NURSERY AND GARDEN SUPPLIES

WAGON Wheels. Genuine Western antiques. For gates, fences, lamps. Details. Beneco, 223 Vernon, Roseville, Calif.

POULTRY, FARM SUPPLIES

EARN \$4 To \$12 hourly. Chick sexing, turkey sexing, culling and caponizing. G.I. approved. Pilch's School, Box SSC-10, Thompsonville, Connecticut.

GEESE, Goslings, goose eggs. Safe shipment anywhere. Bulletins, magazine on breeding, hatching, rearing, marketing. Peyton Goose Farm, Route 2DM, Duluth, Minnesota.

KNOW How to raise poultry for profit. Read Poultry Industry. Every issue packed with helpful hints and practical suggestions. Latest articles on breeding, feeding and management. Subscribe now. 1 year 65c. 2 years one dollar, foreign subscriptions \$1.00 a year. Poultry Industry, Dept. P.M., 376 Boylston St., Boston 16, Mass.

BABY Chicks \$10.00 per 100 c.o.d. New Hampshire, Barred Rocks, White Rocks and heavy assorted. Prices at hatchery. A. F. Hockman, R7, Bellefonte, Penna.

PROFITABLE OCCUPATIONS

WANT A diesel job? Our approved, up-to-the-minute diesel training program can help you qualify for steady, big pay jobs or specialized military training. Covers diesel, tractor, heavy equipment. Easy to master. No loss of present income. Job placement advisory service. Investigate! Write for information today. Interstate Training Service, Dept. 3F, Portland 13, Oregon.

TURN Your spare time into cash. Make quick-selling, highly profitable lamps—every home a prospect. No experience or special tools required. New 1951 56-page illustrated catalog shows shades, shade frames, figurines and bases, oil lamp converters, boring compounds, and dozens of similar items. Also all kinds of sockets, cords, pipes, harps, finials, bases, and hundreds of other parts—everything you need. Special 8-page section shows 6 beautiful lamps in kit form ready to assemble. You buy wholesale, sell at retail—make big profits. Hundreds doing it. You can, too. Send 25c today for catalog and wholesale price list. Refundable first order Gearon Co., Dept. 500-B6, 27 S. Desplaines, Chicago 6, Ill.

MEN, Women. Grow mushrooms. Cellar, shed. Spare, full time, year 'round. We pay \$3.00 lb. We paid O. Babbitt \$4,165 in few weeks. Send \$2.00 for general information book. Washington Mushroom Ind., Dept. 111, 2954 Admiral Way, Seattle, Wash.

FREE Book "How to Make Money With Home Workshop" describes amazing methods used by hundreds of successful craftsmen. Tells what to make, how to sell workshop output spare time. Write at once for details. Remember it's free! Craftsman, 115-A6 Worth St., New York City.

MUSHROOMS Grown. Boxes, barrels. Instructions 50c. Spawn \$1.00. Manureless process. \$2.00. Gordons, 553 William, Winniebeg, Manitoba.

MONEY For you! Frame full-color reproductions of paintings. 400% profit. \$1.00 brings five big 12x16 pictures and plans. Bridgeport Company, 1101 7th St. S.E., Minneapolis, Minn.

DEFENSE Welding jobs pay. Welders needed. Train quickly. VA contract. Hobart Welding School, Box M-613, Troy, Ohio.

RAISE Redworms. Good profits. Complete instructions 25c. Jewells Worm Farm, 14633 Halsted St., Harvey, Illinois.

FOREIGN Employment construction men, building trades, helpers, office men, others, interested in foreign projects. High wages, quarters, trans. Listings of firms actively working on U. S. foreign intercontinental projects. Send \$1 for foreign construction compendium and application forms. Foreign Service Bureau, Dept. PM-6, Box 295, Metuchen, New Jersey. (Not an employment agency—no fees.)

\$250 WEEK Reported! Free book. "505 Odd, Successful Businesses." Work home. Expect something odd! Pacific-49A, Ocean-side, Calif.

PRINT Without a printing press. Big profits! See page 33.

BOLIVIA Offers unlimited opportunities to wealth in mining, gold washing, coffee, tobacco growing, dairy, construction engineering, manufacturing. Information 2 dollars airmail. Dr. Jimmy Kay, Casilla 380, Oruro, Bolivia.

SEWING Machine repairing. To \$8.75 hour. Experience completely unnecessary. Sewing Machine Mart, Fruitvale Box 141, Oakland 1, California.

MAKE Flexible molds! Cast plaques, bookends, figurines! Free sample! H. Tooker, 630-M Chestnut, Hamilton, Ohio.

RESILVER Mirrors at home. Formula 25c. Ideal Service, Park Ridge 4, Illinois.

HAVE Fun! Make money! "Working With Leather"—64-page booklet tells how. Send 25c for copy. No foreign orders. Free catalog and valuable information included. Wilder-Craft, 1039 Crosby, Chicago 10.

RAISE Pheasants on the \$100 week plan. Little capital and space can make you independent. Free details. Great Central Game Management System, Columbus 1, Kansas.

\$5 HOUR Easy! Sell name plates for houses. Free sample, order blanks. Write: National, 214 Summer, Boston, Mass.

LIFETIME Income as notary public. Appointment assistance. Stationers, Helotes 50, Texas.

EARN Up to \$400 monthly raising rabbits. Free particulars. White's Rabbitry, Newark 61, Ohio.

\$40.00 WEEKLY Made growing mushrooms, fresh, dried. Dominion patent 331583. Free spawn. North American, 169P Yonge, Toronto, Canada.

BE The Popular Mechanics representative in your neighborhood and earn big profits in your spare time. Write Popular Mechanics Magazine, Room 408M, 200 E. Ontario St., Chicago, Ill.

FOREIGN And Latin American employment. 1951 "Foreign Service Directory" gives up-to-the-minute facts on military and civilian construction, government jobs, major oil listings, aviation, transportation, steamship lines, mining, importers, exporters, how-when-where to apply, application forms, hot list firms hiring. \$1.00 postpaid. Global Reports, P.O. Box 883-P, Hollywood 28, Calif.

RAISE Fishworms, free literature, complete instructions 10c. Huffmans Ranch, Rives Junction 2, Michigan.

\$46 FROM square foot plywood. Jigsaw necessary. Write, Woodarts, Bridgewater, Mass.

ALASKA—America's frontier. \$1.00 brings 1951 business directory, large government map giving up-to-date construction projects, current employment information, homestead and highway facts; hunting, fishing, game rules; firm's hiring and application forms. Alaska Opportunist, P.O. Box 883-P, Hollywood 28, Calif.

BOOKS, PERIODICALS, PICTURES POSTCARDS

WORLD'S Greatest book bargain. 500 large illustrations and data on fish. Send \$1.00 for dictionary of fish. Great Outdoors Association, Pier 63 Central Basin, St. Petersburg, Florida.

MAGAZINES (Back dated). Free catalog. KNP Co., 183 Scholes, Brooklyn, N. Y.

BOOKS—Government surplus. Textbooks, including International Correspondence School's Home Study Pamphlets. One half million volumes. Bargain prices. Free catalog. Long's College Book Co., Dept. PM, Columbus 1, Ohio.

"THE Houston Story," by Ed Bartholomew; a factual narrative concerning fabulous Houston, Texas and the Texian frontier including heretofore unpublished accounts of Indians, frontiersmen, gunmen, Texian revolution, etc. Deluxe cloth-bound 1st edition, signed by author, \$3.50. Your book-store or the publisher, Frontier Press, 8102 Lockheed, Houston, Texas.

TEN Beautiful postcards \$1.25 money order. Graff, 2 Rue Montauban, Paris, France.

BIG Money in old books! We describe 910 with recent auction prices to \$151,000. Yes, \$151,000! Many over \$1,000; scores over \$100. Only \$1 complete. Old Book Guide, Box 881-I, Washington 4, D. C.

DIESEL Mechanics—1951 pocket edition Diesel Trouble Shooting now available. \$1.00 postpaid to Mercantile Products Co., 270 So. Hartnett, Ferguson, Mo.

ILLUSTRATED Catalog. Indian relics, old guns, factual Southwest books, thousands old-rare books, treasure-lost mine books. 10c. Frontier Bookshop, 8104 Lockheed, Houston, Texas.

HARD-To-find books, send wants. Green, Box 6761, Los Angeles 22, Calif.

POCKET Book swap. Send 12 books and \$1.00, receive 12 different. Lawrence, 120 Boylston St., Boston, Mass.

BOOKHUNTERS! Any subject, send wants! Atlantic Book Service, Lawrence Avenue, Charlestown 29, Massachusetts.

BOOKHUNTERS! All subjects. Send wants! Jaher Book Service, 620-P East 178 Street, New York 57.

GAMES AND ENTERTAINMENT

ADULT Party games, 12 for 50c. Veas, Box 301-PM, Decatur, Georgia.

MAGIC TRICKS, PUZZLES, JOKER NOVELTIES

PLASTIC Ventriloquist dummies and instructions; two for 50c. Roalex, 32 West 39th Street, New York City 18.

FREE Trick and large illustrated catalog, 35c. Lerro Magic, 509 80th Street, Brooklyn 9, N. Y.

FREE Jokers item with catalog, tricks, puzzles, masks, squirting, shooting, snapping items, roaches, hundreds more 25c. Andersen's, 6815P Ardmore, Chicago 31.

CHINESE Division. Astounding. Instantly perform long division backwards writing only answer. 25c. Free catalog. Monti, 219-P Tinton, Eatontown, N. J.

LIQUID Light trick! Beautiful fiery liquid from cold water! 15 minute display. Spectacular for home or professional show. Instructions and materials for 3 shows \$1.00. United Manufacturing Associates, 3605-A Canyon Ridge, Fort Worth 3, Tex.

LATEST Magic for pocket, parlor, stage. Catalog 500 tricks, only 10c. Unequaled magic service for 30 years. Douglas Magicland, Dept. 1, Dallas, Texas.

WORLD'S Largest professional magic shop, keeps you in touch with latest tricks. To receive mailings, send 50c for new catalog. Holden's, M220 West 42nd St., New York.

512-PAGE Catalogue of 2500 tricks, pocket, parlor, stage. World's finest magic. Send \$1.50 for catalogue (refunded first \$6.00 order). Kanter's, M-1311 Walnut, Philadelphia 7.

16 CARD Tricks and catalog 25c. Sterling Magic, Royal Oak, Mich.

200 ELECTRIC Stunts, 110 volts. \$1. Kutting Sons, Los Altos, Calif.

584-PAGE Catalog, 7500 novelties, fun-makers, tricks, jokes, gadgets, hobbies, timesavers, animals, sports, scientific. 10c. Johnson Smith Company, Dept. 349, Detroit 7, Michigan.

PROFESSIONAL Catalog, 124 pages, 25c. Williams, 900 Plymouth, Ellwood City, Penna.

BE A magician. Large professional magic catalog of latest tricks, 35c. Ireland, C-109 North Dearborn, Chicago 2.

COINS, TOKENS, CURRENCY

COIN Collector's new magazine, just out, and two wooden nickels 10c. Lawrence Brothers, Anamosa, Iowa.

FREE! Foreign coin, banknote and coin collectors illustrated catalog to approval service applicants. Send 3c postage. Tatham Coinco, Springfield 30, Mass.

OLD Money wanted. Will pay \$100.00 for 1894 Dime, S. Mint. \$50.00 for 1913 Liberty Head Nickel (not Buffalo). Big premiums paid for all rare coins. Send 4c for large coin folder. May mean much profit to you. Numismatic Co., Dept. 20, Fort Worth, Texas.

GET Profit and pleasure in collecting old coins. Send 10c for 56 page illustrated coin catalog. You'll be delighted with it. Send for it now. B. Max Mehl, 370 Mehl Bldg., Fort Worth, Texas. Largest rare coin establishment in U. S. Established 50 years.

JAPANESE Invasion notes. 1c to \$1,000.00, \$2.00. Burma note and catalogue 25c. Shultz, Salt Lake City 10, Utah.

100 COINS And bills, \$1.00. Oddehon, Box 482, St. Louis, Mo.

GIANT Fifty-two page illustrated price-list of coins, albums, supplies. Send dime to Ben's Coin Shop, 31 N. Clark, Chicago 2.

STAMP COLLECTING

FREE—Complete set of famous Americans, flags, parks and presidentials to approval buyers. Send 3c for 15 of the above stamps plus full particulars. Triboro Stamp Company, 145 Nassau Street, Dept. 106, New York 38, N. Y.

PAYING High prices for approvals? If your collection numbers under 15,000 try our 1c and 2c approvals. In books of 1000 different. Lots to choose from at lowest prices. Also special offer to customers. Clark, Box 544-P, Muskegon, Michigan.

FREE Albums, catalogues, stamps, etc., to our customers. Ask for details and selection of approvals. Prices, stamps, and service that satisfy mounted in books and sheets—priced from 1/10 to 1/2 catalogue. References appreciated. Roseland Stamp Co., Dept. 10, Spring Lake, Michigan.

SAN Marino collection free. 25 different, old and new issues, airmails, commemoratives, high values—absolutely free with approvals. Viking, 130-ZZ Clinton St., Brooklyn, N. Y.

TRIANGLES! Six bicolored beauties (ferocious beasts, tropical birds, etc.). With colorful approvals—only 10c! Atlas, 2830-T Eisenhower, Racine, Wisconsin.

FOLDED Stamp hinges, 1000, 25 cents. Anderson, Box 855, Mountain Homes, Tenn.

TIP-TOP Collections, values galore, 3000 different \$6.00; sample 25c. Lists free. Dale's, 5753A Woodlawn, Chicago 37.

25 DIFFERENT Uruguay only 8c to approval applicants. Johnson, Box 267, Morgan Hill, Calif.

DEALERS—Wholesale list. Postage 3c. Frank, 5031 Queensberry, Baltimore 15, Maryland.

FLAG Stamp—Free with hydrate U. S. approvals. Wenigman, 1933 Patterson, Chicago 13.

FREE! 100 Stamps from Abyssinia to Zanzibar, includes bicolored, triangles, diamonds, airs, with approvals. L. Mounblow, 740 Hegney, Bronx 56, N. Y.

ROOSEVELT Set plus 25 different U. S. 10c. approvals. Locust Stamp Co., Box 390T, Peekskill, N. Y.

STAMP Cleaning service. We will clean your stamps on paper. Write for details. Ray & Ray's Service, 5310 50th Street, Maspeth, L. I., N. Y.

FREE Stamp zoo! Snakes, leopard, rhinoceros, etc.—to introduce our colorful "bargain approvals." Niagara Stamps, Niagara-on-the-Lake 10, Canada.

STOP Fishing! Receive "personalized" approvals. What are your requirements? Brooks, 2352R East 23rd Street, Brooklyn 29, New York.

70,000 STAMPS Sale. Grabbag 30c. Box with hundreds all different \$1. Schollmeyer, Box 48, Brooklyn 25, N. Y.

1/2c-1c APPROVALS! Bargains galore! Cole, 43-A Rinewalt, Buffalo 21, N. Y.

100 SOUTH American stamps, souvenir 10c. approvals. Austin, 2917p Grand Concourse, New York 68.

50 DIFFERENT U. S. 10c. No approvals. Seidenberg, 944, Appleton, Wis.

FIFTEEN Different old U.S. sent for 10c to approval applicants. Donald Brunner, 832-G Union, Lancaster, Penna.

CHINA, 100 Different 15c; 500, \$1.00; 1000, \$3.50. Fagan, 3408 North 41st, Milwaukee 16, Wis.

FREE—Gold Coast, Nigeria! Approvals 40% catalog! Colonial, Box 326A, Passaic, N. J.

31 TIN Can Island, etc., with approvals. Mitchell, Box 923H, Portland, Maine.

50%-75% DISCOUNTS! Approvals from 33,000 collection—1/2c up! Schur, Box 252, Buffalo 12, N. Y.

SWASTIKAS! Leizigs! "Osterreich" on Hitler! Three complete sets—10c! Approvals. Billingslea, Gilmer 4, Tex.

1500 HIGH-Grade mixture, foreign or U.S. \$1.00. Arrowhead, Box 82, San Antonio, Texas.

STAMP Tongs 10c to approvals. Dolinco, 31 Park Row, New York City 38.

GRAB Bags 20c each. Frazer, 1093 "D" Street, Springfield, Oregon.

FINE Approvals. Fast, personal service. What countries do you prefer? I'll send their stamps. Skinner, 438 Locust, Long Beach 12, California.

FREE Album, commemoratives, mint sets—to buyers from our famous penny approvals. Complete details accompany trial selection. Orano, Box 1775, Santa Ana, California.

BUILD Your collection! The easy way—Order by mail. Big illustrated catalog 10c. "Stamps By Mail," 109 N. Dearborn, Chicago 2.

U. S. Catalogue free. Over 500 illustrations for stamps, albums, supplies. Stone, 45 Bromfield, Boston 8, Mass.

FREE! \$10,000 Airmail! Philippines! Fezzan! Uruguay! Approvals. Keating, 2520-P Boulevard, Jersey City 4, New Jersey.

BEAUTIFUL Mint Set, 5c with approvals. Henry Zimmer, 722 Culver, Rochester 9, N. Y.

"GOYA Nude" set (Catalogs 55c) 15c with approvals. Royal Stamp Company, Tamaqua, Penna.

LIBERIAN Triangulars, 10c with approvals. Vargo Stamps, 6044 South Fairfield, Chicago 29, Illinois.

FREE: Mint British Colonies from Brunel, Nauru, Dominica, Ascensions, Solomon Islands, Caymans, Tonga, Gilbert, Ellice, Pitcairns—free with approvals! Viking, 130-Z Clinton St., Brooklyn, N. Y.

WONDERFUL Offer. 7 complete mint sets Manchukuo, Bohemia, etc., only 10c with approvals. Reich Stamp Co., 4647 Kenmore, Chicago 40, Illinois, Dept. M23.

BARGAIN 100 Different Switzerland stamps 25c with foreign approvals. Ward, 241 So. Winchester, Campbell, Calif.

WAR Zone! Formosa, Manchukuo, Mongolia, others, 30 stamps! Rare! Only 3c! Approvals. Concord, 429-E, Beeville, Texas.

STAMPS Wanted. Collections, duplicates, surplus stock, mint and used. Buy outright if bargain. What have you? Vanroy Shirk, Lebanon, Penna.

WHOLESALE Closeouts! 1000 commemoratives, pictorials, airmails, etc. Cataloging \$25.00. Fantastic value. Guaranteed! \$2 postpaid. Waynesco, Box 7008, Long Beach, California.

FREE! 25 Different Switzerland with swell approvals. Kardell, 209 Bower, Santa Fe, New Mexico.

77 DIFFERENT United States—25c. Approvals. Utechts, 1143-D North Keeler, Chicago 51.

FREE Beautifully illustrated complete catalog, 3c postage. Ace, 528B Chester-Ninth, Cleveland 14, Ohio.

FREE Hinges. With 25 large different Mexican airmails, only 60 cents. Robert Boger, 3401 Oakmont Ave., Philadelphia 36, Penna.

FREE Collection—Over 100 different stamps of world; commemoratives, animals, natives, ships, famous men, others all to approval buyers; also Scott albums, catalogs. Bell Stamp Service, Dept. S-2, Bell, Calif.

GIFT Nicaragua baseball airmails. 5 to approval applicants. Deane Stamps, Box 87, Miami 35, Florida.

UNITED States approvals—Select, used or mint. Kingsbury, Woodbury, Vermont.

U. S. Illustrated price list free. DeLisle, 154 S. 2nd St., San Jose, Calif.

307 ALL Different—Only 15c! Beautiful collection: commemoratives, triangles, high values, bicolored stamps, etc. Garcelon, Calais 400, Maine.

UNITED States approvals complete coverage, fine quality, attractive prices. Seminole Stamps, Box 1138-P, Coral Gables, Florida.

5000 DIFFERENT Stamps—\$12.50. Lists free. Beacon Sales, Maynard, Mass.

FREE—Deluxe packet to approval applicants listing countries collected. McQueston, 185 Puritan, Detroit 3, Mich.

...ng. "Hundreds of Subjects."
 Society, 126 Lexington Ave., New York 16,
 N. Y. Entertaining, fascinating.
 Society, only 50c. National Cine
 8-16MM. Silent-sound films. Complete
 rental library. All latest subjects. Free
 catalogue, sample film 10c. Garden Film,
 317 West 50th, New York 19.

BASS Says: Leadership since 1910 guar-
 antees satisfaction. Finest Cine equipment:
 8mm., 16mm., and 35mm., silent and
 sound. Write the old "horse trader." Sat-
 isfaction or your money back always! Bass
 Camera Company, Dept. A, 179 W. Madi-
 son St., Chicago 2.

RENT 16MM. sound films, 50c reel. Large
 selection; free catalog. Film Service, 128
 Chestnut St., Roselle Park, N. J.

LEARN Professional motion picture tech-
 nique at home. Free catalog. Motion Pic-
 ture Institute, Birmingham 4, Mich.

GUARANTEED Fresh 8mm. roll, maga-
 zine; 16mm. roll, magazine movie films.
 Color, b&w. Free catalog. ESO-S, 47th
 Holly, Kansas City 2, Missouri.

MOVIE Camera film: 8mm. roll \$1.00
 16mm. 100' \$3.00. Free processing. ESO-S
 Films, 742 New Lots, Brooklyn, N. Y.

WANTED! Poems for musical set
 Write Songwriters' Service, Clifton,
 PHONOGRAPH Records cheap. C
 logue. Paramount, FQ-313 East Mar
 Wilkes-Barre, Penna.

RADIO AND TELEVISION

FREE—Completely new 1951 radio, tele-
 vision and electronic buyer's guide. Page
 after page of the very latest available sup-
 plies of guaranteed quality at today's low-
 est prices. Thousands of super-values in
 Hi-Fi units, sound television and ra-
 dios, phonos, recorders, books, testers,
 tubes, kits, parts and equipment, and ra-
 for immediate shipment. Big stocks,
 Concord Radio Corp., Dept. LF-51, 90
 Jackson, Chicago 7, Illinois

BUILD
 radio and
 knowledge
 buy

Wash. 120
 BIG M
 home

MUSIC AND MUSICAL INSTRUMENTS
 POPULAR Piano
 ers-advan
 on. Bas
 com
 on

NOTHING FREE! Just good stamps reasonable. Send dime for seventy-four page catalog. Ben's Stamp Shop, 31 N. Clark, Chicago 2.

FREE! United States-Germany Occupation stamps. Approvals. Stampco, #987, Albany 2, New York.

COMMEMORATIVE Philatelic sheet free to approval applicants. Paragon Stamps, Box 1378, Miami Beach 39, Florida.

100 NETHERLANDS. All different. Beautiful assortment. 10c with approvals. Thomson's, Box 4074-P, Miami, Florida.

AMAZING Offer! 500 United States stamps—including commemoratives, airmails, high values to \$5.00. Only 10c to approval applicants! Illustrated bargain lists free. Mystic Stamp Co., Dept. 80, Camden, New York.

FIRST U. S. (1847) government reissues 5c, 10c, plus giant bargain U. S. collection—only 5c to applicants U. S. approvals. Metropolitan, Box 312G, Jackson Heights, N. Y.

10 ASSORTED U. S. Commemorative 15c. Five U. S. Air Mail 15c. 10 Famous Americans 25c. All for 50c. Ideal Stamp Shop, Box 179, Park Ridge, Illinois.

WOW! 203 All different Germany 10c! Zeppelins, semipostals, airmails, high values, etc. to new customers. Jamestown Stamp, Jamestown 512, New York.

WORLD'S Largest stamp (7½x14 inches). A real curiosity! Retail for 50c, only 3c to approval applicants. Tatham Stamp Co., Springfield 30, Mass.

UNITED States stamps nearly 100 years old, Roosevelt set, others, 40c value—only 5c to applicants United States approvals. Wakonda, Box 272K, Jackson Heights, N. Y.

500 STAMPS For only 10c! This mammoth value includes airmails, pictorials; stamps from strange countries, cataloging up to 25c each! Also approvals. Mystic Stamp Company, Camden 80, New York.

COLUMBIANS. Trans-Mississippi, Pan Americans, Pan Pacific, ten other different commemoratives. All 10c with your request for U. S. approvals. Moda Stamps, Box 251-X, C.S.A., New York 8.

MAGNIFIER. Big stamp magazine; first U. S. commemorative; plus unused \$5000 Foreign Legion, diamond, giant, and other worthwhile stamps. Everything free to approval buyers. Capital Stamp Company, Little Rock 2, Arkansas.

FREE! Powerful magnifying glass. Jamestown Stamp, Jamestown 202, New York.

200 DIFFERENT Including Roosevelt triangle, 5c to approval applicants. M. Avalon Stamp Company, Springfield, Mass.

OVER 1,000,000 Sold; 200 different stamps 10c with approvals. Carlton's, Tujunga, Calif.

500 EXOTIC Japan stamps—10c. Kenmore, Richford, J-57, Vermont.

750 FRANCE And colonies stamps 10c. Littleton Stamp Co., Littleton 25, N. H.

50,000 STAMP Grabbags 25c each. Anderson, 630B, Bingham, Reading, Penna.

FREE—Illustrated catalog! Kenmore, Richford, C-57, Vermont.

"HOW To Recognize Rare Stamps." Free book illustrated! Kenmore, Richford, H-57, Vermont.

FREE U. S. price list, postage 3c. Mark Hanna, 335 5th Ave., Pittsburgh 22, Penna.

OLD Scarce U. S. seconds on approval. Slightly defective. Bargain prices. Herfield, Clintonhill Station, Newark 8, N. J.

FREE Supply list. Penny approvals on request. Reed, Box 980, Chicago 90, Illinois.

FREE "Stamp Finder." Tells instantly country to which any stamp belongs. 32 pages profusely illustrated. Garcelon, Calais 17, Maine.

10,000 DIFFERENT 1c Each! Gordon Davison, Box 1019S, Manchester, N. H.

ANTIQUES, RELICS, INDIAN GOODS, CURIOS

ANTIQUE Handguns popularly priced. Beginners or general collectors list 10c. Hi-Fulton Gun Corner, 413 South High, Columbus 15, Ohio.

4 FINE Ancient Indian arrowheads \$1.00. Fine Tomahawks \$2.00 and \$3.00. List free. Lear's, Glenwood, Arkansas.

EIGHT Arrowheads, illustrated catalog, relics, guns, Southwestern books, thousands old and rare books, \$1.00. Frontier Bookshop, 8104 Lockheed, Houston, Texas.

GEMCUTTING, SILVERCRAFT, MINERALS

GEMCUTTING, Silvercraft authority. Illustrated magazine tells how. Cut rocks, make jewelry. 150 ads illustrating equipment, offering gems for collectors, cutters. Rustal brings literature. Lapidary Journal, Palm Desert, Calif.

MORE Brilliant than a diamond. Write for free literature about the Kenya gem, amazing new discovery. Only \$24 (1 carat) to \$120 (4 carats). Kenya Gem Corporation, Dept. 286, Philadelphia 44, Penna.

GEMS—Mined, brilliant. Cut like a diamond. Sample 25c. Money back guarantee. List free. Importers, 432 South Western, Hollywood 5, California.

GEMSTONES, Mineral specimens. Every variety. Lowest prices. Postcard brings free booklet. Plummer's, 2183C Facon, San Diego 7, California.

MINERAL Specimens, cutting material, slabs and gems. Send for free price list. Warren's Minerals and Gems, 1969 Abbott St., San Diego 7, Calif.

HOBBIES AND COLLECTIONS

50 DIFFERENT Army embroidered patches \$1. Other bargains. Insignia Mart, 703A Broadway, New York 3, N. Y.

COLLECT Cartophilic cards! New fascinating hobby. Interesting packet containing birds, butterflies, aeroplanes, flowers, trains and other rare cards. Plus big illustrated catalogue. All for 10c. International Cartophilic Co., Dept. PM, 1152 Yonge Street, Toronto, Ontario.

INVENTING Can be an interesting and profitable hobby. Write for complete particulars. Institute of American Inventors, Dept. 40-E 631-E St. N.W., Washington 4, D. C.

UNUSED Matchbook covers—100 different \$1.00. Catalog 25c. Charles Edelman, 1311C East 84, Cleveland 3, Ohio.

CAMERAS, PHOTO SUPPLIES

PHOTOMURALS. Your negatives or ours. Catalogue 25c. Photomammoth Murals, 12048 Vanowen St., North Hollywood, Calif.

ULTRA Powerful telephoto camera easily made. Trifling cost. Objects miles away photograph close up. Carl Jamer, Box 694, Manorville, N. Y.

BUY Photographic supplies wholesale. Free catalog. Expert camera repairing. Capitol Photo Supplies, 2428 Guadalupe, Dept. 5, Austin, Texas.

\$3.95 ALL-Metal box camera, \$1.00 postpaid! Aero Parts Supply, Municipal Airport, Houston, Texas.

FREE Photographic bargain book packed with hundreds of sensational values in still and movie cameras, lenses and latest accessories. Super savings for you in new and used equipment. Liberal trade-in allowances, too, on your equipment. Write now for your free copy to Central Camera Company, Dept. 9D, 230 S. Wabash Ave., Chicago 4. (Photographic headquarters since 1899.)

SHUTTER Bugs! Learn "how to sell your pictures and make big money." Teach yourself—"Simplified Photography Handbook, step by step methods. Hollywood glamorizing" photos, diagrams show how, plus bargain supply catalogue. Only \$2.00. Muir Studios, Milford 10, Penna.

PHOTOCOPY Anything—Papers, books. No darkroom. 8½" x 11" complete \$6.95. Fotofiek, 8555 Plainfield Lane, Cincinnati 36, Ohio.

BASS Says: Trading cameras a national habit since 1910. Write to Bass the old "horse trader." A postcard will do. Simply say: "Bass, I have and I want. How much will you allow me?" It's fun to trade with Bass. Satisfaction guaranteed. Bass buys, sells, and trades. Bass Camera Company, Dept. AG., 179 W. Madison St., Chicago 2.

PHOTO FINISHING

POST-L-PIX Service. Have your roll films developed with sparkling enlargements bound in attractive plastic ring album. As low as 50c for 8 exposure roll. (12 exp. 70c—16 exp. 90c.) Send film and cash or write for free roll mailers and amazing club savings. Satisfaction guaranteed. Post-L-Pix, Box 1JB, Worcester 4, Mass.

JUMBOS 8—30c, 12—45c. Reprints 4c. Free mailers. Photo electric eye equipment used. Western Photo, Dept. PM61, Box 298, San Francisco 1, Calif.

FREE Reload with each order of 35mm. developed and printed, \$1.50. Any 8 exp. roll 40c; 12 exp. roll 60c; 16 exp. roll 75c. Bonded prints are custom Hollywood professional quality. Why gamble? Free mailers. Bonded Photo, 1021 W. Santa Barbara, Los Angeles 37, Calif.

WE Specialize 620/120 film only. Quality prints. Send \$1.00 and film. Voray Laboratory, Pittsford, N. Y.

NEW Negative and two enlargements one dollar. Curriophoto, 1187 Jerome, New York 52, N. Y.

8 BEAUTIFUL Pictures 30c incl. developing. Jumbo enlargements 20—90c; 36—\$1.25. Mailer and pricelist on request. Duplex Photo, Box 1207, General Post-office, New York 1, N. Y.

100 1x1¼ GLOSSY Photos from any picture \$1.00. Johnny Trueblood, Box 917, Wilson, N. C.

UNDESIRABLE Backgrounds removed from your negatives. Send negative and instructions with \$1.00 each to: Capitol Service, Suite 7, 342 Hanover Street, Boston, Massachusetts.

COLORING, 5c Snapshot! 25c—\$1.00! Send prints. Golebiewski, 5103 Wyoming, Dearborn, Michigan.

SIX Or 8 roll of film developed and printed 35c. Twelve or 16 picture roll 55c. Send coin with roll. No c.o.d. If you fail to get pictures on your roll of film, we will mail a new roll to you at no additional cost. Overnight service. Mailers sent free on request. Deluxe Film Service, Box 1268-A, Shreveport, Louisiana.

MAIL Us your films. Prompt service. 8 exposures developed and printed 30c. Free enlargements. Foto Art Studio, Box 406, San Francisco, Calif.

16 PRINTS Or 8 jumbos from roll, 25c with this ad. S. Skrudland, River Grove, Ill.

FREE Price list on quality developing, printing, enlarging. Write for it today. Bryan's Photo Shop, Dept. M, Panama City, Florida.

MOTION PICTURES AND SOUND EQUIPMENT

NOW! Sound for your 8 and 16 mm. movies. Complete the thrill of home movie projection. Add interest by recording titles, voices and background music. Send for complete details free. Lake Erie Electronics, 9048 Ridgewood Dr., Cleveland 29, Ohio.

16MM. Sound films, bought, sold, exchanged. Send for giant List "A" today. Also state what you have for sale or exchange. Write Institutional Cinema Service, 1560-PM Broadway, New York 19, N. Y.

THRILLS! Action! In exciting 8-16mm. movie film subjects. Big movie and equipment catalog with sample film, 25c. National Film Supply, Toledo 9-H, Ohio.

35 MM. Films: sound. Frank Kavathan, 5514 Media Dr., Los Angeles, Calif.

ALMOST Free— With your request for Blackhawk's big 32-page catalog of film bargains. One brand new film, postpaid. (We select the title.) 100' 16mm. sound, 98c; or 100' 16mm. silent, 59c; or 50' 8mm., 39c—as a special get acquainted offer. Other typical Blackhawk bargains: New 1-reel 16mm. sound films, \$7.95 (formerly \$17.50); new 1-reel 16mm. silents, \$2.98 (formerly \$8.75); new 1-reel 8mm. \$1.89 (formerly \$5.50)—all first quality prints in original cartons. Used Panoram 100' 16mm musicals \$6.89 per dozen. Similar bargains in used features, cartoons, sports, comedies, musicals, travels. Used sound projectors—Ampros, Bell & Howells, Victors—often available low as \$129.95. Bargains in reels, cans, supplies. World's biggest stock 16mm. films; over 100,000 prints. Write today for Blackhawk's free catalog and get acquainted offer. "Sixteen's Super Market." Blackhawk Films Inc., 1200 Putnam Building, Davenport, Iowa.

FREE. Home movies. 8mm.-16mm. Lists. Waldman-Y2, 209 Jackson, Chicago.

BARGAINS In brand new movie films. Close-outs of 8mm. and 16mm. silent, 16mm. sound. Terrific bargains. Send now for free list. Swank, 616 North Skinker, St. Louis 5, Mo.

EARN \$8.00 To \$10.00 daily with your movie projector! Write: Beverly, 10806 Glenroy, Chicago 43, Ill.

5000 NEW-Used 8-16mm. silent-sound films. International, 2120 Strauss, Brooklyn 12.

FREE Movies "Hundreds of Subjects." Interesting. Entertaining, fascinating. Latest Directory only 50c. National Cine Society, 126 Lexington Ave., New York 16, N. Y.

8-16MM. Silent-sound films. Complete rental library. All latest subjects. Free catalogue, sample film 10c. Garden Film, 317 West 50th, New York 19.

BASS Says: Leadership since 1910 guarantees satisfaction. Finest Cine equipment: 8mm., 16mm., and 35mm., silent and sound. Write the old "horse trader." Satisfaction or your money back always! Bass Camera Company, Dept. A, 179 W. Madison St., Chicago 2.

RENT 16MM. sound films, 50c reel. Large selection; free catalog. Film Service, 128 Chestnut St., Roselle Park, N. J.

LEARN Professional motion picture technique at home. Free catalog. Motion Picture Institute, Birmingham 4, Mich.

GUARANTEED Fresh 8mm. roll, magazine; 16mm. roll, magazine movie films. Color, b&w. Free catalog. ESO-S, 47th Holly, Kansas City 2, Missouri.

MOVIE Camera film: 8mm. roll \$1.50, 16mm. 100' \$3.00. Free processing. Better Films, 742 New Lots, Brooklyn, N. Y.

MUSIC AND MUSICAL INSTRUMENTS

POPULAR Piano lessons by mail. Beginners-advanced. Two popular songs each lesson. Bass, fillins by sheet music chords. Not complicated self-instruction. Easy personal lessons. Play songs first lesson or money back. Free details, sample. Chord chart 50c. 14th year. Stuart Studios, 1227 1/2 Morris, Union, N. J.

PIANISTS (Adult). Greatly improve technique, accuracy, sightreading through remarkable mental-muscular coordination. Quick results! Also practical, unique classical; modern popular courses. Composition, songwriting. Free booklet. Write Broadwell Studios, Dept. 51F, Covina, California.

SWING Piano—By mail. 30 self-teaching lessons \$3. (Samples.) Phil Breton Publications, P.O. Box 1402, Omaha 8, Nebr.

POEMS Wanted for musical setting. Send poems for free examination. Five Star Music Masters, 630 Beacon Bldg., Boston, Mass.

SONGWRITERS Service. Newart Publications. GPO Box 1226, Syracuse, New York.

PLAY Piano! Easy-way to learn. Beginners book. Advanced book teaches chords. Rhythm bass. Only \$2; both \$3. Moreau Studios, 139 Mathewson St., Providence 3, R. I.

LEARN Guitar Hollywood way. Short new method. Play songs immediately. Only \$1 Carey Bennett, 629 N. St. Andrews Place, Hollywood 4, Calif.

VOICE Secrets of famous tenor. \$1. Box 864, Hollywood, California.

PRE-War phonograph records wanted, or dealers stock. Schneider, 128 West 66th, New York City 23.

SONGWRITERS — Publishers booklet "Commercial Music"—plus ten valuable musical mailing lists (700 names-addresses) \$1.00. Popular, Box 927-B, Atlanta, Ga.

ELECTRIC Guitars, amplifiers, save 50%. Free literature. Carvin PM, Baldwin Park, Calif.

MUSIC Arranged. Songs printed. Frank Wildt, Music Publisher, Lancaster, Penna.

POEMS Wanted. Broadcast consideration. Sooner Song Co., 22-PM Northwest 8th, Oklahoma City 2.

SWISS Musical movements \$1.00. Catalogue 10c. Bell Music, 1610 First Avenue, New York 28, New York.

ACCORDIONS — All brands. New and used. Save 50%. Wholesale to every one. Del Principe, 307 So. Wabash, Chicago, Ill.

1951 ACCORDIONS — Wholesale. Free catalog. American Accordion Center, 5329 Belmont, Chicago.

YOUR Voice made loud, clear and powerful with my diaphragm exerciser. Write. Inventor "Oz," 34V, Box 665, St. Louis, Mo.

POEMS Wanted to be set to music. Free examination. Send poems. McNeil, Master of Music, 510-PM S. Alexandria, Los Angeles, California.

WRITE Songs. Big money and reputation. Write for information. J. Gordon Pub. Co., 4700 South California Avenue, Chicago.

WANTED! Poems for musical settings. Write Songwriters' Service, Clifton, N. J.

PHONOGRAPH Records cheap. Catalogue. Paramount, FQ-313 East Market, Wilkes-Barre, Penna.

RADIO AND TELEVISION

FREE—Completely new 1951 radio, television and electronic buyer's guide. Page after page of the very latest available supplies of guaranteed quality at today's lowest prices. Thousands of super-values in Hi-Fi units, recorders, television and radios, phonos, sound equipment, testers, tubes, kits, parts and books. Big stocks for immediate shipment. Send for it now! Concord Radio Corp., Dept. LF-51, 961 W. Jackson, Chicago 7, Illinois.

BUILD 15 Radios—Only \$19.95. Learn radio and television at home. Previous knowledge unnecessary. Nothing else to buy. Free tester and tools. Quizzes, trouble-shooting lessons. Money back guarantee. Send check or money order; we pay postage. COD's accepted. Order now or request further information. Progressive Electronics Co., Dept. PM-50, 497 Union Ave., Brooklyn 11, N. Y.

EARN Big money! Now repair TV sets rapidly with Cisin's new "Rapid TV Trouble Shooting Method!" Includes 160 trouble symptoms, simplified directions, etc. Locates all faults, any model TV. Rush \$1.00! Harry Cisin, 200 Clinton St., Brooklyn, N. Y.

RHOMBIC TV antenna outperforms all other types, power gains of 100 for extreme fringe area, reception drawings, complete instructions for 24 sizes \$1.50. R. Buchan, WOTJF, Briceville, Minnesota.

RADIO And television tubes. All numbers. New at excellent discounts. Write us. Immediate response. Beacon Stores, Inc., Anderson Ave., Grantwood, N. J.

SIMPLE Television-radio repairs. Accomplish wonders quickly. Illustrated manual, lifeguard circuit, dollar. George Paterno, Box 1351, New York City 8.

PICTORIAL Instructions. Midget radio, all-purpose tester. Code, crystal sets, 25c. Arthur Alena, Wall Street Station, Box 271, New York 5.

BECOME An amateur radio operator. Fascinating hobby leads to high paying positions. Home study course. Theory preparation for passing government license examinations. Low cost. Personal coaching. Federal Electronics Institute, 45 E. Putnam, Dept. B, Greenwich, Conn.

15 TESTED One-tube circuits 25c, including "Radiobuilder," catalog. Laboratories, 411-C Capitol Hill, Reno, Nevada.

FREE 1951 Catalog—Radio, television and electronic supplies. Hundreds of super values in sound equipment, record changers, Hi-Fi units, TV tubes, antennas. Big stock. Fastest service in the West. Wholesale Television and Radio Supply Company, Dept. PM7, 408 Market Street, San Francisco, Calif.

OPEN Wire transmission line. Perfect reception up to mile from antenna. Cheaper than tape. Permanent. Material list, instructions, \$2.00. TeeVe, Box 20, Silverado, Calif.

AMATEURS—Radio and electrical engineering service. Henry Twillmann, R.R. #1, Chesterfield, Missouri.

MAKE Simple, tubeless, batteryless, distance-getting crystal radios. Crystal and illustrated instructions 25c postpaid. Allen, 427-P, Clinton, Mo.

BUSINESS OPPORTUNITIES

EARTHWORMS: Start with 100 Till-O-Cast breeders. Sent postpaid for only one dollar bill. Test Till-O-Cast results in own soil or breed for gardeners, flower growers, fishermen. Easy, profitable. Free Till-O-Cast instruction sheet with each shipment. Send \$1 today. Mrs. Howard E. Smith, R. 3, Jonesville, Mich.

GO In business for yourself. Make \$50.00 a day with the new Andre Floss Candy Machine. Complete stand and glass case \$498.00. Wire, telephone or write Andre Floss Candy Machine Company, Post Office Box 1827, Knoxville, Tenn.

NEW 4 In 1 kitchen tool—Housewives grab 'em at \$1. Your price 48c each—dozen lots. Agent's sample 50c postpaid—or send postcard for free details only. Edanbob Sales Co., 1906 N. Cicero Ave., Chicago 39, Ill.

TO \$35.00 Weekly. Spare time, home operated mail order business. Successful small "beginner's" plan. Everything supplied. Lynn, 5710-M Bankfield, Culver City, California.

MEN, Women. Grow mushrooms. Cellular shed. Spare, full time, year 'round. We pay \$3.00 lb. We paid O. Babbitt \$4,165 in few weeks. Send \$2.00 for general information book. Washington Mushroom Ind., Dept. 125, 2954 Admiral Way, Seattle, Wash.

BIG Money! Spare or full time in your home. No selling! Spray new miracle finishes, plush and suede, on signs, radios, automobiles, figurines, lamps, toys, etc. Our business is booming. Help us fill huge demand. New easy Flok-Kraft methods. Material costs few pennies. You get dollars. Free samples, complete powerful money-making plan free. Write now! Coast, 1902H S. Los Angeles St., Los Angeles 15, Calif.

MIRROR Resilvering. Wonderful home business. Complete formula 50c. Magic two way mirrors. You can see out—no one can look in. Formula 50c. How to make colored mirrors, vases, glasses. Formula 50c. All three \$1.00. Neiko Chemical Service, Box 3462-MF, Chicago 54, Ill.

LEARN Sewing machine repair. Electricity, rent, trade, sell. Big profit home setup. We show you how. Motor kits, net machines, etc. supplied wholesale. Free particulars. Taylor Service Co., Hamilton, PM-6, Ohio.

START Your own business on credit. Always your own boss. 1559 dealers \$5,000 to \$28,000 in 1949; their average \$6,834. We supply stocks, equipment, credit, 200 home necessities. Selling—experience unnecessary to start. Won't opportunity to own pleasant profitable business backed by world-wide industry. Write Rawleigh's, Dept. FU-PPM, Freeport, Ill.

INVISIBLE Reweaving—Big profit, big demand, easy-to-learn with low-cost complete course—nothing else to buy, ever. Details free, write today: Fabricon, Dept. N-2, 8342 S. Prairie Ave., Chicago 19, Ill.

MAN! These are hot! Make \$6.35 on every sale. Sales are really easy. New adding machines in original factory cartons you can sell for only \$12.95 and you make over 45%. They're executive model portables, precision built, fully guaranteed. Send for life-size color photo with full details. Write today to Lightning Adding Machine Co., Inc., Dept. P-6, 1260 West Second St., Los Angeles 26, California.

TRADE Magazines help you to success. Get latest copies through our easy-to-get-acquainted service. More than 1200 business, professional, agricultural, automotive, educational, sport, hobby, music, television, etc. List free. Commercial Engraving Publishing Co., 34C North Ritter, Indianapolis 19, Indiana.

START Home manufacturing business making cleaning compounds, soaps, insecticides, cosmetics, polishes, food flavors. No machinery. Literature free. Kemix, Park Ridge 7, Ill.

\$10 HOUR! Possible! Home! Part or full time! Invisible textile reweaving instructions, steel tool, five samples, material for life, complete \$2.00. Twenty-seven other "proven" amazingly, unusual money making home plans. Details free. Walsh, 894 Main, Buffalo 2, New York.

ESTABLISH Profitable automatic shoe shine route. Proven. Write Jiffy Shine, 1630 S. 2nd St., Philadelphia, Penna.

YOUR Name and address on postal will bring many local and mail business opportunities. Apex Supply, Box 165, New York 18, N. Y.

MAKE Rubber stamps, repair dolls, repair sewing machines, learn invisible reweaving. Catalogue of "40 Ideas" free. Universal, Box 1076-A, Peoria, Ill.

WHERE To buy at wholesale 100,000 articles. Free list. Maywoode, 1133 Broadway, New York.

FREE Book "372 Unusual Worldwide Businesses." Work home (U.S.A.)! Get surprise! Publishers-79, Carlsbad, Calif.

BIG Profits! Little effort. Tremendous possibilities. No investment. You can't lose. Free valuable information. Vannier, 722 South 29th, Milwaukee 15, Wis.

\$200 WEEKLY Reported! No selling. Free booklet. T. J. Surface, Roanoke 4, Virginia.

NEW Exceptionally profitable plans—ideas for home operated mail business. Rush name. Miller, 1772-P Carlyon Road, East Cleveland 12, Ohio.

MAKE Sell finest perfumes at home. Everything furnished. Sample fragrance, details free. Genmerco, Box 142, Dorchester, 24-L, Mass.

SELL By mail, new 10,000 word booklet shows how, 25c. Satisfaction guaranteed. McCartney, R3, Littleton, Colo.

GOOD Products sell fast. Home kits make generous sample. Kem Products, Montauk Highway, Moriches, N. Y.

SOAPMAKING—Profitable home business. 20 complete formulas, \$1.00. Soap substitutes, complete collection \$1.00. Waterless hand cleaner (no ammonia—no kerosene) \$1.00. All for \$2.00. Neiko Commercial Service, 3462-SM Merchandise Mart Sta., Chicago 54, Ill.

EXPORT-Import! Represent manufacturers! Conduct barter exchange. War-peace time big business. Buy, sell by mail. Let New York experts show you how. "What to Export and Who Wants It" and one 1951 Trade Bulletin \$1, refunded if unsatisfied. International Trades, 246-F Fifth Ave., New York 1.

LIFE-Time security! Manufacturing chemical specialties! Extremely profitable! Formula lists free. Thermolab, Peoria 4, Ill.

FIX Typewriters—Home study course quickly trains you for own business. Factory methods taught. Write: Typewriter Repair, 7915 Corbet, Tarentum, Penna.

AMAZING New moth-proofing Cedar-Wall! Mothproofs closets, drawers, trunks. Guaranteed, laboratory approved; permanent, easily applied like paint; tremendous profit potential to stores, contractors, building supply dealers; attractively packaged displays, sales literature. Exclusive distributors write or wire for samples and details. Millen Mfg., 91-J Summit Ave., Brookline, Mass.

BETTER Yourself in electroplating! Free details. Joseph Kushner Electroplating School, Stroudsburg 262, Penna.

START Your home bookkeeping service. Everything furnished. Ames, 612 Laura, Wichita, Kansas.

FREE Illustrated instructions, casting novelties. Genuine latex for molds. Major Latex & Chemical Co., 25 Allerton St., Boston 19, Mass.

ESTABLISH Profitable home mail business. Exclusive built-to-order proposition service. Everything handled for you. Booklet free. NMD Agency, Box 88-W, Dorchester 22, Mass.

MAIL Order. Unusual opportunity. Item of merit. Millions prospects. Sample, details \$1.00. Manager, P.O. Box 757, Newark 1, New Jersey.

HOMEWORKERS, spartime. Spin angora wool. Interesting work. House of Angora, PM, Springfield, Illinois.

MAKE Perfume. Catalogue free. "International," 6347 Parnell-PM-6, Chicago 21, Illinois.

MAKE Big money at home with Magic Pearl Finish. Free plan. Pearl-Art, 7216 Bear, Bell, Calif.

MAKE Money at home by mail. Amazing new book tells how. 12,000 words. Illustrated. Details sent free. Northmore's, Highland Park 92, Illinois.

SAWDUST. Turn it into cash. 42 methods. Instructions \$1.00. Charles Co., 12-BWM, Norwood, Ohio.

\$10.00 PER Hour, full or spare time demonstrating revolutionary new pinless clothesline. Agents and supervisors opportunity. Zip-Grip Sales, 1200 Niagara St., Buffalo, N. Y.

REVOLUTIONARY Conception of public bookkeeping! \$5.00 hourly. Simple instructions. Full, spare time. Systems, shortcuts, obtaining clients. Auditax, 10775-M Tabor, Los Angeles 34.

OPERATE Hosiery mending business! Free prospectus! Freed, Box 115, Chicago.

CHRONOGRAPH Wrist watch easily earned in one hour. Write Webster, Room 209, 3308 14th Street, Washington 10, D.C.

PRINT Without a printing press. Big profits! See page 33.

ELECTROPLATE Metals, mirrors, non-metals. Inexpensive, profitable home process. Free booklet. Tyco Metals, Box 13231-T, Houston 19, Texas.

\$250 WEEK Reported! Free book. "505 Odd, Successful Businesses." Work home. Expect something odd! Pacific-47A, Ocean-side, Calif.

BOOKKEEPERS, Keep books, small firms spare time. Manual latest technique by C.P.A., \$3.00. Modern Business, Box 406, Youngstown 1, Ohio.

START A venetian blind laundry. Profit opportunity for lifetime business. New machine method. Free booklet on request. F. C. Co., 442 N. Seneca St., Wichita 12, Kansas.

100% PROFIT Plan. Unbelievable but true. Take \$3.00 orders. Keep \$3.00. Order is filled free as advertising. You can't lose. Send \$3.00 today for plan. Hurry as time is valuable. Address Mullins & Co., Windsor, Missouri.

BIG Profits publishing magazines. Your name, low costs. Craigie, RCS., New York 19-B. Quarter brings instructions, samples.

PUT Yourself in the big-money class! Beautify your own home! We show you how to cover the exterior of any building—wood, masonry or concrete—with a lasting and beautiful composition finish. Simulate brick or stone, or do stucco work in any pleasing color or combination of shades. Method is simple and easily learned. Results are amazing in beauty and coloring. Opportunities everywhere. Don't pass this up! Complete directions and formulas, \$10.00. Garwood Construction Co., Blackwell, Okla.

RESURFACE Butcher's chopping blocks with easy, fast-working, portable electric machine. Unique service in wide demand with little competition. Large steady profits from full or part-time work. Hill Machine Company, Box 677B, Rockford, Ill.

SAIL Ho! Be a Merchant Seaman. Enjoy good pay, world travel. Send now for free information. Seaways, Box 47M, Old Chelsea Sta., New York City 11.

MAKE Money at home as renewal headquarters for all magazines. Liberal commissions. No experience, no capital needed. Supplies furnished. Write for free catalog. McGregor Magazine Agency, Dept. 500B, Mount Morris, Ill.

\$5 HOUR Easy! Sell name plates for houses. Free sample, order blanks. Write: National, 214 Summer, Boston, Mass.

SELL By mail, free details. Instructive booklet 25c. Manhattan House, Box 50-M, New York 28, N. Y.

INCOME From local information. No selling. Write Neherco, La Verne, Calif.

FIGURINE Molds and many others, liquid rubber, statuary plasters, flock finishes, etc. Illustrated catalog and "Plastercraft" manual free. Blue Rapids Supply, Blue Rapids, Kansas.

SAWDUST, Scrap wood, over 150 cash uses 25c. Lee, Box 502, Chicago 90.

EARN Money at home with your typewriter! Spare time! Details free. Edwards, Publisher, 3915-PM, 12th, Des Moines 13, Iowa.

NATURAL Molding Latex. Extra thick. Free sample. W. Wooley, 115-A Donald, Peoria, Ill.

MAKE Money at home making fast selling item used by millions. Terrific possibilities. No experience or equipment needed. Everything furnished. Write Strauss, 1211A So. 114, Milwaukee 14, Wis.

QUICK Sign painting. Use letter patterns, avoid sloppy work, wasted time. Write for folder. John Rahn, A1330 Central, Chicago 51.

BOOKKEEPERS Earn \$100.00 weekly operating simplified "Bookkeeping-Tax Service." Details free. Universal, Box 664-M, Springfield, Mo.

SPECIAL Rubber for making molds. Literature and sample free. Universal, Box 1076-A, Peoria, Ill.

BEST Source for nylons. Rich Supply, 215 W. 98, New York 25.

BIG Time earnings selling popular repeat-order merchandise by mail from your home. Everything furnished. Spalding, 254-P Taylor Blvd., Millbrae, Calif.

TERRIFIC Profits selling amazing payroll table \$1.00. Sample 25c. Joseph Ventola, 39 Illinois Avenue, Somerville, Mass.

NEED Money? Stop wishing! Do something! Free information. E. L. Godfelter, Box 23, Loganville, Penna.

UNPAINTED Figurines. Illustrated list. Free. Oman, 642 Broadway, St. Paul 1, Minnesota.

MAKE Flexible molds! Cast plaques, bookends, figurines! Free sample! H. Tooker, 630-R Chestnut, Hamilton, Ohio.

A Business in your own home! Our chemicals, plus free water and cheap "grocery store" materials can bring you over \$500 monthly earnings. Plans and formulas free. Western B Aircraft, Los Angeles 19.

BUY Wholesale—Million articles. Supply source directory, dime. Nelko, Box 3462-DR, Chicago 54, Ill.

LIQUID Marble—Colorful, glossy! Molded, brushed, sprayed! Cast novelties, statuary, colored tiles. Flexible molds. Composition floors. Particulars free. Marbleizing Service, Edwardsville, Illinois.

PART-Time business, full-time profits. Metallizing (plating) equipment, supplies, hard-to-get chemicals and anodes. Complete assemblies for plating baby shoes, jewelry, novelties and industrial products; copper, bronze, gold, silver, nickel, chrome, etc. Home workshop to production shops priced from \$79.50 complete. World's largest line of metal, onyx and marble mounts for bronzed baby shoes. Instructions furnished. Buy direct from manufacturer. Write for free catalog and address of local branch. Hollywood Bronze Supply, Technical Dept., 1624 East First St., Los Angeles 23, California.

NEW Profitable home business repairing zippers. Thousands of customers waiting. No experience required. We furnish everything. Write Texas Specialty Company, 204-B Texas, Texarkana, Texas.

BOOKKEEPERS Boost income operating simplified bookkeeping service. Kern, 4942 Vineland Avenue, North Hollywood, Calif.

UNPAINTED Bookends, plaques, statues, figurines. List. Haverty Products, 822-17th St., Altoona, Penna.

VENDING Machines earn big money! An investment as low as \$10.50 will start you in this fascinating, profitable business that can lead you to the road of success and independence. Routes can be established and operated in either full or spare time with no experience needed. Write for full details and our free catalog illustrating our nut, candy, gum and stamp vendors; also pin ball machines, music boxes, etc. Write immediately to Parkway Machine Corporation, Dept. 7, 715 Ensor Street, Baltimore 2, Maryland.

EARTHWORM Breeding. Valuable bulletins on successful methods mailed free. Earthmaster System, Dept. 14, El Monte, Calif.

YOUR Own profitable home business. Preserve live flowers to last for years. New simple discovery. Enormous demand all year 'round. Tremendous profits! Light fascinating work. Send \$2.00 for working equipment, instructions, and valuable sales plans. Satisfaction guaranteed or money promptly refunded. Alfred Hermansen, 210 Fifth Ave., Suite 1102A, New York 10, N. Y.

WANTED! Home producers by manufacturers in our clearing house service. Become a sub-contractor, casting plastic products for these companies. Thousands of easy to make items required. Cash in at home without previous experience. For details write Plastic Service Guild, Dept. PM, 233 Conder St., E. Boston 28, Mass.

START Mailorder bookshop — Everything furnished. 25c brings booklet, samples, exciting ideas. General Publications, Ossining, N. Y.

THOUSAND Articles wholesale. "Supply Source Directory" 10c. Ideal Service, Park Ridge 30, Illinois.

BE Appointed state notary public now! Details. Stationers, Helotes 50, Texas.

OPERATE Profitable mail order business. Write Walter Service, 4159-A East 112th, Cleveland 5, Ohio.

DOLLARS In personalized baby record books. Sell by mail. Use same literature we do. No-Co-Ro, Oakland 6, Calif.

LEARN Professional candy making profitable home business. Details free. Pate, Kissimmee, Florida.

COMMERCIAL Deep frying course. Mock chicken legs, potatoes. New and proven methods. Learn about this money-making field. \$2.50 p.p. Concession, Toledo 13, Ohio.

FABULOUS Earnings—Fascinating part-time. Growing genuine, living miniature (ming) tree. New sensational business or hobby. Astounding information free. Dwarf Gardens, Box 355B, Briggs Station, Los Angeles 48, Calif.

BRUSH Plating outfits connect to a battery. No tanks necessary. Good paying business at home plating autoparts, bathroom fixtures, bicycles, reflectors, silvering mirrors. No shop or experience required. Outfits furnished. Free booklet. Gunmetal Co., Ave. H, Decatur, Ill.

CASH For your idea, 280 manufacturers need inventions, patented or unpatented. List free. Invention Bureau, 208-M Clinton, Oak Park, Ill.

OWN A printing business. Good profit printing cards, stationery, etc. in spare time. Easy rules furnished. Have home shop. Send dime for complete printer's supply book and samples. Kelsey, Inc., Z-24, Meriden, Conn.

\$25 WEEKLY Working two hours daily. No canvassing. No manufacturing. Lycke, Box 2471-A, Cleveland 12, Ohio.

RECAST Old batteries into new. Latest achievements. Battery Laboratories, Minneapolis.

MADE \$24,500 Using money making plans from Schemer Magazine, world's oldest mailorder publication. Box 275M, Canfield, Ohio. Year \$2.00. Sample 20c.

MINK Raising information free. Complete. Lake Superior Mink Farm. Superior, EEL, Wisconsin.

POPCORN And potato chip equipment. Long Eakins Company, 5160 High, Springfield 99, Ohio.

COPUBLISH Leading m.o. paper. Latest copy Mail Sale Advertiser, details, dime. Vanroy Shirk, Lebanon, Penna.

READ "Advance"—The voice of mail order. Offers money-making opportunities, sources of supply, personal guidance, etc. Issued monthly. Sample copy 25c. Yearly subscription \$2.00. Advance Publishing Company, 313 East 21st Street, Suite 450, New York 10, N. Y.

CO-PUBLISH And advertise in The Central Mail Advertiser. Sample copy 10c. Low rates. Large circulation. Bagby Printing Co., Georgetown, Ohio.

BUY It wholesale! Manufacturers, distributors offer 850,000 items. Literature free. Olsen, 1231-A East Third St., Duluth 5, Minn.

LIQUID Rubber. Make flexible molds. Free sample. Chaney, 1130 E. 16th St., Jacksonville 6, Fla.

RAISE Earthworms for gardening and fishing. Information with each order, \$7.00 per 1000. James Vettrano, 5826 Harding, Detroit 13, Mich.

MAILING Postcards selling repeat merchandise is profitable. Everything supplied. Details free. Gordon Publishers, Box 23, Pawtucket, R. I.

MEN—Women. Everybody likes candy. Learn to make professionally. Our 40th year. Ragsdale Candies, D5, East Orange, New Jersey.

\$46 FROM Square foot plywood; jigsaw necessary. Write, Woodarts, Bridgewater, Mass.

COLORGLAZED Concrete pottery made without molds. Patented method. Cemetery products, novelties, tiles. Basement leak-sealing. Money-making projects. Booklet, details free. Men only. National Potteries Company, Grand Rapids, Minnesota.

MONEY In new greaseless doughnuts. Start in kitchen. No smoke. Sell stores. Free recipes. M. Ray Company, 3605 South 15 Ave., Minneapolis 7, Minnesota.

MONEYMAKING OPPORTUNITIES

MIRACLE everlasting, reusable signs. Retail \$1.00. Up to 65% profit each. Every store a customer for several. Free samples and details. Ad-Stik Company, Dept. PM-1, 5850 Centre Avenue, Pittsburgh 6, Pennsylvania.

AUTOMATIC Roach-insect exterminator \$5.95. Needed by millions. Sample \$3.00 postpaid. Roachtrap M-Factory, Ft. Smith, Ark.

MAKE Backyard profits! Unusual opportunities! Details free. Pickett's, Florence, Kentucky.

MEN, Women. Grow mushrooms. Cellar, shed. Spare, full time, year 'round. We pay \$3.00 lb. We paid O. Babbitt \$4,165 in few weeks. Send \$2.00 for general information book. Washington Mushroom Ind., Dept. 108, 2954 Admiral Way, Seattle, Wash.

INDEPENDENT income! Make leather belts, billfolds, purses. Big catalog and genuine steerhide keyholder, 10c. Tandy Leather, Box 397G, Tulsa, Okla.

OPPORTUNITIES Galore. Particulars, magazines 10c. Monti, 219-P Tinton, Eatontown, N. J.

\$250 WEEK Reported! Free book. "505 Odd, Successful Businesses." Work home. Expect something odd! Pacific-48A, Ocean-side, Calif.

CANDLEMAKING Is fascinating, profitable! Detailed instruction manual explains everything—casting, dipping, scenting, coloring, marketing. Price—only \$1.00 with full return privileges. Candlecraft, Sylvan Lake, Mundelein, Illinois.

CAN You make \$40 a week, typing at home, in your spare time? Write Hood's, Kannapolis 12, N. C. (Enclose stamped, addressed envelope).

STRANGE! Mysterious! Puzzle! Moves without touching, samples 10c. Becklin, 944 West 11th Pl., Los Angeles 15, Calif.

MEXICAN Jumping beans 150% profit. Details. Mann's, 5330 No. Natoma, Chicago 31.

WANT To sail merchant ships? Outstanding wages to \$400.00. Beginners \$220.00 monthly. Only \$3.00 delivers bargain. American Seamans Guide, 545 5th Ave., New York City.

OLD Car tires, turn them into dollars. Don't delay. Instruction 50c. Fenn, B61W, Readfield, Wisc.

MAKE Money while sleeping. Two column, penny candy or nut machines. Hurry for these beauties. Ellis, Box 167, Long Beach, California.

MAKE Money at home. 101 ideas for full or spare time earnings. Proven winners. All for 25c. Thomas F. Patrick, c/o State Farm, Pikeville, Tennessee.

"WATERLESS (Lanolin) Hand Cleaner." (Oil base.) Make, sell. No machinery. Build profitable business. Complete formula \$1.00. Ideal Service, Park Ridge 3, Ill.

DOLLARS Three ways with "Kitty-Kat" readi-cut baby shoes. Complete local and mail order plans. Write No-Co-Ro, Oakland 6-K, California.

RAISE Your business value, standing, as state notary public. Information. Stationers, Helotes 50, Texas.

PUBLISH Your own magazine. Hand-some 52 page format, well edited, illustrated. Cost low as \$1.00 month. Brings you prestige, profits. 25c brings sample, details. National, Ord, Nebr.

READ Progressive Mailtrade, the magazine that tells how to make money by mail. Dime brings sample and special offer. Progressive Mailtrade, Box 357, Sheboygan, Wisconsin.

LEARN How others earn money at home! Write—A. Sizemore, 4917 Kostner, Chicago 30, Ill.

EARN Money evenings, copying and duplicating comic cartoons for advertisers. Adservice, Argyle 1, Wisconsin.

FORMULAS, PLANS, ETC.

ANY Formula \$1.00. Satisfaction guaranteed. Jack, 4292 Parkside Ave., Philadelphia 4.

FREE Formula literature. Popular fast-selling products. Flashy label designs. Majestic, 530 1/2 S. Main, Elkhart, Indiana.

"FORTUNES In Formulas," 10,000 formulas, etc. 900 pages, \$3.98 postpaid. K. Paullin, Loudonville, Ohio.

PAINT And varnish remover formula. Save 50% or more by making in five minutes. Especially profitable for painters, furniture refinishers. Send \$1.00 to Taylor-Armstrong Co., 221 Boulevard, Shreveport, La.

FREE Formula catalog. Anything analyzed \$20.00. Western Chemical, Salem, Oregon.

FORMULAS. Latest, best. Catalog and chemical instruction sheet 10c. (refundable). Neiko Chemical Service, 3462-F Merchandise Mart Sta., Chicago 54, Ill.

REAL Manufacturing formulas. Lists free. Cummings, Chemist, Gordon Ave., Syracuse 4, N. Y.

MAKE—Sell cleaners, soaps, polishes, flavors, cosmetics. No machinery. Formula literature free. Kemico, Park Ridge 16, Illinois.

FORMULAS. Trade secrets, for nearly everything. Catalog free. Creative Publishers, Winnetka 6, Illinois.

TESTED Formulas. Interesting descriptive booklet free. Pont, Box 635-PM, Terre Haute, Indiana.

PLASTICS

MAN Desires suitable position. Color, plastics, purchasing. Curtis, Box 464, Dublin, Va.

LUCITE Plexiglas. Any size sheets, masked. Square foot (12 x 12) cost, 1/16", \$1.20; 1/8", \$1.40; 3/16", \$1.75; 1/4", \$2.08. Include 10% postage. Almac Plastics, 230 Fifth Ave., New York 1, N. Y.

PLASTICS—This catalog is your bible. Wholesale, retail quantities. Lucite, plexiglas, acetate, sheets, rods, tubes. Casting, molding plastics. Dye manufacturer. Internal carving supplies. Findings, supplies. Catalog, 10c. 25c airmailed. Gem-O-Lite, Box 6862, North Hollywood, Calif.

MOLDING Rubber, \$2.95 qt.; \$9.95 gal. prepaidd. Plastercraft Supply Co., 3051 St. Clair Ave., Cleveland 14, Ohio.

HI-Profits, internally hand carved plastics, gifts, jewelry. Free catalog. Pilot Plastics, 67 C-Fulton St., New York City 7.

PLASTIC. Sheets, rods, tubes, etc. Free list. Plastic Supply Co., 2901 N. Grand Blvd., St. Louis 7, Mo.

CHEMISTRY

OH Boy! New Book of Science. Experiments, formulas, secret processes, together with catalogue of laboratory supplies, only 25c. National Scientific Company, Dept. 16, 2204 North Avenue, Chicago 47, Illinois.

NEW Idea chemical and apparatus outfits for home experimenting. Photo-scales, microscopes, chemicals, biological and laboratory supplies in small quantities. Catalog 25c. Established 1931. John H. Winn, 124A West 23rd Street, New York, N. Y.

ILLUSTRATED Catalog: Chemistry, mineralogy, biology, 10c. Tracey Laboratories, Evanston, Illinois.

CHEMICALS And apparatus for industrial, analytical, and private laboratories. Catalog 15c. Dept. M-50, Biological Supply Co., 1176 Mt. Hope Ave., Rochester 20, N. Y.

HELP WANTED

\$5 HOUR Easy! Sell name plates for houses. Free sample, order blanks. Write: National, 214 Summer, Boston, Mass.

AGENTS WANTED

BIG Profits selling Sunshine's famous exclusive Christmas cards. Tremendous values! 21 for \$1.00, holly assortment. All lined envelopes. Snow scenes, religious, gift wraps, stationery, super value imprints, 50 for \$1.25. Many more! Write for samples on approval, free imprint folders. Act now! Sunshine Art Studios, Dept. PM-6, 115 Fulton St., New York 38, N. Y.

IS \$210 A week worth a penny postcard to you? Then rush card with name and address for special free trial plan that sells amazing new automatic refrigerator defroster "like hot cakes!" Write to Mr. Lewis, D-Frost-O-Matic Corp., Dept. PMC-6, 6 N. Michigan, Chicago 2, Illinois.

BUY Wholesale thousands nationally advertised products at big discount. Sent free "The Wholesale Plan." American Buyers' Service, 629-R Linden, Buffalo, New York.

CASH In on tremendous demand for new cheap oil burner that fits in cooking-heating stoves and furnaces. Burns all kinds of oil including crankcase. Lifetime guarantee. Big profits. Be first. Write quick to Northwest Mfg. Co., 317 Main, Mitchell, South Dakota.

MAKE Money selling ties. Free catalog. Write to Philip's Neckwear, Dept. 750, 20 West 22 Street, New York 10.

TAKE Large unit orders with wool and cotton uniforms, initial buckles, belts, badges. Choice 3,000 emblems. Prospects everywhere. Write Hook-Fast, Box 480-PM, Roanoke, Va.

MAKE Wedding profits. Sell invitations, napkins, matches. Samples free. Dunbar's, Middlebush 3, N. J.

MAKE Money easy. Sell everyday cards. 21 for \$1.00, black plastic, metallic and others, children's books, personalized stationery, note paper, wrappings and novelties. Send for samples today. Howard P. Ellis, Dept. PM-6, Pitman, N. J.

IF Your town has parking meters you can sell 39c auto dash coinholder by the thousands. 120% profit. Coinholder Products, Evanston, Illinois.

\$50 WEEKLY Selling finest razor blades, other items. Free details. Edison, Department 274, Far Rockaway, N. Y.

NYLON Uniforms. Immediate delivery. immediate profits. Sell to doctors, dentists, nurses, waitresses, beauticians, housewives. Free sales kit. Superior Fabrics, Dept. P-6, 3936 Market, Philadelphia 4, Penna.

MEXICAN Feather pictures. Sell on sight; 200% profit! Free details; sample 10c stamps. Sylvia-PM, Apartado 9036, Mexico City.

NYLONS! Amazing get rich quick, 100% bonus offering. Essential Products Co., 210 5th Ave., New York City.

LOCAL Franchise. Rotary power mowers—\$59.95 (delivered). Rotacut-PM, Excelsior Springs, Mo.

FREE Sample "3-'n-1" guaranteed nylons. Sell pair with matched spare. No money needed. Bigger profits! Guarantee Hosiery Co., 1000 S. 12th St., (Dept. P6), Philadelphia 47, Penna.

FREE Sample nylon stocking of world's only nationally advertised hosiery line actually guaranteed against runs, snags or excessive wear, regardless of cause! It's amazing but true. Every weight from sheerest 15 denier to heavy 70 denier—all gauges to luxury 60 gauge. Amazingly low prices, starting at \$1.08 prepaid for sheerest 15 denier 51 gauge. Not sold in stores. Good Housekeeping guarantee seal. Also complete line men's hosiery guaranteed one full year or replaced free. Full variety lingerie in crepe, satin and nylon, featuring all nylon slip at \$2.95, satin slip at \$1.58, etc. Housecoats and robes. Kendax sales people will earn one million dollars this year. Get your share. No money or experience needed. Pay nothing now or later. Just show free outfits. Write orders. We deliver and collect. Advance cash plus huge bonus. Earn money spare or full time. Become manager; appoint others to sell for you; earn steady income on their sales. Man or woman—young or old, you can earn more money than you ever thought possible. Everything you need is furnished free and prepaid, including nylon stocking, samples of materials, sales books, 36-page salesmanual, color cards, etc. Simply write your name and address on postcard and mail to Kendex Corporation, Babylon 63, N. Y.

FREE Catalog, wonderful concentrates, 125 products. Qualco, 6E, 20030 Russell, Detroit 3.

BUY Wholesale — 25,000 items. Catalogue 25c. Matthews, 1472-B2 Broadway, New York City.

SPARK PLUGS; reconditioned. (Champions, Autolites). New appearance, 10,000 mile guarantee. Trial dozen \$2.00. Ten dozen \$17.00. Prepaid. Best Reconditioning, 315E 107th, New York 29.

\$50 WEEKLY Spare time selling everyday and Xmas cards, personalized stationery, etc. Sample free. Box ass'ts on approval. Victory Studios Co., 41 W. Lincoln Ave., Mt. Vernon, N. Y.

MAKE Money fast. Sell big value Christmas and everyday card assortments to friends, others. 7 leading 21 card \$1.00 boxes. Religious, metallic, comic, deluxe. Gift wrappings, ribbons, scented stationery. Many gifts—rain sandals, automatic telephone pencils, totebrushes, napkins. Over 100 items. Amazing profits. Bonus plan. No experience necessary. Write today for samples on approval and special "get started" offer. Hedenkamp, 361 Broadway, Dept. PM-12, New York.

NYLONS—New "high-twist" direct from mill. Box 3 (60-15) \$3.40; (51-15) \$3.15 postpaid. Write: Wholesale prices. Ergim Hosiery Mills, 992-PM Columbus Ave., New York.

MEXICAN Feather pictures. High profit selling gift shops, etc. Adelpia, Box 57-B, Bellerose 6, N. Y.

SELL New automatic floor waxer. Trigger on handle. Hands never touch floors or wax. Retail \$2.95. Profit 125%. Write Smith, Inc., Greenfield 45, Mass.

SUMMER Money maker. Every lawn owner wants it! Over million dollars sold last summer. You cash in this summer. Approved by four Universities. Barclay Co., Box 883, Plainfield 8, New Jersey.

STOP Searching! Learn how to select the best products to sell. Free details. Pelham, Box 512, Dallas, Texas.

DO You need money? \$35.00 is yours for selling only 50 boxes of our 300 Christmas card line. This can be done in a single day. Free samples. Other leading boxes on approval. Many surprise items. Experience unnecessary. Free samples personalized Christmas cards, stationery, napkins. Write today. It costs nothing to try. Cheerful Card Co., 220 White Plains, N. Y.

YOU Teach Hawaiian woodwind in ten weeks. Musical instrument \$20.00 including course. John Richman, Box 5473-BF, Philadelphia 43, Pennsylvania.

AGENTS—"Magic Zip" screwdriver sells on sight to motorists, handymen. Changes bits amazing new way. Priced for volume, profits! Arrott Sales, Box 9520, Philadelphia 24, Penna.

LOOK! Big profits—Free samples. Personalized napkins. G. M. Dunn Co., 484 Broadway, Newark, N. J.

BE A money maker. Use your home as magazine headquarters. Liberal commissions. No experience, no capital needed. Everything furnished. Write for free catalog. McGregor Magazine Agency, Dept. 500A, Mount Morris, Ill.

NEED Extra cash? Take orders for personal initialed belts and buckles, cap badges, tie holders, etc. Choice of 3000 emblems. Free sales kit. Hook-Fast, Box 1425PM, Providence, R. I.

"DIAMOND-LIQUID" Car cleans cleaner, waxes brighter, lasts longer. \$1.00 postpaid. 50% commission. Box 394C Union, New Jersey.

SO Easy to sell what everyone wants, when they can get it only from you. That's why ReSilvit, the scientific new magic compound, is pouring big profits into pockets of agents and demonstrators. Spare and full time openings. Quick action needed. Get free details today. American Enterprises, 156 East 52nd Street, New York 22.

SELL Greeting cards—Big profits! Quick sales! Catalog free! Elfco, 432 North Wells, Chicago 10.

FREE Samples. Big profits showing amazing "Glow-in-the-dark" specialties. House numbers, pictures, plastic novelties, ashtrays, keyholders, religious and nursery objects, etc. Madison Plastics, 303 Fourth Ave., New York 10, N. Y.

PHOTO-Salesmen, agents. Sell beautiful hand colored plastic enlargements and sensational new photo compacts, rings, bracelets, lockets, etc. Collect deposit, we deliver. Profitable sideline. Send card for free sample kit. Novel Portrait Co., 3343 North Ave., Chicago, Ill.

EXCELLENT Sideline for printing and advertising salesmen. Decalomania name plates in small quantities. Great demand. Also, make money with our line of automobile initials and sign letters. Free samples. "Ralco" XL-Roxbury, Boston 19, Mass.

JEWELRY Factory desires salesmen, distributors, jobbers. Pickcraft, 19 Bank Street, Attleboro, Mass.

GOLD Lacquered window sign letters. Large sizes penny each. New foils. Absolutely beautiful. Free samples. Atlas, 544 W. 79th, Chicago 20.

\$5 HOUR Easy! Sell name plates for houses. Free sample, order blanks. Write: National, 214 Summer, Boston, Mass.

AGENTS: Stamping names on key protectors. Sample 25c. Stamping outfits, checks, social security and name plates. Hart Mfg. Co., 303 Degraw St., Brooklyn, N. Y.

DRESSES, 18c; Coats \$1.00, blouses 35c. Free catalog. Crown, 164-P Monroe Street, New York.

AGENTS—300% Profit selling genuine gold window letters; stores and offices. Free samples. Metallic Letter Co., 438-B North Clark, Chicago.

WANTED—Purchasing agents. No money or experience required. Write Dept. C, Purchasing Manager, 2719 Lawrence, Chicago, Ill.

SELL Big money-maker to men and women. Easy handwork makes fast-selling useful articles. Sunmade Company, Brockton 64, Mass.

HIGH-GRADE SALESMEN

EXCLUSIVE Territory open to better type representatives. Small unit sales to service stations, garages, etc. (large repeat volume protected), provides excellent income. Must have car. Westford Industries, Attention Production Dept., 410 Asylum St., Hartford 3, Conn.

MAKE Up to 65% profit as territory manager or salesman with colorful, indestructible, re-usable plastic signs. Sells to all stores. Only steady, hard-workers write for information and free samples. Ad-Stik Company, Paper Square, Pittsburgh 6, Penna.

MONEY In perfumes. Lifetime business. Huge profits. Wonder cash producer. Write for free booklet. Roberts, 432 Fremont, Springfield, Ohio.

ADVERTISING Book matches—Cash in on big demand; sell union label matches. Cuts for all businesses and political parties. Free powerhouse selling kit, low prices, protection guaranteed on repeat orders. Cash commissions. Superior Match Co., Dept. M-651, 7530 Greenwood, Chicago.

EARN Big money fast! Sell finest-quality advertising work uniforms to garages, factories, filling stations, etc. Free selling kit. Topps, Dept. 536, Rochester, Ind.

MAN To earn \$85 week and up. Long needed invention. Advertised Colliers and Post. Free sample outfit, no investment. Full or part time. Exclusive territory. Write Red Comet, Inc., 938 Littleton, Colo.

WANT To make real money? You can positively make \$50.00 a day and up selling a brand new item going to every type of food and beverage store, factories, laboratories, hospitals, etc. First time advertised. Write for free details today. Johnson-Hartmann, 53 West Jackson Blvd., Dept. PM-6, Chicago 4, Illinois.

ORANGE Concentrate direct from our Florida groves. One quart bottle makes six quarts delicious natural orange drink simply by mixing with five parts cold water. Groceries, foodmarts, hotels, restaurants, taverns, roadstands, sodafountains, hospitals, resorts, camps, farmers, big buyers. Money-back guarantee. No investment. Protected territory. Salesmen earn \$100 to \$200 repeat commissions weekly. Sunset Valley, Oak Hill 8, Florida.

WALL Paint—Sensational rubber latex, odorless, applies easily. Rex 21, Ossining, New York.

AD Matches! Sell amazing designs—20, 30, 40 and 240-light book matches. Bigger spot cash commissions; every business a prospect. Low prices for high quality. Repeats. Start without experience; men, women; full, part time. Buy nothing! Sales kit furnished. Match Corp., Dept. PM-18, Chicago 32, Illinois.

MAN To earn \$85 week and up. Long needed invention. Advertised Colliers and Post. Free sample outfit, no investment. Full or part time. Exclusive territory. Write Red Comet, Inc., Dept. 956, Littleton, Colo.

SELL Our waterproofings, floor mastic, cement hardener, etc. (30 items) to maintenance men, building owners, contractors. Can start part time. Commission. Territory. Write Haynes Products Co., Desk 6, Omaha 3, Nebr.

"MARY-Mac" gas water heaters—Factory. Steady income. Permanent. McDaniel Manufacturing, 1012 Powhattan, Dallas, Texas.

\$2600 NEXT 9 Weeks—Season starting. Sell calendars, specialties, matches. Prospects everywhere. Advanced commissions. Experience unnecessary. Samples free. Continental Calendar, 542-A South Dearborn, Chicago.

BIG Money taking orders. Shirts, ties, Sox, pants, jackets, sweaters, shoes, uniforms, etc. Sales equipment free. Experience unnecessary. Nimrod, 4922-AN Lincoln, Chicago.

A Fine income, your own nylons free! Show nylons, lingerie, men's socks with amazing free replacement guarantee against runs, snags, tears. Write for free sales kit. Group organizers invited. Roselee Hosiery Co., Clifton 58, N. J.

\$5 HOUR Easy! Sell name plates for houses. Free sample, order blanks. Write: National, 214 Summer, Boston, Mass.

NEW Jobs open in selling! Send name, address for five free issues of Opportunity Magazine's money-making guide, listing hundreds of companies who'll pay you well, full or part-time. No experience needed. Opportunity, 28 E. Jackson, Dept. 17, Chicago 4, Ill.

EDUCATIONAL AND INSTRUCTION

EARN While you learn. Day or night classes. Thorough courses in: automobile mechanics, diesel mechanics, motor tune-up, auto body and fender, welding, etc. Living accommodations. Veterans may earn \$210 to \$290 per month while in school including subsistence. Fully accredited to train veterans. Thirty-two years' experience training men. Nashville Technical College, Dept. #256, Y.M.C.A. Bldg., Nashville 3, Tennessee.

IT'S Fun learning a language by Lingua-phone. At home, quickly, easily, correctly master Spanish, French, German, Russian, —any one of 29 languages through Lingua-phone Conversational Method. Add to service, job, travel opportunities. Send for free book. Courses approved for veterans' training. Lingua-phone Institute, 8306 Rock Plaza, New York 20.

BE A real estate broker through home study or classroom instruction. Write for free book. Approved for veterans. Weaver School of Real Estate, 15 E. Pershing Rd., Box CP-6, Kansas City 8, Missouri.

MAKE Up to \$35-\$45 week as a trained practical nurse! Learn quickly at home. Booklet free. Chicago School of Nursing, Dept. M-6, Chicago.

EXCELLENT Earnings repairing hosiery at home for store customers. Details free. Dolby School of Hosiery Mending, 1221 Westminster, Palo Alto 8, Calif.

SECRET Service, fingerprint training at home, in spare time. Write, Associated Special Investigators, Box 474, Saint John, N.B., Canada.

KEPLER'S Laws are illusions 35c. Williamsburg Station, Box 100, Brooklyn 11, New York.

GOOD Jobs and a sound substantial future await you in hotel and institutional field. Men and women—all ages—needed for well-paid positions that offer color, excitement, ever-new and fascinating duties. Record-breaking travel means even greater opportunities for trained men and women in hotels, clubs and institutions. Lewis School receiving calls for managers, assistant managers, stewards, hostesses, purchasing agents and 55 other types of important positions! From coast to coast there are important positions that offer splendid opportunities for advancement in a business where you are not dropped because you are over 40. Previous experience proved unnecessary! No need to leave your job to qualify. A good grade school education, plus Lewis Training qualifies you at home, in spare time. Our national placement bureau helps to place you—and our amazing certified job plan—actually certifies you will "make good" when placed. Write today for free book! Veterans: Course approved for veteran's training. Lewis Hotel Training School, Room TH-368, Washington 7, D. C. (First and only school of its kind—now in its 35th year.)

HIGH School—No classes. Study at home, spare time. Diploma awarded. Write for free catalog HF-9. Wayne School, 2527 Sheffield, Chicago 14, Ill.

DEFENSE Welding jobs pay. Welders needed. Train quickly. VA contract. Hobart Welding School, Box M-612, Troy, Ohio.

LEARN Technical Metaphysics. Insure success in life. Valuable information. Canada School of Technical Metaphysics, 2532 McKenzie St., Vancouver, B.C. Can.

CAREERS With future at home in public relations, publicity, fashion design, interior decoration, export-import techniques, scientific management, television, air-conditioning, practical nursing. World Trade Academy, Suite 518, 11 West 42nd St., New York.

MEMOROLOGY, Science of memory, amazingly simplified. 84 page book \$1.00. Money back guarantee. Memorology Studio, 2016 Sunnyside Ave., Chicago, Illinois.

3800 LATEST Used correspondence courses catalog \$1.00. EG, Elmsford, N. Y.

INVESTIGATORS Trained, men-women, learn fascinating profession. Spare time study. Big pay. Folders free. Investigator, Box 490, Times Square Station, New York 18, N. Y.

RAPID Writing, like shorthand. Lessons ten cents. Elliott, 4426 Carrollton, New Orleans.

PIANO Tuning pays. Learn this profitable profession at home. Our Tonometer and mechanical aids make learning easy. No knowledge music necessary. Diploma granted. Largest and oldest school—53rd year. G.I. approved. Write for booklet. Niles Bryant School, 78 Bryant Bldg., Washington 16, D. C.

LEARN Linotype (machine typesetting). Good pay, steady work. Booklet "X" free. N. Y. Mergenthaler Linotype School, 244 West 23rd, New York.

EARN \$10,000 Annually! Learners \$2,700. Unlimited opportunities in Merchant Marine. Instruction-Employment Manual \$1.00. Refundable. Titan Company, 45 Clinton St., Newark 2, N. J.

INVESTIGATOR Training. Phillips Secret Service System, 1917-B North Kenneth, Chicago 39.

USED Correspondence courses and books sold and rented. Money back guarantee. Catalog free. Courses bought. Lee Mountain, Pisgah, Alabama.

MEDICAL Laboratory Technicians in great demand. We train you in your own home. Catalogue free. Imperial Technical Institute, Box 973-J, Austin, Texas.

SECRET Investigation. Experience unnecessary. Investigators particulars free. George Wagner, M 125 West 86th, New York.

BOOKKEEPERS! Increase your earnings! Operate your own simplified "dollar-a-week" bookkeeping and tax service. Full or spare time. Details free. No obligation. Ellis, Box 200, Cedar Grove, North Carolina.

VOICE Secrets! Free information. Studio 14356B, Jersey Ave., Norwalk, California.

STUDY To be a doctor of psychology or metaphysics. Obtain Ps.D., Ms.D., D.D. or Ph.D. degree. Chartered by state. Write for free book telling how. The Neotarian Fellowship, Desk 8, Dwight Building, Kansas City 6, Missouri.

HOME Study course, drugless therapy. Free literature. Institute of Drugless Therapy, Tama, Iowa.

USED Correspondence courses and educational books bought, sold, rented. Catalog free. Educational Exchange, Summer-ville, Ga.

EASY Ways to earn extra income are described in Money Making Hobbies. 132 projects you can make and sell anywhere. 160 pages, \$2.00. Popular Mechanics Press, 200 E. Ontario St., Chicago 11, Ill.

LEARN International Morse code by best and fastest method known. Code-voice records get you ready for good Army job, or new Novice ham license. Send only \$4.00 for complete instruction album with Vinylite records. Money-back guarantee. Dept. PM, Raybrun Company, Box 66, Orangeburg, N. Y.

FREE—Amazing new book, "How to Answer Ads." Never before have you seen anything like this. Tells you in simple language the correct way to answer ads. Gets you quicker replies—better results, and greater satisfaction. Will save you time and money and it's absolutely free. No obligation whatever. Every reader of advertising should have this booklet. Send a postcard for your copy now. F. W. Johnson, (Room 600), 200 East Ontario Street, Chicago 11, Ill.

PLAYS, STORIES, MANUSCRIPTS
WE Edit, copyright, publish books. Wetzel Publishing Co., 524 So. Spring, Los Angeles.

I Want new writers to cash checks of \$1 to \$100 offered daily. The easiest way to write for pay. No previous experience necessary. Free details. Saunders M. Cummings, 468-11 Independence Bldg., Colorado Springs, Colo.

BEGINNING Writers: Let us show you how to get \$1.00 to \$20.00 checks daily. Experience unnecessary. Details free. Herwell Company, 7016-M Euclid, Cleveland 3, Ohio.

BUSINESS SERVICE
INCORPORATE Your business. Many advantages. Delaware laws free detail. Tax Research Bureau, Inc., Box 710, Wilmington, Delaware.

HAVE A Chicago mail address. Information free. Schultz House, 3116 Seminary, Chicago 13.

SPECIAL SERVICES
LETTERS, Cards remailed 25c each. Stadler, Box 2335, Hollywood 28, Calif.

CARTOONING, COMMERCIAL ART, SHOWCARD WRITING, SIGN PAINTING

"HOW To Make Money With Simple Cartoons"—A book everyone who likes to draw should have. It is free; no obligation. Simply address Cartoonists' Exchange, Dept. 96-C, Pleasant Hill, Ohio.

TALENT Test—Information. Give age. Art, Box 8066, Dallas 5, Texas.

CARTOONISTS—Amateurs, professionals. Earn \$100-\$200 monthly, with simple cartoons. Proven plans \$1.00. Samples free. Jay Borosky, 1571 Fulton, San Francisco, Calif.

LEARN Sign painting. 152 lesson course. Results guaranteed. Stewart Sign Co., Box 287M, Pasadena, Calif.

CARTOON Pictures \$2.00; 2 cartoon course \$2.95. EG, Elmsford, N. Y.

CHALK Talks. Laugh producing program, \$1.00. Catalog 10c. Balda The Cartoonist, Oshkosh, Wisconsin.

ADVERTISING AGENCIES, LETTER WRITERS, FOR ADVERTISERS

SAVE Money on advertising. List free. Wilbur Errickson, Englishtown, New Jersey.

ADVERTISERS! Reach nearly 18,000,000 readers. 25 Sunday national key newspapers. 18 words, \$59.00. "Terrific pullers." 20 popular newspapers, \$11.50. Free booklet. Special—One inch display 2,-821,198 circulation, \$51.10. Newmark's Advertising Agency, (Established 1893), 217-7th Ave., New York 11.

ADS Placed in out of town newspapers and magazines. Low rates. Catalogue free. Ideas that pay. Baker Advertising Agency, Successors Ankrum Agency, 189 W. Madison, Chicago 2.

MAILING Lists; \$5.00-1000 up. Write Dixie Service, King, N. C.

24 WORDS in 50 weeklies, \$4.96. J. Darnell, 730 Hays, Jackson, Tenn.

ADVERTISE: 24 Words, 40 newspapers \$3.50. Lists free. Advertising Bureau, 10511-C Springfield, Chicago 43.

FREE Copy, layout service. Mailorder ad, 1,700,000 nationwide circulation, \$25.90 inch. 24-word classified, 20 big Sunday newspapers, \$30.00. Advertising ratebook free. Chicago Advertising Agency (established 1900), Chicago 4.

TYPEWRITERS, DUPLICATORS, OFFICE DEVICES

RECONDITIONED Typewriters, printing devices, office machines, equipment. DixieGraph, King, N. Car.

TYPEWRITERS, Wholesale, any quantity. Catalogue free. Apple, 993C Westchester Ave., New York 59, N. Y.

PRINTOMATIC Selffeeding post card printing duplicator \$13.50. Envelope addressing machines \$24.50. Pittsburgh Typewriter Company, 336-R Fourth Avenue, Pittsburgh 22, Penna.

RUBBER STAMPS AND OFFICE SUPPLIES

CHROMIUM Mounted rubber stamps. Illustrated catalog 10c. Williams, Box 648-M, Plainfield 6, N. J.

RUBBER Stamps. Literature free. Lee-Vall Press, Box 1242, Indianapolis 23, Indiana.

3 LINES 50c; Pads 35c; signature \$2.35. Stamp-right, Wauwatosa, Wis.

PRINTING, MULTIGRAPHING, MIMEOGRAPHING GUMMED LABELS

BUSINESS Cards. Genesee Bristol, 1000, \$3.00. 5000, \$12.00 ppd. Anderson, Box 855, Mountain Home, Tenn.

PRINTING, Multigraphing, mimeographing. Prices free. Progressive, 270H Burkhart, Cincinnati 15, Ohio.

1000 BUSINESS Cards \$2.50 prepaid. Samples free. Reliable Print Shop, 905 East Jefferson, Louisville 6, Ky.

100 LETTERHEADS, 100 Envelopes \$1.75. Samples. L. Norman, Sterling, Virginia.

BUSINESS Printing. Samples, prices free. Howprint, 723-M Eunice, Webster Groves 19, Missouri.

100 8½x11 HAMMERMILL Letterheads and 100 envelopes \$2.10. H. Hudson, Centredale, R. I.

QUALITY Printing. We specialize in publications, newspapers, tabloids. Send copy for estimate. Bagby Printing Co., Georgetown, Ohio.

SEND 10c Now for our 48 page 1951 price list—refunded first order. McCall Press, 1326 South 27th, Omaha, Nebraska.

MIMEOGRAPHING—Letters, pricelists, formulas, instructions. Lowest prices. Lem's Letter Shop, 5710 Stanton, Detroit 8.

PHOTO-Offset special, 5000-8½ x 11 \$14. Samples free. Reiffe, 160-P Monroe St., New York 2.

500 ¾x2¼ FOUR Line gummed stickers 50c. Red border \$1.00. Moritz Printery, Saginaw, Mich.

MIMEOGRAPHING—Reasonable. Any copy. Mailers Service, Box 606-T, Chicago 90, Ill.

EXCLUSIVE Embossed business cards. Free samples. Thompson and Sons, Waterville, Ohio.

PHOTO-Offset ordering chart, yours free. American Graphic, 432 Plane, Newark 2, New Jersey.

PRINTING OUTFITS AND SUPPLIES

PRESSES, Type, cabinets, supplies. List for stamp. Lincoln Press Company, 220-W Hartwell, Fall River, Mass.

PRESSES, Bought, sold, list 3c. Exchange, 212 Curtis, Meriden, Conn.

PRINT Your own cards, stationery, circulars, advertising. Save money. Simple rules. Print for others, nice profit. Raised printing like engraving too. Have home shop. Details free. Kelsey Presses, L-11, Meriden, Conn.

PRINTING Presses, type, supplies. Lists 3c. Turnbaugh Service, Loysville, Penna.

MAKE Your own printing cuts. Self-molding process. Plexirubber, Argyle 1, Wisconsin.

PATENT ATTORNEYS

PATENT Protection—This well-known organization will send you promptly upon request and without obligation, a booklet containing detailed information concerning steps to take to protect your invention by a United States patent. Victor J. Evans & Co., Merlin M. Evans, Registered Patent Attorney, 631-G Merlin Building, Washington 6, D. C.

INVENTORS—If you believe you have an invention, we can make a preliminary search on your invention and advise you whether we think it can be patented. Send for copy of our patent booklet "How to Protect Your Invention" and "Invention Record" form. No obligation. Mc Morrow, Berman & Davidson, Registered Patent Attorneys, 134-Y Victor Building, Washington 1, D. C.

INVENTORS: Learn how to protect your invention. Unless the inventor is familiar with patent matters, he should engage a competent registered patent attorney or agent to represent him. We are registered to practice before the U. S. Patent Office and prepared to serve you in handling your patent matters. "Patent Guide for the Inventor" containing detailed information concerning patent protection and procedure with "Record of Invention" form will be forwarded to you upon request—without obligation. Clarence A. O'Brien & Harvey Jacobson, Registered Patent Attorneys, 11B-D District National Building, Washington, D. C.

PATENT Practice before U. S. Patent Office. Booklet and form "Evidence of Conception" forwarded upon request. Lancaster, Allwine & Rommel, Registered Patent Attorneys, Suite 411, 815-15th Street, N.W., Washington 5, D. C.

"**INVENTOR'S Guide**" free. Frank P. Ledermann, Registered Patent Attorney, 154 Nassau Street, New York.

INVENTORS: When you are satisfied that you have invented something of value write me, without obligation, for information as to what steps you should take to secure a patent. Write Patrick D. Beavers (Formerly Randolph & Beavers) Registered Patent Atty., 935 Columbian Bldg., Washington 1, D. C.

PATENTS. "Proof of Invention" folder mailed without obligation. E. E. Vrooman, Registered Patent Attorney, 507 McKim Building, Washington 5, D. C.

INVENTORS: Write for free brochure "Evidence of Invention." Labiner, World Building, New York 38.

C. A. Snow & Co.—M-427, Snow Building, Washington 1, D. C. Registered Patent Attorneys. Write for information.

INVENTORS—For "Record of Invention" form, contact Carl Miller, Registered Patent Attorney, Woolworth Building, New York.

INVENTORS: Without obligation, write for information explaining the steps you should take to secure a patent. John N. Randolph, Registered Patent Attorney, 203 Columbian Bldg., Washington 1, D. C.

PATENTS—Irving L. McCathran, 315 McLachlen Bldg., Washington 1, D. C. Registered Patent Attorney.

CANADA—Ramsay Company Registered, 273 Bank Street, Ottawa, Canada.

REGISTERED Patent attorney offers services. Sanders, 6430 Evans, Chicago 37, Ill.

FOR INVENTORS

INVENTORS—If you believe you have an invention, we can make a preliminary search on your invention and advise you whether we think it can be patented. Send for copy of our patent booklet "How to Protect Your Invention" and "Invention Record" form. No obligation. Mc Morrow, Berman & Davidson, Registered Patent Attorneys, 134-X Victor Building, Washington 1, D. C.

INVENTORS—This form is registered to practice before the United States Patent Office and is available to assist you in the preparation and prosecution of your patent application. "Patent Protection for Inventors" booklet containing detailed information and steps to take toward patent protection will be sent upon request. No obligation. Victor J. Evans & Co., 632-G Merlin Building, Washington 6, D. C.

YOUR Invention or patent developed and promoted. Write us first! Patent Service Institute, 945-D Pennsylvania Avenue, Washington 4, D. C.

PATENT Searches \$5.00, including patent copies. Accurate, reliable results. Free protection forms. 48 hour service. Patent Service Institute, 945-A Pennsylvania Avenue, Washington 4, D. C.

INVENTORS! Have you good, patentable ideas? Write Patent Agent Metzler, 11 West 42nd, New York.

INVENTORS—What have you, patented, patent pending available for manufacturers? Booklet mailed free. Address: Market Contacting & Data Service, 11106-A3 Longwood, Chicago 43.

PATENT Searches \$5.00. Reports airmailed within 48 hours. Invention protection forms free. Write Miss Ann Hastings, Patent Searcher, P.O. Box 176, Washington 4, D. C.

INVENTORS: Learn how to protect your invention. Unless the inventor is familiar with patent matters, he should engage a competent registered patent attorney or agent to represent him. We are registered to practice before the U. S. Patent Office and prepared to serve you in handling your patent matters. "Patent Guide for the Inventor" containing detailed information concerning patent protection and procedure with "Record of Invention" form will be forwarded to you upon request—without obligation. Clarence A. O'Brien & Harvey Jacobson, Registered Patent Attorneys, 11A-D District National Building, Washington, D. C.

PATENT Searches \$5.00. 48-hour service. Patent copies included. Protection forms free. Write Raymond L. Smith, Patent Searcher, 410 Bond Building, Washington 5, D. C.

PATENT Searches conducted for patent attorneys and inventors \$5.00. 48-hour service. Protection forms free. Write Patent Engineering Service, 1404 New York Avenue, Washington 5, D. C.

COMPLETE Financing, patenting, promotion details. Write Technical Service, Box 1434A, Amarillo, Texas.

PATENT Searches \$5.00, including copies of closest patents. Same reliable searches we conduct for patent attorneys. 48 hour airmail service. "Record of Invention" free. Capitol Patent Service, P.O. Box 664-P, Washington 4, D. C.

INVENTORS: Without obligation, write for information explaining the steps you should take to secure a patent on your invention. John N. Randolph, Registered Patent Attorney, 202 Columbian Bldg., Washington 1, D. C.

SEARCHES—Put your patent searches in the hands of a registered patent attorney or agent, as he qualifies to give a worthwhile patentability report. Record of invention form upon request and information on patent protection. Patrick D. Beavers, Registered Patent Attorney, 936 Columbian Bldg., Washington 1, D. C.

INVENTORS. For "Record of Invention" form, contact Carl Miller, Registered Patent Attorney, Woolworth Building, New York.

PATENT Owner representative. Years of experience. Can I help you? Charles A. Scott, 773PM Garson Avenue, Rochester 9, N. Y.

INVENTORS: If you have an invention for sale, patented or unpatented, write Institute of American Inventors, Dept. 40A, 631-E St. N.W., Washington 4, D. C.

CASH For your idea, 280 manufacturers need inventions, patented or unpatented. List free. Invention Bureau, 203M Clinton, Oak Park, Ill.

INVENTIONS WANTED

INVENTIONS Wanted by manufacturers. Free details. Inventors Exchange-B, Hartford 1, Conn.

INVENTORS—What have you, patented, patent pending available for manufacturers? Booklet mailed free. Address: Market Contacting & Data Service, 11106-A2 Longwood, Chicago 43.

INVENTIONS Wanted. Patented or unpatented. 20 years experience promoting inventions. National Service Bureau, 3130 Meramec, St. Louis 18, Mo.

INVENTORS: Hundreds of manufacturers have requested our assistance in locating marketable new products. Complete information free. Institute of American Inventors, Dept. 40-D, 631-E St. N.W., Washington 4, D. C.

INVENTIONS Promoted. Patented or unpatented. Write Adam Fisher Company, 61 Enright, St. Louis, Mo.

NEW Ideas wanted on LPG use for farm power by established, successful manufacturer with large production capacity and national sales organization. Royalty or sale basis. Send patented or patented-applied-for ideas only with full details in first letter. Box 265, Kansas City 10, Mo.

PATENTS FOR SALE

STRONG Patent (2,522,033) on electric, automatic newspaper and magazine vending machine for sale or royalty. Eager Market—Mr. Graham, Rt. 3, Box 687-H, Salem, Ore.

PATENTED Mixing faucet! One handle control! Suitable for sinks, bathtubs, lavatories. Outright or royalties. Lucien Siano, 264 Milton Avenue, Ballston Spa, New York.

INVENTORS: Test the commercial value of your patented or unpatented inventions, quickly and inexpensively. Write for free information. Institute of American Inventors, Dept. 40-B, 631-E St. N.W., Washington 4, D. C.

MANUFACTURING

MODELS—Small lot manufacturing. Metals, plastics, etc. Milburn, Burlington, Kentucky.

MODELS, MODEL SUPPLIES

RAILROADERS Get new catalog-reference manual. O gauge 75c, HO 50c. Walthers, 247 Erie, Milwaukee 2, Wis.

RECEIVE Model airplane and engine practically as gift. Details free. Hobbycraft, 104D Brooklyn 30, New York City.

SHIP And yacht model fittings; blueprints. Send 25c for illustrated catalog No. 26—listing hundreds of items. A. J. Fisher, 1002-1 Etowah Ave., Royal Oak, Mich.

BUILD Historic ship models, complete kits 39c to \$9.00. Catalog 10c. Ideal Models, 19 W. 18th, New York 11, N. Y.

BRASS Gears and model supplies for the inventors. Send 10c for catalog. Pierce Model Works, Tinley Park, Ill.

RAILROADERS—50c Gets new Catalog Reference Manual. State O or HO gauge. Walthers, 247 Erie, Milwaukee 2, Wis.

STEAM Locomotives, 1½", 1", ¾", ½" ¼" scales. Castings, rail, steam fittings! Thorough drawings with instructions. Catalog 50c. Little Engines, Wilmington, California.

HOME CRAFTSMEN

JIGSAW Owners attention! Start earning money at home cutting out wooden novelties and souvenirs. Write H. Cook, Dept. A, 4407 So. Normal Ave., Chicago 9, Illinois.

OSARK Wood samples. Eleven varieties prepaid. \$1.50. Davis Lumber, Cabool, Missouri.

90 ALL New, full size lawn ornament and novelty patterns, up to 20" high. Only \$1.00. Mastercraft 62M, 7041 Olcott, Chicago 31, Illinois.

LEATHERCRAFT Supplies, leather and tools, low prices. Send 10c for catalogue. Jonas Handicraft Co., Dept. 6M, 30 Frankfort St., New York 7.

89 FULL Size jig saw patterns of beautiful shelves, ornaments, toys, novelties. Plus "How, Where to Sell." Only \$1.00. Mastercraft 64M, 7041 Olcott, Chicago 31, Illinois.

MAKE Leather belts, billfolds, purses. Big catalog and genuine steerhide keyholder. 10c. Tandy Leather, Box 397D, Tulsa, Oklahoma.

ILLUSTRATED Catalogue of 30 new crafts 10c. Hobbies. 1701F Macombs Road, New York 53.

PROFESSIONAL type furniture finishing and refinishing supplies. Beautiful new, complete, illustrated catalog and complete simplified instruction manual. Price 25c. Colorall, Dept. M, 515 Cedar Lane, Teaneck, N. J.

WOODCRAFT Patterns—Large whatnots, lawn ornaments, novelties, large assortment \$1.00. Joanness, P.O. Box 141-M, Omaha 7, Nebr.

WHOLESALE Shellcraft book 15c. Large shellcraft kit \$1.85 postpaid. Shell-Art Novelty, 5th and Moore, Philadelphia 48, Penna.

CHAIR Cane. Splints. Rush. Reeds. Instructions, catalogue 25c. Complete Seat Weaving book \$1.15. Fogarty's Craftshop, Troy, N. Y.

SHELLCRAFT—For hobby or profit. Giant illustrated catalogue showing many new breathtaking designs, with easy instructions. Only 25c. Southern Shellcraft Supply, Clearwater, Florida.

NEW 96 Page leather and craft catalog. 1000's of items. Send 10c. Russo Handicraft Supplies, Dept. C-3, 245 South Spring, Los Angeles, California.

NEW Leathercraft catalogue. Pleasure and profit. New styles, belts, purses, shoes. Largest leathercraft school in U.S.A. G. I. approved. Send 10c for catalogue. Dept. PM. Apache Leather Co., 2804 E. Washington St., Phoenix, Arizona.

KNOCKDOWN Cedar chests. Lumber and veneers. Free price list. Giles & Kendall Company, Huntsville, Ala.

LEATHERCRAFT Bargains! Lacing. Francis Byrd, 3406 Montrose Ave., Richmond, Va.

30 LAWN Ornament patterns, ready cut. Full size, color indicated. \$1.00 postpaid. Lincoln Craft Studio, Farmington, Conn.

LEATHERCRAFT, Copper tooling, textile painting. Make spare time, profitable time. Free illustrated catalog shows everything you need. Kit Kraft, 7377 Melrose, Hollywood 46, California.

LEATHER, Tools, lacings, supplies. Free catalog. National Handicraft, 199 William St., New York 7.

MAKE IT YOURSELF

KITS, Modernistic bookcases. Request price list. Shadow boxes \$1.00 plus postage. Horton-Waechter Enterprises, 552 W. Chickasaw, Brookhaven, Miss.

BUILD Your own "tractor." Free information. Eltraco, D-1, Camptonville, California.

UNDERWATER Diving apparatus. Have fun and money too. 3c stamp brings particulars. Hamshaw, W.1 Sumner, Spokane, Washington.

PLANS, Septic tank, or water softener, \$1.00 each. Freeland Engineering, 16587 Freeland, Detroit 35, Michigan.

12 INCH Planer plans \$2.00—Build your own machinery from salvage. Handbook, only 25c (refundable). Free details. Kenneth Reeves, Box 3357-C, El Paso, Texas.

"CONCRETE Block Homes." 32 page booklet on how to build. \$1.00. H. C. Lightfoot, Civil Engineer, Richboro 1, Penna.

RANCH Home five rooms, concrete block. Complete building plans, instructions \$1.00. Watkins, Box 831, Columbus 16, Ohio.

POWER For your lawn mower. Complete instructions, 25c coin. Miller, 758 Normal Circle, Memphis, Tenn.

GRANDFATHER Clock easily built. Big savings. See ad on page 241.

WANNA Beat high costs, shortages? Build machinery from salvage. Others do. Descriptive handbook 25c (refundable). Kimo, New York 19-A.

STREAMLINED, Built-in kitchen cabinets to fit any kitchen. Illustrated manual describes designing and construction. All for \$1.00. Thombert Company, Newton, Iowa.

BUILD Your own concrete blockmaker. Easy. Inexpensive. Motor or hand. Make block per minute. Write, C. Lee, Mountain View, Okla.

WATCHES, OLD GOLD, JEWELRY

7 JEWEL Calendar wristwatch, month and day, sweep-second hand, expansion band. \$14.98, taxes paid. Ervin Jewelry, 330 East Main Street, West Carrollton, Ohio.

WATCHMAKERS' Journal contains instructive articles for watchmakers and beginners. \$1.00 year. Sample copy 20c. Dean Co., Box 3218, Daytona Beach, Fla.

WATCHMAKERS', Jewelers', hobbyists', tools, supplies. Catalogue! Bengal Company, Culver City, California.

RHINESTONES, Jewelry settings, cameos, sequins, beads. Catalog free. J & M Novelties, Dept. CG-3, Griffith, Ind.

WRIST Watches, U. S. Air Corps, Waltham, 16 jewel, water and shock proof, stainless steel case, reconditioned. Value \$55.00. Special \$17.95. Public Sport Shops, 11 S. 16th Street, Philadelphia 2, Penna.

CERTIFIED Watch repairing. Complete overhaul, defective parts replaced, year guarantee—\$7.95. Write for free mailing carton—insured. United Watchmakers, 515 Columbia, LaFayette, Indiana.

DIAMONDS Lowest wholesale prices. Airmail for full information. Joachim Goldenstein Diamond Club, Antwerp, Belgium.

HIGHEST Cash paid for old, broken jewelry, gold teeth, watches, silverware, diamonds, spectacles, platinum. Free information. Satisfaction guaranteed. Government licensed. Rose Smelting Company, 29-A East Madison, Chicago.

GOLD Plated jewelry supplies. Rhinestones, pearls. Illustrated catalog, only 10c. Barry's, 47-N Branford Place, Newark 2, N. J.

TOBACCO, SMOKERS' SUPPLIES

PIPE Smokers. Aromatized bouqueting agents provide flavorful smoking. Information free. Cozza Manufacturing Pharmacist, Pequannock, N. J.

OF INTEREST TO WOMEN

MAKE Money at home sewing useful articles. Liebig Industries, Beaver Dam 10, Wisconsin.

BIG Profits. Make fast-seller chenille holiday flowers, monkey trees, dolls. Literature free. Velva, Bohemia 16, N. Y.

FOR SALE—MISCELLANEOUS

PATENT Pending—"Rafta cutting and positioning jig." Serial No. 196253. Will sell cheap, outright or royalty. Write Evo Tarperi, 621 Grand Blvd., Iron Mountain, Michigan.

TRIPODS, All wood, solid leg with four inch circular metal head, can be threaded, 55" tall, value \$27.50—special \$6.95. Public Sport Shops, 11 S. 16th Street, Philadelphia 2, Penna.

FREE Catalog! War surplus clothing. Amazing bargains. N. Y. Clothing Co., New York 29A.

HANDSIGHTING Levels, improved, new model, used for grading land, contouring and laying out fences, piers, roads and gardens, price \$2.50 postpaid. Public Sport Shops, 11 S. 16th Street, Philadelphia 2, Penna.

FARMERS—Ranchers! Staples, 7/8" x 3/4", flat back, coated, war-surplus, 100# keg \$9.95 f.o.b. G-1 AAF oxygen tank, stainless steel, lightweight, 12" x 24", 450 psi, \$9.95 (\$1.00 postpays). Vickers hydraulic pumps, 1000 psi, \$12.95, 1500 psi, \$17.95 (postpaid). Aero Parts Supply, Municipal Airport, Houston, Texas.

SAVE 50%. Install it yourself. 85,000 Btu oil fired forced air central heating system for 5 rooms. Completely automatic. All necessary electric controls, gun type burner, blower, motor, drive, heater pipe, registers, register boxes. Direct from manufacturer. Details on request. Nichols Company, Box 4, Woburn, Mass.

DRESSES 18c; Coats \$1.00; blouses 35c. Free catalog. Crown, 164-PA Monroe Street, New York.

SAVE Money on army, navy and factory surplus. Write today for new 52-page illustrated catalog. Tennusa Sales Co., Dept. AE, 1451 Market, Chattanooga, Tenn.

WANTED—MISCELLANEOUS

SCRAP Platinum—Any shape or form. Will pay, at present, \$75 per troy oz. (Price subject to market conditions.) Metallurgical Products Company, Est. 1909, 35th and Moore Sts., Philadelphia 45, Penna.

SCRAP Mercury (quicksilver), tantalum, bismuth, tungsten. Metallurgical Products Company, Established 1909, 35th and Moore Sts., Philadelphia 45, Penna.

PERSONAL

BORROW By mail. Loans \$50 to \$300 to employed men and women. Easy, quick. Completely confidential. No endorsers. Repay in convenient monthly payments. Details free in plain envelope. Give occupation. State Finance Co., 210 State Finance Bldg., Dept. Z-14, Des Moines 8, Iowa.

REMAILING Scenic cards, auto luggage tourists stickers. 25c each. Money order only. Brennan, 1566 Unionport Road, New York City 62.

INTERESTING Mails. 25c keeps name on mailing list three months. Bentz, Desk D/31, Chatawa, Mississippi.

LETTERS Remailed from San Francisco 25c each. 6 scenic postcards \$1.00. Martin, Box 414, Alameda, California.

HAIRCUT As you like it. Shaving technique. Booklet tells how. 25c. Mastrolia, 5 1/2-AC Jane, New York City 14.

LETTERS Remailed 25c each. Coin. Six Columbus postcards \$1.00. You send addresses. We mail. McLaughlin, 369 Welch, Columbus 7, Ohio.

BIBLE Course free. Write Victory Service, Dept. 651PM, Emmaus, Penna.

PRINT Without a printing press. Big profits! See page 33.

BIG Valuable mails. Three-month listing 25c. Green, Box 6761, Los Angeles 22, Calif.

LETTERS Remailed 25c each. View cards 3 for 25c. Edward Nadell, Box 345, Los Angeles 53, Calif.

"**HOW** Can I find out?" You can! Information discreetly developed. Any matter, person, problem, anywhere. Worldwide. Officially licensed, bonded service. Established 1922. Reasonable. Confidential. William Herman, 170 Broadway, New York.

MAKE Money in 1951 by mail. Particulars 3c. Swaty, Box 1466-P, San Diego, Calif.

MEXICAN Legal matters reliably handled. Box 1736, El Paso, Texas.

MEXICAN Law. General practice. Attorney. 1203 Arizona St., El Paso, Texas.

HERE'S How and where to borrow \$50.00 to \$300.00 by mail. Confidential. Free particulars. Postal Finance Company, Dept. 45, Sioux City, Iowa.

MISCELLANEOUS

YO-YO'S. "Free wheeling" tournament type. 35c. Goodwins, 11 Buchanan, Warren, Penna.

AIR Corps type sunglasses. Send \$1.00 to C & S Sales, 5748 W. Belmont, Chicago, Ill.

CESSPOOL Trouble? Use Peps-It. Rejuvenates fermentation action, saves pumping costs, deodorizes, reduces masses. Costs only \$2.50. Safe. Sanitary. Free descriptive literature. Chemical Cesspool Cleaning Co., Boston 34, Mass.

ADD Spice to home projection shows with colorful old-time Nickleodeon slides, 2x2. Write for free list. Nickleodeon Co., New Fleidner Bldg., Portland 5, Oregon.

SELL Your products via radio without risking one cent. Write Nickell-P, R-3, Box 94, Bend, Oregon.

INFORMATION. Any subject. The Roxbys, 5440 Fulton Ave., Van Nuys, Calif.

MAILING Lists, live productive, inexpensive, \$5.00 1000. Homemakers, newlyweds, recent mothers, etc. Central Mailing Service, Judsonia, Arkansas.

RECEIVE Giant mails, magazines, catalogs! Three months 25c, year 50c. Waddell's Directory, 341B East 76th, New York 21.

FREE! Swap, sell, buy anything. Free listing in Swappers' Journal, 447 West Broad, Hazleton, Penna. Copy free.

INCREDIBLE! Unprecedented! Become a mental superman overnight! Floor everybody! No studying! "Memoprop" does all your thinking! It's uncanny! Revolutionary! Write: Bijou, Box 1727-MC, Hollywood 28, California.

URANIUM Identified on-the-spot! Prospectors save time, assay fees using proven Menlo uranium test kit with any blacklite. Pocket-size kit contains everything for 25 bead tests. Refillable. Free list uranium ores with every kit. Valuable instruction manual. At your dealer's or order direct. \$5, postpaid. Menlo Research Laboratory, Box 522-A, Menlo Park, California.

GEIGER Counter, skeleton, \$16 postpaid. Low voltage Geiger tubes \$5.00. Pocket counter \$48.50 complete. Western Radiation Lab., 1107 W. 24th Street, Los Angeles 7, Calif.

ROLLER Chain detacher. Handy detaching various sizes steel roller chain, quickly, \$5.25 postpaid. Free information. R. Kemmer, Havelock, Iowa.

TRUSS Wearers—Here's good news! New painless 3-contact pad. Most sensational invention in 50 years. Postcard brings details. Active Man, 549 Randolph, Dept. 9, Chicago 6.

SEEK Gold, uranium, buried treasure! Latest low cost super-sensitive equipment. Free literature. Glen Scientific, Box 151-B, Glen Ellyn, Illinois.

STATE Decals for windshields, luggage. All states available. In demand everywhere. Send 25c for samples and wholesale list. Bristow Novelty Co., Box 403, Dept. 7, Owensboro, Ky.

WATERLESS Hand cleaner. (No ammonia.) Easily made. Good profit. 2 dependable formulas \$1.00. Neiko Chemical Service, Box 3462HC, Chicago 54, Ill.

SQUARE Dance instructions, thirty dances, \$1.00. Wesley Rader, 3926 Alcott, Denver 11, Colorado.

URANIUM Fluorescent test outfit \$3.75 postpaid. Central States Laboratories, 947 N. Avers, Chicago 51, Illinois.

GOLD, Silver, metal detectors. Geiger counters for uranium. Mineralights. Sensational new fully guaranteed models. None finer. Information free. Detector Co., 5631 Cahuenga Blvd., North Hollywood, California.

TREASURE Finders for gold, silver and minerals. Money back guarantee, best available. Also Geiger counters for uranium prospectors, free information. Write Goldak Company, 1541 West Glenoaks, Glendale 1, Calif.

OUTDOOR Toilets, cesspools, septic tanks cleaned, deodorized with amazing new product. Just mix dry powder with water; pour into toilet. Safe, no poisons. Save digging, pumping costs. Postcard brings free details. Burson Laboratories, Dept. C-36, Chicago 22, Illinois.

"RECEIVE Mail." Moneymaking offers, opportunities, catalogs. Name listed 10c. Ideal Service, Park Ridge 10, Ill.

PANNING Gold lesson and catalogue. Beginners supplies, books, "maps where to go" free. Old Prospector, Box 729D1, Lodi, Calif.

DRESSES 18c; Coats \$1.00; blouses 35c. Free catalogue. Crown, 164-PM Monroe Street, New York 2.

TREASURE—M-Scope Geiger counters, mineral locators. Why buy something inferior when you can buy the best at a lower price? Backed by years of experience. Fully guaranteed by factory. Detects minerals, metals, gold, silver, coins. Payment plan available. Proven superior performance. Free 16 page illustrated booklet. Fisher Research Lab., Inc., Palo Alto, California.

\$5 HOUR Easy! Sell name plates for houses. Free sample, order blanks. Write: National, 214 Summer, Boston, Mass.

TATTOOING Outfits, supplies. Illustrated list free. Zeiss, 728 Leslie, Rockford, Illinois.

YOUR Leather jacket renovated expertly. Free circular. Berlew Mfg. Co., Dept. 8, Freeport, N. Y.

EARN Up to \$200 month, inventing toys, games, gadgets. Write, Hendrickson, Argyle 1-A, Wisconsin.

READ Teleshopper's Guidebook before purchasing TV. \$1.00. Details free. Box 91, Birmingham, Michigan.

FREE Illustrated folder and literature describing Sea Craft, famous 25 ft. cabin cruiser you can build yourself. Sleeps four people, fully seaworthy, cruises at 15 knots with converted auto engine. Complete with galley, fresh water tank, sink, toilet and spacious cabin interior. Save hundreds of dollars—use Popular Mechanics blueprints and step-by-step instructions. Popular Mechanics Press, Dept. BP, 200 E. Ontario St., Chicago 11, Ill.



DRAW for MONEY... Be an ARTIST!

Trained Artists are Capable of Earning \$65, \$80 OR MORE A WEEK!

You can learn to draw at home in your spare time the well-known WSA way. COMMERCIAL ART, DESIGNING, CARTOONING — all in ONE complete course. No previous art experience necessary—we teach you step-by-step. Prepare now for a fascinating hobby or profitable career. For 37 years WSA graduates have been making good — WHY NOT YOU?



VETERANS!
COURSE
G. I.
APPROVED

Write today for FREE BOOK, "Art for Pleasure & Profit." It fully describes our correspondence course, instruction service, and commercial opportunities for you. TWO ART OUTFITS and other features with training. Low cost — easy terms.

WASHINGTON SCHOOL OF ART

Studio 126A, Washington 5, D. C.
Please send me full information and your Free Book, "Art for Pleasure and Profit."
Name AGE
Street
City Zone State

WORLD'S FASTEST BOATS!

BUILD and DRIVE your own high speed racing boat



as hundreds of others are doing! Easy to follow our simplified plans for newest types of racing craft. Large selection of full race Hydroplanes ranging from 6 ft. to 20 ft. lengths. Service, Racing, Utilities, and 3 Points. Both inboard and outboards.

SEND 25c for CATALOGUE containing pictures and descriptions of Champion Boats for which plans are designed and distributed exclusively by CHAMPION BOATS, P. O. Box 9038, Dept. 15F, Long Beach, California, U.S.A.

BLOOD PRESSURE GAUGE



for HOME USE..... Keep check on yourself! Prevent strokes, kidney damage, etc. Manual has full details on what is prescribed in 95% of ALL high blood pressure cases. Unit includes a Blood Pressure Gauge, Arm Bandage, Sleeve, 2 Valve Bulb, Base, Stethoscope and 25 Grams of MERCURY. Easy to operate. Complete outfit sent prepaid for \$5.98 or simply send name and address and pay \$5.98 plus C.O.D. and postal charges on arrival.

\$5.98

JOY SPECIALTY COMPANY
Scientific Instrument Department
2320-A W. Hubbard St. Chicago 12, Ill.
Additional information upon request

IDEAL FATHER'S DAY GIFT



FOR ANY FISHERMAN!



100 Bait Combinations in one Magic Casting Lure. Converts quickly into popper, darter, wiggler, etc. Clear all-plastic body with color inserts and four interchangeable heads in pocket-size box. Complete fishing kit in itself. Super fish-catcher! Only \$2.85. Order by mail. Pay postman \$2.85 plus postage on delivery. Or send \$2.85 and we pay postage. Order for Father's Day gift today! NICKEL TACKLE CO., Dept. P, 247 Riverside Ave., Jacksonville 4, Florida.

Leopard* Zebra*

AUTO SEAT COVERS



*Simulated

ZEBRA HIDE

Call of the wild! Gay stripes mean a gay fellow... the ladies love 'em! Satisfaction guaranteed. Custom tailored, complete set—front and rear, \$34.95



LEOPARD SKIN
Let's go native! Smart looking, easy sliding. Look and feel like real Leopard. Custom tailored. Complete set—front and rear \$32.95.

Most makes, Most models
Send \$1.00 deposit, Balance C.O.D.
Pay in Full—save C.O.D. and postage.

MAKE _____ YEAR _____ BODY _____
LEOPARD SHORR'S Dept. 1-361
ZEBRA 10600 Grand River, Detroit 4, Mich.

PISTON SEAL

is "Penicillin" in your AUTO ENGINE!



DON'T spend Big Money overhauling your car! Use Holt's "Piston Seal" instead! Exactly what's your trouble? Burning oil? Lacking power? Piston slap? Worn cylinders? "Piston Seal" effectively eliminates these ailments! By forming self-expanding pliable lubricating seal around the pistons, this amazing British product compensates for wear! Restores compression! Cuts oil loss! Checks piston slap! Lasts 10,000 miles! Cannot harm the finest engine; easily installed. The British call it a "Godsend!" You will, too!



**DETAILS FREE!
WRITE TODAY!**

R. H. PHILBRICK, Dept. 60,
Drawer 4590, Coral Gables 34, Fla.

RUSH details on Piston Seal—without obligation!

NAME.....
ADDRESS.....
CITY.....STATE.....

If you can draw as well as this..



Beginner's work, but shows talent, we told Arnold Allen when he first applied to us for criticism. We were

right! He's now a successful New York illustrator making a fine income!

Do you draw or paint? We'll help YOU see if you have profitable art talent. Take our famous Free Talent Test. Take it alone, at home. Find out if you have real art talent. Clip the coupon. Mail it today.

ART INSTRUCTION, INC., Dept. 6131

500 S. 4th St., Minneapolis 15, Minn.

Please send me your FREE Talent Test.

Name.....Age.....

Address.....Phone.....

City.....Zone.....County.....

State.....Occupation.....



HURRICANE CUT-OUT EXHAUST

This specially engineered cut-out enables you to install special pipes and mufflers without removing the original muffler.

Now control your exhaust tone from a dash control button. Cut back into your original muffler in restricted areas at will.

This cut-out is well constructed: actually strengthens exhaust pipe: made of heavy plate steel, designed for easy installation—no special tools required. Sent post-paid for only \$6.95 check or money order. Satisfaction guaranteed or your money back.

ST. LOUIS PRODUCTS CO., Box 24, Normandy 21, Mo.

BE A GUNSMITH



Like guns? There's a great future when you can make Stocks, ReChamber, Blue Parts & Repair all types of guns. Our residence Course features best equipment and instruction. Low-cost living quarters arranged; part-time work possible. G.I. App'd., easy-pay plan for others. Facts Free, write today.

117 Fourth Ave. Pittsburgh 22, Pa.

The Kissich "FISH-FINDER"

Tiny 2-oz. device, when tied to your line and dropped into current, floats across streams, gently guides bait to all choice fishing spots in stream within 300 feet and holds it there. Enables you to catch fish where others fail. Only \$2 postpaid. Try it 30 days. If not satisfied, return for prompt refund. Write for free literature.

The KISSICH Company — Cedar Rapids, Iowa
211 Third Street N.E.

FREE FULL INFORMATION REGARDING THE NEW GEM TITANIUM RUTILE

everywhere hailed as More Brilliant than a DIAMOND. This Free folder tells you all about it, shows the actual stones actual size in real photos and tells the low cost. SEND POSTCARD TODAY before you buy anywhere. Write Dept. PM-T.

HUDSON GEM CO., 15 E. 47th St., N. Y. C. 17, N. Y.

TRAIN Your VOICE!

RESULTS GUARANTEED

STRENGTHEN your voice this tested, scientific way. Yes—you may now be able to improve the POWER of your speaking and singing voice... in the privacy of your own room! Self-training lessons, mostly silent. No music required. Write TODAY for Eugene Feuchtinger's great booklet, "How to Develop a Successful Voice." It's absolutely FREE! You must state your age. Booklet mailed postpaid in plain wrapper. No salesman will call! Send your name and age RIGHT NOW! Perfect Voice Institute, 210 S. Clinton St., Studio F-2, Chicago 6, Ill.

LAW

STUDY AT HOME for Business Success and **LARGER PERSONAL EARNINGS**. 42 years expert instructions — over 114,000 students enrolled. LL.B. Degree awarded. All text material furnished. Easy payment plan. Send for **FREE BOOK** — "Law and Executive Guidance" — NOW!

AMERICAN EXTENSION SCHOOL OF LAW
Dept. PM-39, 646 N. Michigan Ave., Chicago 11, Ill.

SAY YOU SAW IT IN POPULAR MECHANICS

Learn PHOTOGRAPHY at Home

Splendid opportunities. Prepare in spare time. Practical basic training. Long-established school. Send for free book, "Opportunities in Photography." No obligation.

American School of Photography, 835 Diversey Parkway, Dept. 135A, Chicago 14, Ill.

Earn Big Money

WRITING ORDERS

AMAZING NYLONS

Guaranteed Against
RUNS AND SNAGS
Regardless of Cause!

The world's ONLY complete, nationally advertised nylon hosiery line actually guaranteed against runs, snags or excessive wear, **REGARDLESS OF CAUSE!** It's amazing, but true! No matter what the cause—hard use or deliberate abuse—Kendex nylons are replaced **FREE** if they run, snag or become unfit for wear within entire guarantee period! Every weight from sheerest 15 denier to heavy 70 denier—all gauges up to luxury 60 gauge—all sizes, lengths, popular shades, fancy heels, black seams—full fashioned and seamless. Nothing is missing to make sure every woman is pleased. In spite of the amazing guarantee, retail postage prepaid prices are no higher than comparable quality national brands. Should free replacement be necessary, actual cost is cut in half! How could any woman possibly resist saving money and solving her hosiery problems? **NOT SOLD IN STORES.** Men and women wanted **NOW**, spare or full time, to write orders and earn big money. You can get orders even if you never sold a thing in your life!

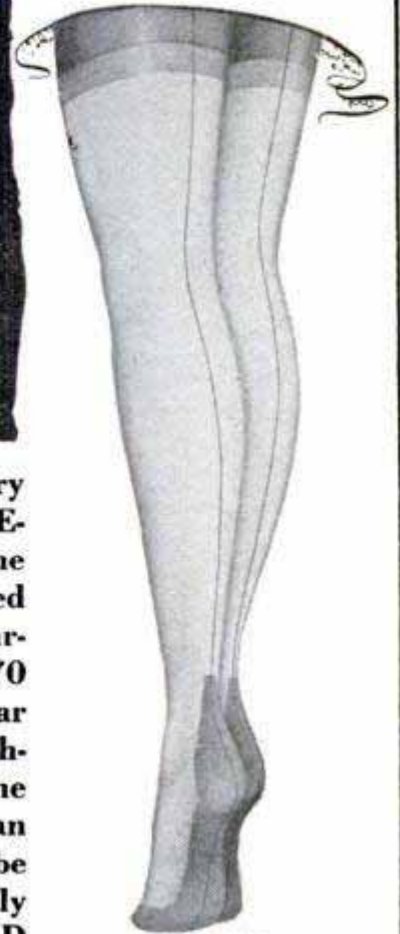

FREE SAMPLE STOCKING

Man or woman—young or old, **YOU** can easily earn steady income, spare or full time. No money or experience needed. We supply **EVERYTHING** free and set you up in business at **OUR** expense. Nothing to buy or deliver. Write orders. We deliver and collect. Big advance pay plus huge cash bonus that increases your earnings up to **40%**! Your name and address on postcard will bring you sample stocking; self-selling sales books with **FULL COLOR** illustrations; 32-page sales manual showing you easy steps to success; color cards, free "door openers" worth \$1 each but which you give away free; special plan to have others sell for you, etc., etc. You can start making money the minute you receive the complete **FREE** outfits!

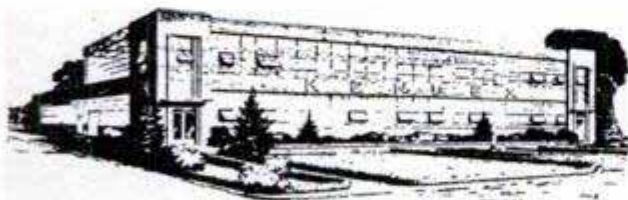

YOUR COST ONE CENT!

SEND NO MONEY. Pay nothing now or later. No obligation. Not even a promise to return outfits. Simply write your name and address on a penny postcard and mail to us. We'll immediately rush you everything you need **FREE** and postage prepaid. **WRITE TODAY!**

KENDEX CORPORATION

● **BABYLON 246, N. Y.**

SALESMEN JAM POCKETS WITH \$10 BILLS



Taking orders for **KEY** expertly tailored auto seat covers
The "LEOPARD" selling sensation of the year

BIG SEASON NOW STARTING!

Tremendous demand for Leopard auto seat covers built up overnight when Cadillac introduced a new 1950 model with Leopard Seat Covers. Car owners are paying \$50.00, \$60.00 and \$70.00 and more for car seat covers with Leopard design. Now you can serve that eager demand at a fraction of the cost your customers would expect to pay! Salesmen making money hand over fist.

7 STYLES
7 Price Ranges. A full line in addition to the leopard. Woven fiber. Woven Saran Plastic.
FREE!
SALES KIT

Take orders from car owners everywhere. Year around income! A line of covers cut to accurate patterns like the finest suit of clothes. Add an accent of elegance to any car... just like an original upholstery job! Full or spare time, you can realize big money in this business. Every car owner a prospect. Be the first in your territory to cash in. Get your free selling kit at once for some real money.

ACTUAL SEAT COVERS GIVEN FREE TO PRODUCERS FOR OWN USE! Write for full details TODAY!

KEY PRODUCTS CORP.
800 N. Clark St., Dept. 4-H, Chicago 10, Ill.

AUTO MECHANICS! BOOST YOUR EARNINGS



AUTO ELECTRICAL SERVICE

made easy!

JUST OFF THE PRESS
Contains technical information

Only **\$2.00**
Price in Canada \$2.25 postpaid. Send cash, check or money order to Electric Auto-Lite Company, Limited, Sarnia, Ontario.

The finest, most completely illustrated full color book on the complete automotive electrical system. Includes full information on the seven basic electrical circuits built by Auto-Lite... Starting—Charging—Ignition—Horns—Windshield Wipers—Instruments—Lighting. Plus Trouble Shooting Charts worth many times the price of the book. Gives you the answer every time.

SPECIAL! NO MONEY COUPON
THE ELECTRIC AUTO-LITE COMPANY—Toledo 1, Ohio
Yes, send me your "Maintenance and Operation Manual" by return mail. I will pay the postman when he delivers my copy \$2.00 plus postage. (If \$2.00 is enclosed with this coupon, the book will be sent postpaid.) If after 10 days I am not satisfied I may return the book and my money will be refunded.
NAME _____
ADDRESS _____

DISPENSE OIL : GAS : GREASE with NO DIRT — NO WASTE



DIRECT FROM CAN TO MOTOR
Use this new dispenser to handle all weight oils, gasoline, gear greases, etc. Delivers a quart of fluid to every four strokes, and a pound to every two. No waste. Fits any five-gallon kerosene-type can.



Steel cylinder, aluminum nozzle, 4' of oil-resistant hose, and pour-spout cap. Cap not included. Guaranteed.

Order Direct
Only \$6.00 prepaid with money-order or check, or C. O. D. plus postage.
Free Literature

**STELLO PRODUCTS COMPANY
HUTCHINSON, KANSAS**

Precision Tested Optics



10 POWER 50 MM PRISMATIC BINOCULAR

Highest Power Binocular in low price field. The last word in extreme range Binoculars produces tremendously brilliant images. Complete with genuine cowhide plush-lined case and straps... feather weight... perfectly balanced... especially designed for utmost light transmission. **UNDOUBTEDLY ONE OF THE MOST POWERFUL INSTRUMENTS AVAILABLE OF HIGHEST IMPORTED QUALITY. NO OTHER MODEL CAN OFFER SUCH COMPLETE UTILITY.**

Finest quality coated achromatic lenses \$10.00 add.

FREE 30 Day Trial OUR OWN unconditional MONEY BACK \$49.50 Plus 20% Fed. Tax

SEND NO MONEY—pay reg. purchase price plus postage on delivery. Prepaid orders will be postpaid.

GREAT NORTHERN DISTRIBUTING COMPANY
Dept. A-2 4701 Sheridan Road Chicago, Illinois



YOUR FAVORITE PHOTO PRINTED ON METAL

RESISTS TIME—WEAR—MOISTURE
Utterly new. Strange process will perpetually preserve your favorite photo in silver-tone on metal! 2" x 3" print is ideal for billfold or purse. Will keep its rich beauty a lifetime. Ideal gift for soldiers, too! Send any photo size up to 8" x 10", and \$1.00 with order. Balance of only \$3.95 C.O.D. plus postage when you receive your metalized photo. Your original photo returned undamaged along with order. Send TODAY!

METAL-FOTO
10 W. Kinzie Street, Dept. 36, Chicago, Ill.

HULA POPPER • GETS BIG BASS

Surface popping lure. Ideal combination of noise, action, casting and hooking qualities. Pops, plunks, jerks, twitches—obeys your slightest wrist command. Rubber Hula Skirt imitates live bug. At your dealer 5/8 oz. or 1/4 oz., \$1.25. Fly rod size, 75c.



FRED ARBOGAST & Co., Inc., 2256 W. North St., Akron 3, Ohio

FREE WRITE TODAY FOR BIG FREE 1951 ARBOGAST COLOR CATALOG—FULL OF PICTURES OF CATCHES

Say You Saw It in
POPULAR MECHANICS

FOAM RUBBER

FOR HOBBYISTS, CRAFTSMEN, EXPERIMENTERS



Lowest Prices—SAVE 50%
16 x 16 x 1 1/2" ... ea. \$1.35
16 x 22 x 1 1/2" ... ea. 1.75
18 x 24 x 1 1/2" ... ea. 2.00
24 x 24 x 1 1/2" ... ea. 2.95
AUTO SEAT TOPPER PADS
Place under seat cover.
24" x 60" x 1 1/2" ... ea. \$6.45
24" x 60" x 2" ... ea. 7.95
12" x 14" x 1 1/2" ... ea. 1.25
Use for furniture cushion fillers, mattresses, mattress pads, cushions. Foam Rubber is available in any size or thickness. Send For Free Price List. Immediate delivery. No C.O.D.'s. Add 10% for Postage & Handling to Above Prices. Please print.

RIOR RUBBER COMPANY, Dept. P-18
50 East 22nd St. Chicago 16, Ill.

BIG DAILY EARNINGS

UP TO **\$200 WEEKLY**

Just Sending Us Names From

No Selling! No Demonstrating!
No Collecting!

If you're the type of man or woman who can call on professional and business men — we'll show you how to easily earn up to \$200 weekly. All that you need to do is to secure names of delinquent accounts and send them to us. We do the collecting! No order for you to secure — no collection to make — just the simple presentation of our excellent and dignified collection service and the names come easily. We pay you daily for names sent us. Excellent opportunity for a District Managership!

Write Today For Starting Plan
Nothing For You To Buy

Preference will be given to applicants from 30 to 65. Our plan permits you to make big money — full time or spare time — and to operate in your own territory or to travel. For quick starting action wire or write us today for our Starting Plan.

UNITED FINANCIAL SERVICE OF AMERICA

178 Plymouth Bldg. Minneapolis 3, Minn.

**DOCTORS
DENTISTS
HOSPITALS
MERCHANTS
BUSINESS
FIRMS**

In Your
Territory

MAGIC-SCREEN INCOME PLAN OFFERS BIG MONEY, AT HOME, SPARE OR FULL TIME

Reproduce any painting, design, trade-mark, picture, printing, in full color, on any surface! Proven new method enables you to cash in on established business where Profits up to \$5.00 or more an hour are being made, right now! Examine complete Plan and equipment without risk! Write today for free sample — complete free details! Act NOW!
CALIFORNIA ACADEMY OF SCREEN PROCESS — Dept. 26
5100 S. VERMONT AVE., LOS ANGELES 37, CALIF.



RETIRE IN FIVE YEARS!

FREE Literature and information

**FISHER'S KEY
CHINCHILLA EXCHANGE**

1611 MONTANA AVE.,
SANTA MONICA, CALIF.



LOCKSMITHING & Key Making

PRACTICAL UP-TO-DATE COURSE—ONLY \$4.95

Easy-to-learn modern information for self-instruction. How to work on locks, de-code, make master-keys, repair, install, service, etc. For every handyman, home owner, carpenter, mechanic, or vice station operator, fix-it shop, hardware dealer, gunsmith. 53 plain illustrated lessons. FULL PRICE ONLY \$4.95. SEND NO MONEY. Just pay postman plus C.O.D. postage. Or send \$4.95 with order, we'll ship postpaid. Satisfaction guaranteed or refund.
NELSON-HALL CO., 210 S. Clinton St., Dept. F-2, Chicago 6, Ill.

BIG MONEY for You Showing NEW MIRACLE Labor Saving Discovery

MEN! WOMEN! Enjoy amazing profits with new "Miracle" Copper Cote Ironing Pad. Plastic Coating saves housewives time, labor, money. 1-minute demonstration sells it. Experience unnecessary. Write for FREE Sample Offer and our other new fast-selling products. SEND NO MONEY. Write for details, sample offer to THE SHELDON CO., Dept. 747, 1223 South 23rd St., Milwaukee 46, Wis.



BOAT KITS

Easy To Build

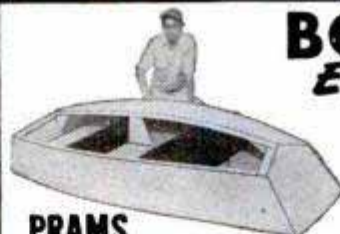

ROWBOATS
10 TO 14 FT.

PRAMS
\$39⁶⁰ up

8 TO 11 FT. ALSO WITH SAILS



OUTBOARDS
12 TO 16 FT.

**INBOARDS &
CABIN CRUISERS**

16 TO 23 FT.



NEW CATALOG
MOST COMPLETE EVER OFFERED

- 1-BOAT KITS—26 MODELS
- 2-MARINE HARDWARE
- 3-MARINE ENGINES
- 4-MARINE CONVERSIONS
- 5-PAINTS & COLOR CHARTS

► All For Only 35c, SEND COIN TODAY

U-MAK-IT PRODUCTS 703P-WHITTIER ST.
New York 59, N. Y.



WHY NOT SAVE GAS?

Be Prepared If Rationing Returns

1/2
Million
Use
Ganes

**BOOK
GIVEN FREE
TO ALL WHO TRY
GANE NEEDLES**

GANES REPLACE CARBURETOR
IDLING ADJUSTMENT SCREW

Install Ganes in a few
minutes on all cars

HOW TO GET
150
MILES PER GAL

TEST FOR

10 DAY
FREE TRIAL
IN YOUR CAR

- ✓ BETTER MILEAGE
- ✓ EASIER STARTING
- ✓ FASTER PICKUP
- ✓ BETTER IDLING



MANY GANE USERS REPORT UP TO 25% MORE MILEAGE AND ALL-AROUND BETTER PERFORMANCE . . . but don't take our word for it . . . see for yourself! Test Ganes in your car for 10 days at OUR EXPENSE. Then, compare your mileage and performance and, if fully satisfied, pay only \$1.50 per needle (8 cylinder cars use 2). If not satisfied, simply return them and owe nothing . . . fair enough? Since authorities differ on the merits of Ganes, and some users report no improvement, TRY BEFORE YOU BUY!

ALSO FREE . . . Auto Economy Manual—SENT ABSOLUTELY FREE TO ALL WHO TRY GANE NEEDLES, tells how to save fuel, tires and brakes; how to obtain more speed, power and better performance from any car. Also introduces many new, ingenious auto economy products.

**WRITE TODAY! ENCLOSE NO MONEY!
PAY POSTMAN NOTHING!**

List your name, address, make and year of car, no. of cylinders and make of carburetor if known. YOUR TWO FREE BOOKS AND GANE NEEDLES WILL BE SENT IMMEDIATELY.
NATIONAL AUTOMOTIVE RETAIL CORP., Dept. J-6
350 W. Washington Blvd., Venice, California

CALK THOSE CRACKS WITH *Nu-CALK* SPEED LOAD



Seal out drafts, dust, around windows and doors



Here's the easy way to calk your home. Just slip a handy Speed Load into the calking gun and you're ready. It's the fastest, most economical way to apply the world's finest calking compound.

USE *Nu-Glaze* INSTEAD OF PUTTY



Macklanburg-Duncan Co., Okla. City, Okla.

BUY THROUGH YOUR LOCAL HARDWARE, LUMBER OR BUILDING SUPPLY DEALER



MACHINE SHOP MEN

Needed Now!

TODAY shop men are in big demand. Don't miss the chance to get into the big money class and to qualify for promotions to high pay positions. Opportunities are open to men who add to their "know how" day by day. Equip yourself without delay.

8 BIG BOOKS ON APPROVAL

Modern Shop Practice, 14th edition, is the 8-volume set for the use of ambitious men. It contains 4,000 pages of vital information—3848 illustrations—167 tables. Written simply and clearly by 41 experts in tool making, pattern making, foundry work, forging, mechanical drawing, blueprint reading and many other skills. With the set we include a special binder of 860 profusely illustrated pages covering machine shop operations step by step, and 293 actual job tickets. 9 books in all! See also our gift offer at the left.

DICTIONARY OF MACHINE SHOP TERMS

Pocket Size included as gift if you act NOW, whether you keep or return the set.

Send the coupon NOW. Examine these books and note their great help to you. If you want to keep the set, pay on the very easy terms. If not, return the 9 books and owe us nothing. Remember—we now give a year's consulting privileges with our engineers without charge.

PUBLISHERS SINCE 1898

AMERICAN TECHNICAL SOCIETY, Dept. 5A19
Drexel at 58th St., Chicago 37, Illinois

Send me the 8 big books and special binder on approval. I will pay delivery charges only. If I decide to keep the books I will send \$3.00 in ten days and \$4.00 per month until the total price of \$34.80 is paid. If I return them in 10 days I can keep the dictionary and owe you nothing. You also agree to send me a certificate entitling me to consulting privileges without extra charge.

Name _____

Address _____

Please attach a letter stating age, occupation, employer's name and address and name and address of at least one business man as reference. Men in service, also please give home address.

AMAZING NEW DISCOVERY! FOR ALL CARS WITH OVERDRIVE



\$9.95 Postpaid & Installed

We enclose FREE installation certificate redeemable for cash by your garage or gas station.

The Gane-O-Matic Overdrive Control puts to work all the hidden advantages of all Ford, Mercury, Lincoln, Studebaker, Nash, Hudson, Kaiser-Frazer, Jeepster, Dodge, DeSoto and other overdrive systems. AUTOMATIC HILLHOLDER holds car on any slope without use of hand or foot brake. OVERDRIVE COMPRESSION saves gas, brakes and tires. SIX FORWARD SPEEDS... three each in overdrive and regular range are selected with the flick of your finger. NO CLUTCH SHIFTING. Enjoyed up or down without touching your clutch. **YOUR MONEY BACK IF NOT FULLY SATISFIED!** Send cash, check or money order. \$1 C.O.D. deposit. NATIONAL AUTOMOTIVE RETAIL CORP., Dept. Y-6
350 W. Washington Blvd., Venice, Calif.

- AUTOMATIC HILLHOLDER
- OVERDRIVE COMPRESSION
- 6 FORWARD SPEEDS
- NO CLUTCH SHIFTING

YOU WILL ALWAYS FIGURE IT RIGHT WITH A HULL AUTOMOBILE COMPASS



For 18 years, the leading name in Automobile Compasses

Write for local dealer's name and literature

HULL MFG. CO.
P. O. Box 246-D6 Warren, Ohio

Beaconlite Illuminated **\$6.95**
STREAMLINE standard (not ill.) **\$4.95**

X.L. RUBBER MOLDS

will realize your great profits quickly!
WRITE FOR NEW FREE CATALOG

YOU can EASILY learn to cast thousands of perfect plaques, book ends, figurines, ash trays, etc. IT'S EASY, FUN, PROFITABLE!
X.L. Rubber, Pts. \$2.50; Qts. \$4.00. Special: 3 molds and enough rubber for 3 molds prepaid for \$1.50.



SEND FOR FREE FACTS

PLASTIC ARTS STUDIO Address Dept. 2
3403 S. Madison St.

Muncie, Ind.



SPORTONE MUFFLERS

- Ford & Chevrolet.....\$ 4.45
 - All other popular cars..... 5.45
 - V-8 Dual Sets..... 15.95
 - Chromed Silentips..... 2.95
- (Please state make & year of car on all orders.)

SANDEE MUFFLER CO.
5643 Corryne Place • Culver City, California



COLT FRONTIER REVOLVERS

Over one hundred in Stock
Send 50c for Beautiful Up to Date Catalog. Price of Catalog applied to first purchase.

HY. HUNTER

5666 W. 3rd St., Dept. PM, Los Angeles 36, Calif.

GETTING AROUND



With over 100 miles per gallon on a VELOCETTE LE 200 Motorcycle

The WATER-COOLED, SHAFT-DRIVEN LE 200 Silent, Clean, Comfortable. Excellent weather protection. Opposed twin-cylinder, adjustable spring frame. Designed to be as reliable as \$495.50 an automobile; useful as a second car.....

FOB LOS ANGELES.

WRITE FOR FREE CATALOG.

LOU BRANCH MOTORS

2019 W. PICO BLVD.

LOS ANGELES 6, CALIFORNIA

UNLIMITED WRITTEN GUARANTEE!

Automatic 17 JEWEL WRIST WATCH

ANTIMAGNETIC!

100% WATERPROOF!

SET IT AND FORGET IT!

SERVICEMAN'S CHOICE!

NORMAL USE KEEPS IT WOUND!

ORIG. \$71.50

\$24.95
PLUS TAX

The most outstanding watch value in the world! Handsomely styled, thin waterproofed case, Swiss engineered 17 Jewel Incabloc movement guarantees split second accuracy because this watch is always fully wound. 1/5 second calibrations, raised gold numerals with luminous hands and hour markers. Compare this amazing value with any other watch on the market! Formerly \$71.50, now only \$24.95, plus \$2.50 tax. Ladies' model available at \$29.95 plus \$3.00 tax. Order now while our supply lasts! **FREE!** Handsome expansion band included with prepaid orders. **MONEY BACK IF NOT COMPLETELY SATISFIED!** Send \$1.00 deposit on C.O.D.'s. We pay postage on all prepaid orders.

Wear at Our Risk for 10 Days! Money Back Guarantee!

MARYLAND DISTRIBUTORS, Dept. 261
501 E. BALTIMORE ST. BALTIMORE 2, MD.

Say You Saw It in Popular Mechanics

Coronado "pose-breefs"

THE NEW BODY-MOLD TRUNKS FOR IDEAL BODY DISPLAY. WORN BY LEADING BODY BUILDERS OF THE WORLD!

Here's the perfect brief trunks for body building, lifting, swimming, physique photography and contests. Designed by champions... worn by leading body builders of the world. No bind, no boxed or chopped off appearance. Body-mold fit for tall or short men in sizes 26 to 38. Complete freedom... complete coverage. Satisfaction guaranteed. Send check or money order today. Postpaid.



A TWO-INCH HIGH WAIST



B MEDIUM HIGH THIGH CUT



C EXTRA HIGH THIGH CUT (BELOW)



LEO STERN
Mr. California
46 in "pose-breefs"

Please indicate three color choices:

- | | | | | | |
|-------|---|---|---|------------|--------------------------|
| Style | A | B | C | WHITE | <input type="checkbox"/> |
| | | | | BLACK | <input type="checkbox"/> |
| | | | | LIGHT BLUE | <input type="checkbox"/> |
| | | | | ROYAL BLUE | <input type="checkbox"/> |
| | | | | RED | <input type="checkbox"/> |
| | | | | GOLD | <input type="checkbox"/> |
| | | | | AQUA | <input type="checkbox"/> |
| | | | | GREEN | <input type="checkbox"/> |

Coronado Surf Shop,
627 8th Avenue, Dept. PM-2
San Diego 1, California

Please send me, postpaid,
Pose-Breefs as follows: (Check)

1. Elasticized Nylon, the very finest . . . 795
2. Elasticized Nylon and Acetate . . . 595
3. Elasticized Leopard Skin . . . 595
4. Elasticized Satin Acetate . . . 495
5. Workout trunks Assorted colors . . . 395

Name _____
Address _____
City _____ State _____

Please send your illustrated brochure



Floyd Clymer's POPULAR MOTOR BOOKS

CLYMER says— "YOU WILL LIKE MY MOTORBOOKS!"

I now offer 70 titles on automobiles, motorcycles and motor racing. Start your Clymer book library NOW. More than 1,300,000 readers of these world-famous books.

Check books wanted below. All postpaid.

- SOUPING THE STOCK ENGINE**.....\$2
Explains the 5 paths to power, covers all engines from road to track, effective speed tuning theories, tells why and how, 150 charts, photos, drawings, fuels, \$2.
- FORD OWNER'S HANDBOOK**.....\$1.50
Complete maintenance and repair data. All models 1932 to 1950. Charts, drawings, photos, tables of clearances and adjustments. Data on Ford SIX included. A COMPLETE Ford repair book. Covers all parts, engine, transmission, rear end, electrical system, fuel system, brakes, shock absorbers, steering and every other important part. \$1.50.
- CHEVROLET OWNER'S HANDBOOK**.....\$1.50
Complete new service data book, all Chevrolets 1929 to 1950 including Powerglide model. Every Chev. owner needs this manual. Many charts, drawings, sketches on every important unit. \$1.50.
- SPORTS CAR ENGINE**.....\$1.50
A new book, 40 photos, charts, drawings. Technical and all other data on all Sports Car Engines. A MUST for Sports Car Fans. \$1.50.
- SPECIALS, SPORTS CARS AND HOT RODS**.....\$1.50
Over 160 photos, charts, drawings on Special Race Cars—England, Germany, France, Austria, U.S., Italy. A complete Manual of Speed data. Handbook for construction. \$1.50.
- THE MODERN CAR CHASSIS**.....\$2
Complete data on Suspensions, Steering, Shocks, Brakes, Weight distribution. New book for owners modern cars, sports cars, Stocks, Hot Rods, Specials. \$2.
- MODERN AUTOMATIC TRANSMISSIONS AND TORQUE CONVERTERS**.....\$2
Contains latest data on modern automatics & torque converters, including Hydra-Matic, Ultramatic, Dynaflo, Powerglide, Studebaker, Mercury-Ford, Chrysler M-6, Allison, Fuller and White Hydro-Torque. Technical articles written so the layman can understand them. Profusely illustrated with photos, charts, drawings useful as a fingertip reference. By noted S.A.E. authorities. \$2.

TREASURY OF EARLY AMERICAN AUTOMOBILES.....\$5
New Clymer antique car book. 224 large pages. 500 photos, N.Y., Paris, Indianapolis, Vanderbilt Cup races. Glidden Tour data. Cartoons, songs, early motor styles, costumes. Gas, steam, electric, spring driven automobiles shown. 1600 makes U. S. Cars named. Clymer's latest, finest, largest automobile history book. Many cars never before shown. Beautiful cloth binding with attractive colored cover. \$5.

AMERICAN HORSE-DRAWN VEHICLES.....\$2
200 illustrations—106 large pages. Large & colorful assortment of carriages, wagons, buggies, phaetons, track sulks, hearses, fire wagons. A pictorial album of the days when many different HORSE-DRAWN VEHICLES were common . . . colorful vehicles of every description. \$2.

INDIANAPOLIS "500" HISTORY.....\$3.50
352 pages—1100 illustrations—detailed History of all races from 1909-46. Special information on drivers and cars. \$3.50.

CATALOG OF NEW U.S. AUTOMOBILES \$2
Illustrates latest models with detailed information as to specifications, heretofore unobtainable information by Engineers.

CATALOG OF NEW BRITISH CARS.....\$2
All British latest models with photos and complete detailed info.

MEXICAN ROAD RACE.....\$2
Complete history 2135 mile race across Mexico. 132 stock cars. Articles by famous authorities, drivers, personalities. Rules, leg by leg description. Travelogue over Mexico's famous new Highway. 152 pages, 300 photographs.

GRAND CANYON ECONOMY RUN.....\$1.50
Records of performance of American stock cars competing over the 751 mile rugged test, sanctioned by AAA. Technical engineering details and special articles on how to increase your own mileage. 150 photos, charts and drawings.

Write for Free Catalog of 75 Motorbooks.

FLOYD CLYMER 1268 S. ALVARADO P-7 LOS ANGELES 6, CAL.

"World's Largest Publisher of books relating to Automobiles, Motorcycles, Motor Racing and Americana"



CLYMER CRASH HELMET \$25
For car, motorcycle, boat racing. Safety. A.A.A. & A.M.A. approved. Give hat size, 6 3/4 to 7 1/2. Model D \$25.
CLYMER HELMET SOUVENIR LAPEL PIN, in color, actual size above, 75c.

MAIL ORDER

FLOYD CLYMER PUBLICATIONS
1268 S. Alvarado, P-7, Los Angeles 6, Cal.

Send postpaid books checked above. Servicemen delivery guaranteed.

Send Free Catalog. I now own some Clymer books. I am a new customer.

Name _____

Address _____

City _____ Zone _____ State _____

Remittance enclosed Send C.O.D. (postage extra)
Add 10% on foreign orders

FREE CATALOG

23 MODELS-SAVE 50%



16' Sport Cruiser

★ EASY TO ASSEMBLE

PACKAGED BOAT KITS

WORLD'S BEST BOAT BUY!

CUSTOM-CRAFT

★ SEMI-FINISHED BOATS (READY TO PAINT)
★ CUSTOM-FINISHED BOATS (READY FOR THE WATER)
FACTORY TO YOU

Racers 12'-14'



Dinghies 8'-10'



Skiffs 10'-14'

\$38.95

UP



Outboards 12'-16'



Runabouts 12'-16'

SEND FOR OUR FREE BOAT CATALOG

See how Packaged Boats are built, how they perform. See how exclusive "Girder Construction" makes assembly easy, makes possible the setting up of the entire framework without driving a single screw. All 23 models fully illustrated with specifications and performance data. It's fun to build your own boat . . . and it's easy! You'll get all the facts from our big 16 page Boat Catalog. Send for your copy today, it's FREE!

MARINE MART
Dept. 52
BUFFALO 7, N. Y.

BOAT PLANS - PATTERNS

Over 70 modern plans and full size patterns. Racing classes, cruisers, inboards, outboards, sail boats . . . by famous designers. 6' to 30'. DESIGN CATALOG 35c. Design Catalog and boat building handbook. \$1.00.

HELPFUL BOOKS

Send post card asking for FREE catalog
Popular Mechanics Press, 200 E. Ontario, Dept. 601, Chicago 11

MIDWEST

Presents its NEW 1951
Line of TELEVISION
and RADIOS

Mammoth
19 1/2
INCH
PICTURE
TUBE



30 DAYS TRIAL

Don't buy any radio or television receiver until you've seen the new 1951 Midwest Line - it's the finest in 31 years.

FACTORY-TO-YOU

EASY TERMS

SEND THIS COUPON ON 1c POST CARD FOR NEW 1951 FREE 4 COLOR MIDWEST CATALOG

MIDWEST RADIO & TELEVISION CORP.

Dept. 25N, 909 Broadway, Cincinnati 2, Ohio

NAME _____

ADDRESS _____

CITY _____ ZONE _____ STATE _____

BURN WATER in your CAR



with the AMAZING OCTA-GANE "50" BURN WATER, ALCOHOL, OR BOTH IN YOUR CAR!

The Octa-Gane "50" is the only all bronze, "fog type," exhaust operated pressure injector on the market today. It is adjustable to burn up to one gal. of water or alcohol to every 10 gal. of gas. U. S. Agricultural Dept. scientists say, "THE GASOLINE MILEAGE OF NEW HIGH COMPRESSION AUTO ENGINES CAN BE INCREASED UP TO 30% WITH ALCOHOL-WATER-GASOLINE FUELS."

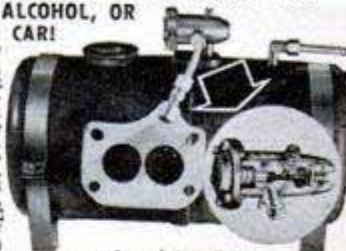

Only \$24.95

postpaid (Send \$2, balance C.O.D.) List car make, year, # cyl.

NEWHOUSE AUTOMOTIVE INDUSTRIES, Dept. OG-6
5807 E. Beverly Blvd. Los Angeles 22, Calif.

WRITE FOR: FREE ILLUSTRATED LITERATURE

DIVING GEAR

Diving suits, swim fins, dive masks, spear guns, breathing tubes. "AQUA-LUNG" as shown February Popular Mechanics page 125. Everything for the diver. Sold on money-back guarantee. Write for free information.



U. S. DIVERS CO., Dept. PM-6
1045 Buxton, W. Los Angeles 24, Calif.

MAKE YOUR OWN!
WITH



GRIFFIN LEATHERCRAFT KITS
Best assortment of tools, materials in U. S. A.! Send 25¢ for 116-page catalog. (money refunded first order)

GRIFFIN CRAFT SUPPLIES
SINCE 1924
5626-A Telegraph Ave., Oakland 9, Calif

Secrets of VENTRILOQUISM
Now Revealed!



Easy to learn in 60 to 90 days with our Home Study Course. RESULTS GUARANTEED. Make Money! Be Popular! Have Fun! Big Opportunity! Radio, Television, Stage Appearances! For FREE information regarding price and terms, WRITE. You must state your age. Dummy Catalog 25c. FRED MAHER SCHOOL OF VENTRILOQUISM Box 36, Studio F, Kensington Station Detroit 24, Michigan

Mustang

LIGHTWEIGHT

\$362.20

(Fed. tax paid, at factory)

9.5 hp. 4-cycle. 3-speed. Foot-shift. Over 70 miles per gal. Over 60 m.p.h. Write for free circular.

MUSTANG, Dept. GP-91

635 W. Colorado, Glendale 4, Calif.



AERONAUTICAL ENGINEERING

Design Aircraft & Components - Study with Jets & Rockets - Great Future - Advanced Aeronautical Subjects - World-Wide Enrollment - Fully Accredited - Established 1929 - Approved for Vets - CAL-AERO grads in heavy demand.

WRITE TODAY for Special Information.

PM-6

NAME _____ AGE _____

ADDRESS _____

CITY _____ ZONE _____ STATE _____

CAL-AERO TECHNICAL INSTITUTE
GRAND CENTRAL AIR TERMINAL • GLENDALE 1, CALIFORNIA

POPULAR MECHANICS

THORESEN NATIONALWIDE SALE

BUY DIRECT AND SAVE



Thoresen's De-Luxe
17 JEWEL PRECISION **14.98**
tax paid

Masterpiece of superb styling and workmanship! Streamlined 14 Karat Rolled Gold Plate case, stainless steel back. Gilt numerals, curved dome crystal. Genuine Lever 17 JEWEL Precision movement of amazing accuracy! Recent list price \$59.50. REDUCED for quick sales! Tax paid price—14.98—no extras!



WATER & SHOCK
Resist Case—G. I. Style! **10.95**
tax paid!

Military style! Drop it! Bang it! UNLIMITED GUARANTEE EXCLUSIVE OF PARTS! Exclusive Swiss INSULATOR invention. 7 jewels. Luminous hands & numerals. Unbreakable crystal. Sweep-second. Heavy chromed. Thin, smart! Marvelous accuracy. Long satisfying service. Tax paid, only 10.95
17 JEWEL Model (Fine Lever Movement) 14.95
Tax paid 14.95

Fulcra-Matic Stop
CHRONOGRAPH **6.90**
tax paid!

Genuine Fulcra-Matic Stop Chronograph & Wrist Watch combined, gives accurate, long satisfying service. Times Races, autos, planes, Sports, etc. 10 WONDER FEATURES: Tachometer, Telemeter & Stop Watch. Luminous Dial. Unbreakable Crystal. Sweep-second hand. Stainless steel expansion band. Best of all—Fulcra-Matic finger tip control! Instructions given. Tax paid, only 6.90.



Thoresen's 17 Jewel
FULL AUTOMATIC **27.45**
tax paid

De-luxe model—fully automatic! Set it, then forget it! It winds itself as you wear it. Patented Incabloc. Anti-Magnetic. Sweep second. Luminous dial. **WATER & SHOCK** resistant. All stainless steel back case. 17 jewels. Near-miracle accuracy. Thin! Handsome! Formerly \$75.00. Thoresen's direct-to-you price, only—27.45—no extras for tax. Rush! Supply limited!



2.97

Initial Men's Ring
Extra special! Genuine sterling silver with gold plate sides. Your own initial in raised gold effect flanked by 2 pseudo ZIRCONS of sparkling brilliance. Tax paid—2.97



1.98

"WEIRD" SKULL
Ruby color eyes flash "weirdly" in semi-darkness! Perfect miniature of skull & bones. Rich 14 Karat Gold Plated. It's the attention-getting ring. Our tax paid price — 1.98



3.55

"Big 5" Men's Ring
Wins distinction! Extra heavy simulation of a Solid Gold 5 Diamond Ring. Made to endure. Rich \$500.00 appearance. Imported stones of amazing brilliancy! Tax paid—3.55

FREE
10 DAY TRIAL

Price promptly refunded if not thrilled within 10 days after receiving. ALL prices tax paid—NO EXTRAS!

UNLIMITED GUARANTEE

Exclusive of Parts! Never a penny's charge for skilled labor, "handling", etc. for the lifetime of this business!

3 SYNCHRO DIAL
Precision-Made SWISS
CHRONOGRAPH

Outstanding value! Sleek, handsome, 3 Dial CHRONOGRAPH. Amazing accuracy! Ideal for hobbyists, mechanics, scientists, doctors, sportsmen, students, aviators, etc. 20 SUPER FEATURES: 3 Synchro Dials! 30 min. register! 1/5th second calibration! Rugged shock-resist case, sweep-second, luminous dial. Built-in tachometer & telemeter. Measures speed & distance planes, autos, horses, photos, etc. without stopping movement. Formerly \$9.95. Now at slashed price of 8.65, tax paid. No extras.



8.65
tax paid

SEND NO MONEY — Pay price Shown, plus postage (no extras for tax) on delivery
THORESEN Direct Sales Dept. 6-F 131 West 33rd St., NEW YORK 1, N. Y.

POWERFUL

Interchangeable rifled barrels for 5 types of ammunition. .22 or .177 Cal. Hy-Score Pellets & Doris, & BB's. Small game HUNTING, indoor and outdoor TARGET shooting. The perfect gift. At your dealer now or write Dept. P-5



NO PUMPING
HY-SCORE
5 in 1
AIR PISTOL

Complete with 2 barrels & asst. ammo.

HY-SCORE ARMS CORP., 25 Lafayette St. Brooklyn 1, N. Y.

WARN HUB CAP MAKES
2 JEEPS OUT OF 1



Ends front wheel drag on 4-wheel drive Willys Station Wagons, Pick-ups and Jeeps
Saves gas up to 5 miles per gallon, tire wear, front axles, increases speed and power. Stops shimmy—front wheels coast out of gear! 4-wheel drive handles, performs, climbs like 2-wheel. Install or remove WARN HUB CAPS in 10 minutes. Polished aluminum, guaranteed. Rush check, M.O., or C.O.D. Write for circular.

\$20.00
Prepaid U.S., Canada
WARN MFG. CO. - 1625 Third Ave., Seattle 1, Wash.

MAKE MONEY In Your Spare Time
\$2.00 PER HOUR Possible RIGHT NOW
with **"ROBO" Knife Grinder** IN ANY COMMUNITY

HERE is an unusual opportunity to start a business and MAKE MONEY (clear profit) every day of the week in your own locality with "ROBO" Knife Grinder. Every Home and Business Places have knives that are dull. In a few minutes any Man, Woman, Boy or Girl can easily sharpen all their knives with the skill of an expert and grind a "Factory" Finish, Quick and Easy. You make a charge of from 15c to 25c each and build up a steady list of satisfied customers. It's fun sharpening knives with the "ROBO". Simply invest in one "ROBO" costing you only \$2.50—we even pay the postage. There are lots of things you can buy with the profits you make with a "ROBO". Try it. GET STARTED MAIL YOUR ORDER NOW



GRINDS A "FACTORY" FINISH QUICK AND EASY

Holds the Blade at the Proper Angle Ready Instantly

only **\$2.50** Postpaid

No C.O.D.'s please

THE ALDEN SPEARE'S SONS CO., 137—6th St., CAMBRIDGE 42, MASS.

"I'M EARNING \$300 A MONTH!"

... says Leonidas Burgoyne of Chicago, Illinois, "Expert individual instruction in the fully equipped shops of Greer Shop Training gave me the right start to get my good paying job."

GREER SHOP TRAINING . . . established 1902, is one of America's largest trade schools. Over 48,000 successful graduates. You learn by tearing down, repairing and rebuilding. Day and evening classes. Mail this coupon today!

LEARN A TRADE NOW!
GREER SHOP TRAINING, Desk 211, 2230 S. Michigan Avenue, Chicago, Ill.

Gentlemen: Please send me information about trade I have checked below. (Specify if you are VET or NON-VET .

IN OUR CHICAGO SHOPS BODY, FENDER REPAIR
 AUTO MECHANICS WELDING—ARC, GAS
 DIESEL MACHINIST
 REFRIGERATION PIANO TUNING

Above courses approved for Vets and Civilians.

ALSO THE FOLLOWING HOME STUDY COURSES
 REFRIGERATION DIESEL PLASTICS

Name _____ Age _____
Address _____
City _____ State _____

GREER SHOP TRAINING

You're always
welcome
when you've got **P.A.**

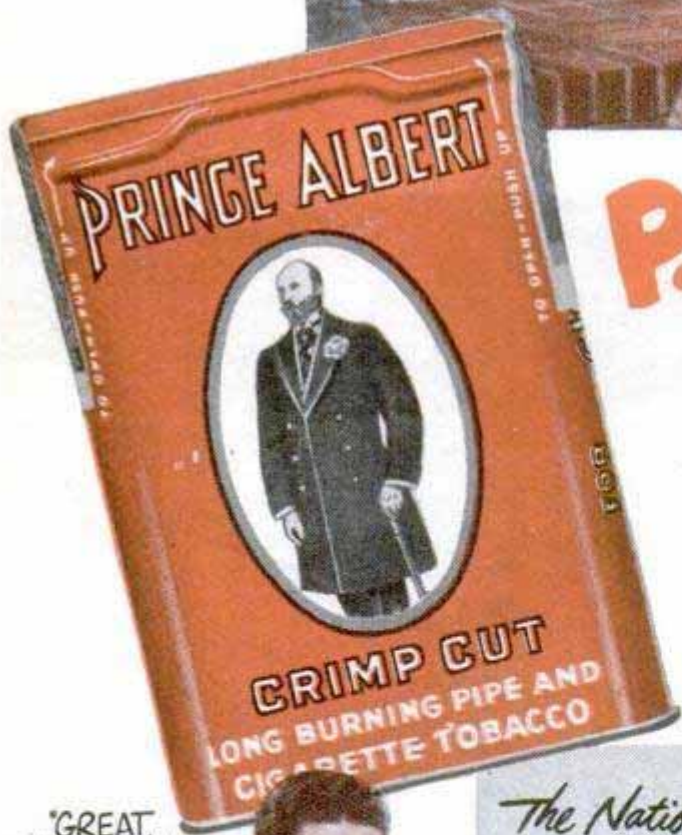

P.A. means
Pipe **A**ppel
and **P**rince **A**lbert

You get a big welcome when you smoke a pipe. And your tongue will welcome the cool mildness of crimp cut Prince Albert—America's largest-selling smoking tobacco. Try flavorful P.A.—choice tobacco, specially treated to insure against tongue bite.

"GREAT,
'MAKIN'S,
TOO, FOR
ROLLING!"



*The National
Joy Smoke*

R. J. Reynolds Tobacco Co.
Winston-Salem, N. C.

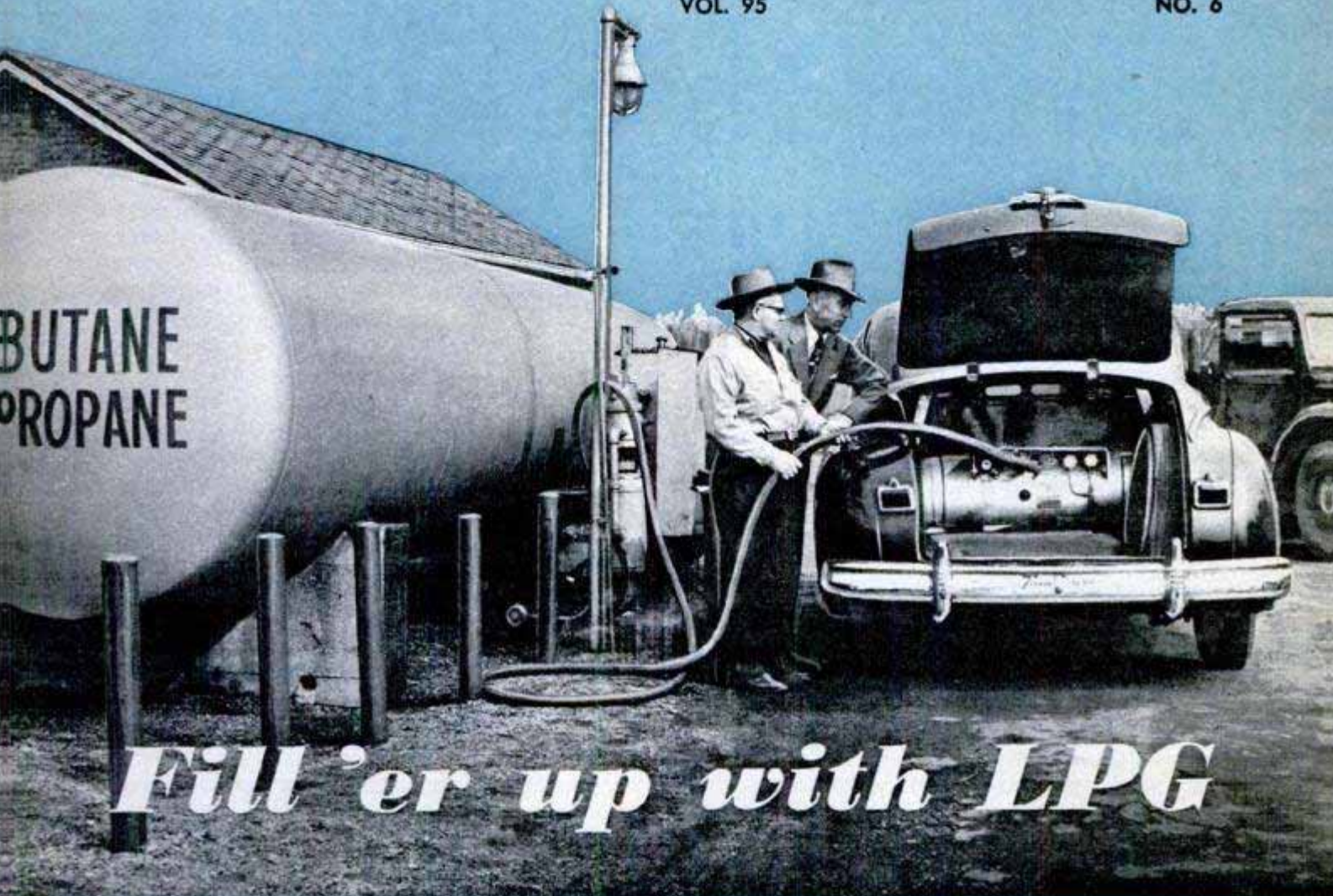

Fill 'er up with LPG

The author, right, gets a tankful of LPG at a Chicago service station. Note the special tank in the trunk

By Jud Purvis

IT IS NO TRICK at all to run an automobile without gasoline **IF**—but thereby hangs quite a tale. It can be done and is being done every day by thousands of people in the United States. My car is one of the many now running on LPG.

LPG is the common term for liquefied petroleum gas which may be butane, propane or a mixture of both in varying proportions. Butane and propane are manufactured in the process of making gasoline and can also be obtained directly from natural gas. For this reason, there is an abundance of both and the price is low. These gases sell at the refinery in liquid form for as little as four cents per gallon and can be bought retail at considerably less cost per gallon than gasoline.

In current refinery practice, about half of each gallon of crude oil is turned into gasoline. During the process about two percent of the crude is converted into butane and another two percent into propane. A cubic foot of natural gas is over half methane, about six percent butane and about 12 percent is propane. Only about 20 percent of the amount of LPG available is sold at present, which accounts for its low cost as an automotive fuel.

LPG is now being used as fuel in airplanes, automobiles, trucks, tractors, buses, taxis and stationary engines. Last year 100,000 farm tractors were equipped with conversion units to burn LPG. There are nearly 600 LPG-burning busses in use in 18 U. S. cities today compared to very few



Operating on LPG, a Minneapolis-Moline tractor pulls a disk plow over a rice seed bed near Lake Charles, La.

only 18 months ago. One enthusiast predicts that in time 15 percent of the motor fuel burned in this country will be LPG. It also is used for heating, cooking and illumination, in blowtorches and cigarette lighters as well as many other applications where pressure containers can be utilized. It must be stored and handled under pressure to keep it in liquid form.

Butane boils at 31 degrees Fahrenheit and propane boils at minus 44 degrees Fahrenheit. As it is impractical to store and handle it at such a low temperature, it is kept in liquid form by storing it under pressure until it is used.

If LPG is to be used in an automobile or other internal-combustion engine, it must be reconverted into a vapor and mixed with air before it will burn in the engine. Space limitations in any automotive vehicle require that it be stored as a liquid and therefore under pressure. This requires a strong tank. Ordinarily, a tank tested to withstand 200 pounds per square inch is used.

As the fluid is under pressure, a sealed system must be used with positive closing valves in the circuit between the tank and

the engine. One of these valves is often of the electric-solenoid type and is connected with the ignition switch so that the valve is open only when the ignition is turned on.

When the ignition is turned on, the solenoid valve admits the liquefied gas at high pressure into a converter where it is allowed to expand into a dry gas. The gas is then piped to the mixing valve, or "carburetor," at low pressure from whence it is admitted to the engine and controlled by a throttle valve. A filter is placed in the fuel line near the converter to filter out any possible contaminants.

The converter has a water jacket around it which is connected to the engine water-circulation system. This heating of the converter prevents any frosting which might occur inside the converter due to the lowering of temperature as the pressure is reduced.

Excess heat is not wanted on the intake manifold either, so engines designed to run on LPG have "cold" manifolds. That is, they are not connected to the exhaust manifold as is the case with gasoline engines. When a gasoline engine is converted to

Right, W. D. Mitchell, engineer for Phillips Petroleum, tests the operation of LPG in a car designed for this purpose. He is trying to detect detonation with the help of a knock meter

Opposite page, left, hidden in the trunk of the Phillips test car are these two heavy tanks, each holding 18 gallons of LPG

Opposite page, right, beneath the hood of the test car there are several "extras" needed to modify the engine for burning LPG. Pressure regulator and vaporizer are in upper left and filter and valve are in center



LPG, it is customary to remove the manifold-heating equipment.

In addition to the fuel system and manifold changes made in conversion to LPG, it is desirable to increase the compression ratio of the engine in order to obtain full advantage of the antidetonating virtues of the gas. The average compression ratio has been increased in the past few years from about 5 to 1 until now it is nearer 7 to 1.

This has been made possible by improvements in design of the engine and improved fuels. The higher the compression ratio the more power is obtained from an engine of given size. The limiting factor is detonation or spark knock and, of course, ethyl fluid helps in this direction by slowing down the rate at which the fuel burns or "explodes" in the cylinder.

LPG burns exceedingly slowly and thus has a knock rating far above that of the best ethyl gasoline obtainable. For this reason, it is possible to operate an engine at a 10-to-1 compression ratio or even higher if desired. This means a tremendous increase in power. In addition to the increase in power, there are other advantages in the use of LPG—and there are some disadvantages.

Among the advantages is decreased engine maintenance. LPG is a clean-burning gas and leaves no deposit of carbon in the engine. As it is a dry gas it does not dilute the oil and form sludge in the crankcase. As it does not wash the oil from the piston rings and cylinder walls, wear is greatly reduced in the engine. With no carbon, no dilution and no sludge, it is not necessary to drain and replace the crankcase oil nearly so often.

All of this results in less frequent replacement of piston rings, bearings and other engine parts as well as less frequent valve

grinding. Other advantages are an inoffensive exhaust and decreased fire hazard.

Among the disadvantages, the principal one is lack of wide distribution facilities in many cases. On the West Coast it is often readily obtainable. Another disadvantage in the case of converting to LPG is the cost of the new tank and other equipment such as converter and valves. It costs \$200 to \$400 for a conversion unit on a passenger car; on tractors built to burn gasoline the units range in cost from \$175 to \$300. Furthermore, the manufacturers of this equipment cannot keep up with the demand and it is difficult to obtain parts needed for the conversion.

The owner of a passenger car would need to run up considerable mileage to justify the cost of such a conversion. The operator of a truck or tractor, however, finds it pays off rather quickly on a dollars-and-cents basis. Many operators of fleets of trucks and most particularly fleets of busses are investing heavily in LPG-powered engines and conversion equipment. A bus company in Phoenix reports that since the company's vehicles have been converted to LPG they go 15,000 miles without an oil change. In Los Angeles, a milk company runs its trucks 8,000 to 16,000 miles without changing oil and estimates a saving of 25 percent on operating costs.

One disadvantage in passenger-car conversion is that the pressure tank is put in the trunk and considerable space is taken up by a 35-gallon tank. Some city authorities are concerned over the safety of LPG-burning vehicles. For example, New York City bars them from operating in tunnels. There should be no more danger from LPG than gasoline if the conversion unit is properly installed. As a matter of fact, an LPG tank will not explode if you have

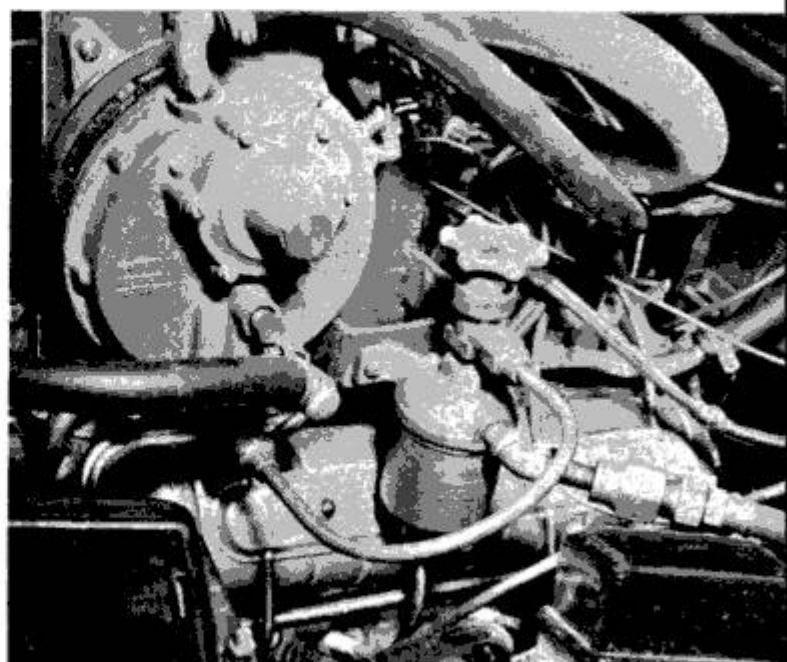
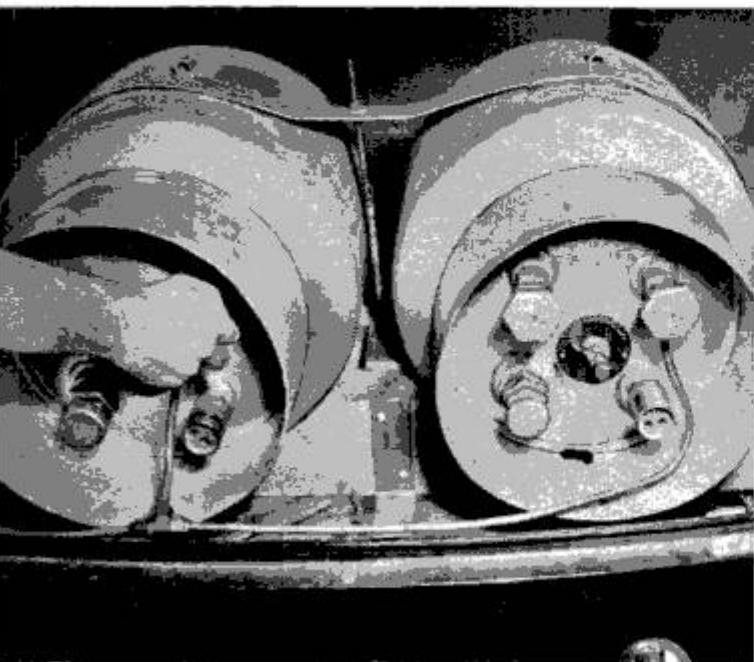



an accident and, if the tank is ruptured, the gas will burn like a blowtorch. This elimination of explosion danger is a factor for the safety experts to consider.

The type of equipment I have in my car is set up to function with the regular gasoline carburetor and, therefore, I can switch from gasoline to LPG and back again merely by flicking a switch on the instrument panel. The new tank was installed in the trunk space and the LPG carburetor on top of the gasoline carburetor.

In order to accomplish this it was necessary to use two electrically operated solenoid valves; one in the LPG line to the converter and another in the gasoline line to the carburetor. These solenoids are connected to a three-way switch on the instrument panel which is connected to the ignition switch. The valve-control switch does not operate until the ignition is turned on so therefore neither valve is open.

In one of the three switch positions, the valve opens for gasoline and closes for

(Continued to page 238)

Even airplanes can use LPG. This Aeronca is being filled with the liquefied petroleum gas at Chicago. Below, the complete conversion kit. In it are the tank, converter, valves, carburetor and other parts

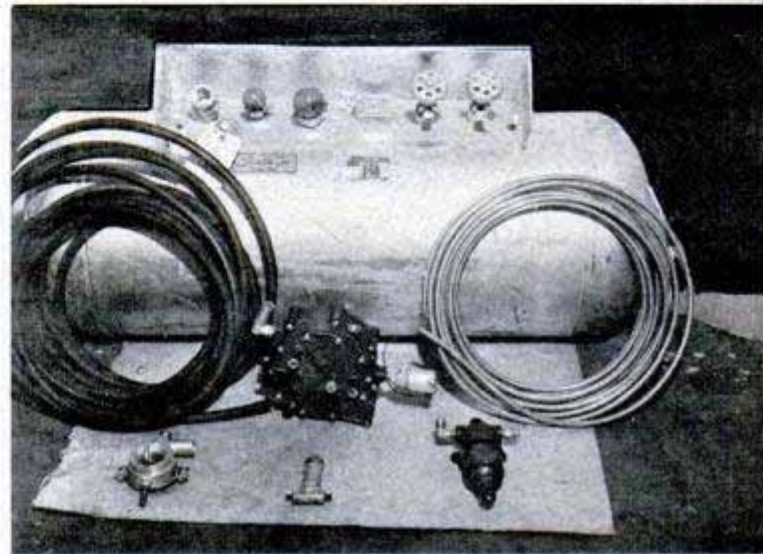

Below, diagram of a combination system that burns either LPG or gasoline. Solenoid valves provide the positive shutoff required for high-pressure liquid

Diagram courtesy American Liquid Gas Co.

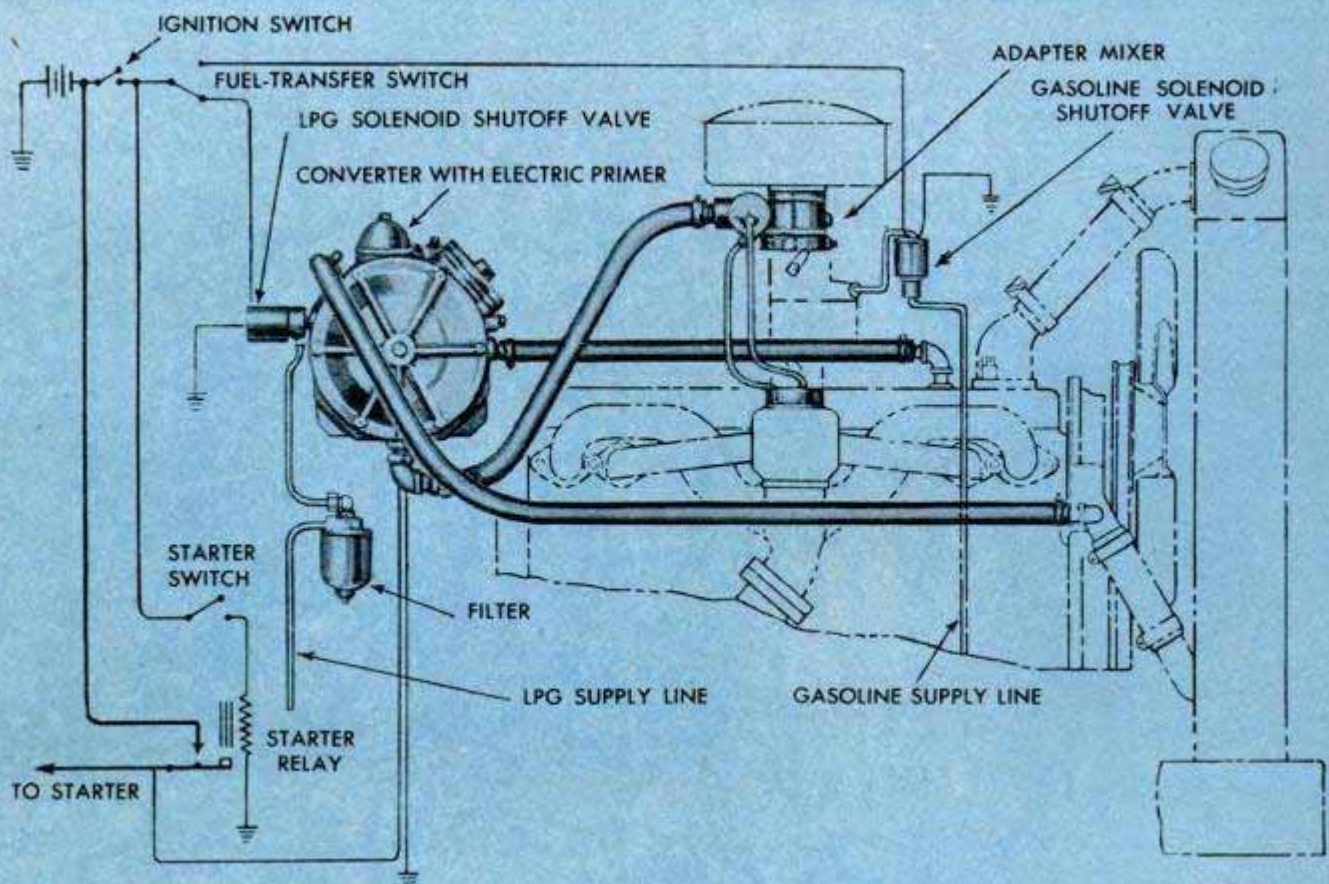



Hollow Log for Birling

Birling, or log rolling, traditional sport of the American lumberjack, may become a national recreational activity now that a hollow practice log has been developed. It was designed by George Glazier of Washburn, Wis., 71-year-old former birling champion. The log is a hollow pine cylinder with four metal tanks inside to add buoyancy. Any desired amount of water can be added to the tanks to make the log float deeper and slow its action. Tennis shoes are worn on the smooth surface instead of the conventional spikes. For beginners, a heavy canvas matting can be fastened around the log to increase traction on the surface. Glazier built the practice log to stimulate interest in the sport of the lumberjack.

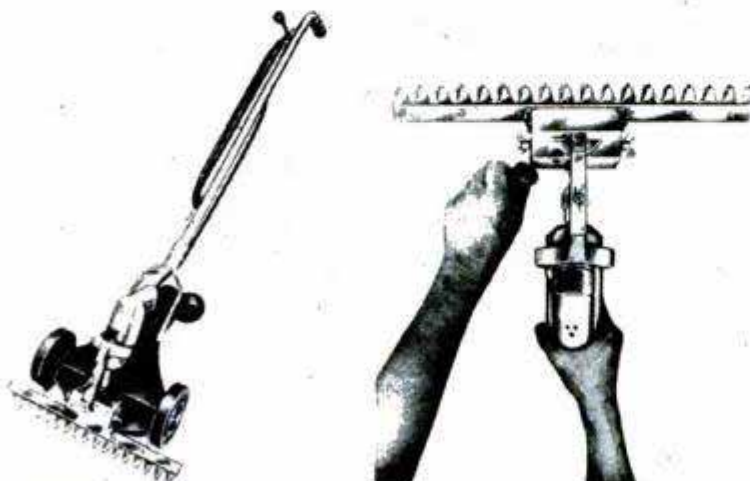

Triple-Duty Garden Tool

Attached to any standard $\frac{1}{4}$ -inch electric drill, a new garden utility tool trims and edges lawns and cuts hedge. It cuts easily under trees, flower beds, shrubbery and fences, and along walks and gates. Operating at low speed, it can be used to trim hedges in any style or shape desired.

☐ In a normal year of driving the average automobile's spark plug fires 72,000,000 times.



Atomproof Camera

On-the-spot photographs are produced in two minutes by an Army Signal Corps camera with plates that are not affected by atomic radiation. These plates need no chemicals for processing. The plates are selenium-coated and sensitized by an electrical charge. When the shutter is open and light hits the charged plate, the electricity leaks off the sensitized material in proportion to the amount of light received and is

grounded on the plate. The electrical image remaining becomes apparent when finely ground charcoal or anthracite dust is blown across the plate. Wherever the electrical charge remains, the dust sticks, and the more electricity left on the plate, the more powder adheres. The powdered image is then transferred to ordinary paper or other material coated with an adhesive layer, such as rubber cement. Transparent plastic film is pressed against the picture to fix the print. Plates can be wiped off and reused.

Soluble Coffee Crystals Formed in High Vacuum

Evaporated in a high vacuum, a soluble coffee is sold in crystal form that dissolves instantly in hot or cold water. In the manufacturing process, the coffee beans are roasted and ground after which the coffee is extracted as a liquid concentrate. This

concentrate is sprayed on a stainless-steel belt that carries it into a high-vacuum chamber where the liquid is evaporated. The crystals which remain are scraped off and packaged by Holiday Brands, Inc., of Boston, Mass.



Balzer Mfg. Co., Mountain Lake, Minn.

Stubble Cleaner

Straw in the path of a plow is gathered by the teeth of a new stubble cleaner and rolled into the furrow for use as humus. The cleaner, designed by Daniel F. Winter of Ceylon, Minn., has been field tested with small grain, flax and soybean straws, cornstalks and other loose-lying vegetation.

U. S. reserves of coal, oil, gas, oil shale and tar sand, all fuel sources, will last 1000 years, says C. F. Kettinger, General Motors director.

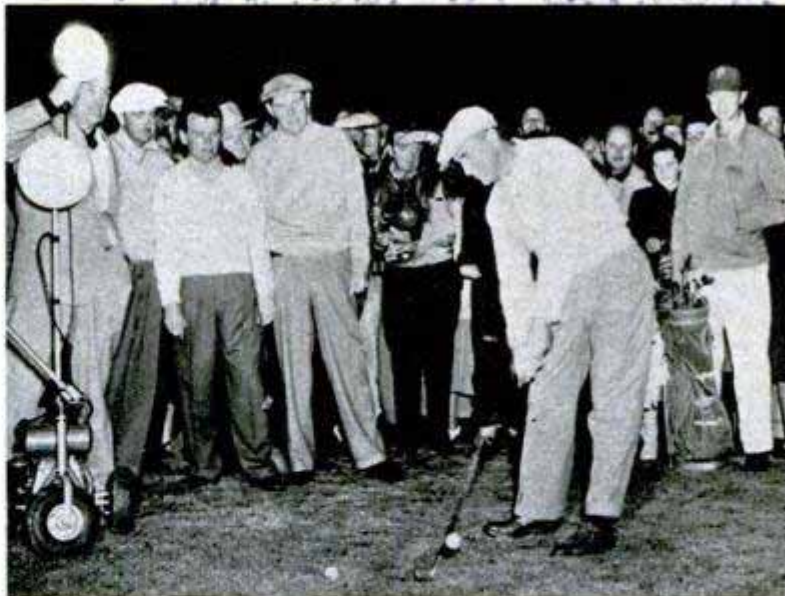

Mobile Spotlights For Night Golf

Use of a mobile "golf spotlight" may enable another daytime sport to follow the night-owl steps of baseball and football. In one test in a California tournament, the winning player shot a one-under-par score. The three elements of the lighting unit are a spotlight that follows the drive, another spotlight that illuminates the tee and driving area and a floodlight that shines over the greens area. Each light generates 600,000 beam-candlepower. A gallon of gasoline keeps the two-horsepower engine driving the electric generator in operation for about four hours of playing time.

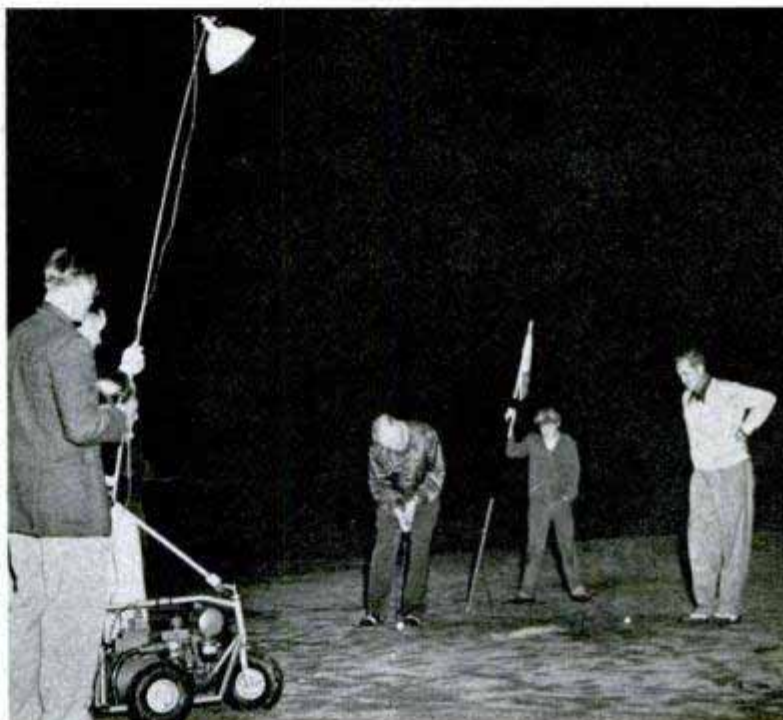

Rubber Brush Cleans Typewriter Type Without Liquid



Requiring no liquids, a small cylindrical brush with raised dots scrubs the ink off typewriter type in a few seconds. The brush consists of three parts—a rubber handle, a sponge-rubber pad and a snap-on rubber cover. Rubbing the brush across the keys cleans off the ink. The cover can be replaced when it wears out.

Sources of supply for available products described in this issue are listed in the index starting on page 12. Sources of further information on other articles in the magazine are listed in the WHERE-TO-FIND-IT LIST, which is available without charge from Bureau of Information, Popular Mechanics, 200 E. Ontario St., Chicago 11



Out of sight below decks of this 150-foot trawler, *Oceanlife*, is a factory for cleaning and freezing fillets

The Frozen-Fish Factory Goes to Sea

By Dick Frederick

OFF THE TEEMING fishing grounds of the Grand Banks, east of Newfoundland, a new kind of fishing ship is riding the North Atlantic swell. Except for her streamlined wheelhouse, where the captain stands amid an array of modern instruments, you can't tell her from a dozen other big trawlers.

But below decks, no other New England trawler ever looked like the *Oceanlife*. The ship is a complete seagoing fish factory. As fast as fish are caught, they are chuted into a compact processing room where experts immediately scale them, fillet them, weigh them out, package them, pop them into a freezer and pack them into cartons.

The cartons are stowed in a refrigerated hold, where they stay frozen solid until the ship reaches port and a refrigerated truck picks them up for delivery to your neighborhood store.

For more than two centuries, New England fishermen, plying out of Gloucester, Boston, Portland and New Bedford, have stored their fish whole in "pens" below decks, using chopped ice to keep them fresh

until they came back to port and the fish could be filleted and frozen in shore plants. There was little or no spoilage of the catch. Vast schools of haddock, cod, redfish and flounder abounded on the banks only a few hours out.

But modern trawling and dragging methods have devastated the area through many years of over-fishing. Nets have gone deeper, not only scooping up most of the fish, but scraping the bottom and destroying the feeding grounds on which the schools thrived. Lately, trawlers have had to stay out for days, chancing spoilage, in order to catch a payload on the depleted banks, or risk going farther north to the flourishing banks off Canada. With the time limitation necessary to prevent spoilage, that meant a three or four-day trip each way, with only a few days left for fishing. This is fine, any fisherman will tell you, if the fish happen to be where you drop your net. But often they're not and many a trawler has returned with pens half empty—or full of half-spoiled fish—a costly operation either way.



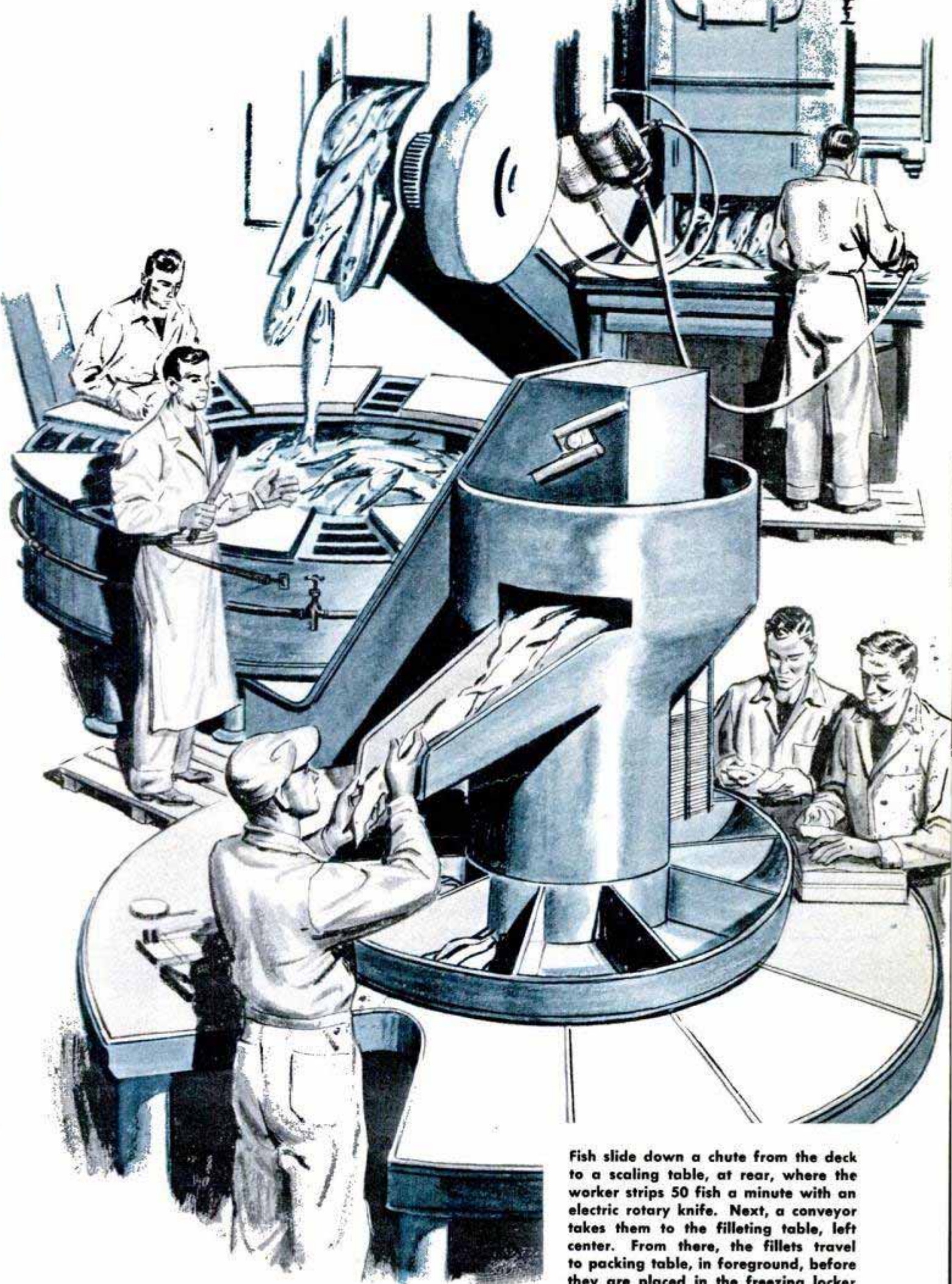

Fish slide down a chute from the deck to a scaling table, at rear, where the worker strips 50 fish a minute with an electric rotary knife. Next, a conveyor takes them to the filleting table, left center. From there, the fillets travel to packing table, in foreground, before they are placed in the freezing locker

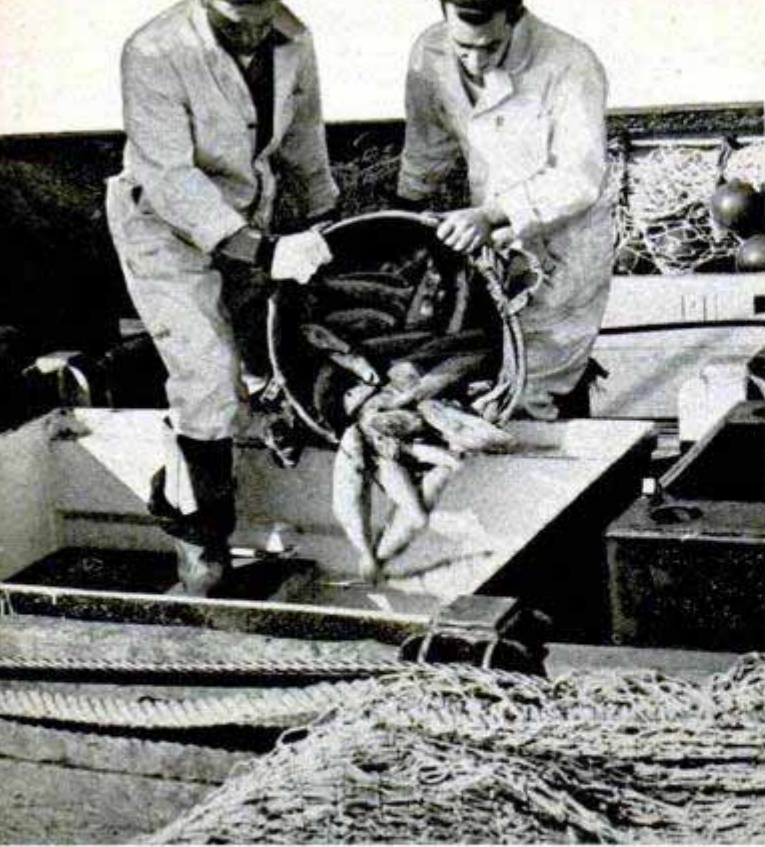

These fishermen are dumping a basketful of fish into the chute that takes them down to the scaling table

This situation set a Boston marine manufacturer named Isadore Bromfield to thinking. "I dreamed of a ship," he says, "that could process the fish in some way to preserve them. For such a trawler, time and distance to fishing grounds would mean nothing. There would be no spoilage. Freezing was the logical answer. If you could freeze a catch in a small freezing plant ashore, I wondered, why couldn't I adapt the same equipment to a ship?"

Bromfield and his sons went to work at the drafting board. With the help of a Boston banker, he bought a 22-year-old trawler. She was 150 feet long, 25 feet

abeam. His men stripped her from stem to stern. Into her engine room went a 690-horsepower diesel, capable of pushing the ship through the waves at a solid 11 knots. Beside the big diesel went a 20-ton refrigeration plant, working on the ammonia-absorption principle.

In this system, ammonia circulates through condensers, heat exchangers and a vast system of pipes that snake back and forth across the overhead like a maze of spaghetti. They keep the entire hold and its capacity of 150,000 pounds of frozen fish at a zero arctic chill. In a glittering modern wheelhouse, with sloping front, went the best in radio and navigation instruments. The ship was altered to carry 30 days' supply of stores, food and fuel.

In the 'tween-decks section went the heart of Bromfield's dream—a stainless-steel factory space, about 25 feet square and a masterpiece of compactness. Circular tables permit 12 men to work in a small space. Revolving trays and conveyors move the fish from station to station and wash them as they go.

"Freezer experts ashore claimed that rough sea conditions were the main reason my floating fish factory wouldn't work," says Bromfield. "Too tippy. Well, they changed their minds. Today, the men who sneered most are the loudest in their praise. We invited them on our first five-hour test run, when we processed 8000 pounds of fish. Every one of those men went home with a package of frozen fish which he'd seen filleted that same day." On three subsequent voyages, the Oceanlife was out about a month each time. And each time she returned to port with her hold sagging under the weight of 150,000 pounds of fresh-frozen fillets.

It takes a crew of 25 men to run the ship. Twelve are factory workers—six cutters,

Water is pumped through rotary knife as workman scales fish with electrically driven tool shown at right



Bromfield, 1179. Co., Inc.
246 Border St.
East Boston, Mass.

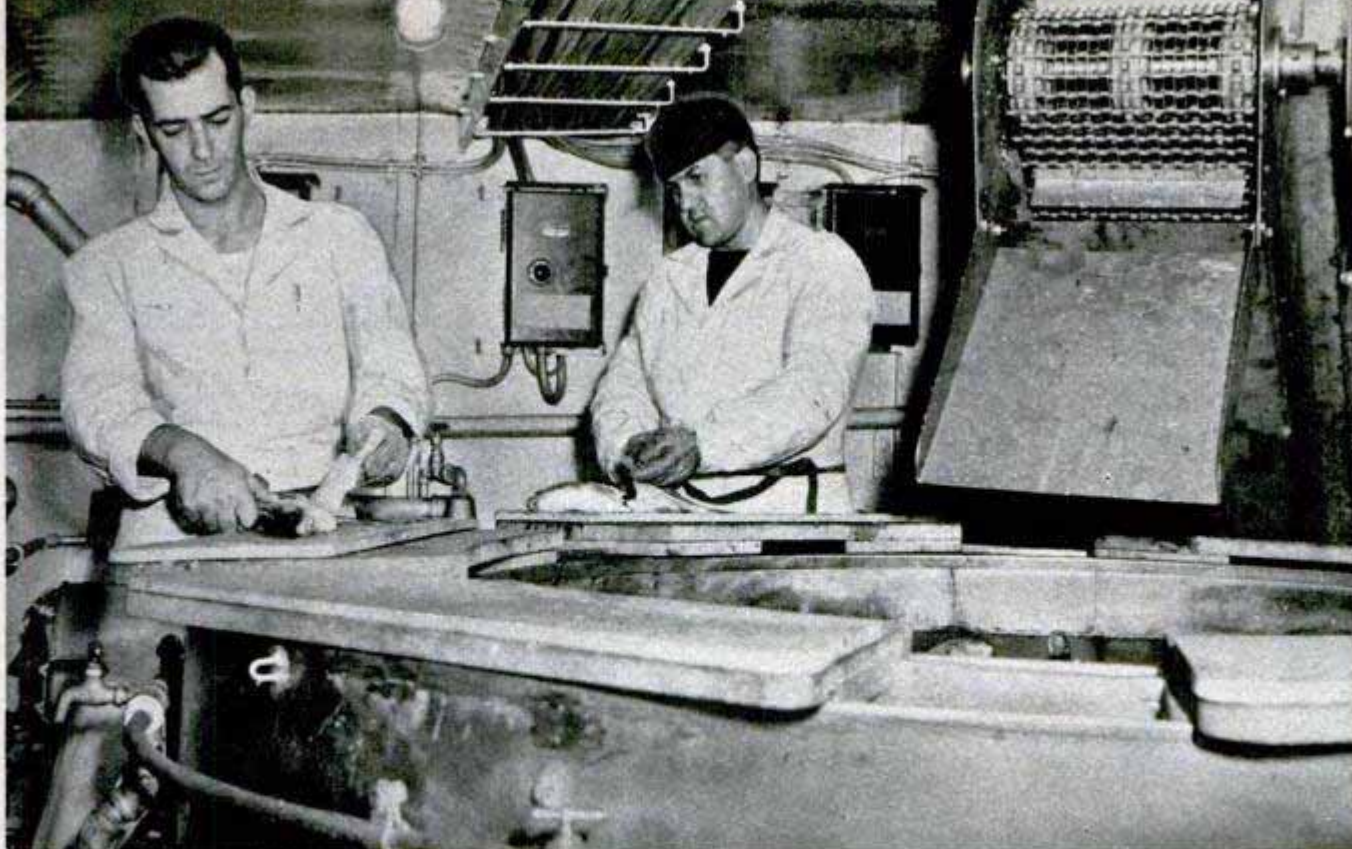

Here are the filleters who swing razor-sharp knives, filleting each fish neatly in just two quick strokes

When the sea gets rough, the filleters wear safety belts around their waists and don steel-mesh gloves

two scalers, two wrappers, one weigher and one general worker. The rest are fishermen and ship's crew.

The big nets on the Oceanlife are 180 feet long. Their mouths open in a 100-foot yawn from side to side, to scoop up the fish.

For one or two hours, the net is dragged astern. Then the winches go into reverse. Slowly the net comes back aboard. At last the cone, or "cod end," fat with a 15,000-pound harvest of silvery fish, is raised dripping from the sea into position above the "checkers," or topside sorting bins. Someone pulls the cord that holds the cod end closed at the bottom like the drawstring on a duffel bag. The bottom of the cone opens, spilling the skittering, flapping fish all over everything. Sorters swarm in to begin the job of separating the redfish from the haddock and the haddock from the sole. Bushel baskets of fish are emptied into a hopper on deck that chutes them straight down to the scaling table beneath. If the catches come in too fast for the workers, the fish are diverted into a refrigerated pen room aft of the factory. There they stay cool and fresh until the factory can handle them. The pens will hold 100,000 pounds of extra fish that can be processed as the ship heads back for port.

"All our sorting and handling are done by hand," Bromfield explains, "so the fish won't be damaged. On regular trawlers men use pitchforks and scarcely a fillet ever reaches the consumer without half a dozen gimlet holes bored through it. Besides, it ruins the fish skins, which can be sold for making pocketbooks, shoes and the like."

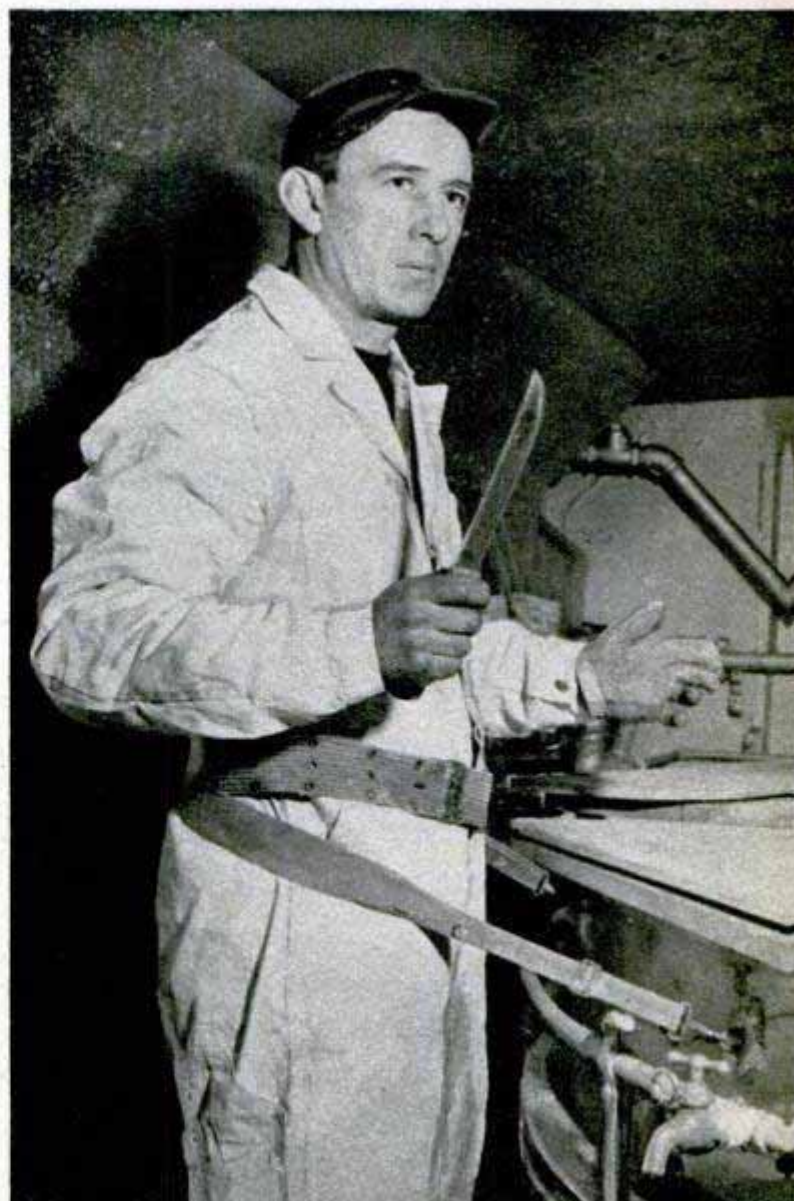

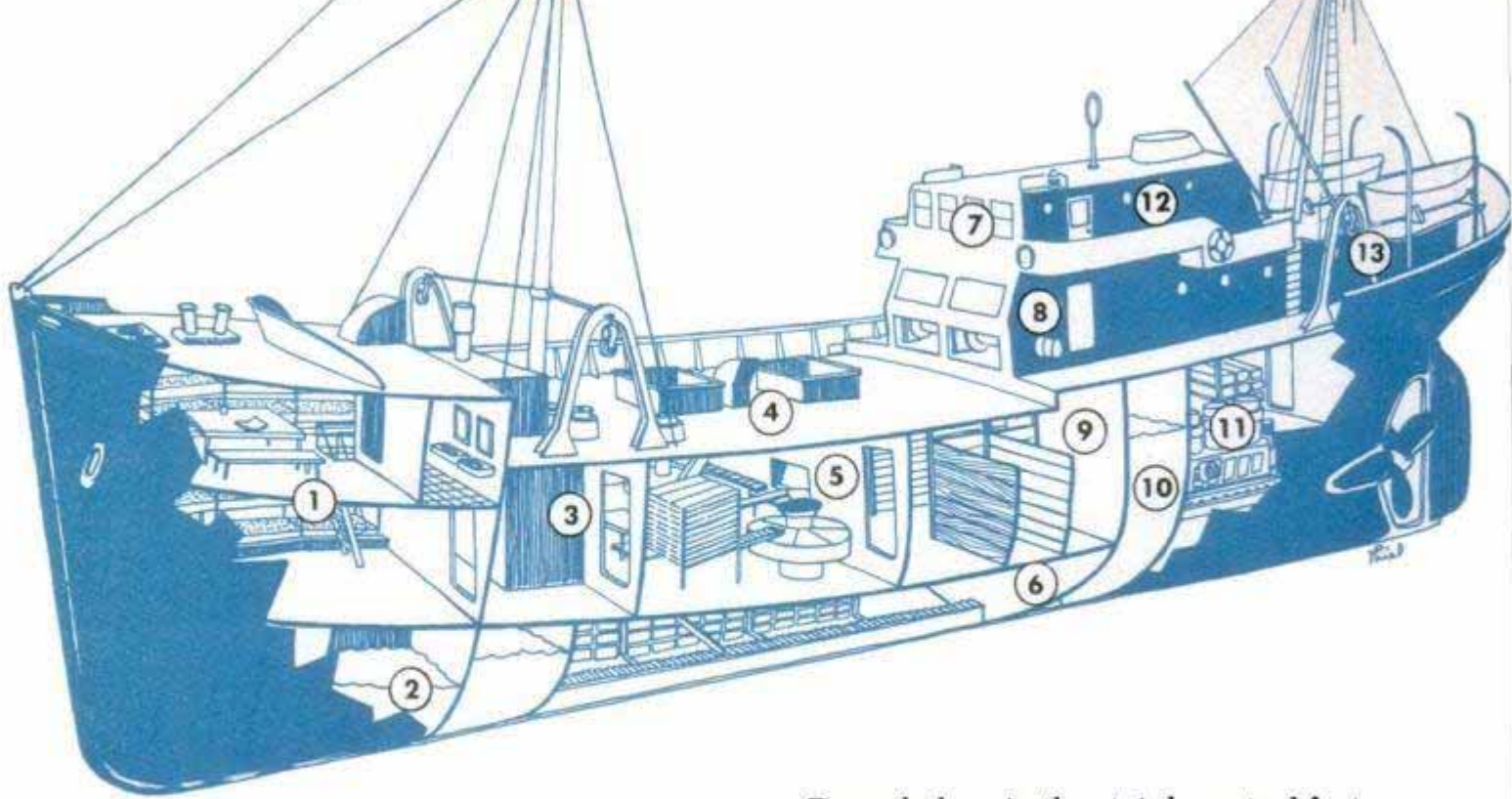

Cutaway drawing of the Oceanlife, showing important parts of vessel. 1. Crew's quarters. 2. Fresh-water tanks. 3. Quick-freeze room. 4. Fishing deck. 5. The processing room. 6. Frozen-fillet storage. 7. Wheel-house. 8. Trawl winch. 9. Fish hold. 10. Oil tanks. 11. Engine room. 12. Captain's quarters. 13. Galley

Close-up of a stainless-steel conveyor shows fillets being carried from cutters to weighers and packers

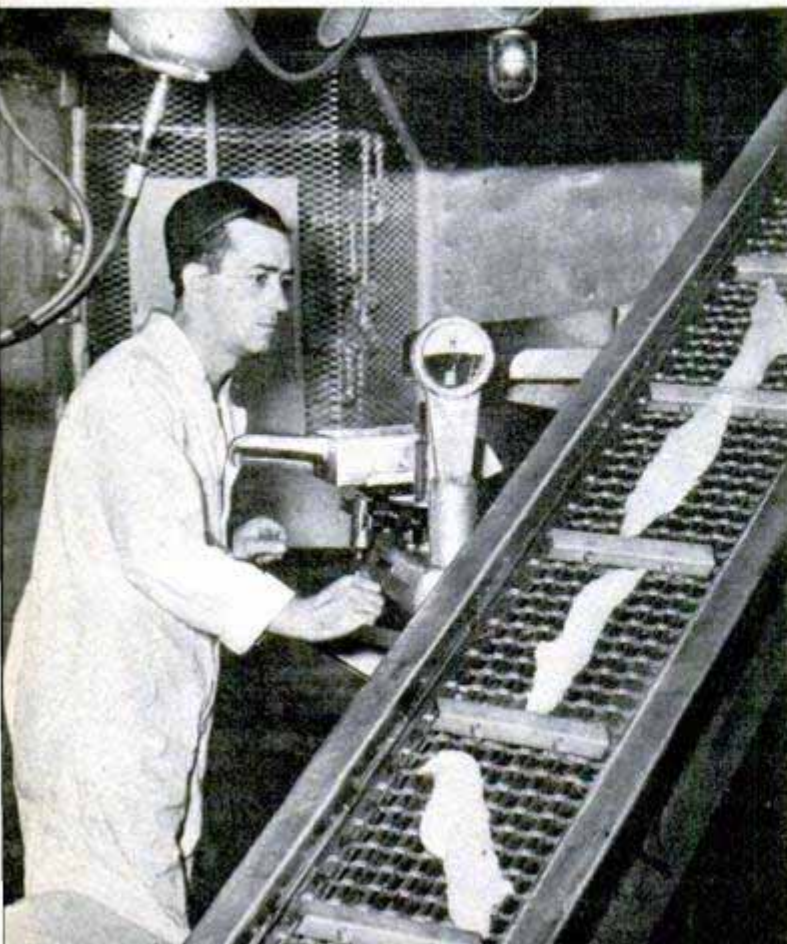

Down below, in the stainless-steel factory room, things are buzzing. At the scaling table, where the fish come chuting from the deck, two men hold electric scalers. These rotary knives, with four swoops up and down a fish, remove all scales. A good scaler can process 50 fish a minute. A stream of water lubricates the fish so the skin doesn't tear and also carries the scales away. Even so, when two scalers are going strong in the factory room, there is a continual snowstorm of wet scales that stick to everything.

Each scaled fish is plopped on a conveyor belt which carries it up, under several sprays to wash off remaining scales, and dumps it into a circular bin. Here the filleters, working with razor-sharp knives, fillet a fish in two motions—once down one side, once down the other.

It's one thing to handle a wicked filleting knife ashore, where the floor stays put, and quite another to wield it on a pitching, rolling craft at sea, where one slip might mean a severed finger. To protect his left hand, which holds the fish, the filleter wears a three-fingered stainless-steel mesh glove. No knife blade can penetrate its mesh. And when the going gets really rough, each filleter dons a safety belt that is lashed to the filleting table. By bracing his feet and leaning back against the belt like a window washer on a skyscraper, the filleter can stand as steady as the Rock of Gibraltar no matter how rough the sea.

As the filleter finishes, he drops the fillet into a deep trough circling the table. It goes to a brine tank, where it gets a thorough washing, and is then carried by conveyor belt to a weighing and packing table. What's left of the fish—head, skeleton and

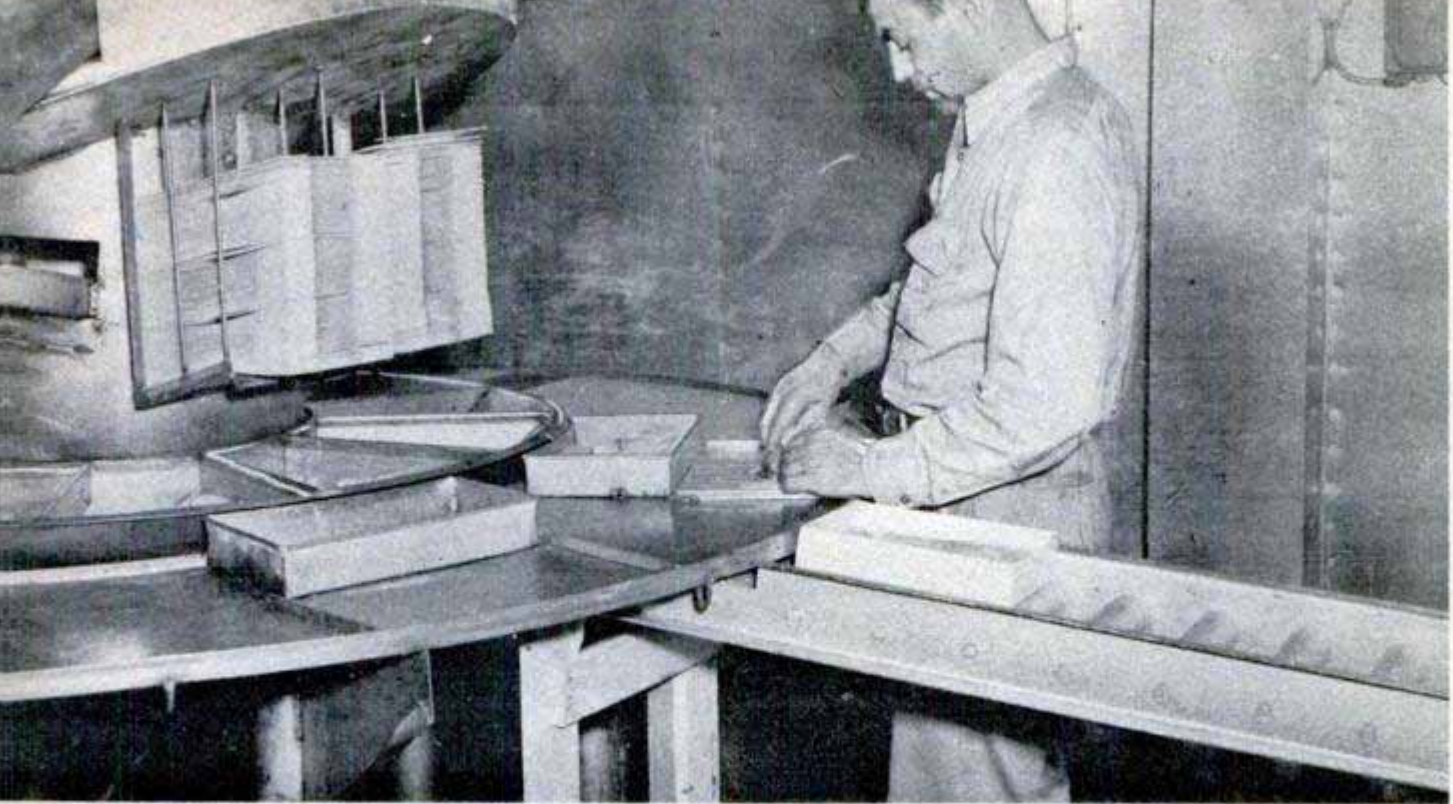

After they have been weighed into five-pound lots, the fillets are packed in these cartons prior to freezing

innards (called gurry) — is brushed into another slot and is carried up to the deck and over the side.

At the weighing table, one man takes the fresh fillets and weighs them into five-pound lots, drops them into trays that move around the table to the packers. These men inspect them for quality.

Packed in five-pound cartons, the fish shoot down a roller conveyor to the freeze

man. Here they are dropped into long trays and readied for the quick-freeze box, which chills them to about 40 degrees below zero. The freezer can handle 1500 pounds of fillet every two hours. The fish, frozen solid, are then packed in 50-pound cartons and stowed in the refrigerated hold where they stay solid in temperatures ranging around zero.

(Continued to page 236)

Loaded on a long tray, the cartons of fillets are placed in the quick-freezer where temperature is 40 below

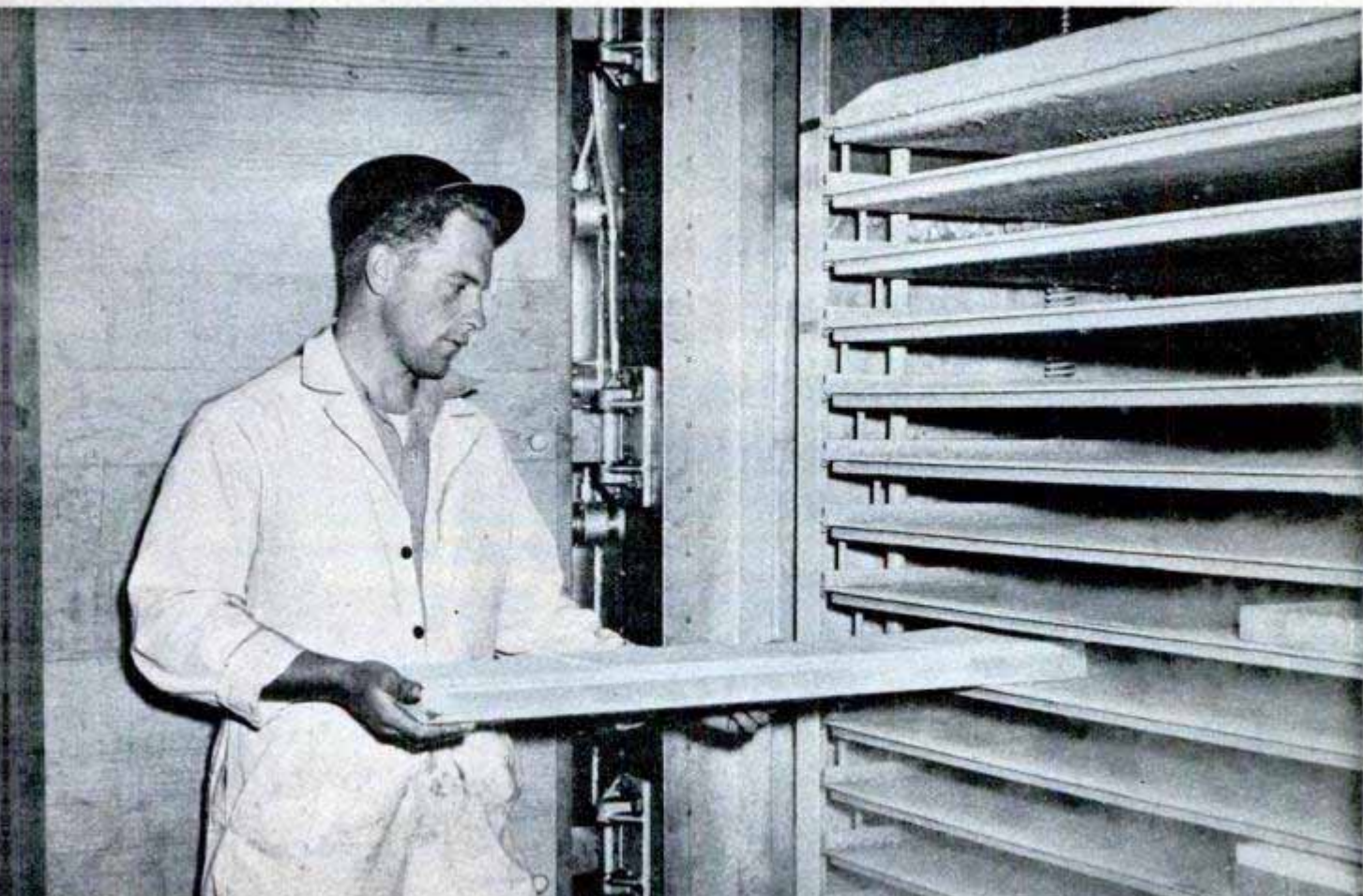



Automatic bowling alley has a processed duralumin-sheeting floor that makes it suitable for outdoor play

Automatic Setter Pulls Bowled-Over Pins Through Alley Floor

AFTER they have been bowled over, pins are removed from the alley by a new automatic pin setter and later reset for the next frame. Each pin rests on a small metal plate set flush with the floor of the bowling alley. When a pin is bowled over, the metal plate sinks down below the level of the floor and a thin wire cable attached to the pin pulls it down after the plate. Next, an auxiliary plate snaps up flush with the floor

to provide a smooth surface over which the next ball can roll unimpeded. The auxiliary plate moves out of the way when the bowler presses a button at his end of the alley, and the bowling pins move up into position again, ready for play. Meanwhile the bowling ball rolls down an incline to an elevator and is moved up to the return track, rolling back to the bowler. The setter is operated by an air compressor.

Immediately after the pins have been knocked over, cables that draw them back through holes are visible

Control button pressed by bowler at his end of the alley automatically raises all 10 pins into place again

Automatic Bowling Enterprises, Inc., 5227 Sepulveda Blvd., Van Nuys, Calif.

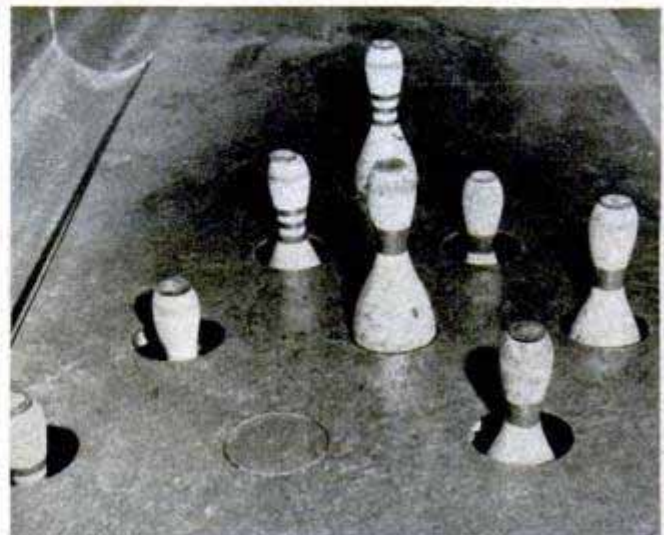
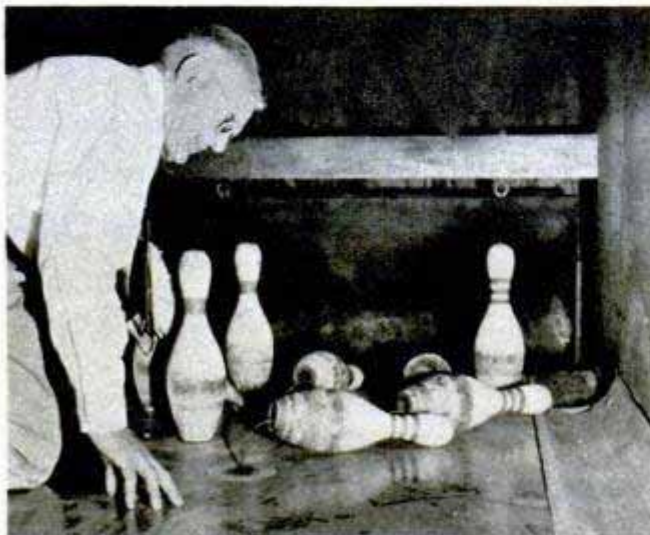

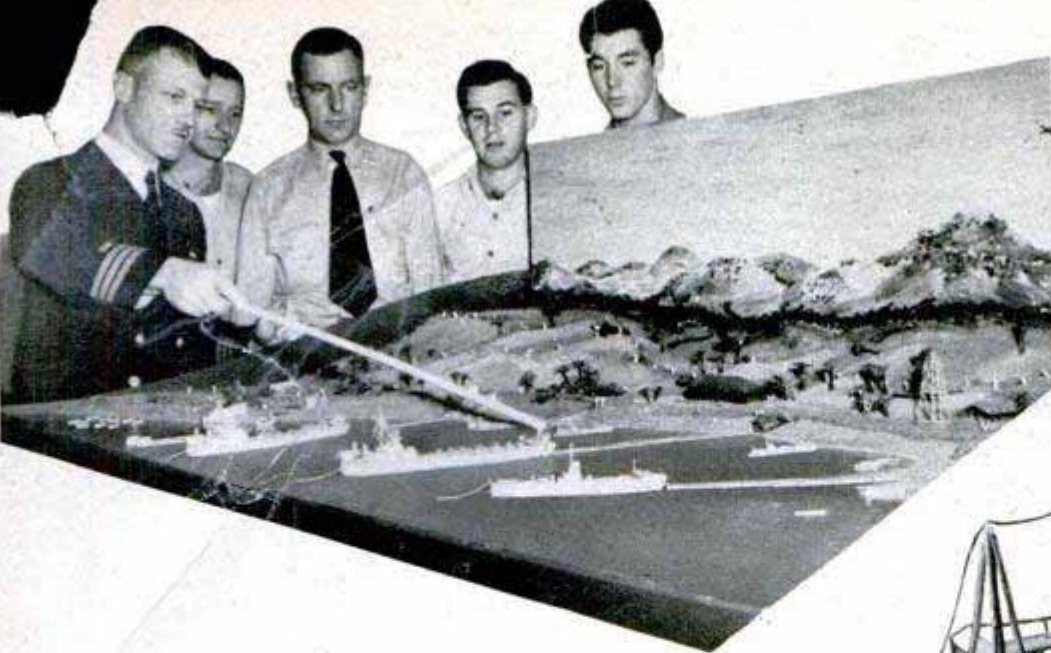

Men of Navy Amphibious Construction Battalion Two have built a complete miniature beachhead to train recruits. Here a Navy instructor explains how an LST is secured to a causeway

Tom Thumb Beachhead

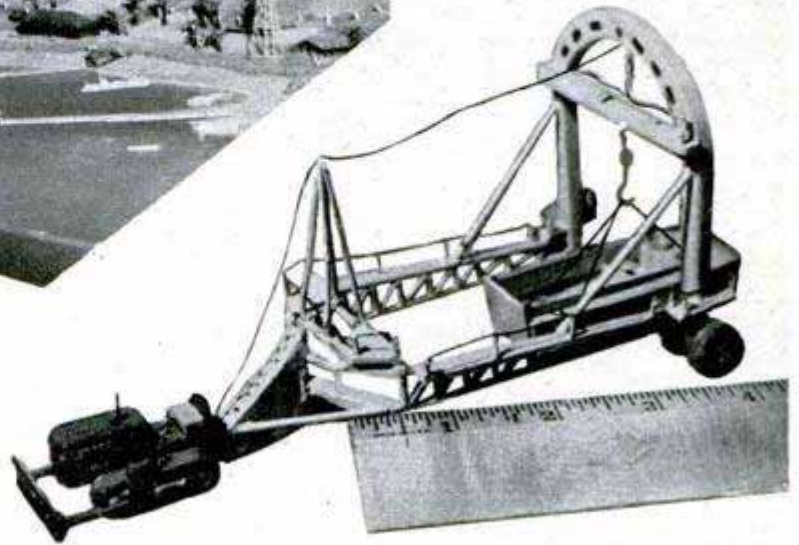

Miniature beachhead is mounted on a four by eight-foot table. There are 93 models which can be moved about during a demonstration landing. They range in size from bulky and realistic LSTs down to miniature cargo trucks. Above is a Gilhoist, an apparatus for rescuing beached landing craft. The real machine is 60 feet long. Left, one of the six-man volunteer team which built the exhibit puts finishing touches on a miniature landing ship. Below, men to be trained absorb the entire picture of a beachhead landing from the big exhibit. Every tactical mission of the battalion can be demonstrated on the board, including righting of landing craft, launching pontoons, clearing beach obstacles and preparing bivouac areas





Flywheel Bus

Rolling the streets of Zurich, Switzerland, is a strange bus which apparently has no power plant. There's no liquid-fuel engine to emit noxious exhaust, and overhead there are no trolley wires. Power for the bus is provided by a six-foot flywheel built into the chassis beneath the floor. At a power station, three arms pivot up from the roof of the vehicle to touch an electric power-supply pole. Current flows to an electric motor on the bus, which spins the big flywheel at speeds up to 3000 revolutions per minute. As the bus pulls away, the motor becomes a generator, powered by the flywheel, and supplies electricity to run the bus. The vehicle will travel from four to six miles on one "charge" of the flywheel. The recharging time varies from 15 seconds to a minute depending on how far the bus has moved. In

At a power-pickup station, three arms reach up to make electric contact. Below, motor spins flywheel and bus rolls off

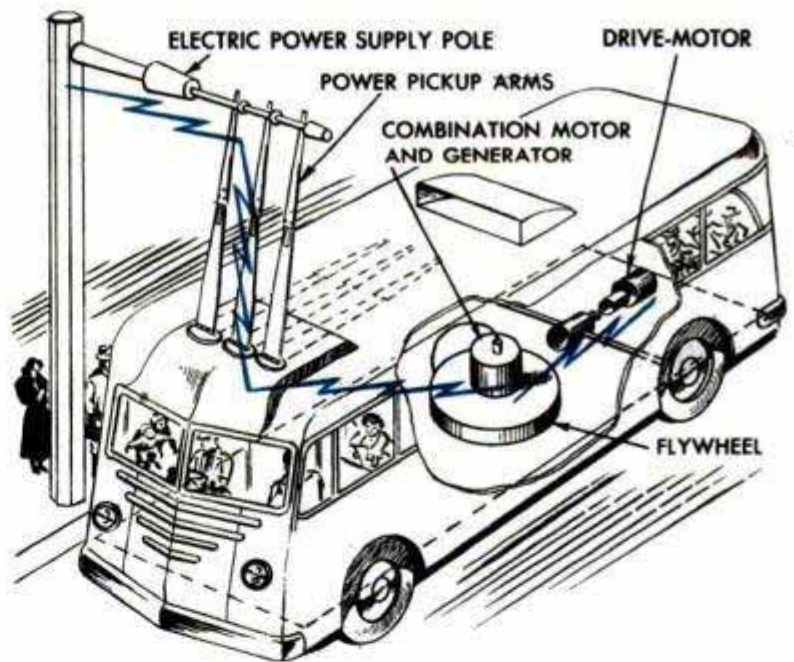

Zurich, the power supply poles are spaced from one-half mile to two miles apart along the bus route.

Concentrated Fresh Milk Reduces Container Cost

Milk in concentrated liquid form has been introduced in Boston and its suburbs, selling for two cents a quart less than the equivalent volume of ordinary milk. The new product, developed by Sealtest Research Laboratories, Oakdale, Long Island, is fresh whole milk from which most of the water is removed. It is homogenized, pasteurized and fortified with Vitamin D. By adding water, the housewife makes a full

quart of milk from a $\frac{1}{3}$ -quart container of the concentrate. The milk sells for less because the saving in containers and storage space can be passed on to consumers. It is said to taste exactly like whole milk.

☑ Splashing raindrops look harmless enough, but if a two-inch rainfall were delivered all at one time it would raise a seven-inch layer of soil a yard into the air.

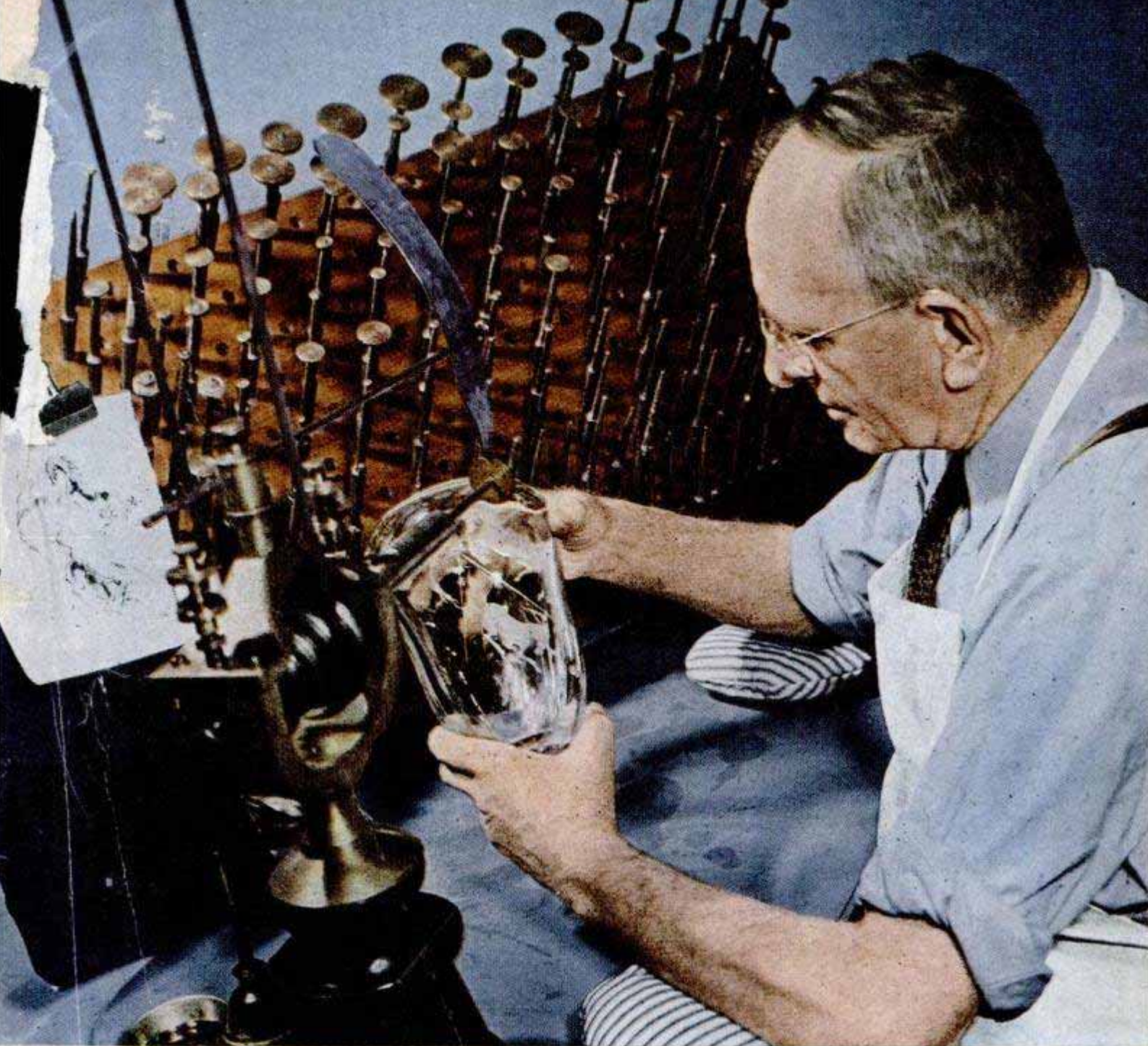

Steuben Glass photo by John Kalinich

Engraver transfers a horse design to a crystal vase. If his hand shakes, the copper wheel will ruin the piece

Masterpieces in Crystal

By Richard F. Dempewolf

YOU'D NEVER GUESS IT if you saw the place, but they're producing museum-piece jewels in the roaring, ruddy gloom of a huge plant, located on Chemung River below New York's Finger Lakes. The cavernous "blowing room" of Steuben Glass in Corning looks like a scene from Dante's *Inferno*. Arched brick openings on each side of the monstrous hexagonal furnaces spew an 1800-degree red glow over everything. Men in shirt sleeves move back and forth in endless procession, carrying gobs of white-hot crystal

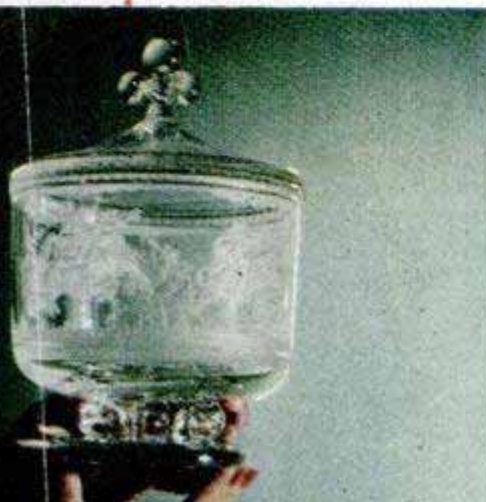



To make a buried teardrop, the gaffer blows a bit of air into his iron, then holds his thumb over opening

on the end of their six-foot blowirons, twirling them as they go so the molten substance doesn't flow to the floor. Over all is the deafening roar of blowers which carry the heat outdoors.

But, gathered around a number of smaller furnaces, or "shops," craftsmen whose skill comes down through generations of forebears dating back to the Middle Ages shape the molten lumps through a series of intricate operations with a deftness that leaves you gawking. Here, in a blob of stuff the color of honey and about the consistency of cold molasses, a gaffer is trapping an air bubble that he shapes into a tiny teardrop. That lump, still yellow with heat, will become a crystal foot for a bud vase. Another man is twisting streamers of trapped air in a long "gather," which he pulls out like taffy to make a delicate air-twist stem for a crystal goblet. At another shop men are twining the hot glass into rope-twists for crystal candlestick stems. Elsewhere, master engravers hunched over lathes grind classic designs into priceless crystal.

There's nothing new about the "off hand" process of glass-making. In the 12th century Theophilus told how to make glass by

melting beechwood ashes and flint and how to form the shapes with a blowiron. But at Steuben today, though the basic steps are the same as those set down by old Theophilus, there's a brand new technique in the making of crystal pieces.

"Today," says Robert Leavy, who manages production, "the gentle curves of crystal from the blowirons follow the natural flow of molten glass." The trapped teardrops, bubbles and air swirls are buried in strategic places to give a gemlike sparkle and simplicity to everything from the thick little crystal mug that retails for \$8.50 to the flowing lines of a table fountain that costs \$1500. The result has brought Steuben some 20,000 customers a year, from just plain folks to President Truman and the Duchess of Windsor. And pieces from the

Here's the completed teardrop, buried in a candlestick. Heat has expanded air, forcing a bubble into the glass



Gaffer begins a rope-twist by pinching grooves into the glass. Photos at right show remainder of process

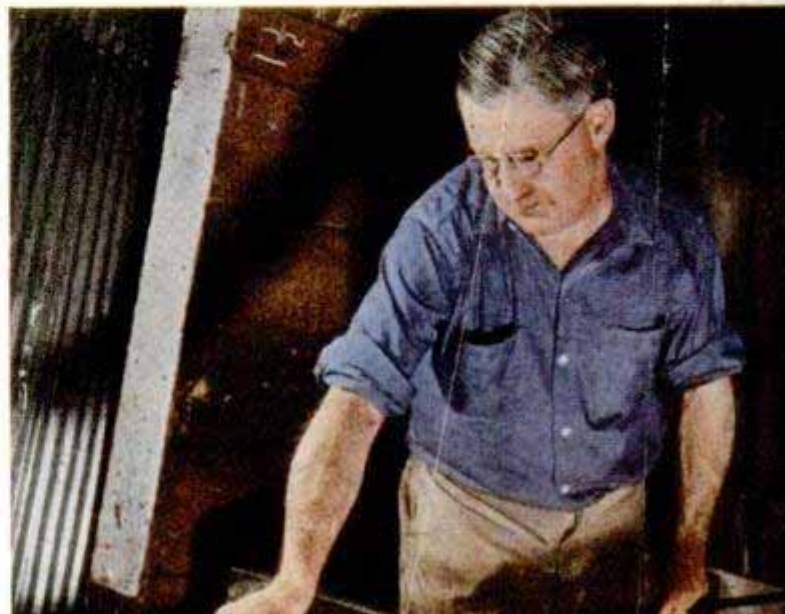

Corning shops are now displayed in some 17 museums throughout the world.

In spite of all this, the shops retain the medieval flavor of the ancient craft of glass blowing. In the red glow of the great furnaces sit the shops, each consisting of a smaller furnace, about 10 feet square. Into this the hot glass occasionally is thrust through a "glory hole" to keep it at workable consistency. Each shop consists of about six men, headed by the master blower, or "gaffer," who gets his name through an old English perversion of "grandfather." Under him are the "servitor," who blows the glass into its basic form; the "gatherer," who pokes his blowiron into the crucible of the big furnace, twirls it to gather on the end just enough of the molten "metal" to make whatever object is being produced,

Bubbles of air trapped inside the glass become long streamers when the glob is stretched and twisted

and blows the first basic bubble in it; the "bit gatherer" who, with a pontil (an iron rod without a hole), gathers tiny gobs of glass for handles, stems or decorative parts; the "stick-up boy," who holds the pieces while the gaffer sticks them together; and the "carry in" boy who, as one old Steuben gaffer likes to explain it, "carries out" the finished piece.

Watching this teamwork on a glass with a teardrop in the center gives you an idea of the judgment of master glass blowers.

At his bench the gaffer spins a balloon of honey-colored molten glass, which the gatherer has brought to him. It's always just the right amount to make the bowl of the glass to exact size. "If you weighed 100 gathers for this piece, they wouldn't vary more than an ounce or so," explains the

This is the result—a beautiful air-twist stem for a goblet which now will be broken off the iron



Grooved "gather" is pulled and twisted at the same time, producing long spirals in the molten glass

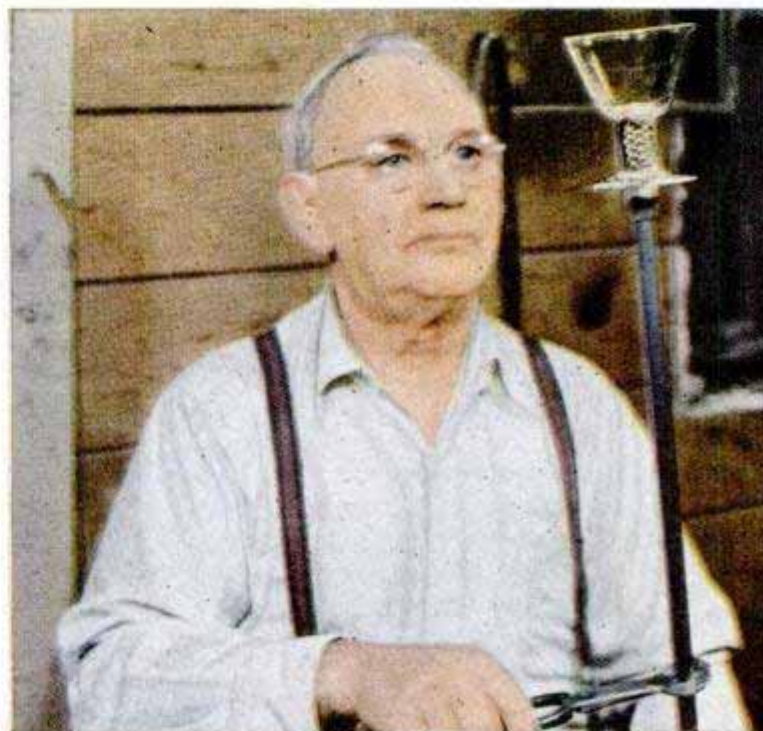

Finished rope-twist candlesticks have curved, gleaming lines. If there's one tiny flaw, piece is discarded





To make white spirals inside glass, milk-glass sticks are placed around mold and crystal dropped in center

gaffer. He twirls the bladder on the edge of his bench and opens the end with the sharp cherrywood tip of his woodjack (a wooden two-pronged fork that looks like a pair of oversized tweezers). Then he shapes it with a cherrywood paddle and clips the excess glass from the rim with steel shears. Though still molten, the snipped glass that falls to the floor startles you with a brittle clink as it shatters. "She always does that," says the gaffer. "Give her a jar and she'll shatter no matter how molten she is."

The gaffer continues to shape the bowl for the glass, twirling it and smoothing it with the wooden paddle. Now and then he shoves the piece in the glory hole to keep it soft, judging its consistency by color and workability.

Grooved gather is inserted into a crystal cup and the entire piece reheated to make bubbles in base



More molten glass is added, then the glob is twisted in an applewood mold, white spirals appearing inside

And here's the finished item, a gleaming crystal paperweight with milk-glass spirals embedded within the glass



Ballad Bowl, a sparkling piece of engraved crystal, cost about \$500. Note the ring of bubbles around base

By squeezing the molten glass, gaffer tools it into shape with bubbles inside. Bowl then is added to base





Master craftsman spent two weeks engraving just the tiger on this bowl. Each cut required different wheel

Meanwhile, the servitor is busy putting a teardrop in the crystal base. If all goes well, both men will finish simultaneously.

To make his teardrop, the servitor blows a tiny puff into the mouth of his blowiron, then clamps his thumb over the opening. "The heat at the end of the iron," he explains, "will expand that puff of air and force a tiny bubble in the glass. Watch . . ." Sure enough, a little air pocket forces its way into the glob of glass on the end of the blowiron. Instantly the servitor grabs his jacks, pinches the bubble off and presses it down into the center of the blob. Then he squeezes the twirling mass until the bubble is pinched at the top into a perfect teardrop. He smooths out the surface of the conical mass with his steaming paddle and the base is finished. The stick-up boy, with a dab of sticky glass on the serrated tip of his pontil, touches the rod to the bottom of the



Valor Cup, given to Great Britain, is considered one of the finest pieces of crystal glass in existence

base. The glass fuses. The servitor gives his blowiron a whack and the blowiron breaks away from the piece, leaving the other end stuck to the pontil of the stick-up boy who carries it around to the gaffer. Now the two pieces are fused together. In a viscous state, one blob of glass will fuse to another permanently, leaving no line or mark at the joint. Quickly, the gaffer runs his calipers over several sections of the glass to see if he missed. It's a rare day when the caliper tips touch the glass.

The finished piece is broken from the pontil with another tap, leaving the rough depression in the base which is the hallmark of handmade glass. Then, the glittering object is carried away on an asbestos-covered stick to the lehr, or annealing oven, where, depending on its size, it will go through hours or days of slow cooling.

"There was a 10-pound crystal elephant,"

Here are examples of the gleaming Steuben crystal. Pieces are designed to follow natural flow of molten glass

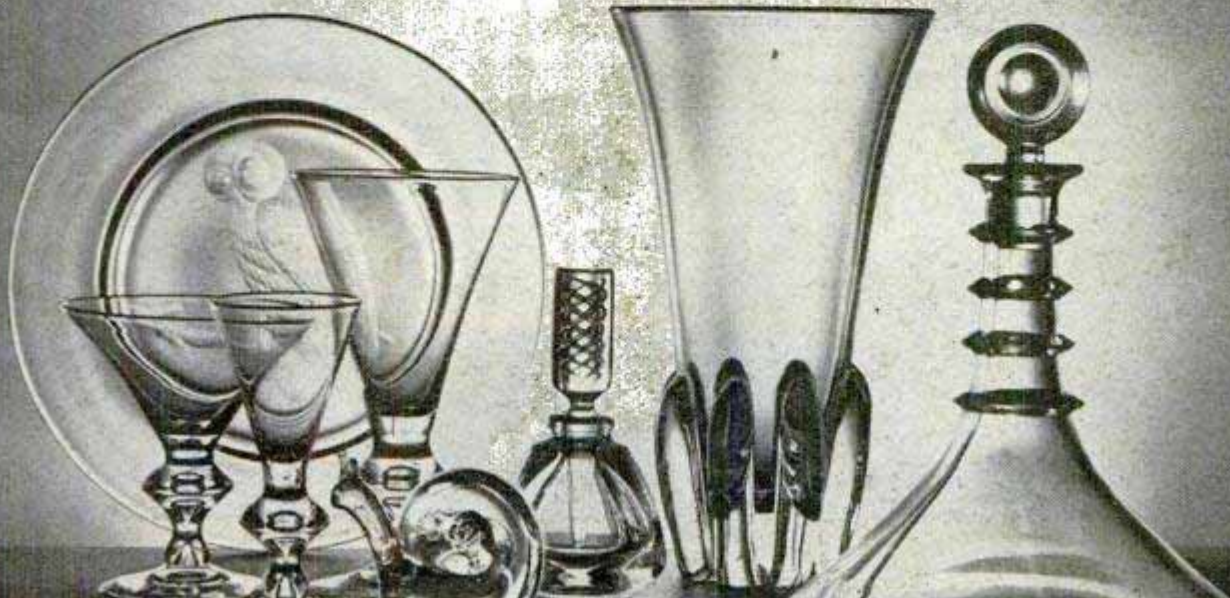



Small balls of glass, formed in a mold, are pinched off, then fused into place on the base of a bowl

one gaffer recalls, "that was in the ovens for five days. Even then, it split through the middle." Gaffers hate big, cumbersome pieces because they tend to break up. If crystal cools quickly and unevenly, tensions are set up inside the glass. To prove this point, Steuben gaffers like to make "St. Anthony's drops" for visitors. The gatherer takes a small wad of molten crystal, and flips it, and it trails a long gossamer tail as it plunges into a barrel of cold water. "Now hold the drop in your fist," instructs the grinning gaffer, "and break off the tail." When you finally snap the tail, there's a startling minor explosion inside your clenched fist. The entire drop has burst into thousands of grains. "Turned right back to sand," says the gaffer. The explanation is

Handle is the last bit of glass added to a pitcher. Gaffer snips off just enough, swings it into place

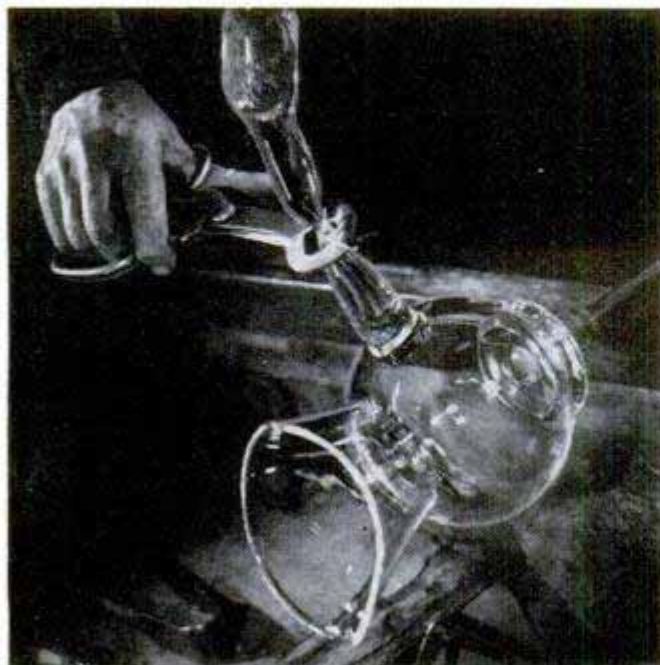

Finished bowl has decorative knobs which serve to steady it. This piece is much heavier than it appears

simple. Tensions set up in the drop from too fast cooling are so great that the jolt caused by snapping the tail is enough to upset molecular balance through the entire piece, and it disintegrates.

Lots of people think real crystal glassware is made from natural rock crystal. Steuben craftsmen are quick to point out the fallacy, though good crystal has the same rocklike purity. Basic ingredients are sand, potash and lead oxide. The mixture is melted in an enormous furnace at 2500 degrees Fahrenheit, cooled to 1800 degrees and becomes a thick, viscous fluid.

Gaffers dread a "spew," which occurs when their blowiron gets too hot. Bits of metal flake off when they blow, get into the

(Continued to page 218)

Shears snip excess glass from the end of a bubble just before it is opened to form the bowl of a goblet

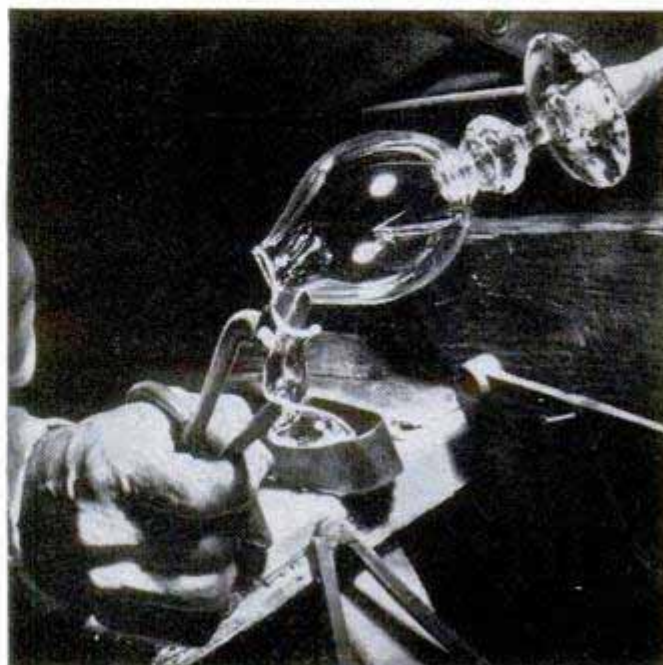

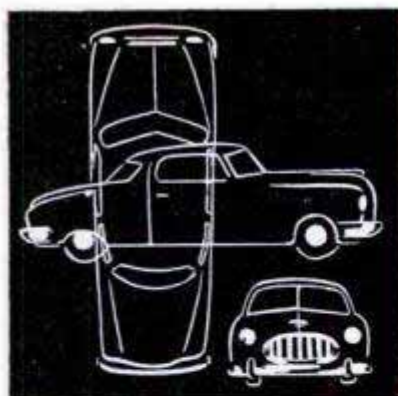

Detroit Listening Post

By Siler Freeman

UNLESS Washington dictates a freeze on new auto models, most if not all of the auto manufacturers will have new 1952 designs on the market late this fall or before the end of the year. Ford will probably be the first with its new models, shooting for an October announcement of its line.

While outwardly the new Fords may not be startling, their engines will make up for what they lack in glamour. The division is pressing for its new overhead-valve engines, which have been finalized. They are being tooled for production. Lincoln too is getting its big engine, which has a displacement of 317 cubic inches and 155 horsepower. The Mercury is smaller, 247 cubic inches and 120 horsepower.

The Ford V-8 is a 221-cubic-inch job with 110 horsepower and the Ford 6 is 215-cubic-inch displacement and 102 horsepower. Lincoln is now scheduled to get its engine ahead of the two other divisions.

General Motors will bring out new designs for 1952, but outward changes will not be too radical. Chrysler will do likewise but will extend the use of its new V-8 engine to other lines, the first being DeSoto. The independents have some important changes to make, especially Studebaker, Hudson and Nash.

Willys-Overland, producing the Jeep line but otherwise without a passenger car as such, has been testing four prototypes of a light car. They are on a 108-inch wheelbase, thus coming between the Nash Rambler and the Henry J and the Big Three's triumvirate, Ford, Chevrolet and Plymouth.

It looks like no company can claim complete coverage of its market these days without a hardtop coupe. The popularity of this styling has been astounding. Buick was the first to invade the field and made it popular by keeping the price just above its regular coupe and sedan lines.

Pontiac, however, widened the price difference and stayed only in the coupe class. It accented the convertible theme by using real leather upholstery. This year, however, it offered its Catalina hardtop in nylon as well as leather.

Latest to enter the hardtop competition

is Ford with its smart Victoria. This caught hold so well that the company is setting up one assembly line which will make the Victoria only. With the Victoria production going good, the stop-gap model Crestliner has been dropped.

How booming it was is shown in figures on hardtop production last year. The industry as a whole turned out and sold 592,550 cars which come under that classification. This included coupes and the sedans which Buick and Oldsmobile pioneered. Cadillac's 60, 61, 62 and 75 sedans, which used the hardtop styling, were included.

Hardtop coupes totaled 268,604, with Chevrolet's Bel Air taking the lead, Buick's Riviera second and Pontiac third. DeSoto, a late-comer, was low. Ford's Crestliner didn't appear until too late to be counted.

This year's hardtop market is expected to be even more extensive. Practically all of the passenger-car builders have at least one candidate or are about to bring one out. Nash has been delayed in announcing its hardtop but is expected to show it in July if it can get the materials to add to its line. Hudson too has one in the works. Chrysler's latest is the Plymouth, which is attracting a lot of attention.

Another change in styling tastes is seen in the gradual dropping of the "fast back" from General Motor's lines. Fisher Body, which has been stymied by the growing list of body styles that it must furnish all the divisions, has been urging elimination of some which have dropped in popularity.

So without any fanfare, the ultra-streamlined fast backs have been lopped off. Only Chevrolet is keeping its Fleetline models complete. Pontiac was the first to drop its Streamliner and Buick stopped making the Super two-door "jet back." Oldsmobile, which last year stopped making the 76, has added the Super 88, which is expected eventually to replace the 88. It has cut down its offerings to 13 body styles, lopping off the 98 club sedan.

But while cutting down its body styles, production emphasis is more and more on the de luxe rather than standard models. The passenger-car builders have accustomed their buyers to extra little frills.

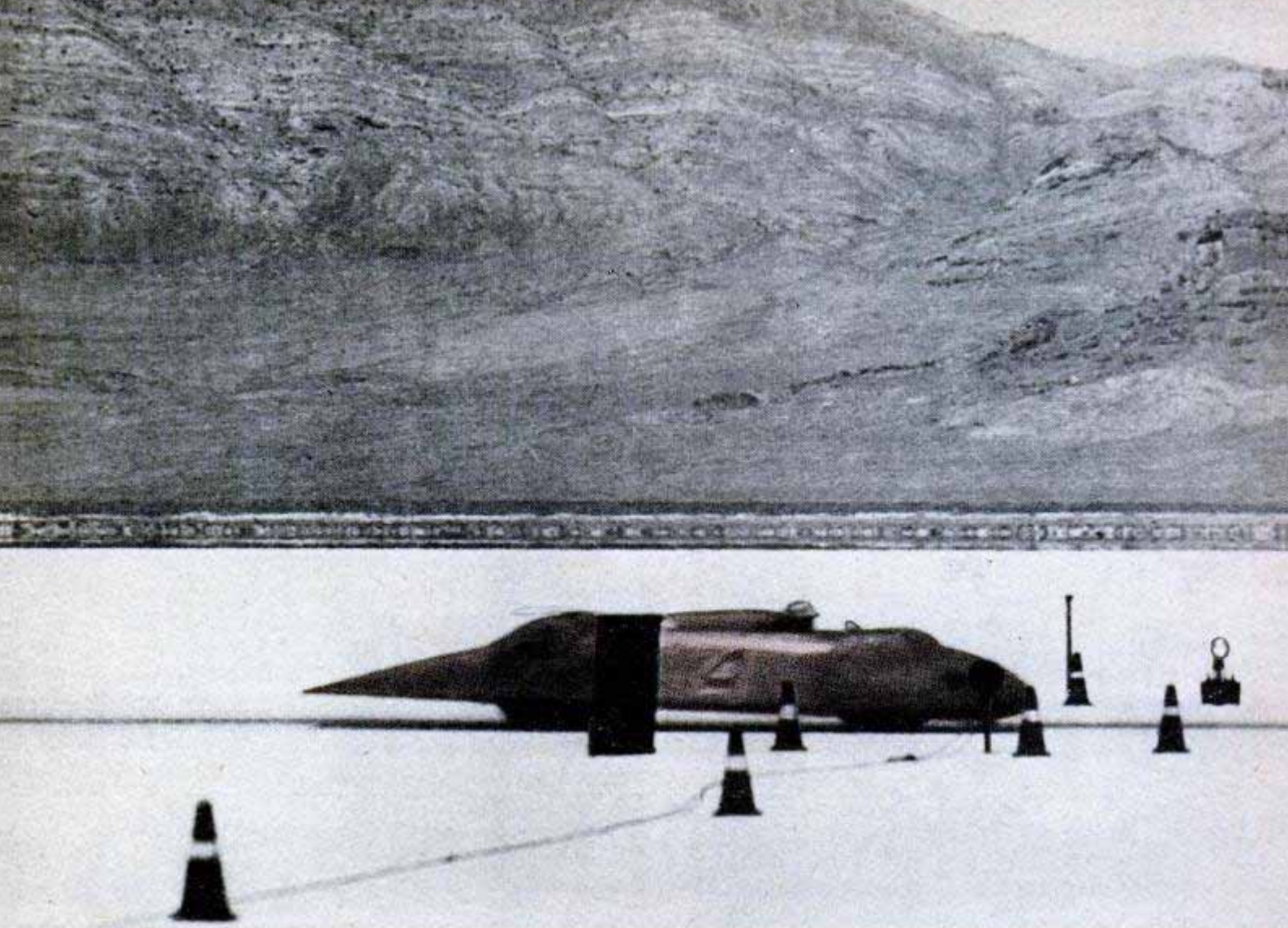

Hod Rod Magazine photo

I Time the Champions

By Otto Crocker

IN THE LAST 10 years I've officiated as chief timer at the setting of 80 new world records by speedboats, aircraft and automobiles. I've seen approximately 180 national speed marks made. In all, I've clocked some 38,000 vehicles in races and time trials during the last couple of decades.

I've seen boats go crazy under the drive of too much power and rear up out of the water and throw their drivers. One boat was tossed 50 feet high when it rammed a swell at 92 miles per hour. The hull was smashed to bits when it crashed, but the driver escaped with no other injuries than a cut on his chin.

In one freak instance, a boat that was doing 50 miles per hour rolled completely over and continued on to an upright position again with the engine still running and the driver still hanging on to the wheel.

Crocker times a speedboat over the course at Salton Sea, Calif. That's his three-dial timer. He always uses his stop watch as well. "Just in case," he says

The driver hardly had time to realize what happened.

I think the best accident I've seen was at Bonneville national speed trials for ama-

Kent Hitchcock photo



Opposite, an unlimited-class streamliner zooms through the light beam that is the finish line at the Bonneville mile time trap. This is one of last year's hot-rod national speed trials

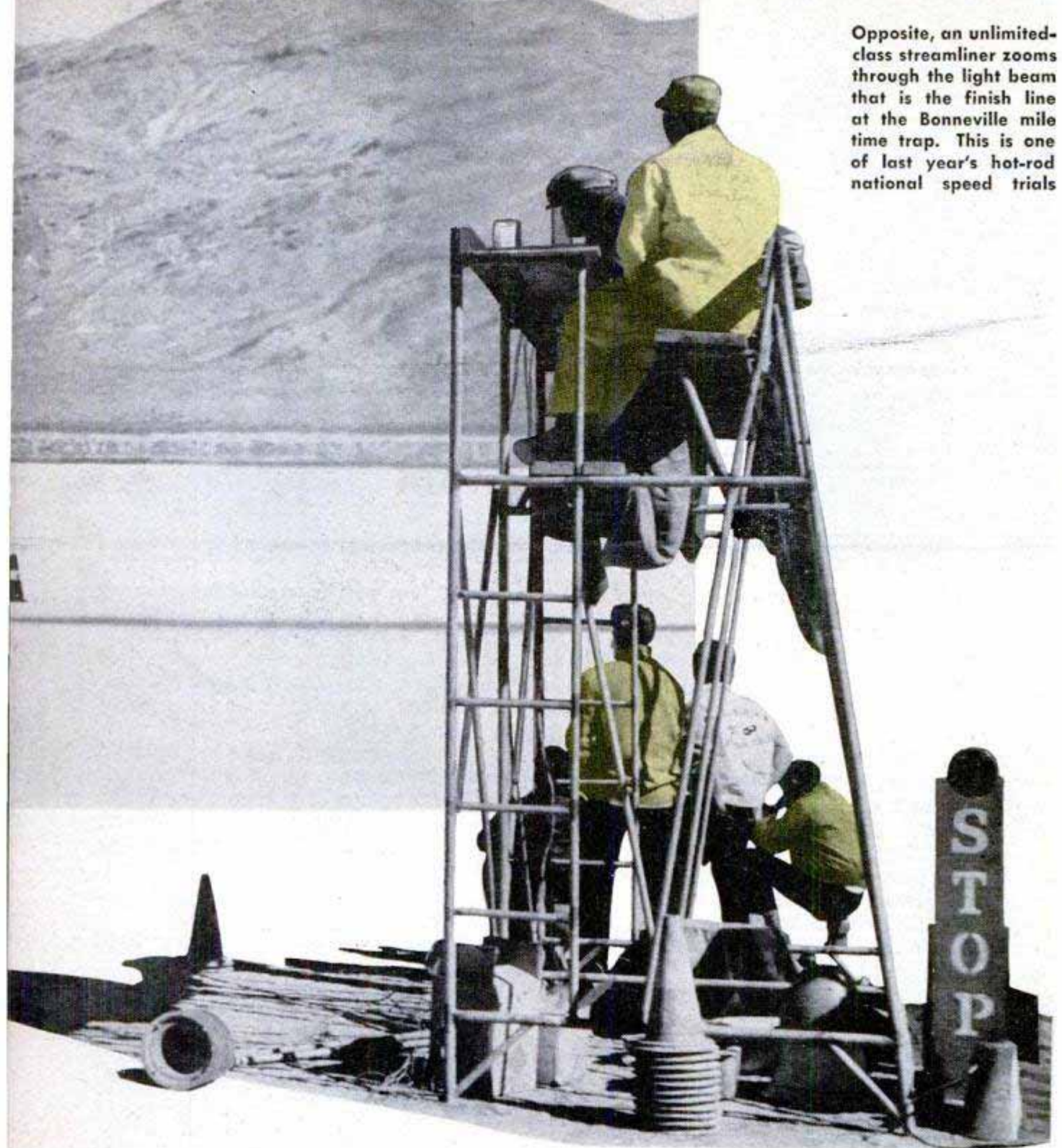

teur-built hot-rod cars last year. I say "best" because the driver didn't even get a scratch even though he was on his head for a while at 200 miles per hour. His safety belt, crash helmet and the good construction of the car saved his life.

Two cars had been clocked at better than 210 miles per hour at Bonneville and the accident happened when C. L. "Puffy" Puffer, driving City of Pasadena II, made an attempt to raise this mark to 220 or better. His engine was wide open when he went through the first beam of the time trap and then the car began to drift. It spun end for end, and rolled over in a series of gyrations across the salt flats. We didn't think Puffy

had a chance and yet he had climbed out of the car and was looking over the damage when the ambulance arrived.

The best way to watch a speeding vehicle, I find, is to hold your eyes motionless and to turn your head. That way, there are no interruptions to full vision and you can see every detail of the run.

Instead of a stop watch, I use a three-dial electronic timer that I designed and built myself, and that is accurate to within a thousandth of a second. With this instrument it's possible to measure a vehicle's speed for three different distances on the same run, or to time separately the first, second and third-place winners of a race.



Timing races like this is complicated even with Crocker's equipment. Time must be recorded for each racer

It can clock objects along a course that is only 12 inches long, if necessary, or it can record the elapsed time of a transcontinental speed dash.

My interest in dependable, split-second timing began 23 years ago when I was speedboat racing. Three official timers were required at each end of the course in those days. Not only was this expensive, there was a long delay after each run while the officials compared their watches and arrived at an average time. Usually, each official had a different reading on his watch. Their reaction times were different.

My first attempt at a better system was

to attach an electric solenoid to a stop watch, figuring that you can push a switch faster than you can punch a watch. That helped, but the possibility of human error was still there.

Next, I tried beams of light at the start and finish lines, focused on photoelectric cells at the far side of the course. When the hull of a boat interrupted the beam, the photocell current would operate the solenoid that in turn punched the watch. This would eliminate all human reaction time and error.

I was trying to do this in broad daylight and the beam of a lamp is pretty dim in

Rocket or speedboat? It's hard to tell here. Miraculously, the boat came down safely and continued in the race

Kent Hitchcock photo



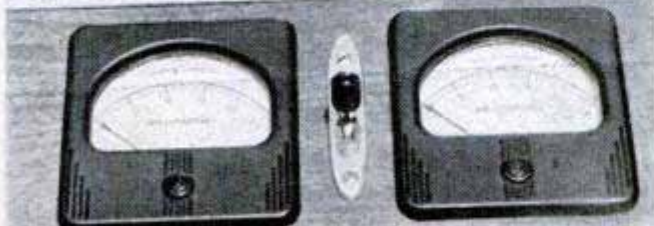
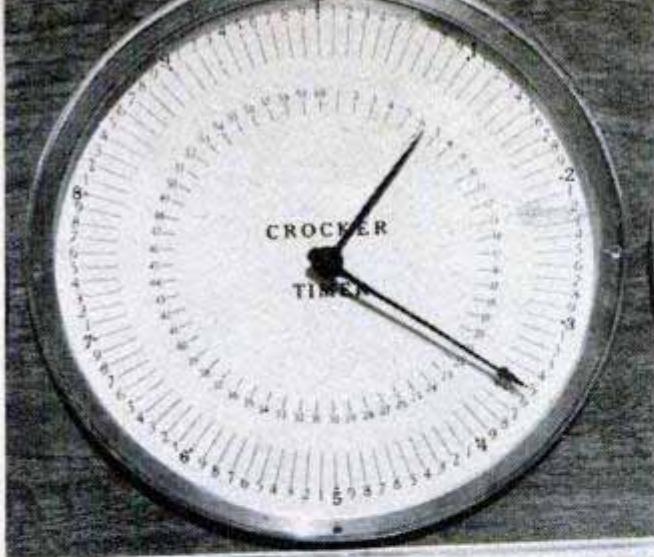

Hot Rod Magazine photo

Close-up of one dial shows small second hand and the long sweep hand that records hundredths of a second. Tip of the long hand breaks it down into thousandths

Crocker often uses his "one sided" timing trap for boat races when photoelectric cells can't be set up. The official tracks the racer. Timing is automatic

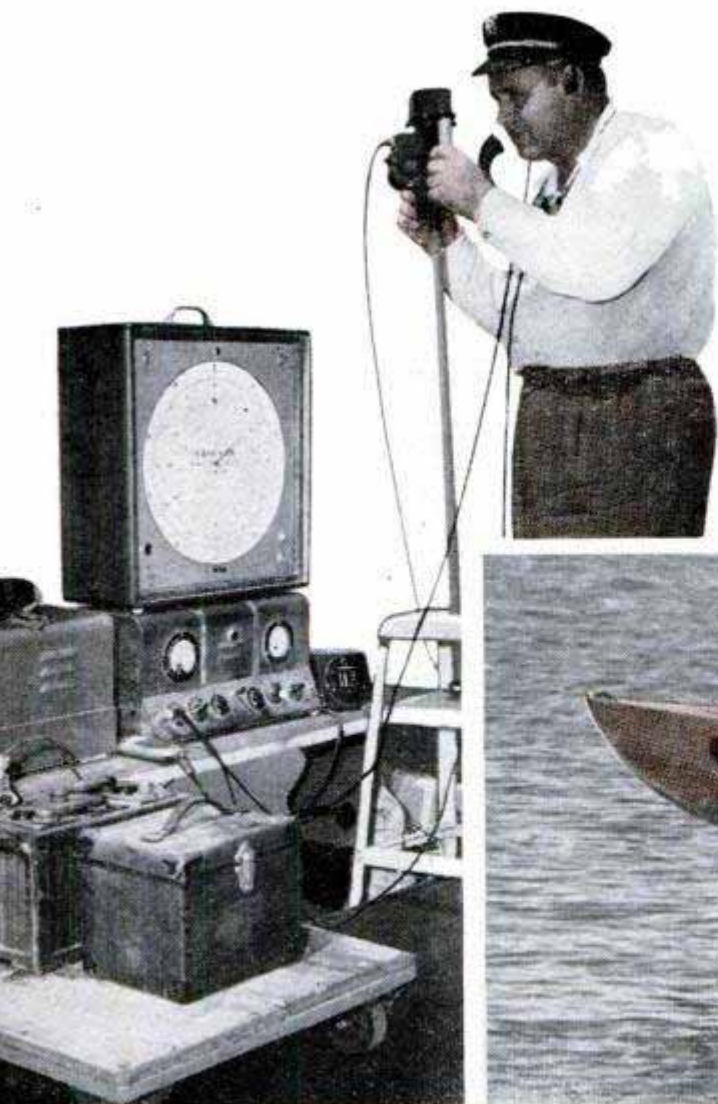

comparison with the sun, so I put a lens on the light and an 11-foot shielding hood in front of each cell to screen out sunlight and reflections from the water. The system worked.

Immediately, boats were clocked two or three miles per hour faster than before. The photocell timing trap almost always gave faster time than did a hand-held watch. The delay caused by human reaction time had been clocking boats at slower than their true speeds.

My next improvement was to get rid of the time delay that occurs inside a watch after it has been tripped. This can amount to $\frac{6}{100}$ second. I switched over to an electric clock that was connected to the solenoids operated by the photocells at the start and finish lines. One cell started the clock, the other stopped it.

There was still a chance for error because of the mechanical movement in a solenoid and so in my newest timer I replaced the relays with a vacuum-tube system that starts and stops the clock directly. The motor of the timer itself is reworked so that no time lag occurs in its mechanism.

Next, I improved the photocell traps. The one I am using now employs a sealed-beam lamp of the automotive type as a light source and an improved photocell of the telephoto type that requires only a short shield. With 10,000-to-1 amplification, the cell can be as far as 1700 feet from the light source, permitting a race course of that width. The wires that connect the cells at each end of the course also serve for two-way phone communication. The whole system operates either from 110-volt alternating current or from storage batteries and a converter.

The instrument still has a slight error—its certificate of accuracy states that it gains $\frac{23}{100}$ second every 24 hours. That's the same

Crocker has timed a revolution in speedboat racing. Today, racers are airborne except for the propeller

Kent Hitchcock photo



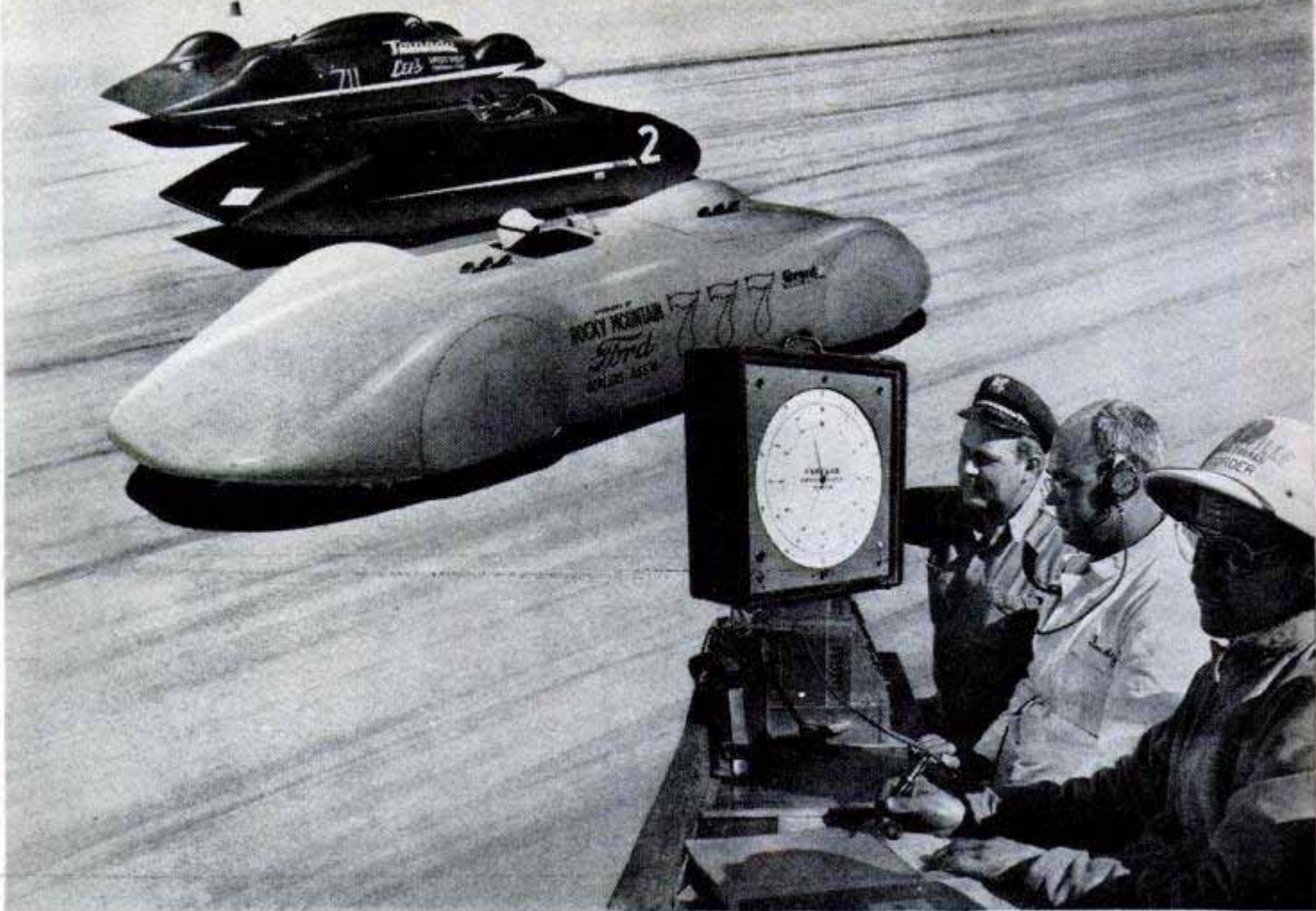

Hot Rod Magazine photo

Three hot rods whiz past the timing stand at better than 200 miles an hour during the Bonneville trials

as one blink of your eye, once a day. I don't know of any other clocking system as accurate as that or that can be used to time vehicles one after the other in rapid succession. I've timed an even 1000 hot-rod cars in one day, each racing wide open through a speed trap in a dash against time.

As chief timer for the American Power Boat Association, I've seen speeds on the water climb to figures that we hardly dreamed were possible 20 years ago. Last

year a little hydroplane with a reworked Mercury automobile engine set a record in the 225-cubic-inch class of 115.045 miles per hour. That's less than 10 miles per hour under the world record for a boat with unlimited horsepower a number of years back.

Present boat speeds have been made possible by the development of the modern hydroplane design of hull. I recall that it was in 1941 at Salton Sea in California when we first saw a boat rise up out of the water and actually fly along the measured mile with only its propeller submerged. It was the first of the hydroplane "prop riders." It was an amazing sight at that time although it's commonplace today.

I missed one of the greatest spectacles of all, the record-breaking run of Stan Sayres' Slo-Mo-Shun at Seattle last year. The four-point hydroplane set a new world record in the unlimited class of 160 miles per hour. I couldn't make the trip and so Kent Hitchcock, A.P.B.A. official, took north with him a "one
(Continued to page 250)



Eliminating the reflex lag present in human timing, photocells at the start and finish make timing exact

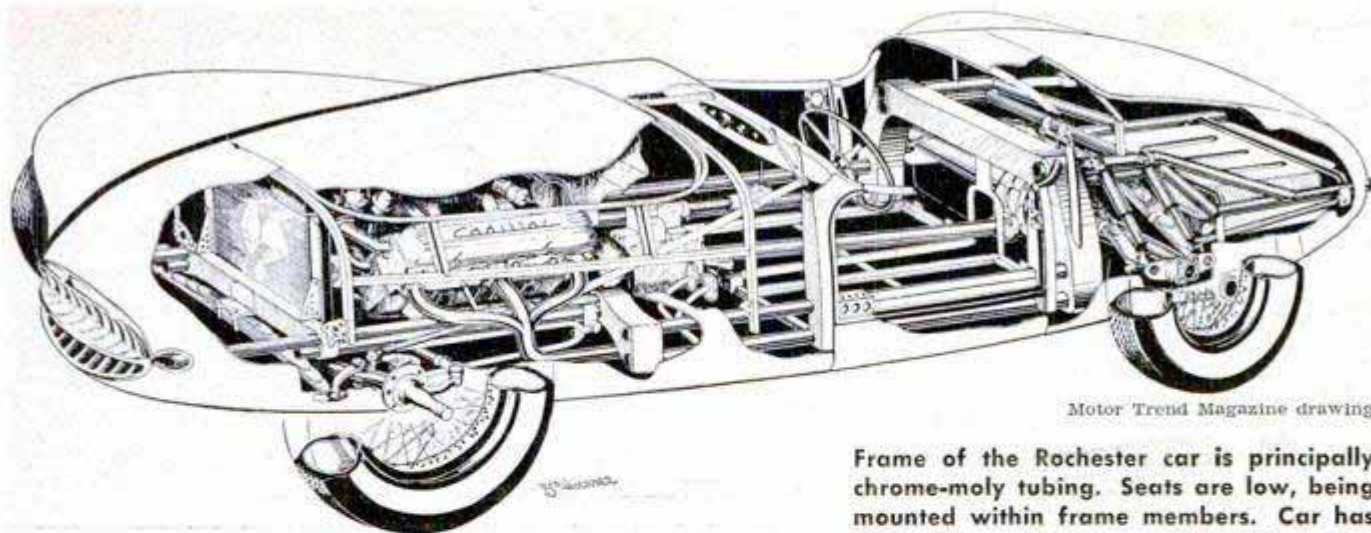

Motor Trend Magazine drawing

Frame of the Rochester car is principally chrome-moly tubing. Seats are low, being mounted within frame members. Car has 6½-inch ground clearance. Below, Rochester and his car. Note the "clamshell" fenders

Rochester Designs Own Speedster

Tired of "driving" the boss' horse-and-buggy Maxwell, Eddie Anderson, famed Rochester of Jack Benny's show, designed himself a sleek sport car that will hit more than 100 miles an hour. Its power plant is a highly tuned Cadillac engine. Anderson proved himself to be no slouch as an engineer, coming up with such innovations as dual soft springs in the rear for a gentle, firm ride. Said to cost about \$20,000, the speedster was made by Emil Diedt, builder of the Blue Crown Special racers.

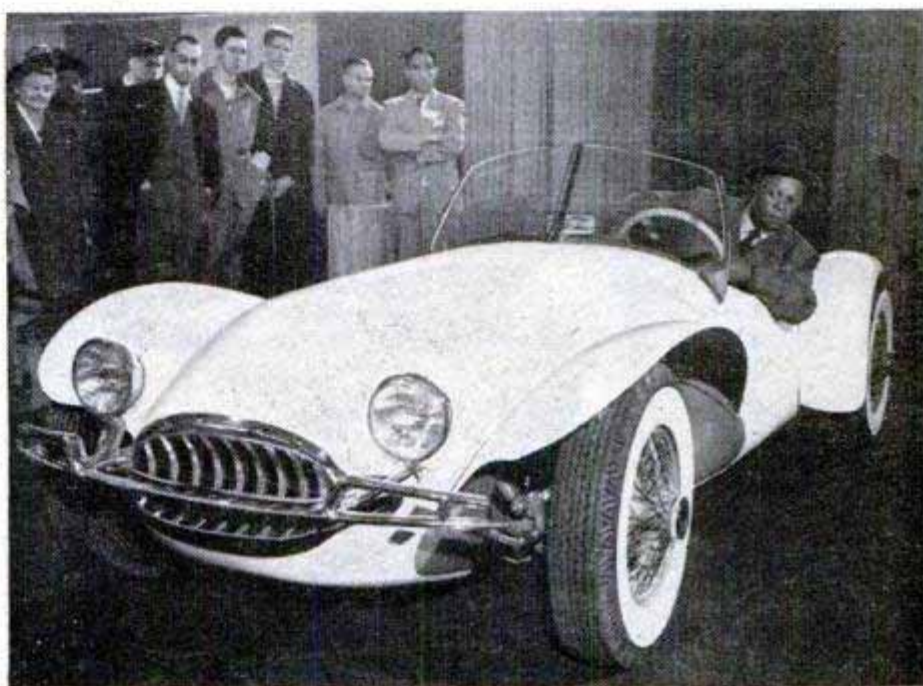

Heat Dome for Car's Manifold

Installed in the manifold of a car, a metal dome is said to give better vaporization of the fuel, thereby reducing carbon formation, improving combustion and saving gasoline. The steel insert transmits heat to the fuel. This assures more complete vaporization of the gasoline, resulting in greater combustion.

Manifold Hot Spot Corp., 612 N. Michigan Ave., Chicago 11

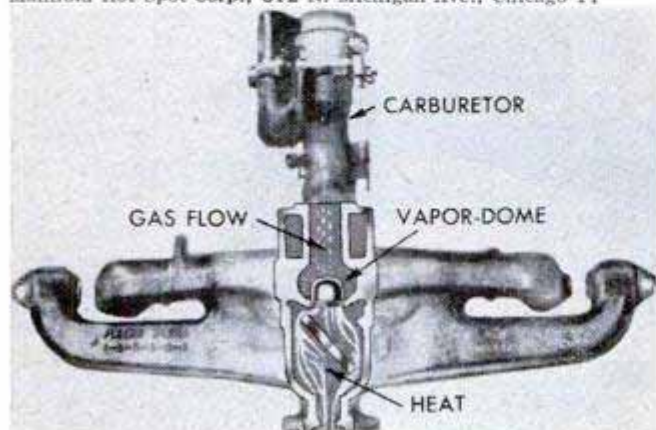

Plug Protector

Four spring-steel wires shaped like the ribs of an umbrella protect your plug or bait from becoming snarled in logs, rocks or weeds. The device can be used with any lure, without interfering with bait action.

Hollingsworth Mfg. Co., Marshalltown, Iowa

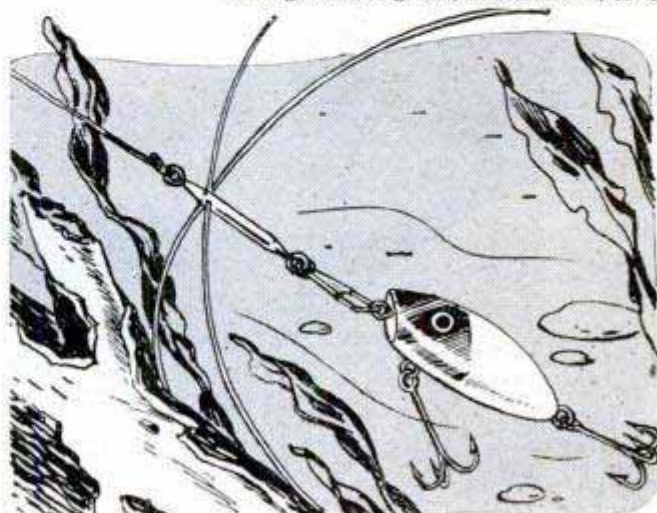

The OWNERS REPORT



The true test of an automobile begins when the owner takes the wheel. This is another report from owners of 1951 cars who answered questionnaires sent by Popular Mechanics to 1000 Chevrolet owners from coast to coast

THE POPULAR MECHANICS MOTOR SURVEY AS CONDUCTED BY FLOYD CLYMER

I am the owner of a 1951 Chevrolet. Fleetline Styleline
I have owned it about 2 months. Speedometer mileage is now 2500

I use only regular gasoline - I use premium (high test) gasoline

My approximate gas mileage in the city is 15 MPG; in country, 17-18 MPG.

I CHANGE OIL every 2000 miles; I ADD OIL - one quart every _____ mi.

My car has: Standard Transmission Powerglide Transmission

How does the car handle on the road? VERY GOOD FOR SMALL CAR

Maneuverability seems to be: Excellent Average Unsatisfactory

Acceleration is: Outstanding Very good Fair Poor

Curb and road clearance is: Satisfactory Too high Too low

Why did you buy a Chevrolet? CHEAPEST FULL-SIZE CAR
What feature do you like best? LOW PRICE - LOW UPKEEP

Do you like the styling? Yes No Why? NO TROUBLE MORE THAN 50. BUT THEY SQUEAK
Do you like the refer aluminum pistons? NOT NECESSARILY
Do you like the styling? O.K.
Do you like the visibility? O.K.

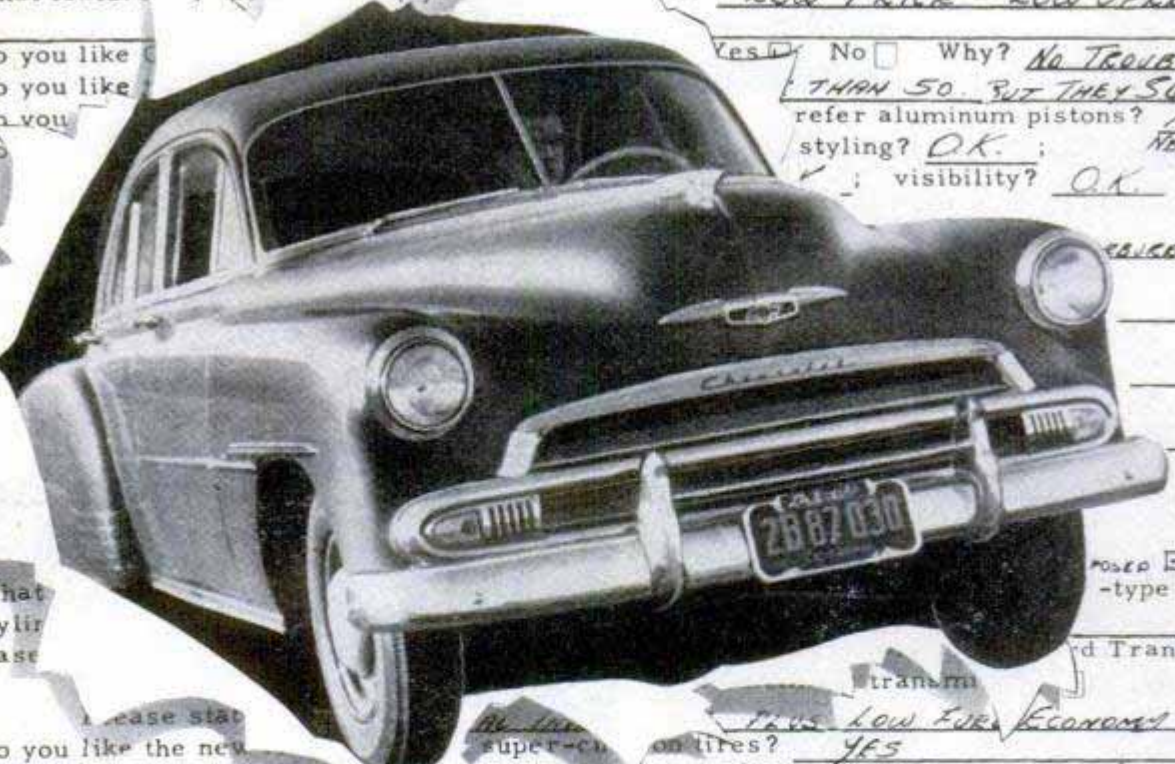

What type of tires? STANDARD
Cylinders? 6
Base? STANDARD

Please state the number of super-cam on tires? YES
Do you like the new? YES
Do you carry recommended load? Yes No How much more? A lbs.
28 PSI TOTAL

Please check the answer boxes (). Your reply will be held in strict confidence.

Please mail promptly to:

FLOYD CLYMER
1268 SO. ALVARADO ST.

My Name: [REDACTED]
Address: [REDACTED]
City & State: INDIANAPOLIS 8 INDIANA

on the '51 CHEVROLET

By Floyd Clymer

ASK THE OWNER what he likes about a '51 Chevrolet. He'll tell you—body styling, the new larger brakes and visibility.

Ask him what he doesn't like. You'll get some squawks—but 90 percent of the owners rate the car as excellent or good.

This month's survey by *Popular Mechanics* of 1000 owners reveals that 26 percent of those who filled out the questionnaire have owned five or more Chevrolets. Opinions recorded in the survey are based on tens of thousands of miles of driving this car under every imaginable condition.

A man in Omaha, Neb., reports that he has owned 350 Chevrolets (a fleet owner, of course) and likes everything about the cars except the low-pressure super-cushion tires. A feature he especially likes is the resale value. This was noted by many other owners but under "best liked features," top rating goes to body styling which had an approving vote of 99 percent.

Odd figures crop up in any survey, probably to prove again that truth is stranger than fiction. The strangest figure in our percentage poll is that 38 percent report they prefer an eight-cylinder engine in their car of the future. As everybody knows, the Chevy is a six-cylinder car.

Eighty-eight percent give their approval to the car's overhead-valve system, but the other 12 percent registered their complaints about noisy tappets. There were more squawks about tappet noise than any other specific item. (I find this a little unjust because of the advantages of overhead valves, particularly accessibility for

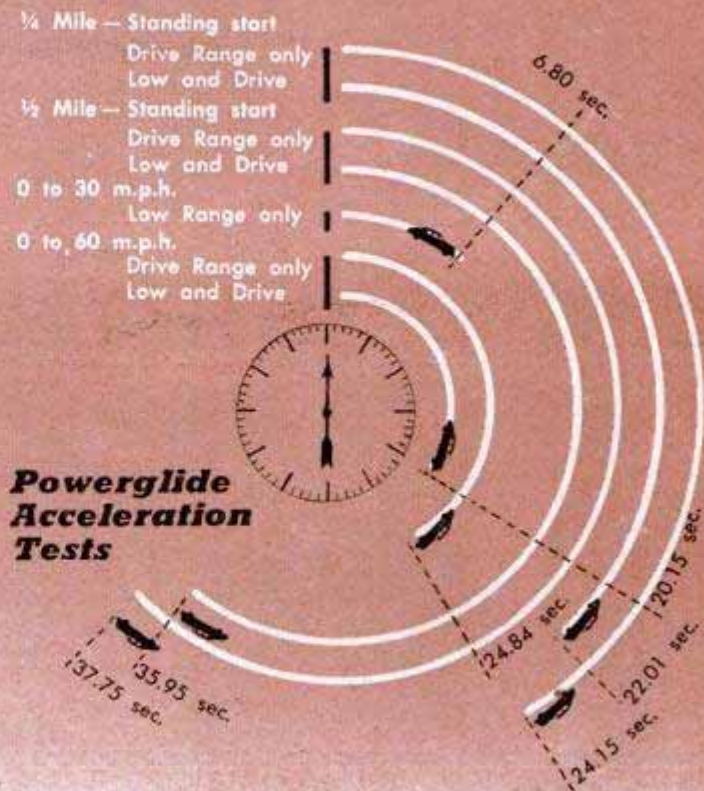

easy maintenance.) The No. 2 complaint, which might more properly be classified as a "lament," is the fact that a Chevy does not have overdrive. Many owners would like a lock inside the car for the hood.

Twenty-eight percent report they bought cars equipped with the new Powerglide automatic transmission. Many others indicated they would have bought Powerglide but it was not available at the time they bought their cars. A great majority of owners like Powerglide and were high in its praise. A Chicago driver says, "It is the smoothest of automatic transmissions with no jerk or indication of gear changing."

A high percentage of the owners commented on good maneuverability, demonstrated here by easy parking





Severe back-road test gave the Powerglide transmission a real workout

Economy Test of Powerglide Chevrolet

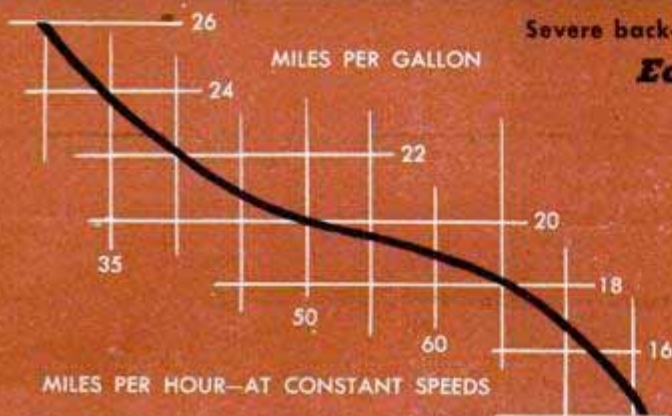

Miles Per Gallon

At constant 30 m.p.h.	26.02
At constant 50 m.p.h.	20.01
At constant 60 m.p.h.	18.95
At constant 75 m.p.h.	14.80

Mileage — (Car showed only 150 miles at start of test).

San Francisco to Bend, Ore.	18.40
Bend to Portland, Ore. (over Cascade Mts.), 200 miles of snow, ice	16.12
Portland to San Francisco	22.45

Oil economy of the '51 Chevy pleases owners. During strenuous 1700-mile test not a drop was added



There were a few complaints such as the one from Clarksburg, W. Va., about "slippage and lost power in accelerating." Several Chevy owners implied that General Motors must think they have cat's-eye vision at night when it comes to reading the initials for the automatic-transmission lever. (I agree with those who would like separate lighting for these initials.)

A Detroit owner writes: "I have owned Chevrolets in 1935, 1937, 1941, 1942 and 1949. My '51 model is the best of all. It never burns oil, and I like Powerglide because you don't have to divide attention between driving and shifting." A Maryland Powerglide owner writes that he has owned 10 Chevrolets in 16 years and doesn't think the '51 rides as easily as it should, and that gasoline mileage is only fair (See percentage chart for averages.) Sixty-eight percent report satisfactory use from regular gasoline.

A Lincoln, Neb., banker writes: "We always have driven larger cars, but recently our Chevrolet gets more hard driving than the larger car. We had heard that Chevrolet would take a great deal of hard driving

Percentages from P. M. Poll

Owners of Styleline models.....	79%
Owners of Fleetline models.....	21%
Bought standard transmission.....	72%
Bought Powerglide automatic transmission.....	28%
Average gasoline mileage (in country).....	20.1 m.p.g.
Average gasoline mileage (in city).....	16.9 m.p.g.
Use regular gas.....	68%
Use premium gas.....	32%
Change oil.....	99%
Average mileage for change of oil.....	1356
Add oil (and also change periodically).....	16%
Average mileage for adding oil.....	931
Maneuverability excellent.....	71%
average.....	28%
unsatisfactory.....	1%
Acceleration outstanding.....	13%
very good.....	61%
average.....	24%
poor.....	2%
Road clearance satisfactory.....	98%
too high.....	1%
too low.....	1%

BEST-LIKED FEATURES

Riding qualities.....	92%
Body styling.....	99%
Interior finish.....	89%
Instrument panel.....	87%
Visibility.....	95%
Prefer cast-iron pistons.....	77%
Overhead-valve system.....	88%
Larger brakes.....	96%

(These percentages are based on the fact that some owners mentioned more than one feature.)

with very little upkeep or operating expense, as well as commanding a satisfactory trade-in allowance. We found all these things to be true." An Omaha, Neb., owner writes that he likes the way his Chevrolet starts in cold weather; parts are cheap to buy, he gets good economy and has low oil consumption, but he doesn't like the door latches or the hand brake. A Norwich, Conn., owner says: "I am completely satisfied, and the fact that more Chevrolets are sold than any other make of car proves to me that it is the best for the money."

In answer to our question, "Why did you buy a Chevrolet?" one owner wrote: "My wife nagged me into getting a light car." In reply to our question, "What do you especially like?" he answered, "My wife has stopped nagging!"

A Nebraska owner writes: "I think Chevrolet has built a very fine car for 1951. The motor seems to be one of the best in Chevrolet history." A Wichita, Kans., owner writes: "It handles just as easily at 90 miles per hour as at 30. The roadability is wonderful; the seats fit you in a comfortable manner, pickup is very good, better on

RATING OF CAR

Excellent or good.....	90%
Average.....	9%
Poor.....	1%

GENERAL INFORMATION

Prefer in-line engine.....	64%
Prefer V-type engine.....	36%
Prefer six cylinders.....	62%
Prefer eight cylinders.....	38%
Prefer overhead-valve system.....	88%
Prefer side-valve arrangement.....	12%
Prefer automatic transmission.....	41%
standard transmission with overdrive.....	30%
standard transmission only.....	29%
Prefer Powerglide automatic transmission.....	74%
(The above figure means 74% of the 41% preferring automatic transmissions.)	
Prefer makes other than Powerglide.....	26%
Like low-pressure tires.....	82%
Previous Chevrolet owners.....	80%
Will or may buy another Chevrolet.....	98%
Will not buy another Chevrolet.....	2%
Dealer service good.....	68%
Dealer service average.....	21%
Dealer service poor.....	11%

Most disliked feature:

Hood locks from outside, excess effort needed to close doors, no overdrive unit available, noisy tappets.

the highway than any other car in its price field." A Maryland owner was short and snappy in reply to our question "Why did you buy a Chevrolet?" He said, "Habit." A Ventnor City, N. J., owner says that he has used Chevrolets exclusively for 17 years and finds them best for local driving. A Cleveland, Ohio, owner complains that "the chrome rusts easily, should be undercoated at the factory. I think aluminum pistons would save gas and give greater pickup." A San Antonio, Tex., owner writes: "The Styleline body is nice; overhead-valve engine is easy to work on."

A Nebraska owner writes: "I like my standard-transmission Chevrolet because I enjoy driving a car, and with an automatic transmission and nothing to do, I might fall asleep. I think the emergency-brake handle is in a poor location." A Miami, Fla., owner wrote that his car was exceptionally easy to handle in traffic and has no side pull on a high-crown road. A Newport, Ky., housewife gave a good and sufficient reason as to why she is a Chevrolet owner: "A Christmas gift."

A Dorothy, N. J., housewife writes that

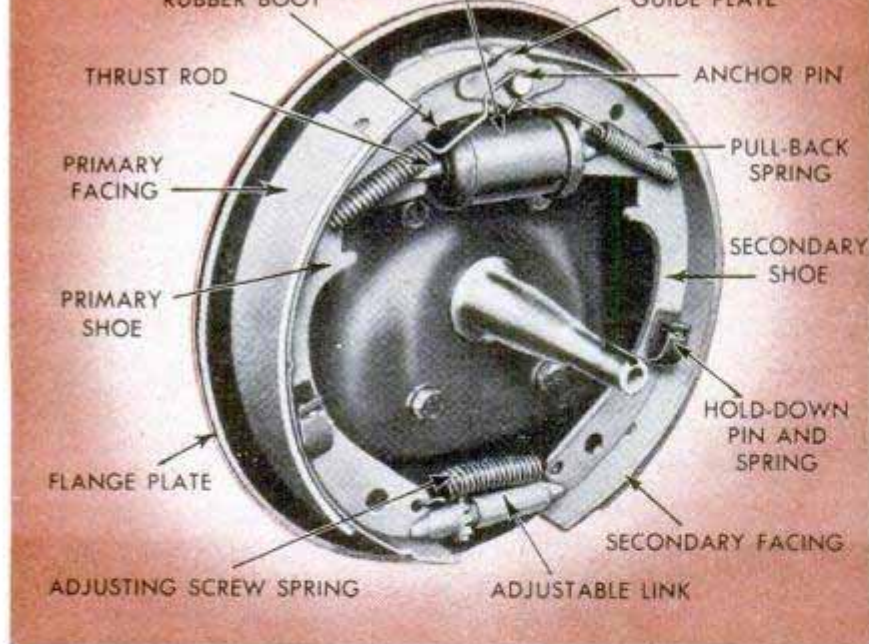

Owners gave Chevrolet's new brakes a 96-percent rating under "best liked features." Below, opinions varied on manually operated choke



she thinks the Chevrolet is the best all-around car in the low-priced field. A Hammond, Ind., owner made the complaint that the cigarette lighter is too far from the driver, and that the level of the floor is too high off the ground to be comfortable. A Columbia, S. C., owner was so well satisfied that he wrote, "I like the Chevrolet because it is a Chevrolet, I guess!" An Indiana owner complains that the clutch and shift are not smooth, ignition points foul up quickly and valve tappets are noisy. A Norwich, Conn., owner writes: "I like the ease of entrance and exit, plenty of passenger and leg room. I think the heating and ventilating features should be improved." A war-conscious Cambridge, Mass., owner came up with: "Interior finish looks mass-produced. (What would he expect from the world's largest producer—a hand-built custom job?) Chevrolet

should have reclining front seats to provide for sleeping as a feature for air defense!" A Waterford, Conn., owner likes the air and heating system, the hand choke and plenty of glass which allows fine vision, and he says the car is easy to park.

On the other hand, an Ohio owner doesn't like the hand choke, thinks the car is too big for a light car and should have more vision. However, he still thinks Chevrolet is the best buy on the market for the money. Another owner from Chicago also is war-conscious because he thinks that there might be gasoline rationing and that is why he bought a Chevrolet. An Overland Park, Kans., owner says the Chevrolet fits his pocketbook best, and that he has owned seven Chevrolet passenger cars and 10 trucks. A Salt Lake City, Utah, owner writes: "I like the new high rear fenders, curved windshield. Steering is exceptional this year and the car is very good on hills." However, he complains that the body metal seems too thin and the doors do not fit as well as in prewar days.

A Massachusetts owner says the only thing he doesn't like about the car is that the hood cannot be locked from the inside. There were numerous similar comments on this feature. A New Jersey owner likes the performance, price and economy, but says the lightweight rear end creates skidding on icy roads. (This is a common complain about modern cars, and it is true, but what can be done about it?)

Now for my own test of the car: Starting from San Francisco, I covered 1700 miles in a 1951 Powerglide Styleline four-door sedan. The route to Portland, Ore., and return also included a severe off-the-highway test into the Oregon backwoods over narrow trails, through mud, snow, slush and ice.

Highway conditions varied from the long straightaways where the car would cruise smoothly and easily from 80 to 85 miles per hour, through the rough, winding and mountainous highway. The car was nearly new, with only 150 miles on the speedometer when we started the test.

(Continued to page 252)

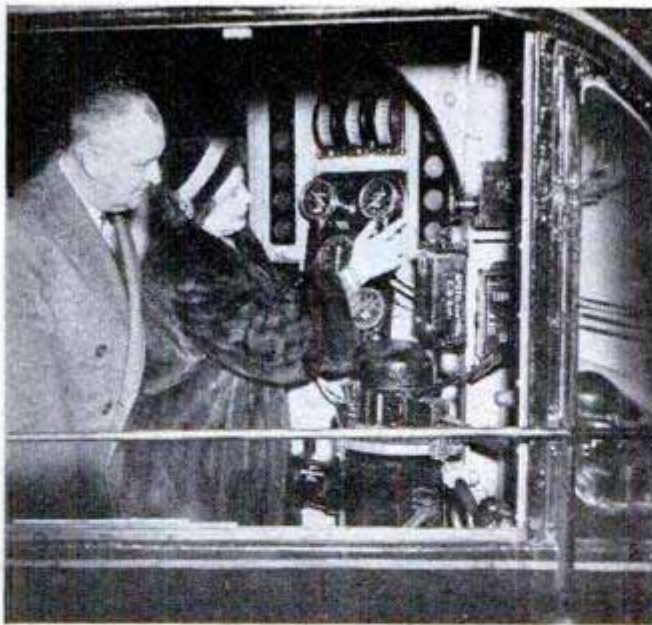

Speed Control for Locomotives Is Traffic Cop of the Rails

Automatically slowing down the train to the required speed if the engineer fails to do so, an electronic speed control is an ever-present policeman in the cab. If the block signals call for a speed reduction, the speed control blows a warning whistle in

the cab. If the engineer fails to reduce speed sufficiently, the electronic control automatically applies the brakes. If the signals indicate stop, and the engineer fails to take action, the train is stopped automatically by the control system.

Mixing Ball Creates "Out-of-This-World" Colors

Completely new colors are being produced daily at the University of Illinois, simply because a researcher there noticed how light beams were focused by his spherical shaving mirror. Why not, thought Prof. Jozef Cohen, use this method to bring colors together from their purest source—a spectrum? He built a machine resembling a large bowling ball, into which a viewer peers through a binocular-like eyepiece. The strange colors appear inside on

a disk the size of a telephone dial. The disk can be split vertically so that different colors appear on each half. Actually, the Cohen machine works like this: A white light is focused upon a diffraction grating, which splits the light into a spectrum. With a mask, the user selects the color or colors wanted and lets them hit the spherical mirror which recombines them. A Lucite tube carries the resulting beam to the viewing spot.

"Otter" Goes Anywhere

Developed by the Ordnance Corps, the Army's new "Otter" can plow through water, mud, snow or sand, and travels 36 miles an hour over level land. The track-laying vehicle is as easy to steer as an automobile, and can turn on a dime. Operated by a crew of two, it can deliver a substantial number of fully equipped soldiers wherever they are wanted, regardless of the terrain. The Otter is a modern, bigger version of the wartime "Weasel."

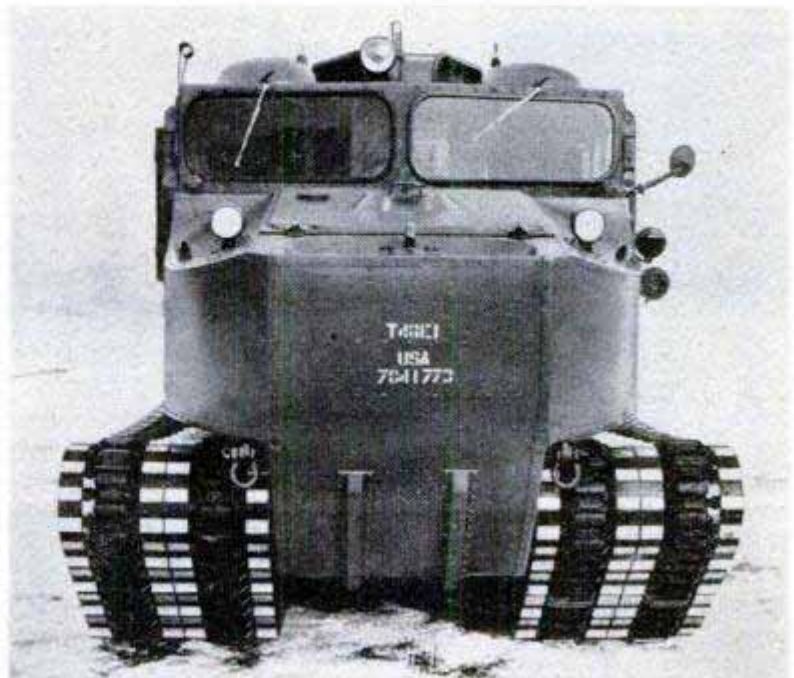

☐ America's main-line railroads acquired 2372 diesel-electric locomotives in 1950, the largest number in history.



Trailside Mercantile Co., 532 Thatcher Rd., River Forest, Ill.

Fishing Rod Five Inches Long

Casts of 50 feet or more are possible with a new fishing rod only five inches long. The rod consists of a plastic handle topped by a disk and six prongs. The prongs form the reel around which the line is wound. Holding the device in one hand, the angler throws the weighted line underhand with the other. The line spins free of the reel as the weight arches through the air. The hand reel can be used with live bait or artificial lures. Following a cast, the line is retrieved simply by rewinding it around the prongs.

Sighting Tee

Golfers can accurately gauge distance to the green with the sighting slit in a new plastic tee. The player holds the tee at arm's length and sights the flagpole through the slit. He moves his thumb up or down until the flagpole appears to fill the height between the top of the slit and his thumb.



Gerrits Bros., Appleton, Wis.

A yardage scale and numbers of the appropriate iron clubs to use from each distance are printed at the sides of the slit and the golfer selects the one appearing nearest the tip of his thumb. When used as a tee, the numbers and gradations act as indicators for players who always want the ball elevated the same height.

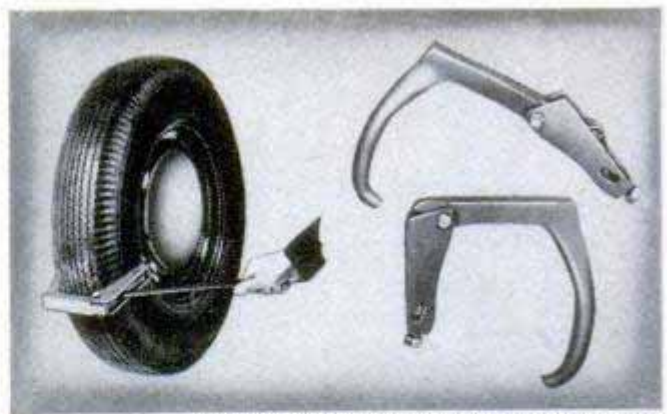

Lantz Manufacturing Co., Inc., Valparaiso, Ind.

Traction Clamp for Tires

One motion fastens a tire traction clamp for cars stuck in the snow, mud, a ditch or on a sheet of ice. The steel clamp fits any 5:90 to 7:00 tire and because of its thickness only one is required for each wheel. A single adjusting screw brings the linkage into position for clamping onto the tire with one stroke of a lever. It fits solid wheels which do not permit lug chains to pass through them.

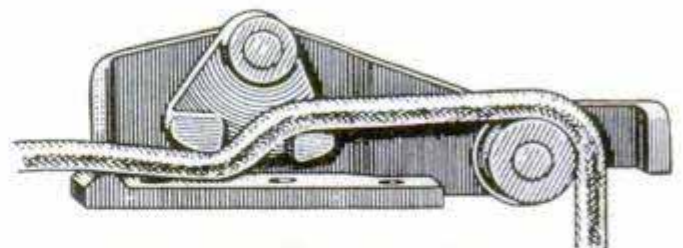
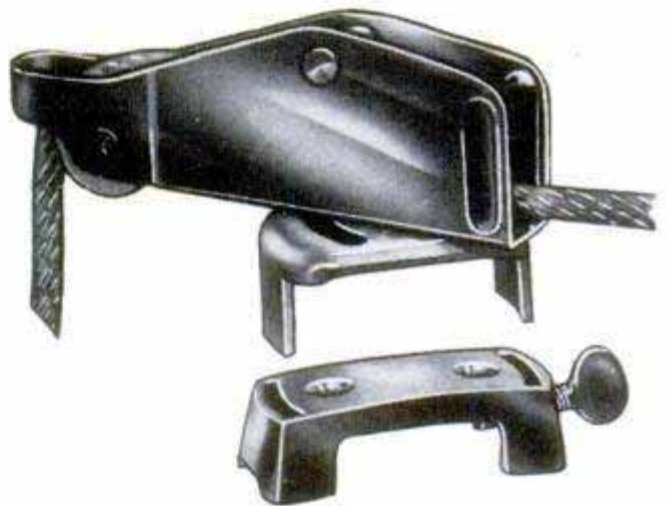

Thoss Mfg. Co., 206 West Third St., North Manchester, Ind.

Anchor Control for Small Boats

Nonslipping and self-locking, a foolproof anchor control can be used with ropes from 1/4 to 1/2 inch in diameter. The locking mechanism is completely automatic. Pulling on the rope unlocks it. Releasing the rope locks it. The rope can be operated from any position in the boat.

Ready-mixed pancake and waffle batter now are available in pressurized cans—the housewife just presses a valve and the batter pours out onto the hot skillet.

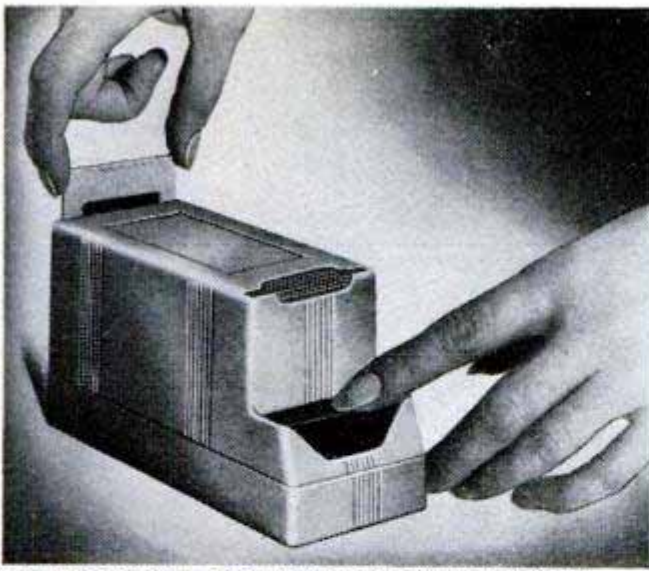

Westerlind Products, 1000 E. Walnut St., Pasadena 4, Calif.

Pop-Up File for Slides

Photo slides are kept in sequence and ready for instant use in a key-operated ejecting file. The operator simply presses a key at one end of the file and the slide pops through a slot at the other end. As many as 200 slides can be filed in the device.

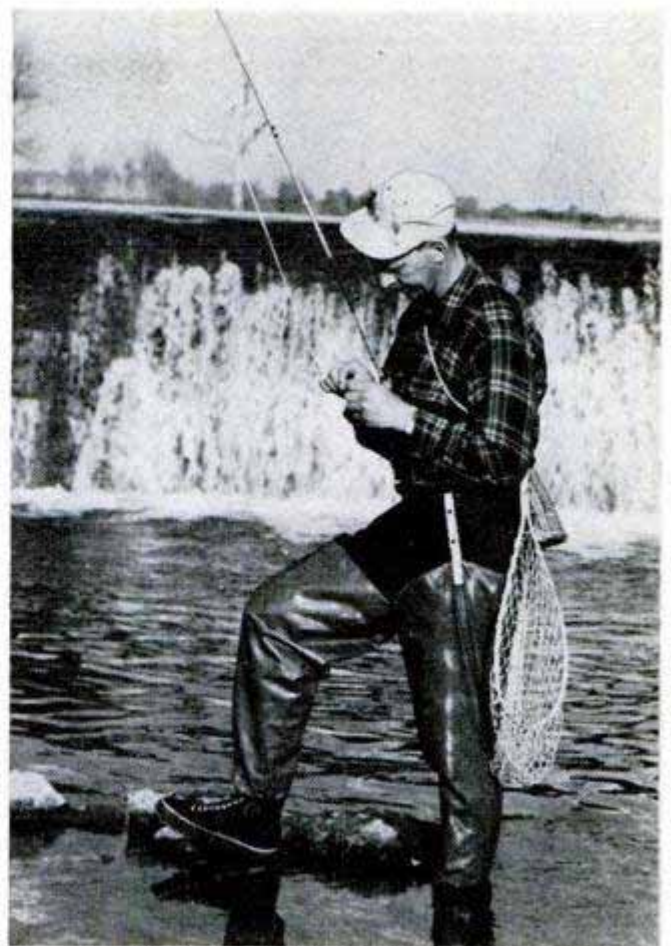

Seal-Dri Sportswear Co., 2514 Kilburn Ave., Rockford, Ill.

Flying "Manure Spreader" Fertilizes Pasture Land

Down in New Zealand, the soil-conservation department is using airplanes to fertilize thousands of acres of pasture land. The largely mountainous terrain which presently supports only one sheep per acre can, when top dressed with phosphatic fertilizer, support twice that or two sheep an acre. The phosphate is distributed over the land as pellets about the size of peanuts. Flying between 400 and 500 feet above the ground, the plane spreads a 100-foot swath at a rate of 200 pounds per acre.

Plastic Hip "Boots"

Worn inside any shoe like overgrown stockings, a pair of plastic hip "boots" keeps the fisherman dry without uncomfortable weight. The foot is shaped to fit into gym shoes and can be worn all day without discomfort. The legs are held up by straps that slip over the belt. When not being worn, the boots, which weigh less than two pounds, can be folded and carried in the pocket or tackle box.

Fielding-Practice Aid

As a practice aid, baseballs thrown at a slatted "cradle" are deflected at different angles to provide a variety of ground balls for infielders to catch. It was devised by Branch Rickey, general manager of the Pittsburgh Pirates.

☐ Though a light bulb could be designed which would burn continuously for a thousand years, Westinghouse engineers say it would be useless for lighting purposes as it would give less illumination than a firefly.



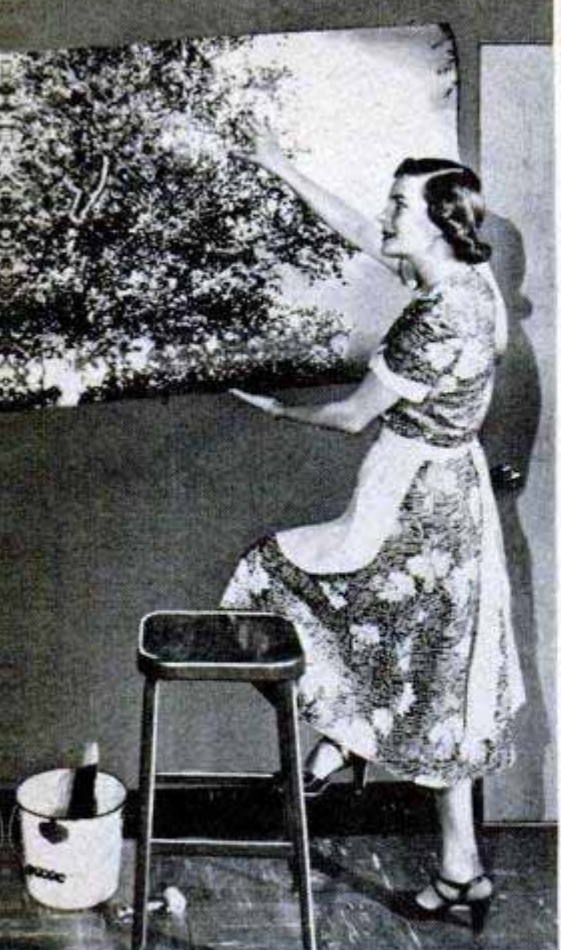

R-C-S Studios, 123 N. Wacker Dr., Chicago 6, Ill.

PHOTO MURALS by mail order enable the average homeowner to decorate his rooms with actual enlarged photographs of beautiful scenes. There are 90 different scenes available in a variety of sizes. All of them are sepia toned to give a rich, warm effect. Once mounted, the murals are washable and last indefinitely

What's New FOR YOUR HOME



Ogden Filter Co., 4214 Santa Monica Blvd., Los Angeles 27, Calif.

WATER FILTER removes many bad tastes and odors. Its replaceable element filters hundreds of gallons

VACUUM LID seals open jars or cans. Depressing membrane expels air, making vacuum that holds lid on

C & S Engineering Co., Woodside, Calif.



PLACE MATS of plastic look like fabric, yet require no washing or ironing. Just rinse under a faucet

Hedwin Corp., 1525 West 41st St., Baltimore 11, Md.



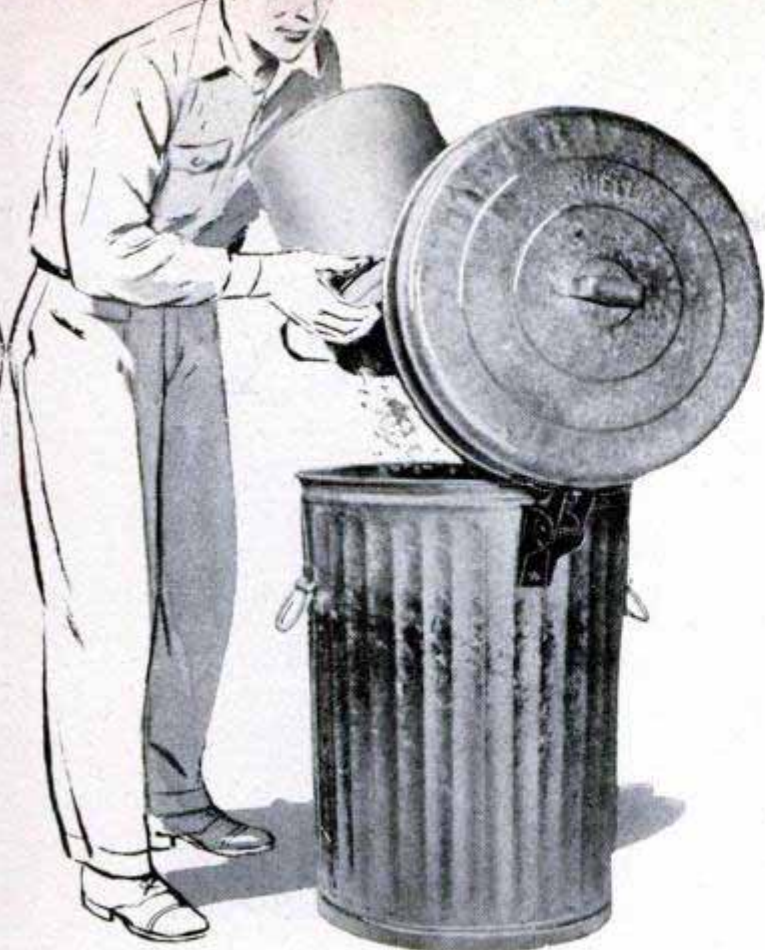

Sta-Kov Corp., 4536 Vernon Blvd., Long Island City 1, N. Y.

SPRING HINGE for garbage cans can be attached in a few minutes. It holds lid open in any of three positions. When lid is down, spring keeps it closed



The Meyerecord Co., 5323 W. Lake St., Chicago 44

DECALS FOR FABRICS decorate clothing, linens and other materials with full-color designs. Simply iron the design on. Laundering won't dim the colors

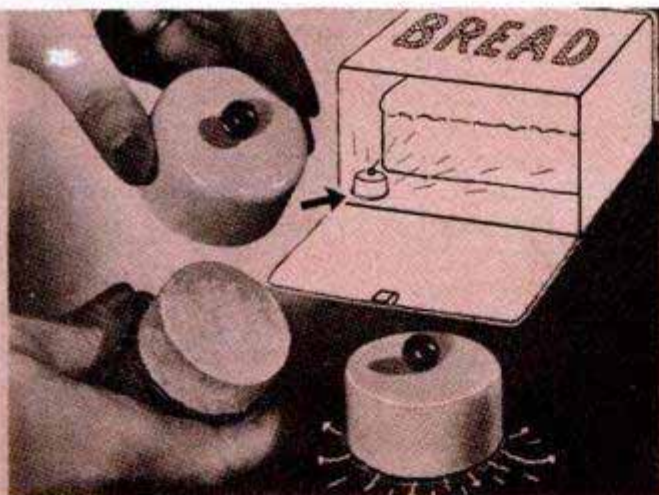

Moist-Sure Products, Box 3870, Merchandise Mart Sta., Chicago 54

HUMIDIFIER for breadbox or tobacco jar retains twice its weight in water and moistens air for days

NEAT PLEATS are made easily with a jig consisting of two slotted forms that shape cloth properly
Hide-A-Brush Container Co., Brook, Ind.



Simplicity Tool Co., 2850 N. Mississippi, Portland, Ore.

NEWS RACK adjusts for books or magazines. It's fine for breakfast readers. It holds cookbooks, too

WALL TREE keeps shoes in shape and allows them to air out thoroughly. It will hold any kind of a shoe
Midwest Metal Products Inc., 315 Westport Rd., Kansas City 2, Mo.

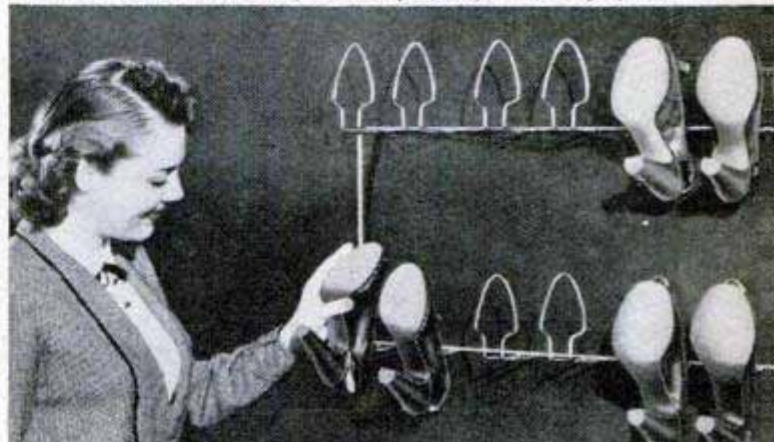



Left, shaft enters water at angle to keep bow of light craft from riding skyward. Right, same engine, with pump and nozzle, sprays trees. Below, fouled propeller can be swung inboard
Atco Motor Mowers, 67 Broad St., New York City 4

Outboard Motor Sprays Trees

With a versatile outboard motor developed in England you can power your boat or spray your trees. The motor weighs 44 pounds and comes in two sections about 30 inches long for easy storage in an automobile trunk. A single wing nut fastens it to the sternboard of a dinghy or rowboat. If weeds foul the propeller, the whole shaft can be swung aboard on its swivel-hinged mount. Inboard, the shaft can be fitted with a suction pump and used to bail the boat. The same pump and engine can be used with nozzles to spray fruit trees.



Fiberglas "Sound Blotters" Deaden Roar of Test Engines

Perforated aluminum cylinders, packed with Fiberglas insulating wool, are helping deaden the roar in aircraft-engine test cells. The cylinders, 7½ feet long and 9 inches thick, hang by cables at the intake and exhaust ends of the cells. The cylinders are suspended in staggered rows. The "sound blotters" aren't damaged by the high wind velocities in the cells.

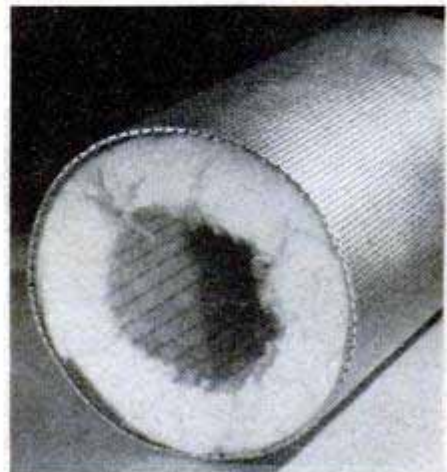
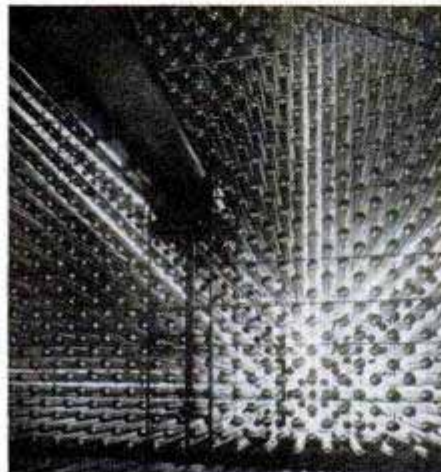

Shock "Breather" Helps Polio Victims

Using electrical-shock impulses to control breathing, a 28-pound machine invented by two German doctors, regulates the involuntary respiration of polio patients. Costing about \$475, the machine may end the need for the cumbersome iron lung for many patients. Rubber straps around the patient transmit shock impulses which control breathing.

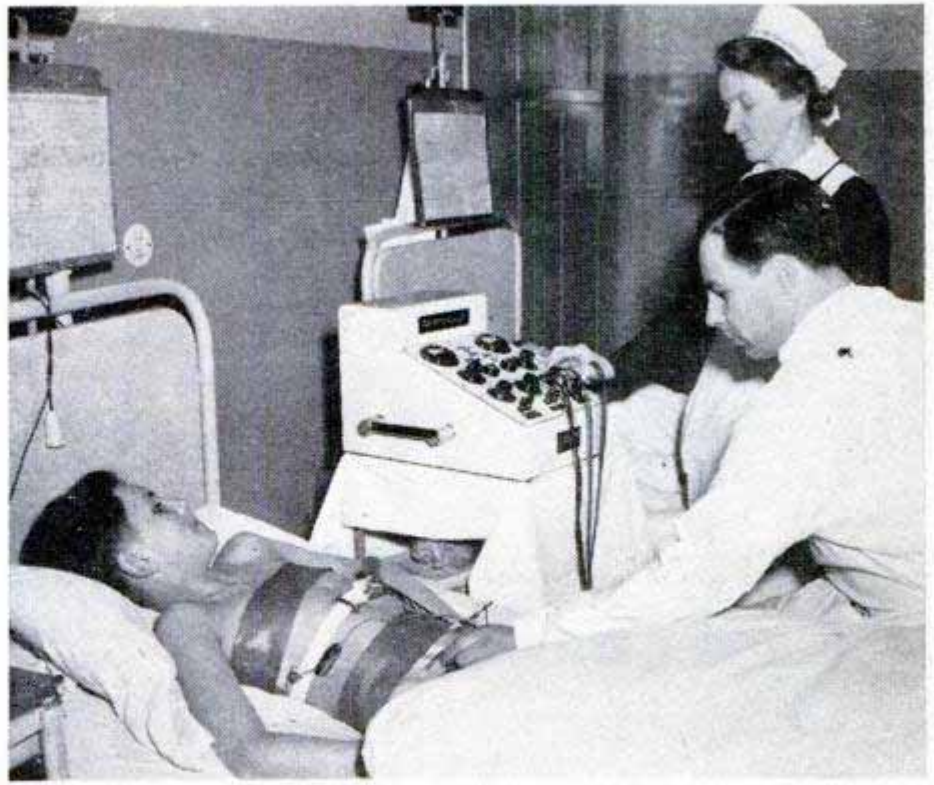

Cropland in Peril

Unless immediate steps are taken to save the nation's remaining cropland, the United States soon will reach a disastrous turning point where there will be insufficient nutrition available for the population, according to Dr. Wendell H. Camp of the Academy of Natural Sciences in Philadelphia. Already, he warns, misuse of the soil has robbed the nation of 100 million acres of cropland out of an original 560 million acres. Since nutritionists estimate that 2½ acres are re-

quired to provide a balanced diet for a single person, the United States seems destined to reach the point where it has just enough cropland within the next 15 to 20 years. Doctor Camp suggests plant breeding, reforestation and improved utilization of soil and fertilizer as methods to save the land, and the possible use of the yeast plant and seaweed as sources for basic foods.



Glass Soldered to Metal

Glass is soldered to metal in a process that makes the bond stronger than the glass itself. Developed by General Electric engineers, the process uses titanium hydride. The glass and metal areas to be soldered are painted with a thin layer of titanium hydride and solder is placed on both areas. The parts are then put together and heated under a vacuum. At about 900 degrees Fahrenheit, the titanium decomposes, causing the molten solder to adhere to the painted areas.

Bureau Raps Battery Aids

Storage batteries can't be rejuvenated by adding various preparations promoted for that purpose, according to the National Bureau of Standards. The bureau has made tests of the preparations. The tests show little or no difference between dead batteries treated with mixtures and similar untreated batteries.

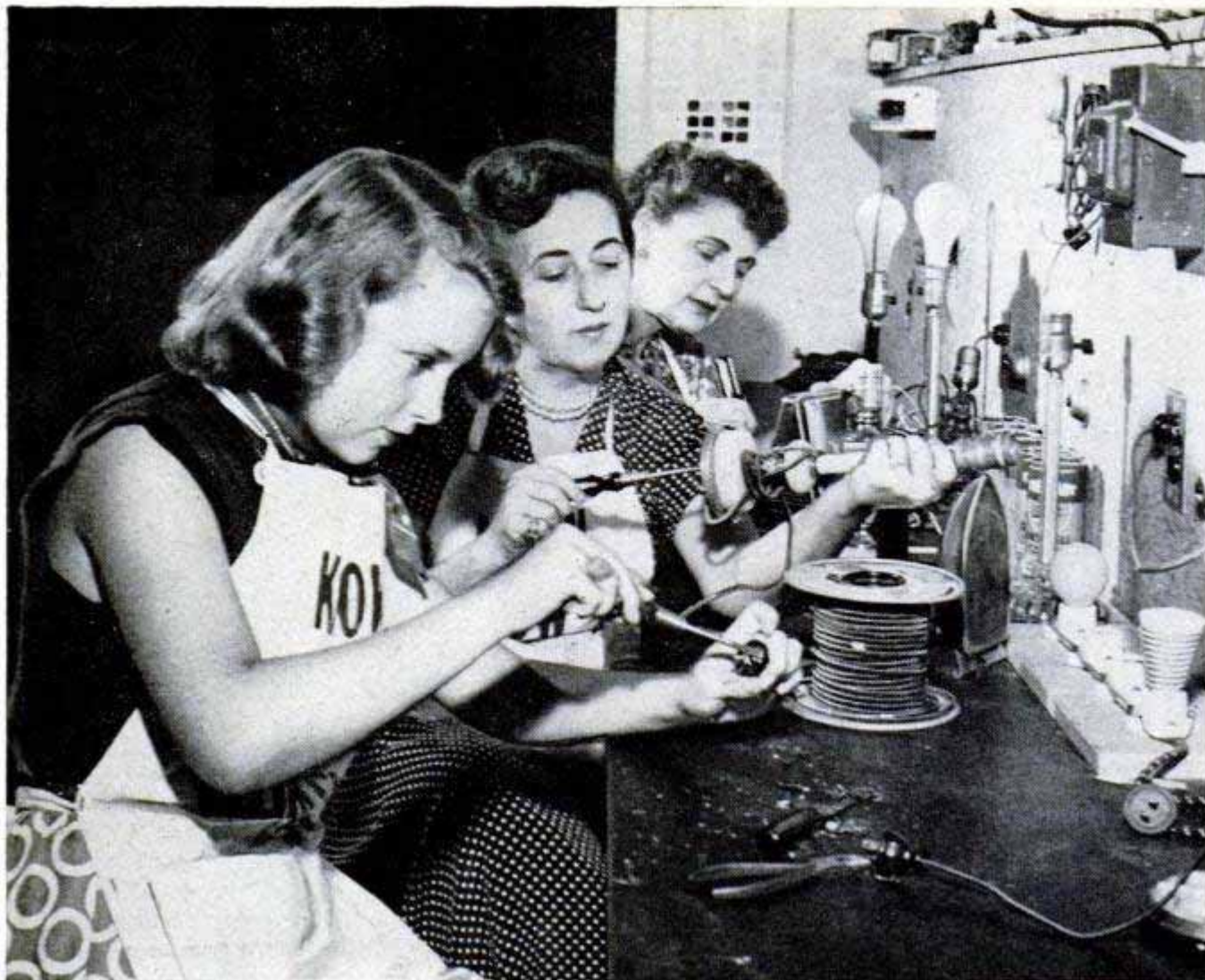

Students learn electrical work, then are handed worn-out appliances which they proceed to fix without help

Sit still, hubby. Your new bride can patch the hole in the plaster. Husbands heartily approve this school



SCHOOL for

MAKE WAY NOW for the woman who not only can do the housework, but also the home plumbing, upholstering, electrical repair work and even can pound a nail straight.

Most housewives, helpless before a burned-out toaster, a dripping faucet or a sofa with a broken spring, spend more time hounding hubby than they would spend in doing the repair work themselves—if they knew how.

Mrs. Lillian Baldwin decided not so long ago that she wanted to learn how to handle odd repair jobs continually cropping up in her home. She found that, at various schools, she could learn to become an upholsterer, an electrician or a plumber, but nowhere could she learn how to be a full-fledged handywoman.

Finally, she discussed the problem with a friend, and together they established a workshop where women could learn to cope with common home emergencies.

The result is a "college" in midtown New York where student-housewives become

proficient in handling such odd jobs as repairing broken crockery, fixing an electric iron or rewiring a lamp.

The housewives also are taught to mix paints, prepare a surface for finishing and how to stain or varnish furniture. Other subjects include the repair of window shades, replacing fuses, rewebbing upholstered chairs and even sharpening a knife or loosening a stuck bureau drawer.

Workbenches are fitted for electrical jobs, and sinks are available for practice on plumbing problems.

Students are charged \$30 for the nine-session course which is completed in 4½ weeks. "Graduates" are prepared to tackle with confidence odd jobs that would overwhelm most of their husbands.

By Joseph Kostin



Below, left, students who normally handle nothing heavier than a dust mop practice the plumber's trade on sinks in the school. Below, two young wives replace a broken cord in a fake window

Does Pop's easy chair have a sprung spring? Here a housewife learns to do an upholsterer's job herself



Handy Housewives





Shop-Made Space Heater

When mechanics of a Western truck line needed a space heater for their shop, they rigged one themselves from materials they found in the building. The gas-fired heater has a steel cylinder for a base. With a few lengths of old stovepipe they built a zigzag "radiator" five feet high, supported by lengths of steel rod. The result is a heater that warms a person from head to toe.

Hand Knitting Machine

With a new hand knitting machine the housewife can turn out fabric up to 30 stitches wide (about eight inches) and as long as desired. Scarves, hats and mittens can be made completely on the machine; larger articles such as afghans and sweaters are made in strips and sewed together. The yarn is first wound on the pins of the machine. Then in one movement the previous row of stitches is released. The final step for each row is casting over the stitches with a few sweeps of the hand.

Ainslie Knitting Machine Co., Inc.,
740-750 Grand St., Brooklyn 11, N. Y.

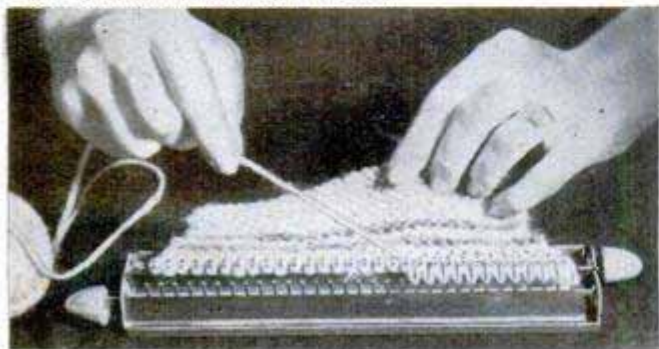

Scott-Atwater Manufacturing Co., Inc.,
2901 E. Hennepin Ave., Minneapolis 13, Minn.

Remote Controls for Outboards

Manual operation is outmoded by remote controls that shift gears and regulate the speed of outboard motors. It permits a helmsman up front, operating two control levers at his side, to maneuver and dock an outboard motorboat just as he would an inboard-type craft.

Degasser Valve Stops Bus Fumes

Pacific Electric busses in Los Angeles produce no dense clouds of eye-irritating fumes when coasting or slowing to a stop. Their gasoline engines are equipped with a degasser valve on the intake manifold that admits fresh air into the manifold when the engine is coasting. The added air creates a lean mixture that burns completely in the combustion chambers. Without the valve, the rich mixture of raw gasoline and air is exhausted in a partly burned state, creating fumes and smoke.

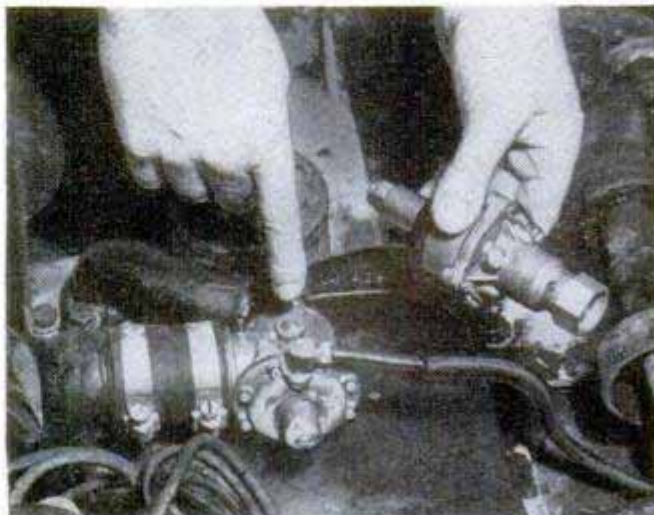

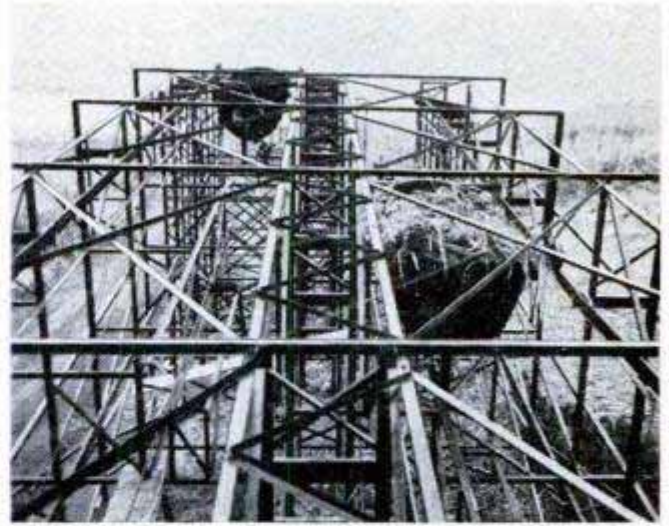

Above, left, buckets are loaded by a power grab atop the plateau, 1300 feet above sea level. Above, the filled buckets travel down the tramway to the mill by gravity. Empties are hauled up by a steel rope. Left, a downhill view from halfway point on tramway

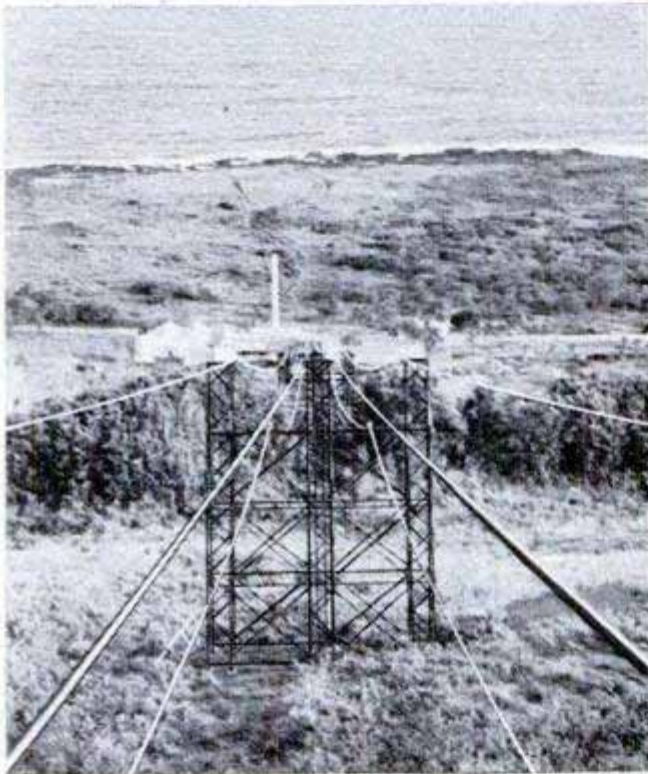

High-Riding Sugar Cane

Tons of sugar cane flow downhill from the high plateau on which it grows to the mill on the Hawaiian seacoast via a mile-long aerial tramway. Despite its cost of \$240,000, the tramway is a dollar-saving investment because it eliminates trucking, an expensive and slow process due to the rugged terrain. There are 23 two-ton buckets in continuous operation delivering as much as 100 tons of cane an hour. Sixteen towers, each 30 feet high and spaced from 100 to 700 feet apart, support the cables. At the mill terminal, buckets filled with sugar cane are automatically tilted, dumping the cane into a chute that leads to the mill yard.

Robot Caddy

It is still thought advisable to have the golfer swing the clubs, although an ingenious Oregonian has simplified life on the links with a radio-controlled caddy cart and lawn mower. Jim Walker of Portland attached a conventional cart to a power lawn mower and added remote control and radio equipment to lessen human effort.

Vegetable "Blood" May Save Lives

Powdered okra, a vegetable widely grown in the South, can be used as a substitute for blood plasma, research at Marquette University has shown. Plasma is administered as a transfusion to victims of shock caused by injury, surgery or anything else causing reduced blood volume. Tests made on animals show that one ounce of okra powder, when mixed with sterile water, is the equivalent of a quart of plasma.



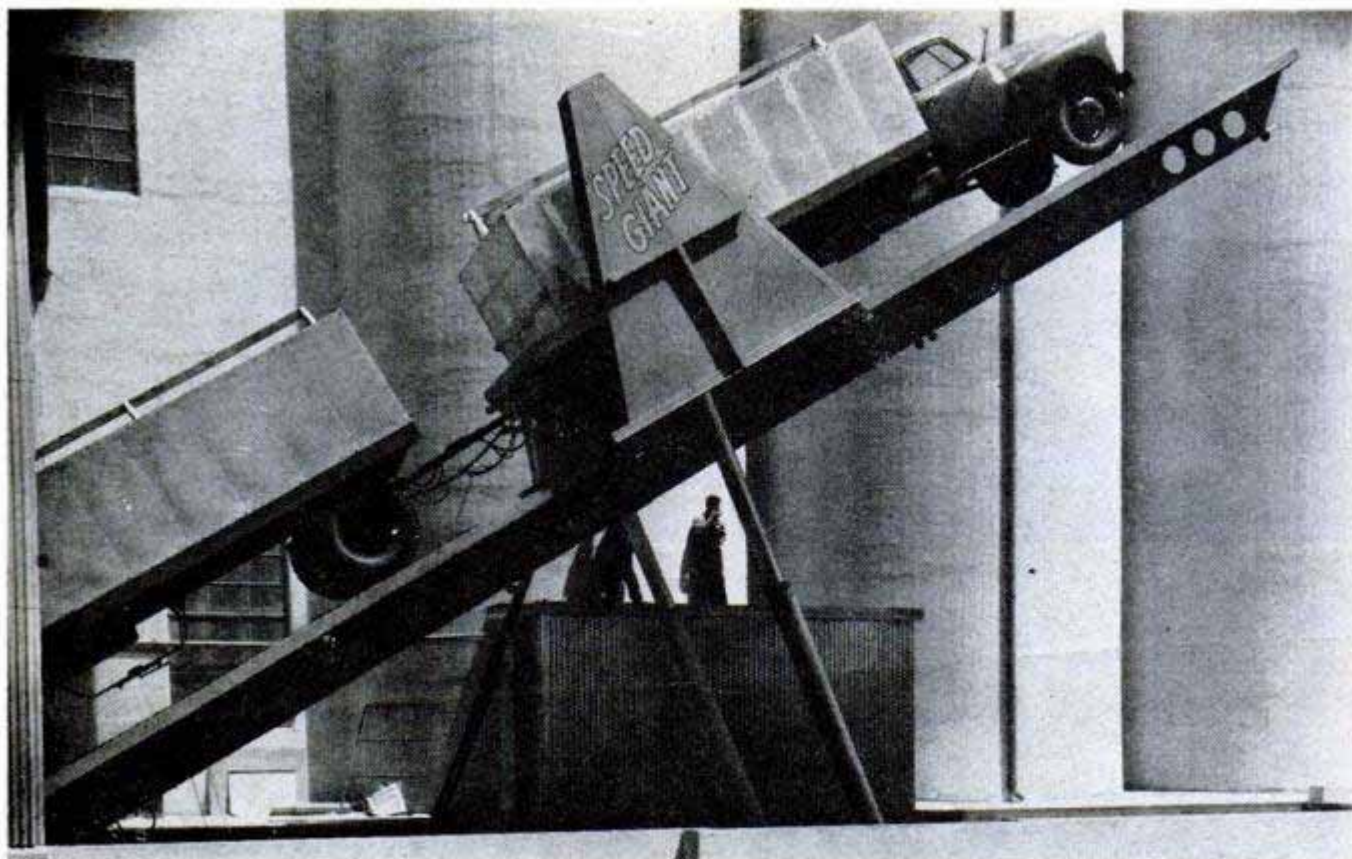

Truck Tilter

Truck loads are quickly emptied by a dumping platform that resembles a giant teeter-totter. After a truck or truck-trailer combination is driven onto the platform,

the operator presses a button that raises a chock behind the truck's rear wheels and then up-ends the platform to any angle up to 35 degrees. It can be lowered back to horizontal in 70 seconds or stopped at any angle desired.

Mechanical Cougher for Infantile-Paralysis Victims

Infantile-paralysis victims who have respiratory difficulties now can be forced to cough naturally inside a pressure chamber

similar to an iron lung. Previously, the patient's inability to cough could lead to serious and sometimes fatal consequences.

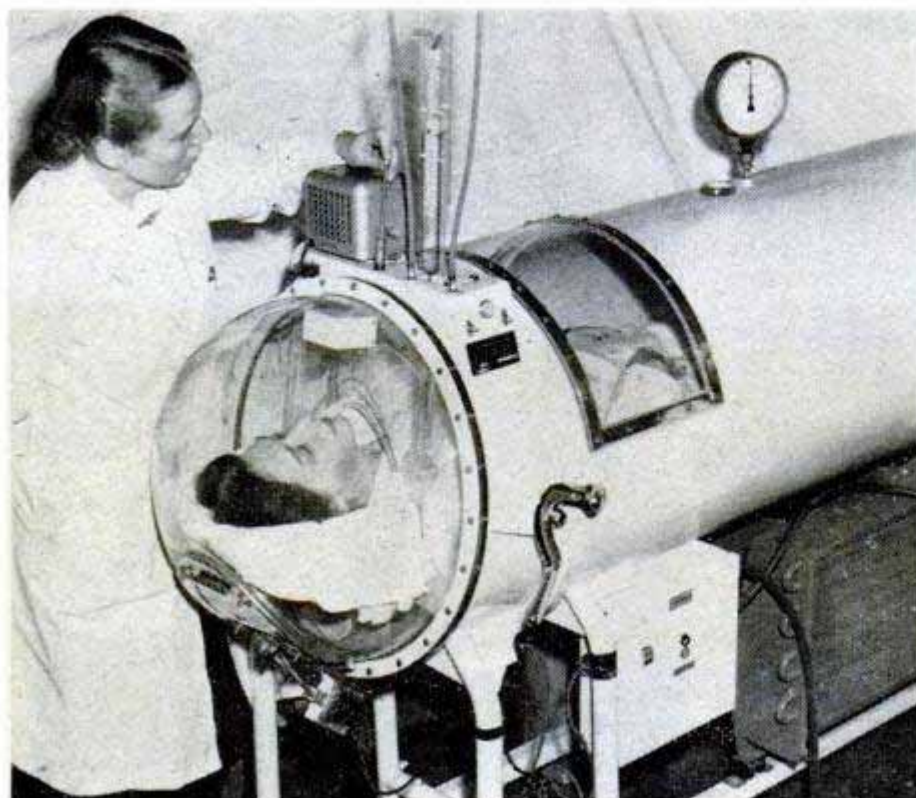

Inside the pressure chamber, a baffle is fitted closely around the patient's neck. An air valve timed to operate in $\frac{1}{1800}$ second permits a sudden and explosive compression of air on the patient's chest. The effect is similar to that of a natural cough by the patient. The pressure chamber was developed by Dr. Alvan L. Barach of Columbia University.

Sources of available products described in this issue are indexed on pages 12, 14 and 16. Sources of further information on other articles are listed in the WHERE-TO-FIND-IT LIST, available from the Bureau of Information, Popular Mechanics, 200 East Ontario St., Chicago 11, Ill.

American Way of Life

PHOTO CONTEST

What does America mean to you?

**Answer that question with a photograph
and win one of these big prizes!**

prizes

	Black and White	Color
1st Prize	\$1,000	\$1,000
2nd Prize	\$ 500	\$ 500
3rd Prize	\$ 300	\$ 300
4th Prize	\$ 100	\$ 100
5th Prize	\$ 100	\$ 100
6th Prize	\$ 100	\$ 100
7th Prize	\$ 100	\$ 100
8th Prize	\$ 100	\$ 100
16 Prizes—Black and White Only	\$ 25 each	

rules

1. The "American Way of Life" photo contest is open to all persons except employees of Popular Mechanics Company and their families.

2. There will be a Black-and-White Competition and a Color Competition with separate prizes in each. Hand-tinted prints are not eligible.

3. Photographs must illustrate your own conception of the "American Way of Life," but the subject you pick can be in any field — industry, agriculture, government or any other. You may see it in a country store, a view, a man at work, a city street or a thousand places. Winners will be selected on (a) how well the picture illustrates the "American Way of Life" and (b) its all-around photographic excellence.

4. All entries must be postmarked not later than midnight, September 1, 1951, and must have been taken between April 1, 1951, and September 1, 1951. No entry fee is required and there is no limitation on the number of entries you may submit. Data sheet, giving information listed at the bottom of this page, must be attached securely to the back of each entry. When submitting transparencies, attach data sheet to the top of the transparent sleeve.

5. All prints and transparencies will be held until after winners are announced in the 50th Anniversary Issue of Popular Mechanics, January 1952. Non-winning prints and transparencies will be returned as soon as possible thereafter, provided that a self-addressed and stamped envelope is enclosed with the entries.

6. Black-and-white prints must be no smaller than 8 by 10 inches and no larger than 11 by 14 inches and must be mailed flat and unmounted. Color prints submitted must be 5 by 7 inches or larger. Color transparencies must be 2¼ by 2¼ inches or larger.

7. All prize-winning photographs become the exclusive property of Popular Mechanics Company. Original negatives of prize-winning prints must be submitted upon request.

8. Judges will be selected by the editors of Popular Mechanics Magazine. Their decisions will be final. In case of ties, duplicate prizes will be awarded.

9. Mail all entries to PHOTO CONTEST, POPULAR MECHANICS, 210 East Ontario St., Chicago 11, Ill.

10. Popular Mechanics Company will use all reasonable care in handling entries, but it can assume no responsibility for loss or damage of any entry.

Attach to each photograph the following information:

- | | | | |
|-------------------|---------------|------------------|----------------|
| 1. Your name | 4. Subject | 7. Shutter speed | 10. Film |
| 2. Street | 5. When taken | 8. Lighting | 11. Lens stop |
| 3. Town and state | 6. Camera | 9. Where taken | 12. Other data |

Adobe...



Above, Mission San Gabriel, near Los Angeles, is an adobe structure that was built more than 150 years ago. Right, each adobe brick (weight: 30 pounds) is examined for cracks. These bricks are drying, a process that takes 10 days. Below, a modern relative of mission, above, is a present-day adobe-brick home

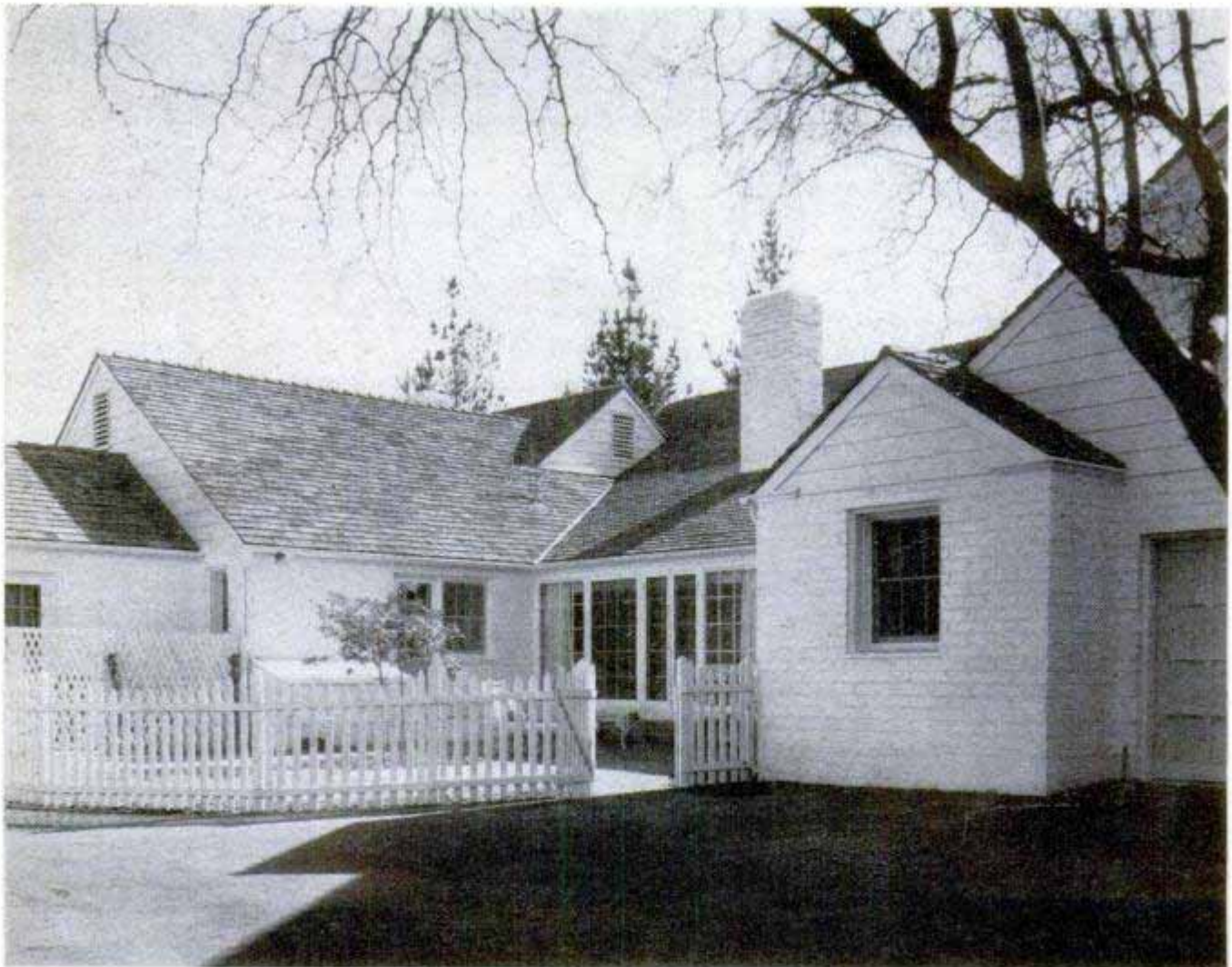

GOES MODERN

By
Jack B. Kemmerer

ADOBE as a building material antedates the discovery of fire. When man first emerged from his cave he constructed a rude framework of sticks and plastered it with mud. Mud or, as we know it, adobe has been used through the ages.

From mud-plastered walls man progressed to making bricks of mud. It was a crude, slow process, and all bricks were handmade in small quantities. These bricks, though not waterproof, for centuries withstood the ravages of both man and the elements. One of the oldest houses in the United States, built entirely of adobe, has stood for hundreds of years in Santa Fe, N. Mex.

Now, petroleum scientists have developed a stabilizing agent. It is guaranteed to make adobe permanently waterproof. The Standard Oil Company of California,

in conducting research to improve road-paving materials, discovered that emulsified asphalt—colloidal asphalt and water—would waterproof any material it was added to.

During these experiments the new stabilizer was mixed with adobe, and we now have stabilized adobe bricks that are waterproof, insectproof, soundproof and, of course, fireproof. This material will make one of the longest-lasting houses ever built.

To be popularly accepted, adobe bricks had to be made in quantity and be readily available. Stationary plants were set up for this purpose. However, once the usable soil in the immediate vicinity was exhausted, long hauls were necessary and this increased the price of the finished bricks.

To overcome this difficulty, Ben Pinsker

Here is the den of the colonial house, shown opposite. Even the interior walls were made of adobe brick



of the Certified Adobe Company, Los Angeles, designed and built a portable machine. It is constructed on the chassis of a one-ton truck and can be moved to any location where the earth has been determined satisfactory for making bricks.

This machine consists of a digging wheel, mill for grinding the earth, mixing mill and an extrusion die.

The adjustable digging wheel can be set to take a cut from three inches above ground level to 12 inches below ground level. Six cutting shovels dig into the earth as the wheel revolves. The earth is carried into the hammer mill by a screw conveyor. In the hammer mill are 60 swinging steel hammers which pulverize the earth until it is as fine as face powder.

Suction created by the engine exhaust removes the dust from the mill, thus preventing dust explosions. This exceedingly fine dust escapes from the bottom of the muffler through a rubber hose. It can be sacked and makes an excellent mortar for the adobe brick.

The pulverized earth then passes from the hammer mill to the forward end of the "pug" mill, which is a deep rectangular trough with two contrarotating shafts six feet long. Each shaft has 48 sets of mixing blades.

The earth is mixed with the stabilizer and water to the proper consistency. As the earth is mixed it moves down the trough until it reaches the last two sets of blades on the shaft. These force the earth into the compression chamber.

The brick is formed and shaped by an extrusion die and shaper cap. The pressure in this chamber is 500 pounds per square inch. The adobe bricks emerge four inches thick and can be made in any width from 2 to 12 inches.

Mounted on a truck, the brick-making machine can be moved to any area where soil is of proper type

The earth is extruded like toothpaste and is cut into bricks 16 inches in length. A length of piano wire serves as the cutting knife.

After the bricks are cut they are stacked on wooden platforms. In warm weather the bricks dry in about 10 days and do not require turning during the process. However, they must be stacked carefully to provide an air space around each brick for even drying.

"The first 30 minutes of a brick's life are the most important," explains Pinsker. "Any strains, stresses or cracks will start during this time."

Before the machine is moved to a new location, Pinsker makes a careful study of the new area. The earth is laboratory tested. It should consist of 60 percent alluvial clay and 40 percent fine, sharp sand. One hundred thousand bricks can be made from one acre of land with an eight-inch cut.

Adobe has superior insulation qualities. Four inches of adobe are equal to one inch of mineral-wool insulation. Adobe laid in good mortar withstands earthquakes, cyclones and tornadoes.

People who live in adobe houses are positive that it is the best material to use. When you build with adobe, you are building for eternity.

1. Adjustable digging wheel on the portable machine for making adobe bricks is set to any desired depth
2. Screw conveyor moves the earth from the digging wheel to the hammer mill that pounds it into powder
3. Emulsified asphalt, the stabilizer, is mixed into the powdered earth by the 96 blades of the "pug" mill
4. Extruded by the machine, the "ribbon" of adobe is cut into bricks and carried by shovel to drying yard



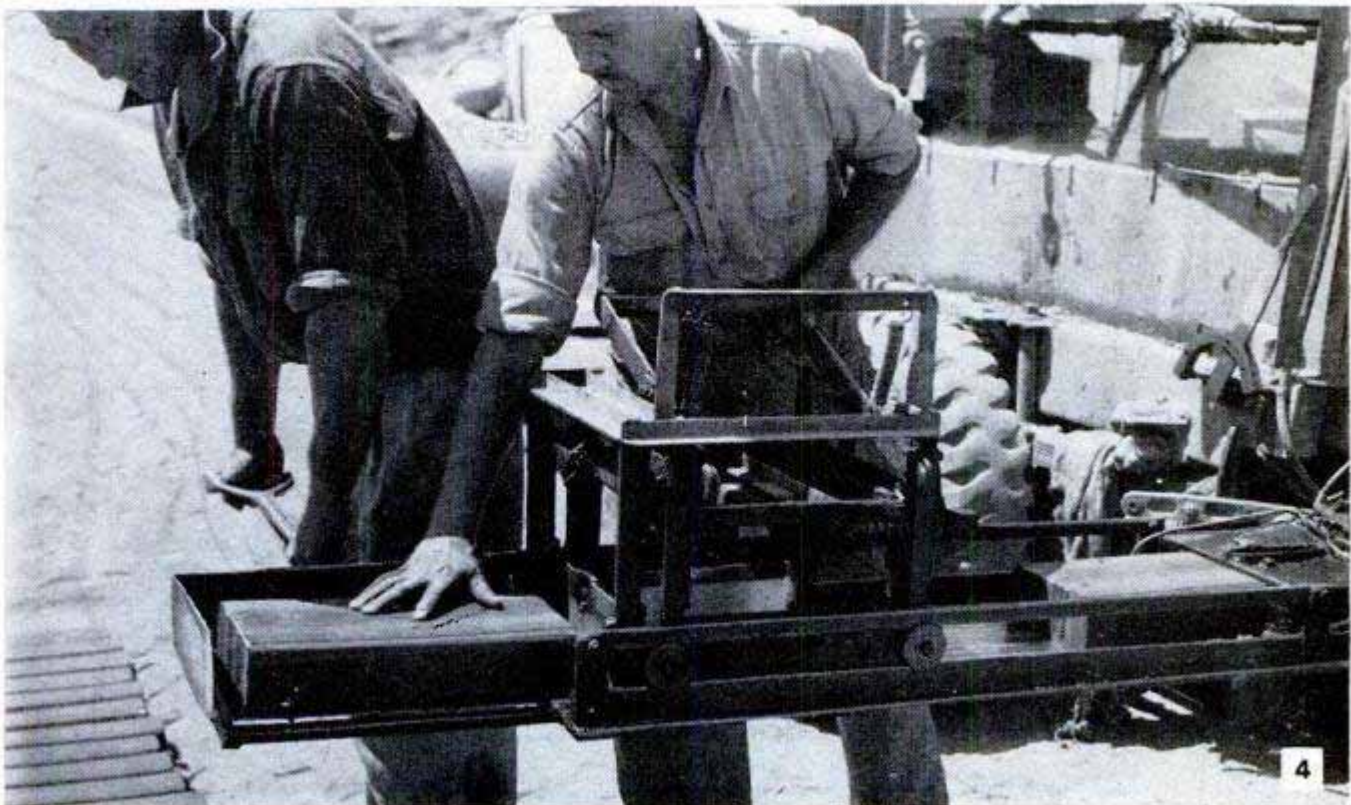
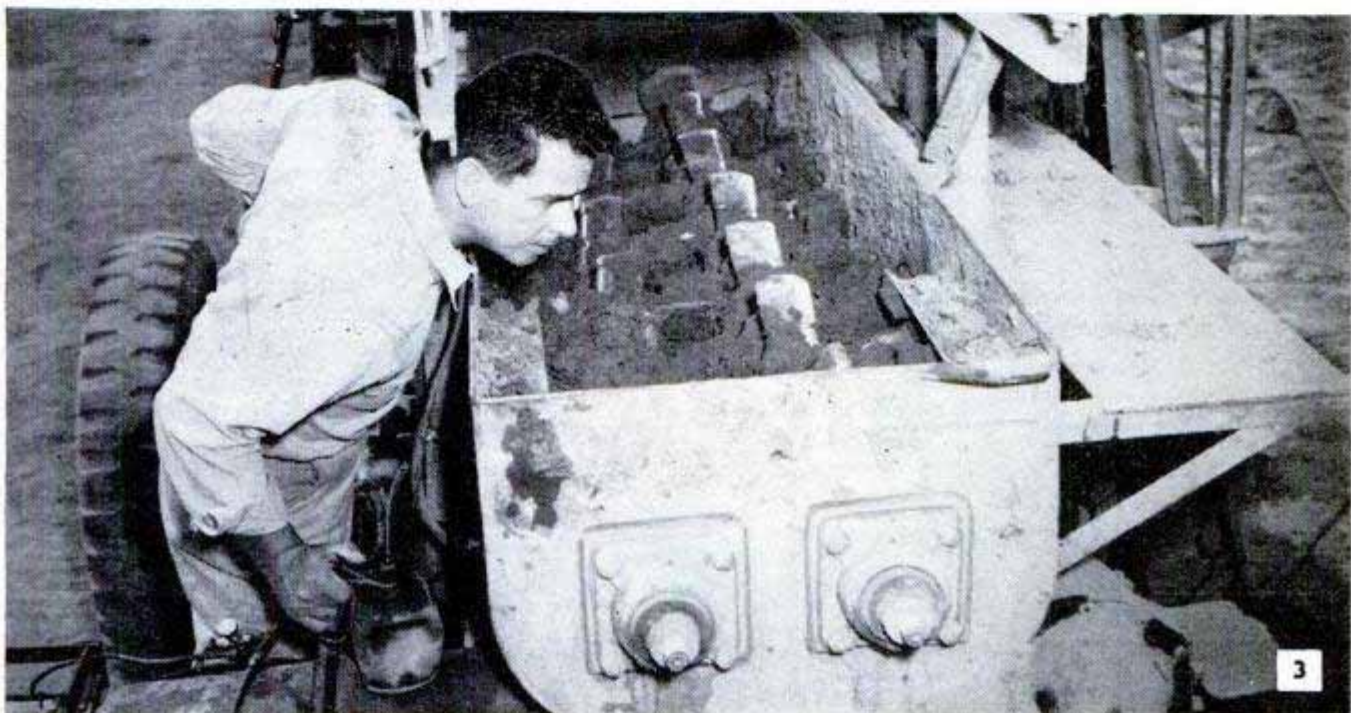

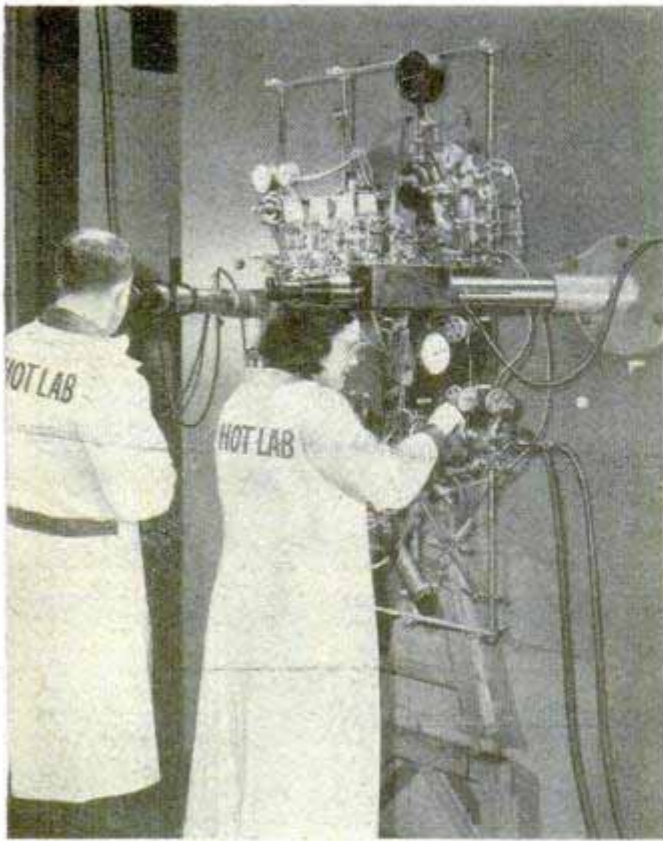

One scientist observes results of tests by periscope as colleague, right, operates the controls

LOCKED TIGHTLY in "cells" with walls thick enough to stop their radiations, "hot" atoms perform for the scientists at Brookhaven National Laboratory's new Hot Lab. These cells are made of stainless steel backed by concrete walls three feet thick. Direct observations are made through periscopes while data observations are made by instruments outside the chamber.

There are three such cells at Brookhaven. These are used only with the hottest of hot materials, or radioisotopes. Eleven-ton steel doors, one foot thick, bar the only opening to each cell while experiments are in progress. These doors slide to open or close and each move takes only five seconds despite the tremendous weight.

Equipment for each experiment is pre-assembled on a panel which is then fitted into one of the doors. When the experiment is completed, the panel is removed for decontamination in special "clean up" rooms near by. This system reduces "dead" time for each cell to a minimum, as one experiment can be set up while another is in progress inside. Because of the stainless-steel lining, the entire cells can be scrubbed clean if contaminated during an experiment.

HOT LAB'S "Cell Block"

Right, these fertile eggs will be bombarded in the "semi-hot" cave, used in experiments where radiation is weaker. Below, a preset panel is moved into its place on the "hot cell" door just before test begins. Below, right, radioactive material is stored in a concrete well

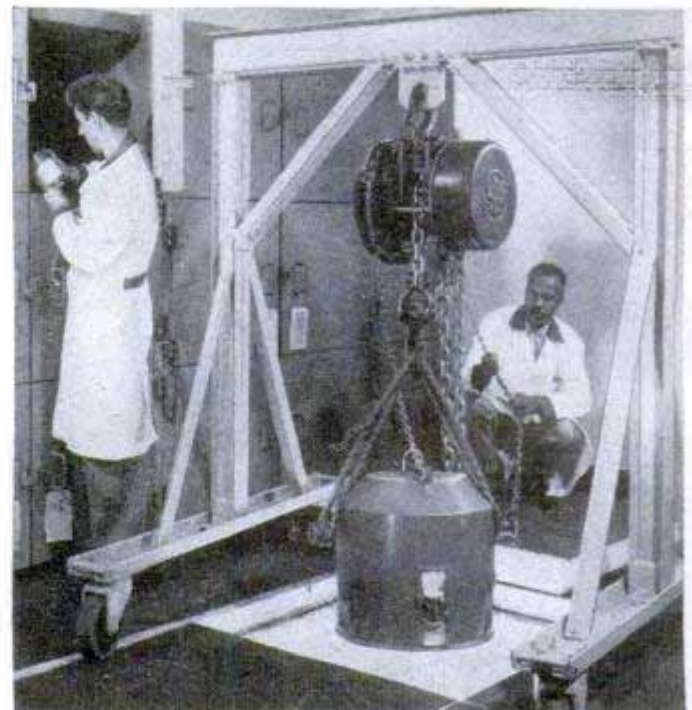
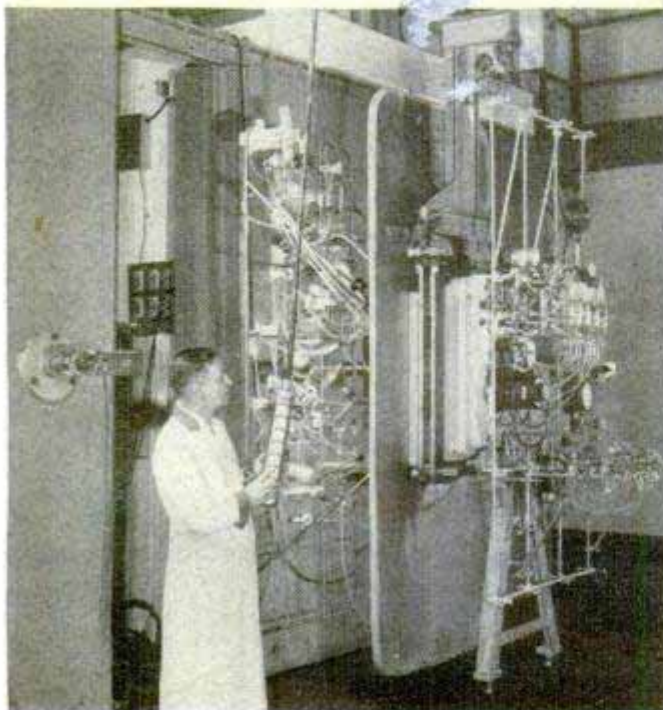
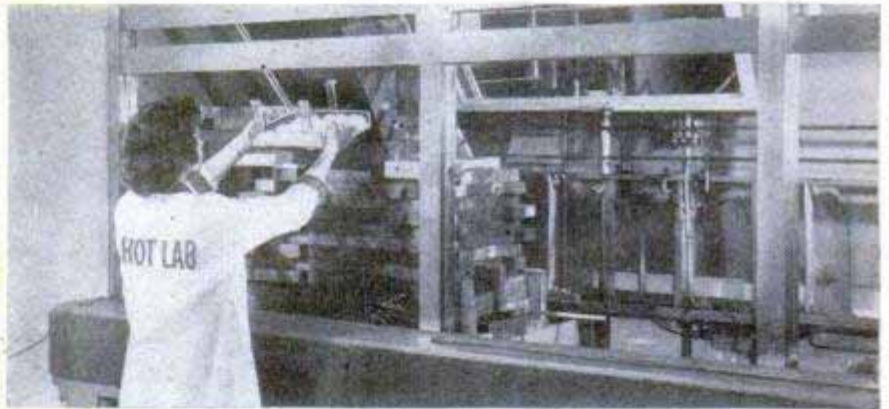



Keyco Mfg. Co., 1250 E. 12th St., Oakland 6, Calif.

Auto-Body Repair Jack has 3000-Pound Punch

Automobile-body mechanics do better work and do it faster with a lightweight body-jack kit that pushes or pulls with a 3000-pound force. The jack itself weighs less than six pounds and is completely me-

chanical in operation. Very compact, it can be used in the close quarters characteristic of body work. A variety of attachments for the jack permits the mechanic to do all straightening jobs with this one tool.

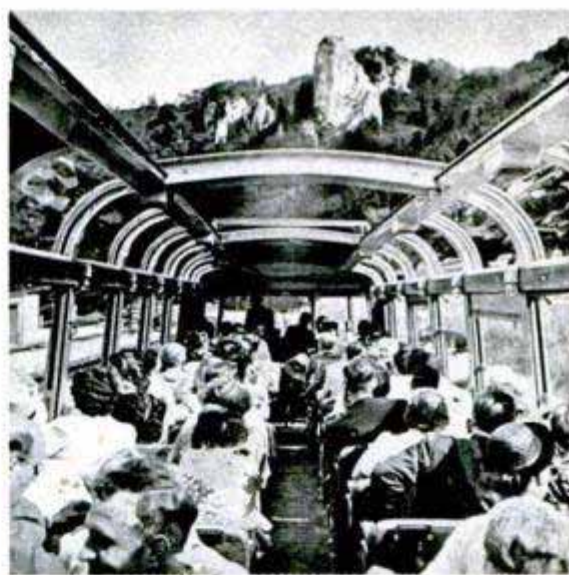

German Federal Railroads photos

Convertible Railroad Coach Has Rollaway Top

Sight-seers see all the sights when they tour the Bavarian Alps in a new open-top diesel train of the German Federal Railroads. Two 180-horsepower engines mounted under the floor are hydraulically coupled to the wheels and drive the single-

coach train up to 72 miles an hour in either direction. The sides and top are all windows except for a narrow strip in the center which has a rollaway canvas cover. In addition to an engineer and conductor, the car carries 60 passengers.

Arsenic—Just a "Pinch"—Makes Lead Alloys Stronger

Just a "pinch" of arsenic added to the lead alloys, which cover underground electric cables, will improve the life and strength of the metal. The University of Illinois, which conducted the research, interprets a pinch as one tenth of one percent of ar-

senic. Lead alloys are used to shield the cables because they are resistant to moisture and corrosion. However, the alloys sometimes crack due to expansion and contraction. The arsenic gives the alloy resistance to such cracks.

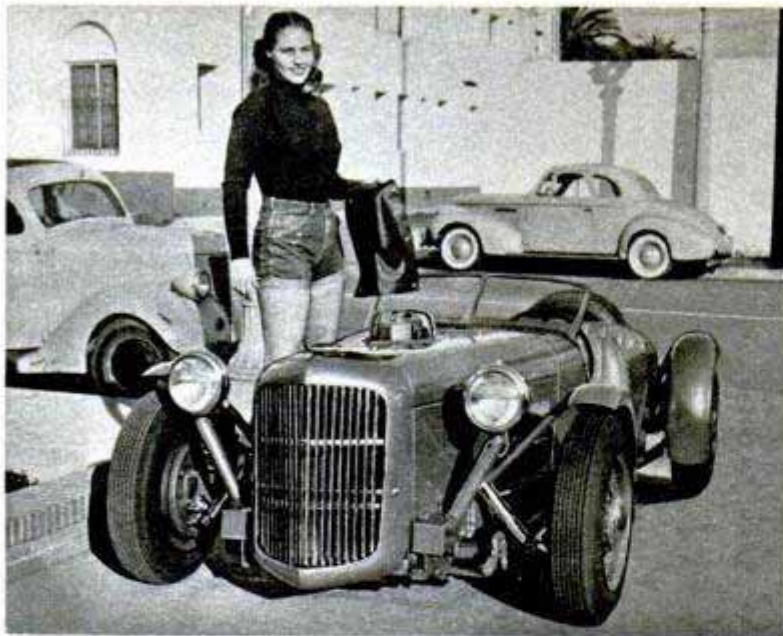

Handmade Sport Car Is Knee-High to Owner

Built so close to the ground that it barely clears its own shadow, a sleek, speedy sport car is the pride of Mrs. Linda Plannette, who is a spare-time Los Angeles mechanic. She and her husband put together the souped-up car, using a standard Mercury frame shortened by 18 inches and a stock 1949 Mercury engine. Weighing 2340 pounds, the custom-made car has a road clearance of only six inches and has hit 110 miles an hour in tests. The Plannettes devoted three years of their spare time to collecting parts and building the car.

Door-Level Truck For Cargo Planes

On-the-ground time can often be halved by a new cargo-loading unit for airplanes that acts as a door-level storage room. The load is made ready prior to the plane's arrival and then immediately placed on board. The platform, which can be built to the cargo-door level of the type of plane that is most frequently loaded, can be either of two sizes, 12 by 20 or 12 by 24 feet.



Crimseo Mfg. Div., Truog-Nichols Inc., 1730 Oak Street, Kansas City, Mo.



Cartridge Starter for Jets

Cordite cartridges are being used to start jet airplane engines. The jets require about 10 times the energy input needed for starting piston engines of comparable horsepower. Each starter unit, which weighs 60 pounds, has two cartridge barrels and a small turbine. A firing button ignites one of the cartridges and its gases start the small turbine, which in turn accelerates the main jet turbine to self-sustaining speed. The starter's normal peak is 40,000 revolutions per minute and a safety device holds it to 45,000 revolutions per minute.

Sources of available products described in this issue are listed on pages 12, 14 and 16. Sources of further information on other articles are given in the WHERE-TO-FIND-IT LIST, which is available without charge from the Bureau of Information, Popular Mechanics, 200 East Ontario Street, Chicago 11, Illinois



Electrified Curtains Warm Air Around Casement Windows

Giving a new twist to the electric-blanket idea, Jack Brightman of Erie, Pa., has installed electrified curtains in his home to warm the chilly air that comes in casement windows. Brightman arranged ordinary heating wire in loops on the lower part of each curtain, then had his wife sew the loops in place. He checked the wattage and voltage of the electrified curtains to make sure they wouldn't be a fire hazard. Now when winter winds blow against the house, the Brightmans "turn on the curtains" and the air near the windows is pleasantly warmed. Brightman, oddly enough, is a refrigeration expert for the General Electric Company.



Lenk Mfg. Company, 30-38 Cummington St., Boston, Mass.

Electric Calf Dehorner

Calves are dehorned faster and with less pain and no bloodshed by a new electric heat unit resembling a soldering iron. The unit's tip, placed against the horn button, comes in contact with the horn growth cells and destroys them, preventing further growth.

TV Teaches Photography

More than 700 persons registered for a course in photography that was given over Station WWJ-TV in Detroit. The television camera showed the students how to focus, how to light a portrait and how to compose a photograph. The course, aimed at the beginner, lasted seven weeks.

German-Built Housefly Model Airplane

Powered by a rubber-band motor, a sub-miniature model airplane built by a German in West Berlin flies like the real thing despite its small size. The hobbyist calls his model the Housefly. Made of water reed, balsa wood, onion-skin paper and fine steel wire, the plane is so light it would take 50 of them to weigh an ounce.

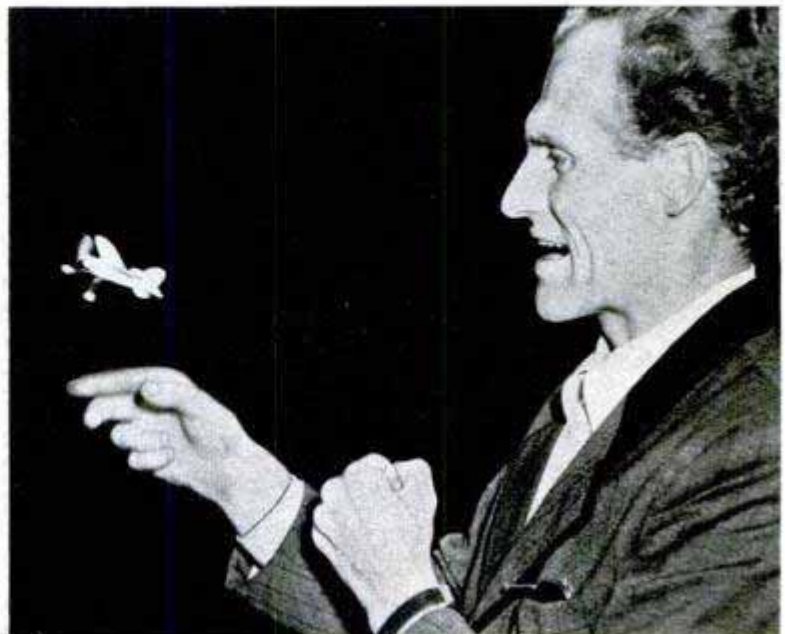

Sources of available products described in this issue are indexed on pages 12, 14 and 16. Sources of further information on other articles are listed in the WHERE-TO-FIND-IT LIST, which is available to readers from Bureau of Information, Popular Mechanics Magazine, 200 E. Ontario St., Chicago 11

Fine Orlon filaments drop from spinnerette into hardening bath. Right, thousands of strands form a rope tow



By Michael Day

BRAND NEW MATERIALS that look and feel exactly like wool, silk or cotton now are being brewed in huge chemical plants. The "woolen" suit you wear tomorrow may be made of corn, spruce trees or peanuts. Your wife's fluffy "cashmere" sweater already may have as its basic ingredient the same stuff that's used to make antifreeze for your car. Milk, brine, crude oil, oxygen, nitrogen, natural gas, glass, chicken feathers—all are basic materials for an assortment of new man-made textile fibers, each one chemically tailored to contain special properties for special purposes.

Out of our modern brew pots are coming woolly blankets and clothes that won't shrink, satinlike overcoat linings as warm as wool, laboratory aprons that acid won't touch, cottonlike skirts that will hold a hundred pleats after being soaked in a jug of water for a month. There are fabrics for curtains that won't wrinkle, stretch or shrink. There are sunproof, mothproof, waterproof, fire-resistant and mildewproof fabrics. There's a fluorescent satin that

glows in dark or daylight. There's even an incredible cloth that looks, feels and acts like cotton—except for one thing. Drop it in a bowl of tap water and it disappears.

Nearly all of these new materials are made by extruding one of a number of basic chemicals through a spinnerette, where it is forced out through tiny holes in long, shimmering strands that instantly are run through chemical baths to solidify them. By using the filaments individually, by gathering them into tows, or hanks, and by crimping, cutting, brushing or combing them in different ways, different fibers are created. From them are produced materials that are fuzzy, like wool, sheer as silk, compact as cotton or linen.

One of the most-talked-about of the new fibers, already on the market, is Orlon, made by the DuPont Company of Wilmington, Del. Acrylonitrile, its chief ingredient, comes from limestone, petroleum, natural gas, coal, air and water. Orlon feels and looks silkier than silk, and silky textiles can be made from it by using the long strands. But by chopping it up into shorter—"staple" fiber and giving it a "permanent

Tow is crimped with heat to give it a springiness similar to wool. It then is cut to desired lengths and fluffed up

After fluffing, Orlon is a staple fiber handled much the same as wool or cotton staple. It can be spun into yarns which simulate almost any natural fabric

Finished material is Orlon yarn drawn from the staple. It can be made into fabrics which resist wrinkles, moths and mildew

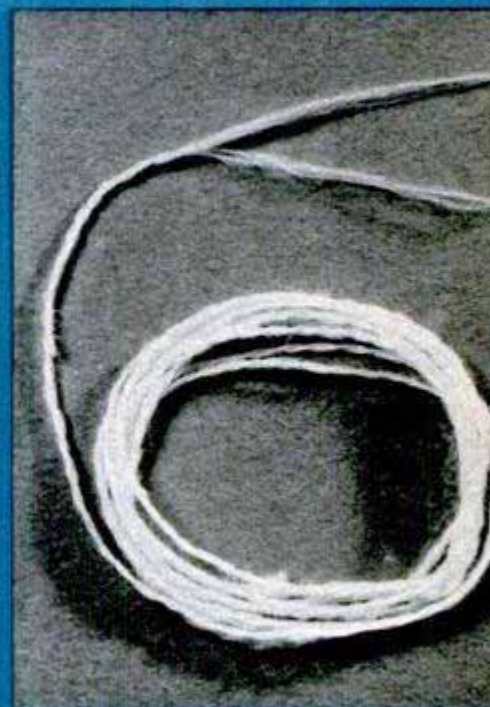
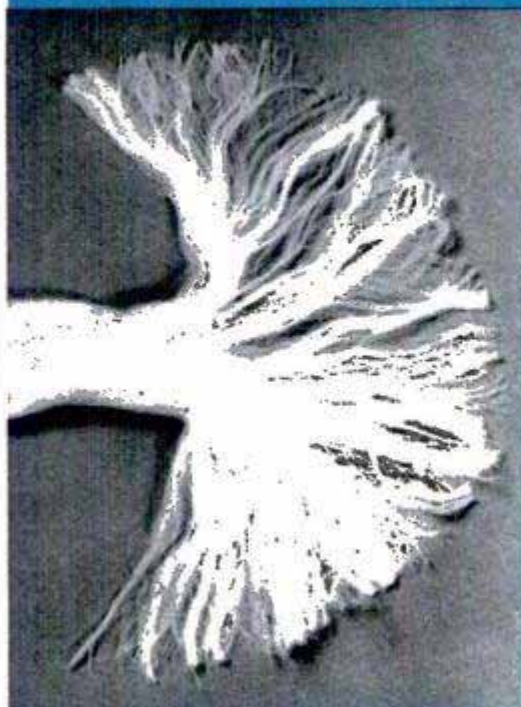

There's a New World in TEXTILES

wave," it can be twisted into a yarn which, according to its developers, is the most woollike fiber yet made by man.

Hot sunrays that dry out and weaken most fibers, have almost no effect on Orlon. It sheds water and refuses to harbor mildew or fungus. It's highly acid-resistant and a lighted cigarette can't set it afire. Moths, carpet beetles and other insects hate the sight of it. In many ways, it's the most rugged fiber going. But despite this, and

unlike tough nylon, it has a warm, soft texture wet or dry. In all-weather tests sponsored by DuPont engineers, the new fiber lost less than a quarter of its strength, after control samples of nylon, silk, wool and rayon had fallen to shreds.

A five-year-old Orlon top on a convertible is still solid, though a control car is shedding its second ordinary canvas top now. An Orlon awning put over a Wilmington shoe store 4½ years ago still looks like new.

Orlon car top, installed in 1946, looks like new. It resists sun, can be flexed without any damage





Worker combs Caslan fibers which look like coarse hair. They will be cut, used as paintbrush bristles

But it isn't just coarse Orlon fabrics that are unique. The fibers can be woven into any finish from the softest cashmere to the toughest carpet pile.

Men's suits made of Orlon look just like wool, but can be cleaned in a washing machine. Wear them in the rain, if you like. The creases stay put, and the suit will dry almost as fast as a pair of nylon stockings.

Silky shirts and underwear of Orlon for men can be washed in a sink and hung over the towel rack to dry. They'll be ready to wear in a few hours, and need no ironing. When Orlon is woven into marquisette curtains, your wife can throw her stretcher away. The material won't shrink. Besides, due to its resistance to sun, heat, smoke and acids, it has a phenomenally long life.

An important use for Orlon at present is in the chimneys of industrial plants, filtering out tons of chemicals, soot and fumes you would otherwise inhale. Most filters today are made of cotton or wool bags, through which smoke is forced. When they're full, an automatic dumper empties them. But tremendous heat and corrosive acids rot out the fabrics in no time, and replacements are frequent and expensive. Here's where Orlon comes in. Filters of it, tested over the past few years, have outlasted any other known material 17 to 1.

When will you find all these wonderful things in your neighborhood store? Within the year, DuPont men say. Right now a

second plant is being built at Camden to produce Orlon staple at a rate of 15,000 tons a year. Industry is taking most of the present output of continuous-filament yarn, which will be used first in awnings, car tops, sails and outdoor-furniture covering. The finer fabrics for clothing and home materials will be along soon after.

A new chemical fiber you'll be seeing quickly, because it's been in production since July of last year is dynel—produced by the Union Carbide and Carbon Corporation. Dynel is made of vinyl chloride and acrylonitrile.

Dynel staple makes a fabric that is literally warmer and woollier than wool. It can be woven soft as mashed potatoes or as tough as mohair. Water has no effect on it. It has a high resistance to bleaches, corrosive chemicals and wrinkling. High heat will set a crease in it as permanent as the Rock of Gibraltar.

To prove these points, dynel men in the home office of the company will show you some startling exhibits. There's a pleated woollike dynel skirt hanging in a container of water. "I think it's been there two months—or is it three . . .?" says the man. Every pleat is as knife-sharp as the day it went in. In a container of pure Clorox there were placed two pieces of dynel and wool. Now there's just dynel. The wool is a hazy fuzz on the bottom of the jug, where it fell after being dissolved by the chemical.

Dynel is the only pure organic fiber that won't support fire in fine textiles, according

Chemical textiles are fuzzed into fluffy fabrics by special method. Here material passes over wavy roll





Every item in this picture is made of Orlon, from socks to umbrellas. Material is mildew and mothproof

Fuzzing cylinders are covered with wire spikes of various lengths which tear open fabric's knitted loops



Lovely lass models a bathing suit made of—peanuts! Government scientists developed the new protein fiber

Result is a furry chemical fabric from which soft bed jackets and fluffy linings for coats are made

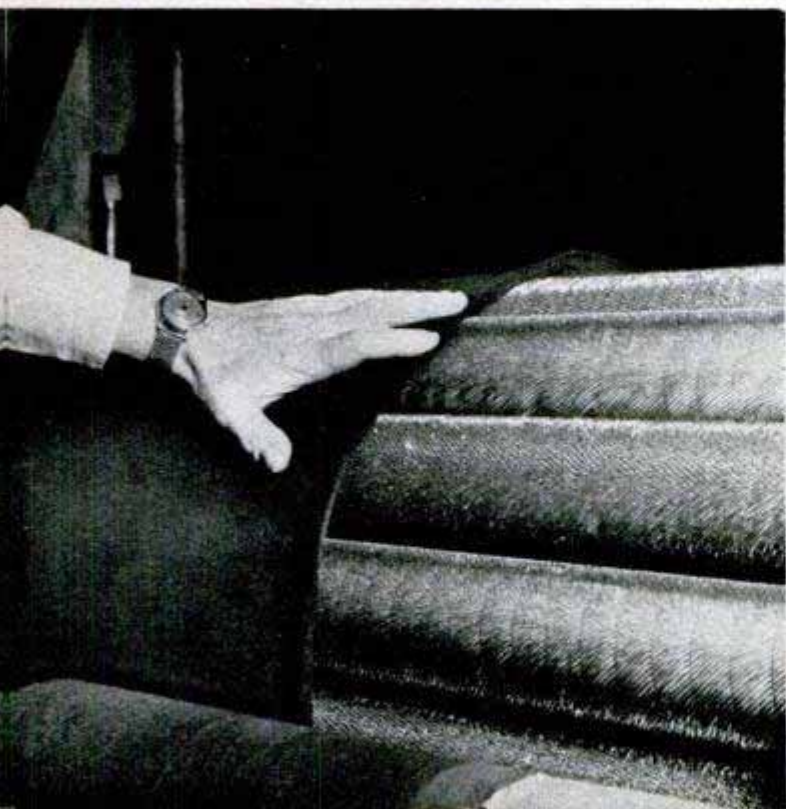

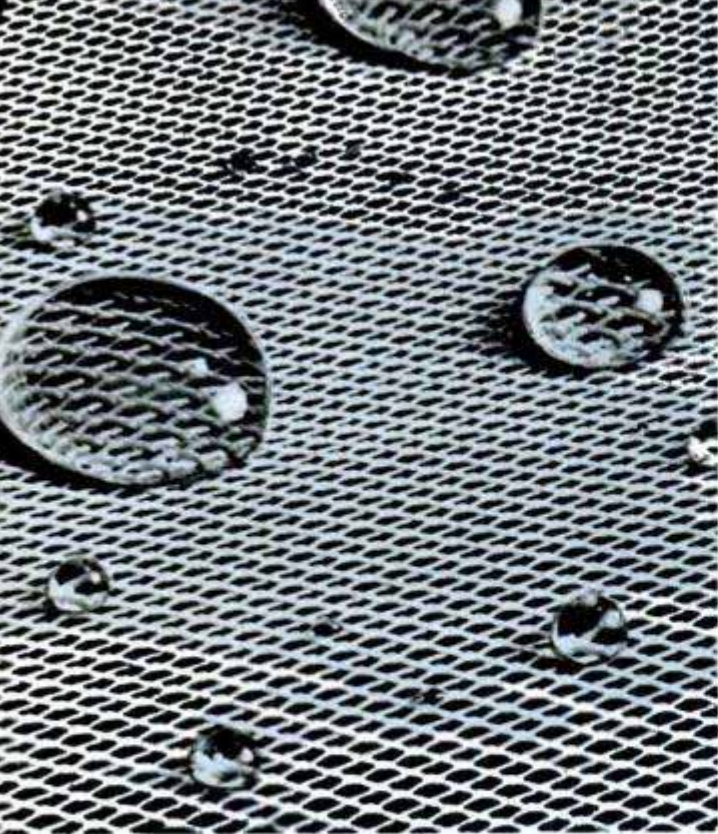

Water gathers in globules instead of penetrating a fiber treated with DeCetex 104, a silicone solution

to Union Carbide. To prove it, you can burn your fingers off lighting matches under a sample maintained for the purpose.

Already, warm, woolly dynel blankets are on the market. They're even making wigs for dolls out of the fiber because, for an odd chemical reason, the synthetic hair can be given a wave by any doll's young mother with a simple solution of sugar and water. There will be a rash of washable, quick-drying fuzzy blankets and socks of the fiber. By next fall, you'll see dynel non-shrinkable sweaters, draperies and women's dress goods. Men's work clothes that acid and chemicals can't burn are already being used in industry; the pleats are permanently creased. The clothing is warm and mothproof. There will be soft, deep, dynel pile for furry collars and coat linings.

What gives wool warmth is its springiness which, when the fibers are bunched up, creates a lot of dead air space that serves as insulation. To give chemical fibers the same effect you get in fuzzy blankets has been a real trick. By putting a heat kink in short-staple fibers, resilience has been added. Fuzzing it up is something else.

At Empire State Mills in New York, the company's president, Arthur Brook, has been fuzzing up heat-crimped, man-made fibers for 20 years. First the staple yarn is knitted into a long, wide bolt. The knitted bolt then goes over a series of wire-brush rollers, bristling with pinlike spikes. The thousands of wire spikes hook into the knitted loops, as the material passes over them, tear them open and spread the fila-



Young lady's suit, treated with the chemical, sheds water like an oilskin while rain soaks her companion

ments in all directions. Result: a soft, downy, thick, woollike blanket.

Still secret is Brook's system, developed more recently, for making long, furlike nap from nylon, rayon, Orlon and many other new fibers. Basically, the process is the same, but for years no one has been able to

Lawn and garden furniture covered with Orlon has been outdoors for two years, both winter and summer, and still retains bright color and appearance



get a consistently long fuzz. From Empire comes a material that looks for all the world like rabbit fur. But it's warmer, softer and more durable.

Most chemical fibers will not replace wool or cotton, but will be blended with them to provide the best qualities of each. One of the most recent synthetics for such blending comes from the farmers' cornfields. It is called Vicara and its basic ingredient is zein—a white powdery substance which is a protein of corn. Up to now it has been a waste product in the manufacture of starch and other corn products. The U. S. Department of Agriculture, a few years ago, did the basic research that has turned this waste into a staple fiber.

Vicara isn't quite as strong as wool, but is softer and just as warm. About 20 million pounds of it a year are already being made by Virginia-Carolina Chemical Corp., and you'll find it in popular bathing suits, sweaters and knitted socks. It gives a beautiful sheen to gabardine and a warm, soft feel to rayon.

The Department of Agriculture has been experimenting with other protein fibers made from peanuts and milk. So far, the soft, downy staple from peanut protein has not proved practical commercially. One fiber from milk casein is, however, finding plenty of use. For fabrics it's not too good. It is so coarse and springy that one textile manufacturer claims "it must have come from discontented cows." However, milk fiber in long, continuous-filament form, as it comes from the spinnerettes, has proved itself in other fields. Great hanks of it were chopped up in a New

(Continued to page 228)



At about 9:30 washday morning, a housewife drops her Orlon curtains in her machine. Below, one hour later she is rehung the clean curtains. The fabric dries quickly and even the fancy ruffles need no ironing



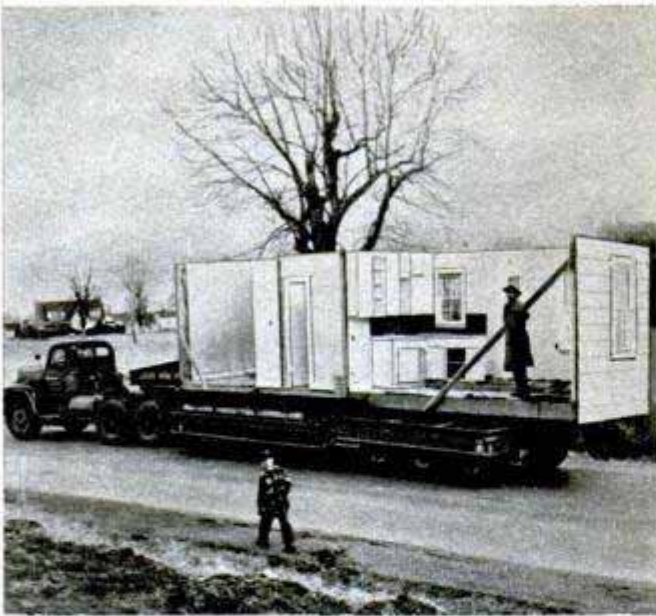

After being cut into five trailer-size sections, the factory-built house is trucked to the building site

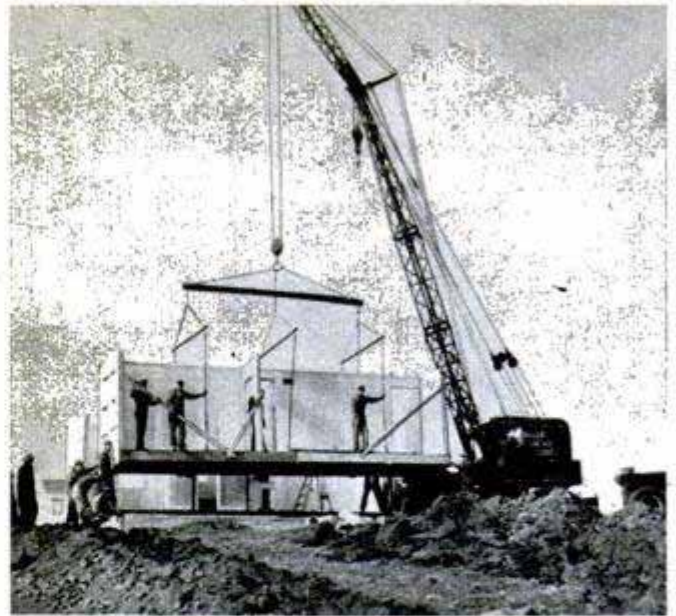

Balanced by the workmen, the second section of the house is lifted onto the foundation by a big crane

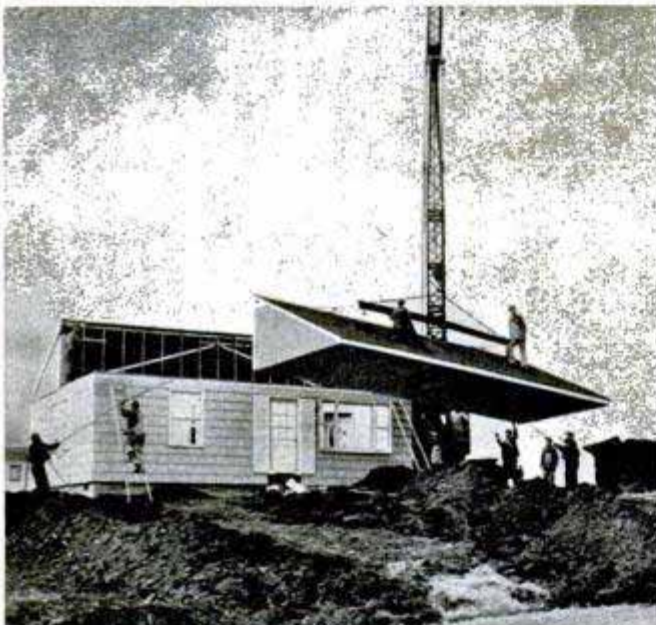

Fifth and last is the front half of the roof which is quickly swung into place, complete with shingles



Workmen seal up the joints of the completed house. It was assembled on the site in less than two hours

B. D. Homes Co., Martin City, Mo.

Factory-Built Houses Cut Up for Delivery

Put together on an assembly line, one-story frame houses are cut into five sections and hauled to the homesite by trailers. There, the five sections are bolted together to form a complete house again. The production line is capable of turning out three

houses a day. Without lot or landscaping, the two-bedroom prebuilt houses sell for about \$7000. The basic floor plan is 24 by 32 feet and includes two bedrooms, living room, dining area, kitchen and storage space plus utility room.

Scientist Seeks Solution to Mystery of Liquids

Scientists with all their progress have never been able to explain satisfactorily what a liquid really is. Gerald J. Holton, Harvard physicist, has developed evidence that water is actually a network of crystals. He learned this by subjecting water to pressures as high as 180,000 pounds per square inch and then shooting sound waves

through it. Normally, liquids absorb sound readily, but when water is compressed, the waves move faster and are less easily absorbed. This, Professor Holton believes, gives a definite clue that liquids have a crystalline structure. Compressing the liquid breaks down the crystals, reducing its ability to absorb sound.

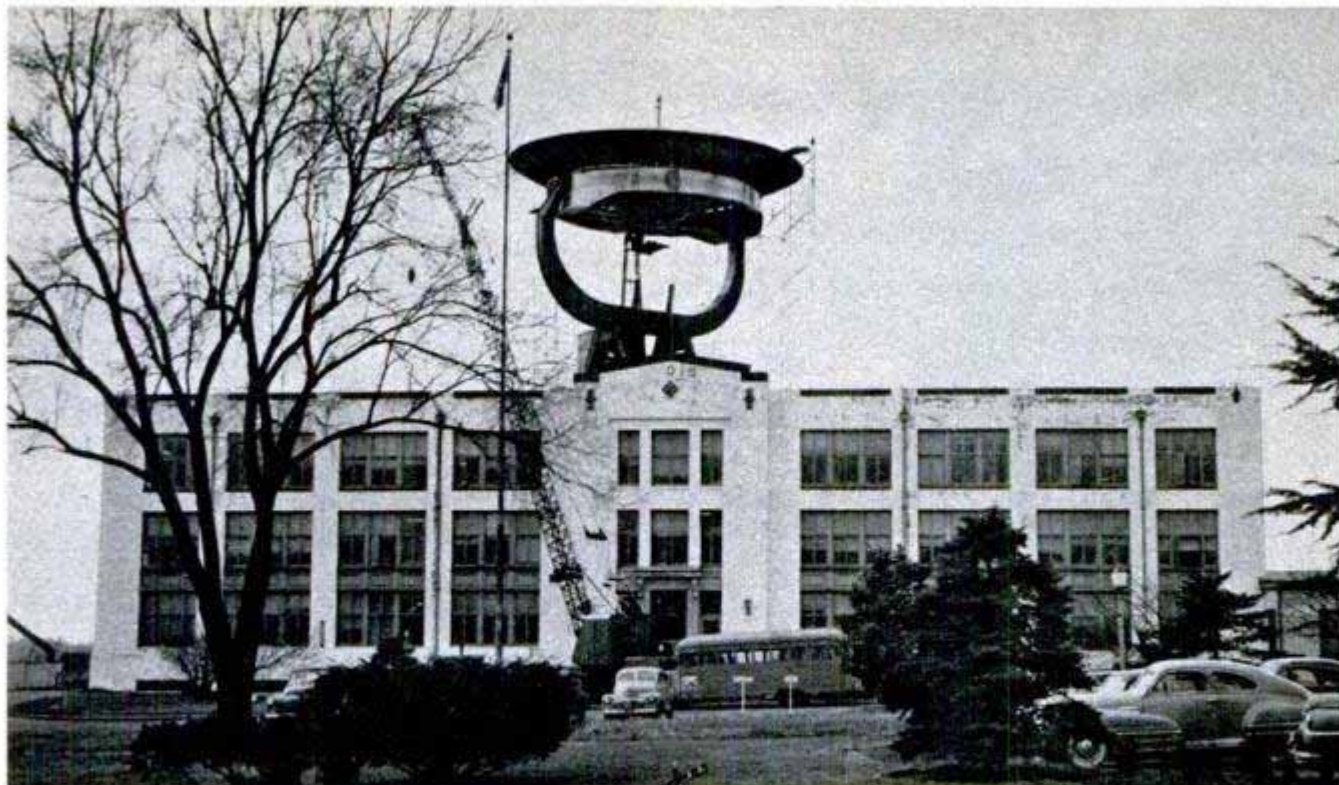

Radio Telescope

Astronomers will look at the universe with a 600-inch radio telescope at the Naval Research Laboratory in Washington, D. C. The 14-ton reflector has a diameter of 25 feet and will pick up the 3, 10 and 30-centimeter wavelengths. Radio astronomy is actually a second "window" into the universe. Classical astronomy, using the conventional telescope, is the first "window" and is limited to radiations in the visible portion of the electromagnetic spectrum. The second window, radio astronomy, is opened by the giant metal reflector and antenna, which concentrate and pick up radio waves from the galaxies.

Long-Distance Appraisal Of Snow's Water Content

Atomic-bomb by-products may soon simplify forecasting of water supplies for Western states. Estimating the volume of water to be expected from melting snows has been difficult in the past because many key mountain areas are virtually inaccessible in winter. In new experiments in California's Sierra Nevadas, small amounts of artificial radioactive isotopes of zinc or cobalt were put on the ground. A lead shield concentrated their gamma rays on a Geiger-Muller tube suspended 15 feet above-ground. The radiation registered at the

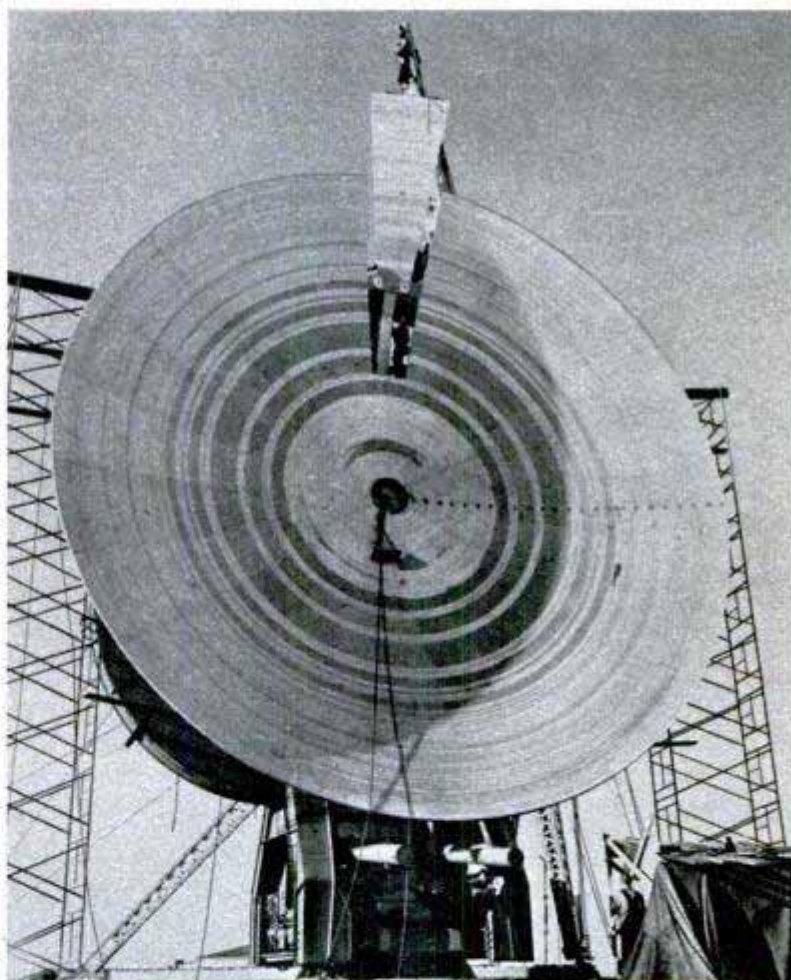

tube, indicating to within a few percent the water content of the snow, can be transmitted to a receiving station miles away.

¶ Ten gas-turbine electric locomotives—the newest form of rail power—have been ordered by the Union Pacific Railroad following tests of a 4500-horsepower unit on regular freight runs for 18 months.



Pretty girl zips along at 25 miles an hour aboard one of the bucking water broncos. Hand lines steer the little craft and operate the throttle control

Daring rider throws his craft into a high-speed slide by turning sharply and gunning the motor suddenly





Aquatic sportsmen play follow-the-leader, maneuvering in close formation. Motor stops if rider is thrown

Water Bronco

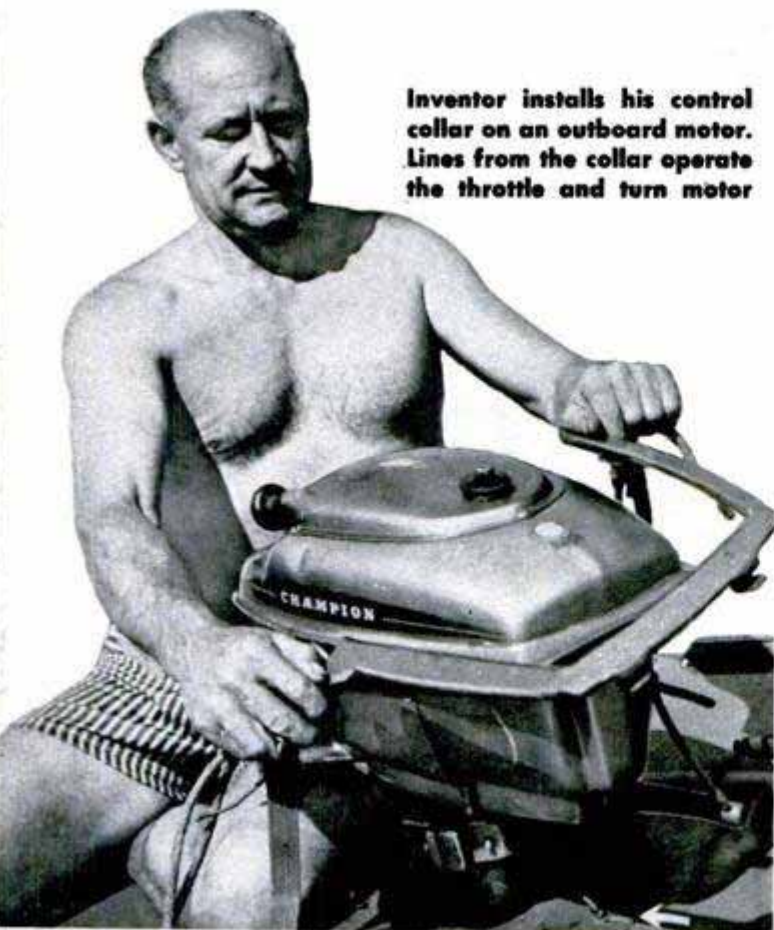

Inventor installs his control collar on an outboard motor. Lines from the collar operate the throttle and turn motor

By Ed Lundburg

A SELF-POWERED water bronco, which skips along at speeds up to 25 miles an hour, currently is thrilling scores of aquatic sportsmen at Long Beach, Calif.

The unique craft, developed by Doty Steele of Hollywood, Calif., is easy to build and economical to operate. It is powered with an outboard motor which may be detached and used elsewhere. The board is 8 feet long, 40 inches wide and 6 inches thick. It weighs 65 pounds without the motor and can be transported to and from the water atop a car.

If the rider is thrown off the board during a speedy maneuver the motor automatically stops. A spring restores the throttle to "zero" position, breaking the circuit of the ignition system. Steele can teach an adult or child to ride the board in three minutes.

The outboard motor is clamped to a head-board located 27 inches back from the prow. The board has a well 10 inches by 30 inches to accommodate the motor, which is fitted



Emergency paddle is clamped to water bronco. Odd-shaped board prevents water from splashing rider

with a steel bracket held fast with a strap. The bracket supports the throttle and guide lines.

Steele says the board can be constructed with a hammer, saw, plane and nails. For lumber he uses waterproof plywood, sugar pine and spruce. The joints are glued.

Riders play follow-the-leader and vie with one another in speed dashes. Skill is exhibited in riding the board backwards, doing headstands and other tricks.

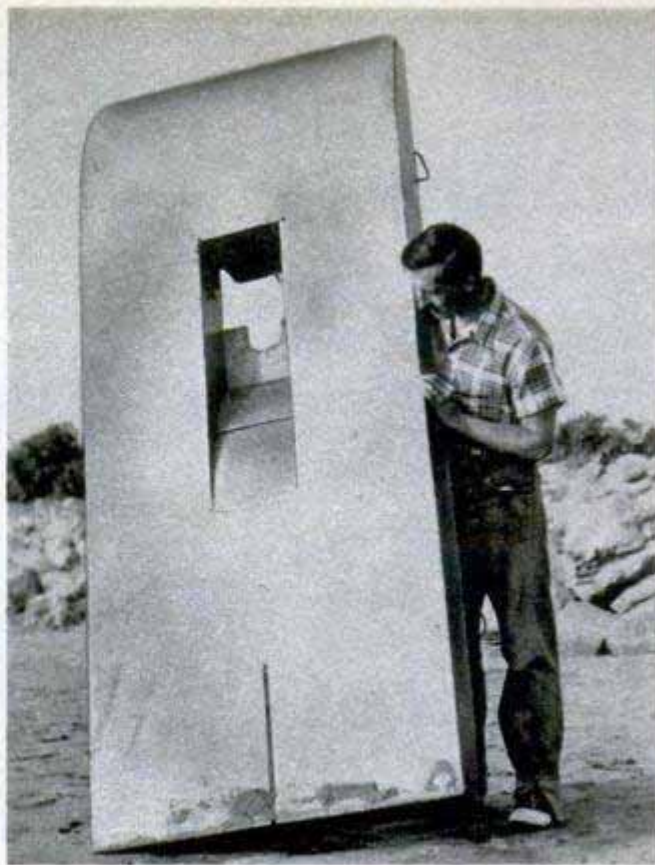

Board weighs only 65 pounds without motor. Bottom of hull has slot for motor and a retractable rudder

The rider can guide the board by shifting his weight from one foot to the other and by steering with the hand controls. He can slide the board across the surface by making a sharp turn and then, as the speeding board begins to slip laterally, quickly turn the motor in the direction of the slide.

Steele says he plans to ride one of the boards from Long Beach to Santa Catalina Island, which is a distance of approximately 30 miles.

Riding the bucking broncos is the latest aquatic craze on the West Coast. Riders scorn use of the rudder

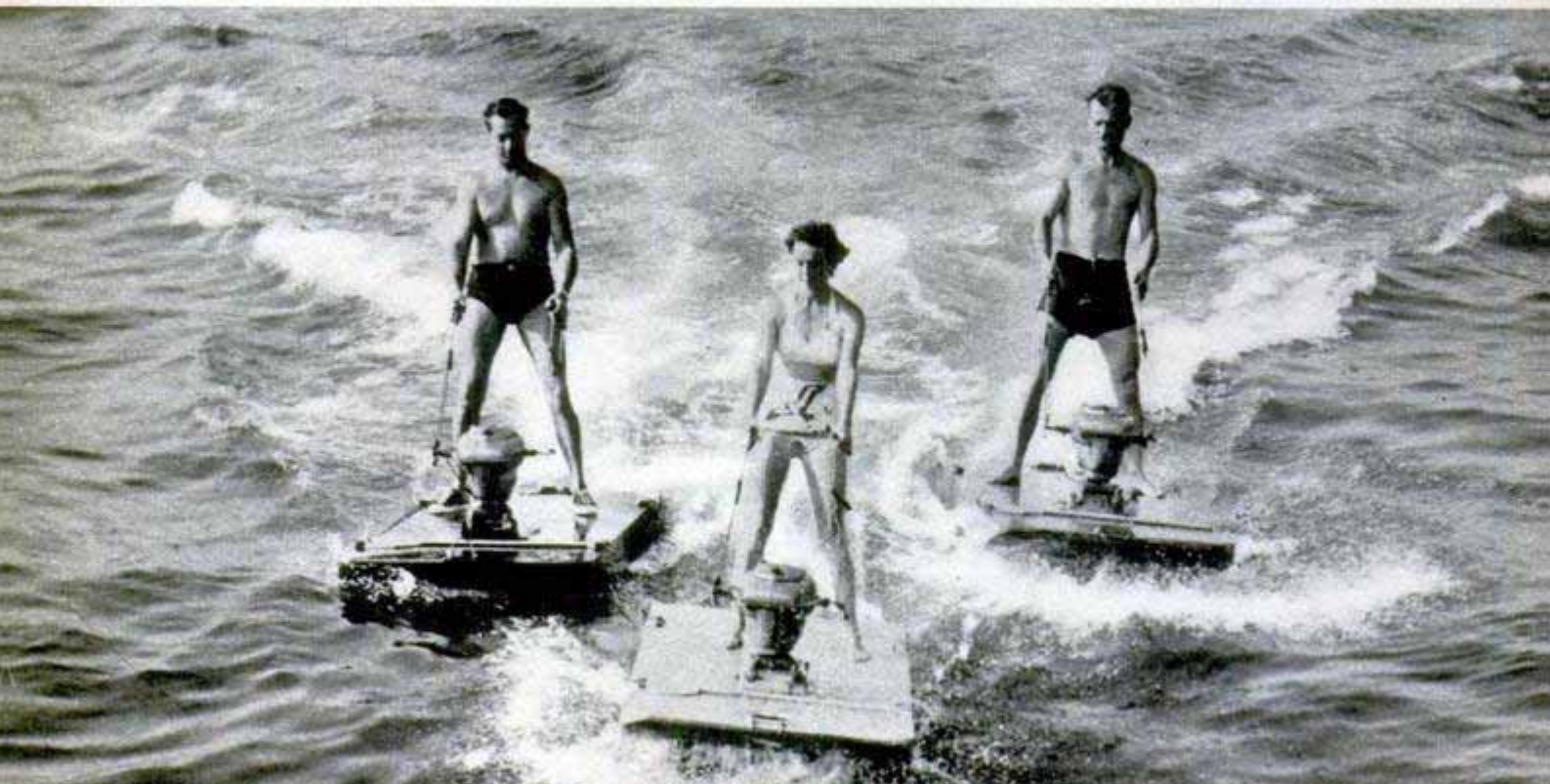

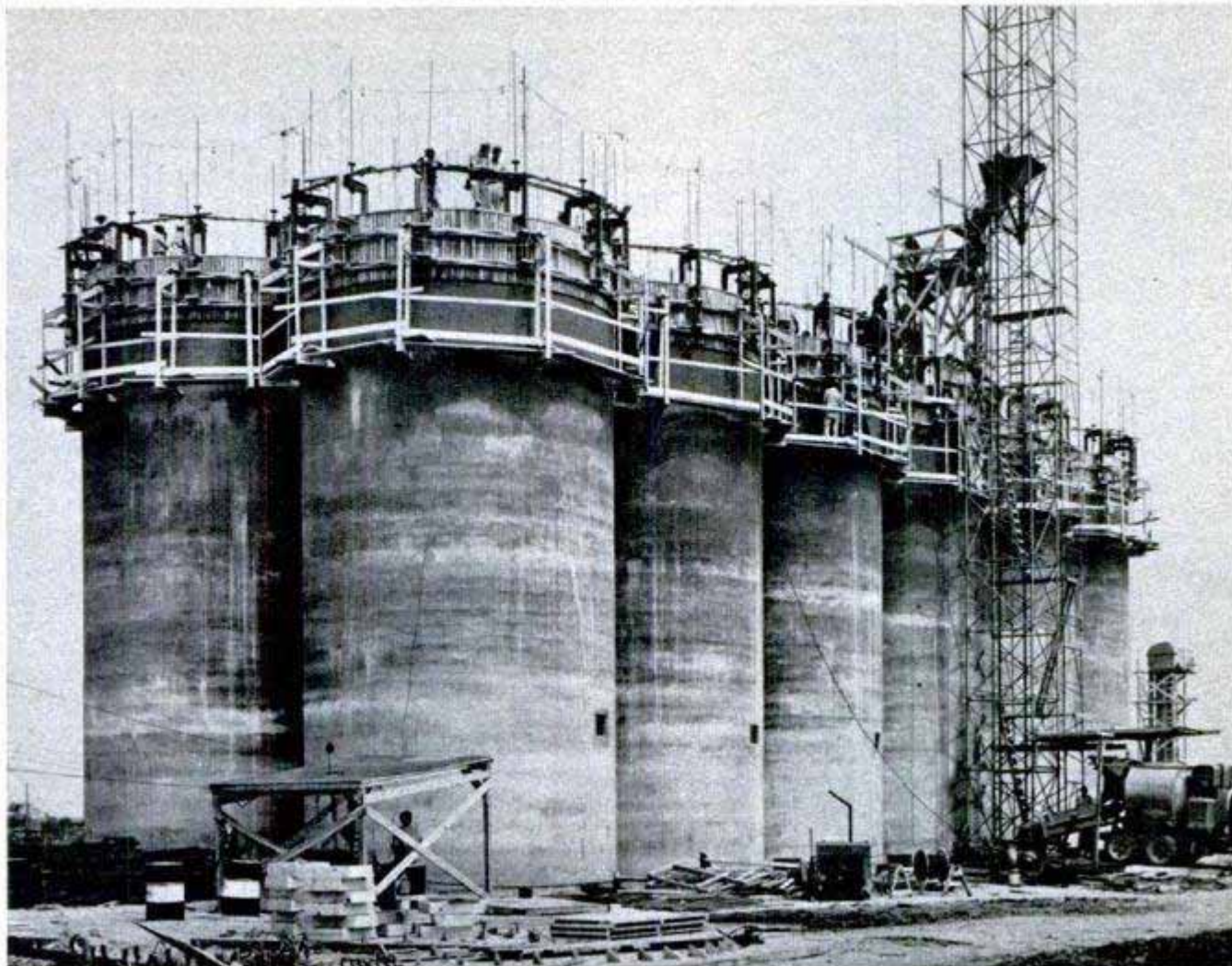

Top, Wednesday morning, after two days of pouring, the job was this far along. Scaffolding below forms is used by the finishers who smooth the walls. Right, early Saturday morning, the job's done

Concrete "Grows" Into Tall Elevators

In only five days, 12 elevators, each 110 feet high, were poured with a sliding-form technique in which the same forms were used throughout, being jacked up as the work progressed. Every 75 seconds, the 180 screw jacks were given one full turn, raising the forms about $\frac{1}{4}$ inch. Thus the elevators "grew" at a rate of about a foot an hour. Since concrete must be poured continuously it was necessary to operate in three shifts, 24 hours a day. More than 2800 cubic yards of concrete were used. The elevators hold 428,640 bushels of grain and are located at Alice, Tex.

☐ There were 70,300,000 telephones in the world at the beginning of 1950, of which 40,709,398 were in the United States.

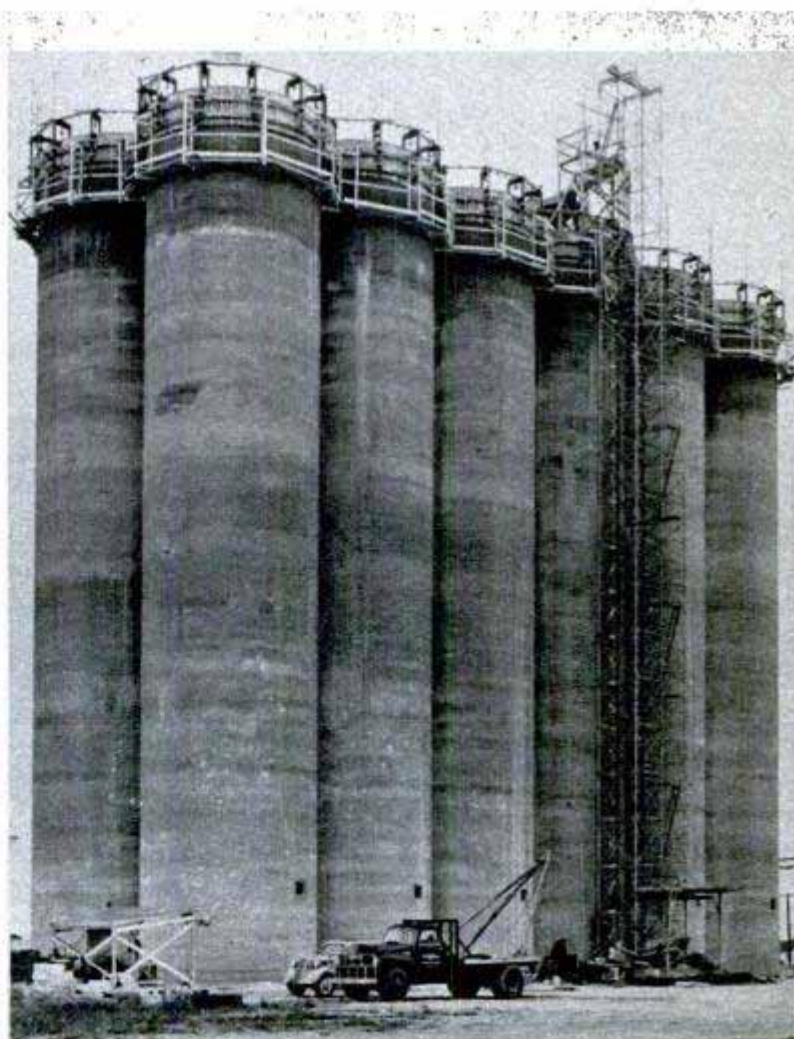

Typewriter Rings Show Page Length

By watching the page gauge on the latest Smith-Corona typewriter the operator knows exactly how close she is to the bottom of the page. The gauge consists of two graduated rings attached to the typewriter platen. The typist adjusts the rings to the size paper she is using. When she is $2\frac{1}{2}$ inches from the bottom of the page, a red signal appears on the outer scale. The scale continues to give her the paper position to within $\frac{1}{2}$ inch of the bottom of the page. Other innovations on the typewriter include an enlarged platen, easy disassembly and a small magnifying glass in front of the carriage scale, giving the typist a clear view of the numbers.

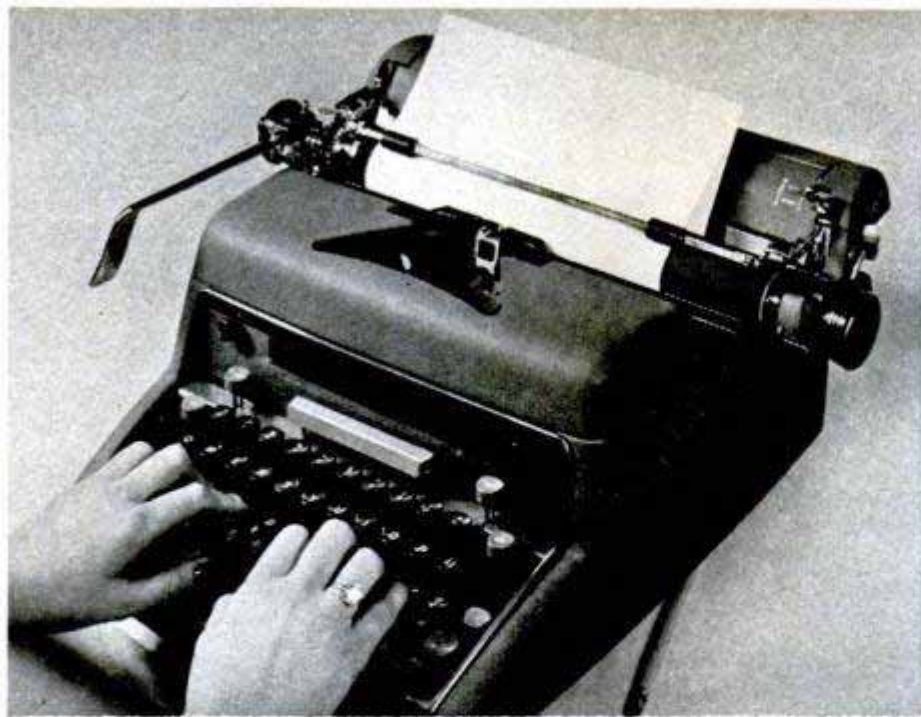

L. C. Smith & Corona Typewriters Inc., 3200 Smith Building, Syracuse 1, N.Y.

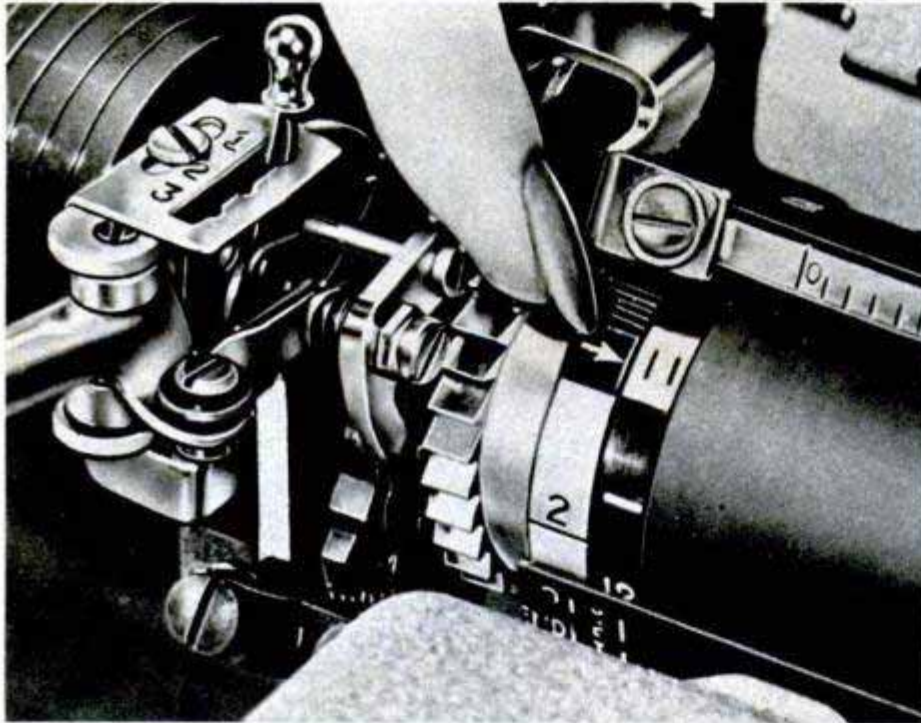

Top, new typewriter has magnifying glass over carriage scale. Left, typist sets rings to match length of paper. Gauge then shows her exactly how many inches to bottom of page

Paper Operates Electric Stapler

Easily portable, a stapler operated by electricity leaves both hands free to feed papers into the device. It requires no foot or hand controls. Insertion of papers in the jaws actuates the stapling mechanism, and the stapling position is always visible to the operator. Staples in strip form are inserted from the front without removing any parts. The device occupies only $4\frac{1}{2}$ by 10 inches of space.

¶ If you don't bind or store your back issues of *Popular Mechanics*, do you burn them? America's defense effort requires a vast number of paper products. Call your local Boy Scouts or veterans' organization to pick up your wastepaper.

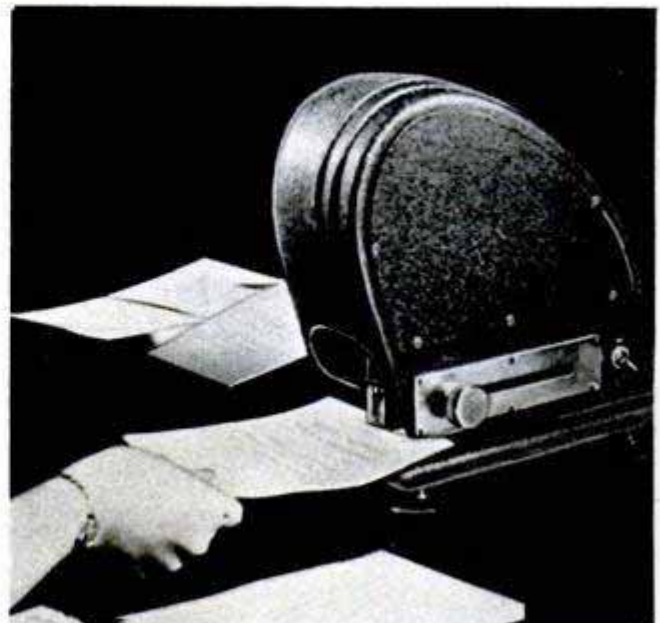

The Staplex Co., 30 Church St., New York City 7

POPULAR MECHANICS

Tight Belts on Trees May Increase Seeding

Narrow steel bands are wrapped tightly around trunks of fir trees by Weyerhaeuser timber men to "frighten" the trees into producing larger seed crops. As the trees grow, the steel bands bite into the trunks, restricting the flow of nutrients. This strangling process is believed to make the trees react as they would if they were dying—by a new burst of energy in cone and seed production. The bands are left in place for two years. Foresters believe, however, that the "scare" effect will linger up to seven years longer after the bands are removed, resulting in much more seeding per acre.

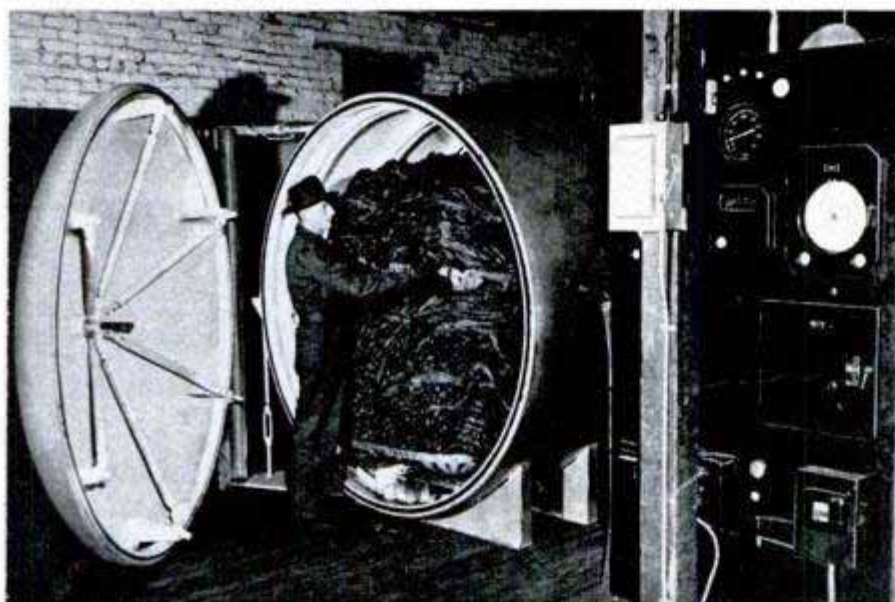

Tobacco Processor

Making the tobacco man independent of weather conditions, an airtight chamber brings 3500 pounds of tobacco to the proper moisture content in less than two hours. The machine will humidify or dry, whichever is necessary, and fumigate the tobacco, eliminating the labor-consuming operation of hanging the tobacco on drying racks. It is in operation at the Colonial Tobacco Company, Springfield, Tenn.

Worm Listener

You can listen to the chatter of tiny worms with a mechanical ear developed in Germany. The instrument is designed to detect worms in wood. It amplifies their gnawing sounds 10,000 times. Once located with the instrument, the destructive little pests are destroyed in the wood by chemical treatment.

❏Iceland is blessed with a natural and virtually unlimited source of power located 700 feet beneath the earth's surface where engineers have tapped a supply of volcanic steam, which promises to provide an estimated 5000-horsepower jet for driving turbines.





There's No Age Limit for Mountain Climbers

By Rafe Gibbs

While his mountain-climbing class watches, Glenn Exum illustrates how a fisherman's knot links two ropes

THE NEW YORK BANKER sucked in his breath—and paunch—as he awaited the verdict of Glenn Exum, operator of the Petzoldt-Exum School of American Mountaineering at Wyoming's Grand Teton National Park.

"Sure, you ought to be able to climb the Grand—all 13,766 feet of it," said Exum. "First, though, you should do a little scenery scanning . . . on foot. Three or four days. Toughen up those legs. Get used to the altitude. Then we'll give you a day in the mountaineering school. Show you how to handle yourself and the tools you'll need.

"After that—well, we'll start up the Grand. First day's trip is to base camp at 11,500 feet. Fairly easy going. If the first

day isn't too hard on you, the next day you can tackle the last couple of thousand feet. But, sure, I believe you can do it."

The banker got a look on his face—a look that doesn't come often in a man's life. Maybe in college when he scores the winning touchdown in the big game, when he becomes a father for the first time, when he is made a partner in the firm—or when Exum opines he is capable at 50 of climbing that magnificent hunk of granite which rises from the Wyoming plains like an arrow shot into the sky.

Actually, mountain climbing is not so much a matter of age or strength as it is of mental attitude and know-how. Older men than the banker have climbed America's

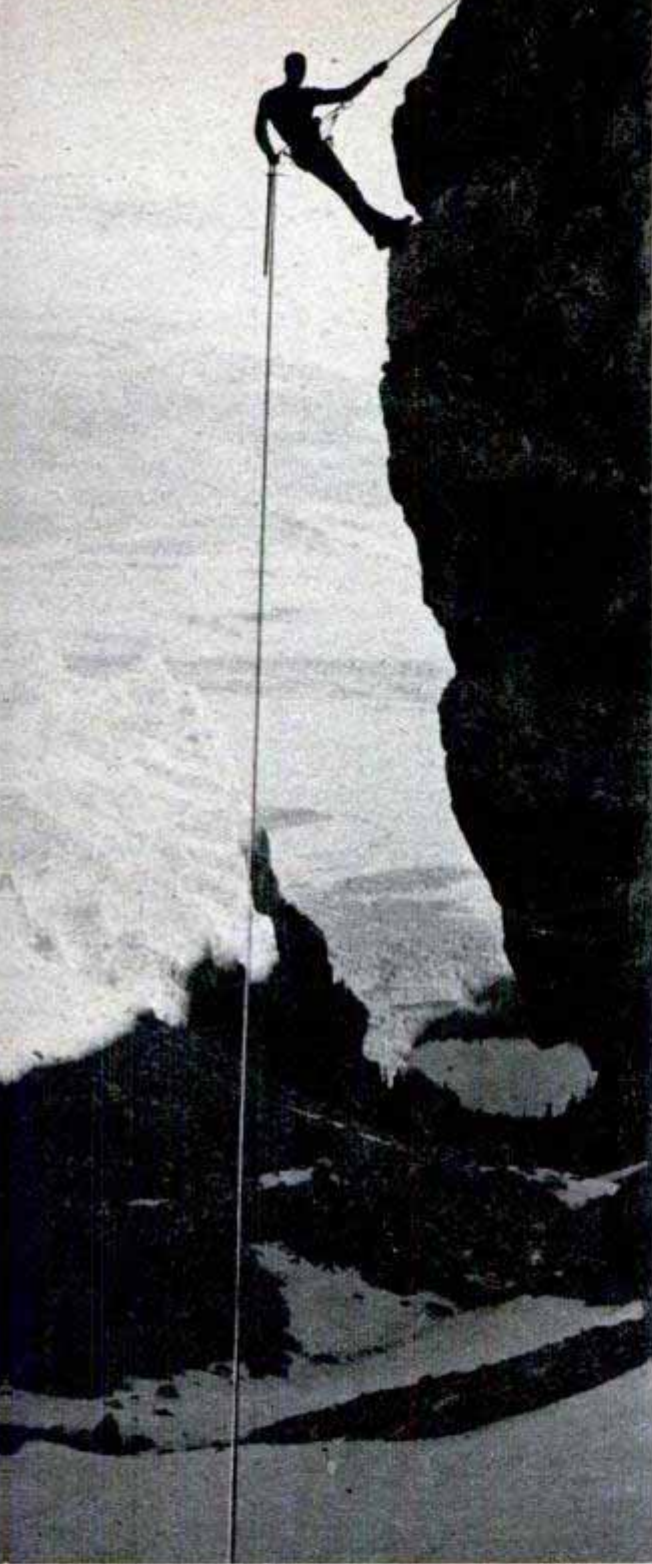

Rule No. 1 for the lead man is: Never fall. Another must, above, is to keep as much weight as possible on the feet

Experts use the speedy Carabiner sling, left, for rapelling

Only on rare occasions does the rope come into play as an aid in ascending. Its main use is as a protective life line



"Matterhorn" located in Wyoming.

Last summer John Hubbard of Nevada City, Calif., ascended the Grand with Exum. Age: 65. On the same ascent was the Exums' son, Eddie. Age: 9.

Mountain climbing, one of the world's oldest diversions, in the last 10 years has become a major American sport.

What should one know about mountain climbing? Well, Exum is a man to answer that question. Although only 39, he has been a Teton mountain guide and instructor for 23 years. In all those years he has never had a serious injury in any



"Wall Street" on the face of Wyoming's Grand Teton, left, key to a route discovered by Exum in 1931. The start of a free rapel, right, in which the mountaineer will drop 40 feet

of his parties. His wife and No. 1 assistant, Beth, a former nurse, told us with a touch of justified pride, "The most I've ever had to do for anyone in Glenn's parties is to treat blisters."

The most important thing for a man to remember in climbing mountains was put this way by Exum: "Only novices and record seekers run up mountains. A rhythmic, slow tempo is best for getting to the top."

Contrary to popular belief, the rope is not a tool for climbing. It is used as a tool in descending in some cases, but in climbing it is strictly a protective life line.

One summer five men connected with 250 yards of clothesline started to climb the Owen Route of the Grand. They passed Exum, and he noticed that they were using the rope to pull one another up bad spots. Exum advised them that they weren't good insurance risks handling the rope that way, but they flatly refused to cooperate with their insurance companies.

At the top of a jutting landmark known as Owen Chimney, it happened. The lead man got too much pressure from below, and started pinwheeling down the mountain. Fortunately, the last man on the rope, a former football player, tackled the



Open-air elevator system. This young lady shows how to come down a mountainside fast, easy and safely

spinning one at the Chimney's base. The tackle prevented a drop—possibly for all five men—of 3500 feet.

"In a climbing party, the rope is everybody's business," said Exum. "Not only should it be kept free at all times, but it should never be permitted to drag. A dragging rope is liable to pull off rocks on those below."

When the climbing becomes dangerously difficult, the man ahead uses a technique called belaying—fixed or artificial. Fixed belaying is tying the rope around a rock or snag, so that if the man coming up should slip the fastened rope will hold him. If a suitable rock or snag is not handy, a piton, which might be classified as an iron spike with a hole through its head, is driven into the mountain with a piton hammer, and the rope tied to it. Artificial belaying is simply looping the rope around the body and bracing the feet firmly.

In descending, the procedure of letting yourself down a mountain with the rope is known as rapelling.

There are three occasions when a knowledge of rapelling comes in handy: When you want to descend an unclimbable pitch—an overhanging cliff, for instance. When storm clouds start pushing against the mountain, and it seems highly desirable to get down fast. When you just hanker for

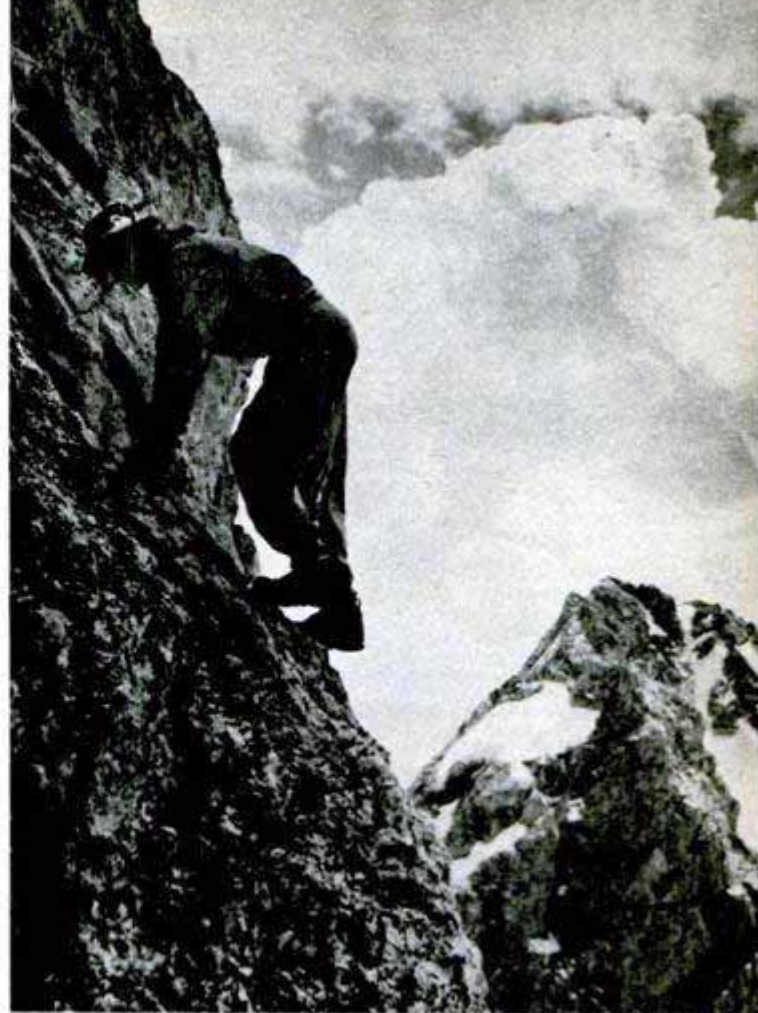

Never fail, Exum warns, to keep at least two feet and a hand, or two hands and a foot, in contact with rock

the sheer sport of dropping off into space.

The basic rapelling method used in the Alps way back in Hannibal's day is simply looping the rope about the body in a way which will slow its release as the descent is made. One way is to run the rope between the legs from behind, crossing it in front of the left leg, and passing it up the front of the body, over the left shoulder and down the back to the right side.

An experienced rapeller can bounce as much as 50 feet at a time. Exum's eight-year-old daughter, Glenda, hasn't sturdy enough legs yet to climb to the top of the Grand, but she is an artist in rapelling. At an age when most girls use a rope for sidewalk skipping, Glenda leaps off a precipice with hers.

Virtually all mountain climbers now use a special nylon rope developed during World War II for American mountain troops. It is $\frac{7}{16}$ inch in diameter and has a tensile strength of 3700 pounds. Under stress, it may stretch more than 50 percent. In rapelling, the rope acts like a rubber band and takes the jerk out of the bounce.

Another new development has made for easier mountain climbing. This is the boot with the rubber-lug soles, replacing the hob-nailed boot. In difficult scaling, sneakers (tennis shoes), or felt or hemp-soled

(Continued to page 232)



Ship's Telegraph System Records Orders

Recording each order given by the ship's bridge, a new engine-order telegraph system provides chronological evidence should the vessel be involved in an accident. The device records the second at which each order is given and also when it is acknowledged by the engine room. If the engine room fails to acknowledge or respond correctly, an alarm system warns the bridge and crew. Lights on the signal panel flash on to identify the order given and minimize errors. The system also records the precise time the ship's whistle is blown, an important legal point because by law the ship first blowing its whistle has the right of way.

Three-Wheel Truck

There's only one front wheel on a new German-built truck. The single wheel beneath the hood is the only one of the three wheels which is powered, yet the truck can haul a one-ton load. Power is transmitted to the wheel by chain drive. The truck travels 35 miles on a gallon of gasoline and has a top speed of about 45 miles an hour.

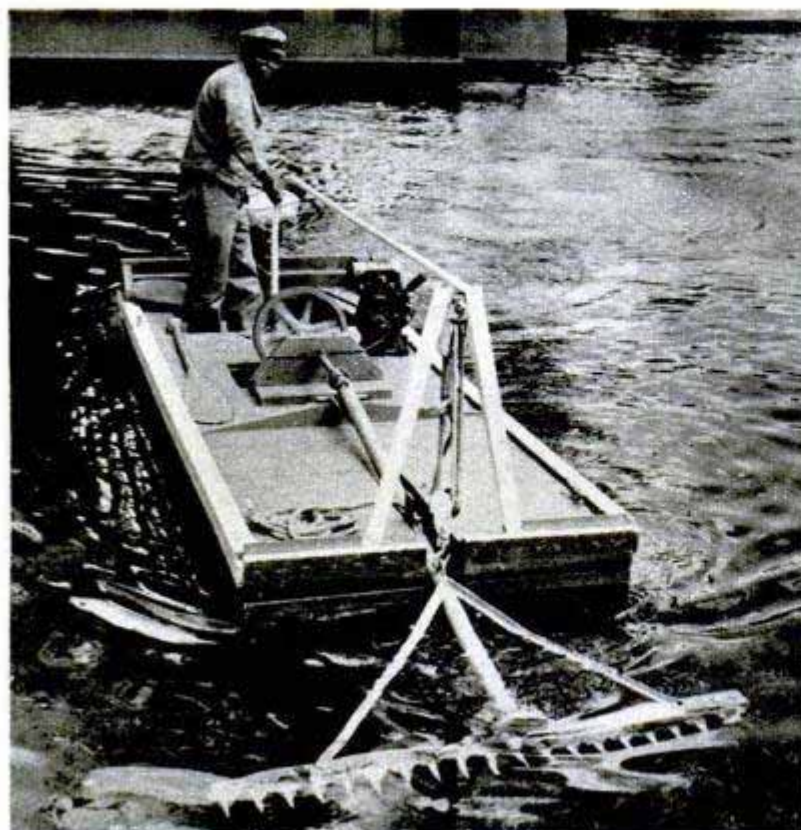
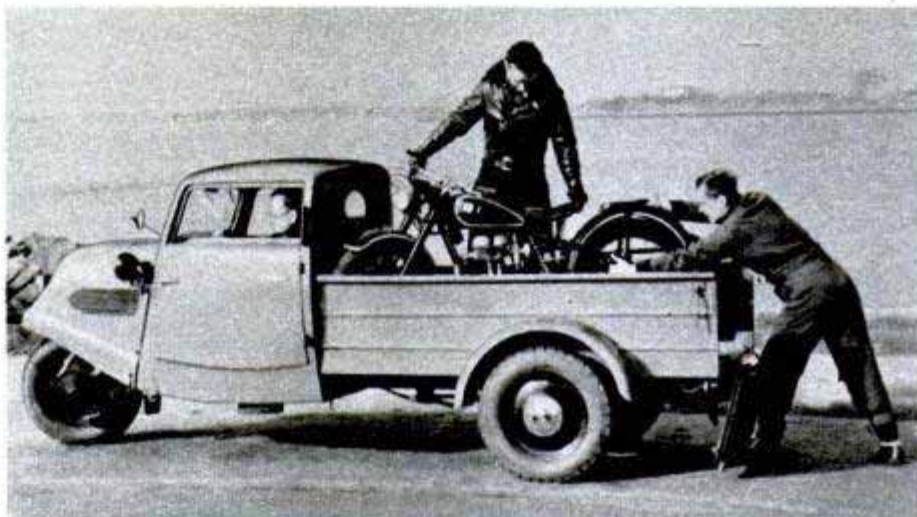

Underwater Power Mower

Mounted on a small barge, an underwater power mower keeps swimming areas free of weeds and does the work of more than 20 men. The cutter arm is powered by a $\frac{1}{2}$ -horsepower engine connected through a Model-T Ford universal joint. A block and tackle raises and lowers the cutting head in a slot in the bow of the barge. The mower was designed and built by Dave Edwards of Rainbow Springs, Fla.

Sources of available products described in this issue are indexed on pages 12, 14 and 16. Sources of further information on other articles are listed in the WHERE-TO-FIND-IT LIST, which is available to readers without charge from Bureau of Information, Popular Mechanics Magazine, 200 E. Ontario Street, Chicago 11, Illinois

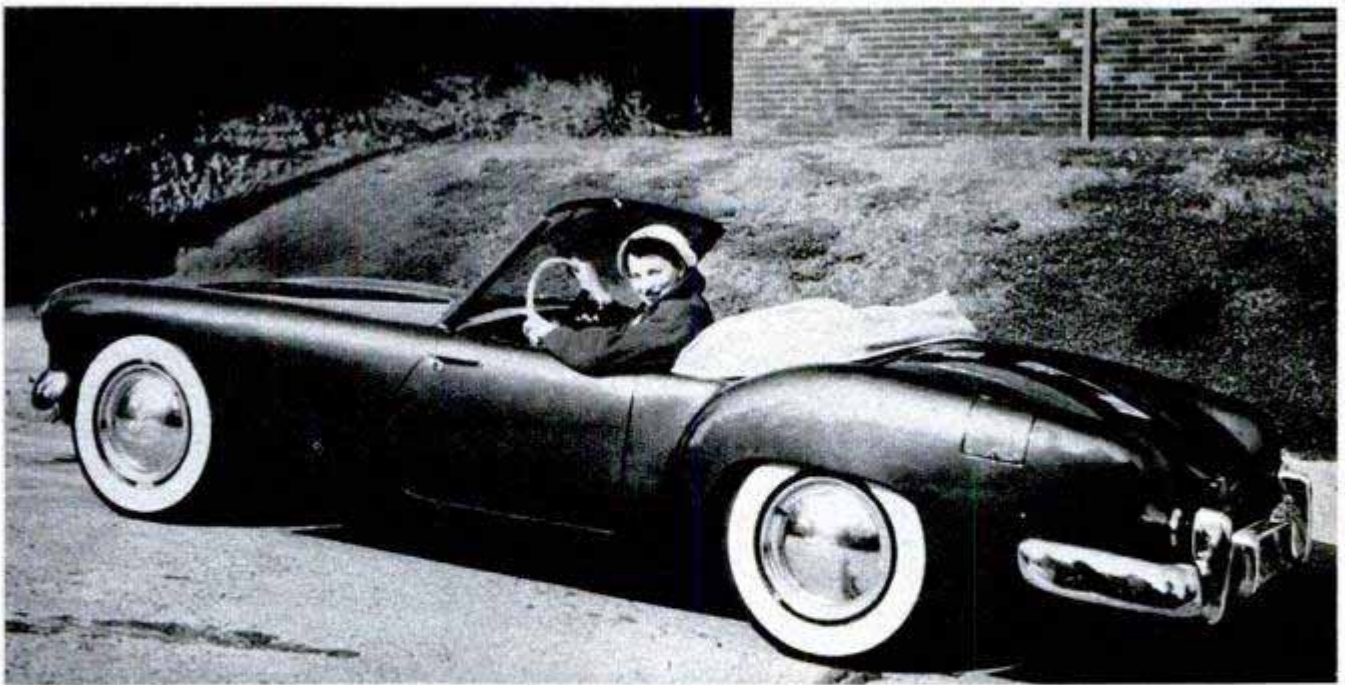

Racy Sports Car Made In U. S. A.

As slick as the raciest European sports car, a custom-made sportster made by Tom Story, body-shop foreman for a Portland, Ore., car dealer, is only 46 inches tall. Story used many stock parts such as Chevrolet and Pontiac fenders, Lincoln windshield and Ford engine, all with modifications. The car has a 97-inch wheelbase and a ground clearance of only five inches under the engine. The old Ford V-8 60-horsepower engine was "souped" up to put out 113 horsepower with a compression ratio of 10½

to 1. The two seats are so low that the drive-shaft tunnel serves as an armrest between them! With a top speed of 105 miles an hour, the car holds the road tightly be-

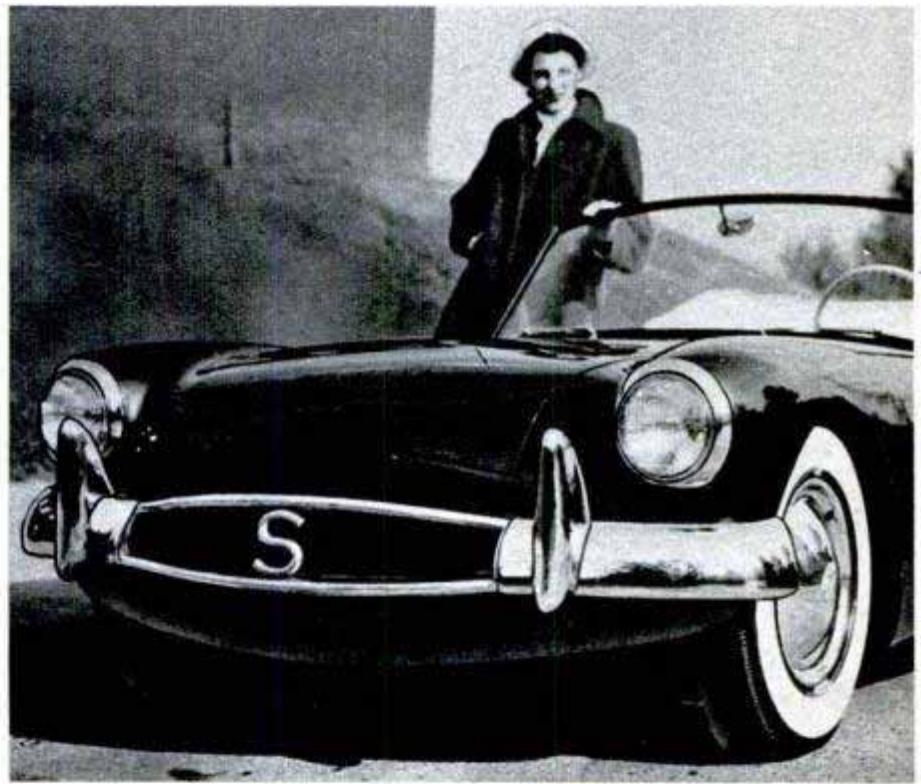

cause of its low center of gravity. It takes right-angle turns safely at 55 miles an hour. Story is now building four-seater models of similar design.

Parachuted Lifeboats Are Radio-Guided to Survivors

Radio will soon guide empty lifeboats, dropped by parachutes for rescues at sea, directly to the survivors. By maneuvering a stick on a small control box, an operator in a plane dropping a boat can hold the craft stationary until survivors have boarded and then set it on course. Its 100-foot parachute is jettisoned by an explosive charge when the craft hits the water. The 15-man boat has rations, gasoline and survival equipment for 800 miles of travel, and

it can be restocked by air for longer distances. The system is expected to be completely installed in all Air Force rescue boats by early 1952.

¶ In event of enemy attack, the amount of radioactive material required to contaminate the water supply of a large city is so great that this danger seems extremely unlikely, according to Brig. Gen. James P. Cooney of the Medical Corps.

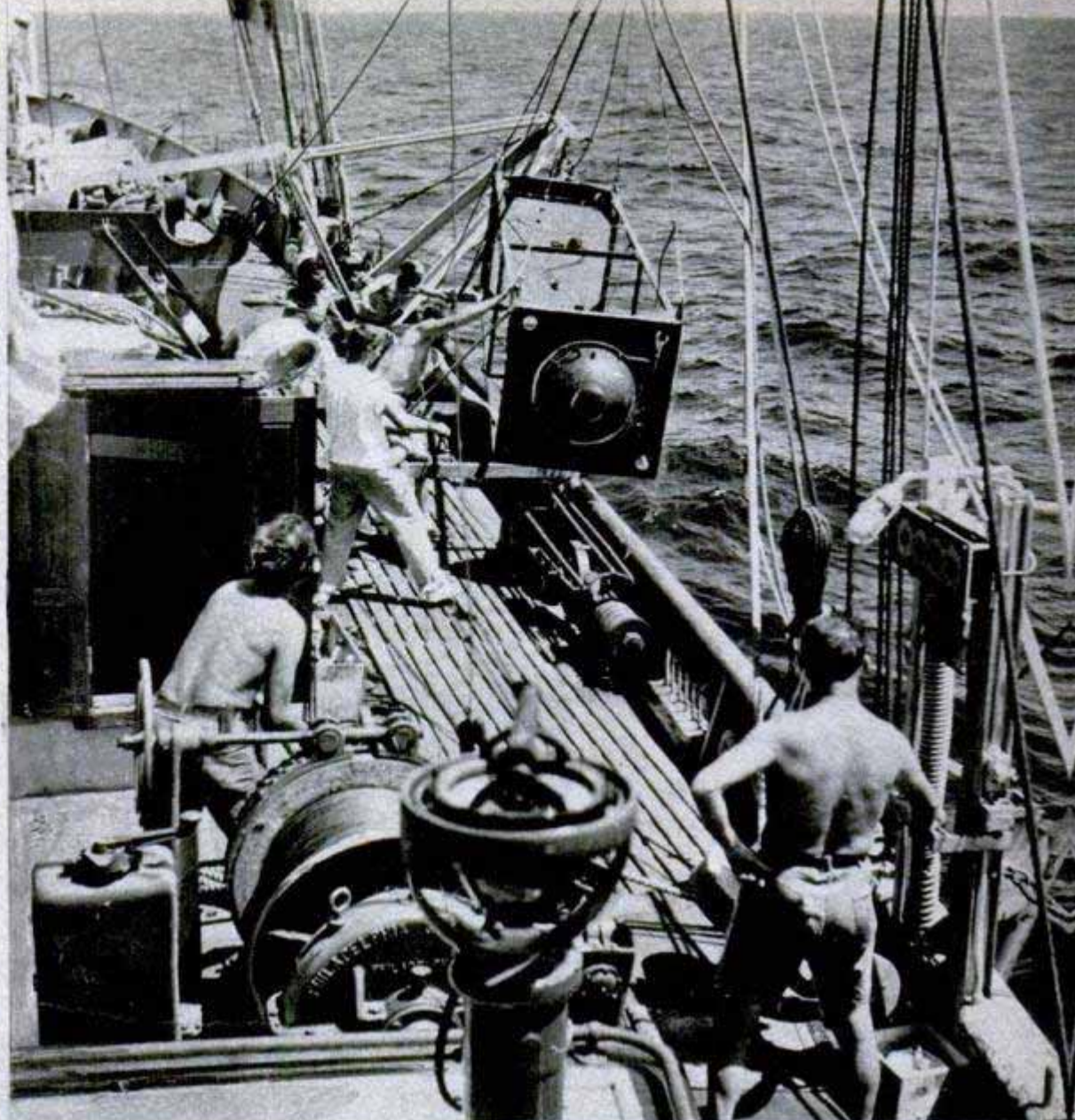
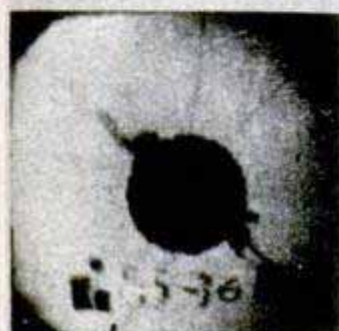
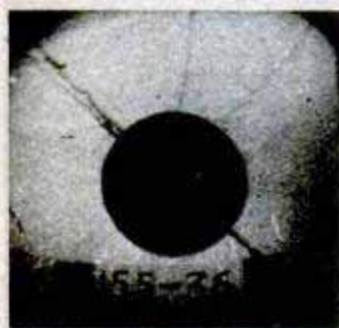
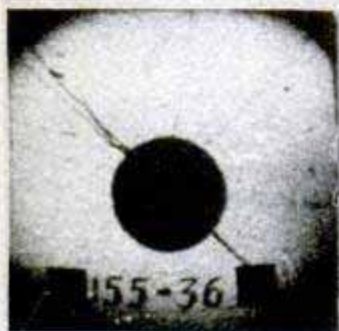
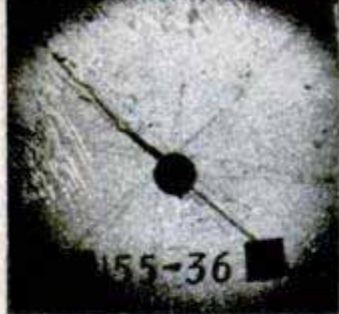

Photos by David Owen, Woods Hole Oceanographic Institution

The rig goes over the side. Left, some explosion photos. Top, the unexploded charge. Next photo shows actual explosion. Others record changing size of bubble made by explosion

The Navy Films a Blast TWO MILES DEEP

IT'S DARK 12,000 feet below the ocean surface and quiet, too. It had always been dark and quiet there until scientists of the Naval Ordnance Laboratory set out to photograph explosions two miles underwater. By taking such pictures they interrupted the age-old silent blackness with bright lights and loud noises.

These scientists not only wanted photographs of explosions under terrific pressure, but they wanted them shot at a rate of more than 20,000 frames a second! To do this, they joined forces with scientists from the famed Woods Hole Oceanographic Institution in Massachusetts.

This combination of skills resulted in a box-kite-like rig that automatically sets off an explosion at any desired depth and shoots 100 pictures of the explosion at a rate of 30,000 a second. It does all this with no help from the surface. The entire operation is automatic once the rig goes over the side of the ship.

The scientists needed a compact camera that would not only withstand tremendous pressures and explosive shocks, but would work at

high speeds on miniature storage batteries. S. J. Jacobs of the Navy lab and A. A. Klebba of Woods Hole designed the camera. A rotating mirror shifts the picture from one frame to another at a speed of 30,000 a second. One hundred framing lenses provide 100 pictures at that speed when the mirror revolves 18,000 times a minute. The camera is shock-mounted in a spherical pressed-steel case 22 inches in diameter with 1¼-inch-thick walls. It shoots through a bulletproof glass port one inch thick.

Mounted at one end of the boxlike metal frame, the camera aims toward the opposite end where four clusters of flash bulbs are sealed inside protective cases. The explosive charge is suspended between the camera and lights just in front of a diffusion screen.

The Woods Hole Oceanographic Institution furnished the ketch, Atlantis, for the project. When the Atlantis arrives at a pre-selected clear-water area, the equipment is lowered over the side. Its only connection with the ship is a slender steel cable. When the desired depth is reached, the ocean pressure closes a depth switch. The camera motor starts and when it gets up to proper speed, a centrifugal switch opens the shutter, fires the flash bulbs and detonates the explosive. The round of 100 pictures is taken, the shutter closes and the motor stops. The equipment is then hauled back to the surface. The entire operation calls for precise synchronization as it is timed in milliseconds!

When the film is developed, the scientists have a record of an explosion under tremendous pressure. To build a tank for such experiments would cost about a half-million dollars. With the help of the Atlantis, the Navy uses nature's own laboratory, the ocean depths, at no charge!

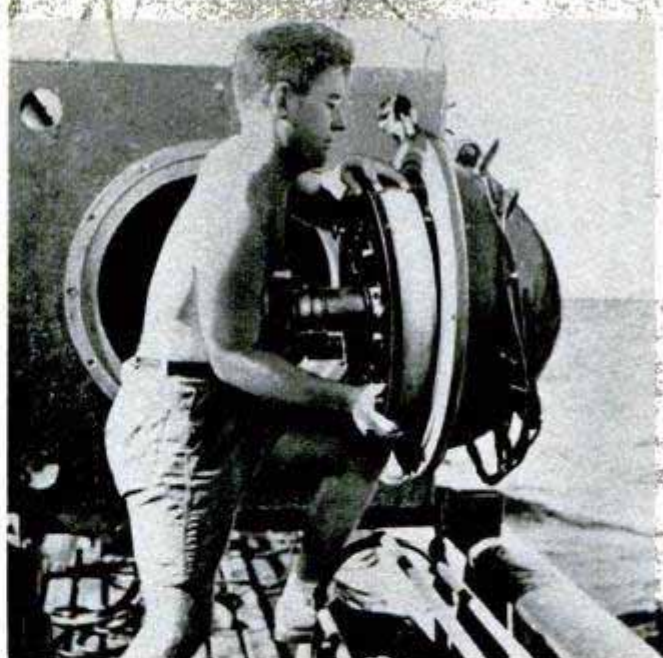

Above, the high-speed camera is sealed in a round, thick case that protects it from pressure and shock

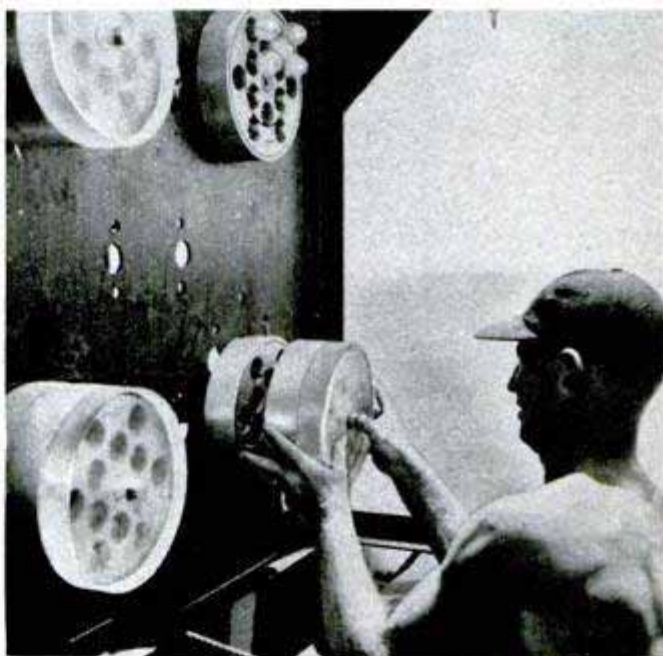

Above, many flash bulbs are needed to illuminate the bubble. They are sealed inside these plastic covers

Below, drawing of the underwater rig. The pressure switch is mounted at right, behind the light board

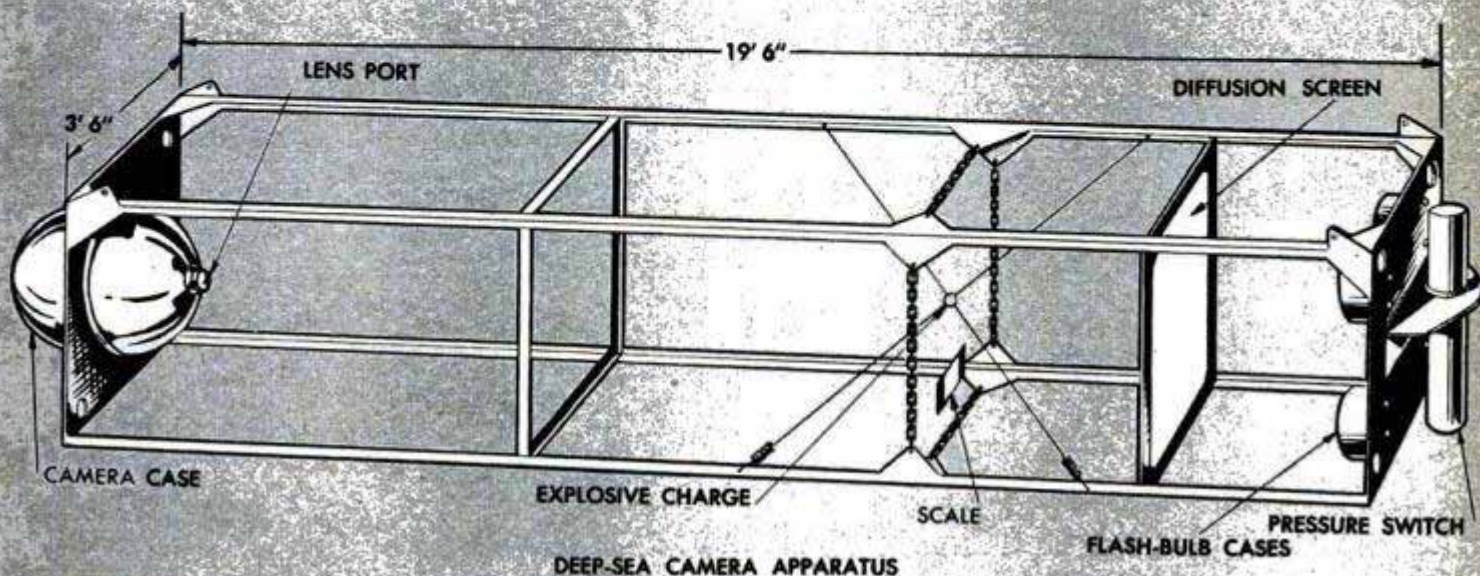

PORTRAITS IN WOOD



While model Joye Stoddard poses, Gresh sketches the lines that will soon guide the blade of his jigsaw

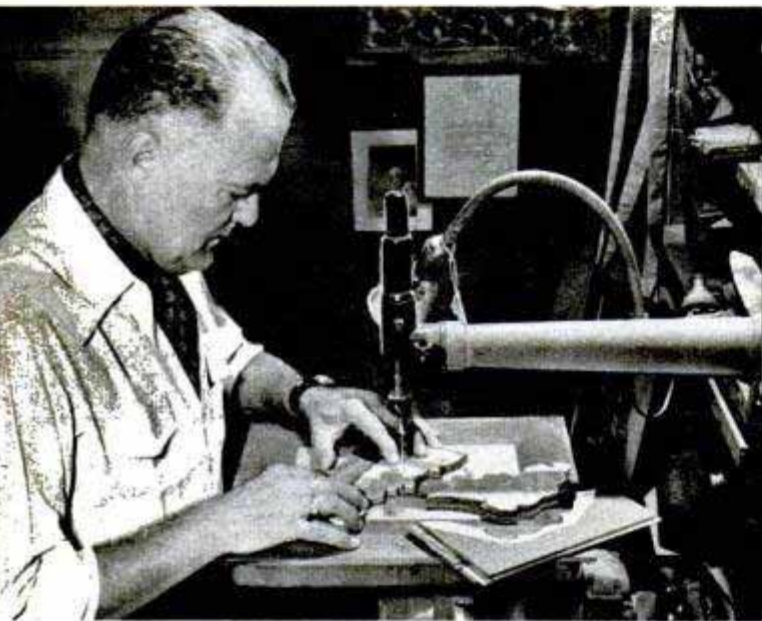

At the jigsaw, with the sketch glued to the wood, the artist skillfully cuts out every definite form

In assembling, the problem is selecting the properly shaded woods to match every detail of hair and skin

WORKING with a jigsaw instead of a brush, Earl Gresh of St. Petersburg, Fla., is an artist in wood. By skillfully cutting and blending thin veneers in a wood inlay, he turns out portraits that are remarkable for their shadows, highlights and careful detail. Gresh, a champion speedboat racer and well-known dance-band leader in the 1920s, has never had an art lesson in his life. After the depression of the '30s wiped out his boat-designing business, he started a small wood-novelty company in his garage. It was there that he discovered his flair for making delicate wood inlays. Gresh pencil sketches the subject and glues the sketch paper to the top of a pad of previously selected wood veneers of colors that match the model's skin and hair tones. The sketch lines guide his jigsaw cutting. In assembling the portrait after the sawing, Gresh's problem is selecting the proper shade of wood to duplicate each highlight and shadow in the sketch.

After the final step, six coats of clear lacquer, the veneer "painting" is an attractive portrait of Joye



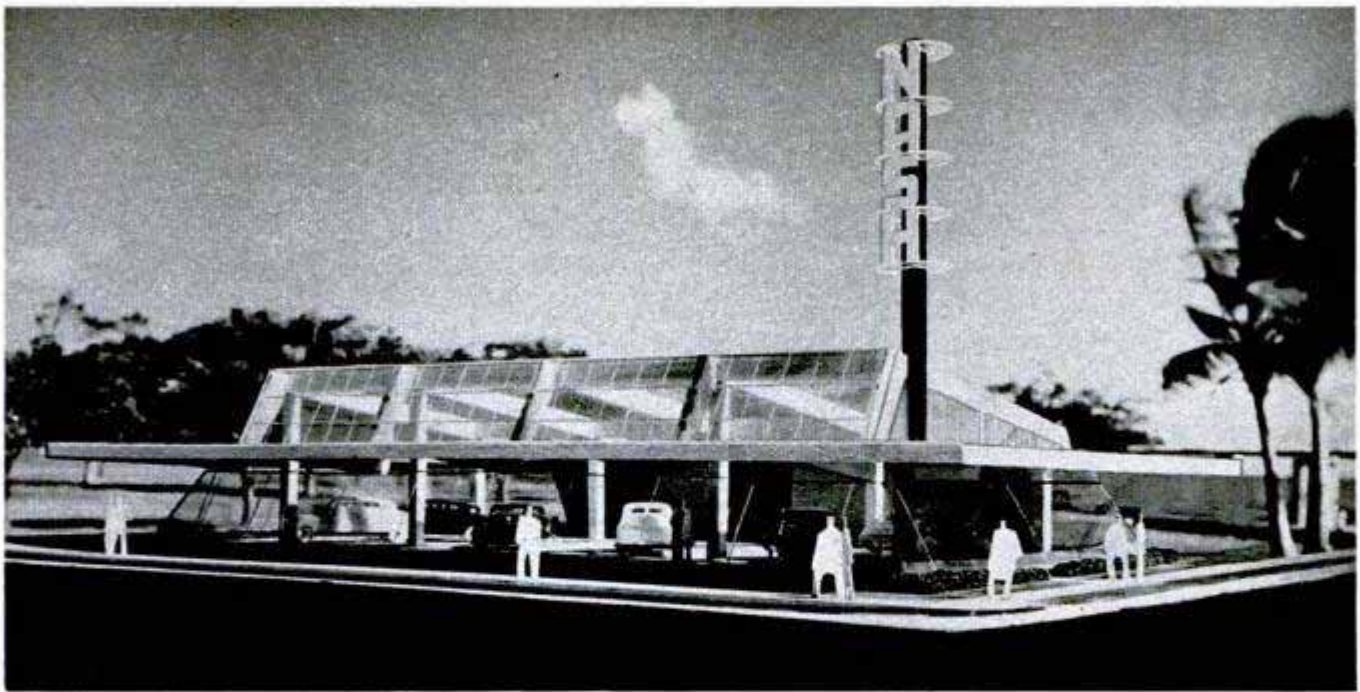

Nonreflecting Glass Forms Showroom Walls

Annoying reflections, common to most store windows, won't exist in a new Honolulu automobile showroom because of its unusual design. The cars will be lighted naturally from slanting skylights above the marquee. The full-length window walls are slanted backward 30 degrees. Because of this tilt, the glass reflects the underside of the marquee which is completely in shadow, thus causing no noticeable reflections. The daylight from the skylights illuminates the cars so brightly that the reflections cannot be seen. This makes the cars clearly visible from all angles.

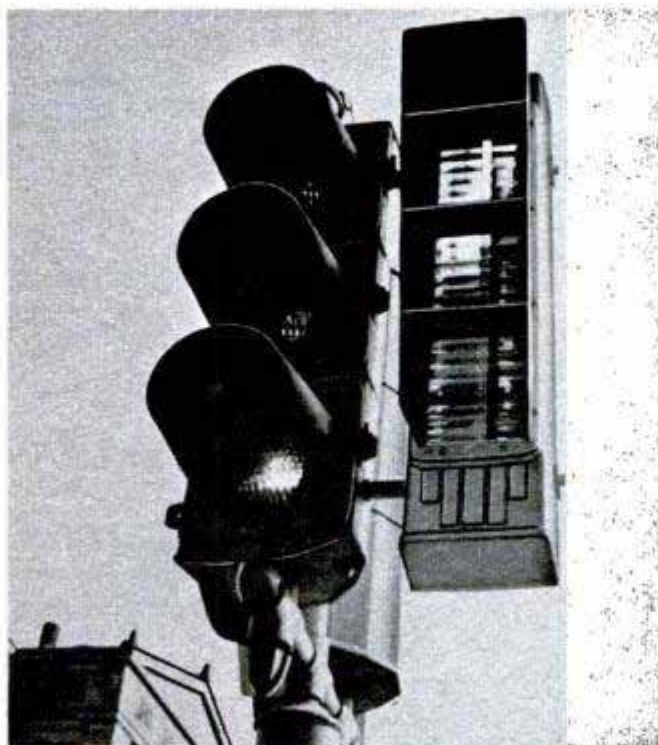
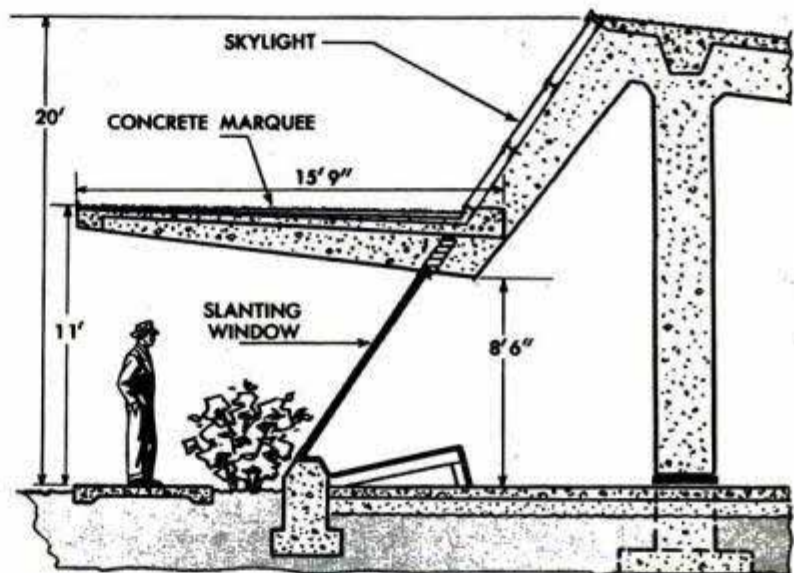

The Main Flo-Control Traffic Light, Inc.
956 Robert St., Jackson, Mich.

JUNE 1951

Traffic-Light Timer

Motorists know at a glance how much longer the light will stay green when the traffic light is equipped with an attachment that "meters" time. The device consists of a vertical column of green light that diminishes as the "go" time runs out, thus showing exactly what proportion is left at all times. The timer can be set for any duration from 15 to 60 seconds.

Oil and Gas Reserves at New High

New supplies of crude oil and natural-gas liquids developed in the United States last year, estimated at 3.3 billion barrels, have brought proved reserves of liquid hydrocarbons to an all-time peak of 29.5 billion barrels. Natural-gas reserves are now up to 185 trillion cubic feet. The reports were made by the American Petroleum Institute and the American Gas Association.



Each year Chris Busch's old-time threshing party attracts about 200 cars full of people to his farm near Colton, Wash.



In 14 years the collection of steam-powered equipment has grown to 24 engines. Most of them cost from \$50 to \$200



His boyhood days in the wheat fields are recalled by an old thresherman, peering into the boiler of an 1890-model rig

Revival IN THE WHEAT FIELD



Chris Busch, Jr., shares his father's enthusiasm for old steam engines

By O. A. Fitzgerald

FOR ONE SUNDAY each fall, the Chris M. Busch farm, three miles south of Colton in eastern Washington turns harvesting back half a century. As many as 800 people have flocked to the farm to see it done. Some come to pitch bundles, haul wood or water, help tend separator or hold down one of the many other jobs necessary to keep a steam outfit rolling. Mostly, however, folks come to see threshing as it used to be.

Just for the thrill of helping run an old-time steam-engine outfit, just to hear the shrill toot of its whistle, many have driven as far as 600 miles for the day. Four of these old-time harvesting parties have convinced Busch there are enough old-time threshermen around to warrant its continuation. In fact, the 1950 party saw plans laid for an association of old-time threshermen to make sure that once a year, at least, they will get a chance to turn back the calendar.

Spark plug of this old-time threshing re-

vival is an eastern Washington farmer who collects old threshing-machine engines the way some people go after salt shakers, cream pitchers, antique furniture, or even match folders. Already he has 24 of them parked around his place, some saved from the unhappy fate of the junk pile. And Busch has his eye on several more old machines he'd like to see in his yard.

Steam-engine collecting poses difficulties not experienced by other hobbyists. Old engines can be had for \$50 to \$200 apiece. He has found more of them lying around out West than most people realize. Storage space isn't his principal headache. He has plenty of land for permanent parking. Getting the monsters to their new home usually is the most difficult task.

The Busch steam-engine collection and his annual old-time threshing party are no publicity stunt. Both stem from the fact that ever since he was eight years old, working in the grain fields of northern Idaho, he has loved steam engines. His first



Complete in all details, the $\frac{1}{3}$ -horsepower midget at left is a copy of one in the Busch collection. It has been tested to 120 pounds of steam

threshing job was driving the team on the water wagon. Easily the biggest thrill of his life came when he landed the job of engineer and had complete charge of the engine.

"There's no machine that gives you quite the sensation you get from handling a steam engine," he declares.

Chris Busch knows he isn't alone in pinning for the old steamers. In his address book he has more than a hundred of them. Practically all are old-time threshermen.

When his big harvest is done, Busch picks out the engine he is going to use for the old-time threshing party. It gets a thorough oiling and clean-up. Its boiler is filled, and a wagonload of firewood is brought in. Then Busch sets the date and sends a letter to all the hundreds of friends on his special mailing list. The last Sunday in September is the customary date.

"This is the happiest day of my life," beamed Otto Loeffler, at the throttle of a 36-year-old engine at the last party. For 33 years Loeffler operated a threshing outfit in eastern Washington. Standing on two partly filled sacks of grain, he cut bundles before they went into the thresher.

Pitching bundles from one of the stacks was Frank Trapp of Colton, Wash. "Chris Busch ran header box for me when he was a little boy," this old-timer recalled. When the separator broke down during the 1950 harvesting party, one of the visiting thresh-

ermen commented, "I'm sort of glad this happened. Now we'll have more time to visit."

Then they took time to inspect the other machines in the Busch collection. Some were in their prime when Chris was a boy and the oldest was doing its stuff around 70 years ago. Busch has been collecting the engines for 14 years.

Old-timers climbed into the engineer's seats of the silent engines. Almost reverently they caressed the cold throttles, sighted down the engine top to where, in their memories, a thresher chewed up bundles of grain and turned out a stream of golden grain. There were friendly arguments as to which engine was the best. Two old-timers became involved in a heated discussion of which of two was the "best buy."

While the old-timers looked over the old engines and relived their threshing days, the youngsters had a steam-engine show all their own. Doing its stuff in the shadow of the big one was a peanut-size version of a Minneapolis engine. This $\frac{1}{3}$ -horsepower midget was made by W. C. Frick, machine-shop instructor and his classes at Lewiston, Idaho, high school. Complete in every detail, even to flues and governors, it carried 40 pounds of steam and had been tested to 120 pounds.

There was a big one just like it in the Busch collection.

It takes a lot of wood and water to thresh grain this way. Revival is customarily held late in September



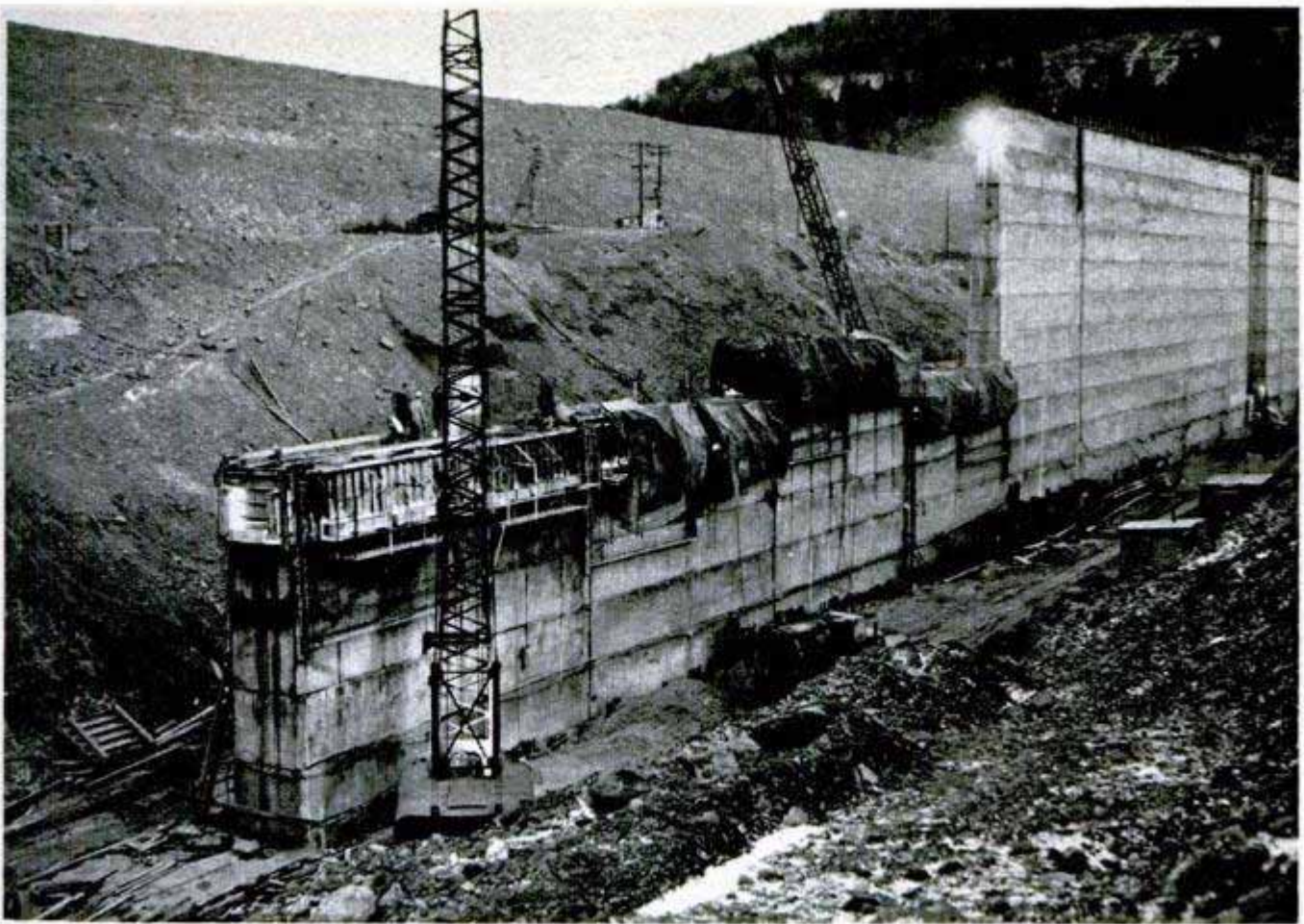

Banks of lamps glow around the just-poured upper sections of the wall. They warm the concrete for 72 hours

Workman prepares a bank of 250-watt lamps. They have proved better than steam pipes or gas heaters

Lamps are wired around sides of huge section of concrete. In severe weather, others are placed on top

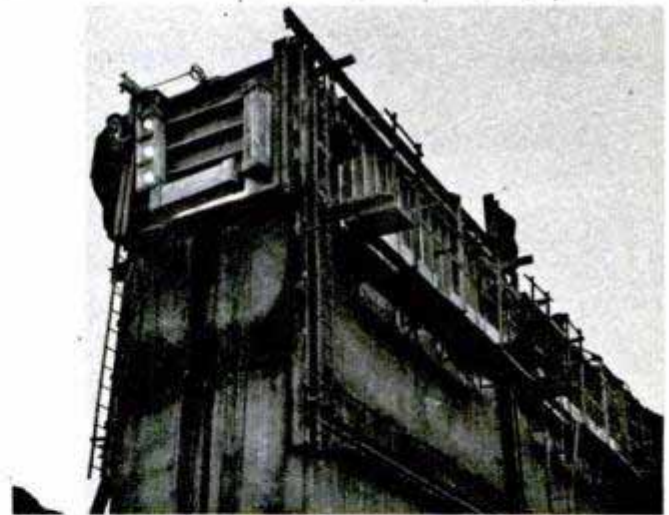
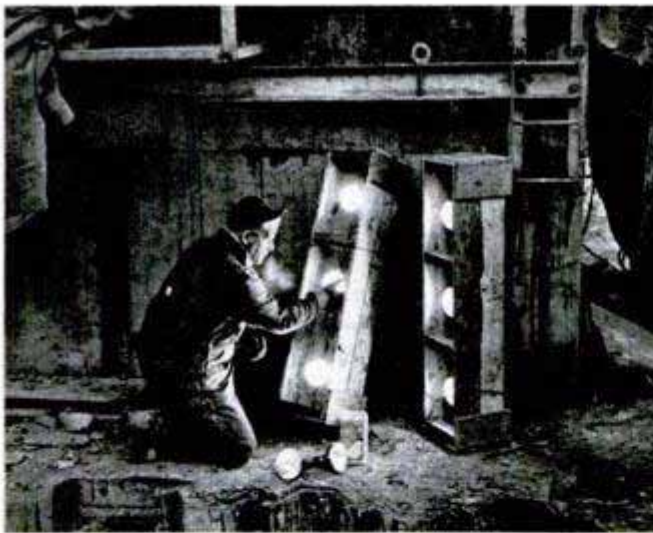

Concrete "Set" in Winter With Infrared Lamps

Rays from infrared lamps helped "set" newly poured sections of a big concrete wall in New York State during freezing weather last winter. The cut-off wall was built as part of a program to increase the water supply to New York City. It was poured in sections more than 46 feet long and 8 feet high. As soon as each section was poured the 250-watt infrared lamps, mounted in troughs, were placed on each side. They maintained a temperature of 55

degrees for a minimum of 72 hours to assure proper setting of the concrete sections. The construction company found the lamps more efficient and cheaper to use than steam pipes or gasoline hot-air heaters.

☐ Argentina has developed a single-seat jet fighter plane armed with four 20-millimeter cannon, its designer and pilot the former technical head of Germany's wartime Focke-Wulf aircraft company.

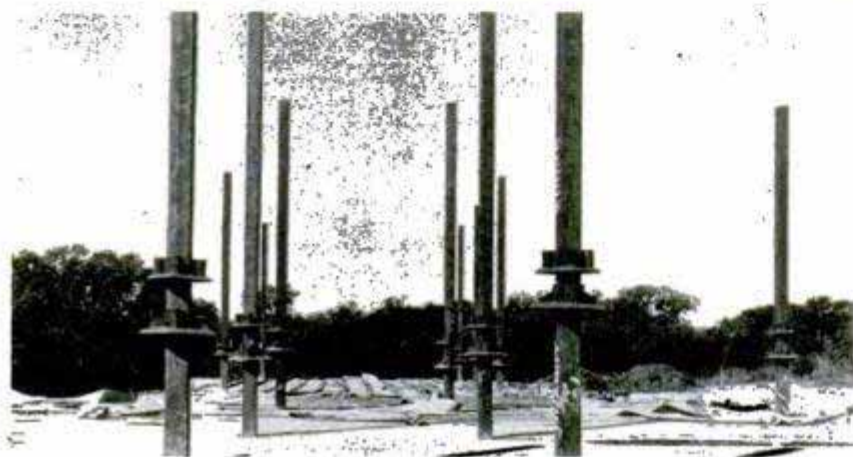

With the second floor and roof slabs already in place in the background, above, another second-floor section is ready to be raised in the foreground. The base slab acts as bottom of form for casting additional concrete slabs

After the foundation and base slabs have been poured, left, the supporting steel columns are set and anchored

Precast Layers Form Building

"RAISING THE ROOF" describes a new building method developed by the Institute of Inventive Research, San Antonio, Tex. Concrete floors and roof are cast at ground level and raised into position by automatic power-lifting equipment. Only edge forms are needed, since the additional concrete slabs are poured on the base slab over a separating medium. They are then welded to the supporting columns of pipe, steel or concrete by collars placed in them during the pouring.

Hydraulic lifting equipment, right, raises the slabs into position. The finished product, a Trinity University building in San Antonio

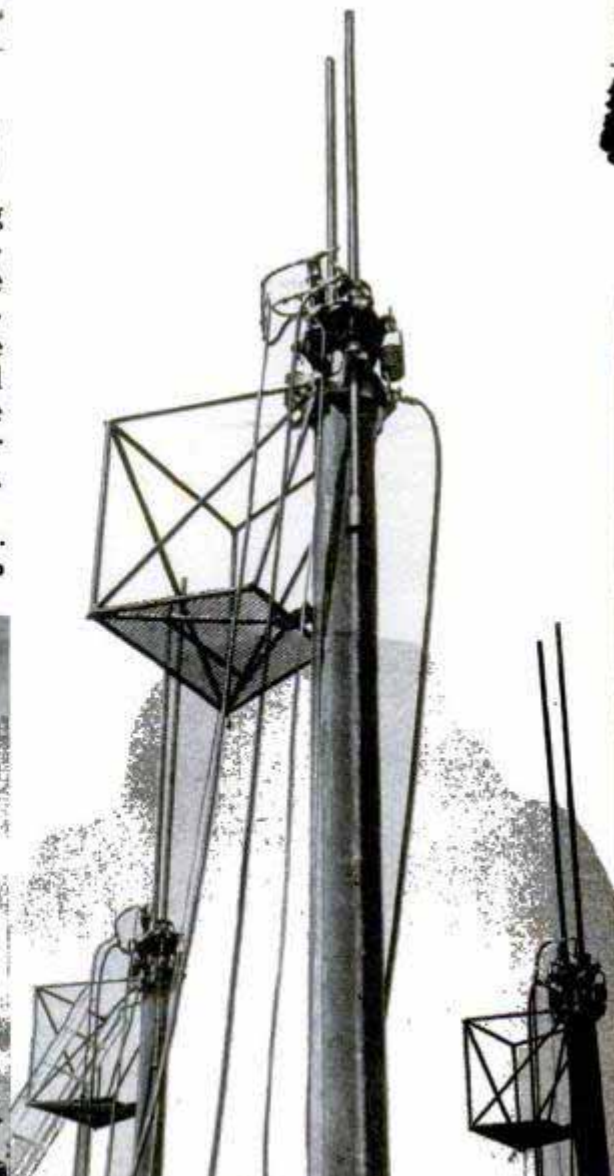

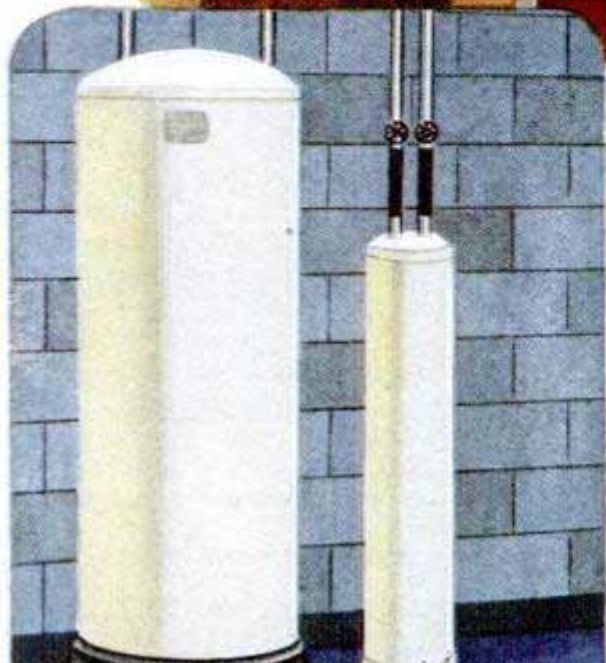

Korta

▲ 15-ton hydraulic press utilizes cylinder from dump truck. See story on page 200

◀ To learn more about the advantages of soft-water service in the home, turn to page 170



Don't try to "walk" into a boat unless you want to go swimming. Stepping onto the seat or gunwale, like this, is sure to push the boat away from the dock



Enter boat from a crouching position, holding boat against dock with one hand while reaching for opposite gunwale with other. Step into center of boat



"Paddle your own canoe" Safely

Handle your boat correctly and save a life—maybe your own. If you know how to board a boat and seat passengers safely, or what to do if the boat capsizes, a passenger falls overboard, or you are caught in a sudden squall, your boating trips can be highly enjoyable instead of terminating in possible tragedies

By Frank N. Stephany

NEITHER you nor I would consider letting our families ride in a car with an inexperienced driver in heavy traffic. But, on an occasional vacation or week-end trip, we willingly expose them to even greater danger by "piloting" them on a ride in a boat of which we know as little about handling as the inexperienced driver knows about the car.

It may be only a canoe, a rowboat, or one of several types of small boats fitted with an outboard motor, but all of these boats have one thing in common—they are subject to "pilot error," the primary cause of boat accidents. However, the fact that you're not an expert at handling the boat need not dampen your enthusiasm nor affect the safety of your excursions. Just be careful on the water, avoiding larger craft and watching the weather. Take a few preliminary precautions, such as seating yourself and the passengers properly, and keep in mind the best things to do if emergencies should arise. With the able assistance of La Nore Morehouse, author of "Know Your Canoeing," and assistant to the Safety Services Director, Chicago Chapter, American Red Cross, the editors of *Popular Mechanics* hope this story will help reduce the number of boating accidents due to unfamiliarity with the craft and the water.

Whenever you venture out in a boat, your best life insurance is knowing how to

To board canoe from beach, bow paddler steadies boat while stern paddler slowly makes way back to position. Bow paddler enters and moves amidships

*Old-Town Canoe Club
Old Town, Maine*



Overloaded craft could be death trap for these canoeists, and the man in the motorboat the "killer." The bow wave from the dangerously close motorboat will wash over the side of the canoe, possibly swamping it

swim—at least sufficiently well so you can accept an unexpected ducking without becoming panicky, and are able to swim a short distance back to the boat. This, of course, holds true for your passengers as well. Remember that a wooden boat, or a metal one with watertight compartments, will support the weight of several persons even though it is capsized or swamped. Never attempt to swim for help. The shore line always appears much closer than it actually is. Instead, hang onto your boat and calmly wait for help to arrive.

If a squall comes up, canoeists may choose to sit in bottom of the craft, thus lowering center of gravity, or remain kneeling for better control of canoe

Boarding a canoe or other small boat from a dock by placing one foot on the near gunwale or end of a seat and stepping into the boat is likely to result in an unexpected soaking. The safe method, which is just as easy, is to crouch down on the dock and place one foot in the center of the boat. While grasping the gunwale and the edge of the dock in one hand, reach for the opposite gunwale with the other hand, and lower yourself gently into the boat. Entering a canoe from a beach may be done in two ways. The canoe can be

Losing or breaking paddle is no cause for alarm. Canoe will make fair speed if hand-paddled as pictured. Note how arm is immersed to elbow during stroke

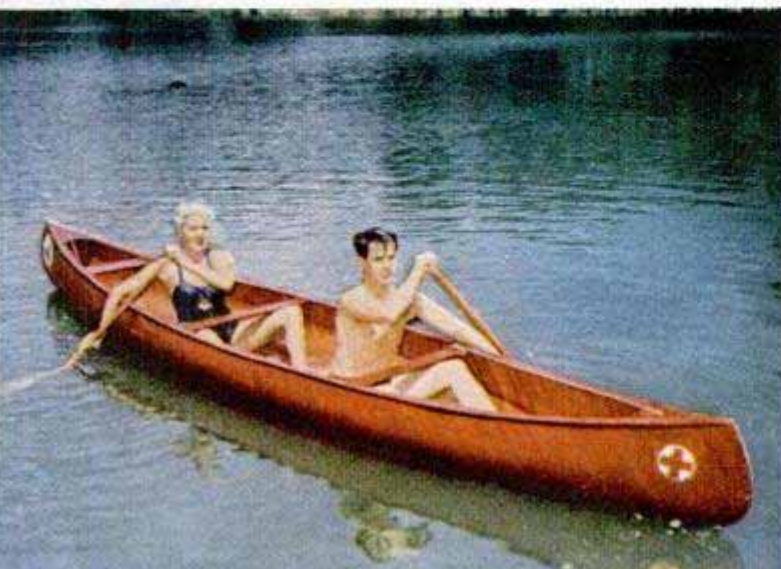



Capsized canoe is excellent life preserver. Canoeists keep heads above water until help arrives, one holding wrists of the other. Each may release an arm to swim craft toward shore



Swamped canoe can be swum or paddled ashore, above, after entering as shown below. If possible, paddle is retrieved and secured under thwarts. Then legs are kicked to "swim" into canoe



floated in 4 in. or more of water, and the paddlers, grasping the gunwales, step smoothly into their positions. The second way, which can be done without getting the feet wet, is to launch the canoe stern first. The bow paddler stands at the edge of the water and steadies the bow between his legs. Then the stern paddler steps into the bow and slowly makes his way back to the stern, keeping his weight low and sliding his hands along the gunwales. When the stern man is in position, the bow paddler enters the canoe.

Overloading any small boat is particularly dangerous, as it reduces the distance from the gunwale to the surface of the water. This results in taking on water from small waves or comparatively slight heeling of the boat. The number of people carried safely depends on the weight of the occupants, the conditions of the water and the characteristics of the boat. A canoe under 16 ft. long is considered a one-man canoe. Two men of average weight, carrying light duffel, usually can use a 16-ft. canoe; three men, a 17-ft. canoe; and four men, an 18-ft. canoe. To keep the center of gravity as low as possible, all passengers should sit on the bottom of the canoe and the paddlers should kneel. If you are alone in a canoe, take up a position near amidships. Kneeling in the stern will bring the bow out of the water and make the canoe difficult to control. A rowboat may be considered fully loaded when the seats are occupied. If an outboard motor is used or if there is danger of rough water, less weight should be carried. Never allow your passengers to stand up in the boat or sit on stem, transom or gunwales. Seat them to distribute their weight evenly throughout the length and breadth of the boat.

Before going out on the water, check up on the weather and take note of the wind as well as the current. If the weather is uncertain, stay close to shore. Remember that an offshore wind may cause the center of a lake to be dangerously rough even though the water is smooth near shore. Also, if you are just going for a ride, travel upwind or upstream first, so the homeward portion of the journey will be the easiest. If you are

caught in a squall while canoeing, you may sit in the bottom of the boat or remain kneeling. Although kneeling does not lower the center of gravity as much as sitting in the bottom, it has the advantage of allowing you to retain paddling efficiency. On a small lake, it is sometimes better to drift with the wind than to attempt to make headway against it. In a rowboat, seat as many passengers as possible on the floor and get the weight amidships so the bow and stern will be buoyant. Then head into the wind, as in Fig. 6. If you have an outboard motor, throttle down until there is just enough speed to control the rudder, as too much speed will cause the bow to bury itself in the waves. When the squall subsides, head for the nearest shelter, but if the wind should again pick up, turn back into it. When the stern of a boat is exceptionally buoyant, you can quarter downwind at low speed, if desired, but don't try this unless you are sure that the boat will not take water over the stern.

If a paddle is broken or lost, a canoe can be returned to shore by hand-paddling. Sit in the bottom of the canoe and grasp the gunwale with one hand. Then tilt the canoe slightly and immerse your free arm up to the elbow. After two or three strokes on one side, lean toward the other side and take a few more strokes with the other arm. Don't try to turn the canoe around. If you want to travel in the opposite direction, turn yourself around in the boat.

Should your canoe capsize, swim back to it and hang onto the bottom until help arrives. If the water is chilly, you can keep warmer by swimming the canoe toward shore with one hand. A swamped canoe also will support the occupants and, in fact, can be paddled to shore. Enter the canoe amidships, with hands directly over the keel. Kick your legs to bring them to the surface of the water, and then swim forward, simultaneously drawing the canoe under your body. Move slowly and steadily to keep the canoe from rolling. When your hips are over the gunwale, roll sideways and sit in the bottom of the canoe. Then, turn, lock your legs under the center thwart and spread your feet well apart. In this way, you are able to control the rolling action of the submerged canoe with your legs. The canoe can be "swum" back to shore with a breast stroke or, if you still have the paddle, use a shallow "sweep" stroke to propel the canoe. Point the canoe toward shore before entering it.

If one of the passengers falls overboard, grab him quickly and hang on—but be careful not to upset the boat. If he is out of reach, immediately extend an oar to him or throw him a buoyant cushion or rope. Then, keeping yourself low in the boat, bring him



Canoe is boarded from dock in same way as rowboat, bow paddler first. Enter from crouching position, transferring body weight smoothly to center of boat





Proper weight distribution in rowboat, left-hand photo, permits maximum speed and best control. Weight too far forward makes rowing a chore. Also, the boat will take on water from small waves washing over the bow

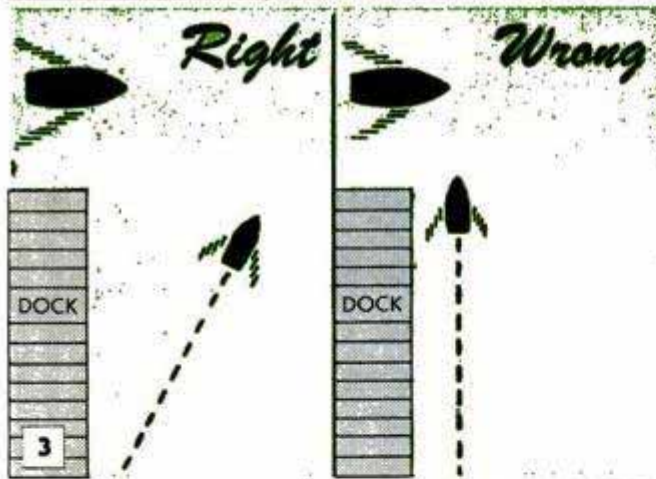
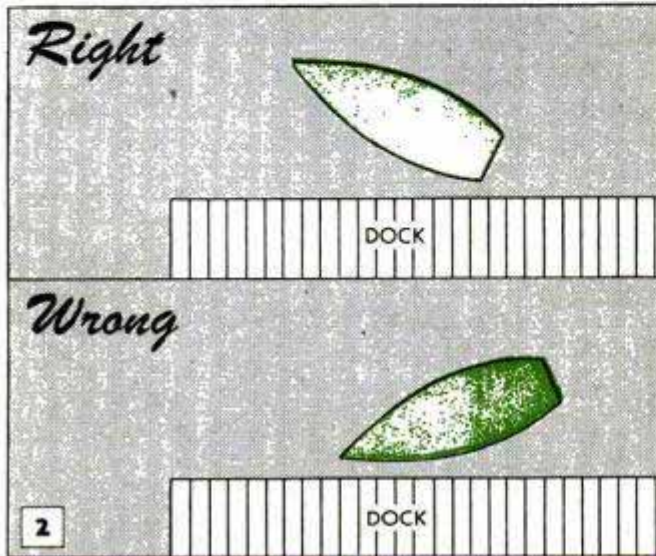

aboard amidships, in a canoe, or over the stern, in a rowboat. If the person is nearly drowned, slip your arms under his armpits and haul him gradually into the boat.

Should you fall from a canoe in deep water, you can re-enter the boat, as in Fig. 1, without capsizing it. Simply place both hands in the near bilge, amidships, as in detail A, and then kick your feet to bring your legs upward and plane your body. As the canoe is drawn under you, place one hand on the opposite bilge, B, turning the arm to keep the elbow high. With most of your weight supported on this arm to keep the canoe from tipping, work your body forward until you can roll into a sitting position, as shown in detail C.

When using an outboard motor, give the bow of the boat a slight shove away from the dock before starting the motor. As the boat begins to make headway, watch the corner of the stern nearest to the dock, and do not turn until it can clear the edge of the dock, Fig. 2. If you cannot see over the dock, head slowly away from the dock, as in Fig. 3. There is danger of collision in running parallel to the dock, as you may not have time to turn away from the path of a boat passing in front of the dock. Fig. 4 shows the safe procedure to follow when you are being overhauled by a larger, fast-

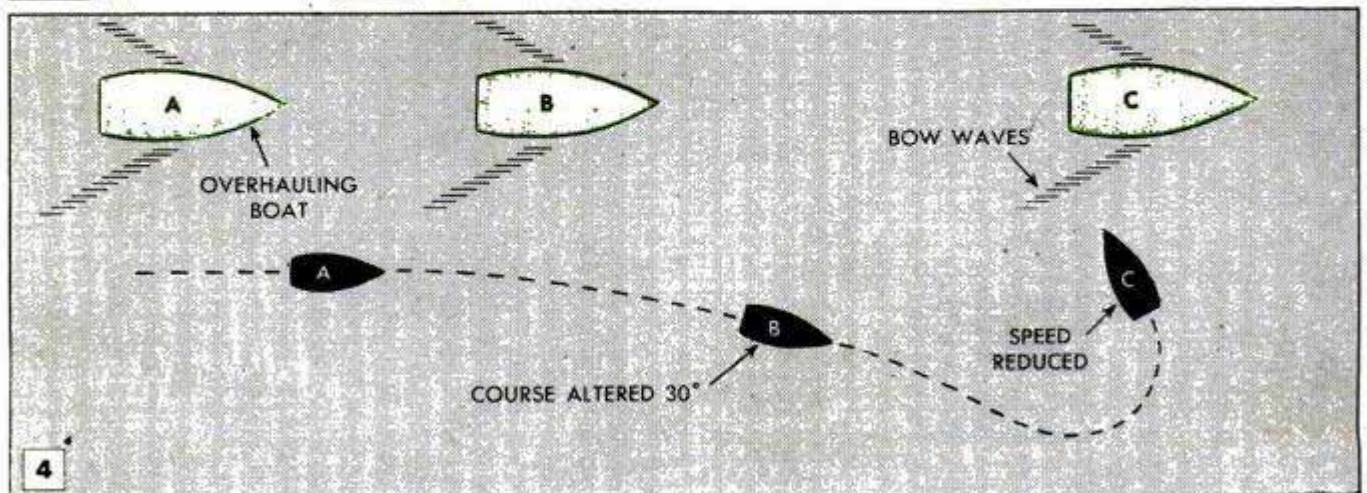



Docking

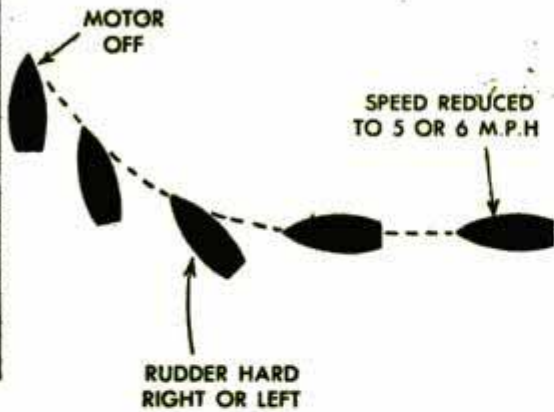

5

er boat. As the boat begins to overtake you, detail A, alter your course 30 deg. away from the overhauling boat, detail B. Then, as the large bow wave approaches, turn and head directly into it, detail C, reducing speed so the bow will lift with the wave.

Correct procedure for docking is shown in Fig. 5. Instead of coasting into the dock at an angle, head straight for it and throttle down to 5 or 6 m.p.h. Roughly a boat length and a half from the dock, throw the rudder hard to one side to begin swinging the boat parallel to the dock. Hold the steering lever in this position and slow the motor to as low a speed as possible. Done properly, you will find that forward motion has been almost entirely lost, with the boat brought up parallel to the dock. Cut off the motor before the boat begins to gain headway. A heavily loaded boat may require more room to respond to the hard rudder.

You are responsible for the wake of your motorboat. Give canoes and rowboats plenty of distance, and if you must pass fairly close to them, reduce your speed. Stay clear of docks, bathing beaches and diving rafts—swimmers are sometimes hard to see. For your own safety, avoid all large boats and treacherous waters.

Squall

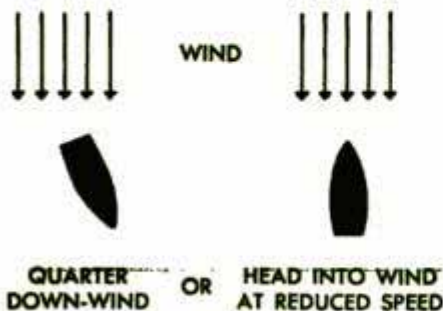

6

Cement Spread From Flexible Tube Through Saw-Slot in Cap

On a job where it is necessary to apply a large quantity of cement from a flexible tube, a slot in the cap will enable you to spread it more rapidly and efficiently. Before slotting the tube, which is done with a hacksaw, remove the cork or cardboard disk inside the cap. Cut the slot just deep enough to break through the inner surface. When storing the cement after use, replace the disk so that the container will be sealed tightly.

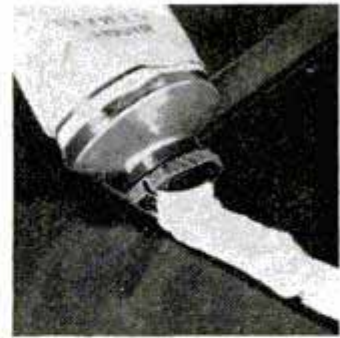

Summer Treatment for Fireplace

After giving the inside of your fireplace its usual spring cleaning, apply a coat of light-colored calcimine to the walls of the fire pit. This will give them a cool, clean appearance for the summer and can be easily removed with warm water and a brush when the fireplace is to be used.

Foil-Lined Gluepot Cleaned Easily

Lining almost any small cooking utensil with aluminum foil provides a gluepot that can be thoroughly cleaned in a jiffy. After the glue job has been completed, the foil is lifted out of the pot, leaving the utensil unsoiled. Any remaining glue can be left in the foil lining and reheated when needed.—Ted Dash, Bronx, N. Y.

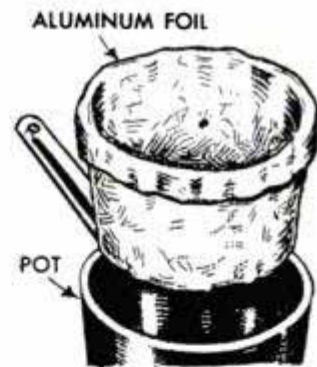

Cardboard Matchbook Cover Quiets "Shorted" Horn

The next time your auto horn "sounds off" and won't stop, don't get excited and start pulling loose all the wires under the hood. Instead, calmly wrap the cardboard cover from a book of matches around the horn wire near the end of the steering column, and slide it over the wire into the opening in the column. A short circuit in the horn wire at this point is often the cause of horns sounding continuously. If this is the case, the cardboard cover, acting as a temporary insulator, will stop the noise.

Julius C. Anderson, Brooklyn, N. Y.

Wedge Blocks Between Two Window Screens Stretch Wire Tightly for Mounting

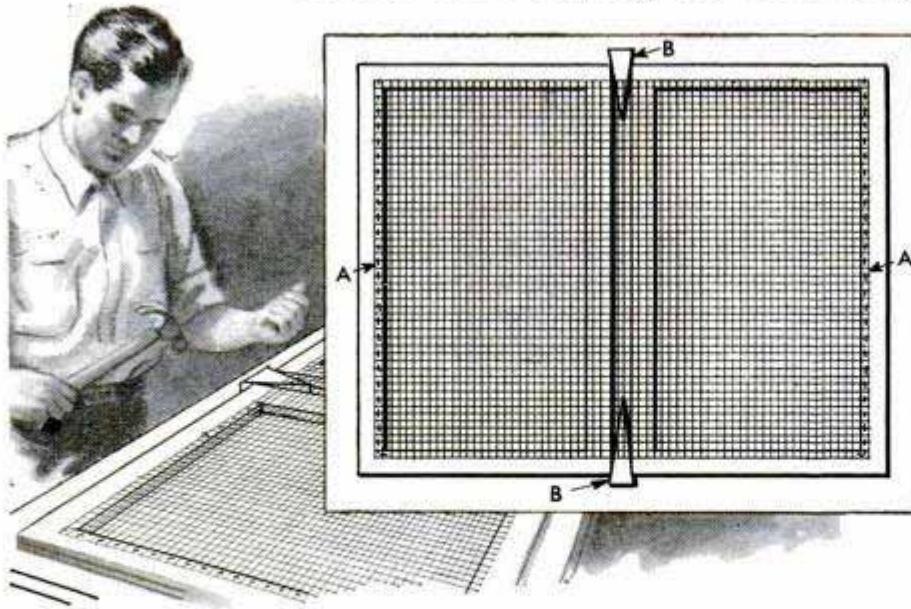

Here is an efficient method of attaching window screening to frames which requires a minimum of time and effort and assures a neat job. Two frames are laid side by side and covered with a length of screen which is tacked to the outside edges of each frame, A. Wedge blocks, B, are then driven between the frames, thus stretching the screen tightly. While the frames are held in this position, the screen is simply tacked around the other edges. Then the frames are cut apart and trimmed. — R. E. Reese, St. Petersburg, Fla.

Rowboat Chines Trimmed With Metal Gussets to Guard Against Scuffing

Flat-bottom rowboats which are beached frequently are subjected to a lot of wear and scuffing at the chines. In time this will cause leaks which necessitate extensive repairs. One owner of rental boats protects the chines from excessive wear by installing metal gussets formed from strips of sheet metal, preferably copper, about 4 in. wide. After cutting to this width, the strip is bent to form an angle and is attached to the bottom and side planking with small flat-headed screws or copper nails spaced about 2 in. apart. Before attaching the strips, nonhardening marine putty is rolled

into long, round strips about $\frac{1}{2}$ in. in diameter and pressed into the corner of the angle to form a water-tight joint. Where the angle must take a bend near the bow and at the stern, cut narrow notches at intervals along one leg of the angle so that it will take the bend without buckling.

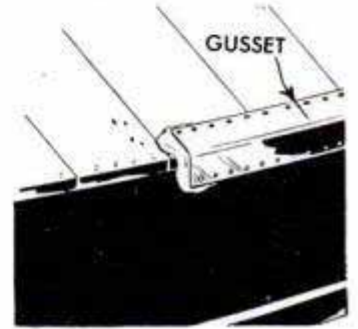

Backfiring Motor Clears Carburetor Jet in Emergency

Often, rough idling of a car engine is due to a partially clogged low-speed jet in the carburetor. Of course, the proper treatment is to take the carburetor apart and clean it out thoroughly, but in an emergency, the clogged jet can sometimes be

cleared by causing the motor to backfire. Interchange the high-tension wires to the No. 3 and 4 spark plugs, start the motor of the car and race it. However, care must be exercised in this procedure as it could cause a fire.—H. W. Swope, Danville, Pa.

Paint Bucket Hung on Ladder Rung Steadied by Device Made From Bail

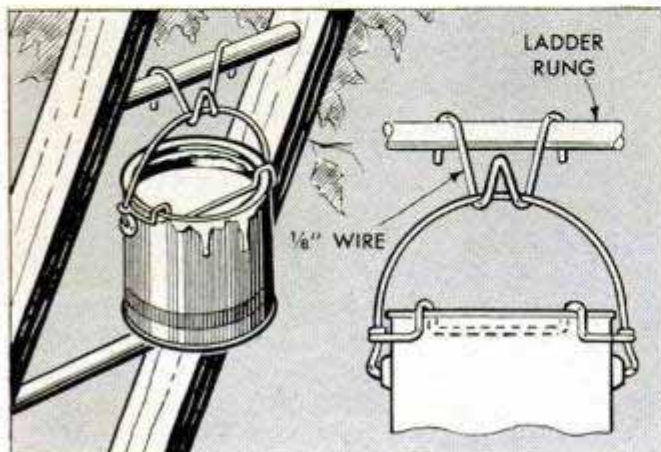

The bail from an old paint can, formed and fastened to a bucket of paint, as shown, makes an inexpensive guard against spillage when painting from a ladder. Note the straight section of the wire which spans a portion of the bucket opening. This is used for scraping excess paint from the brush. The hook which holds the bucket to the ladder rung is formed from wire a little heavier than a bucket bail. It provides two separate points upon which the handle of a bucket is hung, thus preventing the bucket from twisting.

John Strickler, Detroit, Mich.

With this battery-driven tool you can make hammered ash trays, coasters or other articles of soft metal in only a fraction of the time usually required to do the work by hand. The tool, which features easily interchangeable hammer heads and is inexpensive to construct, may be driven with a 6-volt battery or by 110-volt a.c. through a doorbell transformer. To build the unit, first obtain or turn a wooden spool, approximately 2 1/4 in. in diameter and 3 in. long, and drill a 5/16-in. hole through the center. Wind about 15 layers of No. 16 enameled wire on the spool, covering its full length. Then, drill a 1/4 x 2 1/2-in. iron rod at one end

to receive a length of 3/16-in. dowel. Drill and tap the other end for a small machine screw, the head of which has been ground to shape for use as a hammer. The spool-and-rod assembly is supported between brackets which are mounted in a hardwood base as shown. A brass strip, which serves as the contact-breaker arm, is fastened to the base by a single bolt and nut. One of the wires from the coil is wrapped around the bolt and held in place with a thumb nut. The other wire from the coil is attached to a terminal bolt on the brass

Electrically Powered Peening Hammer Saves Time When Embossing Metal

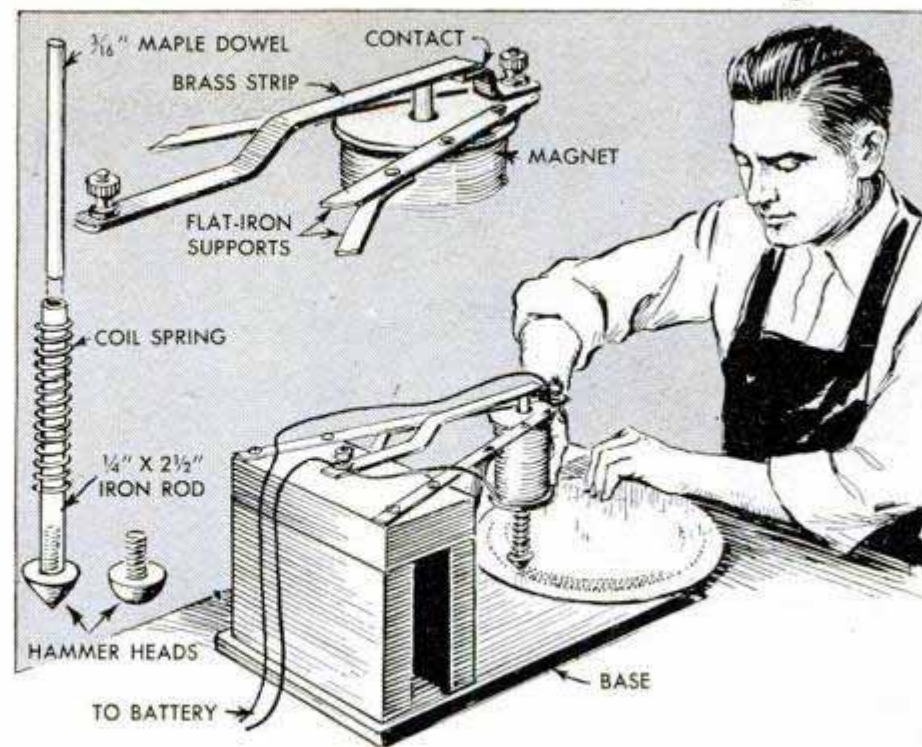

contact piece in a like manner. In operation, the electrical current energizes the coil and causes the iron rod to be drawn upward. The dowel at the end of the rod pushes the breaker arm off the contact point, breaking the circuit. This releases the rod from the magnetic grip, and the spring drives the hammer head against the work. At the same instant, the brass strip drops back on the contact point, thus closing the circuit and causing the sequence to repeat. — R. Morrow, Carrington, N.S.W., Australia.

Line Scribed on Grinder Tool Rest Serves as Drill-Sharpening Guide

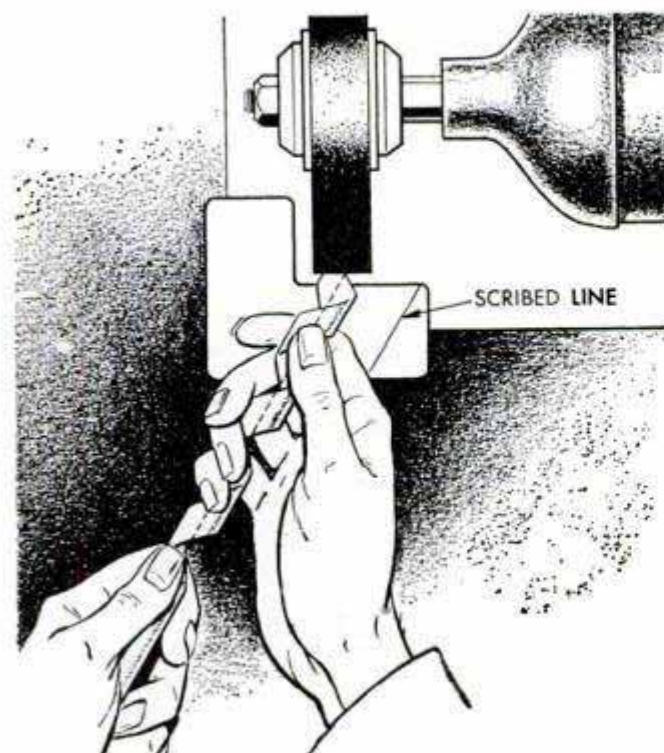

A deep line, scribed at a 59-deg. angle on the surface of a grinder tool rest, provides a handy guide for holding twist drills at the proper angle when sharpening. It is necessary only that the shank of the bit be held parallel with the line. This method is especially helpful in sharpening small drills, as the short lengths of their lips, or cutting edges, make them difficult to gauge in the usual way. If guide lines at angles other than 59 deg. are desired, they can, of course, be scribed on the tool rest and used in a like manner.

Edward Morton, Hartford, Conn.

Strong Sewing Thread

If you need some strong white sewing thread for replacing buttons, etc., dental floss will be ideal. It is very strong for its size, is waxed to minimize tangling and is already in a handy container.

Andrew Vena, Philadelphia, Pa.

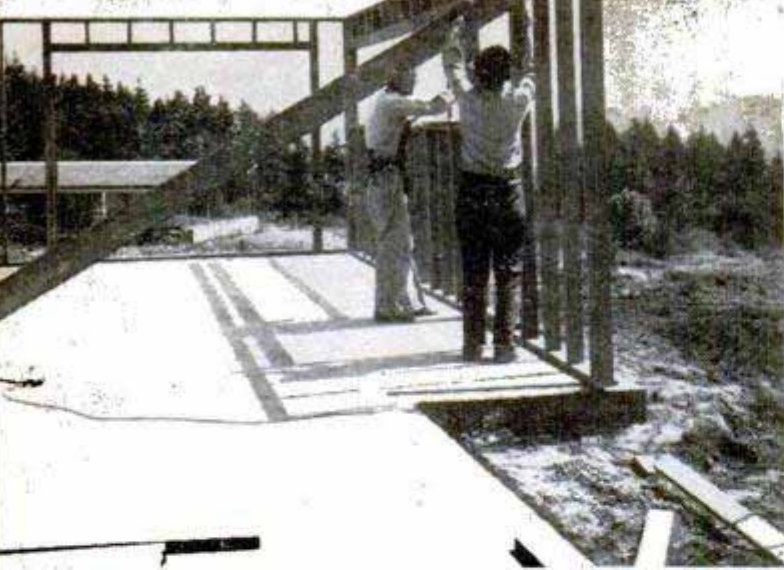

After the walls are "prefabbed" flat on the subfloor, they are raised, plumbed and braced. Later a second top plate will be added to tie wall sections together

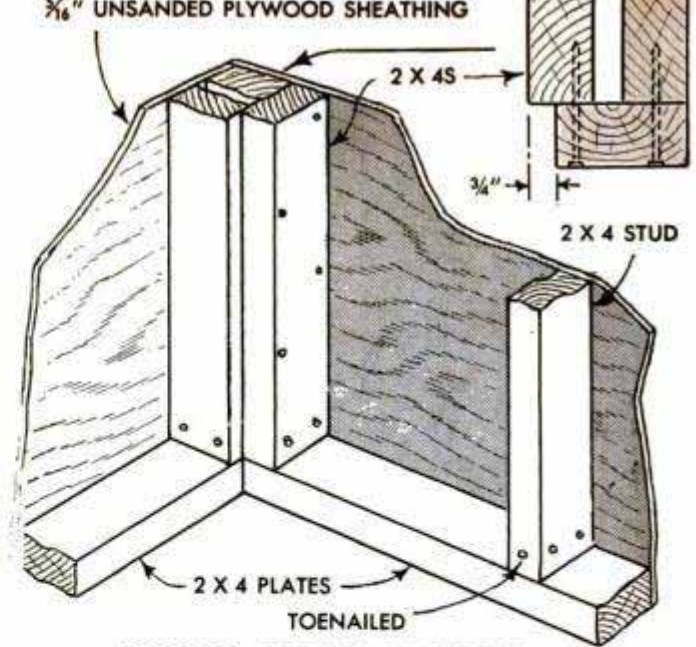

TYPICAL CORNER FRAMING

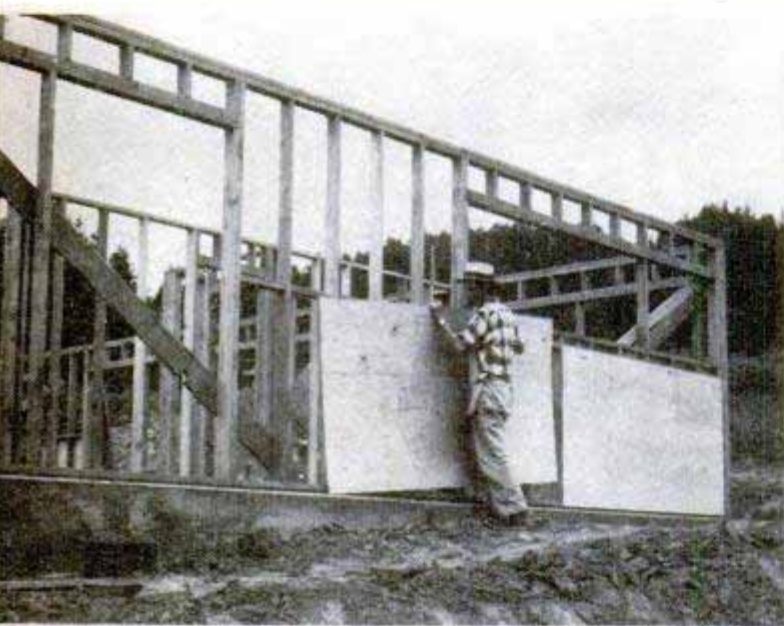

Sheathing the outside with 4 x 8-ft. sheets of plywood goes fast and results in a wall 50 percent stronger than shiplap. Below, R. J. Coffman, Portland brickmason, is laying the "island wall" fireplace



How I Built

PART II

By Tom Riley

AFTER the PM ranch house has been completed to the point discussed last month, the next step is to raise the exterior walls and brace them in position. As you remember, these were framed flat on the subfloor with the bottom plate nailed to the lower ends of the studs, which means that all you have to do when raising the walls is spike the bottom plate to the subfloor.

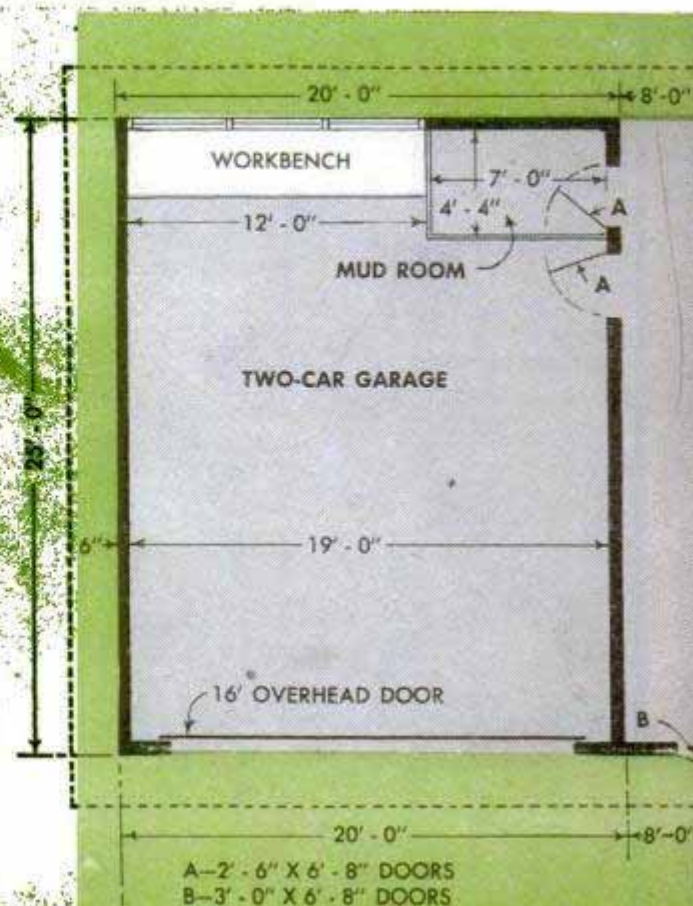

A-2'-6\"/>

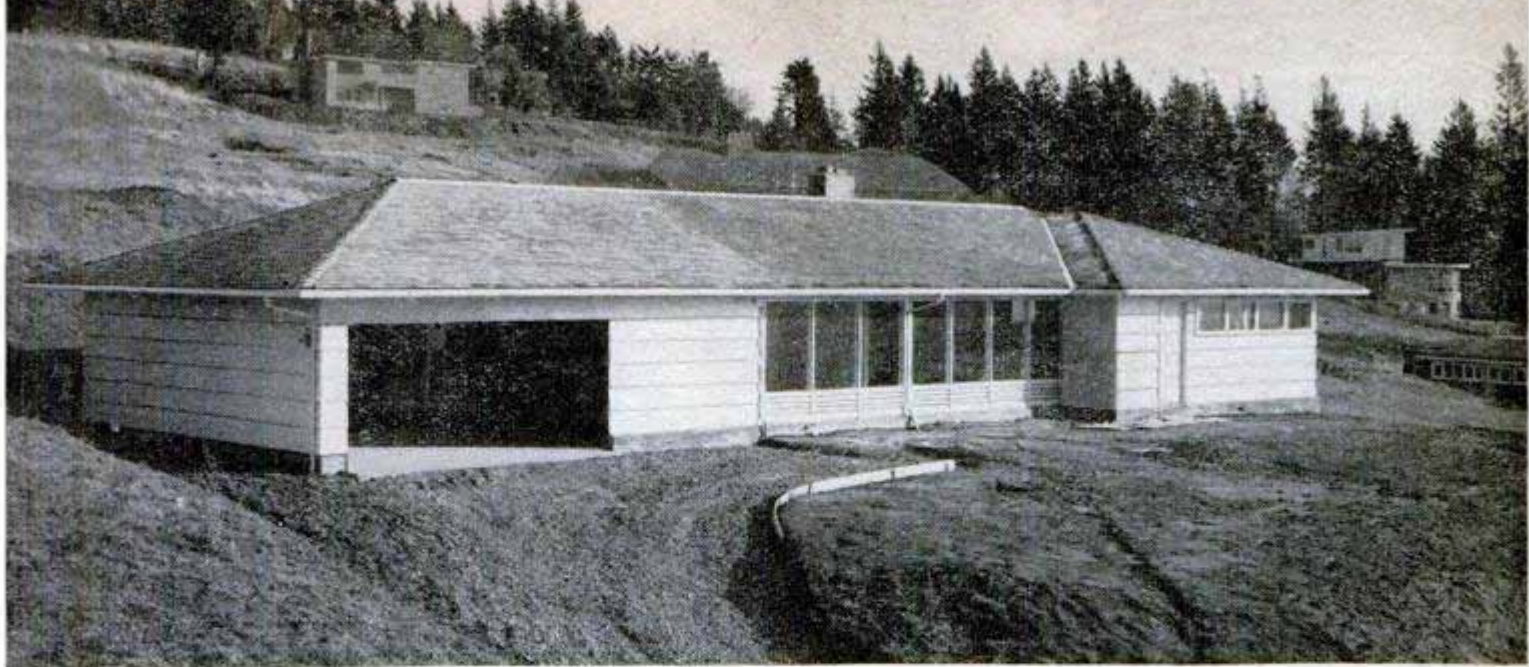

the **POPULAR MECHANICS** Ranch House

This deviates a bit from ordinary practice in that the sole, or bottom, plate usually is spiked to the floor first and then the studs are toenailed to it after the walls are raised. When plumbed and braced in position, the individual wall sections are tied together with a second 2 x 4 plate which is placed on top of the top plates and spiked to them. Lapped at the corners and straddling abutting wall sections, the top plate thus ties all walls together. With the exception of the partition between the kitchen and dining area, which is installed after the ceilings

are paneled, the interior walls are erected next in the same manner and tied to the exterior walls with a top plate as before. I used unsanded plywood, called Plycord, to sheath the exterior walls and, while this material is not generally stocked by the local lumberyard, they can order it for you. It's less expensive than "reject" grade and comes $\frac{7}{16}$ in. thick. Sheathing with plywood goes fast, being merely a job of nailing 4 x 8-ft. sheets horizontally to the studs with 6d common nails spaced 6 in. apart. As the floor plan is based on a 4-ft. module,

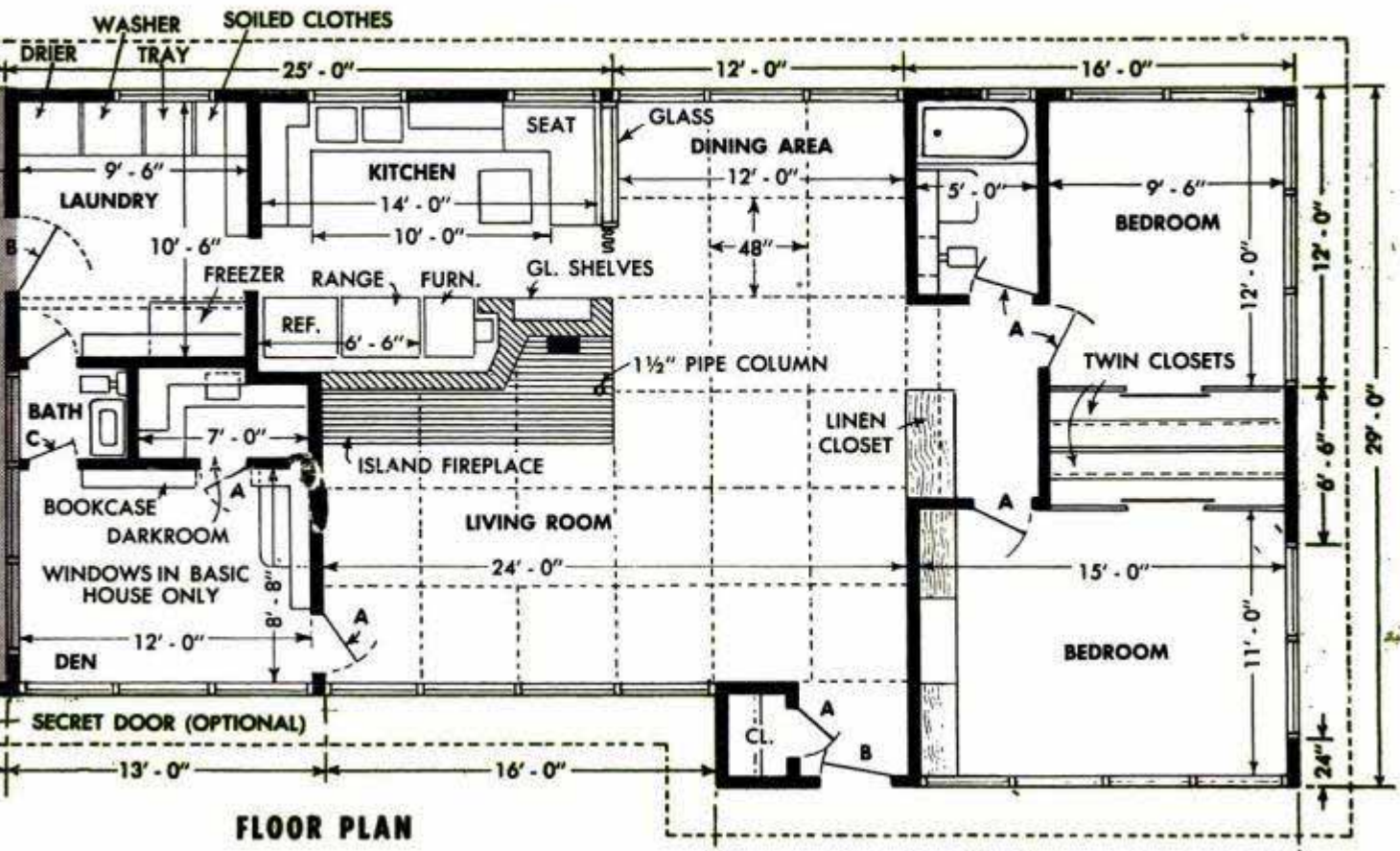



Here I'm beginning to box-in the roof overhang with 2 x 4s which later are faced with clear-grade 1 x 6 boards

very little cutting of the sheets is necessary, other than around window and door openings. Although the use of plywood or a composition-type board saves a lot of time and produces an exceptionally strong, windtight wall, common wood shiplap, laid diagonally, can be used if preferred.

Now comes the truss-type roof. Here, I found that architect Whelan's contention—that a truss roof is easier for the amateur home builder to erect than the rafter type—certainly is true. Prefabricating the trusses right on the floor of the house is a lot easier than doing it up in the air. And, requiring no more lumber than the conventional rafter-type, the trusses actually are as

All parts of each roof truss are nailed together in this simple jig which is laid out right on the subfloor. This method assures all trusses being exactly alike

much as 200 percent stronger. To be sure that all trusses would be alike and thus assure a straight ridge line, I assembled them in a jig which was laid out full size on the subfloor, as shown in the photo below. By using scraps of 2 x 4 nailed to the subfloor along the penciled truss outline, I improvised a jig, or form, which would hold corresponding members of each truss in exactly the same position for nailing. Then, using the carefully cut pieces of the first or master truss as patterns, I pre-cut all the parts for the 42 trusses required, 28 for the basic house and 14 more for the garage and breezeway. Plywood scraps from the subfloor are salvaged for use as truss gussets.

You'll need help to hoist the trusses in

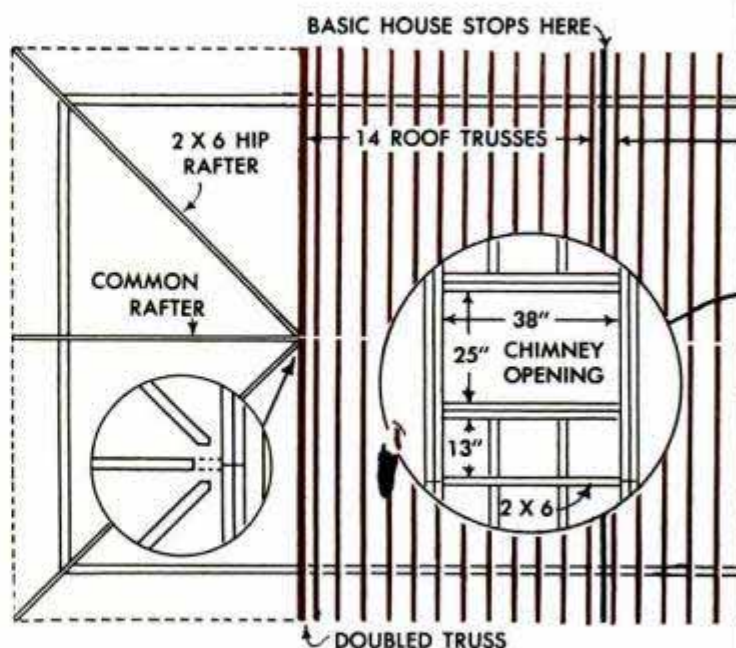
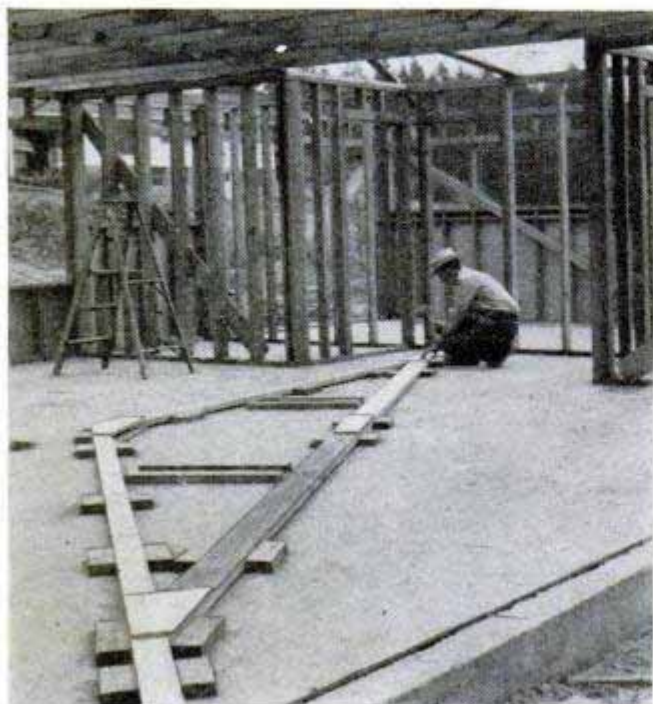

TRUSS AND HIP-RAFTER PLAN

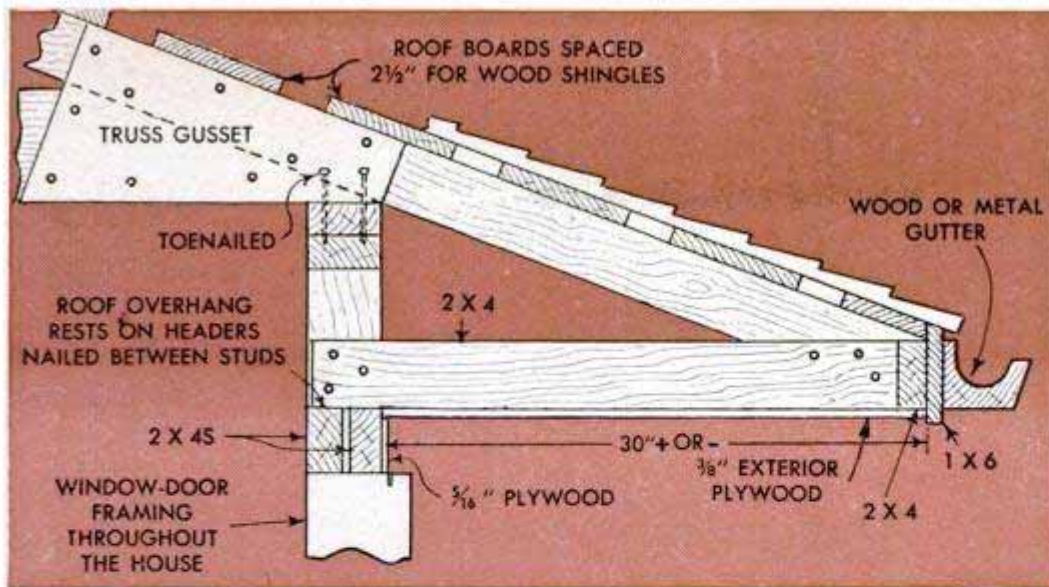

Here is a view of the bedroom end of the house. Note that the window louvers are larger than those in the living room. Both bedrooms feature three "clerestory" windows on one wall which allow beds to be located under them. Right, roof-truss plan is used to lay out the assembly jig on the subfloor. Below, this plan gives location of trusses and shows how hip rafters are tied in

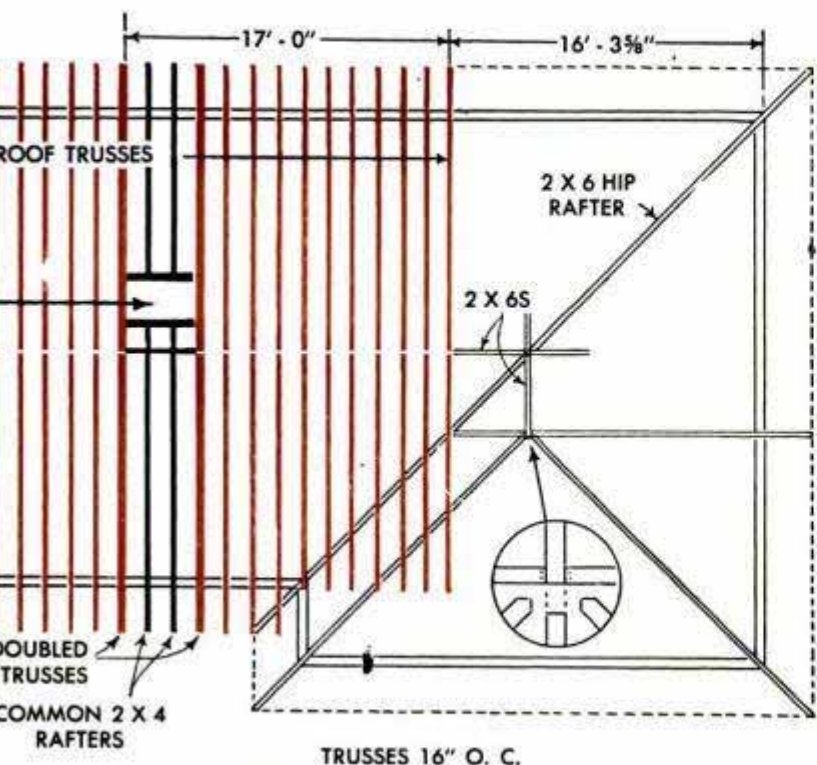
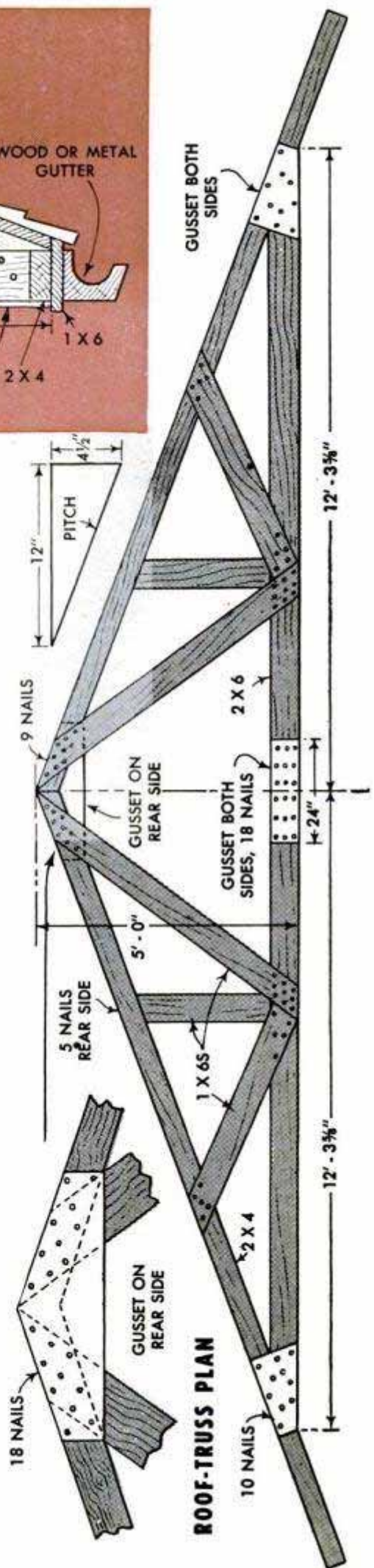



With today's quiet, compact heating units, furnace can be located right in the kitchen. Here you see me installing the reverse-type plenum which the General Electric furnace required. The entire hot and cold-air distribution system is installed under the floor. With the help of a friend, I saved \$200 on the installation



This view of the crawlspace under the floor shows my friend Mel Wilkening installing the 4-in. heating pipes which branch off from the oil-fired furnace

place. By following a method employed by contractors, Norman Chapman and I had little difficulty. We first hung several trusses upside down across the house, resting the ends on opposite walls. Beginning at a point 16 ft. 3⁵/₈ in. from the bedroom end of the house, we flipped the first truss upright with a long pole and a rope. Then with the first truss plumbed and braced, we raised the next one in the same manner, and so on, spacing each one 16 in. on centers and bracing with roof boards as we went along. Note that the front ends of the first six trusses rest on the partition wall

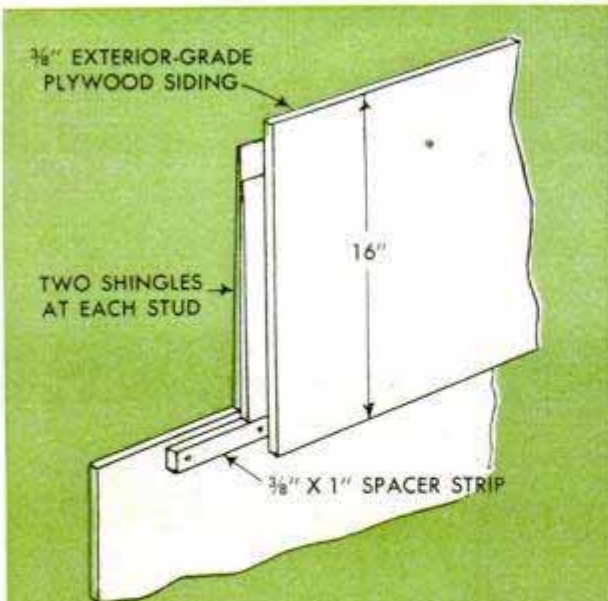

Here's something new in siding. Using exterior grade (marine) plywood, I ripped it into 16-in. strips and backed it at each stud with two cedar shingles and a 3/8-in. spacer strip along the bottom edge. The effect is very modern, only six panels high

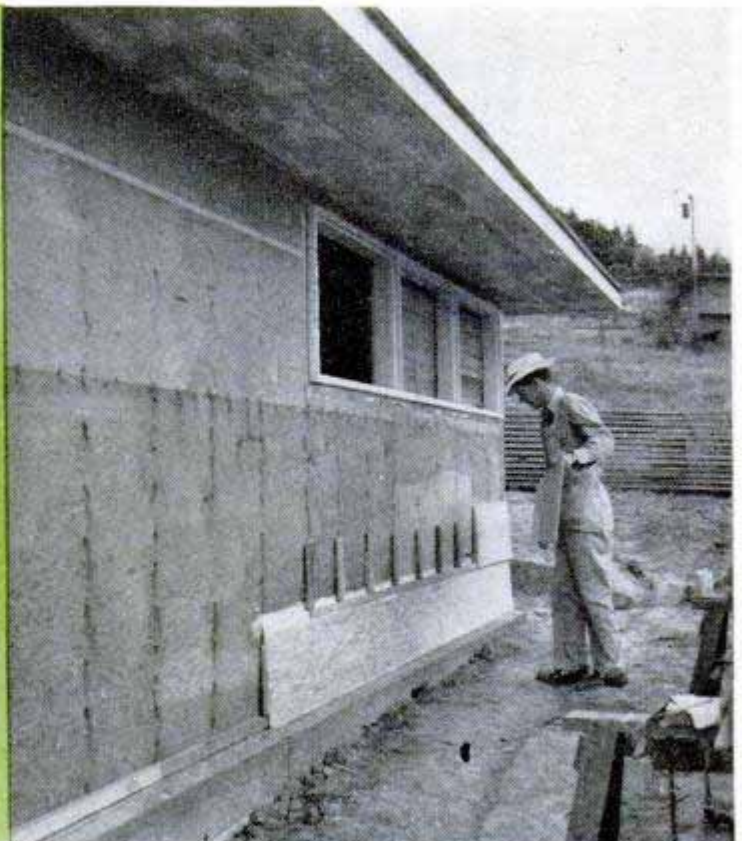

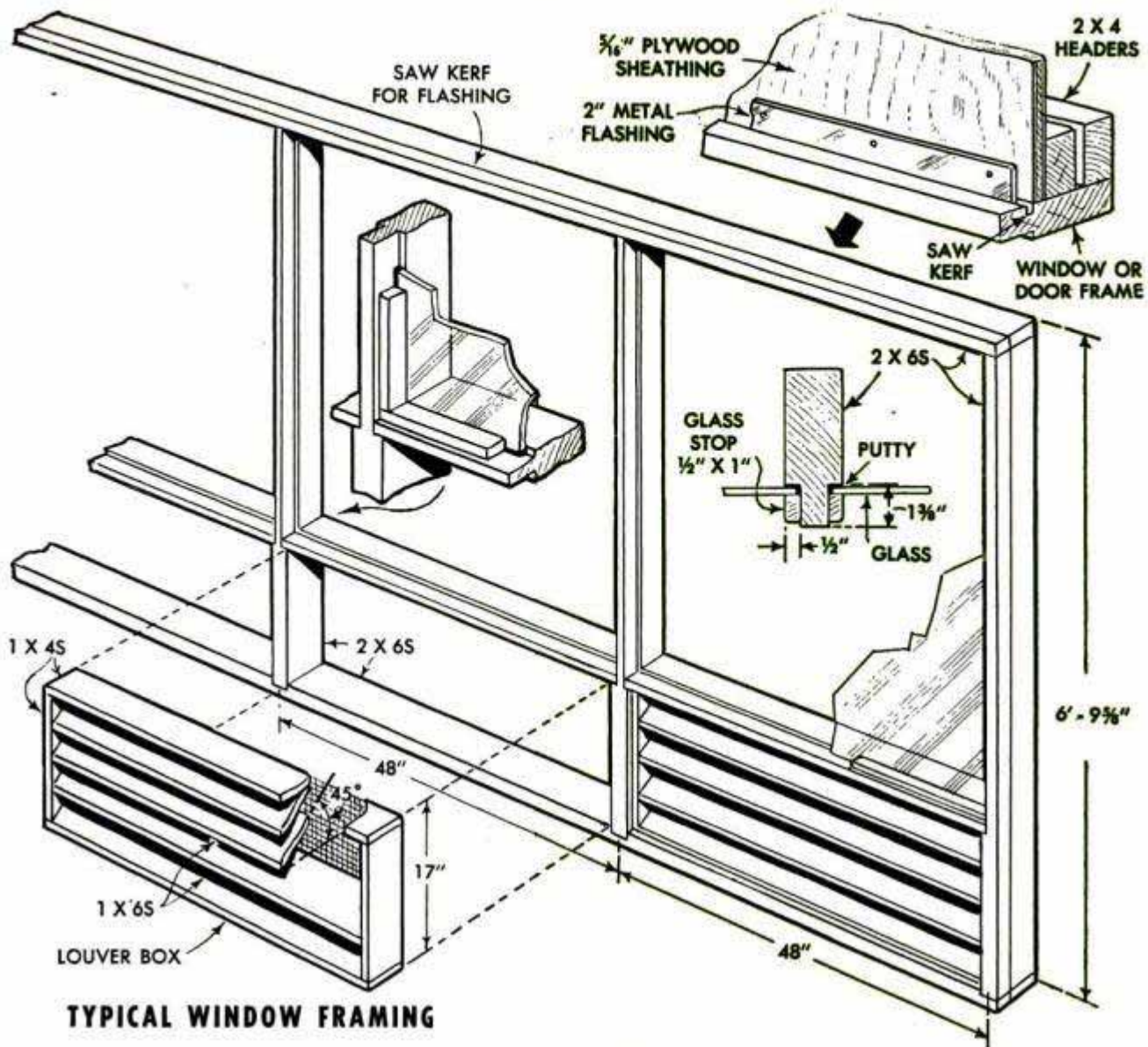

TYPICAL WINDOW FRAMING

of the vestibule closet and the header over the entranceway. Truss and hip-rafter plan shows how hips are framed with 2 x 6s. However, before these are installed, 2 x 6 ceiling joists must be set on edge over this part of the house. These are placed at right angles to the trusses and are butted against the first one and spiked to it. After the hips are in place, the rest of the area is filled in with jack rafters which are toenailed to the wall plates and to the face of the hips in the conventional manner. The chimney opening is framed between doubled trusses according to the rafter plan. Although the basic version of the house, shown in Part I, pictures the house with a gable end, you also can frame this end with a hip if desired. With the roofing members all in place, the overhang is framed completely around the house, first spiking 2 x 4s to the angle-cut ends of the trusses and

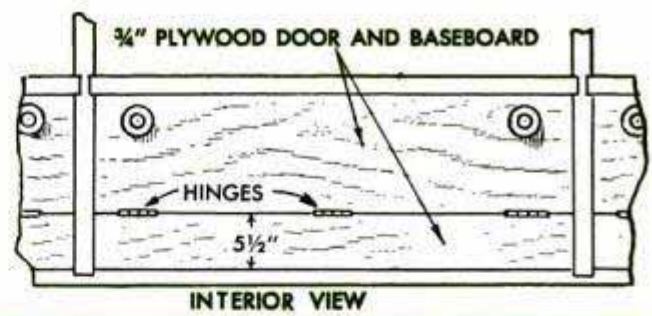

INTERIOR VIEW

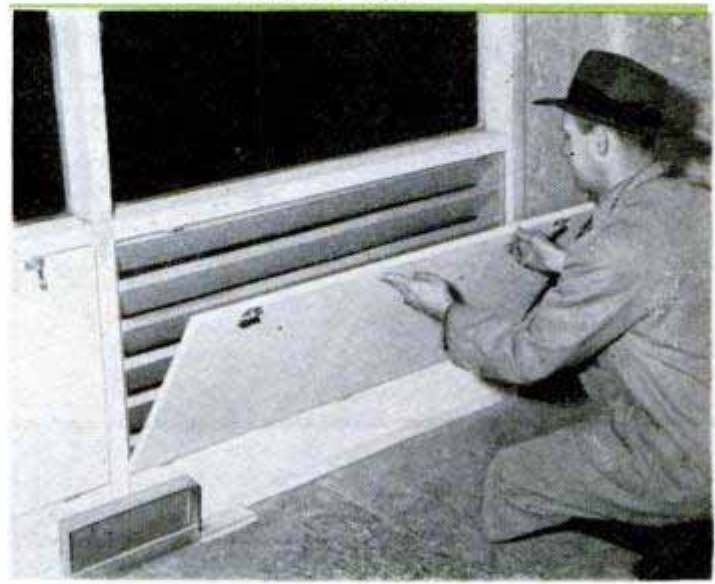

Right, Wayne C. Leckey, assistant craft editor, tries out louver ventilator, a feature of the large windows. "Air wall" type register fans the heat over window area like your auto-windshield defroster

rafters, and then facing the 2 x 4s with boards of 1 x 6 clear lumber. You will notice in the overhang detail, that the short 2 x 4 pieces that form the soffit framing (boxing of the overhang) are placed on top of the window headers and spiked to the face of the studs. I used wooden shingles on the roof, which meant that the 1 x 6 roof boards had to be spaced 2½ in. apart to allow for "breathing." An 8d nail, which is used to nail the boards, is just the right length to use as a spacer. If metal gutters are to be used, they should be hung before shingling; wooden gutters can be installed afterward. In laying the cedar shingles, Vinita and I followed the recommended practice of spacing them ¼ in. apart to prevent buckling when wet and nailing them with only two nails per shingle to permit shrinking and swelling without breakage. The hole for the vent-pipe stack was located and cut later.

From here we moved inside to build the fireplace. As mentioned in Part I, the "island wall" fireplace forms a brick wall between the kitchen and living room, which is bricked from the concrete footing to the ceiling. Common brick are used almost entirely, except on the living-room side of the wall. Here, for a distance from the subfloor to the top of the fireplace opening, we used

Arizona field stone to relieve the plainness. I had the fireplace built, but after watching Robert J. Coffman and jotting down every step, it's a job you can do yourself if shown exactly how. For the most part, it's a case of stringing chalk lines from the footing to ceiling and then laying courses of brick to these lines. Above the ceiling, the fireplace measures 2 x 3 ft., has a double flue, and extends about 2 ft. above the ridge line. Limited magazine space does not permit detailing the fireplace completely, but the instruction book which I am preparing will show every step.

Besides being easy for anyone to make, the windows are a novel feature of the house. Comparing prices of ready-made window units, I figured I saved at least \$300 by making the frames myself and glazing the large ones with crystal glass and the small ones with double-strength glass. The simple stunt of running a saw cut around the frames to take a 2-in. strip of metal flashing gives a weathertight joint that is permanent regardless of shrinkage or settling. The louvers below the glass provide excellent no-draft ventilation. As shown, they are merely simple boxes fitted with slanting louver boards, backed with copper screen wire and fitted on the inside with hinged transom-type doors. The draw-

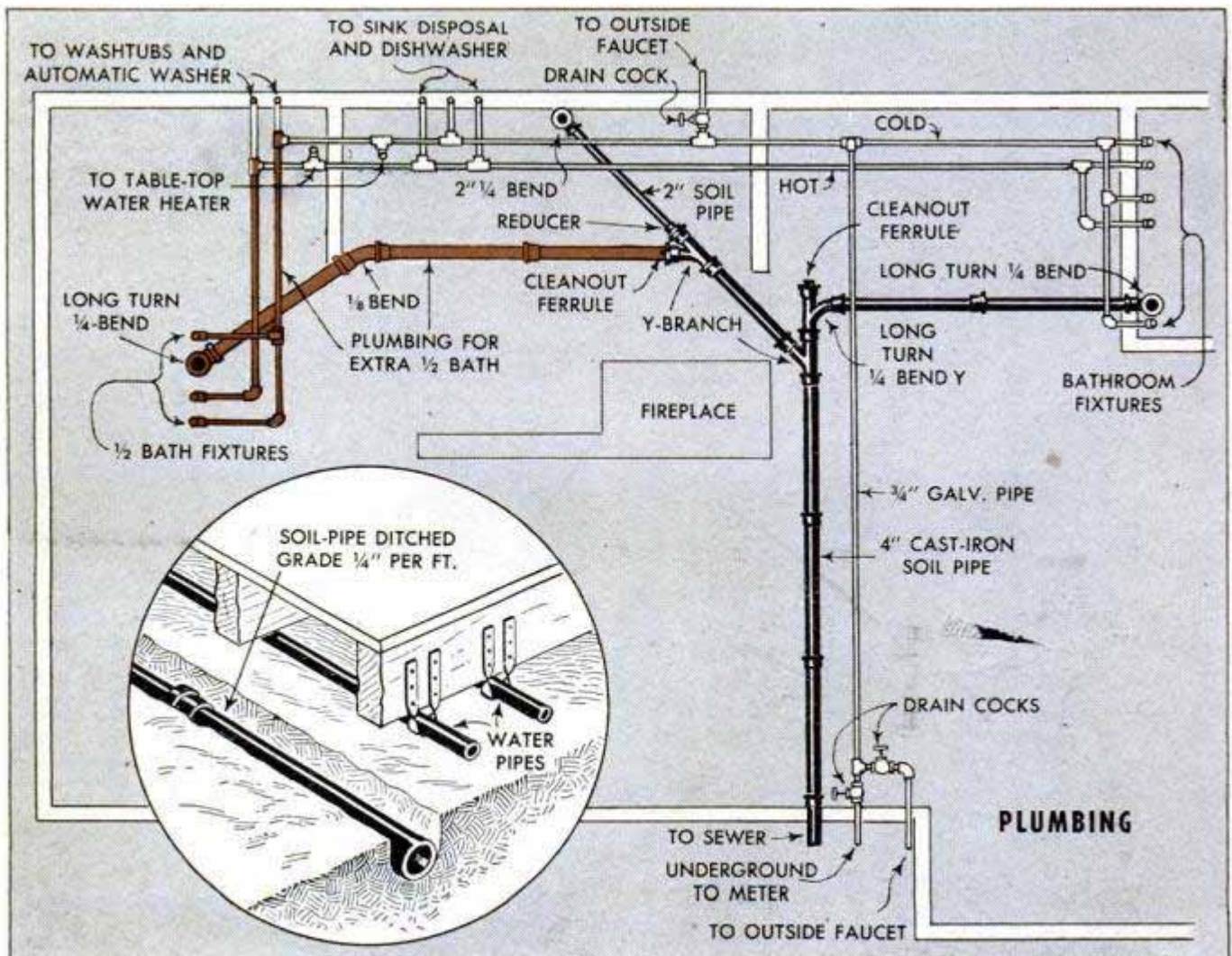

ing on page 163 shows the assembly of the living-room frames which is typical of the other frames. In addition, three casement-type sash, which I purchased from a mail-order house, are used in the bathroom, kitchen and utility room.

Treatment of the exterior walls is a matter of personal preference. I used the new plywood-siding idea in which 4 x 8-ft. sheets of $\frac{3}{8}$ -in. exterior (marine grade) plywood are ripped into 16-in. strips and then lapped as detailed, only six widths being used from grade to overhang. A deep shadow line is obtained by backing up the plywood with two cedar shingles at each stud. Besides lending itself to fast coverage, plywood siding makes an attractive, inexpensive and durable job. Exterior-type plywood also is used to box-in the soffit or underside of the overhang.

The plumbing layout is designed to accommodate all modern appliances, such as garbage disposal, automatic washers, etc., and the extras cost very little more to install at this time, including the extra half-bath off the kitchen. While the plumbing can be installed before the subfloor is laid, I did it afterwards, calking and leading some of the soil-pipe fittings before placing them under the floor. In installing the heating system, I enlisted the aid of an old schoolmate, Mel Wilkening, whose experience and advice helped me save over \$200. Using a forced hot-air system, we located "air wall" registers, which fit in the baseboard, directly below the windows in the living room and bedrooms. This new idea in air registers does not just spill warm air into the room but spreads it over the walls. Thus, moisture condensation on the glass is greatly reduced by a defrosting principle and, by heating the coldest radiation area (the windows), an even temperature is obtained throughout the room. The island-wall fireplace provides a built-in niche in the kitchen for the oil-fired, General Electric furnace which looks and sounds like a refrigerator. Small, 4-in. round pipes, that fit together like sections of stovepipe,



While plumbing can be installed before the subfloor is down, I did it afterwards. Layout plan on opposite page accommodates all future appliances you might consider owning and costs little extra to include now

are used in the distribution system, and are placed under the floor in the crawl space. I had the furnace installed by the dealer but did the rest of the job myself, including installation of the ready-made plenums which are large sheet-metal ducts that attach directly to the furnace. Cold-air ducts were formed in the usual way by boxing-in two floor joists with sheet metal.

Both garage and breezeway floors are 4-in.-thick slabs poured over a 4 or 6-in. gravel fill. If a ready-mix service is available in your locality, I suggest that you order your concrete from them. It's both economical and convenient. Unless you can enlist the aid of a couple of extra helpers, it's best to pour one slab at a time so that it does not set before you can finish troweling it. It's also wise to lay a vapor barrier under each slab to prevent damp and cold floors in winter.

(To be continued)

Open-Type Saltcellars Provide Handy Paint-Mixing Cups for Artists

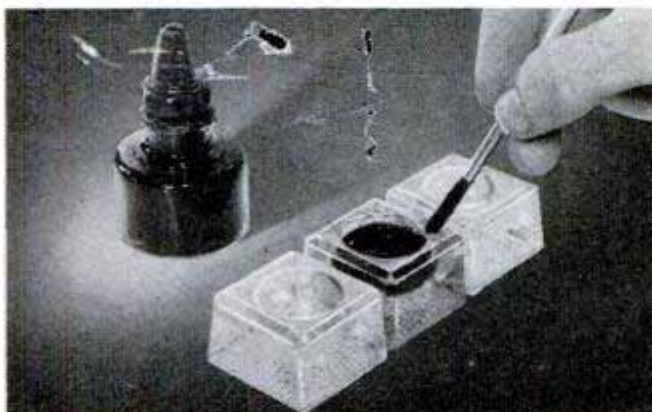

Open-type glass saltcellars, which are used to serve individual portions of salt to diners, make excellent paint-mixing cups for amateur artists. They are fairly heavy, and will not tip easily or skid around when mixing paint in them. Being of heavy glass, they can be easily cleaned and are not readily broken.

☐ The next time you go fishing for carp, try some of the following baits: Pieces of marshmallow candy, canned corn and small white currants or raisins.

see opposite page

WAXING FLOORS is less tiresome if a towel-covered dust mop is used to polish the waxed surface. A turkish towel is excellent for this purpose, as the coarse texture of the material quickly cuts through the top film of wax and speeds polishing. To reduce the pressure that must be exerted on the mop handle, weight the mop by placing a brick or other heavy object on top of it before wrapping with the towel. Use safety pins or spring-type clothespins to fasten ends of the towel



GARBAGE-CAN COVER held in place with screen-door springs cannot be disturbed by stray dogs, and the contents will not spill if the can is tipped over. Hooks on the ends of the spring, which engage the handles, are easily detached for removing the cover

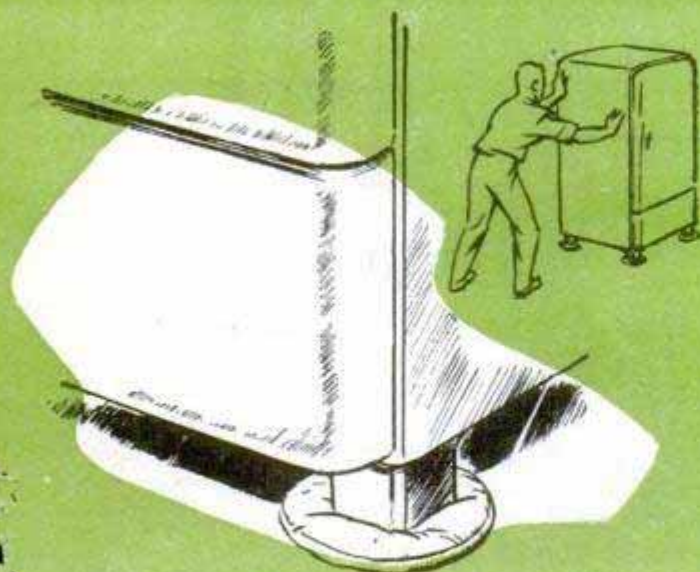

MOVING A REFRIGERATOR or kitchen range is easier if an ordinary powder puff is placed under each leg. With the weight resting on the smooth powder puffs, danger of marring the linoleum also is eliminated

Solving HOME PROBLEMS

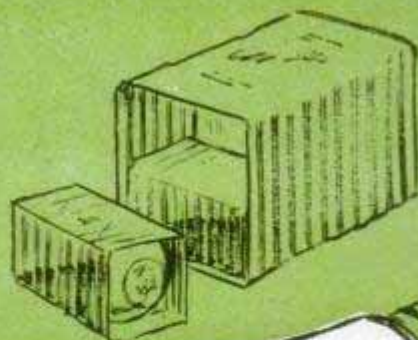

PENCIL
MARK

BURNED-OUT LIGHT BULBS often become mixed with the good ones, thus requiring that all bulbs be tested before returning those to be renewed. To save this trouble, mark burned-out bulbs with a grease pencil

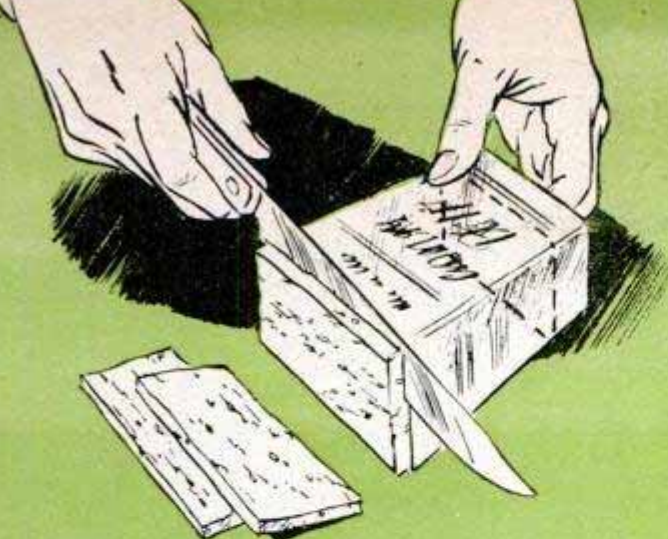

NEAT, UNIFORM SLICES can be cut from canned meat by using top edge of the opened container as a guide for the knife. Cut the bottom free from the sides of the can with a rotary-type opener and press against the bottom to expose the meat for slicing



FLIES STAY AWAY from a screen door when wads of cotton are fastened to the outside of the door, as above. Presumably the cotton, which is tied or pinned to the screen, looks like spider webs to the flies

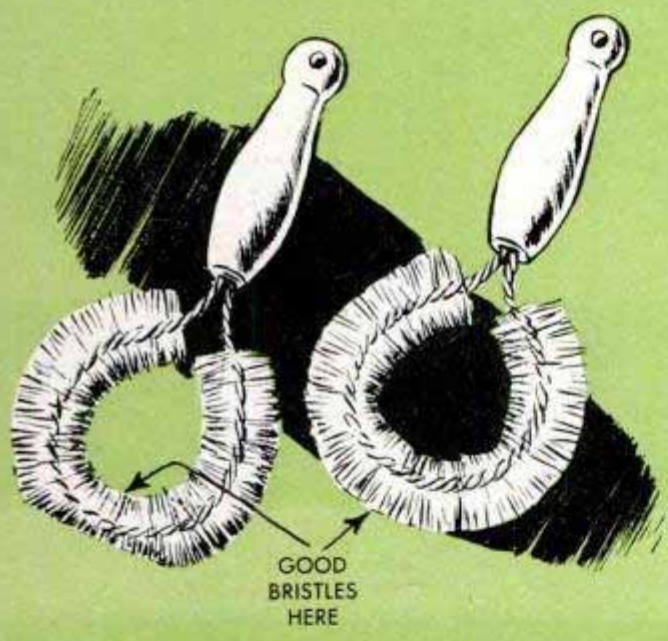

IF THE BRISTLES of a kitchen brush, left, have become worn on one side after prolonged use, they can be renewed simply by removing the wire from the handle, bending it to a reverse curve, and then replacing it

NOTES TO THE MILKMAN, which are inserted in the neck of an empty bottle, frequently are blown away, or sometimes slip inside the bottle where they are difficult to retrieve. To avoid this annoyance, write the note on the inside of a bottle cap and replace the cap on one of the bottles. Rinse off any milk that may have remained on the cap and then write the note with a soft pencil so it can be read easily. Be sure to advise the milkman that you plan to write his order on the bottle cap

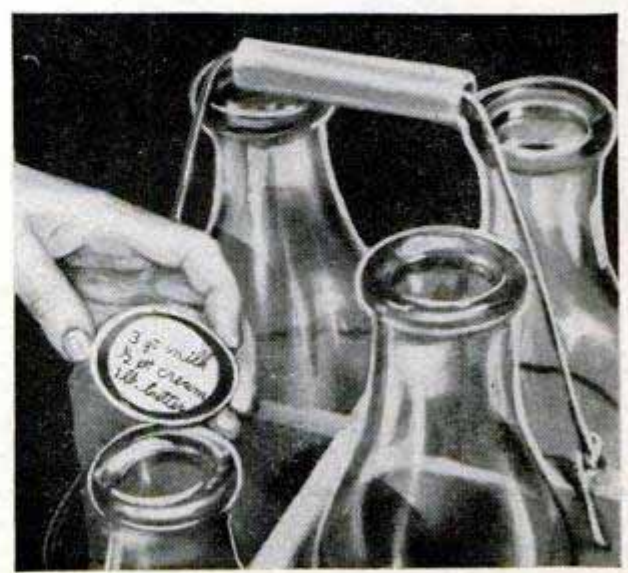



Adjustable "Leg" for Trailer Provided by Auto Jack

A screw-type auto jack, welded to hinge from a trailer drawbar, as shown, provides a ready support for that end of the trailer. As it is easily adjusted to any desired height, the jack is especially convenient for keeping the trailer level when it is parked on uneven ground. The metal hanger shown at the left of the jack is a drawbar link taken from a piece of old farm equipment and welded to the drawbar of the trailer. This holds the jack securely when in the folded position.

Stopping Car-Door Rattle

Building up the rubber cushions with which many car doors are fitted is an effective way to stop door rattles. Apply layers of tire-patch material over the cushions until the thickness of the rubber holds the door tightly against the latch when closed.

Rupert Stround, Oswego, N. Y.

Nail "Corkscrew" Flares Tubing



The next time you have to flare the end of a small copper tube and there is no tool at hand for the job, try this substitute. Just drive a fairly large nail through a piece of broomstick or dowel to serve as a handle,

and then bend the nail to the shape indicated. A vise will hold the nail for bending. In use, insert the end of the nail in

the tube and rotate it so that the bent portion of the nail presses against the edge of the tube. Fairly heavy pressure on the handle will be necessary, and you may have to grip the tube lightly in a vise.

Barrel Serves as Fence Post On Rocky Ground

If you ever find it necessary to run a fence over a rocky area where holes cannot be dug for posts, use empty barrels and fill them with rocks to weight them sufficiently to hold the fence in place. If the fence is higher than the barrel you use, it will be necessary to insert a post before filling in the rocks. Then nail the fence to the barrel and also to the post where the wire projects above the barrel. You will find this method better than the usual one of piling rocks around a post supported on top of the ground. To make the barrels last longer, impregnate them thoroughly with creosote.

Victor Lamoy, Upper Jay, N. Y.



Claw Hammer Removes Insulation From Electrical Wires

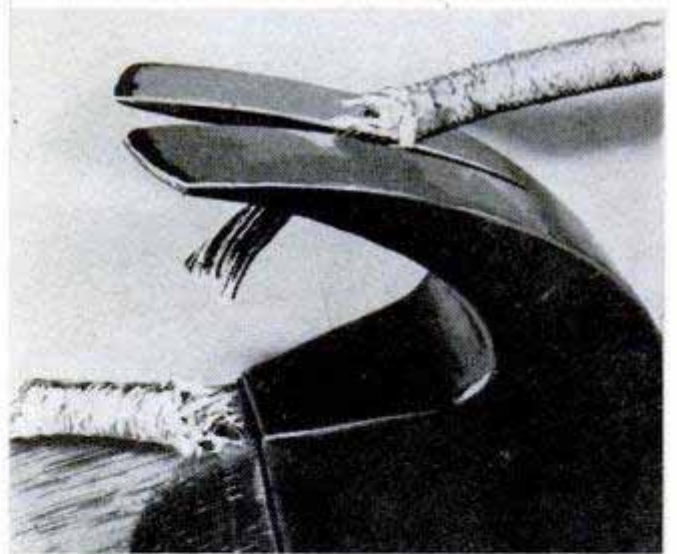

When you are doing an occasional job of electrical wiring and do not have a wire-insulation stripper at hand, use the claw of a hammer. Just drop the wire into the claw at the point where you want the insulation removed, give it two or three twists as you press down, cutting through the insulation, and then pull. The wire will be stripped clean if the inner edges of the hammer claw have not been dulled.

Ed Packer, Chicago.

DOUBLE-DUTY LAWN CHAIR

By W. S. McAlister

Here's a novel trestle-table design adapted to lawn use either as a table or chair. Refinements include fitted seat and back cushions, and use of waterproof plywood instead of solid stock for the frame panels and top. The two front views below suggest modern and colonial-design treatment of the top and legs, but for hand-tool construction use the simple design shown in the perspective view. Assemble the parts which form the legs, seat and arms with screws and angle brackets. Detachable hair-filled cushions are box-type construction, the covers being made with welted seams

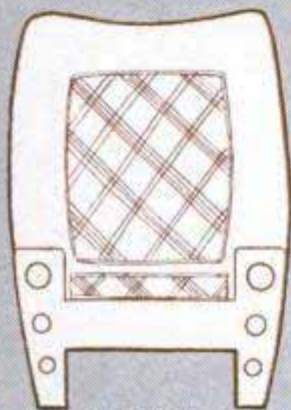

MODERN



COLONIAL

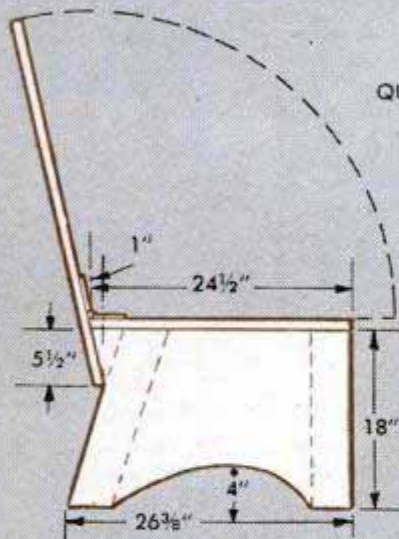

QUARTER-ROUND MOLDING

1" X 4" X 24 1/2"

HINGE

1" X 4 1/2" X 23 1/2"

3/8" PLYWOOD, 32" SQUARE

RUBBER-TIPPED FURNITURE GLIDERS

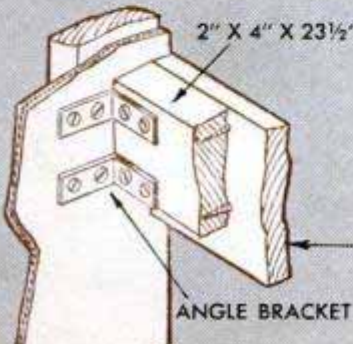
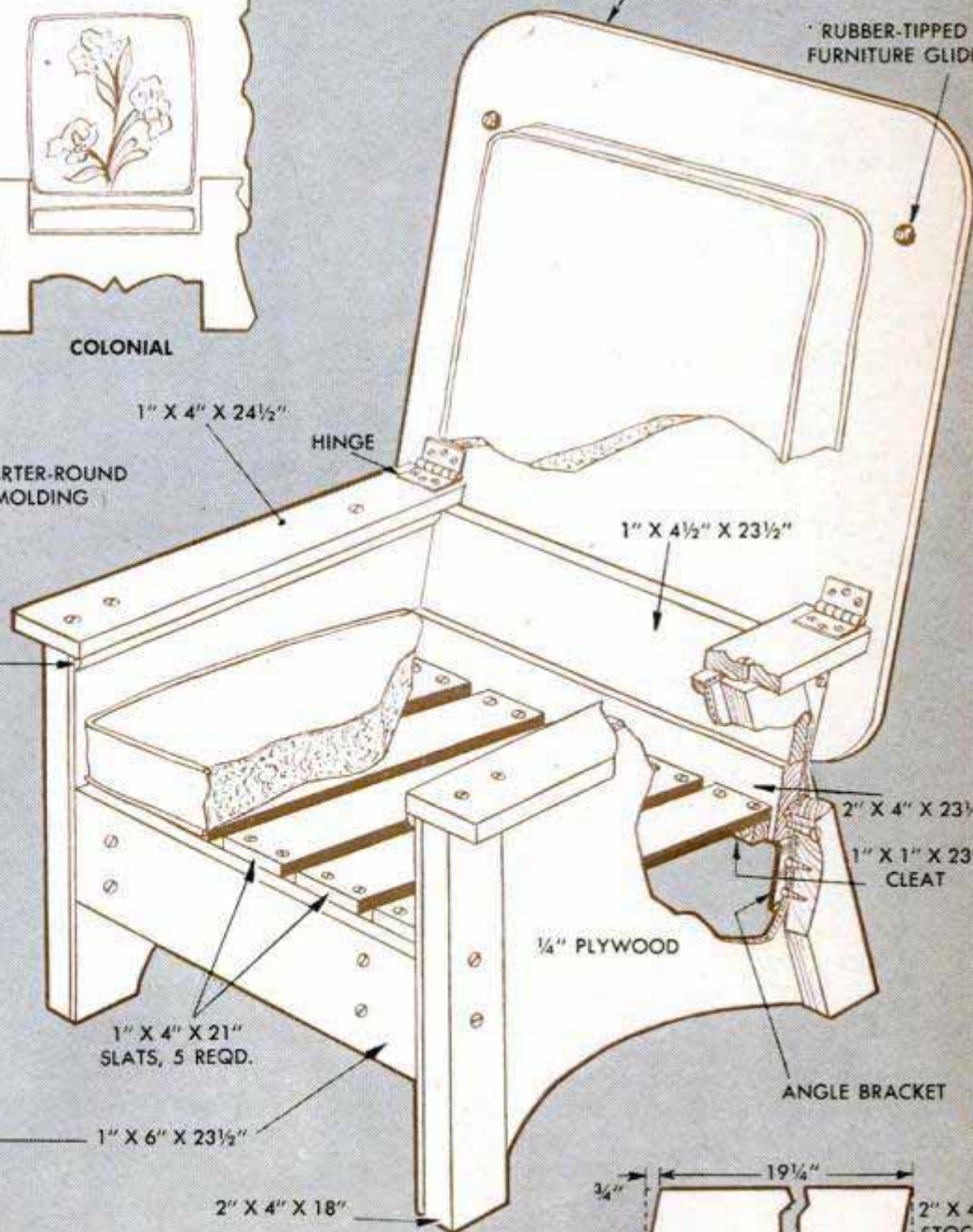

2" X 4" STO



Photos and technical information courtesy Culligan Soft Water Institute

SOFT WATER *Works for You*

Hard water costs you money and extra labor every day you use it in the home, the industrial plant and on the farm. Fabrics washed in soft water last 33 percent longer, and cost of soap is reduced 70 percent

SOFT WATER can be one of the most important helpers in your household by easing daily cleaning tasks and greatly reducing soap costs. Clothing and fabrics washed in softened water require less washing-machine time, dry soft and white, and last at least 33 percent longer. Dishes and glassware dry sparkling clean without toweling and bathtub "ring" disappears. There will be no rusty discolorations on porcelain-enameled kitchen and bathroom fixtures and no sticky soap "curd" in the washing machine and hard-to-clean cooking utensils.

In its journey to your water faucet, subsurface water dissolves and carries with it in solution such hardness-forming minerals as calcium and magnesium, iron and manganese. Over most of the United States and Canada, these minerals are present in varying quantities in the soils and rock forma-

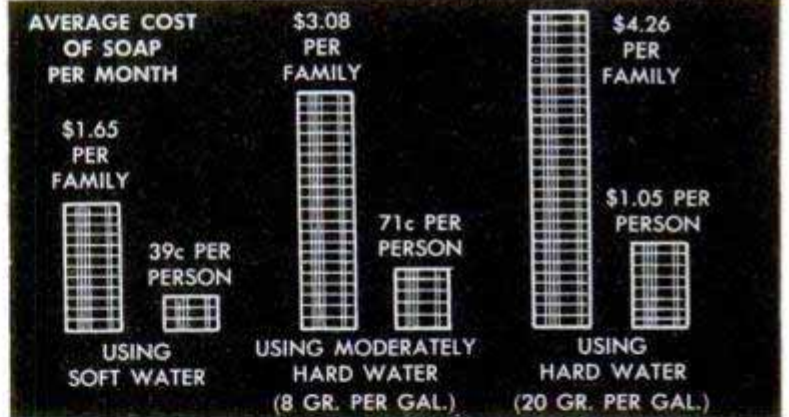

tions through which the water flows. The first two minerals are the principal offenders, although the latter two also contribute materially to water hardness in many localities. Iron and manganese produce the rusty-brown stains on porcelain-enameled sinks and washbowls in your kitchen and bathroom. Calcium and magnesium form the hard scale in pipes, boilers and water heaters, and combine with elements in ordinary soap to form an insoluble curd that leaves the sticky film on utensils, in clothing and fabrics, in the washing machine and in drainpipes from the sink and lavatory. Water hardness is measured either in grains per gallon or parts per million. One grain per gallon is equal to about 17 parts per million and 51 parts per million equals, for practical purposes, about three grains per gallon. Three-grain water is too hard for efficient household or commercial

uses. Yet 85 percent of the water in the United States and Canada is three grains or harder. The main part of the three-grain hardness content will be composed of calcium and magnesium with traces of iron and manganese. The chart on the opposite page shows graphically the increase in the monthly cost of soap per family, and per person per month when moderately hard to hard water is used. Of course, this chart is not all-inclusive and the figures are only average. The insoluble curd which remains in fabrics after washing in hard water (see the lower photo at the right) often becomes an indirect cause of infection from clothing which is in contact with the skin. The curd serves as a protective coating for certain bacteria which cause skin infections. Graphic evidence of the difference in soap reactions in hard and soft water is pictured in the upper right-hand photo. In the bottle at the left the soap is completely dissolved in soft water, forming a rich, creamy suds. In the bottle at the right, containing hard water, the water itself still contains undissolved particles and is clouded with curd. An equal amount of soap produces less than half the normal amount of suds. The end result of scale deposit, often called "liming," is seen in the cutaway water heater pictured on the following page. Long before being opened for exhibition purposes, this heater had passed the stage of usefulness. In this connection it should be pointed out that where a water-softening service is installed and connected to plumbing which already contains considerable scale from hard water, the scale will be gradually dissolved by the action of the softened water. It also should be remembered that when a water softener is connected to an old installation the hot water will be harder

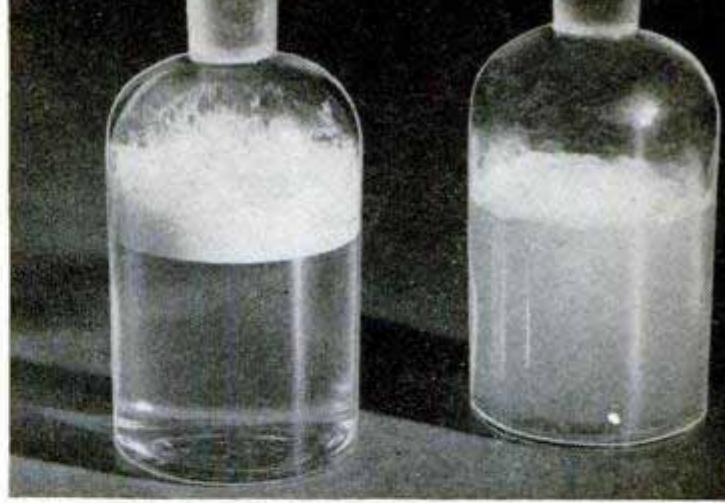

In the bottle at the left, soap has been completely dissolved in soft water, forming rich, thick suds. In hard water, equal amount of soap produces weak suds

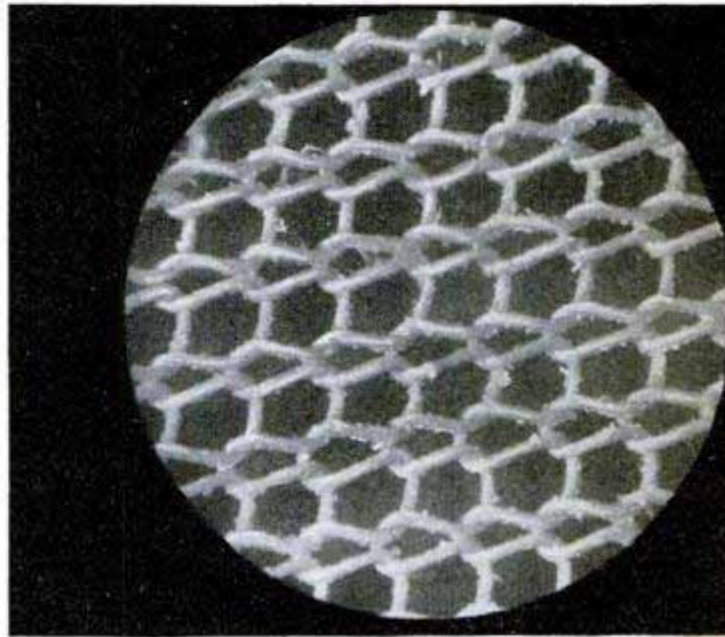

Insoluble soap curd formed in hard water clings to fabrics, gradually building a coating that can harbor and protect bacteria which cause skin infections

INSTALLATION DIAGRAM

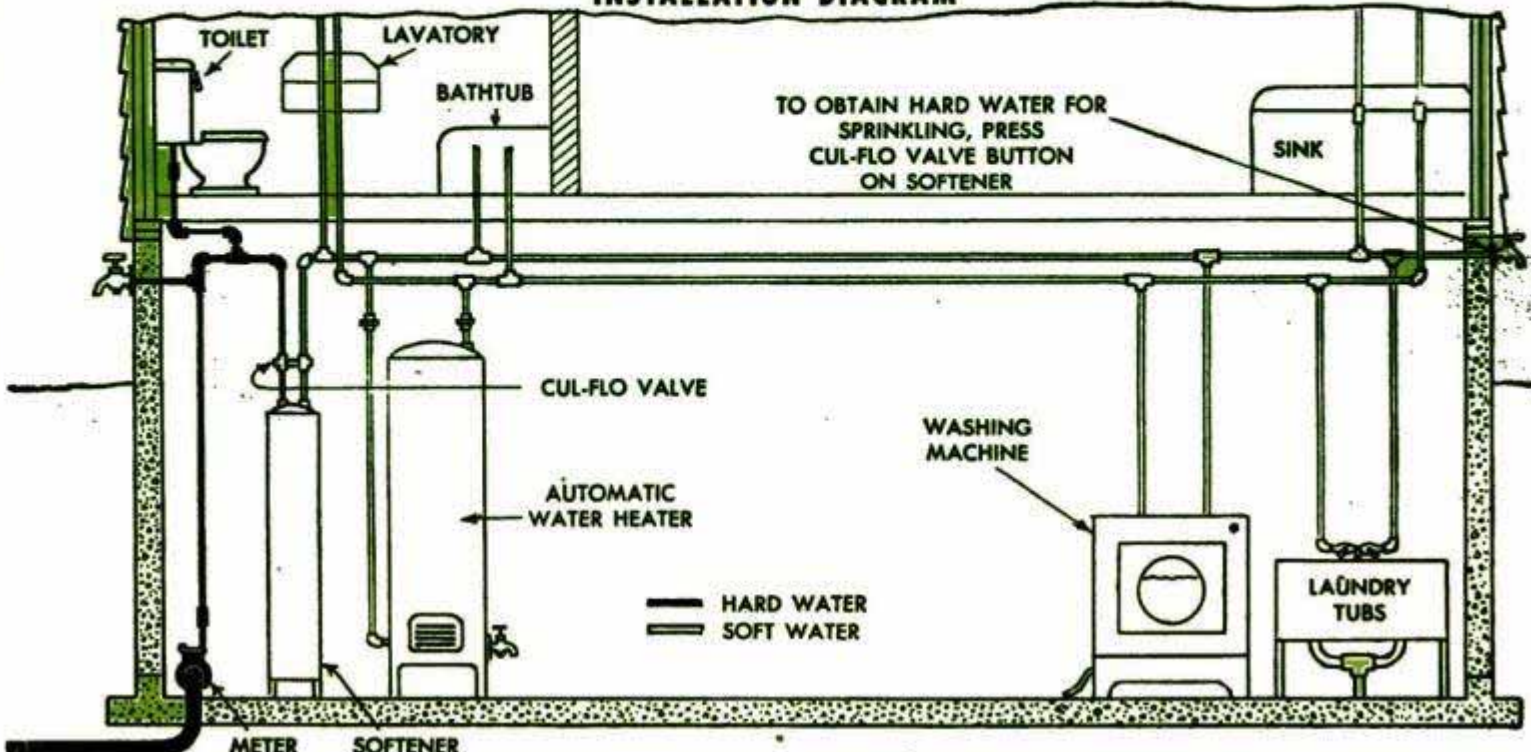



Cutaway view of water heater shows scale along sides of tank and material collected at bottom as a result of heating unsoftened water over long periods



Above, soapsuds overflow the tub when you use soft water for bathing. A quick flushing will leave tub sparkling clean. Below, hard-water curd can greatly reduce efficiency of your washing machine

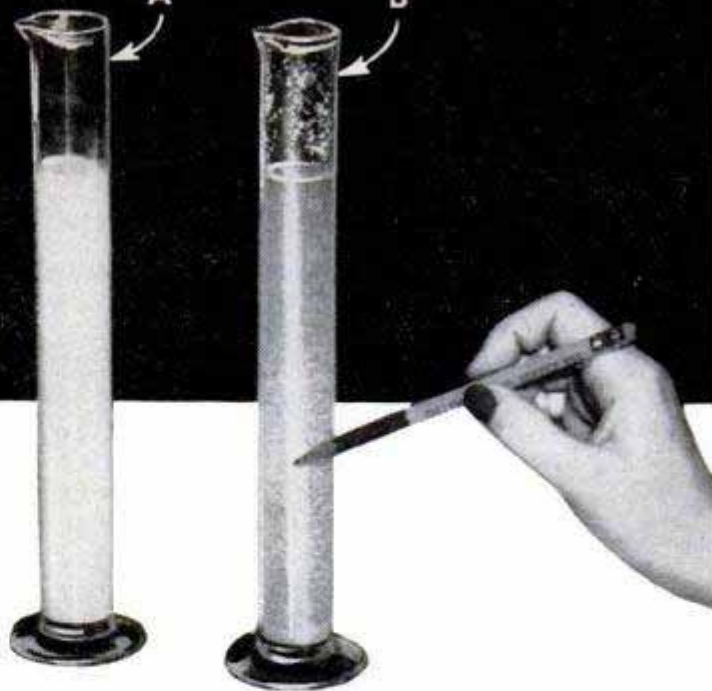

than ever for a time until the scale is dissolved from the pipes.

Details on the preceding page show installation of a water softener of the type which is serviced periodically on either a monthly or bimonthly basis. Another type which contains the same softening agents is purchased outright by the homeowner and is especially designed for periodic professional service. In both types the length of the time between service periods depends on the amount of soft water which is used. The popularity of the service-type softener, in which the tank, or container, is changed every two weeks or once a month as required, is due to the fact that this installation assures a plentiful supply of soft water without investment or labor on the part of the homeowner. The combination owner-service-type softeners, which are purchased outright, are more widely used on farms, in outlying suburban homes and in industrial plants not readily accessible to frequent service. Homeowners and others who desire to prepare for the installation of a water softener should contact a local soft-water service dealer to determine where and how the unit should be connected into existing plumbing, or that which is being installed.

Domestic hot-water heating systems should be drained before installing a softener so that the entire system can be refilled with softened water. The softened water gradually will dissolve the scale deposit in the radiators, boiler and pipes. The introduction of soft water to old, heavily scaled pipes will not cause leaks unless the pipes are completely rusted through. At the end of the first heating season it's a good idea to drain the hot-water heating system again to clear away sedimentation and also scale which is in solution. When refilling the system add a corrosion inhibi-



It's in dishwashing that the cleansing combination of soft water and soap really shows up. After washing, dishes and silverware dry sparkling clean. In composite photo above, right-hand glass and spoons at far right were washed and rinsed in hard water. Spoons and glass at left were washed in soft water

tor of the type recommended for this purpose. This will prevent rust.

In industry, when cutting oils used in high-speed machining operations are mixed with water, a thorough emulsification is essential for satisfactory cooling of cutting tools. On the opposite page, container A shows how cutting oils combine with soft water. Container B holds cutting oil mixed with hard water. Note the separation of the components. In a matter of seconds the cutting oil will separate from the water, showing an almost complete lack of emulsification. Among other industrial users, garages featuring a car-washing service have found that soft water cuts car-washing time and gives better results. A car washed with soft water dries without streaks and water spots. Softened water used in auto cooling systems prevents formation of scale and sediment, just as it does in home hot-water heating systems. If softened water is used from the time the car is new, hard scale and rust will never be a problem.

Softened water aids in all cleaning operations, from photographic processing to daily cleaning of kitchen utensils. Farmers, and dairymen especially, use large amounts of soft water for washing bottles and milking equipment. The use of soft water, with proper washing and drying procedures, will prevent the formation of milkstone on milk cans, milk coolers and milking machines, thus eliminating the necessity of a periodic acid wash in order to keep dairy equipment up to required cleanliness standards. China dishes, glass and silver-

ware wash bright and dry clean with no traces of the waxy soap curd. In the photo above, the glass and the two spoons at the right have been washed in hard water. Note the dull, hard-water film which remains after washing and rinsing. The glass and the two spoons at the left were washed in soft water and air-dried without wiping. This same hard-water curd prevents successful home dyeing of fabrics and makes rug washing a hopeless task. Dyes dissolved in softened water give uniform results. It's easy to home-clean a rug of average size by simply building a suds in warm, soft water. Then dip the scrubbing brush in the foamy suds and apply to the rug with a light, circular stroke. Wipe the suds off the surface of the rug with a cloth wrung out in clear, soft water. When washing a rug the important thing is to avoid getting it too wet. Dip the brush only in the foamy suds, never in the water, and wipe the surface dry as you go. Change the water and build a fresh suds frequently, and always rinse the brush and wiping cloth thoroughly after each application to remove the dirt which collects in the bristles and cloth.

TEST YOUR TAP WATER

You can find out how hard your water is by performing a simple test right at home. POPULAR MECHANICS has arranged with the Culligan Soft Water Institute to give every reader a testing kit free. Write to the Culligan Soft Water Institute, 1815 Shermer Ave., Northbrook, Ill., and ask for the water-testing kit. The instructions are included.

Punctured Spice Can Filled With Powder Charges Chalk Line Quickly

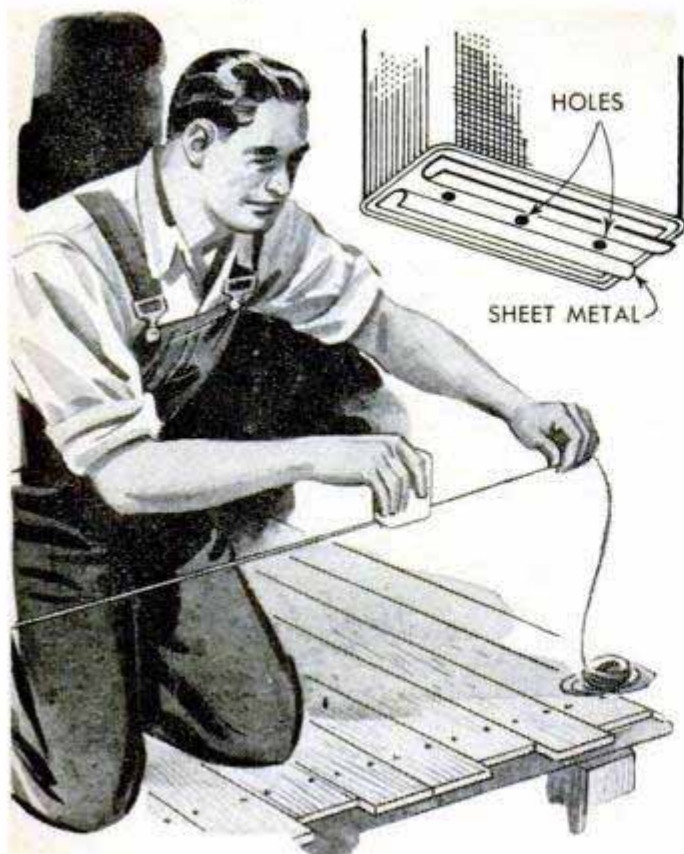

If you dislike using a piece of chalk to cover a chalk line, this powdered-chalk container will serve your purpose ideally. It consists merely of an empty spice can which has three equally spaced holes drilled on a center line in the upper end. Two sheet-metal guides are bent to a U-shape and soldered on opposite sides of the holes as shown in the detail. Then, when the can is passed over the line, the powdered chalk will be distributed uniformly.—John E. Hyler, Peoria, Ill.

Brass Bolts and Cotter Pins Provide Plug-In Jacks

When working on a job where a number of electrical attachments are necessary, such as model-train layouts, you can make the connections neatly by use of these homemade plug-in jacks. Each unit consists of a bolt, nut and a cotter pin. The bolt is, of course, of a size suitable for the purpose at hand and is drilled lengthwise through the center to take the cotter pin as shown in the photo. Brass bolts are preferred as they do not corrode rapidly, but steel ones can be used. In use, the bolt is installed permanently with a contact made to the bolt by means of the usual type of terminal. The wire carrying the other side of the circuit is soldered to the head of the cotter pin, which is inserted in the hole of the bolt.

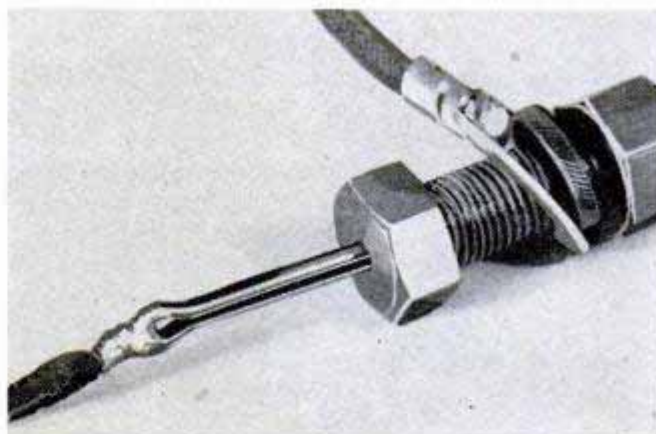

Pipe Cap Removes Barrel Bung

Persons who have broken or split a stave in a barrel when hammering it to force out a bung will appreciate this idea of



using a pipe cap to avoid the damage. Select a cap that is slightly larger in diameter than the bung, place it over the latter and then strike the cap. In this way, the blow of the hammer is distributed uniformly around the bung chime and the bung is "popped" out by the vibrations with considerably less possibility of damaging the wooden stave.

A. H. Waychoff, Phoenix, Ariz.

Glass-Topped End Table Serves as Home Display Case for Small Models

Do you have an end table with a drawer directly underneath the top? It is a relatively simple matter to convert it into a display case for small models and hobby work. It is necessary only to replace the present top with a piece of plate glass and place your models in the drawer beneath it. The method of attaching a top will be determined by the construction of the particular table. In some cases, the top can be completely replaced with glass. In other cases, it may be necessary to cut out the center of the wood-

en top, leaving a strip 1 in. or more wide around the outside for mounting purposes. If this is done, rabbet the edges of the cut-out portion of the top so that the glass can be set flush with the upper surface of the top. The table can still be used for its regular purpose of supporting a lamp or other objects.—Bess Ritter, Yonkers, N. Y.

☞ A rubber band, slipped around the finished pages of a book, makes a handy bookmark which will not easily be lost.

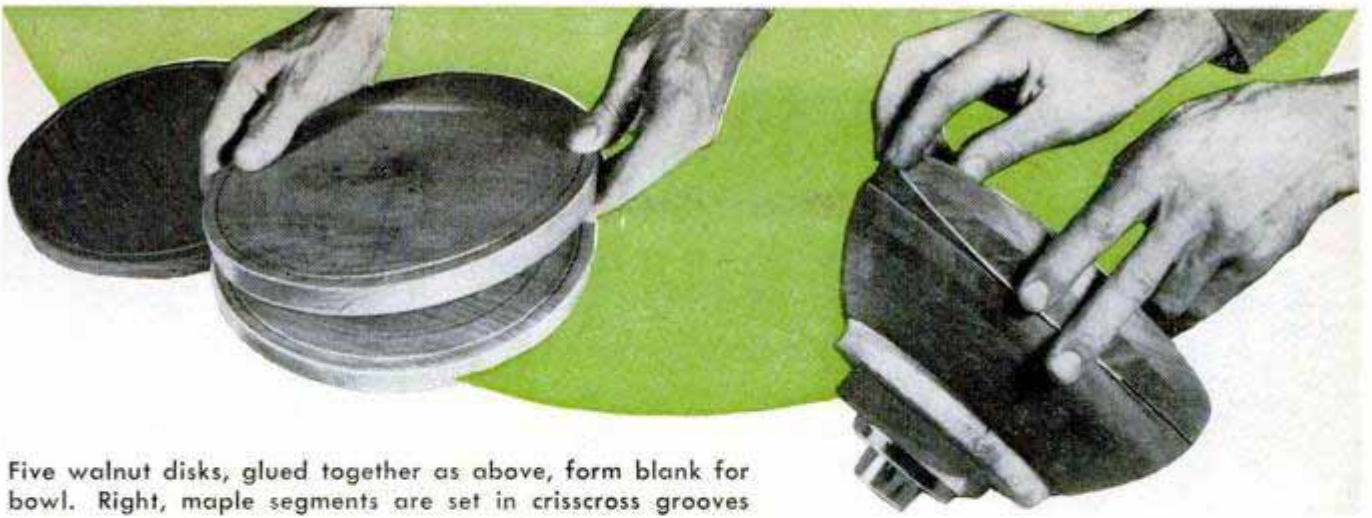

Five walnut disks, glued together as above, form blank for bowl. Right, maple segments are set in crisscross grooves

Inlaid Walnut Bowl

By
Benj. Nielsen

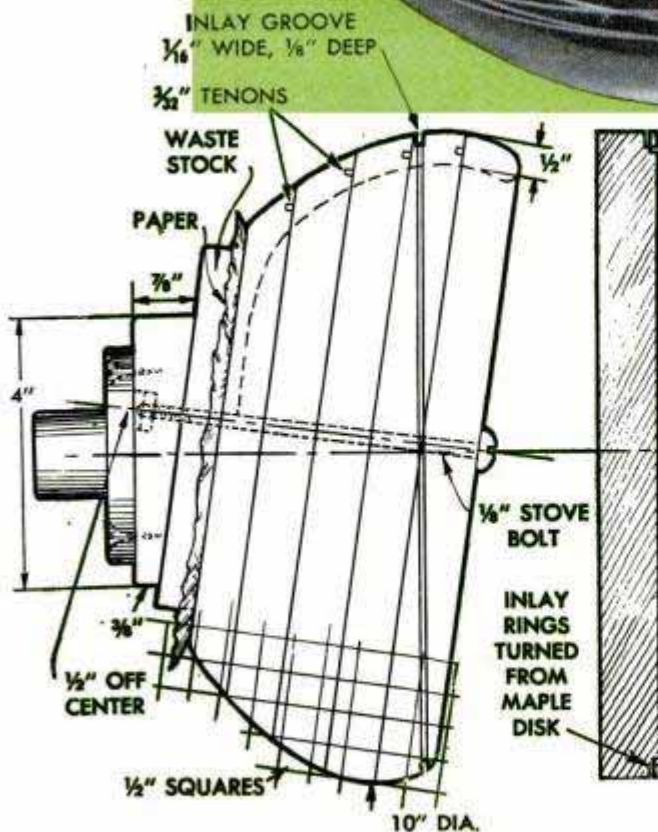
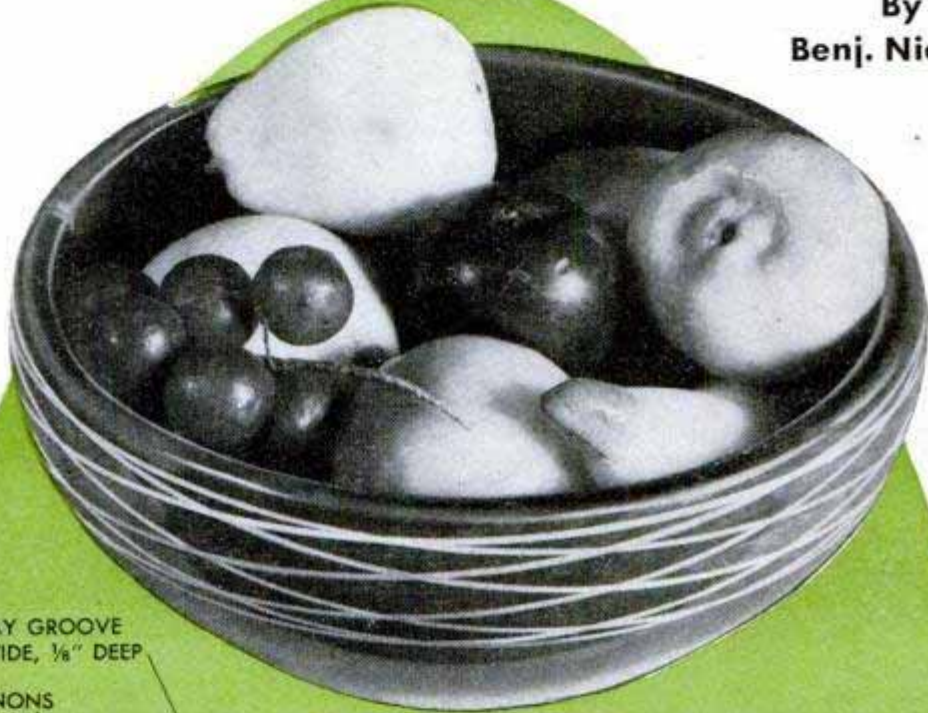

Stacked disks forming bowl blank are turned to shape and waste stock glued to bottom is marked off in eight equal divisions. Blank is bolted to tapered hardwood block which is screwed to faceplate. One division mark on waste stock is aligned with index mark on tapered block and first groove is cut (250 r.p.m. maximum). Then, inlay ring, turned from maple disk, is glued in groove. Ring is trimmed flush with surface, bolt is loosened and bowl turned to align next division mark on waste stock with index mark. Grooving and inlaying are repeated until all eight rings have been used. Then, tapered block is removed, inside of bowl is turned and bolt hole sealed with plug

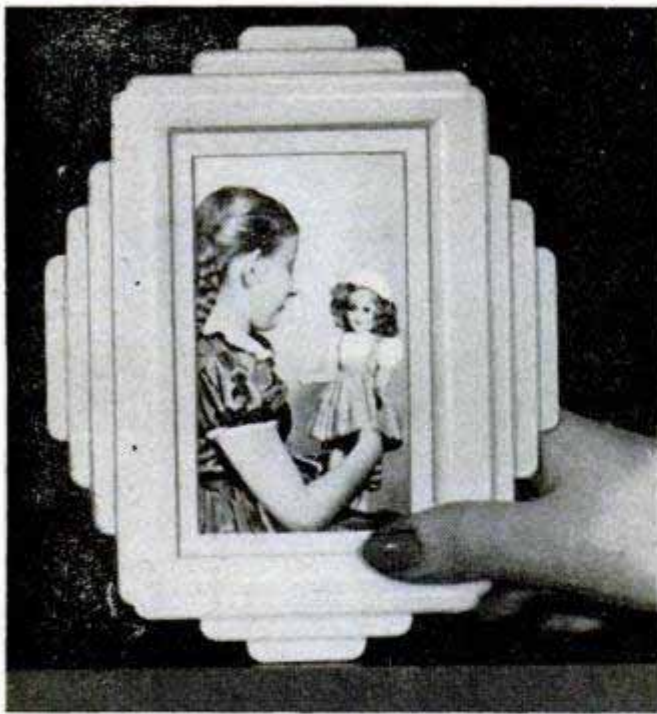

Wall Protector for Light Switch Provides Snapshot Frame

Unusual frames for snapshots and bill-fold-size portraits can be made inexpensively from plastic wall protectors of the type which fits over standard light-switch plates. The prints may be cemented to the back of the frame around the edges of the opening and the frame merely leaned against another object for support. However, if an easel-type stand for the frame is desired, the print should be cemented to the face of a piece of cardboard which, in turn, is cemented to the back of the frame. The easel is made by cutting a second piece of cardboard, the same width but an inch or so longer than the first. Score it across the width to fold about one third of the way from one end. The smaller section of the cardboard is then pasted to the upper surface of the cardboard photo backing so the lower section will hinge at the score and can be swung outward to support the frame.

H. Leeper, Canton, Ohio.

Small Coil Spring Conveniently Separates Groups of Keys on Chain

Two groups of keys, such as those which are used around the home and those used only at the office, may be kept conveniently separate, but on the same chain, by placing a small coil spring between the groups as shown. In this manner it is easy to select the desired key from its particular group.

John J. Rea, Urbana, Ill.

☛ To thread fishing line through a hook at night, insert the eye of the hook through a piece of white paper, which then will provide a background so the hook eye can easily be seen.

Simple Tool Removes Carbon

A scraper for removing carbon from the cylinder head and pistons of a car motor is easily made from a short piece of pipe or tubing and several lengths of piano wire. To make the tool, cut a desired number of equal lengths from

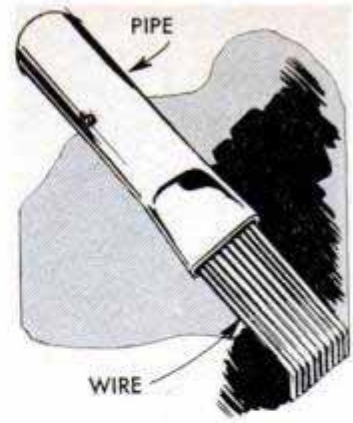

the piano wire and insert them in one end of the pipe or tubing. Then flatten the latter with a hammer until it grips the wires tightly. The free ends of the wire should be locked in a vise and bent as indicated. Then the ends of the wires are squared by grinding. You will find a tool of this type highly efficient because of the fact that its scraping edge is flexible and will adjust itself to the surface being scraped. Since piano wire is highly tempered and quite hard, care must be taken when using it on aluminum pistons or aluminum cylinders as you may score the soft metal quite deeply. Scoring, of course, is to be avoided.

William B. Eagan, Louisville, Ky.

Cement Keeps Gasket From Slipping

If a gasket, such as the one on the water pump of a car, tends to slip out of line while the parts are being assembled, it can be held in place easily with rubber cement. The surface of the metal and the underside of the gasket are coated with black rubber cement, and the cement is allowed to dry until tacky. Then the gasket is positioned, laying the cement-covered surfaces against each other. Although the cement will keep the gasket from slipping during assembly, it does not interfere with later removal when repair or replacement is needed.—Joe Tezak, Glendale, Calif.

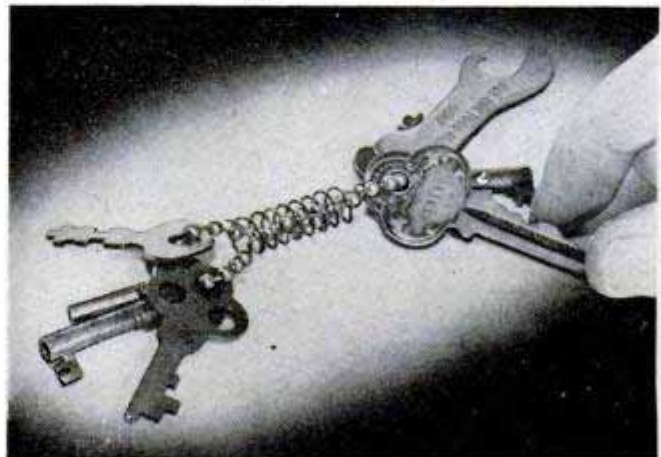

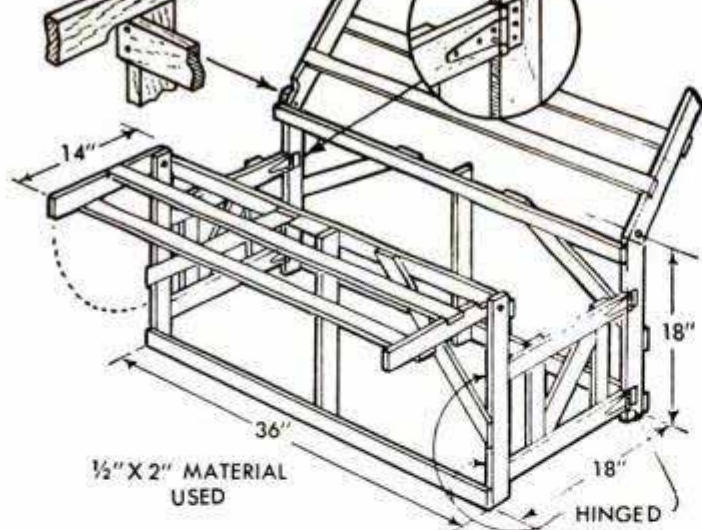

Simple construction of folding rack is detailed above. The leaves are supported in the open position by stakes driven into the ground. The end members are hinged on opposite sides to fold flat for storage, as shown in photo at the right



Folding TOMATO RACK

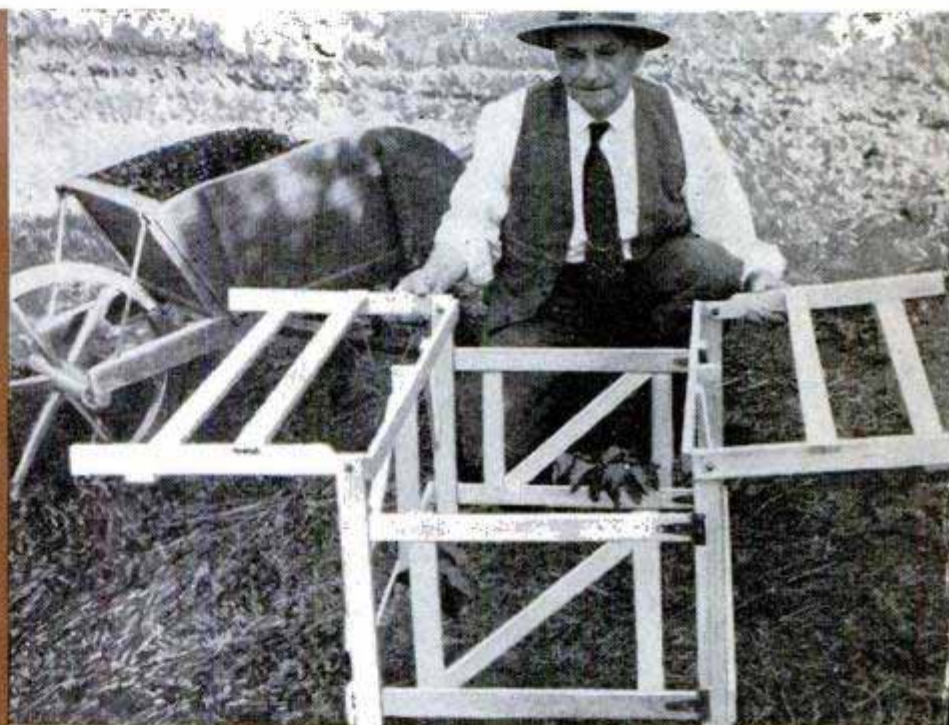

QUICKLY assembled for the summer tomato season or folded compactly for winter storage, this handy rack will accommodate six tomato plants of average size. It consists of an open framework, hinged at the ends, and two leaves which are bolted loosely to the corner posts so they can be folded flat against the side frames for storage and then swung outward when in use. After the rack is set up, two slats are nailed across the top as in the lower right-hand photo. Note that one arm of each leaf is notched to permit folding either leaf over the center of the rack if desired. It is best to place two plants in the center portion of the rack and two under each leaf at the corners. As soon as the plants are in the ground, surround each one with a 12-in. ring of dehydrated lime to discourage cutworms. Then, as the plants mature, spread a mulch of oat straw beneath the frame to retain moisture.

Frank E. Brimmer, Vestal, N. Y.



STAINING is EASY with BRUSH or SPRAY

By Sam Brown



WATER STAIN is the least expensive to buy and is best for color clarity, permanence and lasting brilliance. However, a water stain raises the grain of the wood, making it necessary to sand the surface after staining. A stain of average intensity is made by adding 1 oz. of the dry powder to 1 qt. of hot water (just below the boiling point). Add more water for lighter tones. Keeps indefinitely. Apply the stain with brush or spray and wipe immediately with a clean cloth to even up the color tone. Stain surface-dries in 15 min., but requires overnight drying before sanding. Available in all the common wood-stain colors



PIGMENT OIL STAIN is simply thinned paint. It is colored with a paint pigment instead of a soluble dye. A good pigment stain can be made by thinning any paint or enamel with turpentine or a recommended solvent. Ready-mixed pigment oil stains are available anywhere in wide range of popular colors. They are sometimes referred to as "pigment wiping stains" or "uniforming stains." The colors are permanent and do not bleed through any ordinary finish. Stain is easy to apply with a simple brush-on-and-wipe-off technique. Dries flat in 20 min. and can be coated with other finishing materials after 8 to 12 hrs.



SOLUBLE OIL STAIN is available in powder form for mixing with any light oil or solvent such as benzol, turpentine and naphtha. A small amount of asphaltum or 4-hr. varnish usually is added to give the stain more body. Also available ready-mixed and known as "penetrating stain." Although this stain has great penetrating power, it is less flexible in that it cannot be controlled by wiping and lacks the durability and permanence of the water stains and pigment stains. It must be sealed with shellac or sealer to prevent bleeding through the finish. It dries flat in a few minutes but requires 12 hrs. to dry thoroughly



NON-GRAIN-RAISING STAIN contains the same dyes used in water stains but the solvent used is a nonaqueous liquid. This stain has most of the good features of water stain without the grain-raising fault. Although you can mix your own with stain powders and suitable solvents there is little or no saving in cost. Nearly all nonraising stains can be reduced with alcohol for lighter tones, but special reducers are available and should be used wherever possible. Stain corrodes metal and should be stored only in glass or earthenware containers. Dries in 10 min. to 2 hrs. Available in a wide range of stain colors



SHADING STAINS dry ready for finishing coats in 30 to 60 seconds and can be applied only with a spray gun. Those containing alcohol as a solvent are a little slower, but still not slow enough for brush application. In regular practice, these stains are applied between the top coats, the first shading coat usually being blown on over a sealer. Almost infinite flexibility of color tone is possible by use of this type of stain, using only the stock browns and reds in which it is regularly supplied. Reduce with lacquer thinner or alcohol solvent as directed on the container. Skill in setting and triggering a spray gun is necessary to apply stains successfully. Practice on waste stock



IN MODERN wood finishing, staining is largely confined to the use of just two types of stain, the NGR (non-grain-raising) and the pigmented stains. With these, you can do any job of wood staining easily and quickly. NGR stain is tops for all open-grain woods, while the pigmented oil stains are excellent for soft woods and also certain close-grained hardwoods, such as maple and birch.

How to use pigmented stain: Be sure the work is well-sanded, using a fine garnet sandpaper for the final smoothing. After sanding and dusting, apply the stain with cloth or brush, as shown in Fig. 1. Let the stain dry 5 to 10 min. or until it begins to set, or "flat," and then wipe with a soft cloth, with the grain, as shown in Fig. 2. Normally, you remove all the stain that will come off with moderate wiping. The result will be a color much lighter than the stain itself; the wood takes on a new color without appearing painted. Let the stain dry a couple of hours and then top it with shellac, lacquer, or varnish and finish with wax.

Blonding: Since pigment stain actually is thin paint, it permits blond effects not possible with other stains. Clean wiping should be the rule, and this automatically limits the color range to moderate lightening of the original wood color. You can't, for example, blond-finish black walnut. On light-colored woods such as maple and birch, a blond finish is easily obtained with white-pigment wiping stain. Fir plywood, being a little darker, blonds best with an off-white

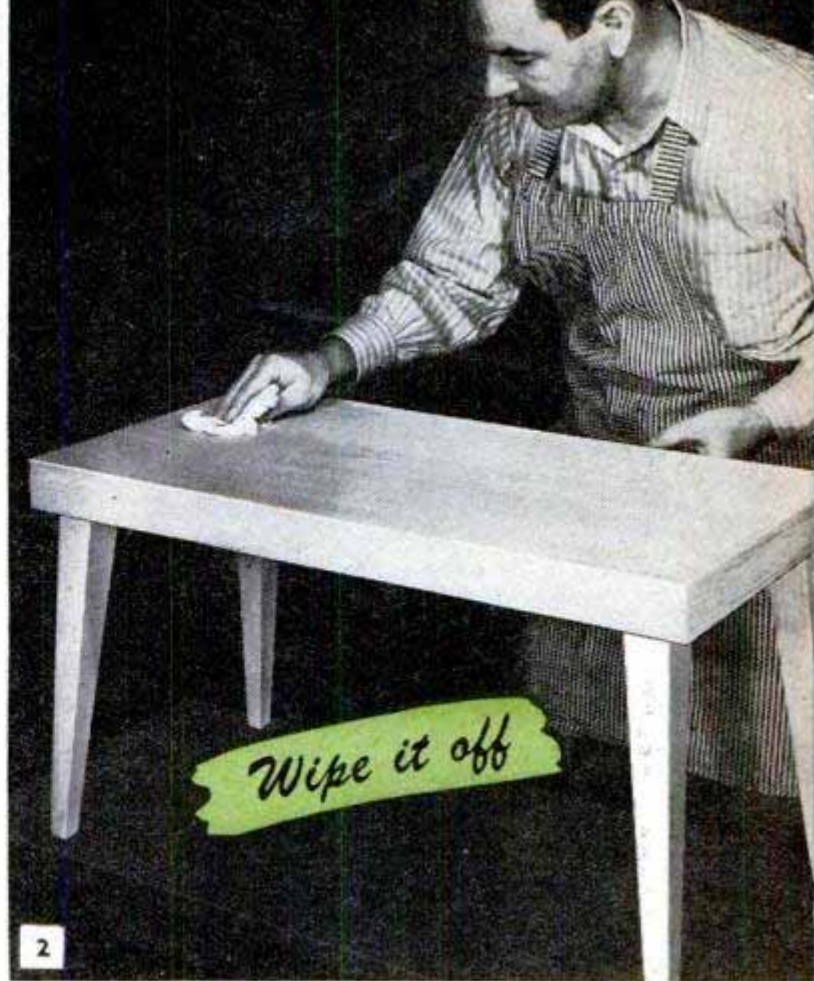

PIGMENT STAINS are best for brown or blond tones. The job pictured above is a blond, or Beachwood, finish on maple. Stain is simply brushed on, wiped off with a soft, dry cloth



OIL COLORS added to white-pigment stain, above, will make any desired color. Below, the blond, or Beachwood, finish on fir plywood. Note grain variations with different treatment

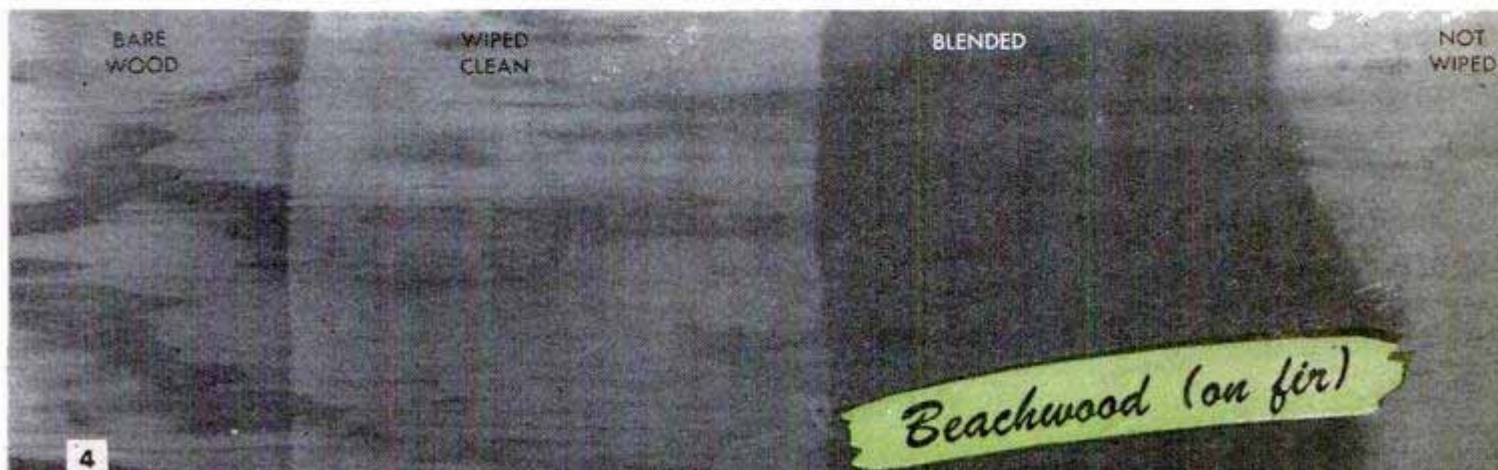



5

SAGE-GREEN COMBED FIR is only one of many color effects that can be worked on combed (striated) fir plywood with the use of a pigment stain. First, apply plywood sealer. Dry 3 hrs., then rub lightly with fine steel wool. Next, add a small amount of chrome-green oil color to white wiping stain. Brush stain on wood and, after 5 min., wipe off with cloth, working with grain of wood, but leaving stain at full intensity in grooves. Dry 2 hrs., then apply a coat of white shellac or water-white lacquer. When finish is thoroughly dry, rub with fine steel wool and finish with wax



6

REDDISH-BROWN MAPLE is typical of the finishes used on Early American furniture. Apply a red-maple wiping stain to the bare wood and wipe off clean after 5 min. Dry 30 min. Spray or brush sanding sealer or white shellac (2-lb. cut). Dry 1 hr., then sand with fine sandpaper, and brush or spray a second coat of same stain. Wipe clean except on edges and moldings to high-light finish. After 30 min., brush or spray one coat of rubbing varnish or water-white lacquer



7

EBONIZED OAK is a popular black finish on oak, the grain of the wood being filled with a white filler. Sand the wood glass-smooth and spray a coat of reduced black lacquer, applying just enough to get a uniform solid black. You also can use a thinned black enamel or black shellac for brushing. When dry, apply a white filler, allow it to dry flat, then wipe off clean with a coarse cloth. Dry 2 to 24 hrs. depending on type of filler used. Top the finish with a water-white lacquer of the nonraising type



8

AMBER MAPLE, sometimes classified as "blond," is done with a light-amber wiping stain. Buy stain ready-made or make your own by adding brown and red oil color to white wiping stain. Apply stain to bare wood and wipe off clean. Spray a coat of sanding sealer. Smooth with fine sandpaper. Then spray two coats of water-white lacquer and rub with No. 280 abrasive paper with soapy-water lubricant. Wipe dry, rub with fine steel wool and finish with wax



9

DOVE-GRAY WALNUT is done by first bleaching wood with a two-solution bleach. Dry 12 hrs. and sand lightly with fine sandpaper. Apply a light-gray wiping stain and wipe off clean. After 30 min., apply a second coat of stain, wipe off clean, shading only lightly at ends and edges. Follow with sanding sealer. After 1 hr., sand with fine sandpaper. This produces the popular open-grain finish. For a level finish, substitute a dove-gray filler for the first pigment-stain coat. Top with water-white lacquer



10

CORDOVAN MAHOGANY is a new reddish-purple finish produced by special nonraising stain recently made available. Apply stain, dry 30 min. to 1 hr., then apply mahogany filler colored very nearly a solid black. Wipe off clean with a coarse cloth just as the filler begins to set, or flat. When filler is dry, spray or brush a coat of sanding sealer. Sand with fine sandpaper after 1 hr., then top-coat with a water-white lacquer or rubbing varnish. Polish to high luster

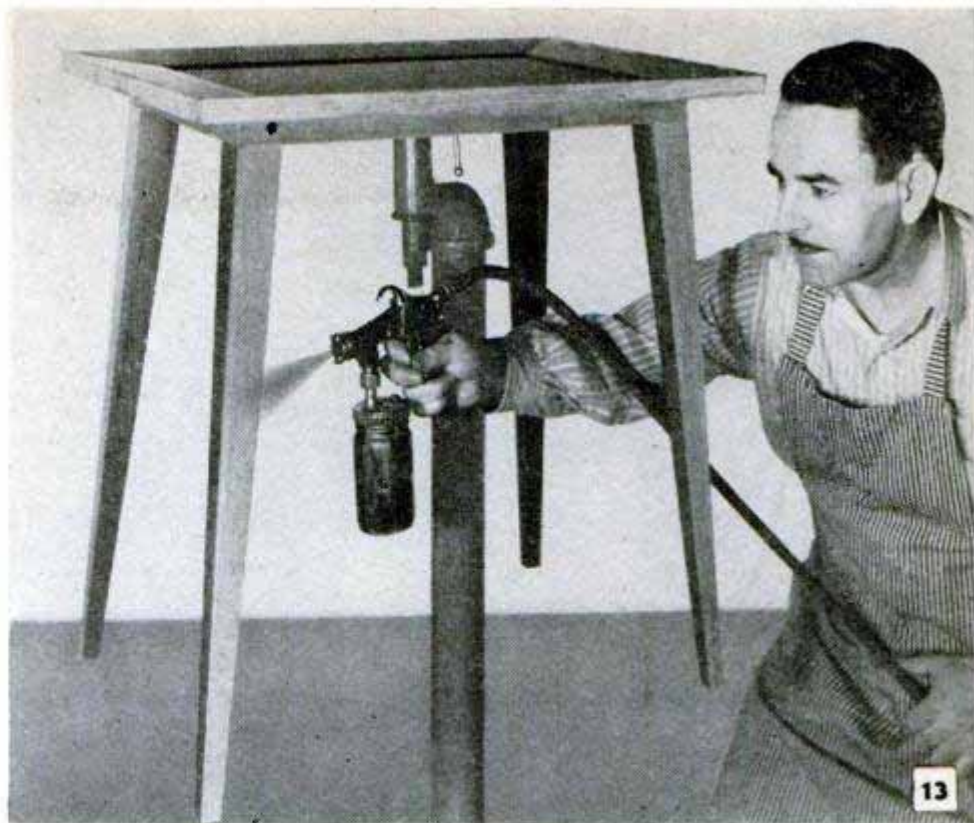
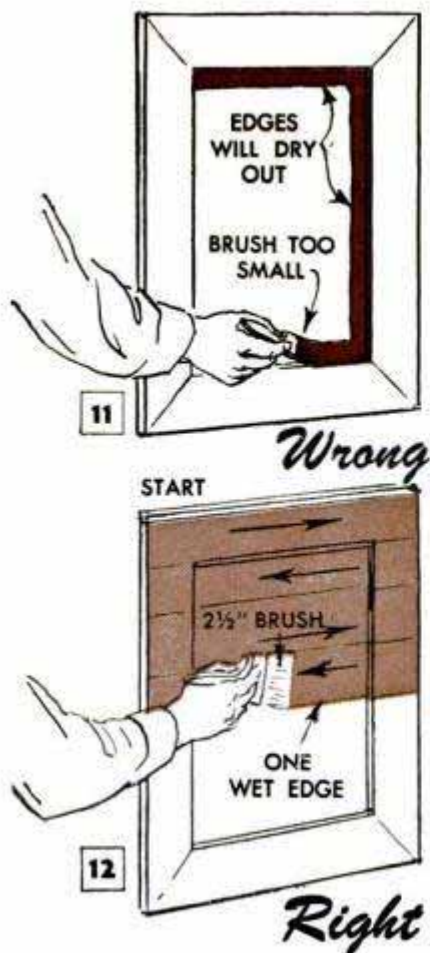

NONRAISING stains are ideal for use on nearly all open-grain woods. Stain dries very quickly and is best applied with a suction-type gun, but smooth work without laps can be done with 3-in. brush by working fast with brush and cloth

or light-gray stain, especially prepared to produce one of the new gray colors. Fir and other similar woods will take a more uniform color if the grain is equalized with a coat of clear plywood sealer. Fig. 4 shows Beachwood stain on fir applied over a sealer. Note how the wild grain of the wood is subdued. Interesting color effects can be obtained by toning white-pigment wiping stain with a little oil color, mixing this separately with turpentine, Fig. 3, and then adding to the stain until the desired color is obtained. Always make a test panel as the wiped stain is not nearly as strong as the stain itself.

Standard finishes: Six standard finishes using pigment and NGR stain are given on the opposite page. Learn how to apply these and you will know just about everything there is to know about wood finishing. With a change in stain and filler color you can produce any kind of finish.

Using NGR stain: Buy this in popular wood colors and be sure to order the special solvent needed. By far the best method of application is with a spray gun as most NGR stains are formulated for fast drying, some being ready for the top coats in 10 min. If you intend to brush the stain, be sure to get the brushing-or-spraying grade. Most NGR stains can be slowed down a bit with the addition of special retarders which are available. Even so, the stain surface-dries very rapidly. A uniform color is most readily obtained by using a large brush

and applying the stain in a very wet coat. Fig. 11 shows what to avoid. The cutting-in technique with a small brush is perfect for varnish top coats, but with NGR stain the edges will be dry before you can get over the surface. On a small table top, such as that in Fig. 11, the best procedure is to start at the upper left-hand corner and, using a well-loaded brush, spread the stain quickly from side to side with fast, sweeping strokes, Fig. 12. Wipe immediately with a soft cloth to uniform the color and pick up the excess stain. No matter what approach you use, the essential thing is to get the stain on fast and follow up immediately with the wiping cloth before it sets. Divide the surface into convenient areas that you can cover in a few seconds. Do the legs, rails and top of a table in separate operations. On large table tops, dilute the stain to half strength with an equal amount of reducer and apply two coats, wiping each one. If you spray NGR stains, use a narrow spray pattern, but fan it out by holding the gun farther from the surface. Best practice is to mount the work on a turntable as in Fig. 13, where you can shoot all inside edges and surfaces first. Always do the work in good light (daylight is preferable) so that you can properly evaluate the color density as you go along. On wood having sap streaks or other color variations, give the light wood a slightly heavier application to obtain uniformity of color.

Double staining: On certain finishing

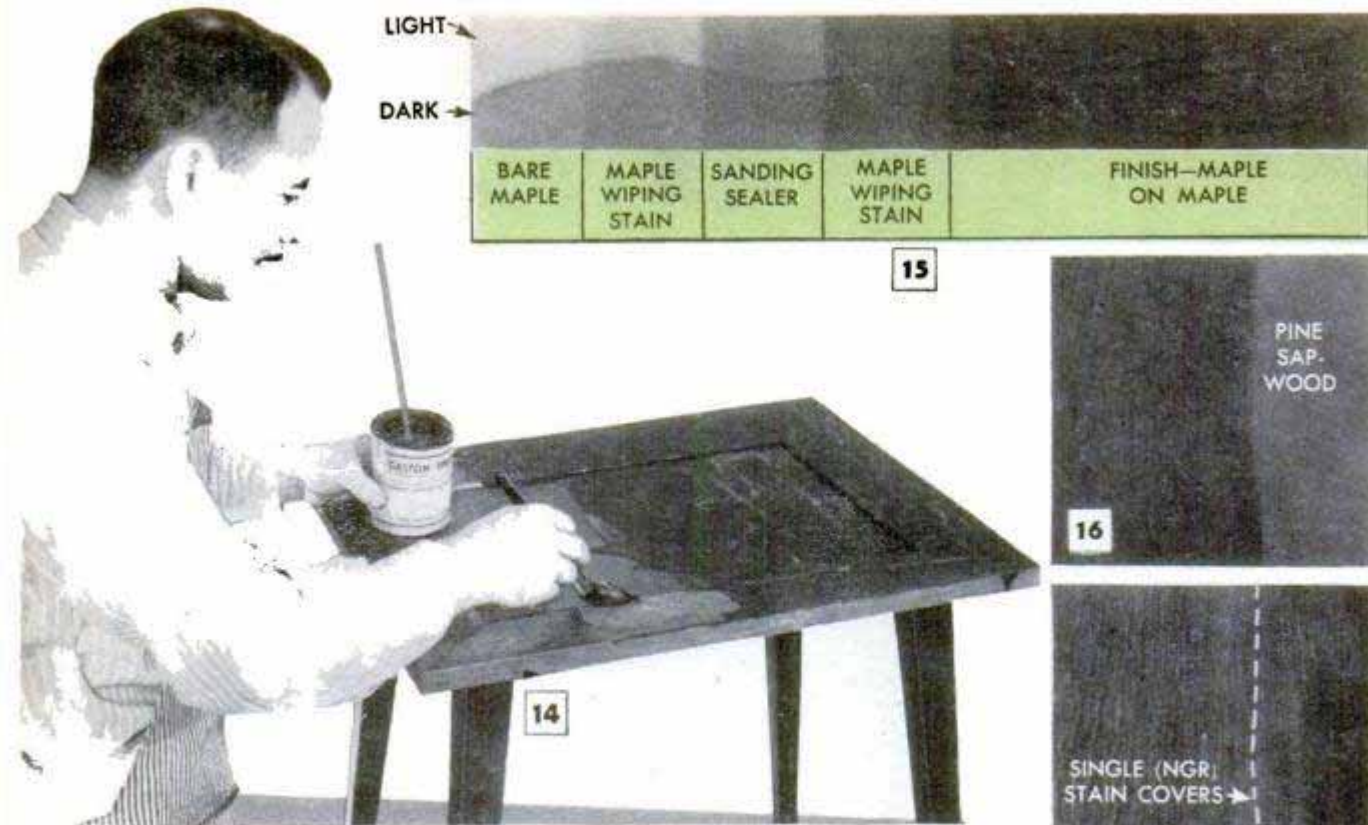

DOUBLE STAINING with pigment stain gives even, uniform color even though wood may vary in color. Panels above and at right show how sap streaks are treated

jobs, you can obtain an even, mellow tone by applying a double stain coat. This can be worked with either a pigment stain or NGR stain, Fig. 14. In ordinary procedure, the first coat is applied and allowed to set and dry before brushing or spraying a second coat. In Fig. 15, the panel is double-stained with a coat of sanding sealer between the stain coats. The sealer gives an exceptionally smooth surface over which to shade the second coat of stain. Wipe the first stain coat clean and allow it to dry thoroughly before applying the sealer. Sand the sealer lightly after it dries. Then apply the second coat of stain and shade with a cheesecloth pad until you have the color depth desired. Careful work with the pad on the second coat of stain will enable you to produce perfect color blends.

Staining sapwood: Many jobs, especially large table and cabinet tops, will have some sapwood of a lighter color which must be equalized when staining and finishing. Sap streaks in certain of the lighter woods usually will "drink" a lot of stain and become darker than the heartwood. On the other hand, on dark woods, such as walnut, the sapwood often is quite dense and will remain light under one and, sometimes, under two coats of stain. As a rule, the light areas on pine will equalize under a single coat of NGR stain, Figs. 16 and 17, but, if there is any doubt about the outcome, coat the light areas with a reduced sealer coat before applying the stain. The wash sealer coat will prevent fast absorption of the

stain. On the other hand, if the sapwood remains light under the first coat of stain, equalize the color by applying reduced NGR stain over the first coat before it is dry. Pigment stains are worked in much the same way and because of the slower absorption and ease of control they often are best for blending sapwood. In any case, be careful to allow sufficient drying time between the stain coats and the top coats.

Job schedules: Figs. 5 to 10 inclusive outline briefly the procedures used in producing six of the most popular modern finishes on various kinds of wood. Most of these procedures are quite simple to carry out without any previous experience in wood finishing. The manufacturer's instructions also tell you how to prepare the materials used. Figs. 18 to 29 inclusive picture a complete double-staining routine on a table top. On this job, an NGR mahogany stain is used for the ground color and a mahogany wiping stain provides the shading coat. With only a change in stain colors and filler, the same schedule will apply to any open-grained wood and, by simply eliminating the filler, to close-grained woods. Many of the light-colored, open-grained woods, such as korina, take an attractive finish when filled with a natural-colored paste filler over the bare wood. Follow with a pigment wiping stain in the new light-gray color. On some light woods it may be necessary to sand the surface thoroughly to remove all traces of the filler except that embedded in the pores of the wood.

Finishing Schedule

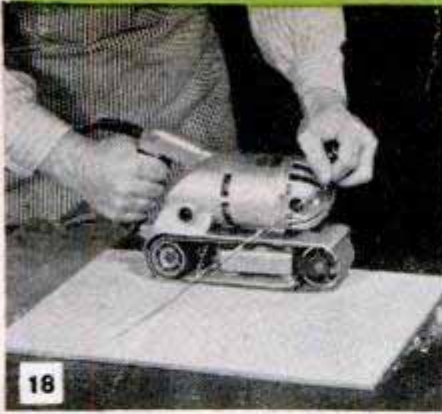

SAND all parts before assembly, using No. 2/0 belt, 3/0 for handwork



DUST work thoroughly, using a brush, tack rag to pick up dust



NONRAISING STAIN is easily applied with suction gun. Dry 30 min.



WASH COAT of white shellac or clear lacquer over stain is optional



FILLER used on all open-grain woods, except open-grain finish



WIPE FILLER across wood grain with coarse cloth. Finish with grain



SEALER is sprayed or brushed. Shellac (2-lb. cut) also can be used



SMOOTH sealer with No. 6/0 garnet paper. Dust off, use tack rag

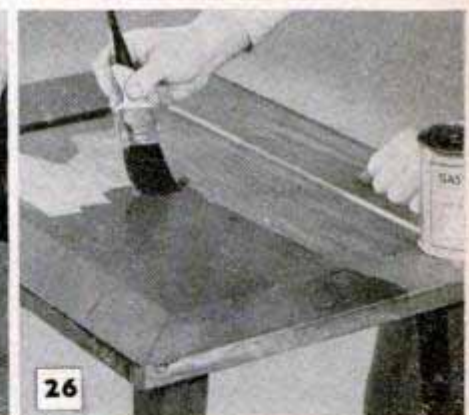

PIGMENT STAIN in mahogany color is brushed on. Can also be sprayed



WIPE STAIN with coarse cloth, shading lightly; leave more stain at edges

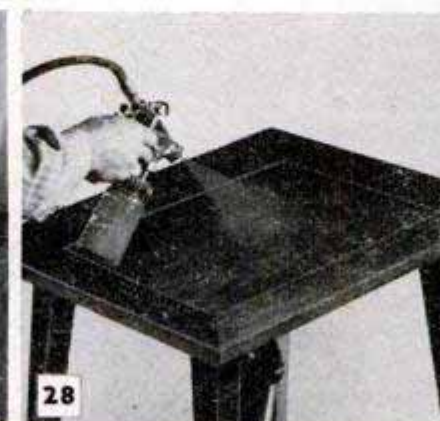

TOP COAT can be lacquer or varnish. Let it dry before rubbing



RUB with rubbing compound on a felt or burlap pad. Work with grain

Flexible Floor Mat for Laundry



One woman, who was tired of standing on a concrete floor in her laundry, had her husband make up a flexible floor mat of wood slats nailed to strips of old V-type fan belting. This provided a mat that could be rolled up and stored when not in use. A mat of this type not only provides a cushioning effect under your feet, but also keeps you off a floor that may be damp and wet while doing the laundry.

Glass Jar Provides Minnow Trap

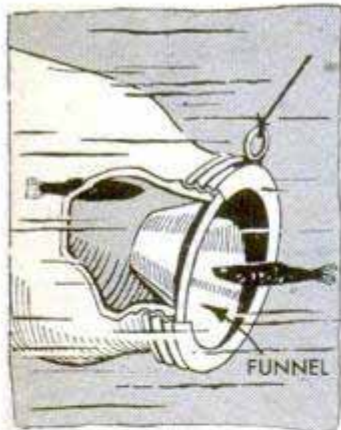

Needing live bait quickly, one fisherman improvised a minnow trap from a small funnel and a fruit jar of the 1-qt. size. He removed the spout from the funnel and placed the bell end in the mouth of the jar. Next, he cut a slot in the ring member of

the two-piece jar lid so that the round wire bail on the funnel would protrude. Then he screwed the lid down tightly to hold the bell end of the funnel in place in the jar as in the detail. A cord or a short length of fishline, tied to the bail, supports the trap in a horizontal position when in the water.

Patching a Leaky Swimming Pool

It is unnecessary to drain a concrete swimming pool or other concrete tank to make repairs. Just mix the necessary cement for the job and, when ready to apply

it, mix a trowel or two of the cement with about one third that amount of quick-setting plaster of paris. Press this into the hole under the water to stop the leak immediately, and then proceed with regular cement to complete the job.

Thumbtack Used as Pivot To Cut Circles on Jigsaw

The next time you want to cut a disk or circle on a jigsaw and have no suitable pivot point at hand, a thumbtack will serve as a temporary pivot. Just push it through a piece of adhesive

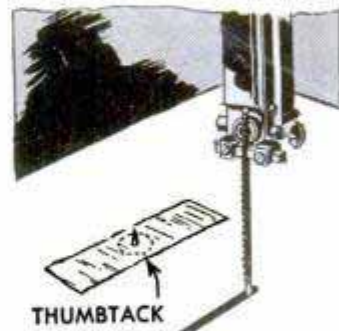

tape, and stick the tape to the saw table with the point of the tack upward as indicated.

G. E. Hendrickson, Argyle, Wis.

Rubber "Torch" Starts Campfire

Excellent fire starters for lighting campfires in wet weather can be made by cutting an old inner tube into 3-in. squares. Such a piece will burn for about 10 min. and will ignite damp firewood. If the rubber is wet, it can be dried by rubbing between the hands for a minute or two. In an emergency the burning rubber can be impaled on the end of a stick for use as a torch.

E. K. Harden, Cincinnati, Ohio.

Outboard-Motor Steering Arm Made Quickly Removable

For quick removal of the steering arm from my outboard motor when it is necessary to carry it in the trunk of my car, I tapped the bolt holes in the arm and turned machine screws tightly into the holes. Then I flowed solder around the heads

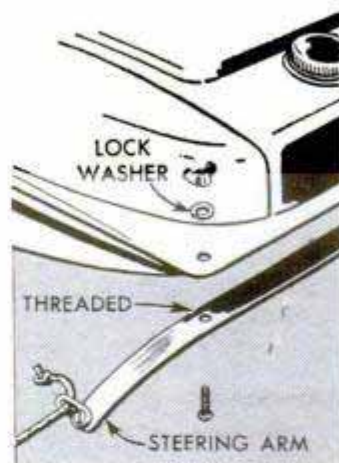

of the bolts to prevent them from working loose. When I assemble the arms on the motor, I use lock washers and wing nuts so that the arms can be tightened in place and also removed without the use of a wrench.

Clinton R. Hull, Costa Mesa, Calif.

Bits of thread can be removed from a wool rug by brushing a damp mop over it.

BOAT "CRUTCHES"

By C. L. Newcomb

OWNERS of small power boats and even sailboats, of the flat-keel type, can paint and make repairs below the water line simply by beaching the boat, if a pair of "crutches" is used to keep the craft from heeling to one side. This, of course, can be done only with a boat having a keel or skeg that will protect the propeller when the boat is aground, as the weight of the boat is supported by the keel, the crutches serving only to steady it. The crutches, one of which is mounted on each side of the boat amidships, are lengths of pipe drilled with a series of holes. Metal pins inserted in the holes prevent pipe-tee brackets from sliding down the uprights, and pivoted wooden blocks provide self-adjusting "feet" to keep the pipes from being embedded in the sand. Note in the detail how the block is pivoted by passing a bolt through two angle brackets and a pipe tee. The pipe tees forming the brackets are assembled to floor flanges which are mounted on wooden pads, the pads, in turn, being screwed permanently to the hull just below the rub rail. To use the crutches, select a beach with a gentle slope and slowly run the boat aground until the keel at the bow just touches the bottom. Put out the anchor astern to permit kedging off if necessary. Then adjust the legs in the sockets so they touch bottom, and set the pins in the holes to keep the boat from heeling when it settles. The crutches can be used in two ways. The boat can be beached in water that is shallow enough for working on the hull, or it can be beached during high tide. In the latter method, the boat is left high and dry when the tide goes out. Be sure that the boat is not beached during a particularly high tide, as the next tide may not be sufficient to float it. To refloat the boat, it usually is necessary only to take in the crutches or secure them against the sides out of the water, and shove off by hand or power. If the boat doesn't float easily, the stern an-

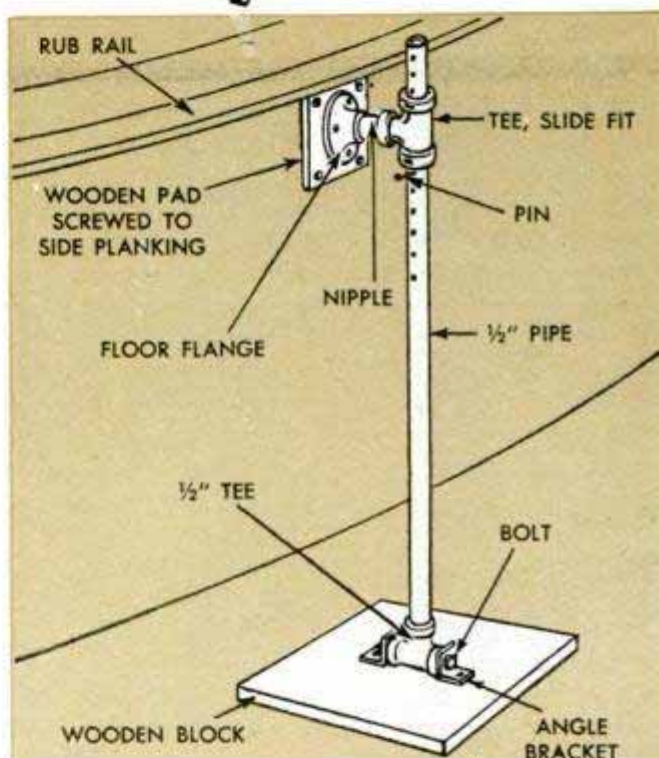
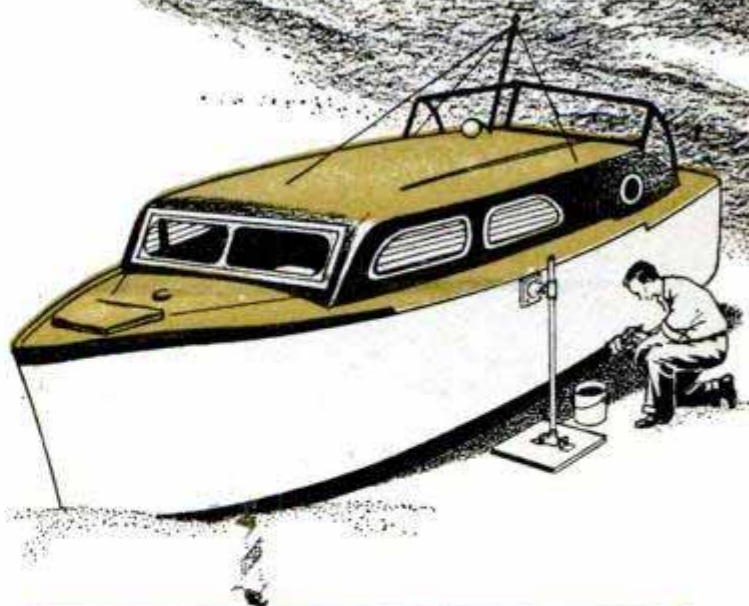

chor line may be taken up and the boat pulled off, using reverse power if necessary. If greater working clearance is needed under the boat, a couple of 4 x 4s can be slipped beneath the keel as the boat begins to settle. The crutches are then adjusted accordingly to steady the boat.

Rubber-Stamp Facing Renewed by Cleaning With Dry Toothbrush



Rubber stamps which leave a smudged impression are not necessarily worn out. Before discarding them, try cleaning the type face of the stamp with a toothbrush. After accumulations of dried ink, dust particles, etc., are removed, most rubber stamps will again leave a clear impression.

☞ Unshelled pecans will stay fresh indefinitely if they are sealed in a fruit jar.

CLEANING THE AUTO *Interior*

By Ed Packer

HOW ABOUT trading a few hours of easy work for a car interior that looks clean and new? You can do most of the job with your vacuum cleaner by attaching the flexible nozzle and giving the rug and upholstery a thorough going over. It will aid the work of the vacuum cleaner if you first brush these parts thoroughly to loosen embedded dirt. Next, go over all the fabric in the interior with a mild soapsuds or a shampoo such as is supplied for this purpose. There also are available rug dyes, fabric finishes, cements and specially prepared materials that renew rubber mats and running boards. However, for coating rubber you also can use a solution of drop black and turpentine. Refinishing kits for the worn steering wheel and window sills come in pressurized containers for use in spraying the finishing material into hard-to-get-at places. Mask adjacent fabric before spraying. Use cement to secure the edges of the rug. Examine the sponge-rubber weather stripping around all the doors, especially at the lower edges. There's a special adhesive made for cementing the weather stripping back in place.

Scrub the fabric with a sponge and mild soapsuds. Remove all the lather with a windshield-wiper blade



Embedded dirt and lint are easily removed from the fabric with a vacuum cleaner, using flexible nozzle

REMOVING SPOTS FROM UPHOLSTERY

CANDY: Candy, other than chocolate, usually can be removed by rubbing with cloth soaked in hot water. Removal of chocolate requires volatile solvent such as carbon tetrachloride.

CHEWING GUM: Use a dull knife and keep spot wet with carbon tet while working out gum.

ENAMELS, LACQUERS AND PAINTS: Use the solvent recommended for thinning the material.

FRUIT: Scrape off pulp with dull knife and sponge spot with very hot water, just under boiling point.

ICE CREAM: Proceed as for candy or fruit.

LIPSTICK: Wet the area with carbon tet and apply blotter. Repeat until stain has been picked up.

TAR: Moisten with carbon tet and work the tar loose with a dull knife, or a wide wall scraper.

WATER SPOTS: Sponge the area with a wet cloth. Follow this with rag moistened with carbon tet.

Rubber cement is used for applying patches to floor mats after both surfaces have been carefully cleaned





A thin mixture of drop black and turpentine makes a good dressing for the rubber mats and running boards



Above, to make seat covers fit snugly, compress the seat by standing on it while attaching them. Below, after cleaning the headliner and brushing thoroughly, spray on a light coat of fabric finish with spray gun



Drill Press Used to Tap Thin Metal

When tapping holes in thin, soft metal, difficulty of holding the tool at the desired angle throughout the operation often causes the threads to be ragged and may result in scratching the surface of the work. This trouble can be avoided by doing the job on the drill press. Clamp the work in position, as shown, and lock the tap in the chuck of the drill press. Then tap the hole by turning the spindle with one hand while applying a firm, steady pressure on the drill-press handle with the other.

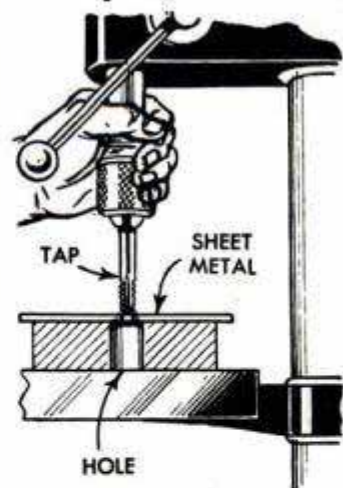

"Beacon" Helps Visiting Friends Locate Your Home at Night

Fitted with a flasher socket and placed on a front-window sill, a blinking table lamp becomes a prearranged "beacon" by which arriving guests can readily find your house. The flasher unit can be purchased at any electrical-supply store and is screwed into the lamp socket in the same manner as a light bulb. The bulb is then screwed into the flasher socket.

Arthur Trauffer, McClelland, Iowa.

Paper Disk Prevents Paint Skin

A partly used can of paint, though it be tightly covered, will form a skin at the surface which must be removed by straining. To prevent this waste and have the paint ready for immediate use, cut a disk from paper or cardboard to approximate as closely as possible the inside diameter of the paint can, and place the disk on the surface of the paint before covering the can. When the paint is to be used again, run a knife blade around the edge of the disk and lift it out of the can.

George J. Cole, Long Island City, N. Y.



☐ An effective method of keeping gilt picture frames from drying out and cracking is to give them a light application of lemon oil every two or three months.

Sturdy Trailer Hitch for Dump Truck Welded From Scrap-Iron Pieces

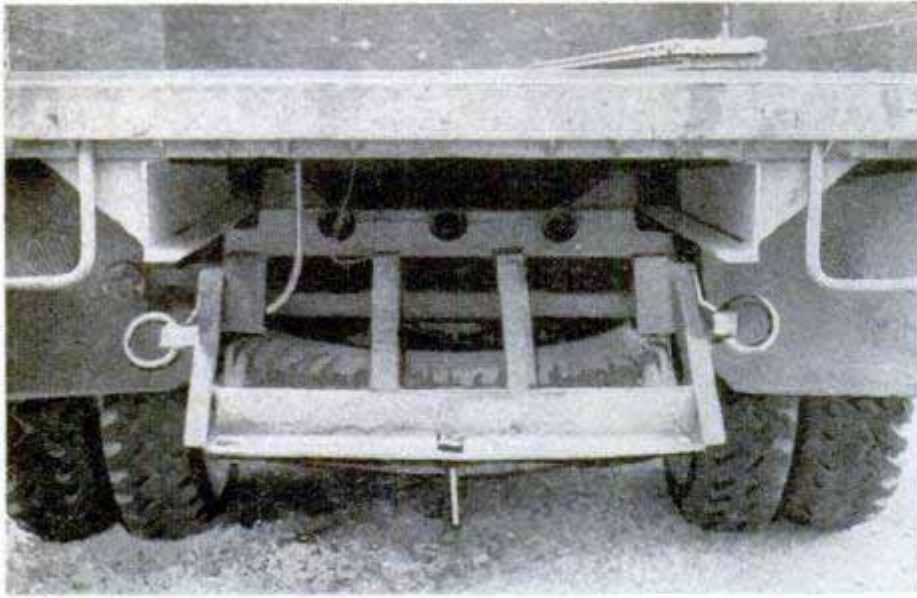

This all-purpose trailer hitch is constructed entirely from scrap pieces of angle steel and welded directly to the chassis of a dump truck. Designed and positioned so as not to interfere with the tilting of the truck bed, the sturdy attachment can be used for the most rugged towing jobs. Heavy rings at each side provide for quick and easy "hooking on" with chain or rope, while a simple kingpin arrangement at the center of the hitch will accommodate trailer and wagon drawbars. — Kenneth R. Imig, Watseka, Ill.

"Popping" of Torch Welding Tip Prevented by Countersinking Flame Hole

Other than improper flame adjustment, "popping" in an acetylene-torch welding tip is most commonly caused by sparks entering the blowpipe and igniting the fuel before it reaches the outside air. It has been found that such trouble can be avoided simply by countersinking the flame hole of the welding tip. This provides a shell which acts to catch the sparks before they enter the fuel stream. The countersinking should be $\frac{3}{32}$ in. deep and should be done

with a drill $\frac{1}{16}$ in. larger in diameter than the flame hole. If, after lighting the torch, the tip seems to overheat, let it cool and polish with a few light strokes of a whetstone. An added advantage of countersunk welding tips is that, after a little skill has been acquired in the adjustment of the flame, a medium-sized tip can often be successfully used to do work ordinarily requiring the use of tips both larger and smaller.—M. J. Fenley, Jr., Velasco, Tex.

Nonspill Outboard Gas-Tank Cap Permits Refueling While Motor Runs

When adding reserve gas to your outboard-motor tank, spillage, as well as the bother of stopping the motor, can be avoided by use of this modified gas-tank cap and an ordinary hand-operated fuel pump. One hose from the pump is attached to a reserve gas can while the other is fitted over a length of $\frac{3}{8}$ -in. copper tubing which, in turn, is soldered to a $\frac{1}{4}$ -in. brass pipe elbow. A $\frac{1}{4} \times 1\frac{1}{4}$ -in. brass nipple is turned into the other end of the elbow and extends through a hole which has been cut in the regular gas cap. The nipple is held to the cap by two washers, two gaskets and a nut. The latter is tightened from the underside of the cap and holds the entire assembly against the shoulder of the elbow. The gaskets are the type impervious to gasoline and are coated with aircraft-gasket compound before being set. Six $\frac{1}{8}$ -in. holes are drilled in the nipple below the nut and a sheet-brass plate is soldered over the bottom opening. A length of $\frac{1}{8}$ -in. copper tubing is located and soldered as shown. Besides serving as an air vent, the tubing provides an overflow which emits a fine stream of gasoline if the tank is too full.

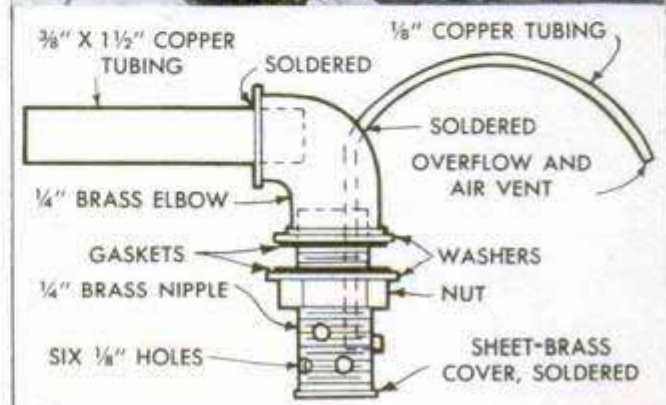
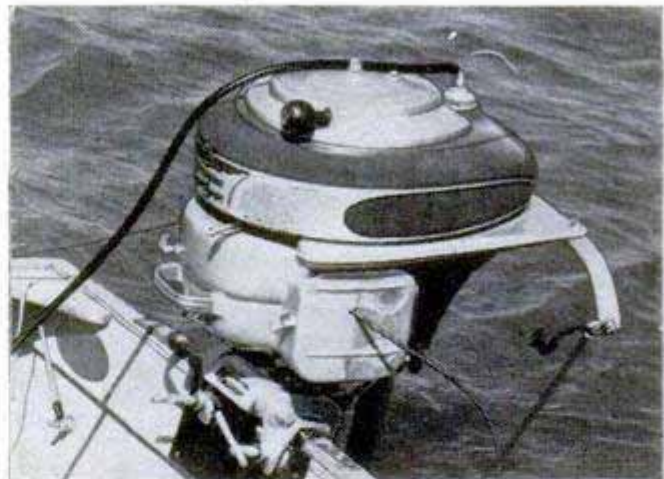

PALETTE COFFEE TABLE

By George Daniels



COMBINING simplicity of construction, plain utility and good design, this coffee table gets its name from the top, which is shaped like an artist's palette. If you have a small bandsaw for making the curved cuts you can easily complete the table in one evening, ready for finishing. Use birch plywood for the top if you like light, modern finishes. Use walnut or mahogany if the table must match other furniture finished in darker colors. Make a full-sized pattern of the top on heavy paper or cardboard from the squared detail below, and use this to lay out the outline of the top directly on the surface of the plywood. Saw just outside the pattern line with a bandsaw or a keyhole saw and then sand the edges smooth with slightly rounded corners. Legs of the original table were cut from red cedar, but birch or walnut will

do. Lay out and make the first diagonal cut on each leg. Then turn the piece onto the adjacent face and make the second cut. This results in a tapered leg which gives the appearance of standing splayed when it is attached to the underside of the table top. Plane the sawed surfaces smooth and attach each leg to the underside of the table top with a dowel screw, glue and four angle brackets. Now, scribe and cut the opening for the bowl, or tray, taking the measurements directly from the tray you intend to use. To finish birch, apply a white filler to the edge of the plywood. Allow to dry, and then apply a blond or a white wiping stain. Finish with sealer and water-white lacquer.

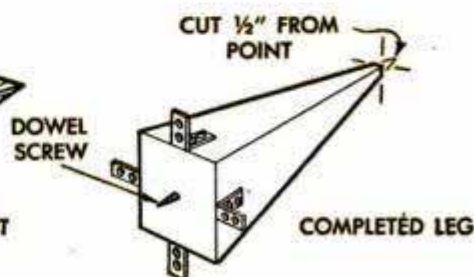
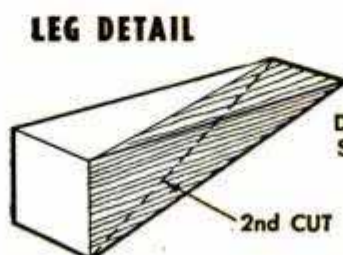
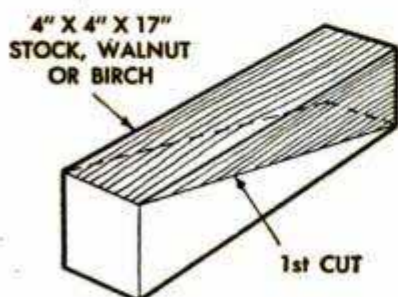
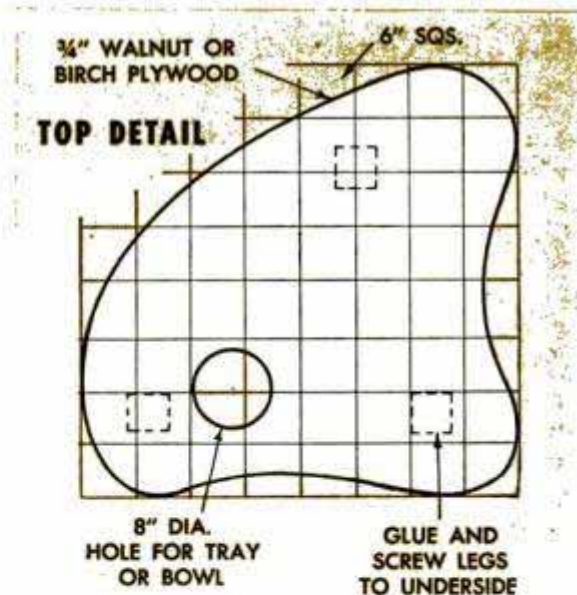

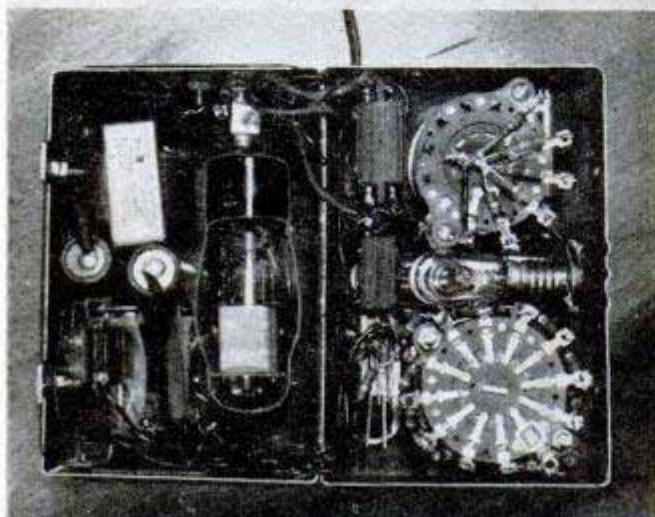
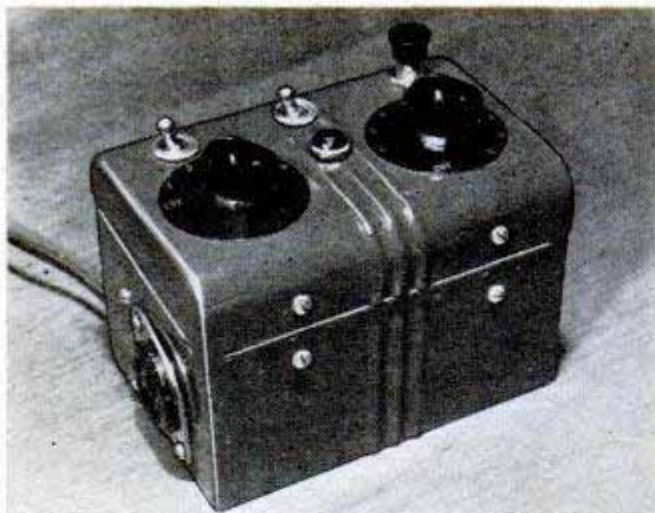

Ferrotyped Prints Dried Quickly By Mounting Plates on Heater

One photographer finds that an electric heater of the type shown in the photograph serves as an excellent drier for ferrotyped prints. The ferrotype plates are bowed to engage the slots of the cylindrical element guard, and, when the prints are dry, they drop from the plate to the table

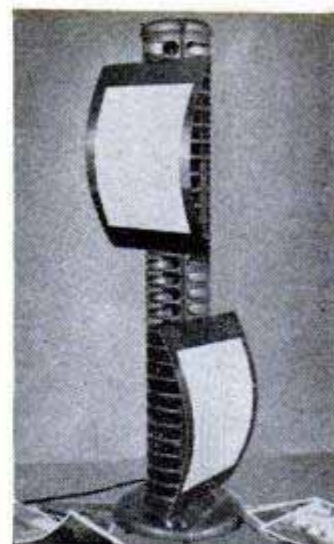

top. The average time it takes to dry the prints is from 6 to 10 minutes.

Paris W. Williams, Jr., Van Nuys, Calif.

Shadowless Stills Taken Using Only One Light

Attempts to rid still subjects of all shadows by use of numerous lights usually results only in creating many smaller shadows. However, by making the shot a time exposure, and with the aid of a single, low-watt light, a shadowless picture can be taken. The light is held by hand and moved from place to place over the top of the subject throughout the time of the exposure. Of course, the light, as well as the person holding it, are kept out of camera range during the shooting. As the negative is being exposed, it records all the various positions of the light as one. All shadows are thus removed.

Electronic Timing Unit Built in Card-File Box

If you are planning to make a photographic electronic timing unit, a 3 x 5-in. steel card-file box, as illustrated, will provide a neat appearing receptacle for the unit. These boxes can be obtained from any office-supply store.

Extra Photoflood Reflector Improvised From Sheet of Aluminum Foil

When you need an extra photoflood reflector for a particular setup and don't have one on hand, you can improvise a suitable reflector from a sheet of aluminum foil. Turn the photoflood bulb into a drop-cord or extension-cord socket and fasten one edge of the foil to the socket with cellulose tape or a piece of string. The foil is easily bent to cast the light in the desired direction.—Hugh Lineback, Stillwater, Okla.



Detergent Improves Negatives

Water spots from sediment in the water supply won't detract from negatives if the latter are soaked in a solution of ordinary household detergent after washing. Soak the negatives for two minutes in a solution of 1 teaspoonful of detergent to 1 gallon of water. Then rinse and dry.

Photographic Spotlight Stand Made From Pipe and Fittings

Made from $\frac{3}{8}$ -in. pipe and fittings, this spotlight stand can be assembled in the average home workshop, and is adjustable from $3\frac{1}{2}$ ft. to $6\frac{1}{2}$ ft. in height. Black pipe and fittings are just as good as galvanized, for this purpose, and will cost less. You will need 76 in. of pipe, four 90-deg. elbows, two flanges, one coupling and one cross, or four-way fitting, plus a 40-in. length of $\frac{7}{16}$ -in. rod, four furniture casters and a thumb-screw. To make the stand, cut the pipe into five pieces, one 40 in. long, and four pieces 9 in. long. Thread the long pipe about double the normal distance on both ends, the short pieces being threaded the usual distance on both ends. Screw the coupling on one end of the longer piece to provide sufficient thickness to tap for the thumbscrew. If there isn't a suitable screw at hand, one can be made from a short length of $\frac{1}{4}$ -20 bolt, which is slotted about $\frac{1}{2}$ in. deep at one end to take a sheet-metal wing. The latter can be peened or pinned in place. The cross and two pipe flanges are assembled on the long pipe as indicated, the cross being bored out in the center to take the threaded end of the pipe with a sliding fit. The short pieces

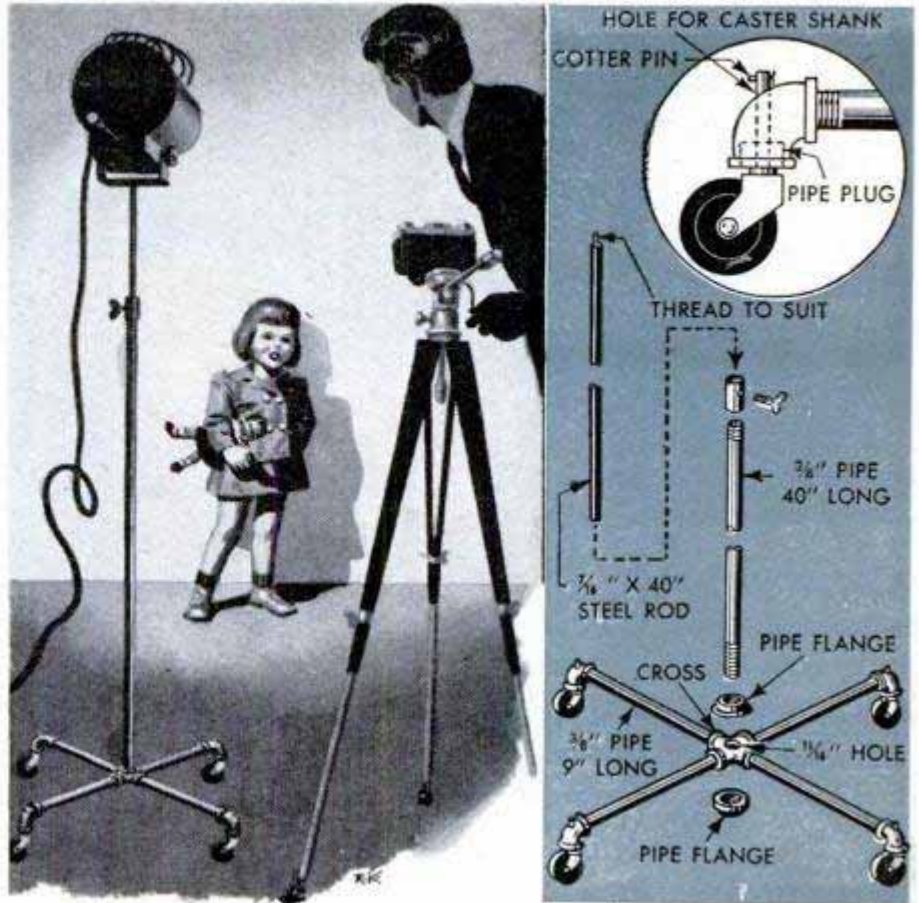

of pipe are screwed into the cross, the feet being screwed to the outer ends. The feet are made from the elbows, which are plugged and then drilled to take the casters as indicated. Be sure to drill small holes near the ends of the caster shanks for small pins or cotter keys to keep the casters from falling out when the stand is lifted. The steel rod, which supports the lamp, telescopes inside the pipe standard and is locked in position with the thumbscrew.

Foot Switch for Photo Enlarger Has Hacksaw-Blade Pedal

Fast, positive control of an enlarger lamp can be had by improvising a foot switch from a normally open sensitive switch

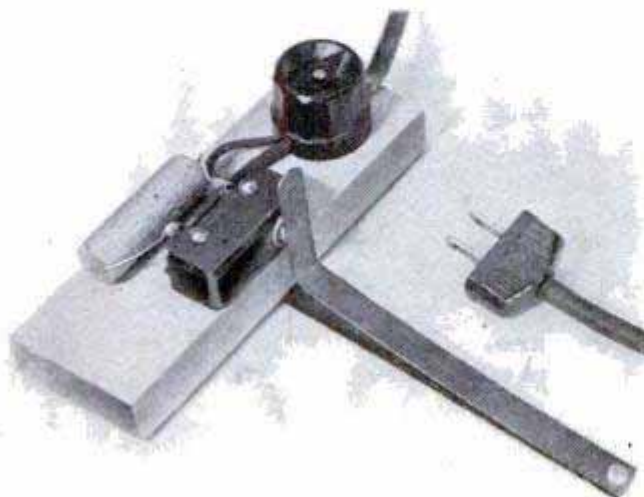

and an old hacksaw blade. A single outlet is wired in series with the switch and both are mounted on a wooden block, the switch being positioned so that the button extends over the edge of the block. The hacksaw blade is broken into two lengths. One length is bent at a 75-deg. angle, roughly $1\frac{1}{2}$ in. from the end, to form an arm which will depress the switch button. Then, both blade sections are riveted together at the outer end, inserting a washer or nut between the two parts to serve as a spacer, and the lower blade section is screwed to the underside of the block. To form the blade, heat it to a reddish glow and let cool to room temperature. If a heavy load of direct current will enter the switch, a .1 mfd. radio-type condenser, connected across the switch terminals, will prevent arcing.

Camera Rigged for Self-Portraits With String and C-Clamp



Even though he had no timing unit on his camera, one photographer was able to take a picture of himself with the aid of the device shown in the illustration. Tying a length of string to the shutter-release lever and attaching an ordinary C-clamp to a leg of the tri-

pod was all that was necessary. With the string looped through the clamp, the photographer simply posed and pulled the string to trip the shutter.

Solution Eliminates Drying Rings

Using heat to speed drying ferrotyped prints frequently results in "eggshell," or imperfections caused by uneven drying. This problem can be eliminated, however, by soaking the prints in a chemical solution for five minutes before drying. The solution consists of either glycerin or monoethyl-ether acetate, 1 part, and water, 10 parts. The monoethyl-ether acetate is available under the names Carbitol Acetate or Diethylene Glycol.

T-Fitting Makes Mixing Faucet

If you use the basement washtubs for photographic processing and the tubs do not have a mixing faucet, one can be improvised very easily with a $\frac{3}{8}$ -in. copper T-fitting and some short pieces of rubber hose. Turn the tub faucets so that their openings face each other. Then use the two short pieces of hose to connect the copper T-fitting to the faucets as shown in the photograph.

Robert Hertzberg, Jackson Heights, N. Y.

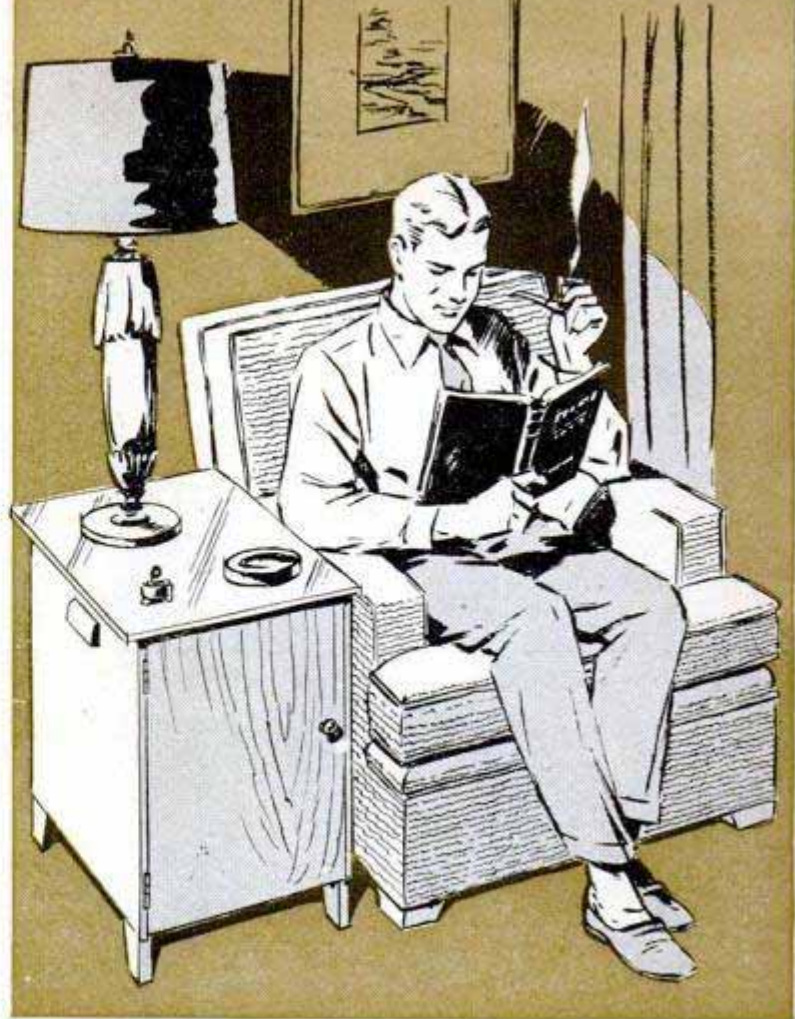
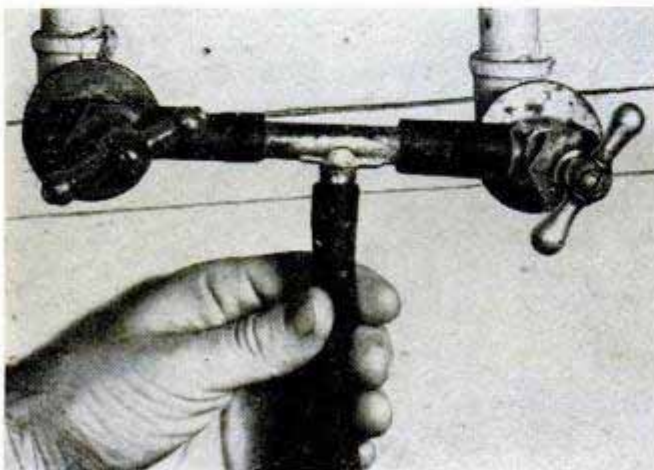

By Robert Hoppough

BECAUSE of the inconvenience usually involved in setting up a slide projector, many photographers don't show their color slides as often as they would like. One color fan solved this problem by building a convenient cabinet which stores all the equipment except the screen and doubles as an attractive chair-side table. When slides are to be shown, the adjustable top is simply raised to hold the projector at the desired height. The cabinet is made by covering a frame of $\frac{3}{4}$ -in. stock with $\frac{1}{4}$ -in. plywood, the frame members being doweled and glued together. The top extension rides in grooves formed by two cleats screwed to each of the rear uprights and, when closed, the extension serves as the back of the cabinet. Plywood partitions divide the cabinet into three storage compartments, while a sheet of plywood installed directly under the top rails provides a tray for the slides. The adjustable top is fastened to the extension as in the upper right-hand detail, wooden cleats and angle brackets being used to hold it rigidly in place. Note that the extension is mortised to receive the bracket arms flush with the surface so they will clear the rear crossrail. An ordinary spring-loaded window bolt installed in one of the inside cleats engages a hole drilled near the lower edge of the extension, locking it automatically in the raised position.

PROJECTOR CABINET

doubles as end table

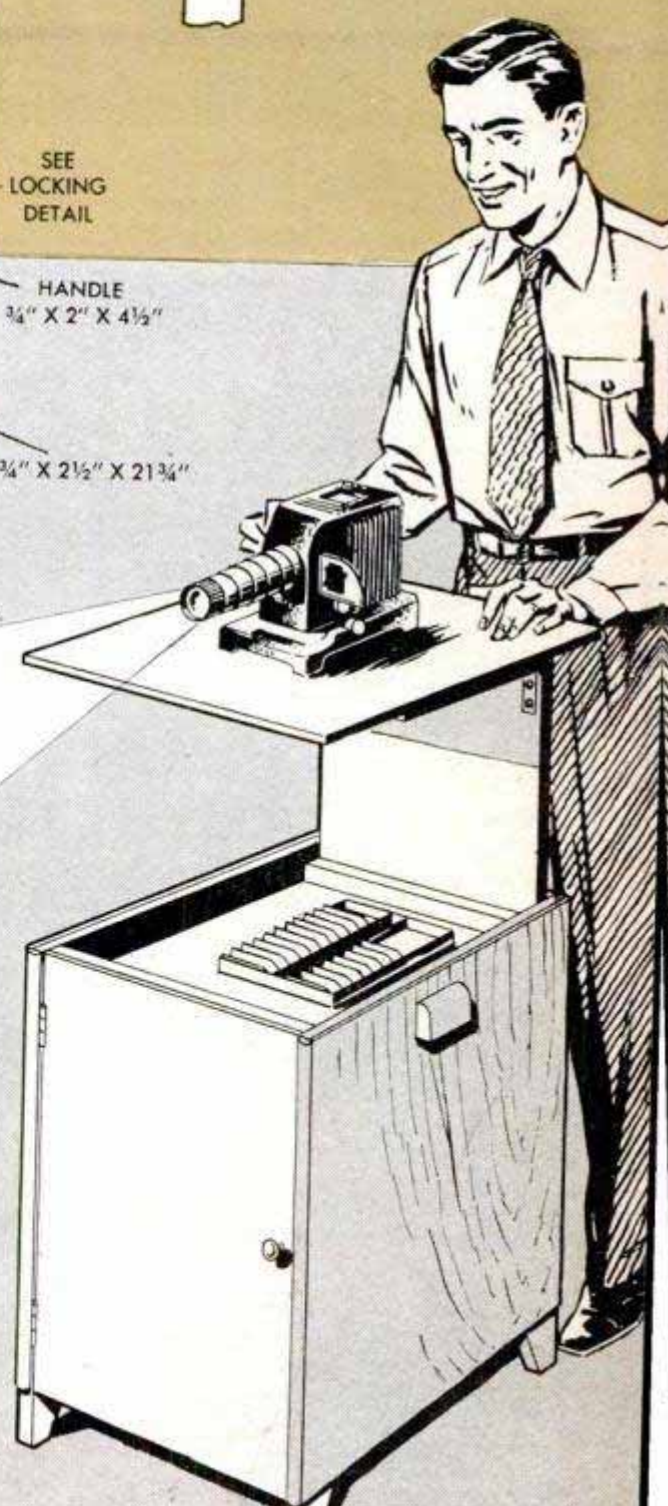
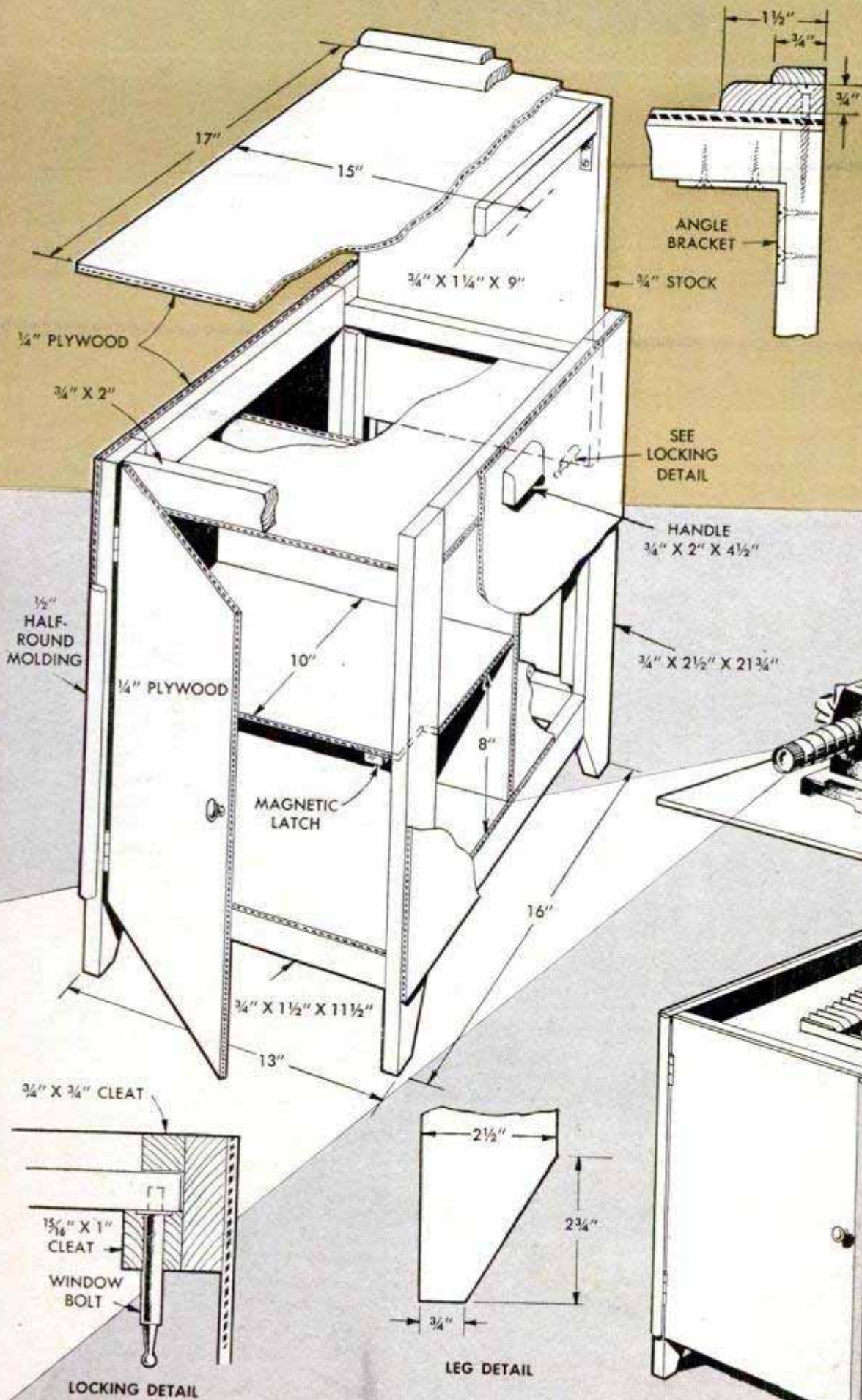

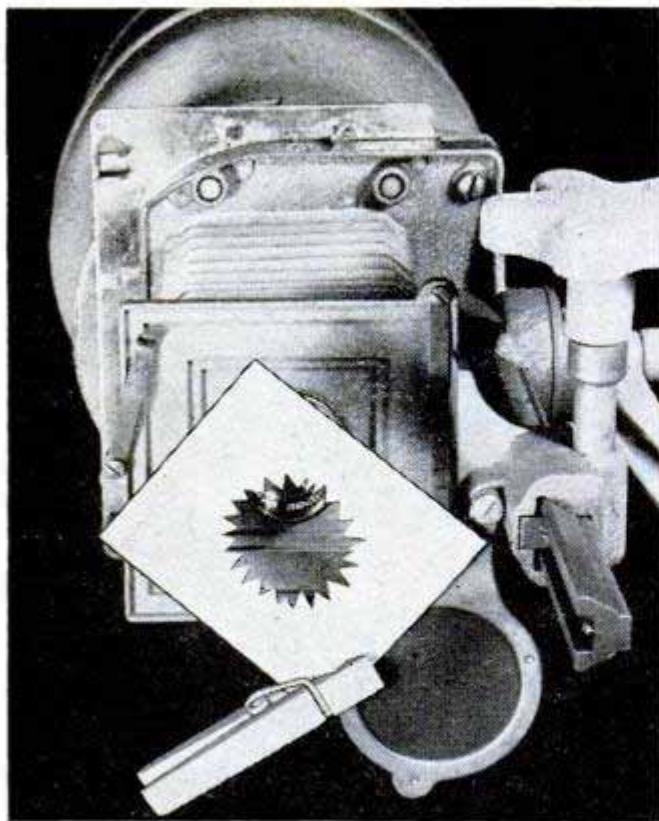

Vignetting Projection Prints By Use of Cardboard Cutout

Although hard-edged projection prints are suitable for most types of picture composition, there are certain subjects that call for vignetting and, in some cases, dodging during exposure. To leave both hands free for this job, one photographer attaches the vignetter to the filter mount with a spring clothespin as pictured. To avoid light reflections, coat the cardboard vignetter with flat-black photographic enamel.

ⓘ Unless a bellows-type camera is closed slowly, air pressure can buckle the film or even damage the bellows.

Improving Your Photo Trimmer

If you have been bothered by having photo prints slip under the guide while being trimmed and thus twist out of square, try the following kink: Remove the rule from the trimmer, after marking its position on the board, and rabbet the latter to a depth of about $\frac{1}{32}$ in. The rule guide can then be placed in this rabbet, which will bring its leading edge slightly below the surface of the trimming board where prints cannot slip.

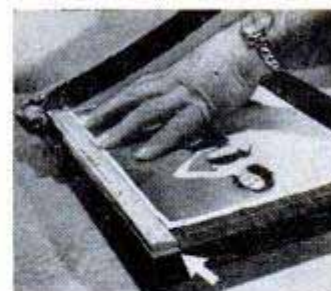

Louis Hochman, Sherman Oaks, Calif.

Photographer Labels Albums With Novel Name Plate

One photographer, who specializes in preparing albums of homes and weddings, uses the novel label pictured below to identify his work. After arranging letters from a movie-titler outfit on a sheet of fiberboard or hardboard, he lights them to cast a long shadow and then photographs them. Prints from the resulting negative are gummed on the back to provide the labels.

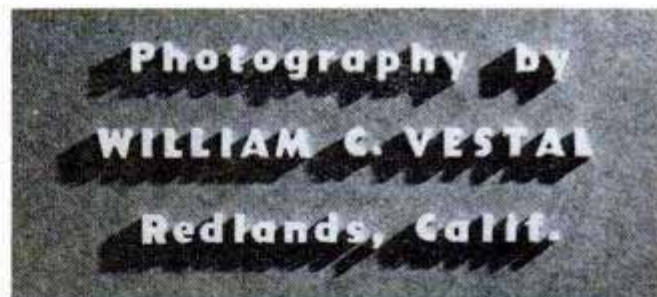

Popular Mechanics Book Shop

How to Paint With Brush and Spray

Here are the answers to the many problems facing the average man who desires to do his own painting. The book contains 144 pages that serve as a complete guide to painting. It gives information on painting your house inside and out, as well as furniture and floors. Novelty finishes, silk stencils and the use of roller and spray gun are also among the subjects included. A handy Material Directory is part of the book. Price, \$2.50.

Money From Ideas

If you have an inventive trend of mind, here is a book that will help you cash in on your ideas. It tells how to apply for a patent, how to make working drawings, which inventions

are profitable and how to get them manufactured, financed, protected against infringement, etc. A remittance of \$2.50 will bring this money-making book to your home.

What to Make for Children

All the money in the world wouldn't buy everything you want for your children. But here is a book by the editors of *Popular Mechanics* that will show you how to make, at little or no cost, many of the things so dear to the hearts of youngsters—things such as nursery and playroom toys, dolls and doll-houses, gymnasium equipment, things to ride and toys that "work" and "go." Send \$2.00 for this book and make some of the toys to keep the little hands in your home busy.

All books available from Popular Mechanics Book Dept., 202 East Ontario Street, Chicago 11

SN 56

Leveling

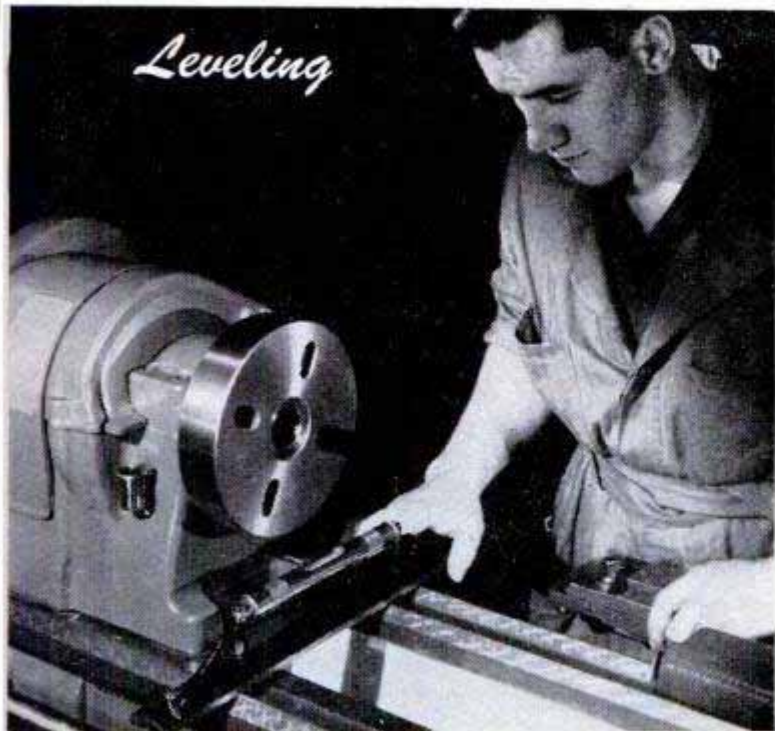

True up your lathe for precision

By E. R. Haan

WHEN GIVEN good care and occasional adjustments to compensate for wear, any well-made metal-turning lathe will do precision work for many years. Some of the things to watch in making periodic checks and adjustments are the bed level, spindle end play, spindle-bearing clearance, alignment of centers and clearance of gibs in the carriage, cross-feed and compound rest. You can also test the accuracy of face-plates and chucks.

Keep the lathe level: Even the best lathes cannot be expected to give precision results if they are not level. If the bed is twisted slightly, headstock and tailstock are thrown out of alignment, causing tapers when turning and boring. As a lathe can be thrown out of level by wind, slight earth tremors and settling of buildings, don't neglect to check the bed occasionally with a precision level, both crosswise and lengthwise as in Fig. 1. Use leveling screws, metal shims or hardwood wedges under the feet to bring the bed level, and then recheck for level after the hold-down bolts or lag screws have been tightened. The lathe or the bench on which it is mounted should be bolted to a rigid floor.

Spindle clearances: Clearances vary with different types of bearings and with the size of a lathe. Adjustments should be made in accordance with the manufacturer's instructions. Before checking the spindle clearances, see that the bolts holding the headstock to the bed are tight. Then loosen the belt on the cone pulley to release the

1

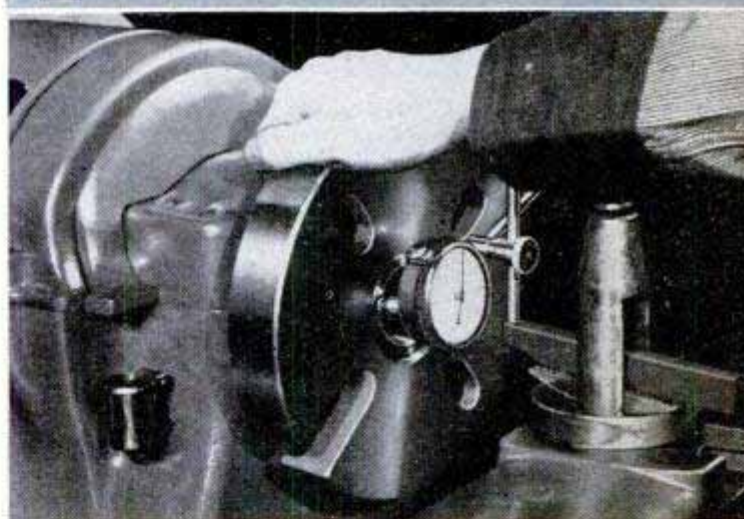
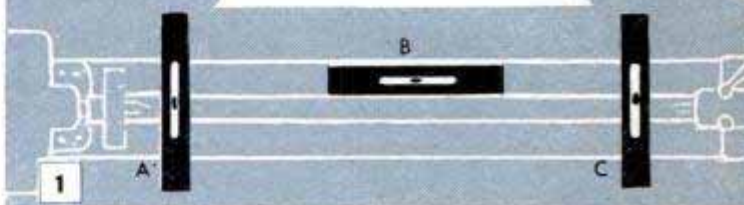

Spindle end play

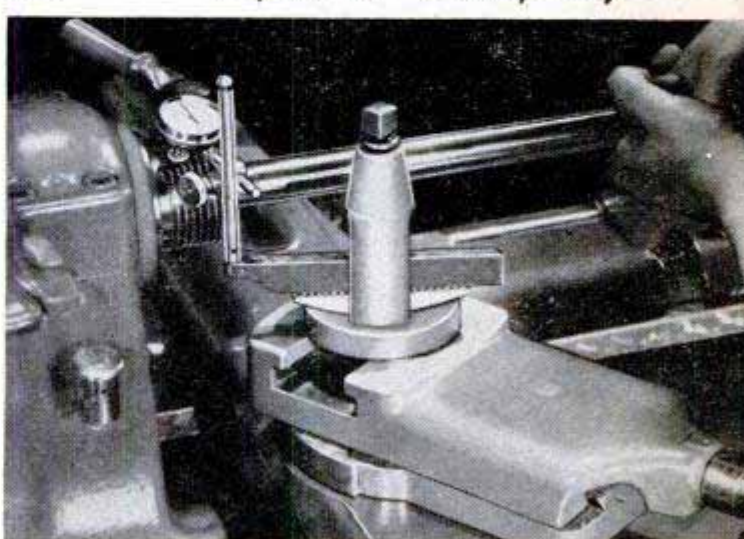

Bearing clearance

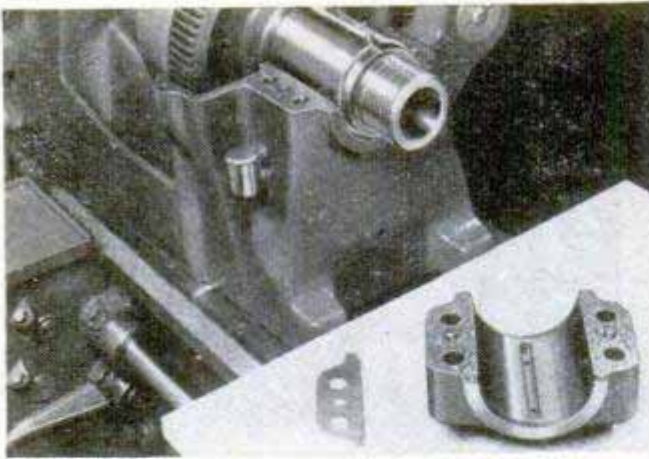

4 Shim laminations

tension on the spindle. Also have the back gears unmeshed. Excessive end play of the spindle may cause chattering and inaccuracy. To check the amount of end play, use a dial indicator. First, screw a faceplate on the spindle and, after the spindle has been pushed all the way back into the headstock, mount the indicator on the tool post, as in Fig. 2, so that the button rests against the end of the spindle—not against the faceplate. Pulling the faceplate in the opposite direction will cause the indicator needle to move, showing the amount of end play. On small lathes having split spindle bearings, end clearance generally should be from .001 to .002 in. If end play is excessive, loosen the setscrew holding the spindle takeup nut at one end of the spindle, and turn the nut until the correct end clearance is obtained. Then retighten the setscrew.

Bearing clearance: Spindle bearings of most small metal-turning lathes should be rather tight so that there is a slight drag when turning the spindle by hand. To check bearing clearance with a dial indicator, set it up so that the button rests against the top outside surface of the spindle as in Fig. 3.

Then use a test bar to lift the spindle, thus moving the indicator needle. A greater clearance than .002 may indicate the need of a bearing takeup. If the clearance is less than .001 in., chattering, heated and scored bearings may result. To reduce clearance of split spindle bearings, first clean off the headstock thoroughly so that no dirt or chips can get on the bearings or spindle. Then loosen and remove the bearing cap and also the laminated shims, Fig. 4. Peel off only one lamination from each shim, wipe the shims clean and remove possible burrs caused by peeling. Then replace the shims and bearing cap, tighten the bolts and recheck the bearing for clearance. If it's still too loose, remove another lamination; if it is too tight, substitute a shim half as thick as the lamination removed. Sometimes a lamination is taken off one shim only, and if this is not enough, a lamination is then removed from the second shim. This method avoids the necessity of replacing a lamination with a thinner shim if the bearing is too tight. Follow the same procedure on the other spindle bearing. Then run the lathe at a moderate speed. If the bearings become uncomfortably hot, readjust the shims.

Alignment of centers: Both centers must be located directly over the center line of the lathe for precision cutting. Centers will be inaccurate if they are not seated properly and, therefore, all contacting surfaces are thoroughly cleaned before assembling. A scratch or burr on the side of a center or sleeve may also cause incorrect seating. Then, the center itself may be worn so that it is not true. To test the live center, use a dial indicator mounted on the tool post with the button touching the side of the center near the point, as in Fig. 5. If the needle fluctuates when you turn the spindle by hand, there is runout. The tail-

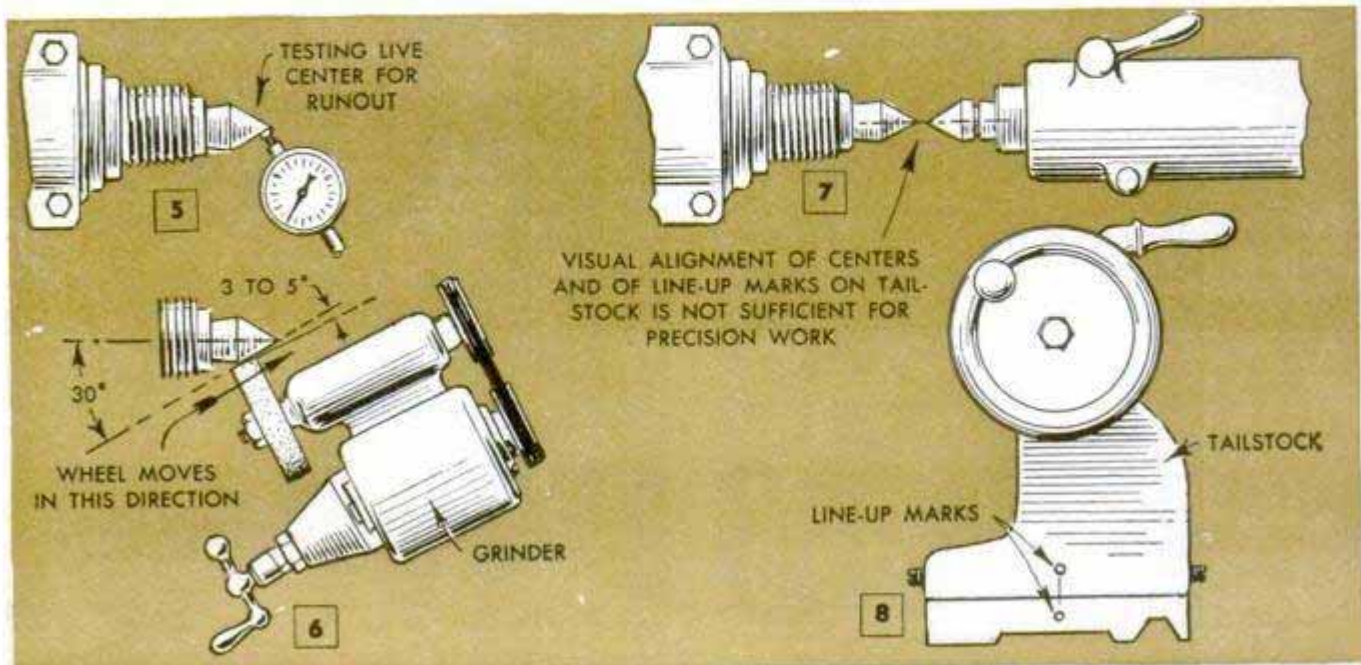

stock or dead center can be put in the sleeve that fits the spindle and checked in the same way. Hardened centers (tailstock center is always hardened) are re-ground and polished; soft centers are turned. Grinding is done with a tool-post grinder set at 30 deg. from the lathe center line with feed screw on the left as in Fig. 6.

With both live and dead centers re-pointed, they may still be out of alignment for precision work, even when visually checked by bringing them together, Fig. 7, and by having the line-up or "witness" marks on the tailstock aligned, Fig. 8. One way to check alignment of centers is to turn a cylinder about 1½ in. in diameter, 14 in. long, with two collars turned about 10 in. apart. Finish both collars with a fine cut without changing the adjustment of the cutting tool. Then measure the collars with a micrometer as in Fig. 9. If both are the same diameter, the centers are in alignment. If not, loosen the clamp bolt of the tailstock, and adjust the tailstock by releasing one of the two setover screws and tightening the other one as in Fig. 10. Then reclamp and make another test cut on the collars. Some lathes have tailstock gibs for takeup adjustment to compensate for wear.

Adjusting gibs: The carriage, cross-feed and compound rest are provided with gibs to take up excess play, which may cause loss of precision. Gibs should be snug but not too tight, as this causes feeding to be jerky and inaccurate. Start gib adjustments by tightening them until the slide is too tight. Then loosen them just enough to make the slide work freely. Gibs are either straight or tapered. Straight gibs have a number of adjusting screws, Fig. 11. These should be turned uniformly. Tapered gibs have only one adjustment screw and a lock screw to hold it.

A loose carriage can undo careful adjustments on the cross-feed and compound rest. There are gibs and also bearing plates on the carriage to eliminate excess vertical and horizontal play. The bearing plates contact the underside of the ways, and are sometimes fitted with laminated shims. The carriage should be tight enough to prevent it from lifting, yet loose enough to avoid binding when moved along the ways with the handwheel. On some carriages, play between the gears connecting to the handwheel and the rack on the bed can be minimized by loosening the screws on the apron, pushing the gear case toward the rack, and tightening the screws.

Faceplates and chucks: Figs. 12 and 13 show how a dial indicator is used to check the accuracy of faceplates and chucks. The indicator is mounted on the tool post and the faceplate or chuck is turned by hand.

Photos courtesy South Bend Lathe Works

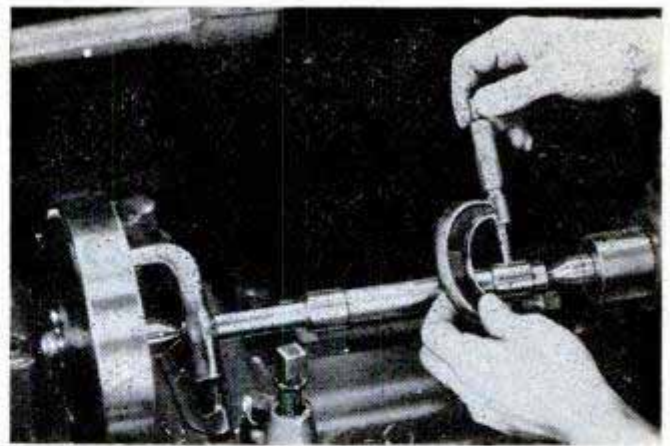

9 *Testing alignment*

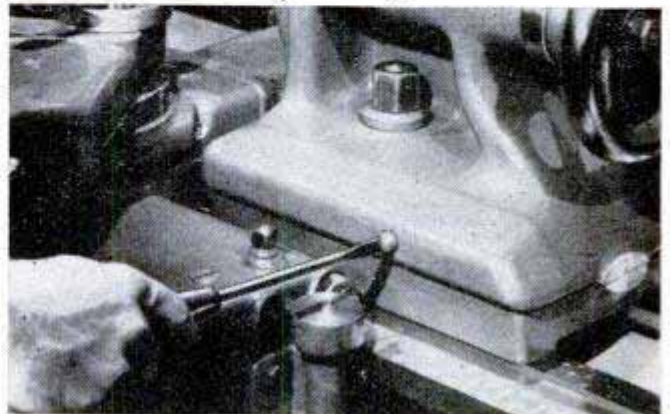

10 *Tailstock setover screw*

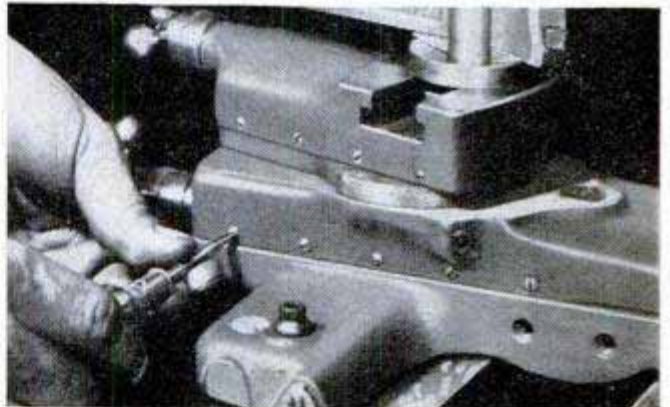

11 *Gib clearance*

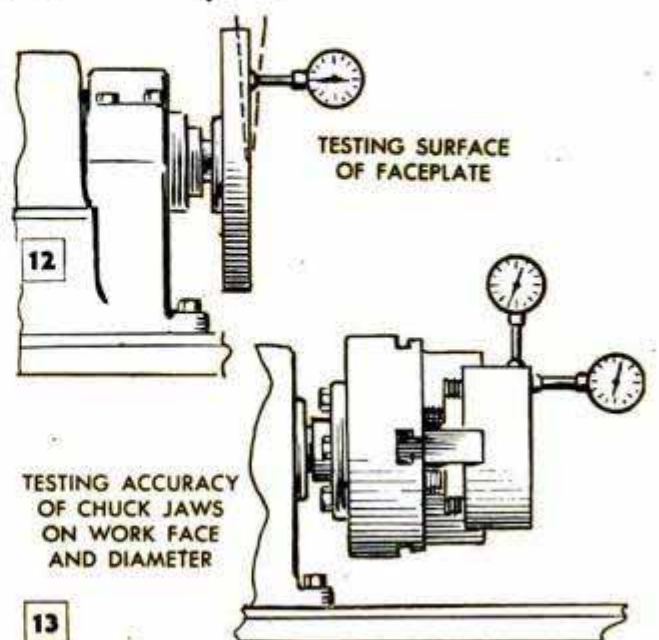

13

Large Cloth Gathers Baby Chicks

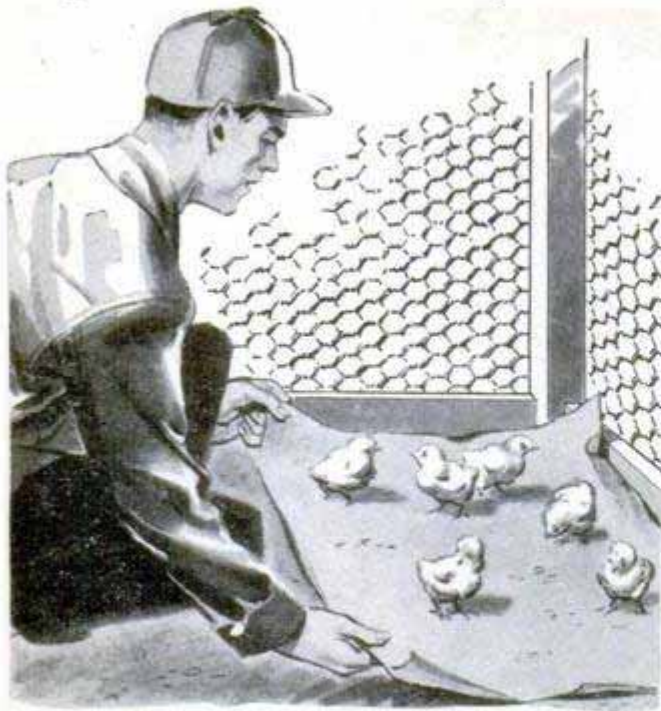

Baby chicks, which are allowed the freedom of a small pen for sun and exercise, are often difficult to get back into the brooder quickly enough to avoid an approaching storm. One poultryman solved this problem with a large cloth, made by cutting open a feed sack, which he spread in one corner of the pen. The chicks were then driven into the corner, on top of the cloth, where they were collected simply by gathering up the edges of the cloth.

Increasing Reamer Capacity

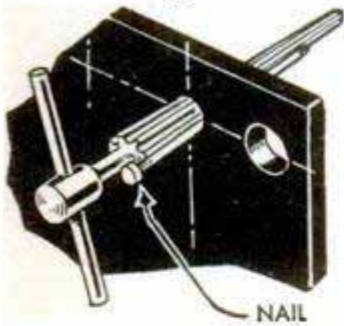

Sheet-metal workers often use this emergency kink when the required hole size exceeds the capacity of the largest taper reamer in the kit. After the reamer has been started and has

progressed through the hole to a little more than half its length, withdraw it slightly and insert a nail through the hole and position it between two of the cutting edges. Then continue the cut to the end of the reamer. In this manner the cutting capacity of the tool may be increased up to $\frac{1}{4}$ in. by using nails of various sizes.

W. H. McClay, Pasadena, Calif.

Length of Small Coil Spring Used to Clean Out Tubing

A length of small coil spring, of the type used for hanging curtains, can be used effectively as a "snake" with which to clean

the inside of small-diameter tubing. The flexibility of the spring permits it to follow the bends, when forced into the tubing, while the individual turns in the coil act as tiny scrapers against the tubing wall. If a smaller spring is required, use a speedometer cable. By rotating the spring inside the tubing, using a hand or power drill, a very thorough cleaning job can be done.

Emergency Gate Latch

If a metal gate latch breaks, here's a way to make an emergency repair quickly. Cut a short leather strap to the form shown in the detail, slotting it as indicated. Drive a

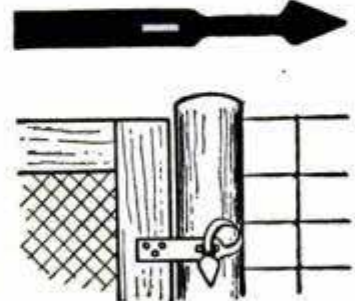

large staple into the post and nail the square end of the strap to the gate stile. Then slip the slot in the strap over the staple and pull the pointed tongue through the staple to hold the strap in place.

Gas-Welding Discoloration Prevented by Smoke Film

To prevent discoloring a stainless-steel or plated molding, when doing a welding job near it, the usual policy is to remove the molding. An easier precaution is simply to cover the molding with a thick layer of black smoke by playing a yellow flame over it. This will protect the surface of the molding from contact with oxygen in the air, so that even though the molding gets very hot, it will not be discolored.

Jackscrew Supported Firmly On Discarded Brake Drum

When it is necessary to place a jackscrew on soft ground for a vertical lift, or if the jack must be located at an angle to exert pressure sidewise, one house-moving contractor attaches it to a large truck-type brake drum.



This is done with bolts or, if the drum is to serve as a permanent base, with a tack weld. When placed on soft ground, the edge of the drum will cut into the soil as pressure is applied, giving a firm bearing which prevents tipping or sliding sidewise.

L. H. Houck, Jefferson City, Mo.



Farm Manual (55ed.)

Build a Better Farm Gate

HUNG from reinforced-concrete posts, this nonsag farm gate permits passage of all standard field implements while being especially designed to keep out livestock. The members of the two-piece gate are assembled with $\frac{1}{4}$ -in. carriage bolts. A stop, made from a length of rod, and a sliding bolt are fitted to one gate section, the tapered end of the stop engaging a pipe socket set in the roadbed. The posts are poured on concrete footings, veneered with

one course of brick, and fitted with concrete caps. Note that the hinge pins are welded to L-shaped brackets of flat steel, the bent ends of which are embedded in the concrete. Reinforcing rods are set in the footings when the latter are poured, and extend the full height of the posts. If preferred, 10 x 10-in. oak posts, set at least 3 ft. in the ground and guyed, may be used instead of the reinforced concrete. The lower portions of the posts should be creosoted.

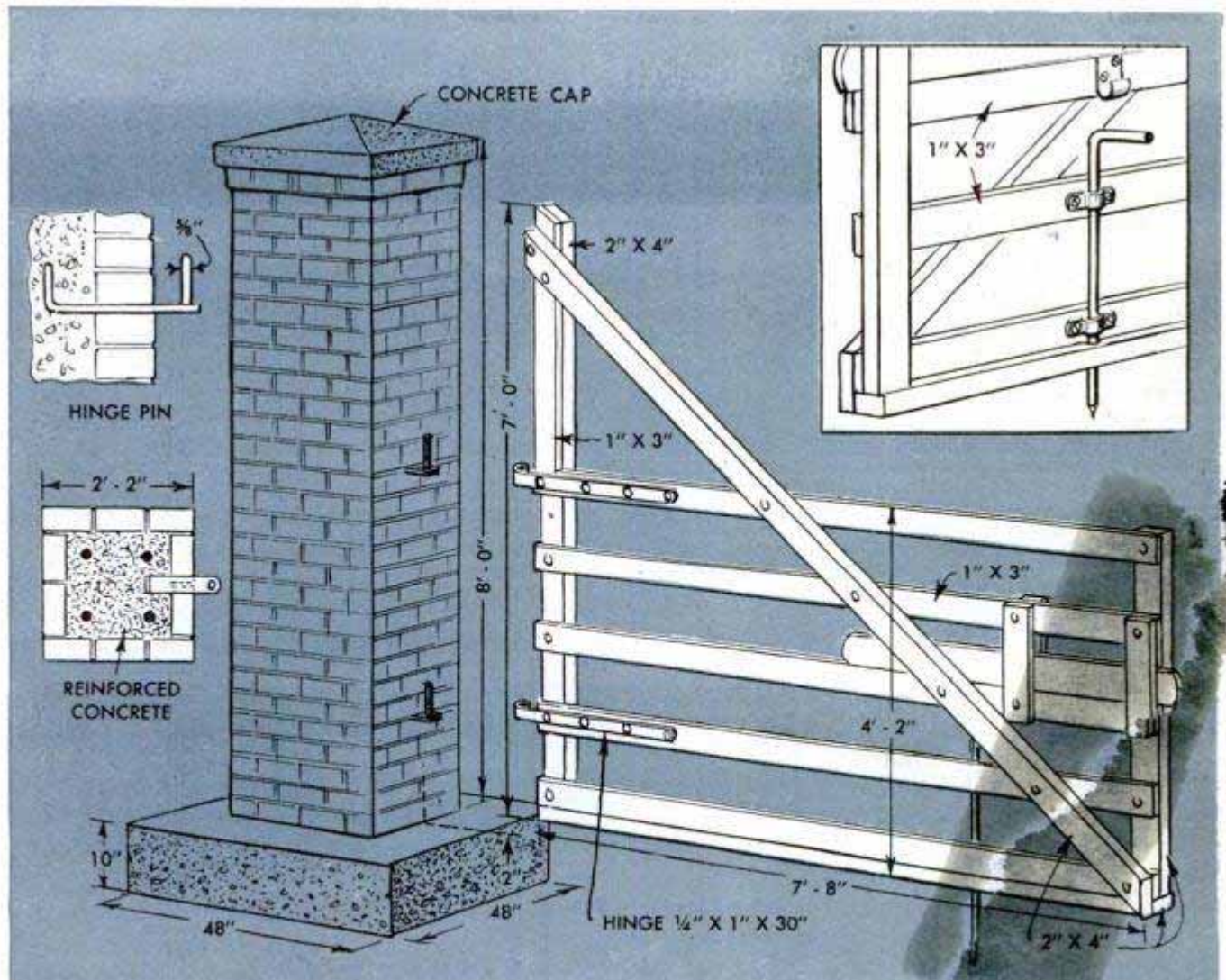

How to Build a 15-Ton HYDRAULIC PRESS

60 0
Tools

By L. H. Houck

SHOP-BUILT and shop-proved for heavy duty, this fast-acting press has several unusual features that adapt it to a wide range of work, requiring plunger pressures up to 15 tons. That makes installation of press-fit bushings, bearings, and keys a simple job, and you also can handle just about any kind of arbor work that can be set up under the plunger. The design of the press frame gives you a lot of latitude in the choice of salvage materials and parts for its construction. As you will see from the illustration on the opposite page, the press beam is a 36-in. length of railroad rail, but you can use instead two lengths of 6-in. channel with spacers, or webs, welded between the channels to provide the necessary rigidity. The uprights can be built up by welding two heavy steel angles together to form channels. Changes in height and width dimensions also can be made to suit special requirements. The principal feature of the press is the pneumatic plunger return which speeds up duplicate operations as much as 50 percent. When it is desired to raise the plunger quickly after a work stroke has been completed, air under pressure is admitted to the hydraulic cylinder below the piston by means of a manually operated valve. This raises the plunger automatically and forces the hydraulic fluid back into the reservoir. As the piston comes down on the next stroke, residual air below the piston is bled off through an

expansion tank. The sequence of operation is quite simple to carry out, even with one hand. To bring the plunger down on the power stroke, the valve at the right in the right-hand photo below, is opened, admitting air under pressure to the hydraulic-fluid reservoir. This forces fluid from the reservoir into the hydraulic cylinder. If necessary, additional pressure on the plunger is built up by a few strokes of the hand pump. Then, to return the plunger, the right-hand valve is closed and the left-hand valve opened to admit air under pressure below the piston. The valves used are of a special type known as key stops, having a reversible check and drain tapping. However, ordinary stop valves having a drain tapping can be used. Note in the general-assembly illustration on the opposite page that the air-bleeder line leading to the air chamber, or expansion tank, is soldered into the drain tapping in the body of the valve. The drain tapping in the body of the right-hand valve is closed with a plug.

In making the pipe connections to the hydraulic reservoir and pump, it is important that the check valves be properly located. Note especially the position of the check valves in relation to the pump in the assembly view on the opposite page, and also on page 202, and be sure that you have them installed so that they permit fluid to flow under pressure to the hydraulic-press

A hand-operated hydraulic pump gives the operator delicate control of pressure applied to the work

Valves control air pressure to hydraulic cylinder and reservoir. Press can be operated with one hand

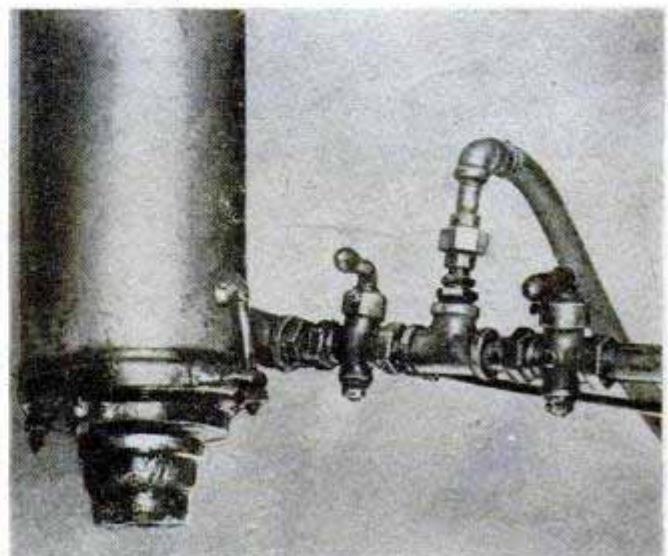
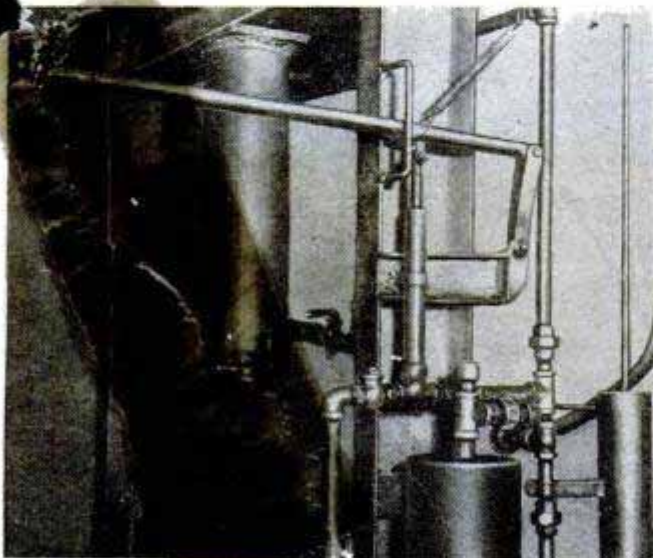

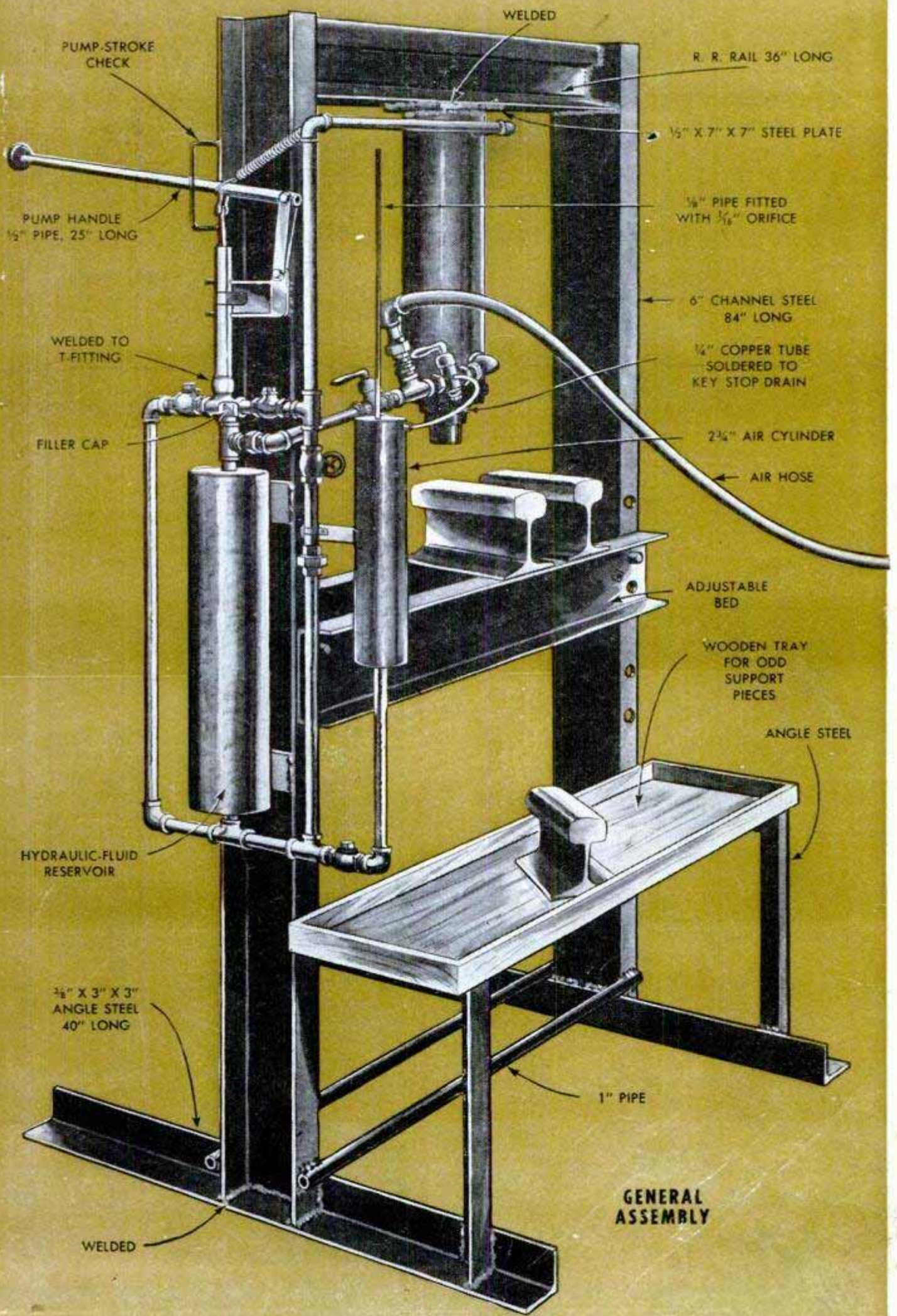

PUMP-STROKE CHECK

WELDED

R. R. RAIL 36" LONG

1/2" X 7" X 7" STEEL PLATE

PUMP HANDLE
1/2" PIPE, 25" LONG

1/8" PIPE FITTED WITH 1/16" ORIFICE

WELDED TO T-FITTING

6" CHANNEL STEEL 84" LONG

1/2" COPPER TUBE SOLDERED TO KEY STOP DRAIN

FILLER CAP

2 3/4" AIR CYLINDER

AIR HOSE

ADJUSTABLE BED

WOODEN TRAY FOR ODD SUPPORT PIECES

ANGLE STEEL

HYDRAULIC-FLUID RESERVOIR

3/4" X 3" X 3" ANGLE STEEL 40" LONG

1" PIPE

GENERAL ASSEMBLY

WELDED

TANK AND PIPE DETAILS

1. Reservoir tank for hydraulic fluid. A short nipple is welded to the openings at each end
2. Small-diameter air-expansion tank. Air and residue fluid enter tank through bleeder tube
3. Check valves, left and right, admit fluid on the pump upstroke, release it on the downstroke
4. Hand valve is closed to prevent the passage of fluid which is being pumped into cylinder
5. Copper tube, soldered to drain opening of key stop, bleeds off air used to raise the piston
6. Small-diameter pipe, fitted with orifice, is welded to opening at the top of the air tank
7. Check valve prevents passage of fluid into air tank, permits fluid residue to pass into line

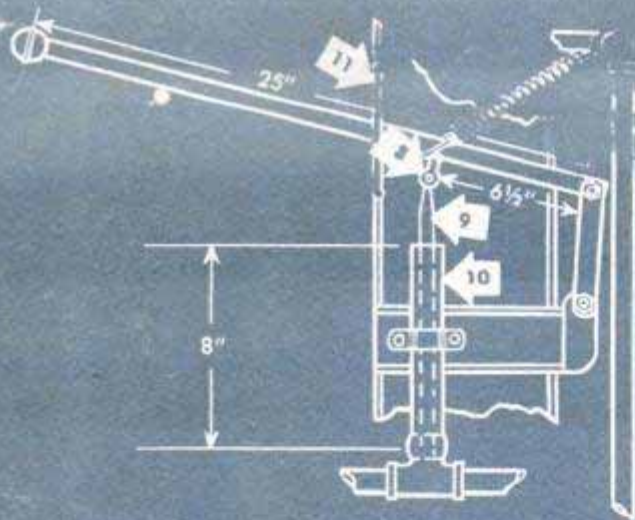
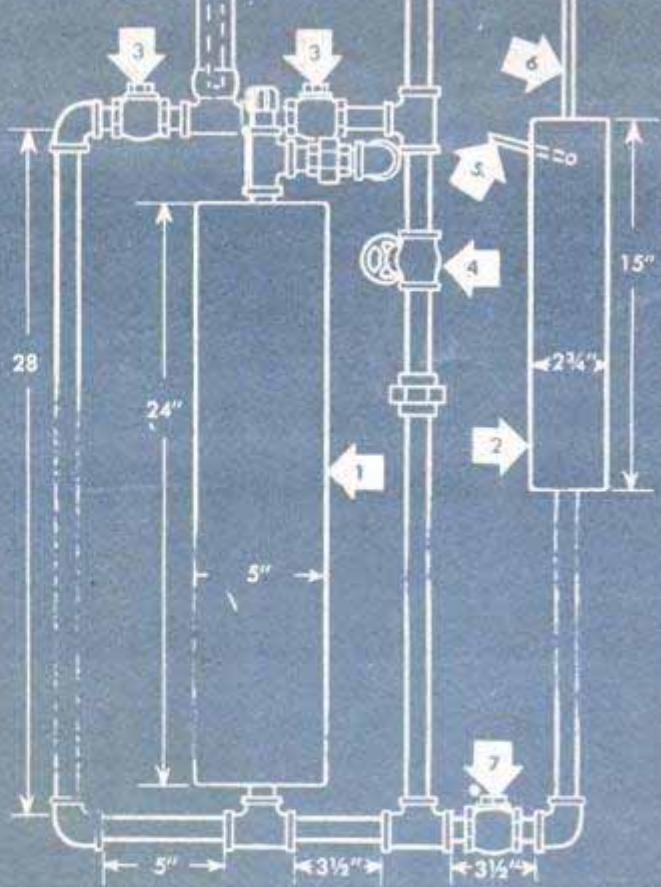

PUMP DETAILS

8. An auto brake-rod yoke is welded to the pump handle to straddle arc hinge to pump plunger
9. The pump plunger is 1/2-in. round steel, 10 in. long, drilled and tapered to hinge in the yoke
10. A 1 x 8-in. steel rod is bored to receive the plunger and welded to a T-fitting in the line
11. A 1/4-in. U-shaped steel rod, welded to straddle the pump handle, serves to check pump stroke

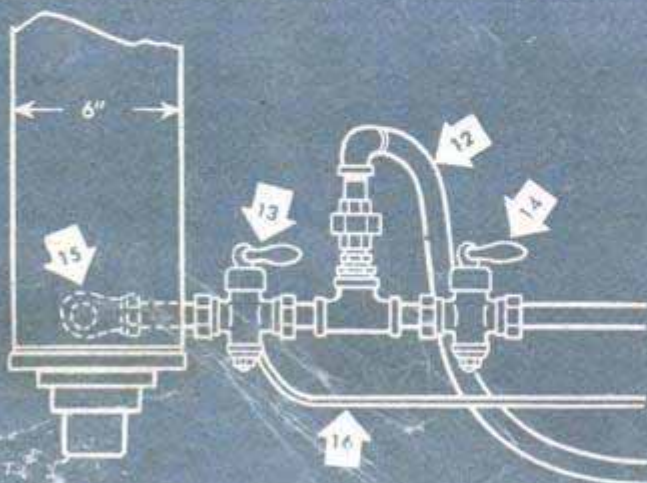

AIR UNIT DETAILS

12. Airline supplies pressure to lift the extended piston and to force fluid from the reservoir
13. Key stop on left admits air pressure to press cylinder, speeds raising the extended piston
14. Key stop on right, with drain plugged, admits air to reservoir, forcing fluid into cylinder
15. Airline is welded to opening in press cylinder, admitting air which raises the extended piston
16. Copper bleeder tube is soldered to key-stop drain opening and leads to fitting in air tank

cylinder above the raised piston. As an example, when the hand-pump plunger is raised, vacuum opens the check valve at the left (see the detail on the opposite page) to allow fluid to enter the pump cylinder. The down stroke of the pump plunger opens the valve at the right and closes the one at the left, forcing fluid to the hydraulic-press cylinder. This manner of utilizing the pump gives the operator a very delicate control of the amount of pressure applied by the plunger.

The hydraulic pump is a simple unit consisting of a handle pivoted in the manner shown and fitted with a return spring, the cylinder being welded to a pipe tee at its lower end. The pump cylinder is made from a 1 x 8-in. length of steel shafting center-bored longitudinally to a diameter of $\frac{1}{2}$ in. The pump plunger is a length of $\frac{1}{2}$ -in. steel shafting, 10 in. long, flattened and drilled transversely at the upper end to form an eye for attachment of the handle yoke. The plunger should be lapped into the hole in the cylinder to assure a tight, leakproof fit. The keyed detail drawings on the opposite page give you the general dimensions of the other parts of the hydraulic assembly. The hydraulic-press cylinder is of the type used on dump trucks. Note in the assembly illustration on a preceding page that the upper end of the cylinder—the lower end becomes the upper end when the cylinder is inverted—is welded to a $\frac{1}{2}$ x 7 x 7-in. steel plate which in turn is welded to the press beam as indicated. Note also that the platen beams, which support a platen or fixtures on which the work is placed, are adjustable vertically. Make sure that the rows of holes drilled in the legs of the channels are located so that the beams will be exactly at right angles to the press cylinder when all parts are assembled in working position. A wooden tray at the back of the press frame holds the various fixtures and blocks when not in use.

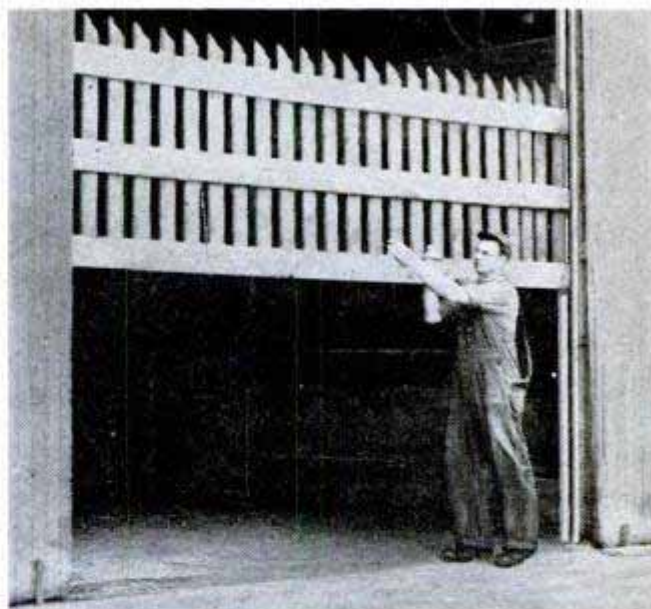

Counterbalanced Dairy-Barn Gate

The gate pictured was installed in a dairy barn where it effectively bars entrance of livestock and at the same time admits an abundance of light and ventilation to the interior. Held in grooves at each side of the doorway, the gate is the type that lifts in the same manner as many garage doors. It is counterbalanced with a 5-gal. bucket filled with sand, which is attached to one side of the gate by means of a rope and pulley arrangement.

Making Carborundum Pastel Board

After being stored in rolled form over a period of time, carborundum pastel paper usually is very difficult to flatten. However, the paper can be flattened by mounting it on a sheet of heavy cardboard to form a pastel board. To do this, a sheet of photo-mounting tissue is cut slightly larger than the pastel paper. "Tack" the tissue to the back of the paper by heating two or three spots on the tissue with the tip of a medium-hot clothes iron. Then iron the tissue-backed pastel paper to the cardboard.

Fuse Wire Doubles as Plastic Thread for Checking Bearing Clearance

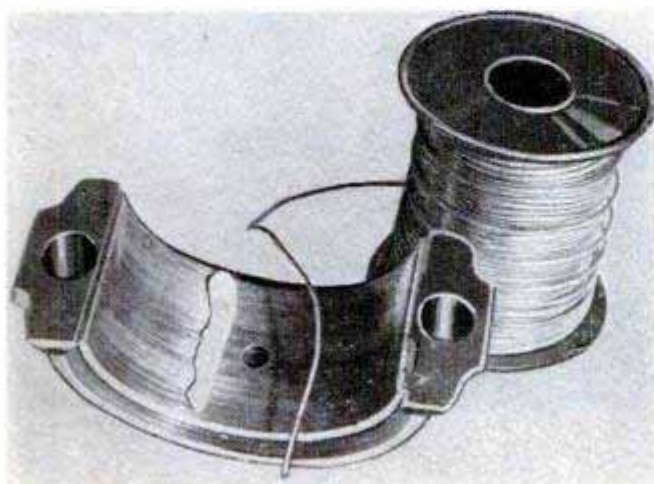

One mechanic found that he was able to use ordinary fuse wire for checking the clearance of bearings, in place of the special plastic thread manufactured for that use. The bearing cap is removed and a short length of 5-amp. fuse wire is laid across it. Then the cap is replaced and the bolts are drawn to the specified tension. This flattens the fuse wire so that when it is removed it can be miked to determine the clearance.

☞ Before tapping a blind hole, fill it with cutting oil. As the thread is cut, the chips will be forced out with the oil.

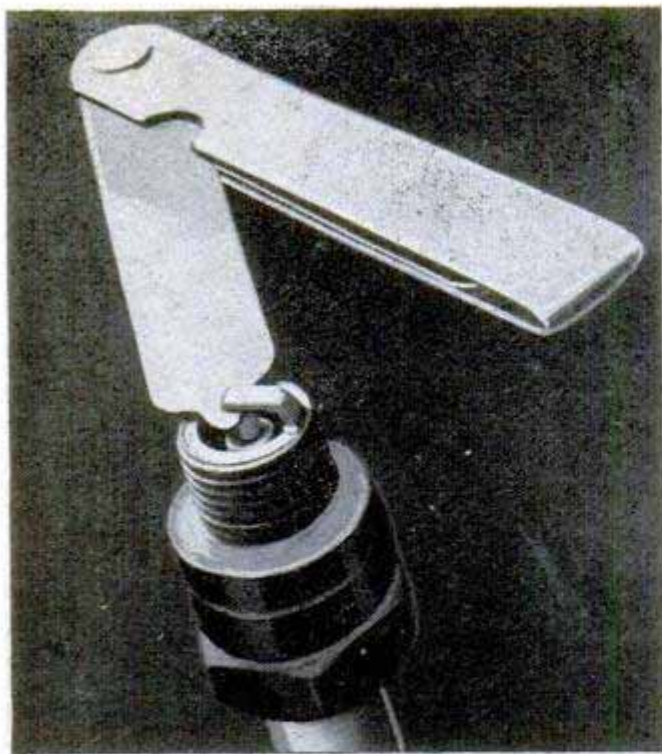

Pipe Lengths Welded to Bumper Hold Warning Flags

When it is necessary to display signal or red warning flags on trucks operating on the highway or on certain types of contracting jobs, the problem is how to attach the flags so that they are readily seen and yet are easily removed when not required. One practical solution is to weld



short lengths of pipe to the ends of the front bumper, as illustrated, to form sockets. The warning flag is attached to a 30-in. length of pipe of a smaller diameter that will telescope loosely into the sockets. The short flagstaves made in this manner are bent slightly at a point approximately 6 in. above the lower end so that when they are in use they will not drop through the sockets.

Grover Brinkman, Okawville, Ill.

Identifying Feeler-Gauge Blades

The "popular" blade on a feeler gauge, the one which is used more frequently than the others, can be made easily recognizable by grinding the end of it as shown. In the event that two or three blades are used quite often, each one can be identified by grinding it a different shape and memorizing the respective thicknesses.

Stacks of Corrugated Roofing Lifted Safely With C-Clamp



Roofers handling sheets of corrugated roofing will find use for this simple kink when it is necessary to hoist the sheets to roof level by means of a tackle or a rope windlass. Just stack five or six

sheets and attach a C-clamp at the edge, near one end. Be sure that the clamp is securely tightened. Then attach the windlass rope or the lower tackle block to the clamp.

Herbert E. Fey, New Braunfels, Tex.

Ink "Flowing" Checked By Pencil-Lead Film

After inked lines have been erased from a drawing, any subsequent use of ink on the same spot is likely to "flow," resulting in ragged lines. To prevent this, rub the erased area with a soft-lead graphite pencil and complete the inking over it.

Index File for Magazine Articles

With a file containing the index pages of each magazine saved, persons who use this type of reference material can quickly locate the article they want. Simply cut out the index pages, punch holes in the margins and file them in a loose-leaf notebook.

Pat Fey, Columbus, Ohio.

Movable Hayrack Saves Feed

This large-capacity hayrack has its base boarded up to save the hay and shatterings worked out by the cattle. Being firmly mounted on skids it may be readily moved by tractor wherever needed.

A. M. Wettach, Mt. Pleasant, Iowa.

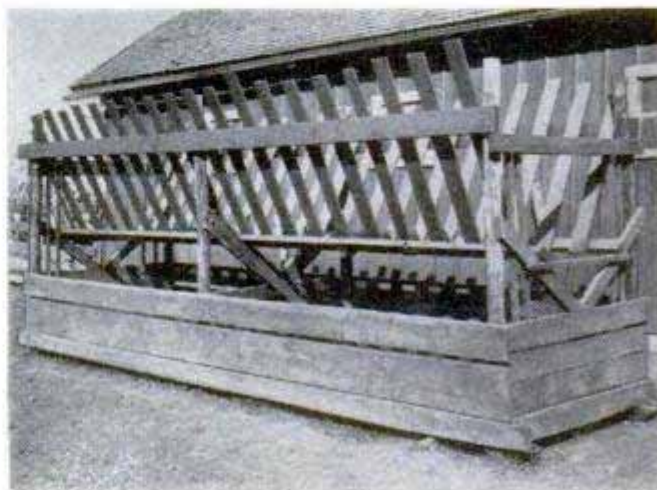

Portable PAINT SPRAYER

By
Hi Sibley

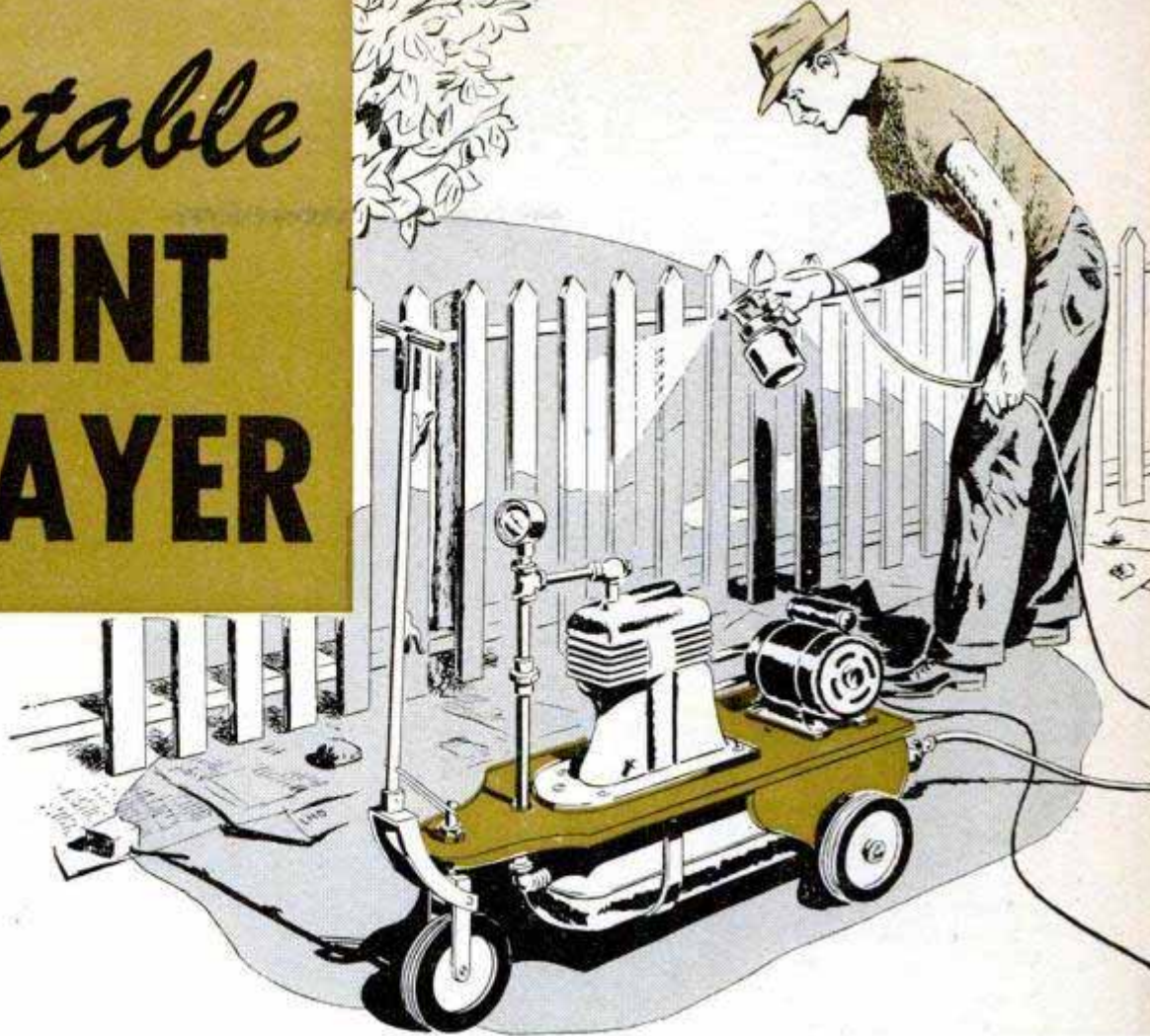

BY USING a number of unrelated parts, you can build this handy paint-spraying unit which has several outstanding advantages for both indoor and outdoor use. Tricycle construction with semi-pneumatic wheels gives the truck the required stability either on rough ground or smooth floors, and the capacity of the compressor unit with its pressure tank is sufficient to handle any sprayable paint, lacquer or enamel. Use it around the home for painting screens, fences or even the house and garage. It does a "factory" job on home-shop projects in wood or metal, and you can't beat it for refinishing furniture with either enamel or varnish.

The compressor can be any of the ordinary belt-driven piston or diaphragm types available either new or secondhand. The motor should be of the capacitor type and of $\frac{1}{4}$ to $\frac{1}{2}$ hp., depending on the size of the compressor used. To operate a bleeder-type spray gun efficiently, the compressor should deliver from 2 to 3 cu. ft. of air per minute, at 30 to 50 lbs. of pressure. On the original unit, an airplane-type oxygen tank serves as the pressure tank. The air line from the compressor to the tank is made up from $\frac{1}{4}$ -in. iron pipe and fittings, and should include a relief valve and pressure gauge as shown in the detail on the following page. Make sure that the relief valve is in working condition before installing, and also that it is of a size suited to the

type of compressor you are going to use.

Note particularly the assembly of the pressure-tank cradle which is built up from flat-steel bands, or straps, and hardwood saddle blocks. The latter are curve-cut on one edge to a radius equal to that of the tank and are rounded to an inside curve on the lower edges, the curve having a radius equal to that of the rear axle. In the assembly, the wheel braces are drilled near their lower edges to fit over the ends of the axle and are screwed to the saddle blocks and the edge of the base or platform. The base is cut from hardwood and one end is bandsawed to the shape shown in the detail on the following page. The upper right-hand detail on the same page shows how to lay out the curves for the wheel braces and the curved end of the base. Both the compressor and motor are bolted to the base in the positions shown. Although not indicated in the detail, it's a good idea to elongate the holes for the bolts holding the motor, as this provision will permit adjusting the belt tension. The caster-wheel yoke and towing handle are assembled from steel tubing, or pipe and fittings, and pieces of steel shafting. Hooks are formed from short lengths of steel rod and welded to the handle column to provide storage for the long motor cord when the unit is not in use. After bending, the wheel yoke is welded to a spindle $3\frac{5}{8}$ in. long which is turned down about $\frac{1}{8}$ in. for a distance of $1\frac{1}{2}$ in.

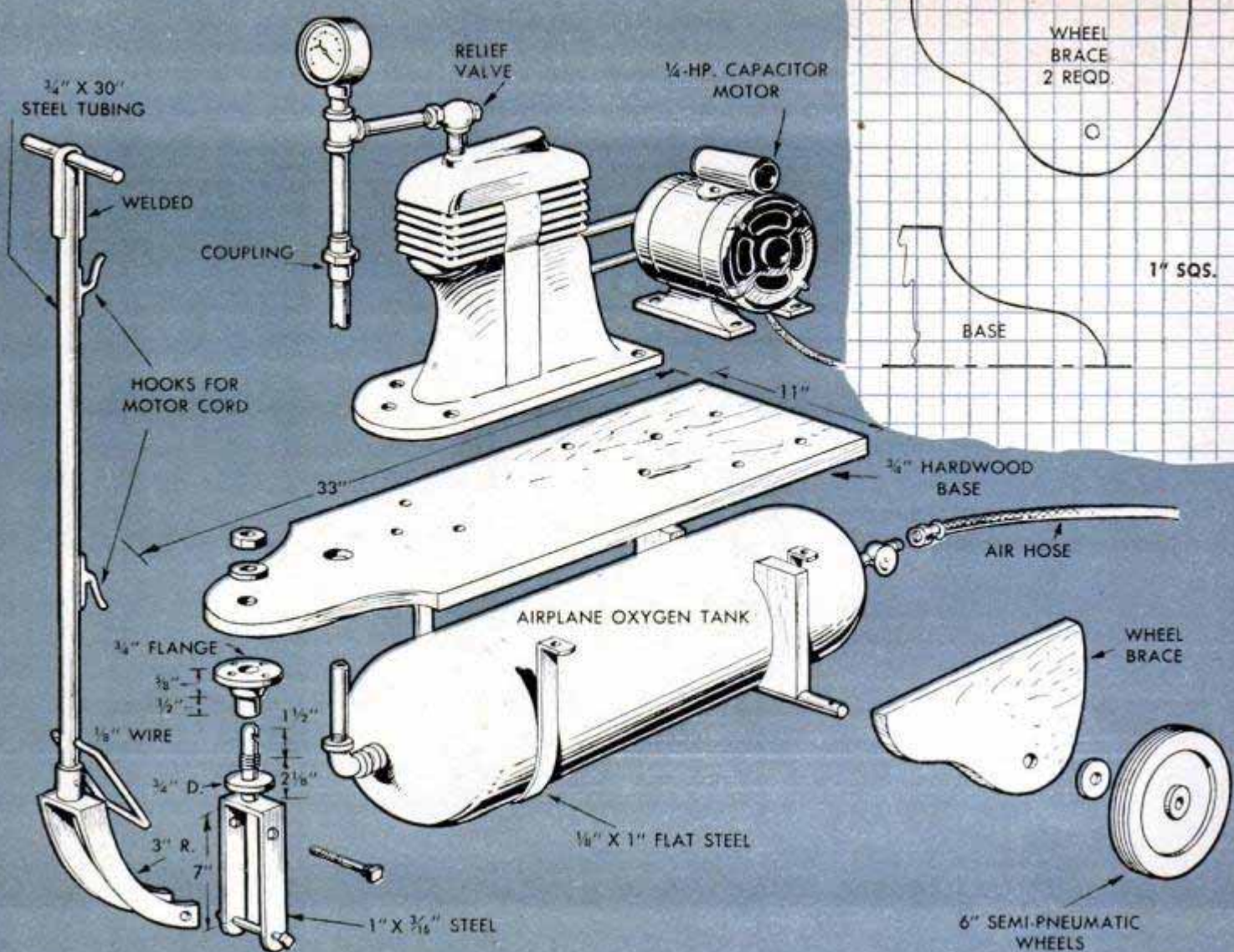

from each end. The remaining section at the center is threaded as indicated in the detail above, and a notch is filed at an angle near the top end of the shaft. A $\frac{1}{8}$ -in. wire bail attached to the handle is hooked into this notch to hold the handle in the upright position when not in use. In assembling the wheel yoke, a washer is first placed over the spindle to form a bearing seat. Then the spindle is inserted through the flange and short pipe nipple, which have been screwed to the underside of the hardwood base, and a washer is placed over the spindle. A nut is turned down onto the

threaded section of the spindle and drawn fairly tight to hold the assembly securely. The handle yoke is attached to the wheel yoke by means of a bolt passing through holes drilled near the upper end of the wheel yoke.

Each time you use the sprayer it is of the greatest importance to clean the gun thoroughly immediately after use. Fill the container about half full of paint or lacquer reducer, open the nozzle slightly and blast out the entire contents of the container. This procedure will remove all paint or lacquer residues from the small passages.

Twin Cupolas Installed on Granary Save Time When Storing Grain

To prevent the loss of time in frequent changing of the portable-elevator distributor when filling side cribs, one farmer installed twin cupolas on his granary. These are spaced on the ridge so that a single length of the distributor will fill both cribs half full, from one end, with a single setting of the elevator. Then the elevator is moved to the second cupola and the process repeated. The short length of the distributor also reduces any tendency to become clogged with ear corn.



By storing chopped hay, grain and feed supplement in the haymow of his cattle barn and using a self-feeder type of delivery hopper, one Illinois farmer was able to reduce the time and labor usually required to feed livestock on the first floor of the barn. The different feeds, in this case chopped hay, ground grains and supplement, were mixed in the correct proportions and then directed into the hopper from which the mixed feed was quickly scooped into feeding bunks. If desired, the bed of the hopper can be hinged so that the front can be swung down, permitting the feed to flow directly into the bunks.

Self-Feeder Type Granary Hopper Saves Considerable Labor in Barn

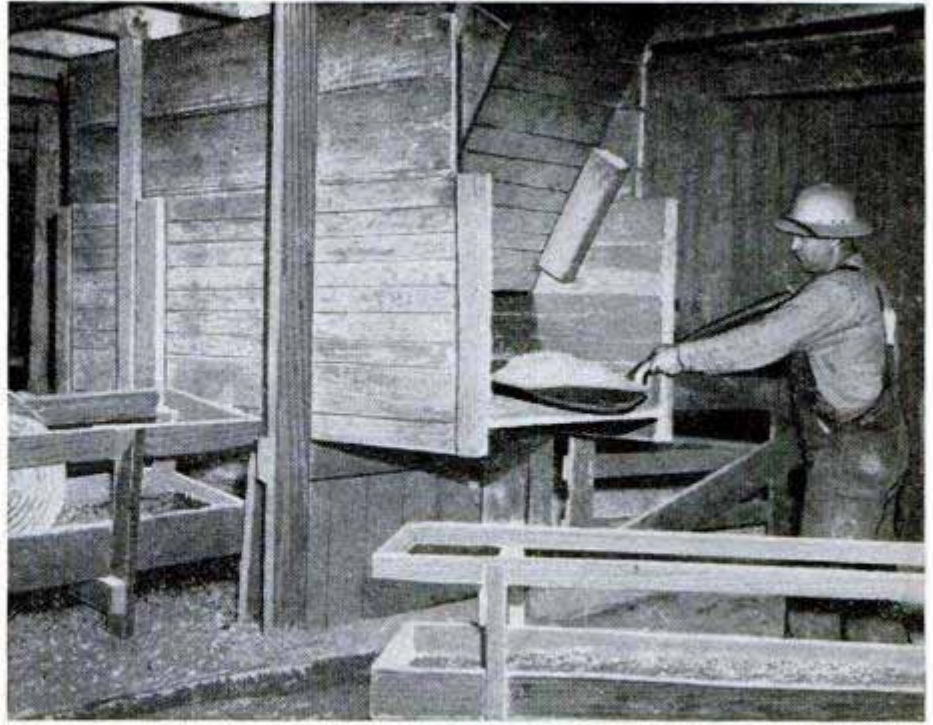

Small Hog Rings Used to Join Lengths of Woven-Wire Fencing

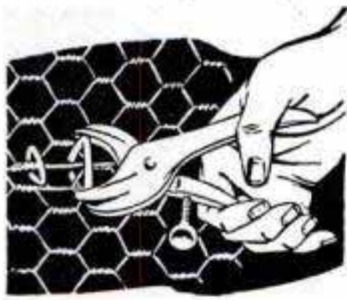

When it is necessary to join lengths of chicken-wire or woven-wire fencing, edge to edge, in order to increase the overall height of the fence, one farmer

uses ordinary hog rings in the smallest size available. First, he staples the two lengths of wire to the posts, one above the other. Then he simply hooks the rings over the stay wires and closes them with a special closer, similar to pliers, which is made especially for this purpose. Ordinarily, the rings are spaced about 4 in. apart.

Kendrick Martin, Hayward, Calif.

Concrete Feeding Floor Between Two Corncribs

A concrete floor between adjacent corncribs, provides a handy feeding place for livestock. Feed stored in the cribs is close at hand and by swinging a gate across the opening at one end of the cribs, livestock can be easily sorted and loaded onto a truck at the other end.

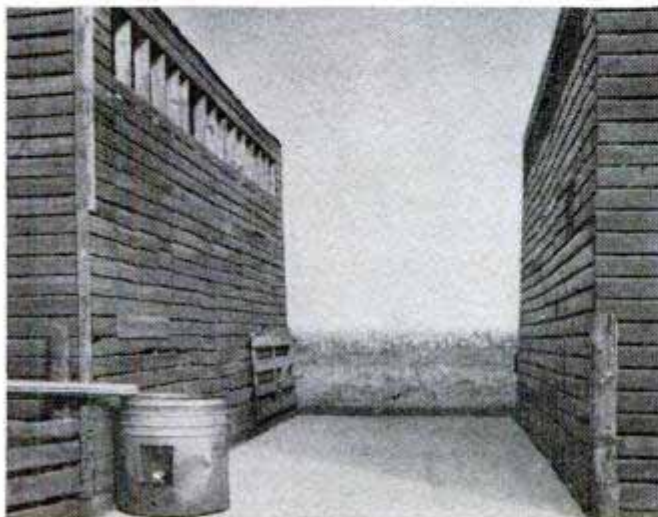

Parallel Lines at Special Angles Inked Directly From T-Square

To ink parallel lines directly from the T-square at angles of 75, 105 and 120 deg., one draftsman saves time by taping a 30 and 45-deg. triangle together as detailed. This has proved to be a more accurate and flexible method than those ordinarily employed to ink parallel lines at angles other than the ones provided by the regular triangles. The triangles, which are taped together as a unit, speed up the tedious job of inking fine-line shading, special cross-section lines and perspective drawings where there are a number of parallel lines at the same angle on large views.

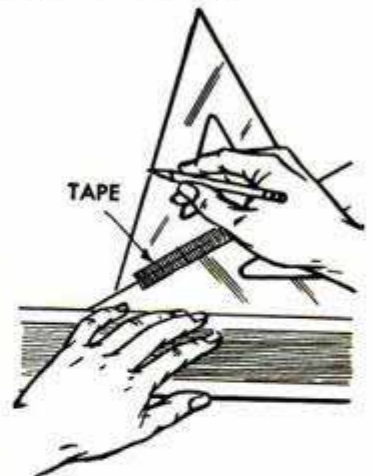

A. J. Ackerman, Binghamton, N. Y.

SHOPPING

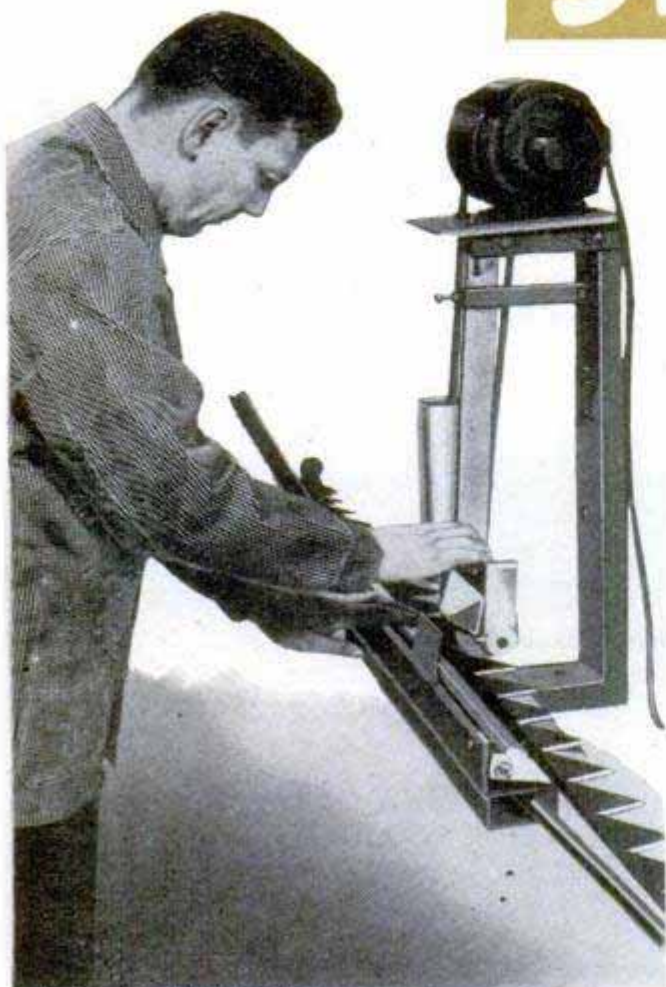

Lantz Mfg. Co., Valparaiso, Ind.

MOTOR-DRIVEN SICKLE GRINDER sharpens all sizes of mower sickles from 1 to 7 ft. long without a change of grinding wheels. The grinding-wheel arbor is mounted on a swinging arm which is pivoted vertically in a channel-steel frame, the arm being operated in a manner similar to a swing saw. Uses the standard beveled sickle-grinding wheel which grinds two edges on adjacent knife sections at one stroke of the swinging arm. Table, or holder, is specially designed with a spring tension for proper grinding pressure

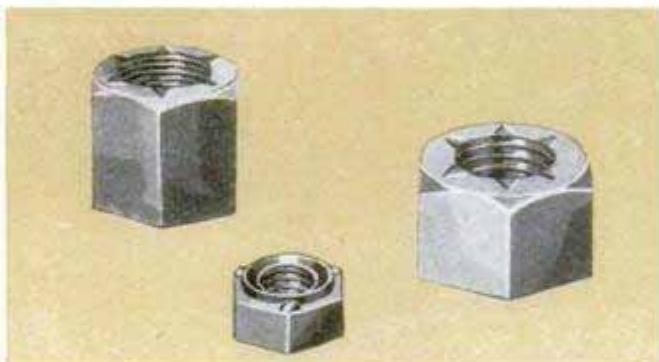

Grip Nut Co., 308-T S. Michigan Ave., Chicago

SELF-LOCKING NUTS with special thread deflectors are designed to withstand severe vibration and tension without loosening. Available in all the standard sizes with various thread specifications and also as high nuts and thin nuts. Come in steel, stainless steel and various nonferrous metals according to individual specification. Also furnished in a special weld nut with projections which have been redesigned to give a firmer, more uniform metal-to-metal contact

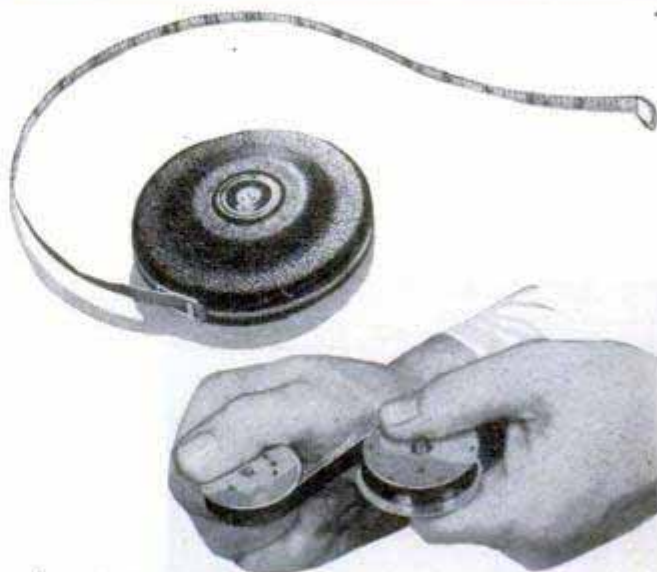

Master Rule Mfg. Co., 40 Mulberry St., Middletown, N. Y.

SELF-RETRACTING TAPE RULE reels its entire length of 50 or 100 ft. back into the case when a button on the side plate of the case is pressed. It is said to be the first self-retracting tape rule that rewinds automatically, a feature which eliminates the necessity of rewinding the steel-tape rule by means of a folding hand crank. Power for rewinding the tape is supplied by a specially designed spring motor driving through a planetary gear shown in the lower photo above. Weight is 23 oz. Available in 50 and 100-ft. lengths

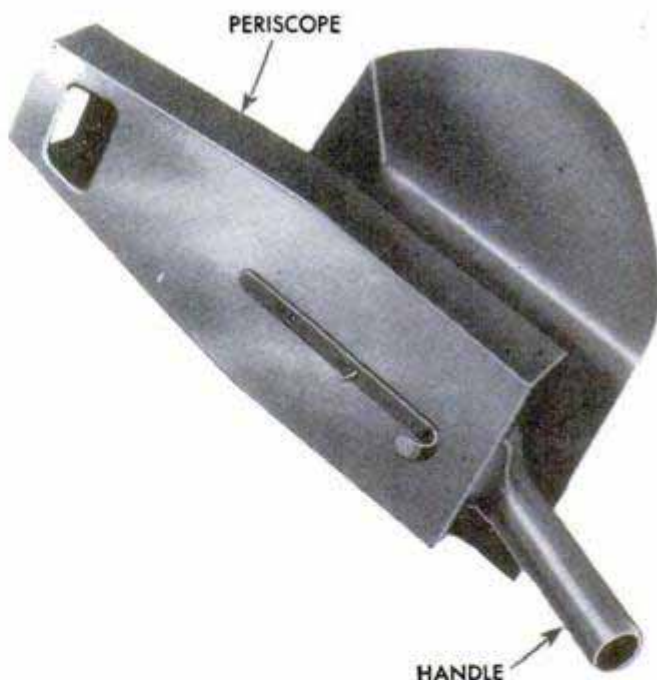

Industrial Products Co., Philadelphia 33, Pa.

NEW WELDER'S SHIELD fitted with a novel periscope is designed for work where the welder cannot normally see to make the necessary weld in fabricated work. Often its use eliminates the necessity of cutting out sections of the work in order to reach the part to be welded. Shield is of conventional design, the welding glass being pivoted in such a way that it is easily moved out of the line of vision when necessary by means of a finger-operated trigger

FOR TOOLS

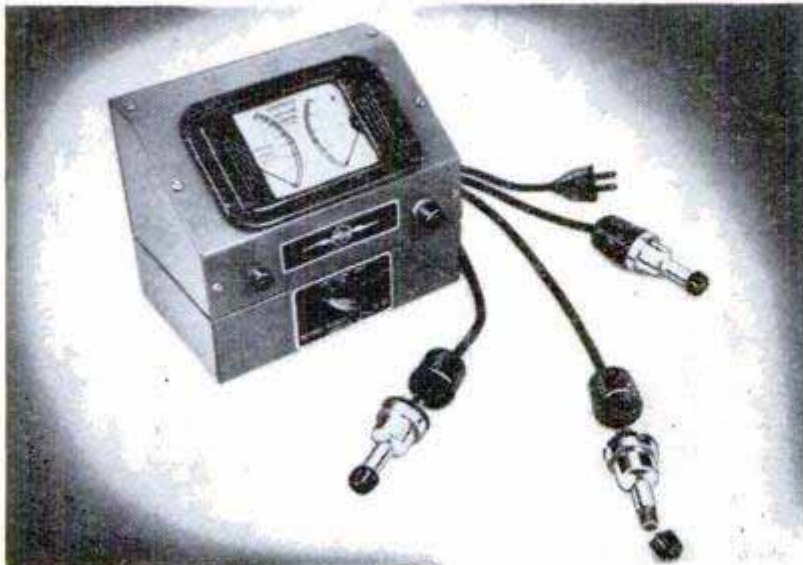

Hastings Instrument Co., Inc., Hampton, Va.

DIRECT-READING VACUUM GAUGE fitted with a five-position switching attachment gives an accurate $\frac{1}{2}$ -second response and is a reliable electrical indicator capable of measuring absolute pressures from 0 to 1000 microns of mercury. These features make the gauge ideally suited for leak-detection warning work or for pressure-operated control systems. The length of the cable from the indicator to the pickup tube does not affect calibration, so extensions for remote readings may be added whenever desirable



Coffing Hoist Co., Danville, Ill.

MIDGET HAND-OPERATED HOIST, or puller, weighs only $9\frac{1}{2}$ lbs., yet handles a 1000-lb. load on any lifting, stretching or pulling job. The lifting mechanism in the head is completely enclosed and the dual-purpose handle can be made to serve either as a straight lever or as a crank simply by swiveling the handhold at right angles to the straight section. Two ratchets, one on the lever and one on the lift mechanism, make it possible to lift heavy loads in close quarters permitting only a partial stroke

ELECTRIC SOLDERING IRON which operates on 6 volts from a battery, or from a transformer on 110-volt line, is especially useful to instrument makers, radio servicemen and others who do soldering on small parts where faultless solder connections are essential. The iron, which weighs only 4 oz., requires no filing or tinning

Palmer Mfg. Co., 57-16 37th Ave., Woodside, L. I., N. Y.

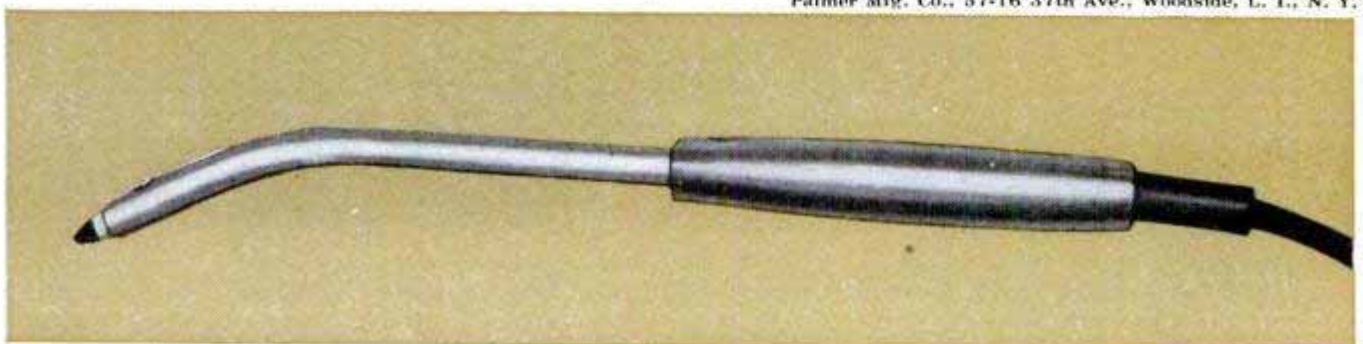

Simplex Level Co., Detroit 7, Mich.

ALL-METAL LEVEL for plumbing door-jamb and window frames is 6 ft. 6 in. long to give maximum bearing in either horizontal or vertical position. Has adjustable, replaceable spirit vials which can be adjusted or removed with a screwdriver. New method of mounting vials gives extra protection against breakage. Level body is made entirely of extruded metal, making it lighter and stronger without any sacrifice in accuracy. It also is available in standard lengths ranging from 24 in. up

Stone Sled for Moving Boulders Improvised From Auto Tire

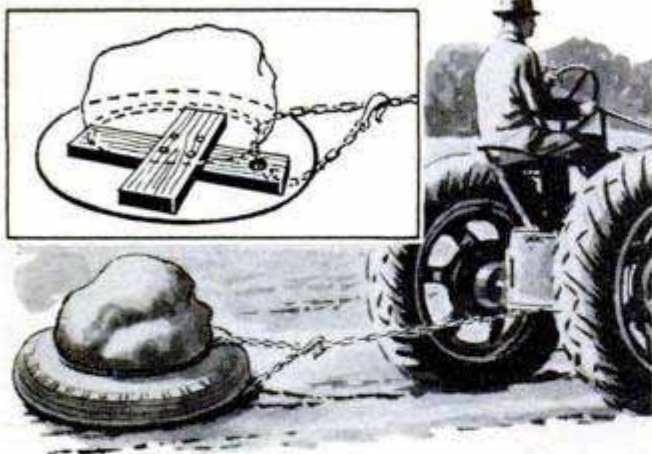

The need to do heavy lifting, in order to clear a field of boulders or otherwise transport them, is completely eliminated when using this unique stone sled. Made from an old truck or auto tire, a heavy stone is loaded simply by rolling it over the tire onto a heavy plank frame in the center. The frame consists of two thick planks which are crossed and spiked together inside the tire as shown. While in transit, the stone is held on the sled by the thickness of the tire. A chain, by which the sled is drawn, is attached to one of the planks.

Automatic Pencil-Scriber Does Fine Layout Work

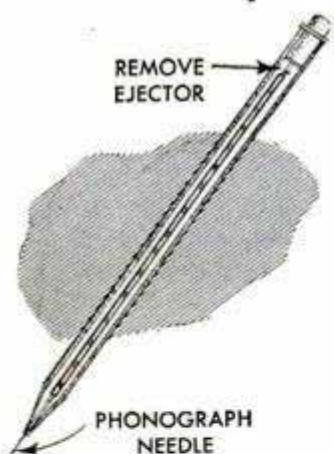

Not satisfied with the performance of an ordinary scriber on a critical layout job, one machinist quickly devised one that suited his purpose by using a steel phonograph needle and an inexpensive automatic pencil. He simply removed the leads and the

ejector from the pencil and inserted the needle. Then he replaced the ejector mechanism. In this way the sharp needle serves as a scriber point and is retractable in the same manner as the lead.

R. C. Brophy, Santa Fe, N. Mex.

Tips on Typewriter Care

If your typewriter is acting sluggish, blow it out with an air hose or hand pump, and oil all obvious places. Do not wash the machine with gasoline or kerosene as these fluids will cause the rubber rollers and other rubber parts to swell. Keys usually

stick because burrs have formed on the edges of the type bars. Remove them by touching lightly with a file. Clean erasure particles from the slots in which the keys pivot with a thin piece of wood, such as a toothpick. Correct paper slipping by rubbing the roller with sandpaper and scrubbing it with alcohol.

Pet White Mouse Put to Work Fishing Wire Through Conduit

Fishing new electric or telephone wires through large-diameter conduit and around sharp bends is facilitated by using a white mouse to pull a length of string through the conduit. The string, in turn, is tied to a stronger cord which is pulled through and the

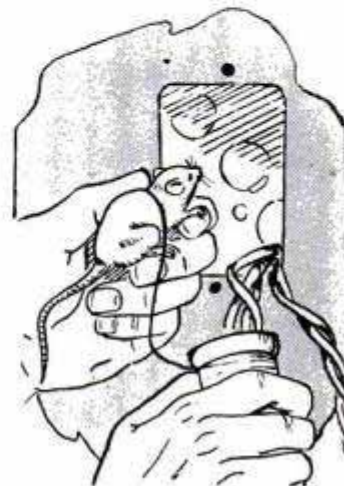

procedure is repeated until the cord in the conduit is strong enough to handle the wire. The original length of string is tied around the mouse so it will not slip off, and the mouse is encouraged to go through the conduit by the scent of a piece of cheese placed at the other end. The scent can be blown through the conduit with an electric fan.

Ross C. Carnahan, Columbia, Mo.

Handy Date-Stamp Holder Formed by Bottle-Cap Lifter

Desiring a means of keeping his date stamp always at hand for frequent use, one shipping clerk found that a bottle-cap lifter attached to the edge of the table with a wood screw was just the thing. The lifter holds the stamp in a vertical position where it is easily reached and at the same time keeps it from being misplaced.

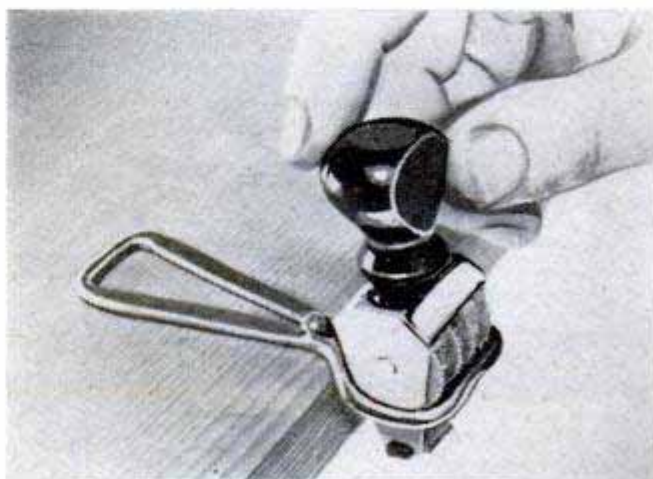

TELEVISION TODAY

A—Television's version of the walkie-talkie is the experimental "walkie-lookie," a portable TV-transmitting station weighing only 53 pounds. Recently demonstrated by the RCA Laboratories division of the Radio Corporation of America, before the Institute of Radio Engineers in New York, this battery-operated TV transmitter sends both voice and video signals for a mile. It is expected to have wide use in news coverage and in industrial operations. It also has obvious military applications.

B—Combination console-table TV set provides the homemaker with a television set that can meet any decorating scheme. It can be used either as a table model or, by attaching the legs which are shipped with each set, it makes a console as illustrated. It employs a 20-in. rectangular tube.

C—This personalized Roundup-Time, TV Director Chair for children saves wear and tear on good furniture and also keeps the children off the floor. It is provided with a Chow Tray, and also a writing-desk attachment shown in the inset photo.

D—One of the television conveniences for owners of home sets is the Lazy-Bones station selector that permits the TV viewer to change reception from one station to another while at ease in an armchair 15 feet or more away from the set. All that is necessary is to press the hand-held switch. No fine tuning or other adjustments are needed. Pressure on the switch revolves the motor-driven turret tuner and brings in station, picture and sound automatically.



LOW-COST RECEIVERS *for*

By Stan Johnson



A

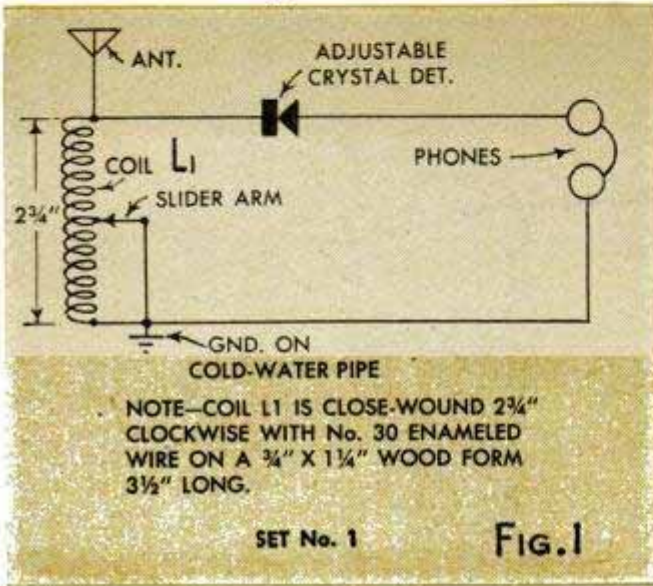

SUITABLE radio-construction articles for beginners and junior builders are not as plentiful as they should be, as every Boy Scout leader knows. The main requirements are low cost, simplicity of design and reasonable efficiency. Both of the broadcast-band receivers described in this article meet these requirements. Set No. 1 is an extremely simple receiver that employs an adjustable galena-crystal detector. It will give very satisfactory reception on strong local stations. It has the added feature that it can be modified to form the No. 2, one-tube set, with very little added cost as the same simple chassis base and tuning coil are employed.

The 3Q5-GT tube in set No. 2 will give greatly increased headphone volume on the same stations. It employs a 1N34 germanium fixed-crystal detector, and the tube operates on flashlight cells. Set No. 2 has the same receiving range as set No. 1 because the tube acts merely as an amplifier for the signals that the crystal detector is able to pick up. Distant reception with any crystal receiver depends on your location and the type of antenna and ground system employed. With a good long and high outdoor antenna, and a ground connection made to a cold-water pipe, the average range is about 25 miles for powerful broadcasting stations. Under exceptionally good receiving conditions, much greater distances have been covered.

Complete construction details for set No.

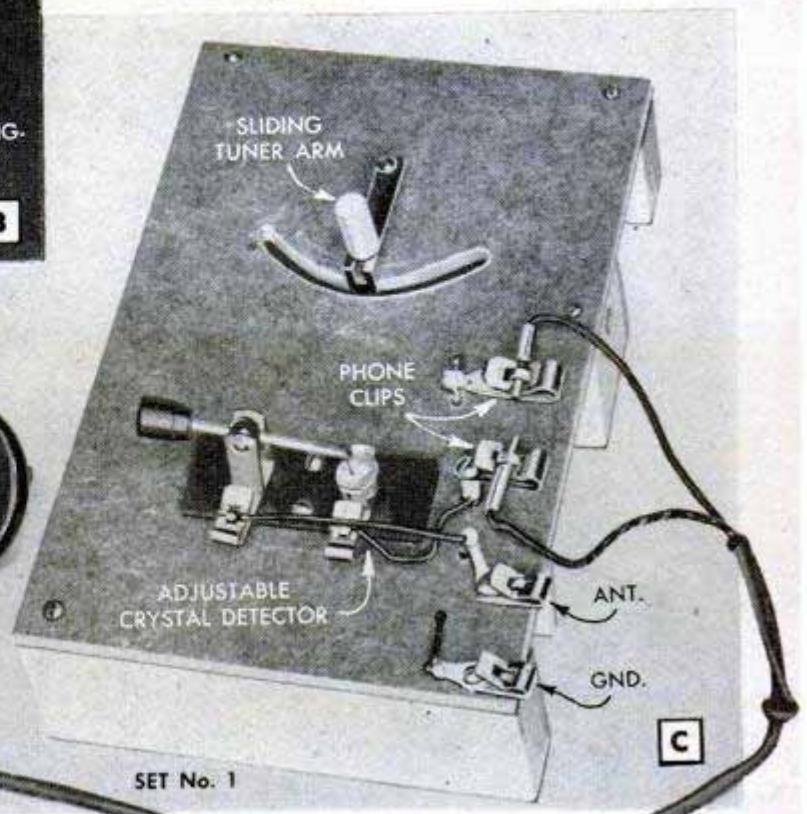
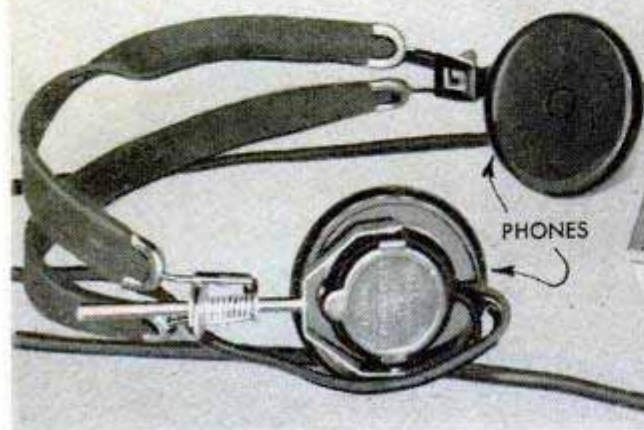
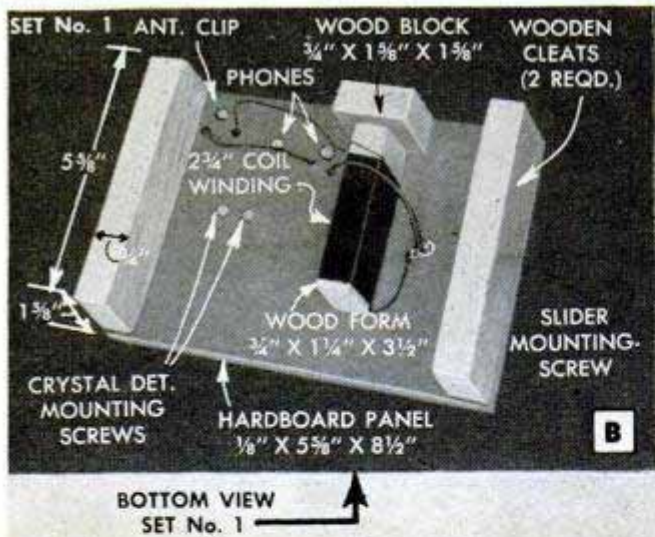

JUNIOR BUILDERS

1 appear on page 212. The set is built up on a small hardboard panel supported by a pair of wooden cleats. The panel is slotted, as shown in photo C, to provide space for the "slider" to contact the coil underneath. The slider is made from two Fahnestock clips flattened and bent to form a wiping contact; they are joined by means of a small wood screw run into a wood dowel, $\frac{3}{4}$ -in. long, which provides a tuning handle. The mounting details for set No. 2 are clearly shown in the pictorial wiring diagram, Fig. 2. The tuning-coil construction is the same in both sets.

The schematic circuit diagram for set No. 1 appears in Fig. 1. Top and bottom views are shown in sketch A and photos B and C. Anchor the coil ends in holes on the wood form. Make the turns tight and as close together as possible. The winding is $2\frac{3}{4}$ in. long. Mount the coil form on the bottom of the panel directly under the slot by means of a wood screw through the wood end block and, on the other end, by a tiny brad through the panel. Once in place, the slider arm should be worked back and forth a few times to wear off the enamel on the wire for good contact. All circuit

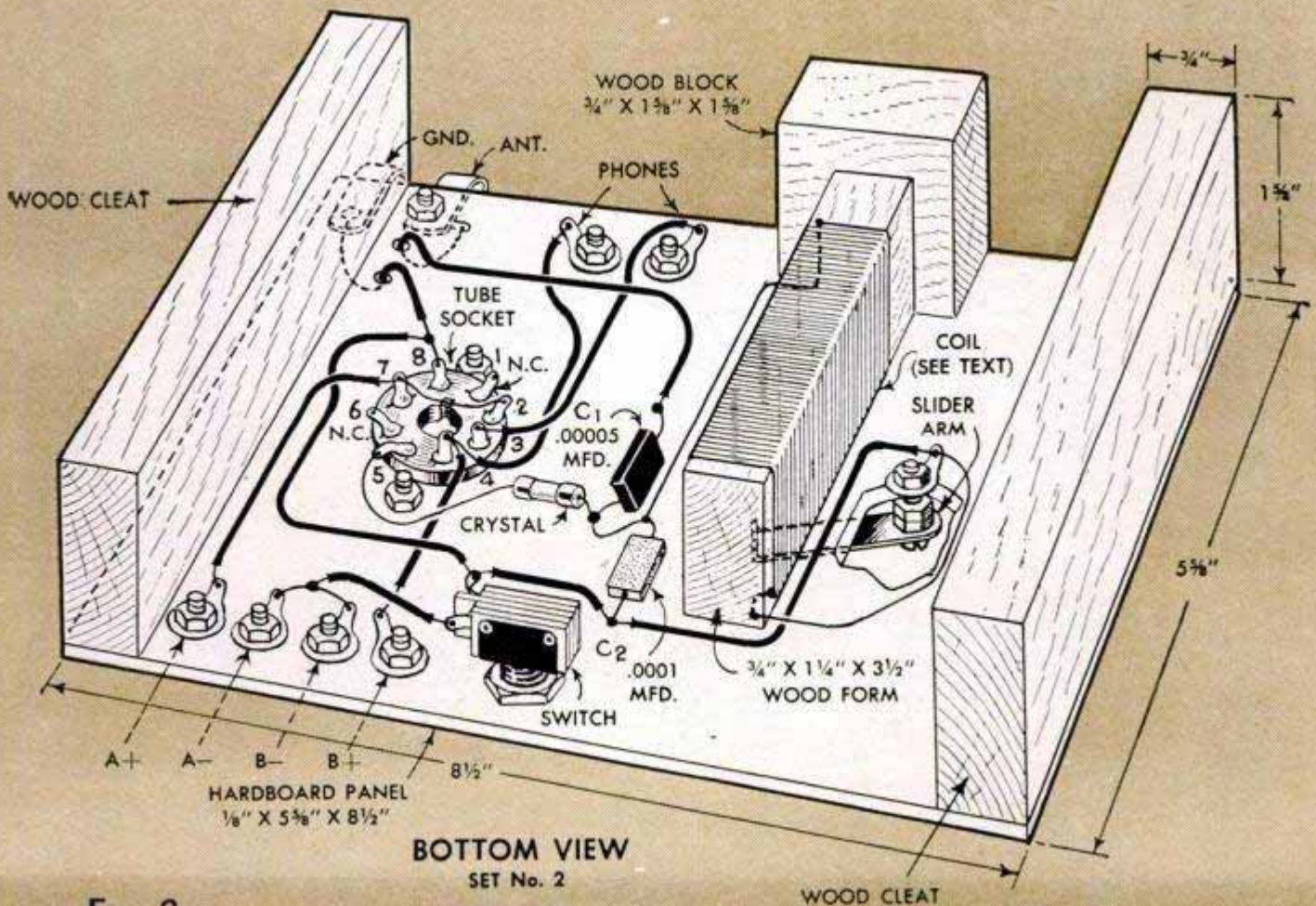
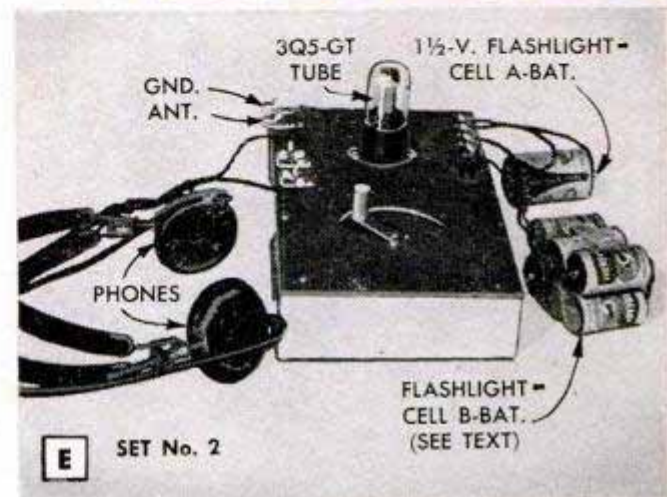
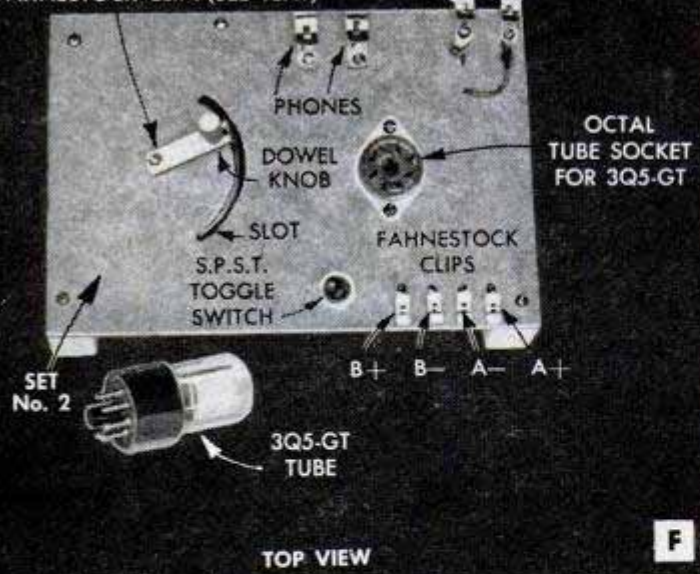

FIG. 2

NOTE

MADE FROM 2
FAHNESTOCK CLIPS (SEE TEXT)



SET No. 2
3Q5-GT TUBE
TOP VIEW

F

connections should be carefully made with rosin-core wire solder. The phones should be sensitive, 2000-ohm type. To tune the set, merely find a sensitive point on the crystal detector and move the tuning arm across the coil until you hear a signal, then adjust for the desired station.

Sketch D and photos E, F and G show various views of set No. 2. The adjustable crystal detector is removed and the fixed 1N34 germanium crystal substituted. This is mounted under the panel as shown in Fig. 2. Cut a hole 1¼ in. in diameter for the tube socket and mount the extra Fahnestock clips and the s.p.s.t. switch. The flashlight-cell B-battery consists of six size C, 1½-volt cells connected in series to give 9 volts. This is the minimum usable B-voltage and it is enough for considerable amplification. However, it can be raised to either 22½, 45 or 90 volts without changing the set in any way, if stronger signals are desired. The A-battery is a single standard-size 1½-volt flashlight cell. A schematic circuit diagram for this set No. 2 appears in Fig. 3. The two fixed condensers, C1 and C2, make the one-tube set tune more sharply than set No. 1, which is an advantage. For the reception of strong local stations, the ground on set No. 2 can be omitted for the easier separation of interfering stations. For maximum battery life, always turn off the switch when the set is not in use. Detailed material list R-401 is available from Popular Mechanics Radio and Electronics department upon receipt of ordinary letter postage.

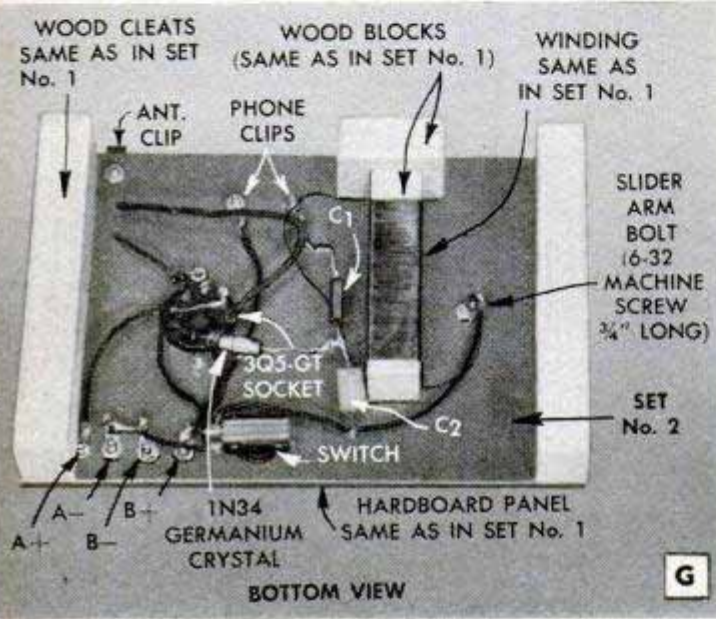

BOTTOM VIEW

G

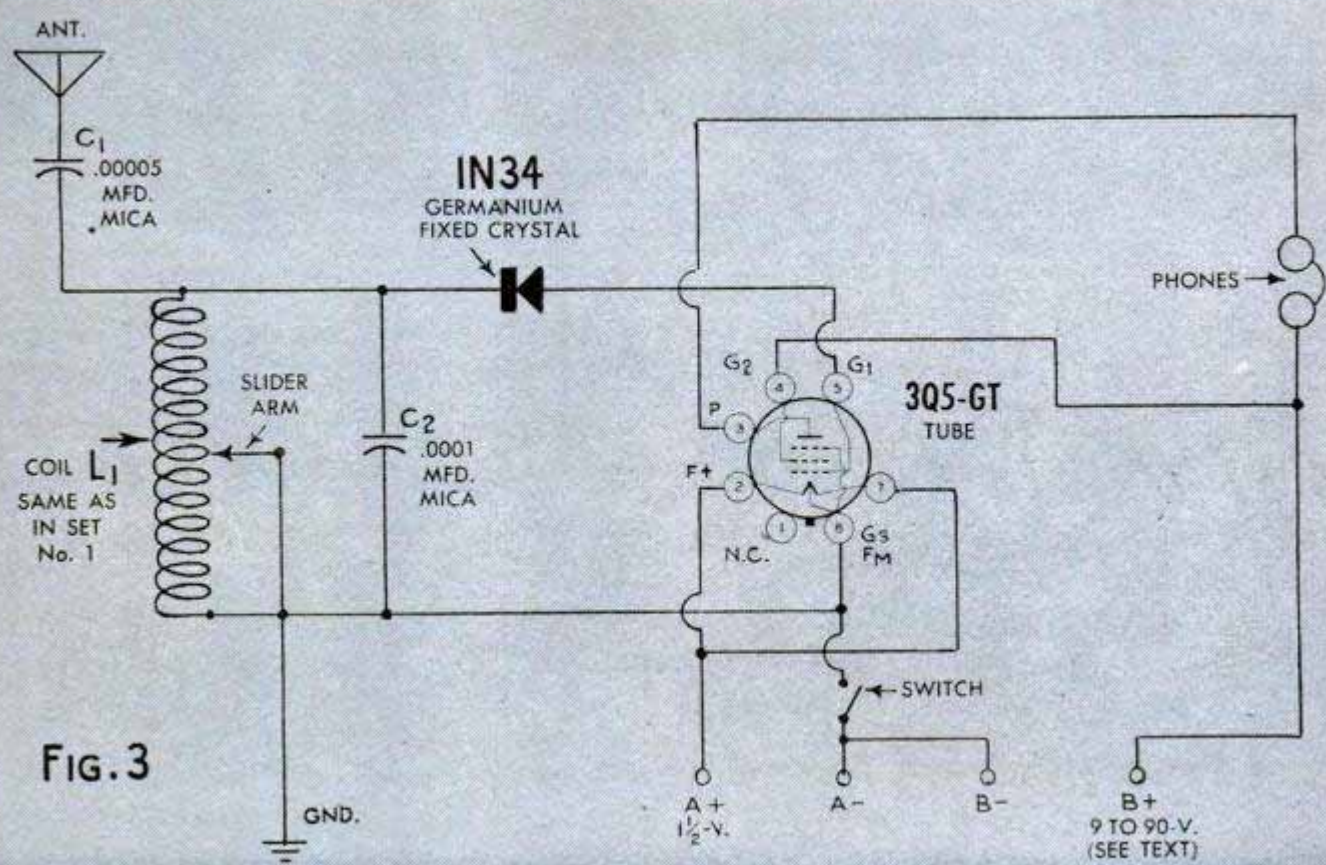

FIG. 3

FIG. 3 - SET No. 2

NOTE: TUBE SOCKET

How To Build A BASS-REFLEX ENCLOSURE

CRITICAL music lovers interested in high-fidelity reproduction realize that with ordinary speaker installations it is usually difficult to obtain colorful bass notes without boom or objectionable resonance. You can bring out those necessary bass notes with this homemade bass-reflex speaker enclosure. Enclosures of this type are ideal for testing high-fidelity AM and FM tuners and audio amplifiers.

Made from $\frac{3}{4}$ -in. plywood stock, this simple cabinet can be given a stain and finish to match other room furnishings. All inside dimensions are given in the chart below. Column A gives the speaker aperture, B is the depth of cabinet, C shows its width and D is the height. The length of the lower port is given in column E, and F is its height. In the dimensions chart, B, C and D are minimum for the speaker sizes listed.

Braces across the inside of the back and front panels keep the cabinet from vibrating at its mechanical resonate frequency.

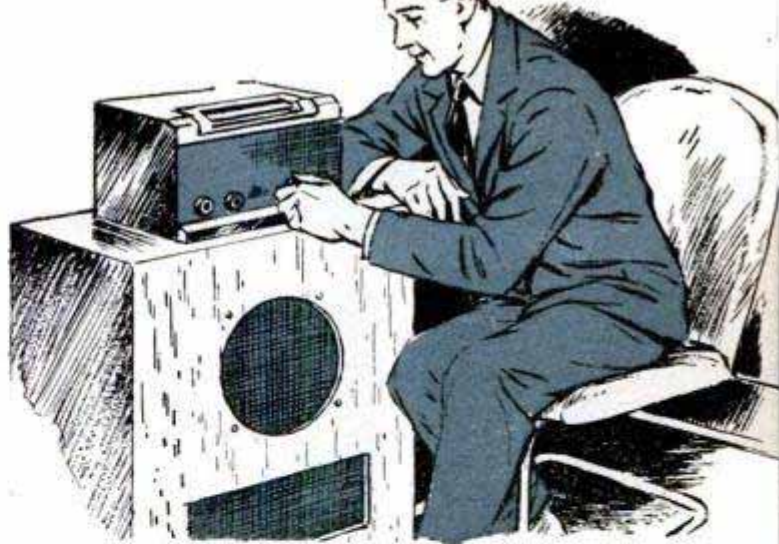

Pad all the interior walls (except the front wall where the speaker is mounted) with two layers of $\frac{1}{2}$ -in. Fiberglas pads, available from radio-parts houses. Ozite under-rug padding will also serve the purpose. Back the speaker aperture and lower port with flocked grille screen. The speaker opening, A, may be centered with respect to width, but not to height. Locate the center of the speaker about one third of the distance down from the top. The lower port, should be kept as close as possible to the speaker opening.

DIMENSIONS CHART						
Note: All dimensions are inside measurements.						
Speaker Size	A	B	C	D	E	F
15"	13 $\frac{3}{4}$ "	12"	23 $\frac{3}{4}$ "	31 $\frac{7}{8}$ "	12 $\frac{3}{4}$ "	5 $\frac{1}{2}$ "
12"	10 $\frac{3}{4}$ "	11"	22"	28 $\frac{7}{8}$ "	10 $\frac{5}{8}$ "	5 $\frac{1}{2}$ "
10"	8 $\frac{3}{4}$ "	10 $\frac{1}{2}$ "	19 $\frac{3}{4}$ "	26 $\frac{1}{4}$ "	8 $\frac{5}{8}$ "	4 $\frac{1}{4}$ "
8"	6 $\frac{7}{8}$ "	9 $\frac{1}{2}$ "	16"	22 $\frac{1}{8}$ "	6 $\frac{1}{2}$ "	3 $\frac{3}{4}$ "

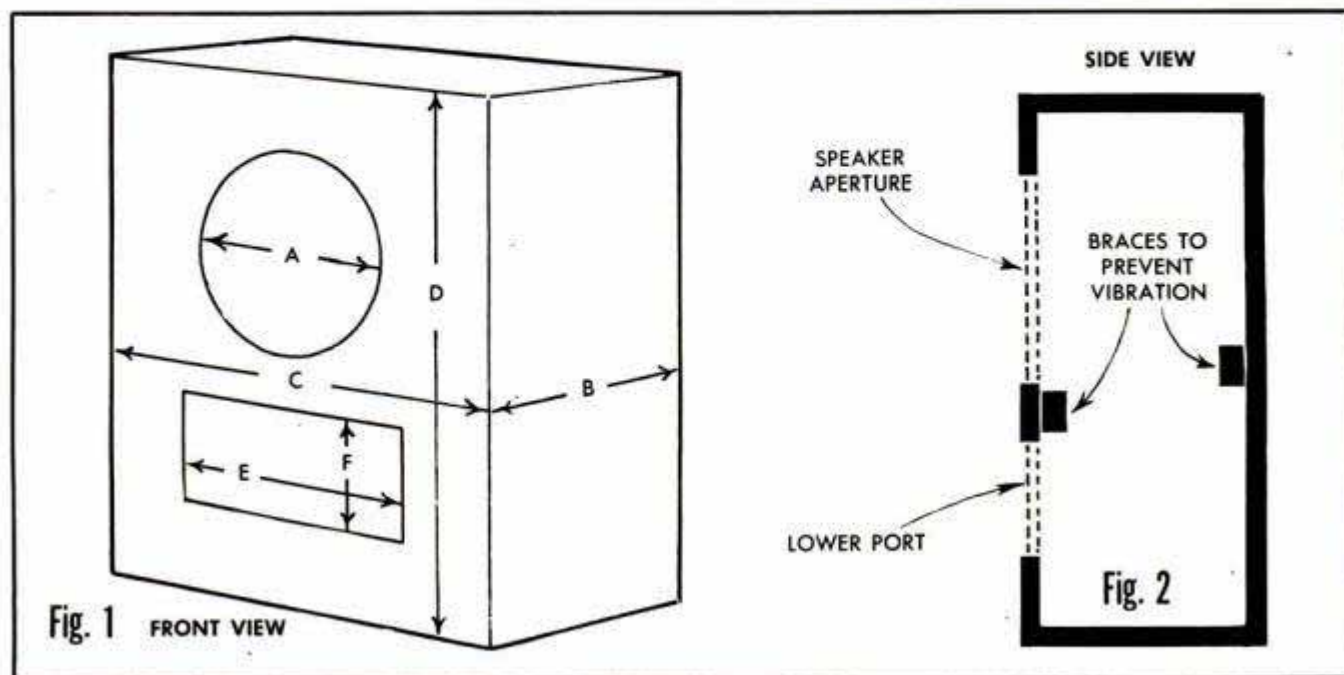



Emergency Replacement Batteries For Portable Receivers

MANY GROUPS operating in the civil-defense program have pointed out the important part that battery-operated receivers will have to play if bombs fall in vital locations, knocking out power-line facilities. Most of these sets in urban localities are of the portable type and are used at the beach and on outings where electric service is not available. It is not always possible to locate exact duplicate replacement batteries when they are urgently needed. The following illustrated hints will be of assistance in using those batteries that may be easily purchased, some of which may not have been manufactured for radio use.

B-batteries of the compact type, shown at the left in photo A, are usually available and should be duplicated for size if possible; the A-battery has much shorter life and must be renewed often. If your set uses a single $4\frac{1}{2}$ -volt A-battery, you can usually substitute three $1\frac{1}{2}$ -volt flashlight cells connected in series as shown in photos A and D. Check the terminal strip carefully for polarity as indicated in photo A. The battery diagram is usually attached to the rear cover of the cabinet, photo B. If a B-battery of correct size is not available it is often possible to obtain a larger size, of the specified voltage, and connect it externally with small spring clips for stationary operation, photo C. It is possible to obtain certain voltages for a long-life external A-battery from No. 6 dry cells connected as shown in photo E. For convenience, various voltages are labeled. Beginning at the positive end, the first tap would be negative $1\frac{1}{2}$ volts, the second 3 volts and the last would be $4\frac{1}{2}$ volts. These are common $1\frac{1}{2}$ -volt ignition-type dry cells.

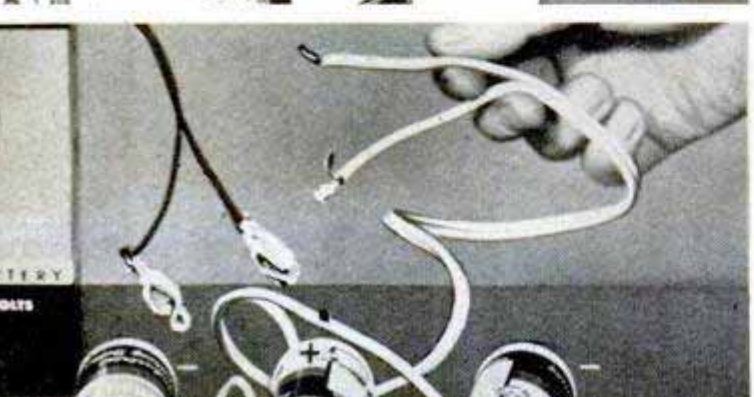
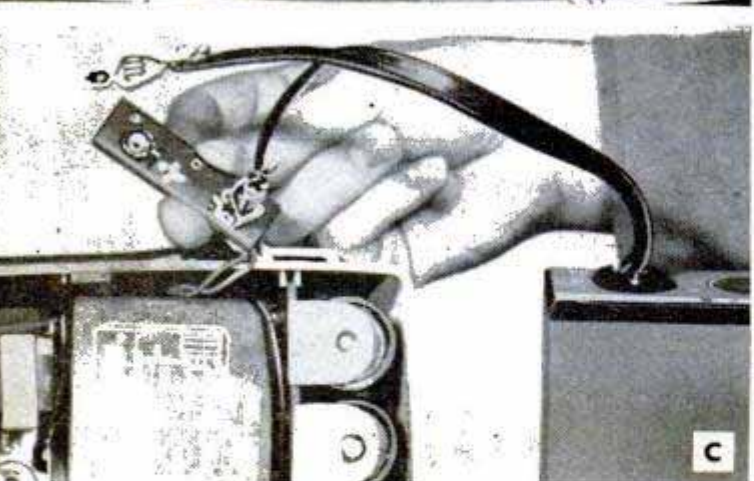
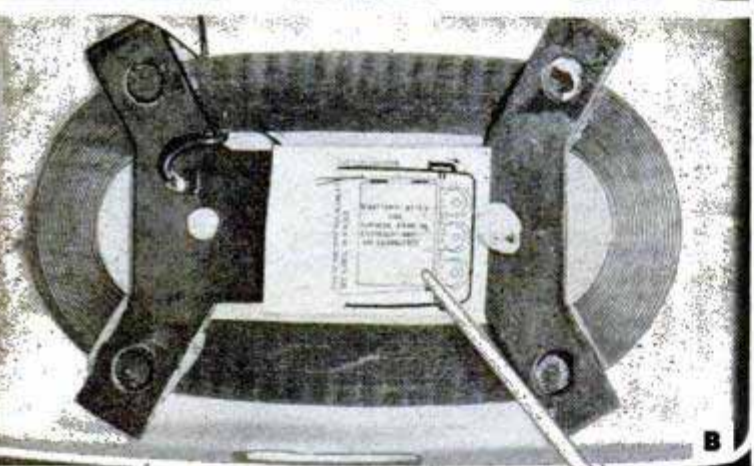
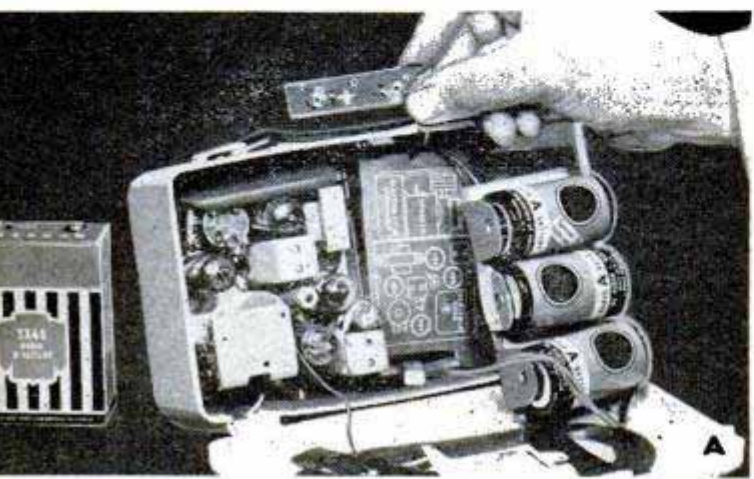

Next Month—
SAFETY FIRST
in TV home-set service

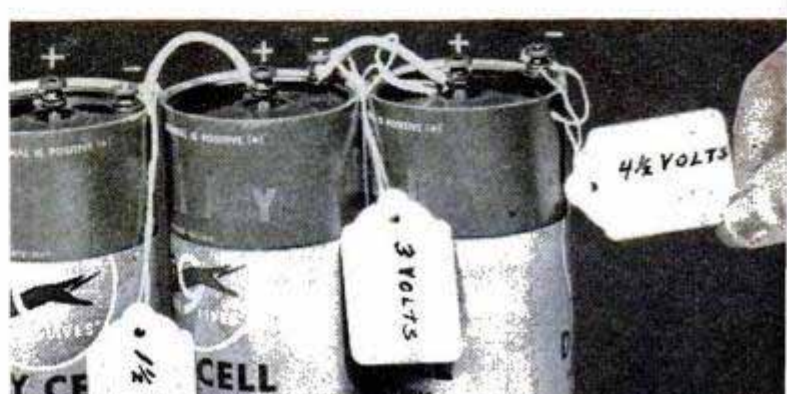

YOU CAN'T BREAK PAR WITH SECOND RATE CLUBS

The golfer who shoots in the seventies doesn't handicap himself with second rate clubs. He insists on one of the famous makes like Wilson, Spalding or MacGregor.

By the same token, the real mechanic demands tools with reputation back of them. In wrenches, for instance, the odds-on favorite among good mechanics is the Bonney, America's most famous wrench.



This is one of a series of spirited sporting scenes (in full color, without advertising) available on request. Write for your free set today.

"CHEAP TOOLS ARE FOR CHUMPS" So say the men who know tools and how to handle them. That is why good mechanics everywhere insist on Bonney Wrenches. They know that for lightness, strength, balance and precision you can't beat a Bonney.



SAVE GAS .. Up to 1 Gallon in Every 4



install a

MILE-O-METER

(Reg. U.S. Pat. Off., International Copyrights & Patents Secured)

(measures miles per gallon)
and motor tune-up gauge

Up to 35 Miles Per Gallon

Mile-O-Meter is a gasoline mileage gauge as well as a motor tune-up indicator, very important in running your car economically.

Fits all cars. Permanently mounted. Checks Spark Plugs, Carburetor and 31 other Motor adjustments. Shows how to increase miles per gallon at every speed. 1 to 5 minute installation — 4 color Easy-To-Read Dial. No holes to drill. Mounting bracket fits dash or windshield frame. No experience needed. Complete instructions and 16-page mileage book included. Tested and proved by leading Automotive Associations and manufacturers. Makes a perfect gift. (Beautifully gift wrapped at no charge.) Over 1,000,000 in use today.

**SURE ACCURACY
AT ALL SPEEDS**

Send for yours, today — Mile-O-Meter shipped prepaid — money back guarantee
Deluxe Chrome Model 3 1/2 Dia. **\$14.95 Ppd.**
Standard Model 2 3/4 Dia. **\$9.75 Ppd.**
Fed. Tax Incl.



Mile-O-Meter will tell you how to correct the engine condition

Certified Test Performance Certificate **1950** CERTIFIED APPROVED



money back guarantee

order from **GALE HALL ENG.**

107 Northampton St.
Boston 18, Mass.



1. **TEACHES** you how to drive economically — eliminates the Jack Rabbit starts and passing on hills — that's where you really drink up fuel.



3. **YOU** can check your engine condition at all times, and if it is not operating efficiently, Mile-O-Meter will tell you how to correct the condition.

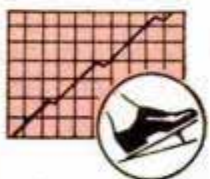

2. **PERFORMANCE** charts and suggestions are enclosed with every meter, enabling you to determine how many miles per gallon you are getting, and what adjustments to make to increase your mileage.



4. **SIMPLY** mount meter on windshield frame or on dashboard area to suit your convenience with the aid of mounting brackets that can be bent into practically any position.

SEND YOUR ORDER TODAY

GALE HALL ENGINEERING DEPT. 1231
BOSTON 18, MASS.

Please send.....Mile-O-Meters at.....
To.....

Check enclosed C.O.D.
 Gift Wrapped (Free)

World's Largest Producers of Tune-Up Gauges

"TOP 3"

for fishin' fun

[most for your dollars, too]

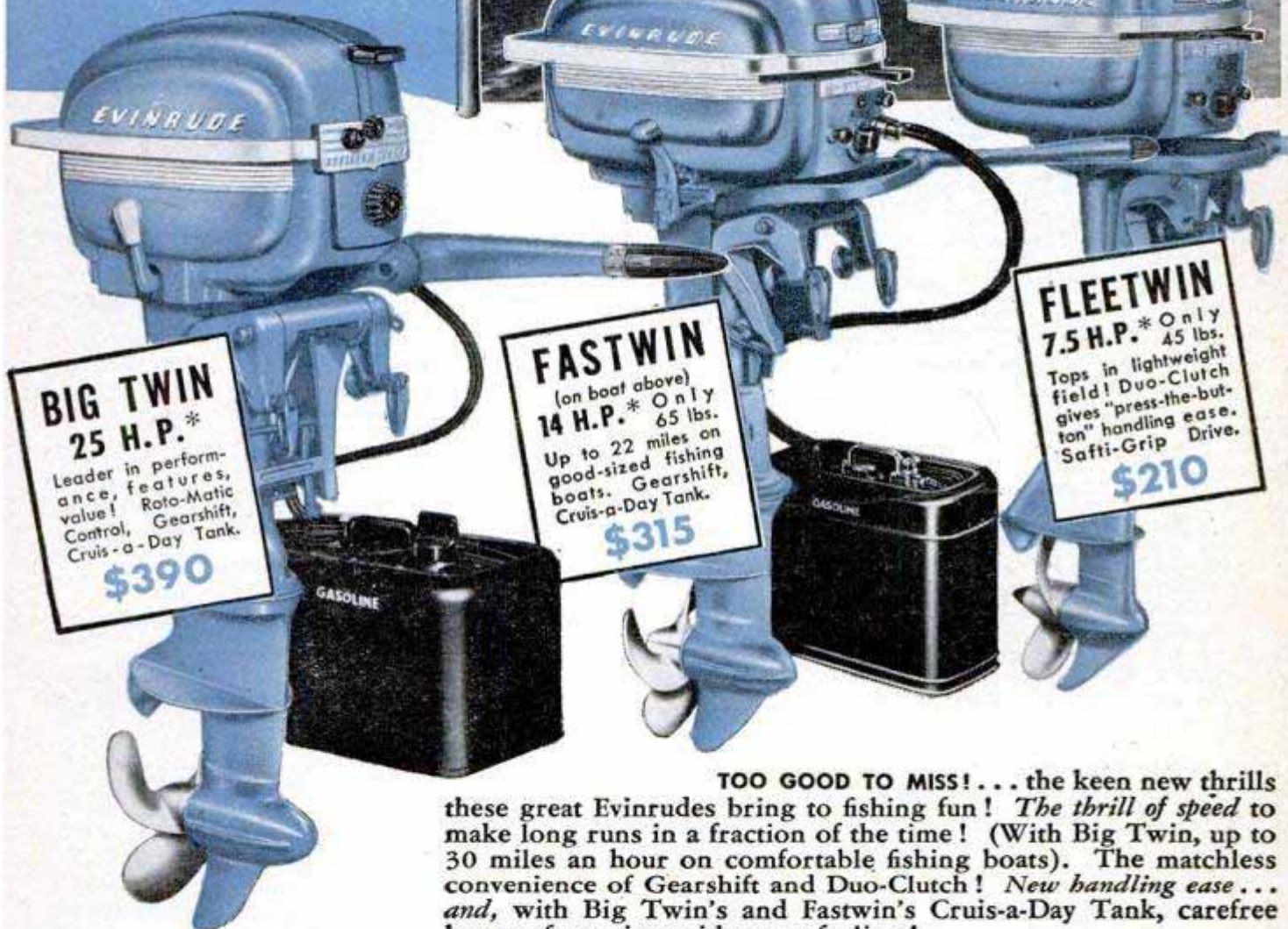

BIG TWIN 25 H.P.*

Leader in performance, features, value! Roto-Matic Control, Gearshift, Cruis-a-Day Tank.

\$390

FASTWIN

(on boat above)
14 H.P.* Only
Up to 22 miles on good-sized fishing boats. Gearshift, Cruis-a-Day Tank.

\$315

FLEETWIN

7.5 H.P.* Only
Tops in lightweight field! Duo-Clutch gives "press-the-button" handling ease. Safti-Grip Drive.

\$210

TOO GOOD TO MISS! . . . the keen new thrills these great Evinrudes bring to fishing fun! *The thrill of speed* to make long runs in a fraction of the time! (With Big Twin, up to 30 miles an hour on comfortable fishing boats). The matchless convenience of Gearshift and Duo-Clutch! *New handling ease* . . . and, with Big Twin's and Fastwin's Cruis-a-Day Tank, carefree hours of running without re-fueling!

All this and trolling, too! Yes . . . even Big Twin, with its eager 25 horsepower, throttles down to a slow and steady gait that wins the most finicky fisherman! Dollar-wise, compare them against the field—for power, performance, features, *fun*—and you'll want to get your order in! See your Evinrude Dealer—look for his name in your phone directory under "Outboard Motors." *Catalog Free*—write for it today!

EVINRUDE MOTORS

4689 North 27th Street
MILWAUKEE 16, WIS.

In Canada: Evinrude Motors,
Peterborough, Ontario

EVINRUDE

*Power ratings are O.B.C. certified brake H.P. at 4000 R.P.M. All prices are F.O.B. Factory and subject to change without notice.



CATALOG FREE! Write today for full-color catalog of complete Evinrude line for 1951.





Care and Feeding of Engines

BY S. P. CORP

SLAP-HAPPY SPRINGS

Ever hear a slapping racket when you're driving over rough roads, especially in wet weather? Slap-happy springs! Lubrication won't fix it, but a plate-type disc inserted next to the main leaf of each rear spring will quiet it down. Most service stations sell these discs. To install, lift rear of car with bumper jack so spring leaves are separated. Pry main and No. 2 leaves apart with a screwdriver and insert discs with smooth side down. If springs are covered, cut a $2\frac{1}{2}$ " slot in side of cover, $4\frac{1}{2}$ " from each end of spring and insert discs. Then peen over the slot in the cover. This should remove cause of slapping.

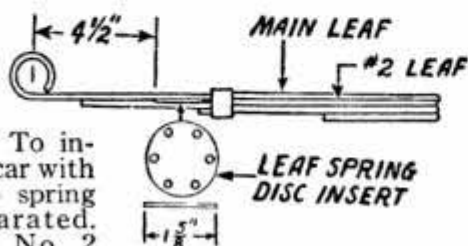

MORE ABOUT TIRE CARE

Now that the air is full of rumblings about rubber shortage and synthetic tires, let's talk some more about making tires last longer. It's a good rule to stop at a service station at least once a week to have tire pressure checked.

While you're doing this, inspect the tire-wear pattern.



A tire that shows wear on the outside edges indicates underinflation. To avoid this, *never check a hot tire*. There is a normal build-up of 3 to 5 pounds over recommended tire pressures as the tire gets hot while being driven.

Never bleed a built-up tire pressure. This built-up pressure prevents excessive sidewall flexing, a cause of tire-damaging heat. A tire carrying 24 lbs. may get up to 27 lbs. under normal driving, or 29 lbs. at high speed. This is normal build-up. Such pressure should not be bled while tire is hot.

On the other hand, center tread wear means overinflation, and that, too, may shorten tire life. Keep pressures correct, and rotate tires every 2500 miles.

RE-RING FOR SUMMER

To get full enjoyment from your summer vacation trip, put in new Sealed Power Piston Rings now—save gas, save oil, and get the thrill of restored power! The Sealed Power MD-50 Steel Oil Ring is the best oil control ring ever built—the only ring with the Full-Flow Spring. Controls oil even in badly tapered and out-of-round bores.

Ask for free booklet, "7 Ways to Save Oil." A card will bring it—just address Sealed Power Corporation, Dept. G-6, Muskegon, Michigan. For triple wear, get Sealed Power Chrome-Faced Rings.

Masterpieces in Crystal

(Continued from page 86)

glass and not only cause ugly specks but may give the whole piece a reddish tint. At Steuben, such a piece is dumped in an ash can immediately. Standards are so high that the tiniest pin-point bubble or hair-line flaw consigns a piece to the junk heap.

"The toughest thing to make," says one gaffer, "is an air twist. Unless you're careful, you get blisters along the edge." The gaffer makes an air twist by taking a blob of molten glass, patting and turning it on the surface of a steel table until it has four square sides. With a tweezerlike implement he squeezes a deep groove down the center of each side. Then, by gathering more molten crystal around the whole square, air is trapped in the four deep grooves. Quickly, now, the gaffer grabs the end of the gob with a plierlike tool, pulling and turning the glass. The trapped air stretches out into thin lines that twine around each other.

The tiny bubble you often see, buried in the heavy crystal base of a bud vase is "duck soup," according to the masters. The gaffer simply starts his base with half enough crystal. Then he punches a tiny indentation in the center of the bottom. Meanwhile the bit gatherer comes in with a fresh gather. This is fused over the base, trapping air in the indentation. The hot glass expands the air, which forces itself into a perfectly round bubble.

Steuben craftsmen sneer at forms and molds for the production of handblown glass. Their limit is usually the tiny, cup-shaped applewood paddles the boys use for what they call, irreverently, a "ball-bearing job." By rotating a small gather in this, they make the little knobs around the foot of a crystal bowl. However, some pieces must be partially formed in a steel mold.

A sparkling ring of bubbles, shaped like quartered melons, around the base of the famous Ballad Bowl are created by dropping molten crystal into a form shaped like a steel cocktail shaker, with gearlike serrations on its inside wall. Meanwhile the gaffer is spinning a thick crystal cup. When the two pieces are ready, the now corrugated piece from the mold is jammed into the cup. The two pieces fuse together, sealing off a dozen wedge-shaped grooves of trapped air. He shoves the whole thing in the glory hole, softens it up and keeps working it until it becomes a squat bowl base. All that trapped air around the edges has been squashed into glittering bubbles.

The gaffer also uses a cuplike steel mold to produce the unique cane twist, or long white swirls you've seen in paperweights.

(Continued to page 224)

The Case of the Lucky Camera



This handsome top-grain leather field case for Kodak "Pony 828" protects its camera well—opens in an instant for quick action. \$6.50.

A slippery rock! Looks like this camper is heading for a fall. But his camera is lucky. It's snug and protected in a smart Kodak carrying case--therein lies a moral: Protect your camera with a Kodak case for carefree snapshotting next time you go camping.

A smart idea at *any* time, for that matter. Kodak camera cases are designed and constructed to take the hardest knocks and come up smiling. *See your dealer for the one that fits your camera.*

OTHER KODAK CARRYING CASES



Kodak Snapsack for Kodak Tourist Cameras. Rugged pouch-type leather case. \$3.95.

FOR ADDED FUN AND FINER SNAPSHOTS . . .

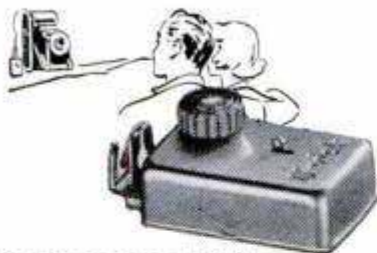

Get into the picture yourself—Attach a KODAK AUTO RELEASE to any camera which has a cable release . . . set it . . . you have 10 seconds before the shutter clicks. (Swell for honeymoon couples!) Good for flash shots, too. \$4.25.

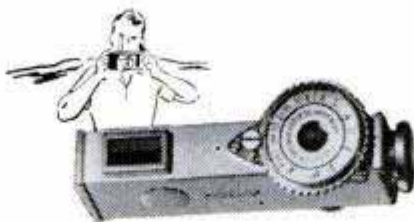

You can even focus on a fly with the neat little KODAK SERVICE RANGE FINDER. Split-field military-type. Adjusts down to 2 feet. Use independently of camera—or attach by means of special bracket provided on many models. \$14.58, including case.

- De Luxe Field Case for Kodak Tourist Cameras—\$10.50
- Field Case for Kodak Flash Bantam *f/4.5* Camera—\$6.50
- Field Case for Kodak Pony 135 Camera—\$6.75
- Field Case for Kodak Duaflex Cameras (simulated leather)—\$2.50

Prices are subject to change without notice and include Federal Tax where applicable.

Your Kodak dealer stands ready to help you get better pictures. Talk with him every chance you get.

EASTMAN KODAK COMPANY, ROCHESTER 4, N. Y.

Kodak
TRADE-MARK

How to paint a room in $\frac{1}{2}$ the time—

WITH

 **SPRED SATIN**

THE WONDER PAINT

You can apply it in half the time with brush or roller. Dries in 20 minutes to a gorgeous satin finish.

- ★ Covers most surfaces
- ★ Shows no laps or brushmarks
- ★ Washes perfectly, over and over
- ★ Has no offensive odor
- ★ New deep colors, ready-mixed

The secret of this amazing paint is its exclusive *synthetic rubber emulsion* formula. The rubber film forms a tight, durable surface that dirt cannot penetrate. See your Glidden dealer today.

Send for
decorating
kit today

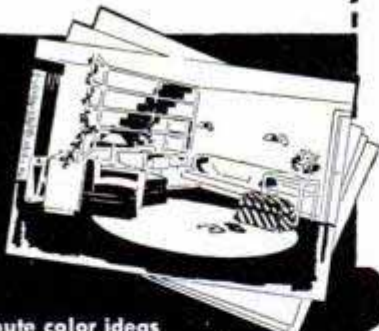

Up-to-the-minute color ideas
you can easily carry out in your own home!
Floor plans and color reproductions for 7
rooms. Practical, made-to-order
for planning home improve-
ment. Send 10 cents
(coin).

Dept. PM-6
The Glidden Co.
Cleveland 2, Ohio

Please send me your decorating kit. I enclose 10 cents (coin).
Tell me where I can buy Spred SATIN.

Name _____

Address _____

City _____ State _____

Clinic for Homemakers

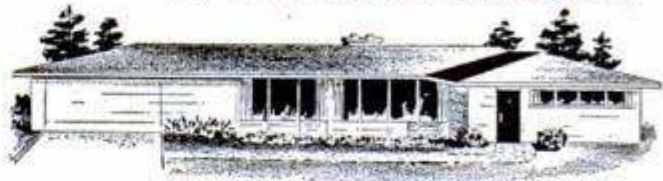

As a service to our readers in solving the hundreds of problems pertaining to a home—inside or out—the editors of *Popular Mechanics* invite you to present your problems to The Clinic Editor for help and advice. Address your questions to The Clinic Editor, *Popular Mechanics Magazine*, 200 East Ontario Street, Chicago 11, Ill.



Hedge Trimming

Q—I am thinking of planting about 60 ft. of hedge along my sidewalk. There are no trees near by and drainage is good. How far should the plants be set from the edge of the walk? Should the plants be cut back close to the ground after setting out? How is such a hedge trained, or trimmed?

L.T., Mich.

A—It is not possible to give complete answers to your questions in the space available. In general, just how far the hedge plants are placed from the edge of the sidewalk will depend to some extent on how the hedge is to be formed, or trained. Ordinarily, 15 to 20 in. is a fair average distance for a deciduous-hedge planting that is to be trained to grow along a sidewalk. Deciduous-hedge plants usually are cut back to within 4 to 6 in. above the ground at the time of planting, but, in some cases, plants that have been nursery-grown especially for hedge will not require such close cutting back. Usually in such cases the top growth is reduced by about 25 to 30 percent to lessen the burden on the root system during the first growing season. Consult your nurseryman at the time of purchasing the plants. A correctly shaped deciduous hedge is somewhat narrower at the top than at the bottom. The top should be trimmed slightly rounded rather than flat. Maintaining a hedge with the sides sloping inward admits more light and air to the inner branches, encouraging them to a full growth of foliage at the center and along the bottom of the hedgerow. Seasonal clipping of the deciduous hedge should begin after the first strong growth of the spring has been well started and should be carried out on schedule thereafter until growth stops in the fall.

Condensation Under Windows

Q—Moisture collects on the wall areas directly under the windows in three rooms on the north side of my home. Walls are insulated. Why does moisture collect only on the area under the windows and not on the rest of the wall surface? Does the moisture come through the wall?

C. T., Minn.

A—Is the wall area under the windows insulated? In some cases, insulation is omitted under the windows and below fire stops, especially when a fill type or blow-in type of insulation is used. Lack of insulation in these areas of the wall is a probable cause of the trouble you describe. Of course, the only permanent remedy indicated in this specific case is to apply insulation under the windows, preferably the same type of insulating

(Continued to page 222)

The ONLY kind of screening that can't Rust, Rot or Corrode!

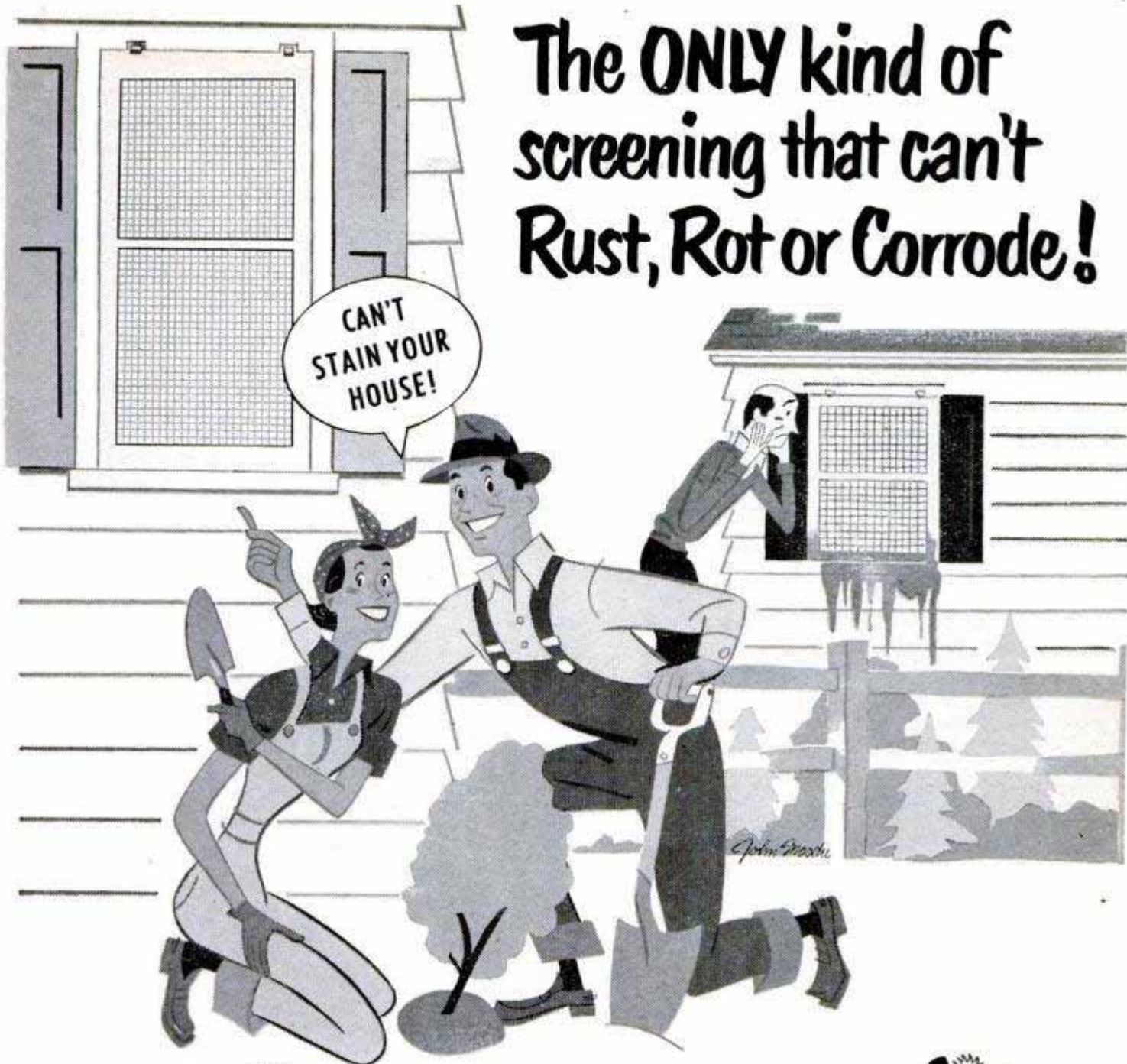

NEEDS NO PAINTING to protect it, because: Neither snow, rain, smoke, fog nor salt air can harm Lumite screening! Cleans easily with a damp cloth.



LASTS LONGER, because Lumite screening has greater resistance to blows, and because it can't rot out! It won't sag or bulge when properly framed . . . and it's easy to handle.



COSTS LESS than all but the cheapest screening! And you can leave these screens up all year 'round. Lumite is the ideal screening for every exterior use.



Buy Lumite screening at your Hardware, Lumber or Building Supply Dealer. Or write for FREE SAMPLE and descriptive folder to: Lumite Division, Chicopee Mfg. Corp. of Georgia, 40 Worth Street, New York 13, N. Y.

LUMITE*

SARAN SCREENING

*Registered Trade-mark

The camera you CAN'T outgrow!

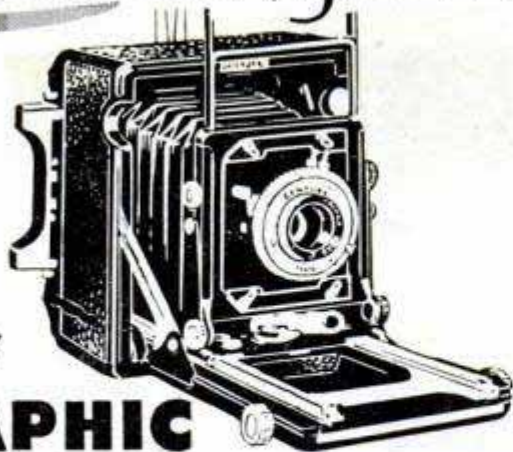

CENTURY GRAPHIC KEEPS PACE WITH YOUR PROGRESS

Here's the camera designed for *you*—for today and years to come! The Century Graphic is compact, efficient, economical — the lowest-priced of the famous Graphics. Versatile and dependable as it stands, and yet designed to take those accessories you'll want as your skill develops. Among them: 120 Roll Holder for economical roll film . . . Graflarger, for enlarging through your camera . . . speedy Grafmatic, for action sequences . . . Graf-lite for flash perfection! See your camera dealer today . . . have him show you all the wonderful features of the Century Graphic including fine, coated f/4.5 lens, built-in flash sync., ground glass focus, fast shutter, Graflok back. Only \$109.50 complete.

(Price subject to change)



120 Roll Holder Graflarger Grafmatic Graf-lite Flash

GRAFLEX

Prize-Winning Cameras

Graflex, Inc., Dept. 89,
Rochester 8, N. Y.
Please send details on:

- Century Graphic 120 Roll Holder
 Grafmatic Graf-lite Graflarger

Name _____
Street _____
City _____
County or Zone _____ State _____

(Continued from page 220)

material that was used in the rest of the wall. However, it should be kept in mind that insulation alone is not a cure for moisture condensation under all conditions. The moisture that collects on the wall surfaces under your windows comes from the air in the rooms, not from the outside.

Varnish Didn't Dry

Q—Recently I varnished a floor in a small bedroom after removing the old finish and bleaching the hardwood flooring to restore the color of the wood. The new varnish has never dried properly. After several weeks it still is sticky in spots and none of it has dried hard. What caused this failure and what can I do to remedy the defect? B.U., Ill.



A—There are several causes of this trouble, but among the most common are failure of the finish to dry due to the age of the finishing materials, lack of adequate air circulation during the drying period, and the presence of residues from a bleaching solution. Also, if the temperature of the room is below 65 deg. for any length of time, the varnish may not dry properly. Of course, the finish in this condition will never be durable. The only permanent remedy is to remove it entirely and build a new finish on the bare wood. After you have removed the varnish from your floor, wash the surface thoroughly with a medium to strong soda solution to neutralize any residues that may remain from the bleach you used. Then, when the wood is thoroughly dry, apply filler, sealer and as many coats of floor varnish as are required to produce the desired results. Have all the windows and doors open during the drying period. In some rooms it is necessary to use a fan to assure adequate air circulation.

Red Spider

Q—Something is wrong with my evergreen plantings. Last year, and now this year, I have noticed that the foliage appeared to be dying, that is, the needle clusters turned a grayish-white color in the affected areas. Nothing is visible except that the clusters seem to be matted together by a fine silkl-like material. What is this, and is it the cause of the trouble? W.T., Mo.



A—Probably your evergreens are infested with red spiders, or, perhaps more properly, spider mites. These tiny insects make their appearance with the coming of warm weather and, unless checked, they can seriously damage an evergreen planting in a comparatively short time. One recommended procedure requires that the foliage be sprayed early in the season, before new growth starts, with a miscible-oil solution made especially for protecting evergreens. Be sure to follow the manufacturer's directions in all details when applying this spray. However, in your own case, it probably is too late in the current season for this spray, but you can discourage the spiders quite effectively and thus give the trees some measure of protection for the balance of the season simply by hosing the foliage periodically, using the full water pressure and directing the stream of water upward as much as possible so that it strikes the underside of the needle clusters. Dusting with sulphur, although more difficult to carry out effectively, also helps to deter the insects. In midseason, spraying with lime-sulphur (summer strength) and rotenone compounds is a fairly common practice. Carry out the miscible-oil (dormant) spray procedure during the following year for full protection.

No-rub way to wax your car!



Johnson's

Car-Plate

gives a lasting "diamond shine"
in 20 minutes!

5,000,000 car owners have proved it's better!

Great news! The quick and easy way to wax your car is actually the best way!

Without rubbing and in 20 minutes, Johnson's Car-Plate gives your car a brighter, tougher, longer-lasting shine than former hard-rub methods that required many hours.

No wonder more than 5 million car owners have used Car-Plate since Reader's Digest published an article describing this sensational chemical discovery.

Just spread Car-Plate on the clean finish of your car . . . let it dry . . . and wipe lightly. That's all you do!

Get Johnson's Car-Plate today at your service station or regular wax dealer's. A 10-oz. can only \$1.00—does any car twice!



HOW TO CLEAN BEFORE YOU WAX

Wax should always be applied to a CLEAN car. The finish should be free of road film and decomposed paint. For this reason it is important that you clean your car thoroughly before applying Car-Plate. For quick, easy cleaning, Johnson's Carnu is recommended. It does the job fast and safely—leaves a perfect surface for a sparkling Car-Plate finish.

"Johnson's", "Car-Plate" and "Carnu" are registered trademarks. © S. C. Johnson & Son, Inc., Racine, Wis., 1951

In the Home, as in Industry, the choice is **WISS METAL SNIPS**

The superior quality of famous **WISS** Metal Cutting Snips has made them the first choice in the home and in industry. Every pair is rigidly tested and guaranteed to cut easily and efficiently for an unusually long time. Carefully adjusted blades are set precisely to reduce wear and permit maximum cutting power with a minimum of effort.

WISS METAL MASTER COMPOUND ACTION SNIPS



Compound leverage produces amazing cutting power with minimum effort. Will cut holes, circles and complicated patterns in metals to 18 gauge. Rubber grips recommended. M 1 (Cuts Left) 10" long; M 2 (Cuts Right) 10" long; M 3 (Cuts Straight) 10" long.

WISS SOLID STEEL STRAIGHT CUTTING SNIPS



Economical in price, these snips meet government specifications. Made of a specially selected grade of solid tool steel. For general metal-cutting. Four sizes, 8" to 12 $\frac{1}{4}$ " long.

WISS SOLID STEEL COMBINATION SNIPS



Will cut straight, curves or irregular shapes with ease. Two sizes, 7" and 13" long.



**J. WISS & SONS CO.
NEWARK 7, N. J.**

Toothpicklike sticks of white milk glass are placed in standing position around the inside wall of the mold, and molten crystal poured in. Then the gob is taken out and more glass is gathered around it. The piece is then twisted until the white glass rods swoop around in gentle curves.

Even more intricate than the forming of crystal at Steuben is the work done in the little shop in a far end of the plant. Here, before lathes and racks, each containing some 50 copper grinding wheels, sit men like Joe Libisch, grinding classic art work on the sparkling crystal. Though the wheels cut concavities, finished figures, like those adorning the bowl President Truman gave Princess Elizabeth for her wedding, appear to the eye to be in bold relief.

Joe began copper-wheel engraving at the age of 12, apprenticed to an engraver in Hungary. He still doesn't take any chances. "See, here's my 'try' glass," he'll tell you, holding aloft a goblet covered with everything from deep cuts to an incredibly tiny seal of Great Britain, cut with a wheel smaller than a pinhead. "Anything new or difficult," he explains, "goes on the try glass before the bowl."

Joe starts an intricate engraving by transferring the design from paper to a crystal surface. "The design is on tissue," he explains, "and the back of the paper is smeared with tallow, usually. But we use shaving cream." By tracing the design, the outline is transferred to the bowl in shaving-cream lines. A fine cut is made with a tiny wheel so the outline won't wear off. Then, Joe goes to work cutting away the crystal, using some nine grades of emery, virtually all his wheels, and an abundance of patience.

One famous engraved piece is the Bowl of Legend, with seven separate scenes marching in a grand parade around the bowl's rim; Paul Bunyan, Rip Van Winkle, Johnny Appleseed, Uncle Remus, Davy Crockett, Pecos Bill and Sleepy Hollow. "It took more than a month," Joe recalls. On every face he carves, he must switch wheels to get different effects on nose, mouth, eyes and cheeks.

"Switching wheels is tough," says the master engraver. "On the Tiger Bowl, no two cuts were alike. It took me a couple of weeks just to make the tiger alone."

Whether it's a simple, undecorated nut dish or a piece like the heavily engraved Valor Cup, designed by John Gates, and claimed to be the most exclusive piece of glass in the world, time and cost mean nothing to these craftsmen. They are all out, as boss Houghton puts it, "to grab on to the coattails of immortality."

Make
the Whole
Country
Your
Vacation
Land!

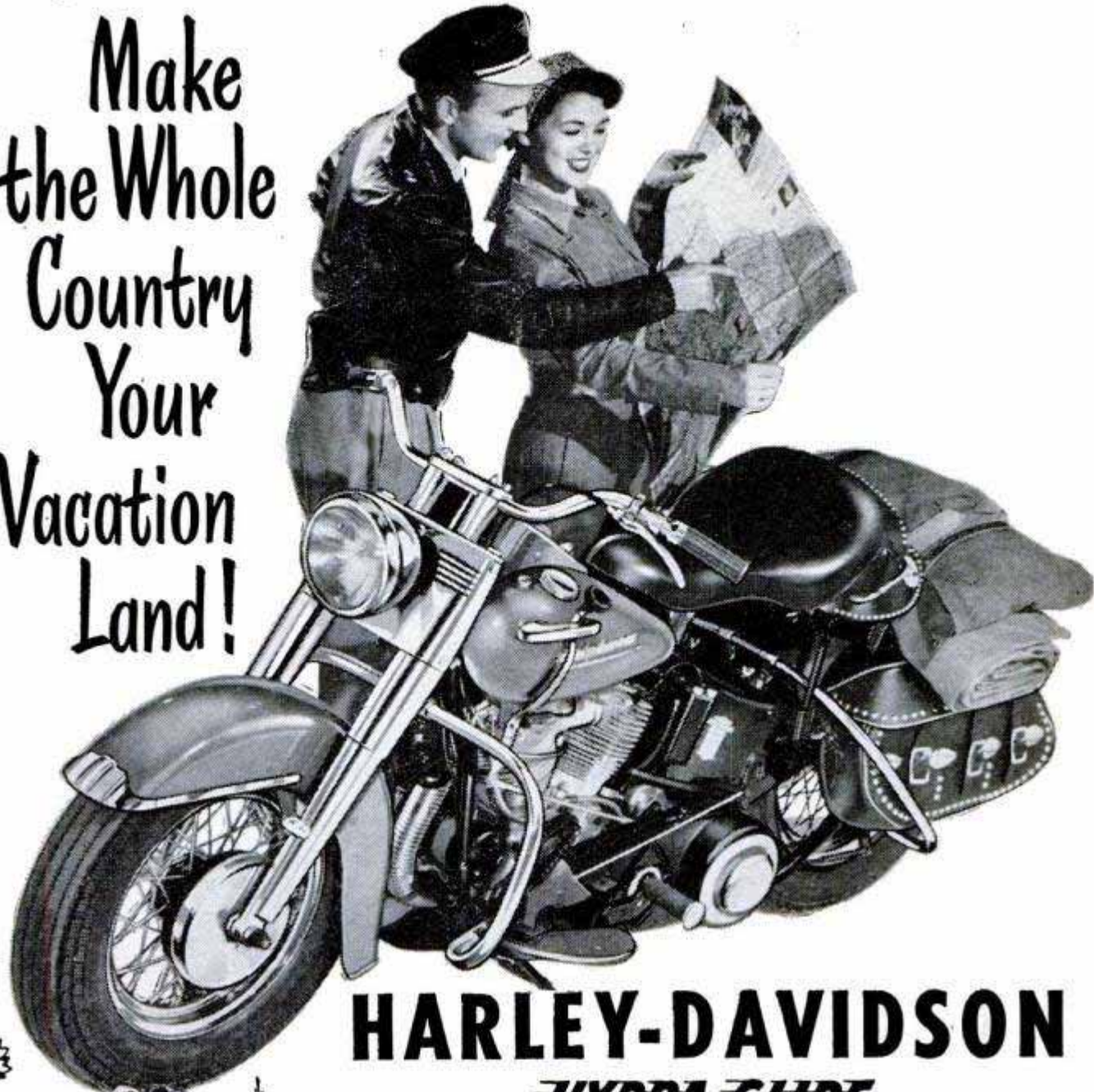

HARLEY-DAVIDSON

HYDRA-GLIDE®

SEE America the scenic, low-cost way — on a Harley-Davidson Hydra-Glide! You'll enjoy a new kind of vacation — an economical and fun-packed tour, with picturesque back-country roads and towns, breath-taking mountain trails, hidden lakes and out-of-way resort regions offering thrilling new adventures and good times. You'll ride swiftly and comfortably, too . . . float along like a breeze! Even on longest trips you'll hardly know you're traveling. Plan now for a thrilling vacation. See your dealer today.



MAIL COUPON NOW

HARLEY-DAVIDSON MOTOR CO., Dept. P, Milwaukee 1, Wisconsin

Name.....

Address.....

City..... State.....

Send me free copy of ENTHUSIAST Magazine filled with motorcycle action pictures and stories; also literature on new models.



DEALERS WANTED: A few franchises available for the full line of famous Big Twins and the 125 Model. Write today.

Buy NOW . . . during this Sale of SEARS fine quality Power Tools

DUNLAP 26-piece 1/4-inch Electric Drill Set
Does hundreds of jobs faster . . . easier!

SEARS REGULAR PRICE \$22.50

Special 30-day Offer

NOW ONLY **\$18⁹⁵** Cash

Complete 26-piece Set



A fine quality, complete drill set of amazing usefulness
Now yours at a bargain price during this special offer!

Now! You can do all of these . . . and much more . . . with this one Electric Drill and Accessories!



Drill wood, metal, plastic



Polish cars, furniture, etc.



Polish silverware, etc.



Grind tools, knives, etc.



Sand floors, furniture, etc.



Mix paint and other liquids

NOW . . . a complete 26-piece 1/4-in. electric drill set of fine quality . . . sensationally low-priced during this 30-day sale! Tremendously handy . . . invaluable for home, farm and hobby shop use. The DUNLAP drill is not a flimsy tool as often found in other sets, but a dependable intermittent-duty drill, powerful enough to drive 1/4-in. bits into steel! **Entire drill (NOT just cord) UL Approved!** Has 1/4-in. 3-jaw chuck; triple reduction gears. Aluminum alloy frame. 12 in. long. No-load chuck speed 1500 R.P.M. Switch has lock for continuous running.

For 110-120-volt, 25-60 cycle AC or DC. 6-ft. cord; plug. With 10 HIGH SPEED drill bits, 1/16 to 1/4-in. (Not carbon bits as in some sets); 4-in. cloth buffing and 3-in. grinding wheels; 4 3/4-in. rubber sanding disc; 5 1/2-in. sheepskin polishing bonnet; 6 sanding discs; paint mixer; auxiliary handle; adapter; horizontal stand for using drill as a bench tool; 13x6 1/4x 6-in. steel carrying case. See this super value at your nearest Sears Retail Store TODAY!

Sears convenient Easy Payment Plan lets you buy power tools NOW . . . pay for them while using them

CRAFTSMAN and **DUNLAP** Tools by **SEARS, ROEBUCK and CO.**
REG. U.S. PAT. OFF.

Money-saving June "Specials"! Price-slashed for 30 days only!

CRAFTSMAN 6½-inch Electric Hand Saw
10 times faster than tedious hand sawing!



REGULAR PRICE Without Case **\$56.95**

Special 30-day Offer

NOW ONLY **\$50.00*** Cash

Only \$5 Down on Easy Terms

Regular price with case \$61.95

NOW ONLY **\$55.00*** Cash



With or without
new-type steel
case that acts
as bench stand

Finest 6½-inch electric hand saw on the market, in our opinion! A tremendous value at this special low price!

Here's the finest saw of its capacity we've ever seen . . . a super-powered, **contractor-type saw** . . . precision-built for continuous heavy duty use! Rips, crosscuts, angle-cuts, siding, flooring, rafters, plywood panels (even concrete, tile, etc. with cut-off wheel) fast and accurately! Easy to handle; weighs only 12½ lbs.! Sealed precision ball bearings throughout! Direct drive gear train permits compact design; perfect balance. Safe! Blade is on right side; away from operator! Depth of cut at 90°, 0 to 2-3/16 in.; at 45°, 1-11/16 in.

Built-in ripping guide; die cast aluminum housing. Has helical cut bronze gear; telescoping saw guard; sawdust blower; trigger switch. **Underwriters' Labs. approved** (industrial standards). Heavy duty universal G. E. motor, 110-120-volt, 25-60 cycle AC or DC.; rated ¾-H.P.; develops 1¼-H.P. No-load speed 4300 R.P.M. With 6½-in. combination blade 10-ft. 3-wire cord; plug; lubricant; wrench. See this saw at your Sears Retail store TODAY!

* Electric Hand Saw, Cut-off Wheel prices slightly higher south of Ohio and west of Mississippi rivers

These handy accessories will make this electric hand saw a universal cutting machine!



Each \$1.19*



Each \$3.75



Each \$12.95

CUT-OFF WHEEL
6-in. diam.; ½-in. round arbor hole. For cutting concrete, tile, granite, metals

NAIL-CUTTING SAW. 6-in. diam.; ½-in. round arbor hole. For rough work (crosscutting, ripping).

CARBIDE-TIPPED SAW. 5-15/16-in. diam.; ½-in. round arbor. For wood, plastics, etc.

Famous for fine quality . . . precision performance . . . low price!

London
Tokyo Paris
BERLIN
THE VATICAN!



5-38B
UL-Approved

hallicrafters

Precision Radio

- **HEAR WORLD NEWS DIRECT!** With the powerful Hallicrafters INTERNATIONAL LONG RANGE receiver.
- **PRECISION RECEPTION** for Standard Broadcast band. Hallicrafters is ALL RADIO... no frills, every ounce a masterpiece of famous Hallicrafters engineering. Modern, functional steel cabinet designed by Raymond Loewy.
- **HEAR AMATEURS FROM ALL OVER THE EARTH!** Tune in on this fascinating hobby, a start towards becoming a radio "Ham."
- **AIRPLANE AND POLICE COMMUNICATIONS** Tunes in short wave reception on three bands, with continuous coverage from 540 kc to 32 Mc.

Hallicrafters is the perfect radio for remotely-located summer homes, farms, suburbs and cities where radio reception is difficult.

AC-DC Price:

hallicrafters \$49⁵⁰



WORLD'S LEADING MANUFACTURER OF
PRECISION RADIO & TELEVISION

MAIL THIS COUPON:

Hallicrafters — Dept. P, Chicago 24, Illinois

Due to the national emergency, only a limited number of these sets are being made. Reserve yours now — mail coupon for name of distributor who can serve you directly. THIS RESERVATION WILL BE HELD FOR 30 DAYS AT YOUR DISTRIBUTOR. Should you not buy within that period of time, the set will be given to the next name on the list. We will also send you free brochure giving full specifications.

YOUR NAME.....

ADDRESS.....

CITY..... ZONE..... STATE.....

There's a New World in Textiles

(Continued from page 125)

Jersey factory and used as bristles for paintbrushes that had a bounce and sheen that couldn't be dulled. Some of the milk is now going from cows to carburetors. Casein fiber is kinked and curled with heat to make a tangled mass that is mixed with wool and an oily chemical by the Fram Company for their carburetor air filters. When a casein-fiber filter is filled with dirt, you just throw it away like a soiled paper plate and put in a new one at low cost.

Weirdest of all the synthetics is the "disappearing" fiber developed by the Southern Regional Research Laboratory of the Department of Agriculture. It is made of ordinary cotton that has been partly converted by chemical treatment to carboxymethyl-cellulose (a substance also used in ice creams and soapless soaps). This unique fiber behaves like ordinary cotton when dry but readily dissolves in water. When spun into yarns and woven into fabrics along with more delicate fibers, it provides the necessary strength in the warp or supporting threads of the fabric. The soluble cotton fibers can later be washed away, making it possible to achieve fancy open-work patterns on standard looms.

Tricky weaving is producing unique fabrics, too. The Air Materiel Command has developed a cotton fabric for Arctic use. It's as warm as wool, and gets that way by means of weaving the material into myriad tiny boxes called a honeycomb weave. Two layers of this are as good as a heavy wool blanket. Another is the same outfit's basket weave which, by means of grouping several strands of fiber together in weaving, results in tarpaulins and tents so strong they're almost indestructible.

In the hunt for better and better fabrics, good old cotton and wool haven't been forgotten. They still account for 80 percent of all textile products. Many companies have developed special treatments for them that let them retain their best qualities, but make them shrinkproof, wrinkleproof, fire-resistant, or give them other qualities that are inherent in the synthetics.

Dow Corning's fabric treatment with De-Cetex 104, a silicone product, is spectacular. Clothes treated with it shed water like oilskin and have a smooth, springy feel. You can stand in the rain all day in a De-Cetexed gabardine suit, then shake off the droplets and wear it again. The creases stay put. Even a De-Cetexed nylon net is so water repellent that drops won't go through its openwork, but will sit on top like tiny crystal blisters.

(Continued to page 230)

**YOU DON'T HAVE TO BE A MECHANIC
TO INSTALL YOUR OWN COLORFUL**

KENTILE FLOOR



*anyone can do it in
his spare time and
save real money!*

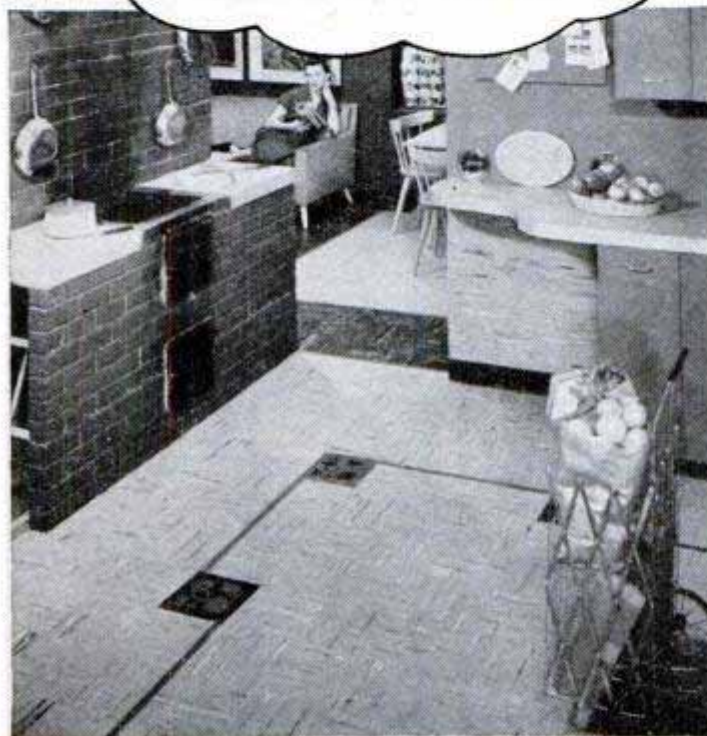

**You can have a floor like this in your kitchen
for only \$1975***

ANYONE can install their own Kentile Floor! The tough, durable squares go down one at a time . . . for just a small section or whole rooms at once . . . and colorful Kentile is ready for years of hard wear as soon as it's down. It's quick, easy, fun!

26 wonderful Kentile colors mean that you can create any design you want . . . match any plan. Kentile's ready-to-install decorative inserts

Your Kentile dealer's low price includes adhesive, instruction booklet and this handy Ken-Kit that contains all of the simple tools needed to do a neat, long-lasting job.



**Or one like this in your living room
for only \$3625***



Write for your **FREE** copy of the **Kentile Color Booklet** showing all of the sparkling, modern colors in low-cost Kentile Floors.

make your own floor the only one of its kind.

And, when you've finished, you'll have an attractive floor that will give almost unbelievable service . . . modern colors that can't wear off because they go clear through to the back of each tile . . . simple and inexpensive to clean with just mild soap and water. And the fresh Kentile beauty needs only an occasional no-rub waxing to always look new.

**Price based on a 8' x 9' kitchen and on a 12' x 15' living room*

KENTILE®

**The Asphalt Tile of
Enduring Beauty** 

KENTILE, INC., 58 2nd AVE., Dept. G-1, BROOKLYN 15, N.Y.

SELF-CONTROL STARTS HERE



and to restore
CAR PERFORMANCE
OIL-CONTROL STARTS HERE

To stop oil-pumping, replace worn engine connecting rod bearings

A rubber band and a wad of paper can start real trouble—and so can worn engine bearings! Worn connecting rod and main bearings in your car engine mean disappointing performance—sluggish pick-up in traffic . . . lack of power on the road. *Worn engine bearings cause oil pumping!* You can't expect new piston rings to correct oil pumping when it starts at the bearings. Give new rings a chance to do their own job—replace worn engine bearings, too. Ask for genuine Federal-Mogul bearings—your mechanic knows they're *engineered* for the job of oil control!

FEDERAL-MOGUL SERVICE

(Division of Federal-Mogul Corporation)

DETROIT 13, MICHIGAN



CONTROL OIL-PUMPING

WHERE IT STARTS—REPLACE WITH

FEDERAL-MOGUL

BEARINGS

OIL CONTROL



To make any fabric flame-resistant, DuPont has what it calls Erifon. By running bolts of cloth through a series of special salts baths, and rollers that squeeze the stuff into the fibers, out comes a material that won't support flame. The characteristics of the fiber aren't changed and the fire resistance isn't removed by cleaning, washing or weathering. The material will singe and char, but the instant the flame is removed the smoldering stops.

Melamine-treated fabrics do much the same thing, and more. Melamine, a thermoplastic set by heat, is being baked into all kinds of cotton clothing fabrics today at Dan River Mills in New Jersey under a special new formula. It gives a permanent set to natural cotton fiber that makes it springy, longer wearing and highly tear-resistant. It won't shrink. It sheds water and wrinkles and becomes mildew-resistant. These qualities are said to be permanent.

Perhaps the greatest eye-stopper fabric treatment of all is one that had sportswear buyers in Los Angeles gawking one recent foggy day. Looking skyward, they saw a bathing beauty in a glowing swim suit floating on the mists. Later, they saw she was standing in the Plexiglas nose of a hovering helicopter, but her dazzling suit was visible long before the machine. The secret was a unique fluorescent Celanese satin that glows in daylight, or nightlight, without benefit of special lamps.

The startling material is dyed with Cold-fire—a combination of chemicals, color and diatomaceous earth—invented by Bob and Joe Switzer of Berkeley, Cal. First used as fluorescent dye for special military fabrics, it is now going into red hunting caps and jackets that scream you right out of the woods.

Besides the fabrics already mentioned, many more are still in the works experimentally. DuPont has Dacron, now being tested in fire hose, industrial belts and filters as well as curtains, sport shirts and summer suits. It's supposed to have higher resistance to some chemicals than Orlon. New, rugged acrylonitrile fibers called Acrylan, another yet unnamed from the Chemstrand Company, and a new Monsanto fiber are on the way. Celcos, a new Celanese fiber combining the best characteristics of acetate and viscose rayons, already is being blended with wools for carpets that are tougher, but just as luxurious as pure wool and less expensive.

Despite it all, textile men point out that the perfect fiber is yet to be invented. "A fabric that is wonderful for some reasons may be horrible for others," they warn. "The idea is to choose the right one for the right purpose."

TERRIFIC VALUES - SURPLUS - SAVINGS UP TO 85%



Portable LIGHT PLANT

PUSH BUTTON START
500-700 watts 110-120 v. — 60 cyc. A.C. Powered by a sturdy dependable, easy starting, air cooled 1 3/4 hp. gas engine. No wiring necessary, just plug in and operate. Plenty of current for any oil burner, freezer, brooder, pump, emergency lights, etc. which require up to 700 watts. Ideal for Civil Defense, Fire Depts; trailers & camps. Complete with Voltmeter and built-in winding to charge 6 v. auto batteries. Wt. 85 lbs. Fully guaranteed. Be prepared if war or storm knocks out power lines.

(Item 24) Reg. \$275.00 value. **\$143.50**
700-800 Watt Plant (Item 44) same as Item 24, but larger generator. **\$169.95**
1000-1200 Watt Plant (Item 45) same as Item 24, but larger generator & engine. **\$199.50**

GIANT 2000-2500 WATT PLANT

110-120 v. 60 cyc., A.C. Absolutely the best made because its heavy windings develop up to 5000 watt overload for motor starting. Skid-mounted—portable. Powered by 5 h. p. easy starting Briggs or Wisconsin engine—complete with all accessories; engine easily disconnected for other uses. Big outlet box, voltmeter, no wiring necessary. Ample current for all purposes. Factory warranty and instructions included. Wt. 220 lbs. Reg. \$585.00. Special at... **\$299.50**
GENERATOR ONLY and control box. \$169.50
Drive it with your engine or tractor

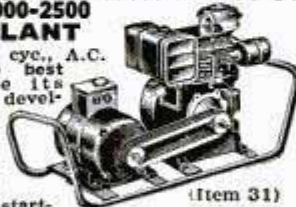

(Item 31)



1/4" DRILL

(Item 34) Hi-power, long-life, smooth running. Alloy steel gears; built-in blower. Cutter-Hammer switch, Jacobs hand-tite chuck. 110-120 v. AC-DC 1000-1600 rpm. Cap. 1/4" in steel, 1 year guar. Wt. 4 lbs. Terrific value at **\$12.95**.

38 Pc. DRILL KIT

(Item 35) Includes above drill, buffers, polishing, cement, sanding discs, grinding wheels, wood bits, steel bits, wire wheels, bench stand, paint mixer, burrs. Complete in heavy steel case. Wt. 13 lbs. 38 pc's., all highest quality. Complete kit worth \$38.50. Our Special, only... **\$19.85**



FIRE or BURGLAR ALARM

(Item 46) Completely automatic. Wind and bang anywhere. Thermostatic element sets off loud clanging bell if heat reaches 140° (setting adjustable). A fool-proof burglar or signal alarm when used with trip cord attached to door, window, invalid's bed, etc. Sturdy metal constr. assures lifetime of protection. Ideal for homes, stores, whse., gar. etc. Wt. 3 lbs. Easily worth \$20. Special... **\$4.95**

GAS ENGINE

(Item 25) Air-cooled. 1 1/2-2 h.p. Complete with gas filter, air cleaner, governor, fuel tank. Ready to run. Speed range 2000-3600 r.p.m. 5/8" shaft. Rope start. Ideal for pumps, air compressors, power tools, generators, etc. Factory warranty and instructions incl. One of the best made. Wt. 40 lbs. Worth \$72.50. Special... **\$46.50**



GAUGE TESTER

(Item 27) Precision made of solid bronze by Star Brass Co. Calibrated weights (incl.) acting against hydraulic piston, provides quick accurate testing of all pressure gauges up to 3000 lbs. per sq. in. Brand new in hardwood cases. Wt. 100 lbs. Reg. \$435.00. Our Spec... **\$135.00**

HYDRAULIC HOSE

High pressure, heavy duty, complete with swivel fittings. Pipe thread connections. Ideal for farm equip., bulldozers, grease guns, airbrakes, etc. Any length. Minimum \$1 per lgh. **INSIDE DIAMETER, 1/4" 50c per ft. 3/8" 60c, 1/2" 80c, 5/8" 90c.**

MANUFACTURERS AND JOBBERS — Write us about your surplus items

HEAVY DUTY ARC WELDER



(Item 38) Use as portable or shop welder. 250 amps. D.C., Senior model. Made for years of trouble-free, continuous service. Will handle light or heavy jobs. Weld up to 1/2" plate using 1/4" rods. Built-in air-cooling system. Arc is easy to strike and hold, because of specially designed arc stabilizer. Hi-lo switch and dial control gives wide range of welding heats. Run welder at 2600 rpm. with tractor, jeep or 10 hp. gas engine, or 7 hp. elec. motor. Complete with instructions, guar. and double V belt or flat pulley. Wt. 110 lbs. **\$99.75**

SPECIAL BONUS (while they last) 5 lbs. asstd. welding rods and \$5.95 helmet incl. with welder.

DUAL TUBE LIFE SAVERS



(Item 54) The new approved type made by Genl. Tire for Navy. 2 rubber cells for double protection. Easily inflated by mouth to 55 inches. Wear one as life preserver. Adj. to fit adults or children. Tie together for raft or big luxurious mattress. Invaluable on boats or beach. Wt. 2 lbs. each. Our Spec. (a fraction of cost) **99c each, 6 for \$5.**

HIGH PRESSURE HAND PUMP



(Item 53) Positive displacement type. Cap. 550 gph. Completely self priming. 3/4" pipe thread inlet and outlet. Use for fuel or water transfer on boats, trailers, air craft, etc. Ideal for insecticides, emerg. sump pump or as vacuum pump. Wt. 15 lbs. Govt. cost \$95. Our Special... **\$12.95**

FIRE EXTINGUISHER



(Item 39) Fully charged at 1,000 lbs. P. S. L. or other) with CO2 (carbon dioxide) the proven miracle fire fighting chemical that smothers oil, gasoline and electrical fires. Play safe; keep one in your car, garage and home. Heavy ICC approved steel cylinder, valve and 3000 lb. gauge that shows available remaining pressure. **REFILLABLE** at nominal cost. Hose included for emergency tire inflator or air blast. Wt. 4 lbs. **\$19.50** value. Special... **\$6.95**

HEATING & VENTILATING FAN

(Item 10) Easily installed in furnace pipes. Forces even heat to all rooms. Over range removes kitchen smoke and odors. Powerful continuous duty motor. 110-120 V. A.C. Quiet, super efficient fan moves huge volume of air (400 to 600 c.f.m.) 8" Fan, wt. 5 lb. **\$6.35**; 9" Fan, wt. 6 lbs. **\$7.45**; 10" Fan, wt. 7 lb. **\$8.45**; 12" Fan, wt. 8 lbs. **\$9.45**.



CARRY-AIR

(Item 32) Stainless steel tank—capacity 500 cu. in. at 400 lbs. press. complete with inlet and shutoff valves, press. gauge, detachable air hose, tire chuck. Fill at any service station. Carry air for tire inflation, blowing out lines, spray painting, insecticides, etc. One emer. agency pays back cost. Wt. 10 lbs. Worth \$20.00. Our price... **\$8.95**
(Item 55) With larger tank (1000 cu. in.)... **\$10.95**



RUBBER HOSE

New genuine Neoprene Hose—outlasts ordinary rubber 3 to 1. Reinforced with super tough cotton cord plies. Flexible. Easy Flo brass couplings with standard pipe threads for quick connections, included. Pump water for irrigation, stock tanks, home, barn, fire fighting, etc. Pump Gas or Fuel Oil. Save more than 60%. (inside) **1 1/4" 14.75 1 1/2" 14.75 1 3/4" 14.75** Length 25 ft. 40 ft. 30 ft. Price **9.25 14.75 14.75** If specified we will send special hose for gas or oil at same prices.



TERRIFIC VALUES!

AIR HOSE

(Item 11) 1/4" Diam. heavy duty, double braid, suitable for gas stations, spray painting, air tools, etc. 20 ft. with standard swivel couplings. Wt. 4 lbs. Reg. \$8.50 val.—only **\$2.95**. Five 20 ft. lghs. (100 ft.). Wt. 20 lbs. Only **\$13.75**.



EXTENSION CORD

(Item 16) 40 ft. heavy duty, made of specially insulated No. 14 2-conductor wire. So tough that you can drive over it and yet amazingly flexible and easy to handle. Resists oil, grease or water. Extends electricity up to 400 ft. without voltage drop. Use indoors or out. Complete with heavy rubber plug and outlet. Wt. 2 1/2 lbs. Usually \$4.50—Special 40 ft. **\$1.99** Comb: 2-40 ft. and 1-20 ft. (total 100 ft.) **\$4.95** 100 foot length (one piece)..... **\$4.85**
TRENCH-LAY WIRE (Item 51) Anaconda #10 —2 cond., for buried service to barns, outdoor lights, etc. Absolutely impervious to soil and moisture. Wt. 25 lbs. per 100 ft. Special surplus price: 100 ft. coils, **19c per ft.**; 250 ft., **18c per ft.**; 500 ft., **17c per ft.**

POTTERS WHEEL

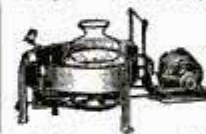

(Item 47) Complete, prof. equip. for making finest ceramics and pottery. Large dynamically balanced cast-aluminum reversible turntable with variable speed drive (38 to 140 rpm) controlled by foot-pedal. Built-in adjustable arm rests, water cup and wedging wire. 16x12" enclosed throwing table—ample area for largest pieces. Reg. 1/4 hp. motor (not incl.). Can be set up on 20x24" table and stored on edge. Complete with pulleys, belts and instructions. Wt. 26 lbs. **\$145 value at... \$59.95**

GEM CUTTER

(Item 49) Complete Prof. Lapidary mach. for cutting, shaping, grinding and polishing precious and semi-precious stones. Precision built with big horiz. power driven gem cutter, built-in cutting lubricator; genuine 6" supercharged diamond saw, lap wheel, abras. whls., 2 scratch whls., 4 felt whls., grinding and polishing compounds, brushes, dop cement and sticks, cutting oil, ext. cord, asstd. gems, complete instructions. Requires 1/4 hp. motor (not incl.). Wt. 22 lbs. Worth \$99.50. Our Special... **\$39.95**



ELECTRIC HAND SAW

(Item 36) Most perfectly balanced and smoothest running saw made. Advanced design provides power and light weight. Easily adjusted for all angles, depth and width of cut. Comes complete with 6 1/4" comb. blade, ripping guide and 10 ft. hvy. duty cord. Built-in saw-dust blower. Autom. telescoping guard. 110-120 v. AC-DC. Depth of cut 2 1/8". 1 year written guar. Wt. 12 lbs. Drastically reduced... **\$39.95**



SPRAY OUTFIT

(Item 37) Twin cyl. piston type compressor direct-connected to powerful 110-120 v. AC-DC motor. Built-in air tank eliminates pulsation and provides steady flow of air at 25-30 lbs. Sprays lacquers, enamels, insecticides, etc. Does beautiful work on autos, furniture, farm equip. 1 qt. spray gun, relief valve and 10 ft. air hose incl. Full instructions and 1 year guar. Wt. 11 lbs. Regularly \$50. Spec... **\$22.95**



ANGLE DRILL

(Item 23) Fits into chuck of any electric or pneumatic drill or flex. shaft. Operates at any angle in a full 360° arc. Makes possible drilling, grinding, carving, routing, etc. in close cramped quarters. Makes impossible jobs easy. Made by Kett Tool Co. Complete with built-in chuck (1/4" capacity) and adjusting key. Hardened alloy gears. Precision built for heavy duty. Lists at \$39.95—while they last... **\$9.95**



G. M. HI-FLO PUMP

(Item 56) 210 gal. per min. Centrifugal turbine type. Unexcelled for fire-fighting, irrigation, sprinkling systems, swimming pools, drainage, fuel transfer, etc. Built by GM for the army at cost of more than \$145. Tremendous volume, will deliver 210 gpm with 5.3 hp. down to 40 gpm with 1 1/2 hp. 2 1/2" stand. pipe thr. inlet (can be reduced to 2" if desired). Twin 1 1/4" outlets, dynamically balanced, 3/4" shaft, hi-speed ball bearings. Easy fast priming. (instr. incl.) Wt. 36 lbs. Sensational value... **\$39.50**



PRESSURE SWITCH

(Item 30) Penn Electric Model 110 BPO2, best made. For pumps and air compressors. Heavy duty. Will handle up to 250 lbs. press. and up to 5 h. p. Autom. unloader valve, for easy starting. 110-220 v. A.C. or D.C. 2 pole. Wt. 5 lbs. Reg. list \$17.50. Our Spec. **\$9.45**.



All items brand new. Prices f.o.b. Chicago area. 10 day Money back guarantee. Send check or M. O. **MASTER MECHANIC MFG. CO., DEPT. 48 Burlington, Wis.**

There's No Age Limit For Mountain Climbers

(Continued from page 137)

shoes are worn. Rubber soles are best on dry rock; felt or hemp on wet.

No boot or shoe, however, can keep you on a mountain if you don't assume the right position in climbing. The natural tendency when you get up on a high place where a fall might be your last is to cling like ivy to a college wall. But this is one case where you abandon instinct.

"You can't hug a mountain and climb it at the same time," explained Exum. "The body must be kept well away from the rock. Otherwise, the frictional advantage is lost. As much of the body weight as possible should be brought to bear on the feet. Another point—always test the rock before putting your weight on it. And this is vitally important—never fail to have at least three points of contact with the rock. That is, two feet and one hand, or one foot and two hands."

If the point of ascent is icy or covered with frozen snow, you can unsheath your ice ax and cut yourself some steps. After you get good, you can use that same ice ax for descending a snow field down the mountain. This is glissading or skiing without skis. The ice ax serves as an anchor.

Now, let's suppose you have decided to climb the Tetons during the summer with Exum or one of a half-dozen of his other guides in the park. You pick a date sometime between about June 15 and September 30 and at least a month before then you start getting yourself in shape. Plain, ordinary hiking or cycling is good. An office worker climbed 23 stories of stairs every morning for two months to get ready for his Teton ascent.

You arrive a week early to get used to the high altitude. The valley itself, once an outlaw lair and now bustin' with dude ranches, is about 6700 feet in altitude. From the valley you get an abrupt view of one of the most stupendous outcroppings of granite in the Western Hemisphere—a 7000-foot rise without foothills.

The Grand, Middle and South Tetons are the historic Trois Tetons of the early French voyageurs. More than a century ago, trappers ignored the North Star and charted their course by the Tetons. They are ideal for climbing because of the firmness of the rock.

The day's mountaineering class is conducted above Hidden Falls, a spot complete with pitches, overhangs and chimneys. Before you try these, you learn such fundamentals as tying knots and belaying, and

(Continued to page 234)

NICHOLSON
U.S.A.
TRADE MARK

The trade-marks
everybody knows

BLACK DIAMOND
TRADE MARK

The files
everybody
likes

THAT'S a short way of saying that through outstanding quality, unsurpassed value, and wide variety, Nicholson and Black Diamond brands constitute the most extensively used files in the world.

They're the leading choice among expert mechanics, industrial concerns, tool, die and instrument makers, "veteran" amateur craftsmen, and others whose experience has afforded opportunities for comparisons.

The sweeping Nicholson guarantee of *Twelve perfect files in every dozen* carries assurance that each file is *properly shaped and balanced, accurately cut, evenly hardened* and made of the *finest steel* obtainable for the purpose. At good hardware stores everywhere.

Free Book, "FILE PHILOSOPHY"
48 pages packed with illustrations and facts about kinds, use and care of files. Write for your free copy.

NICHOLSON FILE COMPANY

22 ACORN STREET
PROVIDENCE 1, R. I.

(In Canada, Port Hope, Ont.)

NICHOLSON
FILES FOR EVERY PURPOSE

enjoy
water
skiing

WITH A KIEKHAEFER

MERCURY
outboard
motor



"SUPER 10" HURRICANE
Sensation of the waterways.
Outruns, outperforms every
outboard in its horsepower
range — bar none! Loaded
with features no other out-
board can match regardless
of price.



FULL JEWELED POWER

Ball and roller bearings throughout . . . First in Mercury. In Every Mercury. Only in Mercury . . . Features of Mercury motors are protected by issued or pending patents.

KIEKHAEFER CORPORATION
Fond du Lac, Wisconsin, U. S. A.

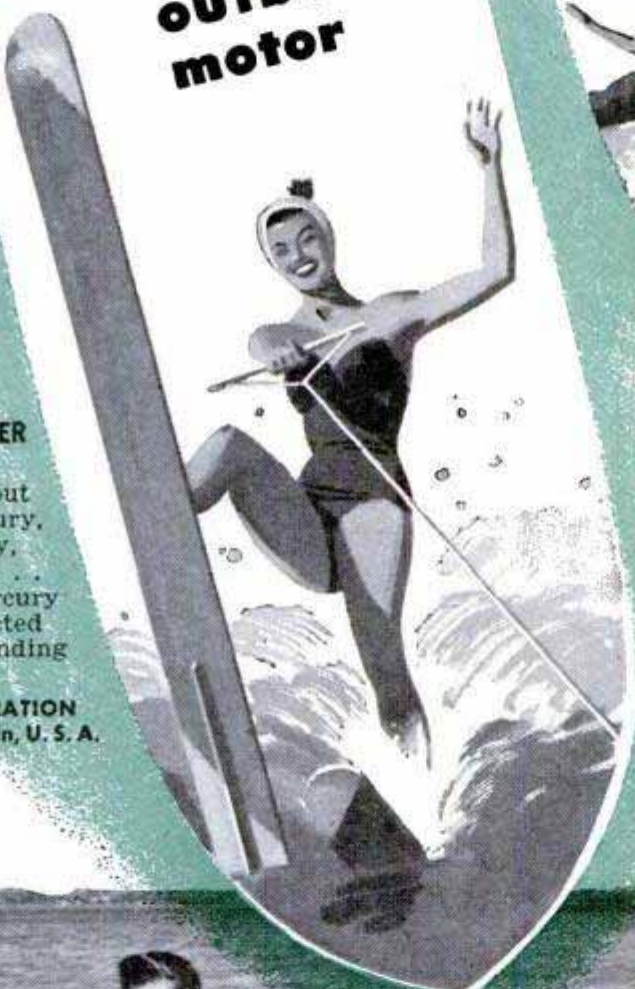

Your family will want to enjoy the thrills and fun of water skiing. And it's easy to learn. You don't need an expensive inboard power boat. Any one of four MERCURY models from the 7½ h.p. Rocket to the 25 h.p. Thunderbolt on your boat gives you plenty of speed and power for water skiing. See your MERCURY dealer for a demonstration.



free — "How to Water Ski With An Outboard" by Bruce Parker, world famous water ski instructor and champion. With these easy to follow instructions you'll be skiing the first day. Get your copy at your MERCURY dealer.

SWITCH TO

MILD

KENTUCKY CLUB

The Thoroughbred
of
Pipe Tobaccos



Get Fine Pipes at Worth-while Savings

— You bet it pays to switch to Kentucky Club. It's the thoroughbred of pipe tobaccos—choice white Burley specially blended to give you a mild, smooth smoke with grand taste and aroma. In addition, every package of Kentucky Club contains a valuable Dividend Coupon. Save these Coupons and get your choice of fine pipes at *big savings*. Beautiful pipes of imported briar made by expert craftsmen. 14 shapes. Do these two things today. Buy your first tin of Kentucky Club.

Mail coupon for free catalog.



FREE

Illustrated catalog showing Kentucky Club Dividend pipes and other premiums.

Mail Pouch Tobacco Co., Dept. 44
Wheeling, West Virginia
Please send—free—Kentucky Club
Catalog.

Name.....
Street.....
City..... State.....

body posture in climbing. Before supper you are rappelling over cliffs as if the feat were nothing more intricate than shoving a lawn mower—regardless of whether you are man or woman. About a third of the Teton climbers are women.

The next morning you are ready for the climb. Chances are it will be up the Grand, the highest in the park. It will provide the thrill of sitting on top of the world—providing, of course, you get to the summit.

You soon realize you must save your wind, so you don't talk much as you go up, up. Some of the climbers are complete strangers to you, but you feel a growing bond with them. Your thoughts steal from Benjamin Franklin, and you paraphrase him to yourself: "If we don't hang together, we will drop off the mountain separately."

You think this particularly as you leave the comfort of evergreen-covered slopes, start up bare rock crusted with patches of snow and ice that never fade. The wind begins to blow, and you wonder why it had to pick your particular day.

You welcome the rest periods. Lunch is oranges, sandwiches and chocolate that seem to have come from the heavens you are approaching.

More climbing. Loose shale. Careful here. Then treacherous, steepening slopes. You learn to spot quickly good handholds, good footholds.

Finally, you come to a rock wall that seems to go straight up for almost 50 feet.

"You are not going to climb that?" someone asks.

"That," says Exum, "is easy."

First, he shows you how to traverse a series of small ledges that come into view only as Exum points them out. Then, utilizing body friction for all it's worth, he negotiates the short chimney leading to the top of the pitch. And funny thing . . . you do it, too.

At last you are at base camp, where you will have supper and spend the night in a sleeping bag cached there for you. Top covering, a blanket of stars.

Early the next morning you gaze down canyon walls to the now distant green valleys and become eager for the final climb to the Grand's roof. You are glad that Exum has decided everyone in the party is equal to the task of going on up. You know all these people well now.

More ice and snow for you to scale, but your sense of caution is quickened and you keep an eye on the rope between you and the next man. Not tight. Not loose.

You come to the cooning place, a horizontal traverse 800 feet from the summit. Along the vertical wall is a crack. Maybe

(Continued to page 236)

WARNING! Your engine may have to last a long time! This spring swing to . . .

MARVEL *mystery oil*



Here's the perfect upper-lube to save the precious engine of your car — keeps valves free, ring and piston wear down. Definitely a must in high-compression engines, for greater pep, power and performance. Add Marvel Mystery Oil to gasoline, crank-case oil, or use in Marvel Inverse Oiler. *Be engine-wise and Marvelize now!*



Install a Marvel Inverse Oiler for proper and controlled feeding to critical upper cylinder areas. Visible supply in 1-qt. glass container.

Write for free information Dept. 118

EMEROL MANUFACTURING CO., INC. 242 WEST 69TH ST., NEW YORK 23, N.Y.

MUCH MORE SPEED FOR OUTBOARDS!



of all makes from 7½ to 50 HP on racing runabouts is provided with the famous Michigan "AQUA-JET" propellers. No rebuilding of lower unit is necessary. Each propeller is specifically engineered for the motor on which it is to be used. Other propellers for superior performance for practically every outboard in every application. Write for 1951 catalog, the "Outboarder's Bible," FREE. Michigan Wheel Co., Dept. 1-2 Grand Rapids 3, Michigan.

New ARMY MINE DETECTOR

An/PRS-1 is aOur portable device forSpecial detecting metallic andPrice non metallic objects. Metals, Buried Cables and sewer Tile.

\$30.25

with battery
\$19.75 without battery

By lengthening dipole rods operator will be able to increase the depth sensitivity. This unit comes complete with spare tubes, antenna dipole and reflector, and instructions manual, in wooden chest 9½" height x 28¼" length x 15½" depth. Weight in operation is only 22 lbs. LESS Batteries. Power supply: Three 45 volt and one 6 volt batteries. Uses standard batteries. Original COST \$364.00. Shipping weight appr. 80 lbs. F.O.B. New York. No C.O.D.'s. Send Order to:

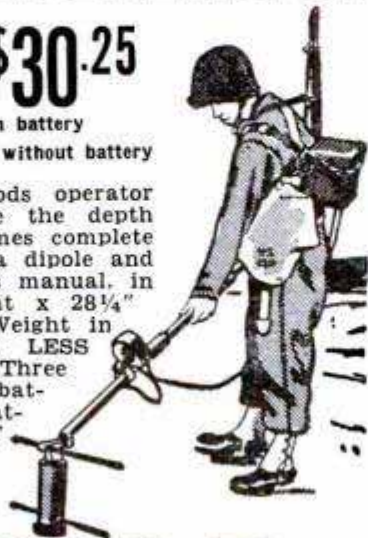

COLUMBO TRADING CO., INC.

383 CANAL ST. DEPT. P.M. NEW YORK 13, N. Y.

NEW! CHROME-CLAD

MEZURALL

"10-FOOTER"
TAPE-RULE
No. C-9210



Chrome-Clad Blade • Easier Reading
Longer Wearing • Self-Adjusting
End Hook • Replaceable Blades

Saves time . . . insures greater accuracy on all measuring beyond capacity of regular 6- or 8-ft. steel Tape-Rules. Permanent jet black markings stand out against non-glare chrome white background. Chrome-Clad satin finish will not chip, crack, peel, or corrode. Replaceable 10-ft. blade has safety catch for easy changing. Patented self-adjusting End Hook. Specify No. C-9210 10-ft. Chrome-Clad Mezurall. Also available with nickel plated blade, specify No. 9210.

BUY
LUFKIN

TAPES • RULES
PRECISION TOOLS
From Your Hardware or Tool Store
THE LUFKIN RULE CO.
SAGINAW, MICHIGAN

132-138 Lafayette St., New York City • Barrie, Ontario

Here's why Cars that **WASTE OIL**
are headed for
PREMATURE OLD AGE

OIL WASTE warns you that
rocking chair pistons
are wearing out
cylinder walls



SEND NOW FOR FREE BOOKLET:

"Inside Facts on Excessive Oil Consumption" brings you the facts about the 10 ways engines start to premature old age when you neglect to replace worn rings at first sign of oil pumping.

RAMCO RE-POWERING

with 10,000 Mile (or 1 Year) Guaranteed
Piston Rings actually
CURBS WEAR

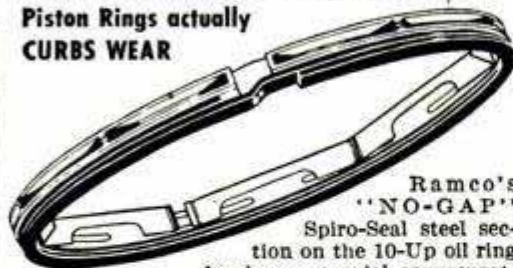

Ramco's "NO-GAP" Spiro-Seal steel section on the 10-Up oil ring develops a special compensating action that minimizes friction on the power stroke. Then, as the piston rises in cylinder, Spiro-Seal lessens its contact thus insuring adequate wall lubrication for exceptionally long life. This is one of many Ramco originations which make possible the control of oil in worn engines through STABILIZATION rather than pressure. See your repair shop displaying the RE-POWERING Sign... or write for free booklet. Send post-card to Ramsey Corporation, Dept. 3764, St. Louis 8, Missouri.



Copyright 1951, Ramsey Corporation 5409



25 feet long, two feet deep. You can take your choice—go "cooning" by crawling along the crack, or dropping your feet below and using the crack for handholds. Cooning looks safer. That's what you do.

You make the mistake—once—of looking down. Just air—for 3000 feet. You turn your eyes quickly away and sigh when you are back on safer rock. The mountain quiet is broken only occasionally by sounds of "On belay!" then "Climbing!"

Two hundred feet from the top Exum says:

"You can unrope now. No difficulties from here on."

Golden words. You half-scramble up that last bit of rock.

Then Exum grabs your hand and grins: "Congratulations! This is it—the top."

You understand how Dimitri Mitropoulos, conductor of the New York Philharmonic Orchestra, felt when he paused in a climb of the Tetons with Exum, gazed ecstatically off into the big beyond, and said:

"I have just two great loves in life. Music—and mountain climbing."

The Frozen-Fish Factory Goes to Sea

(Continued from page 77)

Though in normal operation the catch will travel from net to freezer in about two hours, it is possible for a fish to make the journey in five minutes. "The speed of processing is a big advantage over any previous method," says Bromfield. "Flavor is much better when the fish are frozen soon after being caught. Vitamin content is 50 to 75 percent higher than under the old system. Furthermore, the filleters can work faster because the flesh is firmer and easier to cut when fresh."

There are other advantages. Under the old system, fish were stowed in pens between layers of cracked ice. As the ship rolled its way back to port, fish on the bottom would be damaged by the shifting weight of those above. The jagged ice would tear them into mush. "Often," says Bromfield, "only the top layer of the catch would be salable for table use. Anywhere from 10 to 30 percent of the fish would have to be sold at a low price for fertilizer and animal food. On the Oceanlife, every fish caught commands a top price."

Bromfield still isn't satisfied. "All that gurry going over the side is a terrible waste," he says.

Already the hulls of two bigger and better floating factories are under construction. Twice as big as the Oceanlife, they'll be about 235 feet long. Besides freezing

(Continued to page 238)



The POPULAR Line of Portable Power Tools

*For Better Work...
Easier and Quicker*

**Have Hundreds of Uses Around the Home
In the Shop • On the Farm**

Embodied in every PET portable electric tool and accessory is the excellence and value developed through advanced engineering, modern streamline design, economical manufacturing methods, and the specialization in high-quality electric tools. Each represents the finest precision workmanship and quality features that contribute to dependable performance, trouble-free service, and a new balance and ease in tool handling. The various accessories available for use with PET portable electric tools have been tested and proved in the applications recommended. They conveniently extend the use of this portable power to a variety of jobs that make for easier and better work around the home, in the shop, and on the farm.

You can buy a PET portable electric tool from your dealer with the full confidence of getting the ultimate in the combination of economy, power, light weight, balance, operating convenience, and long life of trouble-free service. Use coupon for complete details.

ZEPHYR

1/4" Drill
Full 1/4"
Capacity
Lock-Type
Trigger Switch
Palm Grip
Price \$17.95



ZEPHYR

1/2" Drill
Streamline Design
Removable Side
Handle.
Price \$31.15



ZEPHYR

**Spraymaster Port-
able Spray Outfit**

For Paint, Lacquer,
Enamels, Mothproof-
ing Solutions, Etc.
Price \$24.95

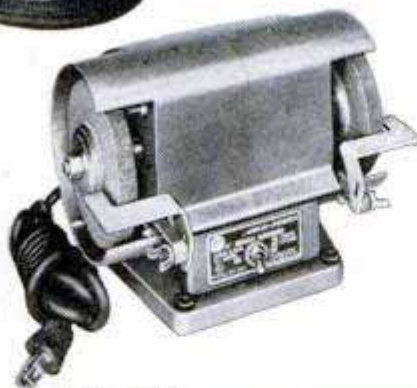

HI-POWER Bench Grinder
4" Diameter Wheels, 3500 RPM.
Price \$18.95

ZEPHYR

Electric Hand Saw

Maximum Depth of Cut 2 1/8". Adjustable for Depth
and Angle of Cut. Price \$41.95



At Hardware, Implement, and Building
Materials Dealers, and Department Stores
—Or Write Direct

PORTABLE ELECTRIC TOOLS, INC.

324 West 83rd St., Chicago 20, Ill.

In Canada: Portable Electric Tools, Ltd., 369 Danforth Road,
Toronto 13, Ontario.

Portable Electric Tools, Inc.

324 West 83rd Street, Chicago 20, Illinois

Please send me your new PET tool catalog and name of
nearest dealer.

Name _____

Address _____

City _____ Zone _____ State _____

Send Coupon Today for Full Information

**Best
Way
To
Fix**



CRACKED CEILINGS- LOOSE PLASTER



APPLY UPSON KUPER-KRAK PANELS

Have a beautiful new ceiling in a matter of hours!

Just four simple steps.
1. Nail furring strips on 16" centers right over old plaster. 2. Nail Upson Floating Fasteners to furring strips. 3. Clinch Fasteners into back of panels. 4. Apply mouldings.

No need to suffer an irritating ordeal of house-cleaning caused by replastering. You can do a beautiful job—have a modern crackproof ceiling—*quickly and at reasonable cost*. Panels are 5 plies thick—laminated for great strength. Distinctive pebbled surface—great for painting. Pre-sized. Hundreds of thousands of Upson Ceilings now in use. Mail 10c now for 32 page Idea Booklet and free Instruction Sheet.



Ingenious Upson Floating Fastener anchors panels securely from the back. Eliminates visible face nailing.

THE UPSON COMPANY

986 Upson Point, Lockport, New York

I enclose 10c for your 32 page Idea Booklet and free Instruction Sheet for applying Upson Ceilings.

Name _____

Street _____

City _____ State _____



plants, they'll have laboratories to test the quality of every net load of fish and to figure ways of keeping more flavor and vitamin content in the product. A second processing plant will take the gurry and convert it into useful by-products. Each ship will have a capacity of 1,000,000 pounds of frozen fillets. They'll be on the water in about two years.

"Fishing vessels of the future out of New England ports will all have to be of this type," says Bromfield, "if New England is going to stay in the fishing business." Meanwhile, his erstwhile scoffers are busy agreeing with him. "As long as we have Bromfields," they say, "we'll stay in business."

Fill 'er Up With LPG

(Continued from page 68)

LPG. In another position, it opens the LPG valve and closes the gasoline valve. In the third position, both valves are closed.

When you are running on gasoline and wish to change over to LPG, the switch closes the lines from both fuels until the engine consumes the gasoline in the float bowl of the carburetor. After running a block or two, the engine will cease to fire and then the switch is operated to open the LPG valve. After a few revolutions the engine will start and run on the LPG.

When running on LPG, to change over to gasoline the switch is simply moved from one to the other. The fuel pump fills the carburetor almost instantly and progress is resumed with the engine ceasing to fire only momentarily.

The engine starts readily on either gasoline or LPG. With gasoline there is a brief warming-up period until the inlet manifold becomes warm enough to help vaporize the gasoline. When starting on LPG, however, there is no need for warming up insofar as the fuel is concerned. It enters the engine completely vaporized and is ready to go when cold. However, the wise operator will take it easy until the engine oil becomes warm enough to circulate freely.

When running on LPG, the carburetor bowl is empty and the air from the fan keeps the bowl cool. Also the gasoline in the line remains cool. For these reasons, the engine will have a pronounced "flat spot" in it for a few seconds after the switch is made to gasoline even though the engine block is thoroughly warm and the heat indicator is up to operating temperature. The cold gasoline is dumped into a cold carburetor, but warms up very rapidly after the carburetor bowl fills.

When installing conversion equipment, it is necessary to anchor the tank securely

(Continued to page 240)

Yogi Berra SAYS

"I add water
only 3 times
a year"

PREST-O-LITE HI-LEVEL BATTERY...

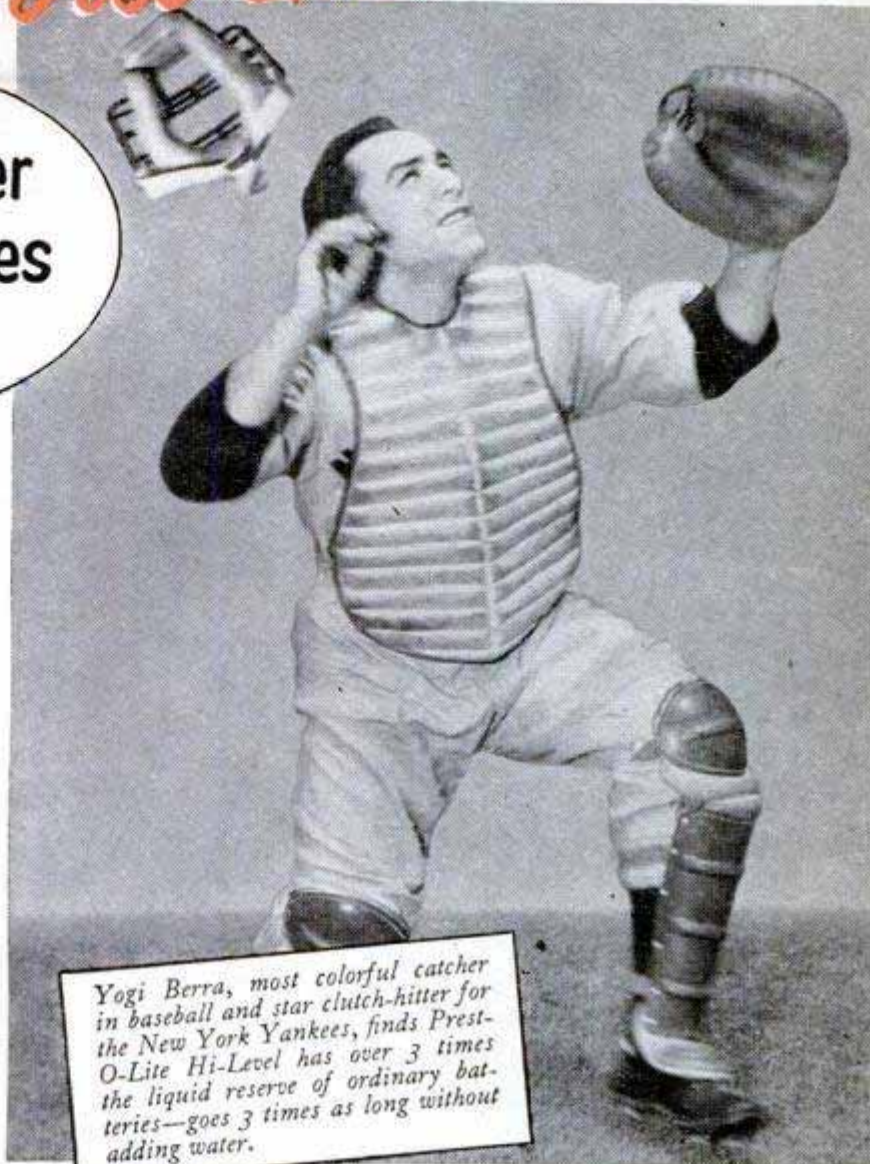

Yogi Berra, most colorful catcher in baseball and star clutch-hitter for the New York Yankees, finds Prest-O-Lite Hi-Level has over 3 times the liquid reserve of ordinary batteries—goes 3 times as long without adding water.

needs water only 3 times a year

IN NORMAL CAR USE

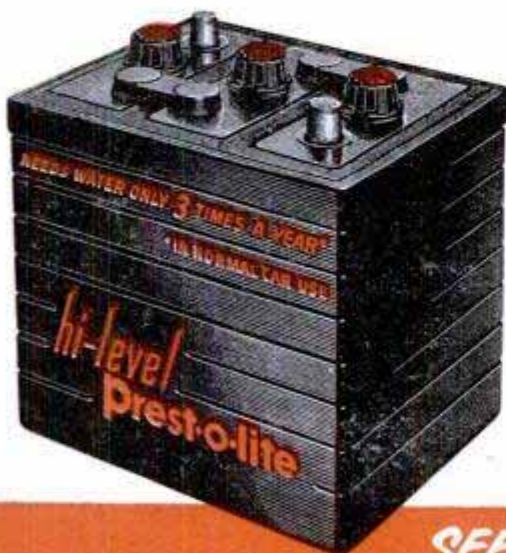

INSTALL a Prest-O-Lite Hi-Level Battery in your car and enjoy the comfort and convenience of this new principle of battery design. The Hi-Level Battery needs water only 3 times a year in normal car use and because of its advanced engineering design, it lasts longer, in tests conducted according to accepted life cycle standards. For quick starts and dependable service, see your Prest-O-Lite Dealer.

PREST-O-LITE BATTERY COMPANY, INC.
Toledo 1 Ohio

SEE YOUR PREST-O-LITE DEALER TODAY

YOU CAN'T BUY

finer
screw
drivers

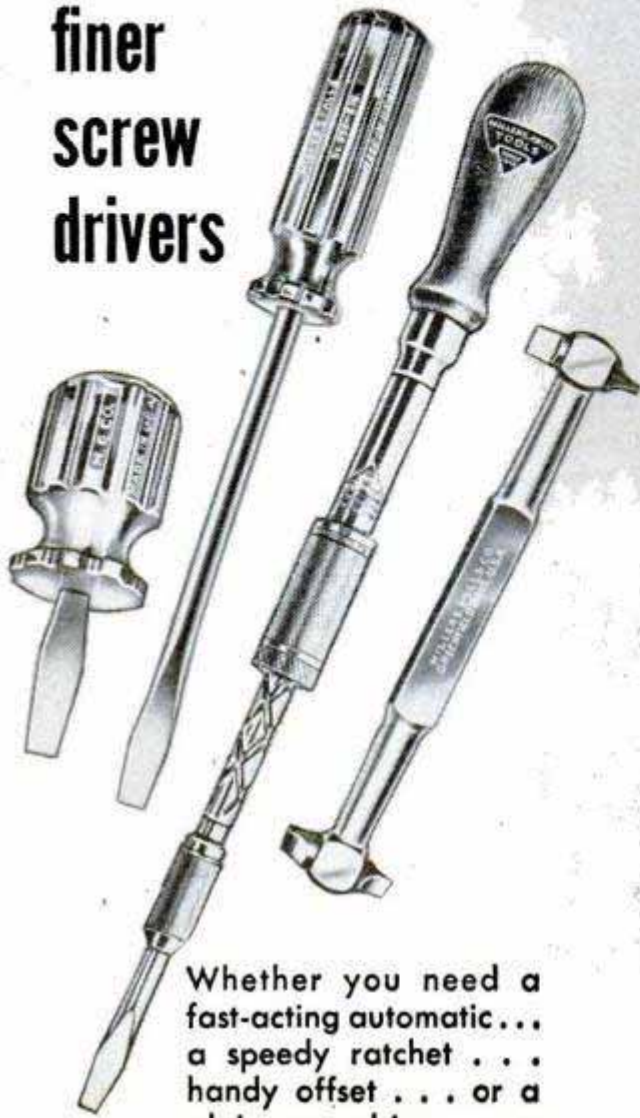

Whether you need a fast-acting automatic... a speedy ratchet... handy offset... or a plain screw driver — you can't beat a Millers Falls. Cross-ground blades of tough, high-grade steel, heat treated for long-lived hardness. Every blade torque tested. Make your next screw driver a Millers Falls — and get the best.

The Mark of Superiority.

**MILLERS FALLS
TOOLS**

SINCE
1868

MILLERS FALLS
COMPANY

GREENFIELD
MASS.

to avoid any movement of the heavy unit. High-quality copper tubing should be used and it should be covered with loom to prevent chafing on the chassis to which the pipe should be securely clamped. It is advisable to double flange the pipe in the SAE fittings with the aid of a suitable flanging tool. A coil, or loop, should be used on both sides of the filter to absorb vibration.

It is well to use a suitable sealing compound on the tapered threads of all fittings as the pressure is quite high. The smallest leak will result in considerable waste of the gas which is under pressure at all times. All joints should be carefully tested with thick soapsuds and a paintbrush just as soon as the LPG tank is filled and turned on for the first time.

The tank can be filled by any dealer in LPG that is equipped to refill the ordinary bottled-gas containers as the fill fittings are all standard.

As more automobiles, trucks, busses and farm tractors are being converted to LPG every day, it may not be too long before facilities for handling it will be widespread.



Headset Aids Blind Minister

In Mobile, Ala., a switchboard-operator's headset and mouthpiece are aiding a blind minister in his work. By using the gear, the Rev. Reese Farnell, Jr., is able to record in Braille the conversations he holds with the 50 or more persons he "visits" daily via telephone. The minister reads these notes with his fingers when he makes his next call to the same person. The Rev. Mr. Farnell uses the headset because the tool with which he punches out the Braille characters requires the use of both hands.

☐ Aureomycin, the germ-killing drug, now is available to dentists in three forms—cones, paste and soluble tablets—for use in combatting infections of the gums and teeth.

IT'S HERE . . .

IT'S DIFFERENT . . .

IT'S DYNAMITE . . .

DYNATONE

Deep, Mellow Tone MUFFLER

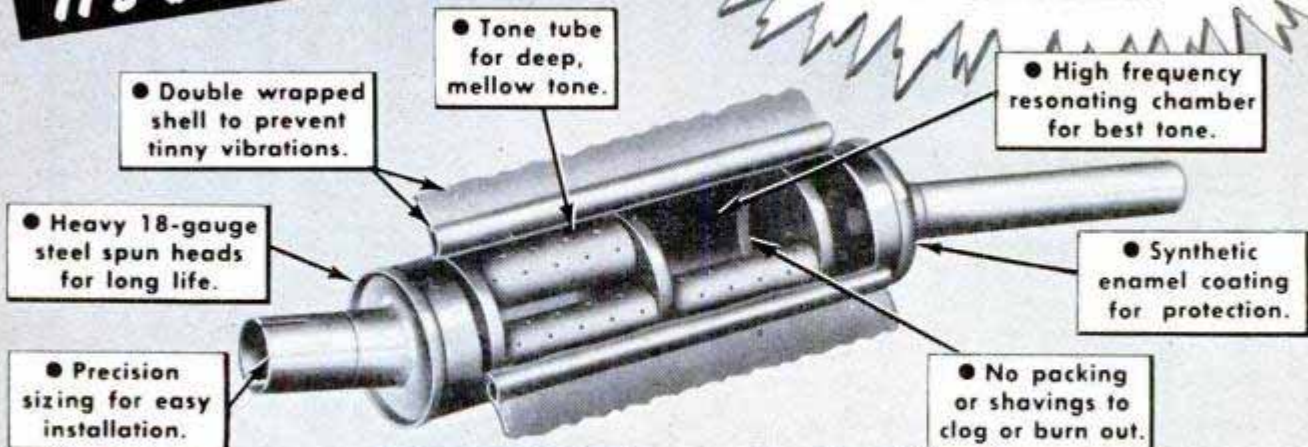

ENGINEERED—Not Packed

YET COSTS LESS THAN MOST HOLLYWOOD MUFFLERS!

The Dynatone has guts! It's the only special muffler engineered for your car. You'll go for its deep, mellow tone—and you'll go for these features, too —

- Lower back pressure
- More power
- More gas mileage
- Longer Life
- No tinny vibrations

Listen to a phonograph recording of the Dynatone at your automotive dealer. Or write us for the name of your nearest dealer.

GOERLICH'S 619 Smith Street • Toledo 1, Ohio



BUILD FINE GRANDFATHER CLOCK NOW

The simple sensible Red-i-Kut way as thousands have—SAVE HALF. SHOP TESTED PLANS "SPIRIT OF THE CENTURY" Narrow waist, 83" tall or stately straight side "SPIRIT OF AMERICA." EASY-TO-FOLLOW photopack PLANS tell all — plus BROCHURE of heavy brass weight Westminster, tube chime, movements, gorgeous dials, 3/4" solid mahogany case kits. Send \$1.00 today — Both Plans \$1.50 NOW.

KUEMPEL CHIME CLOCK CO., #4 Kuempel Bldg., Minneapolis 16, Minn.

MAKE MONEY
SAVE MONEY
BUY
SUPERSHOP

15 DAY
TRIAL



BUY SMART — \$79.95
FACTORY TO YOU

SUPERSHOP offers you a lifetime of power tool pleasure and profit. 100% ball bearing. RUGGED. Accurate. Big capacity. 15 day FREE trial. Money back guarantee. Mail postcard for FREE catalog. Buy on easy pay plan.

POWER TOOLS, INC. 124 YATES AVENUE
BELOIT, WISCONSIN



VERTICAL
DRILL PRESS

NOW ANYONE CAN PUTTY WINDOWS

with the

DUO-FAST PUTTY KNIFE

NEW EASY FAST

Does a perfect job. Packs—Shapes
—Trims putty. Makes a hard job
easy. Pays for itself on first win-
dow. Get yours, today! It will be
your favorite tool!

See \$100

Your Hardware, Paint, Glass or
Lumber Dealer—OR Order Direct.
ONLY \$1.00 POSTPAID IN U.S.A.

Duo-Fast PUTTY KNIFE FASTENER CORP.
864 Fletcher Street, Chicago 14, Illinois

I am enclosing \$1.00 — please send me one Duo-Fast
PUTTY KNIFE

NAME _____

ADDRESS _____

CITY _____ STATE _____

SEND FOR IT!

1951 ALLIED RADIO & TV CATALOG

free!

**COMPLETE UP-TO-DATE
EVERYTHING IN RADIO & TV
AT LOWEST PRICES!**



212 PAGES OF VALUES

Everything for Experimenters, Builders, Amateurs, Servicemen, Engineers and Soundmen..

Save money on every Radio and TV need! Get the big 212-page 1951 ALLIED Catalog featuring the world's largest stocks of top-quality equipment at low, money-saving prices! See the latest TV releases, home radios, radio-phonos, Amateur equipment, P.A. systems and Hi-Fidelity Custom Sound, recorders, test instruments, builders' kits—plus thousands of parts, tools, books and diagrams. Get more for your money from the World's Largest Radio Supply House. Send today for your FREE 1951 ALLIED Catalog!



TV, HOME RADIOS & RADIO-PHONOS



SERVICE SUPPLIES BUILDERS' SUPPLIES



AMATEUR GEAR



P.A. SYSTEMS RECORDERS

free CATALOG
Send For It!

ALLIED RADIO

ALLIED RADIO CORP., Dept. 5-F-1
833 W. Jackson Blvd., Chicago 7, Ill.

Rush FREE 212-Page Catalog No. 126

Name _____

Address _____

City _____ Zone _____ State _____

HAVE FUN!

with Your Own OUTDOOR FIREPLACE

It's easy to build yourself! Just add masonry—to your choice of design—around one of these all-metal units and you have an outdoor fireplace that works right. Costs less! A true recreation spot—for family or guests—right in your own yard. Everyone loves to cook and eat outdoors! Choice of sizes and accessories available. See your dealer, or send check or money order



Model OF-28 Only \$20.95
Size 21"x26"x13 1/2"

THE MAJESTIC COMPANY
367 Erie Street, Huntington, Indiana



56 Pages

DESIGN BOOK

25¢

WRITE FOR COPY TODAY

FULL OF IDEAS

Coated! Featherweight! 16x50 \$69.50



The ultimate in a fine binocular. Tremendous power. Featherweight (weighs only 31 ounces!). Precision made in every detail. COATED providing sharper, brighter images. Individual focus. Objective lens is 50 MM (2 inches) across! UNCONDITIONALLY GUARANTEED. Complete satisfaction or your money refunded. Prices include genuine leather carrying case and straps. Add tax. \$2.00 deposit required on C.O.D.'s. Cash orders prepaid.

United Binocular Co., 9043 S. Western, Dept. ARF-2408, Chicago 20

BULL DOG HITCHES

Heavy Drop Forge Steel Construction. Strong — Safety-Engineered Reliable



Model No. 1-B
NOW ONLY \$4.95
Post Paid (when paid in advance)

Made for trailers with up to 2,500 pounds capacity.
1 3/8" dia. shank Fits 1 1/4" pipe tongue

HAMMER BLOW TOOL COMPANY
Wausau 13F Wisconsin

MAKE MONEY POLISHING FLOORS . . .

You can when you have your own Floor Polishing & Maintenance Service. Write for free plans and ideas on how you can easily get started in this money-making business. Send a postcard to:
MCCANNA SUPPLY CO., 148-E East 40 Street, New York 16, N.Y.

\$ Free Course! Big Profits! \$ Flocks & Sandblasts



Dual Purpose Spray Gun! Uses only 25 lbs. Air Pressure
• Thousands of uses in Home, Shop, Industry: Makes Auto Interiors Clean & New, Lines drawers, Marproofs lamp bases, Refinishes any object. All in colorful Flock. Etch & Frost windows, glassware, etc. Removes Paint & Rust from Autos, Tools. Guaranteed! Send \$24.75 or write for free information. Flocking supplies!
BLASTO SPRAY GUN MFG.
Dept. PM-6, 7007 Haas Avenue, Los Angeles 47, Calif.

Thompson BEATS the World on BOATS



Better Built Lower Prices



Safe Boats With Full Length Spray Rails
Keep passengers perfectly dry—even at high speeds. Catalog also shows two new models of "Take-Along" Boats. Two big factories—save you freight.

CATALOG FREE
Write for your copy. State kind of boat in which you are interested.
THOMPSON BROS. BOAT MFG. CO. (151)
213 Ann St. PESHTIGO, WIS. (Write to either place) 113 Elm St. CORTLAND, N.Y.

NOTHING LIKE IT AT THE PRICE for POWERFUL, FAST CUTTING PRODUCTION

Model 2000 — with straight-line reciprocating action that guarantees scratch-free surfaces — is a fast-cutting production sander for heavy-duty craft and woodworking projects — for hobby work, refinishing and redecorating. It gives you the added stroke and power required for furniture and cabinet making, boat building or refinishing, resurfacing large areas, sanding plastics, leather, etc. Great for building operations such as woodwork, dry wall joints, siding and other exteriors. Also does a superb wax-polishing job! Buy it, try it, compare Model 2000 with any competitive electric sander. You be the judge!

OUTSTANDING Model 2000 FEATURES

- 21 sq. in. sanding surface • weighs only 5 lbs. • easy one hand operation—just guide it • only 2 moving parts • requires no oiling • cam-type holder permits 10-second paper change • dust-proof, fool-proof, fully guaranteed • over-all size 3 1/8" x 4 1/2" x 7" • operates on 110-120 v. 60 cycle, A.C.

ONLY
\$24.50

WITH STEEL
CARRYING CASE
AND COMPLETE
ACCESSORIES

14,400
Sanding
Strokes
Per
Minute

New DREMEL Electric
MODEL 2000
SANDER • POLISHER



POPULAR GIFT
FOR FATHER'S DAY!

WHERE TO BUY DREMEL SANDERS

If your dealer can't supply, send full remittance for postpaid shipment. Or send only \$2. and pay postman balance plus postage and C.O.D. fee. Money back if not delighted after 5 days' trial.

DREMEL MFG. CO., Dept. 111-F, RACINE, WIS.



LIGHTER CAPACITY MODEL "A" FOR ALL HOUSEHOLD SANDING-POLISHING JOBS

Housewives, homeowners, hobbyists go for Model "A". Over a quarter-million now in use! Perfect for all household sanding, polishing, refinishing. Also a soothing massager. Only 2 1/2 lbs.; sanding pad 2 1/4" x 5 1/2". Same construction features as larger Model. With 6 sheets \$14.85 sandpaper, sheepskin, felt pad... Only

BEFORE YOU BUY ANY
SANDER
COMPARE!
BE SURE YOU WILL GET
A SCRATCH-FREE FINISH

ROTARY

Action
About 50 %
cross-grain
motion



ORBITAL

Action
Partial
cross-grain
motion



ARC

Action
100 %
cross-grain
motion



DREMEL
Reciprocal
Action
100 %
WITH
THE
GRAIN
motion
for
scratch-free
finishes

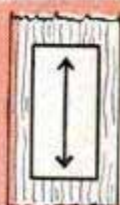

SAVE YOUR LIFE!

Cutter Snake-Bite Kit. Be prepared for emergencies with a Cutter Suction Snake-Bite Kit. Easy to carry—light, small as pocket knife. Contains 3 rubber suction cups, antiseptic, knife blade, lymph constrictor, first aid instructions. Suction treatment only first aid method medically approved. Also used for insect bites.
Sold in drug and sporting goods stores. If not available, send \$2.00 cash, check, M.O. (no C.O.D.'s) to: Cutter Laboratories, Berkeley, California, Dept. S-6.



BEAUTIFIES
natural wood,
pine paneling

POLISHES
furniture,
woodwork

IMPROVES
paint jobs

PROTECTS
wood and
metal surfaces

THE BEST
BUY FOR
EVERY
HOME



101 HANDY HOME USES!

Every home, every workshop, needs Pol-mer-ik BOILED Linseed Oil. Available at all stores. Free folder tells you how to use it. Write Dept. 603 . . .

ARCHER-DANIELS-MIDLAND CO., Minneapolis 2, Minn.

CAR OWNERS Save gas! Cut repair bills!

NEW
Stewart-Warner
**MOTOR
MINDER**



Only
\$10.95

quickly pays for itself in savings

Now, with just a glance at your instrument panel, you know how to get more miles per gallon . . . how to spot engine trouble *in advance*. Clearly marked illuminated Motor Minder dial warns against below par performance of spark plugs, carburetors, valves, timing, piston rings, manifold and other troubles. Motor Minder gives a constant check on engine performance with the same accuracy factory-trained mechanics use in motor tune-ups. You can do it as you drive, *before* costly major repairs are required. Easily attached on instrument panel or steering post. Install it today. Save gas, spot trouble . . . and enjoy a new driving thrill!

See your local dealer or write

Stewart-Warner

Instrument Division, Dept. N-61

1840 Diversey Parkway • Chicago 14, Ill.

STANLEY TOOLS

make "fix-ups" fun...



With easy-to-use Stanley Tools it's fun to do odd jobs and make things for your home. The tools shown here will help you achieve professional quality in your work. Look for the STANLEY trade mark at your hardware dealer's for fine tools at reasonable prices.



STANLEY LEVEL NO. 257
Sugar Pine with four "matched" protected glasses. A tool you'll be proud to own.



STANLEY JACK PLANE NO. 5
The most used plane in the world. 14" long, 2" cutter.

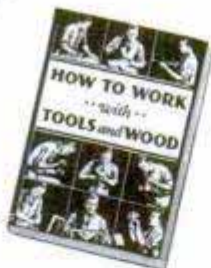

STANLEY TOOLS • NEW BRITAIN, CONN.
THE TOOL BOX OF THE WORLD

STANLEY

Reg. U.S. Pat. Off.

HARDWARE • TOOLS • ELECTRIC TOOLS
STEEL STRAPPING • STEEL

MAIL NOW!

Stanley Tools, 361 Elm St., New Britain, Conn.
(In Canada: Send to Stanley Tool Co. of Canada, Ltd.
361 Stanley St., Roxton Pond, Quebec)
Send me "How to Work with Tools and Wood". I enclose \$1.00

Name.....

Street.....

City..... State.....

↑ This popular "Know-How" book... only \$1.00. 188 pages on tools and woodworking.

Local Colorcretors Can Earn High Incomes

COLORCRETE is today's biggest business opportunity in the building field. High returns from a low investment. Easy, fascinating work. Large waiting market because Colorcrete is applied over all kinds of old and new masonry surfaces — exterior and interior.

Beautifies and Protects All Types of Buildings



Pneumatic pressure sprays plastic-like Colorcrete to give enduring beauty and water-resistant values. Range of 30 gleaming colors; many textures. Easy to wash. Smartly modern. Write or wire today for Opportunity Portfolio, which gives complete story.

COLORCRETE INDUSTRIES, INC.
570 Ottawa Ave., Holland, Mich.

SET-UP - KNOCKDOWN SAWHORSE with Jiffy BRACKETS



No nails or bolts... use 2x4's for legs, 2x4 or wider for crossbar. Easy to move, saves storage space. Buy at hardware or building material dealers, or direct.

GRAND HAVEN STAMPED PRODUCTS CO., Grand Haven, Mich.

BUILD YOUR OWN FAN



One-piece cast aluminum propellers for cooling and ventilating

Size	Polished	Unpolished	Bore
15	\$3.00	\$4.00	\$2.50 \$3.00
18	3.75	5.00	3.00 4.00
20	4.00	5.50	3.25 4.50
24	4.50	6.50	4.00 5.50

Write for pamphlet on larger fan blades, wire guards, fan bases, shutters, pillow blocks, exhaust fan frames, etc. Shipped prepaid if money accompanies order. Dealers write for discount.

KLOPPENBORG ALUMINUM FDY., Dept. PM-551, Davenport, Iowa

BUILD YOUR OWN FAST FREEZER

PLANS \$1



It's easy to build this household appliance with LeJay Plans. Made from new or used parts. Save up to 75%. No expert knowledge needed. Plans show 5 sizes and are easy to follow. All details clearly explained. Enjoy making one of these freezers. Mail \$1 for set of plans and catalog. LEJAY MFG. CO., 447 LeJay Bldg., Minneapolis 8, Minnesota.

17 FOOT 2 INCH KLEPPER FOLDING BOAT for SAIL, PADDLE or MOTOR

PORTABLE:
Pack up in 2 bags for car, air, or train travel

KLEPPER CO.
Dept. PU
1476 Broadway, New York 18



Send for Catalogue!

unsinkable AERIUS

Now, a G-E sealed beam type headlamp for BIKES!

Gives more light, does not grow dim!



Brings the same advantages to bikes as the famous General Electric "all-glass" sealed beam headlamp has brought to automobiles! Has own built-in reflector. Does not grow dim with age. Beam is five feet wide—thirty feet long. Operates on 5-volt hand-lantern battery or electrical generator used on bicycles. Now on sale at hardware and bicycle stores.

GENERAL ELECTRIC

SAY YOU SAW IT IN POPULAR MECHANICS

MODERN LAWN MOWER SHARPENER

FOR LAWN MOWER SHOPS
FIX-IT SHOPS

GOLF COURSES • PARKS
101 OTHER JOBS

Sharpens All Reel Type Mowers • Hand, Power or Gang • 10 to 20 Minutes • No Dismantling • No Extra Attachments Needed. All reel type mowers, from 5-inch edgers to 36-inch power mowers, are quickly sharpened to extreme ends of both left and right twist blades.

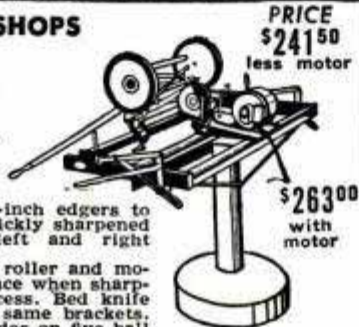

ORDER NOW
Immediate Delivery

Handle, wheels, roller and motor remain in place when sharpening is in process. Bed knife is sharpened in same brackets. Grinding head rides on five ball bearing races. Easy to operate. Also sharpens chisels, joiner knives, planer blades. Big profit maker. Own your own business. Send Today for FREE Illustrated Bulletin No. 10-C. Prices Subject To Change Without Notice.

MODERN MFG. CO. 160 N. FAIR OAKS AVE. PASADENA, CALIFORNIA

TUBE GIVEN WITH EVERY TIRE AT NO EXTRA COST



Why Pay More!

WRITTEN GUARANTEE SENT WITH EVERY TIRE YOU BUY

PLEASE NOTE: Our Tires are NOT Retreaded or Re-Capped. We Serve TRUCKS—BUSES—PASSENGER CARS

GOOD USED TIRES

WE PERSONALLY SELECT YOUR TIRES. A TRIAL OF ONE TIRE WILL CONVINCE YOU.

ONE QUALITY — ONE PRICE ONLY
TUBE GIVEN WITH EACH PASSENGER & TRUCK TIRE AT NO EXTRA COST — SEND THIS AD!

600-16	\$5.32	670-15	\$6.12	710-15	\$6.32	760-16	\$6.92
650-15	5.82	700-15	6.42	750-16	8.72	820-15	7.02
650-16	6.32	700-16	6.62	760-15	6.42	850-17	5.72



600-20	\$9.72	32x6(8)	\$11.72	1000-20	\$22.52
650-20	9.82	32x6(10)	12.32	1100-20	22.52
700-20	12.72	825-20	21.52	1000-22	19.52
750-20	12.42	900-20	17.92	1100-22	20.42

Thousands of tires shipped all over U.S.A. All tires shipped F.O.B. Phila. Send Check or M.O. with this ad. Dept. 2. If your size is not listed write for prices. 17 YEARS AT THIS ADDRESS.

STANDARD 834 N. Broad St., Philadelphia 30, Pa.

NEW! 6" Heavy-Duty Deluxe LECTRO-SAW

(Cuts 2" Lumber)

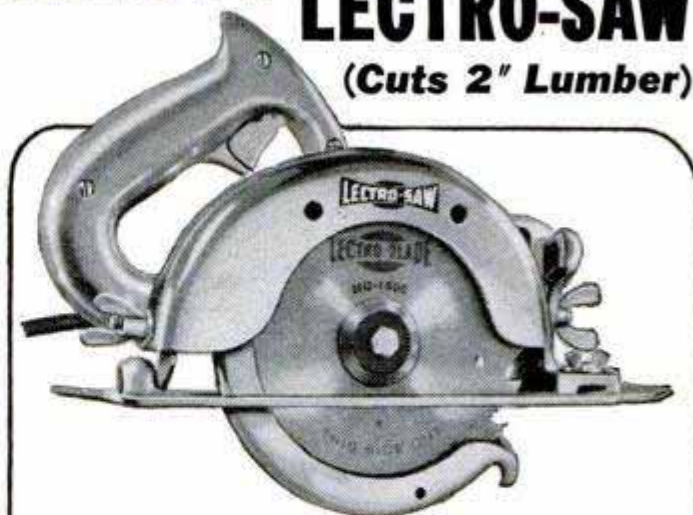

Fast Adjustment! Quick-changing, built-in depth and bevel adjustments permit cuts from 0" to 2" depth; bevels from 45° to 90°.

Power! Powerful universal motor specially designed and built by Black & Decker for non-stop, trouble-free power sawing.

Versatility! Makes most every cut in most all building materials with proper Lectro-Blade or Abrasive Disc.

Safety! Telescoping blade guard. Instant-release trigger switch. Saw-grip handle positioned for safe, easy control.

What speed! What savings!
WHAT A BUY for only \$76.50!

Cut hours off your building jobs, save money and materials with a great, new 6" Heavy-Duty Deluxe LECTRO-SAW! Beats hand sawing 10 to 1. Pays for itself in a few jobs. Close-coupled, perfectly balanced, easy to control. Extra-long life because of dependable motor, full-size ball bearings, high-quality helical gearing, hardened armature shaft, husky housings. Try one at your hardware or building supply dealer.



Bevel Adjustment Quadrant



Two Depth Adjustments (front and rear)



Products of HOME-UTILITY Div., BLACK & DECKER Mfg. Co., Dept. H6M, Towson 4, Md.

FREE BOOK FOR THE DEAF

An authoritative, brilliantly illustrated book, revealing all the facts on the new wonder electronic ear which hides deafness, will now be sent without cost or obligation to any hard of hearing reader of this magazine.

This amazing book discloses full details of the miraculous electronic invention which transmits even whispers with startling clarity—and without a button showing in either ear.

To obtain your free copy, simply address your request to: Electronic Research Director, 1450 W. 19th St., 3246 Beltone Building, Chicago 8, Ill. A penny postcard will do.



EASY PROFIT IN PAINT SPRAYING

Paints walls, ceilings, screens, furniture and machinery faster, better. All complete as shown less motor. Carry anywhere. Fully guaranteed. Could be used with 1/4 H.P. motor or less. Price \$35.00 less motor F.O.B. Chicago. \$5.00 deposit balance C.O.D. or see your dealer. With motor \$55.00.

IDEAL AUTOMATIC PUMP CO., Dept. P.M.8
801 W. Washington Blvd. Chicago 7, Ill.

FOR FABULOUS FISHING USE THE FABULOUS FLATFISH!

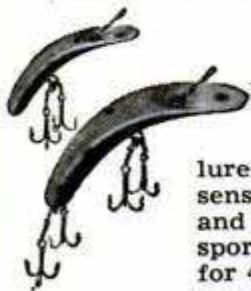

There's nothing like the fabulous Flatfish for insuring fabulous catches. World's largest selling plug. Over 7,500,000 sold. The only lure with offset hooking—a sensational feature. 18 sizes and 28 colors. At nearly all sporting goods stores. Write for 48-page book with fishing secrets of famous anglers.

HELIN TACKLE CO.

3669 Meldrum Detroit 7, Mich.



No Experience Needed To PRINT YOUR OWN POST CARDS

The GEM STENCIL DUPLICATOR saves money... gets results quickly! Hundreds of uses for every type of business and organization. We ship the GEM complete with all supplies, Guide Board for accurate printing and 60-page Book of Ideas at the special low price of only \$8.50 (a \$15 value).

FREE TRIAL OFFER

Use the GEM FREE at our expense! SEND NO MONEY. Write and complete GEM outfit will be sent you postpaid. After ten days, send us only \$8.50 or return the GEM. You must be satisfied!

BOND EQUIPMENT CO.

Dept. 48

6633 Enright • St. Louis 5, Mo.



'WRAP-ON' STOPS SWEATING PIPES
KEEPS BASEMENT PIPES DRY
Simply wrap on the Fiberglass insulation, then the flexible tape for neat cover protection—no mussy tools. Checks condensation that causes rusting and dripping. Keeps water colder. \$1 pkg. ppd. (or at dealer). Protects 17' of 1/2" pipe or 10' of 1". Also Mfrs. "Wrap-On" Cable (electric) to prevent frozen pipes.

GRO-QUICK, 371 W. Huron St., Chicago 10

Build your own JET ENGINE!



SEND NO MONEY

Order these plans today

1. JET PROPELLED BICYCLE, Assemble your own. Photo and instructions, \$1.00.
2. HOW TO MAKE EXPERIMENTAL JET ENGINES. Seven sheets drawings with information and instructions \$2.95.
3. BOTH OF ABOVE in one order \$3.75. SEND NO MONEY. Order both at once \$3.75 C.O.D. in USA plus e.o.d. postage. Send check or Money Order and we pay postage. Get other information too. Rush Order.

J. HOUSTON MAUPIN, Dept. 55, Tipp City, Ohio



TRICKS in WOODWORKING

—made possible by exclusive SHOPSMITH features—details, photographs, specifications—all included in 16-page SHOPSMITH book. Free.



SHOPSMITH, Dept. 167-B
12819 COIT ROAD, CLEVELAND 8, OHIO

SAY YOU SAW IT IN POPULAR MECHANICS



OVER 700% PROFIT!
WITH THE
PDQ CHAMPION PHOTOMASTER

Makes finished pictures in 2 minutes. Takes and finishes 30 to 40 everlasting, black and white or sepia photos an hour. No dark room. Guaranteed not to fade. Photos taken on "SUPER SPEED" direct positive paper. Picture size 2 1/2 x 3 1/2 in. Complete, easy-to-operate portable photo studio. Size 4 1/2 x 5 x 10. Wt. 6 lbs. 700% PROFIT. Write quick, get details about the great PDQ CHAMPION PHOTOMASTER.
P. D. Q. CAMERA CO.
1161 N. CLEVELAND AVE. Dept. PM-6 CHICAGO 10, ILL.

EVERY ELECTRIC DRILL

A PORTABLE SAW

9.95

Can Be Used With One Hand!
Any 1/4" or 3/8" Drill a Powerful Saw
in ONE MINUTE

At
Better
Hardware
Stores
Every-
where

with 4"
"HYCARBON"
Crosscut
Blade

"ARCO-SAW" is a rugged tool with
right angle gear drive (no clumps,
dangerous, direct drive with drill
sideways). Works like a high priced
Portable Saw.



Pat.
Pend.

'ARCO
SAW'

CUTS 1-5/16", or 2x4 by turning over
ONLY ARCO GIVES YOU ALL THESE
FEATURES: Safety-yoke assures
rigid connection and absolute safety—
Visual guide and wide shoe-
plate for straight, square cuts—
Big handle affords firm grip for
two-hand operation—Precision one-
piece gear box—Self-lubricating life-
time bearings—Lowest priced,
quality Replacement Blades.

"HYCARBON" 4" Crosscut or
4" Combination Blade . . \$2.00 ea.

90-day Factory Guarantee

ORDER TODAY at your dealer or send us check
or M.O. (Postpaid). C.O.D.'s—Postage extra

UNCONDITIONAL 10-DAY
MONEY BACK GUARANTEE

DEALERS—Write for
nearest jobber.

ARROW METAL PRODUCTS CO.

DEPT. PM-6, 140 WEST BROADWAY, NEW YORK 13, N. Y.

Genuine MAHOGANY Wood

Large Batch \$1.00 Postpaid. Other Usable Scrap Bargains Postpaid
Sample 25c — Price List 3c

S. R. MARKS CO., Inc., Dept. C-6, Montgomery 5, Ala.

ALL NEW 1951 KING MIDGET AUTO

World's Lowest Priced 2 Passenger Car

Drive it for 75c per week. Amazing performance. Surprising comfort. All steel construction. Full accessories, top and heater. Ready to run or assemble it with our bolt together parts. Rider agents wanted, earn your car free. Send 25c for detailed literature or \$1 (refunded first order) for actual assembly book and service manual filled with photos, drawings, specifications, etc.



MIDGET MOTORS MFG. CO.,
ATHENS 1, OHIO

S AGENTS 300% Profit **SIGN LETTERS**
For Store Fronts and Office Windows. Anyone can
put them on. Free samples. Liberal Offer to General
Agents.
METALLIC LETTER CO., 430 N. Clark, Chicago 10

Say You Saw It in Popular Mechanics

FINE TOOLS
NEED
FINE OIL!



• Lubricates



• Prevents Rust

• Cleans • Polishes

SOLD EVERYWHERE

3-IN-ONE Oil

JUNE 1951

POINTERS FOR HOME PAINTERS

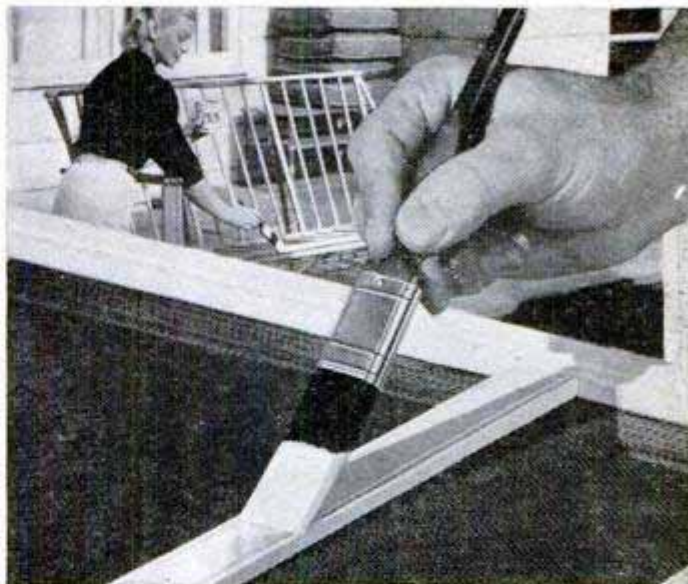

How to improve your paint jobs...
make your brushes last longer



Start in corners of walls,
ceilings and floors, and paint
away from them. Use a strong
stroke and work steadily so
paint doesn't set before ad-
joining strip can be applied.



Don't let your brush "fish-
tail" (see insert) by painting
narrow or round surfaces
with a large brush. Use small
brush—one designed for the
job—bristled with nylon.



Clean brushes with thinner
after daily use. Suspend
brush in thinner overnight.
Bristle tips should not touch
bottom of can. Work out
thinner before painting again.



When you store brushes
for longer periods, clean
thoroughly and wrap securely
in the manner shown here.
Brushes stay in better con-
dition when kept in shape.

For best results use NYLON PAINT BRUSHES

Job after job, you'll get best results with a nylon paint brush. Tests made by an independent research laboratory prove nylon brushes paint smoother. And durable Du Pont nylon bristles don't break off, even on roughest surfaces. They last 3 to 5 times longer than ordinary bristles . . . are clean and sanitary. Nylon paint brushes are made by leading manufacturers in all types and sizes. Look for the word NYLON on the handle.



Better Things for Better Living
. . . through Chemistry

The best brushes have
**DU PONT NYLON
BRISTLES**

247

P&C Hot Forged Tools

**Stay
on the
Job
longer**

Really tough jobs—in industry or at home—prove that special analysis alloy steel and scientific heat treating make P&C tools last longer. More than 300 P&C tools are easier and faster in everyday use or on special jobs. Your hardware dealer recommends P&C hot forged tools; ask him for the P&C tools you need.

Write for new folder on P&C tools —“the BEST tools money can buy”.

P&C

**P&C HAND FORGED
TOOL COMPANY
PORTLAND 22, OREGON**

**best
white tape
made**

ONLY
98¢*

The new “Evans White-Tape” has everything you'll find in tapes costing over \$1.50—plus.

- snow-white blade with bold, legible, jet-black numerals and graduations. Graduated in 32nds for first 6 inches.
- sturdy die-cast case heavily chrome-plated, calibrated for quick reading inside and outside measurements.
- blade 1/2" wide made of finest high carbon steel—tempered—Bonderized—enamelled—baked.
- blade replaceable in seconds—without tools—without even opening case. And Evans replacement blades cost far less.
- every “Evans White-Tape” is unconditionally guaranteed.
- exclusive Evans automatic brake gives smoother push-pull action with absolutely no “creeping” of tape into case.
- underside is white, too. Mark with ordinary pencil, remove mark with flick of thumb.
- unheard-of low price*: 10-ft. \$1.49; 8-ft. \$1.19; 6-ft. 98¢. Prices higher in far west and Canada.

Evans

& CO. • Newark 5, N. J.

Sold only through retailers.

Makers of Evans 6-ft. Folding Rule and “Folding Yardstick”



STOP DRIP

caused from condensation on cold water pipes. Turn idle basement space into play or work rooms. Keep store rooms dry. Just wrap cork-filled



NoDrip TAPE pipes and joints. Do it yourself. Clean and easy to apply. Roll covers about 10 feet of 1/2" pipe, \$1.69. Higher west of Rockies and Canada. Get at Hardware, Department Stores,

or sent postpaid. Write for free circular. J. W. Mortell Co., 522 Burch St., Kankakee, Ill.



**DEPENDABLE
CRAFT SUPPLIES**



LEATHER CRAFT • PLASTICS • POTTERY
CRAFT • BLOCK PRINTING • BELT CRAFT •
TEXTILE COLORS • POWER TOOLS • WOOD
BURNING • INSTRUCTION BOOKS • ETC.

DWINNELL CRAFT SHOP
Dept. PM-651—Wheeling, W. Va.



SHEET METAL BRAKES

Forms angles, flanges and Pittsburgh locks. 26 gauge steel, heavier aluminum. Cam locking. Portable, can be bolted to bench, or clamped to edge of truck. All steel, reinforced. Shipped Exp. Coll. 30" size. Wt. 54 lbs., \$26.50. 36" Wt. 66 lbs. \$31.00. 48" Wt. 100 lbs. \$45.00. Floor mountings, portable. 32" high, 30 lbs. \$7.00. 12" BRAKE. Fits in vise to form difficult compound bends, up to 20 gauge steel. Not illustrated \$12.50 PP. 5" Wide Pliers forms locks, "S" slips, etc. \$ 2.50 P.P. IRON BENDER. 1/4x2" capacity. 9 parts. All steel. \$10.00 P.P. Immediate Delivery. Order direct, cash or C.O.D. or send for folder. **VYKE BRAKE CO., P-1116 So. 27th St., Omaha 5, Nebr.**



LAWN ORNAMENT-NOVELTY PATTERNS

28 Lawn Ornament Patterns, 25c. Other Patterns; 15-20" high; Dutch Girl, Dutch Boy, Pirate, Bull Terrier, Mexican Girl, Mexican Boy, Dwarf, Penguin, Flower Girl, 10c each. 25 Novelty Patterns, 30c. All 62 Full Size Patterns, \$1.00 Postpaid. Strother Pattern Service, Dept. CG-8, Box 128, Belington, W. Va.

ONE-MAN SAWMILL LOW AS... \$50 DOWN

Take BELSAW Portable Sawmill right to the trees—turn out valuable lumber for local yards—do “custom sawing” for neighbors. BELSAW lasts a lifetime. No crew needed. Power with old auto engine. Beginners get excellent results. Send postcard for FREE BOOK, “How To Make Lumber.” **BELSAW MACHINERY CO** 8116 Field Bldg, 315 Westport Rd, Kansas City 2, Mo.

IMPORTED GERMAN BINOCULARS SAVE 60% 12 1/2 MILE RANGE

PRECISION LENSES 3.95 PLUS TAX

New, low cost binoculars from a famous German manufacturer of fine optical instruments. Center focusing adjusts to your own eye strength. Money back guarantee. Compare with glasses at \$15.00 or more! Send check for \$3.95 plus 80c tax... we pay postage, or order C.O.D.



MARYLAND DISTRIBUTORS
Dept. 255, 501 E. Baltimore St., Balto., Md.

GROBAN'S WAR SURPLUS SPECIALS

ALL BRAND NEW

FULLY GUARANTEED

DIRECT CURRENT GENERATORS



For welders, plating, truck and marine use, D. C. appliances, lights, etc. Aircraft quality — lifetime grease sealed ball bearings. Heavy duty.

Item #131—Brand new Electric Auto-Lite 12 volt Direct Current electric generators, rated 18 amps. Complete with blower and pulley. Use for trucks, tractors, loads, battery chargers, etc. Part No. GEP-4805A. In original sealed U. S. Army cartons. \$40.00 value. Shpg. wt. 27 lbs. F.O.B. Chicago. Now Only..... **15.00**

Item #90—Type P-1, rated 200 Amps.—28 Volts, 2500 RPM. Mfd. by General Electric, Ford, Delco-Remy and Westinghouse. Gov't. Acq. Cost \$300.00. Shpg. wt. 70 lbs. F.O.B. Chicago. **22.50**

Item #91—Type R-1, rated 300 Amps.—30 Volts. Mfd. by Jack & Heintz. Gov't. Acq. Cost \$380.00. Shpg. wt. 70 lbs. F.O.B. Chicago. Each individually packed in wooden box..... **35.00**

Byron-Jackson "PUP"

CENTRIFUGAL PUMP UNIT

\$3800.00 Value

COMPLETE WITH FULL ENGINE AND PUMP INSTRUCTIONS

2 STAGE MODEL "PUP" PUMP DRIVEN BY AN 8 CYLINDER MODEL C-36 CHRYSLER INDUSTRIAL ENGINE. ENGINE SPEED 2400 RPM — 100 H.P.

600 GPM AT 175 PSI — PARALLEL CONNECTION
300 GPM AT 375 PSI — SERIES CONNECTION

IDEAL FOR: Pick-up, Gatering, Fire Fighting, Salt Water Disposal, Sprinklers, Irrigation, Dewatering, Construction, etc.

These skid-mounted Pumping Units are standard production models with parts and service readily available. Designed for a wide range of operating conditions particularly where wide variation in head and capacity are required. Twin suction and discharge ports are cast on the same side and so arranged that external piping is interchangeable for either parallel or series pumping applications.

Overall dimensions, 114" L x 29" W x 62" H. Weight 4080 lbs. Now, complete with full priming equipment, operating instructions and performance data....

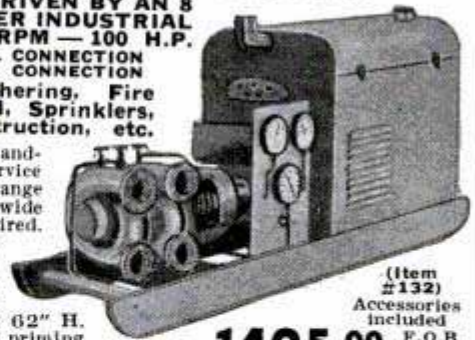

(Item #132) Accessories included F.O.B. Chicago

1495.00

Hydraulic Cylinders—Air or Oil

Large supply of new labor-saving, economical hydraulic equipment in many types and sizes. Use these positive, highly efficient smooth pressure hydraulics on presses, arbors, lifts, loaders, power control, positioning, brakes, plastic dies, auto frame alignment, etc., etc.

ITEM #70—Purrolator hydraulic oil filter. Permanent element type. 3/4" female pipe thread ports. Capacity 16 gallons per minute. A \$13.00 value. Now postpaid. **4.95**

ITEM #4—All steel double action hydraulic cylinder. 1 1/2" bore, 2 1/2" stroke. Clevis mounting. Will lift 1000 lbs. with 1000 P.S.I. line pressure. Perfect for positioning and feeding movements. **4.95**

ITEM #33C—Double action hydraulic cylinder, 1 1/2" bore, 4 1/2" stroke. Clevis mountings at both ends. Uses 1/2" pipe fittings. **8.95**

ITEM #32—Double action, 1 1/2" bore, 9" stroke, will lift 1760 lbs. with 1000 P.S.I. line pressure. Wt. 4 lbs. A \$45.00 value. **10.95**

ITEM #16C—Double acting hydraulic cylinder, 1 1/2" bore, 26" stroke. Will lift 1760 lbs. with 1000 PSI line pressure. Weight 8 lbs. A \$55.00 value. **16.95**

ITEM #103—Double acting hydraulic cylinder, 2 1/2" bore, 1" stroke. Clevis mounting. Will lift 4900 lbs. with 1000 PSI line pressure. 1 1/4" diam. shaft. 3/4" tubing thread ports. Overall length closed 28". Shpg. wt. 11 lbs. F.O.B. Chicago. **21.50**

ITEM #31C—Double action hydraulic cylinder, 3 1/2" bore, 11" stroke. Aluminum alloy cylinder wall and all steel 1 1/4" piston rod. Clevis mounting at base and shaft. 19 1/2" overall length closed. Will lift 9625 lbs. using 1000 PSI from Logan Heavy Duty Hydraulic Pump. Uses 3/4" tubing fittings. Value \$102.00. Ship- **22.50**

ITEM #6—Double action hydraulic cylinder, 3" bore, 24" stroke, will lift 7070 lbs. with 1000 PSI line pressure. Steel barrel, 1 1/4" stainless steel shaft. Gov't. acq. cost \$176.00. Shpg. wt. 26 lbs. F.O.B. Chicago. **28.00**

ITEM #42—Double action hydraulic cylinder, 4" bore, 18" stroke. Rated lift capacity with 1000 PSI line pressure is 12,500 lbs. Ship. wt. 30 lbs. F.O.B. Chicago. An Excellent Buy for..... **32.50**

new! HYDRAULIC SPEED REDUCER

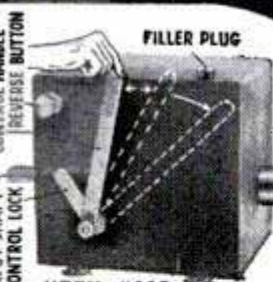

WITH FINGERTIP CONTROL

USE FOR: • Reamer Drives • Midget Cars • Feed Mills • Canning Machines • Conveyors • Lathes • Milling Machines • Motor Boats • Cream Separators • Garden Tractors • Pumps

Variable output speeds ranging from 0 to input speed now available. Merely move control handle until desired speed is attained. Then turn locking handle to maintain the setting. Internal relief valves prevent overloading. Use input power of 1/4 to 1 1/2 H.P. This Westinghouse-Oil Gear Unit converted to commercial use from 40 MM anti-aircraft traversing mechanisms consists of a variable displacement hydraulic pump feeding a fixed displacement hydraulic motor. These components are contained in a crackle-finish steel oil reservoir (capacity 2 qts.). Adjustable relief valves set at factory for 100 inch pounds of torque may be reset up to 180 inch pounds. Independent reverse control allows full output power and speed selection in either direction of rotation. Both input and output shafts measure 3/8" diam., include keyway. Input rotation is counter-clockwise facing shaft. Recommended input speeds not to exceed 750 R.P.M. Over-all dimensions 7 1/2"x7 1/2"x11 1/4". Gov't. acquisition cost, \$428.00. Shipping weight 26 lbs. Complete with 2 qts. of oil and full instructions. F.O.B. Chicago **54.50**

IMMEDIATE DELIVERY—LIMITED QUANTITY—BRAND NEW

GENERATING PLANTS

HEAVY DUTY — DESIGNED FOR CONTINUOUS OR INTERMITTENT SERVICE

3 KW—120 VOLTS—60 CYCLE Single Phase

PLENTY OF CURRENT TO OPERATE YOUR— • OIL BURNER • REFRIGERATOR • HOME FREEZER • SUMP PUMP • POWER SAW • BROODER • CREAM SEPARATOR • INCUBATOR • VENTILATING FANS • MILKING MACHINES • BLOWERS • YARD LIGHTING • OTHER APPLIANCES

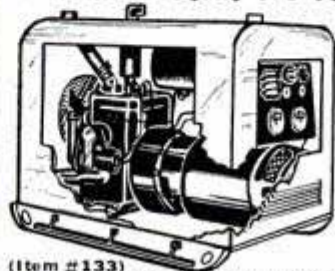

(Item #133) Totally enclosed power unit with 2 cylinder water-cooled Hercules Model BXB engine direct coupled to generator. American Bosch magneto ignition, crank start, 4 gallon gas tank, 3 qt. oil capacity. Skid mounted with handrails for carrying. Complete with full instrument panel including test light, circuit breaker, killer button, oil pressure and water temp. gauges, voltmeter and ammeter. Shipping wt. 560 lbs. F.O.B. Chicago

395.00

Write for information on other size generating plants ranging from 600 watts to 100 KW.

GENERAL MOTORS — ALLISON

BRAND NEW CENTRIFUGAL PUMP

200 GALLONS PER MINUTE

- For Draining Basements • Fire-Fighting • Irrigation • Fuel Transfer • Swimming Pools • Home Water Systems • Dewatering



This General Motors-Allison Centrifugal Pump—designed for use on U. S. Air Force Mustang fighters, now converted for commercial, home, and industrial high volume pumping applications. Inlet, 2 1/2" standard pipe thread, twin outlets with 1 1/4" pipe thread, ball bearing supported 3/4" shaft. Easy, fast simple priming. Rotation, counter-clockwise facing shaft. Shipping wt. 35 lbs. Gov't. acq. cost \$145.00 F.O.B. Chicago Now Only **39.50**

Suction Lift	Head Pressure	Gal. Per Min.	H.P.	R.P.M.
10'	75'	260	6.0	3500
10'	65'	200	5.2	3500
10'	80'	40	1.5	2500
10'	50'	140	5.0	3500
10'	30'	100	3.0	2500

LOGAN HEAVY DUTY HYDRAULIC PUMP or MOTOR

For operating hydraulic cylinders and hydraulic motors on tractors, bull-dozers, construction machinery, lift trucks, industrial applications, etc. Delivers 10 GPM at 600 RPM at 1000 PSI using 6 HP. Has a 3/4" inlet, 1/2" outlet, 3/4" shaft with flat and keyway for direct or pulley drive. For greater capacity tap out ports to 3/4" for 16 gallons per minute. Has flange with 4 bolt holes for convenient mounting. Ship. wt. 22 lbs. Overall dimen.: 7" L x 5 1/2" H x 5 1/2" W. A \$105.00 value FOR ONLY... **22.50** F.O.B. Chicago (Item #78)



HYDRAULIC CONTROL VALVE ITEM #26. Four-way control valve for use with two hydraulic double-action cylinders. Each cylinder may be operated independently of the other or in conjunction with the other. Oil may be locked in any of the cylinders to hold the piston at any required position. Ship. wt. 6 lbs. A \$60.00 value, postpaid. **12.95**

FREE: NEW 48-PAGE CATALOG

ORDER DIRECT FROM AD — SEND PAYMENT OR PURCHASE ORDER TODAY — SATISFACTION GUARANTEED

GROBAN SUPPLY CO. 1139 SO. WABASH AVE., CHICAGO 5, ILL. DEPT. PM-6

Speed

to play
defense
to work



WITH A



not \$139.95

not \$109.95

only **\$79.95**
PLUS TAX

Installed on any bike in
less than 30 minutes.

Here's your most economical transportation to work, to school or to play... over 150 miles to a gallon of gasoline. *World's lowest cost motorized transportation.* Powerful 1½ h.p. motor weighs only 17 pounds and is perfectly balanced. Drives on front tire and has no belts, pulleys or gears... fits any bicycle.



Safest of all for children! Single control gives speeds up to 30 mph. Bike is always under control of coaster brake—compression is released when gas is turned off. Fully guaranteed for 90 days against defective workmanship or material.

Dealer's Note: A few territories are still available—write or wire direct.

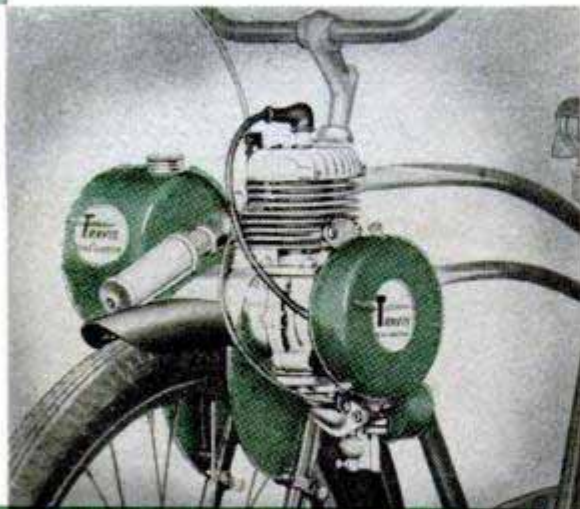

TRAVIS BIKE MOTOR

Manufactured by STARBRAND CORPORATION
1202 N. SHERMAN DR. • INDIANAPOLIS 18, INDIANA

I Time the Champions

(Continued from page 92)

sided" timing trap that I developed for occasions when it isn't practical to use a photocell trap.

This trap consists of a pair of bicycle handle bars on which a medium-power hunting scope is mounted. The handle bars and the scope rotate on a pedestal. One of these devices is set up on shore at the start of a measured mile, a duplicate is placed at the other end of the course. Each contains an electric switch that functions when the handle bars are turned at exact right angles to the course. The switches are connected to my timing instrument.

The timing official at the starting line tracks the oncoming boat by turning the handle bars so that he keeps the cross hair of his scope fixed steadily on the oncoming craft. Thus, automatically, the oncoming boat trips the switch and starts the clock at the instant that it crosses the starting line. Meanwhile, at the far end of the course, the other timing official begins to track the boat. His pedestal switch automatically stops the timer when the boat crosses the finish line.

It's possible to get a false reading with this apparatus if either man fails to track the boat smoothly and surely. To avoid this chance, an official witness is assigned to each timing official. The witness peers through a fixed sight that is aimed across the course and he wears a pair of ear-phones that are hooked in series with the timer circuit. If he hears a click in his phones at the instant that the boat crosses in front of his sight, the tracking is perfect and is accepted as official.

Any moving object that you can see can be timed with these trackers if the object is moving across a known measured distance in front of the scopes. The apparatus is accurate to within one foot at a distance of 1000 feet. I developed it primarily for clocking the speed of aircraft, and it is also ideal for timing boats or cars at locations where the photocell units can't be set up.

No timing system is accurate unless the race course itself has been accurately measured. I employ a licensed surveyor to measure off the start and finish lines and, to make doubly sure, I check his work. At some of the dry lakes of the California desert where the Southern California Timing Association and other automotive speed groups hold time trials, it isn't always physically possible to measure off a one-mile course and still leave sufficient distance at each end for the cars to attain maximum speed by the time they hit the

(Continued to page 252)

PAINT REMOVING MADE EASY!

Take a tip from painters and try their favorite remover. Just apply WONDER-PASTE with a paint brush and let it penetrate the finish. Soon the paint, enamel or varnish becomes a soft mass—quickly, easily stripped off with a putty knife! Surface is left smooth and clean—no sanding needed. Harmless to wood, fabrics or your hands. WONDER-PASTE is found at better paint and hardware dealers.



WONDER-PASTE

America's leading remover

Wilson-Imperial Company, 119 Chestnut Street, Newark 5, N.J.

Write for leaflet

Lightning BUG No. 2

LIFE-LIKE ACTION
2 PIECE HOLLOW TRANSPARENT PLASTIC LURE \$1.25 POSTPAID DIRECT
NIGHT FISHING—with live fireflies or fluorescent material
DAY FISHING—1001 color or insect combinations
FIRE-LITE MFG. CORP. Dept. B, Gosport, Indiana

GUARANTEED TO CATCH FISH!

ONLY
4⁹⁵

Special Offer TO HOBBYISTS



Hard Angle Jobs Set-up in 5 Seconds
Save TIME! MONEY! Drill, mill, grind, etc., round, square, irregular pieces at any angle—Quickly — Easily — Accurately with . . .

PALMGREN "HOBB-E" ANGLE VISE
Accurately machined and graduated, 1 1/2" Jaws, 1-Plain, 1-Grooved. Order NOW! Only \$4.95. Write for "Hobb-E-Tool" Circular.

CHICAGO TOOL and ENGINEERING CO.
8365 South Chicago Ave. Chicago 17, Ill.

Have fun, save money by making things yourself • Delta's wonderful "How To Do It" Books will aid you ASK YOUR DELTA DEALER

DELTA MILWAUKEE



DELTA POWER TOOL DIVISION
Rockwell MANUFACTURING COMPANY

803F E. VIENNA AVE. • MILWAUKEE 1, WISCONSIN

BATTERIES!—START

—a factory at home and re-cast junk batteries into new; latest achievement. We supply complete instructions and everything needed. Big Profits!

BATTERY LABORATORIES, Dept. PM, Minneapolis 4, Minn.



GREATEST SAVING EVER OFFERED!

U. S. GOV'T SURPLUS

"BARGAIN BOOK"



JUST OFF THE PRESS!

Greatest Bargain Book ever offered . . . low, low prices, terrific savings, on scarce war surplus. Mail 10¢ TODAY - NOW - begin saving on hundreds of items for farm, home, shop, sports. Get your Bargain Book by return mail.

500 BARGAINS
• FARMS • SPORTS
• HOME • SHOP

MAIL TODAY Only
10¢

FISLER SALES CO.

723 WALNUT ST., DESK M-4, KANSAS CITY, MO.

JUNE 1951

Make \$20 to \$30 a Week

EXTRA MONEY



MACHINE SAW FILING PAYS UP to \$2 or \$3 an HOUR

Turn your spare time into CASH—sharpening saws with a Foley Automatic Saw Filer pays up to \$2 or \$3 an hour. You will find you can make \$20 to \$30 a week in your spare time as a starter.

You can work in your basement or garage—no experience necessary. "The first saw I sharpened with my Foley Filer came out 100%"—writes Clarence E. Parsons. No canvassing—"I advertised in our local paper and got in 93 saws"—says M. L. Thompson. The Foley is the only machine with which you can file all hand saws, also band saws and cross-cut circular saws.

SEND FOR FREE BOOK "INDEPENDENCE AFTER 40!"

Shows how you can get business from home owners, farmers, carpenters, schools, factories, etc. With a small investment, no overhead, no stock of goods to carry, you can get right into a cash business—and possibly later on develop into a full-time repair shop. Send coupon today for Free Book. No salesman will call.

"Each saw I filed got me six more and business has been picking up that way since a year ago. If it keeps up I will have to buy another Foley Saw Filer." — William C. Baldwin

"I have done 4 or 5 thousand saws in my spare time in the 4 1/2 years since I got the outfit, and they are all coming back." — Len Crego

"Have filed over 2200 saws in 18 months. One customer always brings another." — E. A. Fink.

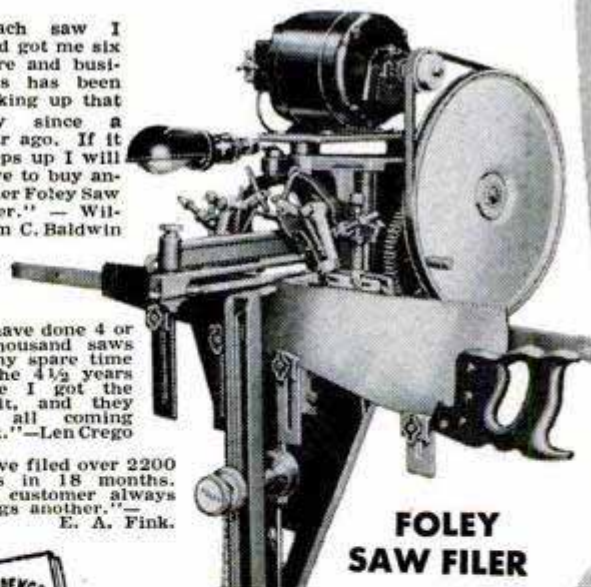

FOLEY SAW FILER



SEND COUPON FOR FREE BOOK

FOLEY MFG. CO.

616-1 Foley Bldg., Minneapolis 18, Minnesota

Send FREE BOOK — "Independence After 40."

Name _____

Address _____

See You Saw It in Popular Mechanics

The Greater Capacity of

CARTER



FUEL PUMPS

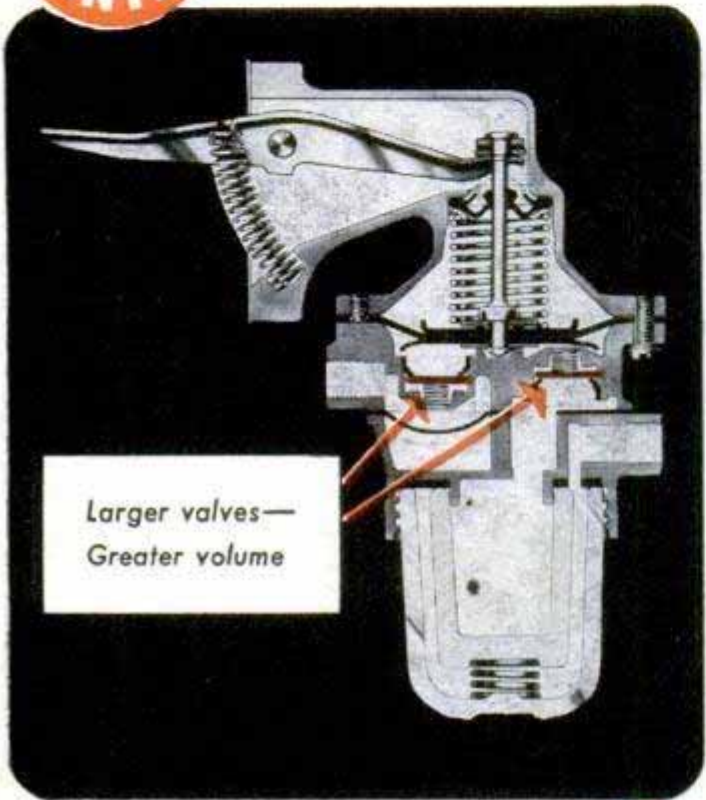

Insures Longer Life

Advanced design with extra large valves assures a volume of fuel more than double your car's requirements which reduces proportionately the tendency toward vapor lock.

See your car dealer, garage or service station

**LIBERAL
TRADE-IN
ALLOWANCE
ON YOUR OLD
FUEL PUMP**

CARTER CARBURETOR CORPORATION
St. Louis 7, Missouri

Division of American Car and Foundry Company



course and then to decelerate. At those locations we use a speed trap that is only 132 feet long. By referring to a speed chart we can read off, at once, the rate in miles per hour at which the car traveled through the trap.

On a long course across water the driver of a fast boat sometimes has trouble in steering a straight line when there is no outstanding object near by which he can use as a guide. Sometimes we use a bright searchlight mounted on a pole far beyond the finish line as a guide for the drivers, sometimes we use a pair of six-foot weather balloons 50 feet in the air, in line at the end of the course.

My present timer is calibrated to 750 miles per hour, the approximate speed of sound. I think it will be satisfactory for timing any surface vehicle that I'm apt to clock in my lifetime, but if anyone has ideas about driving at supersonic speeds, I'll build a new clock that will give him his exact time to a fraction of a mile per hour!

The Owners Report on the '51 Chevrolet

(Continued from page 98)

For approximately 200 miles between Bend and Portland, over the Warm Springs cutoff, we traveled in the Cascades over snow and slush-covered roads and sometimes icy stretches. The car had good stability, although like all modern cars it perhaps was a little light on the rear end where traction was needed most. A heavier rear end would have helped on the slick roads we encountered.

There is no question but that the 1951 Chevrolet is considerably improved over recent models. Brakes have been greatly improved and the new 11-inch drums are the largest used on any car in the low-priced field. Bonded lining is used, which eliminates rivets. The brakes are smooth and positive with no tendency of fading even at high speeds.

The squeaking and chattering which prevailed in some previous models has been eliminated for 1951. The steering seems to be better than on earlier Chevrolets. The wheels respond quickly to the slightest turn of the steering wheel without too much turning, which I think is good. In my opinion, the steering-gear ratio is about right for the type of car that Chevrolet produces. The turning radius is quite short, and that's also a good feature. (See specification on page 254.)

The hand brake has close ratchet graduations which make for ease of operation in

(Continued to page 254)

BUILD YOUR OWN ARC WELDER OR LIGHT PLANT

JACK & HEINTZ R-1 D-C GENERATOR

Save \$250 to \$500

Only **\$25.50**

instructions included rated 300 Amps. 30 Volts. Ship. wt. approx. 70 lbs. PRICE F.O.B. K. C., MO.



CONVERTS TO ARC WELDER 300 AMPS. 350 AMPS. OR LIGHT PLANT CAP. LOAD OVER 7500 WATTS

Stock No. 517—D C Generator P-1 Delco
200 amp 28 Volt. Gov't. cost \$300.00. Instructions for converting to welder or light plant included. Wt. approx. 70 lbs. **\$15.95**

CARBON PILE GENERATOR VOLTAGE REGULATOR
For use with 24 or 32 Volt D.C. Generators. Also recommended for the P-1 and R-1 type generators in "build your own" Light plant. Complete with mounting base. Only **\$6.50**



DYNAMOTORS Brand New. Input 28 Volt DC 10.5 Amps. Has 3-way output HIGH, MEDIUM AND LOW VOLTAGE. 300 Volts, 150 Volts or 14.5 Volts. Stock #DA-3A. Wt. 23 lbs. **\$5.95**



WEAVERS HYDRAULIC HAND PUMP
BRAND NEW INCL. BUILT IN CHECK & RELIEF VALVE. For hydraulic jacks, presses, hoists, etc. For operating hydraulic cylinders to pump oil or hydraulic fluid under pressure. Has built in check valve, and is capable of delivering 1000 lbs. pressure. Wt. 10 1/2 lbs. A \$50.00 value. Instructions incl. Price **\$12.50**

Valuable Gears — Bargains — Speed Reducers
10-1 or 5-1 ratio, 90 degree angle. Shaft driven 1/2" spline shaft with 3 mounting holes 5/16". Gears held in forged and machined aluminum housing with two needle bearings, one bronze bearing, and three high speed shielded bearings. Sealed self lubricating chamber. Price **\$5.50** paid

New Amplidyne Motor Generator
#5AN31NJ18A—Use as 24/32 Volt D.C. motor, pulls 1/2 H.P. or 0/60 V. D.C. Can be adapted to 110 V. A.C./D.C. 10,000 R.P.M. 1/2 H.P. by simple changes in connections. This unit can be adapted to independent rural lighting, power, etc. Instructions incl. (Stock #790). Gov't cost \$140.00. Wt. 30 lbs. Only **\$7.50**



SENSATIONAL SELSYNS
Two or more connected together, work perfectly on 110 V. A.C. For weather vanes, rotating directional antennas or controlling distance operations. Complete with diagram and instructions. Wt. 3 1/2 lbs. PER PAIR **\$6.50** Postage paid



Pesco Four Vane Rotary Positive Displacement Large Volume Pump
Including built in relief and bypass valve. Capacity 400 G.P.H. 1/2" drive spline shaft, 3/4" pipe inlet and outlets. Rotates either direction or in any position. Ideal for gasoline, oils and various types of sprayers. Engineering data incl. (Stock #600) only **\$7.95** Postpaid



Brand New PUROLATOR GASOLINE FILTER
For all cars, trucks, tractors or boats. Permanent type. Data incl. **\$4.95** Postpaid

CUNO OIL FILTER — Brand New
Aircraft type. Filters oil without cartridge replacements. Just turn handle and cartridge is clean. Standard 3/4" inlet and outlet ports to accommodate 12 gallons per minute. STOP CHANGING OIL. Instructions incl. **\$4.95** Postpaid



ELECTRIC MOTOR 1/2 H.P. 27 V. D.C. R.P.M. 4000 No. 750. For Intermittent or Continuous Duty. 3/8" SHAFT. VARIABLE SPEED MOTOR CAN BE ADAPTED TO 110 V. A.C. or R.E.A. line by simple arranging armature brush leads. UNUSED. Instructions incl. **\$5.95**

ELECTRIC MOTOR 1/2 H.P. 24 Volt D.C. R.P.M. 2500. Amp. 22 #HCA24. Gov't cost \$75.00. Brand New. **\$4.95**

ELECTRIC MOTOR 1/4 H.P. 28 Volt D.C. R.P.M. 4000 #2832 with simple instructions to convert to 28-32 Volt A.C. Gov't cost \$82.84. Brand New. **\$4.50**

ELECTRIC MOTOR 6 Volt D.C. Delco — New Ideal as wiper motor, car heater motor, toy applications 1/4" dia. 1 1/8" long Plus \$3.35 mounting studs. **\$2.35** Postage

SOLA CONSTANT VOLTAGE TRANSFORMER
PRI. VOLTS 95-190 to 125-250 RATED V.A. 2000. Secondary output 115 V. A.C. Net wt. 220 lbs., size approx. 8" x 17" x 20". Gov't cost \$369.00. New. Only **\$94.50** KCMo.

AIR FILTERS
Aircraft type. Removes dirt, dust, etc. For industry, home & laboratories. For forced warm air, conditioning units, etc. Made of heavy metallic mesh with metal frame. Permanent, needs no refills. Size 4 1/2" x 6 5/8" x 2". Wt. approx. **\$3.50** ea. 8 lbs. Brand New

Brand New Wonderful ROTATOR MOTOR
For rotating TV, Ham, FM antennas, turntables, etc. Applicable for 110 V. A.C., 60 cycles or for 24 V. A.C. & 12 V. D.C. Approx. 7 R.P.M. Free swing, reversible, light weight, rugged, quiet. Motor & gears oil sealed. Including mounting base on motor. Simple instruction & diagrams for converting incl. Wt. approx. 4 1/2 lbs. Stock #6918. \$50.00 value **\$7.95** postpaid New only

Thompson Motor Driven PUMP
Including Built in Motor. Applicable for 24 V. D.C./A.C. or 110 V. A.C. The motor is explosion proof constructed, making it ideal for pumping GASOLINE, FUEL TRANSFER, HOT WATER HEATING CIRCULATOR, USE IT AS COOLANT PUMP, FUEL BOOSTER, OIL PUMP, etc. Discharge connection is for 1" hose. Rated Capacity 300 G.P.H. Direction & Engineering data incl. A tremendous bargain! Stock No. 1200—Only **\$9.95**

ROMEC FUEL PUMP
Or use as hydraulic pump or for Vacuum drawing. Rated 150 Gallons per hour at 1750 R.P.M. Has cushioned self lubricating, 12 splined shaft. Ports are 1/2" std. Pipe threads. Here's dependable performance. data incl. **\$7.50** postpaid Stock No. RD-4550

Pesco Vacuum Air—General Purpose Pump
Here is a pump for air, fluid, pressure or vacuum. Standard 1/2" pipe thread. Delivers 300 G.P.H. at 2000 R.P.M. Runs forward or reverse. Self aligning shaft. Spline terminal for direct drive, readily replaced with a pulley. Use them for oil burners, MILKING MACHINES, COMPRESSORS, VACUUM PUMP, etc. Engineering report and instructions incl. Now only **\$9.95** Postage Paid

Adel Self-Priming ELECTRIC PUMP
For pumping light oils, oil burners, fluid metering, fuel pump, tool post grinder, coolant, pressure lubricating pump, etc. Double ball bearing series wound motor, continuous duty. 1/30 H.P. rated 12000 R.P.M. Applicable for 24 V. D.C./A.C. or use on 110 Volt A.C. Size 6 3/4" x 3 1/2" x 3 1/4". rated 3 G.P.H. Remove pump and use motor as high speed grinder, etc. Diagram and instructions incl. **\$9.95** Postpaid

Pesco Centrifugal Heavy Duty Electric Pump
With built in 1/4 H.P. MOTOR included. BRAND NEW. COMPLETE. Self Contained, Explosion proof. Ideal for pumping Gasoline, Oils, Water and non-corrosive liquids. Applicable for 24 V. D.C./A.C. or on 110 Volts A.C. The Discharge is for 3/4" hose connection. Capacity 400 G.P.H. Use them for Cottages, Basements, Laboratories, Boats, etc. Here's your Greatest PUMP VALUE IN YEARS. Engineering data and instructions incl. **\$85.00** value. Stock #659 **\$12.95** F.O.B. K.C. Only

Send check or Money Order. Prices f.o.b. K. C. except when marked postpaid U.S.A. only

Stratopower Constant Displacement HEAVY DUTY PUMP
For operating Hydraulic cylinders, bulldozers, Construction machinery, lift trucks. For fuel or oil transfer. Industrial applications, etc. Delivers up to 400 G.P.H. at 3750 R.P.M. Rated 1250 to 1400 P.S.I. 3750 to 4500 R.P.M. HAS BUILT IN RELIEF AT HEAD. Rotation either direction without adjustment. Can be used as hydraulic motor. \$85.00 value. Engineering data & instructions incl. **\$17.50** Stock #37. Wt. 8 lbs.

AIR OR OIL HYDRAULIC CYLINDERS
Stock No. 27 Cylinder, Air operated. Bore 2 1/2", Shaft 2 1/4", Stroke 6", one way Stroke. Can be used as snubber or Brake. Length 15". Wt. 11 lbs. **\$7.50** f.o.b. K.C., Mo. Now

Stock No. 11 Double Action 1 1/2" Bore, 6" Stroke, 3/8" Dia. Shaft, Clevis mounting base and shaft end. Capacity 1.60 lbs. with 1000 P.S.I. input. Has a capacity of 1625 lbs. with our STRATOPOWER 1400 P.S.I. A \$50.00 value. **\$8.95** Postpaid Only

Stock No. 12 Hydraulic Cylinder Double Action output 12560 lbs. with 1000 P.S.I. input. Gives 17584 lbs. with our STRATOPOWER PUMP 1400 P.S.I. or will produce 34168 lbs. with 3000 line pressure. Can also be operated on low pressure system. 4" Bore, 8 1/2" Stroke, 1-5/16" shaft, clevis mounting, O. Gov't. cost \$300.00. **\$22.50**

Pesco Hydraulic Flow Equalizer & Pressure Balancer Valve
Brand New. Guarantees equal flow and equal pressure for two cylinders or two systems. Capacity 360 G.P.H. 1500 P.S.I. Data & instructions incl. A \$75.00 value. **\$14.50** postpaid Stock 1-D-397 only

DE-ICER DISTRIBUTOR VALVE
ECLIPSE. Brand new. Type #572, Model 3, with 24 Volt D.C. motor opens outlet ports in pairs in continuous sequence. Standard pipe ports. Cost Gov't. over \$200.00 ea. **\$32.50**

HYDRAULIC CONTROL VALVE
Brand New Four way control valve with BUILT IN RELIEF VALVE for use with one double action hydraulic cylinder. May be used with 1500 P.S.I. hydraulic system to open and close hydraulic cylinders. Stock #120. \$35.00 **\$8.95** Postpaid

ADEL PRECISION #10086 Brand New. For controlling 2 single action cylinders or one double action cylinder. When pressure is applied to one cylinder the return to the opposite cylinder is opened. Has quadrant for locking in either position. A tremendous bargain **\$8.95** Postpaid

ADEL PRECISION #2799 Large Volume hydraulic control and pressure relief valve, 3/4" ports, spring loaded. Range 1250 P.S.I. adjustable up to 3000 P.S.I. **\$5.50** Postpaid Brand New

ADEL PRECISION VALVE #10335. Brand New. This is for a double end cylinder control or for two cylinders that are to work in opposition to each other. Now only **\$5.50**

Hydraulic Accumulators — Bendix Ball Type
Dia. 5 1/2", Built to stand 2000 P.S.I. Stock #A-65. Wt. 4 lbs. only. **\$5.50**

BENDIX ACCUMULATOR. Ball Type. Dia. 10". Built to stand 2000 P.S.I. Wt. 15 lbs. Stock #A-85. Only **\$15.50**

VICKERS CONSTANT DISPLACEMENT HYDRAULIC PUMP
Brand new. Stock No. PF713 -20. For any liquid pumping job. 375 G.P.H. at 3750 R.P.M. 1000 P.S.I. .410 cu. in. per rev. Gov't. **\$12.50** postpaid cost \$100.00.

VICKERS CONSTANT DISPLACEMENT HYDRAULIC PUMP
Stock No. PF713 -25. Brand new. Powerful, compact. Rated 1000 P.S.I. .507 cu. in. per rev. at 3750 R.P.M. 400 G.P.H. or use as motor. **\$14.50** postpaid

VICKERS UNLOADING VALVE Brand New—By passes full amount output of the pump while the cylinder is not in operation. Takes starting load off of electric motor driving the pump. 1/2" AC TUBE PORTS **\$7.95** Postpaid (3/4"-18) thread. Price

New improved woodworking calculator

answers countless questions
in seconds... speeds jobs!



Here's the improved GREENLEE Calculator with more information on lumber, nails, concrete mixes, painting materials, etc. Convenient... simple to read. Just set dial for nail specifications, to convert linear to board feet, find bit sizes for screws, compare characteristics of wood. 6" diameter, heavily varnished card-board, printed in three colors.

Special offer by the makers of famous GREENLEE tools.

only 25¢
No Stamps, Please!



GREENLEE TOOL COMPANY, 2106 Columbia Avenue
ROCKFORD, ILLINOIS

Enclosed is 25c. Send your "Handy Calculator" by return mail.

NAME.....

ADDRESS.....

CITY..... ZONE..... STATE.....

both applying and releasing. The heating and ventilating system works exceptionally well. The instrument lighting is good (with the exception of the Powerglide position indicator) and a rheostat control switch can be turned to apply any degree of light on the instrument and speedometer panels.

Another thing I noticed on the Powerglide model is that a portion of the vision

1951 CHEVROLET SPECIFICATIONS

ENGINE (REGULAR)

Type.....6-cyl. OHV, in-line
Bore and stroke..... $3\frac{1}{2}$ x $3\frac{3}{4}$ in.
Piston displacement.....216.5 cu. in.
Brake horsepower, gross.....92 at 3400 r.p.m.
Compression ratio.....6.6 to 1
Transmission.....3-speed conventional
Powerglide Option: All models equipped with Powerglide automatic transmission are also equipped with larger engine:
6-cyl. OHV, in-line; bore and stroke— $3\frac{5}{16}$ x $3\frac{15}{16}$ in.; piston displ.—235.5 cu. in.; brake hp., gross—105 at 3600 r.p.m.; compression ratio—6.7 to 1.

GENERAL

Weight, curb (4-door sedan—
style De Luxe).....3270 lbs.*
*(Add approx. 135 lbs. for Powerglide models, due to heavier engine and trans.)
Wheelbase.....115 in.
Tread, front..... $56\frac{1}{16}$ in.
Tread, rear..... $58\frac{3}{4}$ in.
Height.....Styleline 4-door— $65\frac{3}{4}$ in.
Fleetline 4-door— $64\frac{7}{8}$ in.
Height.....Loaded 4-door— $63\frac{5}{8}$ in.
Fleetline 4-door— $62\frac{3}{4}$ in.
Over-all width..... $73\frac{15}{16}$ in.
Length..... $197\frac{13}{16}$ in.

Inside Dimensions (4-door sedan)

Front-seat width.....60 in.
Rear-seat width.....Styleline— $58\frac{3}{8}$ in.
Fleetline— $58\frac{5}{8}$ in.
Leg room, front..... $42\frac{3}{4}$ in.
Leg room, rear.....Styleline—41 in.
Fleetline— $38\frac{5}{8}$ in.
Headroom, front.....Styleline— $35\frac{3}{8}$ in.
Fleetline— $34\frac{3}{8}$ in.
Headroom, rear.....Styleline—35 in.
Fleetline— $34\frac{1}{8}$ in.
Tire size.....6.70 x 15
Recommended tire pressure.....24 lbs.
Road clearance..... $7\frac{7}{16}$ in.
Turning radius.....Right—18.5 ft.; Left—19 ft.
Steering wheel, lock-to-lock.....4.05 turns
Steering ratio.....19.4 to 1

CAPACITIES

Oil (Refill).....5 qts.
Water.....15 qts.
Gasoline.....16 gal.

of the speedometer and instrument panel is obstructed by the gearshift lever or the position indicator. This should be improved. The nonlighting and general appearance of the indicator are not in keeping with the rest of the instruments or interior finish.

The choke is manually operated, which I like. The engine can be started only when the shift-lever indicator is in neutral (marked N) or parking (P) position. This is good. It eliminates danger of starting the engine when the car is in gear.

(Continued to page 256)

Make Ur-Own ROTARY TYPE POWER MOWER

THIS IS NOT A KIT
But A Complete Mower Assembled
As Illustrated

Model 50M KEEN MOWER. Add your electric motor or gas engine. Concealed blade for safety, 3 cutting heights, 1 1/2" to 3 1/2". Ball bearing rubber tired wheels. 18" cut. Cuts to within 1/2" of sidewalk. Weight 48 lbs. America's Greatest Power Mower Value. Order Now **\$44.95**
Shipped F.O.B., K.C.

Send check or money order
Write for FREE Folder for information on "Make Ur-Own" and other models with gasoline engines or electric motors.

ATLAS KEEN MOWER

229 S.W. BLVD.

Dept. MP6

KANSAS CITY, MO.

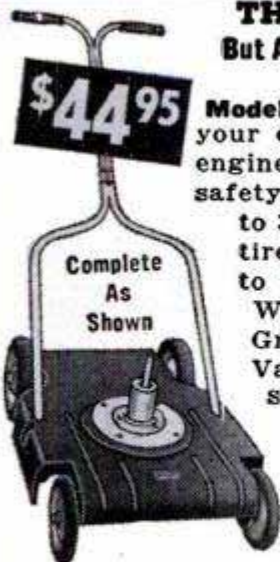

Complete
As
Shown

\$44.95

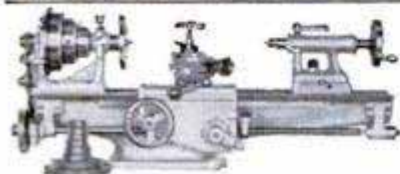

**CASTINGS
BLUE PRINTS**
BUILD YOUR OWN
MACHINE TOOLS!

Catalogue with complete construction drawings of this 8 inch lathe with milling, grinding and hand shaper attachments, 25 cents postpaid, or send one dollar for drawings of three lathes, two milling machines and six inch crank shaper—refund on castings order.

POOTATUCK CORP., SUCCESSOR TO DAVID JONES MACH. CO.
100 SAMMIS PL., STRATFORD, CONN.

BRUSH PLATING OUTFITS

for re-plating articles in the home and shop. No tanks necessary. Free particulars.

GUNMETAL CO., AVE. M, DECATUR, ILLINOIS

HULA DANCER • GETS BIG FISH

Small but mighty, this deadly open-water hooker is heavy enough to make long casts easier. Sinks and runs medium depth. Special "lip" gives special action—fools the wise ones. 5/8 oz. At your dealer. \$1.25 ea.



FRED ARBOGAST & Co., Inc., 2276 W. North St., Akron 3, Ohio

FREE WRITE TODAY FOR BIG FREE 1951 ARBOGAST COLOR CATALOG—FULL OF PICTURES OF CATCHES

2 DRILLS in 1

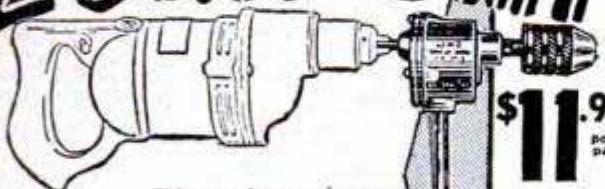

\$11.95
POST PAID

This attachment gives you two drills in one. It converts any 1/4 inch electric drill to 1/2 inch capacity. Reduction gears reduce the drill speed 5 to 1, the average speed of a 1/2 inch drill, and thereby increases the power. Absolutely indispensable for all shop work and home craftsmen.

Send check or Money Order
Satisfaction guaranteed
Order yours now

G. M. CO. MANUFACTURING, INC.
1308 43rd AVE.
LONG ISLAND CITY 1, NEW YORK

A Sander that will really Sand

GIVES THAT HAND-FINISHED LOOK!

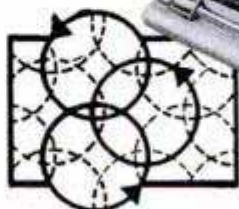

Orbital Motion—Abrasive pad has circular motion—grits move in overlapping 3/8" circles, at high speed. No marring.

PORTER-CABLE
Guild
Orbital
SANDER

(Model 105)



Furniture—Leveling butts and mitres.



Repairs—Fitting screens, smoothing plaster patches.



Autos—Sanding primer, featheredging

Away out in front among finishing sanders! The kind of surfacing you've always wanted! And power that gives brisk cutting action . . . even when you put on extra pressure. Using orbital motion, it sands perfectly *with*, *against*, and *across* the grain. Sands equally well on wood, metal, plastic, or composition—10 times faster than hand sanding.

A Powerful Tool Only \$59.50

The Guild Orbital Sander is *not* a vibrator-type machine, but a motor-driven, counterbalanced, ruggedly-built tool designed for trouble-free, non-stalling operation in home shop or in industry.

Yes, it's *quality* throughout—priced for the home craftsman who takes pride in superior work. Sold with standard pad at \$59.50. Accessories include extra pads for contour sanding and polishing, abrasive cutting template, steel case—all at extra cost. See it—try it at your Guild Tool dealer. Or mail coupon for full details.

PORTER-CABLE MACHINE CO.
6066 N. Salina St., Syracuse 8, N. Y.

Send me full information about the new Guild Orbital Sander . . . also name of my nearest Guild dealer

Name

Street

City..... Zone..... State.....

Manufacturers of SPEEDMATIC and GUILD Electric Tools
In Canada write: Strongridge, Ltd., St. Catharines, Ont.

IT SHINES.. IT GLEAMS..
IT LASTS FOR MONTHS!



BOWES Luster Laughs at Rain



★ Keep your car shining for months—in all kinds of weather! Takes very little work...the quick, easy BOWES way!

BOWES AUTO POLISH removes dirt and dulling road film. Restores original beauty—actually gives you more shine with less work. Pint, 90¢.

BOWES LIQUID WAX makes the shine last. Silicone-activated for longer luster—laughs at weather. Just spread it on and wipe it off. Pint, \$1.00.

BOWES SHINE CLOTH keeps shine spotless. Chemically treated—absorbs dust, leaves no oily film to catch more dust. Fine for home use. 65¢.

★ Go to your nearest Bowes "Seal Fast" dealer for these finish savers. If he cannot supply you, order direct from factory. Send cash, check or postal money order; no C.O.D. Prices slightly higher west of Rockies.

★ You may be driving your present car for some time. Take care of it with the luster that defies weather for months. It's easy, quick, enduring!

BOWES "SEAL FAST" CORPORATION
INDIANAPOLIS 7, INDIANA

The road-holding of the car is excellent, and I should say that the 1951 model is the best Chevrolet I have ever driven so far as roadability is concerned.

The doors are very solid and the assembly of the body seems to be far better than in previous years. No squeaks or rattles developed in the entire test of the car, and many of the miles covered were over twisting, winding and rough roads. We also encountered some rain and snow. There were no leaks in the windshield or the windows.

On long hard pulls and many stretches covered at high speed, the heat indicator remained at normal. No water was added during the entire trip.

Chevrolet long has had the reputation of being a miser when it comes to using oil, and our test was no exception. Not a drop of oil was added and, in my opinion, Chevrolet's cast-iron pistons do assist in oil economy, although personally I would prefer aluminum pistons. There is no question that cast-iron pistons do have some advantages, the principal ones being the fact that they can be fitted with very little clearance, thus reducing noise and also aiding in keeping oil consumption down.

The engine is extremely free of vibration except at wide-open speed (93 to 95 miles per hour by speedometer) when the weight of the cast-iron pistons can readily be detected by the feel of the steering wheel. I'd call it "cast iron pistonitis," which actually is the inertia effect of the reciprocating masses.

The vision is good. Personally, I like the two-piece windshield, and certainly it is more economical when replacement is necessary than is the one-piece curved type which seems to be increasing in popularity.

I found the radio to be excellent. There is considerable space in the trunk and the lid is counterbalanced which makes it convenient. It opens and closes easily.

Like all Fisher-built bodies, the doors can be locked without the use of a key. I consider this an excellent feature and have always liked this arrangement even though there is the danger of occasionally locking the keys in the car.

The engine in the Chevrolet will remain in operation even though the ignition key is removed. Personally, I do not think that this is a good arrangement. I have known drivers sometimes to remove the keys without turning off the ignition switch, and the engine continued to operate.

The counterbalanced hood is fine. It can be opened with very little effort, and I like the fact that the hood remains open without the use of a supporting rod. It is easy to operate. The Chevrolet hood can be opened

(Continued to page 258)



Now
10 FEET long!



Yes, here it is—that extra length you've always wanted... 120 inches of accurate, more useful measuring ease. Jet black markings on a wear-resistant, acid-resistant snow white blade.

Carlson quality throughout with famous 10-second blade change economy and the new convenient swing-tip... a real value at YOUR HARDWARE DEALER. Just be sure it's the White Chief by Carlson.

P.S. And don't forget to get an extra blade to keep on hand as a "spare."

Blade produced under patents 2089209, 2510939

CARLSON STEEL TAPE RULES

CARLSON & SULLIVAN, INC.

MONROVIA, CALIFORNIA

CARLSON

A DOVETAIL MACHINE WITH YOUR SHAPER



With one cutter and a piece of panel you can make perfect mitered dovetails. Through dovetails, groove dovetails and lap-dovetails for drawers, cabinets and chests.

Send \$1.00 for detailed drawings.

Industrial Woodworking
Equipment Co.

60 East 42nd St., New York 17

HOW TO GET BETTER PAINT RESULTS WITH ONE COAT



NEW FREE BOOK ON ALUMINUM PAINT TELLS HOW

Write for your free copy of 24-page illustrated fact-packed book, "Paint it Bright". Prepared by Alcoa experts to help you get best paint results. Absolutely free—no obligation. Write to:

ALUMINUM COMPANY OF AMERICA, 1718F Gulf Building, Pittsburgh 19, Pa.

TRAILER COUPLER



Automatic Wedge-lok coupler cannot rattle or loosen. Locks into position quickly and easily. Designed for rugged heavy duty over

roughest roads. 2" dia. one piece steel ball has 3/4" dia. shank with 3/4" SAE threading. Order today, immediate delivery, we pay postage. No C.O.D.'s please.

\$4.00
Postpaid

DAYTON PRODUCTS CORP., Rockford, Ill.

AUTOMATIC RETOOTHER

MAKES NEW PROFITS

Cuts new teeth in 50 seconds—any size 4 to 16 points. Old teeth fall off as chips. Easy to operate. A perfect job.

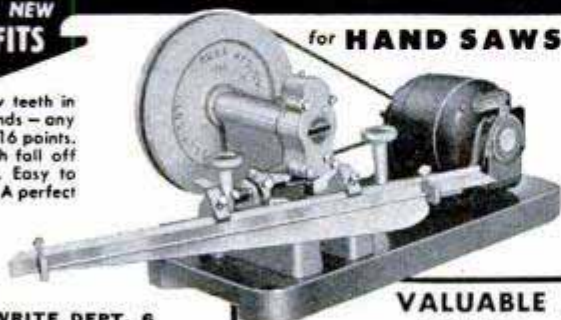

WRITE DEPT. 6

BURR MFG. CO.
8933 VENICE BLVD.
LOS ANGELES 34, CALIFORNIA

VALUABLE BOOK

25¢

Order Burr's Blue Book of Coast to Coast prices for saw shop services

Do armature work faster a lathe!

than on



turn armatures undercut mica

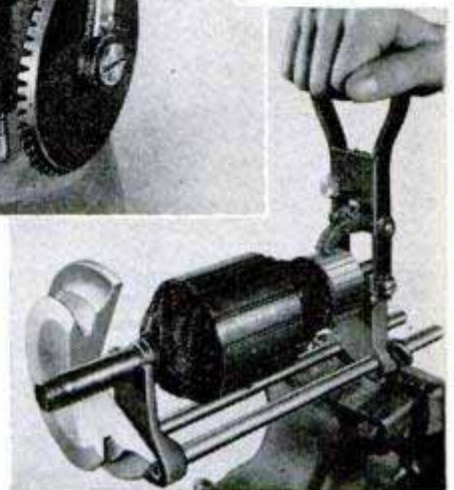

get these **Snap-on** ARMATURE RECONDITIONING TOOLS

With metal shortages, and higher electrical replacement costs, you're bound to get lots of this money-making work from now on! Get set to do it to perfection—faster, easier—than on a costly lathe! With this accurate, sturdy, solidly-built, time-proved tool in your bench vise you control cuts to a thousandth—shave armatures smooth as glass! Takes armatures with shafts 5/16" up to 1 1/16" diameter—adjusts in a moment. Fully warranted by Snap-on—foremost supplier of professional tools to automotive mechanics and others for over 30 years. One of 4,000 Snap-on Tools. Not sold in stores. Write for FREE catalog.

SNAP-ON TOOLS CORPORATION
8062-F 28th Avenue
Kenosha, Wisconsin

*Snap-on is the trademark of Snap-on Tools Corporation.



AMERICA'S FINEST, MOST COMPLETE GARDEN TRACTOR LINE!

Top Value in Every Power and Price Class.

48" Wheelbase

8 h.p.

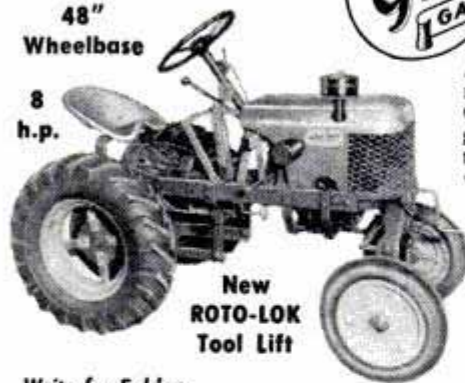

New ROTO-LOK Tool Lift

Write for Folder

THE *Garden-Master* GARDEN TRACTOR

A sensational new riding unit! The Gard'n Mast'r is rugged, powerful, versatile! Compact and well-balanced for easy turning. Length 74 1/4", width 33", plant clearance 19", variable tread width 28" to 38". Auto-type steering, differential and transmission with 3 speeds forward; 1 reverse. See it *Now!*

TOPS IN 2-WHEEL UNITS

Garden-All LAWN and GARDEN TRACTOR

No better buy than Garden-All! Finer features give better performance, more satisfaction, more value! Big variety of models cover every need.

Get the Best! It Costs No More!



5 MODELS

2 to 4 1/2 h.p.

Garden-All Tractor, Inc., Dept. P, Liberty, Indiana



Send for this **BIG NEW** *Hunt's* **WOODWORKERS CATALOG NO. 18**

NEW LOW PRICES

ONLY 15c

Offers greatest selection of fine domestic and imported woods--and hundreds of woodworkers items at bargain prices!

You'll save time and money with this big, new catalog. Contains everything wood craftsman needs. Shows 32 rare and fancy woods in color...43 veneer designs...275 scroll patterns...multicolor inlays, overlays, bandings...all kinds of tools, machinery, cabinet hardware, ornaments, mouldings...and pages of valuable tips, ideas, information, instruction. Send for your copy NOW. Only 15c



144 PAGES

QUICK DELIVERY

on maple, poplar, oak, mahogany, red cedar, cherry, walnut, and many others—all properly seasoned and kiln dried.

MAIL THIS COUPON--TODAY!

CRAFTSMAN WOOD SERVICE CO.

2729 S. Mary St., Dept. A-6
Chicago 8, Illinois

Send me the big, new, money-saving Catalog No. 18. Enclosed is 15c

Name _____
Address _____
City _____ Zone _____ State _____

from the outside even though the doors of the car are locked, and I don't think that this is good. I prefer a hood lock that can be released only from the inside of the car.

Another thing I like about the Chevrolet is the roominess in the driver's compartment and the comfortable driving position.

Chevrolet's new automatic transmission, which they call Powerglide, was a revelation to me and its operation was much better than I expected. There is absolutely no feeling of a change in gear ratios as the Powerglide model accelerates from a standing start to its top speed. There is no jerk at any time and even the expert can't feel when the change in gear ratio takes place.

There is some "mushiness" in the effort of the car getting under way up to about 30 miles per hour when starting in drive position, which ordinarily is used for starting in average operation of the car.

There definitely is a slippage as the Powerglide model gets under way. However, my tests show that this slippage is not as great as the average driver thinks it is. The feeling of the slipping occurs from a dead start up to about 30 miles per hour. The unit becomes positive at about 35 miles per hour or slightly better. From then on it drives as though there were a rigid connection between engine and rear wheels.

Engineers tell me there is only about 12 percent slippage from 0 to 30 miles per hour in this new transmission. I tested the car alongside a Chevrolet with conventional transmission, and when the throttle is fully depressed in the Powerglide model the engine does seem to be revving up more than necessary with slippage occurring.

My tests showed, however, that when a conventionally equipped Chevrolet accelerates alongside a Powerglide model, although the low-gear and second-gear engagements are positive on the conventional model, its engine (especially in low) is revving up very high when the car is traveling at the same speed as the Powerglide model. The operating smoothness of the Powerglide makes one forget that the car actually is gaining momentum quite rapidly in acceleration period. I found the Chevrolet Powerglide reaches its top speed from about 40 miles an hour very quickly.

The mileage a Powerglide owner may secure depends much upon the lightness of his foot on the throttle. The careful driver of a Powerglide can greatly increase his mileage if he will allow the car to accelerate from a standstill by depressing the throttle slowly and holding it about one third open until the car gains momentum to about 30 miles per hour. Pushing the throttle down

(Continued to page 262)

SHOPMASTER POWER TOOLS

Only
\$47.95

Each
Complete,
less motor



Now you can get Shopmaster quality in power tools specially designed for the smaller home workshop, operating on a limited budget. Efficiently designed, they contain features found only on the highest priced tools.

Write for catalog on complete line of Shopmaster Tools.



SHOPMASTER, INC.

1214 Third St. S.

Minneapolis 15, Minn.



CAPE COD CHAIRS TRELLISES • ARBORS DUTCH WINDMILLS

Chairs style B-C-A PLANS 50c Ea., all 3 only \$1.00. 12 different trellis designs PLAN of all 12 only 50c. Authentic 40" high Dutch Windmill Detailed PLAN only 75c. Unique 40" high Light-house having copper lantern, ideal for garden or on lake shore of summer home. Large detailed PLAN 75c.

SPECIAL ALL PLANS ABOVE \$3.00 VALUE ONLY \$2.50

SEND 10c for catalogue of many fine projects.

Dept. P29

CRAFTSMAN'S MODEL CO. DELAFIELD, WISCONSIN

NU-WAY HEAVY DUTY CUTTING UNIT with Timken Roller Bearings

PRICE

\$16.50

WHY PAY MORE



Build your own rotary type lawn or weed cutter.

Take the hard work out of weed cutting. Build yourself an up-to-date weed and lawn mower with the Nu-Way heavy duty unit.

Write for Free Circular—We Supply Cutting Unit Complete
TRACTOR-LITE MFG. CO., Spirit Lake, Iowa

ELECTRICITY *Anywhere*

FOR PORTABLE, EMERGENCY OR HOME USE

ONAN Electric Plants generate 110-volt, 60-cycle current for homes, farms, cabins and resorts beyond the highline. Lightweight, portable plants cut costs, speed work for contractors. Standby plants protect units against power failure. 400 to 55,000 watts. Gasoline or Diesel-powered. Priced from \$219.00.



WRITE FOR CATALOG

D. W. ONAN & SONS INC.

5846 ROYALSTON AVE. • MINNEAPOLIS 5, MINN.

Stuck up?



Cleaned up!



CASITE *Frees* STICKY VALVES

Get rid of engine coughs, jerks, roughness. Chances are, it's caused by sluggish or sticky valves.

Casite through the air-intake quickly frees sticky valves, lets the engine *breathe*, lets the power zoom through. Casite in the crankcase keeps the engine clean and free-running, cuts engine wear by speeding lubrication.

Get Casite for your car today—from your garage, service station or car-dealer. You get Better and Smoother Motor Performance or Double-Your-Money-Back.



CASITE DIVISION
HASTINGS MANUFACTURING CO.
BOX F, HASTINGS, MICHIGAN
Casite Div., Hastings Ltd., Toronto

FREE!

Write for your free copy of "Facts of Engine Life."

Rotomatic Mowing's Fun!



SAVES TIME AND MONEY

SAVES RAKING

SAVES TRIMMING

Cuts Regular Lawn Tall Grass or Weeds

Keeps the lawn velvet smooth and professional looking with a minimum of time and effort. Cuts flush with trees, walks and flower beds so no trimming necessary. Cuts so finely that cuttings act as mulch so no raking required. Automatic clutch stops blade instantly if it strikes obstacle. Precision built for years of dependable service. Send for Folder and name of nearest dealer.

MAJESTIC Rotomatic

MONARK SILVER KING, INC.
6501 W. Grand Ave., Chicago 35, Ill.

BETTER TOOL VALUES!

SEND FOR NEW FREE CATALOG



INDESTRO TOOLS



Ready Soon—Brand New Mechanic's Catalog of Low-Cost, Long-Service Indestro Tools. Full of photographs and detailed descriptions of regular or special tools your dealer can supply for home workshop or professional use. Tells how to select good tools and why you get Better Value when you select Indestro Tools—for instance, all sockets "Hot Broached" to make them wear longer.

Offers you big values in Tool Sets, from 5-pc Punch and Chisel Sets to 114-pc DeLuxe Workshop Sets. Reserve your copy of this Dollar-Saving Pocket-Size Tool Catalog.



FILL OUT AND MAIL NOW FOR FREE COPY

Send to INDESTRO MANUFACTURING CORP.
2649 N. Kildare at Schubert, Chicago 39, Ill.

Write your name and address in margin space

AMAZING TOOL BARGAINS!

ALL BRAND NEW MERCHANDISE

12 MINIATURE CUTTERS \$1.00

FOR CUTTING WOOD, PLASTIC, or METAL



POST-PAID
IN U.S.A.
Actual size. Ass't. shapes on 3/32" shank. For die makers, home workshop, etc.

12 MOUNTED WHEELS



and points on 1/8" Mandrel. For grinding on plastic, wood, soft and hard metals. Regular \$8.40 List Val. ONLY \$2.95

SCHUPACK SUPPLY CO., 7331 Cottage Grove, Dept. M-19, Chicago 19, Ill.

1000s of Tough Jobs Are Easy Now!

WISE-GRIP WRENCH

WISE-GRIP LOCKS with powerful grip — holds anything, can't slip. Turns stubborn nuts, bolts, worn screws, holds small parts. It's actually an Adjustable End-Wrench, Pipe Wrench, Super Pliers—ALL IN ONE HANDY TOOL. With cutter—No. 7W, 7", \$2.25; No. 10W, 10", \$2.60. Without cutter—No. 7C, 7", \$1.95; No. 10C, 10", \$2.25. No. 7, 7", \$1.85; No. 10, 10", \$2.15.



LOCKS with TON-GRIP

ORDER FROM YOUR DEALER. PETERSEN MFG. CO., Dept. P-6, DeWitt, Nebr.

NONE BETTER! SUPER DRILL GRINDER

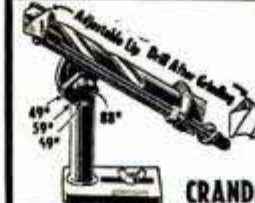

Sharpens round shank drills from 3/32" to 1/2" in diameter, up to 6" long. Grinds old drills like new in 4 different point angles, using hand or power grinding wheels. Money-back guarantee.

Price only \$2.95
At Dealers or Postpaid

CRANDALL MFG. CO. 1512 W. Slauson, Dept. FA-57, Los Angeles 44, Calif.

OWN A Printing Business

Cards, Tickets, Stationery, etc. Good profit in spare time. PRINT YOUR OWN greeting cards, movie titles, church work, etc. Save money. Easy rules supplied. Raised printing like engraving too. Have home shop. Sold direct from factory only. Pays for itself in short time. Write for free catalog of outfits, and all details. KELSEY PRESSES, O-37, MERIDEN, CONNECTICUT

make your own Gems 29.50 F.O.B.

All necessary lapidary equipment is furnished, including a super-charged diamond blade for sawing, and all wheels for grinding, shaping and polishing; also complete instructions. The complete equipment as shown, less motor and belt, for only \$29.50. f.o.b., Burlington, Wisconsin. Write today for information and literature.

B&I MANUFACTURING CO.
Dept. 5 Burlington, Wis.



BeMaCo Dependable AUTOMATIC SAW SET

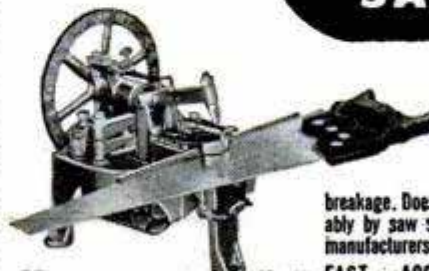

Sets 400 teeth per minute on hand or band saws 4 to 16 point. Hammer and anvil action sets teeth accurately and uniformly... No tooth breakage. Does a perfect job. Used profitably by saw shops everywhere and saw manufacturers. Every machine guaranteed!

FAST - ACCURATE - DEPENDABLE

★ INCREASES PROFITS **BEAVER MFG. CO.**
Saw Machine Div. #6M
800 SO. ISIS AVE. • INGLEWOOD, CALIF.

BUILD YOUR OWN POWER TOOLS - TILT/ARBOR SAW



TILT/ARBOR SAW BANDSAW BELT SANDER
 ● 27x28 in. table stays level. Blade tilts full 45 degrees. ● 10 in. blade cuts 3 1/2 in. deep, jack-screw depth adjustment. ● Floor model, 34 in. table height. ● New Departure ball bearing arbor, 3/4 in. precision shaft, ready to run, 5/8 in. bore blades. ● Quick positioning, self-aligning rip fence guide. ● Sturdy wood, steel and aluminum construction. ● No machining—build easily with hand tools only. ● Capacity and performance of floor saws selling for \$150.00 and up!

SAVE \$50. OR MORE

Same Kit with 10" combination blade.....\$24.90
 Same Kit with 8" combination blade.....\$23.90
 If not satisfied, return Kits in 10 days for refund of purchase price.

(Prices include postage up to 600 miles)
 GIL-BILT Step-by-Step pictorial plans (No blue-print reading required), full scale patterns, actual photographs for above 10" TILT-ARBOR SAW, 12" BAND SAW, BELT SANDER, 8" TILT/TABLE SAW \$1.00 each, postpaid anywhere in the world. ALL 4 Plans for \$3.00, or write for FREE descriptive catalog.

COMPLETE PLANS only \$100 EACH

GILLIOM POWER TOOLS P. O. Box 1-PF, Lambert Field, St. Louis 21, Missouri

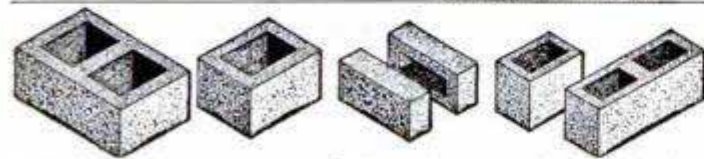

Make Concrete Blocks and Bricks

New superior method makes square, true, easy-to-lay units which will pass any building code. Small investment, high production, big profits. One \$30.00 machine will make four 5"x8"x12" blocks per minute—1000 per day. Pays for itself in a few days. Sell blocks or save 2/3 building cost by making and laying your own.

POST CARD BRINGS FREE FOLDER

Economy Manufacturing Company
 Dept. P Stone Mountain, Georgia

VARIABLE SPEED HYDRAULIC POWER TRANSMISSION



It has Infinite Speeds 0 to 550, Reverse, Automatic Overload Protection; Adjustable Torque up to 180 inch pounds. 3/4" Input and Output Shafts. It will handle 1/2 to 1 1/2 H.P. Motor. Case measures 7 1/2" long 7" high 6 1/2" wide. VALUE OVER \$300. Shipping Wt. 25#. On C.O.D. Orders we require a 10% only \$54.50 Fob. Chicago Deposit.

DIRZIUS MACHINE SHOP "C" 1423-25 So. 52nd Ave., Cicero 50, Ill.

DRAINS Cellars, Laundry Tubs; CIRCULATES Oil; IRRIGATES Gardens

Original "Type P" Pump has 2400 GPH capacity. 360 GPH 75" high, or 1500 GPH from 25" well. Use any 1/2 to 1/2 HP motor. DOES NOT CLOG.

Only \$6.95 postpaid if cash with order. (West of Mississippi, add 50c.)

\$6.95



SATISFACTION GUARANTEED OR MONEY BACK!

LABAWCO PUMPS, BELLE MEAD 7, N. J.

NOW—40 different CUTS with AMAZING, NEW



Warren

DADO SAWING WASHERS On Your Saw Blade

Just dial widths to cut parallel grooves perfectly smooth. No warp, vibration

or trick screws. Strengthens blade, perfect balance. GUARANTEED! At your dealer's or order direct. Give arbor size—1/2", 3/8", 3/4", 1".

ONLY \$4.95 PER SET

WARREN WASHERS COMPANY
 70 MEDBURY, DETROIT 2, MICHIGAN

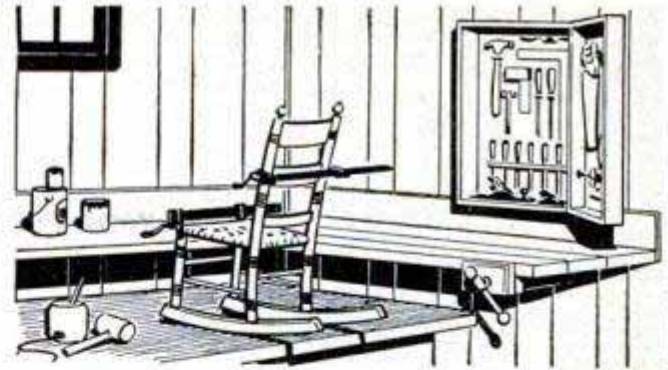

BUILD YOUR OWN PRIVATE WORKSHOP

HOW'D you like to have a snug basement workshop all your own? One where you can hammer and putter to your heart's content without disturbing the family. Build one at low cost with Gold Bond Insulation Board. It deadens noise and insulates against cold. Comes in big ivory-colored Panels as well as Tiles and random-width planks. Tile and planks are finished in harmonizing variegated blends with tongue-and-groove edges to hide nails and staples. Ideal for an attic bedroom, gameroom or any extra room!

Available at your local Gold Bond lumber and building materials dealer!

NATIONAL GYPSUM COMPANY
 BUFFALO 2, NEW YORK

LOOK AHEAD... When power interruptions come the Witte "Redhead" can deliver.

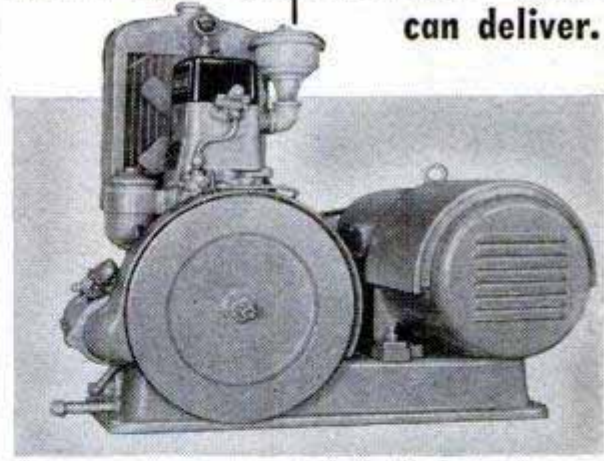

Witte "Redhead" Dieselectric Plant

High winds, cloudbursts or electrical storms won't stop the Witte "Redhead". If you require continuous power, install this Series "AD" Dieselectric Plant now. It will serve you either as a main power supply or as standby. This 5.3 KVA-AC, 4.25 KW-DC plant will operate continuously under full load for 24 hours on a little over 11 gallons of low-cost fuel. Ask your Witte distributor or write for complete information.

WITTE ENGINE WORKS, KANSAS CITY 3, MO.

Division of Oil Well Supply Company
WITTE DIESELECTRIC PLANTS and DIESEL POWER UNITS



UNITED STATES STEEL

SAY YOU SAW IT IN POPULAR MECHANICS

MITI-MITE.

The NEW
AMAZING MAGNETIC
BASE HOLDER FOR MOUNTING

Test Indicators, Handi-Lite,
Magnifying Glass, etc. to Flat or
Curved Surfaces **INSTANTLY!**



ELIMINATES HAPHAZARD CLAMPING

MODEL NO. 100

Single Magnetic Base Indicator Holder for use with smaller indicators. Magnetic pull, app. 50 lbs. Base size 1" x 1 1/2". Ball and socket swivel construction. Complete with 7/32" and 5/16" diam. 4 1/2" extension rod, and adapter for 5/32" type indicators. **\$7.50** in handsome wooden box.

See picture and description of MITI-MITE on P. 225, Jan. Pop. Mecha.

NEW, DOUBLE LENS 4-POWER MAGNIFIER



Available separately No. 125 **\$4.50**

Complete MITI-MITE with Double Lens Magnifier Model No. 120 **\$12.00**



MODEL NO. 200

Single Magnetic Base Handi-Lite for flexible spotlighting of precision work. Magnetic pull, app. 50 lbs. Ball and socket swivel construction.

110-V AC, or DC. 6 ft. plastic cord, 25 watt and 40 watt bulb, handsomely wooden boxed. **\$8.50**



MODEL No. 150 Duplex Magnetic Base Indicator Holder. Magnetic pull, app. 100 lbs. Base size 1 1/2" x 4". Ball and socket swivel construction. Fingertip control magnet release. Accessories include 2 adapters, 2 sweep arms, and bracket arm for accommodating all types and sizes of indicators to 3" dia.

Handsomely wooden boxed **\$15.50**



Order from your mill supply dealer or send order with name of your mill supply dealer

ENCO MANUFACTURING COMPANY

Dept. 561 • 4524 W. Fullerton Ave. • Chicago 39, Ill

as far as possible is more wasteful of gas while accelerating than the same procedure on a conventional-transmission-equipped model. I used regular gasoline in all of my tests and I found it entirely satisfactory in a Chevrolet.

I would like to put in a word for a standardized shift for automatic-transmission cars. If something isn't done about this we shall soon be in the unhappy situation that pertained to gearshift positions many years ago. Remember when Buick and Dodge had shift positions that were entirely different from those used in cars equipped with standard gearshifts?

Let's see what makes the Powerglide tick. The Powerglide is made up of torque converter, planetary unit and clutch, oil pump and hydraulic controls. Actually, Chevrolet combines the principle of a simple fluid coupling with a hydraulic torque converter. Hydraulic torque conversion means using a fluid to provide the proper ratio of speed and torque.

The operation of the car in its smoothness reminds me somewhat of the even flow of power that drivers of early day steam cars will recall. On the steamer, as the throttle was opened a steady flow of power was transferred to the rear wheels. The very same smoothness is evident in Powerglide operation. Powerglide smoothness of operation and its various gear ratios also are somewhat similar to early day friction-driven cars with their numberless gear ratios.

Personally, I was very much pleased and impressed with the operation of the Powerglide. It was far better in its simplicity of operation and in its smoothness in change of gear ratios than I had expected. There is only a slight tendency for the car to creep when standing with the shift lever in (D) position.

The 1951 Powerglide-equipped Chevrolet is the best Chevrolet I've ever driven or tested. I've never found the ideal car and I never expect to. All makes have some features that are both liked and disliked—but owners' ratings, as well as my own, are high on the 1951 Chevrolet.

Almond Hulls Fatten Lambs

If you've been wondering what to do with almond hulls, the answer is this: Feed them to the lambs. When mixed with barley and alfalfa hay, ground almond hulls make a well-balanced ration that is very palatable to the lambs. Dried hulls of the soft-shell almonds are more nutritious than the hard-shell variety, it was announced by the University of California Agricultural Experiment Station.

DRILL BIT MIX
Over 300 pcs. (2 lbs.) of used High Speed Drill Bits up to 1/4". Some require sharpening. Ideal for pin punches, drift pins, etc. Less than 1c ea. at... **\$2.98**

HIGH SPEED STRAIGHT SHANK DRILLS
SET 10 Different Size H. S. Straight Shank Jobber Length Drills, 1/4" to 1 1/2". \$25 Value. Priced at only... **\$4.49**

HIGH SPEED DRILLS
1/2" to 1" with 1/2" Shanks

SET 5 Different Size H.S. Drills, 1/2" to 1", all 2P with 1/2" Shanks... **\$6.95**

SET 10 Different Size H. S. Drills, 1/2" to 1", 3P all with 1/2" Shanks... **\$12.95**

These H. S. precision drills can be used in a 1/2" electric drill or a 1/2" capacity lathe or drill press.

PESCO HYDRAULIC GEAR TYPE PUMP NO. IP203
Rated at 3 GPM @ 3750 RPM @ 1500 PSI. Female type drive... **\$8.98**
Discounts on Quantities

HIGH SPEED WOODRUFF KEY SEAT CUTTER

SET 5 Different Size Cutters. 18K Can be used as mounted milling cutter or circular saw. All with 1/2" shanks, widths up to 1/4", diameters up to 1 1/2". Priced at only... **\$3.95**

HIGH SPEED MORSE TAPER SHANK DRILLS
SET 15 Different Size High Speed Morse Taper Shank Drills up to 9/16" with No. 1 and 2 tapers. \$50.00 value. Priced at only... **\$6.49**

SET 20 Different Size High Speed Morse Taper Shank Drills from 1/4" to 1". 5P \$70.00 Value. Priced at only... **\$12.95**

SET 10 Different Size High Speed Morse Taper Shank Drills from 1/2" to 1 1/4". 6P \$50.00 Value. Priced at only... **\$9.95**

SET 8 Different Size High Speed Morse Taper Shank Drills from 1" to 2" 7P with No. 3, 4 and 5 tapers. \$125 Value. Priced at only... **\$29.95**

HIGH SPEED STRAIGHT SHANK CHUCKING REAMERS

SET 20 Different Size High Speed Straight Shank 8P Chucking Reamers up to 1 1/2". Priced at only... **\$7.95**

SET 10 Different Size High Speed Straight Shank 9P Chucking Reamers from 1/2" to 1 1/4". Priced at only... **\$9.95**

SET 15 Different Size High Speed Straight 10P Shank Chucking Reamers from 1/4" to 1". Priced at only... **\$6.95**

Money-Back Guarantee—All Mds. Mixture of New and Reconditioned Tools Unless Specified Brand New—All Orders (Except Those Specified F.O.B. Tulsa) Are Shipped Post Paid, saving you up to 25% on total delivered cost.

Write for Free Catalog Describing Thousands of Bargain Cutting Tools.

SLITTING SAWS WITH MANDREL
SET 6 Different Size High Speed 11P Slitting Saws, 23 1/2" dia. x 1" arbor. Thickness from .040 to .071. Cuts wood, aluminum, brass, steel, etc. Plus special mandrel which enables use of saws in 1/4" or 1/2" elec. drill. \$25 Value. Only... **\$4.95**

HIGH SPEED HAND TAPS
SET 8 Different Size 12P High Speed Standard Thread Hand Taps up to 3/4", including 2 std. High Speed Pipe Taps... **\$2.95**

Hand Reamers & Tap Handle
SET 10 Different Size Hand Reamers from 1/4" to 1" 13P Majority Brand New Plus No. 6 Tap Handle (5/32" 3/4" Cap.). \$30 Value, Only... **\$9.95**

OXYGEN or AIR TANK with REGULATOR
Volume 104 Cu. in. Maximum pressure capacity 500 lbs. Complete with regulator assembly; 500 lb. pres. gauge; belt clamp. Excellent for breathing apparatus; compressors; small welders, etc. **\$3.95**

NEW MOTOR 1/2 H.P., 24-volt, A.C. or D.C. 22 amp., 6000 RPM. mfgd. by Delco. 3/8" shaft. Can be used on 12 or 36 volts **\$4.95**

T & T TOOL 221 W. SECOND TULSA, OKLA.

B-M POWER MOWERS

CUT HOURS OF WORK into MINUTES of PLEASURE!

Prompt Shipment
* Low Factory Prices
* Fully Guaranteed
* Model D-3

For a quick, slick job and a smooth-as-velvet lawn, you can't beat a B-M Power Mower. Three Models of fine rotary mowers available for your special cutting needs. The D-3 (pictured here), the self-propelled P.D. models, or our light VD-1 Mower with vertical shaft engine and direct blade drive. Quick starting, dependable 1 1/2 to 3 h.p. Clinton engines. Safety features. Easy adjustments. Low factory-to-you Price. Write for **FREE LITERATURE.**

B-M MOWER CO., Box 66-PM, Blue Mound, Kansas

GERSTNER Tool Chests
Gerstner Chests are precision built for longer, more satisfactory service. Free catalog for machinists and toolmakers.
GERSTNER TOOL CHESTS
451 COLUMBIA ST. DAYTON 7, OHIO

Easy and Cheap to Operate
SAVE TIME, WORK, MONEY!
SHAW DU-ALL
and "PEPPY PAL" TRACTORS

PLOW These rugged walking or riding tractors are ideal for farm, truck garden, orchard, poultry farm. Operate on a few cents an hour. A child can handle them.

CULTIVATE **DO DOZENS OF JOBS** Both riding and walking tractors quickly and easily plow, cultivate, harrow, disc, bulldoze, spray, haul, grind, saw wood, etc. **LOW FACTORY PRICES** Buy direct or through your dealer. A year's guarantee!

RIDING TRACTORS Four models from 5 to 12 H. P., 58 in. wheelbase, 36 to 52 in. wide, 24 in. plant clearance. Hand or electric starter. Walking Tractors 1 1/2 to 5 H. P. **FREE** illustrated folders giving complete details, price lists—write today.

SHAW MFG. CO.
4506 Front St., Galesburg, Kans.
668-G North 4th St., Columbus, O.

- Fell Trees
- Saw Wood
- Cut Weeds
- Cultivate
- Plow • Seed
- Rake • Disc
- Bulldoze
- Harrow, etc.

Start a Business in Your Backyard

Earn BIG MONEY MAKING BUILDING BLOCKS

General Concrete Vibrator BLOCK MACHINE
CAPACITY 1000 BLOCKS A DAY
only \$218 LESS MOTOR F.O.B. PLANT
SHIPPING WEIGHT 400 LBS.

Here is a business you can start on small capital—in your own backyard—that earns 100 to 150% profit, with unlimited opportunities. Make concrete or cinder blocks. Millions used for homes, factories, public buildings, garages. Sell all you make to building trade. Do it with a General—and you're headed for success.

1000 BLOCKS A DAY
The General is a high speed, power-driven block machine at amazingly low cost. Rugged all-steel construction. Simple to operate indoors or outdoors. Makes superior 3 core type block meeting all code requirements. Produces up to 1000 blocks per day. Full operating instructions and mixing formulas supplied. Write for **FREE** details.

Wonderful Book Written & Illustrated by Experts

GENERAL ENGINES CO.

DEPT. M-61 • 307 HUNTER ST. • GLOUCESTER, N. J.

Includes floor plans for 6 beautiful, easy to build concrete block bungalows. Shows ways to save money. How to lay blocks, lay out building lines, mix concrete, build steps, porches and concrete floors. Mail coupon at once with \$1.

Name.....
Address.....
City..... Zone..... State.....

NEW!

JUST TWIST AND RAP!
TWIST AND RAP!

IF YOU USE A
SCREWDRIVER OR
WRENCH YOU NEED AN...



**SENSATIONAL! FOR LOOSENING
OR TIGHTENING NUTS, BOLTS
OR SCREWS!**

An amazing new development to save
tempers and skinned knuckles... hours
and dollars... for everyone who works
on screws, nuts or bolts. Impakdriver
translates the impact from a hammer's
blow into a great amount of torque and
starts ornery screws, nuts or bolts with
unbelievable speed and ease! And it's
great for loosening or tightening in hard-
to-get-at places. A simple inexpensive
tool, yet it beats the toughest problems
and the worst time-killers. Belongs in
every tool box... mechanics, machinists,
repairmen, home handymen, hobbyists,
everyone who uses screwdriver or wrench.
Pays for itself on the first tough job made
easy!



Sold in different set combinations
with specially designed attachments
for Hex sockets up to 9/16" and two
sizes of Phillips and ordinary
screwdriver bits.

See the Porter Impakdriver at your dealers
or write for folder showing all details.

H. K. PORTER, INC., Somerville 43, Mass.

Porter Cutters

Porter Pruners

PORTER-FERGUSON Autobody and Fender Repair Tools

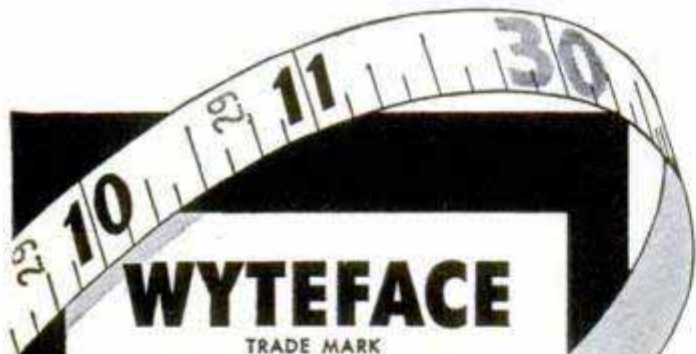

WYTEFACE

TRADE MARK

STEEL TAPES

No squinting, no guessing when
you use WYTEFACE Steel
Tapes. Jet black markings (foot
numbers in red) on a white
background. Easier to read in
any light. Faster, more accurate
measurements. Rust-resisting,
hard to kink, simple to clean.

Protected by U. S. Patent 2,089,209

K+E

"I'll take the WHITE one
every time!"

KEUFFEL & ESSER CO.

A Sturdy-Safe Scaffold IN 3 MINUTES!

with
RICHEY
Safety
**LADDER
JACKS**



Just hook jacks to ladder rungs as pictured, and lay
boards across jacks. Speeds your painting, carpenter
work, masonry, tuck pointing, gutter work, etc. Makes
work easier and safer. Heavy steel construction for ut-
most safety. Adjusts to any angle or height. Order yours
today—only \$10.50 per pair, prepaid, cash with order—
or C.O.D., you pay charges. Satisfaction guaranteed or
money refunded.

Jobber and Dealer inquiries invited.

RICHEY MFG. CO.
Dept. P61

2801 Rochester Road
Springfield, Illinois

New POWER MOWER



FREE

Building Instructions
Write For Them

Amazing invention makes whirl-blade
mower pull and steer itself as well
as cut grass and weeds. Convert
your mower or build a complete
mower with screw-
driver & pliers. Send
name and address, 1c
postcard will do.

Convert Your Mower
Or Build A New One

PULLS ITSELF, STEERS ITSELF

T & H Mfg. Co., Dept. MPC-6, 811 E. 31 St., Kans. City, Mo.



Spindle—Platform—Wheels—Fork—Handles—Driving & Steering Parts
All parts available—kit or separately.



STARRETT "Tools and Rules" BOOK

Describes and illustrates the precision
methods skilled mechanics use. Only one
dime. Write Dept. AP.

THE L. S. STARRETT CO., Athol, Mass., U. S. A.

SPECIAL OFFER!

LOCK-STITCH
SEWING AWL

\$1.

Postpaid

Famous, pat-
ented lock-stitch
sewing awl complete
with needles, waxed thread
and direction folder. Hundred
uses — sewing, repairing leather
goods, canvas, belting, harness, sad-
dles, gun cases, awnings, golf bags. Extra
needles and thread available. Satisfaction guar-
anteed or money back. Send currency, check or money order.
Yates Mfg. Co., 611-H Main St., Lake Geneva, Wisconsin



IDEAL LAWNMOWER SHARPENER

Saves work, saves time,
helps you earn extra
dollars! Sharpens hand,
power mowers without dis-
assembling. Complete shop
in one machine — equipped
with Bed Knife Grinder and
"lapping-in" Reconditioner.
Home owners, parks, clubs,
cemeteries pay good money
for efficient sharpening; get
your share!

WRITE NOW FOR FREE CATALOG

THE FATE-ROOT-HEATH CO., Dept. I-3, Plymouth, Ohio

SAVE OVER 50%

ON THESE BRAND NEW WAR SURPLUS POWER UNITS



BE PREPARED for any emergency!

LIGHT PLANT BUYERS—

in emergency telephone collect—unit shipped same day!
5 KW Plant, 120 volts, 60 cycle AC. List today \$1910.00. Used \$675.00 NEW. Your price only \$895.00

BARGAIN SPECIALS!!

Ball-bearing Arbor... \$ 6.95
 Alarm Siren or Horn... 15.45
 Mercury Heat Control... 6.95
 Barn Ventilator... 69.50
 Electric Hot Water Heater, 10 gal... 24.95
 Hot Rod Supercharger... 31.00
 MALL flexible shaft grinder... 99.50

2500 Watt, AC, 110 volts, 60 cycle. Slightly used but reconditioned and fully guaranteed ONLY... \$295.00
 NEW, same as above... \$345.00
 Plants built in 1951... \$426.00
 300 Watt, Reg. \$145, Now \$ 99.00
 750 Watt... \$232.00
 3000 Watt DC Contractor's PORTABLE. Rubber tired wheels, 5 to 7 HP gas engine. Used like new \$220.; New... \$279.00
 7500 Watt 4 cyl. engine; New \$995.00
 10,000 Watt Used \$1195.00; New \$1495.00
 25,000 Watt Used \$1995.00; New \$2495.00
 35,000 Watt Diesel, Rebuilt \$2995.00
 50,000 Watt Diesel, New \$5900.00
 All units 10,000 and over, 1 or 3 phase 110-220 volts.

HEAVY DUTY, all purpose WINCH

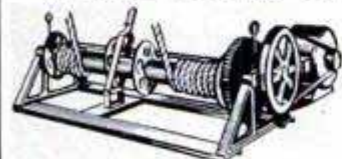

For — CONTRACTORS, BOATS, FARMERS, TRUCKS, LOGGERS, ETC.

Multiply your pulling, hoisting power tenfold. Can be driven by hand, gas, electric, or tractor take off, 10 to 1 ratio; double drum for reverse. Manufactured by Brenner. Wgt. 280 lbs. List price \$119.95. Our price... **\$49.50**

Below are just a few of the many items we have in stock at sensationally low prices:

Pumps	Air Tanks	Fire Pumps	Gear Reducer
Grinders	Drop Cords	Saws	Clutches
Air Compressors	Generators	Winches	Motors

Write today for free catalog. Thousands of \$\$ saving buys.

C & H ELECTRIC Co.
 434 W. JUNEAU AVE.
 MILWAUKEE 3, WISCONSIN

THE NEW AUGER BIT

ORDER TODAY!
70c
 3/8" Size

First real improvement in Auger Bits in years. Entirely different in design! Cuts clean and fast with much less effort. Chips clear themselves quickly. Far better for tough drilling jobs. Easy to resharpen with ordinary grinding wheel. One trial will convince you!



SIZES: 3/8", \$.70; 1/2", \$.75; 5/8", \$.80; 3/4", \$.90; 7/8", \$1.05; 1", \$1.15. Buy set of six in plastic roll case—\$5.95.

Money back guarantee. Cash with order. We pay the postage.

BARCLAY CO. P. O. BOX 883, PLAINFIELD 8, N. J.



The Right Tool for a Right Job
IN YOUR WORKSHOP
EMPIRE LEVELS



Get more value for less money! Make Your Choice an Empire Level

No. 151 Aluminum Level. Extremely accurate with adjustable-interchangeable vials. Has 2 levels, 2 plumbs, and a choice of 2 45° vials or 2 additional plumbs. Beautifully finished, easy to work with. A tool you can be proud to own.

18" ... \$6.75 24" ... \$7.50 28" ... \$8.50

Order EMPIRE Levels from your local dealer, or write for free booklet "Choice and Care of Your Level."



EMPIRE LEVEL MFG. COMPANY

Dept. PM 10930 W. Potter Rd., Milwaukee 13, Wis.



YIPE

...not in my car?

A mucked-up oil filter can cost you plenty in engine repairs. Get in a new Purolator* Refill—quick!

Only a clean filter can trap all the gritty abrasives that get into your oil stream *before* they get a chance to chew away at precision engine parts, skyrocket your repair bills.

What to do? Don't delay—get in a clean filter refill—fast. **Which make?** Pays to buy the best—a Purolator Micronic*. New accordion-type design gives up to 10 times the filtering area—with pores so tiny they trap particles you can't even see. **Cost much?** Strictly small change—\$1.38 to \$3.00 depending on car make. Purolator Products, Inc., Rahway, N.J.; Toronto, Ontario, Canada. *Reg. U. S. Pat. Off.

PurOlator
 MICRONIC
OIL FILTER

Sure you know him . . . he's **DONALD O'CONNOR** starring in "DOUBLE CROSSBONES"—a Universal-International Picture



When Screws Won't Stay TIGHT, Use SMOOTH-ON

Apply Smooth-On No. 1 Iron Cement to screw threads and into the screw hole. Insert and tighten up the screw. It will take hold and, when set, will **STAY TIGHT**, for Smooth-On expands slightly as it hardens, wedging the screw in place. This is only one small use for this general-purpose iron cement. With it you can stop leaks and seal cracks in cast metal parts, tighten loose knobs, casters, tool and utensil handles, make many auto repairs. Buy it in 1³/₄-oz., 7-oz., 1-lb. or larger size at your hardware store. If they haven't Smooth-On, write us.

FREE 40-page Repair Handbook

Many original uses for Smooth-On around the house, on the car, etc. Simple directions. 170 illustrations. Send postcard for YOUR free copy.

SMOOTH-ON MFG. CO., Dept. 37F
570 Communipaw Ave., Jersey City 4, N. J.

Do it with

SMOOTH-ON

THE IRON CEMENT OF 1000 USES



LIFETIME CHRONOGRAPH, STOP-WATCH CALENDAR WATCH



It's also a
TELEMETER &
TACHOMETER

CALENDAR

WINDER

NEW LOW PRICE

8.95

with Steel
Expansion Band
Plus 10% Tax (90c)

31-Day Calendar

Changes dates automatically! For Sportsmen, Scouts, Photographers, Engineers, Chemists, Navigators, Doctors.

FULLY
GUARANTEED
for One Year

Plus Lifetime
Service Certificate
5-Day Free Trial.

Remarkable Import Buy—these ideal all-around timepieces and chronographs at an unbelievable low, low price. Imported Swiss jeweled movement, Radium-Glow 1" dial, red sweep-second hand, shock-resistant case, unbreakable crystal. And—included is the handsome, rich-looking steel expansion wristband. Complete instructions included together with guarantee and service certificate. White, Pink or Black dial face, specify color.

GAYLORD Dept. PF-7, Fifth & Hamilton, Pittsburgh 6, Pa.

I enclose Check Money Order Send C.O.D.
Send _____ Chronograph watches at 8.95 (Postpaid), plus 10% tax on 5-day free trial. Money Back Guarantee. Name & Address on Margin.

SAY YOU SAW IT IN POPULAR MECHANICS

MAKE BIG MONEY Sharpening Lawn Mowers...

SPARE OR FULL TIME

Mr. C. E. Hardy of Missouri says, "I am doing a fine business with the Universal Grinder. One Customer sends another. I spent 40c for a newspaper ad and have done nearly \$500 worth of business." G. E. of Ark. says, "I have had my Universal Grinder 2 months and made a net profit of \$227."



ONLY ON THE UNIVERSAL LAWN MOWER GRINDER

... can the inside face and edge of the stationary blade, as well as the reel blades, be ground to proper clearance ALL IN ONE SET-UP, without removing any blade from either hand or power mower. Send Today for Free Details. **ROGERS MFG. CO. Dept. M-61 LINDSEY, OHIO**

OWN a Business

Clean and Mothproof rugs and upholstery "in the home." Patented equipment. No shop needed. Duraclean dealer's gross profits up to \$15 a day on EACH serviceman. These Nationally Advertised services create repeat customers. Easy to learn. Quickly established. Easy terms. Send today for FREE Booklet — Full details. **DURACLEAN CO., 1-166 DURACLEAN BLDG. DEERFIELD, ILL.**

DUST-O-VAC FOR ALL MACHINES

For Home Workshops & Industry. DUST-O-VAC collects & bags wood & plastic chips, wood & metal dust, wood shavings. Free Bag. Attaches to circular saw, planer, band saw, grinder, belt or disc sander, shaper, drill press with shaper or sander attachment, spindle shaper, wood lathe, jig saw, 110 A.C., D.C. Send for mounting instr. for all machines. **Yonkers F.O.B. \$19.95**

HEAVY CAST ALUMINUM BLOWER — ONLY \$11.25
For workshop, lab., kitchen, cellar, app. 100 CFM. Send for circular. **UNIVERSAL YONKERS CORP., 137 Alexander St., M-6, Yonkers 2, N. Y.**

SILVER SOLDER TORCH & KIT \$6

JOINS ALL METALS PERMANENTLY
Do your own repairing. KIT includes one tube silver solder "XCEL-FLUX" paste and 10 5-in. lengths silver solder alloy. Hottest ALCOHOL TORCH known. 2700° F. flame. Operates in any position, indoors or out. Torch alone \$5.50. KIT alone \$1.50. Add 25c on each order towards shipping charges. **AMERICAN PRODUCTS CORP., 422 S. Dearborn, Dept. 3-F, Chicago**

JUST OUT! 1951 EDITION — It's New!

It's Different! Get world's largest Auto Accessory & Parts Catalog and save money. Over 50,000 items, including Hollywood Accessories, Hi-Speed Equipment, Rebuilt Engines, all parts & accessories for all cars & trucks. We have that Hard-To-Get part! Jam packed with bargains. Completely illustrated. Send 25c (refundable). **J. C. WHITNEY & CO., 1917 ARCHER AVE., CHICAGO 16**

64" Flexible Shaft WITH HANDLE

WOVEN WIRE CORE
Coupling to fit 1/2" motor shaft; other end fits standard chuck. Durable, heavy. Use it for grinding, polishing, buffing, drilling, etc. A real bargain—cannot be duplicated for \$15.00
only 4.95 P.P. Prepaid

Just what you have been looking for. Money refunded if not satisfied. No C.O.D.'s. Send check or money order.

HARRY W. RETTEW
400 WEST AVE., JENKINTOWN, PA.

IT STAYS FIXED



WITH SPEED NUTS

SPEED NUTS—the fasteners that won't vibrate loose—now available in handy kit. Ten popular sizes with matching screws. Replace threaded nuts and lock washers in repairing all types of metal, wood, plastic products. Over 100 parts for only \$1. Send cash, money order, check—no stamps—no C. O. D.



TINNERMAN PRODUCTS, INC.
Dept. 13, Box 6688, Cleveland 1, Ohio

MAGNETS OF ALL TYPES—10c UP

AMAZINGLY POWERFUL!!
1/2 lb. magnet lifts 25 lbs. \$1.95.
Our Leader, 1 lb. magnet lifts 40 lbs. \$2.95. New alloy—will not weaken! Useful for lifting valuables from tanks, lakes, or rivers easily! 7 small magnets \$1.25 with list of many shop and home uses. Satisfaction guaranteed.
R. EYRICH, 1219 W. MEINECKE AVE., MILWAUKEE, WIS.

FORCED AIR

INSTALL IT YOURSELF AND SAVE \$100 OR MORE.

CONVERT YOUR GRAVITY FURNACE TO MODERN EFFICIENT FORCED AIR HEAT. INSTALL MCLARTY FANS IN YOUR COLD AIR PIPES. NO SHEET METAL WORK REQUIRED, PLUGS INTO ANY 110V A.C. OUTLET. LOWEST COST SYSTEM ON THE MARKET.

FREE CIRCULAR

MCLARTY SYSTEMS
2607 DICKMAN RD. BATTLE-CREEK MICH.

HANDY HANDSCRAPER

Hansen's Handscraper is designed by a professional floor-scraper and has many improvements. Adjustable blades of best spring steel. Available at leading paint and hardware dealers or write manufacturer. Large scraper 75c; small 39c. Add 8c for shipping.

HANSEN PRODUCTS
Box 365 Rockville Centre, N.Y.

SAY YOU SAW IT IN POPULAR MECHANICS

584 Page Novelty Catalog Now Ready!

584 Pages; 7500 Amazing Novelties

Send 25c for mammoth new catalog of 7500 novelties. (Each copy costs us over 50c—25c helps pay postage.) More fascinating than World's Fair. Thousands of things you never knew existed—never knew where to get. Includes novelties, tricks, jokes, live animals & pets, scientific supplies, den novelties, hobby supplies, planes & boats, looms, magic, unusual seeds, gadget time savers, camera & optical goods, movies, projectors, lucky jewelry, religious novelties, telegraph sets, magnets, disguises, easy musical instruments, stamps, coins, puzzles, fortune tellers, radios, experimental sets, auto & bike accessories, Western belts & wearing apparel, telescopes, magnifiers, compasses, banks, smokers' gadgets, artists' supplies, printing sets, engines & motors, electric shockers, knives, billfolds, weird articles, archery, swimming helps, 1000 fascinating books, games, locks, live chameleons, barometers, rings, watches, charms, imported novelties, exercisers, money savers, handy tools, Indian novelties, etc., etc., etc. Jammed & packed with sensational funmakers & useful articles. Big catalog—over 1 inch thick. 6 color cover. Rush Coupon to Johnson Smith & Co.

25c

RUSH — THIS — COUPON —

Johnson Smith & Co., Dept. 372, Detroit 7, Mich.
Here's My 25c. Send Big Catalog to:

Name & Address _____

SpeedWay SpeedSander

\$34⁵⁰



**Sands,
Cleans,
Smooths, Polishes Electrically**

Designed for industry, for professional work, this light, beautifully balanced, orbital-motion, SpeedSander is rapidly becoming a standard home appliance. With its powerful electric motor and all-ball-bearing construction, anyone can easily re-surface and refinish furniture, woodwork, metal surfaces or walls. It will quickly remove old paint, stain, or enamel down to the bare wood or metal; will sandpaper to a "piano finish"; remove rust and corrosion or "feather edge" a scraped fender. It will burnish pots and pans or with lambs wool bonnet, delicately polish fine furniture. It makes

tedious, tiresome jobs fun—saves hands! In design, convenience and efficiency it is today's finest sander regardless of price. Ask your local dealer to demonstrate it.

Write for Catalog

SpeedWay MANUFACTURING CO.
1863 So. 52nd Ave., Cicero 50, Illinois

The NEW Model 50 UTILITY TESTER FOR REPAIRING ALL ELECTRICAL APPLIANCES-MOTORS

an all-around electrical trouble shooter

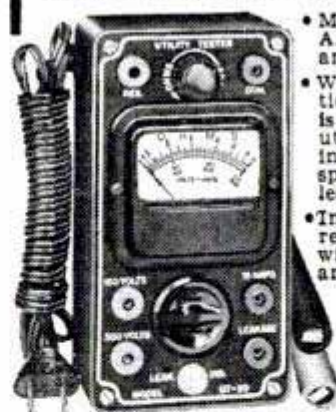

- Measures A.C. and D.C. Voltages, A.C. and D.C. Current, Resistances, etc.
- Will measure the current consumption while the appliance under test is in operation. The appliance or utility may be plugged directly into the front panel receptacle. A special pair of insulated clip-end leads is included for motors, etc.
- Incorporates a sensitive direct-reading resistance range which will accurately measure all resistances commonly used in electrical appliances, motors, etc. This range will enable continuity checks and tests for shorts and opens.
- Will test thermostats, radio tube filaments, bulbs, fuses, fluorescents, condensers, switches, field coils, circuit breakers, lighting systems, etc.

Handsome round cornered molded bakelite case 3 1/8" x 5 7/8" x 2 1/4". Complete with all test leads and instructions.

\$13⁹⁰

SOLD ON EASY PAYMENTS AT THE NET CASH PRICE

No interest or carrying charges added. Simply remit \$3.90 with order, pay balance, \$2.00 per month for 5 months.

SUPERIOR ELECTRONIC CO., INC.
Dept. B-10 • 227 FULTON STREET • NEW YORK 7, N. Y.

BUILD YOUR OWN COOLING FANS

EXCLUSIVE GIL-BILT BUILD-IT-YOURSELF FEATURES

- Engineered for home construction by world's leading manufacturer of build-it-yourself power tools.
- No machine work. Build easily with hand tools only.
- No guess work. No blueprint reading. Step-by-step pictorial plans, full size patterns, actual photographs.
- Sturdy wood & plywood construction, engineered for reduced noise and vibration.

SAVE UP TO
\$50
OR MORE

GIL-BILT 24 INCH WINDOW FAN

- Two heavy OILITE oilless bronze bearings
- 24 inch TORRINGTON 40 degree pitch aluminum blade
- Pedestal mount for blade and pulley simplifies construction. Shipped ready to run.
- Mounts out of way on outside of window.
- Belt driven with any 1/6 or 1/4 h.p. motor.
- Rubber cushioned mounting brackets reduce noise, simplify installation.



• 5000 C.F.M. at 620 r.p.m. cools 4 or 5 room house.
GIL-BILT KIT #520-A Includes Plans, TORRINGTON rustproof blade and V-pulley mounted ready to run on cast aluminum pedestal, V-belt, motor pulley, mounting brackets, plus all necessary screws and bolts. (less motor and wood for wood parts).....**\$19.95**
GIL-BILT Plans #520, Full Size Patterns.....50

GIL-BILT 36 INCH ATTIC FAN

- Molded rubber cushions minimize vibration.
- Sound proofed, ball bearings, sealed against dust and dirt.
- Efficient 36 in. Torrington Steel Blade.

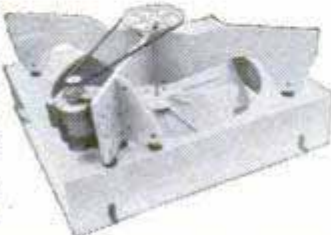

- Horizontal mounting makes installation easier.
- Rubber cushioned mounting brackets reduce noise.
- 9000 C. F. M. with 1/3 h.p. motor. Cools entire house.

GIL-BILT KIT #510-A Includes Plans, bearing blocks, 3/4 inch steel shaft, Torrington blade, two V-pulleys, V-belt, rubber cushions, mounting brackets, plus all necessary screws & bolts (less motor & wood for wood parts).....**\$25.95**
GIL-BILT Plans #510, Full Size Patterns, Installation Instructions 1.00
NO DEALERS—One Low Factory Price! Prices include postage within 600 miles. Over 600 miles add 5%. Send cash, check or money order for fan kit, or send for Plans now and order KIT later less cost of Plans. Also available: 20 in. ROOM COOLER FAN, MOTORS, and BLADES. Write for FREE descriptive folder.

GILLIOM POWER TOOLS

P. O. Box 1-FP Lambert Field St. Louis 21, Mo.



ONLY
\$49.95

FULL
18" SIZE

NOT A KIT—COMPLETELY ASSEMBLED

Use your own gasoline engine or electric motor and save \$50.00. This is a self-propelled power mower on which any engine or motor from another piece of equipment may be easily added. 18" 5 blade cutting reel. Permanently lubricated precision ball bearings, V Plex, automatic clutch, heavy 11 ga. steel top plate. 90 day guarantee. Shipped f.o.b. Indianapolis. Send check or money order today! **\$49.95**

S-C PRODUCTS COMPANY

Box 5127 (Brightwood Station), Indianapolis 18, Indiana

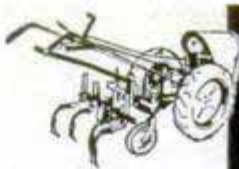

NEW
'51
LINE!

PAGE GARDEN TRACTORS

RIDING AND WALKING MODELS!

NO
CHEAP
BELTS OR
CHAINS!

SAVES
LABOR!

WRITE

2 TO 6 H. P. WITH
COMPLETE GEAR
DRIVE AND REVERSE

LOW PRICES

EASY TERMS

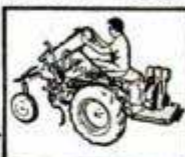

BENEFIT FROM OUR 25 YEARS EXPERIENCE
FREE 24 PAGE CATALOG SHOWS ALL ATTACHMENTS

PAGE FARM EQUIPMENT

1904 S. 81st St. • Milwaukee 14, Wisconsin

MACHINE SHOP EQUIPMENT



• The No. 49 edition of the famous Center Tool Co. Catalog is now ready! Every workshop owner should have a copy. 240 pages full of illustrations, descriptions, and prices of the latest tools made by best known manufacturers in U. S. You pay the cost of printing—50c. We refund your 50c with your first order of \$10.00 or more. Prompt delivery on most tools. Send check or money order today!

CENTER TOOL CO.

153 Centre Street, Dept. C, New York 13

MARCOT KEY MACHINE



MARCOT No. 8 KEY MACHINE, less motor.....\$110.00
Auto Code Book and Depth Keys.....12.50
75 Dz. Popular Key Blanks.....60.00
Set — Key File, Follow-Through Rods, Lock Picks, Bit Key Gauge, Thimble, Pins, Springs.....10.50
"Locksmith Trade Books".....6.75
How to Open Locks without Keys or Picks; Secret of Locksmithing; How to Make Keys by the Impression Method; Master Key Systems.
TOTAL COST.....\$199.75

Immediate Delivery

A. J. MARCOTTE CO., 1200 N. Kedzie Ave., Dept. PM, Chicago 51, Ill.

ACCURATE

Most POWERFUL patented air pistol made. Looks and feels like Luger. For Cal. .177 or .22. Game HUNTING, indoor or outdoor TARGET shooting. At your dealer, or write Dept. PA-5

NO
PUMPING
HY-SCORE
AIR PISTOL



HY-SCORE ARMS CORP., 25 Lafayette St. Brooklyn 1, N. Y.

POSTPAID
ANYWHERE
IN U.S.A.

WE FURNISH ALL MACHINED METAL PARTS, EVERY SCREW, NUT, BOLT, WASHER, AND COMPLETE PLANS FOR THIS...

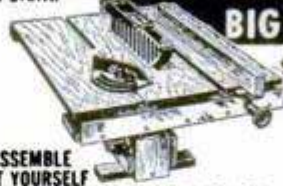

BIG 10" POWER SAW

\$10.95 FULL REFUND IF
LESS GUARD NOT SATISFIED
& WOOD IN 10 DAYS

ASSEMBLE
IT YOURSELF
WITH SIMPLE HOUSEHOLD TOOLS!

COMPLETE PLANS 10c
MARCUS-POLLAK
DEPT. N, ROYERSFORD, PA.

SAY YOU SAW IT IN POPULAR MECHANICS

FORD-MERC. OWNERS STOP BURNING POINTS!

Dual Point Distributor Conversion SAVES COSTLY REPLACEMENTS! Complete kit for '49, '50, '51 Ford 8 or Mercury. Converts single point to dual point distributor using same coil and single condenser. Easily installed.

5 DAY FREE TRIAL

- Eliminates missing Acceleration
- Higher RPM
- All parts stock Ford, buy anywhere.
- Money Back Guarantee. Send 25c For Special "Custom Accessories" Catalog. Dealers Write.

EASTERN AUTO

3319 SO. GRAND AVE. DEPT. P-6, LOS ANGELES 7, CALIF. \$2.00 deposit with C.O.D.'s.



ONLY
\$7.95

**RELIEVES PAIN OF
HEADACHE • NEURALGIA
NEURITIS**

FAST

The way
thousands of
physicians
and dentists
recommend



Anacin® relieves headache, neuralgia, neuritis pain fast because Anacin is like a doctor's prescription—that is, Anacin contains not just one, but a combination of medically proven, active ingredients in easy-to-take tablet form. Thousands have been introduced to Anacin through their own dentist or physicians. If you have never used Anacin, try these tablets yourself for incredibly fast, long-lasting relief from pain. Don't wait. Buy Anacin today.

SAY YOU SAW IT IN
POPULAR MECHANICS

WAR SURPLUS BARGAINS

BRAND NEW WAR SURPLUS!



GENERATORS 115V-AC

FOR AUXILIARY LIGHT PLANTS

NOW . . . here's the buy of the year. Brand new Eclipse Generators in the original box.

These generators have an AC output of 115 volts, 10.4 amps, 1200 watts, single phase, 800 cycles at 2400 R.P.M. They also have a DC output of 28.6 volts, 60 amps. The unit has a spline drive shaft and is self excited. It will serve as a dependable 115 V.-AC auxiliary light plant when driven by a gasoline engine for farms, cottages, flood lighting, trailers, boats, or wherever power is not readily accessible. Shipping wt. 55 lbs. Govt. cost more than 10 times selling price. F.O.B. Pasadena

ONLY
\$199.5



VACUUM PUMPS

PESCO VANE TYPE NO. 194-D

An excellent pump . . . can be used as air or fuel pump for pressure or vacuum. Pumps 7½ gallons of oil at 300 RPM; Builds air pressure 30 PSI at 1000 RPM; Vacuum draws 26" of mercury at 1750 RPM.

\$125.00
EACH

HYDRAULIC HAND PUMPS

DON'T MISS THIS VALUE . . . LIMITED

Highest quality aircraft construction. Integral cast aluminum pump with mounting brackets and detachable handle. Operating pressure up to 1500^{psi} per square inch. Ideal for hundreds of applications. A fast-acting source of tremendous power for almost any heavy work.

Limited Quantity at This Price

\$99.5
EACH

All Equipment F.O.B. Pasadena • Enclose Full Amount With Order

C and H Sales Company

BOX 356 EAST PASADENA STATION • PASADENA 8, CALIFORNIA

Ride it—
Own it!



Great-riding, **COMPLETE**
motorbike — amazing low cost!

WHIZZER Pacemaker

- Full-size heavy-duty frame
- Dual coil telescopic spring fork
- Big, 3-point mounted saddle
- 5-inch expander-type brake

Want the best for the least? Then here's your answer—Whizzer Pacemaker! A factory-built, *complete* motorbike, with features galore and riding qualities that make it a real standout. It's sturdy, dependable, handsome. 5 to 40 m.p.h., up to 100 miles per gallon. Inspect Pacemaker! Ride it! Own it! Only . . . **\$199⁵⁰**

plus tax, FOB Pontiac

SEE THE REST OF THE WHIZZER LINE

SPORTSMAN—A long, low and lively deluxe motorbike. 20" wheels. Star of the light-weights.

AMBASSADOR—Big, rangy and rugged. A full-size luxury motorbike. 24" wheels. A real beauty.

3 H.P. MOTOR—138 c.c., 4-cycle. America's finest bike motor. Fits any man's heavy-duty bike.

ACT TODAY!

See your dealer or mail coupon TODAY!

Whizzer Motor Company
366 S. Sanford St., Pontiac, Mich.

Please send me, at once, free illustrated literature on Whizzer Pacemaker and other Whizzer motorbikes.

NAME _____
ADDRESS _____
CITY _____ STATE _____

SAVES SO MUCH COSTS SO LITTLE!



8" BENCH SAW



ONLY \$33.95

With two extensions, as shown, \$38.90.

Watch the savings pile up with this Workshop saw to help! Makes quick, professional work of home repairs, furniture, cabinets, shelving, toys, etc. Cross cuts, rips, mitres—saves tedious, time-taking hand sawing. Pays for itself on one or two projects alone. Send for detailed catalog today!

40th Year Atlas **ATLAS PRESS CO.**
643-W N. Pitcher St., Kalamazoo, Mich.

DEPENDABLE QUALITY TOOLS



KNOW YOUR COASTER BRAKE INSIDE and OUT!

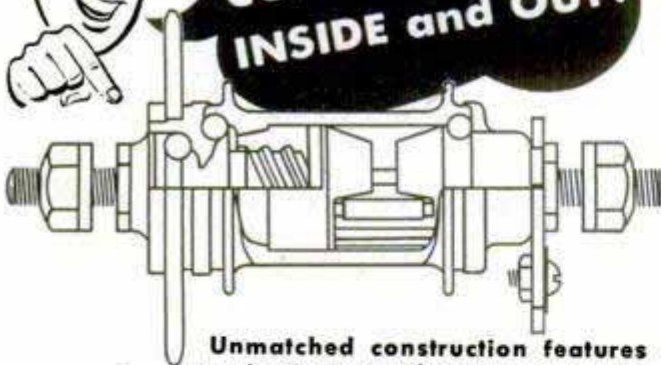

Unmatched construction features make the Bendix* Coaster Brake the outstanding performer in its field. That's why Bendix Coaster Brakes—stop quicker—pedal easier—coast farther—last longer. Your bicycle dealer will put on the brake you want—so just say "Bendix Coaster Brake."

*REG. U. S. PAT. OFF.

Ride a Bike - it's Fun!

DOUBLE THE FUN WITH A Bendix COASTER BRAKE

ECLIPSE MACHINE DIVISION of
Elmira, New York



ABSORB DAMPNESS!

In Basements, Closets, etc.

with the **SOLVAY AIR-DRYETTE, JR.**

and **Solvay Calcium Chloride**

Absorbs moisture—the cause of rust, warping, mildew in workshops, darkrooms, closets, playrooms, storage rooms, vaults. Built to last for years. Big capacity. Works fast, absorbs up to 3 1/2 qts. per day. Compact, inexpensive, clean, safe, odorless. Thousands in use. Write for booklet and name of your nearest dealer. Not available on Pacific Coast. Dept. 89-6, SOLVAY SALES DIVISION, Allied Chemical & Dye Corporation, 40 Rector St., N. Y. 6, N. Y.



DON'T LOSE YOUR TOOLS

SEND 10c FOR SAMPLES

Your name on your tools is best protection against loss or theft... 36 permanent decal transfers for \$2.50, size 3/4"x2", with 1, 2 or 3 lines of type. Applied in a jiffy. Won't rub, wear or wash off. Send money order with copy, plainly printed, to MARKERS, Box 1111, Hollywood 38, California.

Make Money SELLING Eshelman Kulti-Mowers and DOING GARDEN WORK

PLOWS CULTIVATES HARROWS HAULS SPRAYS SAWS DOZER MOWS CUTS ROLLS RAKES



FOR BETTER LAWNS and GARDENS also POWER MOWERS and RIDING TRACTORS Women can operate it.

11-3-6 H.P. Free Catalog. Write Eshelman Co., Dept. 129, 119 Light St., Balto., Md.



BRONZE FOUNDRY

Schools and Home Workshops

Make your own castings of aluminum, copper, bronze, silver. Foundry sets are available in three sizes including 2400 Deg. F. blast Furnaces. \$22.50; \$29.50; and \$42.00. f.o.b. Kansas City. Free Circular.

KANSAS CITY SPECIALTIES CO. P. O. BOX 6022, DEPT. P-6 KANSAS CITY, MO.

IN HOT WEATHER

Get top-notch performance from your electric razor. In sticky, perspiry days of summer when shaving is most uncomfortable, this amazing preparation:

1. Evaporates sticky, razor-clogging perspiration.
2. Lubricates skin for faster, more comfortable shaving.
3. Tautens skin—"brings out" your beard for closer, better-looking shaves.
4. Lubricates your shaver's cutting head.



FREE! Try Lectric Shave at our expense. It is avail-

able at drugstores or toilet goods counters. Only 49¢ plus tax—enough for 80 shaves. For a generous free sample, send name, address to The J. B. Williams Co., PM-3, Glastonbury, Conn. (Offer good only in U.S.A.)

Your ELECTRIC DRILL Trims
HEDGES — SHRUBS — GRASS
with **ROTO-TRIM**
DRILL ATTACHMENT

FITS ANY
1/4" DRILL

Today's Greatest
Hedge Trimmer VALUE \$10.95
Yours, Postpaid, for only \$10.95 (LESS DRILL)

Keep your whole yard neatly tailored . . . trim hedges, shrubs and hard-to-reach grass easily and smoothly with this new, inexpensive drill attachment. ROTO-TRIM quickly converts any 1/4" drill into the easiest-handling, keenest-cutting Hedge Trimmer that money can buy!

Quality Built throughout. Rigid steel and aluminum construction with smooth-running hardened steel gears and cam in one-piece case. Cutting blades are 10" long, of high carbon steel, heat-treated, precision ground and designed for maximum safety and efficiency.

Easy to Use! Quickly attached to drill—flats simplify chucking. Light weight and precision balance make ROTO-TRIM much easier to handle than more expensive trimmers. Handle turns blade to any angle.

Order TODAY! Don't miss this chance to get your ROTO-TRIM Hedge Trimmer Attachment while still available. Start enjoying the work-saving convenience of ROTO-TRIM at today's low price of \$10.95.

YOU RUN NO RISK! If after 10 days you aren't satisfied, return your and your money will be refunded. Send check or M.O. now and we'll ship postpaid — direct from factory to you.

Dept. ROTEX CO., Box 5481 837 WEST DAVIS
651 DALLAS 8, TEXAS

GRIND YOUR OWN
CIRCULAR SAWS USE YOUR OWN saw table. Sharpen combination, rip and hollow ground saws from 6" to 10". Makes hand filing obsolete. Saws last twice as long . . . and stay round . . . with correct tooth bevel . . . for cleaner work. JIG ONLY \$8.95 with \$3.00 grinding wheel & instructions. At dealers or postpaid. Guaranteed.

"Tru-Circle" Automatic Saw Set. Sets teeth at 10° or more. Only \$2.95. At dealers or postpaid.

A. D. McBurney, 317 E. 4th St., Los Angeles 14, Calif., Dept. A-5

HAWAIIAN WIGGLER #1 **WORLD-FAMOUS FISH-GETTER**

Deep runner. No snag-up in pads and brush. Easy to cast. Rubber Mula Skirt acts alive. At your dealer 5/8 oz. or 1/4 oz., \$1.15 each.

FRED ARBOGAST & Co., Inc.
2216 W. North St., Akron 3, Ohio

WRITE TODAY FOR BIG FREE 1951 ARBOGAST COLOR CATALOG—FULL OF PICTURES OF CATCHES

PARTS FOR MILITARY TRUCKS

For Jeep, Dodge, Chev., GMC, Studebaker, 4 wheel drive and 6 wheel drive. Also parts catalog. Write us your requirements.

American AUTO PARTS CO. INC.
1830 LOCUST—DEPT. PM
KANSAS CITY, MISSOURI

New MOTOR BARGAINS for Home, Farm & Industry

New General Electric 1/2 H.P. Induction Type 3450 RPM 110 V, 60 cy. 1 Ph. A. C. Motor. #GEH-5. Feb.	\$23.50
New General Electric 1/2 H.P. Cap/Ind. Ball Brg. 1750 RPM, double 1/2" shaft. 110 V. 60 cy. 1 Ph. A. C. Motor. #GE-17. Feb.	\$29.75
New General Electric 3/4 H.P. Cap/Ind. Ball Brg. 1750 RPM, double 1/2" shaft. 110 V. 60 cy. 1 Ph. A. C. Motor. #GE-75. Feb.	\$34.50
New Emerson 1 H.P. Heavy Duty, Repulsion Induction, 3450 RPM, 110/220 V. 60 Cy., 1 Ph. A. C. Motor. #EH-1. Feb.	\$45.00
Same as above, 1 1/2 H.P. 220-V. #EH-15. . . . only . . . Feb.	\$57.50
Same as above, 2 H.P. 220-V. #EH-20. . . . only . . . Feb.	\$67.50

PUP TENT
FULL SIZE G1 PATTERN —
ONE-PIECE HEAVY GAUGE PLASTIC

Full size 5'x7' 2-man tent. Complete with G1 Poles, pins & tie-down cords. Attractive outdoor colors. Waterproof, mildew proof, dry. (Boy Scouts, churches, clubs 10% Discount on 6 or more). FREE carrying bag for easy packing.

\$5.95

Aqua GOGGLES

Large glass lens. Exclusive inner vacuum lip molds to fit face. Comfortable. Permits continued use. Adjust. head strap. Natural rubber, sea green.

For pool, ocean, lake or river.

\$1.25

JR. GOGGLES, plastic lens . . . **79c**

PITH HELMET

The original Genuine British Army pith helmet. Finest heat-protective helmet made. The same helmet worn by British Eighth Army in Africa. Khaki covered pith cork, foil lined, leather sweat band, ventilated.

Easily \$12.50 value . . .

\$3.95

AIR PISTOL

Has weight, shape, size and "feel" of real army .45; .177 Cal. Shoots BB's, darts, & pellets, all metal. Reg. grip. Muzzle Cocks like real firearm. High powered. Guar. 1 Yr. Comes with assortment BB's, Darts, & Pellets.

\$5.95

GIANT BALLOONS

Neoprene. Genuine Govt. surplus. Used as weather & target balloons. Inflates with vacuum cleaner. Great fun for yards, picnics, fairs, shows. Wonderful for advertising, attracts immediate attention.

3 FT. DIA.	6 FT. DIA.	13 FT. DIA.
39c	79c	\$1.39

Dept. M-651 Postage paid on prepaid orders
FREE CATALOGUE **WAR ASSETS DIV**
3930 Sunset Blvd. VOLUME SALES CO. Los Angeles 26, Calif.

BRAND NEW 30 DAY FREE TRIAL High Power BINOCULARS

Finest Precision Optics
Featherlight
Money Back Guarantee
Easy Pay Plan
Leather Case Inc'd.

Free! Catalog & Book "How to Select Binoculars"
Dealer Inquiries Invited
Bushnell Bldg., Dept. M-26
Pasadena 1, Calif.

33 MODELS \$14.95 up

BUSHNELL Binoculars

FREE GUIDE "How to Select Binoculars"

NAME _____ CITY _____
ADDRESS _____ STATE _____

MOTOR and FAN BLADE COMBINATIONS
BUILD WINDOW FANS, EVAPORATIVE COOLERS, EXHAUST FANS
—With these Efficient Combinations

Set #	Blade Size	H.P.	Blade Price	Guard Price	Motor Price	Combination Motor Guard & Blade
FC-10	10 inch	1/60	\$1.25	\$1.75	\$ 4.50	\$ 7.50
FC-12	12 inch	1/40	\$1.50	\$2.00	\$ 6.50	\$10.00
FC-16	16 inch	1/35	\$2.25	\$2.75	\$ 8.50	\$13.50
FC-18	18 inch	1/6	\$3.75	\$3.75	\$10.00	\$17.50

All above items shipped PREPAID. Motors or parts can be bought separately . . . 10", 12" & 16" size motors have extended thru bolts for mounting. 18" motor has solid base.

Write for FAN CIRCULAR: listing Blades, Guards, Motors, All Sizes for building your own Attic Fan, Window Fan or Room Cooler.

C. MARSHALL SALES, 3546 W. Fullerton Av., Dept. P-6, Chicago 47

WAR SURPLUS AND OTHER BARGAINS



RIVET SETS

Universal type, case hardened tips. Set of dies will head up any brazier or round head rivet from 1/8" to 1/4". With adapters for air gun or hand use. All new... cost Government about \$27.00. Complete 15 piece set, wt., 2 lbs., \$5.00



HAND MITRE

IT'S SENSATIONAL!

"It pays its way in just one day!"

New HAND MITRE saves the carpenter - picture framer - cabinet maker and craftsman hundreds of hours... a "flick" of the hand and a few seconds for a precision mitre every time.

The HAND MITRE will cut any desired angle. Its rugged construction will handle hard and soft wood mouldings, plastic trim, base shoe, dowels, laminated materials, rubber extrusions, leather, linoleums and asphalt tile. Made of heavy gauge stainless steel, electro polish finish. Will endure years of hard usage.

Eliminate bulky mitring equipment... save valuable hours and labor. \$3.95 postpaid.



MICROMETERS

Chrome plated, precision engineered and carefully tooled to give long life. All new. 0-1" capacity . . . ea. \$2.25. 1-2" capacity . . . \$3.50.

HIGH SPEED DRILLS

All New. Fractional & numbered. Orig. Val. \$15. Nationally known brand. Astd. sizes. Set 30, \$3.50

EXTENSION DRILLS

High Speed Steel, like new. Astd sizes from No. 1/4 to 40. Lengths from 6" to 12". Approximately \$20 value. Set of 12 \$3.75

HIGH SPEED DRILL BITS

Like New! Original value over \$16.00. 25 assorted sizes and lengths, \$2.00

DRILL GRINDER

... Sharpens round, square or tapered drills up to 6" long. Even an amateur mechanic can get a new, factory finish on a drill in 25 seconds. New protractor feature gives every drill sharpening angle, with 5 convenient angles already marked off. Usable with hand or power stone. A brand new development, manufactured by Ten Eyck. Shipped postpaid



All New. \$2.80 each.

Send check, money order or cash. 25% deposit required on COD orders. All prices FOB Culver City, California, unless otherwise stated.

Send 25c for Illustrated Catalog.

AIRBORNE SALES CO., INC. DEPT. PM 6-51 CULVER CITY, CALIF.



THIS MOTOR RUNS ON FREE RADIO ENERGY

can you increase its power?

The radio motor pictured here has already been developed and has run for months on the free energy from radio programs. We've already done the so-called impossible. Now we want ingenious experimenters who can increase the power of the motor so that it has more practical applications.

Liberal royalties to the alert person who develops a way of increasing the power of the radio motor for practical application using only radio energy from broadcast programs. We send you a royalty income agreement to protect you on developments you make increasing its power for practical applications. You also get instructions and detailed drawings showing how to build a running model of the radio motor pictured. Enjoy it as a radio.

Complete plans including Royalty income agreement — all for \$5.00.

SCIENTIFIC PRODUCTS OF INDIANAPOLIS DEPT. PM-6, P. O. BOX 6331, INDIANAPOLIS 5, IND.

SAVE THREE WAYS WITH A NEW Cushman

WRITE FOR FOLDER AND PRICES DEPT. 11-M



Get the big three Cushman economies—low purchase price, low operating cost, low maintenance. Ride the Cushman scooter to work, school or shop. Less than a penny per mile to operate. Dealer inquiries invited.

CUSHMAN MOTOR WORKS Lincoln, Nebr.

AIR CONDITION Any CAR

PLANS SHOW YOU HOW . . . \$1.00 ● HOT OUTSIDE . . . COLD INSIDE

Enjoy pleasure driving in cool comfort in scorching outside temperatures, with real mechanical refrigeration. (Not a dry ice or window unit.) Easily installed by anyone handy with tools. No experience necessary. Powered direct from your engine. Completely automatic. PATENT FEATURE controls temperature from idle to 100 mph. Build and install it yourself! Keeps your automobile comfortable—Tractor Cab cool—Truck cooled for hauling perishables. Send \$1 for your set of PLANS now. Do it today!

LEJAY MFG. CO., 547 LeJay Bldg., Minneapolis 8, Minn.



POPULAR MECHANICS

SAW SHARPENER



Table model, gums and sharpens rip saws, combination saws & cut-off saws. Ideal for "Skill-saw" blades. Cap. 4" to 20" diam. Complete with 1/4 h.p. motor & 1 grinding wheel & cord — \$64 f.o.b. Portland. Shipping weight, 63#. SEND FOR FREE LITERATURE.

P. T. HOBBS MACHINERY Dept. PM-55, Portland 17, Ore.

SOUTH BEND

LATHES
DRILL PRESS
SHAPER



9" to 16-24" Lathes 14" Drill Presses 7" Bench Shaper

Write for literature—indicate machine.

SOUTH BEND LATHE, SOUTH BEND, IND.

AUTOMATIC SOLDERING TORCH



\$9.95

CASH WITH ORDER PREPAID. C.O.D. POSTAGE EXTRA.

Instant igniting, automatic acetylene torch for soldering, silver soldering, and light brazing. Durable, precision made, using standard lighter flints. Ideal for amateur or professional use. Money back guarantee.

Gambell Manufacturing Company, Mulino, Oregon

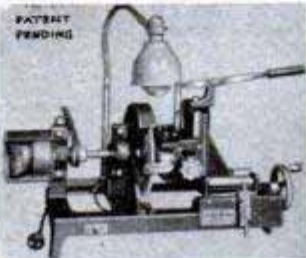

Start a NEW BUSINESS!

or Add to your present Repair Business

SHARPEN DULL PIPE WRENCHES

PIPE TAPS & DIES "GUM" CIRCULAR SAWS

Write for Information

J. C. MOORE INDUSTRIES BOX M 276 FREDONIA, PA.

HELPFUL BOOKS

Send post card asking for FREE catalog Popular Mechanics Press, 200 E. Ontario, Dept. 601, Chicago 11

Don't be

AFRAID

of your Circular Saw



New PTI SAW BLADE STOPS all Kick-Backs

When you use this remarkable new safety saw blade in your circular saw—you know *positively* that dangerous kick-backs are *completely eliminated!* Direct injuries are minimized, too. The PTI Safety Saw Blade operates on a radically new cutting principle. It cuts easier, lasts longer, uses 30% to 40% less power, is much quieter and cleaner, producing chips, not sawdust.

Pat. Pending



PTI IS THE ORIGINAL SAFETY SAW BLADE

tested and approved by leading laboratories, government agencies, industrial concerns. Made of tough Chrome Vanadium Steel—in sizes from 7" to 16". Costs no more than ordinary saw blades. Send *today* for FREE circular giving complete story, specifications and prices. Dept. PM6.

PTI INCORPORATED, 401 Broadway
NEW YORK, N. Y.

Clark EXPANSIVE BIT



CUTS BETTER • COSTS LESS!

Accurate, fast; cuts smooth holes in hard or soft wood. Chrome vanadium steel blades, all chrome body. No. 250, 1/2" - 1 1/2", \$1.89; No. 251, 7/8" - 3", \$2.19. GUARANTEED. At your dealer or write Dept. PM-6

ROBERT H. CLARK COMPANY • Beverly Hills, California

BUILD HEAVY DUTY MACHINES

SAVE UP TO 90%— You can build, using our practical, easy-to-read plans, all kinds of machines, for home, farm or shop — scooters, portable sawmills, metal working machines, concrete machinery of all kinds, printing equipment, woodworking machines, midget autos, dish washers, farm equipment, freezers, tractors.

FREE

CATALOG HANDBOOK
183 SETS OF PLANS
VALUABLE INFORMATION

NICHOLS EQUIPMENT COMPANY
D-11 PURVIS, MISS.

MODEL Builders!

You can get this
New O & R 1951
CATALOG!

Model Aircraft Engines • Marine Engines • Model Racers • Glow Plugs • Fuels • Accessories

MAIL THIS COUPON TODAY!

OHLSSON & RICE, INC. Dept. PM
3344 Emery St., Los Angeles 23, Calif.
Please RUSH _____ copies of the NEW 1951 O&R Catalog at 15c each for which I am enclosing _____ in stamps or coins to cover handling and mailing.

Name _____
Address _____
City _____ Zone _____ State _____

JUNE 1951

HANDEE®

tool of 1001 Uses

FINEST IN POWER TOOLS PLUS 51 ACCESSORIES

Complete... designed for every hobbyist and mechanic! Grind, drill, polish, carve, sand, saw, etc. Packs plenty of power in the 25,000 r.p.m. motor, with approved 7-segment commutator. Handsome fitted steel carrying case.

Complete, with liberal 10-day money back trial offer... **\$27.50**
with 7 accessories... **\$19.95**



HANDEE WORKSHOP

"Tornado-Powered" with NEW HANDEE "85"



Versatile, with 41 accessories... suitable for shop or home use. For novice or expert... precision routing, molding cuts. HANDEE "85" a production wizard... automatically air-cooled, pin-point accuracy. Sensational power!

Complete, packed in handsome case, **\$29.95**

FREE! New 64-page Manual

Chicago Wheel & Mfg. Co., Dept. PM
1101 West Monroe St. Chicago 7, Ill.

Say You Saw It in Popular Mechanics



LAWN MOWING'S A SIMPLE SIT DOWN JOB... WITH MIDLAND

That DANDY BOY quick implement hitch sure is a dandy. Change from garden tool to lawn mower in a minute. The lawn is cut and trimmed and the place looks swell. Lawn mowing and weed cutting is quick fun with my DANDY BOY and its many attachments.

You'll never know how easy mowing or gardening can be until you try the Midland DANDY BOY. Have your dealer bring out a demonstrator, or write to Dept. PM-6 for folder.

THE MIDLAND CO.

1200 Rawson Ave., South Milwaukee, Wis.
Builders of Farm and Garden Implements Since 1911

273

TAKES THE PLACE OF \$500 WORTH OF TOOLS
HI-SPEED [OPE-SAW] DRILL-BIT
 It drills! It cuts! It Saws!

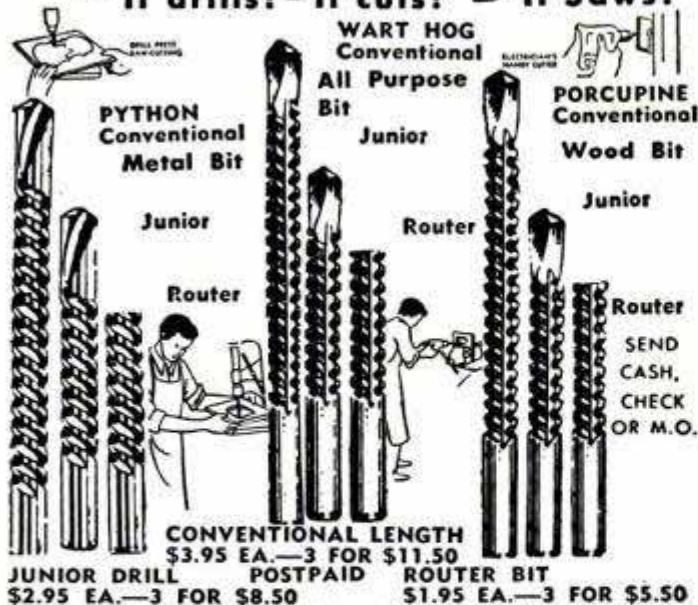

WART HOG Conventional All Purpose Bit
JUNIOR DRILL \$2.95 EA.—3 FOR \$8.50
POSTPAID ROUTER BIT \$1.95 EA.—3 FOR \$5.50

SAWS, CUTS, REAMS sheet metal, angle iron, pipe, wood, plastic, Transite, etc. Amazing high-speed combination bit and saw file, only 1/2" or 3/4" electric drill or slow drill press. Drills even starting hole to quickly start, saw or room opening. Easy to operate. Ideal for carpenters, auto mechanics, electricians, plumbers, hobby workers, many others. Abrasive resistant high speed steel. No breaking. Will withstand severe continuous use. Resharpens of no charge 1/2" diameter. Conventional Drill length 3 1/2" with 2" cutting section. Junior Drill length 2 1/2" with 1" cutting section. Router Bit length 1 3/4" with 1" cutting section. Ground from solid. Shipped same day—money back guarantee. Discounts on quantity orders from dealers.

Each Bit performs its own function. Specify WHICH TYPE PYTHON WART HOG PORCUPINE

SETS WITH
 1 Conventional
 1 JUNIOR
 1 ROUTER
\$8.50

MILLER ROTARY HI-SPEED [OPE-SAW] DRILL-BIT IT SAWS & CUTS REAMS

Manufactured and distributed by
INTERNATIONAL TWIST DRILL CORP.
 624 Wyandotte Rm. 952 Kansas City 6, Mo.

Turn Darkness Into Daylight!

Get a Quality Built **Big Beam Jr.**

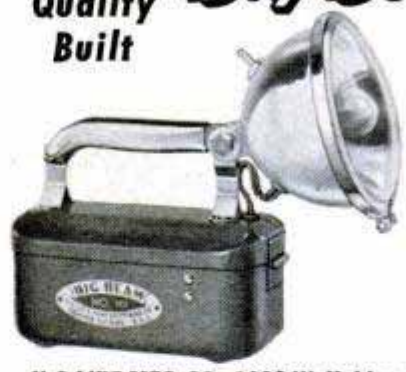

Indispensable around the Home, also for Motorists, Farmers and Sportsmen

\$6.75
 less battery

See your dealer or write for folder

U-C LITE MFG. CO., 1066 W. Hubbard St., Chicago 22, Ill.

Only \$498



OTTAWA Mule Team Tractor

Finest low-cost tractor. Costs too little to do without. Engines burn gasoline. Seven models. Starter and lights available. Other larger Models to choose from. Over 4,000 in world-wide use. Time-proved and tested. At low cost they easily mow, plow, disc, harrow, plant, cultivate, etc. Sold only direct to user. Write for FREE details.

OTTAWA MFG. CO., 2-127 Garden St., Ottawa, Kansas

Saw, Drill & Grind

without stopping, lifting machine or changing set-ups; only one change for lathe work and sanding. No heavy lifting. Basic Emrick 5-in-1 Machine still only \$49.95. 30-day Free trial; Money-Back Guarantee. Write for FREE Catalog of entire line.



EMRICK, INC., 161 Clinton, Kalamazoo, Michigan

USE YOUR ATTIC

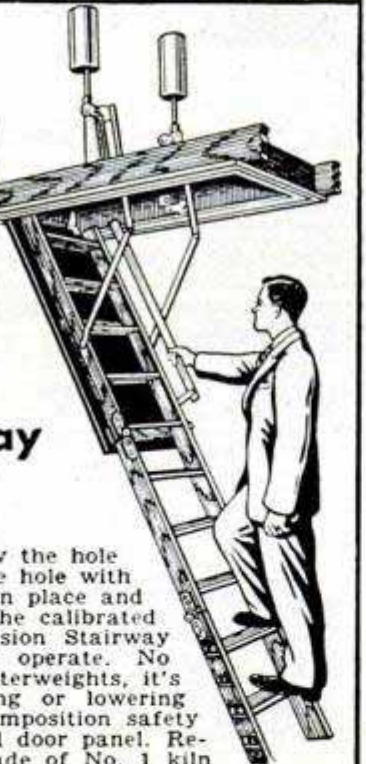

Install the **PRECISION** folding stairway **YOURSELF**

Fits all ceilings. Just saw the hole in your ceiling—frame the hole with 2x6's, nail the stairway in place and cut off the stairway at the calibrated ceiling height. The Precision Stairway is simple and easy to operate. No springs, actuated by counterweights, it's perfectly balanced, raising or lowering easily with one hand. Composition safety treads on steps. Insulated door panel. Requires no attic space. Made of No. 1 kiln dried poplar with cast brass hinges, heavy cast aluminum rocker arms and brackets. Approved by F.H.A. everywhere

See your local lumber dealer or write direct today.

Manufactured by
PRECISION PARTS CORP.
 Nashville 7, Tennessee

ADJUSTABLE HOLLOW AUGER

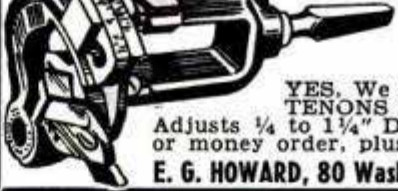

USUAL \$7 VALUE **\$2.00**

YES. We said \$7 VALUE! CUTS TENONS or WHEEL SPOKES. Adjusts 1/4 to 1 1/4" Diam. Send cash, check or money order, plus 25c for mailing to E. G. HOWARD, 80 Washington St., Boston 8, Mass.

Power Products Late Production \$60 Model #1000 GASOLINE ENGINES



1 H.P. "Flyweight" 18 lbs. 2-cycle Air Cooled
 • NEW DEPARTURE BALL BEARINGS ON CRANKSHAFT
 • WICO MAGNETO
 • TILLOTSON FLOAT
 • FEED CARBURETOR
 • ALUMINUM CONSTRUCTION

COMPLETE Reconditioned \$17.00
NEW \$23.00

Check or \$5 Deposit
AIR MERCHANT, SPRINGFIELD 9, MASS., PHONE 2-3313

HELPFUL BOOKS

Send post card asking for FREE catalog
 Popular Mechanics Press, 200 E. Ontario, Dept. 601, Chicago 11

Learn quickly by doing in America's most modern trade school

Earn BIG MONEY arc welding

Big pay defense jobs are open to trained weldors. Start learning now at Hobart Trade School. Thorough training, best equipment, experienced instructors. Write today.

HOBART TRADE SCHOOL, Box M-61, Troy, Ohio



BUILD YOUR OWN 2-PLOW TRACTOR

We Furnish Complete Instructions

SAVE OVER \$1,000.00!



SENSATIONAL VALUE!—a new 2-pow tractor regularly selling for \$1,700.00. NOW our surplus sale makes it possible for you to buy this unit—including ALL NEW PARTS—for just \$295; install your own JEEP engine, tires, and transmission, and it's ready to work. YOU SAVE OVER \$1,000.00. Unit includes: Frame; Wheels—(2) 9.00 x 24, (2) 6.00 x 16; Fenders; Complete Front and Rear Axle; Roller Chain Final Drive; Hood; Hydraulic Seat; Radiator Shell; All Instruments; Draw Bar; Drive Shaft; and a complete stock of all new parts, only \$295. Here's your opportunity to have a complete 2-pow tractor, with hundreds of uses, at TREMENDOUS SAVINGS. We pay freight. Order now, while supplies last. Send your check or money order to

ERNIE RIEKE EQUIPMENT CO.

3201 Merriam Blvd.
Kansas City, Kans.



DRIVE 3 TO 6 DAYS A MONTH



Amazing discovery, tested in Engineering Dept. of leading U. S. University, reduces gasoline consumption as much as 20%—gives you up to 6 days a month gas free driving—may actually pay for itself in cash savings. Also better performance, more power, quicker starts, faster acceleration, on all cars, light trucks, tractors—any age, make or model. It can help keep you rolling if emergency gas restrictions come.

TEST IT 30 DAYS ON YOUR OWN CAR BEFORE DECIDING

No one can appreciate the astounding benefits of this new miracle development without actual day-by-day experience on the road—so we want you to try it for 30 days on your own car at our risk. Write or wire today for complete FREE details, technical explanation and 30-Day Examination Request Blank.

G. B. SCHUYLER, Dept. 46
1665 Mission St. San Francisco 3, Calif.

MAKE MORE MONEY! DECORATE YOUR PRODUCTS WITH DECALS



FREE! color catalog for woodworking shops and home industries

Get better prices! More Sales! Use Meyercord Decals to add the beauty of full-color decoration to your products. Send now for catalog jam-packed with hundreds of inexpensive designs. Offer good only to commercial shops making goods for re-sale.

CLIP COUPON—MAIL TODAY

Please paste this coupon to your business letterhead.

THE MEYERCORD CO., 5323 W. Lake St., Chicago 44, Dept. 67-6
Please send 4-color catalog of decal designs—Free!

NAME _____
ADDRESS _____
CITY _____ ZONE _____ STATE _____
offer good in continental U.S.A. only

Huge Summer Clearance MAIL SALE

\$500,000.00 INVENTORY
War Surplus and Jobbers Closeouts — all to go!!!



- Winches — Clutches — Transmissions — Engines**
- Gar Wood Power Winches. Top quality heavy duty. 15,000 lb. working. With clutch & 150' 1/2" cable. 1 to 23 ratio. Cost \$275. **\$179.40**
 - DeLuxe Hand Winch. Dual ratio 1 to 3, 1 to 9. Finest steel. Powerful. 3,000 lb. \$30.00. Same except with 50' cable & hook. **\$39.50**
 - Truck Hand Winch. Hi-strength. Fine for trucks, farms, load booms. 2,000 lb. \$19.90. Same except with 50' cable & hook. **\$29.90**
 - Boat Hand Winch. 1-4 ratio. 2000 lb. For docks, trailers. **\$19.95**
 - Utility Clutch. For boats, etc. Handles up to 6.5 h.p. **\$13.95**
 - Motor Clutch (1.5 h.p.) For small motors. Specify 1/2, 3/8, 3/4" **\$7.49**
 - Variable Speed Reducer. Drive 1750. Gives 0 to 450 r.p.m. **\$19.95**
 - Gas Engine. Power Products. 2-cycle. 1.0 h.p. Cost \$49.50 **\$28.60**
 - Snatch Block. Heavy duty wire rope. 6". 13,000 lb. working **\$11.78**
 - Snatch Block. Medium duty. 4". 3000 lb. working strength. **\$5.50**
- Air Compressors — Paint Spray Units — Tanks — Hose**
- Build Your Own Compressor Outfit. Finest 1-cyl. piston compressor. Pop off valve. Stainless 12"x25" air tank, 160-lb. gauge, genuine W. R. Brown paint spray gun, dust blow gun, tire chuck, 15' hose, fittings, and "How to assemble" manual. Ideal farm unit. **\$39.90**
 - Home Paint Spray Outfit. 1-cyl. diaphragm comp. hose, fittings, spray gun, drive coupling, base. Use own 1/4 h.p. motor. **\$18.95**
 - De Luxe Piston Air Compressor. Leading make. Finest construction. 1.75" stroke, 2" bore. To 150 lbs. To 3 c.f.m. With pulley. **\$20.50**
 - Air Tanks. Light weight hi-strength type. 400 lb. working. Use on farm, in car, etc. 500 CI **\$4.95**, 1000 CI **\$4.95**, 2100 CI **\$9.95**
 - Air Accessories. Check valves **\$3.75**, Safety valve **\$1.95**, Pressure regulator **\$2.69**, Auto. press. Switch **\$5.89**, heavy duty paint gun **\$8.95**, Pressure gauges **\$1.89**, engine cleaners **\$8.96**
 - Air Hose. Top quality. Leading makes. Two braid heavy duty with fittings (1/4"). 15 ft. **\$2.95**, 20 ft. **\$3.80**, 50 ft. **\$8.50**
Write for free air compressor bulletin and catalog.
- Water Pumps—Water Systems—Farm Gas Pumps—Weed Spray Units**
- Complete Automatic Pressure Water System. Leading make. Fine for farms, cabins, etc. 110-volt 60-cy. 300 g.p.h. 22' lift **\$69.50**
 - Bronze Medium Pressure Rotary Pumps. Up to 25 lbs. Stainless shaft. Self priming. Lift 10' without foot valve, 22' with. Efficient. 1/2" 6 g.p.m. **\$12.95**, 3/4" 10 g.p.m. **\$16.95**, 1" 19 g.p.m. **\$22.95**
 - Bronze High Pressure Rotary Pumps. Up to 150 lbs. Stainless shaft, self priming. Lift 10' without foot valve, 22' with. Excellent. 1/2" 5 g.p.m. **\$14.50**, 3/4" 8 g.p.m. **\$20.95**, 1" 17 g.p.m. **\$27.95**
 - Centrifugal Irrigation Pumps. Cast iron-bronze, stainless shaft. 7500 gal. per hr. 2" suc., 1 1/2" dis. Ball bearing. **\$34.79**
 - All Brass DeLuxe Tractor Weed Spray Outfit. Popular make at over 40% saving. Consists of 4-row brass boom with genuine T-jet 5 g.p.a. nozzles, easy mount air tractor, gauges, valves, hose, direct drive tractor pump, relief valve, etc. A guaranteed value. **\$84.50**
Write for free pump bulletin and catalog.
- A-C Power Plants — A-C Generators — D-C Arc Welders**
- Army 5,000-watt, 110-220 volt, 60-cy. Plants. Excellent. Onan generator direct coupled to 4-cyl. water cooled engine. Push-button start, complete instrument panel, etc. Cost over \$1200. **\$795.40**
 - Army 5,000-watt 110-220 volt, 60-cy. Plants. Very fine units. Mater Electric Co. Manual start 4-cyl. eng. A real buy. **\$691.40**
 - Army 1,400-watt, 110-volt, 400-cy. Plants. Homelite complete with tools—spare parts. Fine for cabins, emergency lights, etc. **\$129.60**
 - Army 5,000-watt, 110-volt, 60-cy. Generator. Kato unit. Excellent emergency source. Complete with 4-sheave pulley, voltmeter, voltage control, throw over switch, breaker, etc. **\$269.50**
 - Air Corp. 1,000-watt, 110-volt, 800-cy. Generator. Made by Bendix. Ball bearing. Fine for lights, heaters, etc. **\$18.96**
 - Delco-Remy 200-Amp. D-C Generators. Voltage 28.5. Excellent for welding generators. Full instructions for construction top quality farm welder. Weight 50 lbs. Cost Govt. over \$250.00 **\$19.95**
 - DeLuxe Farm-Business D-C Arc Welder. Built by a leading Chicago engineering firm using \$276.00 war surplus generators. Will furnish up to 250 amperes of voltage stabilized smooth welding current. Complete with driving pulley, instructions, etc. Ready to use. **\$99.50**
- Miscellaneous Special Equipment Closeout Bargains**
- Rural Magneto Phones. Wall type. Oak case. Modern. 5-bar. **\$12.40**
 - Factory-Contractors Phones. Magneto wall oak. 3-bar. **\$10.25**
 - Private Phones. City Type. Desk handset type. Def. cases. **\$18.25**
 - Private 2 Station Desk Phone Sys. Comp. with buzzers. Pair. **\$9.77**
 - Telechron Clock Time Switch 110-V. Turn radio, stove on, etc. **\$4.98**
 - Gas and Electric Chain Saws. Send for bargain listings on these. **\$1.98**
 - Motor-Gyro Unit. 24-volt d-c (will run on A-C). Fascinating. **\$1.98**
 - Furnace Air Conditioner. (1400 c.f.m.) 12x14x15" **\$17.50**
 - Tachometer Direct-Reading. 0 to 4000 r.p.m. **\$7.49**
- Buy of the Month. Guy Cable-Turnbuckle Units. Consists of 12 ft. flexible steel cable, 14" turnbuckle. Wonderful for guying television antennas, strengthening gates, fences, bldgs., etc. Cost \$1.10. **10 for \$3.89**

ANNOUNCEMENT—We are the sole sales representatives for the remarkable newly developed JEWELL THERMO-NICKEL non-electric nickeling process. JEWELL THERMO-NICKEL pellets enable the hobbyist, machinist, manufacturer, tool and die maker, laboratory, doctor, dentist, etc., to do professional quality plating with simplest equipment. Hundreds of uses. Entirely new. Approved by leading chemists. Write for details of this remarkable new thermo-nickel process.

Order direct from ad or write for latest bargain catalog.

BURDEN SALES COMPANY
808 "O" ST. LINCOLN, NEBR.



SCRUM* can stop your car by "Hib"



*Scale, rust, oil muck in cooling system

Internal clogging of the cooling system with sticky scaly SCRUM is dangerous. If you haven't cleaned out winter's SCRUM yet, do it the safe way with WARNER RADIATOR CLEANER—removes scale, rust and oil muck, keeps your cooling system working safely and efficiently.



WARNER-PATTERSON COMPANY
CHICAGO 5, ILLINOIS

FIXES

Toys, Dishes,
Books, Furniture



It's transparent, waterproof,
flexible and durable.
Get a tube
today.



DUCO CEMENT

REG. U. S. PAT. OFF.

\$10.95



NOW!

Trim that hedge
with your electric drill and
the **BULL HEDGE TRIMMER**

Just chuck the Bull Hedge Trimmer in your 1/4" electric drill, and you've got a "power mower" that does all the work for you! The shuttle action of the 9" hardened high carbon steel blade clips any hedge cleanly . . . quickly . . . more evenly than you can do by hand. Also ideal for trimming grass around walls, house, trees, shrubs, etc. Blade can be turned to any angle. Light, easy to carry. No vibration. Order yours now — and avoid that hot, unpleasant hand work this summer and every summer from now on! Complete, ready to chuck in your drill, \$10.95.

Send cash, check, or money order today to
BERTRAM K. ENGINEERING & SUPPLY CO.
3121 MAIN ST. KANSAS CITY, MO.



ELECTRIC WELDER

AC or DC 110 Volts

"The Little Marvel" All-Metal welder. 5-year written guarantee. Welds 1/8" thick metal or money back. Repairs tanks, tools, fenders, machine parts, etc. Comes complete with everything—rods, unit, eye shield, and directions. We also make a welder for 16 to 22 gauge metal . . . \$3.95 complete. On C.O.D., postage extra.

\$6.45
Com-
plete

ESSAY MFG. CO., Inc., Dept. 51, Quincy 69, Mass.

Make Your Own POWER LAWN MOWER

with this DRIVE CUTTER ASSEMBLY

Constructed for those who desire to build their own mower or to replace your old cutter assembly. Complete with 18" blade and double ball bearing drive, only . . .

\$12.95

Add 50c to cover handling & shipping. No COD's



ATLAS EQUIPMENT CO., Dept. PM6
229 SW BLVD. KANSAS CITY, MO.

CASH IN YOUR SPARE TIME



BIG MONEY IN OWN BUSINESS
YOU CAN MAKE UP TO \$40 A DAY sharpening and setting circular saws for factories, builders, lumber yards — with NEW BELSAW COMPLETE CIRCULAR SAW SHOP. LOW COST, Sharpens 4 to 5 saws per hour, no experience needed, complete instructions. Send today for FREE Catalog.

BELSAW MACHINERY CO

3703 Field Bldg.

Kansas City 2, Mo.

DOUBLE POWER SANDER

READY! New Syncro amazes with double power for sanding, polishing, yet lightweight for vertical, overhead work! Exclusive Double-Arc Motion! 14,400 strokes a minute! With built-in Fractional Horsepower Reactance

SYNGRO
ELECTRIC SANDER

Electric Motor, \$19.95 at dealers or postpaid from SYNGRO CORP., DEPT. D-61, OXFORD, MICHIGAN.



\$19.95

HELPFUL BOOKS

Send post card asking for FREE catalog

Popular Mechanics Press, 200 E. Ontario, Dept. 601, Chicago 11

ELECTRIC MOTOR BARGAINS!



1/4 HP	1750 RPM	110 Volt	60 Cy.	\$ 850
			Split Phase Type...	
1/2 HP	3450 RPM	110V	60 Cy.	2250
			Cap. Type.....	
3/4 HP	3450 RPM	110-220V	60 Cy.	3450
			Repulsion Induction..	
1 HP	1750 RPM	110-220V	60 Cy.	5250
			Capacitor Type.....	

Every Motor Fully Guaranteed
Write for 32-Volt Bargain List ALL PRICES F.O.B.
ROBERTS ELECTRIC CO., 849 W. Grand, Dept. 3, Chicago



WELLWORTH Air Compressor

For Farm and Home Workshop

Compressor has 2" bore, 1 3/4" stroke, 2.8 cfm up to 150 lb. pressure. Motor required: 1/4 h.p. at 100 lbs.; 1/2 h.p. at 125 lbs.; 3/4 h.p. at 150 lbs. or equivalent gas engine. V-belt drive, intake muffler and cleaner, bronze bearings, splash lubrication. Wt. 16 lbs. Replacement parts always available. **\$20.50**

COMPLETE OUTFIT. Compressor, pressure tank, air gauge, air chuck, 20 ft. hose, pop valve, copper tubing with 4 brass flared fittings for connecting compressor to tank, 4-way cross and 3 nipples. **COMPLETE OUTFIT, wt. 30 lbs. \$32.45**

Equipment less compressor **\$12.45**

All Brand New Equipment

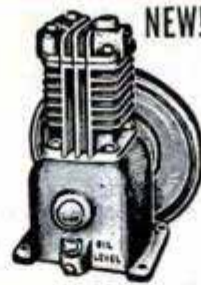

NEW! LIGHT PLANTS

5 KW

\$2200 Value

\$895.00

GENERATORS

500 and 2000 Watts

BARGAINS!

Send for Catalog

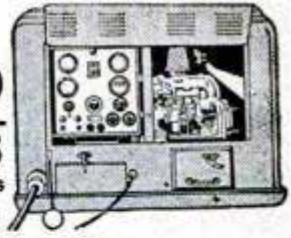

Wisconsin GAS ENGINES

at a big saving!

BRAND NEW

Model A.B., 2.5 to 3.4 H.P., 2 1/2" bore, 2 3/4" stroke, 13.5 cu. in. Wt. 60 lbs. List Price, \$90.00. **\$76.00**

Model A.K., 3.5 to 4.7 H.P., 2 7/8" bore, 2 3/4" stroke, 17.8 cu. in. Wt. 70 lbs. List Price, \$160.50. **\$86.50**

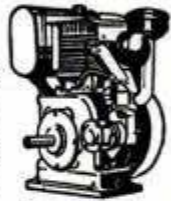

CHICAGO PNEUMATIC RIVETER & CHIPPING HAMMER



CP4X or CP3X Pistol grip handle. Takes up to 3/16" rivet. Weight 6 lbs. List price \$73.00. **\$32.50**
Brand New... Like new, guar. **\$17.50**

AIR REGULATOR and EXTRACTOR

1/4" Air Regulator. Gauge and filter. Wt. 5 lbs.

BRAND NEW! **\$8.95**

Regulator and Gauge only..... **\$5.95**
Air Filter..... **\$3.25**



RED SEAL CONTINENTAL GAS ENGINE

BRAND NEW. 1 1/2 HP with 6 to 1 reduction gear. Operates at 450 R.P.M. For lawn mowers, scooters, garden tractors, pumps, compressors, generators, etc. List Price \$79.50. Shipping weight 54 lbs. **\$47.50**

SPECIAL PRICE..... Same engine furnished at 2600 RPM.



\$46.50

AUTOMATIC COMPRESSOR UNIT

1/4 or 1/2 H.P. heavy duty capacitor motor. AC 110/220 volt, 60 cycle, 2x1 3/4 inch piston type compressor, splash feed lubrication. 12x24 inch tank, automatic pressure switch. CFM 2.8 at 100 lbs. pressure, or 150 lbs. pressure for intermittent duty. Check valve, safety valve, air regulator with gauge and filter, 20 ft. air hose with air chuck for inflating tires. V. belt drive. Mounted on 2 wheels, ball bearing, with 2"x10" semi-pneumatic tires. Portable with handle. Shipping wt. 90 lbs.

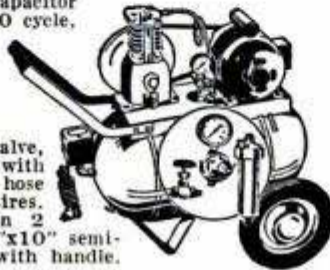

with 1/4 h.p. motor **\$98.50** unit less motor **\$79.50**
\$160 value..... furnished with 1 1/2 h.p. gas engine **\$124.50**
with 1/2 h.p. motor **\$109.50**

AIR TANK & ACCESSORIES

New!



Tank only, Wt. 7 lbs. **\$6.25**

Air receiver, stainless steel. Brand New. 6"x24", 400 lb. test. Ideal for carrying on trucks, autos and wherever compressed air is needed. Equipped with 500 lb. combination air gauge and inflation valve with core for retaining pressure in tank; tire chuck, 3 ft. high test air hose. Ship. Wt. 12 lbs. **\$7.95**

Complete outfit.....

WELLWORTH V-BELT CLUTCH



BRAND NEW! SAME CLUTCH FURNISHED WITH 3/4" BORE **\$8.50**

Takes starting load off engines or motors. When speed is reached, a flip of handle shifts clutch from idling to driving position. Handles "A" belts, 2.35" pitch diameter, 5/8" bore. Ideal for use with lawn mowers, garden tractors, home workshop motors, etc. 3 1/4" long. Safe, easy to mount, sealed bronze bearings, positive action. Shpg. wt. 3 lbs. **\$7.50**
BUSHING FOR 1/2" SHAFT, 15c

"Wellworth" BLOWER BARGAIN

BRAND NEW



Quiet operating. Double wheel inlet, double width blower. For heating, ventilating, cooling, air washing, exhausting and forced draft. DIMENSIONS: 10" wheel; outlet 13 1/4" x 11 3/8"; inlet 8 3/4". Height 19". Width 18". Depth 16 1/2"; C.F.M., 1/4" S.P. 1600; outlet vel. 1575; wt. 45 lbs.

BLOWER LESS MOTOR AND DRIVE \$27.50

With 8" pulley for blower — 3 1/2" variable speed, pulley for motor, and belt **\$2.50 extra.**

Prices f. o. b. Chicago. Money back guarantee. Send check or money order today. Prompt shipment.

NEW CATALOG

AIR COMPRESSORS
LIGHT PLANTS
HOME & FACTORY
WORKSHOP TOOLS
SEND 10c FOR POSTAGE

WELLWORTH TRADING CO. 1831 S. STATE ST., DEPT. D-6, CHICAGO 16, ILL.

30 SHOTS without reloading

30 Shorts or 20 Long Rifle cartridges

No sales at factory



22 cal. Model 146B

'28.95

(\$29.95 west of Rockies)

World's largest magazine capacity. Mossberg's finest sighting equipment. Over a dozen different sighting combinations... Receiver is grooved for Mossberg scope Model #4M4. Scope \$9.95.

It's a beauty. It has everything. Ask to see Mossberg Model 146B at your dealer's.

FREE CATALOG Write for it!

PREVENT FOREST FIRES

Carelessness can destroy timber, game, property and human lives... Snuff out matches and smokes completely. Quench fire embers carefully.



19706 St. John Street, New Haven 5, Conn.

Do it yourself
the
PROFESSIONAL
WAY With



KWIK-METAL

FOR ALL METAL and BODY REPAIRS
The Nation's No. 1 COLD SOLDER

Preferred by
over 120,000
Autobody Shops



**COMPLETE
KIT**
\$2.00
POST
PAID

Repair any broken or dented metal surfaces with this complete kit. Contains amazingly efficient Kwik-Patch fabric (large-area) patching, Kwik-Metal liquid metal solder and Kwik-Solv—Economical—Easy to use.

MAIL

TAYLOR'S Consumer Service, 207 Investment Bldg., Pittsburgh 19, Pa. Please send.....complete cartons Kwik-Metal Repair Kits @ \$2. ea. postpaid. I enclose Check M.O. Send C.O.D. Print name and address in margin. Fully guaranteed.

Water Seepage Ended with Vandex

**YOUR WATERPROOFING
PROBLEMS ARE OVER!**

THE PROPER PROTECTION



ONLY 90c Per Lb.

Vandex protects your home against water seepage and keeps your basement dry. Laboratory and practical tests have proven that Vandex is a highly effective and superior sealing compound. World-wide applications have established Vandex as a peerless waterproofing compound for homes, farms, silos, pools, etc.

Vandex is easy to use; simply mix with water and apply by brush. Complete instructions on every pail. Available only in 8 lb. cans, which will cover 80-100 sq. ft. of wet surface. Vandex may be applied while the surface is still wet and need be applied only to that surface which requires moisture protection.

SOLD WITH A MONEY BACK GUARANTEE. ORDER YOURS NOW — and end those waterproofing problems. White only.

VANDEX, 64 Wall Street, New York 5, N. Y.

MAIL THIS COUPON TODAY!

VANDEX, 64 Wall Street, New York 5, N. Y. Please send me, immediately per parcel post:

One Gallon Cans, each containing 8 lbs. VANDEX, @ \$7.20 per gallon can, postpaid to anywhere in continental U.S.A. or Canada. (Vandex costs you only 90¢ per lb.) I enclose payment in check or money order for \$_____

Name _____

Address _____

Town _____ Zone _____ State _____

PM-6



MAN!...
**This is
Shooting!**

Here's a new type of Target Pistol that has everything . . . perfect balance, rifled-barrel accuracy and safety, plus low-cost operation . . . all combined to give you hours of year 'round shooting thrills indoors or out. Secret of its amazing performance is CO₂ and "no-ricochet" type Super-Pells. Easy to handle . . . all you do is load and shoot! Available in .177 and .22 cal. models at your dealer's. Write for literature.

CROSMAN ARMS CO., INC., ROCHESTER 20, N. Y.
POWER WITHOUT POWDER

Crosman CO₂ PISTOL

**WELD
BRAZE, SOLDER,
and CUT**

ONLY
\$11⁹⁵
F.O.B.
complete!

**EASILY...
QUICKLY!**

No experience needed. Follow simple instructions, weld on iron, steel, bronze, brass, aluminum, and other metals. Plugs into any properly wired 110 volt A.C. or D.C. line. Make or save time and money doing repair work for yourself and others. Repair men, farmers, tinsmiths, home and auto owners, hobbyists, etc., say FOUR-WAY pays for itself over and over. Order today or send for Free details.



**ORDER
NOW
10 DAY
TRIAL**

FOUR-WAY WELDER COMPANY, Dept. F2-FB
2326 So. Michigan Ave. • Chicago 16, Illinois

POWER HACKSAW \$52.75

LESS MOTOR
F. O. B. Benton Harbor

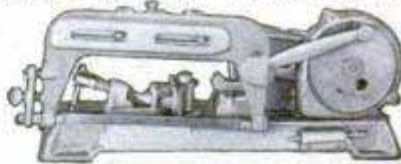

Send for full details and name of nearest dealer.

● Rugged cast iron construction. Wt. 56 lbs. bronze bearings. Draw cut. Auto. return lift. Auto. shut-off. Vise swivels 45°. Cap. 4"x4".

EXCEL MACHINE TOOLS Dept. PM-61
BENTON HARBOR, MICHIGAN

MAKE BIG MONEY!



Be a floor surfacing contractor and sand both new and old floors. Sanders are easy to operate and better still, you're your own boss. Write for latest "tell-all" booklet entitled "Opportunities in Floor Surfacing", enclosing 25 cents in coin or stamps to cover handling.

AMERICAN

FLOOR SURFACING MACHINE CO.
333 So. St. Clair Street • Toledo 3, Ohio

ALNICO MAGNETS LIFT 175-lb.

AMAZING PERMANENT MAGNETS — WILL NOT WEAKEN! NON-ELECTRIC. Retrieve guns, tackle, tools and other steel items from lake, river, plating tanks, drains or other hard-to-reach spots. Recover drills, taps, etc. from floor sweepings. Clear alley of harmful tacks, nails. Many other uses listed. Pays for itself quickly. **GUARANTEED!** Try any magnet one week. Money refunded if you are not well-pleased. Cat. No. 675 (Has pull of 175 lbs. on a flat steel block) . . . \$10.50
Cat. No. 650 (150 lb. pull) \$8.50 Cat. No. 600 (100 lb. pull) \$6.50
Cat. No. 550 (50 lb. pull) \$4.00 Cat. No. 530 (30 lb. pull) \$3.00
Cat. No. 17 (14 lb. pull) \$1.50 Send M.O. or check. We pay postage.
Cat. No. 30—Hobbyist assortment of six medium magnets. . . . \$1.50

MIAMI MAGNET CO.
3240 N.W. 27th Ave., Aviation Bldg. No. 43, Miami, Florida

Here's the Real McCoy!!
Genuine ARMY AIR FORCES SUNGLASSES

 Optically ground and polished Glare-free, PUR-O-RAY lenses. Guaranteed free of all distortion. Made to meet Gov't specifications. Lenses are Air Force Brown or Green. Ideal for smog, fog or haze penetration. Frames are either Nickel Silver or 24K gold finish. Pearloid sweat bar or pads. Handsome belt loop case. A \$17.50 value.
ONLY 3.95

Fisherman's BAROMETER
 Tells whether fishing is good or bad. A simple-to-understand and easy-to-read instrument. Now you can "be there when they're biting." Has a moulded plastic case and a beautiful, 3 1/4" diameter dial in color. This Barometer can be adjusted for altitudes up to 7000 ft. Carrying case included.

8.15

AUTO ALTIMETER
 Has a fine grade Taylor Barometric movement. Range from 1000 ft. BELOW sea-level to 10,000 ft. ABOVE in 1000 ft. divisions. Instantaneous adjustments. Easy mounting. Guaranteed 5 years. A \$10.00 value.

8.95

FOAM RUBBER LEATHERETTE
 Our huge stocks of FOAM RUBBER include a tremendous selection of shapes, sizes & thicknesses. Ideal for seat and chair cushions, bed & bunk mattresses, etc. Our complete stocks of GENUINE LEATHERETTE features 36" and 54" widths in 20 gorgeous colors and beautiful patterns. Write for information.

NEW TARPS HEAVY CANVAS
 Mildew and flame resistant. Cheap outside storage. They are really moving at these prices!!!
 8 1/2' x 12' .. \$12.25
 15' x 16' .. \$28.80
 16' x 32' .. \$63.50
RUBBERIZED NYLON tarp 7' x 11' .. **6.95**
NEW RUBBERIZED LINEN TARP - Waterproof, weighs only 3 LBS. Ideal for BOAT or CAR STORAGE 7' x 11' 18 oz. TARP 6 ft. x 6 ft. O.D. Duck - Innumerable uses on any boat. Can also be used as a tent floor covering or storage protector. A terrific buy!! Used but excellent condition
5.95
4.95

TANK Dural with welded seams, 2" filler with cap, two standard pipe ports for hook-up. Visible liquid level gauge on side. For gas, oil, water or "spare" on auto, tractor, truck or boat. Sturdy, light. Capacity - 6 gal. ...

4.95

MICROPHONE
 Telephone type, highly sensitive. Excellent clear tone. This was the Signal Corps favorite. An ideal instrument for the radio "ham" and professional recording studio, broadcasting, home recording, public address, etc. A sensational buy! Complete with cord and plug.

2.69

PALLEY SUPPLY COMPANY
 6321 SAN FERNANDO RD.
 Dept. PM6, GLENDALE 1, CALIF.

NEW! STATIONARY or PORTABLE D.C. ARC WELDER
 300 Amps Continuous. 350 - 400 Amps Intermittent. For all WELDING - LIGHT or HEAVY!

 This rugged, air cooled, precision built electric ARC WELDER - designed to weld for hours - comes complete with pulley reactor, output controls, Hi-Lo switches, rheostat. The heart of this unit is the famous R-1 generator, specially developed for B-29 Bombers, and with features no other generator has. Heavy steel frame, easily adapted to mounting on Jeep, Tractor or other power supply (10 H.P. gas or electric.) Never before offered at this low price.
9750

WRIST WATCHES Here's a real shock absorbing watch! Has jewel movement, sweep second hand, luminous dial, chrome case. GUARANTEED FOR ONE YEAR. Ideal for young and old.

Now ONLY - 6.95
17 JEWEL AUTOMATIC WRIST WATCH - Swiss made men's wrist watch. A real self-winding watch... winds itself while you wear it. Incabloc (shock protected) movement. Silver white or black face... waterproof nickel chrome case. Stainless steel back. Hours marked in numerals. Genuine leather strap. Red second hand with arrow tip. GUARANTEED...
25.95
 Add 10% Fed. Tax

SAVE UP TO 85% ON WAR SURPLUS
ILLUSTRATED 1951 - 200 PAGE CATALOG
1000'S OF BARGAINS! WRITE TODAY!
 JUST OFF THE PRESSES!! Packed with BARGAINS in NEW & SURPLUS merchandise at UNHEARD OF LOW PRICES!! Items of interest to the Mechanic, Housewife, Farmer, Pilot, Manufacturer, Outdoorsman, Sportsman, etc. SAVINGS UP TO 85% in Clothing, Hand & Power Tools, Housewares, Metals, Rubber, Plastics, Machinery & Hydraulic Supplies such as Cylinders, Valves, Pumps, Motors, Fitting, etc. Send only 50¢ for your copy TODAY!! We'll refund it on your first order for \$1.00 or more.

RIFLESCOPE
 Finest precision Acromatic optics 5 double element lenses, color corrected, spherical aberration. Dot reticle. Magnification 3 power. Length 9", tube dia. 7/8", objective lens 16mm, eye lens dia., 22mm.

8.95

TACHOMETER Type C-11
 Operates on direct drive with flexible shaft. Range is 0 to 4500 RPM. Ideal for use on single engine planes or boats, autos, etc. Drives direct from camshaft or at 2 to 1 reduction from crankshaft.

5.28

BARGAINS in SLEEPING BAGS
100% KAPOK FILLED BAG - a real treasure for hiker or camper. Special heavy duty, water repellent outer cover... filled with 3 lbs. imported Kapok... Has 100" zipper down side and across bottom. Large head flap makes dust cover to keep bag dry and clean when rolled up. Large air mattress pocket. Zip to another bag for double-up sleeping. Wt. 7 lbs. Size 34" x 78" .. **16.95**

MUMMY TYPE BAG Has outer cover of forest green, water repellent balloon cloth. Filled with 15% duck down and 85% chicken feathers. 3/4" length zipper. Size 34" x 77".
15.95

U.S. AIR CORPS RUBBER BOATS
 Reconditioned and ready... with carrying case. Safe, Lightweight, Easy to Pack and Carry. An Ideal boat for fishing or fun.

 1 MAN with PADDLES **14.95** 4 & 5 MAN **29.95** 7 MAN **42.50**
 Oars **2.95 PR.** Pump **2.95 EA.**

SWIM FLIPPERS
 Top quality rubber. Has pebble tread bottom. Adj. heel strap... Re-inforced for strength. Vented for air & drainage. Ideal for diving and swimming.

 Med., & Small **7.95** Large **8.95**

DIVING MASK
 Soft rubber mask fits over eyes. Heavy duty glass shield. Adj. headband.

 Jr. **2.99** Miss **2.69** Mr. **3.95**

FISHING SPEAR
 Corrosion resistant. Ideal for spear fishing. 11" long with barbed end. Dia. of sack 1" 3 for \$1.19

49.00

WADING SUIT
 Makes surf and deep sea fishing a pleasure! Ideal for ranchers, oil fields, or any use where it is necessary to protect body or clothes from moisture, silt, muck, etc... Made of rubberized canvas. Has vulcanized seams & built-in rubber gloves and boots.

 Sizes: - Small, Med., Lge. **6.95**

NYLON FISHLINE
 STRONG - LIGHTWEIGHT - NYLON FISHING LINE. ROT-PROOF and WATERPROOF... Especially treated for strength and long life. ON SPOOLS.

 1500 ft. 10 lb. .. \$1.59
 1000 ft. 25 lb. .. \$1.80
 750 ft. 45 lb. .. \$3.29
 750 ft. 50 lb. .. \$3.50
 300 ft. 72 lb. Braided **7.79**

NAVY Sealed Beam LAMP
 U. S. Navy, Portable type. Has Pistol Grip and aiming sight. Makes an ideal search, spot or emergency light for your auto, boat, farm, etc.

 12V. light - 4" lens **3.29**
 24V light - 5" lens **3.79**
 Set of 3 filters - red, green, amber... (specify type lamp) **99¢**

NAVIGATORS LAMP
 A handy light for desk, work bench... chart table... engine room, etc. Can be used on 6-12-24-110 Volt by changing bulb. 3 ft. shaft has 4 joints to adjust position...

3.29

CLAMP-ON LAMP
 Has adjustable ball & socket swivel head, long rubber covered cord and wall plug. All-purpose - indoor photography, floodlights, baby or large spot, personal bed-reading, work bench, garage, etc.

 Lamp alone... **1.29**
 5" spot reflector } **1.09**
 9" Parabolic reflector }

U.S. NAVY BATTLE LANTERN
 A powerful lamp complete with two 1 1/2 V. dry cell batteries... size: 7" x 7" x 4".

4.29

AIR CORPS BRIEF CASE
 This is a genuine piece of AAF equipment... Made of best grade leather in a handsome pebble finish with a light canvas liner. Has two full length map or paper compartments and three smaller pockets. An ideal case for students, salesmen, artists, etc. Full heavy duty zipper closure. 12" x 16" ... ONLY **2.95**

Aviators (AN-6530) Windproof & Dustproof
GENUINE GOGGLES
 Rubber or chamois covered frame. Clear or Green GROUND LENSES are inter-changeable. Adjustable nose bar. Ideal for flying, motor cycling, etc...

2.19

GO-1 GOGGLE KIT
 NEW! U.S. Navy - Has soft sponge rubber frame, 4 Polaroid lenses 2 green, 1 red, 1 clear. Perfect for racing, cycling, etc.

89¢

No. 151 MARCHING COMPASS
 A precision, officers' type compass of unusual accuracy. Has prismatic hair line guide for sighting a distant object and at same time reading number of degrees. Luminous dial for night. Jewel mounted needle. Canvas carrying case for belt...

2.95

U S NAVY INSULATED FOOD CONTAINER
 Why bother cooking on that trip? This lightweight plastic Thermal Food Container holds enough hot, fresh food for 8 people. Has 2-5 qt. removable Pyrex Baking Dishes for meat, veg. or liquids.

 1-9qt. Plastic container for ice, etc. Each section individual - Case of Sturdy Plastic with carrying handle.
10.95

Order from this ad. All sales final. Prices F.O.B. Glendale. Pay by M.O. or check. P.O.'s accepted from D&B firms. 1/2 deposit with C.O.D.'s.

LARGEST FIRM OF ITS TYPE IN THE WORLD

Don't pin stars on me!



I GOT TO MY ARMY SHOW ON TIME BECAUSE THAT NICE MECHANIC FIXED MY FORD SO QUICKLY. GUESS I HAD STARS IN MY EYES WHEN I THANKED HIM...



...BECAUSE HE INTERRUPTED WITH: "DONT PIN STARS ON ME, LADY. THE THANKS GO TO GENUINE FORD PARTS. THEY MAKE THE JOB SO EASY."



"THEY'RE MADE RIGHT, TO FIT RIGHT, TO LAST LONGER," HE SAID "AND THEY MAKE YOUR CAR RUN LIKE NEW."



"WE ALWAYS USE GENUINE FORD PARTS ON FORDS BECAUSE THEY SAVE OUR TIME AND YOUR MONEY."



...SO WHEREVER YOU SERVICE YOUR FORD ALWAYS SPECIFY GENUINE FORD PARTS. THEY'RE IN STOCK AT ALL FORD DEALERS' AND SELECTED INDEPENDENT GARAGES THAT DISPLAY THIS SIGN."



KEEP YOUR FORD ALL FORD!

Now! YOU CAN MAKE MONEY...

TURNING WORTHLESS OBJECTS INTO VALUABLE TREASURES— ... BY CERAMIZING!

HERE ARE JUST A FEW OF THE HUNDREDS OF ARTICLES THAT CAN BE TRANSFORMED BY "CERAMIZING"—INCREASED IN VALUE—OR "ETERNALIZED" AS KEEPSAKES WITH A VARI-COLORED COATING THAT HAS THE APPEARANCE OF THE FINEST KILN FIRED CHINA



"Ceramized" Costume Jewelry from flowers, leaves, nuts, and shells.



Paper Weights, Trays, and Objects of Art from Nature.



"Ceramized" Busts, Figures from plaster, or wood carvings.



"Ceramized" Objects of glass, leather, plastics, or rubber.



"Eternalize" baby shoes, toys, and other sentimental mementoes.



"Ceramize" Baskets, Plates, Trays, and other metal objects.



Preserve sport and war trophies in sparkling simulated china.

YES—ANY MAN OR WOMAN CAN DO WORK LIKE THIS IN ONE CORNER OF THE KITCHEN OR IN ANY SPARE ROOM!

A Satisfying New Home Art Hobby Pays Up To \$5.00 AN HOUR for SPARE TIME

Amazing book tells you how

HOW to do the work—how to get customers coming to you—how to set up the simple equipment—how and where to buy the materials—what to charge—how to start in spare time—how to expand into a full time business whenever you wish. Shows you in pictures and words how to put a hard "Ceramized" finish on such things as flowers, leaves, insects, shells, wood carvings, plaster castings, busts, statues, religious figures, buttons, baskets, feathers, base balls, golf balls, mementoes of all kinds, such as, baby shoes, party and wedding favors and decorations. Operating a home "Ceramizing" business is one of greatest insurance policies a man could ask for his future. **READ ABOUT IT WITHOUT RISKING A PENNY.**

Think of turning 56 cents worth of materials into a profit of \$5.00 for just a few minutes of easily learned handiwork. Think of beautifying your own home and amazing friends with the artistic skill you can master in less than an hour of study and practice. Sounds fantastic. Yet it's absolutely true... as you can **QUICKLY PROVE to yourself.**

AN EXCITING NEW OPPORTUNITY FOR PLEASURE AND PROFIT!

Just at a time when hundreds of men and women would like to make an extra \$35.00 to \$50.00 a week in spare time home work—just at a time when hundreds would like a new outlet for expressing their artistic skills—just at a time when the country is turning to a revival of appreciation of beautiful handcrafts, the fascinating new art of "Ceramizing" is ready for you. Every step of this process can be learned in less than an hour of home practice.

The process is so simple that even a child can learn it. No knowledge of art or drawing is re-

quired. No knowledge of proportion or design is needed. You work with objects already created, or with the countless thousands of Nature's beautiful forms. You coat the object itself with a hard finish that has the appearance of kiln fired glazed china—and you apply a variety of colors. By following my simple instructions you can develop a deeply satisfying creative hobby—or you can use your hobby in spare time to make as much as \$5.00 an hour. I even show you the easy way to get others to come to you for your products.

ALL THIS INFORMATION IS FREE

The information is free. A postage stamp brings you the exact plan by which hundreds are NOW **MAKING EXTRA MONEY EVERY WEEK**, in an artistic creative hobby. Study my plan. See examples of the beautiful work. Read the special marketing plans that bring you such big profits. If you're not "burning up" to get started, your only loss is a 3c stamp. Read the Plan at my risk.

NO "CATCH" TO THIS OFFER DON'T SEND ME A PENNY ... Just Your Name!



Learn about this wonder "ace in the hole" business that can supply you with a good income—even when other sources fail. Learn how you can start a business in spare time—without risking job or paycheck—that can be turned into a full time business whenever you need a new source of fulltime income. Learn R. E. Brandell, Warner Electric Co., 1512 Jarvis Ave., Dept. 36, Chicago 26, Ill.

this Art Hobby that can lead to personal independence—an income producer that can be operated in the corner of any room in your home—in any part of the country. Scores of men and women have already started... plenty of opportunity for hundreds more. **BUT DON'T PUT IT OFF.** Send your name and address today. It may open new horizons in your life.

R. E. Brandell, Warner Electric Co.
1512 Jarvis Ave., Dept. 36, Chicago 26, Ill.

Rush complete facts on the fascinating new Home Art Hobby of "Ceramizing." Show me how I can make as high as \$5.00 an hour for spare time work at home. No charge or obligation for the information you send.

Name _____

Address _____

City _____ Zone _____ State _____



Today's big value in auto polish!

DU PONT No. 7 POLISH

You clean off dirt film . . . put on a super-shine at the same time with Du Pont No. 7 Polish. There's much less work because No. 7 Polish contains "stroke-saving" methyl cellulose, found only in the Du Pont patented formula. Safe for all cars, it's made by Du Pont, makers of "Duco" and "Dulux," leading auto finishes. Get a can today at your service station or dealer's.



DU PONT CAR WASH

a new detergent which speeds up car washing and makes manual drying unnecessary. Makes car washing a pleasure.



DU PONT TAR REMOVER

a safe, easy way to remove tar, road oil, and tree sap from your car. Will not soften, discolor or dull the finish.



REG. U. S. PAT. OFF.

BETTER THINGS FOR BETTER LIVING . . . THROUGH CHEMISTRY