

POPULAR MECHANICS

MAGAZINE

WRITTEN SO YOU CAN UNDERSTAND IT

REG'D. TRADE MARK, GREAT BRITAIN, No. 410426

REG. U.S. PAT. OFF.

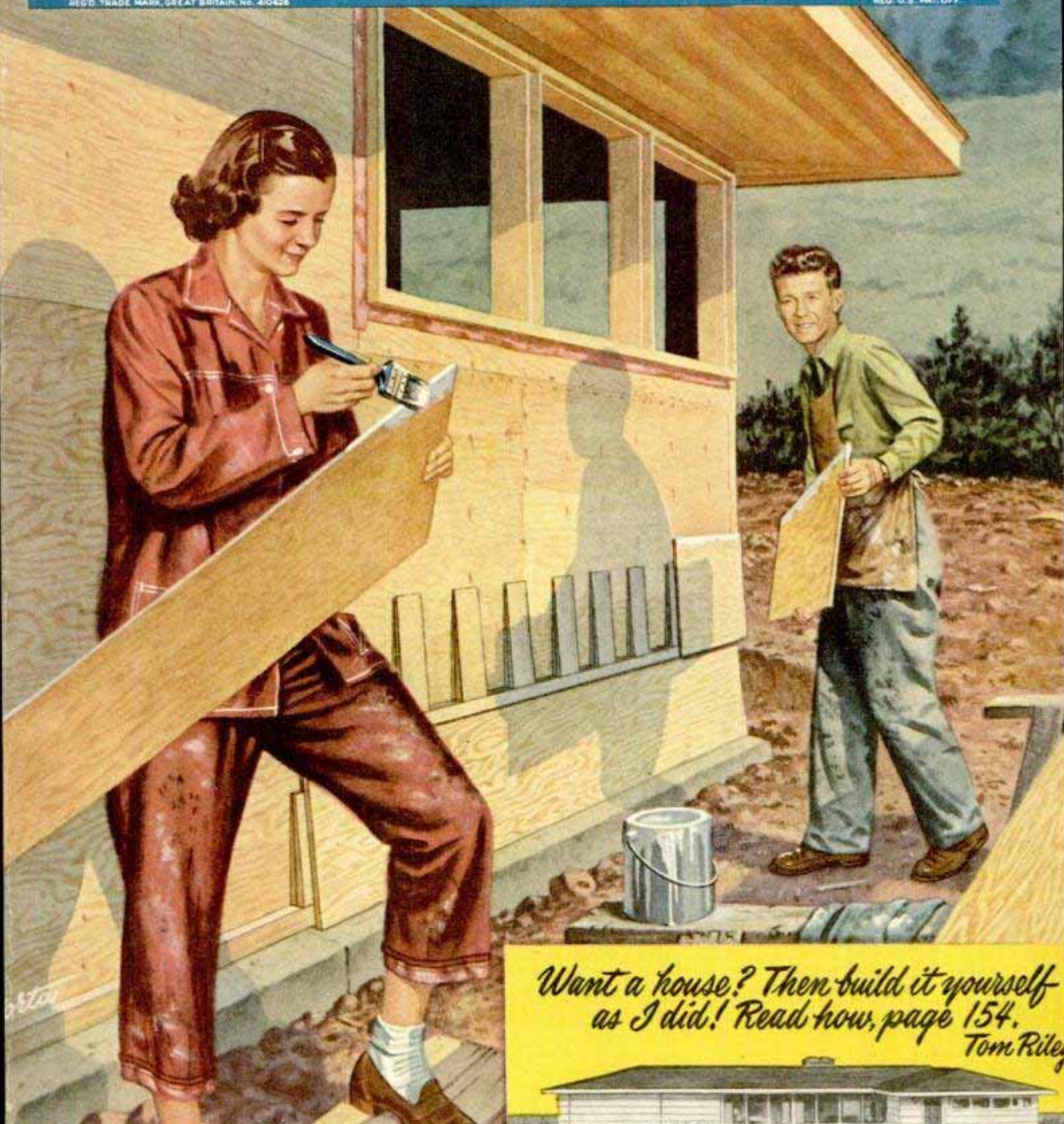

*Want a house? Then build it yourself
as I did! Read how, page 154.
Tom Riley*



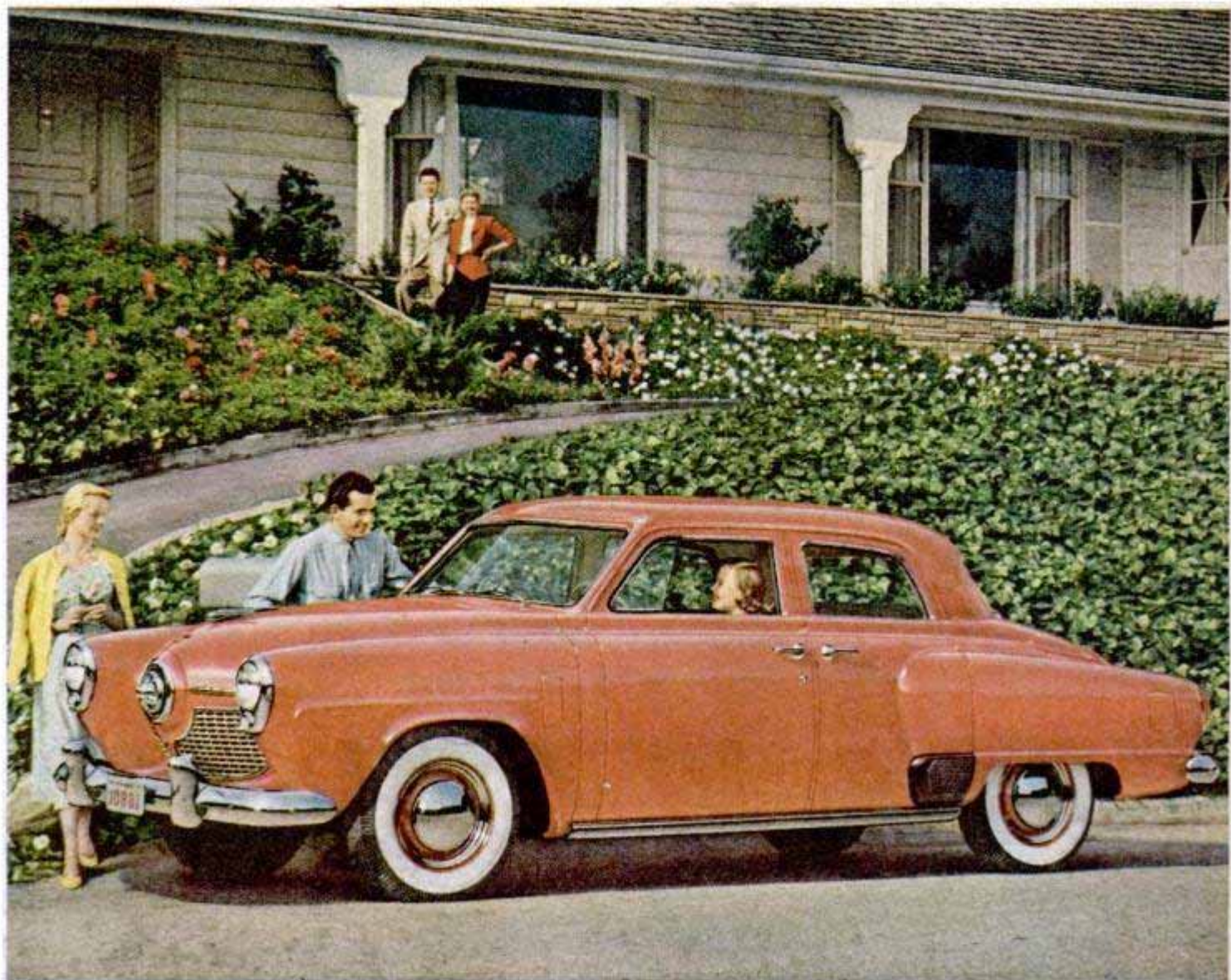

Paul Hesse photo

Decorative and other specifications subject to change without notice.

Drive this 1951 Studebaker Champion and save!

Top value of the top 4 in the lowest price field!

The gas economy you want! The low upkeep you want!

The dependable performance you want!

The Studebaker Champion is one of the 4
lowest price largest selling cars!

SEE THE EIGHT AMERICA RATES AS GREAT...THE 1951 STUDEBAKER COMMANDER V-8

Wheel trim rings, and white sidewall tires if available, at extra cost

©1951, The Studebaker Corporation, South Bend 27, Indiana, U.S. A.

Scientists Create "TAILORED LIGHTNING" For Better Motoring



ELECTRICITY LEAPS from storm clouds to top of Empire State Building as shown in this dramatic night photograph. Engineers harness electrical energy like this to "fire" gasoline in your engine.

In the great engineering laboratories of The Electric Auto-Lite Company in Toledo, Ohio, a group of Auto-Lite Ignition Engineers have been probing inside engine cylinder walls, peering at "blow-by-blow" spark performances, charting the behavior characteristics of man-made "lightning" across the spark plug gap. From endless tests they've determined what your engine's ignition system needs most, and then set about producing spark plugs to fill the bill. Net result: Ignition Engineered Auto-Lite Spark Plugs . . . the spark plugs that are *world famous* for quality and performance.



FRANKLIN'S KITE experiment was first demonstration of electrical nature of spark discharges between clouds. Date: 1752.



"FIRING PIN" of the car engine. Your spark plugs fire as many as 15,000 fuel charges per minute with tailored precision.



RELIABLE STARTING is one important benefit resulting from Auto-Lite research to assure correct materials, dimensions and design.

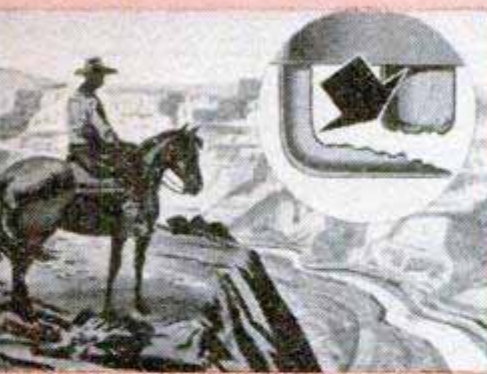

RIVER CUTTING CANYON resembles way urging of electricity wears away electrodes. For solution see next picture.

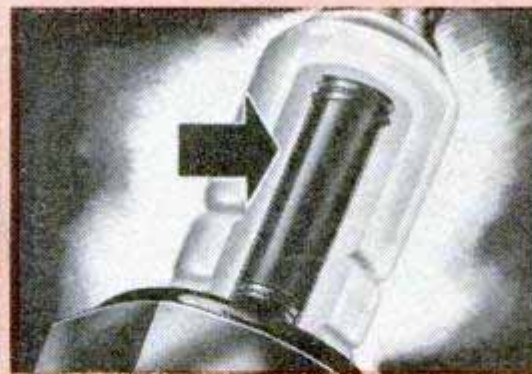

TINY UNIT called a "Resistor" permits wider initial gap setting, makes possible these advantages of Resistor Spark Plugs:

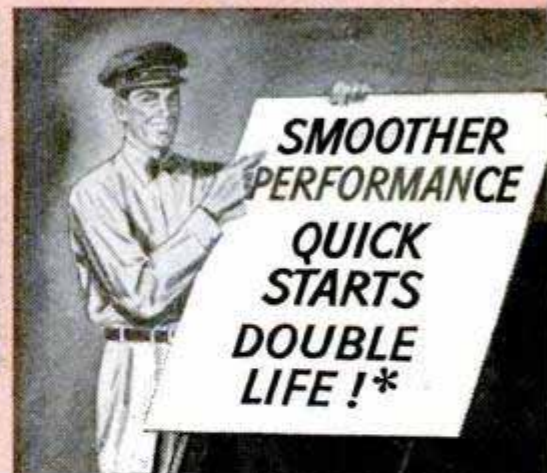

**SMOOTHER
PERFORMANCE
QUICK
STARTS
DOUBLE
LIFE!***

All car, truck and tractor owners benefit from the exhaustive research performed by Auto-Lite Ignition Engineers . . . the men who design the coil, distributor, spark plugs, wire and all the other parts of the complete ignition system used as original factory equipment on many leading makes of America's finest cars and trucks. *You're Always Right With Auto-Lite.*

THE ELECTRIC AUTO-LITE COMPANY
Toledo 1, Ohio Toronto, Ontario

Ignition Engineered
AUTO-LITE
SPARK PLUGS

This "gun" shoots wire around corners

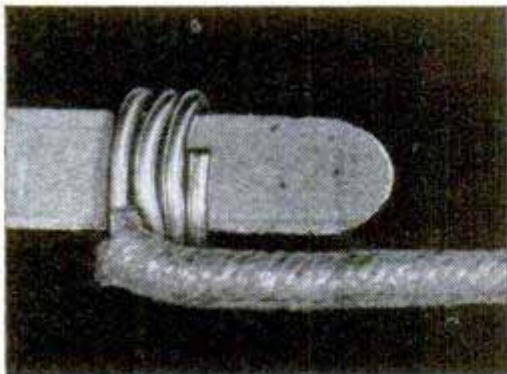
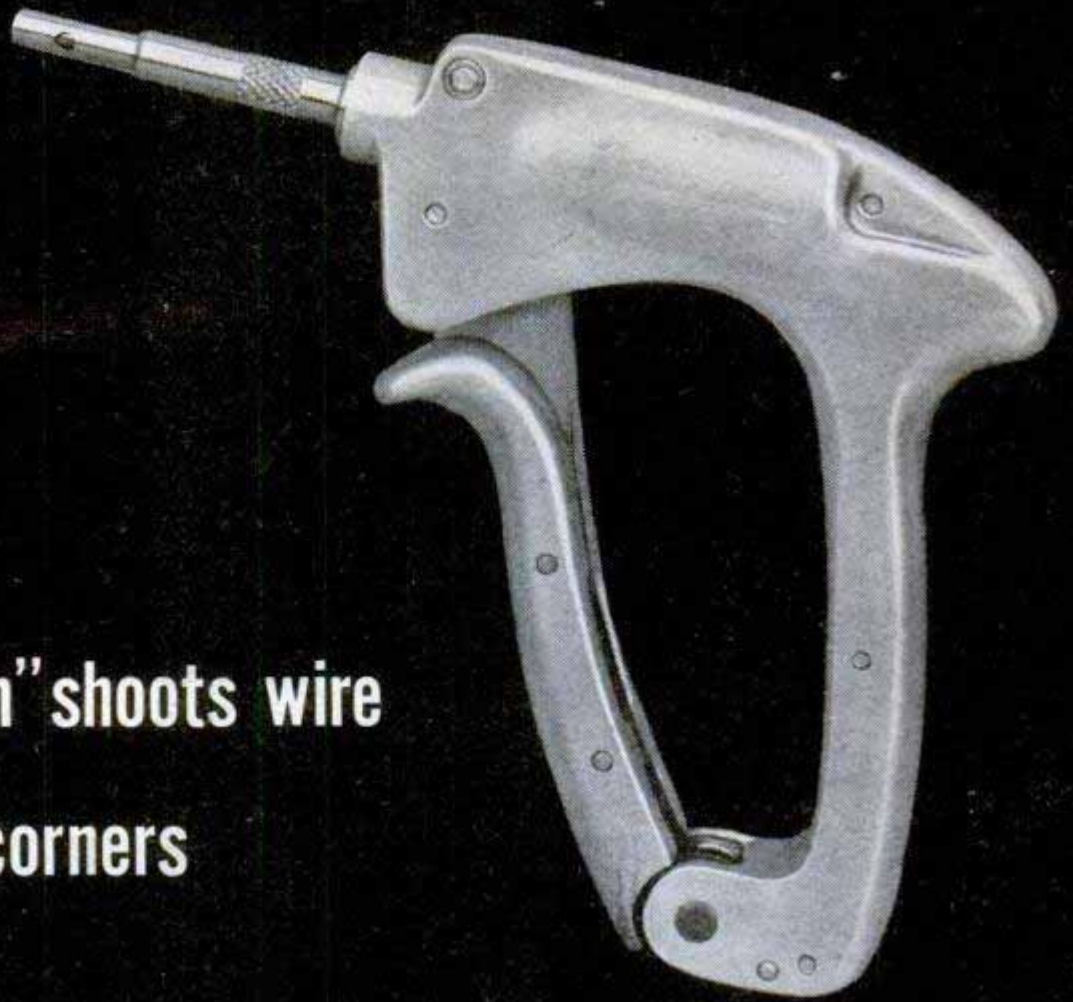

Close-up of connection made with new tool—neat, tight windings.

IT DOESN'T take long to wrap *one* wire around a terminal and snip off the end. But *hundreds of millions* of such connections are being made each year.

Now this job is done much more efficiently with a new wire wrapping tool invented at Bell Laboratories. This "gun" whirls wire tightly around terminals before solder is applied. The connection is better and there is no waste wire.

The hand-operated wrapper shown here is for the telephone man's tool kit. Power-driven wrappers developed by Western Electric, manufacturing unit of the Bell System, are speeding the production of telephone equipment. The gun's small nozzle reaches where fingers couldn't—a big advantage these days when parts are made smaller as well as better.

Bell Telephone Laboratories scientists devise many special tools to help your telephone system meet growing demands—and keep your telephone service one of today's best bargains.

BELL TELEPHONE LABORATORIES

WORKING CONTINUALLY TO KEEP YOUR TELEPHONE SERVICE BIG IN VALUE AND LOW IN COST





MEN WITH SKILLS GET AIR FORCE RATINGS!

Radio repairmen are among hundreds of kinds of skilled specialists . . . men who keep your U. S. Air Force on top . . . needed now by your Air Force.

Men with training as former specialists in any service . . . or non-veterans with special skills . . . are needed to support America's growing air power. Radio, radar, maintenance, weather, armament, camera repair, and many other technical skills are wanted.

For your skill, your Air Force offers better pay and opportunities than ever before . . . in a great Air Force you'll be proud to serve, with a rewarding sense of a job well done in your nation's defense.

Find out where you fit. Visit your nearest U. S. Army and U. S. Air Force Recruiting Station now . . . and get details of these new Air Force offers:

VETERANS: You can now enlist, if qualified, in your old grade or *better* . . . skip basic training . . . and be assigned initially to a nearby Air Force Base.

NON-VETERANS: You can enlist for basic training . . . and get a rating to match any critically needed technical skill or training you have.



Get on Top . . . Stay on Top . . . with the U. S. Air Force!

Here is some interesting news about your automobile

Just suppose you are driving at 40 miles an hour on a level road. The power, of course, comes from the gasoline you feed your motor. Yet 50% of the power generated by the motor doesn't do a thing to make your car go farther or faster, or climb a steeper hill.

Why? Because that power never gets to the rear wheels. It is used to overcome *engine friction*. And we don't ask you to take our word for it—America's automotive engineers have *proved* it.

Now, along comes a motor oil that proves it *further reduces* this engine friction. Which means the engine delivers the same power with *less gasoline*.

It's simple as ABC: The *less engine friction*, the *less gas* it takes to run your car.

This has been strikingly demonstrated in recent months. Hundreds and hundreds of cars—cars of all makes and ages—cars that had been using *every* nationally known brand of motor oil—were given the Dynamometer Test. This is a machine devised by engineers to measure the power an engine delivers to the rear wheels.

And what happened? After the oil in these cars had been changed to Macmillan, the *same power was developed with an average of 8% less gasoline*.

The minute you change to Macmillan, you'll get an increase in power and gasoline mileage. You cut down on "drag"—your gasoline "pushes" easier than before. After your second or third drain, you'll get an average increase in gasoline mileage of 8%!

That's because Macmillan has not only reduced engine friction but also has reduced carbon and gum deposits in the combustion chamber, on rings, valves, and valve stems. This results in higher compression because of better piston seal—smoother operation, and less tendency for the motor to ping.

Do you know what this means in money? Figuring gasoline at an average of 25¢ a gallon, it means you save 2¢ a gallon—simply by changing your motor oil to Macmillan.

That's a big saving— isn't it? Yet it's small when you realize *how much more* you save in repair bills. Because: The less friction, the less wear and tear on your car. New motors stay newer longer.

Finally, remember this Macmillan Motor Oil not only *fights friction* but *removes carbon* from your motor—cleans your motor as you drive.

Ask for this fine motor oil at independent dealers where you see the sign of the big red "M." It means Money in your pocket, Mileage in your car. Try the *OIL* that makes your *GAS* go farther!

President

MACMILLAN PETROLEUM CORPORATION

530 W. 6TH STREET, LOS ANGELES

50 W. 50TH, NEW YORK • 624 S. MICHIGAN, CHICAGO

P.S. *If you are unable to locate a Macmillan dealer, write to me and I'll be glad to direct you to the one nearest you. R.S.M.*



a little

Pyroil

makes a **BIG** difference in your car

A pint of Pyroil in the crankcase, a few ounces in the gas tank, and you'll notice a big difference in your car. Why? Because Pyroil has the extraordinary property of making ordinary oil cling to engine parts. This coating of protective lubrication eliminates friction between piston rings and cylinder walls. Pyroil stops costly wear and tear caused by metal-to-metal contact. It assures instant lubrication when you step on the starter—it prevents oil from draining off vital parts when you turn off the engine.

Yes, a little Pyroil (at so little cost) will make a big difference in the life of your car. Ask your gas station attendant to add Pyroil—add miles to your car.

Pyroil for Aircraft Engines

Use Aircraft Pyroil B for lubricating oil, Aircraft Pyroil A for gasoline.

GIVEN!

An attractive Pyroil metal savings bank — takes coins up to 50¢ pieces. **MOTORISTS**, it's yours for the asking—sent postage paid.



Manufactured and Guaranteed by Pyroil Company, 115 Pyroil Bldg., La Crosse, Wisconsin

Canadian Distributors: Central Purchasing Agencies, Ltd., Toronto, Ontario

PYROIL COMPANY

115 Pyroil Bldg., La Crosse, Wisconsin

I want my car to last and run properly. Please tell me more about Pyroil and how it can accomplish this for me.

Name _____

Address _____

City or Town _____ State _____



in this corner.....

THE EDITORS



FILL 'ER UP WITH LPG. Some 200,000 bus and truck drivers and power farmers are saying it as they drive alongside the big propane-butane pressure tanks at filling stations around the country.

And now private motorists are beginning to join the line. It isn't cheap, converting your car from gasoline to liquefied petroleum gas; but once you've converted, you "fill 'er up" at much lower cost per gallon and you have a sweet-running, knock-free engine.

Take it from Jud Purvis, a Chicago motorist who converted his car to LPG and will vouch for its carbon-free performance. He tells how it's done in a featured article next month.

White-Hot Ingot Takes 200-Mile Ride

In Canada, steelmen have come up with a novel time and labor-saving technique—they recently shipped a white-hot ingot 200 miles by rail. The project was so successful that it has become routine. The 130,000-pound ingots, at a temperature of 1600 degrees Fahrenheit, are packed in vermiculite, an insulating material. During the trip the temperature drops only 195 degrees. Normally, an ingot would have to be cooled six weeks before it could be shipped, then reheated for 10 days at the receiving point before it could be worked.

To the Editor

While looking through the December 1950 issue, I came across a letter to the editor from a man who owns an "Eskimobile." He sent a picture of what was called the "Mail Buggy." He told how much he enjoyed it, but said he did not know to whom the tribute of construction should go.

The original machine was made about

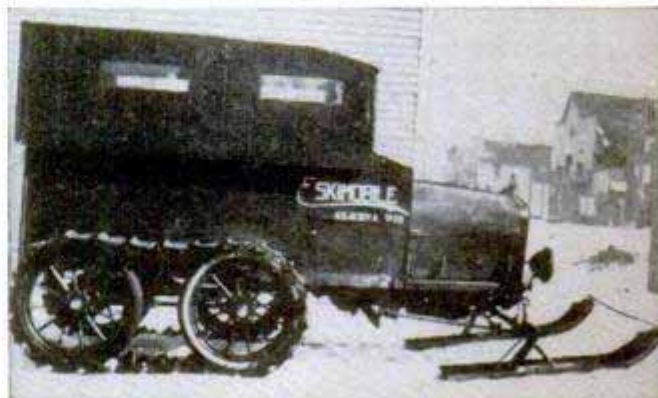

(Continued to page 8)

5 reasons why ACCOUNTANCY

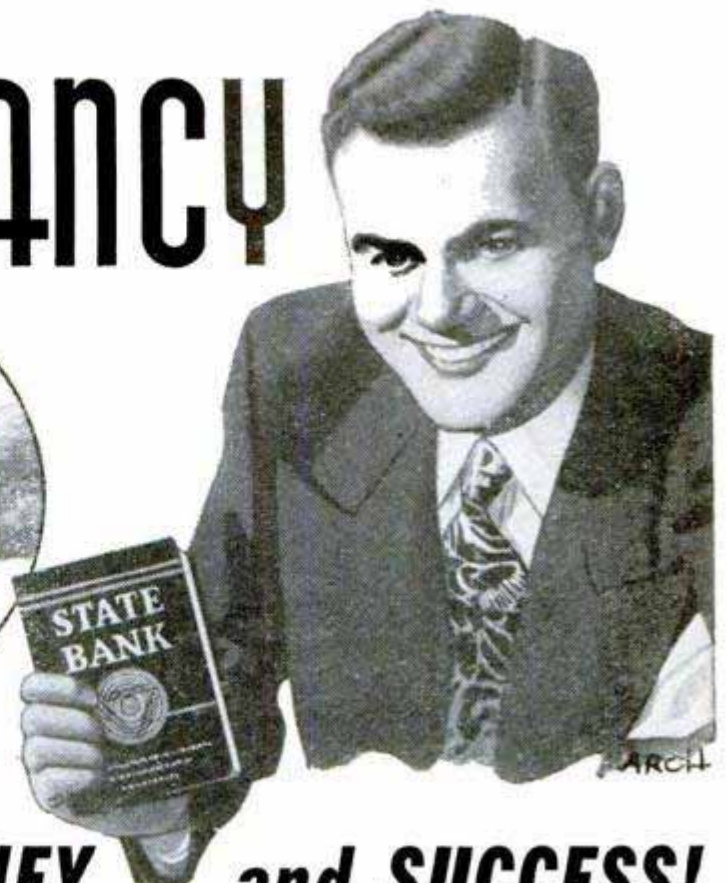
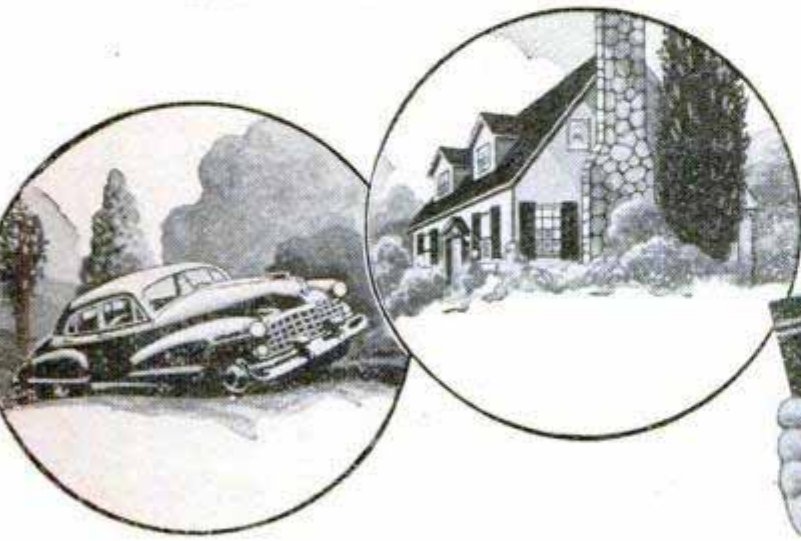

offers you MORE MONEY . . . and SUCCESS!

REASON #1. If you were an expert accountant right now, chances are you would find yourself among the highest-paid of all professional men and women. Even back in "depression years," surveys showed that accountants earned more on the average than men in other major professions.

REASON #2. The demand for accountants is great—everywhere. All businesses must have trained accountants to cope with ever-growing requirements. It's a profession offering wide opportunity—always—to the man who knows.

REASON #3. You can fit into any business, anywhere in the country—because accounting principles are universal. Think what this means in terms of security and independence!

REASON #4. Accountancy is open to all. Any man or woman of good intelligence, who enjoys figure work and is willing to follow LaSalle's systematic "problem method" plan, can rapidly qualify for a highly profitable, enjoyable

lifetime career . . . and he doesn't have to finish his training before beginning to "cash in."

REASON #5. Without losing a day from your present work, you can prepare in spare hours at home, at low cost, under LaSalle's step-by-step "Problem Method" of "learning by doing." This famous plan accounts for LaSalle's remarkable record of having trained nearly 10 per cent of all Certified Public Accountants in the U. S. . . . and of having put many thousands of others into high-paying careers.

Send today for LaSalle's interesting booklets, "Accountancy, the Profession That Pays," and "Success Reports." Learn about the five great fields of opportunity . . . and LaSalle's time-tested plan for helping men and women to rapid advancement, higher income, greater prestige and professional standing. The coupon below will bring these fact-filled booklets to you—without cost or obligation. Mail the coupon NOW.

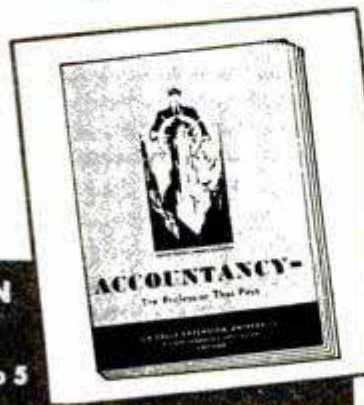

LASALLE EXTENSION UNIVERSITY
417 S. Dearborn St., Chicago 5

LaSalle Extension University A Correspondence Institution

Dept. 564H, 417 S. Dearborn St., Chicago 5, Ill.
Please send me, free of all cost or obligation, your 48-page illustrated book "Accountancy, the Profession That Pays," and the booklet "Success Reports"—send also "Ten Years' Promotion in One"—a book which has helped many men.

Name Age
Address
City, Zone, State

LAST CHANCE

to plan your own career
in Aviation

HIGH SCHOOL STUDENTS & GRADUATES NOW

may be your last opportunity to prepare for a profitable civilian career in Aviation. You learn *fast* and *well* at Embry-Riddle. Even if military service intervenes, you're still way out front with Embry-Riddle training! The Aviation Industry demands thousands of *properly trained* engineers, mechanics and supervisors - NOW. Embry-Riddle offers maximum training in minimum time for top *essential* civil aviation positions.

VETERANS Aviation's most gigantic boom is on the way. Use your last chance for G. I. training benefits to insure your success in this fastest growing career field. Enroll at Embry-Riddle before the July 25th G. I. deadline. Do it TODAY.

Be Ready To Best Serve Your Country And Yourself
With One Of These

4 Keys to Success!

AIRCRAFT & ENGINE MECHANICS

Our C.A.A.-approved school has a quarter-century aviation training experience. Learn fast with modern equipment, including jet... live aircraft, airline-size hangars.

A & E COMBINED WITH COMMERCIAL

Embry-Riddle *combination* training gives you unusual *dual* pilot-engineering ability.

AERONAUTICAL ENGINEERING

Embry-Riddle's accelerated 26-mo. Aeronautical Engineering College Course provides finest training available.

COMMERCIAL PILOT

Benefit from our experience with 30,000 students... best instructors and aircraft, year-'round flying weather.



Embry Riddle

International

SCHOOL OF AVIATION

MIAMI 30, FLORIDA

RIDDLE-McKAY AERO COLLEGE

CLASSES BEGINNING NOW -- SEND COUPON TODAY!

Dean of Enrollments - Dept. 99
Embry-Riddle School of Aviation
Miami 30, Florida

Please Print

NAME _____

ADDRESS _____

City _____

State _____ Age _____

I am interested in..

- A.&E. Mechanic
 Commercial Pilot
 Aeronautical Engineering
 A.&E. Combined with Commercial Pilot
 Flying Mechanic

Check One Veteran Non-Vet

TRAIN IN MIAMI--AIR CAPITAL OF THE WORLD

(Continued from page 6)
1922. It was first manufactured in a little town in middle-western Wisconsin. It was planned and made by two brothers—my dad and uncle—John and Henry Swansen. When the original Eskimobile was planned, these men had in mind to make a machine



that could be used for all kinds of work and pleasure.

There were many different types. The first to be constructed was the Eskimobile. From this developed the Stilt-Mobile, Ski-Mobile and Snow Cat. These were designed to serve well in the kind of weather we have around here—an extreme amount of snow in the winter and lots of mud in spring and summer.

Many of the mobiles were sold in Illinois, Minnesota, Ohio, Iowa and Canada, and we have heard of one in Arizona...

I am sending you some pictures to illustrate the facts I have stated here. The pictures will show you some of the different styles and some of the things they are used for. The picture of the Stilt-Mobile was taken in a wooded area near Almena. This picture is of Mr. and Mrs. Homer Person and their record kill in big bucks.

Yours truly,
Mary Swansen,
Almena, Wis.

Letter to the Editor

(Reader Edward L. Cady, noting comments on the rear-engine car by Arthur W. Stevens, Boston, Mass., in the February Editor's Column, writes as follows:)

When I was serving "apprenticeship" in the auto business in 1911... engineers were

(Continued to page 10)

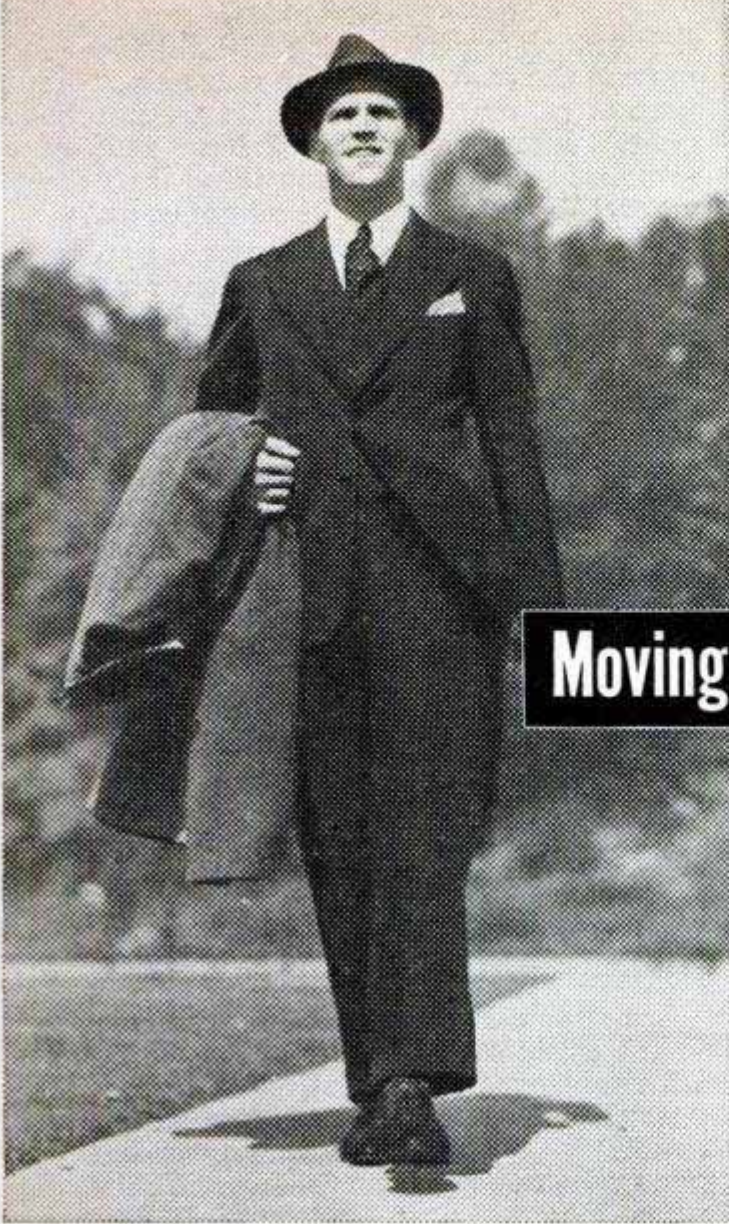

Moving Up Fast...

Everybody liked Dick Gray. He was a man's man. A star athlete. A whiz of a basketball player. A good husband. A hard worker.

But with all those interests, Dick Gray had a busy day *every* day. And Dick Gray was ambitious. He *could* study at a local college nights, but that would take hours of commuting. That's when a friend told Dick about I.C.S. and how he could study at home in his spare time.

Since then, Dick has completed three I.C.S. courses in jig-time. He's moving up fast in the company for which he works. And he's kind enough to say he owes it to I.C.S. Sure, we helped, but Dick Gray really owes his success to Dick Gray.

On the rolls of I.C.S. under many different names there are thousands of "Dick Grays." Maybe you are one. If not, it just takes your name on this coupon to put it there!

INTERNATIONAL CORRESPONDENCE SCHOOLS

APPROVED
under the
G.I. BILL

BOX 5699-K, SCRANTON 9, PENNA.

Without cost or obligation, please send me full particulars about the course BEFORE which I have marked X:

- | | | | |
|---|--|---|--|
| <p>Business and Academic Courses</p> <ul style="list-style-type: none"> <input type="checkbox"/> Accounting <input type="checkbox"/> Bookkeeping <input type="checkbox"/> Business Administration <input type="checkbox"/> Bus. Correspondence <input type="checkbox"/> Certified Public Accounting <input type="checkbox"/> Commercial <input type="checkbox"/> Cost Accounting <input type="checkbox"/> Federal Tax <input type="checkbox"/> First Year College <input type="checkbox"/> Foremanship <input type="checkbox"/> Good English <input type="checkbox"/> Higher Mathematics <input type="checkbox"/> Industrial Supervision <input type="checkbox"/> Motor Traffic <input type="checkbox"/> Retailing <input type="checkbox"/> Salesmanship <input type="checkbox"/> Sign Lettering <input type="checkbox"/> Spanish <input type="checkbox"/> Typing <p>Air Conditioning and Plumbing Courses</p> <ul style="list-style-type: none"> <input type="checkbox"/> Air Conditioning <input type="checkbox"/> Heating <input type="checkbox"/> Refrigeration | <ul style="list-style-type: none"> <input type="checkbox"/> Advertising <input type="checkbox"/> Bus. Law <input type="checkbox"/> Commercial Art <input type="checkbox"/> French <input type="checkbox"/> High School <input type="checkbox"/> Illustration <input type="checkbox"/> Postal Civil Service <input type="checkbox"/> Retail Bus. Management <input type="checkbox"/> Secretarial <input type="checkbox"/> Stenography <input type="checkbox"/> Traffic Management <p>Chemical Courses</p> <ul style="list-style-type: none"> <input type="checkbox"/> Chemical Engineering <input type="checkbox"/> Chemistry, Analytical <input type="checkbox"/> Chemistry, Industrial <input type="checkbox"/> Chemistry, Mfg. Iron & Steel <input type="checkbox"/> Petroleum Refining <input type="checkbox"/> Pulp and Paper Making <p>Civil Engineering, Architectural and Mining Courses</p> <ul style="list-style-type: none"> <input type="checkbox"/> Architecture <input type="checkbox"/> Building Estimating <input type="checkbox"/> Civil Engineering <input type="checkbox"/> Contracting and Building <input type="checkbox"/> Highway Engineering <input type="checkbox"/> Lumber Dealer <input type="checkbox"/> Reading Structural Blueprints <input type="checkbox"/> Sanitary Engineering <input type="checkbox"/> Structural Drafting <input type="checkbox"/> Structural Engineering <input type="checkbox"/> Surveying and Mapping <p>Communications Courses</p> <ul style="list-style-type: none"> <input type="checkbox"/> Electronics <input type="checkbox"/> Prac. FM and Television <input type="checkbox"/> Prac. Telephony <input type="checkbox"/> Radio, General <input type="checkbox"/> Telegraph Engineering | <p>Electrical Courses</p> <ul style="list-style-type: none"> <input type="checkbox"/> Electrical Drafting <input type="checkbox"/> Electrical Engineering <input type="checkbox"/> Electric Light and Power <input type="checkbox"/> Lighting Technician <input type="checkbox"/> Practical Electrician <input type="checkbox"/> Power House Electric <input type="checkbox"/> Ship Electrician <p>Internal Combustion Engines Courses</p> <ul style="list-style-type: none"> <input type="checkbox"/> Auto Technician <input type="checkbox"/> Diesel-Electric <input type="checkbox"/> Diesel Engines <p>Mechanical Courses</p> <ul style="list-style-type: none"> <input type="checkbox"/> Aeronautical Engineer's, Jr. <input type="checkbox"/> Aircraft Drafting <input type="checkbox"/> Forging <input type="checkbox"/> Heat Treatment of Metals <input type="checkbox"/> Industrial Engineering <input type="checkbox"/> Industrial Instrumentation <input type="checkbox"/> Industrial Metallurgy <input type="checkbox"/> Machine Shop <input type="checkbox"/> Machine Shop Inspection <input type="checkbox"/> Mechanical Drafting <input type="checkbox"/> Mechanical Engineering | <ul style="list-style-type: none"> <input type="checkbox"/> Mold-Loft Work <input type="checkbox"/> Patternmaking—Wood, Metal <input type="checkbox"/> Reading Shop Blueprints <input type="checkbox"/> Sheet-Metal Drafting <input type="checkbox"/> Sheet-Metal Worker <input type="checkbox"/> Ship Fitting <input type="checkbox"/> Toolmaking <input type="checkbox"/> Welding—Gas and Electric <p>Railroad Courses</p> <ul style="list-style-type: none"> <input type="checkbox"/> Air Brake <input type="checkbox"/> Diesel Locomotive <input type="checkbox"/> Locomotive Engineer <input type="checkbox"/> Locomotive Fireman <input type="checkbox"/> Locomotive Machinist <input type="checkbox"/> Railroad Section Foreman <input type="checkbox"/> Steam and Diesel Loco. Eng. <p>Stationary Engineering Courses</p> <ul style="list-style-type: none"> <input type="checkbox"/> Boilermaking <input type="checkbox"/> Combust. Engrg. <input type="checkbox"/> Marine Engineering <input type="checkbox"/> Power Plant Engr. <p>Textile Courses</p> <ul style="list-style-type: none"> <input type="checkbox"/> Cotton Manufacturing <input type="checkbox"/> Rayon Weaving <input type="checkbox"/> Woolen Manufacturing |
|---|--|---|--|

Name _____ Age _____ Home Address _____

City _____ State _____ Working Hours _____ A.M. to _____ P.M.

Present Position _____ Employed by _____

Length of Service in World War II _____ Enrollment under G.I. Bill approved for World War II Veterans. Special tuition rates to members of the Armed Forces.

Canadian residents send coupon to International Correspondence Schools Canadian, Ltd., Montreal, Canada.



Shavers Vote NEW 1951

SCHICK INJECTOR BLADES

OUTSHAVE ALL

OTHERS 5 TO 1

Including Our Own Old Blades!



You get
this 1951 blade
only in the **NEW**
GOLD PACK!

20 Blades Only 73¢
12 Blades Only 49¢
6 Blades Only 25¢

IN AUTOMATIC
CARTRIDGE

HERE'S THE FULL SCORE

On Every Point
Important To Shaving:

SMOOTHER SHAVES 5 1/2 to 1
CLEANER SHAVES 5 to 1
SAFER SHAVES 7 to 1
FASTER SHAVES 5 to 1
MORE SHAVES per blade nearly 2 to 1

Men in 10 cities—
nationwide—com-
pared NEW 1951
SCHICK INJECTOR
BLADES with what-
ever they had been
using. About 80% of
the men had a prefer-
ence. Of these, the
votes were in the
ratios shown above.

Special, new surgical steel!
Scalpel-sharp! Precision-
ground! And *only* these
NEW 1951 SCHICK INJEC-
TOR BLADES are made to fit
your injector razor perfect-
ly! So we guarantee this:
EITHER YOU GET THE FIN-
EST SHAVES OF YOUR LIFE—
OR YOUR MONEY BACK,
QUICK!

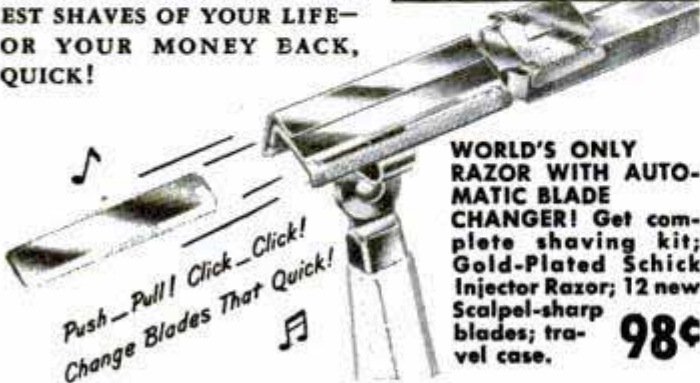

Push—Pull! Click—Click!
Change Blades That Quick!

WORLD'S ONLY
RAZOR WITH AUTO-
MATIC BLADE
CHANGER! Get com-
plete shaving kit;
Gold-Plated Schick
Injector Razor; 12 new
Scalpel-sharp
blades; tra-
vel case. **98¢**

SCHICK INJECTOR RAZOR & BLADES

doing much experimenting with the idea of putting the engine over the rear axle. The verdict at that time was, "It cannot be done." Every year since I have read of somebody trying the same thing, and the verdict still is the same, "It cannot be done."

When the power of the motor is applied to the rear axle, it has a tendency to lift the front end. With the early models, with short wheelbase and the engine in the middle under the seat, they have actually been known to "rare up" and tip over backward when going up a steep hill. Farm tractors still do this sometimes. So in order to have the car hold the road on hills and at high speed on curves, it has been necessary to put the engine up front to hold the front end down . . .

Sincerely,
Edward L. Cady,
5415 34th Ave.,
Kenosha, Wis.

Letter to the Editor

The interesting article, "Rockets on a Timetable," by Richard F. Dempewolff in your November issue has come to my attention. On a level of general information, it is most interesting and informative.

I wish to call your attention particularly to the misinformation the article contains with reference to high-strength hydrogen peroxide. Your attention is invited to the caption for the picture on the lower left of page 98 which reads as follows: "Fuel experts load a big rocket with hydrogen peroxide. Chemical, which will explode if touched, rolls off plastic suits." This caption is deliberately misinforming since we can state, categorically, that hydrogen peroxide will not "explode" by being touched with anything.

Noah S. Davis, Jr., Manager,
Special Projects Dept.,
Buffalo Electro-Chemical Co., Inc.,
Buffalo, N. Y.

Mr. Davis is right. Hydrogen peroxide will not explode on contact with most clean substances, provided it is not in a sealed container. However, a dirty or catalytically contaminated material, which is combustible, can be made to burn by spilling hydrogen peroxide on it. Rocket scientists in the Viking program have used hydrogen peroxide at White Sands for a couple of years without mishaps. "On the other hand," they say, "most of us have a lively respect for the potential dangers of hydrogen peroxide when not handled properly." Fires started by hydrogen peroxide being spilled on contaminated material can be easily extinguished with water.

WHAT Every AUTO MECHANIC Wants to Know

A motor vehicle is a machine of many parts, each part designed and constructed for its own special function.

All good mechanics, like good doctors, should know the working theory and operation of each part and understand what causes trouble and how to remedy it.

LET AUDELS AUTO GUIDE SOLVE YOUR PROBLEMS

Every auto mechanic, helper, serviceman and operator can use a copy of AUDELS AUTOMOBILE GUIDE. The information it gives saves time, money and worry. Highly indorsed by all users. It presents the whole subject of auto mechanics from A to Z in plain language and simple terms.

This Big Practical Book gives full information with working diagrams covering the principles, construction, ignition, service and repair of modern cars, trucks and buses.

A complete Guide of 1800 pages, with over 1500 illustrations showing inside views of the working parts, with instructions for service jobs. Diesel engines, Fluid and Hydra-matic drives fully explained.

IT PAYS TO KNOW HOW TO

How to fit pistons—How to locate engine knocks—How to fit connecting rod bearings—How to service main bearings—How to recondition valves—How to time valves—How to adjust fan belts—How to adjust carburetors & chokes—How to rebuild a clutch—How to service automatic transmissions—How to service brakes—How to adjust steering gear—How to cope with ignition troubles—How to service distributors—How to time ignition—How to "tune up" an engine.

INFORMATION IN A HANDY FORM

73 INTERESTING CHAPTERS—Read this partial list of subjects on which practical information is fully given for quick reference under the headings as shown below. Ready Reference Index.

All Parts of an Automobile—Automotive Physics—The Gas Engine—Gas Engine Principles—Multi-Cylinder Engines—Horse Power—Automobile Engines—Stationary Parts—Moving Parts—Pistons—Piston Rings—Connecting Rods—Crank Shafts—Valves—Valve Gear—Cams and Cam Action—Valve Timing—Cooling Systems—Fuel Feed Systems—Dual Fuel Feed—Mixture—Carburetors—Carburetor Service—Automatic Choke—Super-Chargers—Transmissions—Special Transmissions—Fluid and Hydra-matic Drives—Clutches—Universals and Propeller Shafts

—The Differential—Rear Axles—Rear and Front Suspension—Running Gear—Brakes—Wheel Alignment—Knee Action—Steering Gear—Tires—Lubricants and Lubrication—Automotive Electricity—Ignition Systems—Magneto Ignition—Spark Plugs—Ignition Coils—Distributors—Automatic Spark Control—Ignition Timing—Generators—Starters—Generator and Starter Testing—Lighting Systems—Storage Batteries—Charging and Testing—Diesel Engines and Trouble Shooting.

7 DAYS' FREE TRIAL
TO GET THIS ASSISTANCE
FOR YOURSELF SIMPLY
FILL IN AND MAIL
COUPON TODAY.

\$4 COMPLETE
PAY \$1 A
ONLY 1 MO.

Ask to
See It!

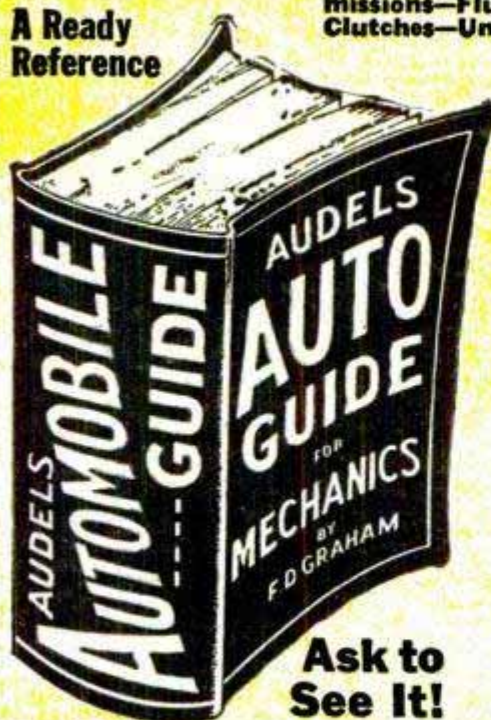

Sent on 7 Days Approval

Step up your own skill with the facts and figures of your trade. Audels Mechanics Guides contain Practical Inside Trade Information in a handy form. Fully illustrated and Easy to Understand. Highly Endorsed. Check the book you want for 7 DAYS FREE EXAMINATION. Send No Money. Nothing to pay postman.

CUT HERE MAIL ORDER

AUDEL, Publishers, 49 W. 23 St., NEW YORK 10, N. Y.

Please send me postpaid for FREE EXAMINATION books marked (x) below. If I decide to keep them I agree to mail \$1 in 7 Days on each book or set ordered and further mail \$1 monthly on each book or set until I have paid price, otherwise I will return them.

- TRUCK & TRACTOR GUIDE, 1299 Pages . . . \$ 4
- AUTOMOBILE MECHANICS GUIDE, 1800 Pages . . . 4
- DIESEL ENGINE MANUAL, 575 Pages . . . 2
- MACHINISTS HANDY BOOK, 1650 Pages . . . 4
- WELDERS GUIDE, 400 Pages . . . 1
- BLUE PRINT READING, 416 Pages . . . 2
- MATHEMATICS & CALCULATIONS, 700 Pages . . . 2
- SHEET METAL PATTERN LAYOUTS, 1100 Pages . . . 4
- SHEET METAL WORKERS HANDY BOOK, 388 Pgs. . . 1
- MECHANICAL DRAWING GUIDE, 160 Pages . . . 1
- MECHANICAL DRAWING & DESIGN, 480 Pages . . . 2
- AIRCRAFT WORKER, 240 Pages . . . 1
- TELEVISION SERVICE MANUAL, 384 Pages . . . 2
- RADIOAMANS GUIDE, 914 Pages . . . 4
- ELECTRONIC DEVICES, 216 Pages . . . 2
- ELECTRIC MOTOR GUIDE, 1000 Pages . . . 4
- ELECTRIC WIRING DIAGRAMS, 272 Pages . . . 1
- ELECTRICIANS EXAMINATIONS, 250 Pages . . . 1
- ELECTRIC POWER CALCULATIONS, 425 Pages . . . 2
- HANDY BOOK OF ELECTRICITY, 1440 Pages . . . 4
- ELECTRIC DICTIONARY, 9000 Terms . . . 2
- ELECTRIC LIBRARY, 7000 Pages (12 Book Set) . . . 18
- MARINE ENGINEERS HANDY BOOK, 1258 Pgs. . . 4
- SHIPFITTERS HANDY BOOK, 250 Pages . . . 1
- REFRIGERATION & Air Conditioning, 1280 Pgs. . . 4
- MILLWRIGHTS & MECHANICS GUIDE, 1200 Pgs. . . 4
- POWER PLANT ENGINEERS GUIDE, 1500 Pages . . . 4
- ENGINEERS & FIREMANS EXAMS, 525 Pages . . . 1
- PUMPS, Hydraulics & Air Compressors, 1658 Pgs. . . 4
- ENGINEERS LIBRARY (3 Book Set) . . . 9
- MECHANICAL DICTIONARY, 950 Pages . . . 4
- GARDENERS & GROWERS GUIDES (4 Book Set) . . . 6
- CARPENTERS & BUILDERS GUIDES (4 Book Set) . . . 6
- PLUMBERS & Steamfitters Guides (4 Book Set) . . . 6
- MASONS AND BUILDERS GUIDES (4 Book Set) . . . 6
- PAINTERS & DECORATORS MANUAL, 450 Pgs. . . 2
- HOUSE HEATING GUIDE, 1000 Pages . . . 4
- OIL BURNER GUIDE, 384 Pages . . . 1

Name _____

Address _____

Occupation _____

Employed by _____ 33A

AUDEL, Publishers, 49 W. 23 St., New York 10, N. Y.



All eyes — even our Plion's — are on PROTO, the truly professional tools. Skilled workers know that PROTO tools speed work, add to safety and serve many long years—that each design meets exacting professional standards. See the extensive PROTO line at your dealer's, and buy the ones you need.

Send 10¢ for 68-page catalog to

PLOMB TOOL COMPANY
2255G Santa Fe Avenue,
Los Angeles 54, Calif.

TOOLAGRAM

Many new sizes and styles of PROTO sockets have been added recently. Improvements to existing sockets include smaller outside diameters, deeper openings and larger bolt clearance holes.



5182

PROTO TOOLS

REG. U.S.
PAT. OFF.

LOS ANGELES

MADE
IN U.S.A.

WHERE-TO-BUY-IT INDEX

Source of supply appears after items commercially available

ATOMIC DEFENSE AND DETECTION

Atomic survival jacket.....	86
"Atomic dog tags".....	88
Canned water for defense.....	131
Trailer hospital.....	131
Radioactivity checker (The Austin Co., Special Devices Division, 19 Rector St., New York City 6).....	142

AUTOMOTIVE

Detroit listening post.....	89
Punctureproof tube made entirely of butyl (Firestone Tire & Rubber Co., Akron, Ohio).....	104
Tubeless tire is punctureproof (Firestone Tire & Rubber Co., Akron, Ohio).....	105
Flashy ornament (Flicker Lights Mfg. Co., Box 995, Grand Junction, Colo.).....	105
Metal top for convertibles (Coachcraft, 8671 Melrose Ave., Los Angeles, Calif.).....	122
British Jaguar (Hoffman Motor Car Co., Inc., 487 Park Ave., New York City).....	122
Pinup hanger for hats (The Auto Hatrack Co., 829 15th St., Denver, Colo.).....	142
Engine attachment fights carbon (Auto-Vac Sales Co., W. 17th and Ave. B, Scottsbluff, Neb.).....	151
Front-view mirror protects children (Safety Cross Mirror Co., Lambertville, Mich.).....	152

AVIATION

Midget Jeep power plant starts shipboard jets.....	79
"Flying Barrel".....	88
Atom plane soon?.....	115
Test runway for landing gear.....	138
Lifesaving "bathrobe" protects rocket workers.....	142
14,000-horsepower jet engine.....	142

BOATS

Boat swung aboard car by one person (Pro-Weld Co., 1835 Cooper St., Jackson, Mich.).....	91
Floating trailer powers rubber boat.....	109
Plane tows magnet to find sunken barge.....	120
Hinged tail gate for rescue boats.....	150

FARM AND GARDEN

Grass trimmers (E.F. Britten & Co., 22-26 South Ave., Cranford, N. J.).....	78
Motorized "earthworm" (Solitaire Industries, 1200 Second Ave., South, Minneapolis, Minn.).....	78
Zippered homes for bumblebees.....	79
Pneumatic tire has grooved tread.....	97
Ride as you mow (The Belknap Mfg. Co., Bridgeport, Conn.).....	105
Push-over gate (Hawley Mfg. Co., 1130 Lockwood Dr., Houston 20, Tex.).....	137
India to double irrigated acreage.....	146

GAMES, HOBBIES AND NOVELTIES

Marble signs.....	91
Card caddy (Card Devices Inc., Troy, Ohio).....	121
Solitaire lapboard (Hunter Sol-Board Co., 520 67th St., Houston, Tex.).....	121
A treeful of heads.....	130
Pocket mirror lights its way (Industrial Mfg. Co., 952 Addison St., Chicago 13).....	146

HOUSE AND HOME

Concrete cuts radiant-heat costs.....	105
Outdoor armchair (Wheeling Corrugating Co., Wheeling Steel Corp. Bldg., Wheeling, W. Va.).....	106
Defrost clock (Philco Corp., Philadelphia 34, Pa.).....	106
Window fan (The Lau Blower Co., Dayton 7, Ohio).....	106
Legless high chair (Sullivan Mfg. Co., 2114 W. Monte Vista Road, Phoenix, Ariz.).....	106
Sprinkler head (Surf Mfg. Co., 333 N. Michigan Ave., Chicago 1).....	107
Radiant platter (Appleman Art Glass Works, Bergenfield, N. J.).....	107
Sliding griddle (Philco Corp., Philadelphia, Pa.).....	107
Book ends (Lordell Corp., 219 W. Chicago Ave., Chicago 10).....	107
Holder with rubber rollers (The Stanley Works, New Britain, Conn.).....	123
Ventilating fan has thermostat (General Electric Co., Appliance & Merchandise Dept., Bridgeport 2, Conn.).....	130
Walker for tots (John Harper, Westinghouse Electric Corp., Transformer Division, Sharon, Pa.).....	130
Tick-tock eyes (Tezuka Clock Co., Ltd., Tokyo, Japan).....	152

INDUSTRY

Super-cold plus heat makes super-hard steel.....	88
Hydraulic ram removes ties (Fairmont Railway Motors, Inc., Fairmont, Minn.).....	97
Crystals amplify X rays.....	104
Ore reserves for 125 years.....	104
Electric "sluice" aids gold miner (Thomas & Henry Maestas, c/o Doenges Long Motor Co., Colorado Springs, Colo.).....	137
Squeezing water from Wyoming's coal.....	232
Make fertilizer, get uranium.....	248

MILITARY

Survival rifle.....	108
Underwater truck.....	115
Plastic insole protects feet.....	244

(Continued to page 14)

INVENTORS

Learn how to protect your invention. The U. S. Patent Laws provide that any new and useful art, machine, article of manufacture, or composition of matter, or any new and useful improvement thereof, may be patented if the act of invention is involved. Therefore, every inventor with a valuable invention should take advantage of the Patent Laws and proceed for patent protection in order to safeguard his rights.

A patent gives the inventor the exclusive right to prevent others from making, using, or selling the invention claimed in the patent for a period of seventeen years.

The Patent Laws were enacted for the benefit of the inventor to give him protection for the features of his invention which are patentable. These features must be properly and concisely set forth and claimed in a formal application for patent, in order to comply with the requirements of the Patent Laws. For that reason, unless the inventor is familiar with patent matters, he should engage a competent registered patent attorney or agent to represent him. We are registered to practice before the U. S. Patent Office and are prepared to serve you in the handling of your patent matters.

A specially prepared booklet entitled "Patent Guide for the Inventor", containing detailed information with respect to patent protection and procedure, together with a "Record of Invention" form will be promptly forwarded to you without obligation upon request.

CLARENCE A. O'BRIEN & HARVEY JACOBSON

Registered Patent Attorneys

11-E DISTRICT NATIONAL BUILDING

WASHINGTON 5, D. C.

NOW!

BRIGGS SMOKES 3 WAYS BETTER*



1. Stays lighted longer ... by 19%



2. Cleaner burning ... by 16.4%



3. Less tar ... by 21.6%

So today ...

Put this
in your
pipe

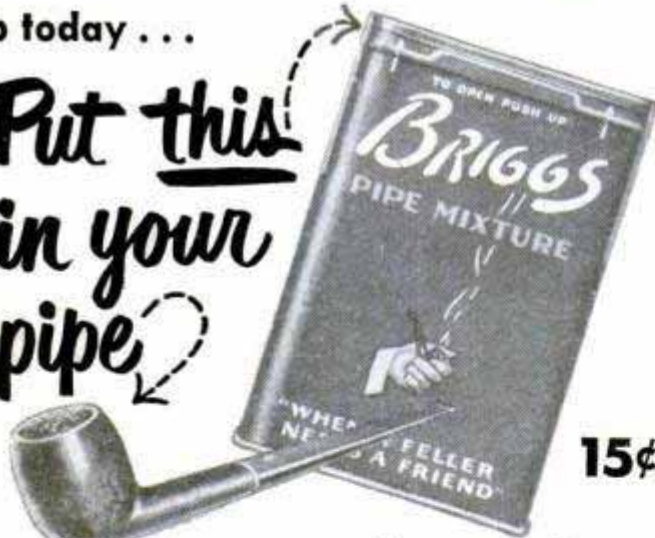

15¢

and smoke it!

*Yes, our new process makes Briggs better by actual test! Better even than the swell-smoking Briggs that proved so fine and friendly in your pipe before. And remember this: when tobacco burns steady, free and clean, that's when you enjoy *all* the goodness of Briggs' fine tobacco, aged and mellowed in oaken casks. Today—try 3-ways-better Briggs!

Also available in Canada

OFFICE

Lettering machine adjusts for size (The Varigraph Co., Inc., Madison 1, Wis.)	104
Plastic drawing board is brief-case size (A. Partrick Co., 9 Grove St., Westwood, N. J.)	123
Remote-control dictation (Thomas A. Edison, Inc., West Orange, N. J.)	123
Electric stylus "pen" (Murray Industries, Inc., 502 W. Colorado Ave., Colorado Springs, Colo.)	151

OUTDOOR RECREATION

Straight from Paris? (Tony Accetta & Son, 890 E. 140th St., Cleveland 10, Ohio)	97
Angler's aid (Jiffy Specialty Co., Box 3022, Fort Worth 5, Tex.)	108
Blind archers "hear" target	131
Nylon tent (C. H. Masland & Sons, Carlisle, Pa.)	152

MISCELLANEOUS

Insecticides from wasp venom?	16
Power wheelbarrow (S and S Vending Machine Co., San Jose, Calif.)	78
Desk-size electronic "brain"	86
The Navy shoots the sun—spots and all	87
Underwater telephone cables have built-in amplifiers	88
Festival of Britain	90
Nonsticking zipper (Kee Zipper Co., 350 Fifth Ave., New York City 1)	104
Instrument checks eyes for odd visual condition (American Optical Co., Southbridge, Mass.)	108
Popcorn packs packages	121
Key-lock for revolvers (Bjorklund Mfg. Co., 16 44th Place, Venice, Calif.)	121
Obstacle course slows would-be speeders	131
Vacuum-cleaner "workshop" (Interstate Engineering Corp., 2250 E. Imperial Highway, El Segundo, Calif.)	138
Palomar "core" becomes telescope	146
A mountain goes up in smoke	147
Three-deck TV studio	148
Garment-bag suitcase (Protex Products Co., 347 Fifth Ave., New York City 16)	150
Forest-fire fighter	150
Radium keg battles cancer	151

Craftsman and Shop Notes Index

AUTOMOBILES, TRAILERS AND TRUCKS

Your car a motel	185
Carriage bolt and feeler gauge serve to check runout of auto flywheel	189
Tilting assembly for trailer bed made from grain-binder parts	208
Rear-axle alignment checked with straightedges and tape	218

FARM

Corn kept "behind bars" to quicken drying	205
Wheels welded in angle-steel frame provide sturdy farm gate	205
Proper care plus yearly inspection makes chimneys fireproof	206
Tractor-drawn land roller	207
Overhead carrier in cattle shed serves long line of feed bunks	208
Calibrated indicator shows weight carried by farm trailer	209
Sectional hurdle for sheep or hogs	214
Automatic hog waterer supplied from stock tank	214
Large capacity shelled-corn feeder made portable	214
Combination brooder-house door	218

HOUSE AND HOME

Sealing double-hung windows against insects	172
Crawl space floored with roofing to reduce moisture under house	174
Waxing thread aids stitching	174
Rack facilitates airing garments	176
Fence keeps toys from rolling under radiator	176
Inexpensive stirring rods for paint	176
Onion juice obtained economically	176
Starting slips from African violet	176
Hard-to-open bottle caps loosened with nutcracker	177
Improvised twine cutter	177
Making thimble fit finger tip	177
Picnic lunch kept cool	177
Flat-iron bumpers for doors prevent interlocking of knobs	178
Mousetrap holds "not home" notes	178
Bread cleans painted fabric	178
Soap-flakes solution used to clean decorative feathers	184
Card table in open doorway serves as baby gate	197
Insulator on clothesline prop prevents rust soilage	197

LAWN AND GARDEN

Weed killer works locally	172
Concrete birdbath	173
Paper cup protects small plants	174
Garden cart doubles as soil sifter	175
Screw-top can forms sprinkler unit	178
Pipe frame supports picnic table and benches	184
Posthole digger holds soil intact when transplanting seedlings	188
Flower pedestal for lawn or porch improvised from sewer tile	189

(Continued to page 16)

IMPORTANT NOTICE—It is the intention of this magazine to provide its readers with information regarding the latest developments in the mechanical arts. We take no responsibility as to whether the disclosures contained in our articles are covered by patents and advise readers to investigate this subject before making, using, or selling any of the products, machines, or processes described in order to avoid possible liability for patent infringements.

INVENTORS

If you believe that you have an invention, you should find out how to protect it. The first step is to have a search made of the prior pertinent U. S. patents. If a report on this search indicates that the invention appears patentable you can apply for a patent, and the specifications and claims should be prepared.

The firm of McMorrow, Berman & Davidson, with offices in Washington, D. C., is qualified to take the necessary steps for you. We can make a preliminary search on your invention, advise you whether we think it can be patented, and prepare your application for patent.

Unless you are fully familiar with the U. S. Patent Laws, we recommend that you engage the services of a Registered Patent Attorney to protect your interests. The patent laws are *your* laws. A patent gives you the right to prevent others from making, using or selling the invention claimed in your patent for a period of 17 years.

Use these patent laws for your protection. Investigate whether your invention can be patented. If you have what you believe to be an invention, we suggest that you have this firm make a search for you.

Send for a copy of our Patent Booklet entitled "How To Protect Your Invention," containing information about patent protection and patent procedure. Along with this we will also send you an "Invention Record" form, for your use in writing down and sketching details of your invention. We will mail them promptly. No obligation. They are yours for the asking.

McMORROW, BERMAN & DAVIDSON

Registered Patent Attorneys

PATENTS • COPYRIGHTS • PATENTS

135-T VICTOR BUILDING, WASHINGTON 1, D. C.

TOUGH GLOVES FOR TOUGH JOBS



Made of super-tough native pig hide for money-saving extra wear—tanned buckskin-soft for luxurious extra comfort by the famous Wolverine triple-tanning process. No other work gloves are made like this—ONLY

WOLVERINE PIGSKINS

While supply lasts, a genuine *Wolverite Mechanical Pencil* Sent FREE if you write for name of nearest Wolverine dealer.

**FREE
WOLVERITE
PENCIL**



WRITE TODAY to WOLVERINE
Rockford, Mich. Dept. HJ-5

**THE
WORLD'S
BEST
BUY
in
low-cost
transportation**



DEALER
INQUIRIES
INVITED



- ✓ LOW PURCHASE PRICE
- ✓ LOW OPERATING COST
- ✓ LOW MAINTENANCE

Save your car—beat expensive transportation. Hundreds of uses for your Cushman—ride it to work, school, shop, play. Ideal for light deliveries. Automatic clutch, silent-action coil spring, dependable heavy duty brakes. Cruise at 40 m.p.h.—over 85 miles per gallon. Cushman saves time, money, worry.

Write for free folder and prices—Dept. 9M

Cushman MOTOR WORKS, INC.
LINCOLN, NEBRASKA

(Continued from page 14)

MODELS AND NOVELTIES

Cornstalk forms pincushion.....	174
Burning brick is fireplace novelty.....	178
Ladies' beauty aids are helpful tools for modelmakers.....	183
Model-railroad tunnels built from asbestos-paste mixture.....	185

OFFICE, SHOP AND STORE

Dowel mounted on shop wall holds rolls of tape.....	174
Magnet screwed to workbench keeps small parts at hand.....	178
"Spotlight" shade for shop lamp improvised from glue can.....	188
Clothespins and pencil hold paper-label roll to typewriter.....	193
Cellulose tape "cleans" envelope.....	193
Ramp moves truck tires.....	206
Handwheel and steering gear speed use of shop hoist.....	206
Cotter-pin hole located by mark filed on bolt.....	208
Bunsen burner.....	209
Dual-purpose motor mounting.....	215
Impregnating bristles with soap renews water-color brush tips.....	218
Tabs made of masking tape identify lead in compass.....	218

PHOTOGRAPHY

C-clamp provides camera mount.....	198
Tilting easel for close-up shots formed from bowling ball.....	198
Storing battery case.....	198
Wire rack stores photo trays.....	198
Milk cartons used in darkroom to store photo solutions.....	202
Safety chain for cable release.....	202
Ice dulls unwanted reflections.....	202

TOOLS

Bench-saw blade filed quickly if held with spring clamp.....	172
Screwdriver bit holds screw.....	172
Choke wire operates toggle switch from front of power tool.....	184
Improvised puller removes bearings from blind holes.....	205
Tilting table on swing saw increases width of cut.....	214
File tang removes broken studs.....	214
Multipurpose saw gun (Mid-States Welder Mfg. Co., 6025 S. Ashland Ave., Chicago).....	216
Vibration tester (The Vibroscope Co., 6 E. 39th St., New York City).....	216
Hand-tapping machine (Photo Research Corp., Burbank, Calif.).....	216
Drill kit (Firth-Sterling Steel & Carbide Corp., McKeesport, Pa.).....	217
Hydraulic flash-welder control unit (Kingsley A. Doult, 18465 Schaefer Highway, Detroit 35, Mich.).....	217
Precision lead sharpener (Rajean Mfg. Co., 906 Kingston Ave., Racine, Wis.).....	217

MISCELLANEOUS

Plastic rods decorated in lathe by use of warmed knurling tool.....	165
Rod anchors boat in sandy shore.....	174
Hole in ground provides mold for lead fishline sinkers.....	175
Small box hinges made from scraps of wire.....	183
Lead ball pilots leader cord through curved piping or tubing.....	183
Tools held safely on scaffold plank.....	189
Oxalic-acid solution cleans leather spotted with grease.....	189
Improvised wheel flanges.....	193
Tangleproofing pull chain.....	193
Tenons turned on hardwood-dowel ends by use of circular saw.....	193
Tape-and-clothespin photo easel.....	197
Armored cable opens drains.....	197
Dishpan provides mold for concrete cistern cover.....	197
Avoiding countersink chatter.....	205
Reversing split-phase motor.....	206
Air pressure opens clogged line.....	208
"Lifter" soldered to oilcan spout opens spring-cap oilers.....	208
Metal jacket for acid bottle.....	209
Welder's clamps made in the shop.....	218

Radio-Television, Electronics

CBS color-TV receivers.....	219
Battery-operated progressive set for experimenters.....	220
Television today.....	223
Hints for radio students (Clock for amateur operators, Allied Radio Corp., 833 W. Jackson Blvd., Chicago; line-voltage adjuster, Standard Transformer Corp., 3580 N. Elston, Chicago; pillow speaker, Wright-Zimmerman, Inc., New Brighton, Minn.; volt-ohmmeter, Heath Co., Benton Harbor, Mich.; phonograph records for code practice, Insuline Corporation of America, 3602 35th Ave., Long Island City 1, N. Y.; radio-code practice set, Martin Manufacturing Co., 194 Gelston Ave., Brooklyn 9, N. Y.).....	224

Insecticides From Wasp Venom?

Scientists are hoping that the powerful venom of a tiny wasp will produce new insecticides. One drop of the venom, so tiny it can barely be seen through a microscope, can kill more than 1600 caterpillars, according to technicians at the Connecticut Agricultural Experiment Station. The scientists hope to determine the nature and action of the venom, then produce synthetic materials with the same deadly effect.

"I pinned my hopes to a penny postal"

International Correspondence Schools
 Box 7061
 Scranton 9,
 Pennsylvania

"I often wonder what sort of job I'd have now if it were not for a penny postal and the International Correspondence Schools.

"Today I'm Chief Building Inspector for the District of Columbia. It's a good job and pays a good salary. Just recently, I got another \$600-a-year raise. I. C. S. instruction made it all possible."

THE coupon you mail today might very well start a chain reaction that could change your entire future. For it brings you information about successful careers and how to prepare for them. It puts you in touch with the world's largest educational institution. It starts you off the way hundreds of today's leaders in business and industry started. Why not mail it today?

ESSE K. KIMBALL
 Chief Building Inspector, Washington, D. C.



INTERNATIONAL CORRESPONDENCE SCHOOLS

BOX 5700-K, SCRANTON 9, PENNA.

Without cost or obligation, please send me full particulars about the course BEFORE which I have marked X:

- | | | | |
|---|--|---|--|
| <p>Air Conditioning and Plumbing Courses</p> <ul style="list-style-type: none"> <input type="checkbox"/> Air Conditioning <input type="checkbox"/> Heating <input type="checkbox"/> Refrigeration <p>Chemical Courses</p> <ul style="list-style-type: none"> <input type="checkbox"/> Chemical Engineering <input type="checkbox"/> Chemistry, Analytical <input type="checkbox"/> Chemistry, Industrial <input type="checkbox"/> Chemistry, Mfg. Iron & Steel <input type="checkbox"/> Petroleum Refining <input type="checkbox"/> Pulp and Paper Making <p>Civil Engineering, Architectural and Mining Courses</p> <ul style="list-style-type: none"> <input type="checkbox"/> Architecture <input type="checkbox"/> Architectural Drafting <input type="checkbox"/> Bridge and Building Foreman <input type="checkbox"/> Building Estimating <input type="checkbox"/> Civil Engineering <input type="checkbox"/> Coal Mining <input type="checkbox"/> Contracting and Building <input type="checkbox"/> Highway Engineering <input type="checkbox"/> Lumber Dealer <input type="checkbox"/> Reading Structural Blueprints <input type="checkbox"/> Sanitary Engineering <input type="checkbox"/> Structural Drafting | <ul style="list-style-type: none"> <input type="checkbox"/> Structural Engineering <input type="checkbox"/> Surveying and Mapping <p>Communications Courses</p> <ul style="list-style-type: none"> <input type="checkbox"/> Electronics <input type="checkbox"/> Practical Telephony <input type="checkbox"/> Radio, General <input type="checkbox"/> Radio Servicing <input type="checkbox"/> Telegraph Engineering <p>Electrical Courses</p> <ul style="list-style-type: none"> <input type="checkbox"/> Electrical Drafting <input type="checkbox"/> Electrical Engineering <input type="checkbox"/> Electric Light and Power <input type="checkbox"/> Lighting Technician <input type="checkbox"/> Practical Electrician <p>Internal Combustion Engines Courses</p> <ul style="list-style-type: none"> <input type="checkbox"/> Auto Technician <input type="checkbox"/> Diesel-Electric <input type="checkbox"/> Diesel Engines <p>Mechanical Courses</p> <ul style="list-style-type: none"> <input type="checkbox"/> Aeronautical Engineer's, Jr. <input type="checkbox"/> Aircraft Drafting <input type="checkbox"/> Forging <input type="checkbox"/> Heat Treatment of Metals <input type="checkbox"/> Industrial Engineering <input type="checkbox"/> Industrial Instrumentation | <ul style="list-style-type: none"> <input type="checkbox"/> Industrial Metallurgy <input type="checkbox"/> Machine Shop <input type="checkbox"/> Mechanical Engineering <input type="checkbox"/> Mold-Loft Work <input type="checkbox"/> Patternmaking—Wood, Metal <input type="checkbox"/> Reading Shop Blueprints <input type="checkbox"/> Sheet-Metal Drafting <input type="checkbox"/> Sheet-Metal Worker <input type="checkbox"/> Ship Drafting <input type="checkbox"/> Tool Designing <input type="checkbox"/> Toolmaking <input type="checkbox"/> Welding—Gas and Electric <p>Railroad Courses</p> <ul style="list-style-type: none"> <input type="checkbox"/> Air Brake <input type="checkbox"/> Diesel Locomotive <input type="checkbox"/> Locomotive Engineer <input type="checkbox"/> Locomotive Fireman <input type="checkbox"/> Locomotive Machinist <input type="checkbox"/> Railroad Section Foreman <input type="checkbox"/> Steam-Diesel Loco. Eng. <p>Stationary Eng'g Courses</p> <ul style="list-style-type: none"> <input type="checkbox"/> Boilermaking <input type="checkbox"/> Combustion Engineering <input type="checkbox"/> Engine Running <input type="checkbox"/> Marine Engineering <input type="checkbox"/> Power Plant Eng'g | <ul style="list-style-type: none"> <input type="checkbox"/> Mech. Drafting <input type="checkbox"/> Reading Shop Blueprints <input type="checkbox"/> Ship Fitting <p>Textile Courses</p> <ul style="list-style-type: none"> <input type="checkbox"/> Cotton Manufacturing <input type="checkbox"/> Loom Fixing <input type="checkbox"/> Textile Designing <input type="checkbox"/> Woolen Manufacturing <input type="checkbox"/> Rayon Weaving <p>Business and Academic Courses</p> <ul style="list-style-type: none"> <input type="checkbox"/> Accounting <input type="checkbox"/> Bookkeeping <input type="checkbox"/> Business Administration <input type="checkbox"/> Bus. Correspondence <input type="checkbox"/> Certified Public Accounting <input type="checkbox"/> Commercial <input type="checkbox"/> Cost Accounting <input type="checkbox"/> Federal Tax <input type="checkbox"/> Foremanship <input type="checkbox"/> Good English <input type="checkbox"/> Higher Mathematics <input type="checkbox"/> Industrial Supervision <input type="checkbox"/> Motor Traffic <input type="checkbox"/> Retailing <input type="checkbox"/> Salesmanship <input type="checkbox"/> Sign Lettering <input type="checkbox"/> Spanish <input type="checkbox"/> Traffic Management <input type="checkbox"/> Advertising <input type="checkbox"/> Bus. Law <input type="checkbox"/> Commercial Art <input type="checkbox"/> French <input type="checkbox"/> High School <input type="checkbox"/> Illustration <input type="checkbox"/> Postal Civil Service <input type="checkbox"/> Retail Bus. Management <input type="checkbox"/> Secretarial <input type="checkbox"/> Stenography |
|---|--|---|--|

Name _____ Age _____ Home Address _____
 City _____ State _____ Working Hours _____ A.M. to _____ P.M.
 Present Position _____ Employed by _____

Enrollment under G.I. Bill approved for World War II Veterans. Special tuition rates to members of the Armed Forces. Canadian residents send coupon to International Correspondence Schools Canadian, Ltd., Montreal, Canada.

Lend Me 15 Minutes A Day



..and I'll prove
I can make you
a **NEW MAN**

I'M trading in old bodies for new! I'm taking men who know that the condition of their arms, shoulders, chests and legs—their strength, "wind," and endurance — is not 100%. And I'm making **NEW MEN** of them!

If you can simply raise your arm and flex it, I can add **SOLID MUSCLE** to your biceps—yes, on each arm—in double-quick time! I can broaden your shoulders, strengthen your back, develop your whole muscular system **INSIDE and OUTSIDE!**

What Only 15 Minutes a Day Can Do

I can add inches to your chest, give you a vise-like grip, make those legs of yours lithe and powerful. I can shoot new strength into your old backbone, exercise those inner organs, help you cram your body so full of pep, vigor and red-blooded vitality that you won't feel there's even "standing room" left for weakness and that lazy feeling! Before I get through with you I'll have your whole frame "measured" to a nice, new beautiful suit of muscle! And you'll be using the method which many great athletes use for keeping in condition—prize fighters, wrestlers, baseball and football players, etc.

I Was a 97-lb. Weakling

All the world knows I was **ONCE** a skinny, scrawny 97-pound weakling. And **NOW** it knows that I won the title, "The World's Most Perfectly Developed Man." Against all comers! How did I do it? How do I work miracles in the bodies of other men in only 15 minutes a day? The answer is "Dynamic Tension," the amazing method I discovered and which changed me from a 97-pound weakling into the champion you see here!

My Illustrated Book Is Yours —Not for \$1.00 or 10c—But FREE

Send **NOW** for my famous book, "Everlasting Health and Strength"—48 pages, packed from cover to cover with actual photographs and valuable advice. Shows what "Dynamic Tension" can do, answers vital questions. Page by page it shows what I can do for YOU.

This book is a **real prize** for any fellow who wants a better build. Yet I'll send you a copy absolutely **FREE**. Just glancing through it may mean the turning point in your whole life! So don't put it off—send the coupon to me personally: **Charles Atlas, Dept. 8E, 115 East 23rd St., New York 10, N. Y.**

Charles Atlas

Actual photo of the man who holds the title, "The World's Most Perfectly Developed Man."



**CHARLES ATLAS, Dept. 8E,
115 East 23rd St., New York 10, N. Y.**

Send me—absolutely **FREE**—a copy of your famous book, "Everlasting Health and Strength"—48 pages, crammed with actual photographs, answers to vital health questions, and valuable advice to every man who wants a better build. I understand this book is mine to keep, and sending for it does not obligate me in any way.

Name _____ Age _____
(Please Print or Write Plainly)

Address _____

City _____ State _____



QUICK-ON, STAY-ON, **SPEED NUTS**[®] NOW IN HANDY TINKER KIT

SPEED NUTS—famous throughout industry—now ready for home use. Ideal for repairing or attaching sheet metal parts on toys, appliances, etc. Kit contains over 100 parts—10 popular size nuts and matching screws. Replace threaded nuts and lock washers this fast, sure way. Tinnerman Products, Inc., Dept. 13 — Cleveland 1, Ohio.

ONLY \$1.00
Including Postage
CASH or CHECK ONLY

MONEY MEN ALL FREE

THE PLASTEX Industry needs manufacturers on small scale and for big production of Lamp and Clock Stands, Art Goods and Novelties in Plastex and Marble imitation. Experience unnecessary. 1/2¢ material makes regular 10¢ store sellers. Rubber moulds furnished for speed production. Small investment brings good returns. We are now placing big Chain Store Orders with manufacturers. Ambitious men have chance for real prosperity. Our Free booklet will interest and benefit you.

PLASTEX INDUSTRIES, Dept. A
3400 Third Ave. New York 56, N. Y.

TRAIN in Our SHOPS - -

in **AIR CONDITIONING, REFRIGERATION,
ELECTRICITY, MAJOR APPLIANCES, AUTOMOTIVE
MECHANICS, BODY and FENDER REBUILDING**

If interested write or wire

COMMERCIAL TRADES INSTITUTE Inc. of Ala.

200 S. 20th ST.
BIRMINGHAM, ALA.

254 IVY ST. N.E.
ATLANTA, GA.

VETERANS ASK ABOUT G I TRAINING

ENGINEERING DEGREE IN 27 MONTHS

**INDIANA
TECHNICAL
COLLEGE**

B. S. DEGREE. Aeronautical, Chemical, Civil, Electrical, Mechanical and Radio Engineering (inc. television). Drafting, 1-yr. Gov't approved for G.I.'s. Low rate. Earn board. Large industrial center. Students from 48 states, 21 countries. Demand for graduates. Enter June, Sept., Dec., March. Write for catalog. 1651 E. Washington Blvd., Fort Wayne 2, Indiana.

SAY YOU SAW IT IN POPULAR MECHANICS

"It Measures As It Rolls"
ROLLER RULE

HANDY MECHANICAL PENCIL

Measures Curves and Straight
Lines. Any Shape. Any
Distance. Any
Surface.

\$1.29
POST
PAID

Roll head over surface. Inches and fractions record accurately on "Inch-O-Meter". Excellent pencil tool! Order Now!
10 Day Money Back Guarantee!
C.O.D. (postage extra). In Calif. add 3% Sales Tax.

PENCIL SALES CO., Dept. PM5
Room 6, 1213 E. Ocean Blvd., Long Beach, California

THESE MEN ARE GETTING PRACTICAL TRAINING IN **ELECTRICITY**

On Real:



**A.C. and D.C. MOTORS
GENERATORS
SWITCHBOARDS
CONTROLLERS
WIRING JOBS
APPLIANCES
ELECTRONIC UNITS**

(Shown at left - Instructor explaining operation and testing of a large Motor Generator in our A.C. Department.)

AND **TELEVISION-RADIO**

On Real:

**TELEVISION SETS
RADIO RECEIVERS
F.M.
(Frequency Modulation)
RECORD CHANGERS
AUTO RADIOS
PUBLIC ADDRESS Systems**

(Right - Instructor helping students check the wiring and trace circuits of television receivers.)



TRAIN QUICKLY in the Great Shops of COYNE for VITAL FIELDS

ELECTRICITY—RADIO—TELEVISION—VITAL in defense program. Trained men whether 16 or up to 50 needed. **TRAIN QUICKLY** for better rating if drafted—Vital job in industry if not.

FINANCE PLAN for non-veterans. G.I. Approved. Special plan for men of draft age.

NOT "HOME-STUDY" COURSES! At Coyne you learn on real, full-size equipment. Trained instructors show you how, then you do typical jobs yourself. We don't teach by mail.

CLIP COUPON NOW for big new illustrated Coyne book. Check whether interested in **ELECTRICITY** or **TELEVISION-RADIO** or both. No obligation; no salesman will call. Get vital facts now!

COYNE

**B. W. COOKE, Pres.
ELECTRICAL & TELEVISION-RADIO SCHOOL
An Institution not for Profit.
500 S. Paulina St., Dept. 51-72H
Chicago 12, Illinois**



**Mail Coupon for
BIG FREE BOOK!**



**B. W. COOKE, President
COYNE ELECTRICAL &
TELEVISION-RADIO SCHOOL
500 S. Paulina St., Chicago 12, Ill. Dept. 51-72H**

Send **BIG FREE** book and details of your training offer. This does not obligate me and **no salesman will call.** I am interested in:

ELECTRICITY **TELEVISION-RADIO**

NAME

ADDRESS.....

CITY.....STATE.....

INVENTORS

A patent is a valuable right. On the basis of a constitutional provision Congress has established a system under which inventors may secure the exclusive right to prevent the unauthorized use, manufacture and sale of their inventions for periods of seventeen years. The inventor secures this protection by obtaining a patent.

Unless an inventor is thoroughly familiar with such matters, he is advised to employ a competent registered patent attorney or registered patent agent, as the value of patents depends largely upon the skillful preparation of the specifications and claims.

This firm is registered to practice before the U. S. Patent Office and is available to assist inventors in the preparation and prosecution of their cases. Detailed information and the preliminary steps to take to obtain patent protection will be furnished upon request.

VICTOR J. EVANS & Co. *Merlin M. Evans*
REGISTERED PATENT ATTORNEY

630-E MERLIN BUILDING, WASHINGTON 6, D. C.

PATENTS

COPYRIGHTS

We shall be glad to send you promptly and without obligation, an instructive booklet, "Patent Protection for Inventors", which was prepared to give inventors detailed information and steps to take toward patent protection—also our convenient "Evidence of Invention" form. Use address Victor J. Evans & Co., 630-E Merlin Building, Washington 6, D. C.

"Hey, You SKINNY BAG of BONES!"
the boys shouted at me
only A FEW SHORT WEEKS ago

John Sill
Jowett
Pupil

But look at me NOW, Pal... A
TROPHY-WINNING ALL-AROUND
HE-MAN as YOU can be SOON
in 10 Thrilling Minutes a day.

Yes! Today everyone admires John Sill's movie-star Champion BUILD. His big mighty ARMS. His heroic CHEST. His broad BACK. His rock-like TORSO. His wide military SHOULDBERS. His newly-won POPULARITY.

Be A Winner at Anything YOU
Tackle with Progressive Power-SPORTS! JOB! SCHOOL! FRIENDS!
JOWETT INSTITUTE Dept. PM-15
230 Fifth Ave., New York 1, N.Y.



Send me only 10¢

Like John Did—
And Get ALL

5 PICTURE - PACKED
HE-MAN BUILDING
COURSES and also get
FREE! PHOTO BOOK
of famous HE-MEN

STAMMERER?

New booklet, "Stammering, and How to Stop It," sent free to any stammerer upon request. Write today. BENJAMIN N. BOGUE, Dept. 514, Circle Tower, Indianapolis 4, Ind.

GET THIS
FREE
BOOK!

CHEMISTRY

LEARN AT HOME... You need chemical knowledge to qualify for thousands of today's good jobs in industry, business, science, the professions. This Course enables you to master practical chemistry. You learn by performing actual experiments at home, using chemicals and apparatus furnished with course. Illustrated lesson books guide you. Course approved. Equivalent to recognized college courses in general chemistry. Send today for free catalog.

INSTITUTE OF PRACTICAL CHEMISTRY
3 PROSPECT AVENUE, HAGERSTOWN, MD.

REAL ESTATE

BE A BROKER

PAYS BIG! SEND FOR FREE, BIG, ILLUSTRATED CATALOG NOW! No obligation. Graduates report making substantial incomes. Start and run your own business quickly. Men, women of all ages, learn easily. Course covers Sales, Property Management, Appraising, Loans, Mortgages, and related subjects. STUDY AT HOME or in our classrooms in big cities. Diploma awarded. G.I. approved. Nationally known.

WEAVER SCHOOL OF REAL ESTATE (Est. 1936)
15 E. Pershing Road Dept. PM Kansas City, Mo.

FREE
BOOK
TELLS
HOW

CASH-IN ON YOUR IDEAS

Reputable manufacturers look to us for new inventions, patented, unpatented ideas. Get the "Inventor's Guide." Gives step by step helpful instructions, how to develop, protect, make money from inventions. Send 50c. Free list of needed products, record of invention form. Inventors Creative Service, Dept. PM, 354 S. Spring St. L.A. 13, Calif.

LAW FREE BOOK



Your FREE copy of "The Law-Trained Man" shows how to gain prestige and greater earnings through Blackstone home law study. All instruction material furnished including 17-volume Law Library written by 65 well-known law authorities. Lawyers, judges among our graduates. LL.B. degree. Low cost; easy terms. Write today.

BLACKSTONE COLLEGE OF LAW Dept. 55, Chicago 1, Ill.

A Correspondence Institution Founded in 1890

POWER MOWERS & KITS

FREE PLANS

LOW FACTORY PRICES DIRECT TO YOU

3 & 4 Wheel Model



4 Wheel Direct Drive

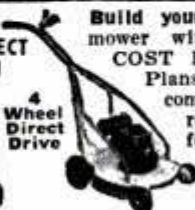

Build your own quality mower with our LOW COST KITS, Parts, Engines. Free Plans guide you. 3 and 4 Wheel Kits, complete. Parts precision finished, ready to use. Write TODAY for Free Plans, Low Prices, Parts List and Guarantee.

3-WHEEL KIT NO. T-800



America's Finest Power Mowers completely assembled in 3 and 4 wheel models. Belt or direct drive. 18" and 20" sizes. Nationally known make engine optional. Latest improved features, sturdy construction and money back guarantee fully described in color folder. Write today.

TRIANGLE MANUFACTURING CO., Dept. M-6, Fort Scott, Kansas

GET INTO

RADIO-TELEVISION

ELECTRONICS By

Shop-Method Home Training

MASTER ALL PHASES!



Get Master Shop-Method Home Training from an Established Practical Resident School with its own Training Shops, Laboratories, and Studios—and almost 50 Years of Successful Experience in Training Ambitious Men.

We Bring National Schools To You

GOOD JOBS AWAIT THE TRAINED RADIO-TV TECHNICIAN

There is a place for you in the great Radio-Television-Electronics industry when you are trained as National Schools will train you at home!

Trained technicians are in growing demand at good pay—in manufacturing, broadcasting, television, communications, radar, research laboratories, home Radio-TV service, and other branches of the field. National Schools offer Shop-Method Home Training, with newly added tools and equipment, trains you in your spare time, right in your own home, for these fascinating opportunities.

OUR METHOD IS PROVED BY THE SUCCESS OF NATIONAL SCHOOLS TRAINED MEN, ALL OVER THE WORLD, SINCE 1905.

EARN WHILE YOU LEARN

Many National students pay for all or part of their training with spare time earnings. We'll show you how you can do the same! Early in your training, you receive "are-time work" Lessons which will enable you to earn extra money servicing neighbors' and friends' Radio and Television receivers, appliances, etc.



Power Generator

Audio Oscillator

T. R. F. Receiver

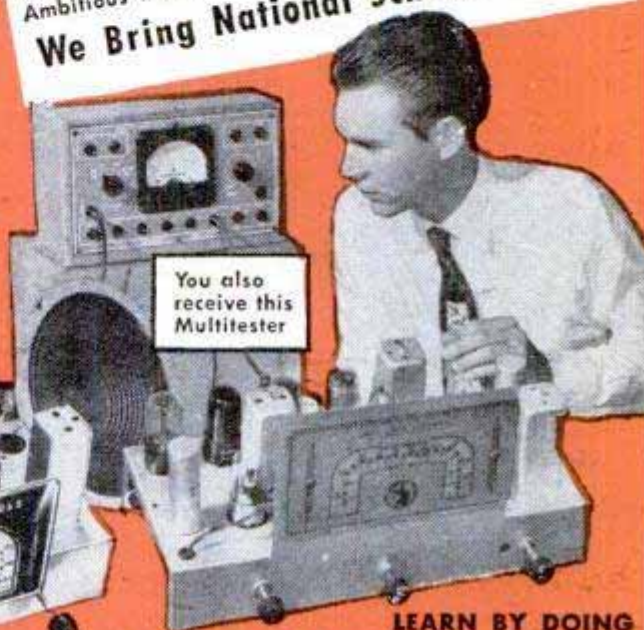

You also receive this Multitester

LEARN BY DOING

You receive and keep all the modern equipment shown above, including tubes and valuable, professional quality Multitester. No extra charges. You build the fine Superheterodyne Receiver with parts we send you.

FREE! These 2 Free Books give you all the facts. Send today for National Schools' new, illustrated Book of Opportunity in Radio-Television-Electronics, and an actual Sample Lesson. No cost—no obligation. Use the coupon now—we'll answer by return airmail.

National Schools Training Is All-Embracing

National Schools prepares you for your choice of many opportunities. Thousands of home, portable, and auto sets are being sold daily—more than ever before. Television is sweeping the country, too. Co-axial cables now under construction will soon bring Television to every town, and farm! National Schools' complete training program qualifies you in all fields. Read this partial list of opportunities for trained technicians:

- Business of Your Own • Broadcasting
- Radio Manufacturing, Sales, Service • Telecasting
- Television Manufacturing, Sales, Service
- Laboratories: Installation, Maintenance of Electronic Equipment
- Electrolysis, Call Systems
- Garages: Auto Radio Sales, Service
- Sound Systems and Telephone Companies, Engineering Firms
- Theatre Sound Systems, Police Radio
- and scores of other good jobs in many related fields.

APPROVED FOR VETERANS AND NON-VETERANS
Check coupon below

Both Resident & Home Study Courses offered

NATIONAL SCHOOLS

LOS ANGELES 37, CALIF. • EST. 1905



TELEVISION TRAINING

A complete series of 12 - to - 15 - minute television lessons is an important part of our course. They cover all phases of television repairing, servicing and construction. The same lesson texts used by resident students in our own modern and complete Television broadcast studios, laboratories and classrooms!



FIND OUT NOW... MAIL COUPON TODAY

National Schools, Dept. 5-PM
4000 South Figueroa Street
Los Angeles 37, California

Mail in envelope or paste on penny postal.

Send me your FREE book "Your Future in Radio" and the sample lesson of your course. I understand no salesman will call on me.

NAME _____ AGE _____

ADDRESS _____

CITY _____ ZONE _____ STATE _____

Check here if Veteran of World War II

In Your Mind's Eye

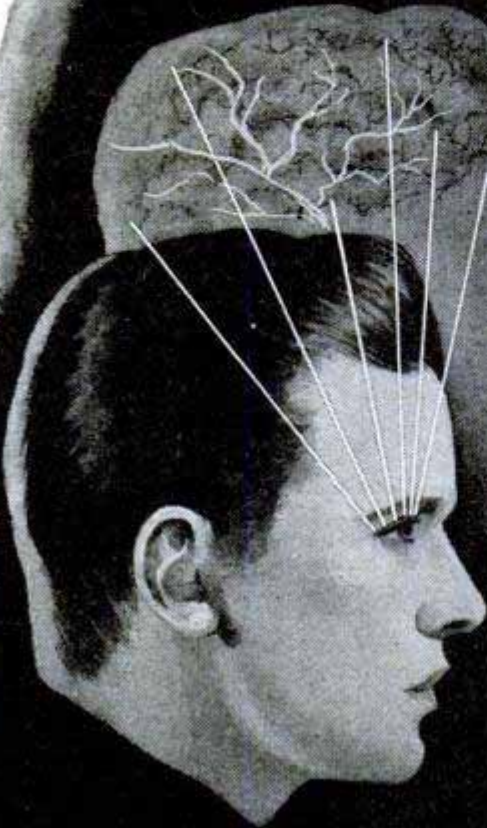

The Secret of MENTAL CREATING

IF you just like to dream, read no further. There comes a time when your fancies *must be* brought into light—and stand the test of every-day, hard realities. Are you one of the thousands—perhaps millions—whose thoughts never get beyond the stage of *wistful wishing*? Do you often come from a daydream with the sigh, "If only I could bring it about—*make it real!*"

All things begin with thought—it is what follows that may take your life out of the class of those who hope and dream. Thought energy, like anything else, can be dissipated—or it can be made to produce actual effects. *If you know how to place your thoughts* you can stimulate the creative processes within your mind—through them you can assemble things and conditions of your world into a happy life of accomplishment. *Mental creating* does not depend upon a magical process. It consists of *knowing how* to marshal your thoughts into a power that draws, compels and organizes your experiences into a worth-while design of living.

ACCEPT THIS *Free* BOOK

Let the Rosicrucians tell you how you may accomplish these things. The Rosicrucians (not a religious organization), a world-wide philosophic fraternity, have preserved for centuries the ancients' masterful knowledge of the functioning of the inner mind of man. They have taught men and women how to use this knowledge to *recreate their lives*. They offer you a free copy of the fascinating book, "The Mastery of Life." It tells how you may receive this information for study and use. Use coupon opposite.

The ROSICRUCIANS
(AMORC)

SAN JOSE

CALIFORNIA

SCRIBE: Y. V. X.
The Rosicrucians (AMORC),
San Jose, California.

Please send free copy of "The Mastery of Life,"
and I shall read it as directed.

Name.....

Address.....

City.....

Now IN YOUR OWN HOME Learn

TELEVISION RADIO

the Amazingly Effective
D.T.I. WAY

—with the aid of **BOTH**
HOME EQUIPMENT
and **HOME MOVIES**

What will mailing the coupon below *do for YOU?* Just this! You'll find out about one of today's most remarkable... practical ways to prepare to get into America's amazing billion dollar opportunity field of TELEVISION-RADIO-ELECTRONICS. You'll see how to get into fascinating work that pays well... that offers one of America's most promising futures... that enables you to start your own business almost "on a shoe string," if you prefer this to a job opportunity.

And above all, you'll get some GOOD NEWS especially welcomed by men anxious to earn REAL MONEY in this thrilling field. For you'll see that NOW you can get the kind of practical, laboratory-type training so desirable for making real progress in Television-Radio-Electronics... and *WITHOUT LEAVING HOME.*

You'll see that DeForest's Training, Inc. sends everything needed to set up your own HOME LABORATORY. You get and keep the same type of basic electronic equipment used in our modern Chicago Training Laboratories. You get home training that includes the knowledge and experience gained from training thousands of students first hand in Chicago. And to top it all, you use DTI's amazingly effective and exclusive home training aid—INSTRUCTIVE MOVIES. But why not get the complete story? Mail coupon today for information-packed literature.

MODERN LABORATORIES

If you prefer, get all your preparation in our new Chicago Training Laboratories—one of the finest of its kind. Ample instructors, modern equipment. Write for details!

NO PREVIOUS EXPERIENCE NEEDED
NOW...get EVERYTHING YOU NEED
for real Laboratory-Type training
AT HOME

Above:
Work over
300
fascinating
experiments
with this
equipment

You
KEEP
all test
equipment

1. Build over 300 fascinating experiments from 16 BIG SHIPMENTS of Electronic-Radio parts which you KEEP.

2. Build valuable commercial-type test equipment—as shown to the left—which you KEEP. This includes a quality OSCILLOSCOPE—a must for Television work.

3. Use a 16 mm. movie projector and new series of Hollywood produced instructive movies—a wonderful aid to help you grasp important fundamentals faster...easier...better.

4. Enjoy well-illustrated, easy-to-read lessons with handy FOLD-OUT diagrams.

5. Get an honest-to-goodness EMPLOYMENT SERVICE to help you get a good job after graduating—or assistance in starting your OWN SALES AND SERVICE BUSINESS. Mail coupon today for the complete details.

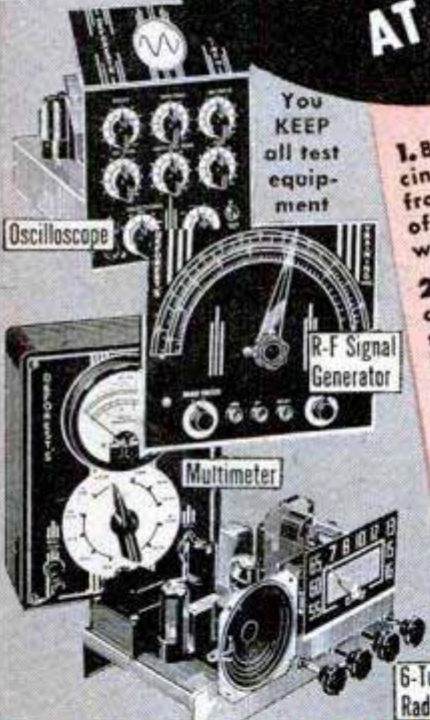

Build and Keep this 16-INCH TV RECEIVER—OPTIONAL after completing regular training.

New "black" RECTANGULAR TUBE

Get **BOTH** of these colorful, information-packed folders **FREE**

SEE FOR YOURSELF
Mail Coupon Today



DeFOREST'S TRAINING, INC. Dept. PM-5-H
2533 N. Ashland Avenue, Chicago 14, Ill

Without cost or obligation, I would like valuable, information-packed folders showing how I may get started toward a good job or my own business in Television-Radio-Electronics.

Name _____ Age _____
Street _____ Apt. _____
City _____ Zone _____ State _____

DeFOREST'S TRAINING, INC.

Chicago 14, Illinois

A DeVry Institution

Build your Career in ELECTRICAL POWER through *This Plan—*

CAREER-OPPORTUNITIES are being created by essential, long-range expansion programs in Electrical Power fields. This 47-year-old nonprofit school offers the following plan whereby the young man can prepare realistically for these opportunities.

Become an Electro Technician in 12 Months. Equip yourself for Technician's work in powerhouse, manufacturing, drawing, laboratory, contracting, specialized sales and related electrical fields.

Electrical Engineer in 24 additional months — Your Technician's certificate applies as one year of full credit toward your B. S. degree in Electrical Engineering. Thus, in a total of 36 months, you achieve a major in Electrical Power. As an added service your aptitudes and desires are analyzed scientifically — thereby guiding you to choose specialized preparation for design or research — manufacturing production—or engineering sales and management.

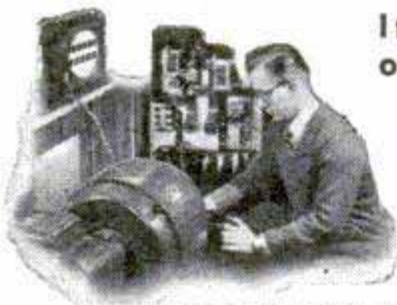

If you have only 6 months to train — ask for full details on the intensive, practical **ELECTRICAL SERVICE** course—complete in itself.

MILWAUKEE SCHOOL of ENGINEERING

Technical Institute • College of Electrical Engineering

Military, practical or prior academic training evaluated for credit. Preparatory courses available. Over 1500 students. Terms open July, October, January, April.

FREE — "Occupational Guidance Bulletin" and 1951 catalog.



MILWAUKEE SCHOOL OF ENGINEERING
Dept. PM-551, 1020 N. Broadway, Milwaukee, Wis.

Without obligation, rush following:

- 1951 Catalog; "Occupational Guidance Bulletin" on
 Electrical Service Electro Technician Electrical Engineering (Power) Radio Television Electrical Engineering (Electronics) Heating Refrigeration Air Conditioning Welding.

Name.....Age.....

Address.....

City.....Zone.....State.....

Check if World War II Veteran

CHRONOGRAPH WRIST WATCH \$9.95
Incl. Tax

Lifetime Guarantee
(EXCLUSIVE OF PARTS)
3 DIALS—5 HANDS—2 BUTTONS

Multi-purpose watch that measures distance, speed, time, moving objects. Used as Stop Watch or Timepiece. Has Sweep-Second Hand for full 60 Second count. Second Dial records up to 45 minutes. Third Dial then records up to 6 hours. Seconds—Minutes—Hours, all recorded automatically.

INDEPENDENT MOVEMENTS
The movement of this fine Swiss Made watch continues to run when sweep hands are stopped. For sportsmen, professional men and women—time-keeper works when other hands and dials are stopped—separate movements permit dual use at same time.

RUGGED CONSTRUCTION
Precision workmanship and shock resistant features are added to enhance the value of this watch. Sold elsewhere for as high as \$17.00. Our low introductory price is only \$9.95 which includes tax. (Total \$9.95). Send check or money order and we prepay postage. Or sent C.O.D. plus charges. **LIMITED STOCK!**

MARDO SALES CO., 480 Lexington Ave., Dept. G-9, N.Y. 17, N.Y.

BECOME AN EXPERT IN TRAFFIC

Traffic men earn \$4,000 to \$10,000 and up. Thousands of firms need experts on rates, tariffs, regulations. We train you thoroughly in spare time at home for executive traffic jobs. Personal training under traffic authorities. Placement counsel and help. Write for free 48-page book "Traffic Management—the Fast Growing Profession."

LASALLE Extension University, 417 So. Dearborn St.
A Correspondence Institution Dept. 564T, Chicago 5, Ill.

GOLD-SILVER-COINS

Easily located with new Lightweight M-Scope Detector. Superior performance, lowest price, monthly payment plan.

FREE LITERATURE
FISHER RESEARCH LAB., INC.
PALO ALTO CALIF.

Free Book

Money In Hamsters

The new wonder animals from Syria. Often called Toy Bears. Delightful pets. Everyone wants them. Laboratories use thousands. Clean, odorless. Raise anywhere. NOW, spotted and golden breeds. We furnish breeders, equipment and manual of instructions. Write today for free illustrated literature.

GULF HAMSTERY 1536 BASIL ST., MOBILE 17, ALA.

Play GUITAR in 10 DAYS

OR GET YOUR MONEY BACK!
Let Ed Sale teach you to play with his famous diagram photo system. Book contains 53 photos, 43 diagrams, showing exactly how to place your fingers. Gives you 110 popular songs, words and music—along with complete, easy to learn instructions. Imagine your joy when you find after only two weeks you are playing beautiful music! Amaze your friends! Be the life of the party! **SEND NO MONEY.** Pay Postman \$1.95 Plus Postage. **ED SALE, Dept. PM-5, Point Pleasant, N.J.**

RE-STRING RACKETS AT HOME—EARN MONEY

Earn Money at home in Spare time. It's pleasant, profitable work. No experience or skill required. Easy to learn. Full line of guaranteed Stringing Tools, Frames, Gut and Nylon Strings. Every item high quality.

FREE
Write today for our Catalog and Instruction Sheet.

W. A. BICKEL & CO., 803 So. Boulevard, Dept. PM-5, Oak Park, Ill.

Learn BAKING At Home

Baking is one of America's high industries in wages. Nearly depression-proof. Thorough basic home course lays sound foundation. If you have aptitude, write for **FREE BOOKLET, "Opportunities in Commercial Baking."**

NATIONAL BAKING SCHOOL
835 Diversey Pkwy. Dept. 1355 Chicago 14, Ill.

Peace
or War
Business



Patented
Equipment

Are YOU the Man?

... if you are honest, willing to work to enjoy success—write today for details on how to Own a Business of Your Own. No experience necessary. You can have your business operating in a very few days.

Clean and Mathproof Rugs and Upholstery

Duraclean cleans and sanitizes. Duraproof protects against moths and carpet beetles. Furnishings are serviced right "in the home" or business building.

No overhead expense. Some dealers open a shop or an office... others operate from their own home. Profits up to \$15 a day on EACH of your service men.

Duraclean and Duraproof are Nationally Advertised in quality magazines to create voluntary orders for you in this year 'round, lifetime business of "your own." Send now for free booklet. No obligation.

DURACLEAN CO., 1-165 Duraclean Bldg., Deerfield, Ill.

Free Catalog

Just off the Press

Fully illustrated, 96 pages, showing special fishing tackle, footwear, clothing and forty-eight other leather and canvas specialties of our own manufacture.

L. L. Bean, Inc.
240 Main St.
Freeport Maine
Mrs. Fishing and
Camping Specialties



LEARN AT HOME LOCKSMITHING

YOU CAN MAKE GOOD PROFITS ALL YEAR ROUND IN FULL OR SPARE TIME!
Locksmiths are always in big demand! Age is no disadvantage in this respected, permanent field. Learn how to make keys, fix locks, make duplicates, etc. Practical, illustrated lessons by experts show you how! All materials and special tools supplied. Send for FREE booklet.
INSTITUTE OF LOCKSMITHING
Dept. P-18 55 Park Ave., Rutherford, N. J.
Licensed & Approved by State of New Jersey

"How to Make Money with Simple Cartoons"



A book everyone who likes to draw should have. It is free; no obligation. Simply address **FREE BOOK**

CARTOONISTS' EXCHANGE
Dept. 95-D Pleasant Hill, Ohio

BE A DETECTIVE
WORK HOME or TRAVEL. Experience unnecessary.
DETECTIVE Particulars FREE. Write to
GEO. P. M. WAGNER, 125 W. 86th St., N. Y.

OUT OF PAWN SAVE UP TO 50% AND MORE

GENUINE DIAMONDS

Approx. 1/2 Carat \$95 Tax Incl. \$200 Value

SAVE ON DIAMONDS FROM ESTATES, BANKS AND UNREDEEMED PLEDGES

MONEY BACK GUARANTEE

All diamonds reset in brand new modern mountings. Values from \$10.00 to \$10,000.

SEND FOR **FREE ILLUSTRATED Catalog**

BERMAN'S DIAMOND LOAN BANK
DEPT. P—BERMAN BLDG., BALTO. 1, MD.

Our Ref.—Your own bank or any mercantile agency.



NOW! YOU CAN EASILY Fix ANY Car IN LESS TIME... and do a better job too!



NEW 1951 Edition of Famous MoToR's Manual Shows You How To Repair—Quickly and Easily—Any Car Built from 1935 THROUGH 1951!

FREE 7-DAY TRIAL

NO job is too tough when you've got MoToR's brand-new AUTO REPAIR MANUAL. Shows how to save work on "ornery" jobs. Helps you make **MORE MONEY** by doing more jobs in less time! Now covers 1951 models; up-to-date information on all automatic transmissions and carburetors.

COVERS 800 MODELS BUILT SINCE 1935!

- | | |
|-----------|-------------|
| Auburn | Lafayette |
| Austin | La Salle |
| Bantam | Lincoln |
| Buick | Mercury |
| Cadillac | Nash |
| Chevrolet | Nash |
| Chrysler | Rambler |
| Crosley | Oldsmobile |
| De Soto | Packard |
| Dodge | Plymouth |
| Ford | Pontiac |
| Frazier | Studebaker |
| Henry J. | Terraplane |
| Hudson | Willys |
| Kaiser | And others. |

COMPILED FROM 150 OFFICIAL FACTORY SHOP MANUALS!

This great book—771 BIG 8 1/2"x11" pages — brings you the complete "dope" from 150 Official Factory Shop Manuals, boiled down in simple easy-to-understand language. 2300 cut-away photos, diagrams, drawings show WHAT to do, HOW to do it. 225,000 service and repair facts! 800 car models! Now YOU can try it FREE—for 7 days.

Same FREE Offer On MoToR's Truck and Tractor Manual

Latest edition! Covers EVERY job on EVERY popular make gasoline truck, tractor, stock engine made from 1936 thru 1949, 961 big pages, 300,000 facts, 1400 pictures. Check proper box in coupon for FREE 7-Day Trial.



SEND NO MONEY

Mail coupon below — without money! When your book arrives—make it show you what it's got! Unless you agree it's the greatest time and work saver you've ever seen—return book in 7 days, pay nothing. Mail coupon NOW! MoToR Book Department, Desk 15, 250 West 55th Street, New York 19, N. Y.

MAIL COUPON NOW FOR 7-DAY FREE TRIAL

MoToR BOOK DEPT.
Desk 15, 250 W. 55th St., New York 19, N. Y.
Rush to me at once (check box opposite book you want):

MoToR's New AUTO REPAIR MANUAL. If O.K., I will remit \$1 in 7 days (plus 35c delivery charges). \$2 monthly for 2 months and a final payment of 95c one month after that. Otherwise I will return the book postpaid in 7 days. (Foreign price, remit \$8 cash with order.)

MoToR's New TRUCK & TRACTOR REPAIR MANUAL. If O.K., I will remit \$2 in 7 days, and \$2 monthly for 3 months, plus 35c delivery charges with final payment. Otherwise I will return book postpaid in 7 days. (Foreign price, remit \$10 cash with order.)

Print Name.....Age.....

Address.....

City..... State.....

Check box and save 35c delivery charge by enclosing WITH coupon entire payment of \$5.95 for Auto Repair Manual (or \$8 for Truck and Tractor Repair Manual.) Same 7-day return-refund privilege applies.



CAN LEAD TO A BETTER JOB IN BUSINESS or INDUSTRY

You can take subjects which have Real Job Value and still earn graduation!

• This is *your* opportunity to make completion of high school *work* for you. Your AMERICAN SCHOOL home study course can include high school subjects closely related to your present job or the kind of work you want to do later. You can qualify for high school course diploma and benefit from course subjects that will aid greatly in winning promotions.

50 Job Help Subjects from Which to Choose

Our FREE, 44-page book of detailed information lists 100 high school subjects, of which 29 are technical and 21 are commercial. Whether you work in a shop, factory, garage or office you will find subjects of practical benefit in your climb toward better jobs at better pay. Some of these are Blueprint Reading, Mechanical and Machine Drawing, Tool Making, Foundry Work, Automotive subjects, Electricity—and Bookkeeping, Accounting, Secretarial Practice, Salesmanship.

Turn Spare Time Into Money

During more than 50 years American School has helped thousands to reach higher job goals by profitable use of spare time at home—and it can help *you*. Others have prepared for college entrance. If you have not completed high school, check that subject on the coupon below, add your name and address and mail it *right now*. Or if you are a high school graduate and are ambitious to succeed in the vocation of your choice, check that subject. Your coupon will bring you the book of information, without obligation of any kind. Mail it *now*.

AMERICAN SCHOOL

DEPT. G-545, DREXEL AT 58th, CHICAGO 37

PRACTICAL, EFFECTIVE HOME - STUDY TRAINING SINCE 1897

Take This First Easy Step

CHECK, CLIP AND MAIL COUPON NOW

AMERICAN SCHOOL, Dept. G-545, Drexel at 58th, Chicago 37, Ill.
Without obligation, please send me FREE information on training course checked below.

<input type="checkbox"/> HIGH SCHOOL COURSES	<input type="checkbox"/> Bookkeeping	<input type="checkbox"/> Plastics Engr.
<input type="checkbox"/> Accounting	<input type="checkbox"/> Business Mngmt.	<input type="checkbox"/> Plumbing—Pract.
<input type="checkbox"/> Air Conditioning	<input type="checkbox"/> Contracting	<input type="checkbox"/> Private Secretary
<input type="checkbox"/> Architecture & Building	<input type="checkbox"/> Diesel Engr.	<input type="checkbox"/> Radio Operating & Servicing
<input type="checkbox"/> Automotive Engr.	<input type="checkbox"/> Drafting & Design	<input type="checkbox"/> Railway Training
<input type="checkbox"/> Aviation—Practical	<input type="checkbox"/> Electrical Engr.	<input type="checkbox"/> Refrigeration
<input type="checkbox"/> Aviation Drafting & Design	<input type="checkbox"/> Electricity—Pract.	<input type="checkbox"/> Sheet Metal
<input type="checkbox"/> Better Forem'nship	<input type="checkbox"/> Electronics, Indus.	<input type="checkbox"/> Pattern Drafting
	<input type="checkbox"/> Machine Shop Operations	<input type="checkbox"/> Shop Management
	<input type="checkbox"/> Mechanical Engr.	<input type="checkbox"/> Tool Making

Name _____ Occupation _____
 Address _____ Age _____
 City & Zone _____ State _____



START YOUR OWN ELECTRICAL APPLIANCE REPAIR BUSINESS

Repair electrical appliances of friends and neighbors. Service electrical equipment in factories, stores, etc. Work full or part time! New Shop Method home-training system. Rush name today for **FREE BOOK** and special form for getting Electronic Kit, Valuable Heating Element Kits, Advisory Service and Illustrated Instructions on new easy-payment plan. Pay later from **EARNINGS WHILE LEARNING**. Rush name today.

CHRISTY TRADES SCHOOL
 4432 N. Kedzie, Dept. D-9303, Chicago 25

BRAND NEW! 7 JEWELS!
3 YEAR SERVICE GUARANTEE
 • Shock Resist.
 • Radium Dial
 • Sweep Second Hand
 • Chromed Case
 • Leather Band

\$6.95 Post Paid Plus 70c tax

Refund if not satisfied. Special! Order Now! Sorry, no C.O.D.'s
LADIES WATCH, as above, smaller Size \$7.95 plus 80c tax

ELCO PRODUCTS, Dept. PM-5 166 W. WASHINGTON CHICAGO 2, ILL.

Our 382nd Advertisement
REAL DIESEL ENGINE
\$2.95 • for planes, boats, midget cars
 • 7500 RPM; 1/7 HP; ht. 3 1/2"; wt. 5 oz.
 • comes completely assembled

You just can't beat this price for a complete precision diesel engine! Streamlined, rugged, compact. Starts quickly, easy to install, runs for years. Fast delivery if you **ORDER TODAY!** Send \$2.95 plus 25c postage.

GOTHAM HOBBY CORP. Dept. P, 107 E. 126 St. New York 35

ARTISTS MAKE MONEY
 Do you like to draw? Send name, address, age and occupation for **FREE ART TEST**, to find out your ability.
ART INSTRUCTION, Inc. 5131 ART INSTRUCTION BLDG. MINNEAPOLIS 15, MINNESOTA

LEARN MEAT CUTTING
At Home — In Spare Time

Get into the vital meat industry. Concise, practical Home Training based on 25 years proven instruction methods used at National's famous resident school. Prepares you for bigger pay as Meat Cutter, Supervisor, market manager or more money in your own store. Go as rapidly as your spare time permits. Diploma. Start **NOW** to turn your spare hours into money. Send for **FREE** bulletin today. No obligation.

NATIONAL SCHOOL OF MEAT CUTTING, INC., Div. U-128, Toledo 4, Ohio

MAKE EXTRA MONEY **PLASTICS** **LEARN AT HOME**

LEARN HOW TO MAKE fast selling PLASTIC NOVELTIES FURNITURE JEWELRY SIGNS TOYS LAMPS

There are **RICH OPPORTUNITIES** for **MEN and WOMEN** with "know-how" in Plastics. Interstate's amazing new Plastics course tells and shows how to make hundreds of fast selling items out of Plastics. Gives complete training in fabrication, casting, lamination, molding, etc., in simple, easy, step-by-step language and pictures.

START A PLASTICS BUSINESS OF YOUR OWN. No other industry holds such promise for the future. You can make big money manufacturing novelties, toys, signs, etc., in your own home in spare or full time. Don't wait! Learn **NOW** how Interstate's Plastics Training qualifies you for success in the plastics field.

Write for FREE Information Today!

INTERSTATE TRAINING SERVICE
 School of Plastics
 PORTLAND 13, OREGON (Dept. 3-E)

GET INTO AUTOMOTIVE DIESEL AND ALLIED MECHANICS

by Shop Method Home Training

JOB LIKE THESE ARE OPEN TO YOU AS A TRAINED ENGINE MECHANIC...CHOOSE THE FIELD YOU LIKE BEST!

Get complete training

- Diesel Fuel Injection
- Automotive Motor Tune-up
- Diesel Engine Maintenance
- General Garage Mechanics
- Agricultural Implements
- Auto Engine Rebuilding • Auto Elec. Service
- Public Utilities • Parts Dealers
- Bus & Truck Lines • Industrial Maintenance
- Contracting & Excavating
- Business of Your Own
- AND MANY other similar openings

EARN WHILE YOU LEARN

With our practical Master Shop-Method Home Training, you study at home in your spare time. You receive Spare Time Work Lessons, which show you how to earn while you learn...for extra money and experience. You Learn by DOING.

YOU RECEIVE AND KEEP ALL THIS MATERIAL:

- | | |
|---|-----------------------------|
| Basic Lesson Texts | Engine Service Manuals |
| Diesel Installation Operation—Maintenance | Engine Repair Drive Systems |
| Diesel Chart Manual | Diesel Electric Power |
| Spare Time Lessons | Thermodynamics |

TOOLS AND EQUIPMENT INVESTIGATE! SECURE FULL INFORMATION

WE GIVE YOU TOOLS OF YOUR TRADE

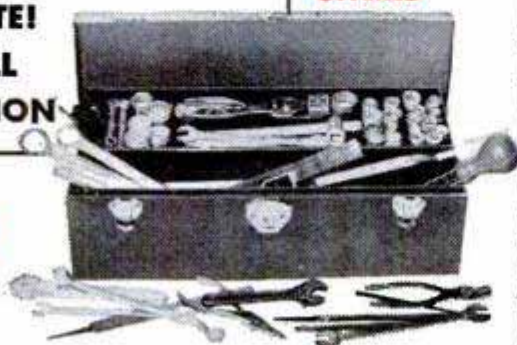

Master All Phases!



Get Master Shop-Method Home Training from an Established Resident School with its own Training Shops and Laboratories—and almost 50 years of Successful Experience in Training Men.

We Bring National Schools To You

National Schools trains you for all opportunities in the dynamic, fast-growing Automotive-Diesel and Allied Industries. You get complete training for this great industry.

Thousands upon thousands of autos, trucks, tractors, ships, trains, farms and factories are dependent upon engine power! Trained engine mechanics are needed in the Armed Forces as well as in civilian production. This huge field needs trained men for servicing, repairing, installing, operating and manufacturing equipment. The pay is good, the future excellent! National Schools offers you a practical, all-embracing Automotive-Diesel Mechanics Course that qualifies you for your choice of many good jobs.

Your National Course covers Gasoline and Special Fuel Engines; Diesels, High Speed and Heavy Duty; Semi-Diesels; Allied Mechanics.

BOTH RESIDENT AND HOME STUDY COURSES OFFERED

AUTOMOTIVE

DIESEL

ALLIED MECHANICS

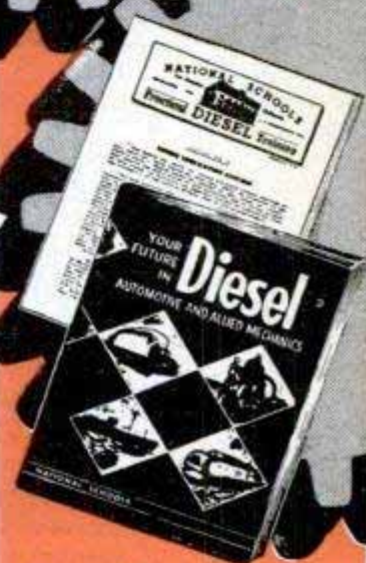

These Two FREE Books Show You How

Send today for National Schools' new, illustrated Book of Opportunity in Automotive, Diesel and Allied Mechanics, and an actual sample lesson. No cost—no obligation. Use the coupon now—we'll answer by return airmail.

APPROVED FOR VETERANS AND NON-VETERANS
Check Coupon Below

NATIONAL SCHOOLS LOS ANGELES 37 CALIFORNIA
TECHNICAL TRADE TRAINING SINCE 1905
FIND OUT NOW...MAIL COUPON TODAY

NATIONAL SCHOOLS, Dept. 5-PM (Mail in envelope or paste on penny postcard)
4000 South Figueroa Street
Los Angeles 37, California
Mail me FREE the book, YOUR FUTURE IN AUTOMOTIVE-DIESEL MECHANICS, together with the Sample Lesson. I understand I may keep and use the information with no obligation.

NAME _____ AGE _____

ADDRESS _____

CITY _____ ZONE _____ STATE _____

Check here if Veteran of World War II

It's here!

Greatest Home Repair

1638
Pages!

THE PRENTICE-HALL

COMPLETE HOME REPAIR HANDBOOK

**THE WORLD'S GREATEST BUILDING
AUTHORITIES CONTRIBUTED EXPERT
DATA FOR THIS MAMMOTH VOLUME**

Professional methods recommended for best results in repair and maintenance of your home were contributed by:

Anaconda Brass
Armstrong Cork Company
Asphalt Roofing Industry Bureau
American Steel & Wire
American Structural Products Company
Black & Decker Mfg. Co.
Brown & Sharpe Mfg. Co.
Bendix Home Appliances, Inc.
Cornell University
Copper & Brass Research Association
Crane Company
Henry Disston & Sons, Inc.
Delta Power Tool Division—
Rockwell Manufacturing Co.
E. I. du Pont Nemours & Company, Inc.
Devco & Reynolds Company, Inc.
Delco Appliance Division—
General Motors Corporation
General Electric Company
Institute of Boiler and Radiator Mfrs.
S. C. Johnson & Son, Inc.
Johns-Manville
Minneapolis-Honeywell Regulator Company
Norge Division—Borg-Warner
Nicholson File Company
Portland Cement Association
Pittsburgh Plate Glass Company
Phllico Corporation
Stanley Tools
L. S. Starrett Company
Toastrmaster Products
United States Rubber Company
United States Plywood Corp.
United States Steel
U. S. Gypsum Corporation
Victor Electric Products
Wall Paper Institute
Yale & Towne Manufacturing Co.

**Saves You Hundreds of Dollars a Year—
Slashes High Labor Costs**

THE PRENTICE-HALL

COMPLETE HOME REPAIR HANDBOOK

**BRAND NEW AND COMPLETELY UP-TO-DATE!
1638 PAGES OVER 1500 ILLUSTRATIONS**

You'll get back the low price of this book in the very first month you own it. After that, it will save you money every month of the year. You'll save plumber's bills, carpenter's bills, electrician's bills, painter's bills, bricklayer's bills. For with this remarkable Handbook you can easily do a professional job of repairing or improving any part of your house—and SAVE UP TO 90% of what it would cost to hire the work done!

These Are Typical of the Savings YOU Can Make:

- Creaky Stair Treads replaced for \$1.00 instead of \$15.00!
- Pipe Leak repaired for 5c instead of \$3.00!
- Kitchen cupboards built for under \$25 instead of \$250!
- Screens and Stormsash built for \$70 instead of \$180!
- Wall Switch installed or replaced for \$1.75 instead of \$7.50!
- Reupholstering Sofa & Chair for \$10 instead of \$125!
- Driveway constructed for \$75 instead of \$200!
- Outdoor Fireplace built for \$45 instead of \$150!
- Vacuum Cleaner repaired for \$1.65 instead of \$10!

**"SHOW HOW" ILLUSTRATIONS — MORE THAN 1500 OF
THEM — GIVE YOU CLEAR, EASY-TO-FOLLOW GUIDANCE.**

Large clear pictures, drawings and diagrams show you just where to start on any job, what step to tackle next, and how to tackle it. Full dimensions are included in every working drawing. In many instances you can do a complete job just by following step-by-step directions on the illustrations, without even referring to the text. You get complete money-and-time-saving directions on HUNDREDS of home repairs and improvements.

POPULAR MECHANICS

Book Ever Offered!

30-DAY TRIAL
without risk or obligation

Here is just a glimpse of what you will find in its 1638 pages:

INTERIOR REPAIRS. How to repair sagging floors—How to fill cracks in floors—Laying linoleum—How to fit and hang doors—Replacing sash cords—Applying weather stripping—How to repair lamp sockets—How to replace electric switches—How to repair electric motors—Repairing leaks in piping—Eliminating noises in plumbing and heating system—Draining plumbing system—Repairing loose, cracked or bulging plaster—Replacing wall and floor tile—Waterproofing basement walls and floors—removing old wallpaper—Painting and Paperhanging.

EXTERIOR MAINTENANCE & REPAIRS. How to locate and repair leakage points on roofs—Reroofing procedures—Shingling—Roll roofing—Repairs to gutters and leaders—inspection and cleaning of septic tank—Patching cracks in concrete walks and walls—Removal of stains from concrete or brick—Exterior painting—How to avoid blistering, cracking, flaking, alligatoring, wrinkling on exterior paint jobs.

FURNITURE UPHOLSTERY & REPAIRS. How to replace defective stuffing, springs, webbing—How to pad seats—How to make cushions—Foam-rubber upholstering—Repairing broken spindles, rails, legs—Correcting sticky drawers—How to repair scratches, dents and nicks—Furniture refinishing.

HOME IMPROVEMENTS & APPLIANCES. Remodeling basements and attics—Constructing porch screens, storm doors and windows—Building a stairway closet—Constructing garden furniture, fences, gates, pergolas, trellises—Installing three-way push button electrical switch—Installing cooler fans in windows—Air conditioning systems—Automatic coal stoker—How to check and repair electric iron, toaster, ironer, range, vacuum cleaner, dish washer, refrigerator, oil burner—Laying a cement or concrete floor—Building concrete sidewalks, driveways, outdoor fireplace.

WOODWORKING HAND TOOLS & MATERIALS. How to use handsaws, screwdrivers, planes, chisels and gouges, braces and bits, scrapers, squares, levels, clamps, sharpening tools—How to identify and properly use woods and wood products—Working with wood—How to make woodworking joints—Glues and gluing methods.

METALWORKING HAND TOOLS & MATERIALS. Metalworking saws, hammers, twist drills, files, pliers and nippers, wrenches, snips and shears, cold chisels, taps and dies, soldering irons, vises—Bending and forming metal—Treating and finishing metal—Fasteners for metal work.

WOODWORKING POWER TOOLS. Proper use, checking, adjusting and maintenance of woodturning lathe, circular saw, band saw, drill press, jointers and shapers, power tool accessories—Cutting miters—Bead cutting—Reeding and Fluting—Making dovetail joints—Cutting rabbets and dados—Matched shaping—Tonguing and grooving—Multiple cutting.

METALWORKING POWER TOOLS. Operation and maintenance of engine lathe, drill press, portable electric hand drill, power tool accessories—Roughing cuts—Finishing cuts—Facing—Boring—Taper turning—Knurling—Thread cutting—Drilling sheet metal—Countersinking—Commutators and carbon brushes.

PLUMBING & HEATING MATERIALS. Proper use and maintenance of all types of plumbing tools—Roughing-in materials—Determining sizes of house drains—Fittings—Selecting correct pipe size—Plumbing fixtures—Heating systems, hot-water, steam, warm air—Stokers—Oil burners—Chimneys and drafts—Automatic heating controls—Domestic water heaters—Radiators and convectors—Radiant heating.

ELECTRICAL MATERIALS. Circuits—Outlets—Indoor and Outdoor Approved Wiring Materials—Batteries—Transformers—Tools—Splicing—Methods of interior wiring—Remote-control wiring system—Use and repair of motors—Code requirements.

CONCRETE, PLASTERING MASONRY. Methods of mixing concrete—Placing or pouring concrete—Cold-weather procedures—Watertightness—Composition and application of stucco—Bricklaying—Concrete blocks—Glass bricks or blocks—Plastering materials and procedures—Plaster cracks—Prepared gypsum finishes.

PAINTING & DECORATING, TERMITE & PEST CONTROL, HOME INSULATION.

COMPARISON PROVES THIS NEW GIANT VOLUME IS BEST OF ITS KIND AVAILABLE TODAY

See how leading home repair volumes compare in 20 important features that mean money-saving, time-saving, work-saving for you:

FEATURES	THIS BOOK	BOOK "A"	BOOK "B"
Use of Power Tools	Complete	Nothing	Incomplete
Electrical Appliance Repairs	Complete	Incomplete	Very little
Furniture Upholstery	Complete	Nothing	Nothing
Pest Control	Complete	Nothing	Nothing
Termite Control	Complete	Nothing	Nothing
Motor Maintenance	Complete	Nothing	Nothing
Insulation Materials and Procedures	Complete	Nothing	Nothing
Septic Tanks	Complete	Nothing	Incomplete
Glass Brick	Complete	Nothing	Very little
Foam Rubber	Complete	Very little	Nothing
Plywood	Complete	Nothing	Nothing
Wallboard	Complete	Incomplete	Incomplete
Spray Guns	Complete	Incomplete	Incomplete
Color Harmony	Complete	Nothing	Nothing
Air Conditioning	Complete	Nothing	Nothing
Vapor Barriers	Complete	Nothing	Incomplete
Radiant Heating	Complete	Nothing	Incomplete
Garbage Disposal Equipment	Complete	Incomplete	Incomplete
Asphalt Tile	Complete	Nothing	Nothing
Home Workshop	Complete	Very little	Incomplete
	Complete	Nothing	Nothing

\$35.00 VALUE — AT ONE-FOURTH THE PRICE!

If sold separately, the 14 big sections would cost from \$35 to \$42 for the entire set—but by printing a tremendous single-volume edition, the cost is only \$8.85 complete. Pay small monthly installments shown in coupon below—AFTER YOUR FREE EXAMINATION proves you want to keep it.

AMAZING 30-DAY TRIAL OFFER!

YOU TAKE NO RISK WHATEVER! SEE DETAILS IN COUPON BELOW.

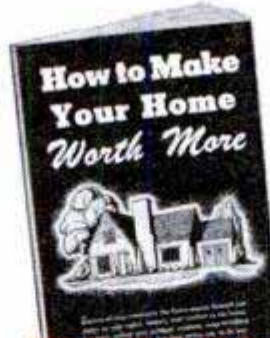

FREE EXTRA GIFT FOR PROMPTNESS

As an added inducement for mailing coupon immediately, we offer you ABSOLUTELY FREE a copy of the practical book "How to Make Your Home Worth More." Tells you dozens of ways to make your home safer, more comfortable, more saleable. Includes attic and basement remodeling; windows, door, and porch screening; picket fences, gates and pergolas; driveways, flagstone walks, ornamental concrete projects and many more. Yours entirely without charge—merely for examining sensational new, illustrated, COMPLETE HOME REPAIR HANDBOOK.

30-DAY TRIAL COUPON—Fill in and Mail Now

PRENTICE-HALL, Inc., Dept. M-PM-551
70 Fifth Avenue, New York 11, N. Y.

Please send me THE COMPLETE HOME REPAIR HANDBOOK for FREE EXAMINATION AND TRIAL. Within 10 days I will either return the book and owe nothing, or send you \$2.00. I will then send you \$2 a month until special price of \$8.85, plus postage and packing, is paid. SPECIAL "NO RISK" OFFER: Any time within 30 days after making initial payment I may still return the Handbook and you will refund my payment.

ALSO SEND FREE the new book "How to Make Your Home Worth More"—mine without cost, whether I keep the COMPLETE HOME REPAIR HANDBOOK or not.

Name

Address

City..... Zone..... State

SAVE MORE! Send full amount of \$8.85 with this coupon and we will pay postage and packing charges on this 5-lb. shipment. Same return privilege—your money back if not satisfied.

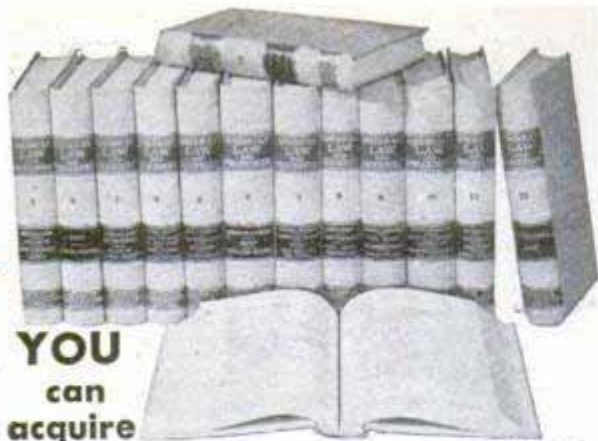

**YOU
can
acquire**

**LAW NIGHTS AT HOME!
L. B. DEGREE**

LaSalle's famous Law Library—used as reference in many Law libraries and Law offices—has enabled thousands to master Law surprisingly fast, in spare hours at home, for business and professional advancement.

These 14 remarkable volumes, compiled by leading professors and lawyers, cover the whole basic field of Law in condensed, orderly, simplified manner.

You advance rapidly with this great library, plus special lectures furnished. We guide you step-by-step with personalized Problem Method of instruction . . . you learn by doing—handling legal problems—not by memorizing rules.

Send for two FREE 48-page booklets, "Law Training for Leadership," and "Evidence," answering questions about Law and its value to you, and telling how LaSalle Law graduates are winning rapid advancement in business and public life. Mail coupon below. No obligation.

**LA SALLE EXTENSION UNIVERSITY
A Correspondence Institution**

417 S. Dearborn St. Dept. 564L Chicago 5, Ill.

Send me your two FREE booklets described above, without obligation.

Name.....Age.....
Street.....
City, Zone & State.....

**ENGINEERING DEGREE IN
27 MONTHS**

Big Demand for Graduates

Aeronautical, Chemical, Civil, Electrical, Mechanical and Radio Engineering (including Television)

Hundreds of young men are earning engineering degrees in this recognized institution each year—continuous operation. New terms start quarterly. Many students earn a major part of their college expenses in this large industrial center.

Low tuition. Competent instruction. Thorough, intense, practical program. Modern laboratory facilities including new physics lab. and modernized wind tunnel. Individualized instruction emphasized.

Approved for Veterans. Engineering preparatory courses. Students from 48 states and 21 foreign countries. Enter June, September, December or March. Send coupon for free catalog and full information. Enroll now.

SEND COUPON TODAY

INDIANA TECHNICAL COLLEGE

551 E. Washington Boulevard
Fort Wayne 2, Indiana

Please send me free information on B.S. Engineering Degree in 27 months as checked.

- Aeronautical, Chemical, Civil, Electrical,
 Mechanical, Radio-Television

Name.....
Address.....

**Watch Repairing Pays
Big Money Learn at home**

Free Literature Tells How

Watchmakers in big demand. You train step-by-step under experts. You learn to take a watch apart—repair and put in perfect working order. 10 easy lessons. We furnish all tools, and a 15 jeweled watch. Practicemovement with first lesson.



Turn spare time into cash—perhaps a business of your own. A licensed school. Students 18 to 65 have profited by our training. Low cost.

Write Today for All the Facts—No Obligation

ILLINOIS SCHOOL OF WATCH REPAIRING
2870 Elston Ave., Dept. PMS1, Chicago 18, Ill.



Your Name
beautifully written, plus special point for shaded writing.
Only 10¢

**A "GOOD HAND" HELPS YOU SUCCEED!
LEARN TO WRITE WELL**

Handwriting quickly improves with our easy-to-understand picture lessons! Put your spare time to good use; send today for FREE BOOK, "How to Become a Good Penman", or check volumes wanted below at \$1 each: Business Writing Artistic Writing Card Writing Bird & Design Flourishing Engraving Alphabets. COMPLETE SET \$4.50

TAMBLYN SCHOOL OF PENMANSHIP
S. A. Ziller, Pres. 442 Ridge Bldg., Kansas City, Mo., USA



Be a DANCING Teacher

Become a certified dance instructor. Remarkable home study course trains you for professional career teaching all modern dances: Fox Trot, Waltz, Rumba, etc. Men, Women, 18 to 56, learn to be popular teachers quickly even if you've never danced before. Quality for well paid position or open your own dance studio. Write for FREE catalog. Give age.

PRINCETON INSTITUTE OF DANCING
119 W. NORTH ST. LIMA 1, OHIO

**START YOUR OWN
MONEY-MAKING BUSINESS**

Clean rugs on customers' floors with highly efficient electric machine which is making **BIG MONEY** for others and giving them independence. Special skill or experience not required. No shop necessary. Write today for complete FREE information. Address: **VON SCHRADER MFG. CO., 510 PL., RACINE, WIS.**



WOULD YOU \$400 PER MONTH INTEREST YOU?

EARN UP TO \$400 A MONTH raising Angora or New Zealand White Rabbits. Good markets for wool, pelts and meat. Particulars free. **WHITE'S RABBITRY, Newark 10, Ohio.**

Tells How You Can Learn to



FREE BOOK MOUNT BIRDS!

Learn At Home
Men, Boys, Hunters, Fishermen, mount and save your lovely wild-game trophies. Be a Taxidermist. Mount Birds, Animals, Heads, Fish, Tax skins. YOU learn easily, quickly in spare time. Have a grand home-museum. The finest and the greatest hobby known, for sportsmen. Fun, real profits.
FREE BOOK
Yes, FREE. Beautiful strange, valuable Book, telling all about Taxidermy. Contains over 100 beautiful game-pictures. And it's yours FREE, if you rush your request. You can mount all kinds of wild-game, and common specimens too. We can positively TEACH YOU. So GRASP this opportunity. RUSH letter or postal for this amazing FREE BOOK. Don't delay. State your AGE.
N. W. SCHOOL OF TAXIDERMY, 2505 Elwood Bldg., Omaha 2, Neb.

GET THIS FREE BOOK!



I CAN HELP YOU GET AHEAD in Civilian OR Military Life!

In military service or civilian life, specialized training and skill are rewarded by better pay and advancement. The construction trades are in constant demand for private and public building projects. In peace or emergency, the building tradesman is NEEDED and WELL PAID. Since 1937 I've trained thousands of young men for

prosperous careers. And, OPPORTUNITY is greater today than ever before. The building trades are YOUR OPPORTUNITY for SECURITY in civilian life or PROGRESS in military life, if you take the trouble to learn by my quick, thorough method. Protect your Tomorrow. ACT TODAY.
Richard J. Zaiden—Founder and President

PREPARE TO MAKE
BIG MONEY
IN

A Skilled Construction Trade



PLUMBING BRICKLAYING PLASTERING

"LEARN BY DOING IT" IN CLASS
AS THOUSANDS OF YOUNG AMERICANS HAVE

HIGH PAID, LIFETIME WORK

Opportunity is continuous for men trained in these trades. Many students earn good money while yet in school. Many save thousands of dollars by building or improving their own homes. Some graduates start their own businesses. Others prefer steady work for contractors at high wage scales. Remember—the cultivated skill of your hands is yours for life—giving you SECURITY and OPPORTUNITY beyond the reach of the untrained man.

Commercial Institute's construction courses are designed for quick and thorough training. By our "project system" the student Plumber, Bricklayer or Plasterer learns professional techniques by actual practice under experienced instructors. Book work is at an absolute minimum. These are manual skills that you "learn by doing."

5 MODERN SCHOOLS IN PITTSBURGH, PENNSYLVANIA

We Also Teach

OFFICE MACHINE REPAIR and ELECTROPLATING

SEND FOR LITERATURE and
"TRADE TALK" TODAY!

We publish separate brochures giving a detailed, illustrated description of each course. ALSO—our monthly paper "TRADE TALK" gives you an up to date, "on-the-spot" view of life at Commercial Institute.

G. I. APPROVED

All our courses are approved for Veteran Training. Non-Veterans may arrange easy, monthly payments.

USE THE COUPON To send for literature and a FREE subscription to "TRADE TALK."



R. J. Zaiden, President
Commercial Institute
2020 West Liberty Avenue (Div. R.)
Pittsburgh 26, Pennsylvania.

Send me complete information on the course checked below — And a FREE SUBSCRIPTION to "TRADE TALK." This does not obligate me in any way.

PLUMBING BRICKLAYING PLASTERING
 Office Machine Repair Electroplating

Name.....

Address.....

City..... State.....

COMMERCIAL INSTITUTE

Main Office
2020 West Liberty Avenue
Pittsburgh 26, Pennsylvania

"THE LARGEST TRADE SCHOOL
IN THE EAST"



9 BIG BUILDING BOOKS

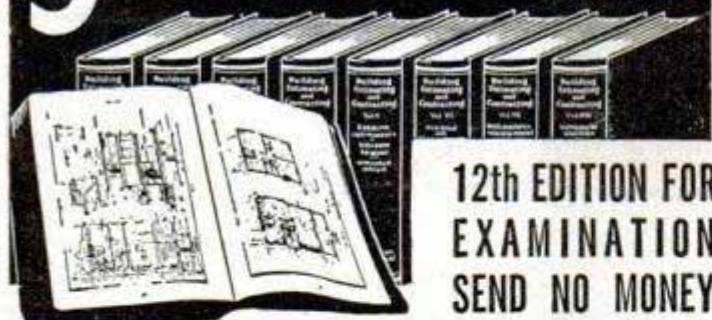

12th EDITION FOR EXAMINATION SEND NO MONEY

Learn to draw plans, estimate, be a live-wire builder, do remodeling, contracting. These 9 practical, profusely illustrated books cover subjects that will help you to get more work and make more money. Masonry, concrete forms, carpentry, steel square, roof framing, construction, plumbing, heating, painting, decorating and many other subjects. More than 4000 pages — 2750 illustrations.

BETTER JOBS — BETTER PAY

A nationwide building boom is in full swing and trained men are needed. Big opportunities are always for MEN WHO KNOW HOW. These books supply quick, easily understood training and handy, permanent reference information that helps solve building problems.

UP-TO-DATE EDITION

These books are the most up-to-date and complete we have ever published on these many subjects.

Coupon Brings Nine Big Books for Examination

AMERICAN TECHNICAL SOCIETY—Publishers since 1898
Dept. G519 Drexel at 58th Street Chicago 37, Ill.

You may ship me the Up-to-Date edition of your nine big books, "Building, Estimating and Contracting," without any obligation to buy. I will pay the delivery charges only, and if fully satisfied in ten days, I will send you \$3.00, and after that only \$4.00 a month, until the total price of only \$34.80 is paid. I am not obligated in any way unless I keep the books.

Name _____

Address _____

City _____ State _____

Please attach a letter stating your age, occupation, employer's name and address, and name and address of at least one business man as a reference. Men in service, also please give home address.

Learn this Profitable Profession



IN 90 DAYS AT HOME

Money-Making Career Open to Men and Women, 18 to 60

Hundreds of men and women between 18 and 60 make \$10 to \$20 in a single day giving scientific Swedish Massage and Hydro-Therapy treatments. There is big demand from doctors, hospitals, sanatoriums and clubs. Graduates earn large full time incomes from these or in private practice in their own offices. Others make good money from home treatments given in spare time. Learn this interesting, money-making profession in your own home, through our home study course. Same instructors as in our nationally known resident school. You can win independence and prepare for future security by qualifying for your Diploma. Course can be completed in 3 to 4 months. Many earn while they learn. Begin your training at once.



NEW 32-PAGE BOOKLET FREE

Fill in the coupon below (please print name and address) and mail it for your FREE copy of 32-page Information Booklet. If you act at once we will include Anatomy Charts and Success Booklet which supply additional information you should have. All will be sent postage paid.

THE COLLEGE OF SWEDISH MASSAGE
Dept. 164E, 41 E. Pearson St., Chicago 11, Illinois

Please send me FREE and postpaid New 32-Page Illustrated Booklet, Anatomy Charts and Success Booklet at once.

Name _____ Age _____

Address _____

City _____ State _____

Listen to this Record!

Speak FRENCH SPANISH

RUSSIAN • GERMAN • ITALIAN BRAZILIAN • JAPANESE

BIG OPPORTUNITIES await Americans who speak languages. Learn as a child learns—"by listening." The **CORTINA METHOD**, famous for 69 years, teaches you, right at home, to speak like a native!



FREE BOOK The "Cortina Short-Cut" describes this amazing method and **FREE TRIAL** offer. **WRITE TODAY**. State language interested in. Also if Veteran.

CORTINA ACADEMY Dept. 645
105 W. 40TH ST. NEW YORK 18, N.Y.



TOOTHACHE?

Ask your Druggist for **DENT'S**

TOOTH GUM TOOTH DROPS POULTICE

STUDY AT HOME

WITH AN EDUCATIONAL INSTITUTION

Courses in ARTS AND SCIENCES: Philosophy; Education; Letters; Public Health; Medical Jurisprudence; Psychology; Sociology; Physics; Chemistry; Geology; Pol. Science; Theology; Law; Business and Commerce; Accounting; Mathematics; Statistics; Agriculture. **Courses in ENGINEERING:** Electrical, Civil, Mechanical, Drafting, Architectural, Automotive, Steam, Diesel, Aeronautical, Radio, Structural, Mining, Industrial, Petroleum, Marine, Refrigeration, Air Conditioning, Chemical. Send for free catalog.

McKinley-Roosevelt Incorporated, 4610-K3, Sheridan Rd., Chicago 40, Illinois



CARTOONING

HAVE FUN! MAKE MONEY! Cash in on your sense of humor **AT HOME—BY MAIL**. No experience needed to start. Write today for **FREE TRIAL LESSON** and full particulars.

MOON Gag Cartoon School, Dept. 1, Fall Creek, Wis.

AVIATION CAREERS



Prepare for success in aviation — **World's fastest growing industry**. Train at **Spartan—Internationally-famous school**. Complete, thorough courses in all phases of aviation. Gov't approved.

Write Department PM-51

SPARTAN SCHOOL OF AERONAUTICS
MUNICIPAL AIRPORT • TULSA, OKLAHOMA

"YOU ARE UNDER ARREST!"



Help Bring Crooks to Justice Through Scientific **CRIME DETECTION!**

We have taught thousands this exciting, profitable, pleasant profession. Let us teach you **in your own home**. Learn **Finger Printing, Firearms Identification, Police Photography, Secret Service Methods** thoroughly, quickly, at small cost. Over 800 of all American Bureaus of Identification employ I. A. S. students or graduates. We can prepare you for this fascinating work, during spare time. Write today, stating age, for "Blue Book of Crime."

INSTITUTE OF APPLIED SCIENCE, 1920 Sunnyside Ave., Dept. 1355, Chicago 40, Ill.

WATCHMAKING

★ Watch Repairing ★ Jewelry Engraving ★ Jewelry Repairing
Combination men earn top pay. Learn in school fully accredited by Horological Institute of America in Washington, D. C. and United Horological Association of America. Approved for veterans. Receive tools, tuition and subsistence while learning.

Established 1935. Write for **FREE booklet**



The Baronian School, Inc.

2116 WALNUT ST. (DEPT. C) PHILA. 3, PA.

TO THOSE WHO THINK LEARNING MUSIC IS HARD

Just strike these notes and you're playing the beginning of the "Merry Widow" Waltz

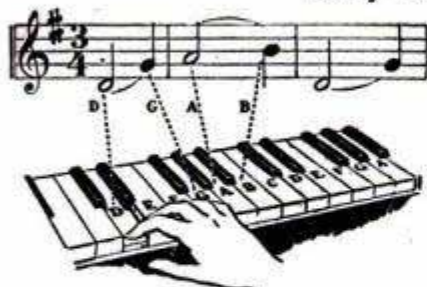

Look at the diagram. The first note of the music is "D." Following the dotted line to the keyboard you'll find "D" is the white key between the two black keys near the middle of the keyboard. Now read below how you can learn to play any instrument quickly and easily.



EASY AS A-B-C — COSTS JUST A FEW CENTS A DAY!

• Perhaps you think learning music is a tedious grind. It isn't any longer! Long hours of practicing scales and monotonous exercise are over.

You have no excuse for not getting started toward musical good times now! For through an easy method you can now learn to play right at home—without a teacher—for a few cents a day.

Learn to Play by Playing

The lessons come to you by mail from the famous U. S. School of Music . . . complete instructions, clear diagrams, and all the music you need. You learn to play by playing real tunes by note. First you are told how to do a thing. Then a picture shows you how. Then you do it yourself and hear it. Remember, don't confuse our method with any system claiming to teach music "by ear" or by trick methods. We teach you to play only from real notes!

SUCCESS!

Here's what one of our thousands of pupils writes: "I learned more from your course than many of my friends who studied under private teachers have for years. The fact that I've already taken 2 courses and am now enrolling for a third, should speak for itself." F. A. S., Indiana.

Remember, don't confuse our method with any system claiming to teach music "by ear" or by trick methods. We teach you to play only from real notes!

Don't delay. Send now for big 36 page illustrated FREE Booklet and "Print and Picture" Sample which fully explain this remarkable method. So decide which instrument you want to play and mail the coupon today. U. S. School of Music, 75 Brunswick Bldg., New York 10, N.Y. (Successful 53rd Year)

FREE PRINT AND PICTURE SAMPLE

U. S. School of Music, 75 Brunswick Bldg., New York 10, N. Y. Please send me Free Booklet and Print and Picture Sample. I would like to play instrument checked below.

Piano	Saxophone	Modern Elementary
Guitar	Trumpet, Cornet	Harmony
Hawaiian Guitar	Pipe, Reed Organ	Mandolin
Violin	Tenor Banjo	Practical Finger
Piano Accordion	Clarinet	Control

Name _____ Have You Instrument? _____

Address _____

City _____ State _____

Save 2c—Stick Coupon on Penny Postcard

MAGIC-SCREEN INCOME PLAN OFFERS BIG MONEY, AT HOME, SPARE OR FULL TIME



Reproduce any painting, design, trade-mark, picture, printing, in full color, on any surface! Proven new method enables you to cash in on established business where Profits up to \$5.00 or more an hour are being made, right now! Examine complete Plan and equipment without risk!



Write today for free sample — Complete free details! Send NOW!

CALIF. ACADEMY OF SCREEN PROCESS DEPT. 25, 5100 SO. VERMONT AVE., LOS ANGELES 37, CALIF.

LEARN MEAT CUTTING AT NATIONAL

Pay After Graduation



The steady dependable trade of Meat Cutting taught easily in 8 short weeks. YOU LEARN BY DOING under actual meat market conditions in big modern school at Toledo.

For beginners or men with experience. Get a profitable store of your own. Remember, PEOPLE MUST EAT! Big pay jobs. Free employment help. Thousands of successful graduates.

Buying, cutting, percentage, pricing, advertising, selling, etc. A complete retail meat education. National School established over 25 years. Get National training NOW. Pay your tuition in easy weekly payments

after you graduate. G. I. approved. Send coupon for FREE 52 page school catalog — TODAY.

National School of Meat Cutting, Inc., Dept. 50-S, Toledo 4, Ohio

Send me your FREE school catalog on National Training at Toledo in Meat Cutting, Meat Merchandising and Self Service Meats. No obligation. No salesman will call.

Name _____

Address _____

City _____ State _____

() Check here if Veteran of World War II

C. T. C. TRAINING IN DRAFTING

PREPARES FOR
PROMOTION
•
MORE MONEY
•
SUCCESS

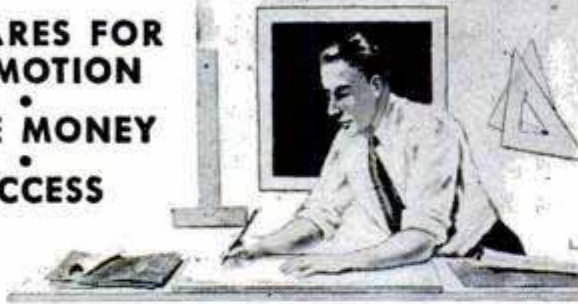

"Here I am at work making good money as a draftsman. I'm glad I sent the coupon to Chicago Tech for that Free Trial Lesson and found out how easy it is to learn Drafting in spare time at home. Today, I feel secure in my job. What's more, I feel I'm slated for promotion and more pay."

LEARN IN SPARE TIME—AT HOME!

(or at the College in Chicago)

A few hours of pleasant home study every week—that's all. All the tools you need; drawing outfit included. This tested method—developed over 46 years of C.T.C. progress—prepares men quickly for good positions in industry.



FREE INFORMATION — SEND COUPON

To prove to you how easy it is to learn Drafting at home, we will send you this FREE TRIAL LESSON. Mail coupon or send post card today.

CHICAGO TECHNICAL COLLEGE

E-214 Tech Bldg., 2000 So. Michigan Ave.
Chicago 16, Illinois

Mail me FREE Lesson with information about big opportunities in DRAFTING.

Name _____ Age _____

Address _____

City _____ Zone _____ State _____



ART FOR A PROFITABLE CAREER

Here's How You Can Learn at Home in Your Spare Time. BE AN ARTIST

Trained Artists Are Capable of Earning \$65, \$80, \$100 AND MORE A WEEK

COMMERCIAL ART, DESIGNING, CAR-TOONING—all in one complete home study course. Become your own boss. Many students earn extra money while learning by doing artwork, designing posters, lettering, etc. W.S.A. now in 37th successful year. No art experience necessary, we teach you step-by-step. **TWO ART OUTFITS** included with training. **FREE BOOK**, "Art for Pleasure & Profit"—tells about our course, instruction, what our graduates say, and commercial opportunities in Art. Low tuition—easy terms. **VETERANS!** Course G. I. Approved.

MAIL COUPON FOR FREE BOOK

WASHINGTON SCHOOL OF ART
Studio 125A, Washington 5, D. C.

Send me without obligation Free Book, "Art for Pleasure & Profit." No salesmen. (Please print).

Name _____ Age _____

Street _____

City _____ Zone _____ State _____



NEW!

POLARVISION SAFETY LIGHT

A revolutionary new light discovery recently released for civilian use.

STOP HEADLIGHT GLARE

FOR SAFETY AND COMFORTABLE DRIVING

The Amazing "Ergon Glass Lens" is an integral part of the Polarvision Light. It produces a Black Light (barely visible to the eye) which counteracts oncoming headlights, street lights, etc. without interfering with your visibility. Easy to install above windshield—beautiful accessory. Light encased in high grade chrome holder. Works off car's central lighting circuit. Limited Supply. Complete (including all parts) **\$6.95**

Send cash, check, or money order. Guaranteed

Electronic Development Company, Dept. 85, Los Angeles 34, Calif.

NO CAR TROUBLE IS HARD TO FIND...

when you have MoToR's new "Trouble Shooter"

Handy, pocket-size, indexed manual lists 1760 CAUSES of car troubles and tells WHERE to look for them. Saves you hours of time and work on difficult jobs. Covers engines, clutches, brakes, ignition, etc. Section on automatic transmissions alone is worth more than price of book! Spiral binding; book stays open while you work. Just pin \$1 to this ad, with your name and address. If not satisfied, return book in 7 days and your money will be cheerfully refunded. MoToR Book Dept. Desk 15T, 250 West 55th St., New York 19, N. Y.

"I HAVE EARNED AN AVERAGE OF \$15.20 AN HOUR"

with Science's New Midget Miracle, the Presto Fire Extinguisher, says W. F. Wydallis, Ohio.

Many others "cleaning up"—so can you! Amazing tiny new extinguisher ends fires fast as 2 seconds. Guaranteed 20 years! Sells for only \$3.98! Write for FREE Sales Kit. No obligation. Merlite Industries, Inc., Dept. 55 201 East 16th Street, New York 3, N. Y. (If you want a regular Presto to use as a demonstrator send \$2.50. Money back if you wish.)

GREAT PROFITS

MAKE YOUR OWN RUBBER MOLDS

Make your own rubber molds quickly, cheaply with X.L. RUBBER. Cast thousands of perfect figurines, book ends, plaques, ornaments, ash trays, etc. **GREAT PROFITS!** Write for NEW Catalog.

X.L. Rubber, Pts. \$2.00; Qts. \$3.50; Models and enough rubber for 3 molds \$1.30 postpaid.

SEND FOR FREE FACTS

PLASTIC ARTS STUDIO Dept. 2, 3403 S. MADISON ST., Muncie, Ind.

MONTH AFTER MONTH, YEAR AFTER YEAR, YOU SEE OUR AD.

REMEMBER IT'S DANGEROUS to pay less if you want the finest matched USED tires.

GOODRICH, UNITED STATES, GENERAL & OTHERS, NOT RECAPS

Our policy is to select your tires so carefully, as if our very future depended on the service given by that particular tire.

FREE TUBE WITH "ALL" BLATT'S GOOD GRADE TIRES					
GOOD GRADE, 16 MONTHS GOLDEN RULE GUARANTEE BOND.					
600-16	\$4.14	700-15	\$4.54	850-20	\$7.94
650-16	5.42	670-15	4.74	700-20	8.54
700-16	5.04	710-15	4.94	750-20	8.64
650-15	4.44	550-17	4.64	825-20	15.92
900-20	13.94	1000-20	13.94		

FINEST GRADE, 26 MONTHS GOLDEN RULE GUARANTEE BOND					
THIS GRADE MADE THE BLATT NAME "WORLD FAMOUS".					
MATCHED BALANCED TIRES			MATCHED BALANCED TRUCK TIRES		
600-16	\$5.49	650-15	\$5.94	600-20	\$9.94
650-16	6.42	670-15	6.24	650-20	9.94
700-16	7.94	700-15	6.54	700-20	12.94
750-16	8.94	710-15	6.34	32x6(8)	12.54
550-17	5.94	760-15	6.54	32x6(10)	13.92
525-18	5.54	820-15	7.04	750-20	12.54
700-17	10.00	475-19	5.94	825-20	25.84
900-16	10.94			750-20	19.84

900-16 MILITARY tread 750-20

Regular 10.94	Reg. Guar. 16 Mos.	Regular 10.94
Best 16.64	Best Guar. 30 Mos.	Best 16.64

BLATT BLATT BLDG., GIRARD & LANCASTER AVES., DEPT. PM., PHILADELPHIA 31, PA.

Send check or money order and this ad for rush shipment. We won't ship a tire we wouldn't use. The name to trust in rubber. Prices subject to change.

Shipments RUSHED Down South, Up North and Far West

NOW! MORE BRILLIANT Than



DIAMONDS

AT Only **1/25TH** THE COST OF DIAMONDS

LOOK PROSPEROUS—IMPRESS YOUR FRIENDS—WEAR BIG BEAUTIFUL TITANIA BRILLIANTS—more SPARKLING THAN DIAMONDS, 57 perfectly cut and polished facets. Ideal for ENGAGEMENT RING, LADIES' EARRINGS, LAVALIERES, BRACELETS, MEN'S SOLITAIRE, REPLACEMENTS FOR YOUR DULL STONES. New man-made gem of incomparable brilliance and fire; only gem on earth MORE BRILLIANT than DIAMOND. 1 CARAT unmounted Titania Brilliant ONLY \$21.60; 2 CARATS \$43.20; 3 CARATS \$64.80; LADIES' RING MOUNTED IN 14K GOLD as low as \$58; MEN'S AS LOW AS \$69—all prices include Federal Tax.

10 DAY RETURN PRIVILEGE If not thrilled and delighted, you may return within 10 days for refund if in same condition as when received. Enclose remittance and we send prepaid or send 25¢ deposit and pay balance on arrival, plus postage. Deal with 35 YEAR OLD COMPANY. SEND CHECK OR MONEY ORDER. ASK FOR FREE BOOKLET M.

BRADLEY MARTIN CO. 495 WASHINGTON AVENUE BROOKLYN 16, N. Y. DEPT. M

BRAND NEW

30 DAY FREE TRIAL

High Power BINOCULARS

Finest Precision Optics
Featherlight
Money Back Guarantee
Easy Pay Plan
Leather Case Incl'd.

Free! Catalog & Book "How to Select Binoculars"
Dealer Inquiries Invited

33 MODELS \$14⁹⁵ up

BUSHNELL Binoculars

Bushnell Bldg., Dept. M-25, Pasadena 1, Calif.

TRAIN

Your VOICE!

RESULTS GUARANTEED

STRENGTHEN your voice this tested, scientific way. Yes—you may now be able to improve the POWER of your speaking and singing voice . . . in the privacy of your own room! Self-training lessons, mostly silent. No music required. Write TODAY for Eugene Feuchtinger's great booklet "How to Develop a Successful Voice." It's absolutely FREE! You must state your age. Booklet mailed post-paid in plain wrapper. No salesman will call. Send your name and age RIGHT NOW! Perfect Voice Institute, 210 S. Clinton St., Studio E-2, Chicago 6, Ill.

WHAM-O SPORTSMAN* \$1.25 45-LB. PULL!

HITS LIKE A .22 RIFLE—KILLS RABBITS, SQUIRRELS. Powerful, silent, accurate. For hunting, target, routing pests. Sportsman's choice sold world over!

HUNTING SLINGSHOT

Heavy duty 7" ash stock. 40 steel balls, extra rubber, target. GUARANTEED - at dealers, or send \$1.25 to Wham-O Mfg. Co., Box 87, South Pasadena, Calif. *Professional model of Nat'l Slingshot Assn.

Wheels Wheels Wheels

Wheels Wheels

5" Disc Wheel 5/8" Tire 5/16" or 3/8" sleeve 30c ea.
6" Disc Wheel 5/8" Tire 5/16" or 3/8" sleeve 35c ea.
7" Disc Wheel 3/4" Tire 3/8" sleeve 45c ea.
8" Disc Wheel 1 1/8" Tire 1/2" sleeve 70c ea.
7" Disc Wheel 1" Tire 1/2" ball bearing 80c ea.
8" Disc Wheel 1 1/8" Tire 1/2" ball bearing \$1.00 ea.
8" Disc Wheel 2" semi-pneum. T. 1/2" B.B. \$1.35 ea.
10" Disc Wheel 1.75 semi-pneum. T. 1/2" B.B. \$1.50 ea.
12" Disc Wheel 1.75 semi-pneum. T. 1/2" B.B. \$1.85 ea.

Above wheel prices include hub cap. Plus Postage, 20¢. C.O.D.'s accepted.

UNITED WHEEL STAMPING CO.
2756 W. 115th STREET PM-5 CHICAGO 43, ILLINOIS

MAXWELL Build This Great Favorite In A Fascinating Scale Model!

1911 Maxwell \$2.50

Everybody loves this little red Maxwell! Once you complete it, you'll treasure it and use it, as a mantelpiece or office decoration! So easy to assemble—so small in price! Maxwell is 7 1/2" in length when completed. 14 famous models to choose from!

1911 BUICK "BIG" — \$2.50	1906 "OLD 16" LOCOMOBILE — \$3.95	1904 OLDSMOBILE — \$1.95
1903 RAMBLER — \$2.50	1903 CADILLAC — \$2.50	1900 PACKARD — \$2.50
1909 STANLEY Steamer — \$2.95	1910 MODEL T FORD — \$2.50	1909 MODEL T FORD — \$2.95
1914 STUTZ BEARCAT — \$3.95	1910 INTERNATIONAL HARVESTER — \$2.95	1911 MERCER RACEABOUT — \$3.95

Check "OLD TIMERS" You Want:

<input type="checkbox"/> 1911 Maxwell \$2.50	<input type="checkbox"/> 1911 Buick \$2.50
<input type="checkbox"/> 1904 Olds. \$1.95	<input type="checkbox"/> 1903 A Ford \$2.50
<input type="checkbox"/> 1910 T Ford \$2.50	<input type="checkbox"/> 1910 Internat. Harvester \$2.95
<input type="checkbox"/> 1909 Stanley Steamer \$2.95	<input type="checkbox"/> 1903 Cadillac \$2.50
<input type="checkbox"/> 1909 T Ford \$2.95	<input type="checkbox"/> 1900 Packard \$2.50
<input type="checkbox"/> 1903 Rambler \$2.50	<input type="checkbox"/> 1914 Stutz Bearcat \$3.95
<input type="checkbox"/> 1911 Mercer \$3.95	<input type="checkbox"/> 1906 "Old 16" Locomobile \$3.95

Mail order to us for your favorites. Add 25c for postage and handling. No C. O. D.'s please.

Hudson Miniatures' "OLD TIMERS"
SCRANTON HOBBY CENTER, Dept. 14, Scranton 10, Pa.

PLEASE SEND ME

for the time checked. I am enclosing . . .

1 year \$3.50
2 years \$6.00

name _____
address _____
city _____ zone _____ state _____

Hand this order to your newsdealer or send it to

POPULAR MECHANICS
200 East Ontario St. Chicago 11, Ill.



INVENTORS

Before you make any effort to market your invention, you should take the first steps toward proceeding for patent protection.

The usual first step is to have a search of the U. S. patent records conducted, so that I can report to you on the question of patentability.

I shall be pleased to furnish you with information relative to patent procedure, upon request from you, and this will be without any obligation on your part.

PATRICK D. BEAVERS

(Formerly RANDOLPH & BEAVERS)

Registered Patent Attorney

934 Columbian Building Washington 1, D. C.

BLOOD PRESSURE GAUGE



for HOME USE..... **\$5.98**
Keep check on yourself! Prevent strokes, kidney damage, etc. Manual has full details on what is prescribed in 95% of ALL high blood pressure cases. Unit includes a Blood Pressure Gauge, Arm Bandage, Sleeve, 2 Valve Bulb, Base, Stethoscope and 25 Grams of MERCURY. Easy to operate. Complete outfit sent prepaid for \$5.98 or simply send name and address and pay \$5.98 plus C.O.D. and postal charges on arrival.

JOY SPECIALTY COMPANY
Scientific Instrument Department
2320-A W. Hubbard St. Chicago 12, Ill.
Additional information upon request

Prepare Now!
ENGINEERING
B.S. DEGREE IN 27 MONTHS
WORLD FAMED SCHOOL - ESTABLISHED 1884

Mechanical, Civil, Electrical, Chemical, Aeronautical, Radio (Television) Engineering; Business Administration and Accounting. Also 36-weeks diploma courses in Surveying and Drafting.

Personalized instruction. Accelerated courses. For ambitious earnest students. Preparatory department. Approved for veterans.

Heavy demand for Tri-State graduates; hold positions of responsibility the world over. Placement service. Serious shortage of engineers indicated for immediate future. Prepare now for the unlimited opportunities ahead. Technical training helpful in military assignments.

VETERANS: You may still obtain training and a college degree at Tri-State College under present G.I. Bill. Last opportunity for new students to enroll is Summer Quarter, June 11, 1951.

Extensive campus. Well equipped, new and modernized buildings; up-to-date labs. Low cost. New terms start quarterly. Enter June, September, January, March.

Write today for free catalog and special information.

TRI-STATE COLLEGE

451 COLLEGE AVENUE ANGOLA, INDIANA

TUBE GIVEN WITH EVERY TIRE AT NO EXTRA COST

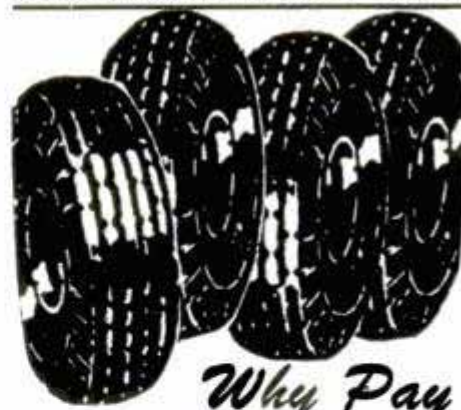

WRITTEN GUARANTEE SENT WITH EVERY TIRE YOU BUY

PLEASE NOTE: Our Tires are NOT Re-treaded or Re-Capped We Serve TRUCKS—BUSES—PASSENGER CARS

GOOD USED TIRES

WE PERSONALLY SELECT YOUR TIRES A TRIAL OF ONE TIRE WILL CONVINCE YOU.

Why Pay More!

ONE QUALITY — ONE PRICE ONLY
TUBE GIVEN WITH EACH PASSENGER & TRUCK TIRE
AT NO EXTRA COST — SEND THIS AD!

600-16	\$5.32	670-15	\$6.12	710-15	\$6.32	760-16	\$6.92
650-15	5.82	700-15	6.42	750-16	8.72	820-15	7.02
650-16	5.82	700-16	6.62	760-15	6.42	850-17	5.72



600-20	\$9.72	32x6(8)	\$11.72	1000-20	\$18.82
650-20	9.82	32x6(10)	12.32	1100-20	19.82
700-20	12.72	825-20	16.52	1000-22	19.52
750-20	12.42	900-20	17.92	1100-22	20.42

Thousands of tires shipped all over U.S.A. All tires shipped F.O.B. Phila. Send Check or M.O. with this ad. Dept. 2. If your size is not listed write for prices. 17 YEARS AT THIS ADDRESS.

STANDARD 834 N. Broad St., Philadelphia 30, Pa.

CRAFTSMEN

Over 6,500 items for the craft enthusiast. Send for your free catalogue today. "When you think of any craft, think of Artcraft."

ARTCRAFT OF CALIFORNIA
271-12th Street, Dept. PM, Oakland 7, California

PATENTS
C. A. SNOW & CO.
REGISTERED PATENT ATTORNEYS
WRITE FOR INFORMATION TO
428 SNOW BUILDING, WASHINGTON 1, D. C.

PATENTS PATENT
GUSTAVE MILLER LAWYER
ASSOCIATE EXAMINER
U. S. PATENT OFFICE 1922-1929
Patent Attorney and Advisor
U. S. NAVY DEPT. 1930-1947
Send for
PATENT INFORMATION book
and "INVENTOR'S RECORD"
without obligation

INVENTORS

Whether an invention is patentable can be substantially determined by a search of the U. S. Patent records. Without obligation, write for information explaining the steps you should take to secure a patent.

JOHN N. RANDOLPH
Registered Patent Attorney

201 Columbian Building, Washington 1, D. C.

INVENTORS

IF YOU WISH TO PROTECT YOUR INVENTION, You should take steps to protect it by a U. S. Patent. Write me for "RECORD OF INVENTION" form.

CARL MILLER
REGISTERED PATENT ATTORNEY

WOOLWORTH BLDG., 35th FLOOR, 51A
NEW YORK CITY

PACKAGED BOAT KITS

LARGEST CATALOG
EVER OFFERED!

16 pages—80 construction
and action photos PLUS
specifications and perform-
ance data.



\$38.95 UP

COMPLETE LINE — SKIFFS, OUT-
BOARDS, RACERS, CRUISERS.
23 Models! Kits, Semi-finished
and Custom-finished boats, hard-
ware, paint.



SEND 35c FOR CATALOG

Catalog PLUS booklet on boat building, \$1.00

BOAT PATTERNS-BLUE PRINTS

Over 70 modern plans and full size patterns. Racing
classes, cruisers, inboards, outboards, sail boats. By
famous designers. 6" to 30". CATALOG 35c. Catalog and
boat building handbook, \$1.00.

MARINE MART-DEPT. 52-BUFFALO 7, N. Y.

BE A LANDSCAPE CONTRACTOR

or a Landscape Architect. Make \$15 to \$50 a
day. Compare the competition in this field to
others & you'll see why we have hundreds of em-
ployed graduates from coast to coast. Course in-
cludes practical instruction here in addition to
approved home study work. Write for free in-
formation.



NATIONAL LANDSCAPE INSTITUTE
Dept. P-5, 310 So. Robertson Los Angeles 48, Calif.

SILVER PLATES WITH A CLOTH!



DO IT YOURSELF! SAVE TIME & MONEY!

Amazing new "Marvel Silver-Plate"
resilverers Sheffield silver & silver-on-
copper ware; gives a gleaming silver
plate to copper, brass & bronze articles.
Satisfaction guaranteed! Big 4 Oz. bottle.

ONLY
\$1.98

2 for \$3.49

GREY INDUSTRIES, 1784 1ST AVE., N.Y.C.

ARRO-PING —the Original Arrow

Slingshot has ac-
curacy and power for small game or tar-
get with swift ping of an arrow. Sturdy,
smoothly-made wood stock, metal-guided
barrel, slender metal-tipped 12-inch
arrows. Powerful rubber propul-
sion sends arrow 300 feet. Try
skill in a new hunting thrill.



Postpaid,
with three
Arrows, \$1.
Or Arrows alone
20 for \$1.

ARRO-PING CO.
Box 25H West End Station,
Colorado Springs, Colo.

SAVE YOUR WALLS! USE A WALL STUD LOCATOR an amazing New Invention

PAT. PENDING



Don't drive a nail into a plaster or
composition wall without first find-
ing a solid wood studding . . .

Use a DOWSER BALL.

The roll of the ball finds the stud
in the wall.

Money back guarantee. \$2.00 with complete instruc-
tions, postpaid. No C.O.D.'s.

YOU MAY NEED ONE TOMORROW
FORD PRODUCTS DEPT. 900
Box 282 Tuckahoe, N. Y.

**NOW
FOR THE
FIRST
TIME**

AUTO Repair Kinks

by
Bill Toboldt

Editor Motor
Service
Magazine

Only
\$3.00

Postaid to your
Home

Combined Experience and
KNOW HOW
of World's BEST
AUTO MECHANICS



ZIP THRU Auto Repair Jobs

Bill Toboldt's **AUTO REPAIR KINKS**, the entirely new and dif-
ferent guide to "doctoring up" ailing autos, describes hundreds
of out-of-the ordinary but practical time and money-saving re-
pair kinks that have helped auto mechanics out of tough spots
... tells How to Step Up Speed, Power; Save Fuel, Cure High Oil
Consumption, Trouble Shoot Engine Knocks, Service Cooling
Systems ... brings you the combined experience and **KNOW
HOW** of World's Best Auto Mechanics. Also, complete Meohan-
ical and Tune-Up Specifications 1938-1950 models on: Buick,
Chrysler, Dodge, Hudson, Mercury, Packard, Studebaker, Cadil-
lac, Crosley, Ford, Kaiser, Nash, Plymouth, Willys, Chevrolet,
DeSoto, Frazer, Lincoln, Olds, Pontiac. Only \$3.00.

SEND NO MONEY - MAIL COUPON



Goodheart-Willcox Co., Dept. 159
1321 S. Michigan Ave., Chicago 5, Ill.

Send at once books checked below. I agree to
remit price indicated plus 25c per book postage
and handling, or return books within 7 days and
owe nothing.

Check Titles Wanted

Examine
Books In
Your Own
Home
Without
Obligation

Outside U.S.
Enclose Re-
mittance.
Same
Return
Privilege

Check here if you remit with order and save
postage and handling charges. If books are
returned within 7 days we will refund full price.

- AUTO REPAIR KINKS**.....\$3.00
- AUTOMATIC TRANSMISSIONS Simplified**
(Covers all types including new Fordomatic
and Merc-O-Matic.) 4.00
- DYKE'S Auto Encyclopedia (new 22nd edition)** 7.50
- AUTO Body & Fender Repairs (New 1951 Ed.)** 3.50
- DYKE'S Carburetor Book**..... 3.50
- AUTOMOTIVE Service Management**..... 5.00
- MODERN Electric & Gas Refrigeration**..... 5.00
- MODERN Welding Practice**..... 4.00
- D. C. POWER WIRING**..... 4.00
- A. C. POWER WIRING**..... 4.00
- PLUMBING & Pipe Fitting**..... 2.50
- SHEET Metal Layout**..... 3.50
- STORAGE Battery Simplified**..... 3.00
- BAILEY'S Handbook for Engineers-Firemen**.. 2.00

Name _____ (Please Print)

Street _____

City _____ State _____

Employed By _____

NEW OPPORTUNITIES for WELDING TECHNICIANS

An immediate need exists for properly trained WELDING TECHNICIANS — men who have more than practical welding experience — to fill laboratory, experimental, supervisory, estimating, sales and managerial positions.

Take your place in the ever-increasing, essential Metal Fabrication Industries!

"Welding as a Career", a new bulletin, describes the many job opportunities for you in the rapidly expanding Welding Industries. Write for it today. It's FREE.



MILWAUKEE SCHOOL of ENGINEERING

Welding Institute
College of Electrical Engineering

MILWAUKEE SCHOOL OF ENGINEERING
PM551W, 1020 N. Broadway, Milwaukee, Wis.

Without obligation, mail "Welding as a Career" manual to

Name.....Age.....

Address.....

City.....Zone.....State.....

Check if World War II Veteran

Other bulletins: Radio-Television, Refrigeration, Heating, Air Conditioning, Electrical Power (Electrical Engineering, B. S. Degree, Major in

Electronics or Power.) 1951 Catalog.

"Your Career", an illustrated bulletin.



"I'M EARNING \$300 A MONTH!"



.... says Leonidas Burgoyne of Chicago, Illinois, "Expert individual instruction in the fully equipped shops of Greer Shop Training gave me the right start to get my good paying job."

GREER SHOP TRAINING established 1902, is one of America's largest trade schools. Over 48,000 successful graduates. You learn by tearing down, repairing and rebuilding. Day and evening classes. Mail this coupon today!

LEARN A TRADE NOW!

GREER SHOP TRAINING, Desk 211, 2230 S. Michigan Avenue, Chicago, Ill.

Gentlemen: Please send me information about trade I have checked below. (Specify if you are VET or NON-VET .

- | | |
|---|--|
| <input type="checkbox"/> AUTO MECHANICS | <input type="checkbox"/> BODY, FENDER REPAIR |
| <input type="checkbox"/> DIESEL | <input type="checkbox"/> WELDING—ARC, GAS |
| <input type="checkbox"/> REFRIGERATION | <input type="checkbox"/> MACHINIST |
| | <input type="checkbox"/> PIANO TUNING |

Above courses approved for Vets and Civilians.

ALSO THE FOLLOWING HOME STUDY COURSES

- REFRIGERATION DIESEL PLASTICS

Name _____ Age _____

Address _____

City _____ State _____

GREER SHOP TRAINING



The
NEW
KISSICH
"FISH-FINDER"

Puts Your Bait Where Fish are Biting

Guides your bait across current, holding it in any desired spot in stream within distance of 300 feet. Covers the stream without boat or boots. Use with any pole and line. Try it for new fishing thrills. Enthusiastically endorsed by users everywhere. See Popular Mechanics, April 1951, page 116. Only \$2.00 Postpaid. Money back if you're not satisfied.

The KISSICH Company

213 3rd St., N.E.,

Cedar Rapids, Iowa

BE A GUNSMITH

Like guns? There's a great future when you can make Stocks, ReChamber, Blue Parts & Repair all types of guns. Our residence Course features best equipment and instruction. Low-cost living quarters arranged; part-time work possible. G.I. App'd., easy-pay plan for others. Facts Free, write today.

423 Federal Street Pittsburgh 12, Pa.

LEARN WATCH REPAIRING



AT HOME. By our modern and original system of instruction you can learn every part of the **WATCH REPAIRING TRADE AT HOME.** Prepare yourself for a well-paying position or start in business after completing our course of instruction. Good watch repairers are in demand and generally earn very good salaries. For particulars apply to the **WISCONSIN SCHOOL OF WATCH REPAIRING** 759 North Milwaukee St., Milwaukee 2, Wis.

LEARN CARTOONING Get in the BIG MONEY

Former Landon students are really cleaning up. Creators of "Steve Canyon", "Freckles", "Out Our Way", "Winnie Winkle", "Regular Fellers", "The Neighbors", "Strange as it Seems" are just a few of them. Simplified Landon Picture Chart method makes progress quick, exciting, easy. Earn while learning. Rush 10c for Picture Chart (to test your ability) and full details. Please state age.



Landon School of Cartooning, 5105 CTS Bldg., Cleveland, O.

RAISE RABBITS, HAMSTERS
Cavies & Chinchillas
FOR FUR and BREEDING PURPOSES
Big Demand - Steady Income - From a Growing and
PROFITABLE INDUSTRY

START A PAYING BUSINESS TODAY
Small space required, a ready market, descriptive folder and magazine 10¢. Book - RAISING SMALL STOCK and Magazine 25¢. All the above and magazine (Monthly) for one year \$1.00

Small Stock Farmer, Holmes Park 1, No., HAMSTER

OIL FILTER REFILLS... 10c

Filters Oil the full length of the Pack

10,000 Sq. In. of Filtering Surface

Plates Last Indefinitely

Here's News! Ordinary toilet paper makes an ideal oil filter. Laboratory tests prove it cleans oil faster and better than popular makes of filter elements. All you need is a simple set of **RETLIF ADAPTER PLATES** ... and you can start using ordinary toilet paper rolls in your present oil filter. For proof and descriptive literature, send name and address to:

RETLIF CORPORATION, Dept. 78
1239 No. Highland Ave., Los Angeles 38, Calif.

DRIVING RELIEF! New LEFT-FOOT ACCELERATOR

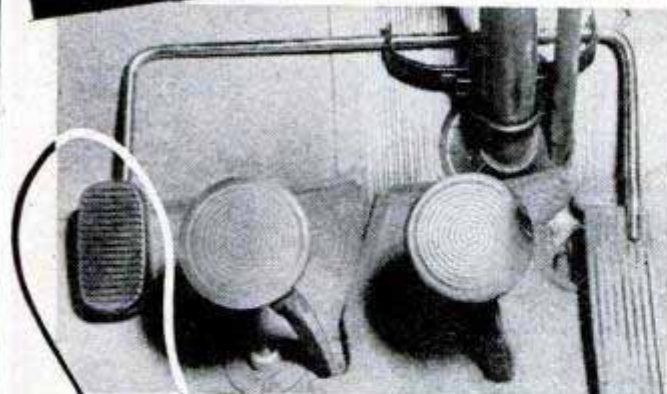

Dealer inquiries invited.

Cut driving fatigue in half with Lefty! Install this new left foot accelerator yourself in 60 seconds with just a wrench--no alterations to your car are necessary. Enjoy relaxed comfort on long drives. Lefty lets you feed the gas with your left foot when you desire, relieves tension and fatigue in leg, back, and foot. Safe, positive and convenient. Swings out of way when not in use. Brings your car up to date. \$5. ppd. Specify year and make. No COD's please.

INVENTOR'S MARKETING LAB.

1210-C De Young Bldg., 690 Market St., San Francisco, Calif.

MAKE \$5 PER HOUR WITHOUT A PRINTING PRESS

PRINTING REVOLUTIONARY NEW SCREEN METHOD

PRINT colorful signs, posters, banners, fabrics, wall paper, show cards--ANYTHING! Print on any surface. NO printing press or special equipment is needed with this amazing "approved" new printing secret. 300% profit on nearly every job. Easy to learn--NO EXPERIENCE or art ability necessary. Exceptional opportunity. Complete illustrated detailed plan and colorful sample FREE--Write.

SCREEN-PRINT COMPANY, Dept. 25
1010 So. Los Angeles St., Los Angeles 15, Calif.

FREE complete "BIG MONEY" Plan and SAMPLE!

EARN AT HOME SPARE or FULL Time

IS \$21000 A WEEK Worth a Penny Post Card?

Then RUSH postcard with name and address. Get FREE details of amazing full-and-spate-time PROFITS made by ambitious men handling new Automatic Defroster for refrigerators on FREE TRIAL basis. Learn how housewives hand you big profits when you just plug in the D-Frost-O-Matic to end defrosting mess forever. Send card for Special Offer TODAY.

D-FROST-O-MATIC Dept. PM-5
6 N. Mich. Ave. Chicago, Ill.

GO PLACES LEARN ANOTHER LANGUAGE

by World's Standard **Linguaphone** METHOD IN 20 MINUTES A DAY

Are you letting interesting job, travel, armed services, opportunities and a whole new world of social advantages pass you by because you speak only one tongue? Speak French, Spanish, German--any of 29 languages, including the Oriental--quickly, easily by the one and only LINGUAPHONE CONVERSATIONAL METHOD. You listen--you learn--you understand--you SPEAK. World-wide educational endorsement; over a million delighted home-study students. FREE BOOK gives fascinating facts. Write TODAY! VETS: 7 languages available under G.I. Bill.

LINGUAPHONE INSTITUTE
143-05 Rockefeller Plaza, New York 20, N. Y.

BOAT KITS Easy To Build



ROWBOATS
10 TO 14 FT.

PRAMS
\$39⁶⁰ up

8 TO 11 FT. ALSO WITH SAILS

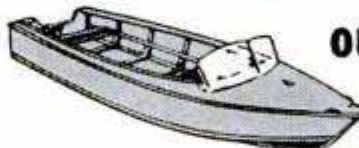

OUTBOARDS
12 TO 16 FT.

INBOARDS & CABIN CRUISERS
16 TO 23 FT.



NEW CATALOG MOST COMPLETE EVER OFFERED

- 1-BOAT KITS--26 MODELS
- 2-MARINE HARDWARE
- 3-MARINE ENGINES
- 4-MARINE CONVERSIONS
- 5-PAINTS & COLOR CHARTS

► All For Only 35c, SEND COIN TODAY
U-MAK-IT PRODUCTS 703P-WHITTIER ST. New York 59, N. Y.



WANT A GOVERNMENT JOB?

START AS HIGH AS \$3,450 YEAR

Many Early Examinations Expected. Prepare NOW!

Veterans Get Special Preference! 40 Page Civil Service Book FREE

Mail Coupon Today SURE

Franklin Institute Dept. S-83

Rochester 4, N. Y.

(Not Government Controlled)

Gentlemen: Rush to me, FREE of charge, list of U. S. government big pay jobs. Send FREE 40-page book describing salaries, vacations, hours, work, etc. Tell me how to qualify for one of these jobs.

COUPON

Name _____
Street _____
City _____ Age? _____

Yes, More Brilliant Than a Diamond!



Amazing New Discovery

Write today for the **FREE** illustrated booklet that tells the full story of the latest miracle of science—the story of a glorious jewel discovered in the laboratories of one of the world's largest corporations. Read all about the Kenya Gem that so closely resembles a diamond that only an expert can tell the difference.

More Fire! More Brilliance!

Yes, this marvelous gem has more brilliance, more fire and a more dazzling display of color than the finest diamond of equal size. You can own an unmounted Kenya gem for only \$27 (1 carat) to \$120 (4 carats); also men's distinctive rings and ladies' fashionable rings and earrings in 14K gold Kenya gems. **EASY PAYMENT TERMS.**

set with expertly cut

The Cinderella of Science

Kenya gems are the sensational discovery you read about in Reader's Digest, Popular Science and Sat. Eve. Post, "the only thing on earth more brilliant than a diamond." It is a true gem, crystallized by science instead of nature.



Write Today or Send Coupon for **FREE** Illustrated Booklet

KENYA GEM CORPORATION, Dept. 285 Philadelphia 44, Pa.

Mail This FREE Coupon Today

Kenya Gem Corporation, Dept. 285, Philadelphia 44, Pa.

Please send me, without obligation, the **FREE** illustrated booklet telling all about Kenya Gems.

Name

Address

City State

CARBURETOR TOO RICH MAKES MOTORIST TOO POOR



Car owners who are wasting money and not getting proper gas mileage due to over-rich mixtures will be pleased to learn how to save gasoline by **VACU-MATING** over-rich mixtures. **VACU-MATIC** fits all cars, trucks and tractors. It is automatic and operates on the supercharge principle. Easily installed in a few minutes.

SALESMEN WANTED! Big Profits! Send name, address on penny postcard for free particulars and how to get yours for introducing.

VACU-MATIC CO., 7617-1750 W. State St., WAUWATOSA, WIS.

High School at Home

Many Finish in 2 Years

No classes. No time wasted going to and from school. Progress as fast as your time and abilities permit. Standard H. S. texts supplied. Thousands enroll each year in this 54-year-old school. Send for **FREE** descriptive booklet.

AMERICAN SCHOOL, Dept. H-545 Drexel at 58th St., Chicago 37, Ill.

Without obligation, please send **FREE** descriptive booklet.

Name

Address

Soap, Wash, & Rinse your car in a Jiffy!

Can also be used to wash windows, walls, boats, porches, garage floors, etc.



Aluminum tube 3 1/2 ft. long. Built-in soap pouch . . . replaceable mop. Insert any household soap or detergent in built-in soap pouch and attach to garden hose.

SUPPLY LIMITED, ORDER NOW!

Money Back Guarantee

E. Z. CAR WASHER

6 Bond St. (Dept. PM2) New York 12, N. Y.



CARTOONISTS

Make money at home while learning as top cartoonists have done. Enjoy success in work you like to do. Simple instructions. Study wherever you live.

We teach Motion Picture and Television Animation, drawing, lettering, colored comic books, and comic strip. Same method as used by film studios. **LATEST TECHNIQUE** FROM CENTER OF CARTOON INDUSTRY. For free information write

HOLLYWOOD SCHOOL OF CARTOONING

Suite 1028P 6253 HOLLYWOOD BLVD.

HOLLYWOOD 28, CALIF.

HISTORY-MAKING TANKS

Accurately scaled, exact replicas by

Authenticast



Send for the Authenticast catalogue, now only 25c.

Miniature models that are the duplicates of the ones used in pre-combat and recognition training and that are scaled replicas of the **EXACT SAME** American and Russian Tanks currently used in combat fighting. Full line of miniature fighting equipment including: Sherman, Gen. Scott and Stalin Tanks, Jeeps, Armored Cars, Tank Destroyers, Landing Vehicle Tanks. Scaled 1" to 108".

COMET METAL PROD. CO., INC.

91-04 132nd ST.

RICHMOND HILL 18, N. Y.

RADIO

ENGINEERING, Broadcasting, Television, FM, Servicing, Electronics, Aviation, Marine & Police Radio taught thoroughly. Engineering course equivalent to 3 years' college radio work. Approved Veteran Training. Catalog free.

VALPARAISO TECHNICAL INSTITUTE, Dept. D, Valparaiso, Ind.

WILL BUY OR PROMOTE YOUR INVENTION OR IDEA

If you have a patented product or an idea of merit, we have the money and organization to buy or promote it nationally. *Complete protection for you!* Bank references available. Write for full information.

Address: **BETTER PRODUCTS • BOX 98, NORTH END STATION • DETROIT, MICHIGAN**

SAY YOU SAW IT IN POPULAR MECHANICS

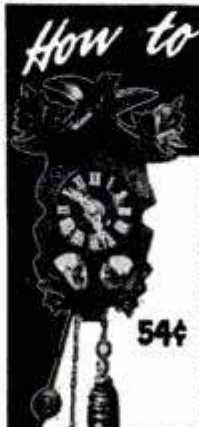

How to IMPORT! For Profit and Pleasure

Men and women! Learn how to import at low foreign prices for buyers in your locality at high U.S. prices.

Big profits possible, no investment in goods, operating world-wide Import-Export business from your own home by mail order, spare or full time. (Example of money saving prices in other countries, at left.) Also big savings on clothes, tools, gems, antiques, watches, china, silk, toys, etc., for your own use. Get **FREE** list of over 1,000 low priced products for import from Europe, the Orient and other parts of the world. World Trade can be carried on in or near small towns—large cities—anywhere—or travel abroad. Practical, low-cost World Trade Course teaches you quickly at home in spare time.

FREE! LIST OF OVER 1000 LOW PRICED IMPORTS

No previous special experience needed. Write today for **FREE** details and your list of Imports. Airmail reaches us overnight.

The Mellinger Co., Exporters-Importers
1418-EB Westwood Blvd., Los Angeles 24, Calif.



GIANT BALLOONS
U. S. Govt. Surplus Genuine Neoprene. Used by Govt. for weather & Target Balloons. Loads of fun for yards, pools, gym, parties. Wonderful for Advertising; Attracts immediate attention.
3 Ft. Dia. 39c 6 Ft. Dia. 79c
13 Ft. Dia. 1.39

**Pride of The Jet Jockeys
U.S.A.F. STYLE BLUE LENS
ZOOM GLASSES**

Quality sunglasses, ground & polished for perfection. Protects vision. Reduces harmful glare. Lens life-time guaranteed. With protective case. Regular \$7.50 value.



\$2.79



TARGET PISTOL ARMY STYLE
Revolutionary new sports pistol. Looks, handles like Army .45. Extremely accurate. Fires B-B's & darts, air powered. Not a toy. With pellets and darts.

FREE Catalogue

\$5.95

Guarantee one year

Dept. Postage paid on prepaid orders
M-551 **WAR ASSETS DIV**
VOLUME SALES CO.
3828 Sunset Blvd., Los Angeles 26, Calif.

LEARN... CERAMIZING
THE NEW HOME ART HOBBY
TURNING WORTHLESS OBJECTS
into VALUABLE TREASURES



\$5 AN HOUR PROFIT
Creating Things of Beauty

Think of learning an artistic hobby in just a few minutes of instruction. Think of turning just 56c worth of material into an art object so beautiful that it brings you \$5.00 an hour for your spare time. Sounds fantastic—yet it's true—as you can easily prove without risking a cent of money. I have ready to mail to you a complete set of instructions so easy to follow that a child can learn this fascinating new art. Within an hour you can be "Ceramizing." The very first day you can create things of beauty from Nature's countless masterpieces of design, such as leaves, flowers, twigs, stones and shells. Preserve and beautify keepsakes such as Baby Shoes—turn 10 cent store products into art objects worth five to ten times their cost—restore and rebeautify hundreds of household articles for yourself and friends.

Amazing Book Tells You

How to do the work—what to decorate—what materials you need—where to buy them cheaply—how to get customers coming—what to charge—how to start a business in spare time without risking job or paycheck that can lead to future independence. You read all this without risking any money at all. Just send name.

FREE Pay Me Nothing for this Information
This fascinating home hobby is used by many as a means of steady extra income. Fun for the whole family—and money besides. Read the entire plan—all instructions—at my risk. **DON'T SEND MONEY—JUST YOUR NAME FOR COMPLETE DETAILS FREE.** Address **R. E. Brandell, WARNER ELECTRIC** 1512 JARVIS AVE., DEPT. 35, CHICAGO 26, ILL.

R. E. Brandell, WARNER ELECTRIC, Dept. 35
1512 Jarvis Ave., Chicago 26, Illinois

Please rush complete facts showing how I can start "Ceramizing" business at home for pleasure or profit. No charge. No obligation. All FREE.

NAME _____
ADDRESS _____
CITY _____ ZONE _____ STATE _____

WANT TO Write Stories
Articles Mysteries?
FREE LESSON shows how you learn at home



The demand for writers is creating great new opportunities and it's not as hard to succeed as you may imagine. At home, you may learn fiction writing, best basis for all fields; short stories, radio & TV, articles, business items. Palmer training is endorsed by famous authors, scores of successful graduates. Complete instruction, professional coaching. FREE book and lesson show how you may enjoy an ideal part-time or full-time career. Write TODAY (no salesman will call). Approved for veterans; advise if eligible.

PALMER INSTITUTE OF AUTHORSHIP, Since 1917
1680 N. Sycamore, Hollywood 28, Calif., Desk T-51

Coated! Featherweight!
16x50 \$69.50

The ultimate in a fine binocular. Tremendous power. Featherweight (weighs only 31 ounces!). Precision made in every detail. COATED providing sharper, brighter images. Individual focus. Objective lens is 50 MM (2 inches) across! UNCONDITIONALLY GUARANTEED. Complete satisfaction or your money refunded. Prices include genuine leather carrying case and straps. Add tax. \$2.00 deposit required on C.O.D.'s. Cash orders prepaid.

United Binocular Co., 9043 S. Western, Dept. ARF-2308, Chicago 20

Say You Saw It in Popular Mechanics

AERONAUTICAL ENGINEERING

Design Aircraft & Components—Study with Jets & Rockets—Great Future—Advanced Aeronautical Subjects—World-Wide Enrollment—Fully Accredited—Established 1929—Approved for Vets—CAL-AERO grads in heavy demand.

WRITE TODAY for Special Information. PM-5

NAME _____ AGE _____
ADDRESS _____
CITY _____ ZONE _____ STATE _____

CAL-AERO TECHNICAL INSTITUTE
GRAND CENTRAL AIR TERMINAL • GLENDALE 1, CALIFORNIA

HERE'S A REAL MONEY MAKER FOR YOUR HOME WORKSHOP



WELDS CUTS SOLDERS BRAZES CHARGES BATTERIES

ORDER YOUR WELDER NOW
Fill out and mail to
THE LINCOLN ELECTRIC COMPANY
Dept. 192
Cleveland 1, Ohio

"LINCWELDER 60"
New Lincoln Arc Welder
Cash in on these Profitable Jobs!

Be the handyman welder for your neighborhood. Repair damaged car bodies and fenders. . . fix toys and garden tools . . . braze and solder broken parts . . . recharge batteries.

- Simple to install . . . operates from 115 volt grounded circuit. (No. 12 wire fused for 20 amps.)
- Approved by Underwriters Laboratories.
- Comes complete with full instructions.

Ship me the "Lincwelder 60" with accessories \$48.00 (Including headshield, electrodes, carbons, electrode holder, ground clamp and cable). Arc Torch \$6.25 extra

Battery Charging Attachment \$10.00 extra.

Enclosed is check money order

Send me free bulletin on the new "Lincwelder 60"

Name _____
Address _____
City _____ State _____ 192

**RELIEVES
HEADACHE
NEURALGIA
NEURITIS PAIN**

FAST



Here's Why...

Anacin® is like a doctor's prescription. That is, Anacin contains not one but a combination of medically proved active ingredients. Anacin is specially compounded to give FAST, LONG LASTING relief. Don't wait. Buy Anacin today.

**Shoot your own
TALKING PICTURES!**

...with the New "Cine-Voice"
16mm Sound-On-Film Camera.
\$695.00, money-back guarantee.



Write for free illustrated folder.

BERNDT-BACH, Inc. 7333 Beverly Blvd., Los Angeles 36, Calif.

16mm SOUND-ON-FILM EQUIPMENT SINCE 1931

**SAY YOU SAW IT IN
POPULAR MECHANICS**

**LEARN TELEVISION
RADIO-ELECTRONICS**

Learn in your home. Then earn BIG PAY and SECURITY. Tremendous growth has made more jobs than there are trained men! NOW is the time to get into this essential, NEW, RICH field of OPPORTUNITY. FREE placement service. SEND FOR FREE, BIG ILLUSTRATED CATALOG.

MAIL TODAY -----

I want complete information on how to succeed in Television, Radio, and Electronics. This does not obligate me in any way.

NAME _____

ADDRESS _____

CITY _____ STATE _____

CENTRAL RADIO & TELEVISION SCHOOLS
Dept. B-5, 1644 Wyandotte, Kansas City, Mo.

**FREE
BOOK**

JUDO

"THE BIGGER THEY ARE —
THE HARDER THEY FALL!"

Two Big Books Clearly Illustrated. Over 1200 Show-How Photos. Many New Holds! 71 Complete Lessons.

Protect yourself and others. Size and strength mean nothing. Knowledge and skill enable you to master any situation even against biggest bullies and armed thugs. Illustrations showing each hold from start to finish. Complete satisfaction guaranteed or your money refunded.

NOW VOL. I & VOL. II \$5.00 pp'd.
or \$3.50 ea. \$1.00 deposit with C.O.D.'s.

No C.O.D.'s outside U.S.A.

IMPROVED JUDO, INC. Dept. PM-5, P.O. Box 7355,
Sta. L. Los Angeles, Calif.



**10 DAY
FREE
TRIAL!**



Bar Bells

Buy Direct From Factory
Approved and Recommended by
Karl Koberle (Foremost Ex-Army
Instructor on Weight Training).

\$895 up

Write for free booklet and price list.
INDEPENDENT IRON WORKS
2416 East 23rd Street, Dept. B
Los Angeles 58, Calif.

TASOPE PHOTO-ENGRAVING PLANTS



Establish your own profitable PHOTO-ENGRAVING business. Make cuts for newspapers, printers, and advertisers. Make etched name plates, plaques etc. Instructions furnished, no experience necessary. Sold direct from factory since 1931. First five hundred cuts sold locally or by mail will pay for plant and pay you well for your time. Write for FREE catalog.

TASOPE DEPT. PM5, AURORA, MO.

MATERIAL COST
OF THIS CUT 1/4
SELLING PRICE
\$1.00 AND UP



SPORTONE MUFFLERS

- Ford & Chevrolet.....\$ 4.45
 - All other popular cars..... 5.45
 - V-8 Dual Sets..... 15.95
 - Chromed Silentips..... 2.95
- (Please state make & year of car on all orders.)

SANDEE MUFFLER CO.
5643 Corryne Place • Culver City, California

Learn NEON

AMERICA'S TOP-PAY TRADE!

BE A NEON EXPERT! Earn \$16 to \$24 a day or start local business. Learn how to make, repair and service NEON SIGNS. Easy, illustrated lessons (15) show how. ONLY COURSE OF ITS KIND! Send \$2 or order C.O.D. Positive Money-back guarantee. **MODERN PUBLISHING CO., Dept. PM-1, 1646 Florida Ave., Long Beach 12, Calif.**



SILVER SOLDER TORCH & KIT \$6



**Joins All Metals Permanently
EQUAL TO WELDING FOR MOST PURPOSES**

Do your own repairing. Kit includes one tube silver solder flux and 10 5-in. lengths silver solder alloy. Hottest ALCOHOL TORCH known. 2700° F. flame. Operates in any position, indoors or out. Torch alone \$5.50. Kit alone \$1.50. Complete instructions included with torch and kit. Add 25c on each order towards shipping charges.

AMERICAN PRODUCTS CORP., 422 S. Dearborn St., Dept. 3-E, Chicago 5

Learn PHOTOGRAPHY at Home

Splendid opportunities. Prepare in spare time. Practical basic training. Long-established school. Send for free book, "Opportunities in Photography." No obligation.

AMERICAN SCHOOL OF PHOTOGRAPHY
835 DIVERSEY PKWY. Dept. 1355 CHICAGO 14, ILL.

WAR SURPLUS OPTICAL BARGAINS

MAKE A MICROSCOPE Get wonderful results. Own an instrument worth many times the cost to you. Simply convert a U. S. Govt. Rifle scope (Govt. cost over \$65.00). It's easy! We show you how. No machining required. Get up to 40 Power. Scope we furnish is used but good condition . . . sent complete with extra lenses and direction sheet.

Stock #959-H \$7.90 Postpaid
TO POWER SPOTTING SCOPE —A WONDERFUL BUY! Pocket-size! Complete with tripod and swivel head. Only 5 1/2" long—8 1/2" high on tripod. Adapted from Army telescope and worth many times our price. Has prism erecting system, achromatic objective, Ramsden Eye-Piece. Lenses low reflection coated.
 Stock #955-H \$14.95 Postpaid

SLIDE PROJECTOR SETS Consists of all unmounted lenses you need to make the following size projectors:
 Stock #4029-H—35 mm. \$2.85 Postpaid
 Stock #4038-H—2 1/4" x 2 1/4" \$3.35 Postpaid
 Stock #4039-H—2 1/2" x 3 1/2" \$3.35 Postpaid

SIMPLE LENS KITS Include plainly written, illustrated booklet showing how you can build lots of optical items. Use these lenses in photography and for dozens of other uses in experimental optics, building TELESCOPES, low power Microscopes, etc.

Stock # 2-H—10 lenses \$ 1.00 Postpaid
 Stock # 5-H—45 lenses 5.00 Postpaid
 Stock # 10-H—80 lenses 10.00 Postpaid

We Have Literally Millions of War Surplus Lenses and Prisms for Sale at Bargain Prices. Numerous Types of Instruments, Too! Write for FREE CATALOG-H

EDMUND SCIENTIFIC CORP., Barrington, N. J.
 (Formerly Edmund Salvage Co.)

Learn CARPENTRY BRICK LAYING

Get into the billion dollar building trades. Learn now while opportunities are greatest. Train in our completely equipped shops under expert instructor. G.I. Approved. Enroll now. Limited classes. Write for FREE Catalog.

MIDWEST SCHOOL OF BUILDING TRADES, Dept. PM-5
 411 N. Center St. Bloomington, Ill.

SHORTHAND IN

Famous Speedwriting system. No signs; no symbols; no machines. Uses ABC's. Easy to learn, write, transcribe. Low cost. 100,000 taught by mail. Also typing. 28th year. Write for FREE booklet to:

Speedwriting
 Dept. 1505-1

55 W. 42 St., N. Y. 18, N. Y.

6 WEEKS AT HOME



NEW, IMPROVED CALCULATOR FOR WOODWORKERS only 25c

Instantly gives information on lumber, nails, concrete mixes, painting materials, etc. Convenient, simple to read. Just set dial for nail specifications, to convert linear to board feet, find bit sizes for screws, compare characteristics of woods. 6" diameter heavily varnished cardboard. Send 25c, no stamps, please to Greenlee Tool Co., 2105 Columbia Avenue, Rockford, Illinois.

WATCHMAKING

Learn at home • FREE sample lesson
CHICAGO SCHOOL OF WATCHMAKING
 1608 N. Milwaukee Avenue Dept. 151 Chicago 47, Ill.

SEND FOR FREE From New York's Leading PAWNBROKER **GENUINE DIAMONDS** CATALOG

Approx. 1/2 Carat Reg. \$89 incl. tax \$200

DIAMONDS

Fantastic values. Fine diamonds from Banks, Estates, Unredeemed Pledges. Re-set in smart new men's or lady's mountings of 14 kt. yellow or white gold. 10 DAY MONEY BACK GUARANTEE. Established 1882, we have sold over 1,000,000 satisfied customers. Order from this ad, or write for FREE CATALOG. Our references . . . your own bank or any Mercantile Agency.

KASKEL'S • Kaskel Bldg., 9 Columbus Ave. New York 23, N. Y. Dept. P-1

MONEY BACK GUARANTEE
SAVE up to 50% and more

FREE



A NEW HOME INDUSTRY



Let us show you how extremely easy and PROFITABLE it is to make beautiful and useful things out of LIQUID PLASTICS, LIQUID MARBLE, LIQUID IVORY, LIQUID GLASS, CERAMICS, ETC. . . . as easy as pouring water out of a glass! We have started THOUSANDS of people in this fascinating and very PROFITABLE home occupation! Make novelties, jewelry, gifts, artware, toys, tools, dies, gadgets, ceramics . . . a million useful things! We supply everything—MATERIALS, INSTRUCTIONS and BUYERS! Send only 25c for 1. Big catalog of 300 casting materials, molds and accessories. 2. A beautiful CASTING FREE (to show you what you can do), and 3. Actual INSTRUCTIONS on how to cast and start in the CASTING BUSINESS! VALUABLE MOLDS given FREE with orders! Send 25c today — this may be the lucky coin that will start the most fascinating and profitable phase of your life.

BILLIONS for DEFENSE!



The country is preparing the greatest peace-time defensive in history . . . BILLIONS are being spent! Our liquid plastics are being used in THOUSANDS of different operations in defense work! NO SPECIAL TOOLS OR MACHINERY REQUIRED! Work can be done at home, garage, shop, etc. Full time or spare time, by the able and the disabled. We help you get defense work and instruct you in all the details! Send only 25c for our big catalog and details how to take part in this tremendous defense program that offers you a grand opportunity to combine patriotism and profit!

PLASTICAST COMPANY (Dept. C)
 P. O. BOX 6737 (Write to P. O. BOX 987 CHICAGO 6, ILL. either address) PALO ALTO, CALIF.



CARTOON SCHOOL

ONLY SCHOOL TEACHING CARTOONING EXCLUSIVELY Billy Hon nationally known cartoonist director. Draw comic strips, gag cartoons, editorials, sports, commercial cartoons and caricaturing. Cartoonists needed for television. Approved for Vets.

2921 Beverly Blvd. BILLY HON Los Angeles 4, Calif.

LET US PUT THIS MAMMOTH NEW 1951 19 1/2" - INCH Picture

MIDWEST TELEVISION
 In Your Home on 30 DAYS MONEY BACK TRIAL



Don't buy any radio or television receiver until you've seen the new 1951 Midwest Line — it's the finest in 31 years.

FACTORY-TO-YOU

SEND THIS COUPON ON 1c POST CARD FOR NEW 1951 FREE 4 COLOR MIDWEST CATALOG

MIDWEST RADIO & TELEVISION CORP.

Dept. 25-M, 909 Broadway, Cincinnati 2, Ohio

NAME _____
 ADDRESS _____
 CITY _____ ZONE _____ STATE _____

EASY TERMS

Announcing the NEW...POPULAR MECHANICS MAGAZINE LIBRARY FILE



Check these
Outstanding
Features

1 Convenient size, measures 6 3/4" wide, 3 3/8" thick x 10" high. Ideal for tabletop, shelf or bookcase storage.

2 Special Reference Index Form, printed on back, records exact location of selected articles, diagrams and other information.

3 Date Label Stickers—enough to index ten years issues, furnished FREE.

NEW! NOVEL! INEXPENSIVE!
Never before so much convenience and utility at such a low price. So act now. Place your order today!

INGENIOUS CUSTOM-BUILT STORAGE FILE

A Sensational Popular Mechanics Value Scoop!

Now you can preserve every issue of Popular Mechanics Magazine in orderly, chronological sequence... indexed and ready for instant reference! Made of high quality kraft fibre board, printed in rich colors and constructed to look like an attractively bound book, Popular Mechanics Magazine Library Files enhance the reference value and double the usefulness of your collection of Popular Mechanics Magazines.

Serviceable, convenient, handsome in appearance, Popular Mechanics Magazine Library Files make every volume and article instantly accessible. No more hunting for the issue or special data you want. No misplaced copies. A "must" for every reader of Popular Mechanics. Order now for immediate delivery. Use the handy coupon below.

PER SET OF 2
(Set holds 12 issues)

Only

70¢

POSTAGE PAID

5 SETS **\$3.10**
ONLY

10 SETS **\$6.00**
ONLY

POSTPAID

Best of all, production economies by the distributor service organization appointed by us to serve your needs—plus our large volume purchases—makes the phenomenally low cost of the Libraries possible.

USE THIS COUPON...Mail Today

POPULAR MECHANICS MAGAZINE, Dept. PL
200 East Ontario Street, Chicago 11, Illinois

P5-51

Please rush PREPAID _____ sets Popular Mechanics Magazine Library Files.

Remittance for \$ _____ is enclosed.
(AMOUNT)

PRICES — 1 set (2 files) Holds 1 yr's. issues only \$.70
5 sets (10 files) Holds 5 yr's issues only \$3.10
10 sets (20 files) Holds 10 yr's issues only \$6.00

Includes Prepaid Parcel Post anywhere in U.S. and Possessions

Name _____

Address _____

City _____ Zone _____ State _____

**WORLD'S
BEST
WANT AD
MEDIUM**

CLASSIFIED Advertisements



Advertisements in this section 85 cents per word, each insertion, minimum 10 words, payable in advance. To be inserted under proper classification, copy must be in our office the 20th of the second month preceding date of issue
F. W. Johnson, Manager, Classified Advertising
Popular Mechanics Magazine, 200 East Ontario Street, Chicago 11, Illinois

YOU'LL PROFIT

By reading and answering the classified ads in this section. Hundreds of opportunities for you to make and save money

AUTOMOBILES, MIDGET CARS

ATTENTION! Ford owners. Model A, B and T parts. Model A Motors, Unionville, Conn.

MOTORISTS—Save gas! New automatic vaporizer helps your car attain more speed, power and better efficiency. Get premium performance with regular gas! Up to 25% better mileage! Money back guarantee. Free literature. Write today while supply lasts, only \$5.95 postpaid, C.O.D.'s require \$1.00 deposit. List make, year and no. cylinders. Vaporizer Company, Box 7033M, Station G, Los Angeles, California.

"HOW To Get 150 MPG." New, authentic book shows how. Full sized passenger cars go 150 miles per gallon gasoline. Also "1951 Speed-Economy Catalogue." Both 50c postpaid. Newhouse Automotive Industries, 5803-B1 East Beverly Boulevard, Los Angeles 22.

CHAMPION, AC, Auto-Lite spark plugs. Rebuilt. Guaranteed 10,000 miles. 25c each, 23c sets of 6. Postpaid. Wholesale discounts available. State brand, type, quantity. Philip Minor, 1723 Holman Street, Covington, Kentucky.

SPEED Directory—Lists speed manufacturers, dealers, clubs, specialists, etc. Lots of pictures. 50c postpaid. Racing book list free. Autobooks, Box 409P, North Hollywood, California.

STOP Headlight glare with new Polarvision light! See page 34.

47 WHIZZER Motorbike engine \$7; Briggs engine \$5; Maytag \$4. Motorette \$25, midget car \$25, less engines. Four balloon tires \$3. Mailorder only. Send 25c for new catalogue number 41, just out, listing these and hundreds of other bargains in new and used midget cars, motor-scooters, homebuilders parts, plans, transmissions, clutches, engines, war surplus, etc. (35c by first class mail). Midget Motors Directory, Athens, Ohio.

"SPEED & Mileage" manual. Famous power book shows how to build speed equipment, racers, fast conversions, California roadsters! Covers souping, speed tuning, racing tricks, fuel formulas, economy information, Indianapolis methods, customizing; all cars! 300 photographs! Drawings! Restyling plans! Complete with hot rod kit, \$1.98. Almuist Engineering, Milford 41P, Pennsylvania.

FROM Speedway to roadway! Track-proved hi-speed heads and manifolds now available for your passenger car! No special tools needed! Increase horsepower 25%! Astounding getaway! Free illustrated catalog. Speedsport, 6215P Diversey, Chicago 39.

BIGGEST Racing and hot rod catalog in world, just out! Lowest prices. Hollywood mufflers \$4.50, duals \$15.90, chrome megaphones \$1.55, dual manifolds \$9.95, racing cams \$29, heads \$23.50, water injectors \$12.95, superchargers, bargains! Free power calculator included. 25c coin or stamps. Almuist Engineering, Milford 43P, Pennsylvania. (Dealers wanted.)

SMITHYS Mufflers for all automobiles. Free list. Buck's Auto Parts, Box 1296H, Merced, California.

CALIFORNIA Custom accessory headquarters. Buy direct from original designers and save. Chrome dash panels, push button door, trunk conversions, chrome motor accessories, lowering kits, speed-dress-up equipment, 1951 catalog, 40 pages, hundreds of photos—25c. Eastern Auto, 3319A South Grand, Los Angeles 7, Calif.

WATER Injection. Also economy, power, methods. Free illustrated information. Neher Industries, La Verne, California.

MIDGET Autos. Assemble yourself. Complete kits. Write David Redlus, 653 State, Camden, N. J.

AUTO SUPPLIES AND EQUIPMENT

AUTO Parts, accessories, body hardware, seat covers. Lowest prices. Fannie Berkson, 2019 So. Wabash, Chicago 16, Ill.

INCREASE! Gasoline mileage three to five miles per gallon; guaranteed gasoline vaporizer increases power; reduces carbon; easier starting. \$3.50 each. Turb-O-Vane, 1024 West Vine, Stockton, Calif.

OFFENHAUSER'S New catalog available. Send 25c. Complete line of speed equipment. Offenhauser Equipment Corp., 5054-p Alhambra Ave., Los Angeles 32, California.

GENUINE Fairprene 7x10 diaphragm fabric, outfits two auto fuel pumps, sent postpaid for \$1. M. Felland, Box 1950, Great Falls, Montana.

STOP Car oil waste. No costly repair. Instructions 25c coin. R. S. Furrage, R. D. #2, Conneaut, Ohio.

PLYMOUTH Owners! Startling new power jet! Amazing get-away! Install it yourself. \$3.00 postpaid. Future Enterprises, Inc., 129 Euclid, Grand Forks, N. D.

NEW Government surplus. Low voltage circuit tester in steel box cost \$202. Our price \$27.50. 3 jaw 2" Universal chuck 19/32" bore \$4.75. Hein Werner hydraulic transmission jacks list \$65.00, net \$27.50. Will test batteries, starters, generators, voltage regulators, grounds, short circuits. Wilt Electrical Company, 7829 S. Racine Ave., Chicago 20, Ill.

"LIQUID-Diamond" car cleans cleaner, waxes brighter, lasts longer. \$1.00 postpaid, 50% commission. Box 394B Union, New Jersey.

SAY, Mr. Motorist! Having car trouble? Perhaps your car burns oil, lacks compression, starts slow. Then you need Piston Seal! Why? Because Piston Seal form pliable, lubricating seal around pistons that is self-expanding. Result: it compensates for excessive cylinder wear! Reduces oil loss, checks piston slap, restores compression—and lasts ten thousand miles! Made in Britain; famous throughout Europe; now available here! Easy to use; absolutely safe. Can be used with similar benefit on tractors and stationary engines. Details on request. Philbrick, Dept. 4, Drawer 4590, Coral Gables 34, Florida.

AIR Horns. Blast like dynamite! Beautiful. I love them. If you do too, send postcard for free new catalog. Tom McCanna, 148-X East 40 Street, New York 16.

SPOTLIGHT, portable. Plugs into cigar lighter. No installation. Free details. Jay Sales, 2857 Sherman Blvd., Milwaukee 10, Wisconsin.

VAPJET Helps save gas, engine wear, carbon accumulation and increase power with water-alcohol vapor injection. \$9.95 postpaid. \$1 deposit c.o.d. 30 day money-back agreement. Easily installed. Free details. Agents wanted. Bantel, 757-AF Venice, Los Angeles 15.

SOMETHING New. Brush for cleaning automobile parts, gears, machinery, tools. Sample 35c. Agents wanted. Enco Sales, Loveland, Ohio.

TIRE And wheel lock. Tamper proof. Fits all passenger cars. \$7.95 postpaid for set of 4. Includes extra keys. Money back guarantee. Mid American Specialties, 137 N. Central Ave., Chicago, Illinois.

OVERDRIVE Sig-Na-Lite for cars with overdrive or fourth speed. Indicator flashes green light when proper speed is reached. No guessing or forgetting. Saves gas, oil, motor wear. Permits "clutchless shifting." Mounts on dash. Installed in 5 minutes. \$2.95 complete postpaid. C.o.d. small fee. Quality Products, 5227 Parker Ave., Chicago, Illinois.

MOTORIST Save gasoline by Vacu-mating overrich mixtures. Fits all cars. For free particulars write Vacumatic, Dept. 1749, Wauwatosa, Wis.

AUTO Seat saver. Protect front seat with durable water-proof, acid-stain resistant heavy plastic cover. Elastic bands insure good fit. Specify solid or split front seat. \$1.50 postpaid. Lin-Mar Company, Box 2568B, Baltimore 15, Md.

MOTORISTS Vacumizer improves performance, economy, power. Protects valves. Easily installed. Inexpensive. Free Literature. Auto-Vacumizer Co., Box 357P, Granville, Ill.

ROAD And Track Racing Magazine. Complete coverage custom, foreign, road tests, technical data, etc. Sample copy 35c, \$3.50 yearly. Complete list of automobile racing books and magazines free. Autobooks, Box 409-P, North Hollywood, California.

LADIES, Gentlemen. Drive car anywhere. Be secured. New trouble shooting booklet, \$1.00. Nicholas Saponar, 5-27—50th Ave., Long Island City 1, N. Y.

TEMSITE Puts money in the pockets of owners of auto, truck, tractor, batteries: Double life (or more) of new batteries; restores life to old batteries, even to 80% of "trade-ins" and "junkers"; eliminates recharging; prevents freezing to 45 below zero and overheating to 120 above; run down any Temsite treated battery, wait 10 minutes and battery turns motor over again; treated batteries require water only 2 or 3 times yearly, and will stand idle 4 to 5 times longer without losing power; starts cars quicker, lessens wear on starter, generator, gives hotter spark, quicker pickup, better mileage, brighter lights. Will not injure battery. Will not restore batteries with shorted or buckled plates, or no plates left. Proved during 14 years' use by hundreds of thousands of users. Now sold only by mail on direct guarantee—if not satisfied after 30 days' use, your money refunded. Send \$2 for "life of the battery" treatment for any 3 cell, 6 volt battery. Industrial users (diesel, bus, airplane, utility, heavy duty truck, etc.) and fleet owners write for information, prices and data sheet. The Tems Corp., P.O. Box 149, Niagara Sta., Buffalo 2, N. Y.

STOP Headlight glare with new Polarvision light! See page 34.

NEW And used guaranteed parts for civilian and army cars and trucks. Largest stock in America. Mail orders. Pioneer Auto Wrecking Co., 734 W. 13th Ave., Denver, Colorado.

CHEVROLET Parts. Scarce motor, body, sheet metal parts. Grossman Chevrolet, Minneapolis, Minnesota.

power in your old Buick. Same day service from world's largest stock of new (not rebuilt) Buick parts and engines. Ship anywhere. Write today. Robertson Buick Co., 1001 S. Wabash Ave., Chicago 5, Ill.

NEW Economy, power, methods. Free information. Neher Industries, La Verne, California.

AUTO Parts and accessories. Briggs Automotive Engineering of Chicago, P.O. B. 3454 Merchandise Mart, Chicago 54, Ill.

FOR Free descriptive literature on alcohol-water injection for cars, trucks, tractors write Shade, Webster, New York.

BRUSH Plating outfits connect to a battery. No tanks or shop required. Free particulars. Gunmetal Co., Avenue J, Decatur, Illinois.

LACHAPELLE'S 100,000 Miles motor and motor fuel treatment (patented). Makes any gasoline motor better. \$3.00 postpaid. Ferns Products, 8120 Walnut Dr., Los Angeles 1, Calif. (Data on request.)

1951 EDITION! It's new! It's different! Get world's largest auto accessory and parts catalog and save money. Over 50,000 items, including Hollywood accessories, hi-speed equipment, rebuilt engines, all parts and accessories for all cars and trucks. We have that hard-to-get part! Jam packed with bargains. Completely illustrated. Send 25c (refundable). J. C. Whitney, 1919 Archer, Chicago 16.

AUTO TRAILERS

PLANS—16'-Trailer, expertly prepared, easy to build, \$2.00. Freeland Engineering, 16587 Freeland, Detroit 35, Michigan.

BUILD Your own trailer! Plans for all kinds. Illustrated catalog 10c. Jim Dandy, 125-M, Wausau, Wisconsin.

MOTORCYCLES, BICYCLES, MOTORSCOOTERS AND SUPPLIES

MOTORCYCLE Pistons, parts, new, used. Harley, Indian, Henderson. List and wings pin 25c. Ballak, 811 N. 9th, St. Louis 1, Missouri.

MOTORCYCLE Magazine—Worldwide coverage. Yearly subscription \$2.00. Sample 20c. Motorcycle News, 5424-A Sawyer, Chicago 25.

INDIAN, Harley, new, used parts book 15c. Bootz, 1700 East University, Des Moines 16, Iowa.

EIGHTY Illinois State Police motorcycles. Harley Davidsons and Indians. Excellent condition. Low mileage. Like new. Public and dealers invited. Elgin Salvage Truck & Auto Wreckers, 751 N. State, Elgin, Ill.

WHIZZER In Schwinn bike \$20; good motorscooter (twist grips) \$22.50; midget racer \$15; Shaw bicycle motor \$15. Send 25c (35c first class mail) for catalog #18 jammed with other sensational bargains in wheels, motors, clutches, motorscooters, midget cars, motorettes, motorbikes, etc. Gail, 538 Erie, Toledo, Ohio.

HARLEY-Davidson parts, accessories, repair manuals on all models. 24 hour service. Authorized factory dealer. Philadelphia Harley-Davidson Company, 857 North Broad Street, Philadelphia 23, Penna.

RECONDITIONED Motorcycles and motors. Chromium accessories. Complete stock Indian parts. Expert rebuilding. Past service. Indian Motorcycle Sales, Kansas City 1, Mo.

REBUILT Gasoline engines \$9.00 to \$30.00. Cauffiel Motor Industries, Temperance, Mich.

HARLEY-Davidsons—All models and prices. Genuine late and old model supplies. Expert service. Send 25c for bulletin. Knuth's, 1753 Muskego, Milwaukee, Wis.

WHIZZER (All attachments) \$25; Cushman motorscooter, extra tires, \$20; Indian motorcycle \$30 complete; midget car \$35. Rush 25c (35c first class mail) for catalog #947 listing these and scores of other amazing bargains in motors, midget cars, motorscooters, motorbikes, motorcycles, etc. Associated, Box 1764-CS, Toledo, Ohio.

AVIATION

PROPELLERS—For sleds, airdrive boats. Literature. Standard Aircraft, Box 387, Ft. Worth, Texas.

REAL Edison batteries. Long unconditional guarantee. 37 to 600 ampere sizes. Free interesting literature. Hawley Smith Co., Croton Falls 1, New York.

ELECTRICAL SUPPLIES

BE Independent, be secure, have your own profitable business—Earn \$20.00 and more a day making beautiful, fast-selling lamps at home. No equipment needed. Illustrated course teaches you quickly. Course, parts catalog, wholesale price list—only \$2. Gearon Co., Dept. 200-B5, 27 S. Desplaines, Chicago 6, Ill.

LAMPS—Build own originals, parts wholesale, any amounts. Catalogue 10c. Brown Lamp Co., Box 501, Wellston, St. Louis 12, Missouri.

LEARN Automotive starter-generator-regulator rebuilding. Introductory manual \$1.00. Modern Technical Manuals, Box 4704, Kansas City, Mo.

ELECTRICAL Pencil—Writes, engraves all metals. \$2.95. Reb Industries, Elmhurst, Illinois.

MOTORS—1/100, 1/25, 1/4, 1/3 Hp. Nationally known make. All a.c. Immediate delivery. Write Mercury Electric Corporation, 719 Wyandotte, Kansas City 6, Mo.

LAMP Parts—Sockets, wire, harps, cords, bases, pipes—all parts to build and repair. 64 page catalog with charts and instructions 25c. Gyro Lamps, 5402P Clark, Chicago 40.

ELECTRIC Pencil: Engraves all metals \$1.50. Beyer Mfg., 10511-H Springfield, Chicago 43.

WELDING, SOLDERING, PLATING

ACETYLENE Welding outfits, new \$49.00; used \$29.00; arcwelders \$46.50. Eagle Welding, Dept. PM, 5085 Broadway, Chicago 40, Ill.

BUY Direct from factory. Welding and cutting equipment. All makes of equipment repaired. Established 1913. Box 331, Hamilton, Ohio.

RADIATOR Repairing books, supplies, equipment, gasoline torch. Write. Curfman Co., Maryville, Mo.

MACHINERY, TOOLS, SUPPLIES

FLEXIBLE Shaft tool and motor by Fairchild for grinding, polishing, sanding, buffing, carving. Original price, \$19.95. While they last special price \$12.95. Public Sport Shops, 11 S. 16th Street, Philadelphia 2, Penna.

MACHINES For your shop. 15" lathe, \$280. 14" crank shaper, \$410. 4 ft. metal planer, \$430. Power hack saw with motor, \$140. Drill press, \$180. 23" x 10' lathe, \$640. 24" x 28", \$1640. Auto conversions and parts. Marine manifolds for all engines. Your transmission converted to marine gear, propellers, shafts, struts, couplings, etc. Everything you need for your boat. Money back guarantee. Conversion Parts Co., 278 Adams Street, Boston 22, Massachusetts.

AUGER Bit. Sensational new design fits all 1/4" or larger power tools. 3/8", \$1.00; 1/2", \$1.05; 5/8", \$1.10; 3/4", \$1.15; 7/8", \$1.20; 1", \$1.25. Best buy, set \$6.50. Money back guarantee. Barclay Co., Box 883, Plainfield 7, New Jersey.

DRILL And reamer booklet. 32 pages know how, plus time saving tap selector, plus tool catalog, all for 25c. Refunded on first order. Barclay Co., Box 883, Plainfield 7, New Jersey.

FREE Catalog. Full line hobby and light industrial power wood working tools. Guaranteed. Dealers wanted. Backus Machine Co., Chippewa Falls, Wisconsin.

WATCH Makers lathe, gov't surplus, complete with motor, foot pedal and chuck. Value \$225.00, like new, \$87.50. Public Sport Shops, 11 S. 16th Street, Philadelphia 2, Penna.

ONLY \$3.95 For 2" Universal lathe chuck, \$14 value. Check or money order. Har-Mur, 2349 Devon, Chicago 45, Ill.

GOVERNORS And butterflies for autos or any gasoline-driven engine. Candee-Smith, P.O. Box 612, Riverside, California.

MACHINE Tools, industrial equipment bought, sold. Berg Machinery, St. Louis, Mo.

CONCRETE Block machines, Standard sizes. \$39.50. Average 400 daily. Free catalog. Concrete Machine Company, 5129 South Compton, St. Louis 11, Mo.

threaded 1 1/2"-8, 1"-8, 1"-10, 1"-12, or with adapter recess. The only complete line of bench lathe chucks built to heavy duty standards. Other chucks to 16" diameter. Write for quotation; free literature. No obligation. Westcott Chuck Co., 3600 Walnut, Oneida, N. Y.

POWER Tools. Build your own with Lewis castings. Save up to 80%. Complete castings, material and blueprints supplied for 23 woodworking and metalworking tools. Illustrated brochure, 10c. Write today. Lewis Machine Tool Co., 3217 Union Pacific Avenue, Dept. M, Los Angeles 23, Calif.

BOATS, OUTBOARD MOTORS

FASTEST Boats in the world—Build now. Complete plans available for sleek three point racing hydroplanes, runabout and others. Send 25c immediately for illustrated catalogue. Champion Boats, P.O. Box 9038, Dept. 22-E, Long Beach 7, Calif.

SAVE 2/3 Cost. Assemble your own boat. We furnish parts. No experience necessary. Rowboats, cruisers. Illustrated catalog 25c. Midwest Boat Company, Menomonee Falls, Wisconsin.

BOATING Men, save many dollars by purchasing a Masters rebuilt marine engine or outboard motor. Also propellers and marine supplies. 10c brings complete lists. Masters, 212 W. Chicago Ave., Chicago 10.

FREE Catalog used engines, conversions. Lind Supply Company, Farmington, Mich.

CONVERT Fords and Jeep to 100% marine engines with Osco's world famous Convo-Kits. Deluxe catalogue 25c (coin). Oscomotors, 3627B Lawrence, Philadelphia 40, Penna.

BUILDING A boat? Save money on hard-to-get items. Send for free catalog. Ozarka, Inc., 67 Borden Lane, Woodstock, Ill.

OUTBOARD Motor parts; new, used. For all makes. Save money. Outboard Motor Mart, 309 Atlantic Avenue, Boston 10, Mass.

TWENTY Plywood boat plans \$1.00. Catalog boat building plans 10c. The Rudder, 15 Murray Street, New York 7.

BOAT Kits: Outboards, inboards, hydroplanes, sail. A cinch to assemble. Minimum expense. Catalog, specifications, prices. 25c. Brooks Boat Company, Carrollton, PM, Michigan.

MARINE Conversions for Ford and Jeep engines. Catalog 10c. Lehman Manufacturing Company, Department D, Newark 2, New Jersey.

NEW, Used, rebuilt marine motors. Marine conversions, fittings. Free catalog. Stokes Marine Supply, Dept. 24, Coldwater, Michigan.

FULL Size, cut to shape boat patterns, blueprints, 7 1/2-38 feet. Illustrated "Build a Boat" catalog, 25c (coin). "How to Build Boats" book, \$1.00. PolyWog houseboat plans \$10. Marine catalog \$1.00. Marine Specialty Mfg. Co., 3107 Detroit Ave., Cleveland 13, Ohio.

"P38 Belly tanks," steel, \$9.95. Free picture. Bucks Auto Parts, Box 89, Merced, Calif.

FORD & Jeep marine conversion kits, request catalog. Arthur Gershel, Dept. 0, 51 Chambers St., New York 7, N. Y.

ENGINES, MOTORS, DYNAMOS

MOTOR Winders, free bulletins. Winding and testing equipment. Motor Industries, Quincy, Illinois.

ARMATURE Rewinding. Cleaners \$5.75. All makes tools, appliances. Triangle Appliance, 4277A Tyler, Detroit 4, Mich.

WINDING Data, listing 225 motors, single and three phase, \$1.00. Motor Data Co., Box 7631, Kansas City 3, Mo.

REBUILT Gasoline engines \$9.00 to \$30.00. Cauffiel Motor Industries, Temperance, Mich.

ATHLETIC EQUIPMENT, BODY BUILDING COURSES

BIG Bargain. 12 health and muscle courses \$2.00. Guaranteed. Sent on approval, pay later. Order today from Sid's System. 8421 1/2 Evergreen, Southgate, Calif.

TALLER. Be one to three inches taller. A new scientific method for permanent height increase has now been developed. Free information. Natural Methods, Box 453 Briggs, Los Angeles.

GAIN Weight! 4 exercises to increase weight. Complete \$1.00. Body Builders, 36 Nevada Street, Winthrop, Mass.

DEADLY Judo—Fiercest fighting technique. Trick knockouts. (Over 200 illustrated pictures.) Expert instructions; three volumes. Complete \$2.25. Variety House, Box 46-B Wall Station, New York 5.

SPORTING GOODS, GUNS, FISHING TACKLE, ARCHERY, TRAPPING

TENTS (pup, pyramidal, wall, umbrella, nylon mountain, etc.); camping equipment (cots, sleeping bags, blankets, rugsacks, hammocks, ponchos, etc.); tarpaulins. Low prices; free 60 page catalogue. Morsan, 10-17G 50th Ave., Long Island City 1, N. Y.

NEW Engineered Richardson "BluGlas" rod. At last a glass rod with the kind of action you want where you want it. Has the tip-action you need for casting of light lures and the backbone in the butt end to set the hook. Will not fade in color. Find out why the New Engineered Richardson "BluGlas" will give you more rod for the money. Write for free catalog. Richardson Rod & Reel Company, 3166 North Sawyer Ave., Chicago 18, Illinois.

SEND 10c For list either rifles, shotguns, handguns, ammunition, or send 25c for all lists. Frayseth's, Willmar, Minnesota.

BRASS Sinker molds graduated for sizes 0-1 oz. 0-4 oz. Price \$1.00 and \$2.00. Precision Machine Co., Wellsville, Ohio.

MOLDS. (For fisherman's sinkers, squids, jigs and lures.) Handled and hinged. Quality fishing tackle. Free catalogue. E. L. Sweet & Son, Tonawanda, New York.

FISHERMEN. Catch hundreds. Amazing secret instructions. \$1 bill. Ed's Sales, Box 207, Timmins 3, Ontario, Canada.

5 CATFISH Bait recipes used by successful cat fishermen. \$1.00. R. Ahrens, Cresco, Iowa.

ENJOY Fishing as never before! Amazing new Kel-O-Bob automatic fishing float measures water automatically. You can cast with it, reel fish all the way. No knots to clog your reel. Satisfaction guaranteed. Order today, one for 60c; two for \$1.00. Keller Laboratories, Onelda, N. Y.

AMMUNITION Immediately available for Lugers, Mausers, Mannlichers, Japs, Italian guns. Send 10c complete list 100 kinds plus imported shotguns, rifles, pistols, cameras, microscopes. Ashton Company, 1511 Gardner, Hollywood 46, Calif.

FISHERMEN—Make your own sinkers with our molds. Free illustrated booklet. Reading Instrument Co., Box 78, Reading, Penna.

5000 BARGAINS, Firearms, binoculars, war relics. Catalog 40c. Smith Firearms, Runnemed, New Jersey.

TAXIDERMISTRY

MODERN Taxidermist Magazine, Greenfield Center 2, N. Y. Devoted entirely to taxidermy, photos, articles, methods. Trial year's subscription, \$1.00.

BINOCULARS, TELESCOPES, MICROSCOPES, MAGNIFIERS

SENSATIONAL Microscope! Imagine 100x-150x magnification (also 50x-75x model), staging device, stand, light reflector. \$9.95 delivered, postpaid, with money-back guarantee. Send for bargain list. Sid Klein, Inc., 7916 Beverly Blvd., Los Angeles 46, Calif.

REFLECTOR Telescope kits, refractors. Free illustrated bulletin. Esco Products, 911 Willow Ave., Hoboken, N. J.

6" TELESCOPE Reflector kit, instructions, \$8.50 plus postage. Aluminizing. F. Cameron, Box 65, Inwood, N. Y.

WAR Surplus bargains, binoculars, telescopes, sextants, millions of lenses, prisms, reticles, eyepieces, objectives, etc. Mail 10c for big "Catalog CH." Send \$1.00 for Stock CH—10-piece lens kit and big instruction booklet. Edmund Scientific Corp. (Formerly Edmund Salvage Co.), Barrington, N. J.

ULTRA Powerful telephoto camera easily made. Trifling cost. Objects miles away photograph close up. Carl Jamer, Box 694, Manorville, N. Y.

POWERFUL Astronomical telescopes easily made. Perfect lenses and instructions; 100X \$3.00; 100X and 200X \$4.00; 100X, 200X and 400X \$6.00. Full power, clear vision guaranteed. Instructions alone 10c. Suffolk Science Service, Riverhead, N. Y.

TELESOPES, Binoculars, microscopes, big bargain catalog free. Brownscope Company, 24 West 45th Street, New York.

ASTRONOMICAL Telescopes, binoculars, microscopes, bought, sold, repaired. Books, Lists 10c. Rasmussen-Reece, Amsterdam, N. Y.

GIANT Astronomical telescope with 6 ft. tripod \$15.00, f.o.b. factory. 100 power. (10,000 area magnification). Clear vision, full power guaranteed. Ready for use. Suffolk Science Service, Dept. BT, Riverhead, N. Y.

REFLECTING Telescopes, 60X, completely assembled \$25.00. Guaranteed observatory clearness. Free information. Skyscope, 475 Fifth Avenue, New York 17.

PETS—DOGS, BIRDS, RABBITS, HAMSTERS, ETC.

GOLDEN Hamsters. Superior breeder and pet stock \$2.50 pair, \$3.75 trio. Free folio. Valley Hamstery, 734 North Milam, San Benito, Texas.

NATURALISTS Catalog 10c. Chameleons 45c. Turtle 45c. Hamsters \$2.75 pair. Quivira Specialties, Topeka 51, Kans.

RAISE Rabbits. Profitable business. Literature free. Tayco Rabbitry, Hapeville, Georgia.

SEE Gulf Hamstery ad on page 24. Shows picture of hamster.

READ Our display advertisement on page 38. Small Stock Farmer.

BEST Hamsters. Lowest prices. Pair \$3.00. Free illustrated folder. Lakeview Hamster Colony, Newfield, N. J.

MAKE Big money! Raise Chinchilla rabbits. Cash markets supplied. Write today! Rockhill Ranch, Sellersville 15, Penna.

FAMOUS Angoras! Giant Chinchillas! World's most profitable rabbits. Finest pedigree, heavy-producing, prize-winners. Catalog free. P. M. Grinsteeds, Edwardsville, Illinois.

RAISE Rabbits. I furnish stock. You pay later from profits. Send 35 cents for market information, housing, plan of furnishing starting stock. Johnson, Box 694, Kansas City 12, Mo.

INCREASE Your income by raising domestic rabbits. Small space needed. Ready market for delicious meat, fur and wool. Largest magazine in the industry tells you how. \$1.50 per year. Sample 15 cents. No stamps. Small Stock Magazine, Lamoni 20, Iowa.

EARN Up to \$400 monthly raising Angora or New Zealand rabbits. Plenty markets. Particulars free. White's Rabbitry, Newark 38, Ohio.

RAISE Guinea pigs. Money makers. Booklet free. Taylors, B426A, Hapeville, Georgia.

MINK Raising information free. Complete. Lake Superior Mink Farm, Superior, EE1, Wisconsin.

A Practical beginning to successful rabbit raising. 48 page illustrated booklet. Dime. American Rabbit Breeders Association. 36 AR & CBA Bldg., Pittsburgh, Penna.

PLANTS, SEEDS, NURSERY AND GARDEN SUPPLIES

GROW Lovely flowers. Invest in earthworms, nature's fertilizer. Free folder. J. W. Porter, 721 S. West Parkway, Louisville 11, Ky.

GINSENG. Goldenseal. Hundred seeds \$1.50; thousand \$5. Dozen plants \$1.50; hundred \$9. Growing, selling instructions included. F. M. Collins, Viola, Iowa.

FARMS, FARM LANDS, REAL ESTATE

NEW Free summer catalog just off press! Farm and country real estate bargains, good pictures, many states, easy terms, many equipped, business opportunities. For special service, state requirements, desired location. United Farm Agency, 220-PM South State St., Chicago 4, Ill.

STROUT'S Farm and business catalog. 3084 bargains. 33 states. Mailed free! Buy now and save through Strout Realty, 7 So. Dearborn St., Chicago 3, Ill.

\$5.00 MONTHLY Buys 40 acres near town; price \$200; free list. Box 425-P, Carthage, Mo.

ARMSTRONG'S Best Ozark lands. 40 acres \$325. Lake resorts \$95. Small farms. Lowest prices, easiest terms. Complete information. Write today. Armstrong, Shook 34, Mo.

WEST'S 1951 Catalog—Free! Farms, estates, ranches, orchards, camps, homes, businesses. East of Mississippi, Maine to Florida. West's, M-3, Pittsburgh 17, Penna.

GOVERNMENT And state ranch, timber, hunting and fishing lands in California, Oregon and Washington at \$1 to \$5 per acre. 10c (coin) brings circulars. Pacific Lands, Box 2350-PM, Hollywood 28, California.

GOOD Farms—Ranches. Washington, Minnesota, Montana, Idaho, Oregon, North Dakota. Dependable crops, favorable climate. Write for literature, lists describing typical farm opportunities. Specify which state. J. W. Haw, 119 Northern Pacific Ry., St. Paul 1, Minn.

CANADIAN Tax sale lands for two dollars an acre and up. Small monthly payments. Farms, timber, hunting and fishing camps, minerals. Limited number of properties. Write at once for free catalogue. Tax Sale Service, Room 105, 120 Bloor St. W., Toronto 5, Canada.

GOVERNMENT Lands \$2.00 acre up. Information all states twenty-five cents. National Tax Service, 901-A Majestic Bldg., Detroit.

POULTRY, FARM SUPPLIES

MAKE More poultry money! Send for amazing egg "Production Tips." \$1.00. Robert Drummond, 139 North St., Stoneham 80, Mass.

GEESE, Goslings, goose eggs. Safe shipment anywhere. Bulletins, magazine on breeding, hatching, rearing, marketing. Peyton Goose Farm, Route 2DM, Duluth, Minnesota.

RAISE Turkeys the new way. Write for free information explaining how to make up to \$3,000 in your own backyard. Address National Turkey Institute, Dept. 3, Columbus, Kansas.

KNOW How to raise poultry for profit. Read Poultry Industry. Every issue packed with helpful hints and practical suggestions. Latest articles on breeding, feeding and management. Subscribe now. 1 year 65c. 2 years one dollar, foreign subscriptions \$1.00 a year. Poultry Industry, Dept. P.M., 376 Boylston St., Boston 16, Mass.

BABY Chicks \$10.00 per 100 c.o.d. New Hampshires, Barred Rocks, White Rocks and heavy assorted. Prices at hatchery. A. F. Hockman, R7, Bellefonte, Penna.

PROFITABLE OCCUPATIONS

TURN Your spare time into cash. Make quick-selling, highly profitable lamps—every home a prospect. No experience or special tools required. New 1951 56-page illustrated catalog shows shades, shade frames, figurines and bases, oil lamp converters, boring compounds, and dozens of similar items. Also all kinds of sockets, cords, pipes, harps, finials, bases, and hundreds of other parts—everything you need. Special 8-page section shows 6 beautiful lamps in kit form ready to assemble. You buy wholesale, sell at retail—make big profits. Hundreds doing it. You can, too. Send 25c today for catalog and wholesale price list. Refundable first order. Gearon Co., Dept. 500-B5, 27 S. Desplaines, Chicago 6, Ill.

WANT A diesel job? Our approved, up-to-the-minute diesel training program can help you qualify for steady, big pay jobs or specialized military training. Covers diesel, tractor, heavy equipment. Easy to master. No loss of present income. Job placement advisory service. Investigate! Write for information today. Interstate Training Service, Dept. 3E, Portland 13, Oregon.

FOREIGN Employment construction men, building trades, helpers, office men, others, interested in foreign projects. High wages, quarters, trans. Listings of firms actively working on U. S. foreign inter-continental projects. Send \$1 for foreign construction compendium and application forms. Foreign Service Bureau, Dept. PM5, Box 295, Metuchen, New Jersey. (Not an employment agency—no fees.)

FREE Book "How to Make Money With Home Workshop" describes amazing methods used by hundreds of successful craftsmen. Tells what to make, how to sell workshop output spare time. Write at once for details. Remember it's free! Craftsman, 115-A5 Worth St., New York City.

GINSENG And seal growing instructions, dime. Specialty Farm, Rockford, Minn.

MAKE Money with frogs. Particulars free! Specialties House, Whiting 12, Ind.

MUSHROOMS Grown. Boxes, barrels. Instructions 50c. Spawn \$1.00. Manureless process. \$2.00. Gordons, 553 William, Winnipeg, Manitoba.

DEFENSE Welding jobs pay. Welders needed. Train quickly. VA contract. Hobart Welding School, Box M-512, Troy, Ohio.

\$250 WEEK Reported! Free book "505 Odd Successful Businesses." Work home! Expect something odd! Pacific-23, Ocean-side, California.

RESURFACING Of meat blocks for stores, restaurants, and institutions is a service in great demand. Our portable resurfacing machine will put you in this steady, profitable business. Minimum of skill required. Full or part time, or in combination with other work. Travel or stay put. Write for details. Hill Machine Co., Box 677P, Rockford, Ill.

RAISE Rabbits. Good profits. We buy all you raise. Full particulars and illustrated booklet, dime. Kelley, 7341 Melrose, University City, Mo.

PRINT Without a printing press. Big profits! See page 39.

MAKE Flexible molds! Cast plaques, bookends, figurines! Free sample! H. Tooker, 630-M Chestnut, Hamilton, Ohio.

RESILVER Mirrors at home. Formula 25c. Ideal Service, Park Ridge 4, Illinois.

HAVE Fun! Make money! "Working With Leather"—64-page booklet tells how. Send 25c for copy. No foreign orders. Free catalog and valuable information included. Wilder-Craft, 1039 Crosby, Chicago 10.

RAISE Pheasants on the \$100 week plan. Little capital and space can make you independent. Free details. Great Central Game Management System, Columbus 1, Kansas.

\$5 HOUR Easy! Sell name plates for houses. Free sample, order blanks. Write: National, 214 Summer, Boston, Mass.

LIFETIME Income as notary public. Appointment assistance. Stationers, Helotes 50, Texas.

EARN Up to \$400 monthly raising rabbits. Free particulars. White's Rabbitry, Newark 61, Ohio.

\$40.00 WEEKLY Made growing mushrooms, fresh, dried. Dominion patent 331583. Free spawn. North American, 169P Yonge, Toronto, Canada.

BE The Popular Mechanics representative in your neighborhood and earn big profits in your spare time. Write Popular Mechanics Magazine, Room 408M, 200 E. Ontario St., Chicago, Ill.

FOREIGN And Latin American employment. 1951 "Foreign Service Directory" gives up-to-minute facts on military and civilian construction, government jobs, major oil listings, aviation, transportation, steamship lines, mining, importers, exporters, how-when-where to apply, application forms, hot list firms hiring. \$1.00 postpaid. Global Reports, P.O. Box 883-P, Hollywood 28, Calif.

RAISE Fishworms, free literature, complete instructions 10c. Huffmans Ranch, Rives Junction 2, Michigan.

\$46 FROM square foot plywood. Jigsaw necessary. Write, Woodarts, Bridgewater, Mass.

ALASKA—America's frontier. \$1.00 brings 1951 business directory, large government map giving up-to-date construction projects, current employment information, homestead and highway facts; hunting, fishing, game rules; firm's hiring and application forms. Alaska Opportunist, P.O. Box 883-P, Hollywood 28, Calif.

BOOKS, PERIODICALS, PICTURES POSTCARDS

"THE Modern Clock." All about clock repair. 502 pages. 173 illustrations. \$4.95 postpaid. 10-day return privilege. North American, Dept. 11E, 2018 North Avenue, Chicago 47, Illinois.

HARD-To-find books, send wants. Green, Box 6761, Los Angeles 22, Calif.

BOOK, "How to Help Your Child in School," \$2.95. Johnson, 1939 Jackson, Evanston, Ill.

RENT Fiction, non-fiction. Catalog free. Santens, 2700-A Ann, St. Louis 4, Mo.

POCKET Book swap. Send 12 books and \$1.00, receive 12 different. Lawrence, 120 Boylston St., Boston, Mass.

BOOKHUNTERS! Any subject, send wants! Atlantic Book Service, Lawrence Avenue, Charlestown 29, Massachusetts.

TELEVISION Book explains how to buy and install receivers. Discusses built-in aerials, distant reception, lightning risk, color, etc. \$1.00. Details free. Hartland Smith, Box 91, Birmingham, Michigan.

BOOKHUNTERS! All subjects. Send wants! Jaher Book Service, 620-P East 178 Street, New York 57.

GAMES AND ENTERTAINMENT

ADULT Party games, 12 for 50c. Vees, Box 301-PM, Decatur, Georgia.

PLAY Yachtzie, new dice game sensation! \$1.49 postpaid. Weldon Sales, Box 11025, Fort Worth, Texas.

MAGIC TRICKS, PUZZLES, JOKER NOVELTIES

FREE Magic tricks! Plan 10c. Magic-Man, 4932 Eighth, Philadelphia.

FOUR Exciting plastic puzzles \$1.00. Stanton, 43 Beechwood, New Hyde Park, New York.

PLASTIC Ventriloquist dummy with instructions 25c. Roalex, 32 West 39th St., New York City 18.

VENTRILQUISM Taught. 3c stamp brings particulars. Smith, 801 Bigelow, Peoria 5, Ill.

NEW Trick-joke catalog 20c. Furr, Box 1882-(D), Norfolk, Va.

LIQUID Light trick! Beautiful fiery liquid from cold water! 15 minute display. Spectacular for home or professional show. Instructions and materials for 3 shows \$1.00. United Manufacturing Associates, 3605-A Canyon Ridge, Fort Worth 3, Tex.

MAGIC Monthly. Year 25c. Sample and latest magic catalogue free. Magic Factory, Minneapolis 2, Minn.

"MAGIC-Mouse" obeys your voice! Funniest (trick) mouse you ever saw! 25c. Lewis, 4932-8th, Philadelphia.

LATEST Magic for pocket, parlor, stage. Catalog 500 tricks, only 10c. Unequaled magic service for 30 years. Douglas Magician, Dept. 1, Dallas, Texas.

600 TRICKS, Magic, cards, masks, puzzles, shooting novelties, jokers, monkey business funmakers, hot stuff, catalogue 25c. Andersen's, 6815-R Ardmore, Chicago 31.

WORLD'S Largest professional magic shop, keeps you in touch with latest tricks. To receive mailings, send 50c for new catalog. Holden's, M220 West 42nd St., New York.

512-PAGE Catalogue of 2500 tricks, pocket, parlor, stage. World's finest magic. Send \$1.50 for catalogue (refunded first \$6.00 order). Kanter's, M-1311 Walnut, Philadelphia 7.

16 CARD Tricks and catalog 25c. Sterling Magic, Royal Oak, Mich.

200 ELECTRIC Stunts, 110 volts. \$1. Kutting Sons, Los Altos, Calif.

584-PAGE Catalog, 7500 novelties, funmakers, tricks, jokes, gadgets, hobbies, timesavers, animals, sports, scientific. 10c. Johnson Smith Company, Dept. 349, Detroit 7, Michigan.

PROFESSIONAL Catalog, 124 pages, 25c. Williams, 900 Plymouth, Ellwood City, Penna.

FREE Trick and catalog 25c. Lerro's Magic, 509 80th Street, Brooklyn 9, N. Y.

BE A magician. Large professional magic catalog of latest tricks, 35c. Ireland, C-109 North Dearborn, Chicago 2.

COINS, TOKENS, CURRENCY

OLD Money wanted. Do you know that coin collectors pay up to \$100.00 for certain U. S. cents? And high premiums for all rare coins? We buy all kinds. Send 4c for large coin folder. May mean much profit to you. Numismatic Co., Dept. 20, Fort Worth, Texas.

HUGE Price list 10c. 20 different foreign coins \$1.00. Ray's, 109 Mathilda, Sunnyvale, Calif.

100 COINS And bills, \$1.00. Oddehon, Box 482, St. Louis, Mo.

FOREIGN Coin and price list, 5c. Angelica, 639 East 79th, Chicago 19.

GRAB Bag! 50 U.S. coins (half-cent to silver dollar) \$6.50. Terrific value! Bargain list 10c. Fairway Company, Rye, New York.

WANTED 1894-S Dime, pay \$500.00. Certain 1913 nickel \$1,000.00, 1901-S quarter \$10.00—\$150.00, hundreds of others. Complete catalogue 25c. Worthy Coin Corporation, D-317, Boston 8, Massachusetts.

GIANT Fifty-two page illustrated price-list of coins, albums, supplies. Send dime to Ben's Coin Shop, 31 N. Clark, Chicago 2.

COIN Collector's big magazine, just out, and rare foreign money 10c. Roy Lawrence, Anamosa, Iowa.

FREE! Foreign coin, banknote and coin collectors illustrated catalog to approval service applicants. Send 3c postage. Tatham Coinco, Springfield 30, Mass.

GET Profit and pleasure in collecting old coins. Send 10c for 56 page illustrated coin catalog. You'll be delighted with it. Send for it now. B. Max Mehl, 370 Mehl Bldg., Fort Worth, Texas. Largest rare coin establishment in U. S. Established 50 years.

JAPANESE Invasion notes. 1c to \$1,000.00, \$2.00. Burma note and catalogue 25c. Shultz, Salt Lake City 10, Utah.

COINS Wanted, will pay up to \$2000 for certain coins, send 25c for catalogue. Burton's, 111 So. Third, Columbus, Ohio.

STAMP COLLECTING

FREE Hinges. With 25 large different Mexican airmails, only 60 cents. Robert Boger, 3401 Oakmont Ave., Philadelphia 36, Penna.

FREE Collection—Over 100 different stamps of world: commemoratives, animals, natives, ships, famous men, others all to approval buyers; also Scott albums, catalogs. Bell Stamp Service, Dept. S-2, Bell, Calif.

PREMIUMS, Prices, and service that satisfy. U. S. approvals at rock bottom prices. Foreign, from 1/10 to 1/2 catalogue, mounted in books and sheets. No matter how large or small your collection is, we can help. References appreciated. Roseland Stamp Co., Dept. 10B, Spring Lake, Michigan.

PAYING High prices for approvals? If your collection numbers under 15,000 try our 1c and 2c approvals. In books of 1000 different. Lots to choose from at lowest prices. Also special offer to customers. Clark, Box 544-P, Muskegon, Michigan.

BELIEVE It or not: 25 different British, West Indies stamps are yours for the asking. Beautiful pictorials, 19th and 20th century, including free monthly magazine. Send only 5c for postage. Empire Stamp Company, Dept. PM, Toronto 5, Canada.

FREE! Jungleland packet. Contains 10 different Congo, Fiji map stamp, Liberia triangle, Mozambique giraffe, Borneo monkey stamps. Approvals. I. Moulblow, 740 Hegney, Bronx 56, N. Y.

FREE: Mint British colonies from Brunel, Nauru, Dominica, Ascensions, Solomon Islands, Caymans, Tonga, Gilbert Ellice, Pitcairns—free with approvals! Viking, 130-Z Clinton St., Brooklyn, N. Y.

LOOK! Set Liberia, Zanzibar, Ascension, Borneo, Sarawak, multitude others. Everything 10c with approvals. Faszold, 10055 Northgate, St. Louis Co., Mo.

GIFT Nicaragua baseball airmails. 5 to approval applicants. Deane Stamps, Box 87, Miami 35, Florida.

FREE—Nigeria, Goldcoast! Approvals 40% catalog! Box 326A, Passaic, N. J.

UNITED States approvals—Select, used or mint. Kingsbury, Woodbury, Vermont.

COMMEMORATIVES, 125 Large U. S. \$1.00. No approvals. Morey, 87 Somerset, Springfield 8, Mass.

ROMANIA Want list filled. List free. L. Pour, 507 5th Ave., New York.

U. S. Catalogue free. Contains over 500 illustrations for stamps, albums, supplies. Stone, 45 Bromfield, Boston 8, Mass.

105 DIFFERENT 10c With approvals. Schmitt, 730 South Jackson, Green Bay 3, Wisconsin.

EXCHANGE Your duplicates. Scott basis. Details free. Superior, 6908 Zoeter, Cleveland 3, Ohio.

2# MIXED U. S. old, new \$1.50. Lists. Weatherby, Medina, Ohio.

UNITED States bargain catalog and approvals. Sullivan, Endicott Arcade, St. Paul 1, Minnesota.

POUND Stamps containing thousands \$1.00. Longacre Shop, 108 West 42nd, New York 18.

FREE—Complete set of famous Americans, flags, parks and presidentials to approval buyers. Send 3c for 15 of the above stamps plus full particulars. Triboro Stamp Company, 145 Nassau Street, Dept. 105, New York 38, N. Y.

U. S. Illustrated price list free. DeLisle, 154 S. 2nd St., San Jose, Calif.

55 DIFFERENT United States—5c approvals. Utechs, 1143-D North Keeler, Chicago 51.

307 ALL Different—Only 15c! Beautiful collection: commemoratives, triangles, high values, bicolored stamps, etc. Garcelon, Calais 400, Maine.

1/2c-1c APPROVALS! Bargains galore! Cole, 43-A Rinewalt, Buffalo 21, N. Y.

1000 SELECT Foreign \$1.00. Hale Stamps, 7609 Grand, Minneapolis 19, Minn.

FREE—Complete U.S. list (commemoratives, airmails, etc.). Breck, 10516 Clifton, Cleveland 2, Ohio.

MONACO "Nudes" 10c. Approvals accompany. Royal Stamp Company, Tamqua, Penna.

FIFTEEN Different old U.S. sent for 10c to approval applicants. Donald Brunner, 832-F Union, Lancaster, Penna.

TRIANGLES! Six bicolored beauties (ferocious beasts, tropical birds, etc.). With colorful approvals—only 10c! Atlas, 2830-T Eisenhower, Racine, Wisconsin.

TRAINS! Trains! Trains! 12 train stamps and 100 different stamps for 10c with approvals. Reich Stamp Company, 4647 Kenmore, Dept. M20, Chicago 40, Ill.

FREE! \$10,000 Airmail! Philippines! Fezzan! Uruguay! Approvals. Keating, 2520-P Boulevard, Jersey City 4, New Jersey.

GIGANTIC Slave stamp! Nude! Triangles! Diamonds! Tempting approvals—only 10c! "Paris," 1819-s Woodland, Racine, Wisconsin.

ALADDIN Has quality approvals for serious collectors. Free price list. Aladdin, 3625 St. Paul, Denver 5, Colorado.

WAR Zone! Formosa, Manchukuo, Mongolia, others, 30 stamps! Rare! Only 5c! Approvals. Concord, Box 23-E, Beeville, Texas.

ROOSEVELT Set plus 25 different U.S. 10c, approvals. Locust Stamp Co., Box 390T, Peekskill, N. Y.

FLAG Stamp—Free with hygrade U.S. approvals. Wenigman, 1933 Patterson, Chicago 13.

MOZAMBIQUE Triangulars, unused set 10c with approvals. Vargo Stamps, 6044 South Fairfield, Chicago 29, Illinois.

FREE Sample interesting, informative. National Stamp News, Box 1948, Miami 35, Florida.

FREE—Nepal, 5 different, catalogue value 51c, to approval applicants. (We pay return postage.) Frank Newman, 3539 Hartford St., St. Louis 18, Mo.

FREE Stamp zoo! Snakes, leopard, rhinoceros, etc., to introduce our colorful bargain approvals. Niagara Stamps, Niagara-on-the-Lake 10, Canada.

FREE 10 Japan war stamps. Approvals. Schroeder, 636 Charles, St. Paul 4, Minn.

UNITED States approvals complete coverage, fine quality, attractive prices. Seminole Stamps, Box 1138-P, Coral Gables, Florida.

205 AUSTRIA—All different only 10c! Beautiful commemoratives, pictorials, airmails, high values. Catalog price nearly \$6.00! Approvals included. Garcelon, Calais 111, Maine.

U.S. Exclusively. Free catalogues. Eagle Stamps, 2221 Romine, Pittsburgh 26, Penna.

FREE. Five foreign sets. Approvals. Stoll, 2632 Burnett, Louisville 10, Ky.

EXAMINE Stamps with "Roto-Gage." Tells size, counts perforations, detects watermarks. All in single compact, convenient accessory! Measures 3x5x3 inches. Special price, \$3.50 postpaid. (Descriptive literature free.) Satisfaction guaranteed! Send money order to Mook Specialties, R-1, Canonsburg, Pennsylvania.

NOTHING Free. Just good stamps reasonable. Send dime for seventy-four page catalog. Ben's Stamp Shop, 31 N. Clark, Chicago 2.

FREE! Big 36 page illustrated catalog of stamps, albums, packets, supplies! Ewing-Stamps, 109 N. Dearborn, Chicago 2.

WOW, 100 Diff. Brit. Colonies 10c with worldwide approvals! Fields, 1939 E. 85, Cleveland 6, Ohio.

PRICED Right approvals, premiums. Dakota Stamps, Box 482, Madison, S. D.

300 DIFFERENT French Colonial stamps \$1.00 with request for foreign approvals. Ward, 241 So. Winchester, Campbell, Calif.

FREE! United States—Germany Occupation stamps. Approvals. Stampco, #987, Albany 2, New York.

ONLY For serious collectors: airmail \$2.00, receive superb assortment Morocco pictorials. Free list! You will never regret it! Idap, 26 Hollande, Tangier, Morocco.

5000 DIFFERENT Stamps—\$12.50. Lists free. Beacon Sales, Maynard, Mass.

FIFTY French Colonies, pocket wallet, 5c with approvals. Fred Pittsley, Napa, Calif.

FREE. Scott's International Album. Other big premiums. Full particulars with approvals. Raymax, 123-Z William St., New York City 38.

FREE—Deluxe packet to approval applicants listing countries collected. McQueston, 185 Puritan, Detroit 3, Mich.

COMMEMORATIVE Philatelic sheet free to approval applicants. Paragon Stamps, Box 1378, Miami Beach 39, Florida.

100 NETHERLANDS. All different. Beautiful assortment, 10c with approvals. Thomson's, Box 4074-P, Miami, Florida.

1863 SAXONY Included with 193 different, 33 countries, 38 19th century 10c. Approvals. Brooks, 2352B East 23rd Street, Brooklyn 29, New York.

AMAZING Offer! 500 United States stamps—including commemoratives, airmails, high values to \$5.00. Only 10c to approval applicants! Illustrated bargain lists free. Mystic Stamp Co., Dept. 80, Camden, New York.

FIRST U. S. (1847) government reissues 5c, 10c, plus giant bargain U. S. collection—only 5c to applicants U. S. approvals. Metropolitan, Box 312G, Jackson Heights, N. Y.

10 ASSORTED U. S. Commemorative 15c. Five U. S. Air Mail 15c. 10 Famous Americans 25c. All for 50c. Ideal Stamp Shop, Box 179, Park Ridge, Illinois.

WOW! 203 All different Germany 10c! Zeppelins, semipostals, airmails, high values, etc. to new customers. Jamestown Stamp, Jamestown 512, New York.

WORLD'S Largest stamp (7 1/2 x 14 inches). A real curiosity! Retail for 50c, only 3c to approval applicants. Tatham Stamp Co., Springfield 30, Mass.

FINE Approvals. Fast, personal service. What countries do you prefer? I'll send their stamps. Skinner, 438 Locust, Long Beach 12, California.

UNUSUAL—Unheard of. Cancelled sets of Roosevelts and Washington bicentennials complete. All yours for fifteen cents. Bargain approvals accompanying. Park Stamp Co., Box 191, New York 21, N. Y.

STAMPS Wanted. Collections, duplicates, surplus stock, mint and used. Trade for printing; buy outright if bargain. What have you, what's wanted. Vanroy Shirk, Lebanon, Penna.

UNITED States stamps nearly 100 years old. Roosevelt set, others, 40c value—only 5c to applicants United States approvals. Wakonda, Box 272K, Jackson Heights, N. Y.

500 STAMPS For only 10c! This mammoth value includes airmails, pictorials; stamps from strange countries, cataloging up to 25c each! Also approvals. Mystic Stamp Company, Camden 80, New York.

COLUMBIANS, Trans-Mississippi, Pan Americans, Pan Pacific, ten other different commemoratives. All 10c with your request for U.S. approvals. Moda Stamps, Box 251-X, C.S.A., New York 8.

MAGNIFIER, Big stamp magazine; first U. S. commemorative; plus unused \$5000 Foreign Legion, diamond, giant, and other worthwhile stamps. Everything free to approval buyers. Capital Stamp Company, Little Rock 2, Arkansas.

FREE! Powerful magnifying glass. Jamestown Stamp, Jamestown 202, New York.

200 DIFFERENT Including Roosevelt triangle, 5c to approval applicants. M. Avalon Stamp Company, Springfield, Mass.

OVER 1,000,000 Sold; 200 different stamps 10c with approvals. Carlton's, Tujunga, Calif.

500 EXOTIC Japan stamps—10c. Kenmore, Richford, J-57, Vermont.

750 FRANCE And colonies stamps 10c. Littleton Stamp Co., Littleton 25, N. H.

FREE! Big United States catalog! Invaluable guide and check list. Hundreds of illustrations. Harrisco, Boston 17-W, Mass.

50,000 STAMP Grabbags 25c each. Anderson, 630B, Bingham, Reading, Penna.

TOPS! Our book "How To Collect Stamps." Send for your free copy today! Littleton Stamp Co., Littleton 37, N. H.

FREE—Illustrated catalog! Kenmore, Richford, C-57, Vermont.

FREE! Big illustrated catalog listing everything for the stamp collector. Harrisco, 202 Transit Bldg., Boston 17, Mass.

"HOW To Recognize Rare Stamps." Free book illustrated! Kenmore, Richford, H-57, Vermont.

FREE U. S. price list, postage 3c. Mark Hanna, 335 5th Ave., Pittsburgh 22, Penna.

FREE—Cuba Roosevelt issue and illustrated catalog. Littleton Stamps, Littleton 12, N. H.

OLD Scarce U. S. seconds on approval. Slightly defective. Bargain prices. Hernefield, Clintonhill Station, Newark 8, N. J.

FREE Supply list. Penny approvals on request. Reed, Box 980, Chicago 90, Illinois.

FREE "Stamp Finder." Tells instantly country to which any stamp belongs. 32 pages profusely illustrated. Garcelon, Calais 17, Maine.

10,000 DIFFERENT 1c Each! Gordon Davison, Box 1019S, Manchester, N. H.

ANTIQUES, RELICS, INDIAN GOODS, CURIOS

4 FINE Ancient Indian arrowheads \$1.00. Extra fine tomahawk, \$2.00, list free. Lear's, Glenwood, Arkansas.

PRECIOUS STONES, MINERALS

GENUINE Deep red Arizona rubies, garnets. Send quarter for packet. Bitner's, Box 724, Scottsdale, Arizona.

GENUINE Colombian emeralds. Cut unmounted. Wholesale lists. Larkin, 2885 Webster, Omaha.

GEIGER Counters, inexpensive improved types which use single flashlight battery. Morgan Instruments Co., 21420 Valerio, Canoga Park, Calif.

CUT Your own gem! Write for catalog on finest line of lapidary machinery in America. Equipment Engineering Co., Dept. B, Box 292, Kansas City, Missouri.

GEMSTONES, Mineral specimens. Every variety. Lowest prices. Postcard brings free booklet. Plummer's, 2183C Bacon, San Diego 7, California.

MINERAL Specimens, cutting material, slabs and gems. Send for free price list. Warren's Minerals and Gems, 1969 Abbott St., San Diego 7, Calif.

HOBBIES AND COLLECTIONS

BASEBALL, Cowboy, boxing, wrestling, sports, movie or radio stars! Fifteen real-life pictures! Postcard size. 25c postpaid! Bushman Sales Company, Box 436-PM, St. Louis 3, Mo.

WANTED: Cigarette, tobacco, cards. Write Charles Bray, East Bangor, Penna.

INVENTING Can be an interesting and profitable hobby. Write for complete particulars. Institute of American Inventors, Dept. 40-E 631-E St. N.W., Washington 4, D. C.

UNUSED Matchbook covers—100 different \$1.00. Catalog 25c. Charles Edelman, 1311C East 84, Cleveland 3, Ohio.

PHOTO FINISHING

FREE Mailers jumbo prints 8 exposure roll 30c. 12-45c, 20-95c. Careful work. Western Photo, Dept. PM51, Box 298, San Francisco 1, California.

8 OVERSIZE Snapshots from roll, 25c with this ad. Foto's, Box 8, Aurora, Illinois.

8 OVERSIZED Prints in album folder 40c, 12-55c, 16-70c. Techni-Foto, Lorain, Ohio.

20 PREMIER Enlargements from your favorite negatives in plastic ring album. Return postage paid. Satisfaction guaranteed. Send \$1 and negatives (standard size) to Post-L-Pix, Box 1B, Worcester 4, Mass.

SIX Or 8 roll of film developed and printed 35c. Twelve or 16 picture roll 55c. Send coin with roll. No c.o.d. If you fail to get pictures on your roll of film, we will mail a new roll to you at no additional cost. Overnight service. Mailers sent free on request. Deluxe Film Service, Box 1268-A, Shreveport, Louisiana.

MAIL Us your films. Prompt service. 8 exposures developed and printed 30c. Free enlargements. Foto Art Studio, Box 406, San Francisco, Calif.

16 PRINTS Or 8 jumbos from roll, 25c with this ad. S. Skrudland, River Grove, Ill.

FREE Price list on quality developing, printing, enlarging. Write for it today. Bryan's Photo Shop, Dept. M, Panama City, Florida.

CAMERAS, PHOTO SUPPLIES

CALLING All shutter bugs. Get facts on "How to Sell Your Pictures and Make Big Money" plus Simplified Photography Handbook, step by step methods, developing, printing, enlarging, portraiture, "Hollywood glamorizing." Also Bargain Supply Catalog. All three for \$1.98. Muir Studios, Milford 9, Penna.

PHOTOCOPY Anything—Papers, books. No darkroom. 8 1/2" x 11" complete \$6.95. Potoflek, 8555 Plainfield Lane, Cincinnati 36, Ohio.

BASS Says: Trading cameras a national habit since 1910. Write to Bass the old "horse trader." A postcard will do. Simply say: "Bass, I have and I want. How much will you allow me?" It's fun to trade with Bass. Satisfaction guaranteed. Bass buys, sells, and trades. Bass Camera Company, Dept. AG., 179 W. Madison St., Chicago 2.

MOTION PICTURES AND SOUND EQUIPMENT

NEW 1-Reel 16mm. sound films low as \$3.98, formerly \$17.50; new 1-reel 16mm. silents, \$1.98 up, formerly \$8.75—All first quality prints in original cartons. Used Panoram 100' 16mm. musicals, \$6.89 per dozen. Equally attractive bargains in good used feature pictures, cartoons, sports, comedies, musicals, travels. Save on new and used reels and cans, projection lamps, and other supplies. We have the biggest stock of 16mm. films in the world—Over 100,000 prints on hand! Write today for your copy of Blackhawk's big catalog. "Sixteen's super market." Blackhawk Films Inc., 628 Putnam Building, Davenport, Iowa.

FREE Movies "Hundreds of Subjects." Interesting. Entertaining, fascinating. Latest Directory only 50c. National Cine Society, 126 Lexington Ave., New York 16, N. Y.

ADD Spice to home projection shows with colorful old-time Nickleodeon slides. 2x2. Write for free list. Nickleodeon Co., New Fleidner Bldg., Portland 5, Oregon.

FREE Home movies! 8-16mm. Lists. Waldman-Y, 209 West Jackson, Chicago.

8-16MM. Silent-sound films. Complete rental library. All latest subjects. Free catalogue, sample film 10c. Garden Film, 317 West 50th, New York 19.

5000 NEW-Used 8-16mm. silent-sound films. International, 2120 Strauss, Brooklyn 12.

BASS Says: Leadership since 1910 guarantees satisfaction. Finest Cine equipment: 8mm., 16mm., and 35mm., silent and sound. Write the old "horse trader." Satisfaction or your money back always! Bass Camera Company, Dept. A, 179 W. Madison St., Chicago 2.

THE World's greatest story. "Entire Life of Christ"; 8mm., 16mm. Sound and silent. Rent or purchase. Hemenway Film, 33 F Melrose Street, Boston 16, Mass.

RENT 16MM. sound films, 50c reel. Large selection; free catalog. Film Service, 128 Chestnut St., Roselle Park, N. J.

LEARN Professional motion picture technique at home. Free catalog. Motion Picture Institute, Birmingham 4, Mich.

GUARANTEED Fresh 8mm. roll, magazine; 16mm. roll, magazine movie films. Color, b&w. Free catalog. ESO-S, 47th Holly, Kansas City 2, Missouri.

MOVIE Camera film: 8mm. roll \$1.50, 16mm. 100' \$3.00. Free processing. Better Films, 742 New Lots, Brooklyn, N. Y.

MUSIC AND MUSICAL INSTRUMENTS

POEMS Wanted for musical setting. Send poems for free examination. Five Star Music Masters, 630 Beacon Bldg., Boston, Mass.

PRE-War phonograph records wanted, or dealers stock. Schneider, 128 West 66th, New York City 23.

SONGWRITERS — Publishers booklet "Commercial Music"—plus ten valuable musical mailing lists (700 names-addresses) \$1.00. Popular, Box 927-B, Atlanta, Ga.

ELECTRIC Guitars, amplifiers, save 50%. Free literature. Carvin PM, Baldwin Park, Calif.

MUSIC Arranged. Songs printed. Frank Wildt, Music Publisher, Lancaster, Penna.

POEMS Wanted. Broadcast consideration. Sooner Song Co., 22-PM Northwest 8th, Oklahoma City 2.

PIANISTS (Adult) quickly improve technique, sightreading, accuracy, memorizing, through remarkable mental-muscular co-ordination. Used by famous pianists, teachers, students, schools. Also, fascinating classical; modern popular piano courses featuring new methods, faster progress. Also, harmony, composition, arranging, songwriting. Free booklet. Broadwell Studios, Dept. 52E, Covina, California.

PIANO 30 Lessons \$3. Free samples. Phil Breton Publications, P.O. Box 1402, Omaha 8, Nebr.

SWISS Musical movements \$1.00. Catalogue 10c. Bell Music, 1610 First Avenue, New York 28, New York.

ACCORDIONS — All brands. New and used. Save 50%. Wholesale to every one. Del Principe, 307 So. Wabash, Chicago, Ill.

1951 ACCORDIONS — Wholesale. Free catalog. American Accordion Center, 5329 Belmont, Chicago.

YOUR Voice made loud, clear and powerful with my diaphragm exerciser. Write, Inventor "Oz," 34V, Box 665, St. Louis, Mo.

POEMS Wanted to be set to music. Free examination. Send poems. McNeil, Master of Music, 510-PM S. Alexandria, Los Angeles, California.

WANTED! Poems for musical settings. Write Songwriters' Service, Clifton, N. J.

WRITE Songs. Big money and reputation. Write for information. J. Gordon Pub. Co., 4700 South California Avenue, Chicago.

PHONOGRAPH Records cheap. Catalogue. Paramount, FQ-313 East Market, Wilkes-Barre, Penna.

POPULAR Piano lessons by mail. Beginners; advanced. Play songs or money back. Free details. Stuart Piano Studio, 1227A Morris Ave., Union, N. J.

RADIO AND TELEVISION

BUILD 15 Radios—Only \$19.95. Learn radio and television at home. Previous knowledge unnecessary. Nothing else to buy. Free tester and tools. Quizzes, trouble-shooting lessons. Money back guarantee. Send check or money order; we pay postage. COD's accepted. Order now or request further information. Progressive Electronics Co., Dept. PM-40, 497 Union Ave., Brooklyn 11, N. Y.

FREE—Completely new 1951 radio, television and electronic buyer's guide. Page after page of the very latest available supplies of guaranteed quality at today's lowest prices. Thousands of super-values in Hi-Fi units, recorders, television and radios, phonos, sound equipment, testers, tubes, kits, parts and books. Big stocks for immediate shipment. Send for it now! Concord Radio Corp., Dept. LE-51, 901 W. Jackson, Chicago 7, Illinois.

PICTORIAL Instructions. Midget radio, code set, tester, 25c. Arthur Alena, Box 271, Wall Street Station, New York 5.

OPEN Wire transmission line. Perfect reception up to mile from antenna. Cheaper than tape. Permanent. Material list, instructions, \$2.00. TeeVe, Box 20, Silverado, Calif.

ANTENNAS Television — \$14.50 each (\$25.00 list). 20 element, aluminum, stackedarray, bakelite. Quantity prices mailed. AC Electric, 39 Sherman Street, Stamford, Conn.

BECOME An amateur radio operator. Fascinating hobby leads to high paying positions. Home study course. Theory preparation for passing government license examinations. Low cost. Personal coaching. Federal Electronics Institute, 45 E. Putnam, Dept. B, Greenwich, Conn.

"RADIO—How It Works" book and crystal 25c. Sadler Radio, Clayton, New Mex.

AMATEURS—Radio and electrical engineering service. Henry Twillmann, R.R. #1, Chesterfield, Missouri.

COLOR Tone your television! Free information! Harvard Laboratory, 657M Fulton St., Brooklyn, N. Y.

RADIO And television tubes. We have all numbers. They're all new at good discounts. Write us for your needs. Immediate response. Beacon Stores, Inc., Anderson Avenue, Grantwood, New Jersey.

M A K E Simple, tubeless, batteryless, distance-getting crystal radios. Crystal and illustrated instructions 25c postpaid. Allen, 427-P, Clinton, Mo.

BUSINESS OPPORTUNITIES

MIRROR Resilvering. Wonderful home business. Complete formula 50c. Magic two-way mirrors. You can see out—no one can look in. Formula 50c. How to make coppered mirrors, vases, glasses. Formula 50c. All three \$1.00. Nelko Chemical Service, Box 3462-ME, Chicago 54, Ill.

HOW To set up and run a mirror shop! Resilvering mirrors. Making chipped glass nameplates. Electroplating salts and rectifiers. John Sprinkle V60, Marion, Indiana.

MAKE Money at home as renewal headquarters for all magazines. Liberal commissions. No experience, no capital needed. Supplies furnished. Write for free catalog. McGregor Magazine Agency, Dept. 500B, Mount Morris, Ill.

\$5 HOUR Easy! Sell name plates for houses. Free sample, order blanks. Write: National, 214 Summer, Boston, Mass.

SELL By mail, free details. Instructive booklet 25c. Manhattan House, Box 50-M, New York 28, N. Y.

MAKE Perfume. Catalogue free. International, 6347 Farnell-PM-5, Chicago 21, Illinois.

\$10 HOUR! Invisible reweaving course, steel tool, samples, material for life, complete \$2. Details free. Walsh, 894 Main, Buffalo 2, New York.

OWN Your lifetime business. Small investment. Mail Order News shows how. Sanchez, 1513 12th St., El Paso, Tex.

INCOME From local information. No selling. Write Neherco, La Verne, Calif.

BULK Perfume beads for making necklaces, earrings, rosaries. Mission, 2328P West Pico, Los Angeles 6, Calif.

\$8,000.00 YEARLY. Proven plan. Home work. Details free. Etterman, 1991-B5 Lake, Muskegon, Mich.

MAN! These are hot! Make \$6.35 on every sale. Sales are really easy. New adding machines in original factory cartons you can sell for only \$12.95 and you make over 45%. They're executive model portables, precision built, fully guaranteed. Send for life-size color photo with full details. Write today to Lightning Adding Machine Co., Inc., Dept. P-5, 1260 West Second St., Los Angeles 26, Calif.

BE A "household pest control operator." Clean, light work. Full or part time. Information free. Adom Exterminating Co., 2304 Arctic Avenue, Atlantic City, N. J.

INVISIBLE Reweaving—Big profit, big demand, easy-to-learn with low-cost complete course—nothing else to buy, ever. Details free, write today: Fabricon, Dept. N-1, 8342 S. Prairie Ave., Chicago 19, Ill.

TRADE Magazines help you to success. Get latest copies through our easy-to-get-acquainted service. More than 1200 business, professional, agricultural, automotive, educational, sport, hobby, music, television, etc. List free. Commercial Engraving Publishing Co., 34C North Ritter, Indianapolis 19, Indiana.

MAKE Perfumes at home. Write Carey Laboratories, 1914 Chouteau PM-5, St. Louis 3, Missouri.

START Home manufacturing business making cleaning compounds, soaps, insecticides, cosmetics, polishes, food flavors. No machinery. Literature free. Kemix, Park Ridge 6, Ill.

BIG Money! Spare or full time in your home. No selling! Spray new miracle finishes, plush and suede, on signs, radios, automobiles, figurines, lamps, toys, etc. Our business is booming. Help us fill huge demand. New easy Flok-Kraft methods. Material costs few pennies. You get dollars. Free samples, complete powerful money-making plan free. Write now! Coast, 1002F S. Los Angeles St., Los Angeles 15, Calif.

FIGURINE Molds and many others, liquid rubber, statuary plasters, flock finishes, etc. Illustrated catalog and "Plastercraft" manual free. Blue Rapids Supply, Blue Rapids, Kansas.

START Your own business on credit. Always your own boss. 1559 dealers sold \$5,000 to \$28,000 in 1949; their average \$6,834. We supply stocks, equipment on credit. 200 home necessities. Selling experience unnecessary to start. Wonderful opportunity to own pleasant profitable business backed by world-wide industry. Write Rawleigh's, Dept. EU-PPM, Freeport, Ill.

LEARN Sewing machine repair. Electrically, rent, trade, sell. Big profit home setup. We show you how. Motor kits, new machines, etc. supplied wholesale. Free particulars. Taylor Service Co., Hamilton PM-5, Ohio.

MAKE Rubber stamps, repair dolls, invisible mending, metalize baby shoes, silver mirrors. Catalogue of "40-Ideas" free. Universal, Box 1076-A, Peoria, Ill.

START Home print shop. Big paying business. Easily learned. Free details. Printing Institute, 4328 N. Lincoln Ave., Chicago 18, Ill.

SAWDUST, Scrap wood, over 150 cash uses 25c. Lee, Box 502, Chicago 90.

EARN Money at home with your typewriter! Spare time! Details free. Edwards, Publisher, 3915-PM, 12th, Des Moines 13, Iowa.

CONCRETE Block machine plans \$2. Build your own machinery from salvage. Handbook, only 25c (refundable). Free details. Kenneth Reeves, Box 3357-C, El Paso, Texas.

MAILORDER Profits 4 ways distributing trade magazines under your name. Instruction samples 25c. Craigie, New York 19.

ELECTROPLATE Metals, non-metals; mirror re-silvering. Inexpensive, profitable home process. Free booklet. Tyco Metals, Box 13231X, Houston 19, Texas.

AUTOMOTIVE Mechanics: \$20.00 and up, in an hour! We show you how. \$5.00 invested can earn \$40.00 for two hours' work. Write Seal Tank Co., 1409 So. Pershing, Muncie, Ind.

NATURAL Molding Latex. Extra thick. Free sample. W. Wooley, 115-A Donald, Peoria, Ill.

MAKE Money at home making fast selling item used by millions. Terrific possibilities. No experience or equipment needed. Everything furnished. Write Strauss, 1211A So. 114, Milwaukee 14, Wis.

TIN-Cans. Turn them into cash. Nine methods. Instructions 50c. Charles Co., 12-BWK, Norwood, Ohio.

QUICK Sign painting. Use letter patterns, avoid sloppy work, wasted time. Write for folder. John Rahn, A1330 Central, Chicago 51.

MAKE Tough, durable plastic—1c pound. Makes attractive floors, walls, built-ins, roofs. Build good home, \$150.00 room. Bays Laboratory, Oklahoma City 9.

FORMULAS: Silicone auto polish \$1.00. Non-slip floor coat 25c. Grant Lovell, 2166 South Shore, Erie 5, Penna.

BIG Money cleaning venetian blinds. Small investment for equipments starts your own lifetime business. Write G. E. Co., 442 N. Seneca, Wichita 12, Kansas.

BOOKKEEPERS Earn \$100.00 weekly operating simplified "Bookkeeping-Tax Service." Details free. Universal, Box 664-M, Springfield, Mo.

REVOLUTIONARY Conception of public bookkeeping! \$5.00 hourly. Simple instructions. Full, spare time. Systems, shortcuts, obtaining clients. Auditax, 10775-K Tabor, Los Angeles 34.

FREE Book "372 Unusual Worldwide Businesses." Work home (U.S.A.)! Get surprise! Publishers-65, Carlsbad, Calif.

NYLONS! Amazing get rich quick, 100% bonus offering. Essential Products Co., 210 5th Ave., New York City.

SPECIAL Rubber for making molds. Literature and sample free. Universal, Box 1076-A, Peoria, Ill.

AUTOMATIC Style pistol lighter, chrome plated, pearl handle, \$14.00 dozen; sample \$2. Robert Celaya, Brownsville, Texas.

BEST Source for nylons. Rich Supply, 215 W. 98, New York 25.

DEFENSE Welding jobs pay. Welders needed. Train quickly. VA contract. Hobart Welding School, Box M-513, Troy, Ohio.

THE Real truth about bronzing baby shoes! Free facts! Electro Craft, Hillside Avenue-Woodlawn, Buffalo 19, N. Y.

FREE Illustrated instructions casting novelties. Genuine latex for molds. Major Chemical Co., 164 Portland St., Cambridge 39, Mass.

BIG Time earnings selling popular repeat-order merchandise by mail from your home. Everything furnished. Spalding, 254-P Taylor Blvd., Millbrae, Calif.

RENT Power tools for profit, what, how, how to figure rates, etc. Information 50c. Richard Finn, Box 873-A3, Buffalo 5, N. Y.

BE Your own boss. 137 practical business plans for men or women anywhere. Details free. United Enterprises, Box 163, Quincy, Florida.

\$250 WEEK Reported! Free book "505 Odd Successful Businesses." Work home! Expect something odd! Pacific-22, Ocean-side, California.

OVER 700% Profit making finished photos in 2 minutes on the spot in daylight without darkroom. No experience needed. Simple directions teach you quickly. Write, P D Q Camera Co., 1161 N. Cleveland Ave., Dept. 70, Chicago 10, Illinois.

MAKE Hollywood stars perfume at home. Big profit. Full information. Write Emly Mig., P.M.-12, Box 319, North Hollywood, California.

RESURFACE Butcher's chopping blocks with easy, fast-working, portable electric machine. Unique service in wide demand with little competition. Large steady profits from full or part-time work. Hill Machine Company, Box 677B, Rockford, Ill.

TERRIFIC Profits selling amazing payroll table \$1.00. Sample 25c. Joseph Ventola, 39 Illinois Avenue, Somerville, Mass.

YOU Can better yourself in electroplating. Free details. Joseph Kushner Electroplating School, Stroudsburg 161, Penna.

MAKE Big money at home with Magic Pearl Finish. Free plan. Pearl-Art, 7216 Bear, Bell, Calif.

NEED Money? Stop wishing! Do something! Free information. E. L. Glodfelter, Box 23, Loganville, Penna.

UNPAINTED Figurines. Illustrated list. Free. Oman, 642 Broadway, St. Paul 1, Minnesota.

TO \$39.00 Weekly. Spare time, home operated mail order business. Successful "beginner's kit." Cash bonuses. Everything supplied. Economy Printing, 23-PM West 6th, Eugene, Oregon.

PRINT Without a printing press. Big profits! See page 39.

FIX Typewriters—Home study course quickly trains you for own business. Factory methods taught. Write: Typewriter Repair, 4915 Corbet, Tarentum, Penna.

TO \$35.00 Weekly. Spare time, home operated mail order business. Successful small "beginner's" plan. Everything supplied. Lynn, 5710-M Bankfield, Culver City, California.

MAKE Flexible molds! Cast plaques, bookends, figurines! Free sample! H. Tooker, 630-R Chestnut, Hamilton, Ohio.

A Business in your own home! Our chemicals, plus free water and cheap "grocery store" materials can bring you over \$500 monthly earnings. Plans and formulas free. Western B Aircraft, Los Angeles 19.

BUY Wholesale—Million articles. Supply source directory, dime. Nelko, Box 3462-DR, Chicago 54, Ill.

PART-Time business, full-time profits. Metallizing (plating) equipment, supplies, hard-to-get chemicals and anodes. Complete assemblies for plating baby shoes, jewelry, novelties and industrial products; copper, bronze, gold, silver, nickel, chrome, etc. Home workshop to production shops priced from \$79.50 complete. World's largest line of metal, onyx and marble mounts for bronzed baby shoes. Instructions furnished. Buy direct from manufacturer. Write for free catalog and address of local branch. Hollywood Bronze Supply, Technical Dept., 1624 East First St., Los Angeles 23, California.

LIQUID Marble—Colorful, glossy! Molded, brushed, sprayed! Cast novelties, statuary, colored tiles. Flexible molds. Composition floors. Particulars free. Marbleizing Service, Edwardsville, Illinois.

MAKE At home. Sell everywhere. Super-Solveen hand soap, Cameo polishing cloth, Tiffnite glass wax, Nu-Gleem furniture polish, Blitzeen roach exterminator, Luxor floor wax, Oxium soldering fluid, Toxite fly spray, Titania metal polish, Daxtol moth spray, Hydrolax drain cleaner, fragrant wick air deodorant. Complete formulas, 25c each. Any five, \$1.00. Label copy, buyer's directory included. Majestic, 530½ S. Main, Elkhart, Indiana.

MEN, Women. Grow mushrooms. Cellar, shed. Spare, full time, year 'round. We pay \$3.00 lb. We paid O. Babbitt \$4.165 in few weeks. Send \$2.00 for General Information Book. Washington Mushroom Ind., Dept. 125, 2954 Admiral Way, Seattle, Wash.

NEW Profitable home business repairing zippers. Thousands of customers waiting. No experience required. We furnish everything. Write Texas Specialty Company, 204-B Texas, Texarkana, Texas.

ROUVIER Perfumes formerly \$4.00 per dram, now \$1.00 postpaid. Box 30, Westchester Square Station, New York 61.

BOOKKEEPERS Boost income operating simplified bookkeeping service. Kern, 4942 Vineland Avenue, North Hollywood, Calif.

UNPAINTED Bookends, plaques, statues, figurines. List. Haverty Products, 822-17th St., Altoona, Penna.

VENDING Machines earn big money! An investment as low as \$10.50 will start you in this fascinating, profitable business that can lead you to the road of success and independence. Routes can be established and operated in either full or spare time with no experience needed. Write for full details and our free catalog illustrating our nut, candy, gum and stamp vendors; also pin ball machines, music boxes, etc. Write immediately to Parkway Machine Corporation, Dept. 7, 715 Ensor Street, Baltimore 2, Maryland.

EARTHWORM Breeding. Valuable bulletins on successful methods mailed free. Earthmaster System, Dept. 14, El Monte, Calif.

YOUR Own profitable home business. Preserve live flowers to last for years. New simple discovery. Enormous demand all year 'round. Tremendous profits! Light fascinating work. Send \$2.00 for working equipment, instructions, and valuable sales plans. Satisfaction guaranteed or money promptly refunded. Alfred Hermansen, 210 Fifth Ave., Suite 1102A, New York 10, N. Y.

WANTED! Home producers by manufacturers in our clearing house service. Become a sub-contractor, casting plastic products for these companies. Thousands of easy to make items required. Cash in at home without previous experience. For details write Plastic Service Guild, Dept. PM, 233 Condon St., E. Boston 28, Mass.

MAKE Money spare or full time, casting metal toys and novelties. Big wholesale and chain store demand for cast metal, autos, soldiers, ashtrays, banks, etc. keeps manufacturers busy. Production molds furnished for up to 100 and more castings per hour. No experience or special place necessary. Write for information and illustrations of patterns needed. Metal Cast Products Co., Dept. A, 1696 Boston Road, New York 60, N. Y.

COLOR Concrete with chemicals. Marble-glaze cement benches, pottery, garden ornaments. Home—shop. 10c brings sample, pictures. Hollywood Cementcraft, 8527-R Wonderland, Hollywood 46, Calif.

START Mailorder bookshop — Everything furnished. 25c brings booklet, samples, exciting ideas. General Publications, Ossining, N. Y.

THOUSAND Articles wholesale. "Supply Source Directory" 10c. Ideal Service, Park Ridge 30, Illinois.

BE Appointed state notary public now! Details. Stationers, Helotes 50, Texas.

OPERATE Profitable mail order business. Write Walter Service, 4159-A East 112th, Cleveland 5, Ohio.

DOLLARS In personalized baby record books. Sell by mail. Use same literature we do. No-Co-Ro, Oakland 6, Calif.

LEARN Professional candy making profitable home business. Details free. Pate, Kissimmee, Florida.

COMMERCIAL Deep frying course. Mock chicken legs, potatoes. New and proven methods. Learn about this money-making field. \$2.50 p.p. Concession, Toledo 13, Ohio.

FABULOUS Earnings—Fascinating pastime. Growing genuine, living miniature (ming) tree. New sensational business or hobby. Astounding information free. Dwarf Gardens, Box 355B, Briggs Station, Los Angeles 48, Calif.

BRUSH Plating outfits connect to a battery. No tanks necessary. Good paying business at home plating autoparts, bathroom fixtures, bicycles, reflectors, silvering mirrors. No shop or experience required. Outfits furnished. Free booklet. Gunmetal Co., Ave. H, Decatur, Ill.

CASH For your idea, 280 manufacturers need inventions, patented or unpatented. List free. Invention Bureau, 208-M Clinton, Oak Park, Ill.

OWN A printing business. Good profit printing cards, stationery, etc. in spare time. Easy rules furnished. Have home shop. Send dime for complete printer's supply book and samples. Kelsey, Inc., Z-24, Meriden, Conn.

\$25 WEEKLY Working two hours daily. No canvassing. No manufacturing. Lycke, Box 2471-A, Cleveland 12, Ohio.

RECAST Old batteries into new. Latest achievements. Battery Laboratories, Minneapolis.

MADE \$24,500 Using money making plans from Schemer Magazine, world's oldest mailorder publication. Box 275M, Canfield, Ohio. Year \$2.00. Sample 20c.

MINK Raising information free. Complete. Lake Superior Mink Farm. Superior, EE1, Wisconsin.

POPCORN And potato chip equipment. Long Eakins Company, 5160 High, Springfield 99, Ohio.

COPUBLISH Leading m.o. paper. Latest copy Mail Sale Advertiser, details, dime. Vanroy Shirk, Lebanon, Penna.

READ "Advance"—The voice of mail order. Offers money-making opportunities, sources of supply, personal guidance, etc. Issued monthly. Sample copy 25c. Yearly subscription \$2.00. Advance Publishing Company, 313 East 21st Street, Suite 450, New York 10, N. Y.

CO-PUBLISH And advertise in The Central Mail Advertiser. Sample copy 10c. Low rates. Large circulation. Bagby Printing Co., Georgetown, Ohio.

MAKE Money at home—Ideas galore to choose from. All fully illustrated and described. Write: Spens Distributors, Box 5511-M, Chicago 7, Ill.

BUY It wholesale! Manufacturers, distributors offer 850,000 items. Literature free. Olsen, 1231-A East Third St., Duluth 5, Minn.

LIQUID Rubber. Make flexible molds. Free sample. Chaney, 1130 E. 16th St., Jacksonville 6, Fla.

RAISE Earthworms for gardening and fishing. Information with each order. \$7.00 per 1000. James Vetraino, 5826 Harding, Detroit 13, Mich.

MAILING Postcards selling repeat merchandise is profitable. Everything supplied. Details free. Gordon Publishers, Box 23, Pawtucket, R. I.

MEN—Women. Everybody likes candy. Learn to make professionally. Our 40th year. Ragdale Candies, D5, East Orange, New Jersey.

\$46 FROM Square foot plywood; jigsaw necessary. Write, Woodarts, Bridgewater, Mass.

COLORGLAZED Concrete pottery made without molds. Patented method. Cemetery products, novelties, tiles. Basement leak-sealing. Money-making projects. Booklet, details free. Men only. National Potteries Company, Grand Rapids, Minnesota.

MONEY in new greaseless doughnuts. Start in kitchen. No smoke. Sell stores. Free recipes. M. Ray Company, 3605 South 15 Ave., Minneapolis 7, Minnesota.

MONEYMAKING OPPORTUNITIES

DRAFTING Pays big money, is light, interesting work. Learn drafting at home in spare time. Professional set drafting instruments, portable drafting table, drafting equipment given you. Easy payment plan. Free book. Christy Trades School, 4432 N. Kedzie, Dept. DC-106, Chicago 25.

FIFTY Different mail order and hobby publications for only 25c. Information galore. Stevens, 716 West Fourth, Michigan City, Indiana.

MEXICAN Jumping beans 150% profit. Details. Mann's, 5330 No. Natoma, Chicago 31.

\$200 WEEKLY Reported! No selling. Free booklet. T. J. Surface, Roanoke 4, Virginia.

\$35 WEEKLY! Home! Two hours daily! Invisible reweaving instructions and 27 other amazingly unusual ways! Walsh, 894 Main, Buffalo 2, New York.

EARN Money at home with money-making hobby! No canvassing. Up to \$100 monthly, possible. 25c brings complete plan. Satisfaction guaranteed! Stevens Hobbies, 12-A Orchard, Wellesley Hills 82, Massachusetts.

EARN Important money, full or part time selling novelty tie clasp. Free details. Columbia Supply, 1060 Ferguson, Newport News, Virginia.

WOULD You pay 3%—first \$350 made? Book "505 Odd Successful Businesses" free! Work home. Expect something odd! Pacific-21, Oceanside, Calif.

MAKE Backyard profits! Unusual opportunities! Details free. Pickett's, Florence, Kentucky.

BUY 450,000 Articles wholesale. Directory 10c (refundable). Publishers, Box 1302-P6, Detroit 31.

DEFENSE Welding jobs pay. Welders needed. Train quickly. VA contract. Hobart Welding School, Box M-516, Troy, Ohio.

SELL! Buy! Trade! anything. Read, "Trading Post Magazine" 20c. Thorne's, 525 Dewey, Jackson, Michigan.

SELL Snowballs—\$7 buys ice shaver that shaves into the cup and enough flavor and cups for thousand Snowballs. \$2.25 buys buys regular shaver and flavor for 500. Illustrated circulars free. Snowball Company, 9334B Lemturner, Jacksonville 8, Florida.

CAN You make \$40 a week, typing at home, in your spare time? Write Hood's, Kannapolis 12, N. C.

WANT To sail merchant ships? Outstanding wages to \$400.00. Beginners \$220.00 monthly. Only \$3.00 delivers bargain. American Seamens Guide, 545 5th Ave., New York City.

OLD Car tires, turn them into dollars. Don't delay. Instruction 50c. Fenn, B61W, Readfield, Wis.

A Shortage? Hardware specialties, cutlery distributors prices. List items. Woodworth, Walworth, 1M5, N. Y.

HOME Electroplating units \$8.95. Includes tank, rectifier. Free details. Reed Engineering, 620 So. Inglewood, Inglewood, Calif.

MAKE Money while sleeping. Two column, penny candy or nut machines. Hurry for these beauties. Ellis, Box 167, Long Beach, California.

MAKE Money at home. 101 ideas for full or spare time earnings. Proven winners. All for 25c. Thomas F. Patrick, c/o State Farm, Pikeville, Tennessee.

"WATERLESS (Lanolin) Hand Cleaner." (Oil base.) Make, sell. No machinery. Build profitable business. Complete formula \$1.00. Ideal Service, Park Ridge 3, Ill.

DOLLARS Three ways with "Kitty-Kat" readi-cut baby shoes. Complete local and mail order plans. Write No-Co-Ro, Oakland 6-K, California.

RAISE Your business value, standing, as state notary public. Information. Stationers, Helotes 50, Texas.

PUBLISH Your own magazine. Hand-some 52 page format, well edited, illustrated. Cost low as \$1.00 month. Brings you prestige, profits, 25c brings sample, details. National, Ord, Nebr.

READ Progressive Mailtrade, the magazine that tells how to make money by mail. Dime brings sample and special offer. Progressive Mailtrade, Box 357, Sheboygan, Wisconsin.

INDEPENDENT Income! Make leather belts, billfolds, purses. Big catalog and genuine steerhide keyholder, 10c. Tandy Leather, Box 397E, Tulsa, Okla.

LEARN How others earn money at home! Write—A. Sizemore, 4917 Kostner, Chicago 30, Ill.

QUICK Profits taking magazine subscriptions, handling greeting cards. Cassell Publishers Service, Westfield, N. J.

EARN Money evenings, copying and duplicating comic cartoons for advertisers. Adservice, Argyle 1, Wisconsin.

FORMULAS, PLANS, ETC.

A Mechanic's hand cleaner. Make your own. No sand or ammonia. Costs approx. 10c per lb. Used by mechanics and machinists for years. \$1.00 brings instructions. Vilnox, 300 N. Gay St., Knoxville, Tenn.

FORMULAS Unlimited. recipes, trade secrets, processes. 3c stamp brings literature and 5 household formulas. American Home Service, Box 96, Cresco, Iowa.

FORMULAS. Latest, best. Catalog and chemical instruction sheet 10c. (refundable). Nelko Chemical Service, 3462-F Merchandise Mart Sta., Chicago 54, Ill.

MILLER'S Modern manufacturing formulas make products that get the business and pay! Fifty years supplying the best. Literature free. Liscomb Miller, Chemical Building, Tampa, Florida.

WATERLESS Hand cleaner. (No ammonia.) Easily made. Good profit. 2 dependable formulas \$1.00. Nelko Chemical Service, Box 3462HC, Chicago 54, Ill.

REAL Manufacturing formulas. Lists free. Cummings, Chemist, Gordon Ave., Syracuse 4, N. Y.

MAKE—Sell cleaners, soaps, polishes, flavors, cosmetics. No machinery. Formula literature free. Kemico, Park Ridge 16, Illinois.

FORMULAS, Trade secrets, for nearly everything. Catalog free. Creative Publishers, Winnetka 6, Illinois.

TESTED Formulas. Interesting descriptive booklet free. Pont, Box 635-PM, Terre Haute, Indiana.

PLASTICS

PLASTICS—This catalog is your bible. Wholesale, retail quantities. Lucite, plexiglas, acetate, sheets, rods, tubes. Casting, molding plastics. Dye manufacturer. Internal carving supplies. Findings, supplies. Catalog, 10c. 25c airmailed. Gem-O'-Lite, Box 6862, North Hollywood, Calif.

\$200.00 BUYS 399 Sheets 20" x 50" ruby transparent 7½ gauge. Thomas, 4884 Felton, San Diego, Calif.

MOLDING Rubber, \$2.95 qt.; \$9.95 gal. prepaid. Plastercraft Supply Co., 3051 St. Clair Ave., Cleveland 14, Ohio.

HI-Profits, internally hand carved plastics, gifts, jewelry. Free catalog. Pilot Plastics, 67 C-Fulton St., New York City 7.

LUCITE Plexiglas. Any size sheets, masked. Square foot (12 x 12) cost, 1/16", \$1.20; 1/8", \$1.40; 3/16", \$1.75; 1/4", \$2.08. Colors add 10%. Include 10% postage. Almac Plastics, 230 Fifth Ave., New York 1, N. Y.

PLASTIC, Sheets, rods, tubes, etc. Free list. Plastic Supply Co., 2901 N. Grand Blvd., St. Louis 7, Mo.

CHEMISTRY

OH Boy! New Book of Science. Experiments, formulas, secret processes, together with catalogue of laboratory supplies, only 25c. National Scientific Company, Dept. 16, 2204 W. North Avenue, Chicago 47, Ill.

NEW Idea chemical and apparatus outfits for home experimenting. Photo-scales, microscopes, chemicals, biological and laboratory supplies in small quantities. Catalog 25c. Established 1931. John H. Winn, 124A West 23rd Street, New York, N. Y.

ILLUSTRATED Catalog: Chemistry, mineralogy, biology. 10c. Tracey Laboratories, Evanston, Illinois.

CHEMICALS And apparatus for industrial, analytical, and private laboratories. Catalog 15c. Dept. M-50. Biological Supply Co., 1176 Mt. Hope Ave., Rochester 20, N. Y.

HELP WANTED

\$5 HOUR Easy! Sell name plates for houses. Free sample, order blanks. Write: National, 214 Summer, Boston, Mass.

AGENTS WANTED

IS \$210 A week worth a penny postcard to you? Then rush card with name and address for special free trial plan that sells amazing new automatic refrigerator defroster "like hot cakes!" Write to Mr. Lewis, D-Frost-O-Matic Corp., Dept. PMC-5, 6 N. Michigan, Chicago 2, Ill.

MAKE Money easy. Sell everyday cards, 21 for \$1.00, black plastic, metallic and others, children's books, personalized stationery, note paper, wrappings and novelties. Send for samples today. Howard P. Ellis, Dept. PM-5, Pitman, N. J.

MAKE Wedding profits. Sell invitations, napkins, matches. Samples free. Dunbar's, Middlebush 3, N. J.

FREE Catalog, wonderful concentrates, 125 products. Qualco, 5E, 20030 Russell, Detroit 3.

CALENDARS, Advertising novelties, matches. All styles, including religious, varnished, 12 sheet, girls. Hundreds of advertising novelties, book matches, etc. Fleming Calendar Co., 6539 Cottage Grove, Chicago 37, Ill.

SUMMER Money maker. Every lawn owner wants it! Over million dollars sold last summer. You cash in this summer. Approved by four Universities. Barclay Co., Box 883, Plainfield 7, New Jersey.

CASH in on tremendous demand for new cheap oil burner that fits in cooking-heating stoves and furnaces. Burns all kinds of oil including crankcase. Lifetime guarantee. Big profits. Be first. Write quick to Northwest Mfg. Co., 316 Main, Mitchell, South Dakota.

NYLON Uniforms. Immediate delivery. Immediate profits. Sell to doctors, dentists, nurses, waitresses, beauticians, housewives. Free sales kit. Superior Fabrics, Dept. P-5, 3936 Market, Philadelphia 4, Penna.

BE A money maker. Use your home as magazine headquarters. Liberal commissions. No experience, no capital needed. Everything furnished. Write for free catalog. McGregor Magazine Agency, Dept. 500A, Mount Morris, Ill.

FREE Sample nylon stocking of world's only nationally advertised hosiery line actually guaranteed against runs, snags or excessive wear, regardless of cause! It's amazing but true. Every weight from sheerest 15 denier to heavy 70 denier—all gauges to luxury 60 gauge. Amazingly low prices, starting at \$1.08 prepaid for sheerest 15 denier 51 gauge. Not sold in stores. Good Housekeeping guarantee seal. Also complete line men's hosiery guaranteed one full year or replaced free. Full variety lingerie in crepe, satin and nylon, featuring all nylon slip at \$2.95, satin slip at \$1.58, etc. Housecoats and robes. Kendex sales people will earn one million dollars this year. Get your share. No money or experience needed. Pay nothing now or later. Just show free outfits. Write orders. We deliver and collect. Advance cash plus huge bonus. Earn money spare or full time. Become manager; appoint others to sell for you; earn steady income on their sales. Man or woman—young or old, you can earn more money than you ever thought possible. Everything you need is furnished free and prepaid, including nylon stocking, samples of materials, sales books, 36-page salesmanual, color cards, etc. Simply write your name and address on postcard and mail to Kendex Corporation, Babylon 53, N. Y.

MEXICAN Feather pictures. Sell on sight; 200% profit! Free details; sample 10c stamps. Sylvia-PL, Apartado 9036, Mexico City.

SCARCITY Line. Power mowers—\$59.95. Sensation. Special deal—delivered. Rotacut-RP, Excelsior Springs, Mo.

SELL Gold wire jewelry. Fast profit. Repeats. Free outfit offer. Phillips Jewelry, Belleville, Michigan.

SO Easy to sell what everyone wants, when they can get it only from you. That's why ReSilvit, the scientific new magic compound, is pouring big profits into pockets of agents and demonstrators. Spare and full time openings. Quick action needed. Get free details today. American Enterprises, 156 East 52nd Street, New York 22.

FERTO-Pot, plant late pot, and lawn-seeded Ferto-Soil, for patching or building new lawns. Commission 33½%. Allen Co., Pittstown 2, N. J.

MEXICAN Feather pictures. Unusual novelty. \$1.00 (stamps) brings \$2.00 worth samples. Refunded if unsatisfied. Aztec Art P, Apartado 762, Mexico City, Mexico.

AGENTS 110% Profit selling new precision built Addomatic adding machine. Adds to 999,999 accurately. Only \$10.00. Artcraft Industries, Westmont, Illinois.

BUY Wholesale thousands nationally advertised products at big discount. Sent free "The Wholesale Plan." American Buyers' Service, 629-H Linden, Buffalo, New York.

BUY Thousands of nationally advertised products direct from manufacturers and distributors. Write for "Buy Direct and Save." Service Publishing, 1420-A Investment Bldg., Pittsburgh 22, Penna.

YOU Teach Hawaiian woodwind in 10 weeks. Musical instrument including course \$20.00. B. E. Richman, 5516 Chester Avenue, Philadelphia, Penna.

BUY Wholesale. 25,000 items, catalogue 25c. Matthews, 1472B1 Broadway, New York City.

BUY Nylons direct from mill. Make good profits on fast selling nylons. Quick delivery on any quantity. Write for confidential wholesale price list. Joy Hosiery Mills, Delawanna 13, New Jersey.

MEXICAN Feather pictures. High profit selling gift shops, etc. Adelphi, Box 57-B, Bellefonte 6, N. Y.

HI-Profits, internally hand carved plastics, gifts, jewelry. Free catalogue. Pilot Plastics, 67C-2, Fulton St., New York City 7.

100% PROFIT. Easy repeat sales. Cash bonuses. Sell embossed business cards. Free information. Economy Printing, 23-P W. 6th, Eugene, Oregon.

GREETING Card bargains. Personalized gift items. Raum's, 4154 Fifth Street, Philadelphia 40.

NYLONS—New "2500-High-Twist" nylons. Direct from mill. Free sample outfits. Guaranteed longer wear, resist runs and snags 40% more. Its 40 turns per inch "High-Twist" in 2500 threads, by laboratory tests prove they outwear all the others. Just few months ago it was believed impossible. We now sell more stockings than ever before. Earn \$1.00 a box, or make more money buying dozen. Box 3 (60-15) \$3.40; (51-15) \$3.15 prepaid. Amazing new "3-step" plan gets orders for nylons. Hand-over fist! Ergim Hosiery Mills, 992-PM Columbus Ave., New York.

MAKE Hollywood stars perfume at home. Big profit. Full information. Write Emly Mfg., P.M.-12, Box 319, North Hollywood, California.

ULTRA-Blue stock signs—6c, sell 35c. 1000 slogans, 7"x11", comedy, religious, general. Free sample. Lowy, 812-MY Broadway, New York 3.

AGENTS: Sell lawn-mower sharpeners to home owners. Write for details. Accurate Sharpener Mfg. Co., Milwaukee 12, Wisconsin.

NEED Extra cash? Take orders for personal initialed belts and buckles, cap badges, tie holders, etc. Choice of 3000 emblems. Free sales kit. Hook-Fast, Box 1425PM, Providence, R. I.

SELL Greeting cards—Big profits! Quick sales! Catalog free! Elfco, 432 North Wells, Chicago 10.

FREE Samples. Big profits showing amazing "Glow-in-the-dark" specialties. House numbers, pictures, plastic novelties, ashtrays, keyholders, religious and nursery objects, etc. Madison Plastics, 303 Fourth Ave., New York 10, N. Y.

PHOTO-Salesmen, agents. Sell beautiful hand colored plastic enlargements and sensational new photo compacts, rings, bracelets, lockets, etc. Collect deposit, we deliver. Profitable sideline. Send card, for free sample kit. Novel Portrait Co., 3343 North Ave., Chicago, Ill.

EXCELLENT Sideline for printing and advertising salesmen. Decalcomania name plates in small quantities. Great demand. Also, make money with our line of automobile initials and sign letters. Free samples. "Ralco" XL-Roxbury, Boston 19, Mass.

JEWELRY Factory desires salesmen, distributors, jobbers. Pickcraft, 19 Bank Street, Attleboro, Mass.

GOLD Lacquered window sign letters. Large sizes penny each. New foils. Absolutely beautiful. Free samples. Atlas, 544 W. 79th, Chicago 20.

\$5 HOUR Easy! Sell name plates for houses. Free sample, order blanks. Write: National, 214 Summer, Boston, Mass.

AGENTS: Stamping names on key protectors. Sample 25c. Stamping outfits, checks, social security and name plates. Hart Mfg. Co., 303 Degraw St., Brooklyn, N. Y.

DRESSES. 18c; Coats \$1.00, blouses 35c. Free catalog. Crown, 164-P Monroe Street, New York.

AGENTS—300% Profit selling genuine gold window letters; stores and offices. Free samples. Metallic Letter Co., 438-B North Clark, Chicago.

WANTED—Purchasing agents. No money or experience required. Write Dept. C, Purchasing Manager, 2719 Lawrence, Chicago, Ill.

SELL Big money-maker to men and women. Easy handwork makes fast-selling useful articles. Sunmade Company, Brockton 64, Mass.

BIG Spring sales! Scat Wick Deodorant gets rid of unpleasant odors quickly. Sample Scat and Kitty \$1.00. Write for 16-page catalog of household items. Sunshine Sales, Dept. WP-8, Loudonville, Ohio.

PAINTS—All kinds. 65c gallon up. Private label. Big profits. Certified Products, Louisville, Ky.

HIGH-GRADE SALESMEN

ADVERTISING Book matches—Cash in on big demand; sell union label matches. Cuts for all businesses and political parties. Free powerhouse selling kit, low prices, protection guaranteed on repeat orders. Cash commissions. Superior Match Co., Dept. M-551, 7530 Greenwood, Chicago.

WRITE 3 Words—Collect \$7.65 on 10-second demonstration to merchants. Write on glass with amazing magic crayon—Presto! 5 color advertising message takes fire, glows like brilliant neon. Three sales daily bring \$22.95 profit. Rush postcard for details. Complete sales kit, free! Max-lume Co., 125 W. Hubbard, Dept. CL-85, Chicago 10, Ill.

EARN Big money fast! Sell finest-quality advertising work uniforms to garages, factories, filling stations, etc. Free selling kit. Topps, Dept. 535, Rochester, Ind.

IS \$210 A week worth a penny postcard to you? Then rush card with name and address for special free trial plan that sells amazing new automatic refrigerator defroster "like hot cakes!" Write to Mr. Lewis, D-Frost-O-Matic Corp., Dept. PMC-5, 6 N. Michigan, Chicago 2, Illinois.

MAKE Over \$100.00 weekly, demonstrating and taking orders for fun-provoking advertising rubber dollars (stretchers), designs, slogans, rhymes, to clinch orders for any business, with worth-while cash deposit. Headquarters for unusual, dramatic, attention-compelling ad-specialties. Write for sales kit. Meinhardt Co., 421 Lincoln Ave., Dept. PM, Chicago 18.

AD Matches! Sell amazing designs—20, 30, 40 and 240-light book matches. Bigger spot cash commissions; every business a prospect. Low prices for high quality. Repeats. Start without experience; men, women; full, part time. Buy nothing! Sales kit furnished. Match Corp., Dept. PM-17, Chicago 32, Illinois.

WANT To make real money? You can positively make \$50.00 a day and up selling a brand new item going to every type of food and beverage store, factories, laboratories, hospitals, etc. First time advertised. Write for free details today. Johnson-Hartman, 53 West Jackson Blvd., Dept. PM-5, Chicago 4, Illinois.

PART Time or side line salesmen to represent factory selling advertising pencils. 25% commission. Union Pencil Co., 389 Broadway, New York City.

EVERY Woman wants lovely monogrammed personal stationery. Easy profitable sales. Show samples for immediate profits. Carson Products, 15-D East 8th St., Kansas City 6, Mo.

SELL Our waterproofings, floor mastic, cement hardener, etc. (30 items) to maintenance men, building owners, contractors. Can start part time. Commission. Territory. Write Haynes Products Co., Desk 6, Omaha 3, Nebr.

BIG Profit selling perfumes. Trial oz. \$1.00. Details free. Roberts, 432 Fremont Ave., Springfield, Ohio.

"MARY-Mac" gas water heaters—Factory. Steady income. Permanent. McDaniel Manufacturing, 1012 Powhattan, Dallas, Texas.

\$2600 NEXT 9 Weeks—Season starting. Sell calendars, specialties, matches. Prospects everywhere. Advanced commissions. Experience unnecessary. Samples free. Continental Calendar, 542-A South Dearborn, Chicago.

BIG Money taking orders. Shirts, ties, Sox, pants, jackets, sweaters, shoes, uniforms, etc. Sales equipment free. Experience unnecessary. Nimrod, 4922-AN Lincoln, Chicago.

A Fine income, your own nylons free! Show nylons, lingerie, men's socks with amazing free replacement guarantee against runs, snags, tears. Write for free sales kit. Group organizers invited. Rosalee Hosiery Co., Clifton 58, N. J.

\$5 HOUR Easy! Sell name plates for houses. Free sample, order blanks. Write: National, 214 Summer, Boston, Mass.

NEW Jobs open in selling! Send name, address for five free issues of Opportunity Magazine's money-making guide, listing hundreds of companies who'll pay you well full or part-time. No experience needed. Opportunity, 28 E. Jackson, Dept. 17, Chicago 4, Ill.

EDUCATIONAL AND INSTRUCTION.

HIGH School—No classes. Study at home, spare time. Diploma awarded. Write for free Catalog HF-8. Wayne School, 2527 Sheffield, Chicago 14, Ill.

BECOME A Doctor of Psychology or Metaphysics. Teach secret of contentment, happiness. Win degree of Ps.D. or Ms.D. Solve mental worries. Free book. College of Universal Truth, 5153-C North Clark, Chicago.

LEARN Technical Metaphysics. Insure success in life. Valuable information. Canada School of Technical Metaphysics, 2532 McKenzie St., Vancouver, B. C., Canada.

PRACTICAL Nursing—Learn easily at home, spare time. Big demand, good earnings. High school not necessary. Write for free facts. Wayne School, Dept. FG-2, 2525 Sheffield, Chicago 14, Ill.

MIDLAND Linotype school. Charles City, Iowa. Civilian, veteran courses. Free placement.

MAKE Up to \$35-\$45 week as a trained practical nurse! Learn quickly at home. Booklet free. Chicago School of Nursing. Dept. M-5, Chicago.

START A collection agency business. Very profitable. Quickly learned. Write Cole & Associates, Syracuse 2, N. Y.

BE A real estate broker through home study or classroom instruction. Write for free book. Approved for veterans. Weaver School of Real Estate, 15 E. Pershing Rd., Box CP-5, Kansas City 8, Missouri.

INVESTIGATORS Trained, men-women. learn fascinating profession. Spare time study. Big pay. Folders free. Investigator, Box 490, Times Square Station, New York 18, N. Y.

LEARN Sign painting. 152 lesson course. Results guaranteed. Stewart Sign Co., Box 287M, Pasadena, Calif.

DRAFTING Jobs available. Qualify at home. Information free. Write today. Monroe Institute, PM-5, Alton, Illinois.

DEFENSE Welding jobs pay. Welders needed. Train quickly. VA contract. Hobart Welding School, Box M-514, Troy, Ohio.

WELDING Training profitable. Learn quickly. Magnificently equipped non-profit school. VA contract. Hobartweld, Box M-515, Troy, Ohio.

AMAZING, New, scientific way to remember. Free details. Memory Institute, P.O. Box 261-M, Staten Island 1, N. Y.

MEMOROLOGY, Science of memory, amazingly simplified \$1.00. Money back guarantee. Memorology Studio, 2016 Sunnyside, Chicago, Illinois.

WAKE Up your success powers. End money worries. Overcome handicaps. Get ahead. Our Behavior Control home study plan produces results or no cost. Free booklet and details. President Ballard, 1008 Washington Bldg., Louisville 2, Ky.

WORK For U.S. gov't. Thousands of emergency program positions open. Men-women. Experience usually unnecessary. Qualify now! Start high as \$66.34 week. Free 40-page book shows jobs, salaries, sample tests. Write: Franklin Institute, Dept. T24, Rochester, N. Y.

EARN While you learn. Day or night classes. Thorough courses in: Automobile Mechanics, Diesel Mechanics, Motor Tune-Up, Auto Body and Fender, Welding, etc. Living accommodations. Veterans may earn \$210 to \$290 per month while in school including subsistence. Fully accredited to train veterans. Thirty-two years' experience training men. Nashville Technical College, Dept. #256, Y.M.C.A. Bldg., Nashville 3, Tennessee.

RAPID Writing, like shorthand. Lessons ten cents. Elliott, 4426 Carrollton, New Orleans.

YOU For president of your own credit-collection business. Many who answered our ads now have their names on office doors. Franklin Credit, Roanoke 7, Va.

PIANO Tuning pays. Learn this profitable profession at home. Our Tunometer and mechanical aids make learning easy. No knowledge music necessary. Diploma granted. Largest and oldest school—53rd year. G.I. approved. Write for booklet. Niles Bryant School, 78 Bryant Bldg., Washington 16, D. C.

LEARN Linotype (machine typesetting). Good pay, steady work. Booklet "X" free. N. Y. Mergenthaler Linotype School, 244 West 23rd, New York.

EARN \$10,000 Annually! Learners \$2,700. Unlimited opportunities in Merchant Marine. Instruction-Employment Manual \$1.00. Refundable. Titan Company, 45 Clinton St., Newark 2, N. J.

INVESTIGATOR Training. Phillips Secret Service System, 1917-B North Kenneth, Chicago 39.

USED Correspondence courses and books sold and rented. Money back guarantee. Catalog free. Courses bought. Lee Mountain, Pisgah, Alabama.

MEDICAL Laboratory Technicians in great demand. We train you in your own home. Catalogue free. Imperial Technical Institute, Box 973-J, Austin, Texas.

SECRET Investigation. Experience unnecessary. Investigators particulars free. George Wagner, M 125 West 86th, New York.

BOOKKEEPERS! Increase your earnings! Operate your own simplified "dollar-a-week" bookkeeping and tax service. Full or spare time. Details free. No obligation. Ellis, Box 200, Cedar Grove, North Carolina.

HOME Study course, drugless therapy. Free literature. Institute of Drugless Therapy, Tama, Iowa.

USED Correspondence courses and educational books bought, sold, rented. Catalog free. Educational Exchange, Summer-ville, Ga.

STUDY To be a doctor of psychology or metaphysics. Obtain Ps.D., Ms.D., D.D. or Ph.D. degree. Chartered by state. Write for free book telling how. The Neotarian Fellowship, Desk 8, Dwight Building, Kansas City 6, Missouri.

VOICE Secrets! Free information. Studio 14356B, Jersey Ave., Norwalk, California.

BUSINESS SERVICE

HAVE A Chicago mail address. Information free. Schultz House, 3116 Seminary, Chicago 13.

SPECIAL SERVICES

WHOLESALE And Mfrs. located. \$1.00 per item, stamps or m.o. Reliable Service, 201 Clinton St., Woodbridge, N. J.

LETTERS remailed, 25 each. Sylvia Brown, 4324 Normal Ave., Hollywood 29, California.

INFORMATION

100 HANDICRAFT Markets: wood, crochet, etc. Big Buyer's Bulletin \$1.00. Free details. Research, 2409 12th Ave., Los Angeles 18, Calif.

PLAYS, STORIES, MANUSCRIPTS

I Want new writers to cash checks of \$1 to \$100 offered daily. The easiest way to write for pay. No previous experience necessary. Free details. Saunders M. Cummings, 468-11 Independence Bldg., Colorado Springs, Colo.

BEGINNING Writers: Let us show you how to get \$1.00 to \$20.00 checks daily. Experience unnecessary. Details free. Herwell Company, 7016-M Euclid, Cleveland 3, Ohio.

CARTOONING, COMMERCIAL ART, SHOWCARD WRITING, SIGN PAINTING

HUMOROUS Caricature from photo. Ideal present. Send photograph and \$15.00. Cecil Lowen, 952 St. Marks Ave., Brooklyn, N. Y.

"HOW To Make Money With Simple Cartoons"—A book everyone who likes to draw should have. It is free; no obligation. Simply address Cartoonists' Exchange, Dept. 95-C, Pleasant Hill, Ohio.

AMATEUR Cartoonists, artists. Earn while learning. Proven plans \$1.00. Circular free. Jay Borosky, 1571 Fulton, San Francisco, Calif.

CHALK Talks. Laugh producing program, \$1.00. Catalog 10c. Balda The Cartoonist, Oshkosh, Wisconsin.

ADVERTISING AGENCIES, LETTER WRITERS, FOR ADVERTISERS

ADVERTISE By radio. Pay stations percentage of each order. No inquiries, no charge. Special 33 station "PI" list, instructions \$1.00. Oakwood Agency, 2109 Aerial, Dayton 9, Ohio.

SAVE Money on advertising. List free. Wilbur Erickson, Englishtown, New Jersey.

ADVERTISERS! Reach nearly 18,000,000 readers. 25 Sunday national key newspapers, 18 words, \$59.00. "Terrific pullers." 20 popular newspapers, \$11.50. Free booklet. Special—One inch display 2-821,198 circulation, \$51.10. Newark's Advertising Agency, (Established 1893), 217-7th Ave., New York 11.

ADS Placed in out of town newspapers and magazines. Low rates. Catalogue free. Ideas that pay. Baker Advertising Agency, Successors Ankrum Agency, 189 W. Madison, Chicago 2.

MAILING Lists; \$5.00-1000 up. Write Dixie Service, King, N. C.

24 WORDS In 50 weeklies. \$4.96. J. Dar-nell, 730 Hays, Jackson, Tenn.

FREE Copy, layout service. Mailorder ad, 1,700,000 nationwide circulation, \$25.90 inch. 24-word classified, 20 big Sunday newspapers, \$30.00. Advertising ratebook free. Chicago Advertising Agency (established 1900), Chicago 4.

ADVERTISE: 24 Words, 40 newspapers \$3.50. Lists free. Advertising Bureau, 10511-C Springfield, Chicago 43.

TYPEWRITERS, DUPLICATORS, OFFICE DEVICES

PRINTOMATIC Selffeeding post card printing duplicator \$13.50. Envelope addressing machines \$24.50. Pittsburgh Typewriter Company, 336-R Fourth Avenue, Pittsburgh 22, Penna.

RECONDITIONED Typewriters, printing devices. Write Dixie Service, King, N. C.

RUBBER STAMPS AND OFFICE SUPPLIES

RUBBER Stamps. Illustrated catalog 10c. Williams, Box 648-M, Plainfield, New Jersey.

3 LINES 50c; Pads 35c; signature \$2.35. Stamp-right, Wauwatosa, Wis.

THREE Line rubber stamp 50 cents. Extra line 25c. Anderson, Box 855, Mountain Home, Tennessee.

RUBBER Stamps. Send for catalog. Excello, Box 500, Shreveport, Louisiana.

PRINTING, MULTIGRAPHING, MIMEOGRAPHING GUMMED LABELS

NEED Printing? Get my samples, prices. Gooch, 202PM, Hernando, Miss.

5000 6³/₄ ENVELOPES Printed \$3.10 per thousand. 1000 embossed business cards \$4.00. Free samples. Michel, Box 76F, New York 16.

DANCE And raffle tickets. Lowest prices. Samples. Printery, 30 Schillinger, Pittsburgh 12, Penna.

1000 BUSINESS Cards \$2.50, 1000 letter-heads \$6.50, envelopes same. Orders prepaid. Model Press, 96 Brown St., Johnson City, N. Y.

100 8¹/₂x11 HAMMERMILL Letterheads and 100 envelopes \$2.10. H. Hudson, Centredale, R. I.

PRINTING—Catalogs, booklets, folders, circulars. Stationery. Garrison Press, Harrisonburg, Va.

MIMEOGRAPHING, Vari-typing. Prompt service. Free prices, samples. Loyal Brush, 3712 Walnut, Kansas City 2, Missouri.

QUALITY Printing. We specialize in publications, newspapers, tabloids. Send copy for estimate. Bagby Printing Co., Georgetown, Ohio.

SEND 10c Now for our 48 page 1951 price list—refunded first order. McCall Press, 1326 South 27th, Omaha, Nebraska.

MIMEOGRAPHING—Letters, pricelists, formulas, instructions. Lowest prices. Lem's Letter Shop, 5710 Stanton, Detroit 8.

PHOTO-Offset special, 5000-8¹/₂ x 11 \$14. Samples free. Reiffe, 160-P Monroe St., New York 2.

500 3¹/₄x2¹/₄ FOUR Line gummed stickers 50c. Red border \$1.00. Moritz Printery, Saginaw, Mich.

1000 BUSINESS Cards \$2.50 prepaid. Samples free. Reliable Print Shop, 905 East Jefferson, Louisville 6, Ky.

48-HOUR Mimeographing service! Samples, prices, free. Thompson, Loganville, Wisconsin.

GUMMED Labels, stationery. Free list. Reed, Box PM-135, Spiro, Okla.

MIMEOGRAPHING—Reasonable. Any copy. Mailers Service, Box 606-T, Chicago 90, Ill.

GOOD Printing, reasonable prices. Samples free. Artmo Shop, Box 984, Memphis, Tenn.

BUSINESS Printing. Samples, prices free. Howprint, 723-M Eunice, Webster Groves 19, Missouri.

EXCLUSIVE Embossed business cards. Free samples. Thompson and Sons, Water-ville, Ohio.

1000 CARDS \$2.49, Embossed \$2.98. Ortiz, 1050 Fox Street, New York.

LETTERPRESS And offset printing. Submit specifications or sample for estimate. Raum's, 4154 Fifth Street, Philadelphia 40.

PRINTED Scotch tape, three lines on 2595 inch roll \$3.50. 3 rolls \$10.00. Modern Litho, Jefferson City, Missouri.

PRESSES, Bought, sold, list 3c. Exchange, 212 Curtis, Meriden, Conn.

PRESSES, Type, cabinets, supplies. List for stamp. Lincoln Press Company, 220-V Hartwell, Fall River, Mass.

PRINT Your own cards, stationery, circulars, advertising. Save money. Simple rules. Print for others, nice profit. Raised printing like engraving too. Have home shop. Details free. Kelsey Presses, L-11, Meriden, Conn.

PRINTING Presses, type, supplies. Lists 3c. Turnbaugh Service, Loysville, Penna.

MAKE Your own printing cuts. Self-molding process. Plexirubber, Argyle 1, Wisconsin.

PRESSES, Supplies, paper. Catalog 10c. Printers Supply, 211, Springfield, Missouri.

PATENT ATTORNEYS

PATENT Practice before U. S. Patent Office. Booklet and form "Evidence of Conception" forwarded upon request. Lancaster, Allwine & Rommel, Registered Patent Attorneys, Suite 411, 815-15th Street, N.W., Washington 5, D. C.

PATENT Protection—This well-known organization will send you promptly upon request and without obligation, a booklet containing detailed information concerning steps to take to protect your invention by a United States patent. Victor J. Evans & Co., Merlin M. Evans, Registered Patent Attorney, 631-E Merlin Building, Washington 6, D. C.

HERMAN Lewis Gordon, registered patent attorney, Warner Building, Washington, D. C.

INVENTORS—If you believe you have an invention, you should find out how to protect it. The firm of McMorrow, Berman & Davidson with offices in Washington, D. C., is qualified to take the necessary steps for you. Send for copy of our patent booklet "How to Protect Your Invention." We will also send you an "Invention Record" form. No obligation. They are yours for the asking. McMorrow, Berman & Davidson, Registered Patent Attorneys, 134-W Victor Building, Washington 1, D. C.

"INVENTOR'S Guide" free. Frank P. Ledermann, Registered Patent Attorney, 154 Nassau Street, New York.

INVENTORS: Learn how to protect your invention. Unless the inventor is familiar with patent matters, he should engage a competent registered patent attorney or agent to represent him. We are registered to practice before the U. S. Patent Office and prepared to serve you in handling your patent matters. "Patent Guide for the Inventor" containing detailed information concerning patent protection and procedure with "Record of Invention" form will be forwarded to you upon request—without obligation. Clarence A. O'Brien & Harvey Jacobson, Registered Patent Attorneys, 11B-A District National Building, Washington, D. C.

INVENTORS: When you are satisfied that you have invented something of value write me, without obligation, for information as to what steps you should take to secure a patent. Write Patrick D. Beavers (Formerly Randolph & Beavers) Registered Patent Atty., 935 Columbian Bldg., Washington 1, D. C.

PATENTS. "Proof of Invention" folder mailed without obligation. E. E. Vrooman, Registered Patent Attorney, 507 McKim Building, Washington 5, D. C.

INVENTORS: Write for free brochure "Evidence of Invention." Labiner, World Building, New York 38.

C. A. Snow & Co.—M-427, Snow Building, Washington 1, D. C. Registered Patent Attorneys. Write for information.

INVENTORS—For "Record of Invention" form, contact Carl Miller, Registered Patent Attorney, Woolworth Building, New York.

INVENTORS: Without obligation, write for information explaining the steps you should take to secure a patent. John N. Randolph, Registered Patent Attorney, 203 Columbian Bldg., Washington 1, D. C.

PATENTS—Irving L. McCathran, 315 McLachlen Bldg., Washington 1, D. C. Registered Patent Attorney.

CANADA—Ramsay Company Registered, 273 Bank Street, Ottawa, Canada.

REGISTERED Patent attorney offers services. Sanders, 6430 Evans, Chicago 37, Ill.

INVENTORS—If you believe you have an invention, you should find out how to protect it. The firm of McMorrow, Berman & Davidson with offices in Washington, D. C., is qualified to take the necessary steps for you. Send for copy of our patent booklet "How to Protect Your Invention." We will also send you an "Invention Record" form. No obligation. They are yours for the asking. McMorrow, Berman & Davidson, Registered Patent Attorneys, 134-V Victor Building, Washington 1, D. C.

PATENT Searches \$5.00, including copies of closest patents. Same reliable searches we conduct for patent attorneys. 48 hour airmail service. "Record of Invention" free. Capitol Patent Service, P.O. Box 664-P, Washington 4, D. C.

PATENT Searches \$5.00, including patent copies. Same search as conducted for attorneys. Free protection forms, 48 hour service. Patent Service Institute, 945-A5 Pennsylvania Avenue, Washington 4, D. C.

INVENTORS—This form is registered to practice before the United States Patent Office and is available to assist you in the preparation and prosecution of your patent application. "Patent Protection for Inventors" booklet containing detailed information and steps to take toward patent protection will be sent upon request. No obligation. Victor J. Evans & Co., 632-E Merlin Building, Washington 6, D. C.

INVENTORS Booklet "Reaching Your Invention Markets"—free. Patented, patent pending only. Market Contacting & Data Service, 11106-W2 Longwood, Chicago 43.

INVENTORS: Without obligation, write for information explaining the steps you should take to secure a patent on your invention. John N. Randolph, Registered Patent Attorney, 202 Columbian Bldg., Washington 1, D. C.

SEARCHES—Put your patent searches in the hands of a registered patent attorney or agent, as he qualifies to give a worthwhile patentability report. Record of invention form upon request and information on patent protection. Patrick D. Beavers, Registered Patent Attorney, 936 Columbian Bldg., Washington 1, D. C.

INVENTORS. For "Record of Invention" form, contact Carl Miller, Registered Patent Attorney, Woolworth Building, New York.

INVENTORS: Learn how to protect your invention. Unless the inventor is familiar with patent matters, he should engage a competent registered patent attorney or agent to represent him. We are registered to practice before the U. S. Patent Office and prepared to serve you in handling your patent matters. "Patent Guide for the Inventor" containing detailed information concerning patent protection and procedure with "Record of Invention" form will be forwarded to you upon request—without obligation. Clarence A. O'Brien & Harvey Jacobson, Registered Patent Attorneys, 11A-A District National Building, Washington, D. C.

PATENT Owner representative. Years of experience. Can I help you? Charles A. Scott, 773PM Garson Avenue, Rochester 9, N. Y.

INVENTORS: If you have an invention for sale, patented or unpatented, write Institute of American Inventors, Dept. 40A, 631-E St. N.W., Washington 4, D. C.

CASH For your idea, 280 manufacturers need inventions, patented or unpatented. List free. Invention Bureau, 208M Clinton, Oak Park, Ill.

PATENT Searches by former patent office examiners \$5.00. 48-hour service. Protection forms free. Write Patent Engineering Service, 1404 New York Avenue, Washington 5, D. C.

PATENT Searches \$5.00. 48-hour service. Patent copies included. Protection forms free. Write Raymond L. Smith, Patent Searcher, 410 Bond Building, Washington 5, D. C.

PATENT Searches \$5.00. Reports airmailed within 48 hours. Invention protection forms free. Write Miss Ann Hastings, Patent Searcher, P.O. Box 176, Washington 4, D. C.

INVENTIONS WANTED

INVENTORS Interested in marketing their invention (Pat. or Pat. Pending) through mutual cooperation and also making money helping other inventors, are invited to write Inventor's Mutual, Dept. 3, 211 W. 7th St., Des Moines, Iowa.

patented. 20 years experience. Patenting inventions. National Service Bureau, 3130 Meramec, St. Louis 18, Mo.

FREE Booklet, "Selling Your Invention." Inventors Patent Exchange—B. Hartford 1, Conn.

INVENTORS: Hundreds of manufacturers have requested our assistance in locating marketable new products. Complete information free. Institute of American Inventors, Dept. 40-D, 631-E St. N.W., Washington 4, D. C.

INVENTIONS Wanted. Your invention and patent developed and promoted. Write for Booklet "P." Elo, Box 172, Long Island City 1, New York.

INVENTIONS Promoted. Patented or unpatented. Write Adam Fisher Company, 61 Enright, St. Louis, Mo.

INVENTORS—What have you, patented, patent pending to offer manufacturers? Request free booklet without obligation. Market Contacting & Data Service, 11106-A2 Longwood, Chicago 43.

PATENTS FOR SALE

CAP Pistol. Patented, automatic. Unusual opportunity. Box 357, Flint, Mich.

INVENTORS: Test the commercial value of your patented or unpatented inventions, quickly and inexpensively. Write for free information. Institute of American Inventors, Dept. 40-B, 631-E St. N.W., Washington 4, D. C.

MANUFACTURING

MODELS—Small lot manufacturing. Metals, plastics, etc. Milburn, Burlington, Kentucky.

MODELS, MODEL SUPPLIES

BUILD. Fly, world's most authentic model airplanes. 47 different kits, motors, supplies. Airplane catalog, 10c. Cleveland, 4507TC81 Lorain, Cleveland 2, Ohio.

SHIP And yacht model fittings; blueprints. Send 25c for illustrated catalog No. 26—listing hundreds of items. A. J. Fisher, 1002-1 Etowah Ave., Royal Oak, Mich.

BUILD Historic ship models, complete kits 39c to \$9.00. Catalog 10c. Ideal Models, 19 W. 18th, New York 11, N. Y.

BRASS Gears and model supplies for the inventors. Send 10c for catalog. Pierce Model Works, Tinley Park, Ill.

RAILROADERS—50c Gets new Catalog Reference Manual. State O or HO gauge. Walthers, 247 Erie, Milwaukee 2, Wis.

STEAM Locomotives, 1½", 1", ¾", ½", ¼" scales. Castings, rail, steam fittings! Thorough drawings with instructions. Catalog 50c. Little Engines, Wilmington, California.

HOME CRAFTSMEN

90 ALL New, full size lawn ornament and novelty patterns, up to 20" high. Only \$1.00. Mastercraft 52M, 7041 Olcott, Chicago 31, Illinois.

LEATHERCRAFT Supplies, leather and tools, low prices. Send 10c for catalog. Jonas Handicraft Co., Dept. 5-M, 30 Frankfort St., New York 7.

OZARK Wood samples. Eleven varieties prepaid. \$1.50. Davis Lumber, Cabool, Missouri.

LEATHERCRAFT Supplies. Tops in leather, tools, designs. Illustrated catalogue 10c. For pleasure and profit. Govan Craft Supplies, 3908 Grove Street, Oakland 9, California.

89 FULL Size jig saw patterns of beautiful shelves, ornaments, toys, novelties. Plus "How, Where to Sell." Only \$1.00. Mastercraft 54M, 7041 Olcott, Chicago 31, Illinois.

WOODCRAFT Patterns—Large whatnots, lawn ornaments, novelties, large assortment \$1.00. Joanness, P.O. Box 141-M, Omaha 7, Nebr.

WHOLESALE Shellcraft book 15c. Large shellcraft kit \$1.85 postpaid. Shell-Art Novelty, 5th and Moore, Philadelphia 48, Penna.

JIGSAW Owners attention! Start earning money at home cutting out wooden novelties and souvenirs. Write H. Cook, Dept. A, 4407 S. Normal Ave., Chicago 9, Ill.

16 NEW Lawn chairs, 22 picnic tables, benches, trellises, etc. All 38 plans with necessary full size patterns, \$1.00. Mastercraft 53M, 7041 Olcott, Chicago 31, Ill.

ILLUSTRATED Catalogue of 30 new crafts 10c. Hobbies, 1701E Macombs Road, New York 53.

FELT For polishing, rubbing, cushioning and insulation. Write for details. Henry M. Nagel, P.O. Box 125, Boulder, Colorado.

FOAM Rubber. Complete stocks. Send for price list. AMC Supply, P.O. Box 1440, Fort Worth, Texas.

CHAIR Cane. Splints. Rush. Reeds. Instructions, catalogue 25c. Complete Seat Weaving book \$1.15. Fogarty's Craftshop, Troy, N. Y.

GEM Stone cutting! America's fastest growing hobby. Fascinating. Profitable. Details and sample Alaska jade \$1.00 airmailed. Alaska Crafts, Box 1891, Fairbanks, Alaska.

SHELLCRAFT—For hobby or profit. Giant illustrated catalogue showing many new breathtaking designs, with easy instructions. Only 25c. Southern Shellcraft Supply, Clearwater, Florida.

80 FULL Sized patterns. Lawn ornaments, toys, novelties \$1.00. Modern Woodcraft, Saginaw, Mich.

LEATHERCRAFTERS: Big illustrated catalog of materials, tools, kits, 10c. Art Leather, 411 Joseph Ave., Rochester 5, N. Y.

NEW 96 Page leather and craft catalog. 1000's of items. Send 10c. Russo Handicraft Supplies, Dept. C-3, 245 South Spring, Los Angeles, California.

NEW Leathercraft catalogue. Pleasure and profit. New styles, belts, purses, shoes. Largest leathercraft school in U.S.A. G. I. approved. Send 10c for catalogue. Dept. PM, Apache Leather Co., 2804 E. Washington St., Phoenix, Arizona.

KNOCKDOWN Cedar chests. Lumber and veneers. Free price list. Giles & Kendall Company, Huntsville, Ala.

LEATHERCRAFT Bargains! Lacing. Francis Byrd, 3406 Montrose Ave., Richmond, Va.

30 LAWN Ornament patterns, ready cut. Full size, color indicated. \$1.00 postpaid. Lincoln Craft Studio, Farmington, Conn.

MAKE Leather belts, billfolds, purses. Big catalog and genuine steerhide keyholder, 10c. Tandy Leather, Box 397C, Tulsa, Okla.

LEATHERCRAFT, Copper tooling, textile painting. Make spare time, profitable time. Free illustrated catalog shows everything you need. Kit Kraft, 7377 Melrose, Hollywood 46, California.

LEATHER, Tools, lacings, supplies. Free catalog. National Handicraft, 199 William St., New York 7.

MAKE IT YOURSELF

BUILD Dream home, concrete block, blueprint, instructions \$3.00. Acceptable restricted areas. Watkins, Box 881, Columbus 16, Ohio.

"HOW To Build" farm, home and workshop machines, free list and sample. Clearprint Plans Company, Box 265, Muskegon, Michigan.

BEAT High costs and shortages. Build home, farm, over 100 production machinery from salvage. Others do at big savings. Descriptive handbook 25c (refundable). Kimo, New York 19.

MOTHPROOF With your own electric moth eradicator. Built inexpensively by any one. Absolute destruction of moths. Ideal as a vaporizer and deodorizer. Complete drawings \$1.00. Arnold Products, Tustin, Calif.

GRANDFATHER Clock easily built. Big savings. See ad on page 255.

BUILD Your own tractor. Plans. Walking, riding. Free information. Ellsworth Tractor Co., D-I, Camptonville, Calif.

STREAMLINED. Built-in kitchen cabinets to fit any kitchen. Illustrated manual describes designing and construction. All for \$1.00. Thombert Company, Newton, Iowa.

BUILD Your own concrete blockmaker. Easy. Inexpensive. Motor or hand. Make block per minute. Write. C. Lee, Mountain View, Okla.

WATCHES, OLD GOLD, JEWELRY

RHINESTONES, Jewelry settings, camoes, sequins, beads. Catalog free. J & M Novelties, Dept. CE-3, Griffith, Ind.

HIGHEST Prices paid for old gold, silver, platinum, diamonds, watches, gold teeth, spectacles. Cash immediately. Goods returned if offer unsatisfactory. Government licensed. United Smelting Works. (The Old Reliable), 39-B South State, Chicago 3.

WATCHMAKERS' Tools, materials, supplies, watches. Catalog. Gales, Box 1000, Chicago 90, Ill.

WATCHES wanted. Any condition. Also broken jewelry, spectacles, dental gold, diamonds, silver. Cash sent promptly. Mail articles or write for free shipping container. Lowe's, 75 Holland Bldg., St. Louis 1, Mo.

WATCHMAKERS! Beginners! Watches, movements, descriptive list. Box 150, Chicago 90, Illinois.

SEND For photograph of men's waterproof and chronograph watches. Accurate Engineers, Berea, Ohio.

DIAMONDS Lowest wholesale prices. Airmail for full information. Joachim Goldenstein Diamond Club, Antwerp, Belgium.

HIGHEST Cash paid for old, broken jewelry, gold teeth, watches, silverware, diamonds, spectacles, platinum. Free information. Satisfaction guaranteed. Government licensed. Rose Smelting Company, 29-A East Madison, Chicago.

GOLD Plated jewelry supplies. Rhinestones, pearls. Illustrated catalog, only 10c. Barry's, 47-N Branford Place, Newark 2, N. J.

OF INTEREST TO WOMEN

START A pleasant hobby that can become profitable. Make artificial flowers, decorative novelties for friends, relatives. Homecrafts catalog, business plan 10c. Chenille bride doll kit, \$1.89. Clevemodell, 4507TC74 Lorain, Cleveland 2, Ohio.

BIG Profits. Make fast-seller chenille holiday flowers, monkey trees, dolls. Literature free. Velva, Bohemia 16, N. Y.

FOR SALE—MISCELLANEOUS

HANDSIGHTING Levels, improved, new model, used for grading land, contouring and laying out fences, piers, roads and gardens, price \$2.50 postpaid. Public Sport Shops, 11 S. 16th Street, Philadelphia 2, Penna.

TRIPODS. All wood, solid leg with four inch circular metal head, can be threaded. 55" tall, value \$27.50, special \$6.95. Public Sport Shops, 11 S. 16th Street, Philadelphia 2, Penna.

FREE Catalog! War surplus clothing. Amazing bargains. N. Y. Clothing Co., New York 29A.

SAVE 50%. Install it yourself. 85,000 Btu oil fired forced air central heating system for 5 rooms. Completely automatic. All necessary electric controls, gun type burner, blower, motor, drive, heater pipe, registers, register boxes. Direct from manufacturer. Details on request. Nichols Company, Box 4, Woburn, Mass.

DRESSES 18c; Coats \$1.00; blouses 35c. Free catalog. Crown, 164-PA Monroe Street, New York.

SAVE Money on army, navy and factory surplus. Write today for new 52-page illustrated catalog. Tennusa Sales Co., Dept. AE, 1451 Market, Chattanooga, Tenn.

WANTED—MISCELLANEOUS

WANTED—Established mail order business. Rawlins, 227 Forest, Royal Oak, Michigan.

WANTED, Plywood 1/16" mahogany aircraft cut-off odd sheets. Scientific Model Airplane Co., 113 Monroe St., Newark, N. J.

PERSONAL

BORROW By mail. Loans \$50 to \$300 to employed men and women. Easy, quick. Completely confidential. No endorsers. Repay in convenient monthly payments. Details free in plain envelope. Give occupation. State Finance Co., 210 State Finance Bldg., Dept. Y-14, Des Moines 8, Iowa.

YOUR Key to brighter tomorrows—Personal handwriting analysis revealing your true personality, character, talents, including famous people you're like. 10c. Norela, Box 1363, Chicago 90, Ill.

BIG Valuable mails. Three-month listing 25c. Green, Box 6761, Los Angeles 22, Calif.

MYSTIFY Friends. Six San Francisco postcards \$1.00. You address. We mail. Martin, Box 414, Alameda, California.

HAIRCUT As you like it. Shaving technique. Booklet tells how. 25c. Mastrolia, 5 1/2-Z Jane, New York 14.

SURPRISE Your boy, girl, "date," general or foreign friends. Beautiful Scandinavian postcards with greetings and your name mailed to ordered different addresses. 3 cards postfree all one dollar, banknote with order. Commercial, personal or philatelic commissions according to possibilities arranged, 25 cent face value in faultless unused commemorative stamps brings communication. Remark! Legible handblocked or typed addresses only accepted. Worldwide correspondence invited. Write Fagerfors Co., Box 19055, Stockholm, Sweden.

LETTERS Remailed 25c each. View cards 3 for 25c. Edward Nadell, Box 345, Los Angeles 53, Calif.

MIAMI Postmark! Letters 25c. McDowell, 504 Pacific Building, Miami 32, Florida.

"HOW Can I find out?" You can! Information discreetly developed. Any matter, person, problem, anywhere. Worldwide. Officially licensed, bonded service. Established 1922. Reasonable. Confidential. William Herman, 170 Broadway, New York.

VALUABLE Big mails, four months listing, 25c. Wright Publications, 2270-M Hubbard, Memphis 8, Tenn.

PRINT Without a printing press. Big profits! See page 39.

MAKE Money in 1951 by mail. Particulars 3c. Swaty, Box 1466-P, San Diego, Calif.

MEXICAN Legal matters reliably handled. Box 1736, El Paso, Texas.

LETTERS Remailed 25c each. Green, Box-6761, East Los Angeles 22, Calif.

MEXICAN Law. General practice. Attorney, 1203 Arizona St., El Paso, Texas.

HERE'S How and where to borrow \$50.00 to \$300.00 by mail. Confidential. Free particulars. Postal Finance Company, Dept. 45, Sioux City, Iowa.

MISCELLANEOUS

INTERESTING Mails. 25c keeps name on mailing list three months. Bentz, Desk D/17, Chatawa, Mississippi.

RECEIVE Hundreds of valuable items absolutely free. Supply source directory 25c. Nelko Service, 3462 Merchandise Mart Sta., Dept. FR-5, Chicago 54, Ill.

YOUR Name in headlines on standard newspaper page. Write 3 headlines, under 36 letters, \$1. Regal, Box 1351, Hartford 1, Conn.

ADVERTISE In 100 Canadian Weeklies. 20 words \$6.00. Four times \$18.00. List free. Mailing lists, fresh names, for sale. Quebec city phone book \$1.00. Get lots of mail. Name in directory 25c. Six times \$1.00. View cards 6 for 20c. Unused match covers, 50 different \$1.00. Quebec felt pennant 50c. Cushion top souvenir \$1.50. York Agencies, Dept. PM-2, Box 1111, Terminal "A," Quebec City, Canada.

IS Your business for sale? Send description. Kashfinder, Wichita, Kansas.

INCREDIBLE! Unprecedented! Become a mental superman overnight! Floor everybody! No studying! "Memoprop" does all your thinking! It's uncanny! Revolutionary! Write: Bijou, Box 1727-MB, Hollywood 28, California.

ATTENTION Home weavers—Maysville carpet warp and rug filler—all colors available; immediate delivery. Kay Craft Co., Olyphant, Penna.

GET Genuine Swiss wrist watch half price. 17 jewels. Made to government specifications. Send for circular. Daurio Enterprises, Teaneck 3, New Jersey.

MAILING Lists, live productive, inexpensive. \$5.00 1000. Home makers, newly weds, recent mothers, etc. Central Mailing Service, Judsonia, Arkansas.

SQUARE Dance instructions, thirty dances, \$1.00. Wesley Rader, 3926 Alcott, Denver 11, Colorado.

70 BIBLE Lessons, 25c. Bulletin, Box 87, Cathedral Station, New York 25.

FREE Personalized key-tag given with each order of Magi-Chem Metal Ink. Send only \$1.00 and information desired on key-tag to: Magi-Chem Metal Ink, P.O. Box 1654, Chicago 90, Illinois.

URANIUM Fluorescent test outfit \$3.75 postpaid. Central States Laboratories, 947 N. Avers, Chicago 51, Illinois.

INDIVIDUAL Handwriting analysis 25c. No forms. Handwriting Clinic, Box 1643, Louisville, Ky.

PLANT Hormone kit. Grow roots on fresh cut branches of trees, bushes and plants. Send \$1.00 to Glen Hollow Gardens, Route 7, Box 5, Kalamazoo, Mich.

CESSPOOL Trouble? Use Peps-It. Rejuvenates fermentation action, saves pumping costs, deodorizes, reduces masses. Costs only \$2.50. Safe. Sanitary. Free descriptive literature. Chemical Cesspool Cleaning Co., Boston 34, Mass.

GEIGER Counter, skeleton, \$16 postpaid. Metal detectors. Mineralights. Western Radiation Laboratory, 1107 W. 24th Street, Los Angeles 7, Calif.

GOLD. Silver, metal detectors. Geiger counters for uranium. Mineralights. Sensational new fully guaranteed models. None finer. Information free. Detectron Co., 5631 Cahuenga Blvd., North Hollywood, California.

OUTDOOR Toilets, cesspools, septic tanks cleaned, deodorized with amazing new product. Just mix dry powder with water; pour into toilet. Safe, no poisons. Save digging, pumping costs. Postcard brings free details. Burson Laboratories, Dept. C-36, Chicago 22, Illinois.

TREASURE Finders for gold, silver and minerals. Money back guarantee, best available. Also Geiger counters for uranium prospectors, free information. Write Goldak Company, 1541 West Glenoaks, Glendale 1, Calif.

"RECEIVE Mail." Money-making offers, opportunities, catalogs. Name listed 10c. Ideal Service, Park Ridge 10, Ill.

HAND Controls wonderfully improve poor penmanship in three hours. Write, "OZ." Box 665 (34P), St. Louis, Mo.

PANNING Gold lesson and catalogue. Beginners supplies, books, "maps where to go" free. Old Prospector, Box 729D1, Lodi, Calif.

DRESSES 18c; Coats \$1.00; blouses 35c. Free catalogue. Crown, 164-PM Monroe Street, New York 2.

RESEARCH: We find, locate buyers, or sellers for anything of value. Registration and listing, \$1.00. Refundable. Wright Publications, 2270-M Hubbard, Memphis 8, Tenn.

\$5 HOUR Easy! Sell name plates for houses. Free sample, order blanks. Write: National, 214 Summer, Boston, Mass.

TREASURE—M-Scope Geiger counters, mineral locators. Why buy something inferior when you can buy the best at a lower price? Backed by years of experience. Fully guaranteed by factory. Detects minerals, metals, gold, silver, coins. Payment plan available. Proven superior performance. Free 16 page illustrated booklet. Fisher Research Lab., Inc., Palo Alto, California.

TATTOOING Outfits, supplies. Illustrated list free. Zeiss, 728 Leslie, Rockford, Illinois.

YOUR Leather jacket renovated expertly. Free circular. Berlew Mfg. Co., Dept. 8, Freeport, N. Y.

EARN UP to \$200 month, inventing toys, games, gadgets. Write, Hendrickson, Argyle 1-A, Wisconsin.



LEARN COMMERCIAL DEEP SEA DIVING

Get Underwater For That Highly Paid and Fascinating Trade!

World famous school. Latest equipment. Specialized instruction. 16 week course covers all phases necessary for building a commercial diving career. Subjects such as Physics & Mechanics of Diving; Technique of Diving; Descending and Ascending; Working on the Bottom; Use of Tools in Under-

water Work; Underwater Rigging, Welding and Burning; Wreck Inspection; Salvage and Underwater Construction. Practical training in diving made from our barges on the blue Pacific. Get started in the trade that offers adventure and high pay, today!

WRITE FOR FREE DETAILED INFORMATION

SPARLING DIVING SCHOOL, Dept. PM5, 1148 Wilmington Blvd., Wilmington, Calif.

DIVING GEAR AND EQUIPMENT

Commercial & Sport Divers, Diving Clubs, Boat Owners & Anchorages, Sea Scout Ships, Marine Research Groups, Others . . . We have the largest, most complete stock of surplus diving equipment in the U. S.! ALL TESTED! EXCELLENT CONDITION! THE LAST OF SURPLUS EQUIPMENT! Send for FREE illustrated price list, decompression tables, & job possibilities.

DIVERS' SUPPLY, Dept. PM 50, 1150 Wilmington Blvd., Wilmington, Calif.

Trades that pay off!



Here's a great chance to learn a high paying skilled trade when the need for craftsmen is urgent. Get actual practical experience in our complete shops. No home study. Approved for veterans. A Post Card brings the story



**CARPENTRY
CABINET MAKING
UPHOLSTERING**

THE TERRACE SCHOOL FOR CRAFTSMEN

TERRACE AVE.
NEW CASTLE, PA.

PHONE
6699



COIN TELESCOPES

EARN \$100 PER WEEK OR MORE at Scenic Locations. Overlooks. Drives. Parks. Beaches. Total Cost \$790.00. Convenient Terms—Pay from Profits. AMERICAN TELESCOPE COMPANY—Evansville 8, Indiana

FEBRUARY

S	M	T	W	T	F	S
	1	2	3			
4	5	6	7	8	9	10
11	12	13	14	15	16	17
18	19	20	21	22	23	24
25	26	27	28			



DRIVE 3 TO 6 DAYS A MONTH Gas Free!

Amazing discovery, tested in Engineering Dept. of leading U. S. University, reduces gasoline consumption as much as 20%—gives you up to 6 days a month gas free driving—may actually pay for itself in cash savings. Also better performance, more power, quicker starts, faster acceleration, on all cars, light trucks, tractors—any age, make or model. It can help keep you rolling if emergency gas restrictions come.

TEST IT 30 DAYS ON YOUR OWN CAR BEFORE DECIDING

No one can appreciate the astounding benefits of this new miracle development without actual day-by-day experience on the road—so we want you to try it for 30 days on your own car at our risk. Write or wire today for complete FREE details, technical explanation and 30-Day Examination Request Blank.

G. B. SCHUYLER, Dept. 45
1665 Mission St. San Francisco 3, Calif.

SEND NO MONEY

A FASCINATING, MONEY-MAKING art career can be yours

AMERICA'S 12 MOST FAMOUS ARTISTS SHOW YOU HOW!



Write Today FAMOUS ARTISTS COURSE
Dept. 6-S, Westport, Conn.

FREE Send book about your home study art course.

Name _____ Age _____
Street _____
City, State, Zone Number _____



OVER 700% PROFIT!
WITH THE
PDQ CHAMPION PHOTOMASTER

Makes Finished Pictures in 2 MINUTES!

- Beautiful, everlasting photos—black and white or sepia, size 2½x3½ in.
- Guaranteed not to fade.
- No darkroom needed.
- Photos are taken DIRECT on "SUPER-SPEED" direct positive paper.
- Loads enough paper for 50 shots in half a minute — in broad daylight.

Complete Portable Photo Studio
Size 4½" x 5" x 10".
Weighs about 6 lbs.
No experience required.
Simple directions teach you quickly.

BE A P.D.Q. PHOTOGRAPHER

Work at home or travel. Make expenses plus extra profits. Pictures cost you only 2c. Sell for 15c to 25c. Folks just grab for 'em. They are amazed to see their own photos come to life in broad daylight. Photomaster "shoots" any subject—individuals or groups—buildings and scenes. This new and fascinating business offers unheard-of money-making opportunities everywhere—every day throughout the year. Write quick! Get FREE INFORMATION about the great PDQ CHAMPION PHOTOMASTER.

P D Q CAMERA COMPANY

1161 N. Cleveland Ave., Dept. PM-5, Chicago 10, Ill.

SEND ME



every month so I am sure to see each new issue. Here's

- \$3.50 for 1 year
- \$8.00 for 3 years

name _____
address _____
city _____ zone _____ state _____
PMB-5

Hand this order to your newsdealer or send it to

POPULAR MECHANICS
200 East Ontario St. Chicago 11, Ill.

Learn WOOD PRODUCTION ENGINEERING

At Home In Your Spare Time

Veterans
You must enroll in training before July 1st to get it free under the G. I. Bill. Act Now!
NON-VETERANS
Money Back Trial Offer

Prepare now for a top pay position in the furniture and woodworking industry... with KLOK SPECIALIZED TRAINING. Teaches you the arts of Sketching—Drafting—Rod Making—Time Study—Cost-Production Scheduling in our Home Study Course or Resident Course at Grand Rapids. An aid to hobbyists... to the successful operation of your own shop.

from **THE ONLY SCHOOL OF ITS KIND**

FREE Booklet



WRITE TODAY—for FREE Booklet that gives you ALL the fascinating facts. State age, veteran, non-veteran, Home Study or Resident Course preference, occupation.

JOHN H. KLOK, Pres. Woodworking Industry Training Since 1928
KLOK INSTITUTE, E, Louis St. N.W., Grand Rapids 2, Mich.

YOU CAN'T LOSE GAS!
DEFIANCE Keyless-Locking Gas Tank Cap
Protects against siphoning, loss or theft.



Save precious gas without nuisance of gas tank key. The Defiance Gas Tank Cap is self locking, no key is necessary. It's theft-proof too, as the cap can't be removed from car or left at station. Grids at bottom of cap prevent siphoning of gas from your tank. Speeds filling. Beautiful chrome finish, fits all cars. 10-second installation. If dealer can't supply, order direct. Money-back guarantee.

Send **\$2.75**
Post Paid (or C.O.D. plus postage)

Defiance Mfg. Co., 1556 N. Wilcox, Los Angeles 28, Calif.

LAW

STUDY AT HOME for Business Success and **LARGER PERSONAL EARNINGS.** 42 years expert instructions — over 114,000 students enrolled. LL.B. Degree awarded. All text material furnished. Easy payment plan. Send for **FREE BOOK** — "Law and Executive Guidance" — NOW!

AMERICAN EXTENSION SCHOOL OF LAW
Dept. PM-38, 646 N. Michigan Ave., Chicago 11, Ill.

DIVING EQUIPMENT

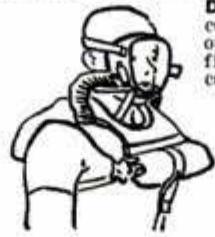

DIVING LUNGS—"Frog Man" type carry self-contained air supply for up to 2 hr. underwater operations. Not a gadget but the newest thing in fine diving equipment for shallow-water salvage, construction, exploration, and sporting use.
DEEP-WATER DIVING GEAR—Standard Navy equipment (Surplus) available at low cost. Complete sets of parts.
SHALLOW-WATER TYPE EQUIPMENT—Surplus. Helmets, Masks, Hose, Pumps, Tanks, etc. Also sport fishing equipment.
Largest Stock of Diving Gear in World.
Catalog 15c (stamps or coin)

M & E MARINE SUPPLY CO. CAMDEN, NEW JERSEY

SAY YOU SAW IT IN POPULAR MECHANICS

FOAM RUBBER

FOR HOBBYISTS, CRAFTSMEN, EXPERIMENTERS



Lowest Prices—SAVE 50%

16 x 16 x 1½" . . . ea. 51.35	AUTO SEAT TOPPER PADS
16 x 22 x 1½" . . . ea. 1.75	Place under seat cover.
18 x 24 x 1½" . . . ea. 2.00	24" x 60" x 1½" . . . ea. \$6.45
24 x 24 x 1½" . . . ea. 2.95	24" x 60" x 2" . . . ea. 7.95
	12" x 14" x 1½" . . . ea. 1.25

Use for furniture cushion fillers, mattresses, mattress pads, cushions. Foam Rubber is available in any size or thickness. Send For Free Price List. Immediate delivery. No C.O.D.'s. Add 10% for Postage & Handling to Above Prices. Please print.

RIOR RUBBER COMPANY, Dept. P-17
50 East 22nd St. Chicago 16, Ill.

Earn Big Money

WRITING ORDERS

AMAZING NYLONS

Guaranteed Against
RUNS AND SNAGS
Regardless of Cause!

The world's **ONLY** complete, nationally advertised nylon hosiery line actually guaranteed against runs, snags or excessive wear, **REGARDLESS OF CAUSE!** It's amazing, but true! No matter what the cause—hard use or deliberate abuse—Kendex nylons are replaced **FREE** if they run, snag or become unfit for wear within entire guarantee period! Every weight from sheerest 15 denier to heavy 70 denier—all gauges up to luxury 60 gauge—all sizes, lengths, popular shades, fancy heels, black seams—full fashioned and seamless. Nothing is missing to make sure every woman is pleased. In spite of the amazing guarantee, retail postage prepaid prices are no higher than comparable quality national brands. Should free replacement be necessary, actual cost is cut in half! How could any woman possibly resist saving money and solving her hosiery problems? **NOT SOLD IN STORES.** Men and women wanted **NOW**, spare or full time, to write orders and earn big money. You can get orders even if you never sold a thing in your life!



FREE SAMPLE STOCKING

Man or woman—young or old, **YOU** can easily earn steady income, spare or full time. No money or experience needed. We supply **EVERYTHING** free and set you up in business at **OUR** expense. Nothing to buy or deliver. Write orders. We deliver and collect. Big advance pay plus huge cash bonus that increases your earnings up to **40%**! Your name and address on postcard will bring you sample stocking; self-selling sales books with **FULL COLOR** illustrations; 32-page sales manual showing you easy steps to success; color cards, free "door openers" worth \$1 each but which you give away free; special plan to have others sell for you, etc., etc. You can start making money the minute you receive the complete **FREE** outfits!

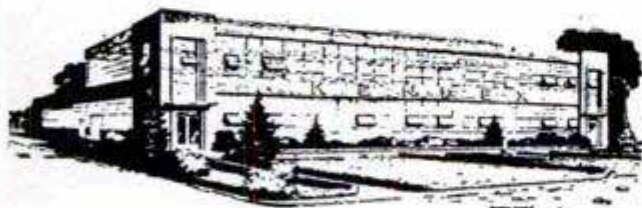

YOUR COST ONE CENT!

SEND NO MONEY. Pay nothing now or later. No obligation. Not even a promise to return outfits. Simply write your name and address on a penny postcard and mail to us. We'll immediately rush you everything you need **FREE** and postage prepaid. **WRITE TODAY!**

KENDEX CORPORATION



BABYLON 146, N. Y.

NEW TRIPLE WINDOW CONVERTIBLE TOP



\$125.00 Value!
Comes Complete
Nothing Else
to Buy.

\$49.95

TRIPLE VISION REAR WINDOW FOLDS DOWN WITH TOP!

Rear window plus corner windows made of Crystal Clear Flexible Plastic—Blind Spots reduced to minimum for greater safety. Convertible owners can drive with top up — enjoy more vision than most closed cars. Top is of durable 3 ply waterproof material with rubber for longer wear & lasting beauty. Rear curtain has Zippers.

For Buick, Cadillac, Chevrolet, Chrysler, DeSoto, Dodge, Ford & Mercury, Olds, Plymouth, Pontiac, 1941-51, Packard & Studebaker, 1946-51. Be sure to Specify Make, Year & Model, Black or Tan Material.

New HOLLYWOOD MUFFLERS

Gives that motorboat tone.



Universal fits all cars.
\$4.45
Each

TOP CYLINDER OILER

For Any Gasoline Engine, Auto, Truck, Tractor or Marine.



Oil is partially vaporized in Top-Oiler, further vaporized in manifold as a fine spray. Feeds oil into engine when lubrication is needed most, during starting or idling. This dissolves gums, etc. Complete with fittings.
Each... **\$8.95**

For that CADILLAC 'LOOK' 'CAD' FINS



Illuminated with Light

For 49-51 Ford, 49-51 Chevrolet and 49-50 Pontiac.

- Main casting made of brass.
- No holes to locate or drill.
- Can be brazed on in 3 spots.
- Wired ready for installation.
- Built-in design appearance.

Give make, year when ordering. Per Pair... **\$29.95**

Send 25% Cash With All Orders, Balance C.O.D.

1951 EDITION! It's new! Get Largest Auto Accessory & Parts Catalog and Save Money! Over 50,000 items, including Hollywood Accessories, Hi-Speed Equipment, Rebuilt Engines, all parts & accessories for all cars & trucks. We have that Hard-to-Get Part! Jam packed with Bargains. Completely illustrated. Send 25c (refundable).

J. C. WHITNEY & CO.

1917SP ARCHER AVE.

CHICAGO 16, ILL.

FLOATING BRAKE SHOES

For Ford, Chevrolet and Chrysler products. Quicker stops prevent accidents and save lives. Write for details. SUPER BRAKE-FLOATER CO. 4024 W. Lake St., CHICAGO 24, ILL.

To STOP Squeal, Overheating, Fading, procure safer and more powerful brakes, install SUPER Brake-Floaters. Tops for Stops at any and ALL SPEEDS!

SHOES

Not Just 1—Nor 2—But
3 SURE WAYS TO SECURE
• YOUR FUTURE •

VETERANS

- (1) WATCHMAKING & CHRONOGRAPH REPAIRING
- (2) ENGRAVING
- (3) JEWELRY—STONE SETTING

"3 HIGH PAYING TRADES IN 1 CAREER"

- Trades that are always in demand.
- Trades that offer outstanding possibilities to YOU right now.

• 3 WIDE FIELDS OF OPPORTUNITY: (1) Defense work or the Armed Forces, where Watchmakers are given preference; (2) High Paying Jobs in the Trade or industry; (3) A Business of your own. Small communities offer unlimited opportunities.

LEARN THESE 3 HIGH-PAYING TRADES AT KCSW, NATIONALLY RECOGNIZED FOR ITS THOROUGH TRAINING IN ALL THREE.

Home Study Courses in Watchmaking and Engraving only.

Resident School Home Study Course

Name _____

Address _____

KANSAS CITY SCHOOL OF WATCHMAKING

1218 Admiral Blvd. — Kansas City 6, Missouri

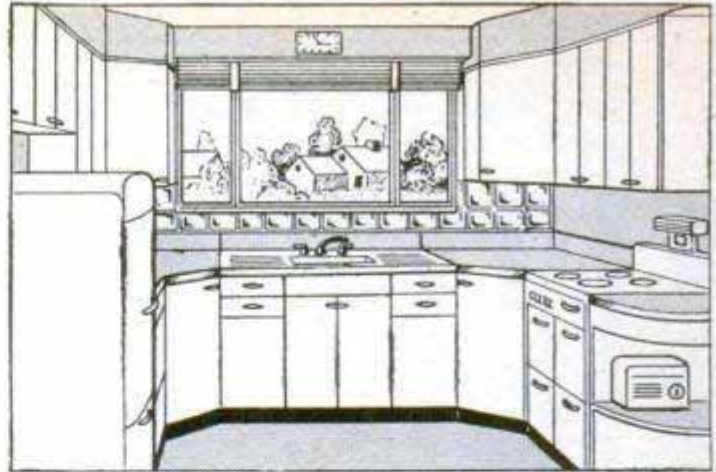

Save Over 50% Remodel Your Kitchen Yourself

It's Easy — It's Fun — No Experience Needed

Why put up with an old inefficient kitchen that takes hours of extra work and drudgery when with some inexpensive materials and a few days or evenings of sparetime work you can transform your kitchen into a sleek, modern beauty with plenty of working space just like those you see in the big full color advertisements in home magazines? And not only will your new kitchen mean a savings in work hours, but it can add as much as a thousand dollars more value to your home.

Eight big plans, drawn to exact scale, guide you every step of the way

Eight large sized plans show you everything you need to know to make your kitchen a room of beauty and efficiency. There are layouts for all different sizes and shapes of rooms. Detailed diagrams show you how to make your own cabinets, snack bar, shelves, stools, sink cabinets, valances, built-in fixtures and many other articles of modern kitchen furniture. Order your plans today on Popular Mechanics famous money-back guarantee. Entire set of eight 17"x22" plans only \$5.00.

POPULAR MECHANICS PRESS, Dept. MK 200 E. ONTARIO ST. CHICAGO 11, ILL.



40 NEW EDITION
Power Tools
YOU CAN MAKE

TURN WOOD, SCRAP AND WASTE INTO PRACTICAL POWER SHOP TOOLS

Don't limit your workshop fun to use of hand tools. Get the new edition of "Forty Power Tools You Can Make" with many new tools, and make your own power machines. Step up your fun and production. Do a better job with power tools. Make them yourself from wood and old discarded materials at small cost.

This book gives every detail in plain language you can understand and follow. Hundreds of pictures and plans show every step to follow. Mail coupon with \$1.50 today. Even though you have the old edition get this new book with 20 new tools. Money back if not satisfied.

40 Power Tools You Can Make at Little or No Cost

Some of the 40 Tools You Can Make

- | | |
|--------------------------------|---------------------------|
| Table Saw with Tilting Arbor | Wood Lathe |
| Saw Sander Unit | Power Hack Saw |
| Drill Press from pipe fittings | Double Duty Sander |
| Bending Brake | Jig Saws |
| Thickness Planer | Band Saws |
| | 40 Different Tools in All |

POPULAR MECHANICS PRESS, Dept. 33
200 E. Ontario St., Chicago 11

Send the new edition of "Forty Power Tools You Can Make."

Remittance for \$1.50 enclosed.

Name _____

Address _____

City _____ Zone _____ State _____



BURN WATER in your CAR

with the **AMAZING OCTA-GANE "50"**

**YES, BURN WATER,
ALCOHOL OR BOTH IN YOUR
CAR, TRUCK OR TRACTOR**

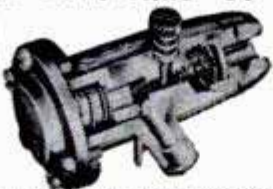

The result of years of research and development, the OCTA-GANE "50" is the only all bronze, "fog type", exhaust operated, pressure injector on the market today. It is adjustable to burn up to one gallon of water or alcohol with every 10 gallons of gasoline.

Here's what United States Agricultural Department Scientists say, "THE GASOLINE MILEAGE OF NEW HIGH COMPRESSION AUTOMOBILE ENGINES CAN BE INCREASED UP TO 30% WITH ALCOHOL-WATER-GASOLINE FUELS."

Only **\$24.95** (Send \$2, balance C.O.D.) Complete unit includes all bronze injector, corrosion proof water tank and all fittings.

NARCO, Dept. OT-5, 350 W. Washington Blvd., Venice, Calif.

WRITE FOR
FREE
ILLUSTRATED
LITERATURE



VARIABLE SPEED

HYDRAULIC POWER TRANSMISSION



It has Infinite Speeds 0 to 550. Reverse, Automatic Overload Protection; Adjustable Torque up to 180 inch pounds. 5/8" Input and Output Shafts. It will handle 1/4 to 1 1/2 H.P. Motor. Case measures 7 1/2" long 7" high 6 1/2" wide. **VALUE OVER \$300.** Shipping Wt. **\$54.50** 25¢. On C.O.D. Orders we require a 10% only Deposit. Fob. Chicago

DIRZIUS MACHINE SHOP "B" 1423-25 So. 52nd Ave., Cicero 50, Ill.

IT'S EASY TO CONVERT YOUR MOWER TO A POWER MOWER

MAKES LAWN MOWING FUN

Equip your hand mower with a LeJay Midge-Tractor. It snaps on in a jiffy. It's ready to go! Backs up and maneuvers amazingly easy. Costs far less than regular power mowers. Unheard of low price—Only \$54.95 complete. Or, \$29.70 less engine... use your own engine (any make 3/4-1 1/2 HP or 1/3 HP electric motor). Free literature. Guaranteed with money back 5-day trial offer. Order your LeJay MidgeTractor from this ad, do it today. If you are a handyman, send 35c for PLAN "Build Your Own MidgeTractor," literature included. **LEJAY MANUFACTURING CO., 2947 S. Emerson, Minneapolis 8, Minn.**



High School at Home

No classes . . . interesting spare-time home study; standard texts; credit for previous schooling; diploma awarded. Equivalent to resident school work. If you've completed 8th grade and are over 17, write for free catalog. Address



WAYNE SCHOOL

Dept. HF-7, 2527 Sheffield Ave., Chicago 14, Illinois

MAKE YOUR OWN! WITH

GRIFFIN LEATHERCRAFT KITS
Best assortment of tools, materials in U.S.A. Send 25¢ for 116-page catalog. (money refunded first order)

GRIFFIN CRAFT SUPPLIES

SINCE 1924

5626-A Telegraph Ave., Oakland 9, Calif



HELPFUL BOOKS

Send post card asking for **FREE** catalog

Popular Mechanics Press, 200 E. Ontario, Dept. 601, Chicago 11



HOT RUNNING WATER!

Attaches easily, quickly to any standard faucet. Regulates temperature by turning faucet. Operates AC or DC. Comes with 8-ft. rubber cable and plug. Our DELUX heater has delighted many thousands of users. Send \$3.95 cash, check, or M.O.—we will ship prepaid or, if you wish, we will ship C.O.D.—you pay postman \$3.95 plus few cents postage. Order 3 for \$10—save \$1.85.

METROPOLITAN ELECTRONICS CO.
Dept. 327, 106 Fifth Ave., New York 11, N.Y.

Throw Away NICOTINE*

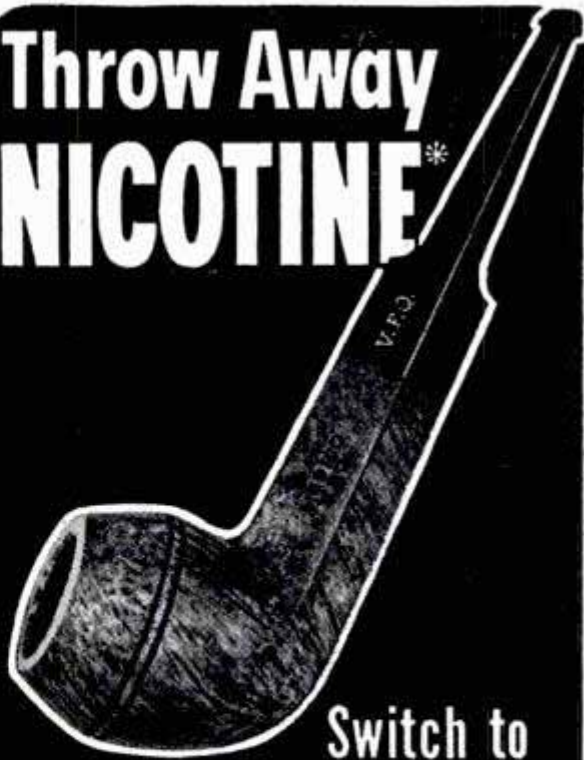

Switch to

MEDICO FILTER PIPES



Box of
10 filters—10¢

* When filter turns brown—in Medico Pipes or Cigarette Holders—throw it away, with the nicotine, juices, flakes and tars it has trapped. Insert fresh filter for cooler, cleaner, drier, sweeter smoking.

MEDICO V.F.Q.
(Very Fine Quality)
Pipes of fine selected imported briar. With 10 filters — \$2

MEDICO MEDALIST
Just Introduced! Pipes of the choicest imported briar. Splendid value—\$1.50

Wide variety of styles and sizes.

Write S. M. Frank & Co., N. Y., for Booklet M

MEDICO CIGARETTE HOLDERS—\$1

MODEL BUILDERS!

NEW 1951 CATALOG

MODEL AIRPLANE ENGINES • GLOW

PLUGS • MARINE ENGINES • FUELS

MODEL RACERS • ACCESSORIES



CUT OUT AND MAIL TODAY

OHLSSON & RICE, INC.
3344 Emery St., Los Angeles 23, Calif.
Los Angeles 23, California

Please RUSH _____ copies of the NEW 1951 O&R Catalog at 15c each for which I am enclosing _____ in stamps or coins to cover handling and mailing.

Name _____

Address _____

City _____ Zone _____ State _____

take a tip
from the pro...

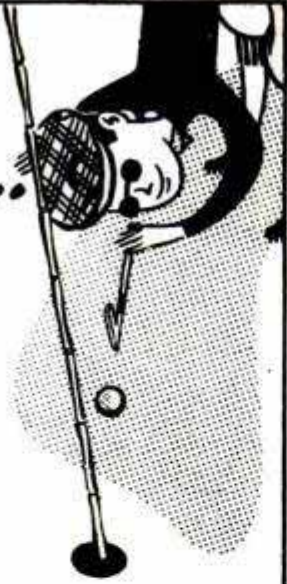

Watch the pro as he builds a skyscraper, a bridge, or a rocket to the Moon. He doesn't cut a stick, or drive a nail until every measurement is carefully laid out in the form of a fool proof plan... To be double sure he checks and rechecks these measurements as he builds.

Take a tip from the Pro. Use a good rule as you plan, whether it be for your hobby or livelihood... Choose the Streamliner for its new design, top-of-case inside reading, push button braking to hold any measurement.

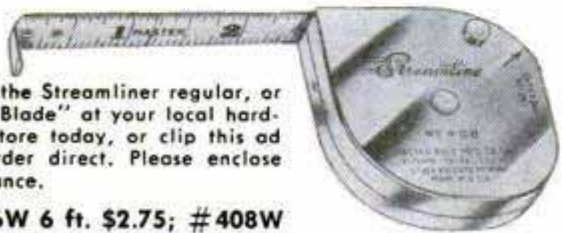

See the Streamliner regular, or "Brite Blade" at your local hardware store today, or clip this ad and order direct. Please enclose remittance.

#406W 6 ft. \$2.75; #408W 8 ft. \$3.00; #410W 10 ft. \$3.25.

MASTER

MASTER RULE MFG., CO. INC.
Middletown • New York

WOOD AND STEEL TAPE RULES

TITANIUM Rutile

The New WONDER GEM of the century

For the first time in history and as a result of intensive experimentation and research on a vital military project brilliant scientists of one of America's largest corporations suddenly hit upon the solution of the ages. The secret of how to crystallize in the laboratory a gem with a refractive index higher than and a dispersion factor greater than a **DIAMOND** was **DISCOVERED**. The discovery is **TITANIUM RUTILE** so widely acclaimed by leading reportorial mediums such as Readers Digest and The Saturday Evening Post.

REFRACTIVE INDEX ABOUT 10% HIGHER THAN DIAMONDS

Compare: Refractive Index of Rutile is between 2.62 and 2.90 as compared to the diamond's 2.42. Dispersion of Rutile ranges between 0.155 and 0.205 in comparison to the diamond's 0.025.

You are living in an age of miracles. As you know, atoms are being split. Actual basic materials are being re-arranged. Fantastic as it may seem to the layman, the secret of what has formerly been referred to as the **DIAMOND** is now known beyond a shadow of

(Actual Photograph of Our Product)

a doubt, **YOU PROFIT**. No longer need you invest large sums of money in a tiny stone the value of which is determined largely by scarcity and control. **YOU** can enjoy the beauty and prestige and the envy of your friends with a stone that no one of lesser ability than a **REAL JEWELER** working with a magnifying glass in his eye under good light can detect as not being a real **DIAMOND**. A handsome engagement ring made of our remarkable gem presented to any girl will inspire her devotion. The hundreds of dollars thus saved will go far towards building a happy, permanent home. Hudson Gem Co. sells **RUTILE** only in the cut stones. Each stone is perfectly cut with full 58 facets per **BRILLIANT** stone. By law we cannot refer to our products as **DIAMONDS** so we ask you to order them in the three most popular **DIAMOND** shapes namely the round or **BRILLIANT**, the oblong or **EMERALD** and the oval or **MARQUISE** cuts. You may order these stones for setting by your local, friendly, trusted jeweler who will be glad to verify your purchase. We do not sell mountings nor do we go in for costly catalogues nor expensive time payment plans. You get the benefit of direct to consumer possession of a valuable product which you can then have mounted and **SAVE THE MONEY YOURSELF. PAWNBROKERS-ATTENTION!** We suggest that you order a sample of this amazing product to have in your shop for comparison. Some pawnbrokers have paid out money under the impression that they were loaning on **DIAMONDS** when in reality people were offering titanium rutile. Lapidarists can make money buying cut stones from us and setting and selling complete rings. **UNCONDITIONAL MONEY BACK GUARANTEE, 30 DAY TRIAL IN YOUR HOME.** You are the **SOLE JUDGE**. In this advertisement you are assured that if for any reason whatever you are dissatisfied with your purchase from us you may, within 30 days, return your purchase for **100% CASH REFUND WITHOUT QUESTION**. Order with confidence. Select the shape you want, either **BRILLIANT** or **EMERALD** or **MARQUISE** shapes. Then select the number of carats you want, either 1, 1½, 2, 2½, 3, 3½, 4, 4½, 5, 5½, 6, 6½, 7, 7½, 8, 8½, 9, 9½ or 10. Remember each **BRILLIANT** is full 58 facets. Check this with your trusted jeweler. Price \$10.00 per carat. Add 20% Fed. Tax. Send Check or Money Order (do not send cash). Everything sent postpaid. **WRITE DEPT. PM-7.**

HUDSON GEM CO., 15 E. 47 ST., N.Y.C. 17, N.Y.

Handy Mail Order List

Little Library of Useful INFORMATION

5 for \$1.00
12 for \$2.00
25¢ Each

Here at amazingly low cost is the practical help and information you have always wanted. Articles in previous issues of Popular Mechanics have been classified according to subject and are now available in these handy reprint booklets.

How to Use Measuring Tools—Micrometers, Calipers, etc.—106.

Power Driven Saws—74.
Drill Presses, Grinders, Etc.—79.
Wood, Metal Turning—Lathes—81.
Filing Machine, Hacksaw, Cutoff Wheel, Shaper—82.

Lathe Tools You Can Make—101.
Workbenches—Tool Cabinets—47.
Spray Painting—94.
From Pattern to Casting—91.
Tool and Saw Sharpening—92.
Sharpening Drills, Wood Bits—90.

Successful Wood Turning—32.
How to Read Blueprint—71.
Metal Turning Lathe Kinks—99.
Operating a Metal Lathe—100.
Heat Treating, Hardening—102.
Working With Glass—103.

Servicing Elec. Motors—75.
Electromagnets & Solenoids—44.
Transformer Construction—41.
The Boy Electrician—43.
Soldering and Brazing—17.
Arc and Spot Welders—5.

Electroplating With Nickel, Chromium, Cadmium, Etc.—56.
Plating Leather, Wood, etc.—87.
Lower Your Fuel Costs—31.
Curing Leaky Basements—45.
Fitting Home Game Room—55.
Indoor & Outdoor Fireplaces—88.

Backyard Gardening—39.
Lawn and Garden Novelties—72.
Trellises, Pergolas, Fences—76.
Lawn and Garden Furniture—77.
Playground Equipment—73.
How to Use Your Drill Press—125.
Making Serving Trays—53.
Knots and Ropework—105.

Sanders—80.
House Wiring—89.
Hanging Wallpaper—38.
Built-in Fixtures—78.
Bird Houses—7.
Magazine Racks—49.
Clock Cases—50.
Book Ends—52.

Small Tables—54.
Smoking Stands—56.
Desks—58.
Book Cases—59.
Action Toys—66.
High Flying Kites—67.
Telescopes—20.
Metal Craft—28.
Small Looms—37.

Working With Plastics—61
Simple Home Improvements—104
Ridding Home of Insect Pests—107
Children's Room Furniture—51.
Jigsawed Novelties—57.

Doll House & Doll Furniture—60.
25 Shelves You Can Make—64.
Novelties Turned on Lathe—62.
Inlay Pictures—Veneering—63.
Wood, Soap Carving—65.
Windmills & Weather-vanes—68.
Lamps from Wood, Metal—69.
Rustic Furniture—18.
Wood Finishing—40.

How to Fix Electrical Appliances—111
Painting Your House—117
Build Your Own Relays—123
Rowboats, Small Dinghy—83.
Small Sail Boats—84.
Two Outboard Runabouts—85.
Build Own Canoe, Kayak—30.
Build Class-E Ice Yacht—22.
Auto Kinks, Shortcuts—10.
Lawn and Garden Equipment—124

Motor-Driven Midget Cars—34.
Stop Auto Elect. Troubles—95.
Photo Printers and Dryers—25.
Photo Darkroom Equipment—96.
Trick and Table Top Photos—97.
Home Movie Equipment—118
Poultry Houses—108.
Guns and Decoys—109.
Re-Silvering Mirrors—70.
Chemical Experiments—93.
Log Cabins, Tourist Houses—14.
Using Basic Tools—120
Farm and Garden Tractors—8.
Building Extra Attic Rooms—23.
Attractive Basement Rooms—24.

Gem Cutting—42.
Photo Enlargers—1.
Photo Kinks—98.
Cleaning Formulas—11.
Taxidermy—9.
Photo Lighting—119
Training Dogs—35.
Small Furnaces—36.

Check Titles Wanted, Clip, Mail with Remittance to

POPULAR MECHANICS PRESS, Dept. 23, 200 E. Ontario, Chicago 11



Famous for authoritative, detailed information on auto racing, every type of race car, rules, specifications, working drawings, plans, etc. No duplication. Every book different. Money back if not satisfied.

AUTO RACING • 6th Edition

Championship cars, big cars, midgets, roadsters, Offenhauser dirt track car. Specifications on Indianapolis cars, four-wheel drive details, front drive drawings, etc. Plans for Ford 60 midget, roadster racer. Data on engines, gear boxes, friction and dog clutches, axle ratios, compression ratios, independent suspensions, Indianapolis rules and regulations, etc. More than 100 illustrations. \$2.00.

TRAILER COACHES

By Ray F. Kuns. Contains information on the history of trailers, trailer parks and camps; materials, furnishings, trailer chassis, engineering, etc. Construction data on 10, 16 and 22 foot trailers which you can build yourself. 100 illustrations. \$1.50.

AUTO RACING • 5th Edition

Tells you—Why the Fast Ones are Fast—How to Make Them Fast—How to Build Engines—How to Build Chassis—How to Build Bodies—Who Holds What Records—What the International Formula Is—What Midget Racing Rules Are—How World's Record Cars Are Built—How to Speed Up Ford V8 Cars. \$1.00.

AUTO RACING • 4th Edition

Includes eight working drawings and complete building instructions for standard midget racers, drawings for midget road cars. Miller-Ford V8 front-drive racers are illustrated and described and other big-time data given. Technical pictures give the inside dope on these cars, together with authentic descriptions. 50 pages. 66 illustrations. \$1.00.

ORDER ON COUPON

POPULAR MECHANICS PRESS, Dept. 31, 200 E. Ontario St., Chicago

Remittance for \$_____ enclosed. Send books checked, postpaid.

- Auto Racing, 6th Edition Trailer Coaches
 Auto Racing, 5th Edition Auto Racing, 4th Edition
 Send C.O.D., postage extra.

NAME _____

ADDRESS _____

CITY _____ ZONE _____ STATE _____

**WHEN GASOLINE
WAS RATIONED
LAST TIME
DIDN'T YOU WISH
YOUR CAR GOT**

**35 to 50
miles per gal.**

Build This Beautiful Modern Table

**1 3/4" OAK OR
MAPLE VENEER
(FAS Quality)**

**TOP - 13" x 36"
HEIGHT - 26"**

(P. end table, occasional table, etc. sanded). dowel pins and complete finishing—only \$9.50 f.o.b. Factory tables.) Send check or money order

P. O. Box 833, Appleton, Wis.

**Printing Machine
Post Cards**



Now thousands of men, in every line, in spite of conditions on postcards by **CARDMASTER** machine. Low price, sold direct. Guaranteed 5 years. **SEND NAME** for free illustrated book, new money-making ideas and complete, unique advertising plans.

Cardmaster Co., 1920 Sunnyside, Dept. 135, Chicago 40, Ill.

SAVE YOUR LIFE!

Snake-Bite Kit. Be prepared for emergencies with a Cutter Suction Snake-Bite Kit. Easy to carry—light, small as a pocket knife. Contains 3 rubber suction cups, a sharp knife blade, lymph constrictor, and instructions. Suction cups used for insect bites.



Available at drug and sporting goods stores. If not available, send \$2.00 cash, check, or money order to: Cutter Laboratories, 1000 S. California, Dept. R-6.

AMAZING NEW DISCOVERY!

FOR ALL CARS WITH OVERDRIVE



ONLY \$995
POSTPAID AND INSTALLED

- AUTOMATIC HILLHOLDER
- OVERDRIVE COMPRESSION
- 6 FORWARD SPEEDS
- NO CLUTCH SHIFTING

We enclose a Free installation certificate redeemable for cash by your garage or gas station.

The Gane-O-Matic Puts to Work All the Hidden Advantages of Your Present Overdrive System

GANE-O-MATIC SAVES GAS, BRAKES & TIRES by allowing the use of overdrive 100% of the time and giving motor compression when in overdrive. THE GANE-O-MATIC AUTO-MATIC HILLHOLDER holds your car on any hill without the use of foot or hand brakes. SIX FORWARD SPEEDS up or down in overdrive and regular can be selected with a single finger. NO CLUTCH SHIFTING at any speed without even touching your gear.

IS EASILY INSTALLED IN A FEW HOURS by your garage or gas station. Unit comes with a FREE certificate of installation. PLUS Free delivery and installation.

FREE: If you are not fully satisfied, we will refund the price within 30 days.

PLYMOUTH OWNERS

SAVE MONEY

Learn How to Make Your Car Run Better . . . Last Longer . . . and Save Hundreds of Dollars



Get this book, written especially for you, without one penny of risk and get more out of your car. Mail coupon for MANUAL FOR PLYMOUTH OWNERS today. When the book comes, skip through the pages and see how your investment in one of America's most popular automobiles can be even a better investment than you thought. If you don't agree, send the book back and you'll get your money back.

A Popular Mechanics Book Written Just for You

Not a re-hash of service manuals. A complete new Popular Mechanics book written for the Plymouth owner by an outstanding automotive authority with the full cooperation of Plymouth engineers and service directors. It will save you money on repairs and longer; give you safe, economical and trouble-free motoring. And it's true whether you take your car to a regular service station or service it at home.

Official, Authoritative, Practical Information

Written by C. E. Packer, formerly service school instructor, auto show lecturer for automobile manufacturers, Member Society of Automotive Engineers, Special Services Editor of Automobile Digest, contributor to some of the biggest selling books on Automotive subjects. Prepared with the full authority and active cooperation of the Plymouth Division of the Chrysler Corporation.



BUILD This BEAUTIFUL MODERN TABLE

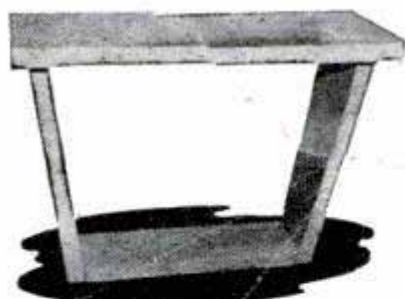

1 3/4" OAK OR MAPLE VENEER (FAS Quality)

TOP — 13" x 36"
HEIGHT — 26"

Perfect for picture window lamp, end table, occasional table, etc. We furnish wood (sized and sanded), dowel pins and complete instructions for assembly and finishing—only \$9.50 f.o.b. Factory. (We include drawings of other tables.) Send check or money order direct to—

SPECIALTY TOOLS CO., P. O. Box 833, Appleton, Wis.

New Advertising Machine Prints Post Cards

FREE LEARN HOW thousands of business men, in every line, boost sales in spite of conditions—with ads printed on postcards by amazing new patented **CARDMASTER** advertising machine. Low price, sold direct. Guaranteed 5 years. **SEND NAME** for **FREE** illustrated book, new money-making ideas and complete, unique advertising plans.

Cardmaster Co., 1920 Sunnyside, Dept. 135, Chicago 40, Ill.



SAVE YOUR LIFE!

Cutter Snake-Bite Kit. Be prepared for emergencies with a Cutter Suction Snake-Bite Kit. Easy to carry—light, small as pocket knife. Contains 3 rubber suction cups, antiseptic, knife blade, lymph constrictor first aid instructions. Suction treatment, only first aid method medically approved. Also used for insect bites.

Sold in drug and sporting goods stores. If not available, send \$2.00 cash, check, M.O. (no C.O.D.'s) to: Cutter Laboratories, Berkeley, California, Dept. R-6.



WANT \$10,000?

Earn the government Super Sensitive P.R.I. bonus. Locate Uranium with a **GEIGER COUNTER**

Also get one for Atom Bomb Defense! Find gold, silver, and other valuable ores with a P.R.I. Treasure Locator. World's finest instruments. **FREE** catalog. Write!

PRECISION RADIATION INSTRUMENTS
4113PM W. Jefferson, Los Angeles 16, Cal.

Dealer Inquiries Invited



WARN HUB CAP MAKES 2 JEEPS OUT OF 1

Ends front wheel drag on 4-wheel drive Willys Station Wagons, Pick-ups and Jeeps

Saves gas up to 5 miles per gallon, tire wear, front axles, increases speed and power. Stops shimmy—front wheels coast out of gear! 4-wheel drive handles, performs, climbs like 2-wheel. Install or remove WARN HUB CAPS in 10 minutes. Polished aluminum, guaranteed. Rush check, M.O., or C.O.D. Write for circular.

WARN MFG. CO. - 1625 Third Ave., Seattle 1, Wash.

\$20.00

Prepaid U.S., Canada

HELPFUL BOOKS

Send post card asking for **FREE** catalog
Popular Mechanics Press, 200 E. Ontario, Dept. 601, Chicago 11

LEARN WATCHMAKING JEWELRY REPAIRING

Start your training now for a better paying job or your own profitable business. Our training is nationally recognized, outstanding and supervised by expert craftsmen. Write for free catalogue.

APPROVED FOR VETERANS

SCIENTIFIC SCHOOL OF WATCHMAKING, Dept. PM-5

3923 San Fernando Road

Glendale 4, California

WHEN GASOLINE WAS RATIONED LAST TIME DIDN'T YOU WISH YOUR CAR GOT

35 TO 50 miles per gallon?

Wouldn't a Crosley car in your garage be good insurance? Then you can count on 35 to 50 miles on a gallon of regular gasoline—150 miles of driving per week on an "A" card while most other cars are getting only 30 to 40 miles. Crosley has powerful engine with cast iron block, 8:1 compression ratio. Hundreds of improvements. And still less than \$1,000. Last time gasoline was rationed, used Crosley cars sold for over 3 times the original purchase price! See your Crosley dealer now.

FREE! 1951 Crosley Catalog! Write Crosley Motors, Inc., 2530-HW Spring Grove Ave., Cincinnati 14, Ohio.

CROSLLEY
a FINE car

You see them everywhere!

Say You Saw It in POPULAR MECHANICS



✓ Saves Money
✓ Works Better
... Faster
✓ Lasts Longer

Washes like a Sponge
Wipes like a Chamois
Du Pont Cellulose yarn woven into a cloth; replaces old fashioned sponge and expensive chamois. • Best yet for Cars, Windows, Woodwork and other household chores.

SEND ONLY \$1.00 NOW, CASH OR CHECK. We are so sure you will like your Woven Wonder, we will return your \$1.00 if you are not satisfied.

TOWER INDUSTRIES, INC., 2407 Terminal Tower, Cleveland 13, Ohio

AMAZING NEW DISCOVERY!

FOR ALL CARS WITH OVERDRIVE



ONLY
\$995
POSTPAID
AND
INSTALLED

**AUTOMATIC
HILLHOLDER**

**OVERDRIVE
COMPRESSION**

**6 FORWARD
SPEEDS**

**NO CLUTCH
SHIFTING**

We enclose a Free installation certificate redeemable for cash by your garage or gas station.

The Gane-O-Matic Puts to Work All the Hidden Advantages of Your Present Overdrive System

GANE-O-MATIC SAVES GAS, BRAKES & TIRES by allowing the use of overdrive 100% of the time and giving motor compression when in overdrive. **THE GANE-O-MATIC AUTOMATIC HILLHOLDER** holds your car on any hill without the use of foot or hand brakes. **SIX FORWARD SPEEDS** . . . three each in overdrive and regular can be selected with a flick of your finger. **NO CLUTCH SHIFTING** . . . up or down . . . can be enjoyed at any speed without even touching your clutch.

THE GANE-O-MATIC IS EASILY INSTALLED IN A FEW MINUTES ON ALL FORD, MERCURY, LINCOLN, STUDEBAKER, CHRYSLER, DODGE, DESOTO, NASH, HUDSON, KAISER-FRAZER, JEEPSTER, AND OTHER CARS WITH OVERDRIVE.

MONEY BACK GUARANTEE: If you are not fully satisfied, we will refund entire purchase price within 30 days. Unit comes complete with illustrated installation instructions PLUS Free installation certificate. Send cash, check or money order. \$1 deposit on C.O.D. orders.

NATIONAL AUTOMOTIVE RETAIL CORP., Dept. Y-5
350 W. Washington Blvd., Venice, Calif.



THRILL HER and Yourself GEM MORE BRILLIANT THAN DIAMONDS

AMAZING JOHANNES GEMS FREE CATALOG

See it—own it—world's most brilliant gem (Titanium). Our amazing catalog tells how, gives largest setting selection, lowest prices. One carat Johannes Gems, set in 14 kt. solid gold ladies' or men's ring . . . only \$25 plus tax. Unset gems and larger sizes available.

As seen in Reader's Digest, Sat. Eve. Post. Deal with reliable gem firm—don't be fooled. See our free catalog before ordering. Johannes Gems (Retailer on display N.Y. Museum of Natural History). Write Dept. PM-1 for your free catalog today!

Only the Finest in Titanium Rutile Bears the name Johannes Gem.
INTERNATIONAL GEM CORPORATION
15 Maiden Lane • N. Y. 38, N. Y.

DO 8 HOURS WORK IN 15 MINUTES

Edge Your Lawn
with an RMC Lawn Edger

Takes the drudgery out of lawn edging. Heat-treated, retractable blades give a clean cut along straight or curved edges. Rugged, well-designed unit is so easy to handle that a child can operate it. Tested for five years by commercial gardeners and fully guaranteed.

Free Literature

Write today for information on the ONE edger that's guaranteed to save you time and money in caring for your lawn.

MODEL 55A
\$104.50
F.O.B.
HOUSTON



Shipping
Weight
62 lbs.

LAWN EQUIPMENT SALES CO.
2030 Westheimer • Houston 6, Texas

PLYMOUTH SAVE MONEY!



Learn How to Make Your
Car Run Better . . . Last
Longer . . . and Save Hundreds of Dollars!

Get this book, written especially for you, without one penny of risk and get more out of your car. Mail coupon for **MANUAL FOR PLYMOUTH OWNERS** today. When the book comes, skip through the pages and see how your investment in one of America's most popular automobiles can be even a better investment than you thought. If you don't agree, send the book back and you'll get your money back.

A Popular Mechanics Book Written Just for You

Not a re-hash of service manuals. A complete new Popular Mechanics book written for the Plymouth owner by an outstanding automotive authority with the full cooperation of Plymouth engineers and service directors. It will save you money on repairs and service; make your Plymouth last longer; give you safe, economical and trouble-free motoring. And this is true whether you take your Plymouth to a regular service station or service it at home.

Prevents Trouble. Cuts Down on Repair Bills

Nothing like this manual anywhere. It covers all phases of operation, service and maintenance. It has entire chapters on the individual parts of your Plymouth—battery, ignition, starter, generator, regulator, lighting, fuel system, engine, lubrication, gasoline qualities, cooling systems, transmission, differential, rear axle, brakes, wheel alignment, tire care, body maintenance, trouble shooting on the road, etc. It covers your Plymouth, new and older models, step by step—bumper to bumper—showing you how parts operate; what can go wrong; how repairs and adjustments should be made and how to avoid all types of troubles.

Money Back if Not Satisfied

Mail the coupon today. Send only \$3.50 or you can pay postman. Money back guarantee protects you.

Official, Authoritative, Practical Information

Written by C. E. Packer, formerly service school instructor and auto show lecturer for automobile manufacturers, Member Society of Automotive Engineers, Special Services Editor of Automobile Digest, contributor to leading magazines, author of some of the biggest selling books on Automotive subjects. Prepared with the full authority and active cooperation of the Plymouth Division of the Chrysler Corporation.

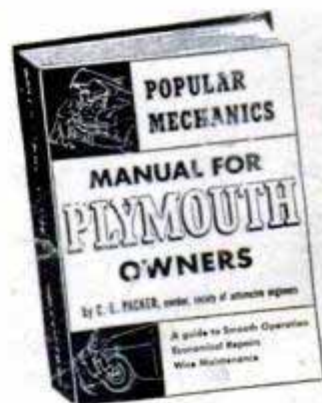

288 Pages. Hundreds of How-To-Do-It Illustrations and Diagrams

The entire book follows Popular Mechanics famous easy-to-read and easy-to-understand style. While primarily intended for the Plymouth owner, to help him get more out of his car at lower cost, it can be worth its weight in gold to the auto mechanic and service station operator who works, not only on Plymouths, but on all other makes as well, to which the information in the book can be easily applied.

Order on this Handy Coupon

POPULAR MECHANICS PRESS, Dept. 17
200 E. Ontario St., Chicago 11, Ill.
Send Manual for Plymouth Owners at once. If not satisfactory I will return it within 5 days and you will refund full purchase price.

Remittance for \$3.50 enclosed. Send C.O.D.

Name _____

Address _____

City _____ State _____

POPULAR MECHANICS

IMPORTED GERMAN BINOCULARS

SAVE 60%
12 1/2 MILE RANGE

PRECISION LENSES 3.95 PLUS TAX

New, low cost binoculars from a famous German manufacturer of fine optical instruments. Center focusing adjusts to your own eye strength. Money back guarantee. Compare with glasses at \$15.00 or more! Send check for \$3.95 plus 80c tax... we pay postage, or order C.O.D.



MARYLAND DISTRIBUTORS

Dept. 249, 501 E. Baltimore St., Balto., Md.

MAKE YOUR HANDS MORE *Creative*



with **x-acto** Knives and Tools

For FUN and PROFIT—from 25¢ to \$25.

SEND 10¢ TO COVER POSTAGE FOR NEW ILLUSTRATED 28-pg. CATALOG X-ACTO CRESCENT PRODUCTS CO. INC., 440 FOURTH AVE., N. Y. 16, N. Y.

TRAILER COUPLER

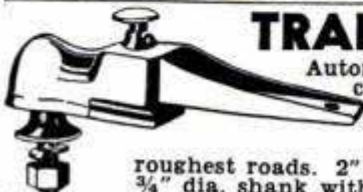

Automatic Wedge-lok coupler cannot rattle or loosen. Locks into position quickly and easily. Designed for rugged heavy duty over roughest roads. 2" dia. one piece steel ball has 3/4" dia. shank with 3/4" SAE threading. Order today, immediate delivery, we pay postage. No C.O.D.'s please.

\$1.00 Postpaid

DAYTON PRODUCTS CORP., Rockford, Ill.



LOOK! New Discovery SAVES YOUR CAR CHROME!

Government emergency restricts chrome plating. Even new cars will soon be without it. Take pride in your car by preserving its chrome against the elements. One application of KROMSEAL, the amazing new anti-rust and corrosion liquid (not a lacquer) will effectively protect your chrome for 5 years and longer under normal conditions. Scientifically tested and proven. Money-back guarantee. 4 oz. bottle only \$1.00 ppd.

R & M Kromseal Co., 4953 Vincent Ave., Los Angeles 41, Calif.

\$ Free Course! Big Profits! \$ Flocks & Sandblasts



Dual Purpose Spray Gun! Uses only 25 lbs. Air Pressure • Thousands of uses in Home, Shop, Industry: Makes Auto Interiors Clean & New, Lines drawers, Marproofs lamp bases, Refinishes any object. All in colorful Flock. Etch & Frost windows, glassware, etc. Removes Paint & Rust from Autos, Tools. Guaranteed! Send \$24.75 or write for free information. Flocking supplies!

BLASTO SPRAY GUN MFG. Dept. PM-5, 7007 Haas Avenue, Los Angeles 47, Calif.

GARDEN AUGERS

for PLANTING—FERTILIZING—STAKING—WEEDING—ETC.

Made of Tempered Steel. Size 2" diameter 18" Twist or Pod 38" overall length \$8.75

Dealers Inquiries Invited

CAPRARA EARTH ANCHOR CO. 1814 N. Leavitt St. Chicago 43, Illinois

MASTER CHAMPION Lawn Mower Sharpening Machine

IMMEDIATE DELIVERY

Here's the Machine Experts Use! Most Simply constructed and easiest machine on the market to operate.

Write for free literature

FRANK'S MFG. CO. DEPT. F, 2501-3-5 E. IMPERIAL HWY. LOS ANGELES 2, CALIF.



WAR SURPLUS AND OTHER BARGAINS

"BALTIC" SWEDISH TOOLMAKERS VERNIER CALIPER

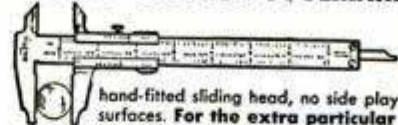

ULTRA PRECISION—0-6" In .001 graduations. Quick, accurate depth, inside and outside measurements, fine engraving. Extra heavy rule, Rockwell C-60, lapped measuring surfaces. For the extra particular mechanic who must have the best—used and recommended by most critical experimental and research machinists at Lockheed • Douglas • Bendix • GM • RCA • General Electric. Save 50%! A \$37.50 value—only \$17.25—Leather case included. Also a standard grade Mauter Design Caliper • made in Germany • For the production machinist, 0-6" in thousandths, the most accurate caliper of this type on the market, thousands of satisfied users—only \$12.95—Leather case included. These are both guaranteed buys. Your money back if not entirely satisfied. Order now!



RIVET SETS

Universal type, case hardened tips. Set of dies will head up any brazier or round head rivet from 1/8" to 1/4". With adapters for air gun or hand use. All new... cost Government about \$27.00. Complete 15 piece set, wt., 2 lbs., \$5.00



MICROMETERS

Chrome plated, precision engineered and carefully tooled to give long life. All new. 0-1" capacity ea. \$2.25. 1-2" capacity \$3.50.

HIGH SPEED DRILLS

All New. Fractional & numbered. Orig Val. \$15. Nationally known brand. Asst. sizes. Set 30, \$3.50

EXTENSION DRILLS

High Speed Steel, like new. Asst'd sizes from No. 1/4 to 40 Lengths from 6" to 12" Approximately \$20 value. Set of 12.....\$3.75

HIGH SPEED DRILL BITS

Like New! Original value over \$16.00. 25 assorted sizes and lengths, \$2.00

DRILL GRINDER

Sharpens round, square or tapered drills up to 6" long. Even an amateur mechanic can get a new, factory finish on a drill in 25 seconds. New protractor feature gives every drill sharpening angle, with 5 convenient angles already marked off. Usable with hand or power stone. A brand new development, manufactured by Ten Eyck. Shipped postpaid

All New. \$2.80 each.



ELECTRIC BELLS—Vibrating type, high pitch, 115 V., 60 Cycle Ideal for use indoors or outdoors—on ranches, for schools, plant installations, as signal systems, burglar alarm systems, etc. Nationally known Mfr. All NEW in orig. Pkgs. Solid brass clapper & 8 1/2" gong. Wt. 8 lbs. Govt. cost about \$67.50. Close out at... \$7.95

Send check, money order or cash, 25% deposit required on C.O.D. orders. All prices F.O.B. Culver City, California, unless otherwise stated. Send 25c for Illustrated Catalog.

AIRBORNE SALES CO., INC. DEPT. PM 5 51 CULVER CITY, CALIF.

Say You Saw It in POPULAR MECHANICS

NEW "PAINT PEN"

PAINT STRIPING TOOL Works like a Fountain Pen Stripes with Paint instead of Ink!

This amazing new "PAINT PEN" is a Paint Striping Tool that makes it easy to do expert striping on furniture, bikes, model planes, autos, signs, toys, linoleum, wall board, etc. Makes plain, painted walls look like tile. Paint straight, curved, circular or evenly spaced parallel lines the same way a professional painter does. Simply fill Tubular Glass Paint Fountain with any color paint and wheel tip feeds paint evenly. Tips interchangeable—jaws split apart for easy cleaning. Tool complete with tip for 1-16 inch strip only \$1.00 postpaid. Other complete tools with 1-64, 1-32, 3-64, 1-16, 5-64, 3-32, 1-8 inch tips, \$1.50 ea. Extra tips, 75c each. Complete KIT with 7 tips, \$5.00. C.O.D.'s postage collect. Here's the handiest tool in your whole painter's kit. Get yours today.



Paint STRAIGHT, CURVED OR PARALLEL LINES

Home Craftsmen

Just the tool you've been waiting for! New Paint Striping Tool gives "professional" results every time, yet simple and easy to use as a fountain pen. Adjustable guide keeps lines straight as an arrow. Just as easy to make curves or free hand designs. Adds new beauty and finished look to everything you paint. Send \$1 now!

DEALERS PAINT STRIPING TOOL packed in display cartons of 1 doz. Fast, profitable seller. Write for illustrated circular, discounts

Only \$1.00

WENDELL MFG. CO., Dept. 35, 4234 LINCOLN AVENUE, CHICAGO 18, ILL.

SALESMEN JAM POCKETS WITH \$10 BILLS



Taking orders for **KEY** expertly tailored auto seat covers
The "LEOPARD"
selling sensation of the year

BIG SEASON NOW STARTING!

Tremendous demand for Leopard auto seat covers built up overnight when Cadillac introduced a new 1950 model with Leopard Seat Covers. Car owners are paying \$50.00, \$60.00 and \$70.00 and more for car seat covers with Leopard design. Now you can serve that eager demand at a fraction of the cost your customers would expect to pay! Salesmen making money hand over fist.

7 STYLES
7 Price Ranges. A full line in addition to the leopard. Woven fiber. Woven Saran Plastic.
FREE!
SALES KIT

Take orders from car owners everywhere. Year around income! A line of covers cut to accurate patterns like the finest suit of clothes. Add an accent of elegance to any car . . . just like an original upholstery job! Full or spare time, you can realize big money in this business. Every car owner a prospect. Be the first in your territory to cash in. Get your free selling kit at once for some real money.
ACTUAL SEAT COVERS GIVEN FREE TO PRODUCERS FOR OWN USE! Write for full details TODAY!

KEY PRODUCTS CORP.
800 N. Clark St., Dept. 4-E, Chicago 10, Ill.



Enough plans, projects, and ideas for **A WHOLE YEAR OF WOODWORKING FUN!**

— in the popular hobbyist's magazine **THE DELTAGRAM®**
Send in your subscription! Mail check or money order.
**POWER TOOL DIVISION
ROCKWELL MANUFACTURING CO.**
803 E. Vienna Ave., Milwaukee 1, Wis.

YOURS to make and KEEP!
This Footstool — Boudoir CHAIR and Lawson Chair!



LEARN UPHOLSTERING



For More Pay—More Profit—OR as a Hobby!
Upholstering needs more trained men for good, steady jobs! Now you can prepare for a better paying position—or your own business—with this practical home training course—by an accredited, established school, largest of its kind in the country!
YOU LEARN WITH REAL EQUIPMENT—YOU BUILD REAL FURNITURE—YOU GET A COMPLETE TOOL KIT & ALL MATERIALS. ALL AT NO EXTRA COST!

FREE! Big, illustrated brochure, sample lessons and details of "PAY AS YOU LEARN" plan. No obligation.

SEND THE COUPON TODAY!

FIELD SCHOOL OF UPHOLSTERY, DEPT. 05
39 West 19th Street, New York 11, N. Y.
Rush FREE illustrated brochure, sample lessons and details of "PAY AS YOU LEARN PLAN."

Name _____ Age _____
Address _____
City _____ Zone _____ State _____
 Check if Veteran of World War II

2 DRILLS IN 1
This attachment gives you two drills in one. It converts any 1/4 inch electric drill to 1/2 inch capacity. Reduction gears reduce the drill speed 5 to 1, the average speed of a 1/2 inch drill, and thereby increases the power. Absolutely indispensable for all shop work and home craftsmen. Satisfaction guaranteed. Order yours now.
\$11.95 post paid
Send check or Money Order with order. Jobbers write for special information.
G. M. CO. MANUFACTURING, INC.
1308 43rd AVE. LONG ISLAND CITY 1, NEW YORK

CHAPMAN CHINCHILLAS

The originator of the first Chinchilla Farm in the United States. For information on purchasing the finest, selected breeding stock of these aristocratic animals that were virtually trapped to extinction write or visit—

Established 1919 **Chapman Chinchilla Farm**
"P. O. BOX 221" 4957 West 104th Street
Inglewood, California

Learn ACCOUNTING BOOKKEEPING
This nationally renowned school has demand for graduates in good salary positions thru nationwide recognition and placement service. Write Department PMX today for Big 32 page Success Book to be sent to you **FREE**

Hills BUSINESS UNIVERSITY AND EXTENSION SCHOOL
619 W. MAIN ST. OKLAHOMA CITY 2, OKLAHOMA

WOODWORKING VISE
for amateurs and professionals
USE UPRIGHT — FLAT — AT ANY ANGLE
MAIL CARD FOR FREE FOLDER TODAY
THE WILL-BURT CO., Dept. PM-7, 202 S. Main, Orrville, O.

stop taking abuse
Why stand being pushed around? Do you long to get back at these pests who take advantage of your size or lack of muscle. The knowledge of **POLICE JIU JITSU** will enable you to throw the biggest and toughest of men. It's Amazing! In a matter of seconds you can be complete master of any situation. A complete course, easy to learn in one illustrated volume. By all means—send for this valuable course today! Just pin \$1 to this ad and your copy of **POLICE JIU JITSU** will come to you by return mail postpaid. Your money back for any reason.

BOOKS PUBLISHING CO., 56 W. 24th St., N.Y. 10

Say You Saw It in POPULAR MECHANICS

VISOLATOR The Oil and Filter Condition Indicator
TELLS AT A GLANCE WHEN OIL OR FILTER CARTRIDGE IS DIRTY and DANGEROUS
Continuous flow of Engine Oil through GLASS DOME tells the Story.
Dirty Oil causes Friction . . . Wear and Break-downs. Dirty, Choked-Up Oil Filter Cartridge lowers Engine Efficiency. **VISOLATOR** shows at a glance the condition of Oil, helps Motorist keep Engine in top running condition. Avoid Costly Engine Repairs. **VISOLATOR'S** brass fitting screws into the bottom of all conventional Filters. Oil Return Line screws into Aluminum base. Easily Installed. For Autos, Busses, Trucks, Tractors. Send Check or Money Order for your **VISOLATOR** Today. Only \$2.98 Postpaid.

VISOLATOR CORP.
807 E. SACRAMENTO ST. ALTADENA, CALIF.

WEAR AT OUR RISK!
Money Back!
If not delighted in 10 days.

LIFETIME *Written* GUARANTEE!

BUY WITH COMPLETE
Confidence!
AMERICA'S GREATEST
WATCH VALUE

BUY DIRECT AT PRACTICALLY WHOLESALE PRICES
FROM ONE OF AMERICA'S LARGEST DISTRIBUTORS!

17 JEWEL AUTOMATIC SELF WINDING, WATER-RESISTANT

ORIG. \$71.95

YOU SAVE \$47

\$24.95



Set it and forget it! Precision self-winding movement keeps 40 hours reliable time after few hours normal wear. Water-tight case, anti-magnetic, shock-built; professional sweep second hand, 17 full jeweled precision Swiss movement. Wear it at our risk... be completely satisfied! Now only \$24.95, plus \$2.50 tax.

Men's **BULOVA** Women's
15 or 17 JEWEL MOVEMENTS

Originally \$58.95 sold up to \$58.95

Also, GRUEN • BENRUS • WALTHAM • ELGIN



YOU SAVE \$42

\$16.95

OUR PRICE NOW ONLY

Genuine Bulova, Benrus, Gruen, Waltham, Elgin and other famous wrist watches in latest style Yellow Gold Cases. You get these unredeemed Lifetime Guaranteed FAMOUS MAKE WATCHES now at truly enormous savings because we bought out SURPLUS STOCKS of leading New York and Maryland Jewelers. Order now while they last. State make preferred. Order men's or ladies'. Only \$16.95, plus \$1.70 tax. Order now.

17 JEWEL CHRONOGRAPH

ORIG. \$71.95

YOU SAVE \$50

\$21.95

- WRIST WATCH
- STOP WATCH
- TELEMETER
- TACHOMETER

Precision 4-in-1 timepiece for professional scientists, aviators, engineers, etc. Nationally advertised. 3 multi-function dials automatically coupled. 30 min. register. Synchronized seconds, 1/5 seconds. Luminous. Instructions included. Unbreakable crystal. Only \$21.95 plus \$2.20 tax. Order now.



17 JEWEL LADIES' WATCH 14 KT. SOLID GOLD!

ORIG. \$59.95

YOU SAVE \$38

\$21.95



Exquisitely styled, petite watch superbly executed in 14kt. solid gold. Rock crystal; gold numerals. Lifetime guaranteed. 17 jewel Swiss movement; adjustable corded band; double safety catch. Limited quantities at this amazing low price. This value cannot be duplicated! Wear it at our risk and see for yourself. Only \$21.95, plus \$2.20 tax.

17 JEWEL INCABLOCK

Water-Shock-Resist

ORIG. \$59.95

YOU SAVE \$44

\$14.95

Handsome. Accurate. Sweep Second Hand; Non-Magnetic; Luminous dial. Worn by Army, Navy, Marines during World War II and praised by servicemen everywhere.

Amazing value at \$14.95, plus \$1.50 tax. Order now.



Free!

Handsome expansion band included free with your order. Write for FREE Watch & Diamond Ring Catalog. Practically wholesale prices to user direct.

TRIAL OFFER! WEAR AT OUR RISK! MONEY BACK IF NOT DELIGHTED! ORDER DIRECT FROM THIS AD, FOR SELF AND FOR THRILLING GIFTS. Lowest prices ever, for these lifetime guaranteed watches! Order now on famous lifetime written guarantee. Send only \$1 down payment with order. Pay balance to postman on arrival, plus postage. Or we pay postage if you enclose full payment plus tax with your order.

Maryland Distributors, Dept. 247, 501 E. Baltimore St., Baltimore 2, Md.

Auto Spark Intensifier Gets ROCKET Performance



- ✓ MORE POWER
- ✓ BETTER MILEAGE
- ✓ MORE SPEED
- ✓ QUICKER STARTING

The ELECTRONIC SPARK INTENSIFIER is an efficient, scientifically developed automotive device which can be easily installed in the center hole of the distributor cap of all autos, trucks and tractors in sixty seconds. By boosting the high voltage current passing through the distributor, it gives a "hotter spark" permitting a wider spark gap... thus reducing "misfiring", ring and cylinder wear and allowing all-around better performance. FREE TRIAL, send \$2.00 cash, check or money order... if not fully satisfied after 10 day trial, return for immediate refund.

ELECTRONIC DEVELOPMENT CO. DEPT. PM-5 LOS ANGELES 34, CALIF.

Earn up to \$6,000 a year!

MORE JOBS THAN WE CAN FILL METAL TRADES BACKBONE OF INDUSTRY

Men who are mechanically inclined have a wide open field to choose employment in the Metal Trades Industry. Jobs are going begging for lack of qualified trained men. You need no previous experience to start your training at this school.

SHORT COURSES TO MEET PRESENT JOB DEMAND.

INDICATE YOUR PREFERENCE—RESIDENT or HOME STUDY TRAINING

ALLIED SCHOOL OF MECHANICAL TRADES, Inc. 1338-1340-1342 S. MICHIGAN AVENUE 405 ALLIED BUILDING, CHICAGO 5, ILL. Write for FREE BOOKS A 1¢ Postcard will do.

MAY 1951

BE A TILE SETTER

SIMPLE, EASY TO LEARN AT HOME! Very high pay. Great and growing demand. Light, interesting work. Even as a side line you may earn \$75.00 or more a week. Send for details TODAY!
AMERICAN INSTITUTE OF TILE SETTING
PO Box 1845 Wilshire-LaBrea Station, Dept. PM5, Los Angeles 36, Calif.

RESET LOOSE HINGES

with



EASY! No skill required. Handles like putty...hardens into wood.

A CELLULOSE FIBRE FILLER

IN CANS OR TUBES

WON'T CHIP OR CRACK

P.S. Lubricate bikes, trains, skates and wagons with 3-IN-ONE Oil

Say You Saw It in Popular Mechanics

The **NEW Model 50 UTILITY TESTER**
FOR REPAIRING
ALL ELECTRICAL
APPLIANCES-MOTORS
an all-around electrical trouble shooter



- Measures A.C. and D.C. Voltages, A.C. and D.C. Current, Resistances, etc.
- Will measure the current consumption while the appliance under test is in operation. The appliance or utility may be plugged directly into the front panel receptacle. A special pair of insulated clip-end leads is included for motors, etc.
- Incorporates a sensitive direct-reading resistance range which will accurately measure all resistances commonly used in electrical appliances, motors, etc. This range will enable continuity checks and tests for shorts and opens.
- Will test thermostats, radio tube filaments, bulbs, fuses, fluorescents, condensers, switches, field coils, circuit breakers, lighting systems, etc.

Handsome round cornered molded bakelite case 3 1/8" x 5 7/8" x 2 1/4". Complete with all test leads and instructions.

\$13⁹⁰

SOLD ON EASY PAYMENTS
AT THE NET CASH PRICE

No interest or carrying charges added. Simply remit \$3.90 with order, pay balance, \$2.00 per month for 5 months.

SUPERIOR ELECTRONIC CO., INC.
 Dept. B-7 • 227 FULTON STREET • NEW YORK 7, N. Y.

S AGENTS 300% Profit SIGN LETTERS
 For Store Fronts and Office Windows. Anyone can put them on. Free samples. Liberal Offer to General Agents.
METALLIC LETTER CO., 430 N. Clark, Chicago 10



SAVE MONEY!

New method simplifies building a house, kitchen cabinets, garage and over 100 other household articles. In Reader's Digest, you may have read how the Easi-Bild* Pattern takes all the mystery out of building whatever you need. In the May Ladies' Home Journal you will read about the new Build It Yourself* house.

Pattern tells how to modernize your entire kitchen using stock size lumber and Stanley Kitchen Cabinet Hardware. Send \$1.00 for Cabinet Pattern No. 201, enclose 20c additional for Pattern Book illustrating over 100 other Pattern Projects.

*Trade Mark Reg. U.S. Pat. Off. by Easi-Bild Pat. Co.

Easi-Bild Pattern Company
 P.O. Box 215, Pleasantville, New York

WANTED!

MEN AND WOMEN TO EARN SPARE TIME MONEY

Many Popular Mechanics neighborhood representatives are making extra cash for easy, after-hours work. A few more are needed.

For details, write:

POPULAR MECHANICS
 ROOM 408
 200 E. ONTARIO STREET
 CHICAGO 11, ILLINOIS

DEPENDABLE CRAFT SUPPLIES

WRITE FOR CATALOG SINCE 1928

LEATHER CRAFT • PLASTICS • POTTERY CRAFT • BLOCK PRINTING • BELT CRAFT • TEXTILE COLORS • POWER TOOLS • WOOD BURNING • INSTRUCTION BOOKS • ETC.

DWINNELL CRAFT SHOP
 Dept. PM-551—Wheeling, W. Va.

BUILD YOUR OWN BARBECUE FIREPLACE \$1.00

Join the thousands who are now enjoying the flavor of that steak cooked OUTDOORS. This book loaded with photographs of modern brick BARBECUE-FIREPLACES gives practical suggestions . . . advice . . . tells YOU exactly how to build from start to finish. EASY. Book also shows the 6 basic plans from which you can build directly—with details and list of materials. BUILD NOW . . . have fun this summer.

FREE —with every order, one large complete detailed BLUEPRINT of tested most popular design

MONEY BACK GUARANTEE
CLEVELAND PUBLICATIONS, INC.
 Dept. 5-X, 369 W. Washington, Pasadena 3, Calif.

Learn PHOTOGRAPHY

There's big money in PHOTOGRAPHY—and an action-packed career for you. Our HOME STUDY COURSE is your spare-time SHORT CUT TO SUCCESS! Or, if you wish—PERSONAL ATTENDANCE TRAINING at our famous New York School is available with subsistence under the G. I. Bill. Our 41st year. Write immediately!

NEW YORK INSTITUTE OF PHOTOGRAPHY
 Dept. "49," 10 West 33 Street, New York 1, N.Y.

HELPFUL BOOKS

Send post card asking for FREE catalog

Popular Mechanics Press, 200 E. Ontario, Dept. 601, Chicago 11

SHARPEN CIRCULAR SAWS LIKE AN EXPERT

THE SUPER GADGET FOR HOME WORKSHOP

Two simple adjustments. Gets hollow-ground, cross-cut or combination saw blades true and sharp. Fits 6" to 12" blades 1/2" to 13/16" centers. Includes file, complete instructions. \$6.95 postpaid. (C.O.D. postage extra.) Guaranteed—Money back if not satisfied after 10-day trial. Soon pays for itself. Order today. Free Folder.

SURE SHARP MFG. CO., Dept. M-51
 P. O. Box 24 Santa Ana, Calif.

\$6⁹⁵

FLASH Your Turns



ELIMINATE HAND SIGNALLING
S & L DIRECTIONAL SWITCH
THE LOWEST PRICED DIRECTIONAL SWITCH THAT MEETS ALL S.A.E. REQUIREMENTS

Here is a safe, comfortable way of signalling your intention to make a left or right turn. Flashes from 60 to 80 times per minute. No need to roll down window to signal turns in cold or rainy weather. Kits furnished with all necessary material for perfect installation. No outside mounting of any kind. Uses your present parking and tail lights. Either of our two models fits most cars from 1942 to 1950.

Specify year and make of car. Money-back guarantee.

A PERFECT GIFT FOR MOTORISTS
S & L AUTO SALES
 Box 6414, Dept. 6, Chicago 7, Ill.



\$6.95 postpaid in U.S.A.
 SEND CHECK OR MONEY ORDER.
 POSTAGE EXTRA ON C.O.D.'s

Have fun! BUILD YOUR OWN CHAMPION



Do what hundreds of others are doing! Build your own sleek racing boat or comfortable pleasure craft in spare time! Have fun and save a lot of money! Send 25c today for new illustrated catalogue of tested boat plans, 18 trim styles ranging from midget outboards to 20 foot lengths. Don't wait. Write now to

CHAMPION BOATS, P.O. Box 9038 15-E, Long Beach 7, Calif.

ACCURATE

Most POWERFUL patented air pistol made. Looks and feels like Luger. For Cal. .177 or .22. Game HUNTING, indoor or outdoor TARGET shooting. At your dealer, or write Dept. PA-5



NO PUMPING
HY-SCORE
AIR PISTOL

HY-SCORE ARMS CORP., 25 Lafayette St Brooklyn 1, N. Y.



F4.5 Precision Midget Camera \$4.98

- INCL. GENUINE LEATHER CASE
 - Capable of Clear 5x7 Enlargements
 - Eye Level and Waist Level View Finders
 - Self Cocking Shutter
 - Detailed Directions with Each Camera
- FILM.....30c Roll
COLUMBIA SUPPLY HOUSE
 1060 FERGUSON AVENUE
 NEWPORT NEWS, VIRGINIA

\$600 BUILDS 4 ROOMS & BATH!

WHY PAY RENT?



For Six Hundred dollars and 30 days of your spare time you can build yourself this Beautiful Home.

Living room 10x15, Front bedroom 9x10, Back bedroom 10x11, Kitchen 8x10, Bath 5x7, Hall 3x4. Wind out steel Casement windows. Concrete block, stuccoed. \$1.00 brings you Step-by-Step Instructions, Blueprint & Material List.

L. H. FARROW, Dept. C
 Box 645 Columbus 16, Ohio

BATTERIES!—START

—a factory at home and re-cast junk batteries into new; latest achievement. We supply complete instructions and everything needed. Big Profits!

BATTERY LABORATORIES, Dept. PM, Minneapolis 4, Minn.



SAY YOU SAW IT IN POPULAR MECHANICS

LIGHTWEIGHT
\$362.20
(Fed. tax paid, at factory)

9.5 hp. 4-cycle. 3-speed. Foot-shift. Over 70 miles per gal. Over 60 m.p.h. Write for free circular.

MUSTANG, Dept. GP-87
 635 W. Colorado, Glendale 4, Calif.

WHY NOT SAVE GAS?

Be Prepared If Rationing Returns

1/2 Million Use Ganes

BOOK GIVEN FREE
 TO ALL WHO TRY
GANE NEEDLES
GANES REPLACE CARBURETOR IDLING ADJUSTMENT SCREW
 Install Ganes in a few minutes on all cars.

HOW TO GET
150 MILES PER GAL

TEST FOR

- ✓ BETTER MILEAGE
- ✓ EASIER STARTING
- ✓ FASTER PICKUP
- ✓ BETTER IDLING

TO DAY **FREE TRIAL** IN YOUR CAR

MANY GANE USERS REPORT UP TO 25% MORE MILEAGE AND ALL-AROUND BETTER PERFORMANCE . . . but don't take our word for it . . . see for yourself! Test Ganes in your car for 10 days AT OUR EXPENSE. Then, compare your mileage and performance and, if fully satisfied, pay only \$1.50 per needle (8 cylinder cars use 2). If not satisfied, simply return them and owe nothing . . . fair enough? Since authorities differ on the merits of Ganes, and some users report no improvement, TRY BEFORE YOU BUY!

ALSO FREE... Auto Economy Manual—SENT ABSOLUTELY FREE TO ALL WHO TRY GANE NEEDLES, tells how to save fuel, tires and brakes; how to obtain more speed, power and better performance from any car. Also introduces many new, ingenious auto economy products.

WRITE TODAY! ENCLOSE NO MONEY! PAY POSTMAN NOTHING!

List your name, address, make and year of car, no. of cylinders and make of carburetor if known. YOUR TWO FREE BOOKS AND GANE NEEDLES WILL BE SENT IMMEDIATELY.

NATIONAL AUTOMOTIVE RETAIL CORP., Dept. J-5
 350 W. Washington Blvd., Venice, California

Learn DRAFTING and BLUE PRINTING!

Both fields offer ambitious men remarkable opportunities for advancement. Neither profession will ever be replaced by machines. Before any production can start, plans must be drawn. Draftsmen are the first to be hired. Blueprints are essential in every shop.

CLEAR UNDERSTANDABLE TRAINING
 Quickly you learn the hows and whys of successful production planning. You are sent professional drafting instruments, drafting table, equipment, etc., at no extra cost. Learn by making actual drawings.

BIG MONEY . . . ADVANCEMENT OPPORTUNITIES
 Offered trained draftsmen. It is light, pleasant work paying big salaries. Drafting is the stepping stone to top managerial jobs. It is work that stimulates the mind . . . keeps one interested.

A BUSINESS OF YOUR OWN
 Either as an independent drafting firm or as the operating head of a business firm producing products you created. Act now.

MAIL THIS COUPON TODAY!

CHRISTY TRADES SCHOOL, Dept. DB-903
 4432 N. Kedzie Ave., Chicago 25

Mail me at once your big FREE book on Drafting and Blue Printing. Tell me how your Home Training and Professional Drafting Instruments, Drafting Table, Drafting Equipment, etc. can be had on PAY AS YOU LEARN plan.

Name _____ Age _____
 Address _____ City _____ State _____

MAY 1951

69

USE YOUR ATTIC

Install the PRECISION folding stairway YOURSELF

Fits all ceilings. Just saw the hole in your ceiling—frame the hole with 2x6's, nail the stairway in place and cut off the stairway at the calibrated ceiling height. The Precision Stairway is simple and easy to operate. No springs, actuated by counterweights, it's perfectly balanced, raising or lowering easily with one hand. Composition safety treads on steps. Insulated door panel. Requires no attic space. Made of No. 1 kiln dried poplar with cast brass hinges, heavy cast aluminum rocker arms and brackets. Approved by F.H.A. everywhere

See your local lumber dealer or write direct today.

Manufactured by

PRECISION PARTS CORP.

Nashville 7, Tennessee

LOCKSMITHING & Key Making

PRACTICAL UP-TO-DATE COURSE—ONLY \$4.95

Easy-to-learn modern information for self-instruction. How to work on locks, de-code, make master-keys, repair, install, service, etc. For every handyman, home owner, carpenter, mechanic, service station operator, fix-it shop, hardware dealer, gunsmith. 53 plain illustrated lessons.

FULL PRICE ONLY \$4.95. SEND NO MONEY. Just pay postman plus C.O.D. postage. Or send \$4.95 with order, we'll ship postpaid. Satisfaction guaranteed or refund.

NELSON-HALL CO., 210 S. Clinton St., Dept. E-2, Chicago 6, Ill.



SPEED & POWER HANDBOOK for all cars

DIRECT FROM THE CALIFORNIA DRY LAKE TESTING GROUNDS... COMES AUTHENTIC, PROVEN INFORMATION ON HOW TO GET LIGHTNING SPEED, SUPER POWER AND BETTER MILEAGE FROM ANY CAR!

Illustrations and construction drawings show how to build fast stock cars, California Roadsters and 225 M.P.H. Hot Rods.

Easy, Step By Step Methods help you save by building your own dual manifolds, superchargers, hot cams, water injectors, high compression heads and mileage devices.

50 BREATH TAKING CHAPTERS TELL ABOUT: Turning techniques, Speed tricks, Economy secrets, Ingenious formulas for attaining racing speed and dynamic power. Includes information on: Racing Frames, Reciprocating Masses, Jet Engines, Wheel Geometry, Dynamometers. Also Re-styling and Customizing all cars. Learn about dual pipes, gears, fuels, porting, relieving, lowering and balancing.

This Great New Book... Plus "1951 Speed Equipment Catalog", Plus "Water Injection", Plus "150 M.P.G. Book"—ALL 4 ITEMS **\$1.98** post-paid

GET 150 MILES PER GALLON WITH YOUR OWN CAR

Full sized modern cars actually get over 100 miles per gallon with regular gas. This sensational book tells you how and suggests amazing economy methods. Send only 50¢ for book, "How to Obtain 150 M.P.G."... plus our big 1951 Speed Equipment catalog Both Books listing and picturing hundreds of automotive items. **50¢ Postpaid**

NEWHOUSE AUTOMOTIVE INDUSTRIES
Dept. B, 5807 East Beverly Blvd., Los Angeles 22, Calif.

MOTORISTS! LEARN HOW TO

SAVE GAS!



TRY WATER-ALCOHOL INJECTION 30 DAYS AT OUR RISK

Add zip to your car with "Vapojet". Automatically combines water, alcohol and oil vapors, with fuel, to help give smoother performance, more power, faster get-away, better pick-up, and amazing fuel economy.

VAPOJET

A REVOLUTIONARY INVENTION



ONLY **\$9.95** Post-paid

EVERYTHING COMPLETE NOTHING ELSE TO BUY

... successfully used on thousands of cars and light trucks, for millions of miles, under every kind of operating conditions. Helps give your motor high octane performance from low octane gas! Helps eliminate carbon—reduce engine wear. Fits most makes, year, or model passenger cars—light trucks and tractors. Easily and quickly installed. Order today sure, on positive money-back agreement.

30-DAY TRIAL OFFER

Install Vapojet on your car and test it for a full month. Return in 30 days for immediate refund of full purchase price if not satisfied it will pay for itself many times over.

AGENTS WANTED — WRITE FOR FREE LITERATURE

BANTEL MFG. CO., 757AE Venice Blvd., Los Angeles 15, Calif.

BUILD YOUR OWN FAN



One-piece cast aluminum propellers for cooling and ventilating

Size Inches	Polished		Unpolished		Bore Inches
	2 Blade	3 Blade	2 Blade	3 Blade	
15	\$3.00	\$4.00	\$2.50	\$3.00	1/2, 3/8, 3/4
18	3.75	5.00	3.00	4.00	1/2, 3/8, 3/4
20	4.00	5.50	3.25	4.50	1/2, 3/8, 3/4
24	4.50	6.50	4.00	5.50	1/2, 3/8, 3/4

Write for pamphlet on larger fan blades, wire guards, fan bases, shutters, pillow blocks, exhaust fan frames, etc. Shipped prepaid if money accompanies order. Dealers write for discount.

KLOPPENBORG ALUMINUM FDY., Dept. PM-551, Davenport, Iowa

POWERFUL

NO PUMPING

HY-SCORE

5 in 1 AIR PISTOL



Interchangeable rifled barrels for 5 types of ammunition. .22 or .177 Cal. Hy-Score Pellets & Darts, & BB's. Small game HUNTING, indoor and outdoor TARGET shooting. The perfect gift. At your dealer now or write Dept. P-5

Complete with 2 barrels & asst. ammo.

HY-SCORE ARMS CORP., 25 Lafayette St. Brooklyn 1, N. Y.

Build your own JET ENGINE!

Order these plans today



SEND NO MONEY

1. JET PROPELLED BICYCLE, Assemble your own. Photo and instructions, \$1.00.
2. HOW TO MAKE EXPERIMENTAL JET ENGINES. Seven sheets drawings with information and instructions \$2.95.
3. BOTH OF ABOVE in one order \$3.75. SEND NO MONEY. Order both at once \$3.75 C.O.D. in USA plus c.o.d. postage. Send check or Money Order and we pay postage. Get other information too. Rush Order.

J. HOUSTON MAUPIN, Dept. 55, Tipp City, Ohio

SAY YOU SAW IT IN POPULAR MECHANICS

GETTING AROUND



With over 100 miles per gallon on a VELOCETTE LE 200 Motorcycle

The WATER-COOLED, SHAFT-DRIVEN LE 200 Silent, Clean, Comfortable. Excellent weather protection. Opposed twin-cylinder, adjustable spring frame. Designed to be as reliable as an automobile; useful as a second car. **\$495.50**

FOB LOS ANGELES.

WRITE FOR FREE CATALOG.

LOU BRANCH MOTORS

2019 W. PICO BLVD.

LOS ANGELES 6, CALIFORNIA

THORESEN NATIONWIDE SALE

BUY DIRECT AND SAVE



Thoresen's De-Luxe
17 JEWEL PRECISION **14.98**
tax paid

Masterpiece of superb styling and workmanship! Streamlined 14 Karat Rolled Gold Plate case, stainless steel back. Gilt numerals, curved dome crystal. Genuine Lever 17 JEWEL Precision movement of amazing accuracy! Recent list price \$59.50. REDUCED for quick sales! Tax paid price—14.98—no extras!



WATER & SHOCK
Resist Case—G. I. Style! **10.95**
tax paid!

Military style! Drop it! Bang it! We guarantee it 3 years against any and all breakages—because of exclusive Swiss INSULATOR invention. 7 jewels. Luminous hands & numerals. Unbreakable crystal. Sweep-second. Heavy Chromed. Thin, smart! Marvelous accuracy. Long satisfying service. Tax paid, only 10.95
17 JEWEL Model (5 year guarantee!), tax paid 16.45

Fulcra-Matic Stop
CHRONOGRAPH **6.90**
tax paid!

Genuine Fulcra-Matic Stop Chronograph & Wrist Watch combined, gives accurate, long satisfying service. Times Races, autos, planes, Sports, etc. 10 WONDER FEATURES: Tachometer, Telemeter & Stop Watch. Luminous Dial. Unbreakable Crystal. Sweep-second hand. Stainless steel expansion band. Best of all—Fulcra-Matic finger tip control! Instructions given. Tax paid, only 6.90.

Thoresen's 17 Jewel
FULL AUTOMATIC **29.88**
tax paid

De-Luxe model—fully automatic! Set it, then forget it! It winds itself as you wear it. Patented Incabloc. Anti-Magnetic. Sweep second. Luminous dial. WATER & SHOCK resistant. All stainless steel back case. 17 jewels. Near-miracle accuracy. Thin! Handsome! 5 YEAR GUARANTEE. Formerly \$75.00. Thoresen's direct-to-you price, only 29.88—no extras for tax. Rush! Supply limited!



2.97
Initial Men's Ring
Extra special! Genuine sterling silver with gold plate sides. Your own initial in raised gold effect flanked by 2 pseudo ZIRCONS of sparkling brilliance. Tax paid—2.97



1.98
"WEIRD" SKULL
Ruby color eyes flash "weirdly" in semi-darkness! Perfect miniature of skull & bones. Rich 14 Karat Gold Plated. It's the attention-getting ring. Our tax paid price — 1.98



3.55
"Big 5" Men's Ring
Wins distinction! Extra heavy simulation of a Solid Gold 5 Diamond Ring. Made to endure. Rich \$500.00 appearance. Imported stones of amazing brilliance! Tax paid—3.55

FREE
10 DAY TRIAL

Price promptly refunded if not thrilled within 10 days after receiving. ALL prices tax paid—NO EXTRAS!
UNLIMITED GUARANTEE
Exclusive of Parts! Never a penny's charge for skilled labor, "handling", etc. for the lifetime of this business!

3 SYNCHRO DIAL
Precision-Made SWISS
CHRONOGRAPH

Outstanding value! Sleek, handsome, 3 Dial CHRONOGRAPH. Amazing accuracy! Ideal for hobbyists, mechanics, scientists, doctors, sportsmen, students, aviators, etc. 20 SUPER FEATURES: 3 Synchro Dials: 30 min. register! 1/5th second calibration! Rugged shock-resist case, sweep-second, luminous dial. Built-in tachometer & telemeter. Measures speed & distance planes, autos, horses, photos, etc. without stopping movement. Formerly 39.95. Now at slashed price of 8.65, tax paid. No extras.



SEND NO MONEY — Pay price Shown, plus postage (no extras for tax) on delivery
THORESEN Direct Sales Dept. 7E-200 131 West 33rd St., NEW YORK 1, N. Y.

GARDEN TRACTORS

SPEEDEX
YOUR CHOICE OF TWO TYPES
8 H.P. RIDING
2 1/2 H.P. WALKING

Exceptionally Low Prices Still in Effect

New catalog gives you full details on the famous Speedex. Illustrates many labor-saving uses. Complete descriptions.

SEND POSTCARD FOR YOUR FREE COPY OF NEW CATALOG TODAY

SPEEDEX GARDEN TRACTOR CO.
Box 216D1E RAVENNA, OHIO 1-251-32

FOR HOBBYISTS, CRAFTSMEN, EXPERIMENTERS

foam rubber

AUTO SEAT TOPPER PADS
Place under seat cover

24" x 60" x 1 1/2"	ea. \$6.45
24" x 60" x 2"	ea. 7.95
12" x 14" x 1 1/2"	ea. 1.25

Lowest Prices—SAVE 50%

16 x 16 x 1 1/2"	ea. \$1.35
16 x 22 x 1 1/2"	ea. 1.75
18 x 24 x 1 1/2"	ea. 2.00
24 x 24 x 1 1/2"	ea. 2.95

Use for furniture cushion fillers, mattresses, mattress pads, cushions. Foam Rubber is available in any size or thickness. Send For Free Price List. Immediate delivery. No C.O.D.'s. Add 10% for Postage & Handling to Above Prices. Please print.

FOAM-KING RUBBER COMPANY
P. O. Box 2676, 1174 W. Monroe St., Jacksonville, Florida

BE PREPARED FOR ANY EMERGENCY
and have fun too with these low priced quality items

SWEDISH ALCOHOL STOVE — The Punker cooks a good meal whether in camp or during an emergency. Made of galvanized steel with brass fittings. Burns like gas. Specify enamel top for home use or galvanized top with guard rail for marine use. Style 11 AA with DOUBLE BURNER \$17.90.

SWEDISH KEROSENE STOVE — The Wardus, a dandy piece of equipment for any cooking use. Made of non-porous brass throughout except for galvanized uprights. Burns with blue flame. Compact.

ROCKGLAS ATOMIC SMOKE SUN GLASSES.
6 base glass set in quality rhodium finish air force frames. Equipped with sweat bar and nose pads. Also available in green glass. A lifetime guarantee with each pair. You will be delighted with these. **\$2.98 with case**

\$6.50

All products sold with money back guarantee. Mail check or money order. Send one half deposit with COD's.

Save Point Repair Costs

with **"PRESTO"**
POINT SHIELD

Presto Point Shield retards the excess current that is generated for a short interval each time the motor is started. It is this excess current running as high as eight to ten volts that "Blues" the points.

Presto Point Shield saves the cost of several sets of points. It is easily and quickly installed—merely connect in series between coil and distributor.

If your service station or dealer can't supply, order direct — only \$1.85 postpaid.

B & G SURPLUS FAIR 2 PURCHASE STREET, RYE, N. Y. **BOCK MFG. CO.** 711-A WEST LAKE STREET MINNEAPOLIS 8, MINN.

PROVED by over 1,000,000 Installations



PERFECT CIRCLE NURLIZING

slashes engine repair costs!

**NEW EXCLUSIVE METHOD OF RESURFACING PISTONS SAVES YOU MONEY
BY RESTORING WORN PISTONS TO ORIGINAL FIT AND EFFICIENCY**

Perfect Circle's new Nurlizing process greatly reduces the cost of engine overhauls by making old pistons re-usable—with absolute safety.

At last, worn pistons can be resized for close, correct fit in cylinders without danger of scuffing or scoring! This restored fit means *restored power* and eliminates piston slap—and the interrupted surface of the Nurlized piston assures better lubrication at all times.

If you have been postponing that overhaul your engine needs because of expense—you can have it done now—but insist that your Doctor of Motors Nurlize your old pistons. It will give those pistons new life—with improved performance—and save you money.

Perfect Circle



The Most Honored Name in Piston Rings

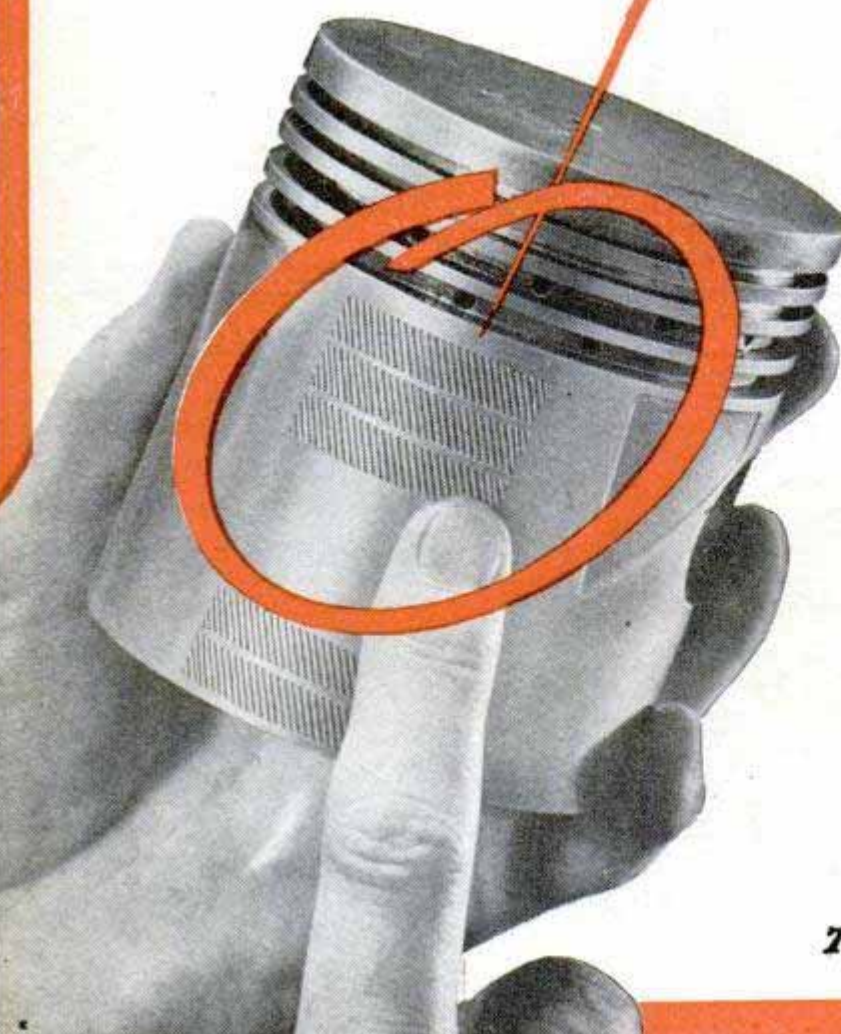

DOCTOR KIRK: This is the Oakland police. We'd like some help on a murder case. Would you examine two coats and a pocket knife if we bring them over tonight?"

Dr. Paul L. Kirk sighed as he put down the phone. As professor of biochemistry at the University of California he was in the midst of writing a paper on "micro and drop scale titration of oxalate." He'd have to drop that, he supposed, while he solved this latest police puzzle.

The officer who delivered the evidence told Doctor Kirk what had happened. Someone had broken into a residence by smashing a window, surprised the owner, and stabbed him.

The brown coat that the officer held in his

Sherlock Holmes of the California campus is Dr. Paul L. Kirk, a fabulous man who doubles as professor of biochemistry and criminalistics

Quick, Watson, the Micromanipulator!

By
Thomas E. Stimson, Jr.

How can you weigh an invisible speck that will tip scales at less than a thousandth of a millionth of a gram? Dr. Paul L. Kirk assembles a quartz torsion balance that will perform the operation. He is wearing magnifying glasses to see tiny rods



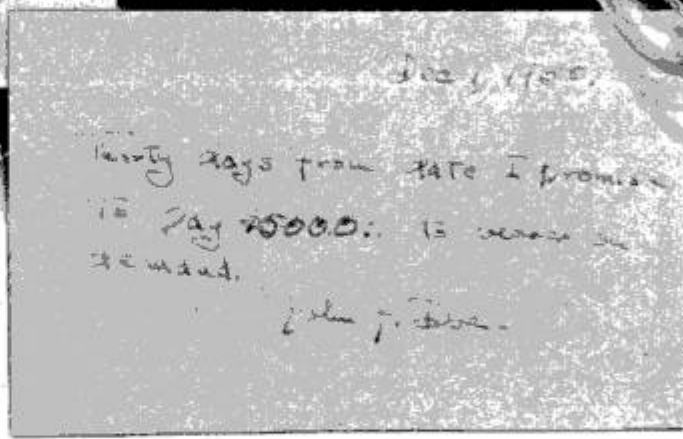
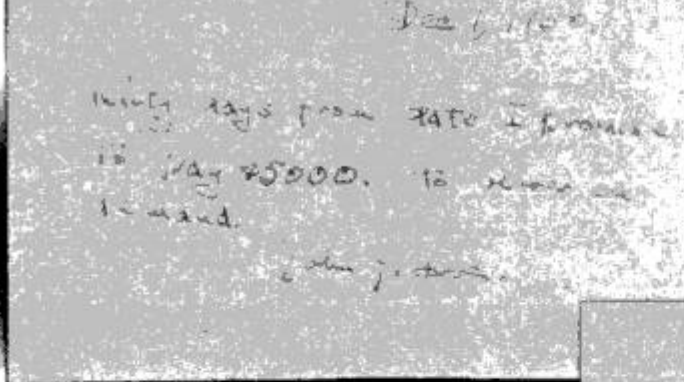

Here is an example of a \$50.00 promissory note that was raised to \$5000 by using ordinary laundry bleach. Fumes of ammonium sulphide used on the paper show (at right) how the original writing appeared

hand had been worn by the slain man; the other, a green coat, had been taken from a person who the police suspected had committed the crime.

Specifically, the police wanted to know if the two coats had been in recent contact with each other, as during a struggle, and whether the knife that was found on the body belonged to the suspect.

Doctor Kirk had his answers shortly after midnight. Using a dust collector of his own design that he attached to a vacuum cleaner, he cleaned the front of one coat and placed the debris that he got from it in a container. Then he cleaned the other garment.

Each coat yielded a small pile of dirt, dust, cloth fibers and miscellaneous material. With a strong glass and a microscope the scientist began to examine this evidence.

The debris from the green coat contained hundreds of green fibers, as could be expected. With them, however, were numerous brown fibers that were identical with fibers from the brown coat. Contrariwise, the brown coat yielded bits of green material that exactly matched the yarn of which the green coat was made. It was apparent that the two coats had been in rubbing contact with each other.

The debris from the green garment also contained some tiny fragments of glass. Whoever had worn the coat probably had broken a window quite recently.

Final evidence came from the knife in spite of the fact that it had been wiped clean of fingerprints. Doctor Kirk scraped from the inside of its case a small amount of debris and compared this material with the lint, dirt, tobacco crumbs and other substances that he vacuumed from the left pocket of the green coat. The proportions

didn't match. Then he tried the right pocket. This time the ingredients were identical. The man who wore the green coat was indisputably linked with the knife and the slaying.

Short, wiry, bursting with energy and perpetually busy, Doctor Kirk is a fabulous character on the U.C. campus. He is not only professor of biochemistry but also professor of criminalistics in the university's school of criminology. He is one of the few educators in the country who holds a full professorship in two unassociated fields. Essentially, he says, he is a gadgeteer who likes to devise equipment that will help solve research problems.

As an offshoot of biochemistry he became a pioneer and leader in ultra-microchemistry, the science of studying bits of matter that are much too small to be analyzed by ordinary methods. He designed his own micromanipulators for handling fragments of material that are visible only in the field of a microscope. Another time, he attached a magnetic vibrator to a glass rod that is hardly thicker than a hair so that he'd have a tool with which to stir a fraction of a drop of liquid. Today, many of his ultramicro tools are being manufactured commercially in Berkeley.

One of Doctor Kirk's Tom Thumb laboratories can fit into a suitcase, in contrast to the usual chemical lab that often spreads over several rooms. Ordinary units of measure are too cumbersome for ultra-microchemistry and new terms have had to be created. A lambda, for instance, is equal to $\frac{1}{1000}$ milliliter. A gamma represents $\frac{1}{1000}$ gram.

During the war an important part of the atom-bomb program was stymied until he was called in. The fission experts had pro-

duced their first tiny speck of plutonium and the next step was to learn how it would react in various chemical combinations. This was possible only by weighing the sample before and after treatment, and as yet there was no balance or weighing machine in the world that was sensitive enough. The entire amount of plutonium could hardly be seen by the naked eye.

To weigh it, Doctor Kirk designed and built a new kind of machine that can weigh an invisible amount of matter.

His delicate instrument is sensitive to five thousandths of a millionth of a gram, and it takes about 28 grams to make one ounce. The mere act of loading material onto the pan of the instrument often must be done under a microscope. It's called a quartz torsion balance.

Thin fibers of quartz glass were used for construction because quartz is the strongest material in relation to weight that could be used. The main beam of the balance is four inches long, is not much thicker than a human hair, and is reinforced by a cantilever strand that is even finer.

At each end of the beam is attached a suspension member that is so thin that it can't be seen unless it's held at a certain angle against a light. Even then you don't see the fiber itself, simply the diffraction band of light that the fiber creates. Appropriately, parts of the balance were built with the aid of a gas flame that was too small to be seen by eye alone.

"The finest of the quartz fibers were created by placing a quartz rod in a large gas flame," Doctor Kirk remarks. "The flame itself did the blowing. Molten quartz streamed upward in the form of a minute rod, so light in weight that the heat of the flame projected it against the ceiling where it collected.

"We hunted for the fibers by looking for their diffraction bands against a light. When we found a piece we would tab an

Main beam of sensitive balance consists of thread of quartz-glass rod. The tool is an electric heater

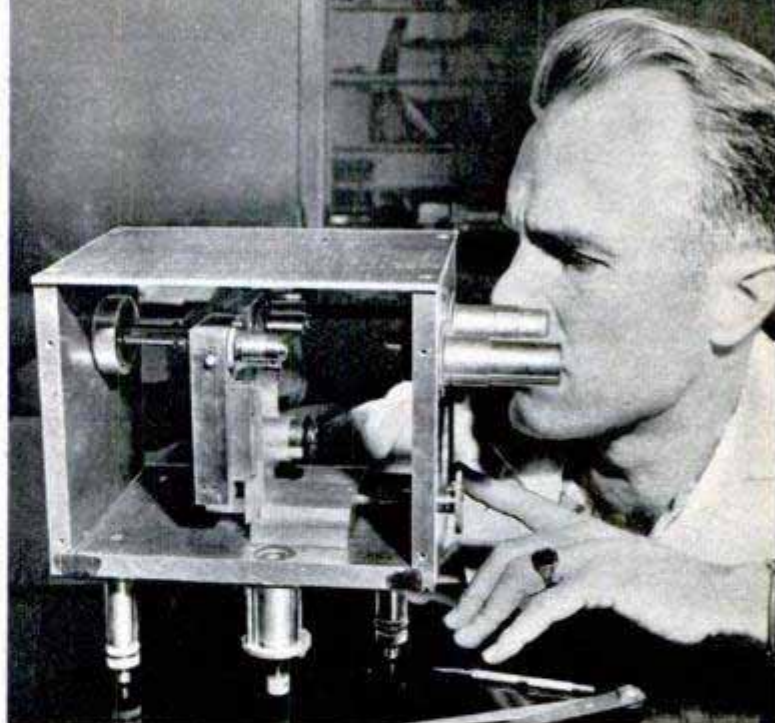
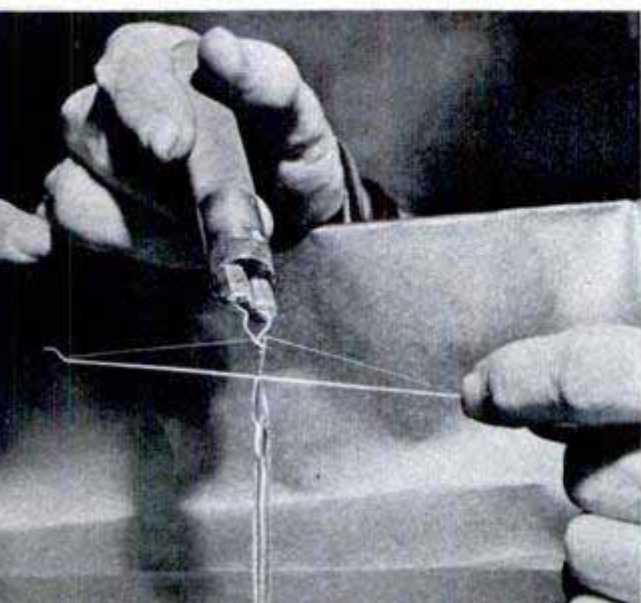

Heavy metal case houses balance for weighing invisible bits of matter. Case has built-in microscopes

end with cellulose tape. The bit of tape served as an anchor and also told us where the rod was. Final selection of short lengths was made under a microscope."

The quartz balance is a combination of an ordinary gravity balance and a torsion balance. The torsion member is attached at right angles to the center of the beam and the torsion member twists under load. The instrument is mounted in a heavy metal case that also contains built-in microscopes for taking the readings.

The original speck of plutonium proved to weigh four micrograms. Doctor Kirk built four ultramicrogram balances in all for the AEC and since then others have been built for that agency. Now Doctor Kirk is trying to borrow one that isn't in use. Unless a lot of red tape can be untangled he'll have to build his own, a long task for which he can hardly spare the time.

Long slanting line in diagram represents the glass fiber which twists to reveal weight on the "scales"

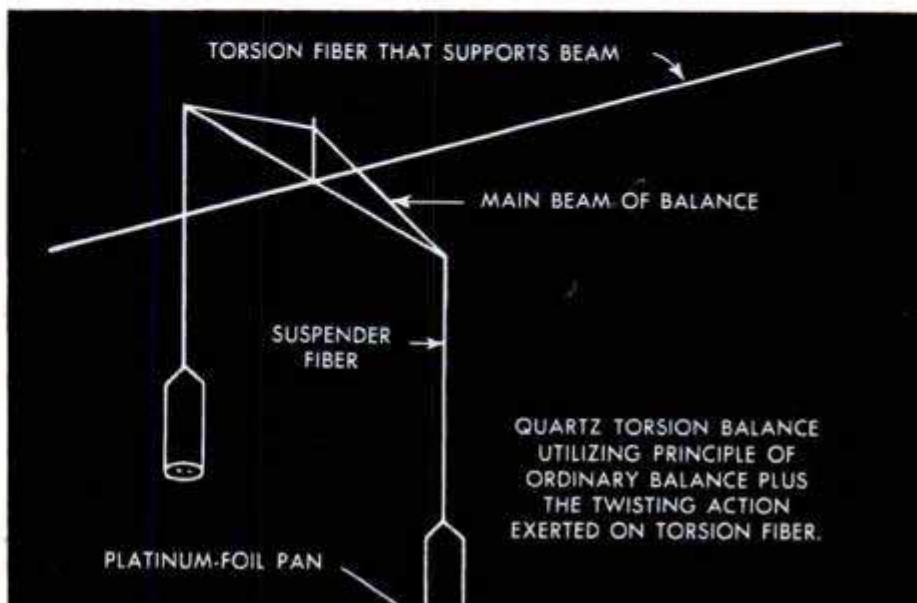

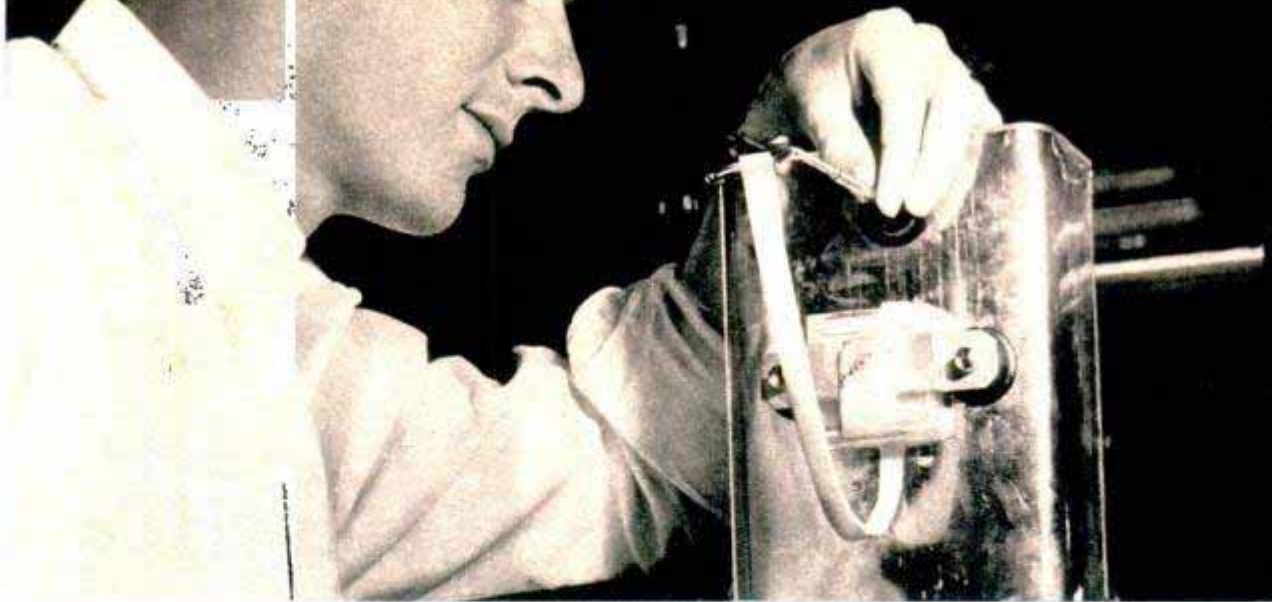

Above, filter-paper apparatus is used to remove smear of blood for analysis from a gasoline can. The device is held to the can by rubber suction cups and has a moistened pad to wet paper and blood

In ultramicrochemistry, parts of drops of liquids are tested in minute flasks shown at right. Here Doctor Kirk is stirring the liquid with a magnetic vibrator and an attached needlelike glass rod

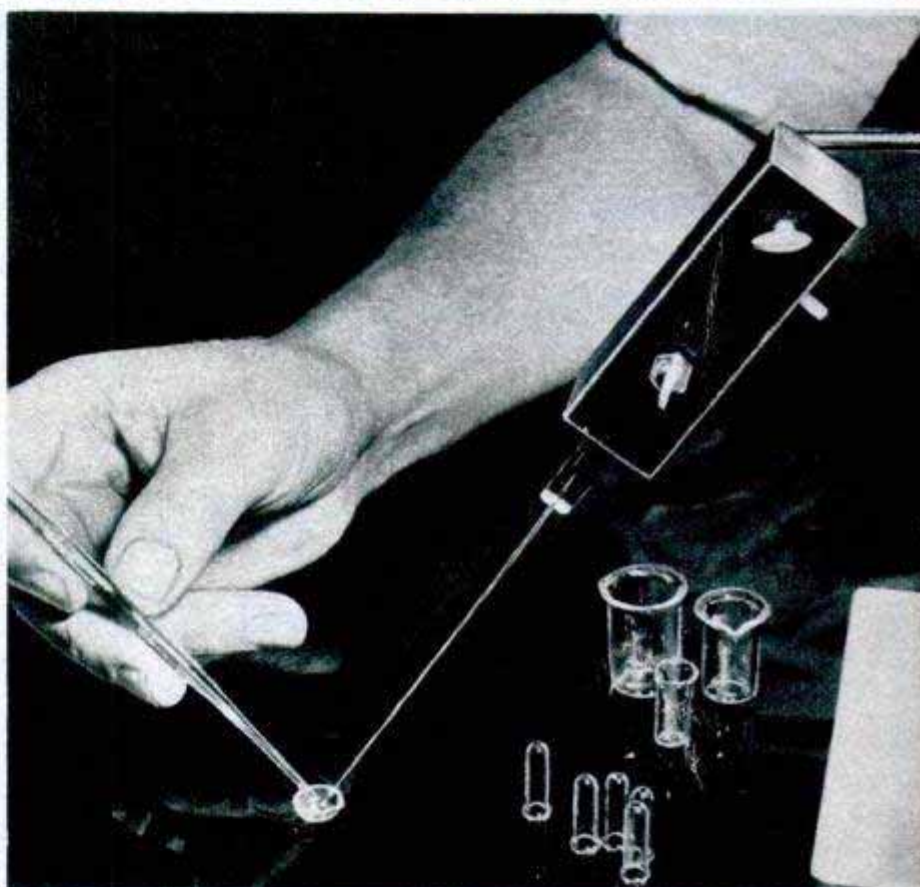

Glass-faced illumination box shines its light through two pages of typewritten material to compare letters in determining if both pages were written on the same machine. The box saves many hours

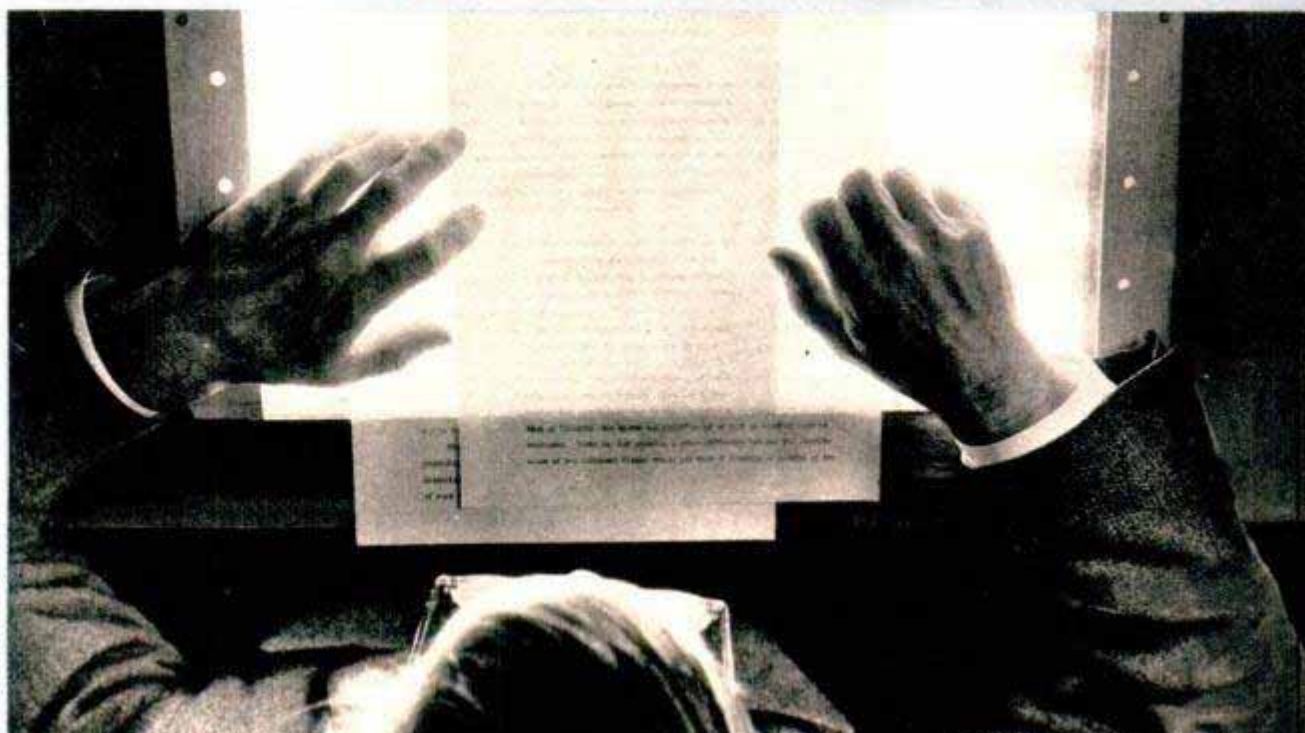

In his criminology laboratory, Doctor Kirk uses an inexpensive camera, magnifier and lights to photograph portions of suspicious-looking document

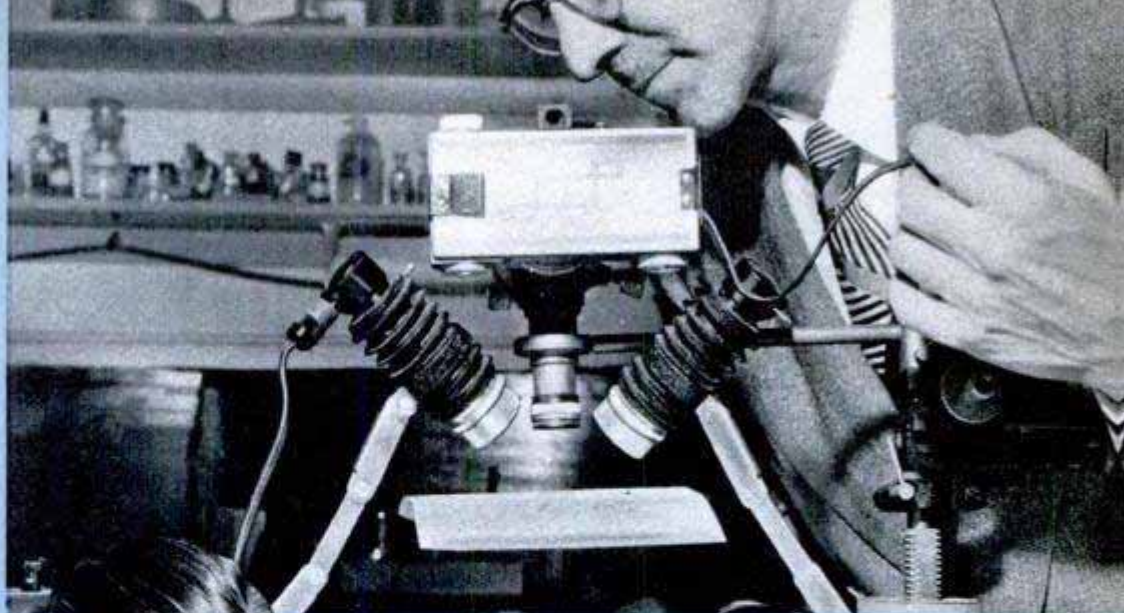

Transparent-plastic dust trap, below, is connected to hose of vacuum cleaner and is used to remove any loose particles from a garment worn by "victim"

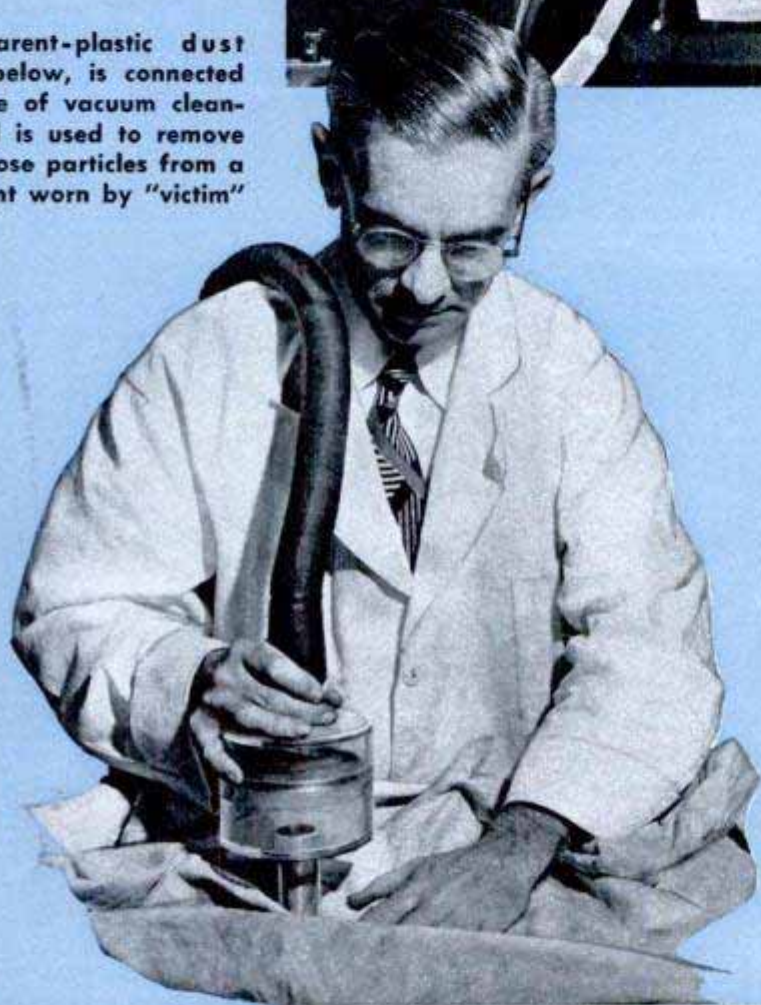

During that part of the school day in which he teaches criminalistics (examination of physical evidence) the scientist tries to give the criminology students some training in all phases of the subject. After all, he says, physical evidence is much the same no matter what type of crime is involved. He is also devising simple, inexpensive methods and equipment for examining evidence. He feels one trained specialist with \$5000 worth of equipment should be able to do just about as much police work as is usually handled by a staff of several people backed up with \$40,000 or more invested in facilities.

He put one cheap tool together on the spot when he was trying to learn if some bits
(Continued to page 242)

Girl works through arm-holes in cabinet to weigh minute particles on quartz helix balance (invisible in the photo). Care is taken to avoid any air currents



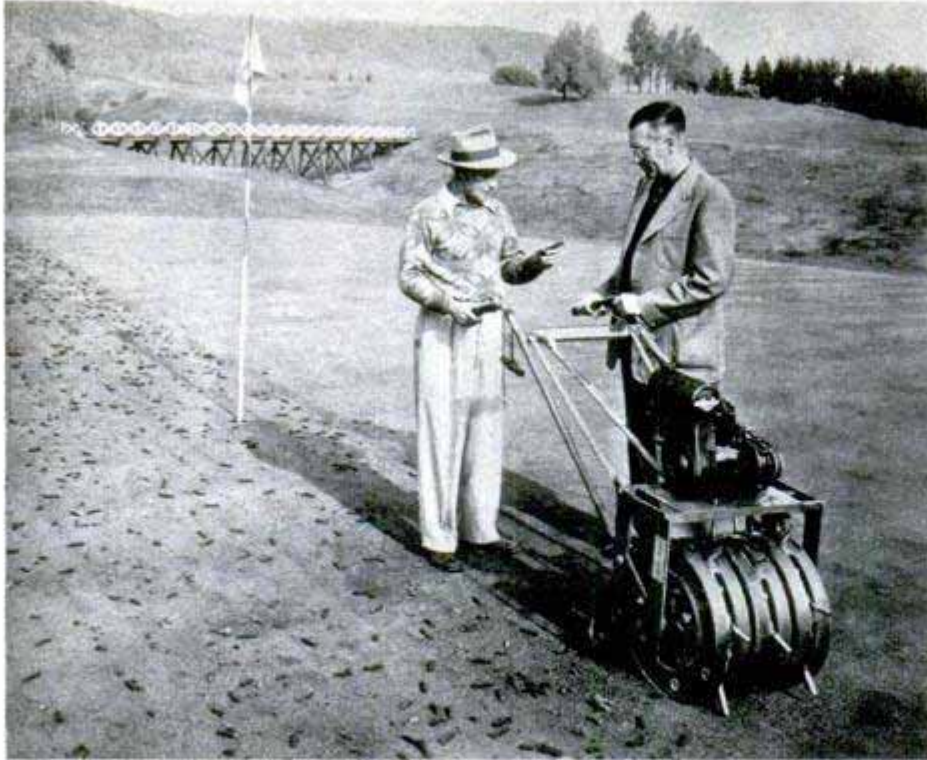

Soilaire Industries, 1200 Second Ave., South, Minneapolis, Minn.

"Earthworm"

As easy as mowing the lawn, a gasoline-operated device makes the ground porous after it has been compacted by rain and traffic. Covering 700 square feet of ground an hour, the motorized "earthworm" has floating tines that dig up cores $3\frac{1}{4}$ inches long. The tapered tines are hollow and automatically eject the earth cores. The floating-tine action prevents scuffing or gouging the surface. According to the manufacturer, aerating the soil enables it to use fertilizer more effectively and requires less water.

Grass Trimmers

That tiresome chore of trimming grass around sidewalks, trees and other objects becomes a quick and easy operation with either of two power trimmers. One of the trimmers, a professional model, is completely self-contained, being powered by a tiny gasoline engine. It weighs only $11\frac{1}{2}$ pounds complete. The second trimmer, designed for the homeowner and small-estate caretaker, is powered by an electric motor and weighs only seven pounds. Both use a rotating blade that is



E. F. Britten & Co., 22-26 South Ave., W., Cranford, N.J.

Above, left, a heavy-duty trimmer has a light gasoline engine built into its compact cutter head. Right, the smaller model has an electric motor

designed to create a partial vacuum, drawing the strands of grass into the cutting circle.

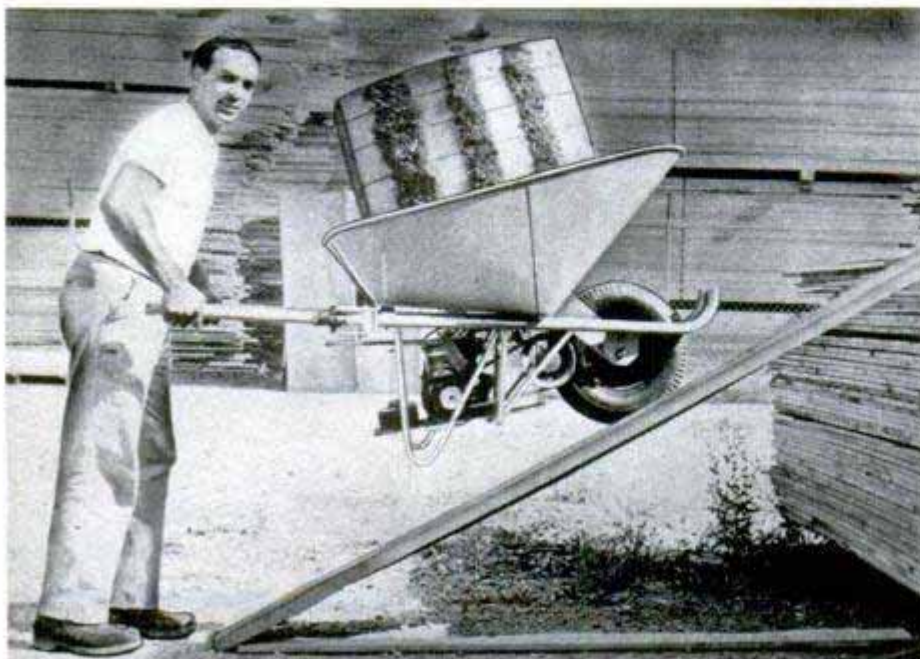

S and S Vending Machine Co., San Jose, Calif.

Power Wheelbarrow

If you've ever pushed a loaded wheelbarrow, you'll appreciate a power model that is driven by an air-cooled engine. The lightweight engine, mounted beneath the bed, drives by friction on the tire tread. It will pull a full load up a 40-percent grade. On a downhill run, compression acts as a brake to ease the laborer's job. Speed on the level is at a comfortable walking pace. The engine controls are located on the right handle.



Willys-Overland Motors photos

Driven by a center power take-off, generator in the mobile midget plane starter, left, supplies either a.c. or d.c. It is less than 36 inches high and just 52 inches wide. On the deck of a carrier, right, turning tail wheel permits it to execute right-angle corners

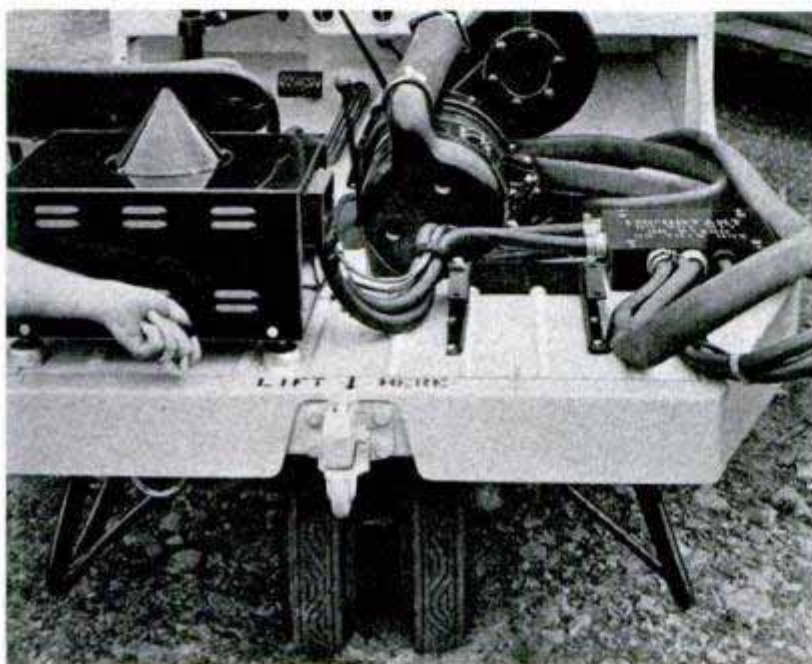

Midget-Jeep Power Plant Starts Shipboard Jets

Small enough to travel beneath airplane wings on crowded carrier decks, a new three-wheel midget Jeep acts as a mobile electric power plant for starting jet fighters. Less than 3 feet high, 19 inches lower than the standard Jeep, only the tail wheel turns and it can execute right-angle corners. The amount of power needed to start a jet airplane makes it impractical for single-engine fighters to carry sufficient battery capacity to do the job. The mobile midgets will replace the power lines formerly strung across flight decks and the generators on hand-drawn dollies that proved too slow and cumbersome.

Zippered Homes for Bumblebees

Cages, complete with zippered doors, provide living quarters for bumblebee "workers" at the Utah agricultural experiment station. Plant scientists, testing a new strain of alfalfa, wanted to speed the production of seed by quick pollinization. They found the bumblebee a vigorous and fast pollinizer, an ideal worker for the job. The research men installed wooden frames around their experimental plots and covered them with plastic screens. Inside each of these cages they placed a family of bumblebees. Zippers were found to be the best means of opening the cages for care of the alfalfa and the bees. The result of resettling the bees — rapid pollinization and a better yield of seed.

Electric wire sheathed in a new jacket that is highly resistant to the effects of gas and oil has been designed by the General Electric Company for use in filling stations and oil refineries.

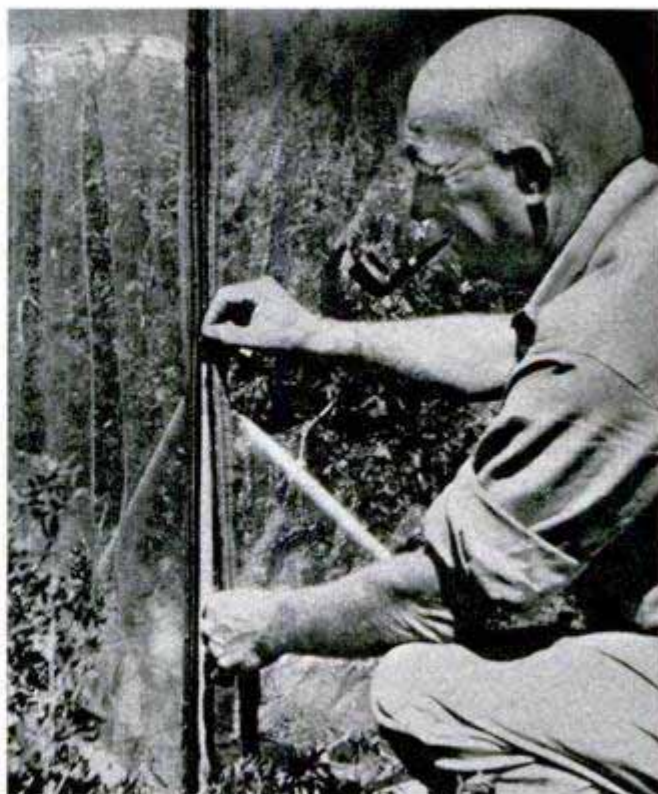

ATOM POWER

Goes

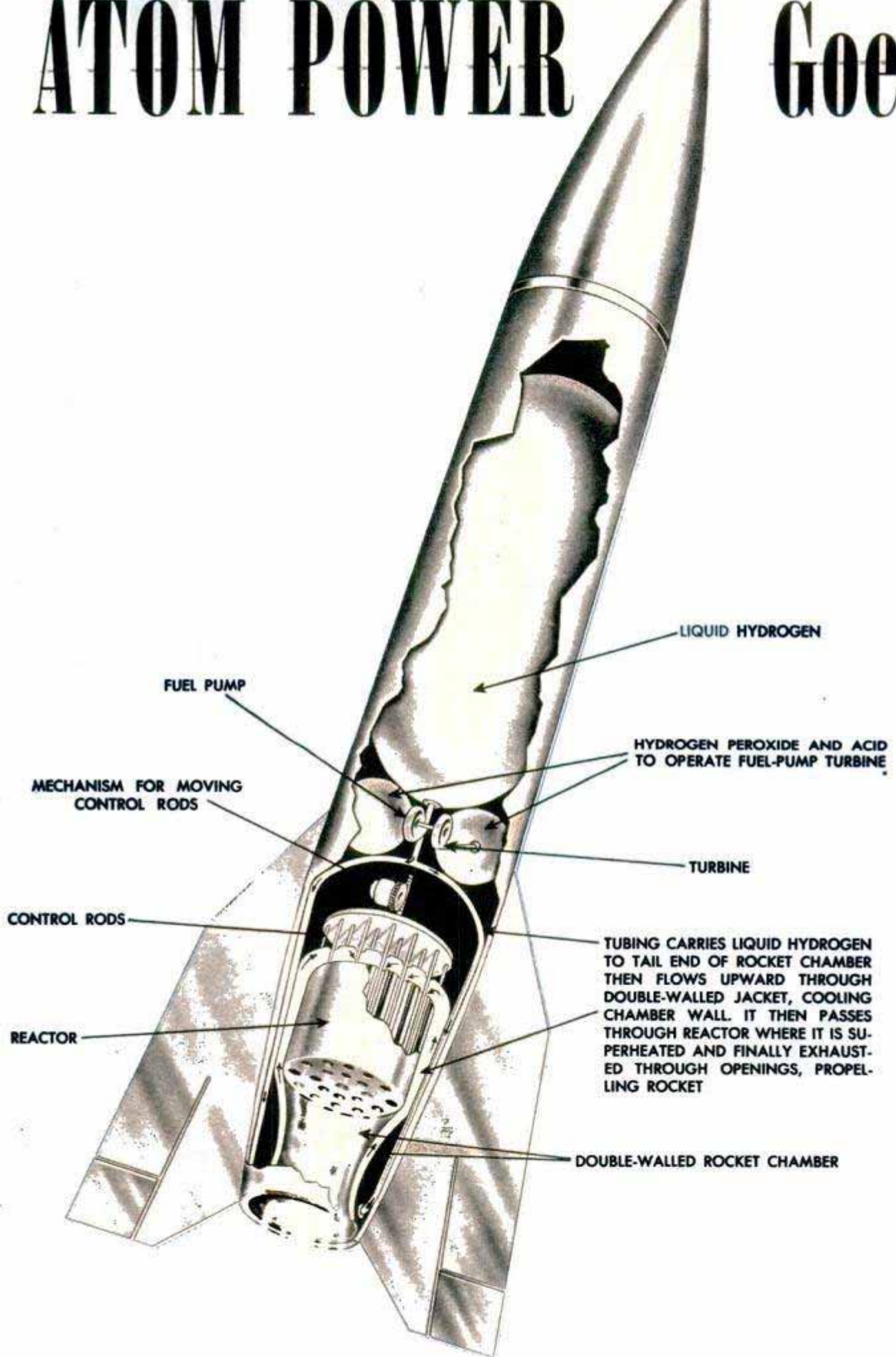

into GEAR

By
Richard F. Dempewolf

WE'LL NEVER SEE uranium pills to run cars or home heaters. Neither will we see those atom furnaces that would melt the Greenland icecap and make a tropical garden of Alaska. Such nonsense was forecast by post-Hiroshima enthusiasts whom Dr. Lawrence Hafstad, the Atomic Energy Commission's boss of atomic piles, calls "subsophomore slapstick artists." But atomic power today is far from the hopeless will-o'-the-wisp that some pessimists would have us believe.

Here and abroad, vast new reactor programs are in high gear. An atom-powered ship that can cruise for months without refueling is no longer pure "pie in the sky." At Britain's huge Harwell atomic station, experimental work on a submarine pow-

ered by uranium fuel has reached a stage where experts are now working out figures and designs for the prototype. Our own plans for a high-speed atom-powered submarine with vastly increased range are complete. One Navy land-based prototype of the reactor that may power the ship is already being constructed under the supervision of Westinghouse at AEC's reactor-testing station in Arco, Idaho. Another is being designed at the Knolls Atomic Power Laboratory operated by General Electric for the AEC at Schenectady, N. Y. It's all part of a whopping \$90,000,000 AEC atomic-power program.

More money and fresh brains have been thrown into the top-secret U. S. project for harnessing atomic power for aircraft and

On opposite page is an artist's conception of the atomic-powered rocket. Liquid-hydrogen fuel would permit flights above earth's atmosphere. Below, three types of nuclear-power plants for tomorrow's aircraft

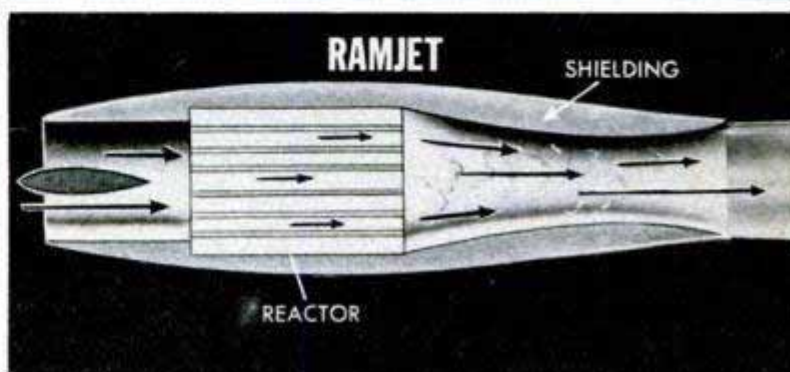
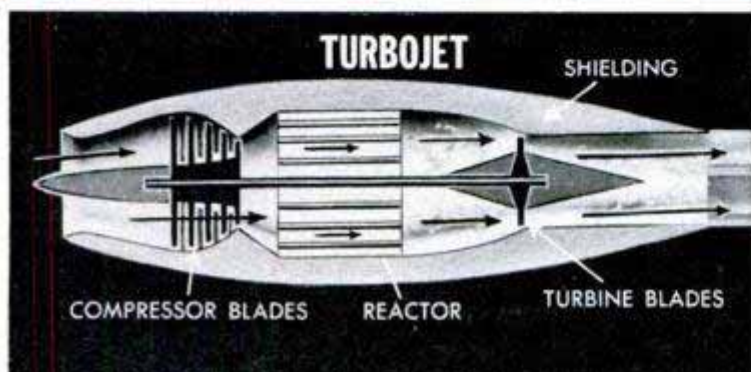
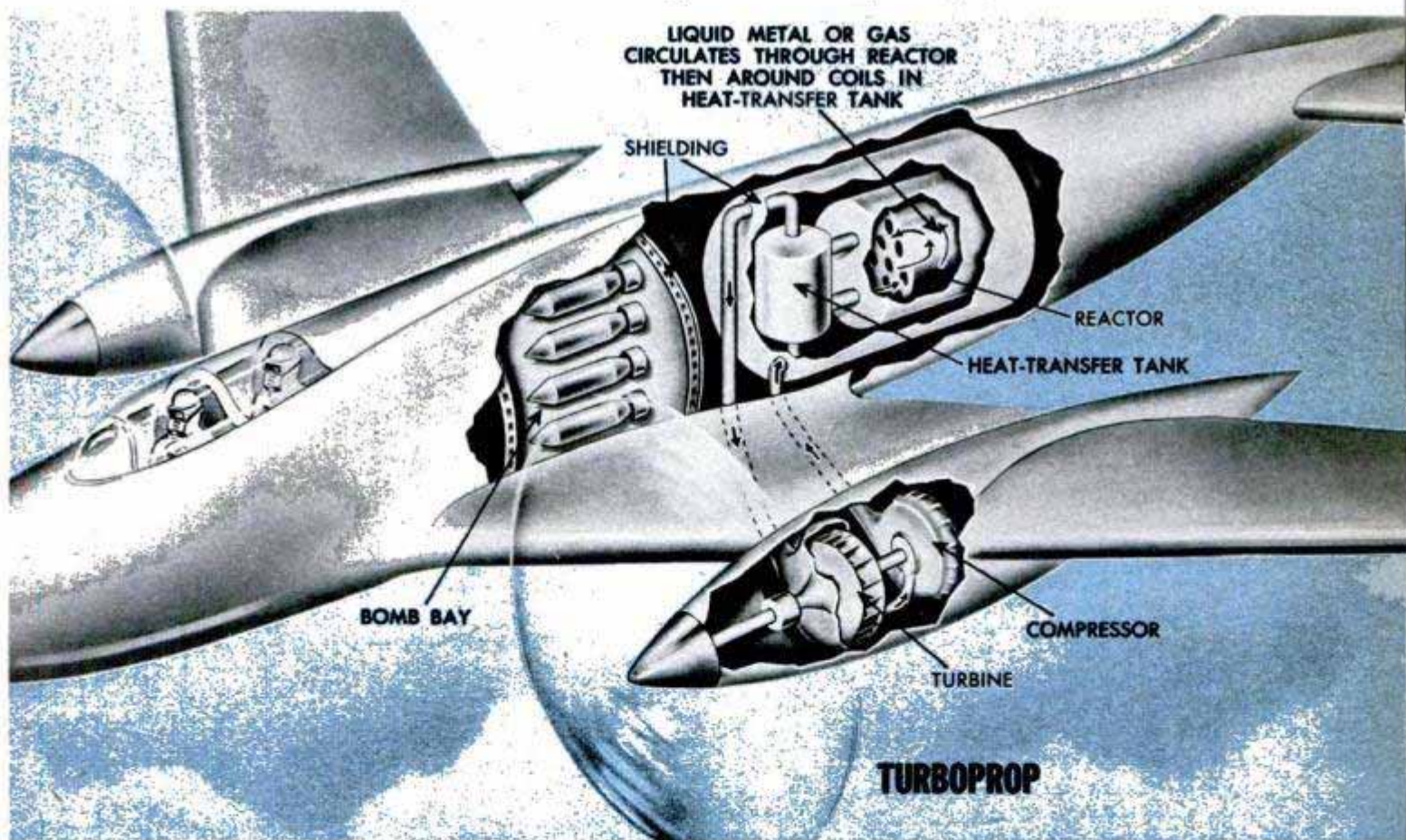



Expectantly, the scientists at the Brookhaven reactor await the start of the first chain reaction in the pile on August 22, 1950. The air is tense because nobody can predict precisely when the fissioning will start

the target date for such a plane—bigger than a B-36—has been advanced (though it's still secret).

At Harwell, nuclear-power units are being devised for the generation of electricity. In fact, such atomic power already is an actuality. Right now, from the big U. S. pile at Hanford, Wash., hundreds of thousands of potential kilowatts in heat are continuously being produced as a by-product of that reactor. So far, that potential power has been carried off by the Columbia River only because there hasn't been time or money to build the kind of plant that could convert it to usable electricity. There's enough heat, however, to raise measurably the temperature of the river downstream of the pile.

Besides all this, two other new atomic piles—neither concerned with the bomb program—are being built at Arco, Idaho. One will test various materials under the bombardment of atomic fission, in the hope of finding, among other things, newer lightweight shielding materials and substances to contain the fierce atomic fires in nuclear ship and aircraft engines. The other Arco pile will experiment with an idea physicists have recently begun to suspect—that atomic fuels can be used to create more and more atomic fuels.

What will these submarines and airplanes and power stations look like? How will they operate?

The engine for our nuclear submarine will be a conventional turbine, turned by

steam produced in a heat-transfer process from the atomic fires in the reactor. Carrying heat from a furnace to a steam-producing boiler in a conventional system is achieved by running a liquid through a system of pipes circulating between the furnace (where it heats up) and the boiler (where it gives up the heat to make steam). In an atomic furnace, any old liquid won't do. It mustn't absorb too many neutrons and thereby slow down the reaction.

To find the right agent, the Navy has been experimenting with many materials, among them searing-hot liquid metals. A suitable heat-transfer agent already has been found, according to Vice-Admiral Charles Lockwood. Special metal alloys to withstand the tremendous heat of the pile have been discovered. Special shieldings of new, secret materials, are lighter and less bulky than cumbersome concrete and are just as effective in confining radiations.

What the whole engine will weigh has not been told, though Britain has released some probable figures on an atomic ship engine capable of delivering 100,000 shaft-horsepower. The pile would be contained in a metal tube 20 feet long. With shielding, the unit would weigh 1000 tons more than a regular turbine—an amount of extra weight equal to the fuel now needed for only 36 hours of sailing in a large ship.

America's atomic submarine, according to Vice-Admiral Lockwood, will outrun, outfright and outmaneuver any underwater

or surface craft in the world. She'll have four times the horsepower of her most powerful diesel sisters. Her atomic furnace will contain plutonium—a man-contrived atomic fuel made by bombarding U-238 with fissionable uranium. Her range will be globe-girdling, since one dose of fuel will last a long, long time. Her super-streamlined hull, designed primarily for underwater cruising, will make her faster when submerged than when operating on the surface—an unheard of thing in modern subs. She is expected to cruise down there at 25 to 30 knots, and will be able to stay down for interminable periods.

No air, of course, is needed to make her atomic furnace burn. Hence, no bulky snorkel will poke above the surface to cut a wake and give her away. Air for the crew can be banked at three to four-day intervals and a small, inconspicuous, retractable snorkel will do the job without any need to surface. The size of the atomic engine is small enough so that much of the space previously taken by some 700 tons of diesel oil and storage batteries will actually be saved for more torpedo storage.

(Additional drawings on next two pages—story continued to page 234)

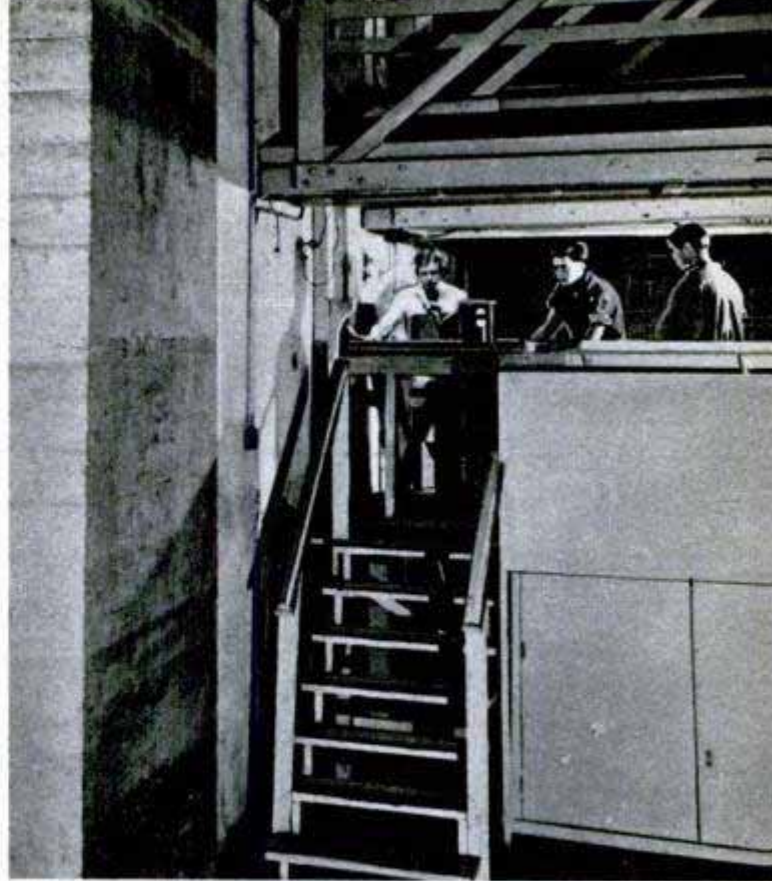

Above, the operating end of the pile at the Argonne National Laboratory. Below, an atomic-power plant

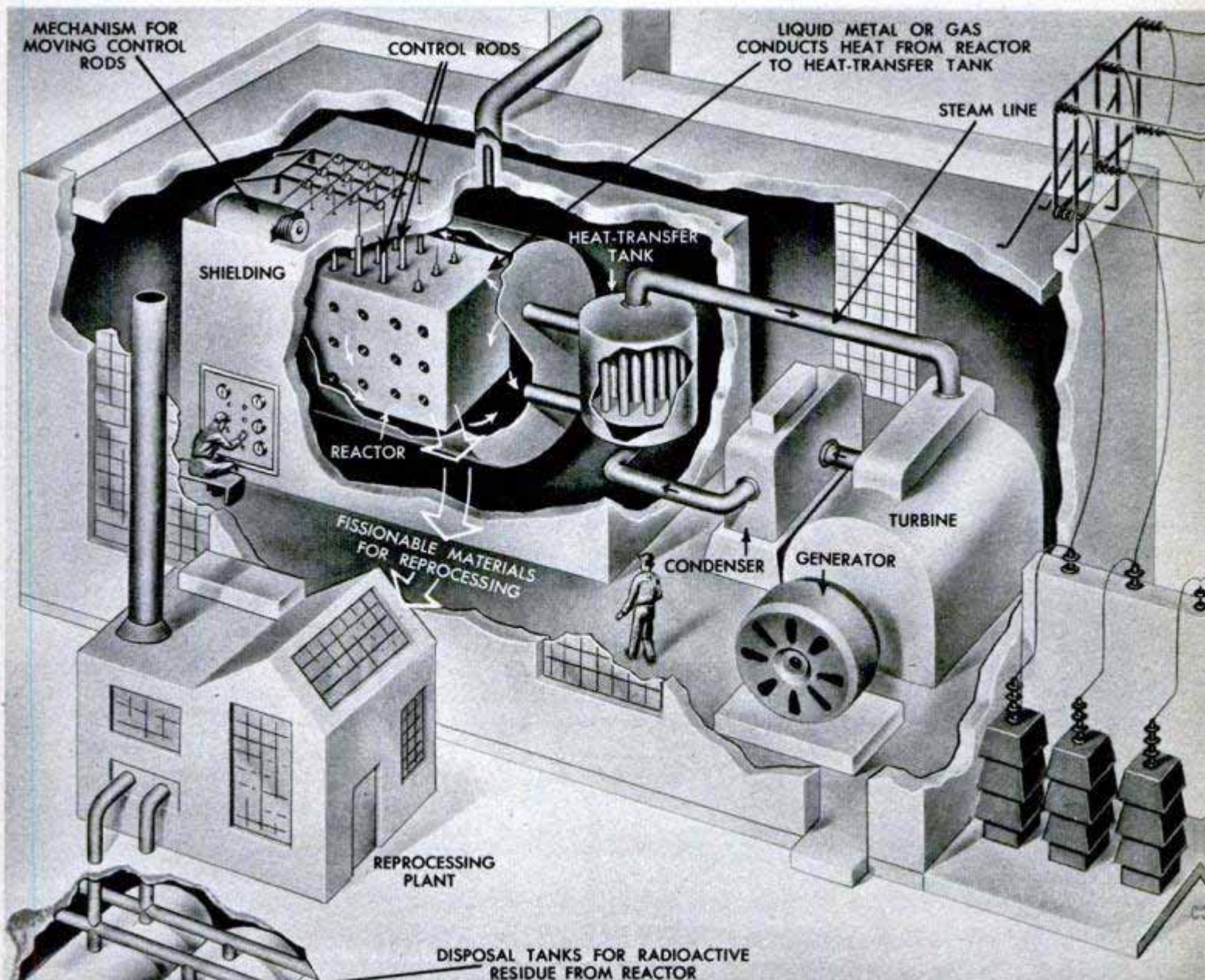

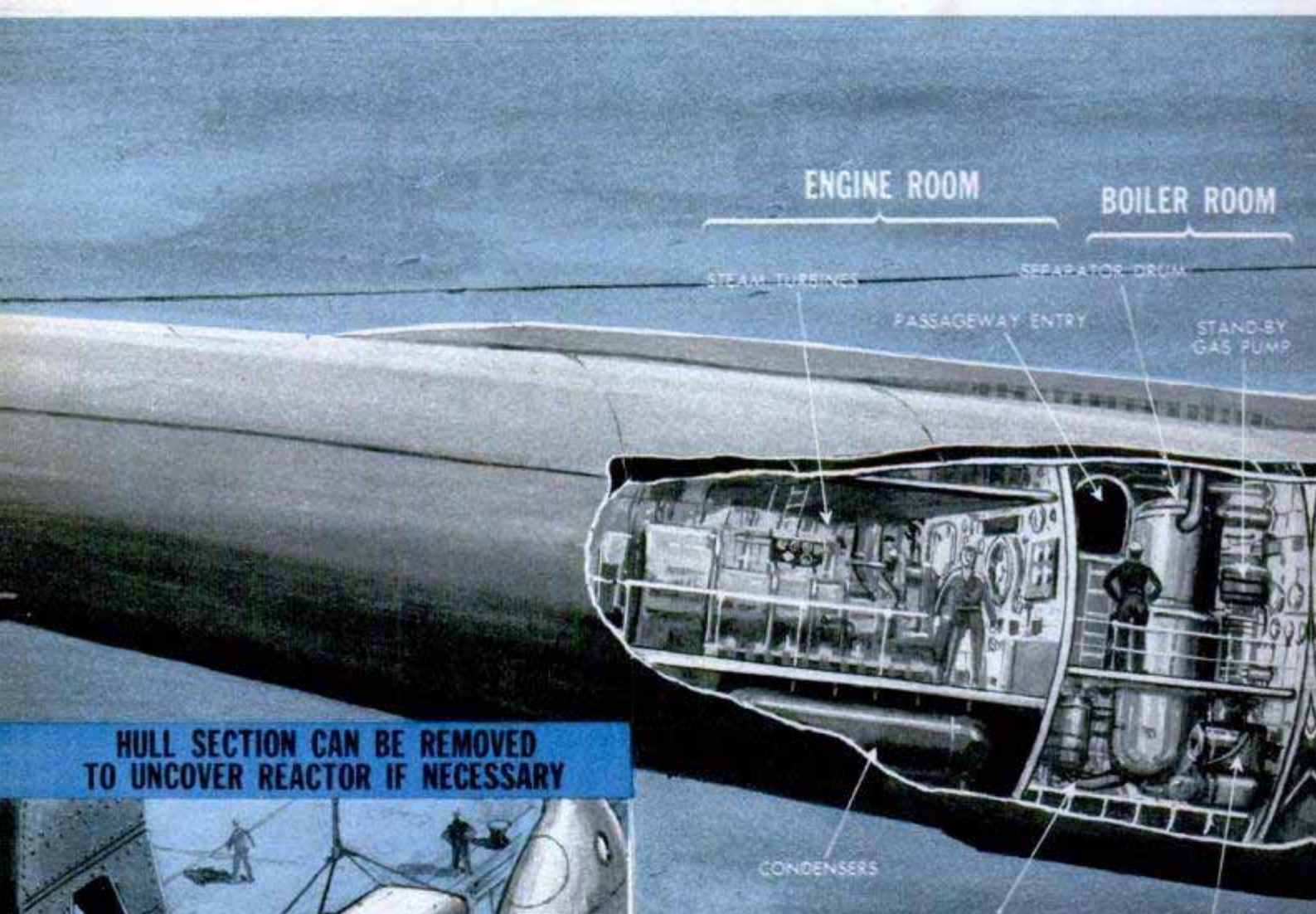
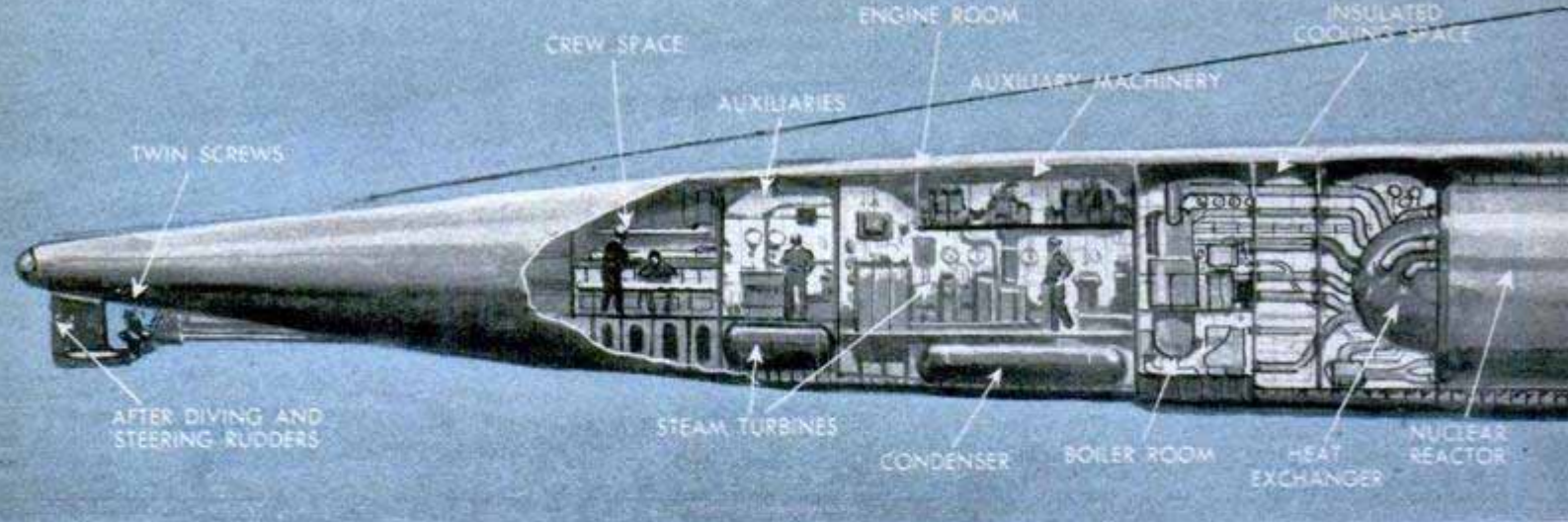

HULL SECTION CAN BE REMOVED TO UNCOVER REACTOR IF NECESSARY

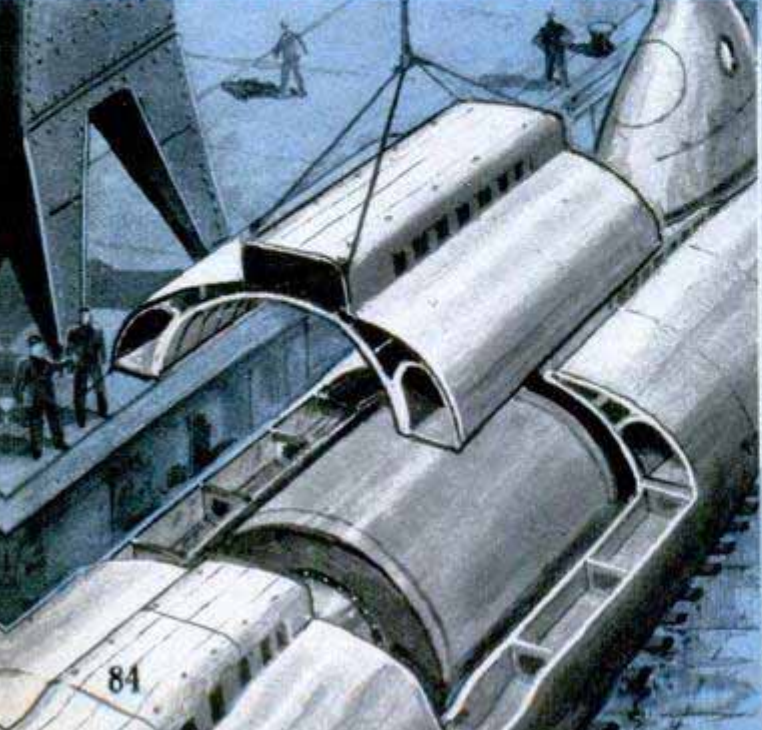

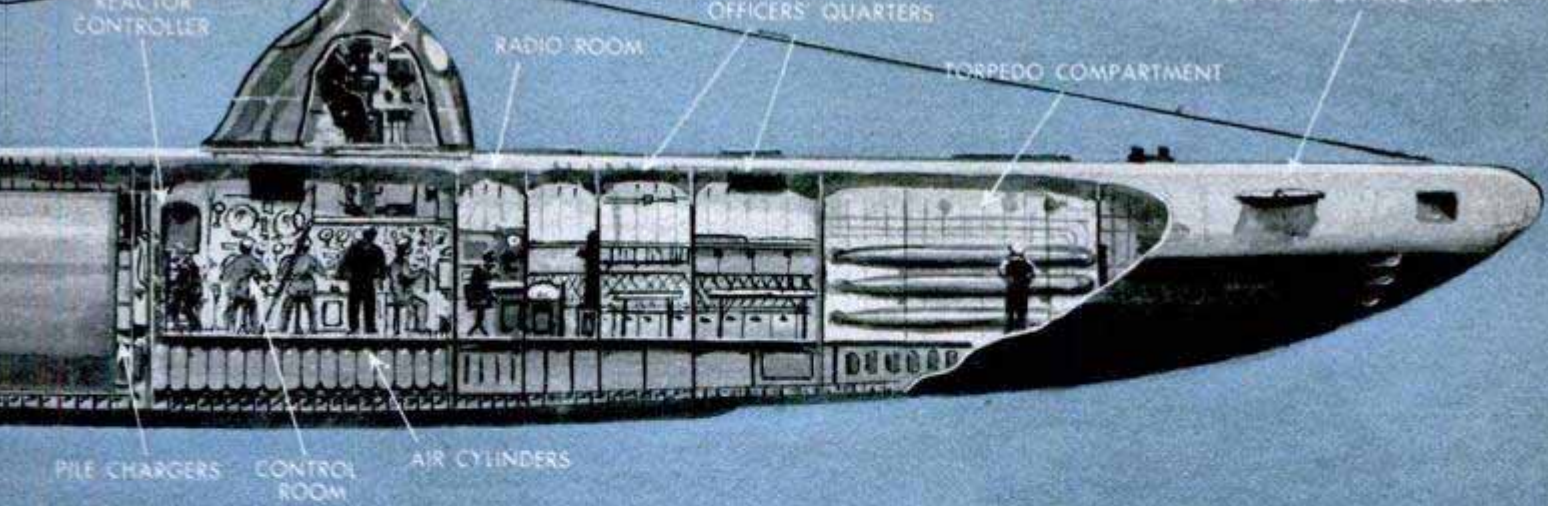

ATOMIC-POWERED SUBMARINE

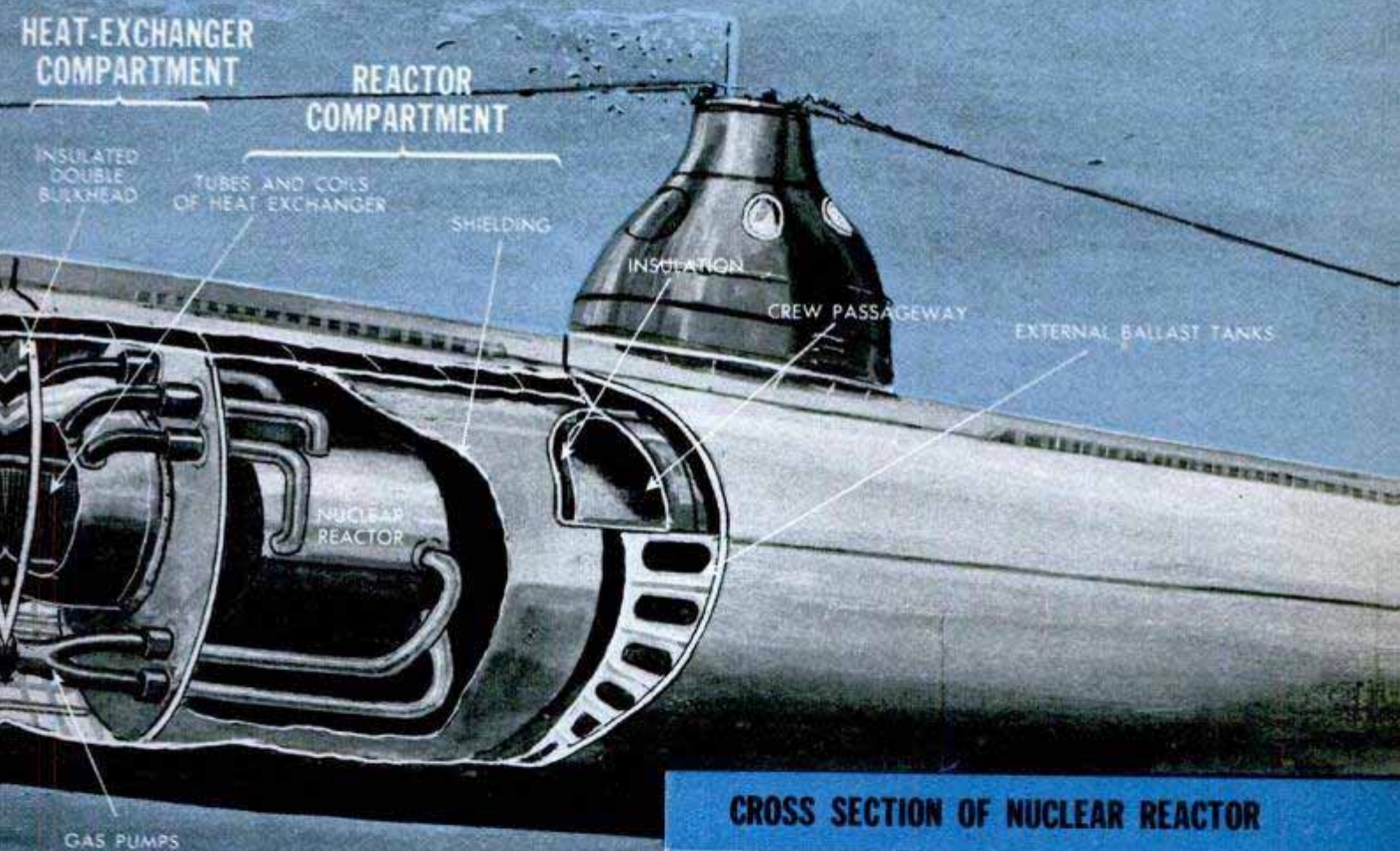

CROSS SECTION OF NUCLEAR REACTOR





Atomic Survival Jacket

Designed for persons who live through the initial blast of an atomic bomb, a survival jacket contains many of the items that might be essential for existence. The jacket in no way protects the wearer from radiation or other bomb effects. It was designed by Michael Shore and Benn Reyes of Chicago, who offer the idea free in the

hope that civil-defense groups will use any version of the jacket applicable to their needs. Pockets contain such items as sulfa powder, a blood coagulant, bandages, burn salve, adhesive tape, water-purifying tablets, iodine ampules, sulfaguanidine tablets, knife, scissors, rope, flashlight and matches. A panel on the jacket carries the name, street address, and city and blood type of the wearer.

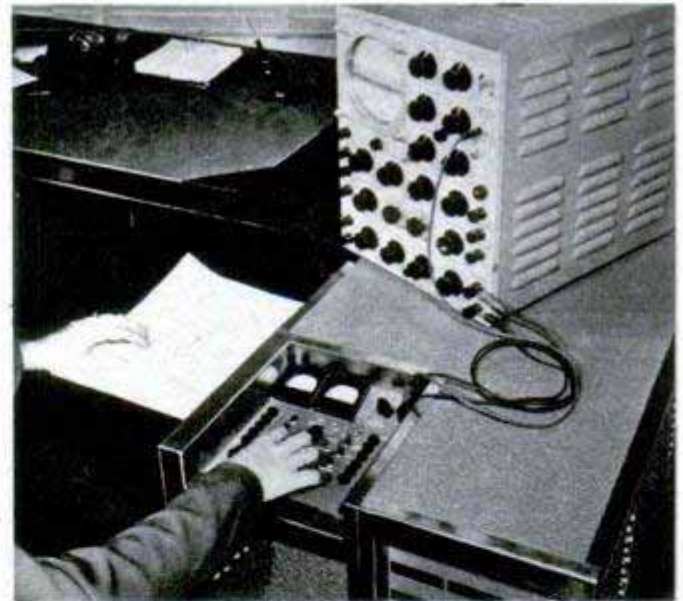

Desk-Size Electronic "Brain"

Smaller than an office desk, an electronic "thinking machine" has a mathematical capacity that places it in a class with the warehouse-size computers used in large universities. Known as "Maddida," it was designed and built by engineers of Northrop Aircraft, Inc., Hawthorne, Calif. The machine has fewer than 100 tubes, very few compared with those required to operate jumbo computers, and only one moving part, a spinning magnetic drum that "re-

members" about 10,000 digits. A simplified typewriter keyboard on the control panel is used to put the problem into the machine for solution. The computer will be used to predict the best designs for ship hulls, underwater rockets and torpedoes by solving complex mathematical formulas.

☐ A new cold-weather boot developed by the Naval Clothing Depot is rubber inside and out, with wool insulation sandwiched and sealed in as an interlining in the sole, tongue and around the foot and ankle.

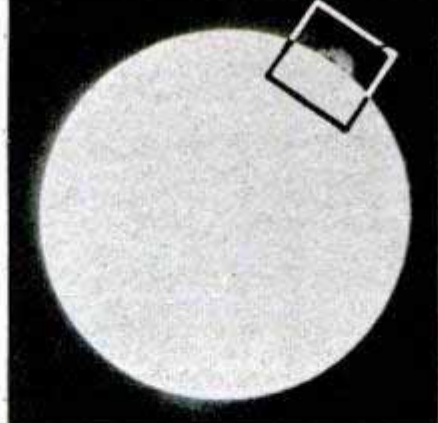

Left, astronomer looks through filter mounted on telescope. Top, the first successful photo through filter. Right, enlargement of section outlined above showing the sunspots clearly

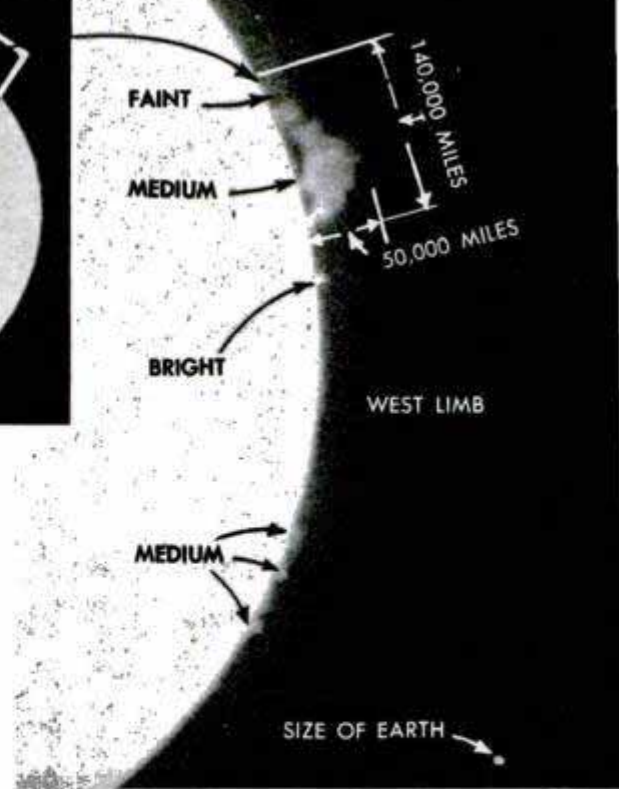

The Navy Shoots the Sun-- Spots and All

SUNSPOTS—cores of burning gas whirlpools on the rim of the sun—periodically throw the world's communications into a tailspin. Telegraph and radio messages are jumbled when the sunspots are severe.

Astronomers have been trying to learn more about this phenomenon for years. Aiding them is a new filter being used at the U. S. Naval Observatory. A barrel-shaped instrument about a foot long, it filters out all light except the red incandescence radiated by hydrogen. Because this is the principal gas on the sun, the filter

permits simultaneous observation of the sun's face and corona. Previously, an artificial eclipse (made by holding a baffle plate between the sun and the eye or film) was used to permit study of the corona.

The new filter, made by Baird Associates, is one angstrom wide, which means it allows only $\frac{1}{3000}$ of the visual color range to pass through it. Dr. William Markowitz of the observatory is using the filter to make the first motion picture ever made of the entire process going on around the surface of the sun.

Movies of the sun are taken through the new filter with this setup. Photocells keep mirrors properly aimed

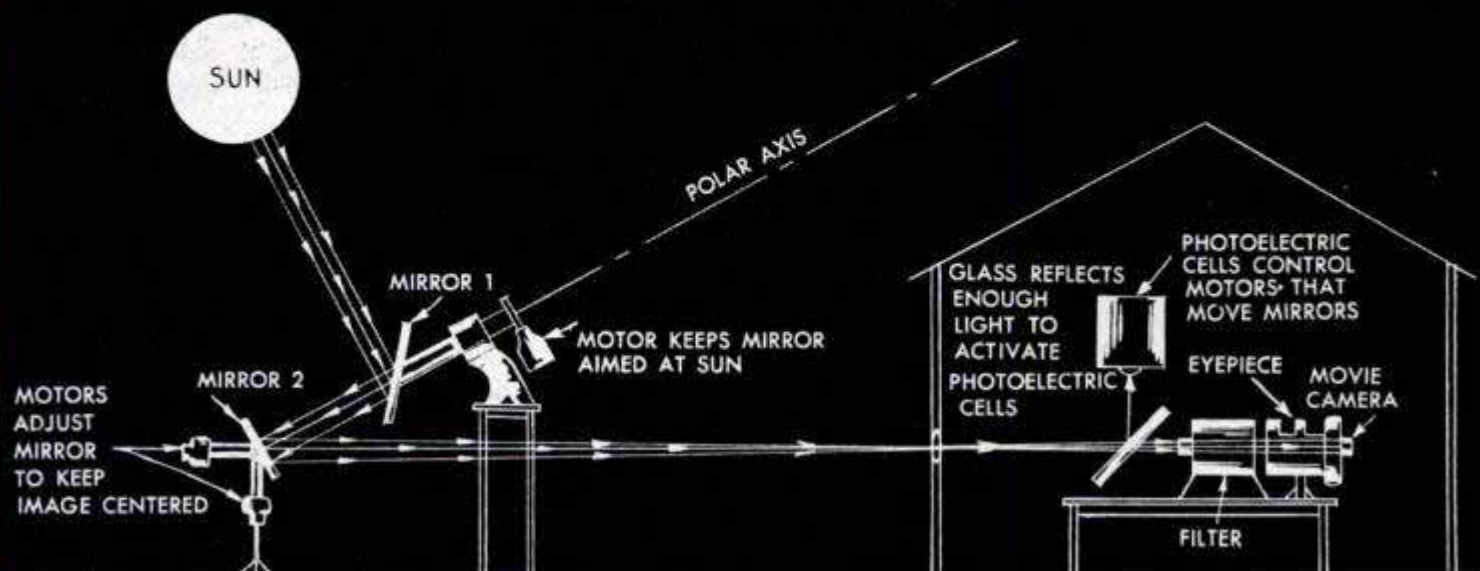



Supercold Plus Heat Makes Superhard Steel

Stainless steels three times harder than those ordinarily available are produced by a newly developed process that uses the supercold of liquid nitrogen. The steel is immersed in the liquid nitrogen at 300 degrees below zero and then quickly transferred to an oven where the temperature is 750 degrees Fahrenheit. A similar superhard steel can also be produced by rolling or forging it as soon as it has been withdrawn from the supercold bath. However, this process does not produce the hardness of the cold-plus-heat method. The steel becomes exceedingly hard because the atoms are shifted into a totally different arrangement, say scientists at the Westinghouse Research Laboratories where the process has been undergoing development.

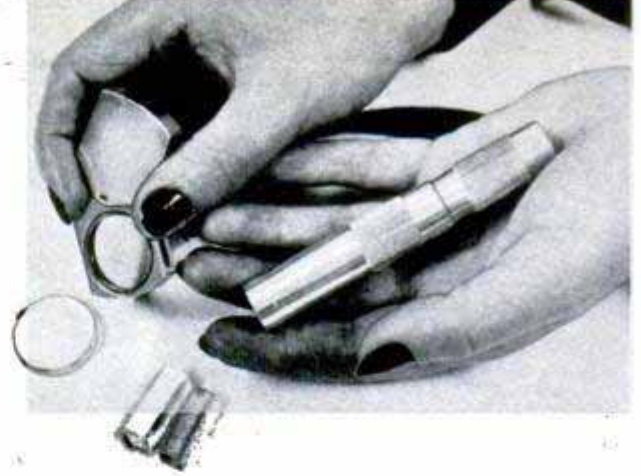

"Atomic Dog Tags"

Two different types of "atomic dog tags" for detection of radioactivity by individuals have been developed by the Navy. The small devices would be carried by personnel in danger of attack. One instrument, which has a swinging metal cover, uses a type of salt crystal that is normally transparent, but turns blue when exposed to gamma rays. The other, shaped like a fountain pen, uses silver-activated phosphate glass as the sensitive element. Gamma rays convert the glass into phosphor, which takes on an orange color under ultraviolet light.

Underwater Telephone Cables Have Built-In Amplifiers

Two underwater cables running between Florida and Cuba have compact amplifying stations built right into the cable and spaced every 40 miles. The cables, normally one inch in diameter, bulge to three inches in the 25-foot section that contains the amplifier. Specially developed tubes, said to be able to function unattended for about 20 years without failure, are used in the amplifier circuit. The cable was designed by Bell Telephone Laboratories.



"Flying Barrel"

Called the "Flying Barrel," a new jet fighter built for the Swedish Air Force has a top speed of over 650 miles an hour. In addition to four 20-mm. nose cannon, it has eight rocket-firing mounts beneath the wings. The engine is a British Ghost.

☐ Wastepaper is needed for America's defense. Don't throw it away.



Detroit Listening Post

By Siler Freeman

SATISFIED with its two big innovations for 1951, the V-8 engine and hydraulic steering device, Chrysler is extending their use this summer into a model so far kept under cover. This is the Saratoga, which has been missing from the 1951 line.

The Saratoga being shipped to dealers next July, is the Windsor with the Firepower 180-horsepower engine and Hydra-guide as optional equipment. Heretofore, only the New Yorker and the Imperial have been sent out with these features.

Unlike the two larger models equipped with Firepower and Hydra-guide, the Saratoga will not have Fluid-Torque, the automatic transmission. Wheelbase is 125½ inches. Some structural changes have been made to accommodate the larger engine. It will be offered in the six-passenger sedan, club coupe, convertible, the Newport hardtop, Town and Country Wagon, and the eight-passenger sedan and limousine.

It is not surprising to find the new engine extended to the Saratoga. The corporation hopes, barring a "hotter" international climate, to extend the engine to DeSoto and possibly Dodge, although perhaps not exactly in the same size as the present V-8.

But extending Hydra-guide to the Saratoga is some indication of the great faith that David A. Wallace, president of the Chrysler division, has in the new device.

Only recently I had occasion to discuss Hydra-guide with Mr. Wallace. The Chrysler president became lyrical in his praise.

"The V-8 engine is a great advance over all other engines of similar design," he said. "But in Hydra-guide, I think we have the greatest advance made in the modern automobile since four-wheel brakes.

"I myself tested it the other day. I had an Imperial model equipped with Hydra-guide placed between two other cars at the curb. I had the cars on either side moved so there was only 18 inches of space to maneuver. Moving the steering wheel with one finger while the car was standing still, I drove it out from between the two others in just three moves."

But Chrysler will not have a monopoly on the device for long. It is reliably reported that General Motors is working on a

similar steering aid, and is rushing it into production. Under ordinary circumstances, it might have reached the market this year in the projected 1952 models. But it is doubtful if tooling can be obtained, with the rush of defense work swamping the shops. Oldsmobile had been slated to use it first, just as it was the first to get Hydra-Matic and the high-compression engine.

Another "first" for GM cars which may reach the market in the 1952 models is a new automatic transmission on which Cadillac engineers have been laboring for a long time. It is reported to combine the best features of all three automatic transmissions now in use on GM's cars. Again the matter of rushing through the tooling holds the fate of the innovation.

Buick this month is sending its dealers the first samples of its Special hardtop. This has been held back by Fisher Body's inability to keep up with the divisions in their varied assortment of body styles.

It will be Buick's latest effort to broaden its coverage of the lower-priced field. The division was just nosed out of third place in the 1950 production lineup by Plymouth.

Meanwhile, the tool and die shops are pushing hard to get out a vast amount of work on 1952 models before July 1. At that time, the machine-tool industry is going to be under government controls for about 70 percent of output.

Ford is reported to have the biggest changes due both in body styling and in engines. A V-8 and an overhead-valve six are both in the works. Already there is a three-month delay in the projected schedule of new-model announcements.

Studebaker of South Bend is another company which has made extensive changes. But like the first postwar models, they may go on a high shelf before they are actually seen in production.

In the midst of all its activity, the industry has taken time out to mourn one of its greatest figures. The sudden passing of Fred Zeder, vice-chairman of Chrysler's board and long the top man in its fine engineering staff, has saddened not only his own confreres but many men in competitive companies.

Full-size version of atomic-energy display, shown in model at right, is 30 feet high at center. In cradle of steel cables, 250-foot "skylon," left, is an eerie spectacle at night when lighted. The supporting pylons are painted black

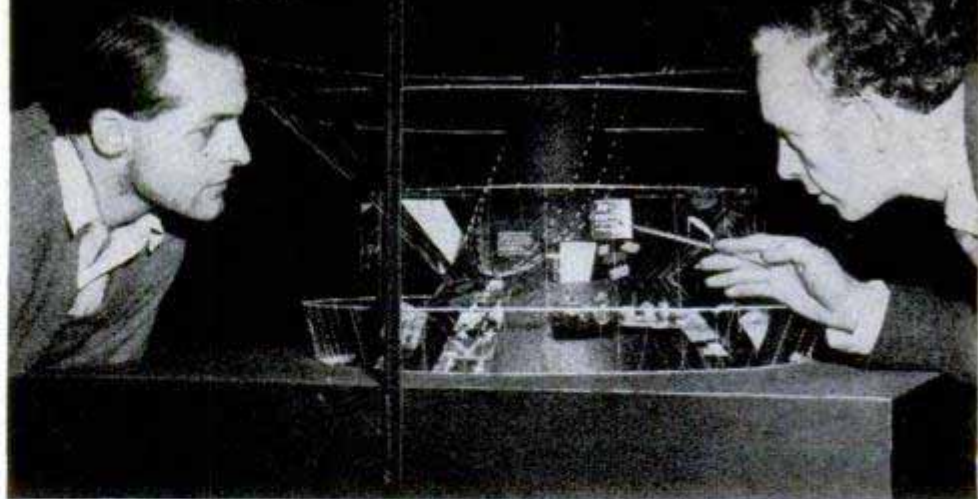

British Official photos



Aluminum roof of Dome of Discovery, below right, in model of exhibition area along Thames River, will be 365 feet across. Visitors, by means of umbrella-shaped aerial on tower at left, can see radio waves from sun

FESTIVAL of BRITAIN

ONE NATION'S contribution to civilization—past, present and future—is the theme of the 1951 Festival of Britain. After being officially opened by King George May 3, it will last through September. It follows exactly a century after the Great Exhibition of London, a smaller, but in many ways similar, event. The largest of London's three major displays will illustrate advances in science, technology and industrial design. Others there will be devoted to books, films and music. Glasgow's exhibition will emphasize the evolution of industrial power, and the growth of the Irish-linen industry and scientific farming will be described at Belfast. A 10,000-ton "display ship" will carry the festival to principal port cities and another mobile exhibition will tour the provinces.

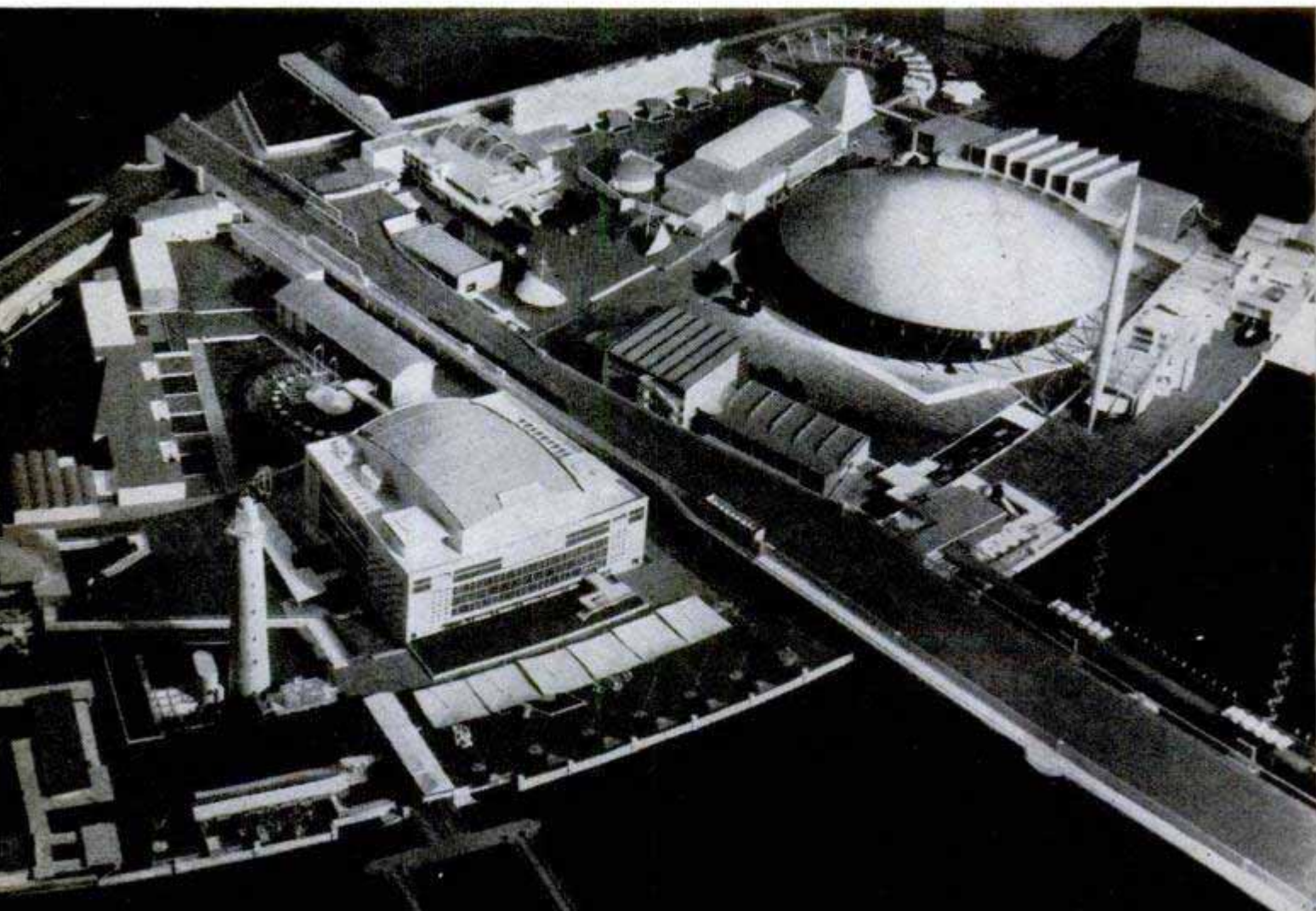

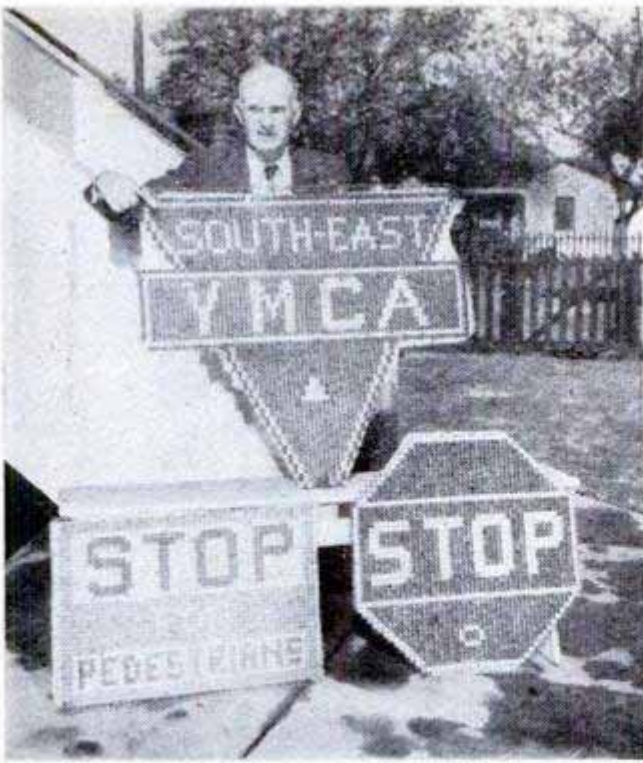

Marble Signs

Making brilliant signs with thousands of glass marbles is the unique hobby of Roy E. Swain of Huntington Park, Calif. The signs

glow in either natural or artificial light. Swain places the marbles between layers of wire mesh, and then welds the mesh to prevent theft of the "aggies." One huge sign required 15,000 marbles.

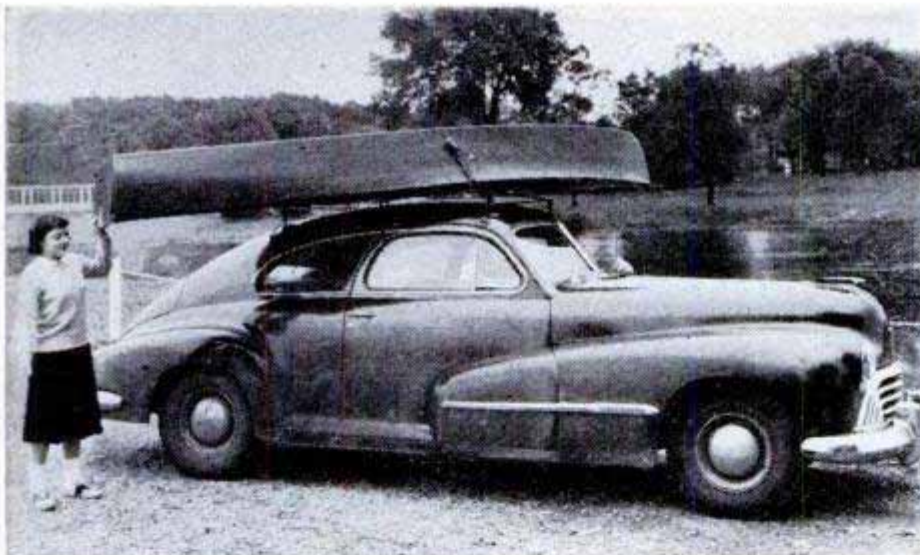

Pro-Weld Co., 1835 Cooper St., Jackson, Mich.



Boat Swung Aboard Car by One Person

Any small boat can be loaded on a new car-top carrier by one person. A swinging bar on the carrier permits the boat to be partially secured before it is on top of the car. The boat is raised by the prow and leaned against the swinging bar. This leaves both the operator's hands free to strap the craft to the bar. The stern then is lifted and "walked" to the rear of the car, where it also is strapped in place. The carrier fastens to the car top with suction cups and clamps, and can also be used to carry other bulky objects such as lumber or ladders.

☐ America's defense effort requires thousands of products made from wastepaper. One of your local civic organizations will be glad to pick up your old magazines and newspapers.

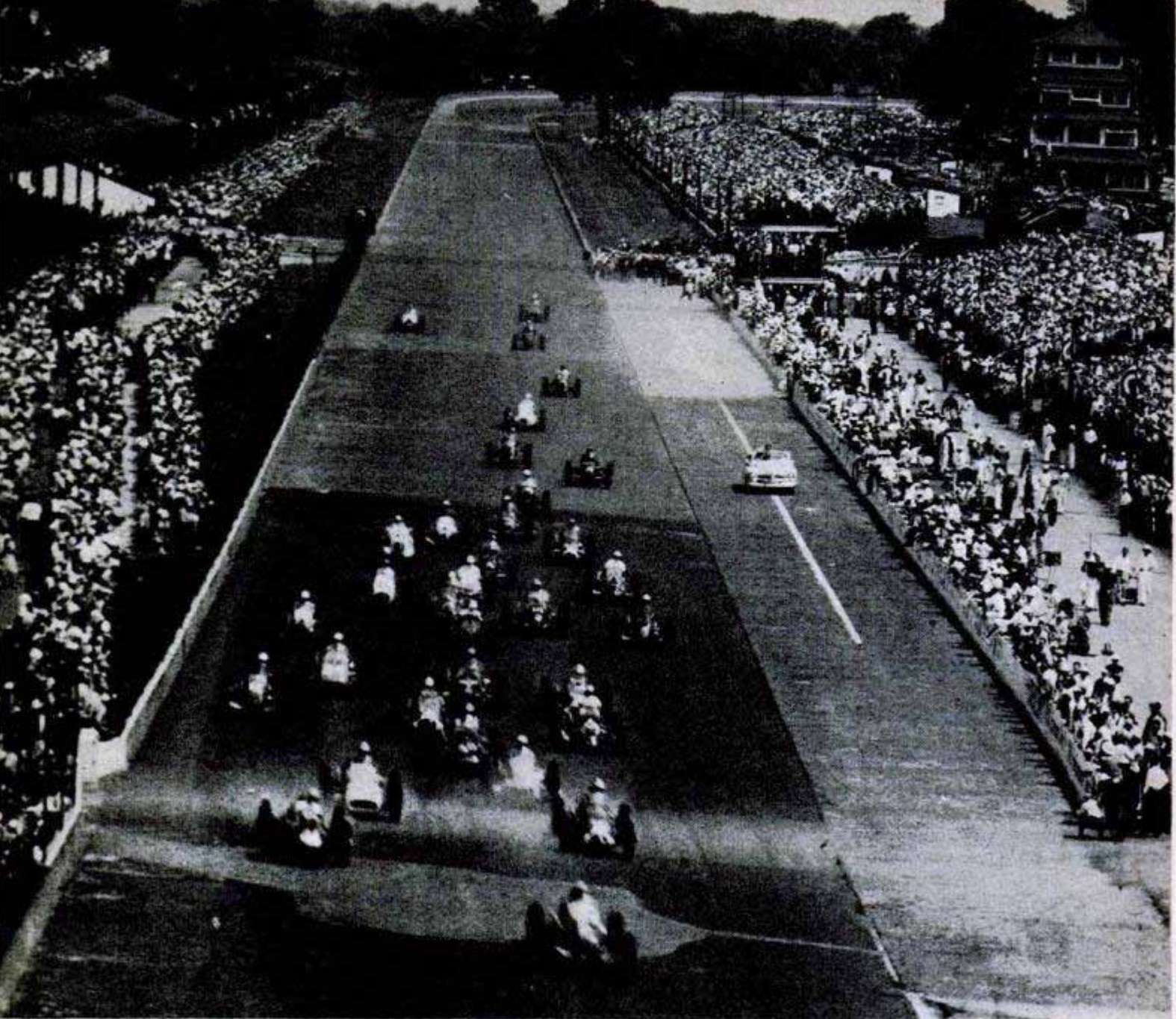

With a rocketing roar of their motors, America's finest racing cars head into the first turn at Indianapolis

They'll Burn Up the SPEEDWAY

By Ewart Thomas

CAN A HOT ROD win the Indianapolis race?

Probably not, though a group of enthusiasts from Los Angeles is going to find out on Memorial Day. They are challenging the field of professional cars with a home-made racing machine of their own design. The car has been entered in the 500-mile race, its backers expect that it will qualify in the time trials, and there's always a chance that it can finish among the leaders.

The amateur automobile looks like a projectile, and is powered with a rebuilt truck engine. This engine, in a different chassis, produced an estimated speed of

218 miles per hour at the Bonneville hot-rod nationals last year. For Indianapolis it is geared down to a top speed of 160 miles per hour to produce better acceleration coming out of the turns.

The car was built by John Koehnle and friends in a back-yard garage. Stock parts include a Ford transmission, Ford hydraulic brakes, a 1925 Franklin steering assembly that was selected for its smoothness and quick steering, and parts of a '49 Lincoln radiator. Most of the rest of the car is hand-built. The frame is made of sections that bolt together so that any section can be replaced in case of damage.

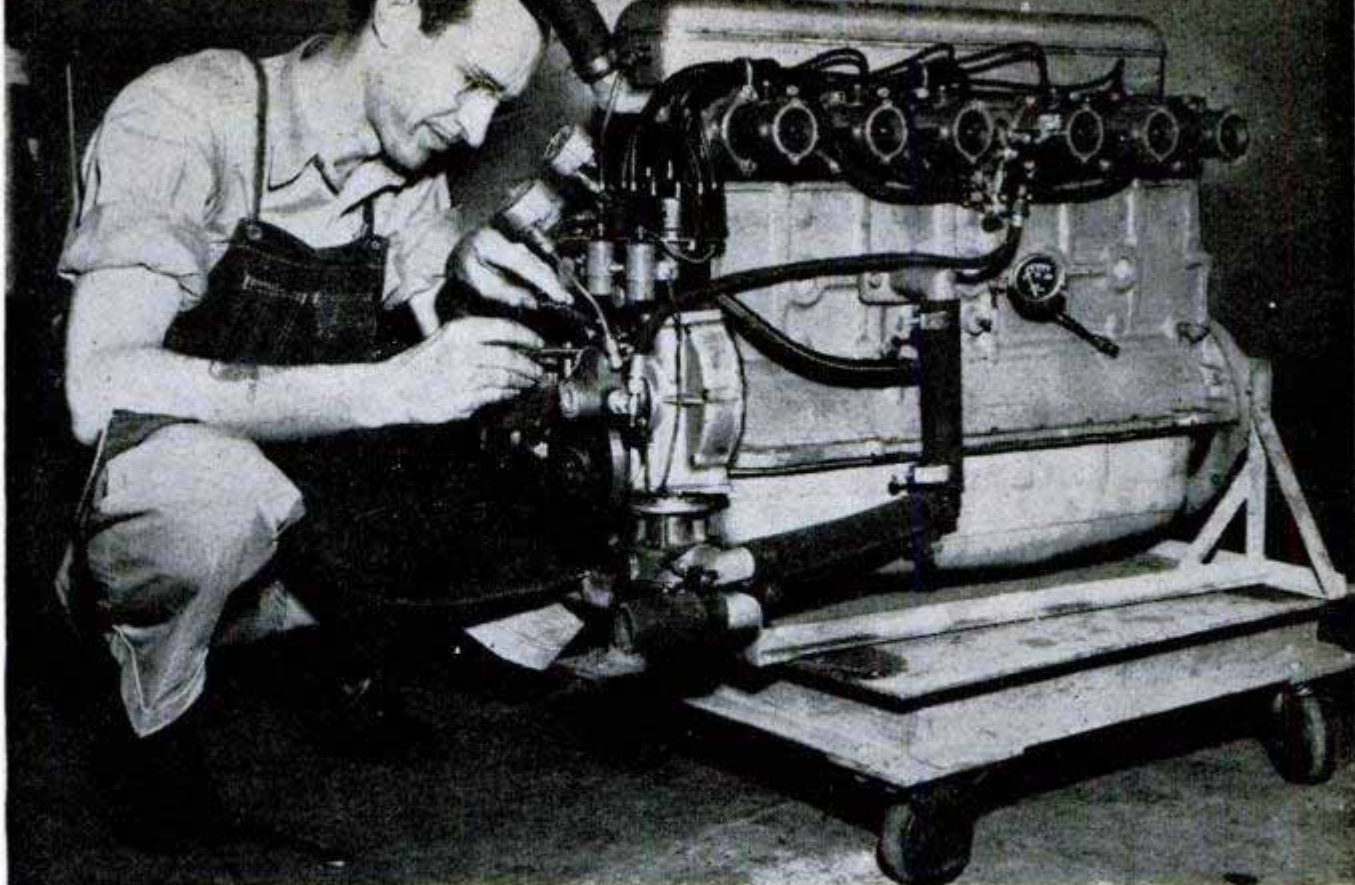

Rebuilt truck engine, fitted with overhead valves and fuel injection, will power the hot-rod entry this year

The car stands 38 inches tall, has a 100-inch wheelbase and weighs about 1900 pounds. Its full cost was \$7500, about half of the cost of the average Indianapolis entry.

Its power plant is a six-cylinder GMC truck engine rebuilt by Wayne Horning to develop 285 horsepower at 5000 revolutions per minute, running on a mixture of 90 percent methanol (alcohol) and 10 percent nitromethane. Compression ratio is 12.4 to 1 and can be raised or lowered by changing pistons. Horning designed a new cast-iron head that makes use of overhead valves, extra-large intake and exhaust ports and shallow combustion chambers. The engine uses a fuel-injection system instead of the usual carburetors. ~~see A form~~

From the standpoints of design and construction, the hot-rod entry is a fast, sturdy car. It needs to be, for this year's race on the big track at Indianapolis will be the fastest and toughest in history, barring bad weather or accidents.

There are three reasons why the drivers expect to drive at record speeds this year:

First, Firestone has modified its Indianapolis racing tire so that it is more sure-footed than in the past. Tests made last summer show that with the new tires a car can average from two to five miles per hour greater speed at Indianapolis with the same safety.

Second, about half the cars will use the Hilborn fuel-injection system instead of

Here's the racer, hand-built in a back-yard garage, that will draw the attention of rabid hot-rod fans

Trend Publications photo

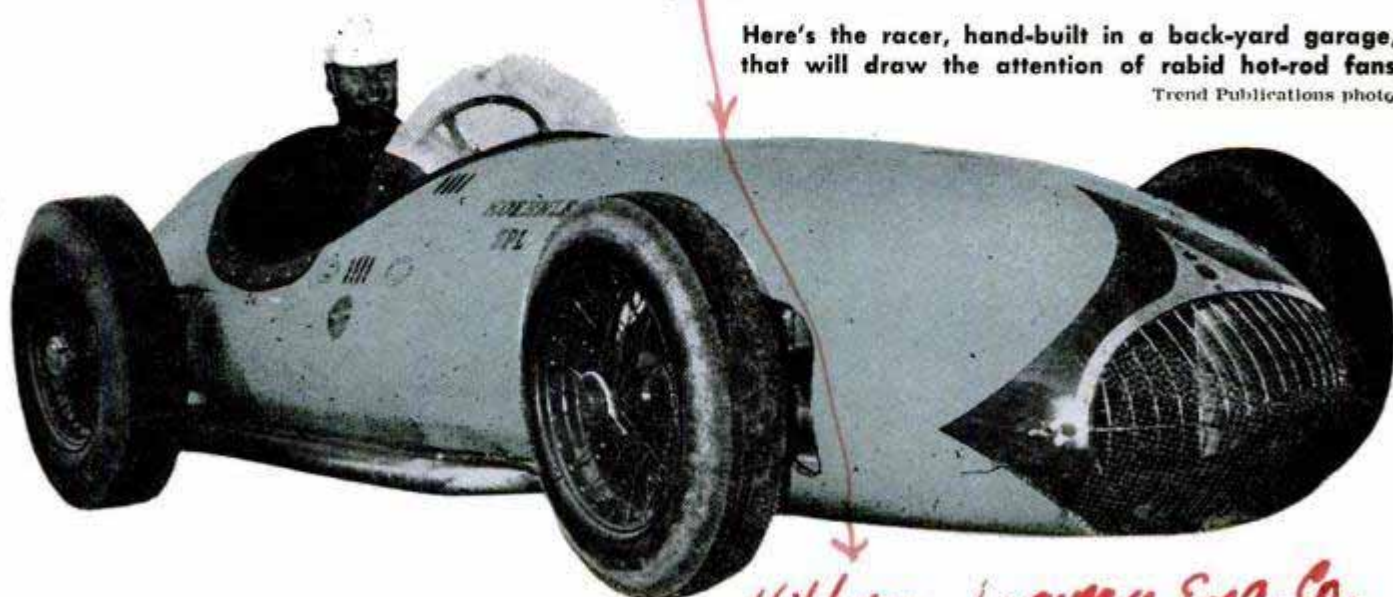

Hilborn-Jraverse Eng. Co.
5641 Hannum Ave.

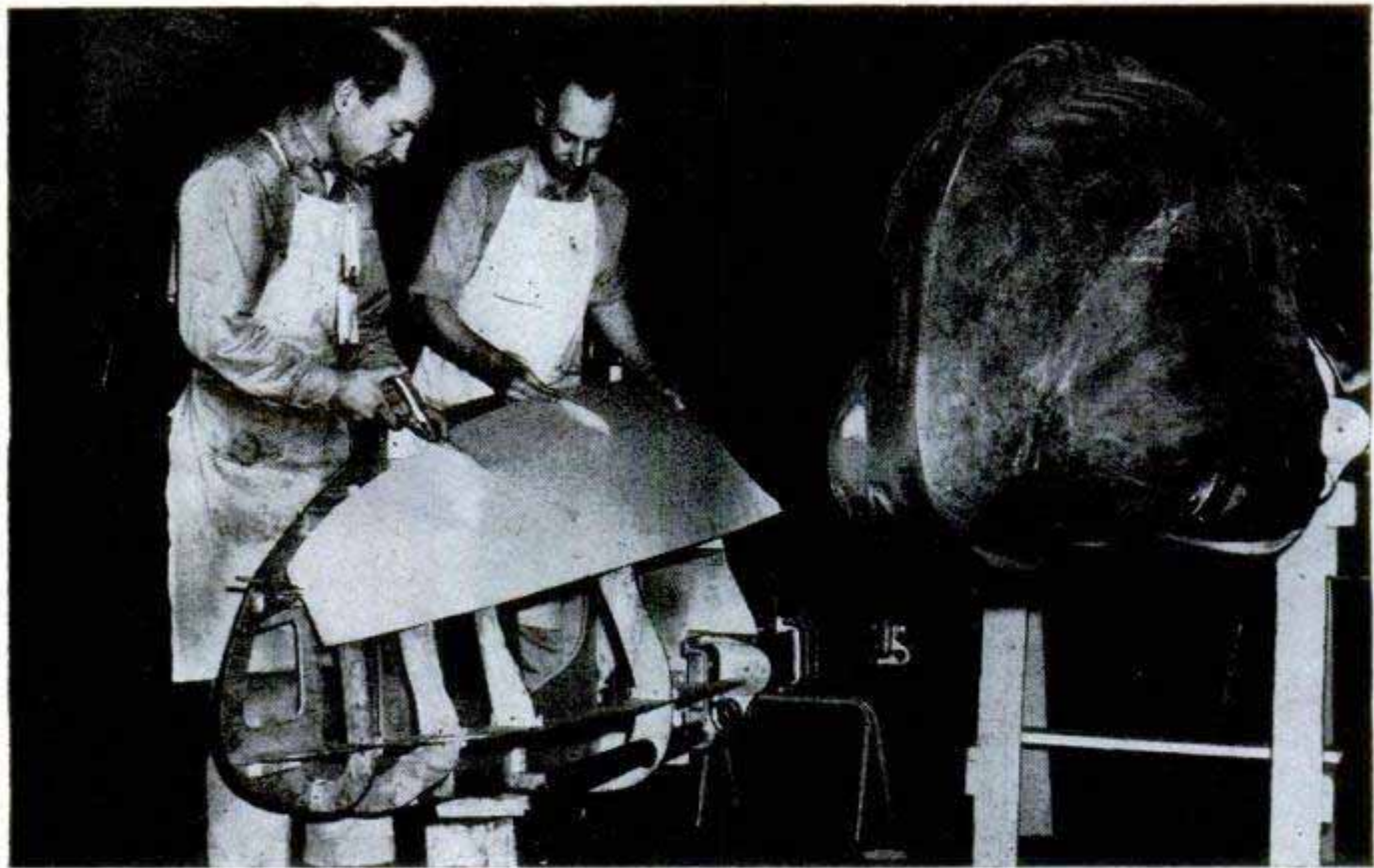

Car-makers, using the wooden mockup at right as a guide, cut a pattern for body panel of an Indianapolis entry

carburetors. With the standard 270-cubic-inch Meyer & Drake racing engine this system is said to increase the original 297 horsepower to as much as 335 horsepower, at the same time allowing greater fuel economy. A separate air intake is used for each cylinder with the fuel-injection system. A high-pressure pump injects fuel to each intake port at the time the valve opens. The fuel is broken up into a fine spray

and enters the combustion chamber under a positive pressure of 25 to 30 pounds.

The third reason why high speeds are anticipated is that many of the cars entered for the 500-mile classic are practically identical. It's almost true to say Indianapolis is becoming a stockcar race, so closely are America's leading race-car designers in agreement as to what constitutes the ideal car for winning that classic.

Front-wheel-drive car entered this year has aluminum and magnesium body parts which cut weight 350 pounds

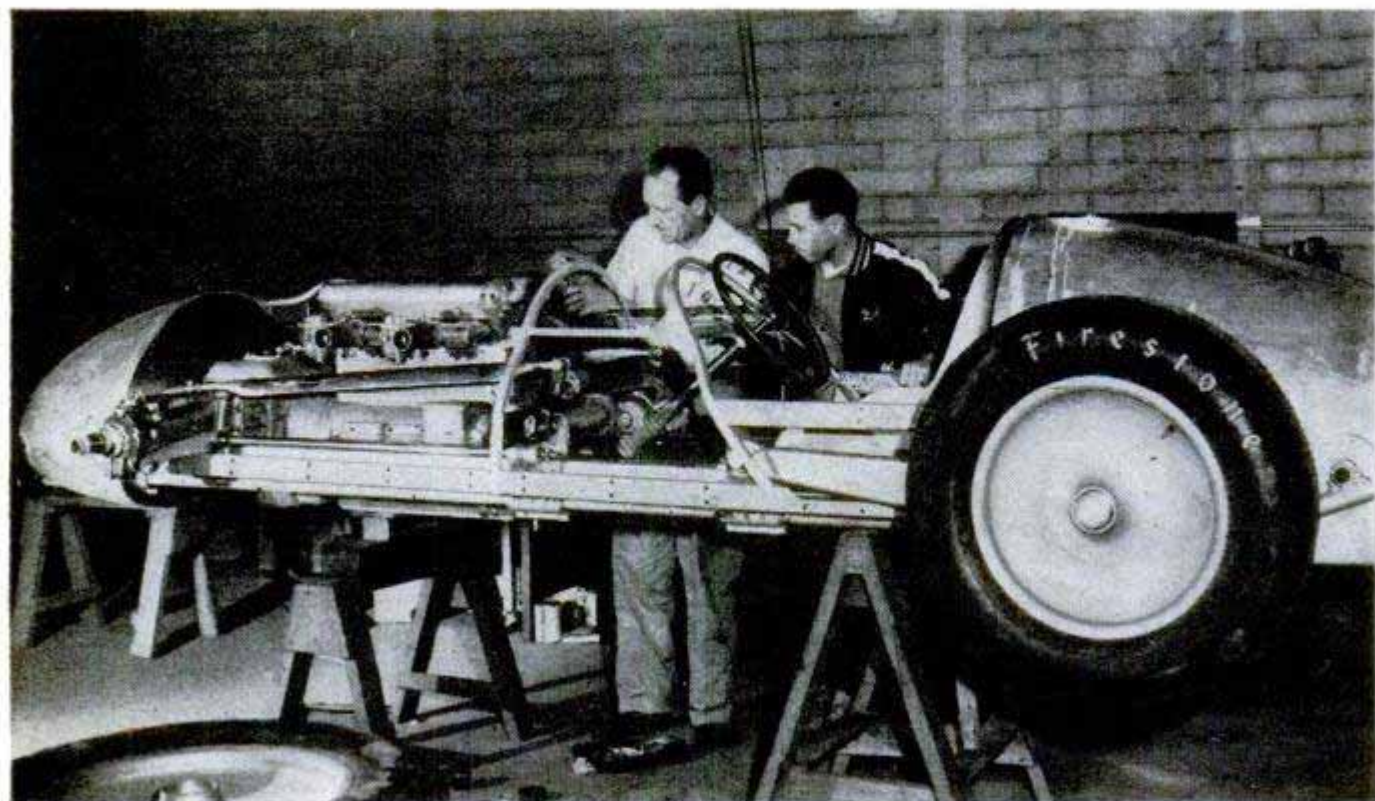

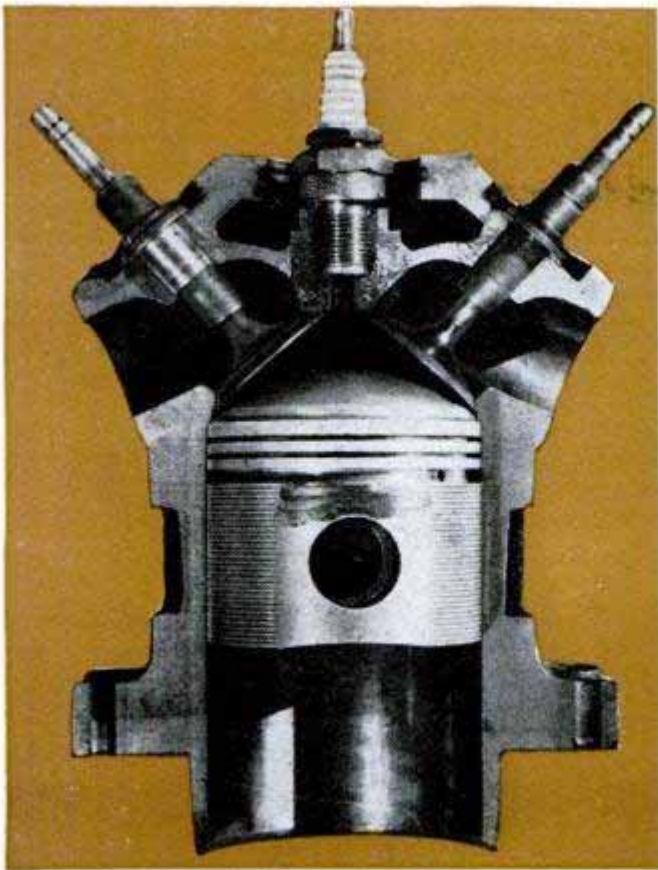

Cutaway cylinder from the 550-horsepower, supercharged Novi engine shows tiny combustion chamber

This composite "Indianapolis Speedway Special" is powered with a 270-cubic-inch Meyer & Drake (Offenhauser) four-cylinder engine, has a wheelbase of 100 inches, torsion-bar suspension in front and possibly in the rear, and is as light as possible. The average car weighs no more than 1800 pounds. Rear drives predominate, although several will be of the front-drive type.



Driver sits in partly finished body while car builders measure the angle and position of steering wheel

At Indianapolis in the past a driver who was leading the field would drop his speed to maintain no more than a safe margin in front of the second-place car. For the 500-mile distance, that reduced the possibility of mechanical failure. This year, with so many of the cars identical or practically so in performance, it will be a race all the way to the checkered flag.

Front-wheel bearings of aluminum-built car are mounted on novel kingpins to keep wheels in perfect alignment

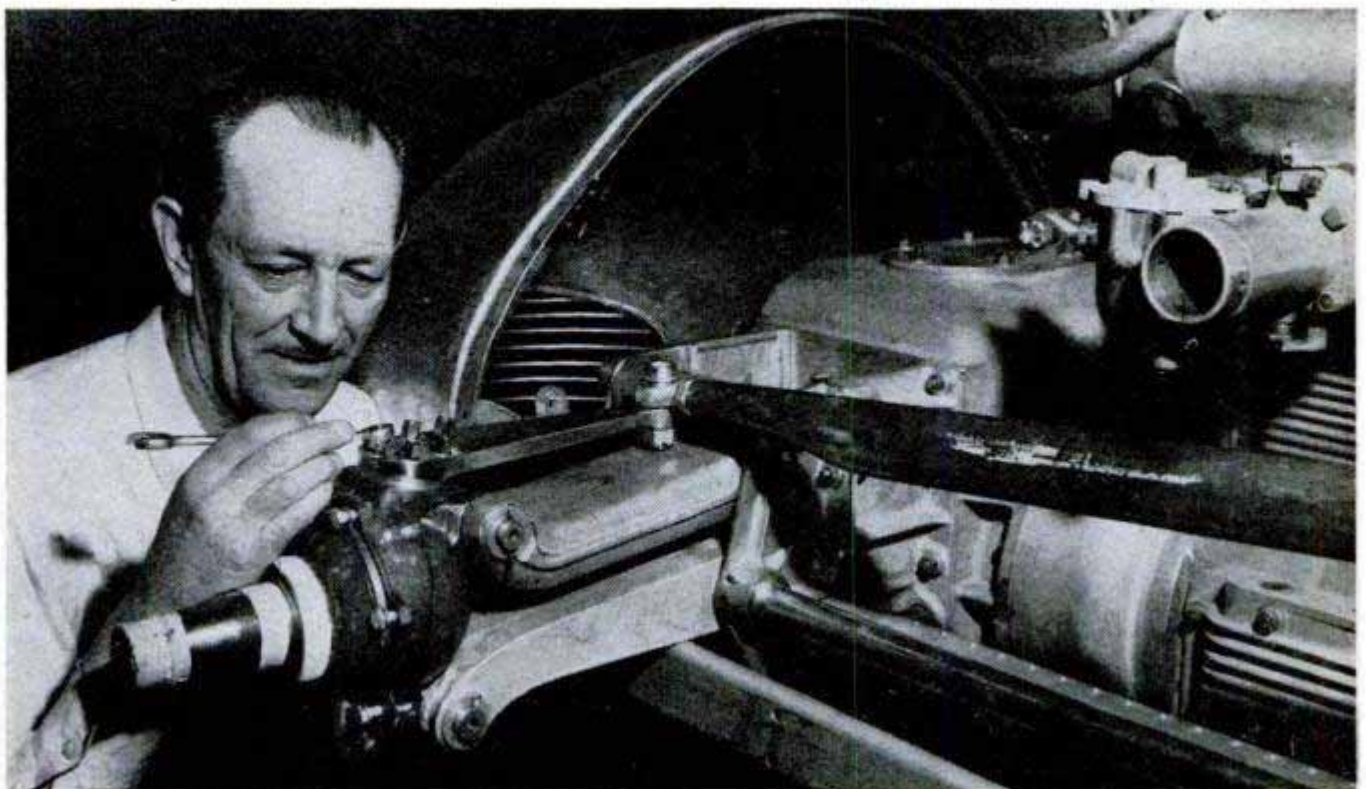



Here's a dramatic moment during last year's race. Car had stopped for fuel, which overflowed and caught fire

As many as eight of the cars will be identical Kurtis-built racing machines of the type that won last year at an average speed of 124 miles per hour.

In the Kurtis cars the main fuel tank in the tail has a capacity of 47 gallons and is built up of rubber and fabric, similar to some aircraft fuel tanks. Many of the race cars, in fact, are using rubber fuel tanks

this year. The Kurtis cars, in addition, carry 26 more gallons in metal fuel tanks built under and on both sides of the driver's seat.

Lesovsky and Shroeder, two well-known builders, have completed two new minimum-weight race cars that are designed for dirt-track racing as well as for use at
(Continued to page 258)

Working against time, car builders start frame of one of the last-minute entries for this year's race

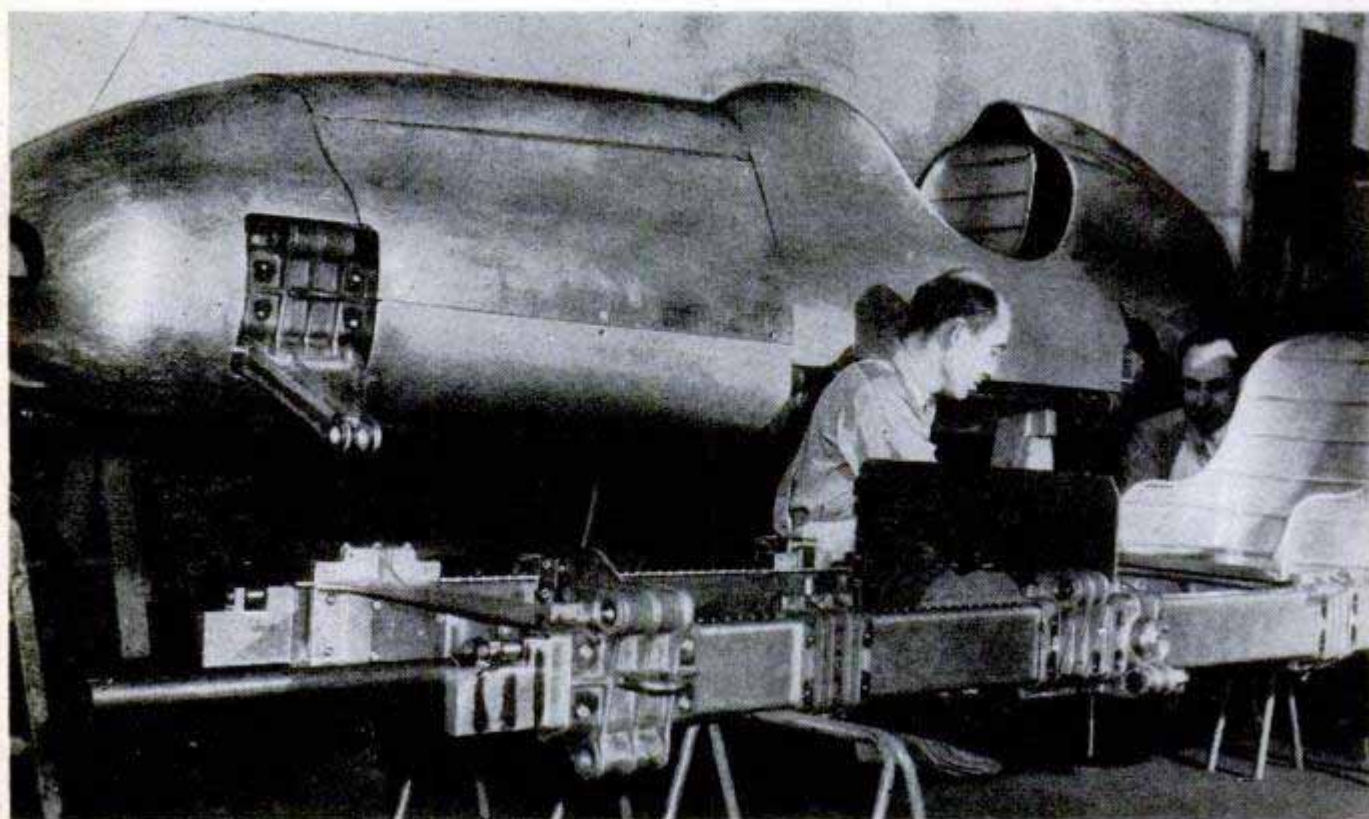

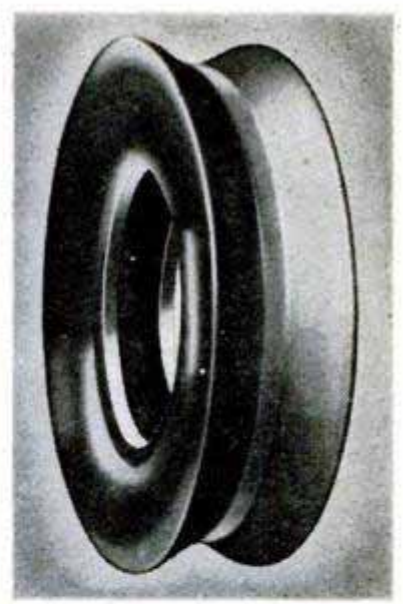

Pneumatic Tire Has Grooved Tread

Corn planters do a better job of firming the soil around the seed when they are equipped with an unusual pneumatic tire developed by the B. F. Goodrich Co., Akron, Ohio. This special tire is constructed with high shoulders and a low center, forming a deep, V-shaped tread. The

grooved tire does a more efficient job than the steel wheels now used on planters. It can be used to plant in wet soil, something that is not possible with steel wheels. It also firms the soil better, produces less side-slip on hillside planting and causes less dust in dry weather.

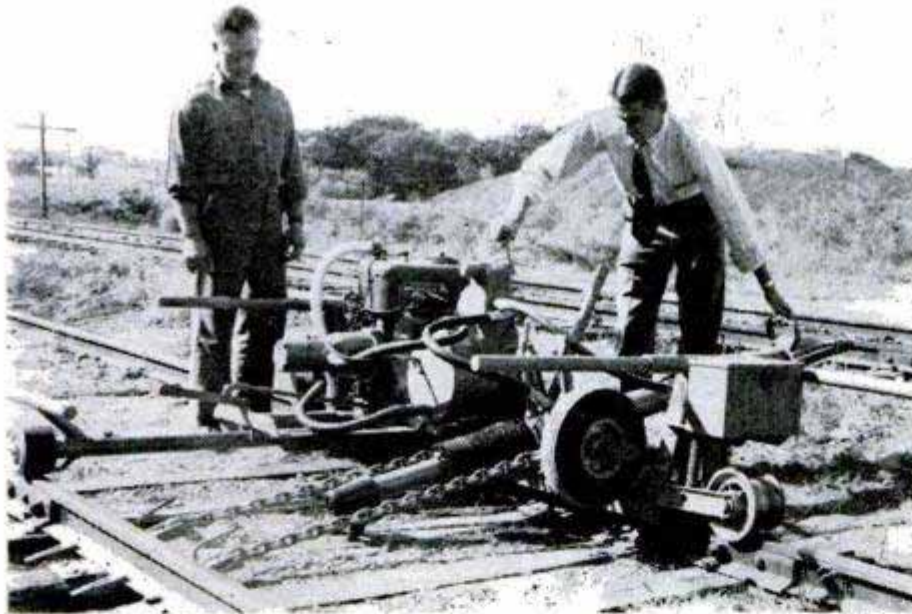

Fairmont Railway Motors, Inc., Fairmont, Minn.

Hydraulic Ram Removes Ties

Exerting a push of 16,000 pounds, a hydraulic ram forces the stubbornest tie out from under the rails in a minute or less. Two men operate the machine which anchors itself to the rails with two chains. The ram has a double-pronged head that digs into the tie, forcing it forward. In three strokes, the ram pushes the tie from under both rails. A two-cylinder gasoline engine drives the unit.

Straight From Paris?

Latest item for the angler's wardrobe is a nylon skirt for his fishing lures. The little skirt can be used to replace worn bucktails, feathers and rubber skirts on plugs and other baits. It is held in place with a screw eye. The skirt also can be used individually, rigged as a fly.

Studies of an age-old layer of rock in southwestern Colorado have revealed that four species of plants, previously unknown, grew in that area during America's Cretaceous period—about 100,000,000 years ago.

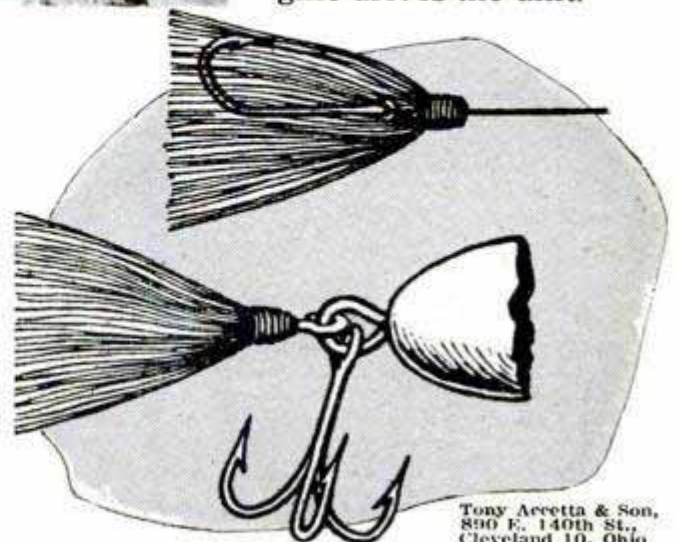

Tony Arcetta & Son,
890 E. 140th St.,
Cleveland 10, Ohio

The OWNERS REPORT on



THE POPULAR MECHANICS MOTOR SURVEY AS CONDUCTED BY FLOYD CLYMER

I am the owner of a 1951 Studebaker. Model Champion 8-cyl. 6-cyl.
I have owned it about 4 months. Speedometer mileage is now 10,000

I use only regular gasoline - I use premium (high test) gasoline

My approximate gas mileage in the city is 20 MPG; in country, 23 MPG.
Gas mileage INCREASE by using overdrive is about _____ MPG.

I CHANGE OIL every 4,000 miles; I ADD OIL - one quart every _____ miles.

My car has : Standard Trans. Overdrive Studebaker Automatic Drive

How does the car handle on the road? Better than any we've had

Maneuverability seems to be: Excellent Average Unsatisfactory

Acceleration is: Outstanding Fair Poor

Curb and Road Clearance is: Satisfactory Too high Too low

Why did you buy a Studebaker? We need a car that would give us

high gas mileage and good durability.

What features about the car do you especially like? We like the gas

mileage and the automatic drive.

Do you like Studebaker's CLIMATIZER? yes; HILLHOLDER? yes;

Self-adjusting BRAKES? yes; APPEARANCE? yes; VISIBILITY? yes

What is your opinion of new V-8 ENGINE? _____

What do you dislike about the car? The only things I can think

of are the place where the starter is located and the tires.

Have you ever owned a Studebaker before? yes If so, how many? one

Would you buy another Studebaker? Yes Possibly No

Do you secure good dealer service? Yes Fair No

How would you rate your new Studebaker? Excellent Good Average Poor

GENERAL INFORMATION

What type of engine would you prefer in your car of the future? In-line V-type: 9 6

Cylinders: 6 8 Valves: Side Overhead one valve just

Based on my present experience, I want my next car equipped with: Standard Trans.

Overdrive Studebaker Automatic Drive Other type of automatic trans.

Please state reasons: no gear changing, better take off

Do you like the new low-pressure, super-cushion tires? no

Do you carry the recommended pressure? Yes No How much more? 4 more lbs.

Please check all answer boxes () Your reply will be held in strict confidence.

Please mail promptly to:

FLOYD CLYMER

My Name: _____

Address: _____

Overdrive Studebaker Automatic
Excellent Average Unsatisfactory
Fair Poor
Satisfactory Too high Too low
wonderful

Report at left is from a
Champion owner who has
driven his '51 Studebaker
10,000 miles in four months

the '51 STUDEBAKER

The true test of an automobile begins when the owner takes the wheel. This is another report from owners of 1951 cars who answered questionnaires sent by Popular Mechanics to 1000 Studebaker owners from coast to coast

By Floyd Clymer

FROM MAINE to California busy Studebaker owners took time to fill out the detailed Popular Mechanics questionnaires about their cars and send them in. The returns came from 24 states and the District of Columbia.

Studebaker owners are definitely articulate about their cars as testified by the hundreds of words written on the backs of the questionnaires. As a glance at the percentage chart will show, the '51 owners as a group are pleased with their cars. Of course, there's an occasional brickbat along with the good sound criticism. The survey brought forth a general round of cheers for the visibility that Studebaker pioneered so successfully in postwar cars. Owners also like the snappy pickup of the V-8 Commander and the Champion's fine maneuverability. Economy of operation is another favorite feature.

Our survey shows that 55 percent of the owners have bought Studebakers year after year. Their reasons range all the way from the man in Tombstone, Ariz. (population 822), who says he buys Studebakers because the only dealer in town sells them,

Excellent Average Unsatisfactory
 Fair Poor
 Satisfactory Too high Too low
 Had a Studebaker before _____
 you especially like? Economical - easy to handle
 TIZER? _____; HILLHOLDER? Yes;
 ? _____; APPEARANCE? Yes VISIBILITY? Yes
 ENGINE? _____

Valves: Side Overhead
 In-line V-type: 8 6
 I want my next car equipped with: Standard Trans.
 Studebaker Automatic Drive Other type of automatic trans.
 Super pressure, super cushion tires? no
 How much more? _____ lbs.
 Your reply will be held in strict confidence.
 My Name: _____
 Address: _____

ENGINE? _____ APPEARANCE? Yes VISIBILITY? _____
 The car? A little too small a motor for a coupe but in town it could use more H.P.
 Had a Studebaker before? Yes If so, how many? 1
 Studebaker? Yes Possibly No
 ? Yes Fair No

With "picture" windows all around, the test car, a Commander Starlight Coupe, has excellent visibility



Bought overdrive	68%
Bought Studebaker Automatic Drive.....	24%
Bought standard transmission	8%
Average gasoline mileage, Champion (country) 23.1 m.p.g.	
Average gasoline mileage, Champion (city).....	19.6 m.p.g.
Average gasoline mileage, V-8 (country).....	18.9 m.p.g.
Average gasoline mileage, V-8 (city).....	17.1 m.p.g.
Use regular gas.....79%	Use premium gas.....21%
Mileage increase by overdrive.....	3.4 m.p.g.
Change oil	96%
Average mileage for oil change.....	1449
Add oil	4%
Average mileage for adding oil.....	1180
Maneuverability excellent	83%
average	17%
unsatisfactory	0%
Acceleration outstanding	44%
average	53%
poor	3%
Road clearance satisfactory	98%
Road clearance too low	2%
Champion model (6-cyl.).....	74%
Commander or Land Cruiser (V-8).....	26%

BEST-LIKED FEATURES

Visibility.....	99%	Hillholder.....	97%
Climatizer heating system.....	95%		
Brakes	94%		
Body styling and appearance.....	78%		

(These percentages are based on the fact that some owners commented on more than one feature.)

How does car handle on the road?

Excellent	51%	Very good	37%
Satisfactory	7%	Fair	5%

Why did you buy a Studebaker?

Price and economy	38%
Previous Studebaker experience	32%
Studebaker reputation and owners' opinions.....	16%
Styling, general appearance	7%
Various other reasons	7%

Opinion of new V-8 engine

Excellent	48%	Very good	27%
Satisfactory	23%	Unsatisfactory	2%

RATING OF CAR

Excellent	56%	Good	34%
Average	8%	Poor	2%

GENERAL INFORMATION

Prefer V-type engine.....	54%	Prefer in-line engine	46%
Prefer eight cylinders.....	54%	Prefer six cylinders.....	46%
Prefer overhead-valve system	61%		
Prefer side-valve arrangement	39%		
Prefer conventional transmission with overdrive.....	66%		
automatic transmission	29%		
conventional only	5%		
Prefer Studebaker Automatic Drive.....	88%		

(The above figure means 88% of the 29% preferring automatic transmissions.)

Prefer auto. trans. other than Studebaker auto. drive.....	12%
Owners who like low-pressure tires	77%
Previous Studebaker owners	55%
Will buy another Studebaker	70%
Might buy another Studebaker	29%
Will not buy another Studebaker	1%
Dealer service good	70%
Dealer service average	23%
Dealer service poor	7%

Most disliked features . . . Sedan rear doors opening from front, dash location of rear-view mirror.

to the 12-time buyer who has a new Land Cruiser with overdrive and says: "The ride is tops . . . I have had satisfactory Studebaker service since 1935. Why should I change?"

Not all the '51 owners are sold on the torpedo design of the front end. Sprinkled through the reports are such comments as "dislike front end . . . I think the '49's front is better looking . . . bit radical in front-end appearance . . . dislike 1951 grille . . . perhaps the front end is slightly radical." In all fairness to Studebaker, however, the great majority of owners approve of the styling.

Several owners mentioned that they dislike the way the rear doors on the sedan open from the front. (I do too.)

A V-8 owner wrote, "The car has exceptional acceleration and practically no engine noise at driving speed." Another said, "I have owned Studebakers for 25 years and every one was a good car." The owner of a new V-8 observed that "the simple automatic transmission operates through driver's choice and not by itself." A Champion Automatic Drive owner says, "For the money, it is the best buy on the market." A V-8 owner says, "This car is excellent, and it has plenty of power in the mountains and is very fast on the open road. I have owned 10 Studes since 1910." Another says, "The V-8 is good . . . but has considerable tappet noise." (This is not uncommon in any overhead-valve engine.)

Clymer uses a portable machine to record his test observations. Also shown are vacuum gauge and gas-consumption meter



Available in Studebakers for many years, the hillholder is among the best extras ever offered, Clymer says. It is mounted on the master cylinder, right. The sketches, below, show how it works. 1. The car is stopped normally. 2. Foot can be removed from brake pedal, but car won't roll backward while clutch is depressed. 3. To drive ahead, the clutch is released and the accelerator depressed. 4. This releases the brakes as car moves ahead

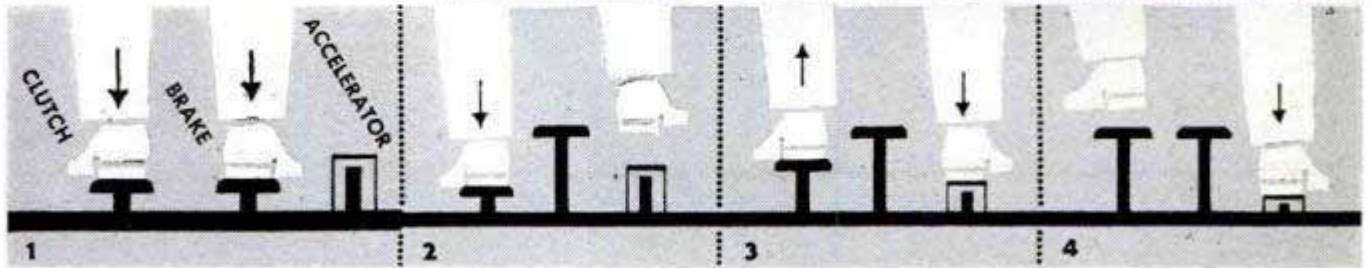
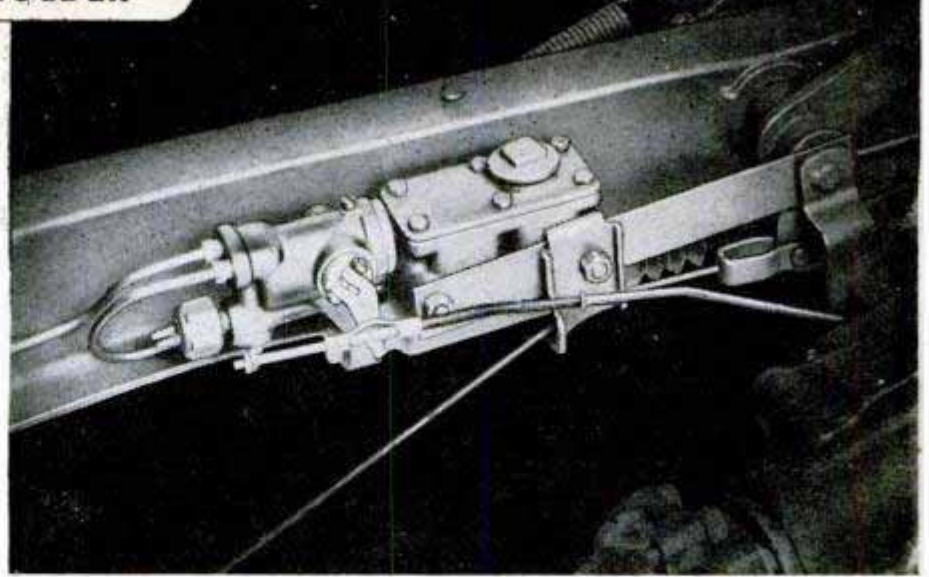

One owner writes: "It has a 'feel' on the road that no other car has and I have owned many different makes."

To the question, "Why did you buy a Studebaker?" one answer was: "Because my previous Studes have given me trouble-free and economical service; I get a high trade-in price . . . and because of my previous experience with Studebaker dependability." Several mentioned in the questionnaire that their Studebakers start easily in cold weather.

An enthusiastic owner of a V-8 with Automatic Drive said he averaged 17½ miles per gallon for 2200 miles, mostly at 80 miles per hour. Another V-8 owner (whose foot was lighter on the accelerator) reports that "on several trips under ideal conditions I did 27 miles per gallon, and on the whole the Studebaker is the best buy I ever made." More than half of the owners

make some mention of the car's economy of operation — gasoline, oil and general maintenance. One man writes: "My first Studebaker gave me 77,000 miles with no repairs." The percentage chart shows 38 percent giving the reason of price and economy after the question, Why did you buy a Studebaker? Actually the percentage of those mentioning economy as an outstanding feature of the car would run into a much higher figure because remarks on this subject are combined with other answers throughout the reports. An example is from a Kansas owner who says his four-door sedan "holds the road at high speeds for a light car. Easy on the oil and gas bill." This man gets 27 miles per gallon in the country.

A few owners dislike the location of the rear-view mirror (mounted on top of the instrument panel instead of at the top of

ACCELERATION TESTS

Studebaker Commander V-8 with Automatic Drive

Standing Start



(In tests using both Low and Drive ranges, shift was made at 35 m.p.h.)
Top Speed (by speedometer) — 102 m.p.h.
Actual top speed, about 7% less (speedometer variation).

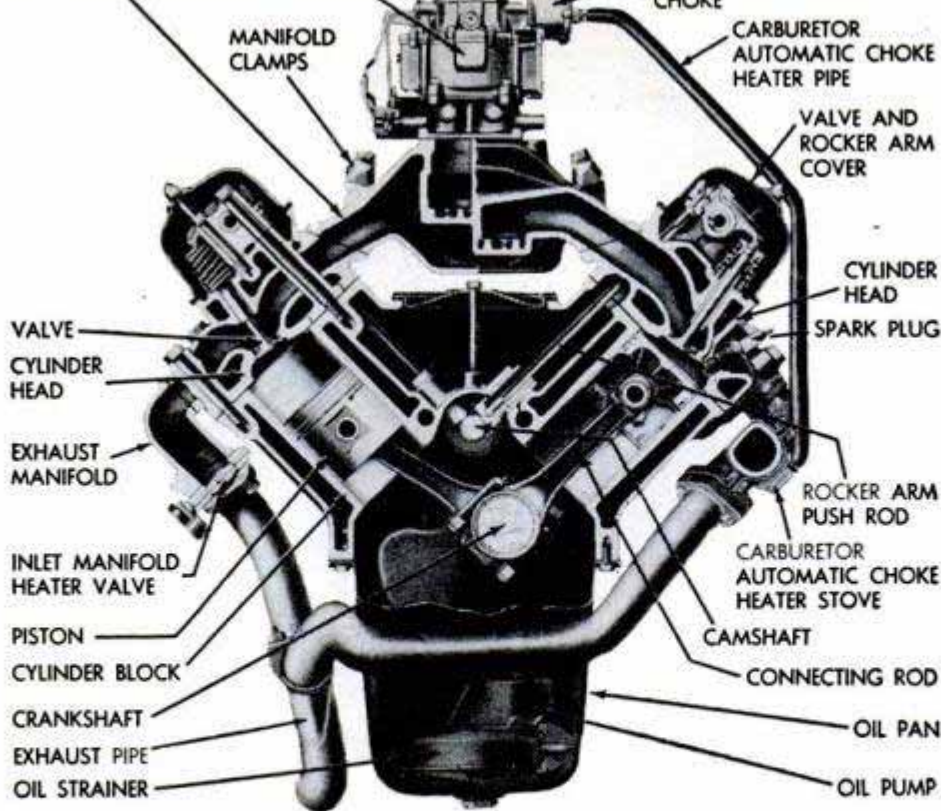

Cross-section view from the front of the new Studebaker 120-horsepower V-8 engine with overhead valves. This is the engine Floyd Clymer tested

the windshield, as in most other makes). One man complains that "the power plant is excellent but noisy and slow to warm up when cold . . . and the springing is too soft." Still, he rated the car "excellent."

Another says, "The Studebaker is a good all-around family car, but the seats are rather low and I can't tell where the right-front fender is." After paying tribute to his Champion's visibility, an owner in New York says the front fenders should be set back six inches for "better protection and increased beauty and streamlined effect."

(I wonder what designer Raymond Loewy will think of that suggestion!)

The owner of four different model Studebakers says: "The engine is tops; it really takes a beating." Another: "I drove a 1950 Champion 36,000 miles without spending a cent for repairs, not even tires, so I certainly will stick with Studebaker."

While boosting the car in general, some other owners stated that the steering ratio is too low and they have to turn the steering wheel too much. One was satisfied with the car generally, but says, "There is not

In 1910, 14-year-old Clymer (at wheel) and his 11-year-old brother left Denver for Spokane in this Studebaker-Flanders. Battling sand, mud and mountains, they finally had to give up and complete trip by train

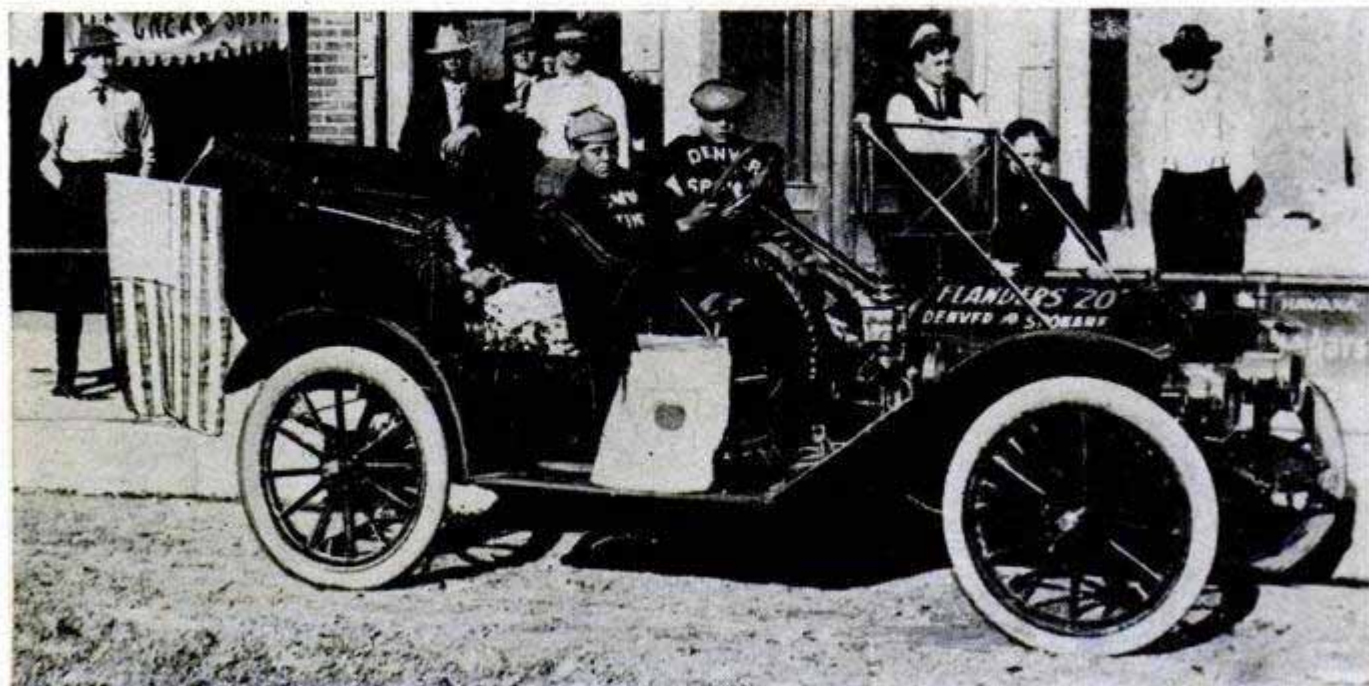

**CLYMER'S ECONOMY TEST OF
THE STUDEBAKER V-8 COMMANDER
WITH AUTOMATIC DRIVE**

MILES PER GALLON

At constant 30 m.p.h.....	25.42
At constant 50 m.p.h.....	19.71
At constant 60 m.p.h.....	17.95
At constant 75 m.p.h.....	14.32

MILEAGE AFTER CAR WAS BROKEN IN

Omaha, Neb., to Cheyenne, Wyo.....	19.32
Cheyenne to Salt Lake City (High-speed driving, some mountains, strong head wind).....	14.61
Salt Lake City to Los Angeles.....	22.09

enough brake surface, and it requires too much pedal pressure to stop at high speed with six persons in the car."

One of the most popular reasons for buying a Studebaker—and probably every other car—is the recommendation by other owners. Other reasons, aside from economy and dependability, which showed up in the survey include, "because it's a light car and easy to handle in traffic," "good dealer service," "I liked the lines."

There were some humorous answers too. One man said he bought a Studebaker "because my father-in-law thinks it is the best buy and is helping finance the car," and "because it is so small and also big." (How's that again?) Another says, "I like the

To see how the Studebaker handles off the pavement, Clymer drove the test car over miles of poor roads

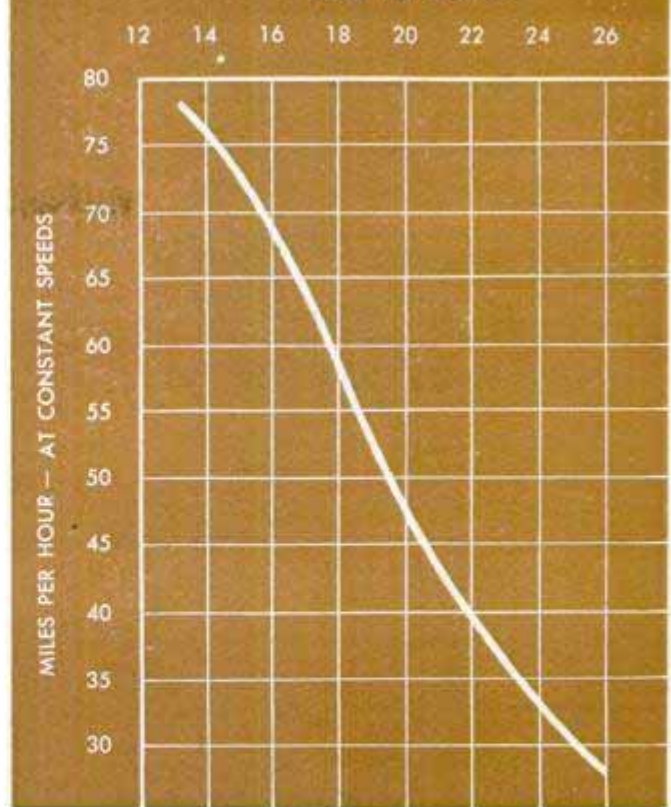

Automatic Drive because I'm too durned lazy to shift." A safety-first-minded owner was displeased because of "failure to put an ash tray on the driver's side, which is bad, as throwing cigarette butts out the window is dangerous and might start a forest fire."

A Champion owner says he likes the way the Studes eat up the road, and that he had driven 85,000 miles before the engine needed a valve job.

An enthused V-8 owner says his car has the fastest getaway of any car he has ever known. (I certainly agree with him that the V-8 Commander has excellent acceleration.) One man reports: "Studebaker is the only car I can buy in my town that is not loaded with extras. All I want is economical transportation and no frills."

Several owners are loud in their praise of Studebaker dealers' service. One of them says: "My Studebaker dealer takes personal interest in seeing that I get good service." A quick-on-the-trigger buyer says: "I just saw it in the window and it looked so sharp I bought it without even driving it, and I'm sure satisfied."

Complaints include "not enough head-room in my sedan," and "the starter pull lever is too close to the hood latch." (I agree with the latter.) Some reported "too many rattles."

Few Studebaker owners reported many serious dislikes and most of those who had a complaint still gave the car a satisfactory rating. Typical is the owner who said there is not enough room between the front and back seats and went on to give glowing approval of Climatizer and the car's visibility. Nearly every one who mentioned

(Continued to page 262)



Firestone Tire & Rubber Co., Akron, Ohio

Punctureproof Tube Made Entirely of Butyl

Three layers of butyl retain the air in a new lightweight, punctureproof tube, the first of its kind to be made entirely of this synthetic rubber. The inner layer is a special soft butyl that flows around a nail or a similar sharp object to prevent loss of air, and the middle layer of specially compounded butyl resists tearing or enlargement of puncture holes. The surface layer is extra tough and heat resistant.

Nonsticking Zipper

You can't jam a new zipper that has a release mechanism for use when fabric or any material is caught in the teeth. A quick turn of the pull tab releases the imprisoned material without damaging either it or the zipper. It is available in many lengths and colors.

Lee Zipper Co., 350 Fifth Ave., New York City 1

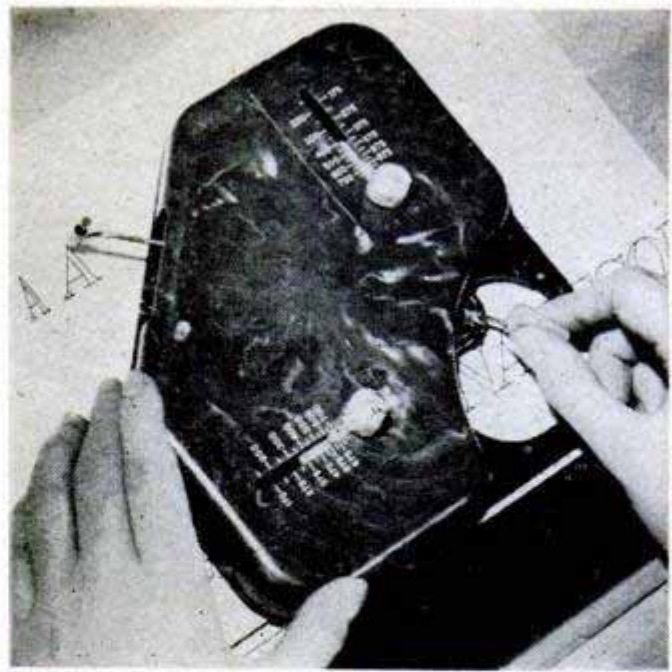
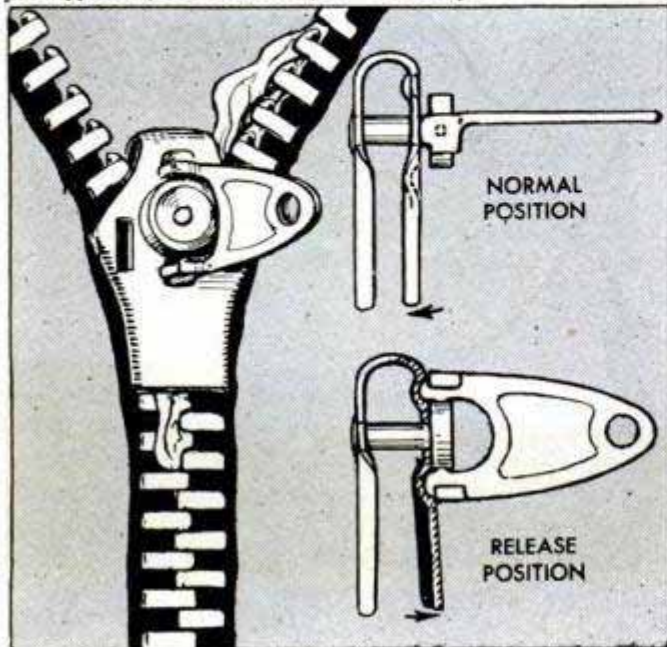

The Varigraph Co., Inc., Madison 1, Wis.

Lettering Machine Adjusts for Size

You can make your lettering letter-perfect with a machine that uses any one of more than 60 templates, each with a different type face. In addition, you can adjust the width and height of the letters as you wish simply by setting two scales on the face of the machine. As you follow the lines of the template with the stylus, a lettering-pen point forms the letter in the size you want. The housing, made of lightweight Tenite, can be reversed for use by a left-handed person.

Crystals Amplify X Rays

Laboratory-grown crystals which amplify X-ray energy a million times may be put to work inspecting industrial products. When the crystals are excited by X rays, they release torrents of electrons which can be used to operate various mechanisms. For example, canned food can be passed between an X-ray machine and the crystal to locate partly filled cans and cans which contain foreign matter. The crystal, which was developed by General Electric X-Ray Corp., does the work that is ordinarily performed by a complex system of vacuum tubes and amplifiers.

Ore Reserves for 125 Years

If U. S. steel mills consume an average of 100,000,000 tons of iron ore annually, there will still be enough iron ore available for 125 years. Over half of an estimated 12,500,000,000 tons of reserve in the U. S., Canada and South America is in Brazil and the Lake Superior district. According to Wilfred Sykes, chairman of the Inland Steel Company's executive committee, the actual reserves will probably prove considerably larger than the estimates.

Ride As You Mow

Now they've taken the walk out of lawn mowing with a power mower that you ride like a tiny tractor. Powered by a 2 or 3-horsepower engine, the mower cuts a 20-inch strip with its rotary blade. Hidden under the frame, this blade can be quickly sharpened with a file. The cutting height is adjustable from 1 to 3 inches. Attachments, including a heavy lawn roller and dump cart, are available for the machine which weighs 180 pounds.



The Belknap Mfg. Co., Bridgeport, Conn.

Flashy Ornament

Connected to the ignition system, an arrow-shaped plastic ornament adds a colorful flashing light to the hood of a car. When the engine is idling, the neon tube inside the plastic twinkles on and off, but as the engine accelerates, the tube glows steadily.

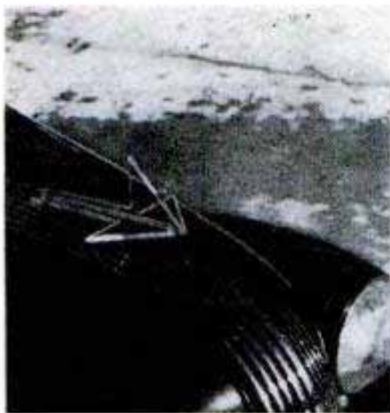

Flicker Lights Mfg. Co., Grand Junction, Colo.

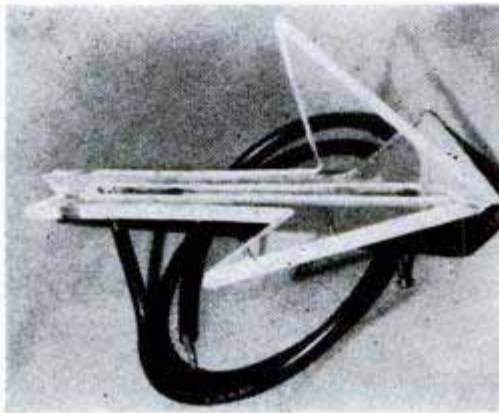

Tubeless Tire Is Punctureproof

Punctures and blowouts are taken out of the danger class and changed to mere annoyances by a tubeless tire that is punctureproof and blowout-safe. Because no inner tube is used, the inside walls of the tire are coated with a self-sealing compound to prevent air loss. A nail cannot cause a leak because it is surrounded by this sealing compound as it punctures the tire. The compound stops any air loss, sealing the hole when the nail is withdrawn. When a blowout occurs, about two thirds of the air is kept in the tire by an inner diaphragm that has an automatic valve. This air pressure is ample to support the car safely at any speed.

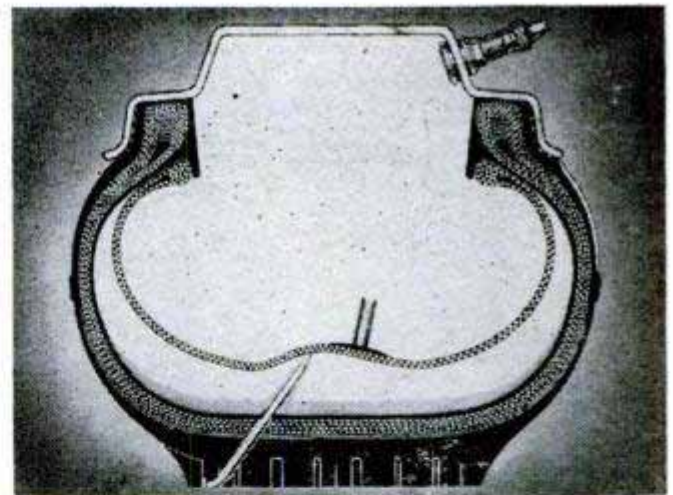

Firestone Tire & Rubber Co., Akron, Ohio

Concrete Cuts Radiant-Heat Costs

Special aggregates for concrete reduce the cost of radiant-heating installations by 25 percent by increasing the heat conductivity of the concrete. This added conductivity permits a reduction in the piping used. Wearing qualities of the concrete are also improved, according to Products Planning Co., Blakewell Bldg., Pittsburgh, Pa., developers of the aggregate.

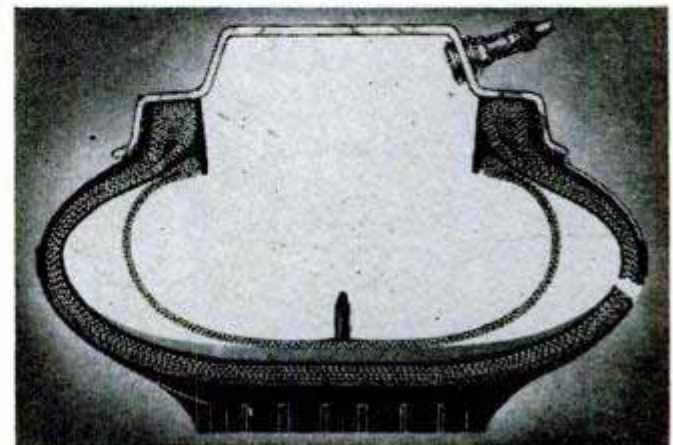

WHAT'S NEW

For Your Home



OUTDOOR ARMCHAIR is pleasing to see and to sit on. One-piece expanded-metal construction makes it light in weight, yet gives enough resiliency for comfort. An important extra is the sliding tray that becomes a handy chairside table at refreshment time. When not needed, the tray slips neatly out of way under the seat. Chair is both snag and rust-proof

Wheeling Corrugating Co., Wheeling Steel Corp. Bldg., Wheeling, W. Va.

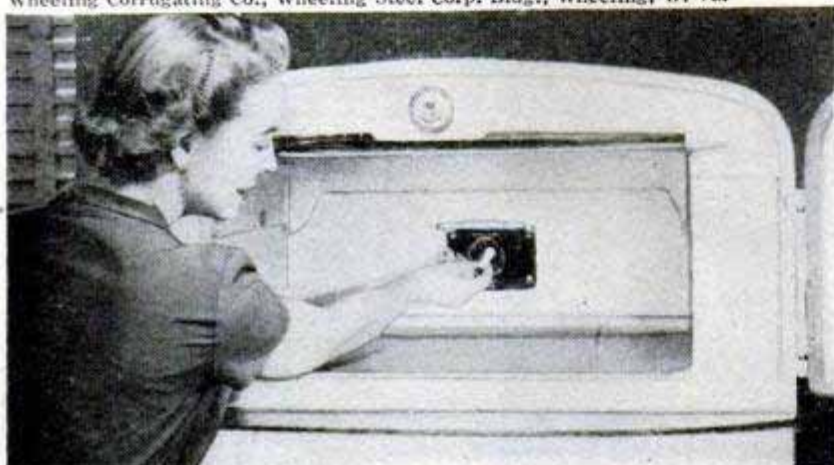

DEFROST CLOCK, left, automatically takes over once a day at a preset time and defrosts refrigerator. Both freezer and main food compartment are cleared of ice. Heaters and evaporators do the job so quickly that food remains frozen

Philco Corp., Philadelphia 34, Pa.

WINDOW FAN, below, is especially designed to mount on casement windows as either an intake or exhaust fan. Because of its shape, it will stand on floor or table to serve as a circulating fan

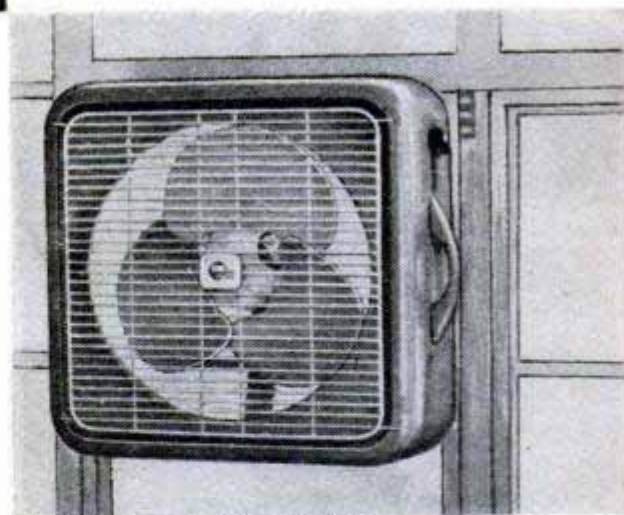

The Lau Blower Co., Dayton 7, Ohio

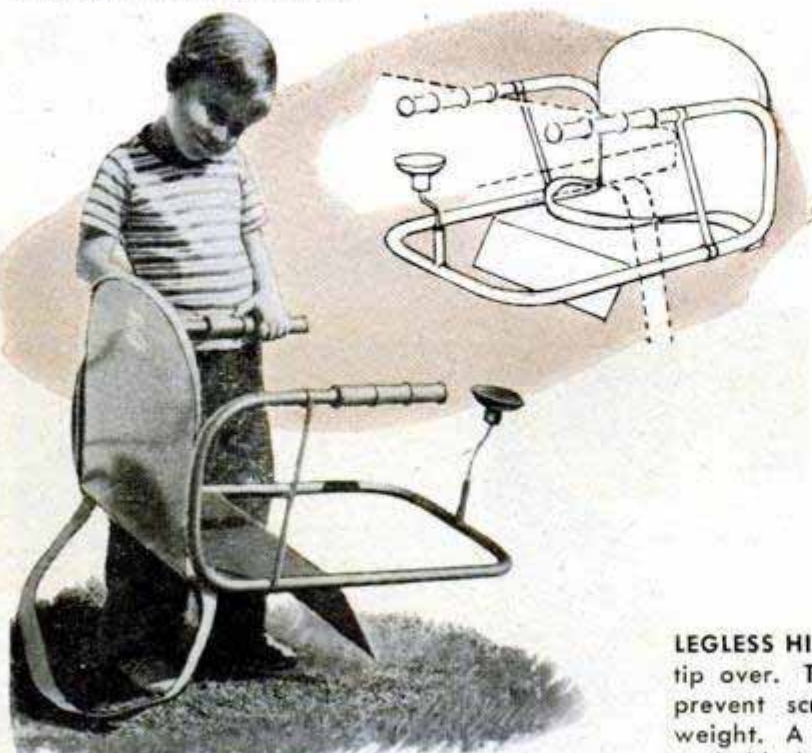

LEGLESS HIGH CHAIR hooks over the table top and can't tip over. Two extended arms, covered with rubber to prevent scratches, rest on the table, supporting the weight. A suction cup grips the underside of the table to hold the chair firmly. Lightweight, it is all metal

Sullivan Mfg. Co., 2114 West Monte Vista Road, Phoenix, Ariz.

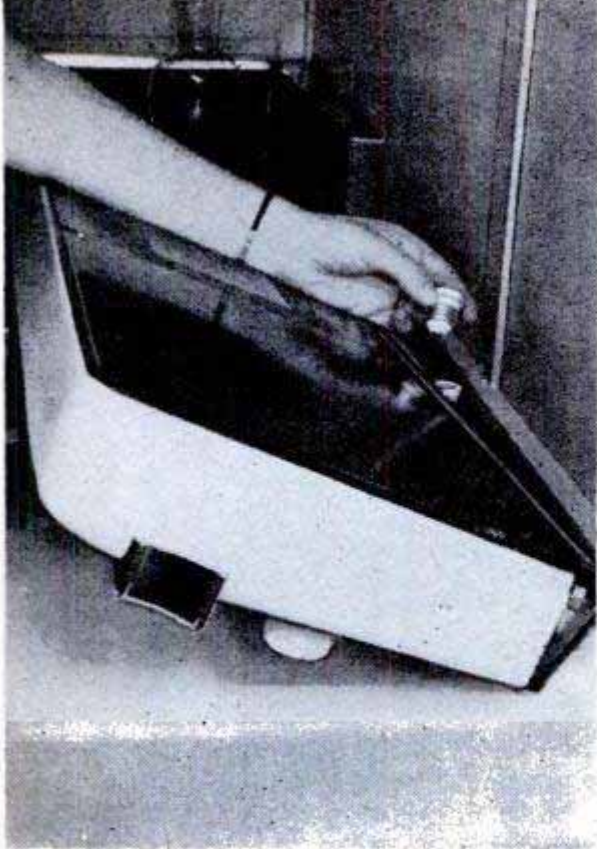

Philco Corp., Philadelphia, Pa.

SPRINKLER HEAD, at right, is made of molded rubber and requires no washer. It won't scratch paint when used while washing the car. The aluminum faceplate forms a fine spray



Surf Mfg. Co., 333 N. Michigan Ave., Chicago 1

SLIDING GRIDDLE, above, on electric range enables you to make pancakes and broil the sausages with same heat! Above, left, range has hinged back for replacement of fuses

RADIANT PLATTER, below, keeps food hot for hours without drying it out. It does it with radiant heat. The platter is made of glass and detaches from a wood base for washing

BOOK ENDS, below, solve the book-display problem neatly. A spring keeps canvas band taut, holding books up. When you remove one book, the ends slide in to prevent toppling



Appleman Art Glass Works, Bergenfield, N. J.

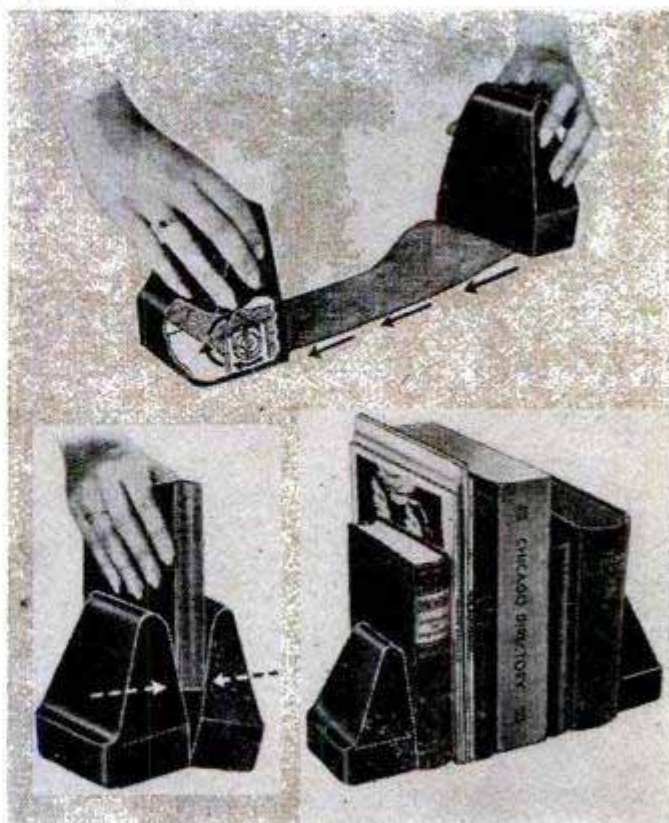

Lordell Corp., 219 W. Chicago Ave., Chicago 10



Survival Rifle

Lightweight survival rifles are being added to the emergency kits of the Strategic Air Command's bomber crewmen. The kits provide the means to keep them alive if they are forced down in remote areas

during long-range flights. The new weapon, which will fit into the pocket of a flying suit when disassembled, weighs 3½ pounds. With the stock extended its length is only 33 inches. Despite a short barrel, the rifle is fairly accurate up to 150 yards and will kill small animals needed for food.

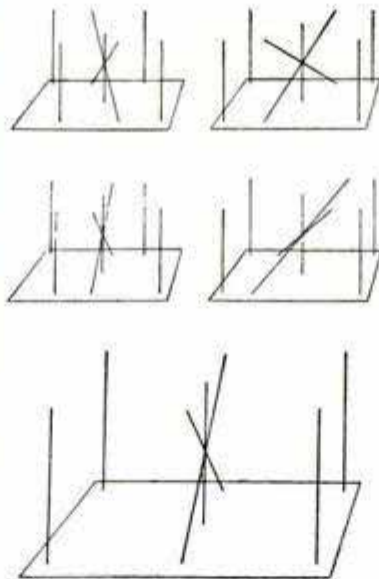

Instrument Checks Eyes For Odd Visual Condition

Eye specialists can detect and correct a strange visual condition called aniseikonia with the aid of a new optical instrument. Eyes afflicted with aniseikonia transmit two different ocular images to the brain. The victim often suffers puzzling headaches, eye pain, motion sickness and nervousness. Only a few instruments have been made in the past for detecting this condition, but the new instrument is intended for general office use. It enables an eye examiner to measure accurately the unequal images within the brain. Complex lenses then are prescribed by specialists to correct the patient's unusual visual condition.

American Optical Co., Southbridge, Mass.

Above, complicated lens system inside the instrument measures the unequal images within the brain where seeing takes place. At bottom right is the test pattern seen by normal eyes. Above are two sets of patterns seen by victims of odd visual condition

Angler's Aid

Just about all the accessories a fisherman may need are included in one versatile tool small enough to fit in the tackle box. There's a tapeline for measuring the catch and a scale for weighing it. Other parts of the tool are used for scaling fish, releasing hooks, cutting line, opening bottles and sawing. A miniature first-aid kit holds two bandages, tweezers, a razor blade and a vial of iodine.

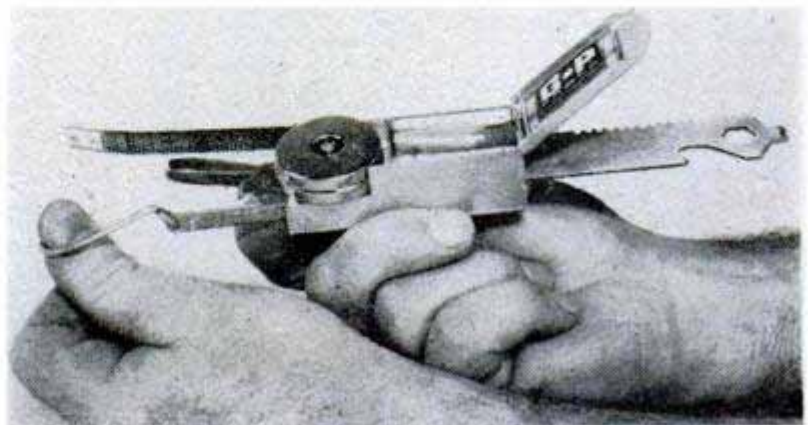

Jiffy Specialty Co., Box 8022, Fort Worth 5, Tex.

POPULAR MECHANICS

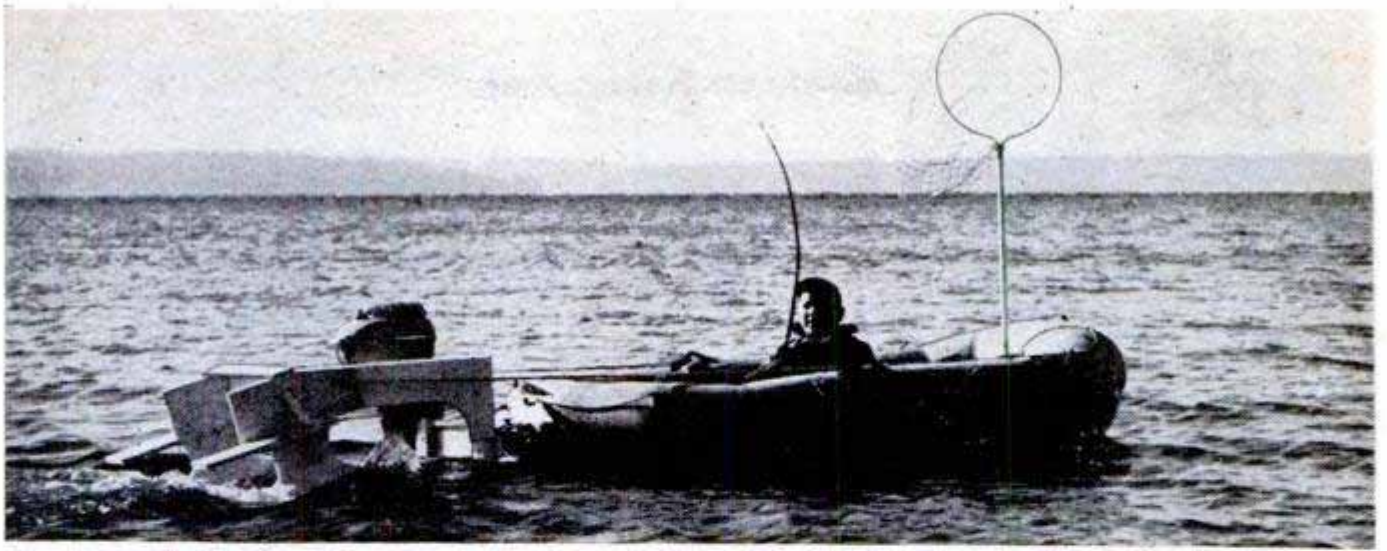

Floating Trailer Powers Rubber Boat

WHEN Robert R. Zastrow of Seattle, Wash., first tried to motorize his war-surplus rubber raft, he ran into trouble—the outboard motor broke away and sank unhesitatingly to the bottom of Puget Sound.

To prevent that from happening again, he decided to mount the motor on floats. By building a plywood “harness” for the motor and mounting it on two teardrop-shaped antennas from junked warplanes, Zastrow made a solid platform for his motor. This floating trailer is attached to the stern of the raft by a single pivot so that it can be swung from side to side to act as a rudder. The floats are set at a 30-degree angle to keep them from digging into the water. Zastrow uses the boat all year ’round for fishing in the sound and says it is seaworthy even in rough weather.

Top, with the outboard motor mounted on a floating harness, the small rubber boat is comfortable and seaworthy. Above, right, the “trailer hitch” for the motor float is mounted on a wood block inside the flap on the boat stern. Right, the motor float out of water. Below, the motor doesn’t hinder beaching

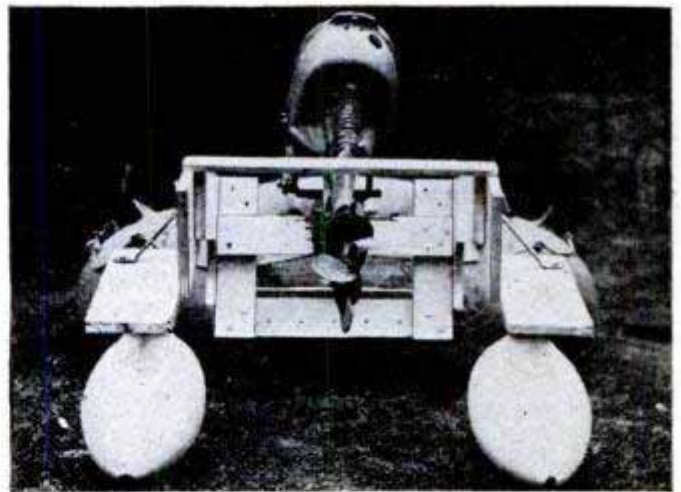
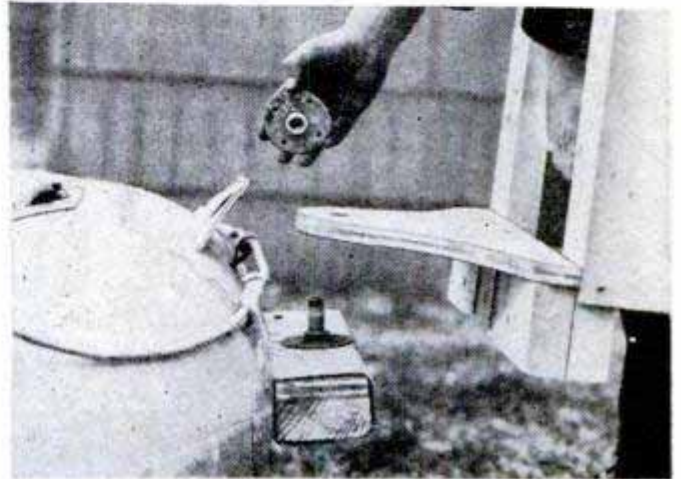



**WE'RE BACK
IN BUSINESS**
—the Seabees



Official U. S. Navy photos

As evidence that they are now a part of the Navy's amphibious forces, the young Seabees above get shooting tips from a Marine officer. The mobile, 19-ton crane hauling in a landing boat below lifts 75-ton loads

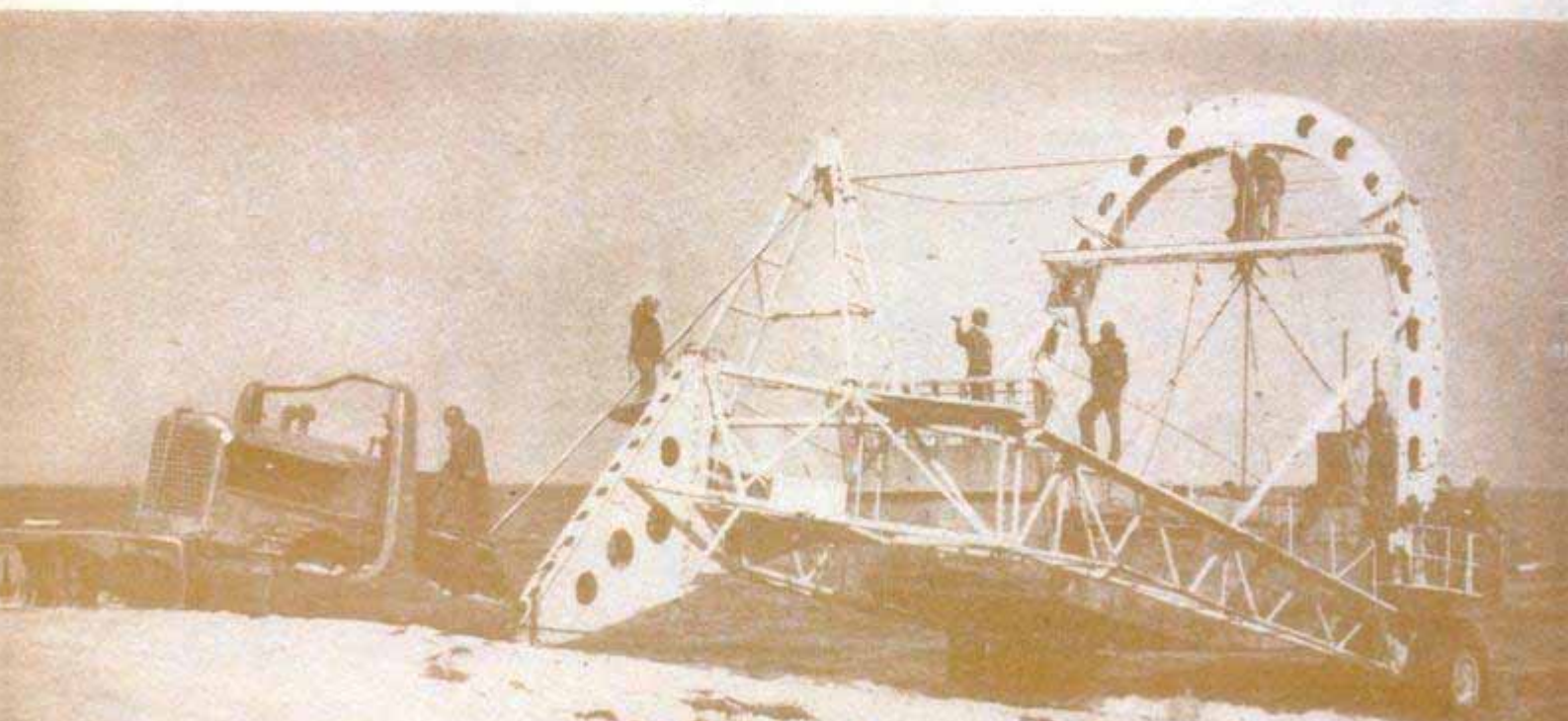



In settings remindful of the last war, troops and supplies came ashore in Korea over sturdy pontoon piers

By Andrew Hamilton

YOU HAVEN'T READ much about them, but the Seabees have been in the thick of the Korean fight ever since the great Inchon landing. When the Marines hit the Wolmido beaches, the Seabees were along too—building and fighting as usual.

They laid pontoon causeways for the unloading of troops and materiel. They rebuilt docks and warehouses. They helped to carve out emergency air strips. They “liberated” North Korean locomotives.

And already new legends about their activities are growing. When Communist snipers in a cave were annoying the Marines near Inchon, a husky Seabee cat-

skinner—as was done frequently in World War II—dipped his 'dozer blade, sealed up the hole and went back to grading a road.

It's a new kind of Seabee organization. The old “can do” spirit is still there—as Korea has proved. But there are new kinds of men, and they're organized differently. They have improved tools and techniques with which to work.

In World War II the Seabees participated in every major amphibious operation conducted by American fighting forces—even including the Rhine crossing. They built 111 air strips, 301 advanced bases, 441 boat and ship piers, 558 ammunition magazines, 700 acres of warehouses, hospitals for 70,000 patients, storage for 100,000,000 gallons of

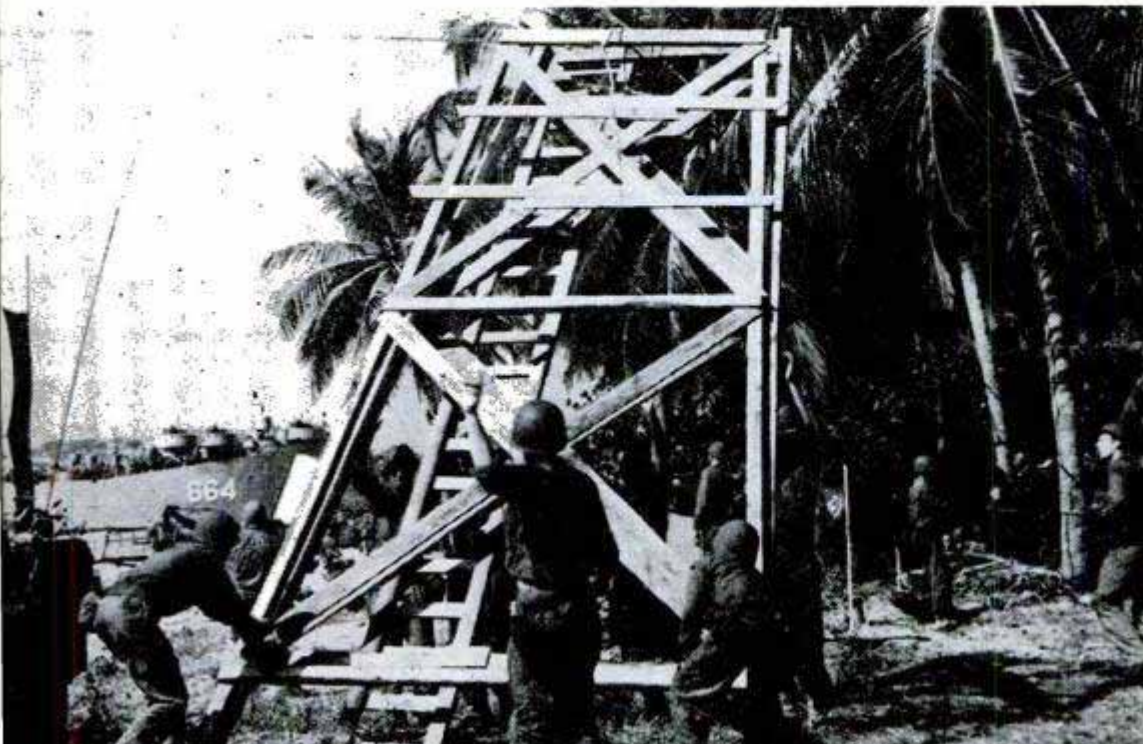

Carpenters erect a control tower for beachmasters during training maneuvers in Caribbean

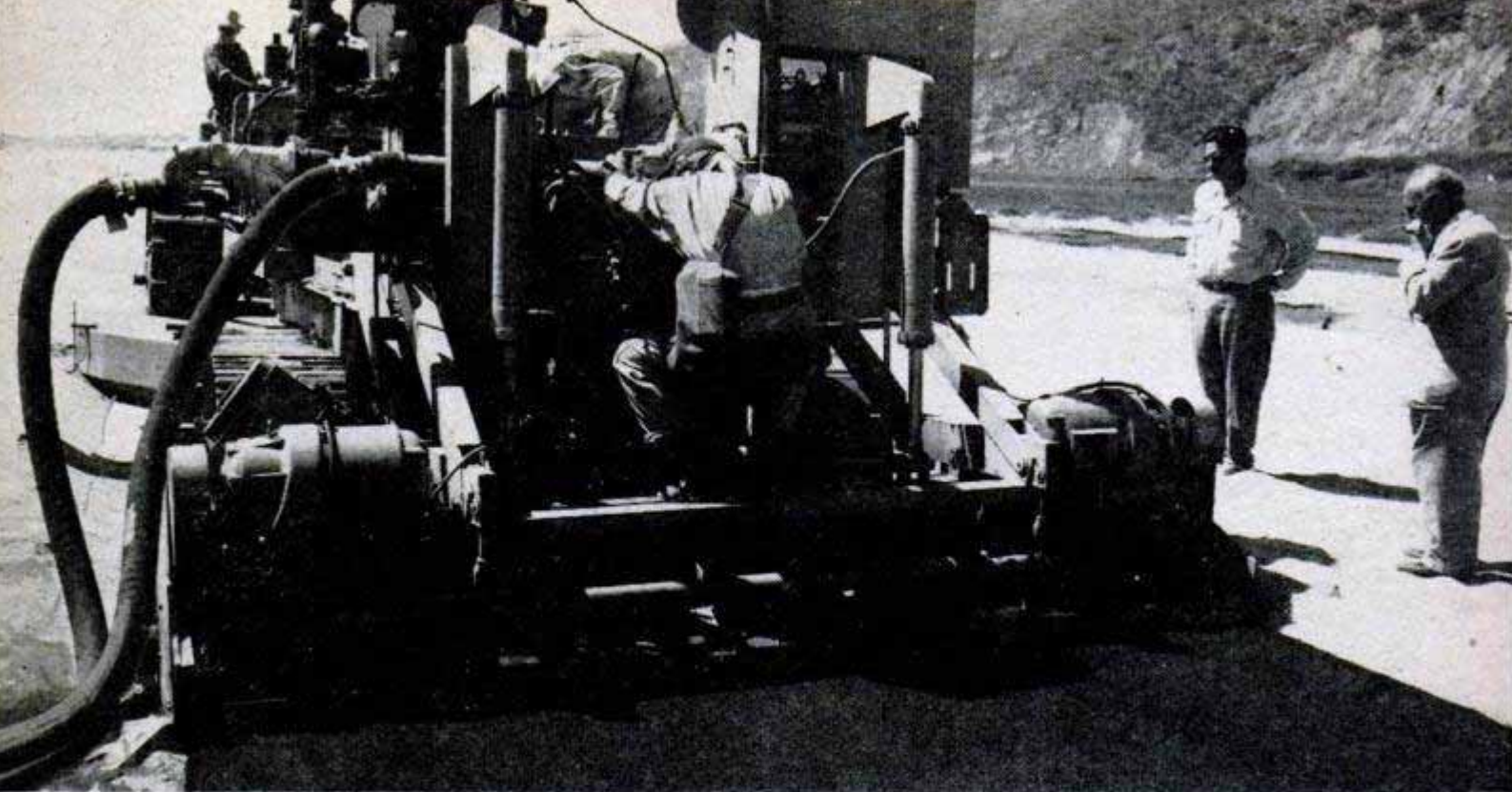

Sand mixed by this machine with a compound made partly from corncobs produces an asphalt-hard pavement

gasoline and housing for 1,500,000 men.

At their peak strength the Seabees had 247,000 officers and men. Four years later there were only 6000—mostly caretakers and maintenance men at the Navy's overseas bases. Now, however, the Seabees are rapidly expanding both active and reserve units, and by the end of 1951 the Navy plans to have a reserve force of at least 75,000.

The Seabee of World War II was the plumber who fixed your leaky faucet, the crane operator who dug the foundation for the new City Hall, the carpenter, the steam-fitter, the electrician, the steel riveter.

Representing more than 60 skills and professions, they were older men (some units averaged 34 years in age) who joined the Navy as a patriotic duty. They held so many petty-officer ratings that, as an individual group, they were one of the highest paid in the war.

The new Seabees are being recruited from the Navy's "boot camps"—17, 18, 19-year olds—and trained from the ground up. Reservists, too, most of whom saw action in World War II, are being called back to duty. But many of today's Seabees didn't know a Stillson from a sheep's-foot roller

Since the next war may be fought in the Arctic, the Seabees are working on devices like this snow compacter

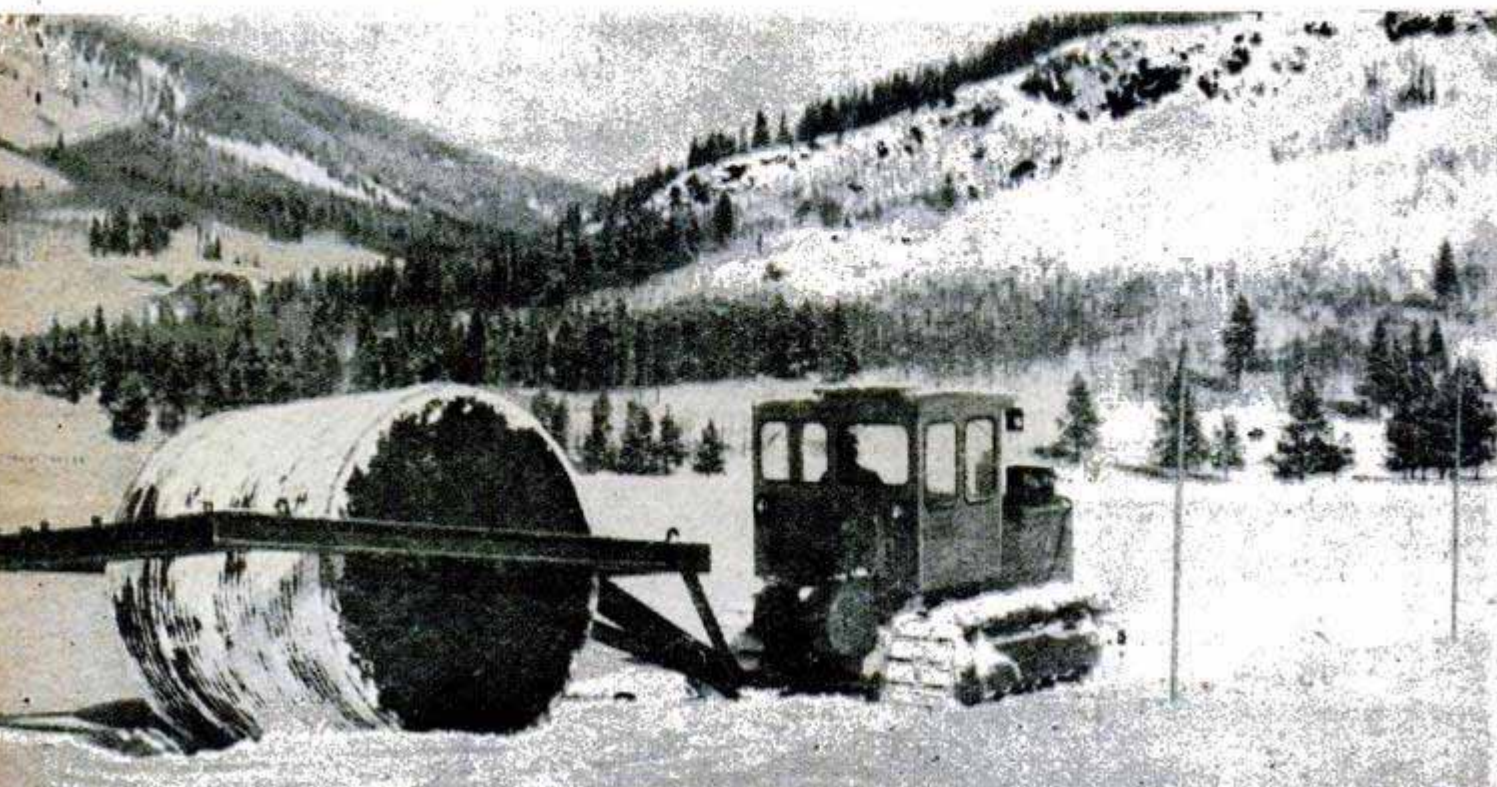

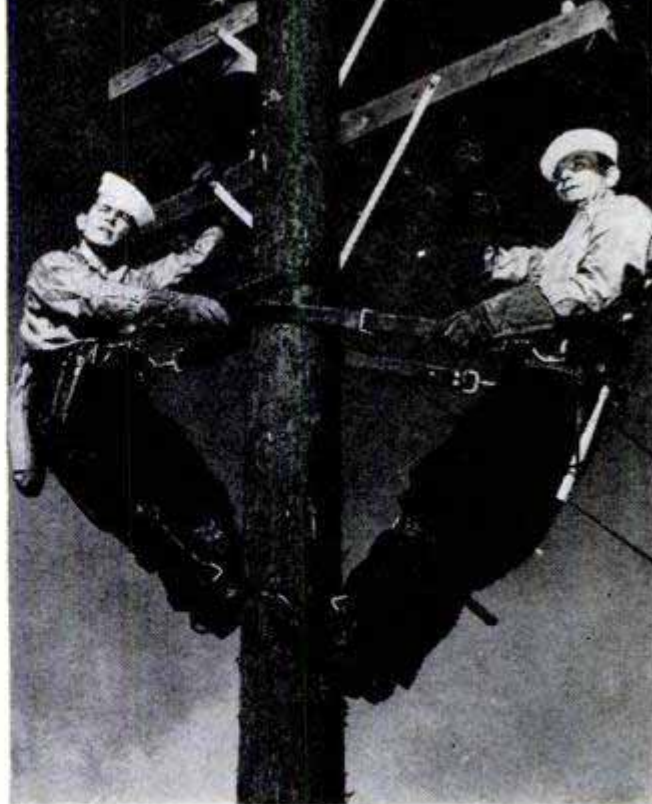
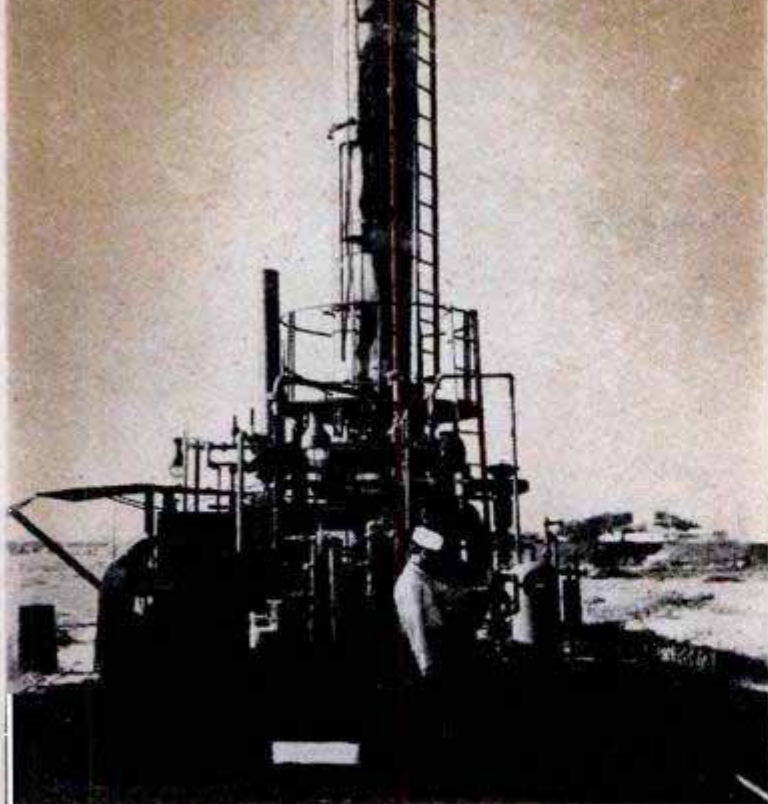

Adapted to amphibious operations, the Lumus topping plant, left, is the world's smallest refinery. A 17-year-old volunteer, on left side of pole, gets expert instruction in how to put up a transformer bank properly

before they donned Navy blue uniforms.

Ratings are different now, too.

"In World War II," said a reservist not long ago, "the Seabees were so new that the Navy didn't know how to classify them. Most of 'em got machinist's and carpenter's ratings—no matter what job they did."

But today the Seabees are classified and trained in seven major skills:

Builders—light construction, such as housing; heavy construction, such as docks and piers.

Drivers—including heavy construction equipment as well as automotive.

Surveyors—mapping and construction layout.

Electricians—including power and communications linemen.

Mechanics—both gasoline and diesel.

Steelworkers—structural and riggers.

Utilities men—boiler-room operators, plumbers, firemen, etc.

One of the important peacetime developments has been the integration of Seabee battalions into the Navy's over-all amphibious forces. Much experimental work has been done at Little Creek, Va., and Coronado, Calif. New techniques for using pontoons, those ever-valuable "building blocks," have been worked out. Ingenious machines, such as the giant Gilhoist crane for salvaging damaged landing craft have been perfected.

Once scattered all over the map, Seabee training is now concentrated at the big 530-acre Hueneme Naval Station, 60 miles north of Los Angeles. Here are the U. S.

Naval Schools, Construction—NAVSCON for short—which turn out newly trained Seabees at a rate which has been stepped up 750 percent since the Korean War began. There is an "A" course for beginners and a "B" course for those with some skills, but who need additional training.

Also at Hueneme is an officers' school for the Navy's Civil Engineering Corps. These are regulars who are making a career of engineering, or reservists who are graduates of schools and colleges of engineering. CEC officers provide the leadership for the Seabees. They know the job and "speak the language."

After Seabee officers and men are trained at Hueneme, they are organized and equipped for reassignment overseas. Part of their training consists of salvaging badly needed bulldozers, cranes, trucks and carryalls out of an enormous pile of "rusted and busted" equipment left over from the last war.

In World War II there were as many as 41 stevedoring battalions in existence at one time, comprising a total of 1350 officers and 40,000 men. Now, the stevedoring chores have been turned over to the Navy Supply Corps, and Seabee units are organized as follows:

(1) **Mobile Construction Battalions**—slightly larger than the World War II counterpart, now consist of 34 officers and 1083 men. The main emphasis is on building—barracks, airfields and roads.

(2) **Amphibious Battalions**—the same size as Mobile Construction Battalions, but

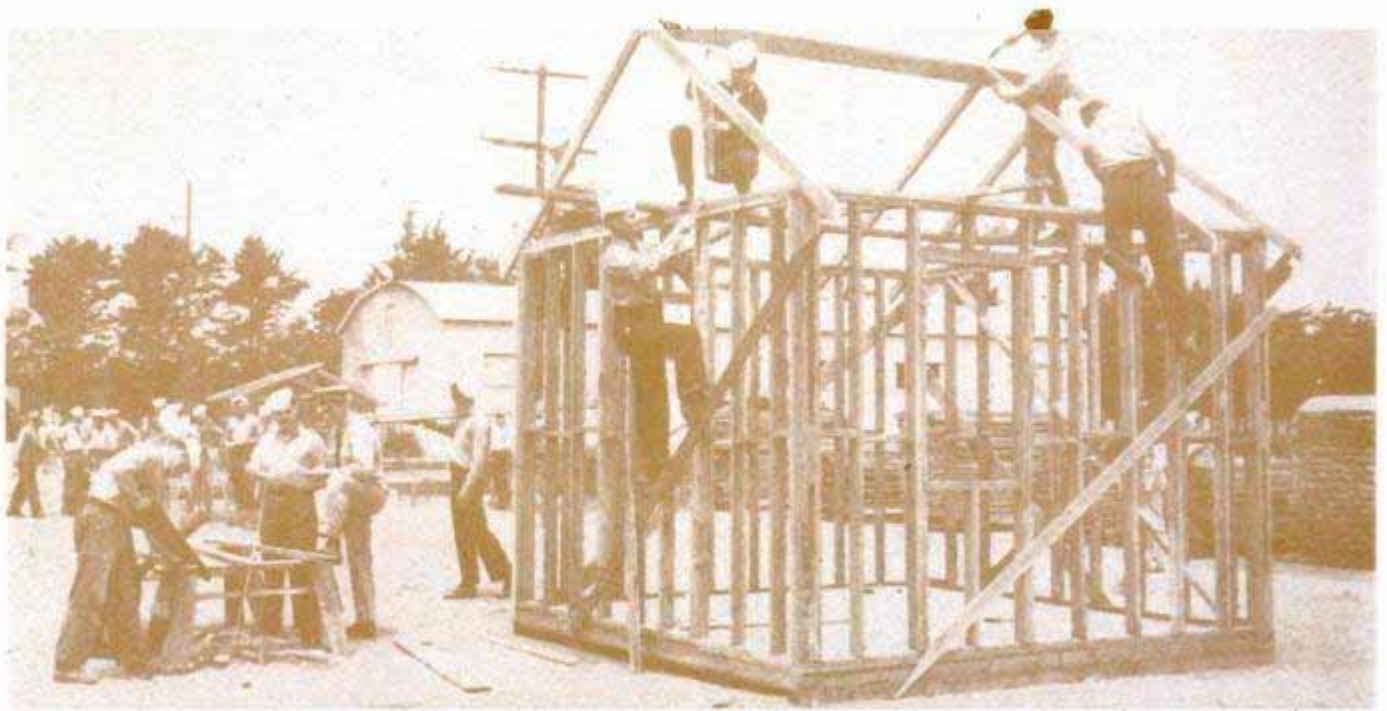

To qualify for new rating as a builder, trainees have to learn to erect buildings speedily and efficiently

especially trained to make amphibious landings and to build under fire.

(3) Special Detachment—these vary in size depending upon assigned job. Their principal work is maintaining a naval base.

Also at Port Hueneme is the Seabee Museum—consisting of the largest collection of Seabee battalion banners, plaques, handiwork, displays, mementos, captured Japanese equipment, scale-model ships and bases and memorable photographs ever gathered under one roof.

Associated with the great Seabee training center at Port Hueneme is the Bureau of Yards and Docks' Civil Engineering Research and Evaluation Laboratory. Housed in what was formerly the Navy's School of Justice, it contains an amazing array of devices, equipment and machinery. The 200 projects under way there will provide many new tools and working techniques for

the Navy's versatile seagoing craftsmen.

Because of the titanic struggle to get men, machines and supplies from ship to shore, the laboratory is conducting experiments in sand compaction. A machine has been developed which sprays the beach with an aniline-furfural compound (made partly from corncocks). Mixed and vibrated, the sand becomes as hard as asphalt paving. Within an hour it will accommodate a Jeep and within three hours will take tanks and bulldozers.

Another ingenious machine is a new type of pile driver captured from the Germans. Instead of cumbersome steam engines or compressed-air tanks to provide driving power, a small, "one lung" diesel motor is built right into the pile-driver head. As the driving head nears the timber to be thudded into the ground, the motor gets an

(Continued to page 270)

CONSTRUCTION RATES

When a sailor wears one of these patches on his uniform, it means he is trained in a particular skill



SURVEYOR



CONSTRUCTION ELECTRICIAN'S MATE



DRIVER



MECHANIC



BUILDER



STEELWORKER



UTILITIES MAN

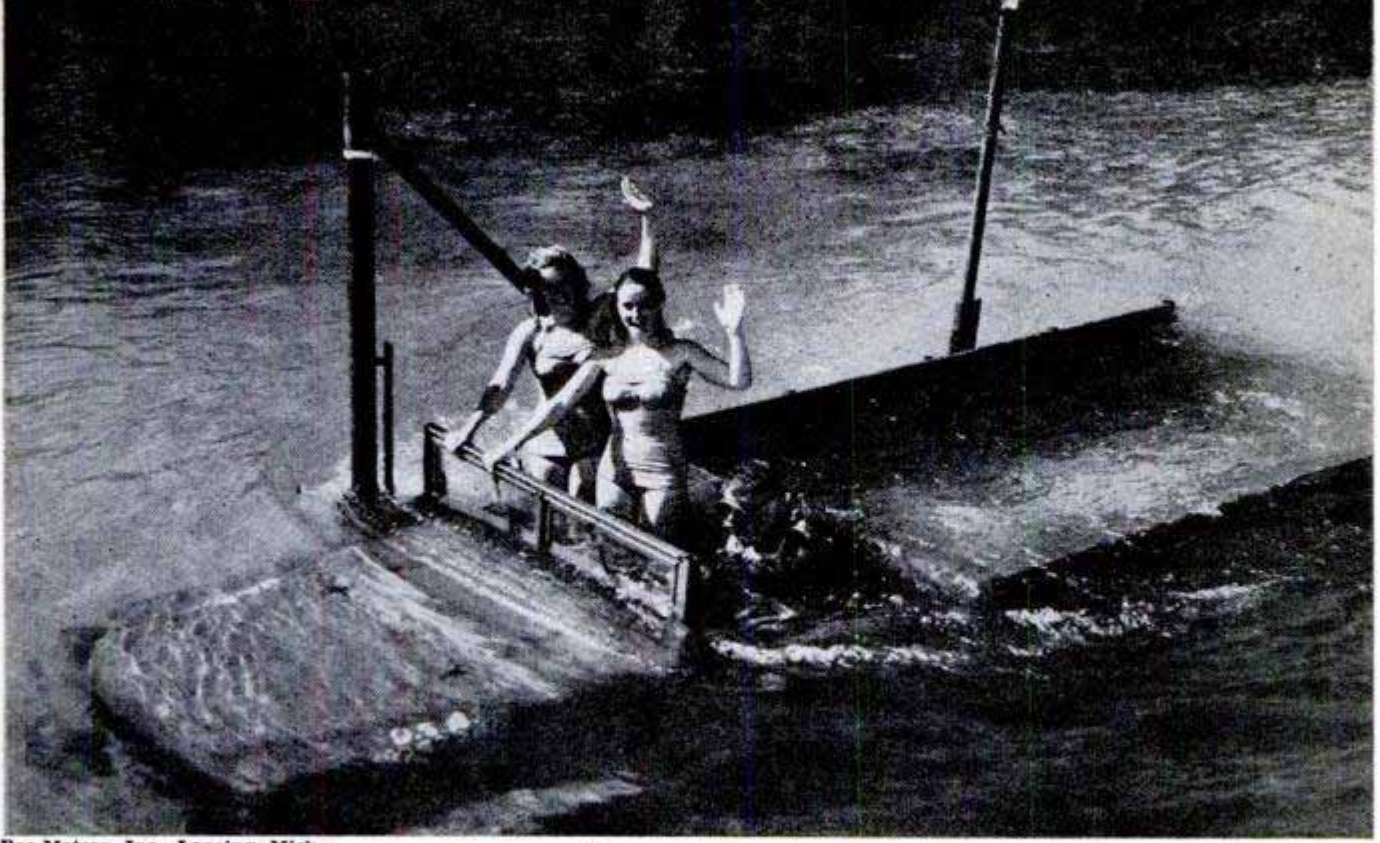

Reo Motors, Inc., Lansing, Mich.

Submarine truck has intake and exhaust pipes which protrude above water. Right, "mermaids" help GI in an underwater test

Underwater Truck

GI truck drivers can roll right along "Davy Jones" highway with a new Army truck that operates almost as well underwater as on the surface. The truck is designed to ford streams or move from landing ship through surf under its own power. With its six-wheel drive it literally can cruise along a river bottom. When the truck is submerged, only two pipes extend above the surface of the water, one for the engine exhaust and the other for the intake.



Atom Plane Soon?

Aircraft powered by atomic energy may be feasible soon. The Air Force and the Atomic Energy Commission have announced completion of the first phase of a program to produce an atomic aircraft engine. This work showed that an atomic engine is theoretically possible. Next step in the research will be to translate the theories into actual blueprints for an experimental model. Such a plane, if successful, could have the speed of a jet fighter, yet remain in the air indefinitely. Calculations show that the proposed craft could fly 80 times around the world on a pound of fuel. The research for an atomic aircraft engine is paralleled by work on a

similar engine for submarines. Sumner T. Pike, commissioner of the Atomic Energy Commission, has announced that the submarine engine already is partly built.

Information not listed on articles in the index, starting on page 12, frequently is listed in the WHERE-TO-FIND-IT LIST, which is available to readers without charge. A copy of this list may be obtained simply by sending a postcard to the Bureau of Information, Popular Mechanics Magazine, 200 East Ontario Street, Chicago 11, Illinois



THEY RACE FOR *Fun*

Story and photographs by
Marjorie and Grant Heilman

Below, the hobbyist horsemen made this starting gate themselves and it works as well as the high-priced commercial models. Left, a 30-pound sulky looks mighty fragile, but it is amazingly sturdy

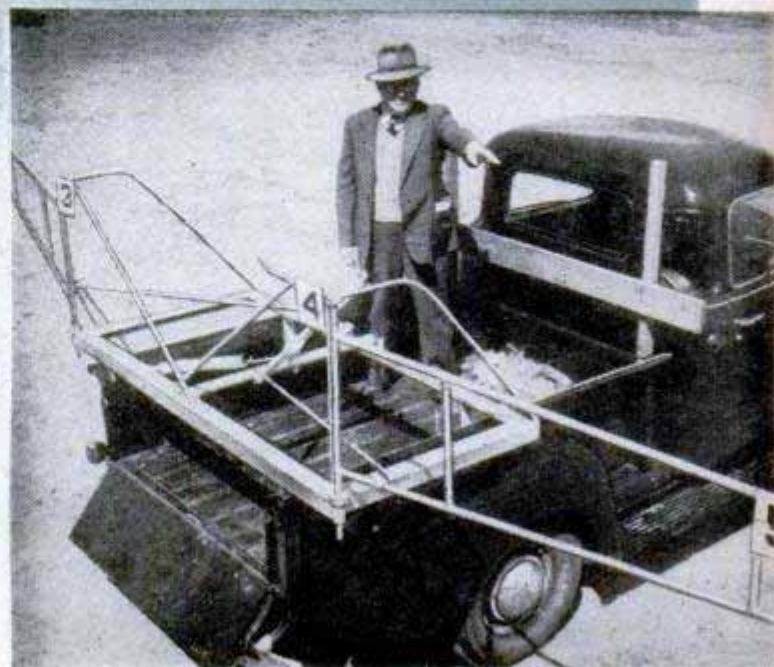
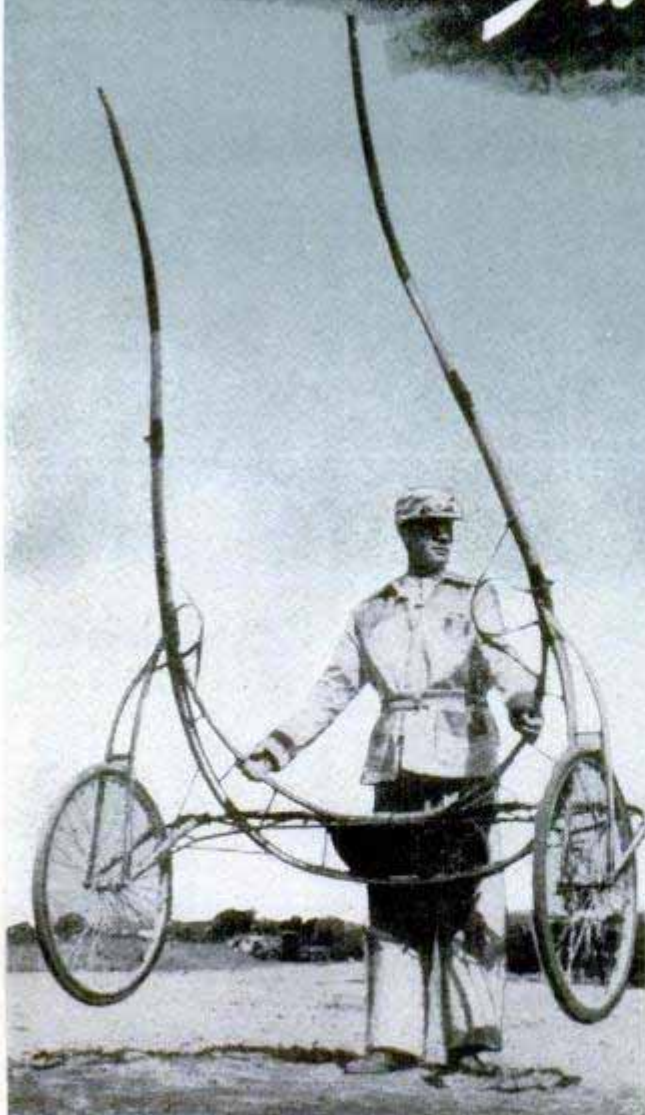

BIG-TIME harness racing may be a millionaire's game," Irving Pettit says, "but we'll match the big tracks any day for pure fun, and our racing setup fits most folks' pocketbooks."

Pettit, president of the South Jersey Driving Club, can speak for several thousand active harness-racing fans from coast to coast whose hobby is riding sulkies behind fleet-footed trotters and pacers.

Everyone who races on South Jersey's homemade track at Paulsboro, N. J., thrills to the smell of sweating horseflesh and the thud of hoofs coming down the home stretch. Yet the 18 horses owned by the club's members cost an average of less than \$500 each. The members built their own track and do most of the maintenance.

"Why," Pettit points out, "one driver picked up a horse for \$50. Sure, he was lame and sore and out of condition. But a winter of good care plus some spring training and the horse was right in there, nose to nose with the rest of us. In fact, last year he won eight races. Fifty dollars isn't much for the fun that owner is having."

Board and feed run about \$30 a month per horse and, of course, the owner takes care of training and exercising—that's part of the fun.

Although jog carts for exercising, and sulkies for racing, cost about \$300 each new, they are almost indestructible and secondhand gear doesn't come high.

Part of the costs come back in the form of race money. For the most part, the South Jersey Club's races aren't run for prize money. They compete solely for fun. Every driver from other clubs gets the same amount of money, regardless of how he places. It's usually only \$20, but this helps pay the bills.



Horses ride to neighboring tracks in trailers their owners build themselves. Here is a two-horse model

At Fair time in Paulsboro, some 40 horses compete for prize money which may go as high as \$500 for a single race.

When the South Jersey group was organized it had no track. With their own labor, the members built stables and a half-mile track on a piece of cheap land.

A discarded highway scraper which they got for \$50 keeps the track scraped. When dust became a nuisance, they persuaded an

Homemade starting gate cost under \$100. At starting line, wings swing forward and truck speeds out of way





Drags made of wire fencing keep the surface smooth. The sprinkler was made from a dilapidated oil truck

oil company to donate a decrepit tank truck. A four-inch pipe bored with dozens of tiny holes was attached across the back of the 3500-gallon tank to make an efficient sprinkler.

To keep the track smooth, a couple of pieces of rusted woven-iron fence which the club got for nothing are dragged down the track behind a truck.

But the prize invention is a starting gate

built by the racing fans. The gate is made from galvanized pipe and can be mounted in a few seconds on the back of a truck. One major track boasts that its starting gate, permanently attached to a Cadillac, cost \$50,000. The South Jersey drivers chuckle and admit that their homemade gate cost less than \$100.

Naturally, none of the South Jersey racing devotees believes his horse is going to step out next year and win the Hambletonian or the Little Brown Jug. But there's surprisingly little difference in time between the race-for-fun horses and the Grand Circuit big shots. One winner at the Paulsboro track this past season was clocked at 2:05, and there's been many a big purse won at speeds slower than that.

"Besides," explains a South Jersey driver as he wipes perspiration and track grime from his forehead, "it isn't the time you're racing against, it's the guy and the horse next to you. If you're neck and neck, it's just as thrilling whether your time is 2:20 or two minutes flat."

The horses are grouped according to an informal handicap rating, based on their records. And as a result most of the races are mighty close. As soon as a horse consistently outdistances his competitors he is shifted to the next faster group, where the going is tougher.

One of harness racing's big advantages as a participant sport lies in the fact that driver weight is not important. The smooth-rolling bicycle wheels of the sulkies have little more drag with 175 pounds of driver than with half that poundage.

Driving a harness horse isn't as strenuous as jockeying a thundering race horse down the home stretch in a tightly packed field. One of South Jersey's consistent win-

Racing is an exciting hobby for this driver who is preparing his horse for a workout on the Paulsboro track

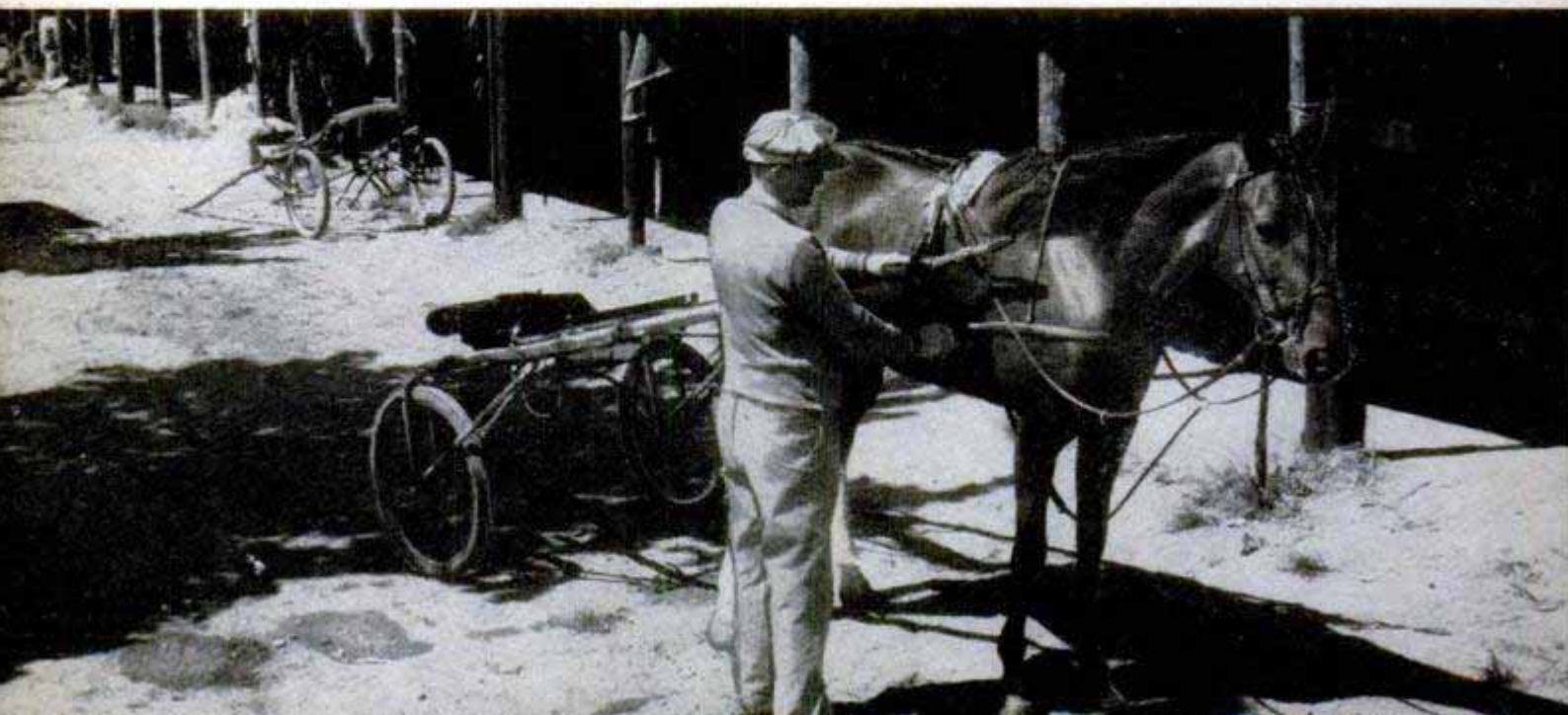



Owners act as their own trainers and handlers. Here, a brace bandage is wrapped by an owner

Race horses need shoes so a blacksmith visits the track's shop often to keep their feet fit

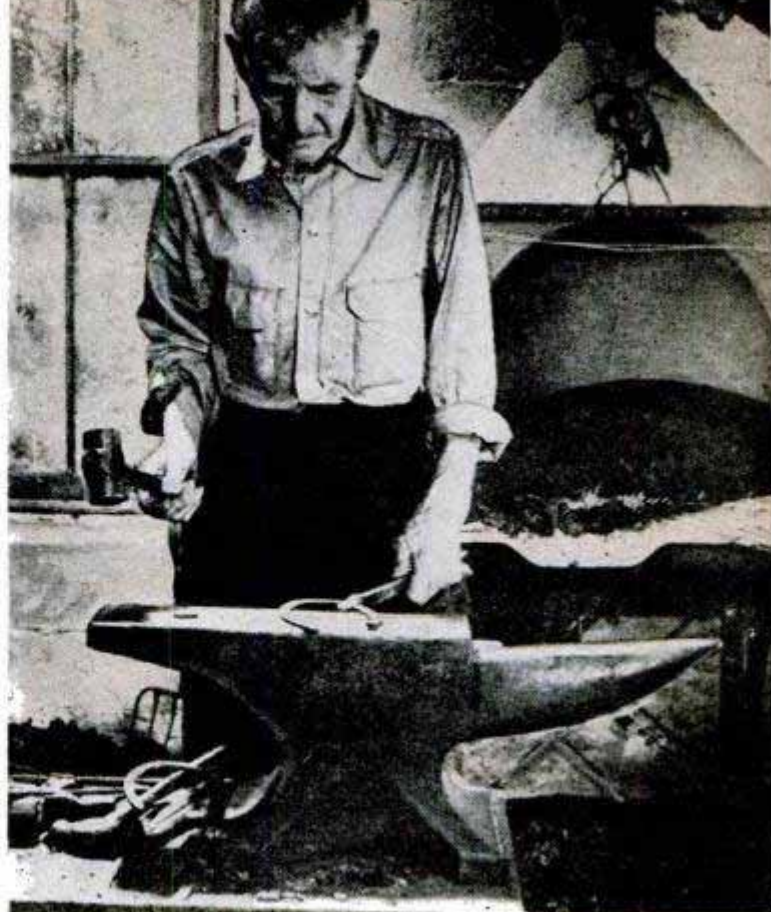

ners is 15-year-old Bob Pyle. Many tracks boast girl drivers. In fact, more than one grandmother has come home a winner.

The horses, too, can race for most of their lives. An average horse may compete for 10 seasons. Single G, one of the all-time top winners, was still tossing dirt in the faces of other horses at 16. Last year a 20-year-old raced alongside horses young enough to be his great-great-grandchildren. This lessens the expense; a \$500 investment, depreciated over 10 years, doesn't amount to much.

A fully rigged harness horse is a sight to behold. If he's a pacer, he may wear a checkrein to hold his head up, a head pole (usually a billiard cue) to keep his head straight, hobbles to keep his legs in an even gait, boots to prevent his hoofs from scraping his legs and even a woolen shadow roll across his nose to keep him from seeing the

track directly ahead and shying from shadows. Trotters' gear is usually slightly less complicated.

Of course, few horses use all of these devices and at the smaller tracks, drivers share equipment.

The sport has been popular for years and South Jersey drivers say there's nothing like it for a hobby.

As one of them put it, "Once you've led the field as you lean around that last turn and you feel your horse stretch out toward the finish line—well, after that everything else seems tame."

These horses are trotters. Left-front and right-hind legs move forward simultaneously as do their opposites





Arrow points to magnetometer and the approximate spot in Chesapeake Bay where sunken barge was located

PLANE TOWS MAGNET TO FIND SUNKEN BARGE

ENGINEERS who are constructing the \$44,000,000 Chesapeake Bay Bridge solved one unexpected problem with an airplane and a magnetometer. During a severe storm three barges broke loose from the construction site, north of Annapolis, Md., and one of them disappeared. There was only one place the barge, which was loaded with specially fabricated steel beams, could be—on the bottom of the bay. Experts in submarine location work were consulted and none held any hope for quick success. In addition to losing the valuable boat and

its cargo, the sunken barge was a hazard to navigation. Geophysicists of the Geological Survey, Department of the Interior, came to the rescue with a DC-3 plane and the magnetometer ordinarily used for aeromagnetic surveys. A course of regularly spaced flight lines was plotted 500 feet apart and five miles long in the suspected area. On the tenth crossing the magnetometer "found" the barge. A small boat marked the spot with a buoy. While engineers cheered, the plane dipped a wing and went back to its regular job.

Work along 4.3-mile length of the bridge was not delayed by one lost barge. Sandy Point, Md., is in distance





Bjorklund Mfg. Co., 16 44th Place, Venice, Calif.

Key Lock for Revolvers Prevents Accidental Firing

Inserted in the trigger guard, a new lock completely covers the trigger to prevent a revolver from being accidentally fired. The lock can be removed only with a key. It prevents discharge should the revolver be handled secretly by children, and provides additional safety when the firearm is carried on a trip.

Card Caddy

Canasta players can hold as many as 30 cards easily with a circular card caddy. Cards can be removed or added without disturbing the rest of the hand. A rubber disk provides the gripping surface. You can even lay down the hand and pick it up again without closing the "fan."

Card Devices, Inc., Troy, Ohio

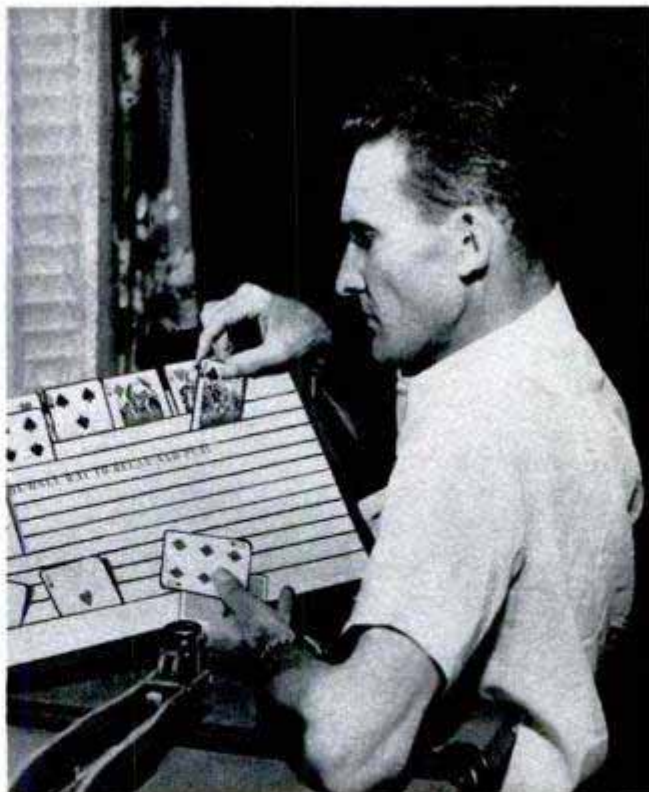

Hunter Sol-Board Co., 520 67th St., Houston, Tex.

Solitaire Lapboard

You can entertain yourself with a game of solitaire no matter where you are with a specially designed lapboard. The board has a series of slits across it in which you insert the cards as you play. The slits hold the cards firmly enough so the game can be played outdoors in the wind. It is excellent for bedridden persons because the cards stay in place even when the board is tilted upright.

Popcorn Packs Packages

Popcorn has been around for years, but now it has been given a new job—for packing fragile articles. The popcorn is lighter than shredded paper, thus reducing shipping costs. It takes about three pints of popcorn to equal the weight of one pint of shredded paper.





British Jaguar

Powered by the same engine that holds the world's stockcar speed record, the Mark VII Jaguar is the first entirely new model this British company has turned out since the war. The 160-horsepower, 6-cylinder engine has a compression ratio of 8 to 1. The same power plant that holds the speed record of 132 miles an hour, this remarkable engine has run continuously for 24 hours at an average speed of 107 miles an hour. Two unusual body features are found in the new Jaguar that sells for \$3875. There are 17 cubic feet of trunk space. This extreme roominess was made possible by removing the gasoline tank from its usual spot below the trunk and placing two tanks in the top halves of the rear fenders in space that is usually wasted. Another unusual feature is a tool kit that is recessed into the lower part of the front door.

Streamlined in a Continental manner, the new Jaguar is a luxurious powerhouse. Below, tool kit recessed into front door. Tools fit in small rubber pockets

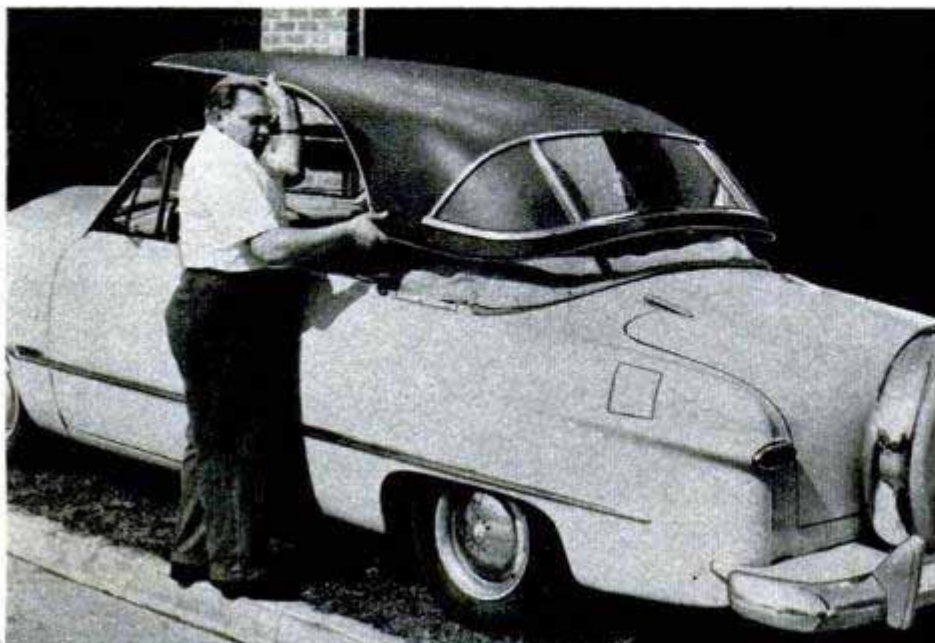

Metal Top For Convertible

Ford convertibles can be converted a new way now that a demountable solid top is available. The sheet-metal top weighs 70 pounds and can be attached to the car in five minutes. The inside of the top is padded with upholstering material. It is not necessary to remove the cloth top from its storage well to make the conversion. The hard top provides a weatherproof roof for use during the winter months.



Remote-Control Dictation

Any number of persons can be "wired in" to a recording system which funnels all dictated letters and memos to one secretary. The system is designed for offices where several persons may have a small amount of dictation during the day, yet not enough to warrant individual recording instruments. A modified telephone is installed on the desk of each dictator. When



Thomas A. Edison, Inc., West Orange, N.J.

a person desires to dictate a letter, he picks up the phone, presses a switch and begins talking. At the secretary's desk the dictation is recorded on a plastic disk. Through another switch on the telephone, the dictator can play back the recording or make correction marks on the index slip. A red light on each phone indicates when the system is in use. Several letters can be recorded on the same disk, and a light indicates when the disk is approaching its end.

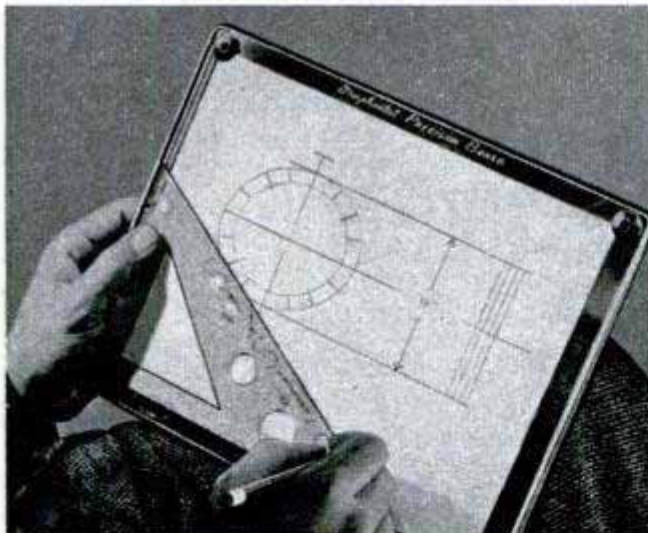

A. Patrick Co., 9 Grove St., Westwood, N. J.

Plastic Drawing Board Is Brief-Case Size

Small enough to slip into your brief case, yet large enough to handle precision drawing, a plastic drawing board is useful to artists who do their work away from a drawing table. Four clamps hold the paper securely and smoothly yet, being recessed, they do not interfere with the smooth surface. Two metal straightedges are retractable and eliminate the need for a T-square. Triangles are stored on the underside of the board, being held in place by tension clamps.

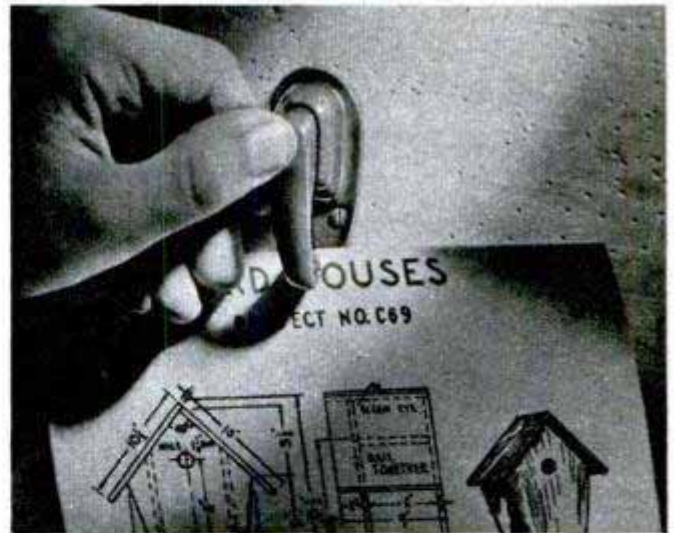

The Stanley Works, New Britain, Conn.

Holder With Rubber Rollers

There are no sharp edges to tear paper or clothing on a grip-type holder with a rubber roller. Secured by two screws, it can be used to hold hats, wall charts, towels, or women's purses.

Sources of available products described in this issue are listed on pages 12, 14 and 16. Sources of further information on other articles are given in the WHERE-TO-FIND-IT LIST, which is available without charge from Bureau of Information, Popular Mechanics, 200 E. Ontario St., Chicago 11, Ill.



Hemmed in on all sides by mountains, Venezuela's capital, Caracas, has to expand underground and up

NEW CITY

THE CLATTER of big machines and heavy construction is shaking the capital city of Venezuela to the foundations of its ancient adobe and stucco houses. Out of the dust and rubble ultramodern skyscrapers spear toward the clouds. Neat, modern apartments with trim balconies sweep along the mountainsides. In the other

direction, broad, subterranean boulevards are tunneling under streets that once echoed only to the creak of basket carts, drawn by dejected donkeys.

Out on the slopes of the Cordilleras, where 11,000 goats once roamed unmolested, a vast "University City" is rising, dominated by a thousand-bed hospital with "saw tooth" walls and chute-the-chute fire escapes. A superhighway, leading from Caracas' 3000-foot valley floor to its sea-coast gateway, La Guaira, will reach across quarter-mile-high viaducts, bridging mountain chasms and tunneling under peaks to eliminate curves.

It all started a few years ago. Reason: Caracas was bursting its seams. The city, confined on every side by rugged Cordillera peaks of the coastal range, lies in a mountain valley 12 miles long and 3 wide. Its drowsy, dirt and cobbled streets, and quaint one-story provincial homes with palm-fringed patios, were fine for a few thousand persons. But, with the coming of oil 25 years ago, Caracas became a boom town. Now, 400,000 persons swarm in its narrow confines. The city has spilled down the valley, and climbed the mountainsides. Sixty thousand automobiles joined the swarms of chat-

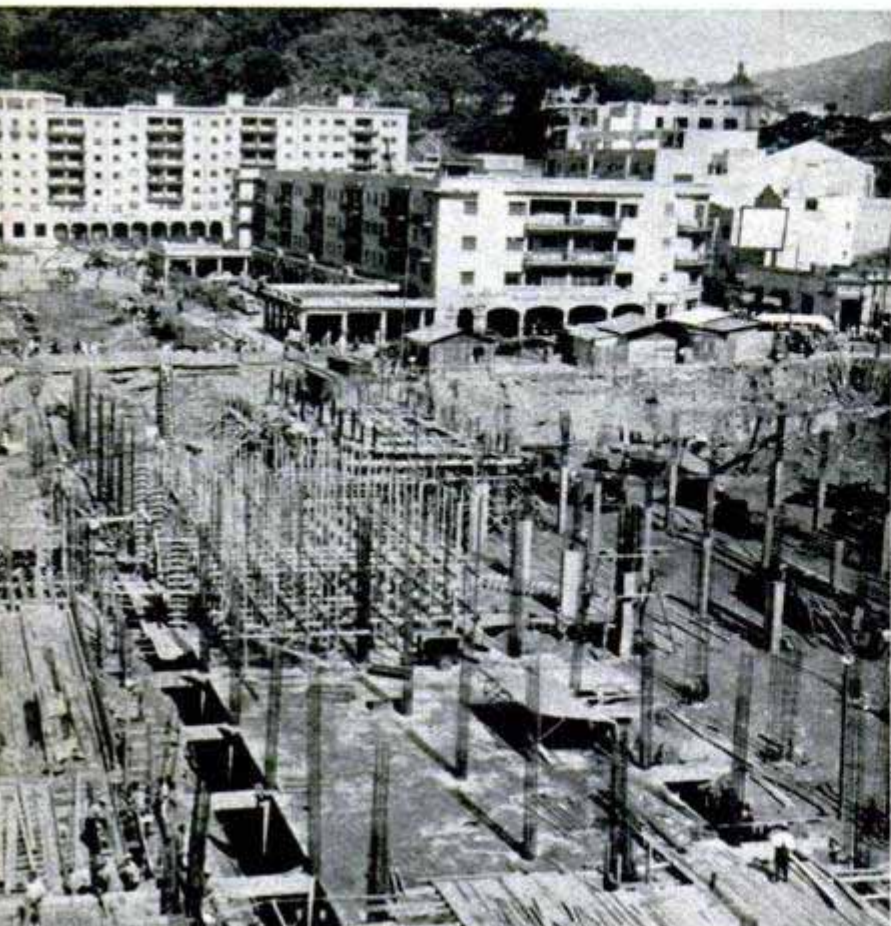

Avenida Bolivar project handles traffic on three sublevels. Modern apartments similar to one in background will line the street



FOR AN OLD

Main ramp from the surface throughway to carry flow of traffic underground is at end of boulevard, also turnaround space

By Michael Day

tering people to triple the confusion. No place in the world has such traffic jams. Hornblowing is outlawed, so Caracas is a bedlam of drivers, all slapping the outsides of their car doors to chase away pedestrians who can't move anywhere without knocking someone down.

For years, the Venezuelan government toyed with the idea of doing something about it. Several false starts were made. Finally, in 1948, they formed a private company and went to work. Trucks, bulldozers and demolition cranes moved in with an army of 6000 workers and cut a swath of destruction through 11 blocks in the center of the old city to make way for a super-boulevard like no other on earth. Day after

day, the roar of crumbling masonry shook the valley. A five-story building at the head of the proposed trafficway, which former contractors claimed would take three years to demolish, was reduced to rubble in two days. Using 50 tons of dynamite to a single

Scale model of finished project shows boulevard lined with skyscrapers and large apartment buildings

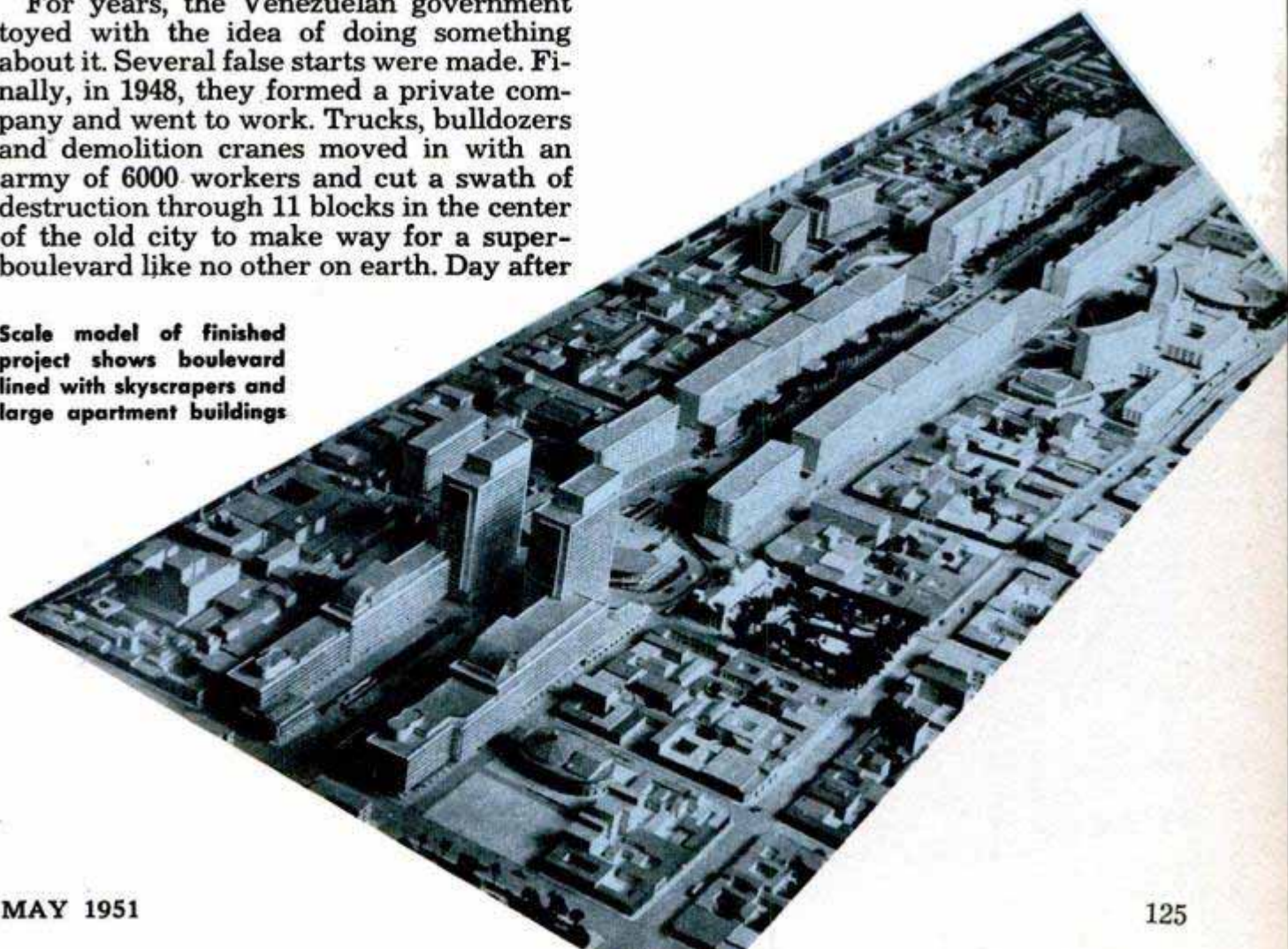



Twisting Caracas-La Guaira road is city's 35-mile life line to sea. New road will be only 12 miles long

charge, and monstrous cranes with two-ton steel balls, the demolition crews bowled over the walls of the city's biggest hotel in 22 hours. Overnight, whole city blocks disappeared. Business and residential buildings for nearly a mile were mowed to ground level in a few months; then huge steam shovels began digging.

Today, the handsome Bolivar Avenue project is nearing completion. At its head stands a modern apartment development for 2400 families, El Silencio (The Silence), so named because of the death-ridden plague which visited the slum that once stood there.

The boulevard consists of a multitiered subtrafficway, already completed, that sweeps through the city. The main artery tunnels under the city's center for almost a mile then stretches for another half mile on the surface to the suburbs. Beneath the surface-feed highway, a second level is



Monument holding wrecked car along Caracas-La Guaira road serves as warning to Venezuelan drivers

reached by an intricate series of ramps. This is a parking area for 4000 cars. Under this is a third level, consisting of a national bus terminal, where fluorescent-lighted sidewalks and stores will give an aura of daylight to Venezuelan travelers. Beneath the entire stack dips the speedway for through traffic following the main highway. At one-block intervals on the bus-terminal level, one-way cross streets from the surface dip under the throughway and come up again on the other side, so traffic on the main artery will not be disrupted by local cross traffic.

At street level, there is a park and a mezzanine, with shopping center. When finished, three blocks of 27-story modern commercial buildings on stilts (to allow surface-feed traffic to go through them) will be erected above the highway. A long row of lower commercial buildings will line the "autopista" for six more blocks. Beyond

Architect's model of University City, part of rejuvenation project, shows schools, stadium and hospital





this will be built rows of modern six-story residential apartments—and the proudest project of all: University City.

In a half-square-mile natural amphitheater on the Cordilleran slopes, the 30 modern buildings of University City are almost completed. The hospital for the medical school sits at the head of the bowl, with four wings pointing out over the campus like fingers.

To give patients privacy in the wards, architects have devised serrated walls that “step” along the corridors like the teeth of a big saw. Each ward holds 12 beds, and each bed fits in a saw-tooth niche; hence, no patient can see another—except for the person across the room from him. In effect, he has a semiprivate room. From each floor, concrete-lined corridor ramps lead to the outdoors. In case of fire, the beds—all on big casters—can be rolled out without disturbing patients. The hospital’s capacity of 1000 patients can be chuted to safety, clearing the entire building in six to seven minutes.

With the millions of cubic yards of soil dug from the center of their city, Caracans began another project—filling in 1000-foot-deep valleys in order to build a superhighway to the sea. The present road, built by dictator Gomez, is a winding, treacherous two-lane suicide trail, rightfully dubbed the “Plate of Spaghetti.” Though it is only about 10 miles, as the crow flies, from Caracas to the sea-level town of La Guaira, the Plate of Spaghetti is 35 miles long. It has 395 switchbacks, nearly all of which hover on ledges thousands of feet above rocky valleys—with no guard rails. Only 10 percent of the road is straight.

Fiery Venezuelan drivers are used to seeing pictures of crumpled wrecks in their daily papers. They scarcely bat an eye

The 1000-bed hospital in University City has “saw tooth” walls in wards; beds fit into private niches

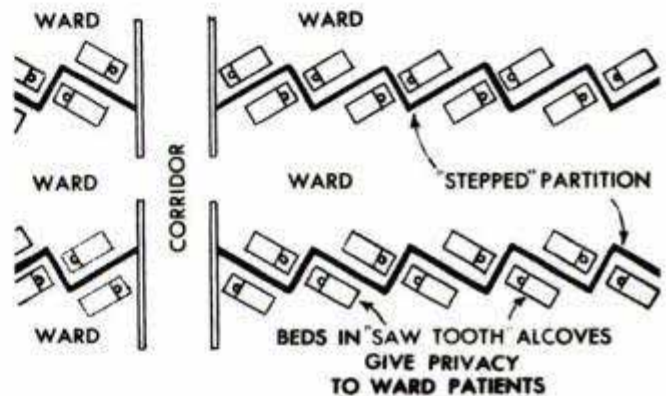
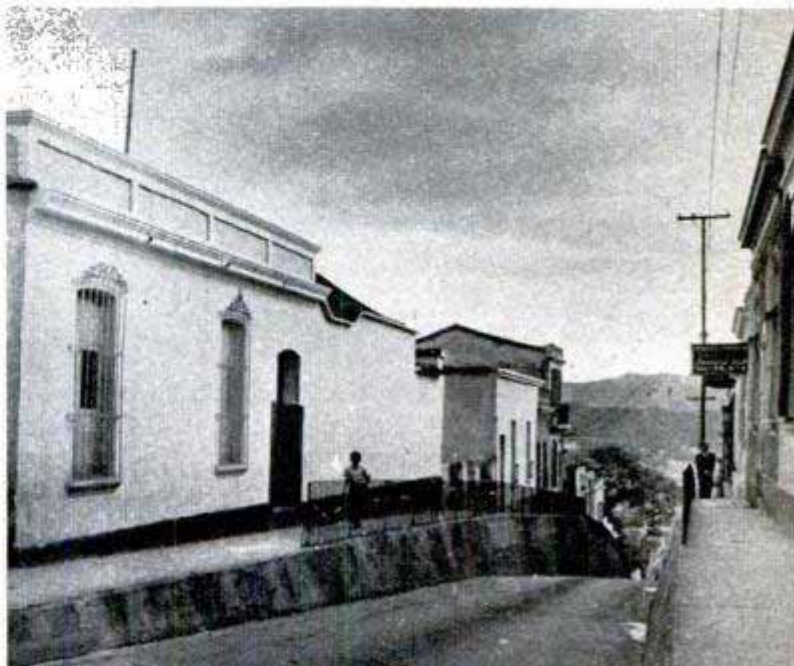
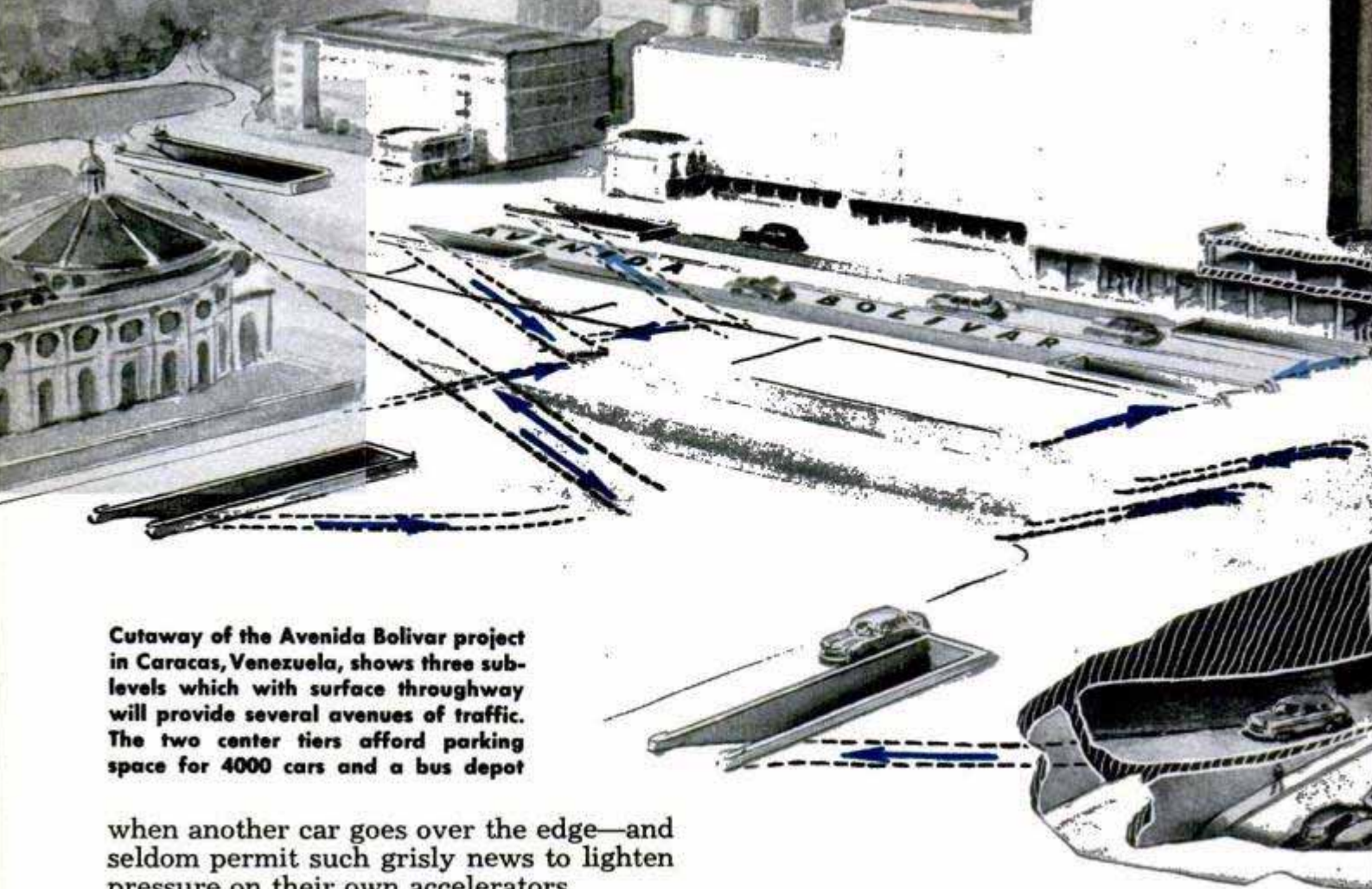

Diagram shows how beds are arranged in the modern hospital now nearing completion. The patient can see only the person directly across the room from him

Below, blocks of old-fashioned Spanish-type adobe and stucco houses were mowed down almost overnight to make room for the Avenida Bolivar project





Cutaway of the Avenida Bolivar project in Caracas, Venezuela, shows three sub-levels which with surface thoroughway will provide several avenues of traffic. The two center tiers afford parking space for 4000 cars and a bus depot

when another car goes over the edge—and seldom permit such grisly news to lighten pressure on their own accelerators.

Government people are not so nonchalant. The old road is Caracas' life line. Down it go coffee, tobacco, cocoa, orchids for the outside world. Up it comes virtually everything needed to sustain a great part of Venezuela, for the country imports practically everything necessary to life. Daily the road groans under the pounding of 2500 vehicles. Hence, the new "autopista" will be a tremendous boon.

From Caracas, it will make a beeline for the coast, riding over chasms, cleaving through mountain peaks that are being chopped off to make way for it. A steady six-percent grade will bring it out at sea level on the coast after an 18-minute run of 12 miles. The present trip takes more than an hour. Four miles of the road will bore through the coastal range via a huge sloping tunnel, entering at about 700 feet altitude and coming out at about 400. Half a million cubic feet of granite will be blasted out. Eight big faults, or slip lines, in the mountain rock will be injected with concrete and reinforced. The tunnel will be equipped with recesses for disabled cars. A motor-powered suction system, operated in chambers carved out of live rock above and below the thoroughway, will ventilate the entire length of the tunnel. Though many Caracans hold their heads over the tunnel project, Don Luis Roche, the Henry Kaiser of Venezuela and the man who conceived the idea, has no qualms about it.

"Faith moved mountains in Biblical days," he says. "Now it is going to perforate them."

Not content with building a stupendous road to the harbor, Caracas is also building a complete new harbor at the port city of La Guaira. Tremendous breakwaters are stretching out into the Caribbean Sea. Old waterlogged piers are coming down to make way for modern steel and concrete structures, with warehouse facilities on the first level, stores, restaurants, movies and other passenger facilities on the upper level. Revolving derricks, with the world's biggest "dustpans" hooked on the ends of their 100-foot beams, lower under the tailboards of double-barreled trucks that dump 20 tons of rock at a time into them. Then they swing around, deposit their staggering loads in steel barges that cart the rock out to the breakwater line and dump it. The 60-foot, reinforced-concrete piles are made right on the spot in special wooden molds. They are run out to the pier site on a miniature railroad and lifted from the cars by cranes that swing them into position and hold them while a massive pile driver hammers them into the harbor bottom.

At one point, the contractors found a rock ledge on the harbor bottom. Ordinary concrete piles crumbled when pounded against that surface. They solved the problem by welding hard steel points on a steel frame,

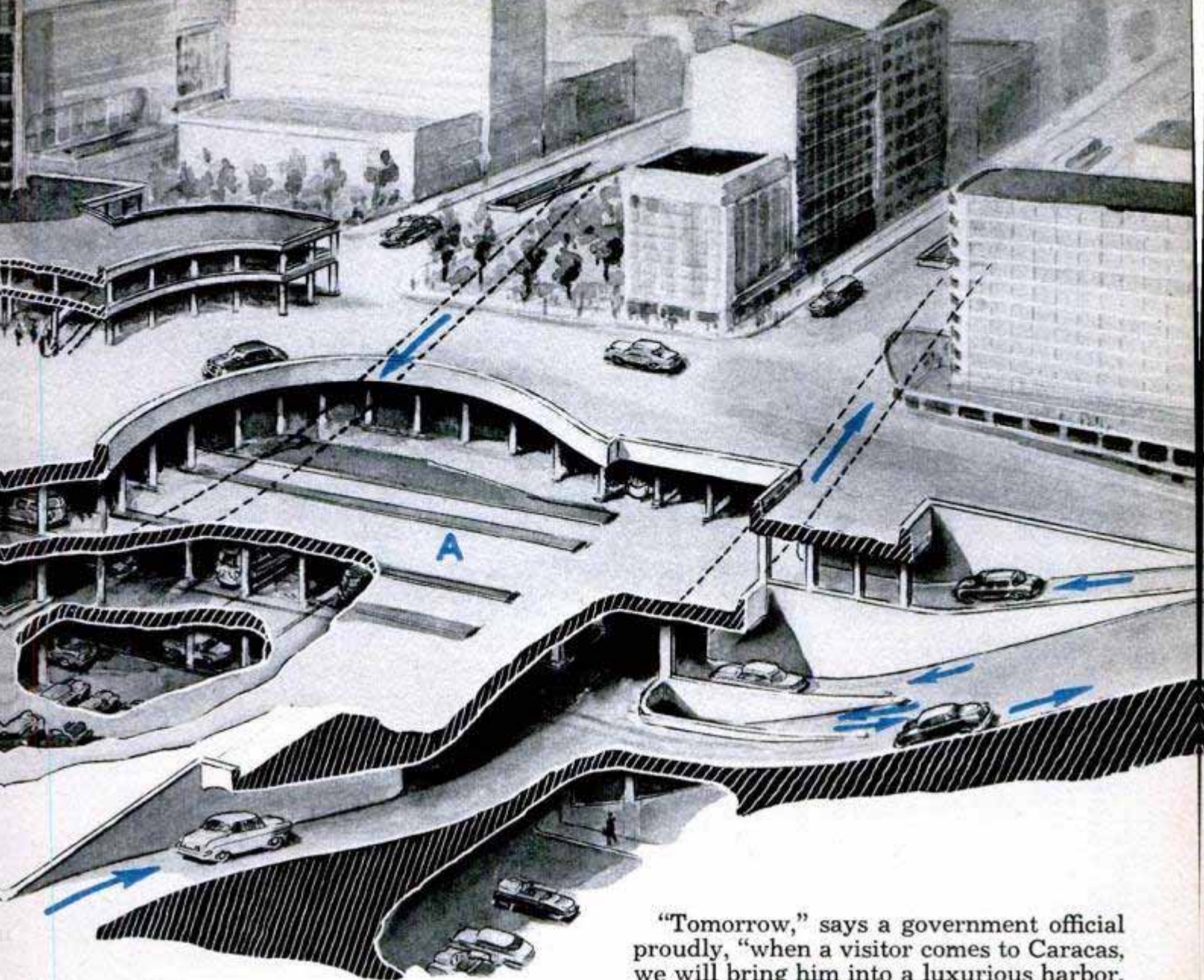

and pouring concrete around this husky skeleton. These piles will drive, point first, into the hard rock. When finished, the new harbor will have facilities for about 25 coastwise ships, a turn basin—a sort of marine turntable—vast new warehouses and piers to handle every conceivable kind of shipping with the most modern equipment.

“Tomorrow,” says a government official proudly, “when a visitor comes to Caracas, we will bring him into a luxurious harbor, whisk him under mountains and through the sky to our city, zip him under our teeming streets and out into the air at the very door of his hotel. And what he will see is the city of tomorrow in every direction. He will be able to walk around without danger of risking his life every time he steps off the curb. In fact, he will see very little traffic. It will all be underground.”

Point “A” in diagram corresponds with marking of cutaway at top of page. Arrows show the flow of traffic

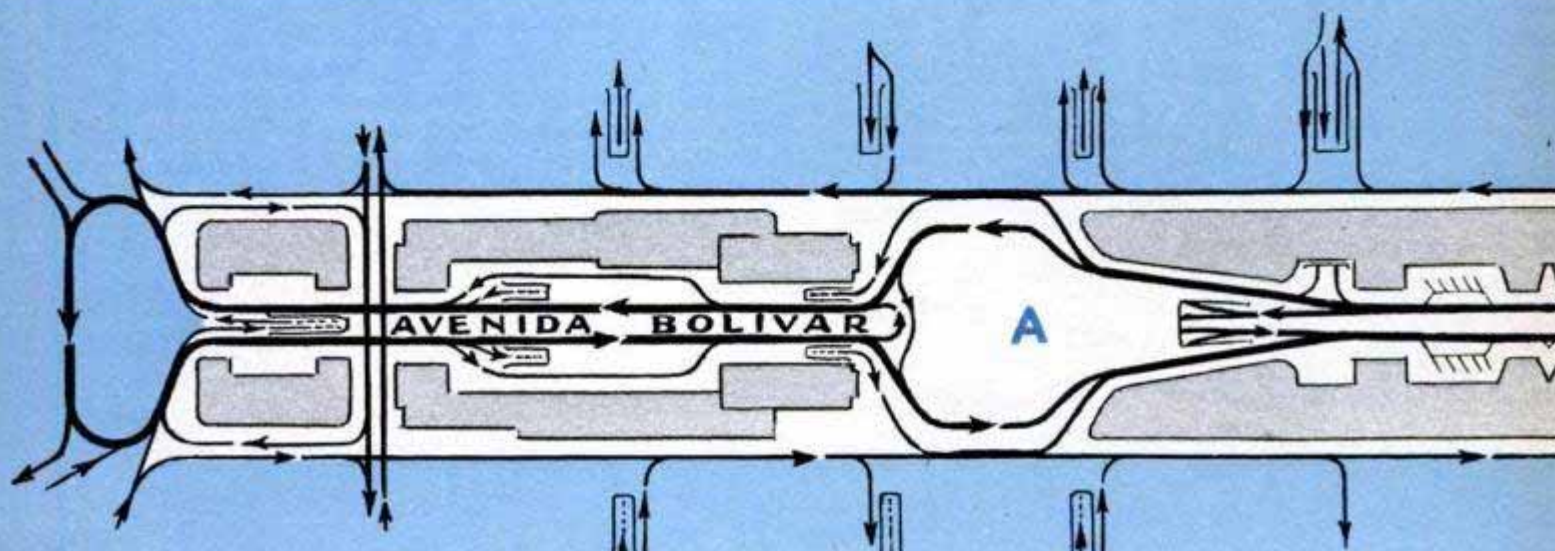

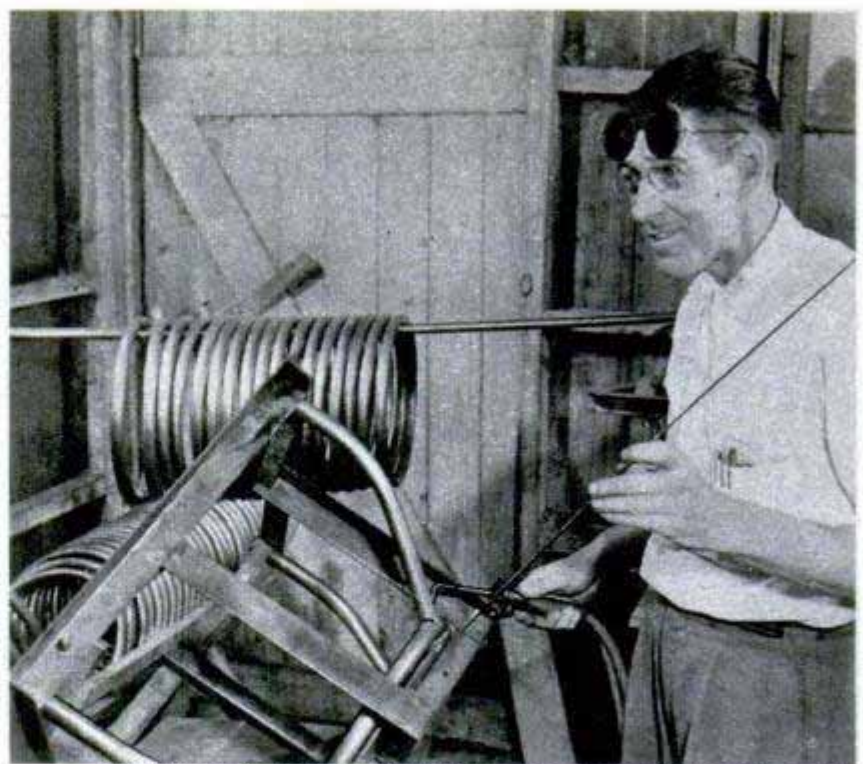

John Harper, Westinghouse Electric Corp., Transformer Division, Sharon, Pa.

Walker for Tots

Little John Benner of Sharon, Pa., has learned to walk in record time, thanks to the ingenuity and welding experience of his grandfather, John Harper. A welding expert for Westinghouse, Harper designed and built a "wee walker" for Johnny. It consists of four tubular-steel legs welded to a tubular ring. Harper put large casters

on the legs and a canvas "saddle" inside the ring. Johnny, placed inside the saddle, scooted in any direction with ease. Rubber bumpers on the legs protect the furniture from scratches. Neighbors liked the walker so well they started placing orders, and now Grandfather Harper is turning out walkers in batches of 500 in a barn he has converted into a workshop for his growing business.

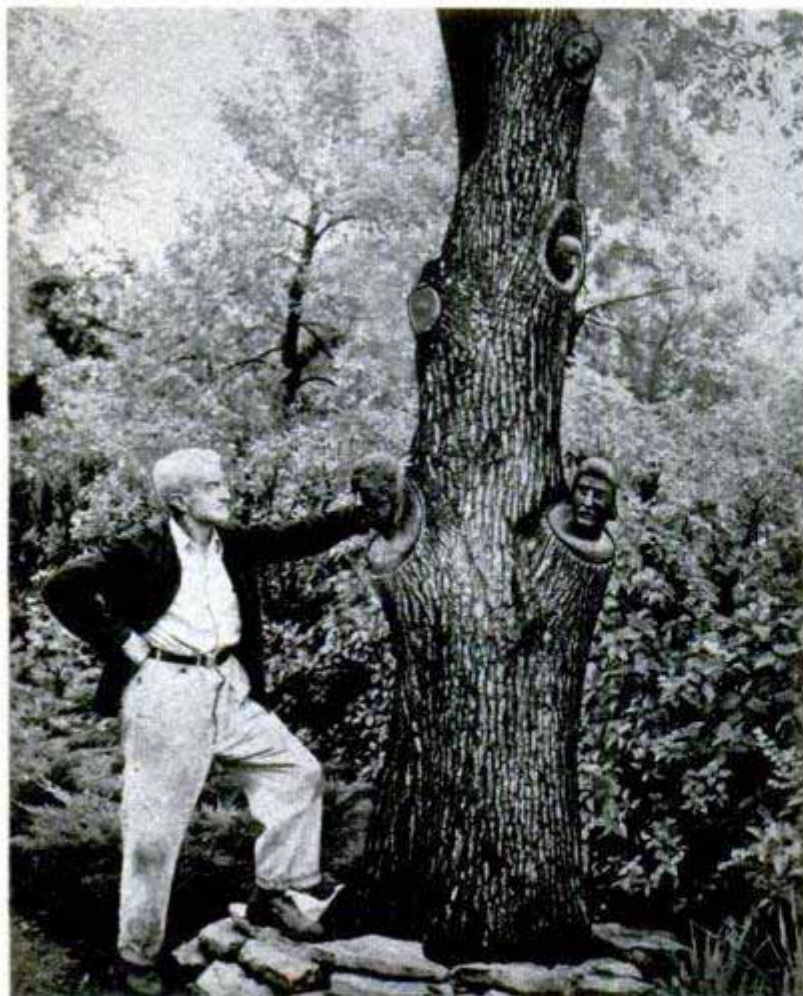

A Treeful of Heads

Strangers who walk into the yard of Louis van Zandt in Elmhurst, Ill., are startled to see heads popping out of a tall elm tree. The 72-year-old Van Zandt has been carving various-sized heads on the stumps of limbs for years as a hobby. A printer by trade, he is now retired and says the pastime is a way to keep busy.

Ventilating Fan Has Thermostat

Placed in your bedroom window, a twin-fan ventilator cools the room to the preset temperature and then automatically shuts itself off. If the room temperature rises during the night, the fans go back into action again. There are two fans in the ventilator unit, which can be used to suck cool air in or blow the hot air out. Made by the General Electric Company, it can also be removed from the window and used to circulate air anywhere in the house.

Blind Archers "Hear" Target

Sound from a doorbell attached above the target gives blind archers a "sight" on the bull's-eye. An assistant with an extension wire and button operates the bell from a safe distance away. The new archery aid was devised by John Hordines, athletic director at the New York Institute for the Education of the Blind, Bronx, N. Y.

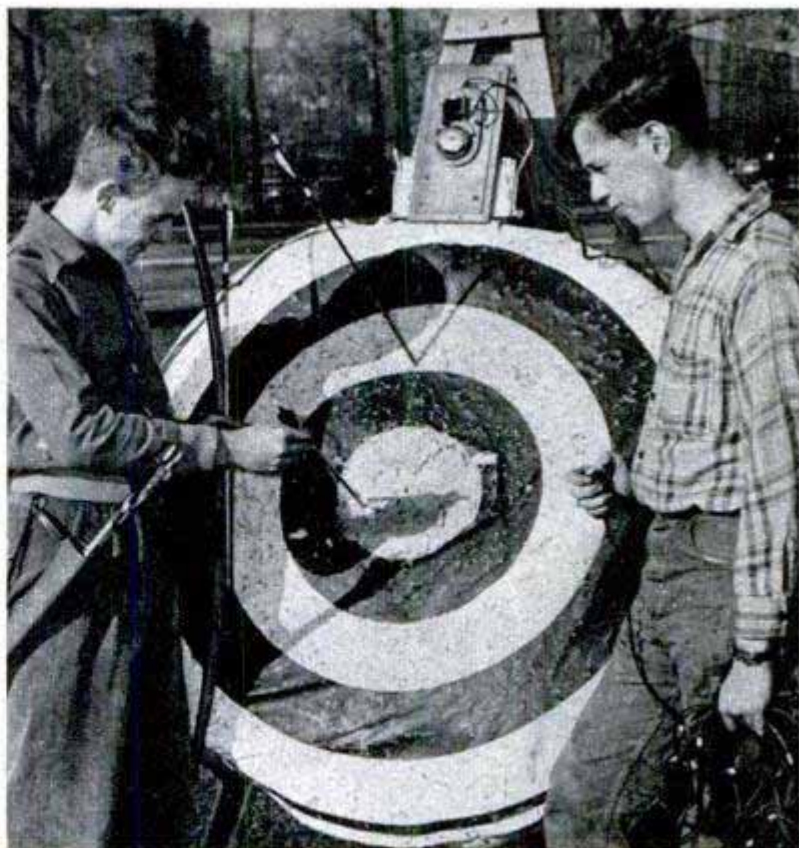

Canned Water for Defense

Water packaged in tin cans may help solve the problem of providing uncontaminated water in the event of atomic attack. Dr. Myer Selby, research director of the Multiple Breaker Co., 82 Commonwealth, Boston, Mass., "developed" the canned water, under contract with the Air Force. Oddly, it is more difficult to can than most foods because it takes on the taste of the can or can lining. Doctor Selby's method keeps the water both sterile and palatable. Many authorities predict that normal water supplies would be

dangerously contaminated with disease or radioactivity if a city came under an atomic-bomb attack.

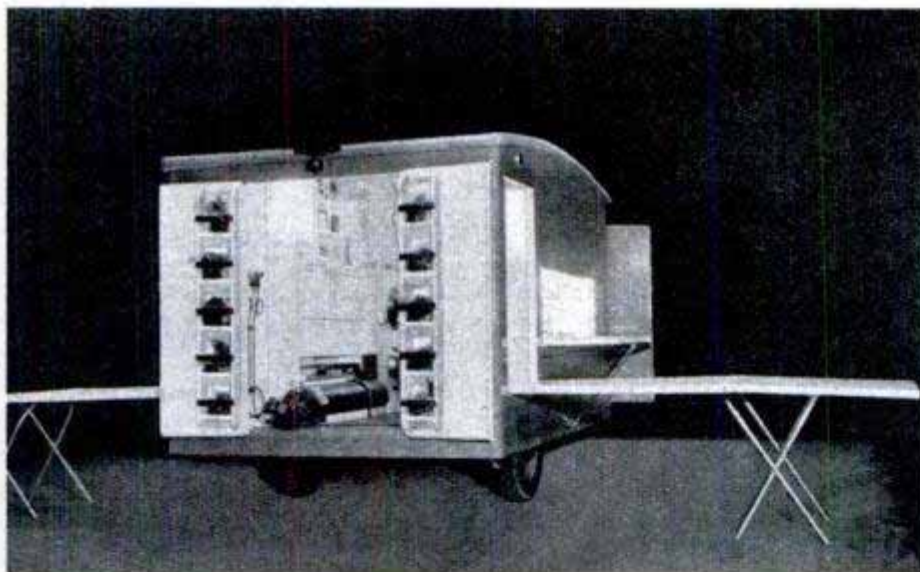

Trailer Hospital

Emergency medical treatment is provided by a 12-foot hospital trailer designed for use in the event of an A-bomb attack. Two operating tables fold down from the sides of the trailer, and equipment inside the unit can dispense oxygen to 10 victims simultaneously. The 2200-pound mobile hospital also carries plasma and the necessary transfusion equipment.

Obstacle Course Slows Speeders

Spaced barriers, extending inward from alternate sides, discourage speeding on the Youghal Bridge in Ireland. There is enough distance between barriers to allow two cars to pass on the way across.

☛ About 81,000 calls a month are made from motor vehicles equipped with radio-telephones.





WESTERNERS are RIDIN' HIGH!

By Rafe Gibbs



WESTERNERS are still at it—pioneering, that is. Only this time they are not cracking a bull whip as they stalk beside a slow-moving ox team. They are fingering the controls on a panel maze as they sit in a swift-traveling airplane high over the spaces that have remained, for the most part, wide open.

Clergymen, doctors, cowboys, farmers, legislators and men from many other walks of life are utilizing planes in going about their business. Results in many cases have been spectacular. Highly practical, too.

For instance, there's the case of Father Blase Schumacher. He had to say two masses every Sunday morning in two different states. The first mass was at 9:30 a.m. in Vernal, Utah, and the second at 11:30 a.m. in Rangely, Colo., 50 miles away.

Father Schumacher found that he had to race his car on the straight stretches to get to Rangely in time for the second mass.

Left, symbol adopted by the flying legislators of Idaho is orating politician standing on soaring desk



Injured fire fighter is rescued by helicopter from remote area in Angeles National Forest, Calif. Below, right, pilot acts as spotter for men on ground

Then one Sunday morning he was delayed at Vernal. Being a sky pilot, both literally and figuratively, he finally decided to borrow a parishioner's plane and fly to Rangely. The trip took less than 30 minutes and, promptly at 11:30, with chalice in hand, Father Schumacher strode to the Rangely altar. The next Sunday he started flying regularly to the Colorado town.

The Rev. Norval Hegland was assigned a Lutheran flock scattered over 3000 square miles in the cattle and sheep country of South Dakota. But he was the man for the job because he was also a flyer.

The people of his sprawling parish previously had enjoyed little social life, so the flying pastor made arrangements for some of that along with church services. In good weather, he scheduled picnics in ranch yards following the services. It soon became a common sight to see him stepping from his plane in a cow pasture, with a Bible in one hand and a five-gallon can of ice cream in the other.

And just as clergymen of the West have turned to the plane in looking after spiritual needs of their far-flung parishes, doctors have turned to it in looking after physical needs. Especially in the mountain country where roads are poor, a doctor often must have wings himself to beat the stork.





Los Angeles Times photo

Helicopter fitted with specially designed seed hopper is made ready for grass-seeding operation on range

Most famous of the West's many flying doctors is Amos Little of Helena, Mont. Doctor Little has even streamlined the procedure of reaching a patient when no landing field is near. He has himself and kit flown to the scene where he is needed, then simply jumps out of the plane — with a parachute.

At Marfa, Tex., Dr. J. P. Searls uses his plane on emergency calls to outlying areas. When a ranchman accidentally lodged a piece of steel in his eye, Doctor Searls operated, then loaded him in his plane and

Flyers dropping supplies by parachute to men working for Forest Service are accurate as bombardiers

U. S. Forest Service photo



flew him to El Paso for special treatment.

Among all the occupations and professions, farming and ranching provide the most fertile fields in the West for airplane salesmen. Many farmers and ranchers have taken to planes simply because they can cover so much acreage so fast. Dusting crops with airplanes has long been standard practice, but now experiments are being conducted with air seeding. Good results are being obtained, too, especially in reseeding depleted range land.

The men who wear high-heeled boots and high-crowned hats have long debated the efficiency of rounding up wild horses by air, but now are generally agreed that this is the best method. One cowboy in a plane can do the work of five in the saddle. Sometimes, too, an unusually smart horse that cannot be trapped at all on the ground can be outwitted with a plane.

An example of this occurred in Wyoming. For years, a glistening palomino stallion, with his omnipresent harem of mares, had defied all attempts to capture him as he roamed the Teapot Butte area north of Crowheart. Time and again the mares would be driven into a trap, but the stallion, neighing his defiance, would gal-

This plane has a real "bucket" seat. Young trout are being poured into it for planting in a remote lake near Sun Valley resort area

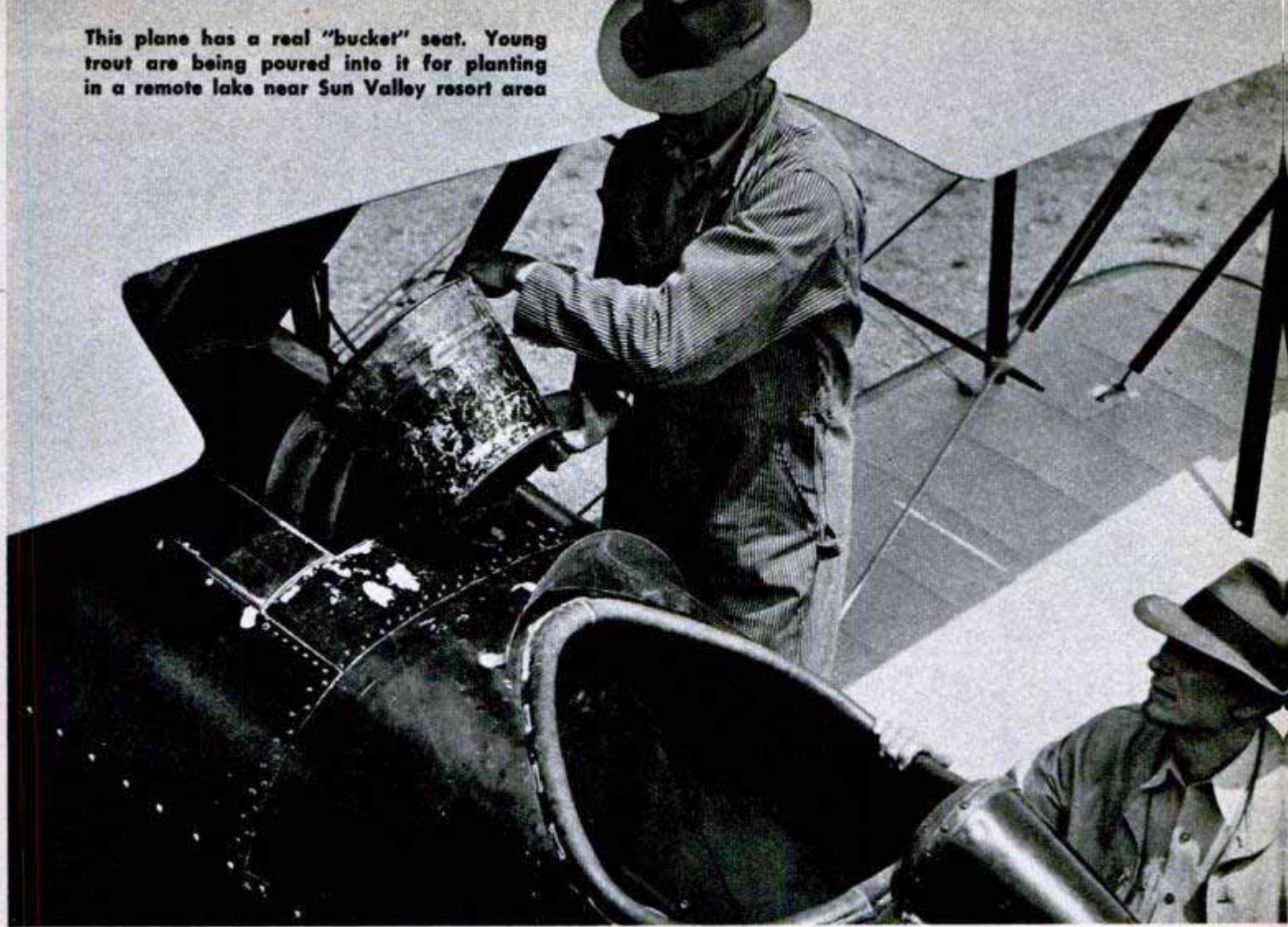

lop off into a brush hideout. When the roundup was over, he would acquire a new harem and keep his old freedom.

Then cowboy Roy Lamoureaux of Casper, who has helped round up more than 2500 head of horses from the air, got on his trail with a plane. Lamoureaux had participated in the capture years ago of Desert Dust of motion-picture fame, and even from the air, the puncher-pilot could see that the palomino stallion was every inch the equal of Desert Dust. He determined to have him.

Flying low, he began his drive toward a trap set up in the sage-dotted hills. The stallion started his brush-dodging routine, but each time he took cover the winged waddy flushed him out. His last bound of the day landed him in the trap.

Rounding up cattle by air is not so practical, because too much high-priced beef can be worn off. The plane, however, is just the thing for patrolling a ranch.

Consider the flying Fuhrimans of northern Utah — the 61-year-old father, A. J., and his four sons, Delbert, Earl, Lee and Duane. All of them fly. They own two airplanes to cover their extensive holdings,

Flying just 30 feet above the water, pilot pulls a lever to drop 2000 rainbow trout into mountain lake





Skilful helicopter pilot shows how he flies low to spray weeds on a canal bank near Prosser, Wash.

and more often than not both planes are in the air.

The Fuhrimans use their planes for keeping an eye on their cattle, but they also find them highly practical for flying between ranches to change water on irrigated land.

"Then," said Delbert, "we use 'em just to run errands. And they're mighty handy when it's a half hour before dinnertime and you're out in the sagebrush, 50 miles away."

Commenting editorially on the use of airplanes by Utah farmers, the Salt Lake Tribune recently said that in over three fourths of the state there are Flying Farmer organizations affiliated with the National Flying Farmers Association. The Tribune added:

"We wonder just how long a farmer who doesn't own his own plane can keep from being called an 'old fogey.'"

But Idaho goes the State of Utah one

(Continued to page 226)



Hunters use plane to penetrate wilds of Idaho. Below, fishing from an amphibian on a lake in Nevada

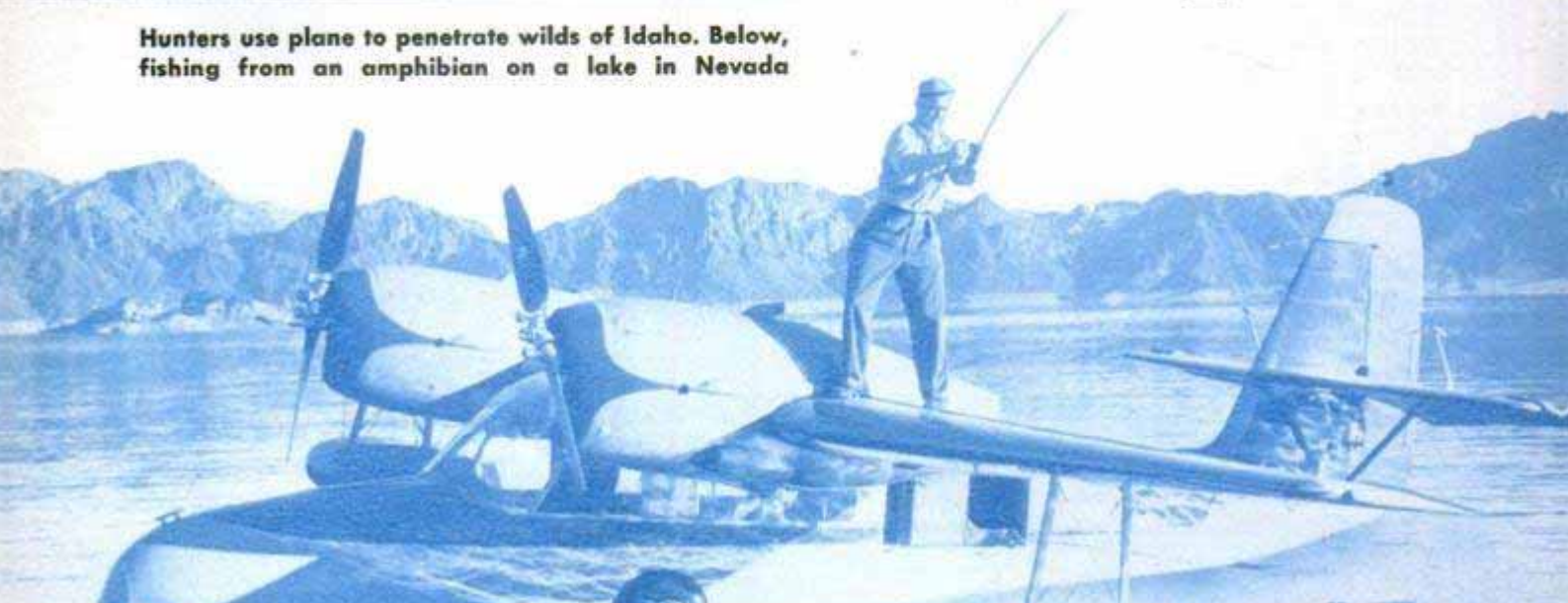

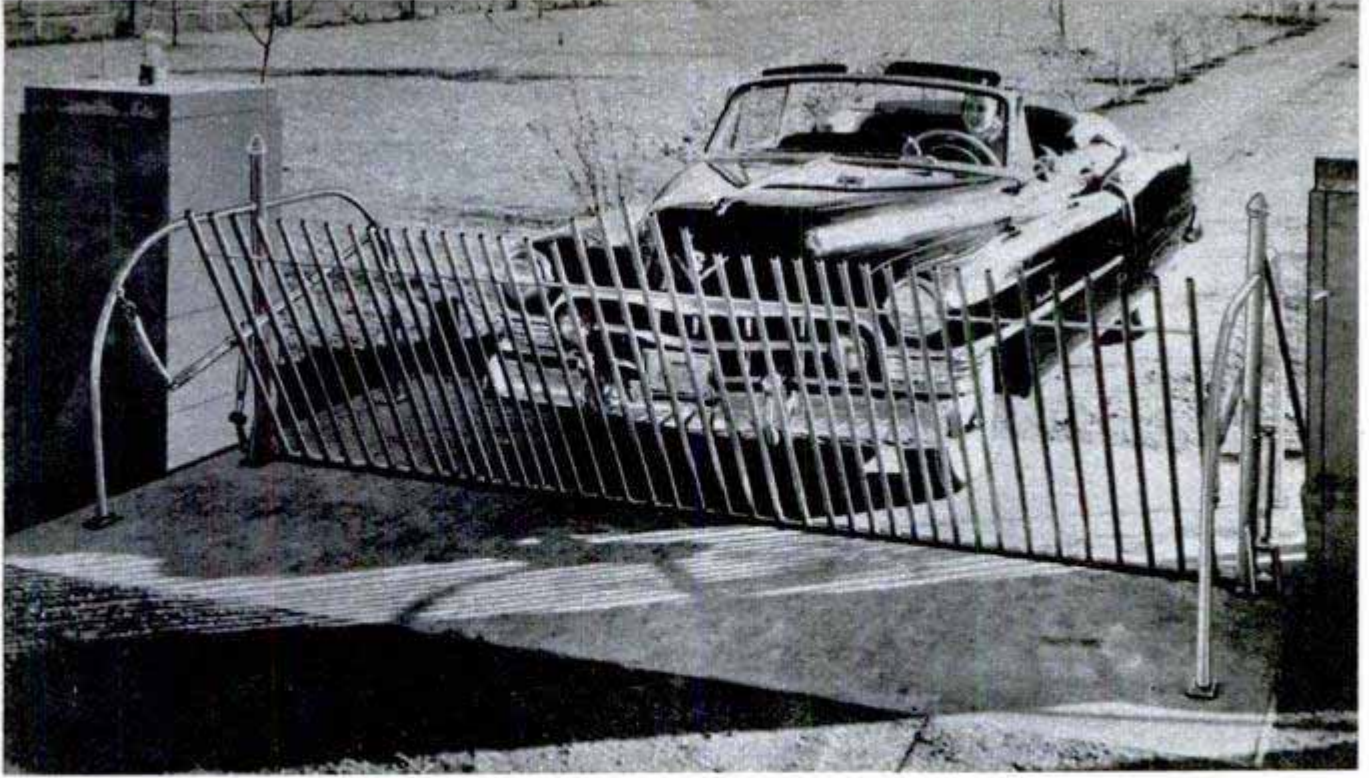

Hawley Mfg. Co., 1130 Lockwood Dr., Houston 20, Tex.

Push-Over Gate

You don't have to get out of the car to open or close an automatic gate because you drive right over it without damage to either the car or the gate. The bumper of your car pushes the gate down to the ground as you drive through. When the car has passed over, the gate shuts itself automatically. Hydraulic checks prevent the gate from rising to the vertical position until the car has had time to get through the opening.

Driver remains seated and the car pushes the gate open. Once the gate is down, hydraulic mechanism prevents it from rising for several seconds

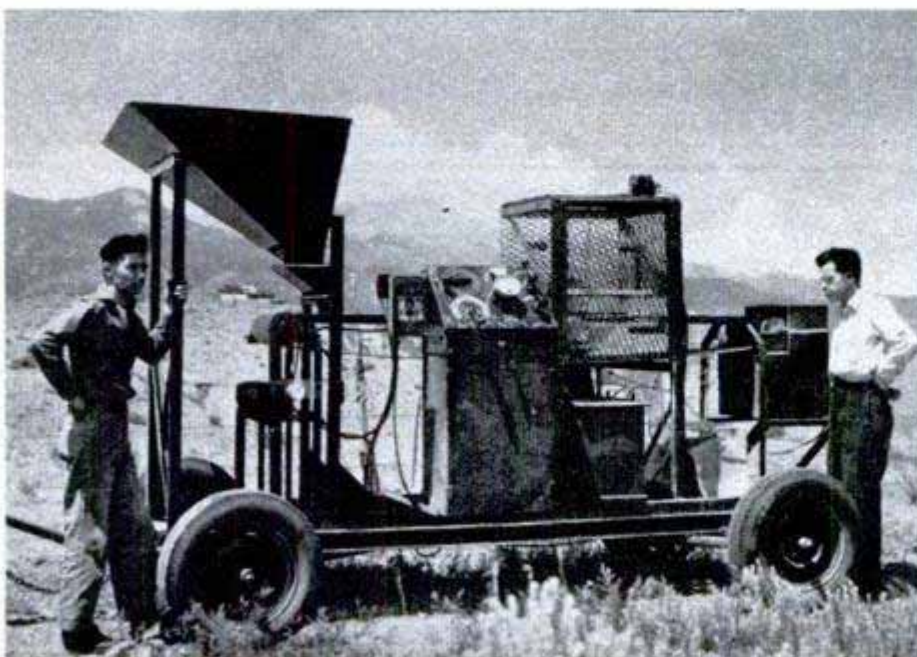

Thomas Maestas, Colorado Springs, Colo.

Electric "Sluice" Aids Gold Miner

It may not look as romantic as a '49er's sluice box, but an electric gold separator does take out more gold and that's what a prospector wants. Gold-bearing earth is carried between two high-voltage electrodes by a conveyor belt. Nonmetallic particles, being nonconductors, take on a static charge and jump up and down. Revolving paddles skim them off as they bounce. The free gold remains on the belt.



Interstate Engineering Corp.,
2250 E. Imperial Highway, El Segundo, Calif.



Above, left, if your knives are dull, sharpen them on a vacuum cleaner. Furniture dull? Shine it with the vacuum, above. It's also a power drill, left. Making this versatility possible is an air-powered turbine



Vacuum-Cleaner "Workshop"

Vacuum cleaners now drill holes, sharpen knives and polish furniture, doing all these jobs with air pressure. A turbine-equipped head containing two rotating brushes provides the power take-off for the tools. A chuck, furnished with the cleaner, mounts on the shaft of the turbine. Two wool buffing pads are used to polish floors, cars and silverware while a pair of contra-rotating bristle brushes scrubs floors to remove even the stubbornest dirt. Designed by a vacuum-cleaner manufacturer for use with his product, the turbine head can also be used on several other brands.

Test Runway For Landing Gear

All the punishment taken by airplane landing gears is duplicated by the Air Materiel Command's new test "runway." It consists of two large endless belts driven by an electric motor over a series of rollers. Aircraft gear are dropped onto the moving belts to simulate landings up to 160 miles an hour.

☐ The same blight which wiped out the American chestnut tree is now threatening to destroy chestnuts and oaks in Italy and Switzerland.

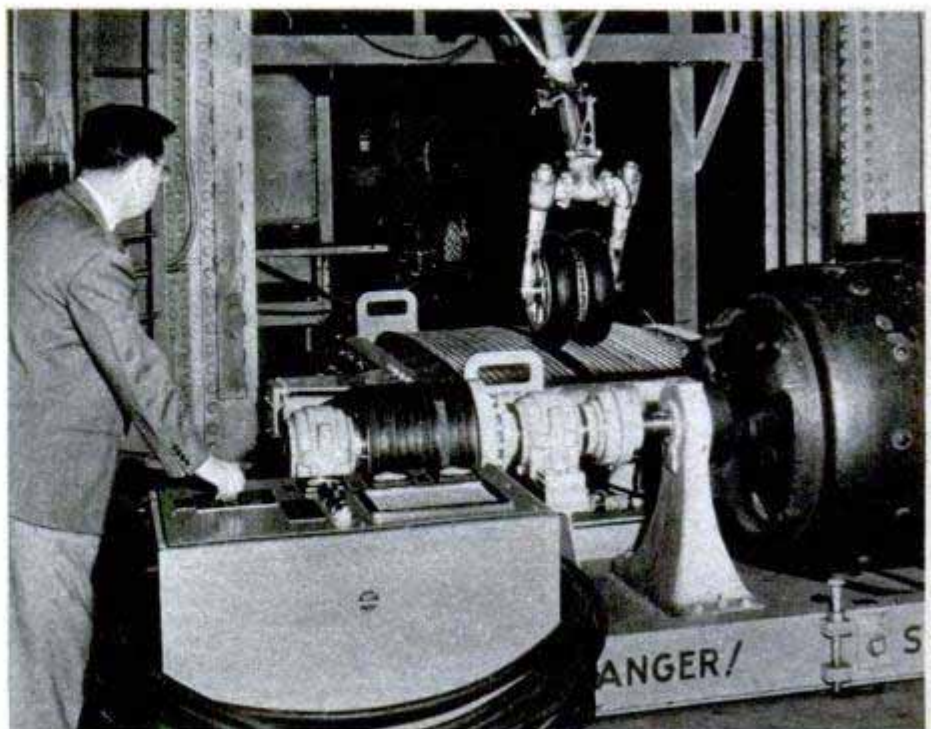

Blue lightning helped an Oklahoma scientist and his college crew of research workers discover the secret of forecasting and tracking the world's most violent storm

Field equipment outside the tornado-tracking station at Oklahoma A & M College consists of two directional antennas and an antenna that is coupled with a cathode follower. Dr. Herbert L. Jones, director, in center

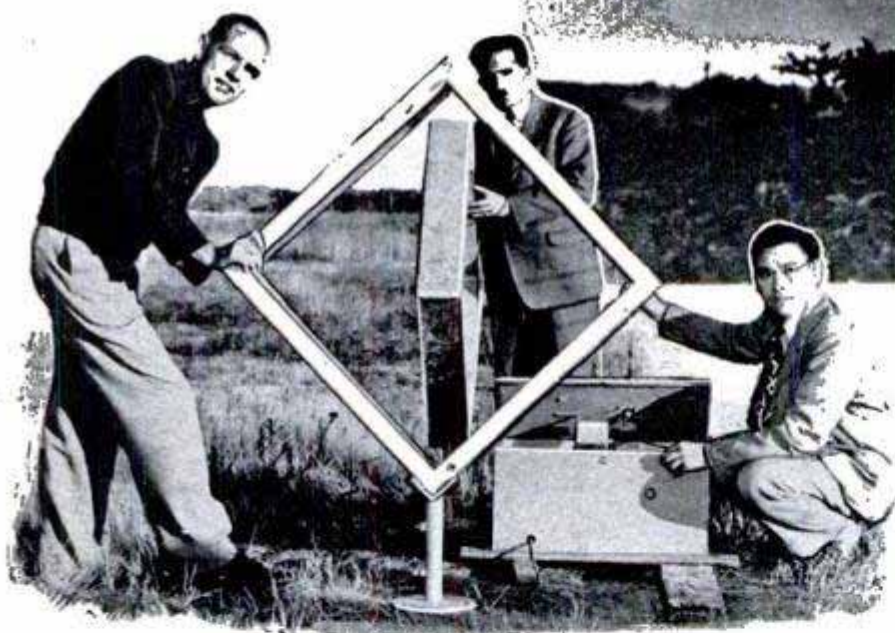

Now They're **FORECASTING TORNADOES**

By Ben Funk

THE UNITED STATES has been helpless against tornadoes in the past, simply because weathermen couldn't tell—until too late—the difference between a brewing twister and an ordinary thunderstorm. High death tolls and incredible destruction were inevitable. Now, after four years of relentless effort, a research team from the Oklahoma Institute of Technology, of the Oklahoma Agricultural and Mechanical College, has cracked the baffling secret—

how to forecast a tornado. This spring, it is holding its first full-dress rehearsal of a system designed ultimately to save thousands of lives.

A tornado generally starts like this. A moist, balmy mass of air leaves the Gulf of Mexico and pushes northward. About the same time, a cold front enters the tides of the upper atmosphere to the north and glides southward. These mighty masses then collide, and the atmosphere, thrown

suddenly off balance, erupts in furious confusion. While torrents of rain bombard the earth, aerial convulsion develops into a great spinning movement that whirls faster and faster until a long, twisting black funnel pokes out of the pitch-black storm clouds. The funnel reaches out until its lower end clutches the ground and then it begins a wild and dreadful journey over the plains. Head for your storm cellars—this is the world's most violent storm.

Every spring and summer these great black funnels wreak their maniacal fury on U. S. towns. Tornadoes have struck in every state and the District of Columbia, but the areas most frequently hit are the great central valleys of the United States. Kansas, Iowa, Texas and Oklahoma have had the greatest number. Oklahoma lies at the "tornado junction," that part of the Great Plains area where north and south air currents frequently clash.

The tornado that took the highest death toll in the country raked the Ohio Valley on March 18, 1925, killing 689 persons and injuring 1980. The St. Louis tornado of 1927 was the worst property-destroyer on record. Damage was estimated at \$22,000,000.

Tornadoes average 300 yards in diameter, although they have been observed from a

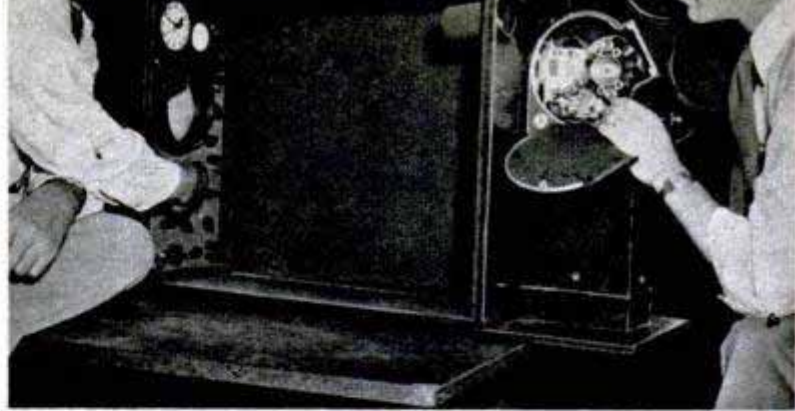

Camera automatically photographs flashes of lightning as recorded in waves on oscilloscope screen

few feet to more than a mile across. The average path is about 12 miles long. While forward speeds up to 150 miles an hour have been reported, these are extremely rare. An automobile can easily outrun most tornadoes without breaking any speed limits. Around the edges of the tornado, however, will be spinning winds that may reach a speed of 500 miles an hour, flattening trees, houses and brick buildings as easily as a sharp scythe cuts through a stand of grain. And at the center of the funnel is a low-pressure area with a suction so powerful that it can cause buildings to explode

Below, left, ordinary lightning looks like this on oscilloscope screen; tornado lightning is shown at right

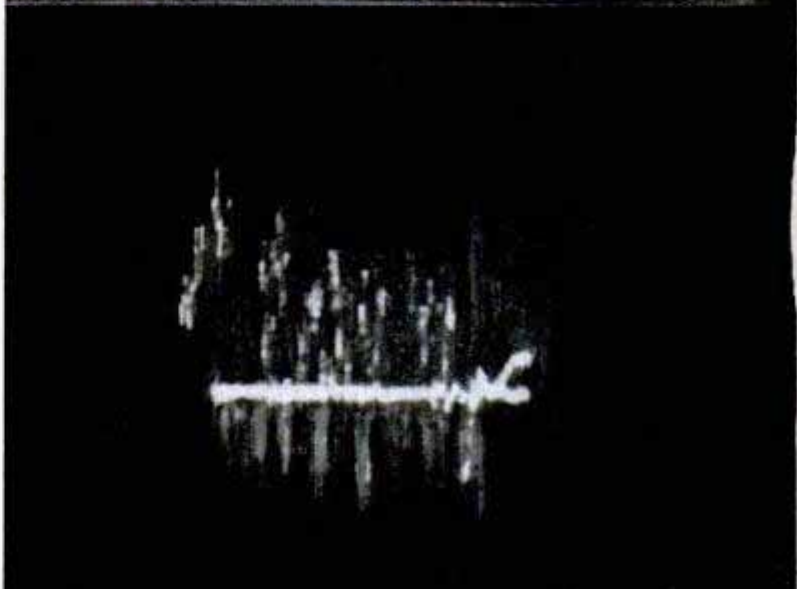
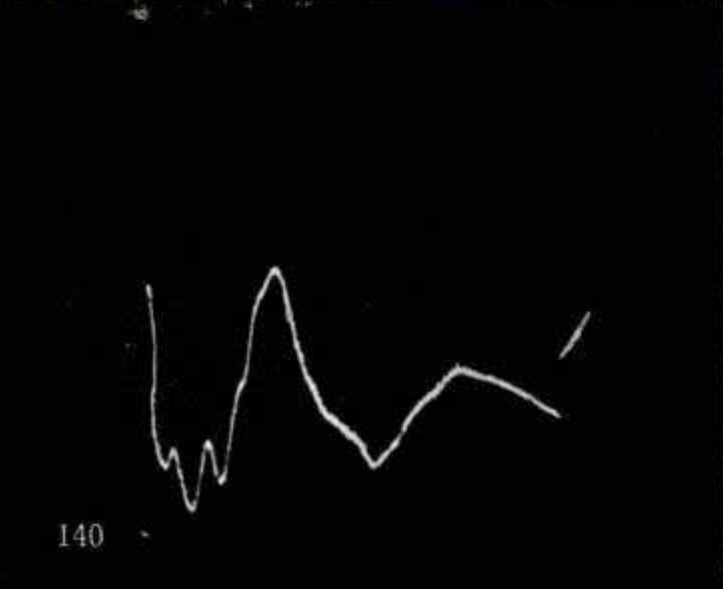
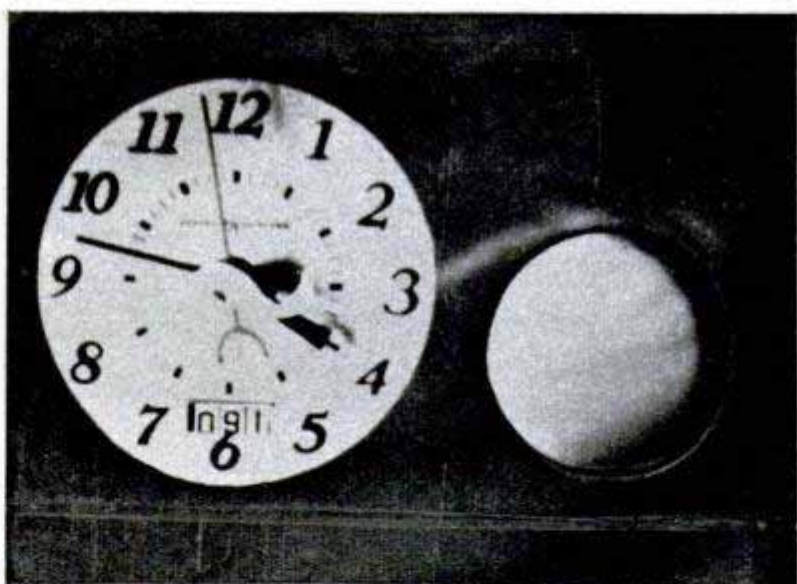
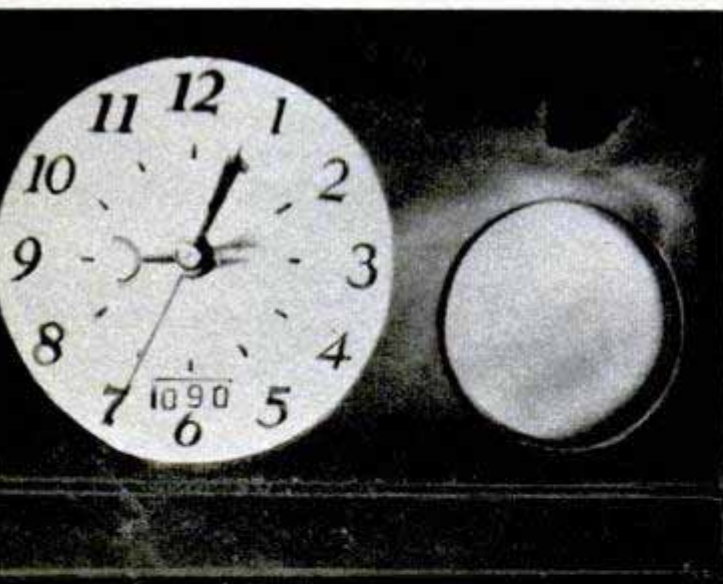

from the outward heave of the air inside them.

Until science finds a way to break up a tornado before it starts to move, nothing can be done about the property damage which it wreaks. But the ability to spot a twister in its formative stage, track its movements and warn people ahead of it will save thousands from death and injury. This is the key which the research team at the Oklahoma Institute of Technology has found.

Using electronic equipment which photographs and identifies "tornado lightning," these researchers get an instantaneous tip-off whenever a twister begins to form in the skies within a radius of 150 to 200 miles of the station which they have set up at Stillwater, Okla. Using direction finders and radar—devices already proved in tracking hurricanes and other types of storms—the team locates a tornado and trails it like a bloodhound. The next step is to establish a preliminary network of electronic stations—four would blanket the state of Oklahoma—and begin working out a method of warning communities that are located in the path of tornadoes.

Dr. Herbert L. Jones, boss of the Oklahoma team and professor of electrical engi-

neering, began talking tornado-tracking as soon as he arrived at the Oklahoma Institute of Technology in 1946, after 10 years on the faculty of the University of New Mexico and six years of telephone laboratory work. He was encouraged by Dr. Clark A. Dunn, director of the institute's engineering research.

The first step was to collect every available eyewitness account of tornado activity. After questioning scores of people, one clue stood out like a beacon—tornado lightning was different from ordinary lightning. William Kruckenberg, of the department of engineering extension at Oklahoma A and M College, reported that when he watched a tornado pass his father's farm near Enid, Okla., the lightning discharges were bright blue, almost violet in color, and far more vicious and intense than thunderstorm lightning. This tallied with an account by Prof. Alexander Langsdorf, Dean Emeritus of Engineering at Washington University, who observed the St. Louis tornado of 1927 from the window of a streetcar. He reported that the lightning discharges had peculiar characteristics and noted that St. Elmo's fire streamed along the trolley rails and engulfed the car.

(Continued to page 246)

By triangulation, two tornado-tracking stations in Oklahoma locate a storm and follow its destructive path

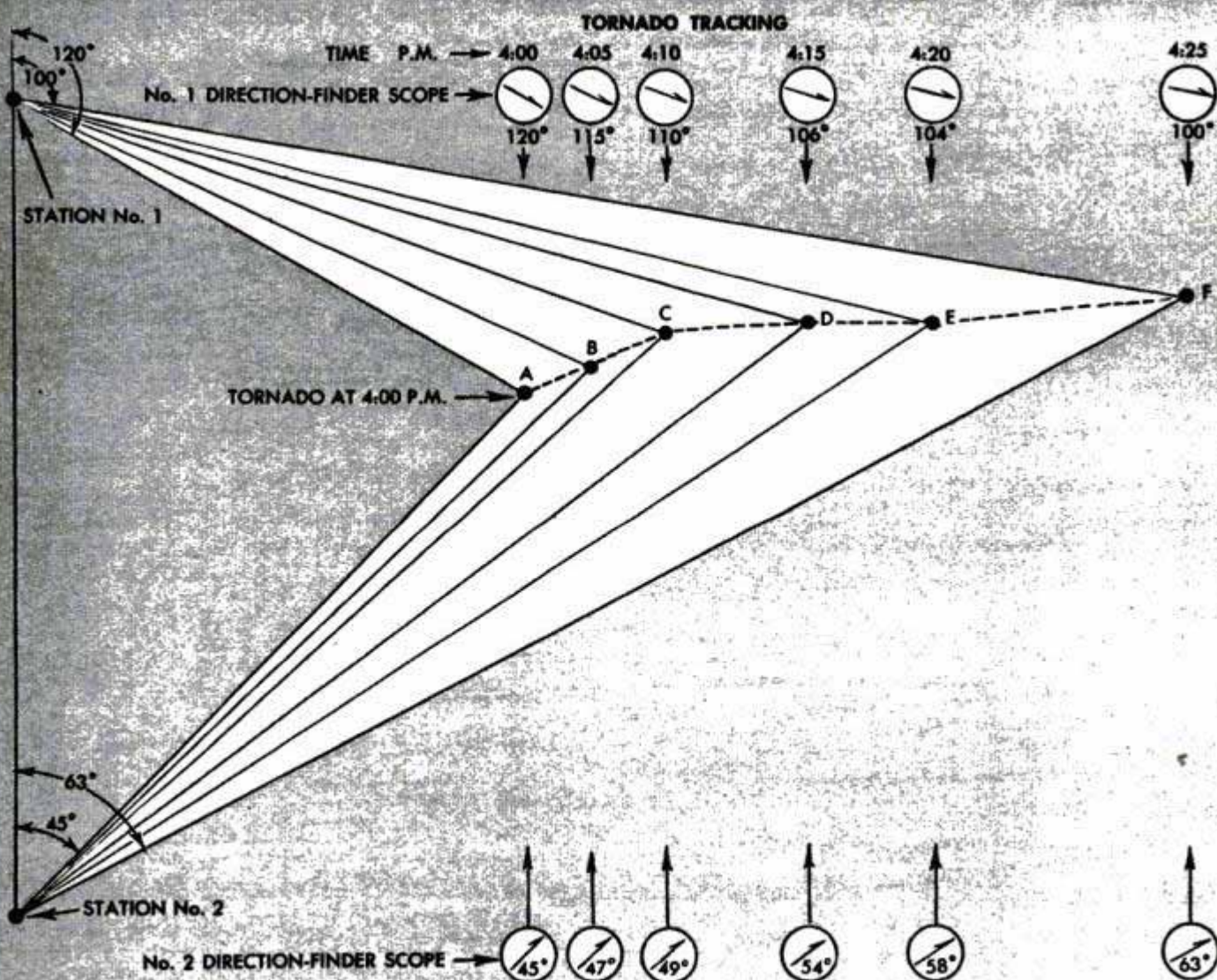



The Austin Co., 19 Rector St., New York City 6

Radioactivity Checker

Laboratory technicians who handle radioactive materials can check the contamination of their hands and feet with a new instrument that measures beta-gamma rays. The operator merely stands upon a platform and thrusts his hands into special compartments in the instrument. In a few seconds the machine gives five different readings, representing the radiation from the palm and back of each hand, and the feet of the worker. If any one reading is too high, the laboratory employee must report for decontamination.

Pinup Hanger for Hats

You can hang your hat on the ceiling of your car with a hat rack that pins to the upholstery. Adjustable from 8 to 13 inches in length, the hanger consists of two springs that hold the hat brim firmly but without damage.

The Auto Hatrack Co., 829 15th St., Denver, Colo.

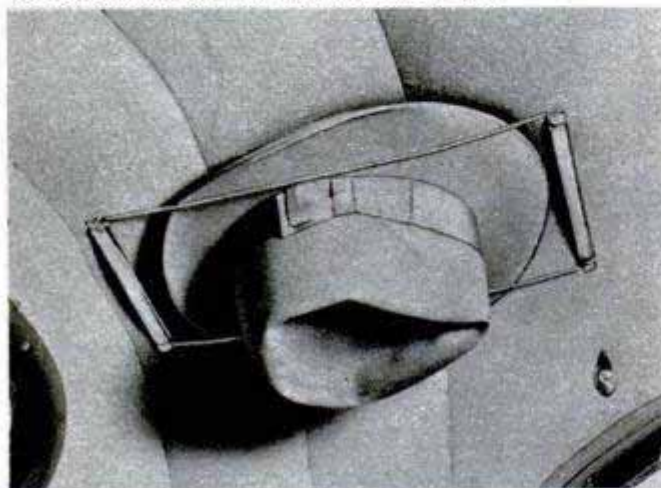

Lifesaving "Bathrobe" Protects Rocket Workers

Men who handle liquid rocket propellants for the Air Force require special clothing to protect them from the toxic fumes of such propellants as red fuming nitric acid and aniline. Fumes from either of these liquids are lethal if absorbed by the body in quantity. To protect workers, the Aero Medical Laboratory at Wright-Patterson Air Base, Dayton, Ohio, has developed a coverall-and-hood assembly fabricated from vinyl-impregnated Fiberglas. To keep the workers cool inside the suits, two methods are used. One is a forced-air system in which cooling air is pumped inside. The second cools by water evaporation. In this method an outer shell of cotton is soaked with water and worn over the coverall. Air for breathing is supplied by a tank worn on the back.

14,000-Horsepower Jet Engine

With thrust equal to 14,000 horsepower, the new Westinghouse J-40 engine is believed by its manufacturer and the Navy to be the most powerful turbojet in the world to qualify for quantity production. Its performance is expected to be almost doubled by addition of an afterburner to reheat the exhaust gases and by other developments now in progress. From starting to full power, operations of the engine are accomplished by one cockpit control.



Student works carefully on a silver teapot of his own design while instructor provides expert advice

Roll-top desk of redwood required months of work, gave student experience for a career in woodworking



They Learn CRAFTS FOR CAREERS

By Alfred Eric

IN A DOWN-TO-EARTH school at Rochester, N. Y., a few dozen students from all over the country are learning every phase of a chosen craft from design to marketing. Students at the School for American Craftsmen don't concentrate on art for art's sake—they study craft as a paying career.

Production training—the making of salable articles—is not sneered at in this school. As soon as the student's skills permit, he goes on production work.

Students must meet rigid entrance requirements, as only a few dozen are enrolled at a time. The student can select as his field any of four hand arts: metalcrafts, which include the making of jewelry, flat silver, holloware and enameling; ceramics, including ceramic sculpture; textiles, with emphasis on design, weaving and printing techniques; and all forms of woodworking and furniture design, a field that includes joinery, turning, carving and finishing.

Instructors emphasize the sale of craft articles. Students are lectured on pricing and market trends by experts in the various fields.

Instead of writing a thesis, the student designs and makes a "journeyman piece" which the faculty must approve before he is recommended for graduation.

In rare cases, students of unusual ability take a third year of work at the school. Most alumni find their craftwork profitable as soon as they leave the school.

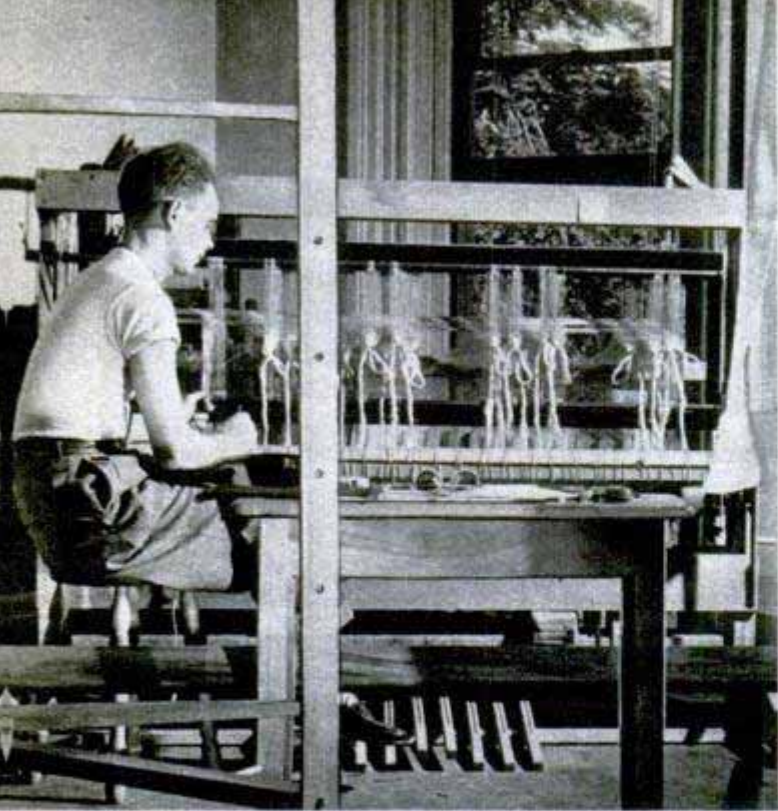

One of the school's most successful students, Karl Laurell, already is deluged with orders for textiles



Out of kiln comes a new ceramic piece. Student in this field learns to master hundreds of glazes

Students, from left to right, work on a primavera commode, a walnut cabinet and a modern dressing table. All three students are in their second year at the school and these projects are their "journeyman pieces"

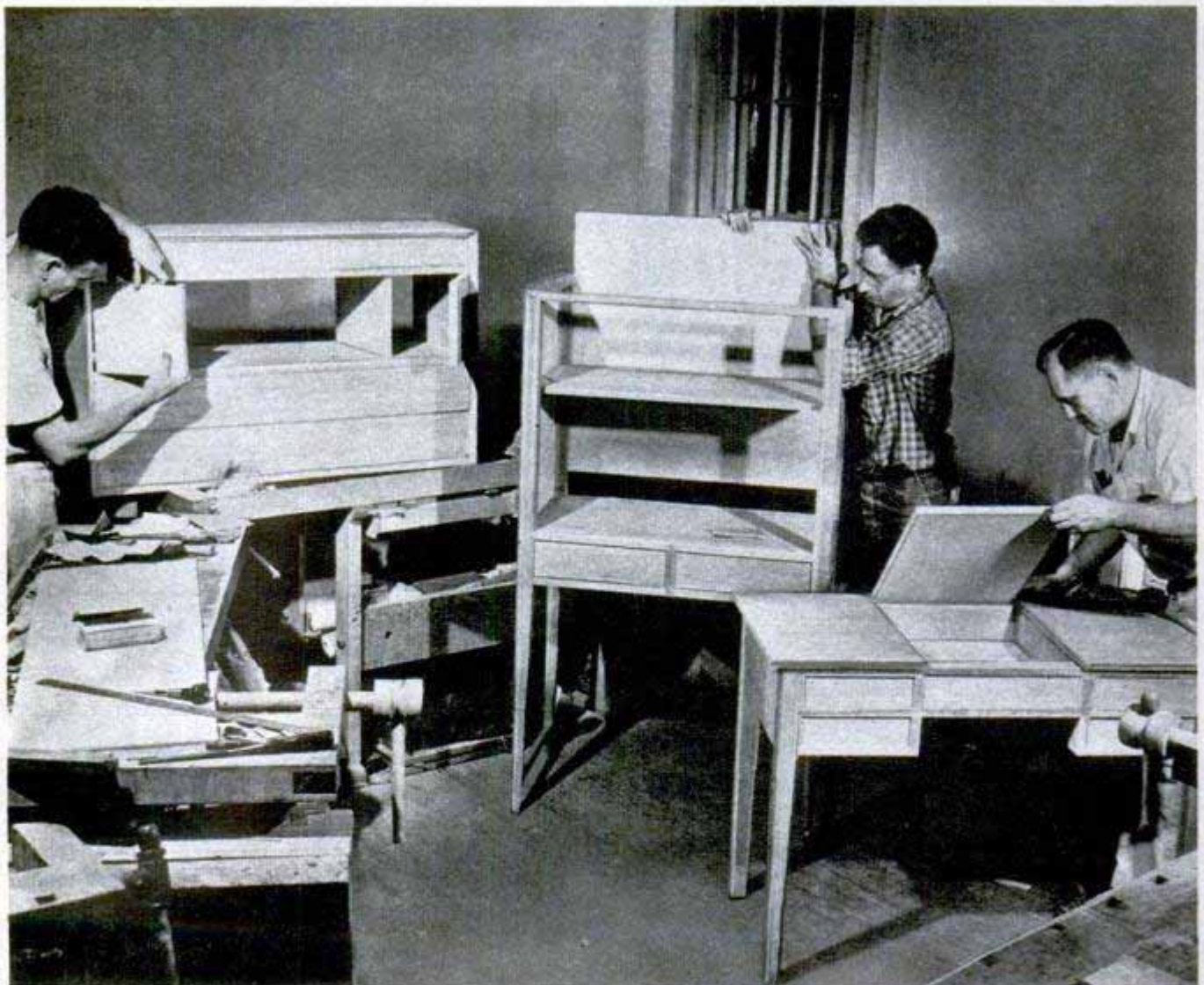



Beautiful—and salable—products come from the textile department. These students are learning how to make silk screens of their own design



Novice ceramic craftsmen not only learn "throwing" but also making and repairing of kilns



Furniture, wood pieces, ceramics—everything shown—represent the craftwork that comes from the novel hand-art school



Palomar "Core" Becomes Telescope

Because a piece of glass 40 inches in diameter and 20 inches thick was left over when the world's largest telescope on Mount Palomar was completed, Los Angeles now has an interesting scientific "light gatherer." The piece of glass, which formed the "core" of the 200-inch telescope before it was removed, now is a mirror, ground to 2/1,000,000-inch concavity. It has been

mounted as a stripped, indoor telescope which demonstrates how the big telescope works. The observer looks at the mirror, 105 feet away, through an eyepiece. The mirror picks up the picture of a transparency about the size of a postage stamp, 119 feet away. The viewer is able to read every letter of print on an object the equivalent of 224 feet away.

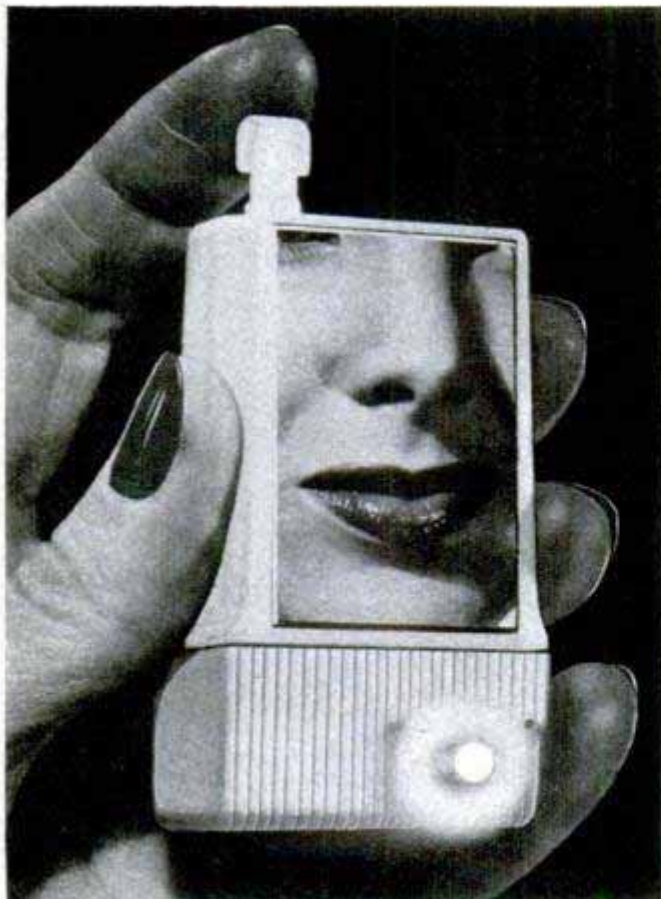

Pocket Mirror Lights Its Way

Serving a double purpose, a combination mirror-flashlight provides illumination for milady as she applies cosmetics in the car, theater or other dimly lit places. There is a spring clip on the case so the light can be attached to the sun visor of the car or to a pocket inside her handbag.

India to Double Irrigated Acreage

India's irrigated acreage will be nearly doubled on completion of a river-harnessing program already begun. The country now has 50,000,000 irrigated acres. Largest of all, and modeled after the Tennessee Valley Authority, the Damodar Valley Project is scheduled for completion in 1955 at a cost of about \$175,000,000.

If you do not find the information you need in the **WHERE-TO-BUY-IT INDEX**, starting on page 12, sources of further information are available without charge from Bureau of Information, Popular Mechanics Magazine, 200 E. Ontario St., Chicago 11

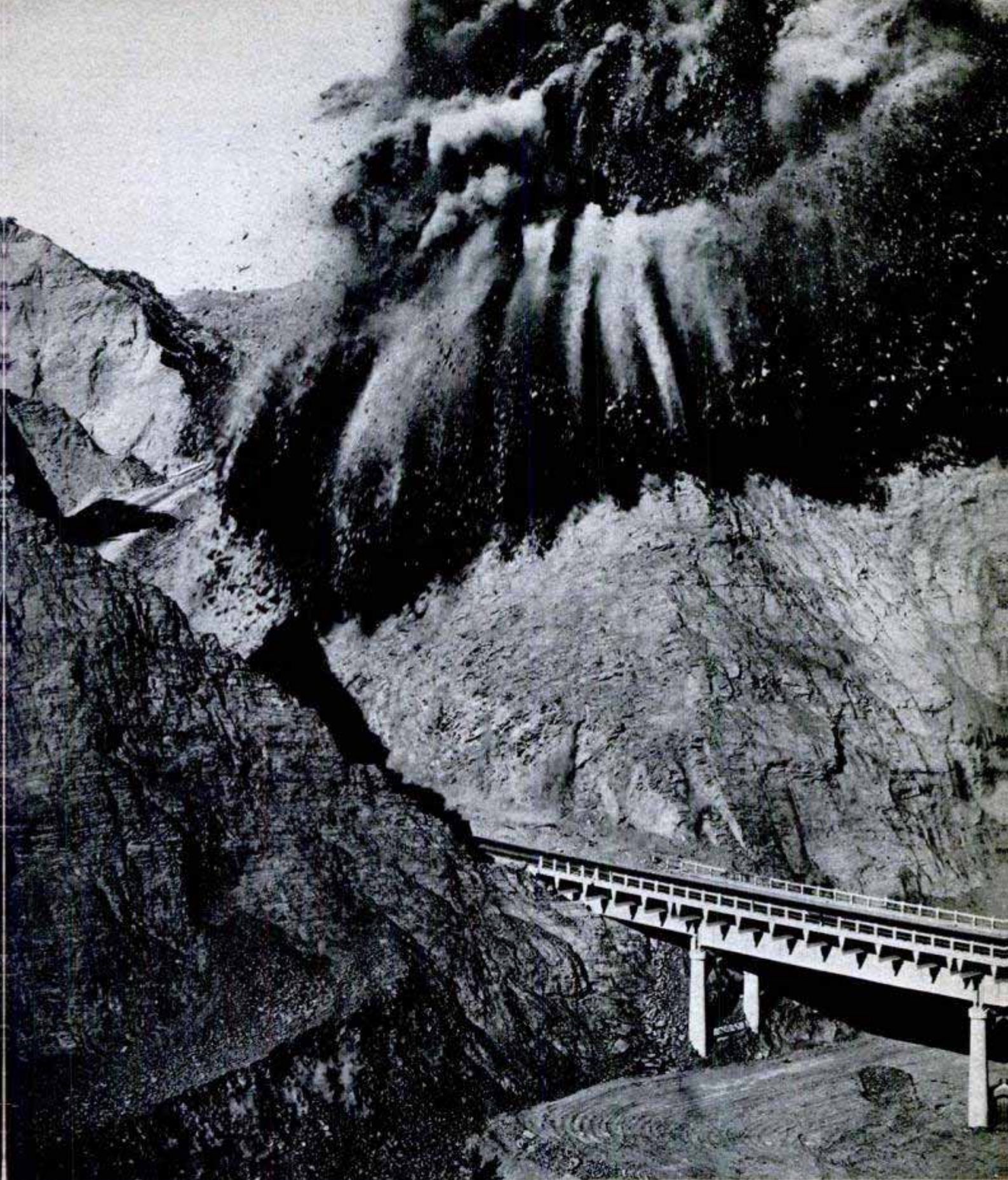

A MOUNTAIN GOES UP IN SMOKE

CALIFORNIA highway engineers are cutting down a mountain with a series of spectacular blasts so that a highway at its base may be widened. The top of the mountain was blown off by the exploding of low-strength powder in 350 holes, each drilled

24 feet into the summit. Traffic was halted 42 minutes while bulldozers cleared fallen rock from the highway. The widening is being done on the so-called Ridge Route portion of U. S. Highway 99 connecting Los Angeles and San Francisco.



Cameraman focuses for close-up, while high overhead another stands ready for shot from floating island

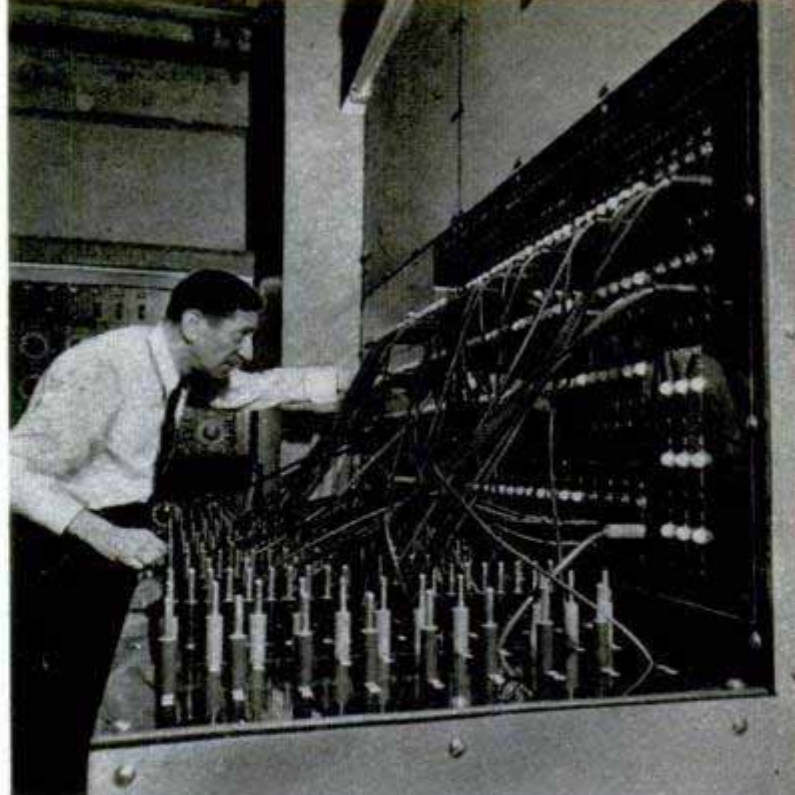

On the electrician's jumbled jack panel more than a million lighting combinations can be prerigged

THREE-DECK TV STUDIO

CUT IN THE OVERHEAD," snaps the technical director into his hand mike. The close-up picture of the orchestra leader on the six TV monitor screens dissolves slowly into a helicopter's-eye view of the entire ensemble. The effect is something like peering over the rim of the Grand Canyon. In the cavernous studio, more than half a football field in length, you gaze through a vast tangle of cables, lights and battens to see what happened. The scene is now being scanned by the lens of a heavy TV camera perched on a floating isle of steel plates three stories above the studio floor. Lost on the huge floor, five other cameras, some on towering boom dollies, stand ready to scan any one of half a dozen other full-size sets.

NBC's new studio 8-H, carved from the honeycomb interior of New York's Radio City, is a modern TV wonder. Its floor area measures 92 by 168 feet, and it towers three stories high. More than 1000 lamps ranging from 100 to 5000 watts pave the vast ceiling. The jack panel, where more than a million different lighting combinations can be prerigged for any sequence, is a jungle of crisscrossed wires when a show is in progress.

All lights, as well as scores of backdrops, are hung on battens that can be raised or lowered at will from a forest of pull ropes along the back wall.

Around the perimeter of the huge studio

are all the facilities of a full-fledged theater. Behind the 30-foot-deep stage (for dramatic shows) are 15 dressing rooms. Along one side is a mezzanine where clients can watch their performers, and an audience gallery that seats 94. Beneath is a plush-lined make-up room. There's a roomy sound-effects booth on the floor level and a vast chorus room tucked away in one corner. Audio, video and light control rooms are stacked two tiers high on one end.

In the main video control room there's a monitor screen for each of the six cameras on the floor—plus three others for preview. "By having a separate monitor for each camera," explains the engineer, "we can, if we want, cover any scene from six different angles, watch the six results up here in the control room, and telecast only the best one for the audience."

NBC engineers are especially proud of their "floating island" high above the studio floor. The platform has an access ladder like the extension on the fire department's "big rig." Hinged to the edge of the island, it is hauled up flush with the ceiling when not in use. TV cameras are planted on the platform for high shots and trick effects.

Another unique piece of equipment in the new studio is a "transistor." This is a motor-driven rotating disk, mounted on a cast-iron truck. Special paintings are mounted on the disk and revolved slowly before the camera to televise weird effects.



Here's one view from high on the floating island. Platform makes possible long angles and tricky shots

Studio, about half the size of a football field, has scores of backdrops, all the facilities of a theater

By running shaded color before the camera's eye, fade-ins and fade-outs can be achieved, for example. Stylized rain and snow can be made to fall across the video screen and fantastic ghosts televised.

There's also a hand and motor-driven "crawl" for titles—a revolving drum on which any amount of text can be reeled off before the camera at any speed.

To carve TV's most lavish studio out of Radio City's interior labyrinth of plaster and steel took some doing. The 32-foot I-beams that support the massive ceilings and walls were hoisted up elevator shafts in 16-foot sections and riveted together in the studio space to avoid carving big holes in the building's outer shell. The tremendous demolition job to make room for the studio's cavernous interior had to be done without pneumatic hammers and other noisy tools so sound wouldn't travel through the building's steel skeleton and disrupt broadcasts going on in other studios while the work was in progress. Tons of debris were carried out to waiting trucks during predawn hours for the same reason.

But results were worth it, according to NBC engineers. "There isn't a show going we can't produce here now," they boast.

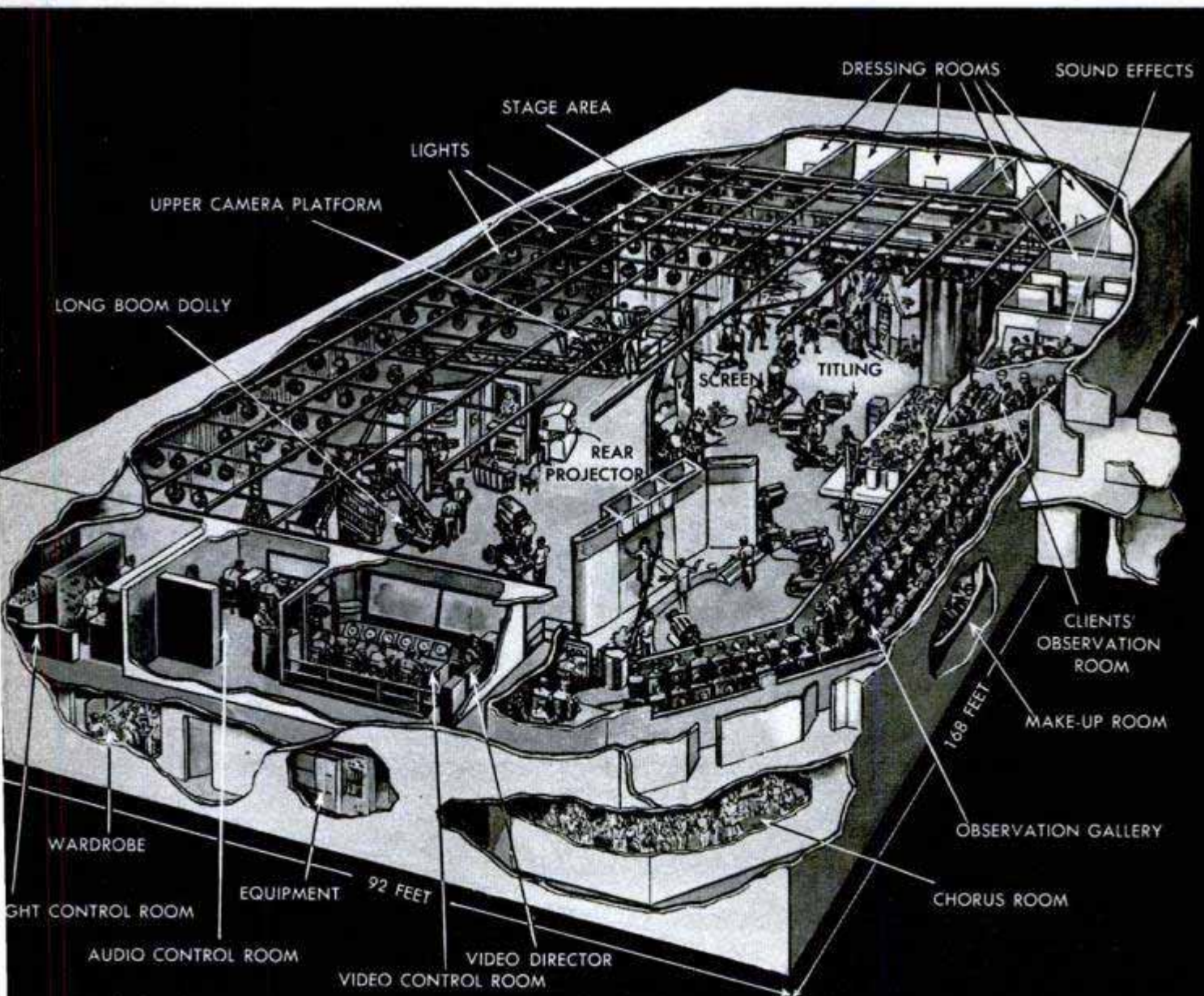



Forest-Fire Fighter

Carrying its own water supply, a forest-fire-fighting vehicle is a one-ton Jeep truck with a disk plow mounted on the rear. Because the Willys truck, a larger version of the familiar Jeep, has a four-wheel drive,

the fire fighters can drive it just about anywhere. It carries a 100-gallon water tank. The plow, operated by a hydraulic lift, turns over the turf to form firebreaks. Pennsylvania's Department of Forest and Waters has put 24 of the vehicles into fire-fighting service.

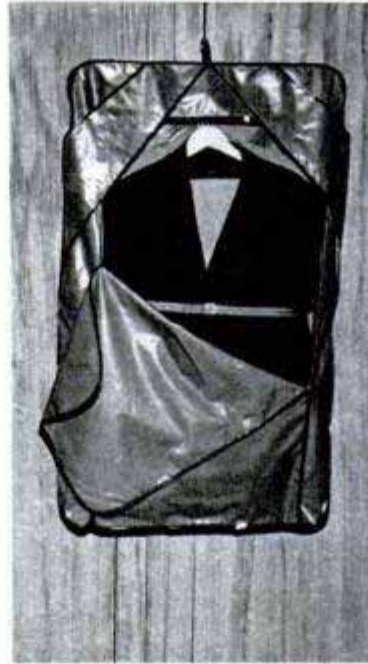
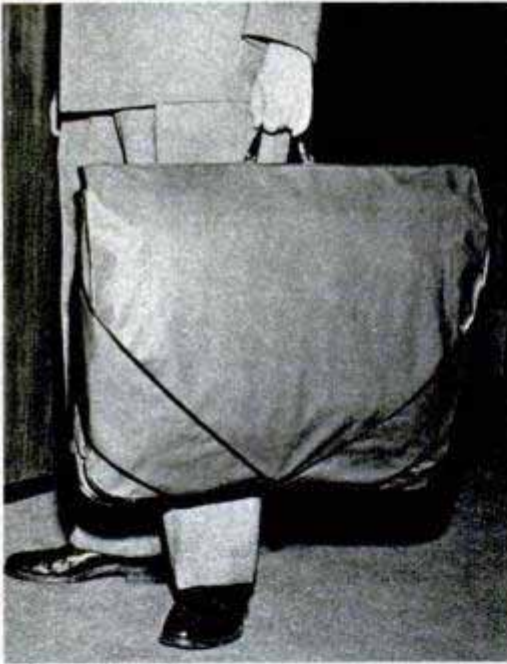

Garment-Bag Suitcase

Made of heavy vinyl plastic, a new garment bag can be folded into a suitcase and carried by a handle. The empty bag is hung up and packed with clothing, which is held in place by straps. The case then is zipped shut, making it moisture and dust-proof, and folded into a suitcase. It can be unfolded and hung in a car or closet. The bag is available in two sizes, one for suits and the other for dresses.

Protex Products Co., 347 Fifth Ave., New York City 16

Hinged Tail Gate For Rescue Boats

With the hinged tail gate down, casualties can be taken into a new rescue boat without the rough handling necessary when they have to be hoisted over the side. The craft has a complete radio-communication system and carries emergency medical supplies.

☐ It takes 65,000 gallons of water, weighing 270 tons, to process a ton of steel.



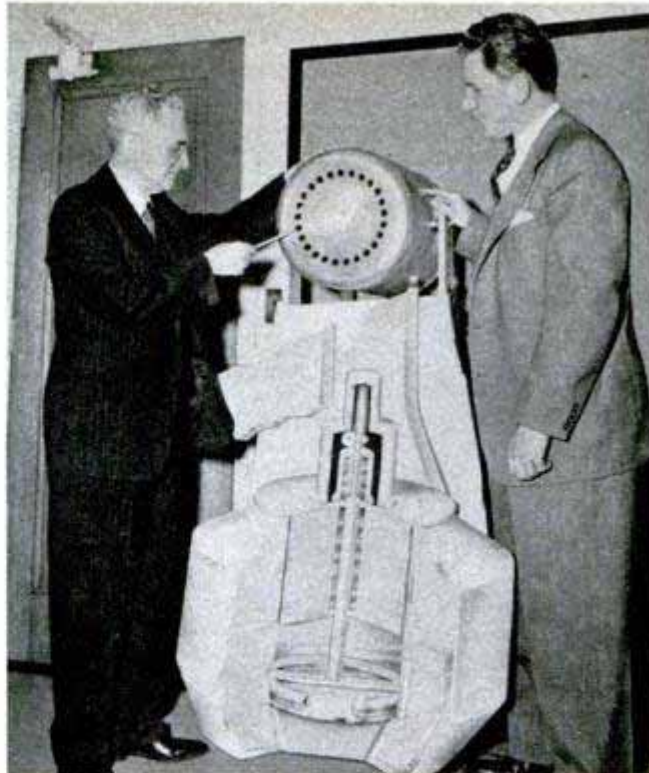
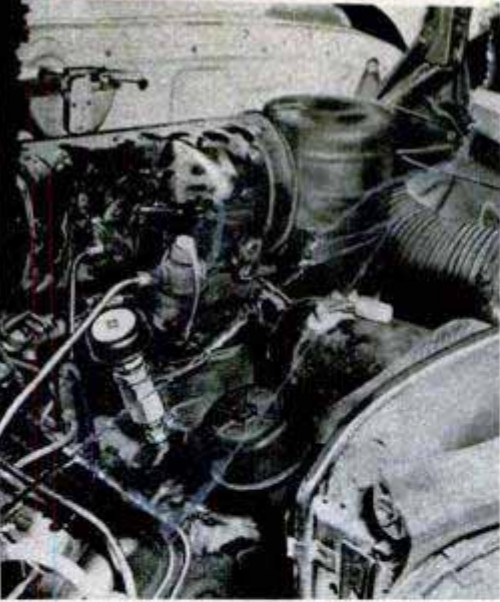

Auto-Vac Sales Co., W. 17th and Ave. B, Scottsbluff, Neb.

Engine Attachment Fights Carbon

Installed directly into the intake manifold, an air-metering attachment prevents carbon and sludge formation in any gasoline-burning engine, according to the manufacturer. Upon normal deceleration of any engine, unexploded gasoline is always left in the combustion chamber. This is caused by a suction which draws excessive amounts of gasoline through the idling jet and sucks oil up and off the cylinder walls. The gasoline cannot burn properly while the motor is operating on a deceleration basis and the butterfly of the carburetor is closed. The manifold attachment meters a proper amount of air for a combustible mixture any time an engine exceeds an idling vacuum. It not only keeps spark plugs and valves clean, but reduces fuel consumption. Fleet operators have reported savings up to 60 percent in oil and 15 percent in gasoline consumption. The attachment can be put on in 30 minutes.

Radium Keg Battles Cancer

Fifty grams of radium, the largest unit of radium in the world for medical use, have been installed in a newly designed radium-beam therapy apparatus for cancer treatment. The keg-shaped container is of lead and mercury with an outer protecting jacket of steel. It is being used at Roosevelt Hospital in New York.

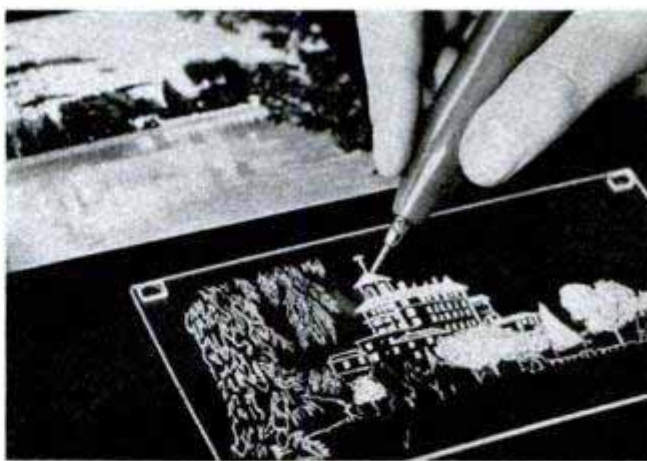

Electric Stylus "Pen" ▶

Shaped and used like a fountain pen, an electric stylus weighing only seven ounces cuts intricate designs into a variety of materials. Operating on 105 to 120-volt alternating current, the stylus will not overheat, cause objectionable noise or interfere with radio reception. It may be used to work on leather, metals, plastics, chinaware, glass and porcelain. By placing a drawing under a mimeograph stencil, you can use the unit to trace the drawing. The stylus may be used to cut identifying data on motion-picture and X-ray film.

Our defense effort requires thousands of products made from wastepaper. Your local Boy Scouts or some other civic organization will pick up your wastepaper, sell it and use the money for a good cause.

Murray Industries, Inc., 502 W. Colorado Ave., Colorado Springs, Colo.



C. H. Masland & Sons, Carlisle, Pa.

Nylon Tent

Made of nylon, a new tent weighs only 10½ pounds including poles, yet it is large enough to accommodate two sportsmen.

The tent rolls into a compact bundle carried by two handles. The poles fit together to form a framework. The tent is suspended beneath the framework by rope and can be erected in four minutes.

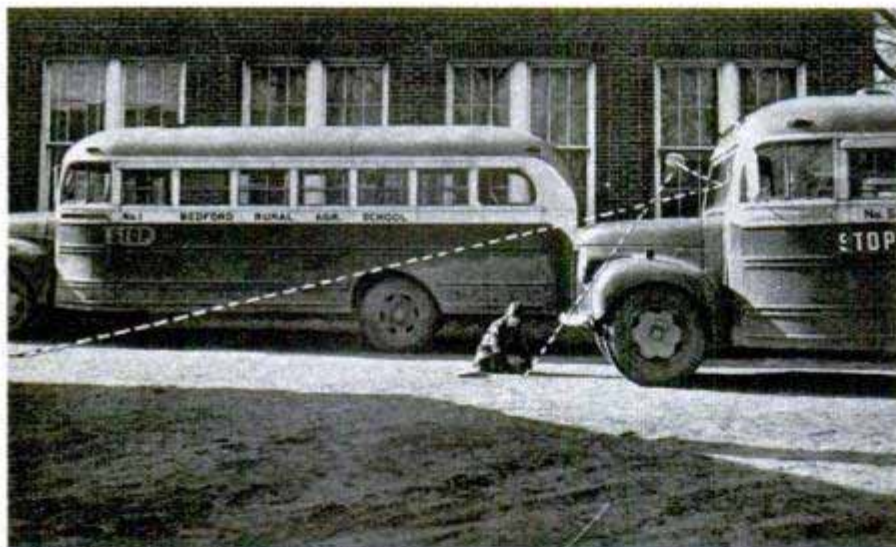

Safety Cross Mirror Co., Lambertville, Mich.

Front-View Mirror Protects Children

Drivers of school busses and other vehicles operating near children's play areas are given added forward vision by an outside mirror that mounts above the windshield. Developed in Michigan, the mirror cuts the blind spot in front of the bus from 20 feet to 3 feet, enabling the driver to see small children who cross in front of the bus at stops.

Tick-Tock Eyes

Owl eyes that follow you across the room are the latest novelty in Japanese clocks. About 12 inches high and 6 inches wide, Mr. Owl is built along the lines of a cuckoo clock with a single weight on a chain drive. The lightweight celluloid eyes are controlled by thin wires. Every time the pendulum ticks, the eyes look left; when it tocks, they look right.

☛ Insects and disease do more damage to forests in the U. S. each year than do forest fires.



Tezuka Clock Co., Ltd., Tokyo, Japan

POPULAR MECHANICS

Studio Camera Tripod.
Page 199

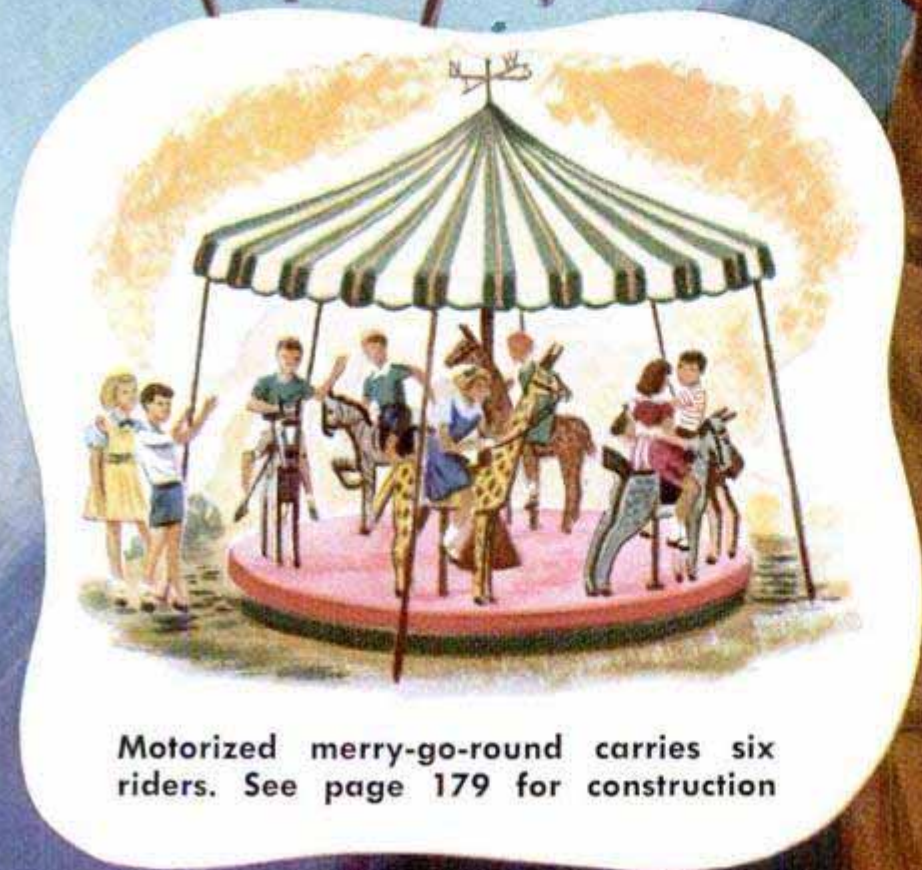
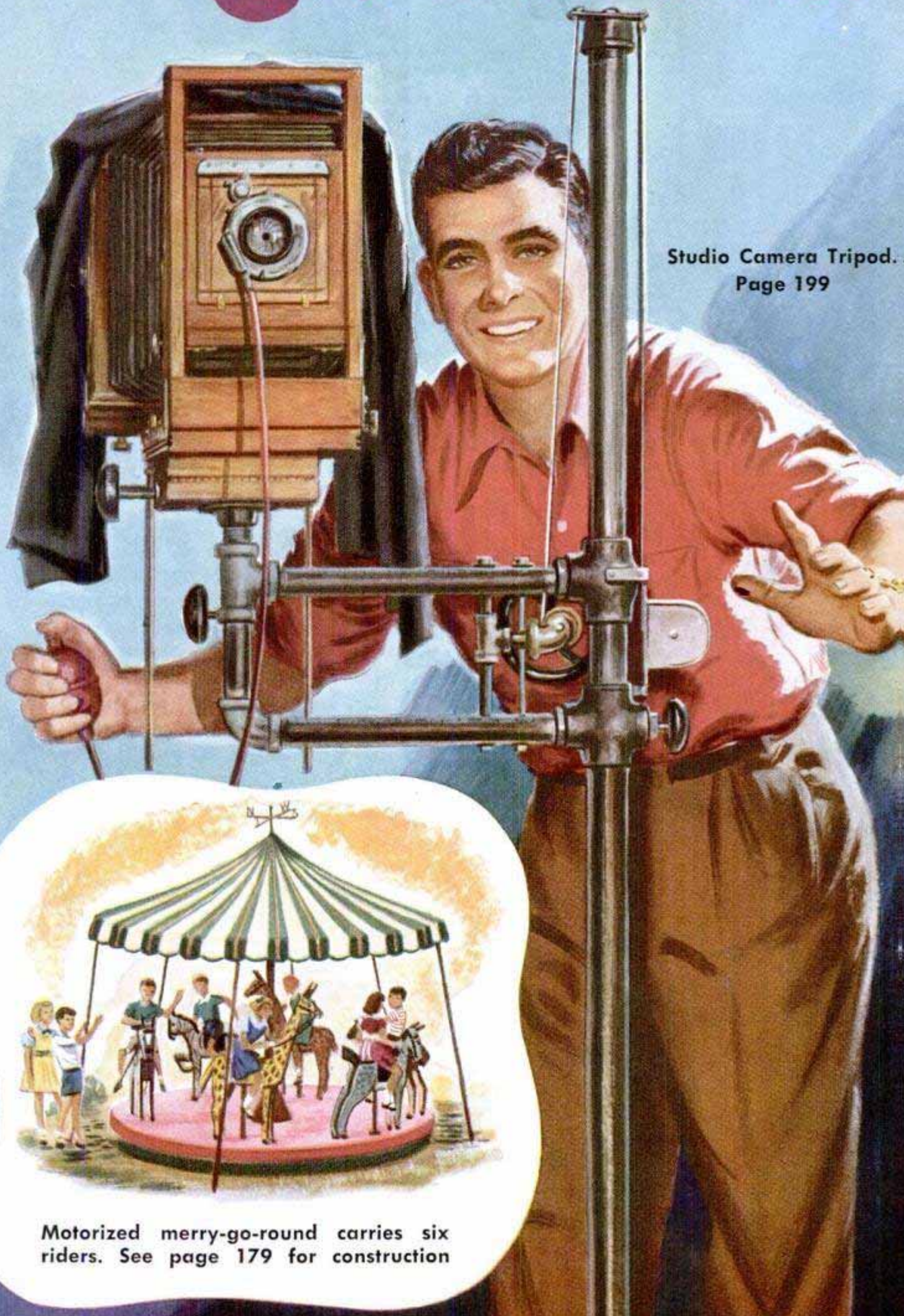

Motorized merry-go-round carries six riders. See page 179 for construction

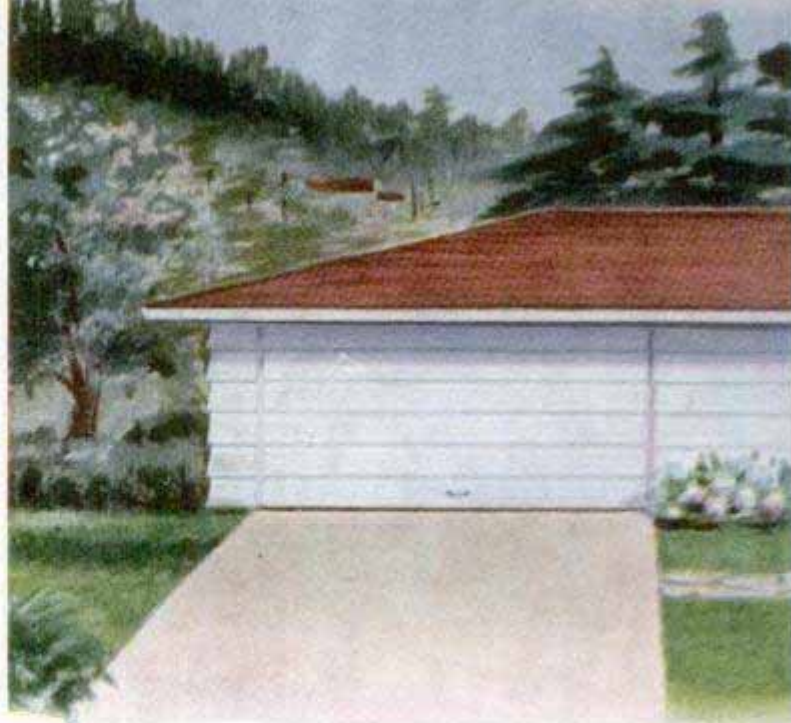

How I Built

PART I

By Tom Riley

ARE YOU AS FASCINATED AS I AM by the simplicity and rambling lines of this beautiful 81-ft. ranch house? Yes, it's mine and it didn't cost half the amount you would imagine. Materials for the completed house shown above, cost me only \$7450, and, for approximately \$5000, you can build the basic version pictured at the bottom of the page. This is the same house less garage and breezeway, with the den being used as a carport. I first built it as in the photo below, just to show how it would look, and then added the garage and breezeway. With the help of a friend, Norman

Here is the basic version of the complete house—minus garage and breezeway. Carport at left later converts to third bedroom when house is extended

Build this modern dream home yourself and save 60% of its cost as I did. You can have seven rooms—1484 sq. ft. of floor space—plus breezeway and two-car garage, as above, without basement for \$7450. Or, six rooms and carport, as below, for \$5000. That's what the materials cost me to build it myself in Portland, Ore. It is modern in every way, thoroughly insulated and is built mostly of plywood, both inside and out, to simplify construction. Begin now. It's not difficult.

Tom Riley



*mentioned in Series available
in Bureau of Files*



the POPULAR MECHANICS Ranch House



Chapman, I did the entire home in less than a year and saved an estimated \$10,000 at current prices in the Portland area.

Like most people today, my wife, Vinita, and I needed a home—and we wanted a beautiful ranch house that was modern to the nth degree. But skyrocketing labor and other costs made our savings for a new home look mighty insignificant, and each day our home seemed farther away. Vinita suggested we build it ourselves—she would help with the lighter work. We had read how some people were personally building every part of their homes and how others were helping out on the carpentry or the electrical work. In fact, we learned that *one out of every five* new homes is self-built. But building a house just wasn't for us. Riley was far from

Having decided on a ranch-type home, James Ward, craft editor, and Norman Guess, book-department manager, point out to Tom Riley, left, how the build-it-yourself book must treat construction



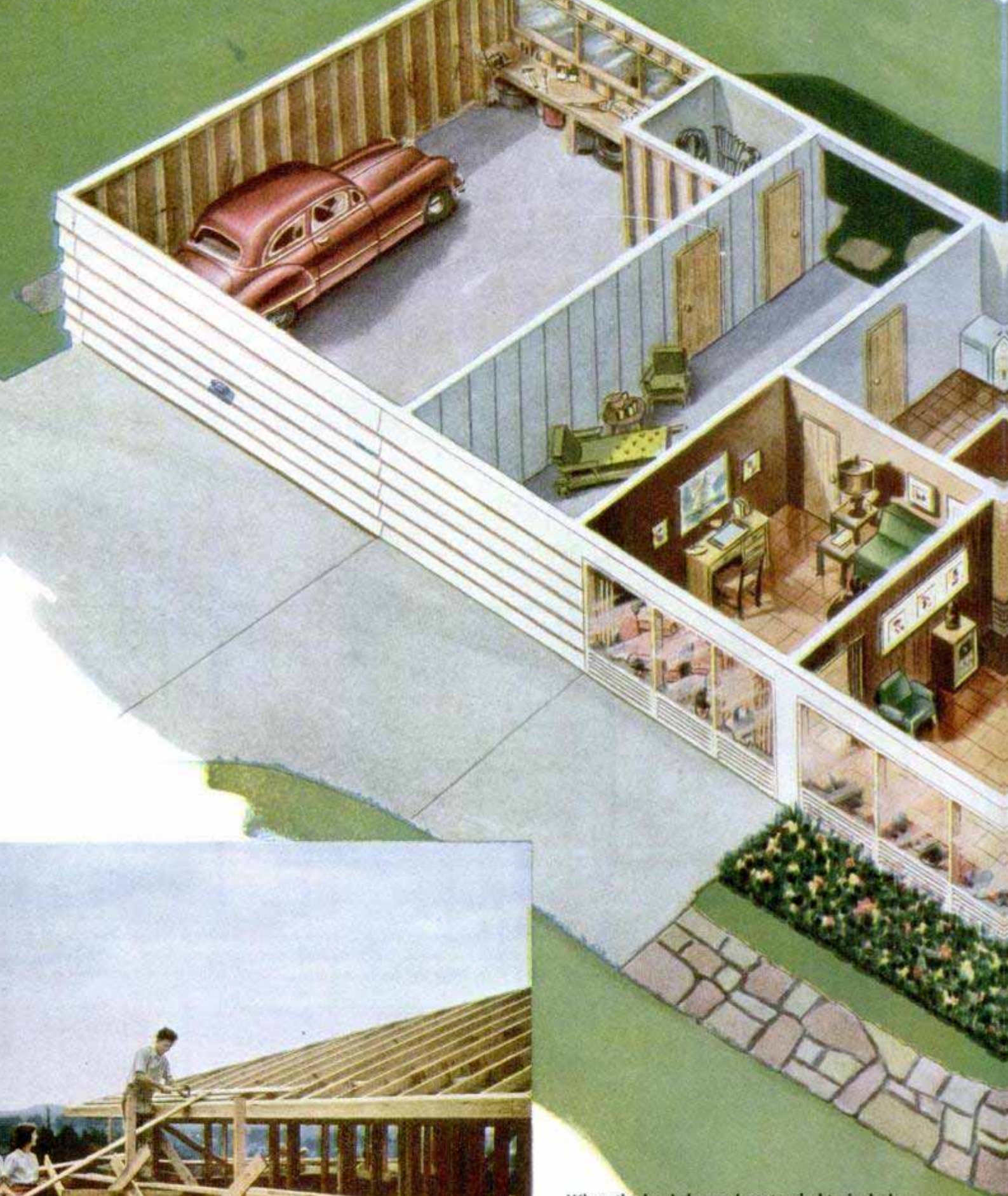

When the basic house is extended to include the garage and breezeway, the room formerly serving as a carport offers several possibilities. It can serve as a third bedroom or, if your hobby is photography, you can build in a darkroom as Tom did. If you like the idea of a half-bath, one can be located off the utility room as in the floor plan on the preceding page. The extra room also can be used as a den or study

"Prefab" roof trusses simplify construction and require no bearing wall across living-dining area. Here Riley is telling his helper how much to tap each truss to align it at the ridge. This photo shows the basic house being partly sheathed with special, inexpensive, unsanded plywood

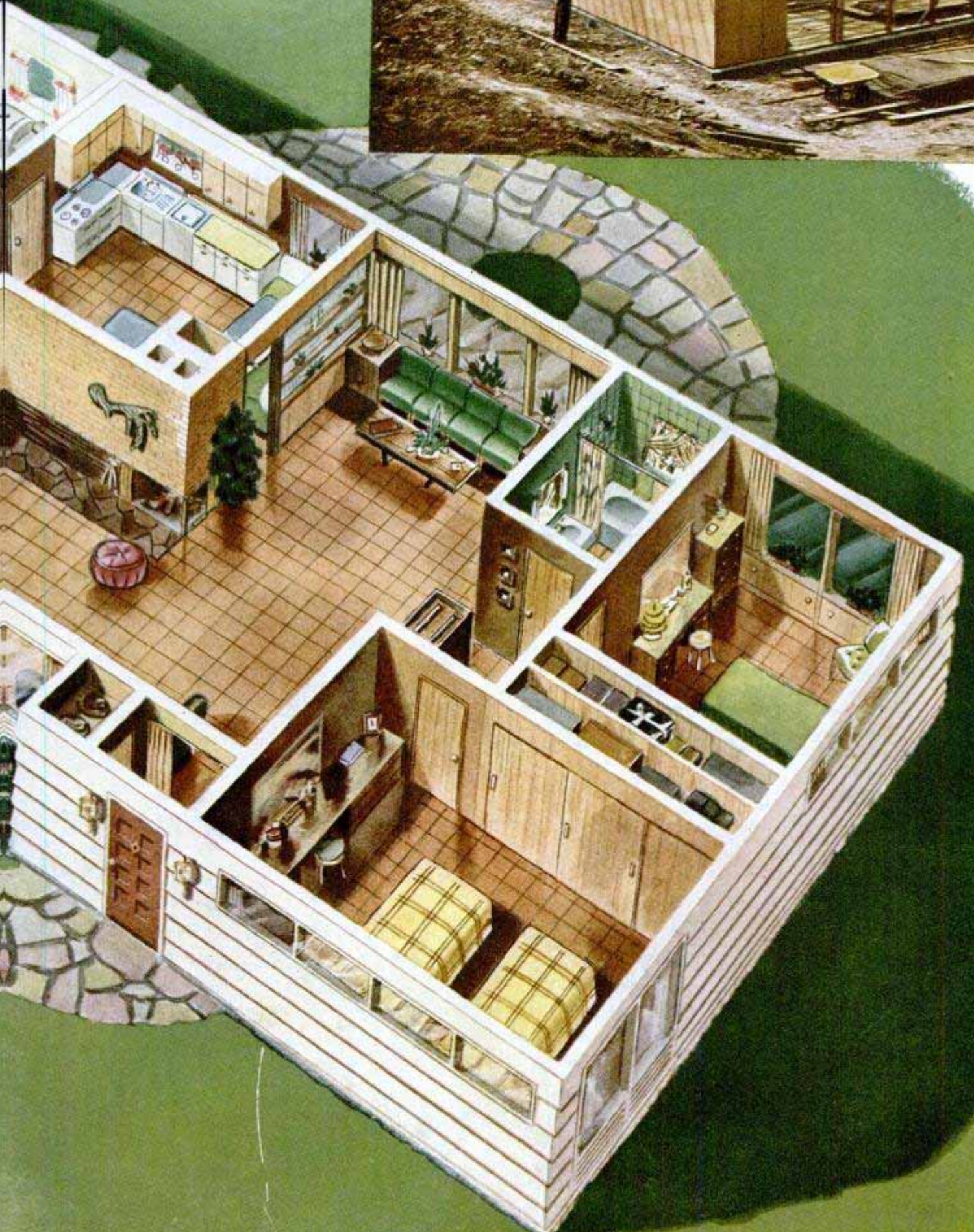

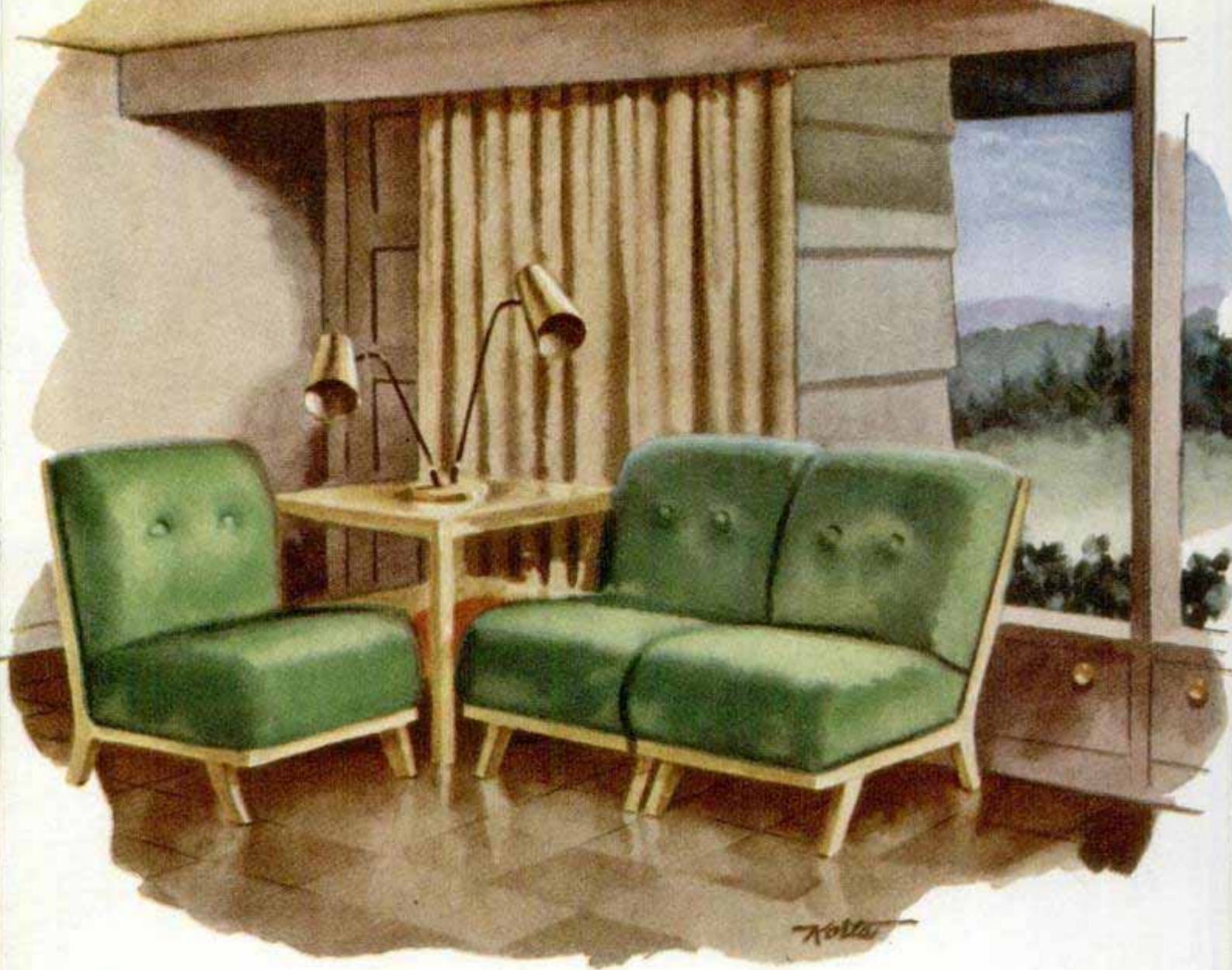

The spacious living room lends itself to innumerable furniture arrangements. Draw draperies covering the huge picture windows are ensconced with a room-length cornice board, and louver-type ventilators along the base of the windows are opened by pulling out hinged panels. Sofa corner illustrated faces fireplace, while door in background is front entrance

A 7-ft. brick wall incorporated in the island fireplace divides the living room and kitchen. Striking combination of face brick and natural stone is enhanced by the use of brass fireplace accessories, mesh screen and a brass post at the corner of the fire pit. The stone hearth is laid so that its surface is about level with that of the cork-tile floor

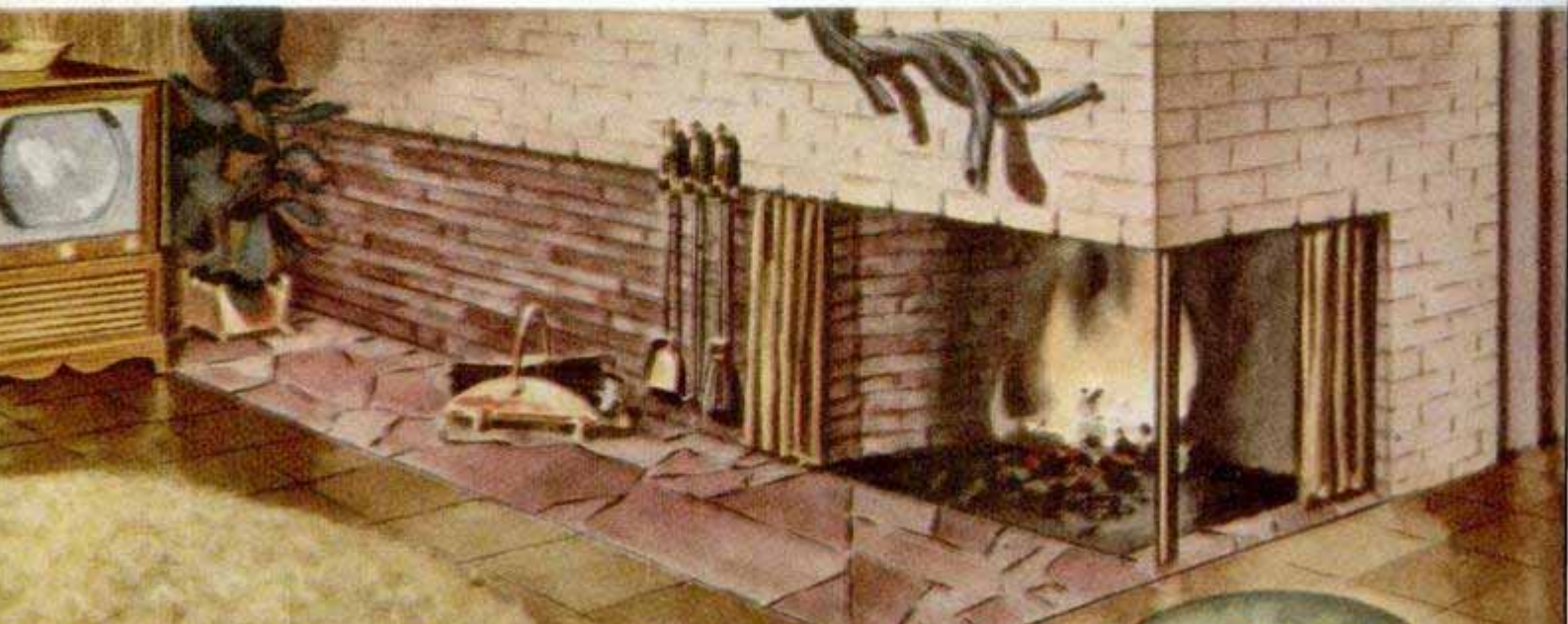



Living-room extension doubles as dining area by raising the "boomerang" coffee table when serving guests

being a carpenter. I had little experience nailing boards together and such lingo as toenailing, bridging and furring was Greek to me. But, the more we thought and read, the more interested we became—maybe it isn't as difficult as it seems, and we would be getting more of the home we wanted with the money we had.

Then fate stepped in. The editors of *Popular Mechanics* asked if I would care to build another of their famous build-it-yourself houses and be a sort of guinea pig to prove further that it can be done by anyone willing to work and follow instructions. Being a free-lance writer, the editors knew

Functional linen closet, right, conceals cold-air register and includes indirect light in the top. Well-ventilated bedrooms, below, feature generous wardrobe closets plus plenty of space for built-ins

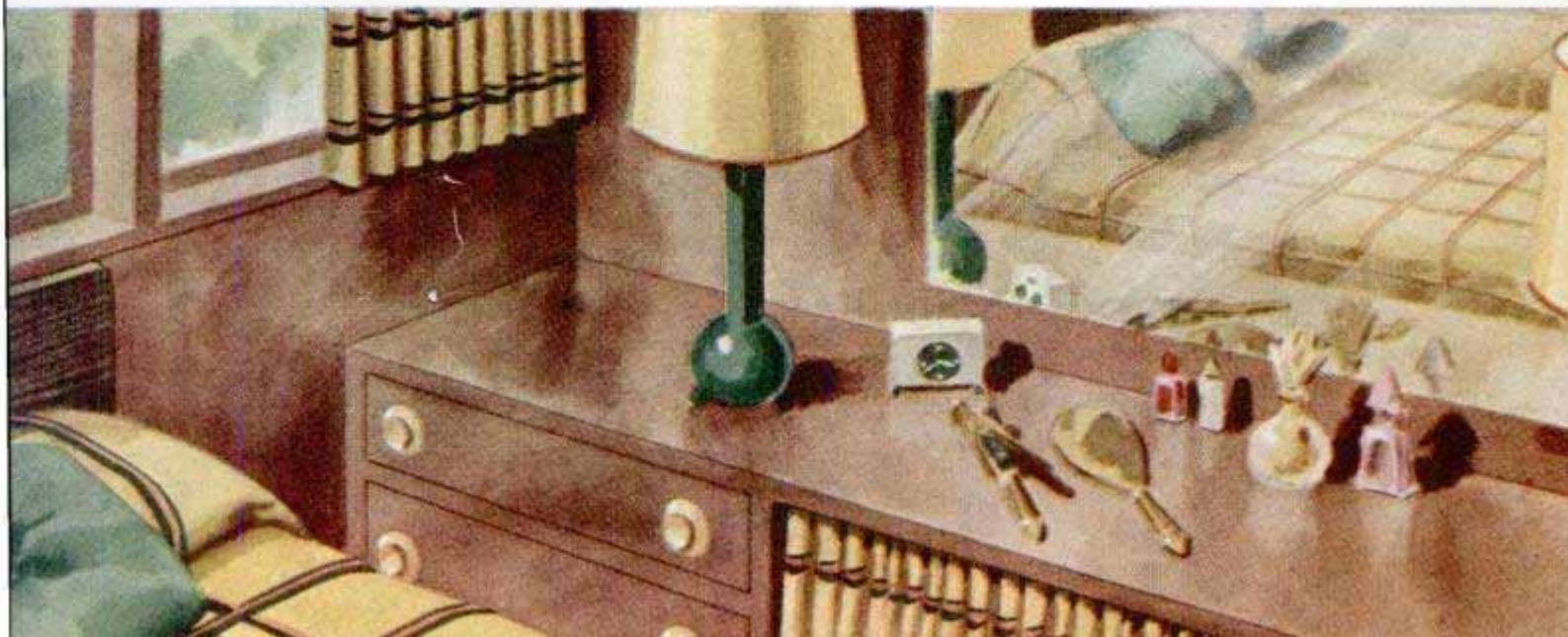



Light, roomy and efficient, here's a kitchen for real living. Breakfast booth is purchased inexpensively

from my background that I understood very little about carpentry. They reasoned that if I could do it, anyone could. The challenge was too great to pass up, so I agreed to do the job.

After deciding on a rough plan and general shape of the house, the services of Mr. John J. Whelan, noted architect, were secured to design the home. Architect Whelan is widely experienced, having designed three embassies in Washington, D. C., the swank Lanai Rooms in the Broadmoor Hotel in Colorado Springs, Colo., as well as the home of columnist Drew Pearson. Also, he has designed many ranch-type homes and likes to specialize in built-ins,

which are featured in this home. As I went along, part of my job was to take pictures of every step and gather data which was later to be compiled in a how-to-do-it book completely detailing the construction. *Popular Mechanics* would furnish the plans if I would contribute the work. Sure, there were nights when I was tired, but I guess that everyone knows that building a house is 90 percent sheer physical labor. Under the supervision of *Popular Mechanics*, our dream home gradually took shape and I soon found to my surprise that building a house required no great amount of skill. For the most part it was rough work—nothing like a piece of cabinetwork.

Offset formed by fireplace wall houses furnace, refrigerator and cabinets. Note niche for china cabinet



Aware of the tremendous upswing throughout the country toward building your own home, as attested by the thousands of books and plans sold on two previous homes, the craft editors turned to a ranch-type dwelling for their third model home. Desiring the ultimate in simplicity, they decided on plywood construction throughout and selected a floor plan of 4-ft. interior module. This meant a minimum of cutting as whole panels could be quickly slapped in place. Also, it meant dry-wall construction which would eliminate the cost of plastering, and permit the builder to do that much more of the job himself. It lent itself to applications of the new and beautiful combed, striated, embossed and straight-grained plywoods. In addition, the editors wanted to present a house that, for the most part, could be prefabricated during the winter in your basement and hauled to the site ready for setting in place. They wanted a plan that could be adapted easily to a full basement if desired. And finally, they wanted a plan that was expandable—a basic plan whereby you could build for your present needs and later add the garage and breezeway as time and money permitted. The basic design provides for either three bedrooms or two bedrooms and a carport, with room for still a fourth bedroom by converting the breezeway.

The house throughout is open-planned, and architect John J. Whelan went all out to provide a home in which room furnishings can be arranged to suit your present needs as well as your future ones. You'll



Above, this is the next step after pouring the footings. Here I am checking the inside corner of the anchor plates for the foundation forms. Below, using sheets of $\frac{5}{8}$ -in. plywood, Norman Chapman and I are beginning to erect the forms along rear of house

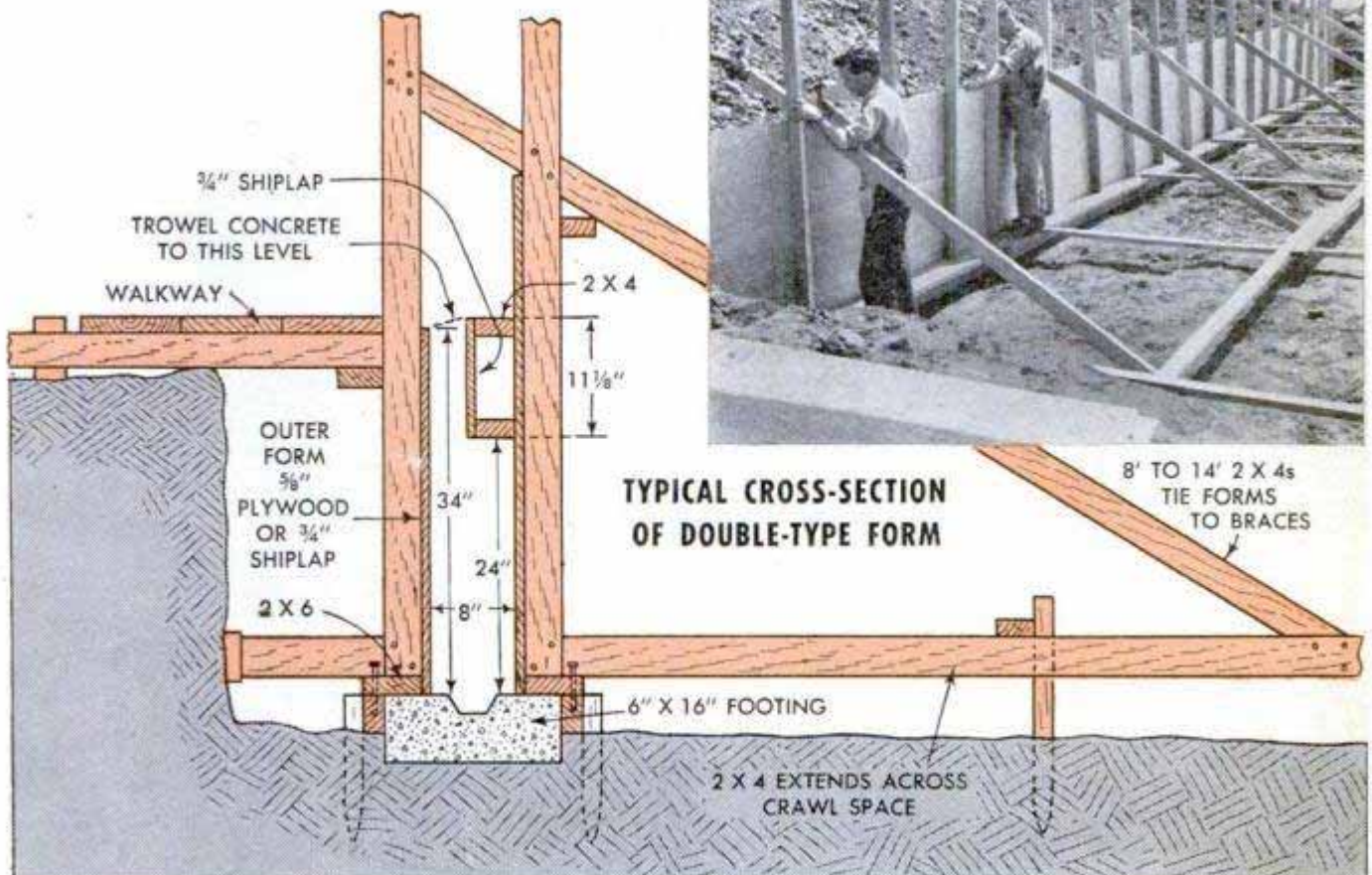
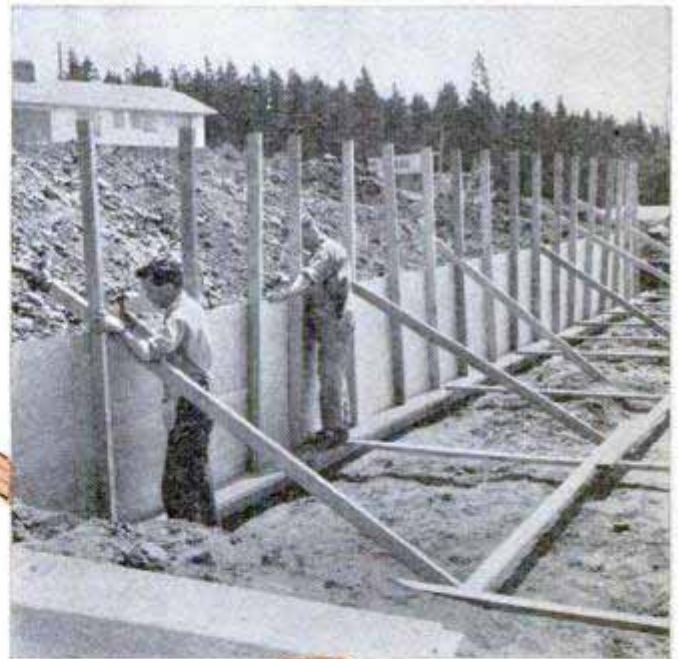

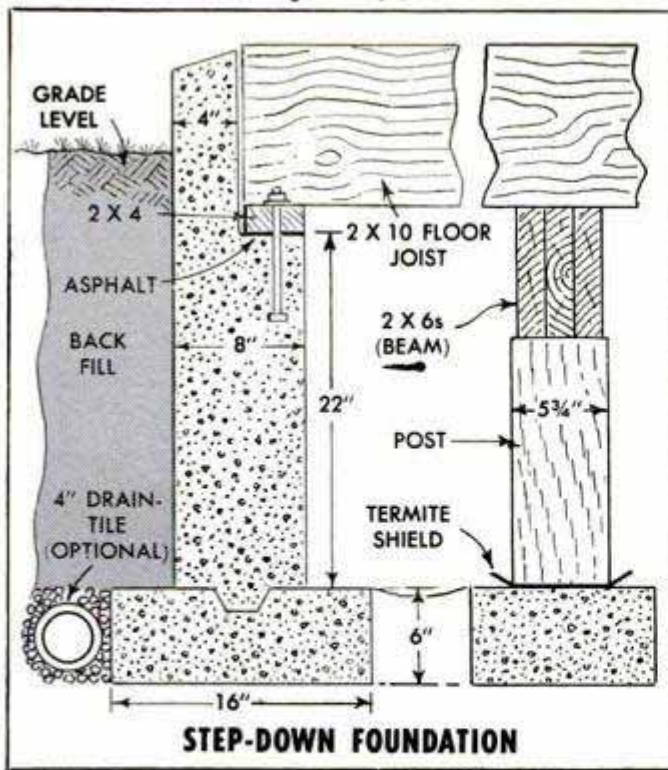

Each beam on which the floor joists rest is built up by spiking together three 2 x 6s on edge. As the joist plan indicates, two separate beams are required

notice in the open planning that the usual space-consuming hallway between bedrooms and bath is eliminated by use of the "island wall" idea which serves a twofold purpose by creating a wall in the form of a practical storage cabinet. The same idea is carried out similarly in the island-type fireplace as it forms a brick wall separating kitchen and living room and also incorporates built-in shelves on the kitchen side. The bedrooms and living room feature floor to ceiling windows with built-in louvers at the bottom for ventilation. A large sliding-door wardrobe closet is built-in in each bedroom with "clerestory" windows being installed in one wall to allow freedom of furniture arrangement. *Popular Mechanics* plans to have my home at 3944 S. W. 36th Place, Bridlemile, Portland, Ore., open for inspection May 5 to May 20.

But let's get to the actual construction. Naturally, limited magazine space does not permit giving every detail, or presenting the many variations, so my only hope is that I can acquaint you with the basic steps in construction. This is the first of a four-part story, and the book and plans will take



Footings for the beam posts and the "island wall" fireplace, which are 12 in. thick, are poured at the same time as the foundation footings. Below, Norman Chapman, my helper, is spiking the joists

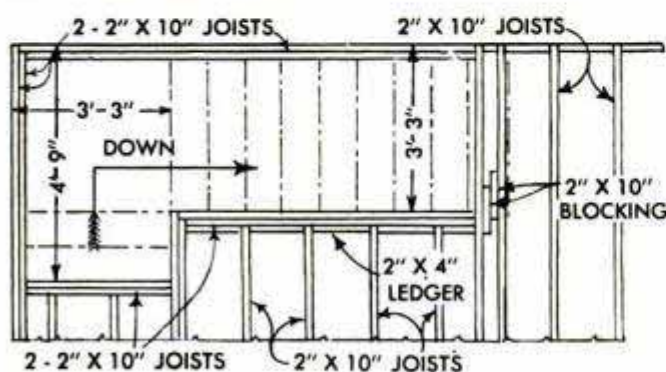

JOIST PLAN FOR BASEMENT STAIRWAY





Above, architect Whelan, right, explains how trimmings from plywood subfloor are economically used later as truss gussets. Below, see how fast and easy the subfloor goes down. Plywood sheets previously used for forms are cleaned off and laid so that the joints are staggered four feet on the floor joists

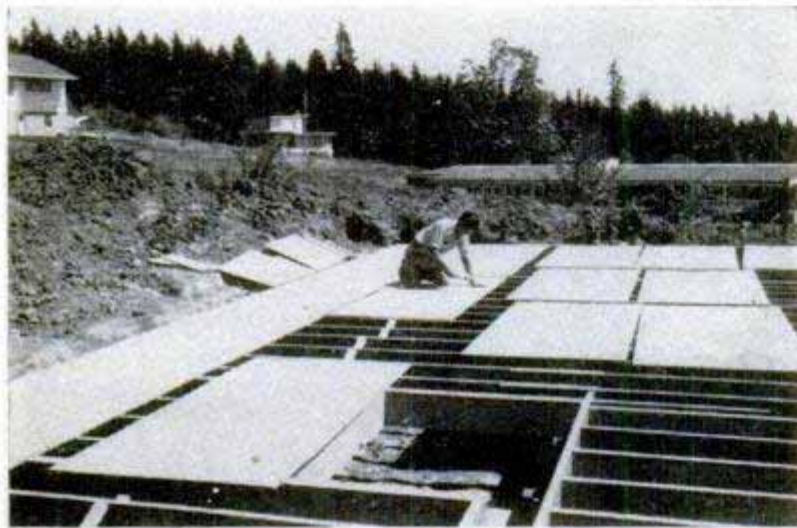

over where the magazine articles leave off. After laying out the building lines, you're ready to excavate. Even if the house is built without a basement, some excavation is necessary to provide crawl space under the floor, and I urge that you have this work done to speed the job and save a lot of hard labor. Forms for the 6 x 16-in. concrete footings, which support the foundation walls, come next and these are made by simply staking and leveling 2 x 6 planks on edge in the bottom of the excavation. When the footings are poured and have hardened, you can start erecting the double forms for the foundation walls. These forms are assembled directly over the footings as shown, using 2 x 4s and 5/8-in.-plywood sheets. Wherever possible, the 2 x 4 material is used without cutting or, at least, the cutting is held to 8-ft. lengths so that the lumber can be reused as wall studs. Like the 2 x 4s, the 5/8-in. plywood also is "borrowed" and later used as subfloor material. The plywood, which is called Plycord grade, is unsanded interior type and less expensive than even the "reject" plywood often used for this purpose. Attach the plywood to the 2 x 4s with 6d finishing nails so it can be easily dismantled, but use 16d nails to fasten the 2 x 4s together. A keypoint of the low, ground-hugging lines of

Now There Are Three

The beautiful ranch house shown on the preceding pages is our answer to your thousands of requests for a build-it-yourself home of this type. Like its two predecessors in *Popular Mechanics'* family of build-it-yourself homes, it, too, will be described in a book, which will give step-by-step instructions enabling anyone to build it. The book and blueprints will be available September 1.

The other two homes, for which similar books and plans are already available, are a beautiful, expandable-type frame house described in the book, **YOUR HOME AND HOW TO BUILD IT YOURSELF**, and a concrete-block house detailed in a book called *Popular Mechanics'* **CONCRETE BLOCK HOUSE**. Books and blueprints give easy-to-follow instructions which make it easy for the handy man to build any of these three houses.

	Book	Plans	Book and Plans
Your Home and How to Build It Yourself.....	\$3.00	\$12.50	\$14.00
Concrete Block House	2.00	12.00	12.50
Ranch-Type House	3.50	13.50	15.00

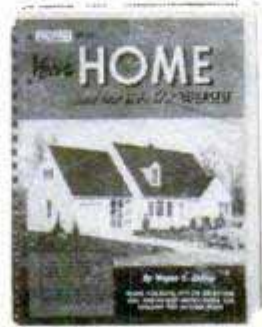
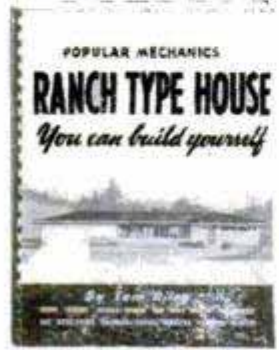

All books available from Popular Mechanics Book Dept., 202 East Ontario Street, Chicago 11

the house is the step-down foundation which brings the floor of the house just 6 in. above lawn level. The step or shelf is framed with 2 x 4s and rough shiplap. Placing some of your 2 x 10 floor-joist lumber on the outside bracing of the forms not only adds additional bracing but will give a smooth runway for wheeling and pouring the concrete. Troweling a thick coating of asphalt on both the side and bottom of the shelf after the forms are removed makes for good construction and affords protection from dampness. Sills (2 x 4s) are placed in the asphalt and anchored with bolts previously set in the concrete or with drive-in concrete nails. If the house is to be built with a basement, the step-down foundation is forsaken for the conventional type which will allow windows to be installed above or partially above grade, and the stairway is located in a corner of the utility room and framed as shown in the lower detail on page 163. When built without a basement, an opening is left in the foundation at one end of the house to permit access to the crawl space under the joists.

The lapped ends of the floor joists are supported on a built-up (laminated) 6 x 6-in. beam or lintel which is supported by short sturdy posts that rest on 12-in. footings, 2 ft. square. The joists are placed on edge and spaced according to the joist plan. Note that the joists under the partition walls are doubled, some being blocked apart to leave openings for the plumbing and the furnace cold-air ducts. Joists around the fireplace opening also are doubled, metal joist hangers being used at the points indicated and abutting joists being supported by 2 x 4 ledger plates. The joists rest on the foundation sills and lap each other across the beam. Here they are spiked together and toenailed to both beam and sill. Short scrap pieces of 2 x 10 stock are nailed between the joists at the outer ends,

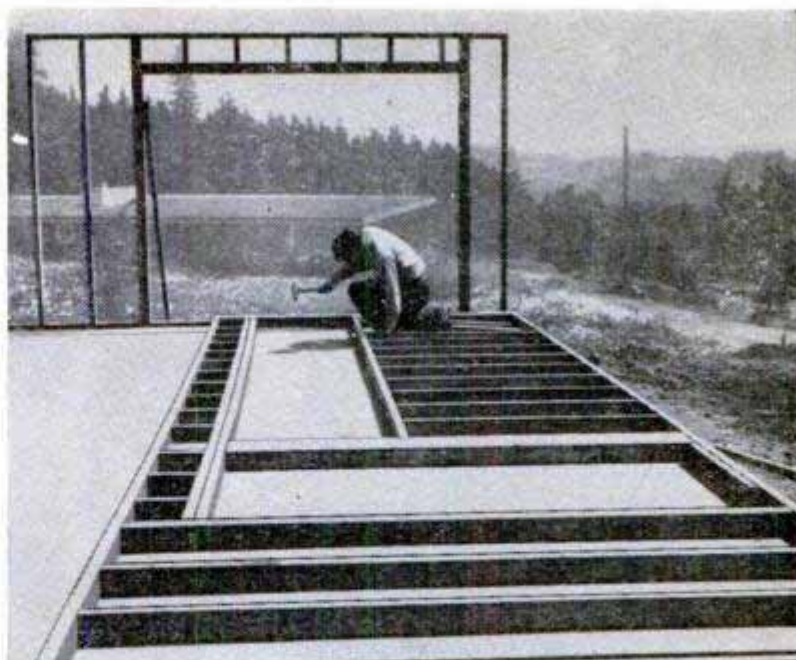

Typical 2 x 4 stud walls are "prefabbed" flat on the subfloor, all windows and door openings being framed in place before walls are erected. Two men can raise 20 to 30-ft. section easily

and 1 x 3 cross-bridging is placed in the center of the joist spans. Nail only the upper ends of the bridging pieces at this time. The lower ends are nailed after the subfloor has been laid.

The subfloor goes fast and consists merely of nailing down the 5/8-in.-plywood sheets previously used in the concrete forms. Do not be concerned about waste in trimming off excess ends of the plywood as any leftovers can be used for gussets in the roof trusses. After the floor is down, the 2 x 4 walls are erected. Each complete wall is conveniently "prefabricated" right on the subfloor of the house, window and door openings being framed in place, and then raised and braced as a unit. Two men can easily raise a 20 to 30-ft. section.

In the prefabricating or "bench built" method, which was developed by architect Whelan, all walls are assembled in 4-ft.-wide sections with door and window openings framed in place, sheathed and ready for erecting. This method will be explained in detail in Part IV of my story.

(To be continued)

Plastic Rods Decorated in Lathe by Use of Warmed Knurling Tool

Plastic rods can be decorated with a knurling tool in a lathe as follows: Warm the knurls to the highest temperature the hand will bear, but be careful not to overheat, which would spoil the temper of the knurls. Then run the work at a high speed, about 1000 r.p.m. for 1/2-in. rods. Apply the knurling tool gently at first, while traversing the carriage back and forth by hand, and gradually increase the pressure. The warm knurls at this high speed will build

up a surface temperature on the plastic sufficient to mold the knurl, while the core remains cool. In the event of a mismatched knurl, remove the piece from the lathe and heat it over an electric heater, which will readily smooth out the knurl.

Howard D. Wildman, Schenectady, N. Y.

☞ A pipe cleaner dipped in ammonia or alcohol will clean medicine droppers, which are to be saved for future use.

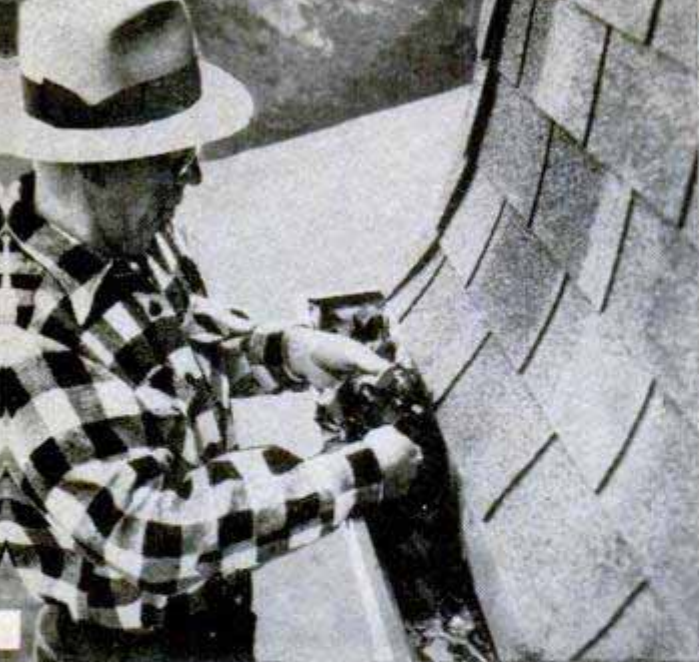

Clean gutters thoroughly after leaves have fallen. Most stoppages are caused by leaves but can be avoided in downspout leaders if strainers are used. After leaves and debris are removed, gutters are flushed with a hose and then checked for leaks and drainage pitch

Adding Years to

Do they leak or overflow? Are they protected against rust? Any homeowner can

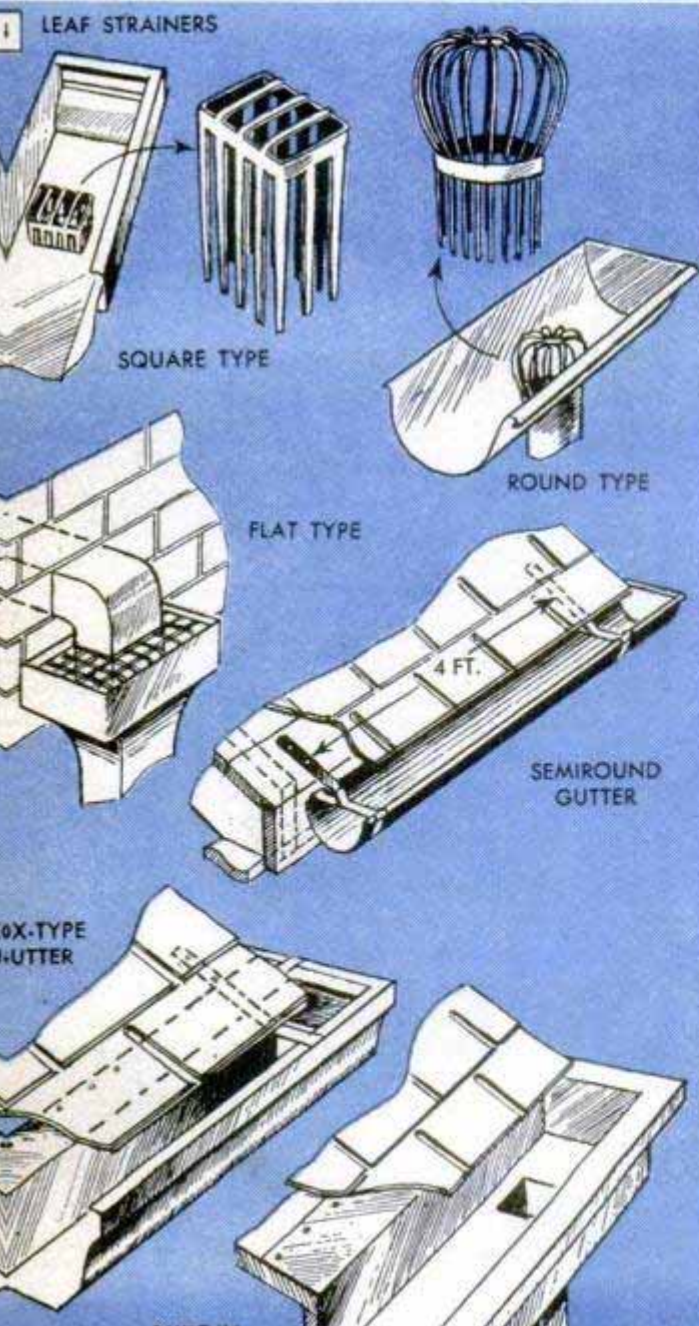

By E. R. Haan

IT'S EASY to put off inspecting and cleaning the gutters and downspouts on your home from year to year until they finally deteriorate to a point where they are beyond repair and must be completely replaced. Yet, it is possible to lengthen the serviceable life of these important fittings from five to ten years by thoroughly cleaning them and making minor repairs on a yearly schedule that any homeowner can carry out himself. Leaky, damaged and partially clogged gutters not only give unsatisfactory service, but they also can be the indirect cause of other, more serious, troubles, such as water getting into the attic or seeping into brick walls, causing unsightly efflorescent stains, Fig. 5, and a gradual deterioration of the brickwork near the cornices. For these reasons, regular servicing of the gutters is a sure way of reducing home-upkeep costs.

Keep gutters clean: Immediately after the leaves come down in the fall is the time to get busy and clean out gutters and downspouts to avoid stoppage resulting from accumulations of leaves and dirt. Even if leaf guards or strainers have been installed at the downspout openings, an accumulation of wet leaves will prevent proper drainage and may cause water to overflow and seep into the walls of the house. Rotting leaves combine with cinders and soot to form an acid that hastens rusting of the sheet-metal gutters. For these reasons, it is essential to remove the leaves, and other debris, as soon as possible after



ROOF GUTTERS

prevent and cure these common troubles to make the gutters last much longer

Photo at left shows efflorescent stains on brick wall subjected to water seepage from roof or gutter. Water may also enter house and cause serious damage. Tight stoppages in downspout may be loosened by using ordinary sink-drain auger, then flushed with hose

they collect, Fig. 1, and then flush the gutters with a hose, Fig. 2. While flushing, inspect both gutters and downspouts for leaks and repair them immediately.

Clearing stopped downspout: If the gutters are not fitted with leaf strainers, Fig. 3, leaves may accumulate in the leaders, Fig. 16, and completely close the passage. In cold weather, water may collect and freeze in clogged elbows and downspouts. Although these parts are corrugated for the purpose of preventing damage from freezing, a large amount of water freezing solidly behind a leaf dam may expand the metal sufficiently to force open the rolled joint. An auger of the type used for clearing obstructions in sink drains, Figs. 6 and 7, can be used to loosen tightly packed leaves in either the leader or downspout. After the mass has been loosened, insert the hose in the leader with the water turned on at full pressure. Sometimes full pressure from the hose alone will do the trick. Where the downspout connects directly to the storm sewer, masses of wet leaves and dirt may collect at the bend below grade. This usually can be cleared by removing the downspout and inserting a drain auger at the joint where the lower end of the downspout enters the bell tile above grade. After the obstruction is cleared, flush with a hose.

Down pitch of gutters: To drain properly, gutters usually are pitched down slightly toward the drop outlet at the end as in Fig. 8. Exceptionally long runs may be fitted with a drop outlet at both ends, or one in the center as shown. Ordinarily, each downspout will handle 30 to 35 ft. of gutter

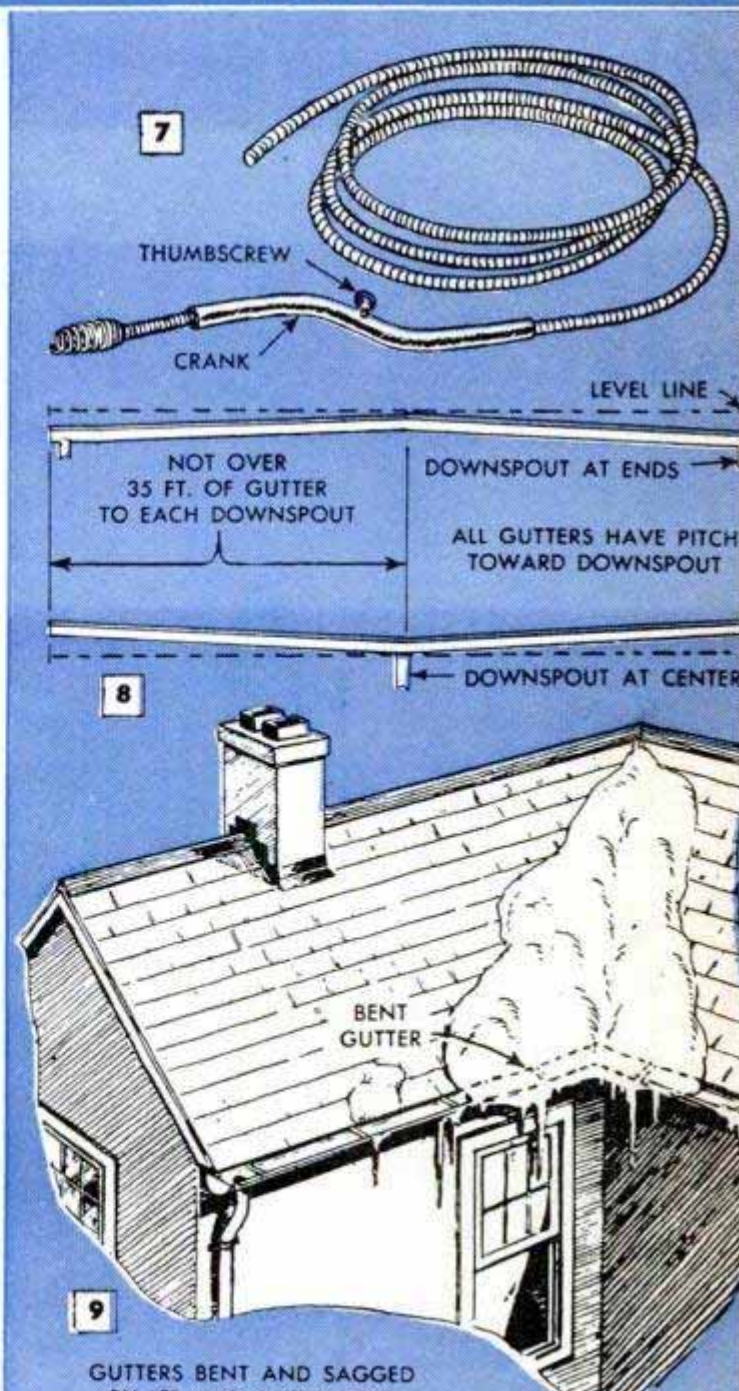



Sheet-metal gutters of all types should be protected with asphalt-base corrosion preventives. After gutters are thoroughly cleaned, material is applied with brush

length. On some types of homes a noticeable pitch of the gutters detracts from architectural lines and in this case the gutters are installed horizontal, or level. This also is true of attached wooden gutters which usually are installed in this manner. Gutters installed level must not be permitted to sag, as otherwise some water will be left standing to evaporate after each summer shower. This accelerates rusting and provides an ideal breeding spot for mosquitoes. If metal gutters become bent or sagged in places, the cause is usually ice or snowslides from a high, steep roof, Fig. 9. As a rule, the gutter is quite easily straightened if none of the hangers has been pulled loose. In case some hangers

have been loosened, it will be necessary to renail or replace them, as the gutter will sag permanently without their support.

Rust prevention: Gutters and downspouts of nonrusting metals, such as copper and aluminum, have been widely used in both new and old construction, but the semi-round and box types of galvanized sheet metal are perhaps the most common. When the galvanized coating is impaired, rust attacks the bare metal and eventually eats through, causing leaks. Sometimes soldered joints pull loose, either because of stresses caused by expansion of freezing water, or because of an inadequately soldered joint. For the same reasons, slip-joint connectors sometimes open and, generally, they should be replaced. Effective rust protection for the inside surfaces of gutters and downspouts is attained by applying a heavy coating of elastic roofing cement, smokestack paint or the asphalt-base compounds used on the underside of autos as a corrosion preventive. Any of these materials will adhere tightly to clean metal and, after drying, they are sufficiently flexible to expand and contract with the metal, thus providing an unbroken protective film. This film, in most cases, also resists acids which form when wet leaves and soot are combined. Asphalt-base coatings should be used only on the inside of the gutter, as they tend to bleed through oil paints applied to the outside of the gutters. The coating is simply brushed onto the bare, clean metal, Fig. 10, after rust and loose dirt have been removed. Small breaks in the metal generally can be stopped with ordinary roofing cement, but large breaks will require a fabric retainer. First, coat the surrounding surface with cement, as in Fig. 11, and then press a piece of muslin or light canvas against the wet surface, Fig. 12. Finally, another coat of cement is applied over the fabric as in Fig. 13. To coat the inside of a downspout, alter an old paintbrush by cutting off the handle and

Small breaks in the metal can be closed by a fabric patch. First, apply compound with a brush as in Fig. 11, then press the canvas patch in place as in Fig. 12. Apply final coat over the fabric, including edges

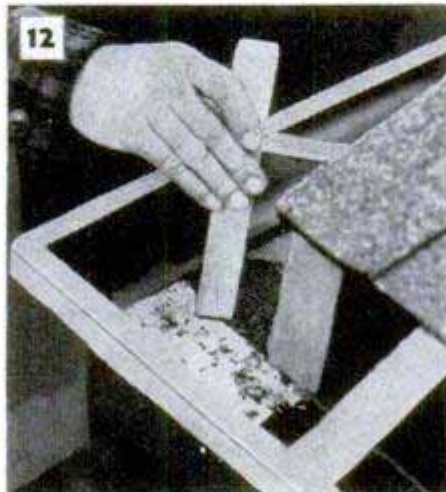

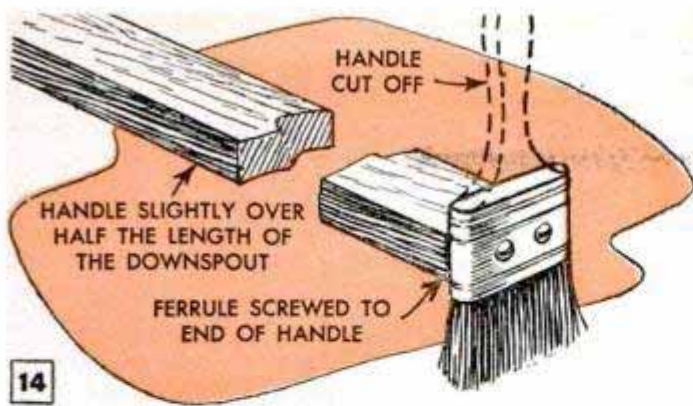

14

screwing the ferrule to one end of a long strip of wood which serves as a handle, Figs. 14 and 15.

Replacing gutters: Gutter and downspout units and accessories of the semiround type are detailed in Figs. 16 and 17. Box-type gutters, Fig. 4, also are used extensively and the fittings and method of attachment vary considerably. Ordinarily gutters come in 8 to 12-ft. lengths, with 10-ft. lengths being perhaps the most commonly furnished. Corner fittings and drop outlets are separate units. Leaders connect gutters to downspouts in most types of installations. When ordering the materials and parts for a major replacement job be sure to include a sufficient number of hangers, Fig. 16, to permit a 4-ft. spacing throughout the length of the gutters. Order 1-in. nails for fastening the hangers and obtain all the slip-joint connectors required. Order leaf strainers for each drop outlet, and also get the proper type of downspout hangers, or bands. If only one or two sections of the gutter require replacement, measure the old ones and renew with the same type and size. When hanging new gutters, don't forget to make sure that the pitch is the same as that of the one being replaced.

Installing gutter hangers: New hangers should be nailed to the roof boards and not over the shingles, as exposed nails are likely to rust away in time and cause a leak. Removing shingles to expose the roof boards



15

Applying protective compounds to the inside surfaces of downspouts pays off by greatly increasing the useful life of these parts. Material is applied to the inside surfaces with an improvised brush

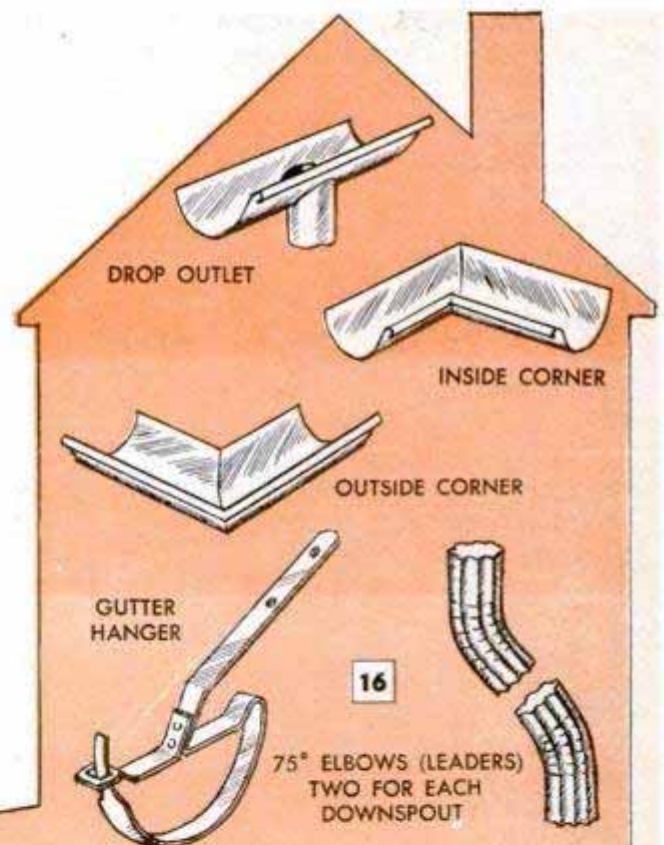

16

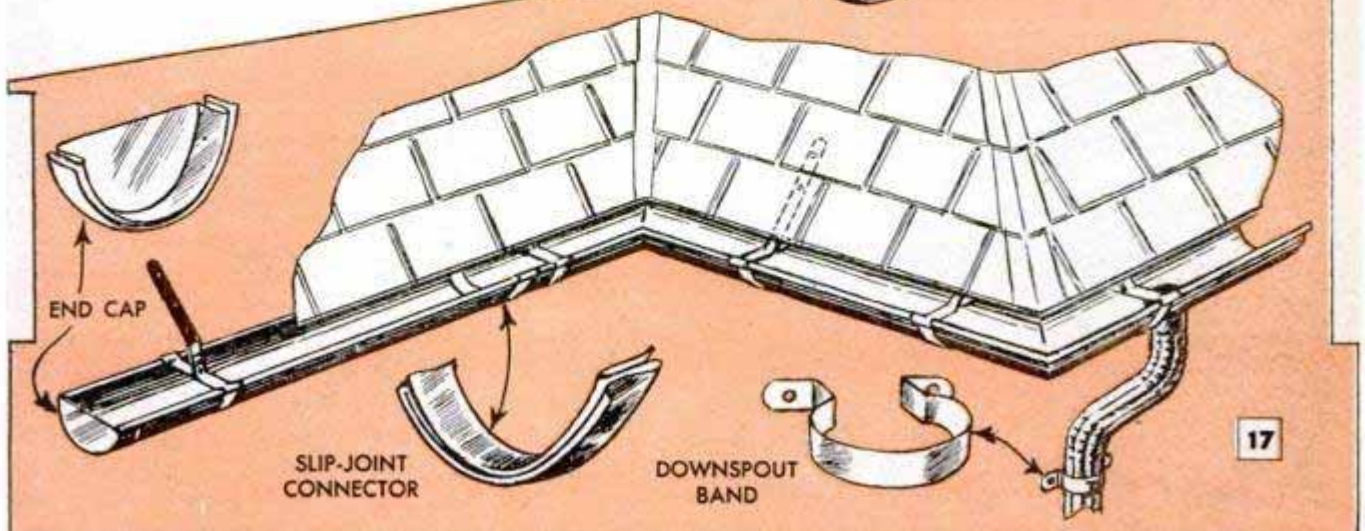

17



When applying new gutter hangers on old roofs, shingles should be lifted so that hanger can be nailed directly to the roof boards. On asphalt-shingle roofs, the individual shingles are easily removed for this job

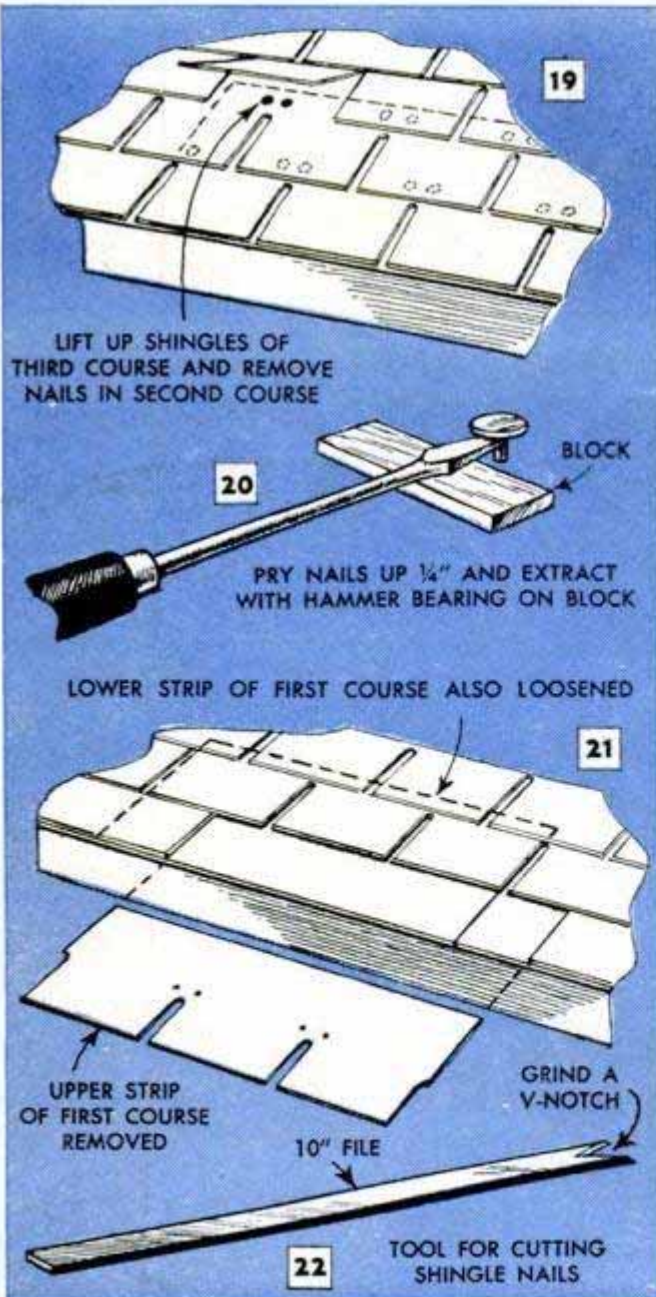

must be done with care to avoid damage. First, remove the nails from two or more individual shingles of the second row, or course. The nailheads are exposed by simply lifting up the butt ends of the third course as in Fig. 19. Pry up the nailheads with a wide-bladed screwdriver as in Fig. 20. To prevent damage to the shingle, place a strip of $\frac{1}{8}$ -in. metal or a short block of hardwood under the screwdriver blade as shown. Remember that the nails holding the second course of shingles usually go through the upper ends of shingles in the first course. Finally, removal of the nails holding the first course of shingles, which usually is of double thickness, permits you to pull the shingles out as in Fig. 21, exposing the roof boards. In some types of construction, especially on wide cornices, there will be a layer of roll roofing under the first course. It is not necessary, of course, to remove this, as the hangers can be nailed over it, provided all nail holes are sealed with roofing cement before re-laying the shingles. After prying off the old hangers and nailing on the new ones as in Fig. 18, drive the nail part way down, and then coat the area around the nail with roofing cement so that when the nail is driven down fully, the cement will form a watertight seal around the nailhead. Now, replace the double course of shingles, making sure that they are located in the same position as they were originally. Drive the new nails slightly to one side or the other of the old holes and, before driving them clear down, apply roofing cement around the heads to form a seal. Be sure all old nail holes are filled with cement. Finally, the loosened shingles of the second course are nailed down again to finish the job. The procedure is repeated at each new hanger position. In a general way the same thing applies to wooden shingles. However, these are more rigid than asphalt shingles and require a few variations in procedure. It is necessary to cut the nails holding each shingle with a special tool improvised from an old file, Fig. 22. The V-notch at one end is ground to a beveled edge and in use the tool is forced under the shingle until the V-shaped cutting edge contacts the nail. A few light taps on the outer end of the tool generally cuts the nail cleanly. When replacing a wooden shingle, the two lower nails are started at approximately the same position as the original nails. Fill the old nail holes with roofing cement. Pry up the shingles of the next course above, slip a piece of sheet metal over the nailheads and press the upper shingle down to force the nails home. Don't tap the shingle with a hammer as you may break it.

When hangers must be attached to metal

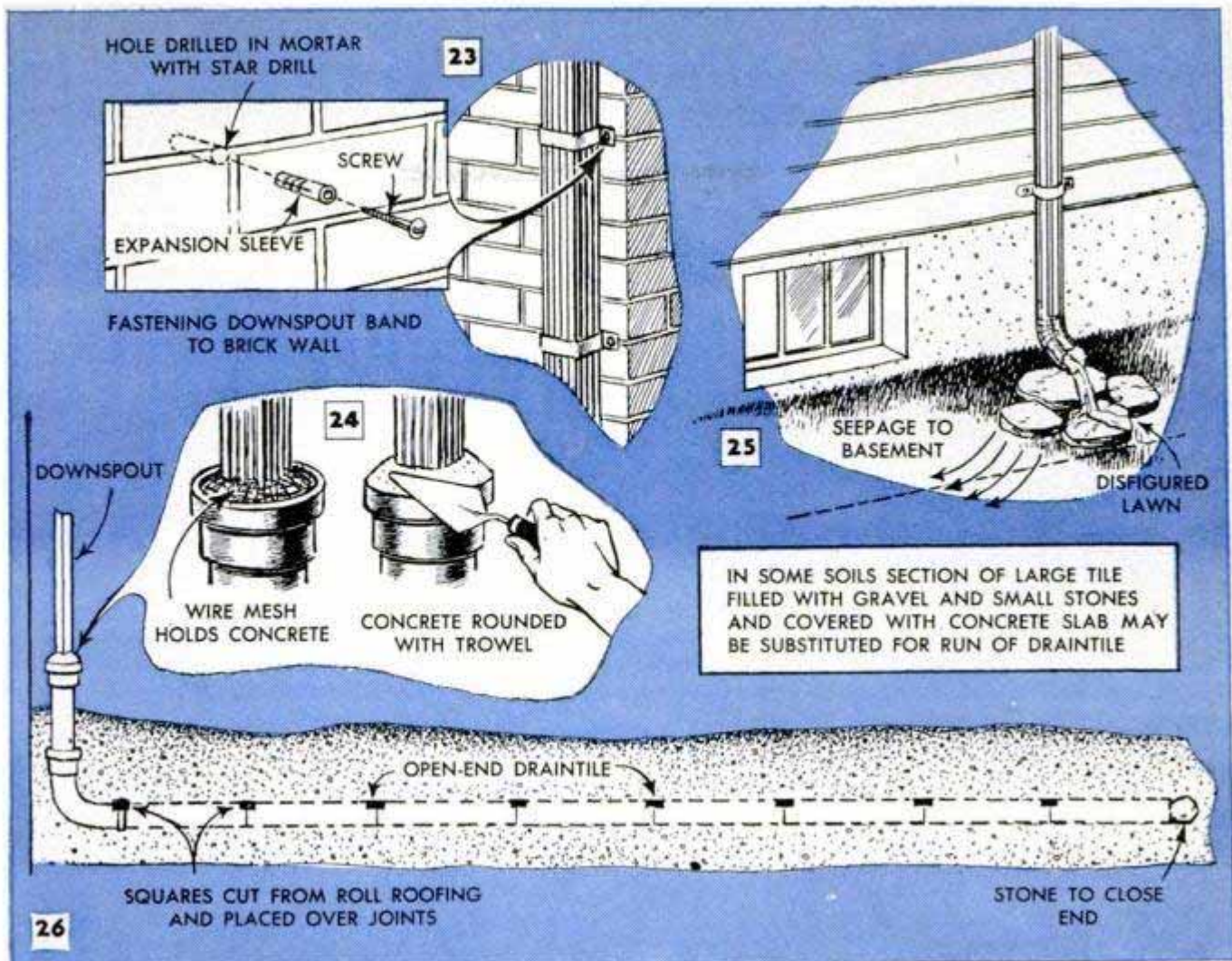

roofing, it's a common practice to solder them in place. Before soldering, the metal must be thoroughly cleaned, fluxed and preheated with a blowtorch. Downspout bands are simply nailed to wooden trim surfaces. However, when fastening the bands to brick, it is necessary to use masonry nails or screws. Screws are driven into expansion sleeves which are placed in holes drilled in the masonry with a star drill as in Fig. 23.

Cementing downspout into drain tile: When downspouts are connected to drain tile leading to the storm sewers, the opening where the downspout enters the tile should be sealed with cement mortar supported by wire mesh pressed into the bell end of the tile. Usually the bell end is only a few inches above grade and if the opening is not closed tightly, small stones, dirt and trash may clog the tile. To seal the joint, first cut and bend a disk of $\frac{1}{2}$ -in. wire mesh to fit into the open end of the tile. Bend up the edges of the wire disk so that it will wedge tightly in place. Then cut a round opening in the disk so that you can insert the lower end of the downspout. After the latter is in place, mix a heavy cement mortar and trowel it into the opening, building it up at the top to form a sloping surface that will shed water, Fig. 24.

Installing splashers and drain tile: When water from the downspout is discharged at ground level, some provision must be made for spreading the flow of water, as otherwise the force of the stream of water will wash away sod and soil. Also, if drainage from the foundation is poor, water may seep into the basement. Where there is ample drainage away from the foundation, a few flat stones placed below the end of the downspout may suffice as a splashers, Fig. 25. However, unless the arrangement is only temporary, it is better to install concrete splashers of sufficient size to direct the water away from the building in a spreading flow. In some soils, a run of open-end drain tile installed below grade as in Fig. 26, will serve as a dispersal unit. Sometimes, builders install a long run of tile in this manner and place a section of large drain tile (24 to 36 in. in diameter) at the lower end of the run. The large drain tile section is placed on end with the bell end up and filled with coarse gravel and small stones to form a dry well. The top of the tile is closed with a cast-concrete cover. Sometimes a tile elbow is cast integral with the cover and the lower end of the drain tile is led into the elbow. In gravelly or sandy soils, this installation works quite satisfactorily.

Bench-Saw Blade Filed Quickly If Held With Spring Clamp

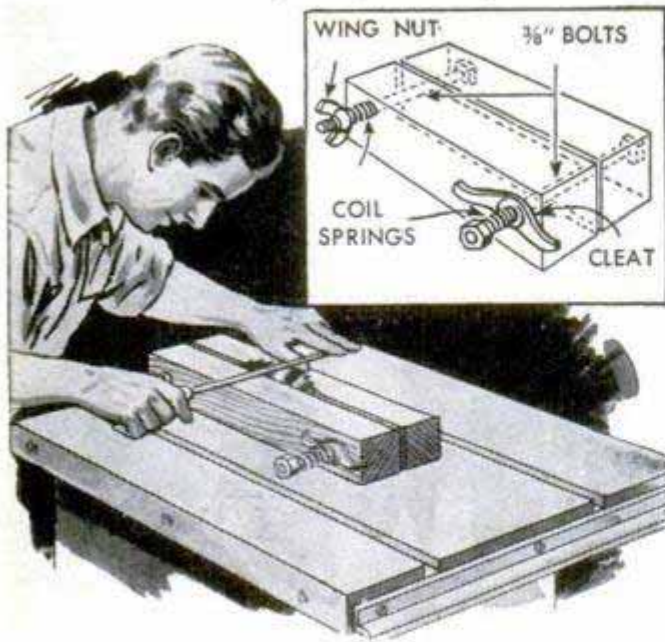

Touching up the teeth of a circular-saw blade is done in a jiffy if the blade is kept from rotating by this easily released clamp. The clamp jaws are formed from two blocks of wood, 10 or more inches long depending on the size of the blade. The blocks are joined together by two bolts passed through aligning holes drilled near the ends of the jaws. Short coil springs are slipped over the ends of both bolts. One spring is held in place with a wing nut, and the other spring is slipped on the second bolt over an awning cleat. This spring is tightened against the cleat with a regular nut. To use the clamp, the jaws are set over the saw blade and the blade is raised until it projects $\frac{1}{2}$ to 1 in. above the jaws. Both nuts are tightened to apply enough pressure on the blade to keep it from rotating while being filed. After the exposed teeth have been touched up, the awning cleat is drawn back with the fingers, thus releasing the clamping pressure and allowing the blade to be moved in order to expose the next two or three teeth.

A. H. Waychoff, Phoenix, Ariz.

Screwdriver Bit Holds Screw



A self-holding screwdriver is a convenience, but is not always at hand and trying to start a screw in a tight place without one is no easy task. One solution to the problem is to hol-

low-grind the blade of an ordinary screwdriver and then upset the screw slot with a prick punch so that the blade can be slid

into the slot from one end. By upsetting the slot just the right amount with the punch, the screwdriver blade is made to grip the sides of the slot sufficiently to hold the screw firmly in place for one-handed driving in a corner or recess.

Ed Packer, Chicago.

Weed Killer Works Locally

Where vines have grown among valuable plants, it is usually impossible to spray them without killing the other plants. In such cases a solution of 2,4-D works successfully when applied locally. Bend several of the vine ends into a can of 2,4-D and weight them down. The vine is killed by absorbing the 2,4-D in heavy concentration.

Adrian Hughes, Hillsboro, Ore.

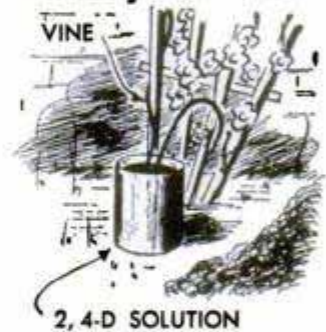

Sealing Double-Hung Windows Against Insects

If small insert-type screens that fit under the bottom edge of the lower window sash are used, insects will enter between the rails when the lower sash is opened unless some means is provided for keeping them out. A good way to do this is to attach a wiper to the bottom of the upper sash which will press against the glass panes

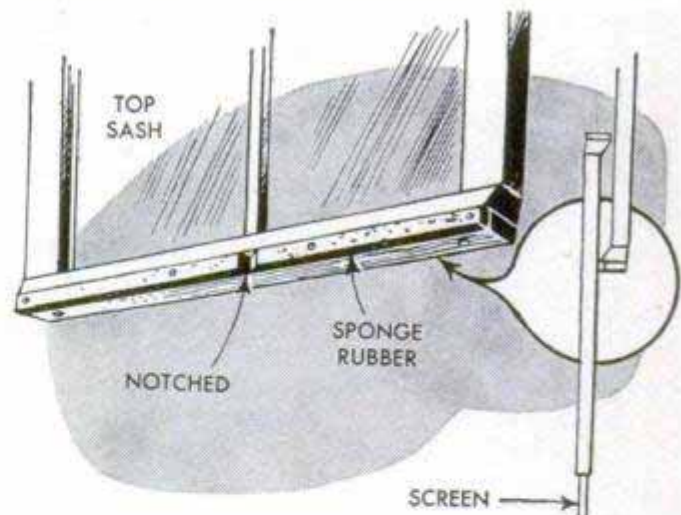

and thus afford a seal. The wiper is made by cementing or nailing a strip of sponge rubber to a wooden strip, which, in turn, is screwed to the lower edge of the sash as indicated in the detail. The rubber should be notched to clear any vertical members on the lower sash.—Thomas M. McCormack, West Rutland, Vt.

☞ Book pages should never be bent back as this weakens the binding of the book.

CONCRETE BIRDBATH

By Raymond Schuessler

CAST INEXPENSIVELY from concrete, this birdbath forms an eye-catching lawn ornament that will attract many of the songbirds in your vicinity. The base and pedestal are poured, while the bowl is molded from a stiff concrete mix. The bowl can be replaced with a sundial or metal sphere if either of these is preferred.

The pedestal is poured in a tapered form which is built as in the center details and greased to prevent sticking. Note that the bottom of the form is drilled to allow four 31-in. reinforcing rods to extend below the pedestal. After the pedestal has hardened, the bottom is removed from the form and the pedestal, still in the form, is supported with a framework over a form for the 3½ x 10-in. base. If preferred, the base may be poured first with the reinforcing rods embedded in the center. Then the pedestal form, minus the bottom, is set over the reinforcing rods and the pedestal poured. Note that a 6-in. hardwood dowel is embedded in the top of the pedestal in order to engage the hole in the center of the bowl.

The concrete bowl is molded on a square wooden platform. This is drilled to receive a dowel or metal rod of the same diameter as the supporting dowel embedded in the pedestal. Wooden or sheet-metal templates

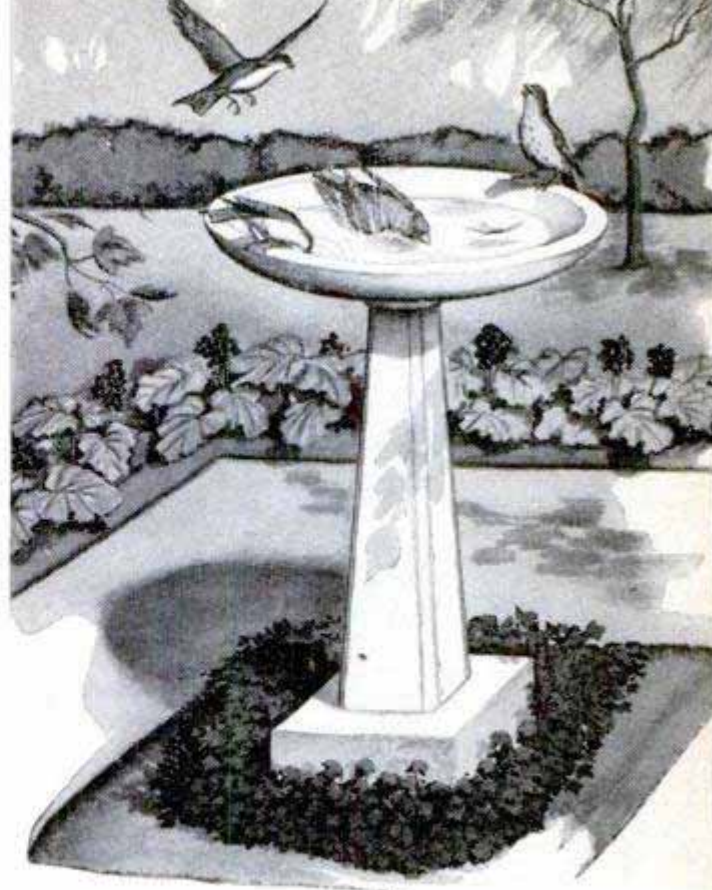

pivoted on the center rod are used to form the contours of both inner and outer surfaces of the bowl. A clay core, built up on the platform and shaped with the smaller template, is allowed to dry, and then a 1-in. layer of stiff concrete is troweled over the clay. Wire mesh is placed over the concrete and a second layer is troweled over this. Finally, the concrete is shaped with the larger template. When the bowl dries, it is set on top of the pedestal and the center hole is filled with concrete. On soft turf, the birdbath is set on a concrete footing.

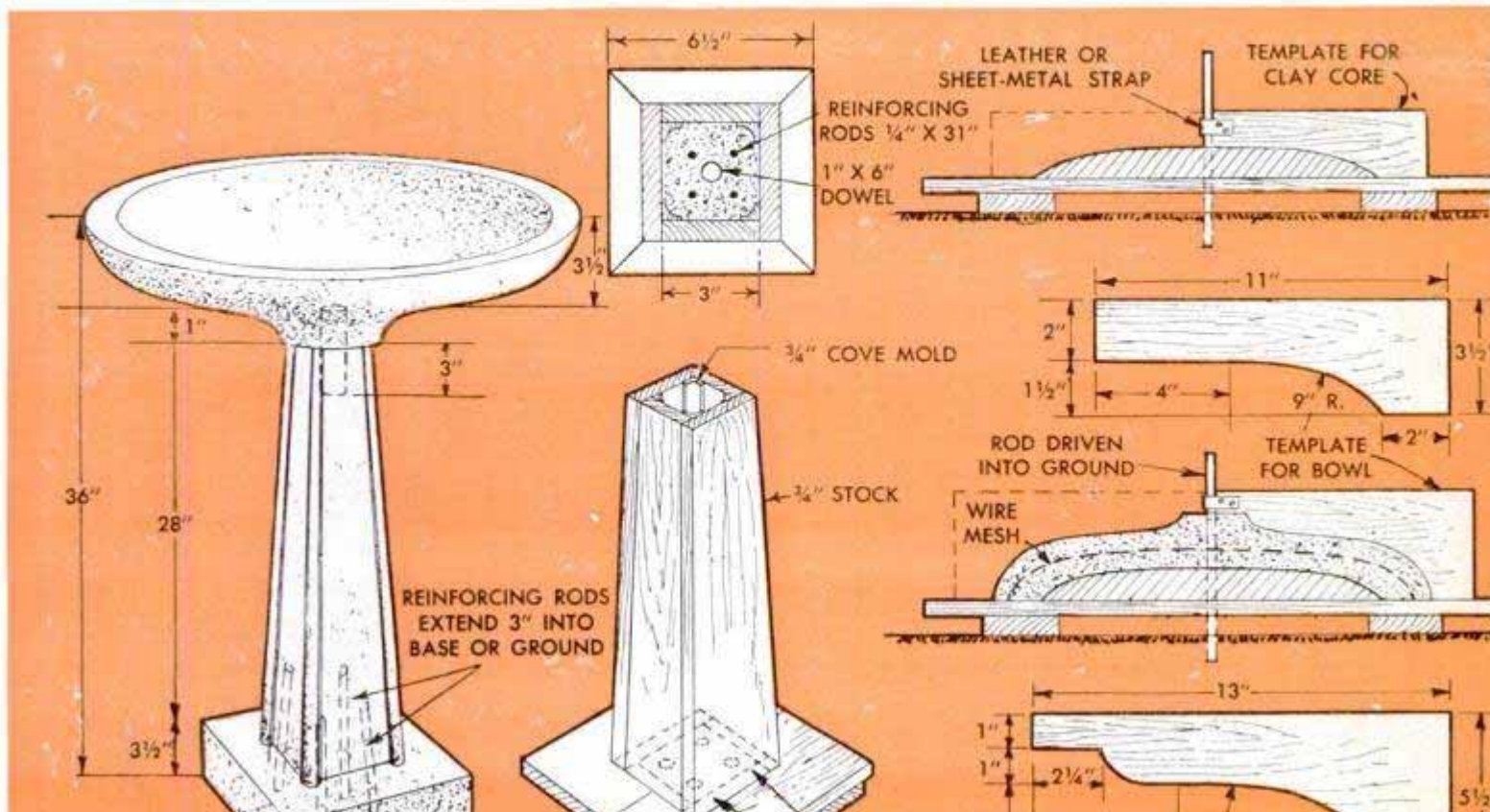

Dowel Mounted on Shop Wall Holds Rolls of Tape

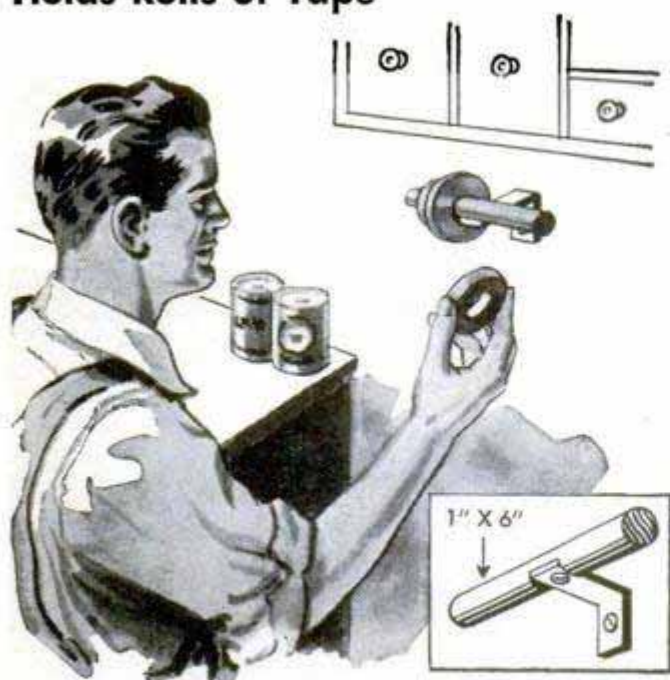

Have you ever needed a piece of friction tape in a hurry and then spent five or ten minutes rummaging through drawers and boxes trying to find the roll? If so, you'll want this simple holder which keeps the rolls of tape right at your finger tips. In addition, you can tell at a glance when it is time to buy another roll of friction or masking tape. Just saw a 6-in. length from a 1-in. dowel, or a broom handle, and cut a shallow notch at the center of the dowel for an angle bracket. Screw the bracket to the dowel, mount the unit on the wall and merely slip the rolls of tape over the ends of the dowel crosspiece.

John J. Rea, Urbana, Ill.

Cornstalk Forms Pincushion

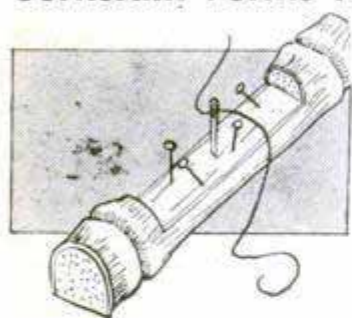

Cutting away one side of a section of cornstalk to expose the pithy center will provide a serviceable pincushion. The opposite side of the section is flattened so it will not roll. If

a golden, shiny stalk is selected, the pincushion will need no decoration.

Fred Cornelius, El Paso, Tex.

Crawl Space Floored With Roofing To Reduce Moisture Under House

The crawl space under a house without a basement can be made drier by completely covering the soil with strips of roll roofing. Heavy roofing—55 lbs. to 100 sq. ft. or heavier—is recommended. It has been

found that this will practically eliminate condensation of moisture under the house, thus giving added protection against rusting of steel, rotting of timbers, deterioration of insulation and short-circuiting of electrical wiring. In many cases, crawl spaces floored with roofing are dry enough to permit storing garden tools, lumber and lawn furniture. A distinct advantage for homeowners in temperate climates is that the amount of ventilation in the crawl space can be reduced by as much as 90 percent. This is important when it comes to keeping the floors warm during the winter months.

Rod Anchors Boat In Sandy Shore

Instead of the usual bucket of cement or other clumsy anchor for securing a small boat to a sandy shore, use a 30-in. length of 1/2-in. steel rod, which can be pushed into the sand to hold the boat fast. Point one end of the rod and form a large eye on the other end. Bend the end having the eye at right angles as shown. An anchor of this type is light in weight, highly effective and easy to carry in a boat.

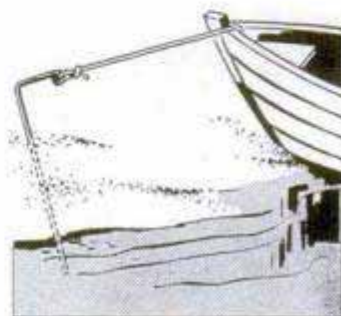

Clinton R. Hull, Costa Mesa, Calif.

Waxing Thread Aids Stitching

Leather and heavy work-clothes material are easier to stitch if the thread is coated with candle wax. If the candle is hard, soften the wax somewhat before passing the thread over it. So the wax coating won't be noticeable on colored threads, use candles of matching colors.

Paper Cup Protects Small Plants

A cone-shaped paper cup makes an excellent shield for protecting small plants from cutworms and the like. After cutting the bottom from it, place the cup upside down over the plant.



Carrying a pair of cutting pliers and a screwdriver on fishing trips will pay dividends when it is necessary to repair tackle or an outboard motor. These tools can be kept handy in the fishing-tackle box.

GARDEN CART

doubles as soil sifter

Gardeners will appreciate the simple construction and labor-saving features of this dual-purpose cart. The box is fitted with a permanent bottom of $\frac{1}{2}$ -in. wire mesh over which a plywood panel is placed when hauling garden tools, fertilizer, leaves or loose soil. Remove the plywood bottom, replace it with a frame covered with 1-in. wire mesh and you have an efficient soil sifter. If desired, sideboards can be added for extra capacity. All surfaces should be covered with two coats of spar varnish.

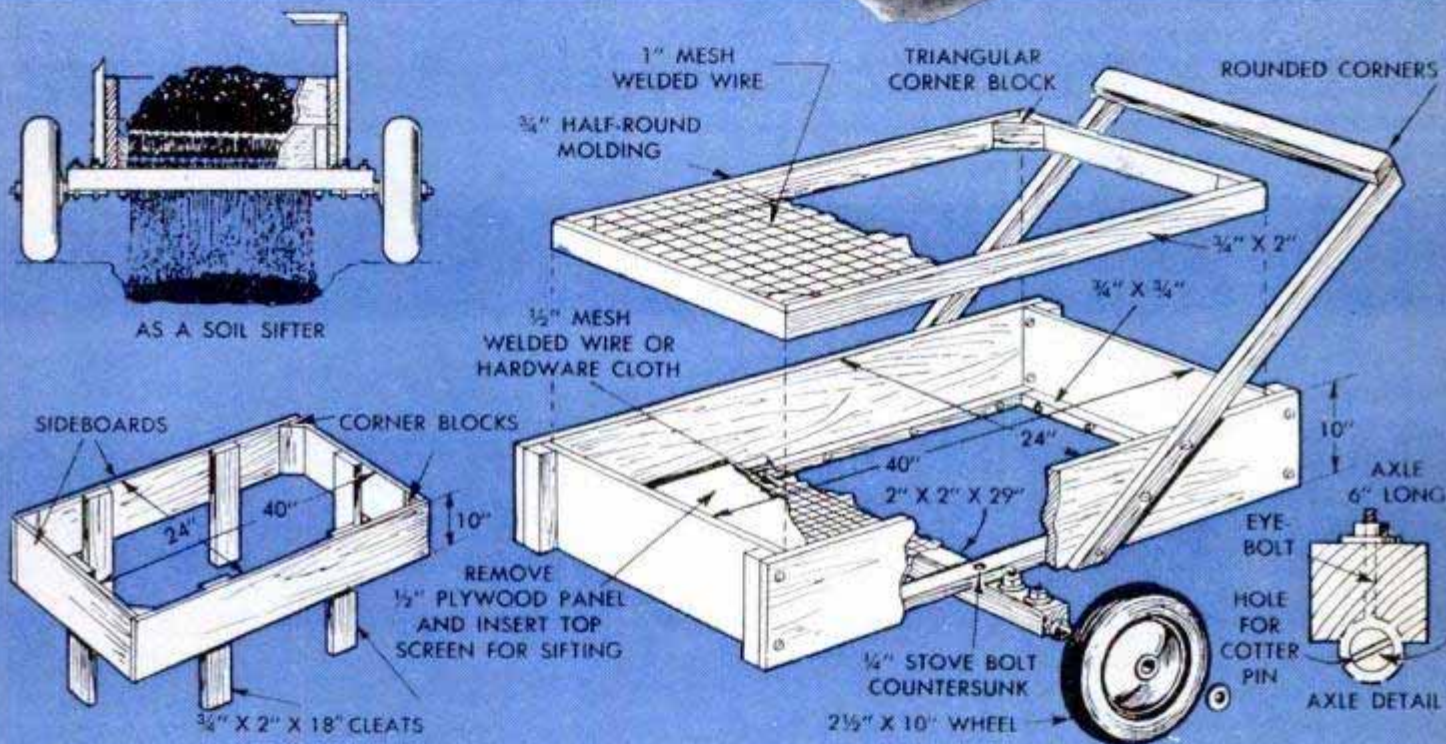

Hole in Ground Provides Mold When Making Lead Fishline Sinkers

The next time you need some fishline sinkers or some sinkers for use on a seine, trotline or throw line, they can be molded right in the ground. Just make a small hole in the ground of the desired shape, using a knife or stick, and fill with molten lead. The

lead can be melted in an old tin can or other suitable container. Be sure that the container is dry as any moisture may cause the lead to spatter. When pouring the molten lead into the mold, you should wear leath-

er gloves and goggles and take extreme care as moisture in the ground may cause the hot lead to spatter up on your hands or into your face. Before pouring the lead into the mold, insert a wire with an eye formed on one end or on both ends, depending on the purpose for which the sinker is to be used. If the eye is formed on both ends, wrap tape around the lower one to prevent the molten lead from running down and filling in the eye.—Charles Hardy, Los Angeles, Calif.

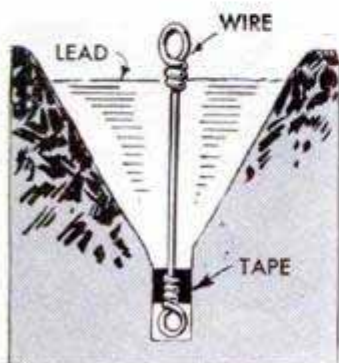

☐ You will find an apron with button-on pockets very handy when working in your shop or making repairs around the home. The pockets in which you keep brads, nails, screws, etc., can be readily attached or removed from the apron as needed.

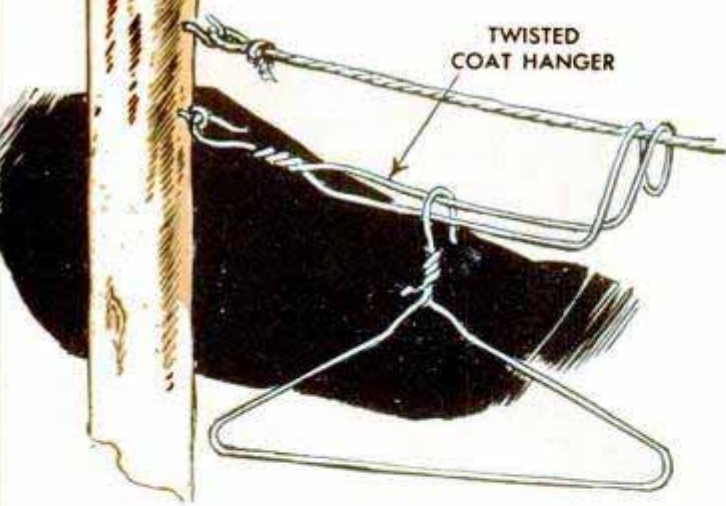

AIRING GARMENTS on an outdoor clothesline is done without danger of their falling to the ground if the hangers are put on a rack made from a wire coat hanger. The latter is bent to fit over the line and engage a screw hook driven into the clothes pole

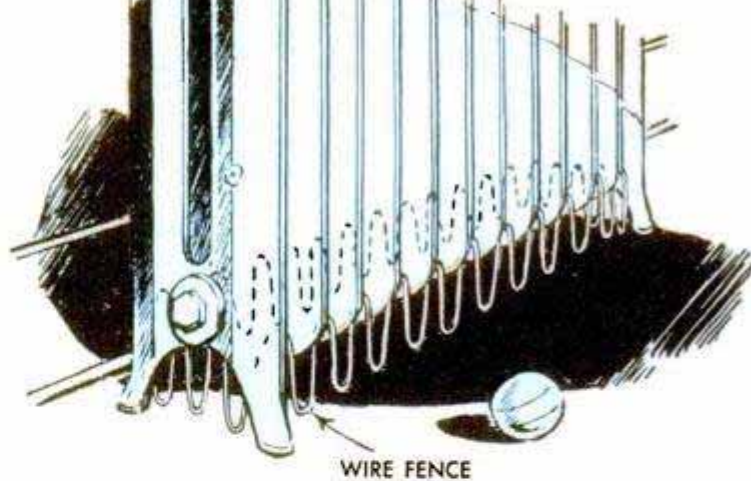

BURNED ARMS, sometimes suffered by children while trying to retrieve toys that have rolled under a hot radiator, can be eliminated by installing a fence, which is bent from stiff wire, around the base of the radiator. The fence is merely pulled out for cleaning



INEXPENSIVE WOODEN SPOONS of the type used on picnics are just the thing for stirring small cans of paint. A separate spoon may be used for each color and discarded when finished, saving the need for cleaning tools sometimes used as stirring rods

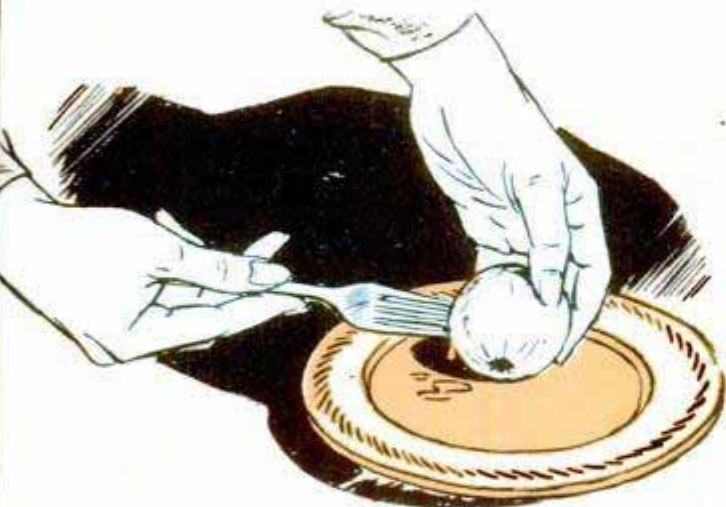

A FEW DROPS OF ONION JUICE for flavoring cooking can be obtained quickly if the onion is simply pierced with the tines of a fork. As the skin is left intact, the onion will keep considerably longer than if it had been peeled and scraped in the usual way

Solving HOME PROBLEMS



AFRICAN-VIOLET SLIPS can be started with greater chance of success if the end of the leaf stem is suspended in a tumbler of water. With a rubber band, fasten a piece of wax paper over the top of the tumbler, and pass the stem through a slit in the paper



HARD-TO-OPEN BOTTLE CAPS of the screw-on type are no problem if they are loosened by using a nutcracker as a wrench. Enough pressure is applied to allow the nutcracker teeth to grip the cap firmly, but be careful not to break the neck of the bottle

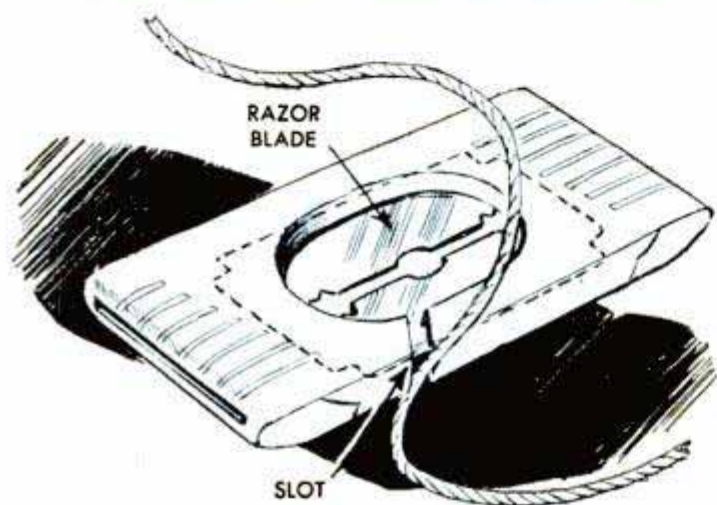

FOR CUTTING TWINE quickly and safely, make this handy cutter from a plastic razor-blade dispenser. Cut or file a slot through both plastic sections, and replace a used blade in the dispenser. The slot in the back section should be about $\frac{1}{2}$ in. deep



IF A THIMBLE IS TOO LARGE for the finger tip, use adhesive tape to pad the thimble so it will fit comfortably. Cut the tape into short, narrow strips and apply the strips, one at a time, to the inside of the thimble until the proper size is attained



TO KEEP THE FOOD in your picnic lunch cool and tasty during the warmest weather, stand an ice-filled fruit jar in the center of the hamper and pack the food around it. After the hamper is packed, cover it with a towel or folded tablecloth tucked in tightly at the sides. If desired, pour concentrated fruit juice or double-strength tea over the ice, keeping in mind that the melted ice will dilute the beverage

Flat-Iron Bumpers for Inside Doors Prevent Interlocking of Knobs

Do you have doors in your home located in such a manner that they open back to back? If so, these simple bumpers, which were used effectively by one homeowner, can prevent the knobs from interlocking. In this case, the bumpers were bent from $\frac{1}{8}$ -in. flat iron, $\frac{3}{4}$ in. wide, and were fastened to the doors with screws. Brass, copper or even plated metal can be used if desired. Width of the hook or curve on the bumper should be just a little greater than the distance that the doorknob projects beyond the surface of the door.

Mousetrap Holds "Not Home" Notes

An ordinary mousetrap mounted near your front doorbell serves as an effective holder for written messages. Remove the trigger attachment and paint the trap to match the trim of the house.

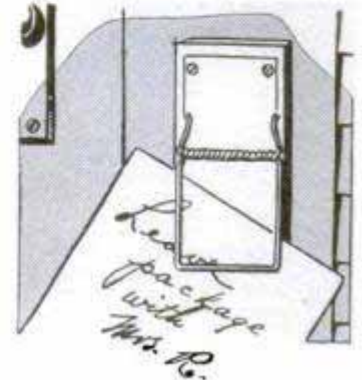

Burning Brick Is Fireplace Novelty

An ordinary brick, soaked in kerosene for 48 hours and allowed to dry for an hour, can be ignited to provide a novel effect in a fireplace. It can be extinguished, if desired, and re-ignited a day or so later, since the kerosene will not evaporate for several days. The total burning time for the brick is five or six hours.

Edward C. Widdis, San Fernando, Calif.

Steel Magnet Screwed to Workbench Keeps Small Metal Parts at Hand

Have you ever had an assembling job that required the use of small nails or other small steel parts, and found that the parts were soon scattered over the bench and difficult to find? A small magnet will keep the parts right where you want them. Any type of magnet will do, but a disk-shaped alnico magnet is best. A hole can be drilled through its brass core and a screw used to mount it on the bench or near-by wall.

Walter E. Burton, Akron, Ohio.

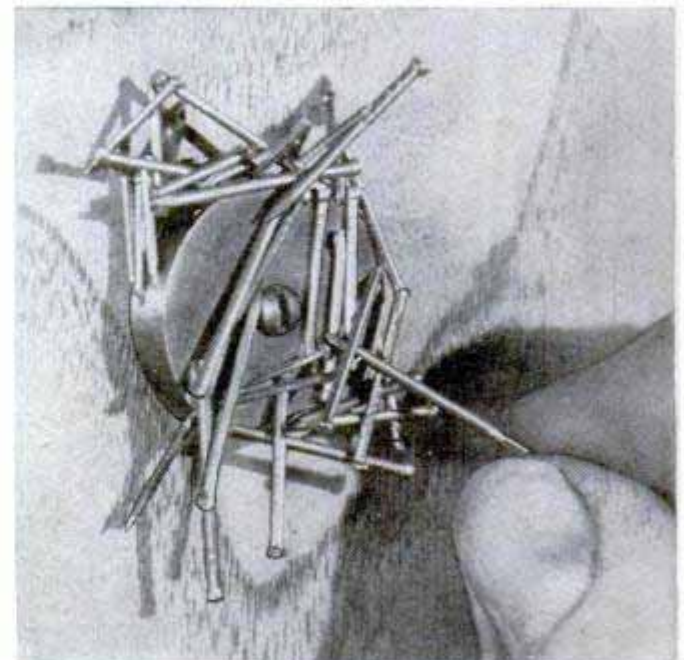

Bread Cleans Painted Fabric

To clean delicate painted fabrics, dip a ball of soft bread into benzine and rub gently. After cleaning, hang the fabric in the open until all benzine odor has evaporated. Work in a well-ventilated room and keep benzine away from open flame.

Screw-Top Can Forms Sprinkler Unit

A pint or quart can, having a neck at the top which is threaded for a cap, can be quickly converted to a garden-hose spray nozzle. Punch three or four rows of holes in the side of the can and turn the threaded neck over the nozzle coupling of the hose. In most

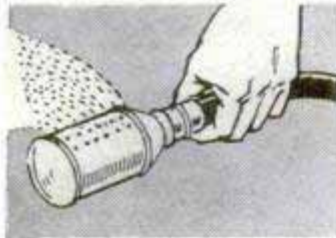

cases, the can will fit as it is. If not, the female fitting from an old hose coupling can be soldered to the neck of the can.

Steel Magnet Screwed to Workbench Keeps Small Metal Parts at Hand

Have you ever had an assembling job that required the use of small nails or other small steel parts, and found that the parts were soon scattered over the bench and difficult to find? A small magnet will keep the parts right where you want them. Any type of magnet will do, but a disk-shaped alnico magnet is best. A hole can be drilled through its brass core and a screw used to mount it on the bench or near-by wall.

Walter E. Burton, Akron, Ohio.

Bread Cleans Painted Fabric

To clean delicate painted fabrics, dip a ball of soft bread into benzine and rub gently. After cleaning, hang the fabric in the open until all benzine odor has evaporated. Work in a well-ventilated room and keep benzine away from open flame.

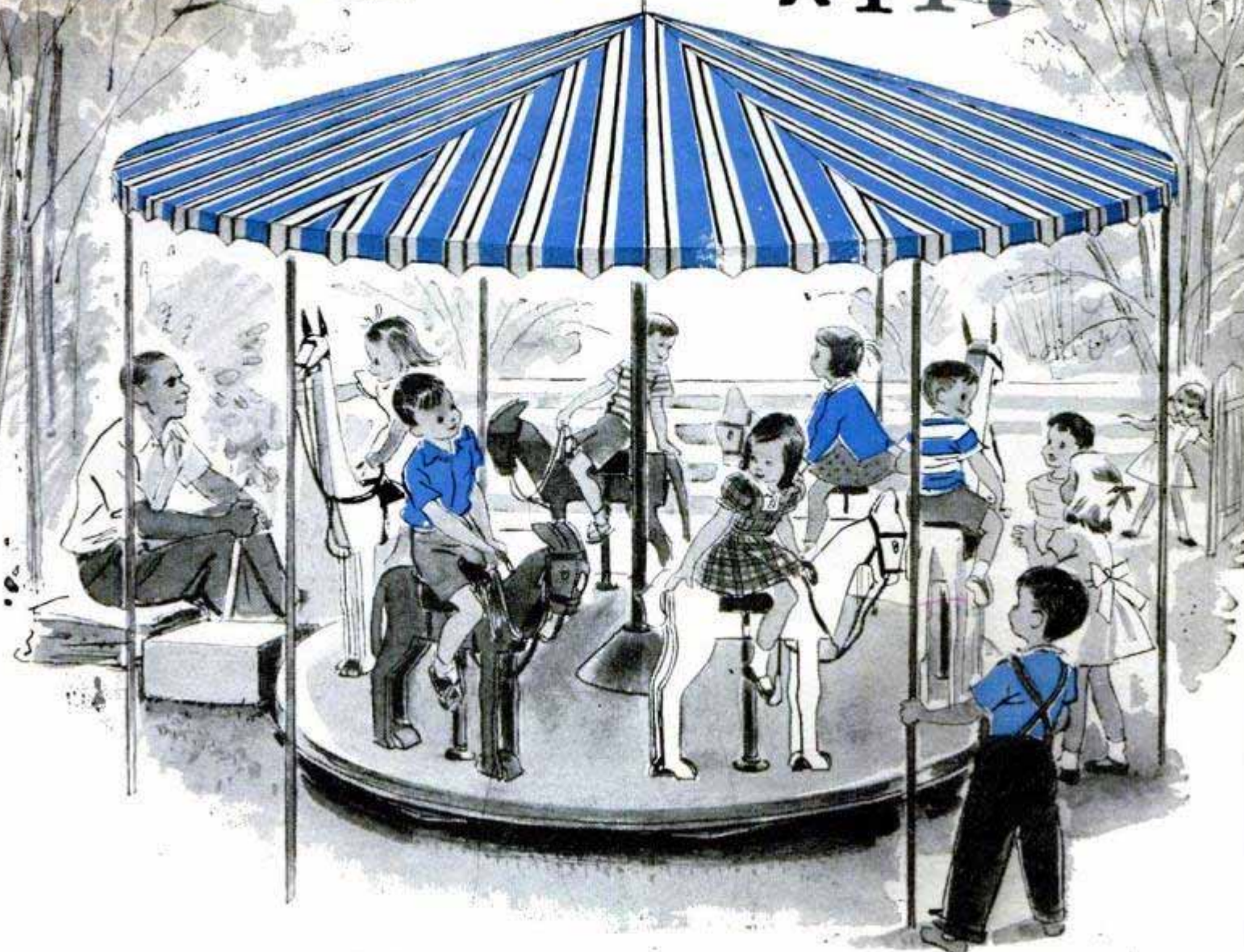

A410

MOTORIZED MERRY-GO-ROUND

By Roy Tichenor W T M 52

Transform your back yard into an exciting "kiddie park" by building this motor-driven merry-go-round. When the neighborhood youngsters walk under the gay canopy and mount the little animals for a merry ride, you'll have as much fun as they

ADAPTED from the original version designed and built by C. P. Parker of Cincinnati, Ohio, this pint-sized merry-go-round gives the youngsters a thrilling ride in a realistic carnival atmosphere. There's no pretending necessary when it comes to this toy—it has everything but the music. A ¼-hp. motor mounted at one side of the turntable, drives the merry-go-round at a moderate rate of speed—not fast enough to result in serious injury if one of the riders should accidentally fall off. The smaller children may be strapped in the saddles, and an adult or older, responsible child should be on hand to drive the turntable and help the tiny tots on and off the six wooden animals. The merry-go-round set-up is shown in the illustration above and

the side view, Fig. 2, on the next page.

Although the turntable of the original merry-go-round pivoted on an assembly of pipe and thrust bearings, the front-wheel assembly from an old car, installed as in Fig. 4, forms a self-contained ball-bearing pivot that will serve the purpose admirably. The car axle is cut apart approximately at the center, the tie rod is welded to the axle and the kingpin is welded to the yoke to hold the wheel spindle in a fixed position. Then a hole is dug in the ground, making it somewhat deeper than the length of the axle section, and filled with concrete. The axle is pressed into the wet concrete and, before the concrete sets, the wheel rim is carefully leveled in both directions. Prop the wheel rim in the leveled position with

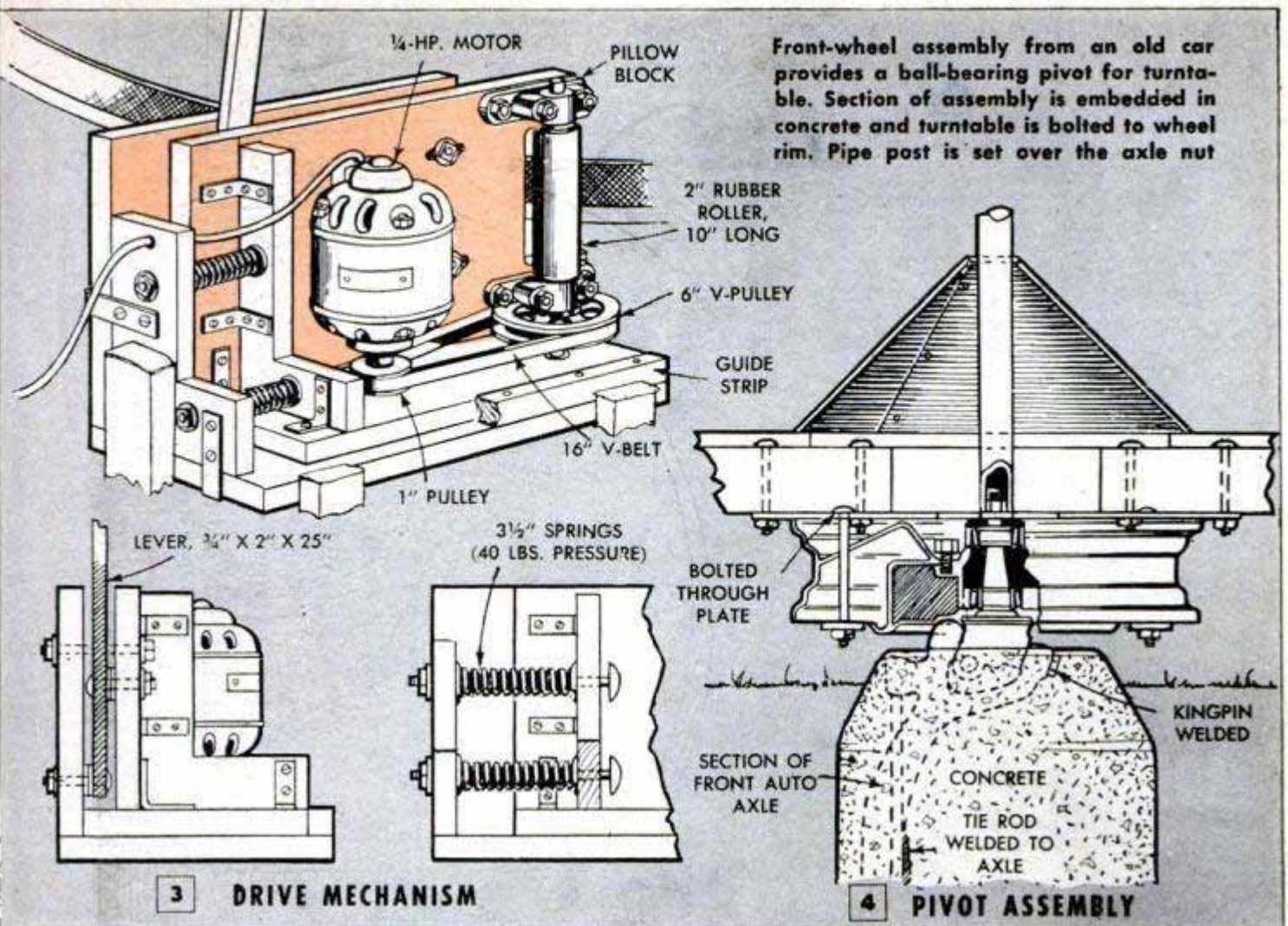

bricks or wooden blocks until the concrete sets. Note, in Fig. 2, that the wheel has been set in a shallow hollow scooped out of the ground. This is optional, and is done to lower the turntable so the smaller children will have less trouble boarding it and also to bring it in contact with the drive roller.

The turntable consists of a frame of 2 x 4-in. stock bolted to a steel plate and covered with flooring or 1/2-in. waterproof plywood. The plate, in turn, is securely clamped to the wheel rim. This is done by passing bolts through the plate, which is placed on the top of the wheel, and two lengths of flat iron on the underside of the wheel, as in Fig. 4. The flat iron must be long enough to rest on the edges of the rim. Note that a hole is cut in the center of the plate to provide clearance for any projection of the wheel spindle and also to permit setting a center post of 1-in. pipe over the axle nut. Eight 2 x 4 members radiate from the plate and are joined to the outer frame segments with plywood gussets as in Fig. 1, section A-A. The flooring segments at the outer edge of the turntable are bandsawed on a 4-ft. radius and the edges are covered by a band of 1/2-in. exterior-grade plywood, 3 or 4 in. wide. The strips of plywood banding are fastened to the edge of the turntable flooring with countersunk flat-headed

screws. The plywood band probably will have to be assembled in four or more sections, and these should be joined together only at points where the band is screwed to the frame. Use half-lapped joints and drive the screws through the lapped portions of the plywood. After assembly, the band is faced with a strip of belting, which is cemented or tacked in place, to provide a friction surface for the drive roller. Should you wish to floor part of the turntable before mounting it on the car wheel, remember that at least two opposite wedge-shaped sections must be left unfloored until the steel plate has been bolted to the rim. Otherwise, it will be extremely difficult to gain access to the underside of the wheel.

The canopy frame is made of 1/2-in. rod or pipe and a flat-iron band. The top ends of the support rods are bent to engage holes drilled in a large pipe flange which is turned on the top of the center post, and the lower ends of the rods are pressed firmly in the ground. The awning top is made up in wedge-shaped segments which are sewed together and placed over the metal framework. A wooden plug, drilled and driven in the top of the center post, can be used to support a pennant.

The drive mechanism, Fig. 3, consists of a rubber-faced roller which is belt-driven

by a ¼-hp. electric motor. The roller can be improvised from a washing-machine wringer or typewriter platen, or it can be made by covering a hardwood turning with a piece of inner tube. The entire drive unit is installed upright on a "floating" mount and is held against the turntable with two coil springs, thus bringing the rotating roller in contact with the belting on the edge of the turntable. The drive-unit mount rides on a wooden base. This is set on the ground alongside the turntable and kept from shifting by means of wooden stakes driven in the ground. A lever bolted to both the mount and the base is used to disengage the drive unit by pulling it away from the turntable. The mount is anchored by two bolts passed through slots in the side of the mount and a wooden guide strip nailed to the base.

→ The three pairs of wooden animals are made from 1-in. stock or plywood. The patterns are given at the left, each square indicating 2 in., and the parts are assembled as shown in Fig. 5. A pipe upright turned into two floor flanges supports each animal. One flange is screwed to the underside of the animal and the other is bolted to the turntable floor, while the feet are screwed to wooden blocks fastened to the floor. The wooden saddles on the animals can be covered with leather or plastic material, or simply painted. The harness can be improvised from old luggage straps or light belting, and the stirrups formed from rod or flat iron, welding the ends together.



5 TYPICAL ASSEMBLY
POPULAR MECHANICS

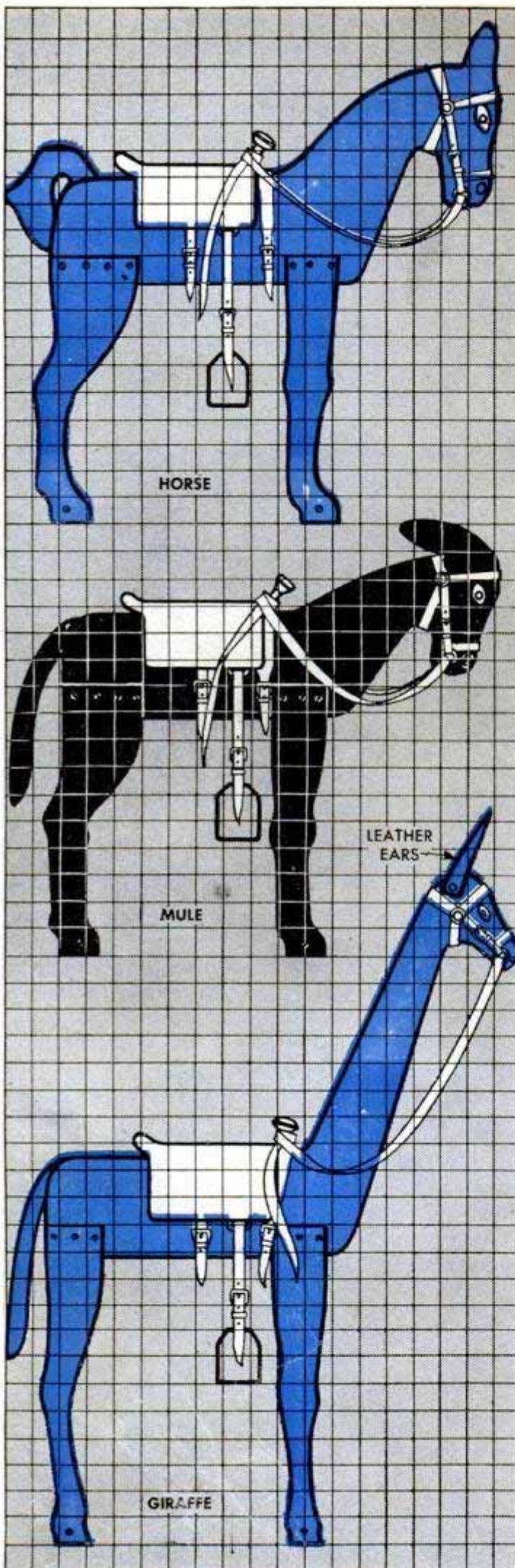

Small Box Hinges Made From Scraps of Wire

Scrap lengths of stiff wire are suitable for making these inexpensive box hinges. The only tools needed are a pair of pliers and a nail or other mandrel slightly larger than the diameter of the wire used. The hinges are made in two parts which link together, one length of wire being wrapped around a nail to form a coil through which the other length is inserted. The inserted length is then bent to a U-shape. Construction of the

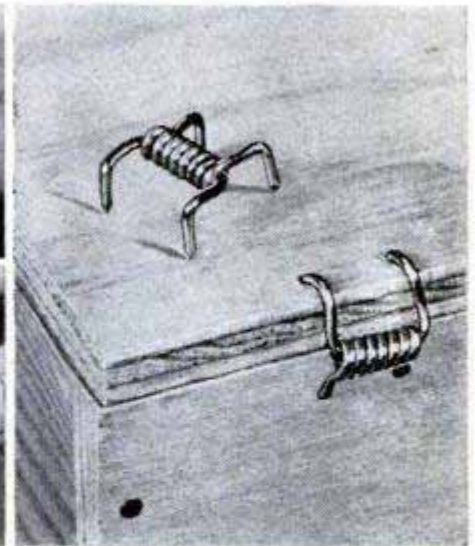
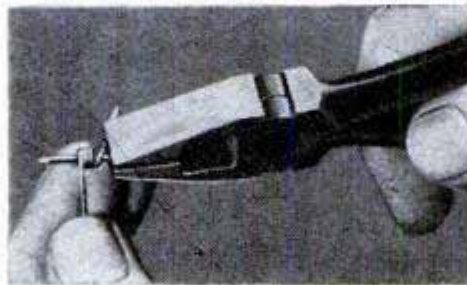
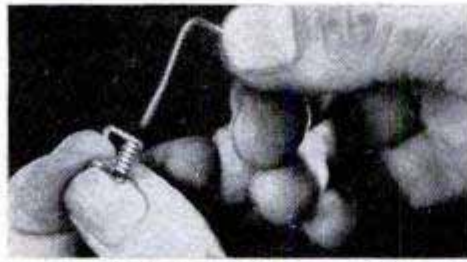

parts to be hinged determines the manner in which the hinges are attached. The photo shows a lid hinged to a wooden box, in which case the wire-hinge arms are bent

at right angles and inserted through holes in the lid and back of the box. The arms of each hinge are then twisted together on the inside of the box.

Ladies' Beauty Aids Are Helpful Tools for Modelmakers

When you need a gimmick that will reach into the deepest corner of an assembled fuselage of a model plane to work down a bulge on a rib, try an emery board. And, for getting up behind the drivers of a model locomotive to scrape down a bit of metal, a nail file will do the job in a jiffy. Don't overlook nail polish, either. The colorless kind is ideal for use on small polished metal parts to retain the luster. It is, in fact, the prototype of the expensive plastic paints that make it unnecessary to polish high-luster copper, brass, and steel except at infrequent intervals. Colored nail polishes have many uses, too, especially the dark, red-mahogany shades. For small touch-up

jobs on woodwork they are superior to shellac as an undercoat, because they dry instantly and can be painted over without even a short wait. Hand mirrors are ideal for looking into dark corners. Screws that often are driven blindly in a hard-to-reach corner can be carefully watched by left-handed juggling of such a mirror. Incidentally, careful manipulation often will reflect light into the corner as well as give a view of the work in hand. Fingernail scissors, the short but strong ones with curved blades, and the thin ones with needle-sharp points, are ideal for cutting light fabric to fit around snug places on a model plane.

George A. Strader, Elmhurst, N. Y.

Lead Ball Pilots Leader Cord Through Curved Piping or Tubing

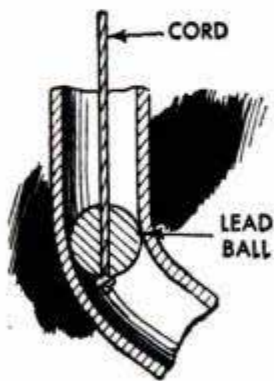

Fishing light chain or wire through curved tubing, conduit or plumbing fixtures sometimes poses a real problem, especially if the run of tubing or pipe curves in more than one direction. Often a lead ball will turn the trick when all other methods fail. Select

a ball which will pass freely through the tube or pipe and drill a small hole through the center. Then pass a cord through the hole and tie an overhand knot in the extreme end of the cord to keep the ball from slipping off. Be sure that the cord is long

enough to reach through the pipe or tubing. Attach the free end of the cord to the chain, wire or whatever is to be pulled through the pipe, and simply drop the ball into the open end. It will travel around sharp bends and through long runs of tubing without fouling if you are careful to keep the cord taut. If desired, the hole in the lead ball can be countersunk to provide a recess for the knotted cord, thus eliminating any chance of the knot to form a point of traction and cause the ball to bind inside the pipe.

W. F. Schaphorst, Newark, N. J.

☞ Try dampening an ironing-board cover before putting it on the board. Allowing it to dry in place on the board will result in a smooth, snug fit.

Pipe Frame Supports Picnic Table and Benches

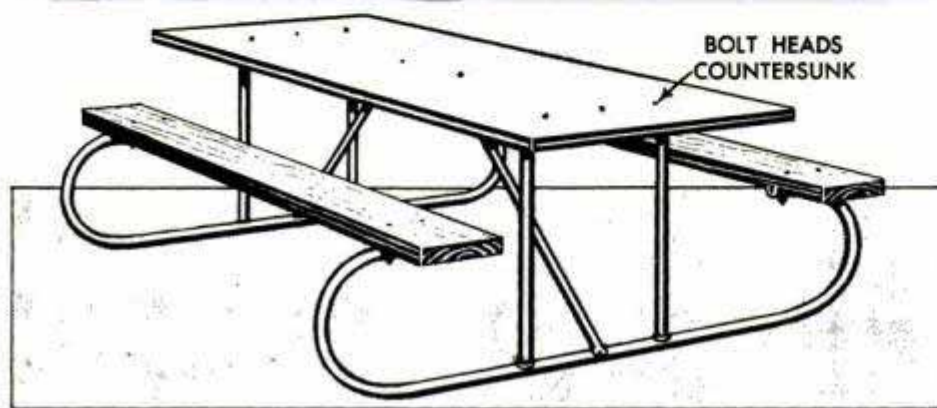

This lightweight table-and-bench combination for the lawn features a pleasing design that results in a sturdy, nontip unit. The entire frame is made of 1-in. pipe, the bottom cross members being formed in the shape of a "C" to double back and support the 2 x 6-in. bench planks which bolt to the pipes. Two lengths of pipe, each bent to form an inverted "U," provide the legs. These are welded to the runners and bolted to the table top, which is a sheet of $\frac{3}{4}$ -in. exterior-grade plywood. Another length of pipe is bolted to the center of the table top and to each runner so that it will serve as a brace.—Grover Brinkman, Okawville, Ill.

Soap-Flakes Solution Used to Clean Decorative Feathers

Decorative feathers used in trimming hats and other objects can be cleaned by moving them vigorously back and forth in a lukewarm solution of soap flakes. Use a wide jar or a container slightly higher than the length of the feathers. Rinse each feather immediately with clear, cold water by holding it under a faucet, and then place it on a white towel or sheet of white blot-

ting paper. When cleaning feathers of different colors, clean white and naturally colored feathers first. Should the soapsuds become tinted by a little excess coloring from artificially colored feathers, use freshly prepared suds for each color. Hang each feather separately by tying at the quill with a rubber band or string. Let them dry thoroughly away from heat.

Choke Wire Operates Toggle Switch From Front of Power Tool

A toggle switch for a power-tool motor is sometimes mounted on the motor base in such a position that reaching the switch is inconvenient or even hazardous. A device to permit operating the switch conveniently from the front of the tool can be made by attaching a length of automobile choke wire to the switch. The wire is threaded through a hole drilled in the toggle arm and is held in place by a stop on each side of the arm. The stops are provided by clamping the wire between two nuts which are turned on a machine screw. The choke wire is supported in front of the switch, and again at the front of the machine, with two sheet-metal brackets formed and bolted to the motor and tool base as shown.

Walter G. Franklin, Penn Yan, N. Y.

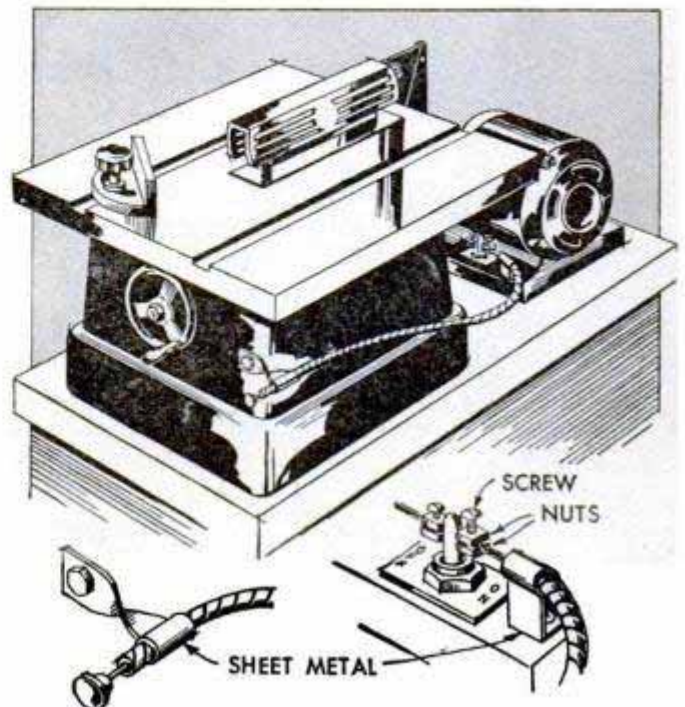

Shellac, applied to the end of a light-switch cord, will keep it from unraveling.



Your Car a Motel

Transforming the back seat of a sedan to a comfortable double bed will slash vacation costs

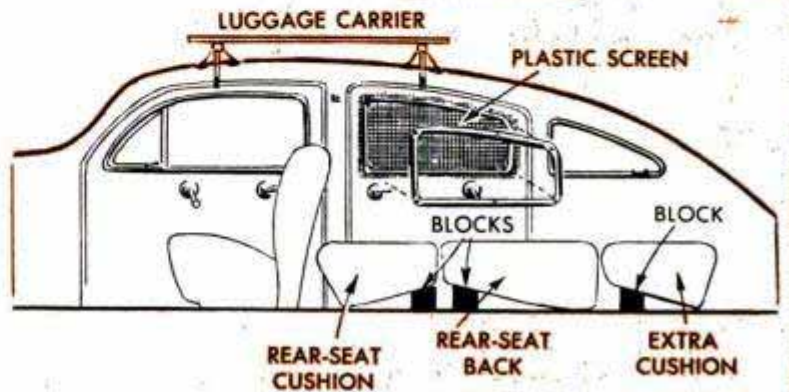

IF YOUR vacation plans include extensive traveling by car, take a few hours to set up a double bed in the back seat of the car, and drop the cost of sleeping accommodations from the vacation budget. An extra, secondhand seat cushion, and six wooden props are all the material needed for the job. First, remove the rear-seat back and take out any partition which separates the trunk compartment from the rear seat. Next, clean out the trunk and remove the spare tire. Prop the seat back and the two cushions with the wooden blocks so the tops of the three cushions form a level surface. Spreading your sheets and blankets directly on the cushions provides a satisfactory bed which can be made even more comfortable by placing a lightweight mattress over the cushions. As the trunk area is utilized for sleeping room, the spare tire

and luggage will have to be carried on top of the car. This is done by fitting a standard car-top carrier with a shallow luggage tray. The latter is made by mounting four sidepieces on a sheet of plywood or base made of boards. The plywood should be drilled for water drainage. A few screw eyes turned into the top edges of the sidepieces will facilitate lashing the items in the tray. You can have plenty of sleeping ventilation without worrying about insects if you remove the metal frame from one or both of the rear windows, cover the window opening with a piece of plastic screen and then replace the frame. This will keep out the insects, but won't interfere with raising and lowering the window. When the vacation is over, only a short time is needed to get the car back in shape for everyday driving.

Matthew Howard, Minneapolis, Minn.

Model-Railroad Tunnels Built From Asbestos-Paste Mixture

Asbestos paste mixed with portland cement forms an excellent material for covering model-railroad tunnels and terrain. After setting up a wooden framework and covering it with window screen, mix asbestos paste, 3 parts, to portland cement, 1 part, adding just enough water to bring the mixture to a spongy consistency. Then smooth the mixture over the screen wire with a small trowel or spatula. The mixture remains workable for about 20 hours,

allowing plenty of time to work out the details, and dries hard in a stone-gray color. Small stones, miniature trees, telephone poles, etc., may be set into the mixture before it hardens, and pieces of mirror can be used to simulate ponds and lakes. After the material is thoroughly dry, it should be given two coats of clear shellac and then painted to approximate the natural colors of the rock and vegetation simulated.

Dick Hutchinson, El Monte, Calif.



CHILD'S CHIFFOROBE

By I. M. Fenn

DESIGNED to complete the furnishings of a child's room, this attractive chifforobe offers generous wardrobe space, a chest of drawers with a full-width storage drawer and a special compartment for toys or linens. It looks its best when made from a close-grained wood such as poplar or birch, and finished in ivory enamel with the interior drawer fronts finished in the natural color of the wood. As the first step in the construction, build up the top to the required width by edge-gluing four to six strips of selected stock. Allow $\frac{1}{2}$ in. all around for trimming to finish size. Although the detail on the opposite page shows the edge of the top molded, this can be omitted if no shaper is available. While the glued-up top is drying, cut selected

stock for the drawer fronts, corner posts and the scrolled front and back aprons. Bandsaw the edges of the drawer fronts and the aprons, laying out the curves full size from the patterns given below. Round the bandsawed edges and sand smooth. Groove and rabbet the front and back posts. Frame the ends by fitting top and bottom rails and then glue and clamp the parts together. Note that the front posts are cut off square at the lower ends, flush with the scrolled edge of the apron, and are fitted with turned feet. Drill a hole in the lower end of each front post to take a $\frac{1}{2}$ x $1\frac{1}{4}$ -in. tenon. After turning out the feet, glue the parts together.

Note the assembly of parts in sections A-A and B-B, then build up the top and bottom frames, using grooved stretchers

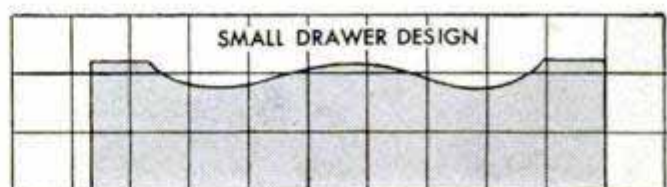
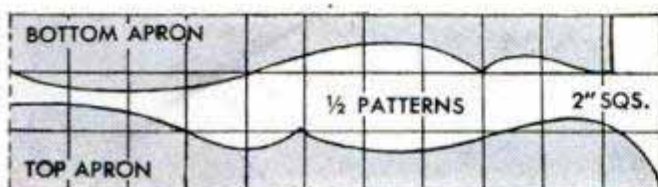



and the tenoned rails. Note that the bottom frame is paneled to provide dustproof construction, and that the back stretchers are rabbeted to take the back panel. Build up the intermediate frame, then drill blind holes for $\frac{1}{2}$ or $\frac{1}{4}$ -in. dowels which join the frames to the posts. After making a trial assembly of the parts to check the fit, apply glue to the doweled joints and clamp the parts together. Check the assembly for square corners before the glue dries, and cut and fit the back panel while the assembly is in the clamps. Attach the panel with screws, but do not use glue in the joints. Now, note that the back ends of the inside drawer runners are housed in grooves cut in uprights fitted into the corners of the drawer compartment, and that this compartment and the special storage space

above are formed by a paneled partition supported on the intermediate frame. Make up this paneled partition first and join to the top and intermediate frames with screws and glue. Now, groove the back drawer-runner supports and screw them in place. The front-runner supports are ripped to the same width but are not grooved, the front ends of the runners being attached with screws as in the detail and section B-B. Rabbet the runners and glue and screw them in place. Attach the top, then fit plywood bottoms in the storage and wardrobe compartments. Now all that remains is the making and fitting of the drawers and doors. Construction of the drawers is clearly shown in the details, but note that the large drawer is fitted with a $\frac{1}{2}$ -in.-plywood bottom for added rigidity and also is fitted with a center guide. Doors can be paneled in the manner shown or the panels can be housed in grooves cut in the stiles and rails. The doors are hinged to close flush, but the lower drawer front is rabbeted all around and the outer edges are beveled to give a raised-panel effect. After the cabinet has been completely assembled, sand all exposed surfaces and apply a coat of sanding sealer. When this is dry, sand lightly and finish with two coats of ivory enamel. Apply a sanding sealer to the inside drawer fronts, sand lightly when dry, and finish in the natural color with two coats of varnish or one coat of water-white lacquer. The exposed center upright and the front drawer-runner supports also can be finished in the natural color if desired. Attach two pulls to the lower drawer.

Posthole Digger Holds Soil Intact When Transplanting Seedlings

A posthole digger (not auger) will be found very useful for transplanting seedlings over short distances in the garden. With it, you can lift the young plant from the ground, holding the soil tightly, transport it to the new location, and gently de-

posit it in a hole which has been dug beforehand. Press the soil down gently with your foot. The large lump of soil removed with the roots in this way prevents disturbing them so that the plant will show no evidence of having been moved.

"Spotlight" Shade for Shop Lamp Improvised From Glue Can

If you use an old flexible type of desk lamp as a portable lamp in your workshop, an empty glue can of the type that has a screw cap will provide an ideal shade for concentrating a bright spot of light on your work. Most cans of this type will fit over the neck of the average lamp socket. If the can has a tendency to get hot, cover it with sheet asbestos to protect your hands.

Walt Seifert, Columbus, Ohio.

□ In the absence of a screwdriver bit for a drill brace, a small steel washer often can be inserted in the jaws of the chuck to serve as a substitute.

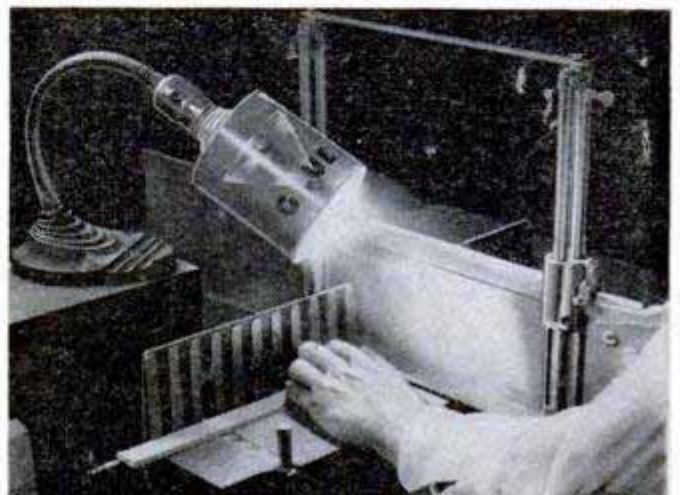

Flower Pedestal for Lawn or Porch Improvised From Sewer Tile

Standing a length of sewer, or drain, tile on end provides an attractive, durable flower pedestal for use in the yard or on a terrace. A large tile may be filled with soil and used in the manner of a flower box, while a smaller size may be used to support a flowerpot, the rim of the pot resting on the end of the tile. A colored or a clear, glossy finish can be had by applying a coat of enamel or lacquer.

Wilton Matthews, Long Valley, N. J.

Tools Held Safely on Scaffold Plank

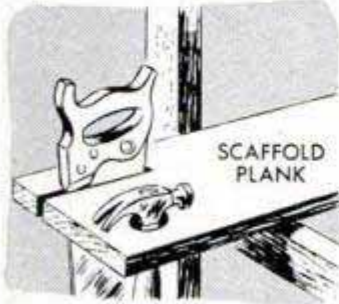

One of the dangers of working on a scaffold is that a tool may be accidentally dropped on someone below. This danger can be minimized by slotting and drilling the planks to provide hangers for the tools. In this way the tools which are not being used are kept handy, but safely out of the way.

provide hangers for the tools. In this way the tools which are not being used are kept handy, but safely out of the way.



Oxalic-Acid Solution Cleans Leather Spotted With Grease

To clean grease spots from leather, first moisten the leather surface with water, using a wad of absorbent cotton or a small sponge. With another sponge or wad of cotton apply an oxalic-acid solution evenly over the soiled surface. This solution con-

sists of oxalic-acid powder or crystals, 1 part, and water, 10 parts. After the spots have been removed with the oxalic acid, apply saddle soap to the leather and polish with a soft chamois or woolen cloth.

Helen Lemberger, Chicago.

Carriage Bolt and Feeler Gauge Serve to Check Runout of Auto Flywheel

Although skilled mechanics use an expensive dial gauge to check runout when installing flywheels on motors, the person who does this job only on rare occasions can devise a fairly accurate substitute with an ordinary carriage bolt and a feeler gauge. The bolt is locked in a bracket by means of two nuts, one on each side of the

bracket, which, in turn, is mounted at some point on the flywheel housing as indicated.

The head of the bolt is located so that it almost touches the flywheel near the outer edge of the surface contacted by the clutch pressure plate. Chalk marks are then placed on the flywheel at 90-deg. intervals. By using a feeler gauge to get the exact distance from the bolt head to the surface of the flywheel in these four positions, the runout can be calculated easily.

For example, if a .010 feeler gauge is required to fill the space between the flywheel and the bolt head at one point, and 90 deg. beyond this point a .012 gauge is required, runout of the flywheel, would be approximately .002 of an inch. If a runout of .005 tolerance is permissible on your particular job, your flywheel is okay. However, if the difference exceeds the tolerance permitted, then the flywheel should be removed and the mating surfaces cleaned thoroughly. The flywheel is then replaced and the check is made again.

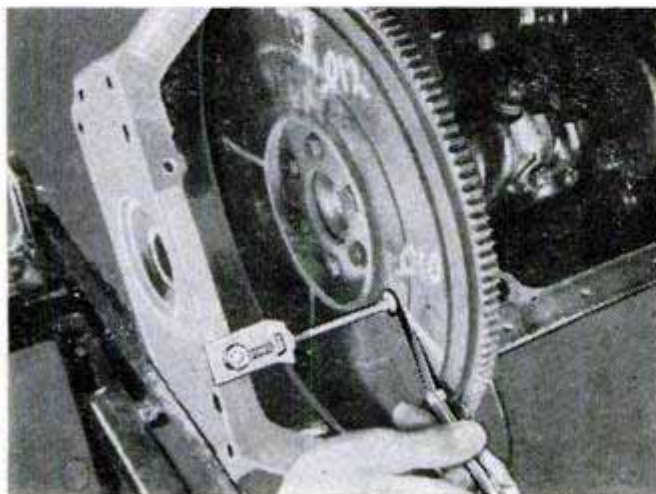

1 EVENING PROJECTS



Mortar-and-Pestle Lamp

THE TWO exceptionally attractive projects pictured on this page provide a real test of craftsmanship, while a third one, on page 192, describes two toy locomotives of thread spools and scrap wood that can be made in an hour or two.

MORTAR-AND-PESTLE LAMP

The base, pestle and the mortar handles are of walnut while the mortar itself is built up of alternating rings of mahogany and poplar. If desired, another light-colored wood may be substituted for poplar. To turn the mortar, three roughly shaped rings of $\frac{7}{8}$ -in. stock are glued together with solid

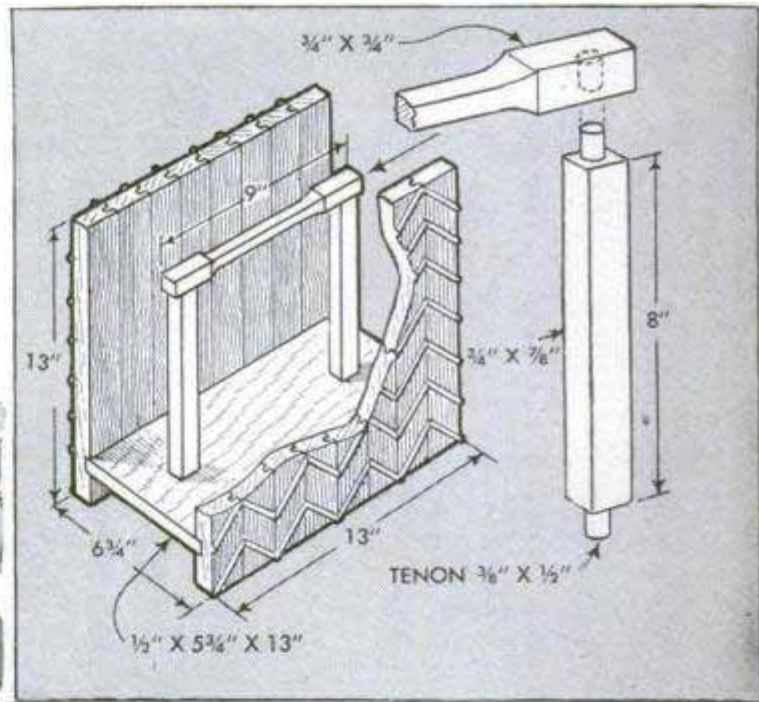

Embossed Magazine Rack

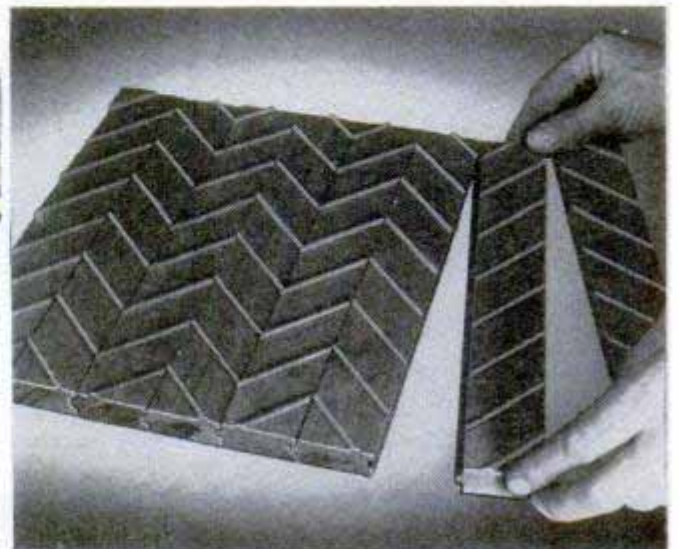

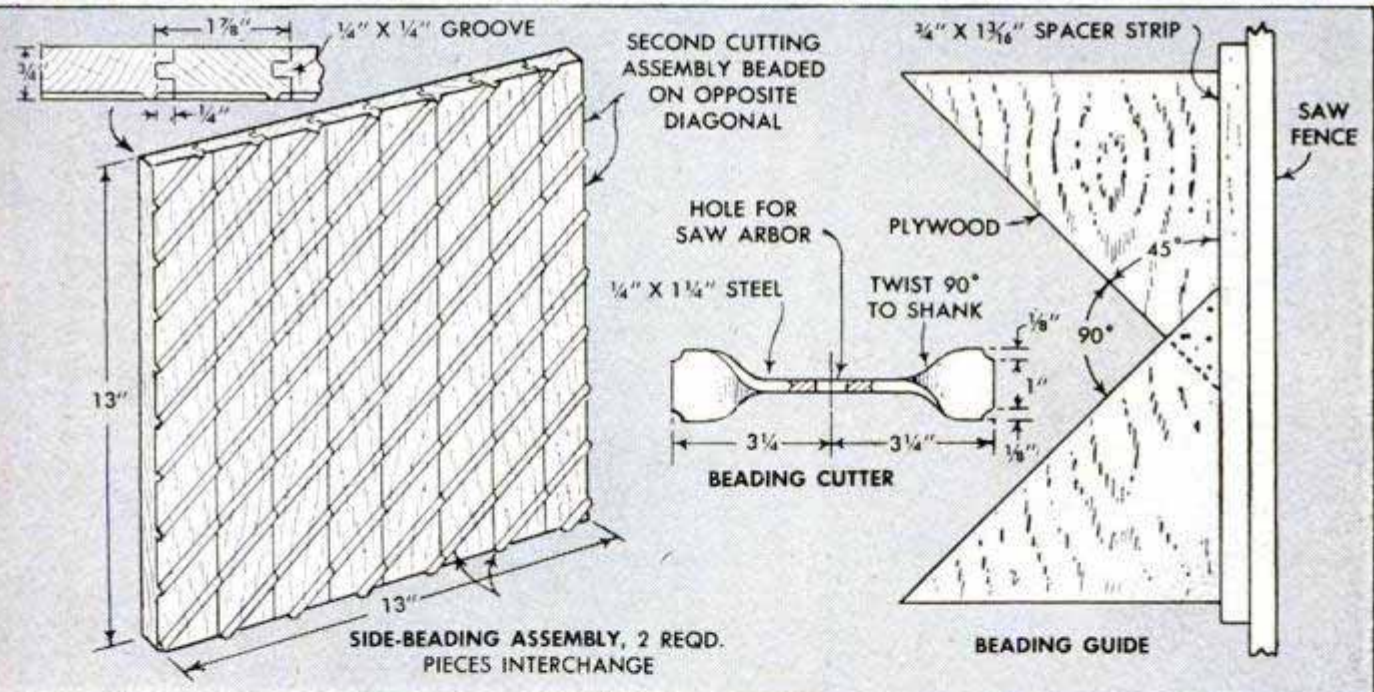
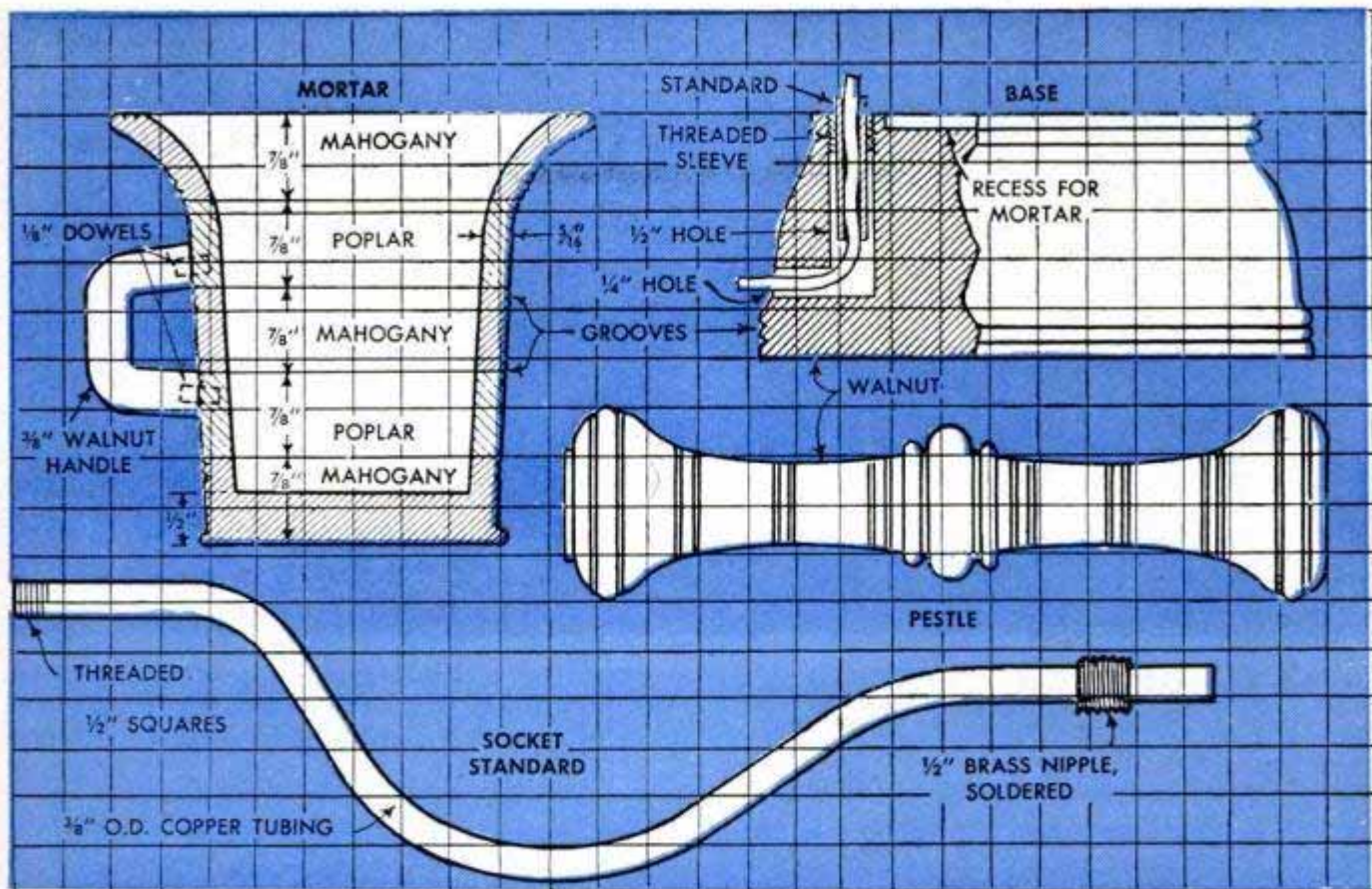

The photo at the left shows the numbered side segments being placed together in their proper order to form one side of the rack. These segments have been removed from both side-beading assemblies, detail above. It is important that the beading be done with extreme care in order to assure that the beads will match and achieve herringbone pattern pictured

Beading operation, with cutter mounted on saw arbor, is pictured at the right. The segments are clamped together by inserting one edge of the assembly in a notched cleat, shown directly under the operator's left hand, and tacking a strip of wood along the other edge. Notched cleat also is tacked in place, all tack holes being filled before finishing rack

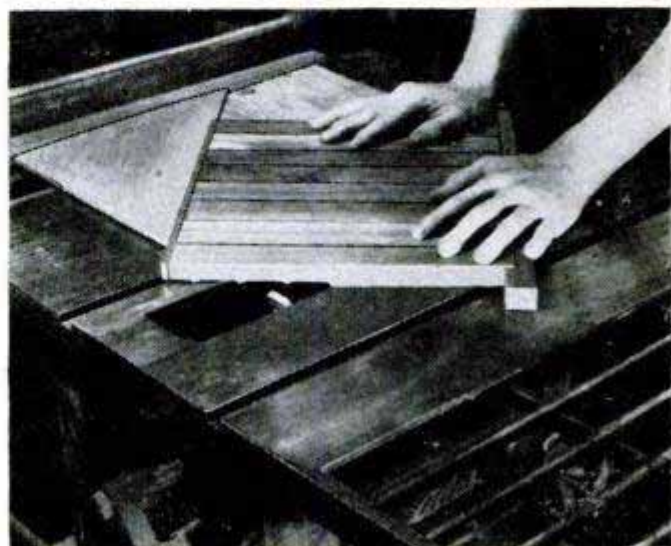



Toy Locomotives

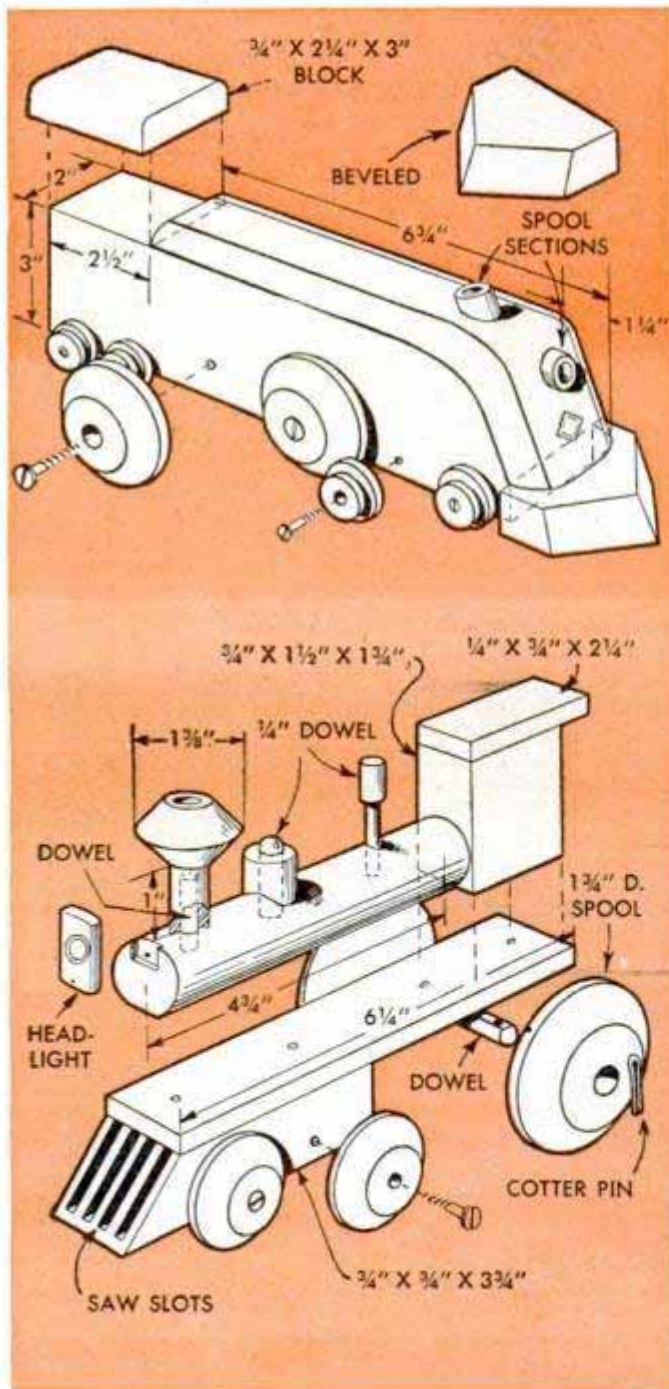

disks of the same thickness being glued to both ends. Note in the detail how the mahogany and poplar are alternated. The bottom disk may be screwed directly to the lathe faceplate, or it may be glued to a piece of waste stock. In the latter case, paper is sandwiched between the two pieces to facilitate separation, and the waste stock is screwed to the faceplate. For turning the outside contours, it is best to run up the tailstock center to help support the work. The handles, which are cut from $\frac{3}{8}$ -in. walnut, are doweled and glued to the sides of the mortar, while a solid walnut turning forms the base.

EMBOSSED MAGAZINE RACK

The embossed herringbone design of this modern magazine rack is achieved by using a homemade cutting tool along with a novel method of cutting and interchanging the side segments. Each side of the rack requires eight pieces of walnut or other hardwood, tongue and grooved. The pieces are matched as closely as possible for regularity of grain and placed together temporarily to form two side assemblies. Now, each piece is numbered consecutively so that it can be returned to its corresponding position after beading. In order to retain the matching grain selected for each side, it is necessary to shuffle the pieces and make up two beading assemblies so that when the pieces are reassembled in consecutive order, the grain will match and the beading will form the herringbone pattern. The beading is done on the circular saw with a special cutter and a guide, one side assembly being beaded on a diagonal opposite to that on the other. A $1\frac{3}{16}$ -in.-wide spacer strip is used to reset the saw fence after each bead is cut. With each pass of the work, the guide is left undisturbed on the saw table and the fence is backed away to permit inserting the spacer strip between the guide and fence. Thus, when the fence is brought up against the spacer strip and the latter removed, the fence will be in position to receive the guide for the next cut. After beading, the segments are returned to their original positions in the two side assemblies and finally glued together. The completed sides are grooved on the inner faces for the bottom of the rack.

TOY LOCOMOTIVES

Made of scrap stock and portions cut from thread spools, either of these locomotives is quickly assembled. The streamliner is simply a wooden block cut to shape and fitted with a cab roof and cowcatcher. The drive wheels are flanges cut from large spools of the kind used for shoemaker's thread and the trucks are cut from ordinary household-thread spools. The boiler of the old-time locomotive is made of broomstick.

Tenons Turned on Hardwood-Dowel Ends by Use of Circular Saw

Should it be necessary to form a tenon on the end of a large dowel, or other round piece of work, and there is no suitable tool at hand to do the job, a circular saw can be used as indicated. First, set the rip fence of the saw a distance from the blade equal to the desired length of the tenon, then clamp two wooden strips to the saw table to help hold the work in position. In use, place the work between the strips directly over the saw, which has been set about $\frac{1}{8}$ in. or less above the table surface. Then, very carefully rotate the work over the saw and, at the same time, move it back and forth horizontally across the saw. When all the stock has been removed to this depth, again raise the saw slightly and repeat the operation. Do this until the end of the work has been turned down to the desired size.

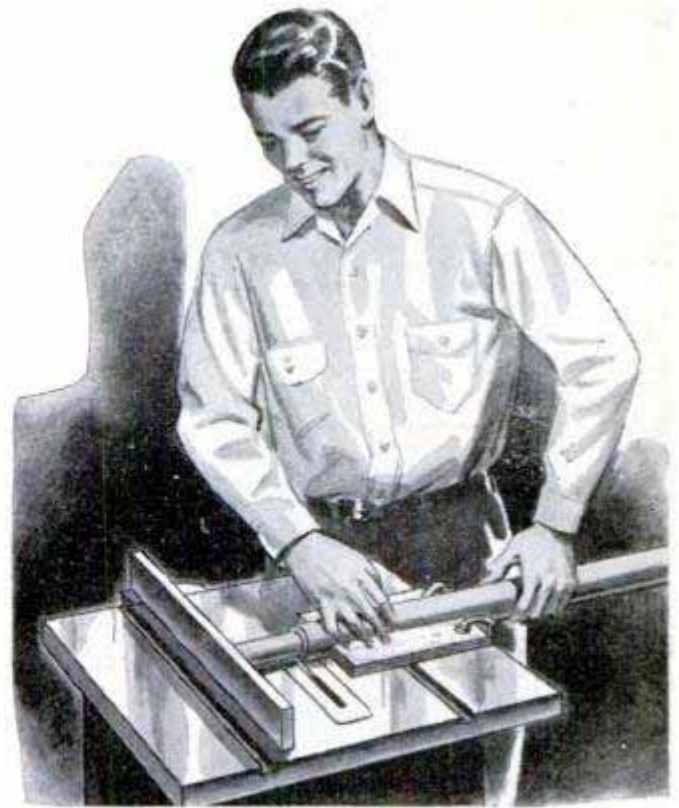

Improvised Wheel Flanges

Special wheel flanges for homemade grinders, circular saws and jackshafts are made easily by welding a hex nut to a large washer.



After the two parts are welded together, the threads are reamed out in order to straighten the hole through the welded parts and bring it to the required diameter. When necessary to attach

the flange to shafting, drill a hole through one of the flats on the hex nut and tap it for a small sockethead setscrew.

Evan Wright, Topeka, Kans.

Tangleproofing Pull Chain

The tendency of the chain on a drop cord or ceiling fixture to snap back and tangle when pulled can be overcome by stiffening the chain with a strip of cellulose tape.

Merely wrap the tape around a short section of the chain near the switch opening as in the drawing.—

G. E. Hendrickson, Argyle, Wis.

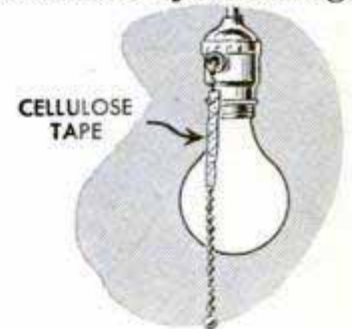

Clothespins and Pencil Hold Paper-Label Roll to Typewriter Carriage

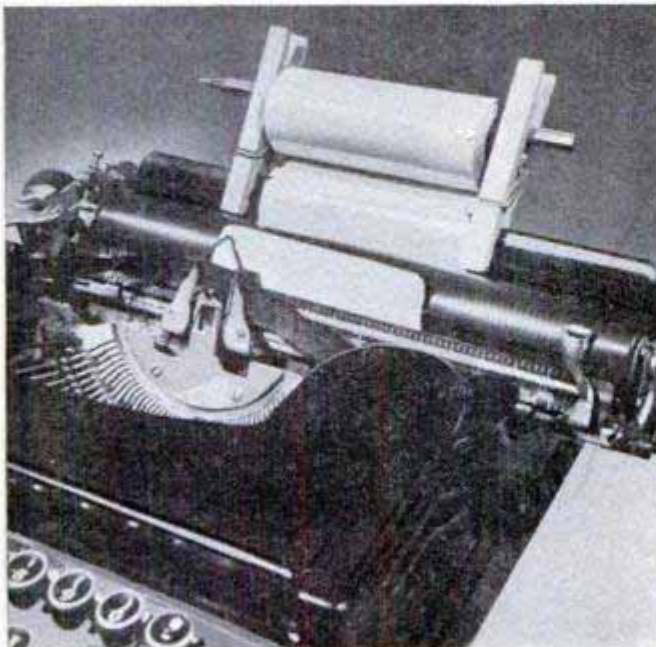

When typing labels which are fed into the machine from a long roll, the problem of supporting the roll on the typewriter can be solved with a pencil and two spring-type clothespins. Clip the clothespins to the typewriter, as pictured, spacing them so that the roll will fit between them. Then run the pencil through the center of the roll and wedge the ends of the pencil between the arms of the clothespins.

Louis Hochman, Sherman Oaks, Calif.

Cellulose Tape "Cleans" Envelope

If you want to reuse a heavy Manila envelope, the stamps and any printing can be removed with cellulose tape. Completely cover the portions to be cleaned with the tape, and then simply pull the tape loose.

Andrew Vena, Philadelphia, Pa.

PRESERVING THE CAR BODY

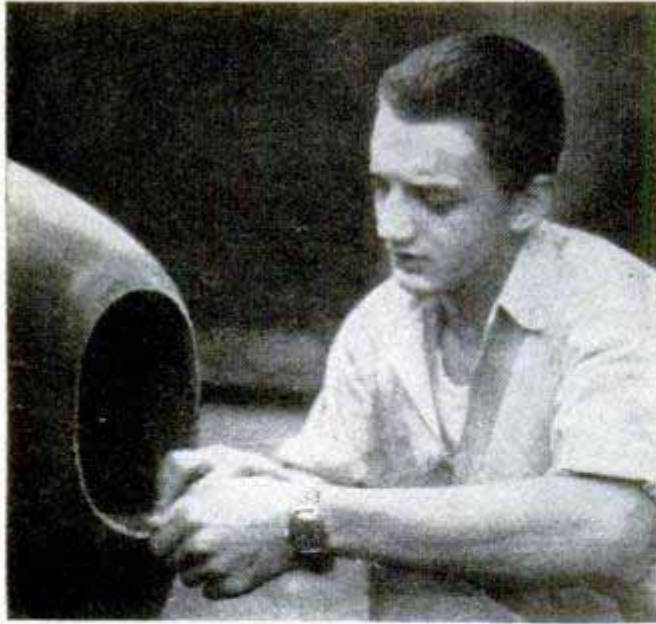

Headlights are removed and rusted portions of fender sanded down to bare metal before applying primer

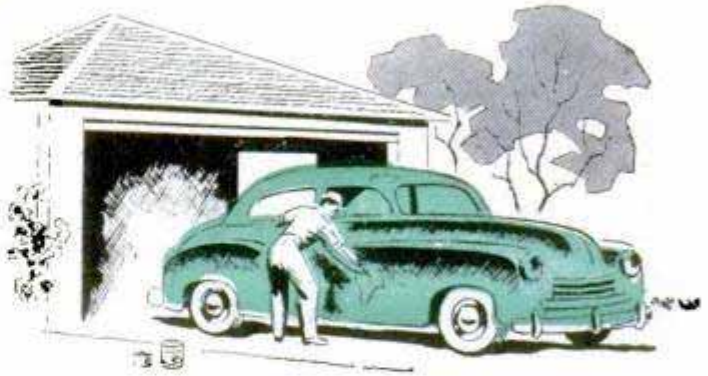

WHETHER you're a top-notch amateur mechanic or the fellow who doesn't know a differential from a wrist pin—and doesn't care—you can keep up the appearance and, in turn, the resale value of your car simply by protecting the body from rust. This may be done in two ways. The first, and preferable, way is to prevent rust by careful attention to the body and to control rust once it starts. The second way is to repair the damage after rust holes have actually appeared. Undercoating the car affords excellent basic protection from rust, and the undercoater can be applied with a brush. Even though you may not wish to do a complete job of undercoating, it is well worthwhile to coat at least the underside of the fender joints and also the areas where impact from road gravel is greatest.

If rust blisters appear in the enamel around the headlights, it is not sufficient to scrape off the blisters and touch up the exposed areas. The damage usually extends under the headlight rim. With the headlight removed, all traces of rust should be sanded from the body, and the bare metal coated with a primer especially made for this purpose. After the primer dries, it is sanded lightly, painted with a matching car finish and then "blended" with rubbing compound.

To prevent rusting of the steel car floor and also the edges around the base of the body, the rubber mat on the floor of the front-seat compartments must be kept in good condition. The mat can be repaired easily by applying patches of mat material with rubber cement. After the patch is cut to shape, it is positioned on the worn mat and outlined with a pencil or chalk. The area of the mat within the outline is cleaned with a wire brush and white gasoline, and after it has dried, both this surface and the back of the patch are covered with a thin, uniform coat of rubber cement. When the cement dries, press the patch to the mat.



Worn floor mats can be repaired by applying patches of mat material, with rubber cement used as adhesive



Here, sheet-metal patch is welded to car body where metal was broken through by rust and flying gravel

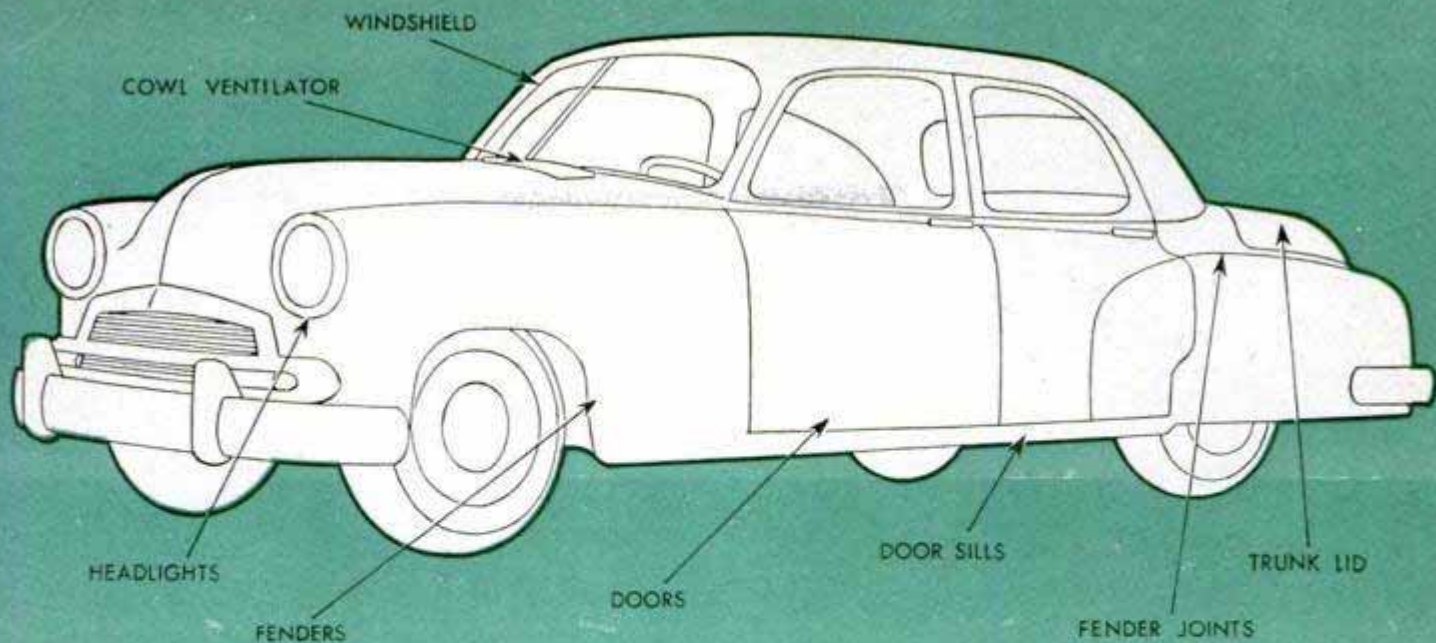

Areas indicated by the arrows in the drawing above are the spots you should watch most carefully for signs of rusting. Metal parts exposed to salt corrosion and pounding by road gravel are especially susceptible

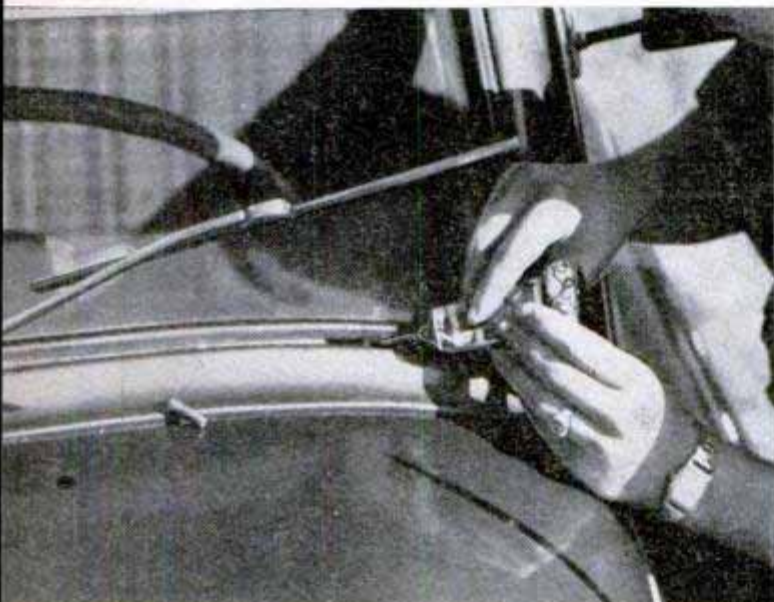

Sealing compound packed in tube is easily applied to the joint between windshield glass and molding



Deteriorated weather stripping on doors can be replaced with sponge rubber to assure a tight seal

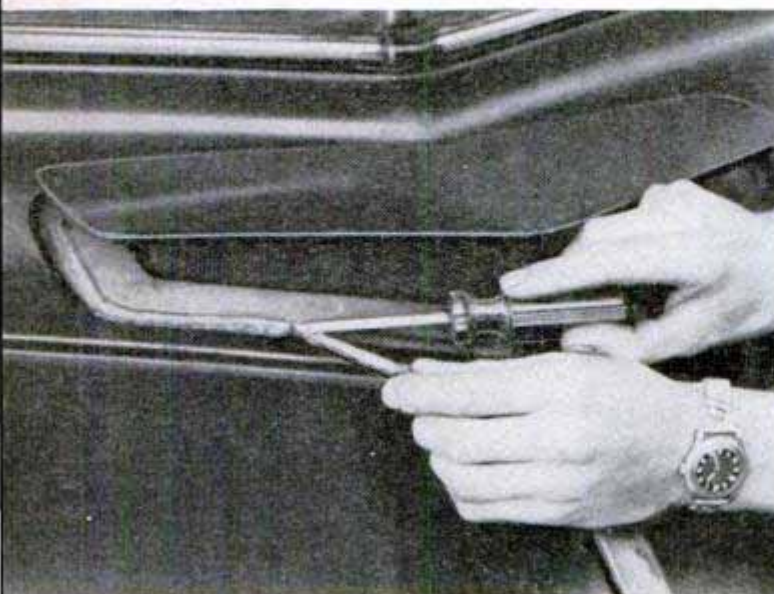

Old gasket is removed from cowl ventilator and new gasket or sponge-rubber strip is cemented in place

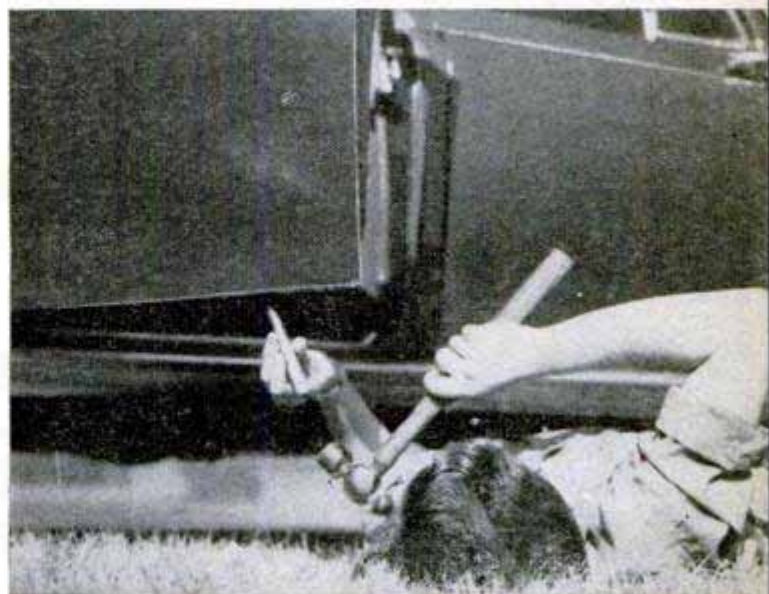

If drain holes are not provided in underside of car door, these can be made by means of a sharp punch

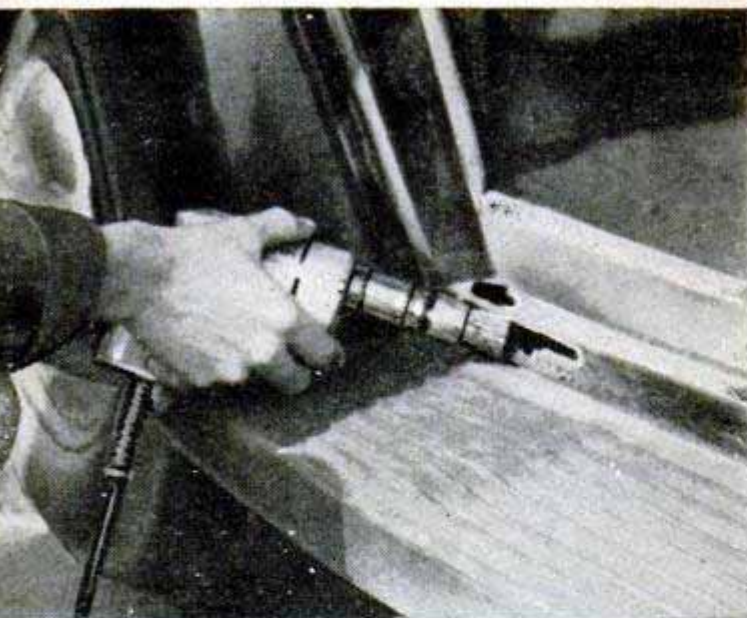

Using portable electric drill to drive wire brush speeds cleaning rusted areas before applying patch



Door-sill patch, which has been bent to shape, is fastened to the car body with self-tapping screws

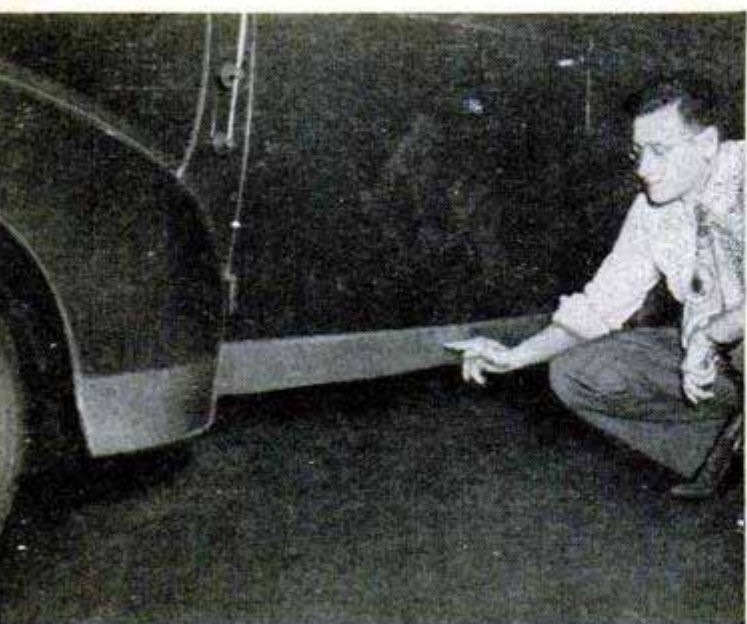

Where lower edges of fenders and body are extensively damaged by rust, full-length patch can be used

Sealing any windshield leaks between the glass and the molding provides further protection from rust and also helps to keep the body watertight. Cement for this purpose can be obtained in tubes and is simply applied under the edge of the molding, if the latter is metal, or along the joint formed by the glass and a rubber molding. If there is still evidence of leakage, check the fit of the windshield-wiper shafts in their bushings and lubricate them if necessary.

To control rust at the cowl-ventilator drains, check them periodically for clogging and, if required, blow out the drain tube with compressed air. Also, replace a worn ventilator gasket with a new one or cement sponge rubber around the opening.

In addition to keeping the car snug and quiet, weather stripping on the doors prevents water, which enters at the top, from rusting out the door sills. The weather stripping should be replaced when it apparently is no longer serving its purpose. Drain-hole plugs that have not been removed from the underside of the door should be pried loose. If the door is not fitted with drains, punch two or three holes in the bottom edge of the door. Use a sharp punch and work it around the edge of the hole to draw the metal downward, as any edges projecting upward will not permit the water to drain out. Coat the edges of the holes with red lead, working it well up onto the inside surfaces.

Car-door sills which have rusted through can be patched easily. First, the metal around the break is cleaned thoroughly with a wire brush, or with emery cloth and steel wool. Then a cardboard pattern for the sheet-metal patch is made, and this is transferred to a sheet of body steel. The metal can be clamped between strips of hardwood and bent to shape with a mallet. The surface of the car body to be covered and the inside surface of the patch are coated with red lead, and the metal is fastened to the body with self-tapping sheet-metal screws.

Lower portions of the fenders and body can be patched in a similar manner. Note the full-length aluminum repair strip applied to the car in the lower left-hand photo. All rust must be removed and any bent portions of the body straightened. Then strips of sheet metal are cut to approximate length, fitted in position and shaped with a mallet. All mating surfaces are coated with red lead and the strips are attached to the body permanently with sheet-metal screws. A neater job can be had by soldering the repair strips in place, provided that aluminum or stainless steel is not used. If solder is used, the edges of the strips are dinged with a sheet-metal-worker's hammer and the joints filled with body metal or solder. Then joints are filed smooth before priming and painting.

Card Table in Open Doorway Serves as Baby Gate

When it is desired to keep a small child from going through a doorway where the door cannot be closed, open up a card table and insert it in the doorway as indicated. The handle of a broom run between the table top and the door casing will prevent the table from being pushed through the doorway. This idea is exceptionally useful where only a temporary means of keeping the baby in one room is desired. An improvised baby gate is also helpful in homes where space heaters are used and doors are left open to allow circulation of heat.

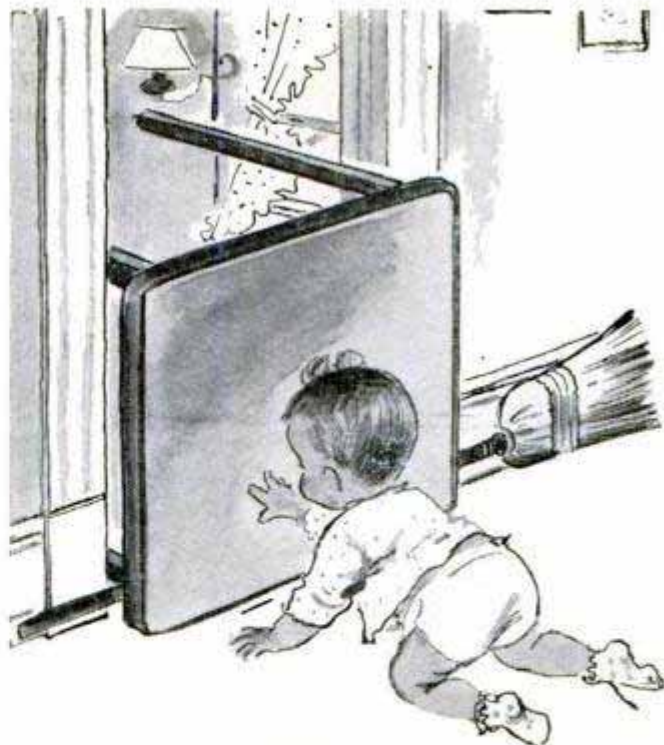

Tape-and-Clothespin Photo Easel



A suitable easel for holding photos or show cards, which are not more than 12 in. high, can be made from a piece of tape and a spring-type clothespin. Merely apply the tape to the back of the piece to be

held, leaving a fold in the middle as shown in the illustration. Then clamp the clothespin to the fold at the necessary angle.

Armored Cable Opens Drains

For freeing clogged runs of soil pipe, a length of electrical armored cable sometimes can be used as a plumber's drain auger. This is possible, however, only where no sharp bends are encountered. To aid in twisting the cable inside the pipe, a 3 or 4-ft. length of rod can be inserted in the cable and bent to form a crank.—Edward M. Dewan, South Amboy, N. J.

Insulator on Clothesline Prop Prevents Rust Soilage

An ordinary porcelain wire insulator, screwed to the end of a clothesline prop, serves as an excellent running eye for holding the clothesline to the pole. The porcelain surface of the insulator minimizes wear and will not rust, as metal running eyes sometimes do. Thus, the danger of soiling the clothesline in such a manner is avoided. The line is easily slipped into the opening of the insulator and is held sufficiently secure to keep the prop from falling off.

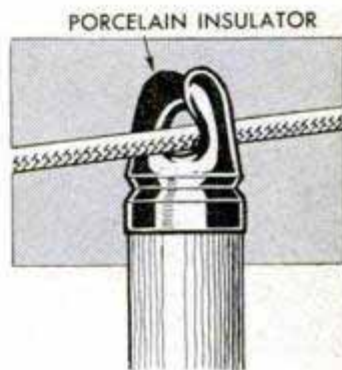

William B. Eagan, Louisville, Ky.

Dishpan Provides Effective Mold When Making Concrete Cover for Cistern

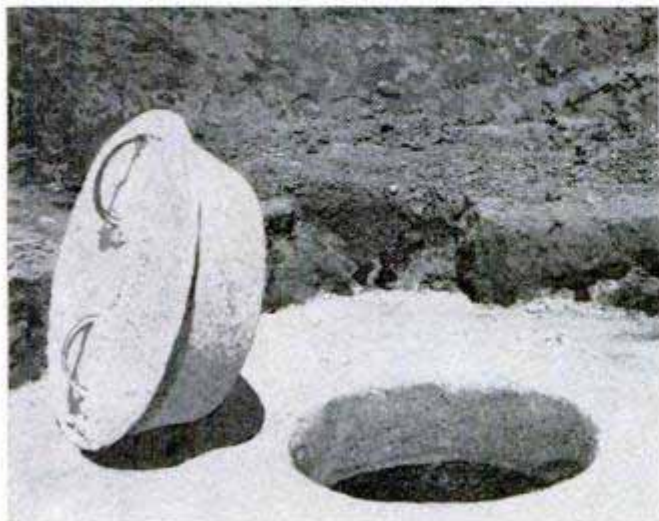

If you want to make a manhole cover for a concrete platform over a cistern, cesspool or septic tank, use an old dishpan of the type that has conical-shaped sides. Oil the inner surface of the pan and fill with concrete. Insert bent rods in the wet concrete to provide handles. The concrete can be removed from the pan as soon as it has set sufficiently to hold its shape. In making a cover of this type, the same pan is used to form the manhole when pouring the concrete platform.

Keith Heryford, Cedarville, Calif.

Wax-covered nut cups are useful for mixing small amounts of water-color paint.

C-Clamp Provides Camera Mount



A C-clamp fitted with two bolts forms an inexpensive "tripod" that can be mounted on a table top or the back of a chair. With a standard tripod head turned on either of the bolts, the clamp will hold the camera steady for portraits, time exposures and copy work, and is small enough so that it can be carried conveniently in the coat pocket. After the heads have been cut from two 1/4-20 bolts, the threaded portions are brazed in notches cut in the C-clamp. Note that the bolts are located to hold the tripod head upright whether the clamp is mounted vertically or horizontally. Outlet-box slugs are brazed to the jaws of the clamp and felt is cemented over the slugs to protect the finish of the furniture.

Wm. H. Lowry, Toronto, Ont., Can.

Tilting Easel for Close-Up Shots Formed From Bowling Ball



Using half of a bowling ball as a stage for table-top photography of jewelry and other small objects provides an inexpensive platform that can be tilted to support the subject steadily in almost any desired

position. A damaged bowling ball, which usually can be obtained from the local bowling alley, is sawed in two, black velvet is glued over the flat face of one of the halves, and this half is then set on the rim of a can. Although a 35-mm. movie-film container was used to support the ball as pictured, a coffee can will serve the pur-

pose. If the can should be too deep for your particular setup, cut off the side all the way around and bend over the sharp edge to afford a smooth bearing surface for the bowling ball. The stage tilts on the ball-and-socket principle, the weight of the ball holding it in position.

Nelson Edwards, Baltimore, Md.

Storing Battery Case

In storing a flash-gun battery case which has a cord plugged into a series outlet, be sure that the free end of the cord does not touch metal. If it should, the battery will run down and possibly corrode in the case. The safest precaution is to disconnect the cord from the case and wrap it around the case before storing.

Wire Rack Stores Photo Trays

When trying to find a place in his darkroom where photo trays could be stored out of the way and yet be conveniently at hand, one photographer hit upon the idea of using a wire dish-towel rack to hold the trays on edge. First, he screwed a board the same length as the rack to the top of a shelf in one corner of the darkroom. Then he set the wire rack against the wall, with one end resting on the board, and stapled the wire to the board to keep it from slipping. Galvanized nails driven into the board hold the trays in the rack. This also can be accomplished by nailing wooden cleats to the board to form individual channels for the trays. A hook, which was originally fastened to one side of the rack, was cut off so that it did not interfere with mounting the rack against the walls.

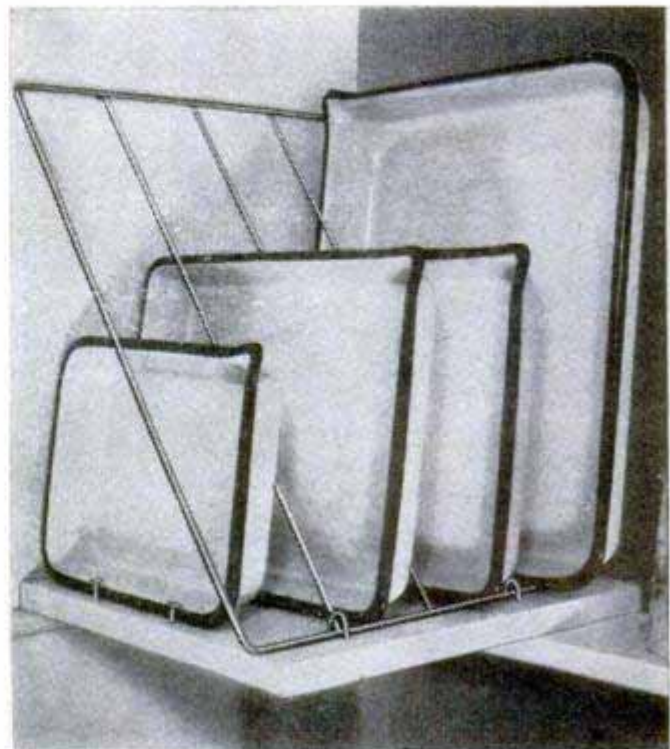

Studio CAMERA STAND

By Richard C. Collins, Jr.

BUILT mainly of pipe and fittings, this studio camera stand provides everything you need for studio work with a view camera. It adjusts from the floor to step-ladder height, and the tilting top will swing the camera through an arc of more than 100 deg. Casters permit the stand to be rolled from one location to another, and when in place the casters are retracted by kick levers, allowing the unit to stand firmly on a three-point support.

In order to support the high column and overhanging arm, the base, or spider, must be of extra-strong construction. Although in the details the hub, or web, of the spider is specified as being a 10-in. hardwood disk, it is better to use $\frac{3}{8}$ -in. flat steel. Three radial arms, spaced 120 deg. apart, are built up by bolting steel channels to a length of hardwood as in one of the sectional details. They are attached to the bottom of the metal disk with two round-headed machine screws in each arm. The threaded ends of the screws are cut off and filed or ground flush with the top face of the disk. Next, a $1\frac{1}{4}$ -in. floor flange is centered on top of the metal disk and holes are center-punched and drilled for machine screws, using the flange as a drilling jig. Before attaching the flange, the top is filed flat and square across to provide a seat for the slip ring, or eccentric. The ring is center-bored to fit over a $1\frac{1}{4}$ -in. short pipe nipple screwed into the flange. This ring forms the eccentric of the caster-retracting mechanism. The swiveling casters must be of the ball-bearing, plate type so that L-brackets, or bell cranks, cut from $\frac{1}{4}$ -in. flat steel can be welded to the plates as in the lower details. The top ends of the brackets pivot on a bolt which passes through a hole drilled near the end of each of the three arms of the base. Now, it will be noted from the extreme upper right-hand details that the caster-retracting assembly consists of the slip ring and six equally spaced members, three of which are $6\frac{1}{2}$ in. long with one end turned to form an eye as in the upper right-hand detail. These parts form the kick levers. The other three are short lugs bolted to the



Both high and low camera angles are easily worked out by adjusting this studio-type camera stand

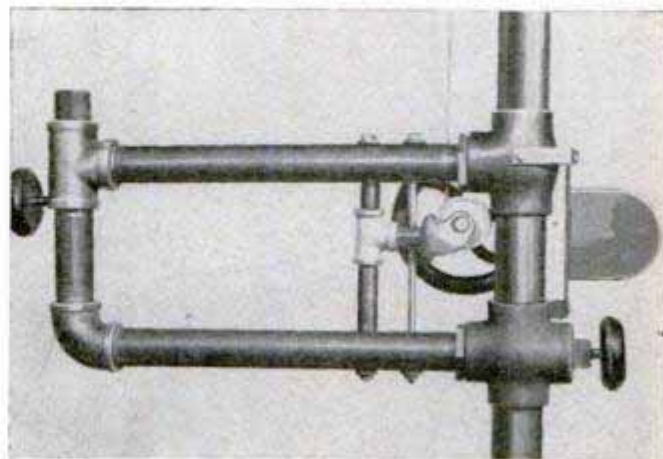

Weight of the camera and sliding arm are counterbalanced by spring sash balance on sliding members

ring and have a hole drilled near the outer end of each. They are located on the ring on a 120-deg. spacing as indicated. In the top view of the base, center right-hand detail, you can see how the lugs are connected to the caster brackets by means of $\frac{1}{4}$ -in. rods. Each rod is threaded at both ends and fitted with tapped connectors held in place with jam nuts. The inner ends of the rods are attached to the slip-ring lugs with bolts, while the outer ends are fastened to the caster brackets with removable pins and spacers held in place by small cotter pins. In service the slip ring becomes an eccentric and by moving the kick levers to right or left, the casters are raised or lowered. When in the lowered position, one of the lugs bears against a stop rod, or pin, as in the detail. The stationary feet are turned down, with one rounded end, from $\frac{3}{4}$ -in. steel shafting and are drilled and tapped for machine screws which pass through holes drilled through the radial arms. Note that the feet clear the floor by $\frac{1}{4}$ in. when the casters are raised.

The length of $1\frac{1}{4}$ -in. pipe that forms the column screws into a pipe coupling which is turned onto the short nipple above the slip ring. It's a good idea to file or grind the lower end of the coupling square to form a seat for the upper face of the ring. The camera-support arm is carried on two fittings of the type supplied for pipe railings. The upper one is a tee, the lower one a cross fitting provided with a $1\frac{1}{4}$ -in. pipe plug drilled and tapped to take a locking hand-wheel. The threads are reamed from the fittings and the pipe column is smoothed with emery cloth so that the parts will slide easily. The construction of the camera arm is simple, but there is one thing to keep in mind when assembling parts of pipe and fittings: Dimensions can never be precise due to the allowable variations in pipe sizes and also to the variations which may be caused by differences in tension on the threaded joints when tightening with a wrench. When assembling, try to draw all pipe joints to as nearly a uniform tension as possible. Even then there will be slight variations in the length dimensions. Before assembling the arm, note the pipe spacer and guide rod between the horizontal members and also the construction of the base for the sash balance which spans the sliding tee and cross. These parts are shown more clearly in the enlarged view of this part of the arm assembly. The pulley, or sheave, on which the lifting cable is wound, is supported in a caster yoke. A short pipe nipple is welded to the top of the yoke and the nipple is drilled through at the center for the guide rod. The cable sheave is pinned, or welded, to a shaft which projects far enough beyond the yoke on one side to per-

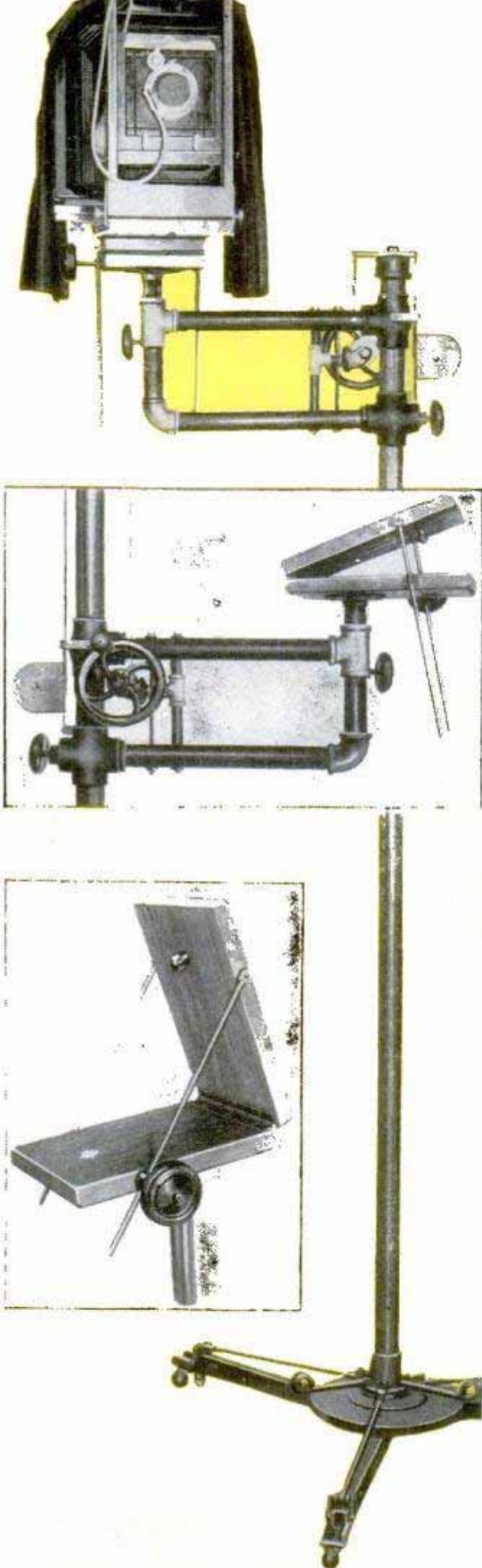



Milk Cartons Used in Darkroom To Store Photo Solutions

Milk cartons in either the quart or half-gallon size provide a good substitute for regular amber-glass bottles when storing prepared photo solutions. The cartons are easily capped, permit pouring the solutions with a minimum of dripping, and may be discarded after the contents are used. Because of their rectangular shape, the cartons take up comparatively little space on the darkroom shelf. The cartons should be washed out thoroughly before use and then labeled to identify the contents.

Safety Chain for Cable Release

To be sure that a cable release does not work loose from a camera and become lost, anchor it to the camera with a short length of lightweight chain. Wire one end of the chain to the cable and wire or clip the other end to a camera-strap, machine screw, or bracket, being sure that the chain will not slip in front of the lens. A spring clip for attaching the chain can be made from a large safety pin. The head is cut from the pin and the wire beneath the head is bent to form a small hook. Then the point is cut off so that this arm will be just long enough to engage the hook.



Frank T. Sokolik, Chicago.

Ice Dulls Unwanted Reflections

In photographing a vase of cut flowers, it is sometimes desirable to subdue overly brilliant reflections. An effective way to do this is to add a few ice cubes to the water in the vase. The reduction of the temperature in the vase will cause a fine dew to collect, dimming the surface reflections.

Popular Mechanics Book Shop

Money-Making Hobbies

Why not make your hobby serve a dual purpose—produce a profit as well as recreation. It also can serve as a means of getting extra cash to add equipment for extending your activities. This unusual book has hundreds of articles on arts and crafts which will help get your hobby started. It contains 160 pages of projects for the beginner as well as the advanced craftsman. Send \$2.00 for the book and get your hobby on a paying basis.

How to Tempt a Fish

It matters not whether you fish regularly, or take only one or two trips a year, this book will more than pay for itself on the first trip. There'll be no more stories that "the big one got away." There is a load of information on fly casting, bait casting and salt-water fishing as well as hundreds of hints on how to make and repair casting rods, how to make line driers and how to waterproof line. There are also instructions in how to retrieve plugs and lures as well as many more suggestions, including information on how to mount fish

or keep them fresh and how to transport live bait. A remittance of \$2.00 will bring the book to your home.

Outdoor Sports Manual

Here is a gold mine of helpful hints for hunters, fishermen, trappers, campers, archers, and boatmen. There are articles on sports equipment and hunting gear, as well as hints on fishing, hunting and other outdoor activities. Also included are projects you can make, such as boats, to aid in your sport interest. The book is a must for anyone interested in sports of any kind. Price \$2.00.

Kitchen Remodeling Plans

Are you planning to modernize or completely remodel your kitchen? *Popular Mechanics* plans will save you many dollars and show you how to do the job. Eight large plans show you layouts for various sizes and shapes of kitchens. There is also information on how to build cabinets, snack bars, shelves, stools, sink cabinets and other articles found in a modern kitchen. Entire set of eight 17x22-in. sheets, \$5.00.

All books available from Popular Mechanics Book Dept., 200 East Ontario Street, Chicago 11

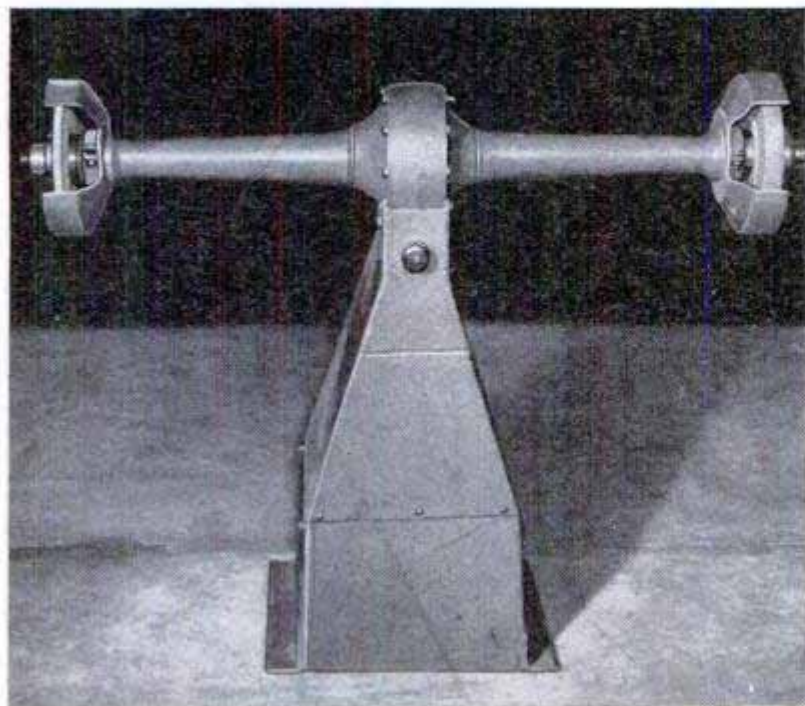
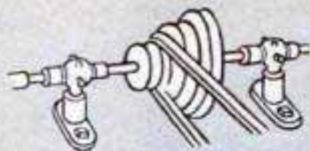

Heavy-Duty GRINDER

By L. H. Houck

ALTHOUGH this grinder was built and proved in a farm workshop, it has a much wider application due to the exceptionally long shaft housings which permit heavy grinding and polishing operations on a variety of large work. Plating shops will find it particularly useful for polishing plated work where large cloth buffs are used. In the farm shop it handles any grinding job that can be done on an 8-in. wheel. As you will see from the photo above, the machine is floor-mounted on a heavy pedestal made from welded steel plates. The motor is housed within the pedestal and drives with a half-crossed V-belt as in the center photo at the right. The grinding spindle is mounted in a Ford model-A rear-axle housing and runs on ball bearings. It is 52 in. long, double shouldered at each end from 1¼-in. diameter to ¾ in. in diameter in two steps. The intermediate step at each end of the spindle is ground to a press fit in a pinion thrust bearing taken from a Chevrolet rear axle. The small ends of the spindle are threaded right and left hand for the grinding-wheel flanges and retaining nuts. Flanges are machined from ¾ or ½-in. flat steel. One corner is broken (rounded over),

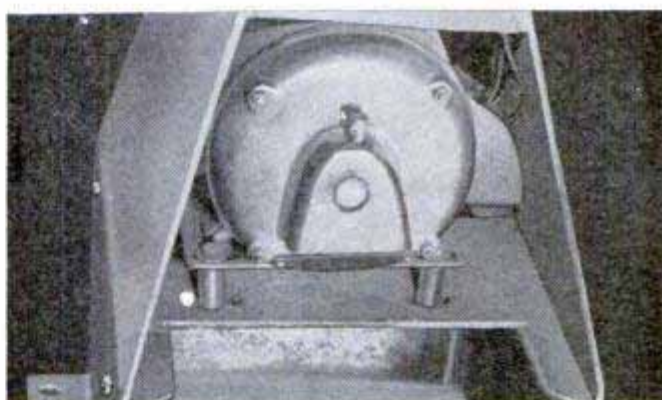

Above, motor is mounted inside pedestal on adjustable base and drives with half-crossed V-belt. Below, wheel guards are made from discarded brake drums fitted with bolt brackets which clamp to housing

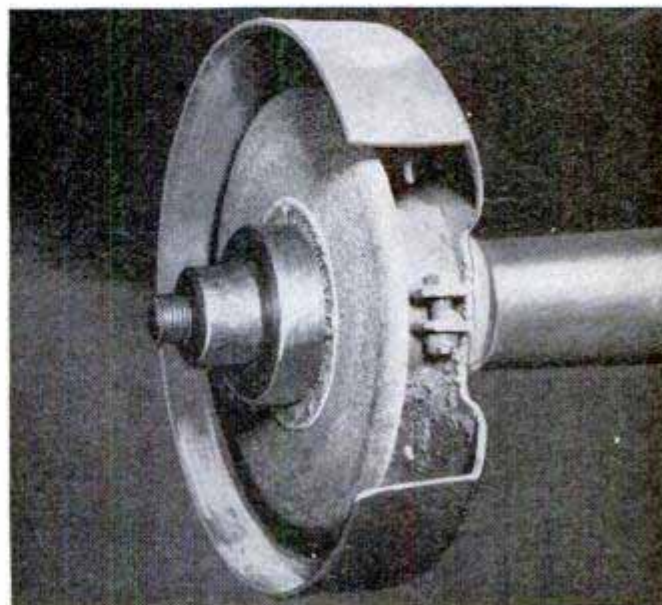

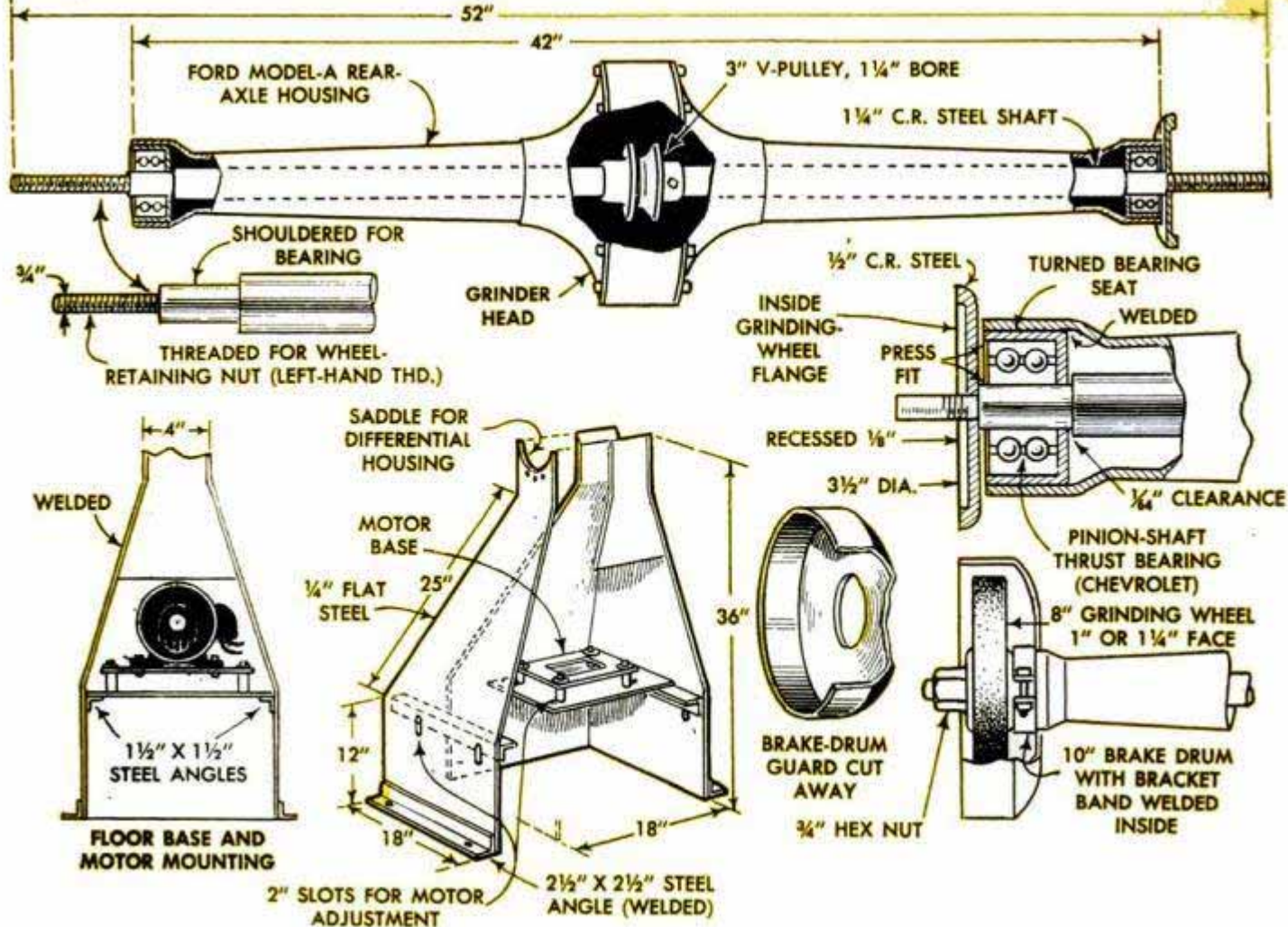

As detailed above, grinder pedestal is made from $\frac{1}{4}$ -in. steel plates cut and welded to form a tapering column. Long spindle makes this unit especially useful for grinding and buffing operations on large, irregular work

and the inner face of each flange is recessed $\frac{1}{8}$ in. as shown in the sectional drawing above at the right.

When assembling, place both the V-pulley and belt on the shaft as it is inserted in the housing. After the shaft has been positioned and the bearings have been pressed in place, the pulley can be properly located on the shaft and the setscrew tightened by reaching in through the drive-shaft opening. Only general dimensions are given on the pedestal-type base in the detail above, as some adaptation is necessary because of varying sizes of motor frames. Note that the $\frac{1}{4}$ -in. steel side plates are bent inward at a point 12 in. above the lower ends and that the edges are cut at an angle to give a width of approximately 4 in. at the top ends. The top ends of the side pieces are cut on a radius approximately the same as that of the differential-gear housing, and holes are drilled through the side pieces on the same spacing as those in the bell ends of the axle housing. In this way, the Ford model-A axle, which becomes the grinder spindle assembly, can be bolted to the top ends of the base pieces simply by removing six of the original cap screws and inserting longer ones. The front piece of the base is a duplicate of the side pieces ex-

cept that it is not cut on a radius at the top end. However, the back piece is only a short plate which serves as a filler, leaving the back of the base open for placement of the motor base and motor. All joints in the base are welded. Steel angles, which support the motor base, are bolted to the sides of the floor base as detailed. Note that the holes are slotted to allow for vertical adjustment of the motor when tightening or loosening the belt. When installing the motor, be sure that the pulleys are correctly aligned so that the half-crossed belt will run freely and without undue friction on the sidewalls of the V-pulleys. Use a $3\frac{1}{2}$ -in.-dia. pulley on a 1725-r.p.m. motor to give the correct grinding-wheel speed for heavy work. Higher speeds may cause the long wheel spindle to whip, with resulting danger of wheel breakage. Wheel guards are made from 10-in. automobile brake drums by cutting away a section of the drum to expose the face of the wheel as in the lower right-hand photo on the preceding page. The drums are attached to the spindle housing with bracket bands made from flat steel and welded to the inside of the drum. Mounted in this way, the wheel guards are quickly removed for buffing operations.

Corn Kept "Behind Bars" To Quicken Drying

To speed the process of drying his corn, as it lay stored in the crib, one farmer devised a method by which the corn at the bottom of the crib could be exposed to the air as well as that at the surface of the pile. The crib had been entirely closed, and as such, had the advantage of protecting the corn from rodents. However, the crib permitted little air to circulate through the corn until he removed the lower portion of one side and replaced the opening with a door, which was made of siding material and hinged to swing down from the top. To hold the corn in the crib, iron rods were stapled to the inner surfaces of the studs, extending the entire length of the opening and spaced just closely enough together to

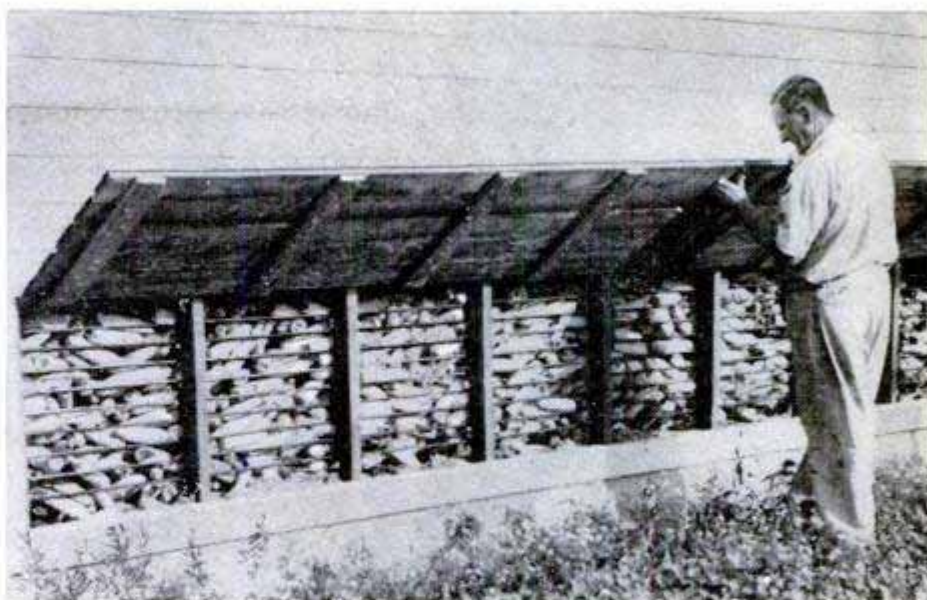

keep the ears of corn from being pushed through them. Now, with the siding doors closed at night, the corn is still not exposed to the rats, but with the door opened in the daytime, air enters the crib and the corn dries much faster.

Improved Puller Removes Bearings From Blind Holes

The next time you have a bearing to remove from a blind hole and there is no suitable puller available, you can improvise one with a long bolt, nut and a short piece of flat steel. The steel piece should be of the largest size that can be slipped through the opening of a bearing and stood on end behind it. It also should be drilled in the center slightly larger than the diameter of the bolt. In use, place heavy grease on the face of the nut and locate it at the bottom of the hole as near the center as possible. Insert the steel piece, stand it on end, and insert the bolt through the bearing and the steel piece. Then turn the bolt into the nut

and continue turning it. As the nut is turned up against the steel piece and the end of the bolt reaches the bottom of the hole, the bearing will be forced out. In order to prevent the nut from turning, it may be necessary to roughen both it and the back of the steel piece so that when the nut is held snugly against the steel piece as the bolt is turned, the nut will not turn too.

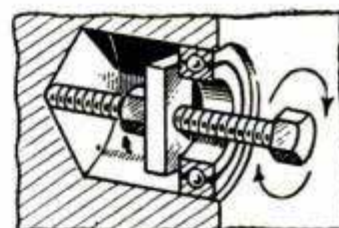

Frank Butrick, Alma, Mich.

Wheels Welded in Angle-Steel Frame Provide Sturdy Farm Gate

Old implement wheels of different sizes plus a couple of horseshoes were welded inside an angle-steel frame to produce this



attractive farm gate that is highly symbolic of its surroundings. The gate is hinged by means of heavy steel eyes which slip over large L-bolts in the gatepost. A hand latch welded to the other end of the gate locks it in the closed position.

Avoiding Countersink Chatter

When a drilled hole in a piece of metal is being countersunk, the tool often chatters, leaving a rough surface in the cut. One way to overcome this is to drill a small pilot hole first. Then countersink, centering the tool in the pilot hole, and afterwards drill the hole to the proper diameter.

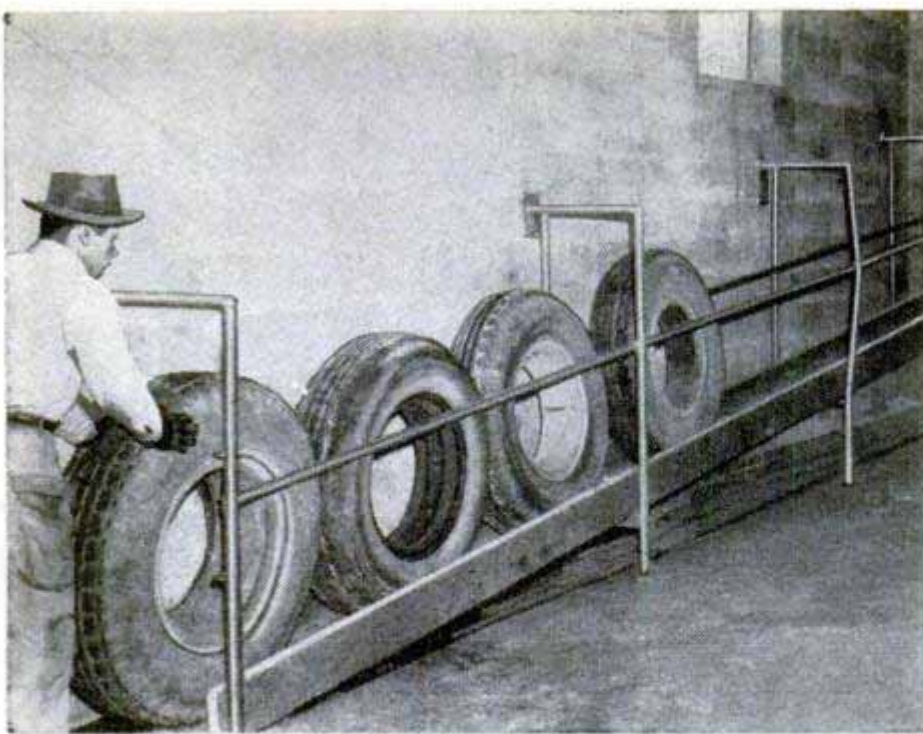

RAMP MOVES TRUCK TIRES

Workers who unload a large volume of heavy tires will find this ramp a real time and labor saver. Lengths of steel pipe are welded to form a series of U-shaped uprights which are bolted to the wall as shown. Pipe railings are welded to the inside of each upright on both sides of the ramp and planks are bolted to welded cross members. Sideboards keep the tires on the ramp. —L. H. Houck, Jefferson City, Mo.

Proper Care Plus Yearly Inspection Makes Chimneys Fireproof

According to statistics, the chief cause of fires in farm homes is defective chimneys. Unlined chimneys are fire hazards for several reasons. Smoke-formed sulphuric acid, weather and heat attack the mortar between the bricks. In time, small openings or cracks form, or bricks work loose, and fire and inflammable gases escape into the dry framework of the house. A fire from this cause is very disastrous, because it gets a good start in hidden places before it is discovered. In addition, the rough interior of an unlined flue collects soot, which burns fiercely once it is ignited. Sparks escape from the chimney and fall on the roof, setting it on fire. Safety engineers recommend

the use of a clay flue lining, which forms a continuous fireproof shell within the chimney. The smooth surface of the lining allows no place for the accumulation of soot and provides a more efficient draft. Joints between the sections of flue lining should be sealed with mortar. Also, it is advisable to fill the void between the flue lining and the surrounding brick with cement mortar. After chimneys have been put in good condition, a few simple rules should be followed yearly. Inspect the chimney and heating system, clean flues, make necessary repairs immediately, and the destructive effect of fires on the farm can be minimized.

Handwheel and Steering Gear Speed Use of Shop Hoist

By replacing the regular crank on a shop hoist with a handwheel, one shop worker found that the operation of the hoist can be speeded up considerably. This is especially convenient when lifting light loads or when operating the empty hoist. The steering gear of an old car provided the worm-gear assembly which was used in connection with the handwheel.

Reversing Split-Phase Motor

To reverse the direction of a split-phase motor, wrap a cord around the pulley and spin the shaft backward. At the same time, switch on the current. The motor will continue to run in the reverse direction until switched off but, when again turned on, it will run in the normal direction.

A. O. Aldrich, Lansing, Mich.

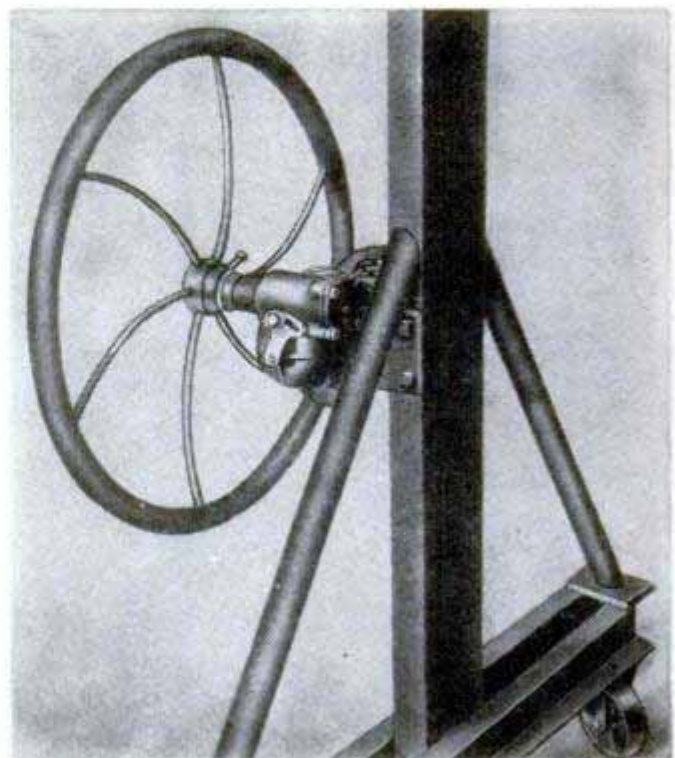

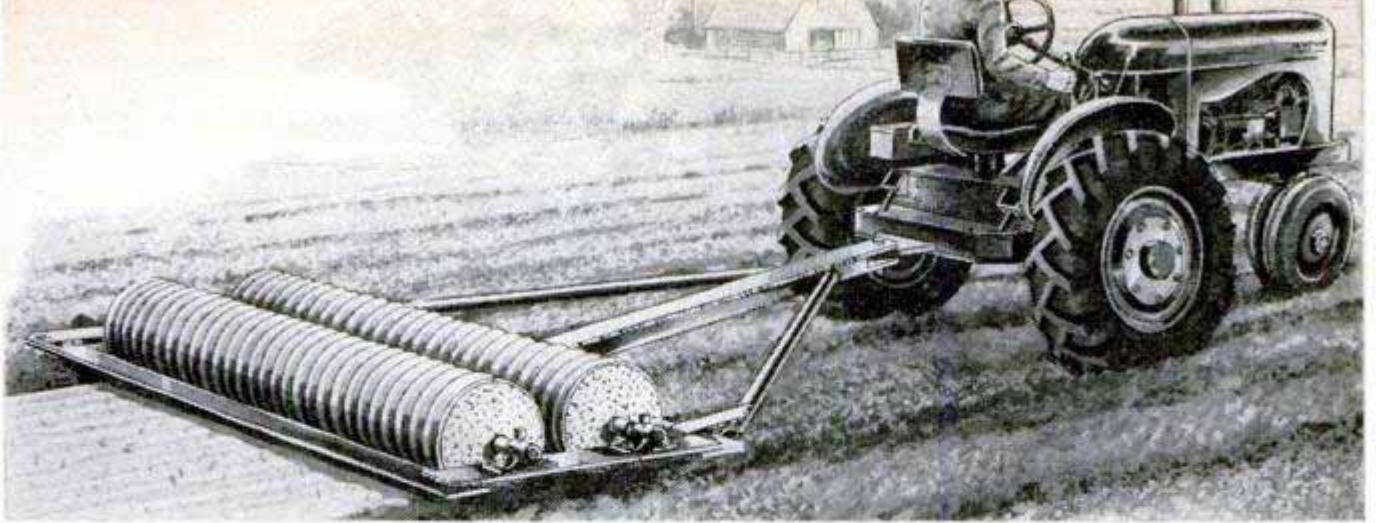

TRACTOR-DRAWN LAND ROLLER

*Farm Manual
(1955 ed.)*

By W. B. Kennedy

IN PREPARING a seedbed for spring or fall planting, there are times when the soil should be packed lightly with a roller to crush surface clods and prevent undue loss of moisture on dry, windy days. Many farmers prefer to build a roller especially for this purpose by using two ordinary round metal culverts of the corrugated type filled with concrete. As the units are being filled with the cement, 1½-in. axles, or shafts, fitted in pipe sleeves are centered and cast into the ends as shown in the upper-right-hand detail below. The sleeve, A in the detail, serves as a spacer when the units are assembled in the frame. At one end of each roller the sleeve projects 3 in., while at the other end it projects 1 in. When

the rollers are placed in the frame, this gives approximately a 2-in. offset so that the trailing roller does not track the leading one. The individual rollers are mounted in a frame made by welding four lengths of ½ x 4-in. steel bar together at the corners and the roller shafts turn in pillow-block bearings fitted with compression grease cups or pressure fittings. Drawbar pivots, upper-center detail, are arranged for easy up-and-down movement of the frame and are assembled from pipe and lengths of flat steel bent to a U-shape and welded to the drawbar tee and the diagonal braces as shown. The drawbar is a box section formed by seam-welding two pieces of steel angle as in the sectional view below. The ends of the angles are cut away to form an eye for the clevis pin.

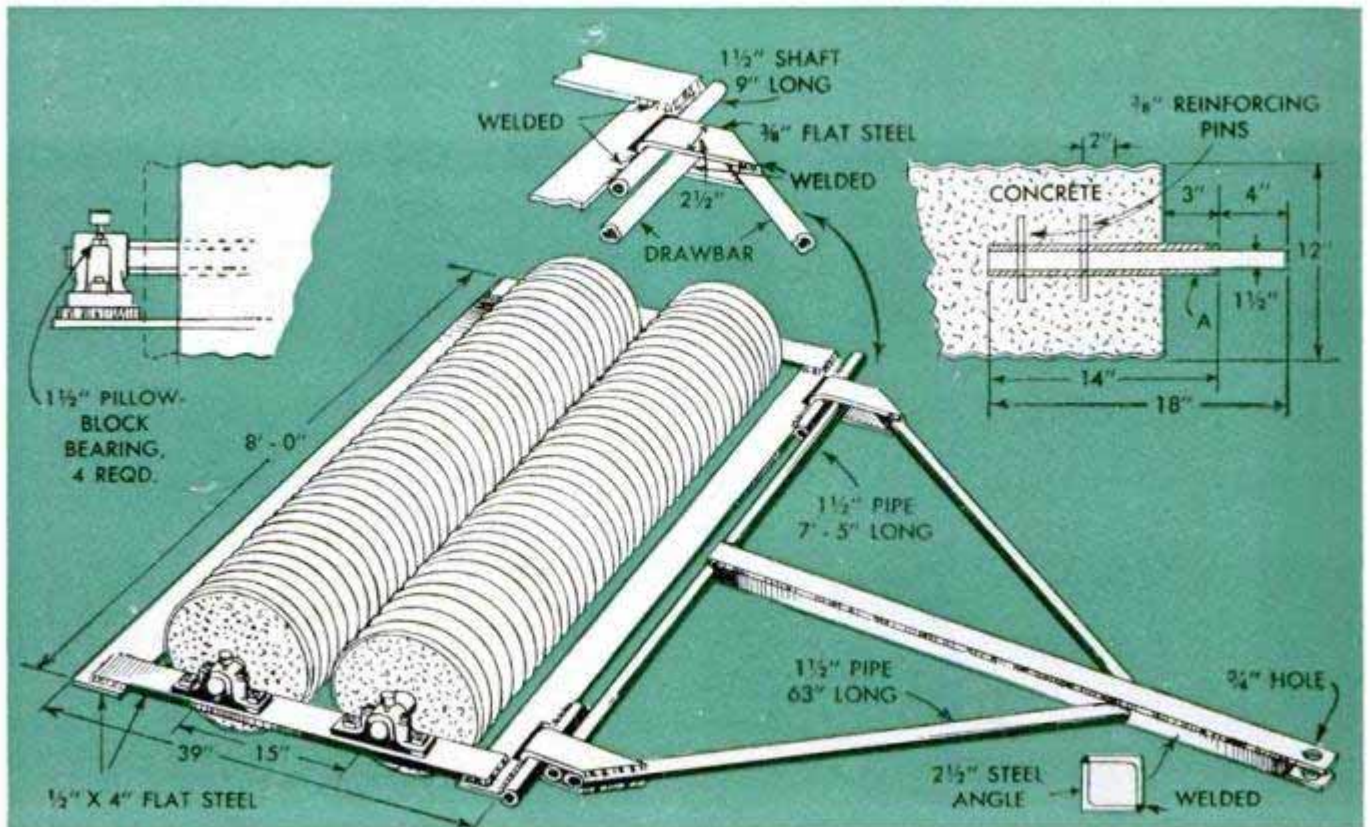

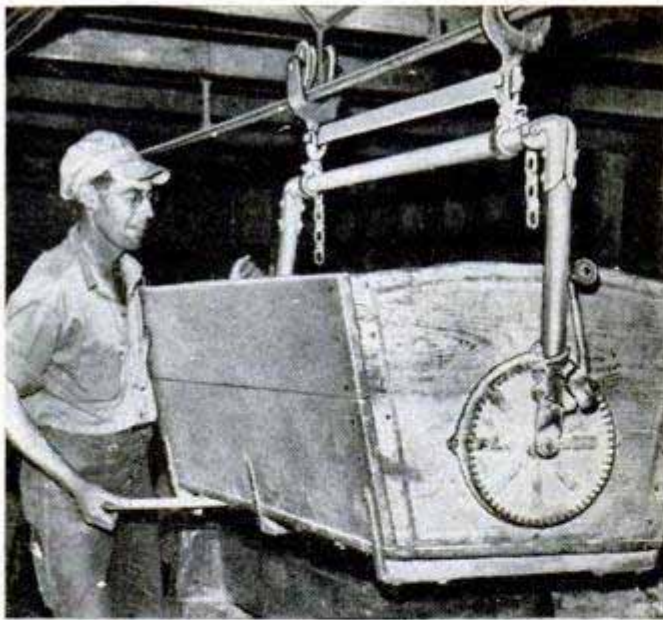

Overhead Carrier in Cattle Shed Serves Long Line of Feed Bunks

To save time and prevent waste in feeding a large herd of cattle, one farmer housed the feed bunks in a long, low shed connecting the barn and granary. An overhead track for a standard feed carrier runs the full length of the shed and directly above a line of feed bunks placed end to end. The carrier hopper is partitioned into two compartments and sheet-metal slides are fitted over rectangular openings cut in the bottom of the hopper near the ends. With this equipment, two kinds of feed grain can be quickly and evenly distributed to all the bunks with a minimum of hand labor.

A. M. Wettach, Mt. Pleasant, Iowa.

Air Pressure Opens Clogged Line

Small pipe lines which carry water from springs or reservoirs sometimes become clogged with moss or silt. However, the pipe frequently can be cleared of the obstruction in a short time by means of air pressure. Fit a tire valve into a pipe cap or plug and, when the line stops up, screw the cap on the threaded end of the pipe. Then, force air into the pipe with a tire pump. If a source of compressed air is available, this, of course, is more efficient.

Tilting Assembly for Trailer Bed Made From Grain-Binder Parts

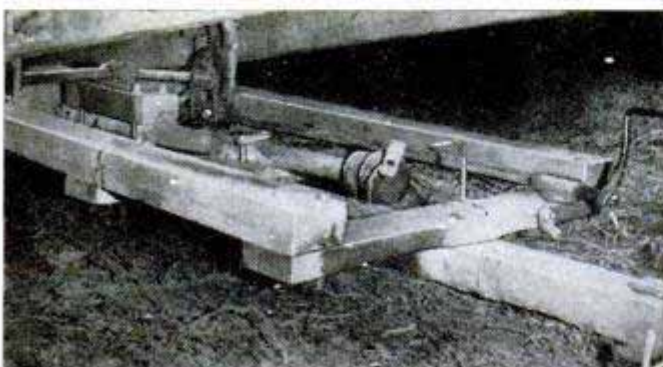

"Lifter" Soldered to Oilcan Spout Opens Spring-Cap Oilers

Because of the difficulty in filling spring-cap oilers, one mechanic soldered a narrow strip of sheet brass near the end of the oilcan spout and then bent the end of the strip upward at right angles to form an L-hook.

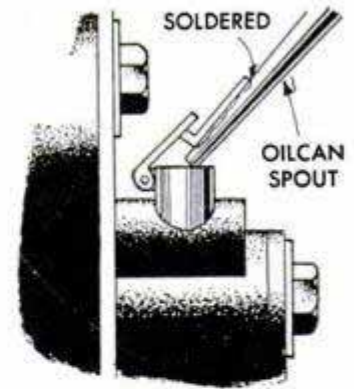

The projection of the L-hook is just long enough to catch under the edge of the spring cap and lift it so that the oilcan spout can be inserted into the oil cup. Pushing the spout downward slightly holds the spring cap open until the cup is filled with oil. Then, as the oilcan is withdrawn, it is turned sidewise to disengage the hook and allow the cap to close. With this simple fitting, one-handed oiling of bearings is made possible in the most inaccessible places.

A. E. Friend, Bloomington, Ill.

Cotter-Pin Hole Located By Mark Filed on Bolt

Here is a shop kink which will save you a lot of time when assembling a job with bolts and castle nuts, especially in a hard-to-get-at place. When the job is being disassembled clean each bolt and file a shallow

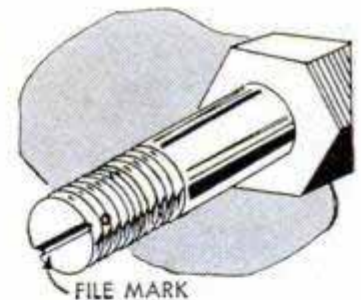

vee across the threaded end of the bolt, the vee being in precise alignment with the cotter-pin hole. Then, when adjusting the nut for pinning, it is easy to see at a glance just where the cotter-pin hole is. Use the same idea when assembling pulleys or gears which are pinned to the shafting.

W. H. McClay, Pasadena, Calif.

The gear mechanism which lifts the ground wheel on a grain binder can be used in a like manner to tilt the bed of a trailer or truck. Mounted to the running gear as in the illustration, with the gear rack attached to the bed, a length of pipe is extended from the worm gear and fastened to a crank for turning.

Some cold cream and a cloth kept in the car permit cleaning hands without water.

BUNSEN BURNER

Needing a large-size bunsen burner for a hundred and one odd jobs in my shop, I made one myself from a length of 1-in. tubing, 16 in. long, and a gas shutoff cock. Two air-intake openings are cut on opposite sides of the tubing, and a metal plug is turned to a tight fit in the lower end of the tube. A blind hole is drilled and tapped in the plug to take one end of the cock. A No. 52 drill is used to bore an orifice through the top of the plug. If a shutoff cock from a gas range is used, the regulating tip, as well as the three-cornered metal block on the inside, are removed. The other end of the cock is turned into a pipe tee, and the tee is turned onto a short nipple which is brazed or soldered to a metal base. Finally, a standard rubber-hose coupling is fitted to the side outlet of the tee. Note that a shouldered bushing may be fitted in the top of the tubing to reduce the size of the flame. The hole should be drilled through the center of the bushing. — Fred Alkire, Santa Barbara, Calif.

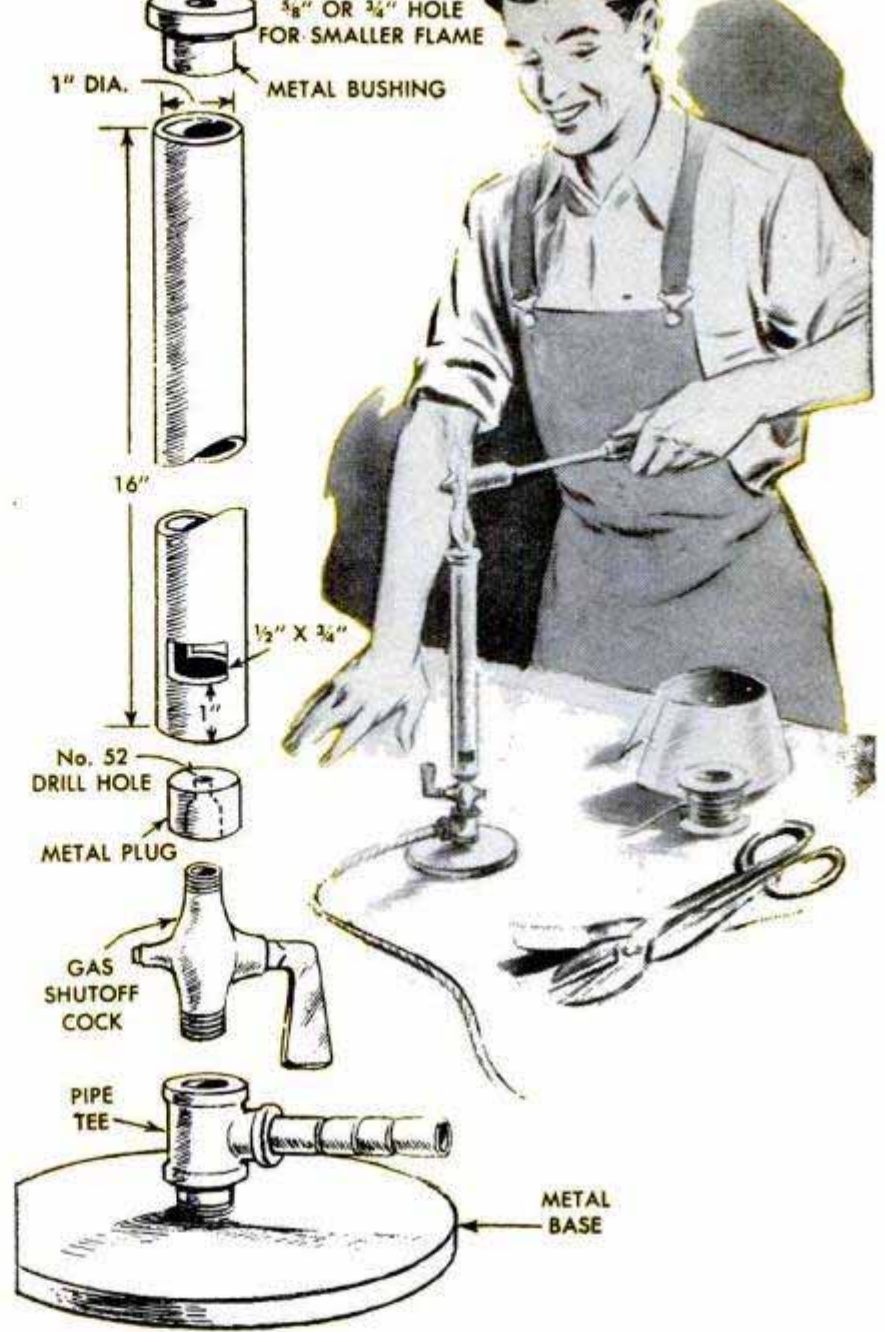

Simple Calibrated Indicator Shows Weight Carried by Farm Trailer

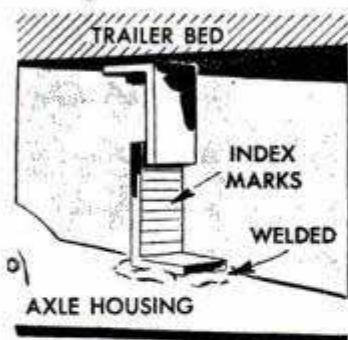

In order to determine the approximate load on his trailer and thus avoid overweight, one farmer used the method shown. A metal angle was welded to the rear-axle housing and a similar angle was

welded to the metal frame of the trailer, locating the two parts so that they overlapped but did not touch. To calibrate the indicator, loads of different weights were put on a trailer and weighed, a mark being made on the lower bracket to indicate the position of the upper bracket on each given weight. However, where accuracy is not too critical, one mark can be made on the lower bracket while the trailer is empty. Then the trailer

can be loaded to maximum capacity and a mark made on the lower bracket at the end of the upper one. The difference in weight between zero and maximum can then be divided into any equal number of marks on the lower bracket, thus saving the procedure of loading the trailer to different capacities and weighing it.

Herbert E. Fey, New Braunfels, Tex.

Metal Jacket for Acid Bottle

When acids and thinners are stored in gallon bottles, setting the bottle in a metal jacket will minimize the loss and reduce the hazard from the spilled liquid if the bottle should be broken. To provide a jacket for the bottle, cut the top from an empty 5-qt. motor-oil can, using a rotary-type can opener, and set the bottle in the can.

A. B. Patsch, Midland, Pa.

Taming that

BALKY MOWER

By Ed Packer

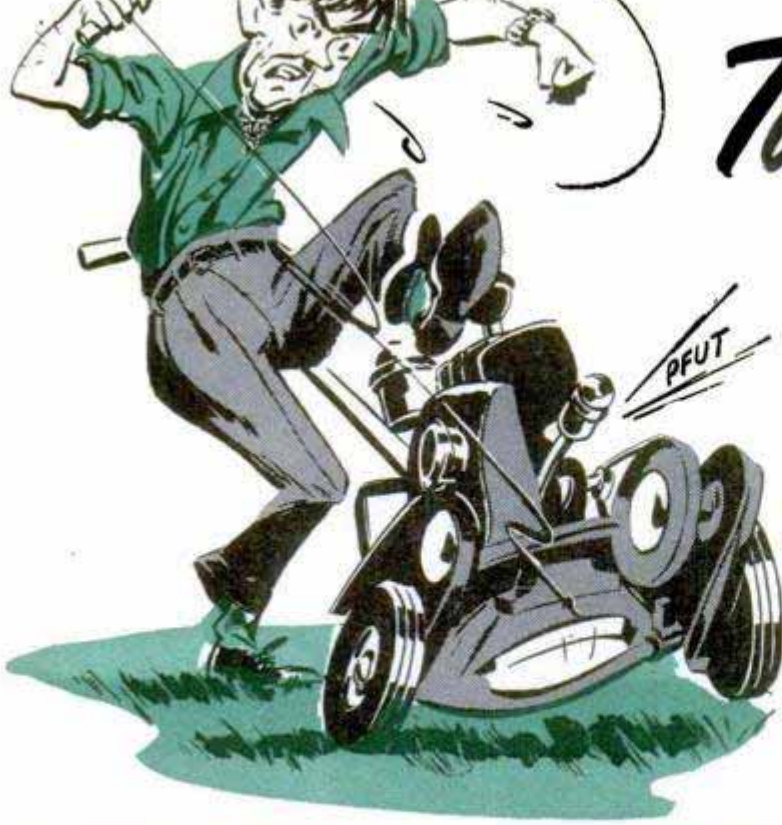

WHAT'S more downright irritating than a temperamental power lawn mower on a sultry summer day? You're all set for what should be only a comfortable walk over the lawn behind the mower, which ordinarily pulls itself and does all the work, but this time one, two, and perhaps three pulls on the starting rope produce nothing more than a desultory gurgle from the engine. In this situation the thing to remember is that after three pulls on the starting rope, you're not likely to get started at all without fixing something. Of course, the problem then is to find out what's wrong.

Assuming that there's plenty of fuel in the tank, you may discover right away what the trouble is by removing the spark plug and examining it closely. If the plug is dirty, fouled with raw fuel, and if the electrodes are eroded and widely spaced, you've already spotted one good reason for the engine's refusal to start promptly. As a rule the instruction book that came with the engine will specify the electrode gap as .025 to .028 in., Fig. 4. If it checks much wider, you'll have trouble starting the engine. While you have the plug out, hold the ignition wire about $\frac{1}{8}$ in. from the cylinder head as in Fig. 5 and spin the flywheel with the starting rope. A hot, blue spark should snap from the terminal to the ground. If the spark is weak, then the chances are that the breaker points in the magneto need adjusting and possibly dressing down a little. The magneto itself rarely is at fault, but sometimes oil from the crankcase will



Above, inspect and clean the sediment bowl in the fuel line at regular intervals. Below, change crankcase oil periodically. When refilling be sure to use oil of grade and quantity specified

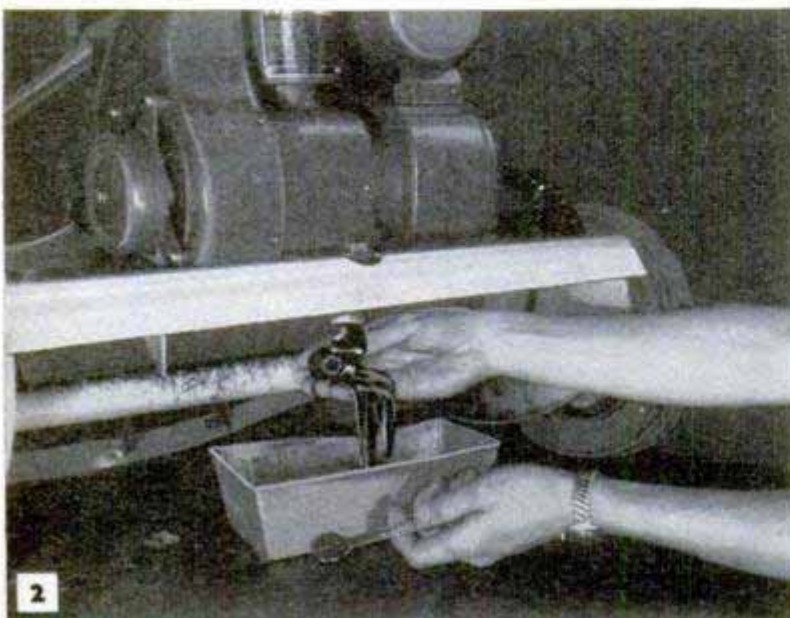

leak through a faulty oil seal at the flywheel end of the crankshaft and foul the magneto. A thorough cleaning and a new oil seal usually take care of this trouble. On some engines it is necessary to remove the flywheel to gain access to the ignition system. First, lock the flywheel so that it cannot rotate, then carefully loosen the nut on the tapered end of the crankshaft and use a wheel puller to start the flywheel off the tapered end. Clean the breaker points, Fig. 14, and space the gap, Fig. 15, according to the instruction book. While you're at it, you can make a pretty accurate check of the condition of the piston and rings by rocking the crankshaft against the compression, using a wrench on the flywheel retaining nut as in Fig. 15. The resistance to turning should be fairly uniform until the piston reaches the top of the stroke. If this is so, then it can be assumed that both piston and rings are still in good condition. On the other hand, if the compression feels "soft" and the piston comes up easily with an audible rush of air past the rings, then further servicing will be necessary to put the engine in good running condition. On most small engines of the type used on lawn mowers, it's a fairly simple job to install new rings and, if necessary, grind the valves as in Figs. 8, 9 and 11. When installing new rings, carefully check the end gap and the groove clearance as in Figs. 12 and 13. Usually end gap will be specified as not less than .007 or more than .017, and groove clearance as .005 in. These values are important, so it's a good idea to check on the specification for your engine. Occasionally, when you take the head off an older engine you'll discover warped and pitted valves and badly worn guides. In this case, both the valves and guides should be replaced and the seats refaced in the service shop.

Only rarely is the carburetor alone at fault when the engine refuses to start, unless, of course, it has been improperly adjusted or is clogged with sediment and dirt. Usually, periodic cleaning at long intervals is all that is necessary to keep a carburetor in good condition, but whenever it is removed



Clean the mower thoroughly after use to remove leaves and grass clippings from mechanism, especially from cylinder cooling fins

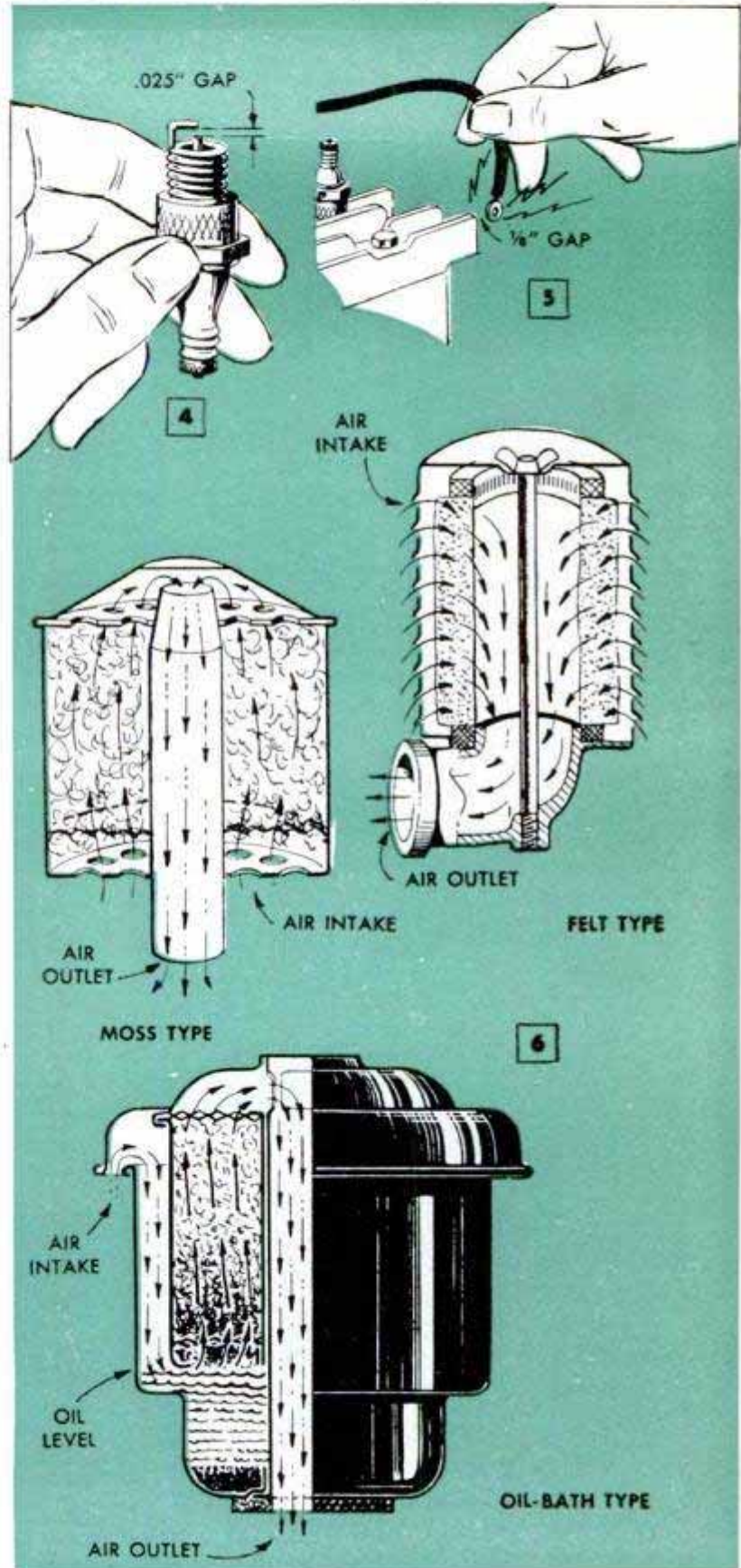

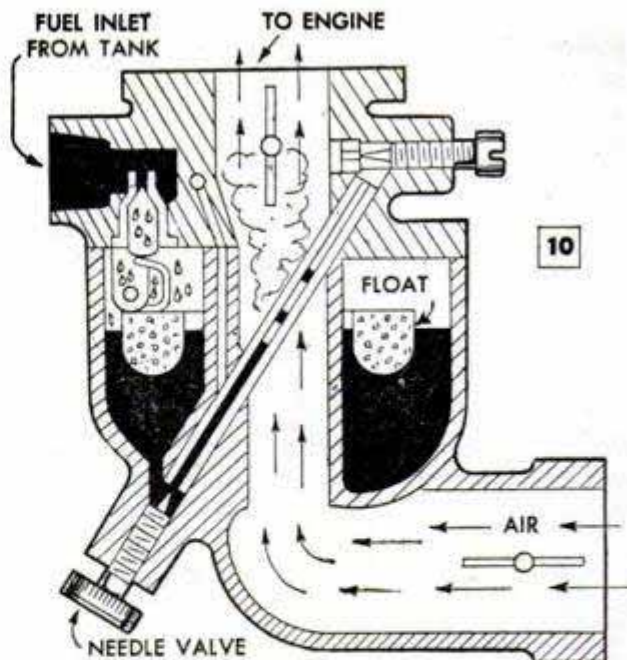

for any reason, always check the float level and, if necessary, adjust it to agree with the manufacturer's specification. When replacing the unit, use new gaskets and be sure that they are properly seated and the bolts drawn to a uniform tension. Air leaks between the carburetor and engine are a common cause of fuel-mixture troubles, and often the tiny leaks are difficult to locate and remedy. Careful placement of the gaskets usually prevents this trouble. If, at any time, it is necessary to adjust the needle valve or the idling adjustment, be especially careful not to screw the needles down hard onto their seats in the fuel jets. Don't attempt to clean the jets with wire or any other sharp-pointed tool. If the jets are clogged, always disassemble the carburetor and blow out the passages individually with compressed air.

A lot of starting headaches and costly major repairs can be forestalled by a simple servicing procedure carried out on a regular schedule. Figs. 1, 2 and 3 picture three things to do at short intervals during the mowing season. The first, Fig. 1, is a periodic check of the sediment bowl in the fuel line to the carburetor. Remove the bowl and clean it thoroughly and also renew the gasket occasionally. Change the oil and flush out the crankcase often, Fig. 2. Be sure to use oil specified by the manufacturer of the engine. All power-mower engines in the popular sizes are air cooled and generally are operated during warm summer days and evenings. To prevent overheating with resulting serious damage to the engine, clean out leaves, twigs and grass clippings as in Fig. 3, giving special attention to the cooling fins on the cylinder and cylinder head. Do this each time the mower is used and

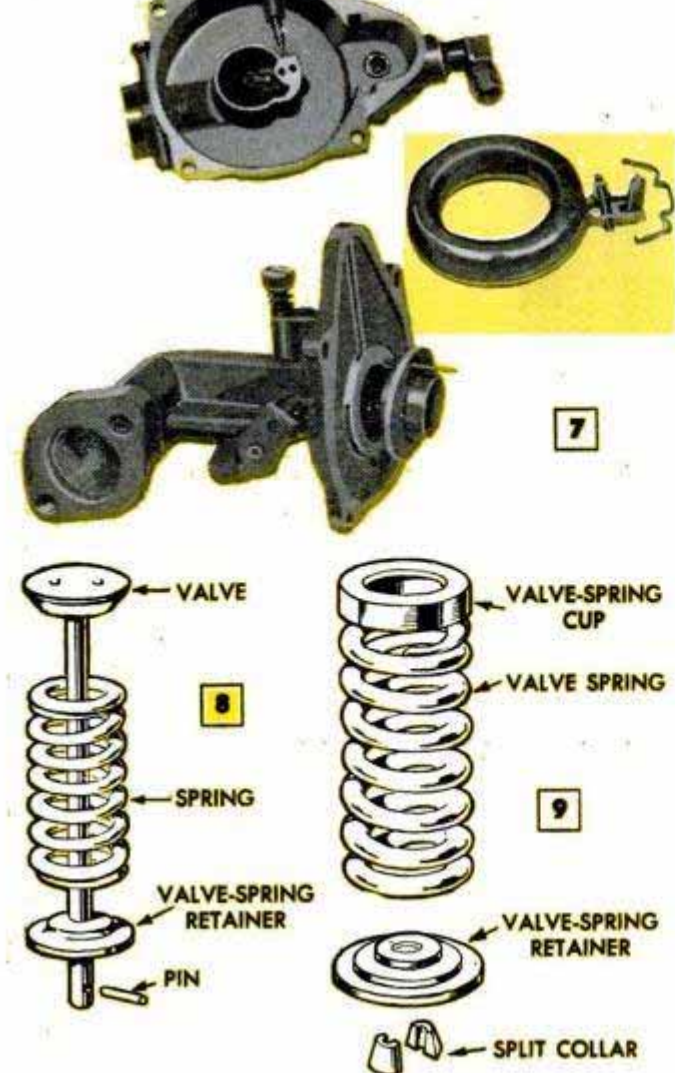

Above and below, cleaning the carburetor and grinding, or lapping, valves are important servicing operations on older engines with long records of extra-hard usage

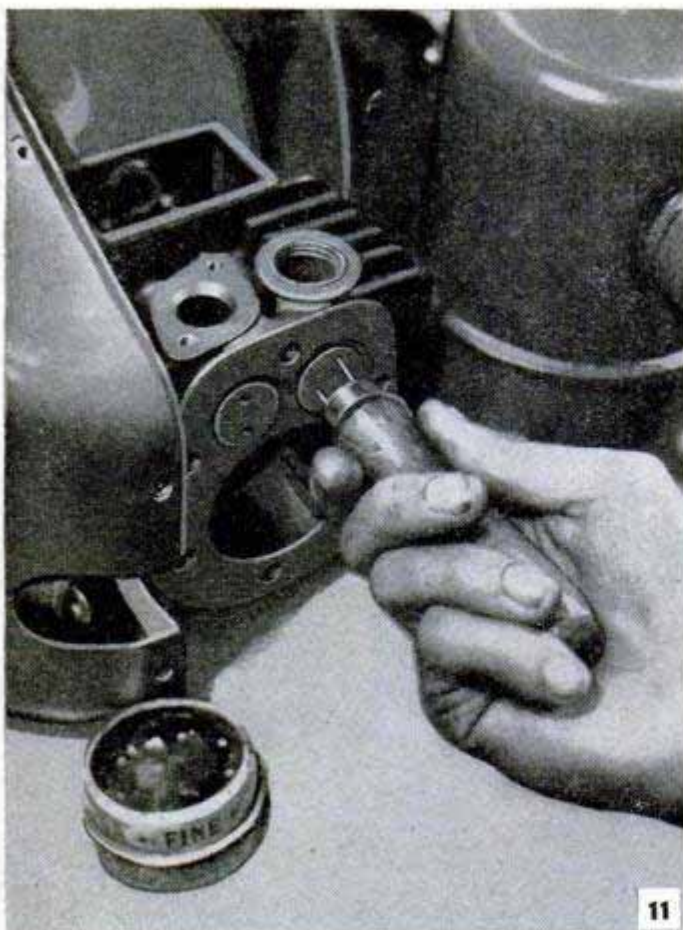

you'll avoid a lot of mysterious mechanical troubles that may otherwise develop. The fourth item on the regular servicing schedule is the air cleaner, which may be any one of the three types shown in Fig. 6. Small engines usually are equipped with either the moss or felt-type cleaner, while the larger sizes generally come equipped with the oil-bath type. All three types require regular servicing, and usually the manufacturer's directions for cleaning will be found on the cleaner housing. In any case, it's important to service the air cleaner at regular intervals, the frequency of cleaning being determined by operating conditions.

While you're servicing the engine, don't neglect the mower, as it requires regular lubrication, and the blades should be ground periodically to keep it in tiptop operating condition. Some mowers are fitted with a reverse gear by means of which the blades can be rotated backward against the cutter bar. Others are supplied with a special round belt which can be crossed for reversing the rotation of the blades. To sharpen, first set the cutter bar so that the blades engage it lightly and uniformly throughout the length. Then reverse the mower reel, paint medium valve-grinding compound on the edges of the blades, Fig. 16, and run the engine at its slowest speed. Don't neglect to clean and lubricate the driving clutch, Fig. 17, at regular intervals. Usually the operating instructions that come with the mower will give you all the information needed for proper servicing of the driving clutch. Follow the instructions in detail.



When truing breaker points, use a flexible hone made for the purpose. Clean ignition system thoroughly

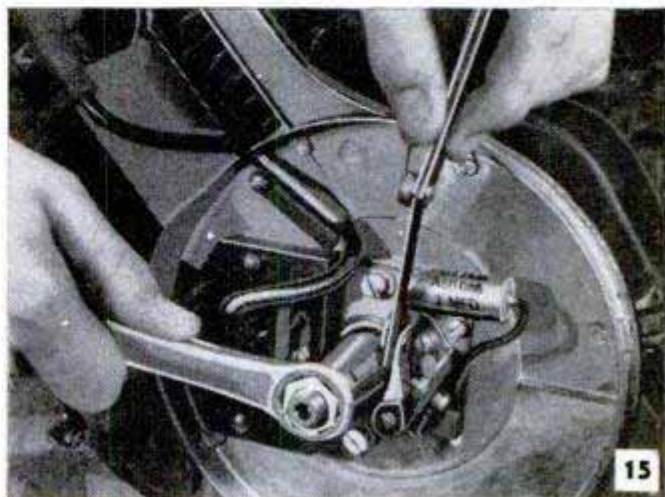

Then check distance points open with feeler gauge. Ordinarily, gap opening should be .20 in. but may vary

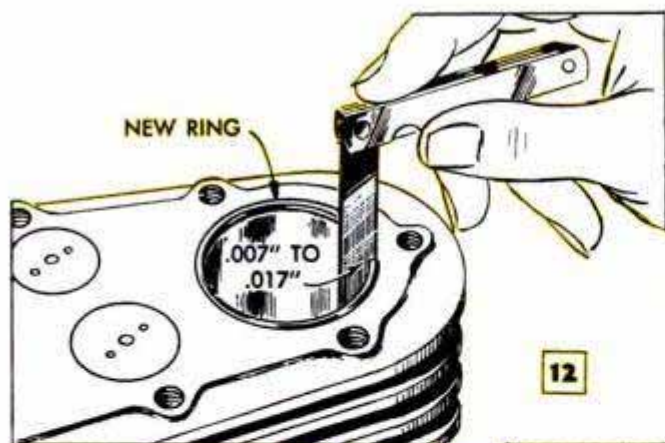

12

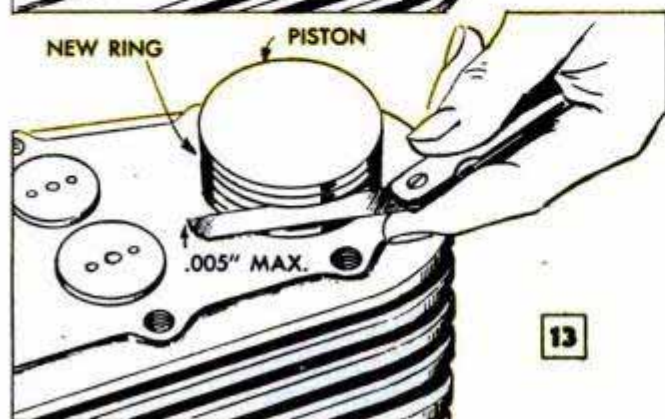

13

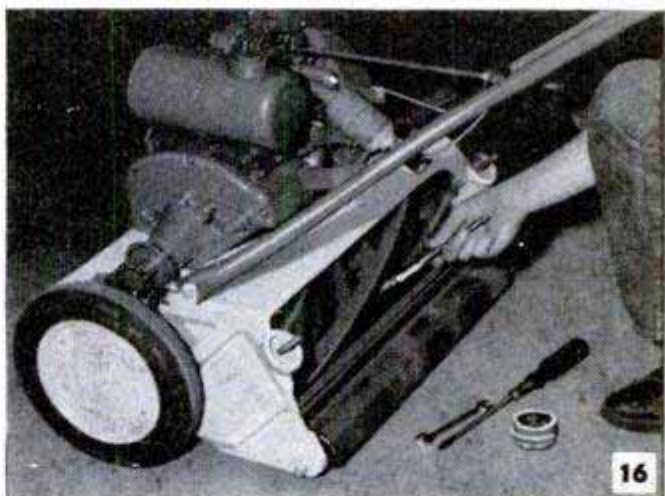

Above, sharpen mower blades regularly for efficient operation. Below, clean and lubricate drive clutch

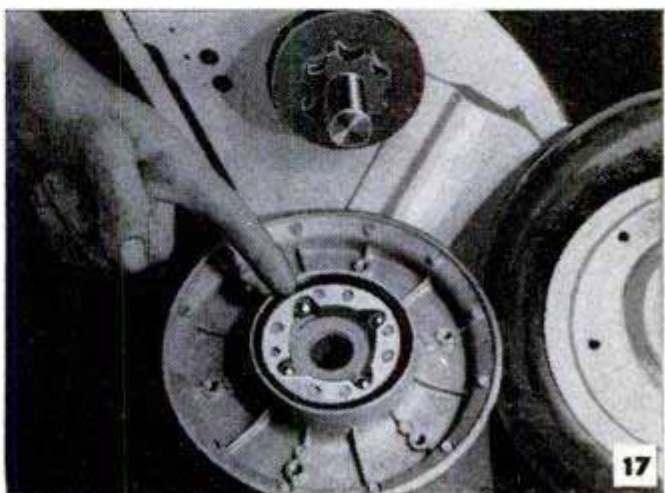

Sectional Hurdle for Sheep or Hogs Assembled Without Fastenings

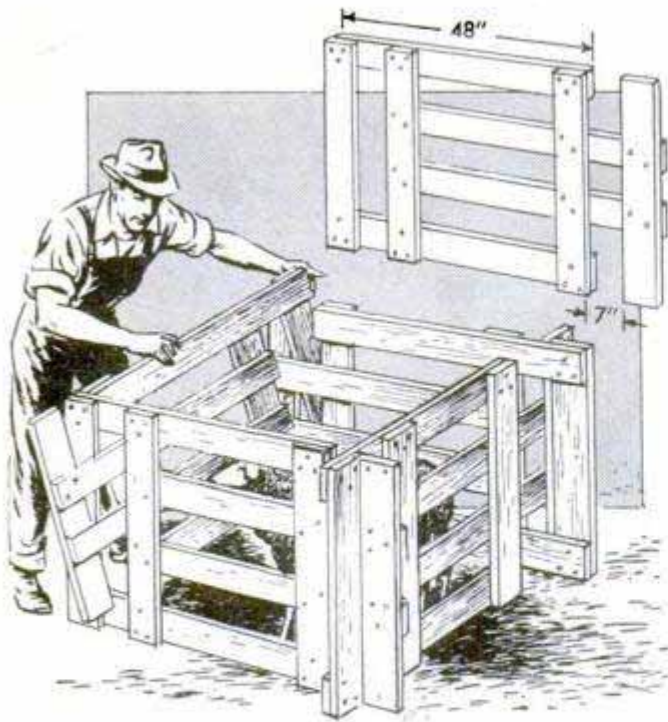

Sheep and hog raisers like these sectional hurdles because they are quickly assembled to form individual pens or adjacent partitioned pens in any number required without the use of fastenings such as nails, hooks or wire. Specially constructed interlocking corners built into the ends of each individual section make this possible. Use 1 x 6s for all parts. Cypress fence boards are the most durable, with white pine the second choice. In building the sections, first make a jig on which each section can be fully assembled and clinch-nailed. This procedure will assure uniformity in the size of the separate sections. If available, use copper clinch nails.

E. C. Hall, Norwood, Man., Can.

Automatic Hog Waterer Supplied From Stock Tank

Solving the problem of providing a constant water supply for hogs which were allowed to run with cattle in a feed lot, one farmer anchored an automatic waterer of the cup type to a heavy timber which supported the regular stock tank. Then he installed a protective board, or fence, just back of the waterer and ran a horizontal length of pipe through the board to the outside. A short length of hose is forced tightly over the open end of the



pipe and extends to the water in the tank. Once a siphoning action is started a constant supply of water is assured.

Tilting Table on Swing Saw Increases Width of Cut

To increase the capacity of his swing saw for cutting extra-wide boards, one contractor made a special tilting table pivoted at the back edge so that it could be raised

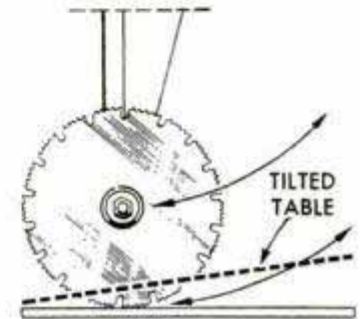

about 2 in., as shown by the dotted line in the detail. This, in effect, extends the cutting arc described by the blade as it is pulled forward through the stock.

Arthur Shults, South Bend, Ind.

File Tang Removes Broken Studs

Broken studs often can be removed by using a file tang to back them out. A hole, slightly smaller than the width of the tang, is drilled in the top of the stud. Then the tang is pressed tightly in the hole and the file is turned slowly, either by hand or with a wrench. The same method also can be used to remove broken grease fittings and pieces of small-diameter pipe.

R. L. MacLean, High Bank, P.E.I., Can.

Large Capacity Shelled-Corn Feeder Made Portable by Adding Runners

Built comparatively narrow and fitted with wood skids, this 225-bu. shelled-corn feeder can be pulled easily to any desired location. Full-length troughs are built on both sides of the feeders where the flow of corn is regulated by an adjustable board. These can be raised or lowered to suit. The ends of the boards fit into channels formed by cleats nailed to the ends of the feeder. Three upright cleats keep the adjustable board from buckling outwards.



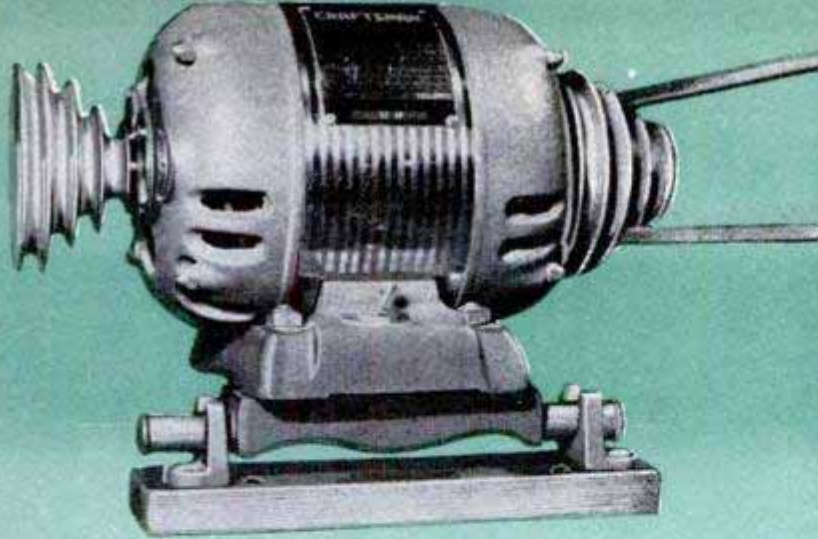

HORIZONTAL MOUNTING

DUAL-PURPOSE motor mounting

By Robert G. Barnes

ORDINARILY, a motor mounted on a floating rail for operating a one-motor shop cannot be used with the same convenience on a drill press because of the necessity of removing the rail in order to mount the motor vertically. Confronted with this problem, one craftsman improvised a special base which permitted mounting the motor on his bench-type drill press without removing the rail from the motor. After the base has been made and fitted to the drill press, it may be left in place permanently. In the detail at the lower right, all dimensions have been omitted purposely, as the base must be fitted to the drill press at hand. Ordinarily, the base can be made from a piece of $\frac{1}{4}$ x $1\frac{1}{2}$ -in. steel plate about 9 in. long. Before cutting this piece, check the over-all length of the motor rail and cut the steel plate to approximately the same length. Center-punch mounting holes by measuring the center-to-center spacing of the slots in the motor-mounting plate on the drill press. Note that the lower hole in the base is elongated with a file to permit tilting the motor slightly when aligning the belt. Next, measure the center-to-center distance of the round flanged projections on the floating rail. This distance will determine the location of the yokes on the base piece. The yokes are cut from $\frac{1}{2}$ -in. flat steel plate, the width and depth of the U-shaped cuts being determined by the diameter of the projections on the rail. The arms of each yoke should be cut long enough to permit drilling transversely for $\frac{1}{4}$ -in. retaining bolts which are provided with wing nuts. These bolts hold the rail in place when in the vertical position. After drilling the yokes for the bolts, weld them to the base piece as indicated. Now, bolt the base to the drill press as in the upper right-hand photo and fit a block of hardwood on the motor-mounting plate to support the opposite side of the motor base as in the center photo.

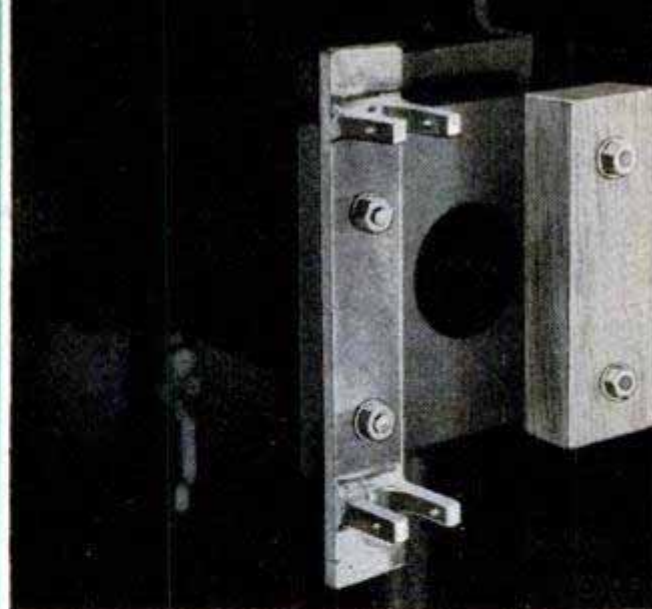

Special floating-rail base and hardwood spacer block are permanently installed

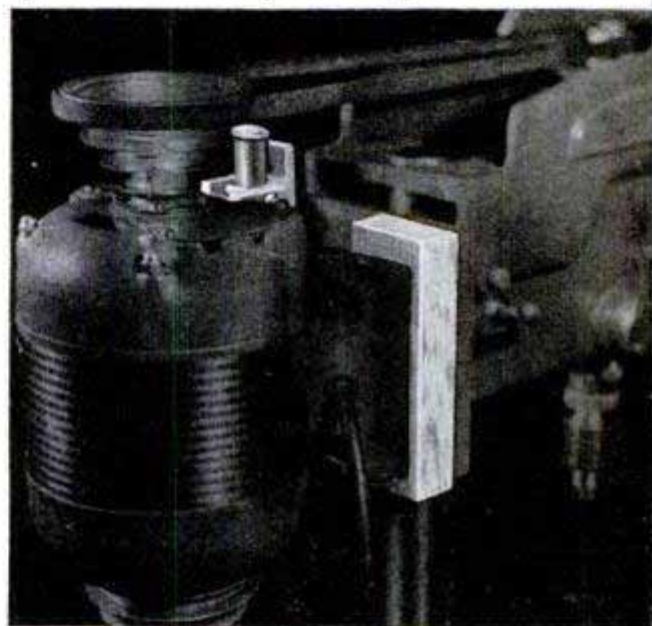

Here's the motor in place and belted to the drill-press spindle. Note spacer block

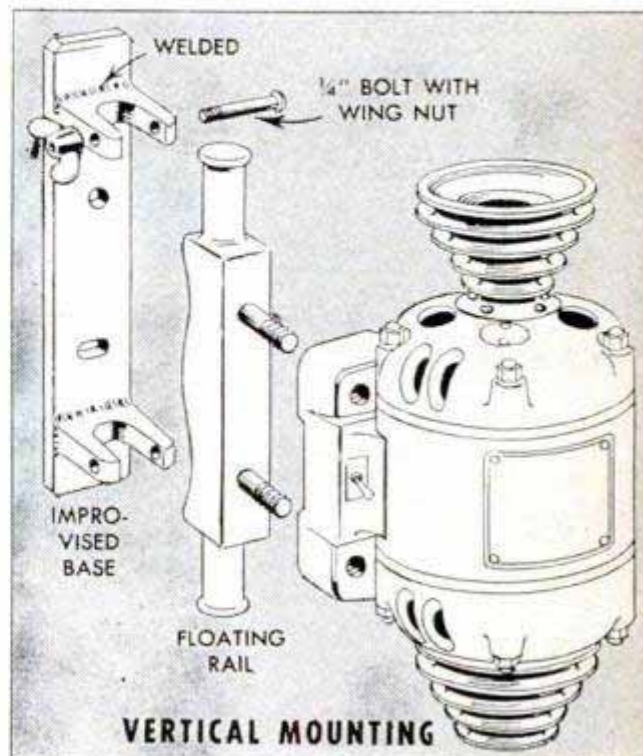

VERTICAL MOUNTING

SHOPPING



Mid-States Welder Mfg. Co., 8025 S. Ashland Ave., Chicago

MULTIPURPOSE SAW GUN, designed for use with a small portable electric drill, makes a handy power tool for mechanics, electricians, carpenters and others with cutting problems in either wood or metal. The blade cuts only on the pull stroke and, therefore, leaves a smooth edge on all types of work. For ordinary jobs, the unit uses a common hand-hacksaw blade inserted in a special holder in end of gun. Also uses all types of hand files

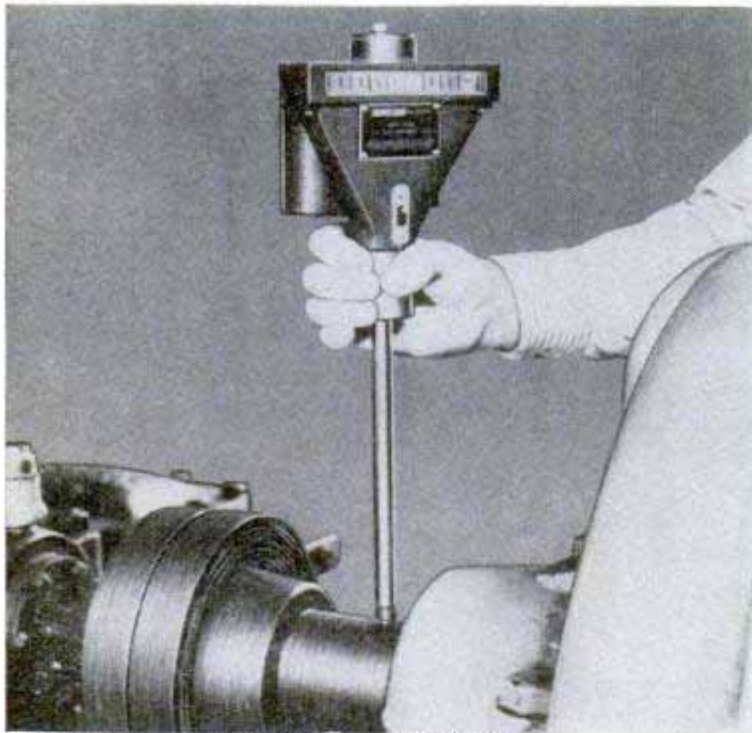

The Vibroscope Co., 6 E. 39th St., New York City

VIBRATION TESTER for high-speed machines employs an oscillating ribbon of light reflected from a mirror onto a dial calibrated in thousandths of an inch. Probe, or spindle, is provided for taking vibration readings direct from rotating shafts. Vibration amplitude is indicated by the width of the ribbon of light. For measuring vibration on stationary parts of the machine, a pickup plunger is used. When instrument is held vertically, its weight exerts sufficient pressure to bring the light beam to the center of the scale. The unusual shape of the instrument makes it possible to reach into otherwise inaccessible places on machines

HAND-TAPPING MACHINE eliminates tap breakage and work spoilage when tapping holes for small screws. Unit is provided with an adjustable worktable, or platen, fitted with a fence against which the work can be held for accurate, straight-line starting of the small taps. Tap is held in a collet chuck mounted on a sliding shaft fitted with a hand crank and adjustable depth stop for use when tapping blind holes. Worktable is carried on sliding parallel guide bars which can be locked in any convenient position. A removable panel for storage of wrenches, collets and taps is attached to the rear of the machine base, as shown in the photo

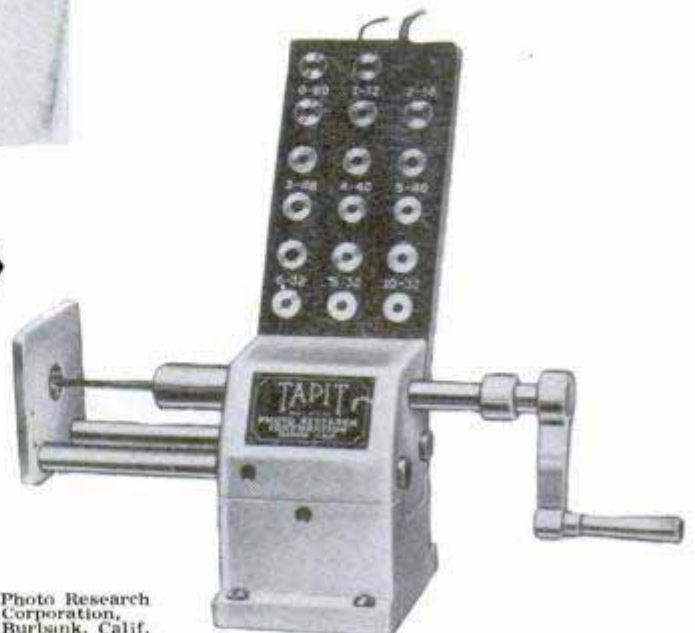
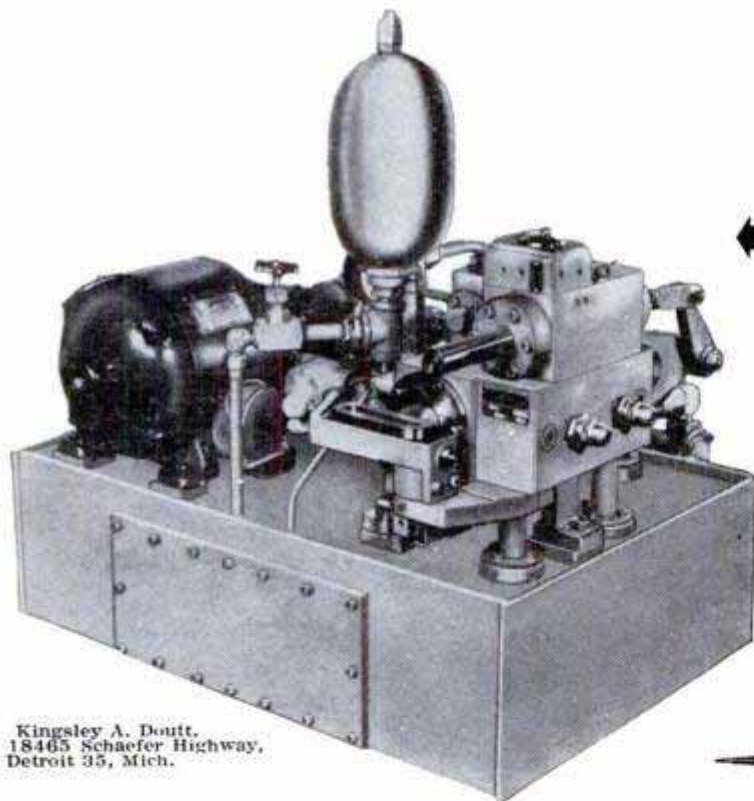
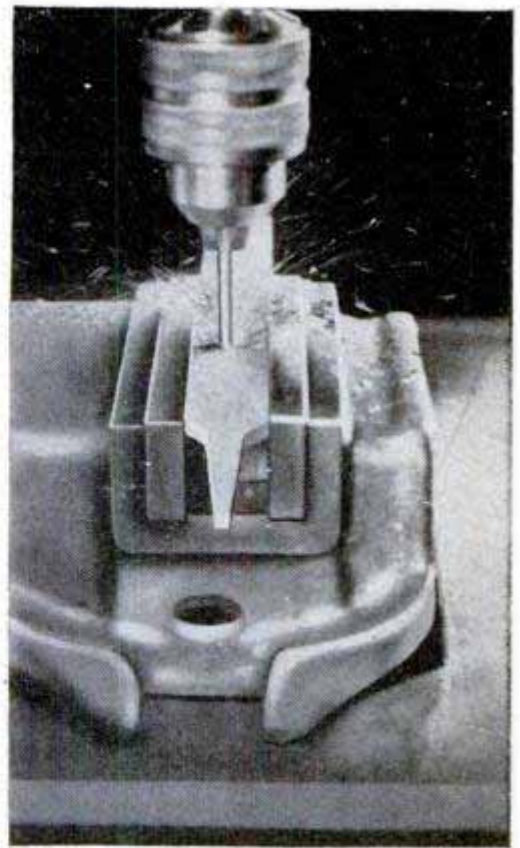
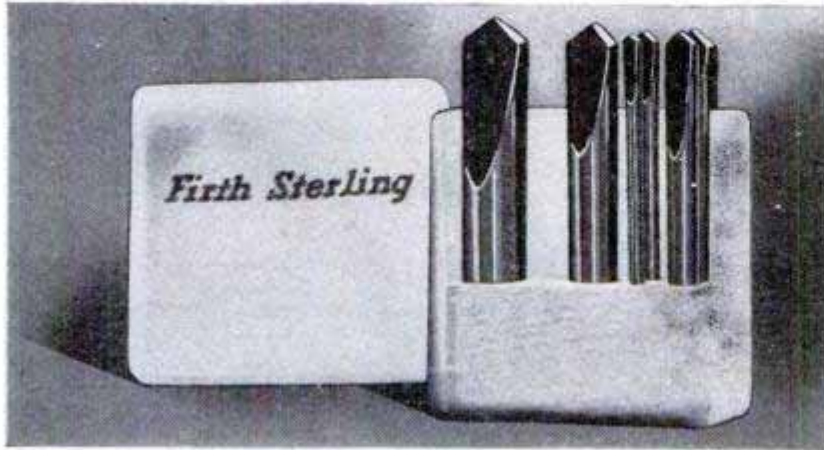

Photo Research Corporation, Burbank, Calif.

FOR TOOLS

NEW DRILL KIT for drilling hard metals has many applications in industry. Drill bits included in the kit range in size from $\frac{1}{8}$ to $\frac{1}{2}$ in. and are made from sintered-carbide rods. They are pointed and relieved for drilling metals to 66 Rockwell C hardness

Firth-Sterling Steel & Carbide Corp., McKeesport, Pa.



Kingsley A. Douth,
18465 Schaefer Highway,
Detroit 35, Mich.

HYDRAULIC FLASH-WELDER CONTROL UNIT has been developed for use with any make of flash welder having a transformer capacity up to 500 KVA. Calibrated adjustments make duplication of setups as easy as turning a dial, and range of cross-sectional areas that any flash welder can handle is greatly extended by use of unit. In effect, it converts mechanically driven flash welders to full hydraulic operation. Unit requires no maintenance except inspection and lubrication

PRECISION LEAD SHARPENER for shaping inserted leads of draftsman's mechanical lead holders has been recently developed. It is electrically driven and sharpens leads by contour grinding, producing both round and chisel points in the variety illustrated in the photo at right. Principal advantage is that the draftsman can obtain a predetermined lead point consistently with only a simple adjustment of the sharpener. This feature makes it possible to do accurate line work on drawings without the necessity of constantly sanding and polishing the lead point by hand methods



Rajeon Mfg. Co.,
906 Kingston Ave.,
Racine, Wis.

Rear-Axle Alignment Checked With Straightedges and Tape

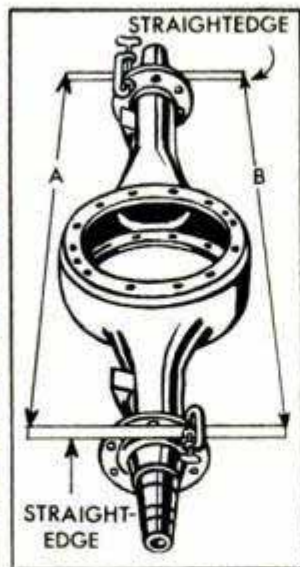

When it is necessary to disassemble the rear axle of a car or light truck in order to make repairs, it's important to check the axle housing for alignment before reassembling. This can be done quickly and without any special equipment by clamping straightedges to the machined flanges at the ends of the housing which carry the brake-backing plates. Bar stock is best for use as straightedges since it will not spring out of true. The detail and illustration show the setup for checking axle sag. A bend caused by a collision is detected by moving the straightedges 90 deg. from the position shown. In either case, when the checkup is made, the variations in the distances A and B should not exceed $\frac{1}{16}$ in. for a passenger-car axle and not more than $\frac{3}{32}$ in. for a truck axle. These are the maximum allowable variations. If the measurements are greater, the entire unit should be replaced.

Welder's Clamps Made in the Shop



Welders working on intricate fabricating jobs often need special C-clamps of a type and size not readily available from suppliers. Special-purpose clamps are quite easily made by cutting

the body of the clamp out of steel plate with a torch, the size of the clamp determining the thickness of the plate used. If care is taken to do an accurate job of cutting with the torch, no other finishing on the body of the clamp will be required.

Then a hex nut from a bolt of suitable size and length is welded to the body of the clamp as detailed, and a bolt of convenient length is turned into the nut to serve as a clamp screw. When the clamp is designed to span 6 in. or more, it probably will be necessary to thread a rod and bend the unthreaded end at a right angle to form a handle for turning the clamp screw.

John Krill, North Lima, Ohio.

Impregnating Bristles With Soap Renews Water-Color Brush Tips

After a certain amount of use, the bristles of most water-color brushes fail to return to their original sharp point which is necessary for fine work. In many cases, working soap into the bristles and shaping them to a point will cause the bristles to retain the desired shape. To do this, simply dampen the brush with water and rub the bristles across a bar of soap several times. Twirl the bristles between the thumb and index finger until the soap is thoroughly worked into the brush and, with the fingers, draw the bristles to a point. Set the brush aside for a few days before attempting to paint with it so the bristles will have time to dry out completely.

Tabs Made of Masking Tape Identify Lead in Compass

One draftsman, who has occasion to use several compasses fitted with leads of varying degrees of hardness, identifies the lead in each one with a lettered tab made from a short length of masking tape. The symbol identifying the lead, such as 2H, 4H, and so on, is lettered with drawing ink on one side of the tape near the end. Then a short piece of the tape is cut off and wrapped around one leg of the compass in such a way that the lettered symbol is easily read at a glance.

H. Drouyn, Montreal, Can.

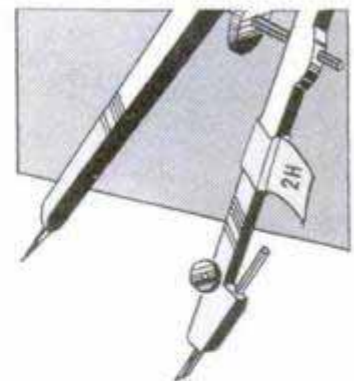

Combination Brooder-House Door

Using a combination storm and screen door on a brooder house permits the chicks to be viewed in all types of weather without disturbing them by opening the door. In cold weather, the storm window keeps heat from escaping while in warm weather the screen will provide ventilation and keep out insects.

Radio Television Electronics

RECEIVERS



BATTERY-OPERATED PROGRESSIVE

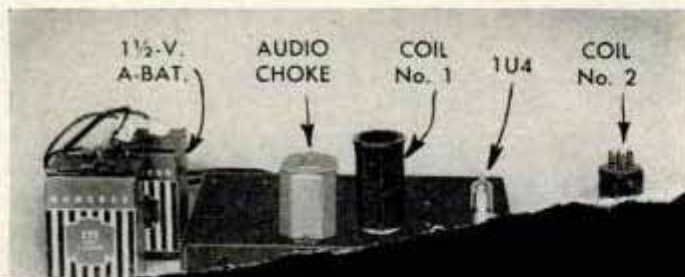

THERE are several good battery-operated radios in demand today. The course, the

CBS COLOR-TV RECEIVERS

RECENT simultaneous color-television demonstrations in Chicago and New York, by the Columbia Broadcasting System, have attracted favorable attention. These public demonstrations have definitely shown the value that color television will have in the entertainment, advertising and educational fields. For the Chicago demonstration the CBS color program was fed from New York over the same coaxial cables used for networking black-and-white television to the Midwest.

One new color-TV receiver in the CBS demonstration group was the direct-view drum type illustrated in photo A. This shows color pictures on a 17-in. rectangular tube without a magnifier, in a console 34 in. high and 27 in. wide. The picture tube is inside the rotating color drum, as indicated in diagrams, Fig. 1. The color drum was originally developed by Dr. Peter C. Goldmark and his CBS laboratory associates in 1941, and was recently improved. A motor is employed to drive the color drum with its segments of television's primary colors.

Other types of TV color receivers using the conventional CBS system of flat, spinning color wheels, were included in the demonstration. The color converter, shown in photo B, slides to one side when the standard black-and-white programs are desired. Others were of the industrial type with the color-disk mechanism and enlarging lenses built in. The mechanical CBS color-TV system is illustrated in Fig. 2. As each red, green and blue color segment comes between the scene and the TV camera, the lens picks up chiefly that particular color. A similar whirling color wheel at the receiver, when synchronized with the one at the transmitter, produces the same effect on the TV screen. Persistence of vision blends the colors into a full-color picture.

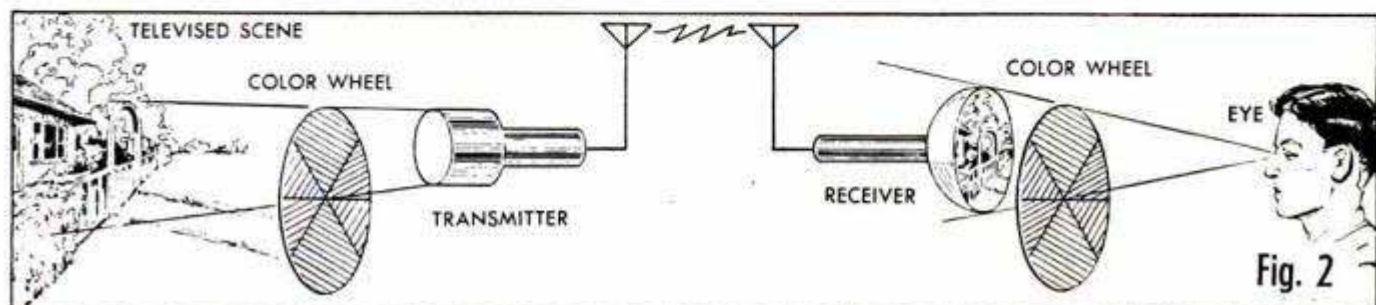
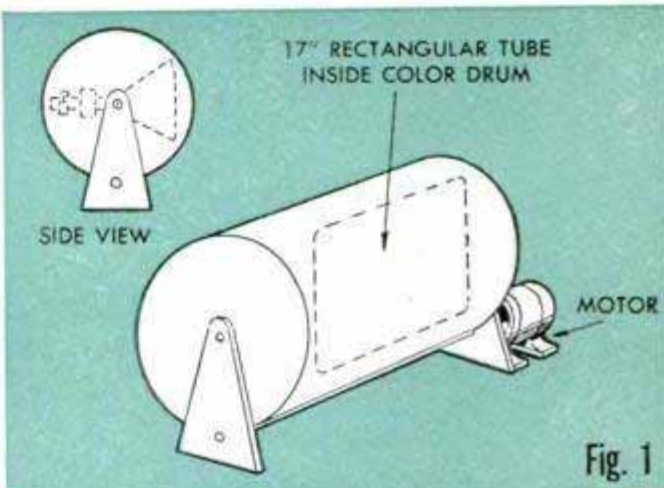
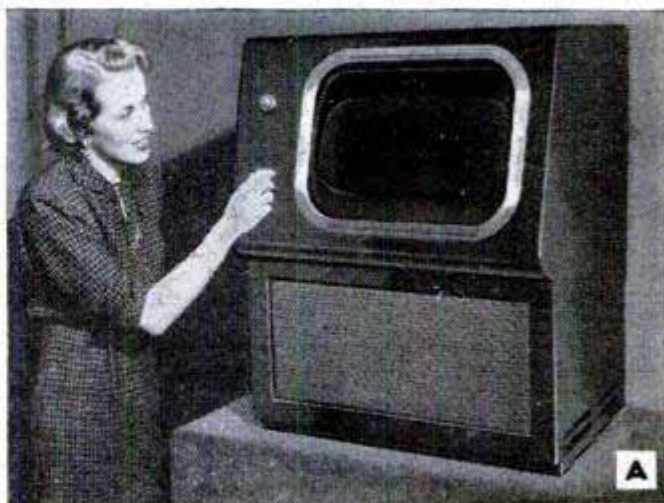

BATTERY-OPERATED PROGRESSIVE

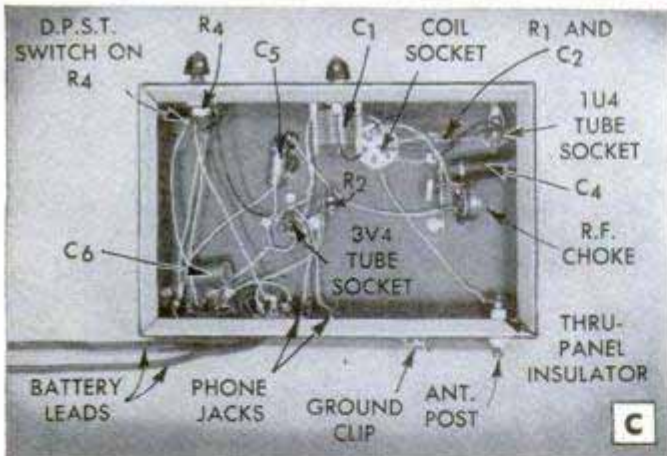
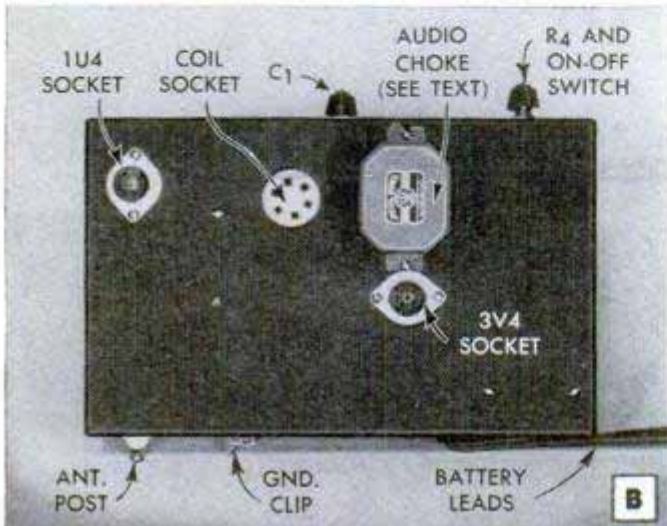
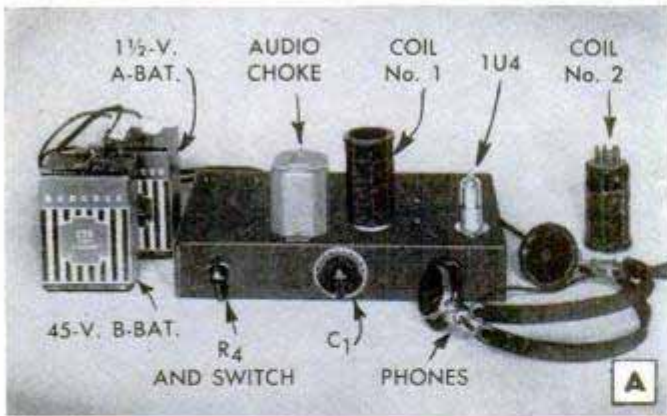

THERE are several good reasons why battery-operated radio sets are in demand today. The outstanding reason is, of course, the fact that they are independent of power lines, an important factor recognized by those who are planning civil-defense programs. The circuits are simpler for beginners and there is no possibility of hum and other baffling power-supply troubles. Modern battery sets compete very favorably with the a.c.-d.c. and similar sets, because the battery-operated miniature tubes have surprising "sock"—making possible very compact sets with good sensitivity for distant reception.

This No. 1 efficient broadcast-band progressive set will be followed at a later date with the second set which will be a full-fledged battery-operated loudspeaker set capable of pulling in short-wave stations from many foreign countries on other continents. It will retain the standard broadcast band but it will be especially designed for all of the important short-wave bands. As is customary with progressive sets, practically all of the parts used in set No. 1 can be employed with additional parts in the second set. This enables the beginner and student to build the first set and become familiar with it before attempting the second and more elaborate receiver and without wasting the useful original parts.

Set No. 1, illustrated in photos A, B, C and D, consists of a regenerative detector impedance coupled to a pentode output stage. The impedance coupling insures full plate voltage on the detector, and is one of the reasons for its excellent sensitivity. Two hand-wound plug-in coils are employed in this set; these are shown in photo E and are fully detailed in Fig. 3. The larger coil, No. 1, tunes the greater portion of

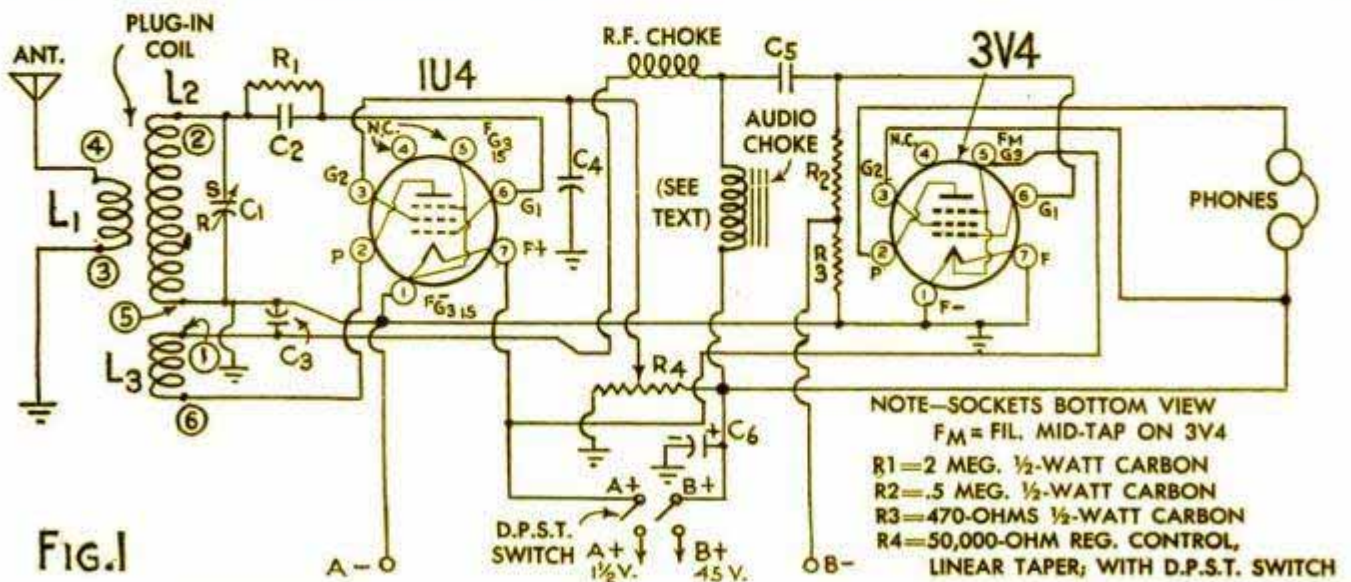
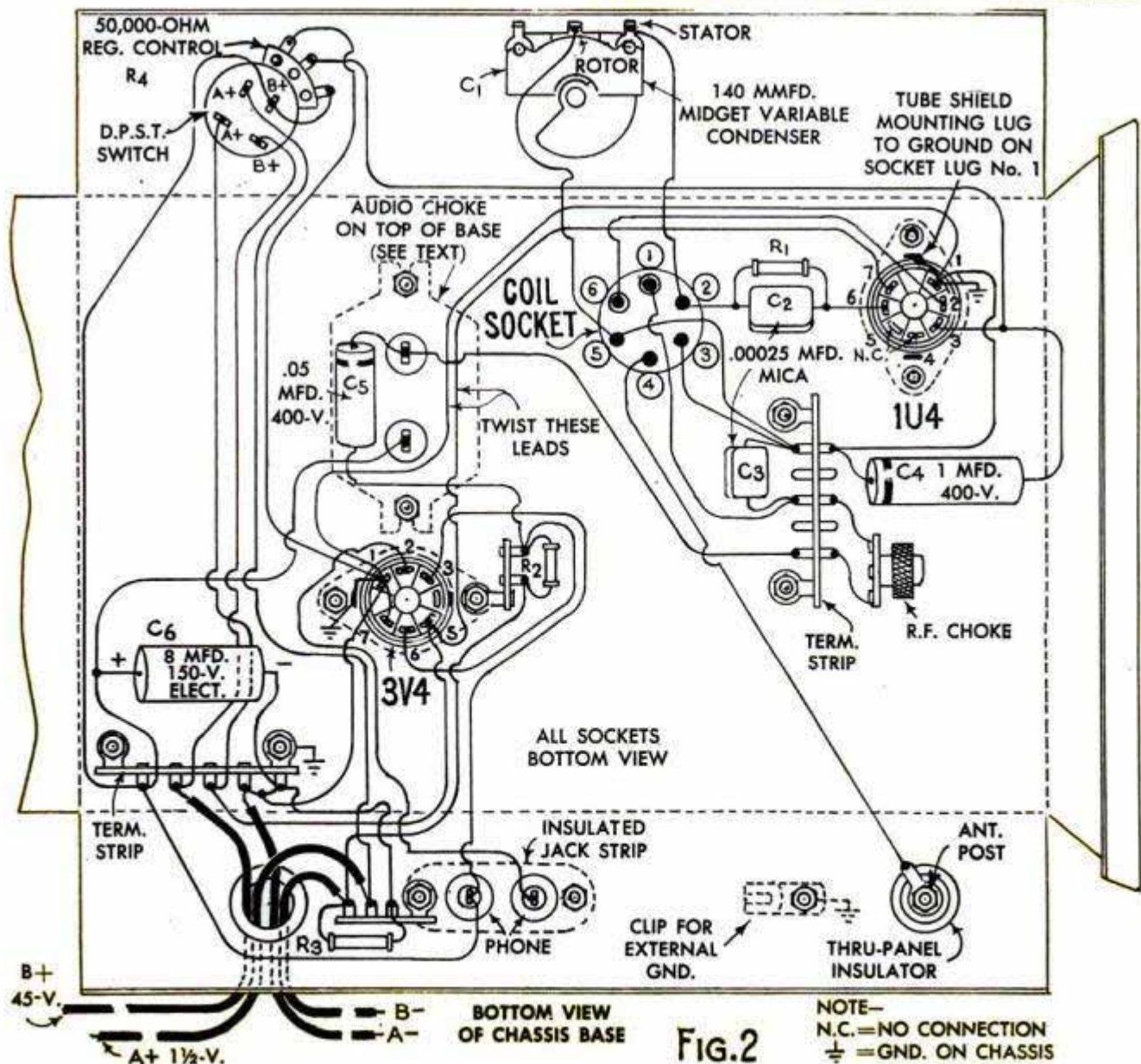
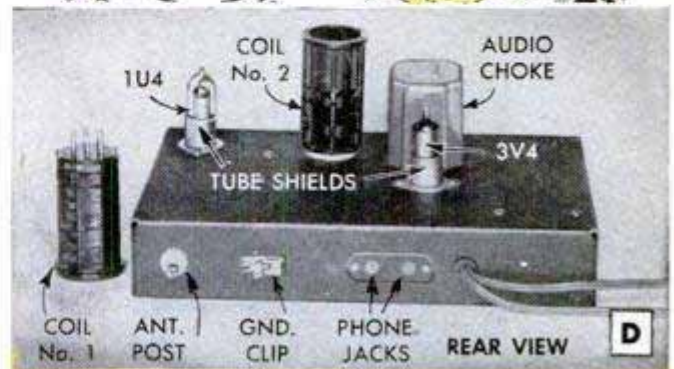
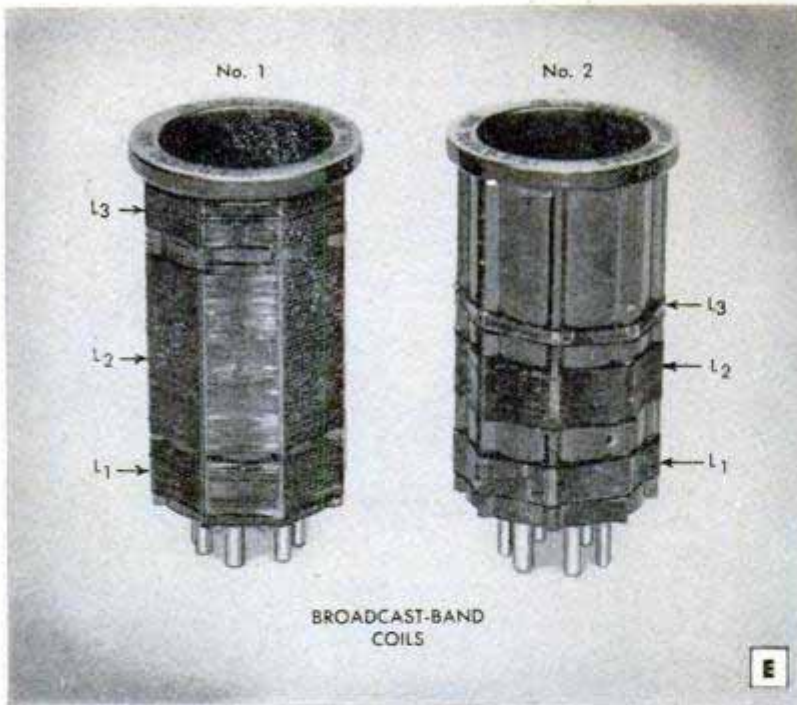

FIG. 1

SET FOR EXPERIMENTERS

the standard broadcast band; coil No. 2 tunes the rest of the broadcast band and extends up to about 2000 kilocycles. The set is built up on a standard 2 x 7 x 11-in. black crackle-finished chassis base. All base-drilling details are shown in Fig. 4. Mount the various parts in the positions indicated in the various photos and pictorial wiring diagram, Fig. 2. When mounting the audio choke on top of the base, make sure that the terminals are centered in the chassis holes and clear the chassis. This is also important in respect to the terminals on the phone-jack strip mounted on the rear of the chassis base. Make certain that the holes in the chassis are plenty large at the points where the connecting terminals go through. The audio choke can be any 500-hy. type such as the UTC S-23 or similar unit. Any standard 3-1 ratio audio transformer with primary and secondary.





windings connected in series may be used instead.

Care should be taken in wiring, especially when making connections to the small tube sockets. Mark the positions of the various tube terminals on the underside of the chassis, as even an experienced set builder can become confused very easily. When winding the coils following the chart, Fig. 3, be sure that the various coils are "poled" properly with the connections to the pins in the six-prong forms made exactly as shown in the diagrams. The same coil terminals match the coil socket in the chassis base, and the corresponding coil terminals are numbered in the schematic circuit diagram, Fig. 1. Cross check all diagrams to be sure that your wiring agrees.

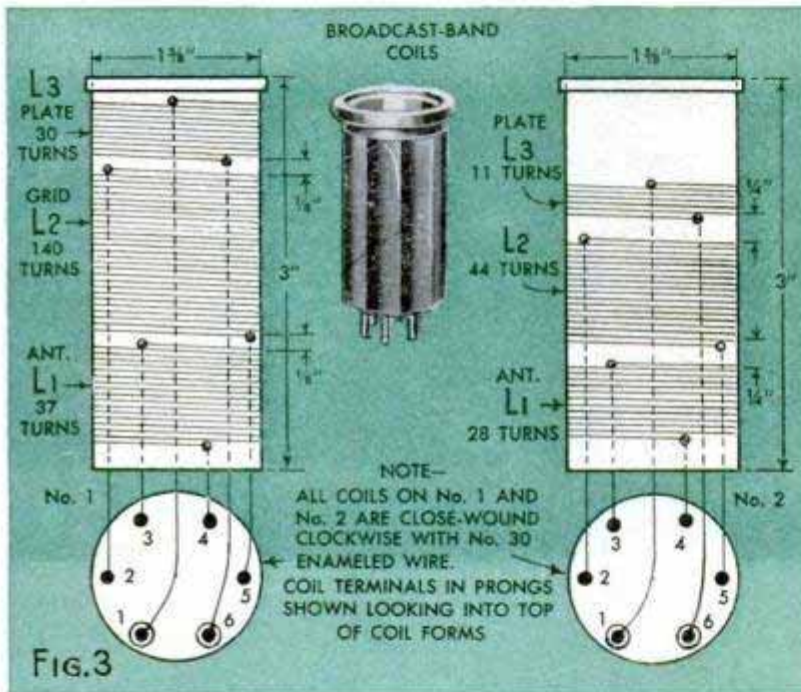

The set operates from a large 1½-volt A-battery and one 45-volt B-battery. A flashlight bulb (size not important) should be connected in series with the positive-B 45-volt lead to serve as a fuse. This protects the tubes from burnouts in case the B-voltage is accidentally applied to the tube filaments. With the batteries connected, and tubes and coil in, plug in the headphones. There should be a loud "click." If nothing is heard, recheck the battery connections and the circuit wiring. Connect the antenna and external ground wires, and if everything is working correctly you will hear a whistle as the set is tuned through a station. Backing off, or turning back, the regeneration control R4 should clear up the whistle and bring in the station clearly. For the local stations, an indoor antenna and a ground connection are all that is required. For greater distance use an outdoor antenna. With a battery-operated emergency receiver of this description, you are not cut off from outside news and vital civil-defense information should local power sources fail. Most of us do not realize just how important this could be. The No. 1 set is quite simple and all parts are easily available. Detailed student material list R-400 for this May 1951 battery-operated No. 1 progressive set is available from Popular Mechanics Radio and Electronics department upon receipt of ordinary letter postage.

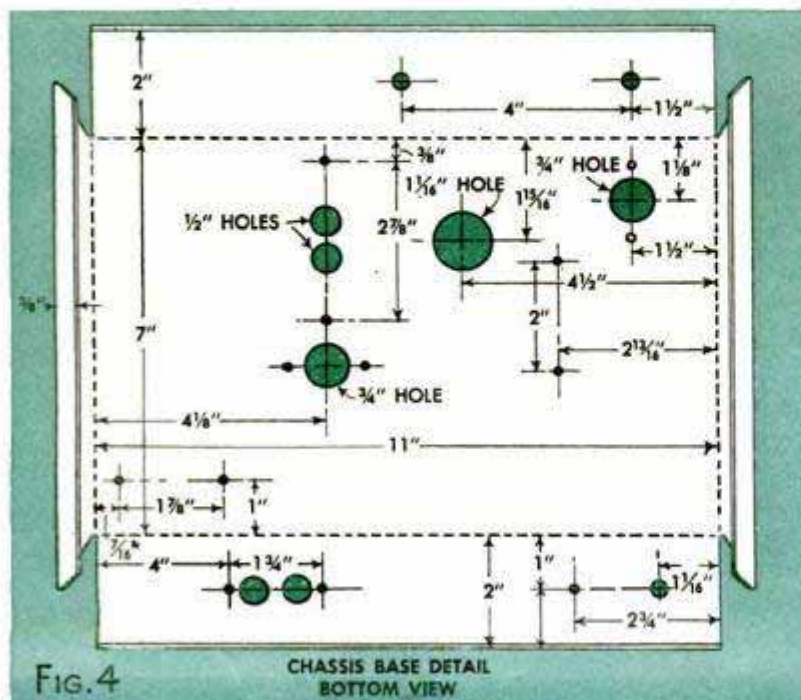



TELEVISION TODAY

NOW THAT warm weather makes television viewing indoors rather uncomfortable and especially in the daytime when the children should be out on the terrace or open porch, some TV-set owners are facing a problem. One owner in New Rochelle, N. Y., solved it in the manner illustrated in photos A and B. He replaced the existing French doors, that opened out on the terrace, with a large single door made of white pine, copper screening, optical glass and the necessary trim. Because of its size, the door required four stout hinges, half-lap joints and full dowel construction to give it the necessary rigidity. The height of the glass section will depend on the height of your TV screen. To facilitate moving the TV set into position at the door, as illustrated in photo A, the console was mounted on heavy rubber casters.

Today, the TV serviceman working in rural areas often has to transport TV antennas to farm homes. Photo C shows a specially designed homemade trailer that is used by an Indiana serviceman. When he reaches the location, he turns a crank that

raises the antenna mast until it is vertical.

When it is necessary to remove a TV-picture tube from the shipping carton, use heavy gloves and goggles. Grasp the tube by the front end as shown in photo D. Certain types of TV tubes are mounted in the cabinet with a U-shaped bracket as shown in photo E. Care must be taken in tightening the locknuts as excessive pressure may result in breakage of the tube.

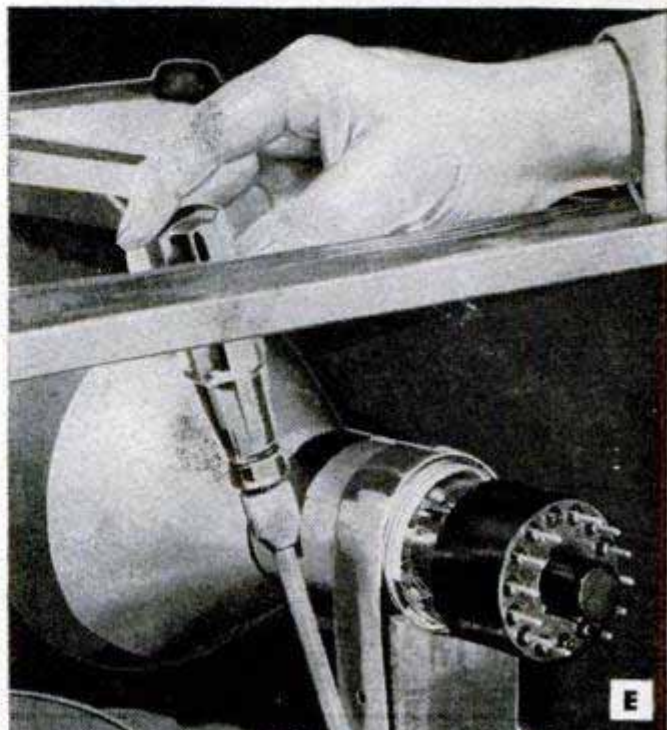

Hints for RADIO STUDENTS



LEARNING the International Morse radio code is of special interest today both to the beginner studying to prepare for "ham" radio amateur-license examinations, and to a large number of persons also preparing to take an active part in the civil-defense program. The learning of the code either by an individual, or by groups of students, is greatly facilitated through the use of a set of five double-faced phonograph records, containing specially transcribed lessons. The disks are 10 in. in diameter and work on any simple 78-r.p.m. record player as illustrated in photo A.

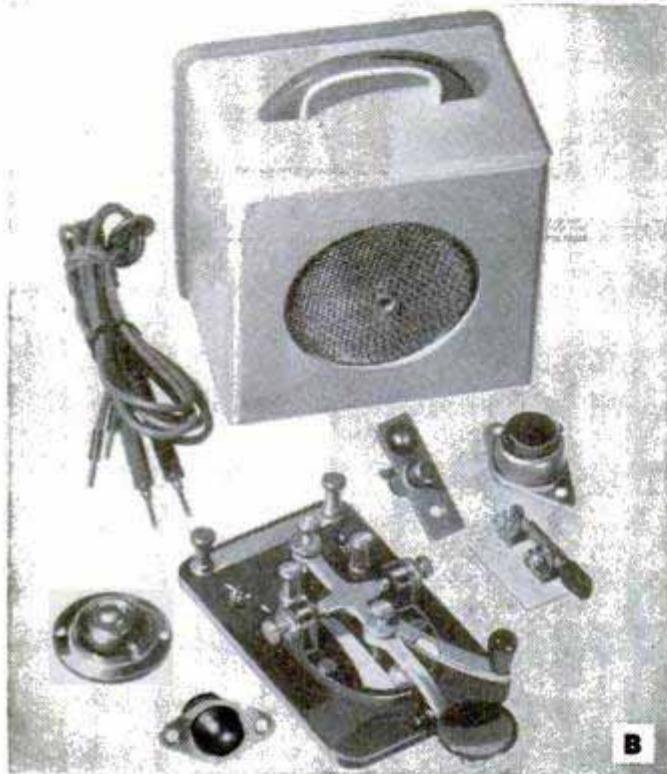

A new type of sound-generating device that may be used as a radio code-practice set, alarm or appliance-continuity tester, is shown in photo B. It employs no vacuum tubes and is powered with only one 1½-volt flashlight cell. It includes a 4-in. speaker, and generates an adjustable 400-cycle loud tone. It is claimed to produce no radio or TV interference. With the switches shown it can also be used as a window burglar alarm and, with the test leads, as a continuity tester.



Photo C shows an electric self-starting 24-hour clock designed for amateurs and short-wave listeners. It makes log-keeping easy in 24-hour time (0000-2400); shows time directly in all world time zones. The flat-type pillow speaker shown in photo D can be connected directly to any radio and can also be used as a dynamic microphone, requiring only two stages of amplification. The compact line adjuster illustrated in photo E permits operation of electrical devices at 115 volts when the supplied voltage is 65, 75, 90, 100, 115, 130 or 145 volts, 50-60-cycle a.c.

Photo F shows a student volt-ohmmeter that is available in an easily assembled kit.

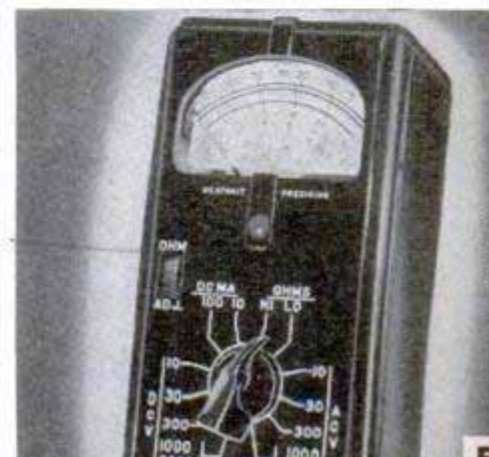
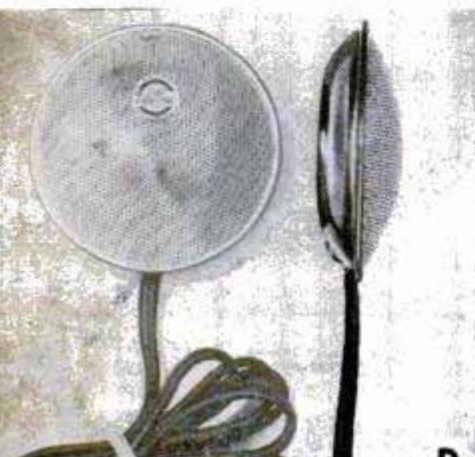

DARKEN THE SKY IN YOUR PICTURES

without changing other tones

The **Kodak Pola-Screen** does the trick—in color and black-and-white. Place one in front of your lens for dark, dramatic sky effects without impairing other tonal values. The accessory **Kodak Pola-Screen Viewer** over the indicator handle of your Pola-Screen “previews” the varying sky tones. Pola-Screens also cut surface reflections in both color and black-and-white pictures. Price of Viewer, \$6.50; Pola-Screens, from \$6.50.

PHOTO TIPS FROM KODAK

WARM UP YOUR COLOR SHOTS with a Kodak Skylight Filter

With this filter you'll wipe out the bluish cast in outdoor color shots. Use it for pictures of mountain, marine, sunlit snow scenes . . . pictures made in open shade under a clear sky and on overcast days. Keeps other colors natural-looking. Prices start at \$1.60.



SHADE THE EYE OF YOUR CAMERA for better pictures

A **KODAK LENS HOOD** attaches in an instant—saves snapshots from sun flare. A “must” for taking those dramatic back-lighted pictures. Useful indoors, too, for pictures side-lighted with photo lamps. Prices start at \$1.60.



“MOVE IN” FOR CLOSE-UPS of flowers and table-top subjects

Slip a **KODAK PORTRA LENS** over your camera lens for black-and-white or color pictures at extremely close range. Portra Lens 1+ is lowest power; 2+ is medium; 3+ is highest power. Combine them for stronger effects. Prices start at \$2.50.

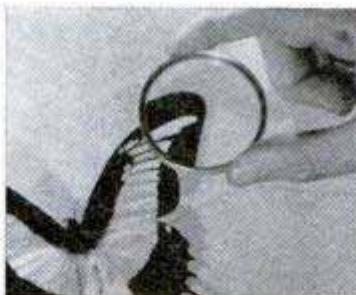

A SINGLE ADAPTER RING accepts Pola-Screen, Filter, Portra Lens, or Lens Hood

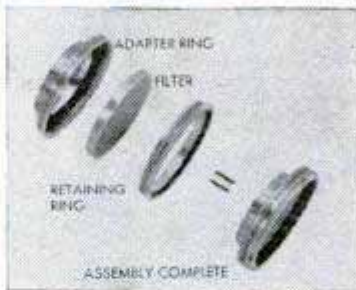

Basic unit of **Kodak Combination Lens Attachments** for attaching above items to camera lens. Series sizes to fit most cameras. Prices start at \$1.25.

BE SURE TO SEE ALL THESE LENS ATTACHMENTS AT YOUR KODAK DEALER'S. Eastman Kodak Company, Rochester 4, N. Y.
Prices subject to change without notice. Consult your dealer.

Kodak
TRADE-MARK

Here's the Camera in YOUR Future

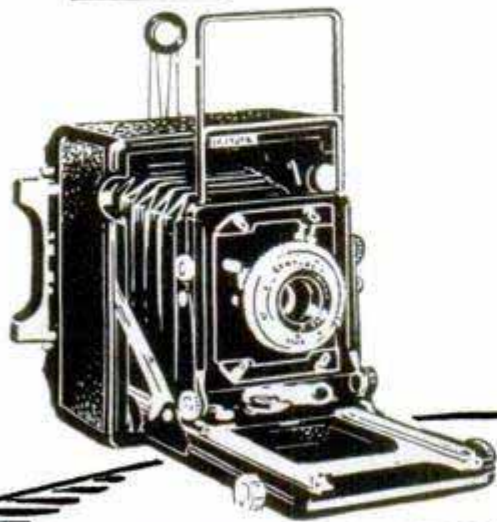

The CENTURY GRAPHIC keeps pace with your skill!

A fine camera as it stands . . . ready to prove its versatility in a hundred ways. The Century is compact, efficient . . . the lowest-priced Graphic camera. It's rugged, dependable and built for your future! No matter how skilled you become, you'll never outgrow your Century, for it's designed to let you add the accessories you'll want as your technique develops . . . 120 Roll Holder, for economy with roll film . . . Graflarger, for enlarging through your camera . . . speedy Grafmatic, for action sequences . . . Graflite for flash perfection! Your dealer has the Century Graphic today, with fine coated f/4.5 lens, built-in flash sync., ground glass focus, Graflok back, complete for only \$109.50.

(Price subject to change.)



120 Roll Holder



Graflarger



Grafmatic



Graflite Flash

GRAFLEX

Prize-Winning Cameras

Graflex, Inc., Dept. 83
Rochester 8, N. Y.

Please send details on:

- Century Graphic 120 Roll Holder
 Grafmatic Graflarger

Name _____

Street _____

City _____ Zone _____ State _____

Westerners Are Ridin' High

(Continued from page 136)

better. There, even the state legislators, many of whom have to travel long distances to the capitol at Boise, make extensive use of private planes. In fact, when 13 flying solons showed up at a session of the legislature, they formed their own organization, the Legislative Flying Club of Idaho. Their symbol is a winged and propellered desk with a solon standing on top and spouting oratory. Most distinguished member: Governor C. A. Robbins.

Use of private airplanes in flying over the mountains of the state at large has become so extensive that there is now a landing field or air strip for every other community. Idaho has approximately 340 communities, and more than 170 landing fields.

In Texas, the utilization of airplanes by cowboys has become so widespread that it is not unusual to see a plane, bulging with saddles, parked beside a rodeo grounds. The owners—bronc busters—use the plane to hop from one show to another.

Practicality of the airplane in geological research was recently demonstrated by Dave Burt and Starr Jenkins, students at the University of New Mexico, who parachuted into 100-yard-wide Glen Canyon in Utah, collected soil and rock samples for six days, then used rubber life rafts to float out on the Colorado River.

Among the heavy industries of the West, most extensive use of civil aircraft is made by lumbering and mining concerns. They haul supplies in large quantities.

Take the Clearwater Valley Light and Power Association of Lewiston, Idaho, which must patrol 1300 miles of line in the rugged mountains of north-central Idaho. It used to take days with car and by horseback or foot to find a break in the line caused by a falling tree or a snowslide. Now, with a plane, it's easy.

One day at 1 p.m. a rancher called Ed Tull, association engineer at Lewiston, to report a line break somewhere deep in the mountains.

"We'll fix it this afternoon," Tull assured the surprised rancher, then proceeded to make good his word.

A licensed pilot, he flew over the area, spotted a fallen pine straddling the line, and dropped a note giving the location to the nearest ground crew. Before sunset, the crew had repaired the break. Power companies probably got the mountain airpatrol idea from the U. S. Forest Service, which began using it years ago in fighting forest fires.

The state fish and game department of

(Continued to page 232)

Here is the 20-minute auto wax —no rubbing!

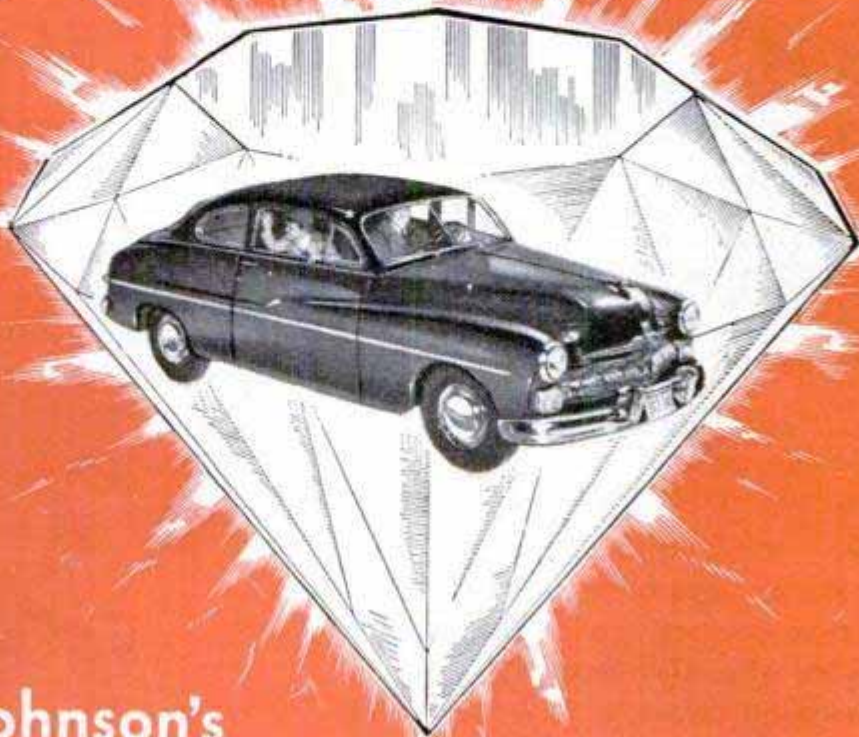

Johnson's

Car-Plate

gives a lasting "diamond shine"!



Proved better on 5,000,000 cars!

Reader's Digest told the world about this sensational new way to wax a car . . .

And in less than 10 months, more than 5 million car owners have changed from old-fashioned hard-rub methods to the easy Car-Plate no-rub method.

This great new chemical discovery from the Johnson's Wax laboratories waxes a car in 20 minutes . . . gives brighter, tougher, longer-lasting wax protection!

Just spread on the clean finish of your car . . . let it dry . . . and wipe lightly. That's all you do.

Get Johnson's Car-Plate today at your service station or wax dealer's. 10-oz. can only \$1.00. (Does any car twice.)

HOW TO CLEAN BEFORE YOU WAX • Wax should always be applied to a CLEAN car. The finish should be free of road film and decomposed paint. For this reason it is important that you clean your car thoroughly before applying Car-Plate. For quick, easy cleaning, Johnson's Carnu is recommended. It does the job fast and safely—leaves a perfect surface for a sparkling Car-Plate finish.

"Johnson's", "Car-Plate" and "Carnu" are the trademarks of S. C. Johnson & Son, Inc. © S. C. Johnson & Son, Inc., Racine, Wisconsin, 1951



How to paint a room in 1/2 the time—

WITH
 **SPRED SATIN**
THE WONDER PAINT

You can apply it in half the time with brush or roller. Dries in 20 minutes to a gorgeous satin finish.

- ★ Covers most surfaces
- ★ Shows no laps or brushmarks
- ★ Washes perfectly, over and over
- ★ Has no offensive odor
- ★ New deep colors, ready-mixed

The secret of this amazing paint is its exclusive *synthetic rubber emulsion* formula. The rubber film forms a tight, durable surface that dirt cannot penetrate. See your Glidden dealer today.

Send for
decorating
kit today

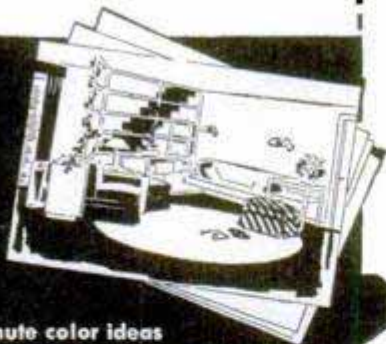

Up-to-the-minute color ideas
you can easily carry out in your own home!
Floor plans and color reproductions for 7
rooms. Practical, made-to-order
for planning home improve-
ment. Send 10 cents
(coin).

Dept. PM-5
The Glidden Co.
Cleveland 2, Ohio

Please send me your decorating kit. I enclose 10 cents (coin).
Tell me where I can buy Spred SATIN.

Name _____
Address _____
City _____ State _____

Clinic



for Homemakers

As a service to our readers in solving the hundreds of problems pertaining to a home—inside or out—the editors of *Popular Mechanics* invite you to present your problems to The Clinic Editor for help and advice. Address your questions to The Clinic Editor, *Popular Mechanics Magazine*, 200 East Ontario Street, Chicago 11, Ill.



Cultivating Garden

Q—What is the correct procedure in cultivating garden plants such as carrots, onions (from sets), tomatoes, sweet corn and potatoes? Should cultivation be shallow or deep, or should it be deep between the rows and shallow near the plants? Should the potato plants be hilled after they have attained their full growth?

F. C., New York.

A—Ordinarily, cultivation during the seasonal growth of vegetable plants is for the purpose of killing weeds, breaking surface crust which forms on some soils after heavy rains, and maintaining a fine soil mulch to conserve moisture. Where the garden is too small to permit the use of a tractor with cultivating attachments, the soil is worked either with a hoe or rake, or with the various types of wheeled hoes available to gardeners. The latter are made so that they will straddle the rows or, with certain adjustments, can be operated between the rows. Ordinarily, cultivation should be shallow to avoid cutting surface feeding roots of plants having spreading root systems. Also, if the soil is stirred deeply by continued cultivation during prolonged dry weather, it will gradually become dry down to the depth of cultivation. This may affect plant growth, particularly in certain types of soils in which the moisture level lowers rapidly during periods of dry weather. Early cultivations of most common garden plants can begin as soon as the seed has been sown and can go as deep as 2 in. or so for the first cultivation. Later cultivations should not exceed 1 to 1½ in. at most, and in fine, friable soils not more than 1 in. in depth. Experienced gardeners do not generally favor deep cultivation, hilling or ridging of any garden vegetable crop, the only exceptions to the rule being the occasional necessity of deep cultivation to loosen and aerate heavy, wet soils where drainage is poor during wet seasons. Also, there is a necessity of ridging a celery crop in the later stages of growth for the purpose of blanching. Many present-day gardeners who grow small patches of potatoes for the table, favor mulching rather than cultivation of this crop. Mulching is done immediately after planting the seed pieces, using peat moss, wheat straw, marsh hay or any other similar coarse material. Dry straw or hay should be spread uniformly to a depth of 6 to 10 in.

(Continued to page 230)

LAKE MEAD

NORTH CHANNEL

TRENT WATERWAY

OHIO RIVER

PUGET SOUND

GEORGIAN BAY

LAKE CHAMPLAIN

FLORIDA

LONG ISLAND SOUND

TVA WATERWAY

INLAND WATERWAY

MISSISSIPPI RIVER

CHESAPEAKE BAY

NOW! Thrilling new horizons for low-cost outboard cruising!



BIG TWIN by Evinrude

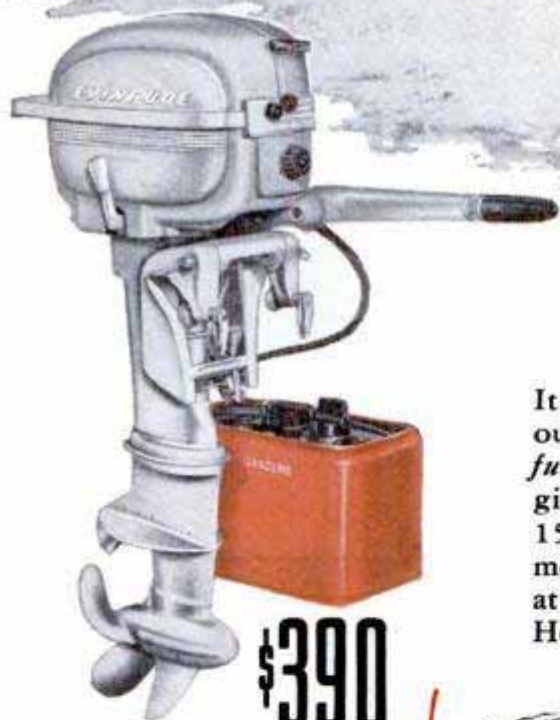

\$390

F.O.B. Factory, subject to change without notice

- 25 HORSEPOWER
- Slow TROLLING
- ROTO-MATIC CONTROL
- GEARSHIFT
- CRUIS-A-DAY TANK



It was bound to come... and it's here... the motor that makes outboard cruising not only completely practical but *tops in cruising fun!* Here's *Power* for the job... reliable *heavy-duty* power that gives the comfortable packet above an easy cruising speed of 15 miles an hour... top speed close to 20... and with two motors, close to 30 miles! Quiet, *flexible* power, superbly smooth at every speed from "wide open" right down to a drifting troll! Here's *new handling ease*... Gearshift with Neutral, Forward, Reverse... and Roto-Matic Speed Control... with complete Remote Controls available for placement at the helmsman's hand. And separate large-capacity Cruis-a-Day Tank. And ALL at the lowest price per horsepower in the field!

CHOOSE YOUR HULL... staunch runabout with shelter top or cabin boat with "all the comforts." Choose your *cruising country*... broad highways lead to America's loveliest cruising waters... your outboard cruiser can be trailered *anywhere!*

SEE YOUR EVINRUDE DEALER—let him show you the complete line of Evinrude models... Big Twin and Fastwin for cruisers, runabouts, large family boats... Fleetwin, Sportwin, Sportsman for smaller craft. Look for your dealer's name under "Outboard Motors" in the yellow pages of your phone directory. **CATALOG FREE!** Write for it today!



#25 O.B.C. certified brake H.P. at 4000 R.P.M. Approved high-speed operating range, 4000 to 5000 R.P.M.



EVINRUDE MOTORS 4678 N. 27th ST., MILWAUKEE 16, WIS.
In Canada: Evinrude Motors, Peterborough, Ont.

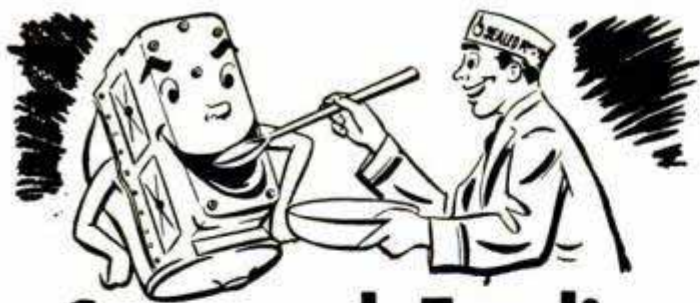

Care and Feeding of Engines

BY S. P. CORP

POSTPONE RETIRING TIME!

Moderate attention will help you postpone the retiring time of your tires. They should be switched every 5000 miles, and when you switch them, check each tire carefully. Probe any small cuts with an ice pick and remove bits of glass, small nails or other sharp particles which could penetrate the tube in time.

Make a habit of checking tire pressures every week. If one tire is much lower than the others, find the reason and correct it right then—to save yourself a lot of annoyance later on—as well as a few thousand miles of tire life. It helps postpone retiring time!



IT PAYS TO BABY BATTERIES A BIT

You're careful about oil. You're careful about gas. You watch your radiator with an eagle eye. Now, if you'll just give the battery in your car that same frequent, careful attention, you'll find it will pay off in several ways. It should be inspected at least every fifteen days.

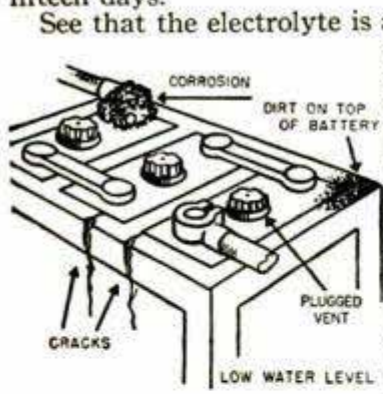

See that the electrolyte is about $\frac{3}{8}$ -inch above the top of the plates. Check specific gravity with a hydrometer. A variation of 25 points or more between cells indicates that the low cell is weak. Look for a battery leak. At 80 degrees F. your battery should show 1.280 S.G. If it shows only 1.225, it is only half charged and needs charging.

If it shows 1.150 or less, it is in a complete discharge condition. If left this way, plates will sulphate, preventing recharge. Keep top of battery dry and clean. If wet, sprinkle baking soda on it, let stand a while, then brush clean. It pays to baby your battery!

MAY'S THE TIME FOR RINGS

Girls get engagement rings and wedding rings in May. Your car is a good girl—give her a set of Sealed Power Piston Rings—the best rings built! The Sealed Power MD-50 Steel Oil Ring controls oil even in badly tapered and out-of-round bores. There is a Sealed Power Ring Set specifically engineered to do the best possible job in your engine, whatever the make, model, or wear condition. Write for free booklet, "7 Ways to Save Oil." Address Dept. G-5, Sealed Power, Muskegon, Mich.

(Continued from page 228)



Finish Turning Gray

Q—Our walnut dining-room set seems to be turning a gray color from what was originally a natural finish on walnut. At first this appeared only in small spots, but now it seems to be spreading. What is the cause of this graying of the finish, and what can be done to correct it? Is it due to the use of furniture polish?
L. F., Tex.

A—It is not likely that the discoloration you describe is caused by the use of furniture polish—that is, if the polish has been properly applied. There are a number of causes of such a change in color of the original finish, but if we understand your description correctly, the most likely one is the bleaching, or bleeding, of the coloring matter in the filler which was used in filling the grain of the wood. Bleaching leaves the filler in its natural color. This particular discoloration sometimes occurs when a wood filler containing stain has been used and a clear lacquer applied over it as a finish coat. The remedy for this defect involves a process which is not easy to carry out without use of special equipment, but furniture refinishers sometimes sand the surfaces lightly with fine sandpaper, then spray on a coat of what is known to the trade as amalgamator. This material softens the original finish somewhat and tends to spread it, changing the reflective properties of the surface and forming a suitable base for new finishing coats. While this treatment generally restores the finish to its original color, in some cases, it will not be entirely successful. If it shows any indication of failure, then it is advisable to remove the defective finish to the bare wood and build up an entirely new finish. Of course, it often is possible to restore the original color, at least temporarily, by the use of shading lacquers applied with a spray gun. Where this is done it is necessary to use a non-raising lacquer.

Cleaning Furnace Filters



Q—Is there any way to clean the filters used in forced warm-air furnaces so that they can be used from year to year without the necessity of renewing them each heating season? I have tried brushing off the matted dust and lint that gathers on the upper surfaces but this did not prove entirely satisfactory.
R. M., Pa.

A—Cleaning of the filters by any ordinary means cannot be recommended without reservation. It is best to renew them at the beginning of each heating season and usually it is necessary to replace them at least once during the winter months. However, you can clean out a portion of the dust and matted lint which collects on the upper surfaces by directing a blast of air from a tire pump through the filtering material. This will blow out much of the lint that tends to collect on top of the filters. Remove the filters from the blower compartment, take them outdoors and direct the air blast from the tire pump through the openings in the thin sheet-metal retainer. Only a light air blast is permissible, as otherwise you may damage the filtering material. When replacing old or new filters in the furnace, be sure to locate them with the correct face up, as indicated by arrows on the ends. It should be understood, of course, that the method of cleaning described above is not a recommended season-to-season procedure.



MARFAK MADE HIS CAR RIDE SO CUSHIONY HE'S SPOILED

Marfak chassis lubrication protects the chassis against wear and friction — far longer! It resists squeeze-out and wash-out — sticks to vital points for 1,000 miles or more. So you get a wonderful “cushiony” ride! Get *Marfak* lubrication today. See your Texaco Dealer, *the best friend your car ever had.*



THE TEXAS COMPANY
TEXACO DEALERS IN ALL 48 STATES

Texaco Products are also distributed in Canada and in Latin America

TUNE IN... TEXACO STAR THEATER starring MILTON BERLE on TV every Tuesday night. See newspaper for time and station.

NEW!

Klean-Strip Remover Peels Off Paint



Throw away messy, dangerous solvents! Klean-Strip, the new-type remover, needs no

after-wash, will neither burn nor explode. Just apply with brush, or spray gun . . . then slide off the loose film. That's all there is to it!

Klean-Strip actually breaks the bond between wood or metal and the finish you want to remove. Peels off any paint, enamel, varnish, synthetic or lacquer. Works fast, leaves the surface clean, smooth and dry, ready for a perfect refinish job.

The next time you buy paint, get a can of Klean-Strip, too! Available at better paint, hardware, and department stores everywhere.

W. M. BARR & CO.
2354 S. Lauderdale
Memphis, Tenn.

Clean · No-Wash
Non-Inflammable



SIMPLE DESIGN
and FEWER PARTS
MEAN TROUBLE FREE
PERFORMANCE!



For lasting satisfaction you can't beat a Bendix* Coaster Brake. Built to give you quicker stops—easier pedaling and longer coasting—it's the outstanding performer in its field. Your bicycle dealer will put on the brake you want—so just say "Bendix Coaster Brake." *REG. U. S. PAT. OFF.

DOUBLE THE FUN
WITH A **Bendix**
COASTER BRAKE

Ride
a Bike
- it's
Fun!

ECLIPSE MACHINE DIVISION of
Elmira, New York



Idaho recently started flying over trout streams just before the fishing season opens. Overanxious anglers are spotted and reported to ground patrols. Next step: justice of the peace.

Another government service that has found use for the airplane in the West is the Department of the Interior. Pilot Marvin Wolfe of the department, who used to fly the "hump" in the China-Burma-India theater of war, has become one of the West's leading coyote killers.

He flies over areas of Nevada, Idaho and Oregon, where there are no fur-bearing animals except coyotes. First he drops tempting chunks of beef, then he circles back and scatters strychnine pills around the meat. When the coyotes get a scent of the meat, they head for it on the double, pausing only to lap up the tasty looking pills. Sometimes they can stagger to the beef, sometimes they die before they get there.

Many coyote hunters, however, still get the livestock killers by flying low over them, and blasting away with a shotgun. Hunters also make extensive use of planes in flying into elk and deer country.

In the Clearwater area of northern Idaho, which offers the world's best elk hunting, pilots often have to buzz a mountain air strip to clear it of elk before landing.

Western fishermen, too, make good use of planes to reach isolated lakes and streams. In the Primitive Area of Idaho, planes are virtually a necessity. Many of the waters had to be stocked by dropping fingerlings from the air, and now it takes a plane to go after the grown-up products.

One of the West's most ardent air-traveling fishermen is Bob Savaria, operator of the airport at Hailey, Idaho. He can land anywhere—if there are fish to be had.

Someone asked him if that kind of fishing weren't dangerous, and he nodded.

"Yes," he said, "I flew into the Sulphur Creek area on a fishing trip and came near losing my life. A salmon I caught bit me, and it took a quart of sulfa pills and a battery of penicillin injections to check the poisoning."

Squeezing Water From Coal

Now generally wasted, Wyoming's slack coal may prove more profitable than raw coal for export in briquet form. A new process developed at the state university dries about one fourth of the weight from Wyoming's high-moisture-content coals, increasing its fuel value up to 25 percent. A study is underway to determine whether it is commercially practical to set up drying and briquetting plants in the state.

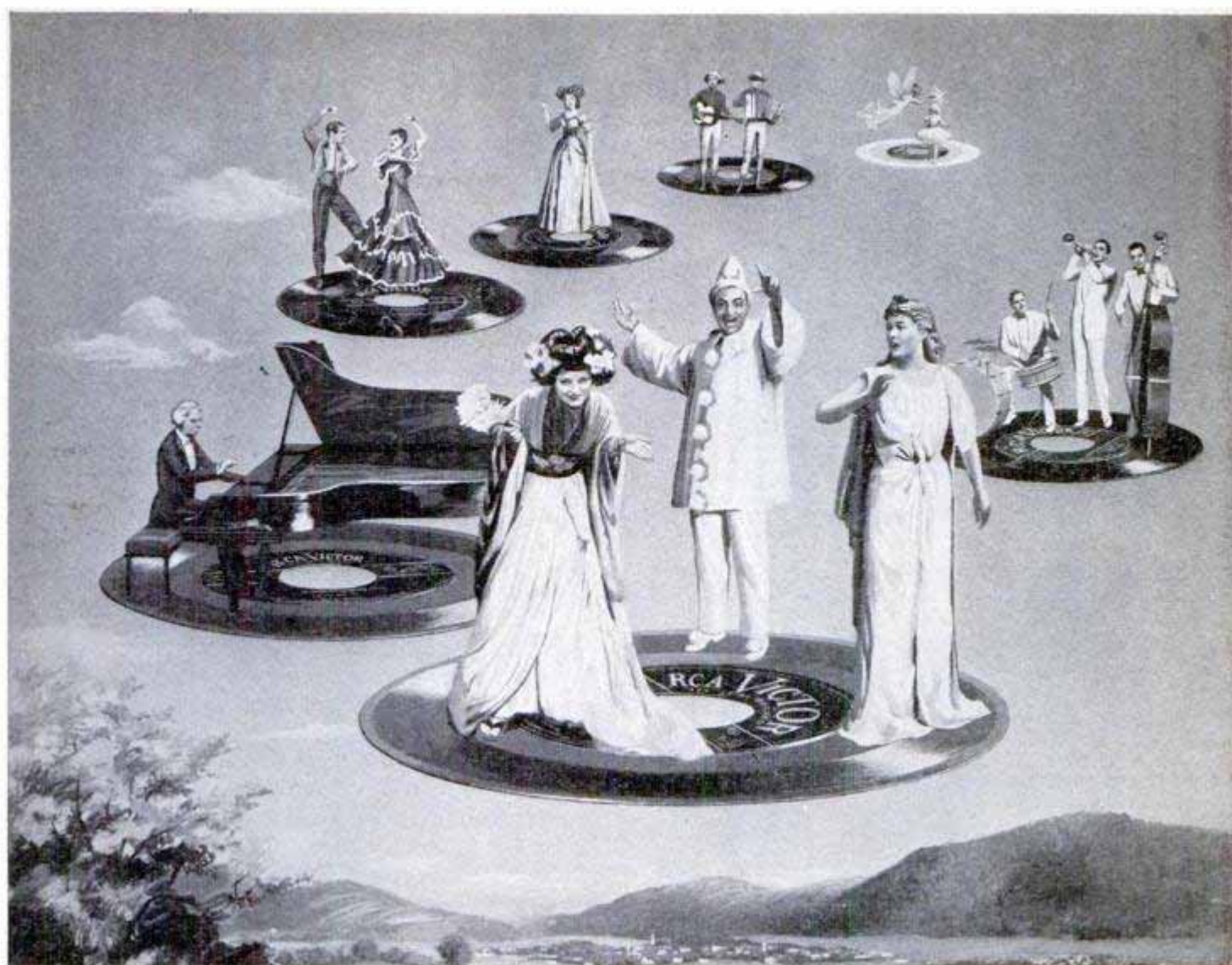

Music's immortals play again, sing again, in RCA Victor's "Treasury of Immortal Performances"

A treasury of Music's Immortals

Now artists whose names are musical legend live again for the modern listener. You can hear them, at their finest, in RCA Victor's "Treasury of Immortal Performances."

In recreating these performances on both 33 and 45 rpm, acoustical engineers drew on a vault of master records guarded for posterity by RCA Victor. But new electronic techniques, developed through RCA research, give the new records a richness and

quality of sound far surpassing that of the originals.

Because RCA Victor could draw on so vast a storehouse, there is something in the "Treasury of Immortal Performances" for every listener. Caruso sings light and serious music—as do Schumann-Heink, Mary Garden, and others . . . Paderewski is here . . . and, if your taste is for popular music, such greats as Berigan, Armstrong, Waller, in rare early records.

* * *

See the latest wonders of radio, television, and electronics at RCA Exhibition Hall, 36 West 49th St., N. Y. Admission is free. Radio Corporation of America, Radio City, New York 20, N. Y.



The magic of RCA Victor's "45" system—as an independent unit, or combined with radio or television—has led 55 record-makers to adopt it.



RADIO CORPORATION of AMERICA

World Leader in Radio — First in Television

BUILD A BUNKROOM



REMODEL THE ATTIC

with
the
**WESTERN
PINES***

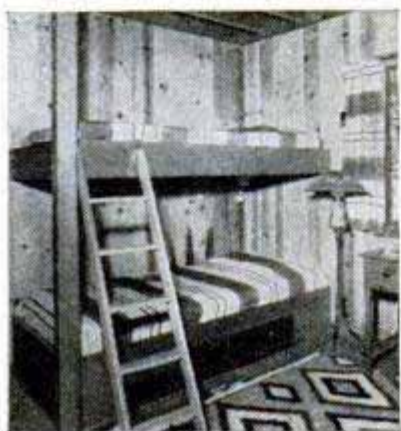

Rugged, he-man quarters for your young buckeroos are a cinch to build with colorful, easy-to-work Western Pines*. Or turn an idle attic into a cozy and hospitable guest room by building double-deck beds of these attractive, economical woods.

The smooth textures and straight, even grain of the woods of the Western Pines*—the wonderful way they grip paint, stain or wax—make them a joy to use on any workshop project. Cabinets, bookcases, tables, built-in fixtures for kitchens or rumpus rooms take on beauty and character from these glowing woods. They have long been favorites with home craftsmen who take pride in turning out a variety of useful and attractive home furnishings.

SEND FOR FREE IDEA PACKET No. 309!

Shows you how, with a little planning and ingenuity, you can work wonders all through your home with the versatile Western Pines*—and have fun doing it. Contains new, colorful illustrated booklet, "Enchanting Homes of Western Pines," "Bunk Bedroom Details," "How to Treat Knotty Pine Paneled Walls," etc. Write to Western Pine Association, Dept. 309-N, Yeon Bldg., Portland 4, Oregon.

These are the Western Pines

* IDAHO WHITE PINE
* PONDEROSA PINE
* SUGAR PINE

Atom Power Goes Into Gear

(Continued from page 83)

roomier crew accommodations and more elaborate sound and radar equipment.

To top it all, her atomic engine is expected to run so quietly that enemy electronic ears will not, in most cases, be able to hear her. Even if they do, her fantastic underwater speed will carry her safely out of danger before an enemy ship could turn around.

Even more intriguing than the atomic submarine, but also more complicated, is the idea of an airplane with a nuclear-driven power plant. It could fly nonstop around the world at supersonic speeds, ride out any bad-weather traffic stacked over an airport and would never be subject to a power failure on take-off or landing. For the past several years, at Oak Ridge, Tenn., the NEAP (Nuclear Energy for Aircraft Propulsion) division of the Fairchild Corporation, prime contractors for the Air Force's atomic program, has been busy designing possible nuclear-powered aircraft engines—including engines for the rocket that may one day overcome the earth's gravitational force and break away into space.

How the atomic reactor can be adapted to different types of aircraft engines is revealed briefly by Andrew Kalitinsky, chief of NEAP. All are thermal power plants, which means that the heat of the reactor is turned into the energy that drives the plant.

In the turboprop, the nuclear reactor heats steam, or mercury, in a pipe system that forms a closed loop between the reactor and the turbine. The violently heated vapor in the pipe expands rapidly through the turbine which, in turn, drives the propeller. The hot vapor, having passed through the turbine blades, then moves through an air-cooled condenser which cools it down. Pumps push it on through the system and back into the reactor again. Round and round it goes as it drives the propeller faster and faster.

"Since this plant requires the use of propeller and air-cooled condenser," Kalitinsky points out, "it will evidently limit the speed of the plane in which it is used." At that, it would probably move faster than anything with propellers today.

Less pokey would be the nuclear-driven turbojet. In this adaptation, the reactor simply replaces the combustion chamber of the standard turbojet. An auxiliary motor starts the forward turbine compressing air into the engine housing where it is forced through the reactor. Here the

(Continued to page 236)

*The more you delay -
the more you pay!*

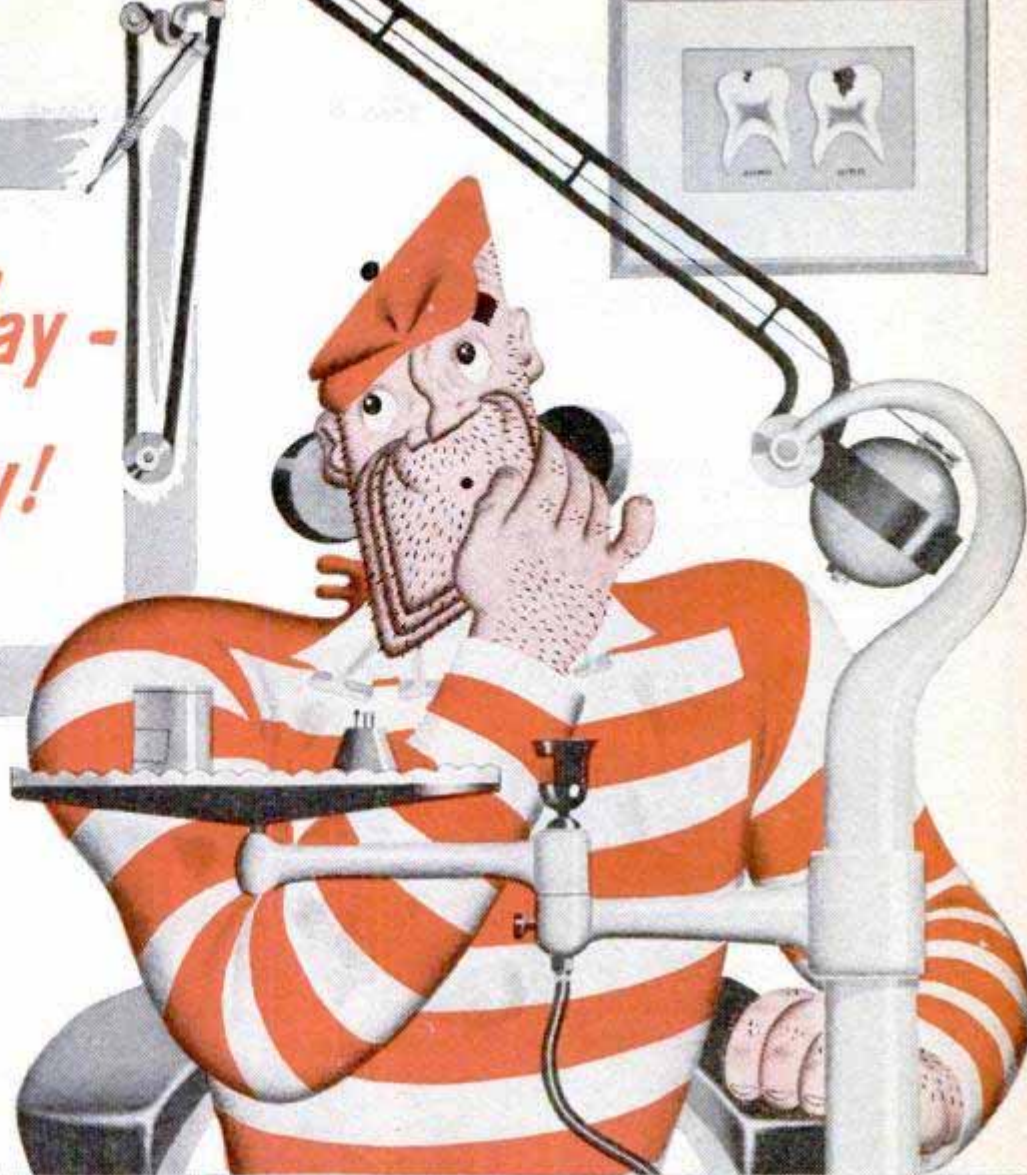

**KEEP YOUR CAR
OUT OF THE
DANGER ZONE**

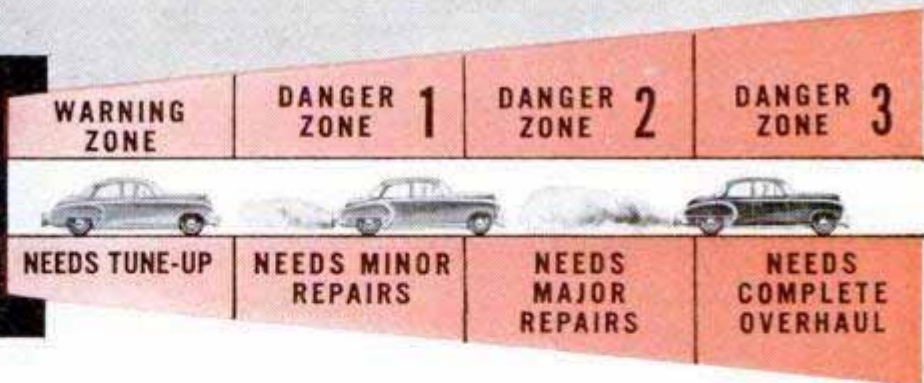

Watch out for oil-pumping. Usually it means your piston rings are worn. And you're headed for costly Danger Zone 3.

See your motor specialist at once. He'll show you how to get out and stay out of the Danger Zone. He'll show you that replacing piston rings early is relatively

inexpensive — but the more you delay, the more you pay.

Replace worn-out rings with Hastings Piston Rings and you stop oil-pumping, check cylinder wear, restore engine performance. It's the best money you can spend on your car.

HASTINGS MANUFACTURING CO., HASTINGS, MICHIGAN • HASTINGS LTD., TORONTO

HASTINGS

STEEL-VENT PISTON RINGS

FREE! Danger Zone Booklet. It shows you how to save money on engine repairs. Write to Dept. P.



**SEND
FOR IT!**

1951 ALLIED RADIO & TV CATALOG

free!

**COMPLETE
UP-TO-DATE
EVERYTHING
IN RADIO & TV
AT LOWEST
PRICES!**



**212 PAGES
OF VALUES**

**Everything for
Experimenters, Builders,
Amateurs, Servicemen,
Engineers and Soundmen..**

Save money on every Radio and TV need! Get the big 212-page 1951 ALLIED Catalog featuring the world's largest stocks of top-quality equipment at low, money-saving prices! See the latest TV releases, home radios, radio-phonos, Amateur equipment, P.A. systems and Hi-Fidelity Custom Sound, recorders, test instruments, builders' kits—plus thousands of parts, tools, books and diagrams. Get more for your money from the World's Largest Radio Supply House. Send today for your **FREE 1951 ALLIED Catalog!**



**TV, HOME RADIOS
& RADIO-PHONOS**



**SERVICE SUPPLIES
BUILDERS' SUPPLIES**



AMATEUR GEAR



**P.A. SYSTEMS
RECORDERS**

**free
CATALOG
Send For It!**

ALLIED RADIO

**ALLIED RADIO CORP., Dept. 5-E-1
833 W. Jackson Blvd., Chicago 7, Ill.**

Rush **FREE 212-Page Catalog No. 126**

Name _____

Address _____

City _____ Zone _____ State _____

air is raised to incredible heat, expands violently and drives itself on through the rear turbine, which is connected to the forward one by an axle. Now the rear turbine picks up speed, turning the forward one with it, and taking over the work of compressing more air in the front. Finally, the hot air whooshes out of the jet nozzle in the rear, creating tremendous thrust. The upper limits of speed for a plane using such an infernal machine are anyone's guess. As Kalitinsky explains, the whole thing simply works on air, which is heated and expanded in the reactor — by convection, instead of by fuel combustion.

Similar in principle, but simplest of all is the atomic-ramjet design, which also works on expansion of air. Air enters the diffuser and is compressed by the forward motion of the plane (the plane must be going several hundred miles per hour before it will start working efficiently). Instead of supplying oxygen for the combustion of fuel in the firing chamber, as it does in today's ramjet, the air passes through the reactor, is heated and expanded, and explodes violently out the rear, shoving the plane forward at supersonic speeds.

Oddly enough, the nuclear rocket, if it is ever built, will have to use a combustible fuel — like liquid hydrogen, otherwise it couldn't operate outside the earth's atmosphere. The hydrogen would be pumped out of a tank, down through the reactor, where it would burn violently and expand out through the exhaust nozzle, driving the rocket upward. Such a nuclear rocket would have about three times the oomph of any rocket leaving the ranges today.

All these engines look fine on paper. But so far, atomic piles consist of a huge stack of graphite blocks, honeycombed with holes for uranium rods and control rods of boron or cadmium. All this is surrounded by layers of lead, graphite and concrete to the tune of about eight feet. How do you install that in an airplane? The answer is, you don't.

Materials-testing piles already have turned up effective shieldings of very dense materials that cut down the bulk and weight. "The first plane," says one top-flight scientist in the atomic-energy program, "will be a military one—not commercial. Hence, it can be parked in an isolated spot where some radiation might escape harmlessly. Crews may be protected from gamma rays by simple shielding across the fuselage." Such a shield might fit around the reactor like a tin can with its rear end left open. Radiations out the back would harm no one. Other shielding, encircling the crew, would have to absorb

(Continued to page 238)

**BECAUSE THEY ARE
ALL ONE PIECE—
G-E "All-Glass"
HEADLAMPS**

**DO NOT
GROW
DIM!**

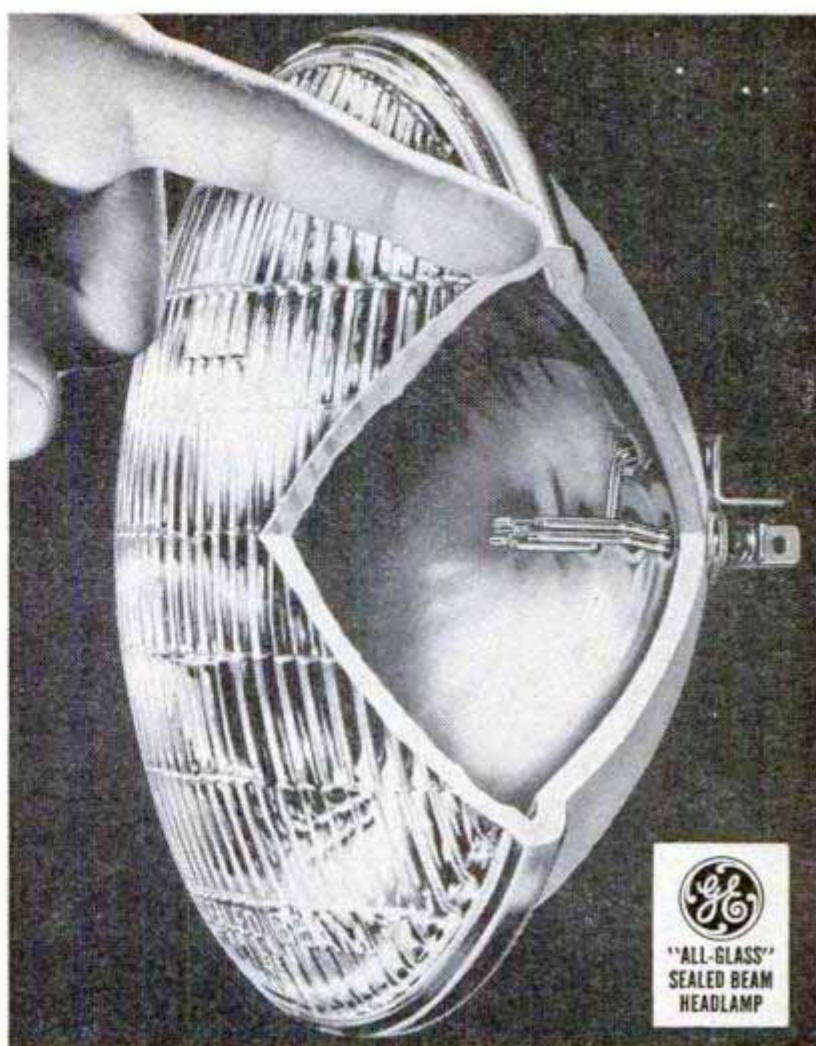

**DIRT AND MOISTURE CAN'T GET IN
TO REDUCE LIGHT OUTPUT**

THE cutaway view above reveals one big reason why General Electric "All-Glass" headlamps do not grow dim. Lens and reflector are *one piece*, with filaments firmly anchored in the reflector, making the whole lamp one unit. Because it's a single unit, dirt and moisture can't get in to dull the reflector.

"All-Glass" headlamps give more light, right from the start. And they continue to give more. Tests show they average 99% as much light at end of lamp life as when new. New or old, G-E "All-Glass" headlamps help make your night driving safer and more comfortable.

Get ready for Summer driving by checking your lamps now. And be sure to ask for General Electric headlamps by name if you need a replacement.

**HERE'S HOW TO PLAY SAFE
WHEN YOU BUY SEALED-BEAMS**



1. FEEL THE SEAL

There is no seam where glass reflector and glass lens are fused into one piece. Dirt and moisture can't get in.

2. SEE THE G-E

It's on the back of the headlamp near the top. It's your assurance that your headlamps **WILL NOT GROW DIM.**



You can put your confidence in—

GENERAL  ELECTRIC



...with these
Wizards with Wood

Mending something that needs gluing? Making something that needs finishing? If it's made of wood, ask for Firzite, Satinlac and Weldwood Glue at hardware, paint and lumber dealers—or mail coupon for leaflets.

Glue That's Stronger than Wood



To make things or fix things, use Weldwood Glue for all wood-to-wood bonds. Makes joints stronger than the wood itself. Mixes easily with water. Stain-free, rot-proof... highly water-resistant!

WELDWOOD®
PLASTIC RESIN GLUE

A MUST for Finishing Fir Plywood



Tame that wild grain with FIRZITE. Virtually prevents grain raise or checking... readies the surface satin-smooth for paint, stain or enamel. (For blond, pickled, or tinted effects on soft or hard woods, use White Firzite).

FIRZITE*

Newer than Shellac or Varnish



For "natural wood" finishes on furniture, panelling or woodwork, there's nothing like Satinlac. Brings out natural grain and color beauty of any plywood or solid wood. Avoids that "built-up" look; will not turn yellow or darken with age. "Water-clear," easy to brush or spray, dries ready for next coat in 2 or 3 hours.

SATINLAC*

*Trade Marks

United States Plywood Corporation,
Dept. 252, 55 West 44th St., New York 18, N. Y.
Send me free leaflets on Weldwood Glue, Firzite and Satinlac.

NAME _____

ADDRESS _____

neutrons. Every effort will be made to reduce weight.

What man has been able to do with one tiny type of uranium atom doesn't release more than $\frac{1}{1000}$ of the energy in that atom. Inside a working reactor, relatively few atoms of unstable U-235 are knocked apart by flying particles (neutrons). Each time a neutron splits an atom, the two halves of the atom fly apart, bump and jostle other atoms and create heat. Meantime, two or three neutrons from the split atom are freed. One may fly off to split other atoms and keep the chain going. The others may bury themselves in the shielding or be absorbed by the control rods or other working parts of the pile.

So far, the only latent power in the whole process that scientists know how to use is the heat from those atomic collisions. Some men feel sure that electricity will some day be produced directly from the fission process, but as yet there's no practical way of doing it.

It all sounds pretty feeble until you know that the tiny bit of heat energy released from one pound of fissioning U-235 is equal to the heat energy produced by 2,600,000 pounds of coal, or 360,000 gallons of gasoline.

That's the heat that will be used to drive the atomic submarine and airplane. It also will be used at Harwell, England, to convert atomic energy into electricity. Some kind of heat-transfer agent—probably one of the liquid metals—will run through the pile and pick up heat, then return to a boiler where it will turn water into steam which will generate electricity.

In all probability, Harwell will have its own refining plant to process raw uranium and extract U-235. Processing plants for the by-products of fission—like isotopes—and reprocessing plants for atomic fuels, may also be close at hand. Radioactive wastes may have to be held in huge underground tanks until radioactivity in them subsides.

All this makes atomic power expensive—one of the reasons why most scientists now estimate 20 years or more before such plants for public power are practical. Recently, the Monsanto Chemical Company discussed plans for a 75,000-kilowatt atomic-power plant at an estimated \$25,000,000, against \$10,000,000 for a comparable coal plant. No one will say for sure what the operating costs would be—but someone has estimated it as about the same as a coal plant, if coal were \$10 a ton.

Cost isn't the only fly in the atomic ointment. Suitable materials for building power units still are a headache. Nuclear

(Continued to page 240)

Buy **CRAFTSMAN** .. REG. U. S. PAT. OFF. America's most dependable low- cost Drill Press!

Outstanding for its Industrial Accuracy!

CRAFTSMAN Drill Presses are famous for their precision-built dependability and amazing lower cost. The only industrial-type drill presses we know of with ALL these features . . . **at anywhere NEAR these low prices!** New, finer Jacobs Safe-Lock key-chuck can't fly off spindle regardless of speed or load; 1/2-in. capacity; No. 33 taper. Precision ball bearings; *lubricated for life!* Longer lasting spiral "Perma-Coil" quill-return-spring. Pre-loaded bearings reduce spindle end-play. 4-in. spindle travel; 11 speeds. See them at (or call) your nearest Sears Retail Store TODAY! Or write Dept. 609, Sears, Roebuck and Co., Chicago 7, Illinois.

** Prices slightly higher south of the Ohio and west of the Mississippi rivers.*



CRAFTSMAN "100" Bench Model
\$8250*
Cash
Without motor
Only \$8.50 Down
on Easy Terms

CRAFTSMAN "100" Floor Model
\$9250*
Cash
Without motor
Only \$9.50 Down

Drills to center
of 15-in. circle

CRAFTSMAN flexibility makes possible dozens of operations like these!



Typical gang drill press set-up for tapping. CRAFTSMAN flexibility can save you money in hundreds of similar industrial applications like this!

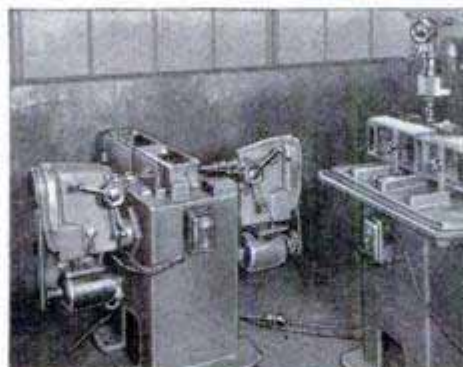

Another example of CRAFTSMAN utility . . . two CRAFTSMAN drill press heads used horizontally in special set-up for production-line side drilling

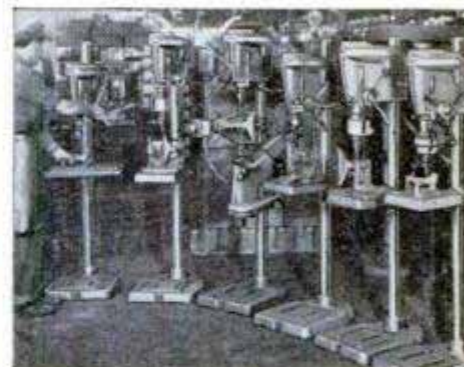

CRAFTSMAN drill press battery set-up for progressive drilling, tapping. Versatility like this can cut costs for dozens of your own operations.

CRAFTSMAN Hand and Power Tools by **SEARS, ROEBUCK and CO.**
REG. U. S. PAT. OFF.
Famous for fine quality . . . precision performance . . . low price!

YOU CAN TELL A GOOD ELECTRIC DRILL BY ITS CHUCK



JACOBS

If it's a JACOBS
It bears the name... look for it!

Jacobs Rubber-Flex Hand-Tite Chuck. One-piece RUBBER-FLEX jaw assembly holds tools true and tight. No loose jaws or springs.

Jacobs Plain Bearing Key Chucks... the most widely used drill chuck in the world.



Jacobs Rubber-Flex Hex-Key Chucks on home workshop power tools prove that their makers put quality first.

IF IT'S A

JACOBS

IT HOLDS

The Jacobs Manufacturing Company
West Hartford 10, Connecticut

piles aren't like high-temperature engines in which you just look for a harder or tougher steel. Fissioning atoms do queer things to most materials. Nitrogen comes out carbon; gold turns into mercury; sodium becomes magnesium; platinum turns into gold; glass comes out phosphorus.

"How would you like," Doctor Hafstad asked a group of airplane manufacturers recently, "to try to design aluminum plane engines which, during use, would slowly turn to cast iron or lead?" That's the kind of thing that happens in a pile.

A brand new reactor at Brookhaven, as well as the one now building at Arco, will be used to test materials and find just which ones will stay put under nuclear bombardment. When they are found, most of the structural problems in atomic-fueled engines will be solved.

But there's another roadblock if we're to have useful atomic power on a large scale. Fuel. Though uranium is plentiful, much of it is scattered all over the world in quantities so minute no miner in his right mind would bother to work it. There's plenty for present plans, but if we started to electrify the United States with all known get-at-able world uranium reserves, we'd only have enough to last a few years. Worse, all uranium isn't fissionable—only U-235, which amounts to about one part in 140 in pure uranium ore. The rest is U-238, which won't fission.

But in the early days of atomics, scientists discovered something: When U-238 was put in a reactor and bombarded, it changed, like many other things. Only this time the change was welcome. It became plutonium—which does fission. Since then, they've discovered another substance that does the same thing—thorium, which is vastly more plentiful than uranium. What's more, the physicists believe that U-235 will make twice its own weight in both other products. And, once U-238 or thorium are made fissionable, they, in turn, can be used to make more and more of themselves. It's something like compound interest and, in fact, the new pile devoted to this atomic-fuel "breeding" experiment, at Arco, is known as "Operation Bootstrap." If it works, our atomic-fuel reserves will be increased some 400 times. However, the laborious process of cycling and recycling fissionable materials to squeeze them dry will take years to perfect.

But that isn't so bad, because there will be plenty of interesting things to watch as the atom develops. It won't be an easy development. "Nobody," says Andrew Kalitinsky, "should expect to see an atomic-powered rocket take off for the moon this year or next."

SUMMER AHEAD!
Install

DEPENDABLE
CHAMPION
SPARK PLUGS



CHAMPION SPARK PLUG COMPANY, TOLEDO 1, OHIO

DREMEL HOME AND SHOP TOOLS

GRINDS • CARVES • ENGRAVES
DRILLS • ROUTS • SHARPENS

DREMEL Electric MOTO-TOOL

FASTEST MOST POWERFUL TOOL OF ITS KIND . . . 27,000 R.P.M.

Most practical tool a man can own—more powerful than any similar tool you can buy. Works well in wood, plastics, and metal. For home maintenance jobs you'll wonder how you got along without it. For model making it's a must. And for general shop operations it saves time and money. Compare it, try it, buy it. You be the judge!

Check These Important Features

- Oilless sealed bearings • Dynamically balanced armature • Shockproof, Bakelite housing • Dust-filtered air cooling system • Sturdy 110-120 V., A.C.-D.C. motor • Wt. only 13 oz. • A precision tool widely used in industry for many years.



MOTO-TOOL No. 2
(with 1 emery wheel point)

\$16.50

MOTO-TOOL KIT No. 2
With 23 Accessories
(High-Speed Steel Cutters,
Grinding Wheels, Polishers)

\$23.50



DREMEL Electric COPING SAW

CUTS SCROLLS LIKE MAGIC—SANDS AS IT SAWS

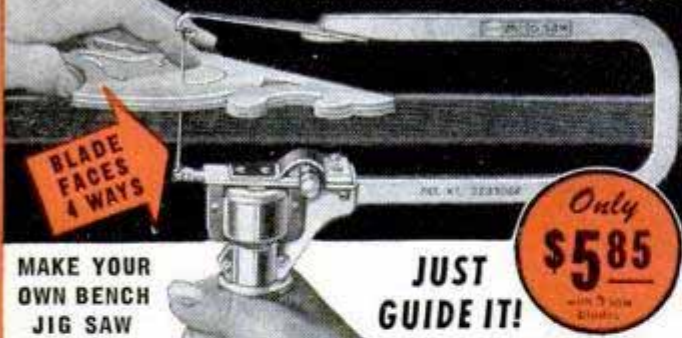

**BLADE
FACES
4 WAYS**

**MAKE YOUR
OWN BENCH
JIG SAW**

**JUST
GUIDE IT!**

**Only
\$5.85**
with 3 saw blades

PLANS FREE!

SAFE! AS A HANDSAW

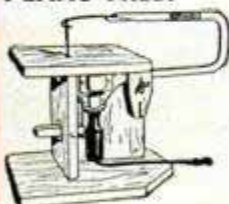

For home, hobby, repair work—no other tool pleases so much for so little cost. Works in any direction—delivers 7,200 strokes per minute smoothly, effortlessly. Saws through 3/4" medium-hard wood at a foot-a-minute speed. Touch-of-the-trigger, foolproof action. Only 2 moving parts, never needs oiling. Uses 110-120 v., A.C. Free plans, packed with each saw, for six useful woodworking projects and for making your own jig saw.

WHERE TO BUY DREMEL TOOLS. Dremel Tools are sold everywhere. If your dealer cannot supply you, send remittance in full and we will ship postpaid. Or send only \$2, and pay postman balance plus postage and fee. Money back if not delighted after 5 days' trial.

DREMEL MFG. CO.
Dept. 111-E Racine, Wis.



Quick, Watson, The Micromanipulator!

(Continued from page 77)

of brown glass embedded in a shoe were identical with other glass fragments found on the rungs of a ladder. All the glass samples appeared to be identical and he wondered if they had the same density.

He prepared a gradient solution from methylene iodide and other heavy transparent liquids and poured it into a pair of tall glass tubes. The mixture is lightweight at the top and increases in weight or density toward the bottom. Anything that is placed in the solution will fall until it reaches liquid of exactly its own density, and there it will stay. Provided, of course, that its own density is within the limits of the precise solution that is used.

When Doctor Kirk dropped his fragments of brown glass into the two tubes he found that the glass particles came to rest at different levels. They were not of the same density and hence they could not establish the link that he was seeking between the shoes and the ladder.

The gradient tubes have proved to have scores of uses. They can "fingerprint" many kinds of materials. A sample of earth, for instance, will sink for a distance in a tube and then separate into several bands of material. Yet not one of a thousand other samples of earth that are taken from different locations will produce the same spectrum of bands. The gradient tubes have helped prove that a suspect actually was at the scene of a crime in spite of his denial, by showing that earth from his shoes and earth from the scene were precisely the same. The tubes produce rapid, positive results and for many purposes can do as good a job as equipment that costs thousands of dollars.

Instead of tediously measuring angles and lengths when comparing samples of penmanship or typewritten material in a case that involves the comparison of documents, Doctor Kirk uses a simple glass-covered box that contains fluorescent tubes. He lays one document on top of the other and places them on the glass top. The light that is transmitted through the papers allows a fast, accurate comparison of the symbols on each.

To read a message that he suspected had been written on one document and then erased, he made a cast of the paper surface with transparent plastic that he had warmed until it would flow into every indentation. When he held the plastic up to the light, later, the diffraction lines of the

(Continued to page 244)

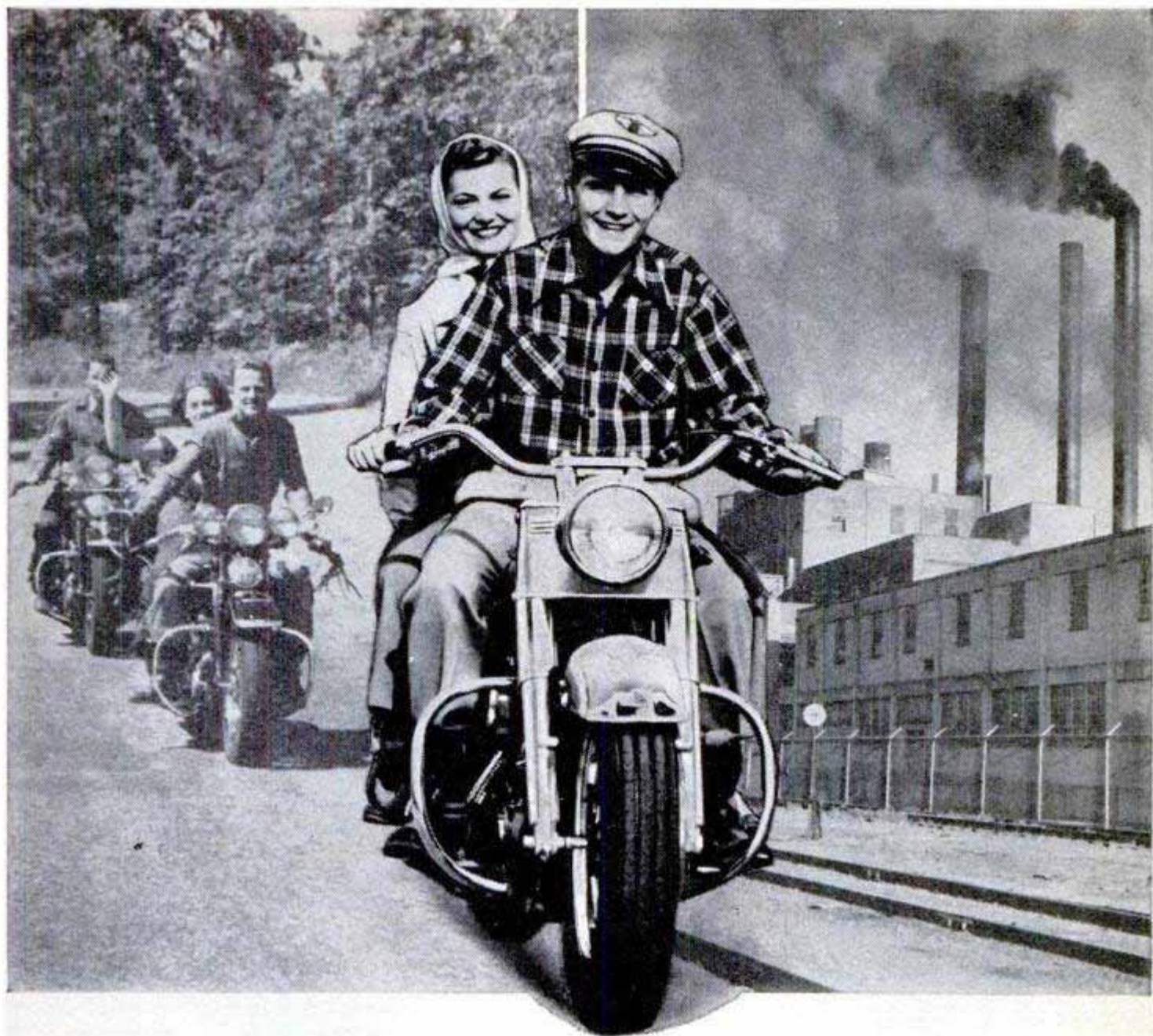

SPORT AND TRANSPORTATION ... at a saving

WHETHER you're heading for good times or going to work, get there faster, more enjoyably and at less cost... on a Harley-Davidson Hydra-Glide. Swift and smooth for long distance travel. Safe and easy to handle in city traffic. Amazingly comfortable even on roughest roads. And so thrillingly power-packed and responsive you'll think you're riding a "Flying Saucer"! Small down payment, convenient terms. Phone or see your dealer. Mail the coupon now.

HARLEY-DAVIDSON

HYDRA-GLIDE®

DEALERS WANTED: A few franchises available for the full line of famous Big Twins and the 125 Model. Write today.



HARLEY-DAVIDSON MOTOR CO.
Dept. P, Milwaukee 1, Wisconsin

Send me free copy of ENTHUSIAST Magazine filled with motorcycle action pictures and stories; also literature on latest models.

Name.....

Address.....

City..... State.....



the plane with the Golden Cutter*

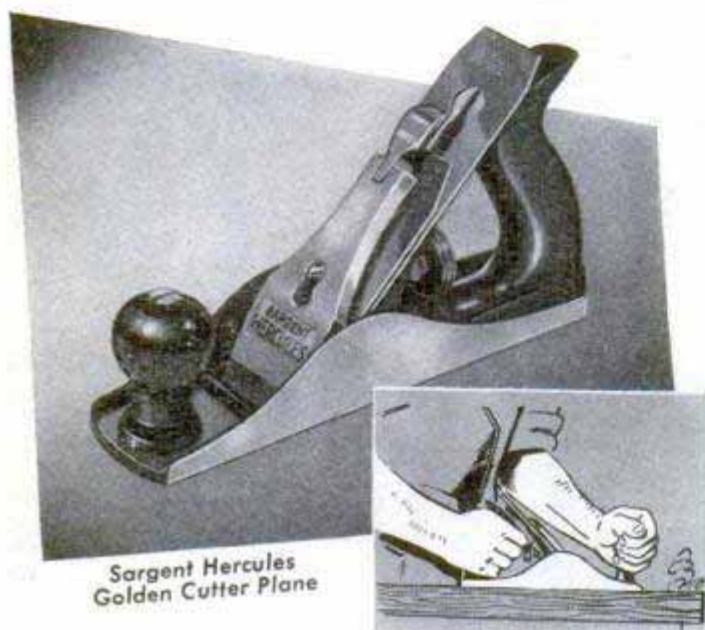

Sargent Hercules
Golden Cutter Plane

— never before such a blade

in a professional plane at a popular price.

*Precision honed from vanadium tool steel.

The Sargent Hercules Plane has a large brass nut for easy adjusting to cut paper-thin or coarse shavings. Steel spring under clamp toggle for firm seat. Knob and easy grip handle are second growth hardwood. Precision machined frog, bed and throat prevent chatter. Fully guaranteed.

Next time you pause at a tool display, check up on the 12 certified advantages of this fine tool.

A better tool by —



Sargent and Company

New York, New Haven, Conn., Chicago

Builders Hardware and Fine Tools since 1864

material outlined every letter of the message that was invisible on the paper itself.

Another document that Doctor Kirk examined seemed to have an erased area but he was unable to read any message that might have been written there. Test after test failed. Possibly the writing had been done with an indelible pencil, he speculated, and thought of a new test.

With a nebulizer, a sort of refined atomizer, he spread a fog of alcohol over the paper. At once, legible traces of writing popped up like magic. His theory had been correct. An indelible pencil had been used and numerous grains of the indelible material had been retained in the paper at the time the writing had been erased. The alcohol spread the dye of these grains and now the writing was clearly visible.

There are all sorts of chemical "erasers" that can remove writing, and there are all sorts of ways to restore what a chemical has obliterated. Most inks contain iron and a message that is written in such an ink can be completely wiped out with ordinary kitchen or laundry bleach. Not a trace remains to the eye, but if the paper is exposed to the vapors of ammonium sulphide you'll find that the message pops back into sight again, as legible as ever.

Once when he was seeking a positive way of collecting a tiny smear of dried blood from the front of an automobile, Doctor Kirk placed a strip of filter paper over the smear and kept it moist. The blood dissolved and then collected in a band on the filter paper, ready to be taken to the laboratory for typing. The method was simple and it worked. It can collect blood from earth, leaves, or almost any material.

Today, Doctor Kirk is working on a couple of other gadgets that will further simplify the task of collecting and studying evidence that is associated with crime. And, not to change the subject, he's also turning over in his mind a new idea in biochemistry: the possibility of making a chemical analysis of a single cell. This would require a "super" ultramicro technique and would be a revolutionary development. He's positive that it can be done.

Plastic Insole Protects Feet

Providing an air space between the sock and the sole of the shoe, a plastic-mesh insole used by American and British soldiers keeps feet dry, thus helping to prevent frostbite and infections like athlete's foot. Made of several layers of woven-plastic fibers, the insole slips inside the shoe. The air space allows the soles of the feet to dry by evaporation, keeping socks dry during long marches.

A Real Lumber Cutter! For Home or Shop!

**PARKER-ALLEN
HEAVY DUTY**

3 IN 1 BENCH SAW

**HALF the PRICE
YOU WOULD EXPECT TO PAY**

\$12.95
LESS MOTOR

**RUST PROOF
CHROME-MOLY
STEEL BLADE**
CROSS CUTS
MITERS
RIPS

CUTS 2 x 4's IN A JIFFY
Cuts Rafters, Joists, Frames
—Large Work
or Small!

**STURDY HEAVY-GAUGE
ALL STEEL
CONSTRUCTION**

• **RUST PROOF**

Self-Adjusting
**SAFETY
GUARD**

**LIFETIME
PULLEY
FOR "V" BELT
DRIVE**



**SAFETY GUIDE
PROTECTS HANDS**
ACCURATELY
MACHINED
MITER GAUGE
★ **RIP FENCE
LOCKS AT BOTH
FRONT & REAR**

**13 1/2 x 12 1/2 IN.
TABLE TOP**

SAVES TIME
MONEY
ENERGY

- ★ CUTS ANY LENGTH
- ★ CUTS ANY WIDTH
- ★ CUTS ANY ANGLE

**STURDY STEEL
BASE BOLTS TO
WORK BENCH**

**CUTS SOFT OR
HARD WOOD
WITH EASE!**
• **RIP FENCE AND
MITER GAUGE
ADJUSTABLE**

MONEY BACK GUARANTEE

Your money will be refunded immediately if this "3-in-1" Bench Saw does not satisfy you completely and if returned within ten days. Guaranteed 1 year against defects in material and workmanship.

SAWS EASIER, FASTER, MORE ACCURATELY!

Precision built, sturdily constructed, 16-gauge steel top. Self-lubricating bearings. All purpose 6-inch, rust proof blade. Works dandy on a 1/4 or 1/3 H.P. motor or even runs on a washing machine motor.

MOST AMAZING POWER TOOL BARGAIN EVER OFFERED!

Yes, amazing but TRUE! You would never dream you could get such a rugged, quality built, powerful Bench Saw at this Sensational Low Price! Don't delay—order yours now!

Jobber and Dealer Inquiries Invited!

PARKER-ALLEN INDUSTRIES

325 W. HURON STREET, CHICAGO 10, ILLINOIS

MAIL THIS COUPON TODAY!

Parker-Allen Ind., Dept. BSP, 325 W. Huron, Chicago 10, Ill.
Please ship at once..... Bench Saws (without motor)
(quantity)
on a 10-day money back trial offer at \$12.95 each. You save
postage and C.O.D. charges by sending check or money-
order with order. (Add 26c Sales Tax if in Illinois).

NAME.....

ADDRESS.....

CITY..... ZONE..... STATE.....

Check enclosed Money-Order enclosed C.O.D.

For **SMOOTHER
MOTORING**

**INSIST ON
BOWES**



**DEPENDABLE
SPARK
PLUGS**

*Here's
Why -*



★ **Every Bowes Plug is Individually Tested**—tested at higher voltage than is ever encountered in your car.

★ **Oversize Special Alloy Electrode . . .** welded construction assures positive connection.

★ **Extra Large Ground Electrode** assures longer life for plug.

★ **Husky Aluminum Oxide Type Insulator** assures against porosity—sure proof against shorting.

★ **One-Piece, Leak-Proof Construction.**

★ **Patented Engine Gasket Retainer Ring** assures better contact and better heat transfer.

BOWES PLUGS
are tailored to **YOUR car's motor**

If your favorite SERVICE STATION does not handle Bowes Spark Plugs, write us direct for further information.

BOWES "SEAL FAST" CORPORATION
INDIANAPOLIS 7, INDIANA

Now They're Forecasting Tornadoes

(Continued from page 141)

The Oklahoma researchers determined, also, that lightning strikes with greater frequency during a tornado. One witness, a pilot who had seen two tornadoes and many thunderstorms from the air, said lightning comes from a tornado cloud "just one stroke after another."

Such reports led Doctor Jones and his assistants to believe that electrical discharges from tornado clouds might be identified.

"We figured that the energy in a tornado-type cumulus cloud would be considerably greater than that in a cloud from which a thunderstorm develops," Doctor Jones says. "The energy necessary to produce the initial whirl, and to permit the development of the funnel, had to be enormous. This suggested more frequent lightning and more voltage in each discharge."

After a comprehensive study of lightning-wave patterns, the research team set up an observation station at the Stillwater airport, away from electrical interferences in the city. There they installed an antenna which would pick up discharges from all storms within a range of 150 to 200 miles and relay them to an oscilloscope, which portrays electric currents as jagged lines on a television screen.

With each lightning discharge picked up by the antenna, three things happened simultaneously: (1) The lightning showed up as a saw-toothed line of light on the oscilloscope screen; (2) a stroboscopic light flashed on, illuminating the screen and the dial of a clock above it; (3) an automatic camera snapped a picture of the screen and the clock dial. As each flash was photographed, the film moved along automatically and the camera was ready to record the next flash.

Ordinary lightning showed up on the screen as a row of small, sharp teeth. Occasionally, a strikingly different type of lightning was recorded, with teeth much longer and wider, indicating a higher voltage. The team believed this was tornado lightning. When their equipment had taken hundreds of photographs of lightning from every type of storm in the area, they were sure of it.

After each set of pictures was taken, and the type of storm later identified, it was catalogued. Finally, the team had a distinctive lightning-wave pattern that could be positively identified as always associated with tornadic storms.

At 2:45 p.m., April 30, 1949, the camera
(Continued to page 248)

WHAT LASTS FOREVER?



THIS DEAD BLADE still looks new but it blurs rain, smears muck, streaks glass. DEAD blades make dead drivers!

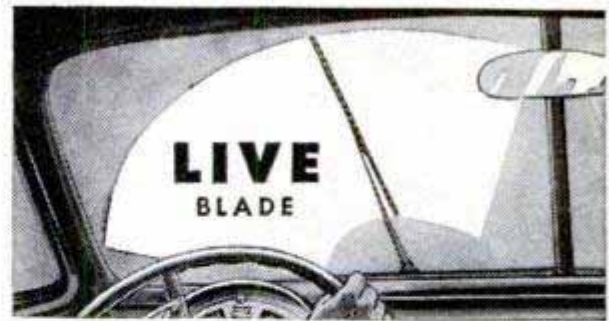

THIS LIVE ANCO BLADE wipes clean, clears rain, clears road muck . . . lets you SEE. Protects your loved ones.

WHAT LASTS FOREVER? Nothing does. This is especially true with Windshield Wiper Blades—even though made of finest natural rubber. Corrosive windshield film, wind burn and hot sun BAKE the life out of wiper blades, often in six months or less. DEAD blades cause dangerous windshield smear. DEAD blades make dead drivers. Make sure your car has live, new windshield wipers.

Change Your Wiper Blades

Next time you buy gas, change to LIVE,

NEW ANCO BLADES . . . RAIN-MASTER for Flat windshields . . . **CLEAR-FLEX** for Flat or Curved windshields. They fit all cars—wipe quicker and cleaner than any other blades.

Mr. Dealer: ANCO Wiper Motors give lots more power, lots less stall. Controlled wiping arc prevents blade slap. Six models only . . . COMPLETE replacement for ALL Cable Linkage, Bar Linkage, and Direct Drive original equipment vacuum wiper motors.

THE ANDERSON COMPANY
GARY, INDIANA

Thompson
BEATS
the World
on BOATS



Better Built
Lower Prices



Canoes



Rowboats



Outboards



Light Boat for Auto

Safe Boats With Full Length Spray Rails
Keep passengers perfectly dry—even at high speeds. Catalog also shows two new models of "Take-Along" Boats. Two big factories—save you freight.

CATALOG FREE
Write for your copy. State kind of boat in which you are interested.

THOMPSON BROS. BOAT MFG. CO. (161)
213 Ann St. PESHTIGO, WIS. 113 Elm St. CORTLAND, N.Y.

Write to (either place)

MODERN LAWN MOWER SHARPENER

FOR LAWN MOWER SHOPS
FIX-IT SHOPS

GOLF COURSES • PARKS
101 OTHER JOBS

Sharpens All Reel Type Mowers • Hand, Power or Gang • 10 to 20 Minutes • No Dismantling • No Extra Attachments Needed.
All reel type mowers, from 5-inch edgers to 36-inch power mowers, are quickly sharpened to extreme ends of both left and right twist blades.

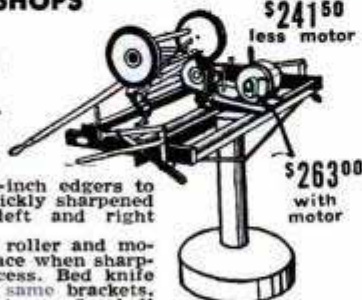

PRICE
\$241.50
less motor

\$263.00
with motor

Handle, wheels, roller and motor remain in place when sharpening is in process. Bed knife is sharpened in same brackets. Grinding head rides on five ball bearing races. Easy to operate. Also sharpens chisels, joiner knives, planer blades. Big profit maker. Own your own business. Send Today for FREE Illustrated Bulletin No. 10-C
Prices Subject To Change Without Notice

ORDER NOW

Immediate Delivery

MODERN MFG. CO. 160 N. FAIR OAKS AVE
PASADENA, CALIFORNIA



Send for this BIG NEW
Hunt's
WOODWORKERS
CATALOG NO. 18

ONLY 15c

NEW LOW PRICES

Offers greatest selection of fine domestic and imported woods—and hundreds of woodworkers items at bargain prices!

You'll save time and money with this big, new catalog. Contains everything wood craftsman needs. Shows 32 rare and fancy woods in color...43 veneer designs...275 scroll patterns...multicolor inlays, overlays, bandings...all kinds of tools, machinery, cabinet hardware, ornaments, mouldings...and pages of valuable tips, ideas, information, instruction. Send for your copy NOW. Only 15c—refundable on your first order.

- 144 PAGES
- **QUICK DELIVERY**
- on maple, poplar, oak, mahogany, red cedar, cherry, walnut, and many others—
- all properly seasoned and kiln dried.

MAIL THIS COUPON--TODAY!

CRAFTSMAN WOOD SERVICE CO.
2729 S. Mary St., Dept. A-5
Chicago 8, Illinois

Send me the big, new, money-saving Catalog No. 18. Enclosed is 15c—refundable on my first order.

Name _____

Address _____

City _____ Zone _____ State _____

YOU DON'T HAVE TO PUSH YOUR CASTS WITH **Actionrod!**

IT'S THE GLASS ROD
WITH LIVE ACTION!

Try *Actionrod* with any weight lure—light or heavy. Just flick the rod forward lightly. Let the power come through—let the tip do the work.

Actionrod is the glass rod with *live* action. It's fast enough to cast your lightest lures, strong enough to handle the heaviest. You don't have to throw the plug... don't have to push your casts.

Pick the *Actionrod* to fit your fishing. Bait casting, spinning and fly rods in solid glass and tubular—starting at only \$7.95

"TARPON FISHING WITH ACTIONROD"
A 15-minute movie with color and sound for sports clubs. 16 mm. Write for it.

ORCHARD INDUSTRIES, INC.
DETROIT, MICHIGAN



Actionrod

"NATION'S BEST-SELLING GLASS ROD"

took exceptionally good pictures of tornado lightning. Five minutes later, 85 miles away, a twister bashed in a section of the city of Norman. A little over a month later, the team had its best stroke of luck. At 4:20 p.m., June 2, a tornado whirled across the prairies 10 miles south of the college. It could be seen clearly from the windows of the engineering building. Doctor Jones and his co-workers raced to the airport, took one look at the pictures from the oscilloscope and danced with joy. They were the best yet of tornado lightning.

After this historic discovery, it was smooth sailing. The oscilloscope told the team that a tornado was forming. Direction finders that would locate the tornado had already been developed. One was installed at Stillwater. This determined a line of direction from which the electrical discharges were coming. However, if the line of direction happened to be north and south, it did not show whether the tornado was north or south of the station, and did not determine the distance. Two direction finders were necessary to do that.

A second set of equipment is to be installed at the Will Rogers Airport in Oklahoma City. When a tornado forms in the area, each station will take a direction reading. The intersection of their two lines of direction will locate the tornado.

The system will be basically the same as that used during World War II to locate and track enemy aircraft and guide friendly planes in distress. The team will chart the running path of a tornado in much the same manner as enemy aircraft were charted in plotting rooms.

The Oklahoma researchers are turning over their findings to the U. S. Weather Bureau, which has the facilities for a nation-wide warning network. When the hoped-for warning system goes into full operation, it will remove the element of surprise from a tornado and give people time to find places of safety. One of nature's most terrifying phenomena will have been stripped of its power to kill.

Make Fertilizer, Get Uranium

That most important element, uranium, now can be extracted as a by-product in the manufacture of fertilizer. It has been known for some time that uranium occurs as a minor component of phosphate deposits in the Northwest and in Florida. In announcing the process, the Atomic Energy Commission says uranium "can be extracted economically in the production of highly refined fertilizer known as triple superphosphate."

BEAUTIFIES natural wood, pine paneling

POLISHES furniture, woodwork

IMPROVES paint jobs

PROTECTS wood and metal surfaces

THE BEST BUY FOR EVERY HOME

NET CONTENTS ONE QUART

REPLACEMENT OR REFUND OF MONEY
 Guaranteed by Good Housekeeping
 IF NOT AS ADVERTISED THEREIN

Pol-mer-ik
LINSEED OIL
 FOR BETTER PAINTING

ARCHER-DANIELS-MIDLAND CO. AND 101 HANDY HOME USES

101 HANDY HOME USES!
 Every home, every workshop, needs Pol-mer-ik BOILED Linseed Oil. Available at all stores. Free folder tells you how to use it. Write Dept. 603 . . .

ARCHER-DANIELS-MIDLAND CO., Minneapolis 2, Minn.

New ARMY MINE DETECTOR

An /PRS-1 is a portable device for detecting metallic and non metallic objects. Metals, Buried Cables and sewer Tile.

Our Special Price **\$30.25** with battery
\$19.75 without battery

By lengthening dipole rods operator will be able to increase the depth sensitivity. This unit comes complete with spare tubes, antenna dipole and reflector, and instructions manual, in wooden chest 9½" height x 28¼" length x 15½" depth. Weight in operation is only 22 lbs. LESS Batteries. Power supply: Three 45 volt and one 6 volt batteries. Uses standard batteries. Original COST \$364.00. Shipping weight appr. 80 lbs. F.O.B. New York. No C.O.D.'s. Send Order to:



COLUMBO TRADING CO., INC.

383 CANAL ST. DEPT. P.M. NEW YORK 13, N. Y.

STOPS LEAKS PERMANENTLY

Cut your fixture replacement, water and fuel bills with Economy Renewable Seats. Make economical, permanent repairs quickly and easily with the Junior Kit (illus.). Repair bathroom, kitchen and laundry fixtures. Everything you need included in steel box. This is a natural for the "Fixit" shops—get extra income from making permanent repairs on your customers' faucets.

Senior Master Kit also available—repairs faucets and valves up to 1" pipe. Write for illustrated circular and prices.



ECONOMY VALVE SEAT CO.

1430 N. Keating Ave. Chicago, Ill.

NEW SENSATION IN LOW-COST TRANSPORTATION the CUSHMAN **EAGLE**

WRITE FOR
 RIDER-AGENT
 PLAN

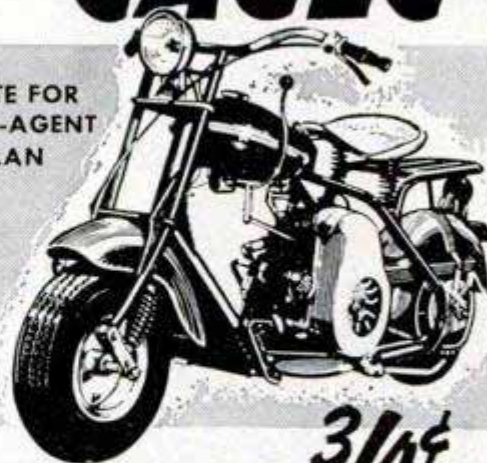

OPERATES FOR ONLY **3/4¢** PER MILE

Your new Cushman EAGLE will give you these famous Cushman features: automatic disc-type clutch; selective gear transmission; silent action shock-absorbing springs; doubly-dependable heavy duty brakes; special heavy-duty tires for added safety and comfort. Powered by the famous Cushman "Husky" engine, the EAGLE has rapid pick-up, quick acceleration, cruises up to 60 m.p.h. — over 75 miles per gal. WRITE FOR FREE FOLDER AND PRICES TO DEPT. 10M

Cushman MOTOR WORKS, INC.
 LINCOLN, NEBRASKA

NOW ANYONE CAN PUTTY WINDOWS

with the

DUO-FAST PUTTY KNIFE

NEW EASY FAST

Does a perfect job. Packs—Shapes —Trims putty. Makes a hard job easy. Pays for itself on first window. Get yours, today! It will be your favorite tool!

See

\$1.00

Your Hardware, Paint, Glass or Lumber Dealer—OR Order Direct. ONLY \$1.00 POSTPAID IN U.S.A.

Duo-Fast PUTTY KNIFE FASTENER CORP.
 864 Fletcher Street, Chicago 14, Illinois

I am enclosing \$1.00 — please send me one Duo-Fast PUTTY KNIFE

NAME _____

ADDRESS _____

CITY _____ STATE _____

Keep Brushes like New

BEFORE



AFTER



• 10c
• 25c

**DICA-DOO
PAINT
BRUSH
BATH**

*Clean and Restore
PAINT BRUSHES*

Perfect for
NYLON BRUSHES, too!
At Paint, Hardware, Dept., and 5 & 10c Stores
Patent Cereals Co. Geneva, N. Y.



**Tyler
SPYRAL
BLADES**

saw
any
line
you
can
draw!

Plastic, rubber, balsa — metals from steel to lead—paper, tubing... they're all the same to Tyler Spyrals blades. Spyrals blades are tough, stay sharp. They cut fast, clean, easy in any direction without chipping, tearing or clogging. Leave edges so smooth sanding is seldom necessary.

Indispensable for industry, modelers, jewelers, hobbyists, housewives, home craftsmen, shops of all kinds. No jagged edges, safe for children!

Spyral blades are perfect companion blades for alternate use with conventional flat blades where intricate pattern cutting is required.

Tyler adapters to fit Spyrals blades to your present hacksaw frames go on in a jiffy! Spyrals blades also fit most coping saws. Or buy Tyler coping saws specially designed for the Spyrals blade. Order through your dealer or write direct.

FREE! Send for details on revolutionary Tyler industrial bandsaw machine. Any speed from 80 to 5000 FPM by simply turning hand-wheel. Uses either flat blade or Spyrals blade with Tyler roller guides to cut in any direction to center of 29 1/2" work piece, any length! If your plant needs a superior bandsaw machine, it will pay you to investigate Tyler's exclusive features. Write today.

Tyler
MANUFACTURING CO., INC.
INGLEWOOD, CALIF.

Western sales: Tyler Spyrals Saw Co., 1005 W. Arbor Vitae, Inglewood, Calif.
Eastern sales: Marlin Trading, Inc., 60 Beaver St., New York 4



STOP DRIP

caused from condensation on cold water pipes. Turn idle basement space into play or work rooms. Keep store rooms dry. Just wrap cork-filled NoDrip Tape around pipes and joints. Do it yourself. Clean and easy to apply. Roll covers about 10 feet of 1/2" pipe, \$1.69. Higher west of Rockies and Canada. Get at Hardware, Department Stores, or sent postpaid. Write for free circular. J. W. Mortell Co., 522 Burch St., Kankakee, Ill.

**NoDrip
TAPE**



ALL NEW 1951 KING MIDGET AUTO

World's Lowest Priced 2 Passenger Car

Drive it for 75c per week. Amazing performance. Surprising comfort. All steel construction. Full accessories, top and heater. Ready to run or assemble it with our bolt together parts. Rider agents wanted, earn your car Free. Send 25c for detailed literature or \$1 (refunded first order) for actual assembly book and service manual filled with photos, drawings, specifications, etc.



**MIDGET MOTORS MFG. CO.,
ATHENS 1, OHIO**

MAKE EXTRA MONEY

**EVERY BUSINESS EVERYWHERE
USES UNION LABEL BOOK MATCHES**

No experience needed to earn big daily commissions. Be a direct factory representative of the world's largest exclusive UNION LABEL Book Match manufacturer. Prospects everywhere. Feature Glamour Girls, Hillbillies, scenes and dozens of other styles—Double Books—Jumbo Books—nearly 100 color combinations. New, bigger portfolio makes this fastest selling line a real profit maker for you. Write TODAY for full details.



SUPERIOR MATCH CO.

Dept. MD-551, 7528 S. Greenwood Ave., Chicago 19, Ill.
WEST COAST SALESMEN, write BOX 1087, SAN JOSE, CALIF.

Say You Saw It in Popular Mechanics

SHOOTS LIGHT 1/4 MILE!

12-VOLT

It's brand new—powerful (12-volt, 1500 ft. beam). Adjustable, all-chrome head. Uses two 6-volt lantern batteries. Total weight only 5-1/4 lbs.! At hardware, sport, and electrical stores.

only \$6⁵⁰ less batteries



Delta ELECTRIC CO.
Marion, Ind.

POWER-KING 12-VOLT ELECTRIC LANTERN

The 3-PURPOSE HAIR TONIC



1. "Wakes Up" Scalp! Your scalp must be healthy if you want handsome hair. Lucky Tiger relieves itching scalp, cleans scalp of loose dandruff scales, gives scalp a keen, zesty tingle.

2. Kills Dandruff Germs.* Doesn't just remove loose dandruff. Almost any hair tonic will do that. Lucky Tiger actually kills on contact the germ *pityrosporum ovale**, a common cause of infectious dandruff.

3. Grooms Hair Perfectly! Lucky Tiger keeps hair in place the modern way . . . so it looks natural . . . without looking "slicked down."



LUCKY TIGER

HAIR TONIC

Sold at all
toilet goods counters

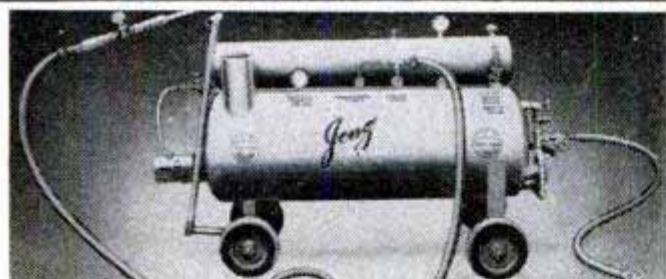

EARN \$6.00 PER HOUR

At a cost of 20c with the NEW JENZ SUPER CHIEF STEAM CLEANER. Portable—No moving parts—Cleans anything—Any place—Motors—Chassis—Machinery—Floors—Buildings—Oil Rigs, etc.—Oil fired—Economical—Fully tested and warranted. 75 lbs. steam in ten min.—Model 80. Complete as illustrated.

\$359.50

F.O.B. shipping point

HI-PURE LABORATORIES, Evansville, Ind.

CONVERT HAND MOWERS to POWER MOWERS

Takes less than 3 hours

The Handy-Dandy Lawn Mower Kit fits any hand mower from the 16 to the 20 inch size. Complete with all necessary parts. Kits can be purchased separately, complete with engines or complete with Pennsylvania mower.

Also manufacturers of complete power mowers and garden cultivators.

DEALERS WANTED

LE CLAIRE MFG. CO., Le Claire, Iowa, Dept. PM



Speed Way
Speed Sander

\$34.50

Sands,
Cleans,
Smooths, Polishes Electrically



Designed for industry, for professional work, this light, beautifully balanced, orbital-motion, SpeedSander is rapidly becoming a standard home appliance. With its powerful electric motor and all-ball-bearing construction, anyone can easily re-surface and refinish furniture, woodwork, metal surfaces or walls. It will quickly remove old paint, stain, or enamel down to the bare wood or metal; will sandpaper to a "piano finish"; remove rust and corrosion or "feather edge" a scraped fender. It will burnish pots and pans or with lambs wool bonnet, delicately polish fine furniture. It makes

tedious, tiresome jobs fun—saves hands! In design, convenience and efficiency it is today's finest sander regardless of price. Ask your local dealer to demonstrate it.

Write for Catalog

Speed Way MANUFACTURING CO.

1863 So. 52nd Ave., Cicero 50, Illinois

USE A PFLUEGER REEL



ENJOY BETTER FISHING AS LONG AS YOU LIVE

Cast lures better—place them more accurately—have instant response hooking strikes. A Pflueger Reel can give you an entirely new appreciation of fishing. The Pflueger quality guarantee never expires. Ask your Dealer.

PFLUEGER SUPREME
\$35.00



THE ENTERPRISE MFG., CO.
AKRON, OHIO
87 Years
Making Fishing Tackle

PFLUEGER
(Pronounced FLEW-GER)

A GREAT NAME IN TACKLE

best
white tape
made

ONLY
98¢*



The new "Evans White-Tape" has everything you'll find in tapes costing over \$1.50—plus.

- snow-white blade with bold, legible, jet-black numerals and graduations. Graduated in 32nds for first 6 inches.
- sturdy die-cast case heavily chrome-plated, calibrated for quick reading inside and outside measurements.
- blade 1/2" wide made of finest high carbon steel—tempered—Bonderized—enamelled—baked.
- blade replaceable in seconds—without tools—without even opening case. And Evans replacement blades cost far less.
- every "Evans White-Tape" is unconditionally guaranteed.
- exclusive Evans automatic brake gives smoother push-pull action with absolutely no "creeping" of tape into case.
- underside is white, too. Mark with ordinary pencil, remove mark with flick of thumb.
- unheard-of low price*: 10-ft. \$1.49; 8-ft. \$1.19; 6-ft. 98¢. Prices higher in far west and Canada.

Evans

& CO. • Newark 5, N. J.

Sold only through retailers.

Makers of Evans 6-ft. Folding Rule and "Folding Yardstick"

Best way to
REMOVE PAINT

WONDER-PASTE

Apply Wonder-Paste with a paint brush and let it work. Then simply strip off the old finish with a putty knife. Easy, fast. No scorched areas. No sanding. A perfect surface for refinishing. For paint, varnish, lacquer, enamel, etc. At paint and hardware stores.



The painter's
favorite!

Write for Wonder-Paste leaflet

Wilson-Imperial Company, 119 Chestnut Street, Newark 5, N. J.

EARN EXTRA
DOLLARS

IDEAL LAWNMOWER SHARPENER



Saves work, saves time, helps you earn extra dollars! Sharpens hand, power mowers without disassembling. Complete shop in one machine — equipped with Bed Knife Grinder and "lapping-in" Reconditioner. Home owners, parks, clubs, cemeteries pay good money for efficient sharpening; get your share!

WRITE NOW FOR FREE CATALOG

THE FATE-ROOT-HEATH CO., Dept. I-3, Plymouth, Ohio

Build this Beautiful LAWN FURNITURE YOURSELF

NO EXPERIENCE NEEDED

Smart Exclusive Styles By John Bergen
... Four Big Plans Drawn to Scale ...
Complete Material List

Now with just a few spare time hours and some inexpensive materials you can build gay comfortable lawn furniture that will make your garden more attractive ... more comfortable and more fun this summer.

No need to pay a small fortune for lawn furniture when you can build your own and save over 50% of what it would cost you already built!

Popular Mechanics four big drawn-to-scale plans show every step to follow. Complete material list tells you just what sizes of wood to buy so there will be no waste.

Make your lawn and garden the finest and most attractive on your block by building this smartly styled furniture. Enjoy real comfort during those hot summer months by making your garden your outdoor living room. Send today for your plans and material list. Complete set of four plans only \$2.00. Complete satisfaction guaranteed or your money refunded.

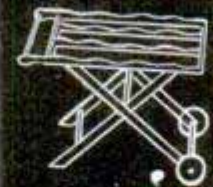

POPULAR MECHANICS
PRESS

200 E. Ontario St.
Chicago 11

POPULAR MECHANICS

No Experience Needed To PRINT YOUR OWN POST CARDS

The GEM STENCIL DUPLICATOR saves money... gets results quickly! Hundreds of uses for every type of business and organization. We ship the GEM complete with all supplies, Guide Board for accurate printing and 60-page Book of Ideas at the special low price of only \$8.50 (a \$15 value).

FREE TRIAL OFFER

Our 21st Year

Use the GEM FREE at our expense! SEND NO MONEY. Write and complete GEM outfit will be sent you postpaid. After ten days, send us only \$8.50 or return the GEM. You must be satisfied!

BOND EQUIPMENT CO. Dept. 48
6633 Enright • St. Louis 5, Mo.



BRUSH PLATING OUTFITS

for re-plating articles in the home and shop. No tanks necessary. Free particulars.
GUNMETAL CO., AVE. M, DECATUR, ILLINOIS

FOR BIG MEN ONLY!



SEND FOR FREE CATALOG

SIZES 10 to 16 WIDTHS AAA to EEE

We SPECIALIZE in large sizes only—sizes 10 to 16; widths AAA to EEE. Loafers, Wing Tips, Moccasins, Dress Oxfords, High and Low Work Shoes, House Slippers, Rubbers, Overshoes, Sox. Extra quality at popular prices. Satisfaction guaranteed. Sold by mail only. Write for FREE Catalog.

KING-SIZE, Inc., 516, Brockton, Mass.



'1995 FAIRCHILD FLEXIBLE SHAFT TOOL & MOTOR

Grinds! Sands! Polishes!
Buffs! Drills! Carves!

110-120 Volt AC-DC motor; 10 tools, accessories, wood case. For wood, metals, glass, plastic. Mounts on wall or bench. Send check or M.O.

12⁹⁵

PUBLIC SPORTS SHOPS
11 S. 16TH ST., PHILADELPHIA 2, PA.

SAY YOU SAW IT IN POPULAR MECHANICS

KEEP THOSE EDGES ON YOUR PLANE BLADES RAZOR SHARP AND CHISELS

With This New, Proven, Carpenter's Accessory That Assures a Straight, Sharpened Edge Always at a Right Angle to the Sides.



PLANE BLADE AND CHISEL SHARPENER

by Marsh

\$1.50

POSTPAID (plus tax in Calif.)

SMALL, COMPACT, READY FOR IMMEDIATE USE—WING SCREW IN THE HOLDING CLAMP IS THE ONLY ADJUSTMENT.
• Holds blade at correct angle for sharpening • A few strokes back and forth on stone keeps the edge razor sharp • No guesswork • No round corners • 14 Ga. steel construction • Wt. only 8 oz. • For the bench or on the job • Satisfaction guaranteed or your money refunded.

BE SHARP! START SHARP - STAY SHARP

SEND YOUR CHECK OR MONEY ORDER TO:

Sportsmens Specialties

47 E. WALNUT ST.

PASADENA 1, CALIF.

POWER and SPEED



Power and speed distinguish the modern carrier—a combination of air and sea might.



Here's the tool that makes the hard part of the job easy. The Plumb Ball Pein Hammer is engineered to strike with power and speed—with the weight centered behind the face to reduce fatigue and add more force to your swing. The cone-shaped pein spreads rivets evenly without mashing them.

Pack power into your work with the speedy Plumb Ball Pein Hammer.

Quality Comes FIRST
PLUMB
is FIRST in Quality

The black head with the red handle—exclusively PLUMB

PLUMB

HAMMERS • HATCHETS • AXES • FILES

HOUSEHOLD SHARPENING IS EASY...



WITH A
NORTON® abrasives Stone!

The right stone is a NORTON Abrasives CRYSTOLON® #JB-8 with coarse and fine sides, oil-filled at the factory for your convenience without added cost. \$2.30 at most hardware stores.

The "know-how" on all kitchen, household, garden and shop tools is in the "HOW TO SHARPEN" Book — 32 profusely illustrated pages that take all the mystery out of sharpening. For your copy, send 10c to Dept. PM-5.



BEHR-MANNING

TROY, N. Y.

Also Mfrs. of Abrasive Paper and Cloth

MENDS

Pottery, Toys,
Furniture, Books



It's transparent, waterproof,
flexible and durable.
Get a tube
today.



DU PONT
REG. U. S. PAT. OFF.

NOW—40 different CUTS with AMAZING, NEW



Warren
DADO SAWING WASHERS
On Your Saw Blade
Just dial widths to cut
parallel grooves perfectly
smooth. No warp, vibration

or trick screws. Strengthens blade, perfect balance.
GUARANTEED! At your dealer's or order
direct. Give arbor size— $\frac{1}{2}$ ", $\frac{3}{8}$ ", $\frac{3}{4}$ ", 1".

WARREN WASHERS COMPANY
70 MEDBURY, DETROIT 2, MICHIGAN

ONLY
\$4.95
PER
SET

Find **HIDDEN TREASURES**



GEIGER COUNTERS for Uranium
Detection. (see at left). **TREASURE
DETECTORS** for gold, silver, etc.
Lightweight, ultra sensitive. None
finer at **ANY PRICE.**
Information FREE.

Detectron co.
5631 Cahuenga, No. Hollywood, Calif.

DRAINS Cellars, Laundry Tubs; CIRCULATES Oil; IRRIGATES Gardens

Original "Type P" Pump has 2400 GPH capacity.
360 GPH 75' high, or 1500 GPH from 25' well.
Use any $\frac{1}{8}$ to $\frac{1}{2}$ HP motor. **DOES NOT CLOG.**

Only \$6.95 postpaid if cash with order.
(West of Mississippi, add 50c.)

**SATISFACTION GUARANTEED OR
MONEY BACK!**

\$6.95



LABAWCO PUMPS, BELLE MEAD 7, N. J.

SET-UP - KNOCKDOWN SAWHORSE with *Jiffy* BRACKETS



No nails or bolts . . . use 2x4's for
legs, 2x4 or wider for crossbar. Easy
to move, saves storage space. Buy at
hardware or building material deal-
ers, or direct.

GRAND HAVEN STAMPED PRODUCTS CO., Grand Haven, Mich.

K-R-O KILLS RATS

• K-R-O BIS-KITS are ready-made, easy to use;
containing *fortified red squill*, they're safer around
livestock, pets, and poultry. K-R-O POWDER
is 100% *fortified red squill*; economical to use in
badly infested areas when mixed with natural
baits. BIS-KITS, 35c and \$1.00; POWDER, 75c
at drug, seed, and feed stores. Money-back guar-
antee. *The K-R-O Company, Springfield, Ohio.*



GRAVELLY
makes tough
jobs **EASY!**



5-HP Gravelly Tractor powers 20 tools—does every lawn, garden, field job *easier, better!* All-gear drive, Reverse. "Power vs Drudgery" Booklet FREE. Write for it today!

GRAVELLY MOTOR PLOW & CULTIVATOR CO.
BOX 563 DUNBAR, W. VA.

FIELD-TESTED FOR 30 YEARS



BUILD FINE GRANDFATHER CLOCK NOW

The simple sensible Red-i-Kut way as thousands have—**SAVE HALF. SHOP TESTED PLANS "SPIRIT OF THE CENTURY"** Narrow waist 83" tall or stately straight side **"SPIRIT OF AMERICA."** **EASY-TO-FOLLOW photopack PLANS** tell all—plus **BROCHURE** of heavy brass weight Westminster, tube chime, movements, *gorgeous* dials, 3/4" solid mahogany case kits. **Send \$1.00 today—Both Plans \$1.50 NOW.**
KUMPEL CHIME CLOCK CO., #4 Kuempel Bldg., Minneapolis 16, Minn.



The Modern **PLASTIC**
for lasting Home Repairs

PERMANENTLY mends cracks or holes in wood, tile, stone or plaster. Sticks and stays put—Does not chip, shrink or fall out. Easy to use. Economical. Mold it, chisel it, polish or paint it. If unobtainable from your lumber, paint or hardware dealer, the big 4-lb. can will be sent you post-paid (in U.S.) for only \$1.15. Full money-back guarantee, order now.

DONALD DURHAM CO.
Box 804-Q, Des Moines, Iowa

MARCOT KEY MACHINE



MARCOT No. 8 KEY MACHINE, less motor \$110.00
Auto Code Book and Depth Keys. 12.50
75 Dz. Popular Key Blanks. 60.00
Set—Key File, Follow-Through Rods, Lock Picks, Bit Key Gauge, Thimble, Pins, Springs. 10.50
"Locksmith Trade Books"..... 6.75
How to Open Locks without Keys or Picks; Secret of Locksmithing; How to Make Keys by the Impression Method; Master Key Systems.
TOTAL COST.....\$199.75

Immediate Delivery

A. J. MARCOTTE CO., 1200 N. Kedzie Ave., Dept. PM, Chicago 51, Ill.

HAVE FUN!

with Your Own
OUTDOOR FIREPLACE

It's easy to build yourself! Just add masonry—to your choice of design—around one of these all-metal units and you have an outdoor fireplace that works right. Costs less! A true recreation spot—for family or guests—right in your own yard. Everyone loves to cook and eat outdoors! Choice of sizes and accessories available. See your dealer, or send check or money order



56
Pages

**DESIGN
BOOK**

25¢

**WRITE FOR
COPY TODAY**

**FULL
OF
IDEAS**



Model OF-28 Only \$20.95
Size 21"x26"x13 1/2"

THE MAJESTIC COMPANY
367 Erie Street, Huntington, Indiana

#2 HAWAIIAN WIGGLER
DIGS THEM OUT OF OKEECHOBEE BRUSH



"Here's the evidence," say Parker Etheredge, Bob Tillman and Dan Cardinal, "a nice string we got on your yellow #2 Hawaiian at Denholm-Etheredge Camp, Okeechobee Lake, Fla. You can't beat the old No. 2 around weeds, pads, brush, stumps and logs. It comes over and through without hanging up." Really gets big bass. Casting size (5/8 oz.) or light tackle and spinning size (1/4 oz.)—each \$1.15

SHALLOW RUNNER

WON'T HANG UP



**MORE FLASH
MORE ACTION—
MORE FISH!**

**AT YOUR
DEALER** Choice 4 colors

FREE

**WRITE TODAY FOR BIG FREE 1951 ARBOGAST
COLOR CATALOG—FULL OF PICTURES OF CATCHES**

FRED ARBOGAST & CO., INC.
2225 WEST NORTH STREET • AKRON 3, OHIO



ROOM FOR EVERYBODY
in Old Town Oceanboat

TAKE the whole family for a spin in your fast, big (16-foot) outboard boat! Well-braced for the heaviest motors, planes beautifully. Safe and seaworthy. Bows flare to keep your passengers dry. Planking's painted gleaming white. Built for years of service.

FREE CATALOG illustrates boats for sport, for the family, and all kinds of canoes, outboard boats, rowboats and dinghies.

OLD TOWN BOATS

Old Town Canoe Co., 745 Elm St., Old Town, Maine

PLEASE SEND ME FREE CATALOG

Name _____

Address _____

City _____ State _____

BUILD AN EXTRA ATTIC ROOM



...this quick, low-cost way! Use handy Gold Bond Sealed Blankets made of fireproof Rock Wool to keep summer heat out, furnace heat in. Then nail big, fireproof panels of Gold Bond Gypsum Wallboard to studs or over old material. It saws like lumber, resists moisture, won't expand, contract or warp. Seal joints with Gold Bond Perforated Tape Joint System. Decorate with Gold Bond Sunflex wall paint, or with amazing Color Texture—brushes on like paint, covers wall like plaster. For full details of these quality products, write Division W, Dept. PM-51.

Available at your local Gold Bond Lumber and Building Materials Dealer!

NATIONAL GYPSUM COMPANY
BUFFALO 2, NEW YORK

CAMPBELL-HAUSFELD Spray Painting Outfits



SAVE time, materials and money

PAINT buildings, tractors, trucks. Refinish furniture and fenders. Inflate tires; lubricate motors and implements.

Destroy weeds. Rid live stock and pens of pests and parasites

First job pays for the outfit. Then it is yours for a lifetime of trouble-free service. 4 models at 4 money-saving prices. If your dealer does not have them, write for literature and prices, giving his name.

pressure queen

The only 4 cylinder portable. Outperforms them all for spray painting without pulsation.

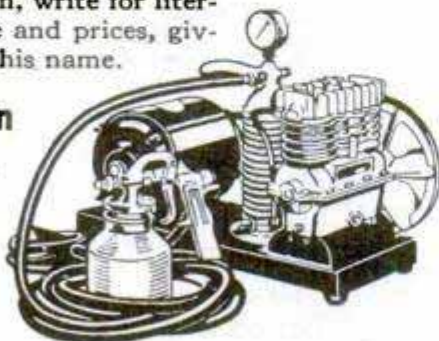

THE CAMPBELL-HAUSFELD CO.
1046 RAILROAD AVE. HARRISON, OHIO

FOR FASTER WORK IN HOME OR SHOP...

HOLD-E-ZEE

The Original AUTOMATIC GRIP SCREWDRIVERS

Pat'd.



See these popular, high-quality drivers with the exclusive Gripper that holds, starts and sets up screws in unhandy places!

New Models FOR RECESSED HEAD SCREWS



At Leading Dealers Everywhere
UPSON BROS., INC., ROCHESTER 4, N. Y.

INCREASE SAW SHARPENING PROFITS!

Sharpens Saws 5" - 30"

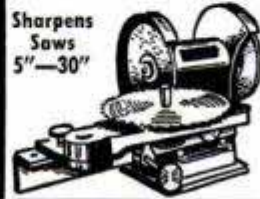

REYNOLDS CIRCULAR SAW GRINDER

Produces top quality results in fraction of time usually necessary for sharpening, jointing, gumming and tooth forming. Accurately sharpens PTI Cut Control Saws! Both hands are free to control position of saw while grinding. Write now for free circular!

PROVIDENCE SAW & KNIFE COMPANY
305 Eddy St. Providence 3, R. I.

BUILD HEAVY DUTY MACHINES



SAVE UP TO 90%— You can build, using our practical, easy-to-read plans, all kinds of machines, for home, farm or shop — scooters, portable sawmills, metal working machines, concrete machinery of all kinds, printing equipment, woodworking machines, midget autos, dish washers, farm equipment, freezers, tractors.

FREE
CATALOG HANDBOOK
183 SETS OF PLANS
VALUABLE INFORMATION

NICHOLS EQUIPMENT COMPANY
D-11 PURVIS, MISS.

MAKE MONEY POLISHING FLOORS . . .



You can when you have your own Floor Polishing & Maintenance Service. Write for free plans and ideas on how you can easily get started in this money-making business. Send a postcard to:

McCANNA SUPPLY CO., 148-D East 40 Street, New York 16, N. Y.



TRAILER PARTS

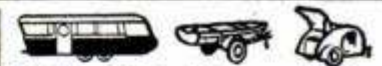

BULL DOG Hitches, Parking Jacks and Axles for all types of trailers!

Write for **FREE** Catalog
Hammer Blow Tool Company
Wausau 13, Wisconsin

SAY YOU SAW IT IN POPULAR MECHANICS



NEW '51 LINE!

PAGE GARDEN TRACTORS

RIDING AND WALKING MODELS!

NO CHEAP BELTS OR CHAINS!
SAVES LABOR!

2 TO 6 H. P. WITH COMPLETE GEAR DRIVE AND REVERSE

LOW PRICES EASY TERMS



BENEFIT FROM OUR 25 YEARS EXPERIENCE
FREE 24 PAGE CATALOG SHOWS ALL ATTACHMENTS

PAGE FARM EQUIPMENT

1904 S. 81st St. • Milwaukee 14, Wisconsin

GROBAN BRAND NEW WAR SURPLUS SPECIALS! UNCONDITIONALLY GUARANTEED

WE'VE MOVED TO NEW - LARGER - BETTER QUARTERS. NOTE NEW ADDRESS AT BOTTOM.

GENERAL MOTORS-ALLISON CENTRIFUGAL PUMP 200 GALLONS PER MINUTE



- For Draining Basements • Fire-Fighting • Irrigation • Fuel Transfer • Swimming Pools • Home Water Systems • Dewatering

This General Motors-Allison Centrifugal Pump—designed for use on U. S. Air Force Mustang fighters, now converted for commercial, home, and industrial high volume pumping applications. Inlet, 2 1/2" standard pipe thread, twin outlets with 1 1/4" pipe thread, ball bearing supported 3/4" shaft. Easy, fast simple priming. Rotation, counter-clockwise facing shaft. Shipping wt. 35 lbs. Gov't. acq. cost \$145.00. F.O.B. Chicago Now Only

Suction Lift	Head Pressure	Gal. Per Min.	H.P.	R.P.M.
10'	75'	260	6.0	3500
10'	65'	200	5.2	3500
10'	80'	40	1.5	2500
10'	50'	140	5.0	3500
10'	30'	100	3.0	2500

39.50

NEW! STATIONARY OR PORTABLE D.C. Arc Welder

250 AMPS. MODEL 252 (ITEM # 65)

For Any Welding Job, Light or Heavy
STOP COSTLY REPAIR BILLS,
WELD IT YOURSELF AND SAVE

Only one or two jobs will pay for entire welder. Designed for many years of trouble-free service. This precision-engineered Direct Current ELECTRIC ARC WELDER is offered at but a fraction of its original value. It can be mounted permanently or easily transported for portable use. Does the job instantly where and when you need it. Has dial type rheostat for easy pinpoint control and a high-low range switch. Run welder at 2500 RPM from drive pulley or power take-off of tractor, a 7 1/2 HP electric motor or a 10 HP gas engine. Use two V belts or flat belt (on pulleys). Price includes double V or flat belt pulley and instruction book. Shpg. wt. 107 lbs. F.O.B. Chicago.



Now at a fraction of its value

99.50

Byron-Jackson "PUP"

CENTRIFUGAL PUMP UNIT

\$3800.00 Value

COMPLETE WITH FULL ENGINE AND PUMP INSTRUCTIONS
2 Stage Model "PUP" Pump Driven by an IDEAL FOR: Pick-up, Gathering, Fire Fighting, Salt Water Disposal, Sprinklers, Irrigation, Dewatering, Construction, etc.
8 Cylinder Model C-36 Chrysler Industrial Engine. Engine Speed 2400 RPM—100 H.P.
600 GPM at 175 PSI—Parallel Connection. 300 GPM at 375 PSI Series Connection.

These skid-mounted Pumping Units are standard production models with parts and service readily available. Designed for a wide range of operating conditions particularly where wide variation in head and capacity are required. Twin suction and discharge ports are cast on the same side and so arranged that external piping is interchangeable for either parallel or series pumping applications. Overall dimensions, 114" L x 29" W x 62" H. Weight 4060 lbs. Now, complete with full priming equipment, operating instructions and performance data.

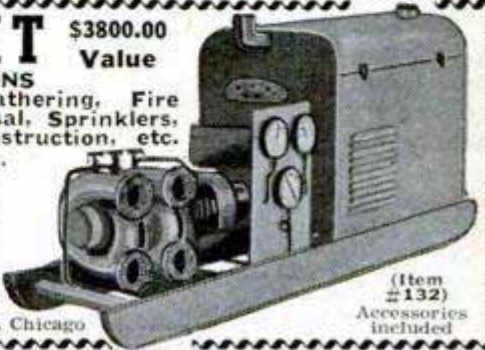

1495.00

F.O.B. Chicago

(Item #132) Accessories included

Hydraulic Cylinders—Air or Oil

Large supply of new labor-saving, economical hydraulic equipment in many types and sizes. Use these positive, highly efficient smooth pressure hydraulics on presses, arborers, lifts, loaders, power control, positioning, brakes, plastic dies, auto frame alignment, etc., etc.

- ITEM #70—Purrolator hydraulic oil filter. Permanent element type. 3/4" female pipe thread ports. Capacity 16 gallons per minute. A \$13.00 value. Now postpaid. **4.95**
- ITEM #4—All steel double action hydraulic cylinder. 1 1/2" bore, 2 7/8" stroke. Clevis mounting. Will lift 1000 lbs. with 1000 P.S.I. line pressure. Perfect for positioning and feeding movements. **4.95**
- ITEM #33C—Double action hydraulic cylinder. 1 1/2" bore, 4 1/2" stroke. Clevis mountings at both ends. Uses 1/4" pipe fittings. **8.95**
- ITEM #32—Double action, 1 1/2" bore, 9" stroke, will lift 1760 lbs. with 1000 P.S.I. line pressure. Wt. 4 lbs. A \$45.00 value. **10.95**
- ITEM #16C—Double acting hydraulic cylinder. 1 1/2" bore, 20" stroke. Will lift 1760 lbs. with 1000 PSI line pressure. Weight 8 lbs. A \$55.00 value. **16.95**
- ITEM #103—Double acting hydraulic cylinder. 2 1/2" bore, 17" stroke. Clevis mounting. Will lift 4900 lbs. with 1000 PSI line pressure. 1 1/4" diam. shaft. 3/8" tubing thread ports. Overall length closed 28". **21.50**
- ITEM #31C—Double action hydraulic cylinder. 3 1/2" bore, 11" stroke. Aluminum alloy cylinder wall and all steel 1 1/8" piston rod. Clevis mounting at base and shaft. 19 1/2" overall length closed. Will lift 9625 lbs. using 1000 PSI from Logan Heavy Duty Hydraulic Pump. Uses 3/8" tubing fittings. Value \$102.00. Shipping wt. 11 lbs. F.O.B. Chicago. **22.50**
- ITEM #6—Double action hydraulic cylinder. 3" bore, 24" stroke, will lift 7070 lbs. with 1000 PSI line pressure. Steel barrel. 1 1/4" stainless steel shaft. Gov't. acq. cost \$176.00. Shpg. wt. 26 lbs. F.O.B. Chicago. **28.00**
- ITEM #42—Double action hydraulic cylinder. 4" bore, 18" stroke. Rated lift capacity with 1000 PSI line pressure is 12,500 lbs. Ship. wt. 30 lbs. F.O.B. Chicago. **32.50**

LOGAN HEAVY DUTY HYDRAULIC PUMP

For operating hydraulic cylinders and hydraulic motors on tractors, bulldozers, construction machinery, lift trucks, industrial applications, etc. Delivers 10 GPM at 1200 RPM at 1000 P.S.I. using 6 HP. Has a 3/4" inlet, 1 1/2" outlet. 3/4" shaft with flat and keyway for direct or pulley drive. Has flange with 4 bolt holes for convenient mounting. Ship. wt. 22 lbs. Overall dimen.: 7" L x 3 1/2" H x 5 1/2" W. A \$105.00 value FOR ONLY **22.50** F.O.B. Chicago (Item #29)



DIRECT CURRENT GENERATORS



For welders, plating, truck and marine use, D.C. appliances, lights, etc. Aircraft quality—lifetime grease sealed ball bearings. Heavy duty.

- Item #131—Brand new Electric Auto-Lite 12 volt Direct Current electric generators, rated 18 amps. Complete with blower and pulley. Use for trucks, tractors, boats, battery chargers, etc. Part No. GEF-4805A. In original sealed U. S. Army cartons. \$40.00 value. Shpg. wt. 27 lbs. **15.00**
- Item #90—Type P-1, rated 200 Amps.—28 Volts, 2500 RPM. Mfd. by General Electric, Ford, Delco-Remy and Westinghouse. Gov't. Acq. Cost \$300.00. Shpg. wt. 70 lbs. **22.50**
- Item #91—Type R-1, rated 300 Amps.—30 Volts. Mfd. by Jack & Heintz. Gov't. Acq. Cost \$380.00. Shpg. wt. 70 lbs. **35.00**

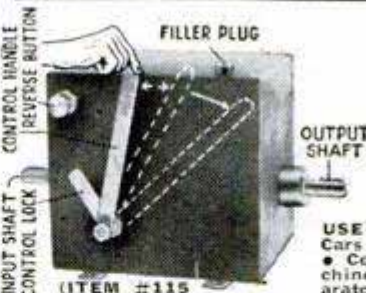

HYDRAULIC SPEED REDUCER

with FINGERTIP CONTROL

USE FOR: Reamer Drives • Midget Cars • Feed Mills • Canning Machines • Conveyors • Lathes • Milling Machines • Motor Boats • Cream Separators • Garden Tractors • Pumps

Variable output speeds ranging from 0 to input speed now available. Merely move control handle until desired speed is attained. Then turn locking handle to maintain the setting. Internal relief valves prevent overloading. Use input power of 1/2 to 1 1/2 H.P. This Westinghouse-Oil Gear Unit converted to commercial use from 40 MM anti-aircraft traversing mechanisms consists of a variable displacement hydraulic pump feeding a fixed displacement hydraulic motor. These components are contained in a crackle-finish steel oil reservoir (capacity 2 qts.). Adjustable relief valves set at factory for 100 inch pounds of torque may be reset up to 180 inch pounds. Independent reverse control allows full output power and speed selection in either direction of rotation. Both input and output shafts measure 5/8" diam., include keyway. Input rotation is counter-clockwise facing shaft. Recommended input speeds not to exceed 750 R.P.M. Over-all dimensions 7 1/2" x 7 1/2" x 11 1/2". Gov't. acquisition cost, \$428.00. Shipping weight 26 lbs. Complete with 2 qts. of oil and full instructions. F.O.B. Chicago **54.50**

FREE: 48-PAGE CATALOG

Listing Brand New War Surplus bargains including Aircraft Quality hydraulics, A.C. generators, pumps, welders, tanks, and many others. Write for yours today!

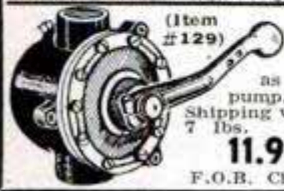

HAND FLUID PUMP Type D4 — Bronze and aluminum construction, 3/4" pipe thread inlet and outlet. Fine general utility hand pump. May be used as a sump pump, barrel pump, fuel transfer pump, etc. Shipping wt. 7 lbs. **11.95** F.O.B. Chicago (Item #129)

GROBAN SUPPLY CO. DEPT. PM-5
1139 SO. WABASH AVE., CHICAGO 5, ILL.

ORDER DIRECT FROM AD
Send Payment or Purchase Order Today

(Continued from page 96)

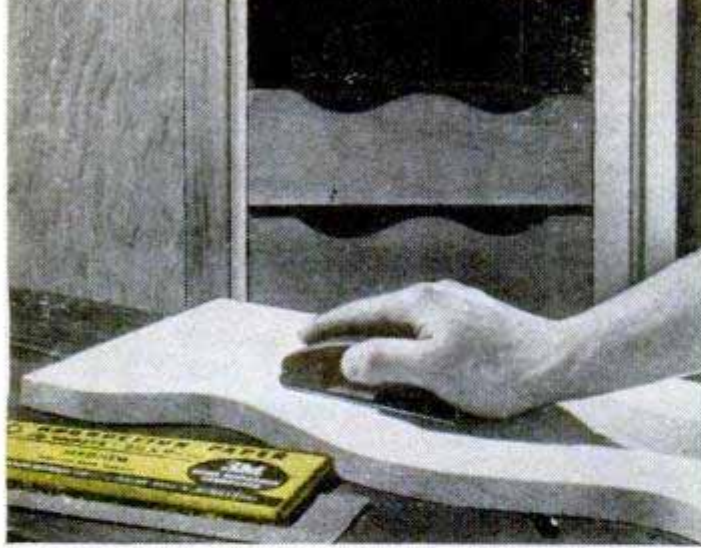

3M Sanding Block gives your projects "professional" touch

The professionals' favorite sanding block is now available for home craftsmen! Solid red rubber, easy to load, easy to handle for wet or dry sanding. Your hardware dealer has the 3M Sanding Block and the new line of 3M Home Workshop Sandpaper—the world's toughest woodworking abrasive—pre-cut to fit the 3M Block and many power tools.

See your hardware dealer today!



3M Sanding Block



"Production" Paper Sheets



"Production" Paper Discs



"Production" Cloth Belts

Made in U.S.A. by Minnesota Mining & Mfg. Co., St. Paul 6, Minn., also makers of "Scotch" Brand Pressure-sensitive Tapes, "Scotch" Sound Recording Tape, "Underseal" Rubberized Coating, "Scotchlite" Reflective Sheeting, "Safety-Walk" Non-Slip Surfacing, "3M" Adhesives. General Export: Minn. Mining & Mfg. Co., International Division, 270 Park Avenue, New York 17, N. Y.



Indianapolis. The cars have aluminum frame rails and magnesium cross members, use a dual drag-link steering gear with no tie rods, and torsion-bar suspension all around. A third car being rushed to completion for Indianapolis consists of bare essentials only. It might weigh no more than 1500 pounds.

Front drives are supposed to have an advantage at Indianapolis because of a reduced tendency to slide when the track gets slippery from oil; on the other hand their construction is unavoidably heavier. Emil Diedt, another race-car builder, is trying to get around the weight objection this year by using aluminum for nearly all chassis parts. Fuel and oil tanks are of the same metal. Diedt expects that the new car will weigh 350 pounds less than any other front-drive car at Indianapolis.

From the standpoint of consistent winning, the nonsupercharged four-cylinder engine is by far the best for Indianapolis, and yet the smaller supercharged engine of 176 cubic inches' displacement is always a threat. Two cars powered with engines of that displacement have been entered this year in addition to the Novi team, the pair of front-drive cars that, on paper, are the cars to beat.

Each Novi Special is built around a 550-horsepower V-8 engine equipped with double overhead camshafts and a centrifugal supercharger. They are twice as powerful as most of the other cars in the race, and they have been dogged by consistent hard luck during the last several years.

For the 1951 race their chief mechanic, Jean Marcenac, has installed new blocks and crankshafts, beefed up to take terrific stresses. When all the bugs are eliminated from these advanced engines, the Novi backers feel sure, no car at the track will be able to keep close to them.

The Cummins diesel entry, which climbed from 33rd to 16th position before being forced out of the race last year by an accessory failure, will not compete this year.

Some 60 cars are entered in this year's race, but only 33 of them can start. That's the number of starting positions. The others will be eliminated in the time trials that are held during the several days preceding the race, during which each car gets a chance to roar 10 laps around the 2½-mile track to establish its qualifying time. This year some of the fans guess that the fastest car will qualify at 138 miles per hour, faster than anyone has ever gone around the track before.



The POPULAR Line of Portable Power Tools

*For Better Work...
Easier and Quicker*

**Have Hundreds of Uses Around the Home
In the Shop • On the Farm**

Embodied in every PET portable electric tool and accessory is the excellence and value developed through advanced engineering, modern streamline design, economical manufacturing methods, and the specialization in high-quality electric tools. Each represents the finest precision workmanship and quality features that contribute to dependable performance, trouble-free service, and a new balance and ease in tool handling. The various accessories available for use with PET portable electric tools have been tested and proved in the applications recommended. They conveniently extend the use of this portable power to a variety of jobs that make for easier and better work around the home, in the shop, and on the farm.

You can buy a PET portable electric tool from your dealer with the full confidence of getting the ultimate in the combination of economy, power, light weight, balance, operating convenience, and long life of trouble-free service. Use coupon for complete details.



ZEPHYR

Spraymaster Portable Spray Outfit

For Paint, Lacquer, Enamels, Mothproofing Solutions, Etc.
Price \$24.95



HI-POWER Bench Grinder

4" Diameter Wheels, 3500 RPM.
Price \$18.95

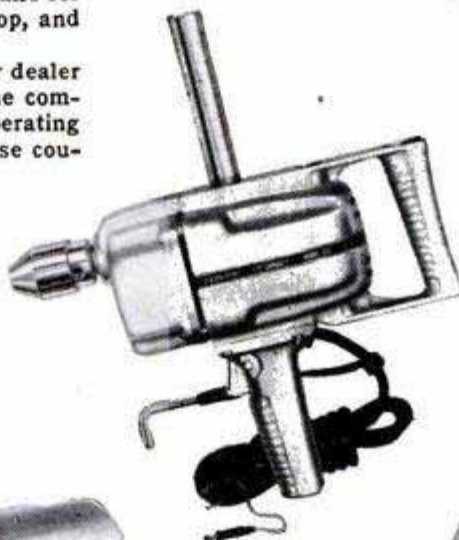

ZEPHYR

1/2" Drill

Streamline Design
Removable Side Handle.
Price \$31.15



ZEPHYR

1/4" Drill

Full 1/4" Capacity
Lock-Type
Trigger Switch
Palm Grip
Price \$17.95



ZEPHYR

Electric Hand Saw

Maximum Depth of Cut 2 1/8". Adjustable for Depth and Angle of Cut. Price \$41.95



At Hardware, Implement, and Building Materials Dealers, and Department Stores
—Or Write Direct

PORTABLE ELECTRIC TOOLS, INC.

324 West 83rd St., Chicago 20, Ill.

In Canada: Portable Electric Tools, Ltd., 369 Danforth Road, Toronto 13, Ontario.

Portable Electric Tools, Inc.

324 West 83rd Street, Chicago 20, Illinois

Please send me your new PET tool catalog and name of nearest dealer.

Name _____

Address _____

City _____ Zone _____ State _____

Send Coupon Today for Full Information

IT'S SHOPSMITH

FOR PRECISION

You can tell, just by looking at it, that multi-purpose SHOPSMITH is a tool of exceptional precision. And the facts prove it!

Pictured here is one of the most revealing tests a power tool can be put to. It's the dial indicator test for spindle "runout"—determines variations in the trueness of spindle rotation. Most power tool manufacturers are satisfied with variations of twenty-five ten-thousandths (.0025) of an inch. The allowable maximum for SHOPSMITH is fifteen ten-thousandths (.0015). And the records of all SHOPSMITHS, registered at time of final inspection, show an average "runout" of only eight ten-thousandths (.0008). That's real precision!

It's the same precision you find in other SHOPSMITH parts. The induction hardened spindle is machined to two ten-thousandths (.0002) of an inch. The two tubular steel ways are centerless ground to two thousandths (.002). The holes in each casting are bored simultaneously to assure perfect alignment of all parts.

But precision is only part of the SHOPSMITH story. SHOPSMITH is a rugged, heavy-duty tool—weighs over 200 pounds. It's compact—takes only 2' x 5' of shop space. It's flexible—converts from tool to tool in less than 60 seconds. And it can handle big work—has capacities equal to or greater than the most expensive, production-type tools.

See SHOPSMITH demonstrated—at leading hardware and department stores or any Montgomery Ward store. And send today for your free copy of the illustrated, 16-page SHOPSMITH booklet.

\$189.50

complete 5-tool unit
without motor.*

*Special SHOPSMITH motor
—heavy-duty, ½ h.p., ball
bearing, capacitor, 110 V,
60 cycles — \$34.50.

NEW RETRACTABLE CASTERS

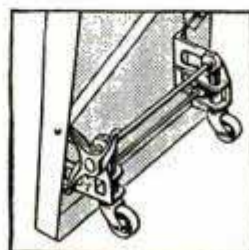

For moving, rolling or locking 225-pound SHOPSMITH. Mount easily on any wood or metal bench. Set by three-stage foot lever. At your SHOPSMITH dealer's. \$11.95.



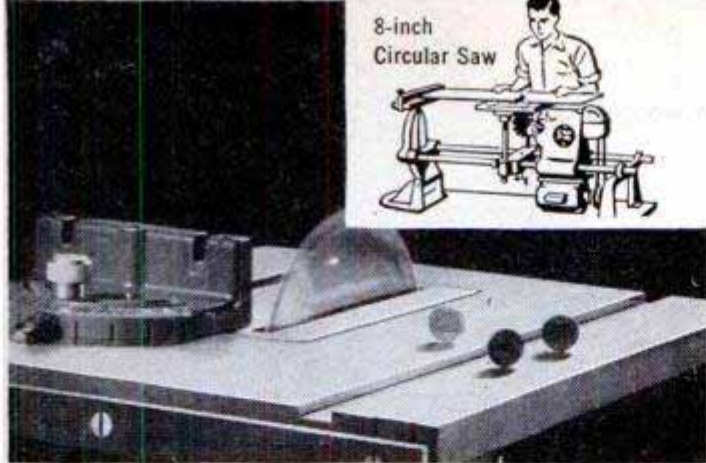

VIBRATION TEST. Nickels stand on edge while SHOPSMTTH saw whirls at full speed. Quiet, vibration-free operation is due to precision construction, four ball bearings in arbor, and extreme rigidity of tubular steel ways.

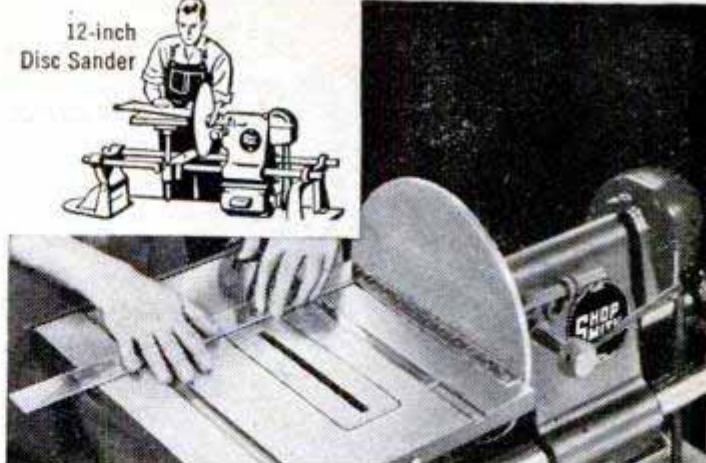

SQUARE FINISH. Carpenter's square demonstrates accuracy of SHOPSMTTH as a disc sander. Accuracy is automatic because of extra-large table, micro-graduated miter gauge, exclusive feature which permits disc to be fed into work.

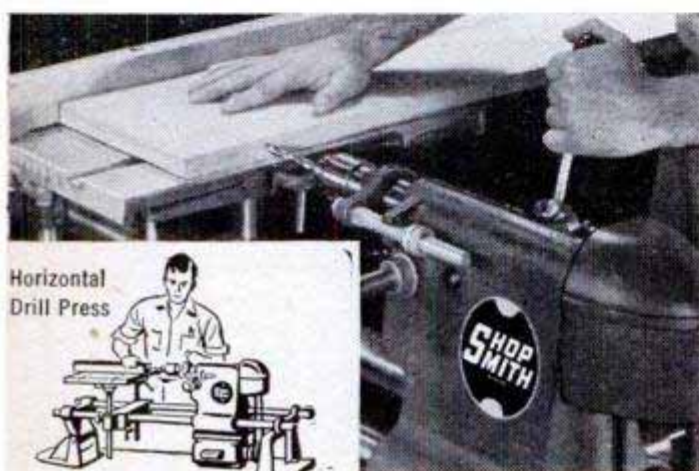

NEW AND PRACTICAL. Horizontal drilling takes the limit off the length of the work you can handle, performs drilling operations that are impossible or which require special jigs on vertical drill. 4-inch quill feed. Adjustable depth gauge. Variable speeds.

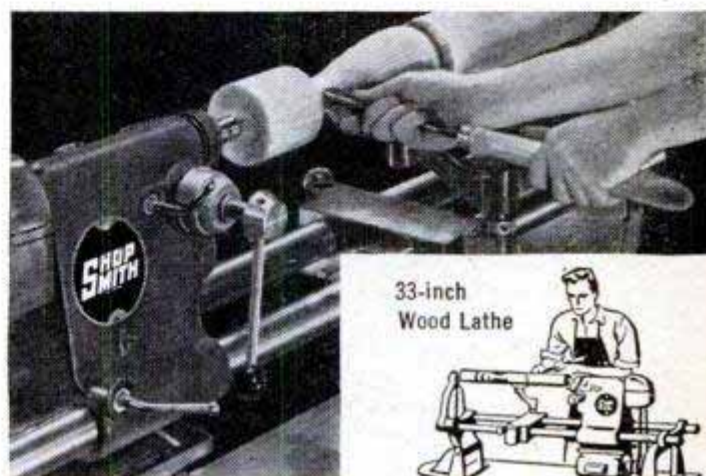

RIGID LATHE BED. In less than a minute, SHOPSMTTH can be converted to a heavy-duty wood lathe with 15-inch swing, 33 inches between centers. Thick-walled centerless ground steel ways, stress-tested at over a ton, assure minimum vibration.

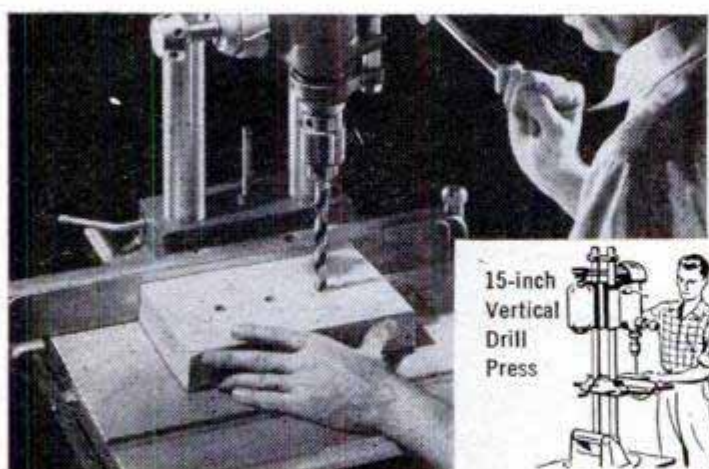

PERFORMANCE PLUS. For accuracy, capacity, precision features, you can't beat SHOPSMTTH as a vertical drill press. Jacobs key chuck takes drills up to 1/2 inch. Note use of rip fence as handy guide for accurate drilling.

PRECISION-MADE SHOPSMTTH IS A PRODUCT OF THE MAGNA ENGINEERING CORPORATION

GET ALL THE FACTS!

Compare before you buy. Illustrated, 16-page booklet brings you detailed specifications, describes SHOPSMTTH's many operations. Send for it! It's FREE!



FREE

**ADDRESS:
SHOPSMTTH**

Dept. 170-B, at factory nearest you:
12819 Coit Road, Cleveland 8, Ohio, OR
417 Montgomery Street, San Francisco 4, Calif.

Name _____

Address _____

City _____ State _____

STOP SCRUM



before it stops
your car!

by "Hib"

Hi fellows! Time to start thinking about the warm weather driving ahead. Get rid of the old SCRUM (scale, rust, oil muck in the cooling system) that's been building up all winter.

Drain anti-freeze as soon as the weather's settled. Your filling station man is your local weather expert for car radiators . . . ask him.

Make the famous "Finger Test." Here's how: Take off the radiator cap and run your finger around inside the opening. See that finger? . . . that's SCRUM, and what it can do to your cooling system isn't fit to print here.



Here's the cure: After flushing, have your service man add a can of Warner Radiator Cleaner . . . leave it in for a couple of hundred miles. Warner Cleaner loosens up SCRUM and when it's flushed the second time—brother, it really comes clean!

Will a clean radiator rust? You bet it will! The minerals in the water and the electrolytic action between the various metals in your cooling system will make it gum up fast and lead to overheating.

So add a can of Warner Cooling System Protector to that clean radiator. Warner Protector coats the entire inner surface of your cooling system with a rustproof, corrosion-proof film. Keep that clean radiator clean!

Radiator leaks? A can of Warner Liquid Solder (non metallic) deposits tiny fibers to repair any small leak in the cooling system . . . no trouble at all!



WARNER-PATTERSON COMPANY
CHICAGO 5, ILLINOIS

The Owners Report on the '51 Studebaker

(Continued from page 103)

Studebaker's famed hillholder had nothing but praise for this feature.

Now for my own test:

I drove the Commander test car (a Starlight Coupe with Automatic Drive) from Chicago to Los Angeles, then from Los Angeles to Grand Canyon and return, a

ENGINE

	CHAMPION	COMMANDER
Type.....	6-cyl. 'L'-head, In-Line	8-cyl. OHV V-type
Bore and Stroke.....	3 in. x 4 in.	3 3/8 in. x 3 1/4 in.
Displacement	169.6 cu. in.	232.6 cu. in.
Brake Horsepower.....	85	120
Compression Ratio.....	7.0:1	7.0:1

GENERAL

Weight (4-door Sedan).....	2845 lbs.	3193 lbs.*
Wheelbase	115 in.	115 in.*
Tread, front.....	56 1/2 in.	56 1/2 in.
Tread, rear.....	54 in.	54 in.
Height	60 1/4 in.	61 3/4 in.
Over-All Width.....	70-11/16 in.	70-11/16 in.
Length	197 1/2 in.	197 1/2 in.*

Inside Dimensions (4-door Sedan)

Front-Seat Width.....	59 1/4 in.	59 1/4 in.
Rear-Seat Width.....	58 1/4 in.	58 1/4 in.
Leg room, front.....	39 3/4 in.	39 3/4 in.*
Leg room, rear.....	39 1/8 in.	39 1/8 in.*
Headroom, front.....	36 1/2 in.	36 1/2 in.
Headroom, rear.....	34 1/2 in.	34 1/2 in.*
Tire Size.....	6.40 x 15	7.10 x 15
Tire Pressure.....	24 lbs.	24 lbs.
Road Clearance.....	8 in.	8 in.
Turning Radius.....	R—20 feet, 7 in. L—19 ft., 10 in.	R—20 feet, 7 in. L—19 ft., 10 in.

Steering Wheel, lock to lock.....	4 turns	5 1/2 turns
Steering Ratio.....	19.5:1	24:1

*LAND CRUISER model: Weight, 3293 lbs.; Wheelbase, 119 in.; Length, 201 1/2 in.; Leg room, front, 40 3/4 in.; Leg room, rear, 39 3/4 in.; Headroom, rear, 35 in.; Same as Commander model otherwise.

CAPACITIES

Oil.....	5 qts.	6 qts.
Water.....	10 qts.	17 1/4 qts.
Gasoline.....	18 gal.	18 gal.

total distance of over 3000 miles. I traveled over all kinds of roads, through a snow-storm in Nebraska, over the Continental Divide (altitude nearly 7000 feet) in the Rockies of Wyoming, through the heat of the Mojave Desert and below sea level in California's Death Valley.

The new 120-horsepower, high-compression V-8 Commander is one of the fastest stock cars I have ever driven. On long open stretches it did over 100 miles an hour

(Continued to page 264)

THE SPORTSMAN

\$249⁵⁰

plus tax
FOB Pontiac

long, low,
and lively



THE AMBASSADOR

\$249⁵⁰

plus tax
FOB Pontiac

big, rangy, and
rugged



Here's your Whizzer!

**BETTER THAN EVER
FOR FUN AND LOW-COST RIDING!**

Yes, now's the time to get your Whizzer!

Three great Whizzer motorbikes to choose from—new Ambassador, full size, fully equipped, with many luxury features; Sportsman, a low-slung beauty with great riding qualities; and Pacemaker, popular-priced motor-

bike that's complete and ready to ride.

All Whizzer motorbikes powered by the famous 4-cycle, 138 c.c., 3 h.p. Whizzer motor. Up to 100 miles per gallon, speeds from 5 to 40 m.p.h. This motor, sold complete with attachments, can make any standard heavy-duty man's bike a motorbike.

See the Whizzer line at your dealer's, or write today for free booklet.

WHIZZER MOTOR COMPANY • 364 S. Sanford St., PONTIAC, MICH.

THE PACEMAKER

\$199⁵⁰

plus tax
FOB Pontiac



THE MOTOR

America's
finest
bike motor

\$109⁹⁷

FOB Pontiac



Everything

you want

in this

New

DURO

6"

JOINTER

... MANY NEW EXCLUSIVE DURO FEATURES

If you want advanced features, increased dependability and maximum safety at lowest cost—choose a Duro Jointer! The host of quality features include: a heavy cast, rear mounted safety fence; a cutter head with 3 high speed blades and grooved chip breakers for fast, clean cuts; heavy cast iron tables which adjust quickly, accurately; a cutter head guard for safety which swings back automatically; adequate rabbetting capacity—and many more time and labor-saving advantages.

3 MODELS TO FIT ALL BUDGETS

Select the Duro Jointer that fits your workshop . . . 3 new models — 4 1/2", 5" or 6" capacity. Designed to fit every need and budget.

Write Today

for full details, specifications and prices on DURO Jointers—and full story on the complete 1951 line of DURO Power Tools.

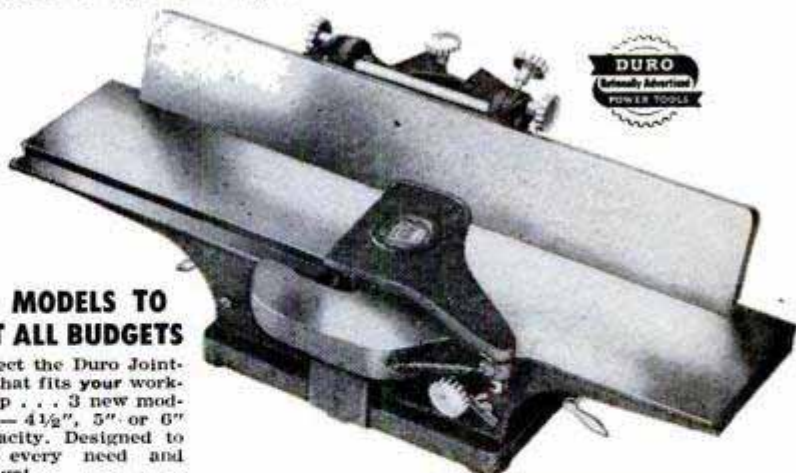

DURO METAL PRODUCTS CO.
2688 N. Kildare Ave.
Chicago 39, Ill.

Please send me specifications and prices on the new DURO Jointers—and full story of the complete 1951 line of DURO Power Tools.

Name _____

Address _____

City _____ Zone _____ State _____

DURO METAL PRODUCTS CO. 2688 N. Kildare Ave., Chicago 39
MAKERS OF DURO CHROME HAND TOOLS

SHOPMASTER

America's Finest Tools at
Amazing Low Prices

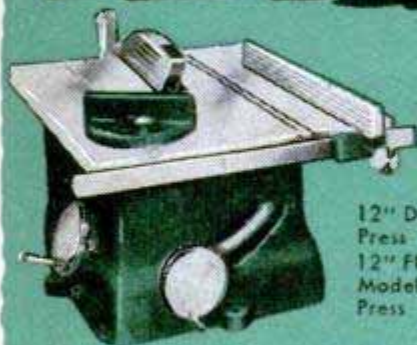

12" Drill
Press \$46.95
12" Floor
Model Drill
Press \$54.00

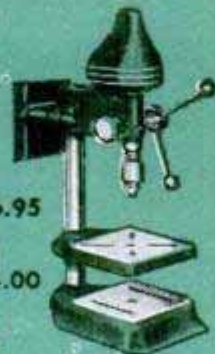

8" Tilting Arbor Bench
Saw . . . \$76.95



- Also
7" Tilting Arbor Bench
Saw . . . \$47.95
8" Tilting Table bench
Saw . . . \$51.50
10" Tilting Arbor
Bench Saw . \$86.95
10" Floor Model
Tilting Arbor
Saw . . . \$105.00

15" Jig
Saw
(Tilting
Table)
\$27.95

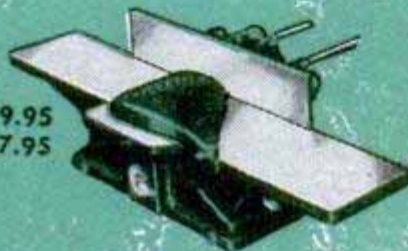

6" Jointer-Planer . \$79.95
4" Jointer-Planer . \$47.95



12" Band Saw . \$79.95
10" Band Saw . \$46.95



Saber
Saw. \$17.95



Belt and Disc
Sander . \$51.50



Spindle Shaper . . \$45.95



10" Wood Turning Lathe . \$45.95

Zone 2 prices,
slightly lower in
Zone 1.

Write today for full color catalog.



SHOPMASTER, INC.

1214 Third St. S., Minneapolis, Minn.

and it hit 95 without apparent effort and with a pleasing smoothness of operation. These were speedometer speeds and with all makes of cars I have found that these are from two to seven percent above actual speeds.

The new overhead-valve V-8 engine packs a terrific wallop. Acceleration and hill-climbing ability are outstanding. Incidentally, the Commander weighs 31 pounds less than the next lightest U.S.-built V-8 car.

I found Studebaker's economy very good with the new high-compression, 120-horsepower engine (see economy chart). However, readers should bear in mind, my tests show that owners of automatic-shifting transmissions, regardless of make, must sacrifice from one to three miles per gallon for the convenience of self-shifting devices. The conventional transmission, when properly handled, is still the most economical.

Studebaker engineers designed the V-8 and also the Champion engine for regular gasoline. I used regular for about half the test distance. I found that the 1951 Studebaker operates satisfactorily with ordinary gasoline under most conditions.

The car steers easily for one equipped with supercushion tires because of the low and variable steering ratio. This makes for ease in parking. However, it results in somewhat excessive turning of the wheel—a feature I don't especially like.

The car is extremely light in the rear end and, as in all modern cars, traction suffers on snow and ice due to this lightness. It corners with little effort, is easily controlled and takes the bumps nicely. Due to the low center of gravity, good balance, sea-leg rear shock absorbers and good springing, the Commander has excellent roadability, far superior to Studebakers built prior to 1950.

The front coil springing is much better than the transverse front spring used by Studebaker for many years. Rear springs are now 43 percent wider with four thin leaves, which improve the ride, and the suspension system is exceptionally good.

Its self-centering brakes are smooth and soft in operation. I did notice a tendency for brakes to fade when used often at extremely high speeds. The wide brake pedal is anchored to the shaft at each side, which makes for ease of operation and no pedal sideplay.

Studebaker's pioneering in styling is such that visibility is unexcelled, a desirable safety feature. Foam-rubber seat cushions, standard on the Regal Champion and all Commander and Land Cruiser models, are extremely comfortable.

(Continued to page 266)



Portable LIGHT PLANT

PUSH BUTTON START
500-700 watts 110-120 v. — 60 cyc. A.C. Powered by a sturdy dependable, easy starting, air cooled 1 3/4 hp. gas engine. No wiring necessary. Just plug in and operate. Plenty of current for any oil burner, freezer, brooder, pump, emergency lights, etc. which require up to 700 watts. Ideal for Civil Defense, Fire Depts.; trailers & camps. Complete with Voltmeter and built-in winding to charge 6 v. auto batteries. Wt. 85 lbs. Fully guaranteed. Be prepared if war or storm knocks out power lines.

(Item 24) etc. which require up to 700 watts. Ideal for Civil Defense, Fire Depts.; trailers & camps. Complete with Voltmeter and built-in winding to charge 6 v. auto batteries. Wt. 85 lbs. Fully guaranteed. Be prepared if war or storm knocks out power lines.
Reg. \$275.00 value. **\$143.50**
700-800 Watt Plant (Item 44) same as Item 24, but larger generator. **\$169.95**
1000-1200 Watt Plant (Item 45) same as Item 24, but larger gen. & eng. **\$199.50**

HEATING & VENTILATING FAN

(Item 10) Easily installed in furnace pipes. Forces even heat to all rooms. Over range, removes kitchen smoke and odors. Powerful continuous duty motor, 110-120 V. A.C. Quiet, super efficient fan moves huge volume of air (400 to 600 c.f.m.) 8" Fan, wt. 5 lb. **\$6.25**; 9" Fan, wt. 6 lbs. **\$7.45**; 10" Fan, wt. 7 lb. **\$8.45**; 12" Fan, wt. 8 lbs. **\$9.45**.



1/2" DRILL

(Item 33) DeLuxe model —powerful, smooth running, precision built. Handles toughest jobs. Cutler-Hammer switch, Jacobs key chuck, 110-120 v. AC-DC 300-450 rpm. Alum. alloy case for high strength and easy handling. Built-in blower assures cool operation. Cap. 1/2" in steel. 1 year written guar. Wt. 11 lbs. Should be \$65. Special. **\$34.50**



1/4" DRILL

(Item 34) Hi-power, long-life, smooth running. Alloy steel gears; built-in blower. Cutler-Hammer switch, Jacobs hand-tite chuck. 110-120 v. AC-DC 1000-1600 rpm. Cap. 1/4" in steel. 1 year guar. Wt. 4 lbs. Terrific value at **\$12.95**.

38 Pc. DRILL KIT

(Item 35) Includes above illness, guar. drill, buffers, polishing bonnet, sanding discs, grinding wheels, wood bits, steel bits, wire wheels, bench stand, paint mixer, burrs. Complete in heavy steel case. Wt. 13 lbs. 38 pc's., all highest quality. Complete kit worth \$38.50. Our **\$19.85** Spec. only.



HEAVY DUTY ARC WELDER

(Item 38) Use as portable or shop welder. 250 amps. D.C., Senior model. Made for years of trouble-free, continuous service. Will handle light or heavy jobs. Weld up to 1/2" plate using 3/4" rods. Built-in air-cooling system. Arc is easy to strike and hold, because of specially designed arc stabilizer. Hi-to switch and dial control gives wide range of welding heats. Run welder at 2600 rpm with tractor, jeep or 10 hp. gas engine, or 7 hp. elec. motor. Complete with instructions, guar. and double V belt or flat pulley. Wt. 110 lbs. A \$400 value at. **\$99.75**
WELDING KIT. Two 10 ft. leads, welding helmet, electrode holder, ground clamp, assorted rods. Sold only with welder at. **\$10.50**

GAUGE TESTER

(Item 27) Precision made of solid bronze by Star Brass Co. Calibrated weights (incl.) acting against hydraulic piston, provides quick accurate testing of all pressure gauges up to 3000 lbs. per sq. in. Brand new in hardwood cases. Wt. 100 lbs. Reg. \$435.00. Our Spec. **\$135.00**

HYDRAULIC HOSE
High pressure, heavy duty, complete with swivel fittings, pipe thread connections. Ideal for farm equip., bulldozers, grease guns, airbrakes, etc. Any length. Minimum \$1 per lft. **INSIDE DIAMETER.** 1/4" 50c per ft. 3/8" 60c, 1/2" 80c, 3/4" 90c.

MANUFACTURERS AND JOBBERS — Write us about your surplus items

GIANT 2000-2500 WATT PLANT

110-120 V. 60 cyc., A.C. Absolutely the best made because its heavy windings develop up to 5000 watt overload for motor starting. g. Skid-mounted — portable. Powered by 5 h. p. easy starting Briggs or Wisconsin engine —complete with all accessories: engine easily disconnected for other uses. Big output box, voltmeter, no wiring necessary. Ample current for all purposes. Factory warranty and instructions included. Wt. 220 lbs. Reg. \$585.00. Special at. **\$299.50**
GENERATOR ONLY and control box. Drive it with your engine or tractor. **\$169.50**

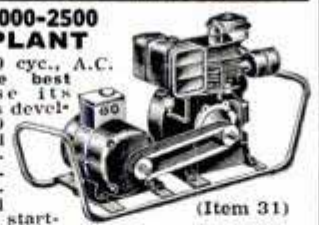

ELECTRIC HAND SAW

(Item 36) Most perfectly balanced and smoothest running saw made. Advanced design provides max. power and light weight. Easily adjusted for all angles, depth and width of cut. Comes complete with 6 1/2" comb. blade, ripping guide and 10 ft. hvy. duty cord. Built-in saw-dust blower. Autom. telescoping guard. 110-120 v. AC-DC. Depth of cut 2 1/8". 1 year written guar. Wt. 12 lbs. Drastically reduced. **\$39.95**



ANGLE DRILL

(Item 23) Fits into chuck of any electric or pneumatic drill or flex. shaft. Operates at any angle in a full 360° arc. Makes possible drilling, grinding, carving, routing, etc. in close cramped quarters. Makes impossible jobs easy. Made by Kett Tool Co. Complete with built-in chuck (1 1/4" capacity) and adjusting key. Hardened alloy gears. Precision built for heavy duty. Lists at \$30.95—while they last. **\$9.95**



CARRY-AIR

(Item 32) Stainless steel tank—capacity 500 cu. in. at 400 lbs. press. complete with inlet and shutoff valves, press. gauge, detachable air hose, tire chuck. Fill at any service station. Carry air for tire inflation, blowing out lines, spray painting, insecticides, etc. One emergency pays back cost. Wt. 13 lbs. Worth \$20.00. Our price. **\$9.75**



POTTERS WHEEL

(Item 47) Complete, prof. equip. for making finest ceramics and pottery. Large dynamically balanced cast-aluminum reversible turntable with variable speed drive (38 to 140 rpm) controlled by foot-pedal. Built-in adjustable arm rests, water cup and wedging wire. 16x12" enclosed throwing table—ample area for largest pieces. Req. 1/4 hp. motor (not incl.). Can be set up on 20x24" table and stored on edge. Complete with pulleys, belts and instructions. Wt. 26 lbs. **\$59.95** \$145 value at.



VARIABLE SPEED DRIVE

(Item 48) Works on variable-pitch pulley principle. Provides instant variable speed range up to 1 to 1. Rugged constr., forced lubrication. Input up to 1/2 hp. Perfect for lathes, drills, grinders, potters wheels, centrifuges, midget vehicles, etc. Wt. 8 lbs. A terrific value at. **\$9.45**



RUBBER HOSE

New genuine Neoprene Hose outlasts ordinary rubber 3 to 1. Reinforced with super tough cotton cord plies. Flexible. Easy Flo brass couplings with standard pipe threads for quick connections, included. Pump water for irrigation, stock tanks, home, barn, fire fighting, etc. Pump Gas or Fuel Oil, save more than 60%. (Inside) 1 1/4" 1 1/4" 1 1/2" Length 25 ft. 40 ft. 30 ft. Price 9.25 14.75 14.75 If specified we will send special hose for gas or oil at same prices.



AIR HOSE

(Item 11) 1/4" Diam. heavy duty, double braid, suitable for gas stations, spray painting, air tools, etc. 20 ft. with standard swivel couplings. Wt. 4 lbs. Reg. \$3.50 val.—only **\$2.95**. Five 20 ft. lghths. (100 ft.). Wt. 20 lbs. Only **\$13.75**.

GAS ENGINE

(Item 25) Air-cooled. 1 1/2-2 h.p. Complete with gas filter, air cleaner, governor, fuel tank. Ready to run. Speed range 2000-3600 r.p.m. 5/8" shaft. Rope start. Ideal for pumps, air compressors, power tools, generators, etc. Factory warranty and instructions incl. One of the best made. Wt. 40 lbs. Worth \$72.50. Special. **\$46.50**



HOT WATER HEATER

(Item 26) Immersion type, heavy duty, 115v. A.C. 300w. Does not require watching. Thermostat shuts off at 165°. Keeps water hot for shaving, washing dishes, etc. Made by Cities Service. Wt. 4 lbs. Worth \$9.50. Our Special. **\$4.50**

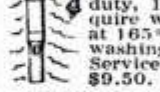

PRESSURE SWITCH

(Item 30) Penn Electric Model 110 B102, best made. For pumps and air compressors. Heavy duty. Will handle up to 250 lbs. press. and up to 5 h. p. Autom. unloader valve, for easy starting. 110-220 v. A.C. or D.C. 2 pole. Wt. 5 lbs. Reg. list \$17.50. Our Spec. **\$9.45**.



CLIP BOARD

(Item 17) Heavy Masonite, with self-adjusting spring hinge to hold up to 100 sheets of 8 1/2 x 11 paper. Push back cover for instant release. Flip cover shut and notes or drawings are protected. Perfect for pilots, engineers, students, artists, truck drivers. Wt. 2 1/2 lbs. Usually \$2.95. Spec. **\$1.10** 2 for **\$2.00**.



FIRE EXTINGUISHER

(Item 39) Fully charged at 1,000 lbs. P. S. I. or more) with CO2 (carbon dioxide), the proven miracle fire fighting chemical that smother's oil, gasoline and electrical fires. Play safe: keep one in your car, garage and home. Heavy ICC approved steel cylinder, valve and 3000 lb. gauge that shows available remaining pressure. REFILLABLE at nominal cost. Hose included for emergency tire inflator or air blast. Wt. 4 lbs. \$19.50 value. Special. **\$6.95**



GEM CUTTER

(Item 49) Complete Prof. Lapidary mach. for cutting, shaping, grinding and polishing precious and semi-precious stones. Precision built with big horiz. power driven gem cutter, built-in cutting lubricator; genuine 6" supercharged diamond saw, lap wheel, abras. whis., 2 scratch whis., 4 felt whis., grinding and polishing compounds, brushes, dop cement and sticks, cutting oil, ext. cord, asstd. gems, complete instructions. Requires 1/4 hp. motor (not incl.). Wt. 22 lbs. Worth \$99.50. Our Special. **\$39.95**



FIRE or BURGLAR ALARM

(Item 46) Completely automatic. Wind and hang anywhere. Thermostatic element sets off loud clanging bell if heat reaches 140° (setting adjustable). A fool-proof burglar or signal alarm when used with trip cord attached to door, window, invalid's bed, etc. Sturdy metal constr. assures lifetime of protection. Ideal for homes, stores, whse., gar. etc. Wt. 3 lbs. Easily worth \$20. Special. **\$4.95**



EXTENSION CORD

(Item 16) 40 ft. heavy duty, made of specially insulated No. 14 2-conductor wire. So tough that you can drive over it and yet amazingly flexible and easy to handle. Resists oil, grease or water. Extends electricity up to 400 ft. without voltage drop. Use indoors or out. Complete with heavy rubber plug and outlet. Wt. 2 1/2 lbs. Usually \$4.50—Special 40 ft. **\$4.95** Comb. 2-40 ft. and 1-20 ft. (total 100 ft.) **\$4.95** 100 foot length (one piece) **\$4.85**



WIRE SPECIALS

(Item 50) #14-2 cond. same as above, but no fittings, wt. 6 lbs. \$4 per 100 ft.
TRENCH-LAY WIRE (Item 51) Anaconda #10-2 cond., for buried service to barns, outdoor lights, etc. Absolutely impervious to soil and moisture. Wt. 25 lbs. per 100 ft. Special surplus price. 100 ft. coils, 19c per ft.; 250 ft., 18c per ft.; 500 ft., 17c per ft.

PARTS WASHER

(Item 20) Store gas or carbon tet. in 5 gal. safety can. Valve releases just the right amount into washing compartment. Parts are washed and drained on a "dunking" screen — no fishing for parts. Eliminates fire-danger, waste, spillage, evaporation. Wt. 14 lbs. Reg. \$19.50—Special. **\$5.95**



All items brand new. Prices f.o.b. Chicago area. 10 day Money back guarantee. Send check or M. O. **MASTER MECHANIC MFG. CO., DEPT. 45, Burlington, Wis.**



Installing kitchen accessories!

HOME-UTILITY
1/4" Electric DRILL
 only
\$22.95

Makes household jobs FUN for the whole family!

You'll zip through home jobs—save on repair bills, too—when you add a Home-Utility 1/4" Electric Drill to your home appliances! It's so easy to operate that the whole family can enjoy using it to build and repair things around the house. This handy fistful of power drives scores of attachments—twist drills, wood augers, masonry bits, sanding discs, polishing bonnets, wire brushes, light grinding wheels, buffing wheels, etc.—for everything from building cabinets to waxing woodwork!

Quality-built by **BLACK & DECKER**, world's largest electric tool maker. Operates on AC or DC. Weighs only 3 1/4 lbs. Comfortable pistol grip and trigger switch. Over a million sold. Try one at your hardware, appliance or department store. Or, if you already have one, be sure to ask for the many attachments that make your drill even more useful!

Products of HOME-UTILITY Div.,
BLACK & DECKER Mfg. Co., Dept. H5M, Towson 4, Md.

ELECTRIC
HOME-UTILITY
TOOLS

1/4"-1/2" DRILLS • LECTRO-SAWS
 SANDER-POLISHERS • BENCH GRINDERS

The instrument panel is easy to read under all conditions. Its nonglare black lighting is outstanding. The combination switch and starter is located at the left of the panel. This is found a little awkward. It would be handier on the right-hand side directly below the light switch.

The Climatizer heating and ventilating system is located under the right-front seat and distributes heat to front and rear.

Both Champion and Commander models have the same wheelbase this year—115 inches—and I find that length satisfactory. The Land Cruiser is four inches longer. Luggage space is average. There could be better counterbalancing of the rear-deck lid for easier opening.

Assembly and workmanship on the body are good. In my 3000-mile test, not a squeak or rattle developed and this is unusual in any new car, regardless of make or price.

What about Studebaker's new Automatic Drive? It came through with flying colors. For ordinary use in starting and driving, the Drive (D) position is used. The air-cooled unit is a combination of a torque converter and an automatic transmission. The hydraulically controlled gearbox bolted on the back of the torque converter provides three forward gear ratios and one reverse. Forward ratios are low, intermediate and direct. Only the low, intermediate and reverse ratios are used with the torque converter, which is by-passed in direct drive. The automatic shift to direct drive, determined solely by throttle position, takes place anywhere from 18 to 60 miles an hour. There is no "mushiness" or apparent loss of energy as the car gets rolling. The hydraulic drive provides an extremely smooth start, combined with quick-action change from low to intermediate gear. The engine can be started only when the selector lever is either in Neutral (N) or Park (P) positions, and in both these positions the power plant is disconnected from the drive line.

For use in mud or snow, or in climbing extremely steep grades, the selector is placed in Low (L). When descending steep hills, use of the low gear acts as a brake on the engine and even at fairly high speeds it can be used to slow the car.

There is a cork and buna-N-rubber-faced single-plate clutch between the engine and the torque converter, which is automatically applied at a time determined by the throttle position. Thus, at the will of the driver, the transmission is locked rigidly in a 1-to-1 ratio. With the converter locked out, engine torque is transmitted directly to the propeller shaft.

(Continued to page 268)



Sharpening cutlery!



Polishing cars!

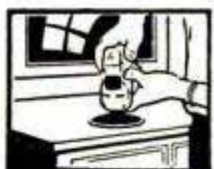

Refinishing furniture!



Shining pots, pans!

WARNING! Your engine may have to last a long time! This spring swing to . . .

MARVEL *mystery oil*



Here's the perfect upper-lube to save the precious engine of your car - keeps valves free, ring and piston wear down. Definitely a must in high-compression engines, for greater pep, power and performance. Add Marvel Mystery Oil to gasoline, crank-case oil, or use in Marvel Inverse Oiler. *Be engine-wise and Marvelize now!*



Install a Marvel Inverse Oiler for proper and controlled feeding to critical upper cylinder areas. Visible supply in 1-qt. glass container.

Write for free information Dept. 117

EMEROL MANUFACTURING CO., INC. 242 WEST 69TH ST., NEW YORK 23, N.Y.

CAMILLUS
has the edge!



No. 21
... made with the skill of 75 years of know-how: 1876-1951

*T.M.

FINER, SHARPER KNIVES for every need

Outstanding leader, the Pony jack knife leads the field for all-around serviceability. Its *Tru-Taper* blades of custom-made surgical steel are specially tempered and honed to the amazing *Permanized** edge that defies dulling.

Also a complete line of household cutlery.

CAMILLUS CUTLERY CO., Camillus, N. Y.

BE YOUR OWN BOSS! *Make*
UP TO **\$50.00** PER WEEK
IN YOUR SPARE TIME

C. E. Hardy of Missouri says, "I am doing a fine business with the Universal Grinder. One Customer sends another. I spent \$40 for a newspaper ad and have done nearly \$500.00 worth of business." G.S. of Ark. says, "I have had my Universal Grinder 2 months and made a net profit of \$227.00."

ONLY ON THE UNIVERSAL LAWN MOWER GRINDER

... can the inside face and edge of the stationary blade, as well as the reel blades, be ground to proper clearance

ALL IN ONE SET-UP

WITHOUT REMOVING ANY BLADE FROM THE MOWER

Users who have tried them all acclaim the UNIVERSAL for above any grinder on the market. Write today for full details of our Proved Success Plan. It's Free.



ROGERS MFG. CO., DEPT. M-51, LINDSEY, OHIO

SEND THIS COUPON NOW

ROGERS MFG. CO., Dept. M-51, LINDSEY, OHIO
Please send me full details about the profit possibilities of Lawn Mower Sharpening.

NAME _____
ADDRESS _____
CITY _____ STATE _____



PLOW



CULTIVATE



SHAW MFG. CO.

SAVE TIME, WORK, MONEY!

SHAW DU-ALL
and "PEPPY PAL" TRACTORS

These rugged walking or riding tractors are ideal for farm, truck garden, orchard, poultry farm. Operate on a few cents an hour. A child can handle them.

DO DOZENS OF JOBS Both riding and walking tractors quickly and easily plow, cultivate, harrow, disc, bulldoze, spray, haul, grind, saw wood, etc. **LOW FACTORY PRICES** Buy direct or through your dealer. A year's guarantee!

RIDING TRACTORS Four models from 5 to 12 H. P., 58 in. wheelbase, 36 to 52 in. wide, 24 in. plant clearance. Hand or electric starter. Walking Tractors 1 1/4 to 5 H. P.

FREE Illustrated folders giving complete details, price lists—write today. 4505 Front St., Galesburg, Kans. 668-G North 4th St., Columbus, O.



SAW DOWN TREES

- Fell Trees
- Saw Wood
- Cut Weeds
- Cultivate
- Plow • Seed
- Snow-Plow
- Rake • Disc
- Bulldoze
- Harrow, etc.



CUT GRASS AND WEEDS

London
Tokyo Paris BERLIN
THE VATICAN!



5-388
UL-Approved

hallicrafters

Precision Radio

- **HEAR WORLD NEWS DIRECT!** With the powerful Hallicrafters INTERNATIONAL LONG RANGE receiver.
- **PRECISION RECEPTION** for Standard Broadcast band. Hallicrafters is ALL RADIO . . . no frills, every ounce a masterpiece of famous Hallicrafters engineering. Modern, functional steel cabinet designed by Raymond Loewy.
- **HEAR AMATEURS FROM ALL OVER THE EARTH!** Tune in on this fascinating hobby, a start towards becoming a radio "Ham."
- **AIRPLANE AND POLICE COMMUNICATIONS** Tunes in short wave reception on three bands, with continuous coverage from 540 kc to 32 Mc. Hallicrafters is the perfect radio for remotely-located summer homes, farms, suburbs and cities where radio reception is difficult.

AC-DC Price:

hallicrafters \$49⁵⁰

WORLD'S LEADING MANUFACTURER OF
PRECISION RADIO & TELEVISION



MAIL THIS COUPON!

Hallicrafters — Dept. P, Chicago 24, Illinois

Due to the national emergency, only a limited number of these sets are being made. Reserve yours now — mail coupon for name of distributor who can serve you directly. THIS RESERVATION WILL BE HELD FOR 30 DAYS AT YOUR DISTRIBUTOR. Should you not buy within that period of time, the set will be given to the next name on the list. We will also send you free brochure giving full specifications.

YOUR NAME.....

ADDRESS

CITY..... ZONE.... STATE.....

As with the standard transmission, the rear-axle ratio is 3.54 to 1. For an extremely fast getaway, I found that by using low gear until about 35 miles an hour and then quickly shifting to drive position with throttle wide open, acceleration is rapid. Studebaker has definitely eliminated creep at traffic lights. When the brakes are applied and the car stopped, a solenoid-operated check valve holds enough hydraulic pressure on the brakes to offset the torque in the converter of the idling engine. A touch of the throttle releases the braking pressure and the car moves instantly. This is the same principle as Studebaker's locking device, called the hillholder, that prevents the car from rolling backward on a hill even though the foot is removed from the brake pedal. This frees the foot to operate the throttle for a smooth getaway from mid-grade stops. Pressure on the throttle releases the hillholder.

For years, Studebaker has offered the hillholder and it is still available in the conventional transmission. In my opinion, it is one of the finest extras ever offered. Ninety-seven percent of all owners of hillholder-equipped Studebakers, whom we polled, approved it. The automatic hillholder is a built-in feature of the new Automatic Drive and, believe me, it is a good one.

Low and reverse selector positions are located next to each other. Thus the car can be rocked in mud or snow by a back-and-forth movement of the lever. The Park (P) position of the lever locks the rear wheels and serves as a parking brake.

Studebaker is one of the few cars offering three different transmissions in all models: (1) conventional three-speed; (2) three-speed with overdrive; and (3) Automatic Drive. Anyone can have his favorite transmission when selecting any Studebaker model.

I have followed with great interest the progress of the Studebaker Corporation. In 1952, it will celebrate its centennial anniversary as the oldest manufacturer of vehicles in the United States. The company may well be proud of its latest, and by far finest, line of automobiles—the 1951 Studebakers.

Next Month—

Owners Report on the
'51 CHEVROLET

**GET ALL THESE
FEATURES!**

- SINGLE HAND WHEEL CONTROL
- RAPID TRAVERSE • PLANETARY SAW TILT
- FLOATING DRIVE • ECCENTRIC FENCE LOCK

ALL CAST IRON 8" TILT ARBOR

(*PATENTED)

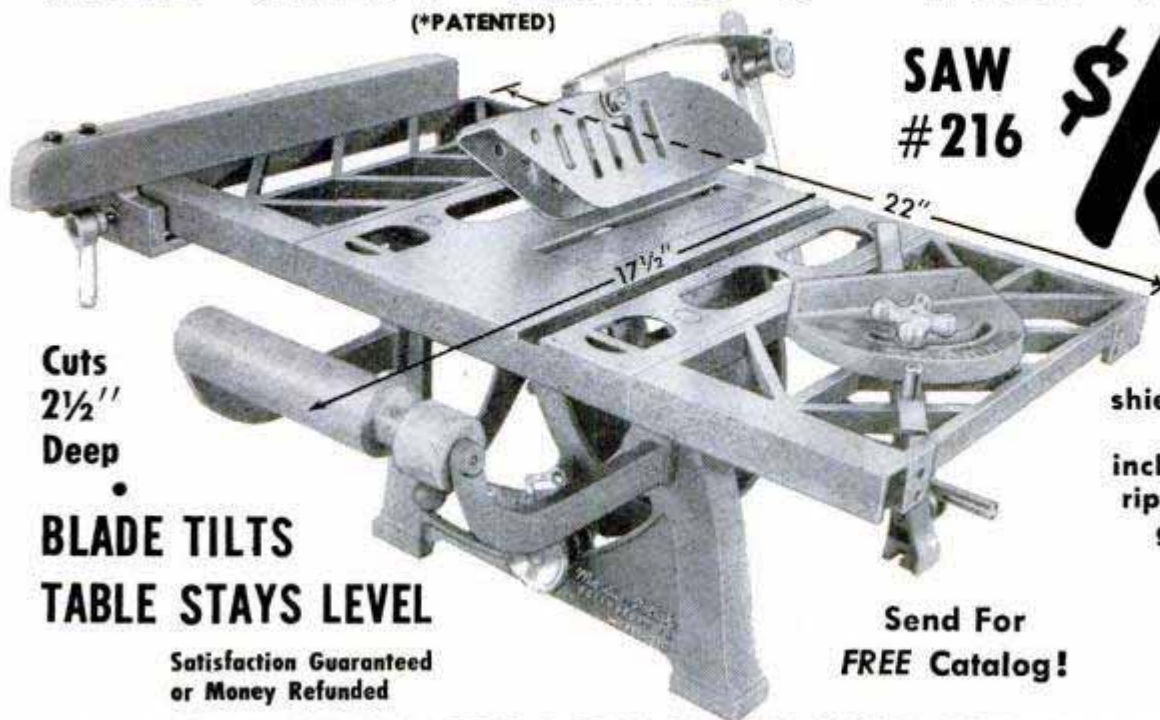

SAW
#216

\$18⁷⁵
(SAW ONLY)

Cuts
2 1/2"
Deep

**BLADE TILTS
TABLE STAYS LEVEL**

Satisfaction Guaranteed
or Money Refunded

With oil impregnated
bronze bearings...
\$22.75 with double
shielded greased-for-life
ball bearings (prices
include mitre gauge and
rip fence)... Aluminum
guard and extensions
extra... F.O.B.
Royersford, Pa.

Send For
FREE Catalog!

**PRECISION
GROUND TABLE**

SOLD ONLY BY MARCUS-POLLAK AND YOUR NEIGHBORHOOD DEALER

**Marcus Pollak* DEPT. C, ROYERSFORD, PA.

ELECTRICITY *Anywhere*

FOR PORTABLE, EMERGENCY OR HOME USE

ONAN Electric Plants generate 110-volt, 60-cycle current for homes, farms, cabins and resorts beyond the highline. Lightweight, portable plants cut costs, speed work for contractors. Standby plants protect units against power failure. 400 to 55,000 watts. Gasoline or Diesel-powered. Priced from \$219.00.

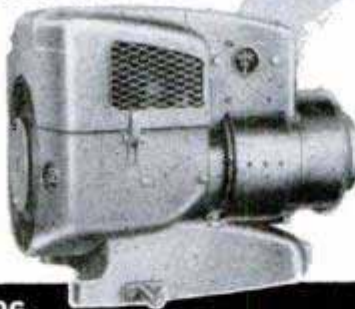

WRITE FOR CATALOG

D. W. ONAN & SONS INC.
5845 ROYALSTON AVE. • MINNEAPOLIS 5, MINN.

ELECTRIFY your SEWING MACHINE



NEW LOW PRICE!
\$12.50 1 YR. GUARANTEE

Buy direct from manufacturer and save! Kit comes fully wired, installed in a jiffy. Fits all machines! You get these all-new parts:

- Motor & Bracket
- AC-DC 115v 60c
- Multi-speed foot control
- Cord set & block
- Easy instructions
- Steel pulley & belt

FREE . . . reg. \$2.95 chrome SEWLITE given with every kit.

10 DAY FREE TRIAL — ORDER NOW!
Send no money, pay COD or send money order and we'll pay postage. Please state whether wheel on your machine turns toward you or away from you. Shipping wt. 6 lbs.

SENIOR SEWING MACHINE CO.
1046 BEDFORD AVENUE Dept. PM-25 Brooklyn 5, N. Y.

Start a Business in Your Backyard



Earn **BIG MONEY**
MAKING
BUILDING BLOCKS

**General Concrete Vibrator
BLOCK MACHINE**
CAPACITY 1000 BLOCKS A DAY

Only \$218 LESS MOTOR
F.O.B. PLANT
SHIPPING WEIGHT 400 LBS.



Here is a business you can start on small capital—in your own backyard—that earns 100 to 150% profit, with unlimited opportunities. Make concrete or cinder blocks. Millions used for homes, factories, public buildings, garages. Sell all you make to building trade. Do it with a General—and you're headed for success.

1000 BLOCKS A DAY

The General is a high speed, power-driven block machine at amazingly low cost. Rugged all-steel construction. Simple to operate indoors or outdoors. Makes superior 3 core type block meeting all code requirements. Produces up to 1000 blocks per day. Full operating instructions and mixing formulas supplied. Write for **FREE** details.
Dealer Inquiries Invited

*Wonderful
Book Written
& Illustrated
by Experts*



GENERAL ENGINES CO.
DEPT. P-20 • 307 HUNTER ST. • GLOUCESTER, N. J.

Includes floor plans for 6 beautiful, easy to build concrete block bungalows. Shows ways to save money. How to lay blocks, lay out building lines, mix concrete, build steps, porches and concrete floors. Mail coupon at once with \$1.

Name.....
Address.....
City..... Zone... State.....

In the Home, as in
Industry, the choice is

**WISS METAL
SNIPS**

The superior quality of famous **WISS** Metal Cutting Snips has made them the first choice in the home and in industry. Every pair is rigidly tested and guaranteed to cut easily and efficiently for an unusually long time. Carefully adjusted blades are set precisely to reduce wear and permit maximum cutting power with a minimum of effort.

**WISS METAL MASTER
COMPOUND ACTION SNIPS**



Compound leverage produces amazing cutting power with minimum effort. Will cut holes, circles and complicated patterns in metals to 18 gauge. Rubber grips recommended. M 1 (Cuts Left) 10" long; M 2 (Cuts Right) 10" long; M 3 (Cuts Straight) 10" long.

**WISS SOLID STEEL
STRAIGHT CUTTING SNIPS**



Economical in price, these snips meet government specifications. Made of a specially selected grade of solid tool steel. For general metal-cutting. Four sizes, 8" to 12 1/4" long.

**WISS SOLID STEEL
COMBINATION SNIPS**



Will cut straight, curves or irregular shapes with ease. Two sizes, 7" and 13" long.



**J. WISS & SONS CO.
NEWARK 7, N. J.**

**We're Back in Business
—the Seabees**

(Continued from page 114)

extra squirt of fuel and a powerful downward push. Immediately afterward, the driving arm is reversed and springs back up, ready for another blow.

Scattered over the mile-square grounds of the laboratory are a number of other machines, all designed to improve the Seabees' efficiency in building overseas bases and installations.

There are rows of huge anchors with new stabilizing arms. There is a midget oil refinery, for emergency front-line use, that would fit into the living room of an ordinary-sized house. There's an improved portable distillation unit for making fresh water out of sea water.

Since the next war may be fought in the Arctic, much laboratory effort concerns techniques for operating machines and equipment in below-freezing weather. Interesting experiments have been made in churning and compacting snow by mechanical means and an Arctic Test Station at Point Barrow, Alaska, evaluates new materials, equipment and techniques.

Even the Quonset hut, which was pretty much standardized in World War II, is being restudied — both from a viewpoint of using it in Arctic climes and finding materials to substitute for near-critical steel. One has been built of aluminum at the Hueneme Laboratory—insulated so that it keeps out cold, holds in heat. In another experiment, Masonite products are being used to build a rectangular hut instead of the usual rounded steel Quonset.

In addition to developing new machines and techniques, the laboratory re-evaluates equipment now in use. After the Inchon landing, for example, there were complaints that barge couplings had failed. So Navy scientists and technicians took a couple of barges and locked and unlocked the couplings for as many as 10,000 times to study their operational weaknesses.

The only man alive who has ever dared to criticize the Seabees is General Douglas MacArthur. He told Admiral Ben Moreell, Chief of the Bureau of Yards and Docks, who organized the Navy's construction battalions:

"The only trouble with your Seabees is that you don't have enough of them."

He said it in 1944 and he was right. But more and more bluejackets today are wearing the insignia — a rugged-looking bee sporting a sailor hat, firing a tommy gun and carrying a wrench and hammer.

The Seabees are back in business again—war business.

Your Work is a **PLEASURE**

with
**MIDLAND
DANDY BOY**



**GARDEN
TRACTORS**

You're all set to make any job easier when you own a DANDY BOY with its work-saving implements and time-saving exclusive features. Harrowing, hilling, furrowing, seeding, cultivating, spraying, lawn mowing, hauling, spray painting, and a lot of other jobs in any season are simple with a 2, 3, or 5 H.P. Midland DANDY BOY. You get greater power and performance per dollar, years longer service, too.

Write Dept. PM-5 for descriptive folders and name of dealer near you

THE MIDLAND CO.

1200 Rawson Ave., South Milwaukee, Wis.
Builders of Farm and Garden Implements Since 1911

NU-WAY HEAVY DUTY CUTTING UNIT
with Timken Roller Bearings

PRICE

\$16.50

WHY PAY MORE



Build your own rotary type lawn or weed cutter.

Take the hard work out of weed cutting. Build yourself an up-to-date weed and lawn mower with the Nu-Way heavy duty unit.

Write for Free Circular—We Supply Cutting Unit Complete
TRACTOR-LITE MFG. CO., Spirit Lake, Iowa



Print Your Own

Cards, stationery, circulars, tags, labels, photo and movie titles, advertising, etc. Save money. **Print for Others, Good Profit!** Easy rules sent. Raised Printing like Engraving, too. Sold direct from factory only. Write for free catalog of outfits and all details. **KELSEY PRESSES, M-37, Meriden, Conn.**

LOWER YOUR CAR
CALIFORNIA STYLE

with the Original Clark Lowering Blocks

- Far greater safety at high speed
- Less body rolling in turns
- Less front end dip on quick stops
- Lowers rear end to front end level

Complete kit only \$3.00, includes parcel post chg. 30 minutes to install—state make & year of car. Special kit for Ford & Merc 1932 to 1948 \$1.00

Over One Million In Use

CLARK HEADER CO.

6980 E. Firestone Blvd., Downey, Calif.

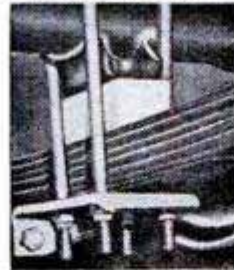

Ball-Bearing SPEED WHEELS



JUVENILE WHEELS		(No bearing, solid tires)	
4"	40c	6"	65c
5"	45c	7"	75c
(Semi-pneumatic tire, ball bearing)			
8 x 1.25	1.85	10 x 1.25	2.20
8 x 1.75	1.95	10 x 1.75	2.30
8 x 2.00	2.20	10 x 2.00	2.65
12 x 1.75		3.45	

INDUSTRIAL WHEELS

Lug Base, Semi-Pneumatic tire			
5 x 1.75	3.65	10 x 2.00	6.10
6 x 2 SW	3.45	10 x 2.75	5.15
6 x 2.00	4.00	12 x 2.00	6.90
8 x 2.00	5.20	12 x 3.00	9.20
8 x 2.50	5.40	16 x 4.00	15.15
Smooth Base, Pneumatic tire and tube			
8 x 3.00	11.00	12 x 4.00	12.10
10 x 2.75	6.80	4.00 x 8	13.10
10 x 3.50	10.55	14 x 4.50	13.40

Dealers, Jobbers, and Manufacturers! Our new prices will interest you.

Available Now—CASTERS
Write for circulars on all wheels.
Prices F.O.B. our plant.

JIM BROWN TOY COMPANY
1093 HOME AVENUE AKRON 10, OHIO

No c.o.d. orders.



PHEW-W
...that muck in my car?

A mucked-up oil filter can cost you plenty in engine repairs. Get in a new **Purolator* Refill—quick!**

Any filter naturally chokes up—loses effectiveness after an average of every 5,000 miles you drive.

What to do? Don't delay—get in a clean filter refill—fast. Which make? Pays to buy the best—a Purolator Micronic*. New accordion-type design gives up to 10 times the filtering area—with pores so tiny they trap particles you can't even see. Cost much? Strictly small change—\$1.38 to \$3.00, depending on car make. Purolator Products, Inc., Rahway, N. J.; Toronto, Ontario, Canada.

*Reg. U. S. Pat. Off.

PurOlator
MICRONIC
OIL FILTER

Why, sure it's **WILLIAM BENDIX**, you knew it all the time.
Co-starring in RKO's "Macao"

BUILD YOUR OWN RADIO CONTROLLED DOOR OPENER

... and 23 other electronic labor-savers

● This book gives complete instructions for building an electronic door lock, a charger for small dry batteries, a radio-controlled relay, pocket stroboscope, remote control for model trains, doorbell "booster", a photoelectric relay, photographic interval timer, simple crystal radio and a dozen other valuable gadgets.

All you need is some inexpensive Sylvania Crystal Diodes and a few everyday materials. Book gives easy-to-follow, illustrated how-to-do-it instructions.

Get Sylvania's 40 page book, "Electronic Shortcuts For Hobbyists" today.

Only 25¢

Send coin or stamps to: Sylvania Electric Products Inc., Department E-1205, Emporium, Pa.



If You Own a Schick or Remington Electric Razor . . .

You get a closer shave and greater comfort by preparing your face before you shave. In just three seconds this wonderful lotion "sets up" your face for shaving.



1. It evaporates sticky, razor-clogging perspiration.
2. It lubricates the skin for faster, more comfortable shaving.
3. It tautens your skin—"brings out" beard for closer shaves.

It also lubricates shaver's cutting head for easier action, longer shaver life!

That's Letric Shave. Only 49¢, plus tax, for 3 oz.—80 shaves. Use with any make shaver. For a free month's supply send name, address to The J. B. Williams Co., (PM-2), Glastonbury, Conn.

WOODWORKERS . . . Get this

CONSTANTINE MASTER MANUAL
Get the Most Fun From Your Hobby
Indispensable to woodworkers. Newest, biggest edition, more pages, more color, helpful how-to-do-it articles, pre-war and new items, more bargains. Send 25c today and we will include **FREE! FULL YRS. SUBSCRIPTION** to Chips and Chats, published bi-monthly. Keeps you up-to-date on everything in woodworking, offers big money-making bargains. Send now. ALBERT CONSTANTINE & SON, Inc., Dept. PM-5 797 East 135th Street, New York 54, N. Y.



LAWN ORNAMENT-NOVELTY PATTERNS

28 Lawn Ornament Patterns, 25¢. Other Patterns: 15-20" high; Dutch Girl, Dutch Boy, Pirate, Bull Terrier, Mexican Girl, Mexican Boy, Dwarf, Penguin, Flower Girl, 10¢ each. 25 Novelty Patterns, 30¢. All 62 Full Size Patterns, \$1.00 Postpaid. Strother Pattern Service, Dept. CF-8, Box 128, Belington, W. Va.

Clark EXPANSIVE BIT

CUTS BETTER • COSTS LESS!
Accurate, fast; cuts smooth holes in hard or soft wood. Chrome vanadium steel blades, all chrome body. No. 250, 1/2" - 1 1/2", \$1.89; No. 251, 3/8" - 3", \$2.19. **GUARANTEED.** At your dealer or write Dept. PM-5

ROBERT H. CLARK COMPANY • Beverly Hills, California

WHY OVER A MILLION MOTORISTS SWEAR BY THEIR HULL AUTOMOBILE COMPASSES

ONLY by installing one BEFORE you get into a mix-up on directions can you fully appreciate what Hull Automobile Compass users mean when they say: "Worth its weight in gold!" Save time, worry, miles with the ONE famous name in automotive compasses.—Write for local dealer's name, free literature.

HULL MFG. CO. Beaconlite \$695
P. O. BOX 246-D5, WARREN, OHIO Streamline \$495
standard (not the 1)

Say You Saw It in POPULAR MECHANICS



for ... POWER LAWNMOWERS, MOTOR SCOOTERS, GARDEN TRACTORS, MOTORBIKES, ETC.

The Way to transmit Power Smoothly

V-PLEX CLUTCHES automatically tighten drive belt as throttle is opened, eliminate belt slippage, cut wear, permit idling engine. Easily installed on any gas engine; practically indestructible. Fit 1/2, 5/8, 3/4" drive shafts. See dealer or write.

WRITE FOR FREE FOLDER
MFG. BY V-PLEX CLUTCH DIVISION
LIGHT INSPECTION CAR WORKS — HAGERSTOWN, INDIANA

SAVES SO MUCH COSTS SO LITTLE!

Atlas WORKSHOP TOOLS 8" BENCH SAW



ONLY \$33.95

With two extensions, as shown, \$38.90.

Watch the savings pile up with this Workshop saw to help! Makes quick, professional work of home repairs, furniture, cabinets, shelving, toys, etc. Cross cuts, rips, mitres—saves tedious, time-taking hand sawing. Pays for itself on one or two projects alone. Send for detailed catalog today!

40th YEAR **Atlas** **ATLAS PRESS CO.**
543-W N. Pitcher St., Kalamazoo, Mich.,
DEPENDABLE QUALITY TOOLS

DIRECT FROM CAN TO MOTOR No Dirty Funnels or Containers

Use this new dispenser to handle all weight oils, gasoline, pour greases, etc. Delivers a quart of fluid to every four strokes, and a pound to every two. No waste. Fits any five-gallon kerosene-type can.



Steel cylinder, aluminum nozzle, four feet of oil-resistant hose, and pour-spout cap. Can, not included. *Guaranteed.*

Order Direct

ONLY \$6.00

Shipped PP if check with order. Add charges for C. O. D.

STELLO PRODUCTS CO.
HUTCHINSON, KS.

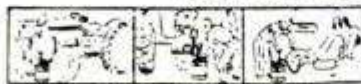

Asbestos Gloves for HOT Jobs

Handle hot things with safety. Wear Industrial's famous 200-14 asbestos gloves. Made of close woven 2 1/2 lb. Underwriters Grade cloth that resists burning. Big roomy cut, airy and comfortable. One piece construction with no seams at wrist or working edges to burn or pull out. Furnished lined or unlined. Over 40 years experience designed and made these dependable gloves. Many styles. Write for prices and catalog.

INDUSTRIAL GLOVES CO.
A Corporation
1415 Garfield St., Danville Ill.
In Canada: Safety Supply Co., Toronto

CRESCENT TOOLS

Give Wings to Work

ASK YOUR
HARDWARE
DEALER

HANDEE

tool of 1001 Uses

FINEST IN POWER TOOLS PLUS 51 ACCESSORIES

Complete... designed for every hobbyist and mechanic! Grind, drill, polish, carve, sand, saw, etc. Packs plenty of power in the 25,000 r.p.m. motor, with approved 7-segment commutator. Handsome fitted steel carrying case.

Complete, with liberal 10-day money back trial offer..... **\$27.50**

with 7 accessories... **\$19.95**



HANDEE WORKSHOP

**"Tornado-Powered"
with NEW HANDEE "85"**

Versatile, with 41 accessories... suitable for shop or home use. For novice or expert... precision routing, molding cuts. HANDEE "85" a production wizard... automatically air-cooled, pin-point accuracy. Sensational power!



Complete, packed in handsome case,
\$29.95

FREE! New 64-page Manual

Chicago Wheel & Mfg. Co., Dept. PM
1101 West Monroe St. Chicago 7, Ill.



EASY PROFIT IN PAINT SPRAYING

Paints walls, ceilings, screens, furniture and machinery faster, better. All complete as shown less motor. Carry anywhere. Fully guaranteed. Could be used with 1/4 H.P. motor or less. Price **\$35.00** less motor F.O.B. Chicago. \$7.00 deposit balance C.O.D. or see your dealer. With motor **\$55.00.**

IDEAL AUTOMATIC PUMP CO., Dept. P.M.8
801 W. Washington Blvd. Chicago 7, Ill.



Fits the hand like a glove. And what power—with wrist firm and straight! Harder you pull the tighter the jaws bite down. Easy to handle in cramped spaces. A tool that should be in every home and workshop. FREE—descriptive folder on request. Or heft a pair at your local hardware store. One of a long line of fine tools made by Utica Drop Forge & Tool Corp., Utica 4, N. Y.

No. 550—8"
\$2.20

IT PAYS
TO BUY

QUALITY
TOOLS



PISTOL GRIP

SLIP JOINT PLIERS

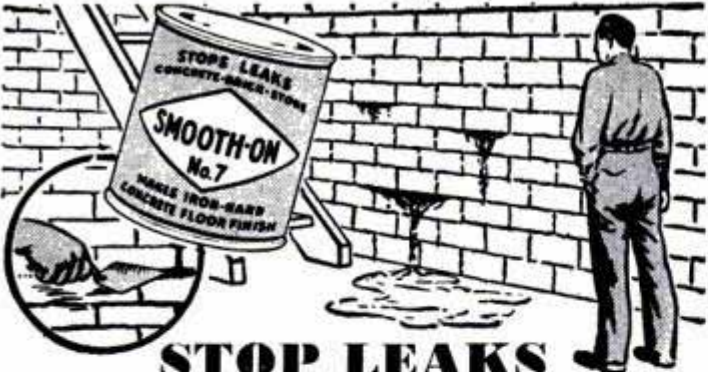

STOP LEAKS IN CELLAR WALLS

Do it with Smooth-On No. 7 Cement! Apply with trowel or stiff brush to leaky cracks, holes, porous spots, seams or other leaks in concrete, brick or stone walls and floors. The leaking will stop and Smooth-On will "stay put", for it expands slightly as it hardens. May be applied to wet or dry surfaces, indoors or outside. Use Smooth-On No. 7, too, to seal openings around pipes passing through walls. Buy Smooth-On No. 7 by name and number in 1-, 5-, 20- or 100-lb. size. If your hardware store hasn't it, write us.

FREE Leaflet and Handbook

We'll send you leaflet showing No. 7 uses, also the famous 40-page Smooth-On Repair Handbook describing other Smooth-On Cements and showing many helpful home repairs. 170 illustrations. Write today.

SMOOTH-ON MFG. CO., Dept. 37E
570 Communipaw Ave., Jersey City 4, N. J.



Do it with SMOOTH-ON NO. 7 CEMENT

a "Must" for every mechanic
FREE, NEW CATALOG of those



DURO-CHROME TOOLS

Soon to be released—a new Duro-Chrome Mechanic's catalog. Crammed with pictures and detailed descriptions of the latest ideas in tools. Shows the right Duro-Chrome Quality Tool for every mechanic's needs, PLUS hard-to-find and "special job" tools your dealer has or can get for you.



Explains why Duro-Chrome Tools have been preferred by professional shop men for over 30 years. Tells what to look for in picking good tools; how Duro puts Extra quality into every tool; for example, gets 25% more wear on Sockets, by exclusive Hot Broaching process. Shows Duro-Chrome Tool Sets from 5-pc Punch and Chisel Sets up to 114-pc DeLuxe Workshops Sets. Reserve your copy of this "cyclopedia" of fine tools.

USE THIS COUPON NOW TO GET FREE COPY
SEND IT TO DURO METAL PRODUCTS COMPANY
2649 N. Kildare Avenue, Chicago, Ill.
Write your name and address in margin space below

SPRAYING MADE EASY

BECKER *Self-Contained* PRESSURE GUN

Saves Cost of Compressor and Motor

TAKE IT ANYWHERE—the first completely portable spray gun. Needs no compressor, motor, or electrical outlet. Pressure-powered with an inexpensive CO2 cartridge that sprays up to 21 liquid ounces, depending on viscosity. Extra cartridges, 10 for \$1, postpaid, or buy from your dealer.

PAINTS • VARNISHES • ENAMELS
MOTH-PROOFS • INSECTICIDES

Every home needs a Becker Spray Gun for dozens of jobs in the house, workshop, garden or garage. Complete instructions furnished for effective results. Order yours today for the season ahead.

HOW TO ORDER—If your dealer can't supply, send \$15.95 and we ship postpaid—or \$2 now and pay postman balance plus postage and fee. Money back if not delighted after 5 days' trial.

SULLIVAN-BECKER CO.
Dept. 111-E, Kenosha, Wis.



ONLY \$15.95 with 3 cartridges



WELD BRAZE, SOLDER, and CUT

ONLY \$11.95 F.o.b. complete!

EASILY... QUICKLY!

No experience needed. Follow simple instructions, weld on iron, steel, bronze, brass, aluminum, and other metals. Plugs into any properly wired 110 volt A.C. or D.C. line. Make or save time and money doing repair work for yourself and others. Repair men, farmers, tinsmiths, home and auto owners, hobbyists, etc., say FOUR-WAY pays for itself over and over. Order today or send for Free details.



ORDER NOW 10 DAY TRIAL

FOUR-WAY WELDER COMPANY, Dept. F2-EB
2326 So. Michigan Ave. • Chicago 16, Illinois

LIQUID MARBLE

COMPOSITION FLOORS FLEXIBLE MOLDS
Mold, Brush, Trowel, Spray It! MOLD novelties, Statuary, Art Goods in Flexible Plastic Molds; 5c material makes \$1 seller. Make Marbleized floors, Tile Walls. Colorful, glossy, amazing! Easily learned; start in garage or basement. Particulars free.
MARBLEIZING SERVICE, Dept. 10-F, Edwardsville, Ill.

POWER HACKSAW \$52.75

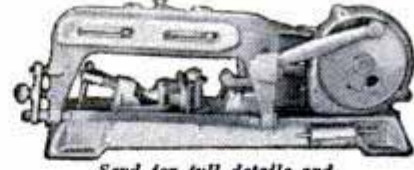

LESS MOTOR
F. O. B. Benton Harbor
● Rugged cast iron construction. Wt. 56 lbs. bronze bearings. Draw cut. Auto. return lift. Auto. shut-off. Vise swivels 45°. Cap. 4"x4".

EXCEL MACHINE TOOLS Dept. PM-51 BENTON HARBOR, MICHIGAN

SAY YOU SAW IT IN POPULAR MECHANICS

WAR SURPLUS BARGAINS

\$500,000.00 INVENTORY for QUICK LIQUIDATION

Surplus items—hundreds of them for home, shop, factory, farm and outdoor use. New items, used items, reconditioned items—all at tremendous savings—all priced for quick sale.

Page After Page of Values

This big catalog shows page after page of amazing money saving values. Write for your copy today. Send 10c to cover postage, mailing, etc. Write today!

SEND TODAY FOR YOUR COPY

10c

STARK'S Dept. 509 So. STATE STREET PM-5 CHICAGO 5, ILLINOIS

Got a new glass rod?
Get the new **COXE** reel!

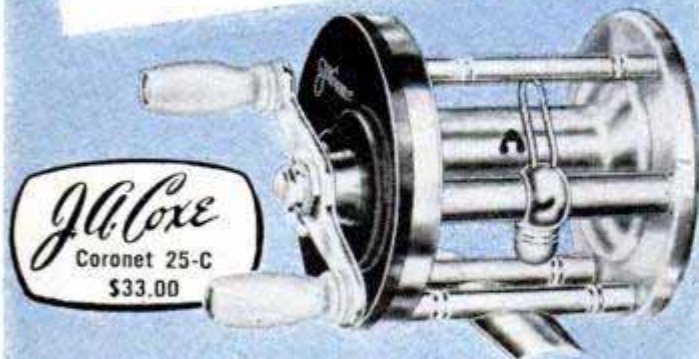

J.A. Coxe
Coronet 25-C
\$33.00

It's the right reel for any rod—the perfect reel for the new glass rods. It's the J. A. Coxe Coronet 25-C—with the new one-piece spool.

This is the reel you've known for years as the world's only automatic free spool reel. You get the same Coxe craftsmanship, the same basic features—cross-bolt construction, 10-second take-down, perfect spool alignment. But now it's completely re-designed—with the weight cut in half!

If you're ready for the finest reel money can buy, ask for the new J. A. Coxe Coronet 25-C.



LIGHTER—it's all aluminum.
RUGGED—it's made in one piece.
BALANCED—it's machined both inside and out! Featured on four Coxe reels, starting at \$11.00



Bronson
GREEN HORNET
\$5.95

Here's the reel that packs premium features into a popular price—the Bronson Green Hornet. Beautifully designed with green anodized head and tail plate. Bronson's easy-to-set drag button lets you pinpoint the correct tension with one simple turn. Just set the dial before you cast—the reel does the rest! If you want the finest reel for the money, ask for the Bronson Green Hornet.

BRONSON REEL COMPANY, BRONSON, MICHIGAN
Division of Higbie Manufacturing Co.

In a tight spot?

"YANKEE"

Offset Screw Driver
Drives . . . draws screws
in close quarters!



Get 'em out or drive 'em easily in tight places with a "Yankee" Offset Ratchet Screw Driver! Lever action gives more power than a regular 8" screw driver. No. 3400 illustrated has 1/4" and 3/8" blades for slotted screws; other models for Phillips Recessed Head Screws. At your Stanley dealer's. Write for free "Yankee" Tool Book.

"YANKEE" TOOLS
NOW PART OF



THE TOOL BOX
OF THE WORLD

NORTH BROS. MFG. CO., Philadelphia 33, Pa.



BARGAIN! BRAND NEW! SPINNER!

only **\$47.95** Save **\$34.55** REG. \$82.50
7-in. disc

While They Last — Direct From Manufacturer

Uses 7-in. or 9-in. disc—Sands, grinds, wire brushes, etc. Makes tough jobs easy. 3/4 h.p., Heavy Duty Motor. 10-day, money-back guarantee. No C.O.D. Send check or M.O. TODAY—while they last! Californians add 3% State Sales Tax

HOLT MFG. CO. 651 20th Street Oakland 12, Calif. | 272 Badger Avenue Newark 8, New Jersey



GERSTNER Tool Chests

Gerstner chests are not cheap, but they are most economical. Free catalog for machinists and Toolmakers.

GERSTNER TOOL CHESTS
451 Columbia St., Dayton 7, Ohio



make your own Gems 29.50
F.O.B.

All necessary lapidary equipment is furnished, including a super-charged diamond blade for sawing, and all wheels for grinding, shaping and polishing; also complete instructions. The complete equipment as shown, less motor and belt, for only \$29.50, f.o.b., Burlington, Wisconsin. Write today for information and literature.

B&I MANUFACTURING CO.
Dept. S Burlington, Wis.



Only **\$498**



OTTAWA MULE TEAM TRACTOR

Over 4,000
In Use

Finest of all low cost tractors. Plows, discs, harrows, mows, saws, plants, hauls, etc. Has draw-bar pull for many jobs. Powerful, economical and super durable. Smartly engineered. Makes play out of hard irksome jobs. Excellent working visibility. Honor built. Designed for farmers, truck gardeners, private homes, estates, etc. Adjustable wheel widths, 16-inch row clearance. Has 3-speed Warner transmission, Rockford Clutch, 2 individual brakes, large roomy spring supported seat, PLOW lift, auto type steering. Sold only direct to user at unusually low price. Prompt shipment. Write today for FREE details. In our 46th year.

OTTAWA MFG. CO., 1-127 Garden St., Ottawa, Kansas

**MAKE MONEY
SAVE MONEY
BUY
SUPERSHOP**

**15 DAY
TRIAL**

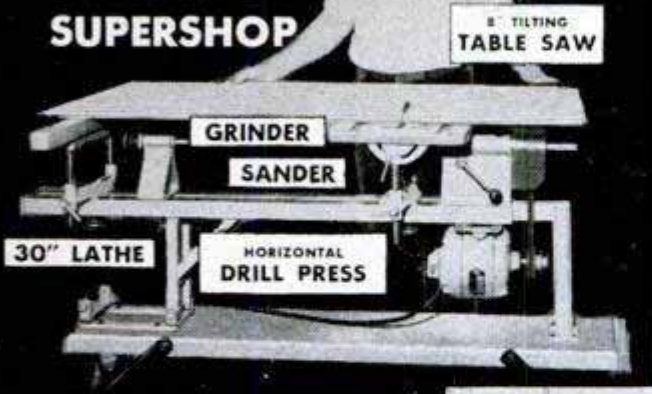

**BUY SMART — \$79.95
FACTORY TO YOU**

SUPERSHOP offers you a lifetime of power tool pleasure and profit. 100% ball bearing. RUGGED. Accurate. Big capacity. 15 day FREE trial. Money back guarantee. Mail postcard for FREE catalog. Buy on easy pay plan.

**POWER TOOLS, INC. 123 YATES AVENUE
BELOIT, WISCONSIN**

**VERTICAL
DRILL PRESS**

B-M POWER MOWERS

**CUT HOURS OF WORK into
MINUTES of PLEASURE!**

- ★ Prompt Shipment
- ★ Low Factory Prices
- ★ Fully Guaranteed
- ★ Model D-3



For a quick, slick job and a smooth-as-velvet lawn, you can't beat a B-M Power Mower. Three Models of fine rotary mowers available for your special cutting needs. The D-3 (pictured here), the self-propelled P.D. models, or our light VD-1 Mower with vertical shaft engine and direct blade drive. Quick starting, dependable 1 1/2 to 3 h.p. Clinton engines. Safety features. Easy adjustments. Low factory-to-you Price. Write for **FREE LITERATURE.**

B-M MOWER CO., Box 66-PM, Blue Mound, Kansas

BRIKCRETE



**Local Manufacturing
of this Modern Masonry
Has High Earning Power**

Several hundred territories are being opened up for local Brikcrete manufacture by men of vision and aggressiveness. Brikcrete ties in with today's huge building program. Makes possible better construction at lower cost. Truly better than brick; actually cheaper than lumber. Combines strength, safety, insulation value, colorful beauty that fits today's styling.

Brikcrete is made in locally owned plants, using local materials and local labor. That's why high quality and low price still permit a 100% to 150% mark-up. We supply complete equipment; easy terms if required. Generous co-operation. Exclusive manufacturing privileges in protected territory. Write for information.



Brikcrete Associates, Inc.
4679 Division Ave. S
Grand Rapids 8, Mich.

**Last Year's Profit
\$3,000!**

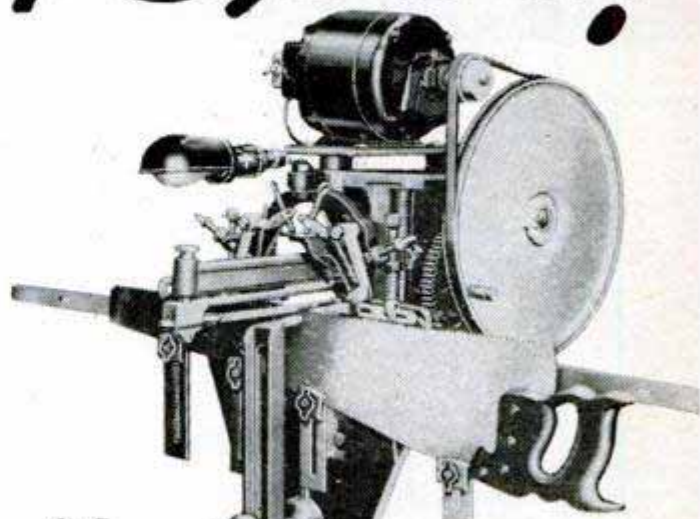

with a

**FOLEY automatic
SAW FILER**

"Last year's profit amounted to \$3,000. Not so bad for a one-man outfit" — from Chas. C. Hough. James B. Williams wrote us—"I made \$765 last year filing saws, and it sure comes in handy. I do this work in my spare time." Men in communities of all sizes make up to \$2 or \$3 an hour with the Foley Saw Filer working full time or part time. That extra money comes in mighty handy in these days of high prices.

It's no trick to take care of the saw filing for your neighborhood hardware or lumber dealer —plus looking after the saws for farmers, townspeople, manual training departments and factories. The Foley files all hand saws, also band and cross-cut circular saws. It's a cash business, no canvassing, no eyestrain and no experience needed.

**FREE BOOK
Shows How to Start**

"INDEPENDENCE AFTER 40" shows just how you can start at home in your spare time working in your basement or garage. It's an immediate cash business that can develop into a full-time repair shop. Send coupon today — no salesman will call.



Send For FREE BOOK

**FOLEY MFG. CO., 516-I Foley Bldg.
Minneapolis 18, Minn.**

Send me free book "INDEPENDENCE AFTER 40!"

Name _____

Address _____

CALK THOSE CRACKS WITH *Nu-CALK* SPEED LOAD



Seal out drafts, dust, around windows and doors

Here's the easy way to calk your home. Just slip a handy Speed Load into the calking gun and you're ready. It's the fastest, most economical way to apply the world's finest calking compound.



USE *Nu-Glaze* INSTEAD OF PUTTY



Macklanburg-Duncan Co., Okla. City, Okla.

BUY THROUGH YOUR LOCAL HARDWARE, LUMBER OR BUILDING SUPPLY DEALER

AMERICA'S FINEST, MOST COMPLETE GARDEN TRACTOR LINE!

Top Value in Every Power and Price Class.

48" Wheelbase
8 h.p.



New **ROTO-LOK** Tool Lift

Write for Folder



A sensational new riding unit! The Gard'n Mast'r is rugged, powerful, versatile! Compact and well-balanced for easy turning. Length 74 1/2"; width 33"; plant clearance 19"; variable tread width 28" to 38" Auto-type steering, differential and transmission with 3 speeds forward; 1 reverse. See it Now!

TOPS IN 2-WHEEL UNITS

Garden-All

LAWN and GARDEN TRACTOR

No better buy than Garden-All! Finer features give better performance, more satisfaction, more value! Big variety of models cover every need.



5 MODELS

2 to 4 1/2 h.p.

Get the Best!
It Costs No More!

Garden-All Tractor, Inc., Dept. P, Liberty, Indiana

BUILD YOUR OWN POWER TOOLS - TILT/ARBOR SAW



TILT/ARBOR SAW

• 27x28 in. table stays level. Blade tilts full 45 degrees. • 10 in. blade cuts 3 1/4 in. deep, jackscrew depth adjustment. • Floor model, 34 in. table height. • New Departure ball bearing arbor, 3/4 in. precision shaft, ready to run, 5/8 in. bore blades. • Quick positioning, self-aligning rip fence guide. • Sturdy wood, steel and aluminum construction. • No machining—build easily with hand tools only. • Capacity and performance of floor saws selling for \$150.00 and up!

BANDSAW

BELT SANDER

SAVE \$50 OR MORE

GIL-BILT Metal Parts Kit, includes Plans, ball-bearing arbor, cast aluminum miter gauge and bar, rip fence guide, machined lock knobs, jackscrew mechanism with 4 1/2 in. handwheel, and all other metal parts including every screw, bolt, nut and washer (less blade).....\$20.95

Same Kit with 10" combination blade.....\$24.90

Same Kit with 8" combination blade.....\$23.90

If not satisfied, return Kits in 10 days for refund of purchase price.

(Prices include postage up to 600 miles)

GIL-BILT Step-by-Step pictorial plans (No blue-print reading required), full scale patterns, actual photographs for above 10" TILT-ARBOR SAW, 12" BAND SAW, BELT SANDER, 8" TILT/TABLE SAW \$1.00 each, postpaid anywhere in the world. ALL 4 Plans for \$3.00, or write for FREE descriptive catalog.

COMPLETE PLANS only \$100 EACH

GILLIOM POWER TOOLS P. O. Box 1-PE, Lambert Field, St. Louis 21, Missouri

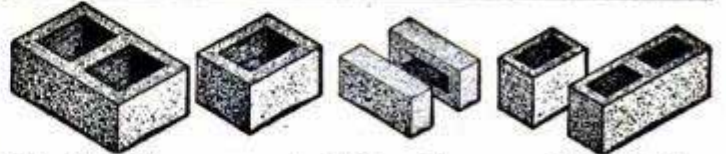

Make Concrete Blocks and Bricks

New superior method makes square, true, easy-to-lay units which will pass any building code. Small investment, high production, big profits. One \$30.00 machine will make four 5"x8"x12" blocks per minute—1000 per day. Pays for itself in a few days. Sell blocks or save 2/3 building cost by making and laying your own.

POST CARD BRINGS FREE FOLDER

Economy Manufacturing Company
Dept. P Stone Mountain, Georgia

ELECTRIC MOTOR BARGAINS!



Every Motor Fully Guaranteed

Write for 32-Volt Bargain List ALL PRICES F.O.B. ROBERTS ELECTRIC CO., 849 W. Grand, Dept. 2, Chicago

1/4 HP	1750 RPM	110 Volt	60	\$ 850
		Cy. Split Phase Type...		
1/2 HP	3450 RPM	110V	60 Cy.	2250.
		Cap. Type.....		
3/4 HP	3450 RPM	110-220V	60	3450
		Cy. Repulsion Induction..		
1 HP	1750 RPM	110-220V	60	5250
		Cy. Capacitor Type.....		

Make Your Own POWER LAWN MOWER

with this DRIVE CUTTER ASSEMBLY

Constructed for those who desire to build their own mower or to replace your old cutter assembly. Complete with 18" blade and double ball bearing drive, only.....\$12.95

Add 50c to cover handling & shipping. No COD's

ATLAS EQUIPMENT CO., Dept. PM5
229 SW BLVD. KANSAS CITY, MO.

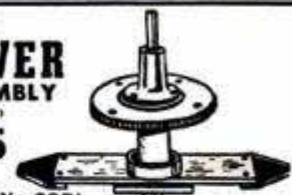

Precision Caliper

M. Z. B. MAUSER-TYPE
VERNIER CALIPER

\$14.00
POSTPAID

An indispensable measuring tool for precision work in any trade or workshop. Highest accuracy and dependability. Measures inside, outside, thread and depth to 1/1000" and 1/20 millimeter. 8" overall, 6" graduation. Highest quality throughout with glass-hard measuring surfaces. M.Z.B. Calipers are made up by the same men who made the old "MAUSER" world-famous. This is your opportunity to buy a first-class precision tool at about half the price of comparable tools. Shipment from stock. Be sure to get yours by ordering it now. Sold with a money back guarantee for only \$14.00 postpaid if you send us your check or M. O. You pay postage on C.O.D.

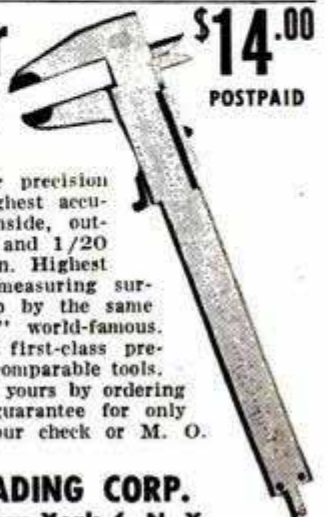

INTER-CONTINENTAL TRADING CORP.
90 West Street New York 6, N. Y.

YOU DOUBLE THEIR VALUE

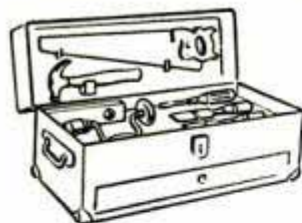

Because your vise is really a multi-purpose tool—used as a "partner" with so many other hand and power tools—it's important that you buy the vise that gives you the most durability and convenient features.

WITH THIS BASIC SHOP TOOL

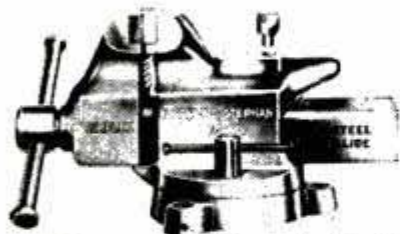

The Desmond Simplex utility vise will make all your tools more useful. Steel jaw inserts, shielded screw, cut-off tool, anvil, swivel base, built-in pipe jaws and other features increase for you the utility of this basic workshop tool. See it at your dealer's, APPLICATIONS folder.

or write us direct for valuable VISE
Desmond-Stephan Mfg. Co., Urbana, Ohio

DESMOND-SIMPLEX VISES

MAGNETS OF ALL TYPES—10c UP
AMAZINGLY POWERFUL!!
1/2 lb. magnet lifts 25 lbs. \$1.95,
Our Leader, 1 lb. magnet lifts 40
lbs. \$2.95. New alloy—will not weak-
en! Useful for lifting valuables from tanks,
jakes, or rivers easily! 7 small magnets \$1.25 with
list of many shop and home uses. Satisfaction guaranteed.
R. EYRICH, 2566 N. 49TH ST., MILWAUKEE 10, WIS.



CAPE COD CHAIRS TRELLISES • ARBORS DUTCH WINDMILLS

Chairs style B-C-A
PLANS 50c Ea., all 3
only \$1.00. 12 differ-
ent trellis designs PLAN of all 12 only 50c. Authentic 40" high
Dutch Windmill Detailed PLAN only 75c. Unique 40" high Light-
house having copper lantern, ideal for garden or on lake shore of
summer home. Large detailed PLAN 75c.

SPECIAL ALL PLANS ABOVE \$3.00 VALUE ONLY \$2.50
SEND 10c for catalogue of many fine projects.
Dept. P28
CRAFTSMAN'S MODEL CO. DELAFIELD, WISCONSIN

AUTOMATIC RETOOTH

MAKES NEW
PROFITS

Cuts new teeth in
50 seconds—any
size 4 to 16 points.
Old teeth fall off
as chips. Easy to
operate. A perfect
job.

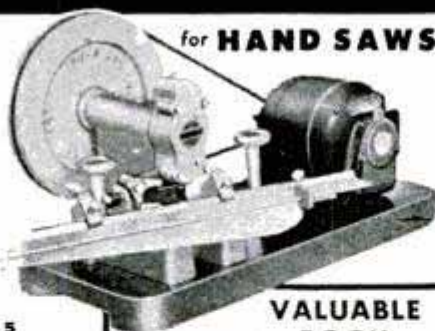

for HAND SAWS

WRITE DEPT. 5
BURR MFG. CO.
8933 VENICE BLVD.
LOS ANGELES 34, CALIFORNIA

VALUABLE
BOOK

25¢ Order Burr's Blue
Book of Coast to
Coast prices for
saw shop services.

AMAZING NEW MERCHANDISE!

ALL BRAND NEW MERCHANDISE

12 MINIATURE CUTTERS \$1.00



SURPRISE VALUE 100 Pieces \$1.00



2 CIRCULAR SAWS \$1.50



12 MOUNTED WHEELS \$2.95



2 DRUM SANDERS \$1.50



7 HIGH SPEED STRAIGHT SHANK DRILLS \$1.00



SCHUPACK SUPPLY CO., 7331 Cottage Grove, Dept. M-18, Chicago 19, Ill.

FREE Book on Painting

Get this illustrated 24-page book absolutely free. Full of facts on how to get better results with aluminum paint—which type to use for different jobs. Absolutely no obligation—just write:

ALUMINUM COMPANY OF AMERICA
1718E GULF BLDG., PITTSBURGH 19, PA.

Start Your Own Welding Business with a HOBART "Simplified" arc welder

Go after WELDING jobs that Pay Big Money!

Never before has the demand for welding been so great—the profits so large. That's why smart operators everywhere are setting up their own welding business... and you can do the same.

Simply choose from our complete line, the welder that best suits your needs—gas or electric drive—portable or stationary. The big pay jobs are waiting, so don't miss this opportunity. Write today.

One of the world's largest builders of arc welders

Write today for complete details on this PROFIT MAKING EQUIPMENT! No obligation!

HOBART BROTHERS CO., Box M-51, Troy, Ohio

We're sitting pretty... for petty cash!



\$110 worth of lawn furniture for only \$47*—built with my **SKIL** home shop Drill

My SKIL Home Shop Drill helped me make all this comfortable and attractive lawn furniture.

The drilling for bolts, dowels and lacing would take hours by hand—but my SKIL Drill made fast work of it. This drill is easy to handle: compact, light weight, perfectly balanced. Plenty of power for a clean, accurate job every time.

Save time and work by using a SKIL Home Shop Drill for all your projects. With SKIL Accessories this handy tool can be used to sand, polish, buff and grind. What a value! . . . yet SKIL Home Shop Drills begin at only \$19.95.

SKIL Home Shop Drills—
Model 518—\$19.95; 1/4" hex-key chuck. Model 549—\$22.95; 1/4" geared chuck. No load speed: 2000 r.p.m. Overall length: 8". Weight: 3 1/2 lbs. Prices subject to change without notice.



*For materials for the four pieces shown. Prices vary locally.



Made only by
5033 Elston Avenue

SKILSAW, Inc.
Chicago 30, Ill.

In Canada: 66 Portland Street, Toronto, Canada

Skilsaw, Inc., Home Shop Division, Dept. C-51
5033 Elston Avenue, Chicago 30, Ill.

FREE! SKIL-Chart No. 103 to show you how to buy the materials and build this sturdy, good-looking lawn furniture. We'll also send you full information on the complete line of SKIL Home Shop Tools. Mail the coupon today.

Name _____
Street _____
City _____ State _____

CALENDAR WATCH

CHRONOGRAPH & STOP WATCH

Only **8.95** + 10% TAX

31-Day Automatic Calendar

A precision timepiece and chronograph at an unusual low price. Imported Swiss jeweled movement, Radium Glow 1" dial, red sweep-second hand, shock resistant case, metal expansion wristband. 1 Year Guarantee, 5-day Free Trial. Choice of white, black dial.



GAYLORD DEPT. PE-7, Fifth & Hamilton, Pittsburgh 6, Pa.
Send _____ Watches @ 8.95 + 90¢ tax. Enclose Check, Money Order, Send C.O.D. Print name, address & dial color in margin.

New POWER MOWER



Build It Yourself And Save.

Amazing new invention makes whirl-blade mower pull and steer itself as well as cut grass and weeds. Build it yourself. Send name and address on 1c postcard for FREE building instructions . . . NO OBLIGATION.

PULLS ITSELF, STEERS ITSELF

FREE Building Instructions

T & H Mfg. Co., Dept. MPC-5, 811 E. 31 St., Kansas City, Mo.



All Parts Available Complete Kit or Separately.



Snap-on Tools
THE CHOICE OF BETTER MECHANICS

4000 fine tools, available direct from factory to user. Snap-on catalog free—send for it today.

Snap-on Tools Corporation
8062-E 28th Ave., Kenosha, Wis.

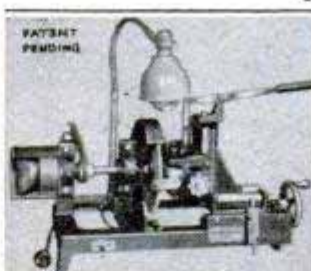

Start a NEW BUSINESS!

or Add to your present Repair Business

SHARPEN DULL PIPE WRENCHES

PIPE TAPS & DIES
"GUM" CIRCULAR SAWS

Write for Information

J. C. MOORE INDUSTRIES
BOX M 276 FREDONIA, PA.

584 Page Novelty Catalog Now Ready!

Rush Coupon



10c

584 Pages; 7500 Amazing Novelties

Send 10c for mammoth new catalog of 7500 novelties. (Each copy costs us over 50c—10c helps pay postage.) More fascinating than World's Fair. Thousands of things you never knew existed—never knew where to get. Includes novelties, tricks, jokes, live animals & pets, scientific supplies, den novelties, hobby supplies, planes & boats, looms, magic, unusual seeds, gadget time savers, camera & optical goods, movies, projectors, lucky jewelry, religious novelties, telegraph sets, magnets, disguises, easy musical instruments, stamps, coins, puzzles, fortune tellers, radios, experimental sets, auto & bike accessories, Western belts & wearing apparel, telescopes, magnifiers, compasses, banks, smokers' gadgets, artists' supplies, printing sets, engines & motors, electric shockers, knives, billfolds, weird articles, archery, swimming helps, 1000 fascinating books, games, locks, live chameleons, barometers, rings, watches, charms, imported novelties, exercisers, money savers, handy tools, Indian novelties, etc., etc., etc. Jammed & packed with sensational funmakers & useful articles. Big catalog—over 1 inch thick. 6 color cover. Rush Coupon to Johnson Smith & Co.

Johnson Smith & Co., Dept. 371, Detroit 7, Mich.
Here's My 10c. Send Big Catalog to:

Name & Address _____

New B-T HACK SAW!

FITS ANY 1/4" ELECTRIC DRILL

For Home
Craftsmen
Farmers
Carpenters
Plumbers
Mechanics
Electricians
Contractors



POWERFUL . . .
PORTABLE . . .
POCKET SIZE . . .

and only **\$4.95**

- SAWS WOOD, PLASTIC, STEEL & SHEET METAL, PIPE, PLASTER BOARD, CELOTEX!
- 2-1 reduction prevents burning saw teeth on metal!
- NO GEARS, NO BEARINGS — ABSOLUTELY NOTHING TO WEAR OUT!
- LIFETIME GUARANTEE — At any time, we'll put this tool in perfect working order for only 75c!
- EXTRA BLADES! For wood . . . 10c ea. For steel . . . 10c ea.

SEND CASH, CHECK, OR MONEY ORDER TODAY.

Bertram F. Engineering & Supply Co.

3121 Main Street

Kansas City, Mo.

SHEET METAL BRAKES

Forms angles, flanges and Pittsburgh locks. 26 gauge steel, heavier aluminum. Cam locking. Portable, can be bolted to bench, or clamped to edge of truck. All steel, reinforced. Shipped Exp. Coll. 30" size. Wt. 54 lbs., \$26.50. 36" Wt. 60 lbs. \$31.00. 48" Wt. 100 lbs., \$45.00. Floor mounting, portable, 32" high, 30 lbs., \$7.00. 12" BRAKE. Fits in vise to form difficult compound bends, up to 20 gauge steel. Not illustrated . . . \$12.50 P.P. 5" Wide Pliers forms locks, "N" slips, etc. \$ 2.50 P.P.

IRON BENDER, 1/4x2" capacity. 9 parts. All steel. . . \$10.00 P.P.

Immediate Delivery. Order direct, cash or C.O.D. or send for folder.

VYKE BRAKE CO., P-1116 So. 27th St., Omaha 5, Nebr.



NOW...you can easily
ZIP THROUGH OAK,



teak, mahogany, hard maple, dirty form lumber, plywoods, Formica, Micarta, Transite, Cimento, and most abrasive materials . . . with the amazing

CARBIDE TIPPED SAW BLADES

precision tools now at popular prices.

- ★ cut faster — smoother
- ★ less maintenance cost on your saw machine
- ★ reduces resharpening costs
- ★ cutting life 25 to 250 times higher than steel saws between sharpenings
- ★ less power required
- ★ will pay for themselves through faster cutting
- ★ far table or portable saw
- ★ ideal for home workshop

Send today for free information

CARBIDE SAW & TOOL COMPANY

Suite 648 327 S. LaSalle Street Chicago 4, Illinois

Please send information on:

Table Saw Blades Portable Machine Blades

Name _____

Address _____

City, Zone, State _____

Name of Your Saw Blade Dealer _____



Ask Your Hardware Store for
FULLER'S
Unbreakable Amber Handle
SCREW DRIVERS

America's most popular line of moderately-priced screw drivers! Wide range of sizes.

FULLER TOOL COMPANY, Inc.
911 Faile St. New York 59

World's largest makers of Amber-Handle Tools

PRICED FROM 5c TO \$1.00 EACH

THE BIGGEST
VALUE
ON THE MARKET
DIRECT FACTORY TO YOU

DYNAMIC SUPER-CHARGED ARC-WELDER

DOES WELDING, BRAZING, SOLDERING, CUTTING

It's the finest, precision built heavy duty transformer-welder available for home, farm, or shop use. Does work you'd expect from costlier machines. EASY TO OPERATE. Do expert work; follow simple instructions. Works on iron, steel, brass, bronze, aluminum and other metals. Operates from any properly wired 110 volt 50/60 cycle AC line. Save time, Make money—Build or repair auto, home, farm or shop equipment, etc. for yourself and others in spare or full time. Comes complete Ready-To-Operate. Order today for 10 day trial on money back guarantee or write for Free Particulars. **DYNAMIC WELDER CO., Dept. D2-EB6, 15 E. 23rd St., Chicago 16, Ill.**



Gift of Tool Marker—Soldering Tool and Electric Torch included for prompt action at no extra cost.



OVER 50,000 SATISFIED USERS

\$41.80 Only \$33.50 F.O.B. VALUE COMPLETE

New MOTOR BARGAINS for Home, Farm & Industry



New General Electric 1/2 H.P. Induction Type 3450 RPM 110 V, 60 cy. 1 Ph. A. C. **\$23.50**
Motor. #GEH-5. Feb.
New General Electric 3/4 H.P. Cap/Ind. Bail Brg. 1750 RPM, double 1/2" shaft. 110 V, 60 cy. **\$29.75**

1 Ph. A. C. Motor. #GE-17. Feb. **\$34.50**
New General Electric 1 H.P. Cap/Ind. Bail Brg. 1750 RPM, double 1/2" shaft. 110 V, 60 Cy. 1 Ph. **\$34.50**
A. C. Motor. #GE-75. Feb.
New Emerson 1 H.P. Heavy Duty, Repulsion Induction, 3450 RPM, 110/220 V, 60 Cy., 1 Ph. **\$45.00**
A. C. Motor. #EH-1. Feb. **\$57.50**
Same as above, 1 1/2 H.P. 220-V. **\$57.50**
#EH-15. only Feb. **\$67.50**
Same as above, 2 H.P. 220-V. **\$67.50**
#EH-20. only Feb.

MOTOR and FAN BLADE COMBINATIONS

BUILD WINDOW FANS, EVAPORATIVE COOLERS, EXHAUST FANS
—With these Efficient Combinations

Set #	Blade Size	H.P.	Blade Price	Guard Price	Motor Price	Combination Motor Guard & Blade
FC-10	10 inch	1/60	\$1.25	\$1.75	\$ 4.50	\$ 7.50
FC-12	12 inch	1/40	\$1.50	\$2.00	\$ 6.50	\$10.00
FC-16	16 inch	1/35	\$2.25	\$2.75	\$ 8.50	\$13.50
FC-18	18 inch	1/6	\$3.75	\$3.75	\$10.00	\$17.50

All above items shipped PREPAID. Motors or parts can be bought separately . . . 10", 12" & 16" size motors have extended thru bolts for mounting. 18" motor has solid base.

Write for FAN CIRCULAR: listing Blades, Guards, Motors, All Sizes for building your own Attic Fan, Window Fan or Room Cooler.
C. MARSHALL SALES, 3546 W. Fullerton Av., Dept. P-5, Chicago 47

MAKE BIG MONEY in Remodeling!



BE YOUR OWN BOSS

You can put **BIG MONEY** in your pocket if you get started now in floor surfacing work! Cash in on today's big demand for home-remodeling and repairs... sand new and old floors. Sell your services and *keep all the profits* from your labor! Sanders are easy to operate—no special schooling—no big investment. Earn \$35 to \$50 a day... pleasant indoor work. Send for "tell-all" booklet, "Opportunities in Floor Surfacing" enclosing 25 cents in coin or stamps to cover handling. The American Floor Surfacing Machine Co., 535 So. St. Clair St., Toledo, Ohio.



AMERICAN

FLOOR MACHINES—PORTABLE TOOLS

Another of 1000s of Uses
For Powerful
WISE-GRIP
WRENCH

low as **\$1.85**

No job too tough for VISE-GRIP! Jaws LOCK with Ton-Grip—hold anything. Works with speed and ease even in difficult places. Powerful grip quickly turns nuts, broken bolts and screws. Pulls headless nails—clamps parts for soldering, sawing, etc. Easily adjusts to ratchet action. With Cutter—No. 7W, 7", \$2.25; No. 10W, 10", \$2.60. Without Cutter—No. 7C, 7", \$1.95; No. 10C, 10", \$2.25. No. 7, 7", \$1.85; No. 10, 10", \$2.15.

Order From Your Dealer

PETERSEN MFG. CO., Dept. P-5, DeWITT, NEBR.

PYTHON Metal Bit	CONVENTIONAL LENGTH DRILL	\$3.95 EA.—3 FOR \$11.50
	JUNIOR DRILL	\$2.95 EA.—3 FOR \$8.50
	ROUTER BIT	\$1.95 EA.—3 FOR \$5.50
	ROUTER BIT	POSTPAID
WART HOG All Purpose Bit	SETS WITH	SPECIFY TYPE
	1 Conventional	PYTHON
	1 JUNIOR	WART HOG
	1 ROUTER	PORCUPINE
		\$8.50
PORCUPINE Wood Bit	Each Bit Performs its own	Function—Specify Which

Will cut stainless Steel. Use side pressure and sawing action for best results on any material.

Make Ur-Own ROTARY TYPE POWER MOWER

THIS IS NOT A KIT
But A Complete Mower Assembled
As Illustrated

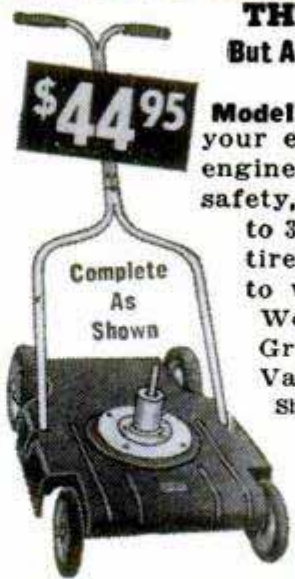

Model 50M KEEN MOWER. Add your electric motor or gas engine. Concealed blade for safety, 3 cutting heights, 1½" to 3½". Ball bearing rubber tired wheels. 18" cut. Cuts to within ½" of sidewalk. Weight 48 lbs. America's Greatest Power Mower Value. Order Now **\$44.95**
Shipped F.O.B., K.C.

Send check or money order
Write for **FREE Folder** for information on "Make Ur-Own" and other models with gasoline engines or electric motors.

ATLAS KEEN MOWER

229 S.W. BLVD. Dept. MP5 KANSAS CITY, MO.

Say You Saw It in Popular Mechanics

NEW POWER TOOL UNITS

Amazing
Values

Write for
Details

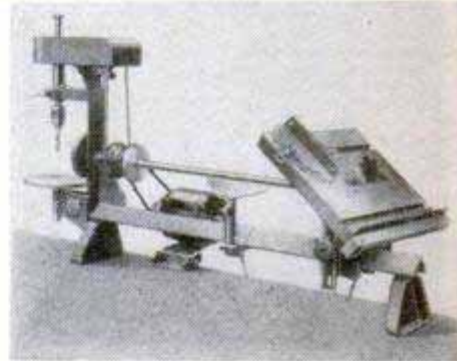

EMRICK, INC., 151 Clinton, Kalamazoo, Mich.

ALNICO MAGNETS LIFT 175-lb.

AMAZING PERMANENT MAGNETS — WILL NOT WEAKEN! NON-ELECTRIC. Retrieve guns, tackle, tools and other steel items from lake, river, plating tanks, drains or other hard-to-reach spots. Recover drills, taps, etc. from floor sweepings. Clear alley of harmful tacks, nails. Many other uses listed. Pays for itself quickly. **GUARANTEED:** Try any magnet one week. Money refunded if you are not well-pleased. Cat. No. 675 (Has pull of 175 lbs. on a flat steel block) \$10.50
Cat. No. 650 (150 lb. pull) \$8.50 Cat. No. 600 (100 lb. pull) \$6.50
Cat. No. 550 (50 lb. pull) \$4.00 Cat. No. 530 (30 lb. pull) \$3.00
Cat. No. 17 (14 lb. pull) \$1.50 Send M.O. or check. We pay postage.
Cat. No. 30—Hobbyist assortment of six medium magnets . . . \$1.50

MIAMI MAGNET CO.,
3240 N.W. 27th Ave., Aviation Bldg. No. 43, Miami, Florida

MILLER ROTARY HI-SPEED SAW DRILL BIT IT SAWS & CUTS REAMS

SAWS, CUTS, REAMS sheet metal, angle iron, pipe, wood, plastic, Transite, etc. Amazing high-speed combination bit and saw fits any ¼" or ½" electric drill or slow drill press. Drills own starting hole to quickly cut, saw or ream opening. Easy to operate. Ideal for carpenters, auto mechanics, electricians, plumbers, hobby workers, many others. Abrasive resistant high speed steel. No breaking. Will withstand severe continuous use. Resharpens at no charge. ¼" diameter. Conventional Drill length 3½" with 2" cutting section. Junior Drill length 2¾" with 1" cutting section. Router Bit length 1¾" with 1" cutting section. Ground from solid. Shipped same day—money back guarantee. Discounts on quantity orders from dealers. Manufactured and distributed by

INTERNATIONAL TWIST DRILL CORP.
624 Wyandotte Rm. 852 Kansas City 6, Mo.
"Pioneers in break resistant short drills"

BUILD YOUR OWN COOLING FANS

EXCLUSIVE GIL-BILT BUILD-IT-YOURSELF FEATURES

- Engineered for home construction by world's leading manufacturer of build-it-yourself power tools.
- No machine work. Build easily with hand tools only.
- No guess work. No blueprint reading. Step-by-step pictorial plans, full size patterns, actual photographs.
- Sturdy wood & plywood construction, engineered for reduced noise and vibration.

SAVE UP TO
\$50
OR MORE

GIL-BILT 24 INCH WINDOW FAN

- Two heavy OILITE oilless bronze bearings
- 24 inch TORRINGTON 40 degree pitch aluminum blade
- Pedestal mount for blade and pulley simplifies construction. Shipped ready to run.
- Mounts out of way on outside of window.
- Belt driven with any 1/6 or 1/4 h.p. motor.
- Rubber cushioned mounting brackets reduce noise, simplify installation.



• 5000 C.F.M. at 620 r.p.m. cools 4 or 5 room house.
GIL-BILT KIT #520-A Includes Plans, TORRINGTON rustproof blade and V-pulley mounted ready to run on cast aluminum pedestal, V-belt, motor pulley, mounting brackets, plus all necessary screws and bolts, (less motor and wood for wood parts)..... **\$19.95**
GIL-BILT Plans #520, Full Size Patterns..... **.50**

GIL-BILT 36 INCH ATTIC FAN

- Molded rubber cushions mini-vibration.
- Soundproofed, ball bearings, sealed against dust and dirt.
- Efficient 36 in. Torrington Steel Blade.

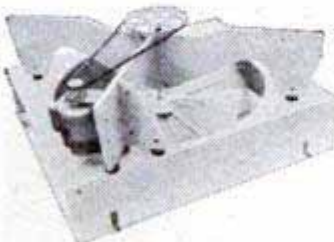

- Horizontal mounting makes installation easier.
- Rubber cushioned mounting brackets reduce noise.
- 9000 C.F.M. with 1/3 h.p. motor. Cools entire house.

GIL-BILT KIT #510-A Includes Plans, bearing blocks, 3/4 inch steel shaft, Torrington blade, two V-pulleys, V-belt, rubber cushions, mounting brackets, plus all necessary screws & bolts (less motor & wood for wood parts)..... **\$25.95**
GIL-BILT Plans #510, Full Size Patterns, Installation Instructions 1.00
NO DEALERS—One Low Factory Price! Prices include postage within 600 miles. Over 600 miles add 5%. Send cash, check or money order for fan kit, or send for Plans now and order Kit later less cost of Plans. Also available: **20 in. ROOM COOLER FAN, MOTORS, and BLADES.** Write for **FREE** descriptive folder.

GILLIOM POWER TOOLS

P. O. Box 1-EP Lambert Field St. Louis 21. Mo.

SAVE OVER 50%

ON THESE BRAND NEW WAR SURPLUS POWER UNITS



BE PREPARED for any emergency!
LIGHT PLANT BUYERS—in emergency telephone collect—unit shipped same day!
5 KW Plant, 120 volts, 60 cycle AC. List today \$1910.00. Used \$675.00 NEW. Your price only \$895.00

BARGAIN SPECIALS!!
 Ball-bearing Arbor... \$ 6.95
 Alarm Siren or Horn... 15.45
 Mercury Heat Control... 6.95
 Barn Ventilator... 69.50
 Electric Hot Water Heater, 10 gal... 24.95
 Hot Rod Supercharger... 31.00
 MALL flexible shaft grinder... 99.50

2500 Watt, AC, 110 volts, 60 cycle. Slightly used but reconditioned and fully guaranteed ONLY... **\$295.00**
NEW, same as above... \$345.00
 Plants built in 1951... **\$426.00**
300 Watt, Reg. \$145, Now \$ 99.00
750 Watt... \$232.00
3000 Watt DC Contractor's PORTABLE. Rubber tired wheels, 5 to 7 HP gas engine. Used like new \$220.; New... **\$279.00**
7500 Watt 4 cyl. engine; New \$995.00
10,000 Watt Used \$1195.00; New \$1495.00
25,000 Watt Used \$1995.00; New \$2495.00
35,000 Watt Diesel, Rebuilt \$2995.00
50,000 Watt Diesel, New \$5900.00
 All units 10,000 and over, 1 or 3 phase 110-220 volts.

HEAVY DUTY, all purpose WINCH

For — CONTRACTORS, BOATS, FARMERS, TRUCKS, LOGGERS, ETC.

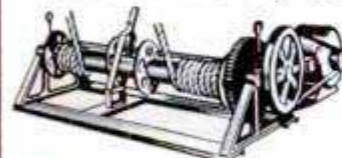

Multiply your pulling, hoisting power tenfold. Can be driven by hand, gas, electric, or tractor take off, 10 to 1 ratio; double drum for reverse. Manufactured by Brenner, Wgt. 280 lbs., List price \$119.95. Our price... **\$49.50**

Below are just a few of the many items we have in stock at sensationally low prices:

Pumps	Air Tanks	Fire Pumps	Gear Reducer
Grinders	Drop Cords	Saws	Clutches
Air Compressors	Generators	Winches	Motors

Write today for free catalog. Thousands of \$\$ saving buys.
C & H ELECTRIC Co.
 434 W. JUNEAU AVE.
 MILWAUKEE 3, WISCONSIN

ANNOUNCING!! A NEW 100% MORE POWERFUL SANDER!



LOOK!
The New Syncro No. 504

With **BUILT-IN MOTOR**
GUARANTEED AGAINST BURN-OUT
ALL DURING YOUR OWNERSHIP!

You'll jump with joy when you grab this new SYNCRO SANDER—when you see how its 100% MORE POWERFUL Stroke—sands TWICE as efficiently! Remember, too, SYNCRO alone has the famous DOUBLE ARC MOTION that sands, polishes BETTER by actual comparison! Every workshop and home NEEDS this amazing, 100% MORE POWERFUL SYNCRO! Also



perfectly wonderful for relaxing tired muscles with its powerful Double Arc Motion! Complete with BUILT-IN Fractional Horsepower Reactance Electric Motor, 10 sandpapers, polishing-massaging pads, cord. Only... **\$19.95**

NEW JIG SAW 70% MORE POWERFUL—QUIET!

Cuts any length 1" wood, thin metal, plastics yet SAFE for children! Thousands used in schools, homes, etc... QUIET... Portable... Use even in apartments... Stroke adjustable... UL-Approved... Complete with Built-in Motor, blades, cord. **\$22.95**



THAT'S THE NAME To ASK For!

SYNGRO

Quality Electric Tools



U.S.A. Model, 60 cycle, 110-120 Volt, A.C. Other Voltages, Cycles available. Buy at dealers. Or send price of article and we will ship direct postpaid.

SYNGRO CORPORATION
 Dept. D-51, OXFORD, MICHIGAN, U.S.A.

Gigantic "Warehouse Remodeling"

MAIL SALE

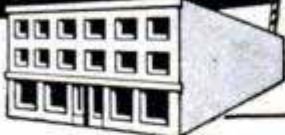

SAVE up to 70%!

Check these bargains:

We Pay Shipping Charges

Power Plants and Generators

- Army Homelite Power Plant: 1500-w, 115-v, 60-c. New condition. Guaranteed. While they last. \$259.50
- Kato Generators. 5000-w, 115-v, 60-c. Single phase. Complete with 4-sheave pulley, controls, voltmeter, etc. Drive with tractor, old auto engine. New condition. Perfect. Cost over \$450. Special. \$259.50
- Power Plants. 110/220-v, 60-c. Large quantity. All types. 3, 5, 10 kw. Write for circular.
- D-C Arc Welder. 0-250 amps. Drive with tractor, engine, etc. Ready to use. Built-in controls, reactor. Brand new. \$99.50
- Build Welding Generator. Delco-Remy, 200 amps, 30-v. Full instructions. Includes control, fan, etc. Cost \$296. \$24.65

Winches, Clutches, Transmissions, Engines

- Boat Hand Winch. Fine for boats, docks, trailers, etc. 1 to 4 ratio. 2000 lbs. \$19.95
- Hand Winch. Finest steel. Powerful, complete, with 50 ft. cable. 2500-lbs. 1 to 3 ratio. \$29.95
- Hand Winch. Dual gear ratio. 1 to 3, 1 to 9, with 50 ft. cable 3000-lbs. \$39.50
- Utility Clutch. Engine end takes 1" shaft. Drive end 3/4". Handles engines or motors up to 6.5 h.p. \$13.95
- Motor Clutch. 1/2", 5/8" or 3/4" shaft size. Up to 1.5 h.p. \$7.50
- Speed Reducer. Drive 1750. Gives 0 to 450 RPM. \$19.95
- Pulley Clutch. 3 h.p. 4 1/2" pulley, easy release. A buy. \$7.95
- Gas Engine Bargains. 1, 2, 5, 20 h.p. Write for list.



SENSATIONAL VALUE! 12-FT. FLEXIBLE STEEL GUY CABLE, 14-IN. TURNBUCKLE

Powerful 48-strand galvanized steel wire cable, 1000-lb. pull. Strong turnbuckle, 12-in. Adjustment. Wonderful for guy, strengthening gates, fences, buildings, doors, windmills—secure television antennas—excellent tow cable. Cost Gov't. \$1.10 each. Special—10 for \$3.89; 50 for \$16.47; 100 for \$29.32. Frt. Ppd.



Water Pumps and Systems

- Bronze Rubber Rotor, Low Pressure Water Pumps. Stainless steel shaft. Pipe thread. Self priming. High efficiency. 1/2", up to 25 PSI, up to 8 GPM. \$12.75
- 3/4", up to 25 PSI, up to 10 GPM. \$16.95
- 1", up to 25 PSI, up to 19 GPM. \$22.95
- High Pressure Pump. Stainless steel shaft. Pipe thread. Self priming. Positive displacement. 1/2", up to 100 PSI, over 5 GPM. \$14.50
- 3/4", up to 150 PSI, over 8 GPM. \$20.95
- 1", up to 150 PSI, over 17 GPM. \$27.95
- Surplus Gear Oil Pump. Cost \$35. \$ 3.95
- Hi-Efficiency Cent. Pump. Garden hose thread, over 15 GPM. \$11.95
- Water System. Automatic, finest 110-v, 60-c motor, 22" lift. 300 GPH. 30 lbs. Fresh water instantly. No tank needed. For cabins, cottages, farm homes, etc. \$69.50

Air Compressors and Spray Equipment

- DeLuxe Air Compressor. Pressure to 150 lbs. Capacity to 3 c.f.m. Single cylinder, 2" bore, 1.75 stroke. \$20.50
- Build Your Own Compressor. 1-cy. piston compressor, stain. less. 13"x25" tank, 160 lb. gauge, paint spray gun, blow gun, tire chuck, 15' hose, fittings and data. \$39.90
- Stainless Steel Air Tank, brand new, 13"x25", 400 lbs. \$ 9.95
- Brass Chuck Valve, (dash pot non-chatter type) 1/4", 3/8" PT \$ 3.75
- Brass Adjustable Pop Off Valve, 25 to 250 lbs. \$ 1.98
- Automatic Pressure Regulator (0 to 150 lbs.). \$ 2.69
- Automatic Pressure Motor Switch, on 115, off 150 lbs. \$ 5.87
- Finest Pressure Gauges (air or water) specify pressure—60, 100, 160, 300 lbs. \$ 1.99
- DeVilbiss Air-Solvent Engine Cleaner, \$14.95 value. \$ 8.96
- Home Paint Spray Outfit. Includes gun, hose, etc. less motor. \$25 value. Special. \$18.95

- WEED SPRAY OUTFIT Close-out sale. Finest 4-row, complete, less barrel. \$140 value. \$84.50
- 5-row. Write for details. \$106.50

Mechanical — Electrical — Electronics

- Rural Phone, Magneto, 5-bar, 2500-ohm, wall type. \$12.40
- Private Phone, Magneto, desk, per pair. \$19.90
- Acro Saw fits on any 1/4" drill, cuts full 1-15/16" \$ 9.95
- Army Switchboard, 12-line, small hotels, factory, etc. \$33.50
- Phone Insulated Wire, twisted pair, outdoor type (100-ft.). \$1.39
- Stone Job Lot, 12 finest Norton wheels, 1" to 4" \$33.89
- Mounted Stone Job Lot, 4 mounted stones, 1 wire brush (1/4") \$ 2.19
- Rotary File Kit Lot. (1/4") 6 Assrt. tool steel units. \$ 3.26
- Electric Water Heater. 5 1/2 gal. 110-v, 1200-w Guar. \$49.50
- Motor 2 H.P., 24-v, D-C, Double shaft, 4000 RPM. \$10.89
- Motor Gyro, 24-v, D-C, 10,000 RPM. Fascinating! \$ 1.98
- Parts Cabinet. All steel, 4 drawer, 16 compartments. \$ 2.78
- Precision Hand Level. With leather case. \$ 7.95
- Finest 7x50 prismatic binoculars, tax paid. \$45.95
- Furnace Squirrel Cage Blowers, \$25 Value. \$18.70

(Hundreds other electrical-radio-mechanical-tools bargains)
ORDER DIRECT FROM AD or Write for Free Catalog!

BURDEN SALES COMPANY
807 "O" ST. LINCOLN, NEBR.

FREE CATALOG

ASSEMBLE YOUR OWN MOWER

\$7995 F.O.B. WICHITA



SAVE 40% INCLUDES NEW 1 1/2-2 HP VERTICAL ENGINE AND ALL PARTS

CAST ALUMINUM BASE

This is a modernized streamlined and nicely finished product. Two-tone baked enamel. Full 20" cut, hardened steel, one-piece cutting blade with safety clutch. Ball bearing, large size rubber-tired wheels.

CUTS TALL GRASS

will mow to carpet smoothness tall coarse grass, cuts close to fence.

OVER 12,000 SATISFIED USERS

Price Complete Satisfaction \$79.95 Guaranteed

Cash With Order or Money Refunded

NEFF EQUIPMENT CO.
510 PETROLEUM BLDG., WICHITA, KAN.

HOBBYISTS! SHOPMEN! Special ONLY \$54.50

PALMGREN "HOBB-E" Rotary, Index, Milling Table

Ideal for Model Parts or Shop Work Mill-Grind-Drill-Index-Route curved or straight-Rabbit and Mortise on drill press or lathe. 8" Table, 4" Cross Feed, 360° Rotation, Accurately Graduated. Bolts to table. Order NOW! SAVE \$100. Only \$54.50. Less Rotary Feed \$42.75. Write for "HOBB-E" Tool Circular. CHICAGO TOOL AND ENGINEERING CO. 8365 South Chicago Ave. Chicago 17, Ill.



PRECISION JIG... GRIND YOUR OWN

ONLY \$8.95 COMPLETE GIVE ARBOR SIZE A. D. MCBURNEY

CIRCULAR SAWS WITH "TRU-CIRCLE" (PAT. PEND.) Sharpens all teeth the same, with correct bevel. Keeps saw round. Fits your saw table. Grinds combination, cutoff & rip saws 6" to 10" Better than new. Makes saws last longer! Quickly pays for itself. Lasts lifetime. Simple to operate; six inch grinding wheel & instructions. At dealers or postpaid 317 East 4th Street, Los Angeles 13, Calif. Dept. A-5

DUST-O-VAC FOR ALL MACHINES

For Home Workshops & Industry. DUST-O-VAC collects & bags wood & plastic chips, wood & metal dust, wood shavings. Free Bag. Attaches to circular saw, planer, band saw, grinder, belt or disc sander, shaper, drill press with shaper or sander attachment, spindle shaper, wood lathe, jig saw, 110 A.C., D.C. Send for mounting instr. for all machines. \$19.95 F.O.B. Yonkers

HEAVY CAST ALUMINUM BLOWER — ONLY \$11.25 For workshop, lab., kitchen, cellar, app. 100 CFM. Send for circular. UNIVERSAL YONKERS CORP., 137 Alexander St., M-5, Yonkers 2, N. Y.

POSTPAID ANYWHERE IN U.S.A. WE FURNISH ALL MACHINED METAL PARTS, EVERY SCREW, NUT, BOLT, WASHER, AND COMPLETE PLANS FOR THIS...



BIG 10" POWER SAW \$10.95 FULL REFUND IF LESS GUARD & WOOD IN 10 DAYS NOT SATISFIED COMPLETE PLANS 10c

ASSEMBLE IT YOURSELF WITH SIMPLE HOUSEHOLD TOOLS! DEPT. N, ROYERSFORD, PA.

STARRETT "Tools and Rules" BOOK

Describes and illustrates the precision methods skilled mechanics use. Only one dime. Write Dept. AP. THE L. S. STARRETT CO., Athol, Mass., U. S. A.

SAY YOU SAW IT IN POPULAR MECHANICS

DO MORE PLANING JOBS WITH LOW-COST BELSAW \$215.00

AMAZING 12 1/4-IN. PLANER Does All Ordinary Planing Mill Jobs. Provides attachments for Jointing, Rabbeting, Tongue, Groove, Matching. 12 1/4 x 6-in. capacity, 3-knife solid round all-steel cutterhead. Power feeds at 24 feet per minute, 42 cuts per inch. Provides for full line of accessory attachments—Grind and Joint knives IN THE CUTTERHEAD WITHOUT REMOVING. BELSAW MACHINERY CO. 1018 Field Bldg., 315 Westport Rd., Kansas City 2, Mo. FREE BOOK



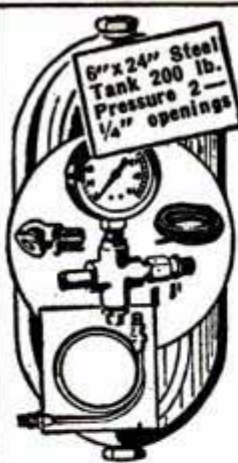

WELLWORTH Air Compressor

For Farm and Home Workshops
Both valves in head, bronze bearings, splash lubrication. "V" belt drive, intake muffler and cleaner. Compressor has 2" bore, 1 3/4" stroke, 2.8 cfm up to 150 lb. pressure. Motor required: 1/4 h.p. at 100 lbs.; 1/2 h.p. at 125 lbs.; 3/4 h.p. at 150 lbs. or equivalent gas engine. Wt. 16 lbs. Replacement parts always available.

\$20.50

COMPLETE OUTFIT Compressor, pressure tank, air gauge, air chuck, 20-ft. hose, pop valve, copper tubing with 4 brass flared fittings for connecting compressor to tank, 4-way cross and 3 nipples. **COMPLETE OUTFIT, wt. 30 lbs.**

All Brand New Equipment

EQUIPMENT LESS COMPRESSOR, \$12.45



NEW!

LIGHT PLANTS

Brand New!
War Surplus

Signal Corps Power Unit PE 197

115 volt 60 cycle A.C. single phase 5 K.W. Hobart, water cooled, 14 h.p. 4 cylinder Hercules engine. Remote Control, complete panel board with instruments, 150 ft. automatic remote control cable with reel; 150 feet #8 heavy duty wire with reel; housed in metal case with replacement parts and tools. Cable with reels alone worth \$400. Regular price of unit \$1000. Shipping wt. 1250 lbs. Our price, complete. f.o.b. Chicago

\$895.00

Same unit, slightly used. Reconditioned, less cable. Fully guaranteed **\$595.00**

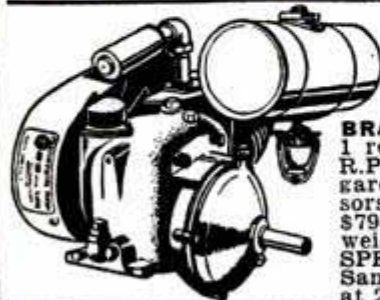
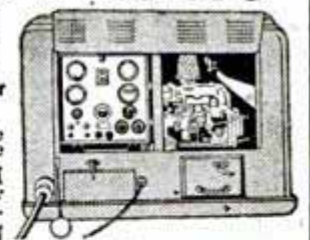

Red Seal Continental 6 to 1 REDUCTION GEAR 1 CYLINDER - 4 CYCLE

BRAND NEW. 1 1/2 HP with 6 to 1 reduction gear. Operates at 450 R.P.M. For lawnmowers, scooters, garden tractors, pumps, compressors, generators, etc. List Price \$79.50. Shipping weight 54 lbs. **SPECIAL PRICE, \$47.50**
Same engine furnished at 2600 RPM **\$46.50**

2000 WATT LIGHT PLANT

2000-Watt Generator, 110 V., 60 cy. A.C. with floating base for Automatic Belt Adjusting, 2-Groove Engine Pulleys, V-Belts, Bolts, etc. 4 1/2 H.P. Wisconsin Engine, Voltmeter, 2 plug-in receptacles. Develops up to 5000 Watt starting load. Portable tubular steel Skid Type carrier. Dim.: L. 34 5/8" x W. 17" x H. 20". **\$325.00**

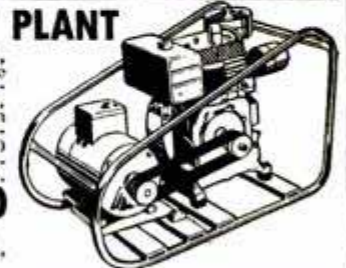

Same unit less mounting base, **\$275.00**

WISCONSIN GAS ENGINES

BUILT WITH SPECIAL HEAVY DUTY FLY WHEEL
at a big saving!

Model A.B., 1.7 to 3 H.P.
Wt. 60 lbs. List Price, \$90.00. Special Price **\$76.00**
Model A.K., 3 to 4.1 H.P.
Wt. 70 lbs. List Price, \$106.50. Special Price **\$86.50**

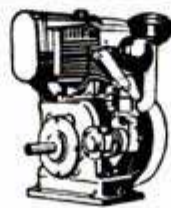

GENERATORS

... Big Values

500 to 750 watt, A.C., 110-120 volt, 60 cycle, 1 phase output. Also 100 watt D. C. battery charging output. May be used at the same time. Voltmeter, 2 outlet boxes. Wt. 55 lbs. Price **\$99.50**
Furnished with 1 1/2 HP Engine with drive **\$149.50**



WELLWORTH V-BELT CLUTCH



Takes starting load off engines or motors. When speed is reached, a flip of handle shifts clutch from idling to driving position. Handles "A" belts, 2.35" pitch diameter, 5/8" bore. Ideal for use with lawn mowers, garden tractors, home workshop motors, etc. 3 1/4" long. Safe, easy to mount, sealed bronze bearings, positive action. Shpg. wt. 3 lbs. **\$7.50**
BUSHING FOR 1/2" SHAFT, 15c

BRAND NEW SAME CLUTCH FURNISHED WITH 3/4" BORE **\$8.50**

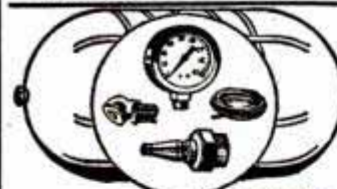

AIR TANK & ACCESSORIES

Air receiver, stainless steel. Brand New, 6"x24", 400 lb. test. Ideal for carrying on trucks, autos and wherever compressed air is needed. Equipped with 500 lb. combination air gauge and inflation valve with core for retaining pressure in tank; tire chuck, 3 ft. high test air hose.

COMPLETE OUTFIT
No. K21
SHIPPING WT. **\$7.95**
12 LBS.

TANK ONLY
Shipping wt. **\$6.25**
7 lbs.

CHICAGO PNEUMATIC CP4X

RIVET & CHIPPING HAMMER



Takes up to 3/16" rivet. Weight 6 lbs. List price \$86.00. **\$32.50**
Brand New

AUTOMATIC PRESSURE SWITCH

For Air or Water 20 to 40 lbs. **\$6.50**



125 to 150 lbs. **\$8.95**
with automatic unloader **\$13.75**
1/4" check valve **\$3.25**
1/2" check valve **\$4.75**

AIR REGULATOR and EXTRACTOR

1/4" Air Regulator, Gauge and filter. Wt. 5 lbs.



New **\$8.95**
Regulator and Gauge only **\$5.95**
Air Filter only **\$3.25**

"Wellworth" BLOWER at a Bargain Price



Quiet operating. Double wheel inlet, double width blower. For heating, ventilating, cooling, air washing, exhausting and forced draft. DIMENSIONS: 10" wheel; outlet 13 1/8" x 11 3/8"; inlet 8 3/4". Height 19". Width 18". Depth 16 1/2"; C.F.M., 1/4" S. P. 1600; outlet vel. 1575; wt. 45 lbs. **\$27.50**
BLOWER LESS MOTOR AND DRIVE **\$2.50**
with belt and variable speed pulleys extra. (Motor required, 1/4 h.p.)

Prices f. o. b. Chicago. Money back guarantee. Send check or money order today. Prompt shipment.

NEW CATALOG

AIR COMPRESSORS, LIGHT PLANTS, HOME AND FACTORY WORKSHOP TOOLS. SEND 10c FOR POSTAGE.

WELLWORTH TRADING CO.

1831 S. STATE ST., DEPT. D-5, CHICAGO 16, ILL.

Communication Problems Solved! ARMY FIELD TELEPHONES & WIRE



Construction men, engineers, farmers, and industrial men everywhere are using portable Army Field Telephones for quick, dependable 2-way to 8-way communication. These phones were built to serve combat forces reliably under battlefield conditions. Simple to install. Just string this 2-conductor wire, attach phones, ring and talk any distance up to 17 miles! Powered by flashlight batteries. No maintenance required.

ACT NOW! LIMITED SUPPLY!

All prices FOB Sacramento. No COD. (Calif. residents add 3% for sales tax.)

Write for **FREE FOLDER.** Send check or money order **LORIS SALES, P. O. Box 1896-85, Sacramento, California**

TELEPHONE WIRE

ALL-PURPOSE — ALL-WEATHER

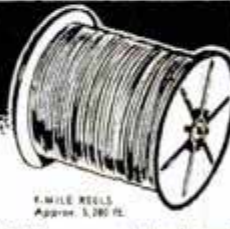

This is genuine W110B Army Field Wire on original steel reels. Insulated, 2-conductor, copper-steel strands. Excellent for all types of communication. Used extensively by telephone companies, industry, engineering projects, ranches, public address systems, etc.

GRADE 1 — New, unused, excellent condition.
Mile reels **\$19.50** Half-mile reels **\$10.00**
(wt. 160 lbs.) (wt. 80 lbs.)
GRADE 2 — New, unused, good condition.
Mile reels **\$15.50** Half-mile reels **\$8.00**

EES FIELD TELEPHONES
Factory reconditioned, Ea. LIKE-NEW. Per pr. **\$16.50** **\$32.50**
Reconditioned, factory-tested, Ea. Per pr. **\$15.00** **\$29.50**
GUARANTEED

MAY 1951

MAKE YOUR Circular Saw SAFER!



Pat. Pending

Eliminates KICKBACKS

Working on a radically new cutting principle — this new PTI Safety Saw Blade completely eliminates dangerous kickbacks, minimizes direct injuries. Cuts smoother, lasts longer, uses 30% to 40% less power, cuts easier, is much quieter and cleaner, producing chips not sawdust. This is the original safety saw blade—tested and approved by leading laboratories, government agencies, industrial concerns. Made of tough Chrome Vanadium Steel—in sizes from 7" to 16". Costs no more than ordinary saw blades. Send today for FREE circular giving complete story, specifications and prices. Dept. PM-5

PTI

PTI INCORPORATED, 401 BROADWAY
NEW YORK, N. Y.

EVERY ELECTRIC DRILL A PORTABLE SAW

JOIN THE THOUSANDS who
SAVE WORK — SAVE TIME
and do the job BETTER with
"ARCO-SAW" (Over 100,000 Sold)

9.95

with
4-inch
ARCO
"Hycarbon"
Crosscut Blade

ARCO
SAW



CAN BE USED WITH ONE HAND!
Any 1/4" or 3/8" Drill a Powerful Saw in ONE MINUTE
"ARCO-SAW" is a rugged tool with right angle gear drive (no clumsy, dangerous, direct drive with drill sideways). Works like a high priced Portable Saw.

CUTS 1-5/16", or 2x4 by turning over

ONLY ARCO GIVES YOU ALL THESE FEATURES: Safety-yoke assures rigid connection and absolute safety—Visual guide and wide shoe-plate for straight, square cuts—Big handle affords firm grip for two-hand operation—Precision one-piece gear box—Self-lubricating lifetime bearings—

Lowest priced, quality Replacement Blades.
"HYCARBON" 4" Crosscut or 4" Combination Blade..... \$2.00 ea.

90-DAY FACTORY GUARANTEE

ORDER TODAY at your dealer or send us check or M.O. (Post-paid). C.O.D.'s—Postage extra. Ask for literature of other tools.

UNCONDITIONAL 10-DAY MONEY BACK GUARANTEE

DEALERS—Write for nearest jobber.

ARROW METAL PRODUCTS CO.

DEPT. PM-5, 140 WEST BROADWAY, NEW YORK 13, N. Y.

PARTS FOR MILITARY TRUCKS

At A Savings New FREE Catalog
For Jeep, Dodge, Chev., G.M.C., Studebaker—4x4 - 6x6. Drive

Brand New — Not Surplus — Complete
JEEP TOPS and SIDE CURTAINS
Fits all Military Jeeps. Also adaptable to some Civilian Jeeps. Waterproof O.D... \$59.50

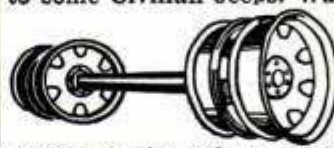

TRAILER AXLE

Heavy duty trailer axle suitable for many types of trailer construction. Also excellent for building of heavy farm trailers and wagons. It is square type straight trailer axle complete with Timken roller bearings, hubs, and 6 hole 750 x 20 Budd Wheels. Without brakes. Axle is 2 inches square and 69 inches between wheel mounting flanges. Std. width.

With Single Wheels. \$59.50 With Dual Wheels. \$69.50
Hundreds of Other Truck & Jeep Parts and Supplies
All prices quoted good 30 days FOB, Kansas City
25% DEPOSIT REQUIRED ON ALL ORDERS

American AUTO PARTS CO. INC.
1830 LOCUST—DEPT. PM
KANSAS CITY, MISSOURI

ROLL-EDGER KEEPS TOOLS KEEN

Simply slip chisel, plane blade, etc. into the Roll-Edger and roll back and forth over your sharpening stone. Adjusts to any desired angle. Prevents grooving of stone. Razor sharp tools mean cleaner jobs. Send only \$1.00 today. We pay postage. No C.O.D.'s please.

\$1.00
POSTPAID



SAMSON ENGINEERING CO.
Dept. PM, 120 Lawn Place, Rockford, Illinois

ONE-MAN SAWMILL LOW \$50.00 AS ... \$50.00 DOWN



Take BELSAW Portable Sawmill right to the trees—turn out valuable lumber for local yards —do "custom sawing" for neighbors. BELSAW lasts a lifetime. No crew needed. Power with old auto engine. Beginners get excellent results. Send postcard for FREE BOOK, "How To Make Lumber."

FREE BOOK

BELSAW MACHINERY CO.
8116 Field Bldg. 315 Westport Rd., Kansas City 2, Mo.



BRONZE FOUNDRY

Schools and Home Workshops
Make your own castings of aluminum, copper, bronze, silver. Foundry sets are available in three sizes including 2400 Deg. F. blast Furnaces. \$22.50; \$29.50; and \$42.00. f.o.b. Kansas City. Free Circular.

KANSAS CITY SPECIALTIES CO. P. O. BOX 6022, DEPT. P-5
KANSAS CITY, MO.

SAY YOU SAW IT IN POPULAR MECHANICS

MAKE YOUR OWN FOLDING TABLES · BENCHES · HORSES



WITH FOLD-A-WAY...
CHANNEL STEEL LEGS!

Shipped complete, ready to fasten to your top in a minute. FOLDS flat for easy carrying or storage. Rubber tipped. Used on the job, in homes, workshops, ping pong tables, camps, boats, trailers, banquet halls, lodges, churches, etc. Send for your pair today!

SEND FOR FREE CIRCULAR

THE DIAMOND MFG. CO. Dept. PM 1100 ALTMONT AVE. SCHENECTADY, N.Y.



SAW SHARPENER

Table model, gums and sharpens rip saws, combination saws & cut-off saws. Ideal for "Skill-saw" blades. Cap. 4" to 20" diam. Complete with 1/4 h.p. motor & 1 grinding wheel & cord — \$64 f.o.b. Portland. Shipping weight, 63#. SEND FOR FREE LITERATURE.

P. T. HOBBS MACHINERY
Dept. PM-54, Portland 17, Ore.

8375 N. Interstate.

HYDRAULIC CYLINDER SPECIAL

20,000 lb. thrust (push pull) using 1500 PSI line pressure as obtained from our hyd. pumps. Or will produce 40,000 lb. thrust with 3,000 lb. line pressure. CAN ALSO BE OPERATED ON LOW PRESSURE AIR SYSTEMS. 4" Bore, 1 1/2" dia. piston shaft, 18" stroke, length 30 1/2". Equipped with ball bearing loaded clevis type mounting and swivel type high pressure steel pipe bracket for easy use. Ideal for road, farm & shop machinery. Ideal for presses, etc. Cost Gov't \$390.00 **29.95**

We carry the World's Largest Supply of New Hydraulic Equipment featuring over 20,000 Cylinders in 61 Sizes & Types. Can also supply all accessories such as Pumps, Fittings, Valves, Tanks, Hose Fittings. Let us solve your Hydraulic problems. Write for information.

No. 3 HYDRAULIC CYLINDER
Double action. Bore is 1". Shaft 1/2". Has a stroke of 2 1/2" to 4". Stroke can be adjusted with internal sleeve stops. Overall length is 8 1/2". Will take 1500 lbs. continuous duty. 3000 lbs. intermittent. Will lift or push to 1100 lbs. **5.75**

No. 9-E HYDRAULIC CYLINDER
Double action cylinder. Has a bore of 1-3/8" and shaft of 1". Stroke is 9". Overall length 15 1/2". Built for 1500 lbs. continuous duty. 3000 lbs. intermittent. Will lift or push up to 2300 lbs. . . . Can be adapted to hundreds of uses. **9.75**

FOUR WAY VALVE
V-28 Poppet type. Valve shuts off at neutral position. Has 3/8" A.C. Tube Ports - 9/16 - 20 thread. Will stand 1500 PSI. **6.75**

V-17 - Poppet type, pressure balanced. Has piston with built-in relief valve to limit cylinder strokes. Inlet and outlet ports have 1/2" std. pipe ports. 1/2" A.C. tube to cyl. (1/4" x 18 thread) **9.75**

STRATO POWER PUMP
With built-in variable flow control valve in head. Positive displacement piston type. Displaces 450 cu. in. per revolution. 2 gal. per min. cap. at 1500 RPM or 1250 PSI. Pressure limit, 1250 PSI continuous, 1400 PSI for 15 sec. Operates at 3750 RPM, intermittent maximum 4500 RPM. Rotates either direction with out adjustment. **19.50**

GEROTER TYPE PUMP
Lagan Geroter type. For operating hydraulic systems on trucks, tractors, etc. Delivers 8 GPM at 1200 RPM at 1000 PSI with 5 H.P. Can also be used as Hydraulic fluid motor. 3/8" std. pipe ports, 1/2" splined shaft for pulley or direct attachment. 5 1/2" dia., 7" long. Used but condition guaranteed. **19.50**

VT-1 VICKERS HYDRAULIC Transmission
Self contained, 2 H.P., constant torque at all speeds with variable volume reversible, piston pump (controlled by outside lever) supplying piston hydraulic motor. Automatic pressure, dash pot for smooth control. Power output RPM - 0 to 1/3 input RPM in both directions. Input RPM 1800 continuous. 4000 intermittent. Dash pot can be removed for greater RPM. Ideal for lathes, duplicator or set-up on mills, conveyors, small cars, drives, gearings, etc. **32.50**
4" SPLINE SHAFTS for input & power take-off. **2.50 ea**

PALLEY SUPPLY CO
6321 SAN FERNANDO RD.
Dept. PMS GLENDALE 1, CALIF.

SAVE UP TO 85% FROM WAR SURPLUS "GADGETEERS HEAVEN"

NOW! MAKE YOUR OWN ARC WELDER!

Here's a real buy! Finest precision built R-1 Generators, used on B-29's, cost the Government approximately \$400.00. Gives from 300 to 400 amps at 27 volts. Ideal for all welding, light and heavy up to 5/8" thickness. FREE complete instructions for conversion of this generator to welding unit.



27.95

Other AIRCRAFT GENERATORS

P-1 27 Volts 200 Amps **15.95** E-5A 12 to 15 Volts 50 Amps **12.95**
1273-1A 27 Volts 75 Amps **15.95** 03 27 Volts 100 Amps **25.00**

NEW! GEAR HEAD MOTOR



GHM-607 - Originally designed to drive large Aircraft Tow-Target reels. . . . Powered by 24 V. DC, 95 Amp., compound wound motor. Rated at 2 H.P. Turns 4,200 RPM and is geared down to 136 RPM at the power take-off shaft. 60 foot pound

torque at take-off. Power drive is 3/4" female adaptation. Unit has magnetic clutch for instant stop control. Comes complete with operating switches and control box. **37.50**

NOW! 1951 ILLUSTRATED - 200 PAGE CATALOG 1000'S OF BARGAINS! WRITE TODAY!

JUST OFF THE PRESSES!! IMMEDIATE DELIVERY!! ORDER NOW!!

Packed with BARGAINS in NEW and SURPLUS merchandise at UNHEARD OF LOW PRICES! Items of interest to Mechanic, Housewife, Farmer, Airman, Manufacturer, Hunter, Sportsman and just about everyone. SAVINGS UP TO 85% on many articles in Clothing, Hand & Power tools, Housewares, Machinery, Electrical Supplies, Metals, Rubber, Plastics, Welding Equipment, Pneumatic & Air tools and Hydraulic Supplies such as Cylinders, Valves, Pumps, Motors, Fittings, etc. Send 50c TODAY! We will refund it on your first order of \$1.00 or more.

ELECTRIC MOTORS

LEAR ELECTRIC MOTOR. 24 volt, 6 amps, series wound reversible motor with overload clutch. Motor turns 11,000 R.P.M. Has 11 to 1 gear reduction box turning 1000 R.P.M. at take-off. Adaptable to flex or rigid drive. Limit switch box. Size 10" x 4". **\$7.95**

SAMSELL MOTOR 27 volts, 16 amps 1-5 H.P. reversible, series wound on motor. 3800 R.P.M., shaft 9/32" diameter. 12-spline. 4-1/8" x 2-3/8". **3.95**

GEAR HEAD MOTOR Heavy Duty G.E. Gear Head Motor. 1 1/2 H.P., 24 volt DC, 125 amp reversible motor will drive reduction gear box unit 44.5 to 1, resulting in 168 R.P.M. at 5/8" diameter take-off shaft. Motor contains electro magnetic break. **4.95**
UNIT COMPLETE **10.95** MOTOR **4.95**
GEAR BOX ALONE **7.95**

No. 500 - New 1/2 H.P. - 27 Volt, D.C.-A.C. This motor can be readily adapted to deliver up to 1/2 H.P. on 110 Volts, A.C. by the simple method of rearranging armature brushes. Free diagram with each order. A sensational value. **5.95**

No. 500-A - Converted to 110 Volts-A.C. Equipped with plug and 3/4" ft. Heavy duty cord. **8.49**

GEAR BOX - VTG-1 - 90° - bevel gear 1 1/2 to 1 reduction. A life-time value. 3.95
Size: 7" x 6"
Has lever control for engaging & disengaging positive clutch. Dust proof housing, pre-lubricated bearings. . . . Can be adapted to Vickers Transmission.

ELECTRIC ACTUATOR

CTU-2 Foote linear actuator, 24 Volt, A.C. or D.C., 8500 R.P.M., 1/6 H.P. - Series wound motor. 4 1/2" stroke in 13 1/2 seconds. Compression and tension loads up to 750 lbs. Adjustable micro-switch for limits of travel. Overall length retracted 11" **6.95**

TWO HEAT SOLDERING IRON
This is really TWO IRONS in ONE!! A control button in handle selects 150 or 300 watt heat. Full size iron for light & heavy work. Removable, solid copper tip. Complete with cord & tip. **4.95**

D. C. METERS
AMMETERS 0-30-0-30+ 0-60-0-60+ 0-120-0-120+ 0-120-0-240 0-300 Any above ammeters. **3.95**
VOLT METERS 0-30 **4.95**
COMBINATION VOLT AMMETERS 30 V. - 30 AMP. 30 V. - 60 AMP. **Only 4.95**

ABOVE AMMETERS HAVE 2" FACE EXCEPT 0-300 WHICH HAS 3" FACE SHUNTS
IT IS NECESSARY TO USE SHUNTS WITH ALL D.C. AMMETERS.
30-A 60-A 120-A **1.25**
150-A 240-A 300-A

PIANO HINGE
Overall - Width - Length - Price ea.
1 1/4" - (5/8" side) - 72" alum. - \$1.00
2" - (1" side) - 9" alum. - \$1.75
3 1/2" - (1 1/2" side) - 54" st. steel - \$1.69
BRASS HINGE - 1 1/2" (5/8" side) .040 thick) Any length at . . . per ft. .29

PALLEY FAMOUS MIXES! Prepared especially for the HOME CRAFTSMAN, HOBBYIST, INVENTOR, GADGETEER or SHOP MECHANIC.

GADGET MIX - Rivets, Spacers, Bolts, Screws, Gears, Wheel bearings, Springs and Clamps. No. 106, 5 lbs. **1.19**

BEARING MIX, No. 170A. Approx. 20 needle, Ball & Roller Bearings, New & Used. Sizes: 1/2" to 4". Some of these cost Gov't \$10 a piece. Never such a value! 5 lbs. ONLY. **1.59**

HINGE MIX, No. 170H. 12 pairs of Strap and butt hinges. Hasps, 1" x 1" to 7/8" x 10" in length and 8" strap. 2 lbs. **1.09**

ABRASIVE AND GRINDING WHEEL MIX - 50 pieces including honing stone, pencil rolls, wheels, etc. A sharp value. No. 170AG **99c**

SPRING MIX, No. 206 - Torsion, Compression & Tension Springs. Ass'd. sizes. A treasure trove for emergencies. Scores of springs - 5 lbs. for ONLY. **1.69**

RIVET MIX - 3 POUNDS - Consisting of sizes from 1/4" long to 3" long in many diameters & alloys. **1.19**

FILE MIX - Ten assorted Files, 4" to 12", includes 3 Vixens, half rounds bastards, mills, etc., in seconds and used but in good condition. 1 Vixen alone worth our price for entire mix. F-1 **99c**

PULLEY MIX, No. PM-1 - You'll want this one around. 10 micarta & metal pulleys ranging from 1" to 5" with ball and one piece bearings. These are aircraft pulleys, the best made with 100's of uses. A WONDERFUL BUY!!! **2.95**

SCREW MIX - 5 lbs., including assortment of wood and machine screws. Many sizes. Save dollars and always have plenty of screws on hand. **1.39**

NUT MIX NM-1 - 3 lbs. approx. 500 nut. Anchor, Lock, Castle, Hex, Elastic Stop Nuts, etc. You'll always have plenty of Nuts in the shop. NM-1 **1.39**

SUPER COMBO MIX - No. SC2. Here's a real bargain. All ten above mixes for ONLY. . . . **12.95**

AIRCRAFT CABLE

Rust resistant, alloyed steel, Extra flexible. Pre-formed, 7 x 19 strand. On reels.
1/16" - 4 1/2 ft. | 5/32" - 7 1/2 ft.
5/64" - 5 ft. | 1/4" - 12 1/2 ft.
3/32" - 5 1/2 ft. | 9/32" - 15 ft.
1/8" - 7 ft. | 5/16" - 16 1/2 ft.
7/32" - 10 1/2 ft. | 3/8" - 18 ft.
1/2" - 20 ft.
Special 3/16" cable, 18 ft. long with turnbuckle ends. **99c**
Stainless Steel Cable - Pre-formed
1/16" - 6 ft. | 5/32" - 20 ft.
3/32" - 14 ft. | 1/4" - 26 ft.
Bronze Cable - Not Pre-formed
1/16" - 5 ft. | 3/16" - 23 ft.
1/4" - 17 ft. | 1/2" - 38 ft.

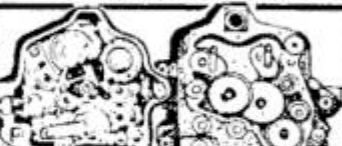

Electronic Transmissn. Gear Train
GT-1 - approx. 50 Bronze Spur & Pinion Gears, 3/8" to 4" dia., 5 sets of 7 cluster gears, 2 complete worm and worm gear drive sets, 40 N.D. ball bearings; 1" to 1 1/2" dia., watch springs, bushings, posts, face plates, housings, micro switches 2 miniature controlled clutches, etc. . . . Gears in multiple size and sequence identical teeth ratio, giving 100's of gear reduction combinations. **8.49**
Wt. 19 lbs.

Order from this ad. All sales final. Prices F.O.B., Glendale, Pay by M.O. or check. R.O.'s accepted from D&B firms. 1/2 deposit with C.O.D.

LARGEST FIRM OF ITS TYPE IN THE WORLD

South Bend LIGHT TEN LATHE

A Better Lathe for Better Work

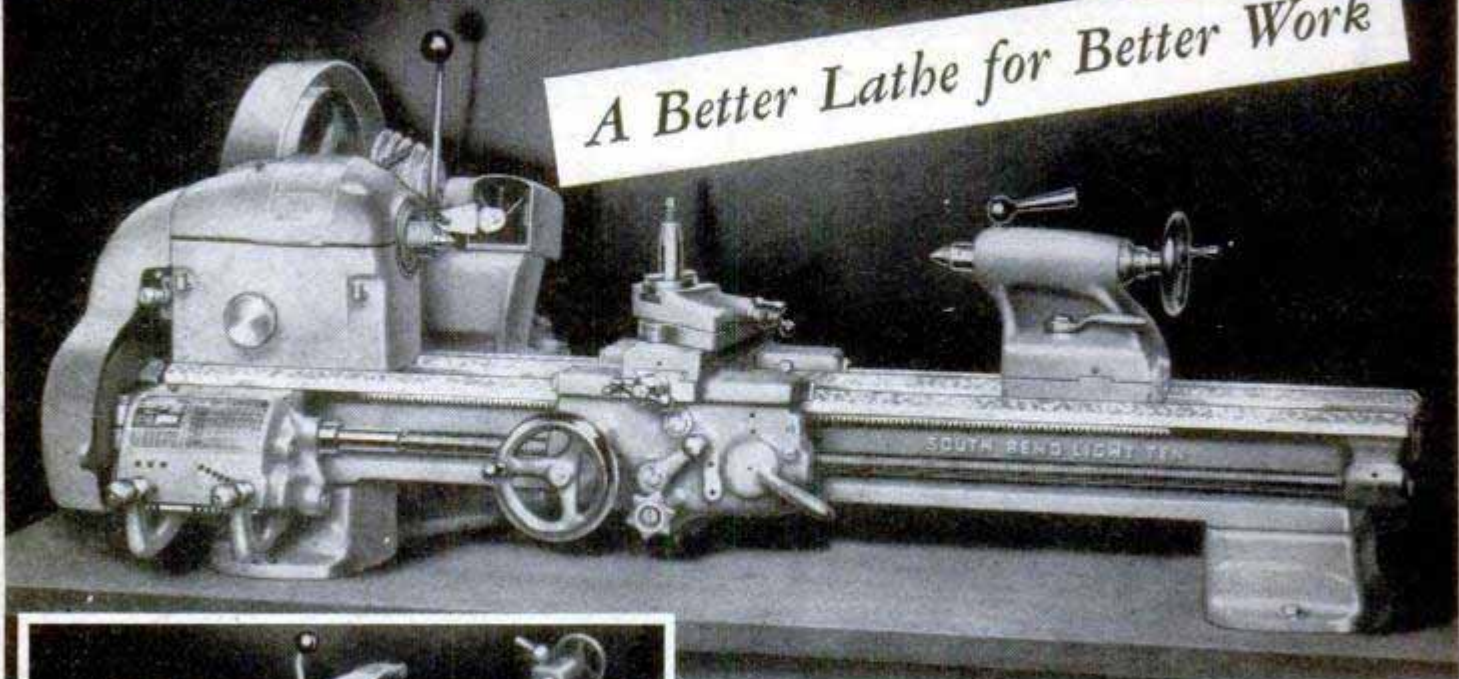

Light Ten Model A Lathe — 10" x 3-1/2"

This new Light Ten Bench Lathe is the result of forty-three years of experience in designing and building fine lathes. It is a modern precision tool having the most recently developed improvements, plus features usually restricted to larger lathes. In this lathe you get big lathe features at small lathe prices. We consider it one of the best values ever offered. The quick change gear box and universal power feed apron provide a full range of 48 screw threads, 48 power longitudinal feeds and 48 power cross feeds. Large, precision-bored bearings for the superfinished spindle insure extreme accuracy and service. The tailstock has graduated spindle and micrometer collar on screw.

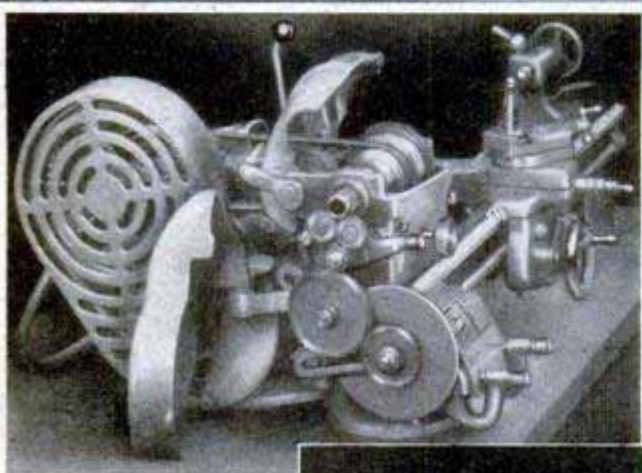

For safety, all gears and pulleys are enclosed, yet they are easily accessible.

Tailstock has 1/10" graduations on spindle and micrometer collar on screw.



Building Better Tools Since 1906 • SOUTH BEND LATHE • South Bend 22, Ind.

Send Information Checked:

Light Ten Lathes

Lathe Attachments

New "How to Run A Lathe" book, (Enclose 25c coin or stamps)



9" and 10" Bench Lathes

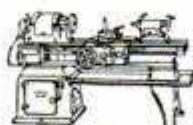

10" to 16-24" Floor Lathes

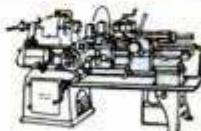

1/2" & 1" Collet Turret Lathes



14" Drill Presses



7" Bench Shapers

Name _____

Street _____

City _____

State _____

Printed by Popular Mechanics Company, Chicago, Ill., U. S. A.

"DAD--WE NEED A MONTAMOWER TOO"

"NO MORE LABOR NEIGHBOR"

DOES NOT SHAVE CROWN
TRIMS AS IT CUTS

Weight only 8 1/4 lbs

MontaMower is a new, efficient kind of lawn mower that literally "sells itself."

This live, 8 1/4 lb. precision machine first gathers then smoothly and easily cuts a full 16" swath through grass, dandelions, spike grass and tall lawn weeds (including those that ordinarily pop back up to cause you extra work).

AND EVEN MORE IMPORTANT . . .
MontaMower does what no conventional mower can do! It cuts right up to walls, fences, trees, under foliage, around close quarter borders — it practically eliminates hand trimming!

MontaMower is sturdy, yet so light that even

MONTA MOWER

MOWS and TRIMS LAWNS
in ONE EASY OPERATION

Trims close to buildings, trees and shrubs.

Cuts clean . . . grass, tall lawn weeds and all.

PASTE THIS COUPON ON A PENNY POSTCARD—MAIL TODAY

Try it
ON YOUR OWN LAWN
. . . on approval!

women and children can operate it easily and efficiently. Improved metal handle has special device to adjust cutting height. Self sharpening, tool-steel cutting discs.

Unsolicited testimonials from thousands upon thousands of satisfied owners everywhere have convinced us that, in your own hands — on your own lawn, under most conditions, the MontaMower will prove itself far superior to any other type of hand operated mower.

This is why we can sell you this fine low priced mower with a "Written Guarantee" — on a most liberal "Try on your own lawn . . . on approval" basis. Write today for full details on this amazing offer.

SOLD DIRECT ONLY NO AGENTS NO DEALERS

MONTAMOWER DISTRIBUTING CO.

Sales and General Offices

P.M. 15 KEELER BLDG. • GRAND RAPIDS 2, MICHIGAN

Gentlemen: Without obligation, kindly send me complete descriptive literature, price, guarantee information, and full details of your amazing "Try it on your own lawn" Approval Offer.

NAME _____

ADDRESS _____

CITY _____ ZONE _____ STATE _____



FRAN WARREN, radio songstress: "As a singer, I welcome Camel mildness. And Camels are such fun to smoke!"



"MY OWN 30-Day Test gave me a new pitch on cigarettes," says ace pitcher **Jim Konstanty**. "Camels hit the spot!"



STYLIST Elaine Bassett: "Ever since I made my own 30-day test, Camels are my favorite! They're so mild!"



PETER LIND HAYES, comedian, says: "Camels smoke cool and mild—they're just right for my throat!"



NADINE CONNER, opera star: "My own 30-Day Camel Test proved how much fun smoking can be!"



VAUGHN MONROE, band leader: "I enjoy every puff of a Camel! Camels taste great—and they're mild!"



TELEVISION STAR Marguerite Piazza agrees: "As a singer, I enjoy Camel mildness—and Camels taste grand!"



BASEBALL MANAGER Ed Sawyer: "Camels made a hit with me from the start. They're mild and taste great!"

More people smoke
Camels
than any other
cigarette!



Make the
30-Day Camel
MILDNESS
Test—
See why!

● No other cigarette can match Camel's rich, full flavor! And no other cigarette can offer you this proof of mildness:

In a coast-to-coast test of hundreds of men and women who smoked only Camels for 30 days, noted throat specialists, making weekly examinations, reported — not one single case of throat irritation due to smoking Camels!

Smoke Camels yourself for 30 days. Compare Camel's choice tobaccos for flavor and mildness... in your "T-Zone" (T for Throat, T for Taste). You'll see why so many smokers say...

ONCE A CAMEL SMOKER, ALWAYS A CAMEL SMOKER!



JOHN WAYNE, movie hero, says: "I found the cigarette I could enjoy as a steady smoke — Camels!"



KYLE MacDONNELL, television star, says: "Yes, I made my own 30-Day Camel Mildness Test. It was fun!"



OPERA STAR, Robert Merrill: "The cigarette I smoke must agree with my throat. Camels are really mild!"

R. J. Reynolds Tobacco Company, Winston-Salem, N. C.



RIFLE CHAMPION Audrey Bockmann: "Camels scored a hit with my taste, too! And they're mild!"



DICK POWELL, movie star, states: "Camels give me more pleasure than I ever got from any other cigarette!"



RISÉ STEVENS, opera beauty, says: "I know how mild Camels are! My own 30-Day Test convinced me!"

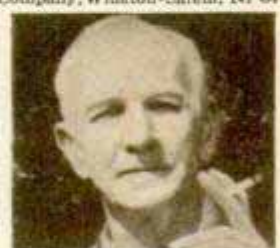

LECTURER AND WRITER Dr. Archibald Rutledge: "I've smoked Camels for years! They're cool and mild."



"I'M A SINGER and my throat comes first! I picked Camels as my steady smoke!" **Anne Jeffreys**, stage star.