

ANC



POPULAR MECHANICS

MAGAZINE

WRITTEN SO YOU CAN UNDERSTAND

REG'D. TRADE MARK, GREAT BRITAIN, NO. 410426

REG. U.S. PAT. OFF.

See page 112



How Do You Like Your New Ford?

Read the answers of the real experts—Ford owners themselves! —another in the great series of

REPORTS FROM THE OWNERS

Here's the MONTA MOWER Story



**TRIMS
AS IT CUTS**

The MontaMower story is about the thousands upon thousands of people who are mowing their lawns in less time than they ever did before . . . with scarcely half the effort.

With a MontaMower you can mow and trim your lawn in one easy operation . . . mow right up to walls, trees, fences . . . under foliage, around close quarter borders . . . with practically no grass left to trim by hand.

Smoothly cut through grass, dandelions, spike grass and tall lawn weeds (including those that always popped back up).

Mow up, down, or across your terraces without scalping the crown . . . anyone can operate it easily and efficiently.

Unsolicited testimonials from thousands of satisfied owners everywhere have convinced us that, in your own hands — on your own lawn, under most conditions, the fine low priced MontaMower will prove itself far superior to any other hand operated mower. **TRY IT on your own lawn . . . ON APPROVAL with our WRITTEN GUARANTEE! Write today!**

HERE'S HOW IT WORKS FOR YOU

Eight pairs of self sharpening, precision made and fitted, tool-steel cutting disks revolving toward each other gather the grass and cut it cleanly at the intersection of the disks. Easily and quickly adjustable to cutting height!

TRY it on YOUR OWN LAWN . . . ON APPROVAL!

Use Coupon Below

TRIMS CLOSE TO WALLS - TREES SHRUBS - FENCES

SO DESIGNED, IT CANNOT SCALP TERRACE CROWN

Weights Only 8 1/4 Lb.
CUTS A FULL STANDARD 16" SWATH

CUTS TALL LAWN WEEDS WITH GRASS

SOLD DIRECT ONLY NO AGENTS NO DEALERS

MontaMower Distributing Co. Sales and General Offices
P.M. 14 KEELER BLDG., GRAND RAPIDS 2, MICHIGAN

Gentlemen: Without obligation, kindly send me completely illustrated, descriptive literature, price, guarantee information, and full details of your amazing "Try it on your lawn" Approval Offer.

NAME _____

ADDRESS _____

FREE

MAIL THIS COUPON TODAY —
PASTE ON A PENNY POST CARD
(if possible)

Get the screening that's guaranteed not to Rust, Rot or Corrode!

NEEDS NO PROTECTIVE PAINTING!

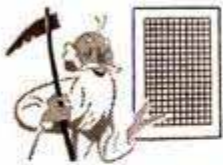

LASTS LONGER . . .

because Lumite Screening has greater resistance to blows, and because it can't rot out! It won't sag or bulge when properly framed . . . and it's easy to handle.



Buy Lumite Screening at your Hardware, Lumber or Building Supply Dealer. Or write for FREE SAMPLE and descriptive folder to: Lumite Division, Chicopee Mfg. Corp. of Georgia, 40 Worth Street, New York 13, N. Y.



CAN'T STAIN

the sills or sides of your house. Cleans easily with a damp cloth. In every way, Lumite is the ideal screening for every exterior use.



COSTS LESS

than all but the cheapest screening! And can stay up all year 'round, because: Neither snow, rain, smoke, fog nor salt air can harm Lumite Screening!

LUMITE*

SARAN SCREENING

*Registered Trade-mark

This One



Read these interesting facts about your own automobile

Listen to what the men who build automobile engines have to say about your car. At 40 miles an hour on a smooth, level highway, 50% of your gasoline is used up to overcome engine friction. Yes, half of the power your gasoline produces never gets to the rear wheels to make your car go faster or farther or climb a steeper hill.

Friction eats a lot of gas, doesn't it?

Now just suppose you can *reduce* that friction. Then some of the power that was being used to overcome it will be *released* to *help* drive your car ahead.

And that's exactly what happens!

In hundreds upon hundreds of scientific Dynamometer tests using cars like yours, the average motorist got 8% more *usable* power from the same amount of gasoline after he had changed from whatever oil he had been using to Macmillan Ring-Free Motor Oil.

The minute you change to Macmillan, you'll get an increase in power and gasoline mileage. You cut down on "drag"—your gasoline "pushes" easier than before. After your second or third drain, you'll get an average increase in gasoline mileage of 8%!

That's because Macmillan has not only reduced engine friction but also has reduced carbon and gum deposits in the combustion chamber, on rings, valves,

and valve stems. This results in higher compression because of better piston seal—smoother operation, and less tendency for the motor to ping.

Let's figure what 8% means to you. First, it means an 8% saving on your gasoline bill—that's about 2¢ a gallon on every gallon you buy. 8% means an average of 20 extra miles on every tankful. Or, look at it this way: over a normal oil drain period, your gasoline saving is \$2.00—enough to *pay for your oil*.

And don't ever forget, it's friction that wears out motors. With Macmillan Ring-Free Motor Oil you *reduce* friction—you save on wear and repair—your motor lasts longer, runs sweeter, uses less oil. New motors stay newer longer.

You'll find Macmillan—the original carbon-removing oil—at independent garages, car dealers and service stations where you see the sign of the big red "M." Drive in, try the *OIL* that makes your *GAS* go farther.



President

MACMILLAN PETROLEUM CORPORATION

530 W. 6TH STREET, LOS ANGELES

50 W. 50TH, NEW YORK • 624 S. MICHIGAN, CHICAGO

P.S. If you are unable to locate a Macmillan dealer, write to me and I'll be glad to direct you to the one nearest you. R.S.M.

Popular Mechanics Magazine

Registered in U. S. Patent Office and Canada

H. H. WINDSOR, Founder

H. H. WINDSOR, JR., Editor and Publisher



this month's cover

HIGH ABOVE the concrete lawn of the city this steeplejack plies his trade. On our cover he's painting a TV and FM radio antenna; but before he could paint that spire he had to build it. He works higher than any earthbound mortal in history, for his business takes him, not only to the top of the highest skyscrapers in the world, but on up the needle-shaped towers that he may erect more than 200 feet higher into the clouds. Dangerous? Of course. But the steeplejack only shrugs his shoulders and philosophizes that a 50-foot fall can kill you just as dead as a 1400-foot plunge. TV has put a premium on cloud-scraping real estate—the higher the tower the farther a picture can be transmitted. Antennas are sprouting like weeds on skyscrapers all over the country. For the stomach-squeezing story of the new steeplejacks who build and maintain these masts turn to page 112

Published monthly by Popular Mechanics Company, 200 E. Ontario St., Chicago 11, Ill. H. H. Windsor, Jr., president; William Harrison Petridge, vice president; D. F. Windsor, vice president and secretary-treasurer; Clover L. Perkins, advertising manager; Alan M. Deyoe, circulation manager. Single copy in the United States and Canada, 35 cents; subscription rates in United States and possessions, Canada, Philippines and countries of the Pan-American Postal Union, 1 year \$3.50; 2 years, \$6.00; 3 years \$8.00. To all other countries add \$1.00 a year over United States prices for overseas postage. If you plan to move, notify us at least 30 days in advance so you will not miss an issue. Give both your old and new addresses.

Entered as Second Class Matter, September 15, 1903, at the Post Office at Chicago, Illinois, under Act of March 3, 1879. Entered as Second Class Matter at Post Office Dept., Canada. Registered as Second Class Matter at the Post Office at Mexico, D. F., Mexico, June 20, 1950.

Copyright 1951 by Popular Mechanics Company. Copyright under International Copyright Union. Copyright in France. All rights reserved under Pan-American Copyright Union. Printed in the United States of America.

APRIL 1951

Volume 95 APRIL 1951 Number 4

Managing Editor.....Roderick M. Grant
 Assistant Managing Editor.....Wayne Whittaker
 Shop Notes and Crafts Editor.....James R. Ward
 Radio-Television, Electronics Editor.....Frank L. Brittin
 Associate Editor, Aviation.....Aubrey O. Cookman, Jr.
 Associate Editor.....Clifford B. Hicks
 Associate Editor.....Donald R. Brooks
 Automotive Editor.....Siler Freeman
 Art Director.....Frank Beatty
 Director, Bureau of Information.....Allan Carpenter
 200 E. Ontario St., Chicago 11

Assistant Editors
 Dorothy E. Hoffmann Arthur R. Railton H. H. Windsor III
 Assistant Editors, Shop Notes and Crafts
 W. Clyde Lamme Wayne C. Lecky Frank N. Stephany
 C. E. Mitchell

Eastern Editor.....Richard F. Dempewolf
 Empire State Bldg., Room 2906, New York 1, N. Y.

Western Editor.....Thomas E. Stimson, Jr.
 302 23rd St., Santa Monica, Calif.

Representative in Great Britain.....Douglas W. Wedderspoon
 77 Baker St., London W. 1, England

IN THIS ISSUE

Fuel With a 260,000-Mile Reach - - - -	81
I'm Building the P.M. Ranch House—Part VI - - - -	88
Quarry-Pit Racers - - - - -	92
Lightning Strikes Your Dinner - - - - -	97
The Owners Report on the '51 Ford - - - -	106
TV's Steeplejacks - - - - -	112
High-Jumping Outboards - - - - -	118
What's New for Your Home - - - - -	124
Helicopter Cowboy - - - - -	126
Scattergunner's Hall of Fame - - - - -	133
Plague in the Big Pines - - - - -	140
Jungle Home on Wheels - - - - -	144
A Whittler's Cowboy Town - - - - -	151
Drinking Fountain Saves the Quail - - - -	160

For the Craftsman

Be Proud of Your Lawn - - - - -	166
One-Evening Projects - - - - -	180
Arbors and Trellises - - - - -	188
A Fountain on Your Table - - - - -	194
Do Your Own Tuck Pointing - - - - -	201
Swing Saw for Your Home Workshop - - - -	212
How to Do Angular Drilling - - - - -	218
Shopping for Tools - - - - -	224
Radio-Television, Electronics - - - - -	227
Clinic for Homemakers - - - - -	236

Other items, and manufacturers of available products described, are listed on pages 12, 14 and 16

Technical Training

...MEANS A BETTER U. S. ARMY

Your United States Army is the best technically and mechanically equipped Army in the world. To keep this equipment in top operating condition, your Army trains thousands of soldiers in the operation, repair and maintenance of the very modern types of equipment now serving the Army.

The men pictured below have been trained by the Army in the repair of battery commander telescopes essential to the effectiveness of the Artillery. Technically skilled men . . . trained to

do an important job . . . trained while serving in the U. S. Army.

You can apply for Army technical training . . . after finishing basic training . . . and, if you qualify for the quota of the school you choose, learn with the best. Today's Army is a man's Army . . . and there is a place in it for you.

Get the details about U. S. Army technical training schools today . . . at your nearest U. S. Army and U. S. Air Force Recruiting Station.



U. S. ARMY



THE MARK OF A MAN!

This is the mark of a man . . . the uniform cap of the U. S. Army. The man who wears it has come up to the mark, has proved his ability to be a soldier.



Quick... Easy... Fun...

Lay your own colorful KENTILE FLOOR

and save money, too!



IT'S SO EASY
WITH THE HANDY
KEN-KIT... IT HAS
ALL THE TOOLS
YOU NEED!

A beautiful 10' x 15' floor like this for only **\$39^{75*}**

NOTHING could be easier than laying your own long-lasting Kentile Floor...it goes down tile-by-tile, a little at a time or the whole room in a few short hours. And, your Kentile Floor is ready for use as soon as it's down.

Kentile lasts and lasts...resists dirt, stays clean and colorful when washed with mild soap and water. And colors stay bright for the long life of the floor because they go all the way through each tough tile. Occasional no-rub waxings give a like-new sparkle to your easy-to-clean Kentile Floor.

*Your floor may cost considerably less or slightly more depending on the colors you choose and the size of your room.



KITCHEN... BATHROOM... BEDROOM
- PERFECT FOR ALL MY ROOMS!

SEE YOUR KENTILE DEALER. His name is listed in your classified phone directory under FLOORING. He'll be glad to give you a FREE estimate and helpful advice when you make your selection from the 26 new Kentile colors.

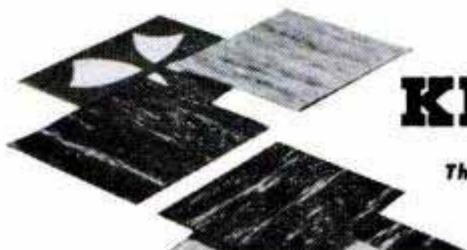

KENTILE®

The Asphalt Tile of
Enduring Beauty



Can my car last longer ?

the answer is Yes...WITH

Pyroil

What every car owner wants to know:

Question: Does PYROIL prevent rust and corrosion?

Answer: Yes, because Pyroil maintains a constant clinging film of oil on piston and cylinder surfaces. It protects these vital metal parts from exposure due to condensation.

Q. Will PYROIL keep my motor clean?

A. Yes, Pyroil prevents gums and carbon deposits and keeps motors clean.

Q. Does PYROIL avoid costly repairs?

A. Yes, Pyroil is so much cheaper than repairs, because it eliminates wear and tear caused by friction of metal surfaces.

Q. Will PYROIL prevent breakdown?

A. Yes, Pyroil is a round-the-clock protector for your motor. It improves lubrication—it prevents wearing "dry starts".

Yes, Pyroil is the answer to the question, "Can I drive my car farther, longer and better than I expected?" Stop questioning the life of your car. Just add Pyroil—add miles to your car.

Pyroil for Aircraft Engines

Use Aircraft Pyroil B for lubricating oil, Aircraft Pyroil A for gasoline.

GIVEN! An attractive Pyroil metal savings bank, takes coins up to 50¢ pieces. **MOTORISTS**, it's yours for the asking—sent postage paid.



Manufactured and Guaranteed by Pyroil Company, 114 Pyroil Bldg., La Crosse, Wisconsin.

Canadian Distributors: Central Purchasing Agencies, Ltd., Toronto, Ontario

PYROIL COMPANY

114 Pyroil Bldg., La Crosse, Wisconsin

I want my car to last and run properly. Please tell me more about Pyroil and how it can accomplish this for me.

Name _____

Address _____

City or Town _____ State _____



in this corner.....

THE EDITORS



WOULD YOU LIKE to have a newly built, modern ranch house at half price?

Tom and Vinita Riley of Portland, Ore., will move into theirs very soon. They built it themselves, from plans provided by *Popular Mechanics*, and by their own labor saved half the cost of the new home.

Next month, in the Craftsman Section, Tom Riley begins his story. It is a sort of triumphant confession. A confession that he is a rank amateur as a carpenter, bricklayer, cabinetmaker, glazier and roofer. But his triumph in the completion of a beautiful plywood home proves that, as Tom says, "If I can do it, anyone can!"

Don't miss the beginning of this great story in the May issue, with seven pages of full-color illustrations. It may bring the inspiration for your own new home.

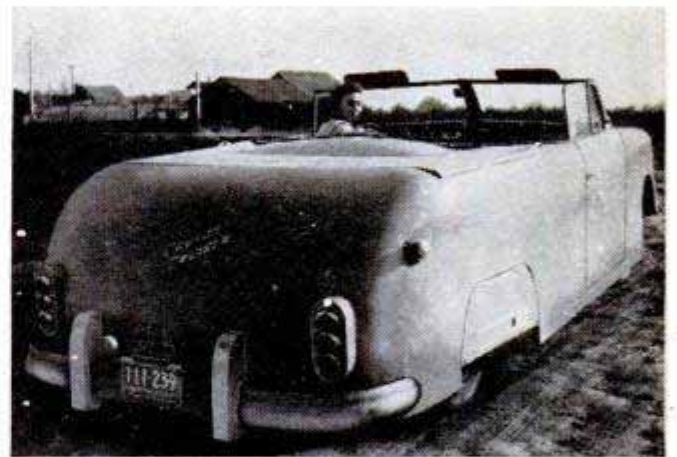

Letter to the Editor

Enclosed herewith please find negatives showing a car built at home by the Juchli Brothers of Edmonton, Alta., Can.

(Continued to page 8)



To the man who wants to enjoy
an ACCOUNTANT'S CAREER



IF you're that man, here's something that will interest you.

Not a magic formula—not a get-rich-quick scheme—but something more substantial, more practical.

Of course, you need something more than just the desire to be an accountant. You've got to pay the price—be willing to study earnestly, thoroughly.

Still, wouldn't it be worth your while to sacrifice some of your leisure in favor of interesting home study—over a comparatively brief period? Always provided that the rewards were good—a salary of \$4,000 to \$10,000?

An accountant's duties are interesting, varied and of real worth to his employers. He has *standing!*

Do you feel that such things aren't for you? Well, don't be too sure. Very possibly they *can* be!

Why not, like so many before you, investigate LaSalle's modern Problem Method of training for an accountancy position?

Just suppose you were permitted to work in a large accounting house under the personal supervision of an expert accountant. Suppose, with his aid, you studied accounting principles and solved problems day by day—easy ones at first—then more difficult ones. If you could do this—and could turn to him for advice as the problems became complex—soon you'd master them all.

That's the training you follow in principle under the LaSalle Problem Method.

You cover accountancy from the basic Principles right up through Accountancy Systems and Income Tax Procedure. Then you add C. P. A. Training and prepare for the C. P. A. examinations.

As you go along, you absorb the principles of Auditing, Cost Accounting, Business Law, Statistical Control, Organization, Management and Finance.

Your progress is as speedy as you care to make it—depending on your own eagerness to learn and the time you spend in study.

Will recognition come? The only answer, as you know, is that success *does* come to the man who is really *trained*. It's possible your employers will notice your improvement in a very few weeks or months. Indeed, many LaSalle graduates have paid for their training—with increased earnings—before they have completed it! For accountants, who are trained in organization and management, are the executives of the future.

Write For This Free Book

For your own good, don't put off investigation of *all* the facts. Write for our free 48-page book, "Accountancy, The Profession That Pays." It'll prove that accountancy offers brilliant futures to those who aren't afraid of serious home study. We'll also include "Ten Years' Promotion in One"—a book which has helped many men. Send us the coupon *now*.

**LASALLE EXTENSION
 CHICAGO 5, ILL.**

Over 3200 Certified
 Public Accountants among
 LaSalle alumni!

- Other LaSalle Opportunities**
- Higher Accountancy
 - C.P.A. Coaching
 - Bookkeeping
 - Law: LL.B. Degree
 - Business Management
 - Salesmanship
 - Traffic Management
 - Foremanship
 - Industr'l Management
 - Stenotypy (Machine Shorthand)

**LASALLE EXTENSION UNIVERSITY
 A CORRESPONDENCE INSTITUTION**

417 S. Dearborn St. Dept. 464 HR Chicago 5, Ill.

I want to be an accountant. Send me without obligation, "Accountancy, the Profession that Pays"—also "Ten Years' Promotion in One."

Name.....Age.....
 Address.....
 City, Zone & State.....



(Continued from page 6)

The car is made from a wrecked half-ton Chevrolet truck and is 7 feet 2 inches wide, the seat is 70 inches wide, wheelbase is 116 inches and it weighs 4500 pounds. The car has an unusual one-piece roof with large Mercury rear window which hinges at the back and disappears completely in the trunk. The body is made of 18-gauge black iron. This car operates well.

A. C. Juchli,
8840 - 87th St.,
Edmonton, Alta., Can.

Letter to the Editor

In the December issue of PM there is an article about "Weapons With a New Wallop." In this article there is a short discussion of the effects of the bazooka and shaped charges on a tank. I would like to find out what would happen if two or three thicknesses of one-inch armor plate spaced about four inches apart were hit by this type of shell. . . . It seems to me that the power delivered from this shell is due to impact, very much like a die-punching steel, which is very effective on solid armor plate of great thickness. If the shell were exploded at a distance from the main armor, it would have relatively little effect.

Charles K. Maxey,
Vallejo, Calif.

According to information provided by the Army Ordnance Laboratories, two or three thicknesses of armor plate would not make any difference to a shaped-charge shell. In the December article reference is made to the fact that the shell does not work on impact, except for triggering purposes. What does the job is a thin stream of supersonic metal proceeding from the apex of the cone-shaped metal lining behind the nose of the shell. This will bore through any number of thicknesses, up to about 11 inches of solid metal, or the equivalent in spaced armor plates.

Letter to the Editor

It has just been my good fortune to read Floyd Clymer's article on the Nash Rambler in your January issue, and I feel I must drop you a line complimenting you on it. This article is refreshingly different from the individual opinions you read on different makes of cars. Here the actual owner voices his opinion, and, you will agree, it is the collective opinions of owners of any product that ultimately will make or break a manufacturer. . . . I feel sure that Mr. Clymer's article will go a long way to increase Rambler sales and popularity.

(Continued to page 10)



"YOU MAY BE THE CLUB DIVING CHAMP —
BUT HE SCORES WITH MENNEN SKIN BRACER!"

THE AFTER-SHAVE LOTION WITH

*The He-Man Aroma
That "WOWS" the Ladies!*

★ You'll Like Its Refreshing,
"Wake-Up" Tingle!

*Helps Heal Tiny
Razor Nicks, Too!*



*Keep Presentable
Longer!*

**CLEANER, SMOOTHER
SHAVES with**

★ *No Burning!*
★ *No Stinging!*

MORE DOCTORS Who Specialize in
Skin Care USE MENNEN SHAVE
CREAMS Than Any Other Brand



Put yourself in the I.C.S. HALL of FAME*



JOIN these men who have made their mark! Men who by dint of ambition, intelligence and sound, practical I. C. S. training now enjoy positions of leadership in business and industry. The sooner you start, the better your chances of making the grade. Right now, with the criti-

cal shortage of skilled labor, trained men are becoming leaders overnight. Hundreds of I. C. S. students are reporting promotions and pay increases, earning greater security for themselves and their families. How about marking and mailing the coupon today?

**Names and positions sent on request*

INTERNATIONAL CORRESPONDENCE SCHOOLS

APPROVED
under the
G.I. BILL

BOX 5697-K, SCRANTON 9, PENNA.

Without cost or obligation, please send me full particulars about the course BEFORE which I have marked X:

- | | | | |
|---|---|---|--|
| <p>Air Conditioning and Plumbing Courses</p> <ul style="list-style-type: none"> <input type="checkbox"/> Air Conditioning <input type="checkbox"/> Heating <input type="checkbox"/> Refrigeration <input type="checkbox"/> Plumbing <input type="checkbox"/> Steam Fitting <p>Chemical Courses</p> <ul style="list-style-type: none"> <input type="checkbox"/> Chemical Engineering <input type="checkbox"/> Chemistry, Analytical <input type="checkbox"/> Chemistry, Industrial <input type="checkbox"/> Chemistry, Mfg. Iron & Steel <input type="checkbox"/> Petroleum Refining <input type="checkbox"/> Pulp and Paper Making <input type="checkbox"/> Plastics <p>Civil Engineering, Architectural and Mining Courses</p> <ul style="list-style-type: none"> <input type="checkbox"/> Architecture <input type="checkbox"/> Architectural Drafting <input type="checkbox"/> Bridge and Building Foreman <input type="checkbox"/> Building Estimating <input type="checkbox"/> Civil Engineering <input type="checkbox"/> Coal Mining <input type="checkbox"/> Contracting and Building <input type="checkbox"/> Highway Engineering <input type="checkbox"/> Lumber Dealer <input type="checkbox"/> Reading Structural Blueprints <input type="checkbox"/> Sanitary Engineering <input type="checkbox"/> Structural Drafting | <ul style="list-style-type: none"> <input type="checkbox"/> Structural Engineering <input type="checkbox"/> Surveying and Mapping <p>Communications Courses</p> <ul style="list-style-type: none"> <input type="checkbox"/> Electronics <input type="checkbox"/> Practical Telephony <input type="checkbox"/> Radio, General <input type="checkbox"/> Radio Operating <input type="checkbox"/> Radio Servicing <input type="checkbox"/> Television <input type="checkbox"/> Telegraph Engineering <p>Electrical Courses</p> <ul style="list-style-type: none"> <input type="checkbox"/> Electrical Drafting <input type="checkbox"/> Electrical Engineering <input type="checkbox"/> Electric Light and Power <input type="checkbox"/> Lighting Technician <input type="checkbox"/> Practical Electrician <p>Internal Combustion Engines Courses</p> <ul style="list-style-type: none"> <input type="checkbox"/> Auto Technician <input type="checkbox"/> Diesel-Electric <input type="checkbox"/> Diesel Engines <input type="checkbox"/> Gas Engines <input type="checkbox"/> Aviation <p>Mechanical Courses</p> <ul style="list-style-type: none"> <input type="checkbox"/> Aeronautical Engineer's, Jr. <input type="checkbox"/> Aircraft Drafting <input type="checkbox"/> Flight Engineer <input type="checkbox"/> Forging <input type="checkbox"/> Heat Treatment of Metals <input type="checkbox"/> Foundry Work <input type="checkbox"/> Industrial Engineering <input type="checkbox"/> Industrial Instrumentation | <ul style="list-style-type: none"> <input type="checkbox"/> Industrial Metallurgy <input type="checkbox"/> Machine Shop <input type="checkbox"/> Mechanical Engineering <input type="checkbox"/> Mech. Drafting <input type="checkbox"/> Mold-Loft Work <input type="checkbox"/> Patternmaking—Wood, Metal <input type="checkbox"/> Reading Shop Blueprints <input type="checkbox"/> Sheet-Metal Drafting <input type="checkbox"/> Sheet-Metal Worker <input type="checkbox"/> Ship Drafting <input type="checkbox"/> Ship Fitting <input type="checkbox"/> Ship Designing <input type="checkbox"/> Toolmaking <input type="checkbox"/> Welding—Gas and Electric <p>Railroad Courses</p> <ul style="list-style-type: none"> <input type="checkbox"/> Air Brake <input type="checkbox"/> Diesel Locomotive <input type="checkbox"/> Locomotive Engineer <input type="checkbox"/> Locomotive Fireman <input type="checkbox"/> Locomotive Machinist <input type="checkbox"/> Railroad Section Foreman <input type="checkbox"/> Steam-Diesel Loco. Eng. <input type="checkbox"/> Car Inspector <p>Stationary Eng'g Courses</p> <ul style="list-style-type: none"> <input type="checkbox"/> Boilermaking <input type="checkbox"/> Combustion Engineering <input type="checkbox"/> Engine Running <input type="checkbox"/> Marine Engineering <input type="checkbox"/> Power Plant Eng'g <input type="checkbox"/> Steam Engr. | <p>Textile Courses</p> <ul style="list-style-type: none"> <input type="checkbox"/> Cotton Manufacturing <input type="checkbox"/> Loom Fixing <input type="checkbox"/> Textile Designing <input type="checkbox"/> Rayon Weaving <input type="checkbox"/> Woolen Manufacturing <p>Business and Academic Courses</p> <ul style="list-style-type: none"> <input type="checkbox"/> Accounting <input type="checkbox"/> Advertising <input type="checkbox"/> Bookkeeping <input type="checkbox"/> Business Administration <input type="checkbox"/> Bus. Correspondence <input type="checkbox"/> Bus. Law <input type="checkbox"/> Certified Public Accounting <input type="checkbox"/> Commercial <input type="checkbox"/> Commercial Art <input type="checkbox"/> Cost Accounting <input type="checkbox"/> Federal Tax <input type="checkbox"/> First Year College <input type="checkbox"/> Foremanship <input type="checkbox"/> French <input type="checkbox"/> Good English <input type="checkbox"/> High School <input type="checkbox"/> Higher Mathematics <input type="checkbox"/> Illustration <input type="checkbox"/> Industrial Supervision <input type="checkbox"/> Motor Traffic <input type="checkbox"/> Postal Civil Service <input type="checkbox"/> Retailing <input type="checkbox"/> Retail Bus. Management <input type="checkbox"/> Salesmanship <input type="checkbox"/> Secretarial <input type="checkbox"/> Sign Lettering <input type="checkbox"/> Spanish <input type="checkbox"/> Stenography <input type="checkbox"/> Traffic Management |
|---|---|---|--|

Name _____ Age _____ Home Address _____
 City _____ State _____ Working Hours _____ A.M. to _____ P.M.
 Present Position _____ Employed by _____
 Length of Service in World War II _____

Enrollment under G.I. Bill approved for World War II Veterans. Special tuition rates to members of the Armed Forces. Canadian residents send coupon to International Correspondence Schools Canadian, Ltd., Montreal, Canada.

LAST CHANCE

to plan your own career
in Aviation

HIGH SCHOOL STUDENTS & GRADUATES NOW

may be your last opportunity to prepare for a profitable civilian career in Aviation. You learn fast and well at Embry-Riddle. Even if military service intervenes, you're still way out front with Embry-Riddle training! The Aviation Industry demands thousands of properly trained engineers, mechanics and supervisors - NOW. Embry-Riddle offers maximum training in minimum time for top essential civil aviation positions.

VETERANS Aviation's most gigantic boom is on the way. Use your last chance for G. I. training benefits to insure your success in this fastest growing career field. Enroll at Embry-Riddle before the July 25th G. I. deadline. Do it TODAY.

Be Ready To Best Serve Your Country And Yourself With One Of These

4 Keys to Success!



AIRCRAFT & ENGINE MECHANICS

Our C.A.A.-approved school has a quarter-century aviation training experience. Learn fast with modern equipment, including jet... live aircraft, airline-size hangars.

A & E COMBINED WITH COMMERCIAL

Embry-Riddle combination training gives you unusual dual pilot-engineering ability.

AERONAUTICAL ENGINEERING

Embry-Riddle's accelerated 26-mo. Aeronautical Engineering College Course provides finest training available.

COMMERCIAL PILOT

Benefit from our experience with 30,000 students... best instructors and aircraft, year-'round flying weather.



Embry Riddle

International

SCHOOL OF AVIATION

MIAMI 30, FLORIDA

RIDDLE-McKAY AERO COLLEGE

CLASSES BEGINNING NOW -- SEND COUPON TODAY!

Dean of Enrollments - Dept. 99
Embry-Riddle School of Aviation
Miami 30, Florida

Please Print

NAME _____

ADDRESS _____

City _____

State _____ Age _____

I am interested in...

- A.&E. Mechanic
- Commercial Pilot
- Aeronautical Engineering
- A.&E. Combined with Commercial Pilot
- Flying Mechanic

Check One Veteran Non-Vet

TRAIN IN MIAMI--AIR CAPITAL OF THE WORLD

(Continued from page 8)

Without a doubt, Mr. Clymer's findings will also prove of great value to Nash engineers.

Let's have more of Mr. Clymer's frank and informative articles.

W. E. Kleimenhagen,
Advertising Manager,
Harley-Davidson Motor Co.,
Milwaukee 1, Wis.

Letter to the Editor

Recently I have had the pleasure of reading an article in your January 1951 issue entitled, "The Owners Report on The Nash Rambler" by Mr. Floyd Clymer.

I have found this report extremely interesting and I hope that it will be possible for many such reports as this to appear in the immediate future. There is one thing for sure, that the facts contained in the article are the absolute truth and there remains no doubt in anyone's mind that any apple polishing exists.

I have always been a reader of the *Popular Mechanics Magazine* and I have always been interested in articles pertaining to motors.

Carl A. Vollrath,
Major AGC,
Camp Pickett, Va.

Letter to the Editor

Since my business is lubrication I have always found your magazine intensely interesting. All articles you publish relative to automobiles, trucks, tractors, engines, etc., I find are distinctly informative.

While your magazine has always been tops in matters pertaining to the mechanical world, I think you do deserve an extra word of praise for the very fine article that appeared in your January issue under the title of, "The Owners Report on The Nash Rambler" by Floyd Clymer.

Mr. Clymer has made a very exhaustive test of the Nash Rambler and has submitted detailed data that most definitely will interest many car owners. Both Mrs. Wynn and I found the article most interesting, in fact, I read it aloud to her. . . . No doubt, there are many other people like ourselves who will enjoy reading further articles written by your very competent field tester, Mr. Floyd Clymer.

Again my congratulations to you for doing a grand job.

Carl E. Wynn,
President,
Wynn Oil Co.,
Azusa, Calif.

WHAT Every MECHANIC Wants to Know

AUDELS CARPENTERS & BUILDERS GUIDES—(4 Book Set).....\$6

A practical illustrated trade assistant on modern construction for carpenters, joiners, builders, mechanics and all woodworkers. 4 vols., 1600 pages, 3700 illustrations. Fully indexed, flexible covers. Each volume sold separately \$1.50 a vol.

AUDELS PLUMBERS & STEAMFITTERS GUIDES—(4 Book Set).....\$6

A Practical Trade Assistant & Ready Reference. Explains in plain language & by clear illustrations, diagrams, charts, graphs, pictures principles of modern plumbing practice including Marine Pipe Fitting and Air Conditioning, 4 Vols.—1670 Pages—3642 Diagrams & Illustrations. Each Vol. Sold Separately \$1.50 a Vol.

AUDELS OIL BURNER GUIDE.....\$1

384 Pages Covering Installation, Servicing & Repairs All Types Domestic & Industrial Burners. Illustrated. Highly Endorsed.

AUDELS HOUSE HEATING GUIDE..\$4

1000 Pages Covering Working Principles, Installation, Service of All Modern House Heating, Ventilating & Air Conditioning Systems. Explains New Radiant Heating. Fully Illustrated & Indexed.

AUDELS REFRIGERATION & AIR CONDITIONING GUIDE.....\$4

New from Cover to Cover—1280 Pages, Fully Illus. Covering basic principles, servicing, operation & repair of household, commercial & industrial refrigeration & air conditioning. A gold mine of essential important facts for engineers, servicemen, users.

AUDELS SHEETMETAL WORKERS HANDY BOOK.....\$1

Practical inside information. Fundamentals of Sheet Metal Work. 388 pages. Illustrated. 11 sections. Clearly written. Essential & important facts, figures, pointers in everyday language. Ref. Index.

AUDELS SHEETMETAL PATTERN LAYOUTS.....\$4

Developed by Experts for Sheet Metal Workers, Layout Men & Mechanics. A Practical Encyclopedia in 10 Sections, size 7 x 10 x 2—1125 Pages—350 Layouts—1600 Illustrations. 1001 Key Facts. Fully indexed for ready reference in answering your layout problems. Covers all phases of sheet metal work including Pattern Cutting, Pattern Development & Shop Procedure.

AUDELS BLUE PRINT READING.....\$2

For Mechanics & Builders. Covers all types of blue print reading including ship & airplanes. 416 pages, fully illustrated.

AUDELS MATHEMATICS & CALCULATIONS FOR MECHANICS \$2

Mathematics for home study or reference. 700 pages, 550 illus. Practical mathematics from beginning. How to figure correctly. Easy, correct methods covering complete review. Illus. & Indexed.

AUDELS AUTOMOBILE GUIDE.....\$4

A practical quick ready reference book for auto mechanics, service men, operators & owners. Explains theory, construction & servicing of modern motor cars, trucks, buses & auto type Diesel engines. 1700 pages, fully illustrated. 55 chapters. Indexed. A standard book for mechanics. New Hydraulic drive covered.

AUDELS DIESEL ENGINE MANUAL....\$2

A practical, concise treatise with questions and answers on the theory, operation and maintenance of modern diesel engines. Over 400 pages, fully illus. All details plainly brought out, this book is of extreme value to engineers, operators & students.

AUDELS WELDERS GUIDE.....\$1

A concise, practical text on operation & maintenance of all welding machines for all mechanics. Over 400 pages, illustrated. Covers all methods of electric and acetylene welding including airplane work.

AUDELS MACHINIST & TOOLMAKERS HANDY BOOK.....\$4

Covers modern machine shop practice in all its branches. Tells how to set up & operate lathes, screw and milling machines, shapers, drill presses & all other machine & hand tools. 1600 pages, fully illustrated. Indexed. 5 sections. 1—Modern Machine Shop Practice. 2—Blue Print Reading & How to Draw. 3—Calculations & Mathematics for Machinists. 4—Shop Physics. 5—How to Use the Slide Rule. 60 chapters. Easy to read and understand. A shop companion that answers your questions.

AUDELS ELECTRIC MOTOR GUIDE \$4

Practical Information Covering Construction, Control, Maintenance & Wiring Hookups of All Types Electric Motors also Armature Winding. 1000 Pages Fully Illustrated & Indexed.

AUDELS ELEC. WIRING DIAGRAMS \$1

216 Pages. Illustrated. Gives practical facts on wiring of electrical apparatus. It shows clearly how to wire apparatus for practically all fields of electricity. Each diagram is complete & self-explanatory. Highly Endorsed Pocket Companion.

AUDELS PRACTICAL ELECTRICITY \$4

A key to a practical understanding of Electricity. For maintenance engineers, electricians & all electrical workers. 1440 Pages, 2600 illus. Covers important electrical information in handy form—including wiring for Light & Power. Indexed.

AUDELS RADIOMANS GUIDE.....\$4

A key to the practical understanding of radio including Frequency Modulation, Television, etc., Aircraft & Marine Radio. For radio engineers, servicemen, amateurs, 914 Pages, 633 Illustrations & Diagrams. Photos. Review Questions & Answers, Reference Index.

AUDEL, Publishers, 49 W. 23 St., N.Y. 10

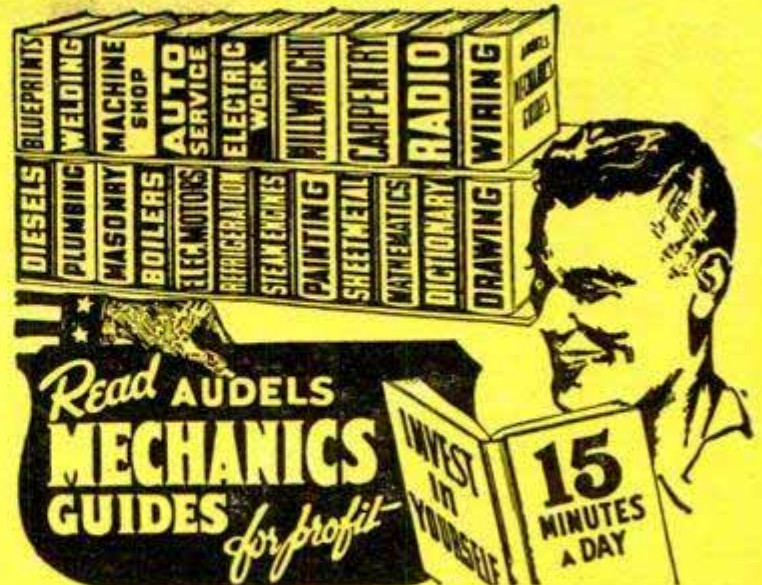

AN AUDEL GUIDE IS A GOOD FRIEND!

Step Up Your Own Skill with the Practical Facts and Figures of Your Trade. Save time and money with right methods, short cuts, labor saving ideas. CHECK NOW! You can look over any Audel Guide in your home. Start the Easy Payments if satisfied.



Check NOW!

Audels List Of Time Tested Practical Handy Books For Mechanics That Will Answer Your Questions — Highly Endorsed

MAIL THIS TODAY

CUT HERE MAIL ORDER

AUDEL, Publishers, 49 W. 23 St., NEW YORK 10, N. Y.

Please send me postpaid for FREE EXAMINATION books marked (X) below. If I decide to keep them I agree to mail \$1 in 7 Days on each book or set ordered and further mail \$1 monthly on each book or set until I have paid price, otherwise I will return them.

- MACHINISTS HANDY BOOK . . . 1650 Pgs. . . \$ 4
- WELDERS GUIDE, 400 Pages . . . 1
- BLUE PRINT READING, 416 Pages . . . 2
- MATHEMATICS & CALCULATIONS, 700 Pages . . . 2
- SHEET METAL PATTERN LAYOUTS, 1100 Pages . . . 4
- SHEET METAL WORKERS HANDY BOOK, 388 Pgs. . . 1
- MECHANICAL DRAWING GUIDE, 160 Pages . . . 1
- MECHANICAL DRAWING & DESIGN, 480 Pages . . . 2
- AUTOMOBILE MECHANICS GUIDE, 1800 Pages . . . 4
- DIESEL ENGINE MANUAL, 575 Pages . . . 2
- AIRCRAFT WORKER, 240 Pages . . . 1
- RADIOMANS GUIDE, 914 Pages . . . 4
- ELECTRONIC DEVICES, 216 Pages . . . 2
- ELECTRIC MOTOR GUIDE, 1000 Pages . . . 4
- ELECTRIC WIRING DIAGRAMS, 272 Pages . . . 1
- ELECTRICIANS EXAMINATIONS, 250 Pages . . . 1
- ELECTRIC POWER CALCULATIONS, 425 Pages . . . 2
- HANDY BOOK OF ELECTRICITY, 1440 Pages . . . 4
- ELECTRIC DICTIONARY, 9000 Terms . . . 2
- ELECTRIC LIBRARY, 7000 Pages (12 Book Set) . . . 18
- MARINE ENGINEERS HANDY BOOK, 1258 Pgs. . . 4
- SHIPFITTERS HANDY BOOK, 250 Pages . . . 1
- REFRIGERATION & Air Conditioning, 1280 Pgs. . . 4
- MILLWRIGHTS & MECHANICS GUIDE, 1200 Pgs. . . 4
- POWER PLANT ENGINEERS GUIDE, 1500 Pages . . . 4
- ENGINEERS & FIREMANS EXAMS, 525 Pages . . . 1
- PUMPS, Hydraulics & Air Compressors, 1658 Pgs. . . 4
- ENGINEERS LIBRARY (3 Book Set) . . . 9
- MECHANICAL DICTIONARY, 950 Pages . . . 4
- GARDENERS & GROWERS GUIDES (4 Book Set) . . . 6
- CARPENTERS & BUILDERS GUIDES (4 Book Set) . . . 6
- PLUMBERS & Steamfitters Guides (4 Book Set) . . . 6
- MASONS AND BUILDERS GUIDES (4 Book Set) . . . 6
- PAINTERS & DECORATORS MANUAL, 450 Pgs. . . 2
- HOUSE HEATING GUIDE, 1000 Pages . . . 4
- OIL BURNER GUIDE, 384 Pages . . . 1

Name _____
 Address _____
 Occupation _____
 Employed by _____

29-A



Handy Hank says:
 "Every man's a handyman with
PLASTIC WOOD"

Reset loose drawer pulls—

Replaces splintered wood . . .
 makes loose screws firm!



Seal drafty cracks—

Fills openings easily . . . dries tight and hard!
 Resists weather!

Repair loose tiles—

Holds tiles firm on wall!
Easy!



Also useful in filling cracks in floors, nail and screw holes, repairing broken toys.
Handles like putty . . . hardens into wood!

PLASTIC WOOD

A CELLULOSE FIBRE FILLER

IN CANS OR TUBES



WEATHER RESISTANT

WHERE-TO-BUY-IT INDEX

Source of supply appears after items commercially available

AUTOMOTIVE

Detroit listening post.....	103
Buick's experimental 300-hp. "dream" car.....	116
Automobile stabilizers (Welding Apparatus Co., 2750 W. Van Buren St., Chicago 12).....	129
Dual-fuel engines (Detroit Diesel Engine Div., General Motors Corp., 13400 W. Outer Drive, Detroit 28, Mich.).....	131
Flashing lights protect motorist (Signal-Stat Corp., 523-539 Kent Ave., Brooklyn 11, N. Y.).....	150
High lift for a car (Walker Mfg. Co. of Wisconsin, Racine, Wis.).....	158

AVIATION

Flying car ferry across English Channel.....	86
Tailless jet for carriers.....	111
Helicopter charts and sounds river above Niagara Falls.....	117
Air-powered grounding.....	163
No skidding for Air Force bombers.....	260

BOATS

Ship ashore.....	86
Unsinkable folding boat (Klepper Co., 28 E. 31st St., New York City 16).....	90
Crystals stop rust in marine engines (Sudbury Laboratory, South Sudbury, Mass.).....	158

HOUSE AND HOME

Experts predict twice as many prefab homes this year.....	117
Kitchen cabinets (General Electric Co., Bridgeport, Conn.).....	124
Folding basket (General Enterprises, Inc., 224 S. Michigan Ave., Chicago 4).....	124
Rolling pin (Kitchen Plastics, 111 N. La Cienega Blvd., Beverly Hills, Calif.).....	124
Egg opener (Jepco, Box 94, Oakland 4, Calif.).....	124
Drying line (Conn Sill Dryer, New Castle, Ind.).....	125
Swing-down shower (Milwaukee Flush Valve Co., 301 E. Reservoir Ave., Milwaukee 12, Wis.).....	125
Flexible paintbrush (J. W. Andrews Co., 166 W. Jackson Blvd., Chicago 4).....	125
Canned batter (Pan Waff, Inc., 525 N.W. Bank Bldg., Minneapolis 2, Minn.).....	125
Rubber wedge (Bancroft & Partners, Ltd., 17 Victoria St., London, S. W. 1, England).....	125
Vacuum shampoo machine (Elron Products, 156 W. Chicago Ave., Chicago 10).....	125
Pickup home (Cree Trailer and Boat Co., Marcellus, Mich.).....	131
Shredded plastic traps dust (Goodyear Tire & Rubber Co., Akron, Ohio).....	150
Tortillas the easy way—just add water and bake.....	159

INDUSTRY

Foam-rubber backing "welded" to fabric (Cleaning cloth: Yellow Creek Mills Co., Akron 3, Ohio; others: Andrews-Alderfer Processing Co., 120 Ash St., Akron 8, Ohio).....	87
Flour mixed with compressed air flows through pipe like water.....	105
Monster earthmover packs itself full.....	105
Steel output zooms.....	122
Jockey for truck trailers.....	139
Cable-drawn "trolley" lays mountain pipe line.....	164
Longer-wearing tires.....	254

LAWN AND GARDEN

Picnic broiler for steaks (Perfection Stove Co., 7609 Platt Ave., Cleveland 4, Ohio).....	91
Electric clippers on a stick (Apex Mfg. Laboratories, Box 283, South Pasadena, Calif.).....	139
"Whip" sprinkler scatters spray (Earl L. Chadwick Co., Box 480, Houston, Tex.).....	143

OUTDOOR RECREATION

Pocket telescope (Grover Photo Co., 201½ E. Broadway, Glendale, Calif.).....	91
Fish float carries line to any spot in stream (The Kissich Co., Cedar Rapids, Iowa).....	116
Motorized packmobile.....	123
200,000 spectators—one soccer game.....	158
Colored jackets on plugs lure hard-to-get fish (H & H Plug Co., 228 Randolph St., Waterloo, Iowa).....	163

PHOTOGRAPHY

Submarine camera.....	87
Coat of lacquer applied by machine protects movie film (Escar Motion Picture Service, Inc., 7315 Carnegie Ave., Cleveland, Ohio).....	129
Binoculars take photographs (Random Corp., 415 Lexington Ave., New York City 17).....	132

TOOLS

Self-heating pavement iron (Wood Mfg. Co., 1516 First St., San Fernando, Calif.).....	91
Mortar gun (Vita Labor Saving Tools, Inc., Station Plaza, Smithtown Branch, N. Y.).....	104
Textured wall roller (American Products Co., 2287 Hollers Ave., New York City 66).....	111
"Tape measure" rolls to work (Rolatape, Inc., 1415 14th St., Santa Monica, Calif.).....	111
Concrete saw (Martin Fireproofing Corp., 2200 Military Rd., Buffalo 17, N. Y.).....	155
Headquarters for precision.....	156

(Continued to page 14)

You Practice COMMUNICATIONS

I send you parts to build this transmitter



As part of my Communications Course you build this low power broadcasting transmitter, learn how to put a station "on the air," perform procedures demanded of Broadcast Station operators, make many tests.

This is just part of the equipment my students build. You keep all parts I send.

You Practice Radio SERVICING

on this modern radio you build with parts I send



As part of my Servicing Course, I send you the speaker, tubes, chassis, transformer, loop antenna, EVERYTHING you need to build this modern, powerful Radio Receiver! I also send parts to build many other Radio circuits. You use equipment for practical experience and to earn EXTRA money in spare time.

BE A RADIO-TELEVISION TECHNICIAN

NOW! Advanced Television Practice

New, special TV kits furnished to build high-definition SCOPE . . . RF OSCILLATOR with flyback power supply . . . complete TV set . . . many other units. You see pulse, trapezoidal, saw-tooth wave forms. Get valuable PRACTICAL EXPERIENCE locating and correcting TV troubles. Mail coupon for facts and pictures.

Learn Servicing or Communications Practice at Home in Spare Time



Do you want good pay, a job with a bright future and security? Would you like to have a profitable shop or store of your own? If so, find out how you can realize your ambition in the fast growing, prosperous RADIO-TELEVISION industry. Even without Television, the industry is bigger than ever before. 90 million home and auto Radios, 3100 Broadcasting Stations, expanding use of Aviation and Police Radio, Micro-wave Relay, Two-way Radio for buses, taxis, etc., are making opportunities for Servicing and Communications Technicians and FCC-Licensed Operators.

Television is TODAY'S Good Job Maker

J. E. SMITH, President National Radio Institute In 1950, over 5,000,000 TV sets sold. By 1954, 25,000,000 TV sets estimated. Over 100 TV Stations now operating. Authorities predict 1,000 TV Stations. This means more jobs, good pay for qualified men all over the United States and Canada.

Many Make \$10 Extra a Week in Spare Time

Keep your job while training. Hundreds of successful RADIO-TELEVISION TECHNICIANS I trained had no previous experience, some only a grammar school education. Learn Radio-Television principles from illustrated lessons. Get PRACTICAL EXPERIENCE—build valuable multimeter—experiment with circuits common to Radio and Television. Keep all equipment. Many students make \$5, \$10 extra a week fixing neighbors' Radios in spare time. SPECIAL BOOKLETS start teaching you the day you enroll.

Send Now For 2 Books FREE—Mail Coupon

Send now for my FREE DOUBLE OFFER. You get actual Servicing lesson to show you how you learn at home. Also my 64-page book, "How to Be a Success in Radio-Television." Read what my graduates are doing, earning; see equipment you practice with at home. Send coupon in envelope or paste on postal. J. E. SMITH, President, Dept. 1DA, National Radio Institute, Washington 9, D.C. Our 38th Year.

Good for Both—FREE

MR. J. E. SMITH, President, Dept. 1DA National Radio Institute, Washington 9, D.C.

Mail me Sample Lesson and 64-page Book about How to Win Success in Radio-Television. Both FREE. (No Salesman will call. Please write plainly.)

Name.....Age.....

Address.....

City.....Zone.....State.....

Check if Veteran Approved for training under G. I. Bill

The ABC's of SERVICING



I TRAINED THESE MEN

"I have been operating my own Servicing business. In two years I did \$14,000 worth of business; net profit \$6,850. Have one full time employee, an NRI student."—PHILLIP G. BROGAN, Louisville, Ky.

"Four years ago, I was a bookkeeper, with a hand-to-mouth salary. Now I am a Radio Engineer with a key station of the American Broadcasting Company network."—NORMAN H. WARD, Ridgefield Park, New Jersey.

"When halfway through the NRI course, I made \$5 to \$8 a week fixing sets in my spare time. Am now selling and installing Television sets and antennas."—E. J. STREITBERGER, New Boston, O.

"My first job was operator with KDLR, obtained for me by your Graduate Services Dept. I am now Chief Engineer of Police Radio Station WQOX. I never hesitate to endorse NRI."—T. S. NORTON, Hamilton, Ohio.

Veterans

Get this training under G. I. Bill.

MAIL COUPON

Have Your Own Business

Many N.R.I. trained men start their own Radio-Television sales and service business without capital. Let me show you how you, too, can be your own boss, have a good income from your own shop. Send coupon for FREE book now!

Tested Way to Better Pay

NOW!

BRIGGS SMOKES 3 WAYS BETTER*



1. Stays lighted longer ... by 19%



2. Cleaner burning ... by 16.4%



3. Less tar ... by 21.6%

So today ...

Put this
in your
pipe

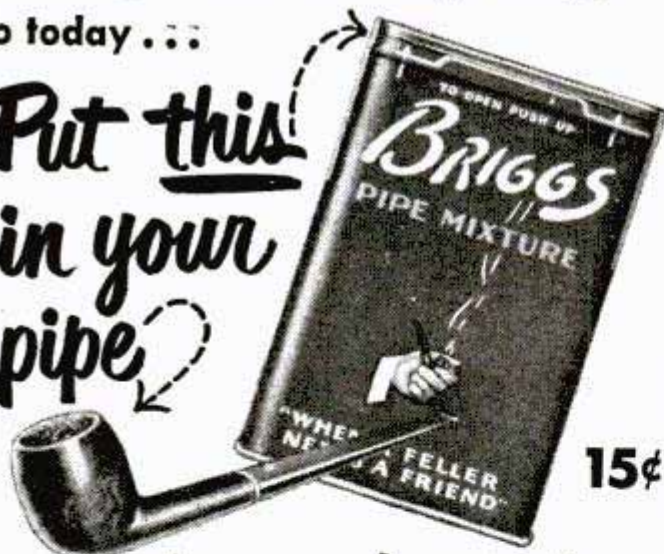

and smoke it!

*Yes, our new process makes Briggs better by actual test! Better even than the swell-smoking Briggs that proved so fine and friendly in your pipe before. And remember this: when tobacco burns steady, free and clean, that's when you enjoy *all* the goodness of Briggs' fine tobacco, aged and mellowed in oaken casks. Today—try 3-ways-better Briggs!

Also available in Canada

(Continued from page 12)

MISCELLANEOUS

"Weatherman" for the atomic age.....	16
Souped-up scooter.....	90
Escape window on bus.....	91
Ocean-bottom sight-seers.....	96
Bonding agent hardened by lack of air.....	104
Radioactive stitching.....	111
Catch-basin emptier (Rootes Motors, Inc., 27-11 Bridge Plaza, North, Long Island City, N. Y.).....	117
"Radar" for the blind.....	122
Suitcase stroller (A. E. Peterson Mfg. Co., 700 Allen Ave., Glendale, Calif.).....	122
Coin-operated alarm clock (Dime-a-Wake Clock Corp., Las Vegas, Nev.).....	122
Heart-lung machines.....	130
Electronic scanner cuts mimeograph stencil (Times Facsimile Corp., 229 W. 43rd St., New York City 18).....	132
Lead-calcium storage battery gives longer life.....	132
Mountain range submerged in the Pacific.....	139
Sugar-cane harvester cuts snarled stalks.....	143
Metal lamp guards (Wheeling Corrugating Co., Wheeling, W. Va.).....	150
Chinchillas go underground.....	154
Prefab A-bomb shelter shipped to site on trailer (A-Bomb Shelter Corp., Teaneck, N. J.).....	155
Garbage truck.....	159
Old Sol's getting hotter.....	163
50-m.p.h. scooter (Cushman Motor Works, Inc., Lincoln 1, Neb.).....	163

Craftsman and Shop Notes Index

FARM

Tractor-driven seeder.....	209
Cement mixer mounted on rear of tractor.....	211
Hook-type gate fastening locked by small pivoted block.....	211
Watering tank for feed lot is made from steel drum.....	216
Horseproof gate latch.....	216
Portable shed gives protection to electric well-pump motor.....	216
Stanchion-type rack prevents waste when feeding flock of sheep.....	217
Single tank waters livestock in four separate lots.....	223
Improvised farrowing-pen creep allows young pigs more freedom.....	223
Oil drums and welded framework provide combination feeder.....	226
Planks bolted to concrete posts make rugged barnyard fence.....	226
Water level in livestock tanks automatically controlled by float valve.....	226
Ridding granary of rats.....	226

HOUSE AND HOME

Cut-down card table provides stand for indoor sandbox.....	172
Holder for ball of twine.....	178
Straightening wall calendars.....	176
Ironing asphalt tile aids laying floor.....	176
Quickie picture frame.....	176
Drying rack for bathroom.....	177
Flowerpot shield.....	177
Removing cooking odors from rooms.....	177
Cutting homemade taffy.....	177
Fireproofing fabrics.....	178
Coat-hanger wire forms holder for basins and rubber bath mat.....	184
Wooden bar adjusts tension of multiple clotheslines.....	192
Flowerpots mended with inner tube.....	192
Plastic protects stair-well wall from children's finger marks.....	197
Lemon rind removes mineral stain.....	197
Movable back-yard incinerator is easily wheeled out of view.....	203
Window boxes hung neatly with storm-sash hangers.....	203

LAWN AND GARDEN

Flagstone walk made by laying scrap stone on concrete.....	172
Yard umbrella of sheet aluminum withstands inclement weather.....	184
Garden row marker.....	184
Nails driven in broom handle provide handy weed puller.....	200
Spreading roots over soil cone when transplanting aids healthy growth.....	203

OFFICE, SHOP AND STORE

Bed lamp provides extra illumination for cash-register keys.....	174
Sorting tray for small parts has built-in funnel.....	192
Small magnet holds paper to metal.....	200
Loosening truck tire from wheel.....	217
Bulbs on lift illuminate car.....	223

OUTDOOR RECREATION

Helpful hints to make hunting and camping trips more enjoyable.....	174
"Hall tree" for use at beach made from walking stick.....	178
Natural insect repellents.....	178

PHOTOGRAPHY

Combination shutter and diaphragm scale simplifies making setting adjustments.....	204
Processing rack cut from plastic box helps guard against film scratches.....	204
Machine screw in cable-release hole keeps-out dust particles.....	204
Mount for movie camera.....	205

(Continued to page 16)

IMPORTANT NOTICE—It is the intention of this magazine to provide its readers with information regarding the latest developments in the mechanical arts. We take no responsibility as to whether the disclosures contained in our articles are covered by patents and advise readers to investigate this subject before making, using, or selling any of the products, machines, or processes described in order to avoid possible liability for patent infringements.

INVENTORS

Learn how to protect your invention. The U. S. Patent Laws provide that any new and useful art, machine, article of manufacture, or composition of matter, or any new and useful improvement thereof, may be patented if the act of invention is involved. Therefore, every inventor with a valuable invention should take advantage of the Patent Laws and proceed for patent protection in order to safeguard his rights.

A patent gives the inventor the exclusive right to prevent others from making, using, or selling the invention claimed in the patent for a period of seventeen years.

The Patent Laws were enacted for the benefit of the inventor to give him protection for the features of his invention which are patentable. These features must be properly and concisely set forth and claimed in a formal application for patent, in order to comply with the requirements of the Patent Laws. For that reason, unless the inventor is familiar with patent matters, he should engage a competent registered patent attorney or agent to represent him. We are registered to practice before the U. S. Patent Office and are prepared to serve you in the handling of your patent matters.

A specially prepared booklet entitled "Patent Guide for the Inventor", containing detailed information with respect to patent protection and procedure, together with a "Record of Invention" form will be promptly forwarded to you without obligation upon request.

CLARENCE A. O'BRIEN & HARVEY JACOBSON

Registered Patent Attorneys

11-D DISTRICT NATIONAL BUILDING

WASHINGTON 5, D. C.



CAN LEAD TO A BETTER JOB IN BUSINESS or INDUSTRY

You can take subjects which have Real Job Value and still earn graduation!

• This is *your* opportunity to make completion of high school *work* for you. Your AMERICAN SCHOOL home study course can include high school subjects closely related to your present job or the kind of work you want to do later. You can qualify for high school course diploma and benefit from course subjects that will aid greatly in winning promotions.

50 Job Help Subjects from Which to Choose

Our FREE, 44-page book of detailed information lists 100 high school subjects, of which 29 are technical and 21 are commercial. Whether you work in a shop, factory, garage or office you will find subjects of practical benefit in your climb toward better jobs at better pay. Some of these are Blueprint Reading, Mechanical and Machine Drawing, Tool Making, Foundry Work, Automotive subjects, Electricity—and Bookkeeping, Accounting, Secretarial Practice, Salesmanship.

Turn Spare Time Into Money

During more than 50 years American School has helped thousands to reach higher job goals by profitable use of spare time at home—and it can help *you*. Others have prepared for college entrance. If you have not completed high school, check that subject on the coupon below, add your name and address and mail it *right now*. Or if you are a high school graduate and are ambitious to succeed in the vocation of your choice, check that subject. Your coupon will bring you the book of information, without obligation of any kind. Mail it *now*.

AMERICAN SCHOOL

DEPT. G-445, DREXEL AT 58th, CHICAGO 37

HOME - STUDY TRAINING SINCE 1897

Take This First Easy Step

CHECK, CLIP AND MAIL COUPON NOW

AMERICAN SCHOOL, Dept. G-445, Drexel at 58th, Chicago 37, Ill.
Without obligation, please send me FREE information on training course checked below.

- | | | |
|---|--|--|
| <input type="checkbox"/> HIGH SCHOOL COURSES | <input type="checkbox"/> Bookkeeping | <input type="checkbox"/> Plastics Engr. |
| <input type="checkbox"/> Accounting | <input type="checkbox"/> Business Mngmt. | <input type="checkbox"/> Plumbing—Pract. |
| <input type="checkbox"/> Air Conditioning | <input type="checkbox"/> Contracting | <input type="checkbox"/> Private Secretary |
| <input type="checkbox"/> Architecture & Building | <input type="checkbox"/> Diesel Engr. | <input type="checkbox"/> Radio Operating & Servicing |
| <input type="checkbox"/> Automotive Engr. | <input type="checkbox"/> Drafting & Design | <input type="checkbox"/> Railway Training |
| <input type="checkbox"/> Aviation—Practical | <input type="checkbox"/> Electrical Engr. | <input type="checkbox"/> Refrigeration |
| <input type="checkbox"/> Aviation Drafting & Design | <input type="checkbox"/> Electricity—Pract. | <input type="checkbox"/> Sheet Metal |
| <input type="checkbox"/> Better Forem'nship | <input type="checkbox"/> Electronics, Indus. | <input type="checkbox"/> Pattern Drafting |
| | <input type="checkbox"/> Machine Shop Operations | <input type="checkbox"/> Shop Management |
| | <input type="checkbox"/> Mechanical Engr. | <input type="checkbox"/> Tool Making |

Name _____ Occupation _____
Address _____ Age _____
City & Zone _____ State _____

(Continued from page 14)

Home-movie editing cabinet.....206
 Tabs of tape aligned diagonally keep photo slides in order.....207
 Strap bracket holds cable release.....207
 Diffusion screen for flash gun provided by plastic mask.....208
 Discarded auto ammeter mounted on plywood checks output of dry cells.....208

TOOLS

Tiny alnico magnet in fountain-pen case cleans tight spots of metal chips.....172
 Modelmakers' small C-clamps made from bolt and stiff wire.....187
 Welder's trestles constructed from pipe lengths are portable and rigid.....211
 Carbide-tipped turning "chisels".....217
 Lead bath heats small tools to minimize distortion.....223
 Multiple hole-punching system (Wales-Stripit Corp., North Tonawanda, N. Y.).....224
 Duplex surface outlet (John I. Paulding, Inc., New Bedford, Mass.).....224
 Single die unit.....224
 Torque-arm reducer (Dodge Mfg. Corp., Mishawaka, Ind.).....224
 Portable thickness gauge (Federal Products Corp., Providence, R. I.).....224
 Mogul-type pump (Gray Company, Inc., Minneapolis, Minn.).....225
 Dual-purpuse hacksaw frame (E. C. Atkins and Company, Indianapolis, Ind.).....225
 Knife sharpener (W. E. Fleming, 1721 B Avenue N.E., Cedar Rapids, Iowa).....225
 Screw-holding screwdriver (Kedman Co., Salt Lake City, Utah).....225

TOYS AND NOVELTIES

Coconut candy dishes.....173
 Toy box.....175
 Table lamps.....198

WOODWORKING

Cotton adds strength to glue joints.....178
 Sofa table.....179
 Weatherproof garden set.....185
 Attractive desk for children's room utilizes orange crates as pedestals.....187
 Portable drying rack for towels and clothes.....197

MISCELLANEOUS

Substitute pull-chain pendant molded with wood putty.....178
 Knife handle drives screw hooks.....178
 Dog hair kept from clogging drain.....184
 Trailer-hitch shock absorber.....184
 Chain helps screen damp sand.....192
 Grease pencil transfers designs.....192
 Refinishing Venetian blinds.....193
 Small anchor fouled in rock is released by cable secured to crown.....196
 Records kept from slipping with fingernail polish.....200
 Length of rod substitutes for funnel.....200
 Pipe cap serves as filter bowl on gasoline engine.....200
 Bar clamps level concrete forms.....203
 Sections of worn push-broom heads are used as bench dusters.....216
 Siding quickly marked for cutting with aid of wooden jig.....223

Radio-Television, Electronics

Television today (Magnatron tube, General Electric Co., Syracuse, N. Y.; front-end tuner, Magnavox Co., Fort Wayne, Ind.; TV-FM receiver, The Radio Craftsman, Inc., 1617 S. Michigan Ave., Chicago 16).....227
 "Yagi" beam antenna with low-cost rotator.....228
 Corner cabinet for your record player and sound system.....230
 Hints for radio owners and experimenters (Tape-disk recorder, The General Industries Co., Elyria, Ohio).....232

"Weatherman" for the Atomic Age

Now you can get a daily radioactivity report, similar to a daily weather report, telling you how much radioactivity is in the atmosphere around you—termed the "background" count. The service is provided by the Atomlab, 489 Fifth Ave., New York City, to several municipalities in the East. The cities are interested in recording any rise in the normal background count. Increases could be caused by atomic explosions, large volumes of air from atomic-energy plants or by more cosmic radiation from outer space.

West Germany is now in third place in automobile production with 300,000 cars built in 1950, surpassed only by the U. S. and Great Britain.

INVENTORS

If you believe that you have an invention, you should find out how to protect it. The first step is to have a search made of the prior pertinent U. S. patents. If a report on this search indicates that the invention appears patentable you can apply for a patent, and the specifications and claims should be prepared.

The firm of McMorrow, Berman & Davidson, with offices in Washington, D. C., is qualified to take the necessary steps for you. We can make a preliminary search on your invention, advise you whether we think it can be patented, and prepare your application for patent.

Unless you are fully familiar with the U. S. Patent Laws, we recommend that you engage the services of a Registered Patent Attorney to protect your interests. The patent laws are *your* laws. A patent gives you the right to prevent others from making, using or selling the invention claimed in your patent for a period of 17 years.

Use these patent laws for your protection. Investigate whether your invention can be patented. If you have what you believe to be an invention, we suggest that you have this firm make a search for you.

Send for a copy of our Patent Booklet entitled "How To Protect Your Invention," containing information about patent protection and patent procedure. Along with this we will also send you an "Invention Record" form, for your use in writing down and sketching details of your invention. We will mail them promptly. No obligation. They are yours for the asking.

McMORROW, BERMAN & DAVIDSON

Registered Patent Attorneys

PATENTS • COPYRIGHTS • PATENTS

135-S VICTOR BUILDING, WASHINGTON 1, D. C.

UNSUSPECTED POWER



The Mysterious Influence In The Air You Breathe!

THE SOUL OF THE UNIVERSE is in the air you breathe. Deposited in your blood—with each inhalation you take—is *the intelligence* that directs the course of the planets through the misty reaches of space, and the strange phenomenon of life itself.

What is it that causes your heart to beat, your lungs to expand and contract? What mind directs *the cells* of your being, each in their purpose—some to create bone, others tissue and hair? What *consciousness* pervades these vibratory *globules of life* and gives them awareness of their Cosmic function?

Are you one of the millions who have looked *beyond yourself* for some external Divine Power or agency? Have you searched in vain for some outer sign or word of Divine assurance when in doubt or in need? Now learn of the *unsuspected power* that exists in every simple breath—and that becomes *part of you*. The ancient Egyptians believed that the essence of life was borne on the wings of the air. The Bible pro-

claims that with the first breath man becomes not just an animated being—but a "*living soul*." *Try this experiment*, and prove a Vital Life Force exists in the air. When you are in pain or despondent take a deep breath. Hold it as long as comfortable—then notice the momentary relief.

This Amazing Free Book

Would you seriously like to know how to draw upon this Intelligence of the Cosmic, with which the air is permeated? You can use it to awaken the creative powers of your mind, and for making life an experience of *achievement*. Use the coupon below for a free copy of the book, "The Mastery of Life." It tells how in the privacy of your home *you may learn* to use these simple, useful, *natural laws*.

-----USE THIS GIFT COUPON -----

Scribe Y. H. S. The Rosicrucians (AMORC)
Rosicrucian Park, San Jose, California

I am sincerely interested in learning how to use the mysterious influences of the universe in the betterment of my life. Please send me a free copy of the book, "The Mastery of Life."

NAME _____

ADDRESS _____

Rosicrucians are NOT a religious organization

THE ROSICRUCIANS (AMORC) SAN JOSE, CALIFORNIA, U. S. A.



Up to the top . . . together



If you've ever asked yourself "What can I do to get ahead?" you'll find the story of Ernest and Janet Jarvis interesting and inspiring

They married young. Neither had finished grammar school. Both worked—and studied.

Ernest was enrolled with the International Correspondence Schools. Janet helped him with his lessons. Together they mastered Chemistry, Metallurgy and other I. C. S. subjects.

Slowly, surely, their training bore fruit. Ernest was made plant manager of a marine pump and valve factory. Mrs. Jarvis worked as a chemist in the laboratory.

Then, with \$3500 savings, they started their own business, the Niagara Falls Smelting & Refining Co. Inside twenty years, it became the nation's largest producer of nonferrous alloys.

In 1944 they sold the company and retired as millionaires. But they couldn't stop. Before the year was out, the Jarvises were working again.

Today, Ernest Jarvis is President of the Continental Copper & Steel Industries, Inc. And Janet Jarvis, a chemist and metallurgist famed throughout the industry, is Vice-President.

Says Mr. Jarvis: "I have always felt that the training we obtained by studying I. C. S. courses at night was responsible for our success in life."

It takes courage and co-operation, hard work and sound training to do what the Jarvises did. The first three are up to you. Sound training starts with the coupon below. Mail it *today*.

INTERNATIONAL CORRESPONDENCE SCHOOLS

BOX 5698-K, SCRANTON 9, PENNA.



Without cost or obligation, please send me full particulars about the course BEFORE which I have marked X:

- | | | | |
|---|---|--|--|
| <input type="checkbox"/> Accounting and Management
<input type="checkbox"/> Architecture
<input type="checkbox"/> Automobiles
<input type="checkbox"/> Chemistry
<input type="checkbox"/> Commercial Art
<input type="checkbox"/> Drafting
<input type="checkbox"/> Electrical Engr.
<input type="checkbox"/> High School
<input type="checkbox"/> Mechanical and Steam Engineering
<input type="checkbox"/> Plumbing
<input type="checkbox"/> Radio & Television
<input type="checkbox"/> Salesmanship
<input type="checkbox"/> Shop Practice
<input type="checkbox"/> Surveying and Mapping
<input type="checkbox"/> Textiles | Air Conditioning and Plumbing Courses
<input type="checkbox"/> Air Conditioning
<input type="checkbox"/> Heating
<input type="checkbox"/> Refrigeration <input type="checkbox"/> Steam Fitting
Chemical Courses
<input type="checkbox"/> Chemical Engineering
<input type="checkbox"/> Petroleum Refining <input type="checkbox"/> Plastics
<input type="checkbox"/> Pulp and Paper Making
Civil Engineering, Architectural and Mining Courses
<input type="checkbox"/> Architectural Drafting
<input type="checkbox"/> Building Estimating
<input type="checkbox"/> Civil Engineering <input type="checkbox"/> Coal Mining
<input type="checkbox"/> Contracting and Building
<input type="checkbox"/> Highway Engineering
<input type="checkbox"/> Lumber Dealer
<input type="checkbox"/> Sanitary Engineering
<input type="checkbox"/> Structural Drafting
<input type="checkbox"/> Structural Engineering
Communications Courses
<input type="checkbox"/> Electronics
<input type="checkbox"/> Practical Telephony
<input type="checkbox"/> Radio, General <input type="checkbox"/> Radio Operating
<input type="checkbox"/> Radio Servicing <input type="checkbox"/> Television
<input type="checkbox"/> Telegraph Engineering | Electrical Courses
<input type="checkbox"/> Electrical Drafting
<input type="checkbox"/> Electric Light and Power
<input type="checkbox"/> Lighting Technician
<input type="checkbox"/> Practical Electrician
Internal Combustion Engines Courses
<input type="checkbox"/> Aviation <input type="checkbox"/> Diesel-Electric
<input type="checkbox"/> Diesel Engines <input type="checkbox"/> Gas Engines
Mechanical Courses
<input type="checkbox"/> Aeronautical Engineer's, Jr.
<input type="checkbox"/> Aircraft Drafting <input type="checkbox"/> Flight Engr.
<input type="checkbox"/> Forging <input type="checkbox"/> Foundry Work
<input type="checkbox"/> Heat Treatment of Metals
<input type="checkbox"/> Industrial Engineering
<input type="checkbox"/> Industrial Instrumentation
<input type="checkbox"/> Industrial Metallurgy
<input type="checkbox"/> Mold-Loft Work
<input type="checkbox"/> Patternmaking—Wood, Metal
<input type="checkbox"/> Railroad
<input type="checkbox"/> Reading Shop Blueprints
<input type="checkbox"/> Sheet Metal Worker
<input type="checkbox"/> Ship Drafting <input type="checkbox"/> Ship Fitting
<input type="checkbox"/> Tool Designing <input type="checkbox"/> Toolmaking
<input type="checkbox"/> Welding Engineering
<input type="checkbox"/> Welding—Gas and Electric | Textile Courses
<input type="checkbox"/> Cotton Manufacturing
<input type="checkbox"/> Loom Fixing <input type="checkbox"/> Rayon Weaving
<input type="checkbox"/> Textile Designing
<input type="checkbox"/> Woolen Manufacturing
Stationary Eng'r's Courses
<input type="checkbox"/> Boilermaking <input type="checkbox"/> Combustion Engr.
<input type="checkbox"/> Engine Running <input type="checkbox"/> Marine Engr.
<input type="checkbox"/> Power Plant Engineering
Business and Academic Courses
<input type="checkbox"/> Advertising <input type="checkbox"/> Bookkeeping
<input type="checkbox"/> Business Administration
<input type="checkbox"/> Bus. Correspondence <input type="checkbox"/> Bus. Law
<input type="checkbox"/> Certified Public Accounting
<input type="checkbox"/> Commercial <input type="checkbox"/> Federal Tax
<input type="checkbox"/> First Year College <input type="checkbox"/> Foremanship
<input type="checkbox"/> French <input type="checkbox"/> Good English
<input type="checkbox"/> Higher Mathematics <input type="checkbox"/> Illustration
<input type="checkbox"/> Industrial Supervision
<input type="checkbox"/> Motor Traffic <input type="checkbox"/> Postal Civil Service
<input type="checkbox"/> Retailing <input type="checkbox"/> Retail Bus. Management
<input type="checkbox"/> Secretarial <input type="checkbox"/> Sign Lettering
<input type="checkbox"/> Spanish <input type="checkbox"/> Stenography
<input type="checkbox"/> Traffic Management
<input type="checkbox"/> Typewriting |
|---|---|--|--|

Name _____ Age _____ Home Address _____
 City _____ State _____ Working Hours _____ A.M. to _____ P.M.
 Present Position _____ Employed by _____
 Length of Service _____
 In World War II _____

Enrollment under G.I. Bill approved for World War II Veterans. Special tuition rates to members of the Armed Forces. Canadian residents send coupon to International Correspondence Schools Canadian, Ltd., Montreal, Canada.

INVENTORS

A patent is a valuable right. On the basis of a constitutional provision Congress has established a system under which inventors may secure the exclusive right to prevent the unauthorized use, manufacture and sale of their inventions for periods of seventeen years. The inventor secures this protection by obtaining a patent.

Unless an inventor is thoroughly familiar with such matters, he is advised to employ a competent registered patent attorney or registered patent agent, as the value of patents depends largely upon the skillful preparation of the specifications and claims.

This firm is registered to practice before the U. S. Patent Office and is available to assist inventors in the preparation and prosecution of their cases. Detailed information and the preliminary steps to take to obtain patent protection will be furnished upon request.

VICTOR J. EVANS & Co. *Merlin M. Evans*
REGISTERED PATENT ATTORNEY
630-D MERLIN BUILDING, WASHINGTON 6, D. C.

PATENTS

COPYRIGHTS

We shall be glad to send you promptly and without obligation, an instructive booklet, "Patent Protection for Inventors", which was prepared to give inventors detailed information and steps to take toward patent protection—also our convenient "Evidence of Invention" form. Use address Victor J. Evans & Co., 630-D Merlin Building, Washington 6, D. C.

WANTED MAN WITH CAR



No Time Like Now to Get In McNess Business

It's no trick to make good money when you use your car as a McNess "Store on Wheels." Farmers buy everything they can from McNess Men because McNess Products are tops in quality, represent extra values. Attractive business-getting prizes and premiums; also money-saving deals to customers make selling McNess daily necessities a snap.

We Supply Capital—Start Now!

There's no better work anywhere. Pays well, permanent, need no experience to start, and we supply capital to help you get started quick. You begin making money first day. Write at once for McNess Dealer Book. It's FREE. Tells all—no obligation. (1)

THE MCNESS CO., 128 Adams St., Freeport, Ill.

Use Your
CAR
to Raise
Your
PAY

WATCHMAKING

★ Watch Repairing ★ Jewelry Engraving ★ Jewelry Repairing
Combination men earn top pay. Learn in school fully accredited by Horological Institute of America in Washington, D. C. and United Horological Association of America. Approved for veterans. Receive tools, tuition and subsistence while learning.

Established 1935. Write for FREE booklet



The Baronian School, Inc.

2116 WALNUT ST. (DEPT. C) PHILA. 3, PA.

RUPTURE



RELIEF...OR YOUR MONEY BACK
Simple, easy to wear truss made by old surgical house. You risk nothing. Write for free booklet. Don't delay.

WEB TRUSS CO., Dept. M-4, Hagerstown, Md.

LAW FREE BOOK



Your FREE copy of "The Law-Trained Man" shows how to gain prestige and greater earnings through Blackstone home law study. All instruction material furnished including 18-volume Law Library written by 65 well-known law authorities. Lawyers, judges among our graduates. LL.B. degree. Low cost; easy terms. Write today. 225 N. Michigan Ave. Dept. 54, Chicago 1, Ill.

BLACKSTONE COLLEGE OF LAW

A Correspondence Institution Founded in 1890

LEFAX POCKET SIZE TECHNICAL DATA BOOKS \$1. EACH

Printed on loose leaf, six hole, 6³/₄" x 3³/₄" bond paper, each book contains about 140 pages of technical data, presenting condensed, accurate and essential data for the student, engineer, technical worker and business man.

Architecture	Building Constr.	Piping Data
Home Heating	Radio	Surveying Tables
Illumination	Television & FM	Trig-Log Tables
Electrician's Data	Electricity, AC	Metallurgy
Builder's Data	Electricity, DC	Analytic Chem.
Lumber Data	AC Motors and	Highway Eng.
Air Conditioning	Generators	Mech. of Materials
General Math.	Transformers,	Pwr. Trans. Mach.
Math. Tables	Relays, Meters	Thermodyn. Tbls.
Physics	Hydraulics	& Charts
Chemical Tables	Surveying	Phys. & Thermo-
Metals	Mech. Drawing	dyn. Data
Gen. Chemistry	Machine Design	Phys. & Org. Chem.
Reinf. Concrete	Machinists Data	

Write for FREE catalogs (over 2000 listings). See for yourself how helpful LEFAX can be to you. Send \$1 for each book, (or \$5 for any six books listed above) to

LEFAX DEPT. PM-7 PHILADELPHIA 7, PA.

Prepare in our
Big Training
Shops for these

GREAT OPPORTUNITY FIELDS!



This big fire-proof building is occupied entirely by Coyne.

TRAINED YOUNG AND OLDER MEN — VITALLY NEEDED IN NATION'S GIANT DEFENSE PROGRAM

Where do you fit in today's gigantic Defense Program and Industrial expansion? Trained young and older men will play an important part in vital fields. Electricity and Television-Radio are essential to our Defense Program in both Industry and Armed Forces. Don't wait to be assigned to a dull, low pay, no future job. Get training and be ready to pick one of many job opportunities or get a better rating if drafted. Today it's not how young or how old you are that counts, but how prepared you are for jobs that demand skilled men. So, whether you are 16 or up to 50 you are needed. Qualify now for:

1. BETTER RATING, HIGHER PAY IF DRAFTED.
2. A VITAL JOB IN INDUSTRY, IF NOT IN DRAFT.

NOT "HOME-STUDY" COURSES

Our famous Television-Radio Practical-Technical method gives you practical experience on a massive outlay of equipment. Not by correspondence, but actual shop work plus necessary technical training. You are trained right here in the great Coyne shops that have been training men and young men for over 50 years.

TELEVISION-RADIO ELECTRICITY

A great opportunity field and vital to Defense. Here at COYNE you're trained for Construction, Testing, Trouble-Shooting on Radio, Public Address, Sound Units. Training includes FM, Television Installations, Servicing, etc. Many Coyne trained men in good jobs or own well paying Television-Radio businesses of their own.

INCLUDING INDUSTRIAL ELECTRONICS

The Power behind the entire Defense Program. Big future in Power Plant Work, Motors, Armature Winding, Home and Factory Wiring, Appliances, Refrigeration, Maintenance, Illumination, etc. Lifetime job service to Coyne graduates. Send for BIG FREE BOOK.

LARGEST, OLDEST, BEST EQUIPPED SCHOOL OF ITS KIND IN THE U.S.

Mail Coupon for
Big FREE Book!



Whether you prefer Television-Radio or Electricity, train on actual equipment at Coyne. We will send you a Big, fully illustrated Book. Indicate below, which course interests you most. No salesman will call. Mail coupon TODAY.



START NOW—PAY LATER

Don't let lack of money hold you back. You can finance most of your tuition and pay for it later, in easy monthly payments. Special plan for men of draft age. We'll help you get part time work, if you need it, to help pay living costs while at Coyne.

G. I. APPROVED

B. W. COOKE, President

COYNE

ELECTRICAL AND TELEVISION-RADIO SCHOOL

An Institution not for Profit

500 So. Paulina St., Dept. 41-72H, Chicago 12, ILL.

B. W. Cooke, President
COYNE ELECTRICAL AND TELEVISION-
RADIO SCHOOL, 500 S. Paulina St.
Dept. 41-72H, Chicago 12, Ill.

Send me your Big Free book, and details of your special plan for men of draft age. I am interested in field checked below. This does not obligate me.

TELEVISION-RADIO ELECTRICITY

NAME.....

ADDRESS.....

CITY..... STATE.....

DRAW ME



\$1,275.00 IN PRIZES!

5 PRIZES! 5 Complete \$255 Art Courses, including Drawing Outfits!

Here's your big chance, if you want to become a commercial artist, designer, or illustrator! An easy-to-try way to win FREE art training!

Whether you win or not we send you our comments on your work, if your drawing shows promise! Trained illustrators, artists and cartoonists now making big money. Find out now if YOU have profitable art talent. You've nothing to lose—*everything to gain*. Start your drawing now. Mail it today.

Amateurs Only! Our students not eligible. Make 1 copy of girl 5 ins. high. Omit lettering. All drawings must be received by May 31, 1951. None returned. Winners notified.

Latest Winner List! Free course winners in previous contest—from list just released: W. Bourgeois, Kenogami, Quebec, Canada; R. Ward, San Antonio, Tex.; Mrs. D. Smith, Dee, Ore.; R. Jones, Huntsville, Tex.; Mrs. E. Harrold, Clarksville, Iowa.

Art Instruction, Inc.

MEMBER NATIONAL HOME STUDY COUNCIL
MINNEAPOLIS • NEW YORK • CHICAGO

ART INSTRUCTION, INC., Dept. 4131
500 S. 4th St., Minneapolis 15, Minn.

Please enter my attached drawing in your May drawing contest. (PLEASE PRINT)

Name _____ Age _____

Address _____ Phone _____

City _____ Zone _____ County _____

State _____ Occupation _____

No Experience Needed To PRINT YOUR OWN POST CARDS

The GEM STENCIL DUPLICATOR saves money... gets results quickly! Hundreds of uses for every type of business and organization. We ship the GEM complete with all supplies, Guide Board for accurate printing and 60-page Book of Ideas at the special low price of only \$8.50 (a \$15 value).

FREE TRIAL OFFER

Use the GEM FREE at our expense! SEND NO MONEY. Write and complete GEM outfit will be sent you postpaid. After ten days, send us only \$8.50 or return the GEM. You must be satisfied!

BOND EQUIPMENT CO. Dept. 48
6633 Enright • St. Louis 5, Mo.



Our 21st Year

TUBELESS Personal RADIO

POCKET SIZE! GUARANTEED to play on local stations

- No Tubes
- No Batteries
- No Electricity



Costs nothing to run, lasts indefinitely. Range up to 25 miles (some users report up to 50 miles on 50,000 Watt stations). New Germanium Diode crystal detector—same as used in Army, Navy Radar sets. Extra sensitive stethophone. Designed, mfgd. by an internationally known electronic engineer. Beautiful red plastic case with green trim. Single-control tuning, has rich, mellow tone. Just hook it up on simple instructions—it plays instantly, never turns off. Nothing to wear out; should last years. Everything complete, \$5.

Send \$1 plus small C.O.D. cost & postage.
Pay postman \$4 balance

Pat. App. for
Patrick Laboratories, Inc.

2450 E. 52nd St., Indianapolis, Indiana — Dept. PM-4



ITALIAN ACCORDIONS

Hand Made. Very Best. Buy Direct from Factory Representative at lowest wholesale prices and Save Money. Send Name and Address for FREE catalog.

ITALIAN ACCORDION MFG. CO.

7600 Cottage Grove Ave., Dept. PM-4, Chicago 19, Ill.

Our 382nd Advertisement

REAL DIESEL ENGINE

\$2.95 • for planes, boats, midget cars
• 7500 RPM; 1/7 HP; ht. 3 1/2"; wt. 5 oz.

- comes completely assembled

You just can't beat this price for a complete precision diesel engine! Streamlined, rugged, compact. Starts quickly, easy to install, runs for years. Fast delivery if you ORDER TODAY! Send \$2.95 plus 25c postage.

GOTHAM HOBBY CORP. Dept. P, 107 E. 126 St. New York 35

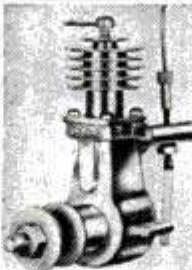

MAKE EXTRA MONEY

PLASTICS

LEARN AT HOME

LEARN HOW TO MAKE fast selling PLASTIC NOVELTIES FURNITURE JEWELRY SIGNS TOYS LAMPS

There are RICH OPPORTUNITIES for MEN and WOMEN with "know-how" in Plastics. Interstate's amazing new Plastics course tells and shows how to make hundreds of fast selling items out of Plastics. Gives complete training in fabrication, casting, lamination, molding, etc., in simple, easy, step-by-step language and pictures.

START A PLASTICS BUSINESS OF YOUR OWN. No other industry holds such promise for the future. You can make big money manufacturing novelties, toys, signs, etc., in your own home in spare or full time. Don't wait! Learn NOW how Interstate's Plastics Training qualifies you for success in the plastics field.

Write for FREE Information Today!

INTERSTATE TRAINING SERVICE

School of Plastics
PORTLAND 13, OREGON

(Dept. 3-D)





Learn RADIO

TELEVISION, ELECTRONICS

by

SHOP METHOD HOME TRAINING

Let NATIONAL SCHOOLS, of Los Angeles, a practical Technical Resident Trade School for almost 50 years, train you for today's unlimited opportunities.

You receive all parts, including tubes, for building this fine, modern Superheterodyne Receiver. This and other valuable standard equipment becomes your property.

these two **FREE** books will tell you how



WE BRING
NATIONAL
SCHOOLS TO YOU!

GOOD JOBS AWAIT THE TRAINED RADIO TECHNICIAN

You are needed in the great modern Radio, Television and Electronics industry! Trained technicians are in constant and growing demand at excellent pay—in Broadcasting, Communications, Television, Radar, Research Laboratories, Home Radio Service, etc. National Schools Master Shop Method Home Study Course, with newly added lessons and equipment, can train you in your spare time, right in your own home, for these exciting opportunities. Our method has been proved by the remarkable success of National Schools-trained men all over the world.

You Learn by Building Equipment with Standard Radio Parts We Send You

Your National Schools Course includes not only basic theory, but practical training as well—you learn by doing. We send you complete standard equipment of professional quality for building various experimental and test units. You advance step by step until you are able to build the modern superheterodyne receiver shown above, which is yours to keep and enjoy. You perform more than 100 experiments—build many types of circuits, signal generator, low power radio transmitter, audio oscillator, and other units. The Free Books shown above tell you more about it—send for them today!



NOW! NEW PROFESSIONAL MULTITESTER INCLUDED



This versatile testing instrument is portable and complete with test leads. Simple to operate, accurate and dependable. You will be able to quickly locate trouble and adjust the most delicate circuits. You can use the Multitester at home or on service calls. It is designed to measure AC and DC volts, current resistance and decibels. You will be proud to own and use this valuable professional instrument.

Lessons and Instruction Material Are Up-to-date, Practical, Interesting

National Schools Master Shop Method Home Training gives you basic and advanced instruction in all phases of Radio, Television and Electronics. Each lesson is made easy to understand by numerous illustrations and diagrams. All instruction material has been developed and tested in our own shops and laboratories, under the supervision of our own engineers and instructors. A free sample lesson is yours upon request—use the coupon below.

TELEVISION TRAINING A complete series of up-to-the-minute Television lessons is an integral part of your course, covering all phases of Television repairing, servicing and construction.

Here are just a few of the interesting facts you learn with the **FREE SAMPLE LESSON**

1. How radio receivers operate.
2. How the antenna circuit is constructed.
3. Converting signal currents into sound.
4. How the R-F transformer handles the signal.
5. How the tuning circuit functions.
6. The Radio "bands."

**APPROVED
FOR
VETERANS**
Check
coupon below.

NATIONAL SCHOOLS

LOS ANGELES 37, CALIFORNIA EST. 1905



MAIL OPPORTUNITY COUPON FOR QUICK ACTION

National Schools, Dept. 4-PM
4000 South Figueroa Street
Los Angeles 37, California

(Mail in envelope or
paste on penny postcard.)

Mail me FREE the book "Your Future in Radio-Television" and the sample lesson of your course. I understand no salesman will call on me.

NAME _____ AGE _____

ADDRESS _____

CITY _____ ZONE _____ STATE _____

Check here if veteran of World War II

GET THE DETAILS - SEND THE COUPON →

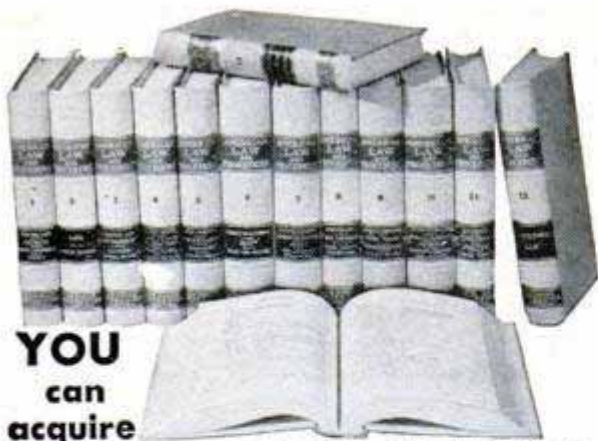

YOU
can
acquire

LAW NIGHTS AT HOME! L. L. B. DEGREE

LaSalle's famous Law Library—used as reference in many Law libraries and Law offices—has enabled thousands to master Law surprisingly fast, in spare hours at home, for business and professional advancement.

These 14 remarkable volumes, compiled by leading professors and lawyers, cover the whole basic field of Law in condensed, orderly, simplified manner.

You advance rapidly with this great library, plus special lectures furnished. We guide you step-by-step with personalized Problem Method of instruction . . . you learn by doing—handling legal problems—not by memorizing rules.

Send for two FREE 48-page booklets, "Law Training for Leadership," and "Evidence," answering questions about Law and its value to you, and telling how LaSalle Law graduates are winning rapid advancement in business and public life. Mail coupon below. No obligation.

LA SALLE EXTENSION UNIVERSITY A Correspondence Institution

417 S. Dearborn St., Dept. 464L, Chicago 5, Ill.

Send me your two FREE booklets described above, without obligation.

Name..... Age.....

Street.....

City, Zone & State.....

ENGINEERING DEGREE IN 27 MONTHS

Big Demand for Graduates

Aeronautical, Chemical, Civil, Electrical, Mechanical and Radio Engineering (including Television)

Hundreds of young men are earning engineering degrees in this recognized institution each year—continuous operation. New terms start quarterly. Many students earn a major part of their college expenses in this large industrial center.

Low tuition. Competent instruction. Thorough, intense, practical program. Modern laboratory facilities including new physics lab. and modernized wind tunnel. Individualized instruction emphasized.

Approved for Veterans. Engineering preparatory courses. Students from 48 states and 21 foreign countries. Enter June, September, December or March. Send coupon for free catalog and full information. Enroll now.

SEND COUPON TODAY

INDIANA TECHNICAL COLLEGE

541 E. Washington Boulevard
Fort Wayne 2, Indiana

Please send me free information on B.S. Engineering Degree in 27 months as checked.

Aeronautical. Chemical. Civil. Electrical.
 Mechanical. Radio-Television

Name.....

Address.....

DESIGN YOUR OWN FUTURE BE A DRAFTSMAN for BIG PAY!



LEARN AT HOME IN SPARE TIME

Drafting offers trained men excellent starting salaries, unlimited advancement opportunities with big earnings. Machines will never replace the draftsman. Before any production starts plans must be drawn and Draftsmen are the first to be hired. Drafting is light, pleasant work, in pleasant surroundings and leads to top managerial positions.

CTS OFFERS NEW TRAINING PROGRAM

You learn the hows and whys of successful production planning by studying at home. You learn by making actual drawings. CTS gives you professional drafting instruments, a drafting table, drafting supplies, everything you need at no extra cost. For Free catalogue write

CHRISTY TRADES SCHOOL, Dept. DB-803,
4432 N. Kedzie Ave., Chicago 25

SEND FOR
FREE
CATALOG

WHY DON'T YOU WRITE?

Writing short stories, articles on business, sports, hobbies, travel, shop crafts, local and club activities, etc., will enable you to earn extra money. In your own home, on your own time, the New York Copy Desk Method teaches you how to write the way newspaper men learn—by writing. Our unique "Writing Aptitude Test" tells whether you possess the fundamental qualities essential to successful writing. You'll enjoy this test. Write for it, without cost or obligation.

Veterans: Course approved for Veterans' Training.

NEWSPAPER INSTITUTE OF AMERICA

SUITE 5591-D, ONE PARK AVENUE, NEW YORK 16, N. Y.

STUDY AT HOME

WITH AN EDUCATIONAL INSTITUTION

Courses in **ARTS AND SCIENCES**: Philosophy; Education; Letters; Public Health; Medical Jurisprudence; Psychology; Sociology; Physics; Chemistry; Geology; Pol. Science; Theology; Law; Business and Commerce; Accounting; Mathematics; Statistics; Agriculture. Courses in **ENGINEERING**: Electrical, Civil, Mechanical, Drafting, Architectural, Automotive, Steam, Diesel, Aeronautical, Radio, Structural, Mining, Industrial, Petroleum, Marine, Refrigeration, Air Conditioning, Chemical. Send for free catalog.

McKinley-Roosevelt Incorporated, 4610-K3, Sheridan Rd., Chicago 40, Illinois



Print Your Own

Cards, stationery, advertising, etc. Save money. Print for others, good profit; easy rules sent. Raised printing like engraving, too. Sold direct only. Write for free details. Kelsey Presses, F-37 Meriden, Conn.

'How to Make Money with Simple Cartoons'



A book everyone who likes to draw should have. It is free; no obligation. Simply address

FREE BOOK

CARTOONISTS' EXCHANGE

Dept. 94-D Pleasant Hill, Ohio

UNREDEEMED DIAMONDS!

Save up to 50% and MORE

30 DAY MONEY BACK
GUARANTEE

SEND FOR
FREE
CATALOG
596



ONE OF
AMERICA'S
OLDEST AND
LARGEST
JEWELRY
LOAN BANKS

NUMEROUS STYLE MOUNTINGS

Mail Orders Given Prompt Attention

Licensed and Bonded by PA. DEPT. OF BANKING

BROFF'S DIAMOND LOAN & FINANCE ASSN.

411 SMITHFIELD ST., PITTSBURGH 22, PA.

Now IN YOUR OWN HOME Learn

TELEVISION RADIO

the Amazingly Effective
D.T.I. WAY

—with the aid of **BOTH**
HOME EQUIPMENT
and **HOME MOVIES**

What will mailing the coupon below do for YOU? Just this! You'll find out about one of today's most remarkable... practical ways to prepare to get into America's amazing billion dollar opportunity field of TELEVISION-RADIO-ELECTRONICS. You'll see how to get into fascinating work that pays well... that offers one of America's most promising futures... that enables you to start your own business almost "on a shoe string," if you prefer this to a job opportunity.

And above all, you'll get some GOOD NEWS especially welcomed by men anxious to earn REAL MONEY in this thrilling field. For you'll see that NOW you can get the kind of practical, laboratory-type training so desirable for making real progress in Television-Radio-Electronics... and WITHOUT LEAVING HOME.

You'll see that DeForest's Training, Inc. sends everything needed to set up your own HOME LABORATORY. You get and keep the same type of basic electronic equipment used in our modern Chicago Training Laboratories. You get home training that includes the knowledge and experience gained from training thousands of students first hand in Chicago. And to top it all, you use DTI's amazingly effective and exclusive home training aid—INSTRUCTIVE MOVIES. But why not get the complete story? Mail coupon today for information-packed literature.

MODERN LABORATORIES

If you prefer, get all your preparation in our new Chicago Training Laboratories—one of the finest of its kind. Ample instructors, modern equipment. Write for details!

NO PREVIOUS EXPERIENCE NEEDED
NOW...get EVERYTHING YOU NEED
for real Laboratory-type training
AT HOME

Above:
Work over
300
fascinating
experiments
with this
equipment

1. Build over 300 fascinating experiments from 16 BIG SHIPMENTS of Electronic-Radio parts which you KEEP.

2. Build valuable commercial-type test equipment—as shown to the left—which you KEEP. This includes a quality OSCILLOSCOPE—a must for Television work.

3. Use a 16 mm. movie projector and new series of Hollywood produced instructive movies—a wonderful aid to help you grasp important fundamentals faster...easier...better.

4. Enjoy well-illustrated, easy-to-read lessons with handy FOLD-OUT diagrams.

5. Get an honest-to-goodness EMPLOYMENT SERVICE to help you get a good job after graduating—or assistance in starting your OWN SALES AND SERVICE BUSINESS. Mail coupon today for the complete details.

You KEEP all test equipment

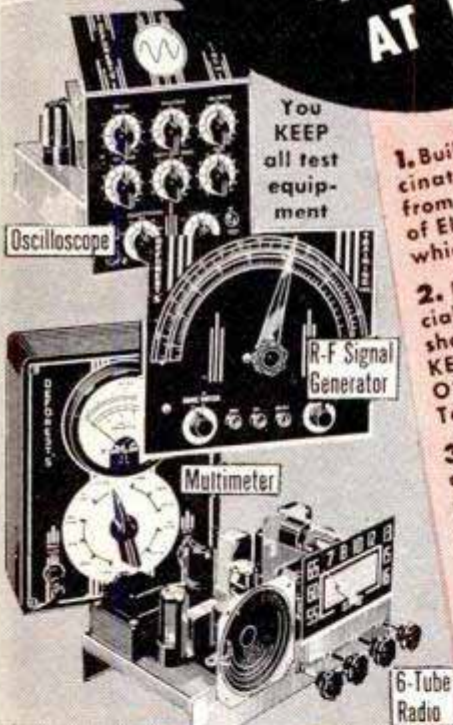

Build and Keep this 16-INCH TV RECEIVER—OPTIONAL after completing regular training.



New "black" RECTANGULAR TUBE

Get **BOTH** of these colorful, information-packed folders **FREE**

SEE FOR YOURSELF
Mail Coupon Today



DeFOREST'S TRAINING, INC. Dept. PM-4-H
2533 N. Ashland Avenue, Chicago 14, Ill

Without cost or obligation, I would like valuable, information-packed folders showing how I may get started toward a good job or my own business in Television-Radio-Electronics.

Name _____ Age _____

Street _____ Apt. _____

City _____ Zone _____ State _____

DeFOREST'S TRAINING, INC.

Chicago 14, Illinois

For FUN and PROFIT learn to



MOUNT BIRDS



AND ALL KINDS OF ANIMALS
SPORTSMEN, SAVE YOUR TROPHIES! Learn at home in spare time to mount all kinds of birds and animals. Decorate your den with trophies of field and stream. We teach you this **FASCINATING SPORTSMEN'S HOBBY**. Quickly, easily learned. Wild game is growing **scarcer**. Trophies now more valuable than ever! Shoot **FEWER** and **MOUNT** them true to life. **IT'S PROFITABLE!** Many report earning \$25 to \$75 a month mounting specimens for hunters. Why not **YOU?** Learn to make **USEFUL** articles from mounted specimens such as book ends, lamps, etc., etc. (See squirrel lighter to left.)
WILD GAME NOT NEEDED. If you don't hunt you can mount **COMMON** specimens: Owls, crows, pigeons, hawks, rabbits, even frogs. **Real FUN.**
LEARN TANNING We also teach you to tan furs soft and pliable and new method to **TAN GENUINE LEATHER** from all kinds of hides. Great spare time money maker.
FREE BOOK Send right now for beautiful free 48-page booklet, illustrated, telling how easily **YOU** can learn to be a Taxidermy Artist. Contains many fine pictures. Intensely interesting. Get **YOUR** copy today. No cost or obligation. **Send now!** State **AGE**.
N. W. SCHOOL of TAXIDERMISTRY, 2504 Elwood Bldg., Omaha, Neb-

Learn this Profitable Profession



IN 90 DAYS AT HOME Money-Making Career Open to Men and Women, 18 to 60

Hundreds of men and women between 18 and 60 make \$10 to \$20 in a single day giving scientific Swedish Massage and Hydro-Therapy treatments. There is big demand from doctors, hospitals, sanatoriums and clubs. Graduates earn large full time incomes from these or in private practice in their own offices. Others make good money from home treatments given in spare time. Learn this interesting, money-making profession in your own home, through our home study course. Same instructors as in our **nationally known resident school**. You can win independence and prepare for future security by qualifying for your Diploma. Course can be completed in 3 to 4 months. Many earn while they learn. Begin your training at once.



Anatomy Charts & Booklet FREE
 Enroll now and we will include, at no extra cost, many needed supplies. Fit yourself to help meet growing demand for **Scientific Swedish Massage**. Send the coupon at once for complete details. **Anatomy Charts and 32-Page Illustrated Booklet, FREE, postpaid.**

THE COLLEGE OF SWEDISH MASSAGE
 Dept. 164D, 41 E. Pearson, Chicago 11, Illinois
 Please send me **FREE** and postpaid, **Anatomy Charts, 32-page Booklet** and complete details on Home Training.

Name _____ Age _____
 Address _____
 City _____ State _____

K-R-O KILLS RATS

• **K-R-O BIS-KITS** are ready-made, easy to use; containing *fortified red squill*, they're safer around livestock, pets, and poultry. **K-R-O POWDER** is 100% *fortified red squill*; economical to use in badly infested areas when mixed with natural baits. **BIS-KITS**, 35c and \$1.00; **POWDER**, 75c at drug, seed, and feed stores. Money-back guarantee. *The K-R-O Company, Springfield, Ohio.*

Rupture Troubles Ended

Advanced method has healed thousands. No leg straps, no elastic, no plasters. No pressure on hips or spine. **Flexo-pad**. Entirely different. Endorsed by doctors, mechanics, clerks. Very light. **INEXPENSIVE. GUARANTEED.** Write for information and trial.

SMITH MANUFACTURING COMPANY
 EST'D 1893 DEPT. PM PRESTON, ONTARIO

Learn PHOTOGRAPHY
 There's big money in PHOTOGRAPHY—and an action-packed career for you. Our **HOME STUDY COURSE** is your spare-time **SHORT CUT TO SUCCESS!** Or, if you wish—**PERSONAL ATTENDANCE TRAINING** at our famous New York School is available with subsistence under the G. I. Bill. Our 41st year. Write immediately!

NEW YORK INSTITUTE OF PHOTOGRAPHY
 Dept. "49," 10 West 33 Street, New York 1, N.Y.

SPECIAL Fishing Line YOUR CHOICE \$1.00 FOR \$1.00

500' 2-PLY NYLON 25 lb. T	250' 3-PLY NYLON 45 lb. T	150' 3-PLY NYLON 85 lb. T	500' Linen Line 24 lb. T
---------------------------	---------------------------	---------------------------	--------------------------

Imported FLIES, Assorted . . . 10 for \$1.00
Level Fly Line, size E & D, 75 ft. \$1.00
 All lines available in longer lengths. Send Check, Money Order. We pay Postage.

MAC-MILLS, Dept. K-4, Pleasant Valley, New York

FREE BERRY'S NEW POULTRY BOOK

DAY-OLD and 4 WEEK CHICKS—52 varieties and 7 cross-breeds. B.W.D. tested. Sexed or Non-Sexed. Chickens, Ducks, Geese, Guinea, mature fowls and hatching eggs. **LOW PRICES. ORIGINAL BERRY FARM, over 50 years service. Beautiful Book Free.** Stamps appreciated.
BERRY'S POULTRY FARM, Box 29, Clarinda, Iowa

"It Measures As It Rolls"
ROLLER RULE
HANDY MECHANICAL PENCIL

Measures Curves and Straight Lines. Any Shape. Any Distance. Any Surface.

\$1.29 POST PAID

Roll head over surface. Inches and fractions record accurately on "Inch-O-Meter". Excellent pencil too! Order Now!
10 Day Money Back Guarantee!
 C.O.D. (postage extra). In Calif. add 3% Sales Tax.

PENCIL SALES CO., Dept. PM4
 Room 6, 1213 E. Ocean Blvd., Long Beach, California

Now Any AUTO REPAIR JOB Can Be a "Push-Over" for You!

Free
7-DAY OFFER!

**MOTOR'S
AUTO
REPAIR
MANUAL**

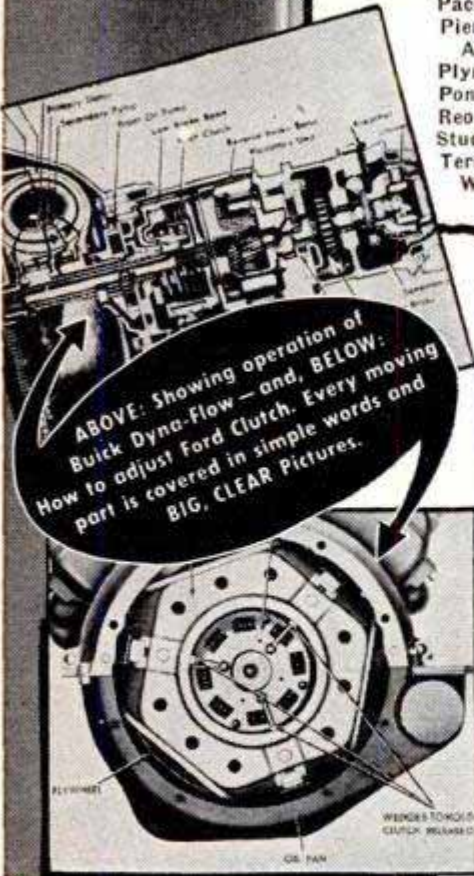

IN LESS TIME—WITH LESS WORK—AND MORE PROFITS!

NOW, tackle anything from carburetor to rear end on ANY car built from 1935 thru 1950. And fix it quick, easy, right the FIRST time! Just look up make, model, and job in quick index of MoToR's brand-new AUTO REPAIR MANUAL. Clear, illustrated instructions lead you step by step all the way. Covers automatic and semi-automatic transmissions; the new GM Rochester carburetor.

ONLY Manual of Its Kind!

The engineer-editors of MoToR Magazine condensed all the meat of over 150 official factory manuals for you. They dug out all the information you need—made sure every word and picture is crystal clear—and put the whole "works" into this one big 750-page book.

Contains 200,000 service, repair, tune-up facts. 35,000 essential dimensions! More than 2100 cut-away photographs, diagrams, charts show what the clear text tells.

Used by
U. S. Army
and Navy

COVERS ANY CAR BUILT SINCE 1935!

- | | |
|-----------|------------|
| Auburn | Frazer |
| Austin | Graham |
| Buick | Hudson |
| Cadillac | Hupmobile |
| Chevrolet | Kaiser |
| Chrysler | Lafayette |
| Cord | La Salle |
| Crosley | Lincoln |
| De Soto | Mercury |
| Dodge | Nash |
| Ford | Oldsmobile |
| | Packard |
| | Pierce |
| | Arrow |
| | Plymouth |
| | Pontiac |
| | Reo |
| | Studebaker |
| | Terraplane |
| | Willys |

Win Prestige! Earn More Money!

MoToR's Manual makes every operation so easy that you'll find yourself tackling jobs you wouldn't think of doing before. And you'll win added prestige and more money in the bargain.

Beginners will find usable helpful guidance on every kind of repair and service job imaginable. Experts will be amazed by the time and labor-saving short cuts.

This GIANT Manual is used by Army, Navy, Technical Schools, and thousands of successful auto-repairmen. Now YOU can try it FREE—for 7 days. Learn first-hand how it can pay for itself the first few times you use it!

SEND NO MONEY

Mail coupon below — without money! When your book arrives — make it show you what it's got! Unless you agree it's the greatest time and work saver you've ever seen—return book in 7 days and pay nothing. Mail coupon NOW! MoToR Book Department, Desk 14, 250 West 55th St., New York 19, N. Y.



Just 2 of the Many Letters of Praise



"MoToR's Manual paid for itself on the first 2 jobs, and saved me valuable time by eliminating guesswork." — W. SCHROP, Ohio



"Instructions so clear have no trouble learning anything about any car. Now working as mechanic in big plant." — SAM ORDONEZ, California

Same FREE Offer on MoToR's TRUCK & TRACTOR MANUAL

Brand - new! Covers EVERY job on EVERY popular make gasoline truck and farm tractor built from 1936 thru 1949! 1400 pictures, 961 pages, 300,000 facts. All types Gasoline Engines, Fuel Systems, Governors, Lubrication, Ignition, Starters, Clutches, Axles, Brakes, etc., etc.

ALSO covers many buses, contractor and road building equipment, stationary power machinery. Check box in coupon at right for 7-day FREE trial.



Published by MoToR, The Leading Automotive Business Magazine.



MAIL COUPON NOW FOR 7-DAY FREE TRIAL

MoToR BOOK DEPT.
Desk 14, 250 West 55th St., N. Y. 19, N. Y.

Rush to me at once (check box opposite book you want):
 MoToR's New AUTO REPAIR MANUAL. If O.K., I will remit \$1 in 7 days (plus 35c delivery charges), \$2 monthly for 2 months and a final payment of 95c one month after that. Otherwise I will return the book postpaid in 7 days. (Foreign price, \$8 cash with order.)

MoToR's New TRUCK & TRACTOR REPAIR MANUAL. (Described at left.) If O.K., I will remit \$2 in 7 days, and \$2 monthly for 3 months, plus 35c delivery charges with final payment. Otherwise I will return book postpaid in 7 days. (Foreign price, remit \$10 cash with order.)

Print Name.....Age.....

Address.....

City.....State.....

Check box and save 35c delivery charge by enclosing WITH coupon entire payment of \$5.95 for Auto Repair Manual (or \$8 for Truck & Tractor Repair Manual). Same 7-day return-refund privilege applies.

I'll Give You BULLDOG COURAGE In 48 Hours

—or no cost!



DAVID V. BUSH

Are you timid? Bashful? Self-conscious? Are you afraid of people—afraid of superiors? Give me 48 hours and I'll give you BULLDOG COURAGE, I'll make you bristle with fighting Determination, or refund your money.

Thousands of men and women are being held back—made miserable—made unhappy. Why? Simply because of bashfulness—self consciousness—fear of criticism—business worries—and dozens of other fears.

Yet fear is ABSOLUTELY UNNECESSARY. An amazing method has been discovered which banishes fear. No trouble! No inconvenience. No long waiting for results. This method is perfectly simple—perfectly natural—perfectly logical. It works almost instantly. Try it. You will be astonished! In just a few hours you may find yourself brimming over with splendid new courage—new daring—new self-confidence.

Only \$1 David V. Bush gives you his secrets of real human courage in his famous book called "Spunk." It is one of the most startling books ever written. You can't read it without a quickening of your pulse—without a surge of red-blooded courage.

This book is declared to be the masterpiece of David V. Bush who has astounded throngs in America's greatest cities and shown thousands the way to health, prosperity and self-confidence. Write for this amazing book today. Send only \$1 in full payment. If you are not delighted, if your fears are not gone by the time you read this book, return the book within 10 days and your money will be instantly refunded.

INSPIRATIONAL PUBLISHING HOUSE, Dept. PM-5, Mehoopany, Pa.
I enclose \$1.00 for copy of "Spunk." You agree to refund if I return it in 10 days.

Name _____

Address _____

City _____ Zone _____ State _____



LEARN MEAT CUTTING At Home—In Spare Time

Get into the vital meat industry. Concise, practical Home Training based on 25 years proven instruction methods used at National's famous resident school. Prepares you for bigger pay as Meat Cutter, Supervisor, market manager or more money in your own store. Go as rapidly as your spare time permits. Diploma. Start NOW to turn your spare hours into money. Send for FREE bulletin today. No obligation.

NATIONAL SCHOOL OF MEAT CUTTING, INC., Div. U-127, Toledo 4, Ohio

High School at Home

Many Finish in 2 Years

No classes. No time wasted going to and from school. Progress as fast as your time and abilities permit. Standard H. S. texts supplied. Thousands enroll each year in this 54-year-old school. Send for FREE descriptive booklet.

AMERICAN SCHOOL, Dept. H-445
Drexel at 58th St., Chicago 37, Ill.

Without obligation, please send FREE descriptive booklet.

Name _____

Address _____



START YOUR OWN ELECTRICAL APPLIANCE REPAIR BUSINESS

Repair electrical appliances of friends and neighbors. Service electrical equipment in factories, stores, etc. Work full or part time! New Shop Method home-training system. Rush name today for FREE BOOK and special form for getting Electronic Kit, Valuable Heating Element Kits, Advisory Service and Illustrated Instructions on new easy-payment plan. Pay later from EARNINGS WHILE LEARNING. Rush name today.

CHRISTY TRADES SCHOOL
4432 N. Kedzie, Dept. D-9203, Chicago 25

TASOPE PHOTO-ENGRAVING PLANTS



MATERIAL COST OF THIS CUT 1/4c
SELLING PRICE \$1.00 AND UP

Establish your own profitable PHOTO-ENGRAVING business. Make cuts for newspapers, printers, and advertisers. Make etched name plates, plaques etc. Instructions furnished, no experience necessary. Sold direct from factory since 1931. First five hundred cuts sold locally or by mail will pay for plant and pay you well for your time. Write for FREE catalog.
TASOPE DEPT. PM4, AURORA, MO.



GOLD-SILVER-COINS

Easily located with new Lightweight M-Scope Detector. Superior performance, lowest price, monthly payment plan.

FREE LITERATURE
FISHER RESEARCH LAB., INC.
PALO ALTO CALIF.



Free Book

Money In Hamsters

The new wonder animals from Syria. Often called Toy Bears. Delightful pets. Everyone wants them. Laboratories use thousands. Clean, odorless. Raise anywhere. NOW, spotted and golden breeds. We furnish breeders, equipment and manual of instructions. Write today for free illustrated literature.

GULF HAMSTERY 1536 BASIL ST., MOBILE 17, ALA.

GROW YOUR OWN SALAD, 10 DAYS



You can taste the results of this fascinating hobby. Plant Vita-Green seeds in your home—harvest a salad crop in 10 days. A year's supply, complete details..... **\$1.** post-paid

GILBERT & COMPANY

3535f ENTERPRISE ST., SAN DIEGO 10, CALIF.

MAKE CRIME YOUR BUSINESS

ON THE SIDE OF THE LAW!

Help fight crime! . . . Earn steady good pay as a Finger Print Expert or Investigator. I.A.S. trains you—by easy, low-cost home study lessons. Learn this exciting work in spare time. Write for full details now!

OVER 800 POLICE BUREAUS...

Employ I.A.S.-trained men . . . proof of what I.A.S. can do. Write today (state age) for details. No obligation. No salesmen will call.

INSTITUTE OF APPLIED SCIENCE

Dept. 1354, 1920 Sunnyside Avenue
Chicago 40, Illinois

GET INTO AUTOMOTIVE DIESEL AND ALLIED MECHANICS

by Shop Method Home Training

**JOBS LIKE THESE ARE OPEN
TO YOU AS A TRAINED ENGINE
MECHANIC... CHOOSE THE
FIELD YOU LIKE BEST!**

Get complete training

- Diesel Fuel Injection
- Automotive Motor Tune-up
- Diesel Engine Maintenance
- General Garage Mechanics
- Agricultural Implements
- Auto Engine Rebuilding • Auto Elec. Service
- Public Utilities • Parts Dealers
- Bus & Truck Lines • Industrial Maintenance
- Contracting & Excavating
- Business of Your Own
- AND MANY other similar openings

EARN WHILE YOU LEARN

With our practical Master Shop-Method Home Training, you study at home in your spare time. You receive Spare Time Work Lessons, which show you how to earn while you learn... for extra money and experience. You Learn by DOING.

YOU RECEIVE AND KEEP ALL THIS MATERIAL:

- | | |
|---|-----------------------------|
| Basic Lesson Texts | Engine Service Manuals |
| Diesel Installation Operation—Maintenance | Engine Repair Drive Systems |
| Diesel Chart Manual | Diesel Electric Power |
| Spare Time Lessons | Thermodynamics |

TOOLS AND EQUIPMENT

**INVESTIGATE!
SECURE FULL
INFORMATION**

**WE GIVE
YOU TOOLS
OF YOUR
TRADE**

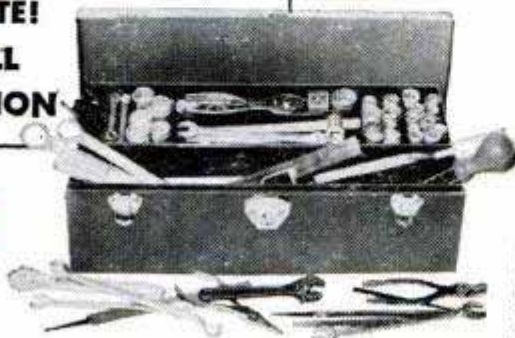

**Master
All
Phases!**



Get Master Shop-Method Home Training from an Established Resident School with its own Training Shops and Laboratories—and almost 50 years of Successful Experience in Training Men.

We Bring National Schools To You

National Schools trains you for all opportunities in the dynamic, fast-growing Automotive-Diesel and Allied Industries. You get complete training for this great Industry.

Thousands upon thousands of autos, trucks, tractors, ships, trains, farms and factories are dependent upon engine power! Trained engine mechanics are needed in the Armed Forces as well as in civilian production. This huge field needs trained men for servicing, repairing, installing, operating and manufacturing equipment. The pay is good, the future excellent! National Schools offers you a practical, all-embracing Automotive-Diesel Mechanics Course that qualifies you for your choice of many good jobs.

Your National Course covers Gasoline and Special Fuel Engines; Diesels, High Speed and Heavy Duty; Semi-Diesels; Allied Mechanics.

**BOTH RESIDENT
AND
HOME STUDY
COURSES
OFFERED**

**APPROVED FOR
VETERANS AND
NON-VETERANS
Check Coupon Below**

NATIONAL SCHOOLS LOS ANGELES 37 CALIFORNIA
TECHNICAL TRADE TRAINING SINCE 1905

FIND OUT NOW...MAIL COUPON TODAY

NATIONAL SCHOOLS, Dept. 4-PMD (Mail in envelope
4000 South Figueroa Street or paste on
Los Angeles 37, California penny postcard)
Mail me FREE the book, YOUR FUTURE IN AUTO-
MOTIVE-DIESEL MECHANICS, together with the
Sample Lesson. I understand I may keep and use
the information with no obligation.

NAME _____ AGE _____

ADDRESS _____

CITY _____ ZONE _____ STATE _____

Check here if Veteran of World War II

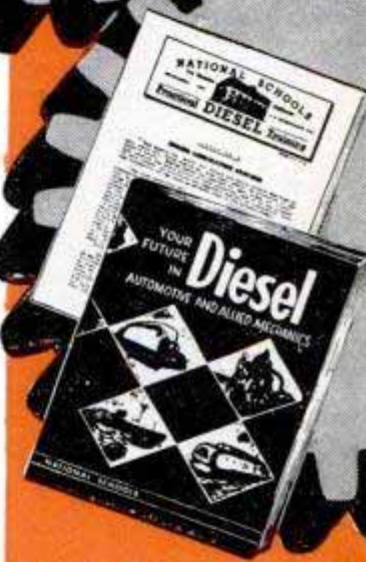
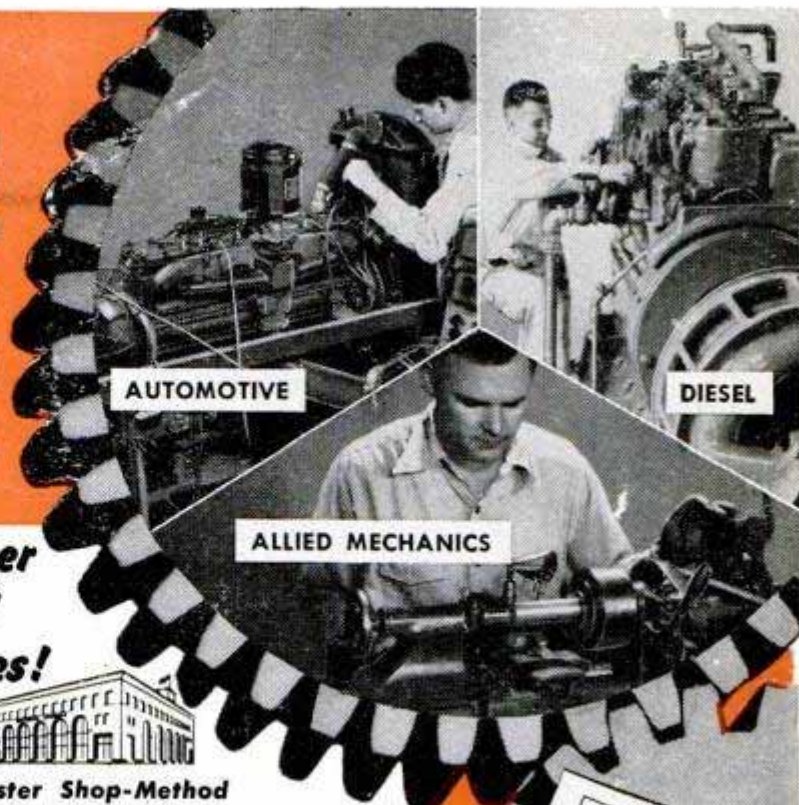

**These Two FREE Books
Show You How**

Send today for National Schools' new, illustrated Book of Opportunity in Automotive, Diesel and Allied Mechanics, and an actual sample lesson. No cost—no obligation. Use the coupon now — we'll answer by return airmail.

SPARE TIME MEANS SPARE CASH with this welder in your home



**WELDS
CUTS
SOLDERS
BRAZES
CHARGES
BATTERIES**

"LINCWELDER 60"
New Lincoln Arc Welder

Be the handyman welder for your neighborhood

Repair damaged car bodies and fenders . . . fix toys . . . braze and solder broken parts . . . recharge batteries . . . and do other profitable work. It's so easy now with the new Lincoln arc welder.

- Comes complete with full instructions.
- Approved by Underwriters Laboratories.
- Operates from 115 volt grounded circuit. (No. 12 wire fused for 20 amps.)

**ORDER
YOUR WELDER
NOW**

Fill out and
mail to
**THE LINCOLN
ELECTRIC
COMPANY**
Dept. 191
Cleveland
1, Ohio

- Ship me the "Linewelder 60" with accessories \$48.00 (Including headshield, electrodes, carbons, electrode holder, ground clamp and cable). Arc Torch \$6.25 extra.
 Battery Charging Attachment \$10.00 extra.
Enclosed is check money order
 Send me free bulletin on the new "Linewelder 60"

Name _____
Address _____
City _____ State _____ 191

"I'M EARNING \$300 A MONTH!"



. . . . says Leonidas Burgoyne of Chicago, Illinois, "Expert individual instruction in the fully equipped shops of Greer Shop Training gave me the right start to get my good paying job."

GREER SHOP TRAINING
established 1902, is one of America's largest trade schools. Over 48,000 successful graduates. You learn by tearing down, repairing and rebuilding. Day and evening classes. Mail this coupon today!

LEARN A TRADE NOW!

GREER SHOP TRAINING, Desk 211, 2230 S. Michigan Avenue, Chicago, Ill.

Gentlemen: Please send me information about trade I have checked below. (Specify if you are VET or NON-VET .

- IN OUR CHICAGO SHOPS**
- | | |
|---|--|
| <input type="checkbox"/> AUTO MECHANICS | <input type="checkbox"/> BODY, FENDER REPAIR |
| <input type="checkbox"/> DIESEL | <input type="checkbox"/> WELDING—ARC, GAS |
| <input type="checkbox"/> REFRIGERATION | <input type="checkbox"/> MACHINIST |
| | <input type="checkbox"/> PIANO TUNING |
- Above courses approved for Vets and Civilians.

ALSO THE FOLLOWING HOME STUDY COURSES

- REFRIGERATION DIESEL PLASTICS

Name _____ Age _____
Address _____
City _____ State _____

GREER SHOP TRAINING

Listen to this Record!

Speak FRENCH SPANISH



**RUSSIAN • GERMAN • ITALIAN
BRAZILIAN • JAPANESE**

BIG OPPORTUNITIES await Americans who speak languages. Learn as a child learns—"by listening." The **CORTINA METHOD**, famous for 69 years, teaches you, right at home, to speak like a native!

VETS
FRENCH or
SPANISH
course avail-
able under
G.I. Bill.

FREE BOOK The "Cortina Short-Cut" describes this amazing method and **FREE TRIAL** offer. **WRITE TODAY.** State language interested in. Also if Veteran.

CORTINA ACADEMY Dept. 644
105 W. 40TH ST. NEW YORK 18, N.Y.



OWN a Business

Clean and Mothproof rugs and upholstery "in the home." Patented equipment. No shop needed. Duraclean dealer's gross profits up to \$15 a day on EACH serviceman. These Nationally Advertised services create repeat customers. Easy to learn. Quickly established. Easy terms. Send today for **FREE Booklet**—Full details.

DURACLEAN CO., 1-164 DURACLEAN BLDG.
DEERFIELD, ILL.

FALSE TEETH

That Loosen Need Not Embarrass

Many wearers of false teeth have suffered real embarrassment because their plate dropped, slipped or wobbled at just the wrong time. Do not live in fear of this happening to you. Just sprinkle a little **FASTEETH**, the **alkaline** (non-acid) powder, on your plates. Holds false teeth more firmly, so they feel more comfortable. Does not sour. Checks "plate odor" (denture breath). Get **FASTEETH** at any drug store.

Learn CARTOONING

HAVE FUN! MAKE MONEY! Cash in on your sense of humor at **HOME—BY MAIL.** No experience needed to start. Write today for **FREE TRIAL LESSON** and full particulars.

MOON Gag Cartoon School, Dept. H, Fall Creek, Wis.



LEARN RADIO-ELECTRONICS



Train for an important job in Radio, Television and Radar—with unlimited future. Spartan resident study is backed with actual construction and operation. Write Department PM-41

SPARTAN SCHOOL of RADIO-ELECTRONICS
MUNICIPAL AIRPORT • TULSA, OKLAHOMA

LEARN WATCH REPAIRING



AT HOME. By our modern and original system of instruction you can learn every part of the **WATCH REPAIRING TRADE AT HOME.** Prepare yourself for a well-paying position or start in business after completing our course of instruction. Good watch repairers are in demand and generally earn very good salaries. For particulars apply to the **WISCONSIN SCHOOL OF WATCH REPAIRING**
759 North Milwaukee St., Milwaukee 2, Wis.

Learn BAKING At Home

Baking is one of America's high industries in wages. Nearly depression-proof. Thorough basic home course lays sound foundation. If you have aptitude write for **FREE BOOKLET.** "Opportunities in Commercial Baking."
NATIONAL BAKING SCHOOL
835 Diversey Pkwy., Dept. 1354, Chicago 14, Ill.





I CAN HELP YOU **GET AHEAD** in Civilian OR Military Life!

In military service or civilian life, specialized training and skill are rewarded by better pay and advancement. The construction trades are in constant demand for private and public building projects. In peace or emergency, the building tradesman is NEEDED and WELL PAID. Since 1937 I've trained thousands of young men for

prosperous careers. And, OPPORTUNITY is greater today than ever before. The building trades are YOUR OPPORTUNITY for SECURITY in civilian life or PROGRESS in military life, if you take the trouble to learn by my quick, thorough method. Protect your Tomorrow. ACT TODAY.
Richard J. Zaiden—Founder and President

PREPARE TO MAKE
BIG MONEY
IN

A Skilled Construction Trade



PLUMBING BRICKLAYING PLASTERING

"LEARN BY DOING IT" IN CLASS
AS THOUSANDS OF YOUNG AMERICANS HAVE

HIGH PAID, LIFETIME WORK

Opportunity is continuous for men trained in these trades. Many students earn good money while yet in school. Many save thousands of dollars by building or improving their own homes. Some graduates start their own businesses. Others prefer steady work for contractors at high wage scales. Remember—the cultivated skill of your hands is yours for life—giving you SECURITY and OPPORTUNITY beyond the reach of the untrained man.

Commercial Institute's construction courses are designed for quick and thorough training. By our "project system" the student Plumber, Bricklayer or Plasterer learns professional techniques by actual practice under experienced instructors. Book work is at an absolute minimum. These are manual skills that you "learn by doing."

5 MODERN SCHOOLS IN PITTSBURGH, PENNSYLVANIA

We Also Teach

OFFICE MACHINE REPAIR and ELECTROPLATING

SEND FOR LITERATURE and
"TRADE TALK" TODAY!

We publish separate brochures giving a detailed, illustrated description of each course. ALSO—our monthly paper "TRADE TALK" gives you an up to date, "on-the-spot" view of life at Commercial Institute.



**G. I.
APPROVED**

All our courses are approved for Veteran Training. Non-Veterans may arrange easy, monthly payments.

USE THE COUPON To send for literature and a FREE subscription to "TRADE TALK."

COMMERCIAL INSTITUTE

Main Office
2020 West Liberty Avenue
Pittsburgh 26, Pennsylvania

"THE LARGEST TRADE SCHOOL
IN THE EAST"



R. J. Zaiden, President
Commercial Institute
2020 West Liberty Avenue (Div. R.)
Pittsburgh 26, Pennsylvania.

Send me complete information on the course checked below — And a FREE SUBSCRIPTION to "TRADE TALK." This does not obligate me in any way.

PLUMBING BRICKLAYING PLASTERING
 Office Machine Repair Electroplating

Name.....
Address.....
City..... State.....

MORE PAY through HOME STUDY TRAINING in SPARE TIME

Do you want a better position—a larger salary? They are within your reach—now. LaSalle experts will guide you step by step in gaining business training which leads to greater earnings.

The time-saving, interesting LaSalle Problem Method helps you prepare at home, without interference with your present duties.

Simply mark on the coupon the field in which you desire success, and we will mail you a valuable book describing the opportunities in that field—plus "Ten Years' Promotion in One"—a book which has helped many men. Let us tell you how we have started thousands of average men and women on the high road to success and more money. Check and mail the coupon now.

LASALLE EXTENSION UNIVERSITY

A Correspondence Institution

417 S. Dearbon St., Dept. 464-R, Chicago 5, Ill.
Send me full information regarding the course I have marked—without obligation—plus "Ten Years' Promotion in One."

- | | |
|--|---|
| <input type="checkbox"/> Higher Accountancy | <input type="checkbox"/> Salesmanship |
| <input type="checkbox"/> C.P.A. Coaching | <input type="checkbox"/> Traffic Management |
| <input type="checkbox"/> Bookkeeping | <input type="checkbox"/> Foremanship |
| <input type="checkbox"/> Law: LL.B. Degree | <input type="checkbox"/> Industr'l Management |
| <input type="checkbox"/> Business Management | <input type="checkbox"/> Stenotypy
(Machine Shorthand) |

Name.....Age.....

Address.....

City.....Zone.....State.....

Free! VITAMIN GUIDE BOOK

Tells how to get—at little cost—the new "Red" Vitamin B-12 recently described in Reader's Digest

Without cost, you can be well informed on vitamins in only 20 minutes' reading. This informative guide book explains the purpose served by vitamins, gives you an understanding of unitage, and will show you how to read a label and compare values so you can get the most for your money. Tells about the newer vitamins—Choline, Inositol, Folic Acid and the "Red" Vitamin B-12 recently dramatically described in Reader's Digest in a story of blood regeneration that thrilled millions. Folks taking vitamins are amazed, on reading this book, that it is not necessary to pay \$4, \$5, \$6 or \$15 for the vitamins they have been using. You, too, once you know how to measure values as explained in this book, can save up to 40%. So, stop buying vitamins blindly. Send postcard today for this free book and catalog of over 100 products to VITAMIN-QUOTA, Dept. 626, 880 Broadway, New York 3, N. Y.

STAMMERER?

New booklet, "Stammering, and How to Stop It," sent free to any stammerer upon request. Write today. BENJAMIN N. BOGUE, Dept. 514, Circle Tower, Indianapolis 4, Ind.



START YOUR OWN MONEY-MAKING BUSINESS

Clean painted walls for customers with highly efficient machine which is making BIG MONEY for others. No special skill or experience required. No shop or office needed. Operate business from your home. Write today for complete FREE information. Address:

VON SCHRADER MFG. CO. 466 PL. RACINE, WIS.

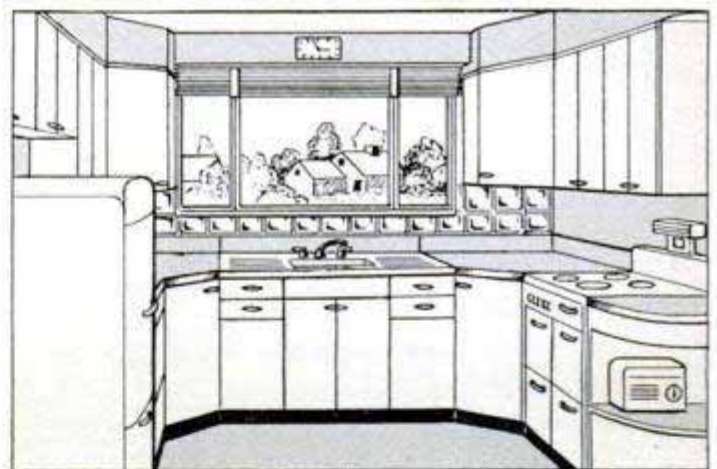

Save Over 50% Remodel Your Kitchen Yourself It's Easy — It's Fun — No Experience Needed

Why put up with an old inefficient kitchen that takes hours of extra work and drudgery when with some inexpensive materials and a few days or evenings of sparetime work you can transform your kitchen into a sleek, modern beauty with plenty of working space just like those you see in the big full color advertisements in home magazines? And not only will your new kitchen mean a savings in work hours, but it can add as much as a thousand dollars more value to your home.

Eight big plans, drawn to exact scale, guide you every step of the way

Eight large sized plans show you everything you need to know to make your kitchen a room of beauty and efficiency. There are layouts for all different sizes and shapes of rooms. Detailed diagrams show you how to make your own cabinets, snack bar, shelves, stools, sink cabinets, valances, built-in fixtures and many other articles of modern kitchen furniture. Order your plans today on Popular Mechanics famous money-back guarantee. Entire set of eight 17"x22" plans only \$5.00.

POPULAR MECHANICS PRESS, Dept. MK 200 E. ONTARIO ST. CHICAGO 11, ILL.

BEAUTIFIES natural wood, pine paneling

POLISHES furniture, woodwork

IMPROVES paint jobs

PROTECTS wood and metal surfaces

NET CONTENTS ONE QUART

REPLACEMENT OR REFUND OF MONEY
Guaranteed by Good Housekeeping
IF NOT AS ADVERTISED THEREIN

49¢ PINT 89¢ QUART

101 HANDY HOME USES!

Every home, every workshop, needs Pol-mer-ik BOILED Linseed Oil. Available at all stores. Free folder tells you how to use it. Write Dept. 603 . . .

ARCHER-DANIELS-MIDLAND CO., Minneapolis 2, Minn.

LEARN ELECTRIC MOTOR REPAIR!

...A GOOD PAYING, UNCROWDED PROFESSION



It pays to train for something different—something that not everybody and his brother are learning—something for which rich opportunities exist everywhere! Every day, more and more electric motors and control systems are being used, BOTH in industry and home appliances. The expert who can install, and repair them is a valuable well-paid man. The field is tremendous. Trained men find part or full-time opportunities everywhere. ELECTRIC MOTOR REPAIR, the big, 560-page training course book, teaches you the work step-by-step—without previous experience.



ONLY \$6 FOR THE COMPLETE TRAINING LEARN FAST . . . No lessons to wait for

Based on what you can learn rapidly at home from ELECTRIC MOTOR REPAIR book, you can train for prompt, profitable installation, servicing, repairing and complete armature rewinding of practically any electric motor in use today. You learn fast! You learn right! Every subject is clearly explained by text AND ALSO by more than 900 clear-cut

illustrations and diagrams. You not only read what to do — you also see in pictures exactly how to do it. An instructor standing at your side could hardly do better! You learn about all sizes of motors from those used on vacuum cleaners or refrigerators to giant industrial motors. Quick reference guides explain many specific jobs on common motor types. When such a motor comes in for repairs, just look it up in the book!



MAKES THIS INTERESTING WORK EASY TO LEARN!

Written by one of the nation's leading motor repair instructors, ELECTRIC MOTOR REPAIR starts right at the beginning—with basic facts about motor operation and construction. Then it proceeds to make even the most complicated parts of the work perfectly understandable. If sold as a correspondence course and sent to you in lesson form, you'd regard it as a bargain at 10 times the price. Instead, you buy it for only \$6 and get it all at once. Many have completed it in a few short weeks. Here are just a few of the basic subjects covered:

- Split-Phase Motors
- Capacitor Motors
- Repulsion-Type Motors
- Polyphase Motors
- Alternating-Current Motor Controls
- Direct-Current Motors
- Direct-Current Motor Armature Winding
- Direct-Current Motor Controls
- Universal, Shaded-Pole and Fan Motors
- D-C Generators
- Synchronous Motors and Generators
- Electronic Motor Controls, etc., etc.

FREE STUDY GUIDE!

A unique home study Guide Book including 500 practical repair questions—priced and sold separately at 25¢—is FREE with your request to examine ELECTRIC MOTOR REPAIR book. Makes learning easier. Speeds up your training. See coupon.

SHOWS YOU HOW . . . Every Step of the Way!

In short, ELECTRIC MOTOR REPAIR covers the entire field from alternating to direct current motors and generators PLUS mechanical and electronic control systems. Unique Duo-Spiral Binding divides the book into two sections so that both text and related diagrams can be viewed together. Thousands of copies are in use in vocational schools, in busy motor shops and, most of all, in homes for study by those who want to cash-in on this fast-growing field.

PRACTICE FROM IT FOR 10 DAYS . . . at our risk!

Send coupon today! See for yourself that really good home study training doesn't need to cost you a lot of money. If not more than satisfied, return ELECTRIC MOTOR REPAIR to us and we will refund your \$6 promptly and no questions asked. What could be fairer than this?



MAIL ORDER! You Can't Lose!

Dept. PM-41, RINEHART BOOKS, Inc., Technical Division, 232 Madison Ave., New York 16, N. Y.

Send me a copy of ELECTRIC MOTOR REPAIR book for which I enclose \$6 (\$6.50 outside U.S.A.); or send C.O.D. and I will pay postman this amount plus postage. If book is not what I want, I'll return it within 10 days and you guarantee to return my \$6. Include a FREE copy of the STUDY GUIDE which will be mine to keep whether or not I decide to keep the ELECTRIC MOTOR REPAIR book. (Cash only outside U. S. A.—Same return privilege.)

Name.....
Address.....
City, Zone, State.....

FISHERMEN!



FREE
Beautiful
Colorful
Shakespeare 1951 Tackle
Book and Fishing Calendar

FEATURING:

- Joe Godfrey's Fishing Calendar—Shows Best Days to Fish!
- Casting lessons, fishing tips, "Balanced Tackle" suggestions by U. S. Champion Ben Hardesty.
- "Fitting the Tackle to the Man—or Woman"—by Jason Lucas, famous angling authority.
- New Shakespeare Direct Drive Reels with LQT NYLON Gears—the tackle sensation of the year.
- Genuine Shakespeare Howald-Process Fiber Glass Wonderods. New Low Prices!
- Wexford Wonder Line, Black and "Invisible".
- The Shakespeare President—NOW built with 3 miracle materials—Carboloy, Nylon and "78-8" Stainless Steel.
- Famous Shakespeare Wondereels that Make You a Fisherman in 5 Minutes.



Shakespeare

Shakespeare Company, Dept. PM-4
Kalamazoo 2, Michigan

Please send me your FREE 1951 Tackle Book and Fishing Calendar.

Name _____

Address _____

City _____ State _____

AERONAUTICAL ENGINEERING



Design Aircraft & Components—Study with Jets & Rockets—Great Future—Advanced Aeronautical Subjects—World-Wide Enrollment—Fully Accredited—Established 1929—Approved for Vets—CAL-AERO grads in heavy demand.
WRITE TODAY for Special Information. PM-4

NAME _____ AGE _____

ADDRESS _____

CITY _____ ZONE _____ STATE _____

CAL-AERO TECHNICAL INSTITUTE
GRAND CENTRAL AIR TERMINAL • GLENDALE 1, CALIFORNIA

DRIVING RELIEF!

New LEFT-FOOT ACCELERATOR

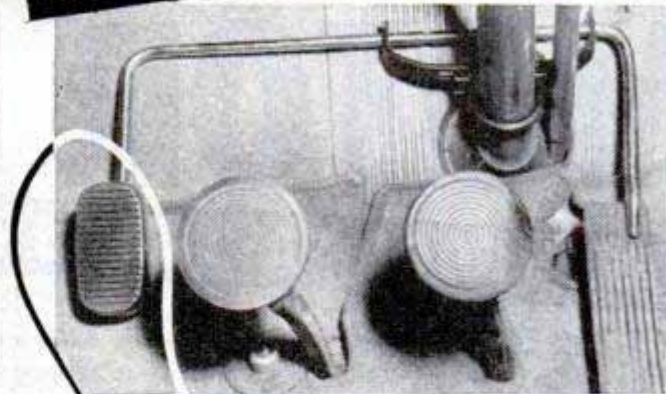

Dealer inquiries invited.

Cut driving fatigue in half with Lefty! Install this new left foot accelerator yourself in 60 seconds with just a wrench—no alterations to your car are necessary. Enjoy relaxed comfort on long drives. Lefty lets you feed the gas with your left foot when you desire, relieves tension and fatigue in leg, back, and foot. Safe, positive and convenient. Swings out of way when not in use. Brings your car up to date. \$5. ppd. Specify year and make. No COD's please.

INVENTOR'S MARKETING LAB.

1210-B De Young Bldg., 690 Market St., San Francisco, Calif.

BECOME AN EXPERT IN TRAFFIC

Traffic men earn \$4,000 to \$10,000 and up. Thousands of firms need experts on rates, tariffs, regulations. We train you thoroughly in spare time at home for executive traffic jobs. Personal training under traffic authorities. Placement counsel and help. Write for free 48-page book "Traffic Management—the Fast Growing Profession."

LASALLE Extension University, 417 So. Dearborn St.
A Correspondence Institution Dept. 464T, Chicago 5, Ill.

COURSE OF INSTRUCTION on INDUCTION TYPE WATTHOUR METERS

A Practical Treatise written so you can understand it. Well Illustrated with accompanying text; and examples of Problems Important to Electrical Students. Theory; Metering Practice, including Network Systems; Demand Meters; Rate Systems; Power Factor, etc.

For information write to **J. GORDON STEISS, P.O. Box 292**
Kitchener, Ontario, Canada

LEARN AT HOME LOCKSMITHING

YOU CAN MAKE GOOD PROFITS ALL YEAR ROUND IN FULL OR SPARE TIME!

Locksmiths are always in big demand! Age is no disadvantage in this respected, permanent field. Learn how to make keys, fix locks, make duplicates, etc. Practical, illustrated lessons by experts show you how! All materials and special tools supplied. Send for FREE booklet.

INSTITUTE OF LOCKSMITHING
Dept. P-17 55 Park Ave., Rutherford, N. J.
Licensed & Approved by State of New Jersey

CLIP THIS! MAKE BIG MONEY

with Sweet-Aire—amazing new magic mist. Keeps breath of spring in house year 'round. Three fragrances. Each scent \$1. with big profit for you, in squeeze-it atomizer bottle. Won't leak, break, evaporate. Demonstration sells it. No experience needed. Get your FREE Sweet-Aire money-making plan now. Check below which plan you want FREE.

- To raise money for organization.
- To use for door-to-door selling.
- To help sell greeting cards.

If you want full size \$1 bottle shipped with FREE plan, check special offer below.

- 50c enclosed for \$1 bottle.
- \$1 enclosed for all 3 \$1 bottles.

Don't delay. Start making big money right now. Just check and mail this ad with your name and address TODAY!

THOMAS TERRY — Dept. 703, Westfield, Mass.

NEW BODIES FOR OLD!

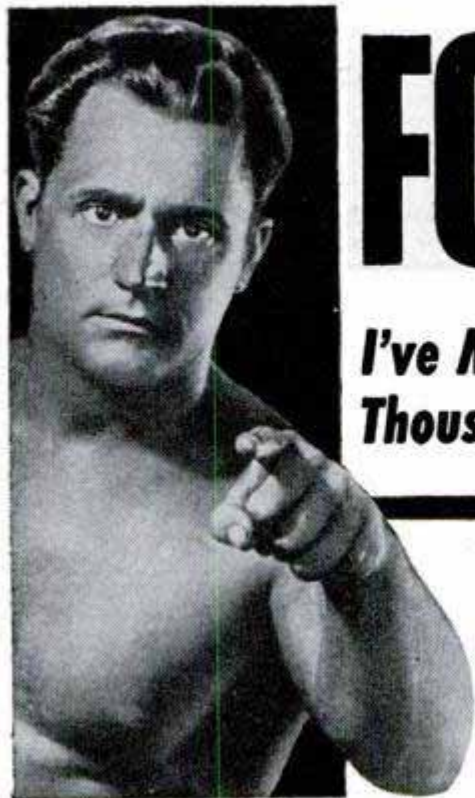

I've Made New Men Out of Thousands of Other Fellows...

"Here's what I did for THOMAS MANFRE...and what I can do for you!"

- Charles Atlas



GIVE me a skinny, pepless, second-rate body—and I'll cram it so full of handsome, bulging new muscle that your friends will grow bug-eyed! . . . I'll wake up that sleeping energy of yours and make it hum like a high-powered motor! Man, you'll *feel* and *look* different! You'll begin to *LIVE!*

Let Me Make YOU a NEW MAN—IN JUST 15 MINUTES A DAY

You wouldn't believe it, but I myself used to be a 97-lb. weakling. Fellows called me "Skinny." Girls snickered and made fun of me behind my back. I was a flop. THEN I discovered my marvelous new muscle-building system — "Dynamic Tension." And it turned me into such a complete specimen of MANHOOD that today I hold the title "THE WORLD'S MOST PERFECTLY DEVELOPED MAN."

ARE YOU Skinny and run down? Always tired? Nervous? Lacking in Confidence? Suffering from bad breath? **What to Do About it** is told in my free book!

What is "Dynamic Tension"? How Does It Work?

When you look in the mirror and see a healthy, husky, strap-

ping fellow smiling back at you — then you'll realize how fast "Dynamic Tension" GETS RESULTS!

"Dynamic Tension" is the easy, NATURAL method you can practice in the privacy of your own room — JUST 15 MINUTES EACH DAY — while your scrawny chest and shoulder muscles begin to swell, ripple . . . those spindly arms and legs of yours bulge . . . and your whole body starts to feel "alive," full of zip and go! And you'll be using the method which many great athletes use for keeping in condition—prize fighters, wrestlers, baseball and football players, etc.

One Postage Stamp May Change Your Whole Life!

Sure, I gave Thomas Manfre (shown above) a NEW BODY. But he's just one of thousands. I'm steadily building broad-shouldered, dynamic MEN — day by day—the country over.

3,000,000 fellows, young and old have already gambled a postage stamp to ask for my FREE book. They wanted to read and see for themselves how I build up scrawny bodies, and how I pare down fat, flabby ones — how I turn them into human dynamos of pure MAN-POWER.



Atlas Championship Cup won by Thomas Manfre, one of Charles Atlas' pupils.

MY ILLUSTRATED BOOK IS YOURS — Not For \$1.00 or 10c — But FREE

Send NOW for my famous book, "Everlasting Health and Strength." 48 pages, crammed with photographs and valuable advice. Shows what "Dynamic Tension" can do, answers many vital questions. Page by page it shows what I can do for YOU.

This book is a real prize for any fellow who wants a better build. Yet I'll send you a copy absolutely FREE. Just glancing through it may mean the turning point in your whole life! Rush the coupon to me personally: Charles Atlas, Dept. 8D, 115 East 23rd St., New York 10, N. Y.



CHARLES ATLAS, Dept. 8D, 115 East 23rd St., New York 10, N. Y.

Send me—absolutely FREE—a copy of your famous book, "Everlasting Health and Strength"—48 pages, crammed with actual photographs, answers to vital health questions, and valuable advice to every man who wants a better build. I understand this book is mine to keep, and sending for it does not obligate me in any way.

Name..... Age....
(Please print or write plainly)

Address.....

City..... State.....

LIFETIME WRITTEN GUARANTEE \$14.95

ORIGINAL PRICE \$59
INCABLOC— Shock Protected
WATER-DUST PROOF
 Worn by Army, Navy & Marines During War

YOU SAVE \$44



Luminous dial . . . Sweep second hand . . . Super Accurate . . . Imported Swiss precision movement and case. You get these men's New Lifetime Guaranteed Watches now for a small fraction of the original price. You save \$44, because we bought-out surplus stock! Don't delay!

Order now . . . while they last.

TRIAL OFFER! Wear at our risk!

Money back in 5 days if not delighted. **SEND ONLY \$1** down payment with order. Pay balance to postman on arrival plus postage. Or we pay postage if you include full payment, plus tax with your order. Return this ad with your order.

FREE! Handsome Expansion Band included. ORDER NOW!

MARYLAND DISTRIBUTORS, Dept. 242
 501 EAST BALTIMORE STREET, BALTIMORE 2, MARYLAND

Free Watch & Diamond Ring Catalog.
 Practically Wholesale Prices to User Direct.

new, easy way to.. STRIPE with PAINT

Do Perfect Paint Striping at Home with New Kind of PAINT STRIPING TOOL

This Master Painters' Striping Tool makes it easy to do expert striping on furniture, bikes, model planes, autos, signs, toys, linoleum, wall board, etc. Makes plain, painted walls look like tile. Paint straight lines . . . curved . . . circular or evenly spaced parallel lines the same way a professional painter does. Simply fill Tubular-Glass Paint Fountain with any color paint and wheel tip feeds paint evenly. Tips interchangeable—jaws split apart for easy cleaning. Tool complete with tips for 1-16 in. stripe only \$1.00 postpaid. Other complete tools with 1-64, 1-32, 3-64, 5-64, 3-32, 1-8 inch tips, \$1.50. Separate tips—75c each. **COMPLETE KIT** with tool and 7 tips, \$5.00. Here's the handiest tool in your whole painter's kit. C. O. D.'s post. coll.



\$1 ONLY

POSTPAID ATTENTION
 Home Craftsmen and Hobbyists

DEALERS
 Paint Striping Tool
 packed in attractive display cartons of 1 doz. Fast, profitable seller. Write for illus. circular, discounts.

Just the tool you've been waiting for! New **PAINT STRIPING** tool gives "professional" results every time, yet simple and easy to use as a fountain pen. Adjustable guide keeps lines straight as an arrow. Just as easy to make curves or free hand designs. Adds new beauty and finished look to everything you paint. Send dollar today.

WENDELL MFG. CO., 4234 N. Lincoln Ave., Dept. 34, Chicago 18, Ill.

LEARN ANOTHER LANGUAGE

EASILY, QUICKLY, at HOME with The One And Only

LINGUAPHONE

World's Standard Conversational Method

In your own home you can learn to speak French, Spanish, German, Russian, an Oriental language, any of 29 languages by the LINGUAPHONE CONVERSATIONAL METHOD . . . quickly, easily, naturally. You listen — you learn — you understand — you SPEAK! Add to job, armed services, travel opportunities. Save time, work, money. Endorsed by educators; used in colleges and by more than one million home-study students. **FREE BOOK** gives fascinating facts about this natural way to learn a language. Write **TODAY!** State if veteran.

LINGUAPHONE INSTITUTE
 143-04 Rockefeller Plaza, New York 20, N. Y.

INVENTORS

Whether an invention is patentable can be substantially determined by a search of the U. S. Patent records. Without obligation, write for information explaining the steps you should take to secure a patent.

JOHN N. RANDOLPH

Registered Patent Attorney

201 Columbian Building, Washington 1, D. C.

PATENTS PATENT LAWYER

GUSTAVE MILLER

REGISTERED PATENT ATTORNEY

41-PM WARNER BLDG.

WASHINGTON 4, D. C.

ASSOCIATE EXAMINER

U. S. PATENT OFFICE 1922-1929

Patent Attorney and Advisor

U. S. NAVY DEPT. 1930-1947

Send for

PATENT INFORMATION book

and **"INVENTOR'S RECORD"**

without obligation

INVENTING

-FOR PROFIT! If you have an inventive turn of mind, write for free 28-page booklet explaining how the Institute of American Inventors is helping inventors pre-test the profit possibilities of proposed devices to fill today's unprecedented demand for useful new inventions.

INSTITUTE of AMERICAN INVENTORS

Dept. 4, 631-E St., N.W., Washington 4, D. C.

INVENTORS

Before you make any effort to market your invention, you should take the first steps toward proceeding for patent protection.

The usual first step is to have a search of the U. S. patent records conducted, so that I can report to you on the question of patentability.

I shall be pleased to furnish you with information relative to patent procedure, upon request from you, and this will be without any obligation on your part.

PATRICK D. BEAVERS

(Formerly RANDOLPH & BEAVERS)

Registered Patent Attorney

934 Columbian Building Washington 1, D. C.



PATENTS

C. A. SNOW & CO.

REGISTERED PATENT ATTORNEYS

WRITE FOR INFORMATION TO
 428 SNOW BUILDING, WASHINGTON 1, D. C.

Say You Saw It in Popular Mechanics

INVENTORS

IF YOU WISH TO PROTECT YOUR INVENTION, You should take steps to protect it by a U. S. Patent. Write me for "RECORD OF INVENTION" form.

CARL MILLER
 REGISTERED PATENT ATTORNEY

WOOLWORTH BLDG., 35th FLOOR, 41A
 NEW YORK CITY

YOUR OPPORTUNITY IS HERE NOW!
LEARN

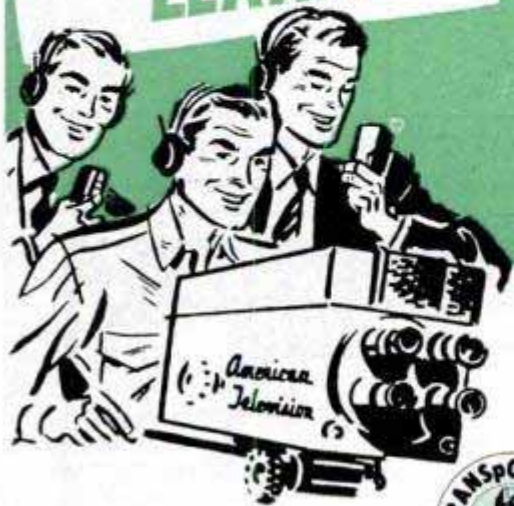

TELEVISION

RIGHT AT HOME!

By the new method of

TRANSPONDENCE

TRAINING ON FILM AND TAPE RECORDINGS

Approved for veterans under the GI bill. Approved for vocational rehabilitation training.

Now the De Forest-Sanabria Corporation—a division of the world's largest television training school—brings *classroom instruction* to you right in your own home! You actually hear your instructor's *recorded* voice. At the same time you watch "blackboard" size projected pictures, diagrams and illustrations. It's the quick, easy way to equip yourself for the big earnings in television—*today!*



LOOK... You get the tape recorder and projector right at the start of your course!



HEAR your instructor

It's even better than the classroom, because you can repeat the instructor's lectures until they're thoroughly understood.



SEE 2000 illustrations

You learn quicker when you see diagrams and illustrations in black-board size.

You get the famous "TRANSPONDER" precision built, high fidelity tape recording machine with your very first lesson—and a powerful projector with which you can view diagrams and illustrations enlarged to a size that makes them easy to see and understand.



READ from reference library

You receive complete books, pamphlets and manuals to supplement your instructor's lessons.



ASK your questions on tape

Tell your instructor about anything that puzzles you and get his answers back pronto.



BE A SUCCESS...ACT NOW!

Millions of television set owners are demanding qualified television technicians to service their sets. There is a tremendous shortage of such qualified men today and will be for many years to come. Get in on the ground floor of this booming industry and be prepared to accept a steady, big pay job for life. We can qualify you quickly, easily, surely—and help get you a job when you complete your course. Send for illustrated booklet that gives the complete details.

MAIL COUPON TODAY!

De Forest-Sanabria Corporation
Dept. PM-4
5050 Broadway, Chicago 40, Ill.

FREE BOOK TELLS HOW

Dear Sirs:

Please send me copy of your free illustrated booklet which describes the new TRANSPONDENCE method of learning television at home under the direction of Dr. Lee De Forest and U. A. Sanabria.

Check if Veteran

NAME _____ AGE _____

ADDRESS _____

CITY _____ STATE _____

(Mail in envelope or paste on a postcard)

The De Forest-Sanabria Corp.

An affiliate of American Television, Inc.

5050 North Broadway, Chicago 40, Illinois

**\$15⁹⁵ BUYS THE
ELECTRIC SHAYER
THAT CONVINCED BARBERS**



**Whisker®
COSTS LESS YET DOES MORE!**

Take the word of leading barbers—*Whisker's* new thin (.002") clipper blade cuts 1 to 7 day beards (even those other shavers will not touch) clean and close. Operates quietly on 110 v., 60 cycle AC; no TV or radio interference! Fast—14,400 shaving strokes per minute! Women like *Whisker* for safely removing superfluous hair on legs and under arms. Get *Whisker* at your Barber or Dealer. **ELECTRO TOOL CORPORATION** DEPT. 521-D • RACINE, WISCONSIN

If Your Barber or Dealer Cannot Supply You
USE THIS COUPON TO ORDER

ELECTRO TOOL CORP., Dept. 521-D, Racine, Wis.
 Encl. find \$15.95 (check, m.o.).
 Encl. find \$5. Send *Whisker* C.O.D. I'll pay postman balance plus postage.

Name _____
Address _____
City _____ Zo. _____ State _____

**Prepare Now for YOUR Tomorrow
"3 TRADES IN 1 CAREER"
Engraving • WATCH REPAIRING • Jewelry**

WATCHMAKERS URGENTLY NEEDED in the trade-defense—industry. Investigate this life-long career... profitable, pleasant work, or a business of your own. Write for FREE CATALOG and information on WATCHMAKING, CHRONOGRAPHS, JEWELRY & ENGRAVING. KCSW's outstanding resident training now offered in WATCHMAKING and ENGRAVING by Home Study.
Only resident training offered under G.I. Bill.

Name _____
Address _____

KANSAS CITY SCHOOL OF WATCHMAKING
1218 Admiral Blvd. — Kansas City 6, Missouri

OIL FILTER REFILLS... 10c



Filters Oil the full length of the Pack

10,000 Sq. In. of Filtering Surface

Plates Last Indefinitely

Here's News! Ordinary toilet paper makes an ideal oil filter. Laboratory tests prove it cleans oil faster and better than popular makes of filter elements. All you need is a simple set of **RETLIF ADAPTER PLATES**... and you can start using ordinary toilet paper rolls in your present oil filter. For proof and descriptive literature, send name and address to:

RETLIF CORPORATION, Dept. 74
1239 No. Highland Ave., Los Angeles 38, Calif.

**IS \$21000 A WEEK
Worth a Penny Post Card?**

Then RUSH postcard with name and address. Get FREE details of amazing full-and-spare-time PROFITS made by ambitious men handling new Automatic Defroster for refrigerators on FREE TRIAL basis. Learn how housewives hand you big profits when you just plug in the D-Frost-O-Matic to end defrosting mess forever. Send card for Special Offer TODAY.

D-FROST-O-MATIC Dept. PM-4
6 N. Mich. Ave. Chicago, Ill.

**Learn ACCOUNTING
BOOKKEEPING**

This nationally renowned school has demand for graduates in good salary positions thru Nationwide recognition and placement service. Write Department PMW today for Big 32 page Success Book to be sent to you **FREE**

**Hills BUSINESS UNIVERSITY AND
EXTENSION SCHOOL**
619 W. MAIN ST. OKLAHOMA CITY 2, OKLAHOMA

**MAKE MORE MONEY • HAVE MORE SECURITY
BE A CAMERA REPAIRMAN**

Camera repair offers ambitious men interesting, well paying, secure careers. We teach you with practical "on the spot" training. Other courses include: Portrait, Commercial, and Natural Color Photography - retouching - air brush technique. Tools furnished with courses.

G.I. Approved • Free Job Placement • Housing accom. secured
GERMAIN WRITE FOR FREE BOOKLET PM
SCHOOL OF PHOTOGRAPHY 225 B'way, N. Y. C. 7
"The School of Personalized Instruction"

**REAL ESTATE
BE A BROKER**

PAYS BIG! SEND FOR FREE, BIG, ILLUSTRATED CATALOG NOW! No obligation. Graduates report making substantial incomes. Start and run your own business quickly. Men, women of all ages, learn easily. Course covers Sales, Property Management, Appraising, Loans, Mortgages, and related subjects. **STUDY AT HOME** or in our classrooms in big cities. Diploma awarded. G.I. approved. Nationally known.
WEAVER SCHOOL OF REAL ESTATE (Est. 1936)
15 E. Pershing Road Dept. PM Kansas City, Mo.

FREE BOOK TELLS HOW

Say You Saw It in Popular Mechanics

**A "GOOD HAND" HELPS YOU SUCCEED!
LEARN TO WRITE WELL**

Handwriting quickly improves with our easy-to-understand picture lessons! Put your spare time to good use; send today for FREE BOOK, "How to Become a Good Penman", or check volumes wanted below at \$1 each: Business Writing Artistic Writing Card Writing Bird & Design Flourishing Engraving Alphabets. COMPLETE SET \$4.50
TAMBLYN SCHOOL OF PENMANSHIP
S. A. Ziller, Pres. 442 Ridge Bldg., Kansas City, Mo., USA
Only 10c

POPULAR MECHANICS

New ARMY MINE DETECTOR

An / PRS-1 is a portable device for detecting metallic and non metallic objects. Metals, Buried Cables and sewer Tile.

Our Special Price **\$30.25**

with battery **\$19.75** without battery

By lengthening dipole rods operator will be able to increase the depth sensitivity. This unit comes complete with spare tubes, antenna dipole and reflector, and instructions manual, in wooden chest 9½" height x 28¼" length x 15½" depth. Weight in operation is only 22 lbs. LESS Batteries. Power supply: Three 45 volt and one 6 volt batteries. Uses standard batteries. Original COST \$364.00. Shipping weight appr. 80 lbs. F.O.B. New York. No C.O.D.'s. Send Order to:



COLUMBO TRADING CO., INC.

383 CANAL ST. DEPT. P.M. NEW YORK 13, N. Y.

Become a Doctor of PSYCHOLOGY

Win the degree of Ps.D. Teach the secret of contentment, happiness. Solve mental worries. Experience the revelation of truth. Chartered college. Individual help. Write for FREE book. COLLEGE OF UNIVERSAL TRUTH, 5153-B North Clark St., Chicago.

GLOWING "DANGER" MARKER **PROTECTS LIFE CAR** WHEN FORCED TO PARK AT NIGHT

MOTORISTS! Here's the greatest invention made to prevent accidents along the highways. Attaches easily and in seconds to the front and rear of car when necessary to park; for changing tires or during mechanical trouble. Made of specially treated, weather-proof cloth 6x18 inches. Folds easily, can be kept in glove compartment. This device GLOWS LIKE A FLAME when headlights approach vehicle. Tested and endorsed by auto experts. Money back guarantee within 10 days. Send Check or M.O. Sorry no C.O.D.'s. TRIAD SCREEN PROCESS, 64 Lispenard St., New York 13, N. Y.

SET OF TWO \$1.00 POST PAID

LEARN CARTOONING Get in the BIG MONEY

Former Landon students are really cleaning up. Creators of "Steve Canyon", "Freckles", "Out Our Way", "Winnie Winkle", "Regular Fellers", "The Neighbors", "Strange as it Seems" are just a few of them. Simplified Landon Picture Chart method makes progress quick, exciting, easy. Earn while learning. Rush 10c for Picture Chart (to test your ability) and full details. Please state age.

Landon School of Cartooning, 5104 CTS Bldg., Cleveland, O.

SILVER SOLDER TORCH & KIT \$6

Joins All Metals Permanently
EQUAL TO WELDING FOR MOST PURPOSES

Do your own repairing. Kit includes one tube silver solder flux and 10 5-in. lengths silver solder alloy. Hottest ALCOHOL TORCH known. 2700° F. flame. Operates in any position, indoors or out. Torch alone \$5. Kit alone \$1.50. Complete instructions included with torch and kit. Add 25c on each order towards shipping charges.

AMERICAN PRODUCTS CORP., 422 S. Dearborn St., Dept. 3-D, Chicago 5

Which of these 2 one time WEAKLINGS PAID 10c like YOU to become an All-Around HE-MAN at Home

Larry Campbell Rex Ferrus

In 10 Thrilling Minutes a Day? Which One Paid Hundreds of Dollars? Rex sent me 10c like YOU should now, to start building into a Champion All-Around HE-MAN.

Larry paid me hundreds of dollars to train at my side.

Rex was a Skinny Bag of Bones. Today he is tops in Athletics, Strength, Popularity, Business.

Send NOW for my 5 PICTURE-PACKED HE-MAN BUILDING COURSES for 10c and Photo Book of Famous Strong Men! FREE

Become an ALL-AROUND HE-MAN — Be A Winner at Anything YOU Tackle with Progressive Power — SPORTS! JOB! SCHOOL! FRIENDS!

JOWETT INSTITUTE, Dept. PM-14—230 Fifth Ave., New York 1

ENTER RADIO-TV thru This Plan—

As a young man with a career to build, you may today be interested primarily in training for Radio — and perhaps for TV. But — who knows . . . you may some day have both the desire and opportunity to climb further and become an Electrical Engineer! Here, then, is a world-renowned educational plan that permits you to use your Radio training as a major stepping-stone to an even greater career.



IN 12 MONTHS

become a

RADIO TECHNICIAN

Train here for radio shop operator or serviceman, mobile receivers and all types of transmitters, and for supervision of service personnel. You

may then advance immediately, or at any future date, into courses described below.

IN 6 ADDITIONAL MONTHS

you become a

RADIO-TELEVISION TECHNICIAN

An additional 6-months course gives you intensive TV Technician's training — under the personal guidance so necessary in this expanding field.

ALSO... your Radio course is full credit toward the B.S. degree in ELECTRICAL ENGINEERING

The Radio course, while complete in itself, is one-third of the college program (major in Electronics—minor in Electrical Power). Further — you are guided scientifically toward specialization beyond basic engineering training.

Military, practical or prior academic training evaluated for advanced credit. Preparatory courses available. Over 1500 enrolled. Terms open April, July, October, January.

MILWAUKEE

SCHOOL of ENGINEERING

Technical Institute • College of Electrical Engineering

FREE — Write for helpful "Occupational Guidance Bulletin" and 1951 Catalog.

MILWAUKEE SCHOOL OF ENGINEERING
Dept. PM-451, 1020 N. Broadway, Milwaukee, Wis.

Without obligation, rush following: 1951 Catalog; Occupational Guidance Bulletin on Electrical Service Electro Technician Electrical engineering (Power) Radio Television Electrical Engineering (Electronics) Heating Refrigeration Air Conditioning Welding.

Name..... Age.....

Address.....

City..... Zone..... State.....

Check if World War II Veteran

Modernize Your Home

Do it yourself and
SAVE 35% TO 65%

This book shows HOW



FREE 10-DAY TRIAL

Get this money-saving volume today for simplified 1-2-3 instructions that tell you how to modernize, enlarge, beautify your home from cellar to attic. Save 35% to 65% on labor costs — build additions and improvements

YOURSELF with the aid of this remarkable new, easy-to-follow guide:

"HOW TO EXPAND AND IMPROVE YOUR HOME"

Everything you need to know from start to finish, on all types of modernizing—from installing built-in cabinets or closets to enclosing a porch or finishing up an expansion attic—clearly explained in this big, practical book. 1225 LARGE, CLEAR "SEE IT—DO IT" DRAWINGS guide you in every detail, show you exactly HOW to do each job step by step.

Shows you how to increase closet capacity, build glass block partitions, build bunk beds, install new kitchen cabinets, add or enclose a porch, install extra bathroom, add dormers, divide rooms to gain space—and much more! **SAVE HIGH LABOR COSTS** with the "know how" this book gives you.

FREE 10-Day Trial Send no money. Just rush coupon below NOW to get your copy for 10 days FREE. If not completely satisfied, return it in ten days and owe nothing. Mail coupon NOW for free-trial copy.

SIMMONS-BOARDMAN PUBLISHING CORP.
Dept. PM-451, 30 Church St., New York 7, N.Y.

Send me, for 10 DAYS' FREE EXAMINATION, a copy of the big, new practical book, "HOW TO EXPAND AND IMPROVE YOUR HOME." I will either return it in ten days and owe nothing, or keep it and send \$1.95 at the end of ten days and then only \$2 a month until the low price of only \$5.95, plus postage, is paid.

Name _____

Address _____

A FASCINATING, MONEY-MAKING
art career
can be yours

AMERICA'S 12 MOST FAMOUS
ARTISTS SHOW YOU HOW!



Write Today
FAMOUS ARTISTS COURSE

Dept. 6-R, Westport, Conn.

FREE Send book about your home study art course.

Name _____ Age _____

Street _____

City, State, Zone Number _____



WRITTEN GUARANTEE SENT WITH EVERY TIRE YOU BUY

PLEASE NOTE: Our Tires are NOT Retreaded or Re-Capped We Serve TRUCKS—BUSES — PASSENGER CARS

GOOD USED TIRES

WE PERSONALLY SELECT YOUR TIRES A TRIAL OF ONE TIRE WILL CONVINCE YOU.

ONE QUALITY ONE PRICE Please Send This Ad

Why Pay More!

TUBE GIVEN WITH EACH PASSENGER TIRE AT NO EXTRA COST — SEND THIS AD!

600-16 \$5.32	670-15 \$5.92	710-15 \$6.22	760-16 \$6.22
650-15 5.72	700-15 6.32	750-16 6.72	820-15 6.22
650-16 5.72	700-16 5.72	760-15 6.22	550-17 5.72



600-20 \$9.72	32x6(8) \$10.22	1000-20 \$17.22
650-20 9.72	32x6(10) 11.72	1100-20 17.22
700-20(8) 10.72	825-20 16.22	1000-22 15.22
750-20(8) 12.22	900-20 16.22	1100-22 17.22

Thousands of tires shipped all over U.S.A. All tires shipped F.O.B. Phila. Send Check or M.O. with this ad. Dept. 2. If your size is not listed write for prices. 17 YEARS AT THIS ADDRESS.

STANDARD 834 N. Broad St., Philadelphia 30, Pa.

ACCURATE

Most POWERFUL patented air pistol made. Looks and feels like Luger. For Cal. .177 or .22. Game HUNTING, indoor or outdoor TARGET shooting. At your dealer, or write Dept. PA-4

NO PUMPING
HY-SCORE
AIR PISTOL



HY-SCORE ARMS CORP., 25 Lafayette St. Brooklyn 1, N. Y.

Bricklaying • Carpentry • Tilesetting
Plastering • Electricity • Welding

APPROVED FOR VETERAN TRAINING • FREE CATALOG

PENNSYLVANIA INSTITUTE SCHOOL OF TRADES
30th & MARKET STS. PHILA. 4, PENNA.

LAW

STUDY AT HOME for Business Success and **LARGER PERSONAL EARNINGS**. 42 years expert instructions — over 114,000 students enrolled. LL.B. Degree awarded. All text material furnished. Easy payment plan. Send for **FREE BOOK** — "Law and Executive Guidance" — NOW!

AMERICAN EXTENSION SCHOOL OF LAW
Dept. PM-37, 646 N. Michigan Ave., Chicago 11, Ill.

LEOPARD COVERS

to fit all automobiles!



• Choice of full front and rear seat covers or split front seat

• Leopard skin effect on colorful plastic

\$2.98

• Water-proof and stain proof
• Comfortable and Cool
• Easy to attach — elastic ties hold securely

Front or rear seat only \$2.98 each or **FULL SET** for \$5.00. Order now. Enclose payment or pay postman plus postal charges. Specify type A or B.

DOMAR SALES CO., Dept. SC-2

480 LEXINGTON AVE.,

NEW YORK 17, N.Y.

THORESEN NATIONALWIDE SALE

BUY DIRECT AND SAVE



Thoresen's De-Luxe
17 JEWEL PRECISION **14.98**
tax paid

Masterpiece of superb styling and workmanship! Streamlined 14 Karat Rolled Gold Plate case, stainless steel back. Gilt numerals, curved dome crystal. Genuine Lever 17 JEWEL Precision movement of amazing accuracy! Recent list price \$59.50. REDUCED for quick sales! Tax paid price—14.98—no extras!

WATER & SHOCK
Resist Case—G. I. Style! **10.95**
tax paid!

Military style! Drop it! Bang it! We guarantee it 3 years against any and all breakages—because of exclusive SWISS INSULATOR invention. 7 jewels. Luminous hands & numerals. Unbreakable crystal. Sweep-second. Heavy Chromed. Thin, smart! Marvellous accuracy. Long satisfying service. Tax paid, only 10.95
17 JEWEL Model (5 year guarantee!), tax paid 16.45

Fulcra-Matic Stop
CHRONOGRAPH **6.90**
tax paid!

Genuine Fulcra-Matic Stop Chronograph & Wrist Watch combined, gives accurate, long satisfying service. Times Races, autos, planes, Sports, etc. 10 WONDER FEATURES: Tachometer, Telometer & Stop Watch. Luminous Dial. Unbreakable Crystal. Sweep-second hand. Stainless steel expansion band. Best of all—Fulcra-Matic finger tip control! Instructions given. Tax paid, only 6.90.

Thoresen's 17 Jewel
FULL AUTOMATIC **29.88**
tax paid

De-Luxe model—fully automatic! Set it, then forget it! It winds itself as you wear it. Patented Incabloc. Anti-Magnetic. Sweep second. Luminous dial. WATER & SHOCK resistant. All stainless steel back case. 17 jewels. Near-miracle accuracy. Thin! Handsome! **5 YEAR GUARANTEE.** Formerly \$75.00. Thoresen's direct-to-you price, only **29.88**—no extras for tax. Rush! Supply limited!



2.97

Initial Men's Ring
Extra special! Genuine sterling silver with gold plate sides. Your own initial in raised gold effect flanked by 2 pseudo ZIRCONS of sparkling brilliance. Tax paid—2.97



1.98

"WEIRD" SKULL
Ruby color eyes flash "weirdly" in semi-darkness! Perfect miniature of skull & bones. Rich 14 Karat Gold Plated. It's the attention-getting ring. Our tax paid price — 1.98



3.55

"Big 5" Men's Ring
Wins distinction! Extra heavy simulation of a Solid Gold 5 Diamond Ring. Made to endure. Rich \$500.00 appearance. Imported stones of amazing brilliancy! Tax paid—3.55

FREE
10 DAY TRIAL

Price promptly refunded if not thrilled within 10 days after receiving. ALL prices tax paid—NO EXTRAS!

UNLIMITED GUARANTEE

Exclusive of Parts! Never a penny's charge for skilled labor, "handling", etc. for the lifetime of this business!

3 SYNCHRO DIAL
Precision-Made SWISS
CHRONOGRAPH

Outstanding value! Sleek, handsome, 3 Dial CHRONOGRAPH. Amazing accuracy! Ideal for hobbyists, mechanics, scientists, doctors, sportsmen, students, aviators, etc. **20 SUPER FEATURES:** 3 Synchro Dials! 30 min. register! 1/5th second calibration! Rugged shock-resistant case, sweep-second, luminous dial. Built-in tachometer & telometer. Measures speed & distance planes, autos, horses, photos, etc. without stopping movement. Formerly 39.95. Now at slashed price of 8.65, tax paid. No extras.

SEND NO MONEY — Pay price Shown, plus postage (no extras for tax) on delivery
THORESEN Direct Sales Dept. 6D-200 131 West 33rd St., NEW YORK 1, N. Y.

"BB" FIBERGLAS BOATS

One-Piece. Leak-Proof, Rot-Proof. Will Never Need Painting or Upkeep. No deterioration. Great Strength, Safe. Permanently buoyant. Nine models. Row-boats, Sailboats.



Send for free folder

BEETLE BOAT CO., INC., New Bedford 6, Mass.

stop taking abuse

Why stand being pushed around? Do you long to get back at these pests who take advantage of your size or lack of muscle. The knowledge of POLICE JIU JITSU will enable you to throw the biggest and toughest of men. It's Amazing! In a matter of seconds you can be complete master of any situation. A complete course, easy to learn in one illustrated volume. By all means—send for this valuable course today! Just pin \$1 to this ad and your copy of POLICE JIU JITSU will come to you by return mail postpaid. Your money back for any reason.

BOOKS PUBLISHING CO., 56 W. 24th St., N.Y. 10

BRAND NEW

30 DAY FREE TRIAL

High Power BINOCULARS

Finest Precision Optics
Featherlight
Money Back Guarantee
Easy Pay Plan
Leather Case Incld.
Free! Catalog & Book
"How to Select Binoculars"
Dealer Inquiries Invited
Bushnell Bldg., Dept. M-24,
Pasadena 1, Calif.

33 MODELS
\$14.95 up

BUSHNELL Binoculars

TRAVEL for "UNCLE SAM"



START as high as \$3,450 Year

Prepare NOW for Next Examinations

VETERANS GET SPECIAL PREFERENCE

Many examinations expected soon

City Mail Carriers
City Postoffice Clerks
Stenographers-Typists

Messengers,
Liquor Inspectors—
and many others.

40-Page Book on Civil Service FREE

Mail Coupon today—**SURE**

★

FRANKLIN INSTITUTE

(Not Government Controlled)

Dept. R-83
Rochester 4, N. Y.

Rush to me, entirely free of charge, 40-page book with:
(1) A full description of U.S. Government jobs; (2) A list of U.S. Government jobs; (3) Tell me how to qualify for a job.

Name.....

Address.....

City.....Age?.....

EARN MORE IN DRAFTING



More Opportunities for Employment and Promotion

"Here I am at work making good money as a draftsman. I'm glad I sent the coupon to Chicago Tech for that Free Trial Lesson and found out how easy it is to learn Drafting in spare time at home. Today I feel secure in my job because the draftsman's work comes first on any new project. And, in addition, draftsmen can't be replaced with machines. What's more, I feel I'm slated for promotion and more pay, because I see so many draftsmen advancing to high-pay jobs."

LEARN IN SPARE TIME—AT HOME! (or at the College in Chicago)

A few hours of pleasant home study every week—that's all. No interference with your present job. All the tools you need; drawing outfit included. With Chicago Tech's help, you train yourself step by step. This tested method—developed over 46 years of C.T.C. progress—prepares men quickly for good positions in industry.



FREE INFORMATION—SEND COUPON

To prove to you how easy it is to learn Drafting at home by the Chicago Tech method, we will send you this FREE TRIAL LESSON. No charge for this lesson, now or later. Fill out and mail coupon, or send post card today.

CHICAGO TECHNICAL COLLEGE

D-214 Tech Bldg., 2000 So. Michigan Ave., Chicago 16, Illinois

Mail me FREE Lesson with information about big opportunities in DRAFTING.

Name _____ Age _____
Address _____
City _____ Zone _____ State _____



ART FOR A PROFITABLE CAREER

Here's How You Can Learn at Home in Your Spare Time. BE AN ARTIST

Trained Artists Are Capable of Earning \$65, \$80, \$100 AND MORE A WEEK

COMMERCIAL ART, DESIGNING, CARTOONING—all in one complete home study course. Become your own boss. Many students earn extra money while learning by doing artwork, designing posters, lettering, etc. W.S.A. now in 37th successful year. No art experience necessary, we teach you step-by-step. TWO ART OUTFITS included with training. FREE BOOK, "Art for Pleasure & Profit"—tells about our course, instruction, what our graduates say, and commercial opportunities in Art. Low tuition—easy terms. VETERANS! Course G. I. Approved.

MAIL COUPON FOR FREE BOOK

WASHINGTON SCHOOL OF ART
Studio 124A, Washington 5, D. C.

Send me without obligation Free Book, "Art for Pleasure & Profit." No salesmen. (Please print).

Name _____ Age _____
Street _____
City _____ Zone _____ State _____

WAR SURPLUS OPTICAL BARGAINS

MAKE A MICROSCOPE Get wonderful results. Own an instrument worth many times the cost to you. Simply convert a U. S. Govt. Riflescope (Govt. cost over \$65.00). It's easy! We show you how. No machining required. Get up to 40 Power. Scope we furnish is used but good condition . . . sent complete with extra lenses and direction sheet.

Stock #959-H \$7.90 Postpaid

10 POWER SPOTTING SCOPE—A WONDERFUL BUY! Pocket-size! Complete with tripod and telescope and worth many times our price. Has prism erecting system, achromatic objective, Ramsden Eye-Piece. Lenses low reflection coated.

Stock #955-H \$14.95 Postpaid

SLIDE PROJECTOR SETS Consists of all unmounted lenses you need to make the following size projectors:

Stock #4029-H—35 mm. \$2.85 Postpaid

Stock #4038-H—2 1/4" x 2 1/4" \$3.35 Postpaid

Stock #4039-H—2 1/2" x 3 1/2" \$3.35 Postpaid

SIMPLE LENS KITS—Include plainly written, illustrated booklet showing how you can build lots of optical items. Use these lenses in photography and for dozens of other uses in experimental optics, building TELESCOPES, low power Microscopes, etc.

Stock #2-H—10 lenses \$ 1.00 Postpaid

Stock #5-H—45 lenses 5.00 Postpaid

Stock #10-H—80 lenses 10.00 Postpaid

We Have Literally Millions of War Surplus Lenses and Prisms for Sale at Bargain Prices. Numerous Types of Instruments, Too! Write for FREE CATALOG-H

EDMUND SALVAGE CO., Barrington, New Jersey

YOU CAN'T LOSE GAS! DEFIANCE Keyless-Locking Gas Tank Cap Protects against siphoning, loss or theft.



Save precious gas without nuisance of gas tank key. The Defiance Gas Tank Cap is self locking, no key is necessary, it's theft-proof too, as the cap can't be removed from car or left at station. Grids at bottom of cap prevent siphoning of gas from your tank. Speeds filling. Beautiful chrome finish, fits all cars. 10-second installation. If dealer can't supply, order direct. Money-back guarantee.

Send Post Paid (or C.O.D. plus postage) \$2.75

Defiance Mfg. Co., 1556 N. Wilcox, Los Angeles 28, Calif.



WOULD YOU \$400 PER MONTH INTEREST YOU?

EARN UP TO \$400 A MONTH raising Angora or New Zealand White Rabbits. Good markets for wool, pelts and meat. Particulars free.

WHITE'S RABBITRY, Newark 10, Ohio.



Be a DANCING Teacher

Become a certified dance instructor. Remarkable home study course trains you for professional career teaching all modern dances: Fox Trot, Waltz, Rumba, etc. Men, Women, 18 to 56, learn to be popular teachers quickly even if you've never danced before. Qualify for well paid position or open your own dance studio. Write for FREE catalog. Give age.

PRINCETON INSTITUTE OF DANCING
119 W. NORTH ST. LIMA 1, OHIO



MAKE MONEY POLISHING FLOORS . . .

You can when you have your own Floor Polishing & Maintenance Service. Write for free plans and ideas on how you can easily get started in this money-making business. Send a postcard to:

MCCANNA SUPPLY CO., 148-C East 40 Street, New York 16, N. Y.

SAY YOU SAW IT IN POPULAR MECHANICS

TRY HOME STUDY WATCHMAKING FREE Sample Lesson

Famous Sweazey System shows how to master watchmaking . . . expertly, quickly, successfully . . . right in your own home. No previous experience needed to learn one of the highest paid trades. Try it without obligation.

G. I. APPROVED RESIDENT COURSES . . . in Watchmaking, Engraving, Jewelry Repair, Diamond and Stone Setting at our modern, fully-accredited resident school. Founded 1908. Write for FREE CIRCULAR.

CHICAGO SCHOOL OF WATCHMAKING
1607 N. Milwaukee Avenue Dept. 141 Chicago 47, Ill.

Yes, More Brilliant Than a Diamond!



Amazing New Discovery

Write today for the **FREE** illustrated booklet that tells the full story of the latest miracle of science—the story of a glorious jewel discovered in the laboratories of one of the world's largest corporations. Read all about the Kenya Gem that so closely resembles a diamond that only an expert can tell the difference.

More Fire! More Brilliance!

Yes, this marvelous gem has more brilliance, more fire and a more dazzling display of color than the finest diamond of equal size. You can own an unmounted Kenya gem for only \$27 (1 carat) to \$120 (4 carats); also men's distinctive rings and ladies' fashionable rings and earrings in 14K gold Kenya gems. **EASY PAYMENT TERMS.**

set with expertly cut

The Cinderella of Science

Kenya gems are the sensational discovery you read about in Reader's Digest, Popular Science and Sat. Eve. Post, "the only thing on earth more brilliant than a diamond." It is a true gem, crystallized by science instead of nature.



Write Today or Send Coupon for **FREE** Illustrated Booklet

Copyright 1950 Kenya Gem Corp.

KENYA GEM CORPORATION, Dept. 284 Philadelphia 44, Pa.

Mail This **FREE** Coupon Today

Kenya Gem Corporation, Dept. 284, Philadelphia 44, Pa.
Please send me, without obligation, the **FREE** illustrated booklet telling all about Kenya Gems.

Name.....
Address.....
City..... State.....

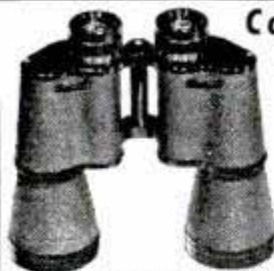

Coated! Featherweight! 16x50 \$69.50

The ultimate in a fine binocular. Tremendous power. *Featherweight* (weighs only 31 ounces!). Precision made in every detail. **COATED** providing sharper, brighter images. Individual focus. Objective lens is 50 MM (2 inches) across! **UNCONDITIONALLY GUARANTEED.** Complete satisfaction or your money refunded. Prices include genuine leather carrying case and straps. Add tax. \$2.00 deposit required on C.O.D.'s. Cash orders prepaid. **UNITED BINOCULAR CO., 9043 S. Western, Dept. IARF-2208, Chicago 20.**

LEARN TELEVISION RADIO-ELECTRONICS

Learn in your home. Then earn **BIG PAY** and **SECURITY**. Tremendous growth has made more jobs than there are trained men! **NOW** is the time to get into this **essential, NEW, RICH** field of **OPPORTUNITY**. **FREE** placement service. **SEND FOR FREE, BIG ILLUSTRATED CATALOG.**

MAIL TODAY

I want complete information on how to succeed in Television, Radio, and Electronics. This does not obligate me in any way.

NAME.....

ADDRESS.....

CITY..... STATE.....

CENTRAL RADIO & TELEVISION SCHOOLS
Dept. B-4, 1644 Wyandotte, Kansas City, Mo.

FREE BOOK

Learn WOOD PRODUCTION ENGINEERING

At Home In Your Spare Time

Veterans
You must enroll in training before July 1st to get it free under the G. I. Bill. Act Now!
NON-VETERANS
Money Back Trial Offer

Prepare now for a top pay position in the furniture and woodworking industry... with **KLOK SPECIALIZED TRAINING**. Teaches you the arts of Sketching—Drafting—Rod Making—Time Study—Cost-Production Scheduling in our Home Study Course or Resident Course at Grand Rapids. An aid to hobbyists... to the successful operation of your own shop.

from **THE ONLY SCHOOL OF ITS KIND**

FREE Booklet



WRITE TODAY—for **FREE** Booklet that gives you **ALL** the fascinating facts. State age, veteran, non-veteran, Home Study or Resident Course preference, occupation.

JOHN H. KLOK, Pres. Woodworking Industry Training Since 1928
KLOK INSTITUTE, D, Louis St. N.W., Grand Rapids 2, Mich.



RE-STRING RACKETS AT HOME—EARN MONEY

FREE

Write today for our Catalog and Instruction Sheet.

Earn Money at home in Spare time. It's pleasant, profitable work. No experience or skill required. Easy to learn. Full line of guaranteed Stringing Tools, Frames, Gut and Nylon Strings. Every item high quality.

W. A. BICKEL & CO., 803 So. Boulevard, Dept. PM-4, Oak Park, Ill.

MINUTE-DEMONSTRATION AMAZES BUSINESS AND PROFESSIONAL MEN

While other lines are standing still our men are making sales running into the hundreds of dollars. Earnings start the very first day and continue to grow with amazing rapidity. Your name and address on a post card is all that is necessary, complete information is **FREE**. Facts that can easily turn the tide of fortune in your direction.

Perpetual Profits Year Round Free Proof Write Today
I. C. A. Corp'n, Dept. P-4, 2801 Sheffield, Chicago 14



Bar Bells

Buy Direct From Factory **\$8.95** up

INDEPENDENT IRON WORKS
2416 East 23rd Street, Dept. B
Los Angeles 58, Calif.

Learn CARPENTRY BRICK LAYING

Get into the billion dollar building trades. Learn now while opportunities are greatest. Train in our completely equipped shops under expert instructors. G.I. Approved. Enroll now. Limited classes. Write for **FREE** Catalog.

MIDWEST SCHOOL OF BUILDING TRADES, Dept. PM-4
411 N. Center St. Bloomington, Ill.

NOW You Can Learn

Show Card Writing and Modern Sign Painting

Get Into These Good Pay "White Collar" Jobs. Master Authority Instruction for Beginners. Advanced Help for Experienced Men.

Start Now! Prepare with these fine big 8 1/2 x 11 inch books by E. J. Duval, the outstanding authority. Get ready for profitable employment or a spare time or full time business of your own. Books show how to get started; what materials and equipment to use; how to do profitable jobs as they are done in the leading shops of the day. Hundreds of pictures and plates of alphabets, lettering and beautiful finished jobs. Show Card Writing, \$4.00. Modern Sign Painting \$3.00. Postpaid. Sold singly or in sets. COD if you prefer. Rush order today. Money back in 5 days if not satisfied.



FREDERICK J. DRAKE & CO. Dept. 14, 117 Green Bay Road, Wilmette, Ill.

EAT ANYTHING WITH FALSE TEETH!

Corn-on-the-cob, hard candy, nuts ... you can eat them all! Simply lay soft strip of Brimms Plasti-Liner on upper, lower or partial plate. Bite and it molds perfectly. Your plate fits snugly and stays that way because Brimms Plasti-Liner hardens permanently to your plate. Even on old rubber plates get good results six months to a year or longer.



EASY TO RE-FIT OR TIGHTEN FALSE TEETH

One application gives instant relief from slipping, rocking plates that cause sore gums. You can talk without embarrassment. Forget temporary "stickums" to hold plates in. Tasteless, odorless, harmless to you and your plates. Removable according to directions. *Money back if not completely satisfied.*

SEND NO MONEY Order a \$1.25 package to reline one plate. Sent in plain wrapper. Pay postman when delivered. **Or send money and save C. O. D. charges.** Also available at leading drug stores. Sample of plate cleaner **free** if you act now.

PLASTI-LINER COMPANY, Buffalo 11, N. Y., Dept. 43-Q

Brimms PLASTI-LINER
The Permanent Denture Reliner

HIGH POWER TELESCOPES



40 Power—opens to 36 inches. Precision & Polished Lenses. Ideal for Studying Stars, Plane Spotting or Interesting Pleasures. Satisfaction Guaranteed or Money Refunded.

Send Check or Money Order to
CRITERION CO., DEPT. PM7 \$3.45
438 ASYLUM ST. HARTFORD 3, CONN. Postpaid

SAVE YOUR LIFE!

Cutter Snake-Bite Kit. Be prepared for emergencies with a Cutter Suction Snake-Bite Kit. Easy to carry—light, small as pocket knife. Contains 3 rubber suction cups, antiseptic, knife blade, lymph constrictor, first aid instructions. Suction treatment only first aid method medically approved. Also used for insect bites. **Sold in drug and sporting goods stores.** If not available, send \$2.00 cash, check, M.O. (no C.O.D.'s) to: Cutter Laboratories, Berkeley, California, Dept. Q-6.



BE A CRIMINOLOGIST

WORK HOME or TRAVEL. Experience unnecessary.
CRIMINOLOGY Particulars FREE. Write to
GEO. C. R. WAGNER, 125 W. 86th St., N. Y.

Improved Americanized

JUDO

"THE BIGGER THEY ARE—
THE HARDER THEY FALL!"

Two Big Books Clearly Illustrated. Over 1200 Show-How Photos. Many New Holds! 71 Complete Lessons.

Protect yourself and others. Size and strength mean nothing. Knowledge and skill enable you to master any situation even against biggest bullies and armed thugs. Illustrations showing each hold from start to finish. Complete satisfaction guaranteed or your money refunded.

NOW BOTH BOOKS ONLY \$5.00 pp'd.
or \$3.50 ea. \$1.00 deposit with C.O.D.'s.

No C.O.D.'s outside U.S.A.

IMPROVED JUDO, INC. Dept. PM-4, P.O. Box 7355,
Sta. 1, Los Angeles, Calif.



**10 DAY
FREE
TRIAL!**

**NOW
FOR THE
FIRST
TIME**

AUTO Repair Kinks

by
Bill Toboldt

Editor Motor
Service
Magazine

Only
\$3.00

Postaid to your
Home

Combined Experience and
KNOW HOW
of World's BEST
AUTO MECHANICS



ZIP THRU Auto Repair Jobs

Bill Toboldt's **AUTO REPAIR KINKS**, the entirely new and different guide to "doctoring up" ailing autos, describes hundreds of out-of-the-ordinary but practical time and money-saving repair kinks that have helped auto mechanics out of tough spots ... tells How to Step Up Speed, Power; Save Fuel, Cure High Oil Consumption, Trouble Shoot Engine Knocks, Service Cooling Systems ... brings you the combined experience and **KNOW HOW** of World's Best Auto Mechanics. Also, complete Mechanical and Tune-Up Specifications 1938-1950 models on: Buick, Chrysler, Dodge, Hudson, Mercury, Packard, Studebaker, Cadillac, Crosley, Ford, Kaiser, Nash, Plymouth, Willys, Chevrolet, DeSoto, Frazer, Lincoln, Olds, Pontiac. Only \$3.00.

SEND NO MONEY - MAIL COUPON



Goodheart-Willcox Co., Dept. 157
1321 S. Michigan Ave., Chicago 5, Ill.

Send at once books checked below. I agree to remit price indicated plus 25c per book postage and handling, or return books within 7 days and owe nothing.

Check here if you remit with order and save postage and handling charges. If books are returned within 7 days we will refund full purchase price.

Check
Titles
Wanted

Examine
Books In
Your Own
Home
Without
Obligation

- AUTO REPAIR KINKS**.....\$3.00
- AUTOMATIC TRANSMISSIONS Simplified**
(Covers all types including new Fordomatic and Merc-O-Matic.) 4.00
- DYKE'S Auto Encyclopedia (new 22nd edition)** 7.50
- AUTO Body & Fender Repairs**..... 3.50
- DYKE'S Carburetor Book**..... 3.50
- AUTOMOTIVE Service Management**..... 5.00
- MODERN Electric & Gas Refrigeration**..... 5.00
- MODERN Welding Practice**..... 4.00
- HOUSE WIRING**..... 3.00
- D. C. POWER WIRING**..... 4.00
- PLUMBING & Pipe Fitting**..... 2.50
- SHEET Metal Layout**..... 3.50
- STORAGE Battery Simplified**..... 3.00
- BAILEY'S Handbook for Engineers-Firemen**.. 2.00

Name _____ (Please Print)

Street _____

City _____ State _____

Employed By _____

WEATHER-PROOF YOUR CAR...

LIKE THE NEW

NASH • FORD • HUDSON • CHRYSLER



Go Thru Rain, Snow, Puddles Protected by the ORIGINAL Ignition Weather-Proofing Line! **SEALTIGHT IGNITION INSULATORS**

Seal Out All Weather from your ignition system **SHORT-PROOFS YOUR CAR**

The most needed protection on your car. At last—manufacturers, too, are recognizing the need for Sealtight Ignition Insulators, which WEATHER-PROOF and SHORT-PROOF the spark plugs, distributor, magneto and coil. Now Sealtights—the first Weather-Proofing Insulators—are original equipment on many new cars. You can weather proof your own car like the new Ford, Nash, Hudson, Chrysler, Pontiac, etc.—in minutes. Why call a tow car or be stalled in rain, snow, sleet, when Sealtights can keep you going thru any weather?

ASK YOUR DEALER or Write Us for Information, Giving Make and Model of Car.

Full Directions for Installation with Each Set

SEALTIGHT CORP.

Dept. PM-451

Cedar Rapids, Iowa

Secrets of VENTRILOQUISM Now Revealed!



Easy to learn in 60 to 90 days with our Home Study Course. **RESULTS GUARANTEED.** Make Money! Be Popular! Have Fun! Big Opportunity! Radio, Television, Stage Appearances! For FREE information regarding price and terms WRITE. You must state your age. Dummy Catalog 25c. **FRED MAHER SCHOOL OF VENTRILOQUISM** Kensington Sta., Box 36, Studio D, Detroit 24, Michigan

Play Piano with BOTH Hands the FIRST Day—or Don't Pay!

AMAZING, NEW, PATENTED SELF-TEACHING DEVICE GIVES "SECRET"

You, too, can play piano with BOTH hands, at once! Thousands have learned to play this fast, easy A-B-C way. With the amazing invention, the **AUTOMATIC CHORD SELECTOR**, there's nothing to it. This is no trick method. You actually read and play any sheet music. And, the Patented **AUTOMATIC CHORD SELECTOR** guides your fingers every note of the way. No scales, no exercise, no boring practice. You play the minute you sit at the piano. In no time at all you're playing Hit Parade numbers, or hymns, or beautiful old ballads... or all three! Send for this marvelous Dean Ross Piano Course today. Consists of 30 illustrated lessons, 40 songs with words and music, special Dean Ross play-along arrangements, and the Patented **AUTOMATIC CHORD SELECTOR**. Only \$1.98 complete. You have nothing to lose and popularity and fun to gain, so mail the 10-Day FREE-TRIAL coupon now!



Send for this marvelous Dean Ross Piano Course today. Consists of 30 illustrated lessons, 40 songs with words and music, special Dean Ross play-along arrangements, and the Patented **AUTOMATIC CHORD SELECTOR**. Only \$1.98 complete. You have nothing to lose and popularity and fun to gain, so mail the 10-Day FREE-TRIAL coupon now!

Dean Ross Piano Studios, Inc., Dept. A-6104 45 West 45th St., New York 19, N. Y.

Send Piano Course of 30 lessons, 40 songs, and Patented Automatic Chord Selector. On delivery will pay postman just \$1.98 plus postage. If not delighted, may return Course in 10 days for purchase price refund. The Automatic Chord Selector is mine to keep.

☐ **SAVE MONEY!** Send payment, we pay postage. Same guarantee.

Name _____

Address _____

WAR SURPLUS BARGAINS!

STARK'S

WAR SURPLUS BARGAINS

\$500,000.00 INVENTORY for QUICK LIQUIDATION

Surplus items—hundreds of them for home, shop, factory, farm and outdoor use. New items, used items, reconditioned items—all at tremendous savings—all priced for quick sale.

Page After Page of Values

This big catalog shows page after page of amazing money saving values. Write for your copy today. Send 10c to cover postage, mailing, etc. Write today!

SEND TODAY FOR YOUR COPY

10c

STARK'S Dept. 509 So. STATE STREET PM-4 CHICAGO 5, ILLINOIS

10 SHELF PLANS

ACTUAL SIZE, easily built, beautiful wall shelf plans, ready to trace on lumber for cutting out. Corner and wall racks with 1 to 3 shelves. Stores charge as high as \$75.00 for these shelves. Make money selling them. PLUS BONUS of 48 other novel cutouts, Dutch Boys, Girls, Toys, etc. PLUS FREE HOBBY BOOK. Send only \$1.00 to

JACKSON STUDIO

104 Poplar Street Oostburg, Wisconsin

\$1.00

HOT RUNNING WATER!

Attaches easily, quickly to any standard faucet. Regulates temperature by turning faucet. Operates AC or DC. Comes with 8-ft. rubber cable and plug. Our DELUX heater has delighted many thousands of users. Send \$3.95 cash, check, or M.O.—we will ship prepaid or, if you wish, we will ship C.O.D.—you pay postman \$3.95 plus few cents postage. Order 3 for \$10—save \$1.85.

METROPOLITAN ELECTRONICS CO.

Dept. 317, 106 Fifth Ave., New York 11, N. Y.

CASH-IN ON YOUR IDEAS

Reputable manufacturers look to us for new inventions, patented, unpatented ideas. Get the "Inventor's Guide." Gives step by step helpful instructions, how to develop, protect, make money from inventions. Send 50c. Free list of needed products, record of invention form.

INVENTORS CREATIVE SERVICE, Dept. PM, 326 W. 3rd St., L.A., Calif.

Find HIDDEN TREASURES

GEIGER COUNTERS for Uranium Detection. (see at left). **TREASURE DETECTORS** for gold, silver, etc. Lightweight, ultra sensitive. None finer at ANY PRICE. Information FREE.

Detectron co.

5631 Cahuenga, No. Hollywood, Calif.

RADIO

ENGINEERING. Broadcasting, Television, FM, Servicing, Electronics, Aviation, Marine & Police Radio taught thoroughly. Engineering course equivalent to 3 years' college radio work. Approved Veteran Training. Catalog free.

VALPARAISO TECHNICAL INSTITUTE, Dept. D, Valparaiso, Ind.

\$600 BUILDS 4 ROOMS & BATH!

WHY PAY RENT?

For Six Hundred dollars and 30 days of your spare time you can build yourself this Beautiful Home.

Living room 10x15, Front bedroom 9x10, Back bedroom 10x11, Kitchen 8x10, Bath 5x7, Hall 3x4, Wind out steel Casement windows, Concrete block, stuccoed. \$1.00 brings you Step-by-Step Instructions, Blueprint & Material List.

MERIDIAN—Dept. HM-2
Box 771, Columbus 16, Ohio

Learn PHOTOGRAPHY at Home

Splendid opportunities. Prepare in spare time. Practical basic training. Long-established school. Send for free book, "Opportunities in Photography." No obligation.

AMERICAN SCHOOL OF PHOTOGRAPHY

835 DIVERSEY PARKWAY Dept. 1354 CHICAGO 14, ILL.

Relax in **Nappers!**
ALL-NYLON, ALL-SEASON
SLIPPER SOX by
Holeproof

Restful after a day on your feet; perfect for lounging or working around the house. Wonderful year-round loafers, completely washable and shrink-proof. Sizes and colors for the whole family.

At stores everywhere.

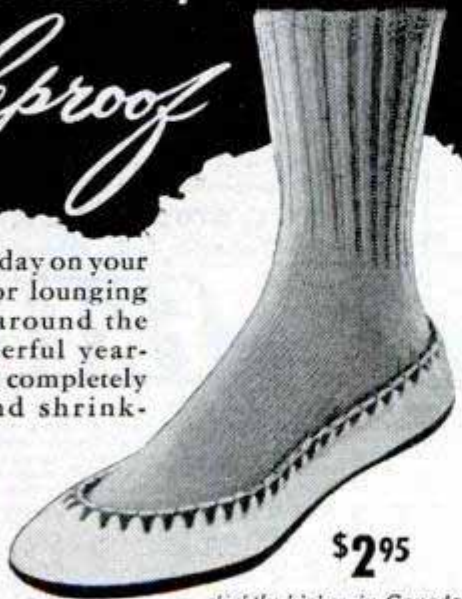

\$2.95

slightly higher in Canada

HOLEPROOF

© HOLEPROOF HOSIERY COMPANY
 Milwaukee 1, Wisconsin • In Canada: London, Ontario

World-Famous Men's Socks • Luxite Lingerie
 Women's Proportioned Hosiery

Pat. 161.097

BLOOD PRESSURE GAUGE



for HOME USE.....
 Keep check on yourself! Prevent strokes, kidney damage, etc. Manual has full details on what is prescribed in 95% of ALL high blood pressure cases. You get a Blood Pressure Gauge, Arm Bandage, Sleeve, 2 Valve Bulb, Base, Stethoscope and 25 Grams of MERCURY. Easy to operate. Complete outfit sent prepaid for \$5.98 or simply send name and address and pay \$5.98 plus C.O.D. and postal charges on arrival.

\$5.98

JOY SPECIALTY COMPANY
 Scientific Instrument Department
 2320-A W. Hubbard St. Chicago 12, Ill.
Additional information upon request

BE A TILE SETTER

SIMPLE, EASY TO LEARN AT HOME! Very high pay. Great and growing demand. Light, interesting work. Even as a side line you may earn \$75.00 or more a week. Send for details TODAY!

AMERICAN INSTITUTE OF TILE SETTING
 PO Box 1845 Wilshire-LaBrea Station, Dept. PM4, Los Angeles 36, Calif.

Earn up to \$6,000 a year!

MORE JOBS THAN WE CAN FILL METAL TRADES BACKBONE OF INDUSTRY

Men who are mechanically inclined have a wide open field to choose employment in the Metal Trades Industry. Jobs are going begging for lack of qualified trained men. You need no previous experience to start your training at this school.

SHORT COURSES TO MEET PRESENT JOB DEMAND.

INDICATE YOUR PREFERENCE—RESIDENT or HOME STUDY TRAINING

ALLIED SCHOOL OF MECHANICAL TRADES, Inc.
 1338-1340-1342 S. MICHIGAN AVENUE
 404 ALLIED BUILDING, CHICAGO 5, ILL. Write for FREE BOOKS
 A 1c Postcard will do.

Now! Get HIGHER PAY This Way—
Learn
MACHINE SHOP METHODS

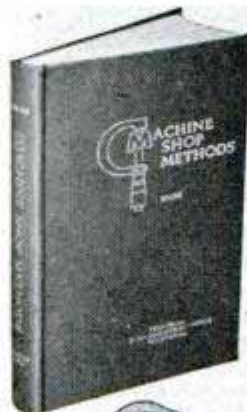

376-page reference book and reading course sent to you on FREE TRIAL for ten days.

For big-pay job as machinist, get this sure-fire working knowledge NOW. American industry demands thousands more machinists for today's huge production output. Opportunities in every town for men who are handy with tools, like to work with machines, and able to figure. Get expert "know how" from 376-page reference book and reading course, "MACHINE SHOP METHODS." Tells you, step by step, how each tool is used and how to do machine shop work efficiently. 432 SPECIAL DRAWINGS show clear details every tool, every operation. Easy-to-read text explains each machining problem in clear, simple language. Examine FREE for ten days—you take no risk. Just mail coupon.

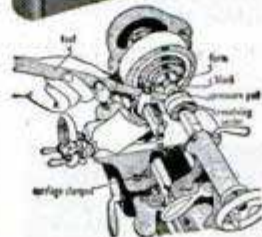

Every Basic Machine Shop Operation Explained and Illustrated

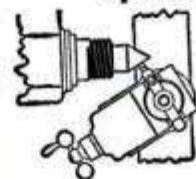

You get full information on how to operate lathe, shaper, planer, miller, drill press, tool grinder. How to use accessories such as chucks, adapters, boring bars, threading gage, twist drills, calipers, lubricants, coolants, etc. How to work from drawings and specifications. How to use gage blocks, sine bar, center gages, calipers, verniers, micrometers, etc.



You get expert guidance on details of turning work between centers; work supported by headstock; outside machining such as taper turning, knurling, and parting; inside machining such as drilling, reaming, boring, counter-boring, countersinking, slotting, broaching, and tapping. Also explains threads and thread cutting, gears and gear cutting, how to achieve accuracy in machining, how to assemble machine parts, how to process and finish metals.

NO PREVIOUS KNOWLEDGE OF SHOP TECHNIQUES REQUIRED. This remarkable volume takes you step by step from elementary beginnings of shop practice through every detail you need to know to work each type of machine and perform each machining operation properly.

EXAMINE BOOK 10 DAYS FREE

Send no money. Just mail coupon to get "MACHINE SHOP METHODS" for FREE ten-day trial. If you keep it, pay only \$1.00 down and then only \$2 a month until special low price of only \$5, plus few cents postage is paid. Or return book in ten days, owe nothing.

MAIL THIS COUPON NOW

PRENTICE-HALL, Inc., Dept. M-PM-451
 70 Fifth Avenue, New York 11, N. Y.

Send me, for 10 DAYS FREE TRIAL, a copy of "MACHINE SHOP METHODS." I will return it in ten days and pay nothing—or keep it and send only \$1.00 down (plus postage) and \$2 monthly for 2 months.

Name _____

Address _____

City _____ Zone _____ State _____

SAVE! Send \$5 WITH THIS COUPON, and we will pay postage and packing. Same return privilege. Money-back guarantee.

OWN A PFLUEGER REEL



Enjoy Fishing at Its Best

You'll get an entirely new appreciation of fishing with a Pflueger Reel. You'll cast better—hook strikes surer—have more fun. Pflueger's fine construction makes any angler more skillful. You can never wear out a Pflueger Reel—its quality guarantee never expires. Ask your Dealer.

PFLUEGER SUPREME
\$35.00



THE ENTERPRISE MFG. CO.
Akron, Ohio
87 Years Making Fine Fishing Tackle

Bait Casting and Trolling Reels \$5.75 to \$35.00
Salt Water Reels \$9.00 to \$31.50
Fly Rod Reels \$1.95 to \$13.50

PFLUEGER
(Pronounced FLEW-GER)

A GREAT NAME IN TACKLE

Smooth Sailing with Old Town



ALL HANDS from new sailor to old salt will take to Old Town's swift-paced lapstrake sailboat. She's 13½ feet long, with 90 square feet of sail. An ample beam assures stability. Built by Down-Easters, easy to handle. Solid deck, full-length decking. Inexpensive upkeep.

FREE CATALOG gives the facts on the sturdy lapstrake sailboat. Also shows canoes, outboard boats, dinghies, rowboats.

OLD TOWN BOATS

Old Town Canoe Co., 744 Elm St., Old Town, Maine

PLEASE SEND ME FREE CATALOG

Name _____

Address _____

City _____ State _____

KRAK Seal

BEFORE

FINISHED

THE EASY INEXPENSIVE WAY

KRAK SEAL a thin white, smooth surfaced gummed cloth tape. Merely wet with water and apply, seals and insulates cracks, over which paint or paper can then be applied. We have been supplying huge quantities of crack sealing tapes for seventeen years. KRAK SEAL is our new and improved product. 2" wide—50 ft. roll \$.80—100 ft. roll 2" wide \$1.58 POSTAGE PREPAID. Leaflet showing latest and best methods of treating cracks enclosed with shipment. Order today.

Dealers—write for nearest jobber.

W. L. STOCKWELL & CO.

808 W. Washington Blvd., Chicago 7, Illinois

KRAK Seal



FREE TO HOME PLANNERS

Our color folder showing 5 popular home designs sent **FREE** to demonstrate our **MONEY SAVINGS** home planning service. Over 1,250 Tested Designs of homes already built shown in beautiful illustrated books. Floor Plan shown with each design. Blue Prints, material lists, specifications available at **LOW COST**. Mail request today or order new 1951 Plan Books below.

1 TO 4 BEDROOMS — ALL TYPES CONSTRUCTION

America's Best Home Plans.....	50c	} ALL Books POSTPAID Order 2 or more and get "Little Red Book" of 29 designs at nothing extra.
125 Designs, many in color.....	50c	
Ranch and Suburban.....	50c	
158 Designs, many moderate cost.....	50c	
All American Homes.....	50c	
120 Designs, varied types, sizes.....	\$1.00	
Our Future Home.....		
149 Designs, all sizes, styles.....		

L. F. GARLINGHOUSE CO., INC., Box PM-10 TOPEKA, KANSAS

CHAPMAN CHINCHILLAS

The originator of the first Chinchilla Farm in the United States. For information on purchasing the finest, selected breeding stock of these aristocratic animals that were virtually trapped to extinction write or visit—

Established 1919 **Chapman Chinchilla Farm**
"P. O. BOX 221" 4957 West 104th Street
Inglewood, California

ENGINEERING DEGREE IN 27 MONTHS

INDIANA TECHNICAL COLLEGE

B. S. DEGREE. Aeronautical, Chemical, Civil, Electrical, Mechanical and Radio Engineering (inc. television). Drafting, 1-yr. Gov't approved for G.I.'s. Low rate. Earn board. Large industrial center. Students from 48 states, 21 countries. Demand for graduates. Enter June, Sept., Dec., March. Write for catalog. 1641 E. Washington Blvd., Fort Wayne 2, Indiana.

Say You Saw It in Popular Mechanics

Auto Spark Intensifier Gets ROCKET Performance



✓ MORE POWER ✓ MORE SPEED
✓ BETTER MILEAGE ✓ QUICKER STARTING

The **ELECTRONIC SPARK INTENSIFIER** is an efficient, scientifically developed automotive device which can be easily installed in the center hole of the distributor cap of all autos, trucks and tractors in sixty seconds. By boosting the high voltage current passing through the distributor, it gives a "hotter spark" permitting a wider spark gap . . . thus reducing "misfiring", ring and cylinder wear and allowing all-around better performance. **FREE TRIAL**, send \$2.00 cash, check or money order . . . if not fully satisfied after 10 day trial, return for immediate refund.

ELECTRONIC DEVELOPMENT CO. DEPT. PM-4
LOS ANGELES 34, CALIF.

WHICH MUSICAL INSTRUMENT DO YOU WANT TO PLAY?

Thousands have learned their favorite instrument this quick, easy, money-saving way!

You, too, can be playing *your* favorite instrument in a few short weeks. With this easy, no-teacher, Print-and-Picture way *you learn to play by playing* . . . real tunes from real notes. No tiresome exercises. You start right off with simple melodies. Gradually you take up more advanced numbers. And soon you're thrilled to find you can play almost any piece on sight.

Best of all, it costs only a few cents a day. If you are really anxious to learn to play quickly and easily . . . to be able to entertain your friends and yourself . . . mail the coupon below for our FREE 36-page Booklet and Print-and-Picture Sample today. Check your favorite instrument. U. S. School of Music, 74 Brunswick Bldg., New York 10, N. Y.

*Pupils' names on request.

With Orchestra in 3 Months

"Three months after I began this course I started playing with an orchestra. Now I have a band of my own."
"B.M., Barnwell, Alberta, Canada"

Like a Teacher Beside Me

"The course is clear and easy to understand. It seems like there's a teacher right beside me."
"M.B., Phila., Pa."

FREE PRINT AND PICTURE SAMPLE

U. S. School of Music, 74 Brunswick Bldg., New York 10, N. Y. Please send me Free Booklet and Print and Picture Sample. I would like to play instrument checked below.

Piano	Saxophone	Modern Elementary
Guitar	Trumpet, Cornet	Harmony
Hawaiian Guitar	Pipe, Reed Organ	Mandolin
Violin	Teng, Banjo	Practical Finger
Piano Accordion	Clarinet	Control

Name _____ Have You Instrument? _____

Address _____

City _____ State _____

Save 2c—Stick Coupon on Penny Postcard



Bass
WEEJUNS
... for leisurely comfort

Bass
QUAIL HUNTERS
... for field and stream

Bass
SKI BOOTS
... for extra control

Bass
SPORTCASINS
... for better golf
G. H. BASS & CO.
60 Main Street
Wilton, Maine

LEARN MEAT CUTTING AT NATIONAL Pay After Graduation



The steady dependable trade of Meat Cutting taught easily in 8 short weeks. **YOU LEARN BY DOING** under actual meat market conditions in big modern school at Toledo.

For beginners or men with experience. Get a profitable store of your own. Remember, **PEOPLE MUST EAT!** Big pay jobs. Free employment help. Thousands of successful graduates.

Buying, cutting, percentage, pricing, advertising, selling, etc. A complete retail meat education. National School established over 25 years. Get National training **NOW**. Pay your tuition in easy weekly payments

after you graduate. G. I. approved. Send coupon for **FREE 52 page school catalog — TODAY.**

National School of Meat Cutting, Inc., Dept. 50-R, Toledo 4, Ohio

Send me your **FREE** school catalog on National Training at Toledo in Meat Cutting, Meat Merchandising and Self Service Meats. No obligation. No salesman will call.

Name _____

Address _____

City _____ State _____

() Check here if Veteran of World War II



AUTO BOOKS ON APPROVAL

SEND NO MONEY. Just mail the coupon for a complete set of 4 Big, Thick Auto Books. 20th Edition. Over 2700 Pages! Whether you are a mechanic or helper, expert or apprentice, auto owner or driver, take immediate advantage of this FREE EXAMINATION OFFER.

MAKE GOOD MONEY NOW HOLD A PERMANENT JOB

America wants its automobiles kept in good repair. Men with "know how" are in demand, at big pay. These books will help you get and hold an important job, or give you a chance to go into business for yourself now or later. Any man who half tries to improve himself can learn auto servicing and repairing by this quick reference method. Use the JIFFY INDEX to find easily understood answer to any auto problem. These wonder books prepared by eleven of America's great automobile engineers. Many hundreds of valuable illustrations. Send the coupon TODAY.

[A year's consulting privileges with our engineers now given with these books without extra charge.]
Publishers Since 1898

CAN YOU FIX IT?

These wonder books tell step by step HOW to make difficult repairs and adjustments, how to keep a car at maximum efficiency, including latest improvements in car design and operation. Engine troubles and how to correct them well covered.

4 BIG, THICK VOLUMES Over 2700 pages, 2000 illustrations, wiring diagrams, etc. Beautiful modernistic, washable cloth binding.

AMERICAN TECHNICAL SOCIETY, Dept. A-419
Drexel Ave. at 58th St., Chicago 37, Ill.

I would like to examine your 4-Volume Set of Auto Books. I will pay the delivery charges only, but if I choose I may return them express collect. If after 10 days' use I prefer to keep them, I will send you \$3 and pay the balance at the rate of only \$4 a month until \$24.80 has been paid. Include consulting service as offered above.

Name _____

Address _____

City _____ State _____

Please attach letter stating age, occupation, employer's name and address and name and address of at least one business man as reference. Men in service, also please give home address.

the NEW *Cushman*

EAGLE

LOTS OF "GET UP AND GO"



TOTAL OPERATING COST JUST **3/4¢ PER MILE**

Get the Cushman Eagle and go for these features: quick acceleration, cruises at 50 m.p.h.,—it's maneuverable, easy-to-ride and park, AND economical—LOW purchase price, LOW maintenance, over 75 miles per gallon. Powered by the famous Cushman "Husky" engine. The Eagle is truly a triumph in low-cost transportation. Write for free folder and prices. Dept. 8M

DEALER INQUIRIES INVITED—WRITE FOR RIDER-AGENT PLAN

CUSHMAN MOTOR WORKS, Inc
LINCOLN NEBRASKA USA

PENN YAN BOATS...



New Striptites!

All Wood—No Soaking, No Leaking!

Outboards, inboards, Cartops®, Trail-boats, canoes, sailers—all beautifully finished, masterfully built. Types for fishing, hunting, cruising. Choose from 100 models of America's Finest Small Watercraft.

Free CATALOG: 40 pages, 100 models. Write TODAY! Penn Yan Boats, Inc., 34th St., Penn Yan, N.Y.



NEW Striptites: All Wood
—No Soaking—No Leaking!

HULA DANCER • GETS BIG FISH

Small but mighty, this deadly open-water hooker is heavy enough to make long casts easier. Sinks and runs medium depth. Special "lip" gives special action—fools the wise ones. 5/8 oz. At your dealer. \$1.25 ea.



FRED ARBOGAST & Co., Inc., 2274 W. North St., Akron 3, Ohio

FREE WRITE TODAY FOR BIG FREE 1951 ARBOGAST COLOR CATALOG—FULL OF PICTURES OF CATCHES



Play GUITAR in 10 DAYS

OR GET YOUR MONEY BACK!

Let Ed Sale teach you to play with his famous diagram photo system. Book contains 53 photos, 43 diagrams, showing exactly how to place your fingers. Gives you 110 popular songs, words and music—along with complete, easy to learn instructions. Imagine your joy when you find after only two weeks you are playing beautiful music! Amaze your friends! Be the life of the party! SEND NO MONEY. Pay Postman \$1.95 Plus Postage. ED SALE, Dept. PM-4, Point Pleasant, N.J.

Reduce RADIO NOISES



SIMPLY PLUG Radio or Appliance cord

into Noise Eliminator & plug into wall socket. Enjoy reception FREE from many distracting noises. Send No Money, pay postman \$1 ea. (2 for \$1.75) plus postage or send cash & we'll mail postpaid. Try 5 days, money back if not delighted. Merit Sales, 6560 Sheridan Rd., Dept. R-30, Chicago 26, Ill.

DEPENDABLE CRAFT SUPPLIES

WRITE FOR CATALOG SINCE 1928
LEATHER CRAFT • PLASTICS • POTTERY CRAFT • BLOCK PRINTING • BELT CRAFT • TEXTILE COLORS • POWER TOOLS • WOOD BURNING • INSTRUCTION BOOKS • ETC.
DWINNELL CRAFT SHOP
Dept. PM-451—Wheeling, W. Va.



Precision Caliper

M. Z. B. MAUSER-TYPE VERNIER CALIPER

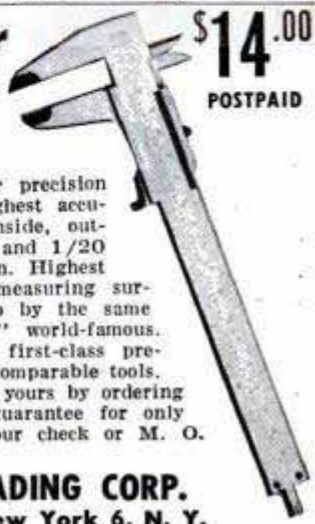

An indispensable measuring tool for precision work in any trade or workshop. Highest accuracy and dependability. Measures inside, outside, thread and depth to 1/1000" and 1/20 millimeter. 8" overall, 6" graduation. Highest quality throughout with glass-hard measuring surfaces. M.Z.B. Calipers are made up by the same men who made the old "MAUSER" world-famous. This is your opportunity to buy a first-class precision tool at about half the price of comparable tools. Shipment from stock. Be sure to get yours by ordering it now. Sold with a money back guarantee for only \$14.00 postpaid if you send us your check or M. O. You pay postage on C.O.D.

INTER-CONTINENTAL TRADING CORP.
90 West Street New York 6, N. Y.

New Car?



No, New Shocks

Don't buy a new car just to get a new car ride. Save your money and get new shock absorbers instead. It's thriftier and easier than you think to replace old, rough riding shock absorbers with new smooth riding MONROE Hydraulics.

Send 10¢ FOR INSTRUCTIONS ON HOW TO INSTALL SHOCK ABSORBERS

One thin dime brings you our A B C Manual and other valuable information on shock absorber installation and service... tells which shocks fit your car, takes you step by step over everything you need to know.

MONROE SHOCK ABSORBERS are Standard Equipment on more makes of new cars than any other brand.

MONROE AUTO EQUIPMENT COMPANY, MONROE, MICH.



PLASTICAST

THE GREATEST THING IN PLASTICS!



A NEW HOME INDUSTRY AND HOBBY!

We have started THOUSANDS of people in a wonderful new kind of occupation! Can be operated at home, garage, shop, etc. **NO SPECIAL TOOLS OR MACHINERY REQUIRED!** No special skill or experience required! Full time or part time... by the able or disabled! The work is very pleasant and easy... *actually as easy as pouring water out of a glass!* **VERY LITTLE investment required!** Really an **AMAZING** new development with **TREMENDOUS POSSIBILITIES!**

YOU CAN MAKE ANYTHING!

This new process of creating unlimited quantities of useful things without machinery is called **CASTING LIQUID PLASTICS** are used! Some as hard and transparent as **GLASS**, others like **IVORY, MARBLE, STONE, EBONY, PORCELAIN**, etc. Mix with a few drops of hardener, pour into molds and in a few minutes the liquid plastics turn into beautiful, durable, strong solid plastics suitable for every conceivable requirement for commerce, industry, hobbies, manufacturing, and now, **NATIONAL DEFENSE!** You can make **PRACTICALLY ANYTHING** with our **LIQUID PLASTICS!** Full instructions provided with all materials. Jewelry, Novelties, Giftware, Figurines, Statuary, Souvenirs, Tools, Dies, Radio and Electronic Parts, Knobs, Bookends... these are just a few of the **THOUSANDS** of **USEFUL** things that are now being made with our materials! **THE FIELD IS REALLY UNLIMITED!**

BILLIONS for DEFENSE! As you know, the government is now preparing the greatest peacetime defensive in history... **BILLIONS** of dollars are being spent to secure our peace and freedoms! Here is a grand opportunity to combine **PATRIOTISM** and **PROFIT!** Our liquid plastics are being used in countless ways in defense work! Plastic parts are now needed in vast quantities by all branches of the armed services! **WE HELP YOU GET DEFENSE WORK!**

FREE INSTRUCTIONS

From any angle, **CASTING** is a very fascinating, easy and **HIGHLY PROFITABLE** occupation. **WE ARE ANXIOUS TO PROVE IT!** send only 25c for our big catalog (No. 11) of **CASTING SUPPLIES, MOLDS**, etc. We will include **ABSOLUTELY FREE** the book, **THE ART & BUSINESS OF CASTING** that tells you how to make molds, how to cast, etc. We will also send you a **SAMPLE CASTING** to show you what **YOU** can do with our materials. Last, and most important, we will send details how to obtain **THOUSANDS OF DOLLARS OF DEFENSE WORK!** All this for only 25c... but be sure to write for it today... *this may be the lucky coin that will start the most fascinating and profitable phase of your life!*

COMPLETE CASTING OUTFIT, only \$7.50

If you want to get started at once, without delay, send for our big **INDUSTRIAL OUTFIT** consisting of 8 molds for making an interesting and practical variety of useful things such as gears, radio dials, tools and novelty items. Complete instructions teach you how to make practically **ANYTHING** in a few minutes... models, gadgets, tools, dies, ... an endless variety of hard, durable plastics. We show you how to obtain **DEFENSE ORDERS** with the samples you can make with this outfit! **INDUSTRIAL OUTFIT, complete with LIQUID PLASTIC, MOLDS, etc. No. 608. Postpaid... only \$7.50**

PLASTICAST COMPANY (Dept. D-C)

P.O. BOX 6737
Chicago 6, Ill.

(Write to either
address)

P.O. BOX 987
PALO ALTO, CALIF.

FOAM RUBBER

FOR HOBBYISTS, CRAFTSMEN, EXPERIMENTERS



Lowest Prices—SAVE 50%		AUTO SEAT TOPPER PADS	
16 x 16 x 1 1/2" ... ea.	\$1.35	24" x 60" x 1 1/2" ... ea.	\$6.45
16 x 22 x 1 1/2" ... ea.	1.75	24" x 60" x 2" ... ea.	7.95
18 x 24 x 1 1/2" ... ea.	2.00	12" x 14" x 1 1/2" ... ea.	1.25
24 x 24 x 1 1/2" ... ea.	2.95		

Use for furniture cushion fillers, mattresses, mattress pads, cushions. Foam Rubber is available in any size or thickness. Send For Free Price List. Immediate delivery. No C.O.D.'s. Add 10% for Postage & Handling to Above Prices. Please print.

RIOR RUBBER COMPANY, Dept. P-16
50 East 22nd St. Chicago 16, Ill.

Amazing Attachment MAKES OLD REFRIGERATORS INTO MODERN Automatic Defrosters!

Thirty Million Prospects. Sell without "selling pressure" on sensational Free Trial Plan. Just plug it in and leave it. Frees women from drudgery and mess of defrosting. Saves electricity. Keeps food longer, better. Gives longer life to refrigerator. Secret "follow-up" Plan often brings five additional sales by making every user your agent. Big season now on! **SENT FREE... JUST SEND NAME!**

Don't send a cent—just your name on penny postcard. We'll send you the biggest money-maker you ever got your hands on and guarantee your sales at profits as high as \$5.00 on each sale. Rush your name!

MAXILUME COMPANY, 125 West Hubbard Street, Dept. D-84, Chicago 10, Illinois

Women buying by the thousands!
Salesmen Cleaning up on "Free Trial" Sales Plan
Sent Free with Instructions.
Make as high as \$5 on Every Sale!

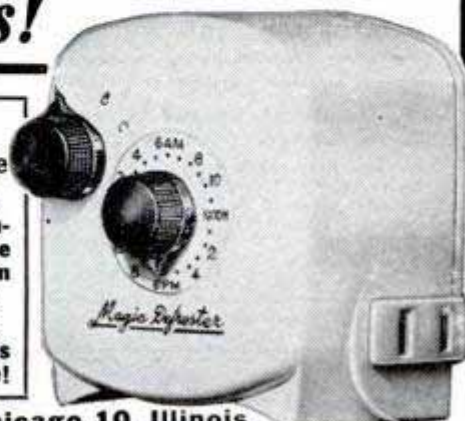

Now! YOU CAN MAKE MONEY...

TURNING WORTHLESS OBJECTS INTO VALUABLE TREASURES— ... BY CERAMIZING!

HERE ARE JUST A FEW OF THE HUNDREDS OF ARTICLES THAT CAN BE TRANSFORMED BY "CERAMIZING"—INCREASED IN VALUE—OR "ETERNALIZED" AS KEEPSAKES WITH A VARI-COLORED COATING THAT HAS THE APPEARANCE OF THE FINEST KILN FIRED CHINA



Costume Jewelry from flowers, leaves, nuts, and shells.



Paper Weights, Trays, and Objects of Art from Nature.



"Ceramized" Busts, Figures from plaster, or wood carvings.



"Ceramized" Objects of glass, leather, plastics, or rubber.



"Eternalize" baby shoes, toys, and other sentimental mementoes.



"Ceramize" Baskets, Plates, Trays, and other metal objects.



Preserve sport and war trophies in sparkling simulated china.

YES—ANY MAN OR WOMAN CAN DO WORK LIKE THIS IN ONE CORNER OF THE KITCHEN OR IN ANY SPARE ROOM!

A Satisfying New Home Art Hobby Pays Up To \$5.00 AN HOUR for SPARE TIME

Amazing book tells you how

HOW to do the work—how to get customers coming to you—how to set up the simple equipment—how and where to buy the materials—what to charge—how to start in spare time—how to expand into a full time business whenever you wish. Shows you in pictures and words how to put a hard "Ceramized" finish on such things as flowers, leaves, insects, shells, wood carvings, plaster castings, busts, statues, religious figures, buttons, baskets, feathers, base balls, golf balls, mementoes of all kinds, such as, baby shoes, party and wedding favors and decorations. Operating a home "Ceramizing" business is one of greatest insurance policies a man could ask for his future. **READ ABOUT IT WITHOUT RISKING A PENNY.**

Think of turning 56 cents worth of materials into a profit of \$5.00 for just a few minutes of easily learned handiwork. Think of beautifying your own home and amazing friends with the artistic skill you can master in less than an hour of study and practice. Sounds fantastic. Yet it's absolutely true... as you can QUICKLY PROVE to yourself.

AN EXCITING NEW OPPORTUNITY FOR PLEASURE AND PROFIT!

Just at a time when hundreds of men and women would like to make an extra \$35.00 to \$50.00 a week in spare time home work—just at a time when hundreds would like a new outlet for expressing their artistic skills—just at a time when the country is turning to a revival of appreciation of beautiful handcrafts, the fascinating new art of "Ceramizing" is ready for you. Every step of this process can be learned in less than an hour of home practice. The process is so simple that even a child can learn it. No knowledge of art or drawing is re-

quired. No knowledge of proportion or design is needed. You work with objects already created, or with the countless thousands of Nature's beautiful forms. You coat the object itself with a hard finish that has the appearance of kiln fired glazed china—and you apply a variety of colors. By following my simple instruction, you can develop a deeply satisfying creative hobby—or you can use your hobby in spare time to make as much as \$5.00 an hour. I even show you the easy way to get others to come to you for your products.

ALL THIS INFORMATION IS FREE

The information is free. A postage stamp brings you the exact plan by which hundreds are NOW MAKING EXTRA MONEY EVERY WEEK, in an artistic creative hobby. Study my plan. See examples of the beautiful work. Read the special marketing plans that bring you such big profits. If you're not "burning up" to get started, your only loss is a 3c stamp. Read the Plan at my risk.

R. E. Brandell, Warner Electric Co.
1512 Jarvis Ave., Dept. 34, Chicago 26, Ill.

Rush complete facts on the fascinating new Home Art Hobby of "Ceramizing." Show me how I can make as high as \$5.00 an hour for spare time work at home. No charge or obligation for the information you send.

Name _____

Address _____

City _____ Zone _____ State _____

NO "CATCH" TO THIS OFFER... DON'T SEND ME A PENNY... Just Your Name!



Learn about this wonder "ace in the hole" business that can supply you with a good income—even when other sources fail. Learn how you can start a business in spare time—without risking job or paycheck—that can be turned into a full time business whenever you need a new source of full time income. Learn R. E. Brandell, Warner Electric Co., 1512 Jarvis Ave., Dept. 34, Chicago 26, Ill.

this Art Hobby that can lead to personal independence—an income producer that can be operated in the corner of any room in your home—in any part of the country. Scores of men and women have already started... plenty of opportunity for hundreds more. **BUT DON'T PUT IT OFF.** Send your name and address today. It may open new horizons in your life.

**WORLD'S
BEST
WANT AD
MEDIUM**

CLASSIFIED Advertisements



Advertisements in this section 85 cents per word, each insertion, minimum 10 words, payable in advance.

To be inserted under proper classification, copy must be in our office the

20th of the second month preceding date of issue

F. W. Johnson, Manager, Classified Advertising

Popular Mechanics Magazine, 200 East Ontario Street, Chicago 11, Illinois

YOU'LL PROFIT

By reading and answering the classified ads in this section. Hundreds of opportunities for you to make and save money

AUTOMOBILES, MIDGET CARS

WIGLESWORTH-Chasteen's Automobile History Scrapbook #1 just published! Over 250 ads and illustrations of antique and vintage automobiles dating back to 1901. Money-back guarantee. \$1.50. Wiglesworth-Chasteen, 7134-PM4 Alhambra, Mission, Kansas.

47 WHIZZER Motorbike engine \$7; Briggs engine \$5; Maytag \$4. Motorette \$25, midget car \$25, less engines. Four balloon tires \$3. Mailorder only. Send 25c for new catalogue number 41, just out, listing these and hundreds of other bargains in new and used midget cars, motor-scooters, homebuilders parts, plans, transmissions, clutches, engines, war surplus, etc. (35c by first class mail). Midget Motors Directory, Athens, Ohio.

ATTENTION! Ford owners. Model "A" and "T" parts. Model A Motors, Unionville, Conn.

SPEED & Power manual! 195 illustrated pages on "souping-up" your car. \$1.75. Speed-O-Motive, Covina 6, California.

ACCELERATION—Gas mileage chart—Compares newest cars. 25c. Sonac, Box 278-F, South Norwalk, Conn.

MODERN Automatic transmissions and torque converters. Latest data on Fordomatic, Dynaflo, Hydramatic, Chrysler M-6, Powerglide, Studebaker, Ultramatic, Allison, Fuller, White. Profusely illustrated with charts, photos, drawings. Technical articles by noted SAE authorities. 80 large pages, attractive two-color cover. Postpaid \$2.00. A. Clymer, 1268 S. Alvarado, Los Angeles 6, Calif.

MOTORISTS—Save gas! Free literature on proven automatic water vapor injector, giving 25% better mileage and performance. \$5.95 postpaid. Write today! Vaporizer Company, Box 7033H Station G, Los Angeles, Calif.

OPERATE Your car on propane. \$1.00. Save up to 1/2 on motor fuel costs. Send for manual "Propane on Car, Truck or Tractor" which completely explains propane carburetion, shows how simple it is to install on any car, truck or tractor. Includes photos, drawings, catalogue of equipment and special prices. Cost of manual refunded on equipment purchase. LPG Products Co., Dept. PM-4, Kearney, Nebraska.

COLLECTORS, Mechanics, hobbyists: Non-profit organization offers literature on old and new cars; shop manuals, engineering papers, data books; free motor magazines. Contact auto nuts everywhere. Write today; get your name on free mailing list. Auto Maniacs, Inc., Stockbridge, Mich.

SEND For free sample copy. Franson's Weekly Motor News, Eugene, Oregon.

SOUPING The stock engine. Explains the 5 paths to power, covers all engines from road to track, effective speed tuning theories, tells why and how. 150 charts, photos, drawings, fuels. All new. Postpaid \$2.00. A. Clymer, 1268 S. Alvarado, Los Angeles 6, Calif.

GUARANTEED Cam shaft regrinding. Most cams \$23.50, exchange. One day service. Auto Electric Service, Box 54, Anderson, Ind.

FOR 1949-1950 Fords—Fog light that turns automatically with steering wheel

MEXICAN Road Race Book just out! Complete history 2135 mile race across Mexico. 132 stock cars. Articles by famous authorities, drivers, personalities. Rules, leg by leg description. Travelogue over Mexico's famous new highway. 152 pages, 300 photographs. Postpaid, \$2.00. Deluxe edition \$3.50. A. Clymer, 1268 S. Alvarado, Los Angeles 6, Calif.

NEW Sensational seat cover. Mono. 6545 Santa Monica Blvd., Hollywood, California.

SPORTS Cars. New "1951" MG-TD roadsters \$1975 delivered. Come to Marion by airline. Get your new M.G. Expenses paid by train or plane. Terms 1/3 down. Literature 50c. Agents wanted. Glenn Walraven Motors, "King of the British Cars," Marion, Ohio. Paone 2-4135.

OVERDRIVE Owners: Get more mileage, automatic hillholder, six speeds forward with Gane-O-Matic. Write today—free information, special discount. Ganes, Box 1160A, Santa Fe, New Mexico.

"SPEED & Mileage" manual. Famous power book shows how to build speed equipment, racers, fast conversions, California roadsters! Covers souping, speed tuning, racing tricks, fuel formulas, economy information, Indianapolis methods, customizing; all cars! 300 photographs! Drawings! Restyling plans! Complete with hot rod kit, \$1.98. Almqvist Engineering, Milford 41P, Pennsylvania.

1951 SUPERIGNITIONITER. Pep, starting, mileage. \$4.50. EG Mfg., Elmsford, N. Y.

BIGGEST Racing and hot rod catalog in world, just out! Lowest prices. Hollywood mufflers \$4.50, duals \$15.90, chrome megaphones \$1.55, dual manifolds \$9.95, racing cams \$29, heads \$23.50, water injectors \$12.95, superchargers, bargains! Free power calculator included. 25c coin or stamps. Almqvist Engineering, Milford 43P, Pennsylvania. (Dealers wanted.)

GASOLINE Economizer \$1.00, you install, state year, make. Money refunded 30 days if dissatisfied. Ribner's Products, 3108 Brighton 5th Street, Brooklyn, N. Y.

FROM Speedway to roadway! Track-proved hi-speed heads and manifolds now available for your passenger car! No special tools needed! Increase horsepower 25%! Astounding get-away! Free illustrated catalog. Speedsport, 6215P Diversey, Chicago 39.

SILENCE Overhead-valves, attachments unnecessary. \$2.00. Derderian, Box 542, Sandston, Virginia.

SMITHYS Mufflers for all automobiles. Free list. Buck's Auto Parts, Box 1296H, Merced, California.

WATER Injection. Also economy, power, methods. Free illustrated information. Neher Industries, La Verne, California.

PHOTOGRAPHS, World's finest automobiles. List, sample 25c. Box 1028, Minneapolis, Minnesota.

CALIFORNIA Custom accessory head-quarters. Buy direct from original designers and save. Chrome dash panels, push button door, trunk conversions, chrome motor accessories, lowering kits, speed-dress-up equipment. 1951 catalog, 40 pages, hundreds of photos—25c. Eastern Auto, 3319A South Grand, Los Angeles 7, Calif.

MIDGET Autos. Assemble yourself.

AUTO SUPPLIES AND EQUIPMENT

INCREASE! Gasoline mileage! Three to five miles per gallon. Guaranteed. Turb-O-Vane Vaporizer; increases power; reduces carbon. Agents wanted. Turbo-O-Vane Distributors, 1024 West Vine, Stockton, Calif.

PLYMOUTH Owners! Startling new power jet, amazing get-away! Install it yourself. \$3.00 postpaid. Future Enterprises, Inc., 129 Euclid, Grand Forks, N. D.

THREE Essential accessories for your car. Free catalogue. Trademart, Dept. 1, Box 97, Oakland Gardens Station, Flushing, N. Y.

SAY, Mr. Motorist! Having car trouble? Perhaps your car burns oil, lacks compression, starts slow. Then you need "Piston Seal"! Why? Because "Piston Seal" forms pliable, lubricating seal around pistons that is self-expanding. Result: it compensates for excessive cylinder wear! Reduces oil loss, checks piston slap, restores compression—and lasts ten thousand miles! Made in Britain; famous throughout Europe; now available here! Easy to use; absolutely safe. \$4.95 tube for 6 or 8 cylinders (to 240 cubic inches.) Details on request. Philbrick, Dept. 2, Drawer 4590, Coral Gables 34, Florida.

TAKE Advantage of the complete new range in driving with the Overdrive Selector. Automatic hillholder, full engine compression, optional free wheeling. Six selective forward speeds. Eliminates use of clutch. Now available for Ford, Mercury, Lincoln, Nash, Kaiser, Fraser, Hudson, Studebaker, Jeepster. Easily installed. When ordering specify year and make. Sent postpaid with check or money order for \$9.95. Send 25c for over 70 page illustrated catalog of auto accessories and speed equipment. Auto Accessories Co., 127Z West Washington, Los Angeles 15, California.

MOISTAIRE In dry weather. For car, truck, tractor. Economical, keep water in supply tank. Plans dollar. Eastern Sales, Ballston Spa, N. Y., Box 335.

REBUILD Your own carburetor. Complete parts-kit, instructions. Ford V-8 \$2.15; Chevrolet, Plymouth, \$2.95 postpaid. Other cars on request. Renewal, 846 Blue Island, Chicago.

"GENUINE Crosley parts." Factory rebuilt engines \$124.00 Exchange. Tires—Firestone seconds \$11.51-H.D. Tubes \$2.88. Glenn Walraven Motors, "King of the Crosleys," Marion, Ohio. Phone 2-4135.

OFFENHAUSER'S New catalog available. Send 25c. Complete line of speed equipment. Offenhauser Equipment Corp., 5054-p Alhambra Ave., Los Angeles 32, California.

VAPOJET Helps save gas, engine wear, carbon accumulation and increase power with water-alcohol vapor injection. \$9.95 postpaid. \$1 deposit c.o.d. 30 day money-back agreement. Easily installed. Free details. Agents wanted. Bantel, 757-Z Venice, Los Angeles 15.

MOTORIST Save gasoline by Vacuumating overrich mixtures. Fits all cars. For free particulars write Vacuumatic, Dept. 1740, Wauwatosa, Wis.

USED Parts hard to get? Not with us, we ship anywhere. Elgin Salvage Truck & Auto Wreckers, 751 N. State, Elgin, Ill.

NEW And used guaranteed parts for civilian and army cars and trucks. Largest stock in America. Mail orders. Pioneer Auto Wrecking Co., 734 W. 13th Ave., Denver, Colorado.

BUICK Parts—Enjoy new-car pep and power in your old Buick. Same day service from world's largest stock of new (not rebuilt) Buick parts and engines. Ship anywhere. Write today. Robertson Buick Co., 1001 S. Wabash Ave., Chicago 5, Ill.

NEW Government surplus. Low voltage circuit tester in steel box cost \$202. Our price \$27.50. Will test batteries, starters, generators, voltage regulators, grounds, short circuits. Wilt Electrical Company, 7829 S. Racine Ave., Chicago 20, Ill.

CHEVROLET Parts, Scarce motor, body, sheet metal parts. Grossman Chevrolet, Minneapolis, Minnesota.

NEW Economy, power, methods. Free information. Neher Industries, La Verne, California.

AUTO Parts and accessories. Briggs Automotive Engineering of Chicago, P.O.B. 3454 Merchandise Mart, Chicago 54, Ill.

FOR Free descriptive literature on alcohol-water injection for cars, trucks, tractors write Shade, Webster, New York.

BRUSH Plating outfits connect to a battery. No tanks or shop required. Free particulars. Gunmetal Co., Avenue J, Decatur, Illinois.

LACHAPPELLE'S 100,000 Miles motor and motor fuel treatment (patented). Makes any gasoline motor better. \$3.00 postpaid. Ferns Products, 8120 Walnut Dr., Los Angeles 1, Calif. (Data on request.)

CHAMPION, A-C, Auto-Lite spark plugs. Rebuilt. Guaranteed 10,000 miles. 25c each, 23c sets of 6. Postpaid. Wholesale discounts available. State brand, type, quantity. Philip Minor, 5707 Arnsby Place, Cincinnati 27, Ohio.

NEW—Key ring. Name and address engraved in plastic, \$3.00. Box 292, Johnson City, N. Y.

1951 EDITION! It's new! It's different! Get world's largest auto accessory and parts catalog and save money. Over 50,000 items, including Hollywood accessories, hi-speed equipment, rebuilt engines, all parts and accessories for all cars and trucks. We have that hard-to-get part! Jam packed with bargains. Completely illustrated. Send 25c (refundable). J. C. Whitney, 1919 Archer, Chicago 16.

AUTO TRAILERS

BUILD Your own trailer! Plans for all kinds. Illustrated catalog 10c. Jim Dandy, 125-M, Wausau, Wisconsin.

MOTORCYCLES, BICYCLES, MOTORSCOOTERS AND SUPPLIES

CUSHMAN, Whizzer, Salisbury, Powell, parts, accessories. Ship anywhere. Ray George, 3322 South Grand, Saint Louis 18, Missouri.

WHIZZER In Schwinn bike \$20; good motorscooter (twist grips) \$22.50; midget racer \$15; Shaw bicycle motor \$15. Send 25c (35c first class mail) for catalog #18 jammed with other sensational bargains in wheels, motors, clutches, motorscooters, midget cars, motorettes, motorbikes, etc. Gail, 538 Erie, Toledo, Ohio.

INDIAN, Harley parts and accessories handbook 15c. Bootz, 1700 East University, Des Moines 16, Iowa.

HARLEY-Davidson parts, accessories, repair manuals on all models. 24 hour service. Authorized factory dealer. Philadelphia Harley-Davidson Company, 857 North Broad Street, Philadelphia 23, Penna.

RECONDITIONED Motorcycles and motors. Chromium accessories. Complete stock Indian parts. Expert rebuilding. Fast service. Indian Motorcycle Sales, Kansas City 1, Mo.

REBUILT Gasoline engines \$9.00 to \$30.00. Cauffiel Motor Industries, Temperance, Mich.

HARLEY-Davidsons—All models and prices. Genuine late and old model supplies. Expert service. Send 25c for bulletin. Knuth's, 1753 Muskego, Milwaukee, Wis.

WHIZZER (All attachments) \$25; Cushman motorscooter, extra tires, \$20; Indian motorcycle \$30 complete; midget car \$35. Rush 25c (35c first class mail) for catalog #947 listing these and scores of other amazing bargains in motors, midget cars, motorscooters, motorbikes, motorcycles, etc. Associated, Box 1764-CS, Toledo, Ohio.

AVIATION

AIRCRAFT Manufacturers need trained men. Learn quickly at home with surplus tools. Handbook with what you need to know and where to find jobs \$1.00. Aviation Research, Box 1287, Peoria, Illinois.

PROPELLERS—For sleds, airdrive boats. Literature. Standard Aircraft, Box 387, Ft. Worth, Texas.

PROPELLERS, Plans, supplies, for ice sleds, snow sleighs, air boats. Catalog 20c. Banks-Maxwell, Box 3301E, Ft. Worth.

BATTERIES, GENERATORS

REAL Edison batteries. Long unconditional guarantee. 37 to 600 ampere sizes. Free interesting literature. Hawley Smith Co., Croton Falls 1, New York.

ELECTRICAL SUPPLIES

BE Independent, be secure, have your own profitable business—Earn \$20.00 and more a day making beautiful, fast-selling lamps at home. No equipment needed. Illustrated course teaches you quickly. Course, parts catalog, wholesale price list—only \$2. Gearon Co., Dept. 200-B4, 27 S. Desplains, Chicago 6, Ill.

LAMPS. Build own originals, parts wholesale, any amounts. Catalogue 10c. Brown Lamp Co., Box 501, Wellston, St. Louis 12, Mo.

LEARN Starter, generator, voltage regulator rebuilding. Introductory manual \$1.00. Modern Technical Manuals, Box 4704, Kansas City, Mo.

SEWING Machine motors, controls, etc. Collins, 230 Bowman, South Bend, Indiana.

MOTORS—1/100, 1/25, 1/4, 1/3 Hp. Nationally known make. All a.c. Immediate delivery. Write Mercury Electric Corporation, 719 Wyandotte, Kansas City 6, Mo.

EVERYTHING Electrical at guaranteed money saving low prices. Illustrated 100 page catalogue sent for 6c stamps. Serpersheim Sales, 1319-A Kundeck St., Jasper, Indiana.

FREE—New catalog. Bargains in welders, motors, generators, surplus equipment. Or, build your own kits—save. LeJay Company, Minneapolis, Minnesota.

ELECTRIC Pencil—Engraves all metals. \$2.95. Reb Industries, Elmhurst, Illinois.

LAMP Parts—Sockets, wire, harps, cords, bases, pipes—all parts to build and repair. 64 page catalog with charts and instructions 25c. Gyro Lamps, 5402P Clark, Chicago 40.

ELECTRIC Pencil: Engraves all metals \$1.50. Beyer Mfg., 10511-H Springfield, Chicago 43.

WELDING, SOLDERING, PLATING

WELDERS 110 Volt a.c., transformer welder in portable metal case. Push button, self activated heat controls. Welds, brazes, solders, cuts all metals. Easy to use. Simple instructions. Complete with flame weld torch, rods, flux, mask only \$28.50. Splendid for shop, farm, home repairs. 10 days trial. Also other models. Magic Welder Co., 241 MK Canal St., New York City.

BUY Direct from factory. Welding and cutting equipment. All makes of equipment repaired. Established 1913. Box 331, Hamilton, Ohio.

RADIATOR Repairing books, supplies, equipment, gasoline torch. Write. Curfman Co., Maryville, Mo.

200 AMP Welding generators. Brand new. \$25.00. Free literature. Thorndyke Mfg. Co., Pipestone, Minn.

BUILD Your own 100 ampere electroplating rectifier at a low cost. Starkweather, Ottawa, Kans.

GENERATORS, AAF types: L-3, 25 amps., 24v, \$12.95. P-1, 200 amps., 24v, \$13.95 f.o.b., no c.o.d. Aero Parts Supply, 8102 Lockheed, Houston, Texas.

MACHINERY, TOOLS, SUPPLIES

WATCH Makers lathe, gov't. surplus, complete with motor, foot pedal and chuck. Value \$225.00, like new, \$87.50. Public Sport Shops, 11 S. 16th Street, Philadelphia 2, Penna.

MACHINE Tools, industrial equipment bought, sold. Berg Machinery, St. Louis, Mo.

REFRIGERATION Parts, new and used. We sell to anyone. Write us your needs. Refrigeration Salvage Co., 1220 South

FOR Sale—Pipe wrench sharpening machine like advertised in this magazine. Edward Brand, Chambersburg, Penna.

CONCRETE Block machines. Standard sizes. \$39.50. Average 400 daily. Free catalog. Concrete Machine Company, 5129 South Compton, St. Louis 11, Mo.

FLEXIBLE Shaft tool by Fairchild for grinding, polishing, sanding, buffing, carving. Original price, \$19.95. While they last, special price \$12.95. Public Sport Shops, 11 S. 16th Street, Philadelphia 2, Penna.

AUGER Bit. Sensational new design fits all 1/4" or larger power tools. 3/8" \$1.00; 1/2" \$1.05; 5/8" \$1.10; 3/4" \$1.15; 7/8" \$1.20; 1" \$1.25. Best buy, set \$6.50. Money back guarantee. Barclay Co., Box 883, Plainfield 5, New Jersey.

ACETYLENE Welding outfits, new \$45.00; used \$25.00; arcwelders \$46.50. Eagle Welding, Dept. PM, 5085 Broadway, Chicago 40, Ill.

CIRCULAR Saw blades. Longer runs without sharpening. 8" diameter \$2.29. Satisfaction guaranteed. Van Dick, Little Falls, New Jersey.

DRILL And reamer booklet. 32 pages know how, plus time saving tap selector, plus tool catalog, all for 25c. Refunded on first order. Barclay Co., Box 883, Plainfield 5, New Jersey.

DRILL Grinder for twist drills, \$2.95. See ad on page 269.

PERFECTED Toolrak with ten interchangeable holders. \$2.00 postpaid. Davis Development Co., Box 670, Colorado Springs, Colo.

PRECISION Cast small parts, jewelry, etc., in your own shop. Be a subcontractor. Lost wax process. Free equipment price list. Southwestern Specialty Co., Box 3506, Station A, El Paso, Texas.

CHUCKS: Independent; Universal—threaded 1 1/2"-8, 1"-8, 1"-10, 1"-12, or with adapter recess. The only complete line of bench lathe chucks built to heavy duty standards. Other chucks to 16" diameter. Write for quotation; free literature. No obligation. Westcott Chuck Co., 3600 Walnut, Onelda, N. Y.

POWER Tools. Build your own with Lewis castings. Save up to 80%. Complete castings, material and blueprints supplied for 23 woodworking and metalworking tools. Illustrated brochure, 10c. Write today. Lewis Machine Tool Co., 3217 Union Pacific Avenue, Dept. M, Los Angeles 23, Calif.

ROUND Stock and pipe jaw made for jaws of any standard vise \$1.00 plus Calif. sales tax. H. A. Johnson, 3921 La Cresta Ave., Oakland 2, Calif.

BOATS, OUTBOARD MOTORS

THRIFTY, Easy-to-build boats. There are 9 new models of Roberts Kit-Craft boats. Priced as low as \$42.50, they range from 8 to 14 ft. Prams, cartops, skiffs, rowboats, sailing prams, speed hulls, runabouts. All brass fixtures. No building platform needed. See your marine dealer, or order direct. Send 10c for new illustrated catalog. Roberts Industries, Inc., 106 Main St., Durham, Connecticut.

SAVE 2/3 Cost. Assemble your own boat. We furnish parts. No experience necessary. Rowboats, cruisers. Illustrated catalog 25c. Midwest Boat Company, Menomonee Falls, Wisconsin.

OUTBOARD Motor bargains—\$35.00 up. Send for free list! Save big money! Crandall-Hicks, 911 Commonwealth, Boston, Mass.

NEW Design sailboat. 14 foot planing hull. Assemble it yourself at big saving. Free details. Leffingwell, 2436 Emerson Ave. South, St. Petersburg, Fla.

FASTEST Boats in the world—Build now. Complete plans available for sleek three point racing hydroplanes, runabout and others. Send 25c immediately for illustrated catalogue. Champion Boats, P.O. Box 9038, Dept. 22-D, Long Beach 7, Calif.

OUTBOARD Motor parts: new, used. For all makes. Save money. Outboard Motor Mart, 309 Atlantic Avenue, Boston 10, Mass.

TWENTY Plywood boat plans \$1.00. Catalog boat building plans 10c. The Rudder, 15 Murray Street, New York 7.

BOAT Kits: Outboards, inboards, hydroplanes, sail. A cinch to assemble. Minimum expense. Catalog, specifications, prices. 25c. Brooks Boat Company, Carrollton, PM, Michigan.

STEERING Wheels, windshield brackets, from \$6.95. Modern fittings, water-skis at lowest prices. Complete pre-cut plywood boats. Bargains galore. Folder

MARINE Conversions for Ford and Jeep engines. Catalog 10c. Lehman Manufacturing Company, Department D, Newark 2, New Jersey.

NEW, Used, rebuilt marine motors. Marine conversions, fittings. Free catalog. Stokes Marine Supply, Dept. 24, Coldwater, Michigan.

FULL Size, cut to shape boat patterns, blueprints, 7 1/2-38 feet. Illustrated "Build a Boat" catalog, 25c (coin). "How to Build Boats" book, \$1.00. PolyWog houseboat plans \$10. Marine catalog \$1.00. Marine Specialty Mfg. Co., 3107 Detroit Ave., Cleveland 13, Ohio.

"P38 Belly tanks," steel, \$9.95. Free picture. Bucks Auto Parts, Box 89, Merced, Calif.

BOAT Plans, patterns, kits. Rowboats, outboards, inboards, cruisers. Descriptive literature and 24 page illustrated book on boat construction 30c postpaid. Germain Boat Company, West Saginaw 3, Mich.

FORD & Jeep marine conversion kits, request catalog. Arthur Gershel, Dept. 0, 51 Chambers St., New York 7, N. Y.

ENGINES, MOTORS, DYNAMOS

MOTOR Winders, free bulletins. Winding and testing equipment. Motor Industries, Quincy, Illinois.

NEW Gas engines, 1 hp., new, \$29.00; reconditioned \$19.00 plus 280.

WINDING Data, listing 225 motors, single and three phase, \$1.00. Motor Data Co., Box 7631, Kansas City 3, Mo.

REBUILT Gasoline engines \$9.00 to \$30.00. Cauffiel Motor Industries, Temperance, Mich.

DYNAMOTOR, PS225, 14v input, 375v at 150a, 4800 r.p.m., \$6.50 postpaid. 110v, 60 cycles motor with stainless steel liquid pump, 1/40th hp., 3450 r.p.m.; total weight 12 1/2 lb., 4" x 8", app. 5 gpm, unused, \$20.00 postpaid. Aero Parts Supply, 8102 Lockheed, Houston, Texas.

ATHLETIC EQUIPMENT, BODY BUILDING COURSES

GAIN Weight! 4 exercises to increase weight. Complete \$1.00. Body Builders, 36 Nevada Street, Winthrop, Mass.

MASSIVE Proportions course quickly. Catalog \$1.00; \$15.75. Barbells, Elmsford, N. Y.

TALLER. Be one to three inches taller. A new scientific method for permanent height increase has now been developed. Free information. Natural Methods, Box 453 Briggs, Los Angeles.

BARBELLS. Exercise equipment. Courses. Free booklet. Good Barbell Co., Reading, Penna.

DEADLY Judo—Fiercest fighting technique. Trick knockouts. (Over 200 illustrated pictures.) Expert instructions; three volumes. Complete \$2.25. Variety House, Box 46-B Wall Station, New York 5.

TAXIDERMY

MODERN Taxidermist Magazine, Greenfield Center 2, N. Y. Devoted entirely to taxidermy, photos, articles, methods. Trial year's subscription, \$1.00

BINOCULARS, TELESCOPES, MICROSCOPES, MAGNIFIERS

SAVE 50% On new binoculars! Free catalog. Free book, "How to Select Binoculars." Write today! Bushnell's 43-M24 Green, Pasadena 1, California.

SAVE 50% On new binoculars! Free catalog. Free book, "How to Select Binoculars." Write today! Bushnell's 43-M25 Green, Pasadena 1, California.

AMAZING Prices brand new binoculars. Free trial. Folder, "Binocular Selecting," pricelist free. Prentiss Importers, Mercury Bldg., West Los Angeles, Calif.

POWERFUL Astronomical telescopes easily made. Perfect lenses and instructions; 100X \$3.00; 100X and 200X \$4.00; 100X, 200X and 400X \$6.00. Full power, clear vision guaranteed. Instructions alone 10c. Suffolk Science Service, Riverhead, N. Y.

TELESCOPES, Binoculars, microscopes, big bargain catalog free. Brownscope Company, 24 West 45th Street, New York.

REFLECTOR Telescope kits, refractors. Free illustrated bulletin. Rake Instrument Laboratory, 612 Adams, Hoboken, N. J.

BINOCULARS, Telescopes, watches, guns. Buy, sell, trade. Schweer's, Donnellson, Iowa.

ASTRONOMICAL Telescopes, binoculars, microscopes, bought, sold, repaired. Books, Lists 10c. Rasmussen-Reece, Amsterdam, N. Y.

GIANT Astronomical telescope with 6 ft. tripod \$15.00, f.o.b. factory. 100 power. (10,000 area magnification). Clear vision, full power guaranteed. Ready for use. Suffolk Science Service, Dept. BT, Riverhead, N. Y.

WAR Surplus bargains, binoculars, telescopes, sextants, millions of lenses, prisms, reticles, eyepieces, objectives, etc. Mail 10c for big "Catalog CH." Send \$1.00 for Stock CH—10-piece lens kit and big instruction booklet. Edmund Salvage Co., Barrington, N. J.

REFLECTING Telescopes, 60X, completely assembled \$25.00. Guaranteed observatory clearness. Free information. Skyscope, 475 Fifth Avenue, New York 17.

SPORTING GOODS, GUNS, FISHING TACKLE, ARCHERY, TRAPPING

RELOAD Your own ammunition—Save real money! 112-page booklet gives detailed "how-to-do-it" information, with complete tables of loads for all popular calibres, bullets, powders. Special chapter on reloading shotgun shells. Profusely illustrated. Regular price 75c; for limited time only, 50c stamps or coin—including free copy The American Rifleman—96-page 35c monthly magazine, exclusively about guns and shooting, \$1.10 value for only 50c. National Rifle Association, 1607-E Rhode Island Ave., Washington 6, D. C.

YOU Can make fine, beautiful fishing rods. Completely detailed, illustrated, simple instructions. Booklet \$1.00. Dreis-Davis Co., 419 Ocean Center Bldg., Long Beach 2, Calif.

DON'T Order this 22x66 inch, 3-target Zulu football dart game unless you want years of fun and entertainment. Free information. "Roy's Riot Shop," Hopewell, Virginia.

SEND 10c For list either, rifles, ammunition, shotguns, handguns, or send 25c for all lists. Frayseth's, Willmar, Minn.

ENJOY Fishing as never before! Amazing new Kel-O-Bob automatic fishing float measures water automatically. You can cast with it, reel fish all the way. No knots to clog your reel. Satisfaction guaranteed. Order today, one for 60c; two for \$1.00. Keller Laboratories, Oneida, N. Y.

AMMUNITION Immediately available for Lugers, Mausers, Mannlichers, Japs, Italian guns. Send 10c complete list 100 kinds plus imported shotguns, rifles, pistols, cameras, microscopes. Ashton Company, 1511 Gardner, Hollywood 46, Calif.

TENTS, Camping equipment, tarpaulins, etc. Also war surplus. Low prices, free catalogue. Morsan, 10-17G 50th Ave., Long Island City 1, N. Y.

NETS And seines to order. Don Cowart, Mtn. Home, Ark.

SHOTGUNS, Rifles, revolvers, 500 modern, obsolete. Also cartridges. Each list 10c coin. Ed Howe, Coopers Mills, Maine.

NEW Engineered Richardson "BluGlas" rod. At last a glass rod with the kind of action you want where you want it. Has the tip-action you need for casting of light lures and the backbone in the butt end to set the hook. Will not fade in color. Find out why the new engineered Richardson "BluGlas" will give you more rod for the money. Write for free catalog, Richardson Rod & Reel Company, 3166 North Sawyer Ave., Chicago 18, Illinois.

MEN. Boys. Fishermen. Amazing reel. Makes kite flying easy—excellent for drying or reversing fishing lines. Make it yourself. Buy no materials, 25c. Self-addressed envelope brings easy to make plans. B. Mulligan, 657 Roscoe, Chicago 13.

FISHERMEN—Make your own sinkers with our molds. Free illustrated booklet. Reading Instrument Co., Box 78, Reading, Penna.

190 PROFUSELY Illustrated pages antique and modern pistols, swords, daggers, armor, etc. 50c. Robert Abels, A860 Lexington Ave., New York 21.

5000 BARGAINS. Firearms, binoculars, war relics. Catalog 40c. Smith Firearms, Runnemed, New Jersey.

PETS—DOGS, BIRDS, RABBITS, HAMSTERS, ETC.

BOXERS, St. Bernards, Hof Kennels, 5136 Cascade Rd. S.E., Grand Rapids 6, Mich.

NATURALISTS Catalog 10c. Reptile bulletin 5c. Chameleons 45c. Turtle 45c. Salamander 45c. Hamsters \$2.75 pair. Quivira Specialties, Topeka 51, Kansas.

BEAUTIFUL Pure white pedigreed police puppies. Ansonia Kennels, Mose, N. Dak.

BEST Hamsters. Lowest prices. Pair \$3.00. Free illustrated folder. Lakeview Hamster Colony, Newfield, N. J.

GENUINE Chinchillas, high quality breeding stock for sale. For information write, Vaughn's Chinchilla Ranch, Leighton, Iowa.

GOLDEN Hamsters: Selected breeders and pet stock at reasonable prices. For your free information write: The E. K. Farm, Route 1, Box 56A, Arlington Heights, Illinois.

MAKE Big money! Raise Chinchilla rabbits. Cash markets supplied. Write today! Rockhill Ranch, Sellersville 15, Penna.

FAMOUS Angoras! Giant Chinchillas! World's most profitable rabbits. Finest pedigreed, heavy-producing, prize-winners. Catalog free. P. M. Grinsteeds, Edwardsville, Illinois.

RAISE Rabbits. I furnish stock. You pay later from profits. Send 35 cents for market information, housing, plan of furnishing starting stock. Johnson, Box 694, Kansas City 12, Mo.

SEE Gulf Hamstery ad on page 28. Shows picture of hamster.

"**TREATISE** On Breeding and Raising Canaries"—\$1.00. American Canary Magazine, 3449 North Western Ave., Dept. PM, Chicago 18, Illinois.

INCREASE Your income by raising domestic rabbits. Small space needed. Ready market for delicious meat, fur and wool. Largest magazine in the industry tells you how. \$1.50 per year. Sample 15 cents. No stamps. Small Stock Magazine, Lamoni 20, Iowa.

EARN Up to \$400 monthly raising Angora or New Zealand rabbits. Plenty markets. Particulars free. White's Rabbitry, Newark 38, Ohio.

RAISE Rabbits. Profitable business. Literature free. Tayco Rabbitry, Hapeville, Georgia.

RAISE Guinea pigs. Money makers. Booklet free. Taylors, B426A, Hapeville, Georgia.

MINK Raising information free. Complete. Lake Superior Mink Farm, Superior, E1, Wisconsin.

A Practical beginning to successful rabbit raising. 48 page illustrated booklet. Dime. American Rabbit Breeders Association. 36 AR & CBA Bldg., Pittsburgh, Penna.

PLANTS, SEEDS, NURSERY AND GARDEN SUPPLIES

GLADIOLUS. New, hardy, fragrant, delicious yellow strawberries. Robinsons, Sebastopol, Calif.

GARDENERS: Grow vitamin-packed vegetables. 1/2 usual space. Discovery of century! Details free. Midwest Farms, Box 999-T, Wichita 1, Kansas.

BIRD Bath in colors. \$5.95. Cast stone; height 25 inches; bowl 18 in. Gold, rose, blue. Mishek, Waseca 2, Minn.

GINSENG. Golden seal. Hundred seeds \$1.50; thousand \$5. Dozen plants \$1.50; hundred \$9. Growing, selling instructions included. F. M. Collins, Viola, Iowa.

FARMS, FARM LANDS, REAL ESTATE

BIG Free spring catalog! Farm and country real estate bargains, good pictures, many states, easy terms, many equipped, business opportunities. For special service, state requirements, desired location. United Farm Agency, 220-PM South State St., Chicago 4, Ill.

\$4.50 PER Acre Missouri "Ozark" land. Large, small tracts; cash, terms. N-w free list, maps. Frederick Calvert (Owner), Winter Haven, Florida.

\$4.75 PER Acre "O-ark" lands. Free list, maps. Box PM165, Cole Camp, Mo.

WEST'S 1951 Catalog—free! Farms, estates, ranches, orchards, camps, homes, businesses. East of Mississippi, Maine to Florida. West's, M-2, Pittsburgh 17, Penna.

ARMSTRONG'S Best Missouri lands, 40 acres \$200. Low terms. Lists and complete Ozark information. Write today. Armstrong, Shook 34, Missouri.

CALIFORNIA—Gov't. Lands Information Bulletin 50c. Box 23, Rosemead, California.

\$5.00 MONTHLY Buys 40 acres near town; price \$200.00; free list. Box 425-P, Carthage, Mo.

GOOD Farms — Ranches. Washington, Minnesota, Montana, Idaho, Oregon, North Dakota. Dependable crops, favorable climate. Write for literature, lists describing typical farm opportunities. Specify which state. J. W. Haw, 119 Northern Pacific Ry., St. Paul 1, Minn.

STROUT'S Spring catalog — Just out! 132 pages. Bargains galore. Coast to coast. Farms, homes, country businesses. Mailed free! Buy now and save through Strout Realty, 7 So. Dearborn St., Chicago 3, Ill.

CANADIAN Tax sale lands for two dollars an acre and up. Small monthly payments. Farms, timber, hunting and fishing camps, minerals. Limited number of properties. Write at once for free catalogue. Tax Sale Service, Room 105, 120 Bloor St. W., Toronto 5, Canada.

GOVERNMENT Lands \$2.00 acre up. Information all states twenty-five cents. National Tax Service, 901-A Majestic Bldg., Detroit.

POULTRY, FARM SUPPLIES

GEESE, Goslings, goose eggs. Safe shipment anywhere. Bulletins, magazine on breeding, hatching, rearing, marketing. Peyton Goose Farms, Route 2DM, Duluth, Minnesota.

BABY Chicks, champion mated, 52 varieties, 7 crosses, licensed, inspected, bloodtested, Rush postal, large colored book free, low prices. Berry's Farm, Route 12, Clarinda, Iowa.

POULTRY Farmers, broiler growers, turkey raisers read the new American Poultry Journal for latest ideas and greater profits. 12 months, 50c. Special offer, 4 years, \$1.00. American Poultry Journal, 565 South Clark, Chicago.

RAISE Turkeys the new way. Write for free information explaining how to make up to \$3,000 in your own backyard. Address National Turkey Institute, Dept. 3, Columbus, Kansas.

KNOW How to raise poultry for profit. Read Poultry Industry. Every issue packed with helpful hints and practical suggestions. Latest articles on breeding, feeding and management. Subscribe now. 1 year 65c. 2 years one dollar, foreign subscriptions \$1.00 a year. Poultry Industry, Dept. P.M., 376 Boylston St., Boston 16, Mass.

BABY Chicks \$10.00 per 100 c.o.d. New Hampshires, Barred Rocks, White Rocks and heavy assorted. Prices at hatchery. A. F. Hockman, R7, Bellefonte, Penna.

PROFITABLE OCCUPATIONS

TURN Your spare time into cash. Make quick-selling, highly profitable lamps — every home a prospect. No experience or special tools required. New 1951 56-page illustrated catalog shows shades, shade frames, figurines and bases, oil lamp converters, boring compounds, and dozens of similar items. Also all kinds of sockets, cords, pipes, harps, finials, bases, and hundreds of other parts — everything you need. Special 8-page section shows 6 beautiful lamps in kit form ready to assemble. You buy wholesale, sell at retail — make big profits. Hundreds doing it. You can, too. Send 25c today for catalog and wholesale price list. Refundable first order. Gearon Co., Dept. 500-B4, 27 S. Desplaines, Chicago 6, Ill.

WANT A diesel job? Our approved, up-to-the-minute diesel training program can help you qualify for steady, big pay jobs or specialized military training. Covers diesel, tractor, heavy equipment. Easy to master. No loss of present income. Job placement advisory service. Investigate! Write for information today. Interstate Training Service, Dept. 3D, Portland 13, Oregon.

FREE Book "How to Make Money With Home Workshop" describes amazing methods used by hundreds of successful craftsmen. Tells what to make, how to sell workshop output spare time. Write at once for details. Remember it's free! Craftsman, 115-A4 Worth St., New York City.

DEFENSE Welding jobs pay. Welders needed. Train quickly. VA contract. Hobart Welding School, Box M-412, Troy, Ohio.

MAKE Flexible molds! Cast plaques, bookends, figurines! Free sample! H. Tooker, 630-M Chestnut, Hamilton, Ohio.

START Own business. Make polishes, cleaners, flavors, etc., in basement workshop. Details free. Monde, Rosholt, Wisc.

\$250 WEEK Reported! Free book "505 Odd Successful Businesses." Work home! Expect something odd! Pacific-67, Ocean-side, California.

FOREIGN Employment construction men, building trades, helpers, office men, others, interested in foreign projects. High wages, quarters, trans. Listings of firms actively working on U. S. foreign inter-continental projects. Send \$1 for foreign construction compendium and application forms. Foreign Service Bureau, Dept. PM4, Box 295, Metuchen, New Jersey. (Not an employment agency — no fees.)

RESILVER Mirrors at home. Formula 25c. Ideal Service, Park Ridge 4, Illinois.

FARMERS—Gardeners: Add to your income introducing New Organic soil conditioner. J & G Sales, Fullerton, Md.

\$200 MONTHLY. Raising fishworms backyard. Booklet 25c. Marvin Dickman-J. Willow Springs, Mo.

MUSHROOMS Grown. Boxes, barrels. Instructions 50c. Spawn \$1.00. Manureless process. \$2.00. Gordons, 553 William, Winnipeg, Manitoba.

RESURFACING Of meat blocks for stores, restaurants, and institutions is a service in great demand. Our portable resurfacing machine will put you in this steady, profitable business. Minimum of skill required. Full or part time, or in combination with other work. Travel or stay put. Write for details. Hill Machine Co., Box 677P, Rockford, Ill.

HAVE Fun! Make money! "Working With Leather"—64-page booklet tells how. Send 25c for copy. No foreign orders. Free catalog and valuable information included. Wilder-Craft, 1039 Crosby, Chicago 10.

RAISE Pheasants on the \$100 week plan. Little capital and space can make you independent. Free details. Great Central Game Management System, Columbus 1, Kansas.

\$5 HOUR Easy! Sell name plates for houses. Free sample, order blanks. Write: National, 214 Summer, Boston, Mass.

TYPISTS. Profitable business at home. Complete copyrighted information 50c. Rosdahl Industries, 4901 Elston Avenue, Chicago 30, Illinois.

LIFETIME Income as notary public. Appointment assistance. Stationers, Helotes 50, Texas.

EARN Up to \$400 monthly raising rabbits. Free particulars. White's Rabbitry, Newark 61, Ohio.

\$40.00 WEEKLY Made growing mushrooms, fresh, dried. Dominion patent 331583. Free spawn. North American, 169P Yonge, Toronto, Canada.

BE The Popular Mechanics representative in your neighborhood and earn big profits in your spare time. Write Popular Mechanics Magazine, Room 408M, 200 E. Ontario St., Chicago, Ill.

"FROG Raising!" New book tells how! Illustrated literature free. Marlboro-A, Box 7002, New Orleans 19, Louisiana.

FOREIGN And Latin American employment. 1951 "Foreign Service Directory" gives up-to-minute facts on military and civilian construction, government jobs, major oil listings, aviation, transportation, steamship lines, mining, importers, exporters, how-when-where to apply, application forms, hot list firms hiring. \$1.00 postpaid. Global Reports, P.O. Box 883-P, Hollywood 28, Calif.

RAISE Fishworms, free literature, complete instructions 10c. Huffmans Ranch, Rives Junction 2, Michigan.

\$46 FROM square foot plywood. Jigsaw necessary. Write, Woodarts, Bridgewater, Mass.

ALASKA — America's frontier. \$1.00 brings 1951 business directory, large government map giving up-to-date construction projects, current employment information, homestead and highway facts; hunting, fishing, game rules; firm's hiring and application forms. Alaska Opportunist, P.O. Box 883-P, Hollywood 28, Calif.

BOOKS, PERIODICALS, PICTURES POSTCARDS

ILLUSTRATED Magazine lists and subscription rates of all popular national magazines, postpaid. Barsketis & Co., 7404 58th Place, Summit, Illinois.

DOUBLE Your reading. Exchange mags. and papers at postage cost only. Clients waiting introduction. Details free. Write Eagle Agency, Bertha Road, Birmingham 11, England.

BOOKHUNTERS! Any subject, send wants! Atlantic Book Service, Lawrence Avenue, Charlestown 29, Massachusetts.

OUT Of print books supplied. Send want. Green, Box 6761, Los Angeles 22, Calif.

BACK Issues magazines supplied. Keller,

EDUCATIONAL — Seven authentic 5x7 photographs of historical Philadelphia Liberty Bell, Independence Hall, Carpenters' Hall, etc. \$1.00. R. Kelly, Jr., 2264 E. Monmouth St., Philadelphia 34, Penna.

POPULARITY Builder! "Clever Remarks" \$1.00. Edmund Bodlais, 1800 Cloverdale, Los Angeles 19, Calif.

TELEVISION Book explains how to buy and install receivers. Discusses built-in aerials, distant reception, lightning risk, color, etc. \$1.00. Details free. Hartland Smith, Box 91, Birmingham, Michigan.

READ With speed. New amazing method. Save hundreds of hours yearly. Free home test and details. Speed-Reading, Dept. E, 9111 Hoyne, Chicago 20.

A Small pocket book containing all lengths and bevels of rafters, 29 pitches, from 2 ft. to 100 ft. wide buildings. 50 yrs. experience. Money back guarantee. Anyone can build roofs illustrated. Price \$2.00. Hans Straalsund, Newport, Wash.

RENT Fiction, non-fiction. Catalog 10c. Santens, 2700-A Ann, St. Louis 4, Missouri.

20 COMIC Magazines \$1. Eisen, 8003 S. Broadway, Los Angeles 3, Calif.

BOOK—"How to Help Your Child in School" \$2.95. Johnson, 1939 Jackson, Evanston, Ill.

BOOKHUNTERS! All subjects. Send wants! Jaher Book Service, 620-P East 178 Street, New York 57.

SELF-Explaining Bible: Illustrated circular free. Box 446-P, Minneapolis, Minn.

HARD-To-Find Books supplied. Send wants. Pierce's, Winthrop, Iowa.

MAGIC TRICKS, PUZZLES, JOKER NOVELTIES

600 TRICKS, Magic, cards, masks, puzzles, shooting novelties, jokers, monkey business funmakers, hot stuff, catalogue 25c. Andersen's, 6815-R Ardmore, Chicago 31.

FUN And exciting playing new game of mystery and intrigue "Cabal." Send \$1.50 check or money order. Game of the Month, 9630 Gold Arbor, Plymouth, Mich.

TWO New tricks—How to transfer a given number from one brain to another by apparently supernatural means. How to make a card thought of appear in any part of the deck. Send \$1.00 for both. Randolph, Box 16546, Hollywood 38, Calif.

SEND 25c For 6 latest tricks. Free catalog. Laramie Sales, 4800 So. Laramie Ave., Chicago, Ill.

FREE! Joke novelty with price lists. Hiawatha Lane, Fergus Falls, Minnesota.

WORLD'S Largest professional magic shop, keeps you in touch with latest tricks. To receive mailings, send 50c for new catalog. Holden's, M220 West 42nd St., New York.

500 TRICKS. New 1950 edition now ready! Send only 10c for your copy, containing latest in good magic for pocket, parlor, stage. Unequaled service to magicians for 30 years. Douglas Magicland, Dept. 1, Dallas, Texas.

512-PAGE Catalogue of 2500 tricks, pocket, parlor, stage. World's finest magic. Send \$1.50 for catalogue (refunded first \$6.00 order). Kanter's, M-1311 Walnut, Philadelphia 7.

MAGIC Tricks, puzzles, books, cards, punch boards. Catalog 10c. Specialty, Box 671, St. Louis 1, Mo.

TRICKS, Jokes, novelties. Catalogue 15c. Furr, Box 1882-D, Norfolk, Va.

16 CARD Tricks and catalog 25c. Sterling Magic, Royal Oak, Mich.

200 ELECTRIC Stunts, 110 volts, \$1. Kutting Sons, Los Altos, Calif.

584-PAGE Catalog, 7500 novelties, fun-makers, tricks, jokes, gadgets, hobbies, timesavers, animals, sports, scientific. 10c. Johnson Smith Company, Dept. 349, Detroit 7, Michigan.

PROFESSIONAL Catalog, 124 pages, 25c. Williams, 900 Plymouth, Ellwood City, Penna.

FREE Trick and catalog 25c. Lerro's Magic, 509 80th Street, Brooklyn 9, N. Y.

BE A magician. Large professional magic catalog of latest tricks. 35c. Ireland, C-109 North Dearborn, Chicago 2.

COINS, TOKENS, CURRENCY

EXCLUSIVE! Confederate facsimile plate proof. 3c stamp. Aries, 453 Utah Street, San Francisco.

40 DIFFERENT Coins, \$1.00. 100 different bills. \$1.00. Oddehon, Box 482

WHAT Are your coins worth? Amazing Fell's United States coin book by Jacques Del Monte. Everything on every single coin minted—Worth, value, how to sell, speculating, investment; other valuable facts on coins. Clothbound, 150 illustrations. Send no money. Pay postman only \$1.50 (plus postage) or \$1.50 postpaid (refundable). Order now! Fell Publishers, 386B 4th Ave., New York 16, N. Y.

OLD Money wanted. Will pay fifty dollars for nickel of 1913 with liberty head (not buffalo). We pay cash premiums for all rare coins. Send 4c for large coin folder. May mean much profit to you. Numismatic Co., Dept. 20, Fort Worth, Texas.

COIN Magazine. Sample copy 25c (100 pages). Hewitt, 5450-J Clark, Chicago 40.

43 MIXED Indian cents, \$1.00. Free lists. Chelsea, 26 W. 18, New York City 11.

COIN Collectors new magazine, just out, and two wooden nickels 10c. Lawrence Brothers, Anamosa, Iowa.

50 ASSORTED Indian pennies, \$1.50; 1892 Columbian half-dollar, 75c; Whitman coin album, 25c; 1863 Civil war cent, 15c; 25 foreign coins \$1.00; check list, 3c; large catalog, 15c; 100 2 x 2 coin envelopes, 25c. Coin Shop, 31 North Clark, Chicago 2.

FREE! Foreign coin, banknote and coin collectors illustrated catalog to approval service applicants. Send 3c postage. Tatham Coinco, Springfield 30, Mass.

GET Profit and pleasure in collecting old coins. Send 10c for 56 page illustrated coin catalog. You'll be delighted with it. Send for it now. B. Max Mehl, 370 Mehl Bldg., Fort Worth, Texas. Largest rare coin establishment in U. S. Established 50 years.

JAPANESE Invasion notes, 1c to \$1,000.00, \$2.00. Burma note and catalogue 2c. Shultz, Salt Lake City 10, Utah.

COINS Wanted, will pay up to \$2000 for certain coins, send 25c for catalogue. Burton's, 111 So. Third, Columbus, Ohio.

WANTED 1894-S Dime, pay \$500.00. Certain 1913 nickel \$1,000.00, 1901-S quarter \$10.00—\$150.00, hundreds of others. Complete catalogue 25c. Worthy Coin Corporation, D-317, Boston 8, Massachusetts.

STAMP COLLECTING

ZANZIBAR, Pitcairn Islands, Turks, Caicos, Gilbert, Ellice, Solomon, Borneo, Gambia, Tanganyika and others. Complete collection free. Send 5c for postage. Gray Stamp Company, Dept. PM, Toronto 5, Canada.

FOREIGN Stamps at 1/10 catalogue value. You send in references and we send the stamps. No low catalogue stamps included. Roseland Stamp Co., Dept. 10A, Spring Lake, Michigan.

FREE—Complete set of famous Americans, flags, parks and presidentials to approval buyers. Send 3c for 15 of the above stamps plus full particulars. Triboro Stamp Company, 145 Nassau Street, Dept. 104, New York 38, N. Y.

WHAT Are your stamps worth? Amazing new Fell's Profitable Stamp Guide by Franklin R. Bruns. Everything on every stamp imprinted; evaluation, paper, watermarks, engraving, rarities, sources, mounting, preservation, etc. A collectors "must!" Clothbound, hundreds illustrations. Only \$1.50 postpaid. C.O.D.'s accepted (refundable). Order now! Fell Publishers, 386T 4th Ave., New York 16, N. Y.

POSITIVELY Greatest free offer—Latest Scott's International \$6.00 stamp album, covering entire world, contains 36,000 illustrated descriptive spaces. Scott's New Standard \$7.00 catalogues "Philately's Encyclopedia" — absolutely free to applicants for foreign approvals becoming customers. Plymouth Specialty Co., Dept. A-9, Box 510, Bell, California.

AUSTRALIAN Unpicked mission mixture \$1 lb. plus postage. Pringle, 79 Griffith St., Balgowlah, N.S.W., Australia.

FREE! Perforation gauge! Approvals, Preston, 51 Holbrook, B-4, Detroit 2, Mich.

FIFTY French Colonies, pocket wallet, 5c with approvals. Fred Pittsley, Napa, Calif.

EMPTY Spaces? Try my select approvals, 50%-60% discount. Neufeld, 643 Eastern Parkway, Brooklyn 13, N. Y.

1000 STAMPS, All different, worldwide, \$1.00. Approvals. E. Stoka, 10511 S. Peoria St., Chicago 43, Ill.

SELLING Out! Choice foreign sets, blocks, sheets, covers, 50%-75% off. Postcard brings particulars. Dianco, 6800 Oakman Dearborn, Michigan.

DEALERS—Wholesale list. Postage 3c. Frank, 5031 Queensberry, Baltimore 15, Md.

FREE—Balkans packet! Approvals 40% catalog! Box 326A, Passaic, N. J.

FREE—1,000 Prefolded hinges! Approvals. DiMilia, 72 Scholes, Brooklyn 6, N. Y.

SAN Marino collection free—25 different, old and new issues, airmails, commemoratives, high values—absolutely free with approvals. Viking, 130-ZZ Clinton St., Brooklyn, N. Y.

PENNY Approvals that satisfy. Neil Gronberg, Box 5441-P, Philadelphia 43, Penna.

OKINAWA—Unused 3 different 25c. Thomas Howell, 374 Maint., APO 704, c/o Postmaster San Francisco, California.

FREE. Scott's International Album. Other big premiums. Full particulars with approvals. Raymax, 123-Z William St., New York City 38.

WHOLESALE Lists to dealers. 3c postage. Grossman, 100 West 42nd, New York 18.

FREE! Canadian sets, royal visit, George VI, George V, coronation, jubilee, others to approval applicants. Ensign, Box 118-M, South Orange, N. J.

PAYING High prices for approvals? If your collection numbers under 15,000 try our 1c and 2c approvals. In books of 1000 different. Lots to choose from at lowest prices. Also special offer to customers. Clark, Box 544-P, Muskegon, Michigan.

EXCHANGE Stamps universe. Particulars free. "Exchangers," Bry 126, Seine, France.

EXAMINE Stamps with "Roto-Gage"—Tells size, counts perforations, detects watermarks. All in single compact, convenient accessory! Measures 3x5x3 inches. Special price, \$3.50 postpaid. (Descriptive literature free.) Satisfaction guaranteed! Send money order to Mook Specialties, R-1, Canonsburg, Pennsylvania.

PACKETS All different 25c each; 100 Austria; 100 Belgium; 100 France; 100 Netherlands; 100 Rumania. Entire lot only \$1.00. Free packet price list. Buczynski, 19315 K Syracuse, Detroit 34, Mich.

U. S. Catalogue free. Contains over 500 illustrations for stamps, albums, supplies. Stone, Box 52-P, Dorchester 24, Mass.

45 DIFFERENT Aircraft covers! Including U.P.U. set. Bargain, \$3.98. Ewing-Stamps, 109 N. Dearborn, Chicago 2.

50 U. S., 50 World, 50 airmail. All for \$1.00. Hale Stamps, 7609 Grand, Minneapolis 19, Minnesota.

WAR Zone! Formosa, Manchukuo, Mongolia, others, 30 stamps! Rare! Only 5c! Approvals. Concord, Box 23-E, Beeville, Texas.

FREE Beautifully illustrated U. S. catalog 3c postage. Ace, 528A Chester-ninth, Cleveland 14, Ohio.

FREE—Deluxe packet to approval applicants listing countries collected. McQuestion, 185 Puritan, Detroit 3, Mich.

COMMEMORATIVE Philatelic sheet free to approval applicants. Paragon Stamps, Box 1378, Miami Beach 39, Florida.

TEN Different U.S.A. First day covers and "Stamp World" for \$1.00. Doctor Feinerman, Macomb, Illinois.

ALADDIN Has quality approvals for serious collectors. No junk. Free price list. Aladdin, 3625 St. Paul, Denver 5, Colorado.

122 U.S. Commemoratives \$1.00. Approvals. Holtco, Box 142, Miami, Florida.

BI-Colored airmails with approvals. Robert B. Kerr, Eagle, Wisconsin.

COMPLETE Army navy set only 10c with United States approvals. Locust Stamp Co., Peekskill, N. Y.

FREE! Diamond, pigmy, jumbo, other queer stamps—to introduce our colorful "Bargain Approvals." Niagara Stamps, Niagara-on-the-Lake 11, Canada.

FLAG Stamp—Free with hydrate U.S. approvals. Wenigman, 1933 Patterson, Chicago 13.

GIGANTIC Slave stamp! Nude! Triangles! Diamonds! Tempting approvals. Only 10c! "Paris," 1819-s Woodland, Racine, Wisconsin.

STAMP Magazine! Copy free! "Stamp Post," South Catalina, Pasadena, Calif.

TRIANGLES! Six bicolored beauties (ferocious beasts, tropical birds, etc.) With colorful approvals—only 10c! Atlas, 2830-T Eisenhower Drive, Racine, Wis.

INDONESIA—16 Different bicolored beauties (worth \$2.75)—only 10c! Approvals included. Stampex, 116K Nassau St., New York 2.

FREE—Complete U.S. list (commemoratives, airmails, etc.) Breck, 10516 Clifton, Cleveland 2, Ohio.

1/2-1c APPROVALS! Bargains galore! Cole, 43-A Rinewalt, Buffalo 21, N. Y.

100 NETHERLANDS. All different. Beautiful assortment. 10c with approvals. Thomson's, Box 4074-P, Miami, Florida.

FREE—100 Different to applicants for unbeatable approvals. Sparta, Box 426, Dansville, N. Y.

100 U. S. Commemoratives 10c. Approvals. Pomeroy, 39 South Eighth, Minneapolis 2, Minn.

1863 SAXONY Included with 193 different, 33 countries, 38 19th century 10c. Approvals. Brooks, 2352B East 23rd Street, Brooklyn 29, New York.

APPROVALS. Beautiful foreign stamps, complete sets, singles. Ward, 241 So. Winchester, Campbell, Calif.

AMAZING Offer! 500 United States stamps—including commemoratives, airmails, high values to \$5.00. Only 10c to approval applicants! Illustrated bargain lists free. Mystic Stamp Co., Dept. 80, Camden, New York.

FIRST U. S. (1847) government reissues 5c, 10c, plus giant bargain U. S. collection—only 5c to applicants U. S. approvals. Metropolitan, Box 312G, Jackson Heights, N. Y.

BARGAIN! Assortment triangles, Borneo, Cook Islands, Swaziland, Mauritius, 10 African pictorials and souvenir. Everything 10c with approvals. Eckman, 2852 S. W. 37 Ct., Miami, Florida.

10 ASSORTED U. S. Commemorative 15c. Five U. S. Air Mail 15c. 10 Famous Americans 25c. All for 50c. Ideal Stamp Shop, Box 179, Park Ridge, Illinois.

WOW! 203 All different Germany 10c! Zeppelins, semipostals, airmails, high values, etc. to new customers. Jamestown Stamp, Jamestown 512, New York.

FIFTEEN Different old U. S. sent for 10c to approval applicants. Donald Brunner, 832-D Union Street, Lancaster, Penna.

WORLD'S Largest stamp (7 1/2 x 14 inches). A real curiosity! Retail for 50c, only 3c to approval applicants. Tatham Stamp Co., Springfield 30, Mass.

FREE Collection—Over 100 different stamps of the world—commemoratives, she-wolf, camels, giraffes, ships, rare Austria race horse, others all to approval buyers; also Scott International Albums, stamp catalogs. Bell Stamp Service, Dept. S-2, Bell, California.

WONDERFUL Offer. 7 complete mint sets Manchukuo, Bohemia, etc., only 10c with approvals. Reich Stamp Co., 4647 Kenmore, Chicago 40, Illinois, Dept. M23.

FINE Approvals. Fast, personal service. What countries do you prefer? I'll send their stamps. Skinner, 438 Locust, Long Beach 12, California.

UNUSUAL—Unheard of. Cancelled sets of Roosevelts and Washington bicentennials complete. All yours for fifteen cents. Bargain approvals accompanying. Park Stamp Co., Box 191, New York 21, N. Y.

STAMPS Wanted. Collections, duplicates, surplus stock, mint and used. Trade for printing; buy outright if bargain. What have you, what's wanted. Vanroy Shirk, Lebanon, Penna.

UNITED States stamps nearly 100 years old. Roosevelt set, others, 40c value—only 5c to applicants United States approvals. Wakonda, Box 272K, Jackson Heights, N. Y.

500 STAMPS For only 10c! This mammoth value includes airmails, pictorials; stamps from strange countries, cataloging up to 25c each! Also approvals. Mystic Stamp Company, Camden 80, New York.

COLUMBIANS. Trans-Mississippi, Pan Americans, Pan Pacific, ten other different commemoratives. All 10c with your request for U.S. approvals. Moda Stamps, Box 251-X, C.S.A., New York 8.

MAGNIFIER. Big stamp magazine; first U. S. commemorative; plus unused \$1000 Foreign Legion, diamond, giant, and other worthwhile stamps. Everything free to approval buyers. Capital Stamp Company, Little Rock 2, Arkansas.

FREE! Powerful magnifying glass. Jamestown Stamp, Jamestown 202, New York.

200 DIFFERENT Including Roosevelt triangle, 5c to approval applicants. M. Avalon Stamp Company, Springfield, Mass.

OVER 1,000,000 Sold; 200 different stamps 10c with approvals. Carlton's, Tujunga, Calif.

FREE! Surprise packet. Penny approvals. Pioneer, Box 414, Pasadena 18, Calif.

500 EXOTIC Japan stamps—10c. Kenmore, Richford, J-57, Vermont.

750 FRANCE And colonies stamps 10c. Littleton Stamp Co., Littleton 25, N. H.

FREE! 100 Worldwide different stamps to approval buyers. Big U.S. and illustrated bargain lists sent with approvals. Bookman, Maplewood, N. J.

FREE! Big United States catalog! Invaluable guide and check list. Hundreds of illustrations. Harrisco, Boston 17-W, Mass.

SPECTACULAR Tustara lizard plus U.P.U. plus 30 others only 10c. Lou Allmendinger, 709 Dover, Philadelphia 31, Penna.

50,000 STAMP Grabbags 25c each. Anderson, 630B, Bingham, Reading, Penna.

U. S. Price list. Send postage. State Stamp Service, 1225 Park Building, Pittsburgh 22, Penna.

TOPS! Our book "How To Collect Stamps." Send for your free copy today! Littleton Stamp Co., Littleton 37, N. H.

FREE! Big illustrated catalog listing everything for the stamp collector. Harrisco, 202 Transit Bldg., Boston 17, Mass.

"HOW To Recognize Rare Stamps." Free book illustrated! Kenmore, Richford, H-57, Vermont.

FREE U. S. price list, postage 3c. Mark Hanna, 335 5th Ave., Pittsburgh 22, Penna.

SPORTS Set plus four others 5c. Approvals. Wirth, Norwichtown, Conn.

"GOYA Nude" set complete 50c. (Catalogs \$1.55.) Approvals. Royal Stamp Company, Tamaqua, Penna.

FREE—Cuba Roosevelt issue and illustrated catalog. Littleton Stamps, Littleton 12, N. H.

OLD Scarce U. S. seconds on approval. Slightly defective. Bargain prices. Herfield, Clintonhill Station, Newark 8, N. J.

FREE! Chinese "midget" war set. Approvals included. Seminole, Leeds, Alabama.

300 DIFFERENT Given free with approvals. Postage 3c. Windsor Stamps, 1435 East 67th Place, Chicago 37.

FREE—Illustrated catalog! Kenmore, Richford, C-57, Vermont.

FREE Supply list. Penny approvals on request. Reed, Box 980, Chicago 90, Illinois.

307 ALL Different—Only 15c! Beautiful collection: commemoratives, triangles, high values, bicolored stamps, etc. Garcelon, Calais 400, Maine.

205 AUSTRIA—All different only 10c! Beautiful commemoratives, pictorials, airmails, high values. Catalog price nearly \$6.00! Approvals included. Garcelon, Calais 111, Maine.

WORLDWIDE Stamps. All different, 200, 25c; 500, 50c; 1000, \$1.00; 2000, \$2.50; 5000, \$12.50. Beacon Sales, Maynard, Massachusetts.

ZOUNDS! Amazing "queer countries" packet—Free with approvals! Saxon, Vista, California.

FREE "Stamp Finder." Tells instantly country to which any stamp belongs. 32 pages profusely illustrated. Garcelon, Calais 17, Maine.

FREE! \$10,000 Airmail! Philippines! Pezzani Uruguay! Approvals. Keating, 637-P Bergen, Jersey City, New Jersey.

50 DIFFERENT U. S. 10c. No approvals. Seidenberg, 944, Appleton, Wis.

200 U. S. Commemoratives, old and new. \$1.00. Weatherby, Medina, Ohio.

SENSATIONAL! Set each Honduras, Martinique, Guadeloupe, Guiana, also \$2.-000,000 stamp, Brunei, over 100 different others. Everything 10c with approvals. Whitehead, 315P South 5th Ave., Canton, Illinois.

GERMANY B257-69, warplanes, destroyers, paratroopers, machinegunners; free with approvals. William Deems, Ravenswood, West Virginia.

10,000 DIFFERENT 1c Each! Gordon Davison, Box 1019S, Manchester, N. H.

ANTIQUES, RELICS, INDIAN GOODS, CURIOS

INDIAN Ceremonial headdress kit, \$2.00. Zane's, 211 Thomas, Wausau, Wis.

INDIAN Beadwork, buckskin, beads, feathers, moccasins, wigs, supplies; buying direct from Indians; prices reasonable; free list. Pawnee Bill's Indian Trading Post, Box 35-P, Pawnee, Okla.

NEW Book antique gun prices. Lists 2,000 American revolvers, \$1. Pioneer Press, Harriman, Tenn.

PRECIOUS STONES, MINERALS

SOUTHWESTERN Treasures, factual book. "Blaze of Gold," Texas, coastal locations, \$1.75. "Yaqui Gold," southern Arizona-Northern Mexico, \$1.75. Postpaid. Frontier Bookshop, 8102 Lockheed, Houston, Texas.

GEMSTONES, Mineral specimens. Every variety. Lowest prices. Postcard brings free booklet. Plummer's, 2183C Bacon, San Diego 7, California.

MINERAL Specimens, cutting material, slabs and gems. Send for free price list. Warren's Minerals and Gems, 1969 Abbott St., San Diego 7, Calif.

HOBBIES AND COLLECTIONS

50 DIFFERENT Army embroidered patches \$1. Other bargains. Insignia Mart, 703A Broadway, New York 3, N. Y.

INVENTING Can be an interesting and profitable hobby. Write for complete particulars. Institute of American Inventors, Dept. 40-E 631-E St. N.W., Washington 4, D. C.

NEW—15 Different match covers 10c. Box 202, Rochester 1, N. Y.

UNUSED Matchbook covers—100 different \$1.00. Catalog 25c. Charles Edelman, 1311C East 84, Cleveland 3, Ohio.

CAMERAS, PHOTO SUPPLIES

FREE Photographic bargain book packed with hundreds of sensational values in still and movie cameras, lenses and latest accessories. Super savings for you in new and used equipment. Liberal trade-in allowances, too, on your equipment. Write now for your free copy to Central Camera Company, Dept. 9D, 230 S. Wabash Ave., Chicago 4. (Photographic headquarters since 1899.)

OBJECTS Miles away photographed close up. Mortar lines in brick house mile away register needle sharp on your prints. Trifling cost. Free proof. Carl Jamer, Box 694, Manorville, N. Y.

ADD Spice to home projection shows with colorful old-time Nickleodeon slides. 2x2. Write for free list. Nickleodeon Co., New Fleidner Bldg., Portland 5, Oregon.

PHOTOCOPI Anything—Papers, books. No darkroom. 8½" x 11" complete \$6.95. Fotoflek, 8555 Plainfield Lane, Cincinnati 36, Ohio.

"HOW To Sell Your Pictures and Make Big Money." 98c. Bargain supply catalog 25c. Muir Photography Mart, Milford 8, Pennsylvania.

PHOTOGRAPHY—Simplified home study course covers "Hollywood glamorizing," short cut methods, developing, printing, enlarging. Complete \$1.98. "Make big money while learning." Bargain supply catalog 25c. Muir Studios, Milford 7, Pennsylvania.

FREE Photo catalogs, cameras, supplies. Rock bottom prices. Trades welcomed. Mogull's, (Dept. P.M.) 112 West 48th, New York 19, N. Y.

SAVE \$41.50. Brand new Zeiss Contessa 35, F:2.8 coated, photo cell, coupled r.f., case, \$164.50 complete. Send for bargain list. Sid Klein, Inc., 7916 Beverly Blvd., Los Angeles 48, Calif.

BASS Says: Trading cameras a national habit since 1910. Write to Bass the old "horse trader." A postcard will do. Simply say: "Bass, I have and I want. How much will you allow me?" It's fun to trade with Bass. Satisfaction guaranteed. Bass buys, sells, and trades. Bass Camera Company, Dept. AG., 179 W. Madison St., Chicago 2.

PHOTOMURALS. Your negatives or ours. Catalogue 25c. Photomammoth Murals, 12048 Vanowen St., North Hollywood, Calif.

PHOTO FINISHING

SIX Or 8 roll of film developed and printed 35c. Twelve or 16 picture roll 55c. Send coin with roll. No c.o.d. If you fail to get pictures on your roll of film, we will mail a new roll to you at no additional cost. Overnight service. Malters sent free on request. Deluxe Film Service, Box 1268-A, Shreveport, Louisiana.

8 BEAUTIFUL Picture roll developed 30c, in album 35c; 12, 45c; 16, 60c; jumbo enlargements 20, 90c; 36, \$1.25. Duplex Photo, Box 1297 General Post Office, New York 1, N. Y.

FREE Reload with each order of 35mm. developed and printed. \$1.50. Any 8 exp. roll 40c; 12 exp. roll 60c; 16 exp. roll 75c. Bonded prints are custom Hollywood professional quality. Why gamble? Free mailers. Bonded Photo, 1021 W. Santa Barbara, Los Angeles 37, Calif.

FREE Mailers. Jumbo prints, 8 exposure roll 30c; 12-45c; 20-95c. Careful work. Western Photo, Dept. PM41, Box 298, San Francisco 1, Calif.

UNDESIRABLE Backgrounds removed from your negatives. Send negative and instructions with \$1.00 each to: Capitol Service, Suite 7, 342 Hanover Street, Boston, Massachusetts.

16 PRINTS Or 8 jumbos from roll, 25c with this ad. S. Skrudland, River Grove, Ill.

MAIL Us your films. Prompt service. 8 exposures developed and printed 30c. Free enlargements. Foto Art Studio, Box 406, San Francisco, Calif.

FREE Price list on quality developing, printing, enlarging. Write for it today. Bryan's Photo Shop, Dept. M, Panama City, Florida.

MOTION PICTURES AND SOUND EQUIPMENT

CLEARANCE Sale of 16mm. films. Want a real buy in 16 mm. sound films? Take advantage of the I.C.S. 1951 clearance sale of 16 mm. sound features: Comedies, cartoons, novelties, musicals, new, used. Specify. Send for our giant list "A" today stating machine you own (make and model). Institutional Cinema Service Inc., 1560-PM Broadway, New York 19, N. Y.

FREE Movies. Thousands of subjects. Interesting, entertaining, fascinating. Latest directory, only 50c. National Cine Society, 126 Lexington Avenue, New York 16, N. Y.

FILM Exchange: 16mm. sound, silent. Send 400' reel and \$1.00; receive different reel, equal value. Postpaid. Estes Exchange, Brunswick, Missouri.

8-16MM. Silent-sound films. Complete rental library. All latest subjects. Free catalogue, sample film 10c. Garden Film, 317 West 50th, New York 19.

THRILLS! Action! In exciting 8-16mm. movie film subjects. Big movie and equipment catalog with sample film, 25c. National Film Supply, Toledo 9-H, Ohio.

FREE Movie catalogs. Wonderful values. 8, 16, 35mm., sound-silent projectors, cameras, film, lenses, accessories. Trades welcomed. Mogull's, (Dept. NP), 112 W. 48th, New York 19.

THESE Six brand new 100' 16mm. silent Pictoreel films—"Brother Golfers," "Flying Feathers," "Here Comes Malicious," "Pinehurst," "Snow Falls" and "Swinging Mallets"—all first quality and in original cartons, only \$4.98 plus 30c postage (regular price, \$16.50). Same six films in 50' 8mm. versions, only \$2.98 plus 20c postage (regular price, \$10.50). New one reel 16mm. sound discontinued Castle films low as \$3.98 plus postage (regular price, \$17.50). Good used 100' 16mm. Panoram musicals. \$9.98 per dozen plus 40c postage. Hundreds of other equally good bargains in 16mm. sound and silent, and 8mm. films. More movies for your money at "Sixteen's Super Market." Write now for our big free 32 page catalog. Blackhawk Films Inc., 620 Putnam Building, Davenport, Iowa.

5000 NEW-Used 8-16mm. silent-sound films. International, 2120 Strauss, Brooklyn 12.

BASS Says: Leadership since 1910 guarantees satisfaction. Finest Cine equipment: 8mm., 16mm., and 35mm., silent and sound. Write the old "horse trader." Satisfaction or your money back always! Bass Camera Company, Dept. A, 179 W. Madison St., Chicago 2.

The World's greatest story. "Entire Life of Christ," 8mm., 16mm. Sound and silent. Rent or purchase. Hemenway Film, 33 F Melrose Street, Boston 16, Mass.

RENT 16MM. sound films, 50c reel. Large selection; free catalog. Film Service, 128 Chestnut St., Roselle Park, N. J.

LEARN Professional motion picture technique at home. Free catalog. Motion Picture Institute, Birmingham 4, Mich.

GUARANTEED Fresh 8mm. roll, magazine; 16mm. roll, magazine movie films. Color, b&w. Free catalog. ESO-S, 47th Holly, Kansas City 2, Missouri.

"CINE-VOICE" Sound-on-film camera shoots your own 16mm. color talking pictures. \$695. Write for free illustrated folder. Berndt-Bach, Inc., 7345 Beverly Blvd., Hollywood 36, California.

MOVIE Camera film: 8mm. roll \$1.50. 16mm. 100' \$3.00. Free processing. Better Films, 742 New Lots, Brooklyn, N. Y.

MUSIC AND MUSICAL INSTRUMENTS

SONGWRITERS! Outstanding, ethical offer. Hibbeler, C-5, 2157 N. Avers, Chicago 47.

MUSICAL Instruments. Reasonable. Specify. Expert repairing. Liberal trade in allowance. Ribner's, 74 Ferncroft Road, Milton 87, Mass.

COMPLETE Piano course. No bass reading. Formerly \$3.00, now \$1.00. Beejay Piano Clinic, Lafayette, Indiana.

POEMS Wanted. Broadcast consideration. Sooner Song Co., 22-PM Northwest 8th, Oklahoma City 2.

POEMS Wanted for musical setting. Send poems for free examination. Five Star Music Masters, Beacon Bldg., Boston, Mass.

PIANO 30 Lessons \$3. Free samples. Phil Breton Publications, P.O. Box 1402, Omaha 8, Nebr.

USED Jukebox records—Popular hill-billy, western. 5-\$1.00 f.o.b. Free catalog. Milners, 204 Griffin, Atlanta, Ga.

SWISS Musical movements \$2.50. Also wholesale. Spielman, 131 West 42nd, New York 18.

POEMS Wanted for songs. Special consideration. Rush! Songmaker, Clinton, N. C.

SWISS Musical movements \$1.00. Catalogue 10c. Bell Music, 1610 First Avenue, New York 28, New York.

ACCORDIONS — All brands. New and used. Save 50%. Wholesale to every one. Del Principe, 307 So. Wabash, Chicago, Ill.

1951 ACCORDIONS — Wholesale. Free catalog. American Accordion Center, 5329 Belmont, Chicago.

SONGWRITERS! Send poems, songs. Music Service, 243 West 72nd St., PM, New York 23.

YOUR Voice made loud, clear and powerful with my diaphragm exerciser. Write, Inventor "Oz," 34V, Box 665, St. Louis, Mo.

POEMS Wanted to be set to music. Free examination. Send poems. McNeil, Master of Music, 510-PM S. Alexandria, Los Angeles, California.

WANTED! Poems for musical settings. Write Songwriters' Service, Clifton, N. J.

WRITE Songs. Big money and reputation. Write for information. J. Gordon Pub. Co., 4700 South California Avenue, Chicago.

PHONOGRAPH Records cheap. Catalogue. Paramount, FQ-313 East Market, Wilkes-Barre, Penna.

MUSIC Arranged. Songs printed. Frank Wildt, Music Publisher, Lancaster, Penna.

POPULAR Piano lessons by mail. Beginners; advanced. Play songs or money back. Free details. Stuart Piano Studio, 1227A Morris Ave., Union, N. J.

RADIO AND TELEVISION

BUILD 15 Radios at home, only \$1.30 each. Experience unnecessary. Home radio course includes trouble-shooting and servicing, lessons, quizzes, and all parts and instructions. Nothing else to buy. Earn money doing radio and television repairs while learning. Prepare for profitable future. Free trouble-shooting tester with each course. Send for full particulars and receive absolutely free a copy of the Progressive Trouble-Shooting Guide. Progressive Electronics Co., 497 Union Ave., Dept. PM-30, Brooklyn 11, N. Y.

AMATEURS—Radio and electrical engineering service. Henry Twillmann, R.R. #1, Chesterfield, Missouri.

COLOR Tone your television! Free information! Harvard Laboratory, 657M Fulton St., Brooklyn, N. Y.

FREE—Completely new 1951 radio, television and electronic buyer's guide. Page after page of the very latest available supplies of guaranteed quality at today's lowest prices. Thousands of super-values in Hi-Fi units, recorders, television and radios, phonos, sound equipment, testers, tubes, kits, parts and books. Big stocks for immediate shipment. Send for it now! Concord Radio Corp., Dept. LD-51, 901 W. Jackson, Chicago 7, Illinois.

LOUDEST Crystal, catwhisker, radio plans: 25c. Amorose, Route Four, Richmond, Virginia.

15 TESTED One-tube circuits 25c, including "Radiobuilder," catalog. Laboratories, 411-C Capitol Hill, Reno, Nevada.

BUILD Modern "diode detector radio." Diode and illustrated instructions, \$1.00. "Five Best Tested Circuits," 25c. Electronics, Dept. A41, Box 7101, Chicago 80, Illinois.

MAKE Simple, tubeless, batteryless, distance-getting crystal radios. Crystal and illustrated instructions 25c postpaid. Allen, 427-P, Clinton, Mo.

PICTORIAL Construction diagrams. List 3c. Arthur Alena, 21-15 35th Avenue, Astoria 6, New York.

RADIO And television tubes. We have all numbers. They're all new at good discounts. Write us for your needs. Immediate response. Beacon Stores, Inc., Anderson Avenue, Grantwood, New Jersey.

BUSINESS OPPORTUNITIES

MAN! These are hot! Make \$6.35 on every sale. Sales are really easy. New adding machines in original factory cartons you can sell for only \$12.95 and you make over 45%. They're executive model portables, precision built, fully guaranteed. Send for life-size color photo with full details. Write today to Lightning Adding Machine Co., Inc., Dept. P-4, 1260 West Second St., Los Angeles 26, California.

BIG Money! Spare or full time in your home. No selling! Spray new miracle finishes, plush and suede, on signs, radios, automobiles, figurines, lamps, toys, etc. Our business is booming. Help us fill huge demand. New easy Flok-Kraft methods. Material costs few pennies. You get dollars. Free samples, complete powerful money-making plan free. Write now! Coast, 1002E S. Los Angeles St., Los Angeles 15, Calif.

EVERYBODY Knows about war surplus, but few know of the huge 100% to 1000% profits that are made. Learn how to buy war surplus direct from government. No certain amount of capital necessary. Report tells how to locate, bid on, and sell surplus. Also many personal experiences of successful buyer that should save you much time and money. Anyone interested in getting rich the easy way should read this report. Mail \$2.00 to War Surplus Report, Box 366, Goldthwaite, Texas.

START Your own business on credit. Always your own boss. 1559 dealers sold \$5,000 to \$28,000 in 1949; their average \$6,834. We supply stocks, equipment on credit. 200 home necessities. Selling experience unnecessary to start. Wonderful opportunity to own pleasant profitable business backed by world-wide industry. Write Rawleigh's, Dept. DU-PPM, Freeport, Ill.

MIRROR Resilvering. Wonderful home business. Complete formula 25c. Magic two-way mirrors. You can see out—no one can look in. Formula 50c. How to make coppered mirrors, vases, glasses. Formula 50c. All three \$1.00. Nelko Chemical Service, Box 3462-MD, Chicago 54, Ill.

FIX Typewriters—Home study course quickly trains you for own business. Factory methods taught. Write: Typewriter Repair, 4915 Corbet, Tarentum, Penna.

TOOL Salesmen, experienced. Catalog showing more than 200 profitable, unusual, service and repair shop, tool specialties available on request. Write. Advise territory covered and experience. Dept. A, Atmars Tool Co., 2411 Chestnut St., Oakland 7, Calif.

TO \$35.00 Weekly. Spare time, home operated mail order business. Successful small "beginner's" plan. Everything supplied. Lynn, 5710-M Bankfield, Culver City, California.

MINIATURE Golf, establish highly profitable money making business. Free literature. Dixieland, 2924 Douglass, Memphis, Tennessee.

START Home manufacturing business making cleaning compounds, soaps, insecticides, cosmetics, polishes, food flavors. No machinery. Literature free. Kemix, Park Ridge 4, Ill.

TRADE Magazines help you to success. Get latest copies through our easy-to-get-acquainted service. More than 1200 business, professional, agricultural, automotive, educational, sport, hobby, music, television, etc. List free. Commercial Engraving Publishing Co., 34C North Ritter, Indianapolis 19, Indiana.

HOW To set up and run a mirror shop! Resilvering mirrors. Making chipped glass nameplates. Electroplating. Salts and rectifiers. John Sprinkle V60, Marion, Indiana.

SHORTHAND In one week. EZ longhand system. \$1.00. Self instructor. Returnable. Zinman, 215-P West 91, New York 24, New York.

PRINT Without printing press—Posters, banners, greeting cards, toys, glassware, neckties; anything! New "easy" revolutionary method. No special equipment or experience needed. Work full or spare time at home. No selling. We set up "your own local business." Wonderful money-making opportunity. Free sample, profitable ideas, beautifully illustrated plan free. Write Screen-Print, 1010 C Los Angeles Street, Los Angeles 15.

IMPORT—Export! Men, women. Learn from established world trader. Your own profitable world-wide business by mail order from home without capital; or travel abroad. Experience unnecessary. Free details. Mellinger, C-6, Los Angeles 24.

DEFENSE Welding jobs pay. Welders needed. Train quickly. VA contract. Hobart Welding School, Box M-413, Troy, Ohio.

MAKE Perfumes at home. Write, "Carey Laboratories," 1914 Chouteau PM-4, St. Louis 3, Missouri.

EARN Extra money. Home mailorder business. Postal brings information. Chadwick's Service, Tacoma 7, Wash.

REACH Australian public through "Modern Hobbyists Handbook" \$1 inch, 3c word. Copy free advertisers. Editor, 79 Griffith St., Balgowlah, N.S.W., Australia.

MAKE Flexible molds! Cast plaques, bookends, figurines! Free sample! H. Tooker, 630-R Chestnut, Hamilton, Ohio.

BOOKKEEPERS Be independent operating our simplified system. Dominion, 74 Sparks, Ottawa, Canada.

EARN While you sleep. Coin radios. John Kratz, Grantham, Penna.

\$35 WEEKLY! Home! Two hours daily! Twenty-seven amazingly, unusual ways! Invisible reweaving including material for life \$2. Details free! Walsh, 894 Main, Buffalo 2, New York.

A Business in your own home! Our chemicals, plus free water and cheap "grocery store" materials can bring you over \$500 monthly earnings. Plans and formulas free. Western B Aircraft, Los Angeles 19.

MAKE Perfume—Catalogue free. "International," 6347 Parnell-PM-4, Chicago 21, Illinois.

MAKE Big money at home with Magic Pearl Finish. Free plan. Pearl-Art, 7216 Bear, Bell, Calif.

BUY Wholesale—Million articles. Supply source directory, dime. Nelko, Box 3462-DR, Chicago 54, Ill.

WHERE To buy at wholesale 100,000 articles. Free list. Maywoode, 1133 Broadway, New York.

PART-Time business, full-time profits. Metallizing (plating) equipment, supplies, hard-to-get chemicals and anodes. Complete assemblies for plating baby shoes, jewelry, novelties and industrial products; copper, bronze, gold, silver, nickel, chrome, etc. Home workshop to production shops priced from \$79.50 complete. World's largest line of metal, onyx and marble mounts for bronzed baby shoes. Instructions furnished. Buy direct from manufacturer. Write for free catalog and address of local branch. Hollywood Bronze Supply, Technical Dept., 1624 East First St., Los Angeles 23, California.

QUICK Sign painting. Use letter patterns. Avoid sloppy work and wasted time. Write for folder. John Rahn, 1330 Central Ave., Chicago 51.

OUTSTANDING Opportunity to make money. Sell Commando lightweight motor bikes. 2-speed transmission. Retail price \$255 plus tax. Big profit for you. Write now. Merx Products, Inc., 1214 Third St. So., Minneapolis 15, Minn.

EARTHWORMS—Free booklet and free plans of house. Barnard, 2121 Vanderbilt Lane, Redondo Beach, Calif.

PHOTO-Negative retouching. Examine home course without risk. Make to \$5.00 hour spare-time. Earn and learn. Free details. Duval, 8911½ Sunset, Dept. PM-4, Los Angeles 46.

AMAZING New foot health invention is biggest moneymaker in men's apparel! Elastic arch support woven into men's socks helps bring foot health and comfort to every man. Huge profits for you. Nothing like it! Free sample and sales kit. Lee Stuart, 1314 Milwaukee, Dept. G-10, Chicago, Ill.

FIGURINE Molds and many others, liquid rubber, statuary plasters, flock finishes, etc. Illustrated catalog and plastercraft manual free. Blue Rapids Supply, Blue Rapids, Kansas.

BEAT Inflation. Wartime plans! Free book "372 Unusual Worldwide Businesses." Work home. Start sparetime! \$800 month reported. Publishers-50, Carlsbad, Calif.

GUARANTEED Formulas. Sensational Silicone auto polish only \$1.00. Grainless mechanics' soap 25c. Big profits. Grant Lovell, 2166 South Shore, Erie 5, Penna.

MAKE Money by mail. 25c booklet, 10,000 words, shows right way. Big mailorder magazine 25c. Both 40c. Southwest, 1309C North Princeton, Albuquerque, New Mex.

MAILORDER Profits 4 ways distributing trade magazines under your name. Instruction samples 25c. Craigie, New York 19.

LIQUID Marble—Colorful, glossy! Molded, brushed, sprayed! Cast novelties, statuary, colored tiles. Flexible molds. Compositon floors. Particulars free. Marbleizing Service, Edwardsville, Illinois.

REVOLUTIONARY Conception of public bookkeeping! \$5.00 hourly. Simple instructions. Full spare time. Systems, shortcuts, obtaining clients. Auditax, 10775-H Tabor, Los Angeles 34.

NEW Different home business opportunity. Raise worms for fishermen. Everything furnished. Flint River Worm Farm, Reynolds 1, Georgia.

PROFITABLE Mailorder business. Free details. Faley, 3519 Charles, Cincinnati 8, Ohio.

MAIL Order News: 57th year, tells how to make money at home. Small capital plans, ideas, instructions. 25c copy. Hirtzel Business Service, Seymour 3, Ind.

MAKE Hollywood stars perfume at home. Big profit. Full information. Write Emily Mfg., PM-1, Box 319, North Hollywood, Calif.

ADVERTISE in 140 Canadian weeklies, 24 words \$8.50. List free. Fresh names m.o. buyers, list free. Quebec city phone book \$1.00. Lots of mail from Canada. Name listed 25c or 6 times \$1.00. View cards 6 for 20c. Unused match covers, 50 different \$1.00. Quebec felt pennant 50c. Cushion top souvenir \$1.50. Write to: York Agencies, Suites 100-101, Dept. PM, Hotel York, Quebec City, Canada.

FREE Illustrated directions casting novelties. Genuine latex for molds. Major Chemical Co., 164 Portland St., Cambridge, Massachusetts.

BIG Money cleaning venetian blinds. Small investment for equipment starts your own lifetime business. Write G. A. Co., 442 N. Seneca, Wichita 12, Kansas.

450,000 ARTICLES Wholesale. Directory 10c. (Refundable). Publishers, Box 1302-P4, Detroit 31.

WHERE To buy 600,000 articles wholesale. Details free. Krueger, 3418 Wolcott, Chicago 13.

TIN Cans. Turn them into cash. Nine methods. Instructions 50c. Charles Co., 12-BWH, Norwood, Ohio.

ELECTROPLATE Metals, non-metals. Inexpensive, profitable home process. Free booklet. Tyco Metals, Box 13231-T, Houston 19, Texas.

HAVE Profitable home business. Get 101 ideas in new booklet only 25c. Arco Sales Co., 505 W. 26 St., Chicago.

NYLONS 100% DuPont. Direct from mill. 51-15 first quality \$1.65 at \$12.50 doz. Box 3 pairs \$3.15 prepaid. Write (prices). Roma Hosiery Mills, 833 Columbus Ave., New York City.

MAKE At home. Sell everywhere. Super-Solveen hand soap, Cameo polishing cloth, Tiffnite glass wax, Nu-Gleem furniture polish, Blitzeen roach exterminator, Luxor floor wax, Oxium soldering fluid, Toxite fly spray, Titania metal polish, Daxtol moth spray, Hydrolax drain cleaner, fragrant wick air deodorant. Complete formulas, 25c each. Any five, \$1.00. Label copy, buyer's directory included. Majestic, 530½ S. Main, Elkhart, Indiana.

\$250 WEEK Reported! Free book "505 Odd Successful Businesses." Work home! Expect something odd! Pacific-68, Ocean-side, California.

FOR Successful mail order career, operate from New York individual office. Rent only \$12.00 yearly. Firms \$18.00 yearly. Established 1926. Co-operative Offices, PM-126 Lexington Avenue, New York 16.

ROUVIER Perfumes formerly \$4.00 per dram, now \$1.00 postpaid. Box 30, Westchester Square Station, New York 61.

NEW Mailorder manual tells what, where, how to sell by mail, from home. Details free. Howard Holmes, 210 Fifth Avenue, Suite 1102, New York City.

MEN, Women. Grow mushrooms. Cellar, shed. Spare, full time, year 'round. We pay \$3.00 lb. We paid O. Babbitt \$4,165 in few weeks. Send \$2.00 for General Information Book. Washington Mushroom Ind., Dept. 125, 2954 Admiral Way, Seattle, Wash.

MAKE Over \$100 week, at home, renewing small auto part for wholesale trade. Exclusive, non-competitive. No machinery or skill required. No sales calls to make. Complete data and sample, 35c. S.P.S. Co., 3033 Main, Kansas City, Mo.

BOOKKEEPERS Boost income operating simplified bookkeeping service. Kern, 4942 Vineland Avenue, North Hollywood, Calif.

FUN! Profitable! Easy! Home business! Assemble amazing "atomic moving circus." No winding—no electricity. Send \$2.00 for complete starting kit, instructions, valuable sales plans. Money back guarantee. Slocumb, 275 Clisby, Macon, Georgia.

CLOSING Out—Collection systems. Formerly \$15.00. Reduced to \$1.00 postpaid. Remit to National Business Service, 210 Broad St., Elizabeth, N. J.

BOOKKEEPERS Earn \$100.00 weekly operating simplified "bookkeeping and tax service." Details free. Universal Bookkeeping, Box 664-M, Springfield, Missouri.

HOW And where to obtain capital. Small and large loans. Free particulars. Star Service, Wapekoneta, Ohio.

UNPAINTED Bookends, plaques, statues, figurines. List. Haverty Products, 822-17th St., Altoona, Penna.

SPIN Angora wool into yarn. Interesting work. House of Angora, PM, Springfield, Illinois.

BOOKKEEPERS Be independent operating our simplified system. Dominion, 74 Sparks, Ottawa, Canada.

VENDING Machines earn big money! An investment as low as \$10.50 will start you in this fascinating, profitable business that can lead you to the road of success and independence. Routes can be established and operated in either full or spare time with no experience needed. Write for full details and our free catalog illustrating our nut, candy, gum and stamp vendors; also pin ball machines, music boxes, etc. Write immediately to Parkway Machine Corporation, Dept. 7, 715 Ensor Street, Baltimore 2, Maryland.

NATURAL Molding Latex. Extra thick. Free sample. W. Wooley, 115-A Donald, Peoria, Ill.

BEST Source for nylons. Rich Supply, 215 W. 98, New York 25.

NEW Profitable home business repairing zippers. Thousands of customers waiting. No experience required. We furnish everything. Write Texas Specialty Company, 204-B Texas, Texarkana, Texas.

24 ASSORTED Small unpainted figurines, \$1.59 postpaid. Illustrated figurine list free. Oman, 642M Broadway, St. Paul 1, Minn.

EARTHWORM Breeding. Valuable bulletins on successful methods mailed free. Earthmaster System, Dept. 14, El Monte, Calif.

YOUR Own profitable home business. Preserve live flowers to last for years. New simple discovery. Enormous demand all year 'round. Tremendous profits! Light fascinating work. Send \$2.00 for working equipment, instructions, and valuable sales plans. Satisfaction guaranteed or money promptly refunded. Alfred Hermansen, 210 Fifth Ave., Suite 1102A, New York 10, N. Y.

WANTED! Home producers by manufacturers in our clearing house service. Become a sub-contractor, casting plastic products for these companies. Thousands of easy to make items required. Cash in at home without previous experience. For details write Plastic Service Guild, Dept. PM, 233 Condor St., E. Boston 28, Mass.

MAKE Money spare or full time, casting metal toys and novelties. Big wholesale and chain store demand for cast metal autos, soldiers, ashtrays, banks, etc. keeps manufacturers busy. Production molds furnished for up to 100 and more castings per hour. No experience or special place necessary. Write for information and illustrations of patterns needed. Metal Cast Products Co., Dept. A, 1696 Boston Road, New York 60, N. Y.

COLOR Concrete with chemicals. Marble-glaze cement benches, pottery, garden ornaments. Home-shop. 10c brings sample, pictures. Hollywood Cementcraft, 8527-R Wonderland, Hollywood 46, Calif.

START Mailorder bookshop — Everything furnished. 25c brings booklet, samples, exciting ideas. General Publications, Ossining, N. Y.

EXTRA Money. No selling; operate vendors. Amazing profits, details free. Silver King, Suite B, 622 Diversey, Chicago 14.

THOUSAND Articles wholesale, "Supply Source Directory" 10c. Ideal Service, Park Ridge 30, Illinois.

BE Appointed state notary public now! Details. Stationers, Helotes 50, Texas.

OPERATE Profitable mail order business. Write Walter Service, 4159-A East 112th, Cleveland 5, Ohio.

MAKE Money at home as renewal headquarters for all magazines. Liberal commissions. No experience — no capital needed. Supplies furnished. Write for free catalog. McGregor Magazine Agency, Dept. 500B, Mount Morris, Ill.

SELL By mail; free booklet, instructions. Manhattan House, PO Box 50-M, New York 28, N. Y.

MAKE Tough, durable plastic—1c pound. Makes attractive floors, walls, built-ins, roofs. Build good home, \$150.00 room. Bays Laboratory, Oklahoma City 9.

SPECIAL Rubber for making molds. Literature and sample free. Universal, Box 1076-A, Peoria, Ill.

WORK At home. Get orders by mail. Everything supplied at low cost. Big earning possibilities. Write: Edmondson, Box 4865-P, Atlanta 2, Ga.

DOLLARS In personalized baby record books. Sell by mail. Use same literature we do. No-Co-Ro, Oakland 6, Calif.

MAKE Rubber stamps, metalize baby shoes, repair dolls, silver mirrors, make beautiful figurines. Catalogue of "30 ideas" free! Universal, Box 1076-A, Peoria, Ill.

LEARN Professional candy making profitable home business. Details free. Pate, Kissimmee, Florida.

COMMERCIAL Deep frying course. Mock chicken legs, potatoes. New and proven methods. Learn about this money-making field. \$2.50 p.p. Concession, Toledo 13, Ohio.

FABULOUS Earnings—Fascinating pastime. Growing genuine, living miniature (ming) tree. New sensational business or hobby. Astounding information free. Dwarf Gardens, Box 355B, Briggs Station, Los Angeles 48, Calif.

137 WAYS To make money, in home or office, business of your own. Full particulars free. Elite Co., 220 Grand St., New York 13.

BRUSH Plating outfits connect to a battery. No tanks necessary. Good paying business at home plating autoparts, bathroom fixtures, bicycles, reflectors, silvering mirrors. No shop or experience required. Outfits furnished. Free booklet. Gunmetal Co., Ave. H, Decatur, Ill.

CASH For your idea, 280 manufacturers need inventions, patented or unpatented. List free. Invention Bureau, 208-M Clinton, Oak Park, Ill.

OWN A printing business. Good profit printing cards, stationery, etc. in spare time. Easy rules furnished. Have home shop. Send dime for complete printer's supply book and samples. Kelsey, Inc., Z-24, Meriden, Conn.

\$25 WEEKLY Working two hours daily. No canvassing. No manufacturing. Lycke, Box 2471-A, Cleveland 12, Ohio.

RECAST Old batteries into new. Latest achievements. Battery Laboratories, Minneapolis.

MADE \$24,500 Using money making plans from Schemer Magazine, world's oldest mailorder publication. Box 275M, Canfield, Ohio. Year \$2.00. Sample 20c.

MINK Raising information free. Complete. Lake Superior Mink Farm. Superior, EE1, Wisconsin.

POPCORN And potato chip equipment. Long Eakins Company, 5160 High, Springfield 99, Ohio.

COPUBLISH Leading m.o. paper. Latest copy Mail Sale Advertiser, details, dime. Vanroy Shirk, Lebanon, Penna.

READ "Advance"—The voice of mail order. Offers money-making opportunities, sources of supply, personal guidance, etc. Issued monthly. Sample copy 25c. Yearly subscription \$2.00. Advance Publishing Company, 313 East 21st Street, Suite 450, New York 10, N. Y.

CO-PUBLISH And advertise in The Central Mail Advertiser. Sample copy 10c. Low rates. Large circulation. Bagby Printing Co., Georgetown, Ohio.

EXCEPTIONALLY Profitable making finest perfume. Sample fragrance, full particulars free. Genmerco, Box 142-L, Dorchester 24, Mass.

NEW Exceptionally profitable plans—Ideas for home operated mail business. Rush name, Miller, 1772-P Carlyon Road, East Cleveland 12, Ohio.

MAKE Money at home—Ideas galore to choose from. All fully illustrated and described. Write: Spens Distributors, Box 5511-M, Chicago 7, Ill.

ESTABLISH Profitable home mail business with your exclusive proposition. Idea to mailbox service. Booklet free. NMD, Agency, Box 88-W, Dorchester 22, Mass.

BUY It wholesale! Manufacturers, distributors offer 850,000 items. Literature free. Olsen, 1231-A East Third St., Duluth 5, Minn.

LIQUID Rubber. Make flexible molds. Free sample. Chaney, 1130 E. 16th St., Jacksonville 6, Fla.

RAISE Earthworms for gardening and fishing. Information with each order, \$7.00 per 1000. James Vettraino, 5826 Harding, Detroit 13, Mich.

MAILING Postcards selling repeat merchandise is profitable. Everything supplied. Details free. Gordan Publishers, Box 23, Pawtucket, R. I.

MEN—Women. Everybody likes candy. Learn to make professionally. Our 40th year. Ragsdale Candies, D5, East Orange, New Jersey.

EARN Money at home with your typewriter! Spare time! Details free. Edwards, Publisher, 3915-PM, 12th, Des Moines 13, Iowa.

\$46 FROM Square foot plywood; jigsaw necessary. Write, Woodarts, Bridgewater, Mass.

COLORGLAZED Concrete pottery made without molds. Patented method. Cemetery products, novelties, tiles. Basement leak-sealing. Money-making projects. Booklet, details free. Men only. National Potteries Company, Grand Rapids, Minnesota.

ELECTRO-PLATE With brush, silver, nickel, copper. Work at home. Wonderful profits. Make your own outfit. Plans, formulas \$2.00. Kemo-Plate, Park Ridge, Ill.

MONEY In new greaseless doughnuts. Start in kitchen. No smoke. Sell stores. Free recipes. M. Ray Company, 3605 South 15 Ave., Minneapolis 7, Minnesota.

RAISE Earthworms. Easy, profitable. Send for free literature or send dollar bill for illustrated book. Money back guarantee. Earthworm Culturists, Box 710, Atlanta 1, Ga.

MONEYMAKING OPPORTUNITIES

SEND Today: 1. Bellows' Dresden plaster figurine mold list. 2. Nationally famous unpainted figurine list. Enclose 25c, refundable first order. Bellows' Plaster Casting Company, Minneapolis 16, Minn.

EARN Extra cash! Get quick profits. Make pearl and rhinestone jewelry! It's easy! It's fun! Sells on sight! For complete instructions and illustrated catalog send only 10c to cover mailing and handling to Immerman & Sons, 1812 C4 E, 13th St., Cleveland 14, Ohio.

DEFENSE Welding jobs pay. Welders needed. Train quickly. VA contract. Hobbart Welding School, Box M-416, Troy, Ohio.

HOME Electroplating units \$8.95. Includes tank, rectifier. Free details. Reed Engineering, 620 So. Inglewood, Inglewood, Calif.

UNUSUAL Opportunities in backyard profits! Free booklet. Pickett's, Florence, Kentucky.

FISHBAIT, Fertilizer profits. Domesticated earthworms convert garbage. 300 worms \$2.00. Booklet 10c. Averie, 112-P Elizabeth, Wichita 12, Kansas.

SELL British sports cars. Liberal commissions. Literature 50c. Walraven M.G. Sales, Marion, Ohio.

MAKE Money while sleeping. Two column, penny candy or nut machines. Hurry for these beauties. Ellis, Box 167, Long Beach, California.

WOULD You pay 3%—first \$350 made? Book "505 Odd Successful Businesses" free! Work home. Expect something odd! Pacific-69, Oceanside, Calif.

FREE Nation-wide advertising, publicity! Advertise your products to 51 million readers thru 77 national magazines, free of charge! Broadcast on 400 radio stations without risking a penny! Send 25c for details today! Treasurer, 149 Storer, New

"SEWING Machine Business Guide" covers service, sales, rentals, conversions, wholesalers. New, complete, guaranteed. \$3.00. Description free. Service, 1321 Melbourne, Corpus Christi, Texas.

FREE, Our 25c folio "The Mail Money Maker," Coiners, P.O. Box 2171-M, Ft. Lauderdale, Florida.

MAKE Money at home. 101 ideas for full or spare time earnings. Proven winners. All for 25c. Thomas F. Patrick, c/o State Farm, Pikeville, Tennessee.

NEW Fascinating, money maker. Professional glass blowing kit, \$5.95. Denton, 170 Lovering, Buffalo, New York.

BEST New mail order plans monthly. Beginners, old timers. Year \$3.00. Details free. Berberich, Box 6527-A, Pittsburgh 12, Penna.

WIN Contest money. General Contest Bulletin gives hundreds of tips. List current contests and rules. Sample 25c. General Contests, 1609½ East 5th, Duluth, Minn.

MAKE Money! Raise birds in spare time. "Parakeet Breeding For Profit" and copy of cage-bird magazine, \$1.50. American Canary Magazine, 3449 N. Western Ave., Dept. PM, Chicago 18, Illinois.

"WATERLESS (Lanolin) Hand Cleaner," (Oil base.) Make, sell. No machinery. Build profitable business. Complete formula \$1.00. Ideal Service, Park Ridge 3, Ill.

DOLLARS Three ways with "Kitty-Kat" readi-cut baby shoes. Complete local and mail order plans. Write No-Co-Ro, Oakland 6-K, California.

MAKE Seamless billfolds at home. Good income. No experience needed. Write to Max Products, HEM 805 East Walnut, Louisville 4, Ky.

RAISE Your business value, standing, as state notary public. Information. Stationers, Helotes 50, Texas.

PUBLISH Your own magazine. Handsome 52 page format, well edited, illustrated. Cost low as \$1.00 month. Brings you prestige, profits. 25c brings sample, details. National, Ord, Nebr.

READ Progressive Mailtrade, the magazine that tells how to make money by mail. Dime brings sample and special offer. Progressive Mailtrade, Box 357, Sheboygan, Wisconsin.

INDEPENDENT Income! Make leather belts, billfolds, purses. Big catalog and genuine steerhide keyholder 10c. Tandy Leather, Box 397E, Tulsa, Okla.

LEARN How others earn money at home! Write—A. Sizemore, 4917 Kostner, Chicago 30, Ill.

QUICK Profits taking magazine subscriptions, handling greeting cards. Cassell Publishers Service, Westfield, N. J.

DOLLARS Make sense. Sell card table advertisement, receive \$130.00. 12 tables free. Unique Gift Club, Pine Hill, New Jersey.

EARN Money evenings, copying and duplicating comic cartoons for advertisers. Adservice, Argyle 1, Wisconsin.

FORMULAS, PLANS, ETC.

COLD Light! Simple experiment makes brilliant, glowing liquid. Chemicals and instructions 25c. United Manufacturing Associates, 3605 Canyon Ridge, Fort Worth 3, Texas.

FORMULAS. Latest, best. Catalog and chemical instruction sheet 10c. (refundable). Neiko Chemical Service, 3462-F Merchandise Mart Sta., Chicago 54, Ill.

MILLER'S Modern manufacturing formulas make products that get the business and pay! Fifty years supplying the best. Literature free. Liscomb Miller, Chemical Building, Tampa, Florida.

REAL Manufacturing formulas. Lists free. Cummings, Chemist, Gordon Ave., Syracuse 4, N. Y.

WATERLESS Hand cleaner. (No ammonia.) Easily made. Good profit. 2 dependable formulas \$1.00. Neiko Chemical Service, Box 3462HC, Chicago 54, Ill.

MAKE—Sell cleaners, soaps, polishes, flavors, cosmetics. No machinery. Formula literature free. Kemico, Park Ridge 16, Illinois.

FORMULAS. Trade secrets, for nearly everything. Catalog free. Creative Publishers, Winnetka 6, Illinois.

FREE Formula catalog, anything analyzed \$20.00. Western Chemical, Salem, Oregon.

TESTED Formulas. Interesting descriptive booklet free. Pont Box 635, PM

PLASTICS

LUMINESCENT Plastics, casting liquids, rods, sheets. Send 25c for list and samples. Storin Plastics, Box 324, Niagara Falls, New York.

NEW Liquid plastic. Clear, colors. Cast without heat. Embed flowers, insects, coins. Saw, drill, carve. Free folder, "Liquid Magic," shows fine things you can make and sell. Write today. Castolite, Dept. D-101, Woodstock, Illinois.

PLASTICS—Wholesale, retail. We make our own full-color carving dyes. Casting plastic, jewelry findings, mold materials. Catalog, bargain lists, instructions. 10c. 25c airmailed. Gem-O-Lite, Box 686B, North Hollywood, Calif.

LUCITE Plexiglas. Any size sheets, masked. Square foot (12 x 12) cost, 1/16", \$1.20; 1/8", \$1.40; 3/16", \$1.75; 1/4", \$2.08. Colors add 10%. Include 10% postage. Almac Plastics, 230 Fifth Ave., New York 1, N. Y.

PLASTIC, Sheets, rods, tubes, etc. Free list. Plastic Supply Co., 2901 N. Grand Blvd., St. Louis 7, Mo.

HI-PROFITS, Internally hand carved plastics. Gift-jewelry. Free catalog. Pilot Plastics, 67 C, New York City 7.

LEARN Plastics at home. Small cost—Spare time. Complete experimental outfit and full instructions furnished. Details free. Plastic Projects, Box 5151-C, Detroit 35, Michigan.

CHEMISTRY

NEW Idea chemical and apparatus outfits for home experimenting. Photo-scales, microscopes, chemicals, biological and laboratory supplies in small quantities. Catalog 25c. Established 1931. John H. Winn, 124A West 23rd Street, New York, N. Y.

EASY Vacuum pump. Screws on faucet. High vacuum for experimenters, doctors, laboratories, etc. \$1.98 postpaid. Equipment Engineering Co., Box 292, Kansas City, Mo.

AMATEUR Scientists and experimenters: Read the "Scientific Experimenter." Full details and free copy. Amateur Science League, P.O. Box 168, New York 56, N. Y.

ILLUSTRATED Catalog: Chemistry, mineralogy, biology. 10c. Tracey Laboratories, Evanston, Illinois.

CHEMICALS And apparatus for industrial, analytical, and private laboratories. Catalog 15c. Dept. M-50, Biological Supply Co., 1176 Mt. Hope Ave., Rochester 20, N. Y.

HELP WANTED

\$7 HOUR. Free sample. Whitney nameplates, 94 Boulevard, West Springfield, Mass.

\$5 HOUR Easy! Sell name plates for houses. Free sample, order blanks. Write: National, 214 Summer, Boston, Mass.

AGENTS WANTED

YOURS For free trial—Everything you need to make extra money! Experience unnecessary. Big profits. Bonus. Request feature all-occasion greeting card assortments on approval, free samples name imprinted stationery, napkins, towels, free catalog, selling guide and surprise gift offer. New England Art Publishers, North Abington 434-B, Mass.

NEED Extra cash? Take orders for personal initialed belts and buckles, cap badges, tie holders, etc. Choice of 3000 emblems. Free sales kit. Hook-Fast, Box 1425PM, Providence, R. I.

BUY Wholesale, earn big money selling thousands nationally advertised products at big discount. No stocks to carry. Sent free "The Wholesale Plan." American Buyers Service, 629M Linden, Buffalo, N. Y.

SELL Blue stock signs to stores, etc. Many slogans, also clock signs. Cost 6c, sells 35c. Send \$1 for 15 different signs. Hudak, 125 Sullivan St., New York 12, N. Y.

MAKE Wedding profits. Sell invitations, napkins, matches. Samples free. Dunbar's, Middlebush 3, N. J.

EVERYDAY Cards. New—21 cards for \$1.00. Also new black plastic cards, metallic cards, children's books, personalized stationery, note paper, wrappings and others. Send for samples today. Howard P. Ellis, Dept. PM-4, Pitman, N. J.

AGENTS—New deluxe "in-a-purse" washable celanese taffeta combination shopping bag. Every housewife buys. Easier sales, bigger profits with 10-second demonstration. Sample \$1.00, postpaid. Seejay Sales, 2416-F North Oakley, Chicago, Ill.

NYLON Uniforms. Immediate delivery. Immediate profits. Sell to doctors, dentists, nurses, waitresses, beauticians, housewives. Free sales kit. Superior Fabrics, Dept. P-4, 3936 Market, Philadelphia 4, Penna.

\$3.00 AN Hour selling cushioned shoes direct. Advance commissions. Bonus. No investment. Experience unnecessary. Free outfit. Samples. Paragon Shoes, 739 Columbus, Boston, Mass.

AT Last! Something new and sensational in everyday cards, 21 for \$1. Make extra money fast! Show satin, velour, metallic cards. Get orders easy. Big line \$1 assortments, scented stationery, personal matches, kiddie books. Prints free. Two \$1 boxes on approval. Puro Co., 2801 Locust, Dept. 140-D, St. Louis 3, Mo.

POSITIVELY New—Over 100% profit. Two sided reversible neckties. Free details. Farrell Company, Dept. P-21, 1377 Van Zandt, Cincinnati 31, Ohio.

SELL Greeting cards—Big profits! Quick sales! Catalog free! Elfco, 432 North Wells, Chicago 10.

POLISH Floors without wax. New invention. Lightning seller. Leaves floors lustrous, beautiful. Samples sent on trial. Kristee 127, Akron, Ohio.

FREE Samples, and amazing plan, giving you gorgeous dress without penny cost. Rush name today, with dress size. Harford, Dept. D-535, Cincinnati 25, Ohio.

SELL Ward's perfumed starch, 140 other fast sellers. 100% guaranteed. 100% average gross profit. Nearly 100 year old company. We sell cash or credit. Details: The Ward Company, Dept. PM-4, Winona, Minn.

ORNIN Leather cleaner and conditioner. Good seller. Developed to distant competition. Maintains oil content. Keeps leather flexible and soft. Takes care of all kinds of leathers. Suede, horse-hide, calf-skin, etc. Sports, upholstery, luggage, garments, saddles, jackets, military goods, shoes, gloves, etc. Territory barely scratched. Sidelines or full time. Ornin Company, 1017 Thirteenth Street, Des Moines, Iowa. This cleaner specializes cleaning suede shoes.

FAST Profits—No investment. Send for big, free catalog. Plastic aprons, tablecloths, etc. 150 sure-fire items. We guarantee sales. Write The Halliday Company, Dept. M-4, 15-19 Pennington Ave., Passaic, N. J.

NYLONS—New "2500" superfine nylons. Direct from mill. Free sample outfits. Guaranteed against snags and runs, any original defects. They are "four-way" checked. Its "2500" superfine nylon threads assures maximum wear. Improvements new finish process, laboratory tested, proved strongly resist snags and runs 40% more. Thousands of women are waiting to buy them. We pay high commissions. 25% on prepaid orders. Nylon neckties \$2.00 at 90c prepaid. Ergim Hosiery Mills, 992 Columbus Ave., New York City.

SUMMER Money maker. Every lawn owner wants it! Over million dollars sold last summer. You cash in this summer. Approved by four Universities. Barclay Co., Box 883, Plainfield 5, New Jersey.

HOT! New! Novel! Practical! Cigarette lighter in miniature whiskey bottles. "Crazy" labels get laughs everytime used. Smokers buy several for table, desk, den and bar. Sells on sight. Fast, easy profits. Send \$2 for sample set of 3 and complete sales data, prices, and exclusive territory plan. Mercantile Enterprises, Dept. 3, Frost Bldg., Norwalk, Conn.

ALL-Purpose gas mower. For grass, weeds, brush. Rotacut, RM-2014, Excelsior Springs, Mo.

PERFUME Beads, sensational seller. Big profit. Particulars free. Mission, 2328P West Pico, Los Angeles 6, Calif.

RELIGIOUS Goods—Add plastic collection plates to your line. Mumpower's, Fairfield, Alabama.

BUY Thousands of nationally advertised products direct from manufacturers and distributors. Write for "Buy Direct and Save." Service Publishing, 1420-A Investment Bldg., Pittsburgh 22, Penna.

TAKE Large unit orders with wool and cotton uniforms, initial buckles, belts, badges. Choice 3,000 emblems. Prospects everywhere. Write Hook-Fast, Box 480-PM, Roanoke, Va.

MEXICAN Feather pictures. High profit selling gift shops, etc. Adelphi, Box 57-B, Bellerose 6, N. Y.

SELL Ward's double strength vanilla, 140 other fast sellers. 100% guaranteed. 100% average gross profit. Nearly 100 year old company. We sell cash or credit. Details: The Ward Company, Dept. VM-4, Winona, Minn.

CASH In on tremendous demand for new cheap oil burner that fits in cooking-heating stoves and furnaces. Burns all kinds of oil including crankcase. Lifetime guarantee. Big profits. Be first. Write quick to Northwest Mfg. Co., 315 Main, Mitchell, South Dakota.

MEXICAN Feather pictures. Sell on sight; 200% profit! Free details; sample 10c stamps. Sylvia-PK, Apartado 9036, Mexico City.

FREE Sample nylon stocking of world's only nationally advertised hosiery line actually guaranteed against runs, snags or excessive wear, regardless of cause! It's amazing but true. Every weight from sheerest 15 denier to heavy 70 denier—all gauges to luxury 60 gauge. Amazingly low prices, starting at \$1.08 prepaid for sheerest 15 denier 51 gauge. Not sold in stores. Good Housekeeping guarantee seal. Also complete line men's hosiery guaranteed one full year or replaced free. Full variety lingerie in crepe, satin and nylon, featuring all nylon slip at \$2.95, satin slip at \$1.58, etc. Housecoats and robes. Kendex sales people will earn one million dollars this year. Get your share. No money or experience needed. Pay nothing now or later. Just show free outfits. Write orders. We deliver and collect. Advance cash plus huge bonus. Earn money spare or full time. Become manager; appoint others to sell for you; earn steady income on their sales. Man or woman—young or old, you can earn more money than you ever thought possible. Everything you need is furnished free and prepaid, including nylon stocking, samples of materials, sales books, 36-page salesmanual, color cards, etc. Simply write your name and address on postcard and mail to Kendex Corporation, Babylon 43, N. Y.

FERTO-Pot, plant eats pot, 33 $\frac{1}{2}$ %; lawn-seeded-Ferto-soil, for patching or building new lawns. 40% commission. Allen Co., Pittstown, N. J.

FREE Samples. Big profits showing amazing "Glow-in-the-dark" specialties. House numbers, pictures, plastic novelties, ashtrays, keyholders, religious and nursery objects, etc. Madison Plastics, 303 Fourth Ave., New York 10, N. Y.

BE A money maker. Use your home as magazine headquarters. Liberal commissions. No experience—No capital needed. Everything furnished. Write for free catalog. McGregor Magazine Agency, Dept. 500A, Mount Morris, Ill.

YOUR Own business selling army surplus, new clothing. Lowest prices. Enormous profits. Catalog free. Moro, 558-J Roosevelt, Chicago 7.

PHOTO-Salesmen, agents. Sell beautiful hand colored plastic enlargements and sensational new photo compact, rings, bracelets, lockets, etc. Collect deposit, we deliver. Profitable sideline. Send card, for free sample kit. Novel Portrait Co., 3343 North Ave., Chicago, Ill.

EXCELLENT Sideline for printing and advertising salesmen. Decalomania name plates in small quantities. Great demand. Also, make money with our line of automobile initials and sign letters. Free samples. "Ralco" XL-Roxbury, Boston 19, Mass.

SELL Arcadian cigars. 100% imported Havana tobacco. Hand made. Steady, repeat profits. Free folder. Seco Cigars, 87 South Drive, Rochelle Park, New Jersey.

SCHOOL Seniors—Earn sensational profits selling classmates America's most beautiful graduation name cards. Largest selection. Outsells all others. Free sample kit. Printercraft, Dept. M, 1425 E. Elm St., Scranton 5, Penna.

JEWELRY Factory desires salesmen, distributors, jobbers. Pickcraft, 19 Bank Street, Attleboro, Mass.

GOLD Lacquered window sign letters. Large sizes penny each. New foils. Absolutely beautiful. Free samples. Atlas, 544 W. 79th, Chicago 20.

\$5 HOUR Easy! Sell name plates for houses. Free sample, order blanks. Write: National, 214 Summer, Boston, Mass.

AGENTS: Stamping names on key protectors. Sample 25c. Stamping outfits, checks, social security and name plates. Hart Mfg. Co., 303 Degraw St., Brooklyn, N. Y.

DRESSES. 18c; Coats \$1.00, blouses 35c. Free catalog. Crown, 164-F Monroe Street,

AGENTS—300% Profit selling genuine gold window letters; stores and offices. Free samples. Metallic Letter Co., 438-B North Clark, Chicago.

WANTED—Purchasing agents. No money or experience required. Write Dept. C, Purchasing Manager, 2719 Lawrence, Chicago, Ill.

WHERE To buy 800,000 articles direct from manufacturers. Including hundreds of scarce items. Sent free, "Your Profits Under the Spotlight." Glass Publishing Co., Ellwood City, Penna.

SELL Big money-maker to men and women. Easy handwork makes fast-selling useful articles. Sunmade Company, Brockton 64, Mass.

BIG Spring sales! Scat Wick Deodorant gets rid of unpleasant odors quickly. Sample Scat and Kitty \$1.00. Write for 16-page catalog of household items. Sunshine Sales, Dept. WP-8, Loudonville, Ohio.

PAINTS—All kinds. 65c gallon up. Private label. Big profits. Certified Products, Louisville, Ky.

SELL Amazing petal action floral everyday cards. Profits to 100%; send 65c for sample. Collins Sales Company, 5914 Hodgman, Parma Hts. 29, Ohio.

TRANSPARENT Liquid rubber coating, non-slip, speed drying, for automobiles, floors, walls, woodwork, linoleum. Damp proof basements. Costs 98c, sells \$2.98. Big demand. Rubber Products, Inc., Station A, New Haven, Conn.

HIGH-GRADE SALESMEN

SELL Ward's floor wax, waxers, 140 other fast sellers. 100% guaranteed. 100% average gross profit. Nearly 100 year old company. We sell cash or credit. Details: The Ward Company, Dept. FM-4, Winona, Minn.

BIG Cash profits for men and women introducing Flexiclogs, sensational new flexible footwear. Experience unnecessary. Nationally advertised styles for women, children, men. Excellent sideline, no investment. Easy to average hundreds of dollars weekly. Free sales helps and sample offer. Get details now! Flexiclogs, Dept. L-4A, New Holstein, Wisconsin.

WRITE 3 Words—Collect \$7.65 on 10-second demonstration to merchants. Write on glass with amazing magic crayon—Presto! 5 color advertising message takes fire, glows like brilliant neon. Three sales daily bring \$22.95 profit. Rush postcard for details. Complete sales kit, free! Maxilume Co., 125 W. Hubbard, Dept. CL-84, Chicago 10, Ill.

DON'T Be discouraged. Let us help you get in business for yourself. Free sample outfit! Tested selling methods. Be your own boss. Sell comfort shoes direct from factory. Write today! Consolidated Shoe System, Dept. S-102, Chippewa Falls, Wis.

TAVERN And grocery salesmen wanted, new fast selling nut display. Foodkraft Distributing Co., Hamburg, N. Y.

IS \$210 A week worth a penny postcard to you? Then rush card with name and address for special free trial plan that sells amazing new automatic refrigerator defroster "like hot cakes!" Write to Mr. Lewis, D-Frost-O-Matic Corp., Dept. PMC-4, 6 N. Michigan, Chicago 2, Ill.

EARN Spare time extra money. Show amazing cushion comfort shoes. To \$3.25 commission per pair, plus big cash bonus. Experience unnecessary. Write for free catalog, full information. Tanners Shoes, 778 Boston, Mass.

AD Matches! Sell amazing designs—20, 30, 40 and 240-light book matches. Bigger spot cash commissions; every business a prospect. Low prices for high quality. Repeats. Start without experience; men, women; full, part time. Buy nothing! Sales kit furnished. Match Corp., Dept. PM-16, Chicago 32, Illinois.

SELL Our waterproofings, floor mastic, cement hardener, etc. (30 items) to maintenance men, building owners, contractors. Can start part time. Commission. Territory. Write Haynes Products Co., Desk 6, Omaha 3, Nebr.

LOW Cost memo books sell on sight. Every business a prospect. Free sample kit. Clayton Advertising, Cardiff, N. J.

BIG Profit selling perfumes. Trial oz. \$1.00. Details free. Roberts, 432 Fremont Ave., Springfield, Ohio.

ADVERTISING Book matches—Cash in on big demand; sell union label matches. Cuts for all businesses and political parties. Free powerhouse selling kit, low prices, protection guaranteed on repeat orders. Cash commissions. Superior Match Co.,

"MARY-Mac" gas water heaters—Factory. Steady income. Permanent. McDaniel Manufacturing, 1012 Powhattan, Dallas, Texas.

\$2600 NEXT 9 Weeks—Season starting. Sell calendars, specialties, matches. Prospects everywhere. Advanced commissions. Experience unnecessary. Samples free. Continental Calendar, 542-A South Dearborn, Chicago.

SELL Art and commercial calendars. Advertising specialties. Over 1000 good-will items. Diversified line. Highest commissions. Territorial protection. Send \$1.00 refundable deposit for prepaid initial set of samples. Standard Calendar Company, Madison, Illinois.

BIG Money taking orders. Shirts, ties, socks, pants, jackets, sweaters, shoes, uniforms, etc. Sales equipment free. Experience unnecessary. Nimrod, 4922-AN Lincoln, Chicago.

A Fine income, your own nylons free! Show nylons, lingerie, men's socks with amazing free replacement guarantee against runs, snags, tears. Write for free sales kit. Group organizers invited. Rosalee Hosiery Co., Clifton 58, N. J.

\$5 HOUR Easy! Sell name plates for houses. Free sample, order blanks. Write: National, 214 Summer, Boston, Mass.

WANT To make real money? You can positively make \$50.00 a day and up selling a brand new item going to every type of food and beverage store, factories, laboratories, hospitals, etc. First time advertised. Write for free details today. Johnson-Hartmann, 53 West Jackson Blvd., Dept. PM-3, Chicago 4, Illinois.

NEW Jobs open in selling! Send name, address for five free issues of Opportunity Magazine's money-making guide, listing hundreds of companies who'll pay you well, full or part-time. No experience needed. Opportunity, 28 E. Jackson, Dept. 17, Chicago 4, Ill.

EDUCATIONAL AND INSTRUCTION

CAN A man my age become a hotel executive even though he has no previous hotel experience? Would you like to step into a well-paid position as hotel or club manager, purchasing agent, social director or assistant manager, etc.? The success of Lewis graduates from 18 to 50 proves you can—though you have no experience in hotel work. Harry E. Roorbach says: "While in the hospital I enrolled for Lewis training. Shortly after completing the course, the Lewis Placement Service informed me of an opening. At present, I am night manager in the largest hotel in Rochester. I owe my success to the Lewis course." Our free book explains how you can qualify for a well-paid position in leisure time, how you are registered free of extra cost in Lewis National Placement Service. Write today. Course approved for Veterans' Training. Lewis Hotel Training School, Desk TD-324, Washington 7, D. C.

LEARN Auto and diesel mechanics, welding, lathe, auto body repair. Practical training. G. I. approved. New classes each week. Free catalogue. Hanson Mechanical Trade School, Box 1780-M, Fargo, N. Dak.

DEFENSE Welding jobs pay. Welders needed. Train quickly. VA contract. Hobart Welding School, Box M-414, Troy, Ohio.

BE A real estate broker through home study or classroom instruction. Write for free book. Approved for veterans. Weaver School of Real Estate, 15 E. Pershing Rd., Box CP-4, Kansas City 8, Missouri.

LEARN Sewing machine repair. Electrify, rent, trade, sell. Big profit home setup. I show you how. Motor kits, new machines, etc. supplied wholesale. Free particulars. Taylor Service Co., Hamilton PM-4, Ohio.

IT'S Fun learning a language by Lingua-Phone. At home, in leisure time, quickly, easily, correctly master Spanish, French, German, Russian, Oriental—any one of 29 languages through Lingua-Phone Conversational Method. Add to service, job, travel opportunities. Send for free book. Lingua-Phone Institute, 8304 Rockefeller Plaza, New York City.

PRACTICAL Nursing—Learn easily at home, spare time. Big demand, good earnings. High school not necessary. Write for free facts. Wayne School, Dept. FG-1, 2525 Sheffield, Chicago 14, Ill.

WELDING Training profitable. Learn quickly. Magnificently equipped non-profit school. VA contract. Hobartweld, Box M-415, Troy, Ohio.

MAKE Up to \$35-\$45 week as a trained practical nurse! Learn quickly at home. Booklet free. Chicago School of Nursing,

SLIDE Rule simplified. Rules furnished. Complete course. Free details. Reed Engineering, 620 South Inglewood, Inglewood 1, Calif.

REAL Estate. Inexpensive home-study course. Successful students throughout America. Free information and proof. School of Real Estate Training, Dept. PM, 128 Broad St., Stamford, Conn.

YOU For president of your own credit-collection business. Many who answered our ads now have their names on office doors. Franklin Credit, Roanoke 7, Va.

MIDLAND Linotype School, Charles City, Iowa. Civilian, veteran courses. Free placement.

SCIENCE Of memory simplified. "The Art of Memory Development" free. Memorology Studio, 2016 Sunnyside, Chicago, Illinois.

DRAFTING—Learn at home. Booklet free. Monroe Institute, PM-4, Alton, Ill.

HIGH School—No classes. Study at home, spare time. Diploma awarded. Write for free catalog HF-6. Wayne School, 2527 Sheffield, Chicago 14, Ill.

READ With speed. New amazing method. Save hundreds of hours yearly. Free home test and details. Speed-Reading, Dept. D, 9111 Hoyne, Chicago 20.

U. S. Gov't Jobs! Start high as \$66.34 week. Men—women. Thousands of emergency program jobs available! Qualify now. Experience usually unnecessary. Free 40-page book shows jobs, salaries, sample tests. Write today. Franklin Institute, Dept. S-24, Rochester, N. Y.

BOUGHT, Sold, rented. Used correspondence courses. Write Baker, 5509-B Winthrop, Chicago 40.

TYPING—Home study course. Free details. Hollowell Typing Service, 4022 Muscatel, Rosemead, Calif.

LEARN Technical metaphysics. Insure success in life. Valuable information. Canada School of Technical Metaphysics, 2532 McKenzie St., Vancouver, B. C., Canada.

PERSONAL Psychology behavior-control lectures sold or rented. End money worries, overcome handicaps, get ahead. Free booklet. President Ballard, 1008 Washington Bldg., Louisville 2, Ky.

COLLEGE Degrees—No classroom work. Golden State University, Hollywood, Calif.

EARN While you learn. Day or night classes. Thorough courses in: Automobile mechanics, diesel mechanics, motor tune-up, auto body and fender, welding, refrigeration, radio, etc. Living accommodations. Veterans may earn \$210 to \$290 per month while in school including subsistence. Fully accredited to train veterans. Thirty-two years' experience training men. Nashville Technical College, Dept. #256, Y.M.C.A. Bldg., Nashville 3, Tennessee.

3800 LATEST Used correspondence courses. Catalog \$1.00. EG, Elmsford, N. Y.

PIANO Tuning pays. Learn this profitable profession at home. Our Tonometer and mechanical aids make learning easy. No knowledge music necessary. Diploma granted. Largest and oldest school—53rd year. G.I. approved. Write for booklet. Niles Bryant School, 78 Bryant Bldg., Washington 16, D. C.

ACHIEVE Business and financial success in your own collection-credit agency business. Home or office. Quickly learned. Free folder. Write Cole & Associates, Syracuse 2, N. Y.

BOOKKEEPERS! Increase your earnings! Operate your own simplified "dollar-a-week" bookkeeping and tax service. Full or spare time. Details free. No obligation. Ellis, Box 200, Cedar Grove, North Carolina.

LEARN Linotype (machine typesetting). Good pay, steady work. Booklet "X" free. N. Y. Mergenthaler Linotype School, 244 West 23rd, New York.

EARN \$10,000 Annually! Learners \$2,700. Unlimited opportunities in Merchant Marine. Instruction-Employment Manual \$1.00. Refundable. Titan Company, 45 Clinton St., Newark 2, N. J.

INVESTIGATOR Training. Phillips Secret Service System, 1917-B North Kenneth, Chicago 39.

USED Correspondence courses and books sold and rented. Money back guarantee. Catalog free. Courses bought. Lee Mountain, Pisgah, Alabama.

MEDICAL Laboratory Technicians in great demand. We train you in your own home. Catalogue free. Imperial Technical Institute, Box 973-J, Austin, Texas.

SECRET Investigation. Experience unnecessary. Investigators particulars free. George Wagner, M 125 West 86th New

HOME Study course, drugless therapy. Free literature. Institute of Drugless Therapy, Tama, Iowa.

USED Correspondence courses and educational books bought, sold, rented. Catalog free. Educational Exchange, Summer-ville, Ga.

STUDY To be a doctor of psychology or metaphysics. Obtain Ps.D., Ms.D., D.D. or Ph.D. degree. Chartered by state. Write for free book telling how. The Neotarian Fellowship, Desk 8, Dwight Building, Kansas City 6, Missouri.

AMAZING New scientific way to remember. Free details. H. Kaye, P.O. Box #261, Staten Island #1, N. Y.

VOICE Secrets! Free information. Studio 14356B, Jersey Ave., Norwalk, California.

PLAYS, STORIES, MANUSCRIPTS

I Want new writers to cash checks of \$1 to \$100 offered daily. The easiest way to write for pay. No previous experience necessary. Free details. Saunders M. Cummings, 468-11 Independence Bldg., Colorado Springs, Colo.

BEGINNING Writers: Let us show you how to get \$1.00 to \$20.00 checks daily. Experience unnecessary. Details free. Herwell Company, 7016-M Euclid, Cleveland 3, Ohio.

BUSINESS SERVICE

HAVE A Chicago mail address. Information free. Schultz House, 3116 Seminary, Chicago 13.

INFORMATION

SUPPLY Sources—Anything! 50c each item. Service Bureau, Box 5053-Z, Chicago 80.

CARTOONING, COMMERCIAL ART, SHOWCARD WRITING, SIGN PAINTING

"HOW To Make Money With Simple Cartoons"—A book everyone who likes to draw should have. It is free; no obligation. Simply address Cartoonists' Exchange, Dept. 94-C, Pleasant Hill, Ohio.

BE Smart. Get in art. Let me start you free. Nick Nichols Arts, 39 W. Adams, Chicago 3, Ill.

STUDY Showcard art. Free details and Strok-O-Graf. Midwest Art School, Fort Wayne 2, Indiana.

CARTOONISTS, Artists. \$100-\$200 monthly, sparetime. Proven plans, \$1.00. J. Borosky, 1571 Fulton, San Francisco, Calif.

2 CARTOON Courses \$3.95. Catalog \$1.00. Art Work, Elmsford, N. Y.

LEARN Sign painting, 152 lesson course. Results guaranteed. Stewart Sign Co., Box 287M, Pasadena, California.

CHALK Talks. Laugh producing program, \$1.00. Catalog 10c. Balda The Cartoonist, Oshkosh, Wisconsin.

ADVERTISING AGENCIES, LETTER WRITERS, FOR ADVERTISERS

SAVE Money on advertising. List free. Wilbur Erickson, Englishtown, New Jersey.

CIRCULARS Distributed in the District of Columbia \$3.00 per 1,000. Israel Company, Dept. 5, Box 6051, Washington 5, D. C.

ADVERTISERS! Reach nearly 18,000,000 readers. 25 Sunday national key newspapers, 18 words, \$59.00. "Terrific pullers." 20 popular newspapers, \$11.50. Free booklet. Special—One inch display 2-821,198 circulation, \$51.10. Newmark's Advertising Agency, (Established 1893), 217-7th Ave., New York 11.

ADS Placed in out of town newspapers and magazines. Low rates. Catalogue free. Ideas that pay. Baker Advertising Agency, Successors Ankrum Agency, 189 W. Madison, Chicago 2.

MAILING Lists: \$5.00-1000 up. Write Dixie Service, King, N. C.

24 WORDS In 50 weeklies, \$4.96. J. Darnell, 730 Hays, Jackson, Tenn.

ADVERTISE: 24 Words, 40 newspapers \$3.50. Lists free. Advertising Bureau, 10511-C Springfield, Chicago 43.

FREE Copy, layout service. Mailorder ad, 1,700,000 nationwide circulation, \$25.90 inch, 24-word classified, 20 big Sunday newspapers, \$30.00. Advertising ratebook free. Chicago Advertising Agency (established 1900), Chicago 4.

TYPEWRITERS, DUPLICATORS, OFFICE DEVICES

PRINTOMATIC Selffeeding post card printing duplicator \$13.50. Envelope addressing machines \$24.50. Pittsburgh Typewriter Company, 336-R Fourth Avenue, Pittsburgh 22, Penna.

RECONDITIONED Typewriters, printing devices. Write Dixie Service, King, N. C.

RUBBER STAMPS AND OFFICE SUPPLIES

RUBBER Stamps. Illustrated catalog 10c. Williams, Box 648, Plainfield 4, N. J.

RUBBER Stamps. Send for catalog. Excello, Box 500, Shreveport, Louisiana.

3 LINES 50c; Pads 35c; signature \$2.00; notary seals. Stampright, Wauwatosa, Wis.

PRINTING, MULTIGRAPHING, MIMEOGRAPHING GUMMED LABELS

DISTINCTIVE Printing, engraving, artwork. Free estimates. Henry, 2815 Boulevard, Jersey City 6, N. J.

50 LETTERHEADS With envelopes \$1.00. Benneville, Box 1931, Pittsburgh 30, Penna.

MIMEOGRAPHING, Typing, embossed business cards. Free literature. Davenport, 1311 Eberhart, Edwardsville, Illinois.

1000 EMBOSSED Business cards \$2.98. Ortiz, 1050 Fox Street, New York.

BUSINESS Printing. Samples, prices free. Howprint, 723-M Eunice, Webster Groves 19, Missouri.

125 LETTERHEADS. Full size, and 125 envelopes, \$2.00 postpaid. Maywood Publishing Co., 1133 Broadway, New York.

PRINTING—Catalogs, booklets, folders, circulars. Stationery. Garrison Press, Harrisonburg, Va.

MIMEOGRAPHING, Vari-typing. Prompt service. Free prices, samples. Loyal Brush, 3712 Walnut, Kansas City 2, Missouri.

QUALITY Printing. We specialize in publications, newspapers, tabloids. Send copy for estimate. Bagby Printing Co., Georgetown, Ohio.

SEND 10c Now for our 48 page 1951 price list—refunded first order. McCask Press, 1326 South 27th, Omaha, Nebraska.

MIMEOGRAPHING—Letters, pricelists, formulas, instructions. Lowest prices. Lem's Letter Shop, 5710 Stanton, Detroit 8.

PHOTO-Offset special, 5000-8½ x 11 \$14. Samples free. Reiffe, 160-P Monroe St., New York 2.

500 ¾x2¼ FOUR Line gummed stickers 50c. Red border \$1.00. Moritz Printery, Saeinaw, Mich.

1000 BUSINESS Cards \$2.50 prepaid. Samples free. Reliable Print Shop, 905 East Jefferson, Louisville 6, Ky.

THREE Day service on printing, multi-graphing, mimeographing. Prices, samples free. Progressive, 270c Burkhardt, Cincinnati 15, Ohio.

100 8½ x 11 HAMMERMILL Letterheads and 100 envelopes \$1.95. H. Hudson, Centredale, R. I.

48-HOUR Mimeographing service! Samples, prices, free. Thompson, Loganville, Wisconsin.

GUMMED Labels, stationery. Free list. Reed, Box PM-135, Spiro, Okla.

MIMEOGRAPHING—Reasonable. Any copy. Mailers Service, Box 606-T, Chicago 90, Ill.

5,000 6¾ ENVELOPES Printed \$3.10 per thousand, price list free. 1,000 simulated engraved business cards \$4.00. Michel, Box 76F, New York 16.

100 ENVELOPES. Printed 2-colors \$1.25. Samples. Box 523, Rochester 2, N. Y.

PRINTING OUTFITS AND SUPPLIES

PRESSES, Type, cabinets, supplies. List for stamp. Lincoln Press Company, 220-U Hartwell, Fall River, Mass.

PRINT Your own cards, stationery, circulars, advertising. Save money. Simple rules. Print for others, nice profit. Raised printing like engraving too. Have home shop. Details free. Kelsey Presses, L-11, Meriden, Conn.

PRINTING Presses, type, supplies. Lists 3c. Turnbaugh Service, Loysville, Penna.

MAKE Your own printing cuts. Self-molding process. Plexirubber, Argyle 1, Wisconsin.

PRESSES, Supplies, paper. Catalog 10c. Printers Supply, 211, Springfield, Missouri.

PATENT ATTORNEYS

INVENTORS—If you believe you have an invention, you should find out how to protect it. The firm of McMorrow, Ber- man & Davidson with offices in Wash- ington, D. C., is qualified to take the neces- sary steps for you. Send for copy of our patent booklet "How to Protect Your In- vention." We will also send you an "In- vention Record" form. No obligation. They are yours for the asking. McMorrow, Ber- man & Davidson, Registered Patent Attor- neys, 134-T Victor Building, Washington 1, D. C.

PATENT Protection—This well-known organization will send you promptly upon request and without obligation, a booklet containing detailed information concern- ing steps to take to protect your invention by a United States patent. Victor J. Evans & Co., Merlin M. Evans, Registered Patent Attorney, 631-D Merlin Building, Wash- ington 6, D. C.

HERMAN Lewis Gordon, Registered Patent Attorney, Warner Building, Wash- ington, D. C.

INVENTORS: Learn how to protect your invention. Unless the inventor is familiar with patent matters, he should engage a competent registered patent attorney or agent to represent him. We are registered to practice before the U. S. Patent Office and prepared to serve you in handling your patent matters. "Patent Guide for the Inventor" containing detailed information concerning patent protection and proce- dure with "Record of Invention" form will be forwarded to you upon request—without obligation. Clarence A. O'Brien & Harvey Jacobson, Registered Patent Attorneys, 11B-A District National Building, Washington, D. C.

INVENTORS: When you are satisfied that you have invented something of value write me, without obligation, for information as to what steps you should take to secure a patent. Write Patrick D. Beavers (Formerly Randolph & Beavers) Registered Patent Atty., 935 Columbian Bldg., Washington 1, D. C.

PATENT Practice before U. S. Patent Office. Validity and infringement inves- tigations and opinions. Booklet and form "Evidence of Conception" forwarded upon request. Lancaster, Allwine & Rommel, Registered Patent Attorneys, Suite 411, 815-15th Street, N.W., Washington 5, D. C.

PATENTS. "Proof of Invention" folder mailed without obligation. E. E. Vrooman, Registered Patent Attorney, 507 McKim Building, Washington 5, D. C.

INVENTORS: Write for free brochure "Evidence of Invention." Labiner, World Building, New York 38.

C. A. Snow & Co.—M-427, Snow Build- ing, Washington 1, D. C. Registered Pat- ent Attorneys. Write for information.

INVENTORS—For "Record of Inven- tion" form, contact Carl Miller, Regis- tered Patent Attorney, Woolworth Build- ing, New York.

INVENTORS: Without obligation, write for information explaining the steps you should take to secure a patent. John N. Randolph, Registered Patent Attorney, 203 Columbian Bldg., Washington 1, D. C.

PATENTS—Irving L. McCathran, 315 McLachlen Bldg., Washington 1, D. C. Registered Patent Attorney.

CANADA—Ramsay Company Registered, 273 Bank Street, Ottawa, Canada.

REGISTERED Patent attorney offers services. Sanders, 6430 Evans, Chicago 37, Ill.

FOR INVENTORS

INVENTORS—This form is registered to practice before the United States Patent Office and is available to assist you in the preparation and prosecution of your patent application. "Patent Protection for In- ventors" booklet containing detailed infor- mation and steps to take toward patent protection will be sent upon request. No obligation. Victor J. Evans & Co., 632-D Merlin Building, Washington 6, D. C.

PATENT Searches \$5.00, including pat- ent copies. Same reliable search as con- ducted for patent attorneys. Free protec- tion forms, 48 hour service. Patent Ser- vice Institute, 945-A Pennsylvania Avenue, Washington 4, D. C.

INVENTORS Booklet "Reaching Your Invention Markets"—free. Patented, pat- ent pending only. Market Contacting & Data Service, 11106-W2 Longwood, Chi-

—INVENTORS—If you believe you have an invention, you should find out how to protect it. The firm of McMorrow, Ber- man & Davidson with offices in Wash- ington, D. C., is qualified to take the neces- sary steps for you. Send for copy of our patent booklet "How to Protect Your In- vention." We will also send you an "In- vention Record" form. No obligation. They are yours for the asking. McMorrow, Ber- man & Davidson, Registered Patent Attor- neys, 134-S Victor Building, Washing- ton 1, D. C.

INVENTIONS. Patents promoted by Inventa, 284 West End Avenue, New York 23.

HOW To handle ideas. Free booklet, Grayland, 5312K Grace, Chicago 41.

INVENTORS: Without obligation, write for information explaining the steps you should take to secure a patent on your invention. John N. Randolph, Registered Patent Attorney, 203 Columbian Bldg., Washington 1, D. C.

SEARCHES—Put your patent searches in the hands of a registered patent attor- ney or agent, as he qualifies to give a worthwhile patentability report. Record of invention form upon request and infor- mation on patent protection. Patrick D. Beavers, Registered Patent Attorney, 936 Columbian Bldg., Washington 1, D. C.

INVENTORS. For "Record of Inven- tion" form, contact Carl Miller, Regis- tered Patent Attorney, Woolworth Build- ing, New York.

INVENTORS: Learn how to protect your invention. Unless the inventor is familiar with patent matters, he should engage a competent registered patent attorney or agent to represent him. We are registered to practise before the U. S. Patent Office and prepared to serve you in handling your patent matters. "Patent Guide for the Inventor" containing detailed information concerning patent protection and proce- dure with "Record of Invention" form will be forwarded to you upon request—without obligation. Clarence A. O'Brien & Harvey Jacobson, Registered Patent Attorneys, 11A-A District National Building, Washington, D. C.

PATENT Owner representative. Years of experience. Can I help you? Charles A. Scott, 773PM Garson Avenue, Rochester 9, N. Y.

INVENTORS: If you have an invention for sale, patented or unpatented, write Institute of American Inventors, Dept. 40A, 631-E St. N.W., Washington 4, D. C.

CASH For your idea, 280 manufacturers need inventions, patented or unpatented. List free. Invention Bureau, 208M Clin- ton, Oak Park, Ill.

PATENT Searches \$5.00. Same reliable searches we conduct for patent attorneys. 48 hour service. Protection forms free. Write Capitol Patent Service, P.O. Box 664, Washington 4, D. C.

PATENT Searches by former patent of- fice examiners \$5.00. 48-hour service. Pro- tection forms free. Write Patent Engi- neering Service, 1404 New York Avenue, Washington 5, D. C.

PATENT Searches \$5.00. 48-hour service. Patent copies included. Protection forms free. Write Raymond L. Smith, Patent Searcher, 410 Bond Building, Washington 5, D. C.

PATENT Searches \$5.00. Reports air- mailed within 48 hours. Invention pro- tection forms free. Write Miss Ann Has- tings, Patent Searcher, P.O. Box 176, Wash- ington 4, D. C.

INVENTIONS WANTED

YOUR Ideas are worth money. Long- established manufacturer with successful record of national distribution on kitchen utensils and light-machinery seeks new products. Cash or royalty. Can assist on development and patent protection. First letter will supply details of Registry Pro- tection Plan to safeguard your interest on ideas submitted. Write Product Division, Foley Mfg. Co., Minneapolis 18, Minnesota.

FREE Booklet, "Selling Your Inven- tion." Inventors Patent Exchange—B. Hartford 1, Conn.

INVENTORS: Hundreds of manufactur- ers have requested our assistance in locat- ing marketable new products. Complete information free. Institute of American Inventors, Dept. 40-D, 631-E St. N.W., Washington 4, D. C.

INVENTIONS Wanted. Your invention and patent developed and promoted. Write for Booklet "P." Elo, Box 172, Long Is- land City 1, New York.

INVENTIONS Promoted. Patented or unpatented. Write Adam Fisher Company,

INVENTORS—What have you, patented, patent pending to offer manufacturers? Request free booklet without obligation. Market Contacting & Data Service, 11106-A2 Longwood, Chicago 43.

PATENTS FOR SALE

CIGARETTE Dispenser; cabinet type; 4½ x 3 x 3 for home or office. Stanley Both, Bay-View Rd. 5, Hamburg, N. Y.

INVENTORS: Test the commercial value of your patented or unpatented inventions, quickly and inexpensively. Write for free information. Institute of American Inventors, Dept. 40-B, 631-E St. N.W., Washington 4, D. C.

MANUFACTURING

MODELS—Small lot manufacturing. Metals, plastics, etc. Milburn, Burlington, Kentucky.

COMPLETE Inventors' model construction services. Mechanical Development Company, Salem, Virginia.

MODELS, MODEL SUPPLIES

POWER Models. Unusual steam, gasoline and traction engines. Metals, tools, accessories. Catalog 50c. Chas. Cole, Ventura, Calif.

BUILD, Fly, world's most authentic model airplanes. 47 different kits, motors, supplies. Airplane catalog, 10c. Cleve-model, 4507TTC56 Lorain, Cleveland 2, Ohio.

FIRE. Fire. Build Will-O-Line ½" scale fire engines. Authentic, fully detailed models. Free circular. Bay Models, Box 1012, Braintree 84, Mass.

LIONEL Trains, accessories, switches. Tremendous stock; fast delivery. Guaranteed repairs. Authorized Lionel Train Station, 72 West Washington, Chicago 2.

SHIP And yacht model fittings; blueprints. Send 25c for illustrated Catalog No. 26—listing hundreds of items. A. J. Fisher, 1002-1 Etowah Ave., Royal Oak, Mich.

SHIP Models and yacht supplies complete. Large 64 page catalogue 30c. Bill Wild's, 510 East 11 St., New York City 9.

BUILD Historic ship models, complete kits 39c to \$9.00. Catalog 10c. Ideal Models, 19 W. 18th, New York 11, N. Y.

BRASS Gears and model supplies for the inventors. Send 10c for catalog. Pierce Model Works, Tinley Park, Ill.

RAILROADERS—50c Gets new Catalog Reference Manual. State O or HO gauge. Walthers, 247 Erie, Milwaukee 2, Wis.

STEAM Locomotives, 1½", 1", ¾", ½" ¼" scales. Castings, rail, steam fittings! Thorough drawings with instructions. Catalog 50c. Little Engines, Wilmington, California.

HOME CRAFTSMEN

LINK Belts, excellent gifts for young or old. Complete instructions with each package. Send 65c for sample belt and leathercraft catalog. Leather Products, Box 596, Sioux Falls, S. Dakota.

WOODCRAFTERS—50 Cents will bring you our sample of six assorted hard and soft wood pieces. P.O. Box 256, Delair, New Jersey.

89 FULL Size jig saw patterns of beautiful shelves, ornaments, toys, novelties. Plus "How, Where to Sell." Only \$1.00. Mastercraft 44M, 7041 Olcott, Chicago 31, Illinois.

WHOLESALE Shellcraft book 15c. Large shellcraft kit \$1.95 postpaid. Shell-Art Novelty, Dept. PM, 5th and Moore, Philadelphia 48, Penna.

LEATHERCRAFT Supplies. Leather and Tools, low prices. Send 10c for catalog. Jonas Handicraft Co., Dept. 5-M, 30 Frankfort St., New York 7.

90-ALL New, full size lawn ornament and novelty patterns, up to 20" high. Only \$1.00. Mastercraft 42M, 7041 Olcott, Chicago 31, Illinois.

JIGSAW Owners attention! Start earning money at home cutting out wooden novelties and souvenirs. Write H. Cook, Dept. A, 4407 S. Normal Ave., Chicago 9, Ill.

OZARK Wood samples. Eleven varieties prepaid. \$1.50. Davis Lumber, Cabool, Mo.

SHELLCRAFT—For hobby or profit. Giant illustrated catalogue showing many new breathtaking designs, with easy instructions. Only 25c. Southern Shellcraft Supply, Clearwater, Florida.

80 FULL Sized patterns. Lawn ornaments, toys, novelties \$1.00. Modern

LEATHERCRAFT For pleasure or profit. Make easy-to-assemble purses, belts, gloves, woolskin toys, 100 other items for gifts or to sell. Send 10c today for big catalog. Largest leathercraft stock in U. S. J. C. Larson Co., 820 S. Tripp, Dept. 975, Chicago 24.

LEATHERCRAFTERS: Big illustrated catalog of materials, tools, kits, 10c. Art Leather, 411 Joseph Ave., Rochester 5, N. Y.

ILLUSTRATED Catalogue of 30 new crafts 10c. Hobbies, 1701D Macombs Road, New York 53.

NEW Amazing chemical triples shoe wear, waterproofs them. \$1.25 bottle treats 8 pairs leather soles. Guaranteed. Homecraft Tool Center, 22 E. Chicago, Elgin, Illinois.

CACTUS Wood, lamp size sample, 60c postpaid. 214E East Yavapai, Tucson, Arizona.

NEW 96 Page leather and craft catalog. 1000's of items. Send 10c. Russo Handicraft Supplies, Dept. C-3, 245 South Spring, Los Angeles, California.

MITER Corners perfectly without box or equipment. Simple details \$1.00. Miterman, Box 265, Spur, Texas.

MOLDS For use with cement to make ducks sets for lawns. Stanley Both, Bay-View Rd. 5, Hamburg, N. Y.

NEW Leathercraft catalogue. Pleasure and profit. New styles, belts, purses, shoes. Largest leathercraft school in U.S.A. G. I. approved. Send 10c for catalogue. Dept. PM. Apache Leather Co., 2804 E. Washington St., Phoenix, Arizona.

KNOCKDOWN Cedar chests. Lumber and veneers. Free price list. Giles & Kendall Company, Huntsville, Ala.

SHELLS, Plastics, findings. Lowest prices. Catalog 5c. Frances Jones, Box 251, Sarasota, Fla.

LEATHERCRAFT Bargains! Lacing. Francis Byrd, 3406 Montrose Ave., Richmond, Va.

8 BEAUTIFUL Full-size whatnot patterns 35c. Joanness, P.O. Box 141-M, Omaha 7, Nebr.

PROFESSIONAL-Type furniture finishing and refinishing supplies. New illustrated catalog and simple instructions 10c. Refunded. Colorall, 515 Cedar Lane, Teaneck, N. J., Dept. M.

30 LAWN Ornament patterns, ready cut. Full size, color indicated. \$1.00 postpaid. Lincoln Craft Studio, Farmington, Conn.

MAKE Leather belts, billfolds, purses. Big catalog and genuine steerhide keyholder, 10c. Tandy Leather, Box 397C, Tulsa, Okla.

LEATHERCRAFT, Copper tooling, textile painting. Make spare time, profitable time. Free illustrated catalog shows everything you need. Kit Kraft, 7377 Melrose, Hollywood 46, California.

LEATHER, Tools, lacings, supplies. Free catalog. National Handicraft, 199 William St., New York 7.

MAKE IT YOURSELF

BUILD Your own soldering gun cheaply from old transformer. Plans 50c. Box 851, Fairborn, Ohio.

BUILD Dream home, concrete block, blueprint, instructions, \$3.00. Acceptable restricted areas. Watkins, Box 881, Columbus 16, Ohio.

FREE Literature describing needed farm and home machinery, easily built by you, from salvage materials. Kenneth Reeves, Box 3357-A, El Paso, Texas.

WORLD'S Newest, most unusual, easy to build "easy up bird house." Complete plans only \$1.00. Glen Craft, 921 W. Cedar, Cherokee, Iowa.

BUILD Over 100 production machinery from salvage. Others do at big savings. Descriptive handbook 25c (refundable). Kimo, New York 19.

BUILD Your own tractor. Plans. Walking, riding. Free information. Ellsworth Tractor Co., D-1, Camptonville, Calif.

GRANDFATHER Clock easily built. Big savings. See ad on page 263.

"**CONCRETE** Block Homes." 32 page booklet on how to build. \$1.00. H. C. Lightfoot, Civil Engineer, Richboro 1, Penna.

STREAMLINED, Built-in kitchen cabinets to fit any kitchen. Illustrated manual describes designing and construction. All for \$1.00. Thornbert Company, Newton, Iowa.

BUILD Your own concrete blockmaker. Easy. Inexpensive. Motor or hand. Make block per minute. Write, C. Lee, Mountain

WATCHES, OLD GOLD, JEWELRY

RHINESTONES, Jewelry settings, cam-eos, sequins, beads. Catalog free. J & M Novelty, Dept. CD-3, Griffith, Ind.

WATCHMAKERS', Jewelers', hobbyists', tools, supplies. Catalogue! Bengal Company, Culver City, California.

HIGHEST Cash paid for old, broken jewelry, gold teeth, watches, silverware, diamonds, spectacles, platinum. Free information. Satisfaction guaranteed. Government licensed. Rose Smelting Company, 29-A East Madison, Chicago.

DIAMONDS Lowest wholesale prices. Airmail for price list. Joachim Goldstein Diamond Club, Antwerp, Belgium.

GOLD Plated jewelry supplies. Rhinestones, pearls. Illustrated catalog, only 10c. Barry's, 47-N Branford Place, Newark 2, N. J.

TOBACCO, SMOKERS' SUPPLIES

PIPE Won't draw? Soggy heel? Problem to empty? Answer—"No-Clog"! Concealed in pipe, prevents clogging. Lifts out, empties pipe. Users say, wonderful results! Improves smoking terrifically! Send 25c. O'Hagan, 413 Race, Cincinnati, Ohio.

PIPE Smokers—My essences will add mildness and aroma to your tobacco. Information free. Vincent Cozza, Pequan-nock, N. J.

FREE Trial. Fresh cigars, factory prices. Smoke, enjoy our risk—100 Tampa Londres—4½" perfecto—100—\$7.95—or c.o.d. (you pay postage). Smoke 5 on us. Return our expense for refund if not delighted. Order now. Thompson & Co., Inc., 200 N. Edison Ave., Dept. PM, Tampa 1, Florida.

MAKE Pipes. It's fun. It's profitable. Details free. Buildapipe, PM4, Ivoryton, Conn.

FREE Color catalog, fine pipes. Terrific bargains, bonuses. Write Gaylords, 522, Brockton, Mass.

OF INTEREST TO WOMEN

FOR Pleasure, profit, make artificial flowers, corsages, chenille novelties, dolls. Starting kits, supplies. Business plan, homecrafts catalog, 10c. Cleve-model, 4507TTC60 Lorain, Cleveland 2, Ohio.

BIG Profits. Make fast-seller chenille holiday flowers, monkey trees, dolls. Literature free. Velva, Bohemia 16, N. Y.

FOR SALE—MISCELLANEOUS

SAVE 50%! Install it yourself. Sell to builders and homeowners. 85,000 Btu oil fired forced air central heating system for 5 rooms. Completely automatic with all necessary electric controls, gun type burner, blower, motor, drive, heater pipe, registers, register boxes. Direct from manufacturer. Details on request. Nichols Company, Box 4, Woburn, Mass.

HANDSIGHTING Levels, improved, new model, used for grading land, contouring and laying out fences, piers, roads and gardens, price \$2.50 postpaid. Public Sport Shops, 11 S. 16th Street, Philadelphia 2, Penna.

SAVE Money on army, navy and factory surplus. Write today for new 52-page illustrated catalog. Tennusa Sales Co., Dept. AE, 1451 Market, Chattanooga, Tenn.

FREE Catalog! War surplus clothing. Amazing bargains. N. Y. Clothing Co., New York 29A.

DRESSES 18c; Coats \$1.00; blouses 35c. Free catalog. Crown, 164-PA Monroe Street, New York.

WANTED—MISCELLANEOUS

WANTED—Naval ordnance and gunnery books. Frank A. Bell, Munising, Mich.

AIRCRAFT Wire rope, to ¼", on spools, any quantity. Send sample, price. Aero Parts Supply, 8102 Lockheed, Houston, Texas.

PERSONAL

BORROW By mail. Loans \$50 to \$300 to employed men and women. Easy, quick. Completely confidential. No endorsers. Repay in convenient monthly payments. Details free in plain envelope. Give occupation. State Finance Co., 210 State Finance Bldg., Dept. W-14, Des Moines 8, Iowa.

INTERESTING Mails. 25c keeps name on mailing list three months. Bentz, Desk D/3, Chatawa, Mississippi.

CALIFORNIA Address! Letters remailed 25c. Also receiving address. Write: Shanks Mail Service, P.O. Box 3110, San Francisco 19, Calif.

LOW Cost hearing device. No battery, no wires. Simple ear plug that carries sound to the ear drum. Beaudry, 4337-30th Avenue South, Dept. H, Minneapolis 6, Minn.

WICHITA Forwarding, 20c letter, dollar month. Avery, 112 Elizabeth, Wichita 12, Kansas.

HANDWRITING Reveals talents, personality, character. Personal analysis, including famous person you're like 10c. Norela, Box 1363, Chicago 90.

\$10 HOUR For magazine ideas! Anyone! Experience unnecessary! Information, Progressive Enterprises, 105-G Seminole, Catonsville 28, Maryland.

MAIL Offers, bargains 25c. Hobby Service, Box 1354, Indianapolis 6, Indiana.

MAKE Money in 1951 by mail. Particulars 3c. Swaty, Box 1466-P, San Diego, Calif.

MYSTIFY Friends. Six San Francisco postcards \$1.00. You address. We remail. Martin, Box 414, Alameda, California.

MEXICAN Legal matters reliably handled. Box 1736, El Paso, Texas.

LETTERS Remailed 25c each. Green, Box-6761, East Los Angeles 22, Calif.

MEXICAN Law. General practice. Attorney, 1203 Arizona St., El Paso, Texas.

RUPTURED? Positive comfort, no understraps, no steel, no elastic. Write Smith Manufacturing Co., Preston, Ont.

HERE'S How and where to borrow \$50.00 to \$300.00 by mail. Confidential. Free particulars. Postal Finance Company, Dept. 45, Sioux City, Iowa.

MISCELLANEOUS

FREE Publicity! New products, inventions. Complete list 489 magazines featuring "what's new" editorial sections. Merchandise existing products! Announce new ones! Publicize inventions! Write for free details. Publication Aids, Dept. P4, 37 West 57, New York 19.

GOLD. Silver, metal detectors. Geiger counters for uranium. Mineralights. Sensational new fully guaranteed models. None finer. Information free. Detectron Co., 5631 Cahuenga Blvd., North Hollywood, California.

OUTDOOR Toilets, cesspools, septic tanks cleaned, deodorized with amazing new product. Just mix dry powder with water; pour into toilet. Safe, no poisons. Save digging, pumping costs. Postcard brings free details. Burson Laboratories, Dept. C-36, Chicago 22, Illinois.

McKEEVER Automobile expense book—New, different. Helps save income taxes. 25c. McKeever Press, Aberdeen, S. Dak.

HAIRCUT As you like it. Shaving technique. Booklet tells how. 25c. Mastrolia, 5 1/2-V Jane, New York 14.

RECEIVE Hundreds of valuable items absolutely free. Supply source directory 25c. Neiko Service, 3462 Merchandise Mart Sta., Dept. FR-4, Chicago 54, Ill.

MEXICAN Jumping beans. Free details. Mann's, 5330 N. Natoma, Chicago 31, Ill.

VERMONT Maple syrup, sugar cream. 100% pure. 1951 crop. Butternuts. List. H. Marshall, Poultney, Vt.

LUMINOUS Paint glows in dark, hobby size \$1.00 postpaid. Guarantee Products, 1110 Tower Bldg., South Bend, Indiana.

COMBINATION: Flashlight, lighter, pencil. \$1.25. Donen, 2065 Creston Ave., New York 53, N. Y.

SQUARE Dancers! The finest square dance magazine \$1.50 per year, \$2.00 for 17 months. We sell books and records. Write for our catalogue. American Squares, 121-76 Delaware, Woodbury, N. J.

"GOLD" Nuggets. Simulated. Look like the real thing! Approximately 1/4 ounce sealed in cellophane bag. 3 bags for 25c; 15 for \$1.00; 100 for \$5.00. Postpaid. Pacton Enterprises, 3323 Lindell Blvd., St. Louis 3, Mo.

URANIUM Prospecting information free. Prospector, Box 142-D North Battleford, Saskatchewan, Canada.

YOUR Old light bulbs easily converted into inexpensive fire extinguishers. Copyrighted instructions \$1.00. Fred A. Lewis, Box 104-A, Kensington Sta., Brooklyn, N. Y.

URANIUM Detection outfit \$3.75. Free particulars. Central States Laboratories, 947 N. Avers, Chicago 51, Illinois.

BUY 450,000 Articles wholesale. Directory 10c (refundable). Publishers, Box 1302-A, Detroit 31.

GENUINE Alligator ladies handbag; Cuban; handmade. Ideal unusual gifts for mother, sweetheart, birthdays. \$25.00. Satisfaction guaranteed. Catalog. Guinea hen chicks, unusual poultry, breeding stock. Albertis Knoll, Holland, Mich.

RESEARCH: We find, locate buyers, or sellers for anything of value. Registration and listing, \$1.00. Refundable. Wright Publications, 2270-M Hubbard, Memphis 8, Tenn.

WATERLESS Hand cleaner for mechanics. 5# \$2.50 or 10# \$4.50 postage paid. Rex Mfg. Co., Box 546, Elyria, Ohio.

FREE Circular on lost gold mines. Write Wyss, 104 1/2 Francis, St. Joseph, Mo.

RADIO, Bedlamp, reading lamp combination, fits any bed. \$29.95. Sleek Ivory or deep toned walnut. Albertis Knoll Co., Holland, Mich.

INCREDIBLE! Unprecedented! Become a mental superman overnight! Floor everybody! No studying! "Memoprop" does all your thinking! It's uncanny! Revolutionary! Write: Bijou, Box 1727-MA, Hollywood 28, California.

GEIGER Counter, skeleton, \$16 postpaid. Metal detectors. Mineralights. Western Radiation Laboratory, 1107 W. 24th Street, Los Angeles 7, Calif.

SAVE Money on paint brushes. Buy direct. Post card brings descriptions and prices. Kenmore Brushes, P.O. Box 53, Kenmore 17, N. Y.

TREASURE Finders for gold, silver and minerals. Money back guarantee, best available. Also Geiger counters for uranium prospectors, free information. Write Goldak Company, 1541 West Glenoaks, Glendale 1, Calif.

"RECEIVE Mail." Moneymaking offers, opportunities, catalogs. Name listed 10c. Ideal Service, Park Ridge 10, Ill.

HAND Controls wonderfully improve poor penmanship in three hours. Write, "OZ," Box 665 (34P), St. Louis, Mo.

PANNING Gold lesson and catalogue. Beginners supplies, books, "maps where to go" free. Old Prospector, Box 729D1, Lodi, Calif.

SQUARE Dance instructions. 40 dances. \$1.00. Wesley Rader, 1922 Grant, Denver 5, Colorado.

RESILVER Mirrors at home. Formula 25c. Ideal Service, Park Ridge 6, Illinois.

DRESSES 18c; Coats \$1.00; blouses 35c. Free catalogue. Crown, 164-PM Monroe Street, New York 2.

\$5 HOUR Easy! Sell name plates for houses. Free sample, order blanks. Write: National, 214 Summer, Boston, Mass.

TREASURE—M-Scope Geiger counters, mineral locators. Why buy something inferior when you can buy the best at a lower price? Backed by years of experience. Fully guaranteed by factory. Detects minerals, metals, gold, silver, coins. Payment plan available. Proven superior performance. Free 16 page illustrated booklet. Fisher Research Lab., Inc., Palo Alto, California.

TATTOOING Outfits, supplies. Illustrated list free. Zeiss, 728 Leslie, Rockford, Illinois.

YOUR Leather jacket renovated expertly. Free circular. Berlew Mfg. Co., Dept. 8, Freeport, N. Y.

EARN Up to \$200 month, inventing toys, games, gadgets. Write, Hendrickson, Argyle 1-A, Wisconsin.

Little Giant SUN-VISOR (3 in 1)



of many essential uses indoors or out, for day or night driving. No other Sun Visor or Sun Glasses offer so much Comfort, and Safety at any price. And why hide one's attractiveness behind dark Sun Glasses?

Green Plastic Shields, well made, folds, (3) ways adjustable. Truly the cheapest insurance money can buy.

So double your working and holiday enjoyment. Send today \$1.98 Each Delivered, or 2 for \$3.50 (A. Hat Model) (B. Head Model). Free folders and proofs. Dealers Agents Wanted.

LITTLE GIANT SUN VISOR MFG.
2433 26th St. S.W., Calgary, Alta., Canada

POROUS METAL INKPAD FOR RUBBER STAMPS

Amazing new invention prints 20,000 crystal clear impressions with each soilproof in(k)jection. Cuts costs 75%. Lasts lifetime. Sent postpaid, \$1.95. Particulars free.

FORGERY PROTECTIVE INKPLATE

2100 F Penobscot Building, Detroit 26, Michigan

A BOOK THAT SHOWS YOU 3000 ILLUSTRATIONS and DESIGNS OF MECHANICAL MOVEMENTS, DEVICES & DETAILS!

Every conceivable kind of mechanical motion and work is briefly explained and illustrated in this unusually helpful book. As far as known, the only work in existence which aims to provide side by side suggested sketches of the various methods in use for accomplishing any particular mechanical movement or work, in a form easily referred to. Every engineer, inventor or mechanic finds the need of devising, simplifying or improving some mechanical process or method. In doing this he has to rely on memory or experience. Here is a reference book of nearly 3000 MEANS AND METHODS for producing any kind of movement or work, classified and arranged for easy reference!

SUCH AS: Accumulators, Anti-friction, Ball and Socket, Bearings, Blowings, Brakes,

Cams, Chain Gear, Chopping, Chucks, Circular Motions, Clutches, Conveying, Cranes, Cranks, Cutting Doors, Drilling, Eccentrics, Engines, Expanding, Filtering, Gears, Governors, Grips, Grinds, Heating, Hinges, Hydraulics, Indicators, Journals, Levers, Links, Lowerings, Lubricators, Measuring and Weighing, Mixing, Nozzles, Parallel Motions, Pipes, Pivots, Power Propulsion, Raising, Ratchets, Rotary Engines, Safety Appliances, Shafting, Signals, Slides, Sounds, Speed, Spindles, Springs, Starting, Striking, Swivels, Tanks, Traps, Turbines, Valves, Water Wheels, Winding, Wipers, etc. If you work with machinery of any kind, you need this **ENGINEERS' SKETCH BOOK** by Thomas W. Barber—355 pages, durably printed and bound in cloth. **Price \$3.98**

Order by mail. If payment sent with order, we pay postage (or sent c.o.d. plus delivery charges, which amount to 37c). Money back if not fully satisfied.

WAVERLY BOOKS, 80 E. 11th St., Dept. SB-2, New York 3, N. Y.

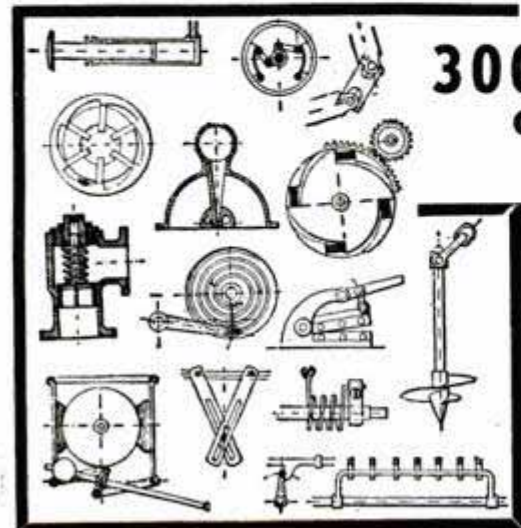

Earn Big Money

WRITING ORDERS

AMAZING NYLONS

Guaranteed Against
RUNS AND SNAGS
Regardless of Cause!

The world's ONLY complete, nationally advertised nylon hosiery line actually guaranteed against runs, snags or excessive wear, **REGARDLESS OF CAUSE!** It's amazing, but true! No matter what the cause—hard use or deliberate abuse—Kendex nylons are replaced **FREE** if they run, snag or become unfit for wear within entire guarantee period! Every weight from sheerest 15 denier to heavy 70 denier—all gauges up to luxury 60 gauge—all sizes, lengths, popular shades, fancy heels, black seams—full fashioned and seamless. Nothing is missing to make sure every woman is pleased. In spite of the amazing guarantee, retail postage prepaid prices are no higher than comparable quality national brands. Should free replacement be necessary, actual cost is cut in half! How could any woman possibly resist saving money and solving her hosiery problems? **NOT SOLD IN STORES.** Men and women wanted **NOW**, spare or full time, to write orders and earn big money. You can get orders even if you never sold a thing in your life!

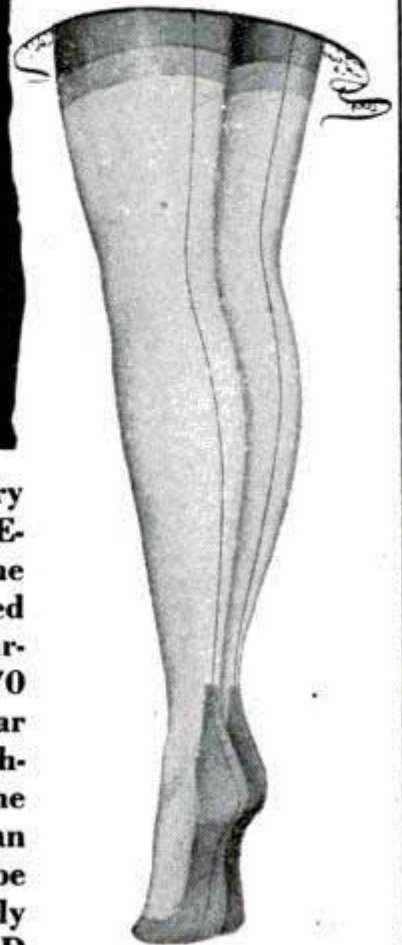

FREE SAMPLE STOCKING

Man or woman—young or old, **YOU** can easily earn steady income, spare or full time. No money or experience needed. We supply **EVERYTHING** free and set you up in business at **OUR** expense. Nothing to buy or deliver. Write orders. We deliver and collect. Big advance pay plus huge cash bonus that increases your earnings up to **40%**! Your name and address on postcard will bring you sample stocking; self-selling sales books with **FULL COLOR** illustrations; 32-page sales manual showing you easy steps to success; color cards, free "door openers" worth \$1 each but which you give away free; special plan to have others sell for you, etc., etc. You can start making money the minute you receive the complete **FREE** outfits!

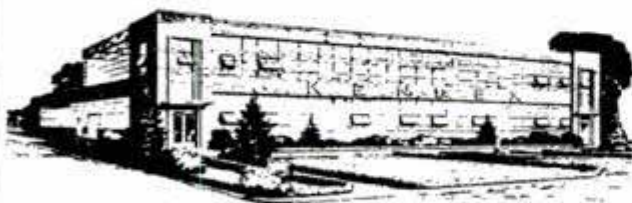

YOUR COST ONE CENT!

SEND NO MONEY. Pay nothing now or later. No obligation. Not even a promise to return outfits. Simply write your name and address on a penny postcard and mail to us. We'll immediately rush you everything you need **FREE** and postage prepaid. **WRITE TODAY!**

KENDEX CORPORATION

● BABYLON 946, N. Y.

Amazing New Auto "Trouble-Shooter"

Spots 1760 Car Troubles - In a Jiffy!

MoToR's Handy, Pocket-Size Manual Enables You To "Find What's Wrong" Quickly and Easily!

NO more guessing or groping for causes of car ailments! Now you can put your finger on every possible cause of car trouble—by turning to indexed check-list in MoToR's amazing NEW "TROUBLE-SHOOTER"!

For example, if car has Fan Belt Noise, just turn to that section and you find EIGHT specific things that can cause it. In the same way, no matter what is wrong, this handy manual checks through 1760 possible causes in a jiffy! Covers engines, clutches, brakes, ignition, axles, battery, starting motor, springs, shock absorbers, steering wheels, tires, transmissions, etc. Section on automatic transmissions alone is worth price of book. Saves time, work, headaches. A "must" for beginner or veteran mechanic. Handy spiral binding; stays open while you work.

Money Back If Not Delighted

Send only \$1 with coupon. If not satisfied, return book in 7 days and your dollar will be cheerfully refunded.



MoToR Book Dept. Desk 14T
250 West 55th St., New York 19, N. Y.

I enclose \$1.00, for which send me a copy of MoToR's NEW "TROUBLE-SHOOTER." If not satisfied, I will return book in 7 days for refund.

Name

Address

City Zone State

9 BIG BUILDING BOOKS

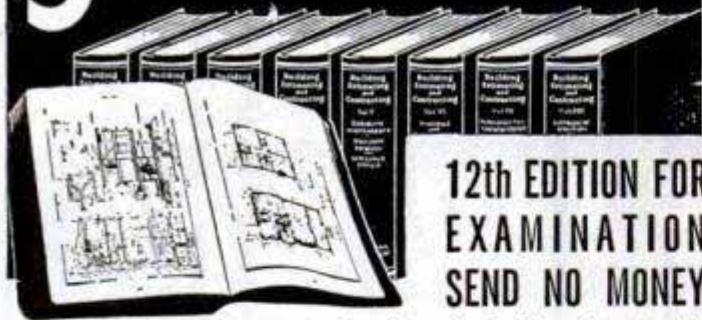

12th EDITION FOR EXAMINATION SEND NO MONEY

Learn to draw plans, estimate, be a live-wire builder, do remodeling, contracting. These 9 practical, profusely illustrated books cover subjects that will help you to get more work and make more money. Masonry, concrete forms, carpentry, steel square, roof framing, construction, plumbing, heating, painting, decorating and many other subjects. More than 4000 pages — 2750 illustrations.

BETTER JOBS — BETTER PAY UP-TO-DATE EDITION

A nationwide building boom is in full swing and trained men are needed. Big opportunities are always for MEN WHO KNOW HOW. These books supply quick, easily understood training and handy, permanent reference information that helps solve building problems.

These books are the most up-to-date and complete we have ever published on these many subjects.

Coupon Brings Nine Big Books for Examination

AMERICAN TECHNICAL SOCIETY—Publishers since 1898
Dept. G419 Drexel at 58th Street Chicago 37, Ill.

You may ship me the Up-to-Date edition of your nine big books, "Building, Estimating and Contracting," without any obligation to buy. I will pay the delivery charges only, and if fully satisfied in ten days, I will send you \$3.00, and after that only \$4.00 a month, until the total price of only \$34.80 is paid. I am not obligated in any way unless I keep the books.

Name

Address

City State

Please attach a letter stating your age, occupation, employer's name and address, and name and address of at least one business man as a reference. Men in service, also please give home address.



GIANT BALLOONS

U. S. Govt. Surplus Genuine Neoprene. Used by Govt. for weather & Target Balloons. Loads of fun for yards, pools, gym, parties. Wonderful for Advertising; Attracts immediate attention.

3 Ft. Dia. 39c
6 Ft. Dia. 79c
13 Ft. Dia. 1.39

Pride of The Jet Jockeys U.S.A.F. STYLE BLUE LENS ZOOM GLASSES

Quality sunglasses, ground & polished for perfection. Protects vision. Reduces harmful glare. Lens life-time guaranteed. With protective case. Regular \$7.50 value.



\$2.79



\$5.95

TARGET PISTOL

Revolutionary new sports pistol. Looks, handles like Army .45. Extremely accurate. Fires B-B's & darts, air powered. Not a toy. With pellets and darts.

Army-Style Guarantee one year

Postage paid on prepaid orders Dept. M-451 War Assets Div.

VOLUME SALES CO.

3828 Sunset Blvd., Los Angeles 26, Calif.

LEARN WATCHMAKING JEWELRY REPAIRING

Start your training now for a better paying job or your own profitable business. Our training is nationally recognized, outstanding and supervised by expert craftsmen. Write for free catalogue.

APPROVED FOR VETERANS

SCIENTIFIC SCHOOL OF WATCHMAKING, Dept. PM-4

3923 San Fernando Road

Glendale 4, California



SPORTONE MUFFLERS

Ford & Chevrolet.....\$ 4.45
All other popular cars..... 5.45
V-8 Dual Sets..... 15.95
Chromed Silentips..... 2.95
(Please state make & year of car on all orders.)

SANDEE MUFFLER CO.
5643 Corryne Place • Culver City, California



CLEAN with Jack-Ni Waterless Cream. A new, waterless hand cleaner developed especially for mechanics, printers, painters, welders, plumbers, etc. Cleans any substance from hands quickly, thoroughly. Softens skin, calouses. Contains Lanolin. Order your supply today! DEALERS WANTED! 3 lb. can: \$1.50, 5 lb. can: \$2.00 postage paid. Available with or without ammonia—please specify. COSMOPOLITAN PRODUCTS CO., Dept. P. 3408 Emery Street, Los Angeles 23, California

SAY YOU SAW IT IN POPULAR MECHANICS

FLASH Your Turns



ELIMINATE HAND SIGNALLING S & L DIRECTIONAL SWITCH THE LOWEST PRICED DIRECTIONAL SWITCH THAT MEETS ALL S.A.E. REQUIREMENTS

Here is a safe, comfortable way of signalling your intention to make a left or right turn. Flashes from 60 to 80 times per minute. No need to roll down window to signal turns in cold or rainy weather. Kits furnished with all necessary material for perfect installation. No outside mounting of any kind. Uses your present parking and tail lights. Either of our two models fits most cars from 1942 to 1950.



\$6.95 postpaid in U.S.A.

SEND CHECK OR MONEY ORDER.

POSTAGE EXTRA ON C.O.D.'s

Specify year and make of car. Money-back guarantee.

A PERFECT GIFT FOR MOTORISTS. S & L AUTO SALES Box 6414, Dept. 5, Chicago 7, Ill.

RUPTURED?

**DON'T
SUFFER
TORTURE**



SQUAT



LIFT



WORK



PLAY

NEW 3-CONTACT PAINLESS PAD ASSURES SAFETY AND COMFORT



New 3-contact painless safety pad anchored to flexible support is bringing safe relief to rupture sufferers everywhere. Supports and replaces weakened muscles. Allows complete freedom of movement. No metal or rigid parts to gouge, chafe or torture you. It's the first really new development in truss design in years. A penny post card will bring full details. Write today!

ACTIVE MAN APPLIANCE CO.
549 W. RANDOLPH (Dept. PM-4) CHICAGO 6, ILL.

JITTERBUG • CATCHES MORE FISH

The old favorite. Noisy surface bait. World's best hooker—day or night. Gurgling, paddling action of the double-lobed lip makes fish strike hard. At your dealer 5/8 oz. or 3/8 oz. \$1.25. Musky size \$2.00.



FRED ARBOGAST & Co., Inc., 2244 W. North St., Akron 3, Ohio

FREE WRITE TODAY FOR BIG FREE 1951 ARBOGAST COLOR CATALOG—FULL OF PICTURES OF CATCHES

TRAIN Your VOICE!

RESULTS GUARANTEED

STRENGTHEN your voice this tested, scientific way. Yes—you may now be able to improve the POWER of your speaking and singing voice... in the privacy of your own room! Self-training lessons, mostly silent. No music required. Write TODAY for Eugene Feuchtinger's great booklet, "How to Develop a Successful Voice." It's absolutely FREE! You must state your age. Booklet mailed postpaid in plain wrapper. No salesman will call. Send your name and age RIGHT NOW! Perfect Voice Institute, 210 S. Clinton St., Studio D-2, Chicago 6, Ill.

WARN HUB CAP MAKES 2 JEEPS OUT OF 1

Ends front wheel drag on 4-wheel drive Willys Station Wagons, Pick-ups and Jeeps

Saves gas up to 5 miles per gallon, tire wear, front axles, increases speed and power. Stops shimmy—front wheels coast out of gear! 4-wheel drive handles, performs, climbs like 2-wheel. Install or remove WARN HUB CAPS in 10 minutes. Polished aluminum, guaranteed. Rush check, M.O., or C.O.D. Write for circular.

\$20.00
Prepaid U.S., Canada

WARN MFG. CO. - 1625 Third Ave., Seattle 1, Wash.

E-Z CAR WASHER

**Soaps & Washes in One Operation
No Special Soap Required**

Easily used—insert teaspoonful of any household soap powder or detergent in built-in soap pouch. 42-inch aluminum handle. Replaceable mop. Washes cars easily without getting yourself wet. Send \$3.50 check or money order. We deliver post paid.

MONEY BACK IF NOT SATISFIED

Simply attach to garden hose.

E-Z CAR WASHER

6 Bond St., (Dept. PM-1) New York 12, N. Y.

\$3.95
POSTPAID

MAXWELL Build This Great Favorite In A Fascinating Scale Model!

1911 Maxwell
\$2.50



Everybody loves this little red Maxwell! Once you complete it, you'll treasure it and use it as a mantelpiece or office decoration! So easy to assemble—so small in price! Maxwell is 7 1/2" in length when completed. 14 famous models to choose from!

 1911 BUICK "BUG"—\$2.50	 1906 "OLD 16" LOCOMOBILE—\$3.95	 1904 OLDSMOBILE—\$1.95
 1903 RAMBLER—\$2.50	 1903 CADILLAC—\$2.50	 1900 PACKARD—\$2.50
 1909 STANLEY Steamer—\$2.95	 1910 MODEL "T" FORD—\$2.50	 1909 MODEL "T" FORD—\$2.95
 1914 STUTZ BEARCAT—\$3.95	 1910 INTERNATIONAL HARVESTER—\$2.95	 1911 MERCER RACEABOUT—\$3.95

Check "OLD TIMERS" You Want:

- | | |
|--|---|
| <input type="checkbox"/> 1911 Maxwell \$2.50 | <input type="checkbox"/> 1911 Buick \$2.50 |
| <input type="checkbox"/> 1904 Olds. \$1.95 | <input type="checkbox"/> 1903 A Ford \$2.50 |
| <input type="checkbox"/> 1910 T Ford \$2.50 | <input type="checkbox"/> 1910 Internat. |
| <input type="checkbox"/> 1909 Stanley \$2.95 | <input type="checkbox"/> Harvester \$2.95 |
| <input type="checkbox"/> Steamer \$2.95 | <input type="checkbox"/> 1903 Cadillac \$2.50 |
| <input type="checkbox"/> 1909 T Ford \$2.95 | <input type="checkbox"/> 1900 Packard \$2.50 |
| <input type="checkbox"/> 1903 Rambler \$2.50 | <input type="checkbox"/> 1914 Stutz |
| <input type="checkbox"/> 1911 Mercer \$3.95 | <input type="checkbox"/> Bearcat \$3.95 |
| <input type="checkbox"/> 1906 "Old 16" Locomobile \$3.95 | |

Mail order to us for your favorites. Add 25c for postage and handling. No C. O. D.'s please

HOBBYISTS and Collectors want these nostalgic Antique Autos—each one easy to assemble with pre-fabricated parts! Actual 1/4" scale models, they're decorative and authentic. 6 1/2" to 10 1/2" in length. See them at hobby, toy or department stores. They're the cutest things on wheels! Or write to us. Prompt delivery. Guaranteed satisfaction.

Hudson Miniatures' "OLD TIMERS"
SCRANTON HOBBY CENTER, Dept. 14, Scranton 10, Pa.

WHICH DO YOU WANT?

BETTER DIGESTION **NORMAL ELIMINATION**
RESTFUL SLEEP **STRONG HEALTHY TEETH**
CONTINUED GOOD EYESIGHT



VITA-MIX Makes it easier to get essential vitamins and minerals from fruits and vegetables.

Only Machine With Stainless Steel Bowl and Bakelite Handle. **ONLY \$34.95**

SELF-CLEANING—ADD SOAP, WATER, TURN ON

In preparing food the ordinary way you peel off and throw away many of those vitamin and mineral filled parts which are so essential to good health. With the Vita-Mix you keep ALL the natural health-giving food value. Liquefies, whips, chops, emulsifies all fruits and vegetables into tangy, appetizing drinks. No cooking, juicing or peeling of rinds necessary. Now has new unbreakable stainless steel bowl. Easy to sterilize. Comes with a ONE YEAR GUARANTEE.

Look What Vita-Mix Does:

Makes health drinks in 1 to 4 minutes, makes soup without boiling in 3 minutes, makes cake batter ready for oven in 3 minutes. Grinds whole grain, chops vegetable salads, whips cream, churns butter, makes omelettes, pie fillers, sauces, sherbet, baby food, purees.

2 VALUABLE GIFTS GIVEN WITH ORDER

VITA MIRACLE RECIPE BOOK Shows you how to make 533 delicious dishes and drinks with your Vita-Mix.	 CORN POPPER Electric. Pops corn without stirring. No mess. Use in living room.	 Corn Popper \$ 5.29 Recipe Book .55 Vita-Mix 34.95 Value \$40.79 You Pay 34.95 You Save \$ 5.84
--	--	--

Order Now Before Rearmament Stops All Production
Natural Foods Institute, Dept. PM4, Olmsted Falls, Ohio
I enclose \$34.95. Rush me your Vita-Mix plus 2 FREE Gifts.

Name _____
Address _____
City _____ State _____

STOP CELLAR WALL LEAKS



Smooth-On No. 7 Iron Cement stops your cellar wall leaks. You can apply Smooth-On No. 7 with a trowel or stiff brush, to cracks, holes, porous spots or seams in concrete, brick, stone walls or floors. This effective Smooth-On Cement will stay in place, because it expands slightly as it sets. You can also use Smooth-On No. 7 to stop leaks in cisterns, swimming pools, troughs, fountains, septic tanks, etc. Use it too, to seal openings where piping passes through walls. Sold in 1, 5, 20, and 100 lb. sizes.

FREE REPAIR HANDBOOK 40 pages packed with helpful suggestions for repairs all around the home, shop and car. Also ask for leaflet describing the uses of Smooth-On No. 7. Write today.

SMOOTH-ON MFG. CO., Dept. 37D
570 Communipaw Ave., Jersey City 4, N.J.



Do it with
SMOOTH-ON
NO. 7 IRON CEMENT

USE YOUR ATTIC

Install the
PRECISION
folding stairway
YOURSELF

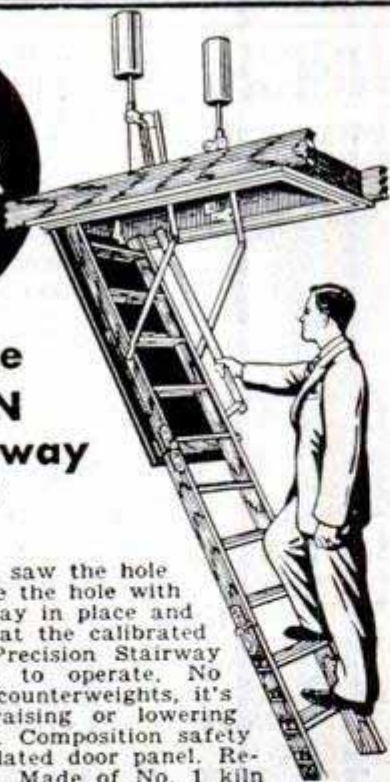

Fits all ceilings. Just saw the hole in your ceiling—frame the hole with 2x6's, nail the stairway in place and cut off the stairway at the calibrated ceiling height. The Precision Stairway is simple and easy to operate. No springs, actuated by counterweights, it's perfectly balanced, raising or lowering easily with one hand. Composition safety treads on steps. Insulated door panel. Requires no attic space. Made of No. 1 kiln dried poplar with cast brass hinges, heavy cast aluminum rocker arms and brackets. Approved by F.H.A. everywhere

See your local lumber dealer or write direct today.
Manufactured by

PRECISION PARTS CORP.
Nashville 7, Tennessee

Here is the Book
Eagerly Awaited
by Millions
of Popular Mechanics Readers

RADIO-TV and ELECTRONICS Handbook

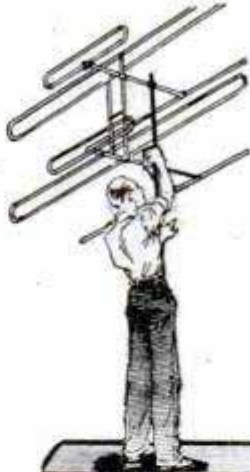

Timely Information

Covers the field of electronics as it applies to everyday life. Radio, television and other electronic devices are fully explained. Here is practical money-making and money-saving information.

For Set Owners, Amateurs, Students

If you own a radio or TV set, are an amateur radio fan or a student, you will find the information you need to know in the fact-packed contents of this new book.

Build Radios, Amplifiers and Electronic Devices

For a fascinating hobby, build your own radios, transmitters, etc. Find out how you can become a "ham" and join ranks with thousands of other radio fans all over the world.

Partial Contents

How to Solder, Simple Radio Repairs, Auto Radio Service Hints, How to Care for Your Record Player, Television in the Home, How to Install TV and FM Antenna Systems, How to build: Progressive Sets, Portable Sets, and other radio and electronic devices.

160 Pages
566 Photos, Drawings and Diagrams
by Frank L. Brittin, Senior Member
Institute of Radio Engineers
Radio-TV and Electronics Editor
Popular Mechanics Magazine

Here is everything you have ever wanted to know about radio, television and electronics written by a man who millions have followed faithfully through the pages of Popular Mechanics Magazine. You need no previous experience or knowledge to understand and make use of the information contained in the text.

Prevent Trouble — Cut Down Repair Bills

If you own a television set or a radio you can use this book to save yourself money. Learn how to select television receivers; how to install and adjust TV antenna systems; how to adjust and tune your TV receiver. Find out how you can make many of your own radio repairs and eliminate unnecessary service calls.

Satisfaction Guaranteed

Mail the coupon now. Send only \$2.50 or you can pay the postman. Money back within five days unless you are completely satisfied.



Pictorial and schematic diagrams, complete material lists, glossaries of common radio and TV terms and color codes included.

Order on this Handy Coupon

POPULAR MECHANICS PRESS, Dept. 38
200 E. Ontario St., Chicago 11, Ill.

Send at once my copy of Radio-TV and Electronics. Unless it is entirely satisfactory I may return it within five days for a full refund.

NAME _____

ADDRESS _____

CITY _____ ZONE _____ STATE _____

Remittance for \$2.50 enclosed

Send C.O.D. (Postage extra)

TITANIUM Rutile

The New WONDER GEM of the century

For the first time in history and as a result of intensive experimentation and research on a vital military project brilliant scientists of America's largest corporations suddenly hit upon the solution of the ages. The secret of how to crystallize in the laboratory a gem with a refractive index higher than and a dispersion factor greater than a DIAMOND was DISCOVERED. The discovery is TITANIUM RUTILE so widely acclaimed by leading reportorial mediums such as Readers Digest and The Saturday Evening Post.

REFRACTIVE INDEX ABOUT 10% HIGHER THAN DIAMONDS

Compare: Refractive Index of Rutile is between 2.62 and 2.90 as compared to the diamond's 2.42. Dispersion of Rutile ranges between 0.155 and 0.205 in comparison to the diamond's 0.025.



(Actual Photograph of Our Product)

You are living in an age of miracles. As you know, atoms are being split. Actual basic materials are being re-arranged. Fantastic as it may seem to the layman, the secret of what has formerly been referred to as the DIAMOND is now known beyond a shadow of a doubt. **YOU PROFIT.** No longer need you invest large sums of money in a tiny stone the value of which is determined largely by scarcity and control. **YOU** can enjoy the beauty and prestige and the envy of your friends with a stone that no one of lesser ability than a **REAL JEWELER** working with a magnifying glass in his eye under good light can detect as not being a real DIAMOND. A handsome engagement ring made of our remarkable gem presented to any girl will inspire her devotion. The hundreds of dollars thus saved will go far towards building a happy, permanent home. Hudson Gem Co. sells **RUTILE** only in the cut stones. Each stone is perfectly cut with full 58 facets per **BRILLIANT** stone. By law we cannot refer to our products as **DIAMONDS** so we ask you to order them in the three most popular **DIAMOND** shapes namely the round or **BRILLIANT**, the oblong or **EMERALD** and the oval or **MARQUISE** cuts. You may order these stones for setting by your local, friendly, trusted jeweler who will be glad to verify your purchase. We do not sell mountings nor do we go in for costly catalogues nor expensive time payment plans. You get the benefit of direct to consumer possession of a valuable product which you can then have mounted and **SAVE THE MONEY YOURSELF. PAWNBROKERS—ATTENTION!** We that you order a sample of this amazing product to have in your shop for comparison. Some pawnbrokers have paid out money under the impression that they were loaning on **DIAMONDS** when in reality people were offering titanium rutile. Lapidarists can make money buying cut stones from us and setting and selling complete rings. **UNCONDITIONAL MONEY BACK GUARANTEE, 30 DAY TRIAL IN YOUR HOME.** You are the **SOLE JUDGE.** In this advertisement you are assured that if for any reason whatever you are dissatisfied with your purchase from us you may, within 30 days, return your purchase for **100% CASH REFUND WITHOUT QUESTION.** Order with confidence. Select the shape you want, either **BRILLIANT** or **EMERALD** or **MARQUISE** shapes. Then select the number of carats you want, either 1, 2, 3, 4 or 5. Remember each **BRILLIANT** is full 58 facets. Check this with your trusted jeweler. Price \$10.00 per carat. Add 20% Fed. Tax. Send Check or Money Order (do not send cash). Reference: Farmers National Bank of Hudson or your local bank. Everything sent postpaid. **WRITE DEPT. PM-6.**

HUDSON GEM CO., HUDSON, N. Y.

BOAT KITS

Easy To Build

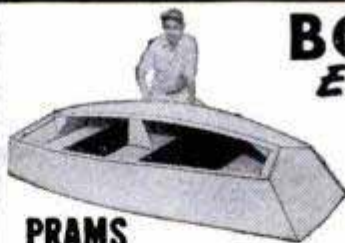

ROWBOATS
10 TO 14 FT.

PRAMS
\$39⁶⁰ up

8 TO 11 FT. ALSO WITH SAILS



OUTBOARDS
12 TO 16 FT.



INBOARDS & CABIN CRUISERS

16 TO 23 FT.



NEW CATALOG
MOST COMPLETE EVER OFFERED

- 1-BOAT KITS—26 MODELS
- 2-MARINE HARDWARE
- 3-MARINE ENGINES
- 4-MARINE CONVERSIONS
- 5-PAINTS & COLOR CHARTS

► All For Only 35c, SEND COIN TODAY

U-MAK-IT PRODUCTS 703P-WHITTIER ST. New York 59, N. Y.



MASTER MIND!

Learn Short-Cut Mathematics

Juggle figures, do baffling number tricks. Make people gasp at your marvelous lightning-quick mind. Multiply 4 figures by 4 figures without using old-fashioned multiplication! Big cloth-bound volume; fully illustrated course. Includes worked-out problems, answers, etc. Sensational bargain, only \$1.95, postpaid or COD plus postage. Satisfaction guaranteed or refund. Order this amazing "Short-Cut Mathematics" today!

NELSON-HALL CO., 210 S. Clinton St. \$1.95
Dept. 2D-2 Chicago 6, Ill. Complete

TRY WATER-INJECTION 30 DAYS AT OUR RISK!

MOTORISTS Add zip to your car with "Vapo-Jet." Automatically combines water, oil vapors, with fuel, to help give smoother performance, more power, faster get-away, better pickup, fuel economy. Complete. Nothing else to buy.

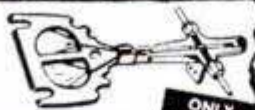

LIMITED SUPPLY Rush order today! Give car make, model, no. of cyl. Remittance with order saves postage!

BANTEL MFG. CO., 757-M Venice Blvd., Los Angeles 15, Calif.

ONLY \$9.95 Post Paid

FAN BLADES AT LESS THAN WHOLESALE!

For Ventilators, Blowers, Fans of All Types

3 inch59 ea.	8 inch99 ea.
4 inch65 ea.	10 inch	1.10 ea.
5 inch79 ea.	12 inch	1.25 ea.
		15 inch	1.99 ea.



Precision made — aluminum — all blades finest quality — less than half normal price. Limited supply — order today! Money-Back Guarantee.

Add 10c per fan postage. \$1.00 Dep. on COD's
AKRON Army & Navy Stores, 4400A Sunset Blvd., Los Angeles, Calif.

WANT \$10,000?

Earn the government Super Sensitive P.R.I. ment bonus. Locate Uranium with a **GEIGER COUNTER**

Also get one for Atom Bomb Defense!

Find gold, silver, and other valuable ores with a P.R.I. Treasure Locator. World's finest instruments. **FREE** catalog. Write!

PRECISION RADIATION INSTRUMENTS
4113PM W. Jefferson, Los Angeles 16, Cal.



Dealer Inquiries Invited

NEW OPPORTUNITIES for WELDING TECHNICIANS

An immediate need exists for properly trained **WELDING TECHNICIANS** — men who have more than practical welding experience — to fill laboratory, experimental, supervisory, estimating, sales and managerial positions.

Take your place in the ever-increasing, essential Metal Fabrication Industries!

"Welding as a Career", a new bulletin, describes the many job opportunities for you in the rapidly expanding Welding Industries. Write for it today. It's **FREE.**



MILWAUKEE

SCHOOL of ENGINEERING

Welding Institute
College of Electrical Engineering

MILWAUKEE SCHOOL OF ENGINEERING
PM451W, 1020 N. Broadway, Milwaukee, Wis.

Without obligation, mail "Welding as a Career" manual to

Name.....Age.....

Address.....

City.....Zone.....State.....

Check if World War II Veteran

Other bulletins: Radio-Television, Refrigeration, Heating, Air Conditioning, Electrical Power (Electrical Engineering, B. S. Degree, Major in Electronics or Power.) 1951 Catalog. "Your Career", an illustrated bulletin.



**RELIEVES PAIN OF
HEADACHE · NEURALGIA
NEURITIS**

FAST

The way
thousands of
physicians
and dentists
recommend



Anacin® relieves headache, neuralgia, neuritis pain fast because Anacin is like a doctor's prescription—that is, Anacin contains not just one, but a combination of medically proven, active ingredients in easy-to-take tablet form. Thousands have been introduced to Anacin through their own dentist or physicians. If you have never used Anacin, try these tablets yourself for incredibly fast, long-lasting relief from pain. Don't wait. Buy Anacin today.

GARDEN TRACTORS

S P E E D E X
YOUR CHOICE OF TWO TYPES
8 H.P. RIDING
2½ H.P. WALKING

Exceptionally Low Prices Still in Effect

New catalog gives you full details on the famous Speedex. Illustrates many labor-saving uses. Complete descriptions.

SEND POSTCARD FOR YOUR FREE COPY OF NEW CATALOG TODAY

SPEEDEX GARDEN TRACTOR CO.
Box 216D1D RAVENNA, OHIO P-251-32

SCIENCE RELEASES POWER

T-C C the NEW STANDARD of CARBURETION developed after years of Scientific experimentation NOW available at small cost to all Motorists for new, or old cars, a must for many of the new high compression engines.

NEW Ultrasonic TURBO-CHARGER CARBURETION releases NEW energy for gasoline Motors, balanced performance with greater economy, more power and smoothness. Fully automatic and no wearing parts, easily installed, **GUARANTEED.**

A DIVIDEND PAYER FOR NEW, or OLD CARS and TRUCKS

Mail Coupon TODAY for FREE details

Name _____ Address _____

City _____ State _____

Car _____ Model _____ Yr. _____ # Cylinders _____

Print, or write plainly

M. M. & M. ENGINEERING & RESEARCH CORP.
4632 San Fernando Road Glendale 4, Cal.

**YOU CAN BUILD
Beautiful Furniture
for every room of your home**

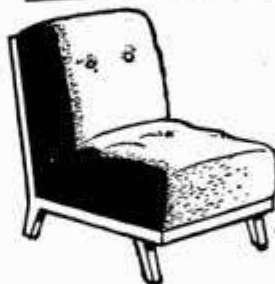

LIVING ROOM



DINING ROOM



BEDROOM



**No Experience Needed
Suites for Living,
Dining and Bedroom
Exclusive Designs
Modern and
Traditional Styles
Scaled Diagrams**

Now you can build beautiful furniture for every room of your home—charming, graceful furniture that will give your house an air of elegance and be the envy of your neighbors and friends.

**For the Man with Few Tools
and Limited Experience**

Take your choice from a wastebasket to a complete suite. Choose any one of 100 beautiful articles. Start with a simple project and end up by refurbishing every room in your home. Step-by-step instructions from the Editors of *Popular Mechanics* and scaled diagrams make building easy.

Save Hundreds of Dollars

Why pay skyhigh prices for furniture when with a few evenings' spare time you can build a desk, dresser, bookshelf or even a complete suite and save as much as 67% of the cost? And the furniture you build will be even more attractive and sturdily constructed than the furniture you could buy. Several designs are exclusives by John Bergen, famous furniture designer.

**160 Pages
16 Full Color Plates
Hundreds of Illustrations,
Photographs, Diagrams**

Start building your furniture now. Send only \$3.00 for your copy of "100 Beautiful Pieces of Furniture You Can Build," or you can pay the postman if you prefer. Money back in five days unless you are completely satisfied.

Order on this Handy Coupon

**POPULAR MECHANICS PRESS, Dept. 39
200 E. Ontario St., Chicago 11, Ill.**

Gentlemen:
Send at once my copy of "100 Beautiful Pieces of Furniture You Can Build" at \$3.00. Unless it is entirely satisfactory I may return it within five days for a full refund.

NAME _____

ADDRESS _____

CITY _____ ZONE _____ STATE _____
 Remittance Enclosed Send C.O.D. (Postage Extra)

NEW TRIPLE WINDOW CONVERTIBLE TOP



\$125.00 Value!
Comes Complete
Nothing Else
to Buy. **\$49.95**

TRIPLE VISION REAR WINDOW FOLDS DOWN WITH TOP!

Rear window plus corner windows made of Crystal Clear Flexible Plastic—Blind Spots reduced to minimum for greater safety. Convertible owners can drive with top up — enjoy more vision than most closed cars. Top is of durable 3 ply waterproof material with rubber for longer wear & lasting beauty. Rear curtain has Zippers.

For Buick, Cadillac, Chevrolet, Chrysler, DeSoto, Dodge, Ford & Mercury, Olds, Plymouth, Pontiac, 1941-51, Packard & Studebaker, 1946-51. Be sure to Specify Make, Year & Model, Black or Tan Material.

New HOLLYWOOD MUFFLERS

Gives that motorboat tone. Universal fits all cars. **\$4.45** Each

TOP CYLINDER OILER

For Any Gasoline Engine, Auto, Truck, Tractor or Marine. Oil is partially vaporized in Top-Oiler, further vaporized in manifold as a fine spray. Feeds oil into engine when lubrication is needed most, during starting or idling. This dissolves gums, etc. Complete with fittings. Each. **\$8.95**



For that CADILLAC "LOOK" 'CAD' FINS



Illuminated with Light

For 49-51 Ford, 49-51 Chevrolet and 49-50 Pontiac.

- Main casting made of brass.
- No holes to locate or drill.
- Can be brazed on in 3 spots.
- Wired ready for installation.
- Built-in design appearance.

Give make, year when ordering. Per Pair. **\$29.95**

Send 25% Cash With All Orders, Balance C.O.D.

1951 EDITION! It's new! Get Largest Auto Accessory & Parts Catalog and Save Money! Over 50,000 items, including Hollywood Accessories, Hi-Speed Equipment, Rebuilt Engines, all parts & accessories for all cars & trucks. We have that Hard-to-Get Part! Jam packed with Bargains. Completely illustrated. Send 25c (refundable).

J. C. WHITNEY & CO.

1917SP ARCHER AVE.

CHICAGO 16, ILL.

CHRONOGRAPH WRIST WATCH **\$9.95**



Lifetime Guarantee

(EXCLUSIVE OF PARTS)

3 DIALS—5 HANDS—2 BUTTONS

Multi-purpose watch that measures distance, speed, time, moving objects. Used as Stop Watch or Timepiece. Has Sweep-Second Hand for full 60 Second count. Second Dial records up to 45 minutes. Third Dial then records up to 6 hours. Seconds—Minutes—Hours, all recorded automatically.

INDEPENDENT MOVEMENTS

The movement of this fine Swiss Made watch continues to run when sweep hands are stopped. For sportsmen, professional men and women—time-keeper works when other hands and dials are stopped—separate movements permit dual use at same time.

RUGGED CONSTRUCTION

Precision workmanship and shock resistant features are added to enhance the value of this watch. Sold elsewhere for as high as \$17.00. Our low introductory price is only \$9.95 which includes tax. (Total \$9.95). Send check or money order and we prepay postage. Or sent C.O.D. plus charges. LIMITED STOCK!

MARDO SALES CO., 480 Lexington Ave., Dept. P-12, N.Y. 17, N.Y.

SAY YOU SAW IT IN
POPULAR MECHANICS



**2
DRILLS
IN 1**

This attachment gives you two drills in one. It converts any 1/4 inch electric drill to 1/2 inch capacity. Reduction gears reduce the drill speed 5 to 1, the average speed of a 1/2 inch drill, and thereby increases the power. Absolutely indispensable for all shop work and home craftsmen. Satisfaction guaranteed. Order yours now.

Send check or Money Order with order. **\$11.95** post paid
Jobbers write for special information.

G. M. CO. MANUFACTURING, INC.
1308 43rd AVE. LONG ISLAND CITY 1, NEW YORK

FREE!

A BILLION DOLLARS IN CHINESE MONEY

Shipped From China At Last Minute —

Offered FREE to Secure Your Name For Our Mailing List

HERE'S an amazing offer. Just mail coupon below. We'll rush you a 500-gold-unit bank note—actual face value ONE BILLION CHINESE DOLLARS. This money is part of last shipment we received before Reds overran China. NOW remaining stocks of Nationalist money will probably be destroyed—making this bill even more scarce.

Get bill FREE. Keep it as collector's item; trade it with other folks for stamps; or sell it. Amaze your friends with this huge amount of money. Do not request more than one bill. Our supply is limited—so offer may never be made again. Rush coupon AT ONCE.

Copyright, 1951, L. S. Co.

Hurry! While They Last!



LOOK! I JUST INHERITED A BILLION DOLLARS!



ALSO Free! Roosevelt Stamp

Issued by Cuba in memory of F. D. R. Sent FREE, together with other offers for your inspection.



Littleton Stamp Co., 404 Littleton, N. H.

LITTLETON STAMP CO., Dept. 404
Littleton, New Hampshire

Rush — AT NO COST TO ME — the ONE BILLION DOLLARS in Chinese money and the FREE Roosevelt Stamp.

Name _____
Address _____
City _____ State _____

The NEW Model 50 UTILITY TESTER FOR REPAIRING ALL ELECTRICAL APPLIANCES-MOTORS

an all-around electrical trouble shooter



- Measures A.C. and D.C. Voltages, A.C. and D.C. Current, Resistances, etc.
- Will measure the current consumption while the appliance under test is in operation. The appliance or utility may be plugged directly into the front panel receptacle. A special pair of insulated clip-end leads is included for motors, etc.
- Incorporates a sensitive direct-reading resistance range which will accurately measure all resistances commonly used in electrical appliances, motors, etc. This range will enable continuity checks and tests for shorts and opens.
- Will test thermostats, radio tube filaments, bulbs, fuses, fluorescents, condensers, switches, field coils, circuit breakers, lighting systems, etc.

Handsome round cornered molded bakelite case 3 1/8" x 5 7/8" x 2 1/4". Complete with all test leads and instructions.

\$13.90

SHIPPED ON APPROVAL

Send \$3.90 with order and pay \$10.00 balance on receipt of merchandise. Try it for ten days. If not completely satisfied — return for refund. No explanation necessary.

SUPERIOR ELECTRONIC CO., INC.
Dept. C-3 • 227 FULTON STREET • NEW YORK 7, N. Y.

WAR SURPLUS AND OTHER BARGAINS



RIVET SETS Universal type, case hardened tips. Set of dies will head up any brazier or round head rivet from 1/8" to 1/4". With adapters for air gun or hand use. All new... cost Government about \$27.00. Complete 15 piece set, wt., 2 lbs., \$5.00

INSIDE MICROMETER 2" to 8"

Precision made of tool steel. Hardened tips on all six measuring rods. One 1/2" spacer. Chrome finish. Complete with case. \$6.95



MICROSCOPE 100 and 150 POWER



A fine precision instrument... not a toy. Highly ground and polished lenses. Overall height 8 1/2 inches. Designed for easy portability and yet stable enough for laboratory use. Microscope, leather case for barrel, four slides and hardwood carrying case box \$9.95 postpaid.

MICROMETERS

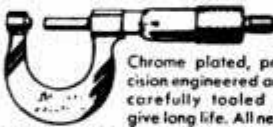

Chrome plated, precision engineered and carefully tooling to give long life. All new.
0-1" capacity . . . each \$2.25
1-2" capacity . . . each 3.50
2-3" capacity . . . each 5.50
3-4" capacity . . . each 6.50

DRILL GRINDER

... Sharpens round, square or tapered drills up to 6" long. Even an amateur mechanic can get a new, factory finish on a drill in 25 seconds. New protractor feature gives every drill sharpening angle, with 5 convenient angles already marked off. Usable with hand or power stone. A brand new development, manufactured by Ten Eyck. Shipped postpaid



All New. \$2.80 each.

"BALTIC" SWEDISH TOOLMAKERS VERNIER CALIPER

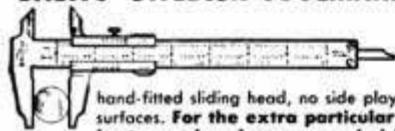

ULTRA PRECISION—0-6" in .001 graduations. Quick, accurate depth, inside and outside measurements, fine engraving. Extra heavy rule, hand-fitted sliding head, no side play. Rockwell C-60, lapped measuring surfaces. For the extra particular mechanic who must have the best—used and recommended by most critical experimental and research machinists at Lockheed • Douglas • Bendix • GM • RCA • General Electric. Save 50%! A \$37.50 value—only \$17.25—Leather case incl. Also a standard grade Mauser Design Caliper • made in Germany • For the production machinist, 0-6" in thousandths, the most accurate caliper of this type on the market, thousands of satisfied users—only \$12.95—Leather case included. These are both guaranteed buys. Your money back if not entirely satisfied. Order now!



ELECTRIC BELLS—Vibrating type, high pitch. 115 V., 60 Cycle. Ideal for use indoors or outdoors—on ranches, for schools, plant installations, as signal systems, burglar alarm systems, etc. Nationally known Mfr. ALL NEW in orig. Pkgs. Solid brass clapper & 8 1/2" gong. Wt. 8 lbs. Govt. cost about \$67.50. Close out at... \$7.95

Send check, money order or cash. 25% deposit required on C.O.D. orders. All prices F.O.B. Culver City, California, unless otherwise stated.

Send 25c for illustrated Catalog.

AIRBORNE SALES CO., INC. DEPT. PM 4-51 CULVER CITY, CALIF.

Say You Saw It in POPULAR MECHANICS

GREAT PROFITS
MAKE YOUR OWN RUBBER MOLDS

X.L. RUBBER MOLDS
will realize you great profits quickly!
WRITE FOR NEW FREE CATALOG
YOU can EASILY learn to cast thousands of perfect plaques, book ends, figurines, ash trays, etc. IT'S EASY, FUN, PROFITABLE!
X.L. Rubber, Pkg. \$2.00; Qts. \$3.50; Models and enough rubber for 3 molds \$1.30 postpaid.

SEND FOR FREE FACTS

Address Dept. 2
3403 S. Madison St. Muncie, Ind.

WHAM-O SPORTSMAN * \$1.25 PRE-PAID

45-LB. PULL!
HITS LIKE A .22 RIFLE—KILLS RABBITS, SQUIRRELS. Powerful, silent, accurate. For hunting, target, routing pests. Sportsman's choice sold world over!

HUNTING SLINGSHOT
Heavy duty 7" ash stock. 40 steel balls, extra rubber, target. GUARANTEED—at dealers, or send \$1.25 to Wham-O Mfg. Co., Box 87, South Pasadena, Calif.
* Professional model of Nat'l Slingshot Assn.

WORK SHIRT

BARGAIN

SURPLUS STOCK FROM MID-WEST SUPPLY FIRM!

79¢

What a buy! These sturdy, serviceable work shirts, though used, have been washed, sterilized and put in perfect condition. Every shirt is cut from durable wash materials, choice of blue or tan. Well made with reinforced stitching at strain points. Order today at our risk! Money-back guarantee!

3 for \$2.29

SEND NO MONEY! Just send name, address, neck size and color choice. Pay postman plus postage or send cash and we ship prepaid. Inspect 10 days. Return for refund if not delighted!

WORK PANTS TO MATCH 99c

Send waist measure and leg length
COVERALLS \$1.49

Send chest measurement
MILCO SALES, Dept. P-266 9350 Roselawn, Detroit 4, Mich.



CARTOONISTS

Make money at home while learning as top cartoonists have done. Enjoy success in work you like to do. Simple instructions. Study wherever you live.

We teach Motion Picture and Television Animation, drawing, lettering, colored comic books, and comic strip. Same method as used by film studios. LATEST TECHNIQUE FROM CENTER OF CARTOON INDUSTRY. For free information write

HOLLYWOOD SCHOOL OF CARTOONING

Suite 1028P
6253 HOLLYWOOD BLVD.

HOLLYWOOD 28, CALIF.



YOU CAN BUILD A VIOLIN FOR PLEASURE OR PROFIT

Now you can build a rich toned mellow violin modeled after a famous "Strad." YOU CAN MAKE A STRADIVARIUS VIOLIN contains 8 full scale plans plus complete instructions. You work directly from the plans with no confusing scale of dimensions to translate. Detailed instructions for each step including varnishing and stringing—even shows how to build your own tools. Cloth bound. Order today from

POPULAR MECHANICS PRESS \$3.50
200 EAST ONTARIO STREET, CHICAGO 11, ILLINOIS

MAKE YOUR OWN!

WITH



Griffin READCUT LEATHER PROJECTS

Over 100 KITS in every kind of Tooling and Carving Leather, accurately cut, all parts included. Only Top Grade Leathers used. You do the choosing. You do the tooling, carving, stamping, the punching and assembling.

SEND 25c FOR COMPLETE CATALOG
116 pages, shows all hand craft supplies.
25c refund with first order.

EVERYTHING FOR THE LEATHER WORKER
Largest, most complete stock of Leathercraft Tools and Accessories in U.S.A.

OUT OF THE WEST, THE HOME OF LEATHER CARVING

Griffin CRAFT SUPPLIES
Since 1924 5626-A TELEGRAPH AVE. * OAKLAND 9, CALIFORNIA



HIDES AND SKINS of Craft Leathers of every kind if you prefer to cut your own.

NEW Tenite Brush Head—Won't Break
Durostyrene Bristles—Won't Mat

← 4 ft. →

**De Luxe "Wonder Wand"
CAR and HOME WASHER**

Greatest Fountain Brush value ever!

Saves \$\$\$ and time. Attaches to garden hose—washes car in 12 min. Pays for itself in a few washings! Amazingly improved: with colorful, unbreakable brush head; 4 ft. handle of featherlite aluminum alloy; big, soft fountain brush of Durostyrene bristles (won't shed or mat). Also cleans windows, porches, walls, etc. Limited quantity. Exclusive with Breck's by mail. Order No. G265.

Home and Garden Gifts
BRECK'S
RELIABLE SINCE 1918

MONEY BACK BY AIRMAIL \$4.95
If you don't say it's the best car washer buy on the market!

ORDER BY MAIL • POSTPAID & GUARANTEED
175 Breck Bldg., BOSTON 10, Mass.



John Corcoran,
well known Wellesley,
Mass. auto dealer
says, "It's a labor-saving
marvel . . . so light
and easy to handle that
my wife and kids say it
makes car washing fun!"



Trades that pay off!

Here's a great chance to learn a high paying skilled trade when the need for craftsmen is urgent. Get actual practical experience in our complete shops. No home study. Approved for veterans. A Post Card brings the story

**THE TERRACE SCHOOL
FOR CRAFTSMEN**

TERRACE AVE.,
NEW CASTLE, PA.

**CARPENTRY
CABINET MAKING
UPHOLSTERING**

PHONE
6699

MAGIC-SCREEN INCOME PLAN OFFERS BIG MONEY, AT HOME, SPARE OR FULL TIME



Reproduce any painting, design, trade-mark, picture, printing, in full color, on any surface! Proven new method enables you to cash in on established business where Profits up to \$5.00 or more an hour are being made, right now! Examine complete Plan and equipment without risk!



Write today for free sample - Complete free details! **Send NOW!**

CALIF. ACADEMY OF SCREEN PROCESS DEPT. 24, 5100 SO. VERMONT AVE., LOS ANGELES 37, CALIF.

**WOULD YOU LIKE TO GET INTO
THE MAIL ORDER BUSINESS
WITH ONLY A SMALL INVESTMENT?**

We are now setting up independent mail order agencies for the distribution of our product. If interested in having a business of your own, which you can operate from your home or place of business, write for details today.

STEUER MFG. CO., INC.
206 East 128th St. Dept. S-7 New York 35, N. Y.

BUILD a "Schneider" SPEEDSTER

Have Fun! Save 1/2 the Cost!

Complete plans with FULL SIZE details for America's finest designed and engineered outboard speedsters, sailing dinks, row-boats and skiffs . . . ALSO . . . easily assembled cut-to-fit KITS.

SEND 10c for illustrated literature

SCHNEIDER BOAT CO. Dept. 141, 1913 W. VLIET ST. MILWAUKEE 5, WIS.

**Say You Saw It In
POPULAR MECHANICS**

WOODWORKERS . . . Get this

CONSTANTINE MASTER MANUAL

Get the Most Fun From Your Hobby
Indispensable to woodworkers. Newest, biggest edition, more pages, more color, helpful how-to-do-it articles, pre-war and new items, more bargains. Send 25c today and we will include **FREE! FULL YRS. SUBSCRIPTION** to Chips and Chats, published bi-monthly. Keeps you up-to-date on everything in woodworking, offers big money-making bargains. Send now. ALBERT CONSTANTINE & SON, Inc., Dept. PM 4 797 East 135th Street, New York 54, N. Y.

**FORD-MERC. OWNERS
DUAL-POINT DISTRIBUTOR CONVERSION KIT**

Greatly improve all-around performance in your 1949-51 Ford 8 or Mercury by converting your single-point distributor to a Dual-Point distributor. Complete kit—Easy to install —Do it yourself! Time-tested, proven, accepted.

ADVANTAGES
Eliminates missing, bucking. • Increased acceleration. • Smoother performance. • Longer point life. • Higher R.P.M. • All wearing stock Ford obtainable anywhere. • Uses only one coil, one condenser. • Includes special breaker plate, 2 sets of points, buss bar.

EASTERN AUTO
3319 S. GRAND AVE., DEPT. P, LOS ANGELES 7, CALIF.

ONLY \$7.95
cash or C.O.D.

"I'll take the WHITE one every time!"



WYTEFACE Steel Tapes, with their jet black markings on a white background, are easier to read in any light. They are rust-resisting, hard to kink and easy to clean.

Protected by U. S. Patent 2,089,209

WYTEFACE

TRADE MARK

STEEL TAPES

KEUFFEL & ESSER CO.

Defense Plans Mean Bigger Pay for Good Machine Shop Men!

Now You Can Be a MASTER MACHINIST!

Get bigger pay in this highly essential field! Learn shop work quickly—with the new and revised American Machinists' Library.

6 Volumes • 2987 Pages • 2900 Pictures

How to operate lathes, drills, other machine tools; turning, boring, grinding, gear cutting, jigs and fixtures, drilling, surfacing, punches, dies, and MUCH MORE! Timely information on airplane assembly fixtures. Illustrations show every operation clearly. This Library brings you the extra "know-how" that means difference between "just another machinist" and a Master



FREE 10-Days' Examination

Machinist. Invaluable for anyone, from apprentice to shop executive. Will help to put you in big-pay class and to rate as an essential worker.

SEND NO MONEY. Mail coupon for 10-day FREE TRIAL. You also get ABSOLUTELY FREE (to keep whether or not you keep the Library) valuable book, "Starting A Small Machine Shop." Note special price, easy terms.

ABSOLUTELY FREE

Years to keep whether or not you keep the Library. "Starting A Small Machine Shop" (Reg. Price: \$3.00)

All about selecting machinery, storing tools, shop layouts; lathe and milling machine work; filing, sawing, drilling. 222 pages. Many illustrations.

McGraw-Hill Book Co., Dept. PM-4
327 West 41st St., New York 18, N. Y.
Send for 10 days' FREE TRIAL, the six-volume American Machinists' Library. Also send ABSOLUTELY FREE. "Starting A Small Machine Shop." If not satisfied, I will return the Library; pay nothing; and keep "Starting A Small Machine Shop." Otherwise, I will send \$3.50, plus postage, then; and \$4 a month for 6 months. (Reg. price \$30.50, you save \$3.00)

Name _____
Address _____
City & State _____ PM-4
Company _____ Position _____
 WE'LL PAY POSTAGE if you enclose \$3.50 first payment WITH coupon. Same return privilege for full refund.

If You Own a Schick or Remington Electric Razor . . .

You get a closer shave and greater comfort by preparing your face before you shave. In just three seconds this wonderful lotion "sets up" your face for shaving.



1. It evaporates sticky, razor-clogging perspiration.
2. It lubricates the skin for faster, more comfortable shaving.
3. It tautens your skin—"brings out" beard for closer shaves.

It also lubricates shaver's cutting head for easier action, longer shaver life!

That's Letric Shave. Only 49¢, plus tax, for 3 oz.—80 shaves. Use with any make shaver. For a free month's supply send name, address to The J. B. Williams Co., (PM-1), Glastonbury, Conn.

CARBURETOR TOO RICH MAKES MOTORIST TOO POOR

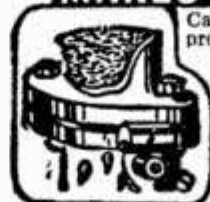

Car owners who are wasting money and not getting proper gas mileage due to over-rich mixtures will be pleased to learn how to save gasoline by VACU-MATING over-rich mixtures. VACU-MATIC fits all cars, trucks and tractors. It is automatic and operates on the supercharge principle. Easily installed in a few minutes.

SALESMEN WANTED! Big Profits!

Send name, address on penny postcard for free particulars and how to get yours for introducing.

VACU-MATIC CO., 7617-1741 W. State St., WAUWATOSA, WIS.



HIGH ELECTRIC BILLS?

Here is an easy way to find out where your electric dollars are going. A watt-hour meter such as your electric company uses will determine the kilowatt hour consumption of every electrical device in your home, shop, farm, etc. These meters are portable, completely reconditioned and guaranteed accurate. Anybody can operate it: JUST PLUG IN. Send for yours today: 1000 W. size complete and postpaid only **\$6.95**

Operators of trailer camps, cabins, etc. write for prices of meters used for conventional purposes. THE ELECTRICAL WATTHOUR METER CO. 76-15 Woodside Avenue Elmhurst, N.Y.

Say You Saw It in POPULAR MECHANICS

HULA POPPER • GETS BIG BASS

Surface popping lure. Ideal combination of noise, action, casting and hooking qualities. Pops, plunks, jerks, twitches—obeys your slightest wrist command. Rubber Hula Skirt imitates live bug. At your dealer 5/8 oz. or 1/4 oz., \$1.25. Fly rod size, 75c.



FRED ARBOGAST & Co., Inc., 2254 W. North St., Akron 3, Ohio

FREE WRITE TODAY FOR BIG FREE 1951 ARBOGAST COLOR CATALOG—FULL OF PICTURES OF CATCHES

Have fun! BUILD YOUR OWN CHAMPION



SPEEDBOAT
Do what hundreds of others are doing! Build your own sleek racing boat or comfortable pleasure craft in spare time! Have fun and save a lot of money! Send 25c today for new illustrated catalogue of tested boat plans, 18 trim styles ranging from midget outboards to 20 ft. cabin cruisers. Don't wait. Write now to CHAMPION BOATS, P.O. Box 7006 15-D, Long Beach 7, Calif.

LOCKSMITHING & Key Making

PRACTICAL UP-TO-DATE COURSE—ONLY \$4.95
Easy-to-learn modern information for self-instruction. How to work on locks, de-code, make master-keys, repair, install, service, etc. For every handyman, home owner, carpenter, mechanic, service station operator, fix-it shop, hardware dealer, locksmith. 53 plain illustrated lessons. **FULL PRICE ONLY \$4.95. SEND NO MONEY.** Just pay postman plus C.O.D. Postage. Or send \$4.95 with order, we'll ship postpaid. Satisfaction guaranteed or refund. NELSON-HALL CO., 210 S. Clinton St., Dept. D-2, Chicago 6, Ill.

MONTH AFTER MONTH, YEAR AFTER YEAR, YOU SEE OUR AD.

REMEMBER IT'S DANGEROUS to pay less if you want the finest matched **USED** tires.

GOOD YEAR  **Firestone** 

GOODRICH, UNITED STATES, GENERAL & OTHERS, NOT RECAPS

Our policy is to select your tires so carefully, as if our very future depended on the service given by that particular tire.

FREE TUBE WITH "ALL" BLATT'S GOOD GRADE TIRES

GOOD GRADE, 16 MONTHS GOLDEN RULE GUARANTEE BOND.		FINEST GRADE, 26 MONTHS GOLDEN RULE GUARANTEE BOND	
600-16	\$4.14	700-15	\$4.54
650-16	5.42	870-15	4.74
700-16	5.04	710-15	4.94
650-15	4.44	550-17	4.64
		825-20	15.92
		1000-20	13.94

FINEST GRADE, 26 MONTHS GOLDEN RULE GUARANTEE BOND
THIS GRADE MADE THE BLATT NAME "WORLD FAMOUS".

MATCHED BALANCED TIRES		MATCHED BALANCED TRUCK TIRES	
600-16	\$5.34	650-15	\$5.94
650-16	6.42	670-15	6.24
700-16	7.94	700-15	6.54
750-16	8.94	710-15	6.34
550-17	5.94	760-15	6.54
525-18	5.54	820-15	7.04
650-18	6.94	475-19	5.94
		825-20	21.82
		900-20	\$19.84
		1000-20	21.84
		1100-20	22.54
		1000-22	19.54
		1100-22	20.54
		1200-22	24.54
		1100-24	23.54

600-16 \$ 6.64		MILITARY 750-20	
900-16	10.94	Reg. 16 Months	Reg. \$10.44
		Super 30 Months	Super 16.64

BLATT BLATT BLDG., GIRARD & LANCASTER AVES., DEPT. PM., PHILADELPHIA 31, PA.
Send check or money order and this ad for rush shipment. We won't ship a tire we wouldn't use. The name to trust in rubber. Prices subject to change.
Shipments RUSHED Down South, Up North and Far West

operate your own business
TEACH DRIVING

DUAL BRAKES For any make car. Easily installed in two minutes. No drilling of holes — no screws — no damage to car. Patented.

EXTENSION PEDALS For short people — easily installed. Eliminates difficulty in reaching clutch, brake and gas pedals.

ART OF DRIVING BOOKLET Indispensable instruction guide for students. Answers 90 safe driving questions. By Richard A. Law. **\$1.00**

Write today for **FREE** literature.
LAW SAFE DRIVING METHOD 146-09A Northern Blvd. Flushing, N. Y.



NEW POPULAR MECHANICS MAGAZINE LIBRARY FILE

Brand New, Grand New Way to Preserve Each and Every Issue of Popular Mechanics

Now you can preserve every treasured issue of Popular Mechanics in these ingenious, custom-built storage files. Constructed to look like an attractively bound book, Popular Mechanics Magazine Library Files afford neat, orderly, flick-of-the-finger convenience. Handy reference index printed on back records the exact location of selected articles, diagrams, etc. A "must" for every reader of Popular Mechanics Magazine. A sensational Popular Mechanics value scoop. Order yours today. Use the handy coupon.

Only 70c
PER SET OF 2
(set holds 12 issues)
POSTAGE PAID
5 sets only **\$3.10**
10 sets only **\$6.00**
POSTPAID

USE THIS COUPON...MAIL TODAY

Popular Mechanics Magazine, Dept. PL P4-51
200 East Ontario Street, Chicago 11, Illinois

Please rush PREPAID _____ set Popular Mechanics Magazine Library Files. (QUANTITY)

Remittance for \$ _____ is enclosed. (AMOUNT)

Name _____

Address _____

City _____ Zone _____ State _____



"Just a kid, but he already knows enough to use a SOUTH BEND FLY ROD!"

NEW! South Bend

HOLLOW GLASS Fly Rods

These new rods give you everything you've ever wanted... South Bend's famous quality for "sweet" action, balance, accuracy—glass for care-free ruggedness. You'll long cherish your XL® Hollow Glass Rod for the joy it will add to your fishing hours.

Hollow Glass
NO
Rot, Set
or Warp

They are made in both dry fly and bass-steelhead actions, **\$22.95 to \$27.50.**



Oren-O-Matic® Reels — most popular automatic fly reels made. Free-stripping. Quiet. Balanced. **\$9.50 up.**



Excel-Oreno® Fly Line — for long, easy casts and hard wear. Nylon or silk. Level and taper sizes. **\$2.20 up.**

Free Book of fishing tips, tackle, etc. Write now.

SOUTH BEND BAIT CO.
891 High Street, South Bend 23, Ind.



SOUTH BEND
A Name Famous in Fishing

AMAZING NEW WOOD-GRAIN TRANSFERS!

Transvener

PLASTIC VENEER

FINISH UNFINISHED FURNITURE!
TRANSFORM OLD FURNITURE INTO NEW!



TRANSVENER is applied as easily as a decal —yet has the beauty of the most expensive wood veneer! 13 beautiful wood grains, marbles and leathers to choose from. It's easy, fast, low-cost, durable. Covers any smooth surface.

Write today for free sample folder!

TRANSVENER

Division of **THE DI-NOC COMPANY**
 1005-B Public Square Bldg. • Cleveland 13, Ohio

DRIVE 3 TO 6 DAYS A MONTH

FEBRUARY						
S	M	T	W	T	F	S
				1	2	3
4	5	6	7	8	9	10
11	12	13	14	15	16	17
18	19	20	21	22	23	24
25	26	27	28			



Gas Free!

Amazing discovery, tested in Engineering Dept. of leading U. S. University, reduces gasoline consumption as much as 20%—gives you up to 6 days a month gas free driving—may actually pay for itself in cash savings. Also better performance, more power, quicker starts, faster acceleration, on all cars, light trucks, tractors—any age, make or model. It can help keep you rolling if emergency gas restrictions come.

TEST IT 30 DAYS ON YOUR OWN CAR BEFORE DECIDING

No one can appreciate the astounding benefits of this new miracle development without actual day-by-day experience on the road—so we want you to try it for 30 days on your own car at our risk. Write or wire today for complete FREE details, technical explanation and 30-Day Examination Request Blank.

SEND NO MONEY

G. B. SCHUYLER, Dept. 44
 1665 Mission St. San Francisco 3, Calif.

MIDWEST

Presents its **NEW 1951**
 Line of **TELEVISION**
 and **RADIOS**

Mammoth
19 1/2
 INCH
 PICTURE
 TUBE



30 DAYS TRIAL

Don't buy any radio or television receiver until you've seen the new 1951 Midwest Line — it's the finest in 31 years.

FACTORY-TO-YOU

EASY TERMS

SEND THIS COUPON ON 1c POST CARD FOR NEW 1951 FREE 4 COLOR MIDWEST CATALOG

MIDWEST RADIO & TELEVISION CORP.
 Dept. 25-L, 909 Broadway, Cincinnati 2, Ohio

NAME _____
 ADDRESS _____
 CITY _____ ZONE _____ STATE _____

CAMILLUS

has the edge!



No. 65

... made with the skill of 75 years of know-how: 1876-1951

*T.M.

FINER, SHARPER KNIVES

for every need
 One of many practical knives for farmers and workmen. Famous *Tru-Taper* blades of custom-made surgical steel, specially tempered and honed to the amazing *Permanized** edge that defies dulling.
 Also a complete line of household cutlery.

CAMILLUS CUTLERY CO., Camillus, N. Y.

WANTED!

MEN AND WOMEN TO EARN SPARE TIME MONEY

Many Popular Mechanics neighborhood representatives are making extra cash for easy, after-hours work. A few more are needed.

For details, write:

POPULAR MECHANICS
 ROOM 408
 200 E. ONTARIO STREET
 CHICAGO 11, ILLINOIS

HELPFUL BOOKS

Send post card asking for **FREE catalog**
 Popular Mechanics Press, 200 E. Ontario, Dept. 601, Chicago 11

MODEL BUILDERS!

NEW 1951 CATALOG



MODEL AIRPLANE ENGINES • GLOW PLUGS • MARINE ENGINES • FUELS
 MODEL RACERS • ACCESSORIES

CUT OUT AND MAIL TODAY

OHLSOHN & RICE, INC.
 3344 Emery St., Los Angeles 23, Calif.
 Los Angeles 23, California

Please RUSH _____ copies of the NEW 1951 O&R Catalog at 15c each for which I am enclosing _____ in stamps or coins to cover handling and mailing.

Name _____
 Address _____
 City _____ Zone _____ State _____

MARVEL MYSTERY OIL and INVERSE OILER

**THIS GREAT COMBINATION KEEPS PERFORMANCE UP
RING, PISTON AND VALVE WEAR DOWN**



MARVEL INVERSE OILER—Feeds Marvel Mystery Oil to the critical upper cylinder areas. Stops dry firing, keeps pistons carbon-free, quiets high compression ping and provides ring seal giving you smooth performance and increased power.

**UNEQUALED
FOR NEW CAR
BREAK-IN!**

MARVEL MYSTERY OIL—keeps valves from sticking, coats engine parts with a wear-resistant film, combats internal motor rust and gives added horsepower. Use in Marvel Oiler, gas tank, or as a crank case additive.



Have your car Marvelized at your dealer today, or write for free information, Dept. 116

EMEROL MANUFACTURING CO., INC.
242 West 69th Street, New York 23, N. Y.



**"I Saved \$12.30 on
My AUTO INSURANCE
with ALLSTATE"**

FREE—Buyers' Guide to Better Auto Insurance and rates for your car. No obligation.

**CLIP AND MAIL
COUPON!**

RAB

ALLSTATE INSURANCE COMPANY
3245 W. Arthington St. Chicago 7, Ill.

Name _____ (Please Print)

Residence Address _____

Post Office _____ Postal Zone No. _____

County _____ State _____

Occupation _____ Age _____

Make of Car _____ Year of Model _____

Model _____ No. of Cylinders _____
(Name, Number or Series)

Type of Body _____ Car Cost You \$ _____

Date Purchased _____ Purchased: New Used

Is the car regularly or frequently used in any business or profession? (Driving to and from work does not count as business use.) _____

Is the car regularly or frequently used to go to and from work? _____

How many miles do you estimate the car will be driven during the next 12 months? _____

What age is the youngest driver in your household? _____

When does your present insurance expire? _____

This saving by Mr. H. J. Lesh of Oak Park, Illinois, is typical of savings made by thousands of Allstate policyholders. Many have saved more!

See for yourself! **COMPARE FEATURES—and RATES!**

Founded by Sears to give you more for your auto insurance dollar, Allstate is famous for low, fair rates (easy payments if you wish) . . . famous for PLUS VALUE features . . . famous for fast, fair claim settlements.

Mail coupon today! Get FREE Buyers' Guide. No obligation. Learn why motorists say, "You're in Good Hands with Allstate."

ALLSTATE
INSURANCE COMPANY
Founded by Sears, Roebuck and Co.

Specialists in Auto Insurance . . . Agents' offices maintained in Sears stores in principal cities. A wholly-owned subsidiary of Sears, Roebuck and Co., with assets and liabilities distinct and separate from the parent company. Home Office—Chicago. **DRIVE SAFELY . . . RETURN SAFELY**

**Basically DIFFERENT!
Basically BETTER!**

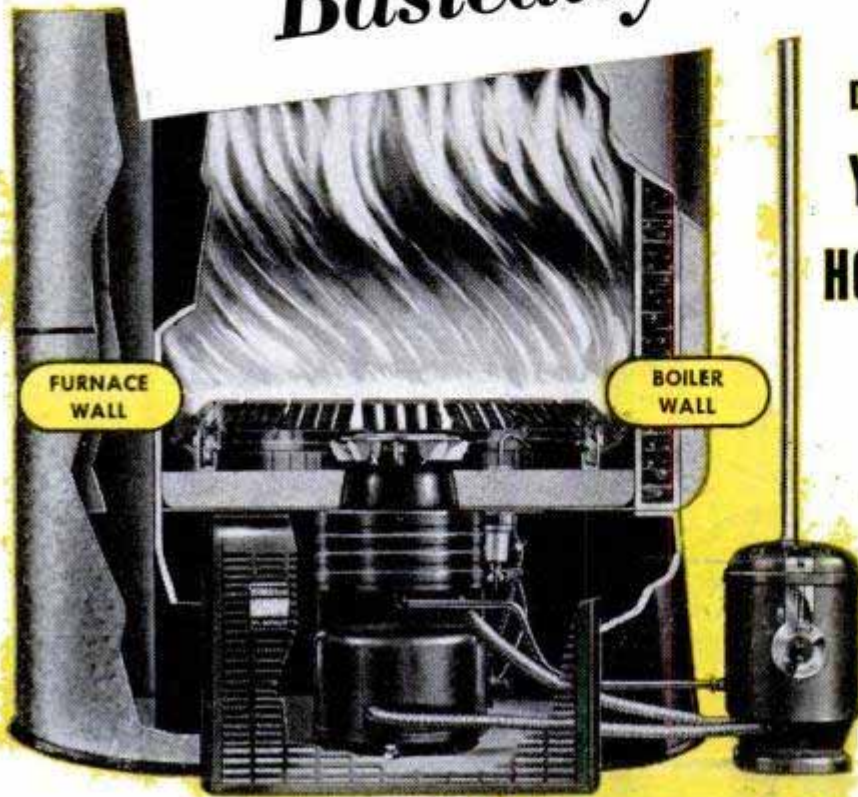

**DESIGNED AND BUILT TO GIVE YOU
YEARS OF ECONOMICAL
HOME HEATING COMFORT!**

Here you see how the Timken Silent Automatic Wall-Flame Oil Burner works in furnaces and boilers. The left half is a sectional view of a warm air furnace, the right half a sectional view of a typical boiler. Note how the burner flame blankets the combustion chamber walls for quick, economical heating—how the hearth, installed at the grate line, seals against loss of heat through basement and ashpit floor.

TIMKEN *Silent Automatic* **WALL-FLAME OIL BURNERS**

True heating comfort is *more* than just automatic heat! The unit must be built to serve you dependably and economically for years and years to come!

Once you've installed a Timken Silent Automatic Wall-Flame Oil Burner you can *relax* in clean, convenient comfort—knowing this unique burner has every needed feature for quiet, dependable,

economical operation! The natural-burning, high-intensity wall-flame turns every drop of oil into useful heat. There's only *one* moving part (self-lubricated) for utmost dependability. And the burner is backed by more than 25 years of heating experience—as are the more than 93 other models of Timken Silent Automatic heating equipment for oil, gas and coal!

MAIL THIS COUPON TODAY FOR ILLUSTRATED LITERATURE!

Timken Silent Automatic, Jackson, Michigan
Please mail illustrated literature. I am interested in:

_____ (type of equipment)

NAME _____

STREET ADDRESS _____

CITY and STATE _____

If you are a student, please check here () for special information.

PM451



TIMKEN
Silent Automatic
HEAT

TIMKEN SILENT AUTOMATIC DIVISION
The Timken-Detroit Axle Company • Jackson, Michigan
The Timken-Detroit Axle Company of Canada, Ltd., Toronto, Ont.



Miracle machines have woven a network of pipe lines beneath United States soil. This 32½-ton monster digs a trench 44 inches wide and 5½ feet deep for the pipe

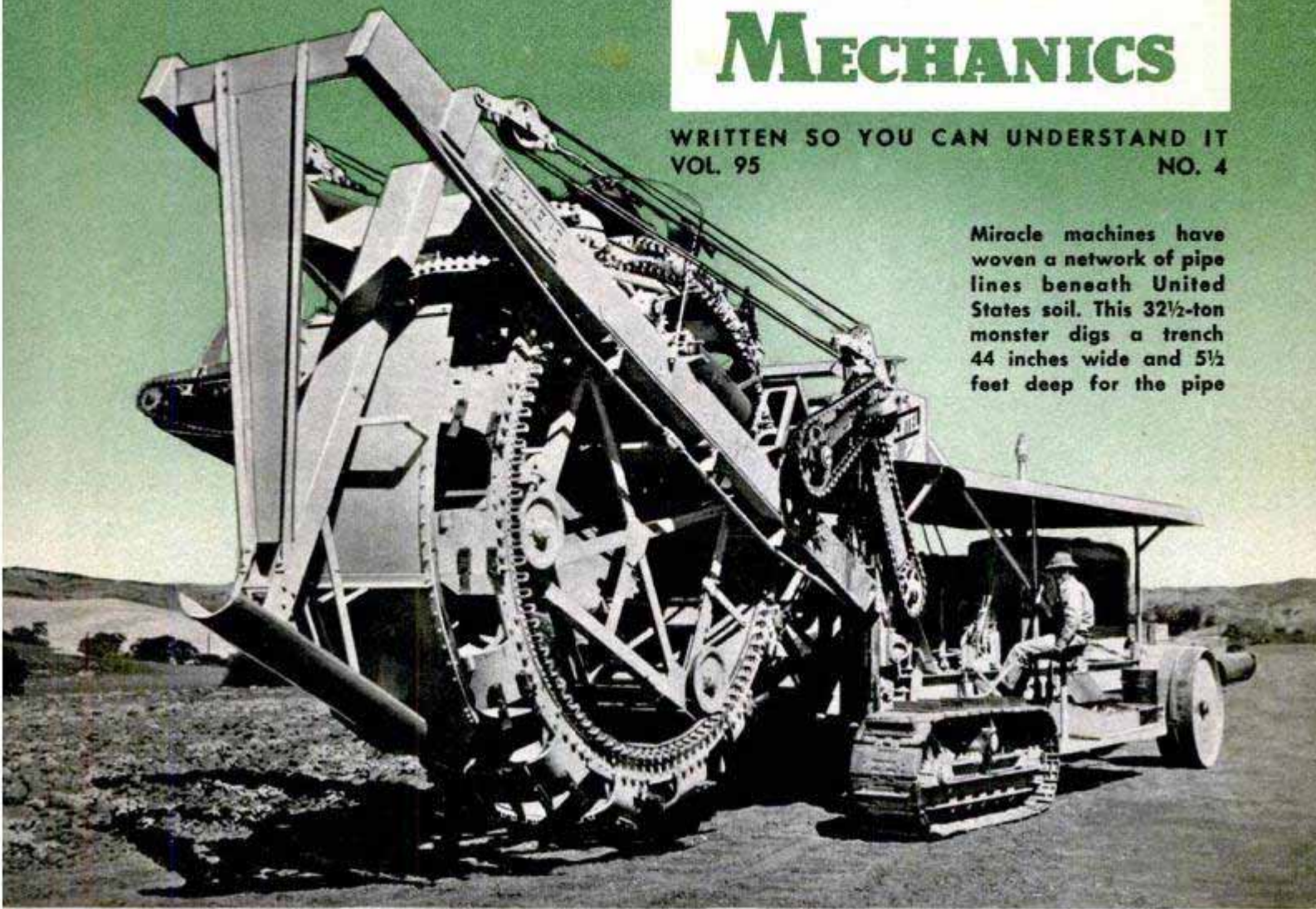

Pacific Gas & Electric Co. photo

FUEL with a 260,000-MILE REACH

By *Thomas E. Stimson, Jr.*

NEW YORK CITY and San Francisco this spring are beginning to use natural gas piped direct from the tremendous underground gas fields of Texas.

The New York line is 1840 miles long and required 20,000 freight cars loaded with 30-inch pipe for its construction. The San Francisco line, the "Super Inch," is 30 and 34 inches in diameter and 1350 miles long.

Completion of these two high-pressure transmission lines at the beginning of the half century is rather appropriate, engineers say, because natural gas will be an increasingly important industrial fuel during the next 50 years. Coal has been losing ground to petroleum in the last couple of decades, they point out, and natural gas in turn may put industrial fuel oils in second place within a few years. America is only now beginning to take full advantage of a great natural source of heat and power.

Line snakes along the right-of-way beside the trench in which it will be buried. The sections of pipe are bent and welded to conform to curvature of the earth

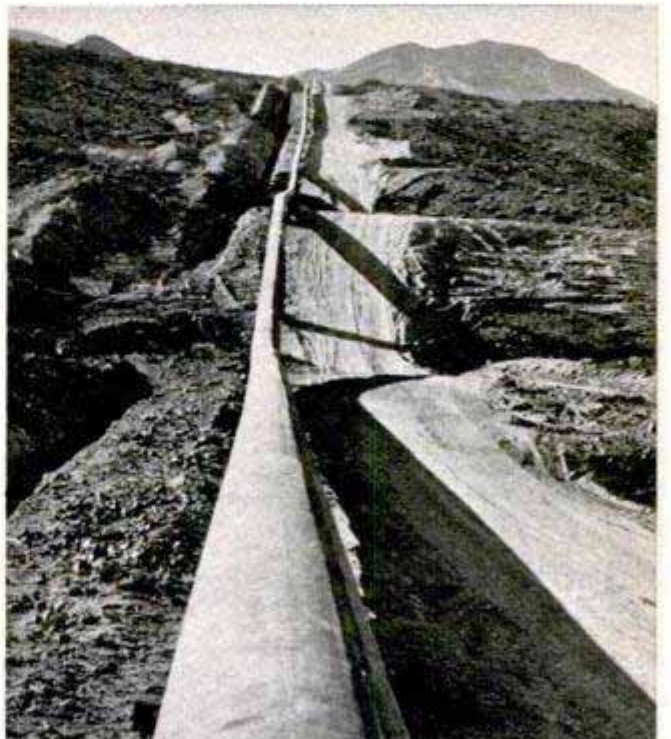



New pipe line is purged of dust and other foreign matter by blowing gas through it under high pressure



Ingenious machine coats the pipe line with asphalt, felt and paper before it is lowered into the ditch

Natural gas is cheap, efficient and clean. Best of all, it is far more plentiful than our known reserves of petroleum. The nation's proved gas reserves amount to some 180 trillion cubic feet, equal on a heat-unit basis to 30 billion barrels of oil. This is five billion barrels more than our known re-

serves of petroleum at the present time. The invisible, combustible stuff consists mostly of methane and other light hydrocarbons of the paraffin series. It is twice as hot as the average manufactured gas. In addition to its widespread household uses, it can take the place of other fuels used by industry. In some areas it produces the steam that spins the turbines of a city's electric-lighting plant. In one new application it is burned underwater in submerged combustion chambers to use every unit of heat efficiently.

It is so dependable, once it is hooked up, that it is used as fuel for emergency motor-generator sets that automatically take over a power or lighting load if the ordinary source of electric current fails. Numerous department stores have installed such emergency equipment in their basements.

Similarly, gas-fueled emergency generators are used at some Atomic Energy Commission installations where a power failure would be disastrous. An interruption in current would be so calamitous, in fact, that not even this safeguard is completely trusted. There's one chance in several million that the flow of gas to an emergency motor generator might be cut off so, as a further precaution, a supply of gasoline is stored alongside the engine. If the power should fail, and if the emergency engine doesn't start up at once on natural gas, liquid fuel starts flowing to the carburetor.

Natural gas is a pretty good fuel for internal-combustion engines, although it wouldn't be practical to connect your automobile to a pipe line. Yet the natural-gas industry is doing just that, in a sense. Propane and other fairly heavy hydrocarbons that are stripped out of the gas at field sources are widely used as liquid fuel by trucks, busses, tractors and by some private cars. The liquefied petroleum gases give about the same miles per dollar as does gasoline, with less maintenance expense. Converting an automobile engine to propane or butane costs less than \$200, including dual-purpose carburetor, pressure fuel tank, electric safety solenoid lock-off and excess-flow check valve.

Diagram shows how natural gas is "scrubbed" and forced along typical transmission line to your gas stove

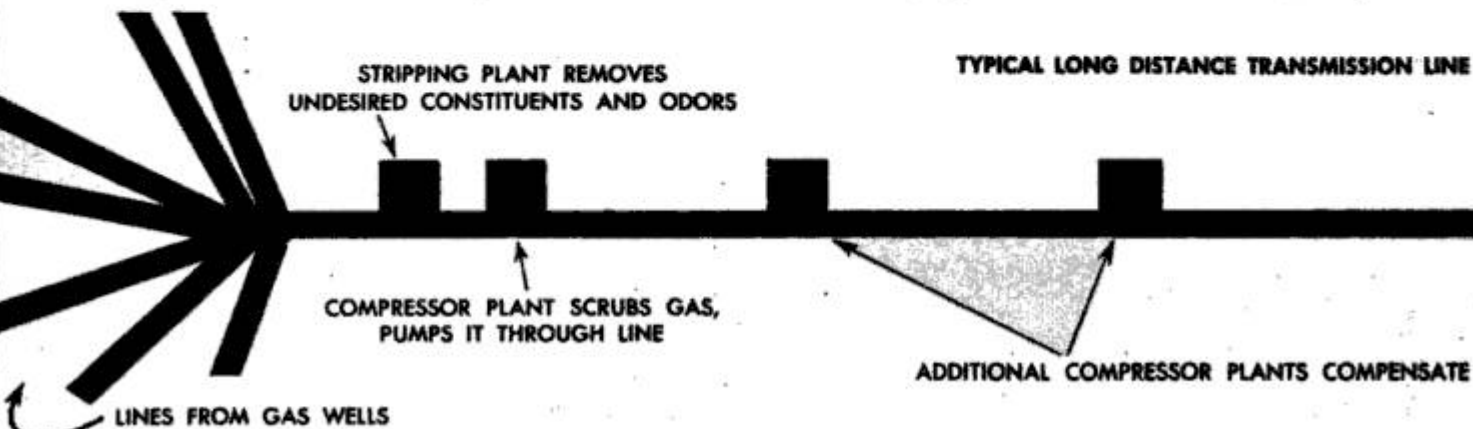

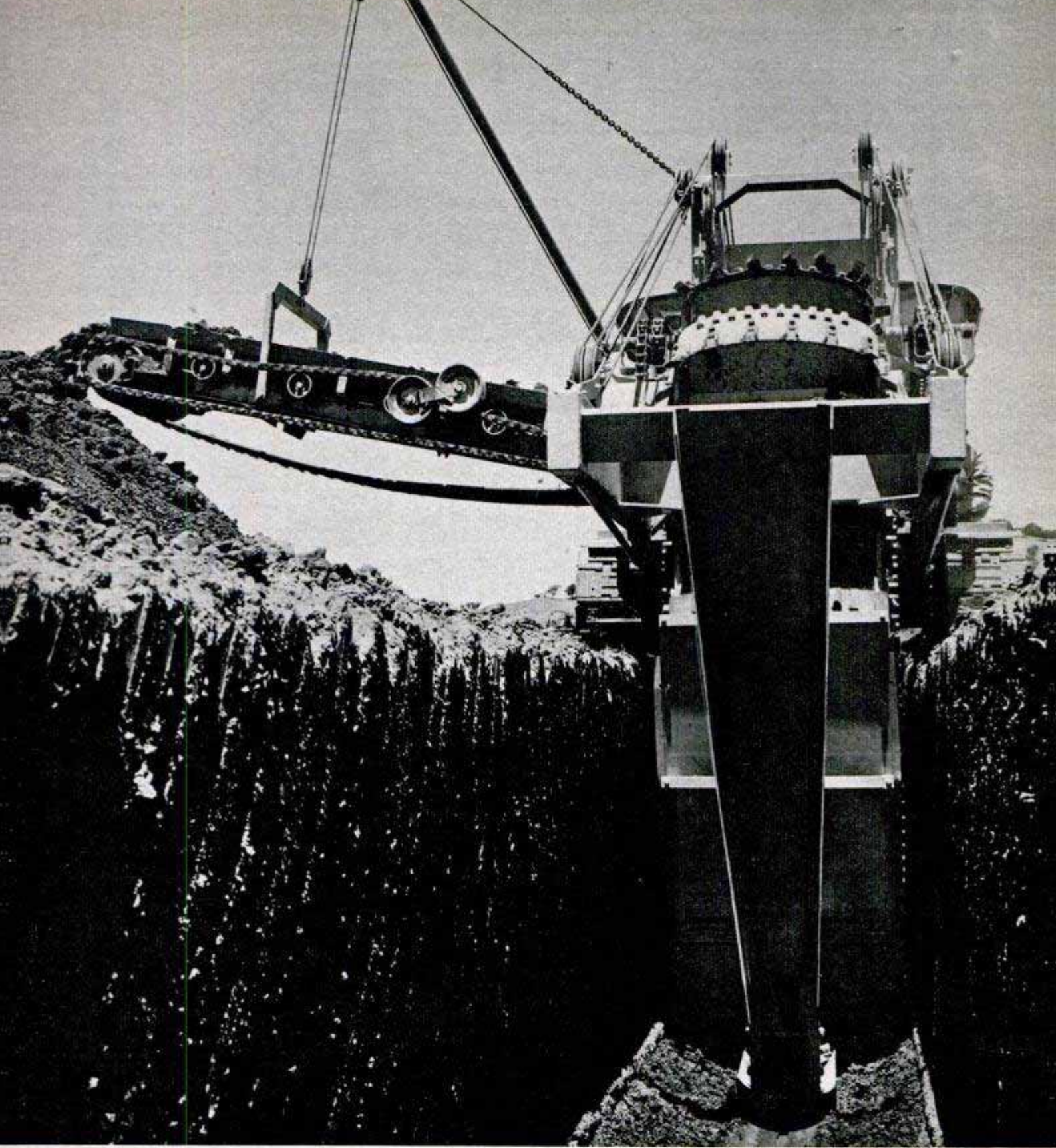

Worm's-eye view of a ponderous trencher at work. The machine can dig more than a mile of trench each day

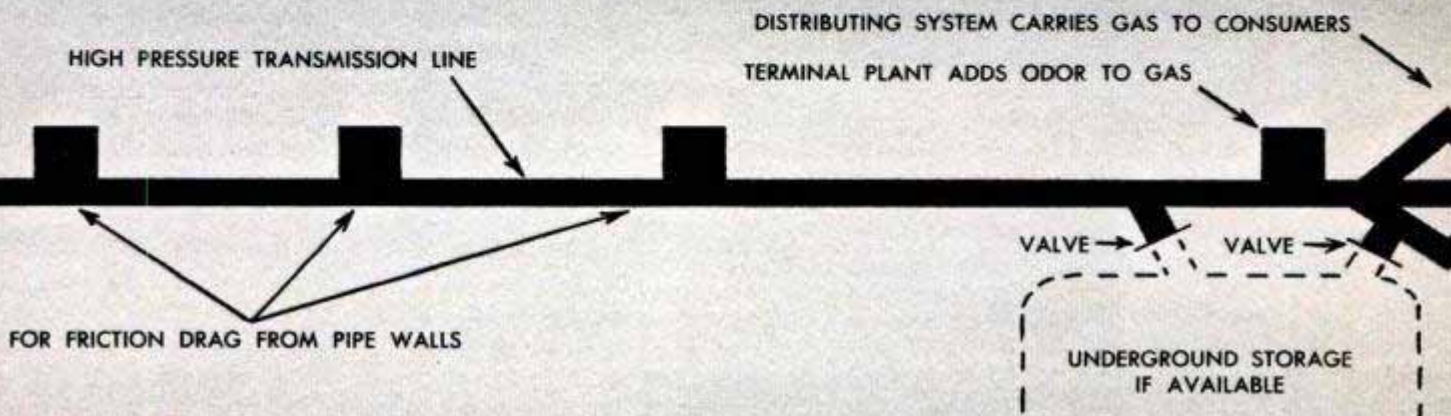

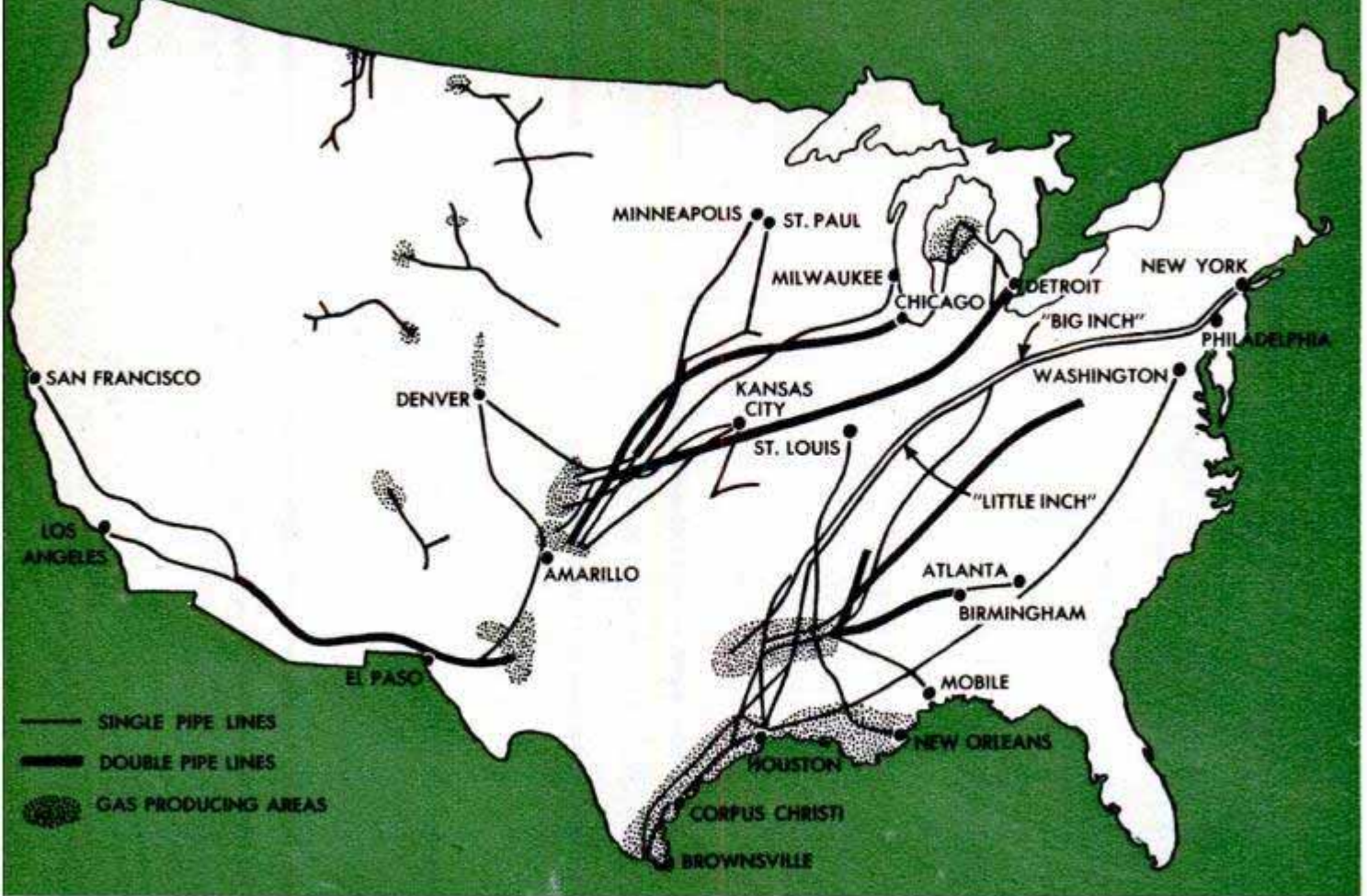

Major pipe lines today carry gas to virtually every industrial sector except New England and Pacific Northwest

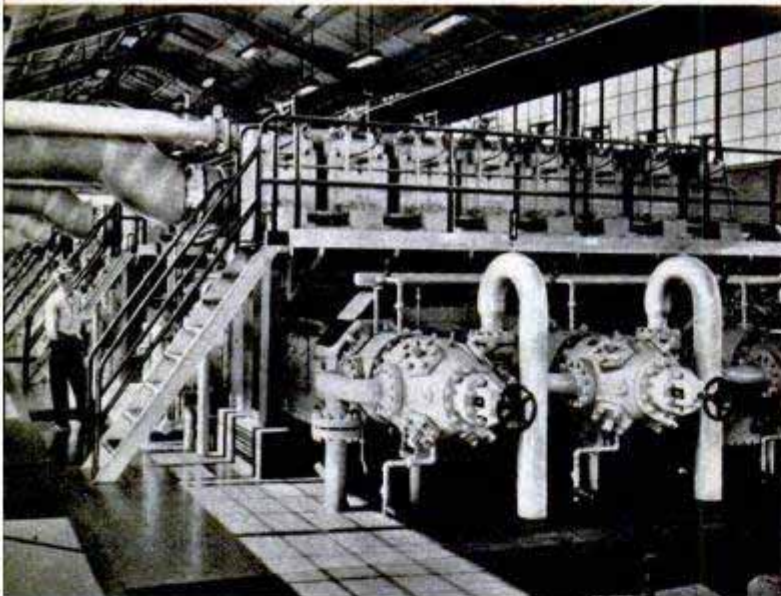

Battery of compressors at pumping station repressures gas to overcome the friction "drag" inside the pipe. Below, side-boom tractors working as a team gently lower welded and wrapped pipe into the deep trench



Today, there's enough natural gas in the proved reserves to keep us going for the next 29 years at the present rate of consumption. We'll double the withdrawal rate in the next few years but geologists say that in the same period we can expect to discover several hundred trillion additional cubic feet of gas that we don't yet know about. All in all, they expect that there's enough gas in the ground to provide heat and power until at least the year 2000.

About half the known supply lies in four major producing areas in Texas. Other important gas fields are in Louisiana and Oklahoma. Smaller fields are supplying local demands in California, Montana, Wyoming, Colorado, New Mexico, Kansas and Mississippi.

These dry-gas fields were discovered accidentally, usually by men prospecting for oil, and they account for 70 percent of the known gas reserves. The balance is in the form of casing-head gas that flows out of an ordinary oil well together with the crude itself. Much of this gas is pumped right back down into the ground again to repressure the formation and keep the crude coming up. After all the recoverable oil has been extracted from a formation, the natural gas itself can be piped away.

Geologists find that the ratio of gas to oil increases with the depth of the formation. Since most future oil discoveries probably will be at great depths, the reserves of gas

will increase considerably from this source alone.

Twenty-five years ago the gas had to be consumed near the wellhead, or not at all, because there were no pipes strong enough to carry it for long distances at high pressure. The development of seamless steel pipe plus improvements in welding techniques changed this situation. The first important long-distance transmission line was built from the Texas Panhandle to Denver in 1928, and was followed by a 900-mile line from northwest Texas to Chicago. Chicago is now serviced by two long gas lines and still a third is under construction.

The first lines were a success so more long lines were built to supply Detroit, Minneapolis and other midwestern cities. After the war the "Big Inch" and "Little Inch" pipe lines that were built to transport Gulf crude oil to Eastern refineries were converted to natural-gas transmission. Meanwhile more lines were built to serve the Midwest, a 1204-mile line was built to Los Angeles, and most recently of all the new San Francisco and New York lines were completed.

Today the country's gas-transmission lines, exclusive of local distribution systems, add up to 260,000 miles. That's greater than the nation's point-to-point railroad mileage.

Every major industrial area is now supplied with natural gas with two exceptions, New England and the Pacific Northwest. The New England states may get a line this year or next that will connect with Texas and Louisiana wells, and the Northwest is seeking one or more lines that would tap



Spiderweb of cables 1200 feet long carries the new West Coast gas pipe line across the Colorado River

gas fields recently discovered in Alberta.

Technically, the natural gas that flows through a pipe line to market is a residual gas because several ingredients are removed from it in the field. Propane and butane constituents are stripped from it because these hydrocarbons would condense into liquid in cold weather and settle in low spots in the line, eventually plugging it. Hydrogen sulphide and considerable water vapor occur in the gas from some fields and both must be removed. Otherwise, they would rust and corrode the steel-alloy pipe.

The so-called sour gas from some formations has a highly objectionable odor caused

(Continued to page 248)

Old oil field in California is biggest underground gas-storage chamber. Gas is pumped in, drawn off as needed

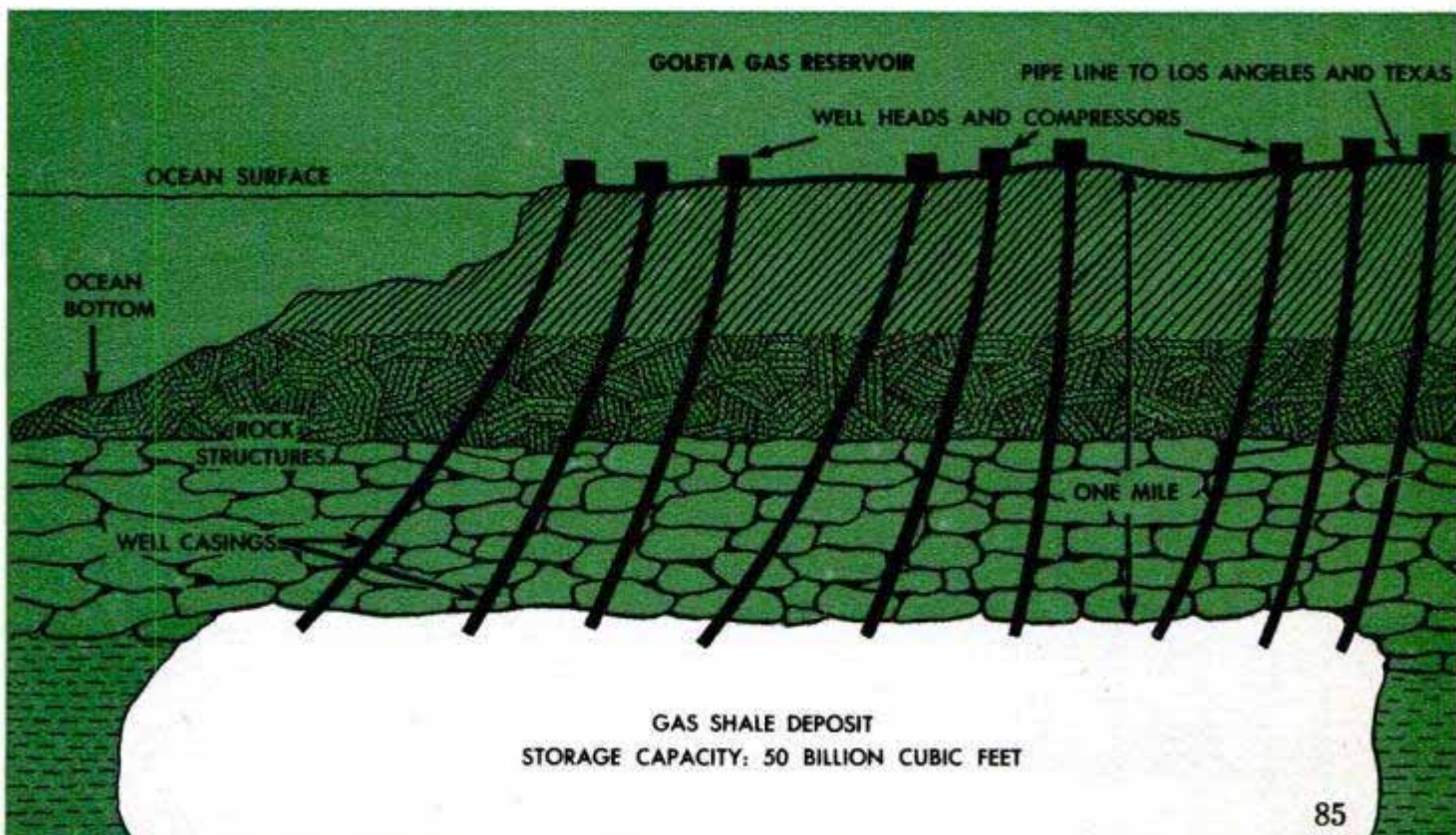



Flying Car Ferry Across English Channel

Twenty-four daily trips are made by an air ferry shuttling automobiles across the English Channel to France. Two automobiles, 12 passengers and their baggage can be carried each trip in the Bristol Freighter

airplanes used for the 20-minute flights. Motorized ramps speed loading and removal. Travelers can be driving along a French highway within an hour after arrival at the English airport.

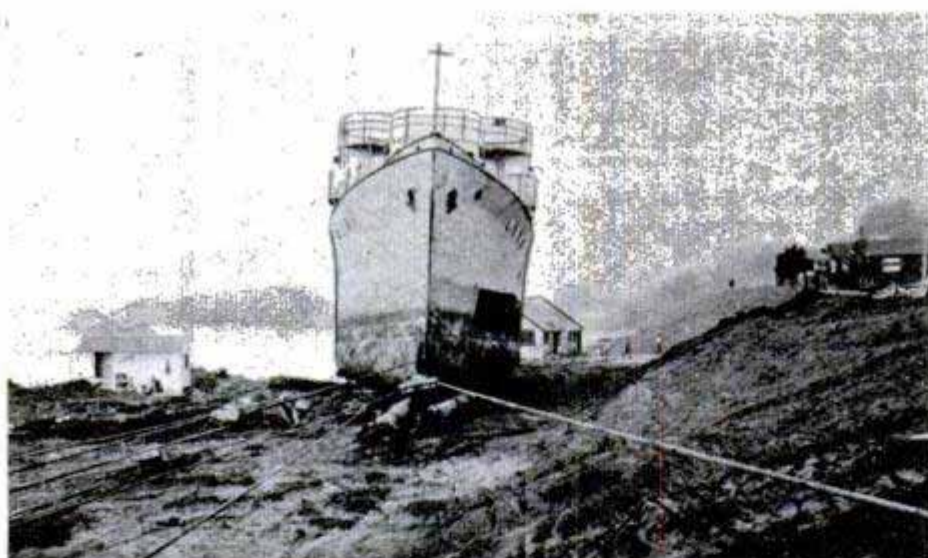

Ship Ashore

Salmon fishermen in northern California can eat their meals and buy their tackle aboard a 156-foot steel yacht which rests on dry ground 20 feet above the Smith River. After serving with the Navy during the war, the grounded ship was sold for its scrap value. The new owner towed it to the mouth of the Smith River and hauled it up on shore along an inclined roadway which was graded out of the bank. When the ship was firmly mounted on dry land, he installed restaurant accommodations and living quarters for his family.



☐ All races of man have the same types of blood and scientists cannot tell, even by microscopic examination, whether a given blood sample came from a Negro, an Indian, a White man or an Oriental person.

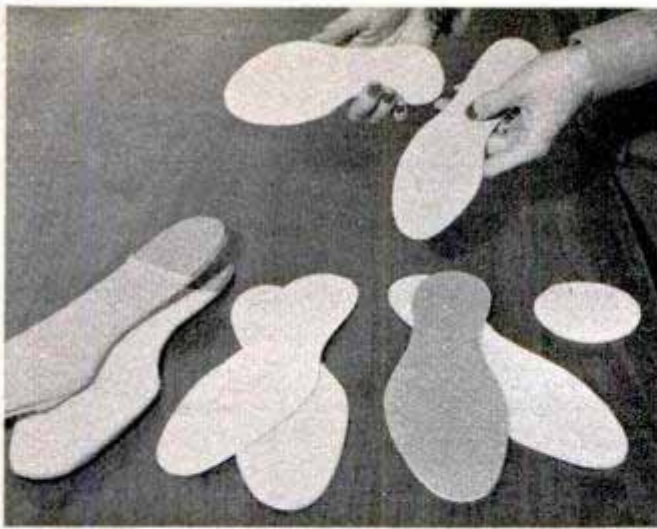

Andrews-Alderfer Processing Co., 120 Ash St., Akron 8, Ohio

Above, inner soles made by laminating foam rubber and fabric. Right, ideal for upholstery and seat covers are foam rubber and fabric combinations like these. Below, rubber-backed carpeting has built-in padding

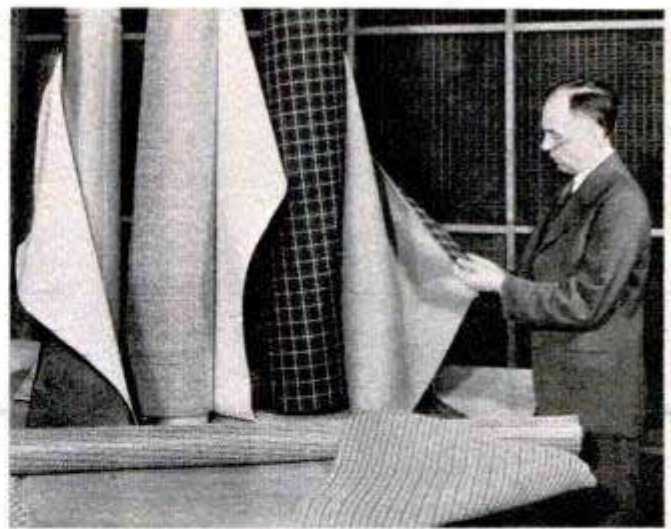

Foam-Rubber Backing "Welded" to Fabric

Fabric and foam rubber can be bonded together to form carpeting, padding and even an unusual cleaning cloth that replaces chamois skin. The unvulcanized latex foam is spread on the fabric in thin sheets. A special curing process interlocks the rubber and fabric so tightly that the joint is stronger than the rubber itself. Because the foam rubber is porous, the combination fabric makes excellent inner soles for shoes. The foam-rubber cleaning cloth feels and acts like chamois. The carpeting consists of a thick pad of foam rubber bonded to rug material. Throw rugs made of the material are nonskid because of the rubber. Seat covers for cars are made by the same process.



Submarine Camera

Like a submarine, the Navy's newest underwater movie camera can be adjusted for positive, negative and neutral buoyancy to allow the cameraman to ascend, descend or float in the water. The camera actually weighs 107 pounds, but when underwater it can be adjusted to "weigh" less than nothing. Fitted with vertical fins and horizontal wings, the camera is controlled by a diver who carries his own air supply.

Four-door sedans currently are the most popular body type among the purchasers of new cars, according to the Automobile Manufacturers Association.

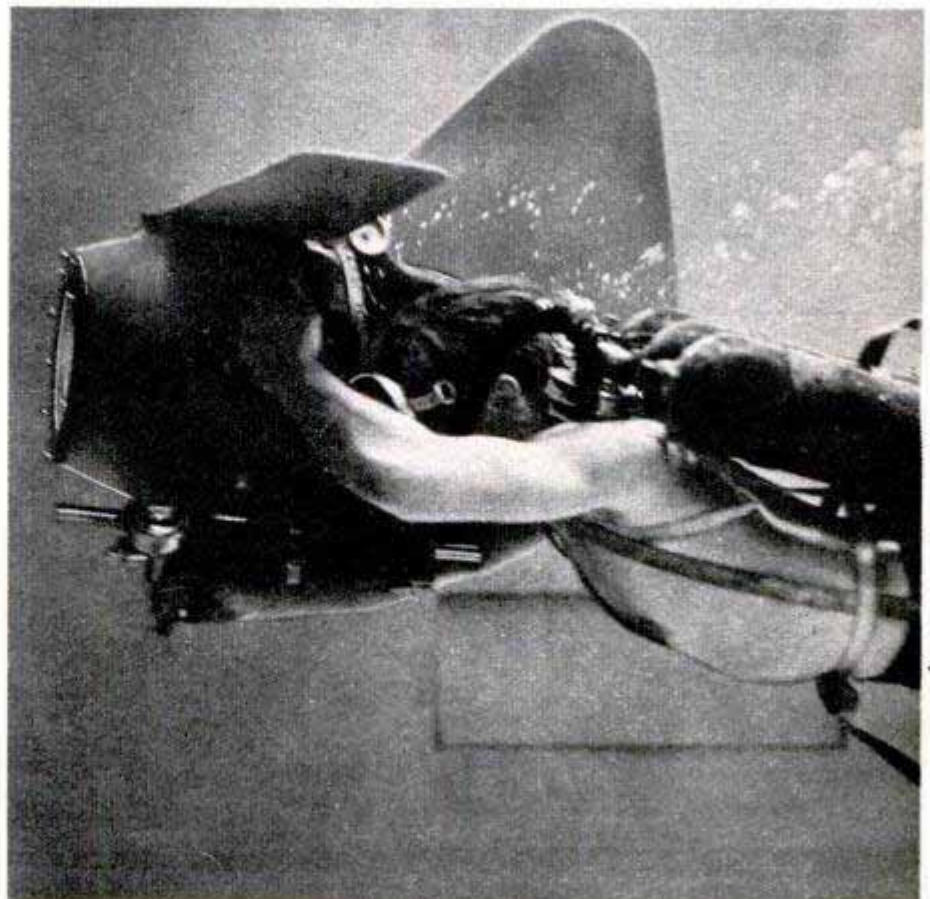

I'm Building the Popular Mechanics

PLYWOOD

Ranch House

By Tom Riley

Part 6

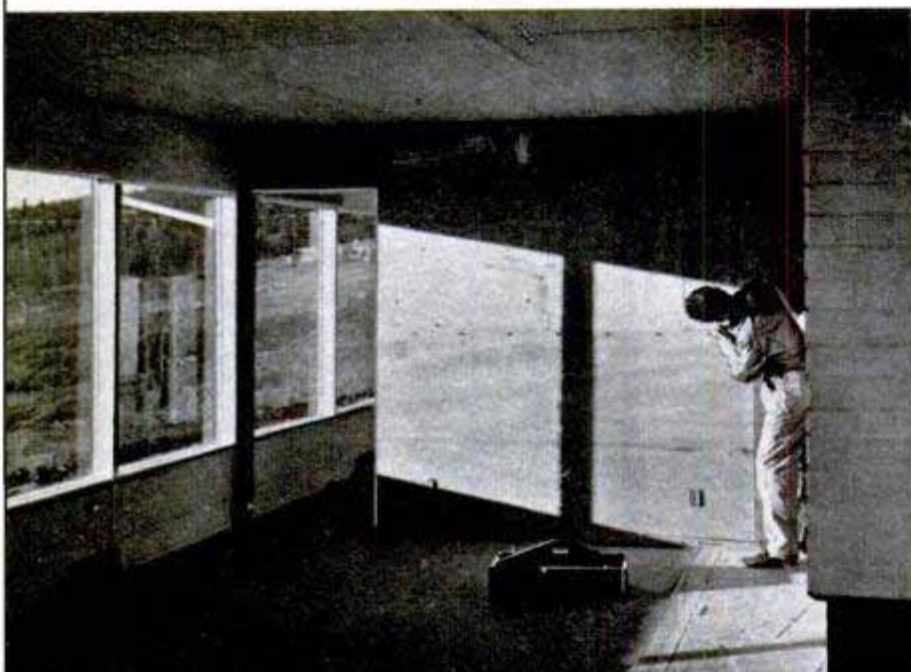

Fir plywood forms the sub-wall in the living room. The finish wall of walnut plywood will be nailed and glued to it later



All lights in the house can be controlled by a 24-volt master switch in the bedroom

NEARING COMPLETION, the amateur-built Ranch House is undergoing its final test—interior finishing. Here is where the novice is apt to leave his mark in easily spotted errors that brand the construction job as nonprofessional.

Now I can tell you enthusiastically that the four-foot module, dry-wall construction we are using is a beautiful job of practical planning. Throughout, I have found that it follows the basic idea of previous *Popular Mechanics* Build-It-Yourself Homes—the 1½-story Frame House and the Concrete Block House—and has such ease of construction that a man can do the job with little or no help. Believe me, if this writer can build it, you can! And here we amateurs can have a genuine home with modern room treatments, open planning and today's other good features in a way that we can afford even in these times!

Starting in next month's *Craftsman's*

Section, the construction details of the Ranch House will be shown.

You will like the final interior finishing and cabinetwork that I am now doing under the supervision of architect John Whelan. This is the modern dry wall which was developed from the research and needs brought on by World War II. Difficult? Not at all. Visitors tell me that finishing is usually the slow, tedious part of house building. That was probably true with woodwork fitted against plaster. But I find it altogether different with dry-wall construction. In the kitchen, for instance, the cabinets fit easily on plywood walls and when you use flush hinges the cabinet doors (usually the tricky part) are just flush pieces of ¾-inch plywood, as simple to make as a box top.

By the way, the little wife will be enthused over the kitchen cabinets which you can build yourself. The upper cabinets that

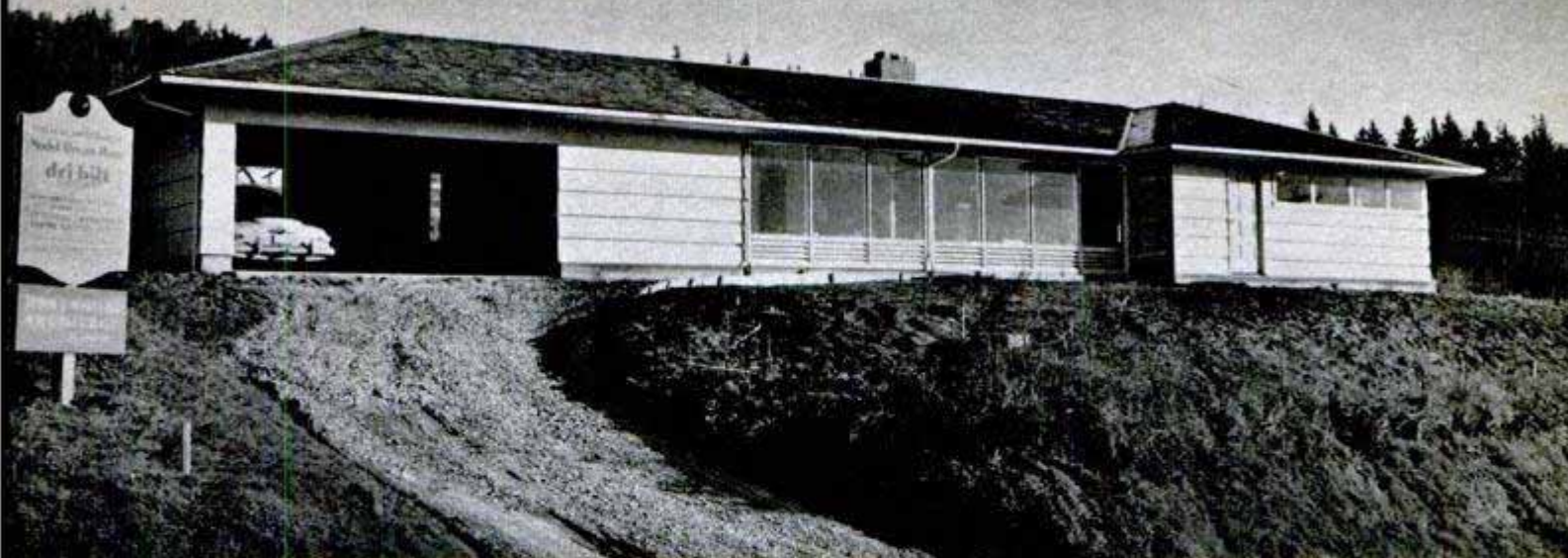

Riley's home, ready for its final coat of paint and landscaping, looks roomy, sturdy and modern

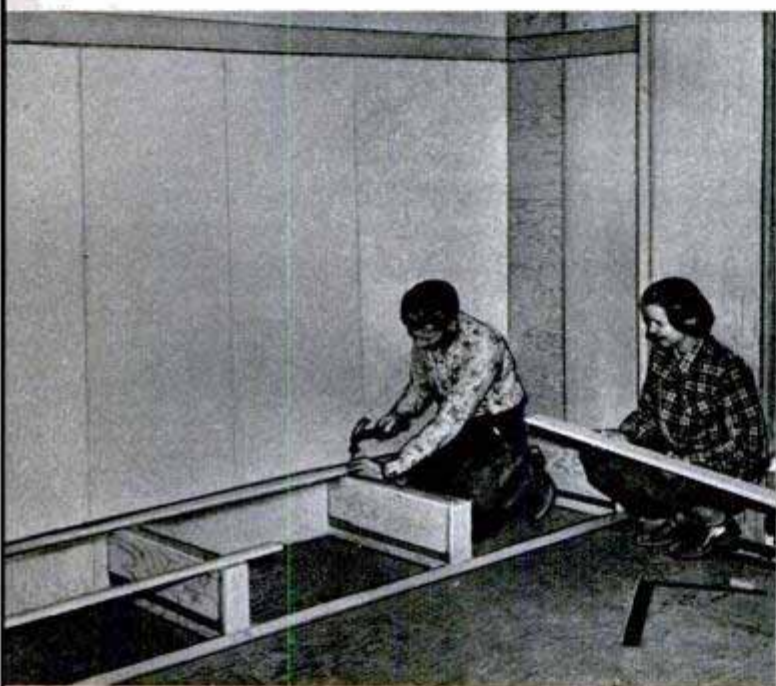

Mr. and Mrs. Tom Riley collaborate on construction of a wardrobe-closet partition between the bedrooms

I am building are of $\frac{3}{4}$ -inch oak plywood and will have a limed-oak finish that gives the kitchen the modern grained-wood effect so popular today, yet blends with the porcelain of range and refrigerator.

The Ranch House kitchen will have the food-preparation center you have asked for. That extra counter space alongside the refrigerator with maple chopping-block top is not difficult to build. All the lower kitchen cabinets are simplified in their construction by being planned so they can receive the new steel drawers which simply screw into a wood frame. There are no drawers to make, and you get all the ad-

vantages of both steel and custom-fit wood cabinets — flour bins, sliding trays, vegetable drawers and the like—without the high cost of ready-built cabinets.

In the past, plywood has been thought of as either a cheap plaster substitute in its common grades or as an expensive wall paneling in its costly hardwood varieties. Today, builders realize that the common, inexpensive plywood is not limited to use as a substitute for plaster. It is an attractive building material in its own right. Plywood companies are now producing unusual grained and textured surfaces that make attractive paneling which is easy to put up and pay for.

John Whelan is a whiz of an architect at achieving luxurious interiors inexpensively and he definitely proves this in the living room of the Ranch House. One short 12-foot wall, alongside the fireplace, is earmarked for hardwood. It requires only three 4 by 8-foot sheets of hardwood plywood. I am using walnut plywood. Thus, with an "island wall" closet of the same material forming the partition between the living room and hall and with the two other walls of the living room being the island-wall fireplace and an expanse of windows, the effect is of a luxurious walnut-paneled living room when actually little of the expensive material is used.

(Continued to page 242)

Next month in the Craftsman Section we will publish the first of three construction articles, including plans, sketches and photos to show how you, like Tom Riley, can build the Popular Mechanics Plywood Ranch House





Souped-Up Scooter

Can a motor scooter go 100 miles per hour? Tony Capanna of Los Angeles thinks so, after having been clocked at 83.53 miles an hour on a scooter that he streamlined with a plywood body. He reworked the stock 10-horsepower engine to deliver slightly more power, reduced the height

of the steering assembly and replaced the stock fuel tank with a one-quart tank to cut down frontal area. Air for the carburetor and engine cooling enters through ports. Capanna rode prone on the body and was clocked at a California dry lake. By further reducing the scooter's weight and adding other refinements, he is positive he can go 90 to 100 miles per hour.



Unsinkable Folding Boat

Wrapped around the hull at the gunwales, two air-filled tubes make the Foldboat unsinkable even though it's completely filled with water. This portable boat has been a favorite in Europe for years. The two-seater model weighs only 56 pounds

The Klepper Co., 28 East 31st St., New York City 16. complete with sails, paddles and leeboards. The collapsible frame is made of seasoned mountain ash. The fabric "skin" is a combination of rubber and canvas. It comes apart to form two compact bundles that can be carried by one person. The bundles will fit into a car trunk. Assembling the boat takes less than 15 minutes.



Wood Mfg. Co., San Fernando, Calif.

Self-Heating Pavement Iron

Asphalt patches in pavement are smoothed and compacted faster by an iron that has a built-in heater. The heater is a blowtorch fitted inside the handle so the flame is directed into the hollow cast-iron smoothing head. Use of this iron eliminates the usual practice of hauling a large furnace trailer to heat the smoothing irons.

Pocket Telescope

Not much larger than a fountain pen, a telescope with a six-times magnification can be carried in the pocket always ready for use. It's useful to sportsmen, motorists and small-boat enthusiasts. The end of the barrel slides in and out for sharp focusing. A clip holds the telescope in the pocket.



Grover Photo Co., 201½ E. Broadway, Glendale, Calif.



Perfection Stove Co., 7609 Platt Ave., Cleveland 4, Ohio

Picnic Broiler for Steaks

Steaks can be cooked on a portable broiler that clamps onto the side of a kerosene camp stove. The broiler lid covers the stove top. Convected heat cooks the meat.

Escape Window on Bus

Four hundred modern busses now in operation in New York City have individual escape windows through which passengers can crawl in event of an accident. The busses also are equipped with loops which hold stretchers so the vehicles can be converted into emergency ambulances. Other innovations are staggered seats, wider doors and nonglaring fluorescent lights.

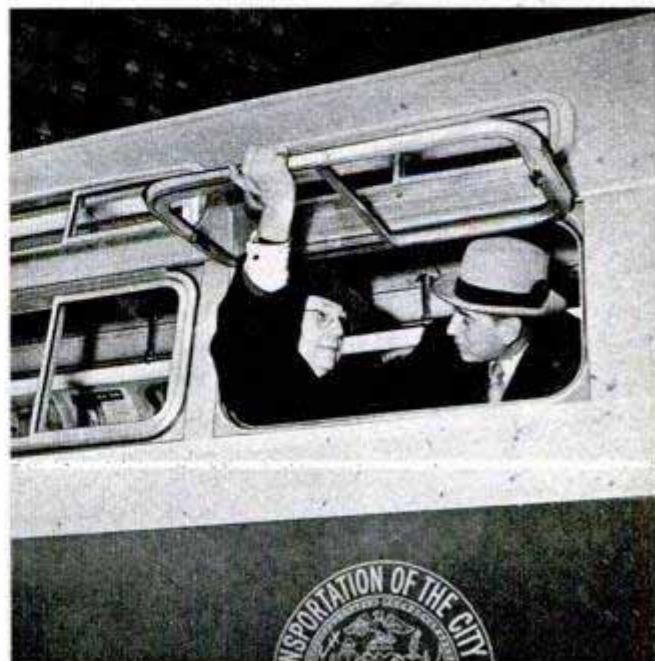

Quarry-Pit Racers

MINIATURE SPEEDBOATING has come of age. In the wake of modern streamlined trains came a new generation of model-railroad fans; and to emulate great schooners that crossed oceans, builders began to fashion small models to cross park lagoons. Now, fascinated by the sleek lines and spectacular speed of today's big power craft, hobbyists are racing hundreds of trim miniatures across the ponds of the nation. From engines up to $\frac{1}{4}$ horsepower, small enough to fit into a drinking glass, they get speeds of 40 to 60 miles an hour. The boats, less than a yard long, are so highly developed now that for competitive purposes they are divided into five classes, varying in engine displacement, total weight and as to whether the power plant is homemade or manufactured. Their racing even has its hazards. The boats spin around circular courses on cables, and when one of them breaks loose at a mile a minute it can do real damage to itself and anybody it strikes.

At speeds up to 60 miles an hour, the pigmy power boats roar around their 1/16-mile racing course

Three Lions photos

For further info write:
Mr. Robert Graham
127 Cottage St.
Jersey City, N.J.

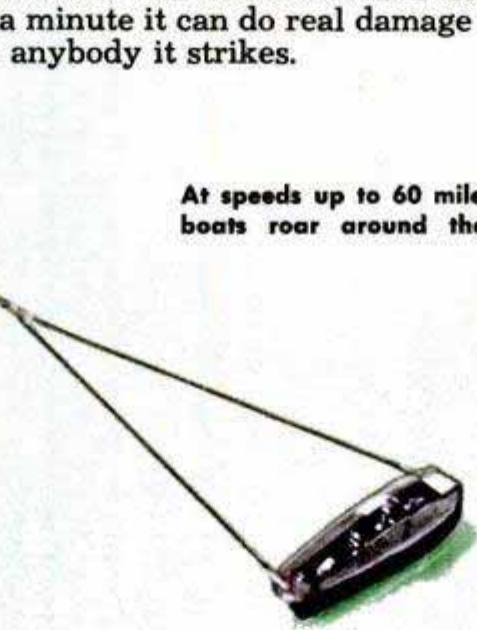

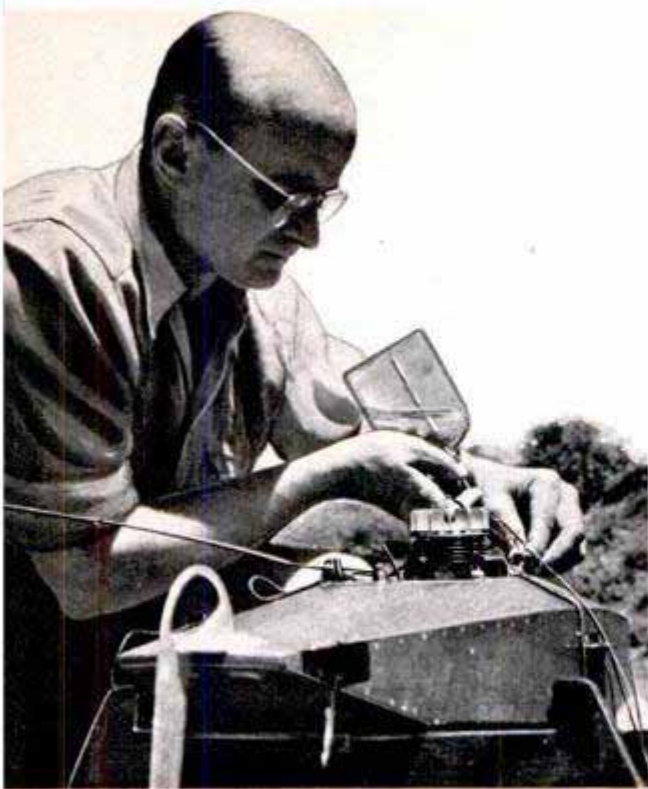

Fuel for the miniatures is a mixture of alcohol and castor oil. Some engines are small enough to fit into a drinking glass



Physical problems don't stymie miniature-racing fans. For a competition at Poughkeepsie, above, they used a bulldozer to scoop out a hole 200 feet wide, then diverted a stream to fill it up

To keep racing records uniform, the boats are held 52½ feet from pole in center of the pond by a bridle and a cable

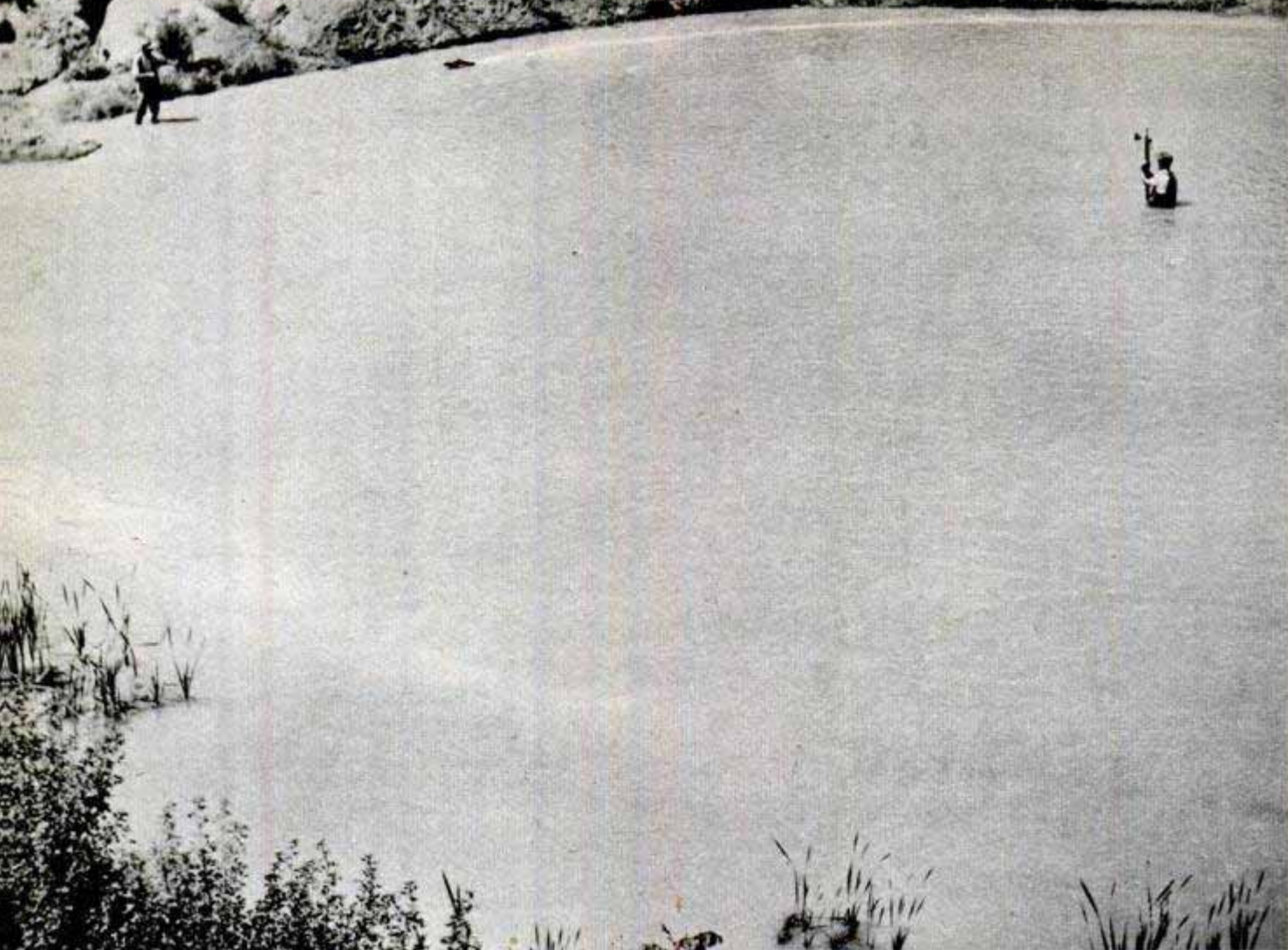

Attachment pole in the center of the pond, where the boy is standing, is greased to reduce friction

Fine equipment deserves extra care, so this owner slips his tiny boat into a handmade canvas rig



Most of the miniatures use stock engines. Note the small toggle switches that turn on ignition in two models (below) at right

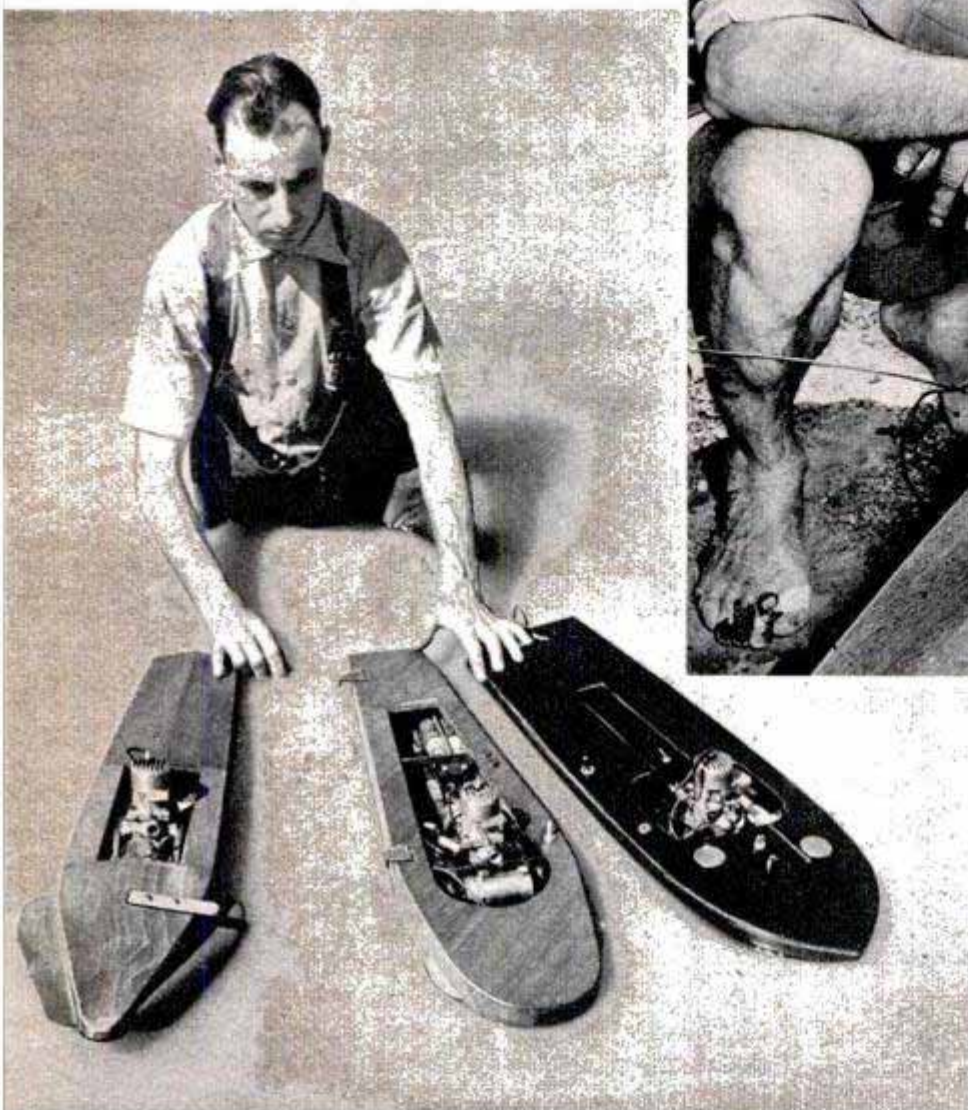

While a young admirer listens avidly, a miniature-boat enthusiast describes working of an engine he built. The rod projecting at left, when touched, stops the craft. Another easy, quick way to stop a boat is to splash water into it as it passes, shorting the ignition

Steps or pontoons on their bottoms enable the boats to hydroplane more effectively. They barely skim along the surface. As a sample of painstaking work, even the mahogany grainings are matched in model at right

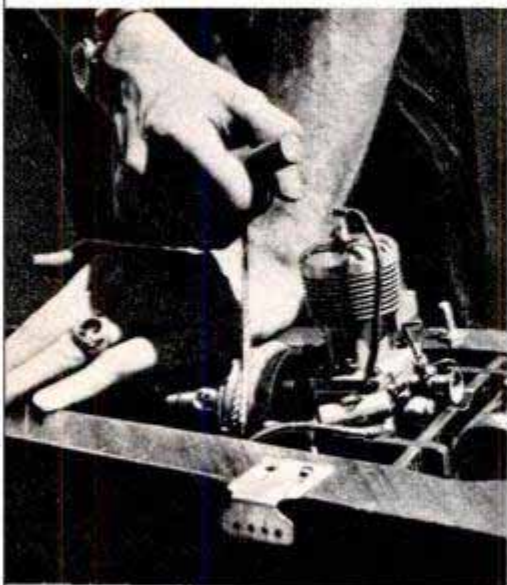

Either a piece of shoestring or a piece of light rope will spin flywheel to start motor





Left, the buoyant bell shoots up from the bottom, breaking through the surface, when the cable is released. Above, ports in the wall provide a view of ocean-bottom scenes

OCEAN-BOTTOM SIGHT-SEERS

LIKE TO TAKE a close look at the ocean bottom? You can do it on Catalina Island, Calif., and you'll be as safe and comfortable as you are in a department-store elevator. You descend 40 feet to the ocean bottom in a diving chamber roomy enough for 12 persons. Glass ports around the walls let you watch brilliantly colored fish dart among tall strands of underwater kelp.

The three-ton steel bell is moved up and down on a central guide shaft by a motor-driven cable. Normally, the car returns to the surface slowly, held back by the cable. But for a real thrill, the grip on the cable is released, allowing the buoyant bell to shoot to the surface like a cork. Motor and air compressor are mounted in a superstructure atop the shaft.

Below, left, sketch explains diving-bell operation. Right, structure above bell houses motor and compressor

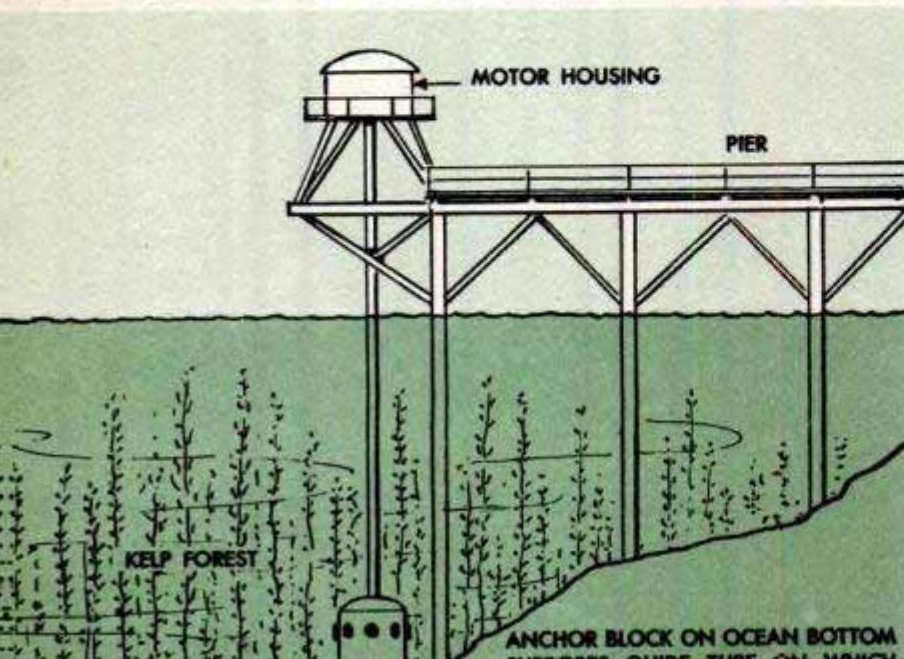



LIGHTNING STRIKES YOUR DINNER

By Richard F. Dempewolf

IT'S DINNERTIME. You open an ordinary kitchen closet, haul out a cellophane-wrapped steak, leg of lamb, hamburger or fillet of flounder which you bought two or three years ago. In a few moments, the aroma of fresh sizzling meat on the stove fills the kitchen. In that same closet, besides meat, are cartons of raw peas, carrots, cheeses, eggs, fruits—practically everything in the way of ordinarily perishable food—stacked up on the shelves the way you'd store sugar, cereals, spices and herbs. They've been setting there at room temperature for months or years. But they're all as fresh and tasty as the day you bought them.

A dream for 1980? Not at all. The first commercial prototype of the machine that does the job will go to work this year. Its inventors believe that the first products from it will find their way to American homes within a matter of months. Already stored away at room temperature in a laboratory in New York City are remarkably fresh samples of four-year-old food. This reporter will attest to their flavor—peas and carrots that taste as though they'd just been brought from the truck patch; raw, red hamburger as fresh as though it had been a cow yesterday. Besides the food, a startling assortment of other well-preserved items line the shelves in glass ampules, aluminum cans and other airtight containers. There are year-old cut flowers as fresh as the instant they were snipped. There are perishables, such as vaccines, hormones, antibiotics, human plasma and other blood derivatives that have been lying around for a year but can be used

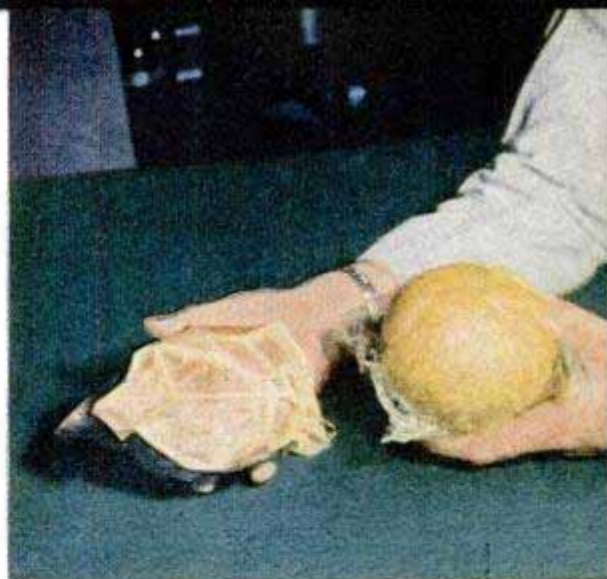

Top left, a technician places corn and grapefruit beneath waffled window of capacitron. Through the window will jab a 3,000,000-volt shot of electrons to destroy bacteria and keep the food fresh indefinitely—without refrigeration

*Dr. Arno O. Passch
Wolfgang Huber
Electrochemical Chemicals
Corp., 842 Lefferts Ave*

Above, test sample of grapefruit at right is still as juicy and appetizing as it was a year ago when it was "electronized." At left is untreated fruit, rotted though kept under refrigeration

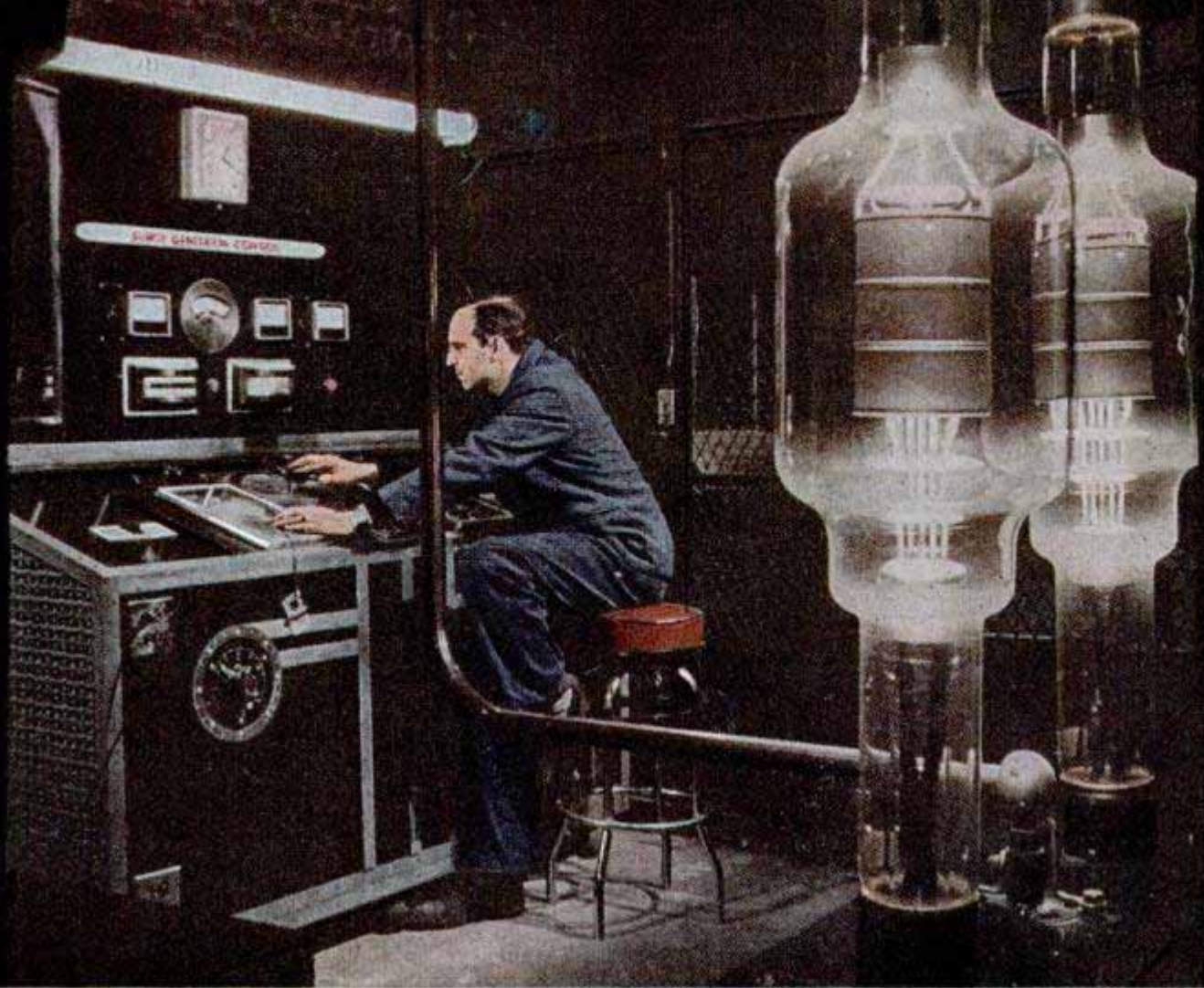

Pix Incorporated photo

Man at control panel hurls lightning bolts at food. Current passes through big rectifier tubes in foreground

safely and effectively at a moment's notice.

The secret preservative behind these amazing products is a monumental bombardment of the same atomic bullets that paint the pictures on your television screen and bring radar pictures to navigators—electrons. In this case, however, the electrons are let loose with a crashing discharge of three million or more volts, in man-killing flashes a millionth of a second long.

Ordinary china plate is placed on the target table and covered with a pattern of heavy metal templates

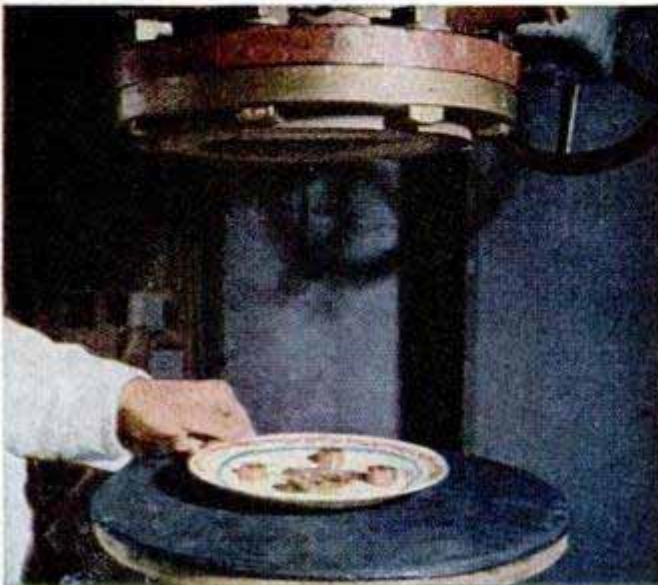

In that time, a light beam would only travel about two city blocks. Under this atomic barrage, every microorganism that makes food decay is destroyed, and the action of enzymes (which can change chemical structure of food) is inhibited. But, due to the singular effect of the electron bursts, the food itself is not injured or changed, since the radiation has no chance to go to work on anything else but the microorganisms.

Here's the same plate after the jolt of electrons. China has been tinted, pattern remains white through plate



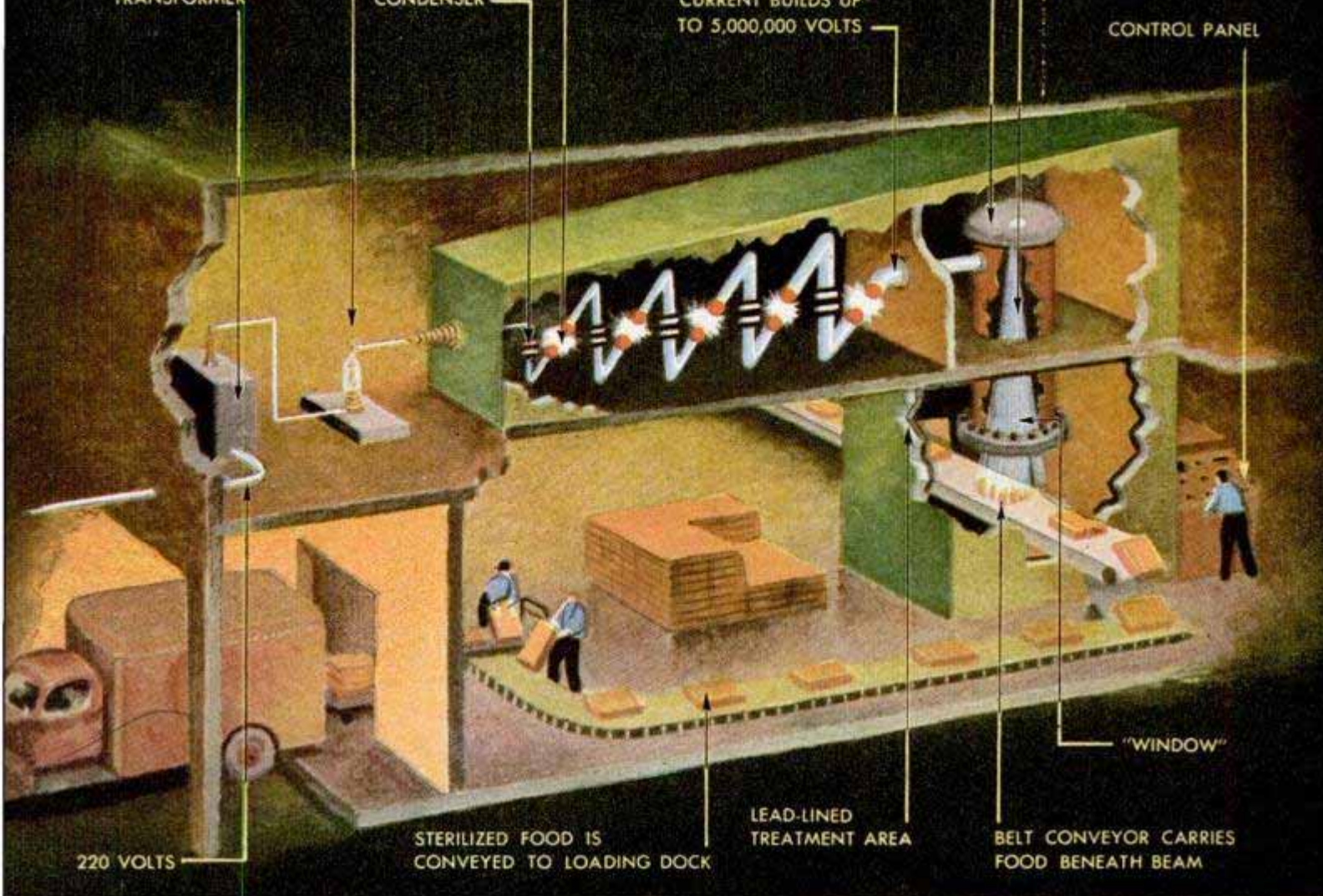

Commercial model of capacitron will stab bacteria-killing electrons into food moving along a conveyor belt

Though the eerie beams that will soon jolt into your steak are equal to the beta radiation of a ton of radium, these electrons leave no harmful residual radiations, such as the gamma rays that poisoned Bikini Lagoon. What they actually do is sterilize all bacteria and viruses by breaking down the nuclei of these one-celled menaces. By wrapping objects to be treated in airtight packages (such as glass jars, heat-

sealed cellophane envelopes or cans) before "electronizing" them, all the microorganisms in and around the food are destroyed by the bombardment, and no new ones can get in. Result: fresh food stays fresh in its container—and appetizing in most cases, regardless of temperature.

The pilot machine that first produced these workable electron showers sets in a cavernous, gloomy icehouse in a remote

Slice of ham "shot" two years ago is fresh and tasty. Untreated slice at right, two years old, is inedible

Electrons tunneled through sheet of Plexiglas to form a lacy pattern. Surface of panel is unaffected

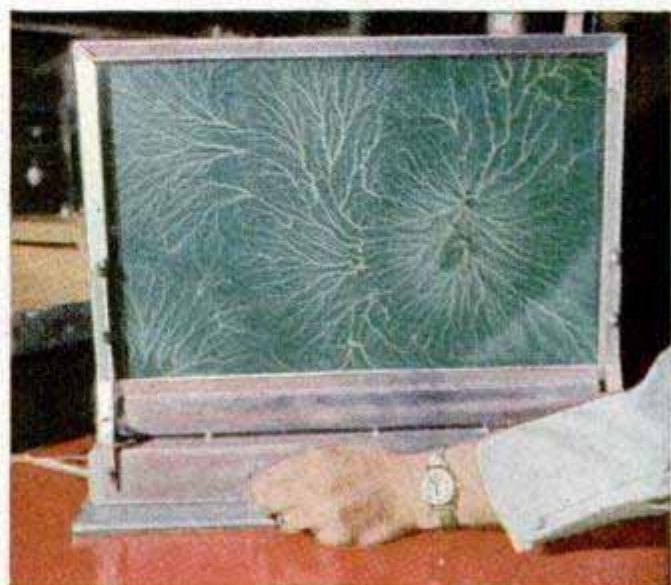
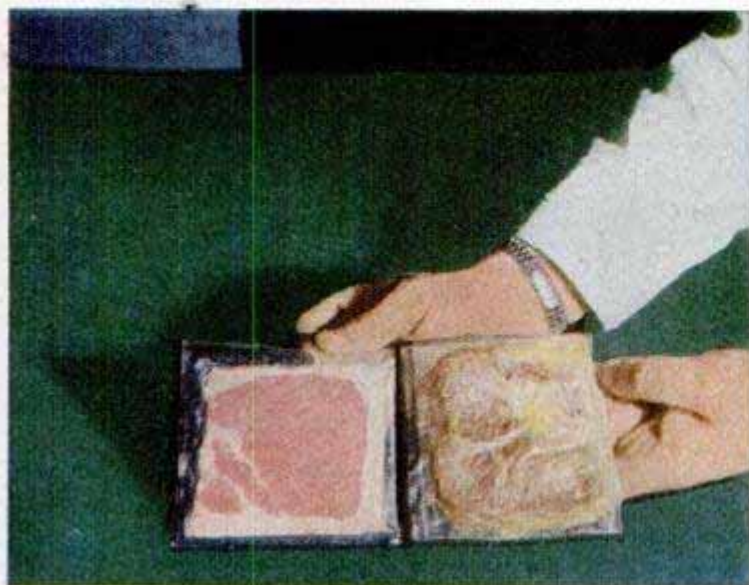

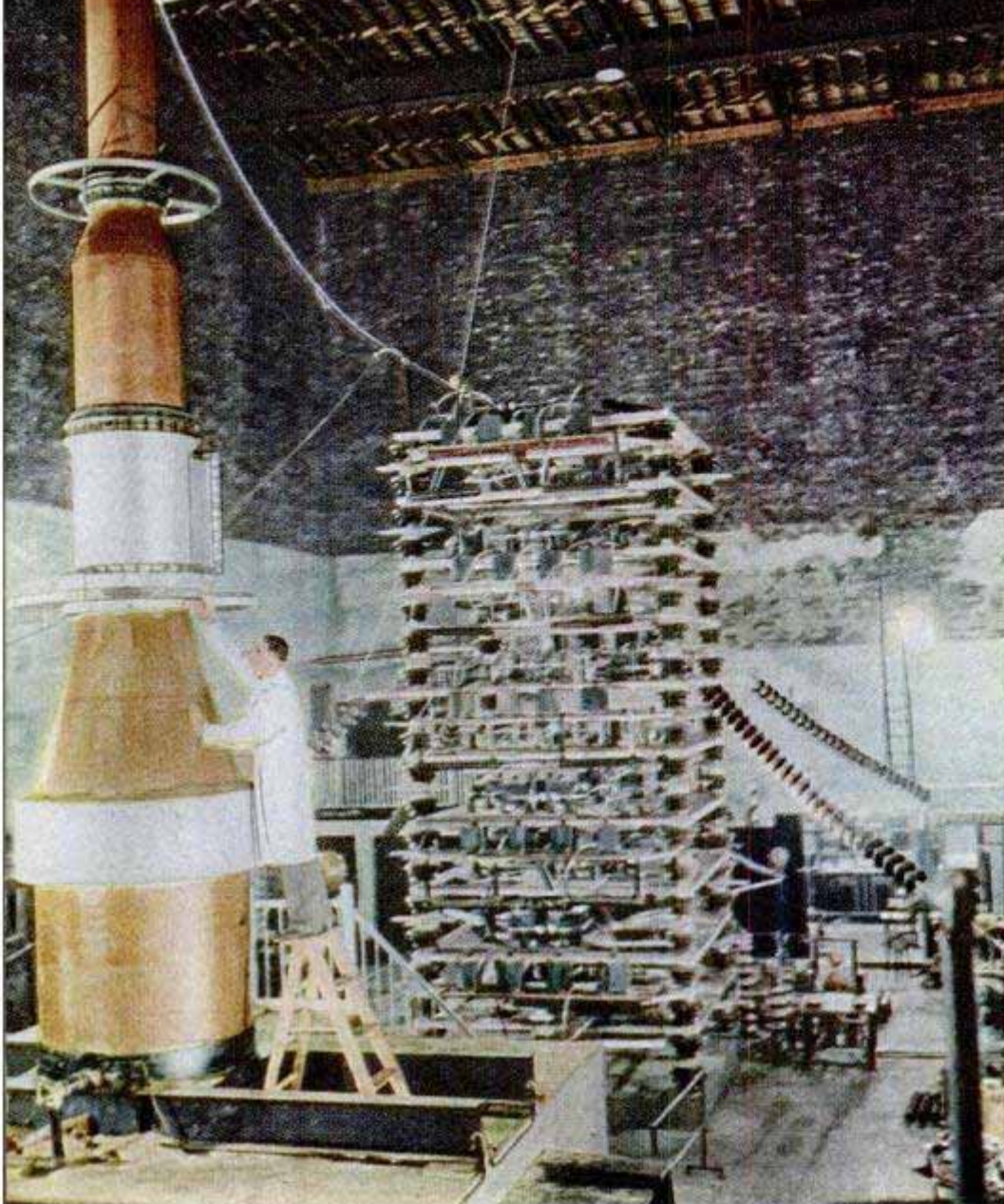

section of Brooklyn, N. Y. Dubbed the "capacitron," this second cousin to a cyclotron particle accelerator is a weird, towering jungle of insulators, transformers, glowing monster electronic tubes, jagged, crackling blue sparks and odd noises. The ice-house looks like an overdone set for a Frankenstein movie. Amid this Buck Rogers clutter, Dr. Arno Brasch, co-inventor of the machine, and his associate, Dr. Wolfgang Huber, have been feeling their way slowly for the past four years. "When you know you have an elephant by the tail," says Doctor Brasch, "you don't try to push him around."

Beside the huge pilot model of the capacitron is the virtually completed commercial model which will begin sterilizing edibles for a large food processor in a few months. It is in a compact, steel-enclosed case, 35 feet long, 6 feet wide and 10 feet high. It will pack a five-million-volt charge and is designed to fit into a special space in a factory above a

Pix Incorporated photo

In pilot model, ordinary house current is stepped up to 3,000,000 volts by tower in the background, then discharged through the huge vacuum tube

Perfectly preserved pear was "shot" two years ago and put on shelf. Beside it is an untreated pear

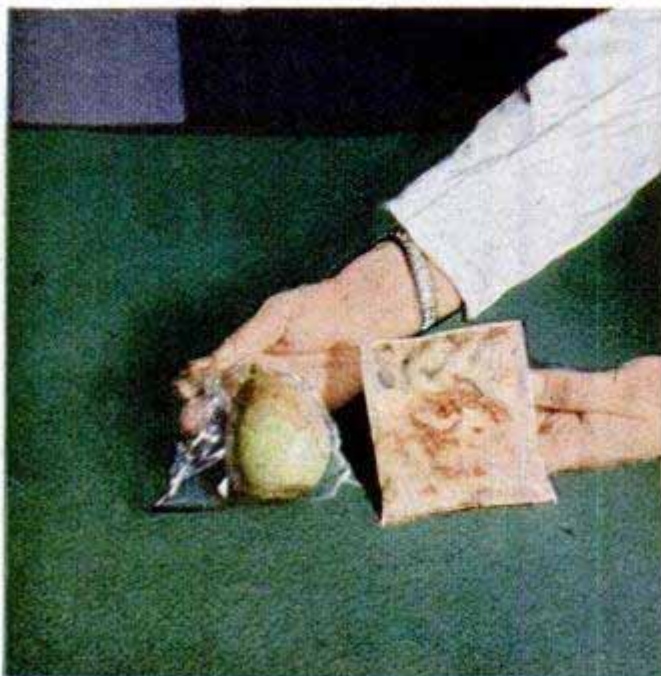

Four-year-old foods, still appetizing, include raw hamburger, fish pudding, raw carrot and pea puree

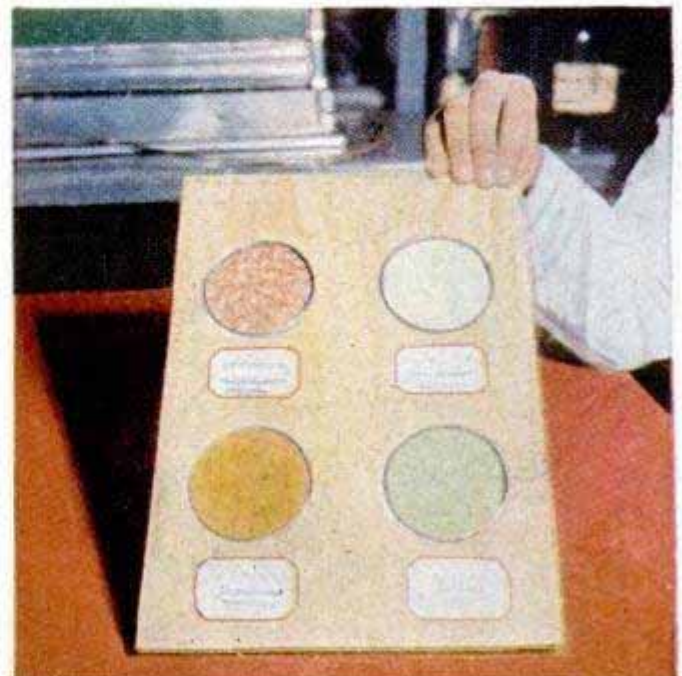

conveyor belt. It will process up to 50 million pounds of produce a year at a cost of about one-half cent a pound.

Doctor Brasch, formerly of the University of Berlin, is a serious, 44-year-old nuclear physicist, who strolls around his electronic kingdom with the faraway look of any scientist deeply absorbed in his brain child. He first grabbed this particular "elephant" by the tail in 1927. He was then working on atom-splitting projects in Berlin, and needed more voltage than anyone could produce to do the job. So, he decided to use lightning during thunderstorms, pull in its staggering voltage and split atoms with it. He built a plant in the Italian Alps, waited for bad weather, and got it—along with brief jolts of power from the heavens that registered up to 20 million volts.

"But you can't make lightning strike when you want it," he says, grinning, "so the next thing was to make my own." Within a year, the first capacitron for atom-splitting was shooting controlled, Brasch-made lightning around a laboratory at a rate of 2½ million volts a whack.

It wasn't easy. First, vacuum tubes kept blowing their walls. "The tremendous cascade of electrons," explains Dr. Adnan Waly, another Brasch associate, "created a negative charge inside the tube. It was so great it shorted out through the tube's walls. Result: breakdown." To solve this, Brasch designed a tube with what he calls a "built-in breakdown." It consists of laminated-plastic rings, interspersed with metal rings that carry the unwanted charge out into the air without disrupting anything.

While working with this lightning-spewing machine, Brasch first noticed the unique behavior of his short jolts of high-volt-

age electrons. Other machines, producing steady streams of low-voltage electrons, inactivated microbes, all right, but they also destroyed the structure of everything else in their path. The sudden flash of the first capacitron, lasting only 1/10,000 second, was so short it didn't seem to hurt anything but the electron-sensitive bugs. Brasch saw visions of his lightning jolt killing plague and tuberculosis organisms without hurting people; sterilizing drugs without changing the substance—and perhaps getting at cancer without harming surrounding tissue. And he saw his lightning playing over conveyor belts of food.

To test his theory, he sealed up a banana and put it under the business end of his machine. "It was perfectly preserved," he recalls, "but it turned an ugly brown—an indication that the blast still did some injury to the food structure. What I needed was more time and money to investigate the effects of this type of radiation on food."

But Hitler wasn't interested in bananas. Brasch, after an altercation with Nazi agents, who didn't see eye to eye with his plans (nor he theirs), packed off to America. After years of heroic "selling," he managed to round up half a million dollars. He rented his icehouse and went to work.

It was 1943. Everything was in short supply. Brasch beat the bushes for material. He haunted secondhand stores in lower New York's junk hardware mart, snagging a condenser here, insulators there. Toward war's end, he got 2000 Navy radar capacitors for his condenser tower at one time.

By the end of 1945, the electronic jungle in the icehouse was full-grown, and in January of 1946, 3,000,000-volt lightning flashes, a millionth of a second long, were

Partial jolt was given hot dogs at left, which kept for many weeks. Refrigerated package at right was untreated

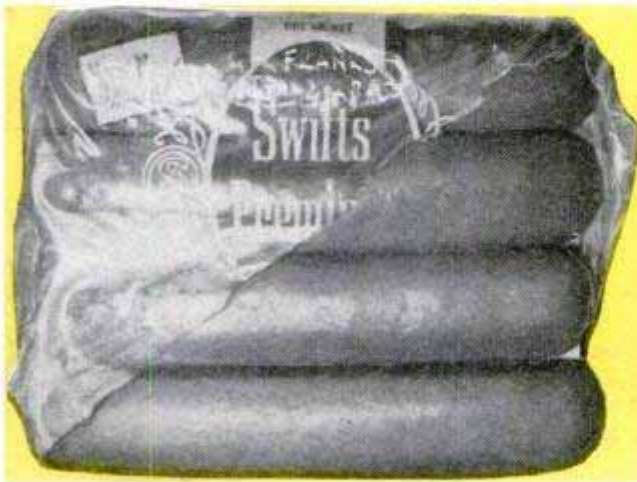

rocketing onto a target table in a lead-lined room.

Despite the gawky size of the impulse generator, which towers three stories in the air toward the icehouse ceiling, even the pilot-model capacitron is a relatively simple affair.

It merely takes ordinary 220-volt alternating current you'd find in a home, converts it to direct current and steps it up through platform after platform of spark gaps and condensers. Each time it leaps, the voltage is doubled. Finally, at the top, it has built itself up to a lightning-like jolt of 3,000,000 volts. Then this king-sized charge is unleashed in a single bolt, through the monster laminated vacuum tube about two feet in diameter and five feet long. A cathode gun atop the tube supplies billions of electrons which are sent cascading down the tube when the lightning bolt hits. In one microsecond, that flood tide of electron bullets whams through an aluminum-foil "window" at the bottom of the tube and stabs into the hamburger, beans or vaccine on the table.

Some of the capacitron's secret of success lies in the controllability of its electron bursts, which can be varied from 1/10,000 to 1/1,000,000,000 second depending on the thickness, density and texture of the material being "shot." Electron bursts can be adjusted to penetrate part way into a potato, for instance, prevent it from growing "eyes" in storage and increase its life for weeks without any airtight container.

Higher acceleration of electrons allows penetration to greater depths, and produces sterilization throughout.

An odd characteristic of electrons is that they do most of their work inside an object, leaving the skin of a potato or apple, for example, unmarred. To illustrate this, Doctor Brasch will show you samples of heavy Plexiglas, shot with heavy jolts. The surface is smooth as glass, but the inside looks like the circulatory system in a bat's wing, where the zipping electrons have tunneled into the substance and carved a lacy pattern of thousands of veins.

What's more, the rays of this incredible machine can be confined to the tiniest imaginable beam. Brasch has a miniature vacuum tube that looks like a slightly oversized hypodermic needle, through which his massive charges can be directed to narrowly confined areas of infection inside living creatures—an invaluable tool for work on cancer, for instance. By governing the amount of charge and voltage, he can tell just how far the beam will penetrate. Its tiny beam will hit only the parts he wants, without damaging surrounding tissues. To find out how to achieve proper dosages, Brasch not only removed tumors from mice, but even directed the beam against himself. By trial and error, penetration figures were worked out. The errors are now dozens of little brown scars that never stop flaking, on the doctor's left arm and his back.

(Continued to page 234)

Comparison photographs prove tangerines and corn on cob retain freshness after high-voltage treatment

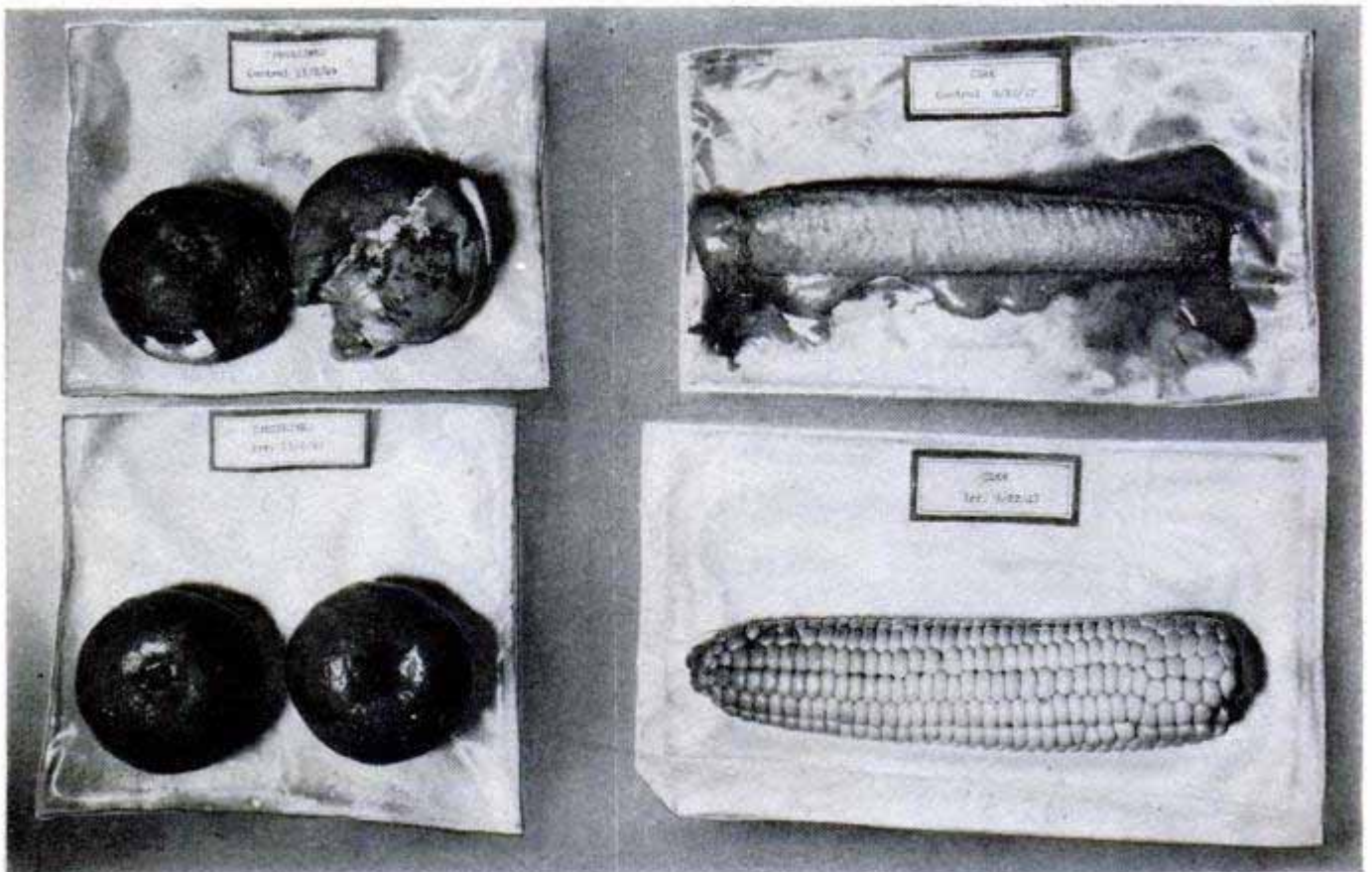



Detroit Listening Post

By Siler Freeman

THE "GUNS AND BUTTER" phase of production is beginning to take shape as defense orders become increasingly important in the automotive plants. While the "butter," or civilian, end is expected to continue for some time, it is on the decreasing scale with the "guns" part emphasized.

An official of the National Production Authority has announced that he doubts there will be any new models appearing "after this fall." In other words, the 1951 models may be with us until some drastic change in the international situation relieves the metal shortages. NPA spokesmen tell of a 25 to 40-percent cut in basic metals allocated for automotive production. The federal agency suggests that resourceful manufacturers may keep up production by conserving materials and using such substitutes as plastics in place of metals. It is doubtful if John Q. Public will enthuse over a 1952 model with plastic fenders and painted bumpers. The result of such substitutions would undoubtedly put a premium on '50 and '51 cars.

Despite the pinch, new models in various lines have been making belated 1951 debuts. The Nash Healey sports car (featured in the March issue of *Popular Mechanics*) is one example. Nash had originally planned to introduce the car in May but decided to advance the date. Then there is the sleek new Ford Victoria, the Packard hard-top Mayfair and convertible.

Already some of the 1951 models are beginning to look different. Here and there plastics are appearing in places never planned by the designers. Iron pistons are replacing aluminum ones and the chrome on some bumpers is only a thin veneer, which could quickly be replaced by body paint. In fact, some have been and others are in the works.

The "combined operations" in the automobile plants haven't stopped companies from planning the 1952 models, however. As the industry works a year ahead, everything is about complete for the new models except the tooling. Of course, the tooling is the crux of the whole situation.

Any mechanical changes in '52 models

will deal with the high-octane requirements of the high-compression-ratio engines. Oldsmobile's 1951 Rocket was brought up to 7.5 to 1, or .25 more than its predecessor. The combustion chamber has been redesigned to obtain advantages that are not entirely dependent upon higher-octane fuels. Some of these changes may have been made to facilitate a change-over.

There is a move afoot to put ceilings on octane ratings to conserve the high-test fuel for the enlarging Air Force. The ceiling on premium would be from 91 to 92 and on regular fuel from 82 to 84. Despite the suspicions of many motorists that this already has been done, the oil companies deny there has been any change so far for the worse. In fact, an Ethyl Corporation researcher stated the octane ratings had gone up slightly since January in the Midwest.

The slowing up of new-car production will be a boon to the tire manufacturers who have been unable to build up inventories and supply the replacement demand in the past few months. The amount of synthetic rubber which they have been receiving from the government plants has been far below the quota.

Synthetic plants, however, are beginning to fill their needs better and the supply for replacements is expected to return to normal in a short time. There is no question that, once the rubber plants are working at full capacity, motorists need have no fear of a tire shortage.

What will be in short supply, however, are things which caused new-car buyers to curse the dealers not so long ago — accessories. Radios, heaters, radio antennas, side-view mirrors, etc., are not being sprinkled as liberally on the cars. Materials which go into accessories are being used to make more profitable items.

Labor shortages, as well as material shortages, are becoming acute. On the factory side, it is the skilled technicians and engineers who are being lured away by firms with defense contracts. On the dealer end, it is the dwindling supply of skilled mechanics. The draft is edging into the service shops.

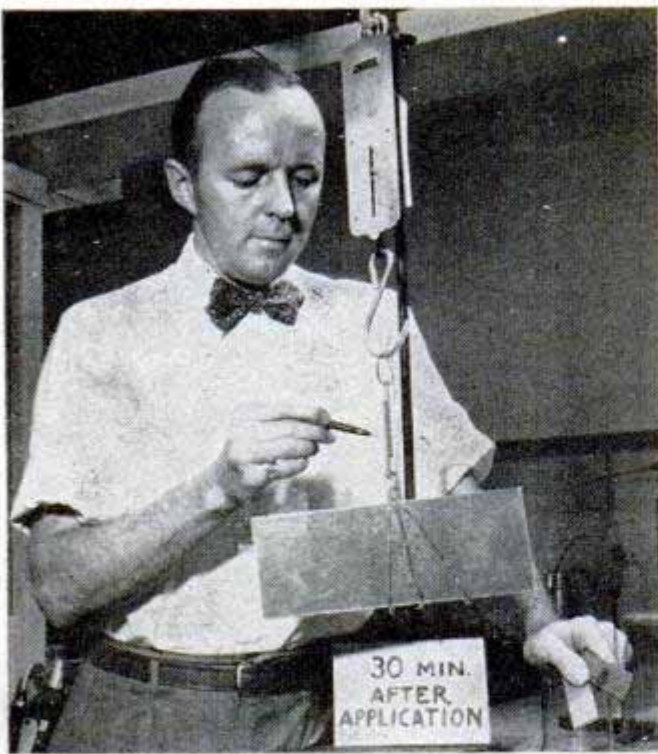

Bonding Agent Hardened by Lack of Air

Lack of air hardens a new General Electric developed material that may find use as a bonding agent or as a "pipe dope" for sealing threaded unions. It is not yet commercially available. Called "anaerobic permafil," it is the latest in a series of solventless varnishes that harden without the

necessity of evaporation. Two metal strips coated lightly with it and clamped together will support 100 pounds after 20 hours. A few drops of the material on the threads of a bolt just before the nut is screwed on hardens so tightly that considerable force is needed to remove it.

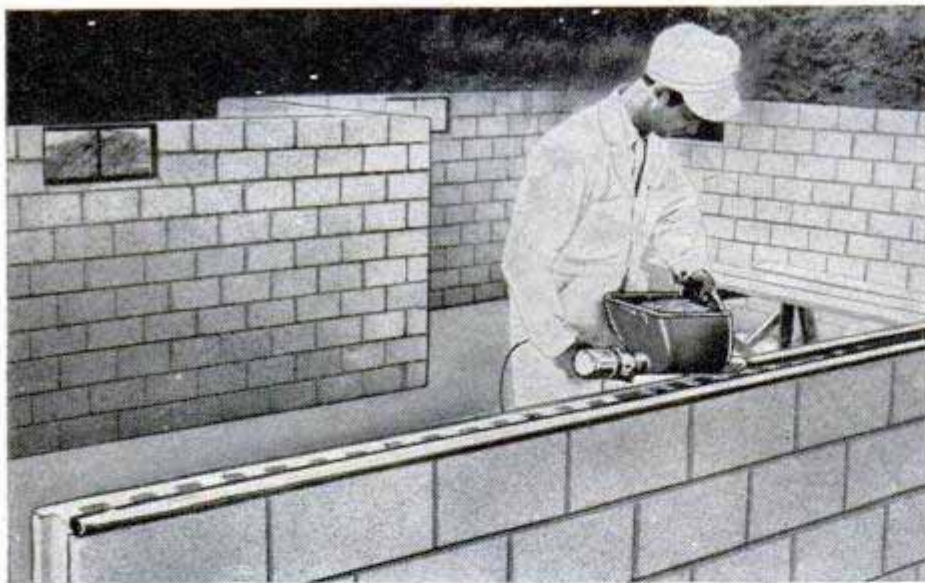

Vita Labor Saving Tools, Inc., Station Plaza, Smithtown Branch, N.Y.

Mortar Gun

Mortar is applied in an even layer along the thin walls of concrete and cinder blocks by an electric-powered mortar gun, reducing the costs on such construction. Mortar is placed in the hopper of the gun and is forced out the nozzle by a worm conveyor. The gun eliminates waste due to spillage that is virtually unavoidable when a hand trowel is used on block construction work. Vertical joints can be filled while the blocks are in place.

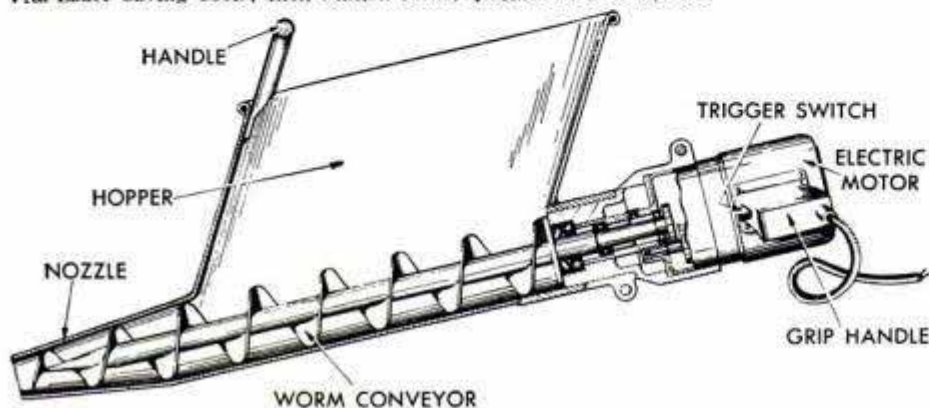

Sources of available products described in this issue are indexed on pages 12, 14 and 16. Sources of further information on other articles are listed in the WHERE-TO-FIND-IT LIST, available from the Bureau of Information, 200 East Ontario St., Chicago 11

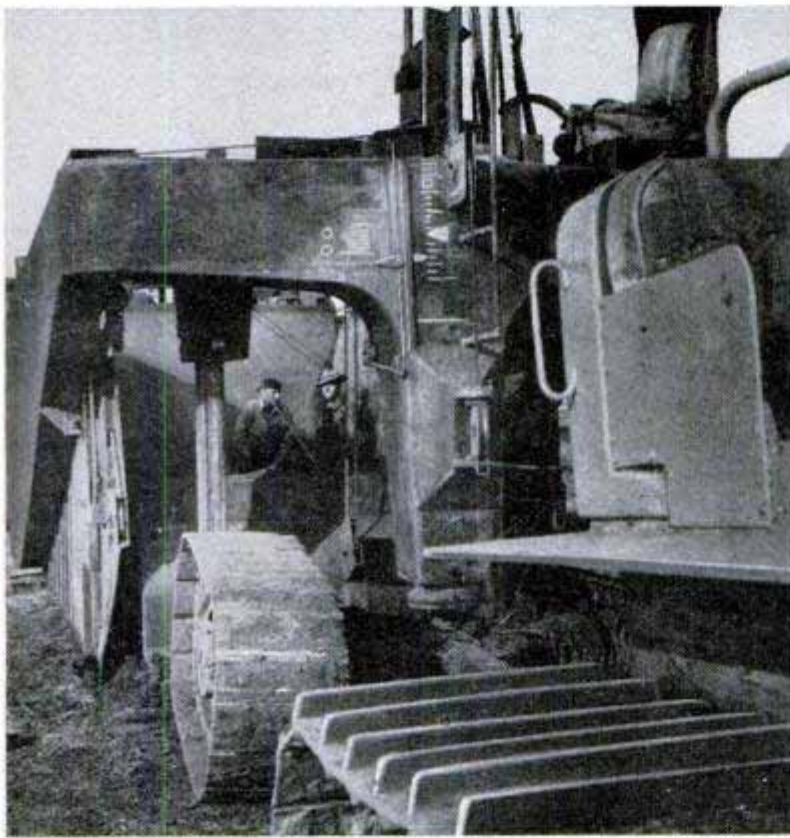
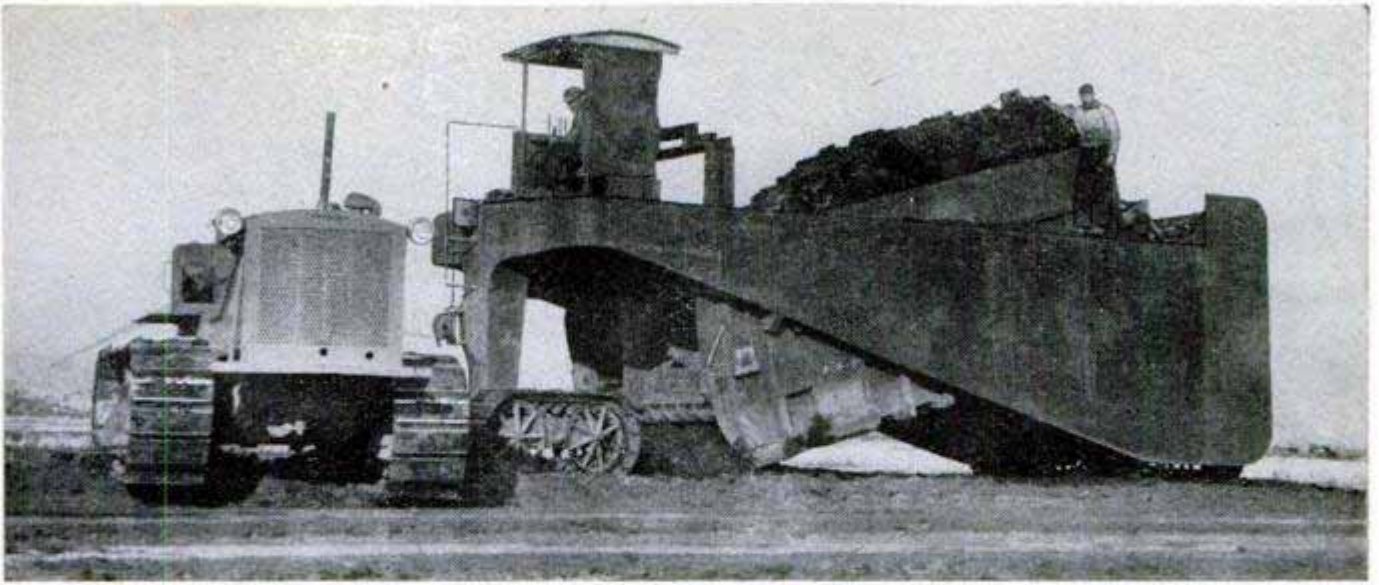

Monster Earthmover Packs Itself Full

Capable of handling 1000 cubic yards of earth in one hour, a giant tractor-drawn scoop has a built-in bulldozer blade that pushes the material to the back of the hopper as it is scooped up. This is said to be about 10 times faster than the hourly rate of standard earthmovers. The strokes of the packing blade inside the bucket or hopper are controlled by the operator who rides in a small cab at the front of the machine. Empty, the machine weighs about 28 tons and rides on four sets of tracks instead of the conventional wheels. A 180-horsepower engine, mounted at the rear of the machine, drives the packing blade. The machine was invented by Barney Hooper of Klamath Falls, Ore.

Flour Mixed With Compressed Air Flows Through Pipe Like Water

Dry flour that behaves like water is flowing through test conduits at the University of Minnesota. The experiments may provide millers with a more economical method of moving large quantities of flour during processing. Compressed air is passed through a membrane into a chamber containing the flour. The mixture of flour and air becomes a "fluid" which can be handled like water. Booster chambers keep the flour particles in a fluid state as they pass through conduits.

□ In 1950 the United States produced a record 96,713,276 net tons of steel, exceeding the output of 1944—the previous record year—by 7,000,000 tons.



ACCELERATION TESTS

FORDOMATIC-EQUIPPED FORD V-8

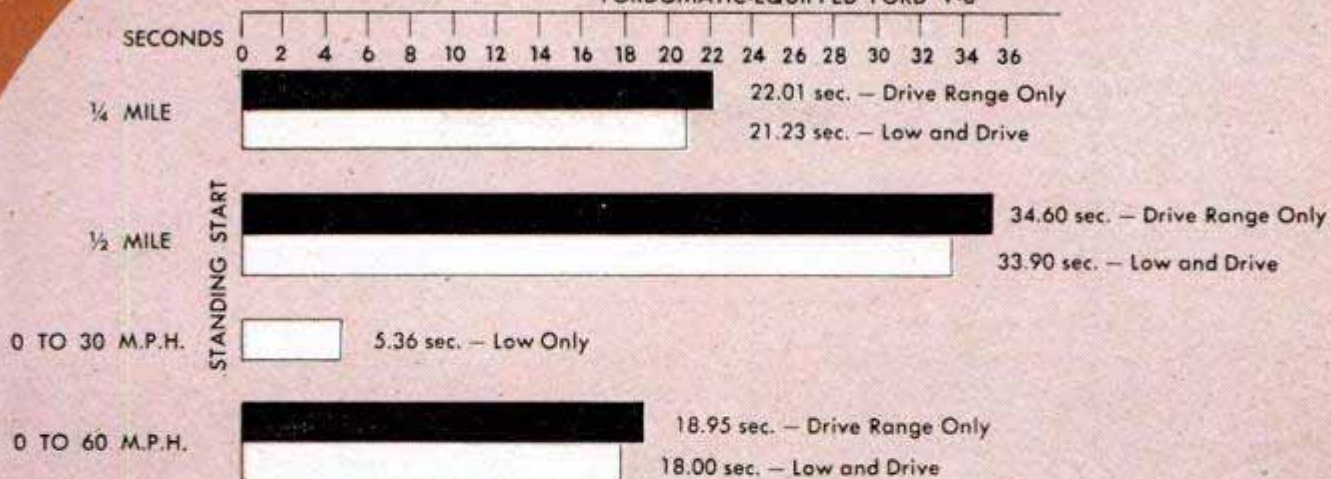

(In tests using both Low and Drive, shift from Low to Drive was made at 30 m.p.h.)
Top Speed (by Speedometer) 93-95 m.p.h. Actual Top Speed, About 6% Less

on the '51 FORD

By Floyd Clymer

IT WAS PRESS TIME for the April issue. The returns on the *Popular Mechanics* questionnaire sent to one thousand '51 Ford owners from coast to coast were in. Percentages had been compiled, charts carefully made, engravings completed and everything in place except this type. Then along came a tardy reply which upset at least one pretty applegart.

After the line, "Would you buy another Ford?" this tardy owner marked "No." This spoiled an amazingly unanimous record for the survey, for all other owners polled had reported they would either definitely or possibly buy another Ford.

The late arrival (too late to enter in the percentages list which still shows no dissenters) explained on the margin of his questionnaire that after six Fords, his next car would be in the top-price bracket. His switch, it seems, reflected his wallet rather

than any dissatisfaction with his '51 Ford which he rates "excellent."

The survey shows that this owner with six Fords in his past is not unusual at all. Almost half of those answering the questionnaires (44 percent) had owned four or more Fords before buying a '51! A man in Kansas has owned 16 Ford passenger cars and seven trucks. Three owners reported they had owned 20 previous Fords. Eighty-four percent had owned one or more Fords before buying a '51.

One of the most neglected questions in the survey was: "What do you dislike about the car?" Thirty-nine percent either left this space blank or wrote "nothing." One wag wrote: "Nothing except the driver. Ha! Ha!"

On the other hand a man from Massachusetts wrote a serious 600-word criticism of his car. He prefaced his criticism by

Slight thumb pressure on the door handle swings the Ford's door open



PERCENTAGES FROM P.M. POLL

Bought Fordomatic Drive	16%
Bought overdrive	39%
Bought standard transmission	45%
Average gasoline mileage (in country).....	20.2 m.p.g.
Average gasoline mileage (in city).....	16.3 m.p.g.
(6-cylinder owners reported an average of 1.9 m.p.g. more than V-8 owners. Fordomatic owners 1.3 m.p.g. less than owners having conventional transmission.)	
Use regular gas	62%
Use premium gas	38%
Change oil	87%
Average mileage for change of oil.....	1441
Add oil	13%
Average mileage for adding oil	1177
Mileage increase by use of overdrive.....	2.1 m.p.g.
Fordomatic was factor in selection.....	16%
Maneuverability excellent	85%
average	15%
unsatisfactory	0%
Size of car just right	98%
too large	1%
too small	1%
Acceleration outstanding	71%
fair	28%
poor	1%
Road clearance satisfactory.....	99%
too low	1%
V-8 engine	82%
6-cylinder engine	18%

BEST-LIKED FEATURES

Interior details, dash, etc.....	45%
Style, design, appearance	38%
Maneuverability, handling	38%
Seating, riding qualities	38%
New mechanical features	33%
Acceleration, pick-up	26%
Gas and oil economy	20%

(These percentages are based on the fact that some owners commented on more than one feature.)

RATING OF CAR

Excellent	63%
Good	31%
Average	5%
Poor	1%

GENERAL INFORMATION

Prefer in-line engine	13%
Prefer V-type engine	32%
Prefer eight cylinders	89%
Prefer six cylinders	11%
Prefer side-valve arrangement	50%
Prefer overhead-valve system	50%
Prefer automatic transmission	45%
Prefer Fordomatic Drive	37%

(The above figure means 37% of 45% preferring automatic transmissions.)

Prefer makes other than Fordomatic	53%
Undecided about automatic transmissions	10%
Owners who like low-pressure tires	77%
Previous Ford owners	84%
Will buy another Ford	81%
Might buy another Ford	19%
Will not buy another Ford	0%
Dealer service good	69%
Dealer service average	30%
Dealer service poor	1%

Most disliked features—

Instrument-panel lighting, horn ring on custom model interfering with speedometer vision, left-side location of starter-switch.

saying "despite its faults, I like my Ford." He objects to the new instrument panel and calls it a "poor substitute for the easy-to-read, easy-to-use dashboard of the 1947 Ford." He finds the new starter switch not to his taste because he used to step on his starter in the old days to move his car without starting the engine. He says the instruments are hard to read at night and that the horn ring obscures the speedometer at 45 miles per hour. This owner complains that the windshield pillars are too thick, creating a bad blind spot. After many other detailed criticisms involving a leaky trunk, too soft tires and squeaky front springs, he concludes: "Despite all these criticisms, I still feel I own a good-looking easy-handling car that I enjoy driving."

Although Ford's new automatic transmission—Fordomatic—is a big feature of the '51s, only 16 percent reported they bought cars thus equipped. This low figure does not give a true picture of the public's acceptance of Fordomatic, however, for many indicated they wanted the automatic transmission but were unable to get it. Many (39 percent) settled for overdrive which was introduced as optional equipment in 1949. Forty-five percent bought standard transmission. Here are a few reactions of Fordomatic owners:

"It's fine because in shifting a

Cutaway of the torque converter shows the unique arrangement for air-cooling the unit

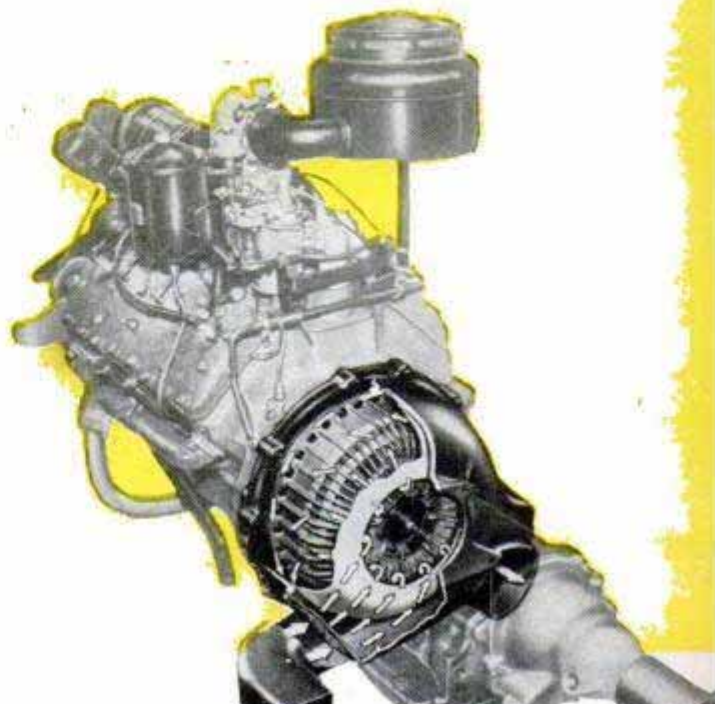

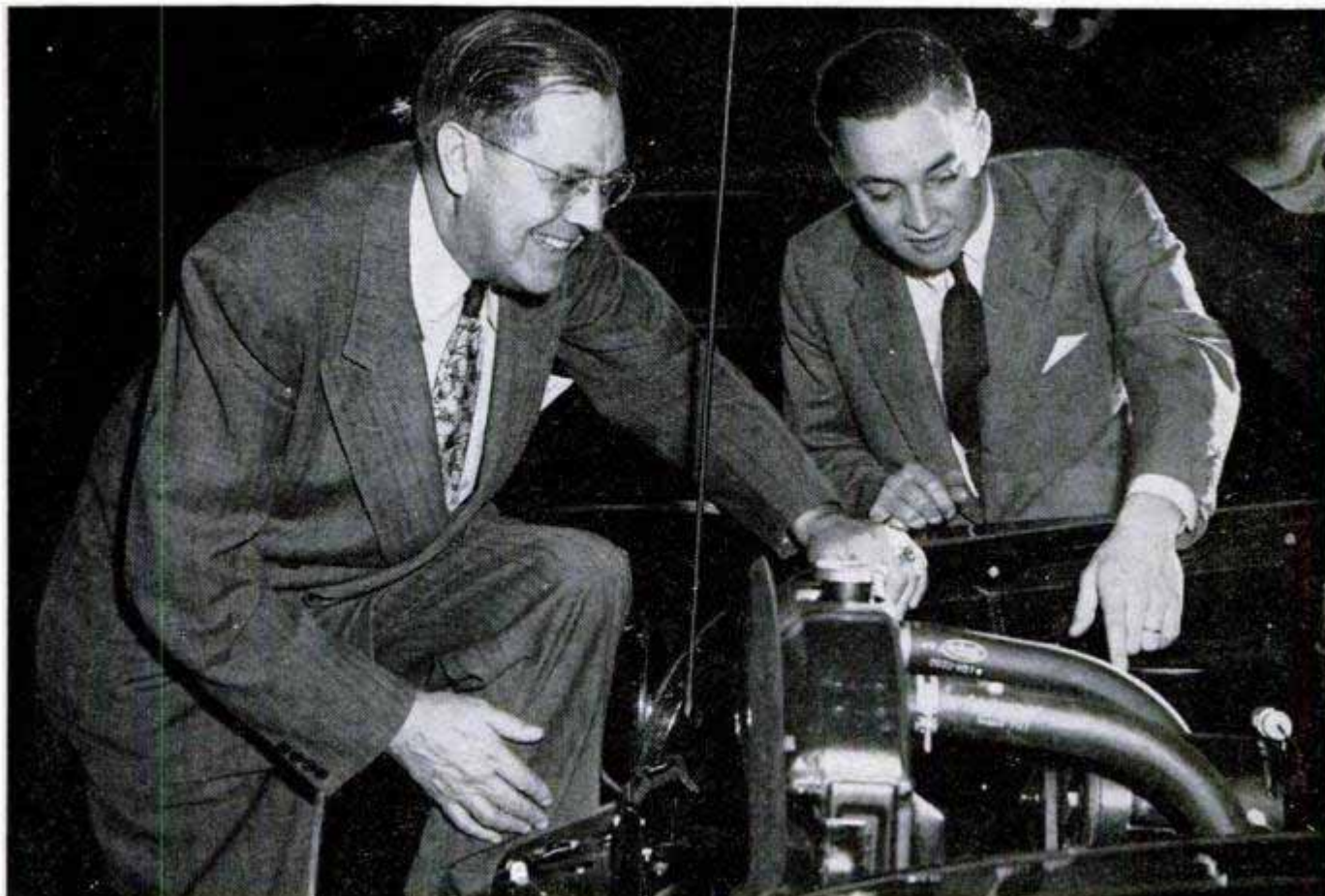

Clymer talks over the weatherproof ignition system of the V-8 engine with Bill Ford, grandson of Henry Ford

driver does not have to pass through drive gear to get into reverse," writes a man from Colorado Springs.

From Newbern, Tenn., the owner of a six-cylinder Ford reports: "Fordomatic smoothness is wonderful. Best automatic I've driven, smooth change, up or down. I like the maneuverability, economy, pickup, comfort, visibility. Some vibration at slow speed."

An aircraft engineer writes: "The 1951 Ford is very stable at all speeds. Fordo-

matic seems to accelerate without too much slippage or engine speedup. It gets going quickly."

An Emporia, Kans., mail carrier says: "The Fordomatic has made my driving the easiest part of my job. The car is excellent."

A Maryland owner says: "I think they could improve that automatic transmission for I don't like the lost time you have shifting from "N" to "D" when you start out—but maybe it's me. I have owned 12 other Fords and this one is the most comfortable

CLYMER'S ECONOMY TEST OF FORDOMATIC-EQUIPPED V-8

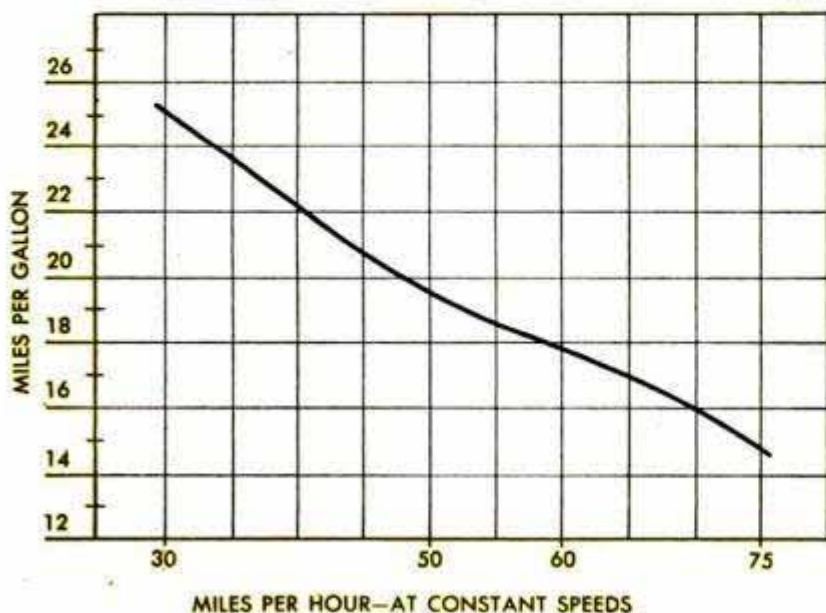

Miles Per Gallon—V-8 Fordomatic

At constant 30 m.p.h.	25.11
At constant 50 m.p.h.	19.48
At constant 60 m.p.h.	17.92
At constant 75 m.p.h.	14.87

Mileage After Car Was Broken In

Kansas City to Denver	17.95
Denver to Holbrook, Ariz., through Rockies over Continental Divide (300 miles through snowstorms)	15.12
Holbrook to Los Angeles	21.72



Gale-Hall Engineering photo

Clymer used a Mile-O-Meter during his test. It was helpful in measuring gas mileage at various speeds

riding I've ever had. The reason I like my Fordomatic, a week after I bought it I got caught in the big snowstorm they had in Pennsylvania and I was going places that most people couldn't go with chains on."

A Clawson, Mich., owner says his Fordomatic "has noisy transmission and rear axle" and that "mechanics so far are not too well versed on Fordomatic service; gas and oil mileage poor."

Most Fordomatic owners seemed to accept the fact that an automatic transmission



Rotary door lock is good, owners report, and they like the locking system—keys can't be locked in car

reduces gasoline mileage. Our poll shows they get 1.3 miles per gallon less than conventional-transmission owners. Ford "6" owners reported an average of 1.9 more miles per gallon than V-8 owners, and owners with overdrive reported 2.1 miles more per gallon than with conventional. (For other figures see the Percentages From Poll chart and my own economy chart.)

A Palm Beach, Fla., owner writes: "Engine is noisy while accelerating. Think gas

(Continued to page 252)

Clymer drove 4000 miles in road test, partly over slippery mountain roads, and found car easy to handle



Tailless Jet For Carriers

Designed for catapult take-off from carriers and for fast climbing, the tailless XF4D is one of the first Navy jet fighters built specially for interception. The test model was flown for 30 minutes at a high altitude over Edwards Air Force Base, Muroc, Calif., but its dimensions and performance were not revealed. A slender nose extending from the swept wing houses the pilot.



Douglas Aircraft Co. photo

Radioactive Stitching

Less irritating to the patient because of its flexibility, a radioactive surgical thread is the latest aid for cancer treatment. The thread, devised by Dr. William J. Meyers of the Ohio State University Medical Center, is made by stretching warm nylon tubing to a small diameter and then inserting radioactive cobalt wire. It is fine enough to fit the eye of the surgeon's usual needles.

"Tape Measure" Rolls to Work

You can measure as you walk with a roller that has a two-foot rule recessed in its face. It measures in fraction of inches up to two feet and for longer distances an automatic counter clocks the measurement in feet. In addition, an audible click sounds for each two feet measured and a bell rings at 100 feet. The handle collapses to make the device compact enough to fit in the glove compartment of a car.



Rollstape, Inc.,
1415 14th St.,
Santa Monica, Calif.

Textured Wall Roller

Textured walls are produced by a new paint roller that creates patterns from coarse to very fine. The background color is applied first. After it dries, a coat of a different color is applied. While the second coat is still wet the wall is rolled with the rough-surfaced roller. One pass with the roller creates a coarse pattern, and repeated passes produce a finer texture. An interchangeable roller is supplied for stippling.

American Products Co., 2287 Hollers Ave., New York City 66

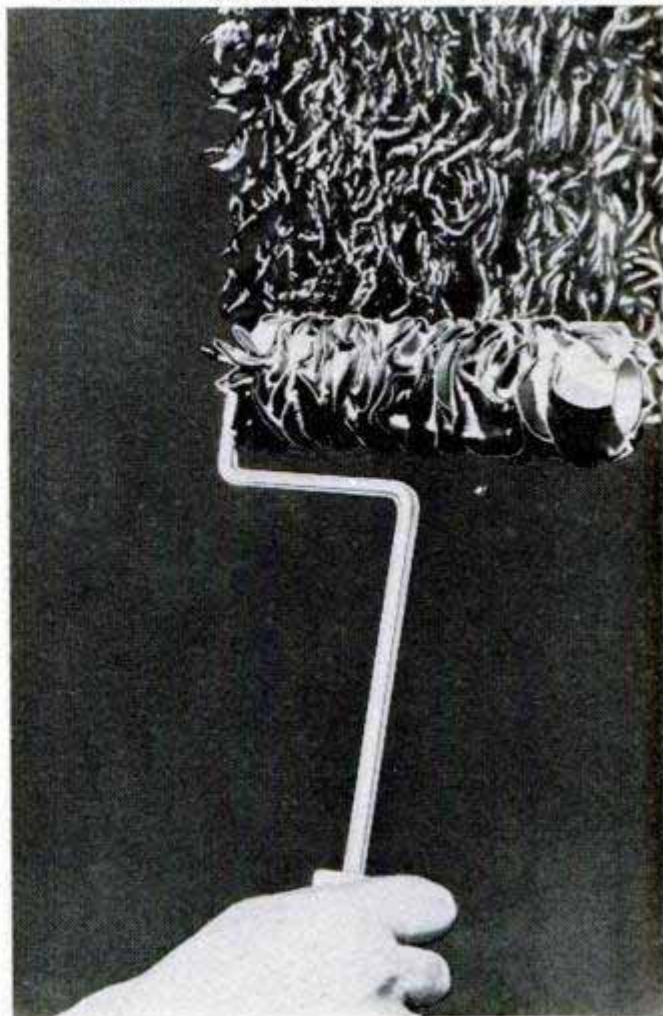

TV's STEEPLEJACKS

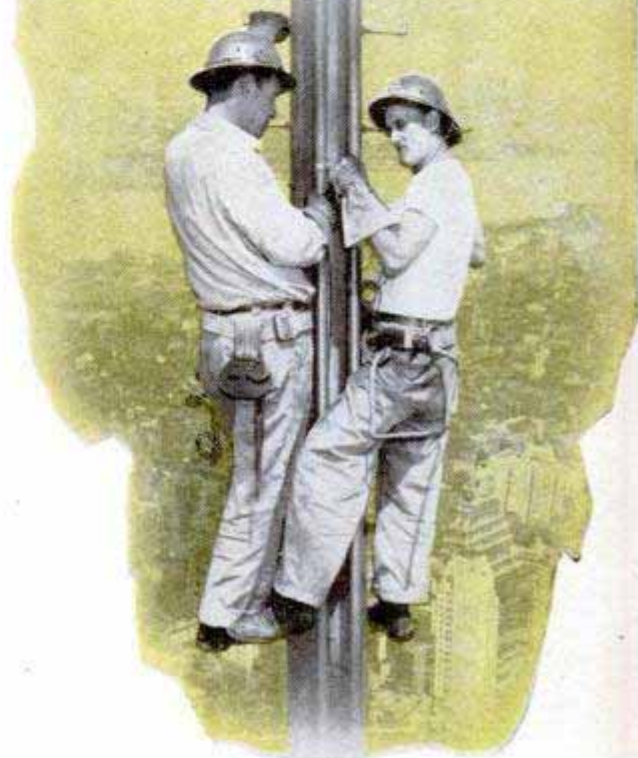

Above, two workmen pause to talk it over on the Empire State mast, a mere 1250 feet high

By Arthur R. Railton

EVEN THE SLICKEST of city slickers has been gawking upward at the steeplejacks performing their workaday gymnastics on the new top of New York's topmost Empire State Building.

The 1250-foot tower of glass and steel has grown 222 feet taller in the last few months as the human flies wove a new television antenna to transmit for five stations. By centralizing most of the city's stations on this peak of Manhattan Island, the TV broadcasters hope to eliminate ghosts on Gotham screens and extend their effective range beyond 50 miles.

The Empire State's "spike," base of the new extension, was—as many have forgotten—designed as a

Left, climbing nimbly on a scaffolding that looks as delicate as a spider web, five men erect an antenna on Chicago's Lincoln Tower

mooring mast for trans-Atlantic dirigibles. It turned out instead to be only an ornament, but fortunately it was built rugged enough to support the 70-ton antenna, largest in the nation.

New skyscraping TV and FM antennas are sprouting all over the country. Frequency-modulation and television waves are light-of-sight travelers. Their range is limited by the curvature of the earth and their clarity is affected by obstacles, such as buildings, that reflect the waves to create ghosts on your TV screen. The higher the antenna, the better the signal and the wider its reach. So the steeplejack is doing a land-office business.

What does it take to make a good steeplejack? The simplest formula is an iron worker with iron nerves. A. A. Belda, whose B.D.N. Steel Erection Co. has raised many of TV spiderwebs atop Chicago's Loop, says, "Some fellows can climb and some can't, that's all. Some of our men are old-timers who began when the tallest structures in town were church

Below, pass the wrench, please! And don't drop it because it's a long way down. Right, you can't see it here, but the ground is 613 feet below the men erecting WENR-TV's antenna on a Chicago building



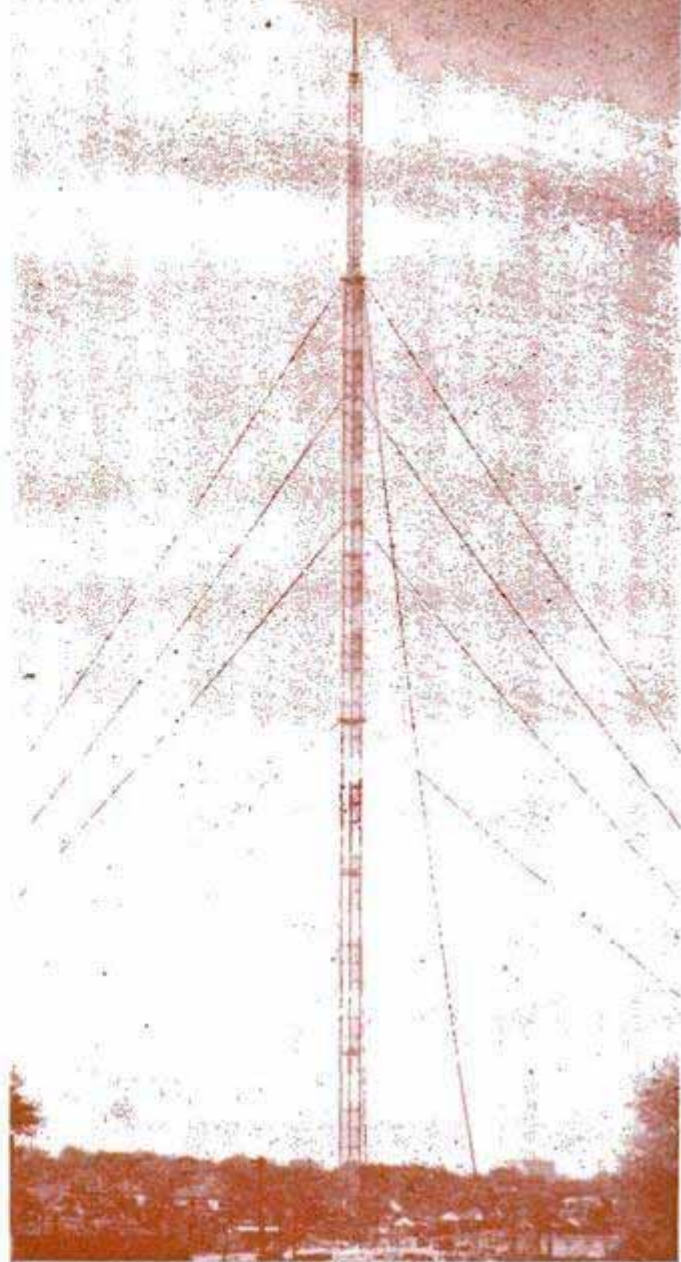
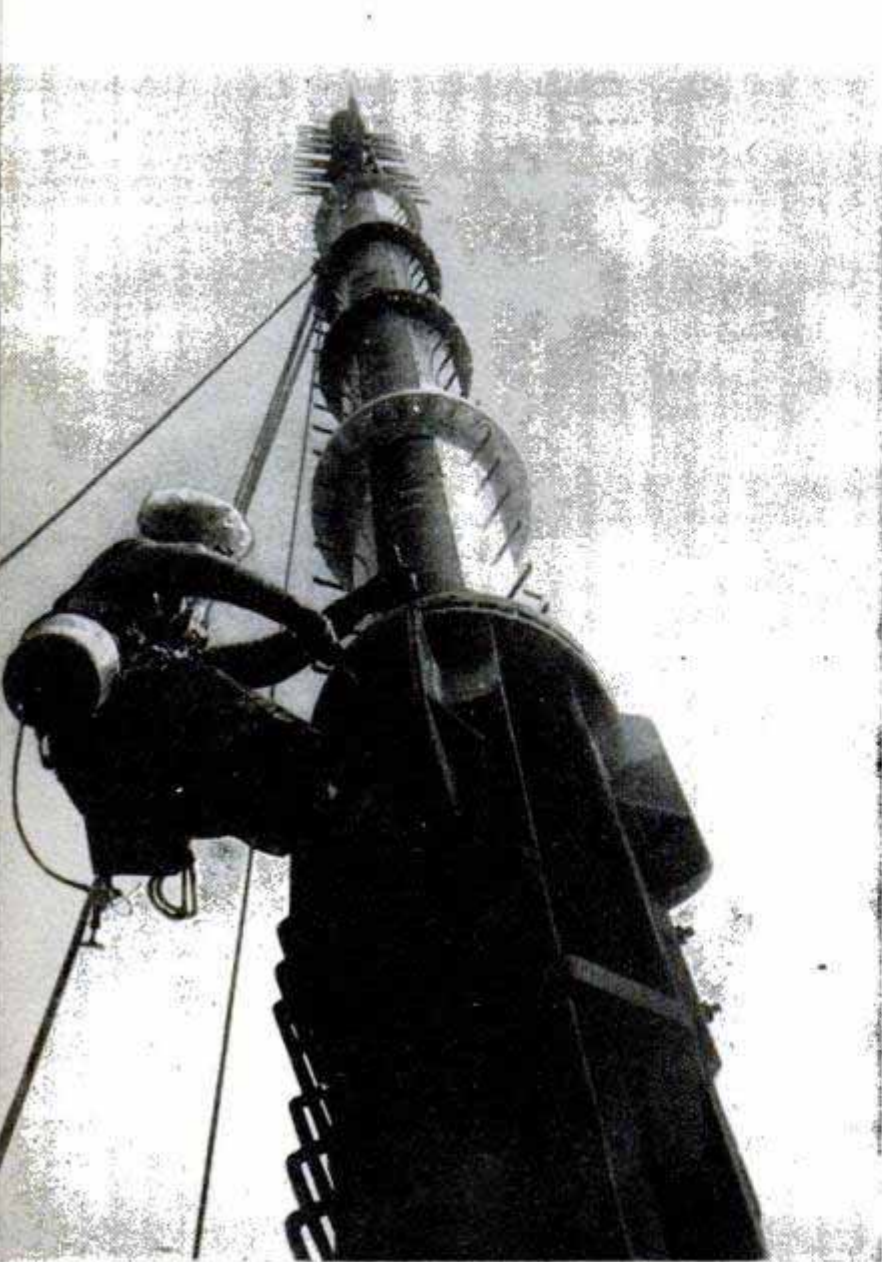

Above, painting cloud-scraping antennas requires calm nerves. Below, old NBC antenna is removed from Empire State Building

Soaring 1057 feet above Atlanta, WSB's tower is the world's second tallest structure

steeples. Others are just kids."

Accidents are infrequent. Every steeplejack knows he can make only one bad mistake. A clumsy or reckless worker is soon looking for another job. The others refuse to work with someone who risks their lives.

Belda's most spectacular job was the WFJL antenna atop the Lincoln Tower Building. Only 562 feet high, it is not in the Empire State Building class. However, it's just as fatal to fall 562 feet as 1500 feet! The biggest complication in this job was not height, but the building.

Virtually a needlepoint, the peak of Lincoln Tower is a smokestack. There is no room around the rim of the chimney for even one man to work. The only way to get up there is to crawl over the rim from below.

Belda's crew built a circular platform three feet wide around the chimney, which sent up gases that

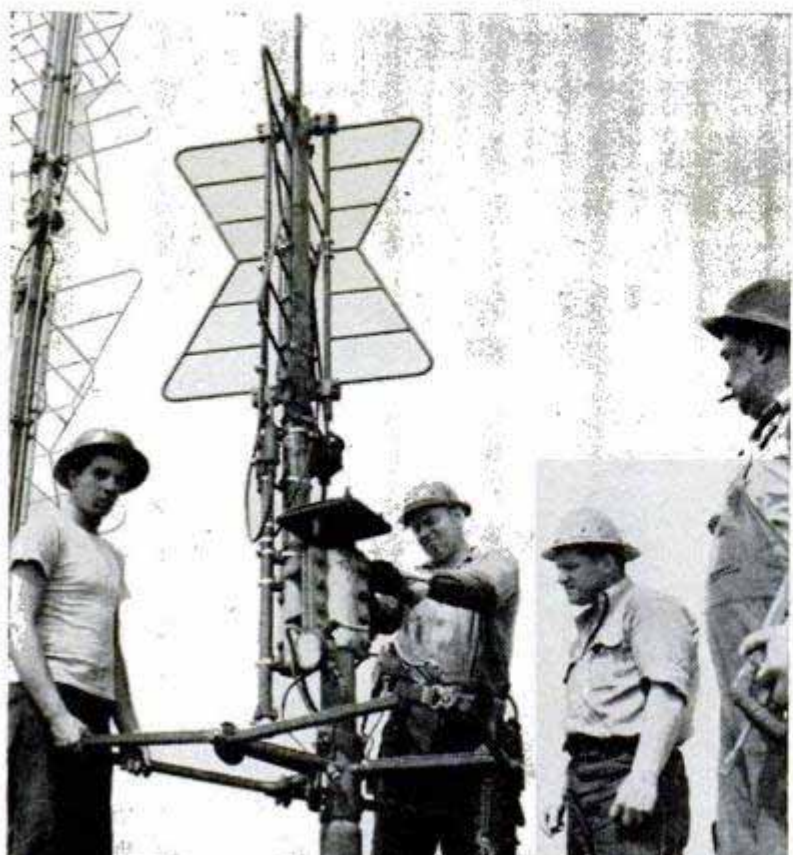



Above, Old Glory flies on man's highest work: Empire State Building mast, 1472 feet high. Over-all view of mast, right, shows the first element for Channel 4 being installed at top

threatened to asphyxiate the men. Much of the time they wore masks. Above the platform, the crew erected a scaffolding of metal tubing. From street level, this tubing looks half as thick as a cat's whisker. Actually, it is only a couple of inches in diameter, but it is bolted and welded for stability. Inside this framework, the antenna was erected, section by section. As the wind blew off Lake Michigan, the scaffolding swayed dizzily, but to the workers that was no more disconcerting than the roll of a ship to a sailor.

Weather causes endless delays. Men refuse (with reason) to work in a high wind. They won't climb if it's icy or too wet. The necks they're risking are their own and when conditions are too dangerous, they stay down.

Sometimes, though, the weather changes suddenly and they have no choice. You can't leave a section of steel tubing hanging precariously up there. If a gale comes up suddenly, they stay on top until all is secure.

It's dangerous business but, as one worker philosophized, "It's not so bad—we don't have to worry about being hit by a car and, so far, nobody's been hit by a plane!"





Charles A. Chayne, designer of experimental Buick, at wheel, shows car to Ivan L. Wiles, manager of Buick

Buick's Experimental 300-Hp. "Dream" Car

Custom-built from its big high-speed racing tires to the vertical side pillars on its corner-curved windshield, Buick's experimental "dream" convertible is powered by a 300-horsepower supercharged V-8 engine that delivers a speed of 150 miles per hour. The car was designed by Charles A. Chayne, former chief engineer at Buick and now vice-president of General Motors in charge of the engineering staff. He also handled mechanical features on *Le Sabre* (*Popular Mechanics*, February 1951, page 116), another GM experimental car. Chayne's car, called the XP-300, is a two-passenger single seater which hugs the ground and stands only 39.1 inches at the cowl. It is mounted on a 116-inch wheelbase and has an over-all length of 192.5 inches. Most distinctive styling feature is a side-louver arrangement that extends the length

of the car. The louvers on the front doors allow air to escape from the engine and those to the rear carry air from the driving compartment. The sloping hood, which affords excellent vision of the road even from the low seat, and front fenders are welded into a single unit. The hood is opened by a hydraulic lift controlled from the instrument panel, as are the side windows. The engine has a 10-to-1 compression ratio and uses only the highest octane fuels. During fast acceleration, methyl alcohol is injected in proper proportions to prevent knocking. The alcohol is carried in a separate fuel tank and is fed into the engine through a second carburetor. Power is transmitted to the rear wheels through a special Dynaflo unit at the rear of the car. Another feature is dual four-wheel brakes. The car was first shown at the Chicago Automobile Show.

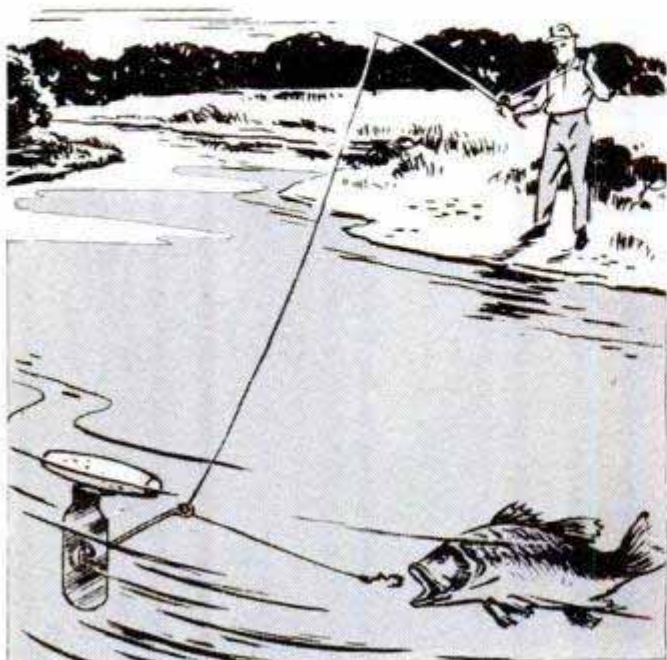

The Kissich Co., Cedar Rapids, Iowa

Fish Float Carries Line To Any Spot in Stream

With a new fishing float the angler can maneuver his hook to virtually any spot in the stream. The action of the current upon a stainless-steel blade forces the float diagonally across the stream toward the opposite bank. Attached to the blade are a cork float and a wire stem. The line is tied to the stem. The float is guided to the desired spot by lowering or raising the tip of the pole and increasing or decreasing tension on the line.

☐ Visitors at the Exhibition of Industrial Power in Glasgow, Scotland, walk through a glass tunnel on which pound 20,000 tons of water a minute to provide a vivid demonstration of water power.



Rootes Motors Inc., 27-11 Bridge Plaza North, Long Island City, N.Y.

One man can handle suction pipe which is thrust into catch basin. Above, right, used as street sprinkler, the vehicle delivers 120 gallons per minute. Below, sidewalk-flushing hose unreels from front of truck

Catch-Basin Emptier

American municipal sanitation departments are showing interest in a British vehicle that quickly cleans catch basins and can also be used to sprinkle streets and sidewalks. A powerful pump sucks the material from the catch basin through a counterbalanced pipe that is easily handled by one man. Inside the tank, a hydraulic ram separates the sludge from the water which is then pumped back into the sewer. When used as a sprinkler truck, the vehicle delivers over 120 gallons of water a minute at 50 pounds' pressure.



Helicopter Charts and Sounds River Above Niagara Falls

Thanks to a hovering helicopter, a survey has at last been made of the river for a mile above the crest of Niagara Falls. A lead-weighted line was extended downward from the craft as it remained stationary at altitudes of 1000 feet or more and readings of the line were taken by surveying parties along the shore. Two-way radio

connected the air and ground groups. The survey will help determine the amount of water that can be diverted to provide electric power, equally to the United States and Canada, without affecting the beauty and grandeur of the falls. A total of 252 soundings were made and as many as 77 were made in a single day.

Experts Predict Twice as Many Prefab Homes This Year

More than 100,000 prefabricated houses will go up from coast to coast in 1951, according to predictions of leaders in the housing industry. That's almost double the number of prefabs turned out during

the past year. The predicted 100,000 for 1951 would account for about 12 percent of the 850,000 homes of all types which government experts estimate will be started during the current year.



Above, taking off from the final jump, these boats fight it out for the lead. "Lightning" won the race. The boats travel 75 feet in air before hitting water

Below, with an almost-perfect start, the zaniest of boat races began. Only three of the six finished. The winner's time for the 11 miles was 22½ minutes



Zaniest race on water is the show performed among the Florida cypress trees by the

HIGH-JUMPING OUTBOARDS

SOME FOLKS LIKE to drive speedboats. Others like to fly. But down at Cypress Gardens, Fla., there are a half dozen speed enthusiasts who like to do both—and at the same time! At that famed resort near Winter Haven, tiny racing hulls leap from the water like flying fish at 35 miles an hour.

Appealing to the daredevilry of these zany outboard enthusiasts, the Cypress Gardens organization put on a Steeplechase Race on Lake Eloise. It was more than a marine steeplechase, it was an obstacle course on land, water and in the air. The noisy waterbugs, forgetting momentarily that boats are supposed to stay in the water, zoomed up inclined ramps to take off like motorized ski jumpers. They slithered across weed-covered peninsulas. There was even a test under fire with the boats speeding through blazing gasoline that floated on the lake.

Naturally, some boats ended up as casualties. Three of the six starters did complete the hazardous course. Dick Pope, Jr., son of the man who thought up the zany pastime, was the winning racer and was treated by the losers to a victor's dunking in the lake.

To take the terrific punishment of the 11-mile course, specially designed and built boats were required. These hulls were

Heading skyward, a racer leaps from the water when it hits the wash of another fast outboard





Even with action like this, not one of the pilots was hurt. These boats are about 18 feet above the water. After this shot was made, the tree-climbing boat toppled into the lake. The pilot jumped out seconds before



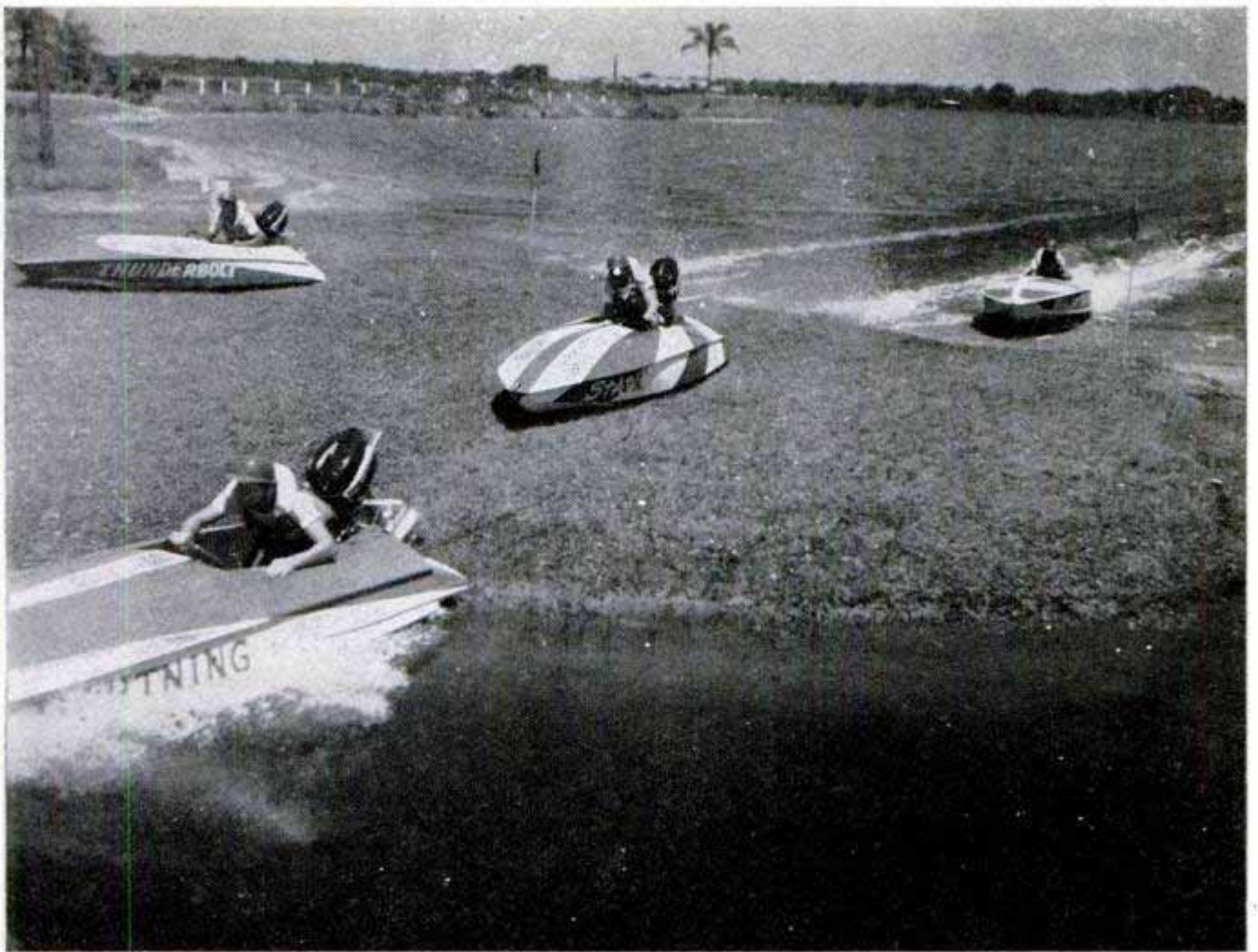

Your eyes aren't fooling you! These boats are racing across land. It is all part of the craziest race ever

patterned after the 1931 Century Hurricane, but, to provide a smooth bottom for climbing ramps and sliding across land, the conventional hydroplane step was omitted. Three oak runners go all the way back to the transom for the hull to slide on. Transoms were reinforced with flat-iron knees to take the shock of the jumps. The motors, standard Mercury 10 Hurricanes, are hung on notched sponsons that project 10 inches aft of the transom. The boats themselves weigh about 200 pounds each.

The Mercury motors were completely stock with no alterations or souping up. No special fuels were used, regular gasoline pushing the boats through the water at about 35 miles an hour. Remote safety throttles were used to stop the motors should a pilot be tossed overboard.

The boats sail through the air as much as 75 feet after leaving some of the ramps. They hit the water with a tooth-rattling jar that tests the construction and seamanship of both pilot and craft. At the peak of the jump, the boats are as high as 20 feet above the water.

Made of one-inch lumber on two-by-four frames, the ramps are 20 feet long and six and eight feet wide, depending on the location. Most of them are eight feet wide. The boards are not waxed or treated.

The pilots prefer that the ramps not be too slick. If they were waxed or highly polished, the boat might slide sidewise should it hit the ramp at an angle. The one-inch lumber has a springiness that adds height to the jump.

To prove that this was the zaniest of all boat races (if more proof was needed), the boats had to race part of the way over land! The course was laid out to cross a narrow peninsula that juts into the lake. The land is covered with weeds and the smooth hulls slid across it, slowing down only slightly before entering the water again.

Winning time for the 11-mile course was a fraction over 22½ minutes, making the average about 30 miles an hour, on land, water and air.

Of the three boats that failed to finish, one became famous as the first boat to climb a tree. When its steering controls were ripped away on a jump, the boat swung around and headed for the cypress trees lining the shore. The pilot, Johnny Robertson, bailed out over the stern about 20 feet from land, but the runaway boat continued until it had climbed a fallen tree. There it lost its momentum and fell back into the lake. Robertson was unhurt.

The finish line was up on the grass, about 80 feet from the shore.



Dime-A-Wake Clock Corp., Las Vegas, Nev.

Coin-Operated Alarm Clock

Travelers who spend the night in one chain of motor courts in the Southwest are awakened at any time they want by a coin-operated alarm clock. The clock runs continuously, but the alarm operates only when a dime is dropped in the slot. Many motels or motor courts do not have 24-hour call service, and the coin-operated alarm provides such a service for the traveler.

"Radar" for the Blind

About the size of a large flashlight, an instrument for the blind utilizes bouncing sound waves to warn of obstacles ahead. The system is similar in effect to radar although sound waves are used instead of radio signals. The instrument sends out clicks barely audible to the blind person, who listens for the reflected clicks from objects in the way. It was developed in England.

Suitcase Stroller

All it takes is a twist of the wrist and a push on the handle to collapse a lightweight baby stroller so it can be carried under the arm or packed in a suitcase. The extensive use of aluminum in the frame keeps the weight down to about 10 pounds. The telescoping handle can be adjusted in length to suit the pusher. A twin model is available, the youngsters sitting in seats side by side. By adding a third seat between the handles, the twin stroller can be used for triplets.



A. E. Peterson Mfg. Co.,
700 Allen Ave., Glendale, Calif.

Steel Output Zooms

At the end of 1952, the total annual steel capacity of the United States will be 117,500,000 tons, according to the American Iron and Steel Institute. This will represent a 45-percent increase, amounting to nearly 36 million tons, since 1940. During the year 1950, capacity was increased nearly 5 million tons, bringing total capacity to more than 104 million tons.

ⓁDon't throw your back-issue magazines away. Our defense effort requires a vast number of products made from wastepaper.



Motorized PACKMOBILE

TWO HUNTERS, their equipment and bagged game are helped over mountainous terrain by a motorized one-wheel packmobile. It was built by Cash E. Giovannoni, a veteran hunter of Boulder City, Nev. His carrier is only 16 inches wide, 18 inches high and a little over 5 feet long—compact enough to be guided between close-growing trees and rock outcroppings. There are sets of handle bars at each end for easy control. A $\frac{5}{8}$ -horsepower washing-machine motor, through a gear-reduction box and a V-type belt, turns a small airplane wheel in the middle of the packmobile. Going uphill the rear operator is pulled along as he bears down on his handle bars to relieve all weight from the front man who is gently pushed forward. A ski turned up at both ends, to allow reverse travel, can be attached for use over snow or mud. The complete carrier weighs only 50 pounds.

With detachable skis, top, the packmobile travels easily over snow. Top speed of the one-wheeled vehicle is a little over three miles an hour. Upside down, the packmobile frame, below, makes a dining table. Cash E. Giovannoni, designer, is at right





WHAT'S NEW *For Your Home*

KITCHEN CABINETS designed with a housewife's eye have doors that swing up, eliminating the danger of cracked skulls. The top cabinet is low enough for the little woman to reach easily. Beneath it, a smaller cabinet provides convenient but out-of-the-way storage

General Electric Co., Bridgeport, Conn.

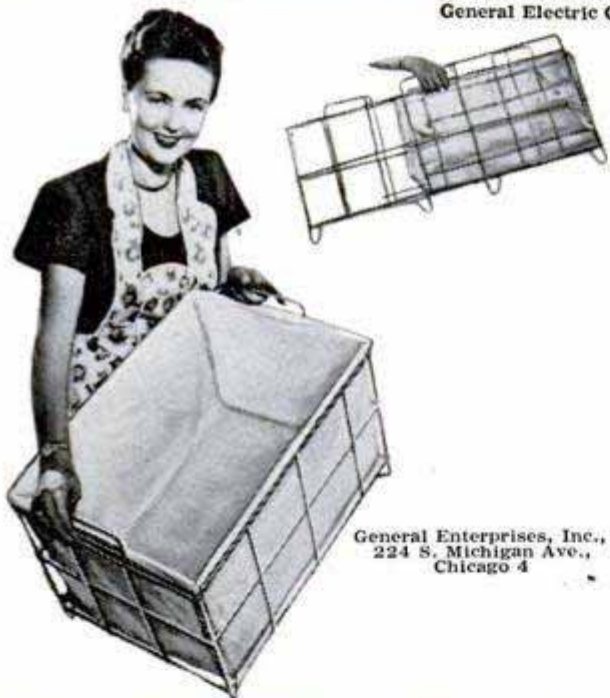

FOLDING BASKET is large enough to hold a full wash, yet, when not in use, collapses to store in a small space. The liner is made of an easily cleaned plastic material. Total weight is only four pounds

ROLLING PIN, below left, carries its own supply of flour to save the cook's time and energy. Made of clear plastic with brightly colored handles, it is easy to clean. You just rinse it and let it air-dry

General Enterprises, Inc.,
224 S. Michigan Ave.,
Chicago 4

EGG OPENER, below, snaps off the top of any egg without breaking the yolk. Nor are any tiny bits of shell pushed into the egg to spoil your meal. To use it, you insert the egg and press down on the blade

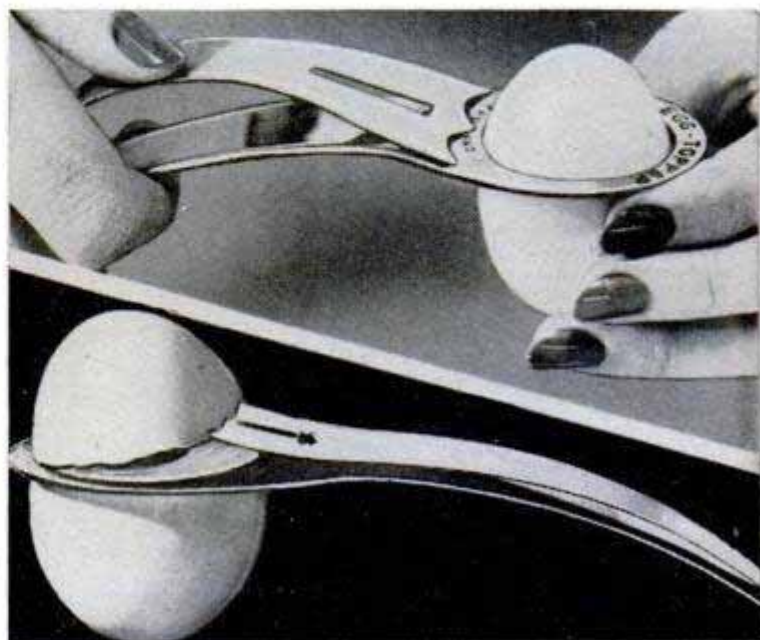
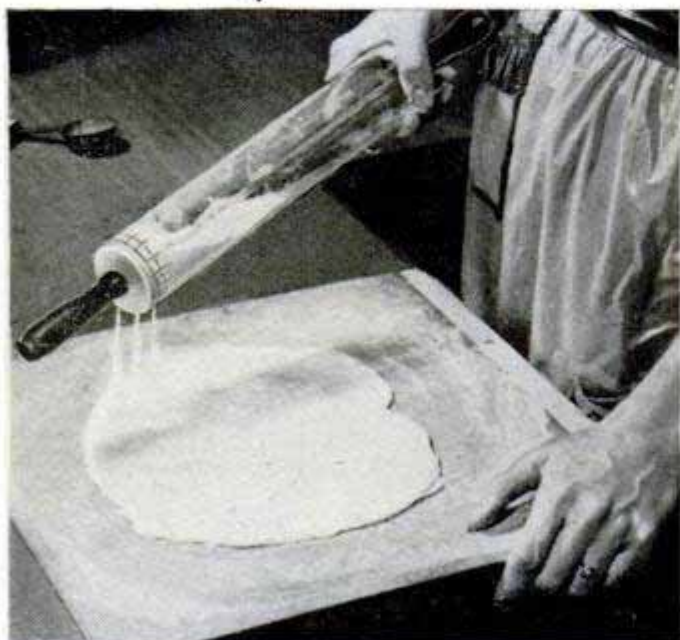

Kitchen Plastics, 111 N. La Cienega Blvd., Beverly Hills, Calif.

Jepeco, Box 94, Oakland 4, Calif.

DRYING LINE, 14 feet of it, is as handy as a window sill if you have this new all-metal rack. The rack slips over two screws which are left in the sill permanently. The seven rods are rustproof
Conn Sill Dryer,
New Castle, Ind.



Milwaukee Flush Valve Co., 301 East Reservoir Ave., Milwaukee 12, Wis.

SWING-DOWN SHOWER, above, does extra duty. Pulled all the way down, it serves as a regular tub-filling faucet. In the vertical position, it becomes a standard shower. It can be used in any position between these extremes for a child, for shampooing or, if you wish, for a sit-down spray

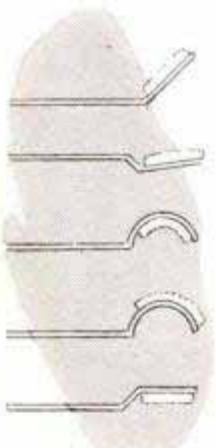

FLEXIBLE PAINTBRUSH, left, has a pad of lamb's wool for its bristles. The handle is a flexible metal strip that bends to any shape to enable you to paint around corners. It's a handy brush for windows and inside or behind radiators

J. W. Andrews Co., 166 W. Jackson Blvd., Chicago 4

CANNED BATTER makes life easier for wives. Packed under pressure, it's ready for a griddle at the touch of your finger

RUBBER WEDGE springs up out of the way when not being used. If you want to keep the door from swinging, you just press wedge with your foot

VACUUM SHAMPOO is the new idea in hair care. Suction device also vibrates, massaging as it removes dandruff and grit from hair



Pan Waff, Inc., 525 N.W. Bank Bldg., Minneapolis 2, Minn.

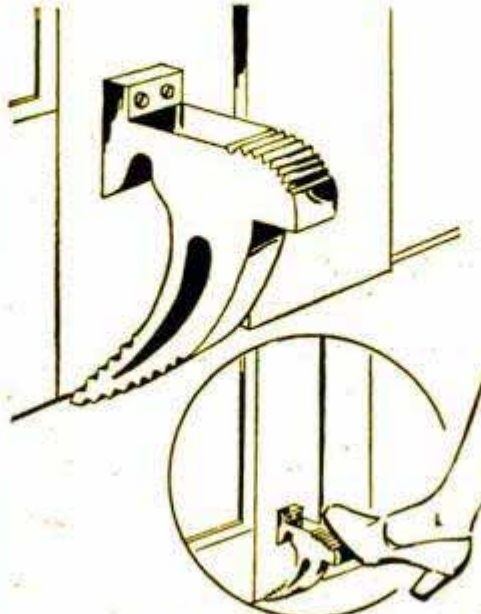

Bancroft & Partners, Ltd., 17 Victoria St., London, S.W. 1, England



Elron Products, 156 W. Chicago Ave., Chicago 10



Using map, game officials show Brady, right, where elk are reported

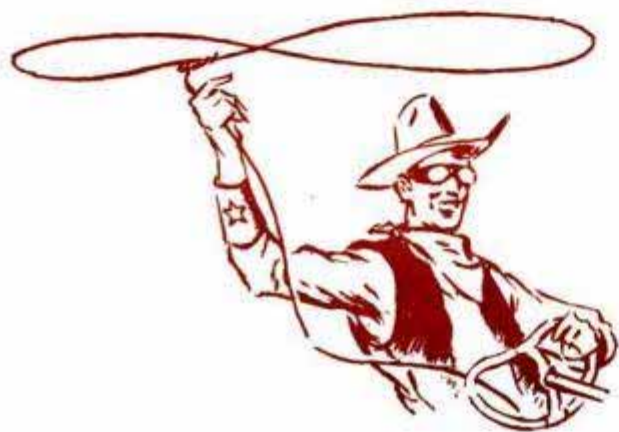

When herds of hungry elk start nibbling at your orchard, it's time to call the . . .

HELICOPTER COWBOY

By Parris Emery

Few elk are "lost" during roundups. Driving a herd of 230, the flying cowboy got to the refuge with 224

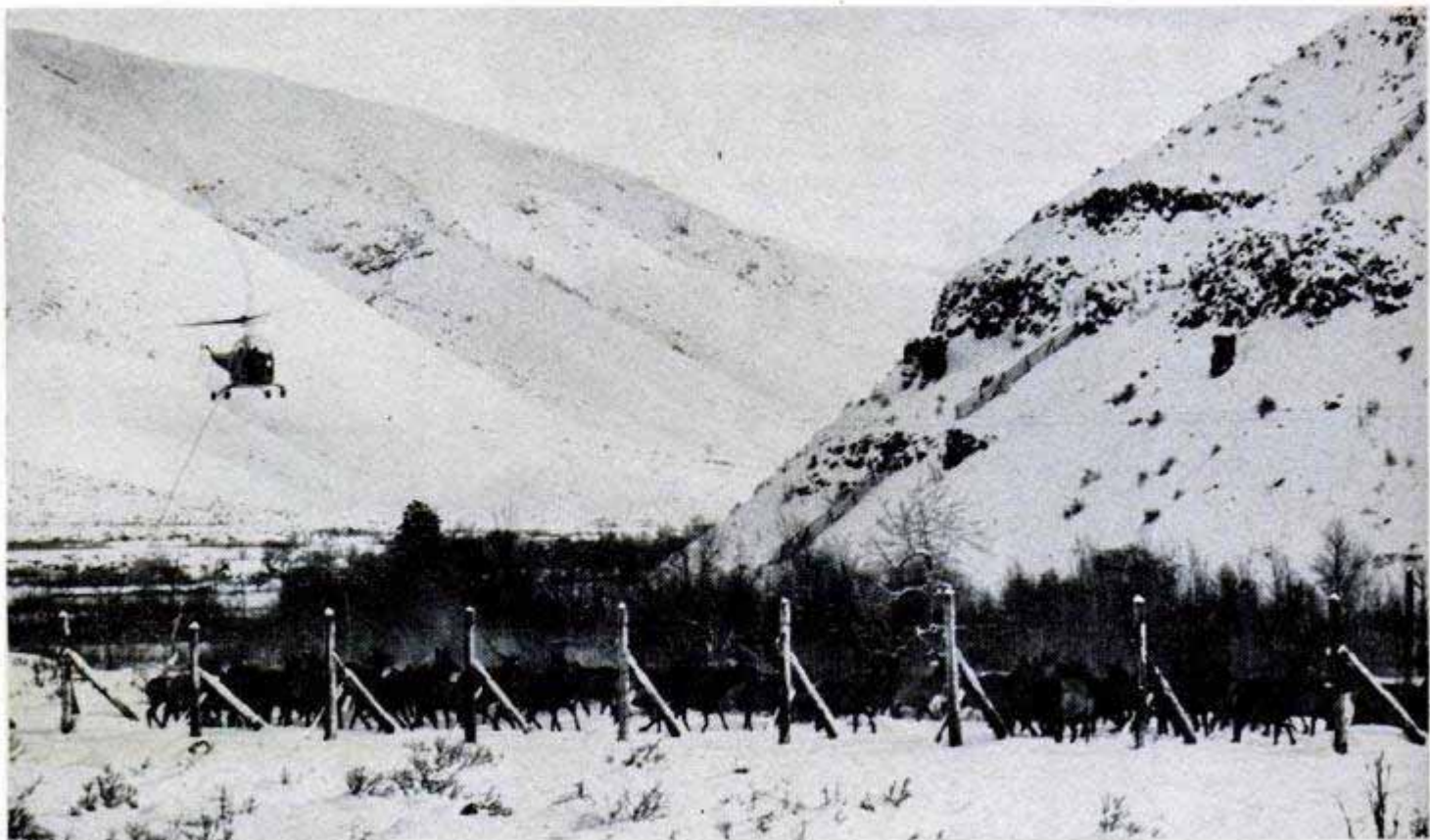



Their mountain feeding grounds buried under heavy snow, 3000 near-starved elk swarmed over farms and orchards during Washington state's bitter 1950-51 winter. There were an estimated 400 in herd shown above

WITH ROTOR BLADES whirling overhead, Carl Brady was leisurely scanning the Cascades through the window of his helicopter.

The apple orchards of the fertile Naches and Tieton farms were some 30 miles away. Directly ahead Brady spotted a small herd of elk. He shifted the controls and went down for a closer view.

The elk must have thought the helicopter was a demon from Mars, for they took off on a dead run. Brady followed, then decided to head them off. In doing so he learned that they turned easily, much like cattle. After practicing a little elk herding he went on to Yakima. Not knowing how the game department would regard his elk herding, he kept it a secret.

In the winter of 1949, starving elk driven by blinding snows and sub-zero weather were swarming from the mountains into the orchards of America's greatest apple country, near Yakima, Wash. Their natural browse covered by several feet of snow, they invaded farms, barns, and robbed haystacks. Thus started a famous "elk war."

The Washington game department, whose job it is to keep the elk on the Oak Creek refuge, was helpless. Fences meant nothing to the giant elk (weighing 250 to 600 pounds), who either leaped or knocked them down.

An almost useless effort was made by the game department to drive elk out of the farms and orchards back to the refuge. Fifty men worked on foot, horseback, and herded with Jeeps, but the invasion went on. An attempt was made to drive 200 elk seven miles from Windy to the Oak Creek

refuge. The men arrived with only 30 elk.

Their patience gone, the farmers started shooting. Nine elk were killed by one farmer, who told the game department to come and get 'em. He pleaded defense of his property. Eighty-nine were killed by angry farmers.

The game department finally herded 525 elk back to the refuge. But still the war went on, and dead elk were found every morning.

Just as the situation seemed hopeless, Brady, remembering his elk-herding episode, called the game department. He told them he thought he could drive the elk from the orchards with his helicopter. They listened, but were skeptical.

Finally, Fred Van Arsdol, district game supervisor, agreed to go for a helicopter ride with Brady. They spotted 15 elk and Brady zoomed down to the treetops. The elk took off. He turned them from the orchard down a steep cliff, picked up several more and drove the small herd through the gate on the Oak Creek refuge.

Van Arsdol was convinced. Fifty dollars was the price agreed upon for America's first helicopter herder.

Four days later Brady had every elk back on the refuge. The elk war was over.

Winters like that in 1949 don't happen often. The natives said it would be another 10 or 15 years before weather would drive the elk down again.

Old Man Winter must have heard their remarks, for this year he put on a repeat performance. This time it was a good show. Mercuries dropped to 17 below. The elk swarmed to the lowlands like locusts. Feed



Driven by the helicopter-mounted herdsman, stray animals were "pushed" through gates like the one above and into the safety of a game refuge



In full flight, above, the elk were a rampaging force. Weighing as much as 600 pounds, the big ones could jump over or knock down most fences. Brady operated most effectively flying at low level, below, where he was able to turn in quickly those that gave the slightest signs of straying



on the range had been poor all season. They were in bad shape.

Van Arsdol saw visions of another elk war. So Van Arsdol called on his star player, Brady, to defend the goal. Hay was rushed to the feeding grounds. If the elk could be held there, the battle would be won.

Some 3000 elk hit the line and, in spite of everything, hundreds got through. This time, however, farmers had confidence in Brady and the game department. When they found elk in their orchards, they merely called Van Arsdol's home and left word to send the helicopter. At daybreak Brady would take off and usually by 11 o'clock he had rounded up the 150 to 230 stray elk and returned them to the refuge.

Brady loses few elk in his roundups. In a recent drive he started with 230 elk, arriving at the refuge with 224. Six just laid down and refused to move.

When Brady formed a crop-dusting company in Yakima with two partners, he called it the Economy Pest Control Company. Little did he dream that some of the "little pests" he would drive from the farms would weigh as much as 600 pounds.

Automobile Stabilizers

Automobiles hold the road better on turns, and have no tendency to road-wander when equipped with spring-steel stabilizers. These stabilizers are rigidly connected to chassis and body to restrict sway and body shift without interfering with up and down movement. On turns, the stabilizers exert pressure on the axle in the opposite direction to that in which the car tends to skid. They also eliminate tire screech on sharp turns. After installation on the car, they require no maintenance.

Top, spring-steel stabilizers are rigidly bolted to chassis and body to restrict sway. Photo shows position of stabilizers

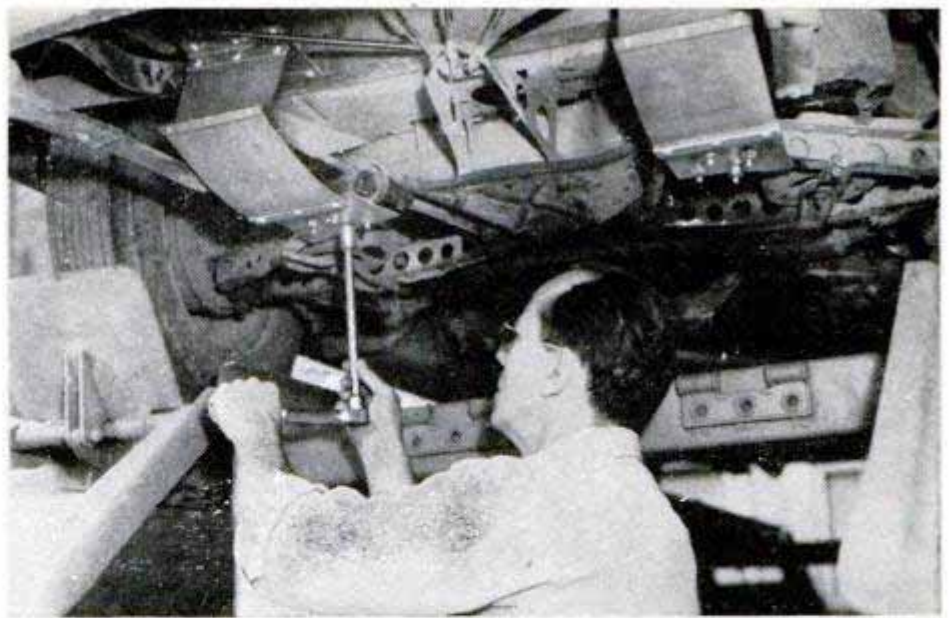

Welding Apparatus Co., 2750 W. Van Buren St., Chicago 12

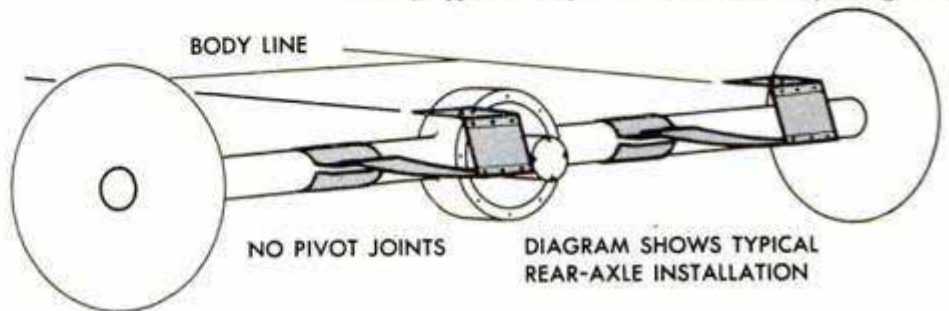

Coat of Lacquer Applied by Machine Protects Movie Film

Valuable movie films are protected from damage by a coating of lacquer that is automatically applied by machine. The lacquer not only protects the film from scratches, but also seals in the normal moisture of the film, reducing to a minimum, breakage due to brittleness. It also tends to seal in

the dyes of natural-color film. The lacquer-coating machine rolls the film past a roller-wick applicator and into a drying chamber where the temperature is rigidly controlled. If the lacquer coating becomes scratched through repeated use, it can be removed quickly and a new coating applied.

Film runs through lacquer chamber, drying cabinet, then to spool. Detail photo at right shows lacquer wick

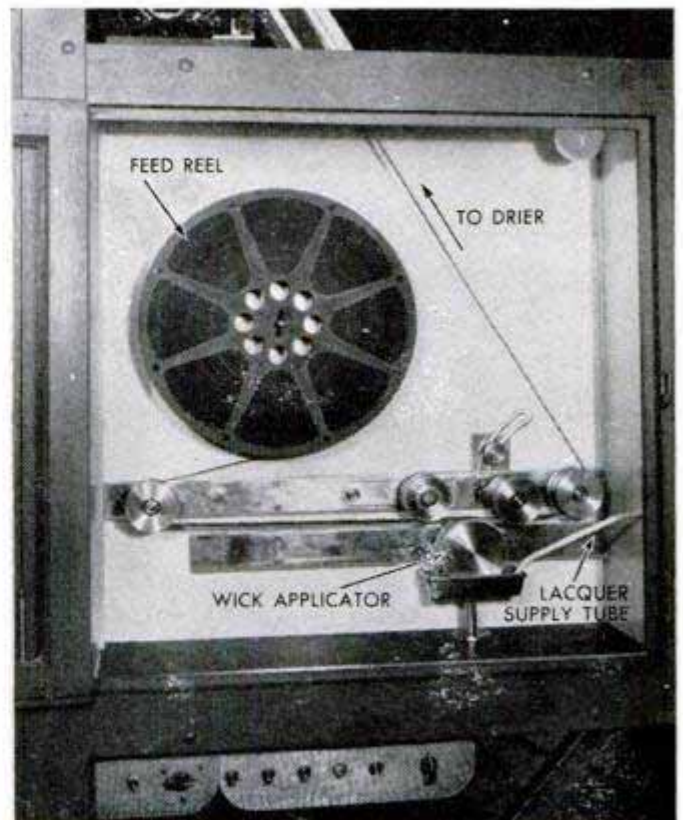
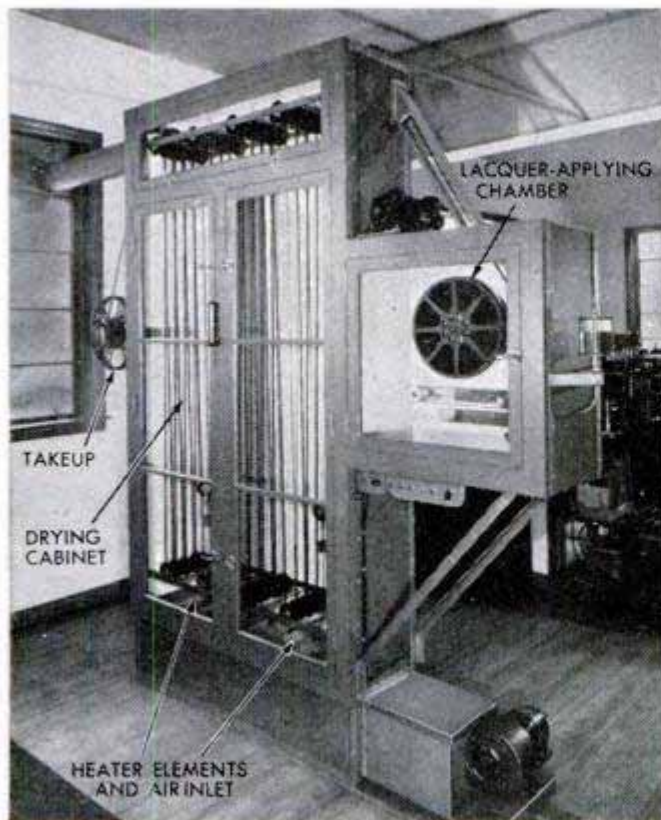

Esocar Motion Picture Service, Inc., 7315 Carnegie Ave., Cleveland, Ohio

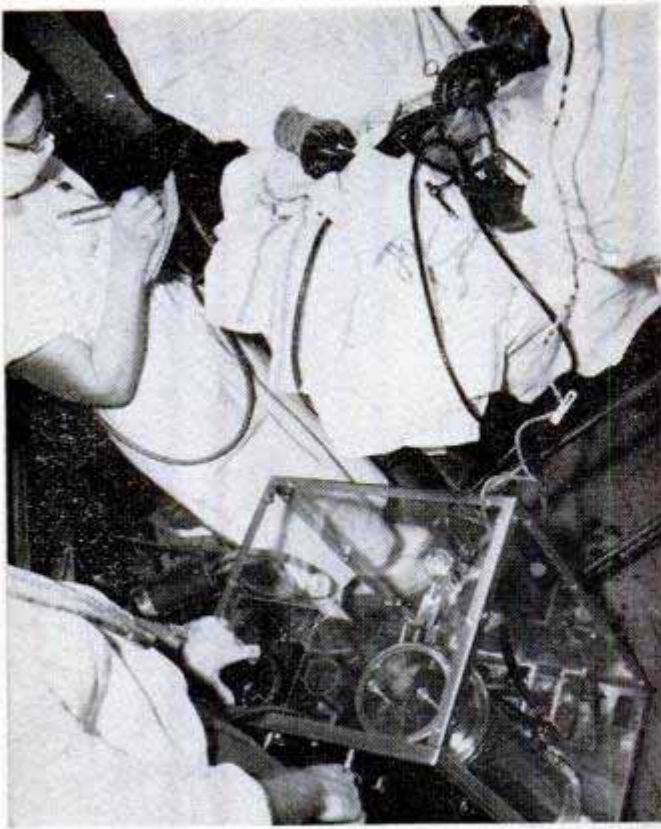

Above, a glass-enclosed, heart-lung machine keeps a dog alive during an operation. Right, a comparison of the human heart and the pump unit of the machine

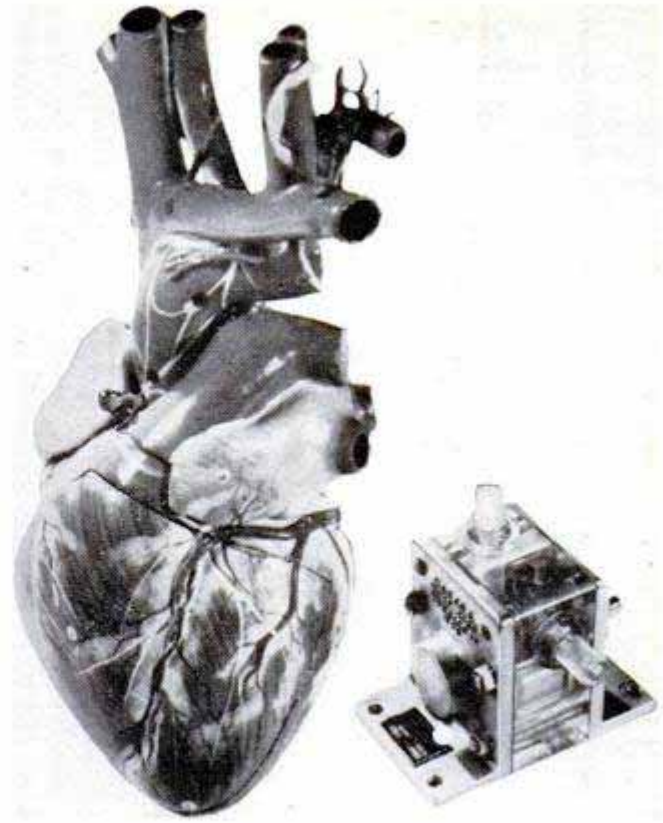

FOR YEARS, chest surgeons have sought a machine to do the work of the heart and lungs. Two such machines are being used successfully on animals and may soon be used on humans. With them, surgeons would operate on a quiet, bloodless heart while the patient is kept alive mechanically. In heart disease, where rest is the best cure, the heart could be assisted by the machine, thus getting life-giving rest.

Heart-Lung Machines

Below, this is how the above heart-lung machine operates. Right, a smaller machine that has no moving parts yet has kept a large dog alive for two hours

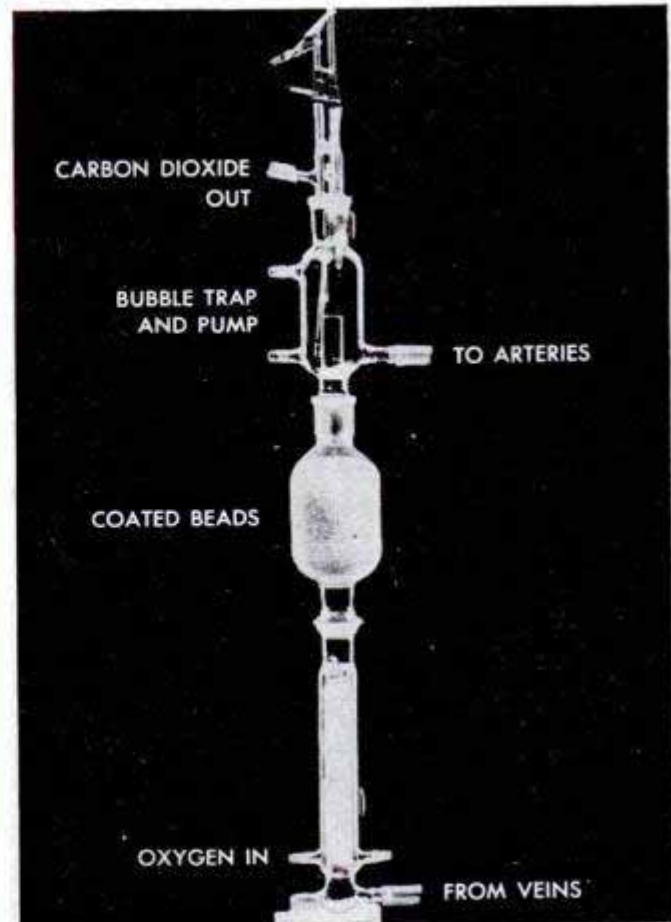
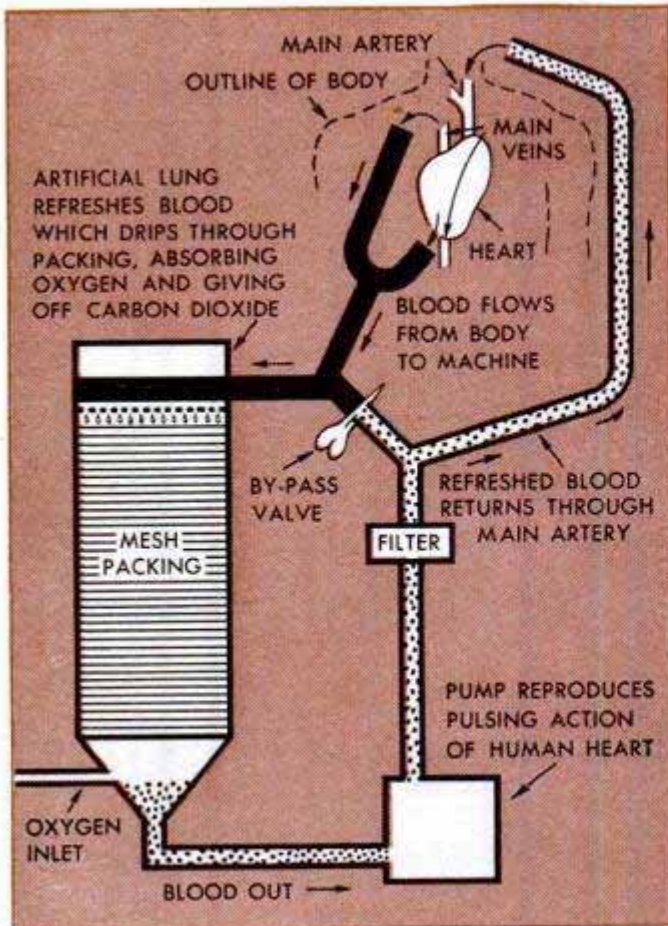



Cree Trailer and Boat Co., Marcellus, Mich.

Interior is complete with dinette which will seat four. Note the bottled-gas cooking range. Above, right, at night the dinette is converted into a bed for two. Below, coach bolts to body of a pickup truck, can be removed at camp site if desired



Pickup Home

Bolted to the body of a pickup truck, a compact home-for-three is complete with a gas stove, ice-box and sink. It takes only a few minutes to put the body on or off the truck. If you wish, it can be used off the truck as an overnight cabin or camp. The seats in the dinette form a double bed at night, and a canvas bunk can be set up above the bed for a third person. The exterior of the body is aluminum and the interior is varnished plywood. It is well insulated and has three windows and a door for ventilation and light.

Dual-Fuel Engines

Either natural gas or diesel fuel can be burned in a new diesel engine. Similar engines, already in use, can be converted to two-fuel operation with a change-over kit. The dual-fuel system was developed for engines which may be operating in several areas. Where it is available, natural gas can be used for more economical operation. Natural gas is delivered to the cylinder and fired by a small charge of diesel fuel. The engine automatically adjusts itself between the use of gas and diesel fuel in case the gas pressure falls off appreciably. Maintenance expenses usually are lower when natural gas is used.

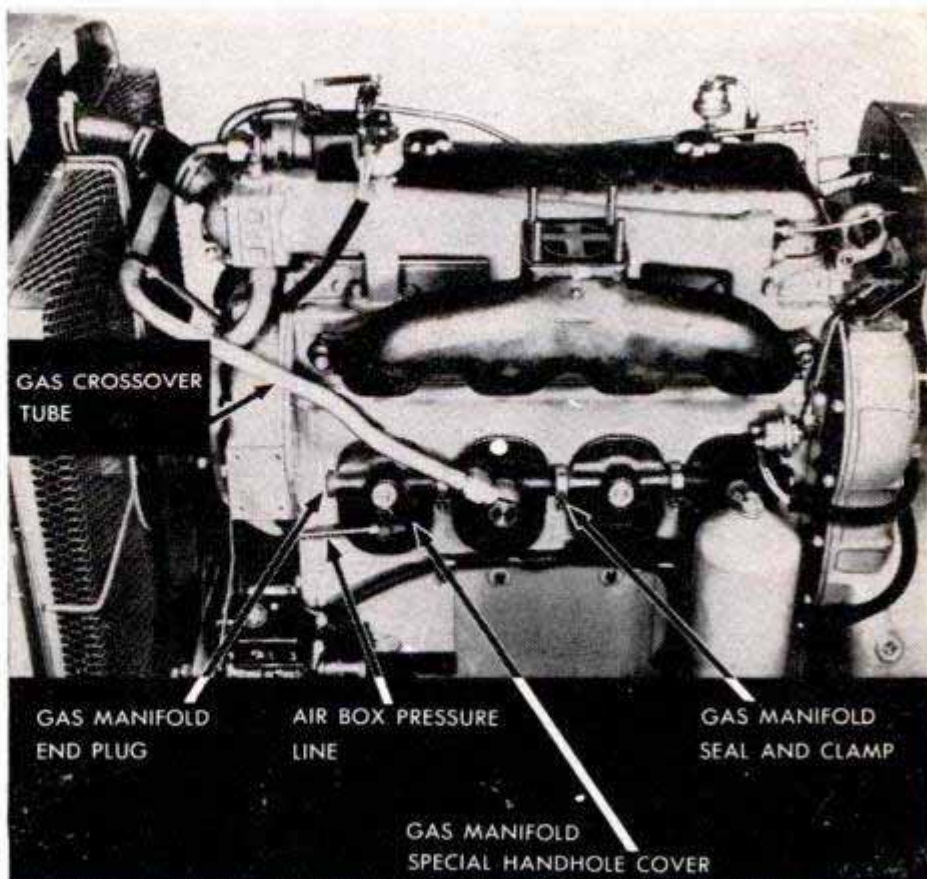

Detroit Diesel Engine Div., General Motors Corp., 13400 West Outer Dr., Detroit 28, Mich.



Random Corp., 415 Lexington Ave., New York City 17

Binoculars Take Photographs

What you see through your binoculars you can preserve on photographic film with a combination binoculars-camera now on the market. The unit measuring $1\frac{1}{8}$ by $2\frac{3}{4}$ by $3\frac{3}{4}$ inches provides 2.5-power binoculars with adjustable focusing. Within the same body, a camera with 4.5 (40-mm. telephoto) lens can be used to take pictures at shutter speeds of $\frac{1}{25}$, $\frac{1}{50}$ and $\frac{1}{100}$ second and on bulb. The camera uses 16-mm. film that is loaded in a daylight magazine. After exposure, the film may be mailed in its carton for developing.

Lead-Calcium Storage Battery Gives Longer Life

Losing only four percent of its charge each month, a lead-calcium storage battery developed by Bell Telephone Laboratories requires much less maintenance than present batteries. This monthly loss percentage is only one fifth the amount considered normal for standard storage batteries. The



Times Facsimile Corp., 229 West 43rd Street, New York City 18

Electronic Scanner Cuts Mimeograph Stencil

From an electronically cut stencil you can make more than 10,000 mimeograph copies of printed or typewritten material, drawings or halftones. The material to be reproduced is wrapped around one of two cylindrical drums revolving on a single axis and a plastic stencil is put on the other. As the drums revolve at the same speed, an electric eye scans the copy and actuates a stylus when it perceives black space. The stylus punches holes in the plastic stencil in the same pattern as on the original copy.

new battery also serves for many months without the addition of water. A major feature is the use of calcium instead of antimony as a hardening agent for the lead alloy in the grids. Developed for the telephone company's stand-by service, the battery is not yet recommended for other uses.

If you do not find the information you need in the WHERE-TO-BUY-IT INDEX, starting on page 12, sources of further information are available to readers without charge and may be obtained by writing Bureau of Information, Popular Mechanics Magazine, 200 E. Ontario St., Chicago 11, Illinois

☐ The Bureau of Mines has found that montan wax, previously imported from Germany as an important ingredient of shoe polish, ink, carbon paper, greases and electrical insulating materials, can be extracted from lignite deposits, notably in Arkansas and California.

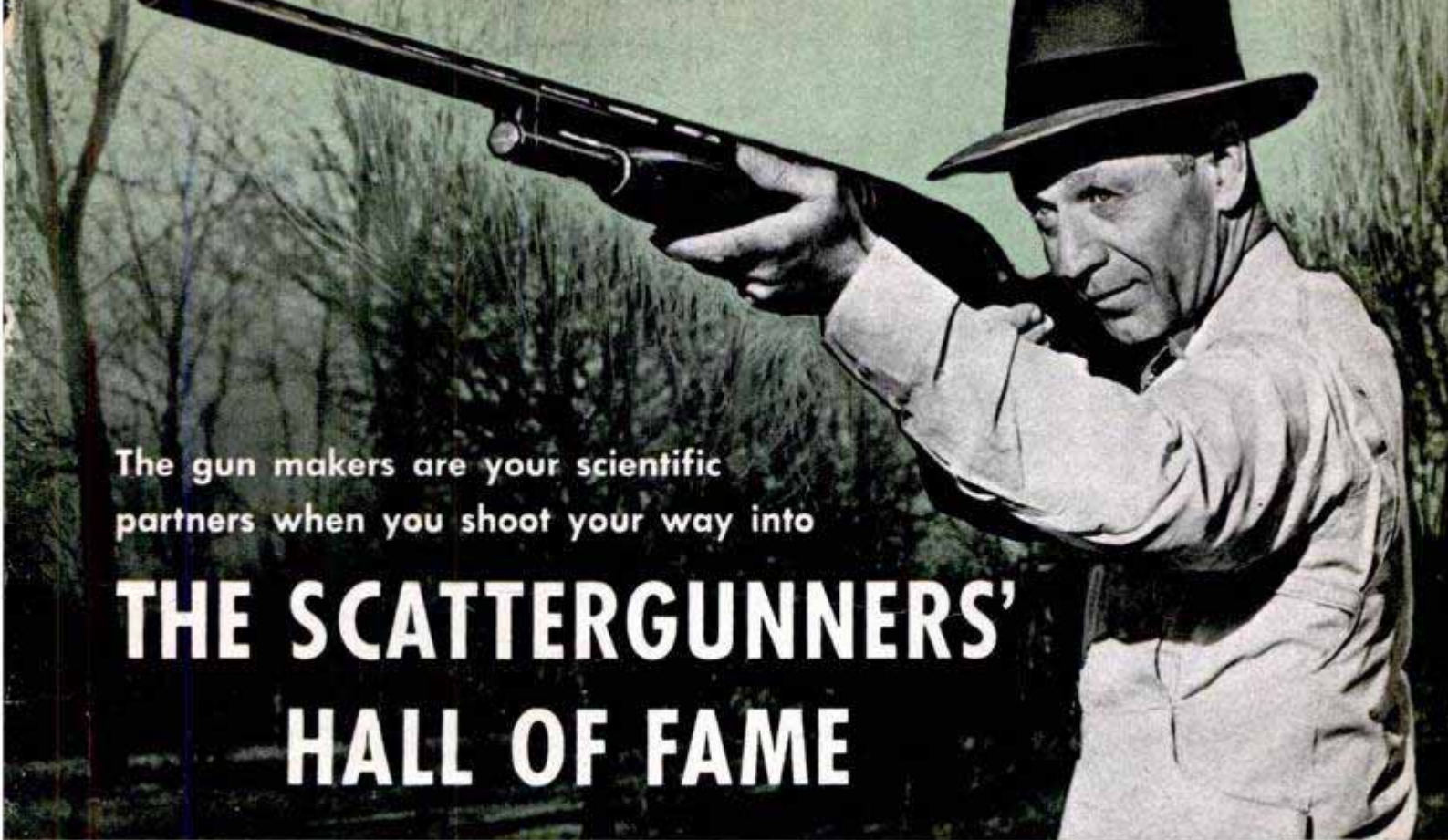

The gun makers are your scientific partners when you shoot your way into

THE SCATTERGUNNERS' HALL OF FAME

By Clifford B. Hicks

IT WAS LATE afternoon when a little man named Oscar Scheske, Jr., stepped up to the firing line. The 51st Grand American Handicap—the “world series” of trapshooting—was almost over.

Thousands of gunnery fans roamed behind the line at Vandalia, Ohio, waiting for Scheske and a few other last-minute shooters to fire so the shoot-off could begin. Seven men had blasted 99 out of a possible 100 clay targets during the day. Now they stood nervously by to take aim at the \$10,000 cash prize.

Oscar Scheske, last year's Grand American winner, is sixth man to fire perfect 100 at the national match

Scheske, an unknown to the gallery, started his trip down the trap line. On the fourth bird he skinned his nose as the gunstock jarred back past his face. Fifty targets later he was running a perfect string; at 75 birds, a crowd began to gather behind him.

Calmly Scheske shot his way through the 80s and into the 90s. He hit 99 without faltering and stood there, a nerveless little man just one shot from trapshooting's most coveted title. Taking the 100th shell from his pocket, he kissed it, thrust it into the

At the Grand American Handicap last year, 1700 crack shooters scattered 500,000,000 pellets across countryside



OF A SHOT

- ① HUMAN REACTION TIME
- ② MECHANICAL DELAY TIME
- ③ SHOT FLIGHT TIME

TARGET IS SIGHTED AND RECOGNIZED 1 SECOND

① HUMAN REACTION TIME 25 SECOND

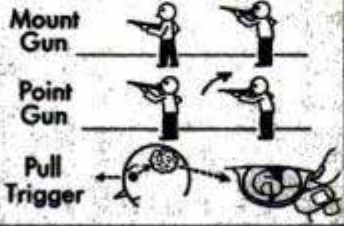

② MECHANICAL DELAY TIME TRIGGER TO FIRING PIN .008 SECOND



③ SHOT FLIGHT TIME 123 SECOND

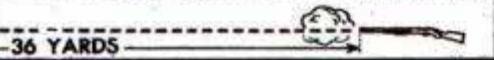

TOTAL TIME 484 SECOND

Western Cartridge Co. drawing

Split-second instrument has broken an average shot into bits. Shooter blasts target about a half second after spotting it

chamber and blasted the last soaring disk into bits.

That 100th shot fired Scheske into trapshooting's hall of fame. He became the sixth man in 51 years to score a perfect 100 at the Grand American.

Scheske is just one of an estimated 200,000 clay-target devotees in the country. The best of the claymen gather for the Grand American and the National Skeet Shooting Tournament each year. At these two events you can see the cream of the shooting crop—men as diverse as their shooting stances. The Grand has been won by barbers and welders and business executives. It's the most elusive title in the sports world—no man ever has won it twice.

Scattergunners themselves admit they are a superstitious lot. Science, since the war, has succeeded in stopping shot pellets anywhere in the barrel or in flight, and has studied every phase of shotgun shooting; but the scattergunner invariably feels he can make his own improvements. It's no strange sight at the Grand to see a shooter whittling big chunks out of an expensive gunstock to "improve his grip," and the chips may be falling beneath a fantastically precise timing instrument which splits one second into 100,000 parts in order to measure the speed of human reaction.

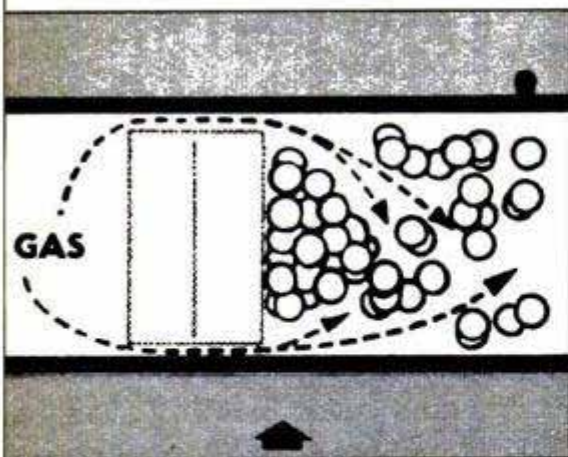

In old shell, gas leaked into shot. Below, new shell's wad seals off the gas

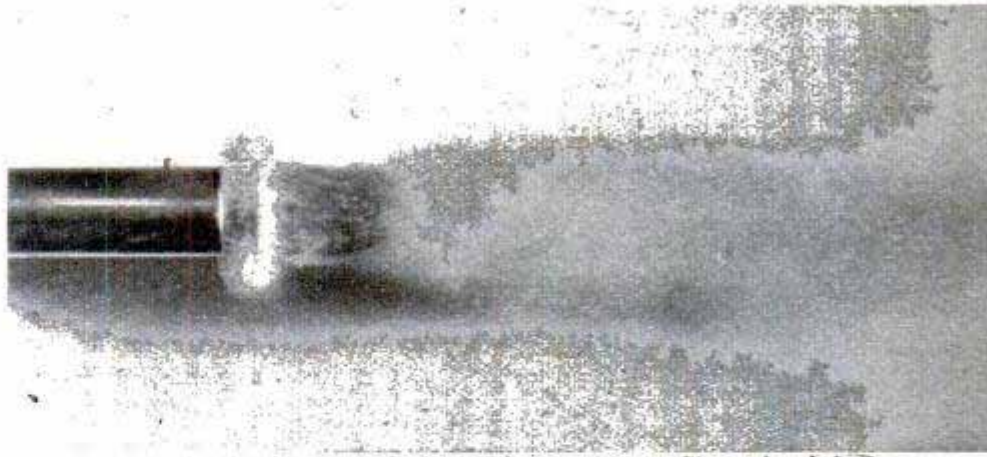
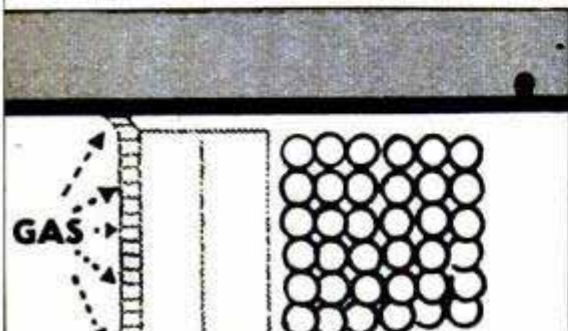

Western-Winchester photos

Result of gas leakage is shown above. Pellets emerge in spotty string. Below, with all the gas sealed from pellets, shot column emerges intact

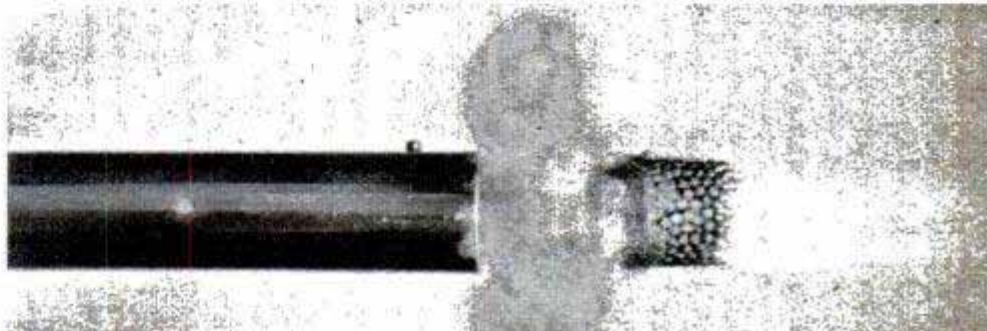



Back-yard trapshoot has miniature trap, targets and ammunition, yet the shooter uses ordinary shotgun

The Grand American shooter who can't hit the targets always has an alibi. The weather was too hot or too cold, too windy or too still. The referee was blind as a bat, somebody put his safety on, or a sweat bee deflected his aim. But science has shot virtually all excuses out from under him. Through scientific research the old-fashioned blunderbuss has become a highly accurate modern shotgun, and the old-time lead pellets have evolved into the latest shot shells that scrub out the bore and deliver a controlled shot pattern about as



Top, .22 shot shell compared with large, standard shell. Above, barrel liner changes bore to .22-caliber

neatly spaced as the holes in a honeycomb. If Oscar Scheske aimed his gun on the button and pulled the trigger at the proper instant, it was virtually a foregone conclusion he'd ring up 100 perfect shots.

For the first time, in the past couple of years, science has successfully followed the flight of shot pellets from chamber to target. Ballisticians can watch the shell explode, see the pellets at any point in the barrel and examine them anywhere in flight. As tools, the research men are using 360,000-volt X rays, still photographs made



Remington photos

Old-type top wad could disarrange the shot. Below, new crimp-top shell has nothing in front of pellets

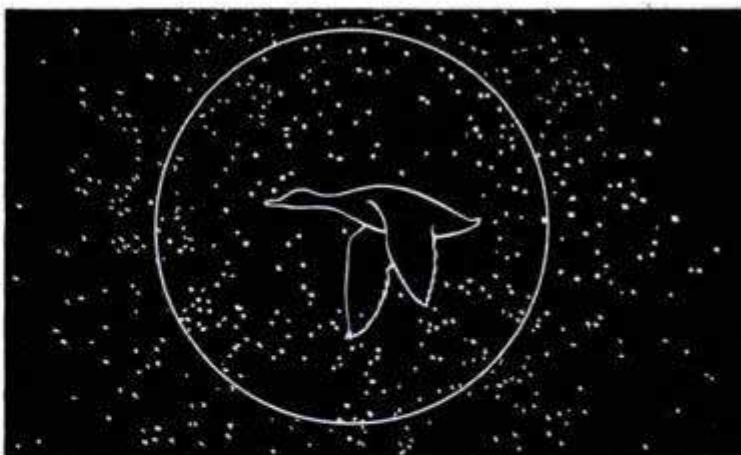
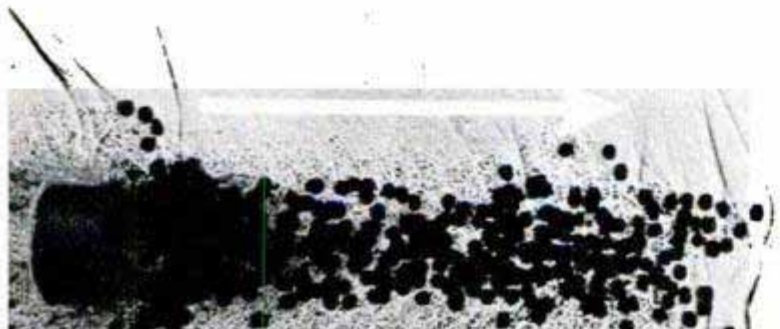

Gas leakage and wad produce spotty pattern. Bird can escape. Below, today's shell yields neat, even pattern



at millionths of a second and motion pictures produced at the dazzling rate of 3500 photos a second.

For some strange reason a good many shotgun shooters, as opposed to the riflemen, don't give a hoot about ballistics, trajectories, shot groups and the other fine points of shooting. Despite their indifference, research with unbelievably precise instruments is paying off on the firing line and in the field.

If you follow, through research, Scheske's last, \$10,000 shot from the time the trap was pulled, you can see how science has improved guns and their ammunition.

Split-second machines, which have put the brakes on time so that a second passes by with the leisure of a year, prove that from the time the target left the trap it took Scheske .1 second to see and recognize it. Then, assuming that his muscular reactions are about average in speed, it took him .25 second to aim the gun and pull the trigger.

This last figure is a measurement of human reaction only—there's no mechanical action involved. Western-Winchester has succeeded in measuring this sliver of a second with that incredible instrument, the counter chronograph, which chops a second into 100,000 bits and then counts the pieces. Thousands of shooters have been tested with the machine. The test shooter, armed with a gun, stands in front of a panel. On the board is a picture of a clay target, which can be illuminated by a light. An electrical switch connects the light with the

counter chronograph. As soon as the light flashes on, illuminating the target and starting the chronograph, the shooter, with his gun already mounted, aims and pulls the trigger. The trigger action stops the chronograph.

Some interesting facts have been uncovered with the chronograph: Skeet shooters between 13 and 19 years old are America's fastest scattergun shooters with an average human reaction time of .222 second; men are .0067 second faster than women; quail hunters are thousandths of a second faster than geese, duck, pheasant and rabbit hunters, who react in that order; vets of World War II are faster than vets of World War I.

After Scheske pulled the trigger on that prize-winning shot, timing mechanisms show it took the firing pin .008 second to lash forward and strike the primer of the shell.

Now, through X-rays at 360,000 volts, watch what happens when the shell explodes. The primer burns so fast it raises the temperature inside the shell high enough to ignite the powder. This takes place in about .001 second.

Then with shattering force the powder burns into a gas which exerts thousands of pounds of pressure in all directions. There's only one exit for this gas—down the barrel, which is plugged by the lead pellets. So the forward end of the shell suddenly blows open and the pellets, pushed by the gas, start their trip toward the target.

All clay targets for trapshooters are thrown from one house in front of five-man squad. In skeet, the birds come from two houses at much more acute angles

New repeater has plugs of various weights which are used to change balance of gun. Bottom, breechblock of the shotgun locks into an extension of the barrel

Remington photos

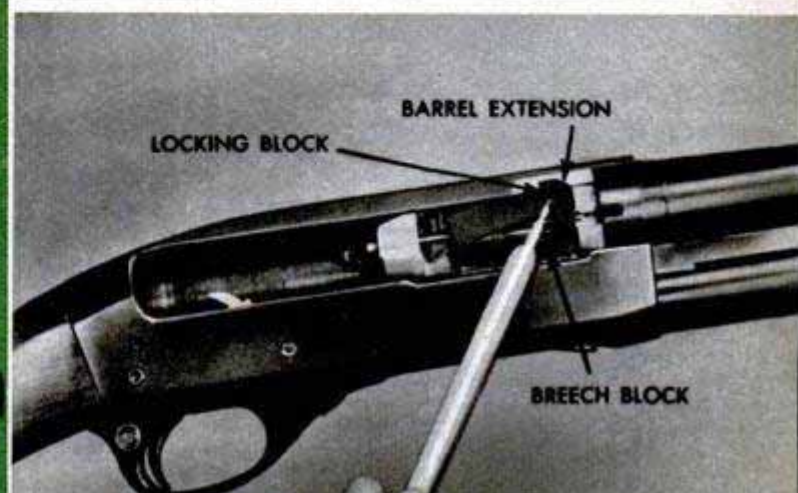
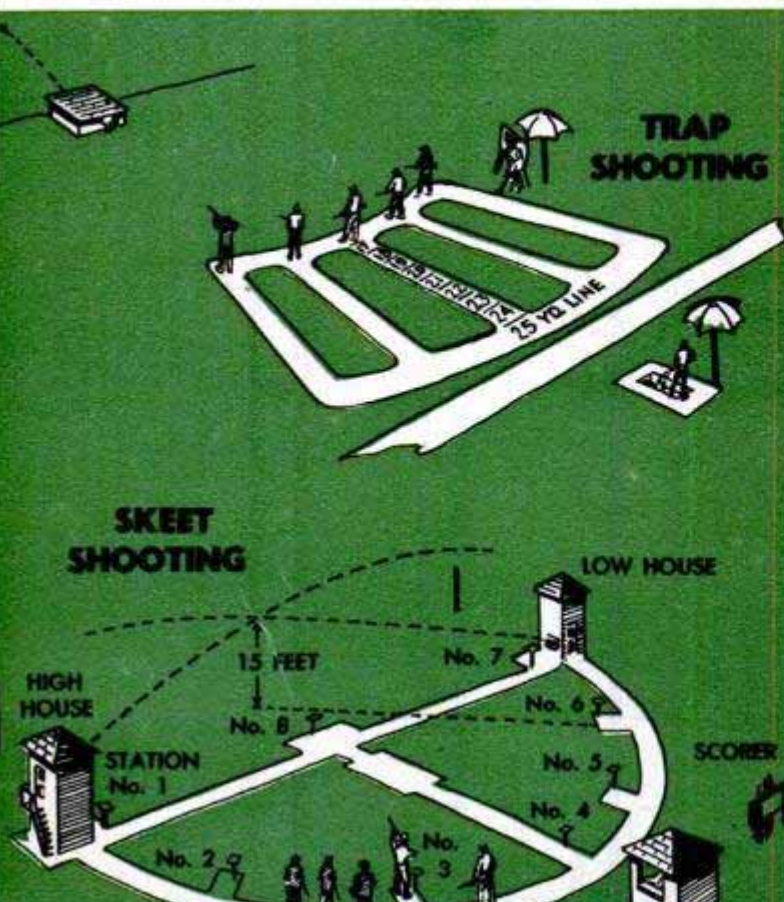

The shell of yesteryear had a disk of cardboard across the top to hold in the pellets and seal out the moisture. Frequently, when the shell was fired this disk was overtaken by pellets, and it disarranged the shot column to produce spotty patterns. In theory (and probably in fact) a duck, partridge or clay target could be smack in the middle of the shot pattern and still escape a hit because of a hole in the pattern.

X-ray research and other ballistic studies of postwar shells have shown the big advantage of eliminating this cardboard top disk. The forward end of today's shell is folded over and crimped into a circular pattern that looks like a pie cut in pieces. When the shell opens up, the crimp unfolds in a split second. There's nothing traveling ahead of the pellets down the barrel.

High-speed X-ray photos also show that another factor can deflect the pellets—gas which leaks among them in the barrel. The gas is so hot it can deform the lead balls (making them corkscrew through the air) or fuse two or more of them together.

Old-type shotgun shells were made with a simple disk of cardboard or wad under the shot, which was supposed to prevent gas from reaching the pellets. But the hot gas frequently leaked around the disk.

Some new shells are made with a lubricated wad, others with a "cup" wad just below the shot. The cup wad resembles a soda-pop-bottle top. At the instant the gas explodes, the crimped edge expands, pressing tightly against the bore to form an airtight wall between the onrushing gas and the pellets. The crimp gives the cup wad enough flexibility so that it can shrink

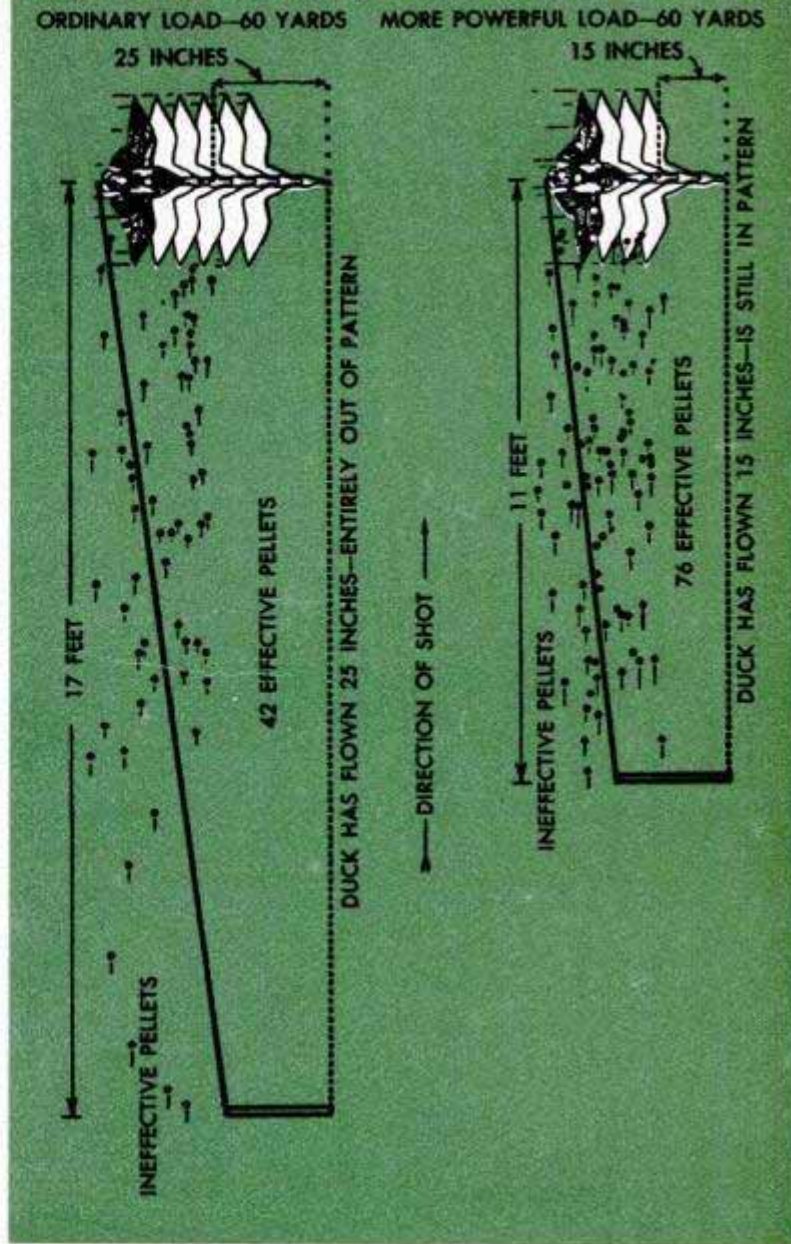

Diagram shows why short shot string is important. Speedy duck flies right out of the string at left

Ingenious gunsmith devised this curved stock for a gunner who lost the sight of his right eye. Stock enables him to sight with left eye while the shotgun is held firmly against his right shoulder

Two barrels are the feature of this two-in-one weapon. The top barrel fires a .22-caliber rifle bullet, the bottom shoots a .410 shotgun shell. There's one trigger but two separate extractors on the gun
Savage photo





Late-model Winchester has interchangeable barrels, slipped into place in a moment. The shooter can install the choke tailor-made for that day's hunting

slightly as it strikes the constriction near the muzzle which determines the choke of a gun.

The choke works just like the nozzle of a hose—it forces the pellets into the size column desired. Choke boring was introduced into the United States about 70 years ago and shooters still are trying to solve the riddle of the best choke for their purpose and ability.

The scattergunner who really wants to scatter chooses a cylinder-bore gun which has no constriction. As a result the shot column opens out wide like the spray of a garden hose. The crack field shot hunting geese or pheasants probably wants a gun which will reach out at long range. He chooses a full-choke gun which squeezes the pellets into a narrow column, like the concentrated flow from a fire hose. It takes an expert to use a full choke.

Recently, for the first time, research men began photographing every pellet of a shot column at various distances from the muzzle, thus putting choke under precise examination. In the future this research with photos made at $36/1,000,000$ second may result in a fuller understanding of what choke can do for the individual shooter.

The shooter actually fires a three-dimensional column of many tiny shot pellets. One dimension, frequently forgotten by the shotgunner, is the length of the column—called the shot string. The length of the string is important because it determines how many pellets reach a moving target. For example, a duck traveling 60 miles

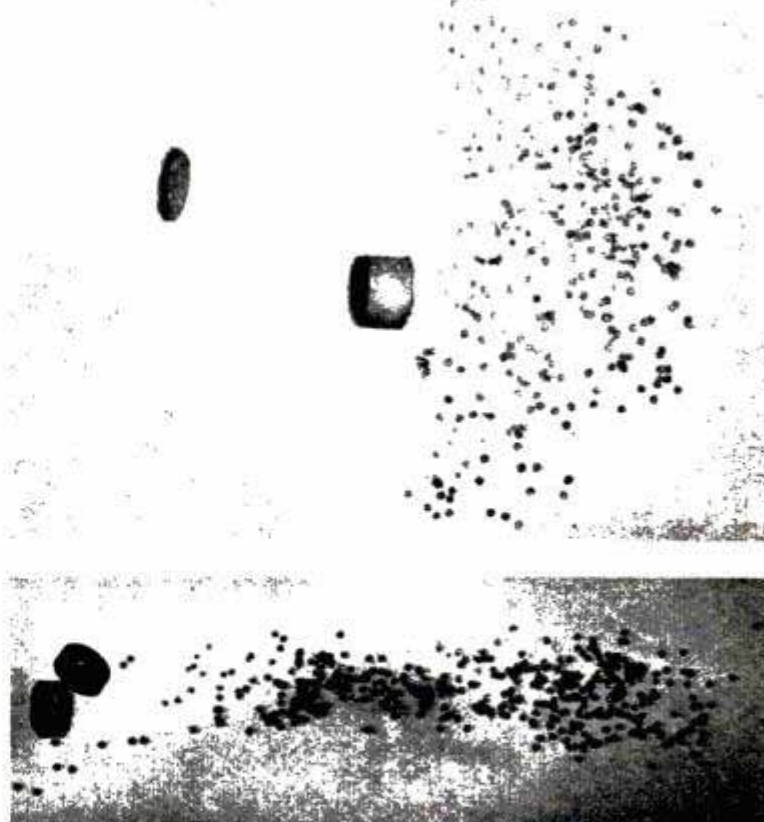

Photos made at $36/1,000,000$ second, 12 feet from muzzle, show effect of choke. Top shot, from cylinder-bore gun, spreads out. Full choke gives little spread

an hour may be directly in the center of the column when the first pellets arrive but may have flown out of the pattern before the last pellets reach that point if the pellets are strung out too far. To check this third dimension, engineers at Western-Winchester are employing a high-speed movie camera that whips through 3350 exposures a second.

Although a short shot string may not be particularly important to the short-range shooter or the man who fires at slow-moving targets, it is of vital interest to the shotgunner who hunts swift game at long range. But long-range shooting is more likely to cripple than to kill—unless the shooter is a hot-shot.

We've followed Oscar Scheske's prize-winning shot down the barrel, through the choke and out through the muzzle. About .003 second has elapsed since the firing pin struck the primer, according to experts conducting ballistic research.

If Scheske hits the target about 36 yards from the muzzle (his own handicap of 19 yards plus 17 yards from the trap) it takes the pellets .123 second to travel out and intersect the line of flight of the clay bird.

Adding it all up, about .484 second has elapsed since the target flew out of the pit. Hundreds of thousands of dollars have been spent in shaving this split-second down into bits and finding out precisely what happens during each bit. Not even the ballisticians are ready to say what further improvements to guns and ammunition can be made,

(Continued to page 256)



Jockey for Truck Trailers

Semitrailers are quickly spotted and "switched" at truck-terminal docks by a yard "donkey" that can turn a trailer in its own length. The little tractor has a hydraulic fifth wheel controlled from the driver's seat. It raises the semitrailer high enough

so the "landing gear" need not be cranked up while the trailer is being moved. The landing gear holds the trailer in a level position when the road tractor is unhitched. From his seat on the donkey, which measures 13 feet 2 inches over-all, the driver also can connect or disconnect the air lines to the trailer's brakes.



Electric Clippers on a Stick

Tall shrubbery or short grass edgings are trimmed quickly and comfortably by a rotary cutter attached to a convenient no-stoop handle. Driven by a powerful electric

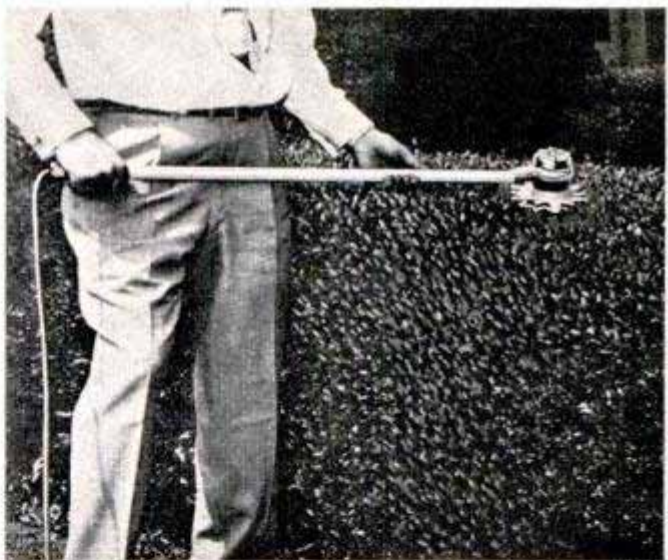

Apex Mfg. Laboratories, Box 283, South Pasadena, Calif.

motor, the circular cutting blade slices through hedges as easily as it does through grass. A lightweight model weighs only three pounds. A larger model, listed as a professional type, tips the scale at 5½ pounds.

Mountain Range Submerged in the Pacific Ocean

Scientists making a 27,000-mile trip over the central Pacific Ocean found a tremendous underwater mountain range, 1000 miles long, 100 miles wide and up to 14,000 feet high. The submerged range stretches all the way from Wake Island to Necker

Island near the Hawaiian group. Hydrographic charts had previously indicated isolated shoal points in this area. The joint University of California—U. S. Navy expedition discovered that these shoals were summits of a long mountain range.

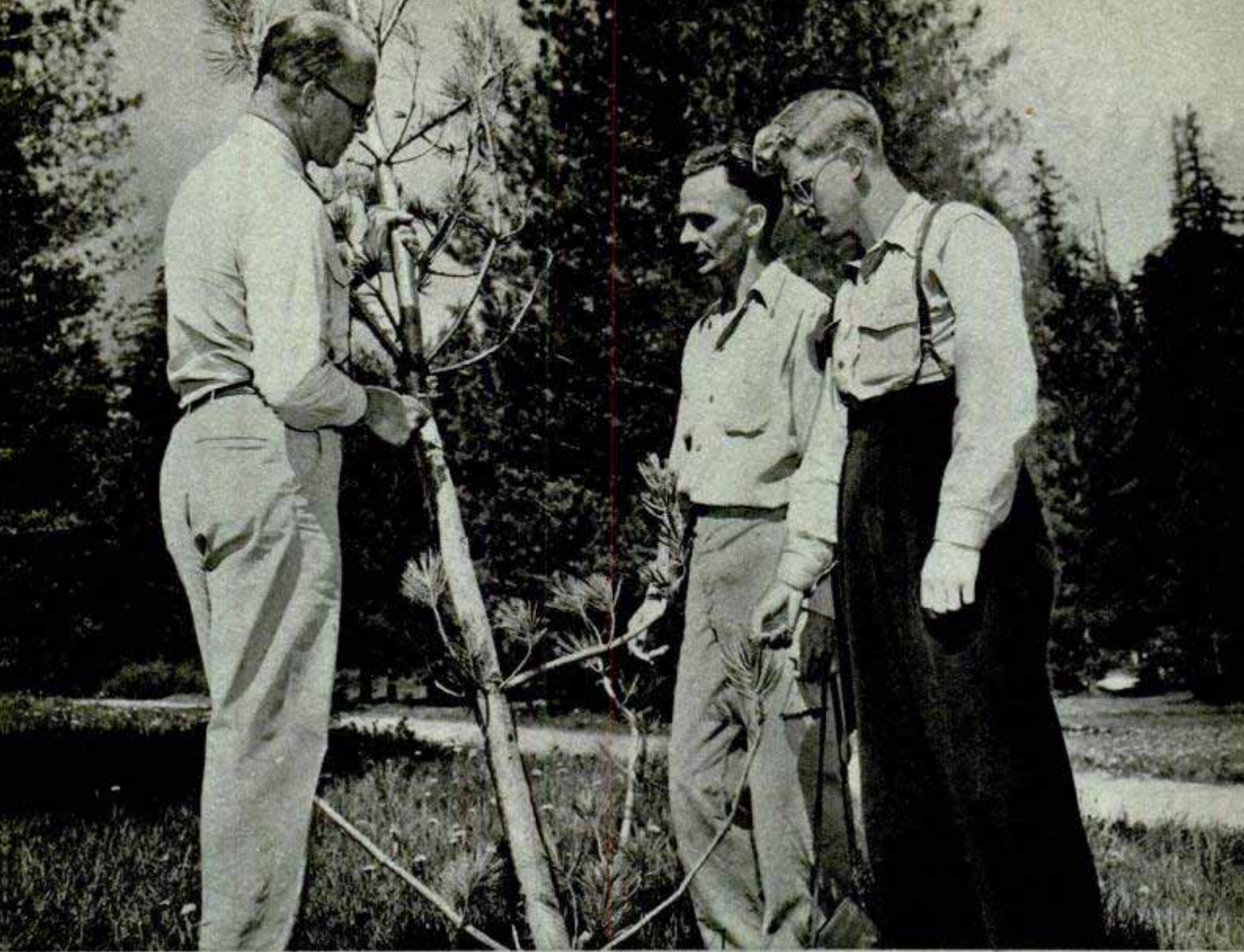

Dr. Thomas E. Buchanan shows Idaho tree students a typical sickly stunted pine. Tree disease costs millions

Bark is peeled from a pine with mystery disease for grafting to a healthy tree

Ground-up needles taken from a sick white-pine tree are reduced to ashes in making one of the many recorded laboratory tests



PLAGUE *in the Big Pines*

By O. A. Fitzgerald

IN COUNTRY where you can still see scars made 90 years ago by greedy sourdoughs who sluiced out gold by the millions, a husky ex-Marine last fall pointed the nozzle of a high-pressure field pump at the base of a white-pine tree and began placering. There may have been gold in the muck that flowed from around the tree, but Dr. T. S. Buchanan, forest pathologist at the University of Idaho, didn't bother to look for any. He was after the tree's roots—all of them.

Not far off, a colleague jammed the needle of his hypodermic syringe under the bark of a healthy appearing tree and shoved down the plunger. Into its system, Dr. Ernest E. Hubert sent a charge of juice squeezed from another tree—a sick one. Moving on to another healthy tree, Doctor Hubert made half a dozen patch grafts, each with a piece of bark from a diseased tree.

Such strange goings-on in the white-pine forests of central Idaho are the result of another mystery disease going beserk. Buchanan, Hubert and many other tree doctors are shooting at stakes which could exceed all the millions in gold the early day miners took from the hills. Pay-off for them will be trees that go to the sawmill.

Foresters call the new disease "pole blight." It is one of the 25 new forest-tree diseases that have appeared in this country since the beginning of the century. Pole blight was first observed nearly 30 years ago. It has also been called "x" disease and the "unknown" disease, and has exploded over large white-pine stands during and since the war.

The present name, which may be only another temporary one, arises from the fact that the disease strikes what are known as pole-size trees—those in the 40 to 100-year, or middle-age, group. It is a mysterious something that seems to shut off their food supply. Slowly but surely the tree begins to die—from the top down.

Dollar loss to date isn't alarming but the mystery killer has struck white pine's most vulnerable spot. The nation's foremost white-pine belt has lots of young stands—the result of good forestry and a type of logging that assures ample natural reseeding on the logged-off hillsides.

"We also have relatively extensive stands of old timber," adds C. A. Wellner of Spokane, in charge of the Inland Empire research center for the U. S. Forest Service.



Mystery disease is called pole blight because it attacks middle-aged pines known as pole-size. The tree dies from the top down. Below, test tubes hold fungus cultures collected from the diseased trees



Researchers extract juice from a section of a diseased tree with "pole blight juicer" designed by Dr. Ernest E. Hubert, standing. The juice is used to inoculate healthy trees

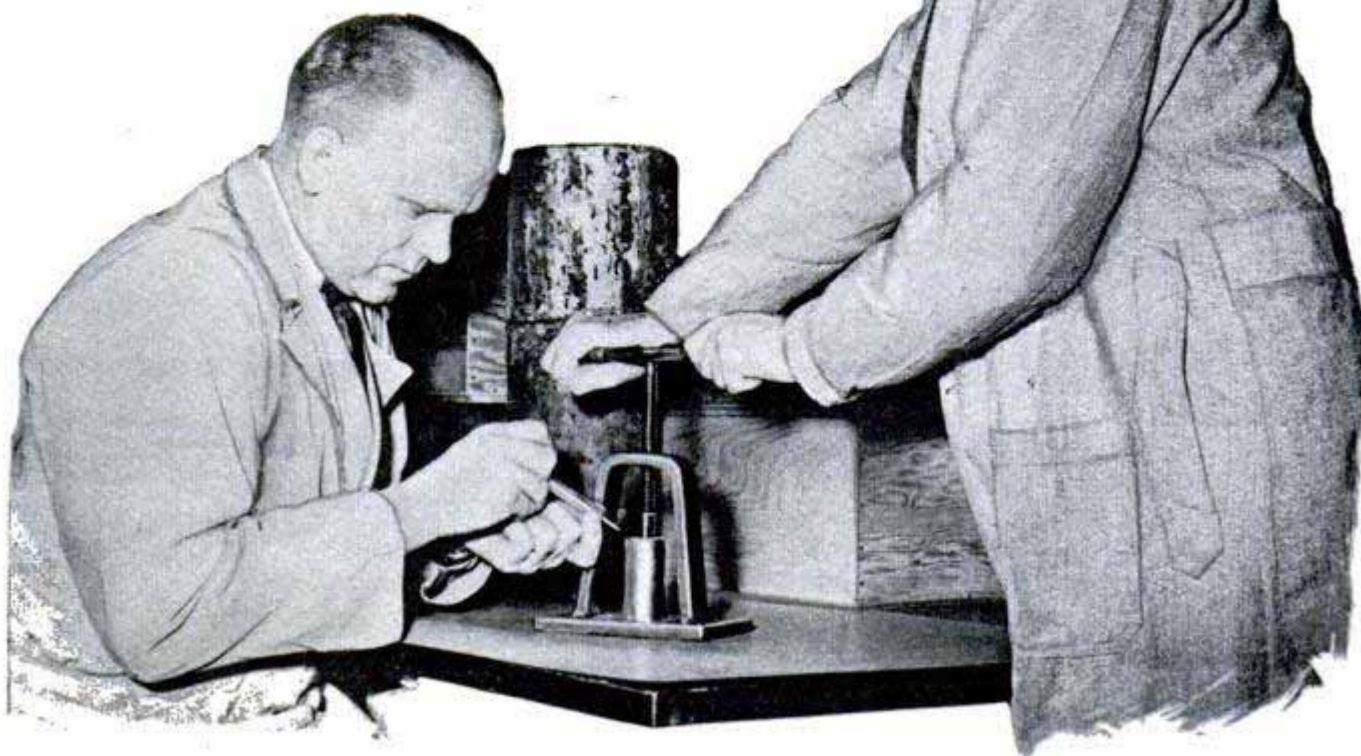

"But we are short on stands in the age group where this new disease has struck."

Tree doctors representing the U. S. Forest Service, the Northern Rocky Mountain Forest and Range Experiment Station, the Division of Forest Pathology, the Bureau of Entomology and Plant Quarantine, and the University of Idaho School of Forestry have teamed up to find out what causes pole blight. Only time can tell whether it will be a short-time project or another long, drawn-out affair similar to the little-leaf puzzle in the South.

For a dozen years, forest pathologists have been trying to figure out what causes the little-leaf disease. Today, it is making heavy inroads on southern pines. Tree doctors feel they are nearing the answer but they aren't sure. Having worked on the little-leaf disease himself, Doctor Buchanan knows just how exasperating a mystery disease can be. Fact is, pole blight has several features that remind him of the unsolved Southern puzzle.

First step in the pole-blight campaign has been to define symptoms of the disease. University of Idaho men, under Buchanan's direction, have done that. Fifty-six trees were completely torn apart, fiber by fiber. From this dissecting they determined how the disease affects the sapwood, the bark, the limbs and the needles. External symptoms were catalogued by studying hun-

dreds of trees. These symptoms were found to be scanty needle growth at the top of the tree, yellow foliage, reduced growth, trunk lesions, flat faces on the trunk, long narrow areas of dead cambium on the main stem, and a heavy pitch flow. Out of this has come a set of standards by which the disease can be recognized and its severity on any tree or stand of trees accurately measured.

With the symptoms brought into sharp
(Continued to page 244)

Working in protector box, Doctor Hubert starts a fungus culture in extensive research on pole blight

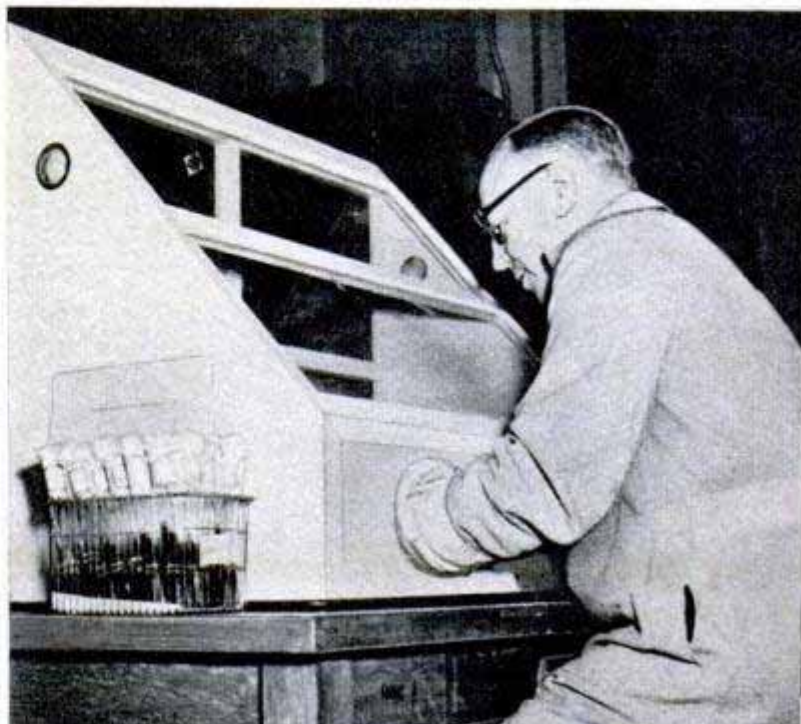

*Subsidiary of Kelly
Washington 5, D.C.*



Cane stalks are cut close to earth by the blade, then are carried up the ramp by pickup rolls and dropped over the side in windrows. Below, biggest problem of harvesting cane has been the snarled stalks. The new machine moves through them easily



Sugar-Cane Harvester Cuts Snarled Stalks

Hawaiian planters recently have solved a knotty problem—how to harvest, mechanically, sugar cane which grows so tall it falls in snarled bunches. A new harvester cuts and piles 40 tons of cane an hour. It is a Caterpillar tractor equipped with a cutting blade and an inclined steel deck. The circular blade rips through the stalks close to the ground. Pickup rolls move up the steel deck to carry the tangled cane to the side of the machine, where it is windrowed and later picked up by crane. Only one of the machines has been built, but others will be turned out soon.

"Whip" Sprinkler Scatters Spray

Water is spread as far as 20 feet in all directions by a sprinkler with no mechanical parts. It flows from a narrow rubber tube, much smaller than a garden hose, and pressure forces the tube into a whipping motion that distributes the water evenly. Medium water pressure is most effective. The tube is at the top of a spear-shaped aluminum base that is pushed into the ground.

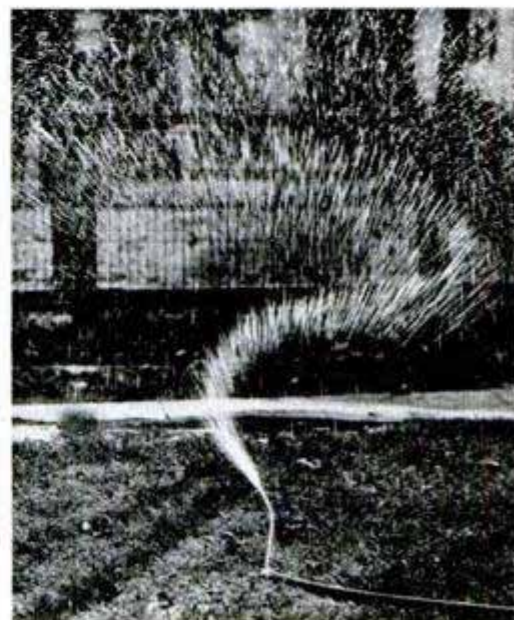

Earl L. Chadwick Co., Box 480, Houston, Tex.

In January 1948 we gave you the first look at the Army command car a Florida couple had rebuilt to explore the back trails of Mexico and Guatemala. Here is a new report on their

By S. Robert Russell

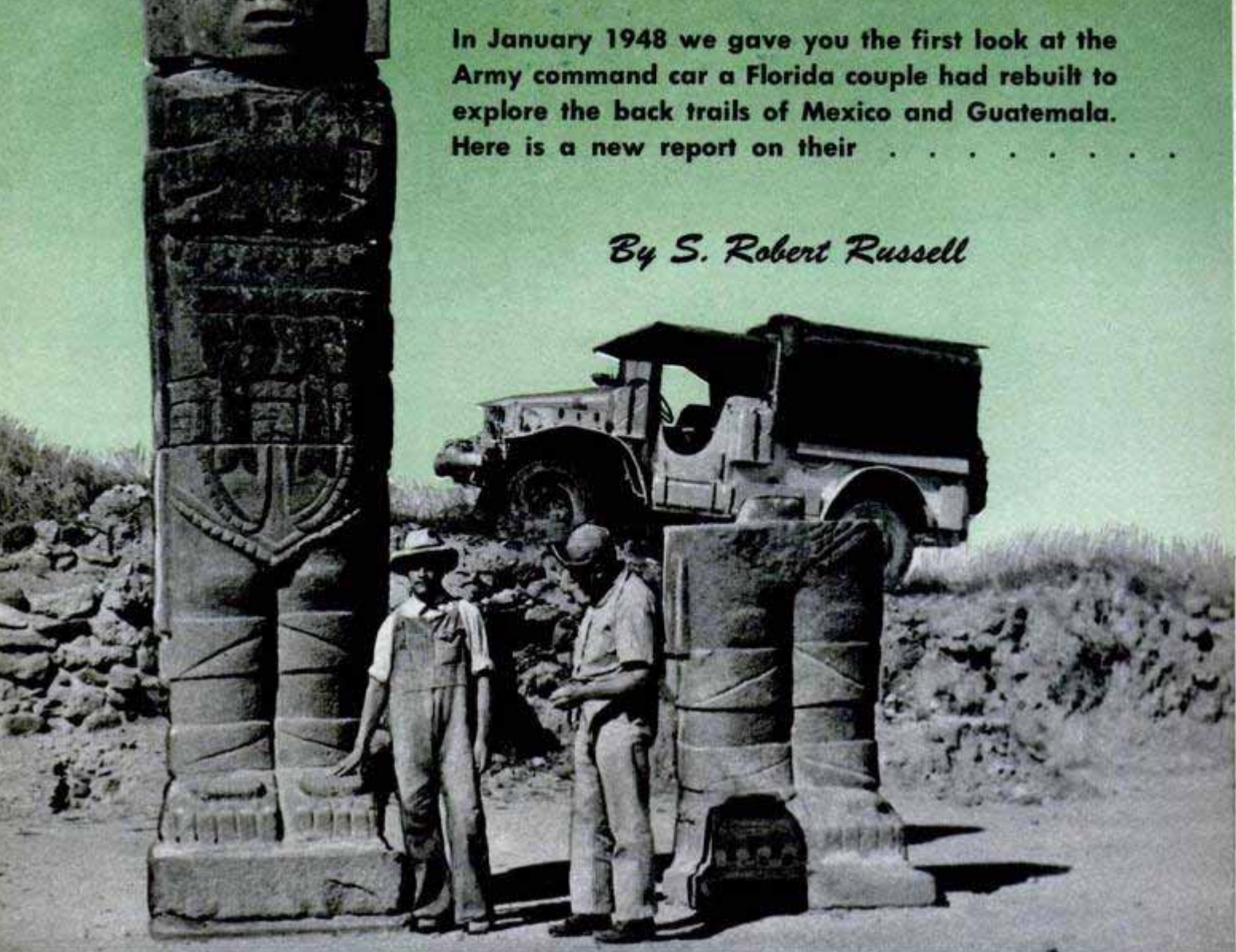

Hunting ancient treasures in remote parts of Central America is easier with the jungle car in background

WHEN YOU HAVE a hobby like mine—searching out ancient legends and archaeological secrets in remote places—you can't depend on busses, trains, airplanes, helicopters or even the ordinary family car to get you there. What you need is a jungle home on wheels like the one in which Mrs. Russell and I made our first expedition into Mexico and Guatemala.

Our research takes us to towns and ancient ruins that have never before felt rubber tires. Most of these places can be reached only by following tortuous trails or, at best, over deeply rutted ox-cart routes. We forced our unique (at least we think so) jungle home through solid thicket, forded streams, moved huge boulders, climbed impossible grades and once practically dug our way across a vast marshy plain where we averaged an exhausting seven miles a day. Throughout the trip we avoided tourist trails.

Despite our car's phenomenal climbing ability there were many promising spots it could not reach. This necessitated going afoot or on horses or burros.

Readers of our first article in *Popular*

Mechanics (Jan. 1948) which told how we bought an old Army command car and added a folding body with trimmings such as sleeping bunks, icebox, dining-room table, typewriter and stand, will be interested to learn that we did not have a single mechanical failure on our first major trip. We learned a lot, though, about our jungle home and what could be done to improve its living quarters and increase the car's over-all efficiency.

Now we are back in Key West, Fla., taking a breather and doing some rebuilding on the car. The job is almost finished and when you read this we will be skimming along some highway on our way into Mexico.

On that first trip our electric winch was the major disappointment. It was selected to give us motive power even if the engine drowned out while fording a stream. It proved too slow and too hard on the car's batteries—something we had not foreseen. We discarded the electric motor and depended on a hand crank. It got us through many tough spots but at too great a cost in blisters and aching muscles.

JUNGLE HOME ON WHEELS

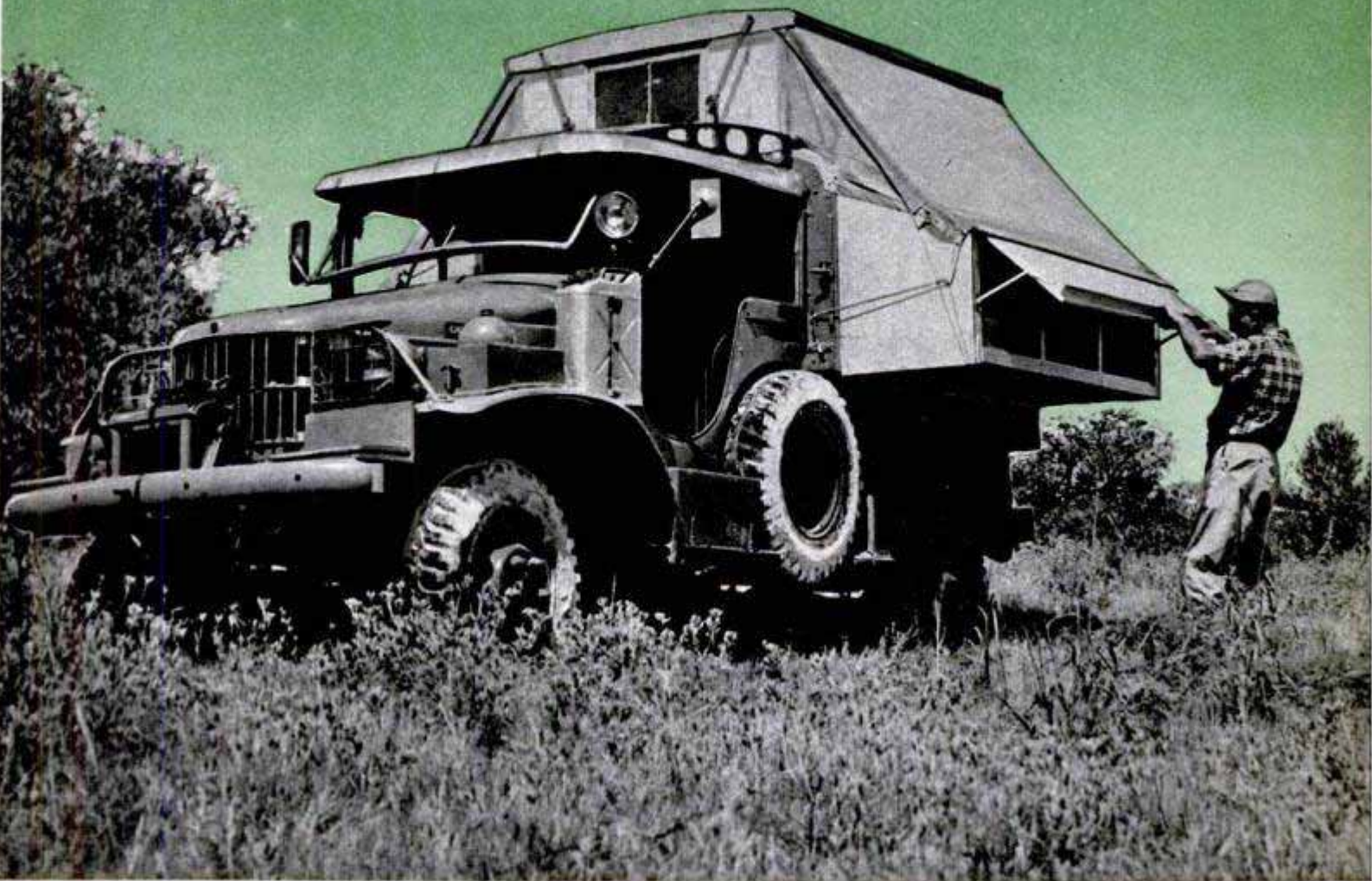

Truck unfolds for added living space; plywood bunk awnings are raised in hot weather, also upper windows

We now have a new winch which is larger and driven by a conventional power take-off. It can also be hand cranked and, as a convenience, it can be reversed by an electric self-starter motor.

Our heavy load plus the terrific grades we encountered when off the paved highways wore out brake linings too rapidly. While the car had husky rear brakes, the front ones were only about half their size. Securing new rear-wheel backing plates, drums and shoes and fitting them to the front wheels gave a substantial increase in braking area. All brakes are now interchangeable, reducing the weight of the spare-parts stock.

Getting in motion after stopping part way up an unusually steep grade always brought unpleasant pictures of burning out a clutch disk while deep in the wilderness. A lower low-gear ratio was indicated. This was obtained by replacing the original one-speed transfer case with a much better two-speed job taken from a GI armored truck. This gave us five forward speeds in place of the original four and two in reverse. When in low-low, and with the en-

gine idling, the car's movement is almost imperceptible.

Shift levers for the new transfer case and winch were installed at the right-hand corner of the driver's seat. This left the front-wheel-drive lever in its original position, way over to the right of the emergency-brake lever, a long unhandy reach for even a tall man. It was moved over with the other two. Now, all three levers are directly under the driver's right hand. An Army sergeant who examined the jungle home said, "I wish the quartermaster engineers would put our six-by-six controls over there!"

A comparatively high-g geared steering worm made whipping the car around sharp bends and dodging trees in heavy woods pretty exhausting. A lower geared, more easily handled assembly taken from a late-model six-by-six has been installed.

An oil-cooling radiator, installed under the right fender during the original rebuilding has been relocated in front of the water radiator. There it delivers better oil cooling because of air sucked through it by the engine fan. In the low, jungle areas



New winch, driven by conventional power take-off, can also be hand cranked. It replaces an electric winch. Below, airplane rib on cab lifts tree limbs

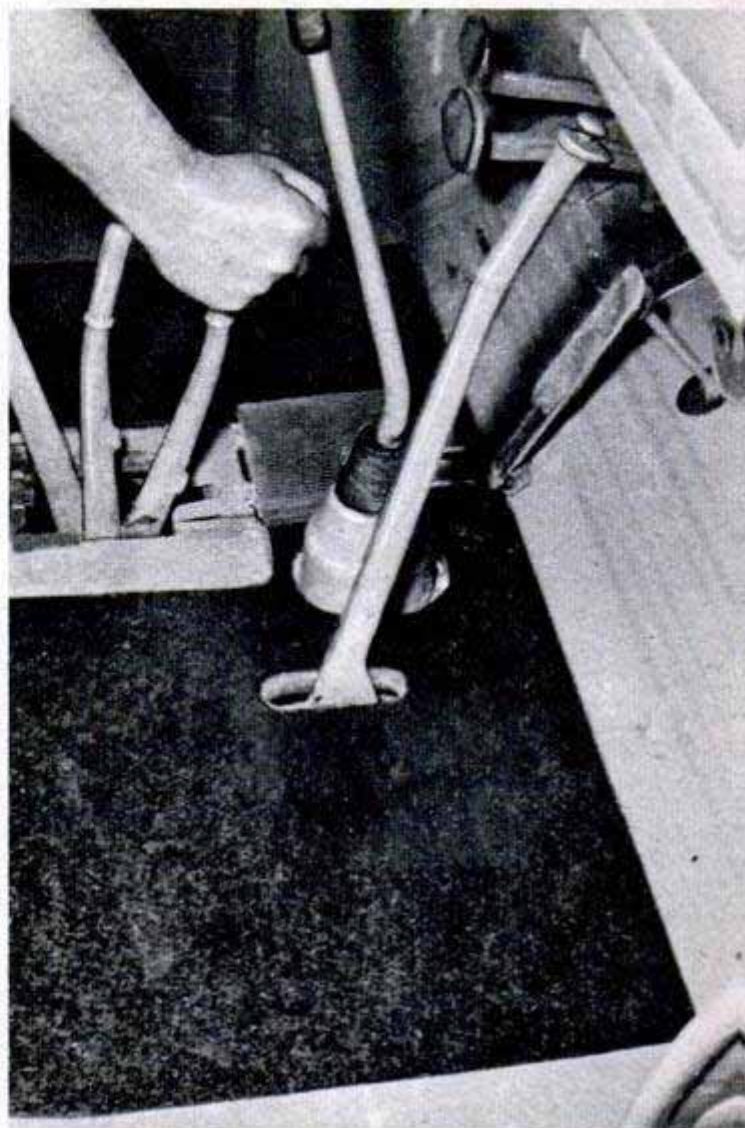

Front-wheel-drive lever was moved over with other two levers so that all would be under the driver's right hand. Below, an oil-refining device was added



where it was necessary to grind along day after day, hardly ever getting out of low or second gear, this oil cooler worked wonders by doubling the time between oil changes. This oil cooler has now been supplemented by a device that re-refines the oil as it is used, replacing the conventional oil filter. I selected a large type designed for heavy trucks and busses.

Front springs have been replaced with heavier ones. The GI carburetor has been discarded in favor of a civilian model for which repair kits are available. Even the original spark coil went by the board. An oversize, oil-filled airplane type has taken its place.

Cab and folding quarters have been almost entirely rebuilt. The original cab top was of canvas. It has been replaced by one of steel, aluminum and marine plywood. Side curtains with plastic windows were junked. Removable, marine-plywood doors with sliding Plexiglas windows now give closed-car protection. We can install or remove and store them in their rack without leaving our seats.

Since it is sometimes a considerable distance between sources of safe drinking water we wanted an additional five gallons of storage capacity. With the car's old design there was just no place to put it. This was remedied during the rebuilding in an ingenious manner. By extending the cab roof forward so that it formed a sunshade we gained a space under the overhang. A tank shaped to fit inside this space holds only a trifle less than five gallons. An electric fuel pump keeps it filled automatically from the main, built-in tank. Water is piped from the new, overhead tank to a little faucet alongside the gasoline stove. When preparing a meal, this feature saves Mrs. Russell many steps between stove and the hand pump in the cab.

We contend that everything which grows



Huge prism binoculars mounted on truck save useless climb on heights barren of archaeological treasures



Side view with canvas rolled up shows new top. There is 75-inch headroom. Below, dual wheels plus chains and winch enabled Russells to reach isolated town



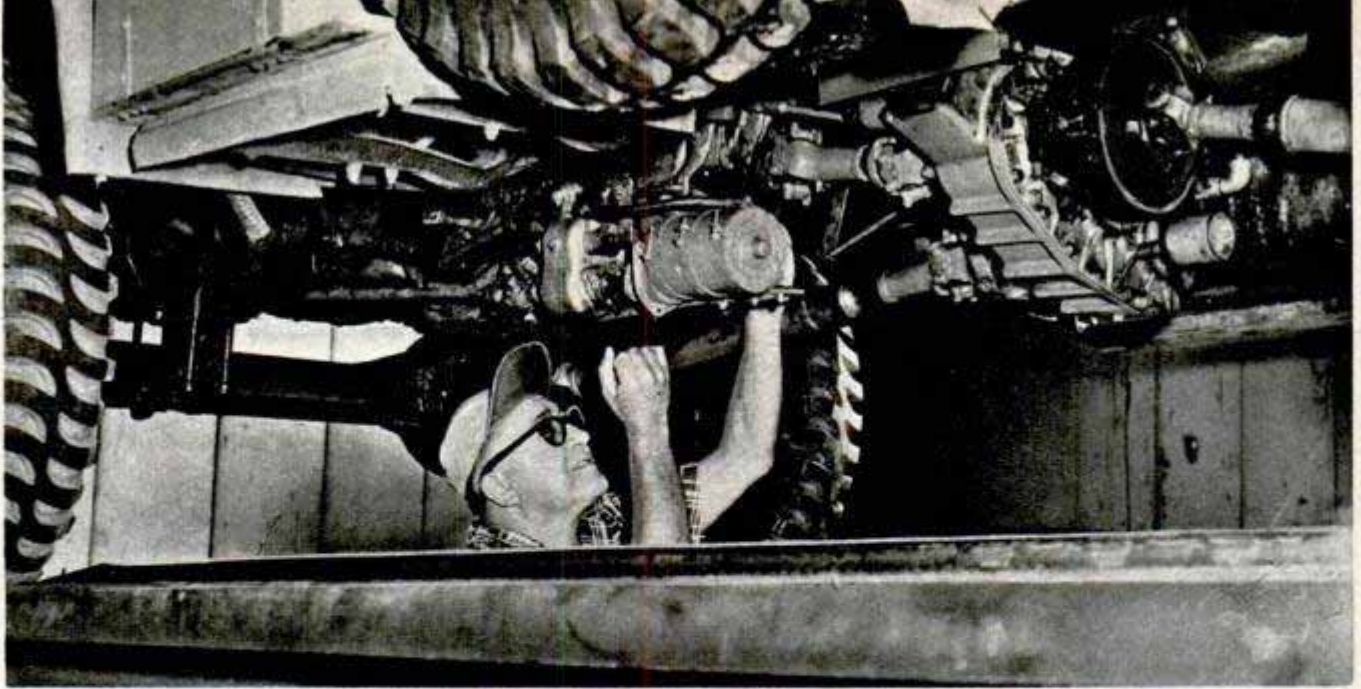

Sturdy two-speed transfer case from a GI armored truck replaces the original, lighter, single-speed job

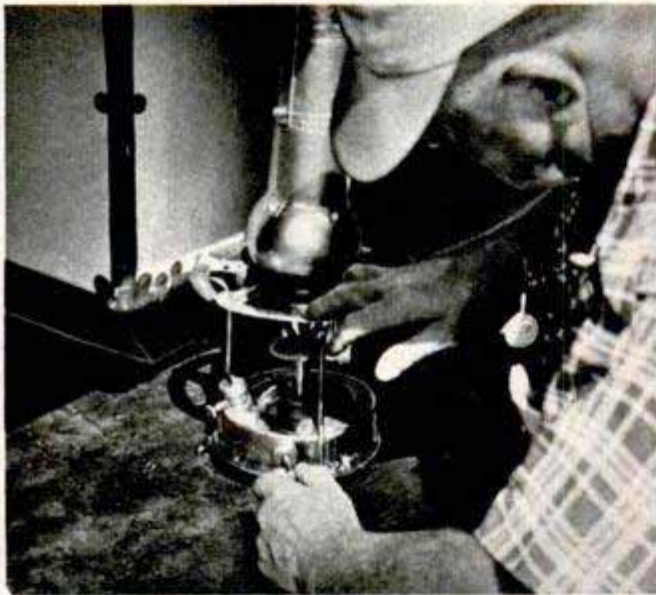

Tiny heating plant is a welcome addition when the Russells travel through mountain country. Below, he holds a small brake drum replaced with oversize

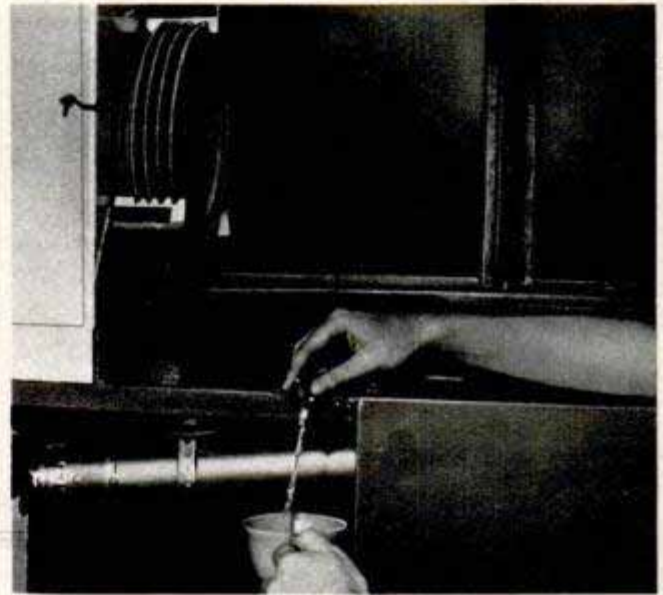

Running water is piped from an overhead tank to a faucet alongside gasoline stove. The plates just above "sink" ride the bumps on a live-rubber rack



in Mexico's chaparral is equipped either with thorns, spurs or daggers. These were hard on the original canvas top of our living quarters. It has been replaced with one of marine plywood. The ends which support this top, when raised for camping (and fold in when the car is closed) are now linked to the top and rise into position automatically when the top is lifted from inside. Four pleasure-car, spring trunk lifters reduce the weight of the top until it all but goes up by itself.

The living quarters now boast a central heating plant. It is a tiny, single-burner, wickless, kerosene stove. A vent pipe crosses the car, distributes the heat and carries dangerous fumes outside.

On the coming trip a pair of powerful field glasses will supplement our basic equipment of cameras, typewriter and notebooks. Once in Mexico we will head straight for the city of San Cristobal de Las Casas which lies in the mountains of Chiapas only 100 miles from Guatemala. Our only stops along the way will be to visit numerous Mexican friends. By following the recently completed Pan American highway we expect to make good time.

We selected San Cristobal because it is the center of the web of legends and mystery which covers the state. East of it lies a great area much of which is virtually unexplored. An ancient tomb, almost within the city limits, has been found to contain nine-foot skeletons.

A few miles distant lies the town of Zinacantan. Its people are direct descendants of Aztec warriors.

Our last act before leaving will be to paint "El Jeep Casita" on the front bumper. That is what an aged native woman christened our jungle home on wheels. It means, "little house on a Jeep."

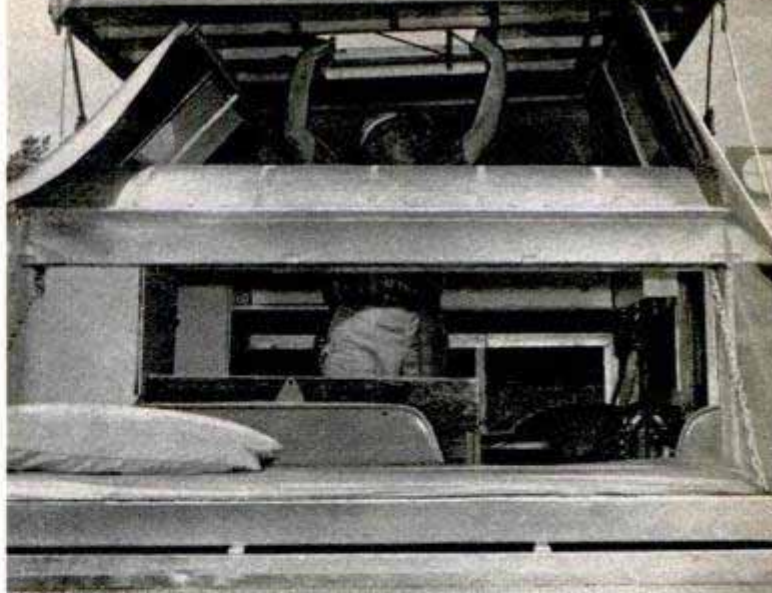

One canvas side is rolled up to show how a gentle lift raises top and the supporting endpieces, too



Everything in Mexico's brush country grows horns, spurs or daggers, say the Russells. Below, field tests. Metal case on fender holds small light plant



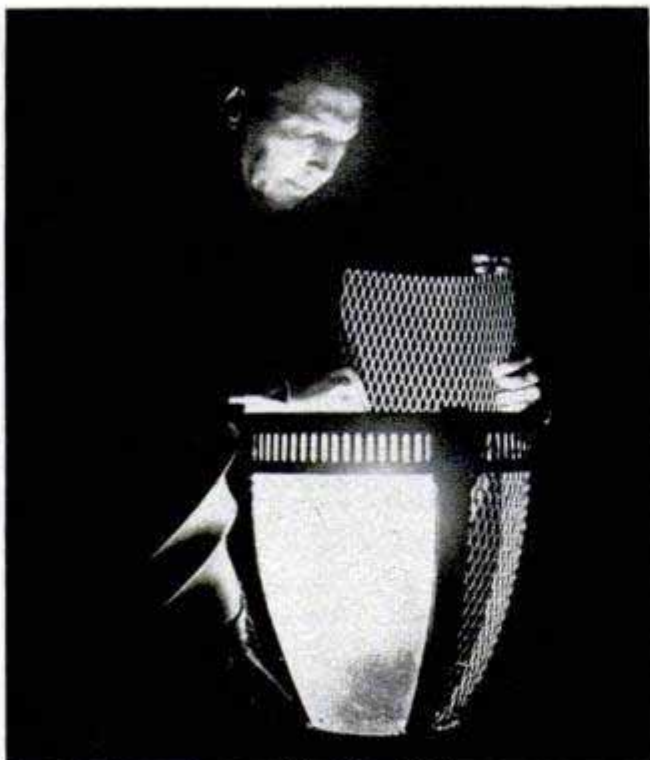

Wheeling Corrugating Co., Wheeling, W. Va.

Metal Lamp Guards

Lamp guards made of a metal construction material are being installed on New York City's street and park lights to foil stone-throwing vandals who, until recently, cost city taxpayers almost \$300,000 per year. The guards are made from expanded metal, fabricated by piercing and stretching solid steel sheet. They are replacing some plastic guards which were broken as frequently as once a week.

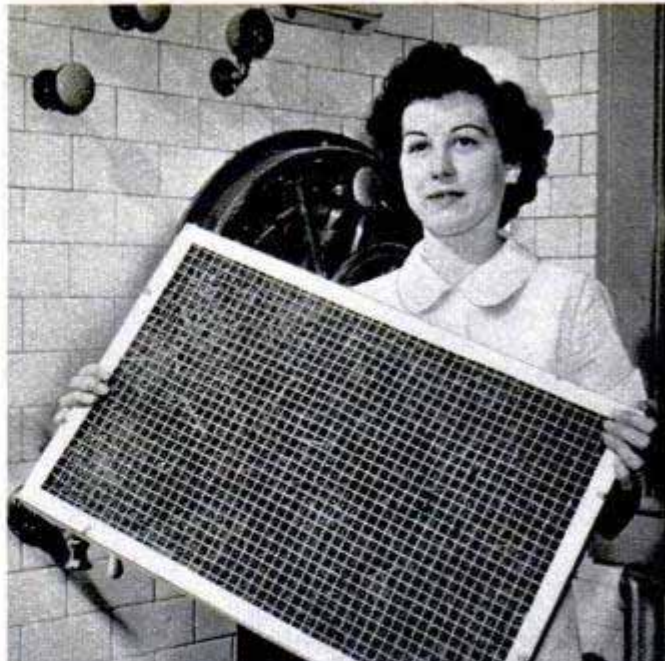

Goodyear Tire and Rubber Co., Akron, Ohio

Shredded Plastic Traps Dust

Dirt that escapes conventional air filters is trapped by a new type of filter that utilizes the dielectric properties of polyethylene and other plastics. When exposed in a current of air, the filtering material, thin film shredded into a porous mass, picks up an electrostatic charge that attracts and retains the finest of dust, soot or smoke particles. Developed for forced-draft, hot-air furnaces and air-conditioning systems, it is also being tested to remove pollen from the air in homes. It is washed by immersing in water containing a detergent.

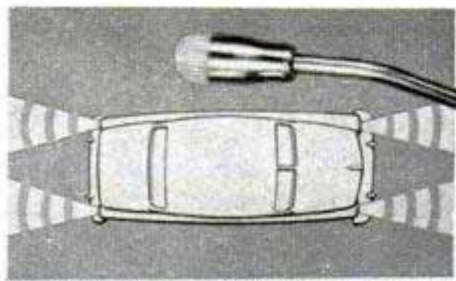
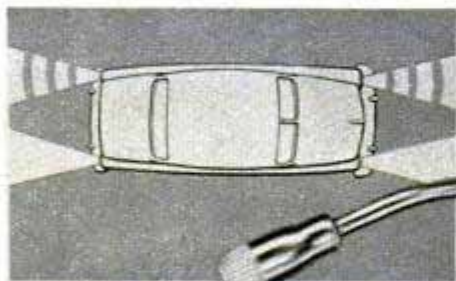
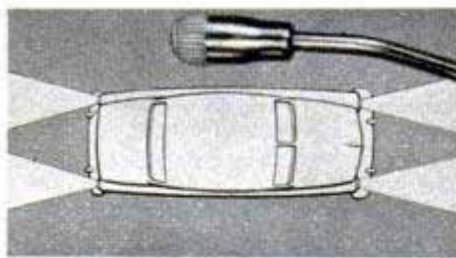

NEUTRAL POSITION



FOR LEFT TURN
REVERSE FOR RIGHT



FOR DISABILITY PARKING

Flashing Lights Protect Motorist

With a flasher switch hooked into the circuit, motorists can use the directional lights on their cars to warn approaching traffic while changing tires or making emergency repairs along a highway. When the switch is in the emergency position, all directional lights, both front and rear, flash continuously, warning cars coming from either direction. The switch, which clamps to the steering column, also signals turns in the conventional manner. It can be used on cars already equipped with directional lights or, if the car is not so equipped, proper lights are easily added.



A WHITTLED'S COWBOY TOWN

GALLOPING COWBOYS, runaway horses and yelping dogs all give violent action to the complete Western town whittled to scale by Mrs. Mary Crouch. Reared in an atmosphere of cowboys and horses, Mrs. Crouch has used her background to create amazingly lifelike Western characters. She has been carving blocks of wood since she was 12 years old. Usually, she works on individual figures or small scenes, but decided to work out an entire town just to prove that she could do it. The craftswoman spent 14 months in completing the scene. She first sketches a figure on a

Photos by A. Halverson

To the rescue! The Cisco Kid gallops heroically after a runaway team to save a damsel in distress. Typical old Western town, carved to scale from sugar pine, measures 15 feet long and three feet wide

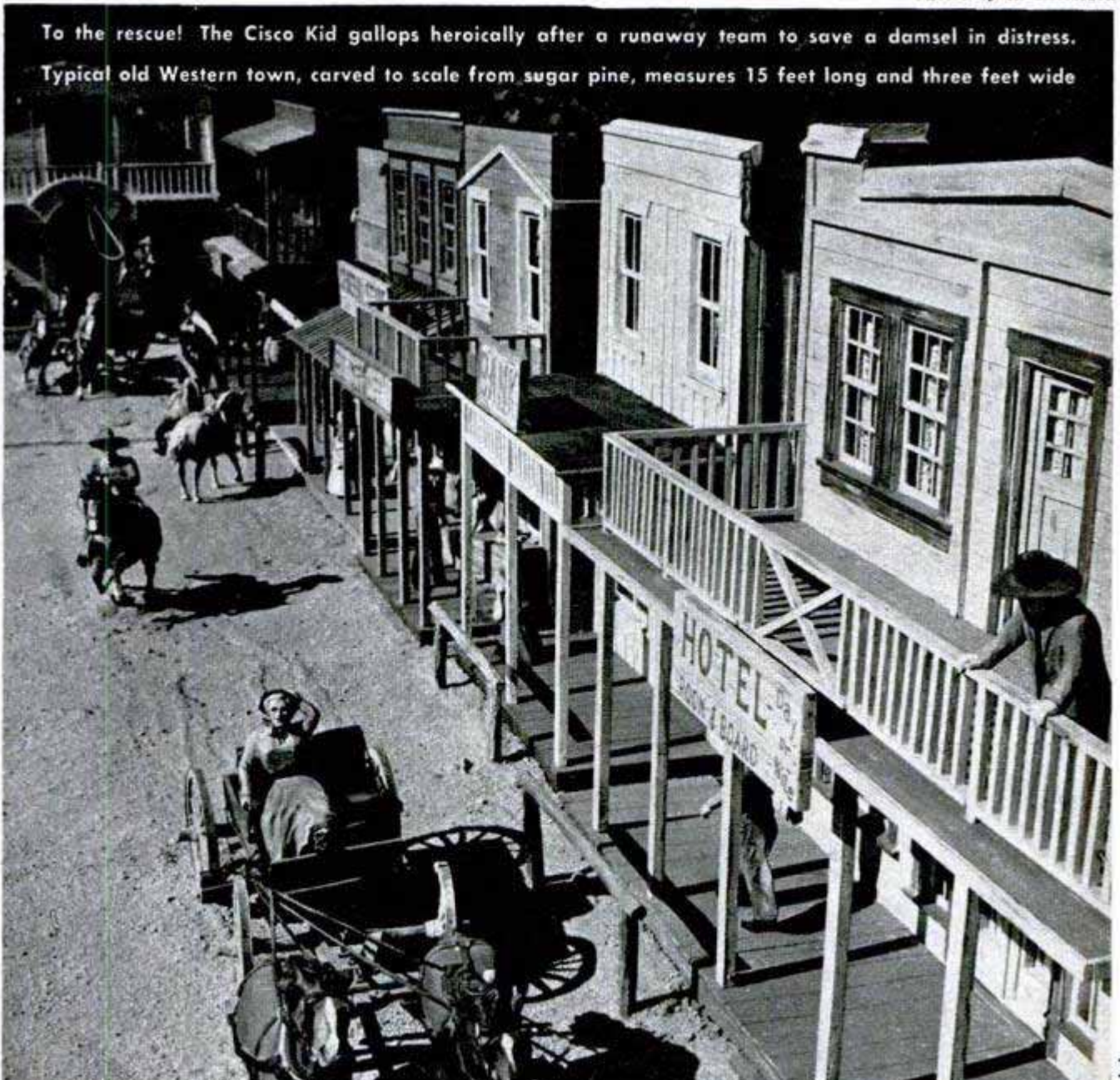

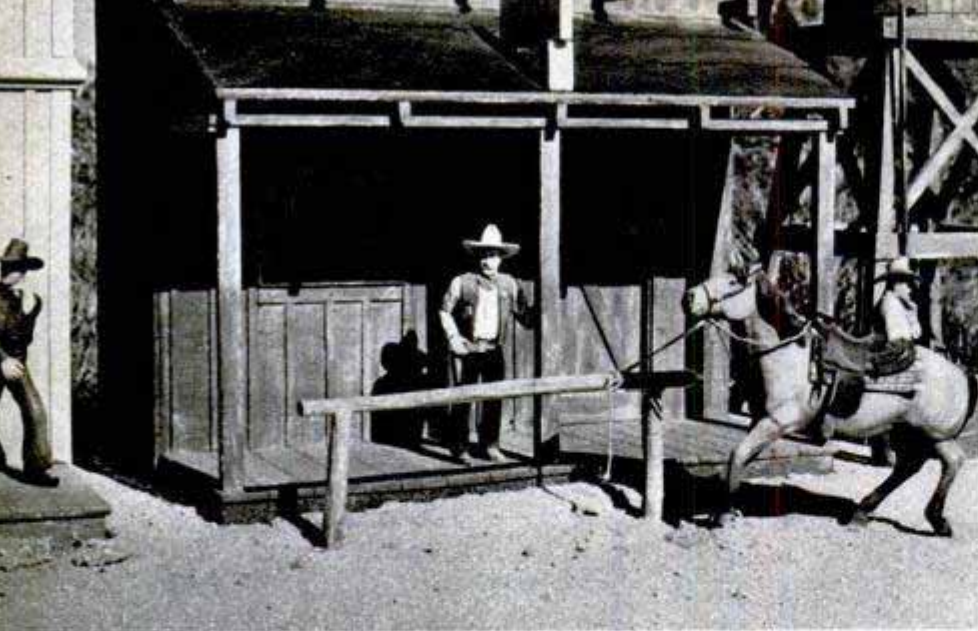

← Sheriff emerges from his office door to see what all the excitement is about while his trusty steed stands by, ready for a gallop up the street

Below, left, a sharp knife carves the final touches on the figure of an idle cowboy playing his harmonica



Mrs. Crouch, who has been whittling since she was only 12 years old, roughs out figure of a tired bronco

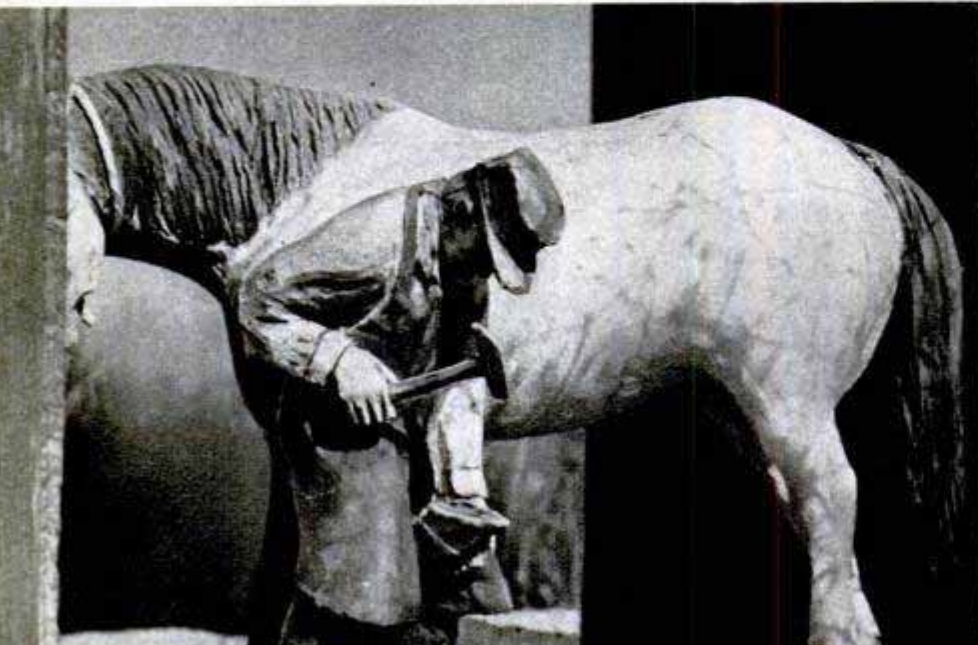

← Old village smithy carefully shoes a horse, oblivious to the excitement created on street by runaway team

sheet of paper, freehand, then transfers the sketch to a block of sugar pine. The rough form is cut out with a coping saw, and the fine finishing work is done with knives and small chisels. Finished figures are given a coat of linseed oil, then painted with oil colors. The entire village scene is 15 feet long, and the figures range from three to seven inches high. Central figures in the scene are Our Hero trying to rescue the hysterical and beautiful Heroine in Distress while the rest of the village looks on. At the other end of the village street a stagecoach, toting a shipment of gold, rolls into town accompanied by a guard, armed and ready for any forays by Western outlaws.



Slightly bowlegged cowboy leads two horses from the livery stable. Figure of the cowboy took about 16 hours to whittle

Stagecoach carrying a shipment of gold rolls into town, accompanied by an armed guard. Comparative size can be judged in this photo of the figures posed with their creator

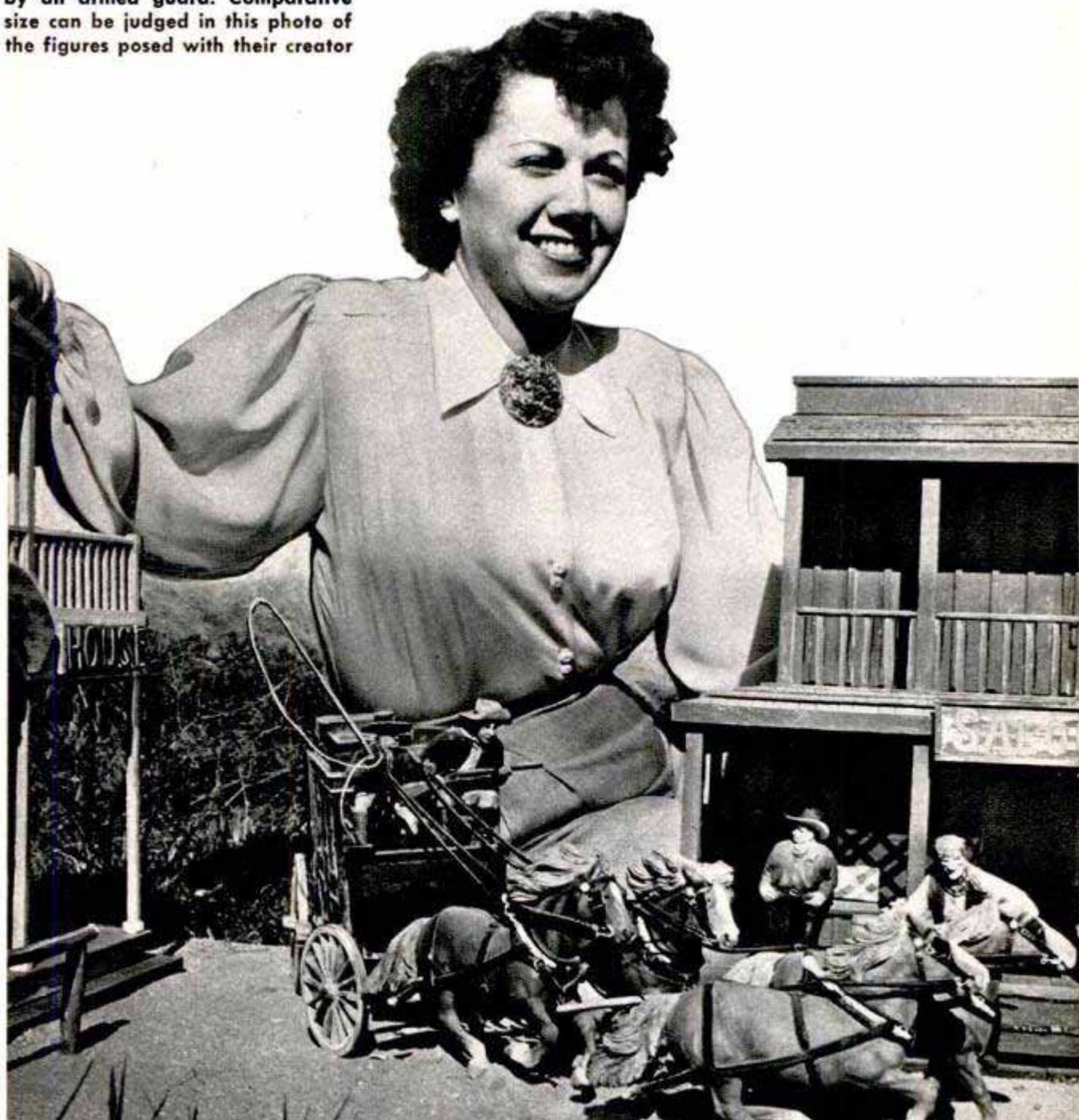



Luxury in clothing. The fur tips of the chinchilla wrap the model is wearing are smoke gray, blending into a slate blue below. Her hat is also chinchilla



Breeder Earl Allen handles his tiny rodents by their six-inch tails. They thrive at moderate temperatures

CHINCHILLAS GO UNDERGROUND

CHINCHILLAS have been housed in quarters ranging from bedroom closets to a Park Avenue penthouse. Some put their \$1,500-a-pair fur-bearing charges in the basement—a technique which has the blessing of Earl Allen, one of the country's largest commercial breeders.

Breeders once considered plenty of sunlight and exercise space necessary. At the Allen ranch, inland from San Diego, Calif., the original animals were reared in a small dugout because space was at a premium.

They did so well that a 100 by 100-foot cave of reinforced concrete was constructed for a maximum of 2000 chinchillas. It has pens measuring only six square feet, elevated 15 inches from the floor to facilitate cleaning and handling.

These tiny natives of the Andes thrive at a temperature ranging from 55 to 65 degrees, and a few dollars worth of vegetables feeds them for a year.

Built when it was learned chinchillas don't require sunlight, concrete cave at left, below, will accommodate up to 2000 animals. Feed cart, right, carries cheap vegetables and pellets to the fur-bearing vegetarians

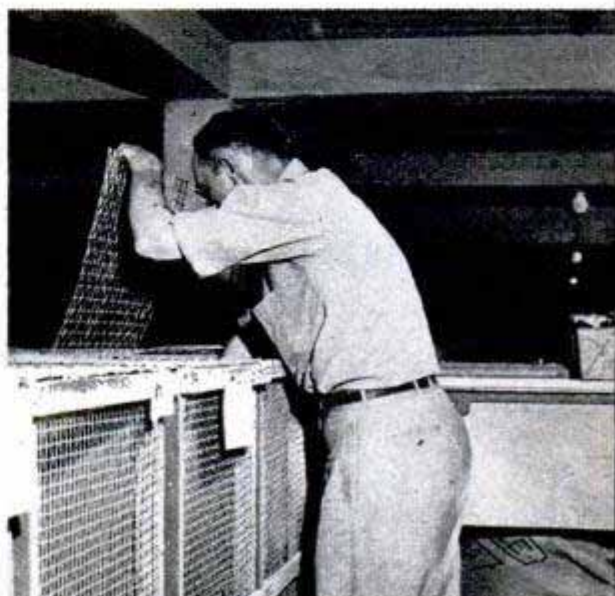
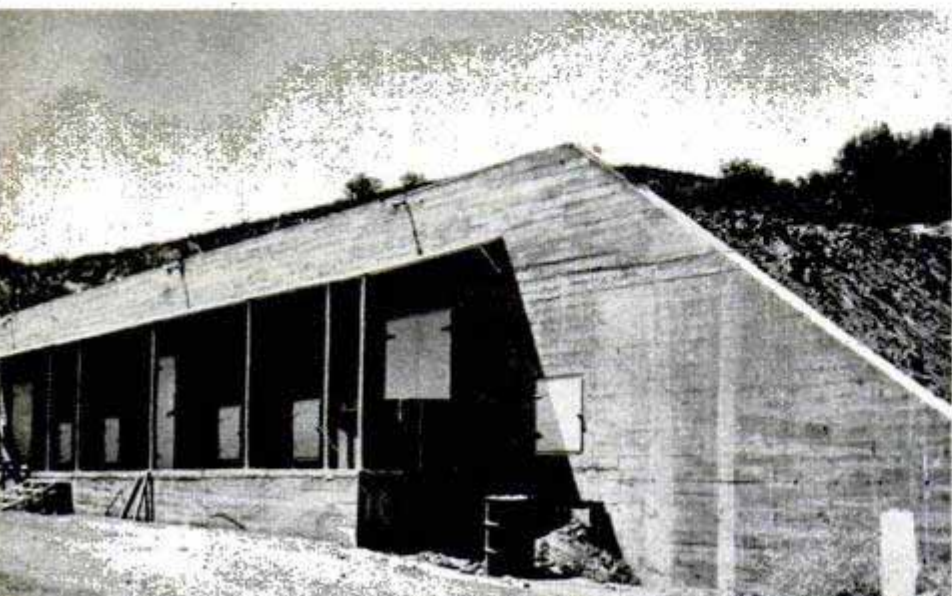

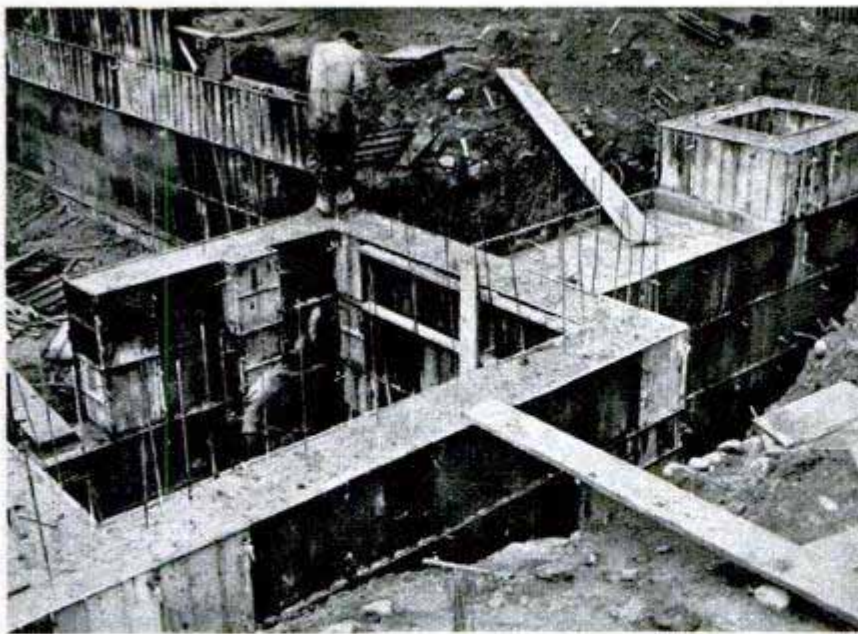

Seymour F. Maikin photos

Prefab A-Bomb Shelter Shipped to Site on Trailer

Atom-bomb shelters now are available in prefabricated form. The parts are shipped by flat-bed trailer, unloaded at the purchaser's home and lowered into a backyard excavation. The main section of the shelter has walls made of five-inch reinforced concrete. The roof is six inches thick. Another section of the shelter, similarly precast, has a steel lid, a slide down the center for fast entrance and stairs at the side. It fits into an opening cast in the main section. Still another section is a vertical escape hatch equipped with ladder rungs and a steel lid. It is connected to the shelter by standard sewer tile and may be installed at

Above, left, one model of bomb shelter is poured on the site. Others are shipped in precast sections. Above, escape hatch can be located anywhere. Below, cutaway model of prefab shelter

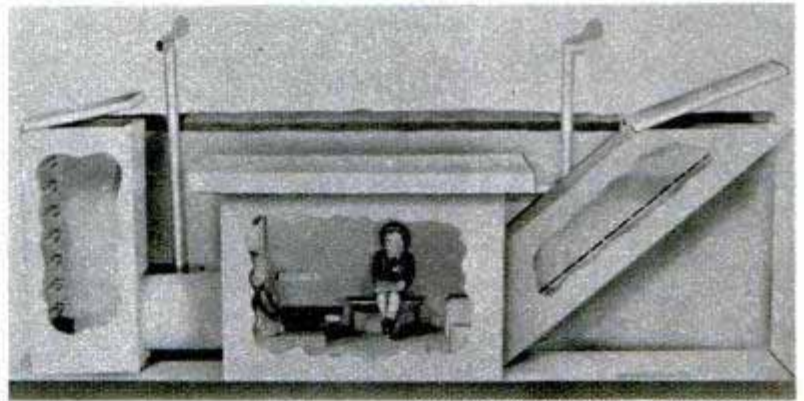

A-Bomb Shelter Corp., Teaneck, N. J.

any desired distance away. When the shelter is assembled, an additional slab of concrete is poured over the roof. The lawn then is backfilled to the level of the steel lids.



Martin Fireproofing Corp., 2200 Military Rd., Buffalo 17, N. Y.

Concrete Saw

Precast concrete slabs can be cut to size and shape on the job by a new portable saw. It is operated by an electric motor and has guide rails to assure a straight cut. A hose attachment permits either wet or dry cutting.

If you do not find all the information you need in the WHERE-TO-BUY-IT INDEX, starting on page 12, sources of further information are available to readers without charge from the Bureau of Information, Popular Mechanics Magazine, 200 East Ontario Street, Chicago 11



Double check: The gauges used to check the threads of bolts are themselves tested with supermicrometer

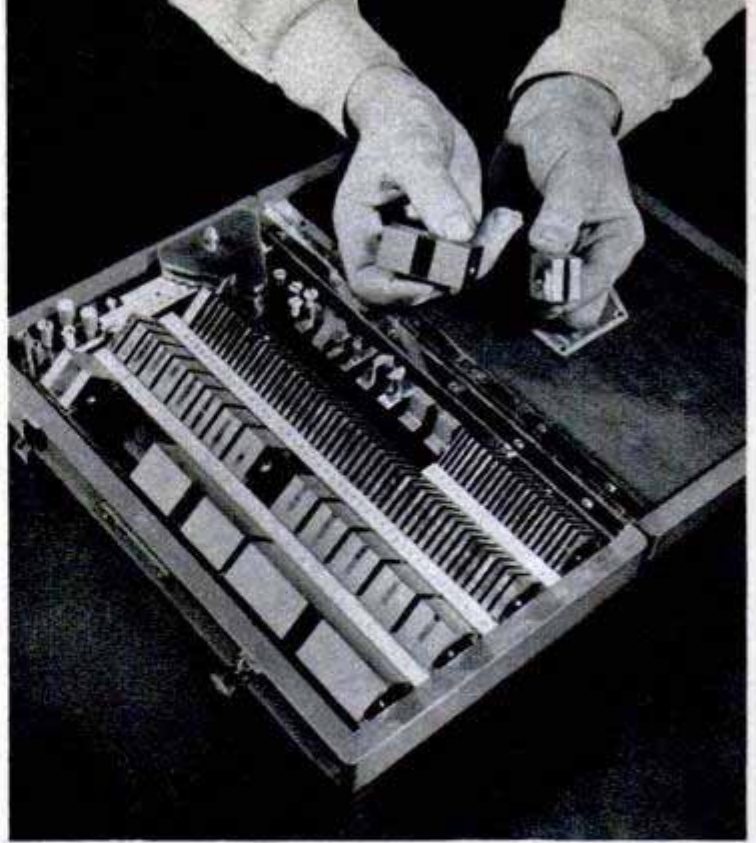

Only dry hands can handle these gauges. Even perspiration left by fingerprint can destroy their accuracy

HEADQUARTERS FOR PRECISION

Hand instruments, including calipers, squares and micrometers, check any dimensions less than 12 inches long

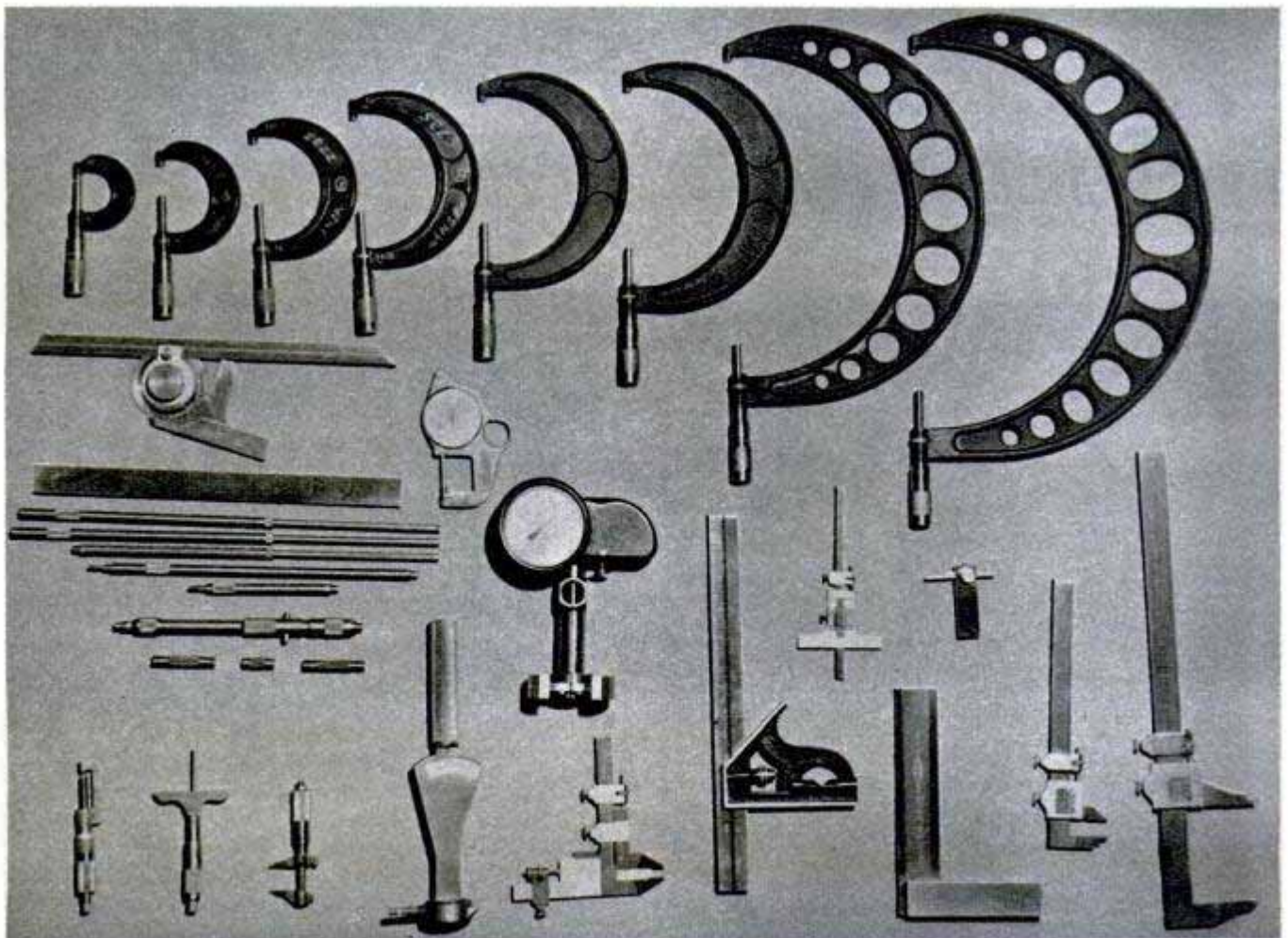



Kit of standard length bars determines whether instruments are accurate. Inaccurate gauges are rebuilt

THAT CELEBRATED dimension, the width of a split hair, is a huge measurement in a unique precision laboratory at Sharon, Pa. The laboratory is a miniature Bureau of Standards representing an investment of \$50,000.

Maintained by Westinghouse, the laboratory not only keeps a hawk's eye on the accuracy of company instruments, but also maintains a constant check on the tools owned personally by shop workers.

Once, years ago, a number of sheets of steel in the plant had to be scrapped because they were too short. A quick check of every worker's six-foot rule exposed the culprit—a rule a fraction of an inch short.

Today, there are instruments in the lab for checking almost every measuring device, from six-foot rules to the smallest micrometers and patterns. One gauge is accurate to $5/100,000$ inch and can detect an error of $1/10,000$ inch.

A sort of a "screen test" is another type of measurement used by the hair-splitters. Tiny patterns and gauges too small to be measured conveniently by ordinary means are placed in an instrument that has a round screen resembling a giant television screen. A beam of light aimed at the tiny object casts a greatly enlarged shadow or silhouette on the ground glass. This shadow then can be measured easily. Every $1/1000$ inch on the object is faithfully reproduced on the screen as $1/16$ inch.

One of the most unusual measurement tools is a set of "Hoke" blocks so temperamental they can only be handled by certain

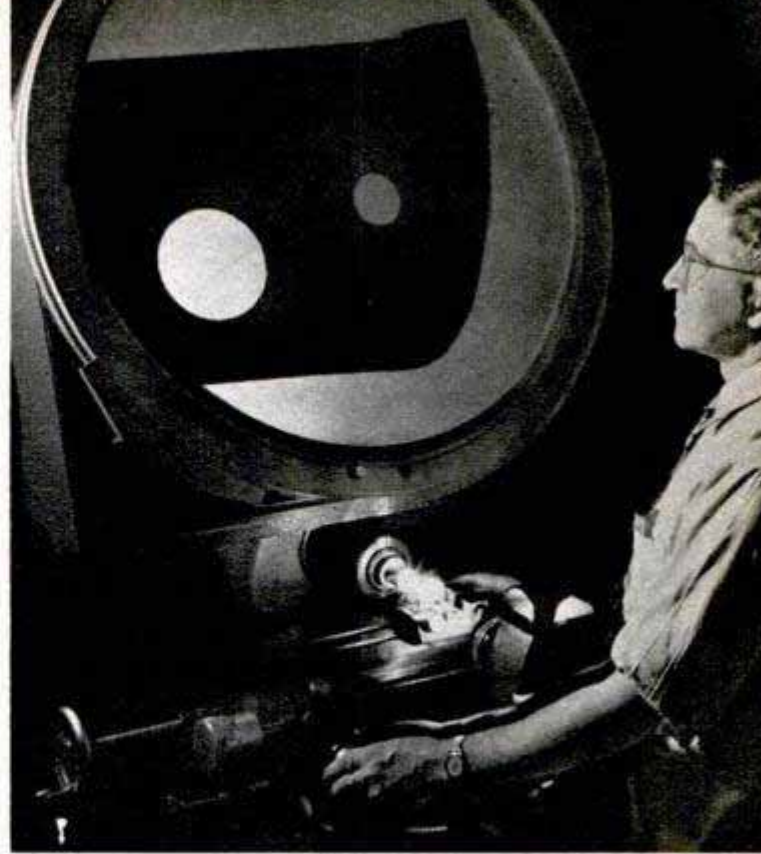

Silhouette of a tiny gauge is cast on a screen. Large outline is measured to check dimensions of the gauge

people. Made of high-grade steel, they are ground to an accuracy of $3/1,000,000$ inch. They are so highly polished that the perspiration left on them by a fingerprint can destroy their accuracy—which means that anyone whose hands tend to perspire excessively cannot use the blocks.

Still other instruments in the laboratory maintain a constant check on the temperature, pressure and humidity in each of the ovens, tanks and vacuum devices throughout the plant.

Even micrometers must be checked. This instrument can show up an inaccuracy of only $1/10,000$ inch



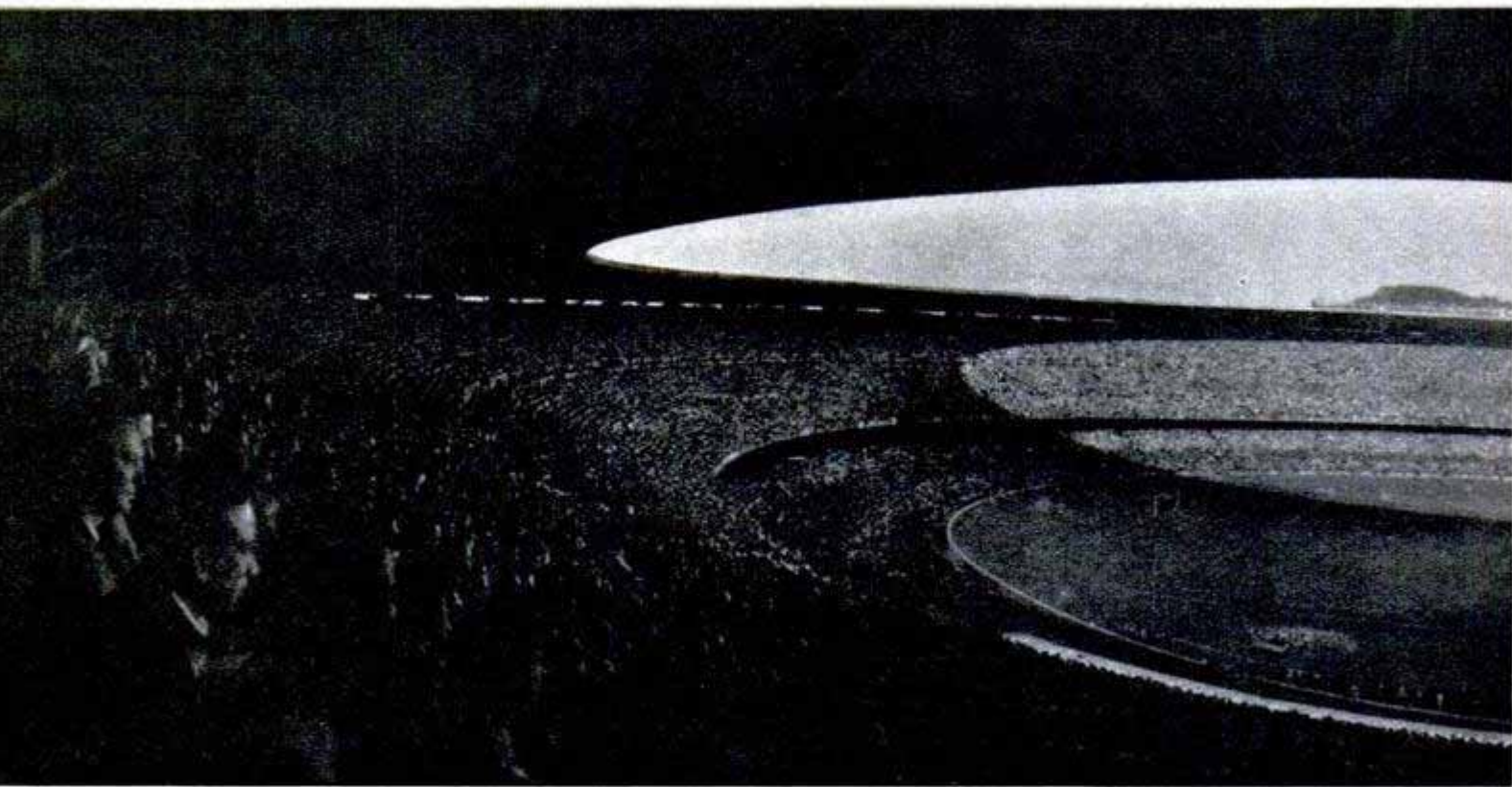

FROM Brazil comes a sweeping photograph of 200,000 people watching a soccer game. Reader Carlos Carneiro of Rio de Janeiro provided the photo after spotting the article on soccer, "The World's Favorite Sport," in the October, 1950, issue of *Popular Mechanics*. The "Colossus" of Maracana is the municipal stadium, especially

200,000 SPECTATORS—

built for the world's cup match, according to Carneiro. He adds that during the last match, when the photo was taken, Uruguay edged out Brazil 2 to 1, "the only thing we couldn't imagine." Carneiro hazards the guess that there's no other stadium as large



Walker Manufacturing Co., Racine, Wis.

High Lift for a Car

One end of an automobile can be raised as high as 46½ inches off the ground by a new hydraulic lift designed for garages and service stations. The jack handles vehicles weighing up to 4300 pounds. Four wide wheels distribute the weight over a large floor area. The jack weighs 375 pounds and has seven positive holding positions in the safety mechanism.

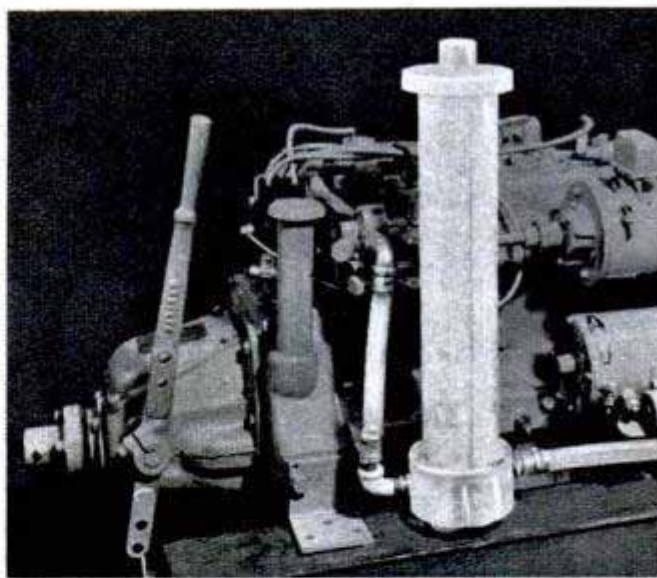

Sudbury Laboratory, South Sudbury, Mass.

Crystals Stop Rust In Engines

Cooling systems on marine engines are protected from corrosion by a thin film that coats all metal and is carried into the engine by the cooling water. Especially designed to stop damage to salt-water-cooled engines, the film is produced by crystals which slowly dissolve. The crystals are stored in a plastic cylinder through which the cooling-system water passes.

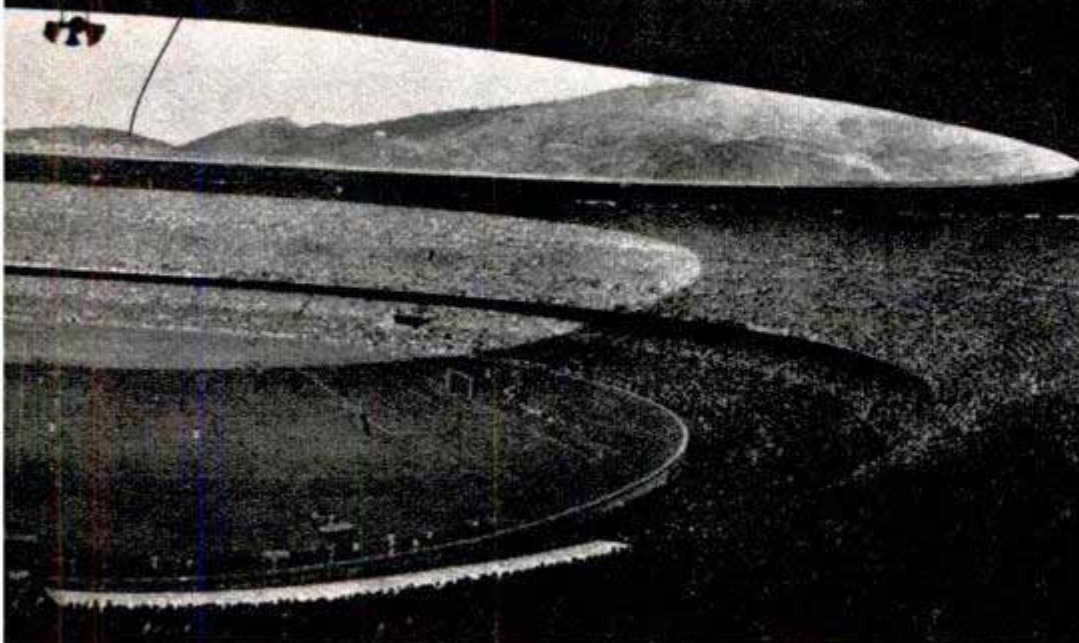

ONE SOCCER GAME

as this one in the world. Soccer, according to this reader, is the principal recreation in Brazil, and even in the sparsely settled areas the traveler can always find two things—a church and a soccer field. He says Brazilians play soccer in a special way of

their own, and describes the famous “bicycle” shot in which the player “jumps, feet upwards, and with a sudden movement of legs that reminds you of someone riding a bicycle, he shoots the ball to a place to which he has his back turned. We play soccer in a very special way of our own—you can’t find in books what our boys do.”



Garbage Truck

When the garbage collector on Kahuku plantation, Hawaii, makes his rounds, he doesn't have to handle the refuse because he hauls the loaded container to the disposal area. Steel bins are placed around the village in places convenient for the residents. An old straddle truck is the garbage vehicle. Extension arms on the front of the truck pick up the large containers as they are hauled to the dump. There, the bottom of the bin opens and the refuse falls out.

Tortillas the Easy Way—Just Add Water and Bake

Mexican housewives can now make their own tortillas right “out of a box” simply by adding water to a prepared mix. Used like American biscuit mixes, the tortilla flour is also suitable for atoles, tamales and other basic items in the Mexican diet. Tortilla

dough is perishable and, prior to the introduction of the new preparation, had to be mixed from freshly ground wet corn shortly before baking. The mix, which can be stored for long periods, will eliminate hand grinding and waste.



Photos courtesy California Division of Fish and Game

Drinking Fountain Saves the Quail

By **Claude M. Kreider**

A CASUAL OBSERVER would be puzzled to see three men put a heavily loaded truck over brush and rocks to reach a point high in a basin of California's arid hills. The actions of the three would be even more mystifying. One serious fellow, the leader, studies the terrain, with special attention to the slope and drainage area. Another starts with pick and shovel to dig a square hole. The third finds faint tracks of birds in the dry wash and exclaims with satisfaction. Their errand promises to avert a tragedy which countless times has threatened the existence of the beautiful California valley quail. A quail "guzzler" will be installed, for collection of rainwater, to carry the birds through another hot, dry summer.

Quail, like chickens and all members of the Gallinae family, require a small amount of water daily. The effective device to supply quail with water is the invention of Ben Glading, assistant chief of game conservation of the State Bureau of Fish and Game.

Quail, once found in thousands throughout the valleys, foothills and adjoining brushlands, have had to give way to encroaching civilization and hunting pressure. Pushed higher into the hills, these hardy little natives are living where springs



and water holes soon dry up after the meager winter rains. It is sheer tragedy when the fluffy little baby chicks, no larger than a walnut, hatching as many as 15 to a nest, die of thirst during the nesting season.

Biologists of the Division of Fish and Game estimate that this mortality in dry seasons is perhaps greater than all other causes combined. Thus, more than 800 guzzlers have been installed during the

past few years, and already their worth has been proved of inestimable value.

The modern guzzler is being constructed largely of plastic-treated Fiberglas sheets. This material is impervious to seepage, wears well in all kinds of weather and is comparatively easy to install. The rain-collecting apron is laid to slope sharply into the buried tank, and is planned to have an area to fill the tank when it catches half

Until conservationist devised dry-weather water fountain for wild quail, thousands died in summer. Water is caught during the rainy season in oval apron below and runs into a big underground tank

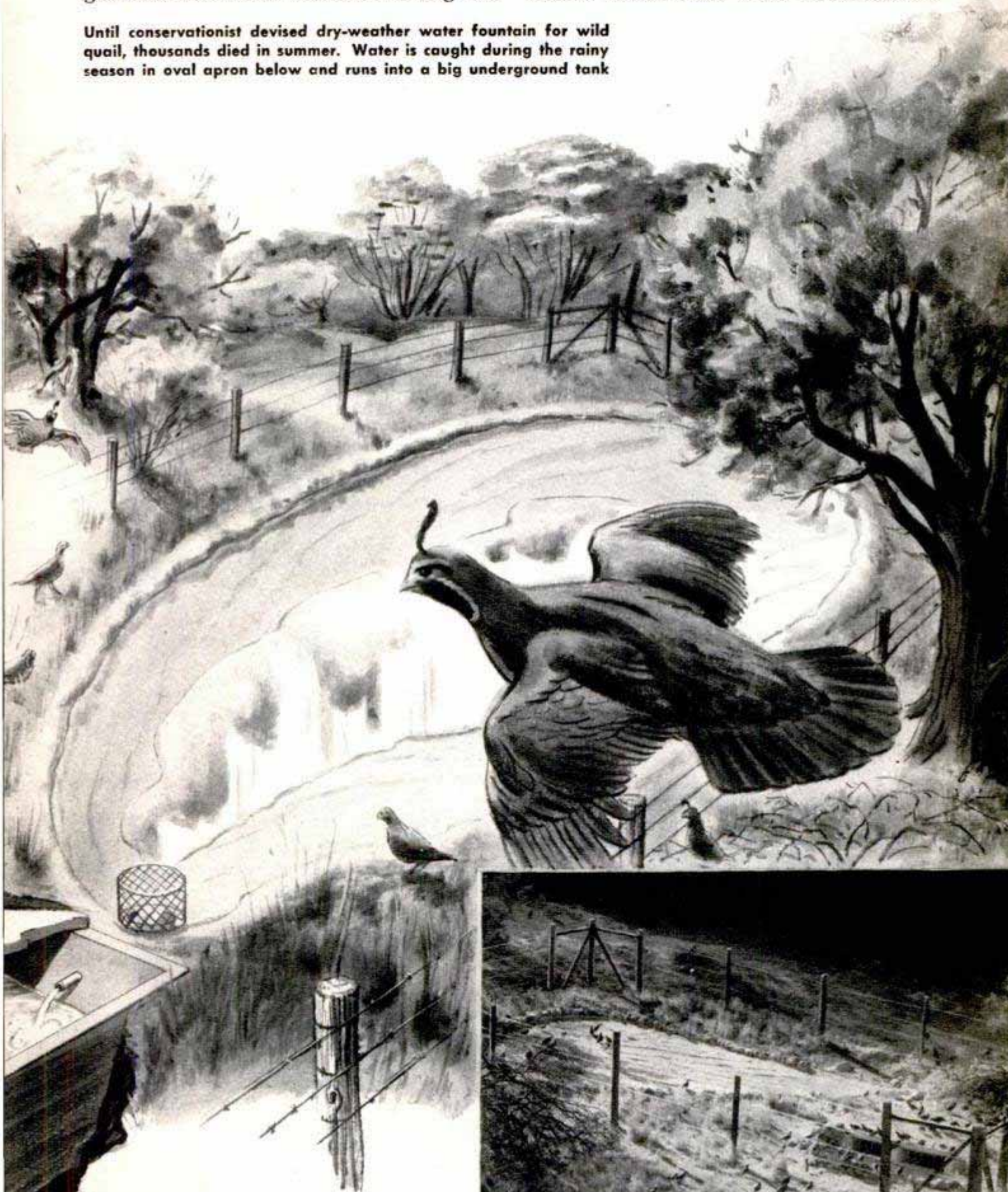



Field worker digs hole for quail "guzzler" tank. An apron for catching rain will be spread on slope above. Protective brush is left around the fountain



Top of water tank is leveled before sealing and installation of drain. Below, glass mat apron is laid on slope above tank with low dirt border around it. Three inches of rainfall will fill 400-gallon tank



the minimum annual rainfall in the area.

In the dry foothills and semidesert regions, having a rainfall of six inches per year, a 400-gallon tank will be filled by three inches of rain falling on an apron of 215 square feet, shaped roughly oval, about 18 feet across. This amount of water, about enough to supply a family of humans for a day or two, will maintain possibly 500 quail, as well as other birds, through the long, hot summer.

Without this constant supply the birds would perish, for they do not seem to have the instinct to enable them to find a new supply. The birds using a guzzler will seldom be found more than a mile from it, so dependent are they on the water supply. For this reason, the devices are usually well hidden, since hunters know this and seek the quail near the watering spots.

The storage tanks are built of concrete and Fiberglas with a heavy tight top, and are buried in the ground. A strainer is built in at the apron outlet. To prevent drowning, as has often been the case when quail water at sheer-sided cattle troughs, a narrow ramp enables them to follow the water down as the supply drops.

Steel rods keep out large animals and a cover of 2 by 4-inch redwood is bolted above the ramp. In other instances, the concrete top projects over the entrance. A strong cattle fence is built around the entire installation to keep stock and game animals from trampling the apron.

The ideal location for a guzzler requires first a good drainage area, then scattered brush to give the birds a feeling of security as they approach. The scant shade also provides a place to rest, dust and preen, just as the barnyard chicken does after a drink.

More than 800 quail have been counted using a single guzzler. Counts made at guzzlers in use three years showed an average use of 185 quail for each. Doves, rabbits and songbirds were also found to be drinking there.

Other states and territories have followed California's lead, and guzzlers have been installed in Oregon, Washington, Utah, Arizona, Nevada, New Mexico, Hawaii and Puerto Rico.

Thus, this comparatively simple and inexpensive device promises to go a long way in game conservation. It is saving the valley quail, the official California "state bird."

Everyone loves and respects this little citizen, with his gay, nodding plume, twinkling feet and beautifully speckled "vest." The foresight and planning of the bureau officials, aided by sportsmen's groups, in many instances, have insured that the valley quail will not go the way of the passenger pigeon.

50-M.P.H. Scooter

Extra riding comfort has been built into the new Cushman motor scooter which features super balloon tires and oversize coil springs on the seat and front wheel. The new model, called the "Eagle," is powered by the Cushman four-cycle, five-horsepower engine that travels as many as 75 miles on a gallon of gas and has a top speed of 50 miles an hour.

Old Sol's Getting Hotter

During the past 20 years, the heat of the sun, as it reaches the earth, has increased a fourth of one percent, according to findings of the Smithsonian Institution. This statistic is the result of an analysis of more than 16,000 measurements at the Smithsonian's observatory on the summit of Mount Montezuma, Chile. While this increase may seem insignificantly small, it

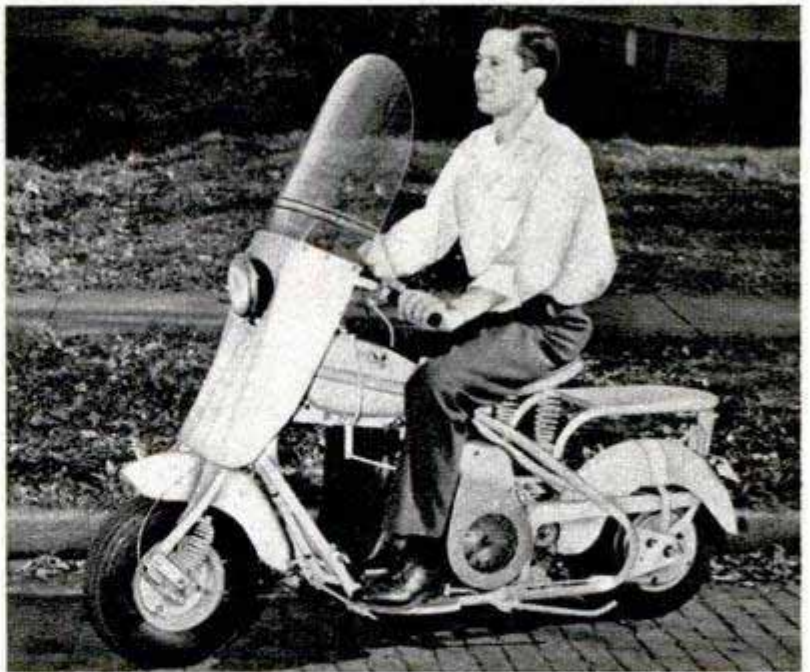

Cushman Motors, Lincoln 1, Neb.

means enough extra heat has reached the earth to have affected climate. This fact, no doubt, has bearing on the tendency toward milder winters in most of the world.

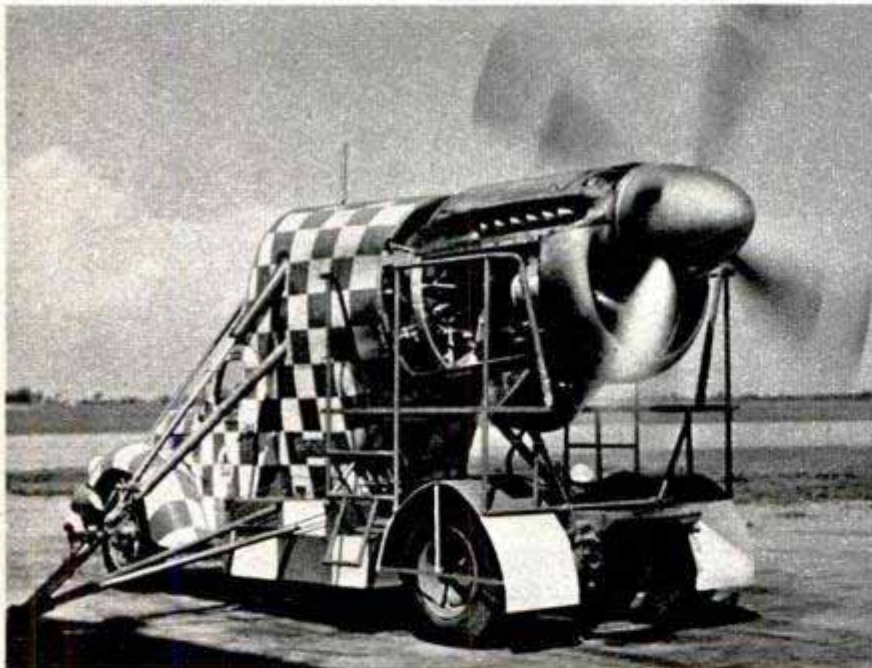

Air-Powered Groundling

Nicknamed "Pluck"—half plane and half truck—a mobile engine run-up stand eliminates a noise nuisance from the main part of Montreal's Dorval Airport. Power plants for Trans Canada Air Lines planes are put in a steel frame at the back of the truck and driven to an isolated part of the field for test run-ups. In addition to being chained down to counteract the engine's 5000-pound pull, "legs" salvaged from a derelict Lancaster are extended down from one side of the truck to give further stability. Inside the cab, dials usually found in a cockpit register every detail of the engine's performance.

Colored Jackets on Plugs Lure Hard-to-Get Fish

Fishermen who aim to please will be interested in the "Strip Teaser." It is a black and white plug that comes with black and green, gray and pink, and yellow and green jackets. If one color doesn't attract fish, the angler can slip on another jacket without removing the plug from the line. An adjustable bib makes the plug travel on the surface or deep down for the big ones. It can also be adjusted to obtain lazy, medium or fast action.

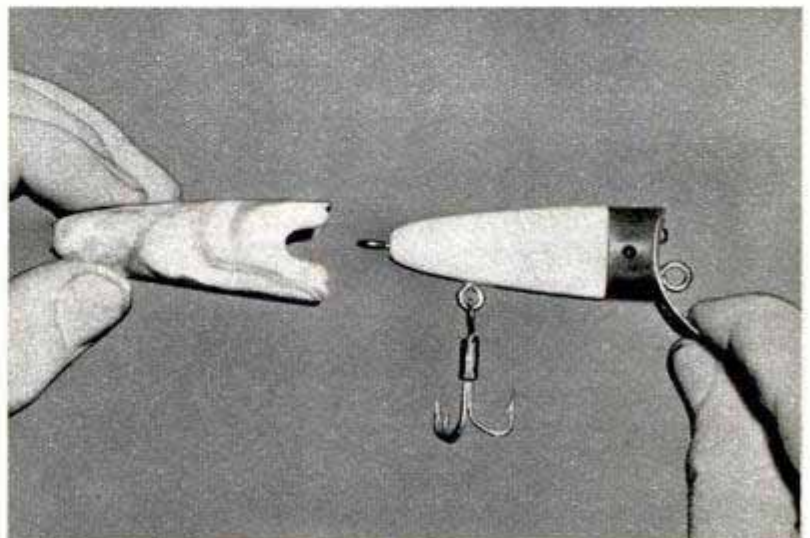

H. & H. Plug Co., 228 Randolph St., Waterloo, Iowa.



This may look like a mammoth roller coaster, but it's a pipe line that will siphon water to the mill of an Hawaiian sugar plantation

Right, the car starts down the sharp incline with its load. Notice the restraining cable that is operated by a gasoline-driven winch

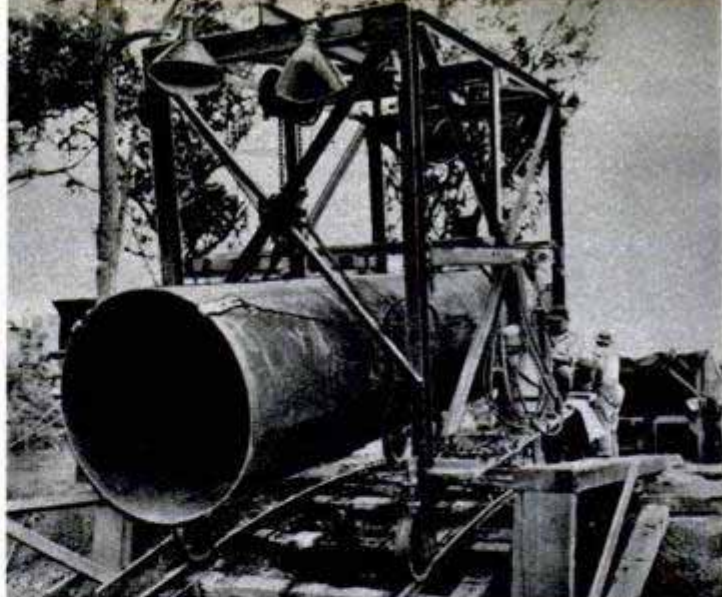

Two men can move the bulky sections of 54-inch pipe down a steep mountainside with this straddle-loading "trolley"

CABLE-DRAWN "TROLLEY" LAYS MOUNTAIN PIPE LINE

LOOKING like a stripped-down Toonerville Trolley, a cable-drawn car is actually a mountain-climbing stevedore in the construction of an Hawaiian pipe line. At the Waialua plantation on the island of Oahu, engineers laying a 54-inch water pipe line over extremely hilly terrain were faced with a transport problem. How could they lower the bulky pipe sections down precipitous slopes, almost too steep for men to work on? Lowering the pipe by hand was slow and dangerous.

Their answer is a cable car that straddles the pipe and carries it down the steepest slope on tracks, holding it securely while the weld is made. A gasoline engine drives a winch to provide the tension needed on the cable to lower the car slowly with its load and to pull it back empty for another pipe section. The pipe line is assembled right on the tracks. Rails and ties are left in place to support the heavy pipe, which serves as a giant siphon, carrying water to the plantation's sugar mill.



the **POPULAR MECHANICS** **CRAFTSMAN**

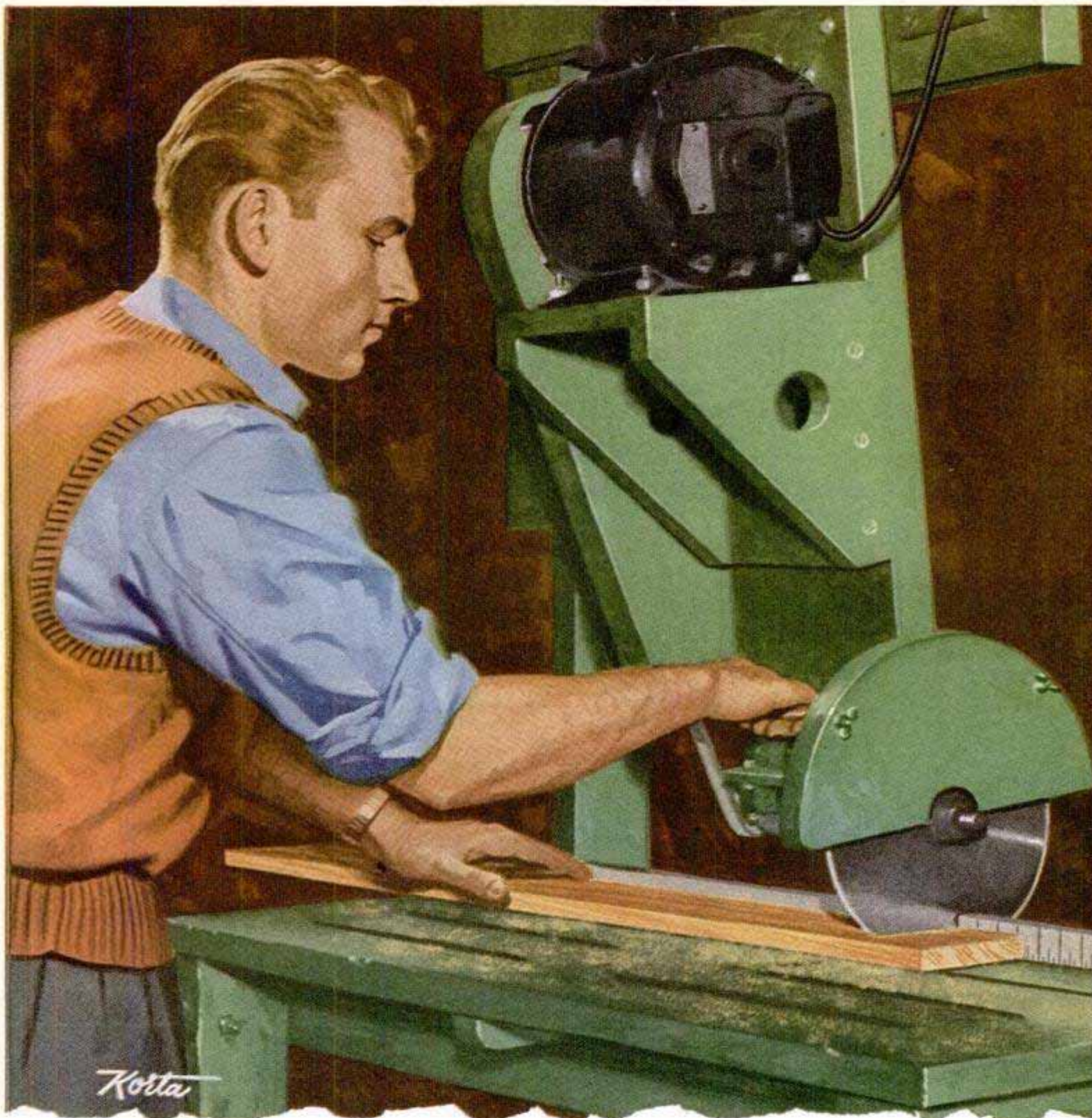

▲ For fast random cutting, there's nothing like a swing cutoff saw to rough out stock in a hurry. Ideal for small cabinet shop. See page 212

Table fountains that spout water realistically make unusual centerpieces. Page 194



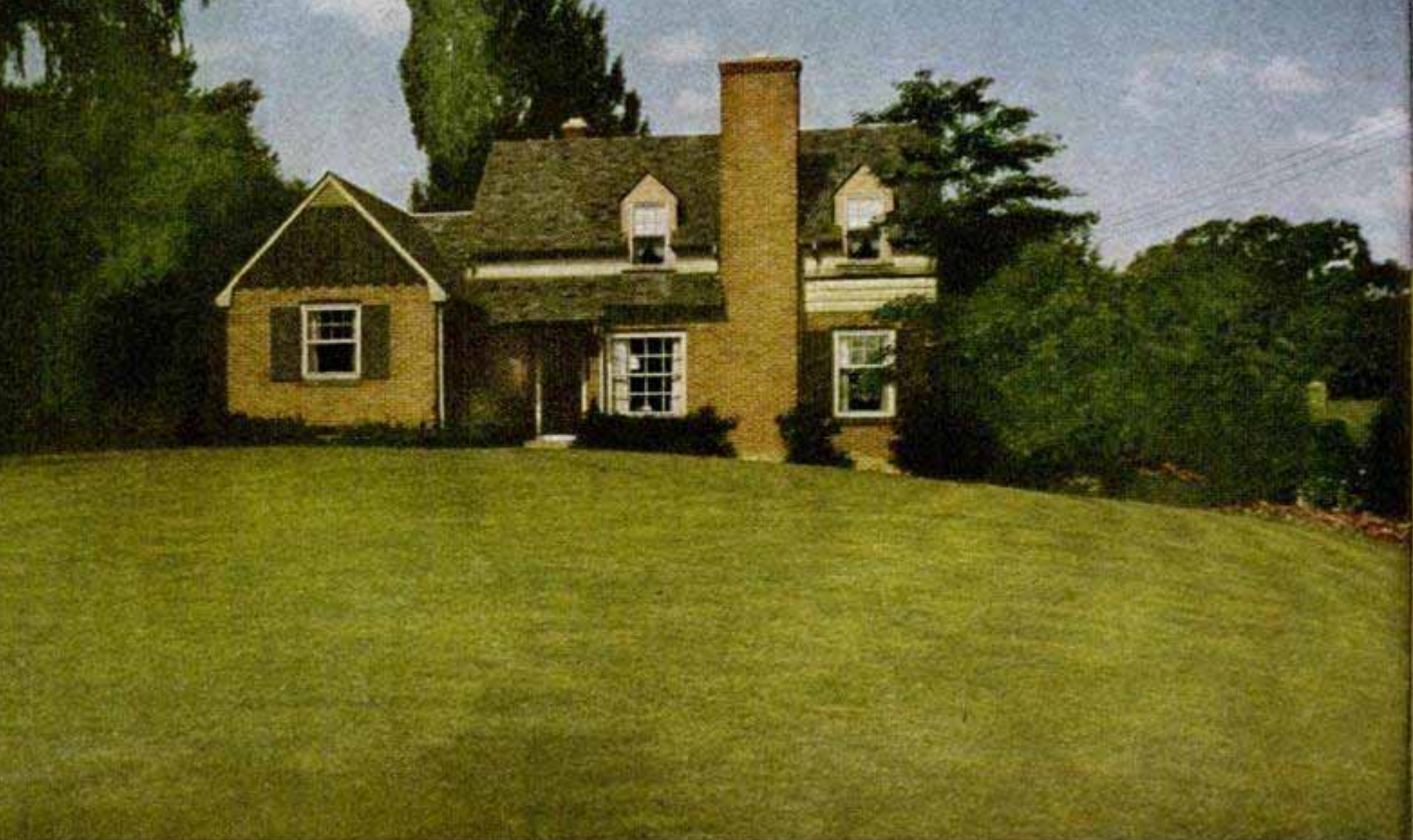

Be proud of your **LAWN**

Photos and story courtesy O. M. Scott & Sons Co.

IT PROBABLY IS safe to say that 75 percent of all the time, effort and money spent on lawns is wasted by the average homeowner. And, yet, this costly waste actually is unnecessary because establishing and maintaining a well-groomed and healthy looking lawn amounts to little more than following a few do's, don'ts and whens.

Many new lawns turn out disappointing-

Like any living thing, your lawn needs a certain amount of sun. Keep any large tree on the lot trimmed to let sunlight come through as much as possible

ly because they were planted at the wrong season. In most localities, the best planting times are late summer and early fall when shorter days and cooler evenings aid root development of the tiny seedlings. Germination and seedling growth are better when the soil is warm, the sun not quite so hot and moisture more abundant. However, in spite of the fact that the best time may be autumn, most grass seed is planted in the

Avoid giving your lawn a "crew" cut. In cool weather, set the mower for a 1-in. cut or more and raise it to 1½ to 2 in. when the weather is hot and dry





Does your lawn produce a harvest of dandelions like this one? Dandelion control is now so simple that you can rid your lawn of them practically overnight. Fill a spreader with 4-XD and simply wheel it over your lawn

spring. Although good lawns can be developed from early spring plantings, they will require more attention than autumn sowings. Thorough preparation of the seedbed, an abundance of available plant food, and proper watering and mowing are the fundamental requirements for success with a spring seeding.

You already have most of the tools: Except for possibly a fertilizer spreader, the average homeowner possesses the few tools needed to maintain a fine lawn, namely an iron garden rake, a spade and a mower. While the rake will do to pulverize any crusted bare spots so that new seed will

Rolling a lawn is somewhat out of fashion now. Harm can be done by compacting heavy soil. Roll only to press new seeding or in cases where roots are heaved

have good lodging, a half-moon turf edger will be found more convenient in loosening and breaking up the soil of such areas.

Many homeowners make a point of getting out the lawn roller on the first balmy day. Rolling of lawns, however, is considered by some to do possibly more harm than good, especially in the case of heavier soils. Good loam soils seldom need rolling. In any event, heavy rolling always should be avoided. About the only reasons for rolling are to firm heaved roots back into the soil or to press soil around new seedings. Here, only a lightweight roller should be used, the hollow water-ballast type

Several spray compounds and one dry-powder type are available for stamping out obnoxious crab grass. The powder compound is applied by using a spreader





The most efficient and economical method of applying both fertilizer and seed is with a mechanical spreader. Uniform coverage is insured and there's far less waste of material as compared to broadcasting by hand

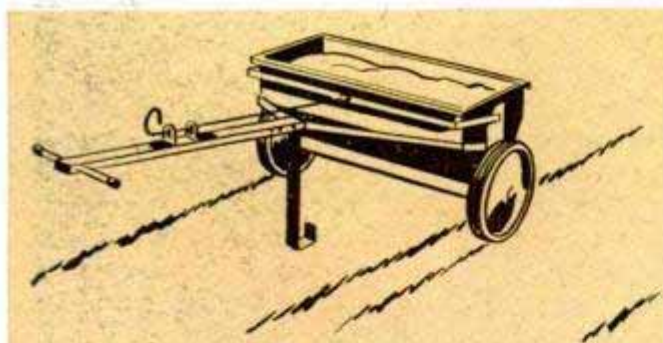

The spreader is used in much the same manner as a lawn mower, overlapping each strip slightly to make sure the area is completely covered

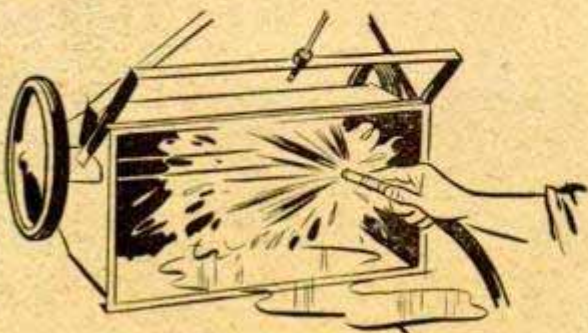

After using it to apply fertilizer, wash out the spreader with a hose before sowing seed. Wipe and push spreader to air-dry agitator

probably being the best when filled with only enough water to accomplish the job. In addition to standard reel-type power mowers, horizontal or rotary-scythe mowers recently have come into wide use.

Many lawns need lime: Not so many years ago it was a common procedure to give a lawn an annual "whitewash" or light dusting of lime, that was as much a spring ritual as sulphur and molasses for the whole family. Later it was found that overuse of lime actually encouraged the growth of weeds. As a result, many made the mistake of not using lime at all. Except in localities having limestone soils or where the sprinkling water contains considerable lime, lawn soils may need "sweetening" with fairly generous applications of lime every two or three years, especially in cases where the soil is quite acid or where there is a deficiency of calcium and magnesium. This is particularly true of the country in and to the east of the Allegheny Mountains. In case of doubt, it is a good idea to arrange for a pH test of the soil, pH designating a unit of measure which chemists use in determining the intensity of alkalinity present. Some of the larger seed companies provide a testing service, as do county agriculture agents and state experimental stations. Do not use quick or slaked lime. Instead, use either hydrated or raw-ground agricultural lime. A typical dose is 25 to

50 lbs. per 1000 sq. ft. Lime may be used almost any time provided it is applied a couple of weeks before sowing seed or adding fertilizer.

The spring program: Applications of special grass foods (fertilizer) are advisable as early in the spring as possible. Frequent feeding is quite important—three or four times a year until the lawn is well established and then at least twice a year. The selection of lawn food is important. Manure in sufficient quantities would provide the nutrients needed but, even if at hand, would introduce too many weeds. The one advantage of manures—slow availability—also is found in those lawn foods composed in substantial part of organic materials. Thus, for a quick pickup for grass, a complete fertilizer, or turf builder, is the ideal material. Uniform application at the proper rate is important and is best accomplished by using a mechanical spreader. Hand broadcasting is bound to be uneven with some spots receiving entirely too much and others none. Uneven color and spotty growth result. Spreaders having a rotary agitator have been found superior to the shaker,

With a spreader, effective crab-grass killer in powder form can be applied to an infected lawn with as little effort and time as it takes to walk the lawn

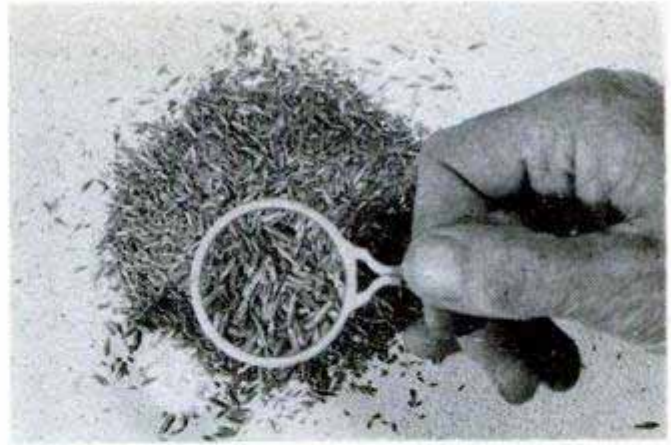

These two photos show graphically that there are more than three times as many seeds in a pound of the best grass seed than in a pound of cheap seed

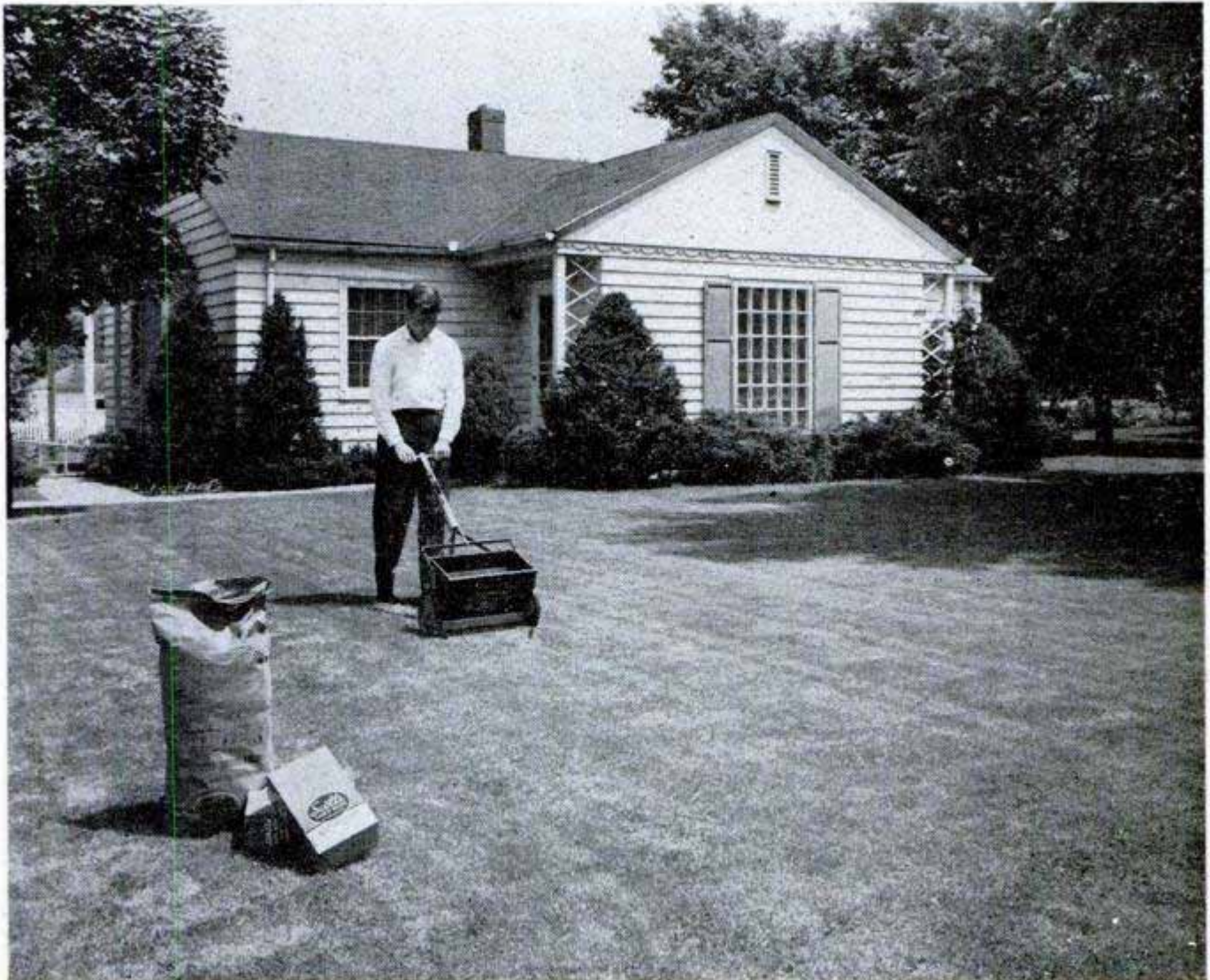



Here, a test plot of a lawn badly infested with crab grass is being treated to show the effectiveness of a powder-type weed killer. Bottom photo shows the test plot completely cleared of crab grass. The test-plot idea also can be used to determine whether or not your lawn needs lime. Treat an area, and then observe if grass becomes greener than that of untreated area

or vibrator, type in delivering an even flow of material. This is important to prevent dumping in ridges, or applying the material in a washboard pattern. Hoppers designed with closely spaced slots in the bottom insure even distribution across the width of the spreader, and actually broadcast the material instead of depositing it in rows.

Seeding and feeding: In cold weather, it is all right to sow seed immediately *after* applying fertilizer. In warm weather, it is best to follow manufacturers' directions. With some materials, it may be advisable to wait a week or so. Freezing or even zero weather will not harm good seed. If lawn food has been applied and the date is such that late-winter or early spring temperatures of 25 deg. or lower are expected, it is all right to sow seed on established lawns without any soil preparation. Alternate freezing and thawing will open small cracks and crevices in which the seed will lodge and where it will find protection and

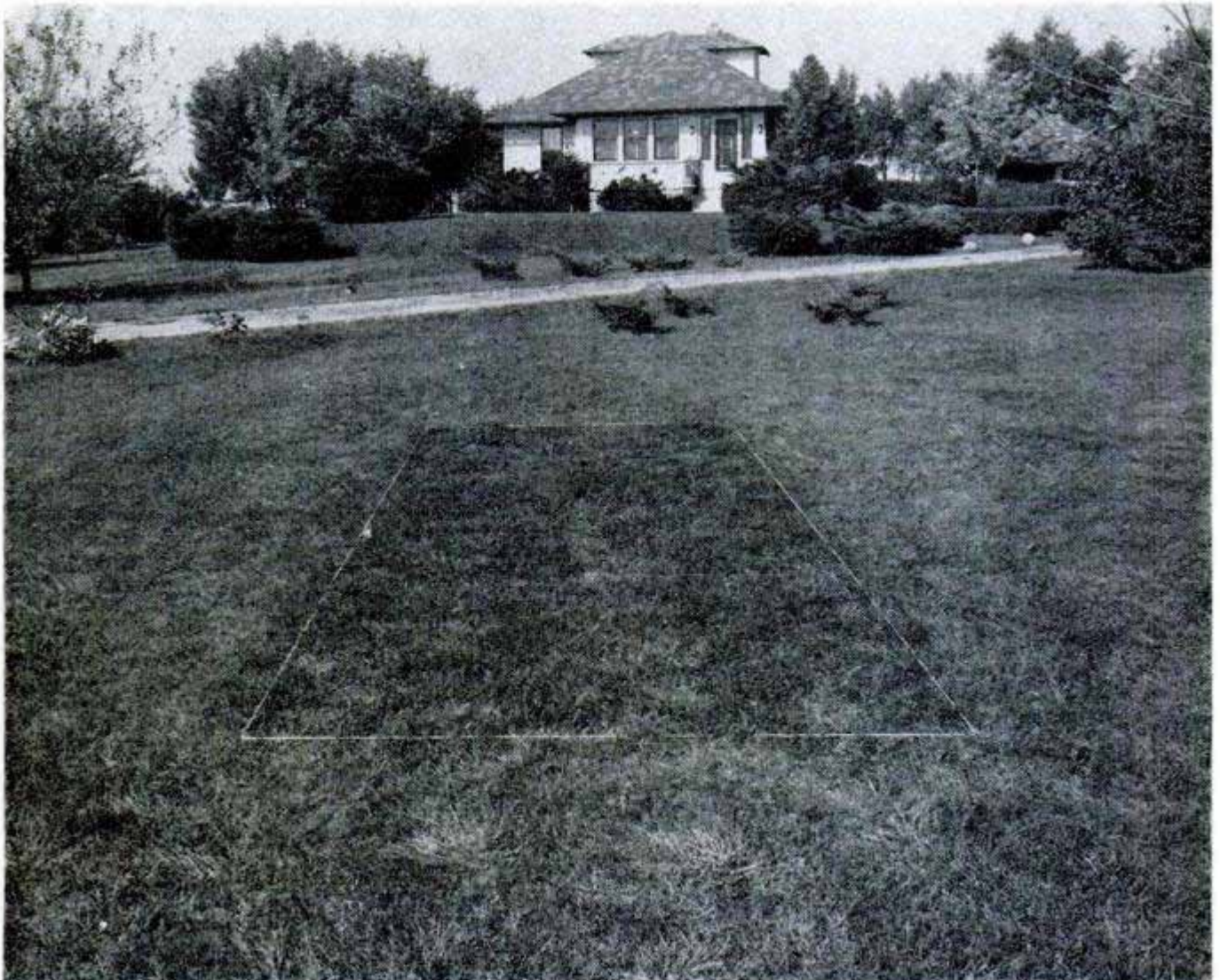

moisture as the ground warms sufficiently for germination. If seeding is delayed until later in the spring, it is advisable to cultivate the bare or thin spots. In some seasons the weather is such that established grass will have grown considerably before the new seeding germinates. In that event, the mower should be set to cut the lawn closely.

The quantity and kind of seed selected have the utmost bearing on the results. The best may cost as much as \$1.50 a lb. but it is worth it, considering that there are as many as 3,000,000 seeds per pound in first-rate mixtures as compared with less than a million in the cheaper grades. As each seed will potentially produce a single plant, the advantage from the numerical standpoint is quite obvious. Then, too, the better the quality, the more sure you can be that it is free of weed seed. When sowing grass seed that contains even small quantities of weed seed, the homeowner is planting a costly headache for the future. Most persons waste seed because they broadcast it by hand and often have the mistaken idea that by sowing seed "good and heavy" they overcome the handicap of poor soil or growing conditions and careless preparation of the soil.

Determining the rate or amount of seed to sow with a spreader is dependent upon the selection of seed (whether it is of high or low count), the relative stand of grass on the lawn and, of course, the budget. It is usually better to sow one pound of good seed than two or three pounds of ordinary run-of-the-mill mixtures.

Weed control: Lawn weeds fall into two main classifications — grass-type weeds, that is, the monocotyledons, and the so-called broad-leaved weeds, the dicotyledons. Until scientists working with and in the U. S. Department of Agriculture discovered the miracle of 2,4-D, the appearance of dandelion, plantain and the like meant laborious hand removal.

In a new product recently put on the market, a way has been found to impregnate alkanolamine salts (of the ethanol and isopropanol series)

of 2,4-dichlorophenoxy-acetic acid in a special grade of vermiculite. The resulting product, called 4-XD, is easily applied with the spreader over any turf areas and is a most effective control for broad-leaved weeds. As 4-XD does not contain fertilizer, it is

less expensive than the weed-and-feed combination. Furthermore, it is more adaptable for repeat applications which are required to eliminate resistant low-growing, vining-type weeds such as chickweed, speedwell and ground ivy. For home-lawn use, 4-XD is relatively foolproof. It is safely applied in cool or warm weather, to either wet or dry vegetation. The product is almost completely free from dust, thus practically eliminating drift which is quite a problem where sprays or finely ground, dry materials are used.

In the past, crab grass has been hand-plucked, burned and cursed without appreciable result. Now, thanks again to a merger of horticultural ingenuity with chemistry, the problem is licked. A number of spray compounds and one dry powder are now available for controlling crab grass. When scattered over crab-grass areas either by hand or with the same mechanical spreader recommended for seed and fertilizer, the powder-type compound is caught on the broad crab-grass blades.

When nightfall brings the dew, the particles absorb moisture, a process that fastens them to the blades like barnacles on the sides of a ship. Firmly anchored, the powder feeds its chemicals (chiefly phenyl mercuric acetate) to the crab grass, causing it to wither and die. Two or even three applications of the powder at intervals of five to seven days may be necessary. Crab grass can be treated from late June to mid-September, the best time being while the grass is growing vigorously before seeds form.

Because crab grass is an annual, it is advisable that it be killed off before it goes to seed. Otherwise, hundreds of seeds will be dropped each year to germinate in the lawn the following spring. Unless this cycle is interrupted short of its seeding time, the crab-grass problem will be more vexatious the following year. In fact, even if all active crab grass is destroyed before it seeds, there will be some crab grass in ensuing years, but in much less degree. The seed

of this weed is highly irregular in germination, some of it lying dormant in the soil for several years before sprouting. These stragglers will offer no great problem of extermination and the lawn can be kept free of crab grass, providing any new invasions are quickly curbed.

LAWN AND GARDEN BOOK

If you have read this story, you are interested in beautifying the grounds around your home, and should own *Popular Mechanics* book **HOW TO GROW THE BEST LAWN AND GARDEN IN YOUR NEIGHBORHOOD**. It contains 176 pages of information on landscaping and lawn maintenance as well as how to plant trees and shrubs, and grow flowers and vegetables—the finest in your neighborhood.

In addition, the book contains plans and instructions for making outdoor fireplaces, garden pools, trellises, ornaments and arbors—all of which are presented in *Popular Mechanics* easy-to-understand style. Send \$2.50 for this book and get your beautifying program started this spring. Mail your order to *Popular Mechanics* Book Dept., 202 East Ontario Street., Chicago 11, Illinois.

Cut-Down Card Table Provides Stand for Portable Indoor Sandbox



Rainy days won't spoil the youngsters' fun if this indoor sandbox is set up in the basement or playroom. An old card table serves as a stand for the sandbox and, when the sand is poured into a bag, the unit can be folded for compact storage. The legs of the table are cut off about 5 in. from the ends to lower the box to a convenient height for the children. A simple box, or tray, is made by nailing four lengths of 1 x 6 to a 30-in.-square bottom of plywood or hardboard. The bottom of the box is then screwed to the card-table top, all wooden surfaces are sanded smooth and the entire unit is given a coat of bright-colored enamel. When the enamel has dried, the surface is sanded lightly and covered with a coat of clear lacquer. Colorful decals can be applied to the sides if desired. The box is filled with clean sand to about 2 in. from the top. Of course, there is going to be a certain amount of sand spilled on the floor. However, this can be minimized by nailing strips of lattice stock along the top edges of the box sides so they overhang the side members toward the center of the box.

Victor H. Lamoy, Upper Jay, N. Y.

Flagstone Walk Made by Laying Scrap Stone on Concrete

By setting a layer of thin, scrap flagstones in a concrete foundation, I was able to build a picturesque walk at considerably less cost than if I had used standard flagstone. To lay this type of walk, start by digging a bed about 8 in. deep. Then build a form from scrap lumber and stake it into position, remembering that the top of the form will determine the surface of the walk. Spread a layer of crushed stone about 5 in. deep at the bottom of the bed and pour a layer of concrete over it, leaving a clearance at the top which is approximately equal to the thickness of the flagstones you will use. Level this coat of concrete with a notched board, as shown, and place the stones in position. Then fill the joints between the stones with a fairly dry cement

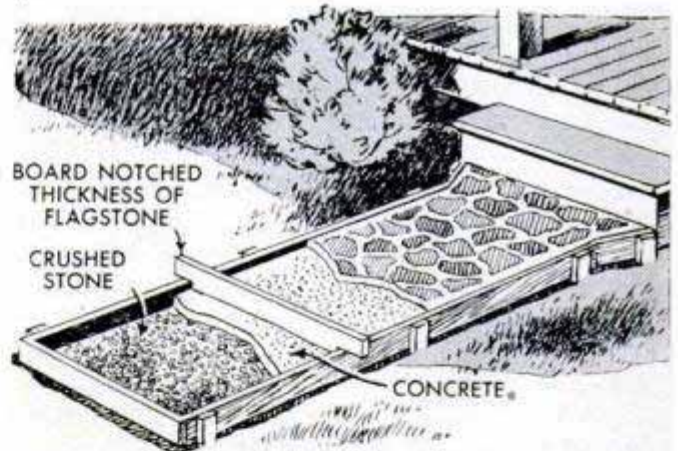

mixture and clean the excess from the faces of the stones, being careful not to remove any of the fill from the joints.

David Lowder, Albemarle, N. C.

Tiny Alnico Magnet in Fountain-Pen Case Cleans Tight Spots of Metal Chips

Readily accessible in your shirt pocket, this little magnet makes it possible to fish particles of metal from almost any small



opening. The tool is made by removing the ink cartridge from an ordinary ball-point pen and inserting a short length of alnico magnet in its place. Usually, a magnet $\frac{3}{16}$ in. in diameter will fit the pen snugly but, if the opening is too small, drill or ream it to the proper size. The projecting end of the magnet is ground to taper.

Andrew Brennan, Philadelphia, Pa.

☛ Tape on the head of a hammer will prevent marring the finish of upholstery tacks.



COCONUT *Candy* DISHES

By William J. Erickson

ATTRACTIVE novelties such as candy dishes, servers, planters and nut bowls can be made from parts of coconut shells combined with scrolled handles or hangers of clear plastic. The hard, dense structure of a coconut shell permits sanding and polishing the outer surface to a high luster. It also takes relief carving exceptionally well and a newer finish resembling hammered metal is achieved by cutting an irregular pattern into the surface of the shell with a rotary file driven by a hand grinder. Novel candy dishes and matching planters are easy to make by cutting a large shell in half, crosswise at the center, and then forming a scalloped rim on each of the halves by scrollsawing around the edges. If desired, the outer surface of the shell can be sanded smooth and buffed to a high polish, or the natural ribbed pattern can be brought into somewhat bolder relief by lightly brushing with a wire wheel and then buffing a high polish on the tops of the ribs. This results in a very attractive finish. Working the surface into a relieved pattern with a rotary file and hand grinder is done freehand as pictured on the following page. Care must be taken in this operation to prevent the rotary file from cutting through the shell. After the surface has been completely worked with the rotary file, it is buffed lightly, the buffer being permitted to touch only the tops of the ridges. No other finishing materials, such as varnish, lacquer or wax, are used. The result is the novel and attractive finish on the three pieces pictured above and at the right.

Cutting coconut shells is simple to do if you use a fine-toothed saw. A coping saw

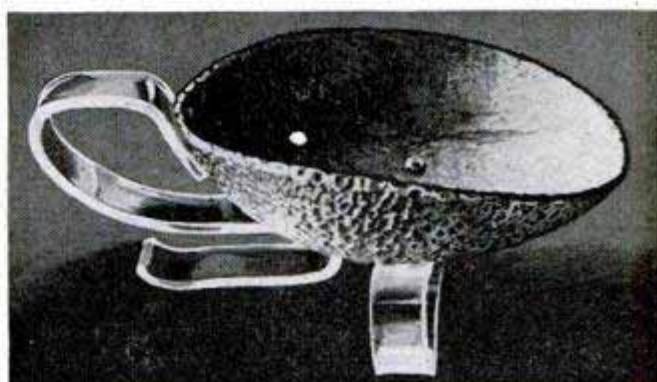

Sawing shell lengthwise gives shallow dish an attractive contour. Reverse bend of handle makes foot

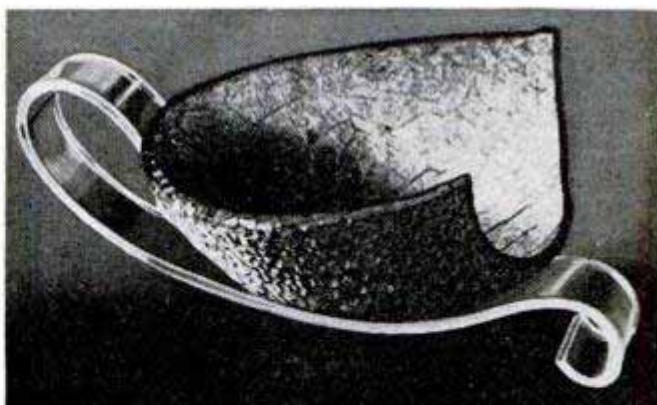

Above, novel server made by cutting away shell rim. Below, heated plastic strip is shaped in wooden form

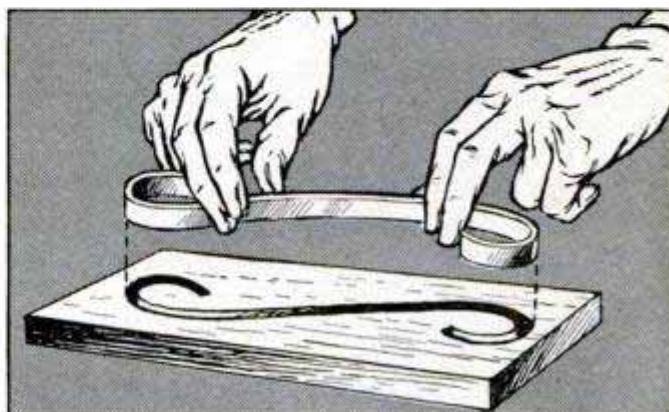

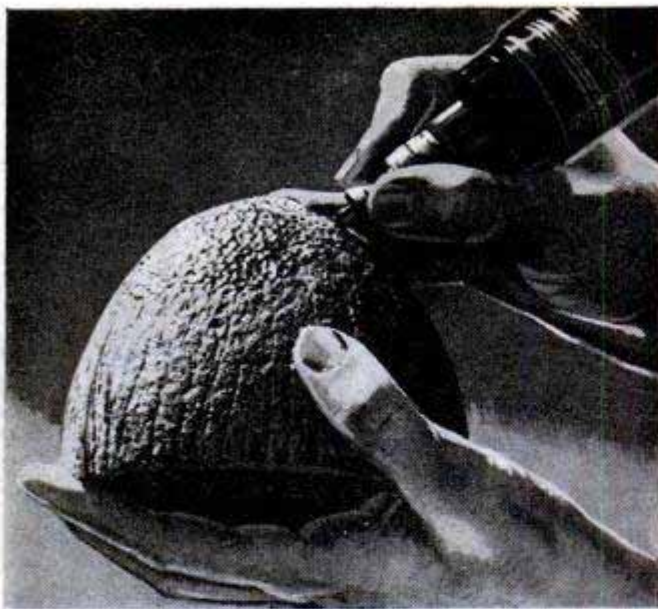

generally is best. Allow the shell to become thoroughly dry before working it with sandpaper, buffer or rotary file. Scrolled plastic handles and feet as well as hanging bails are easily made by cutting clear plastic into strips of suitable size, heating in the oven until pliable and bending quickly to the approximate shape before pressing the strip into a wooden form as in the lower right-hand illustration on the preceding page. Other shapes are shown in the squared detail below. Attach the formed strips to the shells with small bolts inserted through holes drilled in the plastic and shell. Align the holes and drill them at the correct angle, as otherwise the small bolts will not seat properly.

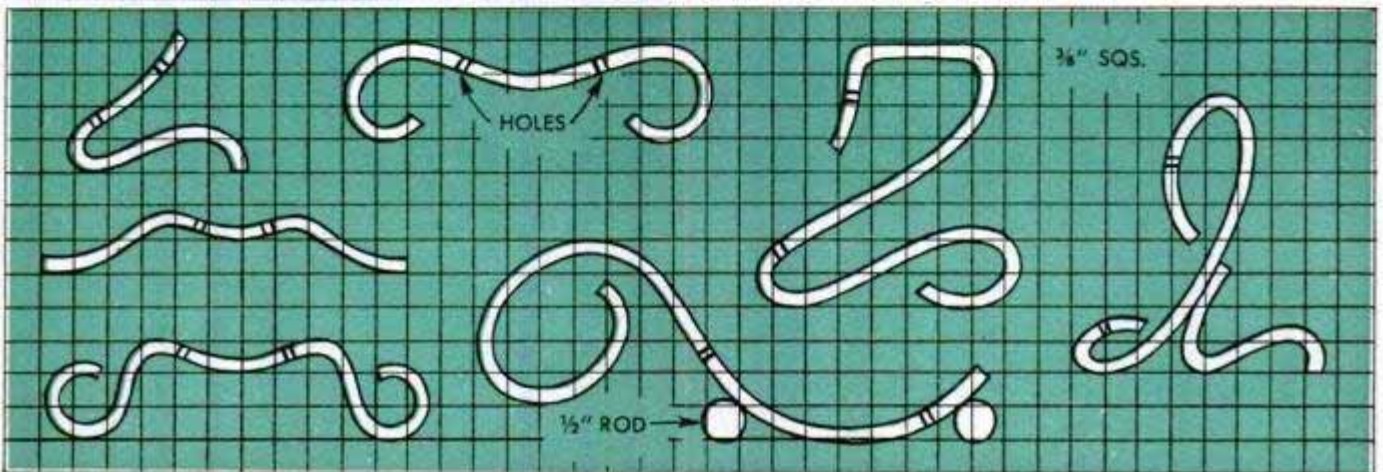

Helpful Hints to Make Hunting and Camping Trips More Enjoyable

Here are a few tips designed to help the sportsman avoid some of the discomforts which plague his outdoor life. Itching and chafing, caused by woolen clothing, can be prevented by dusting the skin with cornstarch before putting on the garment. A zipper won't stick if it is coated with a little gun oil. Olive oil, rubbed on the hands and face, will protect them from windburn and the cold, while a little vinegar, rubbed on the hands, will keep them from chapping. When washing wool shirts or socks, hang

them up to dry without wringing the rinse water from them and they won't shrink. The socks will wear a lot longer if the heels and toes are rubbed with paraffin after each washing. Wool shirts can be waterproofed by rubbing them lightly with a cloth dipped in lanolin. If castor oil has been applied to the outside of boots, the water-soaked leather will not become stiff when it dries. A strip of emery cloth, glued to the inside of a waterproof hunting coat, will provide a dry place to strike matches.

Bed Lamp Provides Extra Illumination for Cash-Register Keys

In places of business where the light is subdued, it is often desirable to have an extra light on the cash register to aid in making change and otherwise handling cash. An ordinary clamp-on bed lamp, having a small fluorescent bulb, will readily suit this purpose. Simply bend the clamp to a shape that allows it to fit over the top of the cash register as in the photograph.

Tom Griberg, Moline, Ill.



☞ Coating wooden fishing rods and plugs with automobile wax will keep their finish from checking and cracking.

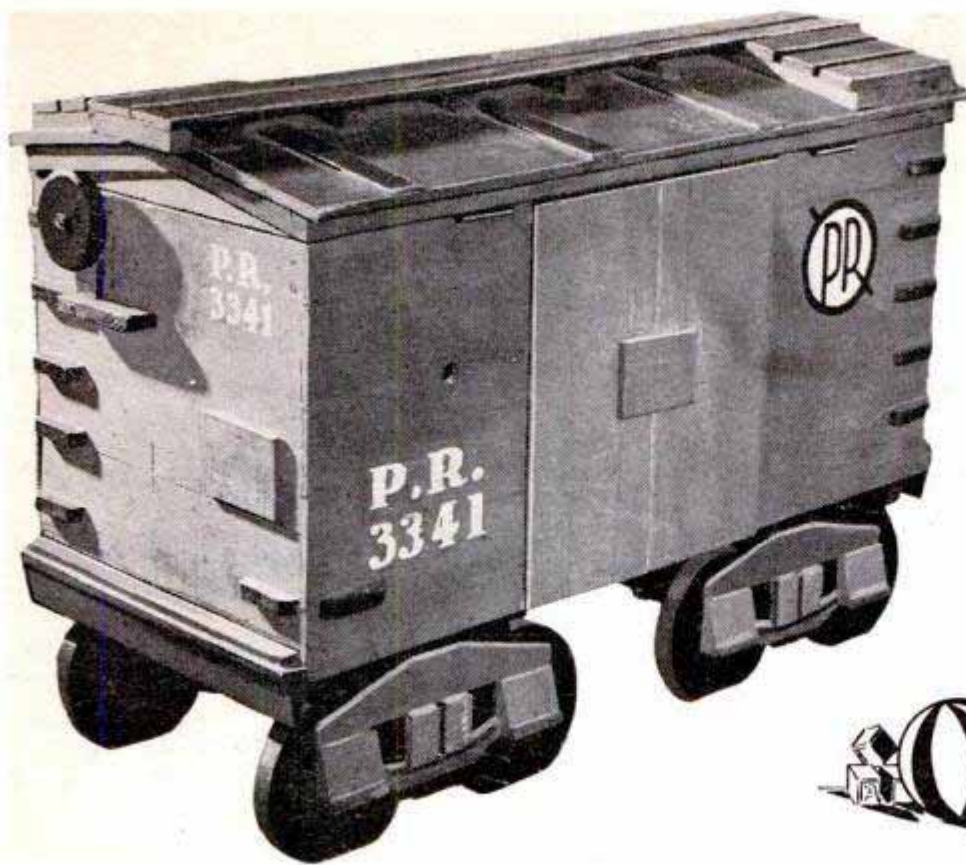

TOY BOX

By F. L. Hendren

YOUNGSTERS will remember this freight-car toy box long after they've outgrown it. Large enough to provide storage for most of the toys in the playroom, the box is made of materials salvaged from orange crates, 1 x 2-in. strips and several wooden Venetian-blind slats or lengths of lattice stock. Endpieces from an orange crate form the boxcar ends. The sides are of 1/4-in. stock tacked to 1 x 1-in. strips, which are nailed to the endpieces as in the detail at the right. The 3/4-in. stock from the crate also is utilized in making the car trucks, and wooden overlays simulate truck frames, bearing boxes and springs. The boxcar top, which serves as a lid, is hinged as shown, and other details on both the top and sides, such as the catwalk, icing doors, brake wheels and grab irons, are made from strips cut from the Venetian-blind slats and fastened with brads and glue. Wheels, car frame, grab irons and brake wheels are painted black, and the rest bright red with the lettering in white.

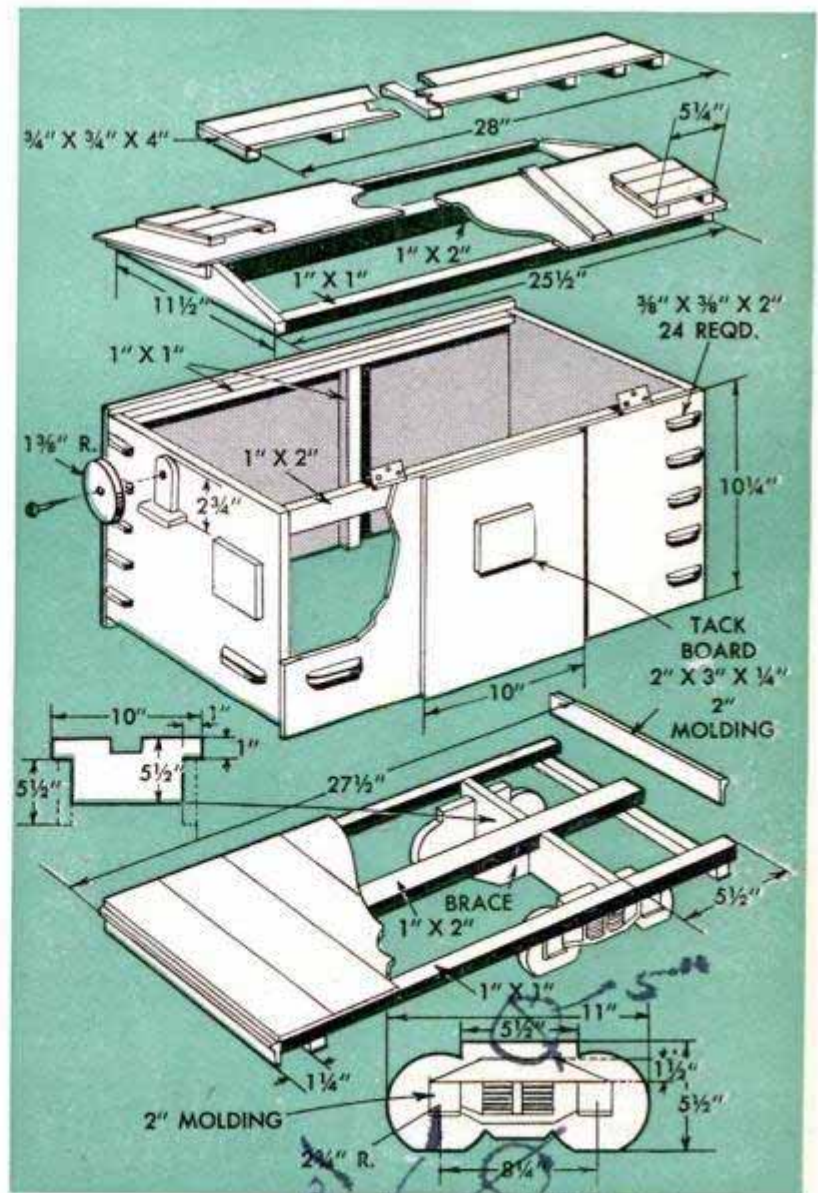

Solving HOME



HOLDER FOR BALL OF TWINE is had by mounting a plastic measuring cup on wall or cabinet door. After screwing cup to wall, place the twine in the cup and pass end of twine through hole in handle



CURLED WALL CALENDARS can be flattened by applying water to the back with a cloth or sponge and rolling paper once in the opposite direction. When unrolled, the calendar will hang almost straight



IRONING ASPHALT TILE is a good stunt to remember when laying a new floor. Not only will the heat soften the brittle tile and permit pressing down any curled edges but it makes a better adhesive bond. Set the electric iron for medium heat

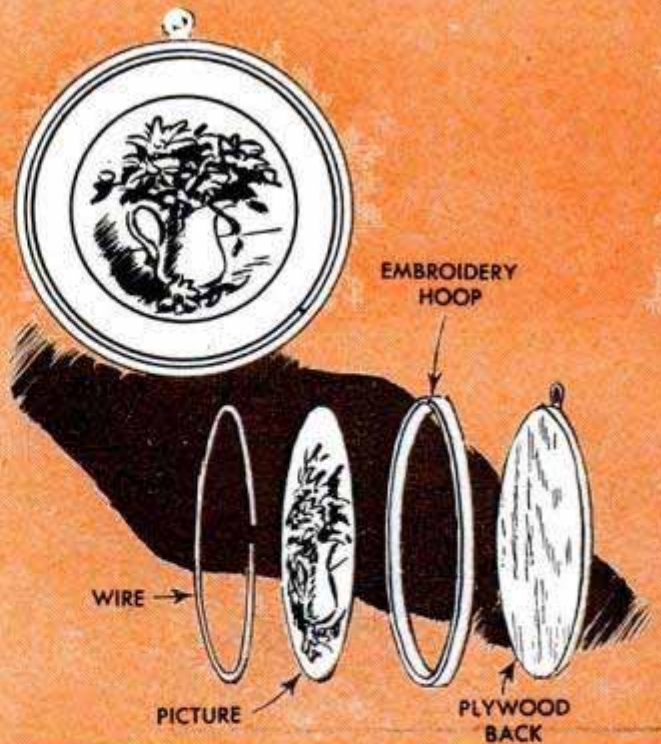

QUICKIE PICTURE FRAME can be improvised from an embroidery hoop, plywood disk and wire ring. The hoop is glued to the edge of the disk to provide a molding and the picture is held in place with a spring-wire ring. Regular hanger is attached to back

PROBLEMS

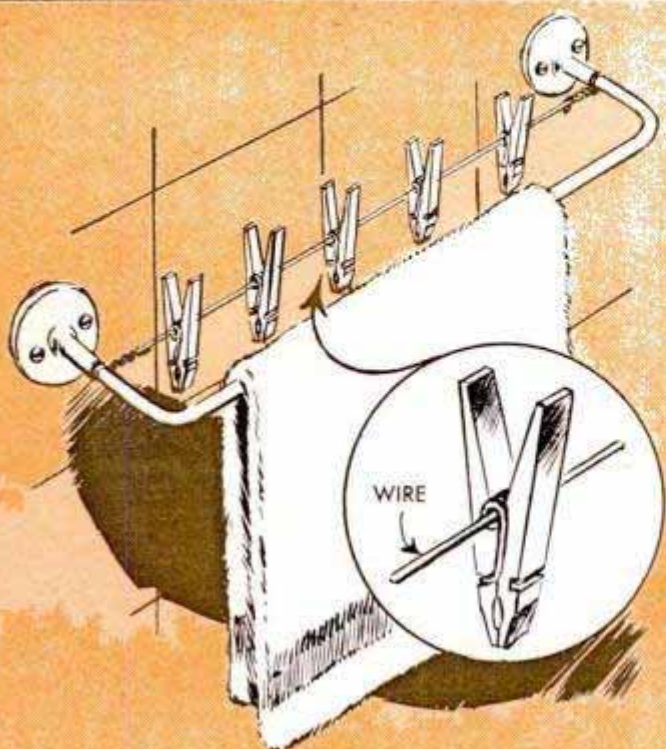

DRYING A FEW CLOTHES in the bathroom is done inconspicuously if the wash is neatly hidden behind a bath towel. Spring-type clothespins are threaded on a length of wire tied between the towel-bar arms



FLOWERPOT SHIELD to protect stems of African violets from rotting is made from a paper plate. Rim of the plate is placed around plant and the cut edges are joined with a strip of cellulose tape

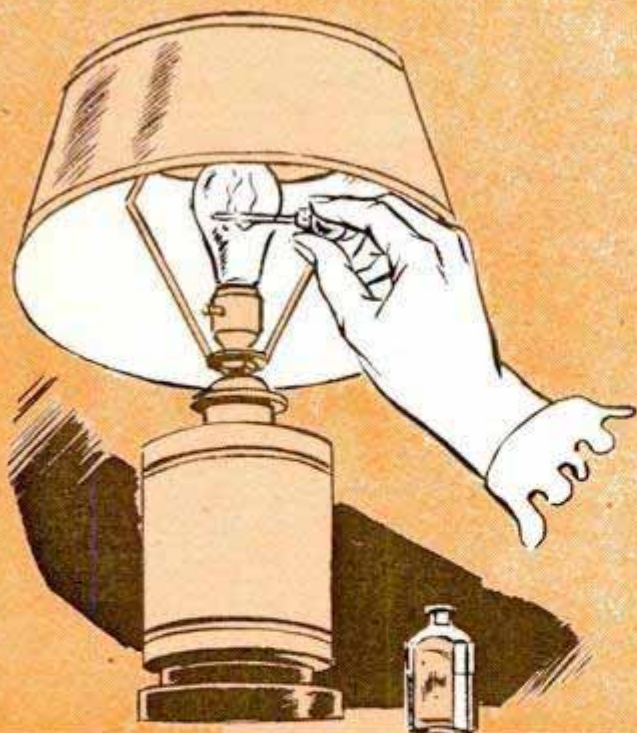

TO REMOVE COOKING ODORS from a room when a deodorizer is not at hand, try placing a little perfume or cologne on the light bulbs of your table lamps. By the time your guests arrive, heat from the bulbs will give off a pleasant aroma to counteract the odor

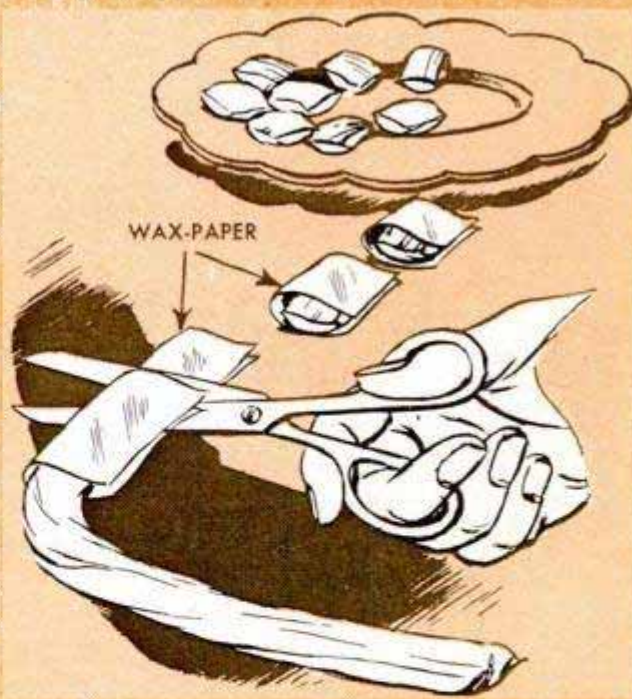

CUTTING HOMEMADE TAFFY into bite-size pieces is a simple task when you use wax paper and scissors. The sticky taffy is merely wrapped in the paper as shown and snipped off in the sizes desired. The waxed paper keeps the taffy from sticking

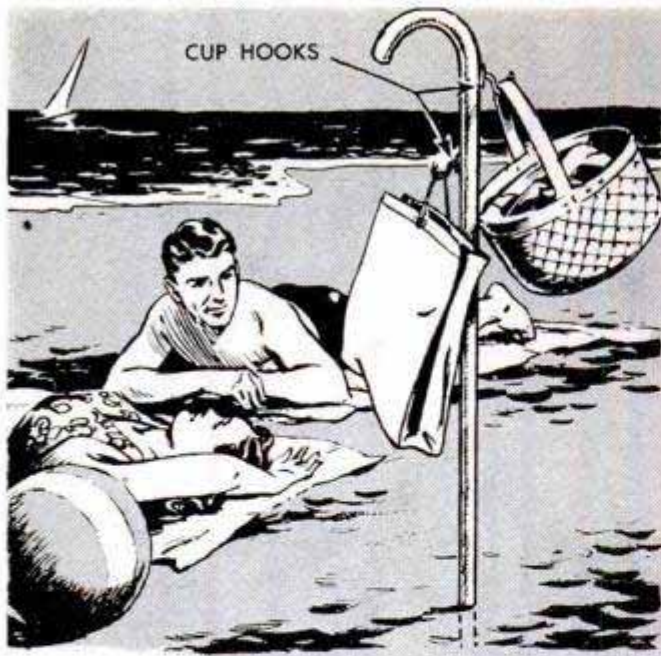

"Hall Tree" for Use at Beach Made From Walking Stick

Here is a novel arrangement for those who find it annoying to discover sand in all their belongings after spending a day at the beach. Take an ordinary walking stick or cane and screw cup hooks or L-hooks into opposite sides as shown in the illustration. On arriving at the beach, push the cane into the sand so it will stand by itself and hang your bathing cap, beach bag, and other odds and ends from the hooks.

Norbert Engels, South Bend, Ind.

Fireproofing Fabrics

Draperies, curtains, ironing-board covers, etc., can be fireproofed by dipping them in a solution consisting of borax, 7 oz., boric acid, 3 oz., and water, 2 qts. Soak the fabric thoroughly, wring out and hang it up to dry. It can be ironed when almost dry.

Substitute Pull-Chain Pendant Molded With Wood Putty

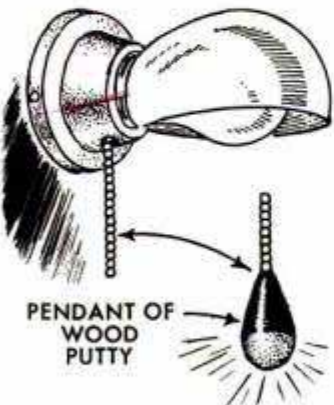

If the metal pendant on the pull chain of a wall or ceiling lamp socket breaks off, a new one can be molded quickly from wood putty right on the end of the original chain. Form the putty to a convenient size over the last few beads of

the chain and, after it hardens, paint to suit. If desired, the lower end of the pendant may be dipped in luminous paint.

Scoop Coates, New Brighton, Pa.

Cotton Adds Strength to Glue Joints

When gluing half-lapped joints together, greater strength is added to the joint if a thin layer of absorbent cotton is inserted between the pieces. The cotton serves as a binder between the two glued surfaces of wood. Fine steel wool also can be used for this purpose.

Benj. Nielsen, Aurora, Neb.

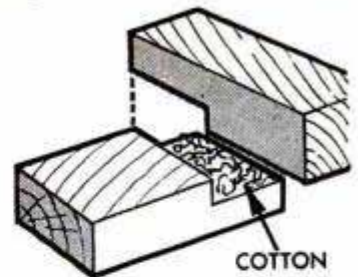

Natural Insect Repellents

Creating a smudge by burning green fern fronds or damp, rotten cedarwood will keep mosquitoes away. Wild-spearmint leaves, crushed and rubbed on the legs, will guard against chigger bites. Applied to the neck, face and hands, it will ward off black flies, gnats and other flying insects.

R. A. Jenkins, Los Angeles, Calif.

Knife Handle Drives Screw Hooks

Cup hooks, screw hooks and screw eyes can be driven quickly by engaging the hook in the slotted end of a pocketknife handle and then turning the hook with the closed knife. To avoid unnecessary strain on the knife handle, drill holes for the screws before driving them.

William Swallow, Brooklyn, N. Y.

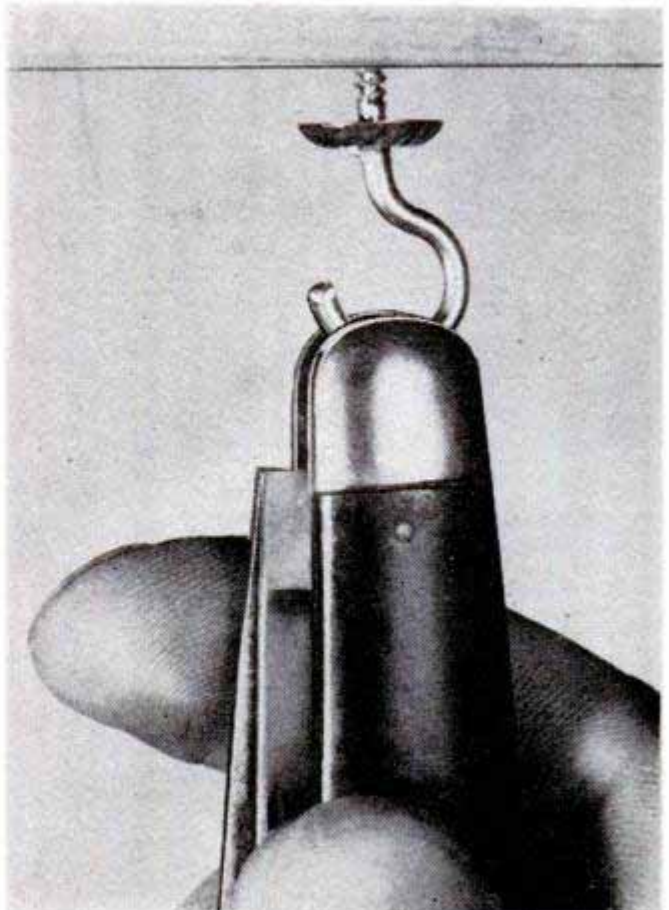

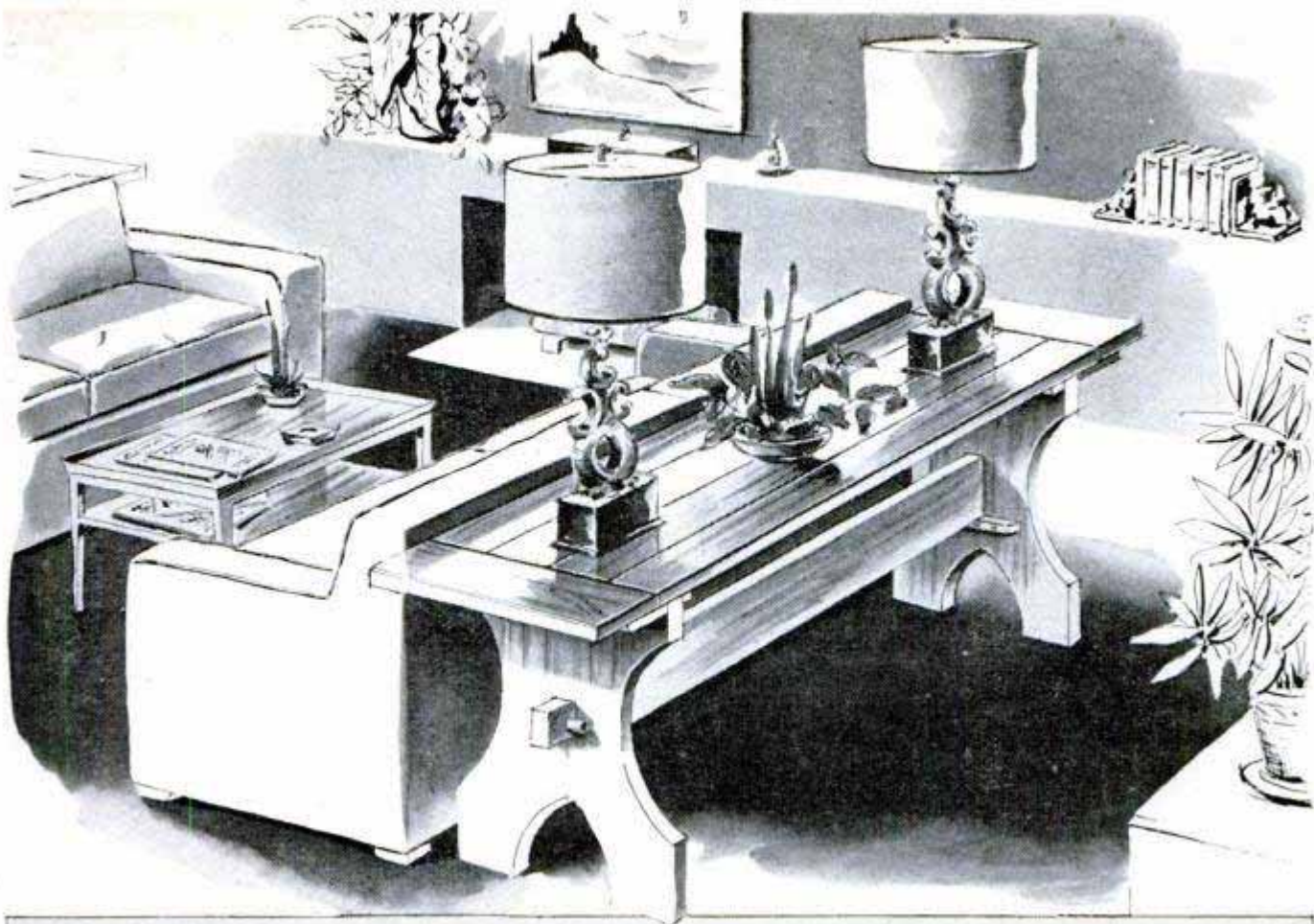

SOFA TABLE

Where room furnishings include facing sofas, a matching pair of narrow sofa tables stand by ready to relieve the dining problem at large family gatherings. Used alone, side by side or placed one at each end of the regular dining table, they provide a quick-change setup that is ideal for cramped living quarters. The drawings below detail the simple, rugged construction, pine or fir being used and then stained

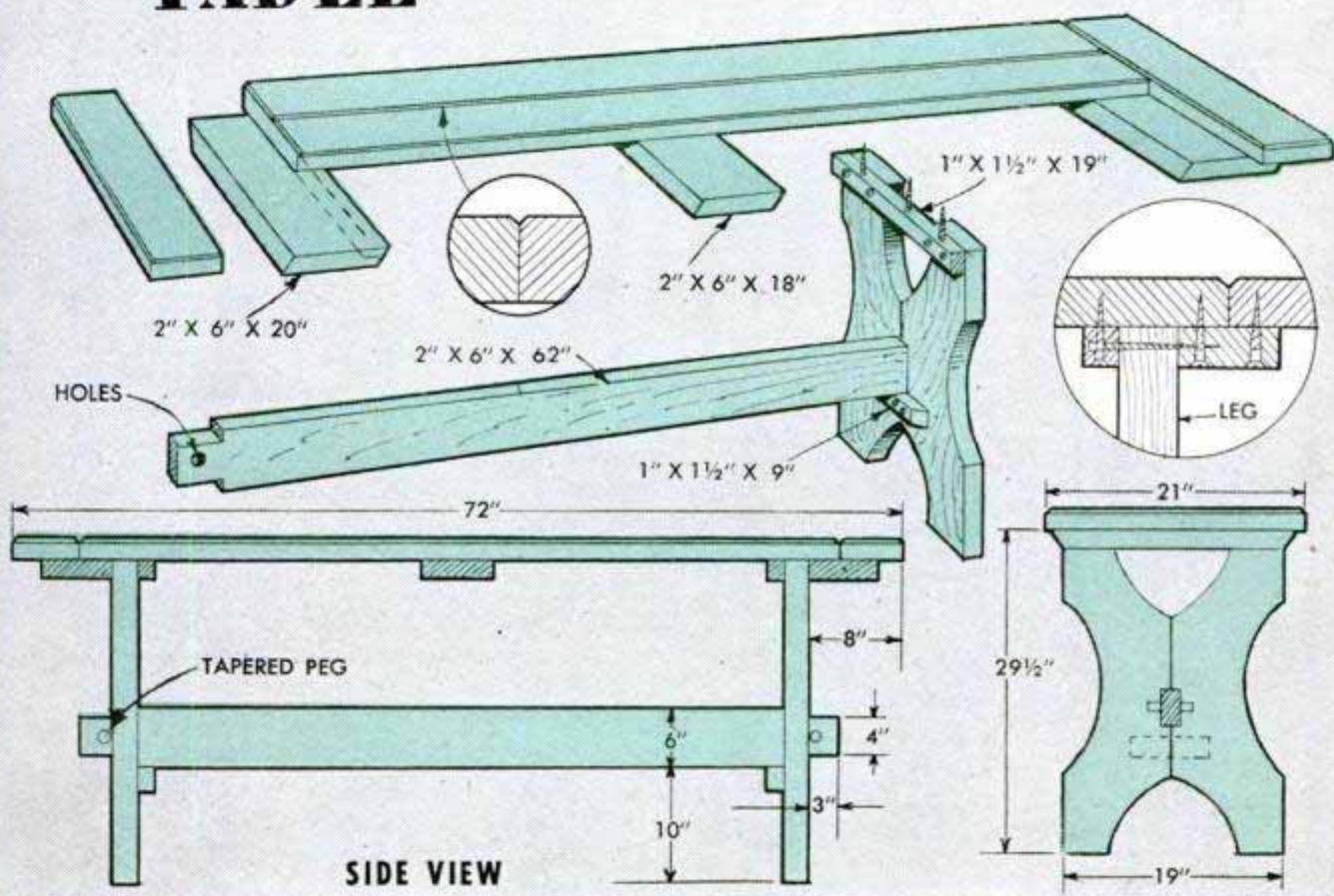

1 EVENING PROJECTS

IF YOU like simple yet practical projects that can be completed in an evening or two, or like an occasional easy one to break the monotony of working on large projects, look over these five "quickies." They lend themselves to the use of hand tools as well as power tools.

CHRISTOPHER, THE CRANE

The gangling fellow pictured at the left bobs his head with every gust of wind and feels right at home in a large lily pond or in the small pool of a rock garden. The head and body of the crane are jigsawed from $\frac{3}{4}$ -in. stock and his single leg is a length of $\frac{1}{4}$ -in. rod. Ordinary curtain rod painted orange will do. A piece of spring steel about $\frac{1}{2}$ in. wide and 12 in. long, such as heavy clock spring, forms Christopher's neck. The ends of the spring are inserted in slots cut in the head and body, the spring being wedged in place with nails driven through the edges of the wood and against the metal. Staples driven over the edges of the spring, as in the detail, keep it from slipping sideways. Head, neck and body of the crane are painted white, while the bill is finished in orange. The mouth, eyes and wing outlines are added with black paint.

Christopher, the Crane

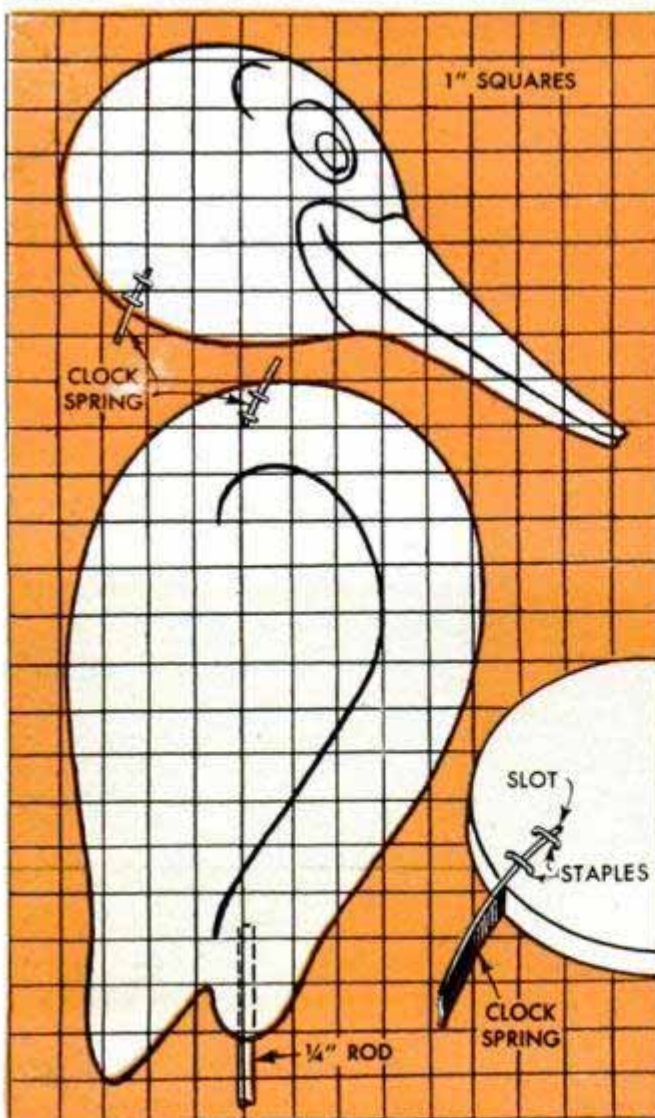

NAIL-POLISH BOX

Outfitted with fingernail polish, file, scissors and similar needs, this unique box forms a useful and attractive manicure kit for the top of a vanity. To make the box, enlarge the squared pattern to provide a template for jigsawing four pieces of $\frac{3}{4}$ -in. stock, one piece of $\frac{1}{2}$ -in. stock and two pieces of $\frac{1}{8}$ -in. stock to the shape of a hand. Cut out the center portion from all the pieces except those of $\frac{1}{8}$ -in. stock, which are used to form the bottom of the box and the top of the lid. After gluing three of the $\frac{3}{4}$ -in. layers together cut off the portion indicated by the gray tint, and glue this section to the fourth $\frac{3}{4}$ -in. piece to form the box lid. Assemble the box as in the lower detail and screw the $\frac{1}{4}$ -in.-thick bottle holder to the bottom of the box. Be sure that the holes cut in the bottle holder are of the correct size and shape for the particular style of nail-polish bottle to be used. The spring latch is optional, and can be made as shown in the center details.

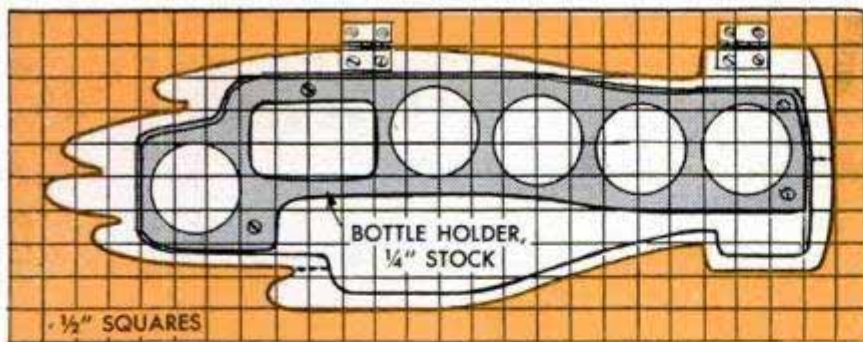

Nail-Polish Box

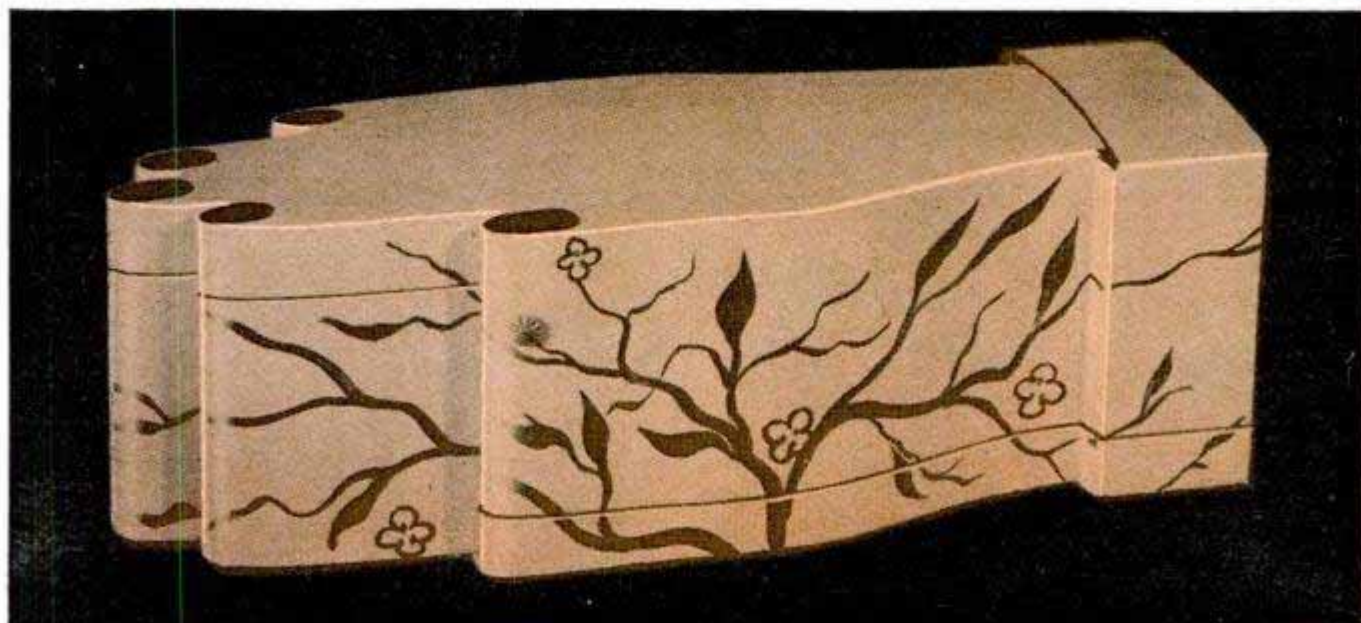
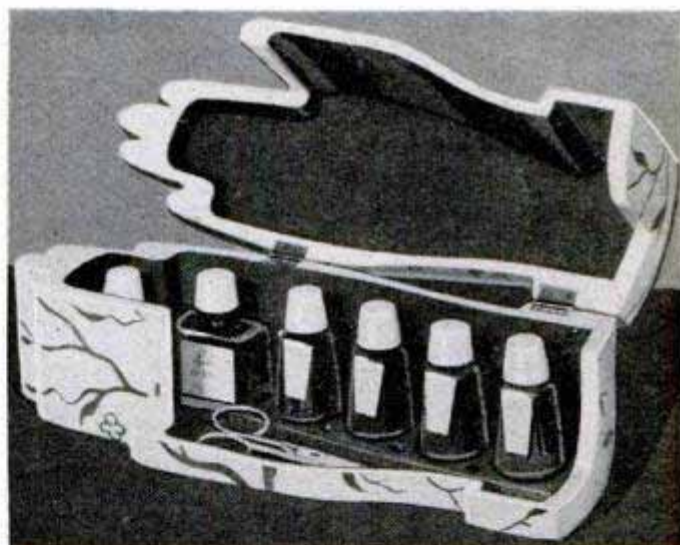
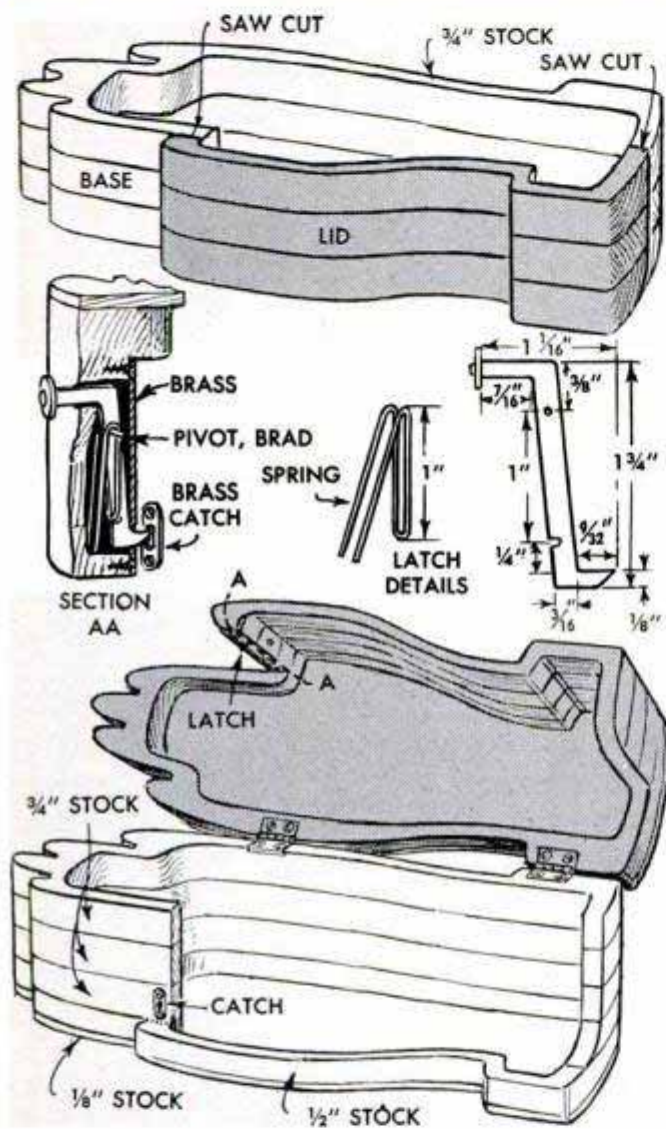

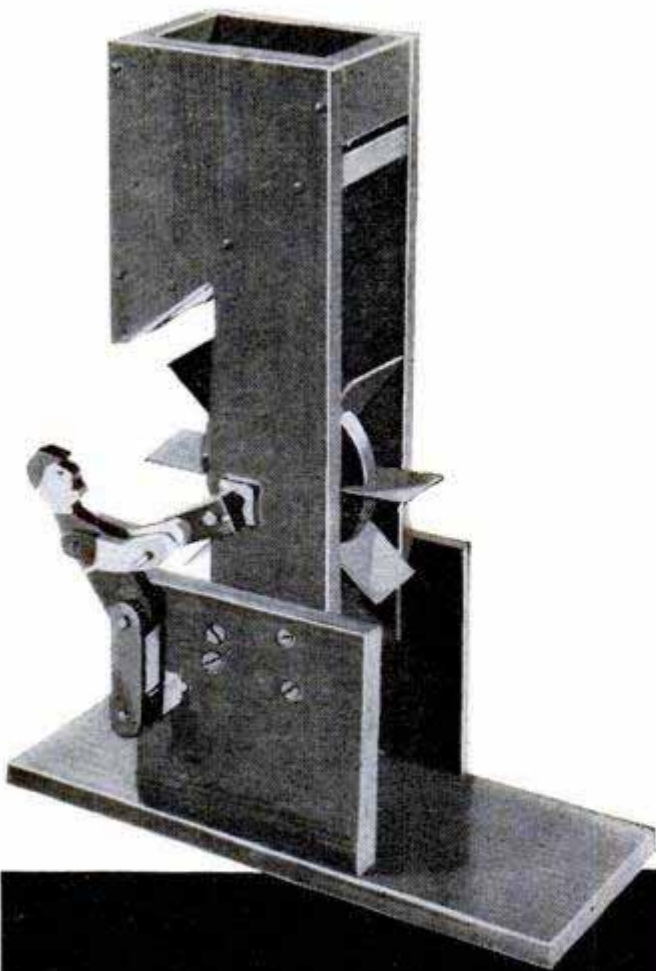

Sand Toy

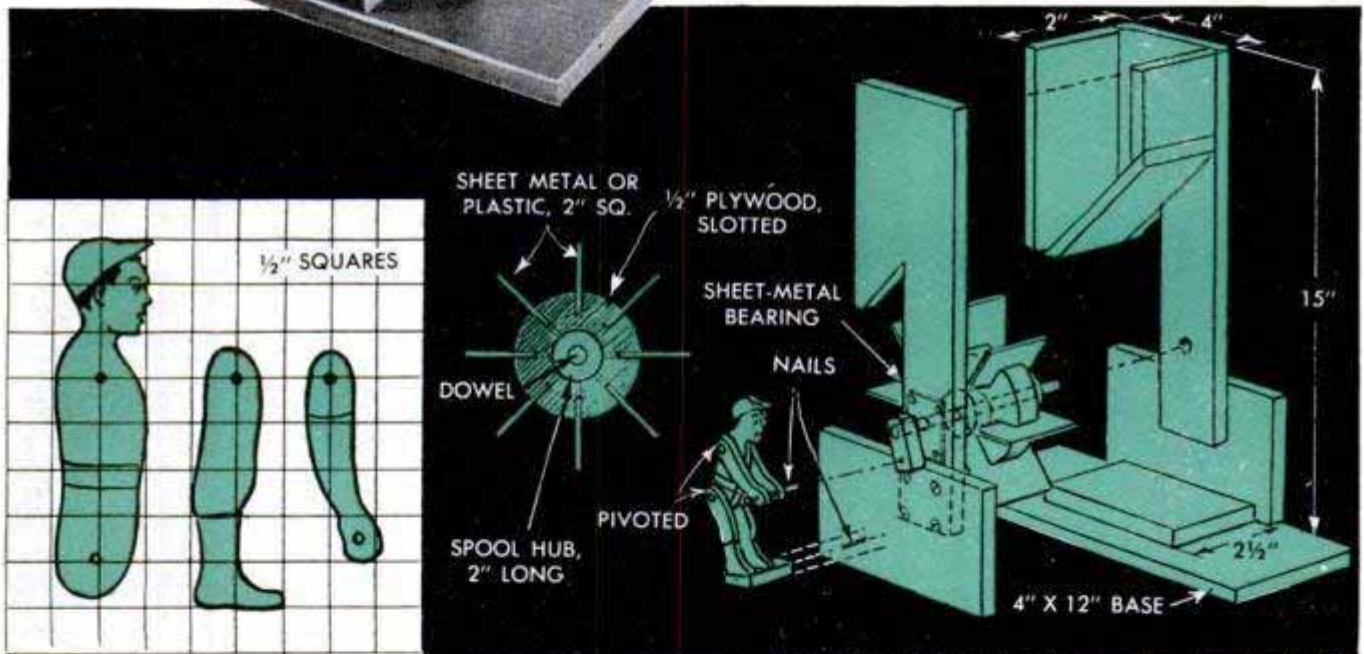

Towel Bar and Shelf

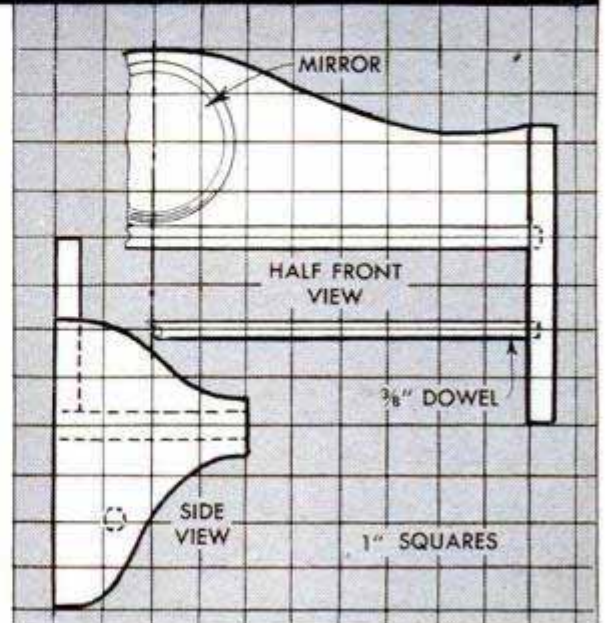

The latch is cut from a piece of $\frac{1}{32}$ -in. brass and, after it is installed in the mortise, a brass disk is soldered over the tenon on the outer end to serve as a push button. The brad on which the latch pivots is driven from the inside of the lid into the offset formed by the thumb tip. Note that the mortise is covered with a strip of brass.

SAND TOY

Youngsters will spend many an hour pouring sand into the toy hopper just to see the little man busily crank the paddle wheel. Made entirely from scrap wood plus a few squares of sheet metal or plastic for the paddle-wheel blades, the toy can be cut out and assembled in an hour or two.

TOWEL BAR AND SHELF

Hanging this dual-purpose shelf on the bathroom wall affords an extra towel bar in addition to increasing the storage space for cosmetics, hairbrushes, etc. A small mirror glued to the shelf back increases its utility. When fitted with a mirror and mounted at just the right height for a small child, the shelf forms a personalized "vanity" that is considerable help in teaching the youngster to comb his hair and wash his hands and face. The shelf, which is assembled with glue and brads, can be stained or enameled to suit.

LAZY SUSAN

A lathe project having a pleasingly simple design, this Lazy Susan can be used with or without the individual bowls. The large tray rotates on a dowel which is glued to the base, and a removable tray is fitted in a mortise cut in the center of the large tray. So that each of the small bowls will be turned to exactly the same size and shape, it is best to use cardboard templates to check both the inside and outside surfaces of the work as turning progresses.

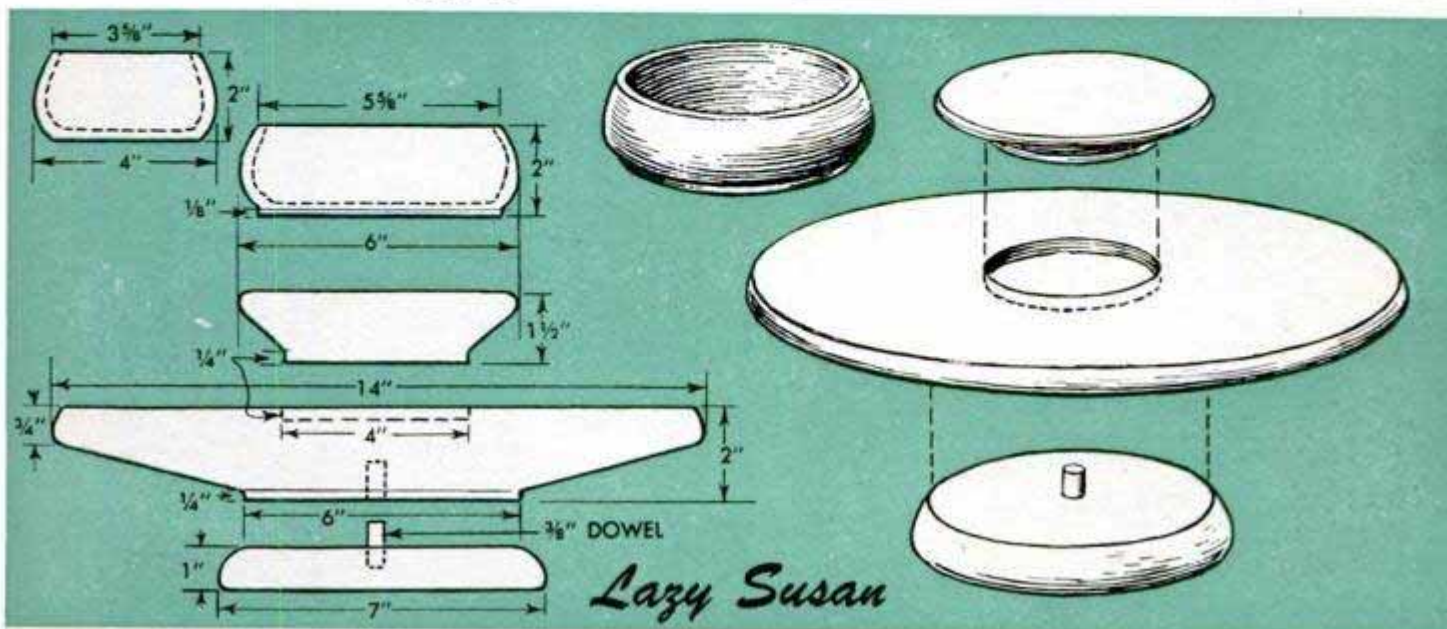

Coat-Hanger Wire Forms Holder for Basins and Rubber Bath Mat

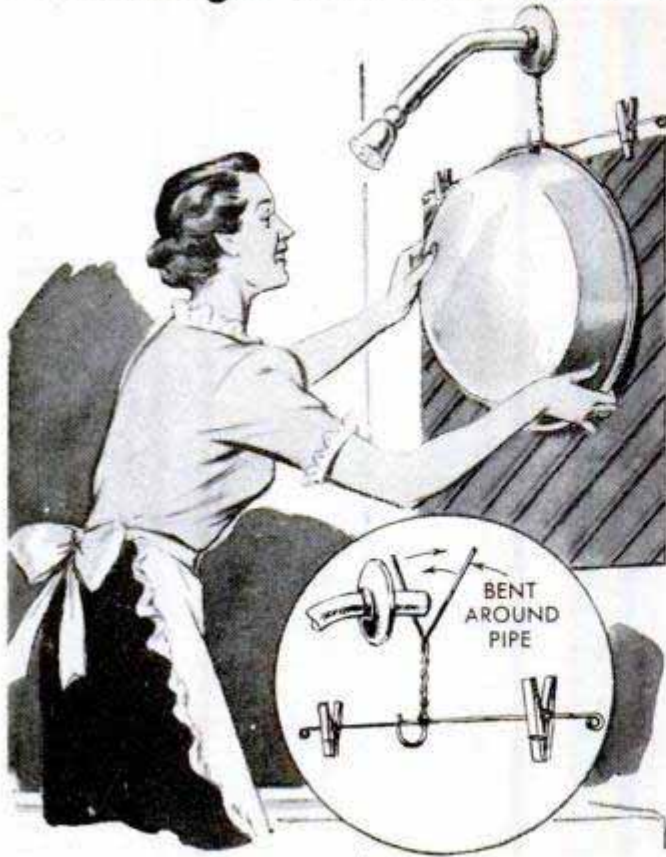

In small apartments and cottages where storing bathroom utensils becomes a problem, a rubber bath mat and several basins can be kept out of the way by hanging them from the shower arm. This is done by making a combination holder from a wire coat hanger as shown in the detail. The hooked portion of the hanger is cut off to leave two arms, 3 or 4 in. long. These are bent around the shower arm and concealed by the wall flange. To hold the bath mat, two spring-type clothespins are threaded on a wire crosspiece which also is cut from the coat hanger. The wire is passed through an opening made by separating the twisted wires of the hook and is bent over at both ends to keep the clothespins from slipping off. If the bathroom wall is tiled, the basins and bath mat can be hung up wet.

G. Jaffin, Silver Spring, Md.

Trailer-Hitch Shock Absorber

To overcome the usual jerk and chatter of a ball-and-socket trailer hitch, place a square of inner-tube rubber over the ball

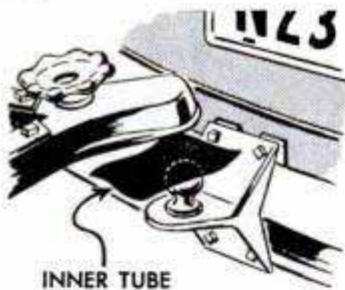

before lowering the socket connection. This also will help to keep the hitch from loosening as a result of vibration. — G. E. Hendrickson, Argyle, Wis.

Yard Umbrella of Sheet Aluminum

Waterproof and rustproof, this aluminum yard umbrella can be left up the year 'round without deterioration from the elements. Sheet-aluminum sections are riveted or welded to bowed stays which also are of aluminum. The umbrella assembly is supported by a wooden upright or one of aluminum or stainless-steel tubing. An application of outdoor paint will improve the appearance of the umbrella, and a novel effect can be attained by applying a different pastel shade to each sheet-metal section, painting the upright a neutral color.

Dog Hair Kept From Clogging Drain

Next time you wash your dog in the bathtub try placing a wad of steel wool in the drain opening. The steel wool strains out the dog hair which might otherwise clog the drain.—Linda Larsen, Ludington, Mich.

Garden Row Marker

Durable row markers for the garden can be made from short lengths of water pipe and spring-type clothespins. Drive the pipe into the ground and insert one leg of the clothespin in the end of the pipe.

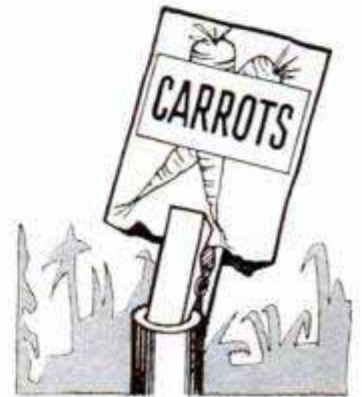

Then catch an empty seed package in the jaws of the clothespin to mark the crop. An alternative is to fasten the clothespin to the top of a wooden stake with a screw or nail.

Withstands Inclement Weather



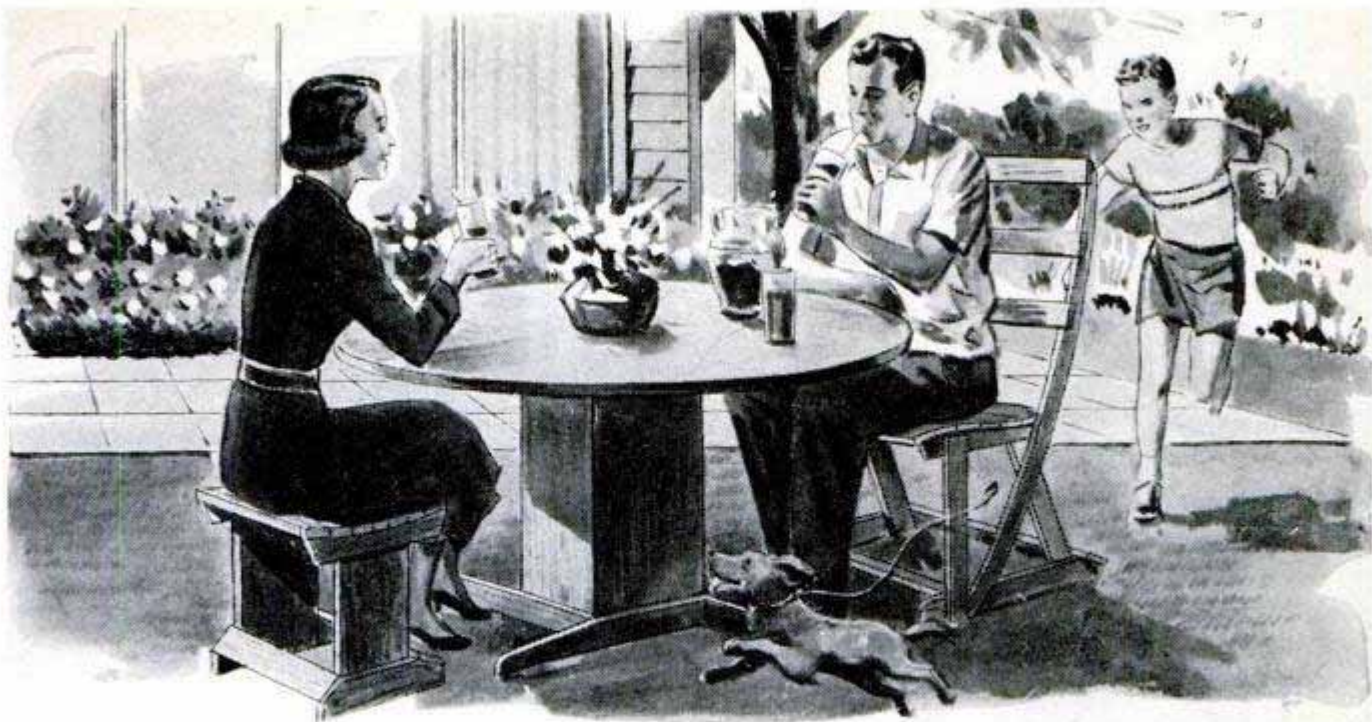

WEATHERPROOF GARDEN SET

INCLUDING a sturdy round table for dining or playing games, plus as many chairs and stools as may be needed, this attractive set of garden furniture can be left outdoors regardless of the weather. The set is unpainted, which allows the elements to supply a mellow, weathered patina to the pieces. Cypress and redwood are excellent for this purpose, but, of course, the set can be made of pine or fir and painted. In this case, however, it is best to store the furniture indoors through the winter months. The pieces are assembled with waterproof glue and galvanized screws, the latter being countersunk and the holes plugged.

The chair detailed below features a com-

fortably curved back, the rails of which are bandsawed from $\frac{3}{4}$ x 5-in. stock. The seat rails are cut to the squared pattern, and both back and seat slats are of $\frac{3}{4}$ x 2-in. material. If desired, the ends of the back slats may be rounded as indicated in the left-hand detail.

The table consists of a novel planked top screwed to a single pedestal. The pedestal is made as shown in the lower left-hand detail on the following page. Each of the four arms at the top extends 3 in. beyond the side of the pedestal to support the table-top frame, the latter being fastened to the arm extensions with countersunk screws before the top boards are assembled. Four 24-in. legs provide a sturdy

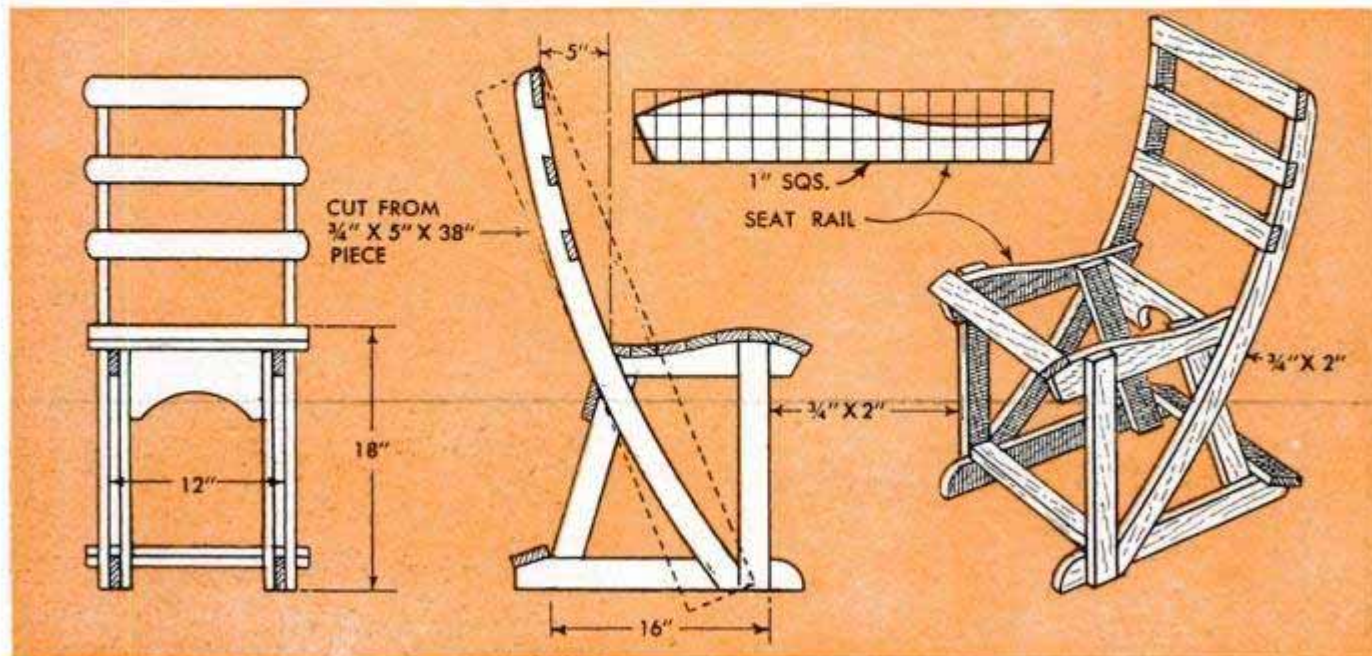

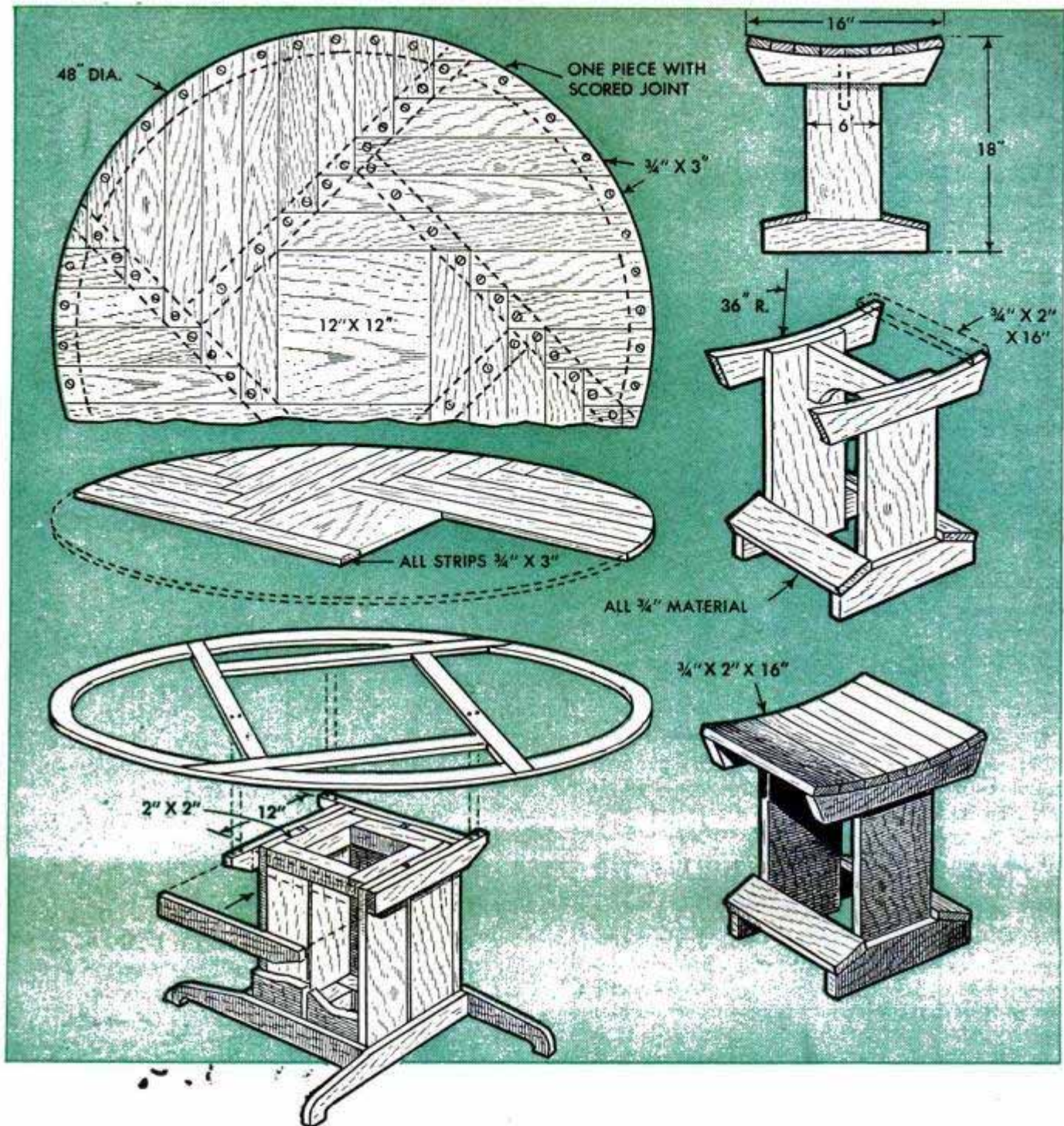

base for the pedestal which stands 29 in. high with the legs in place.

The table-top frame consists of a large wooden ring having four cross braces. To save material when bandsawing the segments of the ring, it is a good idea to glue short lengths of stock together to approximate the desired radius and then bandsaw the segments from the glued pieces. The width of the bandsawed segments should be at least 2 in., and they can be assembled to the four cross braces in either of two ways. They can be glued together to form the complete 48-in. ring and notched to permit half-lapping the ends of the braces. Or, each segment can be cut to length and then doweled and edge-glued to the cross braces. After the frame has been mounted on the top of the pedestal, the 12 x 12-in. center panel and the 3-in.-wide boards are

fastened in place with screws and edge-glued together. The center panel should be blocked up so that its surface is flush with the rest of the table top. The boards which are used to plank the table top are cut to approximate length before assembly, and after the top has been completely covered, the projecting ends of the boards are cut off and planed flush with the outside edge of the circular frame. Note that the pieces used to cover the frame at the cross-brace joints are wider than 3 in. and are scored to give the appearance of two pieces instead of one. This is done to eliminate the use of four small sections of board which could be fastened only to the outer ring of the frame. Several matching stools provide comfortable seating facilities around the table. These are of simple construction, as shown in the details above.

This handsome little desk is especially suitable for the children's room and will provide them with a place of their own for doing homework or other writing. It can be built quickly and at a minimum cost since much of the material is provided by two orange crates which, left intact, are used as the pedestals. Start the job by checking the corners of the crates to see that they are square. Tighten any loose boards, adding nails if necessary, and sand all surfaces which will not be covered in the construction. Cut the drawer dividers, from $\frac{3}{4}$ -in. stock, to fit exactly across the top of the crates. Attach them with nails, driven from the underside of the tops, being careful to keep the parts parallel so that the drawers will slide evenly between them. The back rail, also $\frac{3}{4}$ -in. stock, fits flush with the top edges of the dividers, but extends $1\frac{1}{2}$ in. below the crate tops so it can be nailed to the backs. Next, cut the 1×1 -in. pieces to size. In attaching the base pieces to the pedestals, $1\frac{1}{2}$ -in. wood screws should be used, countersinking them to avoid scratching floor surfaces. The front rail and the center drawer runners may be nailed in position. Now cut the drawer pieces. The fronts are 1-in. stock, the sides and endpieces are $\frac{1}{2}$ -in. stock and the bottom is $\frac{1}{4}$ -in. plywood or hardboard.

Attractive Desk for Children's Room Utilizes Orange Crates as Pedestals

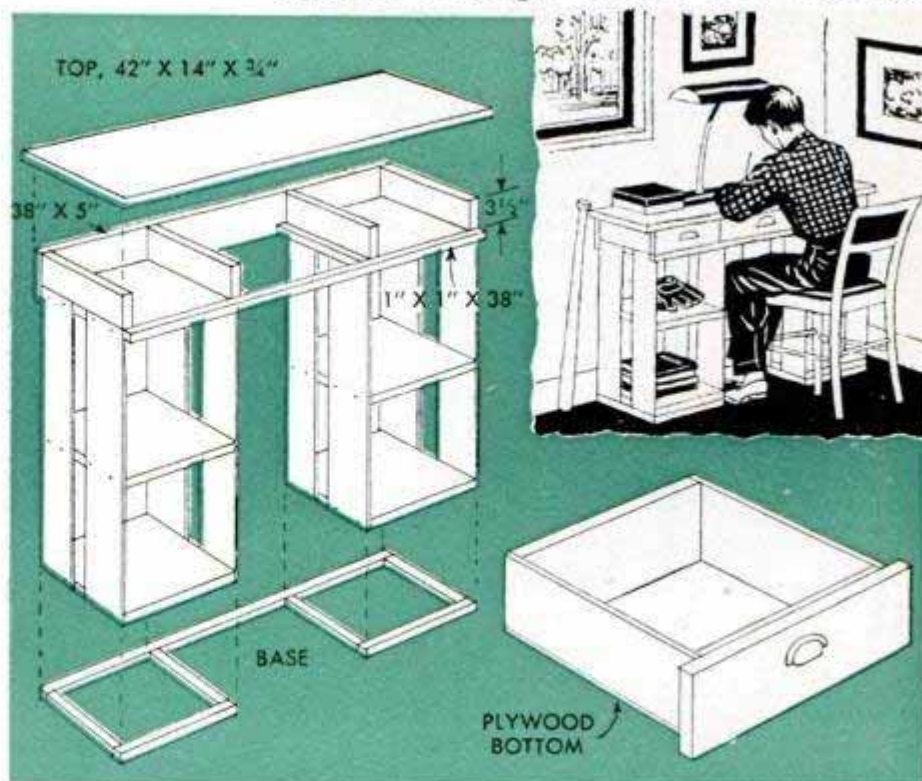

Assemble as indicated, leaving a $\frac{1}{8}$ -in. clearance at the sides and tops of the drawer openings. The bottom pieces are attached to the drawer frames with $\frac{1}{2}$ -in. countersunk screws. Sand the bottom corners lightly and attach the assemblies to the drawer fronts with 1-in. screws. After the drawers are fitted to slide smoothly, attach the desk top with $1\frac{1}{2}$ -in. screws. Countersink the heads about $\frac{1}{8}$ in. below the surface and fill the holes with wood putty. Finish by sanding all surfaces of the desk and applying two coats of paint, or stain, seal and apply shellac or lacquer.

Frances E. Bate, South Berwick, Me.

Modelmakers' Small C-Clamps Made From Bolt and Stiff Wire

Lightweight C-clamps, which often come in handy when building models, can be improvised from stove bolts and stiff wire at a cost of only a few cents each. After the wire is cut to the desired length and

folded double, the ends are soldered to opposite sides of the nut. Then the wire is bent to a U-shape and the bolt turned into the nut to form the clamp screw. The size of the clamp opening is determined by the length of the bolt. A metal shim inserted between the work and the end of the bolt will protect the work surface. The clamp can be fitted with a thumbscrew grip by soldering a metal washer in the bolt slot, and a swivel head for the clamp screw may be fashioned from a second nut. To do this, several of the threads are filed from the end of the bolt to form a tenon, and the nut is slipped over the tenon. Then the end of the tenon is peened over to lock the nut in place. The edges of the hole in the nut should be chamfered so the peened portion of the tenon can be filed flush with the face of the nut.—Ed Packer, Chicago.

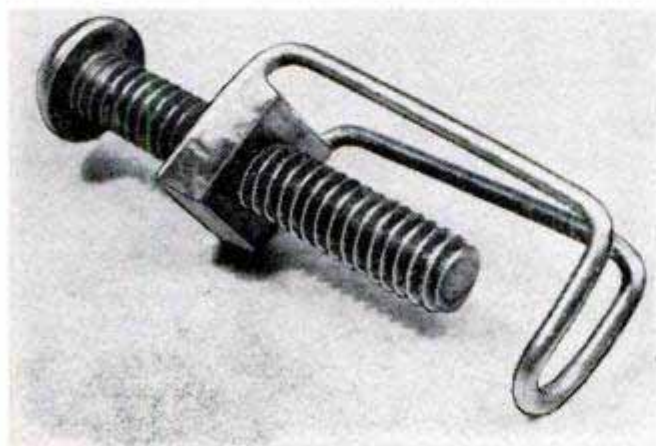

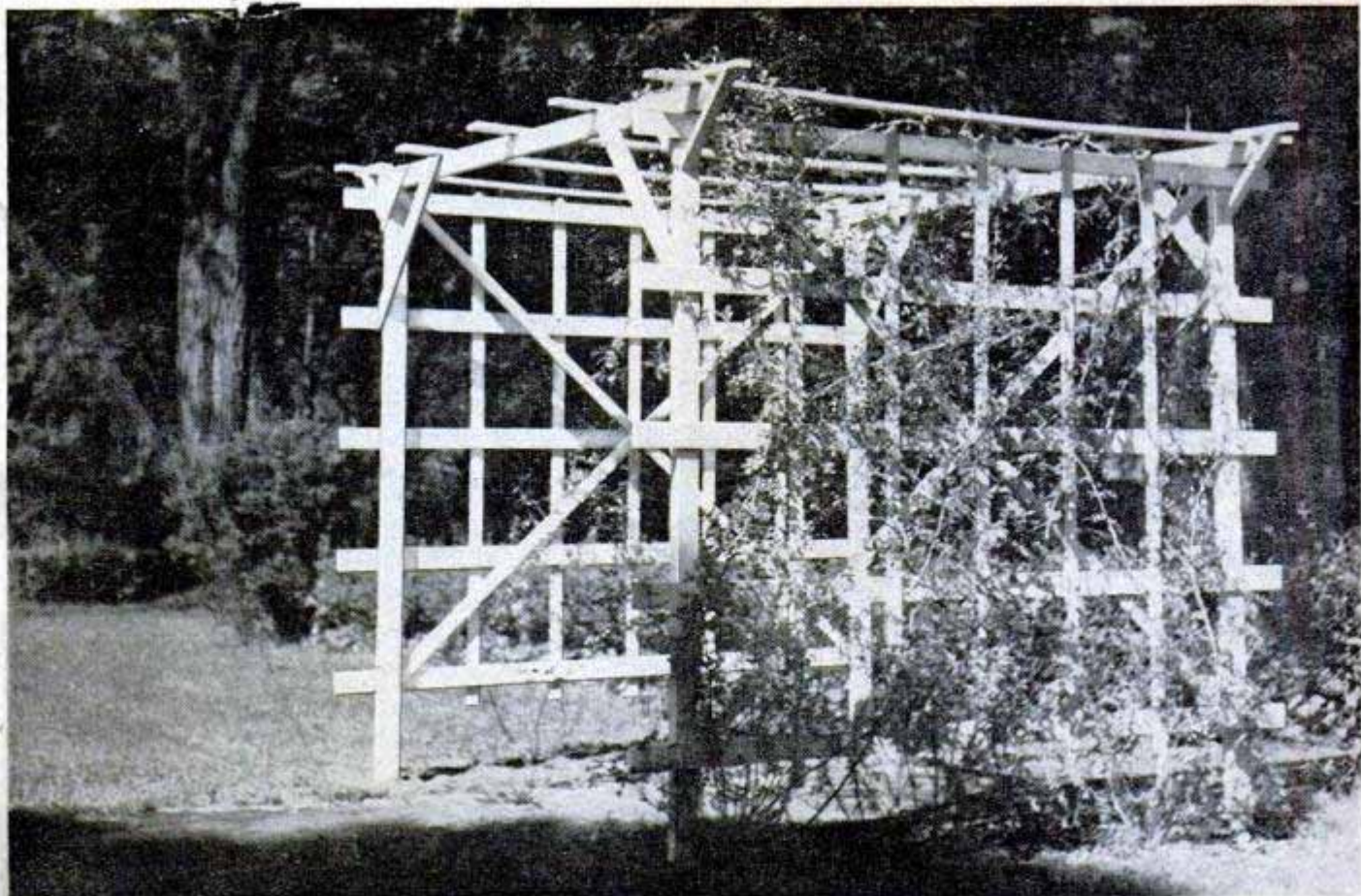

ARBORS and TRELLISES

By Max Alth

CAREFULLY planned placement of ornamental trellises can make a house appear wider, higher or lower, and the simple formality of an arbor lends interest and completeness to any garden. Trellises also are used to screen unsightly corners, conceal the garbage can, serve as a wind-break for delicate plantings, and to provide a patterned backdrop for a formal garden. The design of a trellis can be almost anything that suits your fancy or purpose, but the design and size of an arbor are less flexible because of the vertical and horizontal arrangement of the structural members. The architectural lines of even the simplest arbor make it necessary to plan the design of the structure and its location beforehand. If the arbor is to provide support and guidance for climbing vines or shrubs, then it is well to avoid fine structural detail and use only an open, slat-type construction. The arbor pictured above is a good example of the more practical design. This is just about the simplest saw, hammer and nail job possible, yet the secret of its attractiveness is in the pattern of squares which has been carried out in the construction of the side panels. Note that the supporting corner posts are placed the same

distance apart each way, and that the height equals the length of the sides. The X-braces add both rigidity and an interesting structural detail.

A trellis of more formal design is pictured at the top of the opposite page. The architectural detail has been worked out with the purpose of extending the horizontal lines of the house, and the crisscross, or diamond pattern, above and at each side of the arch is obviously for the purpose of lowering the height of the opening in relation to its width. The gate arbor, or perhaps more properly, arch, shown at the lower right on the opposite page brings up another point in connection with arbor and trellis design. When building such structures, especially an arched gateway in a hedge, it's a good idea to stick to simple design. A heavy, ponderous structure decorated with detailed cornices or elaborate curved work appears rather out of place in the hedgerow. This one, you will note, is simple and effective as a decorative feature of the home grounds and, at the same time, serves the twofold practical purpose of providing rigid, permanent gateposts and a guide, or support, for training the hedge.

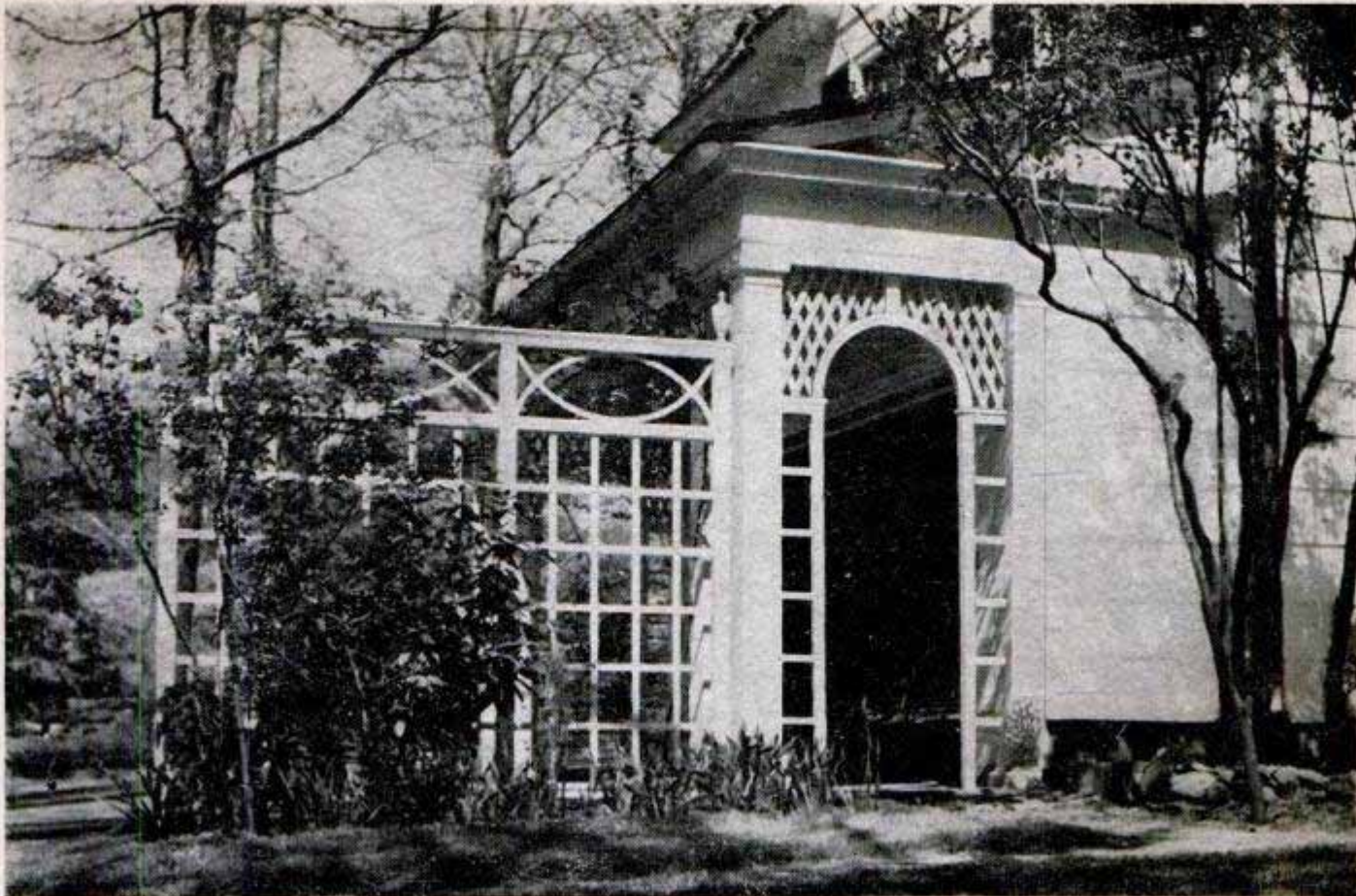

The formal trellis often is used to lower height of an opening or to make the house appear longer or wider

Small trellises, such as the fan type shown below, are easy to build. Bow is nailed to ends of fan slats

Stick to plain design when building a gate arbor in a hedgerow. This type is easy to build and maintain

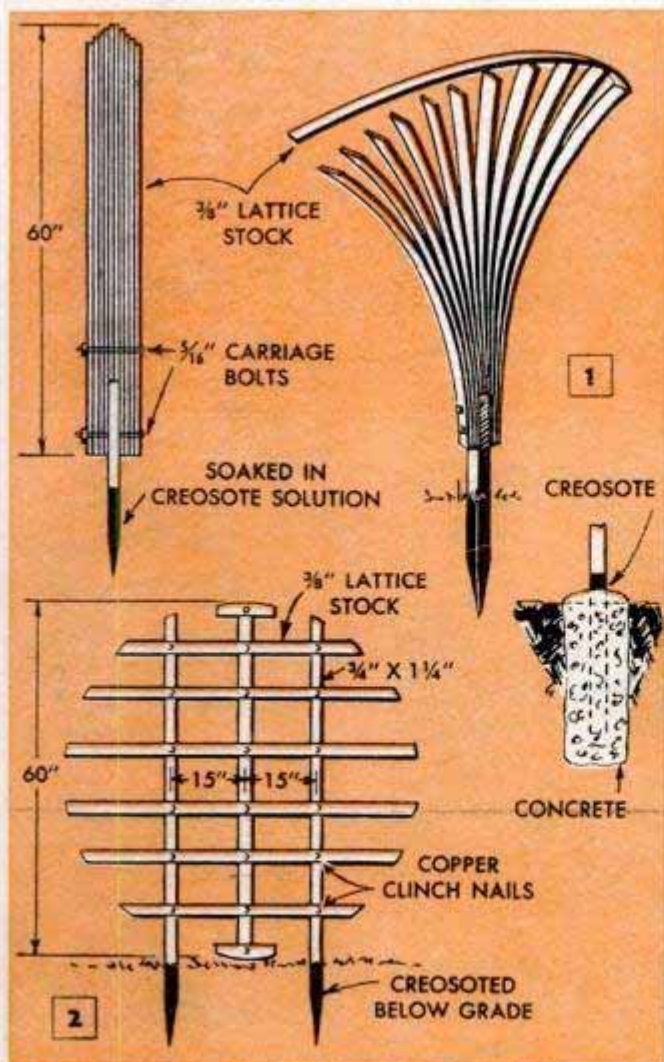

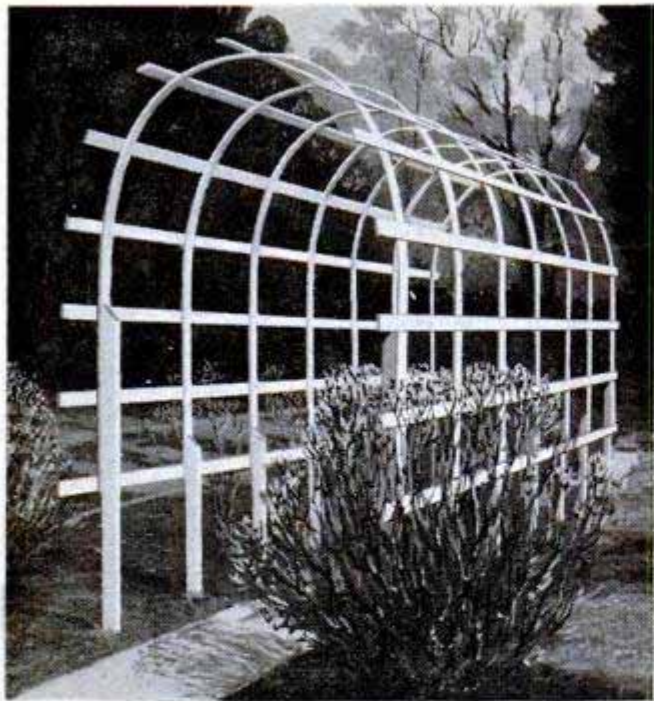

Simple construction of bow-type arbor will appeal to homeowners having natural, or informal, gardens

Two popular types of simple trellises are detailed in Figs. 1 and 2. The fan trellis, shown in the upper detail, is pictured below in the right-hand photo. Here, two horizontal crosspieces have been added in addition to the bow top. The round trellis is made by nailing slats (lattice stock) to two spaced uprights of heavier material. The ends of the slats are cut off on a radius and are arranged in such a way that the structure appears circular in form when assembled. Addition of the center member with end blocks cut on a radius finishes the job. The trellises, arbors and gateways pictured on this and the opposite page are typical, and the various applications pictured are suggestive of the many uses to which these structures are adapted. The curved arbor shown at the left is detailed in Fig. 3. The dimensions given are merely indicative of the average over-all size. It can be built in any length up to 20 ft. and the arched members, or bows, can be installed in any number and spacing desired.

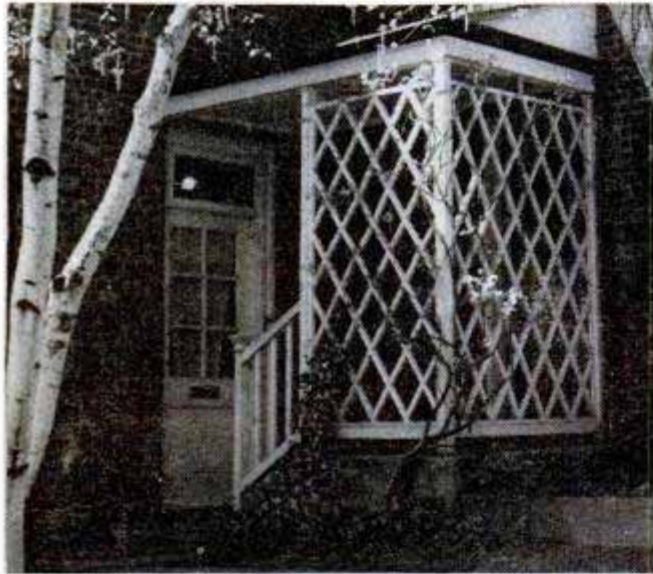

Above and below are two applications of trellises used to partially enclose open porches. Diamond pattern of one above screens a doorway effectively while squared design below lowers height of opening

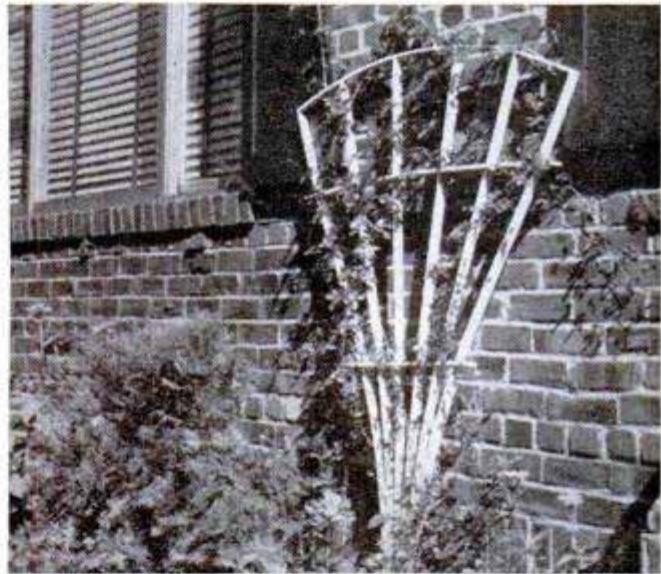

Above, a typical application of the fan-type trellis placed against a red-brick wall to support a rambler rose. Below, diamond-pattern panels enclose hooded garage entryway and screen service door to kitchen

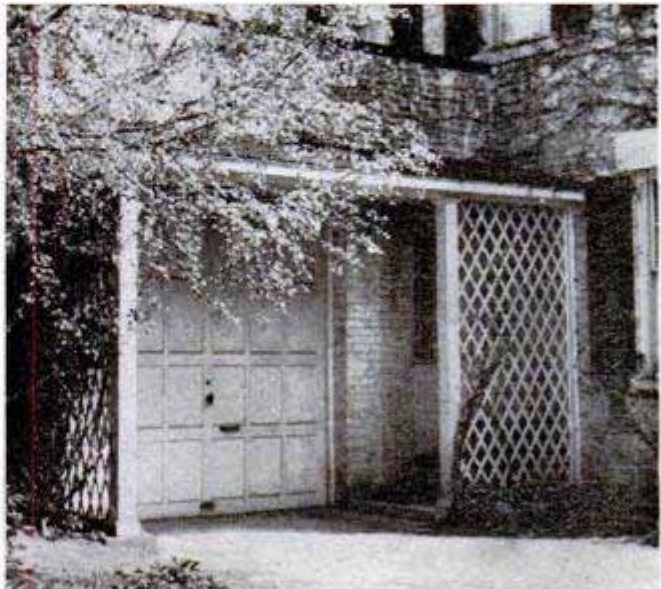

Three quite important construction details of various types are shown in Fig. 4. Another way of making the base for a large fan-type trellis is shown in the upper detail, and the method of anchoring the ends of the bow to the outside slats is covered in the center detail. When making flat, clinch-nailed joints such as are common in trellis and arbor construction, it's important to paint the joining surfaces with a prime coat before assembling. A still better procedure is to prime and paint all parts before joining. Parts driven into the ground or set in concrete below ground level should always be soaked in a creosote solution, Figs. 1, 2 and 3. Place the solution in a container and allow the lower ends of the stakes or posts to soak 48 hrs. or longer. A creosote solution is frequently used as a finish for the entire structure as it stains the wood a weathered brown and at the same time acts as a preservative. However, it should be remembered that oil paints cannot be applied over creosote.

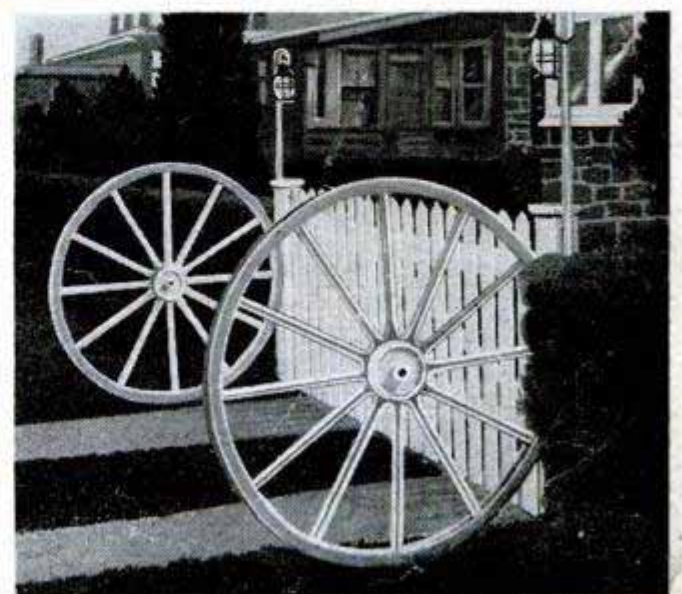
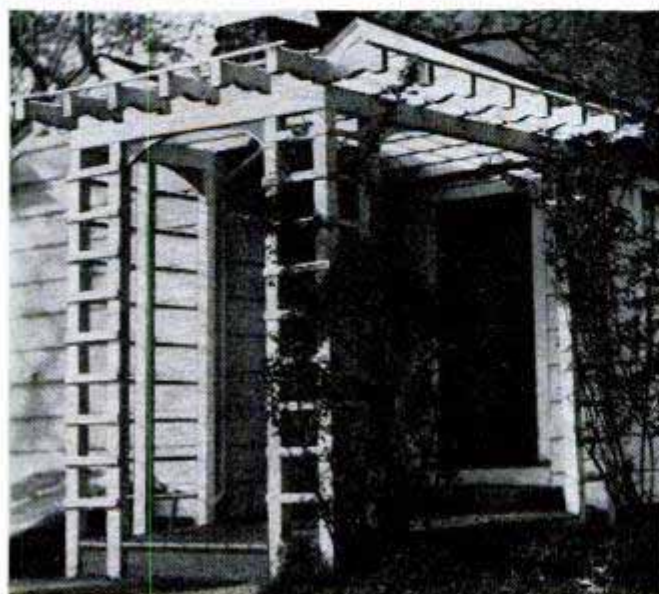
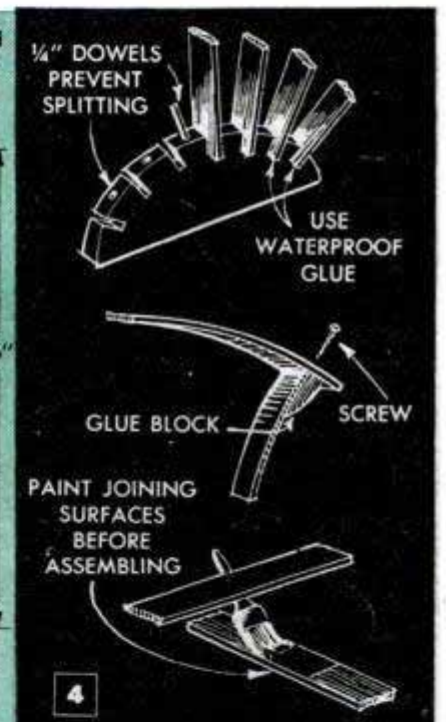
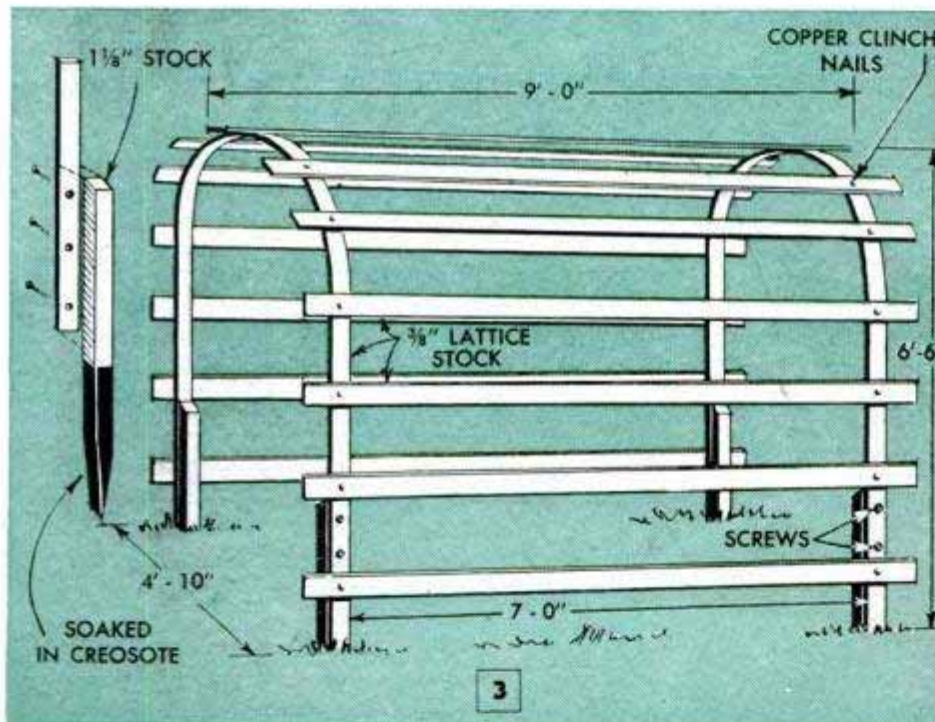
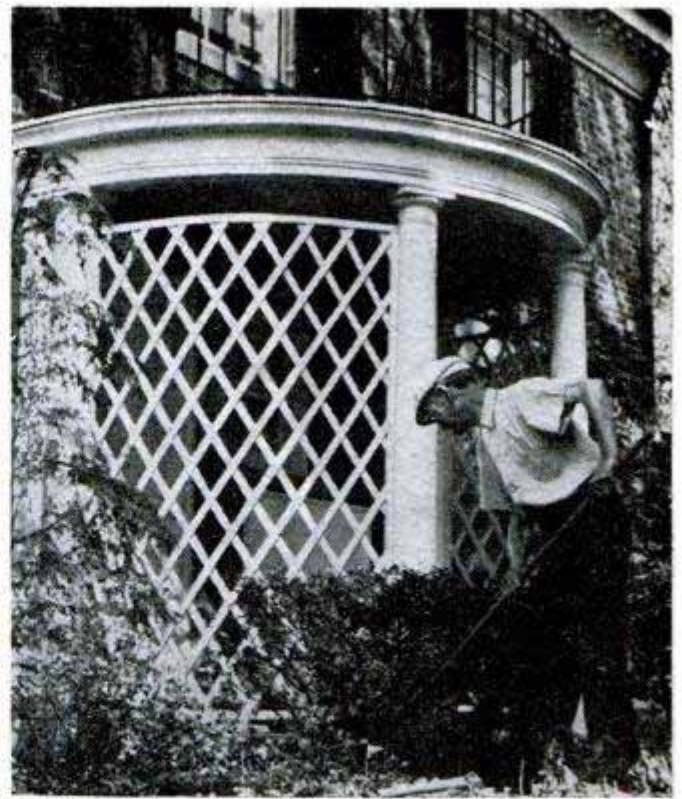

Wooden Bar Adjusts Tension Of Multiple Clotheslines



Sagging of indoor clotheslines or outdoor lines strung parallel and fairly close together can be corrected quickly if they are fitted at each end with a movable wooden crossbar. The bar is simply pushed toward the wall or posts to draw the lines taut, and moved outward to increase the amount of sag if the lines are too high. Two lines are strung from each hook, as shown in the illustration, and the crossbar, which is a length of 1 x 2, is drilled for the clotheslines. In addition to permitting the tension adjustment, the crossbar also serves as a spreader to keep the lines evenly spaced at all times.

Harris A. Palmer, Fairfield, Iowa.

Flowerpots Mended With Inner Tube

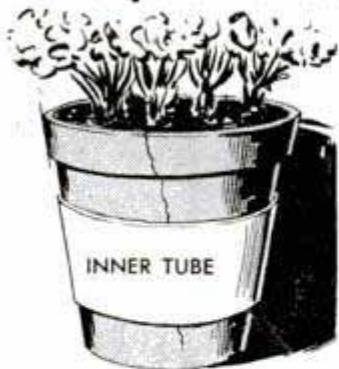

Instead of throwing away your broken flowerpots, you can make them usable again by holding them together with a wide band of rubber cut from an old inner tube. Simply stretch the section of tube

over the base of each broken pot. If you like, the rubber can be painted to match the color of the flowerpot.

Ervin L. Strayhorn, Beebe, Ark.

Grease Pencil Transfers Designs

Repeat designs are transferred quickly and accurately with a grease pencil and tracing paper, provided it does not matter

if the design is reversed. After placing the paper over the original and tracing the design with the grease pencil, lay the tracing upside down on the work. Rub the back of the paper with the thumbnail or the tip of a teaspoon to transfer the design. The grease pencil will print about ten duplications.—Francis J. Kafka, New York City.

Chain Helps Screen Damp Sand

To speed the process of screening sand which is lumpy or difficult to sift because it is damp, place a length of chain, such as a tire chain, in the screen before



pouring in the load of sand. The weight of the chain will serve to break the lumps and force the sand through the screen.

Sorting Tray for Small Parts Has Built-In Funnel

Home craftsmen who keep a wide variety of nails, screws and other small parts in cans or jars will find this sorting tray invaluable for selecting just the right bolt or screw from the collection. After the contents of a jar are emptied onto the tray and the needed parts picked out, the rest of the items are simply poured back into the jar through the funnel-shaped end of the tray. The tray is made as detailed, using plywood or hardboard for the bottom. Note that a screw eye is driven in the end of the tray opposite the funnel spout. This permits hanging the tray from a wall or the side of the workbench where it is out of the way.

Charles C. Thomas, Cambridge, Mass.

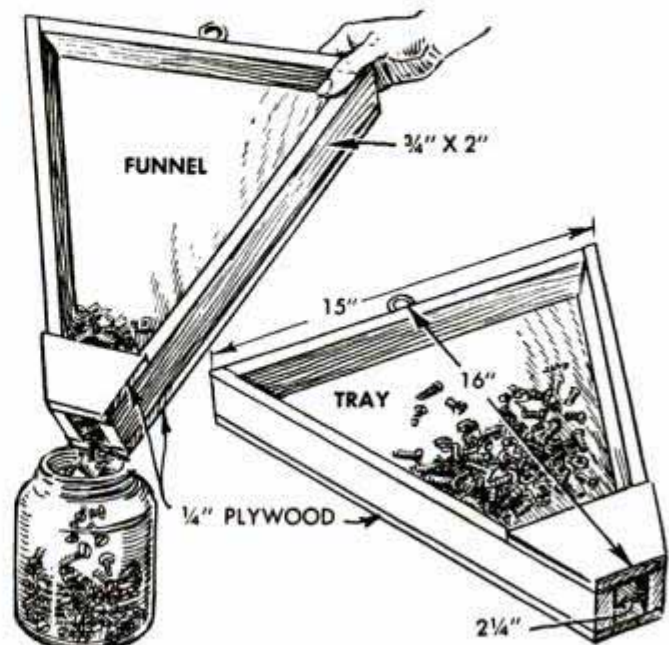

Refinishing VENETIAN BLINDS

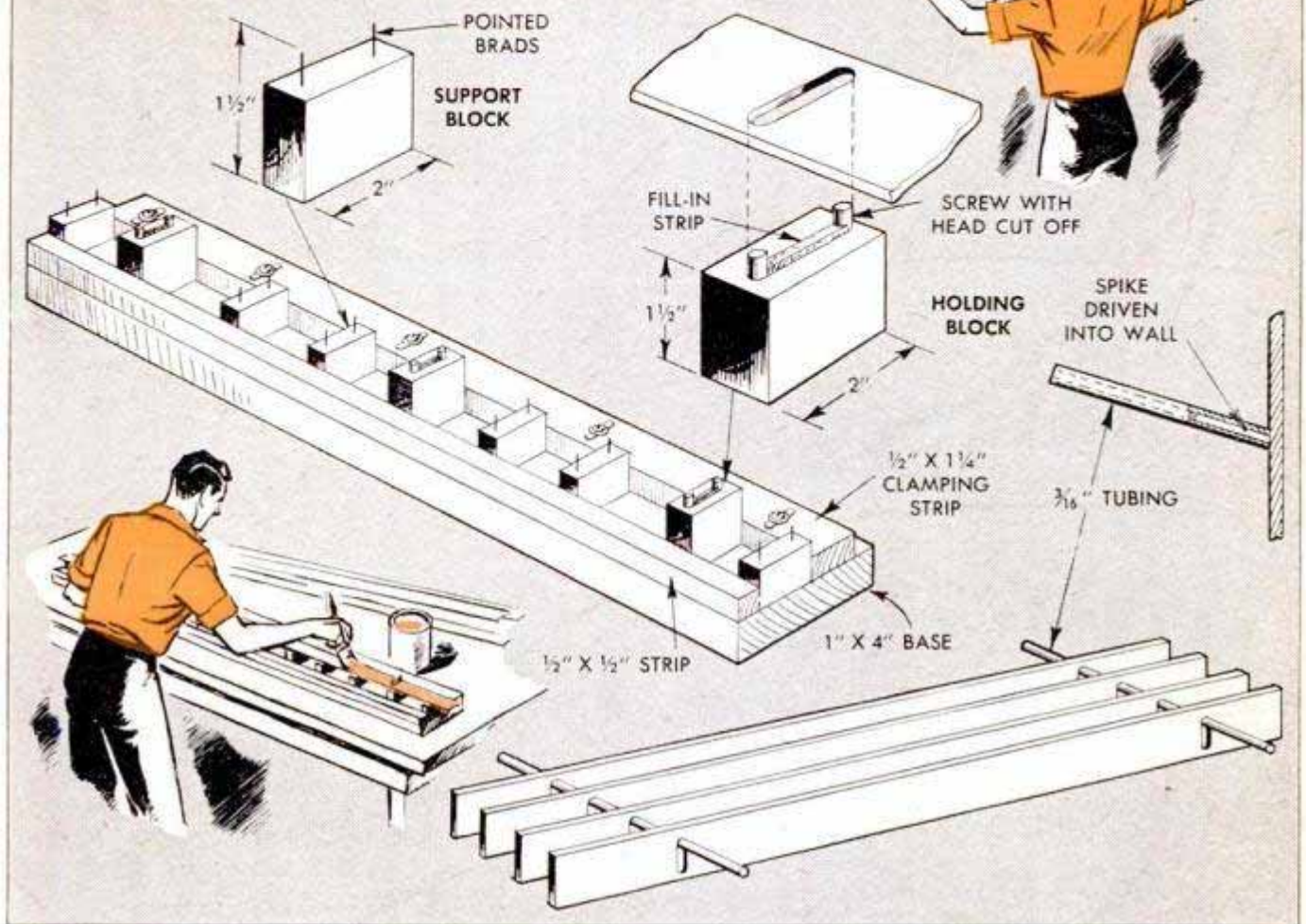

WHEN REFINISHING Venetian blinds, a great deal of time can be saved by building two racks, one for holding the slats while they are being painted, and another for drying them. To build the painting rack, first cut the base piece, the back strip and the clamping strip to a length which will accommodate the longest slats to be painted. Nail the back strip flush with one edge of the base and cut $\frac{3}{16}$ x $\frac{3}{4}$ -in. slots in the clamping piece at intervals of about six inches. Then cut two or three holding blocks, 1 x $1\frac{1}{2}$ x 2 in., one for each cord opening, in the longest slat. Center the opening of a slat over the top of each holding block and, using a sharp pencil, trace a pattern of the opening onto the blocks. These patterns will serve as guides for driving screws which, when the heads are cut off, engage the cord openings of the slats. The screws, of a diameter slightly less than the width of the patterns, are driven just inside the ends of the patterns and extend about $\frac{1}{4}$ in. above the tops of the blocks. After cutting the heads off all screws, place the holding blocks on the base piece, one at each end and one in the center, with their edges against the back

strip. Place the clamping strip in front of the blocks, holding them securely against the back strip as shown. With the clamping strip in this position, drive a round-headed screw through the center of each slot and into the base, seating the head of each screw on a metal washer. Note that the clamping strip can be moved back and the blocks can be adjusted simply by backing off these screws. Now lay a slat in position on the fixture, and fill the space between the headless screws on each holding block with wood putty. Allow the putty to dry before removing the slat. The support blocks are made by driving two brads into the top of each block and cutting them off so that the height from the bottom of the block to the top of the brad is $1\frac{1}{2}$ in. Support blocks are spaced 10 inches apart in the fixture. Provide a drying rack for the painted slats by driving two spikes into the wall, spacing them the same distance apart as the outer cord openings of the slats. Cut the heads from the spikes and press a 12-in. length of $\frac{3}{16}$ -in. tubing over each one. Hang the slats in the wall rack as in the lower right-hand detail, spacing them so they do not touch each other.

A

Fountain

ON YOUR TABLE

By Allan Carpenter



This attractive fountain utilizes a ceramic bowl for the pool and a ceramic flowerpot for the pump housing. Note miniature birdbath cemented to housing

HIGHLY DECORATIVE table fountains, which up to now have been considered a luxury item, can be fashioned at home for only a few dollars. You can make a simple though effective fountain in a half hour or so, or you can spend several days building a miniature table-top rock garden similar to the one pictured in full color on page 165. A recirculating pump like that shown in the lower left-hand photo is the first requirement, and this can be purchased in kit form or completely assembled. In addition to the pump, the fountains are composed of plastic or ceramic dishes, bowls or flowerpots, plus a plastic clothes sprinkler which serves as the fountain spray. The design of the fountain is limited only by your own good taste and imagination. A myriad of novelties, such

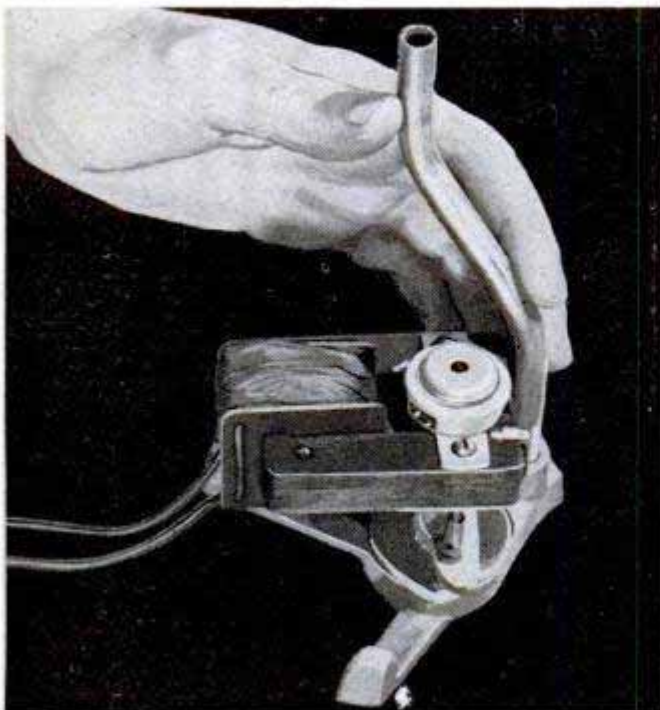

Recirculating pump draws water from bottom of pool and forces it out fountain spray where it cascades back into pool. Only water loss is from evaporation



Rock-garden pump is concealed in deep bowl. Water from plastic dish set on bowl rim drains through holes near sides so motor and wiring are kept dry



Water cascading from birdbath plus a spray of flowers in season form attractive table fountain. Ordinary frog in bottom of pool holds the cut flowers

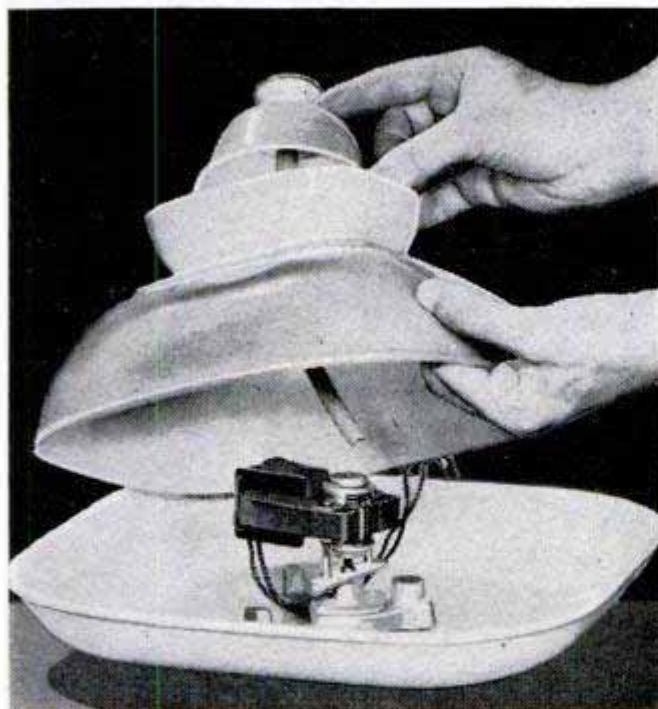

Simplest type of fountain is made from plastic bowls. Rubber tubing replaces pump-outlet tube and waterproof wiring is used to run line over side of pool

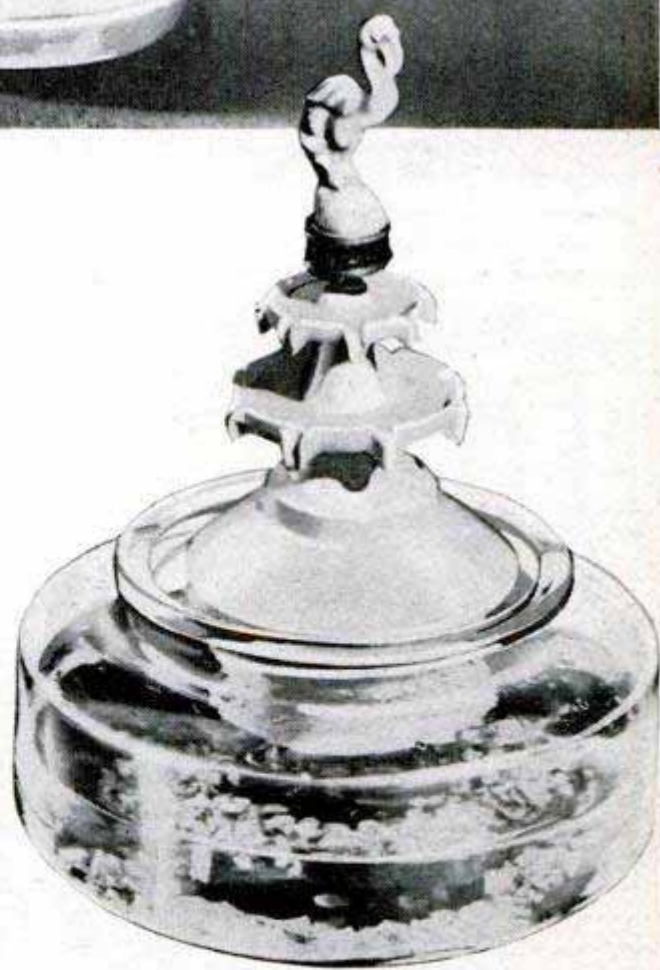

This aquarium fountain uses special fish bowl shown on next page. Extension screws raise recirculating pump off bottom of bowl so the motor is above water

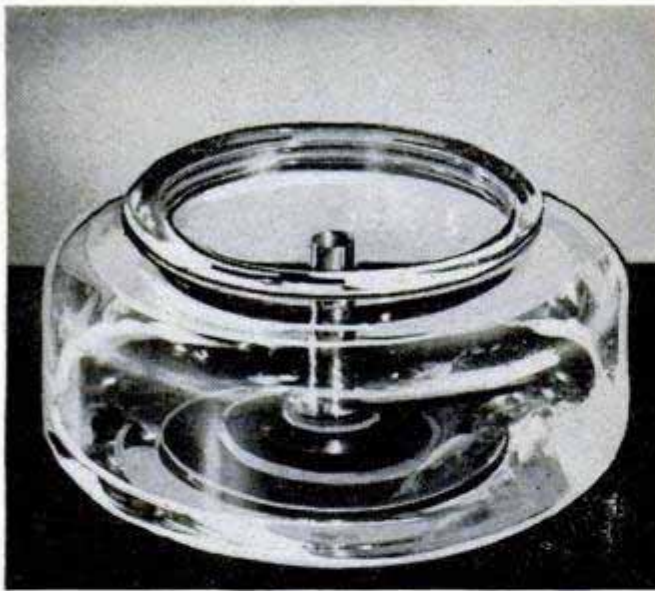

Ready-made fish bowl for use with recirculating pump is fitted with tube to carry wires for motor. Rubber gaskets seal joint between tubing and hole in glass

as simulated water lilies, figurines and toy birdbaths and lawn furniture are available.

In the basic fountain the pump is set in the bottom of a shallow container, which forms the "pool" and is covered with an inverted bowl or flowerpot to protect it. A smaller bowl is set on top of the pump housing and the plastic clothes spray is connected to the pump-outlet tube with a length of rubber tubing. In use, water overflows the small, upper bowl and cascades back into the pool where the pump recirculates it through the fountain. Both the pump housing and the top bowl must be drilled for the rubber tubing. The plastic can be drilled in the same way as wood and the hole enlarged by carving with a knife blade if necessary. A hole can be made in the bottom of a ceramic bowl either by drilling it like glass or by chipping carefully with a sharp, pointed tool, such as a small chisel, an awl or an ice pick.

For the sake of clarity, the leads to the motor are pictured as if they were brought over the edge of the pool and through the water. This may be done in actual use only if waterproof wiring is used, as otherwise

SOCKET CONNECTIONS
TAPPED INTO 110-
VOLT PUMP LEAD

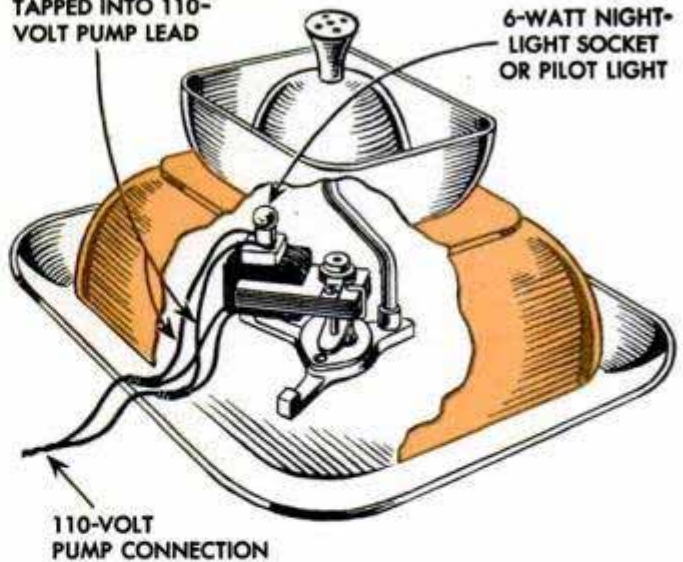

Night light wired in parallel to pump leads is used to illuminate fountain from inside. Even though waterproof wiring is used, connections must be out of water

the 110-volt line will charge the water, making the fountain extremely dangerous. A safer way to bring the line to the motor, and one that adds neatness to the fountain as well, is to insert a threaded copper nipple through the bottom of the pool and run the line under the pool and up through the nipple to the motor. The nipple is held in place with two nuts and rubber washers tightened against both sides of the pool bottom. The rubber washers insure a waterproof seal. Be sure your wiring job is electrically safe as water is a good conductor of electricity, and any short to the water or at a damp connection could cause a severe shock when you touch the fountain. The pool must be raised slightly to allow clearance on the underside for the nut and washer as well as the wires. This can be done by cementing plastic or rubber feet to the underside of the bowl.

The fountain can be given a pleasing illuminated effect by wiring a clear or colored night light to the 110-volt leads. The light is connected in parallel, as shown above, so its burning out will not open the circuit and stop the pump motor.

Small Anchor Fouled in Rock Is Released by Cable Secured to Crown

A small-boat anchor which has become fouled in the rocky bed of a stream or lake usually can be recovered if the anchor cable has been secured to the crown as shown in the photograph. The cable is not attached directly to the eye of the anchor, but is simply lashed to the shank at the eye with a short length of strong cord. The cord is tested to see that it is strong enough to lift the anchor under ordinary conditions, but can be broken by a sharp tug. When the anchor becomes fouled, the boat is moved above the anchor and the cable is jerked

free of the eye. Then the anchor is dislodged by hauling the crown end upward.
Clinton R. Hull, Costa Mesa, Calif.

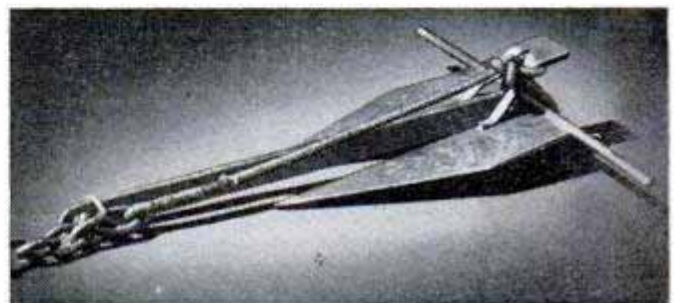

Portable Drying Rack for Towels and Clothes

Easily carried from bathroom to kitchen or set in front of a radiator, this handy rack will hold several towels or washcloths and is just the thing for drying a few articles of clothing overnight. To build the rack, cut each upright endpiece from solid stock, or make in three parts assembled with dowels and glue. Drill both uprights for the $\frac{5}{8}$ -in. dowels which provide the towel bars, drilling the parts simultaneously to assure alignment of the holes. Next cut out and mortise the base pieces, as in the lower detail, to receive the uprights and the bottom panel. Note that the mortise for the 5-in. bottom panel is made only 3 in. long and that 3-in. tenons must be cut on both ends of the panel before assembly. After sanding all the parts smooth, join the uprights to the base pieces with glue and screws. Then complete the assembly by gluing all the parts together and pinning the ends of the dowels in the uprights with brads. To afford maximum protection from moisture,

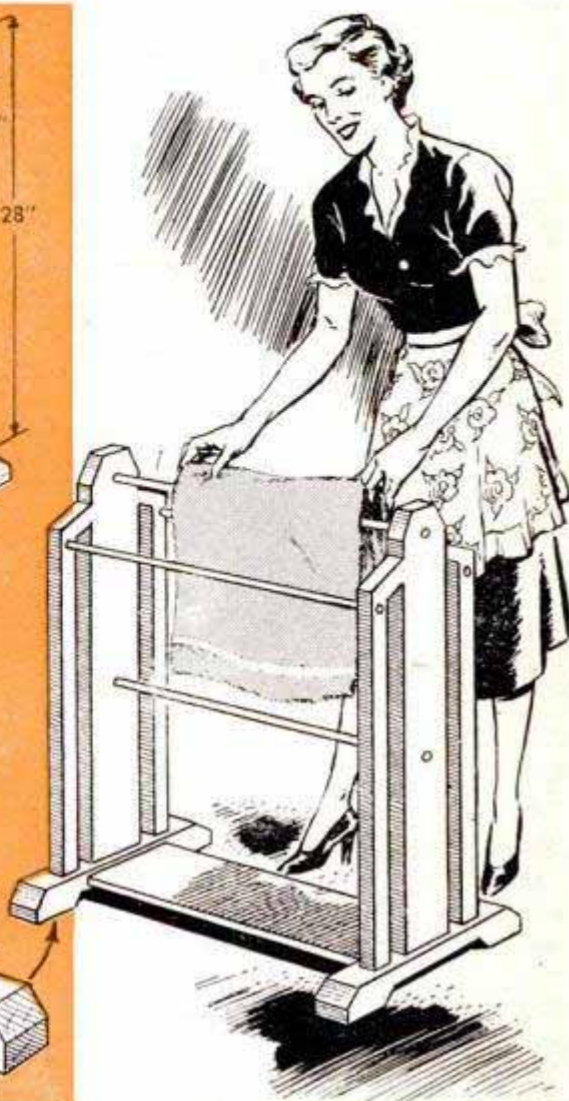
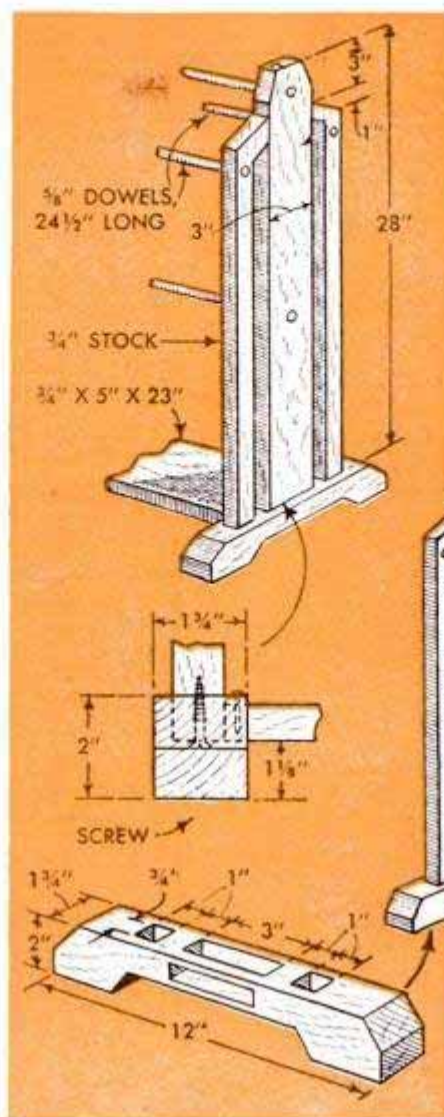

it is a good idea to apply two coats of clear lacquer to the rack. Then, if desired, an additional coat or two of enamel may be applied over the lacquer.

Plastic Protects Stair-Well Wall From Children's Finger Marks

Toddlers who are just learning to creep or walk up the inside stairs are likely to leave finger marks and smudges on the wall



surfaces along the stairway. To protect the wall from becoming soiled, sheets of cellophane or thin, transparent plastic can be tacked to the wall so they completely cover the area which the child will probably use for support. Smudges left on the protective surface can be wiped clean and the plastic shield is easily taken down when no longer needed.—R. M. Woodbury, Haverhill, Mass.

Lemon Rind Removes Mineral Stain

Instead of throwing away the skin after squeezing a lemon, use it with the adhering pulp to loosen mineral deposits from the insides of teapots or other kettles. Simply fill the utensil to be cleaned with lukewarm water, cut up and add the skin of one lemon to each pint of water and allow to soak for four or five hours. Then rinse the kettle with hot water.

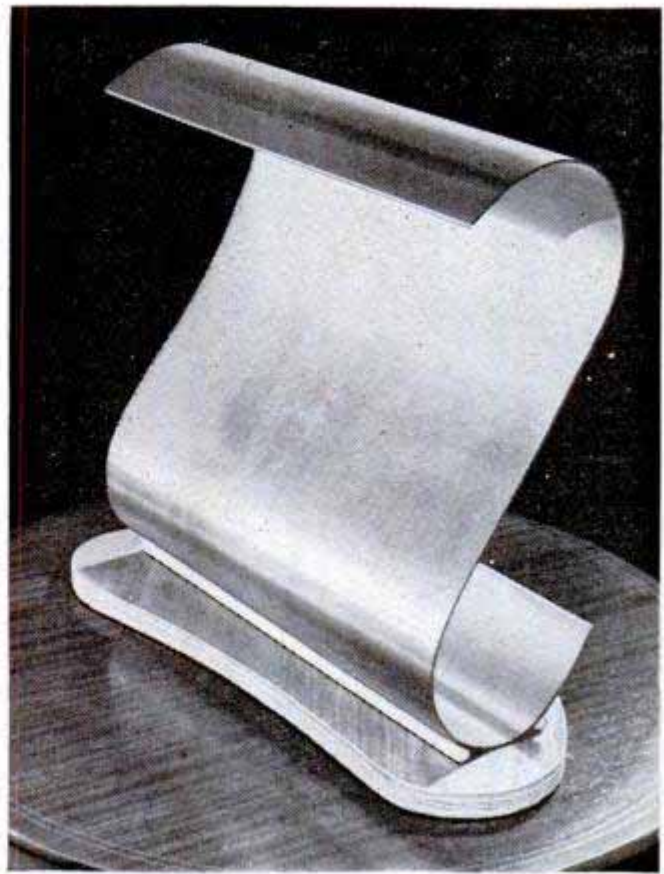

Table LAMPS

By George Daniels



After inserting end of metal roll through baking tin, slit the metal with tin snips and hammer the ends over

TABLE LAMPS like these are available only from your own basement workshop. Although just one of the designs is shown as a planter lamp, both can be readily adapted to this decorative purpose. The reflectors, which are especially styled to go with modern furnishings, should be made from polished aluminum, copper or red brass. In the novel jack-in-the-pulpit design, upper left, the "pulpit" is made from polished copper, a sheet 9 in. wide and 32 in. long being required. "Jack" is a tubular-type filament lamp bulb turned into a keyless socket which is anchored in a plywood base. The latter is cemented to a baking tin of the type used for baking small cakes and for molding salads. The baking tin forms the planter. The first step is to roll the end of the copper sheet in from both edges so that it will slide through the upper end of the conical riser in the center of the tin. Force the rolled end through the riser un-

til it projects about 1 in. from the bottom and then make several cuts with tin snips so that the metal can be bent over and hammered flat, as in the photo at the lower left on the preceding page. The other end of the copper sheet is trimmed to a long, tapering point to simulate the single wide leaf of the jack-in-the-pulpit plant. Bend the point over and down as shown in the photo. Next, cut a circular base from $\frac{1}{4}$ -in. plywood to a diameter slightly less than the diameter of the tin. Drill a hole at the center to take a $\frac{3}{4}$ -in. fixture bushing with slotted nut. Turn the nut on the lower end, insert the bushing in the hole and screw the socket onto the upper end. Wire the socket with standard lamp cord and provide a cord switch for turning the lamp off and on. Drive three rubber-headed tacks, equally spaced, into the underside of the plywood base. Now, turn the lamp bulb into the socket and coat the top side of the base with mastic cement as in the lower photo at the right. Insert the lamp bulb through the neck, or riser, at the center of the tin and press the base tightly against the bottom of the pan, being careful to center the bulb. Wipe off excess cement and weight the tin until the cement sets. Coat the tin and the plywood base with a flat-black enamel.

The novel S-shaped reflector, or shade, on the table lamp shown in the upper right-hand photo on the preceding page is made from a single sheet of copper 16 in. wide and 24 in. long. While you can roll the metal around a bottle as in the top photo at the right, you'll get a better job if you have your tinsmith do this on his slip roll. The lamp and socket are housed in the upper curve of the S, which forms the reflector. Although in the original the socket was simply wrapped with a layer of rubber tape and two layers of friction tape and held in place with a twisted wire, a better installation is to rivet a metal angle bracket in the top curve near one end. Drill the bracket to take a brass fixture bushing, insert the bushing through the hole, turn a nut on one end and screw the keyless socket onto the other end. Bring the lamp cord to the socket through a hole drilled in the back of the reflector. Fit a rubber or fiber grommet in the hole to protect the cord and provide a cord switch for controlling the tubular-type filament lamp bulb. Although the base of the original lamp was made from birch plywood, colored plastic also can be used. In either case, the reflector is attached to the base with three screws and supports are placed at each side of the lower curve. These can be polished birch dowel rods or clear plastic rods cemented in place.

Polish the metal reflectors of both lamps on a buffing wheel and apply a clear metal lacquer to prevent tarnishing.

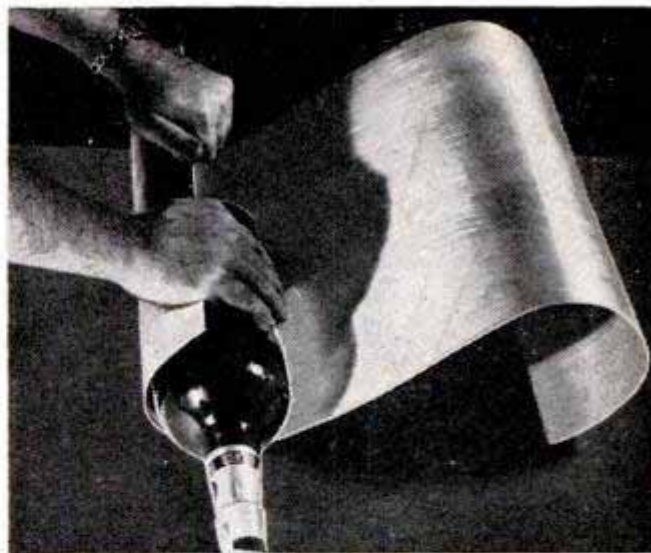

Reflector can be shaped with aid of bottle, but for a better job take it to your tinsmith for forming



Although socket can be wired in place, it is better to support it in an angle bracket and fixture bushing



After fitting socket and lamp bulb, coat the plywood base with cement and attach to bottom of the planter

Records Kept From Slipping With Fingernail Polish



Especially in the case of long-playing phonograph records, any slippage of the records stacked on the changer turntable will result in annoying tone distortion. Although there are many ways in which slipping can be prevented, applying fingernail polish to both sides of each record is an easy method that results in a positive nonslip action. Two or three dabs of fingernail polish are applied near the outer edges of each label, keeping the distance from the center hole the same on all the records. The hardened polish produces slight bosses which interlock when one record is dropped on top of another.

H. G. Frommer, Milwaukee, Wis.

Length of Rod Substitutes for Funnel

In the absence of a funnel, liquids can be poured from a wide-mouthed container into one having a narrow neck by use of a length of rod or tubing. After placing one end of the rod in the container to be filled, pour the liquid so that it flows along the rod and into the small container.

Small Magnet Holds Paper to Metal

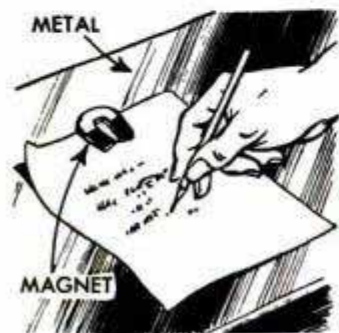

Making notes or sketches when working on an automobile or other piece of machinery is often bothersome, especially if you have only one hand free to hold the sheet of paper

and also do the writing. By means of a small magnet, the paper can be placed against any flat, steel surface of the machine and held securely enough to permit writing even on a vertical surface.

W. F. Schaphorst, Newark, N. J.

Nails Driven in Broom Handle Provide Handy Weed Puller

Supplying its user with an abundance of leverage, this unique weed puller is especially effective in pulling large weeds and devil grass. It is made by fitting a metal ferrule, which can be taken off an old window-shade roller, to a section of broom handle. Drive two 10d nails into the end of the handle, cut off the heads and sharpen the projecting ends. To use the weed puller, stab the center of the weed and turn the handle until the weed starts to wrap around the nails. Then lower the angle of the handle enough so that the weed won't slip off the prongs, and raise the pronged end to pull out the weed.

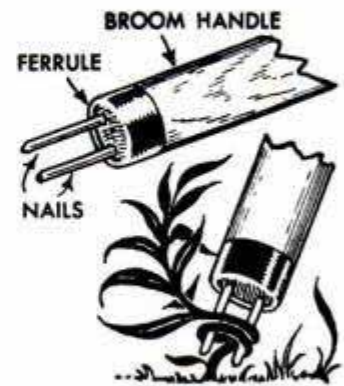

A. A. Stafford, Corona del Mar, Calif.

Pipe Cap Serves as Filter Bowl On Gasoline Engine

Should the glass filter bowl on a gasoline engine break, it often can be replaced by a pipe cap having nearly the same diameter. The pipe cap will serve the purpose until a new bowl can be obtained. For instance, one man found he was able to replace the broken filter bowl of his power-mower engine with a 1/2-in. pipe cap, simply by grinding the sides of the cap to remove the projections and also decrease the outside diameter slightly, so that the cap would fit the filter casting. The threaded end of the cap was filed smooth to provide a tight seal with the filter gasket.

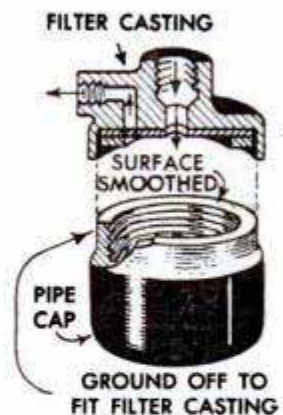

□ An extra mirror, attached to the back of the medicine-cabinet door, is handy when using cosmetics, antiseptics, etc., which are kept in the medicine cabinet. The need to close the door to use the standard mirror mounted on the front of it is avoided.

TUCK POINTING

It's important to keep mortar joints between bricks water-tight to avoid costly repairs

By E. R. Haan

WHETHER your home is of brick or of frame construction with only a brick chimney, you no doubt realize the necessity for tuck pointing; that is, renewing the loose and crumbling mortar in the joints between the bricks. This is one phase of home-repair work in which you can save a sizable amount of money by doing the job yourself, and it does not require any special skill or know-how.

The primary cause of the loosening of the mortar is the entrance of water into hair-line cracks where the bricks have pulled away from the mortar. Constant wetting, especially during the spring and fall, weakens the mortar and, during the winter, the freezing of water in the cracks causes the mortar to crumble. The result, of course, is further deterioration and, if not corrected, results in a dangerous weakening of the structure. All brick surfaces are subject to mortar erosion, but the problem is most likely to be encountered in the chimney brickwork, Fig. 1, and on the walls under parapet copings, leaky eaves troughs and large windows, as well as at any point where brickwork comes in contact with moist earth. Stopping water leakage at its source may require only calking of the



Chimneys frequently need tuck pointing as their location subjects them to all damaging weather elements



Above, before chimney is tuck pointed, the cap is examined and all cracks are sealed to keep out water. Below, remove all loose and crumbling mortar, brush away the dirt and saturate the brickwork thoroughly



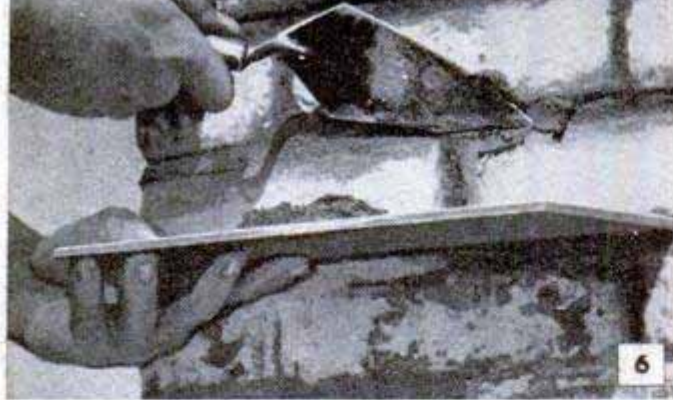

Edge of pointing trowel is pressed over mortar to "strike" the joints, making them compact and smooth

crack through which it is entering. Sometimes this can be done with an application of roofing cement as in Fig. 2. However, occasionally it is necessary to replace a flashing, repair a cracked chimney cap or renew a wall coping.

Danger sign: A white frostlike deposit on the outside of the brickwork is an obvious indication that water is penetrating the mortar joints. The deposit, called efflorescence, is caused by soluble salts being washed out of the bricks and mortar, and can be removed by scrubbing the affected surfaces with a solution of muriatic acid, 1 part, and water, 10 parts, using a fiber brush to apply the solution. All traces of the acid should be rinsed from the brickwork with a garden hose. *Caution: Avoid getting the acid solution on the skin or the clothing. Wear rubber gloves while working.*

Cleaning and soaking: Before tuck pointing, remove all loose mortar with a cold chisel or with a screwdriver and hammer, Fig. 3. Avoid chipping out solid mortar but remove that which can be pried out by hand or with only light tapping. Then brush the dirt and dust away as in Fig. 4. Dry bricks quickly absorb moisture from fresh mortar, causing the mortar to congeal and preventing proper adhesion. To avoid this, thoroughly wet the brickwork before the mortar is applied, Fig. 5.

The mortar mix: Bags of prepared mortar can be obtained from most building-supply stores. Dry-mix the entire bag to be sure that the ingredients are uniformly distributed. Then put a small amount (as much as you will use in about an hour) in an old metal pail and, adding water a little at a time, mix thoroughly until the consistency is quite stiff. If you prefer, you can make your own mortar by mixing portland cement, 1 part, hydrated lime, 1 part, and clean, sharp sand, 6 parts—all measured by volume. For extra-strong mortar, use 3 parts of sand instead of 6 parts. Use the mixed mortar as soon as possible, as it

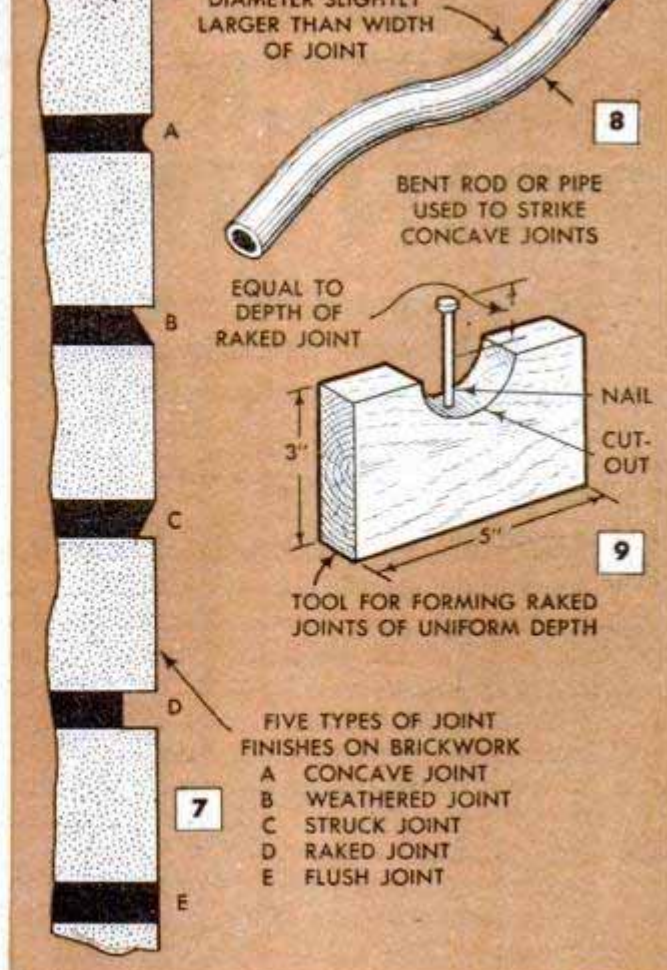

FIVE TYPES OF JOINT FINISHES ON BRICKWORK
 A CONCAVE JOINT
 B WEATHERED JOINT
 C STRUCK JOINT
 D RAKED JOINT
 E FLUSH JOINT

quickly becomes too stiff to work and will lose some of its strength each time it becomes necessary to add water. If you use a wooden mixing board, soak the board with water so it will not absorb moisture.

Applying the mortar: The only tools needed for filling the joints with mortar are a pointing trowel and a 6 x 12-in. hawk for holding the mortar, the latter being cut from sheet metal or hardboard. With the hawk, hold a small amount of mortar alongside a horizontal joint and work it in place with the trowel, Fig. 6. Try to avoid smearing the face of the bricks. After a few of the joints have been filled and before the mortar sets, finish them by pressing the trowel or other tool against the joints and drawing it across the surface of the mortar. This is called "striking" and is done vertically first, then horizontally.

Kinds of joint finishes: Fig. 7 shows a number of joint finishes commonly used. Concave joints, detail A, are usually considered the best since the mortar in them is packed tightly against both sides of the joint. They are easily made with a rounded tool like the one pictured in Fig. 8. If the raked joint, detail D, is the one you must match, use a tool such as the one shown in Fig. 9. After recessing the joint with the raking tool, compact the mortar with a flat tool.

Movable Back-Yard Incinerator Is Easily Wheeled Out of View

If an incinerator must be set up where it spoils the appearance of your back yard, you can get rid of the eyesore by using this portable incinerator. Keep it tucked away alongside the garage or behind some concealing shrubbery and just wheel it out whenever it is needed. The unit is made by bolting or welding a section of oil drum on a pair of old hand-truck wheels. The latter or a satisfactory substitute often can be obtained at the local junk yard. A grate is installed in the drum about 6 in. from the bottom and a hole is cut in the side below the grate to provide sufficient draft. The hole also permits access beneath the grate for removing ashes. Pipe or flat-iron handles are bolted to the sides of the drum and, if desired, a lid can be fashioned from wire mesh or sheet metal.

Hallie H. Holt, Springfield, Ill.

W. T. M. Concrete Bar Clamps Level Concrete Forms

Setting up and leveling heavy panels for concrete forms can be done by only one man with the aid of a pair of long bar clamps. Working with one side of the form at a time, drive a clamp about 5 in. into the ground at points a few feet from each end. Rest the form boards on the lower jaws of the clamps and then estimate the approximate level, and run in the top jaw as far as the adjusting screw will permit. Loop

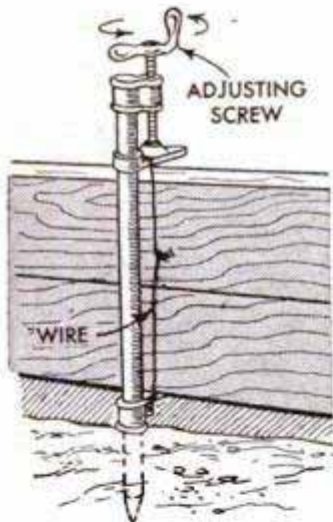

a heavy wire over the two jaws. Then, when the top jaw is backed off, the lower jaw will raise and bring the form panels level.

W. G. Waggoner, Sacramento, Calif.



Window Boxes Hung Neatly With Storm-Sash Hangers

Ordinary storm-sash hangers are excellent for hanging window boxes, as they simplify the job of mounting and removing the boxes and also eliminate rust streaks caused by conventional metal brackets. Two or three hangers are fastened to the back of the box and to corresponding positions on the window sill as shown. To keep

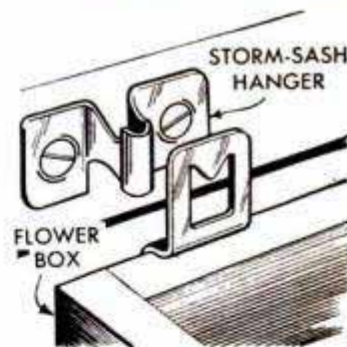

the box from tilting outward, nail a cleat to the back of the box near the lower edge.

William T. Burke, Mineola, N. Y.

Spreading Roots Over Soil Cone When Transplanting Aids Healthy Growth

Much of the loss occasioned in transplanting small bushes, such as rose and berry bushes, results from incorrect placement of the roots. Often the roots are wadded so that soil cannot be worked down



around them. This leaves air holes around the roots which kill them. To avoid this condition, form a cone of rich earth in the bottom of the hole where the plant is to be placed. Then separate the roots and place them firmly down over the cone of soil as shown in the drawing. When filling the remainder of the hole, work the soil carefully and firmly around the roots. This will help prevent air pockets and assure the bushes a good start in their new location.

John Krill, North Lima, Ohio.

Combination Shutter and Diaphragm Scale Simplifies Making Setting Adjustments

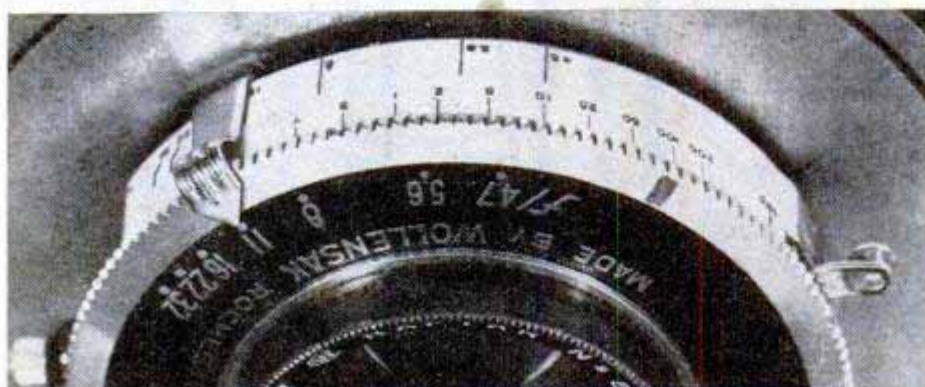
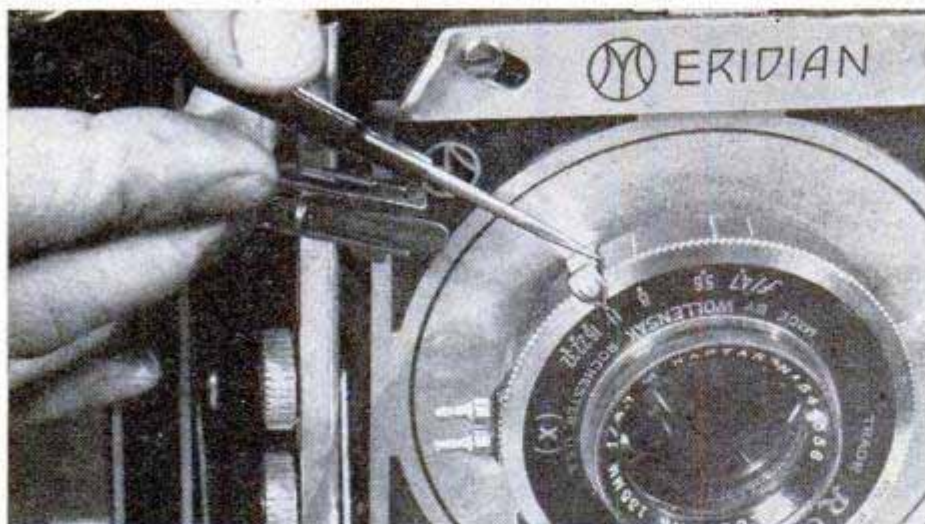

Shutter and diaphragm settings on cameras having between-the-lens shutters can be read from the top of the lens housing if the latter is mounted upside down and a combination scale is taped to the housing. First, tape a strip of overexposed film to the top of the inverted lens housing and scribe a mark alongside the diaphragm lever at each setting, upper photo. Next stick a piece of tape to the face of the shutter ring, lower photo, and use this as an index mark in scribing the shutter speeds on the film strip. Make an enlarged tracing of the marks on white paper, adding the proper numerals, and copy the tracing down to the exact size of the original strip. Then tape a contact print of the strip to the lens housing.—Alfred Coda, Englewood, N. J.

Processing Rack Cut From Plastic Box Helps Guard Against Film Scratches

To keep scratches on cut film to a minimum, I use a rack made from a plastic sandwich box that makes it unnecessary to touch the film while developing, fixing and washing. During processing, the rack is simply set in the trays of solution. The bottom of the box is drilled with numerous $\frac{1}{4}$ -in. holes and sections are cut from the corners to permit thorough immersion of the film. A strip of plastic, cut from the cover of the box, is used to divide the rack into two compartments. The strip fits in channels formed by cementing rectangular pieces of plastic to opposite sides of the rack. With the separator installed, each compartment of the rack holds two sheets of $2\frac{1}{4} \times 3\frac{1}{4}$ film, placed back to back. With the strip removed, the rack holds two $3\frac{1}{4} \times 4\frac{1}{4}$ sheets. All holes are countersunk and all edges are filed smooth so there will be no danger of scratching the emulsion.

Oliver C. Grant, Springfield, Mass.

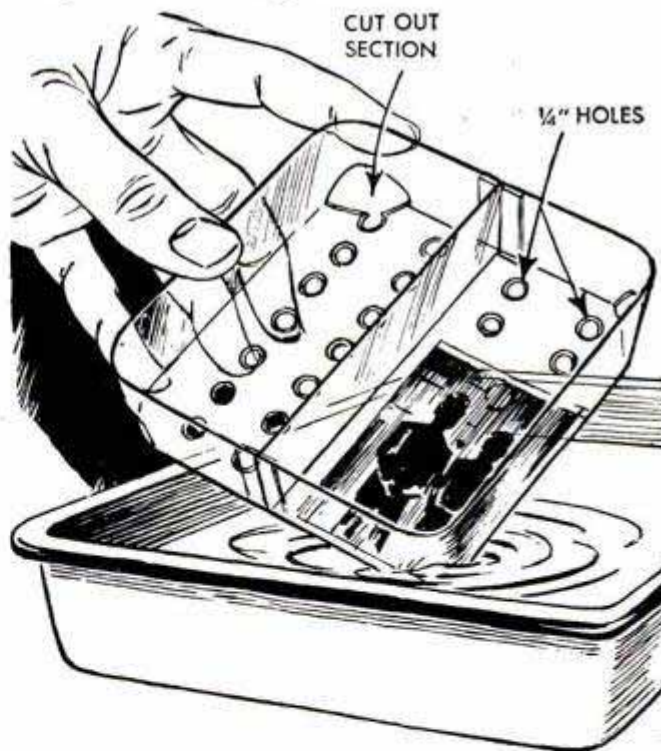

Machine Screw in Cable-Release Hole Keeps Out Dust Particles

Many cameras which are equipped with cable releases are subject to defective shutters caused by dust and dirt particles that enter the shutter through the cable-release hole. To keep this opening sealed when the cable is not being used, one photographer

simply turns a small machine screw into the hole. The local hardware dealer should be able to supply a screw of the proper size, as the threads in the cable-release opening usually are standard.

George J. Berkowitz, New York City.



Mount for MOVIE CAMERA

By John Moyer

USING a movie camera to shoot fast action, such as birds in rapid flight, racing autos, and planes taking off and landing, calls for the same point-and-swing technique used by shotgunners on moving targets. Small movie cameras are not shaped for rock-steady holding with both hands, and a tripod cannot be used for this special work. So amateurs and professionals who regularly shoot fast action with a small movie camera use a gunstock aimer like the one pictured. First, measure your camera to determine the height and length of the body, or box. Then lay out and pencil the outline of the aimer on a piece of $1\frac{3}{4}$ -in. mahogany to the overall dimensions given on the lower right-hand photo. Bandsaw to the layout lines and shape the parts to contour with a spokeshave and sandpaper. Cut a rabbet in the left side of the camera seat to permit the hinged side of the camera to open fully for reloading, as in the upper photo at the right. Locate and install a camera-locking screw in the seat to hold the camera securely in place. This screw should be of the type used in tripod heads which has a knurled jam nut to prevent the screw from loosening. Now, bandsaw and shape the forward hand-grip to a size and contour that fit your hand comfortably. Drill it lengthwise and attach to the bottom of the camera seat

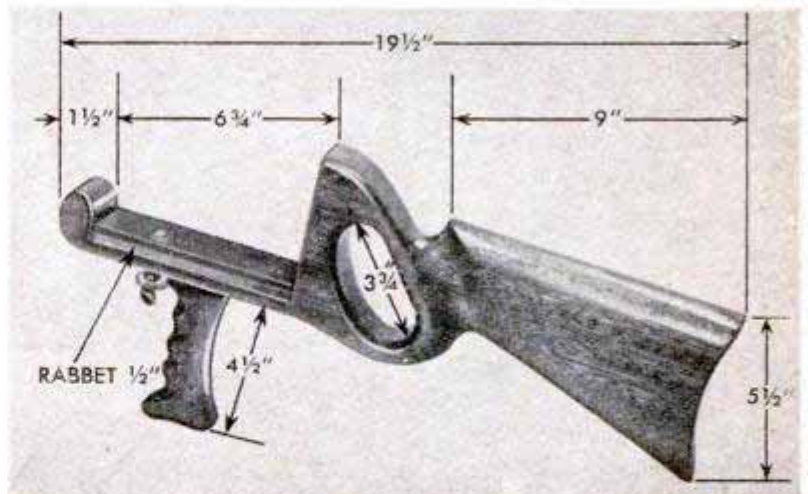
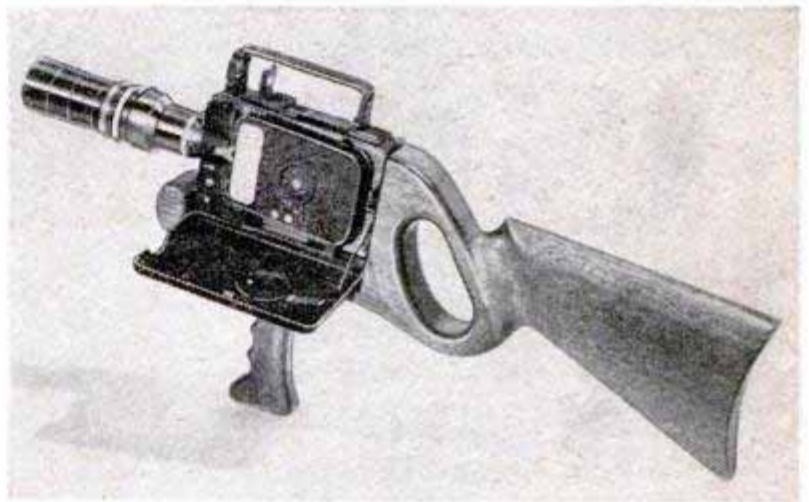

with a stove bolt. Countersink the nut flush in the seat. Sand the wood smooth, apply a colored filler, then a sealer coat and finally a coat of water-white lacquer. To prevent marring the leather covering of the camera, it's a good idea to glue a strip of $\frac{1}{16}$ -in. felt to the bottom and back of the seat. Dimensions given above on the stock and seat are only approximations.

HOME - MOVIE EDITING

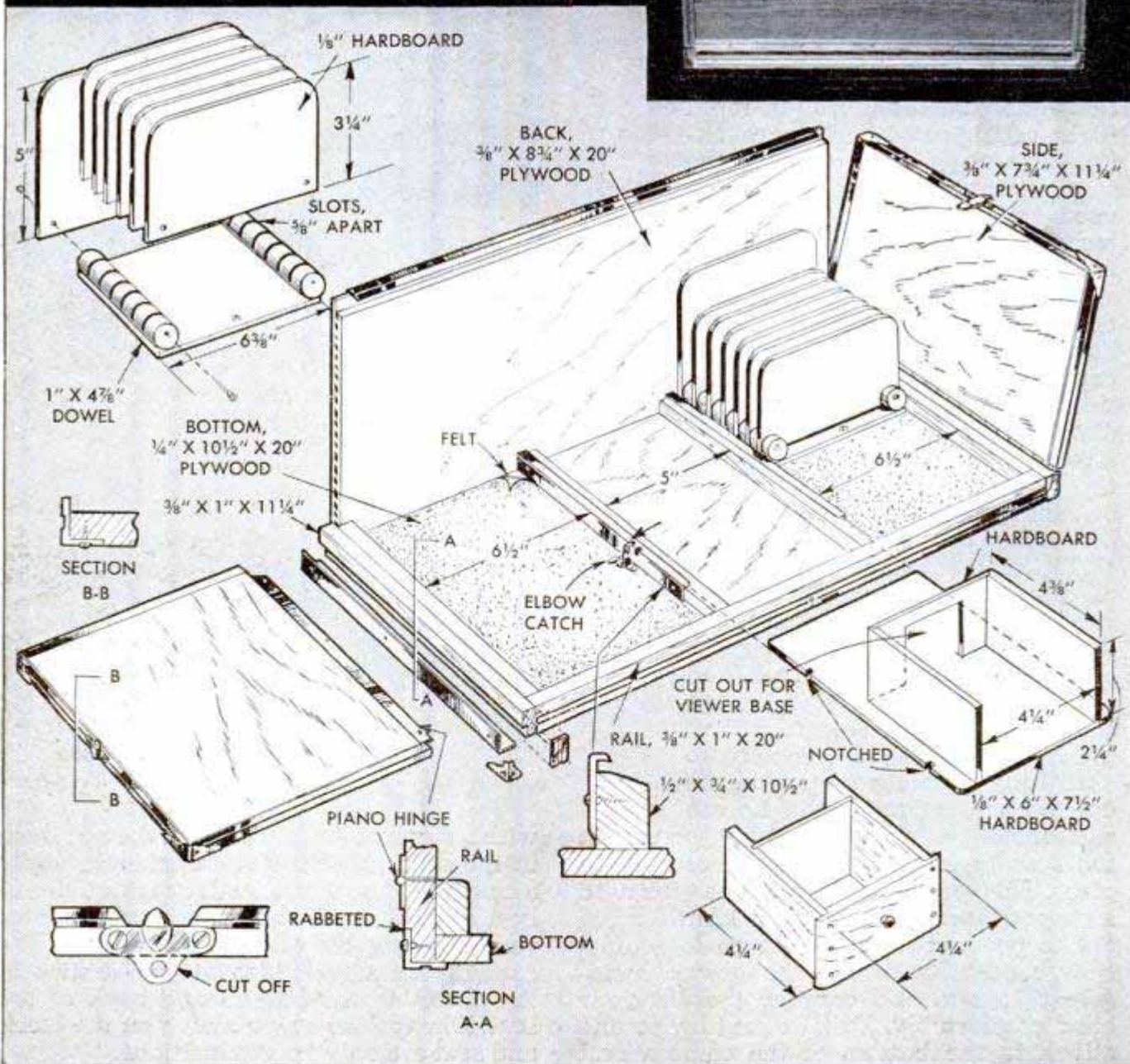
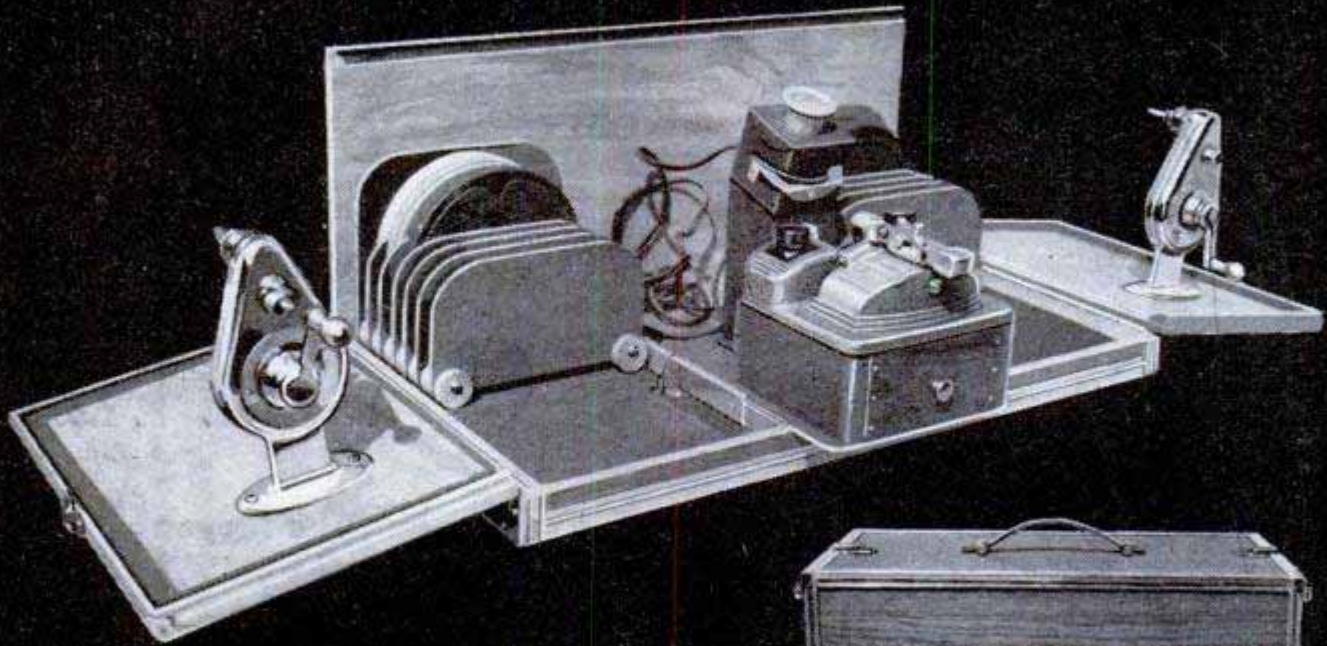

CABINET

By R. C. Grote

EDITING movie film becomes a real pleasure when you have all the necessary equipment grouped conveniently at your fingertips in this attractive cabinet. It closes dust-tight for protection of film and accessories, and is equipped with latches and a handle for carrying like a suitcase. When opened, it provides a sliding base for lining up the viewer-splicer unit, racks for storing film containers and a rigid support for the film winders. All construction details are shown on the opposite page except the hinged front and top which are detailed below. These parts are separate and are removed entirely when the cabinet is in use. Note in the details how metal edgings and corner angles are used to provide slides and reinforcing members for various parts of the cabinet. One leg of the corner angle is fitted in a rabbet cut in the end rail as shown in section A-A. Note also how the same type angle is fitted at the top of the endpiece, section B-B. The sides, end panels and top of the original cabinet were cut from $\frac{3}{8}$ -in. oak-faced plywood, which takes a very attractive natural finish. It's a good idea to finish the wooden parts before assembling. Then, after the assembly is complete, it will only be necessary to polish with wax to remove finger marks. After finishing and assembling the parts in a trial fit, attach the luggage latches which hold the cabinet closed. These latches are of the two-piece type, the striker being attached to the top of the hinged endpiece, as in the lower left-hand detail on the opposite page. The latches are shown in position in the detail below. The top and front are hinged to fold flat and the back edge of the top fits into a channel formed by a rabbet in the top edge of the back and a length of corner angle.

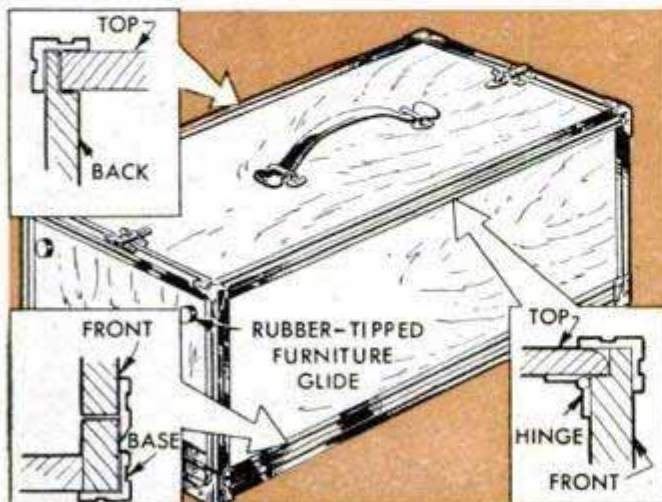

APRIL 1951



Tabs of Tape Aligned Diagonally Keep Photo Slides in Order

With the aid of a diagonal line of tape across the edges of a box of photo slides, you can tell at a glance if any are out of place. Before establishing the line, make certain that each slide is in its place. Then stretch a strip of tape from one of the lower corners of the row to the opposite upper corner and press it to the top edges of the slides. Cut the tape midway between the slides and press the severed ends down over the sides. By using a different color of tape for each row of slides, it becomes easy to avoid mixing them.

Evan Wright, Topeka, Kans.

Strap Bracket Holds Cable Release

Many photographers find it easier to steady a hand-held camera if they snap the picture with a cable release anchored to the camera case instead of using the manual release on the shutter. The ferrule at the plunger end of the cable is pressed into the channel which is formed by the carrying-strap bracket at the upper corner of the camera, as shown in the photo. If the cable ferrule is tapered, it can be pressed into the channel without prying the metal apart and is removed easily when the free cable release is used with the camera mounted on a tripod.



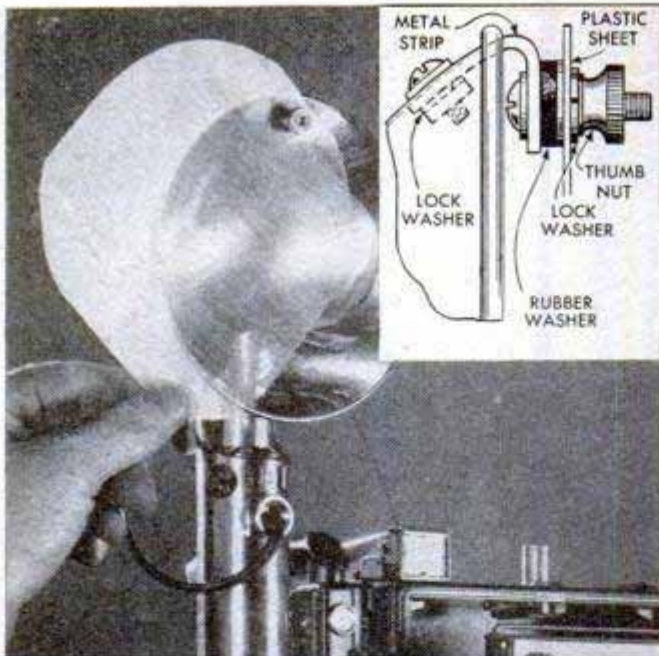

Diffusion Screen for Flash Gun Provided by Plastic Mask

When using a flash gun as a fill-in light, the flash can be diffused to give a softer effect by covering the reflector with a sheet of transparent plastic. The sheet is cut somewhat larger over all than the diameter of the reflector and the plastic surfaces are made translucent by rubbing lightly with very fine emery cloth. A metal bracket bolted to the top of the reflector holds the plastic in place. The mask, which is drilled or slotted to fit over a bolt, is sandwiched between a rubber and a metal washer, the rubber washer allowing the sheet to be swung out of the way in order to change bulbs. A thumb nut facilitates attaching and removing the plastic sheet.

Frank P. Fritz, Chicago.

Discarded Auto Ammeter Mounted on Plywood Checks Output of Dry Cells

If the flash attachment to your camera is used only on rare occasions, it will pay to have this simple tester on hand to check the condition of the battery before an important shot is to be made. The tester consists of an old auto ammeter which is merely mounted on a piece of plywood that is raised with cleats to provide clearance for the ammeter terminals and wire leads. The leads are passed through holes cut in the base and the ends of the leads are dipped in solder to assure good contact

with the cell. A rack for the cell is formed by tacking two small cleats to the plywood. To indicate that a cell is in good condition, the ammeter should read

between 5 and 10 amps., depending on the type of gun used and the number of flash bulbs to be fired simultaneously.



Popular Mechanics Book Shop

HOW TO GROW THE BEST LAWN AND GARDEN IN YOUR NEIGHBORHOOD

Here, you will find 176 pages packed with information of interest to every homeowner who desires to beautify his lawn and garden. The book covers landscaping and lawn maintenance as well as how to plant trees, flowers and shrubs. You will find plans for making

equipment for your lawn and garden, such as furniture, outdoor fireplaces, garden pools, trellises, ornaments and arbors. For the person who is interested in a vegetable garden, stories by successful growers of vegetables tell how to produce the finest kinds. Price \$2.50.

POPULAR MECHANICS VETERINARY GUIDE

It matters not whether you own only a pony for the children or just one milch cow, or are a farmer with many animals, this book will pay for itself in a few weeks. In most cases, just one trip of the veterinary to your home will cost more than the price of the book, which is \$3.50. Naturally, this book will not

make you a graduate veterinary, but it will enable you to diagnose and treat many common ailments of animals. Written in easy-to-understand terms, the book is divided into various sections covering different animals. It is a must for anyone having an animal for a pet, or anyone who produces animals for sale.

WHAT TO MAKE

If you are looking for plans or suggestions of things to make in your home workshop, this series of 12 books will be a gold mine of information. Each book contains an average of 300 things to make. The complete set of books includes almost anything you can think of, from the simplest projects to the more com-

plicated ones that would require a construction time of many weeks. There are projects in leather, wood, metal and glass as well as toys of all kinds. There are also projects for your lawn and garden as well as your home workshop. Each book is priced at \$1.75 per copy, or all 12 books may be had for \$18.00.

All books are available from Popular Mechanics Book Dept., 202 E. Ontario St., Chicago 11

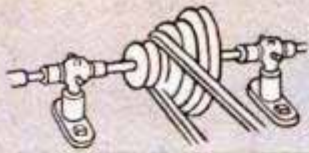

Shop Notes



TRACTOR-DRIVEN SEEDER

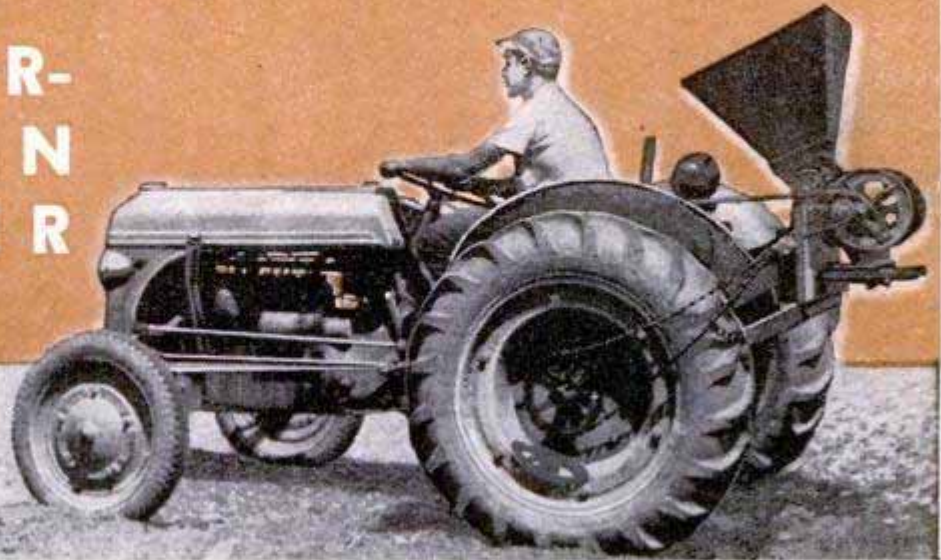

By Hi Sibley

FOR BROADCAST seeding of pastures, cover crops, small grains, and for re-seeding of established meadows, this tractor-mounted seeder saves hours of valuable time and assures uniformity of seeding rate at higher speeds. Designed by Clarence Walker of Nuevo, California, it's simply an ordinary endgate seeder mounted on a special angle-iron frame and adapted for use with the Ford tractor. Of course, a similar mounting can be designed with only a few alterations to fit other makes of tractors having hydraulic implement lifts. The top photo shows the seeder in operation, the center photo pictures the mounting, and the lower one shows how the sprocket drive must be mounted on the drive wheel of the Ford tractor. The seeder is regularly supplied with an endgate suited to a wagon or trailer box of standard dimensions. Note from the center photo at the right and the details on the following page that the seeder is offset slightly on the angle-iron frame to which the endgate is bolted. This is necessary in order to align the sprockets correctly when the seeding unit is in operating position. To permit raising and lowering with the tractor lift, the drive chain must run slack. On some types of endgate seeders this will require a spring-mounted idler, which can be either a curved chain slide or a flanged roller. Usually a suitable idler can be picked up at a farm-service shop or junk yard. On the Ford tractor, which has no shaft extension beyond the hub of the drive wheel, it is necessary to

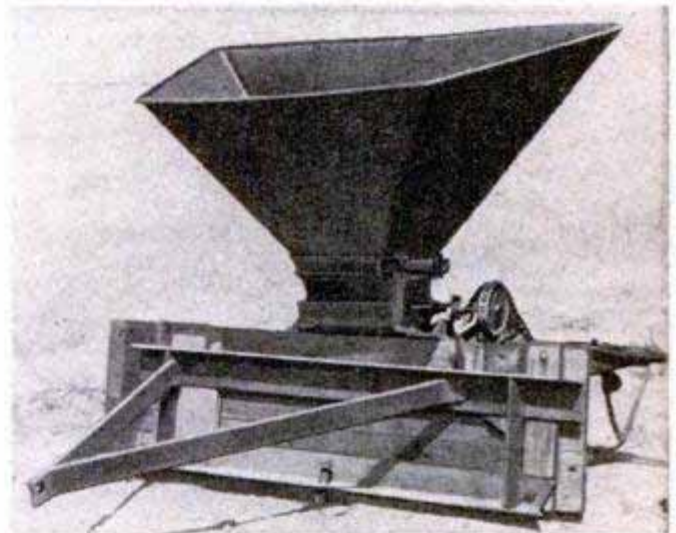

Endgate seeder is mounted on a special angle-iron frame for use with Ford tractor. Seeder usually comes equipped with wooden endgate of standard width



Drive sprocket is mounted on stub shaft welded to a steel channel which is cut long enough to span the hub bolts. Use a skip-tooth sprocket for the drive

Although not necessary in all mountings, rear ends of the supporting yoke, detailed below, should be pivoted to the angle-iron frame when it is used on the Ford tractor

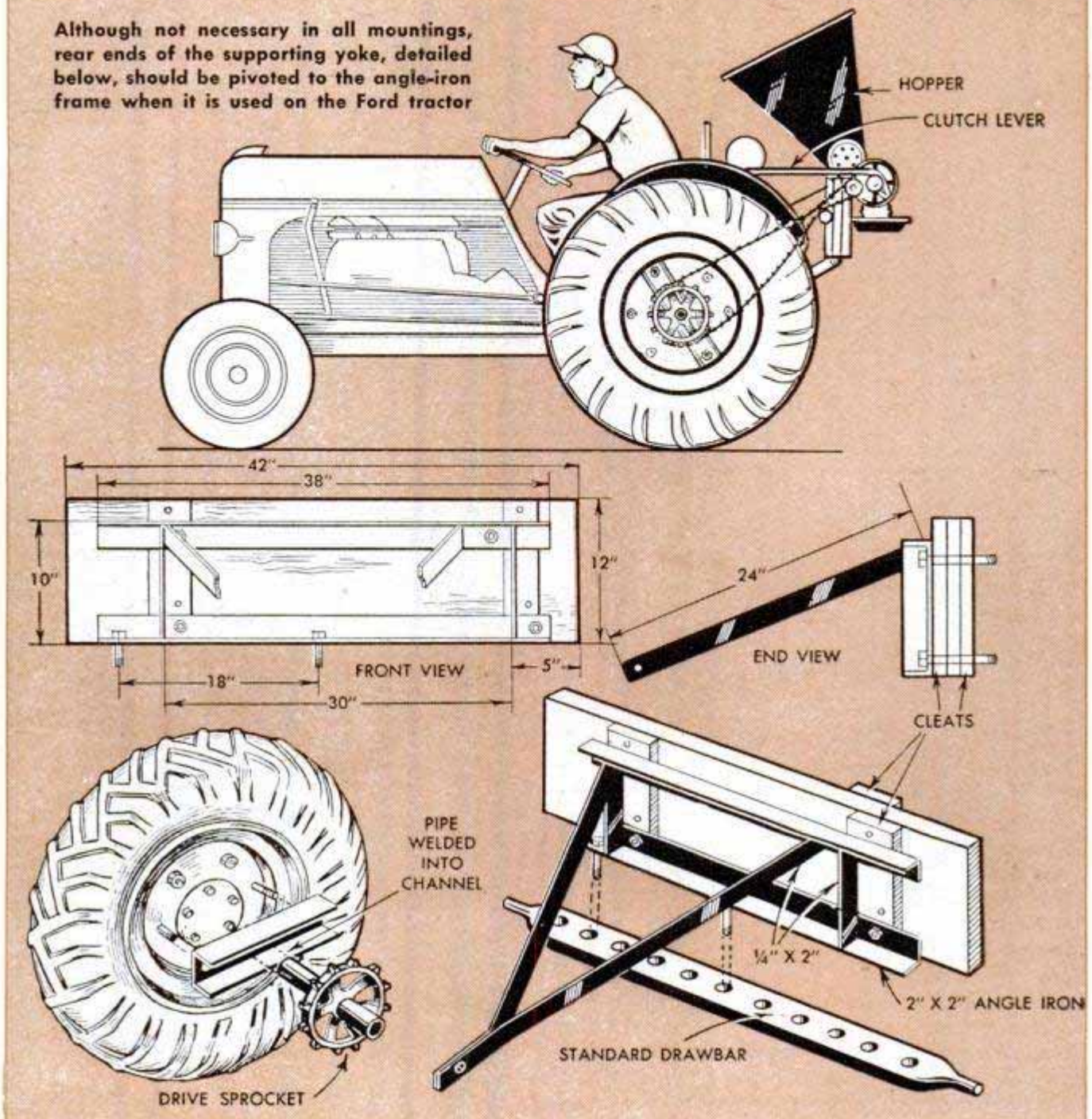

mount the drive sprocket on a bracket consisting of a piece of steel channel to which a stub shaft or a length of pipe is welded at the center to take the sprocket wheel. The channel should be long enough to span the wheel-hub studs. In some cases, when using a flat sprocket wheel, it would be possible to use a longer piece of channel and drill holes near the ends to fit over opposite rim bolts. On tractors having splined shaft extensions, it generally is possible to mount the sprocket on the shaft by reboring the hub and fitting a setscrew. On some tractor wheels it is possible to mount the ring sprocket which is ordinarily supplied with the seeder. In any case, use a skip-tooth sprocket to avoid breakage caused by the slack chain riding up on the tips of the sprocket teeth.

One thing to watch in the construction

is the length of the Y-shaped yoke which replaces the tension bar on the lift mechanism of the Ford tractor. The rear ends of the yoke are attached to the angle-iron frame supporting the seeder with bolts so the parts can pivot as the seeder is raised and lowered. The length of the yoke must be carefully calculated beforehand so that, when the seeder is raised to operating position, it will be level, or nearly so. One arm of the yoke is attached to the frame with an angle bracket because of its offset position. As will be seen in the detail, the supporting frame is bolted to the tractor drawbar which can be raised and lowered by the lift mechanism of the Ford tractor. In most instances it will be necessary to provide a lever for engaging and disengaging the jaw clutch on the seeder shaft from the tractor seat.

Cement Mixer Mounted on Rear of Tractor

By mounting a small cement mixer on the rear of his tractor, one man was able to pour his own ready-mixed concrete directly into the forms when constructing a new driveway. Thus, he was able to save the work of mixing the cement by hand and transporting it manually. By driving the mixer from the power take-off of the tractor, the batch of concrete is thoroughly mixed while being hauled to the place where it is to be used. The position of the dumping lever on the mixer allows the driver to pour the concrete without leaving the tractor. As the mixer is bolted to the tractor, it is easily removed. — Elmer L. Weaver, Chicago.

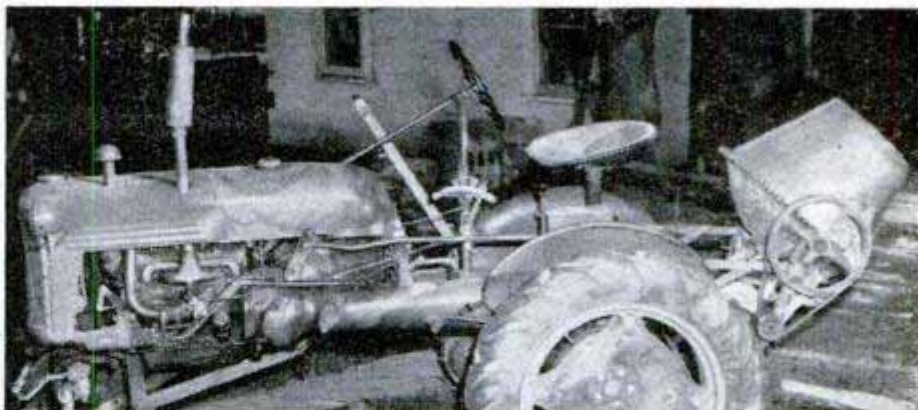

4830 Washington Blvd.

Hook-Type Gate Fastening Locked by Small Pivoted Block

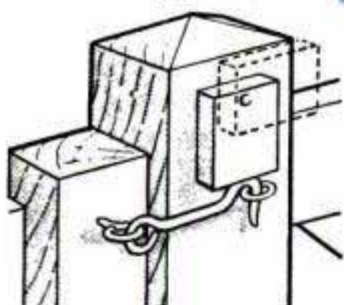

Gates and doors held closed by hook-and-eye fastenings are quite easily opened by livestock and, often, movement caused by the wind will disen-

gage the hook. This can be prevented by nailing a small block of hardwood to the post, or casing, just above the hook. A slightly oversize hole is first drilled through the block near one end so that it will pivot freely on the nail. In attaching the block, care must be taken to locate it so that it will clear the hook when turned.

R. W. Kainulainen, Spokane, Wash.

Welder's Trestles Constructed From Pipe Lengths Are Portable and Rigid

Although these trestles, or horses, were designed and built expressly for use in a welding shop, carpenters and builders will like them because they are portable,



weatherproof and extra strong. All parts except the leg braces are of $\frac{3}{4}$ -in. black pipe. The braces are of $\frac{1}{2}$ -in. pipe and are welded to each pair of legs close to the lower ends. The outstanding feature of the design is the construction of the trestle beams, or rails. These are made up as units and consist of two identical lengths of $\frac{3}{4}$ -in. pipe welded to spacers. This construction gives the trestles their unusual lightness and rigidity. The trestles can be made to the conventional sawhorse height, or the legs can be made any length up to 60 in. so that the units will serve as sturdy, lightweight trestles for low scaffolds.

Lengths of small rubber hose can be connected easily by using short sections of glass tubing to link them together. Round the sharp edges of the tubing before slipping the ends of the hose over it.

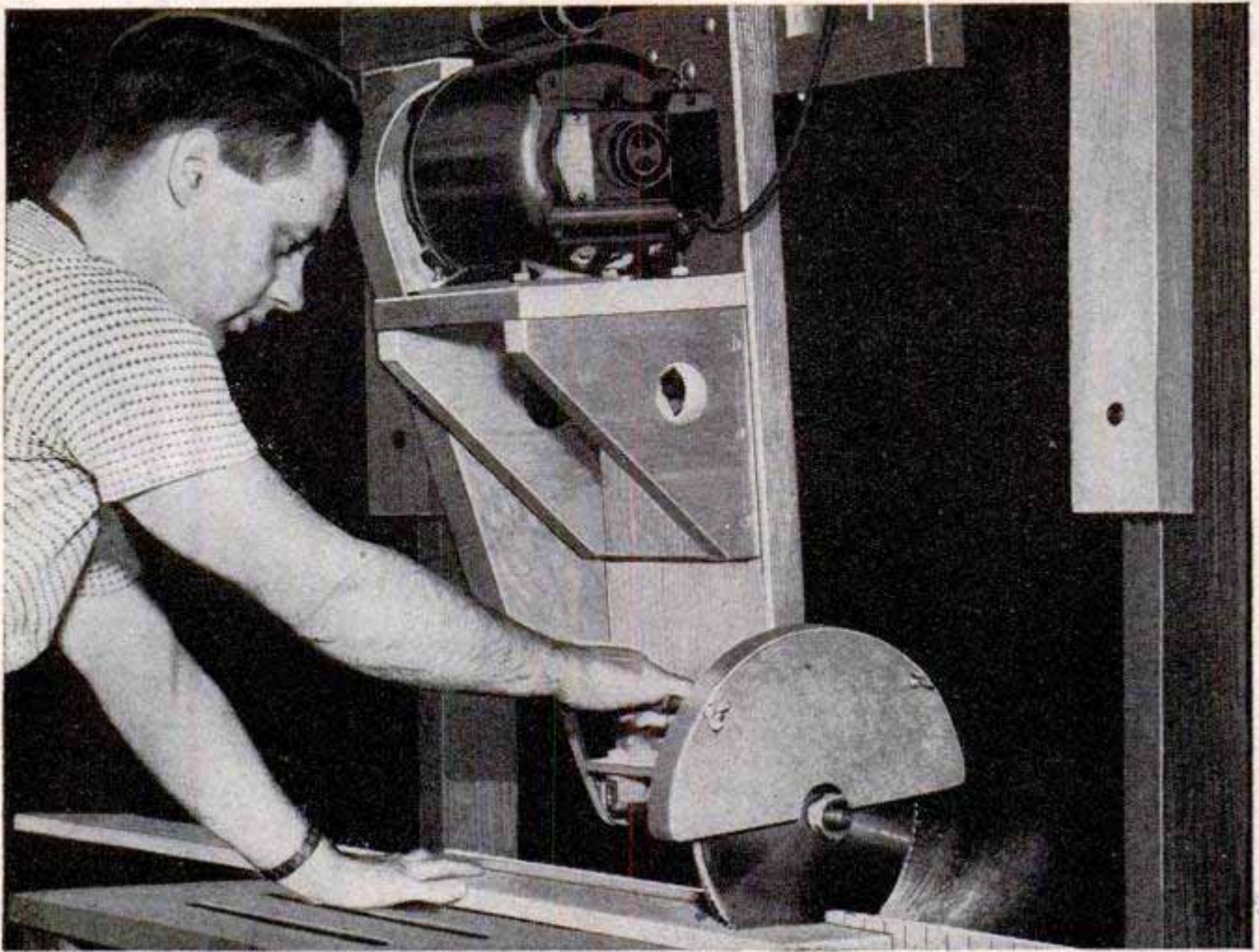

SWING SAW

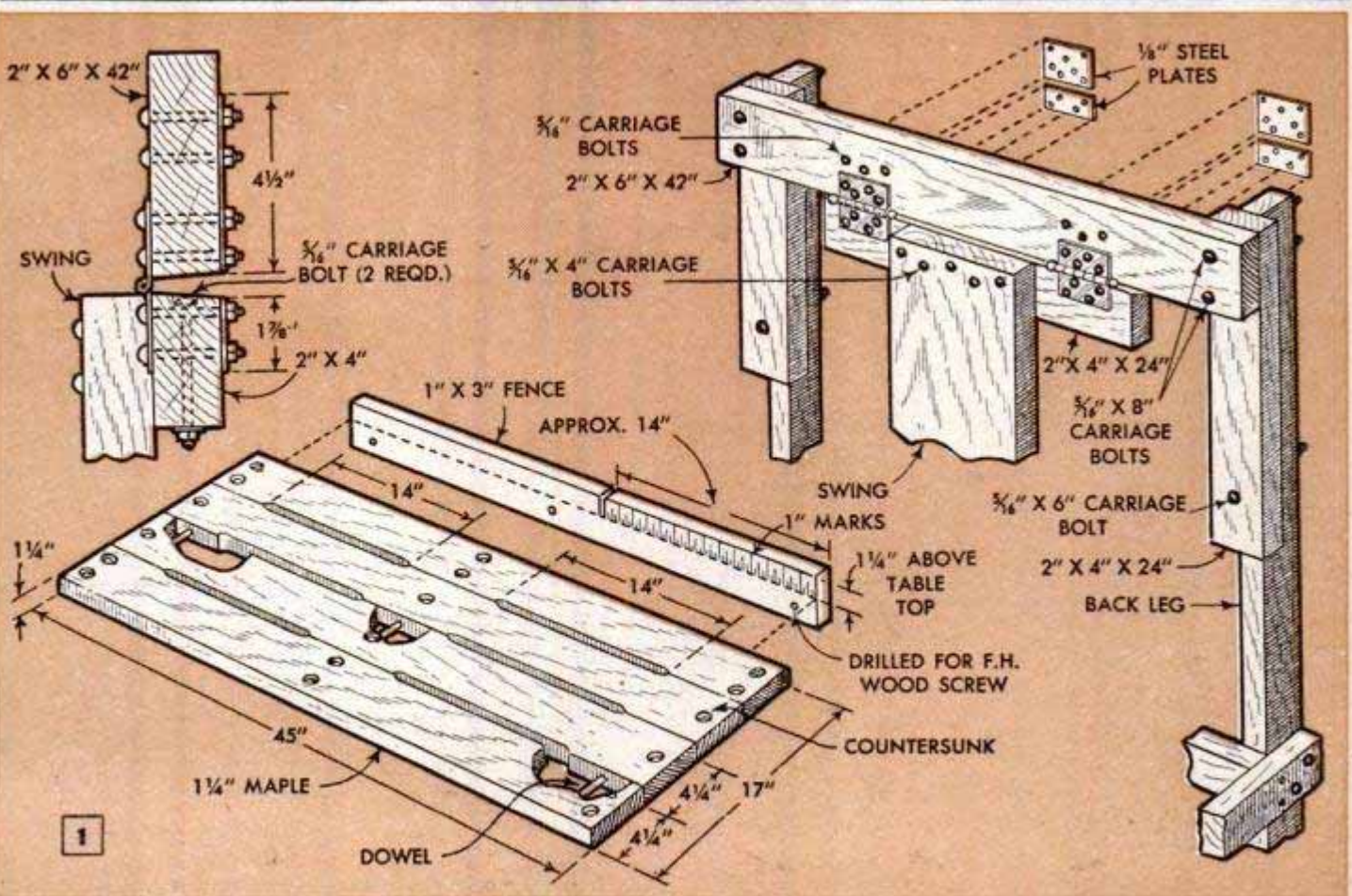

FOR CROSSCUTTING long boards and framing lumber to precise lengths, you can't beat a swing saw for speed and accuracy. That's why experienced home craftsmen, cabinetmakers and carpenters usually build one for use in the shop. The principal units and parts you'll need for the job are a ½-hp. motor, a ball-bearing saw arbor of the type having a housing cast with bolt lugs, suitable pulleys and belt, a pair of heavy butt hinges and a few straight 2 x 4s and 2 x 6s with which to build the table frame and the back support. Figs. 1 and 2 detail the saw table and frame. Before cutting the stock, note that the table height will be 32 in. plus 1¼ in., the thickness of the table top, or, a total height of 33¼ in. Some craftsmen prefer a table height of 36 in. on a swing saw. Check beforehand to make sure which table height you desire. Note also that the table-top length is 45 in. and that the saw blade is on the operator's right. Many craftsmen prefer the blade on the left, as it is somewhat easier to see the dimension marks when cutting to pencil lines rather than using the scale on the table fence. This will require a saw arbor with a left-hand thread.

The back legs of the table extend to 6 ft. in height as in Fig. 2. First, cut the legs and the end and side rails, or stretchers. Be sure that all parts are cut square at the ends and to the lengths specified. Assemble the end members with glue and bolts as in Fig. 2 and check both assemblies for squareness before the glue dries. Then set up the frame with the side rails in place and place bar clamps across the top and bottom end rails, using one clamp at each corner so that the frame can be drawn together tightly before drilling the holes for the 6-in. carriage bolts. Use waterproof glue in the joints and, when the frame has been glued, clamped and bolted, check for squareness.

The table top, Fig. 1, is a simple edge-gluing job with the joints doweled. To form the slots, bandsaw both edges of each of the inner pieces, and one edge of each of the outer pieces to a depth of ½ in., each cut being 14 in. long. Start the cuts in on a ½-in. radius, run straight for 13 in., then out to the edge on a ½-in. radius. When the table strips are assembled, the cuts will form 1-in.-wide slots with rounded ends, permitting sawdust and chips to fall through to the floor. Although the table length is given

By Edward R. Lucas

for Your Home Workshop

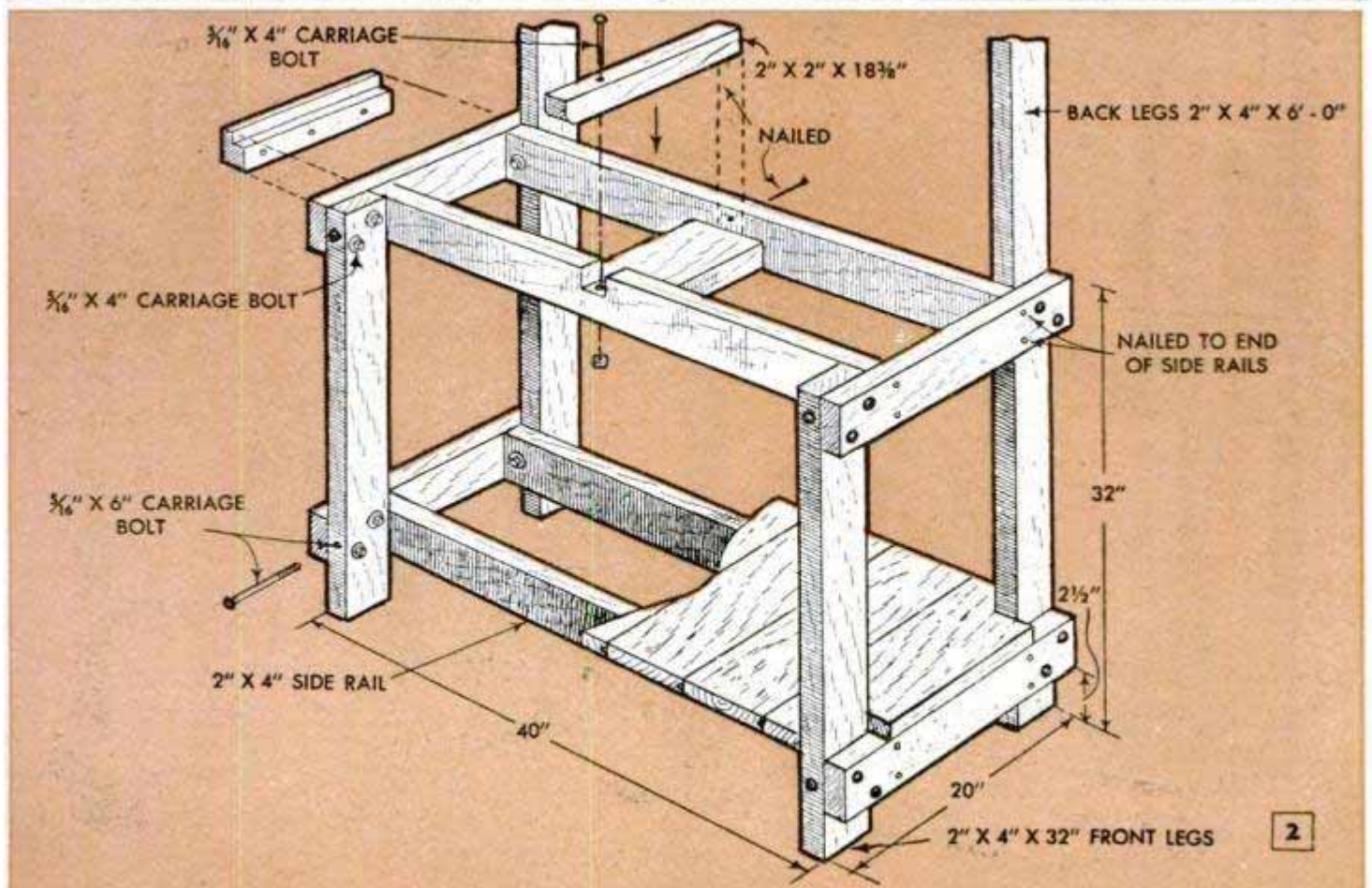

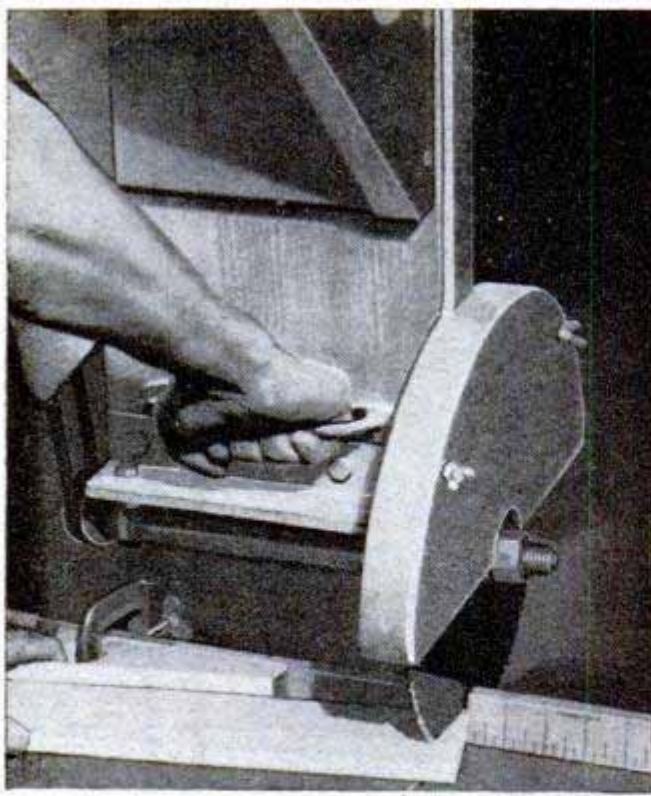

By using angle blocks clamped against the fence, you can make angle cuts up to 45 deg. on narrow stock

here as 45 in., it can be made any convenient length up to 6 ft. by using the same general construction and thickness of material. The table top is attached to the frame with spaced wood screws driven in countersunk holes. If desired, the holes can be filled with wooden plugs after driving the screws. Note in Fig. 2 that the table top is supported at the center by a 2 x 2-in. cross member bearing on a 2 x 6-in. spreader glued between the rails. The cross member is notched through the front rail as shown. Sand the table top smooth and apply a thin coat of orange shellac. Finish with wax. The lower shelf, Fig. 2, can be omitted if desired.

The swinging column, motor shelf, guard and arbor mounting are detailed and pictured in Figs. 3 and 4. The top of the swinging column is attached to a cross member, and this is hinged to the horizontal support which is bolted to the top ends of the back table legs as in Fig. 1. Before attaching the hinges, cut out and drill backing plates from $\frac{1}{8}$ -in. flat steel so that the hinges can be attached with bolts as in the sectional view, Fig. 1. Lay the hinges on an anvil and indent the hinge eyes with a prick punch so that the pins will be a tight press fit when the hinges are assembled with the parts in place. This will prevent any play in the swinging arm and also will prevent the pins from working out while the saw is in operation. Note in Fig. 4, right-hand detail, that the motor shelf rides on a key, or guide, fitting in a groove cut on the back face and that the bolt

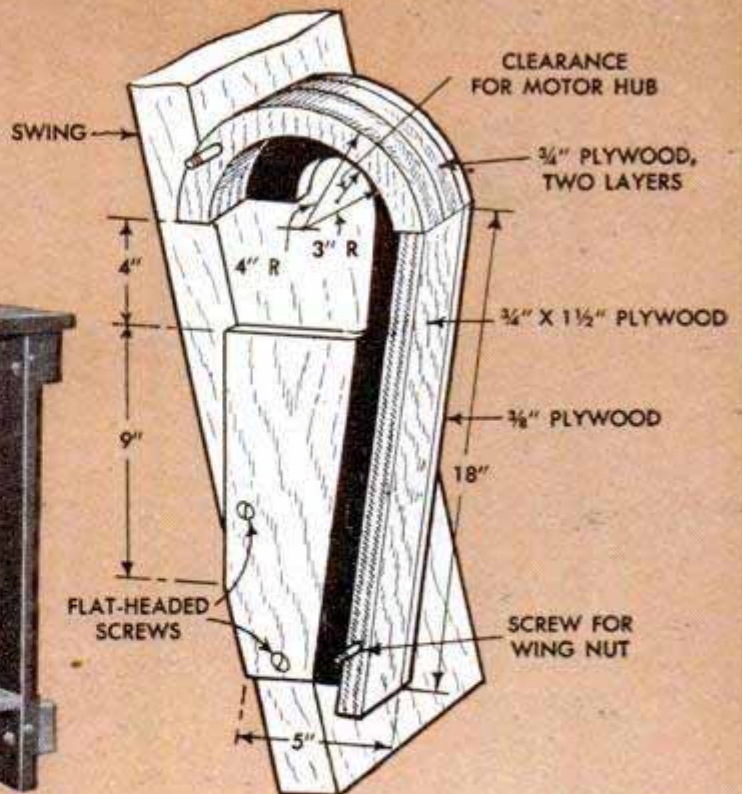

3

holes are elongated so that the motor may be adjusted to give the correct belt tension. Two pieces of angle iron are bolted to opposite sides of the column at the lower end to form a mounting pad for the saw arbor. Because of slight irregularities of the cast arbor housing, it's a good idea to insert a piece of 1/4-in. plywood between the arbor and the angle-iron pad as in the right-hand detail, Fig. 4. It is essential that the saw arbor and motor shaft be as nearly parallel as it is possible to make them. As dimensioned, the parts accommodate an 8-in. blade. After mounting the motor and arbor, make the belt and blade guard, following the details in Figs. 3 and 4. Now, mount the swing unit in the frame and locate at the proper height in relation to the table top by adjusting the supporting cross member of the frame slightly up or down. When properly adjusted for height the blade will cut a groove in the table top about 1/8 in. deep. Screw the fence in place and make this first cut through the fence and across the table top. Then remove the fence and mark it in 1/8 or 1/16-in. graduations to the right of the saw cut. Note in the right-hand detail in Fig. 1 that the swing support is blocked out from the uprights. These blocks are not necessary for cutting stock up to 10 in. wide, but for full capacity of about 13 in. they will move the unit forward just the right distance. For correct blade speed with a 1725-r.p.m. motor, use a 5-in. pulley on the motor and a 2-in. pulley on the arbor.



Belt guard is built up as a unit before attaching to swinging column. Note relative size of pulleys

Details below show the construction of column and angle-iron pad on which the saw arbor is mounted

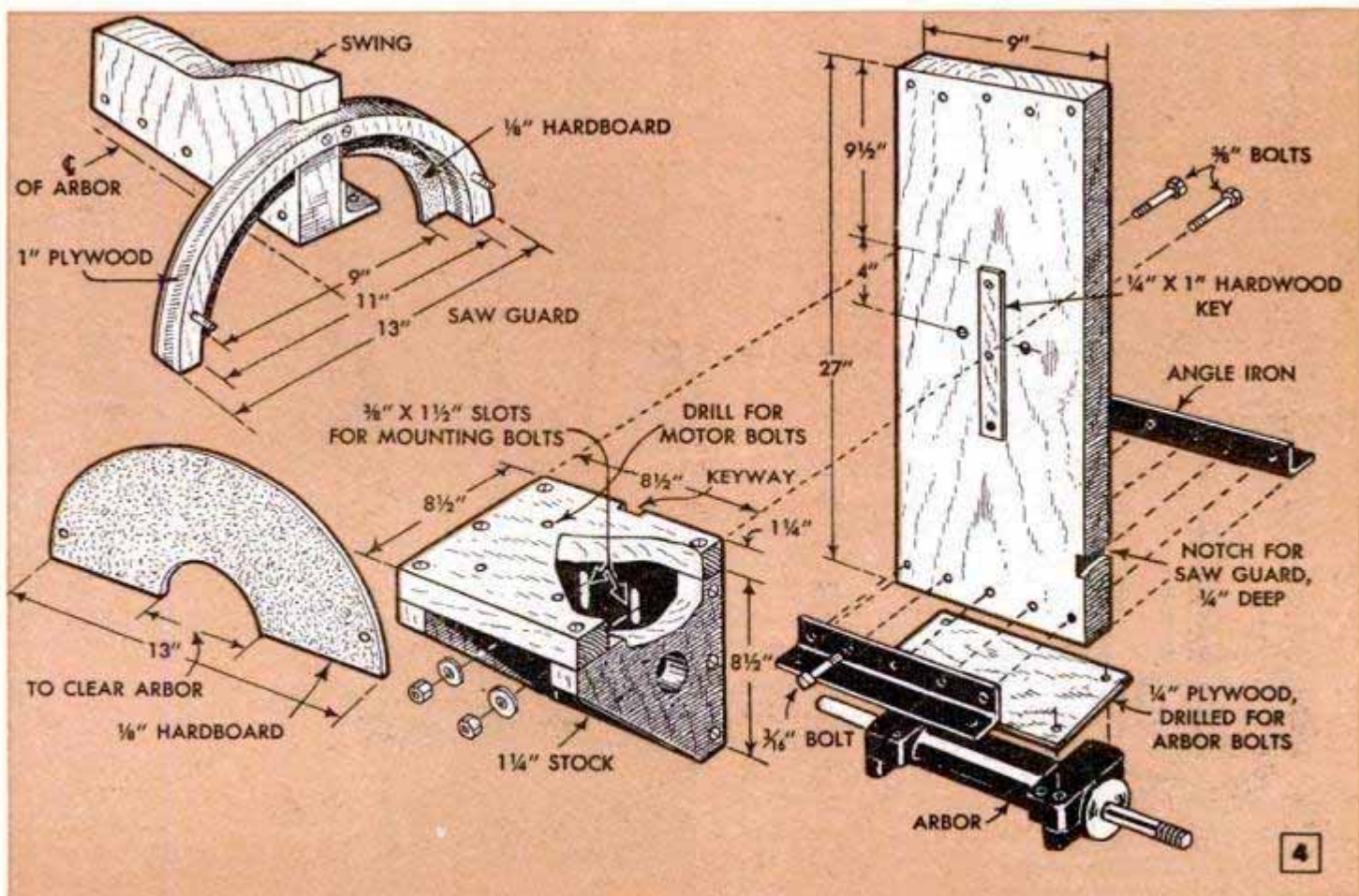

Watering Tank for Feed Lot Is Made From Steel Drum

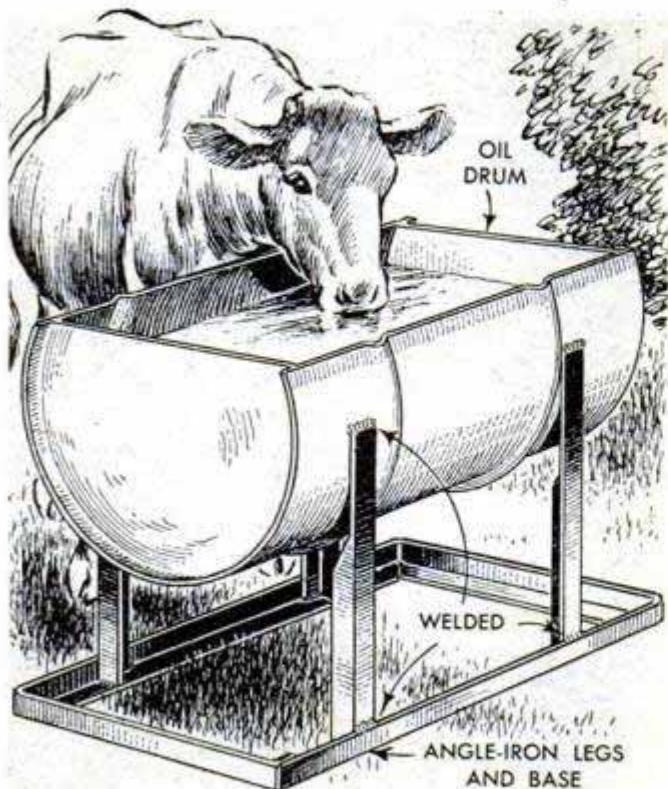

Made from a 55-gal. steel drum, this portable watering tank is designed especially for use in small pastures and feed lots where there is no permanent water supply. The upper one third of the drum is cut away and the edges smoothed with a file. (Caution: It's a good idea to steam-clean the drum before cutting with a torch, as there is some danger of an explosion being caused by flammable residues unless the inside of the drum is thoroughly cleaned.) The tank is supported on four angle-iron legs welded to the sides of the tank and also to a rectangular frame of welded angle iron. The frame, or base, is made larger than the over-all size of the tank so that the tank will be supported without tipping or settling on soft ground.

Kenneth R. Imig, Watseka, Ill.

Horseproof Gate Latch



The farm saddle pony who habitually nuzzles open the gate or barn door and roams over the lawn or garden patch will be completely baffled by this simple latch. The moving part is a long link made by bending and welding $\frac{3}{8}$ -in. steel rod, the radius at the ends being about $1\frac{1}{2}$ in. The handle and the catch, which is attached to the gatepost, are bent from $\frac{1}{4}$ x

$1\frac{1}{4}$ -in. flat steel. Before bolting the handle to the gate, slip one end through the link. The secret of the effectiveness of this latch is that when in the locked position the link drops below the offset bend in the catch and can be raised only by pulling the link outward and upward simultaneously.

Sections of Worn Push-Broom Heads Are Used as Bench Dusters

In time, a push broom becomes worn to the point where it is no longer useful for the purpose for which it is designed. However, by cutting the broom into two or three sections and rounding the cut ends by sanding, the parts still can be utilized as bench dusters. Just attach a short handle to each of the sections and trim the worn bristles to a uniform length.



Portable Shed Gives Protection To Electric Well-Pump Motor

This easily built miniature shed provides complete weather protection for an electric pump motor. The roof is hinged for easy access to the power plant, and the switch is conveniently mounted outside. The shed, being heavy enough to resist ordinary winds, is not fastened down so that it can be readily removed when necessary to service the motor.

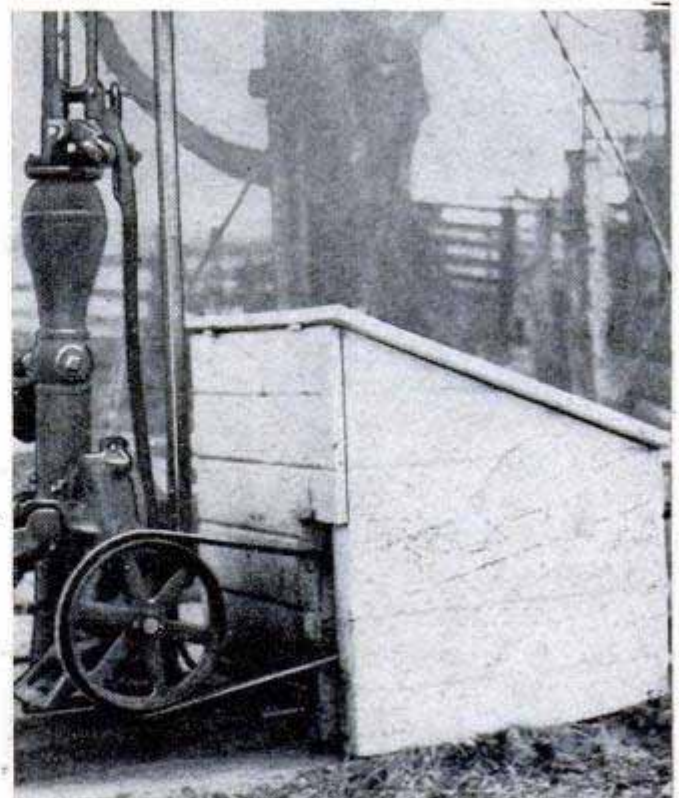

CARBIDE-TIPPED TURNING 'CHISELS'

By Harrison Neustadt

Made from a square bar of aluminum, this two-ended handle permits carbide-tipped tools to be used as wood-turning chisels. The carbide tips require less frequent sharpening than the steel of ordinary lathe chisels and can be used for turning other materials such as plastic and soft metals. Holes drilled in the shaped ends of the handle take $\frac{1}{4}$ -in.-square bits of the type used in metal-turning lathes. Note that one end of the handle is shaped with two, short, slightly rounded bevels, and that the other is provided with three long bevels. Holes are drilled longitudinally in each end and transverse holes are drilled and tapped for set-screws. A third hole is drilled at 45 deg. near one end to provide an angle setting for one turning chisel. These special features enable the lathe operator to work in deep recesses, undercut square shoulders, and bore large-diameter holes in hardwoods and plastics at cutting speeds not possible with ordinary turning tools. After shaping, drilling and tapping of the handle have been finished, round the corners of the aluminum bar near the center to provide a comfortable handhold but be sure to leave the faces of the bar square near the ends to provide a firm bearing on the tool rest.

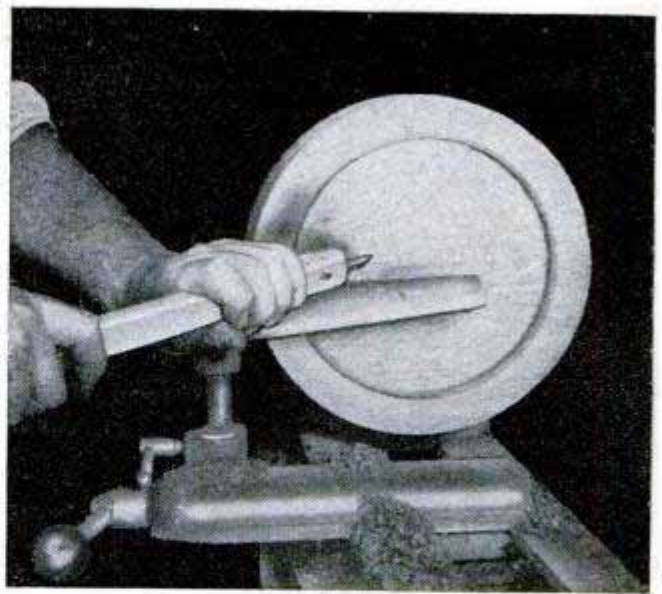

Shaped ends of this chisel handle enable the operator to work in deep recesses and narrow undercuts

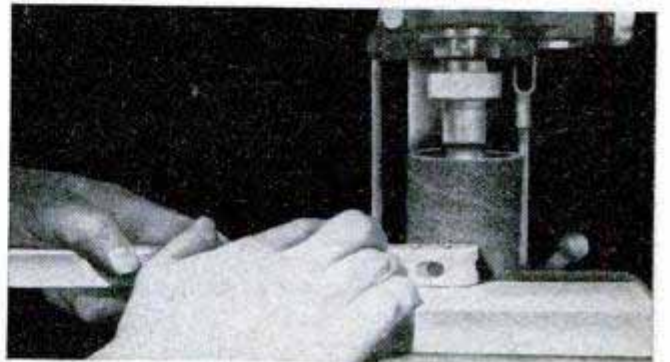

Ends of the handle are ground to shape on the drill press by attaching aluminum-oxide sleeve to drum

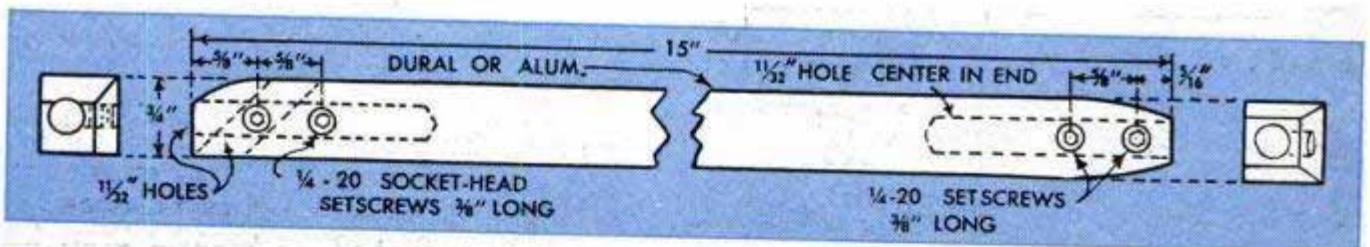

Stanchion-Type Rack Prevents Waste When Feeding Flock of Sheep

The problem of preventing waste when feeding hay and other roughage to a large flock of sheep led one farmer to design this rack especially for the purpose. It is 16 ft. long, 24 in. wide and 36 in. high. The

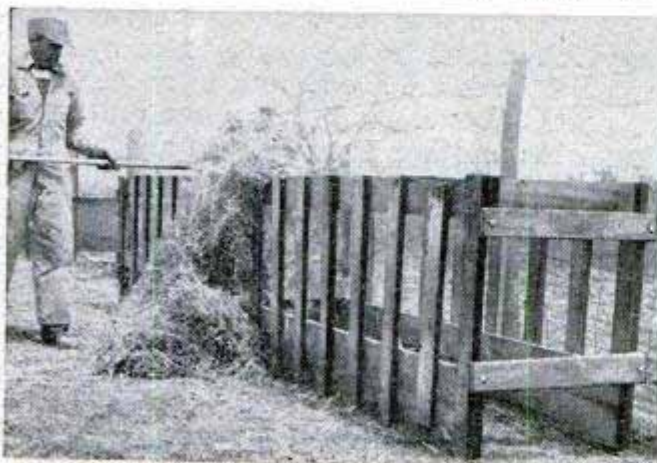

spaced uprights, which are cut from 1 x 6-in. cypress fence boards, are nailed to a 2 x 12-in. plank at the bottom and a 2 x 6-in. plank at the top. The vertical end members, and also the two cross members at each end are oak 2 x 4s. These are joined together with $\frac{3}{8}$ -in. bolts. This assembly makes the rack easy to take down and store in a narrow space when not in use. When set up, the rack can be anchored with wire to four steel fence posts driven into the ground near the ends.

Loosening Truck Tire From Wheel

Failing to pound the bead of a truck tire from the wheel rim, one mechanic used the hydraulic hoist to force the tire loose. He placed the wheel on the garage floor and carefully lowered the hoist onto the tire.

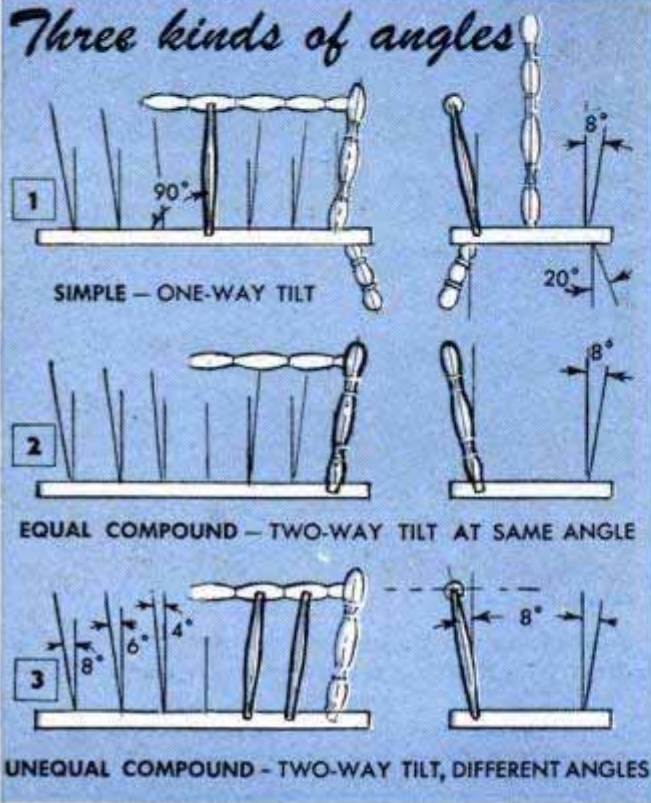
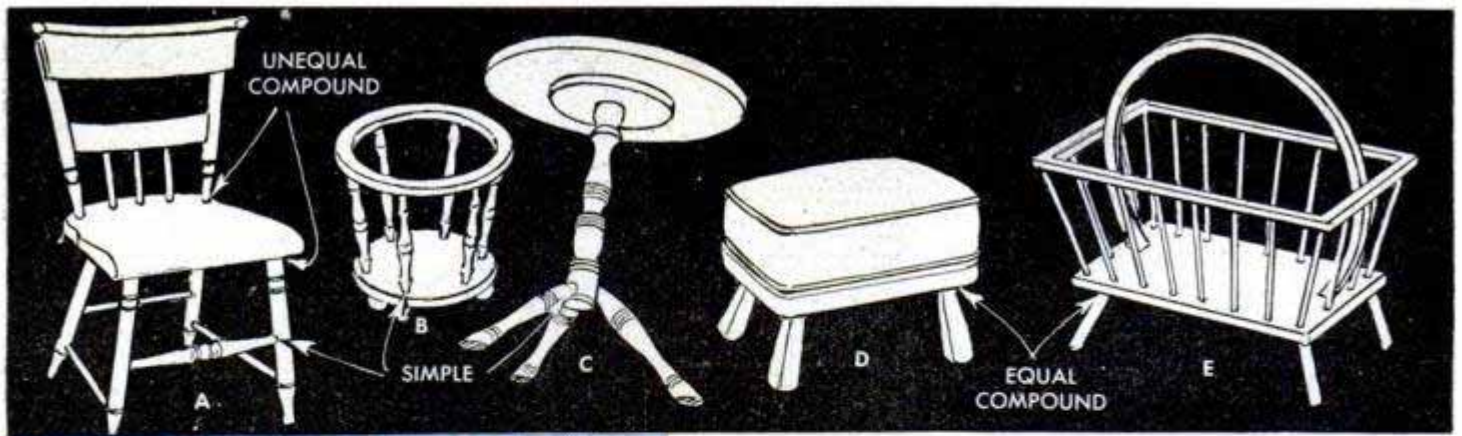

How to do ANGULAR DRILLING

By Sam Brown

IF YOU PLAN to build furniture, likely you will run into a job where holes must be drilled at an angle. Although angular drilling may seem complicated, it actually is quite simple.

Kinds of angles: There are three main kinds of angles as shown in Figs. 1, 2 and 3. All three types are required in construction of the magazine rack pictured in Fig. 4. The simple angle involves a one-way tilt only. Most used is the equal compound angle, Fig. 2, which involves a tilt of the same magnitude as viewed from the front and end of the work. The unequal compound angle, Fig. 3, is likewise a two-way tilt, but with one angle greater than the other.

The simple angle: A basic rule in drilling at a simple angle is that the work must be square with the table, Fig. 8. It will be apparent that if the work is off to one side, the hole will show a similar error as in Fig. 9. However, positioning of the work is not too critical at low angles so that placement of the work by eye alone usually is sufficiently accurate. Examples of the simple angle are shown in sketches A, B, and C above. Note that when one turning joins another turning, the angle is always a simple angle—a one-way tilt. Radial work, sketch B, is always a one-way tilt and requires only that a radial line from the center of the work to the drilled hole must be square with the drill table.

Work requiring a simple angle usually is specified at so many degrees of tilt. The simplest way to set the tilt is to use a circular-saw miter gauge set at the needed

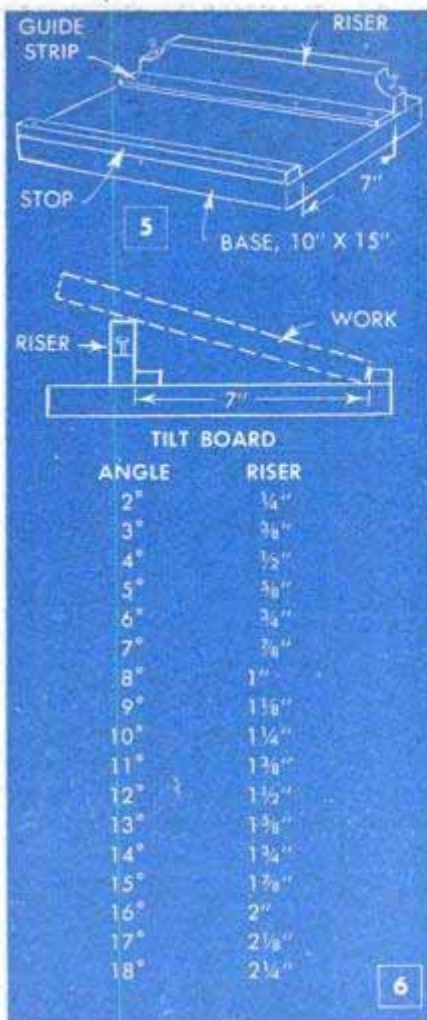

angle, and sight the bar to the drill column while adjusting the table as in Fig. 10. Use of a T-bevel, as shown in Fig. 11, is obvious. Also, instead of tilting the drill table, you can leave the table level and make the tilt with a tilt board as indicated in Figs. 7 and 12. If the tilt board is made exactly 7 in. between stop and riser, Figs. 5 and 6, height of the riser needed for any specified angle up to 20 deg. will be 1/8 in. per degree. This is tabulated in handy form in Fig. 6. Over 20 deg., the progression of 1/8 in. per degree will show a constantly increasing

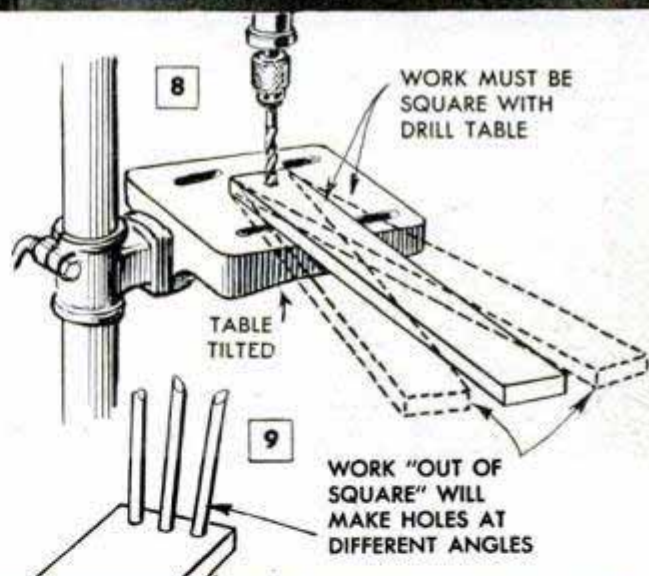

Setting the simple angle



... BY SIGHTING WITH MITER GAUGE

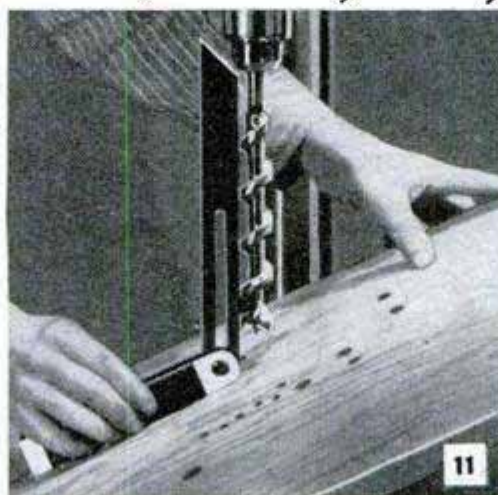

... WITH SET BEVEL

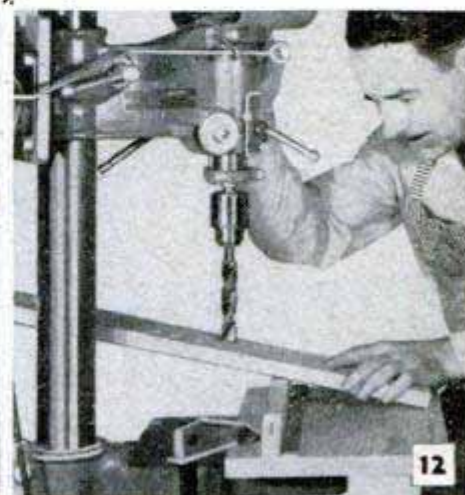

... WITH TILT BOARD



14
EQUAL COMPOUND ANGLES CAN BE CONVERTED TO SIMPLE ANGLES BY USING THE TABLE SHOWN AT THE TOP OF THE PAGE. NOTE THAT THE DRILLING LINE IS ALWAYS 45° TO THE EDGES OF THE WORK SURFACE

EQUAL COMPOUND ANGLES			
WORK ANGLE	TABLE TILT	WORK ANGLE	TABLE TILT
2°	2¾°	12°	16¾°
3°	4¼°	13°	18¼°
4°	5½°	14°	19½°
5°	7°	15°	21°
6°	8¼°	17½°	24¼°
7°	9½°	20°	27°
8°	11°	22½°	30¼°
9°	12½°	25°	33°
10°	13¾°	27½°	36°
11°	15¼°	30°	39°

error, but within the limits of the table given is reasonably accurate.

The equal compound angle: On a drilling job like the one in Fig. 2, where the corner spindles tilt 8 deg. as viewed from the front, and 8 deg. when viewed from the end, you have an equal compound angle. Since the tilt is equal both ways, the drilling line is always at 45 deg. to the work, as in Fig. 15. Placement of the work is done easily by using a V-block. If the lower edge of the V-block is placed square with the table, the work and the drill will be in correct alignment. Tilt of the drill table itself, Fig. 14, is simplified by consulting the table in Fig. 13, which converts the equal compound angle to a simple angle. Thus, in the

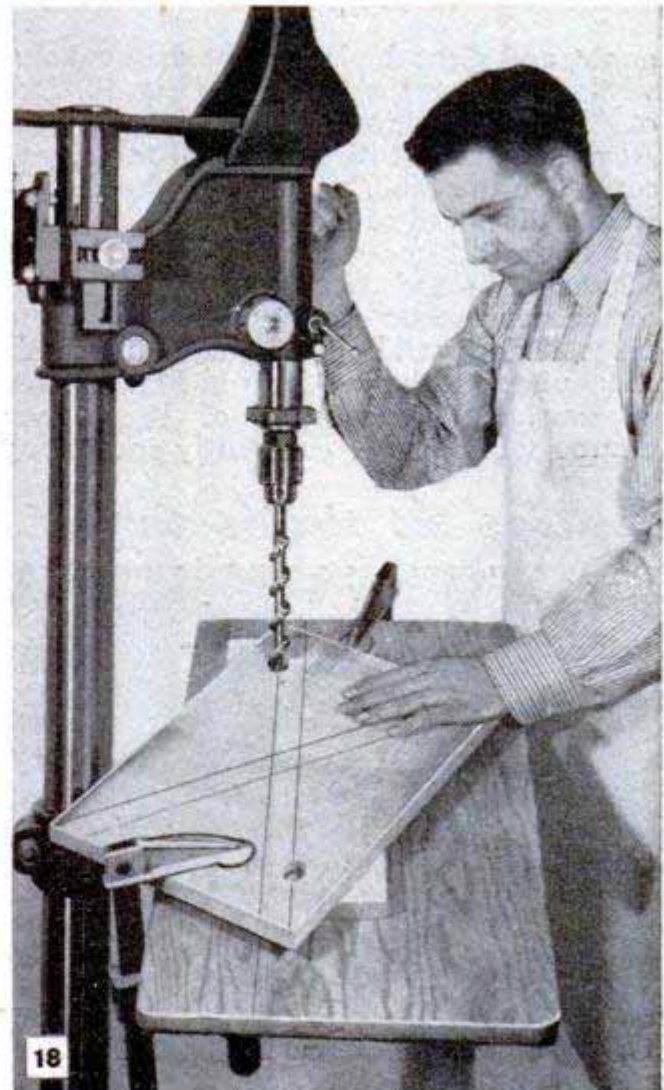
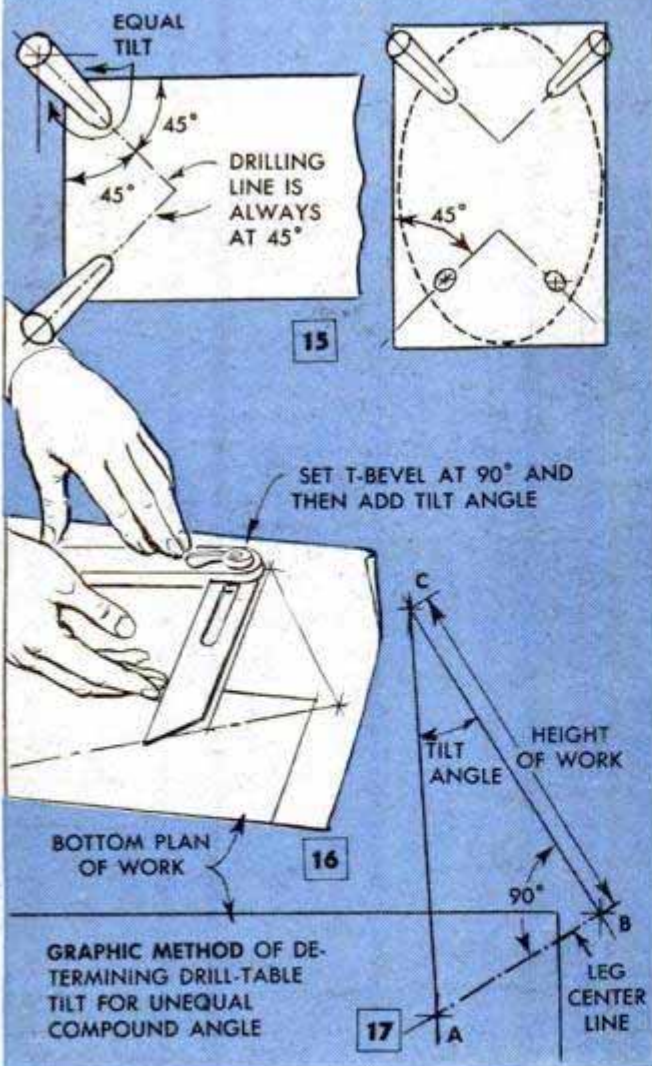

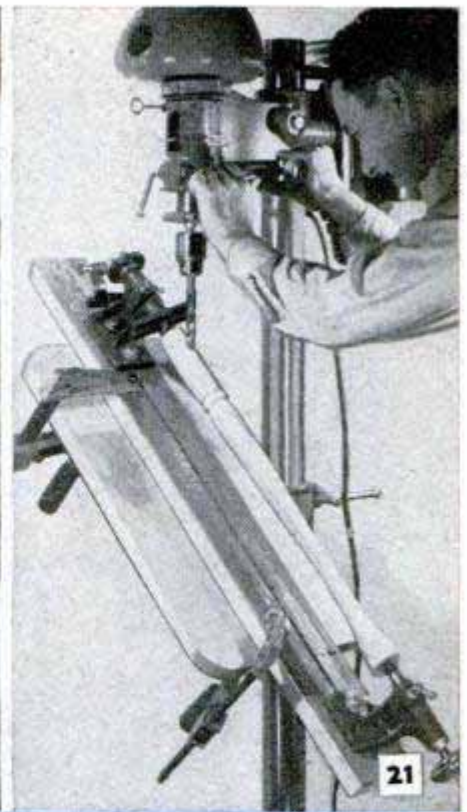
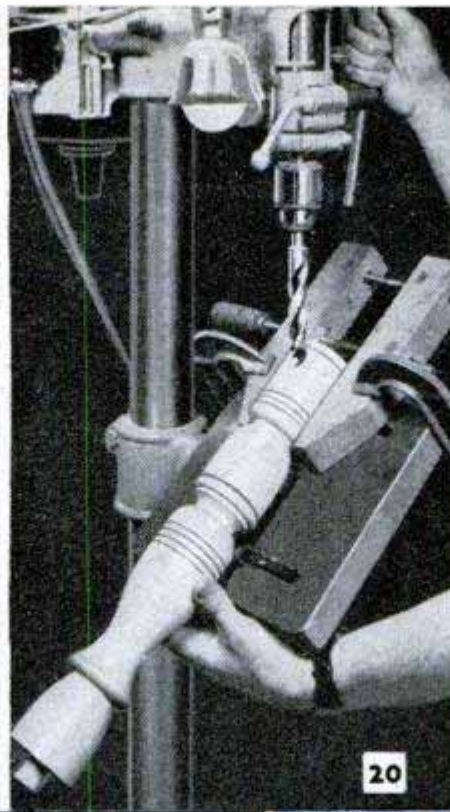

MOUNTING THE WORK CAN BE DONE BY ANY OF THE THREE METHODS SHOWN ABOVE. THE ANGLE VISE DETAILED AT THE RIGHT AND SHOWN IN USE IN THE LEFT-HAND PHOTO ABOVE, IS USEFUL FOR A VARIETY OF DIFFERENT JOBS

example previously mentioned, Fig. 2, a two-way tilt of 8 deg. is a one-way tilt of 11 deg., keeping the 45-deg. drilling line square with the table. Sketches D and E also picture the use of the equal compound angle.

The unequal compound angle: This is best worked by actually making the two tilts required. The example in Fig. 3 shows that all turnings for the side of the magazine rack have a uniform tilt of 8 deg. when viewed from the end, but vary in tilt as viewed from the front. Set the 8-deg. tilt needed with the use of the tilt board. As shown in Fig. 6, this will require a 1-in. riser. Then, with the work placed on the tilt board, Fig. 7, the center spindle hole can be drilled as a simple angle. The two spindles on either side of center require a tilt of 4 deg. In the same way, set the 6-deg. tilt, and then, since you have the setup made, the equal compound angle required for corner spindles is made similarly, with 8 deg. on the tilt board and 8 deg. on the drill table. The work has to be square with the drill table for both tilts.

A drawing-board method of determining the drilling line and tilt for an unequal compound angle is shown in Fig. 17. From drawings of the project it is easy to make a bottom plan view, locating on this the leg center line, as shown by line AB. From B erect a perpendicular, making it as long as the height of the project. Join C to A. The angle at C will be the required tilt of the drill table. To take off the angle, set a T-bevel at 90 deg. as in Fig. 16, and then add the angle.

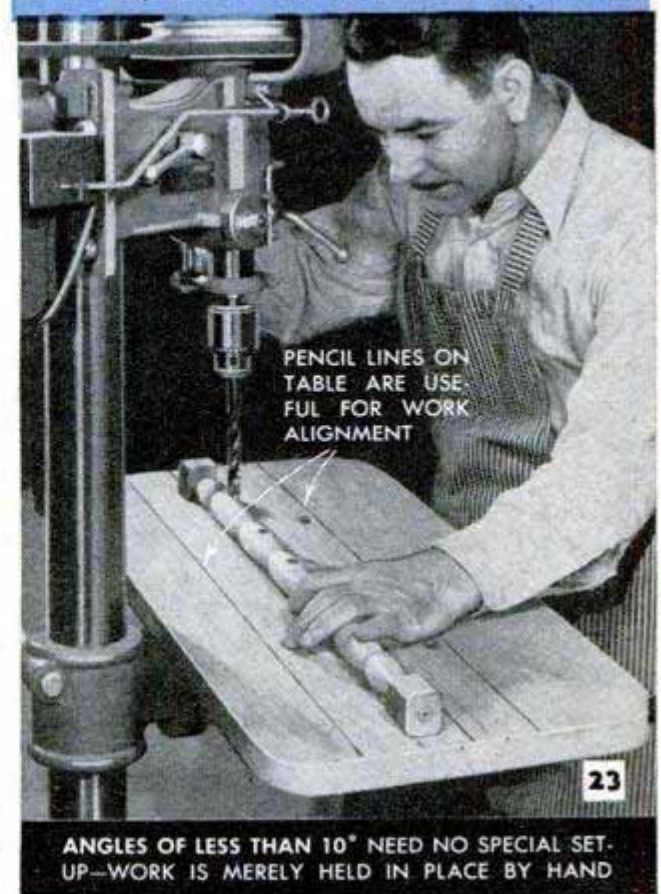
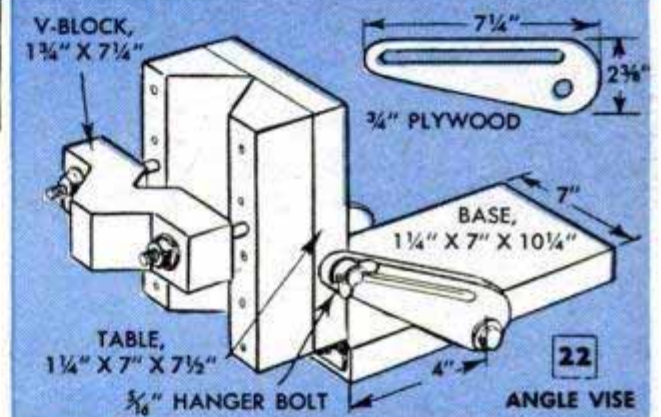

ANGLES OF LESS THAN 10° NEED NO SPECIAL SET-UP—WORK IS MERELY HELD IN PLACE BY HAND

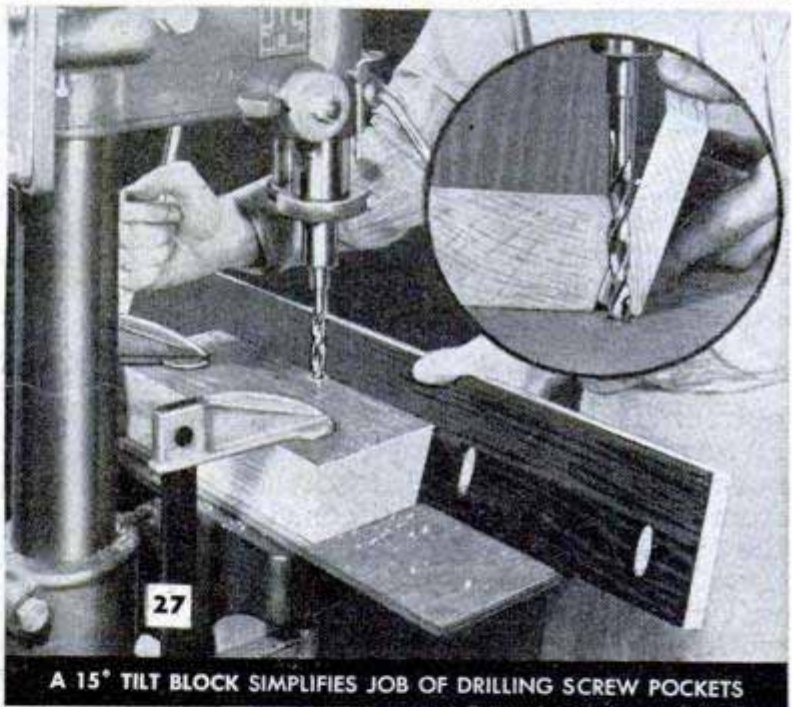
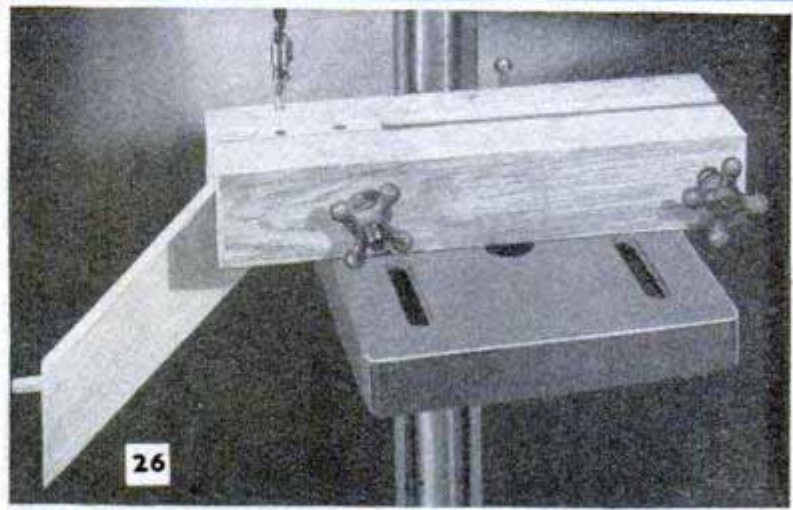
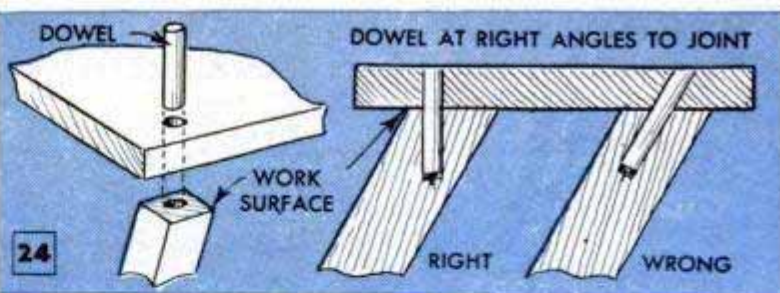
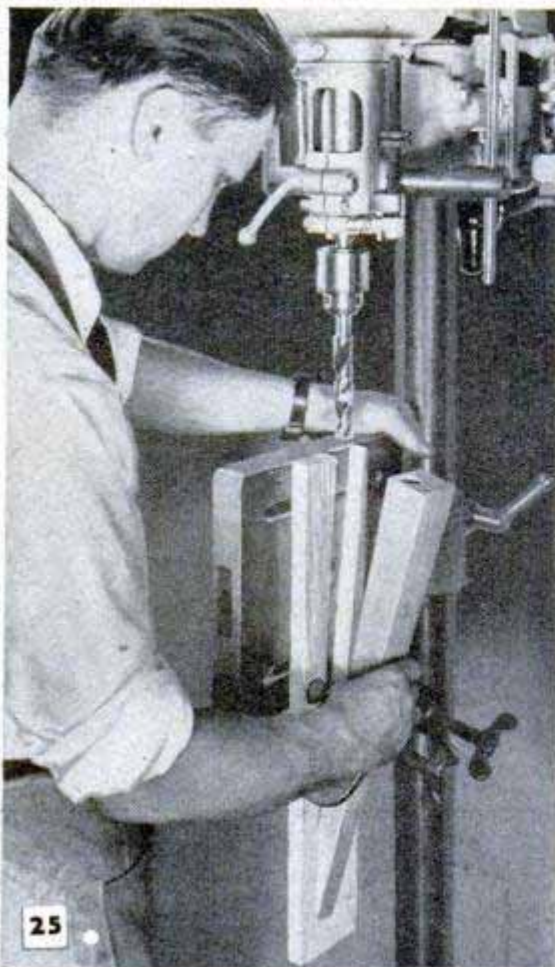

A 15° TILT BLOCK SIMPLIFIES JOB OF DRILLING SCREW POCKETS

DOWEL HOLES OFTEN REQUIRE ANGULAR POSITIONING OF WORK BUT THE HOLE ITSELF IS ALWAYS AT RIGHT ANGLES TO SURFACE OF JOINT

Use the T-bevel, set in this way, to set the drill table, as shown in Fig. 11. Fig. 18 shows the job being drilled.

Mounting the work: Besides knowing how to set the angle, there is the job of mounting the work. A useful gadget for spindle work is the angle vise, shown in Figs. 19 and 22. Fig. 20 shows a simple handscrew mounting. The fluting jig, Fig. 21, is a good mounting for spindles, especially if spacing around the circumference is required. If the tilt angle is not over 10 deg., then simple placement of the work on the drill table as in Fig. 23, will do the trick. Note the pencil lines drawn on the table to help align the work. Note also how square sections are left uncut on turning. In order to keep the square sections on the table when drilling various holes along the turning, the drill table can be swung right or left as desired. This does not affect the drilling angle.

Curved work: When angular or straight holes must be drilled in curved work like the handle in example E, saw a jig block to fit the curve, keeping the opposite end of the jig block true and square. With the curved member held in the jig, you will

have the equivalent of a square piece of work, and the tilt and positioning of work can be made accordingly.

Dowel holes: Angular drilling frequently is required in drilling dowel holes, but with the important difference that here you have a working surface. In Fig. 25, for example, a jig is made to hold the table leg in the required angular position, but the hole itself is no puzzle—it must be square with the work surface, Fig. 24. A similar case is the doweled miter joint, Fig. 26. Angular drilling for screw-pocket holes requires no calculation. A guide board with one edge cut at a 15-deg. bevel, Fig. 27, is clamped to the table so that the drill makes a hole at the extreme edge of the bevel.

Lead Bath Heats Small Tools To Minimize Distortion

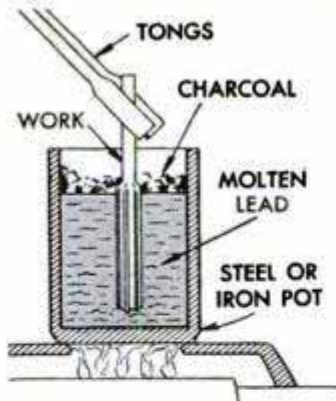

Heating small shop-made taps, reamers and other similar tools in a lead bath preparatory to hardening prevents the formation of scale and pits and minimizes the possibility of distortion of parts having small sectional

area. After the lead has been heated to the melting point—about 620 deg. F.—the tools to be hardened are preheated slightly before immersing in the lead bath. During the heating period, keep the bath covered with a layer of charcoal pellets to prevent oxidation of the lead. To guard against warpage be sure that the tool does not rest on the bottom of the lead pot. Also make sure that the work is clean before immersing, as otherwise the lead may stick to it and interfere with proper quenching.

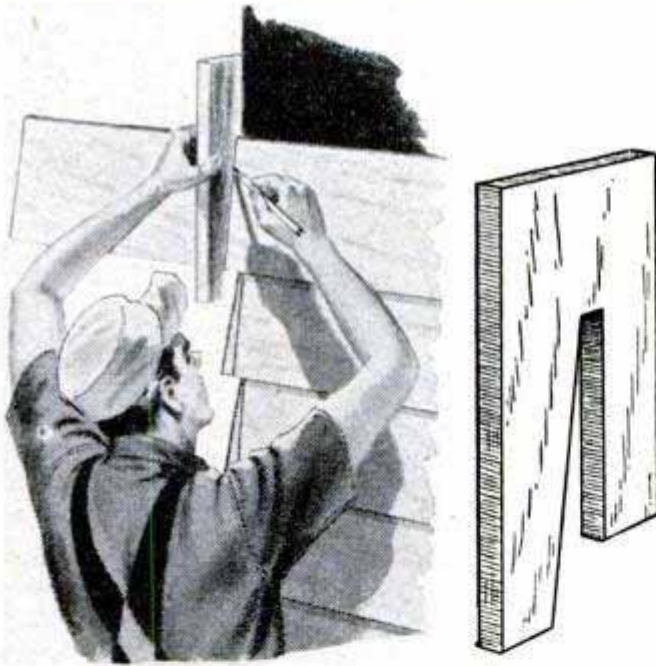

Siding Quickly Marked for Cutting With Aid of Wooden Jig

To speed cutting off siding at the corners of a house, one carpenter made this wooden jig which permits marking the siding in one simple operation. It is merely placed over the top edge of the siding and the cutting line is marked on the face of the board, thus eliminating transferring the line from the underside.

☐ When shopping for fish, leakage of water and odors from the packages can be prevented by placing them in a plastic bag.



Single Tank Waters Livestock In Four Separate Lots

A large water tank, placed at the intersection of two fences, will accommodate livestock in four separate lots. Note the positions of the four fence posts. These hold the tank securely and, at the same time, provide support for the wires which continue across the top of the tank.

Improved Farrowing-Pen Creep Allows Young Pigs More Freedom

In the permanent farrowing house, growing pigs may be allowed the run of the wide alley simply by fitting a 2 x 4 across the opening to the alley from each individual pen. This arrangement confines the sows to the pens but allows the young



pigs access to special feeds and minerals placed in small feeders and troughs located along the sides of the alley. The 2 x 4 bars are held in place by flat-steel brackets bolted to the inside face of the sliding-door frame. In this way the bars may be inserted or removed without detaching any part, or interfering with the operation of the doors.

Bulbs on Lift Illuminate Car

One garage owner provided plenty of light to aid the lubrication man by installing sixteen 60-watt light bulbs on the hydraulic lift. Eight of the bulbs were mounted on the inside of each channel and spaced to extend the full length of the lift.

L. H. Houck, Jefferson City, Mo.

SHOPPING



Wales-Strippit Corp., North Tonawanda, N.Y.
MULTIPLE HOLE-PUNCHING SYSTEM in which the die units are self-contained and interchangeable permits the same units to be used in a variety of setups. Arranged in a box-type unit, the dies are inserted in holes drilled with a master template. In box-type assemblies, holes can be punched in almost any pattern over a working area 21 in. wide and 23 in. long. Twin-plate assemblies are used for larger work

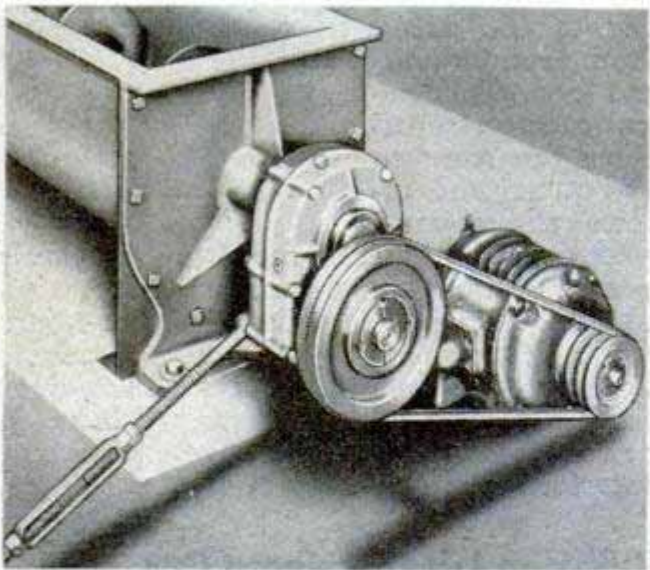

Dodge Mfg. Corp., Mishawaka, Ind.
TORQUE-ARM REDUCER for output speeds from 115 to 330 r.p.m. is new item in the field of power-transmitting equipment. It is said to be the first shaft-mounted speed reducer designed for this speed range. The unit is attached to the shaft to be driven by means of two locking collars, one being placed on each side of the housing which is anchored to floor by a torque arm



John I. Paulding, Inc., New Bedford, Mass.
DUPLEX SURFACE OUTLET is designed for easy surface mounting and has extra knockout for use when wiring in series. Double-spring phosphor-bronze clips assure positive electrical contact when plug is inserted

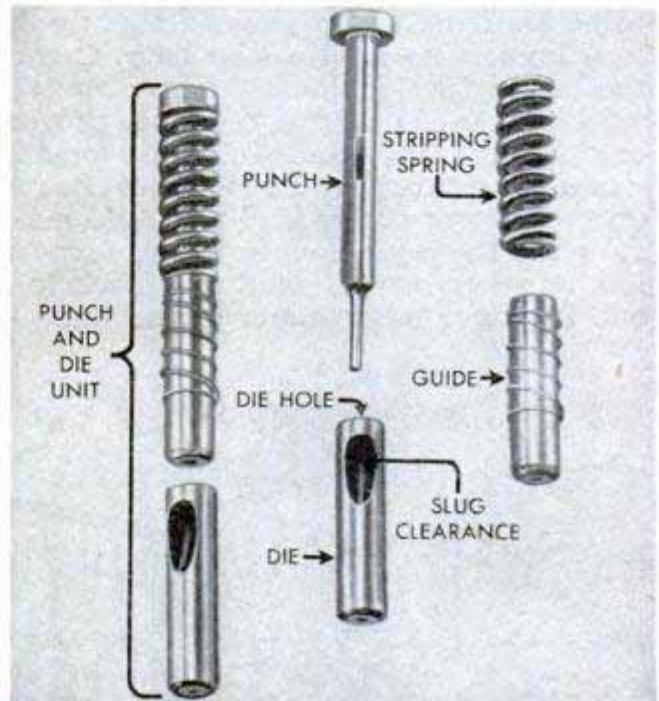

SINGLE DIE UNIT of the multiple hole-punching system is pictured above disassembled to show various parts. These are available to users as individual units for assembling setups to suit their own requirements. Dies are inserted in holes drilled in the plates



Federal Products Corp., Providence, R.I.
PORTABLE THICKNESS GAUGE assures precise check on thicknesses of sheet stock used for stamping and forming. Full-jeweled dial indicator, of either the direct or continuous-reading type, is graduated to .001 in. Movable and fixed anvils, or jaws, grip stock and hold gauge perpendicular to the surface. Hardened contact points transfer measurement to dial hand

FOR TOOLS

Gray Company, Inc., Minneapolis, Minn.

MOGUL-TYPE PUMP is designed to handle heavy spray materials without spurting. It's air driven and operates within a broad pressure range from 20 to 175 pounds per square inch. Handles such heavy sprayable materials as corrosion and rust preventives, calking compounds, adhesives, sound deadeners and also mastics of certain types. The power head, or housing, which encloses air motor, is of aluminum. This reduces unit weight to 35 lbs.

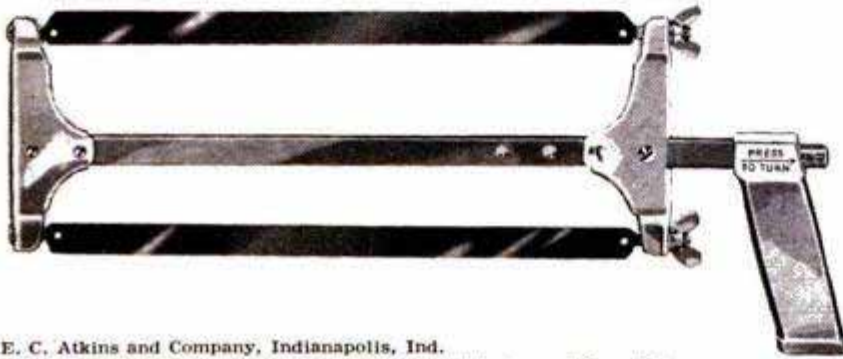
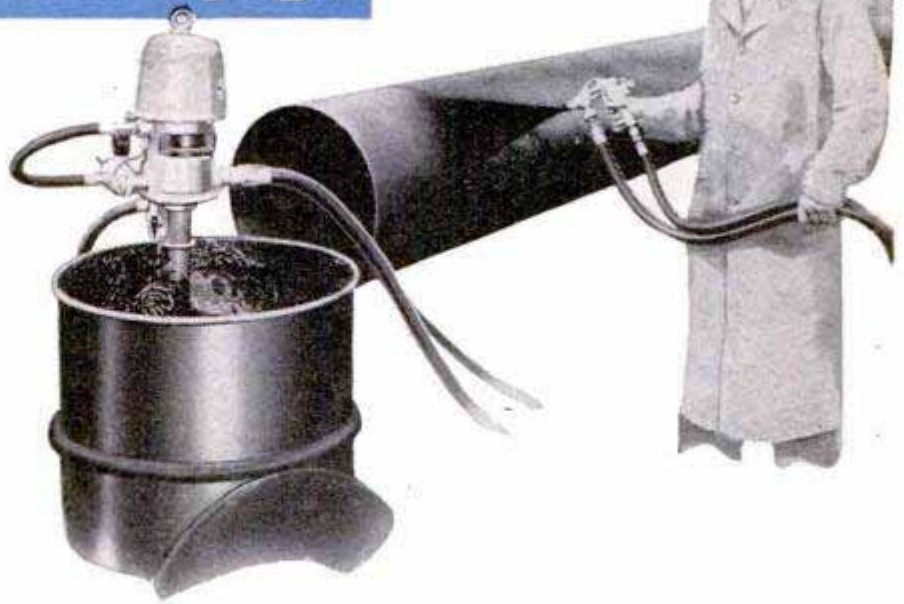

E. C. Atkins and Company, Indianapolis, Ind.

DUAL-PURPOSE HACKSAW FRAME holds two 10 or 12-in. blades of same length but of different tooth points. The frame is rotated to bring either blade into any one of four cutting positions by a release button in handle

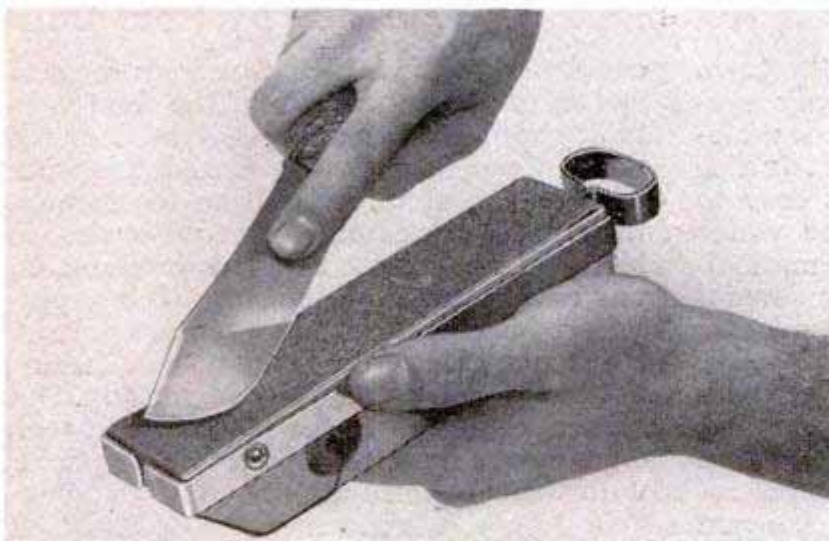

W. E. Fleming, 1721 B Avenue N.E., Cedar Rapids, Iowa

KNIFE SHARPENER is designed primarily for the purpose of putting a keen cutting edge on all types of knives, but serves equally well as a hand-sanding block. Principal feature of the unit is the unique device for locking the sandpaper or emery cloth under sufficient tension to prevent folding under sanding or grinding pressure. When the pivoted locking lever is in the closed position, exposed portion of the sandpaper is held rigidly at each end of the block



Kedman Co., Salt Lake City, Utah

THIS PRACTICAL SCREWDRIVER has a two-piece blade designed to hold the screw, start it and drive it in restricted spaces. Screw is held by two hollow-ground blades that expand by means of a sliding sleeve to grip the sides of the screw slot flush from top to bottom. When half-round blades are locked in place by sliding sleeve they cannot slip. Has shockproof handle and is made in small, medium and large sizes and in a range of blade lengths to fit screws with flat and round heads



Oil Drums and Welded Framework Provide Combination Feeder

Permanence, exceptional strength and neat appearance are special features of this portable all-metal feed rack which provides a rack for roughage and a round-bottom trough, or bunk, for ground feeds on each side of the welded frame. The bunks are made by cutting steel oil drums in half lengthwise, cutting out one end of each drum and then welding the halves together endwise. *Caution:* Before cutting the drums with a torch be sure to steam-clean them thoroughly, inside and out. The frame members are of 1½ or 2-in. pipe assembled with all joints welded. The sloping sides and the ends of the rack are spaced steel rods, ⅜ or ½ in. in diameter, and are welded into holes drilled in the frame members and the corner posts. Two lengths of 3-in. pipe welded to the ends of the corner posts form skids for easy portability.

Planks Bolted to Concrete Posts Make Rugged Barnyard Fence

W.T.M. Concrete

After wasting considerable time in temporary repair of barnyard fencing, one farmer took time to build this permanent fence. He cast special concrete posts in a wooden form designed so that the heads of bolts could be accurately embedded in the concrete mix. The bolts were located in pairs spaced at regular intervals along the length of that portion of the post which was to be aboveground. Then the posts were set to a uniform depth of 36 in. below ground level with the bolt ends facing one way. To finish the job, 2 x 6-in. planks were bolted

to the posts and painted white. In order to turn hogs and sheep, it is advisable to space the three lower planks closer together than those above, and the bolts must be located accordingly. — A. M. Wettach, Mt. Pleasant, Iowa.

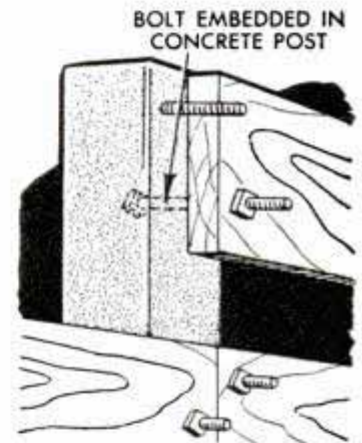

Water Level in Livestock Tanks Automatically Controlled by Float Valve

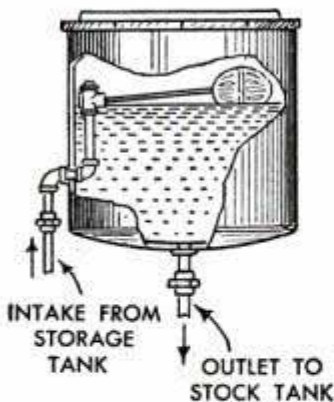

Where the farm water-supply system includes elevated storage tanks, it's easy to control the water level automatically in one or several livestock tanks by fitting a float valve in the supply pipe at any convenient point between the storage and stock tanks. Cut the pipe, remove a short section, and fit elbows and risers onto the two ends. The upper ends of the risers are connected to a float-valve tank made by cutting off the top of an old hot-water tank about 18 in. from the end. This unit is then turned upside down, a suitable cover is fitted, and the inlet and outlet connections are made as in the detail. An ordinary toilet-tank float valve is

connected to the intake pipe from the storage tank. When installing, the float-valve tank should be carefully adjusted so that when the float valve is closed the water level in the chamber will be the same as that in the stock tank. Then, when the water level in the stock tank is lowered, the valve will open, replenishing the supply. Where location of the supply lines permits, the float-valve unit can be placed inside a building for protection from freezing. Outside units can be protected by a temporary enclosure made from boards and packed with straw for insulation.

Ridding Granary of Rats

To keep rats out of his granary, one farmer fastened a small bell around a rat which had been caught in a trap. The rat was turned loose in the granary and the sound of the bell frightened other rats, keeping them out of the granary.

Radio Television Electronics

TELEVISION TODAY

PHONEVISION has been available to 300 typical Chicago families for 90 days. The test, authorized by the Federal Communications Commission, was conducted by the Zenith Radio Corporation from their special transmitter (photo A) atop the Field building. The families selected to take part in the test to determine public opinion were named by the National Opinion Research Center of the University of Chicago, and the result will be submitted to the FCC. Phonevision is a "scrambled" combination of television and telephone transmission of a movie or other special entertainment in such a way that the viewer must pay a fee to view a desired program. The necessary decoder unit, indicated by the arrows in photo B, is installed in each home set.

Photo C shows a big-picture TV tuner designed for quality custom-built installations. It features simplified tuning with a double-shadow "magic eye" tuning indicator and can be used with the latest 16, 17 or 19-in. picture tubes. The young lady in photo D is demonstrating a compact 2-tube "finger tip" TV front-end tuner of improved design, which is housed in a chassis 2 $\frac{5}{8}$ in. wide, 2 $\frac{7}{8}$ in. high and 4 $\frac{3}{4}$ in. long. These front-end tuning units select the desired TV channel. Photo E shows a tiny "magnetron" tube developed for use in new ultra-high-frequency television receivers.

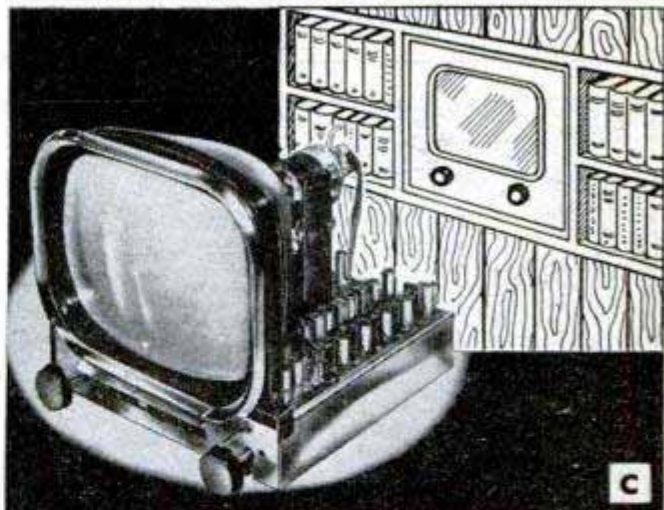
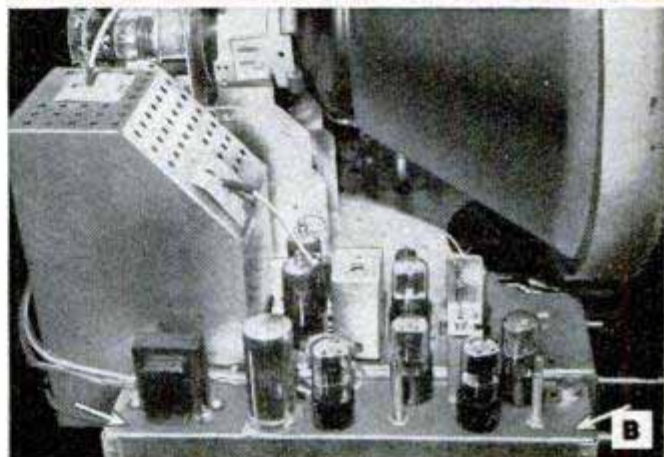
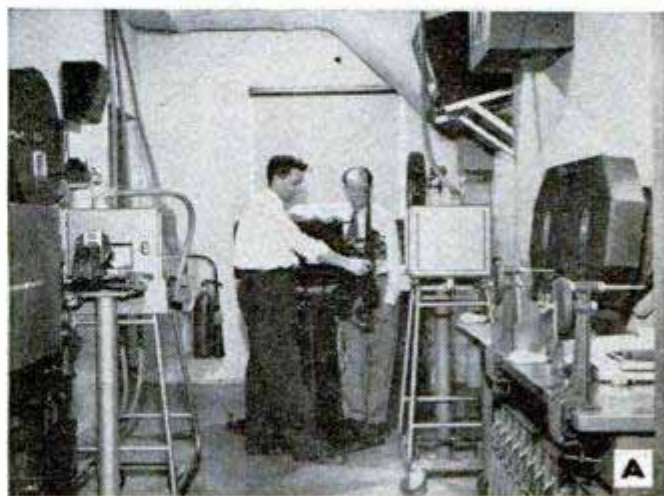

"YAGI" BEAM ANTENNA

By S. A. Johnson WØLBV

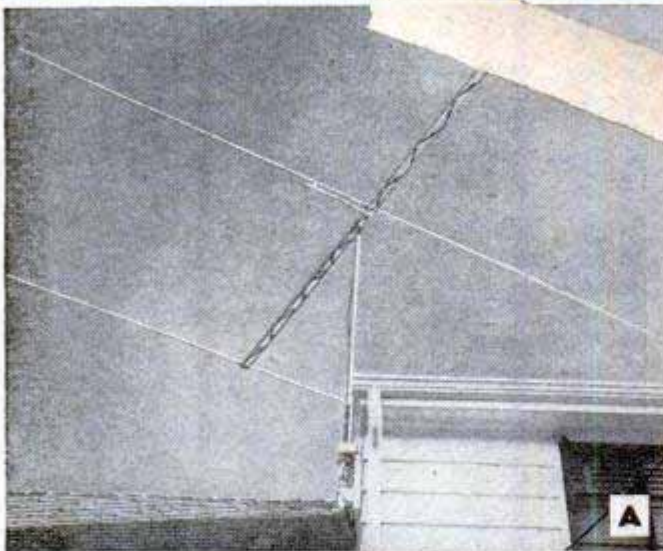

PERHAPS the most popular, and certainly one of the most effective, single-beam-antenna arrays employed by amateur radio operators and recently for certain channels by TV-antenna manufacturers, is the "Yagi" multiple parasitic-element array. This is commonly known to hams as the "plumber's delight" owing to its all-metal type of construction. The usual method of home construction involves mounting the elements through a boom made of large tubing, a difficult job which is not very strong mechanically.

The antenna shown in photos A and C was designed for the 10-meter band and the boom construction was simplified and strengthened by making it of 1-in. hard aluminum angle; or $\frac{3}{4}$ -inch aluminum or steel angle "trim" may be used with some sacrifice in rigidity. The same boom can be used for the 6-meter band, the dimensions for which are given in Fig. 1. Self-tapping screws are used to fasten the angle together to form a "U." When these are completed, they are spaced the proper distance apart to carry the 1-in. vertical pipe which supports the antenna. The boom is then built up into the form of a girder, as indicated in Fig. 3. When completed, small strips are placed across the top, as shown in Fig. 2, to provide "beds" for the elements. These are bolted to the boom as

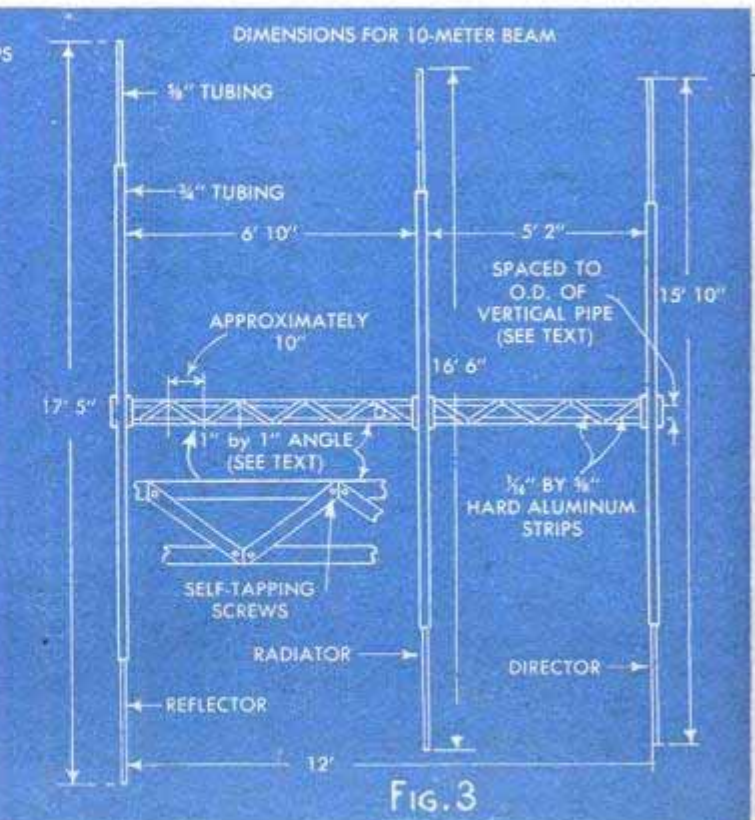
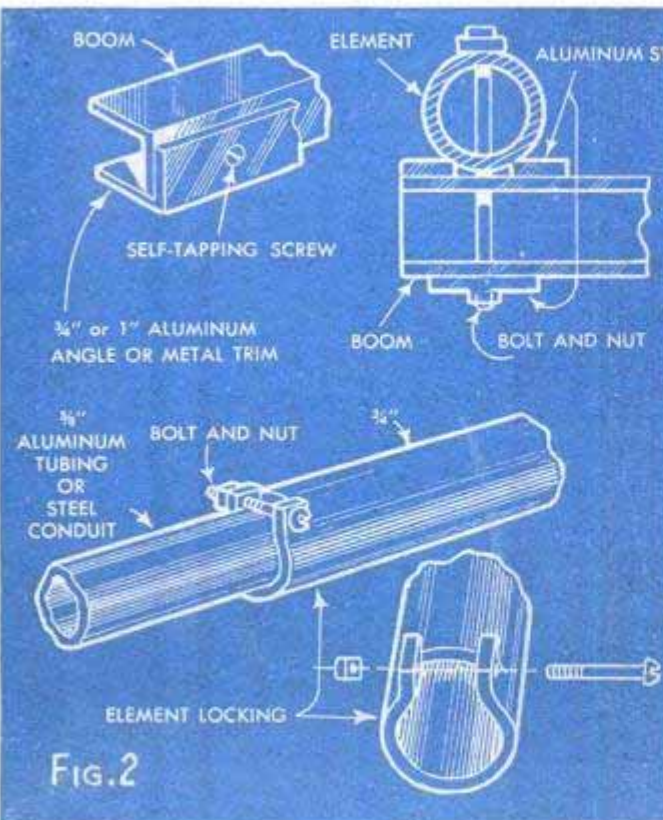
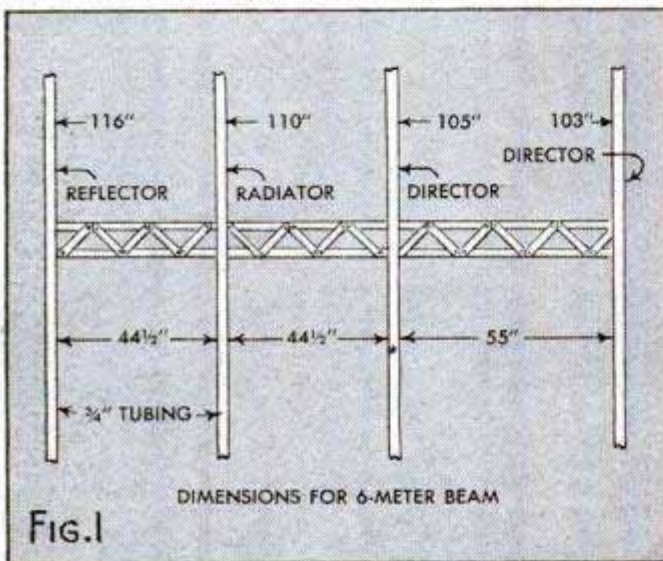

with LOW-COST ROTATOR

indicated in the sectional diagram. Either hard aluminum tubing or ordinary steel conduit may be used for the elements.

The telescoping elements can be locked in position in the manner shown in Fig. 2, or the builder can use ordinary hose clamps of the proper diameter. The beam is bolted to the pipe by means of two brackets as detailed in Fig. 4. Top guying adds further strength to the assembly.

The inexpensive, homemade rotator consists of a simple device that can also be employed to rotate any type of television-antenna array. The rotator, detailed in Fig. 6, utilizes a television-antenna thrust bearing costing about \$3. This carries the load, and the antenna pipe is held vertical by means of the simple bearing made of a piece of chassis and the 2 x 4-in. wood blocks. The pipe, or mast, is fitted with a 4-in. V-pulley rim of the Gates type sold by many hardware stores.

Rotation is obtained by a rather unique principle: The antenna is "loaded" with a coil spring and rotated by simply pulling against this spring. The flexible steel cable is passed through large pulleys and run into the basement or other convenient spot for turning the antenna about 355 degrees. The lever arm is calibrated with nail stops for direction, Fig. 6 and photo B. The beam illustrated was fed with the popular "gamma match" shown in Fig. 5, the matching section being adjusted with the clamp strap.

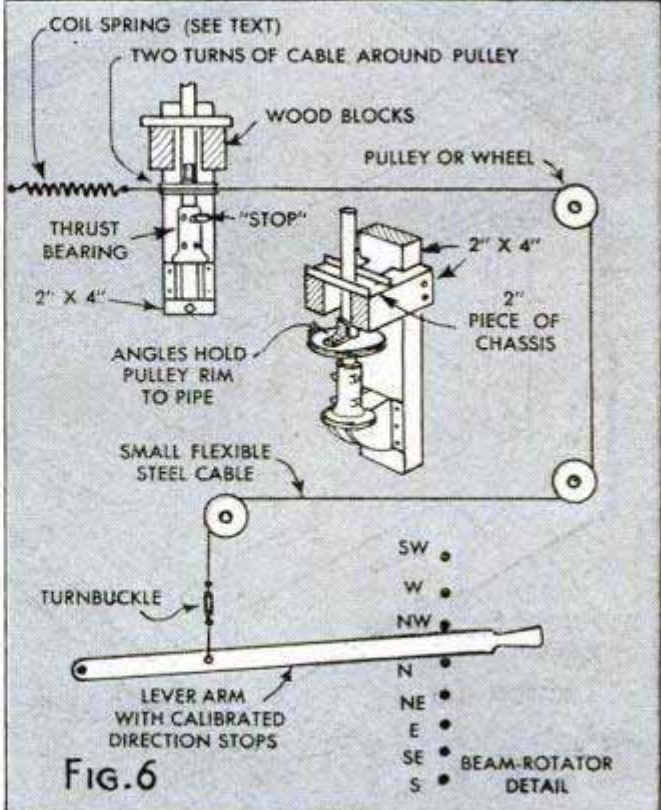
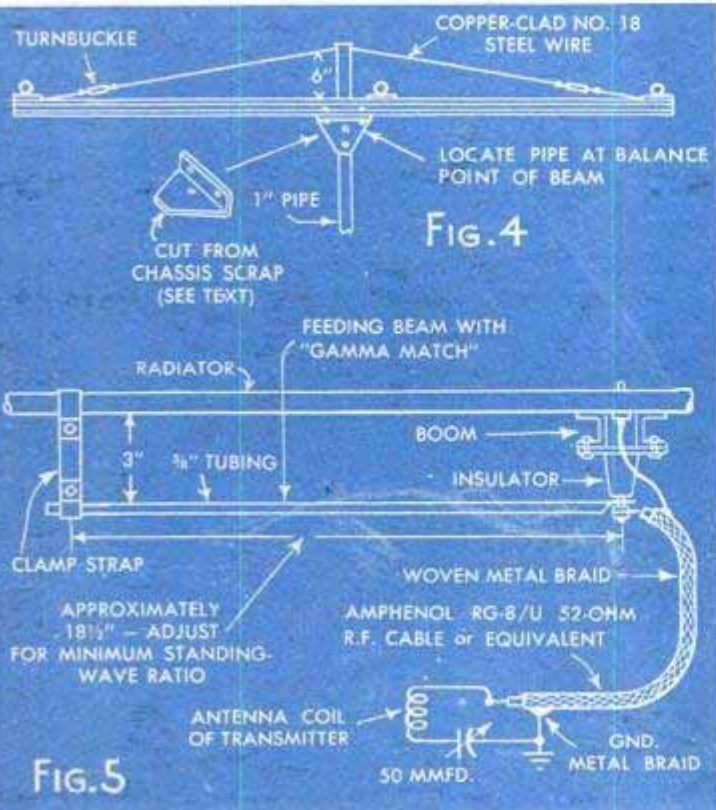
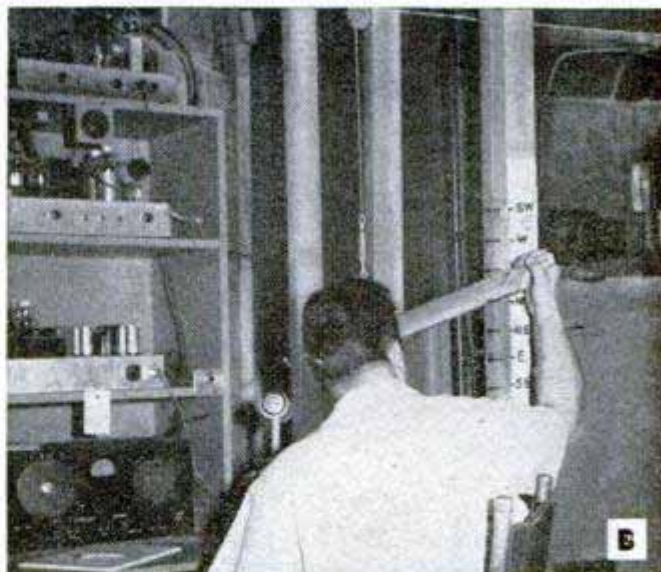

CORNER CABINET for

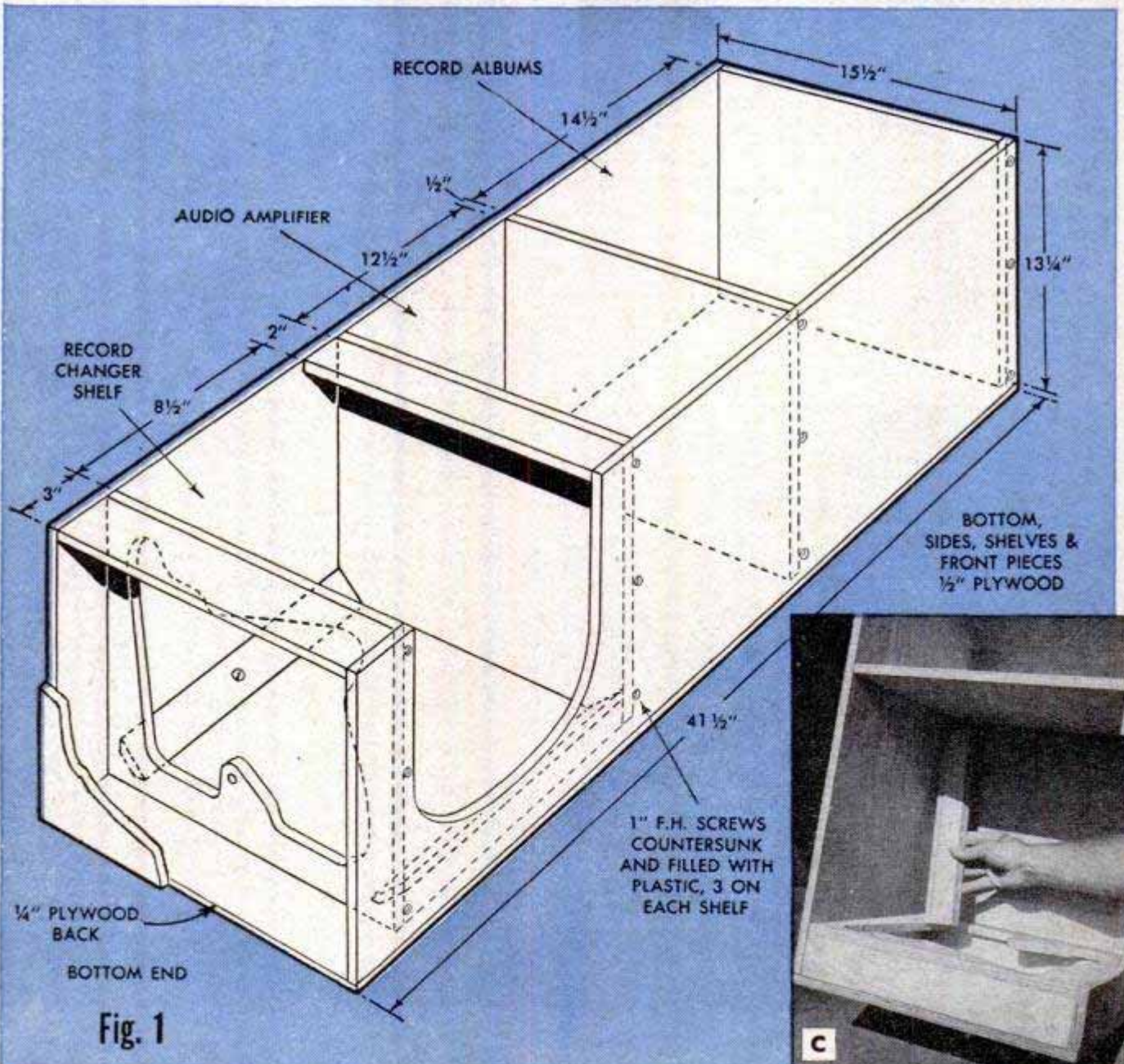
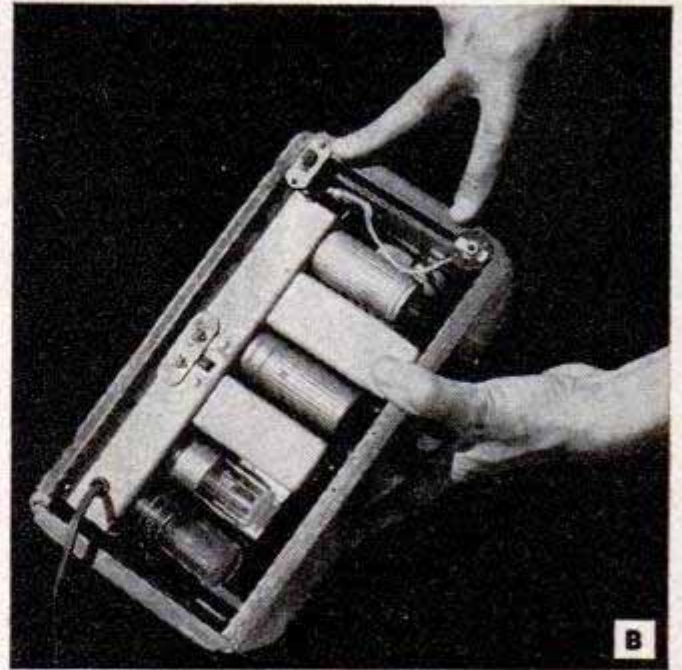

your RECORD PLAYER and SOUND SYSTEM...

By Peter Gowland

HAVE YOU ever wished that your home was equipped with a super sound system that would enable you to play quality records or radio in almost every room? A radio experimenter friend told me that there was really nothing to installing such a system in a simple space-saving wall or closet cabinet that I could build, and the cost would depend on what I would like to spend for equipment. Separate amplifier, record changer, radio tuner and speaker units are available from radio parts houses. Any serviceman can arrange a simple control panel like the one shown in photo E so that either the records or radio can be played through speakers located in various rooms.

The simple plywood wall cabinet shown in photo A was the end result of this conversation. All dimensions and construction details are given in Fig. 1 and Photos C, F and H.

Two strips of $\frac{1}{2}$ -in. plywood are fitted in the corners where the wires are to run up from the changer to the amplifier D and control panel E. The builder can use any available record player or a tape-disk type of recorder and playback unit such as the one illustrated in photo E on page 232. In this case, however, the cabinet would have to be wider as this unit measures $12\frac{1}{4} \times 17\frac{1}{2}$ in.

Illumination for the record changer is provided by two small 7-watt lamps mounted on the 2-in. strip as in photo H. Instead of a radio tuner, my radio serviceman installed a plug and switch on a small radio set as shown in photo B, and ran a shielded wire from the set to a plug and jack on the amplifier control panel.

Remote speakers can be located in suitable wall cabinets as shown in photo G.

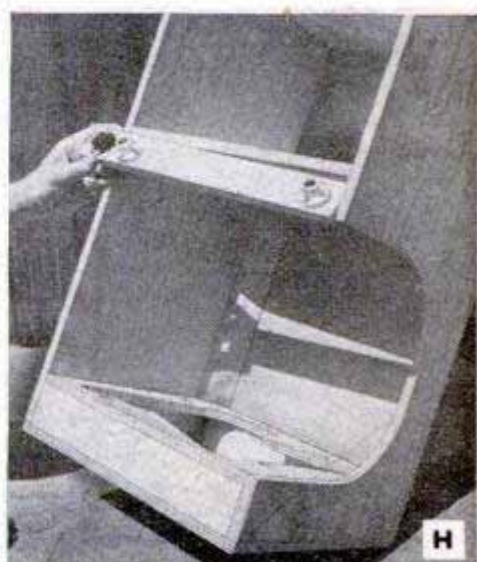
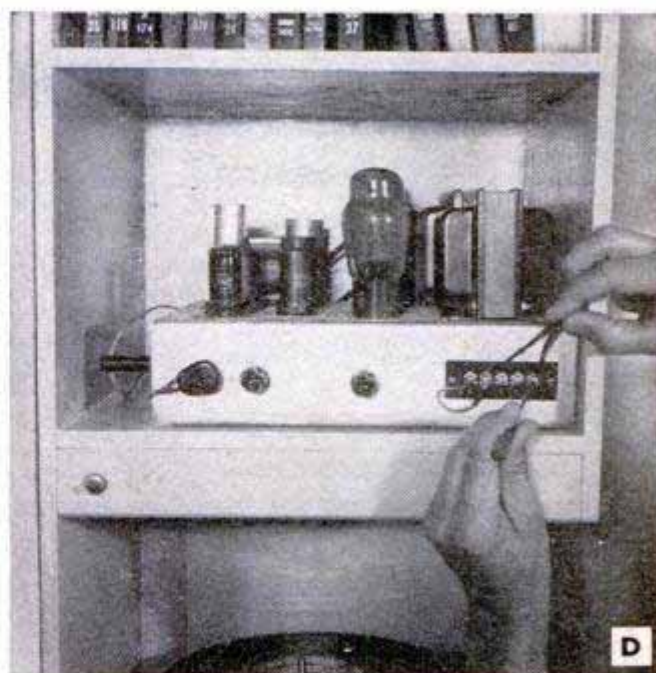

HINTS FOR RADIO OWNERS AND EXPERIMENTERS

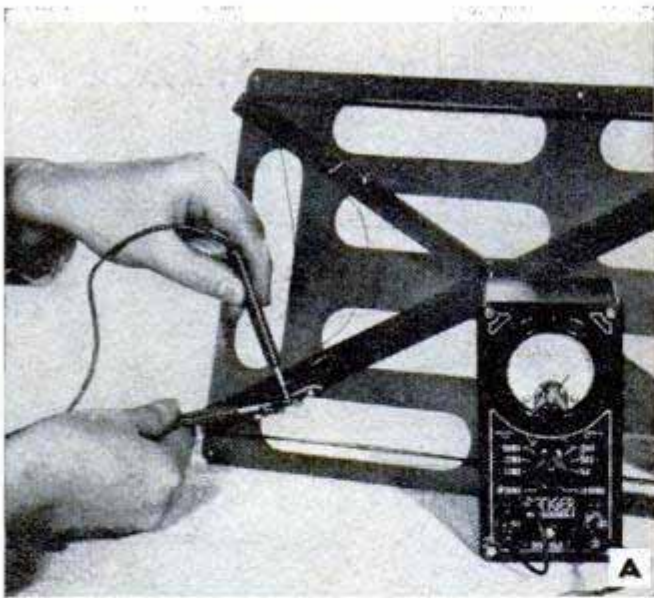

A—A low-reading voltmeter may be used as illustrated to check loop antennas for open circuit or shorts. Remove loop from the set before checking.

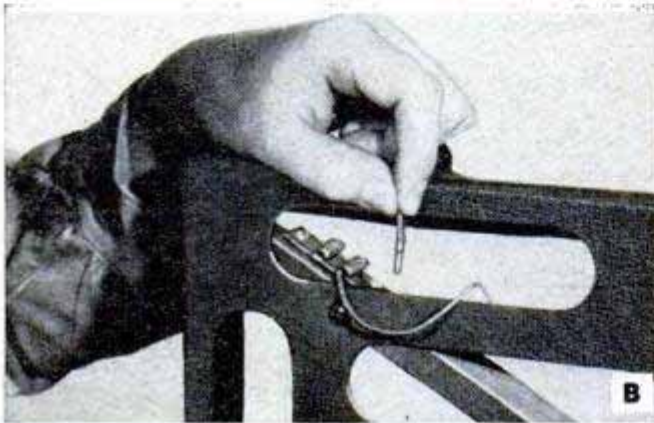

B—Small table-model receivers employing loop antennas with plug-in connectors will sometimes give whistling noises when tuned. Try reversing the loop plug connectors as they may have been reversed when the loop was removed for test.

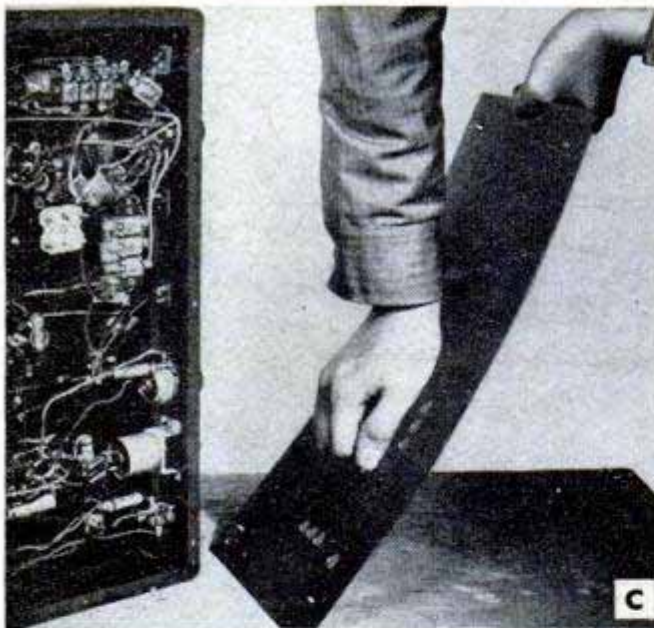

C—In large receivers, the metal bottom plate may become bent inward and possibly short to some "live" part. The simple remedy is illustrated.

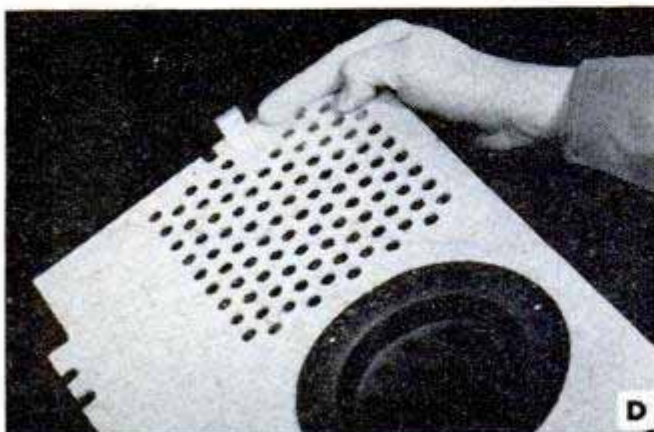

D—It is important in TV receivers that the interlock catch, or plug, on the back cover makes good contact. These are sometimes damaged in service. Always disconnect the set line plug before checking.

E—Experimenters and builders of custom installations in the home can employ the versatile combination General Industries tape-disk recording and playback assembly unit to solve unusual space and recording problems. It records on disks from tape, on tape from records or on either from microphone or radio, and then plays them back. It also plays 78-r.p.m. records.

F—TV sets operated in shops or other dusty locations should be frequently checked to see that all ventilating holes in the cabinet are open.

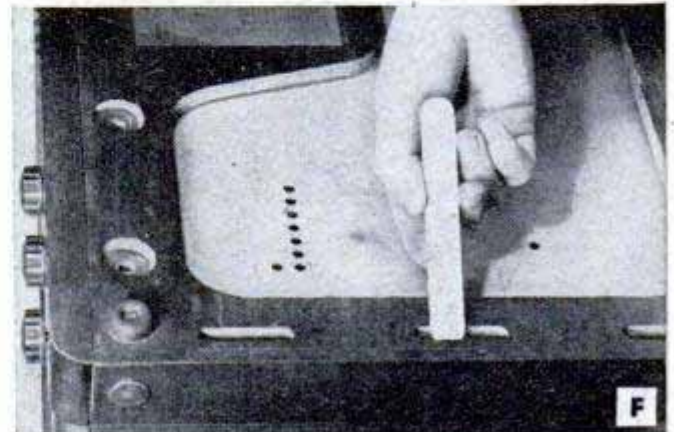
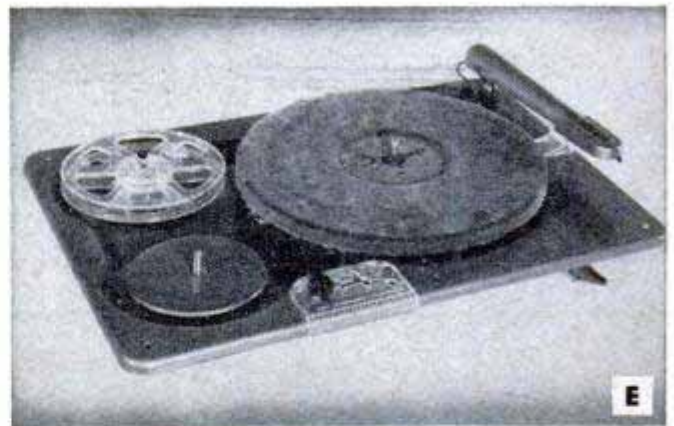

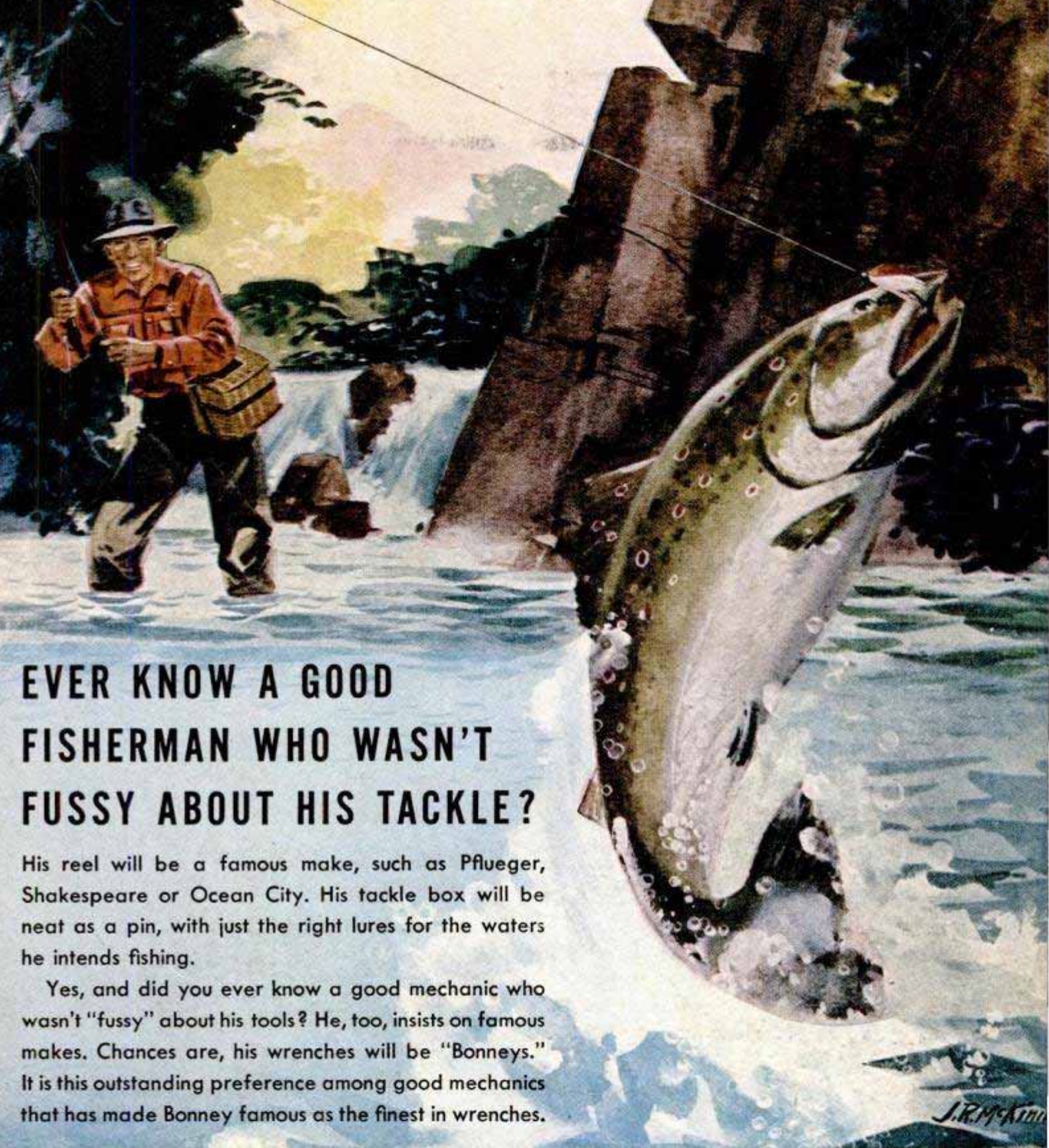

EVER KNOW A GOOD FISHERMAN WHO WASN'T FUSSY ABOUT HIS TACKLE?

His reel will be a famous make, such as Pflueger, Shakespeare or Ocean City. His tackle box will be neat as a pin, with just the right lures for the waters he intends fishing.

Yes, and did you ever know a good mechanic who wasn't "fussy" about his tools? He, too, insists on famous makes. Chances are, his wrenches will be "Bonneys." It is this outstanding preference among good mechanics that has made Bonney famous as the finest in wrenches.

This is one of a series of spirited sporting scenes (in full color, without advertising) available on request. Write for your free set today.

"CHEAP TOOLS ARE FOR CHUMPS" say men who know tools best. And the highest recommendation for Bonney Wrenches is the kind of men who use them.

Among thousands of real mechanics, "Bonney" is just another way of saying "best." For lightness, strength, balance and precision you can't beat a Bonney.



**Your radiator needs
a spring cleaning, too!**

**CLEAN
OUT
RUST**

with

DU PONT Cooling System CLEANSER



A rust-clogged radiator can cause you trouble and expense. Don't take chances. You can clean out rust, scale and scum easily and safely. Just pour a

can of DU PONT CLEANSER into your radiator, run the engine for 30 minutes or more, then drain. No reverse flushing is required.

KEEP OUT RUST WITH



**DU PONT
Acid and Rust
INHIBITOR**

After cleaning, you can keep your radiator free from rust all season by pouring in DU PONT ACID AND RUST INHIBITOR. It retards rust and keeps out acid.

PREVENT LEAKS WITH



**DU PONT
Cooling System
SEALER**

You can stop leaks quickly and securely—and help prevent leaks in the future—by pouring in DU PONT COOLING SYSTEM SEALER. It won't clog the radiator.



REG. U. S. PAT. OFF.

BETTER THINGS FOR BETTER LIVING . . . THROUGH CHEMISTRY

The "ALL-GLASS" headlamp gives most light when new
... most light throughout life



"ALL-GLASS"
sealed beam
HEADLAMPS



General Electric headlamps are

ALL-GLASS...they do not grow dim!

Road and laboratory tests prove the average G-E Sealed Beam headlamp gives 99% of original light output right up to the end of lamp life. They do not grow dim, because:

1 "All-Glass" seal makes possible the one-piece construction that

keeps out dirt and moisture.

2 Rugged filament supports—filaments won't shake loose.

3 Reflector *stays* mirror-bright.

4 Hard-glass lens gives accurate beam pattern.

Check your lights ... and replace burnouts with General Electric "All-Glass" headlamps!

You can put your confidence in—

GENERAL  **ELECTRIC**

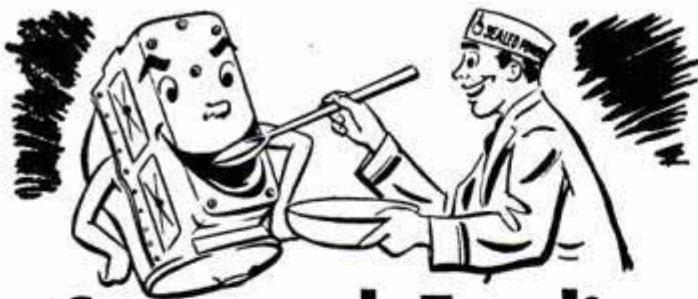

Care and Feeding of Engines

BY S. P. CORP

CHECK PLUGS FOR MORE SPARK!

To remove a spark plug that has been in use for some time, blow dirt out of spark plug well, then remove wire and unscrew plug one turn to remove carbon formed around threads. Now tighten plug again and connect wire. Idle engine fast, to get rid of carbon deposits that dropped off bottom of plug when you loosened it. If engine misses, idle until miss is gone. Then remove all plugs and inspect gaskets.

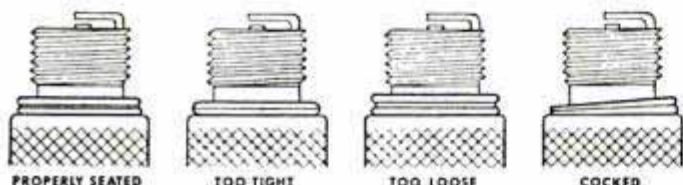

If gasket crease is closed tight, plug was installed too tight, causing a compression leak around porcelain. If gasket is not compressed at all, plug was installed too loosely, permitting leakage around base of plug. If gasket is cocked when installed, results will be the same as with a loose plug. Spark gap will be too high in combustion chamber, causing delayed action, incomplete combustion, and poor gas mileage.

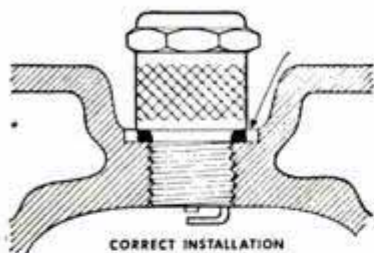

TO INSTALL:

1. Set gap according to your car manual.
2. Always use new gaskets.
3. Clean threads in cylinder head by screwing in old plug without any gasket.
4. Clean spark plug seat in cylinder head.
5. Screw plug in by hand until seated on gasket.
6. After seating, tighten $\frac{3}{4}$ of a turn with wrench.
7. Connect wires and idle engine. Correct idle speed shows charge on ammeter. Do not idle too slowly.

SPRINGTIME IS RING TIME

If you need a re-ring job, be sure to use Sealed Power Rings—the best rings built! Sealed Power MD-50 Steel Oil Ring is the only ring with the Full-Flow Spring—best for oil control even in badly tapered and out-of-round bores. There is a Sealed Power Ring Set specifically engineered to do the best possible job in your engine! For free booklet, "7 Ways to Save Oil," write Sealed Power, Muskegon, Mich., Dept. G-4.

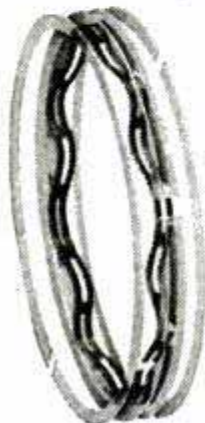

Lightning Strikes Your Dinner

(Continued from page 102)

"Want to see how she works?" asks the doctor. You are escorted through a concrete, lead-lined chamber, into which the bottom of the big vacuum tube projects from the ceiling. Under it is a circular target table, with remote-controlled motors that can revolve, raise or lower it, so that successive bursts can hit the target from every possible angle. Your destination is the lead-lined closet in the corner, with a slit window of heavy glass.

A white-coated assistant puts a calcite crystal on the table and goes out. The lead safety door locks behind him. The evacuating pump for the vacuum tube throbs dully. Outside, a horn beeps, announcing all clear in the radiation chamber. A gong clangs to signal circuit readiness. It is followed almost instantly by an ear-stabbing crack, as powerful sparks leap gaps on the tower, and three million volts of blue haze jab down from the aluminum window under the tube. With a blinding flash it stabs the gloom of the chamber, striking dazzling fire in the crystal, which now glows like semi-molten glass. The air is loaded with the smell of ozone. "Here, examine it," says the doctor handing you the crystal. It looks as though it would burn right through your hands, but it's cool as a mountain brook.

Other objects go on the table—tiny crystals in a closed box, a tray of salt, a china plate with metal templates fastened to it with cellulose tape. They all prove something. Again the sound effects, the lightning flash, and what has happened? The tin box looks the same, but inside it those crystals are alive with fluorescent glow, proving that electrons will penetrate cans of vegetables or meat and still do their job. The salt has turned a dark brown, and the plate tinted. But under the heavy metal templates, the china is white—and a design has been forever emblazoned on the dish. Turn it over, and you'll see that the pattern goes all the way through. "Just another commercial adaptation," says Brasch, "but we'll never get a chance to develop it. Too many more important things."

Brasch and Huber still are solving a number of problems. Odd things have happened to some items under the electron blast.

Milk, for instance, can be sterilized easily. "But," says Doctor Huber, "it acquired an awful taste at first. We don't know why." However, by experimenting, the scientists found that "irradiated taste" could be minimized in many items by "shooting" them in vacuum containers.

(Continued to page 240)

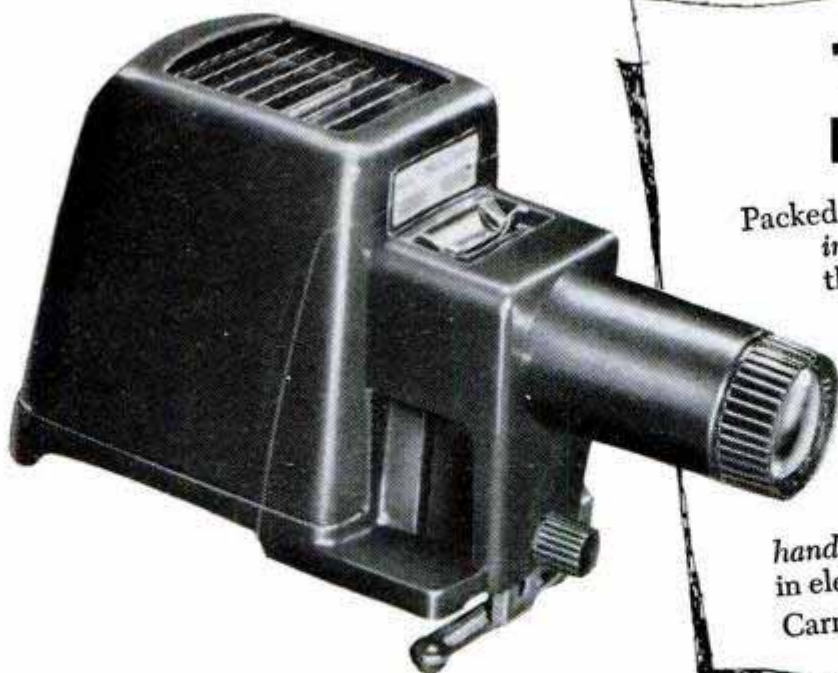

The Kodaslide Merit Projector

Packed full of features. For easier slide insertion—you feed 2 x 2-inch slides through recess in top, remain seated at right of projector—no jarring or moving of instrument. For even illumination—Lumenized Kodak Projection Ektanon Lens, 5-inch f/3.5-powerful 150-watt lamp. For slide protection—large, cool lamp house keeps slides flat. For handy elevation—built-in elevating mechanism. Carrying case, \$9.50.

only \$24⁵⁰

SMART COLOR TEAM

Kodak Pony 828 Camera

Makes superb color slides on Kodachrome Film; sharp black-and-white negatives. Kodak Anaston f/4.5 Lumenized Lens; Kodak Flash 200 Shutter with built-in "synch"; body shutter release; simplified exposure settings marked in red. Takes 8-exposure rolls. Field case, \$6.50.

only \$29⁹⁵



For intimate color shows in a fully lighted room— The Kodaslide Table Viewer 4X

Projector and screen in a single unit. You need never dim the lights—its projected image, enlarged more than four times, brings out the full beauty of transparencies even in a fully lighted room. Price of viewer, \$47.50. Handsome protective case, \$14.50.

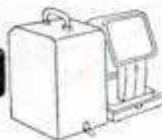

Prices are subject to change without notice and include Federal Tax where applicable. Consult your dealer.

Kodak
TRADE-MARK

EASTMAN KODAK COMPANY, ROCHESTER 4, N. Y.

Now it's **EASY**
to have modern
oak floors



Your choice of block or strip design

Just lay prefinished Bruce oak flooring right over your old floors...no sanding or finishing

You can give your home new beauty at low cost with a prefinished Bruce Hardwood Floor. Completely finished—even waxed—at the factory, this highest quality oak flooring can be nailed right over old floors. No sanding or finishing...no mess or smell. Ready for use as soon as laid. Made in strip or block (parquet) design.

"Scratch Test" Finish — The Bruce factory-applied finish is baked into the pores of the wood. The "Scratch Test" (left) will prove to you that this durable finish does not scratch or chip or mar like an ordinary floor finish.



Moderate in cost — A new Bruce Hardwood Floor will cost you less than a good rug or carpet. Easy to keep clean and beautiful, too. It's just the thing to use in fixing up or adding a room. Let your lumber dealer give you an estimate. Mail coupon below for colorful literature.

MAIL FOR FREE LITERATURE

E. L. Bruce Co., Box 397-K, Memphis 1, Tenn.
Send complete information on prefinished Bruce Hardwood Floors.

Name.....

Address.....

City..... State.....



Bruce Hardwood Floors
Product world's largest hardwood flooring maker

Clinic



for Homemakers

As a service to our readers in solving the hundreds of problems pertaining to a home—inside or out—the editors of *Popular Mechanics* invite you to present your problems to The Clinic Editor for help and advice. Address your questions to The Clinic Editor, *Popular Mechanics Magazine*, 200 East Ontario Street, Chicago 11, Ill.



Putty Hardens

Q—After purchasing a pound or two of putty to repair a window sash, I wrapped the remainder in two thicknesses of oiled paper for storage. Sometime later when I opened the package I found the putty had hardened over the whole outside surface, making it unfit for use. I tried to cut away the hardened material without success. Isn't there some way to prevent this?
O.F., Superior, Wis.

A—One way is to pack the putty in a glass jar having a tight-fitting screw top. After packing the putty tightly in the jar so that it is fairly level across the top of the mass, pour a small quantity of water over it and tighten the lid of the jar. Stored in this way, small amounts of putty will keep in good condition for long periods of time. When the putty is removed from the jar, it should be thoroughly worked before using, as it may be somewhat soft and sticky. Another fairly reliable method of preserving putty for short periods of time is to wrap small amounts in two thicknesses of cellophane and seal the folds with cellulose tape to exclude air.

Polishing Silverware

Q—I have some rather choice solid-silver tableware, some of it quite old, which seems to have been dulled by continued polishing. At any rate, it tarnishes rapidly to a dark color and it appears impossible to restore it to a high luster with any of the ordinary silver polishes. I've tried a number of these polishes with about the same result. How can I clean this tableware and polish it?
G.S., Memphis, Tenn.

A—We do not believe that any of the silver polishes you have used are the cause of your trouble. We think it more likely that your old silverware has become blackened by silver sulphide. One method of removing this coating is to dip the items, one by one, for just an instant in hydrochloric acid and then rinse immediately and thoroughly in running water. However, we cannot recommend this as a household procedure because of the hazards involved in the use of powerful acids. A safer method is to mix (dry) cream of tartar, 2 parts, levigated chalk (not precipitated), 2

(Continued to page 238)

It's **CRAFTSMAN** . . . America's most famous and dependable, low-cost 12-in. Band Saw!

The ONLY Band Saw at ANY price . . . with ALL these Features!

Only CRAFTSMAN has this superior ONE-PIECE frame and back cover, with bridge-girder type, ribbed reinforcement . . . a scientifically engineered development that permits a much more rigid, stronger, more accurate saw!

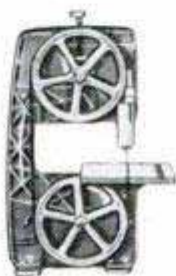

SAFE! All operating parts except actual cutting edge of blade completely enclosed for maximum operator protection!

Self-aligning upper saw guide automatically adjusts itself with blade path . . . reduces friction . . . prolongs blade life!

Saw guides above and below table, have oil-impregnated bronze blocks and ball bearing thrust wheels for true cutting!

Drive shaft and ball bearings are an integral unit; no possible misalignment!



See this accurate, economical CRAFTSMAN Band Saw NOW! It's outstanding for pattern shop, furniture, boatbuilding!

This superb CRAFTSMAN Band Saw belongs in your shop because it will give you better performance . . . longer service . . . and cost you far less money! Handles all kinds of straight and contour sawing . . . in wood, plastics, rubber felt, paper . . . even thin sheet metal work. Cuts to center of 24-in. circle, in wood up to 6-in. thick. Dynamically balanced, cast iron saw wheels, with rubber tires ground true, for smoother operation. Table tilts 45°. See it at (or call) your nearest Sears Retail Store TODAY! Or write Dept. 609, Sears, Roebuck and Co., Chicago 7, Illinois.

**COMPARE ITS QUALITY!
COMPARE ITS PRICE!**

\$71⁵⁰*
Cash

Without motor or bench

** Prices slightly higher south of the Ohio and west of the Mississippi rivers.*

CRAFTSMAN Hand and Power Tools by **SEARS, ROEBUCK and CO.**
Famous for fine quality . . . precision performance . . . low price!



CEILING CRACKED? NEED MORE ROOM? WANT TO Modernize YOUR HOME?

Do the job easily,
quickly at low cost with
UPSON PANELS

FOR CRACKED CEILING:
No messy replastering! No ordeal of housecleaning! Apply Upson Kuver-Krak Panels on furring strips right over cracked plaster! Have a beautiful, crack-proof ceiling in a matter of hours! Unique Floating Fasteners eliminate visible face nailing! Panels are 5 plys thick, laminated for extra strength! Do not "drink" paint, one coat covers!

FOR MODERNIZATION:
Upson Panels saw like wood. Take screws, nails, fixtures, drilling! Pebbled, tile embossed or smooth surfaces! Hundreds of uses! Most lumber dealers carry Upson Panels in a variety of lengths, widths and thicknesses. All panels trademarked for specific uses. Heavy duty Strong-Bilt for new construction, Kuver-Krak for re-covering cracked ceilings. 3/4" Upson Panels for lighter uses. Use only as directed.

THE UPSON COMPANY
984 Upson Point, Lockport, N. Y.

I enclose 10c for 32 page Idea Booklet. Include Instruction Sheet for applying Upson Ceilings and working drawings for Storage Wall FREE.

Name _____
Street _____
City _____
State _____



Upson Floating Fastener



Closet under stairs



Beautify your fireplace



Extra closet in bedroom

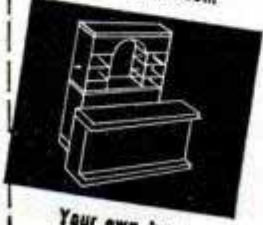

Your own bar

(Continued from page 236)

parts, and alum, 1 part. Store the unused portion of the mixture in a tightly corked bottle. Wet whatever amount is to be used with sufficient water to form a fairly heavy paste, and rub the silverware lightly with a linen cloth charged with the mixture. This treatment usually removes the black coating with very little rubbing. Thereafter you can clean your solid silverware quite easily by a simple process. Place a sheet of aluminum in a shallow aluminum pan filled with soft water, and add 3 to 5 tablespoons of ordinary salt, depending on the size of the pan and the amount of water. Immerse the silverware in the solution and boil 3 to 5 minutes, or until the light tarnish disappears. Then remove the silverware, rinse in running water and rub dry with a soft cloth. Of course, this process should not be used on silverware having handles of any other material, such as real or artificial pearl, etc.

Pipe Insulation

Q—The hot-water pipe from my heater to the bathroom is about 25 ft. long and in cold weather it is necessary to let the faucet run for some time before getting even warm water. I tried wrapping the pipe with newspapers, which seemed to help some, but was not very satisfactory from the standpoint of appearance and durability. Isn't there some simple way of preventing this loss of heat and at the same time making the job more attractive?

F.R., Buffalo, N.Y.

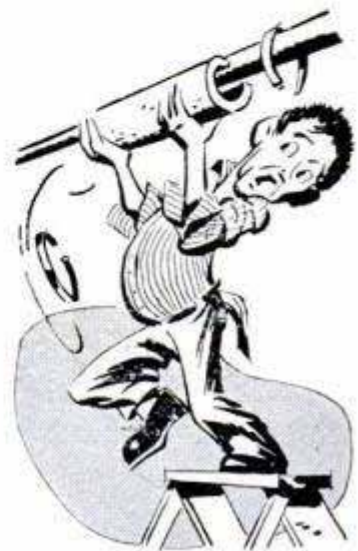

A—If the pipe runs from the heater to the bathroom are fairly straight and clear the floor joists by 2 in. or so, then perhaps the most practical remedy is to cover the pipe with a cellular insulating material of the type used for covering the hot-water and steam lines of heating systems. This is readily available in various sizes and usually is furnished in 3-ft. lengths. It is easily cut into shorter lengths if required. To apply it, simply cut the muslin covering along one side, open it and place over the pipe. The material is held in place with special metal fasteners which are supplied.

Staining Bricks

Q—My red-brick fireplace has what appears to be a smoke stain directly above the opening and extending nearly up to the mantel. It covers almost all the bricks above the opening. How can I remove this stain? Also, is there any way of renewing the color of the bricks, other than painting? They seem to be rather faded, because of embedded dust, I suppose.

K.T., Paducah, Ky.



A—If the discoloration is on the surface of the bricks and is not coming through from the flue, it usually can be removed quite easily by scrubbing the bricks with a medium solution of trisodium phosphate. Ordinary household ammonia sometimes proves quite effective. **Caution:** When using any ammonia, or ammonia solution, indoors, provide ventilation, as under some conditions the concentrated fumes are toxic. To brighten the bricks after a cleaning, make a stain by mixing equal parts of linseed oil and turpentine and adding enough Venetian-red oil color to give the bricks the shade and depth of color desired.

performance

above all!

DESIGNED by Kiekhaefer engineers who recognize that **PERFORMANCE** is important to the fisherman, **PERFORMANCE** in your Mercury "Super 5" means hours on end of the slowest, sweetest trolling any fisherman could ask for.

PERFORMANCE means easier starting and reliable operation in fair weather or foul, because of the waterproofed ignition system. **PERFORMANCE** means reliable operation in shallow, stumpy bays or thick weed beds, because of the clog proof rubber rotex pump, low level water inlet, multiple disc propeller clutch and truly weedless position, dual purpose drive.

PERFORMANCE means "Full Jeweled Power.*" Power to push your fishing boat and all your gear at speeds that will thrill you. You spend more time fishing with a Mercury.

Features of Mercury motors are protected by issued or pending patents.

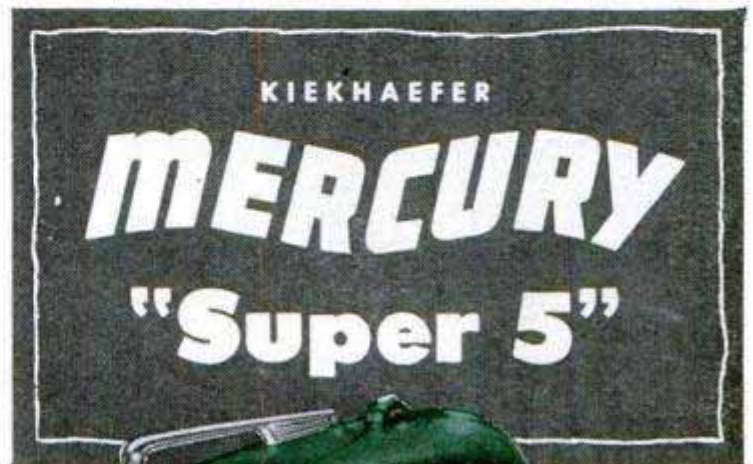

* Ball and Roller Bearings Throughout

KIEKHAEFER Corporation
Fond du Lac, Wis., U.S.A.



How you can paint a room in 1/2 a day

WITH

 **SPRED SATIN**

THE WONDER PAINT

Here's the ideal paint for "do it yourself" redecorating. Goes on faster than any paint you've ever used. Apply with brush or roller. Start or stop any time, any place—no laps or brushmarks will show. Dries in 20 minutes to a gorgeous satin finish.

- ★ Covers most surfaces.
- ★ No offensive odor.
- ★ Washes perfectly—again and again without loss of color or texture.
- ★ Beautiful pastel and deep-tone colors—ready to use.

The secret of this amazing paint is its exclusive *synthetic rubber emulsion* formula. The rubber forms a tight, durable surface that dirt can't penetrate. See your dealer today!

SEND FOR DECORATING KIT

Up-to-the-minute color ideas you can easily carry out in your own home! Floor plans and color reproductions for 7 rooms. Practical, made-to-order for planning home improvement. ▲

Send 10 cents (coin) to cover handling and mailing.

Dept. PM-4
The Glidden Co.
Cleveland 2, Ohio

Please send me your decorating kit. I enclose 10 cents (coin).

Tell me where I can buy Spred SATIN.

Name _____

Address _____

City _____ State _____

And because of its cold energy, the electron burst is ideal for producing powdered milk. Butter gets a "taste" too, and so does cream cheese, but in the latter it disappears a couple of months after storage. Lettuce collapses completely, gets soggy, flat tasting and bleaches out almost white. So do strawberries, whereas cherries, grapes, blueberries and apples come out fine. So do fruit juices. Irradiated heavy fruit-juice concentrates can be effectively preserved at room temperatures.

"One of the funniest things," says Huber, "is castor oil. It comes out sterile and clean and just like castor oil—except for one thing. It smells like daisies."

In early tests, some meats like beef, while they were perfectly good, acquired an ugly purplish-brown color. "That was corrected by refrigerating the meat before bombarding it," explains Brasch.

In spite of the failures, the scales are balanced well on the positive side for the capacitron. From its target table has come raw beef that is still fresh after being kept at room temperature for more than four years. There are well-aged fillets of flounder, bacon, chicken a la king, eggs, corn on the cob, still fresh and firm. Lima beans and cabbage, four years old, show no signs of collapsing. Diced cauliflower, stowed on a shelf in 1947, is as crisp as the day it was put away. Camembert cheese quit "ripening" the instant it was shot, but is perfectly preserved after four years in a warm room.

Cut roses and carnations, snipped from their stalks in 1948 are still fresh and crisp in their plastic envelopes, while "control" flowers that weren't irradiated have rotted away to black blobs.

In the field of medicine, vitamins can be thoroughly sterilized with a single burst of energy, without losing their potency. In one swoop, biologicals like serums can be made sterile, eliminating the long, involved process now necessary. Bacteria and viruses can be killed with electrons so that they still keep the substance that lets them fight subsequent infection by disease germs. This opens the door to preparation of a whole new series of vaccines. Antibiotics, like penicillin and streptomycin, can be given a tremendous jolt, which stabilizes them without interfering with the substance that works against infection.

Work is being done, too, on whole blood, which must now be kept cold and used within two weeks. The capacitron's lighting should increase its life by many times, and obviate the need for refrigeration.

Both men have tremendous faith in the eventual use of electrons to destroy cancer cells. "No other beam," says Brasch, "has

(Continued to page 242)

Scientists Create "TAILORED LIGHTNING" For Better Motoring

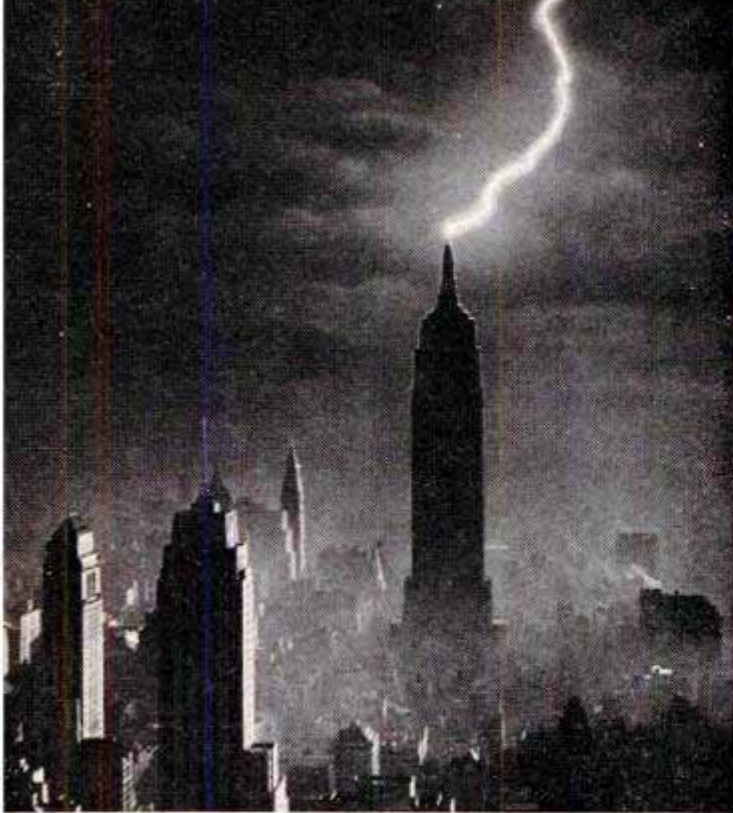

ELECTRICITY LEAPS from storm clouds to top of Empire State Building as shown in this dramatic night photograph. Engineers harness electrical energy like this to "fire" gasoline in your engine.

In the great engineering laboratories of The Electric Auto-Lite Company in Toledo, Ohio, a group of Auto-Lite Ignition Engineers have been probing inside engine cylinder walls, peering at "blow-by-blow" spark performances, charting the behavior characteristics of man-made "lightning" across the spark plug gap. From endless tests they've determined what your engine's ignition system needs most, and then set about producing spark plugs to fill the bill. Net result: Ignition Engineered Auto-Lite Spark Plugs . . . the spark plugs that are world famous for quality and performance.



FRANKLIN'S KITE experiment was first demonstration of electrical nature of spark discharges between clouds. Date: 1752.



"FIRING PIN" of the car engine. Your spark plugs fire as many as 15,000 fuel charges per minute with tailored precision.



RELIABLE STARTING is one important benefit resulting from Auto-Lite research to assure correct materials, dimensions and design.

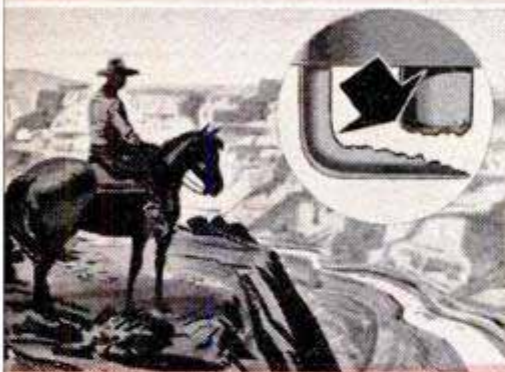

RIVER CUTTING CANYON resembles way surging of electricity wears away electrodes. For solution see next picture.



TINY UNIT called a "Resistor" permits wider initial gap setting, makes possible these advantages of Resistor Spark Plugs:

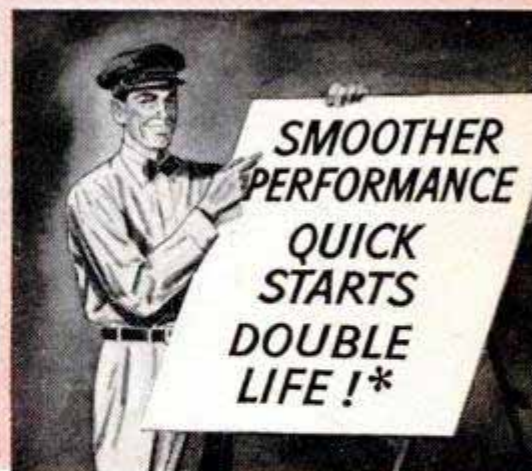

**SMOOTHER
PERFORMANCE
QUICK
STARTS
DOUBLE
LIFE!***

All car, truck and tractor owners benefit from the exhaustive research performed by Auto-Lite Ignition Engineers . . . the men who design the coil, distributor, spark plugs, wire and all the other parts of the complete ignition system used as original factory equipment on many leading makes of America's finest cars and trucks. *You're Always Right With Auto-Lite.*

THE ELECTRIC AUTO-LITE COMPANY

Ignition Engineered
AUTO-LITE
SPARK PLUGS



Here's why Cars that WASTE OIL
are headed for

PREMATURE OLD AGE

OIL WASTE warns you that
rocking chair pistons
are wearing out
cylinder walls



SEND NOW FOR FREE BOOKLET:

"Inside Facts on Excessive Oil Consumption" brings you the facts about the 10 ways engines start to premature old age when you neglect to re-lace worn rings at first sign of "pumping."

RAMCO RE-POWERING

with 10,000 Mile (or 1 Year) Guaranteed
Piston Rings actually
CURBS WEAR



Ramco's "NO-GAP" Spiro-Seal steel section on the 10-Up oil ring develops a special compensating action that minimizes friction on the power stroke. Then, as the piston rises in cylinder, Spiro-Seal lessens its contact thus insuring adequate wall lubrication for exceptionally long life. This is one of many Ramco originations which make possible the control of oil in worn engines through STABILIZATION rather than pressure. See your repair shop displaying the RE-POWERING Sign... or write for free booklet. Send post-card to Ramsey Corporation, Dept. 3764, St. Louis 8, Missouri.

Copyright 1951, Ramsey Corporation 5409



the killing power of these atomic bullets—in combination with the exquisite control we can achieve."

The beam does other impressive things. Without harming grain, like barley, wheat, soybeans and corn, it will knock dead every weevil, moth or bug it touches. These insects destroy as much as \$600,000,000 worth of grain each year. "By loading grain into storage elevators via a conveyor belt passing beneath a capacitron tube," says Brasch, "all that grain would be saved."

Doctor Huber points out that the capacitron will not make refrigeration a thing of the past by a long shot. "Rather, the two will work together," he says. Many items—like beef—preserve best if cooled before treatment. Others keep their flavor, color and texture best if kept in a cool place. But instead of being down below freezing, much less refrigeration will be necessary."

The incredible beam even has the unique property of solidifying some liquid plastics to a point where they have some of the properties of steel.

The real story will come once that new capacitron goes to work this year. Unlike its forebear, it will make no racket, ring no bells or toot no horns. All its 17 banks of condensers are sunk in an insulating fluid. Sparks leap through special gaps from post to post and make no more noise than the tick of a big clock. But out of the huge vacuum tube in a completely safe, lead-enclosed treatment area at the far end, five million volts of lightning will begin to prove themselves, while the conveyor belt on the floor below carries tons of new merchandise to waiting delivery trucks.

Meanwhile, in the Brooklyn icehouse, the rebuilt pilot-model capacitron will preserve many different items for special wholesale customers—cut flowers, foods, drugs—and experiments will continue.

I'm Building the Popular Mechanics Plywood Ranch House

(Continued from page 89)

A multitude of various paneling methods can be used in the different rooms. Here in our Ranch House the bedrooms have plywood walls that can be painted, papered or given any other finish desired. The kitchen, utility room and bathrooms will be enameled. The living room will have its walnut paneling, large windows and brick walls. The dining-area walls will be stained. There are many little tricks to use on these walls, such as metal linoleum edging for the ceiling-wall joint.

Every room in the Ranch House has

(Continued to page 244)



STEVENS MODEL 124*

—12 ga., 3 shot repeating shotgun. Fast cross bolt action. Has the lines and balance and comparable performance of repeaters and auto-loaders, costing up to *twice* as much. Checkering . . . paneling and fluting of durable plastic stock give added eye appeal and value.

STEVENS MODEL 59

— .410 ga., 6 shot, tubular magazine, repeating shotgun. Chambered for 3" or 2 1/4" shells, take-down. Self-cocking bolt action . . . convenient thumb operated safety. Handles and shoots like a "22". Model 58 — same specifications, except fitted with 3-shot detachable clip magazine.

STEVENS MODEL 258*

—20 ga., 3 shot clip magazine repeater. . . Another "First in the Field" value in a popular gauge for pest control on the farm and all-around sports shooting.

You've got to look 'em over . . . throw 'em to your shoulder—before you'll believe that so many features, so much *value*, can be built into repeating shotguns at such low prices. They're good to look at, handle and shoot. Rugged, dependable, well balanced, too, for years of top shooting service.

Write for free catalog of Savage, Stevens and Fox shotguns and rifles. See your dealer.

SAVAGE ARMS CORPORATION
Firearms Division • Chicopee Falls, Mass.

* Both Models 124 and 258 double as deer guns, when loaded with rifled slugs or buckshot.



First in the Field



SAVAGE

SAVAGE • STEVENS • FOX Rifles and Shotguns

SAVAGE • WORCESTER Power and Hand Lawn Mowers

Nothing finer for

CIRCULARS

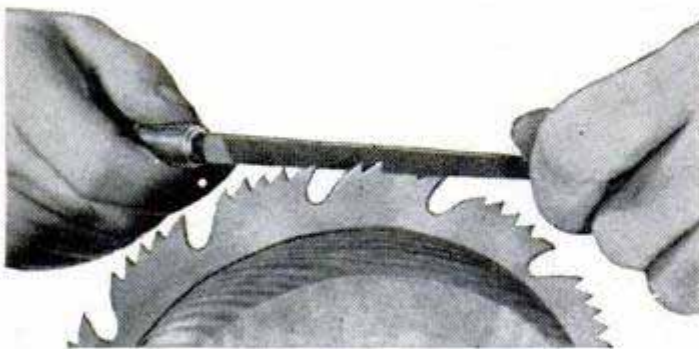

You can't beat the Nicholson or Black Diamond Slim Taper File for home-workshop combination circular saws*. (Handsaws, too, for that matter.) It has an even bite that never throws your filing stroke off stride. A shape that enables putting just the right point, edge and bevel on circular saw teeth. A hardness that keeps it cutting efficiently long after "cheaper" files are ready for the scrap heap.

Fine tools have a way of reflecting themselves in the quality of the work they turn out. You'll find that true whenever you use Nicholson or Black Diamond files. Mill files for sharpening and smoothing. Flat files for general purpose filing. X.F. Swiss Pattern files for precision work. Keep a good assortment of these famous files handy at all times. No home workshop is complete without them.

* For larger combination circular saws, the Nicholson or Black Diamond 10" Cantsaw File is recommended. And for filing the teeth of large circular rip saws, the Mill Bastard file with one round edge is often used. Your hardware dealer has all these files, or can get them for you.

HOW TO SHARPEN CIRCULAR SAWS, handsaws, auger bits, shop tools, etc., is all covered in the Nicholson 48-page booklet, "FILE PHILOSOPHY." It's free. Send for your copy today.



NICHOLSON FILE CO.
22 Acorn St., Providence 1, R.I.
(In Canada, Port Hope, Ont.)



NICHOLSON FILES FOR EVERY PURPOSE

modern and practical features you will like. My wife can hardly wait for me to complete the dining room. You can furnish it with standard furniture, but my completed dining room will both save you money and give a better room.

It has been carefully planned so that it can be a dual-purpose dining and living area—most of us today do not use a formal dining room enough to devote the floor space to that use exclusively. You make the dining table yourself from a flush hardwood door, the simplified "boomerang" table designed especially by John Whelan for the Ranch House. It is a huge, low coffee table that ingeniously lifts up to become a generous dining table for six to eight people. Behind the table, against the dining-room windows are two low buffet cabinets that you can buy or build and between these cabinets four modern dining chairs fit together to form a sofa or davenport. Thus your dining room is a lounging or reading area of the living room, yet in two minutes it becomes a dining area that will accommodate even that big Thanksgiving dinner.

There are many other features of the house and its furnishings that I would like to tell you about now, but that will have to await future issues. I will say only that it has been fun building the Ranch House, that you needn't have any fear of attempting it and that you accomplish more than just savings in completing your home with your own hands. Don't miss the story of this amateur-built home as it begins in next month's issue with drawings and photographs in full color.

Plague in the Big Pines

(Continued from page 142)

focus, pole-blight recognition schools were held last summer. These were to teach foresters and lumber-company fieldmen how to recognize a sick tree. First part of the school comprised lectures around a dozen pole-blighted trees. Lastly came the "exam." The questions concerned another dozen trees of different disease severity.

Out of the recognition schools has come a survey to determine just how much white pine already has been hit. Current guess is that it will be 100,000 acres or more. Pole-blight devastation so far has been mainly in the Cabinet and Kootenai national forests in Montana and in the Coeur d'Alene and St. Joe in Idaho. Extensive airplane checking will be done this summer by the Division of Forest Pathology in areas which have not yet reported any trouble from the mystery disease.

(Continued to page 246)

Replace Your
Winter-Wearied Spark Plugs
with new

CHAMPIONS



BE A CHAMPION DRIVER ... *New Spark Plugs now insure better performance all Summer*



Old, winter-wearied spark plugs make engines sluggish and wasteful. Dependable new Champions do just the opposite!



As an important family utility your car deserves regular care. Give it new Champions now for better performance all summer!



More motorists replace with Champions than any other make—America's favorite spark plugs for over 25 years!

CHAMPION SPARK PLUG COMPANY, TOLEDO 1, OHIO





Listen to the CHAMPION ROLL CALL . . . Harry Wisner's fast sportscast every Friday night, over the ABC network

**HANDYMAN
HOBBYIST
OR
EXPERT MECHANIC**



Starrett TOOLS ARE MADE FOR YOU

Precision made by craftsmen for craftsmen, the name Starrett on any tool has been the hallmark of accuracy for over 70 years. Among the more than 3000 fine precision tools now made by Starrett, you'll find the right tools to help you do any job with greater ease and accuracy.

	No. 230 — "Satin Chrome" Micrometer. 1" capacity, tapered frame, in Sycamore case.
	No. 440 — Micrometer Depth Gage with lock nut and "Satin Chrome" finish. 2½" base.
	No. 823 — "Satin Chrome" Inside Micrometer with tubular rods. Two sizes: 1½ to 8" and 1½ to 12".
	No. 902B — Kit of Tools for apprentices and home workshops. The same fine tools used by skilled mechanics.
	No. 530 — Quick Reading Steel Tape. 25, 50, 75 and 100 foot lengths.

SPECIAL OFFER—Only 10¢

50-Page "Tools and Rules" Book

"The Tools and Rules for Precision Measuring" tells how to make accuracy a habit, shows the methods skilled mechanics use, 100 pictures plus reference tables. Send only one dime. Address Dept. AP.



THE L. S. STARRETT CO. • ATHOL, MASS., U. S. A.

TRADE MARK
Starrett
REG. U. S. PAT. OFF.

Since 1880... Standard of Precision

MECHANICS' HAND MEASURING TOOLS AND PRECISION
INSTRUMENTS • DIAL INDICATORS • STEEL TAPES • HACKSAWS
BAND SAWS AND BAND KNIVES • PRECISION GROUND FLAT STOCK

Buy Through Your Distributor

Because the most easily recognized symptoms are at the very tops of the trees, aerial spotting is expected to serve for the preliminary survey. When the aerial spotters report suspicious stands, ground crews will move into the territory to make close-up investigations.

The big target in pole-blight research, however, is to find out what causes the disease. Seeking the cause, scientists are exploring every possibility, below ground as well as above. Eight complete root systems, mostly of diseased trees, already have been plucked out for complete analysis.

"White-pine tree roots are shallow, seldom going down more than four feet," explains Doctor Buchanan. "But they certainly do spread out. We washed soil out 35 feet from the trunks of some trees to get all the running roots."

Soil around the trees has been completely analyzed. Idaho's Dr. William K. Ferrell is checking the tree soils for chemical content, acidity, nitrogen content, origin and texture, depth, slope, drainage and organic-matter content. Every angle is being explored for a possible lead.

All kinds of "juice" squeezed from the bark and wood of sick trees has been shot into healthy ones. Dr. Lake S. Gill of the Division of Forest Pathology collected 120 different fungi off sick trees. Each gets a laboratory test. Doctor Hubert has punched his hypodermic needle into more than 50 trees, giving each a shot of juice from a diseased tree. In addition, he has made nearly 500 patch grafts. Pieces of bark from diseased trees are grafted onto healthy ones. In cold storage in his laboratory, Doctor Hubert has hundreds of test tubes containing fungus cultures from sick trees. Entomologists are exploring the possibility that some forest bug may be the culprit spreading the disease.

Masses of data from the many-sided field studies being carried on in some two dozen field plots in six national forests in Montana, Idaho and Washington, go into what one worker jokingly described as a "mathematical grinding machine." Even high-speed computers have a place in modern research.

Right now the white-pine tree doctors are agreed on but one thing. They have a first-class killer on their hands. There is no evidence to indicate that any tree, once it gets pole blight, ever gets well.

Standing on the sidelines watching the forest pathologists, the entomologists, the soil scientists, the ecologists and other specialists interested in the general health and welfare of our forest trees pooling their resources, one is convinced the patient is in competent hands.

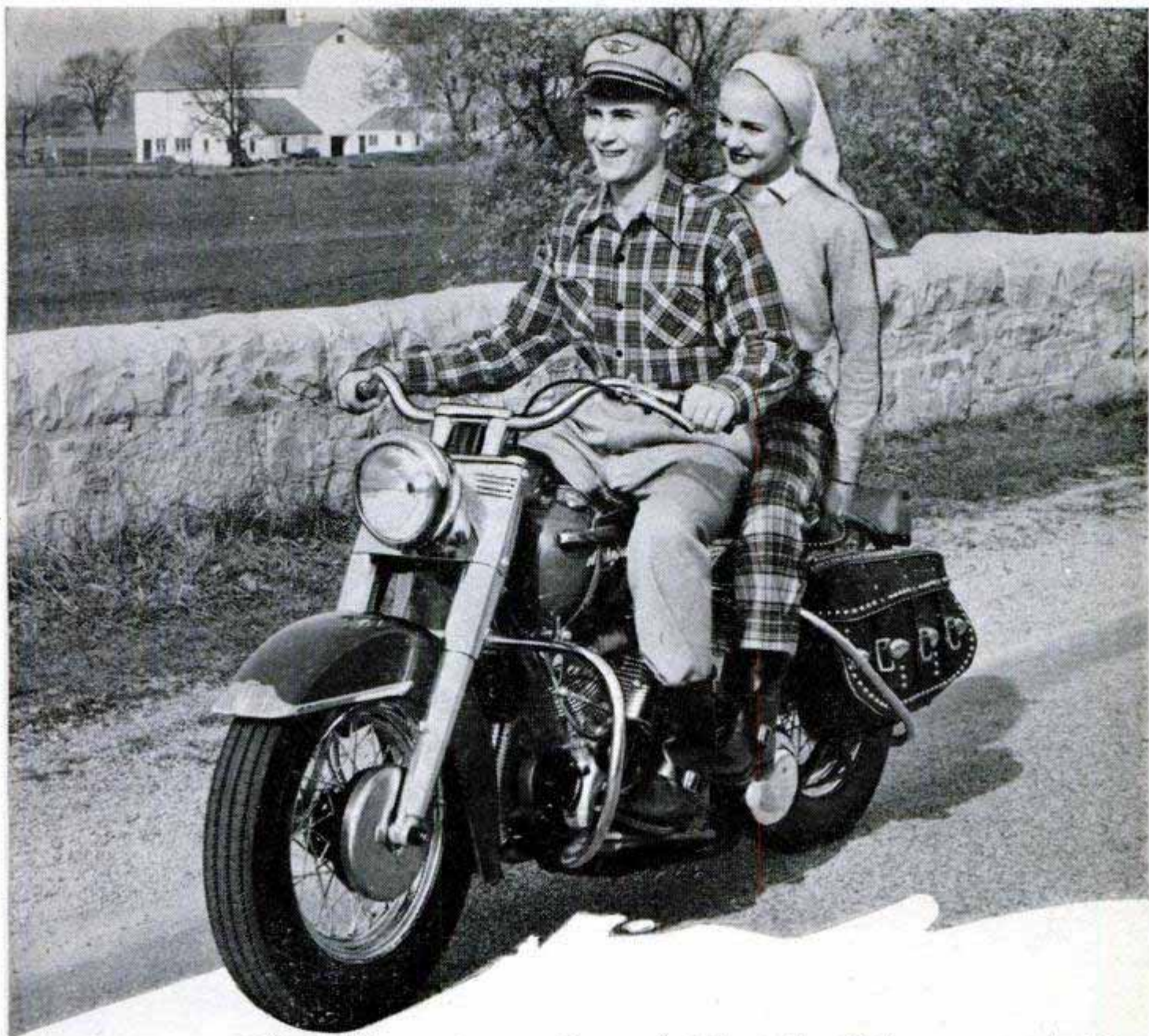

Thrilling Sport and Thrifty Transportation

HARLEY-DAVIDSON *HYDRA-GLIDE*®

Every mile is money saved, every moment a thrill... when you ride this swift, smooth "streamliner"! It takes you comfortably to daily work or distant points... at amazingly low cost. It brings you endless good times at race-meets, tours and other exciting motorcycling fun events. With it you can play a vital part in your local defense program. Easy terms. See your dealer. Mail coupon.



Send me free copy of ENTHUSIAST Magazine filled with motorcycle action pictures and stories; also literature on new models.



HARLEY-DAVIDSON MOTOR CO., Dept. P, Milwaukee 1, Wisconsin

Name.....

Address.....

City..... State.....

DEALERS: Valuable franchises available for the full line of famous Big Twins and the 125 Model. Write today.

SANDS FASTER Than 10 Pairs of Hands!

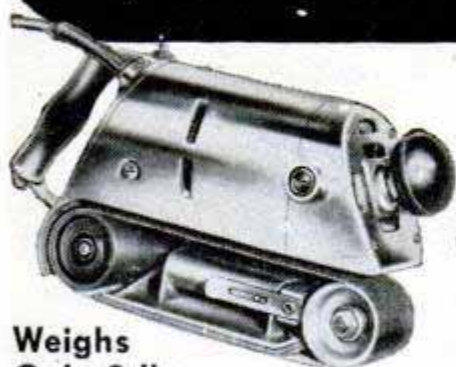

Weights
Only 9 lbs.

PORTER-CABLE
Guild
SANDER

only

\$59.50



Speeds Paint Removal . . . Used to be tough and messy to remove paint and varnish — not any more! It's easy with this powerful motor and high belt speed working for you.



Plane-Sands Faster . . . Another job made easy. The Guild A-2 Sander is perfect for taking off stock to close dimensions.



A Whiz at Preparing for a Finish . . . Always a uniformly fine, velvet-smooth surface. No waves or swirls — levels perfectly — cleans blemishes! And that's not all!



Speeds Screen, Sash and Door Fitting . . . And does a workmanlike job that will amaze you.

• Guild Sander does that job *fast* without hand-sanding drudgery! No bearing down — the powerful motor insures effortless, efficient cutting. So light, so perfectly balanced, Guild handles easily in *any* position. High speed abrasive belts have a variety of grits for work on wood, composition, plastic, metal, glass. Handy bench stand (extra) converts Guild Sander to a tool grinder — and to a machine for truing and smoothing butt and mitre joints.



Bench Stand

See your dealer for free demonstration.
It'll open your eyes. Send in coupon today.

Send me literature on the Guild A-2 Sander and Bench Stand.
Also name of my nearest dealer

Name

Address

City State

PORTER-CABLE MACHINE CO.

6064 N. Salina St., Syracuse 8, N. Y.

Fuel With a 260,000-Mile Reach

(Continued from page 85)

by high sulphur content. When the sulphur is removed, the gas has no odor at all, so it is given an artificial odor at the distribution end of the pipe line. This enables almost anyone to detect leaking gas.

Natural gas is pumped into a long-distance pipe line at pressures up to 800 pounds per square inch, and it flows through the line at an average speed of around 30 miles per hour. After a distance it slows down because of friction with the pipe, and is then repressured at compressor stations spaced about 125 miles apart. The 20 compressor stations of the new line to New



X-ray film is wrapped around weld. Radium salt inside pipe will expose film through any weak spot

York have a capacity of 209,120 horsepower, and each station takes gas out of the pipe line to use as fuel.

All the oncoming gas is "scrubbed" as it enters a compressor station by being bubbled through an oil bath. This removes the dust, rust and metal particles that it has picked up along the line and that could injure the compressors.

One of the biggest problems the gas industry faces is a way to meet the fluctuating seasonal demands for its fuel. Due to the increased use of gas for heating in cold weather the load factor may be seven times greater in January than it is in August. A

(Continued to page 250)

Around the clock usefulness...

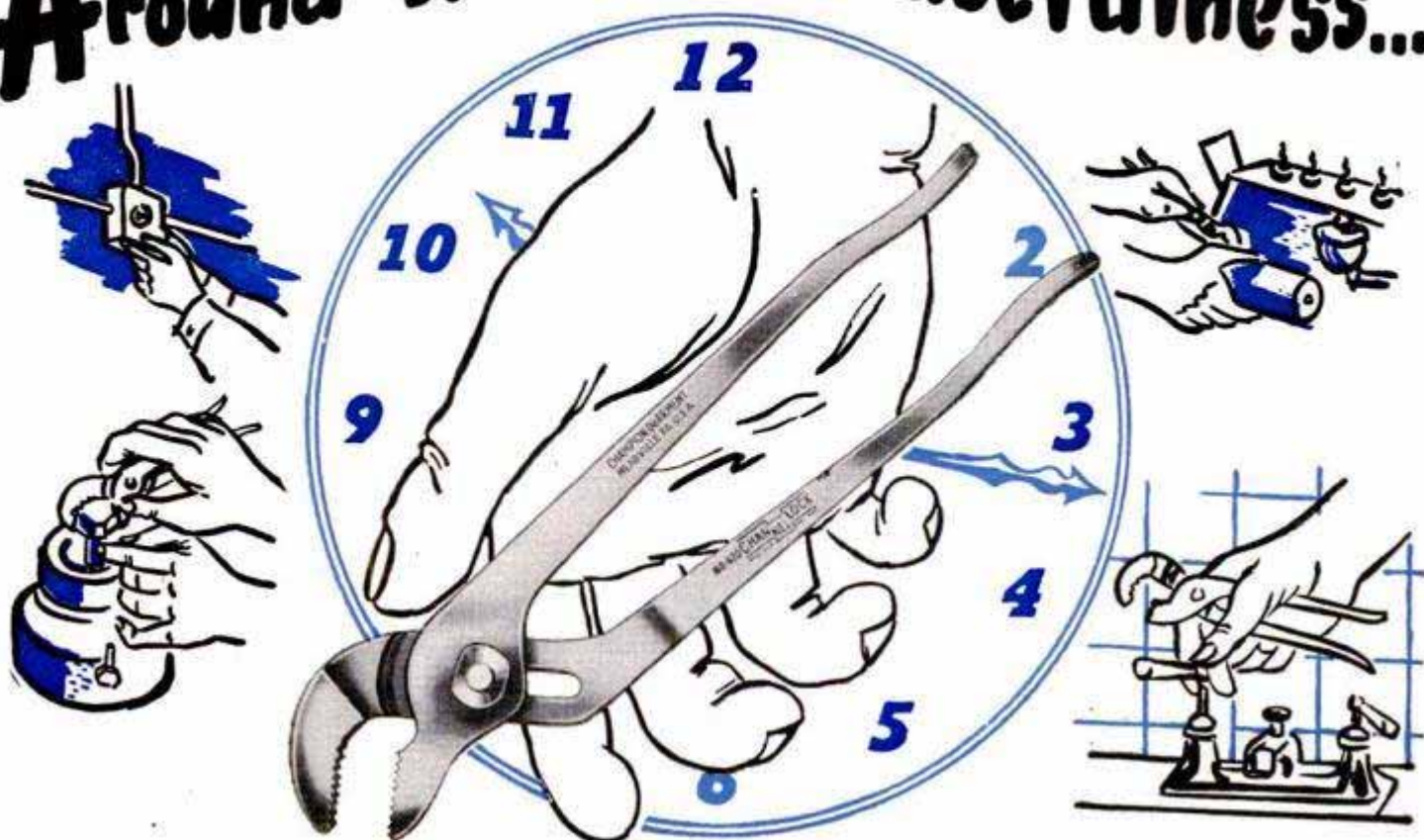

CHANNELLOCK PLIERS

Made only by CHAMPION DEARMENT!

No matter what the job—plumbing, electrical, automotive or whatever, Channellock pliers are handy to have around. The patented Channellock principle permits a wide range of size adjustments without decreasing gripping power or leverage.

Channellock pliers are made by Champion DeArment—for nearly 3/4 of a century manufacturers of highest quality tools.

Dad, Mom, or the kids will find plenty of uses for Channellock pliers.

And remember—Only Champion DeArment makes Channellock.

Send for Catalog D15 today.

CHAMPION DEARMENT TOOL CO. • Meadville, Pa.

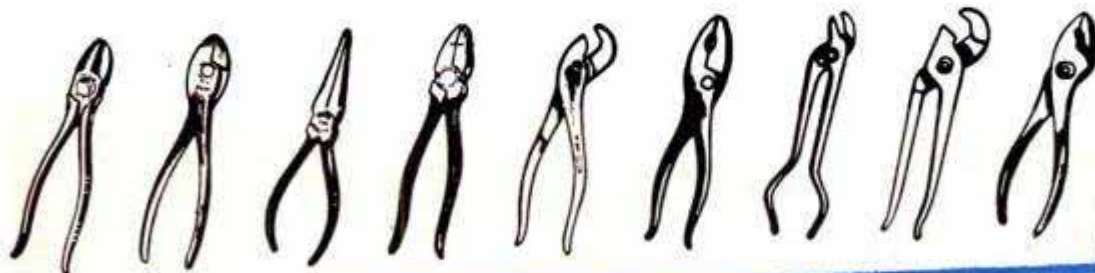

Channellock pliers are listed in the Yellow Pages of most Telephone Directories under "Tools"



Only CHAMPION DEARMENT...

makes

CHAN NEL LOCK

TRADE MARK REG. U. S. PATENT OFFICE

WHO ELSE BUT

SHOPMASTER

BRINGS YOU

QUALITY TOOLS AT
LOW PRICES

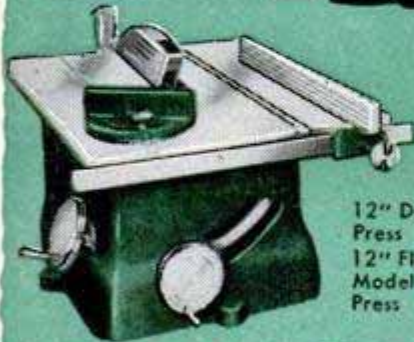

12" Drill Press \$46.95
12" Floor Model Drill Press \$54.00

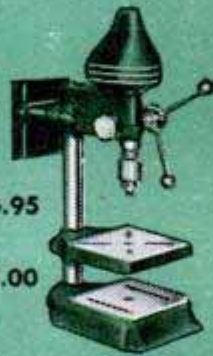

15" Jig Saw (Tilting Table) \$27.95



8" Tilting Arbor Bench Saw . . . \$76.95

Also
7" Tilting Arbor Bench Saw . . . \$47.95

8" Tilting Table bench Saw . . . \$51.50

10" Tilting Arbor Bench Saw . \$86.95

10" Floor Model Tilting Arbor Saw . . . \$105.00

6" Jointer-Planer . \$79.95

4" Jointer-Planer . \$47.95

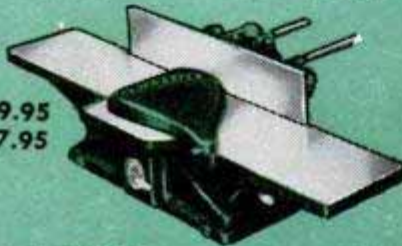

12" Band Saw . \$79.95
10" Band Saw . \$46.95

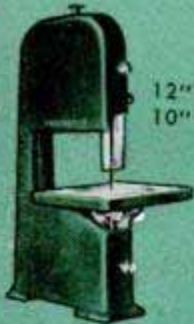

Saber Saw . \$17.95

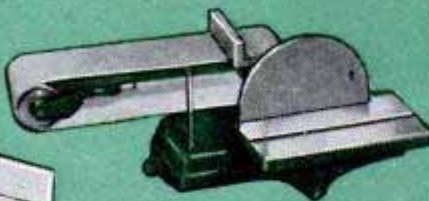

Belt and Disc Sander . \$51.50

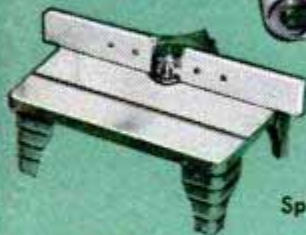

Spindle Shaper . . \$45.95

10" Wood Turning Lathe . \$45.95



Zone 2 prices, slightly lower in Zone 1.

Write today for full color catalog.



SHOPMASTER, INC.

1214 Third St. S., Minneapolis, Minn.

pipe line can be "packed" with higher than normal pressure in anticipation of a cold snap but this is of only slight help.

What is needed is enormous storage facilities adjacent to the market areas. In a few instances where a partly depleted oil or gas field lies close to a marketing terminal, it's normal practice to pump gas into the structure all summer long. It's drawn back out again and into the distribution system in the winter. Last year about 250 billion cubic feet were stored underground. An old gas field near Austin, Mich., is being filled with Texas gas for winter withdrawals, and similar underground storage facilities are being developed in old oil fields in Pennsylvania.

On the West Coast the Southern California Gas Company and its affiliates have developed the largest underground storage facility of all, the depleted La Goleta field near Santa Barbara. This subterranean reservoir is a mile below the surface and lies in part under the Pacific Ocean.

Engineers estimate that the tightly sealed structure has a capacity equal to a gas tank covering 300 city blocks and 28 stories tall. It can hold 50 billion cubic feet of gas under a pressure of 2000 pounds per square inch. Compressors at the tops of nine wells that pierce the formation inject natural gas into the reservoir all summer long. During the winter months Los Angeles and other cities can draw as much as 365 million cubic feet of gas per day from this natural storage tank.

From this and other sources, southern California consumers can be provided daily with natural gas equal in heat energy to 753,000 tons of coal or equal to the electrical output of 24 Hoover dams. The region won't run short this year or next, but engineers expect that by 1953 they will require another pipe line extending to Texas or even to Canada, plus additional storage facilities equal in capacity to two more Goleta reservoirs.

Another method of terminal storage that may be tried on a smaller scale in other areas would be to condense natural gas into a liquid and flow it into pressure containers filled with a solid absorbent material prepared from fuller's earth. Six hundred cubic feet of gas can be stored in two cubic feet of space in this way.

Still another possibility that has been tested is to ship liquid propane and other condensed gases by rail from a producing to a marketing area. There the liquid is vaporized, mixed with air and pumped into the low-pressure distribution system to boost the supply.

The era of pipe-line building is by no

(Continued to page 254)

THE NEW JOHNSON *Sea-Horse* 25

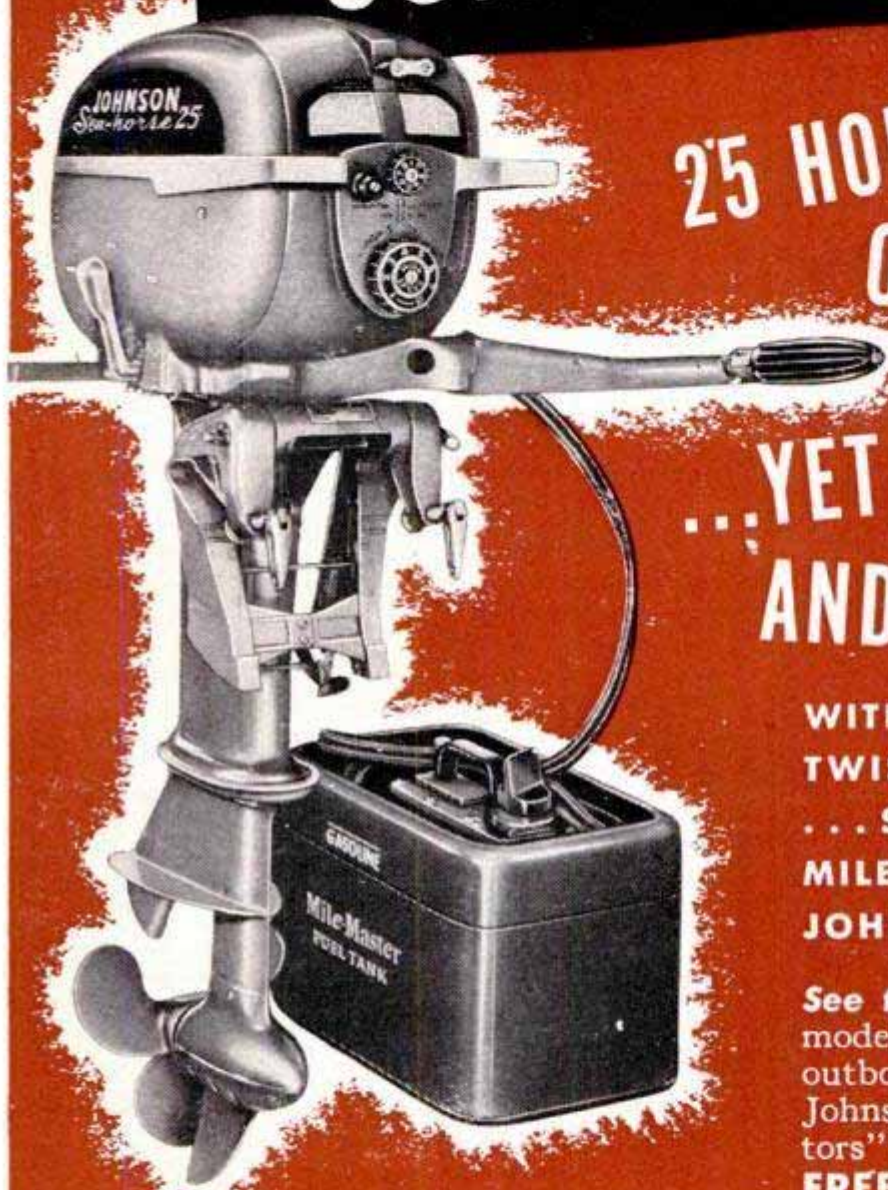

**25 HORSEPOWER!
OVER 30 M.P.H.!**

**...YET IT TROLLS!
AND ONLY \$390***

**WITH GEAR SHIFT...SYNCHRO
TWIST-GRIP SPEED CONTROL
... SEPARATE, PLUG-IN
MILE-MASTER FUEL TANK AND
JOHNSON DEPENDABILITY**

See the new Sea-Horses. 4 versatile models for 1951. A motor for every outboard need! Look for name of your Johnson Dealer under "Outboard Motors" in your classified phone book.

FREE! New 1951 Handy Chart. Full details on all new features. Write for **FREE** copy.

JOHNSON MOTORS
400 Pershing Road, Waukegan, Illinois
In Canada: Johnson Motors, Peterborough

4 VERSATILE SEA-HORSES FOR 1951

SEA-HORSE 25: 25 H. P. With Gear Shift, Synchro Twist-Grip Speed Control, separate, six-gallon Mile-Master Fuel Tank **\$390.00***

SEA-HORSE 10: 10 H. P. With Gear Shift and separate Mile-Master Fuel Tank (6 gallon) **\$295.00***

SEA-HORSE 5: 5 H. P. Neutral Clutch. No shear pin. World's favorite fishing motor **\$187.50***

SEA-HORSE 2½: 2.5 H. P. World's lightest Alternate Firing Twin - Only 31 lbs. Smooth as silk . . . **\$137.50***



**All prices f.o.b. factory, subject to change without notice. All ratings OBC Certified brake h.p. at 4000 r.p.m.*



SWITCH TO

MILD

KENTUCKY CLUB

The Thoroughbred
of
Pipe Tobaccos



Get Fine Pipes at Worth-while Savings

— You bet it pays to switch to Kentucky Club. It's the thoroughbred of pipe tobaccos—choice white Burley specially blended to give you a mild, smooth smoke with grand taste and aroma. In addition, every package of Kentucky Club contains a valuable Dividend Coupon. Save these Coupons and get your choice of fine pipes at *big savings*. Beautiful pipes of imported briar made by expert craftsmen. 14 shapes. Do these two things today. Buy your first tin of Kentucky Club.

Mail coupon for free catalog.



FREE

Illustrated catalog showing Kentucky Club Dividend pipes and other premiums.

Mail Pouch Tobacco Co., Dept. 43
Wheeling, West Virginia

Please send—free—Kentucky Club Catalog.

Name.....
Street.....
City.....State.....

Owners Report on the '51 Ford

(Continued from page 110)

mileage could be improved." Another man says: "I have found low-pressure tires do not give as many miles per gallon by one or two miles."

A woman in Massachusetts says: "I get 22 or 23 miles per gallon with regular transmission. Car handles fine, well balanced. Assembly could be better."

A Pittsburg, Kans., owner says he especially likes "the quiet, smooth performance, the heavy solid feel of front end and steering, styling, quick and sure-fire start in cold weather, door latches, easy front seat, dash design, smooth ride without pitch." He objects to "water running down inside of closed window, sharp-edged bumpers, transmission and drive shaft up too high on the floor." He concludes: "I've owned three Fords and my next will be a Ford."

1951 FORD SPECIFICATIONS

ENGINE—(6 or 8-cyl.)

8-cyl. L-head, V-type. 3-3/16-in. bore, 3 3/4-in. stroke. Piston displacement—239.4 cu. in. Brake hp.—100. Compression ratio—6.8:1.

6-cyl. L-head, in-line. 3.3-in. bore. 4.4-in. stroke. Piston displacement—225.9 cu. in. Brake hp.—95. Compression ratio—6.8:1.

Transmission options: (1) Conventional 3-speed, (2) Conventional with overdrive, (3) Fordomatic Drive automatic transmission.

GENERAL

Weight (4-door Sedan)—V-8: 3224 lbs., 6-cyl.: 3180 lbs. Wheelbase—114 in. Tread—front 56 in., rear 56 in. Height—64.7 in. Over-all width—72.8 in. Length—196.7 in. Tires—6.00 x 16 standard or 6.70 x 15 super-balloon. Recommended pressure—28 lbs. front, 25 lbs. rear; super-balloons—24 lbs. front and rear. Road clearance—7.9 in. Turning radius—20 ft. 6 in. Steering wheel, lock-to-lock—4 turns. Steering ratio—17.7:1.

CAPACITIES

Oil—5 qts. Water—(V-8) 21 qts., (6-cyl.) 16 qts. Gasoline—16 gal.

A Mondamin, Iowa, farmer says: "I'm a long-time Ford owner and I like the improved heating system, fast pickup and ease of handling."

A North Bend, Ore., owner likes the "parts and service facilities available anywhere, and the good resale value."

Many were loud in their praise with such remarks as: "Easy to handle, has that safe feeling . . . front-seat adjustment is wonderful for a short person . . . I like the new electrical equipment and fuel pump is outstanding . . . new door-locking system is fine, as keys cannot be locked in car . . ."

(Continued to page 262)

SPRAYING MADE EASY

BECKER *Self-Contained* PRESSURE GUN

Saves Cost of Compressor and Motor

TAKE IT ANYWHERE—the first completely portable spray gun. Needs no compressor, motor, or electrical outlet. Pressure-powered with an inexpensive CO2 cartridge that sprays up to 21 liquid ounces, depending on viscosity. Extra cartridges, 10 for \$1, postpaid, or buy from your dealer.

PAINTS • VARNISHES • ENAMELS
MOTH-PROOFS • INSECTICIDES

Every home needs a Becker Spray Gun for dozens of jobs in the house, workshop, garden or garage. Complete instructions furnished for effective results. Order yours today for the season ahead.

HOW TO ORDER—If your dealer can't supply, send \$15.95 and we ship postpaid—or \$2 now and pay postman balance plus postage and fee. Money back if not delighted after 5 days' trial.

SULLIVAN-BECKER CO.
Dept. 111-D, Kenosha, Wis.



ONLY
\$15.95
with 3
cartridges



MONEY *for* MEN ALL DATA FREE

THE PLASTEX Industry needs manufacturers on small scale and for big production of Lamp and Clock Stands, Art Goods and Novelties in Plastex and Marble imitation. Experience unnecessary. 1/2¢ material makes regular 10¢ store sellers. Rubber moulds furnished for speed production. Small investment brings good returns. We are now placing big Chain Store Orders with manufacturers. Ambitious men have chance for real prosperity. Our Free booklet will interest and benefit you.

PLASTEX INDUSTRIES, Dept. A
3400 Third Ave. New York 56, N. Y.

ONE-MAN SAWMILL AS LOW AS \$50.00 DOWN

Take BELSAW Portable Sawmill right to the trees—turn out valuable lumber for local yards—do "custom sawing" for neighbors. BELSAW lasts a lifetime. No crew needed. Power with old auto engine. Beginners get excellent results. Send postcard for FREE BOOK, "How To Make Lumber."

BELSAW MACHINERY CO.
711 8116 Field Bldg., 315 Westport Rd., Kansas City 2, Mo.

BUILD HEAVY DUTY MACHINES

SAVE UP TO 90%— You can build, using our practical, easy-to-read plans, all kinds of machines, for home, farm or shop — scooters, portable sawmills, metal working machines, concrete machinery of all kinds, printing equipment, woodworking machines, midjet autos, dish washers, farm equipment, freezers, tractors.

FREE
CATALOG HANDBOOK
183 SETS OF PLANS
VALUABLE INFORMATION

NICHOLS EQUIPMENT COMPANY
D-11 PURVIS, MISS.

Thompson BEATS the World on BOATS

Safe Boats With Full Length Spray Rails
Keep passengers perfectly dry—even at high speeds. Catalog also shows two new models of "Take-Along" Boats. Two big factories—save you freight.

CATALOG FREE
Write for your copy. State kind of boat in which you are interested.
THOMPSON BROS. BOAT MFG. CO. (151)
213 Ann St. PESHIGO, WIS. (Write to either place)
113 Elm St. CORTLAND, N.Y.



Better Built Lower Prices



Light Boat for Auto
THOMPSON BROS. BOAT MFG. CO. (151)
113 Elm St. CORTLAND, N.Y.

SEND FOR IT!

1951 ALLIED RADIO & TV CATALOG

free!

COMPLETE UP-TO-DATE
EVERYTHING IN RADIO & TV
AT LOWEST PRICES!



212 PAGES OF VALUES

Everything for Experimenters, Builders, Amateurs, Servicemen, Engineers and Soundmen..

Save money on every Radio and TV need! Get the big 212-page 1951 ALLIED Catalog featuring the world's largest stocks of top-quality equipment at low, money-saving prices! See the latest TV releases, home radios, radio-phonos, Amateur equipment, P.A. systems and Hi-Fidelity Custom Sound, recorders, test instruments, builders' kits—plus thousands of parts, tools, books and diagrams. Get more for your money from the World's Largest Radio Supply House. Send today for your FREE 1951 ALLIED Catalog!

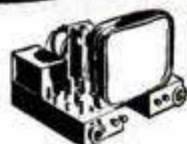

TV, HOME RADIOS & RADIO-PHONOS



SERVICE SUPPLIES BUILDERS' SUPPLIES



AMATEUR GEAR



P.A. SYSTEMS RECORDERS

free CATALOG Send For It!

ALLIED RADIO

ALLIED RADIO CORP., Dept. 5-D-1
833 W. Jackson Blvd., Chicago 7, Ill.

Rush FREE 212-Page Catalog No. 126

Name _____

Address _____

City _____ Zone _____ State _____

New improved woodworking calculator

answers countless questions
in seconds... speeds jobs!

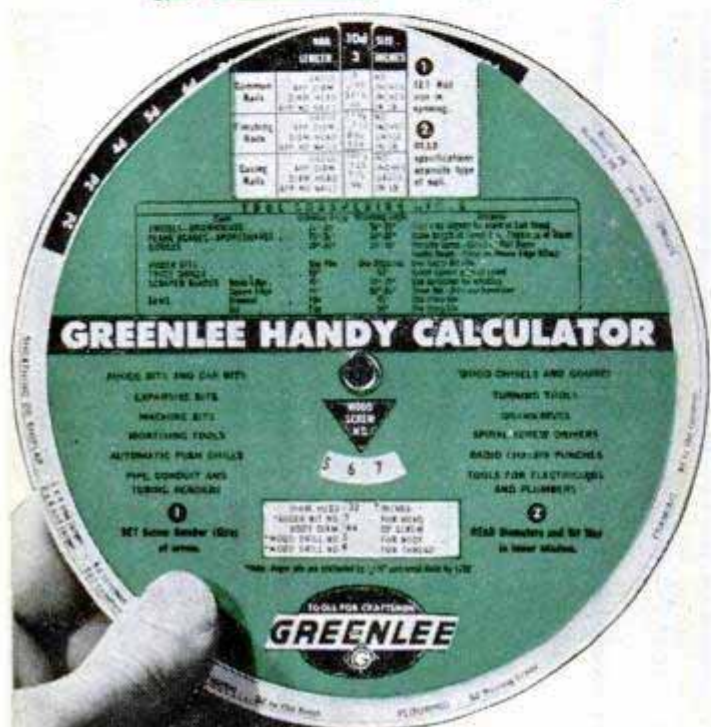

Here's the improved GREENLEE Calculator with more information on lumber, nails, concrete mixes, painting materials, etc. Convenient... simple to read. Just set dial for nail specifications, to convert linear to board feet, find bit sizes for screws, compare characteristics of wood. 6" diameter, heavily varnished card-board, printed in three colors.

Special offer by the makers of famous GREENLEE tools.

only 25¢

No Stamps, Please!



GREENLEE TOOL COMPANY, 2104 Columbia Avenue
ROCKFORD, ILLINOIS

Enclosed is 25c. Send your "Handy Calculator" by return mail.

NAME.....

ADDRESS.....

CITY..... ZONE..... STATE.....

means over. Areas that are already served are asking for more gas and the industry expects that it will spend 2½ billion dollars on new transmission lines as soon as steel is available and long-term contracts can be written.

Construction men have developed special methods for building the lines, an example being Pacific Gas and Electric Company's new "Super Inch" that serves San Francisco. More than a million dollars' worth of extraordinary equipment, much of it designed especially for the job, was required for its construction. Mightiest units were a pair of trenching machines, 50 feet long and weighing 32½ tons. One of these can dig more than a mile of trench per day, 5½ feet deep and 44 inches wide. One of the smallest pieces of equipment is a tiny bulldozer, 42 inches wide, that is driven along the bottom of the trench to level the earth.

Pipe is delivered along the right-of-way in 32-foot lengths. These are welded into units 4000 to 6000 feet long. Each weld is photographed with X-ray film that reveals any weak spots. An ingenious self-propelled machine coats the pipe with asphalt and double-wraps it with felt and kraft paper as a protection against corrosion and electrolysis.

Each 33-mile length of pipe is purged by admitting gas into the line, building up the pressure to 600 pounds per square inch, and opening a gate at the end of the pipe. Dust, gravel and extraneous material in the pipe are swept away by the rushing gas. After the line is buried, the right-of-way is seeded with grass by low-flying aircraft to prevent future erosion.

Natural gas is a versatile raw material that can be converted into various products. It is the basis of almost all the carbon black that is manufactured for the printing trades and for use in automotive tires. Ammonium-nitrate fertilizer is made from it, and it can be transformed into gasoline and a wide range of hydrocarbon liquids. Probably it never will become an important source for these synthetic products, however. It makes such an ideal fuel in its original state that every cubic foot of it may be needed for creating heat and power.

Longer-Wearing Tires

Use of a new carbon black is expected to increase the wear of "cold" rubber tires as much as 50 percent. Carbon black constitutes about one third the weight of both natural and synthetic-rubber tires. Developed by the Phillips Petroleum Company, the new black could aid in rubber conservation. Thinner-tread tires that wear as long as present-day tires may be possible.

HACKSAW THAT'S EASY TO USE WITH A HANDLE THAT'S HARD TO BREAK!

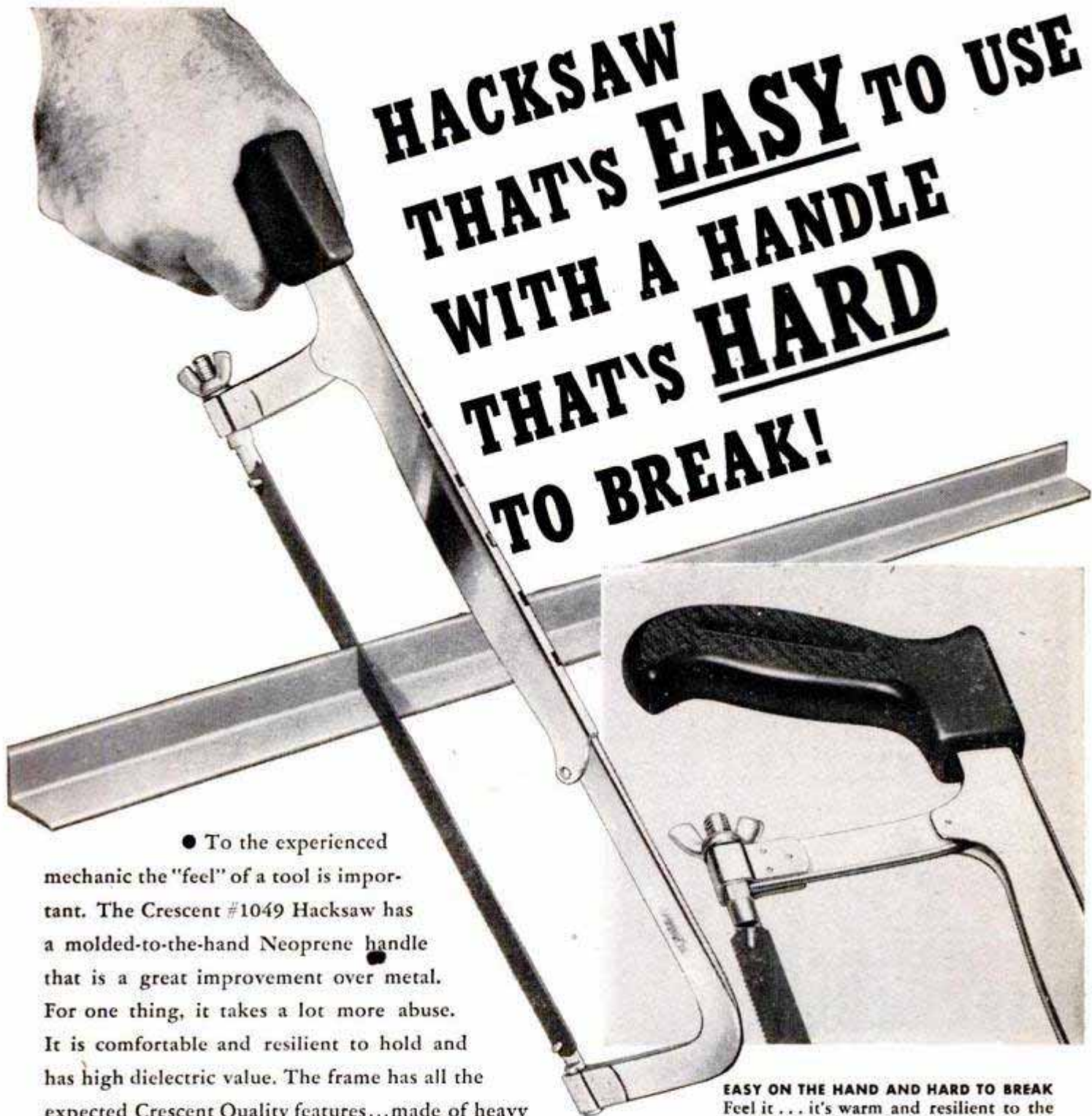

● To the experienced mechanic the "feel" of a tool is important. The Crescent #1049 Hacksaw has a molded-to-the-hand Neoprene handle that is a great improvement over metal. For one thing, it takes a lot more abuse. It is comfortable and resilient to hold and has high dielectric value. The frame has all the expected Crescent Quality features...made of heavy gauge steel...nickel-plated for corrosion resistance...beautifully balanced. You'll find all the features that make a good hacksaw in this Crescent model.

CRESCENT TOOL COMPANY, JAMESTOWN, N. Y.

EASY ON THE HAND AND HARD TO BREAK
Feel it . . . it's warm and resilient to the touch. Drop it . . . it won't break. Use it . . . it is impervious to oil and acids. Temperatures 100 degrees below to 200 above will not affect it. Has high insulating value under all conditions.

"Crescent" is our trade-mark, registered in the United States and abroad, for wrenches and other tools. Sold by leading distributors and retailers everywhere and made only by Crescent Tool Company, Jamestown, N. Y.



CRESCENT TOOLS

Give Wings to Work

*Sign of the Artisan
Symbol of Excellence*

**FOR SURE
QUICK STARTS**

**INSIST ON
BOWES**



Corrodeless

**TERMINAL
Battery Cables**

Most battery cable trouble starts at the terminal because of corrosion or bad fit. Bowes "Seal Fast" battery cable terminals positively will not corrode. They are specially engineered, tailored to fit the posts snugly, assuring longer cable life and full power from your battery. Stop battery cable trouble before it begins. For sure, positive starts insist on Bowes "Corrodeless Terminal" Battery Cables—then you'll get all the power your battery is designed to give you.



BOWES

**DEPENDABLE
SPARK PLUGS**

Assure

**SMOOTHER
MOTORING**

There is a Bowes Spark Plug specially designed for your car! Oversize Special Alloy Electrode—with welded construction for positive connection assures longer life. One-piece, leakproof construction.

Every Bowes Plug is individually tested to assure complete motoring efficiency. **INSIST ON BOWES SPARK PLUGS FOR SMOOTHER MOTORING.**

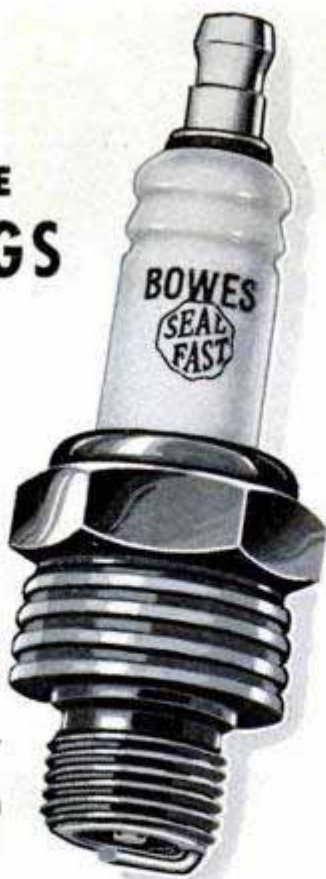

BOWES "SEAL FAST" CORPORATION
INDIANAPOLIS 7, INDIANA

The Scattergunners' Hall of Fame

(Continued from page 138)

but it's a safe bet that tomorrow's alterations will be based on this type of basic study.

While this precise research is underway in ballistics laboratories, applied research is



Blind in right eye, right-hand shooter aims with left eye down special sight parallel to the barrel. Below, rifled-slug shot shells, before and after firing



resulting in better arms, ammunition and new products for the scattergun shooter right now.

Take the new Remington Wingmaster. For the first time in any pump-action shotgun, the breechblock locks up into an extension on the barrel, closing the action against the head of the shell. The result is more constant "head space," the old bugaboo of almost any type of firearm. The Wingmaster also is equipped with plugs of various weights made of wood and steel. By leaving the weights out entirely or inserting them in various combinations, the gunner can change the balance, weight and shot capacity of the gun.

An old idea with a new twist is the neat Savage over-and-under rifle and shotgun. The top barrel fires .22 rifle shells, while

(Continued to page 258)

THIS LIGHT HITS THE SPOT!

Aim its 800 ft. beam at any spot—stays put. 360° swivel. Uses 6-volt dry battery. At hardware, sport, elec. stores.

DELTA ELECTRIC CO.
MARION, IND.

\$3.50 less battery

Delta REDDYLITE

ELECTRIC LANTERN



WOOD FASTENERS



Don't split wood—Use "CHEVRONS" hardened steel FASTENER. Draws wood together eliminating doweling, mortising, nailing. Hammer in—"Presto"—a firm joint! No wobble, no distortion. Lends artistic appearance. Easily countersunk and concealed with wood fillers. For hard and soft woods. For mill workers, artisans, HOME CRAFTSMEN, for making and repairing screens, doors, sash, frames, cabinets, furniture, moulding. 3/8" depth, for thickness wood up to 1 1/2". At your dealer or send only \$1.00 NOW for GIANT box, postpaid. Money back if not delighted.

E. B. PACKARD CO., Inc.
Dept. M4 139 Cedar St. New York 6, N. Y.

How to Get Better Paint Jobs!



Send for free illustrated 24-page booklet—tells how to buy and apply right aluminum paint for all jobs around the house. We don't make paint, but prepared this booklet to help you get better results with aluminum paint. Write for free book "Paint it Bright". ALUMINUM COMPANY OF AMERICA, 1718D Gulf Building, Pittsburgh 19, Pa.



Clark EXPANSIVE BIT
CUTS BETTER • COSTS LESS! Accurate, fast; cuts smooth holes in hard or soft wood. Chrome vanadium steel blades, all chrome body. No. 250, 1/2"-1 1/2", \$1.89; No. 251, 3/8"-3" \$2.19 GUARANTEED. At your dealer or write ROBERT H. CLARK COMPANY, Beverly Hills, Calif.

D. C. ARC WELDER

\$300 VALUE — ONLY \$97.50

200 Amperes Continuous Duty. Up to 250 amps. intermittent duty. Easily mounted on your tractor. Welding range from 0-up by dial type control. 1-yr. guarantee with money back 10-day trial period. Write for FREE literature. OR send 35c for PLAN "Build Your Welder from Aircraft Generator." Write today.
LEJAY MFG.
847 LeJay Bldg., Minneapolis 8, Minn.



SAY YOU SAW IT IN POPULAR MECHANICS

CONVERT HAND MOWERS to POWER MOWERS

Takes less than 3 hours

The Handy-Dandy Lawn Mower Kit fits any hand mower from the 16 to the 20 inch size. Complete with all necessary parts. Kits can be purchased separately, complete with engines or complete with Pennsylvania mower.



Also manufacturers of complete power mowers and garden cultivators.

DEALERS WANTED

LE CLAIRE MFG. CO., Le Claire, Iowa, Dept. PM

PARTITION OFF AN EXTRA ROOM



Provide more usable space in your home by turning a large room into two smaller ones. For example, partition off a large double parlor into two rentable bedrooms or a small apartment. You can do it easily at low cost with Gold Bond Gypsum Wallboard. Nail the sturdy fireproof panels to a 2 x 4 framework. Seal joints with Gold Bond Tape Joint System and paint with Gold Bond Sunflex—the one hour wall paint. Or, if you prefer, Gold Bond Gypsum Wallboard takes wallpaper or texture beautifully. For further information, write Div. W, Dept. PM-41.

Available at your local Gold Bond lumber and building materials dealer

NATIONAL GYPSUM COMPANY
BUFFALO 2, NEW YORK



Send for this
BIG NEW
Hunt's
WOODWORKERS
CATALOG NO. 18

ONLY
15c

NEW LOW PRICES

Offers greatest selection of fine domestic and imported woods—and hundreds of woodworkers items at bargain prices!

You'll save time and money with this big, new catalog. Contains everything wood craftsman needs. Shows 32 rare and fancy woods in color...43 veneer designs...275 scroll patterns...multicolor inlays, overlays, bandings...all kinds of tools, machinery, cabinet hardware, ornaments, mouldings...and pages of valuable tips, ideas, information, instruction. Send for your copy NOW. Only 15c—refundable on your first order.

- 144 PAGES
- **QUICK DELIVERY**
- on maple, poplar, oak, mahogany, red cedar, cherry, walnut, and many others—
- all properly seasoned and kiln dried.

MAIL THIS COUPON—TODAY!

CRAFTSMAN WOOD SERVICE CO.
2729 S. Mary St., Dept. A-4
Chicago 8, Illinois

Send me the big, new, money-saving Catalog No. 18. Enclosed is 15c—refundable on my first order.

Name _____

Address _____

City _____ Zone _____ State _____

Got a new glass rod? Get the new **COXE** reel!

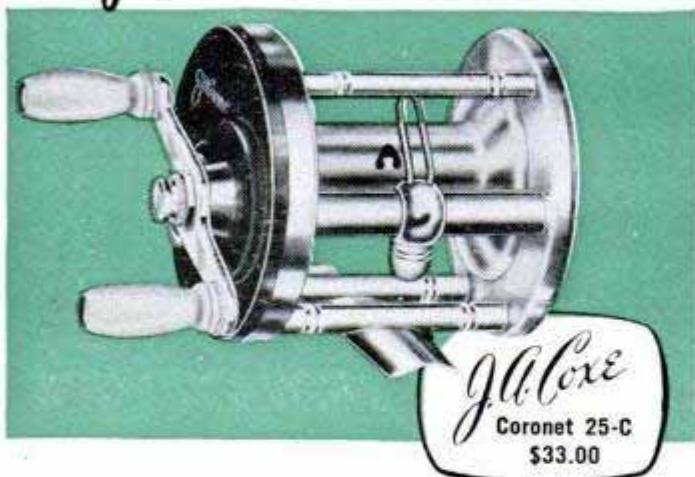

● Here's the reel we designed especially for the new glass rods—the J. A. Coxe *Coronet 25-C* with the new one-piece spool!

This is the reel you've known for years as the world's only automatic free spool reel. You get the same Coxe craftsmanship, the same basic features—cross-bolt construction, 10-second takedown, perfect spool alignment.

But now it's completely re-designed—with the weight cut in half!

If you're ready for the finest reel money can buy, ask for the new J. A. Coxe *Coronet 25-C*—right for any rod, perfect for glass rods!

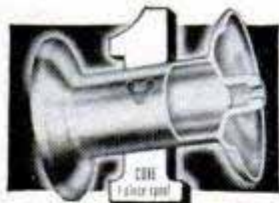

LIGHTER—it's all aluminum.
RUGGED—it's made in one piece.
BALANCED—it's machined both inside and out! Featured on four Coxe reels, starting at . . . \$11.00

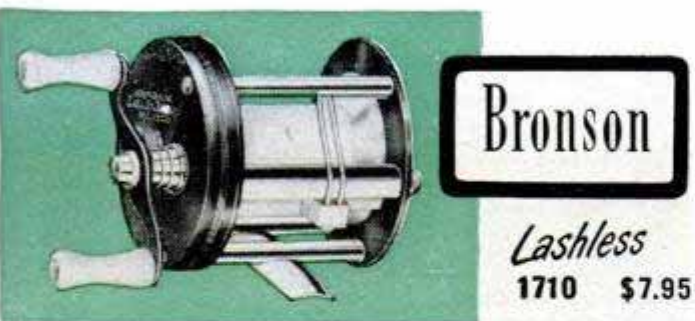

Bronson

Lashless
1710 \$7.95

Precision built, precision balanced, here's the light-weight reel of the Bronson line—the new *Lashless 1710*. Finished in green anodized aluminum, it weighs only 4¾ oz. Has the easy-to-set Bronson drag button, snap-on plastic arbor, and the Bronson Duo-Pawl—the double pawl that doubles the life of your reel!

BRONSON REEL CO. • BRONSON, MICH.
Division of Higbie Manufacturing Company

the bottom one shoots .410 shotgun shells. There's a single trigger, but a separate extractor for each barrel.

The shotgunner who wants to use the scattergun as a rifle can do so, in effect, with the rifled-slug shot shell. In the old days the only such ammunition available was the "pumpkin" ball—a round, single-ball load, somewhat erratic in flight and



Wounded during war, Nolan E. Wilcutts can't raise arm above waist. Swiveled extension which he developed helps him shoot a high score at Grand American

short in range—and buckshot. With the rifled slug the shotgun approaches a rifle in accuracy. Spiral lands on the slug expand against the bore to spin the bullet slightly as it moves down the barrel.

For the hard-pressed shotgunner who likes to indulge in skeet or trapshooting but feels he can't afford it, there's a new miniature clay-target setup on the market. It permits him to use .22-caliber *shot* shells in his own shotgun *regardless of the bore*. An adapter—virtually a bore liner—slips into the barrel to reduce the gauge to .22-caliber. There's a built-in ejector. The smaller shells cut down the punishing jolt to the shoulder and the even more punishing jolt to the pocketbook. Miniature clay disks, scaled to the .22 shot, and small traps are available.

Some gunners are making their own alterations and improvements, although in most cases these adaptations are to adjust the gun to a physical handicap. Horace Aldritt, of Excelsior, Minn., showed up at the last Grand American with a weird-looking sight. Aldritt, a right-hand shooter, has a blind right eye. He designed a

(Continued to page 260)

MODERN LAWN MOWER SHARPENER

FOR LAWN MOWER SHOPS
FIX-IT SHOPS

GOLF COURSES • PARKS
101 OTHER JOBS

Sharpens All Reel Type Mowers • Hand, Power or Gang • 10 to 20 Minutes • No Dismantling • No Extra Attachments Needed. All reel type mowers, from 5-inch edgers to 36-inch power mowers, are quickly sharpened to extreme ends of both left and right twist blades.



PRICE
\$241.50
less motor

\$263.00
with motor

ORDER
NOW
Immediate
Delivery

Handle, wheels, roller and motor remain in place when sharpening is in process. End knife is sharpened in same brackets. Grinding head rides on five ball bearing races. Easy to operate. Also sharpens chisels, jointer knives, planer blades. Big profit maker. Own your own business. Send Today for FREE Illustrated Bulletin No. 10-C. Prices Subject To Change Without Notice

MODERN MFG. CO. 160 N. FAIR OAKS AVE.
PASADENA, CALIFORNIA



MAKE YOUR OWN SCABBARD

Live Oak Texas Steerhide 60c to \$1.10 per sq. ft. Learn the easy and simple way to make all kinds of leather goods. We sell for less. Since 1919. Write for Free Catalog

TANDY LEATHER CO

P. O. BOX 791-C, FORT WORTH, TEXAS



ELECTRIC WELDER

AC or DC 110 Volts

"The Little Marvel" All-Metal welder. 5-year written guarantee. Welds 1/2" thick metal or money back. Repairs tanks, tools, fenders, machine parts, etc. Comes complete with everything—rods, unit, eye shield, and directions. We also make a welder for 16 to 22 gauge metal . . . \$3.95 complete. On C.O.D., postage extra.

\$6.45
Complete

ESSAY MFG. CO., Inc., Dept. 51, Quincy 69, Mass.

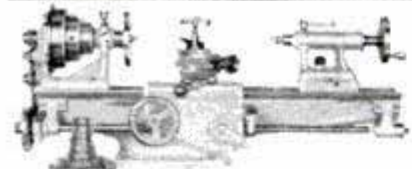

CASTINGS BLUE PRINTS

BUILD YOUR OWN MACHINE TOOLS!

Catalogue with complete construction drawings of this 8 inch lathe with milling, grinding and hand shaper attachments, 25 cents postpaid, or send one dollar for drawings of three lathes, two milling machines and six inch crank shaper—refund on castings order.

DAVID JONES MACHINE CO.,
1064 HOWARD AVE. BRIDGEPORT, CONN.

TOOLS AT WHOLESALE

DIRECT FROM FACTORY
Full line of top quality, fully guaranteed, chrome, factory-new mechanics hand tools. You save HALF REGULAR PRICE for tools of this quality. Our Permanent Price Protection Plan guarantees you wholesale prices.

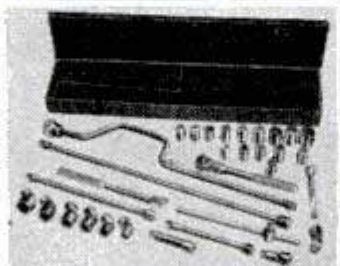

WRITE TODAY FOR FREE CATALOG

MECHANICS CO-OP

Dept. A OAKLAND 8, CALIFORNIA

CAMPBELL-HAUSFELD Spray Painting Outfits

Outperform them all!



DO more and better painting in an hour than you can brush on in a day. Same compressor inflates tires, lubricates cars, tractors, implements.

4 models, precision built for trouble free service. Last a lifetime. Gasoline or electric power.



See them at your dealer or write for literature, giving his name.

pressure
maid

New Low Priced Pressure Maid . . . dwarf in size . . . giant in power.

THE CAMPBELL-HAUSFELD CO.

1046 RAILROAD AVE. HARRISON, OHIO

ANNOUNCING NOT ONE—NOT 12—BUT 40 DIFFERENT CUTS!



NEW Warren DADO SAWING WASHERS

Multiply the uses of your circular saw with sensationally improved Warren Dado Sawing Washers! Make smooth, parallel dados or grooves in 40 different widths with your present saw blade! Dial the width with Micro-matic adjustment on four simple washers—precision-made in matched sets. Does not bend or warp blade, no gadgets to get out of alignment, strengthens blade. No burning, chewing—no sanding. Four sizes 1/2", 3/8", 3/4", 1"—fit all popular saw arbors. See your dealer or send coupon today—ABSOLUTELY GUARANTEED!

ONLY \$4.95 PER SET

NO INCREASE IN PRICE!

WARREN DADO SAWING WASHERS CO., Dept. 24.

70 Medbury, Detroit 2, Mich.

Enclosed (check or M.O.) \$4.95 for one set of NEW Warren Washers. My arbor size is 1/2" 3/8" 3/4" 1". Send free booklet. (PLEASE PRINT)

Name _____

Address _____

City _____ State _____

CARTER



FUEL PUMPS

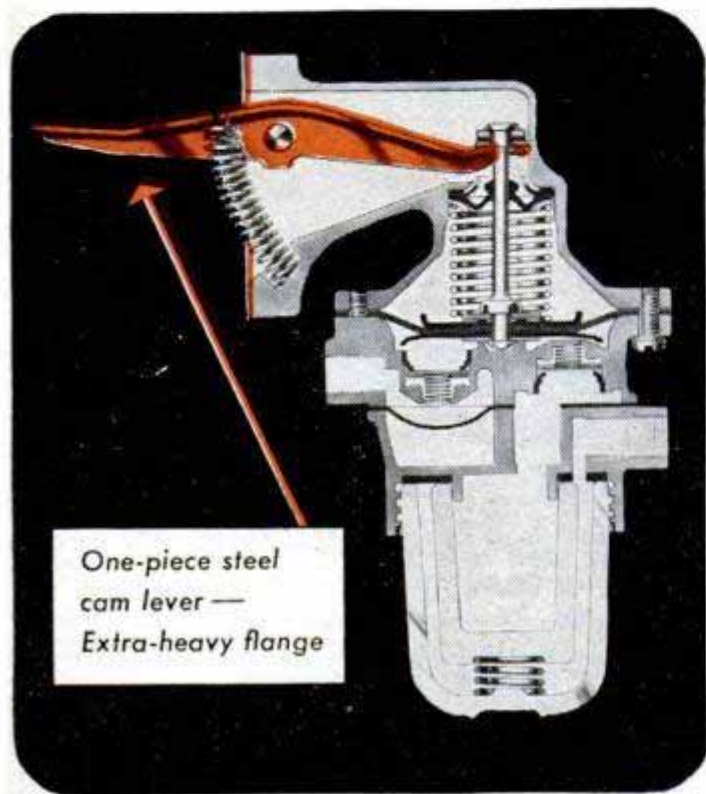

One-piece steel cam lever —
Extra-heavy flange

Have strength and durability

at **Vital Points** to
insure Longer Life

See your car
dealer,
garage or
service
station

LIBERAL TRADE-IN
ALLOWANCE ON
YOUR OLD
FUEL PUMP

The extra-heavy flange that bolts to the engine is designed to prevent warpage and oil leakage. The one-piece steel cam lever has an extra-wide cam bearing surface hardened for longer wear.

CARTER CARBURETOR CORPORATION
St. Louis 7, Missouri
Division of American Car and Foundry Company



precise, offset sight which protrudes two inches to the left of the barrel and is $\frac{7}{8}$ inch higher than the barrel to compensate for the tilt of his head as he aims. The sight enables him to aim with his left eye and fire right-handed.

An old-time New York gunner had exactly the same problem—he lost the sight of his right eye—but a skillful gunsmith solved it in a different way. The gunsmith made a curved stock for the shooter's favorite gun. Now the man is able to plant the odd-looking firearm against his right shoulder and line up the sights with his left eye.

Nolan E. Wilcutts, a Grand American shooter from Felton, Del., was wounded in the right arm during the war, and is unable to raise his right hand above his waist. A left-hand shooter, Wilcutts devised a swiveled extension which pivots down from the forearm of his shotgun. By grasping the lower end of this handle below his waist, he can hold the gun as steady as he did before the war.

Millions of men were exposed to firearms for the first time during the past war. As a result the number of shotgun shooters has soared higher than a wily mallard on the second day of the duck season. There are around 10,000,000 shotgun owners in the country today.

Shooters at the Grand American and the other events at Vandalia last August numbered 2000 odd. In six days' time along a $\frac{1}{2}$ -mile trap line they fired 1,205,300 shotgun shells and scattered 500,000,000 pellets across the green countryside. They littered the field with 84,748 pounds of lead, a good many cubic feet of shell casings and the shattered dreams of some 1700 men who hoped—this once—to shoot a perfect 100 at the Grand.

Now they are dreaming of the next national match; and science, through ballistic research, is improving their chances of hitting that elusive 100.

No Skidding for Air Force Bombers

Detectors which "sense" a skid—and stop it—are now on all of the Air Force's B-47 and B-51 airplanes. One of the detectors, six inches in diameter, is placed on the outside of each airplane wheel and it has an energy wheel that rotates directly with the airplane wheel. When a skid develops, the energy wheel over-travels, causing a valve to interrupt the brake pressure. Another device similar in principle, uses a skid detector to energize a solenoid valve that releases the brake pressure. Both re-establish brake pressure automatically when the skidding stops.



GRAVELLY
makes tough
jobs **EASY!**

5-HP Gravelly Tractor powers 20 tools—does every lawn, garden, field job *easier, better!* All-gear drive, Reverse. "Power vs Drudgery" Booklet FREE. Write for it today!

GRAVELLY MOTOR PLOW & CULTIVATOR CO.
BOX 463 DUNBAR, W. VA.

FIELD-TESTED FOR 30 YEARS

ACE TOOLS



Be permanently
tooled-up for every operation
on your Metal Cutting Lathe.

No. 8-A Ace Tool Set for 9" and 10" Swing Lathes—fits shank size 3/8" x 3/4". Includes Turning, Cutting-off, Boring, Knurling and Threading Tools with high speed cutters, blades and wrenches. 8 complete tools in fitted steel case—nothing else to buy. See your local dealer or order direct.

ARMSTRONG BROS. TOOL CO.
5268 W. Armstrong Ave., Chicago 30, Ill.

\$26⁹⁵

SET-UP - KNOCKDOWN SAWHORSE with *Jiffy* BRACKETS



No nails or bolts . . . use 2x4's for legs, 2x4 or wider for crossbar. Easy to move, saves storage space. Buy at hardware or building material dealers, or direct.

GRAND HAVEN STAMPED PRODUCTS CO., Grand Haven, Mich.



BOYS! MAKE YOUR OWN RADIO

Make your own simple, tubeless, batteryless Crystal Radio. SEND 25c for a GENUINE MELOMITE CRYSTAL with complete illustrated instructions for making your own set. Crystal sent postpaid with instructions and our own publication, "THE MAGIC CRYSTAL" which is full of news, diagrams, questions and answers of interest.

SEND 25c FOR YOUR CRYSTAL TODAY!
ALVA ALLEN RADIO Dept. 164 Clinton, Mo.

KEEP THOSE EDGES ON YOUR PLANE BLADES AND CHISELS RAZOR SHARP

With This New, Proven, Carpenter's Accessory That Assures a Straight, Sharpened Edge Always at a Right Angle to the Sides.



PLANE BLADE
AND CHISEL
SHARPENER

by Marsh

\$1.50

POSTPAID
(plus tax in Calif.)

SMALL, COMPACT, READY FOR IMMEDIATE USE—WING SCREW IN THE HOLDING CLAMP IS THE ONLY ADJUSTMENT.
• Holds blade at correct angle for sharpening • A few strokes back and forth on stone keeps the edge razor sharp • No guesswork • No round corners • 14 Ga. steel construction • Wt. only 8 oz. • For the bench or on the job • Satisfaction guaranteed or your money refunded.

BE SHARP! START SHARP - STAY SHARP

SEND YOUR CHECK OR MONEY ORDER TO:

Sportsmens Specialties

47 E. WALNUT ST.

PASADENA 1, CALIF.

Boating is a
real man's
sport
in the NEW

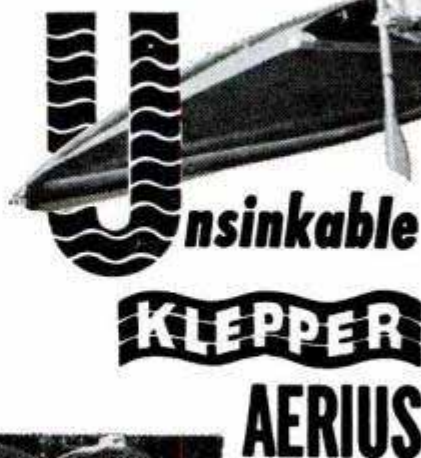

USED BY BYRD,
Amundsen, others.
Used by Capt. Romer
to cross Atlantic!

PORTABLE . . . Pack up the AERIUS for car, boat, or train travel. Easy to assemble in ten minutes . . . easy to pack up again!

FREE! "Wandering by Water". . . Color Story of Foldboating. Write to
KLEPPER COMPANY, Dept. PM
28 East 31st Street, New York 16

Shoot rapids, fish, hunt, wherever you want to go, with sail, paddle, or out-board, the rugged, fast, new KLEPPER AERIUS will prove up to the game. And air-tubes built into the hull at the gunwales make it UNSINKABLE too . . . your **safest** bet for a real man's boat!

4,000 WATTS

from this compact, low-cost
Witte Dieselectric Plant

Model ADRBA
Witte Dieselectric Plant

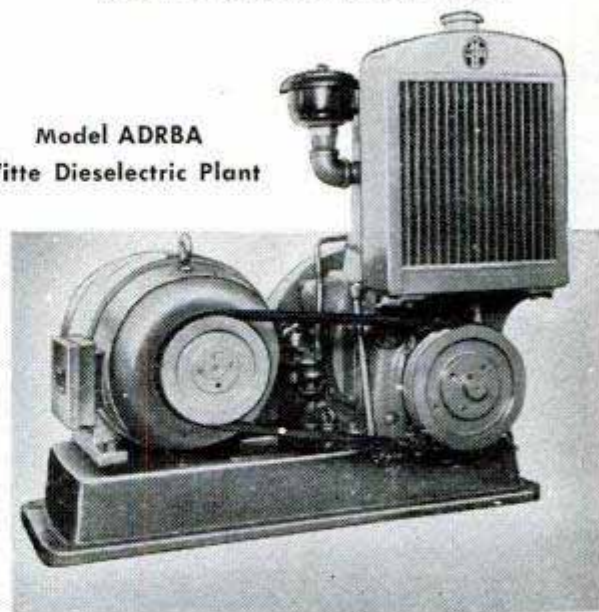

WITTE ENGINE WORKS

KANSAS CITY 3, MISSOURI

Division of Oil Well Supply Company

UNITED STATES STEEL

SAY YOU SAW IT IN POPULAR MECHANICS



Peels
Off
Paint

New!

NO WASH!

Non-Inflammable!

Now you can "strip off" any finish safely, easily, without mess.

Old-fashioned, inflammable solvents work by "dissolving," leaving a sticky, waxy surface that must be carefully washed, or "neutralized." But Klean-Strip penetrates all layers of old paint and actually "breaks" the bond between the bottom layer and the surface to be stripped.

Klean-Strip changes any finish into a wrinkled film that is easily peeled off with brush or putty knife. Leaves surface smooth, clean and dry.

Buy Klean-Strip whenever you buy paint. At better paint, hardware and department stores.

KLEAN-STRIP REMOVER

Product of W. M. BARR & CO.
2350 S. Lauderdale, Memphis, Tenn.

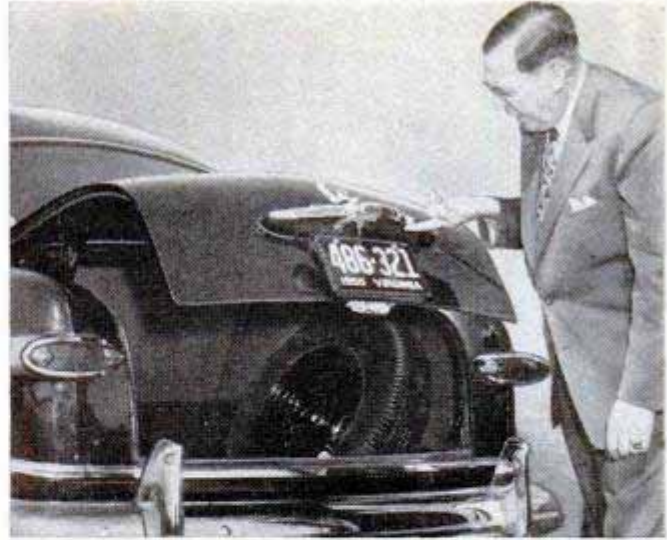

One finger easily lifts the counterbalanced trunk lid. Most owners were pleased with the body styling

balanced trunk lid is fine, car rides much better than I expected."

On the other side of the ledger, a Colorado owner writes that he is skeptical about the small fan belt. A Dedham, Mass., owner thinks more attention should be given to the car's performance on ice and snow because his traction was poor even with snow-tread tires. Another owner says: "The speedometer hand is very hard to read and poorly lighted at night." Another complains: "I dislike the starter-switch location and there should be a crank for vent windows."

Another man turned over his questionnaire to write on the back: "Beautiful interior, wonderful car, but the top of the custom-model horn rim is directly in line of eye to speedometer vision; it partially obscures the high-beam warning indicator; the speedometer dial is poorly lighted and hard to see quickly. The old pointed needle indicator with closer graduations on the speedometer dial was better." (I agree.)

Several owners opined that lightness of the Ford rear end gives poor traction on snow, ice and mud. (I agree, but most modern cars have engine and weight so far forward that this is a common complaint.)

If there ever has been any doubt about the loyalty of Ford owners, this survey should end it for all time. There were many kicks, as reported above, but in almost every case, between the lines was this sentiment: "Even my best friend has a fault or two and I forgive him."

Now for my own impressions of the car:

I put 4000 miles on a 1951 custom Ford V-8 with Fordomatic, in three weeks . . . and they were hard, tough miles from the Ford plant at Dearborn through snow to Kansas City, then on icy roads in bitter-cold weather to Denver. I drove over the high

(Continued to page 264)

Be Your Own Boss



There's a great feeling to being in something for yourself, where all the profits go into your own pocket. American floor sanders make it possible for you to realize this ambition without special schooling or a big investment. Begin small and work up to as large an enterprise as you desire . . . It all depends on your ambition to get ahead.

Ask for "tell-all" booklet entitled "Opportunities in Floor Surfacing". Use coupon and enclose 25 cents in coin or stamps to cover handling.

AMERICAN FLOOR SURFACING MACHINE CO.

535 So. St. Clair St. • Toledo 3, Ohio

Gentlemen:
Enclosed find 25c in stamps or coin for booklet "Opportunities in Floor Surfacing," telling me how I can start my own floor sanding business.

Name _____
Street _____
City _____ State _____



**PAINT
COMES
OFF**

... QUICKLY-EASILY!

Don't waste time and effort with old-fashioned methods of removing paint. Do it the fast, modern WONDER-PASTE way.

Wonder-Paste is a deep-cutting solvent applied with a paint brush. It softens up tough, thickly coated paint, varnish, enamel, lacquer, shellac, etc. and forms a soft sludge that comes off clean. Does not run on upright surfaces. Use it indoors or outdoors. Harmless to hands or fabrics.

Get Wonder-Paste — at paint and hardware stores.

Wilson-Imperial Company, 119 Chestnut Street, Newark 5, N. J.

Write for WONDER-PASTE leaflet



BUILD FINE GRANDFATHER CLOCK NOW

The simple sensible Red-i-Kut way as thousands have—**SAVE HALF. SHOP TESTED PLANS "SPIRIT OF THE CENTURY"** Narrow waist, 83" tall or stately straight side **"SPIRIT OF AMERICA," EASY-TO-FOLLOW photopack PLANS** tell all — plus **BROCHURE** of heavy brass weight Westminster, tube chime, movements, *gorgeous* dials, 3/4" solid mahogany case kits. **Send \$1.00 today — Both Plans \$1.50 NOW.**

KUEMPEL CHIME CLOCK CO., #4 Kuempel Bldg., Minneapolis 16, Minn.

**BETTER PERFORMANCE
FOR OUTBOARD MOTORS**



Enjoy more speed, smoother performance, greater carrying capacity by equipping your motor with the Michigan propeller recommended for your particular motor and type of boat used. Write for **FREE** copy of 1951 catalog — "Outboarder's Bible" covers all motors old and new. Describes the "Aqua-Jet," super speed wheel for racing runabouts. For finer inboard performance investigate our "Aqua-Master." Write **NOW!** Michigan Wheel Co., Dept. 1-1 Grand Rapids 3, Michigan.

KINKADE TRACTOR

and Power Lawnmower

A Practical Power Plow and Cultivator for Suburbanites, Gardeners, Florists, Estates, Fruit, Nursery & Poultrymen.

Easy Terms - Write Today

American Farm Machine Co.
1058 33rd Ave. S. E. Minneapolis, Minn.



Catalog
Free

**DRAINS Cellars, Laundry Tubs;
CIRCULATES Oil; IRRIGATES Gardens**

Original "Type P" Pump has 2400 GPH capacity. 360 GPH 75' high, or 1500 GPH from 25' well. Use any 1/8 to 1/2 HP motor. **DOES NOT CLOG.**

Only \$6.95 postpaid if cash with order. (West of Mississippi, add 50c.)

SATISFACTION GUARANTEED OR MONEY BACK!

\$6.95



LABAWCO PUMPS, BELLE MEAD 7, N. J.

ARC WELDING
FOR PROFIT OR PLEASURE

60 LBS. OF READY MADE PARTS

Only \$24.95

**BUILD YOUR OWN
HEAVY DUTY WELDER**

SAVE
Buy Only
NECESSARY
PARTS

All necessary parts Ready-Made and easy to assemble. You can do all around welding on steel, cast iron and other metals after only a few hours practice. Illustrated instruction manual included. Free plans for building case. Sold on 30-Day Money-Back Guarantee!

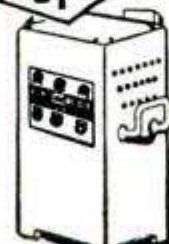

FREE:

Write today for fully illustrated Pamphlet P-4

ATOMIC ARC WELDER CO.
1037 So. 19th St. OMAHA, NEBR.

Gives 100% penetration. Welds are stronger than original metal. Operates on 110 or 220 AC.

Enjoy COMFORT
By The Fist Full In
WOLVERINE
PIGSKIN WORK GLOVES



Tops in comfort—tops in wear—they're made of tough, wear-defying pigskin tanned buckskin-soft by the famous Wolverine triple-tanning process. No other work gloves like 'em!

**FREE
Wolverite
Mechanical Pencil**

While supply lasts we'll send you one **FREE** and name of your nearest Wolverine dealer. Address

WOLVERINE

Dept. HJ-4

Rockford, Michigan

BUILD

Stronger Models

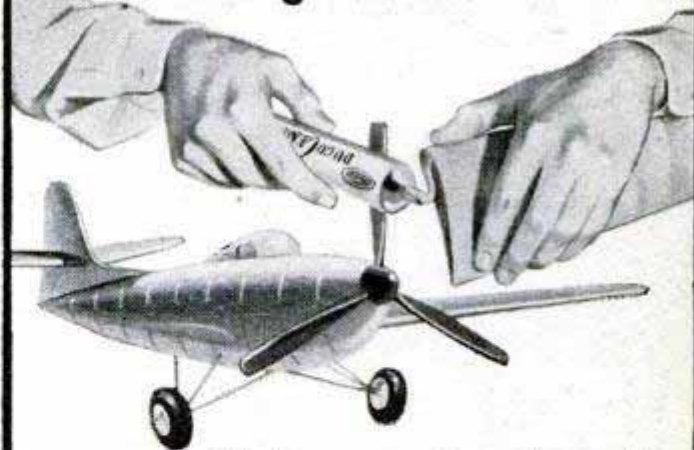

It's transparent, waterproof, flexible and durable. Get a tube today.



DU PONT
REG. U. S. PAT. OFF.
DU CO CEMENT

REG. U. S. PAT. OFF.

NEW NO. 1950
BIT BRACE with
unbreakable
head and han-
dle of glossy,
red "Tenite."



NEW NO. 714
BENCH PLANE
— 14-inch, col-
orful, stream-
lined — with
many unique
features. Also
made in 9-inch
model No. 709.

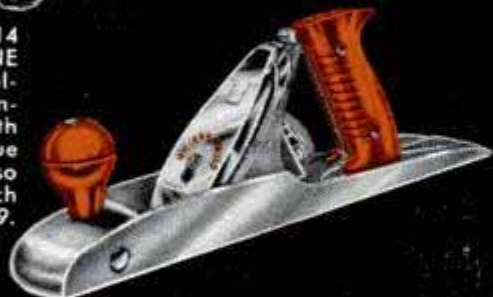

For the best in tools . . .

buy MILLERS FALLS

If you want the very best, ask your hardware dealer to show you these beautiful new Millers Falls tools. See, too, the many other Millers Falls hand and portable electric tools he is now displaying. They're the finest line in Millers Falls 83 years of quality toolmaking. Millers Falls Company, Greenfield, Mass.

**MILLERS FALLS
TOOLS**

SINCE
1868

The Mark of Superiority.



NO. 100 AUTOMATIC
DRILL. A beautiful new
tool with all the time-
tested features which
have made Millers Falls
automatic drills famous
the world over.



NO. 300 HACK
SAW FRAME. New
lever tensioning
device speeds
blade changing,
supplies greater
tension with less
effort.



NEW NO. 525 KEY-
HOLE SAW. Cuts
most anything—most
anywhere. Inter-
changeable blades
— rotatable handle.

passes of the Rocky Mountains, across the plains and desert and through still more mountains to Los Angeles, and then more miles were added in California.

After the car was broken in I did my best to uncover any weakness in performance. In a bad snowstorm we climbed to the 10,850-foot Wolf Creek Pass in Colorado. The highway was slick with snow and ice.

The car handled well on winding mountain roads. Skids could be well controlled due to the excellent stability of the car, and super-cushion tires helped some in the snow. Like most modern cars, a little more weight on the rear end would provide better traction on snow and ice.

For about 70 miles between Gallup, N. Mex., and Holbrook, Ariz., we ran into a real blizzard. The highway was so slick that several cars had slid off the road. It became difficult to see the road as we crept along in a line of cars at 10 to 20 miles per hour in the blinding, fast-falling snow. Out of Holbrook, the morning after the storm, we hit the open, straight stretches. On long, level straightaways, about 95 was top speedometer reading, but we cruised nicely at 80 to 85.

Brakes proved smooth in every instance. Perhaps a little more brake-pedal pressure is needed than in previous Ford models where only light and very sensitive pedal pressure was required. The hand brake has close ratchet graduations, which make for ease of operation.

Of great interest is Ford's new automatic transmission. Fordomatic combines a three-speed torque-converter transmission with a 3.31-to-1 rear-axle ratio (as against 3.73-to-1 ratio with regular transmission). The gearbox is the planetary type, permitting shifting between all ratios without torque interruption. Gear ratios are 2.44 in low, 1.48 in second, 1.00 in high, and 2.00 in reverse. Before the engine can be started, the shift lever must be in neutral position.

Starting in drive range with moderate throttle, all gear changing takes place smoothly and almost effortlessly between 17 and 65 miles per hour, depending on throttle opening. It shifts to high gear at 65 miles per hour with a slight forward surge, but only when the throttle is held wide open. In ordinary driving, it shifts to high between 25 and 30 miles per hour when the throttle is held in one position or foot pressure is taken off the throttle. Acceleration is good, using the drive range only, but can be increased somewhat by starting in low, allowing the engine to "rev" up to about 30 miles per hour, then pushing the selector lever quickly to drive position while the throttle is wide open.

(Continued to page 266)

GROBANS' WAR SURPLUS SPECIALS

ALL BRAND NEW FULLY GUARANTEED

LOGAN HEAVY DUTY HYDRAULIC PUMP

For operating hydraulic cylinders and hydraulic motors on tractors, bulldozers, construction machinery, lift trucks, industrial applications, etc. Delivers 10 GPM at 1200 RPM at 1000 P.S.I. using 6 HP. Has a 3/4" inlet, 3/8" outlet, 3/4" shaft with flat and keyway for direct or pulley drive. Has flange with 4 bolt holes for convenient mounting. Ship. wt. 22 lbs. Overall dimen.: 7" L x 5 1/2" H x 5 1/2" W. A \$105.00 value FOR ONLY.....



22.50

F.O.B. Chicago (ITEM #29)

GENERAL MOTORS-ALLISON

CENTRIFUGAL PUMP

200 GALLONS PER MINUTE



- For Draining Basements • Fire-Fighting • Irrigation • Fuel Transfer • Swimming Pools
- Home Water Systems • Dewatering

This General Motors-Allison Centrifugal Pump—designed for use on U. S. Air Force Mustang fighters, now converted for commercial, home, and industrial high volume pumping applications. Inlet, 2 1/2" standard pipe thread, twin outlets with 1 1/4" pipe thread, ball bearing supported 3/4" shaft. Easy, fast simple priming. Rotation, counter-clockwise facing shaft. Shipping wt. 35 lbs. Gov't. acq. cost \$145.00

Suction Lift	Head Pressure	Gal. Per Min.	H.P.	R.P.M.
10'	75'	260	6.0	3500
10'	65'	200	5.2	3500
10'	80'	40	1.5	2500
10'	50'	140	5.0	3500
10'	30'	100	3.0	2500

F.O.B. Chicago Now Only **39.50**

new! HYDRAULIC SPEED REDUCER WITH FINGERTIP CONTROL

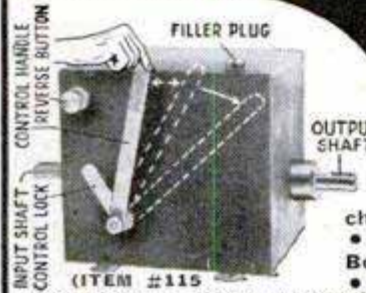

- USE FOR: • Reamer Drives • Midget Cars • Feed Mills • Canning Machines • Conveyors • Lathes • Milling Machines • Motor Boats • Cream Separators • Garden Tractors • Pumps

Variable output speeds ranging from 0 to input speed now available. Merely move control handle until desired speed is attained. Then turn locking handle to maintain the setting. Internal relief valves prevent overloading. Use input power of 3/4 to 1 1/2 H.P. This Westinghouse-Oil Gear Unit converted to commercial use from 40 MM anti-aircraft traversing mechanisms consists of a variable displacement hydraulic pump feeding a fixed displacement hydraulic motor. These components are contained in a crackle-finish steel oil reservoir (capacity 2 qts.). Adjustable relief valves set at factory for 100 inch pounds of torque may be reset up to 180 inch pounds. Independent reverse control allows full output power and speed selection in either direction of rotation. Both input and output shafts measure 5/8" diam., include keyway. Input rotation is counter-clockwise facing shaft. Recommended input speeds not to exceed 750 R.P.M. Over-all dimensions 7 1/2" x 7 1/2" x 1 1/2". Gov't. acquisition cost, \$428.00. Shipping weight 26 lbs. Complete with 2 qts. of oil and full instructions. F.O.B. Chicago

54.50

DIRECT CURRENT GENERATORS



For welders, plating, truck and marine use, D. C. appliances, lights, etc. Aircraft quality—lifetime grease sealed ball bearings. Heavy duty.

- Item #131—Brand new Electric Auto-Lite 12 volt Direct Current electric generator, rated 18 amps. Complete with blower and pulley. Use for trucks, tractors, boats, battery chargers, etc. Part No. GEF-4805A. In original sealed U. S. Army cartons, \$40.00 value. Shipg. wt. 27 lbs. F.O.B. Chicago. **15.00**
- Item #90—Type P-1, rated 200 Amps.—28 Volts, 2500 RPM. Mfd. by General Electric, Ford, Delco-Remy and Westinghouse. Gov't. Acq. Cost \$300.00. Shipg. wt. 70 lbs. **22.50**
- Item #91—Type R-1, rated 300 Amps.—30 Volts. Mfd. by Jack & Heintz. Gov't. Acq. Cost \$380.00. Shipg. wt. 70 lbs. **35.00**
- F.O.B. Chicago. Each individually packed in wooden box

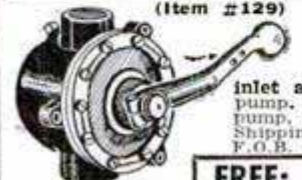

AIRCRAFT WOBBLE PUMP

Type D4—Bronze and aluminum construction, 3/4" pipe thread inlet and outlet. Fine general utility hand pump. May be used as a sump pump, barrel pump, fuel transfer pump, etc. Shipping wt. 7 lbs. F.O.B. Chicago. **11.95**

FREE: NEW 48-PAGE CATALOG

Byron-Jackson "PUP"

CENTRIFUGAL PUMP UNIT

AT LESS THAN 1/2 PRICE

2 Stage Model "PUP" Pump Driven by an 8 Cylinder Model C-36 Chrysler Industrial Engine.

IDEAL FOR: Pick-up, Gathering, Fire Fighting, Salt Water Disposal, Sprinklers, Irrigation, Dewatering, Construction, etc.

Engine Speed 2400 RPM
—100 HP. 600 GPM at 175 PSI—Parallel Connection
—300 GPM at 375 PSI—Series Connection

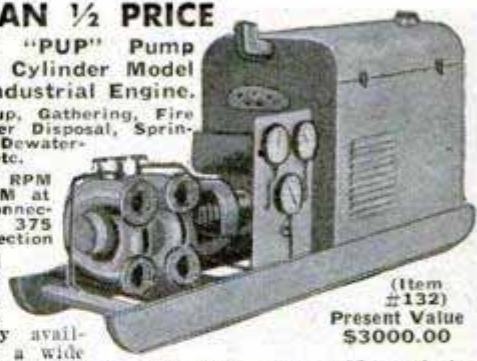

(Item #132) Present Value \$3000.00

These skid-mounted Pumping Units are standard production models with parts and service readily available. Designed for a wide range of operating conditions particularly where wide variation in head and capacity are required. Twin suction and discharge ports are cast on the same side and so arranged that external piping is interchangeable for either parallel or series pumping applications. Overall dimensions, 114" L x 29" W x 62" H. Weight 4060 lbs. Now, complete with operating instructions and performance data.

ONLY **1495.00**

F.O.B. Chicago

NEW! STATIONARY OR PORTABLE

D.C. Arc Welder

250 AMPS. MODEL 252 (ITEM #65)

For Any Welding Job, Light or Heavy STOP COSTLY REPAIR BILLS, WELD IT YOURSELF AND SAVE

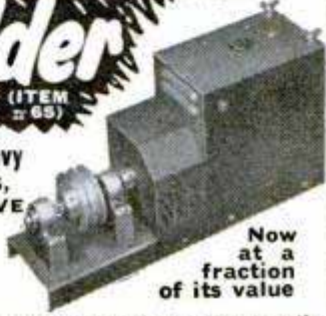

Now at a fraction of its value

Only one or two jobs will pay for entire welder. Designed for many years of trouble-free service. This precision-engineered Direct Current ELECTRIC ARC WELDER is offered at but a fraction of its original value. It can be mounted permanently or easily transported for portable use. Does the job instantly where and when you need it. Has dial type rheostat for easy pinpoint control and a high-low range switch. Run welder at 2500 RPM from drive pulley or power take-off of tractor, a 7 1/2 HP electric motor or a 10 HP gas engine. Use two V belts or flat belt (on pulley). Price includes double V or flat belt pulley and instruction book. Shipg. wt. 107 lbs. F.O.B. Chicago.....

99.50

Hydraulic Cylinders—Air or Oil

Large supply of new labor-saving, economical hydraulic equipment in many types and sizes. Use these positive, highly efficient smooth pressure hydraulics on presses, arbors, lifts, loaders, power control, positioning, brakes, plastic dies, auto frame alignment, etc., etc.

- ITEM #70—Purolator hydraulic oil filter. Permanent element type. 3/8" female pipe thread ports. Capacity 16 gallons per minute. A \$13.00 value. Now postpaid..... **4.95**
- ITEM #4—All steel double action hydraulic cylinder, 1 1/2" bore, 2 7/8" stroke. Clevis mounting. Will lift 1000 lbs. with 1000 P.S.I. line pressure. Perfect for positioning and feeding movements. **4.95** Shipg. wt. 4 lbs. Postpaid.....
- ITEM #33C—Double action hydraulic cylinder, 1 1/2" bore, 4 1/2" stroke. Clevis mountings at both ends. Uses 1/4" pipe fittings. **8.95** Postpaid.....
- ITEM #32—Double action, 1 1/2" bore, 9" stroke, will lift 1760 lbs. with 1000 P.S.I. line pressure. Wt. 4 lbs. A \$45.00 value. **10.95** Postpaid.....
- ITEM #16C—Double acting hydraulic cylinder, 1 1/2" bore, 26" stroke. Will lift 1760 lbs. with 1000 PSI line pressure. Weight 8 lbs. A \$55.00 value **16.95** Now Only, Postpaid.....
- ITEM #103—Double acting hydraulic cylinder, 2 1/2" bore, 17" stroke. Clevis mounting. Will lift 4900 lbs. with 1000 PSI line pressure. 1 1/4" diam. shaft. 3/8" tubing thread ports. Overall length closed 28". Shipg. wt. 11 lbs. F.O.B. Chicago. **21.50**
- ITEM #31C—Double action hydraulic cylinder, 3 1/2" bore, 11" stroke. Aluminum alloy cylinder wall and all steel 1 1/8" piston rod. Clevis mounting at base and shaft. 19 1/2" overall length closed. Will lift 9625 lbs. using 1000 PSI from Logan Heavy Duty Hydraulic Pump. Uses 3/4" tubing fittings. Value \$102.00. Shipg. wt. 11 lbs. F.O.B. Chicago. **22.50**
- ITEM #6—Double action hydraulic cylinder, 3" bore, 24" stroke, will lift 7070 lbs. with 1000 PSI line pressure. Steel barrel, 1 1/8" stainless steel shaft. Gov't. acq. cost \$176.00. Shipg. wt. 26 lbs. F.O.B. Chicago. **28.00**
- ITEM #42—Double action hydraulic cylinder, 4" bore, 18" stroke. Rated lift capacity with 1000 PSI line pressure is 12,500 lbs. Ship. wt. 30 lbs. F.O.B. Chicago **32.50**
- An Excellent Buy for.....

ORDER DIRECT FROM AD — SEND PAYMENT OR PURCHASE ORDER, TODAY — SATISFACTION GUARANTEED

GROBAN SUPPLY CO. 1507 SOUTH MICHIGAN AVE. Chicago 5, Ill. Dept. PM-4

New for craftsmen! Super-tough sandpaper

Professional-quality 3M sandpaper
pre-cut for your home power tools

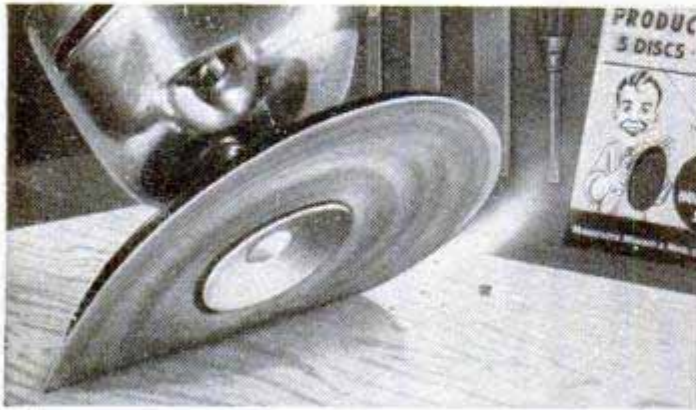

TOUGH DISCS, belts and sheets of 3M Home Workshop Sandpaper coated with aluminum-oxide mineral are now available for hobbyists and home craftsmen. This is the same sandpaper specified by woodworking plants for faster, smoother cutting and longer life. It's many times tougher than flint, garnet or emery. It's the toughest woodworking abrasive known!

Get 3M Home Workshop Sandpaper today



3M Sanding Block



"Production" Paper Sheets



"Production" Paper Discs



"Production" Cloth Belts

"Production" Paper Face Plate Discs



Made in U.S.A. by Minnesota Mining & Mfg. Co., St. Paul 6, Minn., also makers of "Scotch" Brand pressure-sensitive Tapes, "Scotch" Sound Recording Tape, "Underseal" Rubberized Coating, "Scotchlite" Reflective Sheeting, "Safety-Walk" Non-Slip Surfacing, "3M" Adhesives. General Export: Durex Abrasives Corp., New Rochelle, N.Y. In Canada: Canadian Durex Abrasives Ltd., Brantford, Ont.



Even with full or light throttle, Fordomatic shifts down to intermediate gear below 20 miles per hour when in drive position. Down shifting is smooth and at speeds below 40 miles per hour and regardless of throttle opening, the shift to low range places the transmission in its lowest ratio (2.44 to 1). This immediately aids braking in descending grades or for fast stops. Below 57 miles per hour intermediate ratio is brought into use by pressing the throttle quickly to the floorboard; at speeds below 20 miles per hour down shift to intermediate occurs at less than full throttle. Under closed-throttle conditions, the automatic down shift occurs between 5 and 8 miles per hour.

I found when coasting downhill or pushing or towing the Fordomatic, that the engine can be started by moving the lever quickly from "N" position to low at 15 miles per hour or faster. The car can be rocked in mud and snow by quickly moving the lever between reverse and drive or low positions. Ford has practically eliminated the "jackrabbit" start in the automatic. Incidentally, engaging reverse is easy, without going through a forward range. The car has a slight tendency to creep while standing in drive or low with the throttle closed. "P" position on the quadrant is for parking; it locks the transmission with or without the engine running. This is a fine feature as the car will not roll in either direction. I tested this feature on a 30-percent grade and the car did not move an inch when in "P" position, without hand or foot brake being used.

Fordomatic is very flexible in operation. There seems to be very little slippage or effort in getting under way. There is a slight hum while accelerating, which diminishes as speed increases.

The new automatic ride control is good. Front springing is not unduly flexible and is a little stiffer than in previous Fords when you hit the bumps hard, and that's good. It seems to steer a little tighter than previous models and, combined with the stiffer and better-controlled springing, this makes for better cornering stability and road-holding — not as much front-end "floating."

The new instrument panel is the most attractive Ford has ever offered. I'm not too happy with the new speedometer needle; that ring attached to the end is hard for the eye to follow; also, night illumination of the instruments could be better — and they are not too easy to read in daylight. The top of the horn ring obstructed some of my speedometer vision (and high-beam indicator at night) . . . a lower, half

(Continued to page 268)



S-L-O-W TROLLING....

... TO 30 MILES AN HOUR!

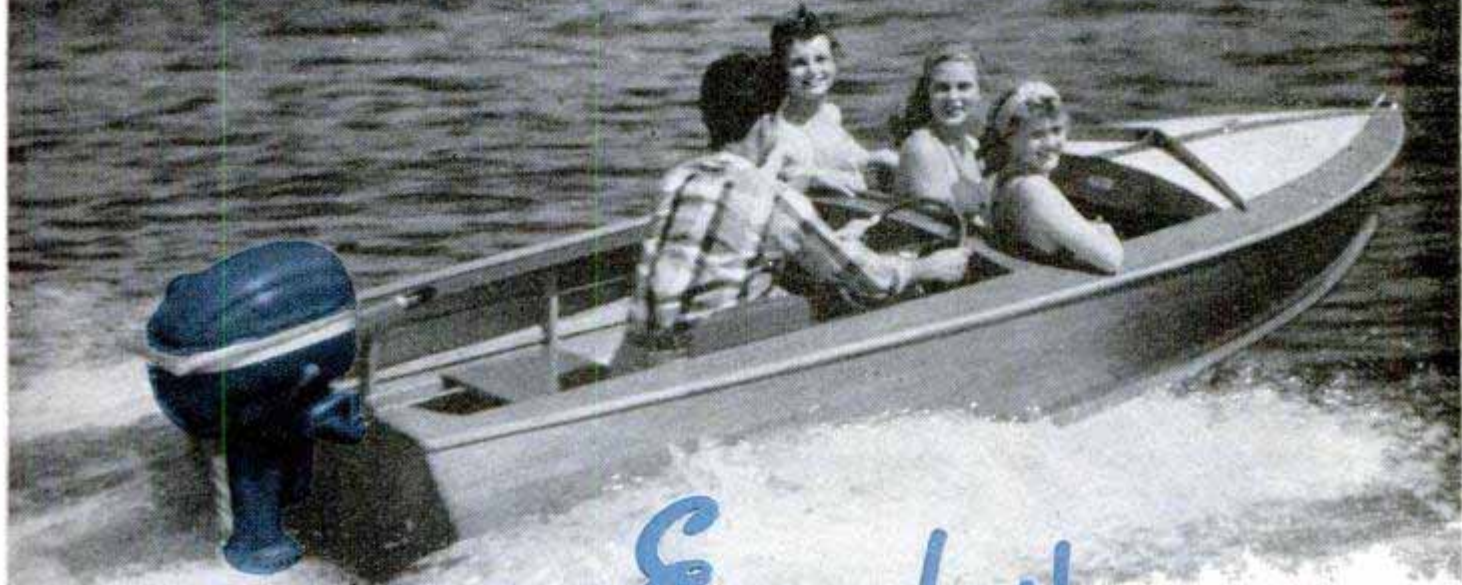

Enjoy both... with one great motor!

IT'S BIG TWIN... it's a new kind of high-powered motor! It trolls. You can ease along at less than 2 miles an hour. For hours if you like... quiet, smooth, steady! Then—time to get goin'? Flick the Roto-Matic control... that's all... and that's plenty! 25 eager "horses" dig in... like a flash you're away on a cloud of foam! And you'll know that something really new and wonderful has been added to fishing fun!

SEE YOUR EVINRUDE DEALER... and see the motor that's years ahead! Lowest weight per horsepower. Gearshift with Neutral, Forward, Reverse. Simplex Starter. Roto-Matic speed control. Big-capacity Cruis-a-Day Tank. And scores of other advancements, all at the lowest-price-per-horsepower in modern outboard history!

Look for your dealer's name under "Outboard Motors" in the yellow pages of your phone directory. For full-color catalog of the complete line of 1951 Evinrude models, write

EVINRUDE MOTORS

4667 N. 27th STREET, MILWAUKEE 16, WIS.

In Canada: Evinrude Motors, Peterborough, Ontario

EVINRUDE
FIRST IN OUTBOARDS • 42nd YEAR



BIG TWIN
25 HORSEPOWER*
\$390

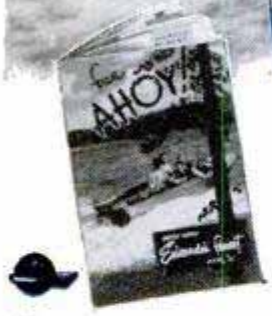

Write for free catalog of the complete Evinrude line—the right motor for every boat!

FASTWIN 14 H.P.* Gearshift with neutral, forward, reverse and Cruis-a-Day Tank. \$315

FLEETWIN 7.5 H.P.* Duo-Clutch for neutral starting and Softi-Grip Drive..... \$210

SPORTWIN 3.3 H.P.*—Tops in small motors—with famed Fisherman Drive..... \$150

SPORTSMAN 1.5 H.P.*—Light and handy "single" with Fisherman Drive..... \$85

*O.B.C. certified brake H.P. at 4000 R.P.M. PRICES are F.O.B. Factory and subject to change without notice.

*As featured in color
January and February
Popular Mechanics*

MEYERCORD'S AMAZING, LIFELIKE

PLASTIC VENEER

it's easy to
DECORATE

- furniture
- cabinets
- lamp bases
- book ends
- walls, doors
- table tops
- re-finish old pieces

Re-creations of
rare wood grains
and fine marble

SAVE MONEY! SEND FOR NEW INTRODUCTORY KIT

Read the amazing story of MeyerCORD Plastic Veneer in the January and February issues of Popular Mechanics. See actual reproductions in full color of wood grains and marbles—the detailed plans for use on wood, composition, metal or glass. Then plan a project of your own. MeyerCORD, originators of Plastic Veneer, offer a special kit of any 3 sheets to start you. 50 patterns to choose from! Act now!

INTRODUCTORY OFFER!

3 sheets of plastic veneer

1 can of cement **\$5.00**

1 squeegee

ALL FOR ONE PRICE

5.00
POST PAID

CHECK COUPON—MAIL TODAY!

THE MEYERCORD CO., Dept. 67-4, 5323 W. Lake St., Chicago 44, Ill.

Please send me your \$5.00 introductory offer of 3 sheets of MeyerCORD Plastic Veneer, squeegee, cement and complete instructions. Patterns are checked below.

Enclosed find check, M.O. for \$5.00. Plus \$_____ for _____ additional sheets, @ \$1.50 for wood grains, \$1.60 for marble, pearl and gingham. Each sheet contains 6 sq. ft.

- | | |
|--|---|
| <input type="checkbox"/> Prima Vera | <input type="checkbox"/> Carpathian Burl |
| <input type="checkbox"/> Aspen Crotch | <input type="checkbox"/> Brazilian Rosewood |
| <input type="checkbox"/> Straw Carpathian | <input type="checkbox"/> French Rosewood |
| <input type="checkbox"/> Satinwood | <input type="checkbox"/> Butt Walnut |
| <input type="checkbox"/> Straw ZebraWood | <input type="checkbox"/> Circassian Walnut |
| <input type="checkbox"/> Lined Oak Tan | <input type="checkbox"/> Rhododendron Burl |
| <input type="checkbox"/> Straw Stump | <input type="checkbox"/> Macassar Ebony |
| <input type="checkbox"/> Blond Harewood | <input type="checkbox"/> Guineawood |
| <input type="checkbox"/> Bleached Mahogany | <input type="checkbox"/> Fiddleback Walnut |
| <input type="checkbox"/> Bleached Fiddleback | <input type="checkbox"/> Walnut Angle Grain (45°) |
| <input type="checkbox"/> Gray Harewood | <input type="checkbox"/> Basketweave (Walnut) |
| <input type="checkbox"/> Prima Vera Gray | <input type="checkbox"/> Mottled Pearl—Gray |
| <input type="checkbox"/> Lined Oak Gray | <input type="checkbox"/> Mottled Pearl—Maroon |
| <input type="checkbox"/> Striped Mahogany | <input type="checkbox"/> Mottled Pearl—Blue |
| <input type="checkbox"/> Fiddleback Mahogany | <input type="checkbox"/> Red-White Gingham |
| <input type="checkbox"/> Mahogany Crotch | <input type="checkbox"/> Blue-White Gingham |
| <input type="checkbox"/> Mahogany Stump | <input type="checkbox"/> Black and Gold Marble |
| <input type="checkbox"/> Walnut Crotch | <input type="checkbox"/> Breche Rose Marble |
| <input type="checkbox"/> French Walnut | <input type="checkbox"/> Jaune Benou Marble |
| <input type="checkbox"/> Quartered Walnut | <input type="checkbox"/> Brazilian Onyx |
| <input type="checkbox"/> Ribbon Walnut | <input type="checkbox"/> Mexican Onyx |
| <input type="checkbox"/> Striped Walnut | <input type="checkbox"/> Rose de Brignole Marble |
| <input type="checkbox"/> Walnut Stump | <input type="checkbox"/> Skyros Marble |
| <input type="checkbox"/> Italian Walnut | <input type="checkbox"/> Verdi Antique Marble |

NAME _____

ADDRESS _____

CITY _____ ZONE _____ STATE _____

(Offer good in continental U.S.A. only)

horn ring would be better. I like Ford's manually operated choke.

I had a pleasant surprise in the hours of rain or snow . . . not a drop of water leaked in the windshield, trunk or windows. The heating system is excellent . . . I've never had a more comfortable winter ride across country. The ventilating system is also good. Doors are tight, fit nicely, open easily and few rattles or squeaks developed in 4000 hard test miles. Vision is good, although corner posts might be narrower. The hood is some lower at front than heretofore, which helps forward vision.

Gas mileage of the 1951 Ford V-8 engine is about the same as in other years, but the motoring public will have to get used to fewer miles per gallon with any make of automatic transmission; my tests show that one to three fewer miles per gallon is the penalty one must pay for the smooth, "lazy man's" shift of any automatic transmission. I found little difference in performance between regular and premium gasolines. All in all, I'd say the 1951 Ford is definitely a good car and better than previous models. I consider either the "6" or V-8 an excellent buy.



American Optical Co., Southbridge, Mass.

Spectacles With Side-View Mirror Aid Partially Blind

To aid a person with one partially blind eye, the American Optical Company has designed spectacles with a special side-view mirror. Objects approaching on the wearer's blind side are reflected by the mirror onto the still functioning portion of the eye's retina, broadening the restricted field of vision.

NEW POWER KING 4" Jointer-Planer

BUILT BY
Atlas

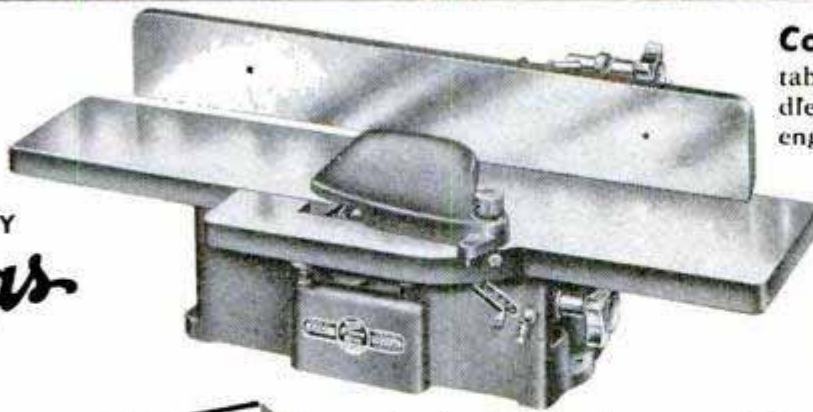

Completely new in design — tables, fence, bearings, cutter-head-spindle, base, controls — with every feature engineered to give you greater accuracy and efficiency — that's the new Atlas-Power King.

The rugged 25" table you'll appreciate at a glance—the fence will surprise you. Try it. Notice how it stays put. It's solid. Operate the controls — you'll be amazed how easy it is to position, how smoothly it tilts for bevel cuts. Then remove

the fence — that's easy, too. Note how the fence bracket provides extra support for wide boards.

Then consider these standout features. Sealed-for-life ball bearings. One piece solid steel cutter head. You can take the head right out of the machine and sharpen the blades without disturbing their setting. And once the head is replaced, the blades position simultaneously.

Those are but a few of the outstanding improvements of this great new tool. See them all at your Power King dealers, or send for new catalog.

You'll Value These Features

- 25" Precision-Ground Grey-Iron Table with 21"x3" Fence.
- Removable Cutter Head.
- Stationary Rear Table for Greater Accuracy.
- Simultaneous Blade Adjustment.
- Sealed-for-Life Ball Bearings.

FREE
NEW CATALOG
SHOWS ALL 8
POWER KING Tools
Send a Postcard

ATLAS PRESS CO.

435 N. Pitcher St., Kalamazoo, Mich.



**MATCHED PRECISION TOOLS FOR
WOODWORKING AND METALWORKING**

NONE BETTER! SUPER DRILL GRINDER



Sharpens round shank drills from 3/32" to 1/2" in diameter, up to 6" long. Grinds old drills like new in 4 different point angles, using hand or power grinding wheels. Money-back guarantee.

Price only \$2.95

At Dealers or Postpaid

CRANDALL MFG. CO. 1512 W. Slauson, Dept. FA-56, Los Angeles 44, Calif.

CULTIVATING IS FUN WITH A DANDY BOY

Garden Tractor

Cultivating is only ONE of about thirty tasks you can do easier with a Midland DANDY BOY Garden Tractor and its all-season work-saving attachments. Find out how DANDY BOY pays you a profit every month of the year, in time-saving, work-simplification. THREE models, 2, 3, 5 H. P., fit every need on farms, estates, gardens. Write Dept. PM-4.



THE MIDLAND CO.

1200 Rawson Ave.

South Milwaukee, Wis.

BUILDERS OF FARM EQUIPMENT SINCE 1911

APRIL 1951

Start a Business in Your Backyard



Earn **BIG MONEY**
MAKING
BUILDING BLOCKS

General Concrete Vibrator
BLOCK MACHINE
CAPACITY 1000 BLOCKS A DAY

only \$218 LESS MOTOR
F.O.B. PLANT

SHIPPING WEIGHT 400 LBS.



Here is a business you can start on small capital—in your own backyard—that earns 100 to 150% profit, with unlimited opportunities. Make concrete or cinder blocks. Millions used for homes, factories, public buildings, garages. Sell all you make to building trade. Do it with a General—and you're headed for success.

1000 BLOCKS A DAY

The General is a high speed, power-driven block machine at amazingly low cost. Rugged all-steel construction. Simple to operate indoors or outdoors. Makes superior 3 core type block meeting all code requirements. Produces up to 1000 blocks per day. Full operating instructions and mixing formulas supplied. Write for FREE details.

Dealer inquiries invited

Wonderful-
Book Written
& Illustrated
by Experts

HOW TO
BUILD
YOUR OWN
CONCRETE
BLOCK
HOME
Only 1 Prepaid

GENERAL ENGINES CO.

DEPT. P-18 • 307 HUNTER ST. • GLOUCESTER, N. J.

Includes floor plans for 6 beautiful, easy to build concrete block bungalows. Shows ways to save money. How to lay blocks, lay out building lines, mix concrete, build steps, porches and concrete floors. Mail coupon at once with \$1.

Name.....
Address.....
City..... Zone... State.....



\$189.50

*complete 5-tool unit without motor. Includes rip fence, miter gauge, saw blade and guard, Jacobs key chuck, sanding disc, extension table, lathe centers and tool rest.

It's SHOPSMITH for ECONOMY

ONE LOW PRICE . . . one compact power unit . . . *five* big money-saving tools—that's SHOPSMITH economy! You save on cost—\$300 and up! You save on space—50 sq. ft. or more. You save on the hundreds of things you can make.

And you save *time*—because SHOPSMITH changes from tool to tool in less than sixty seconds; because it features simplified adjustments and *ready-made jigs* for every operation.

SHOPSMITH's "change-ability" does away with the costly duplication of parts, motors, benches. Each part is top quality. The

stress-proof steel spindle, for example, has an induction hardened tip; it's machined to watchmaker's tolerances; it floats on *four* grease-sealed ball bearings. *Part for part, job for job, dollar for dollar, you can't buy a finer power workshop.*

See SHOPSMITH and compare! At leading hardware and department stores or at any Montgomery Ward store. And for complete details and specifications, write for your copy of the information-packed, 16-page SHOPSMITH booklet. It's *free!*

*Special SHOPSMITH motor — heavy-duty, 1/2 h.p., ball bearing, capacitor, 110 V, 60 cycles—\$34.50.

SHOPSMITH Dept. 163-B, at factory nearest you
12819 Coit Road, Cleveland 8, Ohio, OR
417 Montgomery Street, San Francisco 4, Calif.

Please send me the free SHOPSMITH booklet.

Name _____

Address _____

City _____ State _____



FREE

16-page illustrated booklet brings you complete information about SHOPSMITH—America's largest-selling power tool.

SHOPSMITH AS AN 8-INCH CIRCULAR SAW

Large-capacity saw with blade to fence distance up to 48 inches. You can cut to the center of 8-foot plywood panels. $2\frac{1}{4}$ -inch depth of cut. Large miter gauge with automatic stops every 15° . Self-aligning rip fence with front and back locks.

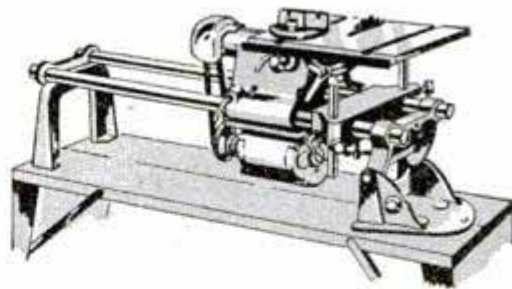

SHOPSMITH AS A 12-INCH DISC SANDER

In less than a minute you can convert SHOPSMITH to a disc sander second to none. Extra-large, tilting table. Miter gauge and rip fence provide accurate, convenient jigs. Unique micro-quill adjustment lets you feed disc into work.

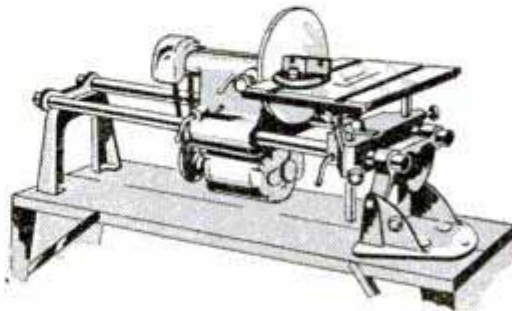

SHOPSMITH AS A 33-INCH WOOD LATHE

Turns table legs, lamp bases, bowls up to 15 inches in diameter (4 inches more than most heavy-duty lathes), 33 inches in length. Tool rest slides parallel to work, requires fewer adjustments. Speeds from 800 to 3600 rpm. Rigid, tubular ways, stress-tested at over a ton.

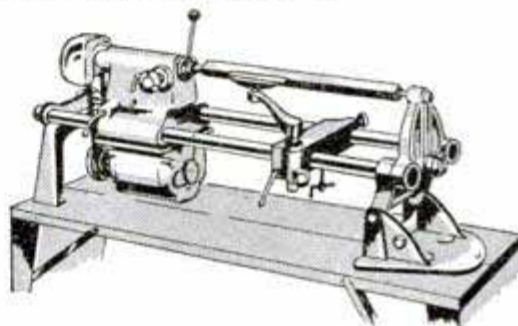

SHOPSMITH AS A HORIZONTAL DRILL PRESS

It's new! It's practical! It's extremely useful! Performs drilling operations too awkward or bulky for a vertical drill press. Handles work of unlimited length. Makes an easy job of dowel-jointing boards for table tops or wide shelves.

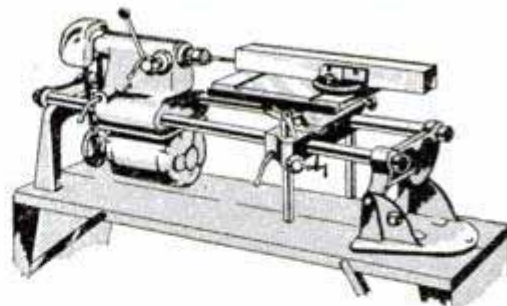

SHOPSMITH AS A 15-INCH VERTICAL DRILL PRESS

Table to chuck clearance, to 27 inches; floor to chuck, to 55 inches. Jacobs key chuck takes drills up to $\frac{1}{2}$ inch. Variable speeds. 4-inch quill feed. Stress-proof spindle floats on *four* grease-sealed ball bearings.

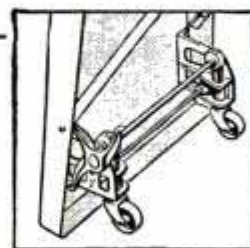
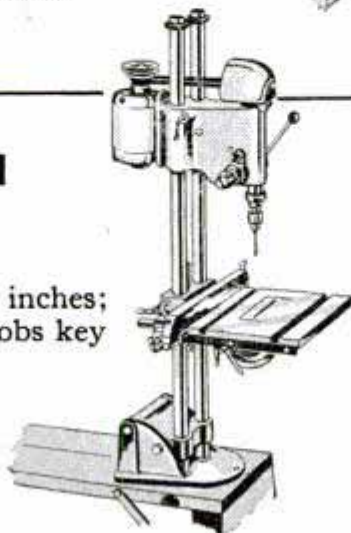

NEW RETRACTABLE CASTERS

They increase SHOPSMITH's already great flexibility. Easily mounted on any wood or metal bench. Easy to set, too, with three-stage foot levers that raise or lock unit. Your SHOPSMITH dealer has them. Complete assembly . . . \$11.95

1951 SPEED AND POWER HANDBOOK for all cars

DIRECT FROM THE CALIFORNIA DRY LAKE TESTING GROUNDS... COMES AUTHENTIC, PROVEN INFORMATION ON HOW TO GET LIGHTNING SPEED, SUPER POWER AND BETTER MILEAGE FROM ANY CAR!

Illustrations and construction drawings show how to build fast stock cars, California Roadsters and 225 M.P.H. Hot Rods.

Easy, Step By Step Methods help you save by building your own dual manifolds, superchargers, hot cams, water injectors, high compression heads and mileage devices.

50 BREATH TAKING CHAPTERS TELL ABOUT: Turning techniques, Speed tricks, Economy secrets, Ingenious formulas for attaining racing speed and dynamic power. Includes information on: Racing Frames, Reciprocating Masses, Jet Engines, Wheel Geometry, Dynamometers. Also Re-styling and Customizing all cars. Learn about dual pipes, gears, fuels, porting, relieving, lowering and balancing.

THIS GREAT NEW BOOK... PLUS "1951 SPEED EQUIPMENT CATALOG", PLUS "WATER INJECTION", PLUS "150 M.P.G. BOOK"—ALL 4 ITEMS \$1.98 postpaid.

128 Page Library Edition
Over 300 Illustrations

BURN WATER IN YOUR CAR!

YES, BURN WATER OR WATER AND ALCOHOL IN ALL CARS, TRUCKS AND TRACTORS! UNITED STATES AGRICULTURAL DEPARTMENT SCIENTISTS SAY, "THE GASOLINE MILEAGE OF NEW HIGH COMPRESSION AUTOMOBILE ENGINES CAN BE INCREASED UP TO 30% WITH ALCOHOL-WATER-GASOLINE FUELS." WE HAVE ILLUSTRATED, DESCRIPTIVE LITERATURE ON THE BENEFITS OF WATER-ALCOHOL INJECTION.

WRITE TODAY FOR FREE LITERATURE

150 MILES PER GALLON WITH YOUR OWN CAR

Full sized modern cars actually get over 100 miles per gallon with regular gas. This sensational book tells you how and suggests amazing economy methods. Send only 50¢ for book, "How to Obtain 150 M.P.G."... plus our big 1951 Speed Equipment catalog listing and picturing hundreds of automotive items. BOTH BOOKS: 50¢ postpaid.

NEWHOUSE AUTOMOTIVE INDUSTRIES
Dept. B, 5807 East Beverly Blvd., Los Angeles 22, Calif.

ONLY 98¢*



best white tape made

The new "Evans White-Tape" has everything you'll find in tapes costing over \$1.50—plus.

- snow-white blade with bold, legible, jet-black numerals and graduations. Graduated in 32nds for first 6 inches.
- sturdy die-cast case heavily chrome-plated, calibrated for quick reading inside and outside measurements.
- blade 1/2" wide made of finest high carbon steel—tempered—Bonderized—enamelled—baked.
- blade replaceable in seconds—without tools—without even opening case. And Evans replacement blades cost far less.
- every "Evans White-Tape" is unconditionally guaranteed.
- exclusive Evans automatic brake gives smoother push-pull action with absolutely no "creeping" of tape into case.
- underside is white, too. Mark with ordinary pencil, remove mark with flick of thumb.
- unheard-of low price*: 10-ft. \$1.49; 8-ft. \$1.19; 6-ft. 98¢. Prices higher in far west and Canada.

Evans & CO. • Newark 5, N. J. 7429

Makers of Evans 6-ft. Folding Rule and Folding Yardstick

THE AMAZING NEW GANE-O-MATIC Overdrive Control



ONLY \$9.95

POSTPAID & INSTALLED
(We pay your garage or gas station)

Dealer inquiries invited

- ✓ SAVE GAS, BRAKES & TIRES
- ✓ GET AUTOMATIC HILL HOLDER
- ✓ USE SIX FORWARD SPEEDS
- ✓ ENJOY NO-CLUTCH SHIFTING

THE GANE-O-MATIC PUTS TO WORK HIDDEN ADVANTAGES OF YOUR PRESENT OVERDRIVE. FINGER-TIP CONTROL GETS OVERDRIVE OR REGULAR RANGE... AT ANY SPEED... IN ANY GEAR

A. Save gas as Gane-O-Matic allows using overdrive 100% of the time. Get down-hill compression when in overdrive thus braking your car... saving tires and brakes when stopping.

B. The Gane-O-Matic hill holder holds your car on any incline without the use of your hand or foot brake.

C. Utilize more of your motor's power with six forward speeds... three each in regular and overdrive range.

D. Enjoy the speed and ease of gear shifting at any speed... up or down... without touching your clutch pedal.

THE GANE-O-MATIC IS EASILY INSTALLED IN A FEW MINUTES ON ALL FORD, MERCURY, LINCOLN, STUDEBAKER, CHRYSLER, DODGE, DESOTO, NASH, HUDSON, KAISER-PRAZIER, JEEPSTER AND OTHER CARS WITH OVERDRIVE.

MONEY BACK GUARANTEE If you are not fully satisfied with your Gane-O-Matic, we will refund the entire purchase price if it is returned within 30 days.

FREE LITERATURE. Comes complete with illustrated installation instructions plus free installation certificate redeemable for cash by your garage or gas station. Send cash, check, money order or \$1 deposit on C.O.D.

NATIONAL AUTOMOTIVE RETAIL CO.
Dept. Y-4, 350 West Washington Blvd., Venice, Calif.

STANDARD GARDEN AND SMALL FARM TRACTORS



RIDE or WALK Powerful Gas Tractors for Small Farms, Gardeners, Florists, Suburbanites, Fruit and Poultrymen.

1 & 2 Cylinders
Rubber or Steel Tires.

Easy Terms — Free Catalog

Plow Seed Cultivate Mow Haul Belt Work

STANDARD ENGINE COMPANY
MINNEAPOLIS, MINN. NEW YORK, N. Y.
3221 Como Avenue 617 West 26th Street

MAGNETS OF ALL TYPES—10c UP

AMAZINGLY POWERFUL!

1/2 lb. magnet lifts 25 lbs. \$1.95.
Our Leader, 1 lb. magnet lifts 40 lbs. \$2.95. New alloy—will not weaken! Useful for lifting valuables from tanks, takes, or rivers easily! 7 small magnets \$1.25 with list of many shop and home uses. Satisfaction guaranteed.

R. EYRICH, 2566 N. 49TH ST., MILWAUKEE 10, WIS.

Say You Saw It in Popular Mechanics

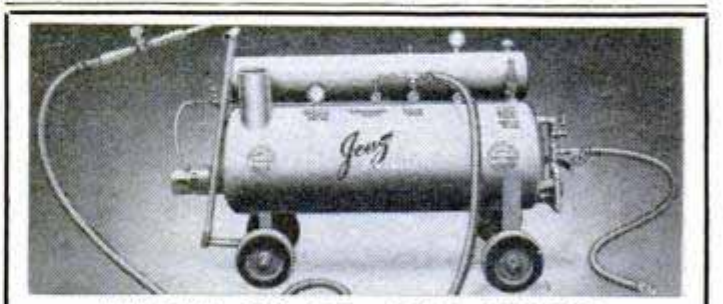

EARN \$6.00 PER HOUR

At a cost of 20¢ with the NEW JENZ SUPER CHIEF STEAM CLEANER. Portable—No moving parts—Cleans anything—Any place—Motors—Chassis—Machinery—Floors—Buildings—Oil Rigs, etc.—Oil fired—Economical—Fully tested and warranted. 75 lbs. steam in ten min.—Model 80. Complete as illustrated.....

\$359.50

F.O.B. shipping point

HI-PURE LABORATORIES, Evansville, Ind.

OVER 1/4
MILLION
GAMES
NOW
IN USE



WANT TO SAVE GAS?

BE PREPARED IF RATIONING RETURNS

10 DAY
FREE TRIAL
IN YOUR CAR

You can easily install Ganes
In A Few Minutes

- ✓ TEST FOR
- ✓ BETTER MILEAGE
- ✓ EASIER STARTING
- ✓ FASTER PICKUP
- ✓ BETTER IDLING

The Amazing
**GANE
AIR FLOW
NEEDLE**

Gane re-places the idling adjustment screw in gasoline carburetors.



LOOK

BECOME A GANE ECONOMY CLUB MEMBER
ENJOY BIG AUTO ACCESSORY DISCOUNTS

All Gane Needle purchasers automatically become life members of the new Gane Economy Club and pay no dues, fees, or expenses. This organization extends big discount privileges to members on auto supplies and accessories, auto economy products and many household and personal items.

All members receive benefits which can only be offered to large, organized groups. Special club benefits include a shopping service that will direct you to club wholesale house affiliates throughout the nation. Full particulars on the Economy Club will be sent free of charge to all who try GANE NEEDLES. WRITE TODAY!

MANY GANE NEEDLE USERS REPORT UP TO 25% MORE MILEAGE AND CLAIM FASTER PICK-UP, EASIER STARTING AND BETTER ALL AROUND PERFORMANCE... but don't take our word for it... see for yourself! Test a Gane Needle in your car for 10 days at our expense... Then compare your mileage and performance. If fully satisfied, send us only \$1.50 per needle (8 cylinder cars take two). If not satisfied, just return the needle and you owe nothing... fair enough? Since authorities differ on the merits of Ganes and some users report no improvement, try before you buy!

Send us the make and year of your car, number of cylinders and carburetor make if known. Your Free Trial Ganes will be sent immediately.

AUTO ECONOMY MANUAL SENT FREE

Sent absolutely free to all who try Gane Needles, this manual tells how you can save gas, tires and brakes; how to gain more speed, power and better performance from any car. This fine new manual-catalog also introduces many new and ingenious auto economy products and accessories.

WRITE TODAY FOR YOUR:

SEND NO MONEY • PAY POSTMAN NOTHING

- ✓ FREE TRIAL GANE NEEDLE
- ✓ FREE ECONOMY DRIVING MANUAL
- ✓ FREE ECONOMY CLUB INFORMATION

NATIONAL AUTOMOTIVE RETAIL CORP.

350 W. Washington Blvd. • Dept. J-4 • Venice, Calif.

HOTTER GAS TORCH

SELF CONTAINED - NO COMPRESSED AIR

Burns natural house gas at 2100° F. - 1500 BTU for soldering (silver, etc), paint removing, bending, glass forming, etc. Precision engineered & guaranteed. \$6.90 with attachments and 5' hose. \$3.45 without attachments. Save C.O.D. fees. Send check or M.O. DEPT. PM-4.

KELLER GAS APPLIANCES

439 W. FOOTHILL BLVD. • MONROVIA, CALIF.



make your own Gems 29.50 F.O.B.

All necessary lapidary equipment is furnished, including a super-charged diamond blade for sawing, and all wheels for grinding, shaping and polishing; also complete instructions. The complete equipment as shown, less motor and belt, for only \$29.50, f.o.b., Burlington, Wisconsin. Write today for information and literature.

B&I MANUFACTURING CO.

Dept. S Burlington, Wis.



FASTER, MORE PROFITABLE LAWNMOWER SHARPENING

with the IDEAL!

Your customers are steady customers when you sharpen their mowers on the IDEAL! Does a fast, precision job with any size mower; sharpens power mowers without removing engine or handle! Complete with bed knife grinder and lapping-in reconditioner. Send post card today for free catalog.

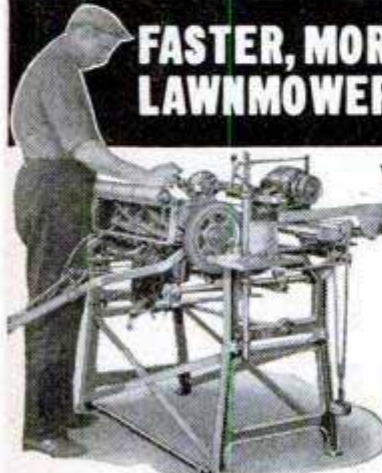

THE FATE-ROOT-HEATH CO., Dept. K-3, Plymouth, Ohio

LOCKS onto the work
"HOLDS ON," after you let go.

Finest locking plier because...

Clamps on better with patented swivel jaw which adapts itself to shape being held. Faster working because of patented jaw size indicator; you pre-set jaw size to approximate size of object. Easier opening with patented lock release; finger-operated lever readily releases 2000 pound bite.

\$1.95
7" size
10"-\$2.50
Both bright nickel finish

At your dealer's. Send for FREE folder.

**SEYMOUR SMITH
"Snap-Lock"
PLIER - WRENCH**

SEYMOUR SMITH & SON, INC.
11204 Main St., Oakville, Conn.
100 years of quality tools

SEYMOUR SMITH
The Love of Quality
SINCE 1850



AFFORDS A FIRM GRIP ON SHORT ENDS

REMOVES STUBBORN THEN RESETS THEM

Keep Brushes like New

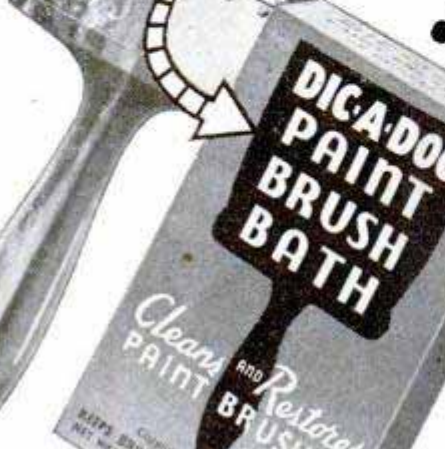
BEFORE  **AFTER** 

10c
25c

DICADOO PAINT BRUSH BATH

Clean and Restore PAINT BRUSHES

Perfect for **NYLON BRUSHES**, too!

At Paint, Hardware, Dept., and 5 & 10c Stores

Patent Cereals Co. Geneva, N. Y.

MILLER ROTARY

HI-SPEED (OPE-SAW) DRILL-BIT
IT SAWS & CUTS DREAMS

Presents **The Big 3**



Each Bit Performs its own Function
Specify Which

SAWS, CUTS, REAMS Sheet metal, angle iron, pipe, wood, plastic, Transite, etc. Amazing high-speed combination bit and saw fits any 1/4" or 1/2" electric drill or slow drill press. Drills own starting hole to quickly cut, saw or ream opening. Easy to operate. Ideal for carpenters, auto mechanics, electricians, plumbers, hobby workers, many others. Abrasive resistant high speed steel. No breaking. Will withstand severe continuous use. Resharpener at no charge. 1/4" diameter, over-all length 3 1/2", cutting section 2" long with flutes ground from solid. Shipped same day—money back guarantee. Discounts on quantity orders from dealers. Takes place of up to \$50 in tools.

SEND CASH, CHECK OR M. O.

Each \$3.95 Post-paid **3 for only \$11.50** Post-paid

Manufactured and distributed by

INTERNATIONAL TWIST DRILL CORP.

624 Wyandotte Rm. 260 Kansas City 6, Mo.

"Pioneers in break-resistant short drills"

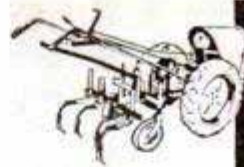

NEW '51 LINE!

PAGE GARDEN TRACTORS

RIDING AND WALKING MODELS!

NO CHEAP BELTS OR CHAINS!

2 TO 6 H. P. WITH COMPLETE GEAR DRIVE AND REVERSE

LOW PRICES EASY TERMS



SAVES LABOR!

BENEFIT FROM OUR 25 YEARS EXPERIENCE FREE 24 PAGE CATALOG SHOWS ALL ATTACHMENTS

WRITE

PAGE FARM EQUIPMENT

1904 S. 81st St. • Milwaukee 14, Wisconsin

BUILD DUTCH WINDMILLS

Lighthouses, Lawn Figures, Lawn Chairs, Trellises, Etc., Beautify Your Garden

Model B-30 Windmill 24" high. Wings operate farmer at bucksaw. Blueprint .50c
Model B-10 Windmill hexagon style, 40" high overall. A beautiful model. Blueprint .75c
Model H-10 Lighthouse, 40" high. Blueprint .75c
Comfortable, Sturdy Cape Cod Lawn Chair. Blueprint .50c
12 Artistic Trellises, Blueprint all 12 only .50c
Special All Blueprints mentioned above for only \$2.50.

"Over 25,000 Satisfied Customers"
Send 10c for illustrated Catalog.

CRAFTSMAN'S MODEL CO.

Dept. P-27

DELAFIELD, WIS.



BRONZE FOUNDRY

Schools and Home Workshops

Make your own castings of aluminum, copper, bronze, silver. Foundry sets are available in three sizes including 2400 Deg. F. blast Furnaces. \$22.50; \$29.50; and \$42.00. f.o.b. Kansas City. Free Circular.

KANSAS CITY SPECIALTIES CO.

P. O. BOX 6022, DEPT. P-4
KANSAS CITY, MO.

\$ Free Course! Big Profits! \$ Flocks & Sandblasts



Dual Purpose Spray Gun! Uses only 25 lbs. Air Pressure
• Thousands of uses in Home, Shop, Industry; Makes Auto Interiors Clean & New, Lines drawers, Marproofs lamp bases, Refinishes any object. All in colorful Flock. Etch & Frost windows, glassware, etc. Removes Paint & Rust from Autos. Tools. Guaranteed! Send \$24.75 or write for free information. Flocking supplies!

BLASTO SPRAY GUN MFG.
Dept. PM-4, 7007 Haas Avenue, Los Angeles 47, Calif.

BRUSH PLATING OUTFITS

• for re-plating articles in the home and shop. No tanks necessary. Free particulars. •

GUNMETAL CO., AVE. M, DECATUR, ILLINOIS

ELECTRICITY Anywhere

FOR PORTABLE, EMERGENCY OR HOME USE

ONAN Electric Plants generate 110-volt, 60-cycle current for homes, farms, cabins and resorts beyond the highline. Lightweight, portable plants cut costs, speed work for contractors. Standby plants protect units against power failure. 400 to 55,000 watts. Gasoline or Diesel-powered. Priced from \$219.00.

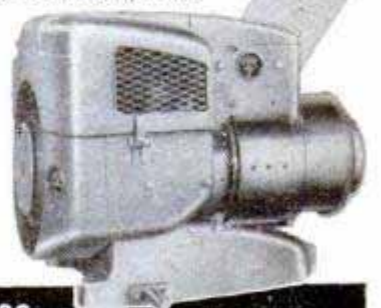

WRITE FOR CATALOG

D. W. ONAN & SONS INC.

5844 ROYALSTON AVE. • MINNEAPOLIS 5, MINN.

A Natural For Mr. Fixit

WISE-GRIP WRENCH

low as
\$1.85



No other tool does so much so easily. LOCKS to the work with more than Ton-Grip! Easily adjusts to ratchet action. Works in close quarters—no lost motion. Is actually an Adjustable End-Wrench, Pipe Wrench, Pliers, Clamp, Wire Cutter, and Toggle Press—all in one trim hand tool. With Cutter—No. 7W, 7", \$2.25; No. 10W, 10", \$2.60. Without Cutter—No. 7C, 7", \$1.95; No. 10C, 10", \$2.25. No. 7, 7", \$1.85; No. 10, 10", \$2.15.

Order From Your Dealer

PETERSEN MFG. CO., Dept. P-4, DeWITT, NEBR.

PARTS FOR MILITARY TRUCKS

At A Savings New FREE Catalog
For Jeep, Dodge, Chev., G.M.C., Studebaker—4x4 - 6x6. Drive

Brand New — Not Surplus — Complete
JEEP TOPS and SIDE CURTAINS
Fits all Military Jeeps. Also adaptable to some Civilian Jeeps. Waterproof O.D. . . . **\$59.50**

TRAILER AXLE
Heavy duty trailer axle suitable for many types of trailer construction. Also excellent for building of heavy farm trailers and wagons. It is a 12,000 lb. capacity square type straight

trailer axle complete with Timken roller bearings, hubs, and 6 hole 750 x 20 Budd Wheels. Without brakes. Axle is 2 inches square and 69 inches between wheel mounting flanges. Std. width.

With Single Wheels. \$59.50 With Dual Wheels. \$69.50

Hundreds of Other Truck & Jeep Parts and Supplies

All prices quoted good 30 days FOB, Kansas City
25% DEPOSIT REQUIRED ON ALL ORDERS

American AUTO PARTS CO. INC.
1830 LOCUST—DEPT. PM
KANSAS CITY, MISSOURI

EVERY ELECTRIC DRILL A PORTABLE SAW

9.95 Can Be Used With One Hand!
Any 1/4" or 3/8" Drill a Powerful Saw in ONE MINUTE

"ARCO-SAW" is a rugged tool with right angle gear drive (no clumsy, dangerous, direct drive with drill sideways). Works like a high priced Portable Saw.

CUTS 1-5/16", or 2x4 by turning over ONLY ARCO GIVES YOU ALL THESE FEATURES: Safety-yoke assures rigid connection and absolute safety—Big handle affords firm grip for two-hand operation—Precision one-piece gear box—Self-lubricating life-time bearings—Visual guide and wide shoe-plate for straight, square cuts—Lowest priced, quality Replacement Blades.

"HYCARBON" 4" Crosscut or 4" Combination Blade. . . \$2.00 ea.

90-day Factory Guarantee

ORDER TODAY at your dealer or send us check or M.O. (Postpaid). C.O.D.'s—Postage extra

At Better Hardware Stores Everywhere

Pat. Pend.

ARCO SAW

UNCONDITIONAL 10-DAY MONEY BACK GUARANTEE

DEALERS—Write for nearest jobber.

ARROW METAL PRODUCTS CO.

DEPT. PM-4, 140 WEST BROADWAY, NEW YORK 13, N. Y.

Tune it up **THE EASY WAY!**



TUNE YOUR ENGINE — KEEP IT TUNED

Casite gets rid of winter's gum and goo, frees sticky valves and rings, lets the power zoom through. Casite guarantees Better and Smoother Motor Performance or Double-Your-Money-Back.

Casite in the crankcase keeps the engine free-running—gives cleaner, keener performance the whole year round.

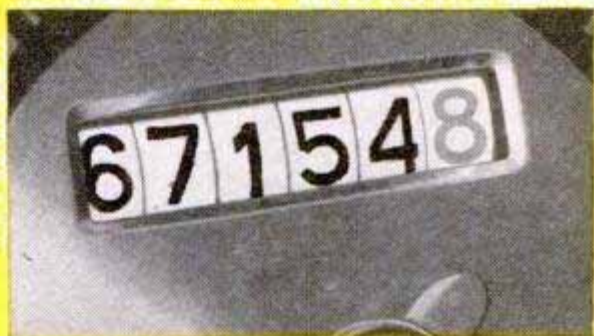

KEEP IT RUNNING LONGER

Casite gives extra protection against engine wear, by speeding lubrication. Casite speeds the flow of No. 10 motor oil 24.3% at 50°F. —more when the engine is colder—greatly reducing start-up wear. Casite gets enough oil to the right places at the right time—cuts repair bills throughout the life of your car.

Get Casite today from your garage, service station or car-dealer.

**CASITE DIVISION, • HASTINGS MANUFACTURING COMPANY
HASTINGS, MICHIGAN**

Casite Division, Hastings Ltd., Toronto

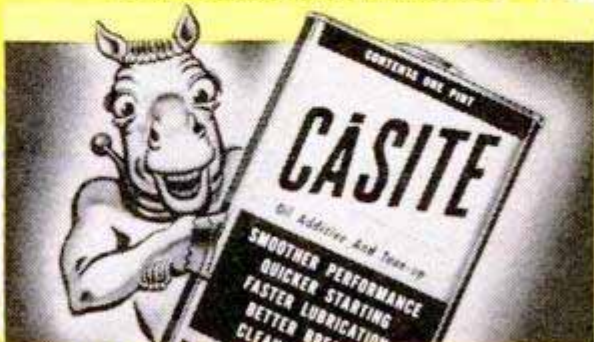

FREE! Write for your free copy of "Facts of Engine Life."

Handle-Rod

patent applied for

NEW COMPACTNESS

A FIVE FOOT CASTING ROD that COMPLETELY TELESCOPES INTO ITS HANDLE TO JUST ELEVEN INCHES!! Fits into pocket, tackle box, suitcase or glove compartment. Ideal for boat or plane. Rod sections made of *Beryllium Copper* Can never rust or corrode Weighs only Six ounces

\$13⁵⁰

NEW DESIGN

A Precision Made casting rod, engineered for perfect balance, with all the action and Flexibility of a fine one-piece bamboo rod. Fully guaranteed.

If your Dealer can't supply you, send money direct to

CHAMPION PRODUCTS CO.
MUSKEGON HEIGHTS, MICHIGAN



EASY PROFIT IN PAINT SPRAYING

Paints walls, ceilings, screens, furniture and machinery faster, better. All complete as shown less motor. Carry anywhere. Fully guaranteed. Could be used with 1/4 H.P. motor or less. Price \$35.00 less motor F.O.B. Chicago. \$5.00 deposit balance C.O.D. or see your dealer. With motor \$55.00.

IDEAL AUTOMATIC PUMP CO., Dept. P.M.8
801 W. Washington Blvd. Chicago 7, Ill.

584 Page Novelty Catalog Now Ready!

584 Pages; 7500 Amazing Novelties
Send 10c for mammoth new catalog of 7500 novelties. (Each copy costs us over 50c—10c helps pay postage.) More fascinating than World's Fair. Thousands of things you never knew existed—never knew where to get. Includes novelties, tricks, jokes, live animals & pets, scientific supplies, den novelties, hobby supplies, planes & boats, looms, magic, unusual seeds, gadget time savers, camera & optical goods, movies, projectors, lucky jewelry, religious novelties, telegraph sets, magnets, disguises, easy musical instruments, stamps, coins, puzzles, fortune tellers, radios, experimental sets, auto & bike accessories, Western belts & wearing apparel, telescopes, magnifiers, compasses, banks, smokers' gadgets, artists' supplies, printing sets, engines & motors, electric shockers, knives, billfolds, weird articles, archery, swimming helps, 1000 fascinating books, games, locks, live chameleons, barometers, rings, watches, charms, imported novelties, exercisers, money savers, handy tools, Indian novelties, etc., etc., etc. Jammed & packed with sensational funmakers & useful articles. Big catalog—over 1 inch thick. 6 color cover. Rush Coupon to Johnson Smith & Co.

RUSH — THIS — COUPON

Johnson Smith & Co., Dept. 370, Detroit 7, Mich.
Here's My 10c. Send Big Catalog to:

Name & Address _____



for ... POWER LAWNMOWERS, MOTOR SCOOTERS, GARDEN TRACTORS, MOTORBIKES, ETC.

The Way to transmit Power Smoothly

WRITE FOR FREE FOLDER

V-PLEX CLUTCHES automatically tighten drive belt as throttle is opened, eliminate belt slippage, cut wear, permit idling engine. Easily installed on any gas engine; practically indestructible. Fit 1/2, 5/8, 3/4" drive shafts. See dealer or write.

MFD. BY **V-PLEX CLUTCH DIVISION**
LIGHT INSPECTION CAR WORKS — HAGERSTOWN, INDIANA

SHEET METAL BRAKES

Forms angles, flanges and Pittsburgh locks. 26 gauge steel, heavier aluminum. Cam locking. Portable, can be bolted to bench, or clamped to edge of truck. All steel, reinforced. Shipped Exp. Coll. 30" size, Wt. 54 lbs., \$26.50. 36" Wt. 66 lbs. \$31.00. 48" Wt. 100 lbs., \$45.00. Floor mountings, portable, 32" high, \$7.00 12" BRAKE. Fits in vise to form difficult compound bends, up to 20 gauge steel. Not illustrated. . . . \$12.50 PP.

18" CURVE FORMER, Capacity — 1 1/2" gauge steel. . . . \$10.00

IRON BENDER, 1/4x2" capacity, 9 parts. All steel. . . . \$10.00 P.P.

Immediate Delivery. Order direct, cash or C.O.D. or send for folder.

VYKE BRAKE CO., P-1116 So. 27th St. Omaha 5, Nebr.

MACHINE SHOP EQUIPMENT

The No. 49 edition of the famous Center Tool Co. Catalog is now ready! Every workshop owner should have a copy. 240 pages full of illustrations, descriptions, and prices of the latest tools made by best known manufacturers in U. S. You pay the cost of printing—50c. We refund your 50c with your first order of \$10.00 or more. Prompt delivery on most tools. Send check or money order today!

CENTER TOOL CO.
153 Centre Street, Dept. C, New York 13

ASSURES THE RIGHT KIND OF MILES-PER-GALLON HULL AUTOMOBILE COMPASS

YOU GET the right kind of miles from a gallon of gas, set of tires, your car itself, only when you drive every mile in the right direction. Eliminate wrong-way travel with a HULL, the only automobile compass in general use for 18 years.

Write for local dealer's name and free literature

HULL MFG. CO.
P. O. BOX 246-04, WARREN, OHIO

Beaconlite \$6.95
Illuminated
STREAMLINE \$4.95
standard (not illus.)

TRAILER COUPLER

Automatic Wedge-lok coupler cannot rattle or loosen. Locks into position quickly and easily. Designed for rugged heavy duty over roughest roads. 2" dia. one piece steel ball has 3/4" dia. shank with 3/4" SAE threading. Order today. immediate delivery, we pay postage. No C.O.D.'s please.

\$4.00
Postpaid

DAYTON PRODUCTS CORP., Rockford, Ill.

SAY YOU SAW IT IN POPULAR MECHANICS

BLACK CLOUD only
ELECTRIC \$6⁹⁵
WATER PUMP

For Fountains in Bird Baths. Have real running water in creeks for water falls and water wheels, etc. in Christmas displays.

Size 2 1/4" x 6"

Pumps approx. one gallon per min.

PAUL MCFARLAND
R. D. No. 1 ROYERSFORD, PA.

DOES 80% OF YOUR WOODWORKING JOBS

DELTA MILWAUKEE

Saw-Jointer Combination

One motor runs two tools at the same time!

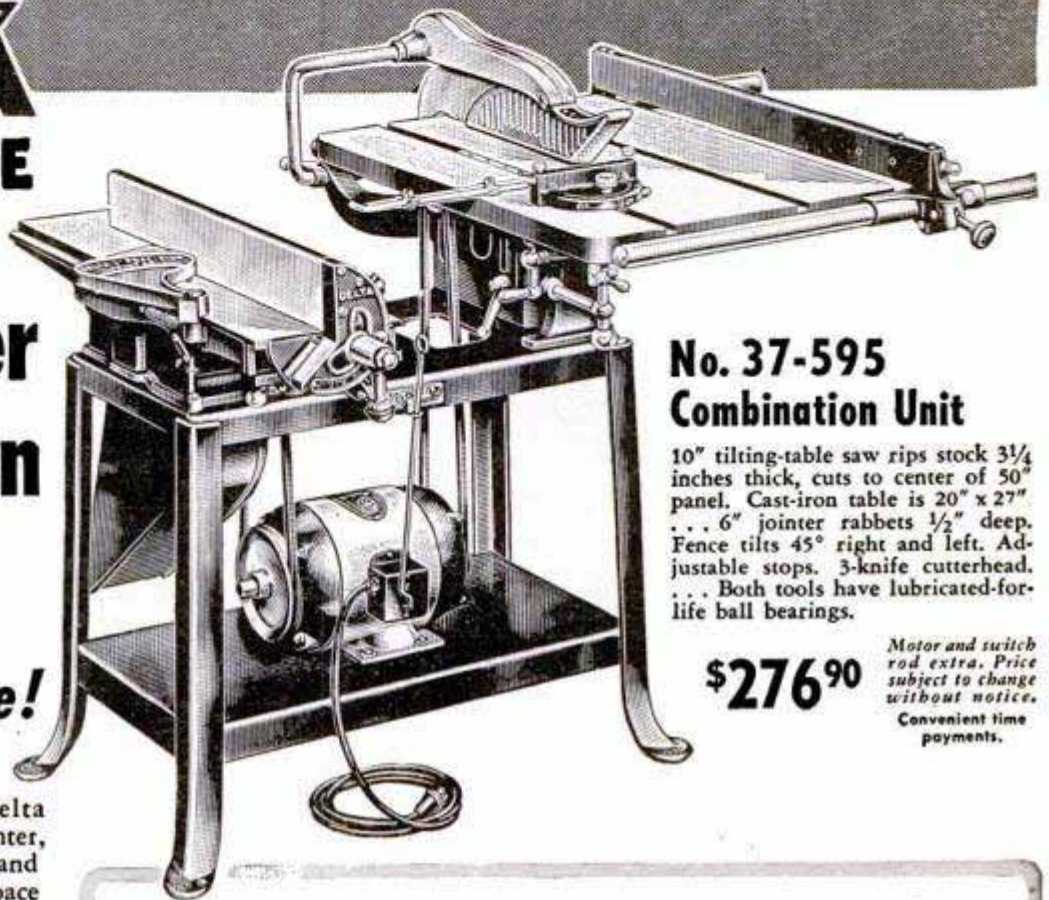

No. 37-595 Combination Unit

10" tilting-table saw rips stock 3 1/4 inches thick, cuts to center of 50" panel. Cast-iron table is 20" x 27" . . . 6" jointer rabbets 1/2" deep. Fence tilts 45° right and left. Adjustable stops. 3-knife cutterhead. . . Both tools have lubricated-for-life ball bearings.

\$276⁹⁰

Motor and switch rod extra. Price subject to change without notice. Convenient time payments.

Here's a low-cost, big-capacity Delta 10" saw and a rugged Delta 6" jointer, mounted together on a single steel stand. Takes up only 37" x 60" floor space. Mobile weight . . . use it in your shop or take it to your job!

Use the two tools singly or double up and work them together . . . one unit keeps two men busy. Rip a board then joint it. No fuss with adjustments . . . save time usually lost walking from one machine to another!

Built for years of faithful service. It's one of the most popular units in the famous Delta quality line . . . a favorite with builders, cabinet-makers, woodworkers and in shops of all kinds.

Here are some of the accessories that make this saw-jointer a tool of many uses



DADO CUTS UNLIMITED — Delta's Dado Set will straight dado, gain, plough, rabbet, groove, spline cut.



MAKE ALL BASIC SAW CUTS — Cross-cut, miter, rip, bevel, cut-off, double miter, angle rip. Delta offers the right blade for every job!



MAKE THOUSANDS OF SHAPES — One low-cost Delta Moulding Cutterhead Set makes your saw a shaper! And Delta's 27 different Moulding Knife Sets give you thousands of shapes!



See your Delta dealer now!



CUT ODD SHAPES SAFELY — Exclusive Delta clamp attachment on miter gage holds odd-shaped pieces firmly.



CUT TENONS ACCURATELY — Delta Tenoner safely cuts square, parallel tenons for furniture, storm sash, screens, doors, etc.



CUT METALS AND OTHER MATERIALS — Cut tubing, bars or sheets—cut tile, brick, plastics, and other materials with proper blade or abrasive wheel.



Look for the name of your Delta dealer under "Tools" in the classified section of your telephone directory.

Free!

Catalogs and bulletins on complete Delta line.

DELTA POWER TOOL DIVISION
Rockwell
 Manufacturing Company
 MILWAUKEE 1, WISCONSIN



TEAR OUT COUPON AND MAIL TODAY!

DELTA POWER TOOL DIVISION
 Rockwell Manufacturing Company
 803D E. Vienna Ave., Milwaukee 1, Wis.

Send me free catalogs and bulletins on the complete Delta line of tools and accessories.

Name.....
 Title.....
 Company.....
 Address.....
 City..... (.....) State.....

on some jobs
a man's just GOT to have
pull

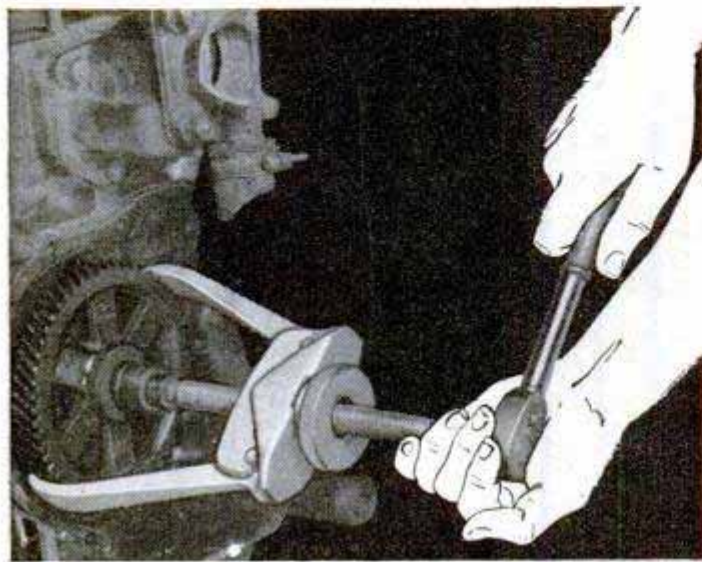

Snap-on

TRADE-MARK

gear pullers

boost earnings for thousands

Save hours of mean, hard work! Avoid broken, distorted, battered, burred, ruined parts! Do better work quicker, with easy-action Snap-on Gear Pullers, favorite professional

FOR FAST, EASY REMOVAL OF:

- Wheels
- Gears
- Hubs
- Pinions
- Valve Guides
- Universal Joint Splines
- Marine Propellers
- Pulleys
- Bearings
- Retainers
- King Pins
- Battery Terminals
- Flywheels
- Bushings
- Races
- Steering Wheels
- Tie-Rod Ends
- Pitman Rods
- Outboard Flywheels

"taker-offers" in thousands of shops. They'll ease off 'most any keyed, splined, pressed, sweated-on, shrunk-on or rusted-on part—gently, without damage. Save muscles! Save costly parts! Save time! Build a reputation for skilled, professional work! Snap-on Gear Pullers are beautifully made, of tough alloy steels—varied sizes and types—small, medium, large (4½, 8½, 14-inch spreads) up to 20-ton power—screw, slide-hammer and combination types—wide choice of jaws, adaptors, attachments. If you are a user of quality tools, send for free 104-page catalog. Snap-on Tools are not sold in stores. Buy from your Snap-on man or order from factory.

SNAP-ON TOOLS CORPORATION
8062-D 28th Avenue
Kenosha, Wisconsin



IT STAYS FIXED



WITH SPEED NUTS®

SPEED NUTS—the fasteners that won't vibrate loose—now available in handy kit. Ten popular sizes with matching screws. Replace threaded nuts and lock washers in repairing all types of metal, wood, plastic products. Over 100 parts for only \$1. Send cash, money order, check—no stamps—no C. O. D.



TINNERMAN PRODUCTS, INC.
Dept. 13, Box 6688, Cleveland 1, Ohio

ASSEMBLE YOUR OWN HEAVY DUTY TRANSFORMER WELDER

ONLY \$18.95
F.O.B. Quincy

Save \$41.00 — This Buy-Direct Way

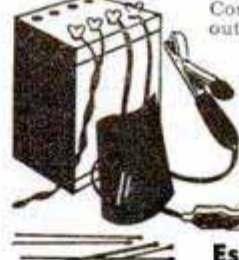

Complete with everything . . . except outside case which you can make at home. All parts precision made. You get Plastic Helmet, professional rod-holder, ground wire with clamp, plug-in wires and rods. No extras to buy. Positively safe and foolproof to operate. Welds ¼" iron or steel, even thicker with practice. Assemble & weld in less than 1 hour. 110-115 volts A.C. only. No C.O.D. Money-back guarantee. Send check or money-order to:

Essay Mfg. Co., Quincy 69, Mass.

Make Ur-Own ROTARY TYPE POWER MOWER

THIS IS NOT A KIT
But A Complete Mower Assembled As Illustrated

Model 50M KEEN MOWER. Add your electric motor or gas engine. Concealed blade for safety, 3 cutting heights, 1½" to 3½". Ball bearing rubber tired wheels. 18" cut. Cuts to within ½" of sidewalk. Weight 48 lbs. America's Greatest Power Mower Value. Order Now **\$44.95**
Shipped F.O.B., K.C.

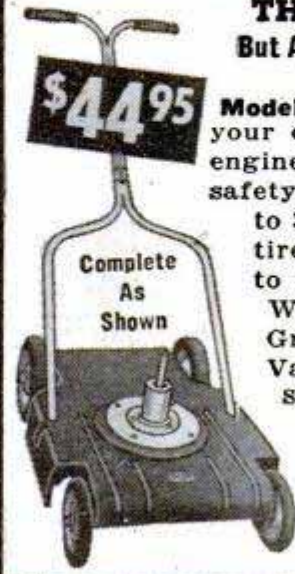

Send check or money order Write for FREE Folder for information on "Make Ur-Own" and other models with gasoline engines or electric motors.

ATLAS KEEN MOWER
229 S.W. BLVD. Dept. MP4 KANSAS CITY, MO.

Sale! WAR SURPLUS BARGAINS Sale!

HEAT CONTROL



Made by Minneapolis-Honeywell—a name known for the best in controls. 1000 watts—115 to 220 volts. Element length 10 ft. Range 70° to 212° Fahrenheit. Control fans, motors, furnaces. This control makes an ideal automatic combination when hooked up to the heat boosters below! List price \$16.00. Your price \$6.95

BOOSTER FANS for

Cooling or Heating



Fits any 8", 9", 10" furnace pipe. 1500 RPM motor with 6" cord, mounting frame, 7" blade. Motor 110 volt 60 cycle 1550 RPM. Easy to install. Silent operation.

Warm those rooms with long runs. Stock #583. Regular \$11.95. Your price \$6.95

10" ball bearing fan Mfr. by Redmond. Can be run vertically or horizontally. 110 volt AC 60 cycle motor with plug and cord. New in original box. Use it for the kitchen as an exhaust fan, heat booster, etc. High pitch blade, 1/25 HP 1550 RPM. only \$11.95



Automatic Control Ventilator

FOR BARNs, ATTICs, BASEMENTS, MILK-HOUSES, etc. Provides fresh air flow—keeps farm stock healthy—increases production. Thermostat range 15° to 95°. 1/4 HP motor.

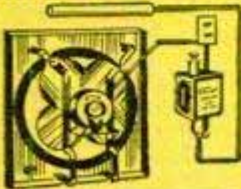

16 inch \$69.50;
20 inch \$89.50;
24 inch \$109.50

PORTABLE ELECTRIC HOT WATER HEATER



Complete unit consisting of 10 gal. steel tank; thermostatically controlled Westinghouse or Calrod immersion heating unit—110 V. A.C. adjustable from 312-825-1250 watts and automatic cutoff valve. Ideal unit for household use, milkhouses, poultry water warmer, etc. Valued at \$59.50. Limited number at \$34.95. Without controls \$24.95

IMMERSION HEATING UNIT alone, as described above, worth \$42.50. Only \$7.95

ALARM HORNS • SIRENS



Motor driven, (not a vibrator). Heavy duty with great power and long life. Adjustable for high, medium or low tone. 110 volt AC current. Weather proof. For alarm or signal horn on boats, school yards, factories, air raid siren, etc. List price \$47.00. NEW. Stock #302. Your price \$15.45.

JARVIS GRINDER



Three phase, 220-440 volt, with flexible shaft; 3450 RPM. Totally enclosed motor.
1 HP. List \$185. Now \$65.00
1 1/2 HP. List \$195. Now \$75.00
2 HP. List \$225. Now \$85.00
1/2 HP, 110 Volt stand & shaft \$59.00

CLUTCHES

For Motor-scooters, Motor-bikes, Lawn Mowers, etc. Mercury centrifugal clutch for use with any small gas engine. 3" "A" belt pulley. 3/4" bore. Brand new only. Stock #400 \$9.95
3/4" bore, NEW \$10.95
1" bore \$11.95



ROCKFORD CLUTCH Manual, bronze throw yoke 1 1/2" bore, 1" female spline; 5" long, 5 1/2" OD. Takes to 25 HP. PRICE ONLY \$20.00

GENERATORS

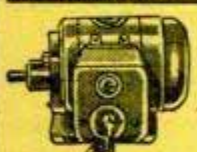

300 Watt, RPM 3400, 110 and 220 volt, 1/2" shaft \$40.00; 2500 Watt, RPM 1800, 115 volt AC \$235.00; 3000 Watt, RPM 2800, 110 volt DC Delco ball bearing, 1" shaft. List \$343.00 to you at only \$99.00
TRACTOR DRIVEN GENERATOR 110-220 volts with floating mount to keep belts tight \$287.00. Generator only \$235.00

BUY NOW and SAVE
**BRAND NEW!
WAR SURPLUS**

LIGHT PLANTS

BE PREPARED

for any emergency!

Use for: Farms, cottages, stores, garages, floodlighting, drilling rigs, refineries, house trailers, fire departments, sound trucks, yachts, tugs, construction, airports, police radios, etc.

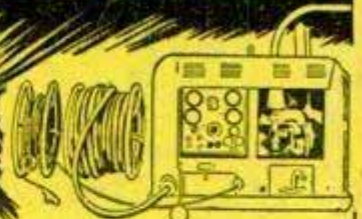

SENSATIONAL BUYS at 50 to 75% savings

LIGHT PLANT BUYERS, in emergency telephone collect—unit shipped same day!

300 WATT, 110-220 volt AC, 60 cycle light plant powered by 1 HP gas engine, direct drive. Mounted base, weight 40 lbs., just right for bomb shelter or P. A. system. New Stock #409 \$99.00

750 WATT, AC 110 volt, 60 cycle, direct drive, air cooled, Briggs & Stratton gas engine, Model AP, Pioneer generator, radio filter, self exciter, rope start, 190 lbs., 20" long, 17" wide, 18 1/2" deep with carrying handle. New. Stock #573 \$232.00

2500 WATT, AC 115 volt, 60 cycle, single phase. ENGINE: Briggs & Stratton, air cooled. 8 1/2 HP. GENERATOR: Kurtz & Root or Leland, belt drive. Complete with \$30.00 worth of spare tools, instructions and fully GUARANTEED. Was formerly priced at approximately \$710.00. Now priced for you NEW. War surplus, at only \$345.00. Reconditioned \$295.00. Plants built in 1951 \$426.00. To make plant 110-220 add \$48.00 for transformer.

3000 WATT CONTRACTOR'S PORTABLE, Briggs & Stratton 5 to 7 HP gas engine with Delco generator and rubber tired wheels. Rope start, weight 275 lbs. Used like new at \$220.00. NEW \$279.00

5000 WATT, 120 volt, 60 cycle AC. HERCULES 4 cycle gas engine. Generator mfr'd

by Hobart Bros. Unit includes remote control cable, 150' 2-wire #8 and 150' 3-wire #18, exhaust pipe, power cable plug, KVA at 80% power factor, radio and television filtered. Unit is completely automatic. List price today \$1910.00. Now priced for you at \$675.00 used. NEW \$895.00. To make plant 110-220 add \$72.00 for transformer.

7500 WATT, 110 volt AC, 60 cycle, powered by a VE 4 Waukesha 4 cyl. gas engine, Continental or Hollinsworth generator. Remote control starting. Complete with switch board. NEW \$995.00. To make plant 220 volt, 3 phase, add \$76.00 for transformer.

10,000 WATT, 110-220 volt AC, 60 cycle. Remote control. Powered by a Jeep 4 cyl. gas engine. Used but like new \$1195.00. NEW \$1495.00.

25,000 WATT, 220 volt AC, 3 phase, or 110-220 volt single phase. Used but like new and GUARANTEED \$1995.00. NEW \$2495.00.

35,000 WATT, 110-220 volt, Diesel. Rebuilt, \$2995.00.

50,000 WATT, Cummins Diesel generator, 240 volt, 3 phase, 60 cycle, AC, 1200 RPM, 150 amps. Rating 50% continuous exciter. NEW. GUARANTEED \$5900.00.

SPECIAL! HOT ROD SUPERCHARGER



Here's a hot rod supercharger at a price you can't afford to miss. SEE HOW SIMILAR SUPERCHARGER IS USED IN PICTURE and ARTICLE on Page 67 AUG. Issue of POPULAR MECHANICS. Mfg. by Borg & Warner. SPECIFICATIONS: 7 1/2" wide, 5" deep, 7" high. Weight 17 lbs. Compact and sturdy, 4 base mounting holes. 3/4" outlet, 5/8" shaft. Includes female Lovejoy coupling. Priced today at \$85. OUR SPECIAL SALE PRICE ONLY \$31.00

HEAVY ELECTRIC CABLE

Electric rubber cable, 16 cond., No. 18, solid. 100 feet or more, per foot \$.16
Electric rubber cable, 10 cond., No. 18 solid. 100 feet or more, per foot \$.10
Electric rubber cable, 4 cond., stranded, No. 18, water and oil resistant; run in parallel No. 16; 100 ft., \$6.25; 250 ft., \$12.50; 500 ft., \$25.00; 1320 ft. reel \$56.00
Electric rubber cable, 2 wire, No. 14; 50 ft., \$11.00; 100 ft. \$21.00; 250 ft. \$50.00
Electric rubber cable, 3 wire, stranded, No. 10; 65 ft. with lugs, Val. \$46.00 \$28.00
Electric rubber cable, 3 wire, stranded, No. 10, submarine cable, underwater, underground, overhead—50 ft., \$20; 100 ft. \$40; 250 ft. \$100; 500 ft. \$200.00
Electric rubber cable, 3 wire, stranded, No. 6—150 ft. reel, with 1 male connector; 2 female, crouse hinds connectors \$125.00
Electric rubber cable, 2 wire, No. 4—75 ft. lengths, male & female connectors \$75.00

BALL BEARING ARBORS



Grinding and saw arbor, has 1/2" double end shaft, 1 1/2" long with 2" center pulley. New Departure double roll ball bearings. Right and left hand thread. Self aligning Dodge pillow block, 10,000 RPM. Bearings alone list at \$10. Complete arbor new. Stock #305 only \$6.95

STAINLESS STEEL TUBE

HALF PRICE — 6' to 10' Lengths

SIZE	O.D.	WALL	MILL PRICE	OUR PRICE
1/4	3/16	01506	51c FL.	FL. 25c
3/8	11/32	01301	63c FL.	FL. 32c
7/16	13/32	01508	70c FL.	FL. 35c
1/2	15/32	01205	72c FL.	FL. 36c
3/4	11/16	05001	91c FL.	FL. 46c
7/8	1-3/16	03125	1.01 FL.	FL. 50c

New "MALL" Portable Flexible Shaft Grinder



1/2 HP, 3450 RPM 110 or 220 volt dustproof motor mounted on universal swinging trunion. Heavy base has a convenient tool tray and large, easy rolling casters. Flexible shaft is equipped with both full speed, angle spindle and straight spindle. List price \$172.00. Your price with all attachments \$99.00.

AIR COMPRESSORS

Gas or electric. Awarded from government.

1/2 HP	12 gal. tank	\$ 99.00
1 HP	50 gal. tank	\$239.00
1 1/2 HP	50 gal. tank	\$265.00
2 HP	50 gal. tank	\$295.00
3 HP	60 gal. tank	\$410.00
5 HP	60 gal. tank	\$485.00
7 1/2 HP	80 gal. tank	\$675.00
10 HP	80 gal. tank	\$775.00

and other bargain items

BLOWER and MOTOR. Enclosed squirrel cage type for cooling, heating, suction or blowing. Ball-bearing Redmond Motor, 1550 RPM. Discharge 3"x3". Intake 5". Weight 9 lbs. \$11.95

WELDING ROD. Not less than 50 lbs.—50 lb. box \$4.00

HAND WINCH. Ideal for boats, trailers, etc. Ratchet operated \$8.95

BRIGGS & STRATTON Marine Model AP Gas Engine, 2 1/2 HP, NEW; Regularly priced at \$115.00. Your price \$69.00

ALL ITEMS GUARANTEED AS REPRESENTED C & H ELECTRIC Co. 434 W. JUNEAU AVE. MILWAUKEE 3, WISCONSIN

All prices F.O.B. Milwaukee. 25% deposit required on all C.O.D. orders. No C.O.D.'s under \$10.00. Use stock number when ordering. Many other bargain items not listed—write for our free circulars.

We Dare Anybody — ANYBODY — to Beat These Marlin .22s!



We're asking for it! Asking you to compare the Marlin 88-C against any—ANY—other .22 automatic. For we know the more you

compare, the more you'll realize this amazing Marlin is first in its field.

Visit your Marlin dealer. He's showing this Marlin 88-C and other Marlin .22's—the greatest in Marlin's 81 years—bolt-action, lever-action, automatic. From \$25.80*

SENSATIONAL NEW .22 AUTOMATIC

Marlin 88-C. No-jam action. Fires as fast as you can trip the trigger. Ammunition "funnels" into buttplate (15 rounds). Fires standard caliber .22 long-rifle ammunition only. Regular or high-velocity. Sear lock safety. Side ejection for low central 'scope mounting. Easy take-down.

*Prices subject to change without notice. Slightly higher west of the Rockies. Marlin guns—also single-edge and sensational new magnetized double-edge Marlin Razor Blades are available in U.S.A. and Canada.

The Name
for Game

Marlin

FINE GUNS SINCE 1870

VALUABLE COUPON—MAIL TODAY!

The Marlin Firearms Company, Dept. PM-4
New Haven, Conn.

Please send me your catalogue with full information and photo-illustrations of Marlin Guns. I understand you will also send me a pack of (please specify) . . . single or . . . new magnetized double-edge Marlin Blades. I enclose 10¢ for postage.

Name.....

Street.....

City..... Zone..... State.....

P&C Hot Forged Tools

Stay on the Job longer

Really tough jobs—in industry or at home—prove that special analysis alloy steel and scientific heat treating make P&C tools last longer. More than 300 P&C tools are easier and faster in everyday use or on special jobs. Your hardware dealer recommends P&C hot forged tools; ask him for the P&C tools you need.

Write for the new folder on P&C tools—"the BEST tools money can buy".

P&C **P&C HAND FORGED TOOL COMPANY**
PORTLAND 22, OREGON



Check or \$5 Deposit

F & F SALES

Box 446, Highland Station, Springfield, Mass., Phone 2-3313

Power Products Late Production \$60 Model #1000

GASOLINE ENGINES

- 1 H.P. "Flyweight" 18 lbs. 2-cycle Air Cooled
- NEW DEPARTURE BALL BEARINGS ON CRANKSHAFT
- WICO MAGNETO
- TILLOTSON FLOAT
- FEED CARBURETOR
- ALUMINUM CONSTRUCTION

COMPLETE

Reconditioned \$19

NEW \$29.50

F.O.B. Springfield

Make Your Own POWER LAWN MOWER
with this DRIVE CUTTER ASSEMBLY

Constructed for those who desire to build their own mower or to replace your old cutter assembly. Complete with 18" blade and double ball bearing drive, only.....

\$12.95

Add 50c to cover handling & shipping. No COD's

ATLAS EQUIPMENT CO., Dept. PM4
229 SW BLVD. KANSAS CITY, MO.

Genuine MAHOGANY Wood

Large Batch \$1.00 Postpaid. Other Usable Scrap Bargains Postpaid
Sample 25c — Price List 3c

S. R. MARKS CO., Inc., Dept. C, Montgomery 5, Ala.

SAY YOU SAW IT IN POPULAR MECHANICS

CASH IN YOUR SPARE TIME

BIG MONEY IN OWN BUSINESS
YOU CAN MAKE UP TO \$40 A DAY sharpening and setting circular saws for factories, builders, lumber yards—with NEW BELSAW COMPLETE CIRCULAR SAW SHOP. LOW COST, Sharpens 4 to 5 saws per hour, no experience needed, complete instructions. Send today for FREE Catalog.

BELSAW MACHINERY CO
3703 Field Bldg. Kansas City 2, Mo.

BUY DIRECT-BRAND NEW-UP TO 85% DISCOUNT



Portable LIGHT PLANT

PUSH BUTTON START
500-700 watts 110-120 v. - 60 cyc. A.C. Powered by a sturdy dependable, easy starting, air cooled 1 3/4 hp. gas engine. No wiring necessary, just plug in and operate. Plenty of current for most oil burners, emergency lights, freezer, radio, incubator, etc. Ideal for trailers or camping. Complete with Voltmeter and built-in winding to charge 6 v. auto batteries. Wt. 85 lbs. Fully guaranteed. Be prepared if war or storm knocks out power lines.
Reg. \$275.00 value. **\$143.50**

GIANT 2000-2500 WATT PLANT

110-120 V. 60 cyc., A.C. Absolutely the best made because its heavy windings develop up to 5000 watt overload for motor starting. Skid-mounted—portable. Powered by 5 h. p. easy starting Briggs or Wisconsin engine—complete with all accessories; engine easily disconnected for other uses. Big outlet box, voltmeter, no wiring necessary. Ample current for all purposes. Factory warranty and instructions included. Wt. 220 lbs. Reg. \$585.00. Special at. **\$299.50**
GENERATOR ONLY and control box. \$169.50
Drive it with your engine or tractor

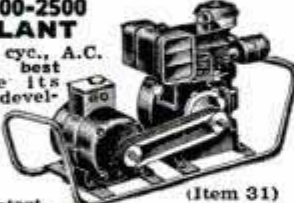

(Item 31)

EXTENSION CORD

(Item 16) 40 ft. heavy duty, made of specially insulated No. 14 2-conductor wire. So tough that you can drive over it and yet amazingly flexible and easy to handle. Resists oil, grease or water. Extends electricity up to 400 ft. without voltage drop. Use indoors or out. Complete with heavy rubber plug and outlet. Wt. 2 1/2 lbs. Usually \$4.50—Special 40 ft. **\$1.99** Comb: 2-40 ft. and 1-20 ft. (total 100 ft.) **\$4.95**



PRESSURE SWITCH

(Item 30) Penn Electric Model 110 BPO2, best made. For pumps and air compressors. Heavy duty. Will handle up to 250 lbs. press. and up to 5 h. p. Autom. unloader valve, for easy starting. 110-220 v. A.C. or D.C. 2 pole. Wt. 5 lbs. Reg. list \$17.50. Our Spec. **\$9.45.**

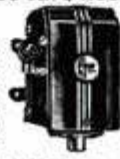

HOT WATER HEATER

(Item 26) Immersion type, heavy duty, 115v. A.C. 300w. Does not require watching. Thermostat shuts off at 165°. Keeps water hot for shaving, washing dishes, etc. Also good for keeping water from freezing in big troughs or tanks. Made by Cities Service. Wt. 4 lbs. Worth \$9.50. Our Spec. **\$4.50.**



CLIP BOARD

(Item 17) Heavy Masonite, with self-adjusting spring hinge to hold up to 100 sheets of 8 1/2 x 11 paper. Push back cover for instant release. Flip cover shut and notes or drawings are protected. Perfect for pilots, engineers, students, artists, truck drivers. Wt. 2 1/2 lbs. Usually \$2.95. Spec. **\$1.10, 2 for \$2.00.**



GAS ENGINE

(Item 25) Air-cooled. 1 1/2-2 h.p. Complete with gas filter, air cleaner, governor, fuel tank. Ready to run. Speed range 2000-3600 r.p.m. 5/8" shaft. Rope start. Ideal for pumps, air compressors, power tools, generators, etc. Factory warranty and instructions incl. One of the best made. Wt. 40 lbs. Worth \$72.50. Special. **\$46.50**



GAUGE TESTER

(Item 27) Precision made of solid bronze by Star Brass Co. Calibrated weights (incl.) act in g against hydraulic piston, provides quick accurate testing of all pressure gauges up to 3000 lbs. per sq. in. Brand new in hardwood cases. Wt. 100 lbs. Reg. \$435.00. Our Spec. **\$135.00**



HYDRAULIC HOSE

High pressure, heavy duty, complete with swivel fittings. Pipe thread connections. Ideal for farm equip., bulldozers, grease guns, airbrakes, etc. Any length. Minimum \$1 per lgh. **INSIDE DIAMETER, 1/4" 50c per ft. 3/8" 60c, 1/2" 80c, 5/8" 90c.**

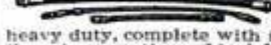

ELECTRIC HAND SAW

(Item 36) Most perfectly balanced and smoothest running saw made. Advanced design provides max. power and light weight. Easily adjusted for all angles, depth and width of cut. Comes complete with 6 1/4" comb. blade, ripping guide and 10 ft. hv. duty cord. Built-in sawdust blower. Autom. telescoping guard. 110-120 v. AC-DC. Depth of cut 2 1/8". 1 year written guar. Wt. 12 lbs. Drastically reduced. **\$39.95**



ANGLE DRILL

(Item 23) Fits into chuck of any electric or pneumatic drill or flex. shaft. Operates at any angle in a full 360° arc. Makes possible drilling, grinding, carving, routing, etc. in close cramped quarters. Makes impossible jobs easy. Made by Kett Tool Co. Complete with built-in chuck (1/4" capacity) and adjusting key. Hardened alloy gears. Precision built for heavy duty. Lists at \$39.95—while they last. **\$9.95**



CARRY-AIR

(Item 32) Stainless steel tank—capacity 500 cu. in. at 400 lbs. press. complete with inlet and shutoff valves, pres. gauge, detachable air hose, tire chuck. Fill at any service station. Carry air for tire inflation, blowing out lines, spray painting, insecticides, etc. One emergency pays back cost. Wt. 13 lbs. Worth \$20.00. Our price. **\$8.95**



SPRAY OUTFIT

(Item 37) Twin cylinder, piston type compressor direct-connected to powerful 110-120 v. AC-DC motor. Built-in air tank eliminates pulsation and provides steady flow of air at 25-30 lbs. Sprays lacquers, enamels, insecticides, etc. Does beautiful work on autos, furniture, farm equip. 1 qt. spray gun, relief valve and 10 ft. air hose incl. Full instructions and 1 year guar. Wt. 11 lbs. Easily worth \$50. Spec. **\$29.95.**



PARTS WASHER

(Item 20) Store gas or carbon tet. in 5 gal. safety can. Valve releases just the right amount into washing compartment. Parts are washed and drained on a "dunking" screen—no fishing for parts. Eliminates fire-danger, waste, spillage, evaporation. Wt. 14 lbs. Reg. \$19.50—Special. **\$5.95**



FIRE EXTINGUISHER

(Item 39) Fully charged (at 1000 lbs. P.S.I. or more) with CO2 (carbon dioxide), the proven miracle fire fighting chemical that smothers oil, gasoline and electrical fires. Play safe; keep one in your car, garage and home. Heavy ICC approved steel cylinder, valve and 3000 lb. gauge that shows available remaining pressure. REFILLABLE at nominal cost. Hose included for emergency tire inflator or air blast. Wt. 4 lbs. \$19.50 value. Special. **\$6.95**



5 GAL. STRAINER FUNNEL

(Item 28) Made of heavy galv. steel. Fine brass strainer built into neck. Perfect for straining milk, gas, diesel fuel, spray mixes, etc. Wt. 7 lbs. Worth \$5.95. Our Spec. **\$2.25, 2 for \$3.95.**



RUBBER HOSE

New genuine Neoprene Hose—outlasts ordinary rubber 3 to 1. Reinforced with super tough cotton cord plies. Flexible. Easy Flo brass couplings with standard pipe threads for quick connections, included. Pump water for irrigation, stock tanks, home, barn, fire fighting, etc. Pump Gas or Fuel Oil. Save more than 60%.
(Inside Diam.) 1 1/4" 1 1/2" 1 3/4"
Length 25 ft. 40 ft. 30 ft.
Price 9.25 14.75 14.75
If specified we will send special hose for gas or oil at same prices.



TERRIFIC VALUES!

AIR HOSE

(Item 11) 1/4" Diam. heavy duty, double braid, suitable for gas stations, spray painting, air tools, etc. 20 ft. with standard swivel couplings. Wt. 4 lbs. Reg. \$6.50 val.—only **\$2.95.** Five 20 ft. lghs. (100 ft.). Wt. 20 lbs. Only **\$13.75.**

HEATING & VENTILATING FAN

(Item 10) Easily installed in furnace pipes. Forces even heat to all rooms. Over range, removes kitchen smoke and odors. Powerful continuous duty motor, 110-120 V. A.C. Quiet, super efficient fan moves huge volume of air (400 to 600 c.f.m.) 8" Fan, wt. 5 lb. **\$6.35;** 9" Fan, wt. 6 lbs. **\$7.45;** 10" Fan, wt. 7 lb. **\$8.45;** 12" Fan, wt. 8 lbs. **\$9.45.**



1/2" DRILL

(Item 33) Deluxe model—powerful, smooth running, precision built. Handles toughest jobs. Cutler-Hammer switch, Jacobs key chuck. 110-120 v. AC-DC 300-450 rpm. Alum. alloy case for high strength and easy handling. Built-in blower assures cool operation. Cap. 1/2" in steel. 1 year written guar. Wt. 11 lbs. Should be \$65. Special. **\$34.50**



1/4" DRILL

(Item 34) Hi-power, long-life, smooth running. Alloy steel gears; built-in blower. Cutler-Hammer switch. Jacobs hammer chuck. 110-120 v. AC-DC 1000-1600 rpm. Cap. 1/4" in steel. 1 year guar. Wt. 4 lbs. Terrific value at **\$12.95.**



38 Pc. DRILL KIT

(Item 35) Includes above illus. guar. drill, buffers, polishing bonnet, sanding discs, grinding wheels, wood bits, steel bits, wire wheels, bench stand, paint mixer burrs. Complete in heavy steel case. Wt. 13 lbs. 38 pcs., all highest quality. Complete kit worth \$38.50. Our **\$19.85** Spec. only.



HEAVY DUTY ARC WELDER

(Item 38) Use as portable or shop welder. 250 amps. D.C., Senior model. Made for years of trouble-free, continuous service. Will handle light or heavy jobs. Weld up to 1/2" plate using 1/4" rods. Built-in air-cooling system. Arc is easy to strike and hold, because of specially designed arc stabilizer. Hi-lo switch and dial control gives wide range of welding heats. Run welder at 2600 rpm. with tractor, jeep or 10 hp. gas engine, or 7 hp. elec. motor. Complete with instructions, guar. and double V belt or flat pulley. Wt. 110 lbs. **\$99.75**
WELDING KIT. Two 10 ft. leads, welding helmet, electrode holder, ground clamp. Sold only with welder at. **\$8.50**

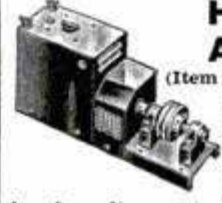

FRAM OIL FILTER

(Item 12). Model F21, Big 73 cu. in. size. Ample capacity for all cars, trucks, tractors. Universal bracket, standard openings. Fram filters are tops. Easy to install. Wt. 8 lbs. Usually \$7.95—now **\$3.75**



MANUFACTURERS SPECIALS

RHEOSTATS (Item 40) variable load, 480 v., AC or DC, arranged in 80 steps of 8 kw each to provide instant selection of any power output desired. Controlled by magnetic contactors; remote control possible. Ideal for testing setup, group starting, frequency control, variable speed, etc. Made by Cutler Hammer. Brand new. Worth \$4000. Only 2. each **\$1100**

MUD CHAINS (Item 43). Extra heavy for dual truck tires, 7.50x20, triple side links, made by Intl. Chain. Reg. list \$57.50—our spec. **\$19.50**

DUCT FANS (Item 42) Amor. Blower Co.; powerful 24" 3-bladed fan mtd. in circ. steel duct which tapers from 25" to 30" diam., 16" hi. Duct flanged for easy installation. Fan powered by 1 hp. 115 v. DC motor, 1150 rpm. Tremendous output. A \$20 Cutler Hammer starter control incl.; also big steel tool box, spare armature, bearings, brushes, etc. Easily worth \$195; a terrific value at. **\$39.50**

READY POWER GAS-ELECTRIC PLATFORM TRUCKS (Item 41) 5 ton capacity; wide, 17" hi. Platform 90" long, 40" wide. Equipped with coupler for trailers; very maneuverable; used but in exc. operating condition. Will ship on approval to well-rated firm. New price \$4000—our special. **\$1350**

MANUFACTURERS AND JOBBERS—Write us about your surplus items

All items brand new. Prices f.o.b. Chicago area. 10 day Money back guarantee. Send check or M. O. **MASTER MECHANIC MFG. CO., Dept. 40, Burlington, Wis.**

No end of uses
for the speedy
**HOME-UTILITY
SANDER-POLISHER**



ONLY
\$32.95

Use it to **POLISH YOUR CAR** ▲



Use it to **SAND
DOWN FURNITURE!**



Use it to
DRILL LEAD HOLES!



Use it for
WOOD BORING!



Use it to
SHARPEN CUTLERY!



Use it to
REMOVE RUST!

**This husky, versatile tool
drives many attachments
to save you time, money
and muscle!**

You haven't handled a really versatile tool until you've tried the Home-Utility Sander-Polisher! It comes complete with sanding discs, lambswool bonnet, 1/4" drill chuck, cans of auto polish and wax. It drives many other attachments for grinding, sharpening, buffing, burnishing and cleaning. And it weighs only 3 1/2 lbs., so it's easy for the whole family to use!

QUALITY-BUILT BY WORLD-FAMOUS BLACK & DECKER, this Sander-Polisher is a real tool, not a mere toy! It has an extra-powerful motor for high-speed work from AC or DC outlets. Its housing is strong, light die-cast aluminum. It has an instant-release trigger switch. Its balanced design means comfortable handling. Try it today at your hardware, electrical or implement dealer's or department store.

Products of HOME-UTILITY Division,
The BLACK & DECKER Mfg. Co.,
Dept. H4M, Towson 4, Maryland

**ELECTRIC
HOME-UTILITY
TOOLS**

1/4"-1/2" DRILLS • SANDER-POLISHERS
LECTRO-SAWS • BENCH GRINDERS



The Right Tool for
a Right Job
**IN YOUR WORKSHOP
EMPIRE LEVELS**



Get more value
for less money! Make
Your Choice an Empire Level

No. 151 Aluminum Level. Extremely accurate with adjustable-interchangeable vials. Has 2 levels, 2 plumbs, and a choice of 2 45° vials or 2 additional plumbs. Beautifully finished, easy to work with. A tool you can be proud to own.

18" ... \$6.40 24" ... \$6.80 28" ... \$7.80

Order EMPIRE Levels from your local dealer,
or write for complete information.



**EMPIRE LEVEL
MFG. COMPANY**

Dept. PM

10930 W. Potter Rd., Milwaukee 13, Wis.

ALL NEW 1951 KING MIDGET AUTO

World's Lowest Priced 2 Passenger Car

Drive it for 75c per week. Amazing performance. Surprising comfort. All steel construction. Full accessories, top and heater. Ready to run or assemble it with our bolt together parts. Rider agents wanted, earn your car free. Send 25c for detailed literature or \$1 (refunded first order) for actual assembly book and service manual filled with photos, drawings, specifications, etc.



**MIDGET MOTORS MFG. CO.,
ATHENS 1, OHIO**



DUST-O-VAC FOR ALL MACHINES

For Home Workshops & Industry. DUST-O-VAC collects & bags wood & plastic chips, wood & metal dust, wood shavings. Free Bag. Attaches to circular saw, planer, band saw, grinder, belt or disc sander, shaper, drill press with shaper or sander attachment, spindle shaper, wood lathe, jig saw. 110 A.C., D.C. Send for mounting instr. for all machines.

**\$19.95
F.O.B.
Yonkers**

HEAVY CAST ALUMINUM BLOWER — ONLY \$11.25
For workshop, lab., kitchen, cellar, app. 100 CFM. Send for circular.
UNIVERSAL YONKERS CORP., 137 Alexander St., M-4, Yonkers 2, N. Y.

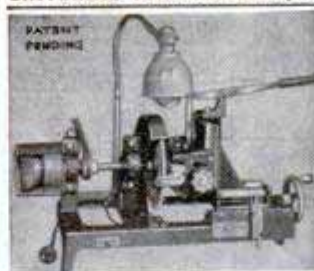

Start a NEW BUSINESS!

or Add to your present
Repair Business

SHARPEN DULL PIPE WRENCHES

**PIPE TAPS & DIES
"GUM" CIRCULAR SAWS**

Write for Information

**J. C. MOORE INDUSTRIES
BOX M 276 FREDONIA, PA.**

ASSEMBLE YOUR OWN MOWER

**\$79.95
F.O.B. WICHITA**

SAVE 40%
INCLUDES NEW 1 1/2-2 HP
VERTICAL ENGINE AND ALL PARTS

CAST ALUMINUM BASE

This is a modernized streamlined and nicely finished product. Two-tone baked enamel. Full 20" cut, hardened steel, one-piece cutting blade with safety clutch. Ball bearing, large size rubber-tired wheels.

CUTS TALL GRASS

will mow to carpet smoothness tall coarse grass, cuts close to fence.

OVER 12,000 SATISFIED USERS

Price Complete Satisfaction
\$79.95 Guaranteed

Cash With Order or Money Refunded
**NEFF EQUIPMENT CO.
510 PETROLEUM BLDG., WICHITA, KAN.**



**"MISTER,
YOU SAVED
MY DAY!"**



"MY SCHEDULE'S TIGHTER THAN EVER THESE DAYS," I TOLD THE MECHANIC, "AND THANKS TO YOU, I'M KEEPING RIGHT ON TIME."

"DON'T THANK ME," HE SAID. "THANK THE GENUINE FORD PARTS I USED IN YOUR FORD. THEY'RE THE REAL TIME SAVER."

"YOU SEE, GENUINE FORD PARTS ARE RIGHT FOR FORDS — MADE RIGHT TO FIT RIGHT TO LAST LONGER. THEY KEEP YOUR FORD ALL FORD."

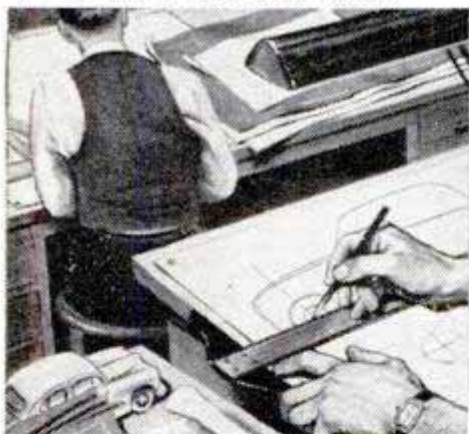

"THEY'RE DESIGNED BY MEN WHO DESIGNED YOUR FORD, TO SAVE YOU TIME, MONEY AND ASSURE REAL SATISFACTION."

**"THAT'S WHY YOU'RE SMART TO
LOOK FOR THIS SIGN (AT FORD
DEALERS' AND SELECTED
INDEPENDENT GARAGES)
AND ALWAYS SPECIFY
GENUINE
FORD PARTS"**

AVAILABLE WHEREVER YOU SEE THIS SIGN AT ALL FORD DEALERS AND SELECTED INDEPENDENT GARAGES



**THEY KEEP
YOUR FORD
ALL FORD!**

SURPLUS MACHINE SHOP TOOLS AT PRICES YOU CAN AFFORD

HIGH SPEED MORSE TAPER SHANK DRILLS

SET 20 Different Size High Speed Morse Taper Shank Drills from 1/4" to 1". \$70 Value. Priced at only..... **\$12.95**

SET 10 Different Size High Speed Morse Taper Shank Drills from 1/2" to 1 1/4". \$50 Value. Priced at only..... **\$9.95**

SET 7 Different Size High Speed Morse Taper Shank Drills from 1" to 2", with No. 3, 4, and 5 tapers. At least 3 drills over 1 1/2" in size. \$125 Value, only..... **\$29.95**

High Speed Taper Shank Chucking Reamers

SET 15 Different Size High Speed Morse Taper Shank Chucking Reamers up to 1/2" with No. 1 and 2 tapers. Priced at only..... **\$6.95**

SET 8 Different Size High Speed Morse Taper Shank Chucking Reamers from 1/4" to 1". Priced at only..... **\$4.95**

SET 10 Different Size High Speed Morse Taper Shank Chucking Reamers from 1/2" to 1 1/4". \$65.00 value. Priced at only..... **\$9.95**

SLITTING SAWS

SET 7 Different Size High Speed Slitting Saws 2 3/4" dia. x 1" arbor. Thickness from .040 to .071. Cuts wood, aluminum, brass, steel, etc. \$25 Value. Priced at only..... **\$4.95**

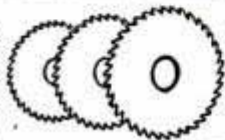

SET 1 TAP HANDLE No. 6 (5/32" to 3/4" Cap.) Only..... **\$3.19**

Discounts on Quantity

HIGH SPEED HAND TAPS

SET 8 Different Size High Speed Standard Thread Hand Taps up to 3/4". Including 2 std. High Speed Pipe Taps..... **\$2.95**

SET 10 Different Size Hand Reamers from 1/4" to 1". Majority brand new, only..... **\$7.95**

SET 20 Different Size Hand Reamers as above, 10M only..... **\$13.95**

BRAND NEW HIGH SPEED COMBINATION DRILL AND COUNTERSINKS

SET 8 Different Size from C2 to M1 (1/16 drill x 13/64 body to 7/32 drill x 11M 5/8 body), 60 degree of Countersink. These New Countersinks Sell New from 75c to \$2.50 each. Your price for this set of 8, while they last, only..... **\$3.95**

SET Mixture of 12M Mounted Stones with 3/4" Shanks Only..... **\$2.75**

Money-Back Guarantee—All Mide. Mixture of New and Reconditioned Tools Unless Specified Brand New—All Orders (Except Those Specified F.O.B. Tulsa) Are Shipped Post Paid, saving you up to 25% on total delivered cost.

Write for Free Catalog Describing Thousands of Bargain Cutting Tools.

BRAND NEW CUT OFF WHEELS

SET 1/2" Arbor—Can be Reamed to Larger Size. Set of 4 - 5" x 1/8" Norton 60 grit, Only... **\$1.95**

SET 8, Same as above, 14M Only..... **\$3.25**

SET Set of Four 8 x 1/8 x 1/2" or 5/8" arbor Cut Off Wheels, only..... **\$2.85**

SET Set of 10, 16M Same as above..... **\$5.98**

BRAND NEW PESCO PUMP

Complete with Mounting Bracket

Pump is gear type with built-in relief valve, 3/4" pipe ports; rated at 3 GPM, 3750 RPM and 1000 PSI. Requires 1/3 to 1/6 H.P. to drive directly or by pulley. Plus MOUNTING KIT made of 3/8" heavy steel, with 5/8" ball-bearing mounted shaft designed for maximum utility. Pump and bracket complete, only..... **\$12.95**



BRAND NEW REX HIGH SPEED TOOL STEEL BITS

1/4 x 1/4 x 3"	10 pcs.	\$2.25
1/2 x 1/2 x 4"	4 pcs.	\$1.95
3/4 x 3/4 x 4 7/8"	2 pcs.	\$2.49
7/8 x 7/8 x 5 7/8"	1 pc.	\$1.95

CUT OFF BLADES

1/4 x 3/4 x 6	\$1.25 ea.
1/8 x 7/8 x 8	\$1.25 ea.
3/16 x 1 x 8	\$1.49 ea.
3/16 x 1 1/8 x 8	\$1.65 ea.
1/4 x 1 1/4 x 10	\$1.75 ea.

T & T TOOL 221 W. SECOND TULSA, OKLA.

NU-WAY HEAVY DUTY CUTTING UNIT with Timken Roller Bearings

PRICE **\$16.50**

WHY PAY MORE



Build your own rotary type lawn or weed cutter. Take the hard work out of weed cutting. Build yourself an up-to-date weed and lawn mower with the Nu-Way heavy duty unit.

Write for Free Circular—We Supply Cutting Unit Complete
TRACTOR-LITE MFG. CO., Spirit Lake, Iowa

NO PRICE RISE ON SCARCE ITEMS! Send for this CATALOG TODAY!
WAR SURPLUS BARGAINS

Probably your last chance to buy SCARCE WAR SURPLUS at these low, low prices! Terrific savings for Sportsmen—Farm & Home. The greatest stock of gov't Surplus in America.

Send 10c for Your Catalog Today!

FISLER SALES CO. DEPT. M-1, 723 WALNUT STREET KANSAS CITY, MISSOURI

WOODWORKING VISE for amateurs and professionals
USE UPRIGHT - FLAT - AT ANY ANGLE
MAIL CARD FOR FREE FOLDER TODAY
THE WILL-BURT CO., Dept. PM-6, 202 S. Main, Orrville, O.

POWER MOWERS & KITS FREE PLANS

Build your own quality mower with our LOW COST KITS, Parts, Engines. Free Plans guide you. 3 and 4 Wheel Kits, complete. Parts precision finished, ready to use. Write TODAY for Free Plans, Low Prices, Parts List and Guarantee.

3-WHEEL KIT NO. T-800

America's Finest Power Mowers completely assembled in 3 and 4 wheel models. Belt or direct drive. 18" and 20" sizes. Nationally known make engine optional. Latest improved features, sturdy construction and money back guarantee fully described in color folder. Write today.

TRIANGLE MANUFACTURING CO., Dept. M-5, Fort Scott, Kansas

FINE TOOLS NEED FINE OIL!

• Lubricates • Prevents Rust • Cleans • Polishes

SOLD EVERYWHERE

3-IN-ONE Oil

The Most Practical Watch in the World!



HANDSOMELY STYLED **17 JEWELS!**

WRIST ALARM

IMPORTED SWISS MOVEMENT with LUMINOUS DIAL

19.95
PLUS 10% TAX

WITH METAL EXPANSION BAND OR LEATHER STRAP
Never before available at less than \$71.50



ALARM ON-OFF SWITCH
FINGER-TIP CONTROL



REMINDS YOU OF APPOINTMENTS



AWAKENS YOU ON TIME



AMAZES & SURPRISES YOUR FRIENDS

The ideal business man's watch that serves double-duty at office or home. A guaranteed accurate fine timepiece that becomes a precision ALARM Watch when you set the dial for it. Merely set the alarm indicator to ring at the time you want—that's all—no complicated extras. This exclusive Gaylord Wrist Alarm features thin, smart chrome and stainless steel case; red sweep-second hand; choice of black or white face; single winding principle for both alarm bell and watch spring; leather or metal expansion band. It's neat, smart, wonderfully-convenient—handy just when you need its help, will be a great convenience to any man in ANY work.

INCREDIBLE ACCURACY

Guaranteed
FOR ONE YEAR

Precision movement in the best Swiss craftsmanship; moisture and shock resistant; time-tested; alarm bell integral with movement.



GAYLORD

Dep't. PD-2 Fifth & Hamilton, Pittsburgh 6, Pa.

Please send me.....Wrist Alarm Watches @ 19.95 + 10% Tax (2.00) with Black Dial; White Dial; Wristband in Metal or Leather. I enclose Check, Money Order, Send COD. **Money-Back Guarantee!** PRINT NAME & ADDRESS IN MARGIN

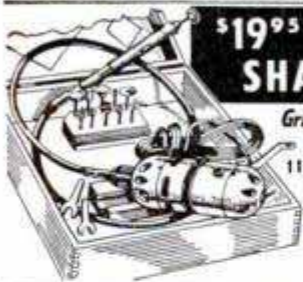

'1995 FAIRCHILD FLEXIBLE SHAFT TOOL & MOTOR

Grinds! Sands! Polishes!
Buffs! Drills! Carves!
110-120 Volt AC-DC motor;
10 tools, accessories, wood case. For wood, metals, glass, plastic. Mounts on wall or bench. Send check or M.O.

12.95

PUBLIC SPORTS SHOPS
11 S. 16TH ST., PHILADELPHIA 2, PA.

SAY YOU SAW IT IN POPULAR MECHANICS



BINOCULARS TELESCOPES

Big Bargain Catalog Free

BROWSCOPE CO.
Dept. 4M
24 WEST 45TH ST.
NEW YORK 19, N. Y.

7x50
\$36
Illustrated

BATTERIES!—START

—a factory at home and re-cast junk batteries into new; latest achievement. We supply complete instructions and everything needed. Big Profits!



BATTERY LABORATORIES, Dept. PM, Minneapolis 4, Minn.

AUTOMATIC RETOOTHER

MAKES NEW PROFITS

for HAND SAWS

Cuts new teeth in 50 seconds—any size 4 to 16 points. Old teeth fall off as chips. Easy to operate. A perfect job.

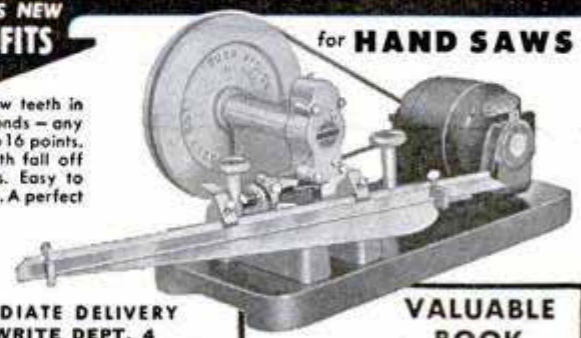

IMMEDIATE DELIVERY
WRITE DEPT. 4
BURR MFG. CO.
8933 VENICE BLVD.
LOS ANGELES 34, CALIFORNIA

VALUABLE BOOK

25¢

Order Burr's Blue Book of Coast to Coast prices for saw shop services

IDEAL SAW FOR Big Summer Savings!

40th YEAR
Atlas
8"
**TILT/ARBOR
SAW**



Make home repairs . . . build useful furniture, cabinets, cupboards, garages, tool houses, fences, porches, recreation or attic rooms, screens.

GET YOUR *Atlas* SAW
NOW WHILE YOU CAN

Take it from men who know! There's no end to the savings you can make during the summer with an Atlas 8" saw. It's so easy to use, so fast, so accurate . . . a cinch to turn out "factory quality" work on any project you try. Everything you want in a saw is built into the Atlas. It's exceptionally rugged. It has the capacity for construction work, yet is so precisely made you can use it for the finest cabinet work. But a word to the wise. Get your Atlas saw *now* — before they become any scarcer. See your Atlas dealer today — or send for catalog.



FREE CATALOG—WRITE

Please send your latest catalog showing the 8" saw and other woodworking tools.

Name _____

Address _____

City, State _____

ATLAS PRESS CO.

443 N. Pitcher St. • Kalamazoo, Michigan

SAY YOU SAW IT IN POPULAR MECHANICS

AMAZING TOOL BARGAINS!

ALL BRAND NEW MERCHANDISE

2 CIRCULAR SAWS \$1.50
ON 2 MANDRELS—
ALL AT ONE LOW PRICE
1" diameter saws on 1/8" Mandrels. For cutting wood, plastic, or soft metals. Order at once! Send Check or Money Order.
Post Paid in U.S.A.

12 MINIATURE CUTTERS \$1.00
FOR CUTTING WOOD, PLASTIC, or METAL
POST-PAID IN U.S.A.
Actual size. Ass't. shapes on 3/32" shank. For die makers, home workshop, etc.

2 DRUM SANDERS \$1.50
With 12 Bands in Assorted Grits. 1/2" dia. x 1" long on 1/8" arbor with 12 bands.
P.P. in U.S.A.
ONE DRUM, 1" DIA. x 1" LONG ON 1/4" ARBOR WITH 6 EXTRA SLEEVES \$1.00
P.P. in U.S.A.

12 MOUNTED WHEELS and points on 1/8" Mandrel. For grinding on plastic, wood, soft and hard metals. Regular \$8.40 List Val. ONLY \$2.95

SCHUPACK SUPPLY CO., 7331 Cottage Grove, Dept. M-17, Chicago 19, Ill.

STOP GENERATOR REGULATOR BATTERY TROUBLE
WITH THE AMAZING NEW INVENTION
THE WATTAGE REGULATOR
THE GREATEST NEW DEVELOPMENT IN AUTO IGNITION SINCE THE SELF STARTER
YOU CAN DRIVE WITHOUT BATTERY
It's Thermo-Automatic for Better All-Weather Performance
Guaranteed 100,000 Miles or One Year
SCIENTIFIC ELECTRIC CO. P. O. BOX 2162-0 STA. H CLEVELAND 8, OHIO

B-M POWER MOWERS

CUT HOURS OF WORK into MINUTES of PLEASURE!

Prompt Shipment
★
Low Factory Prices
★
Fully Guaranteed
★
Model D-3

For a quick, slick job and a smooth-as-velvet lawn, you can't beat a B-M Power Mower. Three Models of fine rotary mowers available for your special cutting needs. The D-3 (pictured here), the self-propelled P.D. models, or our light VD-1 Mower with vertical shaft engine and direct blade drive. Quick starting, dependable 1 1/2 to 3 h.p. Clinton engines. Safety features. Easy adjustments. Low factory-to-you Price. Write for **FREE LITERATURE.**

B-M MOWER CO., Box 66-PM, Blue Mound, Kansas

CALENDAR WATCH

CHRONOGRAPH & STOP WATCH \$8.95 + 10% TAX
31-Day Automatic Calendar
A precision timepiece and chronograph at an unusual low price. Imported Swiss jeweled movement, Radium Glow 1" dial, red sweep-second hand, shock resistant case, metal expansion wristband. 1 Year Guarantee, 5-day Free Trial. Choice of white, black dial.

Fully Guaranteed

GAYLORD DEPT. PD-7, Fifth & Hamilton, Pittsburgh 6, Pa.

Send.....Watches @ 8.95 + 90¢ tax. Enclose Check, Money Order, Send C.O.D. Print name, address & dial check in margin.

BUILD YOUR OWN ARC WELDER OR LIGHT PLANT

JACK & HEINTZ R-1 D-C GENERATOR

Save \$250 to \$500

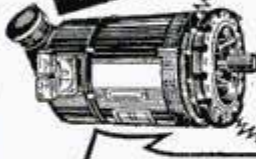

Only **\$25.50**
Instructions included
rated 300 Amps-30 Volts
Ship. wt. approx. 70 lbs.
PRICE F. O. B. K. C. MO.

CONVERTS TO ARC WELDER 300 AMPS; 350 AMPS. OR LIGHT PLANT CAP. LOAD OVER 7500 WATTS

Stock No. 517—D C Generator P-1 Delco 200 amp 28 Volt. Gov't. cost \$300.00. Instructions for converting to welder or light plant included. Wt. approx. 70 lbs. **\$15.95**

CARBON PILE GENERATOR VOLTAGE REGULATOR
For use with 24 or 32 Volt D. C. Generators. Also recommended for the P-1 and R-1 type generators in "build your own" Light plant. Complete with mounting base. Only **\$6.50**

DYNAMOTORS Brand New Type DA-3A. Input 28 V. DC 10.5 amps. Output 300 Volts, 150 volts or 14.5 Volts. R.P.M. 4700 Continuous **\$5.50** f.o.b. KC

WEAVERS HYDRAULIC HAND PUMP BRAND NEW. For hydraulic Jacks, presses, hoists, etc. For operating hydraulic cylinders to pump oil or hydraulic fluid under pressure. Has built in check valve, and is capable of delivering 1000 lbs. pressure. Wt. 10 1/2 lbs. A \$50.00 value. **\$8.95** Postage Instructions incl. Price... Paid

Valuable Gears — Borgains — Speed Reducers 10-1 or 5-1 ratio, 90 degree angle. Shaft driven 1/2" spline shaft with 3 mounting holes 5/16". Gears held in forged and machined aluminum housing with two needle bearings, one bronze bearing, and three high speed shielded bearings. Sealed self lubricating chamber. Price... **\$5.50** (Plus 35c postage)

New Amplidyne Motor Generator #SAN31N718A—Use as 24/32 Volt D.C. motor, pulls 1/2 H.P. or 0/60 V. D.C. Can be adapted to 110 V. A.C./D.C. 10,000 R.P.M. 1/2 H.P. by simple changes in connections. This unit can be adapted to independent and rural lighting, power, etc. Instructions incl. (Stock #790). Gov't cost \$140.00. **\$7.50** Wt. 30 lbs. Only

SENSATIONAL SELSYNS Two or more connected together, work perfectly on 110 V. A.C. For weather vanes, rotating directional antennas or controlling distance operations. Complete with diagram and instructions. Wt. 3 1/2 lbs. PER PAIR **\$6.50** Postage paid

Pesco Four Vane Rotary Positive Displacement Large Volume Pump Including built in relief and bypass valve. Capacity 400 G.P.H. 1/2" drive spline shaft, 3/4" pipe inlet and outlets. Rotates either direction or in any position. Ideal for gasoline, oils and various types of sprayers. Engineering data incl. (Stock #600) only **\$7.95** Post-paid

Brand New PUROLATOR GASOLINE FILTER For all cars, trucks, tractors or boats. Permanent type. **\$4.95** Post-paid Data incl.

CUNO OIL FILTER — Brand New Aircraft type. Filters oil without cartridge replacements. Just turn handle and cartridge is clean. Standard 3/4" inlet and outlet ports to accommodate 12 gallons per minute. STOP CHANGING OIL. Instructions **\$4.95** Post-paid

ELECTRIC MOTOR 1/2 H.P. 27 V. D.C. R.P.M. 4000 No. 750. For intermittent or Continuous Duty. **3/8" SHAFT VARIABLE SPEED MOTOR CAN BE ADAPTED TO 110 V. A.C. OR R.E.A. line by simple arranging armature brush leads. UNUSED.**

Instructions incl. **\$5.95**

ELECTRIC MOTOR 1/2 H.P. 24 Volt D.C. R.P.M. 2500. Amp. 22 #HCA24. Gov't cost \$75.00. Brand New. \$5.50

ELECTRIC MOTOR 1/4 H.P. 28 Volt D.C. R.P.M. 4000 #2832 with simple instructions to convert to 28-32 Volt A.C. Gov't cost \$82.84. Brand New. **\$4.95**

ELECTRIC MOTOR 6 Volt D.C. Delco — New Handles 6" fan blade. Use as windshield wiper motor, hot water car heater motor, commercial or toy applications. 1/4" Dia. 1 1/8" long shaft. Size 5" long X 3". 2 mounting studs. 1200-2000 **\$2.35** (plus 35c R.P.M. NEW Only postage)

SOLA CONSTANT VOLTAGE REGULATOR Pkt. 95-125 Volt—Sec. Output 115 V.—2000 V.A. Wt. 250 lbs. Gov't cost \$369.00. Close out price **\$75.00** f.o.b. KC.

BRAND NEW KIDDE HY-PRESSURE CYLINDER Valve and safety locking pin. Applicable as tire inflator, fire extinguisher, spray painting, life raft, etc. Shatterproof. Size 12" x 2 3/4". Wt. 3 lbs. **\$2.95** (plus 35c postage) Now only

Brand New Wonderful ROTATOR MOTOR For rotating Ham, FM Antennas, Turntables, Telescopes, etc. Applicable for 110 V. A.C. 60 cycles or for 24 V. D.C. as reversible motor. Approx. 7 R.P.M. Free Swing, Reversible, Light Weight, Rugged, quiet. Motor & Gears oil sealed, including 3 mounting lugs on motor. Simple instructions & diagram incl. Wt. approx 3 1/2 lbs. Stock No. 572. **\$7.95** Post-paid Now Only

ECLIPSE MOTOR & GEAR UNIT Brand New. This is a 24 V. D.C. motor with built in planetary and bevel gear reduction. Has 1- horizontal and 1- vertical take off shaft. Overall gear ratio to motor is 40-1. Can be adapted for 2-1 or 20-1 ratio. Unit can be operated from 32 D.C. Farm light plant. Ideal as OVERHEAD GARAGE DOOR OPERATOR, DRIVE FOR SMALL HOIST, WELL PUMP JACK, LAWN MOWER DRIVE, DRIVE FOR POST DRILL, etc. Wt. 23 lbs. Gov't. cost \$221.00. (Instructions incl.) Only **\$9.95**

ROMEK WOBBLE PUMP Hand lever operated. Ideal for camp, farm, ranch, for fuel transfer to boat, etc. **\$8.50** Post-paid New

Pesco Vacuum Air—General Purpose Pump Here is a pump for air, fluid, pressure or vacuum. Standard 1/2" pipe thread. Delivers 300 G.P.H. at 2000 R.P.M. Runs forward or reverse. Self aligning shaft. Spline terminal for direct drive, readily replaced with a pulley. Use them for oil burners, MILKING MACHINES, COMBINES, SORS, VACUUM PUMP, etc. Engineering report and instructions incl. Now only **\$9.95** Postage Paid

Adel Self-Priming ELECTRIC PUMP For pumping light oils, oil burners, fluid metering, fuel pump, tool post grinder, coolant, pressure lubricating pump, etc. Double ball bearing series wound motor, continuous duty, 1/30 H.P. rated 12000 R.P.M. Applicable for 24 V. D.C./A.C. or use on 110 Volt A.C. Size 6 3/4"x3 1/2"x3 1/4". rated 3 G.P.H. Remove pump and use motor as high speed grinder, etc. Diagram and instructions incl. **\$9.95** Post-paid Only

Pesco Centrifugal Heavy Duty Electric Pump With built in 1/4 H.P. MOTOR included. BRAND NEW COMPLETE. Self contained. Explosion proof. Ideal for pumping gasoline, Oils, Water and non-corrosive liquids. Applicable for 24 V. D.C./A.C. or on 110 Volts A.C. The Discharge is for 3/4" hose connection. Capacity 400 G.P.H. Use them for Cottages, Basements, Laboratories, Boats, etc. Here's your Greatest PUMP VALUE IN YEARS. Engineering data and instructions incl. **\$85.00** value. Stock #659 **\$12.95** P.O.B. Only. K.C.

All items Guaranteed as represented. Send check or Money Order. Prices f.o.b. K. C. except when marked postpaid U.S.A. only

Stratopower Constant Displacement HEAVY DUTY PUMP
For operating Hydraulic cylinders, bulldozers, Construction machinery, Lift trucks, For fuel or oil transfer. Industrial applications, etc. Delivers up to 400 G.P.H. at 3750 R.P.M. Rated 1250 to 1400 P.S.I. 3750 to 4500 R.P.M. HAS BUILT IN RELIEF AT HEAD. Rotation either direction without adjustment. Can be used as hydraulic motor. \$85.00 value. Engineering data & instructions incl. **\$17.50** Stock #37. Wt. 8 lbs.

ELECTRIC HYDRAULIC PRESSURE SWITCH— Brand new—acts as Shutoff-Turnon, safety on load limit device. For all Hydraul. Pos. Systems. Stock #73—only. **\$4.95** paid

AIR OR OIL HYDRAULIC CYLINDERS
Stock No. 27 Cylinder, Air operated. Bore 2 1/2", Shaft 2 1/4" Stroke 6", one way Stroke. Can be used as snubber or Brake. Length 15". Wt. 11 lbs. **\$7.50** f.o.b. Now. K.C., Mo.
Stock No. 11 Double Action 1 1/2" Bore, 6" Stroke, 5/8" Dia. Shaft, Clevis mounting base and shaft end. Capacity 1160 lbs. with 1000 P.S.I. input. Has a capacity of 1625 lbs. with our STRATOPOWER 1400 P.S.I. A \$50.00 value. **\$8.95** Postpaid Only

Stock No. 12 Hydraulic Cylinder Double Action output 12560 lbs. with 1000 P.S.I. input. Gives 17584 lbs. with our STRATOPOWER PUMP 1400 P.S.I. or will produce 34168 lbs. with 3000 line pressure. Can also be operated on low pressure system. 4" Bore, 8 3/4" Stroke. 1-5/16" shaft, clevis mounting. **\$22.50** O. Gov't. cost \$300.00

Pesco Hydraulic Flow Equalizer & Pressure Balancer Valve. Brand New. Guarantees equal flow and equal pressure for Two cylinders or Two systems. Capacity 360 G.P.H. 1500 P.S.I. Data & instructions incl. A **\$75.00** value. Stock 1-D-397 only **\$14.50** postpaid

Brand New Hydraulic CONTROL VALVES Four way control for use with two hydraulic double action cylinders. Each cylinder may be operated independently of the other or in conjunction with the other. Oil may be locked in any of the cylinders to hold the piston at any required position. Brand New. **\$60.00** **\$8.95** Post-paid. Stock #620. Only

ADEL PRECISION #10086 Brand New. For controlling 2 single action cylinders or one double action cylinder. When pressure is applied to one cylinder the return to the opposite cylinder is opened. Has quadrant for locking in either position. A tremendous bargain **\$8.95** Post-only

ADEL PRECISION #2799 Large Volume hydraulic control and pressure relief valve, 3/4" ports, spring loaded. Range 1250 P.S.I. adjustable up to 3000 P.S.I. **\$5.50** Postpaid Brand New

ADEL PRECISION VALVE #10335. Brand New. This is for a double end cylinder control or for two cylinders that are to work in opposition to each other. Now only **\$5.50**

Hydraulic Accumulators — Bendix Ball Type Dia. 5 1/2". Built to stand 2000 P.S.I. Stock #A-65. Wt. 4 lbs. only **\$5.50**
BENDIX ACCUMULATOR. Ball Type. Dia. 10". Built to stand 2000 P.S.I. Wt. 15 lbs. Stock #A-85, Only. **\$15.50**

VICKERS CONSTANT DISPLACEMENT HIGH PRESSURE PUMP Use it for any type liquid pumping job. 375 gal. per hr. at 3750 R.P.M. 1000 pounds pressure per sq. in. Can be used as hydraulic motor. O. Acq. \$100.00. Brand new directions **\$9.95** post-incl. Wt. 7 lbs.

VICKERS HYDRAULIC PUMP 400 G.P.H. 3750 R.P.M. 1000 PSI **\$12.50** post-Brand New

VICKERS UNLOADING VALVE Brand New—By passes full amount output of the pump while the cylinder is not in operation. Takes starting load off of electric motor driving the pump. 1/2" AC TUBE PORTS **\$8.50** Post-(3/4"-18) thread. Price



Made
\$900
IN SPARE TIME

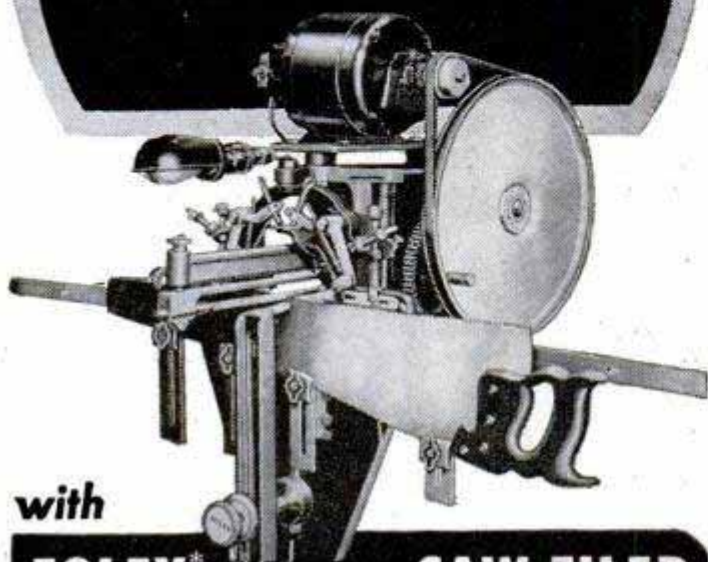

with

FOLEY* automatic SAW FILER

*Trade Mark Reg. U. S. Pat. Off.

"I did very well last year with my Foley equipment, about 950 saws and 240 lawn mowers, in my spare time. About \$900 for me." Leo H. Mix. Len Crego says: "I have done 4 or 5 thousand saws in my spare time in the 4½ years since I got the outfit, and they are all coming back."

Make up to \$2 or \$3 an hour in Spare Time. With the high prices of food, clothing and everything else, just think what you could do with extra money every week! With a Foley Automatic Saw Filer you can file hand, band and circular saws better than the most expert hand filer. "The first saw I sharpened with my Foley Filer came out 100%"—writes Clarence E. Parsons. Every saw you sharpen with the machine accuracy of the Foley Saw Filer is an ad that brings you more customers. Cash business, no canvassing. No eyestrain, no experience needed.

FREE BOOK

INDEPENDENCE AFTER 40!

Shows just how you can start at home in spare time in your basement or garage. Just think—with a small investment, no overhead, no stock of goods to carry, you can get right into a cash business—and later on develop into a full-time repair shop. Send coupon today. No salesman will call.



Send Coupon for FREE BOOK

FOLEY MFG. CO., 416-1 Foley Bldg., Minneapolis 18, Minn.
Send FREE BOOK—"Independence After 40."

Name _____

Address _____

SAY YOU SAW IT IN POPULAR MECHANICS

Stucco Spraying Can Be Your Opportunity



You can build a profitable, lifetime business with Colorcrete. Large waiting market. Work is easy and interesting. Moderate investment; high return. Large waiting market. Full instructions and liberal co-operation.

Sprayed-On Beauty

Colorcrete is modern beauty treatment for masonry surfaces—exterior and interior. Fuses to concrete, stucco, etc. Applied by air pressure. Range of many smart colors. Proven by 20 years of use on all kinds of buildings.

Write or wire for Opportunity Book.

COLORCRETE INDUSTRIES, INC.

570 Ottawa Ave.,
Holland, Mich.



VARIABLE SPEED

HYDRAULIC POWER TRANSMISSION



It has Infinite Speeds 0 to 550. Reverse, Automatic Overload Protection; Adjustable Torque up to 180 inch pounds. 5/8" Input and Output Shafts. It will handle 1/4 to 1 1/2 H.P. Motor. Case measures 7 1/2" long 7" high 6 1/2" wide. VALUE OVER \$300. Shipping Wt. 25#. On C.O.D. Orders we require a 10% only Deposit. **\$54.50** Fob. Chicago

DIRZIUS MACHINE SHOP "A" 1423-25 So. 52nd Ave., Cicero 50, Ill.

WOOD AND METAL WORKERS!

CASTON SURFACE CLAMP

\$200
Pst.
Pd.



Spot this removable, three-inch surface clamp anywhere on any bench or metal surface. Holds work in place for sawing, drilling, or any operation. Slides on or off without tools. No obstruction on bench. Firm, rugged. Send two dollars for clamp and instructions, post paid. Money-back guarantee.

HENRY CASTON

788 YALE ST., AKRON, O.

DO MORE PLANING JOBS WITH LOW-COST BELSAW \$21500

AMAZING 12¼-IN. PLANER Does All Ordinary Planing Mill Jobs. Provides attachments for Jointing, Rabbeting, Tongue, Groove, Matching. 12¼ x 6-in. capacity, 3-knife solid round all-steel cutterhead. Power feeds at 24 feet per minute, 42 cuts per inch. Provides for full line of accessory attachments—Grind and Joint knives IN THE CUTTERHEAD WITHOUT REMOVING.

BELSAW MACHINERY CO.
1018 Field Bldg., 315 Westport Rd., Kansas City 2, Mo.

Easy and Cheap to Operate

SAVE TIME, WORK, MONEY!

SHAW DU-ALL

and "PEPPY PAL" TRACTORS

PLOW These rugged walking or riding tractors are ideal for farm, truck garden, orchard, poultry farm. Operate on a few cents an hour. A child can handle them.

CULTIVATE DO DOZENS OF JOBS Both riding and walking tractors quickly and easily plow, cultivate, harrow, disc, bulldoze, spray, haul, grind, saw wood, etc.

LOW FACTORY PRICES Buy direct or through your dealer. A year's guaranteed!

RIDING TRACTORS Four models from 5 to 12 H. P., 58 in. wheelbase, 36 to 52 in. wide, 24 in. plant clearance. Hand or electric starter. Walking Tractors 1¼ to 5 H. P.

FREE Illustrated folders giving complete details, price lists—write today.

SHAW MFG. CO.
4504 Front St., Galesburg, Kans.
668-G North 4th St., Columbus, O.

- Fell Trees
- Saw Wood
- Cut Weeds
- Cultivate
- Plow • Seed
- Snow-Plow
- Rake • Disc
- Bulldoze
- Harrow, etc.

POPULAR MECHANICS

Look AHEAD...be AHEAD...



MAN A

Martin "75"

WITH

SYNCROTWIST CONTROL

FACE FORWARD
WHILE YOU
CONTROL SPEED
AND DIRECTION!



"Go '75'!"

... with one of the 8 great MARTIN MOTORS for '51! Precision-built, "Performance-Tested" by expert craftsmen, MARTIN offers incomparable power, speed and maneuverability! EXCLUSIVE features put control of speed and direction RIGHT IN THE PALM OF YOUR HAND!

ONLY MARTIN GIVES YOU: ✓ "SYNCROTWIST" ✓ "TWIST-SHIFT" ✓ "AQUAMATIC CONTROLS" ✓ Mechanically-controlled intake poppet valves ✓ Vertical stern adjustment ✓ Full 360-degree steering ✓ Improved carburetion and cooling systems, and many others!

FREE! Complete, illustrated booklet with descriptions of The 8 Great Martin Motors for 1951. Sent on request. Write: Martin Motors: Dept. 5131, Eau Claire, Wisconsin

8 GREAT MARTIN MOTORS:

- MARTIN "200" with full "Twist-Shift" 17 H.P.
- MARTIN "200" Hi-speed "P-T" 17 H.P.
- MARTIN "100" with neutral "Twist-Shift" 10 H.P.
- MARTIN "100" with "Aquamatic Control" 10 H.P.
- MARTIN "75" with neutral "Twist-Shift" 7.5 H.P.
- MARTIN "75" with "Synco-Twist" 7.5 H.P.
- MARTIN "45" with "Synco-Twist" 4.5 H.P.
- MARTIN "20" 2 1/3 H.P.

MARTIN MOTORS are priced from \$114.75 F.O.B. Factory

MARTIN "75" with "Synco Twist" 7.5 H.P. Twin 44 lbs.



"Best Outboards Ever Built!"

MARTIN MOTORS

Division: National Pressure Cooker Co., Eau Claire, Wis.

Canadian Sales by: MARTIN MOTORS

Division: National Pressure Cooker Co. (Canada) Ltd., Wallaceburg, Ontario



SpeedWay Speed Sander

\$34.50



Sands, Cleans, Smooths, Polishes Electrically

Designed for industry, for professional work, this light, beautifully balanced, orbital-motion, SpeedSander is rapidly becoming a standard home appliance. With its powerful electric motor and all-ball-bearing construction, anyone can easily re-surface and refinish furniture, woodwork, metal surfaces or walls. It will quickly remove old paint, stain, or enamel down to the bare wood or metal; will sandpaper to a "piano finish"; remove rust and corrosion or "feather edge" a scraped fender. It will burnish pots and pans or with lambs wool bonnet, delicately polish fine furniture. It makes

tedious, tiresome jobs fun—saves hands! In design, convenience and efficiency it is today's finest sander regardless of price. Ask your local dealer to demonstrate it.

Write for Catalog

SpeedWay MANUFACTURING CO.
1863 So. 52nd Ave., Cicero 50, Illinois

MAKE BIG MONEY
Sharpening
LAWN
MOWERS
WITH THE
Universal
LAWN MOWER
GRINDER



Enjoy a profitable lawn mower sharpening business of your own. No previous experience needed. Place a hand or power mower on the Universal Grinder. With only one set-up you quickly grind the stationary blade and all of the reel blades to proper clearance without removing a single blade from mower. A Real Money Maker.

PROOF

J. L. Peterman of Pa. writes: "Thank you for getting me started in this wonderful business... I averaged \$100.00 a week in May, and made \$1000.00 spare time this season."
G. Spurlock of Arkansas writes: "I have had my Universal Lawn Mower Grinder only 2 months. Live 1 1/2 miles from town. Yet have already made net profit of \$227.00."

TRULY A BIG MONEY MAKING BUSINESS
ROGERS MFG. CO., Dept. M-41 Lindsey, Ohio

SEND THIS COUPON NOW!

ROGERS MFG. CO., Dept. M-41 Lindsey, Ohio
Please send me full facts about the Universal Lawn Mower Grinder and its big money making opportunities.

NAME _____
ADDRESS _____
CITY _____ STATE _____

For special jobs
for hobbyists

ATKINS JR. SAWS!



Jr.-65

High speed, "Silver Steel"—straight back. 16" blade Perfection-pattern, apple wood handle. Identical in everything but size with one of the world's most famous saws. Also available as 18" 6-point rip saw.

Jr.-5



Keyhole Saw Special rounded end for safety. Fully lacquered plain beech handle. Perfectly tempered, flat-ground blade. Atkins "Silver Steel" quality through and through!



**Jr.-2
Back Saw**

Expertly tempered special steel for long-wearing, stay-sharp qualities. Fully lacquered beech handle. Filed and set, ready for duty for dozens of jobs in shop and home.

AND 3 MORE JR. HAND SAWS

Jr.-6, Jr.-4 and Jr.-2. Each a perfect replica of its larger counterpart. Perfect for craftsmen and women with smaller hands. Both the Jr.-4 and Jr.-2 models are available as 18" 6-point rip saws, as well as 16" 11-point crosscuts.

Only ATKINS makes  products

E. C. ATKINS AND COMPANY

Home Office and Factory:
402 S. Illinois St., Indianapolis 9, Indiana

Branch Factory: Portland, Oregon

Knife Factory: Lancaster, N. Y.

Branch Offices

Atlanta • Chicago • Portland • New York



THERE'S AN ATKINS FOR EVERY SAWING PURPOSE!

101 USES

- Steel slide
- One-piece handle
- Swivel base
- Pipe jaws
- Cut-off tool
- Anvil
- Removable steel jaw inserts
- Semi-steel body
- Accurately made

for this basic shop tool



Make all your shop work easier, faster, with a Desmond-Simplex Utility Vise: it gives you the most practical features and versatility, yet costs no more than ordinary vises. See it at your local hardware store . . . ask for free new valuable folder showing ways to use the Desmond-Simplex Utility Vise. THE DESMOND-STEPHAN MFG. CO., URBANA, OHIO.

DESMOND-SIMPLEX VISES

HAWAIIAN WIGGLER #1

WORLD-FAMOUS FISH-GETTER

Deep runner. No snag-up in pads and brush. Easy to cast. Rubber Mula Skirt acts alive. At your dealer 5/8 oz. or 1/4 oz., \$1.15 each.



FRED ARBOGAST & Co., Inc.
2214 W. North St., Akron 3, Ohio

FREE WRITE TODAY FOR BIG FREE 1951 ARBOGAST COLOR CATALOG—FULL OF PICTURES OF CATCHES

THE NU-WAY WEED CLIPPER

Eliminates hand cutting of dandelion stems and other weeds too high for your mower to cut. Attach a Nu-Way Clipper to your hand operated or power mower and do a clean job of mowing in one operation. Save time and work. Easy to put on and remove as needed. Order one today. Give make of mower, length of blades and inside distance between drive wheels. \$5.29 for 16 and 18 inch mowers. \$5.95 for 20 inch mowers. Ohio residents include 3% sales tax. NU-WAY CLIPPER, 658 South Washington Street

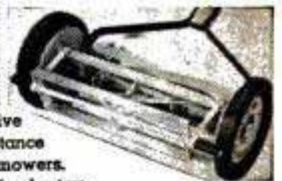

TIFFIN, OHIO

MARCOT KEY MACHINE



MARCOT No. 8 KEY MACHINE, less motor \$110.00
Auto Code Book and Death Keys . . . 12.50
75 Dz. Popular Key Blanks 60.00
Set — Key File, Follow-Through Rods, Lock Picks, Bit Key Gauge, Thimble, Pins, Springs, 10.50
"Locksmith Trade Books" 6.75
How to Open Locks without Keys or Picks; Secret of Locksmithing; How to Make Keys by the Impression Method; Master Key Systems.

Immediate Delivery

TOTAL COST \$199.75

A. J. MARCOTTE CO., 1200 N. Kedzie Ave., Dept. PM, Chicago 51, Ill.

ALL EQUIPMENT FOR LITTLE COST

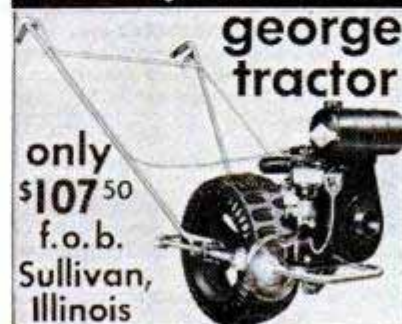

only \$107.50

f.o.b. Sullivan, Illinois

george tractor

SPECIFICATIONS . . . 2 HP gasoline engine, power drive to tractor wheel. Power take-off for sickle bar. Write for complete information.

You can still get the George Tractor for only \$107.50, f.o.b. Sullivan, Illinois. It's ruggedly built for lawn and garden work. Has 2 HP Briggs or Clinton Engine with handle bar gas and clutch control. Attachments for all garden work cost little. Plow \$14.50. Disc Harrow \$15.95. Cultivator \$14.50. Sickle Bar Mower \$39.75. Tool Hitch for lawn mower \$4.50. Bulldozer Blade \$10.75. . . all prices f.o.b. Sullivan, Illinois. This year don't be without a tractor. ORDER NOW when supply is still available. Write direct or see your dealer. Complete information will be mailed . . . ask for George Tractor and Attachments bulletin. Write today.

GEORGE GARDEN TOOL DIVISION
COMMUNITY INDUSTRIES ASSOCIATION

SULLIVAN ILLINOIS

Choose your
WHIZZER NOW!

**NEW '51
WHIZZERS...**

are better than ever!

UP TO
100 MILES PER GALLON

5 TO 40
MILES PER HOUR

3 H.P. 4-CYCLE,
138 C.C. MOTOR

The NEW
AMBASSADOR

A **BIG** fully-equipped
motor bike

- 24" Heavy Duty Wheels
- Positive, E-Z-Glide Clutch
- Quick Starting Kick Starter
- Whizzer 5" Expander-Type Rear Brake, Pedal Controlled
- Hi-Low Beam Headlight, Tail Light, and Generator
- Dual Coil Telescopic Spring Fork

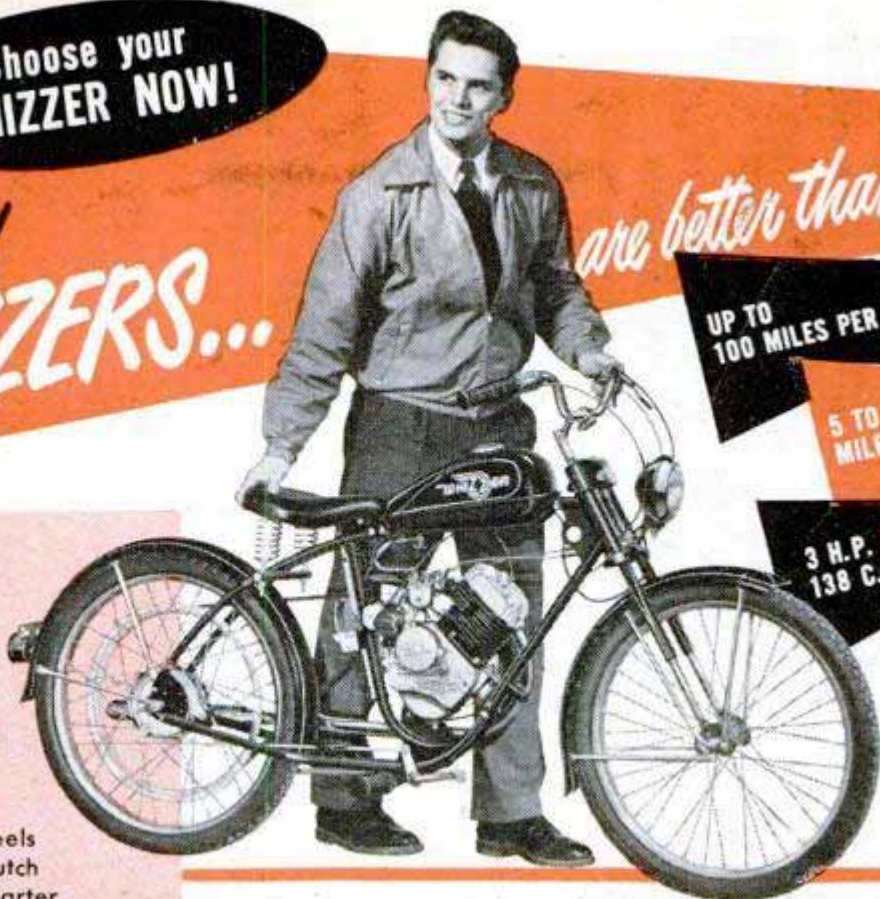

Newest, finest motorbike on the road! The big, rangy, and rugged Whizzer Ambassador—a great motorbike for comfort, beauty, power and dependability. You'll like its full size and its flashing performance. Be first in your crowd to own a Whizzer Ambassador!

\$249⁵⁰

plus tax,
F.O.B. Pontiac

The Pacemaker

Complete, low priced
motorbike



You'll get mile after mile after mile of riding pleasure out of Whizzer Pacemaker! Heavy-duty frame, dual coil telescopic front fork, big 5" Whizzer expander-type rear brake, special 3-point mounted saddle. **\$199⁵⁰**
Complete for only.....

plus tax, F.O.B. Pontiac

The Sportsman

Star of the
Lightweights



It's long, low, and lively! All the features of the Ambassador on a heavy-duty frame with 20" wheels and motorcycle-type tires. Whizzer Sportsman has a distinctive style and appeal that will make you **\$249⁵⁰** proud to own it. Only.....

plus tax, F.O.B. Pontiac

Whizzer Motor



makes your bike a motorbike

Fits any standard heavy-duty man's bike. 138 c.c., 3 h.p., 4-cycle motor sets the pace for dependability and economy. America's finest bike motor. **\$109⁹⁷**

F.O.B. Pontiac, attachments included

SEE YOUR
DEALER . . .

OR WRITE FOR
LITERATURE

WHIZZER MOTOR COMPANY
356 S. Sanford St., Pontiac, Michigan

Gigantic "Warehouse Remodeling" MAIL SALE

SAVE up to 70%!

Check these bargains:



We Pay Shipping Charges

- Power Plants and Generators**
- Army Homelite Power Plant: 1500-w, 115-v, 60-c. New condition. Guaranteed. While they last. **\$259.50**
 - Homelite 115-v, 1400-w, 400-c, Light Plant. Complete. New. With tools, parts, manual. Ideal for lights, heaters, radio-campers, contractors, etc. Cost Gov't. **\$129.60**
 - Power Plants, all types, 300-w to 25 kw. Write for listing or send requirements. All guaranteed.
 - D-C Arc Welder, 0-250 amps. Drive with tractor, engine, etc. Ready to use. Built-in controls. reactor. Brand new. **\$99.50**
 - Build Welding Generator, Delco-Remy, 200 amps, 30-v. Full instructions. Includes control, fan, etc. Cost **\$296.00**. **\$29.89**
- (Power plant bargains—500-w to 25 k.w.—write)

Winches, Clutches, Transmissions, Engines

- Gas Engine, 2-cycle, 1 h.p. Finest design. **\$28.60**
- Gas Engine, Briggs 1.5 h.p. Model N. **\$36.90**
- Power Winch, 80-to-1 ratio, 5000-lb. cap. Mounts on front trucks, jeeps, cars. Cost over **\$175**. **\$24.95**
- Hand Winch, Finest steel. Powerful. Complete with 3,000-lb. 50' cable. 1 to 3 ratio. **\$29.95**
- Same Winch, dual ratio 1-3, 1-9. **\$39.50**
- Winch Snatch Block, 3,000 lb. cap. Roller Bearings. **\$ 5.50**
- Utility Clutch, Engine end takes 1" shaft. Drive end, 3/4". Handles engines or motors up to 6.5 h.p. **\$13.95**
- V-Belt Clutch, 1/2", 5/8" or 3/4" shaft size. Up to 1.5 h.p. **\$ 7.50**
- Speed Reducer, Drive at 1750. Gives any speed 0 to 450 RPM. **\$19.95**
- Pulley Clutch, 3 h.p. 4 1/2" pulley, easy release. A buy! **\$ 7.95**

SPECIAL! FLEXIBLE GUY and TURNBUCKLE UNIT

New 12-ft. 48-strand, 1/8" galv. steel cable, 1000-lb. strength, 14-in. turnbuckle. Guy, strengthen gates, fences, buildings, wagons, television towers, etc. Cost Gov't. \$1.10 each. Special ... 10 for **\$3.89**; 50 for **\$16.47**; 100 for **\$29.32**

Water Pumps and Systems

- Bronze Rubber Rotor, All-Purpose Water Pumps. Stainless steel shaft. Pipe thread. Self priming. High efficiency.
 - 1 1/2" up to 25 PSI, up to 6 GPM. **\$12.75**
 - 3/4" up to 25 PSI, up to 10 GPM. **16.95**
 - 1" up to 25 PSI, up to 19 GPM. **22.95**
 - Bronze Nylon Roller Pressure Pump. Stainless steel shaft. Pipe thread. Self priming. Positive displacement.
 - 1 1/2" up to 100 PSI, over 5 GPM. **\$14.50**
 - 3" up to 150 PSI, over 8 GPM. **20.95**
 - 1" up to 150 PSI, over 17 GPM. **27.95**
 - Low Cost Centrifugal Pump, over 15 GPM. **\$6.85**
 - Hi-Efficiency Cent. Pump, Garden hose thread, over 15 GPM **\$11.95**
 - Fadden Centrifugal Pump, bronze, stainless steel shaft.
 - 3/4"x1 1/2", 30 GPM. **\$28.80**; 1x3/4", 45 GPM **\$37.60**;
 - 1 1/4"x1 1/2", 60 GPM. **\$46.50**
 - Water System, Automatic, finest 110-v, 60-c motor, 22' lift, 300 GPM. 30 lbs. Fresh water instantly. No tank needed. For cabins, cottages, farm homes, etc. **\$69.50**
- (Write for free pump circular. Give details your problem.)

Air Compressors and Spray Equipment

- DeLuxe Air Compressor, Pressures to 150 lbs. Capacity to 3 c.f.m. Single cylinder, 2" bore, 1.75 stroke. **\$20.50**
 - Build Your Own Compressor, 1-cyl. piston compressor, stainless 13"x25" tank, 160-lb. gauge, paint spray gun, blow gun, tire chuck, 15' hose, fittings and manual. **\$39.90**
 - Stainless Steel Air Tank, brand new, not used, 13"x25", 400 lbs.
 - \$ 8.95
 - Brass Check Valve (dash pot non-chatter type) **\$ 3.75**
 - Brass Adjustable Pop Off Valve, 25 to 250 lbs. **2.19**
 - Automatic Pressure Regulator (0 to 150 lbs.) **2.49**
 - Automatic Pressure Motor Switch, on 115, off 150 lbs. **5.87**
 - Finest Pressure Gauges (air or water) specify pressure—60, 100, 160, 300 lbs. **\$ 1.99**
 - DeVilbiss Air-Solvent Engine Cleaner, \$14.95 value. **\$ 8.96**
- (Write for paint spray equipment bulletin.)

Weed Spray Unit

- All-brass 14-foot boom, 4-row, tee jets, bronze direct-drive gear pump, gauge, relief, shut-off, strainer, fittings, etc. **\$74.65**

Mechanical — Electrical — Electronics

- Rural Phone, Magneto, 5-bar, 2500-ohm, wall type. **\$12.40**
 - Private Phone, Magneto, desk, many uses. **\$11.60**
 - Acro Saw fits on any 1/2" drill, cuts full 1-15/16". **9.95**
 - Army Switchboard, 12-line, small hotels, factory, etc. **\$33.50**
 - Phone Insulated Wire, Twisted pair, outdoor type (100-ft.) **\$ 1.39**
 - Stone Job Lot, 12 finest Norton wheels, 1" to 4". **3.89**
 - Mounted Stone Job Lot, 4 mounted stones, 1 wire brush (3/4") **2.19**
 - Rotary File Kit Lot, (1/4") 6 Assrt. tool steel units. **3.26**
 - Electric Water Heater, 5 1/2 gal, 110-v, 1200-w Guar. **\$49.50**
 - Tractor Weed Spray Unit, Complete, finest 17 ft. outfit. **\$99.50**
 - Motor 2 H.P., 24-v, D-C, Double shaft, 4000 RPM. **\$10.89**
 - MotorGyro, 24-v, D-C, 10,000 RPM. Fascinating! **\$ 1.98**
 - Oil Pressure Gear Pump (supercharger type) new. **4.95**
 - Parts Cabinet, All steel, 4 drawer, 16 compartments. **2.78**
 - Precision Hand Level, With leather case. **7.95**
- (Hundreds other electrical-radio-mechanical-tools bargains)

ORDER DIRECT FROM AD or Write for Free Catalog!

BURDEN SALES COMPANY

806 "O" ST. LINCOLN, NEBR.

BUILD YOUR OWN POWER TOOLS - TILT/ARBOR SAW



- TILT/ARBOR SAW**
- 27x28 in. table stays level. Blade tilts full 45 degrees. • 10 in. blade cuts 3 1/4 in. deep, jack-screw depth adjustment. • Floor model, 34 in. table height. • New Departure ball bearing arbor, 3/4 in. precision shaft, ready to run, 5/8 in. bore blades. • Quick positioning, self-aligning rip fence guide. • Sturdy wood, steel and aluminum construction. • No machining—build easily with hand tools only. • Capacity and performance of floor saws selling for \$150.00 and up!
 - GIL-BILT Metal Parts Kit, includes Plans, ball-bearing arbor, cast aluminum miter gauge and bar, rip fence guide, machined lock knobs, jackscrew mechanism with 4 1/2 in. handwheel, and all other metal parts including every screw, bolt, nut and washer (less blade). **\$20.95**
 - Same Kit with 10" combination blade. **24.90**
 - Same Kit with 8" combination blade. **23.90**
- If not satisfied, return Kits in 10 days for refund of purchase price.

BANDSAW BELT SANDER
SAVE \$50 OR MORE

(Prices include postage up to 600 miles)

GIL-BILT Step-by-Step pictorial plans (No blue-print reading required), full scale patterns, actual photographs for above 10" TILT-ARBOR SAW, 12" BAND SAW, BELT SANDER, 8" TILT/TABLE SAW \$1.00 each, postpaid anywhere in the world. ALL 4 Plans for \$3.00, or write for FREE descriptive catalog.

COMPLETE PLANS only \$1.00 EACH

GILLIOM POWER TOOLS P. O. Box 1-PD, Lambert Field, St. Louis 21, Missouri

NEW POWER TOOL UNITS

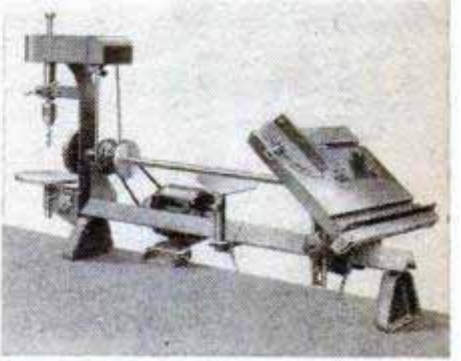

Amazing Values
Write for Details

EMRICK, INC., 141 Clinton, Kalamazoo, Mich.

SAW SHARPENER



Table model, gums and sharpens rip saws, combination saws & cut-off saws. Ideal for "Skill-saw" blades. Cap. 4" to 20" diam. Complete with 1/4 h.p. motor & 1 grinding wheel & cord — \$64 f.o.b. Portland. Shipping weight, 63#. SEND FOR FREE LITERATURE.

P. T. HOBBS MACHINERY
Dept. PM-53, Portland 17, Ore.

HOBBYISTS! SHOPMEN! Special ONLY \$54.50

PALMGREN "HOBB-E" Rotary, Index, Milling Table

Ideal for Model Parts or Shop Work

Mill-Grind-Drill-Index-Route curved or straight-Rabbit and Mortise on drill press or lathe. 8" Table, 4" Cross Feed, 360° Rotation, Accurately Graduated, Bolts to table. Order NOW! SAVE \$100. Only \$54.50. Less Rotary Feed \$42.75. Write for "HOBB-E" Tool Circular.

CHICAGO TOOL and ENGINEERING CO.
8365 South Chicago Ave. Chicago 17, Ill.



SAY YOU SAW IT IN POPULAR MECHANICS

New POWER MOWER

Build It Yourself And Save. Amazing new invention makes whirl-blade mower pull and steer itself as well as cut grass and weeds. Build it yourself. Send name and address on 1c postcard for FREE building instructions. NO OBLIGATION.

PULLS ITSELF, STEERS ITSELF

FREE Building Instructions
T & H Mfg. Co., Dept. MPC-4, 811 E. 31 St., Kansas City, Mo.



All Parts Available Complete Kit or Separately.

**STRAIGHT-LINE ACTION
FOR GUARANTEED
SCRATCH-FREE SURFACES**

Get this fast-cutting production sander for heavy-duty craft and woodworking projects—for hobby work, refinishing and redeco-rating. Gives you the added stroke and power required for furniture and cabinet making, boat building or refinishing, resurfacing large areas, sanding plastics, leather, etc. Great for building operations such as woodwork, dry wall joints, siding and other exteriors. Also does a superb wax-polishing job! Buy it, try it, compare Model 2000 with any competitive electric sander. You be the judge!

CHECK THESE IMPORTANT FEATURES

- 21 sq. in. sanding surface • weighs only 5 lbs.
- easy one hand operation—just guide it • only 2 moving parts • requires no oiling • cam-type holder permits 10-second paper change • dust-proof, fool-proof, fully guaranteed • over-all size 3 1/8" x 4 1/2" x 7" • operates on 110-120 v. 60 cycle, A.C.

WHERE TO BUY DREMEL SANDERS



If your dealer can't supply, send full remittance for post-paid shipment. Or send only \$2, and pay postman balance plus postage and C.O.D. fee. Money back if not delighted after 5 days' trial.

DREMEL MFG. CO., Dept. 111-D, RACINE, WIS.

New DREMEL Electric
**MODEL 2000
SANDER • POLISHER**



14,400
SANDING
STROKES
PER
MINUTE

ONLY \$24.50

with steel carrying case, 25 asstd. sheets abrasive paper, and a sheepskin polishing pad.

(PATENTED)

**BEFORE YOU BUY ANY
SANDER
COMPARE!
BE SURE YOU WILL GET
A SCRATCH-FREE FINISH**

**ROTARY
Action**
About 50%
cross-grain
motion



**ORBITAL
Action**
Partial
cross-grain
motion



**ARC
Action**
100%
cross-grain
motion



**DREMEL
Reciprocal
Action**
100%
WITH
THE
GRAIN
motion
for
scratch-free
finishes

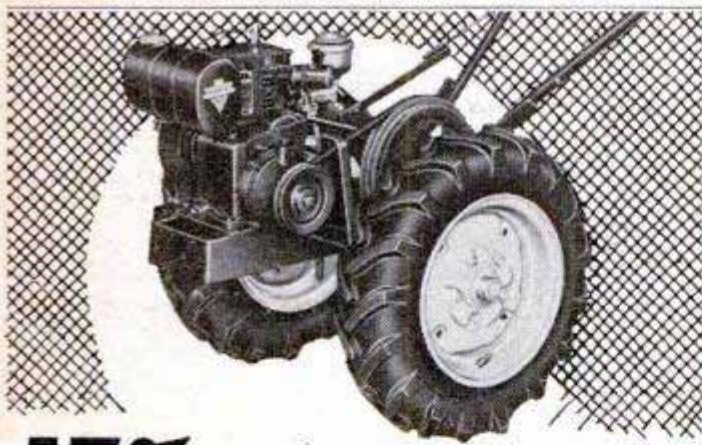
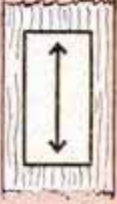

17% GREATER TRACTION

No hop . . . no jerk . . . no slipping wheels on heavy loads. Get up to 17% more traction because of 1) ahead-of-axle attachment connection exerts down thrust and, 2) super wide 6" tires. Springfield tractors pull so smoothly handles aren't needed on attachments.

Get handy power anywhere with direct power take-off (speed reducer not needed). Two models—2 h.p. at \$179.50—3 h.p. at \$239.50 (f.o.b. Springfield). All attachments available.

WRITE FOR FREE CATALOG.

**Springfield
GARDEN TRACTOR**

Choice Dealerships Available

QUICK MFG., INC., 3372 S. Limestone St., Springfield, Ohio

**SAVE 3 WAYS WITH THE
Cushman MOTOR SCOOTER**

- ✓ **LOW** purchase price
- ✓ **LOW** maintenance
- ✓ **LOW** operating cost



THE WORLD'S MOST FAMOUS MOTOR SCOOTER

Cut car expenses—solve commercial transportation problems with a Cushman. Ride to work, school, shop, play, on errands. Very practical for light deliveries. Automatic clutch, special heavy duty tires, dependable heavy duty brakes. Cruises at 40 m.p.h., over 85 miles per gallon. An easy-riding Cushman saves time, money, worry! **WRITE TODAY FOR FREE FOLDER AND PRICES.** Dept. 7M

**WRITE FOR
RIDER-AGENT
PLAN**

CUSHMAN MOTOR WORKS, Inc
LINCOLN NEBRASKA USA

HANDEE®

tool of 1001 Uses

FINEST IN POWER TOOLS PLUS 51 ACCESSORIES

Complete . . . designed for every hobbyist and mechanic! Grind, drill, polish, carve, sand, saw, etc. Packs plenty of power in the 25,000 r.p.m. motor, with approved 7-segment commutator. Handsome fitted steel carrying case.

Complete, with liberal 10-day money back trial offer **\$27.50**

with 7 accessories . . . **\$19.95**



HANDEE WORKSHOP

"Tornado-Powered" with NEW HANDEE "85"

Versatile, with 41 accessories . . . suitable for shop or home use. For novice or expert . . . precision routing, molding cuts. HANDEE "85" a production wizard . . . automatically air-cooled, pin-point accuracy. Sensational power!

Complete, packed in handsome case,

\$29.95

FREE! New 64-page Manual

Chicago Wheel & Mfg. Co., Dept. PM
1101 West Monroe St. Chicago 7, Ill.

Say You Saw It in Popular Mechanics

Make Quick Work of Small Jobs

with the "Yankee-Handyman" No. 2H Ratchet Screw Driver

Handy a hundred and one ways around the home, on appliances, fixtures, etc., this "Yankee-Handyman" No. 2H Screw Driver makes quick work of tightening or loosening small screws. Famous "Yankee" positive ratchet action. You can drive . . . draw fast with a No. 2H "Yankee-Handyman". Measures just 4 1/16" overall. See this and other "Yankee" time-saving tools on display at your local dealer's.

North Bros. Mfg. Co., 441 West Lehigh Ave., Philadelphia 33, Pa.

"YANKEE" TOOLS NOW PART OF **STANLEY** THE TOOL BOX OF THE WORLD



NORTH BROS. MFG. CO., Philadelphia 33, Pa.

PACKAGED BOAT KITS

COMPLETE LINE!
SKIFFS—OUTBOARDS
—RACERS—CRUISERS
\$38.95 UP



WORLD'S
BEST BOAT
BUY!



LARGEST CATALOG
EVER OFFERED!

- ★ BOAT KITS—23 MODELS
- ★ MARINE PAINTS and BOAT HARDWARE
- ★ SEMI-FINISHED BOATS
- ★ CUSTOM-FINISHED BOATS

16 pages — 80 construction and action photos, plus specifications and performance data.

SEND 35c FOR CATALOG

Catalog PLUS booklet on boat building, \$1.00

BOAT PATTERNS—BLUE PRINTS

Over 50 modern plans and full size patterns. Racing classes, cruisers, inboards, outboards, sail—by famous designers. 6'-30'. CATALOG 35c. Catalog and boat building handbook, \$1.00.

MARINE
MART
DEPT. 52
BUFFALO 7, N. Y.



Magnetic Layout Punch

At last hand center punching can now be done with a guaranteed accuracy of .001". For defense and at home. Write today for FREE booklet explaining the many uses for this hardened and ground precision tool, and also Shortcuts To Layout Work. \$3.85 postpaid.

Magnet Hold Perfect Center Punch Co.

837 Central Park Ave.

Yonkers 4, N. Y.

Make Money
SELLING
Eshelman
Tractors
and DOING
GARDEN
WORK

RAKES
SEEDS
CULTIVATES
HARROWS
HAULS
SPRAYS
SAWS
DOZER
MOWS
CUTS
ROLLS
PLOWS

ESHELMAN

FOR BETTER
LAWNS
and GARDENS
also POWER MOWERS
and RIDING TRACTORS
Women can operate it.



As low as
\$95
Plus tools

Free Catalog, Write
ESHELMAN CO.,
Dept. 12B
119 Light St., Balto. 2, Md.

POSTPAID
ANYWHERE
IN U.S.A.

WE FURNISH ALL MACHINED METAL PARTS, EVERY SCREW,
NUT, BOLT, WASHER, AND COMPLETE PLANS FOR THIS . . .

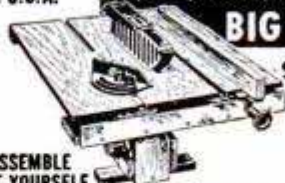

BIG 10" POWER SAW

\$10.95 FULL REFUND IF
LESS GUARD & WOOD NOT SATISFIED
IN 10 DAYS

ASSEMBLE
IT YOURSELF
WITH SIMPLE HOUSEHOLD TOOLS!

COMPLETE PLANS 10c
MARCUS-POLLAH
DEPT. N, ROYERSFORD, PA.

DRILL PRESS OWNERS!

HERE'S 1 TOOL WITH 5 DISTINCT USES



THE BARRON MULTI-PURPOSE ROTARY WOOD PLANER

PLANES & SURFACES • PANELS & BEADS
ROUTS & GROOVES • RABBETS • TENONS **\$7.50** COMPLETE

Finest precision performance—certainty of skilled workmanship—time-saving, money saving short cuts—yours with world famous Barron Drill Press Tools. Fifteen important operations—all available on any standard drill press—with Barron Accessories. Equip your shop with these versatile exclusively designed tools—and save up to \$500. 200,000 Barron owners have bought on our liberal 10 day full money back guarantee. Order, or write for catalog.

BARRON TOOL CO. INC.
305 Architects Bldg., Detroit 1, Mich.

FREE
Workshop
Guide &
Catalog

NEW SAFE SAW CUTS ONE INCH WOOD

50% FASTER
with 70%
LESS NOISE



No. 201
only
\$22.95

New Improved **SYNGRO** ELECTRIC JIG SAW

Here's the largest, most powerful, most versatile jig saw of its kind... yet safe for children! Perfect for Dad's workshop! NOW 70% quieter operation with 50% MORE power. Cuts any length 1" wood, thin metal, plastic. Precision-built to last a lifetime. 14,400 safety strokes a minute. Portable. Use anywhere—even apartments! Just plug in and saw. Not a "lumber" cutter, but for fine, delicate craftsmanship. ENTIRE JIG SAW (not just the cord!) listed by UNDERWRITERS' LABORATORIES, INC. and Power Unit GUARANTEED BY SYNCRO all during your ownership against burnout or replaced Free! Buy with confidence. COMPLETE with BUILT-IN Fractional Horsepower Reactor Type Electric MOTOR, 3 Blades, Cord and Plug. \$22.95 at dealers. If Dealer hasn't it, send \$22.95 direct, we'll ship Saw postpaid.

SYNCRO CORPORATION, Dept. D-41, Oxford, Mich., U. S. A.

EXACTING MEASUREMENTS IN SECONDS WITH AN **X-6**

Whatever your hobby or home building project, you will agree that one of the principal bars to its success are accurate foolproof measurements—a bar which completely disappears once you own an X-6.

Open your X-6 as you would any good folding rule. Butt it against one side of those hard-to-get inside measurements. Pull out the handy extension to fill any gap under 6 inches, and you have it. Thoroughly reliable, easy to use, the X-6 extension rule retails for \$1.85. See it at your local hardware store or send remittance to Department P-1.

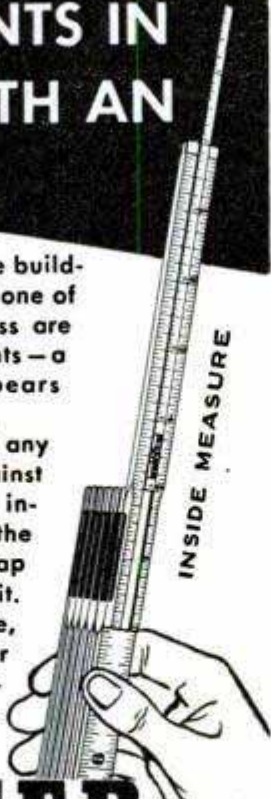

HOT BEARINGS

can
FREEZE
the crankshaft

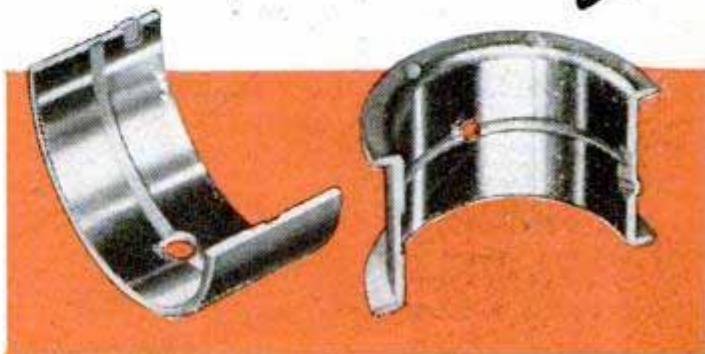

HARD TO BELIEVE? Not when you consider the two purposes of engine oil—to lubricate, and to *cool*. Badly worn main bearings oil-starve the connecting rod bearings they are supposed to feed. "Shorting" the bearings of necessary oil leads to heat and friction. In the worst cases, bearings overheat and fail—they "freeze" or seize on the crankshaft, causing costly damage.

If your engine is pumping oil, check for worn main and connecting rod bearings. Replace with genuine Federal-Mogul bearings, *engineered* for the job of oil control!

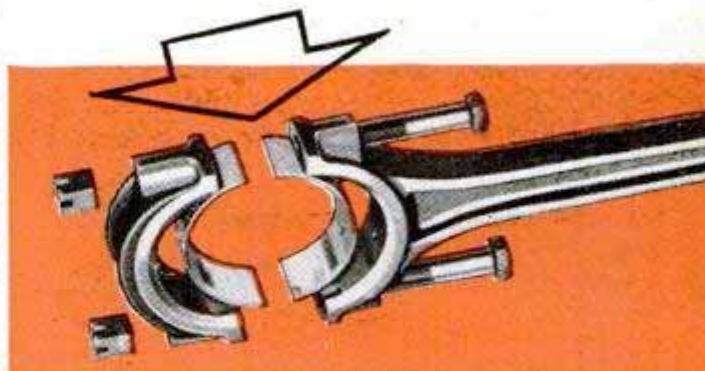

FEDERAL-MOGUL SERVICE

(Division of
Federal-Mogul Corporation)

DETROIT 13, MICHIGAN



**In the Home, as in
Industry, the choice is
WISS METAL SNIPS**

The superior quality of famous **WISS** Metal Cutting Snips has made them the first choice in the home and in industry. Every pair is rigidly tested and guaranteed to cut easily and efficiently for an unusually long time. Carefully adjusted blades are set precisely to reduce wear and permit maximum cutting power with a minimum of effort.

**WISS METAL MASTER
COMPOUND ACTION SNIPS**



Compound leverage produces amazing cutting power with minimum effort. Will cut holes, circles and complicated patterns in metals to 18 gauge. Rubber grips recommended. M 1 (Cuts Left) 10" long; M 2 (Cuts Right) 10" long; M 3 (Cuts Straight) 10" long.

**WISS SOLID STEEL
STRAIGHT CUTTING SNIPS**



Economical in price, these snips meet government specifications. Made of a specially selected grade of solid tool steel. For general metal-cutting. Four sizes, 8" to 12 1/4" long.

**WISS SOLID STEEL
COMBINATION SNIPS**



Will cut straight, curves or irregular shapes with ease. Two sizes, 7" and 13" long.



**J. WISS & SONS CO.
NEWARK 7, N. J.**

UTICA MagneKit

**3 RIGHT
TOOLS
FOR
101
JOBS**



Here's a special set of 3 top quality tools that will do just about any GRIPPING job that comes along. Having the RIGHT tool speeds the task, improves the result.

And to keep 'em handy and always in sight—UTICA's amazing Magnetic Holder. Holds up to 13 pounds of tools.

A wonderful gift for any home owner, hobbyist or workshopper.



**NATIONAL HARDWARE
WEEK—APRIL 12-21**

Visit your IRHA hardware store for gala offerings and special values—among them the Utica MagneKit—an outstanding value at only \$5.85. Bought separately, the items would cost \$7.24.

Utica Drop Forge & Tool Corporation • Utica 4, N. Y.

IT PAYS
TO BUY



QUALITY
TOOLS

FILE your own SAWS ... easy!



Do expert saw filing without experience. Keep your hand saws extra sharp, true-cutting. Easy to use. Money back guarantee. Cash COMPLETE \$2.95 with order, prepaid. (COD WITH FILE postage extra.)

THE SPEED CORP. PM-4

512 N.E. 73 Ave., Portland, Oregon

A SPEEDCOR TOOL!

BeMaCo Dependable

**AUTOMATIC
SAW SET**

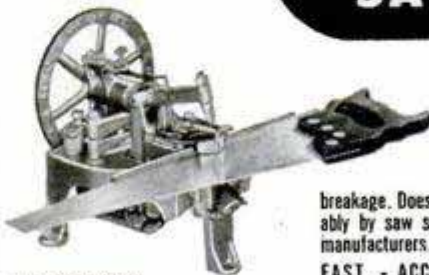

Sets 400 teeth per minute on hand or band saws 4 to 16 point. Hammer and anvil action sets teeth accurately and uniformly... No tooth breakage. Does a perfect job. Used profitably by saw shops everywhere and saw manufacturers. Every machine guaranteed!

FAST - ACCURATE - DEPENDABLE

★ INCREASES
PROFITS

BEAVER MFG. CO.

Saw Machine Div. #5M
800 SO. ISIS AVE. • INGLEWOOD, CALIF.

BETTER TOOL VALUES!

SEND FOR NEW FREE CATALOG



INDESTRO TOOLS

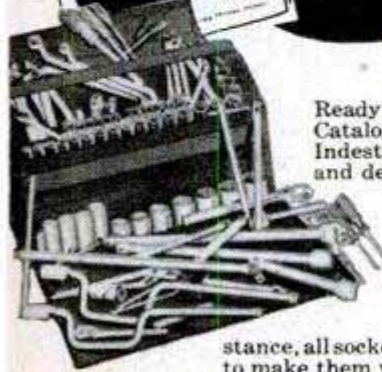

Ready Soon—Brand New Mechanic's Catalog of Low-Cost, Long-Service Indestro Tools. Full of photographs and detailed descriptions of regular or special tools your dealer can supply for home workshop or professional use. Tells how to select good tools and why you get Better Value when you select Indestro Tools—for instance, all sockets "Hot Broached" to make them wear longer.

Offers you big values in Tool Sets, from 5-pc Punch and Chisel Sets to 114-pc DeLuxe Workshop Sets. Reserve your copy of this Dollar-Saving Pocket-Size Tool Catalog.



FILL OUT AND MAIL NOW FOR FREE COPY

Send to INDESTRO MANUFACTURING CORP.
2653 N. Kildare at Schubert, Chicago 39, Ill.

Write your name and address in margin space below.

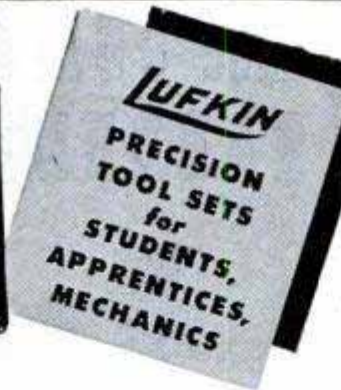

Whatever your specific requirements, you can buy a complete set of matched Lufkin Precision Tools that are just the selection you need for apprentice class or advanced shop work. Sets are made up of standard Lufkin Tools . . . same as used by fine mechanics . . . nicely arranged in compact, convenient-to-carry fitted cases that protect the tools from damage or misplacement.

LUFKIN SET NO. 3 includes: a 1-in. Chrome-Clad Micrometer; 12-in. Combination Square with Center Head; 6-in. Flexible Steel Rule; 4-in. Toolmaker's Spring Divider; 4-in. Toolmaker's Outside Spring Caliper; 4-in. Toolmaker's Inside Spring Caliper; 4-in. Firm Joint Hermaphrodite Caliper; Center Punch; and Center Gage.

Set, with durable fitted case \$33.60

LUFKIN SET NO. 1 is similar to No. 3, but without Micrometer, and with 6-in. Combination Square and Center Head. Calipers and Dividers are of the flat leg type.

Set, with nicely fitted case \$17.00

123

BUY LUFKIN TAPES • RULES • PRECISION TOOLS
From Your Hardware or Tool Store
THE LUFKIN RULE CO.

SAGINAW, MICHIGAN • New York City • Barrie, Ontario

COME CLEAN!

Rid car cooling system of Winter's

SCRUM



This "finger test" inside the radiator fill cap will show dangerous "Scrum" in cooling system.

Spring means time to clean house on "Scrum"—the accumulation of scale, rust and oil muck that clogs your car's cooling system.

"Scrum" endangers your car and your pocket book three ways: a clogged radiator means an expensive repair job; "Scrum" deposits act as insulation, causing overheating which cuts operating efficiency or causes serious damage; "Scrum" accumulations at vital points cause hidden hot spots that lead to big repair bills.

Just draining anti-freeze and flushing with water is not enough. A chemical cleaning is necessary to dissolve the binder that holds rust and scale in place.

Be sure the thermostat is functioning properly, also. If the valve fails to open within 10 to 15 degrees of the rated temperature, it should be cleaned if gummy or replaced. A faulty thermostat causes engine overheating.

It pays to check water hose and fan belt, too. Loose rubber particles from rotted hose can clog the radiator and tubing that is too soft may collapse from suction. Be sure fan belt play is $\frac{3}{4}$ " when belt is depressed between pulleys. A slipping belt causes overheating, a tight belt causes excessive bearing wear.

When you clean out cooling system "Scrum," use WARNER RADIATOR CLEANER—the finest and safest product of its kind on the market. After flushing, add a can of WARNER COOLING SYSTEM PROTECTOR to stop rust and scale all summer long. To repair leaks, use WARNER LIQUID SOLDER.

Get Warner Products at service stations, garages and automotive supply stores everywhere.



Warner-Patterson Company
920 S. Michigan,
Chicago 5, Ill.

**5 reasons
why good
craftsmen
prefer the
Walworth
GENUINE
Stillson**



1. It's zinc plated
2. It's perfectly balanced
3. It has the latest metallurgical improvements
4. It is low priced
5. It has been the standard of quality for farm . . . home . . . and industrial use since 1869

Get a Walworth *Genuine Stillson* . . . feel its balance . . . check its teeth . . . and find out why hobbyists and workmen all over America sing the praises of the Walworth *Genuine Stillson*. Order your *Genuine Stillson Wrench* from your local hardware store, today.

*No shop is complete without
Genuine Stillson Wrenches*
— The Stillson Diamond Trademark
identifies the
Walworth *Genuine Stillson*

WALWORTH

New York, N. Y.

VALVES . . . PIPE FITTINGS . . . WRENCHES

The easy way to paint!

Speedy Sprayer

ONLY \$32.50 LESS MOTOR

Favorite of home owners and craftsmen for 20 years! SPEEDY SPRAYER gives your work that professional paint finish everyone admires. Sprays paint, enamel, varnish, lacquer, etc. . . . 4 to 7 times faster than hand brushing! Lightweight, portable, uses any 1/4 H.P. motor. Improved diaphragm principle assures clean, oil-free air. You'll find dozens of time and money saving uses for SPEEDY SPRAYER, including spraying insecticides 2-4-D and DDT. Complete outfit, without motor, only \$32.50.

At leading hardware, lumber, and auto supply dealers.
FREE—write for handy booklet "How to Spray."

W. R. BROWN CORPORATION
5717 Armitage Ave. • Chicago 39, Ill.

**"the COMPLETE
GARDENER"**



Bready **GARDEN TRACTOR**

- Plows
- Discs
- Harrows
- Seeds
- Cultivates
- Rolls Lawn
- Mows Lawn
- Cuts Weeds

Gardening's more fun when BREADY does the work! You'll use BREADY, too, to mow the lawn and do other chores the year around. See BREADY GARDEN TRACTOR at your dealer's soon. Five models to choose from. Powerful, easy-guiding, economical. Write today for free folder.

THE BREADY TRACTOR & IMPLEMENT CO.

BOX 230 • SOLON, OHIO



"ONE-STOP SHOPPING"

for ALL electric drill accessories — ORDER TODAY!



New
B-T HACK SAW
Powerful...
Portable... **\$4.95**
Pocket-size!



For 1/4" elec. drill. Saws wood, plastic, steel & sheet metal, pipe, plaster board, celotex. No gears, no bearings, nothing to wear out. Full 3/4" chip clearance. Weighs only 11 oz. Complete with blade, \$4.95 (Extra blades, 10c each.)

Polish, Sand 'n Save with the BULL BUFFER



Polish and sand the easy, right angle way. Gear reduction, swivel action. Over 100,000 now in use. Complete with sheepskin bonnet, rubber pad, 2 sanding discs.

\$9.95

A PORTABLE POWERHOUSE!



NEW
BULL "200"
1/4" **ELECTRIC DRILL**
only **\$16.95**

WE GUARANTEE YOUR MONEY BACK if it isn't more powerful than any 1/4" electric drill at ANY PRICE.

Runs at 1500 r.p.m. under heaviest hand pressure! Designed for use with drill accessories. New specially wound AC-DC motor! A man-sized drill for man-sized jobs—at an unheard of price. **\$16.95**

BULL MANDREL KIT



includes mandrel, 2 1/2" grindstone, 3" wire brush, 4" cloth buffing wheel. **\$2.19**

HIGH SPEED JITTER SANDER



for those professional finishes on wood or metal. Ideal for furniture, fenders, etc. Easy one-hand operation.

\$10.95

NEW BULL SAW

\$9.95

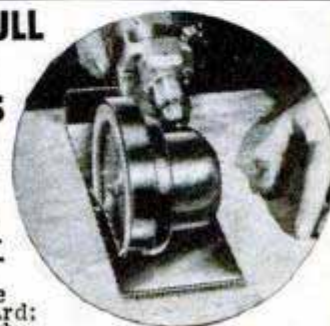

Converts any 1/4" electric drill into a portable saw. One-hand operation. One-piece safety guard; visual guide. Depth of cut: 1 1/8". Complete with high carbon saw blade.

\$9.95

All Bull Tools are Guaranteed

AUTOMATIC SCREWDRIVER

for any electric drill, drill press, or flexible shaft. When ordering specify standard or Phillips head. **\$4.95**

A word to the wise — ORDER NOW!

BERTRAM H. ENGINEERING & SUPPLY CO.

3121 MAIN STREET Dealers — Write today for information KANSAS CITY, MO.

THE BIGGEST VALUE
ON THE MARKET
DIRECT FACTORY TO YOU

DYNAMIC SUPER-CHARGED ARC-WELDER

DYNAMIC WELDER

DOES WELDING, BRAZING, SOLDERING, CUTTING
It's the finest, precision built heavy duty transformer-welder available for home, farm, or shop use. Does work you'd expect from costlier machines. EASY TO OPERATE. Do expert work; follow simple instructions. Works on iron, steel, brass, bronze, aluminum and other metals. Operates from any properly wired 110 volt 50/60 cycle AC line. Save time, Make money—Build or repair auto, home, farm or shop equipment, etc. for yourself and others in spare or full time. Comes complete Ready-To-Operate. Order today for 10 day trial on money back guarantee or write for Free Particulars, DYNAMIC WELDER CO., Dept. D2-DB6, 15 E. 23rd St., Chicago 16, Ill.

Gift of Tool Marker—Soldering Tool and Electric Torch included for prompt action at no extra cost.

OVER 50,000 SATISFIED USERS

\$41.80 Only \$33.50 F.O.B. VALUE COMPLETE

SHARPEN CIRCULAR SAWS LIKE AN EXPERT

THE SUPER GADGET FOR HOME WORKSHOP
Two simple adjustments. Gets hollow-ground, cross-cut or combination saw blades true and sharp. Fits 6" to 12" blades 1/2" to 13/16" centers. Includes file, complete instructions. \$6.95 postpaid. (C.O.D. postage extra.) Guaranteed—Money back if not satisfied after 10-day trial. Soon pays for itself. Order today. Free Folder.

SURE SHARP MFG. CO., Dept. M-41
P. O. Box 24 Santa Ana, Calif.

\$6.95

ALNICO MAGNETS LIFT 175-lb.

AMAZING PERMANENT MAGNETS — WILL NOT WEAKEN! NON-ELECTRIC. Retrieve guns, tackle, tools and other steel items from lake, river, plating tanks, drains or other hard-to-reach spots. Recover drills, taps, etc. from floor sweepings. Clear alley of harmful tacks, nails. Many other uses listed. Pays for itself quickly. GUARANTEED: Try any magnet one week. Money refunded if you are not well-pleased.

Cat. No. 675 (Has pull of 175 lbs. on a flat steel block).....	\$10.50
Cat. No. 650 (150 lb. pull).....	\$8.50
Cat. No. 600 (100 lb. pull).....	\$6.50
Cat. No. 550 (50 lb. pull).....	\$4.00
Cat. No. 530 (30 lb. pull).....	\$3.00
Cat. No. 17 (14 lb. pull).....	\$1.50

Send M.O. or check. We pay postage.
Cat. No. 30—Hobbyist assortment of six medium magnets.....\$1.50

MIAMI MAGNET CO.,
3240 N.W. 27th Ave., Aviation Bldg. No. 43, Miami, Florida

Say You Saw It in Popular Mechanics

New MOTOR BARGAINS for Home, Farm & Industry

New General Electric 1/2 H.P. Induction Type 3450 RPM 110 V. 60 cy. 1 Ph. A. C. Motor. #GEH-5.....	\$21.75
New General Electric 1/2 H.P. Cap/Ind. Ball Brg. 1750 RPM, double 1/2" shaft. 110 V. 60 cy. #GE-17.....	\$26.50
New General Electric 3/4 H.P. Cap/Ind. Ball Brg. 1750 RPM, double 1/2" shaft. 110 V. 60 Cy. 1 Ph. A. C. Motor. #GE-75.....	\$34.50
New Emerson 1 H.P. Heavy Duty, Repulsion Induction, 3450 RPM, 110/220 V. 60 Cy., 1 Ph. A. C. Motor. #EH-1.....	\$45.00
Same as above, 1 1/2 H.P. 220-V. #EH-15.....	\$57.50
Same as above, 2 H.P. 220-V. #EH-20.....	\$67.50

New EXPLOSION PROOF MOTORS

New Motors approved by Fire Underwriters for pumping gasoline, lacquer, or operation in explosive fumes, spray booth, fans, etc. Totally enclosed motors, excellent for dusty damp jobs. Extra heavy duty motors, will pull twice rated H.P. for intermittent service.

#EX-16—New Westinghouse 1/4 H.P. Rep/Ind 110/220 V. 60 Cy. 1 Ph. 1725 RPM.....	Only \$23.50
#EX-35—New Westinghouse 1/2 H.P. Rep/Ind 110/220 V. 60 Cy. 1 Ph. 1725 RPM.....	Only \$28.50
#EX-32 DC—New Westinghouse 1/4 H.P. 32 VOLT DIRECT CURRENT 1725 RPM.....	Only \$27.50
#EX-115 DC—New Westinghouse 1/4 H.P. 115 VOLT DIRECT CURRENT 1725 RPM.....	Only \$33.50
#EX-230 DC—New Westinghouse 1/4 H.P. 230 VOLT DIRECT CURRENT 1725 RPM.....	Only \$22.50

BE SURE AND ORDER BY NUMBER
Order by number. We have large stock of special & standard motors. ALL SIZES. Write for prices on the motor you need.
C. MARSHALL SALES, 3546 W. Fullerton Av., Dept. P-4, Chicago 47

BETTY HUTTON—Co-starring in Cecil B. DeMille's
"THE GREATEST SHOW ON EARTH"
 A Paramount Release



OO-OO-OOH!

...that awful stuff in my car?

A mucked-up oil filter can cost you plenty in engine repairs. Get in a new **Purolator* Refill**—quick.

Would you believe it—two pounds of this dirty sludge in *your* car? Yet that's about average for every 5,000 miles you drive.

What to do? Don't delay—get in a clean filter refill—fast. **Which make?** Pays to buy the best—a Purolator Micronic*. New accordion-type design gives up to 10 times the filtering area—with pores so tiny they trap engine-wrecking abrasives you can't even see. **Cost much?** Strictly small change—\$1.38 to \$3.00, depending on car make. Purolator

Products, Inc., Rahway, N. J.; Toronto, Ontario, Canada.

*Reg. U. S. Pat. Off.

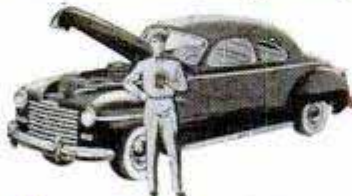

PurOlator
 MICRONIC
OIL FILTER

This Emblem on Your Engine Means that You Have the World's Quickest-Starting Most Reliable Small Gasoline Engine

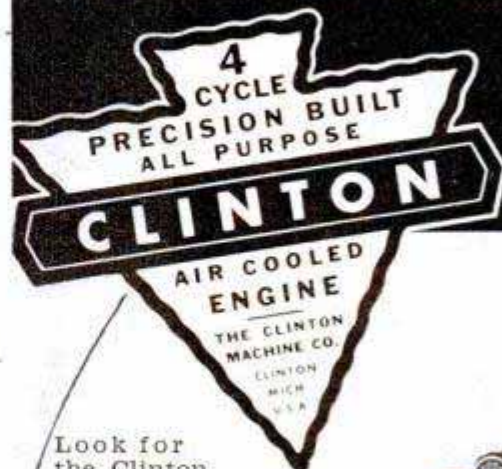

Look for the Clinton Emblem when you buy your farm implement or power equipment. You'll find Clinton Engines on leading farm implements—such as this Roof Fence Row Weed Cutter with Mower attachment.



CLINTON ENGINES



GERSTNER Tool Chests

Gerstner Chests are preferred by better craftsmen. There is a size for every machinist and toolmaker. Free catalog.

GERSTNER TOOL CHESTS

451 Columbia St.,

Dayton 7, Ohio

POWER HACKSAW \$52.75

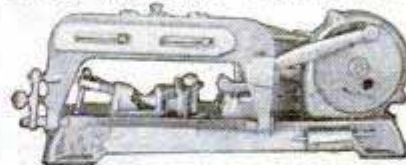

Send for full details and name of nearest dealer.

LESS MOTOR
 F. O. B. Benton Harbor

• Rugged cast iron construction. Wt. 56 lbs. bronze bearings. Draw cut. Auto. return lift. Auto. shut-off. Vise swivels 45°. Cap. 4"x4".

EXCEL MACHINE TOOLS Dept. PM-41 BENTON HARBOR, MICHIGAN

WELD
 BRAZE, SOLDER,
 and CUT →

ONLY
 \$11.95
 F.O.B.
 complete!

EASILY...
 QUICKLY!

No experience needed. Follow simple instructions, weld on iron, steel, bronze, brass, aluminum, and other metals. Plugs into any properly wired 110 volt A.C. or D.C. line. Make or save time and money doing repair work for yourself and others. Repair men, farmers, tinsmiths, home and auto owners, hobbyists, etc., say **FOUR-WAY** pays for itself over and over. Order today or send for Free details.

FOUR-WAY WELDER COMPANY, Dept. F2-DB
 2326 So. Michigan Ave. • Chicago 16, Illinois



ORDER
 NOW
 10 DAY
 TRIAL

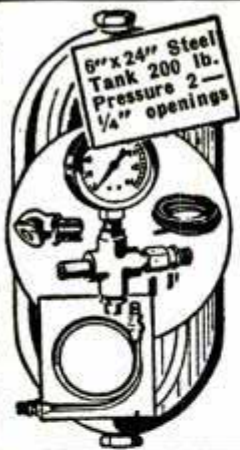

WELLWORTH Air Compressor

For Farm and Home Workshops
Both valves in head, bronze bearings, splash lubrication. "V" belt drive, intake muffler and cleaner. Compressor has 2" bore, 1 1/4" stroke, 2.8 cfm up to 150 lb. pressure. Motor required: 1/4 h.p. at 100 lbs.; 1/2 h.p. at 125 lbs.; 3/4 h.p. at 150 lbs. or equivalent gas engine. Wt. 16 lbs. Replacement parts always available.

\$20.50



NEW!

COMPLETE OUTFIT Compressor, pressure tank, air gauge, air chuck, 20-ft. hose, pop valve, with 4 brass flared fittings for connecting compressor to tank, 4-way cross and 3 nipples. **COMPLETE OUTFIT, wt. 30 lbs.**
All Brand New Equipment.....

\$32.50

LIGHT PLANTS

Brand New!
War Surplus
Signal Corps Power Unit PE 197

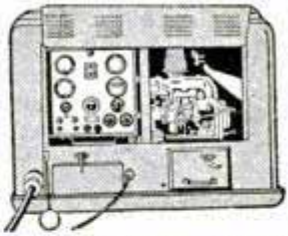

115 volt 60 cycle A.C. single phase 5 K.W. Hobart water cooled, 14 h.p. 4 cylinder Hercules engine. Remote Control, complete panel board with instruments. 150 ft. automatic remote control cable with reel; 150 feet #6 heavy duty wire with reel; housed in metal case with replacement parts and tools. Cable with reels alone worth \$400. Regular price of unit \$1900. Shipping **\$895.00**
wt. 1250 lbs. Our price, complete. f.o.b. Chicago

Same unit, slightly used. Reconditioned, less cable. Fully guaranteed **\$595.00**

RED SEAL CONTINENTAL GAS ENGINE

BRAND NEW. 1 1/2 HP with 6 to 1 reduction gear. Operates at 450 R.P.M. For lawn mowers, scooters, garden tractors, pumps, compressors, generators, etc. List Price \$79.50. Shipping weight 54 lbs.
SPECIAL PRICE \$47.50
Same engine furnished at 2600 RPM.....

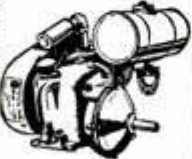

\$46.50

AUTOMATIC PRESSURE SWITCH



For Air or Water 20 to 40 lbs.

\$6.50
125 to 150 lbs. with unloader **\$13.75**
1/4" check valve **\$3.25**
1/2" check valve **\$4.75**



Chicago Pneumatic CP4X Pistol grip handle. Takes up to 3/16" rivet. Weight 6 lbs. List price \$73.00
Brand New..... **\$32.50**
Used, like new, guar..... **\$17.50**

WELLWORTH V-BELT CLUTCH



Takes starting load off engines or motors. When speed is reached, a flip of handle shifts clutch from idling to driving position. Handles "A" belts, 2.35" pitch diameter, 3/4" bore. Ideal for use with lawn mowers, garden tractors, home workshop motors, etc. 3 1/4" long. Safe, easy to mount, sealed bronze bearings. positive action. Shpr. wt. 3 lbs.
\$7.50
BUSHING FOR 1/2" SHAFT, 15c

BRAND NEW SAME CLUTCH FURNISHED WITH 3/4" BORE **\$8.50**

WISCONSIN GAS ENGINES

at a big saving!

Model A.B., 1.7 to 3 H.P. Wt. 60 lbs. List Price, **\$76.00**
\$90.00. Special Price.....
Model A.K., 3 to 4.1 H.P. Wt. 70 lbs. List Price, **\$86.50**
\$106.50. Special Price.....

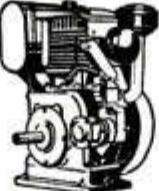

LIGHT PLANT

Brand New 1 Year Guarantee
Portable Light Weight

1500 watts, 110-120 volt, 1 phase 60 cycle, A.C. 12 Volt starting and charging 30 watts, 2 receptacles for plug in, Rheostat for voltage control. Voltmeter. Complete with Briggs & Stratton or Wisconsin Air Cooled engine. Shipping wt. 220 lbs.
SPECIAL PRICE. \$325.00

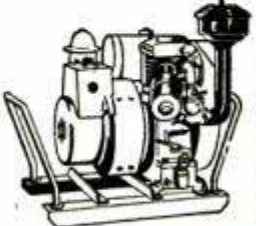

GENERATORS . . . Big Values



500 to 750 watt, A.C., 110-120 volt, 60 cycle, 1 phase output. Also 100 watt D. C. battery charging output. May be used at the same time. Voltmeter, 2 outlet boxes. Price..... **\$99.50**
Wt. 55 lbs.
Furnished with 1 1/2 HP Engine with drive..... **\$149.50**
2000 Watt, 110-120 volt, 60 cycle, A.C. 1 phase, 35 amperes, Starting, overload capacity up to 51 amps. Voltmeter, 2 plug-in receptacles. Wt. 75 lbs. Complete instructions furnished. Special Price..... **\$169.50**
Furnished with 4 1/2 H.P. Wis. AK Engine and drive..... **\$275.00**

2000 WATT LIGHT PLANT

2000-Watt Generator with Floating Base for Automatic Belt Adjusting, 2-Groove Engine Pulleys, V-Belts, Bolts, etc. 4 1/2 HP Engine, Briggs & Stratton Model 14 Engine, Voltmeter. 2 plug-in receptacles. Portable Tubular Steel Skid Type Carrier. Dim: L 34 1/2" x W 17" x H 20". Wt. 180 lbs.
\$365.00

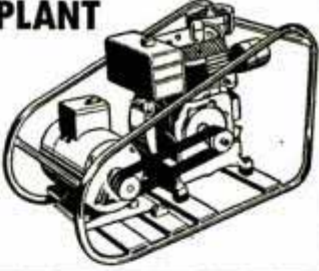

AIR REGULATOR and EXTRACTOR

1/4" Air Regulator, Gauge and filter. Wt. 5 lbs. New **\$8.95**
Regulator and Gauge only..... **\$5.95**
Air Filter only..... **\$3.25**



AIR TANK & ACCESSORIES

Air receiver, stainless steel. Brand New. 6"x24", 400 lb. test. Ideal for carrying on trucks, autos and wherever compressed air is needed. Equipped with 500 lb. combination air gauge and inflation valve with core for retaining pressure in tank; tire chuck, 3 ft. high test air hose.

COMPLETE OUTFIT \$7.95
No. K21 SHIPPING WT. 12 LBS.

TANK ONLY \$6.25
Shipping wt. 7 lbs.

"Wellworth" BLOWER BARGAIN



Quiet operating. Double wheel inlet, double width blower. For heating, ventilating, cooling, air washing, exhausting and forced draft. DIMENSIONS: 10" wheel; outlet 13 1/8" x 11 3/8"; inlet 8 3/4". Height 19". Width 18". Depth 16 1/2". C.F.M., 1/4" S.P. 1600; outlet vel. 1575; wt. 45 lbs.

BLOWER LESS MOTOR AND DRIVE \$27.50
with belt and variable speed pulleys \$2.50 extra. (Motor required, 1/4 h.p.)

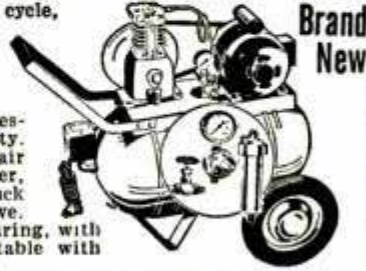

AUTOMATIC COMPRESSOR UNIT

Requires 1/2 H.P. heavy duty capacitor motor. AC 110/220 volt, 60 cycle, 2x1 1/4 inch piston type compressor, splash feed lubrication. 12x24 inch tank, automatic pressure switch. CFM 2.8 at 100 lb. pressure, or 150 lbs. pressure for intermittent duty. Check valve, safety valve, air regulator with gauge and filter, 20 ft. air hose with air chuck for inflating tires. V. belt drive. Mounted on 2 wheels, ball bearing, with 2"x10" pneumatic tires. Portable with handle. Shipping wt. 90 lbs.
Price **\$79.50** Furnished with 1 1/2 H.P. gas engine..... **\$124.50**
Less Motor ..

Prices f. o. b. Chicago. Money back guarantee. Send check or money order today. Prompt shipment.

NEW CATALOG

Motor guide, air compressors, home and factory workshop tools, light plants, luggage bargains. Send 10c for postage.

WELLWORTH TRADING CO.

1831 S. STATE ST., DEPT. D-4, CHICAGO 16, ILL.

**NEW HIGH QUALITY - NEW LOW PRICES!
MIDGET COMBINATION**

**9 pc.
WRENCH
SET**

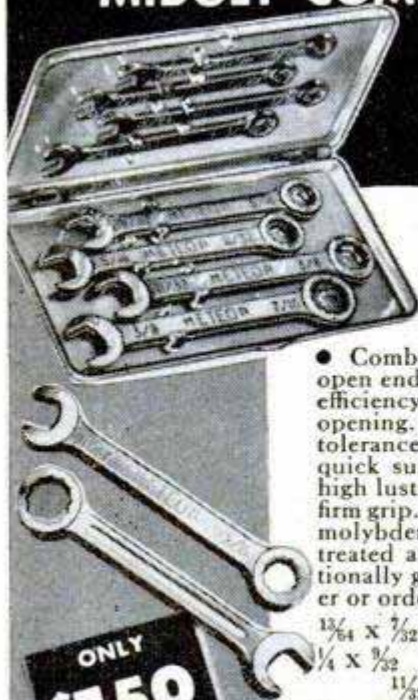

• For Carburetor, Timers, Generators, Radios, TV Sets, Electrical Equipment and all Home Handy Work.

• Combination wrenches with open end angled at 15° for better efficiency, box end has 12 point opening. Broached to accurate tolerance in graduated sizes for quick sure fit. Heads plated to high lustre, handles panelled for firm grip. In strong, tough chrome molybdenum alloy steel, heat treated and hardened. Unconditionally guaranteed. At your dealer or order direct from factory.

1/4 x 3/32 7/32 x 15/64 15/64 x 1/4
1/4 x 9/32 9/32 x 5/16 5/16 x 11/32
11/32 x 3/8 3/8 x 7/16

Snapped in Pocket Size Plastic Kit 2 1/2" x 4 1/2".

**ONLY
\$1.50**

METEOR MFG. CORP. 1441 MAIN ST. BUFFALO 9, N. Y.

Enclosed is check _____, money order _____ for \$1.50
Send Meteor Midget Wrench Set to:

Name _____
Address _____
City _____ State _____

**MAKE MONEY
SAVE MONEY
BUY
SUPERSHOP**

**15 DAY
TRIAL**



**BUY SMART — \$79.95
FACTORY TO YOU**

SUPERSHOP offers you a lifetime of power tool pleasure and profit. 100% ball bearing. RUGGED. Accurate. Big capacity. 15 day FREE trial. Money back guarantee. Mail postcard for FREE catalog.

POWER TOOLS, INC. 122 YATES AVENUE
BELOIT, WISCONSIN

**VERTICAL
DRILL PRESS**

S AGENTS 300% Profit SIGN LETTERS

For Store Fronts and Office Windows. Anyone can put them on. Free samples. Liberal Offer to General Agents.

METALLIC LETTER CO., 430 N. Clark, Chicago 10

**Start Your Own
Welding Business
with a HOBART
"Simplified"
arc welder**

Go after WELDING jobs that Pay Big Money!

200 amp.
300 amp.
400 amp.
Electric or
Gas Drive

Never before has the demand for welding been so great—the profits so large. That's why smart operators everywhere are setting up their own welding business . . . and you can do the same.

SIMPLY CHOOSE from our complete line, the welder that best suits your needs—gas or electric drive—portable or stationary. The big pay jobs are waiting, so don't miss this opportunity. Write today.

"One of the world's largest builders of arc welders"

HOBART BROTHERS CO., Box M-41, Troy, Ohio



**FEDCO get this
Saw-Rite WONDER-WORKING
DRILL SAW**

Fits any
1/4" drill

**FINEST YET MADE... ZIPS THROUGH
WOOD, PLASTICS, WALLBOARD, ETC.**

You'll never use a handsaw again after you try this light-weight, fast-cutting beauty. Careful design, rugged, precision manufacture and a better blade make this an outstanding buy. Quick-acting, worm-drive, patented clamp gets it on and off your drill in seconds. Combination blade is chrome nickel alloy steel, precision ground, correctly heat treated, balanced and fitted. Cuts grooves, dados, crosscut, rip, hour after hour without sharpening. Depth of cut fully adjustable from 1/8" to 1 1/2". cuts plywood, shelving, wallboard, 2x4's to 2x10's in two cuts, one from each side. Special sighting notch enables you to follow line. Lifetime Oilite bearings, finest quality hardened steel gears, shafts. One or two hand operation with hand-fitting knob. Use coupon to order at once for immediate delivery. Try it for 10 days, full refund if not completely satisfied.

**Fedco also makes Saw-Rite Jr. at \$7.75 and
Stanzall at \$2.95 . . . ask for FREE literature**

FEDCO \$10.95
Saw-Rite
Attachment

COMPLETE WITH COMBINATION BLADE
ELECTRO SPECIALTY CO.
128-A Church Street, N.Y. 7, N.Y.

Electro Specialty Co.,
128-A Church St., N. Y. 7
Send me _____ Saw-Rite #600 Saw Attachment(s) @ \$10.95; _____ Additional blades @ \$2.00; _____ metal cutting blades @ \$3.00; _____ FREE literature.
(Write name and address on margin)
(All prices postpaid except C.O.D.'s)

**LIQUID MARBLE COMPOSITION FLOORS
FLEXIBLE MOLDS**

Mold, Brush, Trowel, Spray It! MOLD novelties, Statuary, Art Goods in Flexible Plastic Molds; 5c material makes \$1 seller. Make Marbleized floors, Tile Walls. Colorful, glossy, amazing! Easily learned; start in garage or basement. Particulars free.

MARBLEIZING SERVICE, Dept. 10-F, Edwardsville, Ill.

OWN A Printing Business



Cards, Tickets, Stationery, etc. Good profit in spare time. **PRINT YOUR OWN** greeting cards, movie titles, church work, etc. Save money. Easy rules applied. Raised printing like engraving too. Have home shop. Sold direct from factory only. Pays for itself in short time. Write for free catalog of outfits, and all details.
KELSEY PRESSES, 0-37, MERIDEN, CONNECTICUT

LAWN ORNAMENT-NOVELTY PATTERNS

28 Lawn Ornament Patterns, 25¢. Other Patterns; 15-20" high; Dutch Girl, Dutch Boy, Pirate, Bull Terrier, Mexican Girl, Mexican Boy, Dwarf, Penguin, Flower Girl, 10¢ each. 25 Novelty Patterns, 30¢. All 62 Full Size Patterns, \$1.00 Postpaid.
Strother Pattern Service, Dept. CE-8, Box 128, Belington, W. Va.

**Say You Saw It in Popular Mechanics
Build your own JET ENGINE!**



SEND NO MONEY

Order these plans today
1. JET PROPELLED BICYCLE, Assemble your own. Photo and instructions, \$1.00.
2. HOW TO MAKE EXPERIMENTAL JET ENGINES. Seven sheets drawings with information and instructions \$2.95.
3. BOTH OF ABOVE in one order \$3.75. SEND NO MONEY. Order both at once \$3.75 C.O.D. in USA plus c.o.d. postage. Send check or Money Order and we pay postage. Get other information too. Rush Order.

J. HOUSTON MAUPIN, Dept. 55, Tipp City, Ohio

SAVE UP TO 85%

IN WAR SURPLUS from "GADGETEERS" HEAVEN

SWIM FLIPPERS

Top quality rubber. Has pebble tread bottom. Adj. heel strap. Re-inforced for strength. Vented for air & drainage. For diving and swimming.



lg. 695 small, med. 545

DIVING MASK

Soft rubber mask fits over eyes. . . Has heavy duty glass eyepiece . . . Adj. head-band.



4 1/2" 299 Miss 5" 219 W. 5 1/2" 345

FISHING SPEAR

Corrosion resistant . . . for spear fishing. 11" long with barbed end. Dia. of socket 1".



39¢

NAVY WADING SUIT

Makes Surf & Deep Stream Fishing A Pleasure! Ideal for ranchers, oil fields or anywhere where it is necessary to protect body or clothes from moisture, silt, muck, etc. Made of rubberized canvas. Has vulcanized seams & built-in, rubber gloves and boots. Cost Gov't \$60.00 Small - Medium & Large



AAF CASE

Genuine top grade leather. Multi-compartment. Lock and Straps. Ideal for Artists, Students, Salesmen, etc. Used, good condition.



695

AIR CORPS BRIEF CASE

This is a genuine piece of AAF equipment . . . Made of best grade leather in a handsome pebble finish with a light canvas liner. Has two full length map or paper compartments and three smaller pockets. An ideal case for students, salesmen, artists, etc. Full heavy duty zipper closure. 12" x 16" . . . ONLY



295

CHEMISTRY SET

Made for Chemical Warfare Division for testing water, etc. A handy addition to the chemistry lab or an exciting experiment for the amateur. Set includes test tubes, complete instructions, 15 different items. Packed in attractive lucite box with cover and dividers . . .



695

GOOSENECK LAMP

Consists of 24 volt control box with dimmer switch, 18" flexible extension & frosted glass shade. Can be used on 110 volt current.



272

NAVIGATORS LAMP

A handy light for desk, work bench, chart table, engine room, etc. Can be used on 6-12-24-110 volt by changing bulb. 3 ft. shaft has 4 joints to adjust position . . .



329

Sealed Beam LAMP

U.S. Navy Portable Pistol Grip light. Has sealed beam and aiming sight. Ideal for search spot or emergency light on auto, boat, farm, etc. 12 Volt light, 4" lens . . . 329 24 Volt, 5" lens & carry case . . . 379 Set of 3 filters, red, grn. amber. (specify type lamp) . . . 994



269

NEW! STATIONARY or PORTABLE D.C. ARC WELDER

300 Amps Continuous. 350 - 400 Amps Intermittent. For ALL WELDING LIGHT or HEAVY!

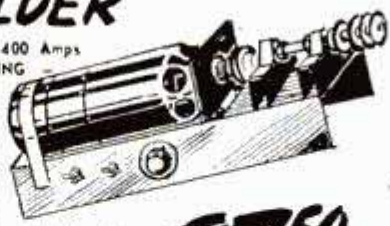

This rugged air-cooled precision built electric ARC WELDER - designed to weld for hours comes complete with pulley reactor, output controls, Hi-Lo switches, rheostat. The heart of this unit is the famous H-1 generator, specially developed for B-29 Bombers, and with features no other generator has. Heavy steel frame, easily adapted to mounting on Jeep, Tractor or other power supply (10 H.P. gas or electric). Never before offered at this low price.

97.50

NEW WATCHES

NEW WATCH . . . Here's a real shock absorbing watch. Has jewel movement, sweep second hand, luminous dial, chrome case. Guaranteed for one year. Ideal for young and old. **695**

WALTHAM NAVIGATION WATCH. (Type A-8) An ideal timer for following of horse racing, boating or any other sports event where split-second timing counts. Large dial with sweep second hand counts the seconds in 1/10ths. Small dial records up to 5 minutes. Originally designed for aircraft navigation. THIS IS A TREMENDOUS BUY!! **22.50** Plus 10% FED. TAX

17 JEWEL CHRONOGRAPH One of the finest made anywhere. Cased in Switzerland. Sweep second hand, stop and re-set button. Measures distance, airspeed, groundspeed, races. Ideal for the sportsman. **26.95**

17 JEWEL AUTOMATIC WRIST WATCH . . . Swiss made men's wrist watch. A real self-winding watch. . . winds itself while you wear it. Incabloc (shock protected). Silver white or black face. Waterproof nickel chrome case, stainless steel back. Hours marked in numerals. Genuine leather strap. Red second hand with arrow tip. Guaranteed **26.95** Plus 10% FED. TAX



WHEELS For Wagons, Dailys, Handtrucks, Wheelbarrows, etc.

10" dia., with 1/2" center hole. (can be drilled out to take 5/8" axle) Wheel is 1/8" steel with 10 x 1.75 heavy duty, semi-pneumatic cushioned rubber tire. . . . **\$1.95**

NEW TARPS - HEAVY CANVAS

Mildew & Flame Resistant. Cheap outside storage! They are really moving at these prices.

5' x 7' . . . \$4.29
15' x 16' . . . \$28.80
16' x 32' . . . \$63.50
Rubberized Nylon Tarp 7' x 11' **6.95**

New Rubberized Linen Tarp - 7' x 11' Waterproof, weighs only 3 lbs. Ideal for outside car storage. **5.95**

18 OZ. TARP - 6' x 6' - O.D. Duck Can be used as a tent floor covering or storage protector. A terrific buy! Used - but in excellent condition **4.95**

MICROPHONE

Telephone type - Highly Sensitive with excellent, clear tone. This was the Signal Corps favorite. An ideal instrument for the radio 'ham' and professional recording studio, broadcasting, home recording, public address, etc. A Sensational Buy! Complete with cord and plug. . . . ONLY **2.69**



PLEXI DOME

Overall length 21" - Width at widest point 11" - at base 4" depth 6". For decorative fish or flower bowls or for cab roof - lights **1.89**



FOAM RUBBER

Moulded, pre-shaped. Can be cut to fit your chair, boat, truck, auto or trailer seats. Ideal for all sports events.

4" x 18" x 23" x 22" . . . \$5.70
18" x 19" x 4 1/2" \$6.45
25" x 60" x 1 1/2" \$8.90
25" x 63" x 1 1/2" \$9.95
25" x 62" x 1 1/2" \$10.95

SHEET FOAM RUBBER

3" Cored Stock . . . No. 2 1/2 compression. Ideal for cot, bed, bunk, couch or chair.

3" x 44" x 80" \$59.50 | 3" x 44" x 49" \$33.50
3" x 22" x 80" \$3.50 | 3" x 22" x 40" \$17.50
1" x 44" x 40" \$14.50
2 1/2" x 44" x 40" \$31.00
4 1/2" x 44" x 40" \$47.50

Genuine LEATHERETTE

to cover Chairs, Patio Furniture, Nooks, Auto Seats, etc. - 10 COLORS - at a BARGAIN PRICE

36" tile, red, brn, black . . . \$1.19
36" tile, grn, dk. grn, blue . . . \$1.65
54" (approx.) red, brn, lt. blue, ivory and yellow \$1.95



PRESSURE TANKS

1000's of uses around farm, shop & factory for storage, pressure, paint & insecticide spraying, etc.

F-2 - 6" x 45" - (1000 cu. in. capacity) - Stainless Steel **4.95**
F-2A - Same as F-2 but in Corrosion resistant steel **3.95**
D-2 - 6 1/2" x 24" - (500 cu. in. capacity) - Stainless Steel **3.49**
D-2A - Same as D-2 but in Corrosion resistant steel **2.49**

TANK

Dural with welded seams, 2" filler with cap, two standard pipe ports for hook-up. Visible liquid level gauge on side. For gas, oil, water or "spare" on auto tractor, truck or boat. Sturdy, light. Capacity - 6 gal. . . . **14.95**



NEW 1951 CATALOG

PACKED WITH BARGAINS!!! Just Off The Presses! Bigger Than Ever! 200 Pages of NEW and SURPLUS Clothing, Teats, Camp Equipment, Electrical Supplies, Hydraulics, Motors, Pumps, Valves, Row Stock, etc. AT UNHEARD OF LOW PRICES! Send 50c Today! (refunded with your initial order of \$1 or more)

FLYING HELMET

Fine grade leather . . . Chamois lined with chin cup on strap. Intermediate weight . . . Ideal for summer wear. NEW ONLY . . . **1.59**



All New! Winter type with fleece or chamois lining. Has ear puffs & chin cup. Ideal for pilots, cycle - drivers, sportsmen, etc. **1.95**

Aviators (AN-6530) Windproof & Durable GENUINE COGGLES

Rubber or chamois covered frame. Clear or Green GROUND LENSES are inter-changeable. Adjustable nose bar. Ideal for flying, motor cycling, etc. . . . **1.69**

GO-1 GOGGLE KIT

NEW! U.S. Navy - Has soft sponge rubber frame. 4 Polaroid lenses. 2 green, 1 red, 1 clear. Perfect for racing, cycling, etc. **89¢**



RUBBER BOOTS

A sturdy boot of the finest pliable rubber. Completely waterproof with adjustable strap. Can be worn with or without shoes. A REAL BUY **3.95**



SHOE PACS

Assures complete foot and shoe protection in the coldest weather. Specially designed to keep the feet warm & comfortable & the shoes dry. Has 14" leather boot top, rubber shoe & sole - felt inner sole. **3.95**



Plexiglass & Macrolite clear plastic shts.

MACROLITE - Full sheets app. 1/8" x 37 1/2" x 49 1/2", app. 10 1/2 lbs. each **\$14.25**

PLEXIGLASS - Full Sheet 3/16" x 36" x 48" Per Sheet. **\$17.95**
5/16" x 36" x 48" . . . Per Sheet. **\$27.50**
Fabricators write in for our special quantity prices, all above are new & masked. Also inquire about other large stocks of Plastics

PLASTIC PARALLEL

with knobs and rubber pads for non-slipage on each section. A must for navigators, mechanics, draftsmen and engineers. You've never seen 'em at . . . **97¢ ea.**



IMPORTED BINOCULARS

Lightweight but sturdy. Navy type. Full 50mm objective lenses that insure maximum brightness and sharp definition. Finely balanced for easy handling extra wide field of vision, individual eye-focusing. With genuine leather case . . . **33.95**



NYLON FISHLINE Special

Strong - Lightweight - 2 ply NYLON FISHING LINE. ROT PROOF and WATERPROOF . . . Especially treated for strength and long life. ON SPOOLS.

1500 ft. 25 lb. test - wht. **\$1.86**
1500 ft. 10 lb. test - blk. **\$1.42**
1000 ft. 25 lb. test - grn. **\$1.64**
2500 ft. 10 lb. test - brn. **\$1.86**
750 ft. 50 lb. test - brn. **\$3.18**
400 ft. 50 lb. test - brn **\$1.31**
750 ft. 45 lb. test - grn. & brn. . . . **\$2.96**
300 ft. 100 lb. test - wht. . . . **\$4.35**
300 ft. 75 lb. test - silver grey . . . **\$3.51**



PALLEY SUPPLY CO
Dept. PM-4 GLENDALE, CALIF.

LARGEST FIRM OF ITS TYPE IN THE WORLD

SOUTH BEND

Precision Lathes

For Better Machining

Whether you are doing production, maintenance, service or experimental work, you have need for South Bend Lathes. They produce better machining efficiently.—especially when close tolerances are specified. Consequently, their use often results in appreciable savings in machining costs. And, being reasonable in price, they do not require heavy capital investment.

South Bend Lathes are your best buy. They're designed right—built right. Check coupon for complete information.



Building Better Tools Since 1906

SOUTH BEND LATHE
SOUTH BEND, INDIANA

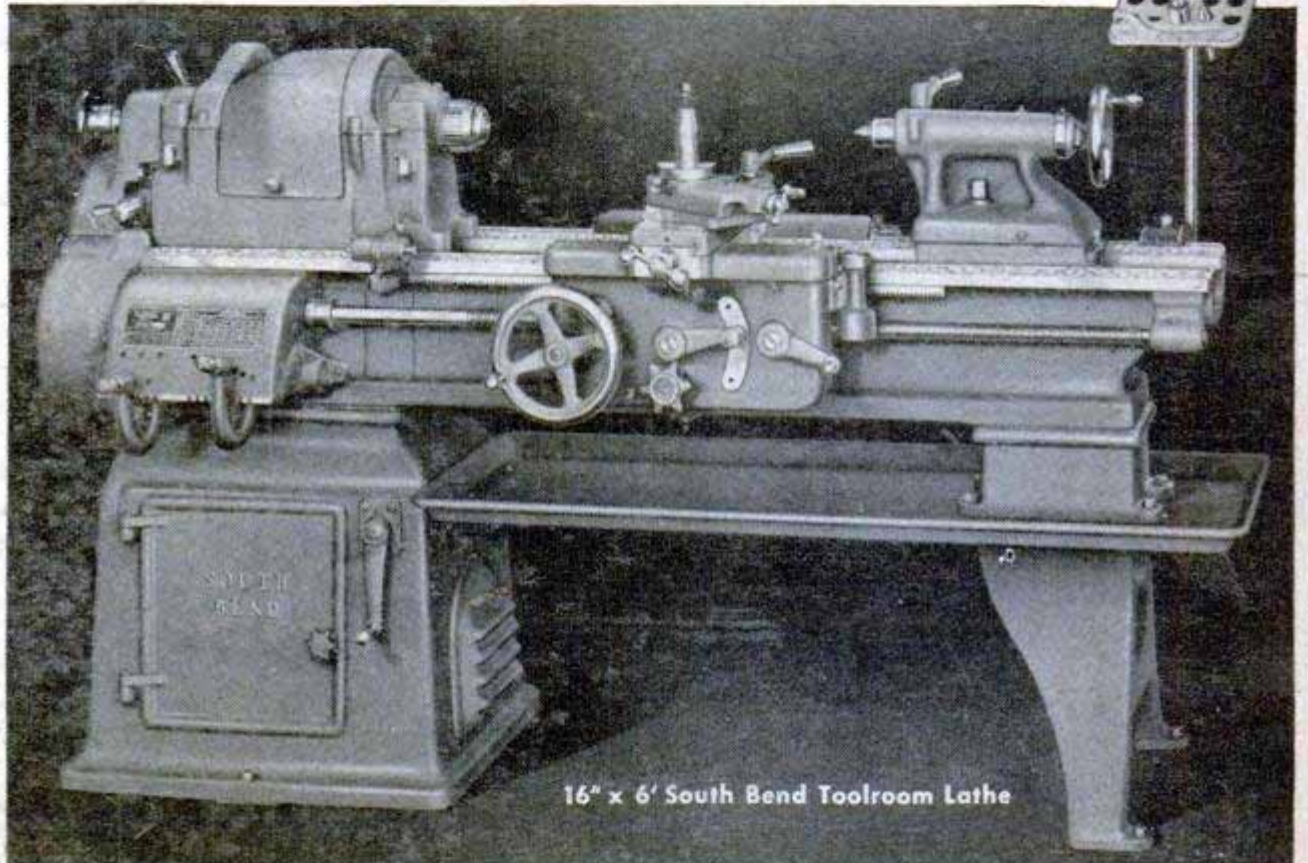

16" x 6' South Bend Toolroom Lathe

SPECIFICATIONS OF SOUTH BEND 16" LATHES

Swing: 16 $\frac{1}{4}$ " over bed, 9 $\frac{5}{8}$ " over cross slide.
 Bed Lengths 6 to 12 feet
 Center Distance 33 $\frac{1}{2}$ " to 105 $\frac{1}{2}$ "
 Cross Slide Travel 10 $\frac{1}{2}$ "
 Spindle Speeds:
 8-Speed Drive 25 to 770 r.p.m.
 12-Speed Drive 20 to 945 r.p.m.

Collet Capacity 1"
 Spindle Bore 1 $\frac{1}{8}$ "
 Power Feeds:
 Longitudinal: 48 R.H. or L.H., .0015" to .0841"
 Cross Feeds: 480006" to .0312"
 Thread Cutting: 48 R.H. or L.H. pitches 4 to 224 per inch

Send Information Checked:

- 16" TOOLROOM LATHES
- 16" QUICK CHANGE GEAR LATHES
- LATHE ATTACHMENTS



- 9" and 10" BENCH LATHES

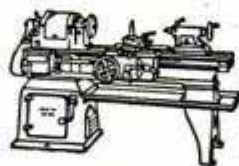

- 10" TO 16-24" FLOOR LATHES



- 14" DRILL PRESSES

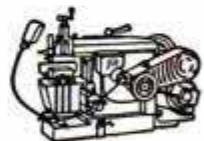

- 7" BENCH SHAPERS

Name _____

Street _____

City _____ Zone _____ State _____

- TURRET LATHES
1/2" and 1" Collet



Printed by Popular Mechanics Company, Chicago, Ill., U. S. A.

SAVE GAS .. Up to 1 Gallon in Every 4



install a

MILE-O-METER

(Reg. U.S. Pat. Off. International Copyrights & Patents Secured)

(measures miles per gallon)
and motor tune-up gauge

Up to 35 Miles Per Gallon

Mile-O-Meter is a gasoline mileage gauge as well as a motor tune-up indicator, very important in running your car economically.

Fits all cars. Permanently mounted. Checks Spark Plugs, Carburetor and 31 other Motor adjustments. Shows how to increase miles per gallon at every speed. 1 to 5 minute installation — 4 color Easy-To-Read Dial. No holes to drill. Mounting bracket fits dash or windshield frame. No experience needed. Complete instructions and 16-page mileage book included. Tested and proved by leading Automotive Associations and manufacturers. Makes a perfect gift. (Beautifully gift wrapped at no charge.) Over 1,000,000 in use today.

SURE ACCURACY
AT ALL SPEEDS

Send for yours, today — Mile-O-Meter shipped prepaid — money back guarantee
Deluxe Chrome Model 3 3/8 Dia. . . . \$14.95 Ppd.
Standard Model 2 3/4 Dia. . . . \$9.75 Ppd.
Fed. Tax Incl.

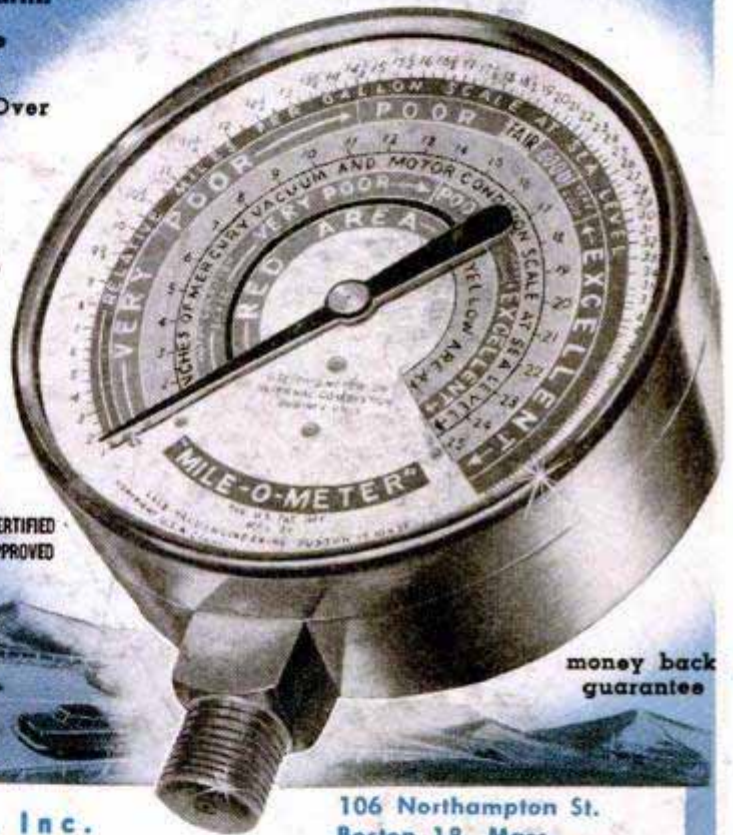

money back guarantee



Mile-O-Meter will tell you how to correct the engine condition

Certified Test Performance Certificate **1950** CERTIFIED APPROVED



order from **GALE HALL ENG., Inc.**

106 Northampton St.
Boston 18, Mass.



1. **TEACHES** you how to drive economically — eliminates the Jack Rabbit starts and passing on hills — that's where you really drink up fuel.



3. **YOU** can check your engine condition at all times, and if it is not operating efficiently, Mile-O-Meter will tell you how to correct the condition.

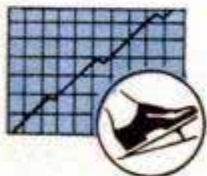

2. **PERFORMANCE** charts and suggestions are enclosed with every meter, enabling you to determine how many miles per gallon you are getting, and what adjustments to make to increase your mileage.



4. **SIMPLY** mount meter on windshield frame or on dashboard area to suit your convenience with the aid of mounting brackets that can be bent into practically any position.

Don't Delay
Order Today
For
Immediate Delivery

Available in Canada from:
Mile-O-Meter of Canada
Division of
Century Products, Ltd.
174 Bloor Street, East
Toronto 5, Ontario

In Canada
\$17.95 Ppd. \$11.95 Ppd.



With Baseball's Big Winners...

it's COOL, MILD

CAMELS!

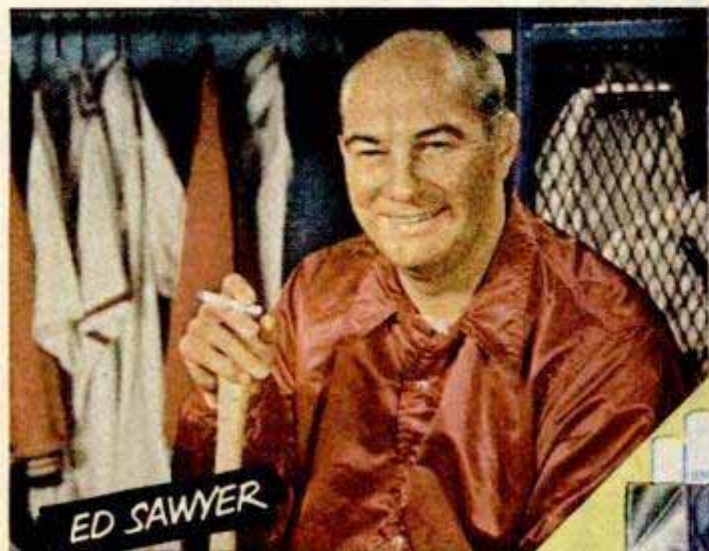

ED SAWYER

"Manager of the Year" in 1950, Ed masterminded the Phils into the pennant. "My own 30-Day Camel Mildness Test proved how mild a cigarette can be!"



JIM KONSTANTY

Most Valuable Player of 1950 in National League, Jim Konstanty says: "Camels give me the kind of flavor and mildness I find in no other brand."



VIC RASCHI

Top Pitcher of the World Champions, Vic Raschi, of the New York Yankees. "Camels are my choice for mildness. Camels never tire my taste," says Vic, opening game winner in the World Series.

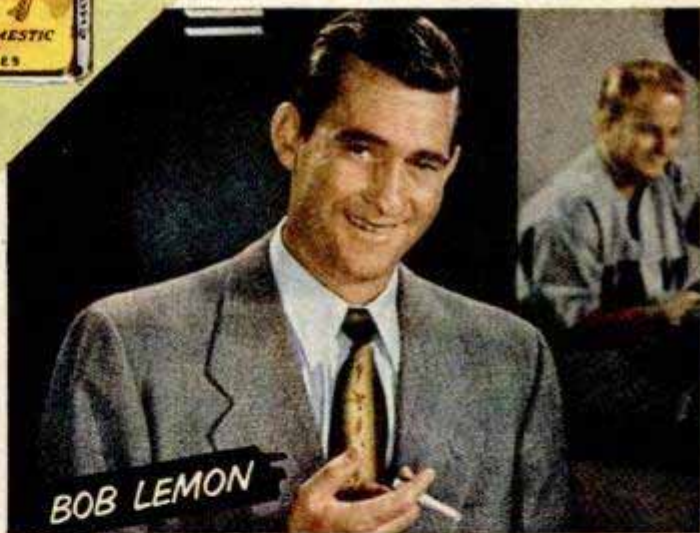

BOB LEMON

Leading Right Hand Pitcher of 1950, Cleveland's Bob Lemon, only hurler to win 20 games or more in each of the past 3 years, says: "I'm glad I made my own 30-Day Test. Camels hit the spot!"

Make the sensible cigarette test. Change to mild, flavorful Camels for 30 days. You'll know why...

MORE PEOPLE SMOKE CAMELS than any other cigarette!



Make your own 30-Day Camel MILDNESS Test in your "T-Zone"

(T for Throat, T for Taste!)

R. J. Reynolds Tob. Co.
Winston-Salem, N. C.