

POPULAR MECHANICS

MAGAZINE

WRITTEN SO YOU CAN UNDERSTAND

REG'D. TRADE MARK, GREAT BRITAIN, NO. 410426



The more you delay -
the more you pay!

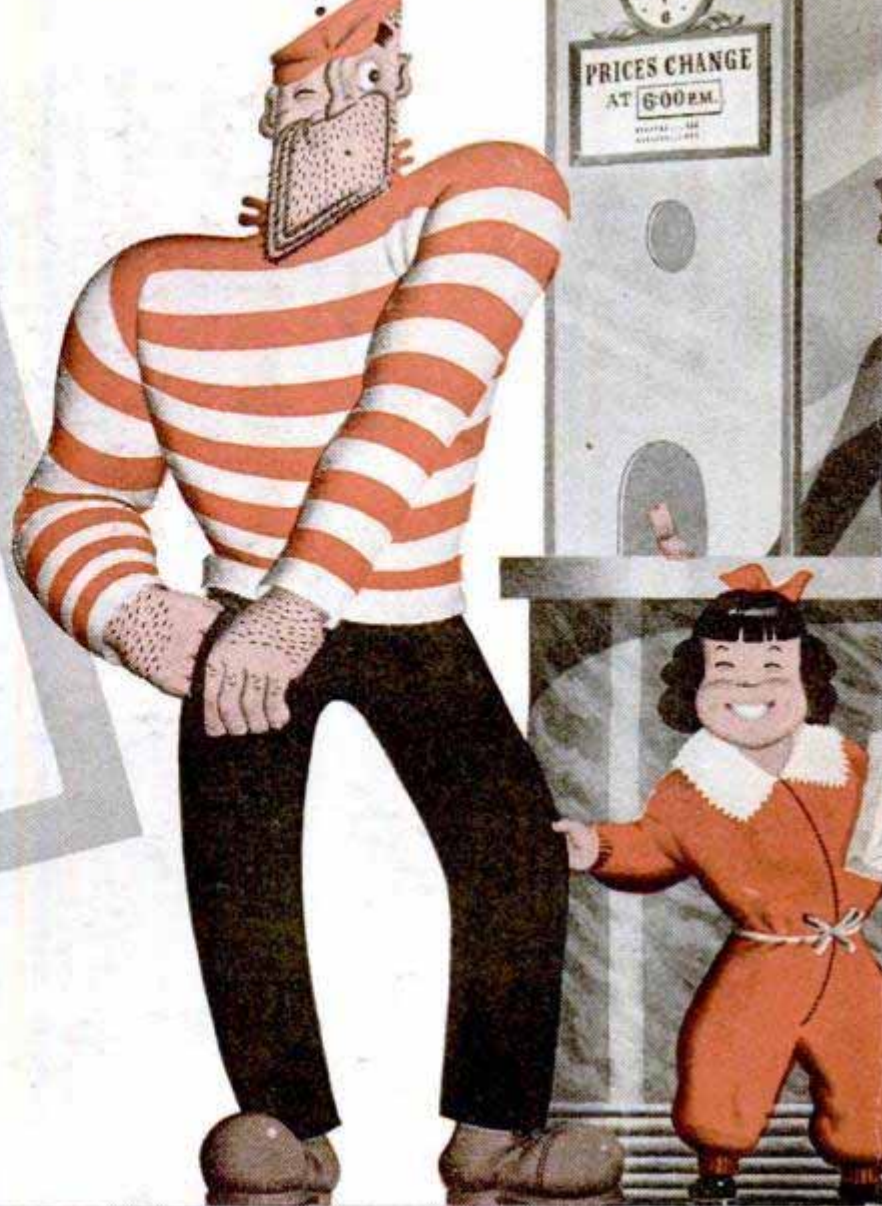

**KEEP YOUR CAR
OUT OF THE
DANGER ZONE**

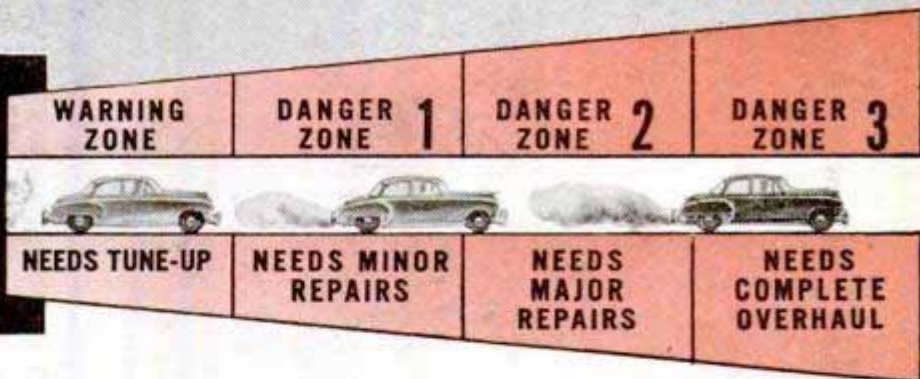

When oil-pumping starts in your car, you can be pretty sure your piston rings are wearing out. And, unless you replace them, you can be very sure you are headed for costly Danger Zone No. 3.

Piston rings are designed to take the wear—to be replaced again and again—to save your engine.

So, when your car first needs new rings, ask your motor specialist to replace them with Hastings Rings. They are engineered exclusively for replacement service. They stop oil-pumping, check cylinder wear, restore performance. The more you delay, the more you pay. Hastings Manufacturing Co., Hastings, Michigan. Hastings Ltd., Toronto.

HASTINGS

STEEL-VENT PISTON RINGS

FREE! Write for Danger Zone Booklet. It shows you how to save money on engine repairs.



**TOUGH ON OIL-PUMPING
GENTLE ON CYLINDER WALLS**

"TOP 3"

for fishin' fun

[most for your dollars, too]



BIG TWIN 25 H.P.*

Leader in performance, features, value! Roto-Matic Control, Gearshift, Cruis-a-Day Tank.

\$390



FASTWIN

(on boat above)
14 H.P.* Only 65 lbs.
Up to 22 miles on good-sized fishing boats. Gearshift, Cruis-a-Day Tank.

\$315



FLEETWIN

7.5 H.P.* Only 45 lbs.
Tops in lightweight field! Duo-Clutch gives "press-the-button" handling ease. Safti-Grip Drive.

\$210

TOO GOOD TO MISS! . . . the keen new thrills these great Evinrudes bring to fishing fun! *The thrill of speed* to make long runs in a fraction of the time! (With Big Twin, up to 30 miles an hour on comfortable fishing boats). The matchless convenience of Gearshift and Duo-Clutch! *New handling ease . . . and, with Big Twin's and Fastwin's Cruis-a-Day Tank, carefree hours of running without re-fueling!*

All this and trolling, too! Yes . . . even Big Twin, with its eager 25 horsepower, throttles down to a slow and steady gait that wins the most finicky fisherman! Dollar-wise, compare them against the field—for power, performance, features, fun—and you'll want to get your order in! See your Evinrude Dealer—look for his name in your phone directory under "Outboard Motors." Catalog Free—write for it today!

EVINRUDE MOTORS
4636 North 27th Street
MILWAUKEE 16, WIS.
In Canada: Evinrude Motors,
Peterborough, Ontario

EVINRUDE

*Power ratings are O.B.C. certified brake H.P. at 4000 R.P.M. All prices are F.O.B. Factory and subject to change without notice.



CATALOG FREE! Write today for full-color catalog of complete Evinrude line for 1951.



IT'S "LOADED" WITH BETTER TELEPHONE SERVICE

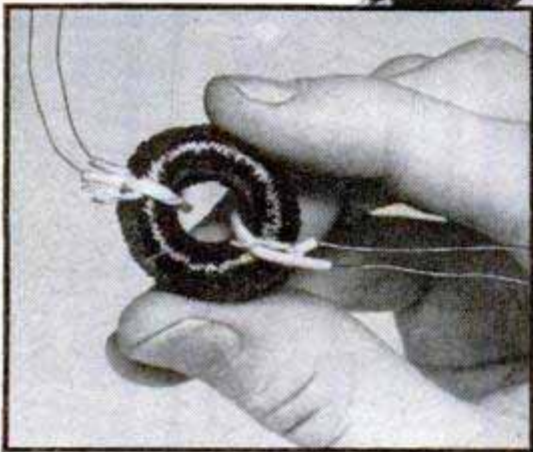

Twenty of the Bell System's newest small loading coils—like the one at the left—are housed in the long black case, mounted in a cable splice. This type of installation permits the economical extension of city cables to serve out-of-town subscribers.

MANY more wires can be crowded into a cable sheath when the wires are fine. But normally, wires don't transmit as well when they are fine and closely packed.

Bell engineers long ago learned to make wires do better work by loading them with inductance coils at regular intervals. The coils improve transmission and let messages travel farther. But originally the coils themselves were large, heavy and expensive. The cases to hold them were cumbersome and costly too.

So year after year Bell scientists squeezed the size out of coils. To make magnetic cores

of high permeability they developed Permalloy. Tough but extra-thin insulation permitted more turns to a core.

New winding machines were developed by the Western Electric Company. Coil size shrunk to one-fiftieth. Some—like the one shown above—can be mounted right in cables themselves.

The 15,000,000 coils in the Bell System today mean thinner wires, more wires in a cable—more economical service for you. They demonstrate once more how Bell Telephone Laboratories work continually to add to your telephone's value.



BELL TELEPHONE LABORATORIES

WORKING CONTINUALLY TO KEEP YOUR TELEPHONE SERVICE BIG IN VALUE AND LOW IN COST

Popular Mechanics Magazine

Registered in U. S. Patent Office and Canada

H. H. WINDSOR, Founder

H. H. WINDSOR, JR., Editor and Publisher



this month's cover

SOUTH OF THE BORDER, señor, some strange cargo is traveling by air these days. The blooded Argentine race horses pictured on the cover are commonplace "freight," according to Richard F. Dempewolff, eastern editor, who flew from Venezuela to Florida on one of Pan American's cargo carriers. The pilots who fly the Latin America freight run carry orchids, automobiles, boa constrictors, bananas, diamonds, emeralds, wild animals, tropical birds (and how they squawk), domestic cattle, cigarettes, chickens, helicopters and monkeys. In his article, "Tropical Tramps" Link the Americas, page 88, Dempewolff tells how 300 monkeys got loose from their cages and practically took over the plane. When one of these cargo ships lands, no South American is surprised at anything that might be peering out the windows. Horses, such as shown on the cover, ride in canvas stalls and behave themselves as long as they don't have to look at each other. Before the pilots discovered this, the animals rode in padded stalls

Published monthly by Popular Mechanics Company, 200 E. Ontario St., Chicago 11, Ill. H. H. Windsor, Jr., president; William Harrison Petridge, vice president; D. F. Windsor, vice president and secretary-treasurer; Clover L. Perkins, advertising manager; Alan M. Deyoe, circulation manager. Single copy in the United States and Canada, 35 cents; subscription rates in United States and possessions, Canada, Philippines and countries of the Pan-American Postal Union, 1 year \$3.50; 2 years, \$6.00; 3 years \$8.00. To all other countries add \$1.00 a year over United States prices for overseas postage. If you plan to move, notify us at least 30 days in advance so you will not miss an issue. Give both your old and new addresses.

Entered as Second Class Matter, September 15, 1903, at the Post Office at Chicago, Illinois, under Act of March 3, 1879. Entered as Second Class Matter at Post Office Dept., Canada. Registered as Second Class Matter at the Post Office at Mexico, D. F., Mexico, June 20, 1950.

Copyright 1951 by Popular Mechanics Company. Copyright under International Copyright Union. Copyright in France. All rights reserved under Pan-American Copyright Union. Printed in the United States of America.

Volume 95

MARCH 1951

Number 3

Managing Editor.....Roderick M. Grant
 Assistant Managing Editor.....Wayne Whittaker
 Shop Notes and Crafts Editor.....James R. Ward
 Radio-Television, Electronics Editor.....Frank L. Brittin
 Associate Editor, Aviation.....Aubrey O. Cookman, Jr.
 Associate Editor.....Clifford B. Hicks
 Associate Editor.....Donald R. Brooks
 Automotive Editor.....Siler Freeman
 Art Director.....Frank Beatty
 Director, Bureau of Information.....Allan Carpenter

200 E. Ontario St., Chicago 11.

Assistant Editors

Dorothy E. Hoffmann Arthur R. Railton H. H. Windsor III
 Assistant Editors, Shop Notes and Crafts
 W. Clyde Lammey Wayne C. Leckey Frank N. Stephany
 C. E. Mitchell

Eastern Editor.....Richard F. Dempewolff
 Empire State Bldg., Room 2906, New York 1, N. Y.

Western Editor.....Thomas E. Stimson, Jr.

Representative in Great Britain.....Douglas W. Wedderspoon
 77 Baker St., London W. 1, England

IN THIS ISSUE

SSN 1037—Triple-Threat Man of the Jet Bombers	81
"Tropical Tramps" Link the Americas	88
Sculptor of a Prehistoric World	97
Nash Builds a Sports Car	107
Close-Ups From Miles Away	112
I'm Building the P.M. Ranch House—Part V	120
Five Miles Under the Sea	124
What's New for Your Home	130
Stunt Drivers Will Do Anything to Please	133
At Home in a Silo	140
PBY Penthouse	144
One River Borrows From Another	154
Some Get Rich, Some Don't	158

For the Craftsman

Try Your Hand At Metalwork	166
One-Evening Projects	180
How to Make Storm Sash and Screens	186
"Kidster" Pedalmatic for '51	190
Solution—a 16-Foot Plywood Sailing Scow	194
Underinflation and Overinflation of Tires	203
Better Results With Hand Hacksaws	211
Handling Big Work on Your Circular Saw	218
Radio-Television, Electronics	227
Clinic for Homemakers	236

Other items, and manufacturers of available products described, are listed on pages 10, 12 and 14



**Ready
for take-off...**

... to a top spot in the U. S. Air Force!

The flight engineer of a U. S. Air Force B-29 . . . waiting the pilot's signal to return props to high pitch for take-off after engine run-up . . . is a man with power at his command. This Master Sergeant is a vital member of a flying team . . . a man who has proved his power to get on top and stay on top in a topflight job with a great Air Force.

Technical courses for flight engineers . . . available to qualified Air Force enlisted personnel . . . are typical of training in 42 Air Force career fields. *You* can have this kind of training . . . furthering your service career and paralleling civilian jobs . . . as an Airman in the U. S. Air Force.

To be ready for take-off, with power to climb . . . take to the Air Force.



**U. S.
AIR FORCE**

**GET DETAILS AT YOUR NEAREST
U. S. ARMY AND U. S. AIR FORCE
RECRUITING STATION TODAY**

Get on Top . . . Stay on Top . . . in the U. S. Air Force!

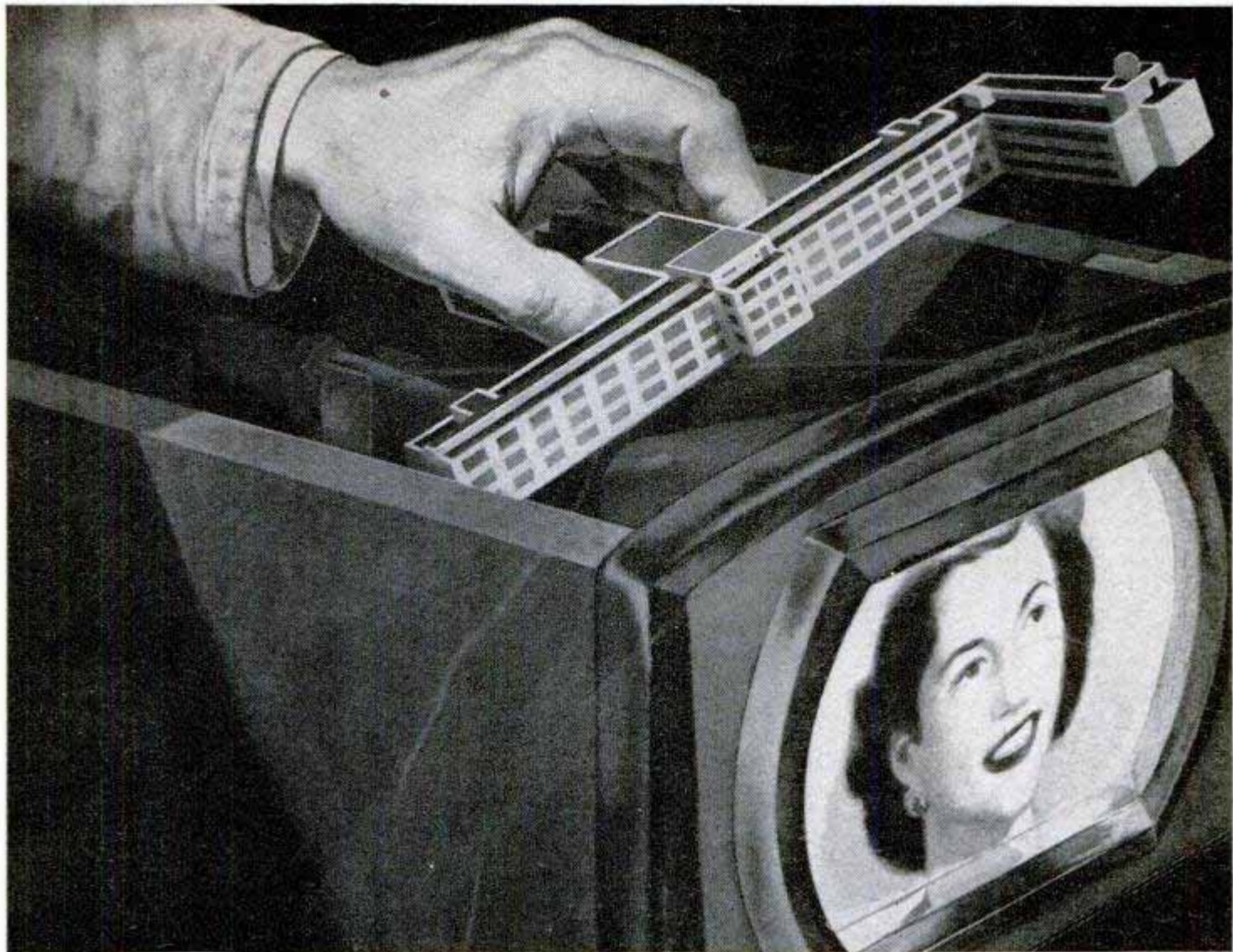

Basic research at RCA Laboratories has led to most of today's all-electronic television advances.

At the heart of every television set!

Why show RCA Laboratories *inside* your television receiver? Because almost every important advance leading to all-electronic TV was pioneered by the scientists and research men of this institution.

The supersensitive image orthicon television camera was brought to its present perfection at RCA Laboratories. The kinescope, in these laboratories, became the mass-produced electron tube on the face of which you now

watch television pictures. New sound systems, better microphones—even the phosphors which light your TV screen—first reached practical perfection here.

Most important, the bulk of these advances have been made available to the television industry. If you've ever seen a television picture, you've seen RCA Laboratories at work.

* * *

See the latest wonders of radio, television, and electronics at RCA Exhibition Hall, 36 West 49th St., N.Y. Admission is free. Radio Corporation of America, Radio City, New York 20, N. Y.



Through research at RCA Laboratories, today's RCA Victor home television receivers are the finest example of modern electronic engineering.



RADIO CORPORATION of AMERICA

World Leader in Radio — First in Television

a case of simple addition

PYROIL + OIL = better lubrication

The simple addition of Pyroil to your gas tank or crankcase gives you a lot of "plus" performance at little cost. Your car will run better, last longer and cost less in repairs, because Pyroil improves lubrication.

Pyroil keeps expensive engine parts protected against corrosion. It prevents battery drain and excessive wear due to friction. Pyroil cleans out sludge and carbon deposits and keeps your motor clean.

For better lubrication, better add Pyroil — add miles to your car.

Pyroil for Aircraft Engines

Use Aircraft Pyroil B for lubricating oil, Aircraft Pyroil A for gasoline.

GIVEN!

An attractive Pyroil metal savings bank, takes coins up to 50c pieces. **MOTORISTS**, it's yours for the asking — sent postage paid.



Manufactured and Guaranteed by Pyroil Company, 113 Pyroil Bldg., La Crosse, Wisconsin.

Canadian Distributors: Central Purchasing Agencies, Ltd., Toronto, Ontario

PYROIL COMPANY

113 Pyroil Bldg., La Crosse, Wisconsin

I want my car to last and run properly. Please tell me more about Pyroil and how it can accomplish this for me.

Name _____

Address _____

City or Town _____ State _____



in this corner.....

THE EDITORS



HOW DO YOU LIKE YOUR NEW FORD? *Popular Mechanics* put the question to 1000 owners. Next month we bring you the answers in another of this series by Floyd Clymer on what the owners really think of their automobiles.



Letter to the Editor

While vacationing near the Gallatin River in Montana, my son and I spotted an abandoned miner's cabin deep in the forest (see photo). It obviously had not been used for many years. We thought you'd be interested to know that the miner, whoever he was, had among his reading material a 1913 issue of *Popular Mechanics* . . .

Fremont A. Chandler, M.D.,
6 N. Michigan Ave.,
Chicago 2.

Letter to the Editor

Your article on page 101, December 1950 ("Driver Take Your Choice—Life or Death on Ice"), should be on the front page of all newspapers. I have been a test driver for 46 years on the public highways and never had a single accident. Fifty to a hundred thousand miles per year, all kinds of weather, snow, mud and sand, and never was pulled out. Keep up the good work.

S. Carbaugh Allen,
33510 N. Hampshire, R. 5,
Plymouth, Mich.

Lightning Strikes Your Dinner

If you don't happen to have a refrigerator, shoot a bolt of lightning through your leg of lamb and put it on a pantry shelf. It will keep for years.

It's not quite that simple, of course. You don't have a bolt of lightning. But you

(Continued to page 8)

Let me send You **FREE PROOF** that you can become an expert **ACCOUNTANT... BOOKKEEPER** **OR C.P.A.**

LOWELL C. DOAK
C. P. A., M. B. A.
Director of
LaSalle Accountancy
Instruction



FREE SAMPLE LESSON

I offer you this free sample lesson so that you can prove to yourself that you CAN master Accountancy—quickly, thoroughly—in spare time at home.

You will see exactly how LaSalle's famous "Problem Method" works... how you are led step-by-step through actual accounting work—learning by doing and not by study of theory alone. First you tackle easy problems, then more difficult ones—until soon you master them all. And at every step you have the close personal guidance of LaSalle's large staff of C.P.A. instructors.

HIGHER ACCOUNTANCY

By the LaSalle Problem Method..

• Practical Accounting

Assignment 1
THE BALANCE SHEET

QUOTING from the "Journal of Accountancy," the authoritative organ of the professional accountants of the United States:
"... the accounting profession is probably the best paid in the world. It there be a profession in which the average compensation is higher, it is not known to us."
"There is need for accountants. There is ample compensation for accountants. There is no prospect that the supply will overtake the demand within the lifetime of even the youngest of us."

LaSalle Extension University
A Correspondence Institution
CHICAGO

THIS SAME LESSON STARTED ME

toward a well-paid public accounting career—and my C.P.A. degree. I knew nothing of accounting before—yet my progress was rapid—my earning power climbed fast. This sample lesson will show you why.

If you have been envying the high incomes and good jobs enjoyed by thousands of men and women Accountants today... incomes ranging from \$4,000 to \$10,000 and more per year... why not launch such a career for yourself?

Do you doubt that you can?

Then let me send you—without cost or obligation—the same Lesson Number One with which LaSalle has started several hundred thousand

men and women toward successful accounting careers. I want you to see for yourself how this remarkable method, originated by LaSalle, makes Accountancy simple, interesting, practical, and certain... how it leads you step-by-step to a complete mastery of Accounting—and on up to the coveted degree, of Certified Public Accountant if you so aspire.

It doesn't matter whether you've had previous bookkeeping experience, or whether you don't know a debit from a credit. Whether you wish to qualify as an expert bookkeeper, advanced accountant, cost accountant, auditor, government accountant, income tax specialist, or public accountant... you'll find in LaSalle's Problem Method the exact plan to prepare you rapidly and inexpensively—in spare hours at home—without losing a day from your present job.

So right now, today... if you are an adult, employed, and earnestly ambitious for rapid advancement in this highest-paying of all professions... send your name and address to me on the coupon below. I'll send the free sample lesson—plus our 48-page book outlining today's career opportunities and how you can qualify for them. A coupon like this has started many thousands toward greater success. It can do the same for you. Mail it today!

Clip Coupon... Mail TODAY!

LaSalle Extension University... A Correspondence Institution
Dept. 364H, 417 S. Dearborn Street, Chicago 5, Illinois

YES, MR. DOAK, I want to see how LaSalle's "Problem Method" works... how I can qualify for high-pay Accountancy positions. Also, send your 48-page book, "Accountancy, the Profession That Pays"... all without cost or obligation.

Name..... Age.....

Street Address.....

City, Zone & State.....

Present Position.....



Nearly 10%
of all C.P.A.'s
in the U.S. have
been trained by the
LaSalle Problem
Method

GOOD-PAY JOBS IN 5 BIG FIELDS

If you were an expert accountant right now, chances are you would find yourself among the highest-paid of all professional men and women. Surveys show that accountants earn more than those in other major professions.

There are five big fields of opportunity open to Accountancy-trained men and women... opportunities that are wide open and highly inviting, offering maximum income and job security in good times or bad. And under LaSalle's "Problem Method" you can start earning while still learning—either in spare-time or full-time employment... or in business for yourself with no capital required.

Get the latest information by sending for our 48-page book, "Accountancy, the Profession That Pays"... plus free sample lesson. The coupon at right will bring both to you without cost or obligation. LaSalle Extension, 417 S. Dearborn St., Chicago 5, Ill.

This One



LAST CHANCE

to plan your own career
in Aviation

HIGH SCHOOL STUDENTS & GRADUATES NOW may be your last opportunity to prepare for a profitable civilian career in Aviation. You learn fast and well at Embry-Riddle. Even if military service intervenes, you're still way out front with Embry-Riddle training! The Aviation Industry demands thousands of properly trained engineers, mechanics and supervisors - NOW. Embry-Riddle offers maximum training in minimum time for top essential civil aviation positions.

VETERANS Aviation's most gigantic boom is on the way. Use your last chance for G. I. training benefits to insure your success in this fastest growing career field. Enroll at Embry-Riddle before the July 25th G. I. deadline. Do it TODAY.

Be Ready To Best Serve Your Country And Yourself
With One Of These

4 Keys to Success!

AIRCRAFT & ENGINE MECHANICS

Our C.A.A.-approved school has a quarter-century aviation training experience. Learn fast with modern equipment, including jet... live aircraft, airline-size hangars.

A & E COMBINED WITH COMMERCIAL

Embry-Riddle combination training gives you unusual dual pilot-engineering ability.

AERONAUTICAL ENGINEERING

Embry-Riddle's accelerated 26-mo. Aeronautical Engineering College Course provides finest training available.

COMMERCIAL PILOT

Benefit from our experience with 30,000 students...best instructors and aircraft, year-round flying weather.



Embry Riddle

International
SCHOOL OF AVIATION
MIAMI 30, FLORIDA
RIDDLE-McKAY AERO COLLEGE

CLASSES BEGINNING NOW -- SEND COUPON TODAY!

Dean of Enrollments - Dept. 99
Embry-Riddle School of Aviation
Miami 30, Florida

Please Print

NAME _____

ADDRESS _____

City _____

State _____ Age _____

I am interested in..

- A.&E. Mechanic
 Commercial Pilot
 Aeronautical Engineering
 A.&E. Combined with Commercial Pilot
 Flying Mechanic

Check One Veteran Non-Vet

TRAIN IN MIAMI--AIR CAPITAL OF THE WORLD

(Continued from page 6)

may, very soon, stock your shelves with foods that do not require refrigeration; the first commercial machine to preserve foods electronically will go to work this year, and it may well revolutionize the packing industry. You'll read the story in our April issue, illustrated with full-color photographs of hamburger, grapefruit and vegetables that look as fresh today as when they were shot through with 3,000,000 volts and stored at room temperature four years ago!



Letter to the Editor

"Those Handy-Andy Eggbeaters" by Lt. Comdr. Arthur L. Schoeni, U.S.N.R., in the December issue, is jam-packed with interesting anecdotes of odd uses of helicopters by the Navy and Air Force. There seems to be no end to the ways in which civilian operators have put the sky-going "Mix-masters" to work as well.

For example: When the gridiron was wet before the Stanford-California game at Berkeley in November, a helicopter was flown back and forth over the field to speed evaporation and it was dry at game time.

The enclosed photo shows Pilots E. B. "Red" Carson and R. J. "Bart" Barton in front of a helicopter owned by the Arizona Helicopter Service, deep in Grand Canyon. The Arizona firm has been taking tourists into the canyon since last May. One may see more of the canyon interior in an hour's flight than may be viewed on the two-day mule-back trip from Grand Canyon Village to Phantom Ranch at the bottom of the mighty abyss.

Since this photo was taken in October, Carson has gone to work for Rick Helicopter, Inc., of Los Angeles, and is patrolling the maintenance lines of the Bonneville Power Authority in the Pacific Northwest.

A. L. Clark,
Great Falls, Mont.

WILL YOU BE CLIMBING? OR STUCK?

WHAT you'll be doing *one year* from today depends on what you do *today*.

Take advantage of today's opportunities and you're sure to move ahead. Put off doing anything about them and you chance being left behind.

The opportunities open to trained men are greater today than at any time in the past five years. Skilled technicians and specialists are the *men of the hour*. And thousands of them are I. C. S. students.

The chance for World War II veterans to train under the G. I. Bill is another of today's great opportunities. But the offer is due to expire. To qualify, you must enroll before July 25, 1951!

Start now! Study at home, in your spare time, with the world's largest school—I. C. S. Mail the coupon today for full information. It may be later than you think!



INTERNATIONAL CORRESPONDENCE SCHOOLS

BOX 5695-K, SCRANTON 9, PENNA.

Without cost or obligation, please send me full particulars about the course BEFORE which I have marked X:

- | | | | |
|---|--|---|---|
| <p>Air Conditioning and Plumbing Courses</p> <p><input type="checkbox"/> Air Conditioning
<input type="checkbox"/> Heating
<input type="checkbox"/> Refrigeration
<input type="checkbox"/> Plumbing
<input type="checkbox"/> Steam Fitting</p> <p>Chemical Courses</p> <p><input type="checkbox"/> Chemical Engineering
<input type="checkbox"/> Chemistry, Analytical
<input type="checkbox"/> Chemistry, Industrial
<input type="checkbox"/> Chemistry, Mfg. Iron & Steel
<input type="checkbox"/> Petroleum Refining
<input type="checkbox"/> Plastics
<input type="checkbox"/> Pulp and Paper Making</p> <p>Civil Engineering, Architectural and Mining Courses</p> <p><input type="checkbox"/> Architecture
<input type="checkbox"/> Architectural Drafting
<input type="checkbox"/> Bridge and Building Foreman
<input type="checkbox"/> Building Estimating
<input type="checkbox"/> Civil Engineering
<input type="checkbox"/> Coal Mining
<input type="checkbox"/> Contracting and Building
<input type="checkbox"/> Highway Engineering
<input type="checkbox"/> Lumber Dealer
<input type="checkbox"/> Reading Structural Blueprints
<input type="checkbox"/> Sanitary Engineering
<input type="checkbox"/> Structural Drafting</p> | <p><input type="checkbox"/> Structural Engineering
<input type="checkbox"/> Surveying and Mapping</p> <p>Communications Courses</p> <p><input type="checkbox"/> Electronics
<input type="checkbox"/> Practical Telephony
<input type="checkbox"/> Radio, General
<input type="checkbox"/> Radio Operating
<input type="checkbox"/> Radio Servicing
<input type="checkbox"/> Television
<input type="checkbox"/> Telegraph Engineering</p> <p>Electrical Courses</p> <p><input type="checkbox"/> Electrical Drafting
<input type="checkbox"/> Electrical Engineering
<input type="checkbox"/> Electric Light and Power
<input type="checkbox"/> Lighting Technician
<input type="checkbox"/> Practical Electrician</p> <p>Internal Combustion Engines Courses</p> <p><input type="checkbox"/> Auto Technician
<input type="checkbox"/> Diesel-Electric
<input type="checkbox"/> Diesel Engines
<input type="checkbox"/> Gas Engines
<input type="checkbox"/> Aviation</p> <p>Mechanical Courses</p> <p><input type="checkbox"/> Aeronautical Engineer's, Jr.
<input type="checkbox"/> Aircraft Drafting
<input type="checkbox"/> Flight Engineer
<input type="checkbox"/> Forging
<input type="checkbox"/> Foundry Work
<input type="checkbox"/> Heat Treatment of Metals
<input type="checkbox"/> Industrial Engineering
<input type="checkbox"/> Industrial Instrumentation</p> | <p><input type="checkbox"/> Industrial Metallurgy
<input type="checkbox"/> Machine Shop
<input type="checkbox"/> Mech. Drafting
<input type="checkbox"/> Mechanical Engineering
<input type="checkbox"/> Mold-Loft Work
<input type="checkbox"/> Patternmaking—Wood, Metal
<input type="checkbox"/> Reading Shop Blueprints
<input type="checkbox"/> Sheet-Metal Drafting
<input type="checkbox"/> Sheet-Metal Worker
<input type="checkbox"/> Ship Drafting
<input type="checkbox"/> Ship Fitting
<input type="checkbox"/> Ship Designing
<input type="checkbox"/> Tool Designing
<input type="checkbox"/> Toolmaking
<input type="checkbox"/> Welding—Gas and Electric</p> <p>Railroad Courses</p> <p><input type="checkbox"/> Air Brake
<input type="checkbox"/> Car Inspector
<input type="checkbox"/> Diesel Locomotive
<input type="checkbox"/> Locomotive Engineer
<input type="checkbox"/> Locomotive Fireman
<input type="checkbox"/> Locomotive Machinist
<input type="checkbox"/> Railroad Section Foreman
<input type="checkbox"/> Steam-Diesel Loco. Eng.</p> <p>Stationary Eng'r's Courses</p> <p><input type="checkbox"/> Boilermaking
<input type="checkbox"/> Combustion Engineering
<input type="checkbox"/> Engine Running
<input type="checkbox"/> Marine Engineering
<input type="checkbox"/> Power Plant Eng'r's
<input type="checkbox"/> Steam Engr.</p> | <p>Textile Courses</p> <p><input type="checkbox"/> Cotton Manufacturing
<input type="checkbox"/> Loom Fixing
<input type="checkbox"/> Textile Designing
<input type="checkbox"/> Rayon Weaving
<input type="checkbox"/> Woolen Manufacturing</p> <p>Business and Academic Courses</p> <p><input type="checkbox"/> Accounting
<input type="checkbox"/> Advertising
<input type="checkbox"/> Bookkeeping
<input type="checkbox"/> Business Administration
<input type="checkbox"/> Bus. Correspondence
<input type="checkbox"/> Bus. Law
<input type="checkbox"/> Certified Public Accounting
<input type="checkbox"/> Commercial
<input type="checkbox"/> Commercial Art
<input type="checkbox"/> Cost Accounting
<input type="checkbox"/> First Year College
<input type="checkbox"/> Foremanship
<input type="checkbox"/> French
<input type="checkbox"/> Good English
<input type="checkbox"/> High School
<input type="checkbox"/> Higher Mathematics
<input type="checkbox"/> Illustration
<input type="checkbox"/> Industrial Supervision
<input type="checkbox"/> Motor Traffic
<input type="checkbox"/> Postal Civil Service
<input type="checkbox"/> Retailing
<input type="checkbox"/> Retail Bus. Management
<input type="checkbox"/> Salesmanship
<input type="checkbox"/> Secretarial
<input type="checkbox"/> Sign Lettering
<input type="checkbox"/> Spanish
<input type="checkbox"/> Stenography
<input type="checkbox"/> Traffic Management</p> |
|---|--|---|---|

Name _____ Age _____ Home Address _____
 City _____ State _____ Working Hours _____ A.M. to _____ P.M.
 Present Position _____ Employed by _____

Length of Service _____
 in World War II _____

Enrollment under G.I. Bill approved for World War II Veterans. Special tuition rates to members of the Armed Forces. Canadian residents send coupon to International Correspondence Schools Canadian, Ltd., Montreal, Canada.

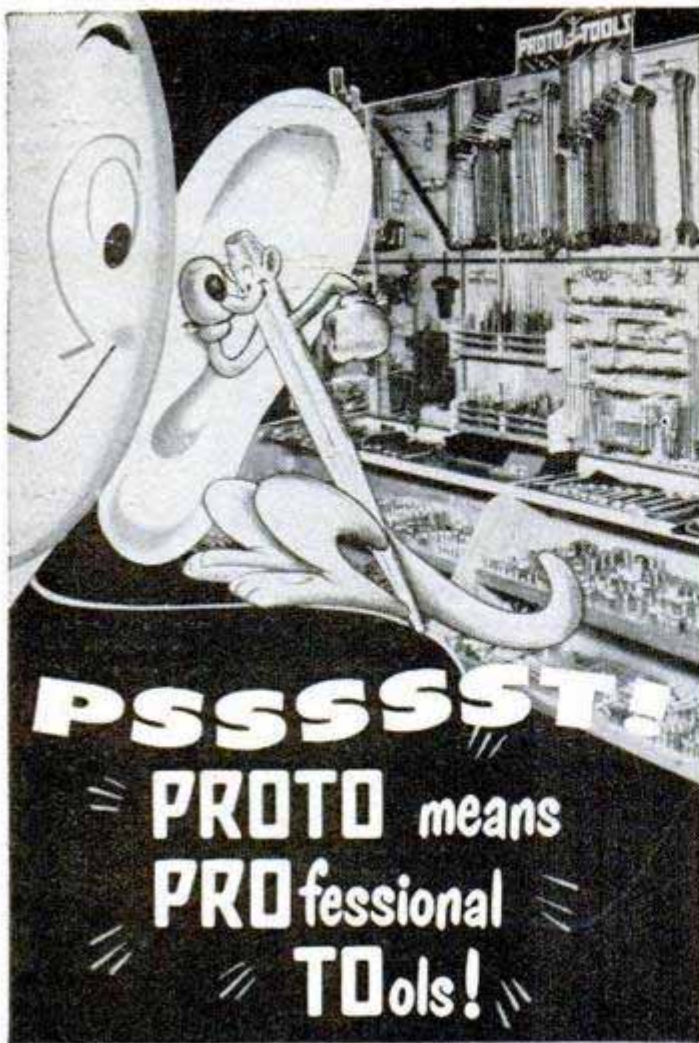

Our puncharoo is boasting that PROTO tools are designed and manufactured for professionals. These tools have tested designs, are accurately made from special alloy steels and are scientifically heat treated. As a result, they fit right, handle easily and stand hard work for many years. To buy truly professional tools—see your PROTO dealer.

Send 10c for 68-page catalog to
PLOMB TOOL COMPANY
 2255F Santa Fe Ave., Los Angeles 54, Calif.

TOOLAGRAM

Redesigned PROTO open end, box and combination wrenches have narrower jaws and heads, stronger designs, smoother shanks, better finish, revised lengths.

1120-1164 3016-3070 1208-1252 81G

5181

PROTO TOOLS
 Professional Quality
 REG. U.S. PAT. OFF. LOS ANGELES MADE IN U.S.A.

WHERE-TO-BUY-IT INDEX

Source of supply appears after items commercially available

AUTOMOTIVE

Jack-in-bumper	86
Detroit listening post.....	103
180-hp. V-8 engine for big Chryslers.....	105
Oil filter for overhead-valve engines (Wolfer Corp., 3723 Wilshire Blvd., Los Angeles 5, Calif.).....	106
Casey Jones auto.....	138
Microwave "interphone" aids motorists.....	143
Pump drains engine oil through dip-stick hole (Chisholm Industries, Inc., 109 Central Ave., Lynn, Mass.).....	143
Battery checker on dashboard (Myriatron Corp., Pontiac, Mich.).....	161
Rattle-stopper for car windows (Rolexco, Box 11, Orange, N. J.).....	264

AVIATION

Flying "raincoats" (E. I. du Pont de Nemours & Co., Inc., Wilmington 98, Del.).....	86
Cargo model of B-36 sets tonnage record.....	87
Alertness indicator.....	87
"No hands" helicopters (Piasecki Helicopter Corp., Morton, Pa.).....	87
Sweet-wing Thunderjet (Republic Aviation Corp., Farmingdale, L. I., N. Y.).....	104
Expandable ladder for packplane (Fairchild Aircraft Div., Hagerstown, Md.).....	110
Radar "eyes" for target planes.....	142
Propellers tested in buried "spin pit".....	161
Homemade safety-belt tester.....	260

BOATS

Turning of auto's rear wheels propels ferry on the Thames.....	129
Plastic filler makes wood boats leakproof (Penn Yan Boats, Inc., Hammondsport, N. Y.).....	161
Lightning-proof boat.....	164
Electric "eyes" watch modern ship break apart during tests.....	260

FARM AND GARDEN

Bulldozer blade for farm tractor (Danuser Machine Co., Fulton, Mo.).....	96
Fertilizing with gas.....	111
Pint-size tractor (Standard Mfg. & Sales Co., Lebanon, Ind.).....	117
Plastic tape grafts seedlings (Resin Industries, Box 1589, Santa Barbara, Calif.).....	122
Brush cutter (Caterpillar Tractor Co., Peoria 8, Ill.).....	132
Hand pump operates garden sprayer (Earl L. Chadwick Co., Box 480, Houston, Tex.).....	132
Versatile farm implement does five jobs at a time (Taylor Machine Works, Louisville, Miss.).....	149
Chopper converts potatoes into animal feed.....	153

HOUSE AND HOME

Self-sticking hooks (Selfix Products Co., 30 E. Adams St., Chicago 3).....	130
Drying hamper (Argyle Mfg. Co., 600 Coal St., Colchester, Ill.).....	130
Adjustable shower (Lylton Distributing Co., 508 E St., San Bernardino, Calif.).....	130
Ice-cream freezer (Louisville Electric Mfg. Co., 3010 Magazine St., Louisville 11, Ky.).....	130
Bathroom heater (Fresh'nd-Aire Co., 221 N. La Salle St., Chicago 1).....	131
Emergency hinges (Safety Hinge Corp., Box 111, Cranford, N. J.).....	131
Milk-bottle rack (G. E. Trombley & Associates, 58 Front St., Worcester, Mass.).....	131
Automatic Pressure Cooker (Proctor Electric Co., 480 Lexington Ave., New York City 17).....	131
No-rub furniture wax (S. C. Johnson & Sons, Inc., Racine, Wis.).....	260

INDUSTRY

Silent sound spots flaws in rails (Sperry Rail Service, Sperry Products, Inc., Danbury, Conn.).....	86
Super-smooth elevators (Westinghouse Electric Co., Elevator Div., Jersey City, N. J.).....	95
Seaweed indicator aids jet tests.....	104
Tower on stem.....	106
Bearings that run on air (North American Aviation, Inc., International Airport, Los Angeles 45, Calif.).....	110
"Eye" on cutter follows pattern (General Electric Co., Schenectady 5, N. Y.).....	138
Corrugated building requires no frame (Behlen Mfg. Co., Columbus, Neb.).....	148
Power digger (Sherman Products, Inc., Royal Oak, Mich.).....	149
Sensitive computer speeds missile design.....	156
Compact ditch digger weighs only 550 pounds (Charlie's Machine Works, 625 Birch St., Perry, Okla.).....	164

MEDICAL

Radio calls the doctor (Telanserphone, 224 E. 38th St., New York City).....	139
141 mold remedies.....	149
Automatic breather (Mine Safety Appliances Co., 230 N. Braddock Ave., Pittsburgh 8, Pa.).....	152
Music in the operating room.....	152

MODELS AND NOVELTIES

Show window is clock.....	95
Army "task force" in wood.....	96
Little giant.....	148
Handicraft on Manhattan (Americraft, 903 1st Ave., New York City).....	150

(Continued to page 12)

WHAT Every AUTO MECHANIC Wants to Know

A motor vehicle is a machine of many parts, each part designed and constructed for its own special function. All good mechanics, like good doctors, should know the working theory and operation of each part and understand what causes trouble and how to remedy it.

LET AUDELS AUTO GUIDE SOLVE YOUR PROBLEMS

Every auto mechanic, helper, serviceman and operator can use AUDELS AUTO GUIDE. The information it gives saves time, money and worry. Highly endorsed by all users. It presents the whole subject of auto mechanics from A to Z in plain language and simple terms.

This Big Practical Book gives full information with working diagrams covering the principles, construction, ignition, service and repair of modern cars, trucks and buses.

A complete Guide of 1800 pages, with over 1500 illustrations showing inside views of the working parts, with instructions for service jobs. Diesel engines, Fluid and Hydra-matic drives fully explained.

IT PAYS TO KNOW HOW TO

How to fit pistons—How to locate engine knocks—How to fit connecting rod bearings—How to service main bearings—How to re-condition valves—How to time valves—How to adjust fan belts—How to adjust carburetors & chokes—How to rebuild a clutch—How to service automatic transmissions—How to service brakes—How to adjust steering gear—How to cope with ignition troubles—How to service distributors—How to time ignition—How to "tune up" an engine.

INFORMATION IN A HANDY FORM

73 INTERESTING CHAPTERS—Read this partial list of subjects on which practical information is fully given for quick reference under the headings as shown below. Ready Reference Index.

All Parts of an Automobile—Automotive Physics—The Gas Engine—Gas Engine Principles—Multi-Cylinder Engines—Horse Power—Automobile Engines—Stationary Parts—Moving Parts—Pistons—Piston Rings—Connecting Rods—Crank Shafts—Valves—Valve Gear—Cams and Cam Action—Valve Timing—Cooling Systems—Fuel Feed Systems—Dual Fuel Feed—Mixture—Carburetors—Carburetor Service—Automatic Choke—Super-Chargers—Transmissions—Special Transmissions—Fluid and Hydra-matic Drives—Clutches—Universals and Propeller Shafts

A Ready Reference

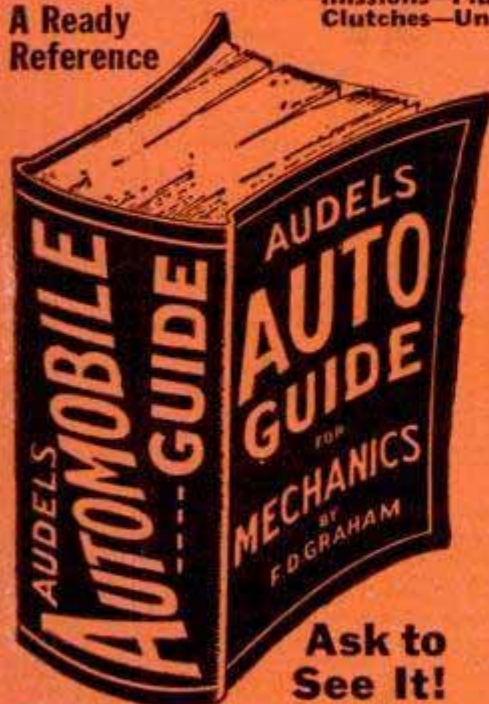

—The Differential—Rear Axles—Rear and Front Suspension—Running Gear—Brakes—Wheel Alignment—Knee Action—Steering Gear—Tires—Lubricants and Lubrication—Automotive Electricity—Ignition Systems—Magneto Ignition—Spark Plugs—Ignition Coils—Distributors—Automatic Spark Control—Ignition Timing—Generators—Starters—Generator and Starter Testing—Lighting Systems—Storage Batteries—Charging and Testing—Diesel Engines and Trouble Shooting.

7 DAYS' FREE TRIAL
TO GET THIS ASSISTANCE FOR YOURSELF SIMPLY FILL IN AND MAIL COUPON TODAY.

\$4 COMPLETE PAY \$1 A ONLY 1 MO.



Sent on 7 Days Approval

Step up your own skill with the facts and figures of your trade. Audels Mechanics Guides contain Practical Inside Trade Information in a handy form. Fully illustrated and Easy to Understand. Highly Endorsed. Check the book you want for 7 DAYS FREE EXAMINATION. Send No Money. Nothing to pay postman.

CUT HERE MAIL ORDER

AUDEL, Publishers, 49 W. 23 St., NEW YORK 10, N. Y.

Please send me postpaid for FREE EXAMINATION books marked (X) below. If I decide to keep them I agree to mail \$1 in 7 Days on each book or set ordered and further mail \$1 monthly on each book or set until I have paid price, otherwise I will return them.

- AUTO GUIDE**, 1800 Pages . . . \$4
- DIESEL ENGINE MANUAL, 400 Pages . . . 2
- WELDERS GUIDE, 400 Pages . . . 1
- MACHINISTS Handy Book, 1600 Pages . . . 4
- POWER PLANT ENGINEERS Guide, 1500 Pages . . . 4
- ENGINEERS & FIREMANS EXAMS, 528 Pages. . . 1
- PUMPS, Hydraulics & Air Compressors, 1658 Pgs. . . 4
- MARINE ENGINEERS Handy Book, 1280 Pages . . . 4
- ENGINEERS & Mechanics Guides (8 Book Set). . . 12
- Answers on Practical ENGINEERING, 254 Pages . . . 1
- ELECTRIC WIRING DIAGRAMS, 210 Pages . . . 1
- ELECTRICIANS EXAMINATIONS, 250 Pages. . . 1
- ELECTRICAL DICTIONARY, 9000 Terms . . . 2
- ELECTRIC MOTOR GUIDE, 1000 Pages . . . 4
- HANDY BOOK OF ELECTRICITY, 1440 Pages . . . 4
- ELECTRICAL POWER CALCULATIONS, 425 Pgs. . . 2
- RADIOMANS GUIDE, 914 Pages . . . 4
- ELECTRONIC DEVICES, 216 Pages . . . 2
- ELECTRIC LIBRARY, 7000 Pages (12 Book Set). . . 18
- Vols. I, II, III, IV, V, VI, VII, VIII, IX, X, XI, XII \$1.50 Ea. . . 1
- OIL BURNER GUIDE, 384 Pages . . . 1
- HOUSE HEATING GUIDE, 1000 Pages . . . 4
- CARPENTERS & Builders Guides (4 Book Set). . . 6
- PLUMBERS & Steamfitters Guides (4 Book Set). . . 6
- MASONS & Builders Guides (4 Book Set). . . 6
- BLUE PRINT READING, 416 Pages . . . 2
- PAINTERS & DECORATORS MANUAL, 450 Pgs. . . 2
- GARDENERS & GROWERS Guides (4 Book Set). . . 6
- REFRIGERATION & Air Conditioning, 1280 Pgs. . . 4
- SHEET METAL WORKERS Handy Book, 388 Pgs. . . 1
- SHEET METAL PATTERN LAYOUTS, 1100 Pgs. . . 4
- AIRCRAFT WORKER, 240 Pages . . . 1
- MECHANICAL DRAWING GUIDE, 160 Pages. . . 1
- MECHANICAL DRAWING & DESIGN, 480 Pgs. . . 2
- MATHEMATICS & CALCULATIONS, 700 Pgs.. . . 2
- MECHANICAL Dictionary, 968 Pages . . . 4
- MILLWRIGHTS & Mechanics Guide, 1200 Pgs. . . 4

Name _____
Address _____
Occupation _____
Employed by _____

AUDEL, Publishers, 49 W. 23 St., New York 10, N. Y.

PLASTICAST

THE GREATEST THING IN PLASTICS!



A NEW HOME INDUSTRY AND HOBBY!



We have started **THOUSANDS** of people in a wonderful new kind of business! Here are 4 reasons why: (1) The work is pleasant and very easy... actually as easy as pouring water out of a glass! (2) **VERY LITTLE** investment is required; imagine, less than \$5.00 is required in order to start you off in your own manufacturing business! (3) Can be started **ANYWHERE**... at home, garage, basement, etc. and most important (4) The things you can make in **QUANTITY PRODUCTION** are not only exceptionally attractive and useful but are always in big demand every season of the year!

VAST QUANTITIES OF PLASTIC COMPONENTS NOW NEEDED BY ARMED FORCES!

YOU CAN MAKE ANYTHING!

What is this new business? It is **CASTING**... Casting with liquid plastics. **CASTING** is a method of production manufacturing **WITHOUT MACHINERY OR TOOLS!** **CASTING** is the exceedingly simple process of pouring liquids into molds... it is as simple as that! Like making Jello, only these liquid plastics **SOLIDIFY** in a few minutes after mixing into extremely **HARD, DURABLE** and **ATTRACTIVE** articles such as Jewelry, Novelties, Giftware, Figurines, Statuary, Knick-Knacks, Baby Shoes, Souvenirs, Ceramics, Imitation Marble, Bookends, Lamps, Pen sets, Cigarette Lighters, Toys, Dolls, Banks, Fishing Lures, Tools... **A THOUSAND USEFUL THINGS!** The field is really unlimited. We supply **EVERYTHING**... Casting Materials, Molds, Accessories and Instructions.



1000 GOLDEN OPPORTUNITIES!



Regardless what you are doing now you can get into the **CASTING BUSINESS** in your spare time or evenings. We assure you, once you do, you will be eagerly devoting all of your time to this very easy, fascinating and **HIGHLY PROFITABLE OCCUPATION** until it leads into a dependable business all your own! **BUT LET US PROVE IT.** Send only 25c for our big 40 page Catalog of Casting Materials, hundreds of Molds, etc. We will also send you **FREE** an attractive **CASTING** to show you what can be done with liquid plastics in a few minutes! We also send you **FREE** a valuable book giving you details on the **ART AND BUSINESS OF CASTING** which shows you how to cast and get started! All this for only 25c, but write for it today. This may be the lucky coin that will start the most fascinating and profitable phase of your life!

10 VALUABLE MOLDS FREE!



If you want to get started at once without delay then send for our big **SENIOR PLASTICAST OUTFIT**... here is what you receive! **TEN VALUABLE MOLDS** for making extremely beautiful and useful **TRANSPARENT** crystal-clear or colored plastic articles as illustrated directly above! Make unusual Penholders, Cigarette Lighters, Ash Trays, Perfume Sets, Pendant Hearts, Imbedded Flowers and Photos, Buttons, Key Chain Fobs and countless other attractive items! Outfit also includes 1 qt. **PLASTICAST** liquid casting plastic and hardener which will make about \$100. worth of material, pipette, measuring glass, colorful imbedding material, polishing material, 2 dyes and Instruction Manual. **OUTFIT No. 646, price postpaid \$7.50**

Our **MASTER OUTFIT** contains 4 molds, pint of **PLASTICAST** and hardener, pipette, measuring glass, imbedding material and Manual. **OUTFIT No. 4 Price, postpaid, \$3.50**
C.O.D. orders filled (not postpaid) if \$1.00 deposit sent with order.

FREE

An attractive Casting and valuable **BOOK** shown at the right sent **FREE** with our Catalog! See 3rd paragraph above.

PLASTICAST COMPANY (DEPT. C)
170 N. Halsted St. (Write to P. O. Box 987
Chicago 6, Ill. nearest address) Palo Alto, Calif.
CANADIAN CUSTOMERS, please order directly from: **CANADIAN INDUSTRIAL PLASTICS, LTD.**, 1056½ Pender West, Vancouver, B.C.

(Continued from page 10)

RECREATION

Snow cycle	95
Each player's totals on lighted scoreboard	110
Snow packer for ski slopes	111
Flutter bait (Kentucky Bait Co., 2528 Greenup Ave., Ashland, Ky.)	118
Convertible lure (Nickel Tackle Co., Box 1827, Jacksonville 1, Fla.)	139
Back-yard merry-go-round	156
Hand-hit "bird" (W. J. Ruscoe Co., 2170 W. Market St., Akron 13, Ohio)	262
Pole holder (Bassett & Clark Industries, Vinton, Iowa)	264

MISCELLANEOUS

Hot files	14
U. S. has more than half of world crude-oil output	95
Hand-operated lift truck (Allied Mfg. & Sales Co., 3101 W. Grand Ave., Chicago 22)	104
Underwater ear	106
Unexploded bombs are defused by remote control	117
"Sky hook"	118
Storm-belt microwave keeps trains running	119
Loom can be folded for storage with work intact (Mr. and Mrs. Arthur A. Allen, 3322 S. E. Concord Rd., Milwaukie 22, Ore.)	122
Horse-house trailer	123
Drive-in library	129
"Folding fan" flash reflector (E. Leitz, Inc., 304 Hudson St., New York City 13)	132
Copying "lucy" (Prisma-Scope Laboratories, 3151 E. Colorado Blvd., Pasadena 8, Calif.)	138
Forest killing disease stopped by knife or poison	143
Plastic igloo (East Coast Aeronautics, Inc., 896 S. Columbus Ave., Mount Vernon, N. Y.)	157
Camp kitchen on wheels	162
Three-decker paint "sandwich" resists worst weather (Transformer Div., Westinghouse Electric Co., Sharon, Pa.)	164
A little terramycin makes a lot of pork	262

Craftsman and Shop Notes Index

AUTOMOTIVE

High beams tilted downward for emergency driving	178
Switch on dashboard reduces noise of twin horns	184
Wire under exhaust deflector prolongs tail-pipe life	193
Replacing rubber hood cushions	200
Correcting car-door rattle	202
Pointing ends of generator bolts helps starting in bracket	217
Lacquer protects car wiring	223

FARM

Determining amount of seed	193
Back-yard egg and fryer plant	201
Spring water cleaned of sediment by utilizing perforated milk can	214
Counterbalanced pump jack for deep-well operation	214
Baled-hay cart saves heavy lifting	215
Portable buzz saw is gasoline powered for cutting cordwood or building cabin	216
Sled-type platform holds hog-feeding and oiling equipment	216
Weatherproof self-feeder handles ground feed	217
Floor plate on farm tractor provides nonslip platform	217
Sharpening disk harrow	217
Portable farm anvil	223
Improved barn door latch	223
Dairy stanchion has positive lock	226

HOUSE AND HOME

Sprinkling with DDT powder rids house wall of wild bees	174
Tightening loose brush handle	176
Curtain stretchers stored compactly	176
Fireplace "logs"	176
Emery cloth helps open jar cap	176
Paintbrush care	177
Increasing closet-shelf capacity	177
More heat reflected from radiators	177
Flower frogs of paraffin	177
Garden gate closed automatically by sash-weight balance	189
Plastic food bags shield sockets while cleaning ceiling fixture	193
Kitchen range set on even keel by means of carpenter's level	200
Boiling prevents dish cracking	202
Retaining appearance of suede	202
Improvised bottle opener	202

OFFICE, SHOP AND STORE

Improvised duplicator for printing club notices	175
Hacksaw-blade straightedge for cutting paper	200
Dusting Zip-A-Tone with talc permits loose brush effect	223
Clothespun holds rubber stamp	226
Vertical lines on drawing board speed sign painter's work	226

OUTDOOR RECREATION

Water-color pellets mark trail on unfamiliar waterway	174
Portable bleacher seat with canvas back adds comfort to plank-type bench	184
Cork provides fishhook holder	202

(Continued to page 14)

IMPORTANT NOTICE—It is the intention of this magazine to provide its readers with information regarding the latest developments in the mechanical arts. We take no responsibility as to whether the disclosures contained in our articles are covered by patents and advise readers to investigate this subject before making, using, or selling any of the products, machines, or processes described in order to avoid possible liability for patent infringements.

INVENTORS

Learn how to protect your invention. The U. S. Patent Laws provide that any new and useful art, machine, article of manufacture, or composition of matter, or any new and useful improvement thereof, may be patented if the act of invention is involved. Therefore, every inventor with a valuable invention should take advantage of the Patent Laws and proceed for patent protection in order to safeguard his rights.

A patent gives the inventor the exclusive right to prevent others from making, using, or selling the invention claimed in the patent for a period of seventeen years.

The Patent Laws were enacted for the benefit of the inventor to give him protection for the features of his invention which are patentable. These features must be properly and concisely set forth and claimed in a formal application for patent, in order to comply with the requirements of the Patent Laws. For that reason, unless the inventor is familiar with patent matters, he should engage a competent registered patent attorney or agent to represent him. We are registered to practice before the U. S. Patent Office and are prepared to serve you in the handling of your patent matters.

A specially prepared booklet entitled "Patent Guide for the Inventor", containing detailed information with respect to patent protection and procedure, together with a "Record of Invention" form will be promptly forwarded to you without obligation upon request.

CLARENCE A. O'BRIEN & HARVEY JACOBSON

Registered Patent Attorneys

11-C DISTRICT NATIONAL BUILDING

WASHINGTON 5, D. C.

NOW!

BRIGGS SMOKES 3 WAYS BETTER*



1. Stays lighted longer ... by 19%



2. Cleaner burning ... by 16.4%



3. Less tar ... by 21.6%

So today ...

Put this
in your
pipe

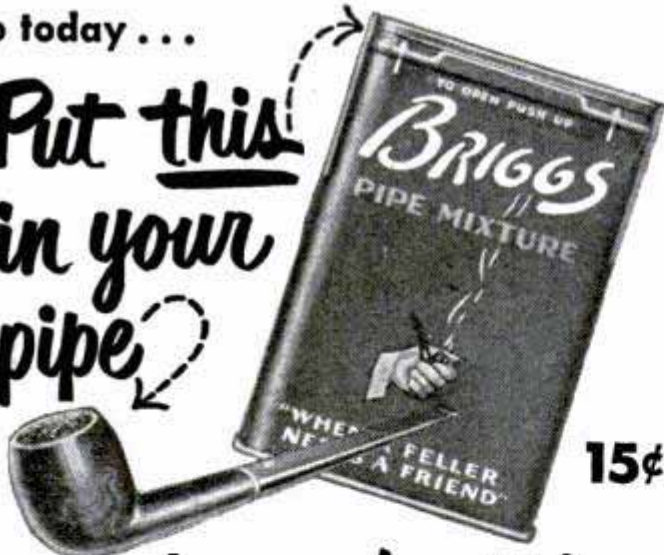

15¢

and smoke it!

*Yes, our new process makes Briggs better by actual test! Better even than the swell-smoking Briggs that proved so fine and friendly in your pipe before. And remember this: when tobacco burns steady, free and clean, that's when you enjoy *all* the goodness of Briggs' fine tobacco, aged and mellowed in oaken casks. Today—try 3-ways-better Briggs!

Also available in Canada

(Continued from page 12)

PHOTOGRAPHY

Photo album in plastic.....	166
Rubber band across enlarger lens facilitates sharp focusing.....	206
Storing spare photoflood bulbs in individual wall racks.....	206
Spoons measure photo chemicals.....	206
Staples identify print paper.....	206
Warning on loaded film tank.....	206
Picture frame fitted with hinged back provides inexpensive copying easel.....	207
Pocket fastened to camera case holds tab for quick film identification.....	207
Safe lens-cleaning methods.....	207
Using a reflex camera.....	208
Film-holder slides easy to find when kept in record file.....	209
Bamboo provides overflow drain for washing prints.....	209
Dusting color transparencies.....	209
Vise for binding color slides is clamped to table top.....	210
Accessories hung from pan head.....	210
Bath-spray hose washes negatives.....	210

TOOLS

Loose-pin hinges provide motor mount for driving power tools.....	189
Tape marks hand-drill depth.....	189
Yardstick tacked to level provides handy tool.....	200
Removing rusted or damaged key from large-diameter keyway.....	214
Round gaskets cut in lathe.....	214
Finishing bushings speeded by locking on special shouldered mandrel.....	216
Spinner chucked in electric drill drives truck wheels for balancing.....	223
Precision center punch (Lakelin Products Co., 2316 Rugby Rd., Dayton 6, Ohio).....	224
Self-adjusting toolholder (R. K. Products Co., Dept. P-4, 731 S. W. Front Ave., Portland, Ore.).....	224
Automatic brake adjuster (Brakemaster Corp., 205 W. Wacker Dr., Chicago 6).....	224
Headrest goggles (General Scientific Equipment Co., 2700 W. Huntington St., Philadelphia 32, Pa.).....	224
Metal stamp holder (M. E. Cunningham Co., 83 E. Carson St., Pittsburgh 19, Pa.).....	225
Spark-plug socket wrench (Gabb Mfg. Co., Windsor Locks, Conn.).....	225
Vacuum-sealed unit for carburetor (Speed Specialty Co., 5314 Mt. Royal Dr., Los Angeles 41, Calif.).....	225
Automatic Bunsen burner (Hanau Engineering Co., 1231-33 Main St., Buffalo 8, N. Y.).....	225
Fast-cutting router bits made from broken drills.....	226

WOODWORKING

Functional end table.....	173
Attractive youth bed for growing child built sturdily to withstand rough use.....	174
Planing board holds small pieces.....	178
Wall pipe rack combines humidior.....	179
Modern teacart.....	185

MISCELLANEOUS

Pendulum controls model-airplane elevators to avoid steep dives.....	172
Baling wire quickly cuts sheets of corrugated roofing.....	175
Paths of atomic particles observed with continuous cloud chamber.....	178
Gasolineproof aluminum paint.....	184
Chimney blocks form piers for supporting small buildings.....	184
Sponge fitted to hose speeds bathing dog.....	189
Block simplifies pulling nails.....	193
Tubing holds eye glasses in place.....	193
Flashlight fitted with mirror "sees" around corners.....	200
Handy carrier for bicycle lock fits under horizontal bar.....	202
Concrete base for road torch.....	226

Radio-Television, Electronics

Television in England.....	227
1951 Little Giant "hi-fi" T.R.F. broadcast receiver.....	228
Faulty installations of TV-antenna systems.....	231

"Hot" Flies

Houseflies tagged with radioactive compounds are helping science learn more about the travel habits of the disease-carrying summertime pests. Government entomologists experimenting at Corvallis, Ore., caught "hot" flies in baited traps 12 miles from their release point. They found that tougher, DDT-resistant insects from neighboring areas are apt to move into sections where nonresistant flies have been killed off. The insects were fed a syrup sugar containing radioactive phosphoric acid, making them easily identifiable by Geiger counter devices in the traps.

INVENTORS

If you believe that you have an invention, you should find out how to protect it. The first step is to have a search made of the prior pertinent U. S. patents. If a report on this search indicates that the invention appears patentable you can apply for a patent, and the specifications and claims should be prepared.

The firm of McMorrow, Berman & Davidson, with offices in Washington, D. C., is qualified to take the necessary steps for you. We can make a preliminary search on your invention, advise you whether we think it can be patented, and prepare your application for patent.

Unless you are fully familiar with the U. S. Patent Laws, we recommend that you engage the services of a Registered Patent Attorney to protect your interests. The patent laws are *your* laws. A patent gives you the right to prevent others from making, using or selling the invention claimed in your patent for a period of 17 years.

Use these patent laws for your protection. Investigate whether your invention can be patented. If you have what you believe to be an invention, we suggest that you have this firm make a search for you.

Send for a copy of our Patent Booklet entitled "How To Protect Your Invention," containing information about patent protection and patent procedure. Along with this we will also send you an "Invention Record" form, for your use in writing down and sketching details of your invention. We will mail them promptly. No obligation. They are yours for the asking.

McMORROW, BERMAN & DAVIDSON

Registered Patent Attorneys

PATENTS • COPYRIGHTS • PATENTS

135-R VICTOR BUILDING, WASHINGTON 1, D. C.

The Mechanism of Mind

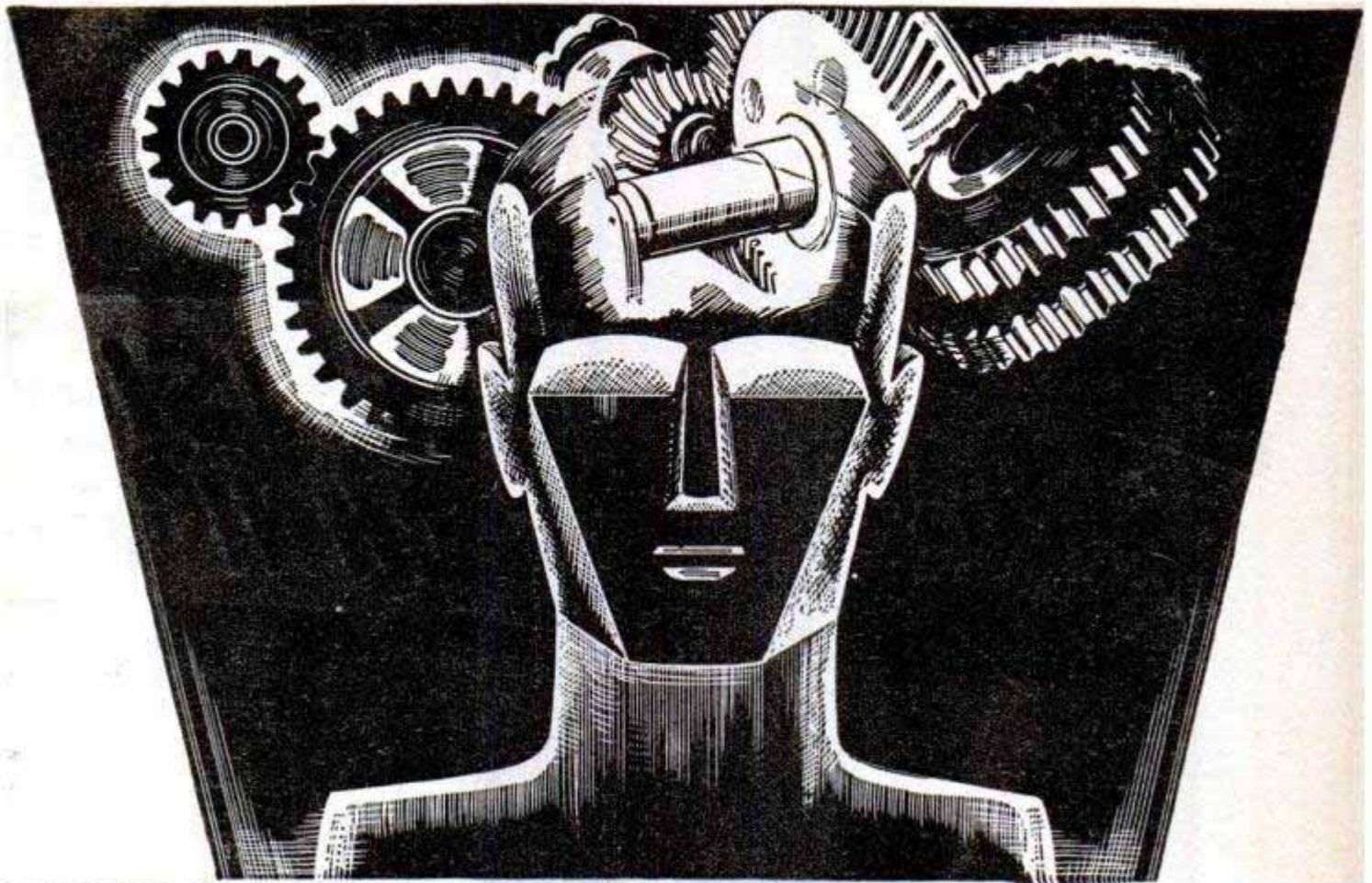

WHY YOU ARE AS YOU ARE—

and What You Can Do About It!

DID you ever stop to think *why* you do the things you do? Have you often—when alone—censored yourself for impulsive urges, for things said or done that did not truly represent *your real thoughts*, and which placed you at a disadvantage? Most persons are *creatures of sensation*—they react to instinctive, impelling influences which surge up within them and which they do not understand—*or know how to control*. Just as simple living things involuntarily withdraw from irritations, so likewise thousands of men and women are content to be motivated by their undirected thoughts which haphazardly rise up in their consciousness. *Today you must sell yourself* to others—bring forth your best abilities, manifest your personality, if you wish to hold a position,

make friends, or impress others with your capabilities. You must learn how to draw upon your latent talents and powers, not be bent like a reed in the wind. There are simple, natural laws and principles which—if you understand them—make all this possible.

For centuries the Rosicrucians (not a religious organization), a worldwide movement of men and women devoted to the study of life and its hidden processes, have shown thousands how to probe these mysteries of self. Renowned philosophers and scientists have been Rosicrucians—today men and women in every walk of life owe their confidence and ability to solve personal problems to the Rosicrucian private, *sensible* method of self-development. Send today for a copy of the book, "The Mastery of Life," which will be sent to you without obligation. It will tell you of the Rosicrucians *and what they can do for you*. Address: Scribe Y.B.C.

THE ROSICRUCIANS (AMORC), SAN JOSE, CALIFORNIA, U. S. A.

Put yourself in the I.C.S. HALL OF FAME*

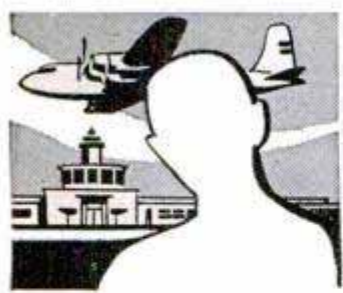

PRESIDENT of a leading airline.



CHAIRMAN of an important national defense board.



INVENTOR of a well-known U. S. Army rifle.

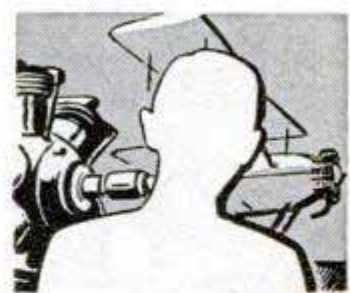

DESIGNER of a famous aircraft engine.

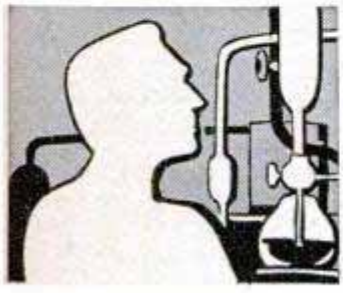

CHEMICAL director of nationally known research laboratory.

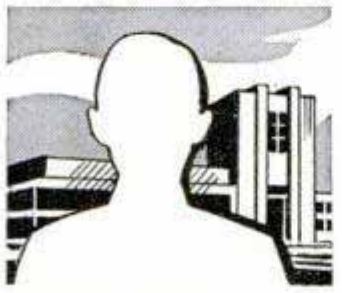

ENGINEER in charge of a famous company's engineering laboratory.

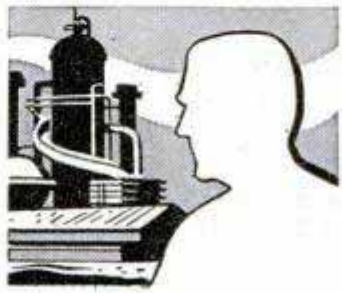

GENERAL MANAGER of one of America's largest chemical companies.



YOU

JOIN these men who have made their mark! Men who by dint of ambition, intelligence and sound, practical I. C. S. training now enjoy positions of leadership in business and industry. The sooner you start, the better your chances of making the grade. Right now, with the criti-

cal shortage of skilled labor, trained men are becoming leaders overnight. Hundreds of I. C. S. students are reporting promotions and pay increases, earning greater security for themselves and their families. How about marking and mailing the coupon today?

*Names and positions sent on request.

INTERNATIONAL CORRESPONDENCE SCHOOLS

APPROVED
under the
G.I. BILL

BOX 5696-K, SCRANTON 9, PENNA.

Without cost or obligation, please send me full particulars about the course BEFORE which I have marked X:

<p>Business and Academic Courses</p> <input type="checkbox"/> Accounting <input type="checkbox"/> Advertising <input type="checkbox"/> Bookkeeping <input type="checkbox"/> Business Administration <input type="checkbox"/> Bus. Correspondence <input type="checkbox"/> Bus. Law <input type="checkbox"/> Certified Public Accounting <input type="checkbox"/> Commercial <input type="checkbox"/> Commercial Art <input type="checkbox"/> Cost Accounting <input type="checkbox"/> Federal Tax <input type="checkbox"/> First Year College <input type="checkbox"/> Foremanship <input type="checkbox"/> Good English <input type="checkbox"/> French <input type="checkbox"/> Higher Mathematics <input type="checkbox"/> High School <input type="checkbox"/> Illustration <input type="checkbox"/> Industrial Supervision <input type="checkbox"/> Motor Traffic <input type="checkbox"/> Postal Civil Service <input type="checkbox"/> Retailing <input type="checkbox"/> Retail Bus. Management <input type="checkbox"/> Salesmanship <input type="checkbox"/> Secretarial <input type="checkbox"/> Sign Lettering <input type="checkbox"/> Stenography <input type="checkbox"/> Spanish <input type="checkbox"/> Traffic Management <input type="checkbox"/> Typing	<p>Chemical Courses</p> <input type="checkbox"/> Chemical Engineering <input type="checkbox"/> Chemistry, Analytical <input type="checkbox"/> Chemistry, Industrial <input type="checkbox"/> Chemistry, Mfg. Iron & Steel <input type="checkbox"/> Petroleum Refining <input type="checkbox"/> Plastics <input type="checkbox"/> Pulp and Paper Making <p>Civil Engineering, Architectural and Mining Courses</p> <input type="checkbox"/> Architecture <input type="checkbox"/> Architectural Drafting <input type="checkbox"/> Building Estimating <input type="checkbox"/> Civil Engineering <input type="checkbox"/> Coal Mining <input type="checkbox"/> Contracting and Building <input type="checkbox"/> Highway Engineering <input type="checkbox"/> Lumber Dealer <input type="checkbox"/> Reading Structural Blueprints <input type="checkbox"/> Sanitary Engineering <input type="checkbox"/> Structural Drafting <input type="checkbox"/> Structural Engineering <input type="checkbox"/> Surveying and Mapping <p>Communications Courses</p> <input type="checkbox"/> Electronics <input type="checkbox"/> Prac. FM and Television <input type="checkbox"/> Prac. Telephony <input type="checkbox"/> Radio Operating <input type="checkbox"/> Radio, General <input type="checkbox"/> Radio Servicing <input type="checkbox"/> Telegraph Engineering	<p>Electrical Courses</p> <input type="checkbox"/> Electrical Drafting <input type="checkbox"/> Electrical Engineering <input type="checkbox"/> Electric Light and Power <input type="checkbox"/> Lighting Technician <input type="checkbox"/> Practical Electrician <input type="checkbox"/> Power House Electric <input type="checkbox"/> Ship Electrician <p>Internal Combustion Engines Courses</p> <input type="checkbox"/> Auto Technician <input type="checkbox"/> Aviation <input type="checkbox"/> Diesel-Electric <input type="checkbox"/> Diesel Engines <input type="checkbox"/> Gas Engines <p>Mechanical Courses</p> <input type="checkbox"/> Aeronautical Engineer's, Jr. <input type="checkbox"/> Aircraft Drafting <input type="checkbox"/> Flight Engineer <input type="checkbox"/> Forging <input type="checkbox"/> Foundry Work <input type="checkbox"/> Heat Treatment of Metals <input type="checkbox"/> Industrial Engineering <input type="checkbox"/> Industrial Instrumentation <input type="checkbox"/> Industrial Metallurgy <input type="checkbox"/> Machine Shop <input type="checkbox"/> Machine Shop Inspection <input type="checkbox"/> Mechanical Drafting <input type="checkbox"/> Mechanical Engineering	<input type="checkbox"/> Mold-Loft Work <input type="checkbox"/> Patterning—Wood, Metal <input type="checkbox"/> Reading Shop Blueprints <input type="checkbox"/> Sheet-Metal Drafting <input type="checkbox"/> Sheet-Metal Worker <input type="checkbox"/> Ship Drafting <input type="checkbox"/> Ship Fitting <input type="checkbox"/> Tool Designing <input type="checkbox"/> Toolmaking <input type="checkbox"/> Welding—Gas and Electric <p>Railroad Courses</p> <input type="checkbox"/> Air Brake <input type="checkbox"/> Car Inspector <input type="checkbox"/> Diesel Locomotive <input type="checkbox"/> Locomotive Engineer <input type="checkbox"/> Locomotive Fireman <input type="checkbox"/> Locomotive Machinist <input type="checkbox"/> Railroad Section Foreman <input type="checkbox"/> Steam and Diesel Loco. Eng. <p>Stationary Engineering Courses</p> <input type="checkbox"/> Boilermaking <input type="checkbox"/> Combust. Engrg. <input type="checkbox"/> Engine Running <input type="checkbox"/> Marine Engineering <input type="checkbox"/> Power Plant Engr. <input type="checkbox"/> Steam Engineer <p>Textile Courses</p> <input type="checkbox"/> Cotton Manufacturing <input type="checkbox"/> Loom Fixing <input type="checkbox"/> Rayon Weaving <input type="checkbox"/> Textile Designing <input type="checkbox"/> Woolen Manufacturing
--	---	---	--

Name _____ Age _____ Home Address _____

City _____ State _____ Working Hours _____ A.M. to _____ P.M.

Present Position _____ Employed by _____

Length of Service _____ Enrollment under G.I. Bill approved for World War II Veterans. Special tuition rates to members of the Armed Forces.
in World War II _____ Canadian residents send coupon to International Correspondence Schools Canadian, Ltd., Montreal, Canada.

HE Mailed This Coupon

CHARLES ATLAS
115 East 23rd St, New York 10, N. Y.
I want the proof that your system of "Dynamic Tension" will help make a New Man of me—gives me a healthy, husky body and big muscle development. Send me your free book, "Everlasting Health and Strength."

Name **THOMAS MANFRE** (Please print plainly)
Address **212-45 St**
City **BROOKLYN** State **N.Y.**

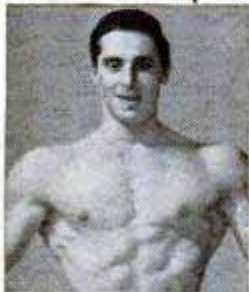

...and Here's the Handsome Prize-Winning Body I Gave Him!

Thomas Manfre of New York mailed my coupon. Got my free book. Won my Atlas-Champion, Sterling Silver Cup. He says: "Look at me NOW! 'Dynamic Tension' WORKS! I'm proud of the natural, easy way you made me an 'Atlas Champion!'"

Let Me Prove I Can Make You a New Man!

Would you like greater development—a muscular body? Then listen: I was once a 97 lb. weakling. Afraid to fight, ashamed to be seen in a swimming suit. Then I discovered the secret that changed me into "World's Most Perfectly Developed Man." My secret is "Dynamic Tension." Its purpose is to give you powerful rippling muscles you like to see in your mirror. And for those with systems sluggish from lack of exercise—to help them tone up their entire body, inside and out.

Only 15 Minutes a Day

My method—"Dynamic Tension"—will turn the trick for you. No theory—every exercise is practical. And man, so easy! Spend only 15 minutes a day in your own home. From the very start you'll be using my method of "Dynamic Tension" almost unconsciously every minute of the day—walking, bending over, etc.—to BUILD MUSCLE and VITALITY. And you'll be using the method which many great athletes use for keeping in condition—prize fighters, wrestlers, baseball and football players, etc.

My Illustrated Book is Yours —Not For \$1.00 or 10c— But FREE!

Send for my book, "Everlasting Health and Strength." 48 pages, packed with actual photos, valuable advice. A real prize for any fellow who wants a better build...but yours FREE! Rush coupon to me personally:



CHARLES ATLAS,
Dept. BC, 115 E. 23 Street,
New York 10, N. Y.

CHARLES ATLAS, Dept. BC
115 East 23 Street, New York 10, N. Y.

Send me—absolutely FREE—your famous book, "Everlasting Health and Strength"—48 pages, crammed with photos, answers to vital questions, valuable advice. I understand book is mine to keep, and sending for it does not obligate me in any way.

Name _____ Age _____
(Please print or write plainly)
Address _____
City _____ State _____

CHARLES ATLAS

Twice winner and holder of the title "The World's Most Perfectly Developed Man."



BURKS WATER SYSTEMS Last Longer



You'll want a BURKS Dual Purpose Super Turbine Water System because of its LIFE-LOK feature. It'll outlast any other water system by many years—give you more water—at lowest cost.



For deep or shallow wells

BURKS Dual System gives you completely automatic service from deep or shallow wells. New folder explains this, also LIFE-LOK feature. Shows why BURKS is best buy. Self Priming—One Moving Part—Dependable Service. Write for literature—prices.

DECATUR PUMP CO., 61 Elk St., DECATUR 70, ILL.

FALSE TEETH

KLUTCH holds them tighter

KLUTCH forms a comfort cushion; holds dental plates so much firmer and snugger that one can eat and talk with greater comfort and security; in many cases almost as well as with natural teeth. Klutch lessens the constant fear of a dropping, rocking, chafing plate. 25c and 50c at druggists... If your druggist hasn't it, don't waste money on substitutes, but send us 10c and we will mail you a generous trial box.

KLUTCH CO. Box 5193-C ELMIRA, N. Y.

"How to Make Money with Simple Cartoons"



A book everyone who likes to draw should have. It is free; no obligation. Simply address

FREE BOOK

CARTOONISTS' EXCHANGE

Dept. 93-D Pleasant Hill, Ohio

AVIATION CAREERS



Prepare for success in aviation—World's fastest growing industry. Train at Spartan—Internationally-famous school. Complete, thorough courses in all phases of aviation. Gov't approved. Write Department PM-31

SPARTAN SCHOOL OF AERONAUTICS

MUNICIPAL AIRPORT • TULSA, OKLAHOMA

MAKE EXTRA MONEY

PLASTICS LEARN AT HOME

LEARN HOW TO MAKE fast selling PLASTIC NOVELTIES FURNITURE JEWELRY SIGNS TOYS LAMPS

There are RICH OPPORTUNITIES for MEN and WOMEN with "know-how" in Plastics. Interstate's amazing new Plastics course tells and shows how to make hundreds of fast selling items out of Plastics. Gives complete training in fabrication, casting, lamination, molding, etc., in simple, easy, step-by-step language and pictures.

START A PLASTICS BUSINESS OF YOUR OWN. No other industry holds such promise for the future. You can make big money manufacturing novelties, toys, signs, etc., in your own home in spare or full time. Don't wait! Learn NOW how Interstate's Plastics Training qualifies you for success in the plastics field.

Write for FREE Information Today!

INTERSTATE TRAINING SERVICE

School of Plastics
PORTLAND 13, OREGON

(Dept. 3-C)

LEARN TELEVISION-RADIO OR ELECTRICITY

ON REAL EQUIPMENT
IN THE GREAT SHOPS OF **COYNE**

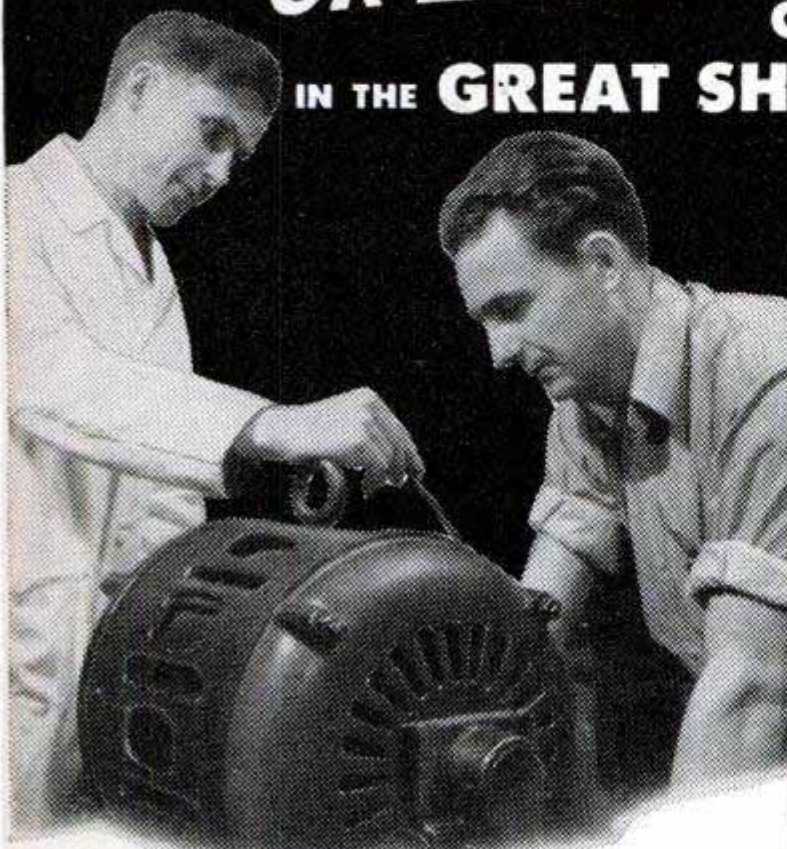

TELEVISION-RADIO



NEW OPPORTUNITY FIELD

The tremendous growth of the new field of TELEVISION is almost unbelievable. New stations are springing up rapidly bringing television to millions of people in all parts of the country. Fast becoming one of the top industries. Unusual opportunity to get in on ground floor of this great opportunity field. Coyne offers practical-technical training in Television-Radio. Installation, testing, trouble shooting and service on Television, F-M and Radio equipment. Get big free book today.

Get into the OPPORTUNITY FIELD OF ELECTRICITY

For many years Electricity has been a most vital factor in industry. This great field will continue to grow and become more important. Thousands of trained Electrical men will be needed. Why be satisfied with a "no future" job? Prepare for a good job with a real future in Electricity.

Coyne Trained Men in Good Jobs

Thousands of Coyne trained men in good jobs or in a business of their own in Television-Radio and Electricity, make real money while others putter along. Yes, you can get ready for Good Pay—a Big Future—by training at COYNE here in Chicago. Here you work on real equipment—do actual wiring and trouble-shooting—get the practical-technical training you need.

Not "Home-Study"

We do not teach by mail. All training is given in our Great Training Shops in Chicago, plus necessary theory. Expert instructors guide you. No advanced education or previous experience needed.

START NOW—PAY LATER

Enroll now, pay most of tuition later. If you need part-time work to help out with living expenses while at Coyne, we'll help you get it. G.I. approved.

Mail Coupon for Big FREE BOOK

Whether you prefer Television-Radio, or Electricity, train on actual equipment, at Coyne. We have a Big, fully illustrated book we'll send you if you will indicate below which course you are interested in. Fill in and mail coupon TODAY. Paste it on a penny postcard if you wish. Complete details will come by return mail. No salesman will call.

B. W. COOKE, President
COYNE ELECTRICAL & TELEVISION-RADIO SCHOOL
An Institution not for Profit
500 S. Paulina St., Chicago, 12
Dept. 31-72H



B. W. COOKE, President
COYNE ELECTRICAL & TELEVISION-RADIO SCHOOL
500 S. Paulina St., Chicago 12
Dept. 31-72H

Send your BIG FREE BOOK and details of your training offer. This does not obligate me and no salesman will call. I am interested in
 TELEVISION-RADIO ELECTRICITY

NAME.....

ADDRESS.....

CITY.....STATE.....



1 You are TOLD the how and why of each job.



2 You're shown how to do typical jobs by trained instructors.



3 You DO practical job YOURSELF on equipment.

INVENTORS

A patent is a valuable right. On the basis of a constitutional provision Congress has established a system under which inventors may secure the exclusive right to prevent the unauthorized use, manufacture and sale of their inventions for periods of seventeen years. The inventor secures this protection by obtaining a patent.

Unless an inventor is thoroughly familiar with such matters, he is advised to employ a competent registered patent attorney or registered patent agent, as the value of patents depends largely upon the skillful preparation of the specifications and claims.

This firm is registered to practice before the U. S. Patent Office and is available to assist inventors in the preparation and prosecution of their cases. Detailed information and the preliminary steps to take to obtain patent protection will be furnished upon request.

VICTOR J. EVANS & Co. *Merlin M. Evans*
REGISTERED PATENT ATTORNEY

630-C MERLIN BUILDING, WASHINGTON 6, D. C.

PATENTS

COPYRIGHTS

We shall be glad to send you promptly and without obligation, an instructive booklet, "Patent Protection for Inventors", which was prepared to give inventors detailed information and steps to take toward patent protection—also our convenient "Evidence of Invention" form. Use address Victor J. Evans & Co., 630-C Merlin Building, Washington 6, D. C.

WANTED MAN WITH CAR TO RUN STORE ON WHEELS

USE OUR CAPITAL

NO SALES EXPERIENCE NEEDED

The biggest opportunity ever, to quickly establish a money-making, lifetime business, now awaits you as a McNess Dealer. Sell things farmers need and use up. Serve same families year after year. Pleasant work--no bosses--easy to do. We supply capital to work on. Also provide offers--advertising--premiums and trade secrets that bring sales.

First to apply get best trading areas. Don't wait--write us today for McNess proposition. Tell us county and state you want to serve. Ask for free McNess Book.

The McNESS CO., 112 Adams St., Freeport, Ill.

AJAX WHITE GIANTS

FAMOUS MEAT-EGG PRODUCERS. Extra big profit breed. Contest - show winners. Massive capons, quick maturing. U. S. Approved-Pullorum Controlled. Low farm prices. Colored catalog FREE. Write TODAY.

AJAX HATCHERY, BOX 915, QUINCY, ILL.

REAL ESTATE

BE A BROKER

PAYS BIG! SEND FOR FREE, BIG, ILLUSTRATED CATALOG NOW! No obligation. Graduates report making substantial incomes. Start and run your own business quickly. Men, women of all ages, learn easily. Course covers Sales, Property Management, Appraising, Loans, Mortgages, and related subjects. **STUDY AT HOME** or in our classrooms in big cities. Diploma awarded. G.I. approved. Nationally known.

WEAVER SCHOOL OF REAL ESTATE (Est. 1936)
15 E. Pershing Road Dept. PM Kansas City, Mo.

FREE BOOK TELLS HOW

LEARN MEAT CUTTING
At Home - In Spare Time

Get into the vital meat industry. Concise, practical Home Training based on 25 years proven instruction methods used at National's famous resident school. Prepares you for bigger pay as Meat Cutter, Supervisor, market manager or more money in your own store. Go as rapidly as your spare time permits, Diploma. Start NOW to turn your spare hours into money. Send for FREE bulletin today. No obligation.

NATIONAL SCHOOL OF MEAT CUTTING, INC., Div., U-126, Toledo 4, Ohio

IS YOUR FUTURE WORTH **1¢?**
that's all it costs to find out about correspondent courses in **FREIGHT TRAFFIC MANAGEMENT**

\$60 a week is the average starting salary... others earn up to \$20,000 a year in this uncrowded field.

Courses: General, Advanced, Air Freight, Export and Import, Motor Carrier. Practical training given as well as theory—by men daily engaged in Traffic Management. Get the facts today.

Send a penny card for **FREE BOOKLET**
Co-educational Veterans Inquiries Invited

RESIDENT CLASSES: Hartford, Bridgeport, Trenton, Rochester, New Haven, Buffalo, Erie, Baltimore. Booklet P

TRAFFIC MANAGERS INSTITUTE

154 Nassau Street, New York

Branches: 294 Washington St., Boston, Mass.; 10 South 18th St., Phila., Pa.

GET INTO AUTOMOTIVE DIESEL AND ALLIED MECHANICS

by Shop Method Home Training

JOBS LIKE THESE ARE OPEN TO YOU AS A TRAINED ENGINE MECHANIC... CHOOSE THE FIELD YOU LIKE BEST!

Get complete training

Diesel Fuel Injection
Automotive Motor Tune-up
Diesel Engine Maintenance
General Garage Mechanics
Agricultural Implements

Auto Engine Rebuilding • Auto Elec. Service
Public Utilities • Parts Dealers
Bus & Truck Lines • Industrial Maintenance
Contracting & Excavating
Business of Your Own

AND MANY other similar openings

EARN WHILE YOU LEARN

With our practical Master Shop-Method Home Training, you study at home in your spare time. You receive Spare Time Work Lessons, which show you how to earn while you learn... for extra money and experience. You Learn by DOING.

YOU RECEIVE AND KEEP ALL THIS MATERIAL:

Basic Lesson Texts	Engine Service Manuals
Diesel Installation Operation—Maintenance	Engine Repair Drive Systems
Diesel Chart Manual	Diesel Electric Power
Spare Time Lessons	Thermodynamics

TOOLS AND EQUIPMENT

INVESTIGATE!

SECURE FULL INFORMATION

WE GIVE YOU TOOLS OF YOUR TRADE

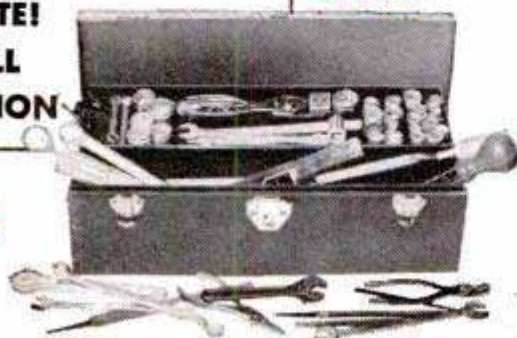

Master All Phases!



Get Master Shop-Method Home Training from an Established Resident School with its own Training Shops and Laboratories—and almost 50 years of Successful Experience in Training Men.

We Bring National Schools To You

National Schools trains you for all opportunities in the dynamic, fast-growing Automotive-Diesel and Allied Industries. You get complete training for this great industry.

Thousands upon thousands of autos, trucks, tractors, ships, trains, farms and factories are dependent upon engine power! Trained engine mechanics are needed in the Armed Forces as well as in civilian production. This huge field needs trained men for servicing, repairing, installing, operating and manufacturing equipment. The pay is good, the future excellent! National Schools offers you a practical, all-embracing Automotive-Diesel Mechanics Course that qualifies you for your choice of many good jobs.

Your National Course covers Gasoline and Special Fuel Engines; Diesels, High Speed and Heavy Duty; Semi-Diesels; Allied Mechanics.

BOTH RESIDENT AND HOME STUDY COURSES OFFERED

APPROVED FOR VETERANS AND NON-VETERANS
Check Coupon Below

NATIONAL SCHOOLS LOS ANGELES 37 CALIFORNIA
TECHNICAL TRADE TRAINING SINCE 1905
FIND OUT NOW...MAIL COUPON TODAY

NATIONAL SCHOOLS, Dept. 3-PMO (Mail in envelope or paste on penny postcard)
4000 South Figueroa Street
Los Angeles 37, California
Mail me FREE the book, YOUR FUTURE IN AUTOMOTIVE-DIESEL MECHANICS, together with the Sample Lesson. I understand I may keep and use the information with no obligation.

NAME _____ AGE _____

ADDRESS _____

CITY _____ ZONE _____ STATE _____

Check here if Veteran of World War II

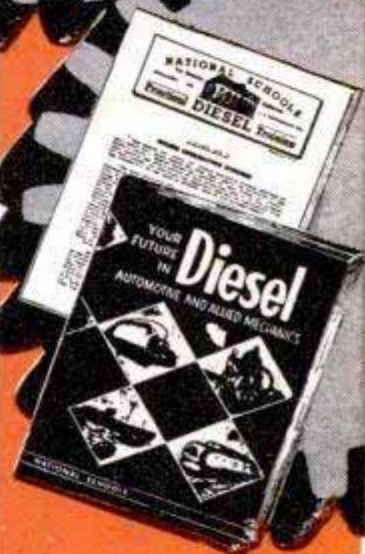
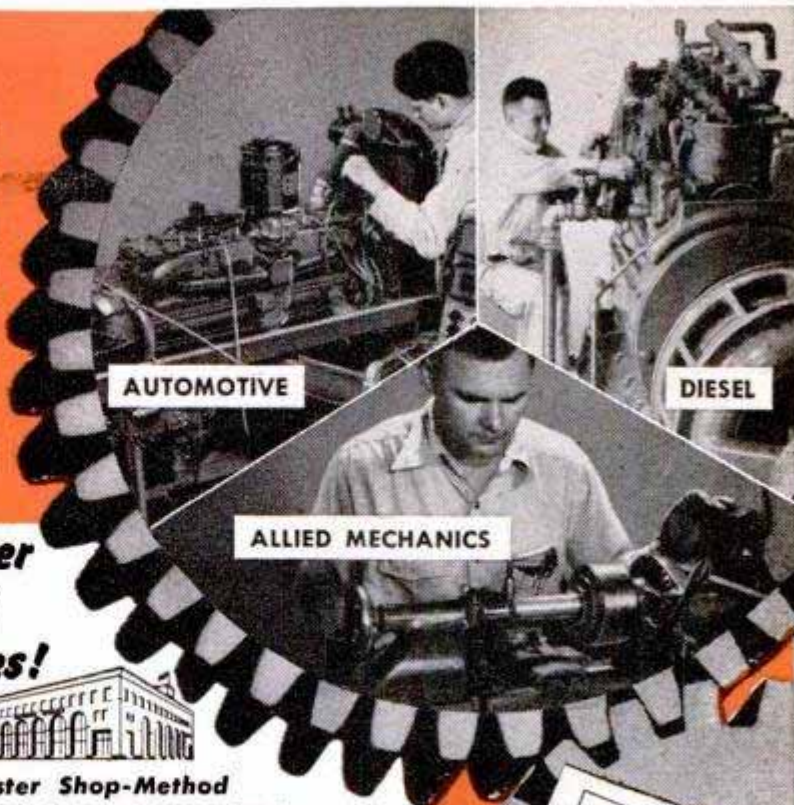

These Two FREE Books Show You How

Send today for National Schools' new, illustrated Book of Opportunity in Automotive, Diesel and Allied Mechanics, and an actual sample lesson. No cost—no obligation. Use the coupon now — we'll answer by return airmail.

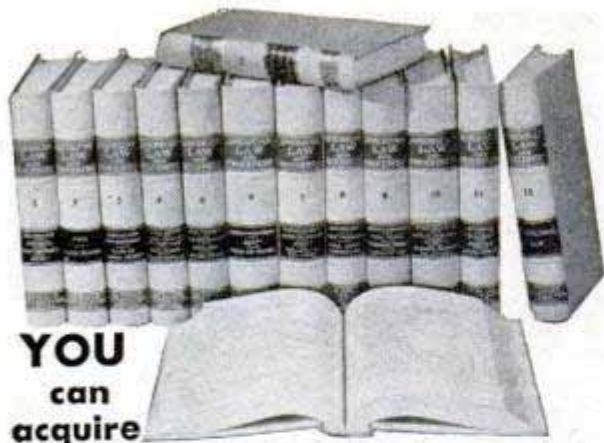

YOU
can
acquire

LAW NIGHTS AT HOME! L. L. B. DEGREE

LaSalle's famous Law Library—used as reference in many Law libraries and Law offices—has enabled thousands to master Law surprisingly fast, in spare hours at home, for business and professional advancement.

These 14 remarkable volumes, compiled by leading professors and lawyers, cover the whole basic field of Law in condensed, orderly, simplified manner.

You advance rapidly with this great library, plus special lectures furnished. We guide you step-by-step with personalized Problem Method of instruction . . . you learn by doing—handling legal problems—not by memorizing rules.

Send for two FREE 48-page booklets, "Law Training for Leadership," and "Evidence," answering questions about Law and its value to you, and telling how LaSalle Law graduates are winning rapid advancement in business and public life. Mail coupon below. No obligation.

LA SALLE EXTENSION UNIVERSITY A Correspondence Institution

417 S. Dearborn St., Dept. 364-L, Chicago 5, Ill.

Send me your two FREE booklets described above, without obligation.

Name _____ Age _____

Street _____

City, Zone & State _____

Which of these 2 one time WEAKLINGS PAID only a Few Cents?
to become an All-Around HE-MAN at Home!



Larry Campbell Rex Ferrus

WHICH ONE PAID HUNDREDS OF DOLLARS TO TRAIN AT MY SIDE?

Rex Ferrus mailed a coupon and paid only a few cents. Larry Campbell paid me hundreds of dollars.

LET ME PROVE I CAN MAKE YOU TOO an "ALL-AROUND" HE-MAN FAST — or it won't cost you a cent — says George F. Jowett—

World's Greatest Body Builder

Just as I did Rex Ferrus, I'll teach you, at home, the "Progressive Power Method" through which I rebuilt myself from a wreck at 15, to holder of more strength records than any other living teacher!

BUILD A BODY YOU WILL BE PROUD OF . . .

Send only 10c for my 5 easy-to-follow, picture-packed courses now in 1 volume, "How to Become a Muscular He-Man."

10 DAY TRIAL! IF these 5 courses do not PRODUCE results in ONE WEEK, send them back and I'll return your dime.

FREE! Jowett's Photo Book of Famous Strong Men!

JOWETT INSTITUTE, Dept. PM-13
230 Fifth Avenue, New York 1, N. Y.

Dear George: Please mail to me prepaid FREE Jowett's Photo Book of Strong Men, plus all 5 Muscle Building Courses, "How to Become a Muscular He-Man." ENCLOSED FIND 10c in complete payment for EVERYTHING.

NAME _____ AGE _____
(Please Print Plainly, Include Zone Number)
ADDRESS _____ NO C.O.D.'s
CITY _____ ZONE & STATE _____



GEORGE F. JOWETT "Champion of Champions"

SPEED AND POWER 1951 HANDBOOK

Direct from the Dry Lakes of California comes authentic information to thrill the most sedate motor enthusiast.



300
BIG LIBRARY EDITION . . . 128 PAGES ILLUSTRATIONS
Tens of thousands of copies have been sold— Shows by photos and drawings how to build fast stock cars! California Roadsters! 225 M.P.H. Rods! Covers ALL MAKES. Build your own Dual Manifolds! Superchargers! Hot Cams! Water Injectors! Hi-Compression Heads! Mileage Devices! Get up to ten more miles per gallon! Get racing speed, lightning acceleration, dynamic power increases from any make passenger automobile! Get construction drawings! Tuning techniques! Speed tricks! Economy secrets! Ingenious formulas! Covers "Racing Frames"—"Wheel Geometry"—"Reciprocating Masses"—"Jet Engines"—"Wheel Geometry"—"Dynamometers"—"Re-Styling"—



SPEED SHOP METHODS

"Customizing"—Dual Pipes, Gears, Fuels, Porting, Relieving, Lowering! Balancing, 50 breathtaking chapters! GREATEST VALUE EVER OFFERED Also get 40 page "DRIVING ECONOMY BOOK", plus big "1951 SPEED EQUIPMENT CATALOGUE", plus "WATER INJECTION", plus "MILEAGE INFORMATION", with purchase of 128 page "SPEED & POWER"—5 items \$1.98 postpaid.

NEWHOUSE AUTOMOTIVE INDUSTRIES
5805 EAST BEVERLY BLVD., DEPT. B-24, LOS ANGELES 22, CALIF.

FREE BOOKS

LEARN POULTRY BUSINESS AT HOME!

Thorough knowledge can mean greater success in this \$3 1/2 billion business. Our interesting, practical, home-study courses have trained thousands during past 30 years. For full information on courses, methods, opportunities—Write Today to Dept. 50



NATIONAL POULTRY INSTITUTE Adams Center, N.Y.



CARTOONING

HAVE FUN! MAKE MONEY! Cash in on your sense of humor AT HOME—BY MAIL. No experience needed to start. Write today FOR FREE TRIAL LESSON and full particulars.
Moon Gag Cartoon School, Dept. G, Fall Creek, Wis.

Learn ACCOUNTING BOOKKEEPING

This nationally renowned school has demand for graduates in good salary positions thru National wide recognition and placement service. Write Department PMV today for Big 32 page Success Book to be sent to you FREE



Hills BUSINESS UNIVERSITY AND EXTENSION SCHOOL
619 W. MAIN ST. OKLAHOMA CITY 2, OKLAHOMA



Money In Hamsters

The new wonder animals from Syria. Often called Toy Bears. Delightful pets. Everyone wants them. Laboratories use thousands. Clean, odorless. Raise anywhere. NOW, spotted and golden breeds. We furnish breeders, equipment and manual of instructions. Write today for free illustrated literature.

GULF HAMSTERY 1536 BASIL ST., MOBILE 17, ALA.

TOOTHACHE? DENT'S



Ask your Druggist for DENT'S

TOOTH GUM
TOOTH DROPS
POULTICE

FREE TO HOME PLANNERS

Our color folder showing 5 popular home designs sent FREE to demonstrate our MONEY SAVINGS home planning service. Over 1,250 Tested Designs of homes already built shown in beautiful illustrated books. Floor Plan shown with each design. Blue Prints, material lists, specifications available at LOW COST. Mail request today or order new 1951 Plan Books below.

1 TO 4 BEDROOMS — ALL TYPES CONSTRUCTION
America's Best Home Plans 50c } ALL Books POSTPAID
125 Designs, many in color. }
Ranch and Suburban 50c } Order 2 or more and
158 Designs, many moderate cost. } get "Little Red Book"
All American Homes 50c } of 29 designs at nothing extra.
120 Designs, varied types, sizes. }
Our Future Home \$1.00

L. F. GARLINGHOUSE CO., INC., Box PM-9 TOPEKA, KANSAS

Now IN YOUR OWN HOME Learn

TELEVISION RADIO

the Amazingly Effective

D.T.I. WAY

—with the aid of **BOTH HOME EQUIPMENT and HOME MOVIES**

What will mailing the coupon below *do for YOU?* Just this! You'll find out about one of today's most remarkable... practical ways to prepare to get into America's amazing billion dollar opportunity field of TELEVISION-RADIO-ELECTRONICS. You'll see how to get into fascinating work that pays well... that offers one of America's most promising futures... that enables you to start your own business almost "on a shoe string," if you prefer this to a job opportunity.

And above all, you'll get some **GOOD NEWS** especially welcomed by men anxious to earn **REAL MONEY** in this thrilling field. For you'll see that **NOW** you can get the kind of practical, laboratory-type training so desirable for making real progress in Television-Radio-Electronics... and **WITHOUT LEAVING HOME.**

You'll see that DeForest's Training, Inc. sends everything needed to set up your own **HOME LABORATORY.** You get and keep the same type of basic electronic equipment used in our modern Chicago Training Laboratories. You get home training that includes the knowledge and experience gained from training thousands of students first hand in Chicago. And to top it all, you use **DTI's** amazingly effective and exclusive home training aid—**INSTRUCTIVE MOVIES.** But why not get the complete story? Mail coupon today for information-packed literature.

MODERN LABORATORIES

If you prefer, get all your preparation in our new Chicago Training Laboratories—one of the finest of its kind. Ample instructors, modern equipment. Write for details!

SEE FOR YOURSELF
Mail Coupon Today

NO PREVIOUS EXPERIENCE NEEDED
NOW...get EVERYTHING YOU NEED
for real Laboratory-Type training **AT HOME**

Above: Work over **300** fascinating experiments with this equipment

1. Build over 300 fascinating experiments from 16 **BIG SHIPMENTS** of Electronic-Radio parts which you **KEEP.**

2. Build valuable commercial-type test equipment—**as shown to the left**—which you **KEEP.** This includes a quality **OSCILLOSCOPE**—a must for Television work.

3. Use a 16 mm. movie projector and new series of Hollywood produced instructive movies—a wonderful aid to help you grasp important fundamentals faster...easier...better.

4. Enjoy well-illustrated, easy-to-read lessons with handy **FOLD-OUT** diagrams.

5. Get an honest-to-goodness **EMPLOYMENT SERVICE** to help you get a good job after graduating—or assistance in starting your **OWN SALES AND SERVICE BUSINESS.** Mail coupon today for the complete details.

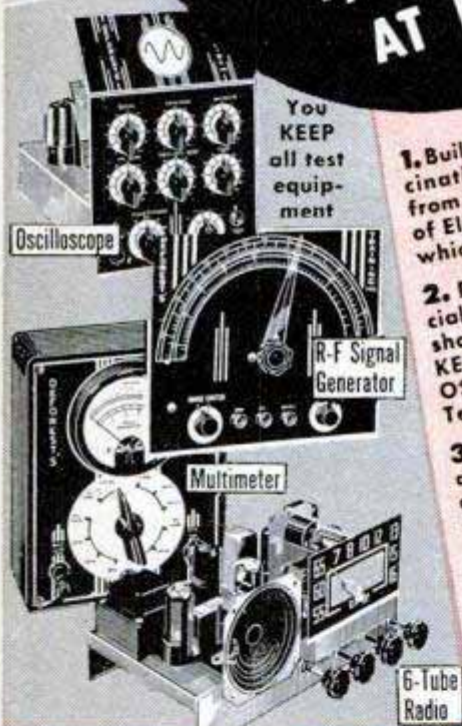

You **KEEP** all test equipment

Oscilloscope

R-F Signal Generator

Multimeter

6-Tube Radio

Build and Keep this 16-INCH TV RECEIVER—**OPTIONAL** after completing regular training.



New "black" RECTANGULAR TUBE

Get **BOTH** of these colorful, information-packed folders **FREE**

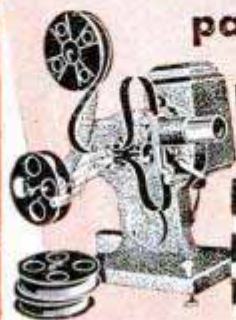

DeFOREST'S TRAINING, INC. Dept. PM-3-H
2533 N. Ashland Avenue, Chicago 14, Ill

Without cost or obligation, I would like valuable, information-packed folders showing how I may get started toward a good job or my own business in Television-Radio-Electronics.

Name _____ Age _____
Street _____ Apt. _____
City _____ Zone _____ State _____

DeFOREST'S TRAINING, INC.

Chicago 14, Illinois
A DeVry Institution

Learn this Profitable Profession



IN 90 DAYS AT HOME

Money-Making Career Open to Men and Women, 18 to 60

Hundreds of men and women between 18 and 60 make \$10 to \$20 in a single day giving scientific Swedish Massage and Hydro-Therapy treatments. There is big demand from doctors, hospitals, sanatoriums and clubs. Graduates earn large full time incomes from these or in private practice in their own offices. Others make good money from home treatments given in spare time. Learn this interesting, money-making profession in your own home, through our home study course. Same instructors as in our nationally known resident school. You can win independence and prepare for future security by qualifying for your Diploma. Course can be completed in 3 to 4 months. Many earn while they learn. Begin your training at once.



Anatomy Charts & Booklet FREE

Enroll now and we will include, at no extra cost, many needed supplies. Fit yourself to help meet growing demand for Scientific Swedish Massage. Send the coupon at once for complete details. Anatomy Charts and 32-Page Illustrated Booklet, FREE, postpaid.

THE COLLEGE OF SWEDISH MASSAGE

Dept. 164C, 41 E. Pearson, Chicago 11, Illinois

Please send me FREE and postpaid, Anatomy Charts, 32-page Booklet and complete details on Home Training.

Name _____ Age _____
 Address _____
 City _____ State _____

"GET ON," Uncle Sam's PAYROLL

START as high as \$3,450.00 Year
Emergency Program Creates 50,000 Additional Jobs

VETERANS GET SPECIAL PREFERENCE
 Railway Postal Clerks
 City Mail Carriers
 City Postoffice Clerks
 Stenographers-Typists
 Liquor Inspectors
 Messengers, Etc.

40-Page Book on Civil Service FREE.

Mail Coupon today—SURE

FRANKLIN INSTITUTE
 (Not Government Controlled)
 Dept. P-83,
 Rochester 4, N. Y.

Rush to me, entirely free of charge, 40-page book with: (1) A full description of U. S. Government jobs; (2) A list of U. S. Government jobs; (3) Tell me how to qualify for a job.

COUPON

Name _____
 Street _____
 City _____ Vet? _____

No Experience Needed To PRINT YOUR OWN POST CARDS



The GEM STENCIL DUPLICATOR saves money... gets results quickly! Hundreds of uses for every type of business and organization. We ship the GEM complete with all supplies, Guide Board for accurate printing and 60-page Book of Ideas at the special low price of only \$8.50 (a \$15 value).

FREE TRIAL OFFER

Our 21st Year

Use the GEM FREE at our expense! SEND NO MONEY. Write and complete GEM outfit will be sent you postpaid. After ten days, send us only \$8.50 or return the GEM. You must be satisfied!

BOND EQUIPMENT CO. Dept. 48
 6633 Enright • St. Louis 5, Mo.

STUDY AT HOME

WITH AN EDUCATIONAL INSTITUTION

Courses in ARTS AND SCIENCES: Philosophy; Education; Letters; Public Health; Medical Jurisprudence; Psychology; Sociology; Physics; Chemistry; Geology; Pol. Science; Theology; Law; Business and Commerce; Accounting; Mathematics; Statistics, Agriculture. **Courses in ENGINEERING:** Electrical, Civil, Mechanical, Drafting, Architectural, Automotive, Steam, Diesel, Aeronautical, Radio, Structural, Mining, Industrial. Petroleum, Marine, Refrigeration, Air Conditioning, Chemical. Send for free catalog.

McKinley-Roosevelt Incorporated, 4610-K3, Sheridan Rd., Chicago 40, Illinois



AUTO WASHER

Your car sparkling clean—in a jiffy—magic "sponge" cleaning-cloth. Simply glide over car. PRESTO! Dust, grease, dirt, and grime disappear in a jiffy. Leaves finish clear, lustrous. Autos gleam like a mirror.

SAMPLES for AGENTS

Sample offer sent immediately to all who send name at once. Penny postal will do. Send no money—JUST YOUR NAME. **KRISTEE CO., Dept. 686, Akron 8, Ohio**

BE A CRIMINOLOGIST

WORK HOME or TRAVEL. Experience unnecessary. CRIMINOLOGY Particulars FREE. Write to GEO. C. R. WAGNER, 125 W. 86th St., N. Y.

GROW YOUR OWN SALAD, 10 DAYS



You can taste the results of this fascinating hobby. Plant Vita-Green seeds in your home—harvest a salad crop in 10 days. A year's supply, complete details..... **\$1. post-paid**

GILBERT & COMPANY
 3535f ENTERPRISE ST., SAN DIEGO 10, CALIF.

EASY TO LEARN CODE

Learn or increase speed with an Instructograph—the Radio-Telegraph Code Teacher that takes the place of an operator-instructor and enables anyone to master code without further assistance. Available tapes from beginners alphabet to typical messages on all subjects. Speed range 5 to 40 WPM. Always ready—no QRM. Thousands have "acquired the code" with the Instructograph System. Write today for convenient rental and purchase plans.



INSTRUCTOGRAPH COMPANY
 4701-V Sheridan Road, Chicago 40, Illinois

Learn BAKING At Home

Baking is one of America's high industries in wages. Nearly depression-proof. Thorough basic home course lays sound foundation. If you have aptitude, write for FREE BOOKLET. "Opportunities in Commercial Baking." **NATIONAL BAKING SCHOOL**



835 Diversoy Pkwy. Dept. 1353 Chicago 14, Ill.

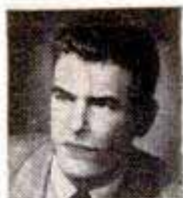

"We have been using your book on Auto Repair for the past year and feel like it is a third man around the shop."—*F. M. Scott, Stanwood, Wash.*



"Fixed motor in 30 minutes another mechanic had worked on half a day."—*C. Auberry, Murfreesboro, Tenn.*



"Instructions so clear, have no trouble learning anything about any car. Now working as mechanic in big plant."—*S. Ordóñez, San Francisco, Calif.*



"So easy to understand—have done jobs with Manual I would not have attempted without it."—*C. L. Vanerstrom, Hazel Park, Mich.*



"I have found my MoToR Manual a wonderful help. It has put me in a position to do every job."—*S. L. Sharpless, Los Angeles, Cal.*

THOUSANDS OF MEN ARE RAVING ABOUT THIS GIANT GUIDE!

Now YOU Can Be a "Cracker-jack" at Auto Repairs!

BRAND-NEW REVISED EDITION!

Thousands of Easy-to-Follow Step-by-Step Pictures

Easy-Step-by-Step Instructions Show How to do ANY Job on ANY Car—from 1935 through 1950!

THOUSANDS of men are raving about MoToR's BIG NEW ILLUSTRATED AUTO REPAIR MANUAL! It enables them to do any job FASTER and better; do MORE jobs; make MORE money!

Whether it's on a 16-year-old "jalopy" or a brand-new '50 beauty, YOU, too, can "breeze through" any repair job quickly, easily, right! Just look up the make, model, and job in the quick index—and go to it!

Everything You Need to Know to Repair Any Car!

This NEW, REVISED, edition has MORE REPAIR INFORMATION THAN EVER—right up to the minute! 740 big pages, 2180 "This-Is-How" pictures—clear drawings, diagrams, cut-away photos that lead you every step of the way. Over 200 "Quick-Check" charts containing more than 35,000 essential repair specifications. Over 200,000 service and repair facts. Clear, simple directions. You can't go wrong!

Any man—even a green beginner—can do a good job. If you're a top-notch mechanic, you'll find yourself tackling jobs now that you wouldn't touch before!

Earn More Money! Win Greater Prestige!

The editors of MoToR's Manual have put together all the "Know-How" from over 150 Official Factory Shop Manuals; "boiled it down" into one handy book!

Includes Automatic Transmissions and Semi-Automatic Transmissions. Covers the new GM Rochester Carburetor, Engines... Chokes... Carburetors... Fuel Pumps... Hydramatic Drives... Overdrives... Oil Filters... Starting Motors... Generators... Distributors... Clutches... Universals... Axles... Brakes... Steering Gears... Shock Absorbers, etc.

Valuable help in Body Service. Factory Specifications and Adjustment Tables. Tune-up Charts. Tables of Measurements and Clearances. Overhauling and Replacement Facts—AND MUCH, MUCH MORE.

Used by Armed Forces, hundreds of thousands of auto service men! YOU'll want it, too, once you see its 740 giant pages—almost a foot high!—its 2180 close-up pictures! Try it on the following UNCONDITIONAL GUARANTEE:

Try Book for a Week FREE

Send No Money. Pay nothing to postman. Test book in your own garage or shop. It's GUARANTEED to pay for itself in 7 days. If it doesn't, just return the book, and owe nothing. You don't risk a penny. Rush coupon for your free-trial copy of this great money-saver Manual. MoToR Book Dept., Desk 13, 250 West 55th St., New York 19, N. Y.

SEND NO MONEY! TRY BOOK FREE! FOR A WEEK FREE!

MAIL COUPON NOW FOR 7-DAY FREE TRIAL

MoToR Book Dept., Desk 13, 250 West 55th Street, New York 19, N. Y.

Rush to me at once: (Check box opposite book you want)

- MoToR's New AUTO REPAIR MANUAL. If O.K., I will remit \$1 in 7 days (plus 35c delivery charge), then \$2 monthly for 2 months, and a final payment of 95c a month later. Otherwise I will return book postpaid in 7 days. (Foreign price, remit \$8 cash with order.)
- MoToR's New TRUCK AND TRACTOR REPAIR MANUAL. (Described at left.) If O.K., I will remit \$2 in 7 days, and \$2 monthly for 3 months, plus 35c delivery charge with final payment. Otherwise I will return book promptly. (Foreign price, remit \$10 cash with order.)

Print Name Age

Print Address

City & Zone No..... State.....

SAVE 35c delivery charges by enclosing WITH COUPON check or money order for full payment of \$5.95 for Auto Repair Manual (or \$8.00 for Truck and Tractor Manual). Same 7-day return-for-refund privilege applies.

EVERY MODEL OF ALL THESE CARS COVERED:

- American
- Bantam
- Auburn
- Austin
- Buick
- Cadillac
- Chevrolet
- Chrysler
- Cord
- Crosley
- De Soto
- Dodge
- Ford
- Frazer
- Graham
- Hudson
- Hupmobile
- Kaiser
- Lafayette
- La Salle
- Lincoln
- Lincoln
- Zephyr
- Mercury
- Nash
- Oldsmobile
- Packard
- Pierce
- Arrow
- Plymouth
- Pontiac
- Reo
- Studebaker
- Terraplane
- Willys

USED BY U.S. ARMED FORCES

Same FREE 7-Day Offer on MoToR's NEW TRUCK and TRACTOR REPAIR MANUAL

BRAND-NEW! Covers EVERY job on EVERY gasoline-powered truck and farm tractor made from 1936 thru 1949! 1887 pictures, 963 big 8 1/2 x 11-inch pages, 300,000 facts. Used by Armed Forces. All types Gasoline Engines, Fuel Systems, Governors Lubrication Systems, Ignition Systems, Starters, Generators, Clutches, Transmissions, Axles, Torque Dividers, Transfer Cases, Brakes, Steering, etc. Check proper box in coupon for free trial.



9 BIG BUILDING BOOKS

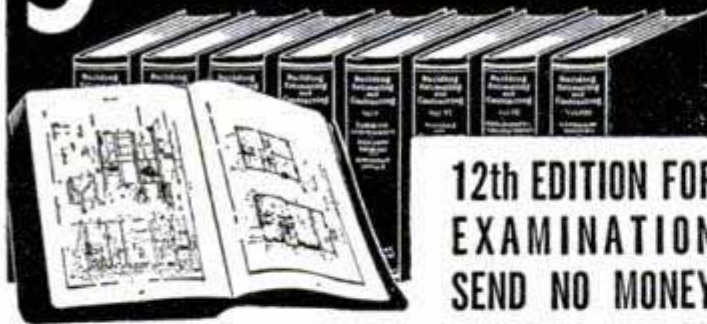

12th EDITION FOR EXAMINATION SEND NO MONEY

Learn to draw plans, estimate, be a live-wire builder, do remodeling, contracting. These 9 practical, profusely illustrated books cover subjects that will help you to get more work and make more money. Masonry, concrete forms, carpentry, steel square, roof framing, construction, plumbing, heating, painting, decorating and many other subjects. More than 4000 pages — 2750 illustrations.

BETTER JOBS — BETTER PAY UP-TO-DATE EDITION

A nationwide building boom is in full swing and trained men are needed. Big opportunities are always for MEN WHO KNOW HOW. These books supply quick, easily understood training and handy, permanent reference information that helps solve building problems.

These books are the most up-to-date and complete we have ever published on these many subjects.

Coupon Brings Nine Big Books for Examination

AMERICAN TECHNICAL SOCIETY—Publishers since 1898
Dept. G319 Drexel at 58th Street Chicago 37, Ill.

You may ship me the Up-to-Date edition of your nine big books, "Building, Estimating and Contracting," without any obligation to buy. I will pay the delivery charges only, and if fully satisfied in ten days, I will send you \$3.00, and after that only \$4.00 a month, until the total price of only \$34.80 is paid. I am not obligated in any way unless I keep the books.

Name _____

Address _____

City _____ State _____

Please attach a letter stating your age, occupation, employer's name and address, and name and address of at least one business man as a reference. Men in service, also please give home address.

Can a Man MY Age Become a

HOTEL EXECUTIVE

Even Though He Has No Previous Hotel Experience?

Would you like to step into a well-paid position as Hotel, Club, Restaurant or Inn Manager, Purchasing Agent, Social Director or Assistant Manager? Would you like to look forward happily to the future? The success of Lewis graduates from 18 to 50 PROVES you can — though you have no experience in hotel work.

Louis M. Remy, Veteran, Without Hotel Experience Wins Assistant Hotel Manager's Position



"I took the Lewis Course after leaving the Air Force. Even before graduation I had accepted a position through your Placement Department. Now Assistant Manager of a fine Washington, D.C. hotel. All this could not have happened without the help of the Lewis Hotel Training School. I am looking to the future with confidence."

Step Into a Well-Paid Hotel Position FREE Book Gives Fascinating Facts

Our FREE Book, "Your Big Opportunity," explains how you can qualify for a well-paid position at home, in leisure time; tells how you are registered FREE of extra cost in the Lewis National Placement Service. Most important, it shows how you can be a Lewis Certified Employee—certified to "make good" when placed in a position. Mail the coupon NOW!

Course Approved for Veterans' Training

LEWIS HOTEL TRAINING SCHOOL
Room TC-324, Washington 7, D. C.

35th SUCCESSFUL YEAR

Send me the Free Book, "Your Big Opportunity," without obligation. I wish to know how to qualify for a well-paid position at home, in my leisure time.

Name _____ (Please Print Name & Address)

Address _____

City _____ Zone _____ State _____

Check here if eligible under G. I. Bill of Rights.

PAINT STRIPING TOOL

Works Like a Fountain Pen Stripes with PAINT instead of INK!

New Master Painters' STRIPING TOOL makes it easy to do expert striping on furniture, bikes, model planes, autos, signs, linoleum, toys, wall board, etc. Makes plain painted walls look like tile. Paint straight lines, curved, circular or evenly spaced parallel lines the same way a professional painter does. Simply fill Tubular Glass Paint Fountain with any color paint & wheel tip feeds paint evenly. Tips interchangeable—Jaws split apart for easy cleaning. Tool complete with tip for 1-16 in. stripe only \$1 postpaid. Other complete tools with 1-64, 1-32, 3-64, 5-64, 3-32, 1-8 in. tips, \$1.50. Separate tips, 75c. Complete Kit with tool and 7 tips, \$5.00. Handiest tool in painter's kit. Get it now. C.O.D.'s postage collect.

\$1.00

POST PAID

Tubular Glass Paint Fountain

A Visible Paint Supply

DEALERS Paint Striping Tool

Packed in attractive Display Cartons of one dozen. Fast, profitable seller. Write for illustrated circular, discounts.

WENDELL MFG. CO.

4234 N. Lincoln Avenue
Dept. 33, Chicago 18, Illinois

Paints Curved, Circular or Straight Lines

Thumb and Finger Rests. Easy to Guide Tool

Guide Keeps Lines Straight Knurled Wheel Distributes Paint

CHEMISTRY

LEARN AT HOME... You need chemical knowledge to qualify for thousands of today's good jobs in industry, business, science, the professions. This Course enables you to master practical chemistry. You learn by performing actual experiments at home, using chemicals and apparatus furnished with course. Illustrated lesson books guide you. Course approved. Equivalent to recognized college courses in general chemistry. Send today for free catalog.

INSTITUTE OF PRACTICAL CHEMISTRY
3 PROSPECT AVENUE, HAGERSTOWN, MD.

STAMMERER?

New booklet, "Stammering, and How to Stop It," sent free to any stammerer upon request. Write today. **BENJAMIN N. BOGUE, Dept. 514, Circle Tower, Indianapolis 4, Ind.**

GET THIS FREE BOOK!

LAW FREE BOOK



Your FREE copy of "The Law-Trained Man" shows how to gain prestige and greater earnings through Blackstone home law study. All instruction material furnished including 18-volume Law Library written by 65 well-known law authorities. Lawyers, judges among our graduates. LL.B. degree. Low cost; easy terms. Write today. **BLACKSTONE COLLEGE OF LAW 225 N. Michigan Ave. Dept. 53, Chicago 1, Ill.**

A Correspondence Institution Founded in 1890

Do You Make These Mistakes in English?

MANY persons say "between you and I"—use "who" for "whom"—don't know whether to use one or two "e's" or "m's" or "r's." Every time you speak or write you show what you are. A command of effective English brings you added advantages, better opportunities.

You can improve your English through Sherwin Cody's 100% self-correcting invention. If you are ever embarrassed by mistakes in grammar, spelling, punctuation, or pronunciation, write for FREE book "How You Can Master Good English in 15 Minutes a Day." No obligation. **SHERWIN CODY COURSE IN ENGLISH, 53 B & O Bldg., Rochester 14, N. Y.**

WATCHMAKING

★ Watch Repairing ★ Jewelry Engraving ★ Jewelry Repairing

Combination men earn top pay. Learn in school fully accredited by Horological Institute of America in Washington, D. C. and United Horological Association of America. Approved for veterans. Receive tools, tuition and subsistence while learning.

Established 1935. Write for FREE booklet



The Baronian School, Inc.

2116 WALNUT ST. (DEPT. C) PHILA. 3, PA.

GET INTO

RADIO-TELEVISION ELECTRONICS By

Shop-Method Home Training

MASTER ALL PHASES!

Get Master Shop-Method Home Training from an Established Practical Resident School with its own



Training Shops, Laboratories, and Studios—and almost 50 Years of Successful Experience in Training Ambitious Men.

We Bring National Schools To You

GOOD JOBS AWAIT THE TRAINED RADIO-TV TECHNICIAN

There is a place for you in the great Radio-Television-Electronics industry when you are trained as National Schools will train you at home!

Trained technicians are in growing demand at good pay—in manufacturing, broadcasting, television, communications, radar, research laboratories, home Radio-TV service, and other branches of the field. National Schools Master Shop-Method Home Training, with newly added lessons and equipment, trains you in your spare time, right in your own home, for these fascinating opportunities. **OUR METHOD IS PROVED BY THE SUCCESS OF NATIONAL SCHOOLS TRAINED MEN, ALL OVER THE WORLD, SINCE 1905.**

EARN WHILE YOU LEARN

Many National students pay for all or part of their training with spare time earnings. We'll show you how you can do the same! Early in your training, you receive "Spare-time Work" Lessons which will enable you to earn extra money servicing neighbors' and friends' Radio and Television receivers, appliances, etc.



Signal Generator

Audio Oscillator

T. R. F. Receiver



You also receive this Multitester

LEARN BY DOING

You receive and keep all the modern equipment shown above, including tubes and valuable, professional quality Multitester. No extra charges. You build the fine Superheterodyne Receiver with parts we send you.

Superheterodyne Receiver

FREE! These 2 Free Books give you all the facts. Send today for National Schools' new, Illustrated Book of Opportunity in Radio-Television-

Electronics, and an actual

Sample Lesson. No cost—

no obligation. Use the

coupon now—we'll

answer by return airmail.

National Schools Training Is All-Embracing

National Schools prepares you for your choice of many job opportunities. Thousands of home, portable, and auto radios are being sold daily—more than ever before. Television is sweeping the country, too. Co-axial cables now under construction will soon bring Television to every city, town, and farm! National Schools' complete training program qualifies you in all fields. Read this partial list of opportunities for trained technicians:

- Business of Your Own • Broadcasting
- Radio Manufacturing, Sales, Service • Telecasting
- Television Manufacturing, Sales, Service
- Laboratories: Installation, Maintenance of Electronic Equipment
- Electrolysis, Call Systems
- Garages: Auto Radio Sales, Service
- Sound Systems and Telephone Companies, Engineering Firms
- Theatre Sound Systems, Police Radio
- And scores of other good jobs in many related fields.

APPROVED FOR VETERANS AND NON-VETERANS
Check coupon below

Both Resident & Home Study Courses offered

NATIONAL SCHOOLS

LOS ANGELES 37, CALIF. • EST. 1905

FIND OUT NOW... MAIL COUPON TODAY

National Schools, Dept. 3-PM
4000 South Figueroa Street
Los Angeles 37, California

Mail in envelope or paste on penny postal.

Send me your FREE book "Your Future in Radio" and the sample lesson of your course. I understand no salesman will call on me.

NAME _____ AGE _____

ADDRESS _____

CITY _____ ZONE _____ STATE _____

Check here if Veteran of World War II

TELEVISION TRAINING

A complete series of up-to-the-minute Television lessons is an important part of your course. They cover all phases of Television repairing, servicing and construction. The same lesson texts used by resident students in our own modern and complete Television broadcast studios, laboratories and classrooms!

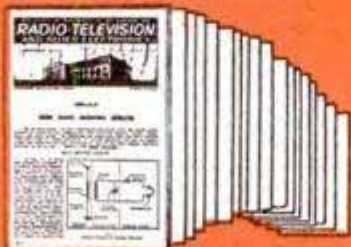

OWN A PFLUEGER REEL



Enjoy Fishing at Its Best

You'll get an entirely new appreciation of fishing with a Pflueger Reel. You'll cast better—hook strikes surer—have more fun. Pflueger's fine construction makes any angler more skillful. You can never wear out a Pflueger Reel—its quality guarantee never expires. Ask your Dealer.

PFLUEGER SUPREME
\$35.00



THE ENTERPRISE MFG. CO.
Akron, Ohio
87 Years Making Fine
Fishing Tackle

Bait Casting and Trolling Reels \$5.75 to \$35.00
Salt Water Reels \$9.00 to \$31.50
Fly Rod Reels \$1.95 to \$13.50

PFLUEGER
(Pronounced FLEW-GER)

A GREAT NAME IN TACKLE

"I'M EARNING \$300 A MONTH!"



.... says Leonidas Burgoyne of Chicago, Illinois, "Expert individual instruction in the fully equipped shops of Greer Shop Training gave me the right start to get my good paying job."

GREER SHOP TRAINING established 1902, is one of America's largest trade schools. Over 48,000 successful graduates. You learn by tearing down, repairing and rebuilding. Day and evening classes. Mail this coupon today!

LEARN A TRADE NOW!

GREER SHOP TRAINING, Desk 211, 460 S. State St., Chicago, Ill.

Gentlemen: Please send me information about trade I have checked below. (Specify if you are VET or NON-VET .

- IN OUR CHICAGO SHOPS
- | | |
|---|--|
| <input type="checkbox"/> AUTO MECHANICS | <input type="checkbox"/> BODY, FENDER REPAIR |
| <input type="checkbox"/> DIESEL | <input type="checkbox"/> WELDING—ARC, GAS |
| <input type="checkbox"/> REFRIGERATION | <input type="checkbox"/> MACHINIST |
| | <input type="checkbox"/> PIANO TUNING |

Above courses approved for Vets and Civilians.

ALSO THE FOLLOWING HOME STUDY COURSES

- REFRIGERATION DIESEL PLASTICS

Name _____ Age _____

Address _____

City _____ State _____

GREER SHOP TRAINING

SPRAYING MADE EASY

BECKER *Self-Contained* PRESSURE GUN

Saves Cost of Compressor and Motor

TAKE IT ANYWHERE—the first completely portable spray gun. Needs no compressor, motor, or electrical outlet. Pressure-powered with an inexpensive CO2 cartridge that sprays up to 21 liquid ounces, depending on viscosity. Extra cartridges, 10 for \$1, postpaid, or buy from your dealer.

PAINTS • VARNISHES • ENAMELS
MOTH-PROOFS • INSECTICIDES

Every home needs a Becker Spray Gun for dozens of jobs in the house, workshop, garden or garage. Complete instructions furnished for effective results. Order yours today for the season ahead.

HOW TO ORDER—If your dealer can't supply, send \$15.95 and we ship postpaid—or \$2 now and pay postman balance plus postage and fee. Money back if not delighted after 5 days' trial.

SULLIVAN-BECKER CO.
Dept. 111-C, Kenosha, Wis.



ONLY
\$15.95
with 3
cartridges



CHAPMAN CHINCHILLAS

The originator of the first Chinchilla Farm in the United States. For information on purchasing the finest, selected breeding stock of these aristocratic animals that were virtually trapped to extinction write or visit—

Established 1919 **Chapman Chinchilla Farm**
"P. O. BOX 221" 4957 West 104th Street
Inglewood, California

BE A LANDSCAPE CONTRACTOR

or a Landscape Architect. Make \$15 to \$50 a day. Compare the competition in this field to others & you'll see why we have hundreds of employed graduates from coast to coast. Course includes practical instruction here in addition to approved home study work. Write for free information.



NATIONAL LANDSCAPE INSTITUTE
Dept. P-3, 310 So. Robertson Los Angeles 48, Calif.

RADIO ENGINEERING, Broadcasting, Television, FM; Servicing, Electronics, Aviation, Marine & Police Radio taught thoroughly. Engineering course equivalent to 3 years' college radio work. Approved Veteran Training. Catalog free.
VALPARAISO TECHNICAL INSTITUTE, Dept. D, Valparaiso, Ind.

Play GUITAR in 10 DAYS

OR GET YOUR MONEY BACK!

Let Ed Sale teach you to play with his famous diagram photo system. Book contains 53 photos, 43 diagrams, showing exactly how to place your fingers. Gives you 110 popular songs, words and music—along with complete, easy to learn instructions. Imagine your joy when you find after only two weeks you are playing beautiful music! Amaze your friends! Be the life of the party! SEND NO MONEY. Pay Postman \$1.95 Plus Postage. **ED SALE**, Dept. PM-3, Point Pleasant, N.J.

How to win an Executive's JOB and PAY

Only one thing stands between you and a top executive's pay—the right kind of ability. You may be skilled in your work, yet if not trained in management you are not likely to be promoted to important executive jobs. Thousands win promotions thru LaSalle's Executive Training—and YOU too can gain tremendous advantage over others by knowing management principles. Write today for FREE 48-page book, "14 Steps to Executive Leadership."

LASALLE Extension University, 417 So. Dearborn St.
A Correspondence Institution Dept. 364BM, Chicago 5, Ill.

Thrilling Work COLORING PHOTOS

Fascinating vocation learned at home by those with aptitude. Thrilling pastime. National method brings out life-like colors. Free booklet.

NATIONAL PHOTO COLORING SCHOOL
835 Diversey Pkwy., Dept. 1353, Chicago 14

EASY TO LEARN



**TO HELP YOU PREPARE FOR
ONE OF THE BETTER JOBS
IN BUSINESS or INDUSTRY**

**You can take subjects which have *Real Job Value*
and still earn graduation!**

• This is *your* opportunity to make completion of high school *work* for you. Your AMERICAN SCHOOL home study course can include high school subjects closely related to your present job or the kind of work you want to do later. Not only can you qualify for your high school course diploma but you can benefit from course subjects that will aid greatly in winning promotions.

**50 Job Help Subjects
from Which to Choose**

Our FREE, 44-page book of detailed information lists 100 high school subjects, of which 29 are technical and 21 are commercial. Whether you work in a shop, factory, garage or office you will find subjects of practical benefit in your climb toward better jobs at better pay. Some of these are Blueprint Reading, Mechanical and Machine Drawing, Tool Making, Foundry Work, four Automotive subjects, Electricity, Carpentry—and Bookkeeping, Accounting, Secretarial Practice, Office Machines, Salesmanship.

Turn Spare Time Into Money

During more than 50 years American School has helped thousands to reach higher job goals by profitable use of spare time at home—and it can help *you*. Others have prepared for college entrance. If you have not completed high school, check that subject on the coupon below, add your name and address and mail it *right now*. Or if you are a high school graduate and are ambitious to succeed in the vocation of your choice, check that subject. Your coupon will bring you the book of information, without obligation of any kind. Mail it *now*.

PRACTICAL, EFFECTIVE HOME - STUDY TRAINING SINCE 1897

Take This First Easy Step

CHECK, CLIP AND MAIL COUPON NOW

AMERICAN SCHOOL, Dept. G345, Drexel at 58th, Chicago 37, Ill.
Without obligation, please send me FREE information on training course checked below.

- | | | |
|---|--|--|
| <input type="checkbox"/> HIGH SCHOOL COURSES | <input type="checkbox"/> Bookkeeping | <input type="checkbox"/> Plastics Engineering |
| <input type="checkbox"/> Accounting | <input type="checkbox"/> Business Management | <input type="checkbox"/> Plumbing—Practical |
| <input type="checkbox"/> Air Conditioning | <input type="checkbox"/> Contracting | <input type="checkbox"/> Private Secretary |
| <input type="checkbox"/> Architecture & Building | <input type="checkbox"/> Diesel Engineering | <input type="checkbox"/> Radio Operating & Servicing |
| <input type="checkbox"/> Automotive Engr. | <input type="checkbox"/> Drafting & Design | <input type="checkbox"/> Railway Training |
| <input type="checkbox"/> Aviation—Practical | <input type="checkbox"/> Electrical Engineering | <input type="checkbox"/> Refrigeration |
| <input type="checkbox"/> Aviation Drafting & Design | <input type="checkbox"/> Electricity—Practical | <input type="checkbox"/> Sheet Metal Pattern |
| <input type="checkbox"/> Better Foremanship | <input type="checkbox"/> Electronics, Industrial | <input type="checkbox"/> Drafting |
| | <input type="checkbox"/> Machine Shop Operations | <input type="checkbox"/> Shop Management |
| | <input type="checkbox"/> Mechanical Engineering | <input type="checkbox"/> Tool Making |

Name _____ Occupation _____
Address _____ Age _____
City & Zone _____ State _____

AMERICAN SCHOOL

Dept. G345, Drexel at 58th Street, Chicago 37

MORE PAY
through
HOME STUDY TRAINING
in
SPARE TIME

Do you want a better position—a larger salary? They are within your reach—now. LaSalle experts will guide you step by step in gaining business training which leads to greater earnings.

The time-saving, interesting LaSalle Problem Method helps you prepare at home, without interference with your present duties.

Simply mark on the coupon the field in which you desire success, and we will mail you a valuable book describing the opportunities in that field—plus "Ten Years' Promotion in One"—a book which has helped many men. Let us tell you how we have started thousands of average men and women on the high road to success and more money. Check and mail the coupon now.

LASALLE EXTENSION UNIVERSITY

A Correspondence Institution

417 S. Dearborn St., Dept. 364-R, Chicago 5, Ill.
Send me full information regarding the course I have marked—without obligation—plus "Ten Years' Promotion in One."

- | | |
|--|---|
| <input type="checkbox"/> Higher Accountancy | <input type="checkbox"/> Salesmanship |
| <input type="checkbox"/> C.P.A. Coaching | <input type="checkbox"/> Traffic Management |
| <input type="checkbox"/> Bookkeeping | <input type="checkbox"/> Foremanship |
| <input type="checkbox"/> Law: LL.B. Degree | <input type="checkbox"/> Industr'l Management |
| <input type="checkbox"/> Business Management | <input type="checkbox"/> Stenotypy
(Machine Shorthand) |

Name.....Age.....

Address.....

City.....Zone.....State.....

Prepare Now!
ENGINEERING
B.S. DEGREE IN 27 MONTHS
WORLD FAMED SCHOOL • ESTABLISHED 1884

Mechanical, Civil, Electrical, Chemical, Aeronautical, Radio (Television) Engineering; Business Administration and Accounting. Also 36-weeks diploma courses in Surveying and Drafting.

Personalized instruction. Accelerated courses. For ambitious earnest students. Preparatory department. Approved for veterans.

Heavy demand for Tri-State graduates; hold positions of responsibility the world over. Placement service. Serious shortage of engineers indicated for immediate future. Prepare now for the opportunities ahead. Technical training helpful in military assignments.

Extensive campus. Well equipped, new and modernized buildings; up-to-date labs. Low cost. New terms start quarterly. Enter March, June, September, January.

Write today for free catalog and special information.

TRI-STATE COLLEGE
431 COLLEGE AVENUE ANGOLA, INDIANA

MEN! WOMEN!
New Car given
as Bonus!



TAKE ORDERS for
Nationally Advertised

NYLONS

GUARANTEED NINE MONTHS

Sensational Guarantee creating a tremendous demand for Wilkmit Nylons! If they run, wear out or even snag from any cause whatever... within NINE MONTHS... depending on quantity... they are replaced FREE OF CHARGE. No wonder it's easy to quickly build up fine, steady, year-round income. Earnings start immediately. Look at these exceptional figures—Ralph Shearer made \$67.11, first week—Mrs. Paul Estes, \$42.92—Mrs. Ivey Gentry, \$43.37. Doris Jensen in addition to making as much as \$17.00 in a single day, earned two cars as EXTRA BONUSES. Learn how you can make money in your full or spare time without a bit of previous experience.

EARNED
TWO NEW CARS

... and as much as \$120.00 in one week

That's the exceptionally fine record of Chas. Mills with the famous Wilkmit hosiery line. Offer of New Chevrolet as a bonus open to EVERYONE. Send name for facts FREE.

SEND NO MONEY... Just Hose Size

When you send for Selling Outfit, I also send your choice of Nylons or Socks for your personal use. Don't lose a minute. Rush name on penny postcard for full money-making facts on Sensational Sales Kit. Send hose size, too. Lowell Wilkmit, WILKNITHOSIERY CO., 303 Midway, Greenfield, Ohio

WHAM-O SPORTSMAN*



45-LB. PULL

HITS LIKE A .22 RIFLE—KILLS RABBITS, SQUIRRELS.

Powerful, silent, accurate.

For hunting, target, routing pests.

Sportsman's choice sold world over!



HUNTING SLINGSHOT

Heavy duty 7" ash stock.

40 steel balls; extra rubber straps.

GUARANTEED—of dealers, or send \$1. to

Wham-O Mfg. Co., Box 2L, South Pasadena, Calif.

*Professional model of Nat'l Slingshot Assn



AJAX AUSTRALORPS

SENSATIONAL WORLD CHAMPION LAYERS. Black Australorps mature fast. Excellent roasters—capons. Massive size. U. S. Approved—Pullorum Controlled. Low farm prices. Catalog FREE. Write TODAY. AJAX HATCHERY, BOX 914, QUINCY, ILL.

WHY DON'T YOU WRITE?

Writing short stories, articles on business, sports, hobbies, travel, shop crafts, local and club activities, etc., will enable you to earn extra money. In your own home, on your own time, the New York Copy Desk Method teaches you how to write the way newspaper men learn—by writing. Our unique "Writing Aptitude Test" tells whether you possess the fundamental qualities essential to successful writing. You'll enjoy this test. Write for it, without cost or obligation.

Veterans: Course approved for Veterans' Training.

NEWSPAPER INSTITUTE OF AMERICA

SUITE 5591-C, ONE PARK AVENUE, NEW YORK 16, N. Y.



ITALIAN ACCORDIONS

Hand Made. Very Best. Buy Direct from Factory Representative at lowest wholesale prices and Save Money. Send Name and Address for FREE catalog.

ITALIAN ACCORDION MFG. CO.

7600 Cottage Grove Ave., Dept. PM-3, Chicago 19, Ill.

POWER MOWERS & KITS

FREE PLANS

LOW FACTORY PRICES DIRECT TO YOU

3 & 4 Wheel Model



Build your own quality mower with our LOW COST KITS, Parts, Engines. Free Plans guide you. 3 and 4 Wheel Kits, complete. Parts precision finished, ready to use. Write TODAY for Free Plans, Low Prices, Parts List and Guarantee.

3 and 4 Wheel Kits, complete. Parts precision finished, ready to use. Write TODAY for Free Plans, Low Prices, Parts List and Guarantee.

3 and 4 Wheel Kits, complete. Parts precision finished, ready to use. Write TODAY for Free Plans, Low Prices, Parts List and Guarantee.

3 and 4 Wheel Kits, complete. Parts precision finished, ready to use. Write TODAY for Free Plans, Low Prices, Parts List and Guarantee.

3 and 4 Wheel Kits, complete. Parts precision finished, ready to use. Write TODAY for Free Plans, Low Prices, Parts List and Guarantee.

3 and 4 Wheel Kits, complete. Parts precision finished, ready to use. Write TODAY for Free Plans, Low Prices, Parts List and Guarantee.

3 and 4 Wheel Kits, complete. Parts precision finished, ready to use. Write TODAY for Free Plans, Low Prices, Parts List and Guarantee.

3 and 4 Wheel Kits, complete. Parts precision finished, ready to use. Write TODAY for Free Plans, Low Prices, Parts List and Guarantee.

3 and 4 Wheel Kits, complete. Parts precision finished, ready to use. Write TODAY for Free Plans, Low Prices, Parts List and Guarantee.

3 and 4 Wheel Kits, complete. Parts precision finished, ready to use. Write TODAY for Free Plans, Low Prices, Parts List and Guarantee.

3 and 4 Wheel Kits, complete. Parts precision finished, ready to use. Write TODAY for Free Plans, Low Prices, Parts List and Guarantee.

3 and 4 Wheel Kits, complete. Parts precision finished, ready to use. Write TODAY for Free Plans, Low Prices, Parts List and Guarantee.

3 and 4 Wheel Kits, complete. Parts precision finished, ready to use. Write TODAY for Free Plans, Low Prices, Parts List and Guarantee.

3 and 4 Wheel Kits, complete. Parts precision finished, ready to use. Write TODAY for Free Plans, Low Prices, Parts List and Guarantee.

3 and 4 Wheel Kits, complete. Parts precision finished, ready to use. Write TODAY for Free Plans, Low Prices, Parts List and Guarantee.

3 and 4 Wheel Kits, complete. Parts precision finished, ready to use. Write TODAY for Free Plans, Low Prices, Parts List and Guarantee.

3 and 4 Wheel Kits, complete. Parts precision finished, ready to use. Write TODAY for Free Plans, Low Prices, Parts List and Guarantee.

3 and 4 Wheel Kits, complete. Parts precision finished, ready to use. Write TODAY for Free Plans, Low Prices, Parts List and Guarantee.

3 and 4 Wheel Kits, complete. Parts precision finished, ready to use. Write TODAY for Free Plans, Low Prices, Parts List and Guarantee.



3-WHEEL KIT NO. T-800

America's Finest Power Mowers completely assembled in 3 and 4 wheel models. Belt or direct drive, 18" and 20" sizes. Nationally known make engine optional. Latest improved features, sturdy construction and money back guarantee fully described in color folder. Write today.

▼ TRIANGLE MANUFACTURING CO., Dept. M-4, Fort Scott, Kansas

\$200 GROSS IN MY FIRST WEEK!



Some Make More, Some Less . . . Start This Business for YOUR OWN

Would YOU like to own a permanent, year-round business in which it is possible to take in as much as \$200 gross the first week, as did L. A. Eagles? R. E. Traynor says, "I made \$62 gross in one day." R. R. Newlin reports, "I have averaged \$173 gross per week." Others report gross from \$100 per week to \$12,000 per year.

Surely YOU will want to investigate a golden opportunity like that. You need not have any special skill or experience, but if you are ambitious, honest and courteous, we will help you to start and succeed in YOUR OWN money-making business where net profits are high.

No Shop Necessary

Our Electric Rug Washer cleans rugs and carpets like new right on the customer's floor. This quick, thorough and highly efficient method removes dirt and grime, thus restoring the natural, fresh beauty of floor coverings. Anyone can do it. Rugs and carpets are not harmed.

There are hundreds of possible customers in YOUR vicinity. Most of the have several rugs needing regular cleaning. To get a quick start,

FREE BOOK! MAIL COUPON

VON SCHRADER MFG. CO.
310 PL, Racine, Wis.

Send at once (no obligation) your FREE booklet containing information about your Electric Rug Washer and how I can own my own permanent profitable business.

Name _____
Address _____
City _____ (Zone) _____ State _____

shampoo a few rugs or carpets. These customers tell their friends and soon you should have an independent, prosperous business, and you should be able to keep it growing. Send the coupon RIGHT NOW for booklet that explains everything.

Every Machine Guaranteed and Easy to Own

You take no risk. These wonderful, fully guaranteed machines have been used and endorsed by largest hotels, railroads—also used by U. S. Government. Many individuals have built up successful businesses that made big profits. Mail the coupon TODAY and we will send complete information, including how to start and succeed in YOUR business without a large investment. Don't delay your BIG opportunity. Send the coupon AT ONCE.



MAIL COUPON TO

VON SCHRADER MFG. CO., 310 PL, RACINE, WIS.

WANTED! DRAFTSMEN!

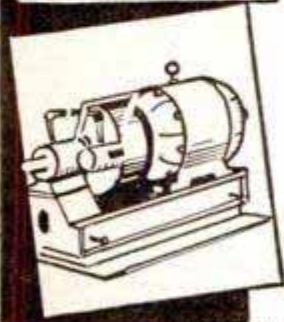

LEARN THIS BIG PAY PROFESSION AT HOME IN YOUR SPARE TIME

The need for more skilled draftsmen continues to grow. Essential jobs await trained draftsmen in every major industry. The war emergency has increased an existing shortage. Machines will never replace the draftsman. Before production can start plans must be drawn. Draftsmen are the first to be hired. Drafting is light, pleasant work, in pleasant surroundings and leads to top managerial position.

CTS OFFERS NEW TRAINING PROGRAM

A program that teaches you the hows and whys of production planning while studying at home. You learn by making actual drawings. CTS sends you a set of professional drafting instruments, portable drafting table, drafting supplies, etc., everything you need at no extra cost.

EVERYTHING IN THE FIELD OF

**• ARCHITECTURE •
ELECTRONICS • MACHINERY**

MAIL COUPON FOR FREE BOOK!

CHRISTY TRADES SCHOOL, Dept. DB-703
4432 N. Kedzie Ave., Chicago 25, Ill.

Mail me at once your big FREE book on Drafting and Blue Printing. How your Home Training and Professional Drafting Instruments, Equipment, etc. can be had on PAY AS YOU LEARN PLAN.

NAME..... Age.....
ADDRESS..... CITY..... STATE.....

**NOW
FOR THE
FIRST
TIME**

Combined Experience and
KNOW HOW
of World's BEST
AUTO MECHANICS

**AUTO
Repair
Kinks**

by
Bill Toboldt
Editor Motor
Service
Magazine

Only
\$3.00

Postpaid to your
Home

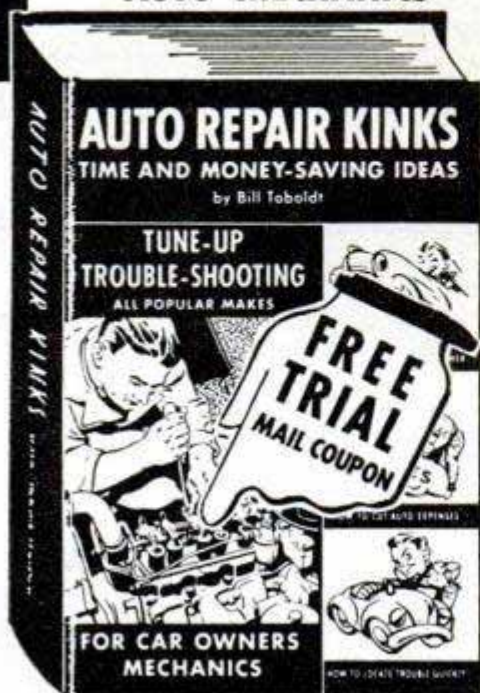

ZIP THRU Auto Repair Jobs

Bill Toboldt's AUTO REPAIR KINKS, the entirely new and different guide to "doctoring up" ailing autos, describes hundreds of out-of-the-ordinary but practical time and money-saving repair kinks that have helped auto mechanics out of tough spots . . . tells How to Step Up Speed, Power; Save Fuel, Cure High Oil Consumption, Trouble Shoot Engine Knocks, Service Cooling Systems . . . brings you the combined experience and KNOW HOW of World's Best Auto Mechanics. Also, complete Mechanical and Tune-Up Specifications 1938-1950 models on: Buick, Chrysler, Dodge, Hudson, Mercury, Packard, Studebaker, Cadillac, Crosley, Ford, Kaiser, Nash, Plymouth, Willys, Chevrolet, DeSoto, Frazer, Lincoln, Olds, Pontiac. Only \$3.00.

SEND NO MONEY - MAIL COUPON

✓
**Check
Titles
Wanted**

**Examine
Books In
Your Own
Home
Without
Obligation**

- Goodheart-Willcox Co., Dept. 152
1321 S. Michigan Ave., Chicago 5, Ill.**
- Send at once books checked below. I agree to remit price indicated plus 25c per book postage and handling, or return books within 7 days and owe nothing.
- Check here if you remit with order and save postage and handling charges. If books are returned within 7 days we will refund full purchase price.
 - AUTO REPAIR KINKS.....\$3.00
 - AUTOMATIC TRANSMISSIONS Simplified (Covers all types including new Fordomatic and Merc-O-Matic.) 4.00
 - DYKE'S Auto Encyclopedia (new 22nd edition) 7.50
 - AUTO Body & Fender Repairs..... 3.50
 - DYKE'S Carburetor Book..... 3.50
 - AUTOMOTIVE Service Management..... 5.00
 - MODERN Electric & Gas Refrigeration..... 5.00
 - MODERN Welding Practice..... 4.00
 - HOUSE WIRING..... 3.00
 - D. C. POWER WIRING..... 4.00
 - PLUMBING & Pipe Fitting..... 2.50
 - SHEET Metal Layout..... 3.50
 - STORAGE Battery Simplified..... 3.00
 - BAILEY'S Handbook for Engineers-Firemen.. 2.00

Name _____ (Please Print)
Street _____
City _____ State _____
Employed By _____

DRIVING RELIEF! **New LEFT-FOOT ACCELERATOR**

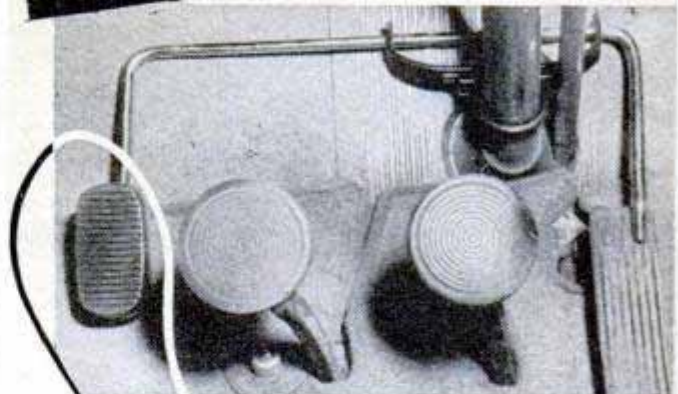

Dealer inquiries invited.

Cut driving fatigue in half with Lefty! Install this new left foot accelerator yourself in 60 seconds with just a wrench—no alterations to your car are necessary. Enjoy relaxed comfort on long drives. Lefty lets you feed the gas with your left foot when you desire, relieves tension and fatigue in leg, back, and foot. Safe, positive and convenient. Swings out of way when not in use. Brings your car up to date. \$5. ppd. Specify year and make. No COD's please.

INVENTOR'S MARKETING LAB.

1210-A De Young Bldg., 690 Market St., San Francisco, Calif.

BRAND NEW! 7 JEWELS!
3 YEAR SERVICE GUARANTEE

- Shock Resist.
- Radium Dial
- Sweep Second Hand
- Chromed Case
- Leather Band

\$6.95

Post Paid
Plus 70c tax



Refund if not satisfied. Special! Order Now! Sorry, no C.O.D.'s
LADIES WATCH, as above, smaller Size \$7.95 plus 80c tax

ELCO PRODUCTS, Dept. PM-3 166 W. WASHINGTON CHICAGO 2, ILL.

Print Your Own

Cards, stationery, advertising, etc. Save money. Print for others, good profit; easy rules sent. Raised printing like engraving, too. Sold direct only. Write for free details. **Kelsey Presses, F-37 Meriden, Conn.**

RUPTURE!

An amazing Air-Cushion Invention allows body freedom at work or play. Light, neat, cool, sanitary. Durable, cheap. Day and night protection helps Nature support weakened muscles gently but surely. No risk. **Sent on Trial!** Write NOW for free Booklet and **Proof of Results.** All correspondence confidential.
Brooks Company, 161-H State St., Marshall, Mich.



SAY YOU SAW IT IN POPULAR MECHANICS



BRUSHES

SUITABLE

- for
● PAINT, ENAMEL
● LACQUER
● GLUE, PASTE
● OIL & CHEMICALS
ideal for

**Workshop Use, Household
Factory and Hobbyists**

- 100 Assorted Brushes.....\$4.00
 - 50 Assorted Brushes..... 3.00
 - 25 Assorted Brushes..... 2.00
- MINIMUM ORDER \$2.00
POSTPAID NO C.O.D.

PM. ELGENE MFG. CO.

9015 FIFTH AVE.

BROOKLYN 9, N. Y.

MILLIONS OF APPLIANCES NEED REPAIR!

EARN BIG MONEY.. WORK PART OR FULL TIME IN ELECTRIC APPLIANCE REPAIRING!

ELECTRIC REFRIGERATORS

WASHING MACHINES

VACUUM CLEANERS

ELECTRIC RANGES

MOTORS

SEWING MACHINES

TOASTERS

WAFFLE IRONS

MANGLES

HEATING PADS

FREEZERS

ELECTRIC FANS

ELECTRIC IRONS

LAMPS

ETC., ETC.



ELECTRONIC KIT TROUBLE DETECTOR

(Checks shorts, wattage, continuity, etc.) is sent to all students

MAIL COUPON FOR FREE BOOK

Learn this fascinating big money paying profession at home in your spare time. Learn by doing, by working with your hands building, testing, repairing electrical appliances of all kinds. Electrical appliance repairmen are needed everywhere — wherever electricity is used. You need no special previous training or experience. Age is no handicap. CHRISTY has trained over 33,000 men in all parts of the world. Men who today command big wages or own profitable businesses of their own.

PAY LATER FROM EARNINGS WHILE LEARNING

CHRISTY shows you how to make money while still learning, what to charge, how to set up your own shop, how to build power tools from spare parts, etc. It will pay you to write today.

CHRISTY TRADES SCHOOL, Dept. D-9103
4432 N. Kedzie Ave., Chicago 25, Ill.

Send me your **FREE** book on Electrical Appliance Repairing and special form for "paying later from earnings made while learning."

NAME _____ AGE _____
ADDRESS _____
CITY _____ STATE _____

BE A PHOTO-ENGRAVER

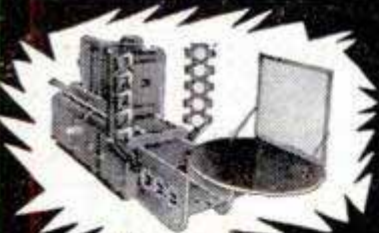

We furnish complete equipment and supplies. Learn at home or in our modern, friendly APPROVED school in MISSOURI. Get into this big demand, high profit, high wage field. You can start your own profitable, full time or part time PHOTO-ENGRAVING business right in your own home.

Be independent, be your own boss or pave the way to a high pay job with experience gained in your own shop.

TASOPÉ TRAINING and TASOPÉ EQUIPMENT has enjoyed world wide recognition since 1931. Write for descriptive literature today. No obligation.

THE AURORA SCHOOL OF PHOTO-ENGRAVING, DEPT. 9PM., TASOPÉ BLDG., AURORA, MO.

LEARN MEAT CUTTING AT NATIONAL

Pay After Graduation



The steady dependable trade of Meat Cutting taught easily in 8 short weeks. **YOU LEARN BY DOING** under actual meat market conditions in big modern school at Toledo.

For beginners or men with experience. Get a profitable store of your own. Remember, **PEOPLE MUST EAT!** Big pay jobs. Free employment help. Thousands of successful graduates.

Buying, cutting, percentage, pricing, advertising, selling, etc. A complete retail meat education. National School established over 25 years. Get National training NOW. Pay your tuition in easy weekly payments

after you graduate. G. I. approved. Send coupon for **FREE 52 page school catalog — TODAY.**

National School of Meat Cutting, Inc., Dept. 50-Q, Toledo 4, Ohio

Send me your **FREE** school catalog on National Training at Toledo in Meat Cutting, Meat Merchandising and Self Service Meats. No obligation. No salesman will call.

Name _____
Address _____
City _____ State _____
() Check here if Veteran of World War II

new 1951 ALLIED

RADIO and TV CATALOG



free

SEND FOR THIS
212-PAGE
Value-Packed
CATALOG

COMPLETE
UP-TO-DATE

**SAVE ON EVERYTHING
IN RADIO & TELEVISION**

Get Radio's Leading Buying Guide

Save money on every purchase you make from the world's largest radio supply house! Send for ALLIED'S 212-page 1951 Catalog, the value-packed guide to *everything* in Radio and Television. Biggest selections of home radios, TV equipment, radio-phonos, Amateur equipment, P.A. systems, Hi-Fidelity Sound, recorders, test instruments, builders' kits—plus thousands of parts, tubes, tools, books and diagrams. Get more for your money—send today for your FREE 1951 ALLIED Radio and TV Catalog!

EVERYTHING FOR:
Servicemen
Engineers
Experimenters
Builders
Amateurs



**FREE
CATALOG**

ALLIED RADIO

ALLIED RADIO CORP., Dept. 5-C-1
833 W. Jackson Blvd., Chicago 7, Ill.

Rush FREE 212-Page Catalog No. 126.

Name _____

Address _____

City _____ Zone _____ State _____

MONTH AFTER MONTH, YEAR AFTER YEAR, YOU SEE OUR AD.
REMEMBER IT'S DANGEROUS to pay less if you want the finest matched USED tires.

GOOD YEAR Firestone

GOODRICH, UNITED STATES, GENERAL & OTHERS, NOT RECAPS

Our policy is to select your tires so carefully, as if our very future depended on the service given by that particular tire.

FREE TUBE WITH "ALL" BLATT'S GOOD GRADE TIRES

GOOD GRADE, 16 MONTHS GOLDEN RULE GUARANTEE BOND.		FINEST GRADE, 26 MONTHS GOLDEN RULE GUARANTEE BOND	
600-16	\$4.14	700-15	\$4.54
650-16	4.64	670-15	4.74
700-16	5.04	710-15	4.94
650-15	4.44	550-17	4.64
600-20	\$7.94	32x6(8)	\$8.64
700-20	8.54	32x6(10)	9.94
825-20	13.94	900-20	13.94
		1000-20	13.94

FINEST GRADE, 26 MONTHS GOLDEN RULE GUARANTEE BOND
THIS GRADE MADE THE BLATT NAME "WORLD FAMOUS".

MATCHED BALANCED TIRES		MATCHED BALANCED TRUCK TIRES	
600-16	\$5.34	650-15	\$5.94
650-16	5.94	670-15	6.24
700-16	5.94	700-15	6.54
750-16	7.94	710-15	6.34
550-17	5.94	760-15	6.54
525-18	5.54	820-15	7.04
650-18	6.94	475-19	5.94
600-20	\$9.94	900-20	\$18.54
650-20	9.94	1000-20	18.54
700-20	11.94	1100-20	18.54
750-20	13.94	1000-22	17.54
825-20	17.84	1100-22	18.54
		1200-22	22.54
		1100-24	21.54

	MILITARY	750-20
600-16	\$ 6.64	Reg. 16 Months \$10.44
900-16	10.94	Super 30 Months 16.64

BLATT BLATT BLDG., GIRARD & LANCASTER AVES.,
DEPT. PM., PHILADELPHIA 31, PA.

Send check or money order and this ad for rush shipment. We won't ship a tire we wouldn't use. The name to trust in rubber. Shipments RUSHED down south, up north and far west.

NO CAR TROUBLE IS HARD TO FIND...

when you have MoToR's new "Trouble Shooter"

Handy, pocket-size, indexed manual Hats 1760 CAUSES of car troubles and tells WHERE to look for them. Saves you hours of time and work on difficult jobs. Covers engines, clutches, brakes, ignition, etc. Section on automatic transmissions alone is worth more than price of book! Spiral binding; book stays open while you work. Send no money—just pay postman \$1, plus postage and C.O.D. charges. If not satisfied, return book in 7 days for refund. Or SAVE C.O.D. charges by sending only \$1 NOW. Same return-for-refund privilege. MoToR Book Dept., Desk 13T, 250 West 55th St., New York 19, N. Y.

\$1

MAKE MONEY POLISHING FLOORS . . .

You can when you have your own Floor Polishing & Maintenance Service. Write for free plans and ideas on how you can easily get started in this money-making business. Send a postcard to:

McCANNA SUPPLY CO., 148B East 40 Street, New York 16, N. Y.

A "GOOD HAND" HELPS YOU SUCCEED!

LEARN TO WRITE WELL

Handwriting quickly improves with our easy-to-understand picture lessons! Put your spare time to good use; send today for FREE BOOK, "How to Become a Good Penman", or check volumes wanted below at \$1 each: Business Writing Artistic Writing Card Writing Bird & Design Flourishing Engrossing Alphabets. COMPLETE SET \$4.50

TAMBLYN SCHOOL of PENMANSHIP
S. A. Ziller, Pres. 442 Ridge Bldg., Kansas City, Mo., USA

OUR 53rd YEAR

Only 10¢

WOULD YOU \$400 PER MONTH INTEREST YOU?

EARN UP TO \$400 A MONTH raising Angora or New Zealand White Rabbits. Good markets for wool, pelts and meat. Particulars free. **WHITE'S RABBITRY, Newark 10, Ohio.**

TRY HOME STUDY WATCHMAKING

FREE Sample Lesson

Famous Sweazey System shows how to master watchmaking . . . expertly, quickly, successfully . . . right in your own home. No previous experience needed to learn one of the highest paid trades. Try it without obligation.

G. I. APPROVED RESIDENT COURSES

. . . in Watchmaking, Engraving, Jewelry Repair, Diamond and Stone Setting at our modern, fully-accredited resident school. Founded 1908. Write for FREE CIRCULAR.

CHICAGO SCHOOL OF WATCHMAKING
1607 N. Milwaukee Avenue Dept. 131 Chicago 47, Ill.

A FASCINATING...MONEY-MAKING art career can be yours

America's 12 Most Famous Artists Show You How!



Norman Rockwell
Al Parker
Jon Whitcomb
Ben Stahl
Stevan Dohanos
Robert Fawcett
Peter Helck
Austin Briggs
Harold Von Schmidt
John Atherton
Fred Ludekens
Albert Dorne

Now, for the first time, you can study art under the personal supervision of America's 12 most famous artists. And you learn at home, in your spare time! Write today for our handsome illustrated booklet that tells you all about it. **It's FREE—Write today!**

• FAMOUS ARTISTS COURSE •

FREE

Dept. 6-P, Westport, Conn.
Please send book about
your home study art course.

Mr. Mrs. _____ Age _____
Miss _____
(Please Print)

Street _____

City, Zone, State _____

Trades that pay off!

Here's a great chance to learn a high paying skilled trade when the need for craftsmen is urgent. Get actual practical experience in our complete shops. No home study. Approved for veterans. A Post Card brings the story

CARPENTRY
CABINET MAKING
UPHOLSTERING

ENROLL NOW **THE TERRACE SCHOOL FOR CRAFTSMEN** **PHONE 6699**
TERRACE AVE., NEW CASTLE, PA.

'Amazing Attachment MAKES OLD REFRIGERATORS INTO MODERN Automatic Defrosters!

Thirty Million Prospects. Sell without "selling pressure" on sensational Free Trial Plan. Just plug it in and leave it. Frees women from drudgery and mess of defrosting. Saves electricity. Keeps food longer, better. Gives longer life to refrigerator. Secret "follow-up" Plan often brings five additional sales by making every user your agent. Big season now on!
SENT FREE... JUST SEND NAME!
Don't send a cent—just your name on penny postcard. We'll send you the biggest money-maker you ever got your hands on and guarantee your sales at profits as high as \$5.00 on each sale. Rush your name!
MAXILUME COMPANY, 125 West Hubbard Street, Dept. D-83, Chicago 10, Illinois

Women buying by the thousands!
Salesmen Cleaning up on "Free Trial" Sales Plan
Sent Free with Instructions.
Make as high as \$5 on Every Sale!



INVENTORS

Before you make any effort to market your invention, you should take the first steps toward proceeding for patent protection.

The usual first step is to have a search of the U. S. patent records conducted, so that I can report to you on the question of patentability.

I shall be pleased to furnish you with information relative to patent procedure, upon request from you, and this will be without any obligation on your part.

PATRICK D. BEAVERS

(Formerly RANDOLPH & BEAVERS)

Registered Patent Attorney

934 Columbian Building Washington 1, D. C.

High School at Home

Many Finish in 2 Years

No classes. No time wasted going to and from school. Progress as fast as your time and abilities permit. Standard H. S. texts supplied. Thousands enroll each year in this 53-year-old school. Send for FREE descriptive booklet.

AMERICAN SCHOOL, Dept. H-345
Drexel at 58th St., Chicago 37, Ill.

Without obligation, please send FREE descriptive booklet.

Name _____

Address _____

ENGINEERING DEGREE IN 27 MONTHS

Big Demand for Graduates

Aeronautical, Chemical, Civil, Electrical, Mechanical and Radio Engineering (including Television)

Hundreds of young men are earning engineering degrees in this recognized institution each year—continuous operation. New terms start quarterly. Many students earn a major part of their college expenses in this large industrial center.

Low tuition. Competent instruction. Thorough, intense, practical program. Modern laboratory facilities including new physics lab. and modernized wind tunnel. Individualized instruction emphasized.

Approved for Veterans. Engineering preparatory courses. Students from 48 states and 21 foreign countries. Enter March, June, September or December. Send coupon for free catalog and full information. Enroll now.

SEND COUPON TODAY

INDIANA TECHNICAL COLLEGE

531 E. Washington Boulevard
Fort Wayne 2, Indiana

Please send me free information on B.S. Engineering Degree in 27 months as checked.

Aeronautical, Chemical, Civil, Electrical,
 Mechanical, Radio-Television

Name _____

Address _____

Safer Night Driving

When Visibility Is Low



Don't take chances. Luma-Rim, the red circle, reflects light from all angles, throwing off bright red glow. Colorfast, made from finest reflective material. Precision cut. Easy to apply. Lasts for years.

Be sure to state if for 15 or 16 inch rims. Postage prepaid, per set (for 4 wheels) ONLY. **\$2.95**

LUMA-RIM Corporation

Pacific Bldg. Oakland 12, Calif.

*See article page 98 December 1950 Popular Mechanics

LOCKSMITHING & KEYMAKING

HOME TRAINING OUTFIT INCLUDES KEY MACHINE, SUPPLIES AND TOOLS TO GET STARTED IN BUSINESS. Professional outfit. Get practical training from Master Locksmiths. Learn to cut keys by code, master locks, change combinations, quickly identify key blanks, many profitable "tricks of the trade." Booklet of Information FREE. Write today. UNITED SUPPLY & SERVICE, 3327 Madison St., Dept. PM-3, Chicago, Illinois.

INVENTING

-FOR PROFIT! If you have an inventive turn of mind, write for free 28-page booklet explaining how the Institute of American Inventors is helping inventors pre-test the profit possibilities of proposed devices to fill today's unprecedented demand for useful new inventions.

INSTITUTE of AMERICAN INVENTORS

Dept. 4, 631-E St., N.W., Washington 4, D. C.

PATENTS

C. A. SNOW & CO.

REGISTERED PATENT ATTORNEYS

WRITE FOR INFORMATION TO

428 SNOW BUILDING, WASHINGTON 1, D. C.

PATENTS PATENT LAWYER

GUSTAVE MILLER ASSOCIATE EXAMINER
U. S. PATENT OFFICE 1922-1929
REGISTERED PATENT ATTORNEY Patent Attorney and Advisor
U. S. NAVY DEPT. 1930-1947
31-PM WARNER BLDG. Send for PATENT INFORMATION book
WASHINGTON 4, D. C. and "INVENTOR'S RECORD" without obligation

INVENTORS

Whether an invention is patentable can be substantially determined by a search of the U. S. Patent records. Without obligation, write for information explaining the steps you should take to secure a patent.

JOHN N. RANDOLPH

Registered Patent Attorney

201 Columbian Building, Washington 1, D. C.

INVENTORS

IF YOU WISH TO PROTECT YOUR INVENTION, You should take steps to protect it by a U. S. Patent. Write me for "RECORD OF INVENTION" form.

CARL MILLER

REGISTERED PATENT ATTORNEY

WOOLWORTH BLDG., 35th FLOOR, 31A
NEW YORK CITY

IMAGINE THEIR JOY when they found they could play this easy-as-ABC way!



LEARNED QUICKLY AT HOME
 "I didn't dream I could actually learn to play without a teacher. Now, when I play for people they hardly believe that I learned to play so well in so short a time."
 *H.C.S., Calif.



PLAYS AT DANCES
 "Your lessons have been most satisfactory. I can play all of the popular songs. I have earned money playing at dances."
 *E.N.J., New York.



PLAYS ON RADIO
 "I can't keep from telling you that I have a good position playing from **K.T.H.S., Hot Springs, Ark.**, every morning."
 *J. S., Okla.

What Instrument Would You Like to Play?

JUST name your instrument and we'll show you how you can learn to play it—quickly, easily, in spare time at home. Never mind if you don't know one note of music from another—don't worry about "special talent." And forget all you've ever heard about music being hard to learn.

The truth of the matter is that *thousands now play who never thought they could!* Yes, men and women everywhere have discovered this amazingly easy way to learn music at home.

Now they are enjoying the thrilling satisfaction of playing the piano, violin, guitar, saxophone or other favorite instruments. Some of them are playing in orchestras and over the radio; others are teaching music, making money in spare or full time. And thousands are having the time of their lives playing for their own enjoyment and the entertainment of their friends.

No tedious study and practice, no tiresome exercises. You learn to play by

Easy as A-B-C



playing—start right in with the melody of a simple tune! It takes only a few minutes a day; the cost is trifling. Does it sound too good to be true? Mail the coupon and get the **FREE PROOF!**

SEND FOR FREE PROOF

Fascinating illustrated booklet answers all your questions; free Print and Picture Sample shows how method works. If interested, just mail coupon. U. S. School of Music, 73 Brunswick Bldg., New York 10, N. Y. 53rd Successful Year.

**Actual pupils' names on request. Pictures by professional models.*

FREE! Print and Picture Sample

U. S. School of Music, 73 Brunswick Bldg., New York 10, N. Y. Please send me Free Booklet and Print and Picture Sample. I would like to play instrument checked below.

- | | | |
|-----------------|-----------------|--------------------------|
| Piano | Saxophone | Modern Elementary |
| Guitar | Trumpet, Cornet | Harmony |
| Hawaiian Guitar | Organ | Mandolin |
| Violin | Tenor Banjo | Practical Finger Control |
| Piano Accordion | Clarinet | |

Name _____ Have You Instrument? _____
 Address _____
 City _____ State _____

Save 2c—Stick Coupon on Penny Postcard

Learn PHOTOGRAPHY

There's big money in PHOTOGRAPHY—and an action-packed career for you. Our HOME STUDY COURSE is your spare-time **SHORT CUT TO SUCCESS!** Or, if you wish—**PERSONAL ATTENDANCE TRAINING** at our famous New York School is available with subsistence under the G. I. Bill. Our 41st year. Write immediately!

NEW YORK INSTITUTE OF PHOTOGRAPHY

Dept. "49," 10 West 33 Street, New York 1, N.Y.

X.L. RUBBER MOLDS

Will realize your great profits quickly!
WRITE FOR NEW FREE CATALOG
 YOU can EASILY learn to cast thousands of perfect plaques, book ends, figurines, ash trays, etc. IT'S EASY, FUN, PROFITABLE!
 X.L. Rubber, Pts. \$2.00; Qts. \$3.50; Models and enough rubber for 3 molds \$1.30 postpaid.



SEND FOR FREE FACTS

GREAT PROFITS
 MAKE YOUR OWN RUBBER MOLDS

PLASTIC ARTS STUDIO Address Dept. 2 3403 S. Madison St. Muncie, Ind.

LEARN TELEVISION RADIO-ELECTRONICS

Learn in your home. Then earn **BIG PAY** and **SECURITY**. Tremendous growth has made more jobs than there are trained men! **NOW** is the time to get into this **essential, NEW, RICH** field of **OPPORTUNITY**. **FREE** placement service. **SEND FOR FREE, BIG ILLUSTRATED CATALOG.**

MAIL TODAY

I want complete information on how to succeed in Television, Radio, and Electronics. This does not obligate me in any way.

NAME _____
 ADDRESS _____
 CITY _____ STATE _____

CENTRAL RADIO & TELEVISION SCHOOLS
 Dept. B-3, 1644 Wyandotte, Kansas City, Mo.

GET FASCINATING NEW FREE PROFIT PLAN



MR. NELS IRWIN

SEND NO MONEY. I WANT YOU TO EXAMINE EVERYTHING WITHOUT RISKING A CENT.

BIG DEMAND FOR NEW MIRACLE FINISH.
 We show you every step. Filling huge year-round demand...easy to understand instructions tell you how. Earn up to \$5 an hour spare—full time. A few cents' worth of materials brings you dollars!

GRASP THIS OPPORTUNITY TODAY.

It's too good to miss... Fill out coupon, mail today. Get **FREE** sample, **FREE** plan, big **IDEA** booklet. No salesman will call! Do it **NOW**... be first in your community to cash in on this huge new market!

COAST INDUSTRIES Dept. 23 1004 S. Los Angeles Street Los Angeles 15, California.

Tired of monotonous, low-pay jobs — of working for the *other fellow*? Tap rich profits in huge **NEW** field. Have your own lifetime business — earn **REAL** money —

say goodbye forever to time clocks bosses! Become part of tremendous expanding industry — yet work right at home!

LEARN IN A FEW DAYS THROUGH PROVED, TESTED METHODS

to start earning more money with this amazing **MIRACLE** finish—gives a velvety, luxurious surface to radios, lamps, toys, signs, store displays,

figurines, auto dashboards—hundreds of items. **FREE PROFIT PLAN** offers everything you need to start at once. Fill out coupon, mail today.

PROFIT UP TO \$500 PER HOUR

INVESTIGATE TODAY!

USE COUPON FOR FREE SAMPLE

COAST INDUSTRIES Dept. 23, 1004 S. Los Angeles St., Los Angeles 15, Calif.
 Gentlemen: Please rush me all details **FREE**

NAME _____
 STREET _____
 CITY _____ STATE _____

C. T. C. TRAINING IN DRAFTING

PREPARES FOR
PROMOTION
MORE MONEY
SUCCESS

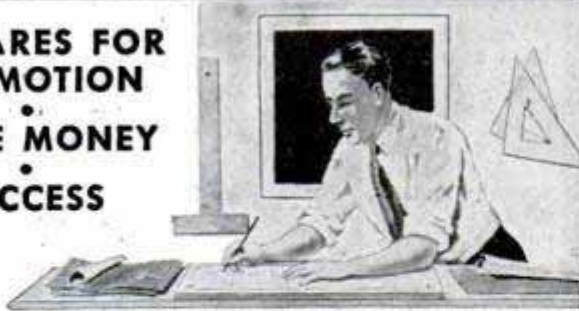

"Here I am at work making good money as a draftsman. I'm glad I sent the coupon to Chicago Tech for that Free Trial Lesson and found out how easy it is to learn Drafting in spare time at home. Today, I feel secure in my job. What's more, I feel I'm slated for promotion and more pay."

LEARN IN SPARE TIME—AT HOME!

(or at the College in Chicago)

A few hours of pleasant home study every week—that's all. All the tools you need; drawing outfit included. This tested method—developed over 46 years of C.T.C. progress—prepares men quickly for good positions in industry.



FREE INFORMATION — SEND COUPON

To prove to you how easy it is to learn Drafting at home, we will send you this FREE TRIAL LESSON. Mail coupon or send post card today.

CHICAGO TECHNICAL COLLEGE

C-214 Tech Bldg., 2000 So. Michigan Ave.
Chicago 16, Illinois

Mail me FREE Lesson with information about big opportunities in DRAFTING.

Name _____ Age _____

Address _____

City _____ Zone _____ State _____

GET THE FACTS ABOUT FISHING RODS FREE!

• What kind should you buy? Solid steel, tubular steel or glass? What are the advantages of each? Which gives best action—most sport—best value? A new "True Temper Fact Folder" explains the merits of each. It describes world's finest, most complete line of rods—including the new True Temper Dynalite laminated glass fiber rod. No obligation—write today for free copy.

USE THIS COUPON PLEASE

TRUE TEMPER Corporation
MAKERS—THE ROD OF CHAMPIONS

Sporting Goods Division, Dept. 9
Geneva, Ohio

Please send your new True Temper Fact Folder to—

Name _____

Street _____

City _____

State _____

Tells How You Can Learn to

FREE BOOK MOUNT BIRDS!



Learn At Home

Men, Boys, Hunters, Fishermen, mount and save your lovely wild-game trophies. Be a Taxidermist - Mount Birds, Animals, Heads, Fish, Tan skins. YOU learn easily, quickly in spare time. Have a grand home-museum. The finest and the greatest hobby known, for sportsmen. Fun, real profits.

FREE BOOK

Yes, FREE. Beautiful strange, valuable Book, telling all about Taxidermy. Contains over 100 beautiful game-pictures. And it's yours FREE, if you rush your request. You can mount all kinds of wild-game, and common specimens too. We can positively TEACH YOU. So GRASP this opportunity. RUSH letter or postal for this amazing FREE BOOK. Don't delay. State your AGE. N. W. SCHOOL OF TAXIDERMISTRY, 2503 Elwood Bldg., Omaha 2, Neb.

GET THIS FREE BOOK!

BECOME A BETTER PAID MAN BY BEING A WELL TRAINED MAN

Learn a profitable trade—the Eastern Technical School way. Enroll now for an eight month course in Radio or Refrigeration. New classes beginning every April—August—December. Veterans—Nonveterans. Write for free catalogue. Graduates successfully placed from Coast to Coast.

EASTERN TECHNICAL SCHOOLS

888 PURCHASE STREET NEW BEDFORD, MASSACHUSETTS



Make BIG MONEY!

RAISE CHINCHILLA RABBITS!

Cash Markets Supplied for Your Production

FREE - Illustrated Booklet - WRITE TODAY!

ROCK HILL RANCH, SELLERSVILLE 36, PA.

World's Largest Breeder of Chinchilla Rabbits

LEARN WATCHMAKING JEWELRY REPAIRING

Start your training now for a better paying job or your own profitable business. Our training is nationally recognized, outstanding and supervised by expert craftsmen. Write for free catalogue.

APPROVED FOR VETERANS

SCIENTIFIC SCHOOL OF WATCHMAKING, Dept. PM-3

3923 San Fernando Road

Glendale 4, California

Secrets of VENTRILOQUISM Now Revealed!



Ventriloquism can NOW be learned by any one with our Home Study Course. Let an expert teach YOU. RESULTS GUARANTEED. Make Money! Be Popular! Have Fun! Big Opportunity, Radio, Television, Stage Appearances. For Free Information Write, stating your age, Dummy Catalog 25c.

FRED MAHER SCHOOL OF VENTRILOQUISM
Box 36, Studio C, Kensington Station
Detroit 24, Michigan

Use Easter Seals

This New Type Accordion Is Much Easier to Play

It combines the advantages of the piano and the chromatic accordion. With our New Method you can even learn to play it all by yourself.

For free information write to
HUNIBEL ACCORDIONS

5154 N. Clark St.
Chicago 40, Ill.



DRAW for MONEY

BE AN ARTIST



YOU CAN LEARN AT HOME IN YOUR SPARE TIME

Enjoy this fascinating hobby — Train for a profitable career

Trained artists are capable of earning \$75, \$100 and more a week. No previous Art experience necessary. We teach you step by step. Only WSA offers you this proven method famous since 1914. **COMMERCIAL ART, DESIGNING, CARTOONING** all in one up-to-date, complete course. You even can make money in spare time while learning. Qualify for good art jobs in Advertising, Television, Newspapers, Magazines, Studios, etc. For 37 years WSA graduates have been "making good" — **WHY NOT YOU?**



VETERANS!
Course G. I. Approved

TWO BIG ARTISTS OUTFITS GIVEN. When you enroll you receive your first complete set with all the materials you need to start. Mail coupon for **FREE BOOK**, "Art for Pleasure and Profit,"—it fully describes course and commercial opportunities for you in art. Low cost—easy terms. (No salesman will call)

FREE BOOK gives details!



WASHINGTON SCHOOL OF ART, Studio 123A
Washington 5, D. C.

Please send me full information and your Free Book, "Art for Pleasure and Profit." (please print)

Name _____ Age _____
Street _____
City _____ Zone _____ State _____

New Giant DAHLIAS



NEVER BEFORE OFFERED

2 BULBS for 25¢ POSTPAID

ONE BULB EACH **RED CHIEF, LAVENDER BLUE** Grows 12" to 15" flowers on strong, sturdy stems. Separately labelled. Culture included. Send only 25c for 2, 50c for 4, \$1 for 8 and Seed & Nursery Catalog. **R. H. SHUMWAY Seedsman, Dept. 891, Rockford, Illinois**

USE the POLICE METHOD to handle wise guys and bullies

The bigger they come, the harder they fall when the Commanding knowledge of **POLICE JIU JITSU IS YOURS!** Brute strength, giant size and bulging muscles will not beat you when You master Police Jiu Jitsu. A complete course easy to read and learn in one illustrated volume. **JUST PIN \$1** to this ad and we will send Police Jiu Jitsu to you **POST-PAID.** Satisfaction guaranteed or money refunded.

BOOKS PUBLISHING CO. 56 W. 24 St. New York 10

AJAX LIGHT BRAHMAS

Wonderlay Strain Egg — show winners. Gigantic size. Quick growing. Heavy layers. Exceptional big capons. U. S. Approved — Pullorum Controlled. Thousands hatching weekly. Low farm prices. Catalog **FREE.** Write **TODAY.** **AJAX HATCHERY, BOX 916, QUINCY, ILL.**

OWN a Business

Clean and Mothproof rugs and upholstery "in the home." Patented equipment. No shop needed. Duraclean dealer's gross profits up to \$20 a day on **EACH** serviceman. These Nationally Advertised services create repeat customers. Easy to learn. Quickly established. Easy terms. Send today for **FREE Booklet** — Full details. **DURACLEAN CO., 1-163 DURACLEAN BLDG. DEERFIELD, ILL.**

EASTER SEALS HELP CRIPPLED CHILDREN

MEN! WOMEN!

TAKE ORDERS FOR NATIONALLY ADVERTISED WATERLESS COOKWARE

Big Money Full or Spare Time Starting a Carlton Cookware Club

Big earnings daily taking fast orders for amazing new kind of **Stainless Steel Waterless Cookware** under Sensational Plan that makes it easy for every housewife to buy. Club privileges permit your customers to get **Matched Sets of CARLTON WARE** without missing the money—on sensational new Easy Payment "ADD-A-PIECE" Plan—PLUS up to \$8.00 worth of **gift bonuses.** No experience needed. We show you everything—supply everything **FREE.** Earnings start at once. Rush name and address. Be First!

CARLTON OF CARROLLTON, Dept. 33-C, Carrollton, Ohio

FREE! 20-Use Set of Stainless Steel Cookware Given As a Bonus

Grow with diesel

and **SCIENTIFIC MOTOR TUNE-UP**
—One of America's **Fast-Growing Big-Pay Industries!**

● Lay the foundation now for something bigger and better—get into the fabulous Diesel industry. The U.E.I. Plan for learning Diesel and Scientific Motor Tune-Up is simple, practical and is based upon the principle of learning-to-do-by-doing. Essential fundamentals are gained through spare-time home-study, followed by actual shop practice. Competent instructors guide you step by step—you learn the **HOW** and **WHY** of Diesel operation, service and maintenance. Get all the facts—mail the coupon and we'll send you a free copy of "Earning Power in Diesel." Mail coupon today!

UTILITIES ENGINEERING INSTITUTE
Chicago 14, Illinois *Founded 1927*

UTILITIES ENGINEERING INSTITUTE, Dept. DC-13
2525 Sheffield Ave., Chicago 14, Illinois

Please send me, without obligation, your book "Earning Power in Diesel."

NAME (print).....AGE.....
ADDRESS

CITY..... Zone..... State.....
 Check here for information if you are under 17

THE
WORLD'S
BEST
BUY
in
low-cost
transportation

Cushman
MOTOR WORKS

DEALER
INQUIRIES
INVITED



- ✓ LOW PURCHASE PRICE
- ✓ LOW OPERATING COST
- ✓ LOW MAINTENANCE

Save your car—beat expensive transportation. Hundreds of uses for your Cushman—ride it to work, school, shop, play. Ideal for light deliveries. Automatic clutch, silent-action coil spring, dependable heavy duty brakes. Cruise at 10 m.p.h.—over 85 miles per gallon. Cushman saves time, money, worry.

Write for free folder and prices—Dept. 5M

Cushman MOTOR WORKS, INC.
LINCOLN, NEBRASKA

FIND OUT

FREE!

HAVE YOU
GOT WHAT
IT TAKES?

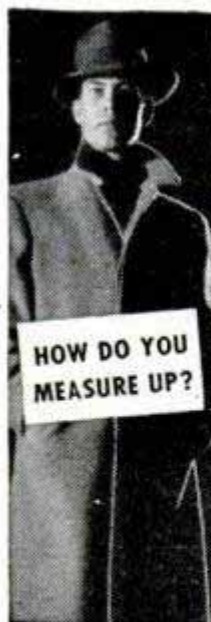

SUCCESS
HOME STUDY
WILL TO WIN
CHARACTER
HEALTH

to be a
**FINGER PRINT EXPERT or
TRAINED INVESTIGATOR?**
Send for free IAS
Qualification Question-
naire. If in our opinion
your answers indicate
that you "have what it
takes," then you will
receive absolutely free
the famous "Blue Book
of Crime" . . . plus full
details on how to train
at home in Crime De-
tection and Finger
Printing! IAS gradu-
ates are key men in
over 800 Police Bu-
reaus. See if YOU can
train for this exciting,
steady, "good pay"
work! No obligation.
No salesman will call.
Write today, stating age.

INSTITUTE OF APPLIED SCIENCE
1920 Sunnyside Ave., Dept. 1353, Chicago 40, Ill.

INSTITUTE OF APPLIED SCIENCE
1920 Sunnyside Ave., Dept. 1353, Chicago 40, Ill. *

Gentlemen: Without obligation or expense on my part, send me your qualification questionnaire. I understand that upon receipt of my answers you will immediately advise me if you think they indicate that I have a chance to succeed in criminal investigation or fingerprint work. Then I will receive FREE the "Blue Book of Crime," and information on your course and the 800 American Identification Bureaus employing your students or graduates.

Name _____
Address _____ RFD or Zone _____
City _____ State _____ Age _____

Auto Spark Intensifier Gets ROCKET Performance



- ✓ MORE POWER
- ✓ BETTER MILEAGE
- ✓ MORE SPEED
- ✓ QUICKER STARTING

The ELECTRONIC SPARK INTENSIFIER is an efficient, scientifically developed automotive device which can be easily installed in the center hole of the distributor cap of all autos, trucks and tractors in sixty seconds. By boosting the high voltage current passing through the distributor, it gives a "hotter spark" permitting a wider spark gap . . . thus reducing "misfiring", ring and cylinder wear and allowing all-around better performance. FREE TRIAL, send \$2.00 cash, check or money order . . . if not fully satisfied after 10 day trial, return for immediate refund.

ELECTRONIC DEVELOPMENT CO. DEPT. PM-3
LOS ANGELES 34, CALIF.

POROUS METAL INKPAD FOR RUBBER STAMPS

Amazing new invention prints 20,000 crystal clear impressions with each soilproof in(k)jection. Cuts costs 75%. Lasts lifetime. Sent postpaid, \$1.95. Particulars free.

FORGERY PROTECTIVE INKPLATE
2100 F Penobscot Building, Detroit 26, Michigan

How to Make Money with Simple Cartoons



A book everyone who likes to draw should have. It is free; no obligation. Simply address

FREE
BOOK

CARTOONISTS' EXCHANGE
Dept. 93-A Pleasant Hill, Ohio



SILVER SOLDER TORCH & KIT \$6

JOINS ALL METALS PERMANENTLY
Do your own repairing. KIT includes one tube silver solder flux and 10 5-in. lengths silver solder alloy. Hottest ALCOHOL TORCH known. 2700° F. flame. Operates in any position, indoors or out. Torch alone \$5. KIT alone \$1.50.
AMERICAN PRODUCTS CORP.
422 S. Dearborn St. Dept. 3-C Chicago 5, Ill.

LEARN AT HOME LOCKSMITHING

YOU CAN MAKE GOOD PROFITS ALL YEAR ROUND
IN FULL OR SPARE TIME!

Locksmiths are always in big demand! Age is no disadvantage in this respected, permanent field. Learn how to make keys, fix locks, make duplicates, etc. Practical, illustrated lessons by experts show you how! All materials and special tools supplied. Send for FREE booklet.

INSTITUTE OF LOCKSMITHING
55 Park Ave., Rutherford, N. J.
Dept. P-16 Licensed & Approved by State of New Jersey

Use Easter Seals

"WOVEN-Gards"

BETTER
Hand Protection
at Amazing Low Cost

"Woven-Gards" are hand protectors, mitts, pads and sleeves made of a new long-wearing safety material. They provide flexibility, comfort, resistance to abrasion and cutting far beyond that of anything used before. They are extremely oil-absorbent and do an excellent job when handling oily, slippery sheets. The porous weave makes them one of the finest protectors for handling lower temperatures. Enthusiastic users say they have never seen values like "Woven-Gards." Excellent protection at lowest cost. Send now for descriptive folder and prices.

INDUSTRIAL GLOVES CO.
1414 Garfield St., Danville, Ill.
(In Canada: Safety Supply Co., Toronto)



Steel-Grip
INDUSTRIAL
Safety Apparel

New Advertising Machine



Prints & Illustrates 1¢ Post Cards

FREE Learn how thousands of business men, in every line, are boosting sales in spite of conditions—with 1¢ messages—printed and illustrated in a few minutes on gov't post cards—with amazing new patented **CARDMASTER**. Your "today's" ideas, read by your prospects next morning. Not a toy, but a sturdy advertising machine, built to last for years. Low price, sold direct. Guaranteed for five years. Send name today. **SEND NAME** We'll send **FREE** illustrated book of money-making **IDEAS** for your business and complete, unique advertising plans. **RUSH YOUR NAME TODAY.**
CARDMASTER COMPANY
 1920 SUNNYSIDE, Dept. 133, CHICAGO 40, ILL.

NEW! TIRE-TUBE-WHEEL Complete!

For Trailers, Hand Carts, Wheelbarrows, Midget Racers, Dollies, Feed Trucks, Boat Trailers, etc. With 10 1/2"x4" 6-ply tire (standard, replaceable), choice of heavy duty or "balloon" tread; tube; and choice of 3 wheels:

- A. Pressed steel, 5/8" ball bearing \$7.95
- B. Pressed steel, 3/4" ball bearing \$7.95
- C. Permanent mold cast aluminum, heavy duty, high speed, 1" I.D. bearing \$10.95

All prices freight prepaid. 5% discount for 4 or more units. Immediate delivery. Send cash, check or M.O.—sorry, no C.O.D.'s.

CRAFT, INC., Dept. PM-3, 6671 Telegraph Rd., Los Angeles 22, Calif.

Wanted! - HOME PRODUCERS

By Manufacturers in our Clearing House Service. Become a sub-contractor, casting plastic products for these companies. Thousands of easy to make items required. Cash in at home. No previous experience required. For details write

PLASTIC SERVICE GUILD
 Dept. P3, 233 Conder St., East Boston 28, Mass.

JIFFY-BAK THE AUTOMATIC KEY RETRIEVER

Watch-size JIFFY-BAK fastens to your belt or trousers. Keys pull out on 2 feet of chain, return automatically. Belt loop or clip-on model. Attractive chrome finish, precision built, fully guaranteed.

only \$2.50

ORDER TODAY!
 Send cash, check, money order or specify C.O.D. Specify belt loop or clip-on model.
MAST-R-KRAFT Engineering & Sales Company
 Department M, Box 288, San Diego 5, California

ENTER RADIO-TV thru This Plan-

As a young man with a career to build, you may today be interested primarily in training for Radio — and perhaps for TV. But — *who knows . . .* you may some day have both the desire and opportunity to climb further and become an Electrical Engineer! Here, then, is a world-renowned educational plan that permits you to use your Radio training as a *major stepping-stone* to an even greater career.



IN 12 MONTHS
 become a
RADIO TECHNICIAN
 Train here for radio shop operator or serviceman, mobile receivers and all types of transmitters, and for supervision of service personnel. You

may then advance immediately, or at any future date, into courses described below.

IN 6 ADDITIONAL MONTHS
 you become a
RADIO-TELEVISION TECHNICIAN
 An additional 6-months course gives you intensive TV Technician's training — under the *personal guidance* so necessary in this expanding field.

ALSO... your Radio course is full credit toward the B.S. degree in ELECTRICAL ENGINEERING
 The Radio course, while complete in itself, is *one-third* of the college program (major in Electronics—minor in Electrical Power). Further — you are guided scientifically toward specialization beyond basic engineering training.

Military, practical or prior academic training evaluated for advanced credit. Preparatory courses available. Over 1500 enrolled. Terms open April, July, October, January.

MILWAUKEE SCHOOL of ENGINEERING
 Technical Institute • College of Electrical Engineering

FREE — Write for helpful "Occupational Guidance Bulletin" and 1951 Catalog.

MILWAUKEE SCHOOL OF ENGINEERING
 Dept. PM-351, 1020 N. Broadway, Milwaukee, Wis.

Without obligation, rush following: 1951 Catalog; Occupational Guidance Bulletin on Electrical Service Electro Technician Electrical Engineering (Power) Radio Television Electrical Engineering (Electronics) Heating Refrigeration Air Conditioning Welding.

Name _____ Age _____
 Address _____
 City _____ Zone _____ State _____
 Check if World War II Veteran

Last Week I Made \$259.92



RAY BARTA

with Science's New Midget Miracle,
PRESTO Fire Extinguisher

So reports **RAY BARTA** of Wisconsin. Many others
"cleaning up" — so can YOU!



Science's
New Midget
Miracle
"PRESTO"

AMAZING new kind of fire extinguisher. Tiny "Presto" (about size of a flashlight!) does job of bulky extinguishers that cost 4 times as much, are 8 times as heavy. Ends fires fast as 2 seconds. Fits in palm of hand. Never corrodes. **Guaranteed for 20 years!** Sells for only \$3.98!

Show it to civil defense workers, owners of homes, cars, boats, farms, etc., and to stores for re-sale—make good income. H. J. Kerr reports \$20 a day. C. Kama, \$1,000 a month. Write for **FREE Sales Kit**. No obligation. **MERLITE INDUSTRIES, Inc.**, Dept. 53, 201 East 16th St., New York 3, N.Y. **IN CANADA: Mopa Co., Ltd.**, 371 Dowd St., Montreal 1, P. Q. (If you want a regular Presto to use as a demonstrator, send \$2.50. Money back if you wish.)

**WANT TO MAKE MORE MONEY?
CUT OUT, FILL IN AND
MAIL THIS COUPON!**



*Find Out How to Become
the Man with Know-How
Who Gets and Holds
Big Pay Jobs in
Machine Shop Work*

● Right now and extending far into the future is a great money-making opportunity in essential machine shop work. The demand for shop men is growing fast and the chance to get ahead is wide open to those who are ambitious and willing to prepare for the better jobs at bigger pay.

Industry must produce more and more and must have qualified men. If you are a beginner we can show you how to acquire the know-how that will help you climb. If you are experienced we can offer what it takes to fit you for promotions. **MAIL THIS COUPON NOW.**

AMERICAN TECHNICAL SOCIETY, Division MI-319
Drexel at 58th Street, Chicago 37, Illinois

Without obligation of any kind, please rush information offered in your advertisement.

Name _____

Address _____

City & Zone _____ State _____

Please check square which applies to you—
 Beginner Experienced

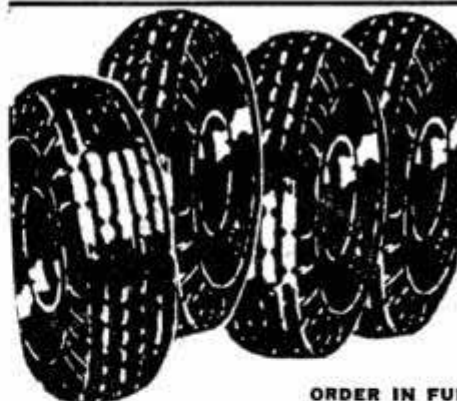

WRITTEN GUARANTEE SENT WITH EVERY TIRE YOU BUY

PLEASE NOTE: Our Tires are NOT Re-Treaded or Re-Capped We serve TRUCKS — BUSES — PASSENGER CARS

GOOD ORIGINAL TREAD USED TIRES

WE PERSONALLY SELECT YOUR TIRES A TRIAL OF ONE TIRE WILL CONVINCE YOU.

SEND CHECK OR MONEY

ORDER IN FULL WITH THIS AD NOW

These Are Original Tread Tires — OUR BEST GRADE

ONE QUALITY — ONE PRICE ONLY

600-16	\$5.55	670-15	\$6.05	710-15	\$6.55	760-16	\$6.55
650-15	6.05	700-15	6.55	750-16	7.05	820-15	6.55
650-16	6.05	700-16	6.55	760-15	6.45	550-17	6.05



800-20	\$9.72	32x6(8)	\$10.95	1000-20	\$17.95
650-20	9.72	32x6(10)	12.95	1100-20	17.95
700-20(8)	10.72	825-20	17.05	1000-22	15.95
750-20(8)	12.22	900-20	17.05	1100-22	17.95

Thousands of tires shipped all over U.S.A. All tires shipped F.O.B. Phila. Send Check or M.O. with this ad. Dept. 2. If your size is not listed write for prices. 17 YEARS AT THIS ADDRESS.

STANDARD 834 N. Broad St., Philadelphia 30, Pa.

AUTHENTIC COMMANDO KNIFE



THE FAMOUS "FAIRBAIRN" WORLD WAR II BRITISH ISSUE

A rare and beautiful souvenir—the actual knife used by British Commandos in hand-to-hand fighting. We have imported the British government's last quantity made in wartime at Sheffield. Blade length 7", overall 12". Complete with official leather sheath with metal tip as issued. Knives are brand new, combat blue! Send check, cash or m.o.

ONLY \$2.95 POSTPAID

R. H. VAZQUEZ & COMPANY, Dept. PM-3
972 East Colorado Street • Pasadena 1, California

Learn **CARPENTRY
BRICK LAYING**

Get into the billion dollar building trades. Learn now while opportunities are greatest. Train in our completely equipped shops under expert instructors. G.I. Approved. Enroll now. Limited classes. Write for FREE Catalog.

MIDWEST SCHOOL OF BUILDING TRADES, Dept. PM-3
411 N. Center St. Bloomington, Ill.

BE A TILE SETTER

SIMPLE, EASY TO LEARN AT HOME! Very high pay. Great and growing demand. Light, interesting work. Even as a side line you may earn \$75.00 or more a week. Send for details TODAY!

AMERICAN INSTITUTE OF TILE SETTING
PO Box 1845 Wilshire-LaBrea Station, Dept. PM3, Los Angeles 36, Calif.

ENGINEERING DEGREE IN 27 MONTHS

INDIANA TECHNICAL COLLEGE

B. S. DEGREE. Aeronautical, Chemical, Civil, Electrical, Mechanical and Radio Engineering (inc. television). Drafting, 1-yr. Gov't approved for G.I.'s. Low rate. Earn board. Large industrial center. Students from 48 states, 21 countries. Demand for graduates. Enter March, June, Sept., Dec. Write for catalog, 1631 E. Washington Blvd., Fort Wayne 2, Indiana.

**Wheels
Wheels**



**Wheels
Wheels**

5" Disc Wheel	5/8" Tire	5/16" or 3/8" sleeve	30c ea.
6" Disc Wheel	5/8" Tire	5/16" or 3/8" sleeve	35c ea.
7" Disc Wheel	3/4" Tire	3/8" sleeve	45c ea.
8" Disc Wheel	1 1/8" Tire	1/2" sleeve	70c ea.
7" Disc Wheel	1" Tire	1/2" ball bearing	80c ea.
8" Disc Wheel	1 1/8" Tire	1/2" ball bearing	\$1.00 ea.
8" Disc Wheel	2" semi-pneum.	T. 1/2" B.B.	\$1.35 ea.
10" Disc Wheel	1.75 semi-pneum.	T. 1/2" B.B.	\$1.50 ea.
12" Disc Wheel	1.75 semi-pneum.	T. 1/2" B.B.	\$1.85 ea.

Above wheel prices includes hub cap. Plus Postage, 20%. C.O.D.'s accepted.
UNITED WHEEL STAMPING CO.
2756 W. 115th STREET PM-3 CHICAGO 43, ILLINOIS

Amazing Invention Defrosts Refrigerators

AUTOMATICALLY

Pays Salesmen Up To \$210.00 a Week!

No wonder our salesmen are getting so rich and happy, with 29,000,000 eager prospects for the sensational Patented D-Frost-O-Matic that defrosts refrigerators Every Night without fuss or bother. Saves electricity, wear on refrigerator, food and work. You, too, should make up to \$210.00 a week on our FREE TRIAL plan that clinches up to 4 orders out of 5, paying you up to \$7.00 each.



START SPARE TIME

Yes, just a few hours in an evening should pay you up to \$18.00 PROFIT! Just plug in D-Frost-O-Matic — women won't let you take it out!

PROFITS GUARANTEED

No risk—if you don't find this the most fascinating, best paying business you ever heard of, we'll refund every cent you paid for your initial order.

Rush name and address on postcard TODAY for generous FREE TRIAL plan.

D-FROST-O-MATIC

Dept. PM-3, 6 N. Michigan, Chicago



END THIS FOREVER

Use Easter Seals

Listen to this Record!

Speak **FRENCH SPANISH**

RUSSIAN • GERMAN • ITALIAN BRAZILIAN • JAPANESE

BIG OPPORTUNITIES await Americans who speak languages. Learn as a child learns—"by listening." The **CORTINA METHOD**, famous for 69 years, teaches you, right at home, to speak like a native!

VETS
FRENCH or SPANISH
course available under G.I. Bill.

FREE BOOK The "Cortina Short-Cut" describes this amazing method and **FREE TRIAL** offer. **WRITE TODAY**. State language interested in. Also if Veteran.

CORTINA ACADEMY Dept. 643
105 W. 40TH ST. NEW YORK 18, N.Y.



MEN! send for this MONEY-MAKING OUTFIT FREE!

MAKE \$15.00 IN A DAY UP TO

Do you want to make more money in full or spare time... as much as \$15.00 in a day? Then write for this **BIG OUTFIT**, sent you **FREE**, containing more than 150 fine quality

fabrics, sensational values in made-to-measure suits and overcoats. Take orders from friends, neighbors, fellow-workers. No experience needed. You'll say it's the greatest way to make money you ever saw.

SAMPLE SUITS TO WEAR Pay No Money! Send No Money!

Our plan makes it easy for you to get your own personal suits and overcoats without paying 1c. in addition to your big cash earnings. This offer is limited. Rush your name and address for big **FREE OUTFIT**—today!

W. Z. GIBSON, INC., Dept. R-516
500 S. THROOP ST., CHICAGO 7, ILL.

EARN BIG MONEY AT HOME!
FREE Television Catalog **FREE**
and Sample Lesson **FREE**

Prepare now for high-pay jobs with **SECURITY**. Big demand for trained men! Get to the top faster through practical shop-training methods! You earn big money at home while learning; start your own business! Fastest growing industry in the country!

RTTA FURNISHES

EVERYTHING—

TUBES,

BATTERIES,

LARGE TV

PICTURE TUBE



YOURS TO KEEP AND ENJOY

YOU KEEP ALL EQUIPMENT!

FREE...At No Extra Cost... YOU GET A ROUND TRIP TO NEW YORK CITY

After completing home study training, your transportation both ways from any point in U.S. or Canada will be paid by RTTA. At our affiliated training shops in New York City you get 2 solid weeks of laboratory work on newest equipment.

NO PREVIOUS EXPERIENCE NECESSARY FREE EMPLOYMENT HELP

RTTA helps you earn while you learn. Open to men of all ages! RTTA prepares you for **BIG PAY** and to open your own shop.

DRAFT AGE MEN

Special "SPEED-UP" Radio Communications program helps you get **BETTER SERVICE RATING—BETTER PAY!** You can find out by return mail! Send Coupon TODAY!

YOU BUILD THIS LARGE SCREEN TELEVISION RECEIVER

YOUR CHOICE OF 10, 12½, OR 16 INCH PICTURE TELEVISION TUBE

CAN BE CONVERTED FOR COLOR TELEVISION



STUDY AT HOME IN YOUR SPARE TIME

YOU GET 15 BIG TELEVISION-RADIO KITS AT NO EXTRA COST! YOU BUILD THESE & THREE OTHER UNITS

RF SIGNAL GENERATOR

AUDIO OSCILLATOR

FREE "SPEED-UP OFFER" COUPON

RADIO TELEVISION TRAINING ASSOCIATION
972 Broad Street, Dept. 243, Newark 1, N. J.

Rush me **FREE** Sample Lesson & Catalog "How to Make Money in Television," in spare time. **AT HOME**, while learning; also () Special Home Plan for Men over Draft Age. () "Speed-Up" Service Rating Plan for Draft Age Men. No obligations! I understand no salesman will call.

Name.....Age.....
Address.....

ARTISTS MAKE MONEY

Do you like to draw? Send name, address, age and occupation for **FREE ART TEST**, to find out your ability. **3131 ART INSTRUCTION BLDG. ART INSTRUCTION, Inc. MINNEAPOLIS 15, MINNESOTA**

AERONAUTICAL ENGINEERING

Design Aircraft & Components—Study with Jets & Rockets—Great Future—Advanced Aeronautical Subjects—World-Wide Enrollment—Fully Accredited—Established 1929—Approved for Vets—**CAL-AERO** grads in heavy demand.

WRITE TODAY for Special Information. **PM-3**

NAME.....AGE.....
ADDRESS.....
CITY.....ZONE.....STATE.....

CAL-AERO TECHNICAL INSTITUTE
GRAND CENTRAL AIR TERMINAL • GLENDALE 1, CALIFORNIA

EASTER SEALS HELP CRIPPLED CHILDREN



WAS GRANDPA **CORNY**?

When I was young, grandpa was so embarrassing...

If anyone questioned his pet brands, he'd take it as a personal insult.

Once, when an old crony made some slurring remarks about grandpa's favorite brand of pipe tobacco, he refused to speak to the man for two years.

But he was most embarrassing about that car of his. He'd bought it back in 1919... and from that day on, he took full credit for everything about it.

Whenever he saw another car of the same make, he'd go up to the owner like the fellow was a long-lost brother. He'd button-hole perfect strangers, and practically kiss 'em!

To a small boy it was agony... could anything be *cornier*?

As I grew older, I began to see that having brand names you could look for and *trust*, wasn't a bad idea at that.

Maybe it is "corny" to think of familiar brands as old friends...

But it's good to know exactly what you're getting. It's reassuring to realize that most manufacturers of brand name products spend money for research and quality control to make their brands live up to their name.

They know the best way to make money is to make *friends!*

Every day thousands of these brands are fiercely competing for your friendship... trying to give you *more and more value and quality.*

If value, and better products, and better living are "corn," let's have more of it.

As you study the ads in these pages, remember... brand names are names of friends you can *count on!*

**Whenever you buy—
demand the brand you want**

Brand Names Foundation
INCORPORATED

A non-profit educational foundation
37 WEST 57 STREET, NEW YORK 19, N. Y.

BEAUTIFIES natural wood, pine paneling

POLISHES furniture, woodwork

IMPROVES paint jobs

PROTECTS wood and metal surfaces

49¢ 89¢
PINT QUART

101 HANDY HOME USES!
Every home, every workshop, needs Pol-mer-ik BOILED Linseed Oil. Available at all stores. Free folder tells you how to use it. Write Dept. 603 . . .

ARCHER-DANIELS-MIDLAND CO., Minneapolis 2, Minn.

Build and Sell
GRANDPA BREIDERT'S BIRDHOUSES

Fun to Make — a Profitable Hobby or Business

Beautify your yard with one of these attractive birdhouses! You'll find a ready market for them among home and estate owners, golf clubs, parks, schools, playgrounds, etc.

NO EXPERIENCE NECESSARY. Complete plan book gives detailed, easy-to-follow instructions for six designs, from simple 10 compartment "Stockade" House to elaborate 66-compartment "Castle" House. Also includes valuable data on living and feeding habits of various songbirds; selection of site; material specifications; and tested information on how and where to sell the houses.

Order your Kit of **GRANDPA BREIDERT'S BIRDHOUSE PLANS** today. Enclose only \$2.00 for each postpaid, check or money-order. Order extra kits as gifts for your hobbyist friends.

GEORGE J. BREIDERT, P.O. Box 1283, LaCanada, Calif.

CHECK BATTERY CONDITION
without leaving the driver's seat!
DETECTO-CELL

Saves Money by Prolonging Battery Life . . .

Add as much as 70% to battery life! **DETECTO-CELL** shows instantly — in glowing lights — battery strength, condition of each cell, water levels, warns of battery weakness in time to prevent failure. No more unexpected dead batteries, no more needless, costly replacements!

Works with any 3 cell battery, on any car. Simple installation, takes just a few minutes and ordinary hand tools. No moving parts, fool-proof operation. Will last life of your car, or longer. Send check or money order today!

MYRIATRON CORP., Pontiac, Mich.
Dept. 23

\$6.95 complete.

DEALERS • JOBBERS
Write—We've got a good deal for you!

Now! The Most Fabulous Road Racer In Auto History!

Our scale model from the original "Old 16" now owned by Peter Helick, the well-known artist. Build this Vanderbilt Cup Winner! Length 10" when completed — newest "Old Timer" Antique Auto Set! Below we show 12 other famous "Old Timers":

1906 "Old 16" Locomobile \$3.95

1911 BUICK "BUG"—\$2.50	1911 MAXWELL—\$2.50	1904 OLDSMOBILE—\$1.95
1903 RAMBLER—\$2.50	1903 CADILLAC—\$2.50	1900 PACKARD—\$2.50
1909 STANLEY Steamer—\$2.95	1910 MODEL T FORD—\$2.50	1909 MODEL T FORD—\$2.95
1914 STUTZ BEARCAT—\$3.95	1910 INTERNATIONAL HARVESTER—\$2.95	1911 MERCER RACEABOUT—\$3.95

Check "OLD TIMERS" You Want:

<input type="checkbox"/> 1911 Maxwell \$2.50	<input type="checkbox"/> 1911 Buick \$2.50
<input type="checkbox"/> 1904 Olds. \$1.95	<input type="checkbox"/> 1903 A Ford \$2.50
<input type="checkbox"/> 1910 T Ford \$2.50	<input type="checkbox"/> 1910 Internat. Harvester \$2.95
<input type="checkbox"/> 1909 Stanley Steamer \$2.95	<input type="checkbox"/> 1903 Cadillac \$2.50
<input type="checkbox"/> 1909 T Ford \$2.95	<input type="checkbox"/> 1900 Packard \$2.50
<input type="checkbox"/> 1903 Rambler \$2.50	<input type="checkbox"/> 1914 Stutz Bearcat \$3.95
<input type="checkbox"/> 1911 Mercer \$3.95	<input type="checkbox"/> 1906 "Old 16" Locomobile \$3.95

Mail order to us for your favorites. Add 25¢ for postage and handling. No C. O. D.'s please.

HOBBYISTS and Collectors want these nostalgic Antique Autos—each one easy to assemble with pre-fabricated parts! Actual 3/4" scale models, they're decorative and authentic. 6 1/2" to 10 1/2" in length. See them at hobby, toy or department stores. They're the cutest things on wheels! Or write to us. Prompt delivery. Guaranteed satisfaction.

Hudson Miniatures' "OLD TIMERS"
SCRANTON HOBBY CENTER, Dept. 14, Scranton 10, Pa.

MAKE GOOD MONEY in Television Servicing

TV is expanding—and it pays big!

Get this brand-new, complete handbook for sure-fire working knowledge of TV installation, maintenance and trouble-shooting. Tells you step-by-step procedures for audio IF alignment, video IF alignment, aligning RF amplifiers, mixers, oscillators, etc. All possible defects classified for ready reference, thoroughly analyzed to show what is wrong and why . . . and what to do to correct the defect. No mathematical knowledge needed! Practical, authoritative, up-to-the-minute, the perfect handbook for set owners, trainees, and repairmen.

USE IT 10 DAYS FREE

Coupon below brings you "Television Servicing" on FREE trial for 10 days, without obligation. Mail it NOW.

Symptoms of defective operation easily recognized, quickly corrected by illustrations, diagrams and how-to-do-it facts in this new book.

340 pages
170 illustrations

PRENTICE-HALL, Inc., Dept. M-PM-351
70 Fifth Avenue, New York 11, N. Y.

Send me, for 10 DAYS' FREE TRIAL, "Television Servicing." I will return it in ten days and pay nothing—or keep it and send \$1.35 down (plus postage) and \$2 monthly for 2 months.

NAME

ADDRESS

CITY STATE

SAVE! Send \$5.35 with this coupon, and we'll pay postage and packing.

BUILD ONE OF THESE Popular Mechanics Homes YOURSELF... Save Thousands of Dollars!

Build This 5-Room Concrete Block House for Only **\$3650**

Popular Mechanics Build-It-Yourself Concrete Block House is 26'-8" deep by 32'-8" wide. It has 675 square feet of comfortable living space—living room, two bedrooms, cabinet kitchen, utility room, bath and three closets, concrete block walls, poured concrete floors. Insulated ceiling, hot air heating, gas or oil. Hot air ducts in ceiling, cold air ducts laid under floor. Its total cost was less than \$3650 including all material, heating, plumbing and electrical equipment and outside labor for installing the equipment and plastering all rooms.



Build This 5 Room 1 1/2 Story Frame House for **\$7000**



This beautiful, modern home, with breezeway and garage, as pictured, has been built in many locations at an average cost of \$7000 for all materials, equipment and some outside labor. It is 1 1/2 stories with basement, recreation room, living room, kitchen, dining nook, two bedrooms, bath, plenty of closets and space

for 2 additional bedrooms on the second floor. It has an unusually large amount of good, usable living space that can easily be increased to meet the needs of a growing family. The house itself is 35'-9" x 28'-11"; the breezeway is 20'-10" x 8', and the garage is 20'-10" x 12'.

Beat the High Cost of Home Building! Get Book and Plans Now! No Previous Experience Needed!

If you can mix a batch of concrete and saw a board straight you can build either of these Popular Mechanics Build-It-Yourself houses, yourself. Yes Sir! In a few months of spare time you can laugh at the housing shortage and save several thousand dollars while acquiring a home you will be proud to own.

The big, basic idea behind the design of the Build-It-Yourself Houses is ease of construction (so a man could do the job himself with very little assistance) and get the most living at the least cost, considering attractiveness and suitability for any neighborhood. Either is a home anyone can enjoy and be proud to own.

A detailed Build-It-Yourself Book and a set of 10 full-size building blueprint plans are available for each house. Every part of the construction is simplified and thoroughly explained in the Build-It-Yourself Books from the turning

of the first shovel full of earth to the last flick of the paint brush. Every paragraph is written in plain, understandable terms and over half of each book is pictures and diagrams, some in two and four colors, that make every construction detail simple as ABC. The Concrete Block House book also tells how to make your own concrete blocks, how to select and buy a lot and how to build a house of bricks. The Frame House Book includes lumber and mill lists and design variations. Book and set of ten working blueprint plans are all you need to get started and enjoy the thrills of home owning, doing the job yourself and saving thousands of dollars.

If you want to hire a contractor or builder, instead of doing the job yourself, you can still enjoy a tremendous saving by working from the Build-It-Yourself Book and Plans.

POPULAR MECHANICS PRESS, 200 E. ONTARIO ST., CHICAGO 11, ILL.



I MADE
\$14 PER DAY
While still learning!

T. E. H. - WEST VIRGINIA



I MADE
\$800 IN 3 MONTHS
While taking your course!

F. V. - NEW YORK

Get into the

ELECTRIC APPLIANCE REPAIR & SERVICE BUSINESS



OPEN YOUR OWN SHOP

As soon as you enroll, I send you my New Book "How to Open Your Own

Business" at no extra cost. PTS training is more than a home study course in electric appliance repair and service. It gives you the "know how" on the operation of your shop from a business standpoint: What to charge, how to get customers. Everything possible is done to start you on the road to success.

WE TEACH YOU:

Electric motors, house wiring, refrigerator, auto ignition, automatic washers, garbage disposals, fluorescent lights, irons, cleaners, etc., at home.

FULL OR SPARE TIME

SEND FOR THIS FREE BOOK



SPARE OR FULL TIME

You can actually increase your income while still learning—spare or full time

ACT NOW

Want a good-paying business—a job in a fast-growing industry? Send now for your BIG FREE BOOK—"My Plan for your Success." Get started NOW

EASY TO LEARN

Men of all ages, yes, even the man of 69 can get into this expanding field. A REAL OPPORTUNITY for the practical man who wants the BETTER THINGS IN LIFE. The easy PTS Home Study Plan prepares you for greater earnings NOW!

I SEND YOU A

BIG KIT of TOOLS at No Extra Cost



H. T. ARMSTRONG

MAIL THIS COUPON TODAY

PACIFIC TRAINING SCHOOL H. T. ARMSTRONG
7219 So. Broadway, Dept. P-513, Los Angeles 3, Calif.
Please send me, without obligation, your free booklet and details.

Name _____

Address _____

City _____ Zone _____ State _____



EVERY SEAL YOU USE HELPS CRIPPLED CHILDREN

Watch Repairing Pays Big Money Learn at home

Free Literature Tells How

Watchmakers in big demand. You train step-by-step under experts. You learn to take a watch apart—repair and put in perfect working order. 10 easy lessons. We furnish all tools, and a 15 jeweled watch. Practicemovement with first lesson.



Turn spare time into cash—perhaps a business of your own. A licensed school. Students 18 to 65 have profited by our training. Low cost.

Write Today for All the Facts—No Obligation

WATCH REPAIRING Dept. PM-31, 2870 Elston Ave., Chicago 18, Ill.

YES! SEND

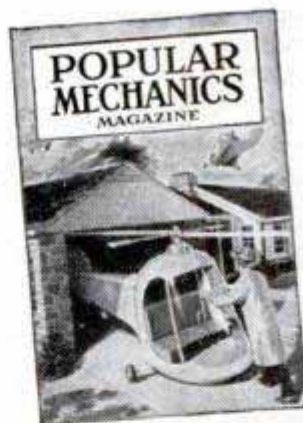

directly to my door every month

I am enclosing

- \$3.50 for 1 year
 \$8.00 for 3 years

name _____

address _____

city _____ zone _____ state _____ A-3

Hand this order to your newsdealer or send it to

POPULAR MECHANICS
200 East Ontario St. Chicago 11, Ill.

LEARN METALIZING!

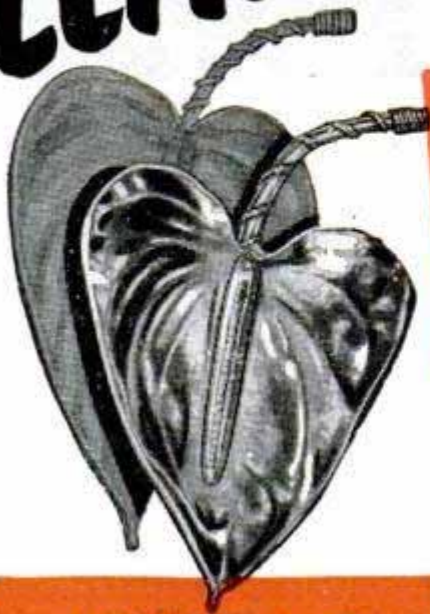

The amazing home art that enables you to
TURN NATURE'S MASTERPIECES
 OF DESIGN INTO
GOLDEN TREASURES!

Think of turning 52c worth of material into a profit of almost \$5.50 for less than an hour of your time. Think of picking up leaves, buds, nuts, shells, and others of Nature's beautiful forms—then for a few cents in materials and a few minutes of time turning them into silvered and gold covered costume jewelry and other novelties so exquisite in design that they command fantastic prices. Sounds like a dream? Yet it is *absolutely true*—as YOU CAN QUICKLY PROVE TO YOURSELF without risking more than a three cent stamp.



HUNDREDS OF MONEY MAKERS

My Amazing book tells How to do the work, how to set up the simple equipment—how to get customers coming to you—how to get stores to sell your products—how to metalize hundreds of different kinds of non-metallic objects with Copper, Silver and 14 karat Gold. Below are just a few of the big money makers that can be produced in a corner of the kitchen or any spare room.



MAKE AS HIGH AS \$5 AN HOUR FOR SPARE TIME!

... own your own home-operated business!

Here's one of the most exciting opportunities of the new half century. Just at a time when hundreds of men and women would like to make an extra \$35.00 to \$50.00 a week in spare time home-work, the old-established—and highly profitable Metalizing Business has been turned into a home-work money-maker. Where in the past a few big companies have been making fortunes, now hundreds of smaller home operators can become independent. I have ready to send you a complete set of simple instructions by which anyone—regardless of age or education—can learn the fascinating art of metalizing. By this process you can replate worn objects in silver, copper, or real gold—you can change silver to gold

by overplating—you can even deposit a heavy coating of solid metal on non-metallic objects such as baby shoes, golf balls, toys and other precious keepsakes—or you can take inexpensive articles and make them worth 10 to 20 times their cost by jewel plating with precious metals.

ALL THIS INFORMATION IS FREE

A stamp brings you the details of the exact plan by which hundreds are NOW MAKING EXTRAMONEY EVERY WEEK. Study it over. Analyze the possibilities. Then if you don't think it's made to order for you—your only loss is your 3c stamp. You can read every fact, every secret, every step of the instructions—all at my risk.



NO "CATCH" TO THIS OFFER

DON'T SEND ME A PENNY, JUST YOUR NAME!

Learn about this wonderful "Ace in the hole." See how you can start without risking job or pay check—how you can actually have fun making money in a business that all the family can help with. No charge now or at any time for the complete facts about this permanent lifetime business that has now opened its door to home operation. Scores of men and women have already started . . . Plenty of opportunity for hundreds more. **BUT DON'T PUT IT OFF. Send your name and address TODAY.**

R. E. BRANDELL, WARNER ELECTRIC CO.
 1512 Jarvis, Dept. 33, Chicago 26, Ill.

R. E. BRANDELL, WARNER ELECTRIC CO.
 1512 Jarvis, Dept. 33, Chicago 26, Ill.

Rush complete facts showing how the old and profitable Metalizing Business has now been converted into a home-work money-maker for full or spare time. No charge or obligation for the information you send.

NAME _____

ADDRESS _____

CITY _____ ZONE _____ STATE _____

**WORLD'S
BEST
WANT AD
MEDIUM**

CLASSIFIED Advertisements



Advertisements in this section 75 cents per word, each insertion, minimum 10 words, payable in advance.

**NEW RATE
MAY 1951 ISSUE
85c PER WORD**

To be inserted under proper classification, copy must be in our office the 20th of the second month preceding date of issue
F. W. Johnson, Manager, Classified Advertising
Popular Mechanics Magazine, 200 East Ontario Street, Chicago 11, Illinois

YOU'LL PROFIT

By reading and answering the classified ads in this section. Hundreds of opportunities for you to make and save money

AUTOMOBILES, MIDGET CARS

WIGLESWORTH-Chasteen's Automobile History Scrapbook #1 just published! Over 250 ads and illustrations of antique and vintage automobiles dating back to 1901. Money-back guarantee. \$1.50. Wiglesworth-Chasteen, 7134-PM3 Alhambra, Mission, Kansas.

FROM Speedway to roadway! Track-proved hi-speed heads and manifolds now available for your passenger car! No special tools needed! Increase horsepower 25%! Astounding getaway! Free illustrated catalog. Speedsport, 6215P Diversey, Chicago 39.

BRITISH Car headquarters. Quick delivery—New fresh "1951 models." M.G.-TD; Riley; Morris; Hillman Minx; Humber Hawk; Sunbeam Talbot; Rover; Austin, Rolls Royce; and Jaguar. Terms 1/3 down. We finance anywhere U.S.A. Come get your car now. Airline ticket furnished. Literature 50c. Agents wanted. Glenn Walraven Motors, "King of the British Cars," Marion, Ohio. Phone 2-4135.

NEWHOUSE Now offers the world's greatest automotive book deal. See page 22 for details.

SILENCE Overhead-valves, attachments unnecessary. \$2.00. Derderian, Box 542, Sandston, Virginia.

SMITHYS Mufflers for all automobiles. Free list. Buck's Auto Parts, Box 1296H, Merced, California.

SPECIAL Hot rod cam shaft regrinding most cams \$23.50 exchange. Guaranteed racing equipment. One day service. Auto Electric Service, Box 54, Anderson, Ind.

WATER Injection. Also economy, power, methods. Free illustrated information. Neher Industries, La Verne, California.

AIR Horns! Blast like dynamite! I love them. If you do too, send postcard for catalog. Tom McCanna, 148Z East 40 Street, New York 16.

SPARK Intensifier—Gives more power, quicker starting, better mileage all cars, trucks, tractors. Only \$2.00. See ad page 40.

PHOTOGRAPHS, World's finest automobiles. List, sample 25c. Box 1028, Minneapolis, Minnesota.

CALIFORNIA Custom accessory headquarters. Buy direct from original designers and save. Chrome dash panels, push button door, trunk conversions, chrome motor accessories, lowering kits, speed-dress-up equipment. 1951 catalog, 40 pages, hundreds of photos—25c. Eastern Auto, 3319A South Grand, Los Angeles 7, Calif.

THOUSANDS Of speed equipment items now ready for all makes of cars. See big catalogue offer on page 22.

MOTORISTS—Save gas! Free literature on proven automatic water vapor injector, giving 25% better mileage and performance. \$5.95 postpaid. Write today! Vaporizer Company, Box 7033B Station G, Los Angeles, Calif.

FLOATING Brake shoes for Ford, Mercury, Chevrolet, Plymouth, Dodge, DeSoto and Chrysler cars make brakes super powerful. They eliminate squeal, chatter, groan, fading brakes, "hard" pedal and scoring of drums. All models—\$4.00 to \$6.90. Make linings wear two to three times longer. Easily installed by yourself. Write for details. Super Brake-Floater Company, 4022 West Lake Street, Chicago 24, Illinois

NEWHOUSE—One of the world's largest speed equipment distributors, now makes amazing offer. See page 22.

MIDGET Autos. Assemble yourself. Complete kits. Write David Redius, 653 State, Camden, N. J.

"SPEED Equipment bargains catalog." Hollywood mufflers \$4.50, duals \$16, racing cams \$29, dual manifolds \$9.95, racing heads \$23.50, water injectors \$6.95, custom accessories galore! (Free Power Handbook) with catalog, 25c. Almqvist Engineering, Milford 33P, Pennsylvania. (Dealers wanted.)

FREE Books. Don't miss the world's greatest automotive book offer by Newhouse. See page 22.

AUTO SUPPLIES AND EQUIPMENT

NEW And used guaranteed parts for civilian and army cars and trucks. Largest stock in America. Mail orders. Pioneer Auto Wrecking Co., 734 W. 13th Ave., Denver, Colorado.

BUICK Parts—Enjoy new-car pep and power in your old Buick. Same day service from world's largest stock of new (not rebuilt) Buick parts and engines. Ship anywhere. Write today. Robertson Buick Co., 1001 S. Wabash Ave., Chicago 5, Ill.

NEW Government surplus. Low voltage circuit tester in steel box cost \$202. Our price \$27.50. Will test batteries, starters, generators, voltage regulators, grounds, short circuits. Wilt Electrical Company, 7829 S. Racine Ave., Chicago 20, Ill.

AUTO And truck parts. New and used. Lowest prices. Complete stock. Prompt replies. Babbitt Auto Parts, 2833 Chicago Ave., Chicago 22, Ill.

"GENUINE Crosley parts." Factory rebuilt engines \$164.00. Tires 2 ply \$8.01—4 ply \$11.51. Tubes \$2.88. Chains \$5.95. Glenn Walraven, "King of the Crosleys," Marion, Ohio, Ph. 2-4135.

CHEVROLET Parts. Scarce motor, body, sheet metal parts. Grossman Chevrolet, Minneapolis, Minnesota.

NEW Economy, power, methods. Free information. Neher Industries, La Verne, California.

AUTO Parts and accessories. Briggs Automotive Engineering of Chicago, P.O.B. 3454 Merchandise Mart, Chicago 54, Ill.

FOR Free descriptive literature on alcohol-water injection for cars, trucks, tractors write Shade, Webster, New York.

BRUSH Plating outfits connect to a battery. No tanks or shop required. Free particulars. Gunmetal Co., Avenue J, Decatur, Illinois.

GARAGEMEN: Build your generator or magneto tester, free circular. Abbott Supply Co., Quincy, Ill.

LACHAPPELLE'S 100,000 Miles motor and motor fuel treatment (patented). Makes any gasoline motor better. \$3.00 postpaid. Ferns Products, 8120 Walnut Dr., Los Angeles 1, Calif. (Data on request.)

INCREASE Gasoline mileage! Three to five miles per gallon. Guaranteed Turb-O-Vane Vaporizer also increases power; reduces carbon. Agents wanted. Turb-O-Vane, Box 1167, Stockton, Calif.

CHAMPION A-C Auto-Lite spark plugs. Rebuilt. Guaranteed 10,000 miles. 25c each, 23c sets of 6. Postpaid. Wholesale discounts available. State brand, type, quantity. Philip Minor, 5707 Arnsby Place, Cincinnati 27, Ohio

TIRE Whistle—Blows when puncture occurs (easily installed). Set of 4, \$3.95. T. Hall Corp., 240 East 19th Ave., Denver 5, Colorado.

NEW—Key ring. Name and address engraved in plastic, \$3.00. Box 292, Johnson City, N. Y.

SPONGES, Chamois—Buy direct, save 40%. Excellent quality English chamois 18"x17", \$1.30; 21"x22", \$1.95; large 7" wool sponge \$1.25. Other sizes available. Cuban Sponge Co., Joliet, Ill.

MOTORIST Save gasoline by Vacuumating overrich mixtures. Fits all cars. For free particulars write Vacuumatic, Dept. 1723, Piquette, Wix.

1951 EDITION! It's new! It's different! Get world's largest auto accessory and parts catalog and save money. Over 50,000 items, including Hollywood accessories, hi-speed equipment, rebuilt engines, all parts and accessories for all cars and trucks. We have that hard-to-get part! Jam packed with bargains. Completely illustrated. Send 25c (refundable). J. C. Whitney, 1919 Archer, Chicago 16.

OFFENHAUSER'S New catalog available. Send 25c. Complete line of speed equipment. Offenhauser Equipment Corp., 5054-P Alhambra Ave., Los Angeles 32, Calif.

AUTO TRAILERS

BUILD Your own trailer! Plans for all kinds. Illustrated catalog 10c. Jim Dandy, 125-M, Wausau, Wisconsin.

MOTORCYCLES, BICYCLES, MOTORSCOOTERS AND SUPPLIES

MOTORCYCLE Pistons, parts, new, used. Harley, Indian, Henderson. List and wings pin 25c. Ballak, 811 N. 9th, St. Louis 1, Missouri.

HARLEY, Indian parts and accessories handbook, 15c. Bootz, 1700 East University, Des Moines 16, Iowa.

HARLEY-Davidson parts, accessories, repair manuals on all models. 24 hour service. Authorized factory dealer. Philadelphia Harley-Davidson Company, 857 North Broad Street, Philadelphia 23, Penna.

MIDGET Racer, less motor \$10; 1946 Whizzer \$15; 1938 Cushman \$35; James motorcycle \$45; Indian \$30; Smith motorwheel \$8; motorbike conversions \$5; 2 h.p. engine \$5. Four balloon tires \$3 (mail-order only). Send 25c for catalogue Number Thirty-Nine just out listing these and hundreds of other bargains, in new and used machines, parts, plans, war surplus, etc. (35c by first class mail). Midget Motors Directory, Athens, Ohio.

MOTORCYCLE Magazine — Worldwide coverage. Yearly subscription \$2.00. Sample 20c. Motorcycle News, 5424-A Sawyer, Chicago 25.

REBUILT Gasoline engines \$9.00 to \$30.00. Cauffiel Motor Industries, Temperance, Mich.

WHIZZER In Schwinn bike \$20; good motorscooter (twist grips) \$22.50; midget racer \$40; Shaw bicycle motor \$15. Send 25c (35c first class mail) for catalog #18 jammed with other sensational bargains in wheels, motors, clutches, motorscooters, midget cars, motorettes, motorbikes, etc. Gail, 538 Erie, Toledo, Ohio.

HARLEY-Davidsons—All models and prices. Genuine late and old model supplies. Expert service. Send 25c for bulletin. Knuth's, 1753 Muskego, Milwaukee, Wis.

WHIZZER (All attachments) \$25; Cushman motorscooter, extra tires, \$20; Indian motorcycle \$30 complete; midget car \$35. Rush 25c (35c first class mail) for catalog #947 listing these and scores of other amazing bargains in motors, midget cars, motorscooters, motorbikes, motorcycles, etc. Associated, Box 1764-CS, Toledo, Ohio.

AVIATION

PROPELLERS—For sleds, airdrive boats. Literature. Standard Aircraft, Box 387, Ft. Worth, Texas.

PROPELLERS, Plans, supplies, for ice sleds, snow sleighs, air boats. Catalog 20c. Banks-Maxwell, Box 3301E, Ft. Worth.

BATTERIES, GENERATORS

REAL Edison batteries. Long unconditional guarantee. 37 to 600 ampere sizes. Free interesting literature. Hawley Smith Co., Croton Falls 1, New York.

ELECTRICAL SUPPLIES

BE Independent, be secure, have your own profitable business—earn \$20.00 and more a day making beautiful, fast-selling lamps at home. No equipment needed. Illustrated course teaches you quickly. Course, parts catalog, wholesale price list—only \$2. Gearon Co., Dept. 200-B3, 27 S. Desplains, Chicago 6, Ill.

MOTORS—1/100, 1/25, 1/4, 1/3 hp. Nationally known make. All a.c. At a sacrifice price. Write Mercury Electric Corporation, 719 Wyandotte, Kansas City 6, Mo.

REBUILD Starters, generators. Introductory manual \$1.00. Wholesale parts catalog 10c. Modern Technical Manuals, Box 4704, Kansas City, Mo.

MAGNETWIRE, Insulation, varnish, repair supplies. Morton Electrical Service, Maywood, Ill.

FREE—New catalog. Bargains in welders, motors, generators, surplus equipment. Or, build your own kits—save. LeJay Company, Minneapolis, Minnesota.

ELECTRIC Pencil—Engraves all metals. \$2.95. Reb Industries, Elmhurst, Illinois.

4½ INCH G.E. six volt sealbeam lamps, red or clear, 50c each. Balford Corporation, Brookier, Florida.

LAMPS. Build own originals, parts wholesale, any amounts. Catalogue 10c. Brown Lamp Co., Box 501, Wellston, St. Louis 12, Mo.

ELECTRIC Pencil: Engraves all metals \$1.50. Beyer Mfg., 10511-H Springfield, Chicago 43.

EVERYTHING Electrical at guaranteed money saving low prices. Illustrated 100 page catalogue sent for 6c stamps. Somersheim Sales, 1319-A Kundeeck St., Jasper, Ind.

LAMP Parts—Sockets, wire, harps, cords, bases, pipes—all parts to build and repair. 64 page catalog with charts and instructions 25c. Gyro Lamps, 5402P Clark, Chicago 40.

WELDING, SOLDERING, PLATING

WELDERS 110 Volt a.c., transformer welder in portable metal case. Push button, self activated heat controls. Welds, brazes, solders, cuts all metals. Easy to use. Simple instructions. Complete with flame weld torch, rods, flux, mask only \$28.50. Splendid for shop, farm, home repairs. 10 days trial. Also other models. Magic Welder Co., 241 MK Canal St., New York City.

BUY Direct from factory. Welding and cutting equipment. All makes of equipment repaired. Established 1913. Box 331, Hamilton, Ohio.

SPIT-FIRE Guaranteed world's hottest, most dependable alcohol blow torch. Write Robert Livingston, 1425 Scott, Williamsport, Penna.

RADIATOR Repairing books, supplies, equipment, gasoline torch. Write. Curfman Co., Maryville, Mo.

200 AMP. Welding generators. Brand new. \$25.00. Free literature. Thorndyke Mfg. Co., Pipestone, Minn.

"BUILD Your own" portable arc welder. Hobart generator plus your auto engine. Saves hundreds, get big paying jobs. Catalog free. Hobart Welders, Box M-312, Troy, Ohio.

BUILD Your own 100 ampere electroplating rectifier at a low cost. Stark-weather, Ottawa, Kans.

ELECTROPLATE Brass, nickel, chromium, baby shoes. Free literature. Electroplate, Box 293, Red Lion, Penna.

ACETYLENE Generator, 100#. \$2.00. Write Blueprint, Box 326, Hopewell, Virginia.

ACETYLENE Welding outfits, new \$45.00; used \$25.00; arcwelders \$46.50. Eagle Welding, Dept. PM, 5085 Broadway, Chicago 40, Ill.

GENERATORS, AAF types: L-3, 25 amps., 24v., \$12.95. P-1, 200 amps., 24v., \$13.95 f.o.b., no c.o.d. Aero Parts Supply, 8102 Lockheed, Houston, Texas.

MACHINERY, TOOLS, SUPPLIES

STEEL Boxes — Government surplus. Ideal for tools, valuable papers, etc. Size 10" x 3½" x 7" 30c each, six for \$1.50. Size 12" x 8" x 6" 65c each, six for \$3.50. Send check or money order to Wallace Steel & Supply Co., Ithaca, N. Y.

McCULLOCH Chain saw parts. Complete stock. Orders sent out same day. Barnett Equipment Co., South Glens Falls, N. Y.

PERFECTED Toolrak with ten interchangeable holders. \$2.00 postpaid. Davis Development Co., Box 670, Colorado Springs, Colo.

AUTO Conversions and parts. Marine manifolds for all engines. Your transmission converted to marine gear, propellers, shafts, struts, couplings, etc. Everything you need for your boat. Money back guarantee. Conversion Parts Company, 278 Adams Street, Boston 22, Massachusetts.

WATCH Makers lathe, gov't. surplus, complete with motor and foot pedal. Value \$225.00, like new, \$87.50. Public Sport Shops, 11 S. 16th Street, Philadelphia 2, Penna.

AUGER Bit. Sensational new design. See Barclay Co. advertisement on page 266.

PRECISION Cast small parts, jewelry, etc., in your own shop. Be a subcontractor. Lost wax process. Free equipment price list. Southwestern Specialty Co., Box 3506, Station A, El Paso, Texas.

CIRCULAR Saw blades—Longer runs without sharpening. 8" diameter \$2.29. Satisfaction guaranteed. Van Dick, Little Falls, New Jersey.

CHUCKS: Independent; Universal—threaded 1½"-8, 1"-8, 1"-10, 1"-12, or with adapter recess. The only complete line of bench lathe chucks built to heavy duty standards. Other chucks to 16" diameter. Write for quotation; free literature. No obligation. Westcott Chuck Co., 3600 Walnut, Oneida, N. Y.

POWER Tools. Build your own with Lewis castings. Save up to 80%. Complete castings, material and blueprints supplied for 23 woodworking and metalworking tools. Illustrated brochure, 10c. Write today. Lewis Machine Tool Co., 3217 Union Pacific Avenue, Dept. M, Los Angeles 23, Calif.

DRILL And reamer booklet 32 pages know how, plus time saving tap selector, plus tool catalog, all for 25c. Cost refunded on first order. See Barclay advertisement on page 266.

STAMPING Sets, 37 steel dies, both letters and figures. Government surplus, for marking metals, wood, leathers. ½" for home workshops, garages, gunsmiths, machine shops. Exceptional value, satisfaction guaranteed. \$2.98 postpaid. Numrich Arms, Dept. P.M., Mamaroneck, N. Y.

ONLY \$3.95. 2" Universal lathe chuck, \$14.00 value, check or money order. Har-Mur, 2349 Devon Ave., Chicago 45, Ill.

GOVERNORS And butterflies for autos or any gasoline-driven engine. Candee-Smith, P.O. Box 612, Riverside, California.

ROUND Stock and pipe jaw made for jaws of any standard vise \$1.00 plus Calif. sales tax. H. A. Johnson, 3921 La Cresta Ave., Oakland 2, Calif.

PUMP, Stainless steel, with 115v. 1/40 hp., 3450 r.p.m. motor, app. 12½" net, 4" x 8", app. 5 gpm, new postpaid, \$20.00. Socket sets, Waldren ½" drive, 21 pieces, ¼" to 1", new surplus, postpaid, \$18.50. Aero Parts Supply, 8102 Lockheed, Houston, Texas.

ENGINES, MOTORS, DYNAMOS

MOTORS ½ Horse \$15. ¾, \$22. 1, \$30. Compressors \$22.50. Other bargains. State your needs. Butler, 1885 Milwaukee, Chicago.

WINDING Data, listing 225 motors, single and three phase, \$1.00. Motor Data Co., Box 7631, Kansas City 3, Mo.

NEW 1 H.P. gasoline engines, 2 cycle horizontal. Original package. Shipping weight 23 lb. \$27.50 f.o.b. Jedway Corporation, Acton, Indiana.

REBUILT Gasoline engines \$9.00 to \$30.00. Cauffiel Motor Industries, Temperance, Mich.

DYNAMOTOR, PS225, 14v input, 375v at .150a, 4800 r.p.m., \$6.50 postpaid. 110v, 60 cycles motor with stainless steel liquid pump, 1/40th hp., 3450 r.p.m.; total weight 12½#, 4" x 8", app. 5 gpm, unused, \$20.00 postpaid. Aero Parts Supply, 8102 Lockheed, Houston, Texas.

BOATS, OUTBOARD MOTORS

OUTBOARD Motor parts, new—used, all makes. Rebuilt outboards. Standard and oversize pistons any make regardless of age. Our boring bar rebore cylinders 1½" to 2¾" diameter. Outboard motor magneto specialists. Estimates given, no charge. Outboard Motor Mart, Inc., 309 Atlantic Avenue, Boston 10, Mass.

CONVERT Fords and Jeep to 100% marine engines with Osco's world famous Convo-Kits. Deluxe catalogue 25c (coin). Oscomotors, 3627B Lawrence, Philadelphia 40, Penna.

TWENTY Plywood boat plans \$1.00. Catalog boat building plans 10c. The Rudder, 15 Murray Street, New York 7.

BOAT Kits: Outboards, inboards, hydroplanes, sail. A cinch to assemble. Minimum expense. Catalog, specifications, prices. 25c. Brooks Boat Company, Carrollton, PM, Michigan.

OUTBOARD Motor bargains—\$35.00 up. Send for free list! Save big money! Used parts for most makes and models. Crandall-Hicks, 911 Commonwealth, Boston, Mass.

STEERING Wheels, windshield brackets, from \$6.95. Modern fittings, water-skis at lowest prices. Complete pre-cut plywood boats. Bargains galore. Folder 10c. Marine, Box 681, Mendota, Minnesota.

MARINE Conversions for Ford and Jeep engines. Catalog 10c. Lehman Manufacturing Company, Department D, Newark 2, New Jersey.

NEW, Used, rebuilt marine motors. Marine conversions, fittings. Free catalog. Stokes Marine Supply, Dept. 24, Coldwater, Michigan.

THRIFTY, Easy-to-build boats—There are 9 new models of Roberts Kit-Craft boats. Priced as low as \$42.50, they range from 8 to 14 ft. Prams, cartops, skiffs, rowboats, sailing prams, speed hulls, runabouts. All brass fixtures—best building materials. Send 10c for new illustrated catalog. Roberts Industries, Inc., 103 Main St., Durham, Connecticut.

GET Our big 224-page low-price marine hardware and boat equipment catalog for 1951! Send \$1.00 to cover packing and mailing; refunded with first order. Garland Frasher Marine Sales, 540-J 31st Street, Huntington, West Virginia.

FULL Size, cut to shape boat patterns, blueprints, 7½"-38 ft. Illustrated "Build a Boat" catalog, 25c (coin). "How to Build Boats" book, \$1.00. PolyWog houseboat plans \$10. Marine catalog \$1.00. Marine Specialty Mfg. Co., 3107 Detroit Ave., Cleveland 13, Ohio.

"P38 Belly tanks", steel, \$9.95. Free picture. Bucks Auto Parts, Box 89, Merced, Calif.

BOAT Plans, patterns, kits. Rowboats, outboards, inboards, cruisers. Descriptive literature and 24 page illustrated book on boat construction 30c postpaid. Germain Boat Company, West Saginaw 3, Mich.

SAVE ¾ Cost. Assemble your own boat. We furnish parts. No experience necessary. Rowboats, cruisers. Illustrated catalog 25c. Midwest Boat Company, Menomonee Falls, Wisconsin.

220 PAGE Marine hardware catalog beautifully illustrated for \$1.00. Money refunded with first order plus 10% discount. Marine Products, 7 Longfellow St., Baldwin, Long Island, New York.

FORD & Jeep marine conversion kits, request catalog. Arthur Gershel, Dept. 0, 51 Chambers St., New York 7, N. Y.

ATHLETIC EQUIPMENT, BODY BUILDING COURSES

TALLER. Be one to three inches taller. A new scientific method for permanent height increase has now been developed. Free information. Natural Methods, Box

BARBELLS. Exercise equipment. Courses. Free booklet. Good Barbell Co., Reading, Penna.

BARBELLS, Dumbbells, exercise equipment. Price list free. Superior Foundry, Box 549, Hopewell, Virginia.

GAIN Weight! Four exercises to increase weight. Complete \$1.00. Body Builders, 36 Nevada Street, Winthrop, Mass.

DEADLY Judo—Fiercest fighting technique. Trick knockouts. (Over 200 illustrated pictures.) Expert instructions; three volumes. Complete \$2.25. Variety House, Box 46-B Wall Station, New York 5.

TAXIDERMY

MODERN Taxidermist Magazine, Greenfield Center 2, N. Y. Devoted entirely to taxidermy, photos, articles, methods. Trial year's subscription, \$1.00.

BINOCULARS, TELESCOPES, MICROSCOPES, MAGNIFIERS

POWERFUL Astronomical telescopes easily made. Perfect lenses and instructions; 100X \$3.00; 100X and 200X \$4.00; 100X, 200X and 400X \$6.00. Full power, clear vision guaranteed. Instructions alone 10c. Suffolk Science Service, Riverhead, N. Y.

TELESCOPES, Binoculars, microscopes, big bargain catalog free. Brownscope Company, 24 West 45th Street, New York.

REFLECTOR Telescope kits, refractors. Free illustrated bulletin. Rake Instrument Laboratory, 612 Adams, Hoboken, N. J.

AMAZING Prices, brand new precision binoculars. Free trial. Folder, "Binocular Selecting," pricelist free. Prentiss Importers, Mercury Bldg., West Los Angeles 25, Calif.

SAVE 50% On new binoculars! Free catalog. Free book, "How to Select Binoculars." Write today! Bushnell's 43-M23 Green, Pasadena 1, California.

BINOCULAR Specialists, all makes repaired. Authorized Zeiss, Hensoldt dealer. Tele-Optics, 5514 Lawrence, Chicago 30, Illinois.

BINOCULARS, Telescopes, watches, guns. Buy, sell, trade. Schweer's, Donnellson, Iowa.

MICROSCOPES, Pocket pen type, 20 power, \$2.95; 40 power, \$4.95 postpaid. Pocket pen telescope, 6 power, coated lens, \$9.95. Public Sport Shops, 11 S. 16th Street, Philadelphia 2, Penna.

GIANT Astronomical telescope with 6 ft. tripod \$15.00, f.o.b. factory. 100 power. (10,000 area magnification). Clear vision, full power guaranteed. Ready for use. Suffolk Science Service, Dept. BT, Riverhead, N. Y.

WAR Surplus bargains, binoculars, telescopes, sextants, millions of lenses, prisms, reticles, eyepieces, objectives, etc. Mail 10c for big "Catalog CH." Send \$1.00 for Stock CH—10-piece lens kit and big instruction booklet. Edmund Salvage Co., Barrington, N. J.

BINOCULARS Reconditioned, cleaned and aligned, any make. Special, fast service, work guaranteed, \$11.50. Miller's Sport Shop, Dept. P, 142 North 8th Street, Philadelphia 7, Penna.

REFLECTING Telescopes, 60X, completely assembled \$25.00. Guaranteed observatory clearness. Free information. Skyscope, 475 Fifth Avenue, New York 17.

ASTRONOMICAL Telescopes, binoculars, microscopes, bought, sold, repaired. Books. Lists 10c. Rasmussen-Reece, Amsterdam, N. Y.

SPORTING GOODS, GUNS, FISHING TACKLE, ARCHERY, TRAPPING

MEN. Boys. Fishermen. Amazing reel. Makes kite flying easy—excellent for drying or reversing fishing lines. Make it yourself. Buy no materials, 25c. Self-addressed envelope brings easy to make plans. B. Mulligan, 657 Roscoe, Chicago 13.

FISHERMEN—Make your own sinkers with our molds. Free illustrated booklet. Reading Instrument Co., Box 78, Reading, Penna.

FISHING Rods. Make them right. It's easy with our detailed, illustrated booklet. Only \$1.00. Dreis-Davis Co., 419 Ocean Center Bldg., Long Beach 2, Calif.

190 PROFUSELY Illustrated pages antique and modern pistols, swords, daggers, armor, etc. 50c. Robert Abels, A860 Lexington Ave., New York 21.

NEW Book! Antique gun prices! Lists 2000 American revolvers, \$1. Pioneer Press,

NEW Richardson "Biu Glas" rod. At last a glass rod with the kind of action you want where you want it. Has the tip action you need for casting of light lures and the backbone in the butt end to set the hook. Will not fade in color. Find out why the new Richardson "Biu Glas" will give you more rod for the money. Write for free catalog. Richardson Rod & Reel Company, 3166 North Sawyer Avenue, Chicago 18, Illinois.

5000 BARGAINS, Firearms, binoculars, war relics. Catalog 40c. Smith Firearms, Runnemed, New Jersey.

FREE Crow hunting information, calling, Decoys. Toad Woodward, Lamar, Missouri.

PETS—DOGS, BIRDS, RABBITS, HAMSTERS, ETC.

ST. Bernards, Boxers, Hof Kennels, 5136 Cascade Rd. S.E., Grand Rapids 6, Mich.

"TREATISE On Breeding and Raising Canaries"—\$1.00. American Canary Magazine, 3449 North Western Ave., Dept. PM, Chicago 18, Illinois.

HAMSTERS—Superior strain, selected breeders. \$3.00 pair. Pet, in clearview, self-cleaning cage \$5.00. Free, illustrated booklet. Lakeview Hamster Colony, Newfield, N. J.

HAMSTERS. One pair virgin breeders plus 80 page manual and market folio for \$3.50 f.o.b. Live delivery guaranteed. Have market facilities. Free literature. Manual separately costs \$1.00. Pat's Hamster Farm, Waterford 3, N. J.

MAKE Big money! Raise Chinchilla rabbits. Cash markets supplied for your production. Write today! Rockhill Ranch, Sellersville 15, Penna.

INCREASE Your income by raising domestic rabbits. Small space needed. Ready market for delicious meat, fur and wool. Largest magazine in the industry tells you how. \$1.50 per year. Sample 15 cents. No stamps. Small Stock Magazine, Lamoni 20, Iowa.

EARN Up to \$400 monthly raising Angora or New Zealand rabbits. Plenty markets. Particulars free. White's Rabbitry, Newark 38, Ohio.

RAISE Rabbits. Profitable business. Literature free. Tayco Rabbitry, Hapeville, Georgia.

RAISE Guinea pigs. Money makers. Booklet free. Taylors, B426A, Hapeville, Georgia.

NATURALISTS Catalog 10c. Reptile bulletin 5c. Chameleon 45c. Turtle 45c. Salamander 45c. Quivira Specialties, Topeka 51, Kansas.

MINK Raising information free. Complete. Lake Superior Mink Farm, Superior, EE1, Wisconsin.

BRED Female mink. Booklet, pen plans, \$1.00. Lake Ontario Mink Ranch, Gravel Road, Webster, N. Y.

A Practical beginning to successful rabbit raising. 48 page illustrated booklet. Dime. American Rabbit Breeders Association. 36 AR & CBA Bldg., Pittsburgh, Penna.

SEE Gulf Hamstery ad on page 22. Shows picture of hamster.

CAGE Birds, interesting, profitable. Circulars 10c. Poisal's Bird Farm, Box 1133, Sacramento, Calif.

TRAIN Your dog to be obedient and a better companion. Home correspondence course teaches you how. Features individual supervision. Thousands in use, it's simple. Send 10c for illustrated booklet. Canine League of America, Dept. PM-3, 258 Fifth Ave., New York City 1.

PLANTS, SEEDS, NURSERY AND GARDEN SUPPLIES

MULTIFORA Rose, the living self-repairing fence. For ornament, erosion control, windbreak, snow fence, other uses. A rapid grower. Raise from seed. Free planting guide. Woodlot Seed Co., Norway, Zone 4, Michigan.

AMERICAN Shamrock, honeysuckle, sarsaparilla, rooted, 60c postpaid. Flowercroft, Leesburg, Georgia.

GLADIOLUS—March special. Hundred blooming size \$1.49 postpaid. Robinsons, Sebastopol, California.

GINSENG. Goldenseal. Hundred seeds \$1.50; thousand \$5. Dozen plants \$1.50; hundred \$9. Growing, selling instructions included. F. M. Collins, Viola, Iowa.

PLANT The lawn you never have to cut. Free circular. Midget Grass Co., 3370 N.

GLADIOLUS—Spring special. Delicious yellow strawberries. Glad Haven, Sebastopol, California.

FARMS, FARM LANDS, REAL ESTATE

NEW Free spring catalog! Farm and country real estate bargains, good pictures, many states, easy terms, many equipped, crops included. For special service, state requirements, desired location. United Farm Agency, 220-PM South State St., Chicago 4, Ill.

FLORIDA. Beautiful homesites in new Lake County development. \$245 at \$10 monthly. Near Ocala National Forest, many pretty lakes, streams, pavement. World's best bass fishing, wonderful hunting. Folder free. Howard Vernor, DeLand, Florida.

GOOD Farms—Ranches. Washington, Minnesota, Montana, Idaho, Oregon, North Dakota. Dependable crops, favorable climate. Write for literature, lists describing typical farm opportunities. Specify which state. J. W. Haw, 119 Northern Pacific Ry., St. Paul 1, Minn.

STROUT'S Spring catalog—Just out! 132 pages. Bargains galore. Coast to coast. Farms, homes, country businesses. Mailed free! Buy now and save through Strout Realty, 7 So. Dearborn St., Chicago 3, Ill.

CANADIAN Tax sale lands for two dollars an acre and up. Small monthly payments. Farms, timber, hunting and fishing camps, minerals. Limited number of properties. Write at once for free catalogue. Tax Sale Service, Room 105, 120 Bloor St. W., Toronto 5, Canada.

GOVERNMENT Lands \$2.00 acre up. Information all states twenty-five cents. National Tax Service, 901-A Majestic Bldg., Detroit.

\$5.00 MONTHLY Buys 40 acres near town; price \$200.00; free list. Box 425-P, Carthage, Mo.

WEST'S 1951 Catalog—Free! Farms, estates, ranches, orchards, camps, homes, businesses. East of Mississippi, Maine to Florida. West's, M-1, Pittsburgh 17, Penna.

POULTRY, FARM SUPPLIES

BABY Chicks, champion mated, 52 varieties, 7 crosses, licensed, inspected, bloodtested. Rush postal, large colored book free, low prices. Berry's Farm, Route 12, Clarinda, Iowa.

POULTRY Farmers, broiler growers, turkey raisers read the new American Poultry Journal for latest ideas and greater profits. 12 months, 50c. Special offer, 4 years, \$1.00. American Poultry Journal, 565 South Clark, Chicago.

RAISE Turkeys the new way. Write for free information explaining how to make up to \$3,000 in your own backyard. Address National Turkey Institute, Dept. 3, Columbus, Kansas.

KNOW How to raise poultry for profit. Read Poultry Industry. Every issue packed with helpful hints and practical suggestions. Latest articles on breeding, feeding and management. Subscribe now. 1 year 65c. 2 years one dollar, foreign subscriptions \$1.00 a year. Poultry Industry, Dept. P.M., 376 Boylston St., Boston 16, Mass.

BABY Chicks \$10.00 per 100 c.o.d. New Hampshires, Barred Rocks, White Rocks and heavy assorted. Prices at hatchery. A. F. Hockman, R7, Bellefonte, Penna.

PROFITABLE OCCUPATIONS

TURN Your spare time into cash. Make quick-selling, highly profitable lamps—every home a prospect. No experience or special tools required. New 1951 56-page illustrated catalog shows shades, shade frames, figurines and bases, oil lamp converters, boring compounds, and dozens of similar items. Also all kinds of sockets, cords, pipes, harps, finials, bases, and hundreds of other parts—everything you need. Special 8-page section shows 6 beautiful lamps in kit form ready to assemble. You buy wholesale, sell at retail—make big profits. Hundreds doing it. You can, too. Send 25c today for catalog and wholesaler price list. Refundable first order. Gearon Co., Dept. 500-B3, 27 S. Desplaines, Chicago 6, Ill.

HAVE Fun! Make money! "Working With Leather"—64-page booklet tells how. Send 25c for copy. No foreign orders. Free catalog and valuable information included. Wilder-Craft, 1039 Crosby, Chicago 10.

MAKE Flexible molds! Cast plaques, bookends, figurines! Free sample! H. Tooker, 630-M Chestnut, Hamilton, Ohio.

WANT A diesel job? Our approved, up-to-the-minute diesel training program can help you qualify for steady, big pay jobs or specialized military training. Covers diesel, tractor, heavy equipment. Easy to master. No loss of present income. Job placement advisory service. Investigate! Write for information today. Interstate Training Service, Dept. 3C, Portland 13, Oregon.

RAISE Pheasants on the \$100 week plan. Little capital and space can make you independent. Free details. Great Central Game Management System, Columbus 1, Kansas.

EARN Money in spare time in radio and television. Send for full information. Receive free copy of Radio Trouble-Shooting Guide. Progressive Electronics Co., 497 Union Ave., Dept. PM-200, Brooklyn 11, N. Y.

\$5 HOUR Easy! Sell name plates for houses. Free sample, order blanks. Write: National, 214 Summer, Boston, Mass.

TYPISTS, Profitable business at home. Complete copyrighted information 50c. Rosdahl Industries, 4901 Elston Avenue, Chicago 30, Illinois.

LIFETIME Income as notary public. Appointment assistance. Stationers, Helotes 50, Texas.

EARN Up to \$400 monthly raising rabbits. Free particulars. White's Rabbitry, Newark 61, Ohio.

YOU Can raise domesticated earthworms. Sensational profits. Instructions free. Midwest Earthworm Farms, Box 999-M, Wichita 1, Kansas.

\$40.00 WEEKLY Made growing mushrooms, fresh, dried. Dominion patent 331583. Free spawn. North American, 169P Yonge, Toronto, Canada.

BE The Popular Mechanics representative in your neighborhood and earn big profits in your spare time. Write Popular Mechanics Magazine, Room 408M, 200 E. Ontario St., Chicago, Ill.

"FROG Raising!" New book tells how! Illustrated literature free. Marlboro-A, Box 7002, New Orleans 19, Louisiana.

START Own business. Make polishes, cleaners, flavors, etc., in basement workshop. Details free. Monde, Pulaski, Wis.

FOREIGN Employment. Construction men, building trades, mechanics, helpers, Office men. Good workers interested in foreign development projects. Pipe lines, dams, power plants, roadways, shipping, oil refineries, etc. Transportation and quarters furnished; High wages. Listings of firms actively working on projects in Arabia, Persian Gulf, Africa, Alaska, Canada, South America, Europe, etc. Send \$1.00 for Foreign Construction Compendium and application forms. Foreign Service Bureau, Dept. PM-3 (Employment) P.O. Box 295, Metuchen, N. J.

FREE Book "How to Make Money With Home Workshop" describes amazing methods used by hundreds of successful craftsmen. Tells what to make, how to sell workshop output spare time. Write at once for details. Remember it's free! Craftsman, 115-A3 Worth St., New York City.

FOREIGN and Latin American employment. 1951 "Foreign Service Directory" gives up-to-the-minute facts on military and civilian construction, government jobs, major oil listings, aviation, transportation, steamship lines, mining, importers, exporters, how-when-where to apply, application forms, hot list firms hiring. \$1.00 postpaid. Global Reports, P.O. Box 883-P, Hollywood 28, Calif.

JUMBO Frog raising very profitable, information free. Brashears, Berryville, Ark.

RAISE Fishworms, free literature, complete instructions 10c. Huffmans Ranch, Rives Junction 2, Michigan.

\$46 FROM square foot plywood. Jigsaw necessary. Write, Woodarts, Bridgewater, Mass.

WOULD You pay 3%—first \$350 made? Book "505 Odd Successful Businesses" free! Work home. Expect something odd! Pacific-MM, Oceanside, Calif.

MUSHROOMS Grown. Boxes, barrels. Instructions 50c. Spawn \$1.00. Manureless process. \$2.00. Gordons, 553 William, Winnipeg, Manitoba.

HOME Starting income. Write Kramer, 1309 South Cheyenne, Tulsa 14, Oklahoma.

ALASKA—America's frontier. \$1.00 brings 1951 business directory, large government map giving up-to-date construction projects, current employment information, homestead and highway facts; hunting, fishing, game rules; firm's hiring and application forms. Alaska Opportunist, P.O. Box 883-P, Hollywood 28, Calif.

DEFENSE Welding jobs pay. Welders needed. Train quickly. V. A. contract. Hobart Welding School, Box M-314, Troy, Ohio.

BOOKS, PERIODICALS, PICTURES POSTCARDS

ANY Book you want we have it or will get it. 1/4 million stock. World wide contacts. Shorey Book Store, 815 3rd, Seattle 4.

BOOKHUNTERS! Any subject. Send wants! Atlantic Book Service, Lawrence Avenue, Charlestown 29, Mass.

POCKET Novels. Used. 8 for \$1.00. Send for list. Trunkat, Glenshaw, Penna.

BOOKHUNTERS! All subjects. Send wants! Jaher Book Service, 620-P East 178 Street, New York 57.

SHIP Photographs. List 10c. Scozzafava, 1648 59th Street, Brooklyn 4, N. Y.

SAVE Through subscriptions. Free list. Rural Magazine Agency, Grenada-1, Miss.

FREE Novelty lists! Police Jiu-Jitsu, 50c! 130 Main, Spring Valley, N. Y.

SELF-Explaining Bible: Illustrated circular free. Box 446-P, Minneapolis, Minn.

HARD-To-Find Books supplied. Send wants. Pierce's, Winthrop, Iowa.

RENT Fiction, non-fiction. Catalog 10c. Santens, 2700-A Ann, St. Louis 4, Missouri.

BARGAINS—Hobby and outdoor books. Send stamp. P. Vallon, 63 Perry, Greenwich Village, New York 14.

BOOKS—Encyclopedias, arts, crafts, Jiu-Jitsu. Novels four \$1.00. Catalogs 10c. Kogan, 1032-PM Church Annex, New York 8.

DON'T Be alarmed—Be prepared. You may save a life, it could be yours. Copies now available. "The Atom Bomb and Your Survival." Send 35c to Liberty Sales Div., P.O. Box 2171, Ft. Lauderdale, Florida.

LEARN About Houston and the Great Texas Frontier! "Mudtown," the Texas book details the great story of pioneers, frontiersmen, Indians, the story of Fabulous Houston! postpaid \$3.00. Frontier Bookshop, 1813 Main, Houston, Texas.

GAMES AND ENTERTAINMENT

BE A hit, be popular, be the life of the party. 100 pages of games, tricks, and novelties, fully illustrated. Send \$1.00 to Pleasure Sales, Dept. PM-1, Box 817 G.P.O. 1, New York City.

MAGIC TRICKS, PUZZLES, JOKER NOVELTIES

WORLD'S Largest professional magic shop, keeps you in touch with latest tricks. To receive mailings, send 50c for new catalog. Holden's, M220 West 42nd St., New York.

VENTRILOQUISM Taught. 3c stamp bring particulars. Smith, 801 Bigelow, Peoria 5, Ill.

500 TRICKS. New 1950 edition now ready! Send only 10c for your copy, containing latest in good magic for pocket, parlor, stage. Unequaled service to magicians for 30 years. Douglas Magicland, Dept. 1, Dallas, Texas.

MAGIC Monthly. Year 25c. Sample and 1949 catalogue free. Eagle Magic, Minneapolis 2, Minn.

512-PAGE Catalogue of 2500 tricks, pocket, parlor, stage. World's finest magic. Send \$1.50 for catalogue (refunded first \$6.00 order). Kanter's, M-1311 Walnut, Philadelphia 7.

500 TRICKS, Magic, cards, jokers sensational funmakers, puzzles, shooting novelties, hot numbers. Catalog 20c. Andersen's, 6815-P Ardmore, Chicago 31.

MAGIC Tricks, puzzles, books, cards, punch boards. Catalog 10c. Specialty, Box 671, St. Louis 1, Mo.

TRICKS, Jokes, novelties. Catalogue 15c. Furr, Box 1882-D, Norfolk, Va.

16 CARD Tricks and catalog 25c. Sterling Magic, Royal Oak, Mich.

200 ELECTRIC Stunts, 110 volts, \$1. Kutting Sons, Los Altos, Calif.

584-PAGE Catalog. 7500 novelties, funmakers, tricks, jokes, gadgets, hobbies, timesavers, animals, sports, scientific. 10c. Johnson Smith Company, Dept. 349, Detroit 7, Michigan.

PROFESSIONAL Catalog, 124 pages, 25c. Williams, 900 Plymouth, Ellwood City, Penna.

JOKE Cigars! Exploding! Spring-out! Jumbo! Campaign! Dealer catalogue free. Ernie Enterprises, 725 D. Pine St.

FREE Trick and catalog 25c. Lerro's Magic, 509 80th Street, Brooklyn 9, N. Y.

BE A magician. Large professional magic catalog of latest tricks, 35c. Ireland, C-109 North Dearborn, Chicago 2.

FREE Rubber dollar with gigantic magic, joker catalog, dime. Funland, 6419 San Vicente, Los Angeles 48, Calif.

SEND Your name and address for free catalog. Augustin, 4534 N. Oakley Ave., Chicago 25, Ill.

1951 CATALOG Of magic—Send 25c to Hornmann's Magic Co., 304 W. 34th St., New York City. America's oldest magic shop.

OLD STAMPS WANTED

I Will pay \$100.00 each for 1924 1c green Franklin stamps, rotary perforated eleven (up to \$1,000 each unused). Send 10c for large illustrated folders showing amazing prices paid for old stamps, coins and collections. Vernon Baker, PM-3, Elyria, Ohio.

COINS, TOKENS, CURRENCY

50 ASSORTED Indian pennies, \$1.50; 1892 Columbian half-dollar, 75c; Whitman coin album, 25c; 1863 Civil war cent, 15c; 25 foreign coins \$1.00; check list, 3c; large catalog, 15c; 100 2 x 2 coin envelopes, 25c. Coin Shop, 31 North Clark, Chicago 2.

FREE! Foreign coin, banknote and coin collectors illustrated catalog to approval service applicants. Send 3c postage. Tatham Coinco, Springfield 30, Mass.

GET Profit and pleasure in collecting old coins. Send 10c for 56 page illustrated coin catalog. You'll be delighted with it. Send for it now. B. Max Mehl, 370 Mehl Bldg., Fort Worth, Texas. Largest rare coin establishment in U. S. Established 50 years.

LARGE List of lots, sets and individuals with foreign set 10c. Globe, 3238 Orange, Chicago 34, Illinois.

SCARCE Lincoln pennies 1913S, 1914S, 1915S, 1915D, 1921S, 1923S, 1924S, 1926S, 1931D, 1932D, 1933D. 10c each. 11 for \$1.00. Reynolds Coins, Flint 13, Mich.

ILLUSTRATED Coin collecting information folder 3c. Hewitt, 5450-J Clark, Chicago 40.

FORTY Different coins, \$1.00. 100 different bills, \$1.00. 70 coins, bills, \$1.00. Oddehon, Box 482, St. Louis, Mo.

JAPANESE Invasion notes. 1c to \$1,000.00, \$2.00. Burma note and catalogue 25c. Shultz, Salt Lake City 10, Utah.

COINS Wanted, will pay up to \$2000 for certain coins, send 25c for catalogue. Burton's, 111 So. Third, Columbus, Ohio.

\$10.00 EACH For certain Lincoln pennies, Indianheads \$50.00. Send dime for catalogue listing prices paid. Lincoln Coin Company, Elkhart 29, Indiana.

WANTED 1894-S Dime, pay \$500.00. Certain 1913 nickel \$1,000.00, 1901-S quarter \$10.00—\$150.00, hundreds of others. Complete catalogue 25c. Worthy Coin Corporation, D-317, Boston 8, Massachusetts.

CONFEDERATE Facsimile plate proof. 3c stamp. Aries, 453 Utah Street, San Francisco, California.

BIG \$2 Bill \$2.75. Giant bargain catalogue 25c. Buying list 10c. Bebee's, 1180 East 63rd, Chicago 37, Illinois.

LARGE 48 Page illustrated book showing prices we pay for all U.S. coins—Only 50c. Held, 372 Dodge, Buffalo 8, N. Y.

COIN Collector's new magazine, just out, and two wooden nickels, 10c. Lawrence Brothers, Anamosa, Iowa.

STAMP COLLECTING

AMAZING Offer! 500 United States stamps—including commemoratives, airmails, high values to \$5.00. Only 10c to approval applicants! Illustrated bargain lists free. Mystic Stamp Co., Dept. 80, Camden, New York.

FIRST U. S. (1847) government reissues 5c, 10c, plus giant bargain U. S. collection—only 5c to applicants U. S. approvals. Metropolitan, Box 312G, Jackson Heights, N. Y.

BARGAIN! Assortment triangles, Borneo, Cook Islands, Swaziland, Mauritius, 10 African pictorials and souvenir. Everything 10c with approvals. Eckman, 2852 S. W. 37 Ct., Miami, Florida.

10 ASSORTED U. S. Commemorative 15c. Five U. S. Air Mail 15c. 10 Famous Americans 25c. All for 50c. Ideal Stamp

WOW! 203 All different Germany 10c! Zeppelins, semipostals, airmails, high values, etc. to new customers. Jamestown Stamp, Jamestown 512, New York.

UNITED States approvals complete coverage, fine quality, attractive prices. Seminole Stamps, Box 1138-P, Coral Gables, Florida.

FIFTEEN Different old U. S. sent for 10c to approval applicants. Donald Bruner, 832-D Union Street, Lancaster, Penna.

FREE! Big worldwide collection! Commemoratives, high values, etc. Approvals, Concord, Box 23-D, Beeville, Texas.

100 LARGER U. S. commemoratives, used, all different, mounted, numbered; fine or better; \$1.50 postpaid by air. Jess T. Green, P.O. Box 698, Mountain View, California.

10,000 PENNY Approvals waiting for you. Many from exotic countries, pictorials, airmails, new issues. Tilbury, Box 862, Newark 1, N. J.

WORLD'S Largest stamp (7 1/2 x 14 inches). A real curiosity! Retail for 50c, only 3c to approval applicants. Tatham Stamp Co., Springfield 30, Mass.

FREE—Complete set of famous Americans, flags, parks and presidentials to approval buyers. Send 3c for 15 of the above stamps, plus full particulars. Triboro Stamp Company, 145 Nassau Street, Dept. 105, New York 38, N. Y.

FREE! International stamps—Approvals. One pound U. S. mixtures 60c; two pounds \$1.00; five pounds \$2.00. Superior, 6908 Zoeter, Cleveland 3, Ohio.

FREE Collection—Over 100 different stamps of the world—commemoratives, she-wolf, camels, giraffes, ships, rare Austria race horse, others all to approval buyers; also Scott International Albums, stamp catalogs, Bell Stamp Service, Dept. S-2, Bell, California.

GIGANTIC! Wonderful! Penny approvals! Sensational bargains cataloging to \$1.00! Commemoratives, pictorials, airmails! Free lists! Premiums! Waynesco, Box 7008, Long Beach, California.

JUST Arrived from France all diff. 300 France \$2.00; 200, \$1.00; 150, 60c. 300 French colonies \$2.00; 200, \$1.00; 100, 60c. Crone, 592 Prospect Pl., Brooklyn 16, N. Y.

TRY "Gold Nugget" approvals: U. S., Americas, British Colonies, world. Nothing like them! 312 mixed U. S. only 10c to approval applicants. Kessel's, Folsom, California.

WONDERFUL Offer. 7 complete mint sets Manchukuo, Bohemia, etc., only 10c with approvals. Reich Stamp Co., 4647 Kenmore, Chicago 40, Illinois, Dept. M23.

GIANT Approvals book 500 penny stamps, 40 stamps 1 1/2c up. 5 sets. Wahl's Stamp Exchange, 7008P Farragut, Chicago 31, Ill.

FREE Albums, catalogues, stamps, etc., to our customers. Ask for details and selection of approvals. Prices, stamps, and service that satisfy mounted in books and sheets—priced from 1/10 to 1/2 catalogue. References appreciated. Roseland Stamp Co., Dept. 10, Spring Lake, Michigan.

PAYING High prices for approvals? If your collection numbers under 15,000 try our 1c and 2c approvals. In books of 1000 different. Lots to choose from at lowest prices. Also special offer to customers. Clark, Box 544-P, Muskegon, Michigan.

FINE Approvals. Fast, personal service. What countries do you prefer? I'll send their stamps. Skinner, 438 Locust, Long Beach 12, California.

SPECIAL: 25 Pakistan, British Commonwealth, all different, your collection won't have them yet. 10c. Approvals, Impex, Box 134F, Jackson Heights, N. Y.

BELIEVE It or not: 25 different British, West Indies stamps are yours for the asking. Beautiful pictorials, 19th and 20th century, including free monthly magazine. Send only 5c for postage. Empire Stamp Company, Dept. PM, Toronto 5, Canada.

ABSOLUTELY Free—Gilbert Ellice, Cook Islands, Tonga, Seychelles, Ascensions. Free to approval applicants. Viking, 130-Z Clinton St., Brooklyn, N. Y.

UNUSUAL—Unheard of. Cancelled sets of Roosevelts and Washington bicentennials complete. All yours for fifteen cents. Bargain approvals accompanying. Park Stamp Co., Box 191, New York 21, N. Y.

FREE. Scott's International Album. Other big premiums. Full particulars with approvals. Raymax, 123-Z William St., New York City 7.

STAMPS Wanted. Collections, duplicates, surplus stock, mint and used. Trade for printing; buy outright if bargain. What have you, what's wanted. Vanroy Shirk, Liberty, N. Y.

UNITED States stamps nearly 100 years old. Roosevelt set, others, 40c value—only 5c to applicants United States approvals. Wakonda, Box 272K, Jackson Heights, N. Y.

500 STAMPS For only 10c! This mammoth value includes airmails, pictorials; stamps from strange countries, cataloging up to 25c each! Also approvals. Mystic Stamp Company, Camden 80, New York.

COLUMBIANS, Trans-Mississippi, Pan Americans, Pan Pacific, ten other different commemoratives. All 10c with your request for U. S. approvals. Moda Stamps, Box 251-X, C.S.A., New York 8.

MAGNIFIER, Big stamp magazine; first U. S. commemorative; plus unused \$5000 Foreign Legion, diamond, giant, and other worthwhile stamps. Everything free to approval buyers. Capital Stamp Company, Little Rock 2, Arkansas.

FREE! Powerful magnifying glass. Jamestown Stamp, Jamestown 202, New York.

200 DIFFERENT Including Roosevelt triangle, 5c to approval applicants. M. Avalon Stamp Company, Springfield, Mass.

UNITED States bargain catalog and approvals. Sullivan, Endicott Arcade, St. Paul 1, Minnesota.

PAY Less, buy more, books of 1,000 at 1c and 2c each. Very good fillers. Attractive stamps. Adults only. Daniel Grave-line, 14702 Troester, Detroit, Michigan.

OVER 1,000,000 Sold; 200 different stamps 10c with approvals. Carlton's, Tujunga, Calif.

U. S. Complete price list free. Lush, 47 Tyler, Detroit 3, Mich.

NEWEST Issues, world-wide approvals. McQuesten, 185 Puritan, Highland Park 3, Mich.

FREE! Surprise packet. Penny approvals. Pioneer, Box 414, Pasadena 18, Calif.

POUND Stamps containing thousands \$1.00. Longacre Shop, 108 West 42nd, New York 18.

500 EXOTIC Japan stamps—10c. Kenmore, Richford, J-57, Vermont.

750 FRANCE and colonies stamps 10c. Littleton Stamp Co., Littleton 25, N. H.

FREE! 100 Worldwide different stamps to approval buyers. Big U. S. and illustrated bargain lists sent with approvals. Bookman, Maplewood, N. J.

FREE! Big United States catalog! Invaluable guide and check list. Hundreds of illustrations. Harrisco, Boston 17-W, Mass.

NORTH Borneo, 25 different postwar \$1.00; 15 Brunei \$1.00; 25 Sarawak \$1.00. Douglas Voon, Sandakan, North Borneo.

25 FOREIGN Or U.S.A. covers—\$1.00. Doctor Feinerman, Macomb, Illinois.

1000 DIFFERENT \$1.00. Approval applicants only. Schmitt, 730 South Jackson, Green Bay 3, Wisconsin.

FIFTY Canadian and Newfoundland 10c. Approvals. Reede, 18 Toronto, Toronto.

CANADA 1950 Scarce error set 10c, attractive approvals. Rheuma, 6591 11th Ave., Montreal 36, Canada.

SPECTACULAR Tustara lizard plus U.P.U. plus 30 others only 10c. Lou Allmendinger, 709 Dover, Philadelphia 31, Penna.

BEAUTIFULLY Illustrated U. S. catalog 10c refundable. 528 Chester-ninth Building, Cleveland, Ohio.

FREE! Big 36 page illustrated catalog of stamps, albums, packets, supplies! Ewing-Stamps, 109 N. Dearborn, Chicago 2.

LOOK! Haiti set 8 stamps picturing George Washington, etc., Grenada shilling stamp picturing boat, with approvals, all for 3c. E. Moublow, 740 Hegney, Bronx 56, N. Y.

50,000 STAMP Grabbags 25c each. Anderson, 630B, Bingaman, Reading, Penna.

U. S. Price list. Send postage. State Stamp Service, 1225 Park Building, Pittsburgh 22, Penna.

TOPS! Our book "How To Collect Stamps." Send for your free copy today! Littleton Stamp Co., Littleton 37, N. H.

FREE! Big illustrated catalog listing everything for the stamp collector. Harrisco, 202 Transit Bldg., Boston 17, Mass.

LAURELBILT World selections—All excitingly different. 555, 55c; 1111, \$1.11. Long Beach Stamp Company, Long Beach, New York.

"HOW To Recognize Rare Stamps." Free book illustrated! Kenmore, Richford, H-57, Vermont.

MINT (Unused) U.S. approvals. Patrick Agencies, 3650F Central, Indianapolis 5.

FREE U. S. price list, postage 3c. Mark Hanna, 335 5th Ave., Pittsburgh 22, Penna.

LOOKING For better U. S. on approval? Write New-Way Stamp, Lawrence, Mass.

SPORTS Set plus four others 5c. Approvals. Wirth, Norwichtown, Conn.

PENNY Approval bargains. Write Department PM, 1267 Tutwiler, Memphis 7, Tennessee.

"GOYA Nude" set complete 50c. (Catalogs \$1.55.) Approvals. Royal Stamp Company, Tamaqua, Penna.

TERRIFIC Approvals. Free gifts. Hutchinson's, 3463 "I" Street, Philadelphia 34, Penna.

FREE—Cuba Roosevelt issue and illustrated catalog. Littleton Stamps, Littleton 12, N. H.

OLD Scarce U. S. seconds on approval. Slightly defective. Bargain prices. Hernefield, Clintonhill Station, Newark 8, N. J.

GIFT Nicaragua baseball airmails, 5 to approval applicants. Deane Stamps, Box 87, Miami 35, Florida.

50 BRITISH, French, Italian colonies only 15c. Aladdin, 3625 St. Paul, Denver 5, Colorado.

FREE! Chinese "midget" war set. Approvals included. Seminole, Leeds, Alabama.

300 DIFFERENT Given free with approvals. Postage 3c. Windsor Stamps, 1435 East 67th Place, Chicago 37.

BEST U. S. stamp mixture, 1/2 commems, 700 for \$1.00. C. Ritchie, Watertown, So. Dak.

FREE—Illustrated catalog! Kenmore, Richford, C-57, Vermont.

COMPLETE Army Navy set only 10c with United States approvals. Locust Stamp Co., Box 390T, Peekskill, N. Y.

FREE—Pan-American packet! Approvals 40% catalog! Box 326A, Passaic, N. J.

STAMP World. Six months 25c. Sample free. Box 1147, Chicago.

TRIANGLES!—Six dazzling bicolored beauties depicting ferocious beasts, gorgeous tropical birds, antelopes—10c with tempting foreign approvals. Atlas, 3210-T Republic, Racine, Wisconsin.

FREE—Complete U. S. list (commemoratives, airmails, etc). Breck, 10516 Clifton Boulevard, Cleveland 2, Ohio.

FREE \$1, \$2, \$5 U. S. stamps with U. S. used approvals. Glades, Box 2842-M, Miami 18, Florida.

10 U. S. Commemoratives, used. Given to approval applicants. Rossom, 218 West 59th Street, Chicago 21, Illinois.

FREE! 25 Different Switzerland, with well approvals. Kardell, 209 Bower, Santa Fe, New Mexico.

U. S. Catalogue free. Contains over 500 illustrations for stamps, albums, supplies. Stoney, X-52, Dorchester 24, Mass.

QUALITY Approvals, U. S. price list free. Lash, 196 Morris Avenue, Denville, New Jersey.

500 DIFFERENT! With approvals—25c! Gateway Stamps, Box 662, LaCrosse, Wisconsin.

FREE 10 Japan war stamps. Approvals. Schroeder, 636 Charles, St. Paul 4, Minn.

FREE Supply list. Penny approvals on request. Reed, Box 980, Chicago 90, Illinois.

307 ALL Different—Only 15c! Beautiful collection: commemoratives, triangles, high values, bicolored stamps, etc. Garcelon, Calais 400, Maine.

MOZAMBIQUE Triangulars, unused set 10c with approvals. Vargo Stamps, 6044 South Fairfield, Chicago 29, Illinois.

STAMP Magazine! Copy free! "Stamp Post," South Catalina, Pasadena, Calif.

205 AUSTRIA—All different only 10c! Beautiful commemoratives, pictorials, airmails, high values. Catalog price nearly \$6.00! Approvals included. Garcelon, Calais 111, Maine.

WOW! 500 Foreign stamps plus surprise set, 10c with approvals. Stearns, 1249-B Griswold, Detroit 26, Michigan.

BARGAIN Borneo, Norfolk, largest stamp. Virgins, Iceland, old U. S. 100 different others, everything 10c with approvals. Satra, Valentine, Nebr.

1/2c-1c APPROVALS! 12,000 Bargains! Cole, 43-A Rinewalt, Buffalo 21, N. Y.

40 RUSSIA—All different, only 10c with dandy approvals! Sapphire, Box 44, Times Square Station, New York 18.

MARCH 1951

100 DIFFERENT Free, 10% discount on all approvals. Hofstra Stamps, West Midway, Mass.

GIGANTIC Slave stamp! Nude! Bicolored triangles! Diamonds! 10c with colorful foreign approvals. "Paris," 1819-s Woodland, Racine, Wisconsin.

WORLDWIDE Stamps. All different. 200, 25c; 500, 50c; 1000, \$1.00; 2000, \$2.50; 5000, \$12.50. Beacon Sales, Maynard, Massachusetts.

FLAG Stamp—Free with hygrade U. S. approvals. Wigman, 1933 Patterson, Chicago 13.

GOOD Values, unique premiums, U. S. approvals. Jarr, 309 Taft, Riveredge, N. J.

100 WORLD 10c. 1/4c Approvals. Page-wood, 1355-P No. Dearborn, Chicago 10, Ill.

WORLD. All different. 1000, \$1.00; 3000, \$5.50; 5000, \$12.25. Air mails. All different. 200, \$2.80; 300, \$4.50; 500, \$11.50. Hale Stamps, 7609 Grand, Minneapolis 19, Minnesota.

ZOUNDS! Amazing "queer countries" packet—Free with approvals! Saxon, Vista, California.

14 ROOSEVELT Memorials 10c! Interesting approvals. Robert Wilks, Beverly, Mass.

SWASTIKAS—Complete mint set, 10c. Approvals. Curtis Billingslea, Gilmer, Texas.

START Your own stamp business. Send for free circular. Donald Shepard, Box 1147, Chicago.

FREE "Stamp Finder." Tells instantly country to which any stamp belongs. 32 pages profusely illustrated. Garcelon, Calais 17, Maine.

FREE! \$10,000 Airmail! Philippines! Fezzan! Uruguay! Approvals. Keating, 637-P Bergen, Jersey City, New Jersey.

50 DIFFERENT U. S. 10c. No approvals. Seidenberg, 944, Appleton, Wis.

200 U. S. Commemoratives, old and new. \$1.00. Weatherby, Medina, Ohio.

SENSATIONAL! Set each Honduras, Martinique, Guadeloupe, Guiana, also \$2.-000,000 stamp, Brunei, over 100 different others. Everything 10c with approvals. Whitehead, 315P South 5th Ave., Canton, Illinois.

10 SCARCE Countries 10c. Afghanistan, Korea, Nedj, etc: Approvals. Chase, 152 Court St., Portsmouth, N. H.

GERMANY B257-69, warplanes, destroyers, paratroopers, machinegunners; free with approvals. William Deems, Ravenswood, West Virginia.

FREE 20 Diff. Portugal, comm. to beginner and medium approval applicants. Stanley Zajac, 710 Shaw St., Toronto, Can.

FREE! 50 Different Japanese stamps! Approvals. Star Stamps, 225 Willard, Jamestown, New York.

FANTASTIC! 1/30th Catalog! Germany rare 1905 booklet pane cataloging \$7.50, only 25c! With approvals. Stampex, 116-G Nassau St., New York City.

GO Treasure hunting! Worldwide mission mix. About 1500 stamps. Many finds! Only \$1 postpaid. Special packet cat. \$1 free if prompt. Hanson Co., P.O. Box 6613, Portland 66, Ore.

10,000 DIFFERENT 1c Each! Gordon Davison, Box 1019S, Manchester, N. H.

110 DIFFERENT Hitlers, Roosevelt, Liberia, Haiti, etc. 10c. Buckley, 208 Ludlow Bldg., Dayton 2, Ohio.

WHOLE Mint sheet Germany (100 stamps) 10c with approvals. Lusk, Smiley, Sask., Canada.

FREE: 20 Precancels for return postage. Rev. Backore, Marion Center, Penna.

ANTIQUES, RELICS, INDIAN GOODS, CURIOS

INDIAN Relics, guns, books; thousands items; catalog 25c. Frontier Bookshop, 1813 Main, Houston, Texas.

4 FINE Ancient Indian arrowheads \$1.00. Extra fine tomahawk, \$2.00, list free. Lear's, Glenwood, Arkansas.

LADIES' Fine top grain leather beaded moccasins \$4.95. White, tan, or red. Without beads \$3.95. The Wigwag, Box 519, Flagstaff, Arizona.

SPEARHEAD, Arrowhead, birdpoint, stunner, scaler, knife, scraper, \$1.00. Catalog free. Nirscher's, 111 South 31st, Belleville, Illinois.

INDIAN Beadwork, buckskin, beads, feathers, moccasins, wigs, supplies; buying direct from Indians; prices reasonable; free list. Pawnee Bill's Indian Trading Post, Box 35-P, Pawnee, Okla.

ILLUSTRATED Catalog old guns, Indian relics, Indian-frontier books; old and new. 25c. Frontier Bookshop, 1813 Main, Houston, Texas.

PRECIOUS STONES, MINERALS

GEMSTONES, Mineral specimens. Every variety. Lowest prices. Postcard brings free booklet. Plummer's, 2183C Bacon, San Diego 7, California.

MINERAL — Treasure locators, Geiger counters. Superior performance, lowest prices. Payment plan available. Free literature. Fisher Research Lab., Inc., Palo Alto, California.

GENUINE Deep red Arizona rubies, garnets. Send quarter for packet. Bitner's, Box 724, Scottsdale, Arizona.

MINERAL Specimens, cutting material, slabs and gems. Send for free price list. Warren's Minerals and Gems, 1969 Abbott St., San Diego 7, Calif.

ROSE Quartz, jasper, agate and catalogue. Quarter. Gemco, Elkhart Lake, Wisconsin.

AGATES, Gems, free list. North West Gems, Box 305, Tacoma 1, Washington.

HOBBIES AND COLLECTIONS

START A profitable and fascinating hobby. Learn radio and television at home at a minimum cost. Send for full particulars. Receive free copy of Radio Troubleshooting guide. Progressive Electronics Co., 497 Union Ave., Dept. PM-300, Brooklyn 11, N. Y.

LEATHERCRAFT Supplies. Write for catalogue. Leather Products, Box 596, Sioux Falls, S. Dak.

FREE Catalogues. Handicrafts-Models. Magic-Jokes. Postage please. Fun, Vee-PM2, Avalon, California.

WANTED Cigarette, tobacco, cards. Write Charles Bray, East Bangor, Penna.

BUTTERFLIES Beautiful tropical; 25 specimens \$2.00. American Butterflyer, 3457 Park Heights Ave., Baltimore 15, Maryland.

INVENTING Can be an interesting and profitable hobby. Write for complete particulars. Institute of American Inventors, Dept. 40-E 631-E St. N.W., Washington 4, D. C.

NEW—15 Different match covers 10c. Box 202, Rochester 1, N. Y.

COLLECTORS Locomotive photographs, 1837 up. List free. Carl Smith, Concord, N. H.

UNUSED Matchbook covers—100 different \$1.00. Catalog 25c. Charles Edelman, 1311C East 84, Cleveland 3, Ohio.

CAMERAS, PHOTO SUPPLIES

"HOW To Sell Your Pictures and Make Big Money," plus bargain supply catalog 25c. Muir Photography Mart, Milford 2, Pennsylvania.

BASS Says: Trading cameras a national habit since 1910. Write to Bass the old "horse trader." A postcard will do. Simply say: "Bass, I have and I want. How much will you allow me?" It's fun to trade with Bass. Satisfaction guaranteed. Bass buys, sells, and trades. Bass Camera Company, Dept. AG., 179 W. Madison St., Chicago 2.

FREE Photographic bargain book packed with hundreds of sensational values in still and movie cameras, lenses and latest accessories. Super savings for you in new and used equipment. Liberal trade-in allowances, too, on your equipment. Write now for your free copy to Central Camera Company, Dept. 9B, 230 S. Wabash Ave., Chicago 4. (Photographic headquarters since 1899.)

ANSCO Camera construction kit. Complete, with lens, \$3.50. Guaranteed. Pittsburgh Photo Shop, Dept. PM-51, 1618 Westmont Avenue, Pittsburgh 10, Penna.

PHOTOMURALS. Your negatives or ours. Catalogue 25c. Photomammoth Murals, 12048 Vanowen St., North Hollywood, Calif.

PHOTOGRAPHY—Simplified Hollywood home study course, covers glamorizing, short cut methods, developing, printing, enlarging. Complete \$1.98. Make big money while learning. Bargain supply catalog 25c.

PHOTO FINISHING

FREE 5 x 7 Enlargement with each roll developed and printed. 6 or 8 picture roll 35c. 12 or 16 picture roll 55c. Send coin with roll. No c.o.d. If you fail to get pictures on your roll of film, we will mail a new roll to you at no additional cost. Overnight service. Mailed sent free on request. Deluxe Film Service, Box 1268-A, Shreveport, Louisiana.

16 PRINTS Or 8 jumbos from roll. 25c with this ad. S. Skrudland, River Grove, Ill.

ONLY 25c For 8 beautiful enlarged prints from your roll or negatives. (Trial offer). 16-50c. Quick service. Willard Studios, Box 3535A, Cleveland, Ohio.

FREE Album and 5x7 enlargement with every 8 exposure roll, developed and over-size printed, 35c. Caron Photo Service, Box 6399P, Chicago 80, Illinois.

OIL Coloring photographs can be a fascinating hobby or profitable sideline for those with artistic talent. Learn at home. Easy simplified method. Send for free booklet. National Photo Coloring School, 835 Diversey Parkway, Dept. 3441, Chicago 14, Illinois.

MAIL Us your films. Prompt service. 8 exposures developed and printed 30c. Free enlargements. Foto Art Studio, Box 406, San Francisco, Calif.

FREE Price list on quality developing, printing, enlarging. Write for it today. Bryan's Photo Shop, Dept. M, Panama City, Florida.

MOTION PICTURES AND SOUND EQUIPMENT

BASS Says: Leadership since 1910 guarantees satisfaction. Finest Cine equipment: 8mm., 16mm., and 35mm., silent and sound. Write the old "horse trader." Satisfaction or your money back always! Bass Camera Company, Dept. A, 179 W. Madison St., Chicago 2.

NEW 1 Reel 16mm. sound films low as \$3.98, formerly \$17.50; new 1-reel 16mm. silents, \$1.98 up, formerly \$8.75—all first quality prints in original cartons. Used Panoram 100' 16mm. musicals, \$9.95 per dozen. Equally attractive bargains in good used feature pictures, cartoons, sports, comedies, musicals, travels. The biggest stock of 16mm. films in the world—over 100,000 prints on hand! Write today for new free catalog. "Sixteen's Super Market." Blackhawk Films Inc., 405 Grampp Building, Davenport, Iowa.

THE World's greatest story. "Entire Life of Christ;" 8mm., 16mm. Sound and silent. Rent or purchase. Hemenway Film, 33 F. Melrose Street, Boston 16, Mass.

FILMS And equipment exchanged or bought for cash. Sound, silent. Bargains. Lists free. Frank Lane, Little Bldg., Boston, Mass.

RENT 16MM. sound films, 50c reel. Large selection; free catalog. Film Service, 128 Chestnut St., Roselle Park, N. J.

LEARN Professional motion picture technique at home. Free catalog. Motion Picture Institute, Birmingham 4, Mich.

GUARANTEED Fresh 8mm. roll, magazine; 16mm. roll, magazine movie films. Color, b&w. Free catalog. ESO-S, 47th Holly, Kansas City 2, Missouri.

MOVIE Camera film: 8mm. roll \$1.50, 16mm. 100' \$3.00. Free processing. Better Films, 742 New Lots, Brooklyn, N. Y.

50% OFF. Brand new films, \$5.50 8mm. now 2 for \$5.50. \$8.75 16mm. now 2 for \$8.75. Other bargains. Send for list. Stark-Films, Baltimore 1, Md., Dept. PM.

1000' 16MM. Silent-sound projection film \$7.50. International, 2120 Strauss, Brooklyn 12, N. Y.

EXCLUSIVE Films, all types. Mammoth bargain catalog, largest ever compiled, sample film, 10c. Frontier, 6411-F Hollywood Blvd., Los Angeles 28, Calif.

"CINE-VOICE" Sound-on-film camera shoots your own 16mm. color talking pictures. \$695. Write for free illustrated folder. Berndt-Bach, Inc., 7345 Beverly Blvd., Hollywood 36, California.

FREE Movies "Hundreds of Subjects." Interesting. Entertaining, fascinating. Latest directory only 50c. National Cine Society, 126 Lexington Ave., Dept. A, New York 16, N. Y.

300 PROJECTS You can make in Popular Mechanics 32 page Blueprint Catalog. Send 3c stamp for copy. Popular Mechanics Press, Dept. BP, 200 E. Ontario St.,

MUSIC AND MUSICAL INSTRUMENTS

ACCORDIONS — All brands. New and used. Save 50%. Wholesale to every one. Del Principe, 307 So. Wabash, Chicago, Ill.

WHOLESALE—Popular used jukebox records, \$15.00—100. No catalog. Milners, 204 Griffin St., Atlanta, Ga.

PLAY The piano, guitar, and ukulele by ear. Instructions \$1. La Monte, 533 East Princeton Circle, Fullerton, Calif.

1951 ACCORDIONS — Wholesale. Free catalog. American Accordion Center, 5329 Belmont, Chicago.

SONGWRITERS! Send poems, songs. Music Service, 243 West 72nd St., PM, New York 23.

YOUR Voice made loud, clear and powerful with my diaphragm exerciser. Write, Inventor "Oz," 34V, Box 665, St. Louis, Mo.

POEMS Wanted for musical setting. Send poems for free examination. Five Star Music Masters, 630 Beacon Bldg., Boston, Mass.

POEMS Wanted to be set to music. Free examination. Send poems. McNeil, Master of Music, 510-PM S. Alexandria, Los Angeles, California.

WANTED! Poems for musical settings. Write Songwriters' Service, Clifton, N. J.

WRITE Songs. Big money and reputation. Write for information. J. Gordon Pub. Co., 4700 South California Avenue, Chicago.

POEMS Wanted. Broadcast consideration. Sooner Song Co., 22 PM North West 8th, Oklahoma City 2.

WANTED: Saxophones, clarinets, musical instruments. Highest prices paid. Miller's Sport Shop, Dept. P, 142 North 8th Street, Philadelphia 7, Penna.

WRITE Songs easily! "500 Original Song Titles"—35c. Information free. Hoffs, 42 Hinsdale Street, Brooklyn 7, New York.

PLAY Piano! Easy self-way to learn. Beginners book. Advanced book teaches chords, rhythm, bass. Only \$2. Both \$3. Moreau Studios, Dept. M, 139 Mathewson St., Providence 3, R. I.

PHONOGRAPH Records cheap. Catalogue. Paramount, FQ-313 East Market, Wilkes-Barre, Penna.

ELECTRIC Guitars, amplifiers, save 50%. Free literature. Carvin PM, Baldwin Park, Calif.

MUSIC Arranged. Songs printed. Frank Wildt, Music Publisher, Lancaster, Penna.

POPULAR Piano lessons by mail. Beginners; advanced. Play songs or money back. Free details. Stuart Piano Studio, 1227A Morris Ave., Union, N. J.

"**SONGWRITING**, Selling Secrets," \$1 postpaid, guaranteed. Sherwin, (Ascap), Mill Valley 339, California.

RADIO AND TELEVISION

BUILD 15 Radios at home, only \$1.30 each. Experience unnecessary. Home radio course includes trouble-shooting and servicing, lessons, quizzes, and all parts and instructions. Nothing else to buy. Earn money doing radio and television repairs while learning. Prepare for profitable future. Free trouble-shooting tester with each course. Send for full particulars and receive absolutely free a copy of the Progressive Trouble-Shooting Guide. Progressive Electronics Co., 497 Union Ave., Dept. FM-20, Brooklyn 11, N. Y.

FREE—Send for new 1951 Buyer's Guide. Has thousands of top values in television, radio, electronic supplies. Concord Radio Corp., Dept. LC-51, 901 W. Jackson, Chicago 7, Illinois.

MAKE Simple, tubeless, batteryless, distance-getting crystal radios. Crystal and illustrated instructions 25c postpaid. Allen, 427-P, Clinton, Mo.

PICTORIAL Construction diagrams. List 3c. Arthur Alena, 21-15 35th Avenue, Astoria 6, New York.

RADIO And television tubes. We have all numbers. They're all new at good discounts. Write us for your needs. Immediate response. Beacon Stores, Inc., Anderson Avenue, Grantwood, New Jersey.

FREE! 212 Page radio and television catalog! World's largest stocks, lowest prices. Complete supplies for builders, experimenters, amateurs, servicemen. Latest radios, phonos, television, recorders, sound equipment. Thousands of parts, tubes, test instruments, books, diagrams. Top quality money saving values. Get it now! Allied Radio Corp., 833 W. Jackson Blvd.

RADIO, TV, Electronics, Radar, Day and evening classes. App. for vets. Also photosound home training for FCC radio-fone and radiotelephone license, also amateur license. (Recordings sent students no ex. cost.) Electronic Tech. Institute, Dept. PMC, 769 Venice Blvd., Los Angeles 15, Calif.

BUSINESS OPPORTUNITIES

BOOKKEEPERS Earn \$100.00 weekly operating simplified "bookkeeping and tax service." Details free. Universal Bookkeeping, Box 664-M, Springfield, Missouri.

START Home manufacturing business making cleaning compounds, soaps, insecticides, cosmetics, polishes, food flavors. No machinery. Literature free. Kemix, Park Ridge 3, Ill.

HOW And where to obtain capital. Small and large loans. Free particulars. Star Service, Wapekoneta, Ohio.

UNPAINTED Bookends, plaques, statues, figurines. List. Haverty Products, 822-17th St., Altoona, Penna.

MIRROR Resilvering. Wonderful home business. Complete formula 25c. Magic two-way mirrors. You can see out—no one can look in. Formula 50c. How to make coppered mirrors, vases, glasses. Formula 50c. All three \$1.00. Nelko Chemical Service, Box 3462-MC, Chicago 54, Ill.

SPIN Angora wool into yarn. Interesting work. House of Angora, PM, Springfield, Illinois.

PUBLISH Your own magazine for as little as 50c per issue. Sample copy, details, 10c. Junior Maness (P.M.), East Rockingham, N. C.

BOOKKEEPERS Be independent operating our simplified system. Dominion, 74 Sparks, Ottawa, Canada.

VENDING Machines earn big money! An investment as low as \$10.50 will start you in this fascinating, profitable business that can lead you to the road of success and independence. Routes can be established and operated in either full or spare time with no experience needed. Write for full details and our free catalog illustrating our nut, candy, gum and stamp vendors; also pin ball machines, music boxes, etc. Write immediately to Parkway Machine Corporation, Dept. 7, 715 Ensor Street, Baltimore 2, Maryland.

MINIATURE Golf, establish highly profitable money making business. Free literature. Dixieland, 2924 Douglass, Memphis, Tenn.

NATURAL Molding Latex. Extra thick. Free sample. W. Wooley, 115-A Donald, Peoria, Ill.

SAND And finish 6" maple salad bowls for profit. Cost 40c, sell for \$1.00. Ottawa Woodcraft, Grand Haven, Mich.

BEST Source for nylons. Rich Supply, 215 W. 98, New York 25.

NEW Profitable home business repairing zippers. Thousands of customers waiting. No experience required. We furnish everything. Write Texas Specialty Company, 204-B Texas, Texarkana, Texas.

FORTUNES Made from sandwiches. New system. Equipment furnished. Dickerson Manufacturing, Drawer 30-A, Springfield, Missouri.

24 ASSORTED Small unpainted figurines, \$1.59 postpaid. Illustrated figurine list free. Oman, 642M Broadway, St. Paul 1, Minn.

EARTHWORM Breeding. Valuable bulletins on successful methods mailed free. Earthmaster System, Dept. 14, El Monte, Calif.

YOUR Own profitable home business. Preserve live flowers to last for years. New simple discovery. Enormous demand all year 'round. Tremendous profits! Light fascinating work. Send \$2.00 for working equipment, instructions, and valuable sales plans. Satisfaction guaranteed or money promptly refunded. Alfred Hermansen, 210 Fifth Ave., Suite 1102A, New York 10, N. Y.

BUY Wholesale—Million articles. Supply source directory, dime. Nelko, Box 3462-DC, Chicago 54, Ill.

MAKE Flexible molds! Cast plaques, bookends, figurines! Free sample! H. Tooker, 630-R Chestnut, Hamilton, Ohio.

WANTED! Home producers by manufacturers in our clearing house service. Become a sub-contractor, casting plastic products for these companies. Thousands of easy to make items required. Cash in at home without previous experience. For details write Plastic Service Guild Dept.

SELL Our waterproofings, floor mastic, cement hardener, etc. (30 items) to maintenance men, building owners, contractors. Can start part time. Commission. Territory. Write Haynes Products Co., Desk 6, Omaha 3, Nebr.

OPERATE Profitable mailorder business. Particulars free. George Lenhoff, Lincoln 8, Nebraska.

EARN \$5 Hour full, spare time, tuning, repairing pianos. Tools, easy home instructions furnished. Information free. Empire School, 602 University, Champaign, Illinois.

MAKE Money spare or full time, casting metal toys and novelties. Big wholesale and chain store demand for cast metal autos, soldiers, ashtrays, banks, etc. Keeps manufacturers busy. Production molds furnished for up to 100 and more castings per hour. No experience or special place necessary. Write for information and illustrations of patterns needed. Metal Cast Products Co., Dept. A, 1696 Boston Road, New York 60, N. Y.

TRADE Magazines help you to success. Get latest copies through our easy-to-get-acquainted service. More than 1200 business, professional, agricultural, automotive, educational, sport, hobby, music, television, etc. List free. Commercial Engraving Publishing Co., 34C North Ritter, Indianapolis 19, Indiana.

COLOR Concrete with chemicals. Marble-glaze cement benches, pottery, garden ornaments. Home—shop. 10c brings sample, pictures. Hollywood Cementcraft, 8527-R Wonderland, Hollywood 46, Calif.

BOOKKEEPERS Boost income operating simplified bookkeeping service. Kern, 4942 Vineland Avenue, North Hollywood, California.

START Mailorder bookshop — Everything furnished. 25c brings booklet, samples, exciting ideas. General Publications, Ossining, N. Y.

EXTRA Money. No selling; operate vendors. Amazing profits, details free. Silver King, Suite B, 622 Diversey, Chicago 14.

THOUSAND Articles wholesale, "Supply Source Directory" 10c. Ideal Service, Park Ridge 30, Illinois.

BE Appointed state notary public now! Details. Stationers, Helotes 50, Texas.

OPERATE Profitable mail order business. Write Walter Service, 4159-A East 112th, Cleveland 5, Ohio.

A Business in your own home! Our chemicals, plus free water and cheap "grocery store" materials can bring you over \$500 monthly earnings. Plans and formulas free. Western Aircraft, Dept. B, Los Angeles 19.

IMPORT, Export! Men, women. Learn from established world trader. Your own profitable world-wide business by mail order from home without capital; or travel abroad. Experience unnecessary. Free details. Mellinger, C-5, Los Angeles 24.

MAKE Money at home as renewal headquarters for all magazines. Liberal commissions. No experience — no capital needed. Supplies furnished. Write for free catalog. McGregor Magazine Agency, Dept. 500B, Mount Morris, Ill.

\$5 HOUR Easy! Sell name plates for houses. Free sample, order blanks. Write: National, 214 Summer, Boston, Mass.

SELL By mail; free booklet, instructions. Manhattan House, PO Box 50-M, New York 28, N. Y.

MAKE Perfume. Catalogue free. International, 6347 Parnell-PM-3, Chicago 21, Illinois.

MAKE Tough, durable plastic—1c pound. Makes attractive floors, walls, built-ins, roofs. Build good home, \$150.00 room. Bays Laboratory, Oklahoma City 9.

EARN Money at home. Sample 25c, tells how. Mail Order News, 1041 S. Garfield, Alhambra, California.

SPECIAL Rubber for making molds. Literature and sample free. Universal, Box 1076-A, Peoria, Ill.

START New easy moneymaking home business. No selling. Details 10c. Southwest, 1309A North Princeton, Albuquerque, New Mexico.

LIVE, Work, play in sunny Florida. Job, business opportunities galore. Details free. Bulletin, Box 182, Gilman, Vermont.

SAWDUST. Turn it into cash. Six methods. Instructions 25c. Charles Co., 12-BWF, Norwood, Ohio.

HUNDREDS Of mail local opportunities. Clinton Sales, 88 Weaver, Buffalo 6, N. Y.

TO \$35.00 Weekly. Spare time, home operated mail order business. Successful small "beginner's" plan. Everything supplied. Lynn, 5710-M Bankfield, Culver City, California.

START Home manufacturing business. Formula catalog free. June, 101-M Beech, Holyoke, Mass.

MAIL Order opportunities galore. Sanchez, Box 66-P, Chelsea Station, New York 11.

TIN-CANS. Turn them into cash. Nine methods. Instructions 50c. Charles Co., 12-BWG, Norwood, Ohio.

WORK At home. Get orders by mail. Everything supplied at low cost. Big earning possibilities. Write: Edmondson, Box 4865-P, Atlanta 2, Ga.

MAILORDER Business. Free details. Mailorder magazine 25c. Filey, 3519 Charles, Cincinnati 8, Ohio.

DOLLARS In personalized baby record books. Sell by mail. Use same literature we do. No-Co-Ro, Oakland 6, Calif.

MAKE Rubber stamps, metalize baby shoes, repair dolls, silver mirrors, make beautiful figurines. Catalogue of "30 ideas" free! Universal, Box 1076-A, Peoria, Ill.

SOURCES 1,000,000 Items wholesale. Details free. Cottage Industries, Omaha 12, Nebr.

LEARN Professional candy making profitable home business. Details free. Pate, Kissimmee, Florida.

START Your own business on credit. Always your own boss. 1559 dealers sold \$5,000 to \$28,000 in 1949; their average \$6,834. We supply stocks, equipment on credit. 200 home necessities. Selling experience unnecessary to start. Wonderful opportunity to own pleasant profitable business backed by world-wide industry. Write Rawleigh's, Dept. CU-PPM, Freeport, Ill.

BIG Money! Spare or full time in your home. No selling! Spray new miracle finishes, plush and suede, on signs, radios, automobiles, figurines, lamps, toys, etc. Our business is booming. Help us fill huge demand. New easy Flok-Kraft methods. Material costs few pennies. You get dollars. Free samples, complete powerful money-making plan free. Write now! Coast, 1002D S. Los Angeles St., Los Angeles 15, Calif.

COMMERCIAL Deep frying course. Mock chicken legs, potatoes. New and proven methods. Learn about this money-making field. \$2.50 p.p. Concession, Toledo 13, Ohio.

FABULOUS Earnings—Fascinating pastime. Growing genuine, living miniature (ming) tree. New sensational business or hobby. Astounding information free. Dwarf Gardens, Box 355B, Briggs Station, Los Angeles 48, Calif.

137 WAYS To make money, in home or office, business of your own. Full particulars free. Elite Co., 220 Grand St., New York 13.

BE Independent—Operate America's lowest price penny vending machine. Big profits. Immediate shipments. Write for bulletin and prices. Fielding Mfg. Co., Desk 30, Jackson, Mich.

BRUSH Plating outfits connect to a battery. No tanks necessary. Good paying business at home plating autoparts, bathroom fixtures, bicycles, reflectors, silvering mirrors. No shop or experience required. Outfits furnished. Free booklet. Gunmetal Co., Ave. H, Decatur, Ill.

CASH For your idea, 280 manufacturers need inventions, patented or unpatented. List free. Invention Bureau, 208-M Clinton, Oak Park, Ill.

OWN A printing business. Good profit printing cards, stationery, etc. in spare time. Easy rules furnished. Have home shop. Send dime for complete printer's supply book and samples. Kelsey, Inc., Z-24, Meriden, Conn.

\$25 WEEKLY Working two hours daily. No canvassing. No manufacturing. Lycke, Box 2471-A, Cleveland 12, Ohio.

RECAST Old batteries into new. Latest achievements. Battery Laboratories, Minneapolis.

MADE \$24,500 Using money making plans from Schemer Magazine, world's oldest mailorder publication. Box 275M, Canfield, Ohio. Year \$2.00. Sample 20c.

MINK Raising information free. Complete. Lake Superior Mink Farm. Superior, EE1, Wisconsin.

POPCORN And potato chip equipment. Long Eakins Company, 5160 High, Springfield 99, Ohio.

COPUBLISH Leading m.o. paper. Latest copy Mail Sale Advertiser, details, dime. Vanroy Shirk, Lebanon, Penna.

READ "Advance"—The voice of mail order. Offers money-making opportunities, sources of supply, personal guidance, etc. Issued monthly. Sample copy 25c. Yearly subscription \$2.00. Advance Publishing Company, 313 East 21st Street, Suite 450, New York 10, N. Y.

CO-PUBLISH And advertise in The Central Mail Advertiser. Sample copy 10c. Low rates. Large circulation. Bagby Printing Co., Georgetown, Ohio.

\$10 HOUR! Complete invisible rewearing course, everlasting equipment and supplies \$2. Details free. Walsh, 894 Main, Buffalo 2, N. Y.

EXCEPTIONALLY Profitable making finest perfumes. Sample fragrance, full particulars free. Genmerco, Box 142-L, Dorchester 24, Mass.

NEW Exceptionally profitable plans—ideas for home operated mail business. Rush name. Miller, 1772-P Carlyon Road, East Cleveland 12, Ohio.

MAKE Money at home—Ideas galore to choose from. All fully illustrated and described. Write: Spens Distributors, Box 5511-M, Chicago 7, Ill.

ESTABLISH Profitable home mail business with your exclusive proposition. Idea to mailbox service. Booklet free. NMD Agency, Box 88-W, Dorchester 22, Mass.

FREE Inside information. 101 new successful home businesses. Unlimited possibilities. Research Bureau, Stanton 49, California.

BUY It wholesale! Manufacturers, distributors offer 850,000 items. Literature free. Olsen, 1231-A East Third St., Duluth 5, Minn.

EARTHWORMS. Capsules, baby worms and breeders. 400 egg capsules \$5.00, 1400 for \$15.00. Free folder. Beloit Earthworm Farm, 1154 Johnson, Beloit, Wisconsin.

FOR Sale—Home study course. State licensed, incorporated. Motion picture, a war valuable opportunity. Manuals, catalogue. Must sell immediately. Best offer. Box 229, Birmingham, Mich. or phone Birmingham, Midwest 4-3625.

NEW Different home business opportunity. Raise worms for fishermen. Everything furnished. Write Flint River Worm Farm, Reynolds 1, Georgia.

BUILD Home business by mail. Extra money. Future independence. Details free. Arnold, Butler Road, Fort Wayne 8, Indiana.

REVOLUTIONARY Conception of public bookkeeping! \$5.00 hourly. Simple instructions. Full, spare time. Systems, shortcuts, obtaining clients. Auditax, 10775-C Tabor, Los Angeles 34.

MOLD Makers—Attention! Genuine natural latex for reproduction of figurines, statuary, plaques, etc. Instructions free. B. M. Barron, 77 Francis St., Everett, Mass.

RUBBER Molds! 50 different! Dollar up! Illustrated lists free! Castcraft Studios, 508-P Marion St., Brooklyn 33, N. Y.

UNUSUAL Uncommon specialties get the business and pay. Make these yourself from Miller's guaranteed formulas. Fifty years supplying the best. Lists free! Liscombe Miller, Chemist, Tampa, Florida.

EARN While you sleep. Coin radios. John Kratz, Grantham, Pennsylvania.

LIQUID Rubber. Make flexible molds. Free sample. Chaney, 1130 E. 16th St., Jacksonville 6, Fla.

INSTALL Seat covers. Buy wholesale. Profit on sale; profit on labor. Details free. Jay Sales, 2857 Sherman Blvd., Milwaukee, Wis.

MAILING Postcards selling repeat merchandise is profitable. Everything supplied. Details free. Gordan Publishers, Box 23, Pawtucket, R. I.

DRESDEN Craft figurine molds and many others, natural liquid rubber, statuary plasters, flock finishes, etc. Illustrated catalog and "Plastercraft" manual free. Blue Rapids Supply, Blue Rapids, Kansas.

OPERATE Profitable mailorder bookshop at home. Write Publishers, 3625-P3 Third, Detroit 1.

MEN—Women. Everybody likes candy. Learn to make professionally. Our 40th year. Reesdale Candies, D5, East Orange

EARN Money at home with your typewriter! Spare time! Details free. Edwards, Publisher, 3915-PM, 12th, Des Moines 13, Iowa.

EXPORT—Import! Represent manufacturers. Conduct barter-exchange without capital. War-peace time big business. Buy-sell by mail. Let New York experts show you how. Uncrowded fields. Easily learned. International Trades, 246-P, New York 1.

\$46 FROM Square foot plywood; jigsaw necessary. Write, Woodarts, Bridgewater, Mass.

THERE Is big money in printing. Details dime. Printing Institute, 4328 Lincoln, Chicago 18, Ill.

COLORGLAZED Concrete pottery made without molds. Patented method. Cemetery products, novelties, tiles. Basement leak-sealing. Money-making projects. Booklet, details free. Men only. National Potteries Company, Grand Rapids, Minnesota.

ELECTRO-PLATE With brush, silver, nickel, copper. Work at home. Wonderful profits. Make your own outfit. Plans, formulas \$2.00. Kemo-Plate, Park Ridge, Ill.

OUR Patented machine creating new service business in fast growth field. Free booklet "Aiming at a First Year \$15,000 Profit" and letter of introduction to one of 60 successful plants operating near you. New yet proven. Price \$6750 in 24 payments. E. M. Co. Inc., 101 S. 44 St., Philadelphia 4, Penna.

MONEY In new greaseless doughnuts. Start in kitchen. No smoke. Sell stores. Free recipes. M. Ray Company, 3605 South 15 Ave., Minneapolis 7, Minnesota.

INVISIBLE Reweaving—Big profit, big demand, easy-to-learn with low-cost complete course—nothing else to buy, ever. Details free, write today; Fabricon, Dept. N, 8342 S. Prairie Ave., Chicago 19, Ill.

WOULD You pay 3%—first \$350 made? Book "505 Odd Successful Businesses" free! Work home. Expect something odd! Pacific-MM, Oceanside, Calif.

BEAT Inflation. Wartime plans! Free book "372 Unusual Worldwide Businesses." Work home. Start sparetime! \$800 month reported. Publishers-MM, Carlsbad, Calif.

SAWDUST, Scrap wood, over 150 cash uses 25c. Lee, Box 502, Chicago 90.

HAVE Profitable home business. Get 101 ideas in new booklet. Only 25c. Write: Arco Sales Co., 505 W. 26th St., Chicago, Ill.

RAISE Earthworms. Easy, profitable. Send for free literature or send dollar bill for illustrated book. Money back guarantee. Earthworm Culturists, Box 710, Atlanta 1, Ga.

ELECTROPLATE Metals and non-metals with the Tyco Electro-Plater! Portable. Inexpensive. Free booklet. Tyco Metals, Box 13231-F, Houston 19, Texas.

START Profitable mail order business, over 100 ways. Send 10c full particulars. Patrician Studios, Bridgman, Michigan.

MADE Big money. So can you. Wamsteker, Box 34-A, Wynberg, Cape, South Africa.

BE Income happy. New local and mail selling opportunities. Free literature. L. Mallory, 266 South Court, Neillsville 3, Wisconsin.

ELECTROPLATING—Know-how, includes baby shoe, chrome and brush plating; other lucrative fields. Learn easily. Free booklet. Joseph B. Kushner, Electroplating Engineer, Stroudsburg 52, Penna.

DEFENSE Welding jobs pay. Welders needed. Train quickly. V.A. contract. Hobart Welding School, Box M-315, Troy, Ohio.

POPCORN Poppers, peanut roasters, candy floss, vending machines, new, used. Northside Co., Indianola, Iowa.

MAN! These are hot! Make \$6.35 on every sale. Sales are really easy. New adding machines in original factory cartons you can sell for only \$12.95 and you make over 45%. They're executive model portables, precision built, fully guaranteed. Send for life-size color photo with full details. Write today to Lightning Adding Machine Co., Inc., Dept. P-3, 1260 West Second St., Los Angeles 26, California.

FOR Successful mail order career, operate from New York individual office. Rent only \$12.00 yearly. Firms \$18.00. Co-operative Offices, PM-126 Lexington Avenue, New York 16.

MEN, Women. Grow mushrooms. Cellar, shed. Spare, full time, year round. We pay \$3.00 lb. We paid O. Babbitt \$4,165 in few weeks. Send \$2.00 for guaranteed market information, illustrated book and start. Washington Mushroom Ind., Dept. 125.

MONEYMAKING OPPORTUNITIES

MAKE Money! Raise birds in spare time. "Parakeet Breeding For Profit" and copy of cage-bird magazine, \$1.50. American Canary Magazine, 3449 N. Western Ave., Dept. PM, Chicago 18, Illinois.

START A profitable subscription business in spare time! We need men and women (young or old) as representatives for all leading national magazines. Liberal commissions paid for new and renewal subscriptions. You will be delighted to discover how much you can earn through this pleasant work. Start earning money at once! Clip this ad and send with your name and address to: International Circulation Division, Dept. PM, Hearst Magazines Inc., 250 W. 55th St., New York 19, N. Y.

PLEASURE. Profitmaking crepe paper, chenille, woodfibre, plastic fringe, into flowers, corsages, wreaths, dolls, decorative novelties. Complete supplies, kits, instructions. Proposition, Crafts catalog, 10c. Clevemodell, 4507TC24 Lorain, Cleveland, Ohio.

POLISH Floors! Free new plans and ideas. How to start your own money-making, lifetime business. Send postcard: McCanna Supply, 148M East 40 Street, New York 16.

"WATERLESS (Lanolin) Hand Cleaner." (Oil base.) Make, sell. No machinery. Build profitable business. Complete formula \$1.00. Ideal Service, Park Ridge 3, Ill.

DOLLARS Three ways with "Kitty-Kat" readi-cut baby shoes. Complete local and mail order plans. Write No-Co-Ro, Oakland 6-K, California.

PROFITABLE Mail order 10c. Copper Hill Sales Service, Copper Hill, Va.

UNPAINTED Bookends, plaques, novelties. Free list. Plastercraft Arts, 1611 E. Fifteenth, Cheyenne, Wyo.

BEST New mail order plans monthly. Beginners, old timers. Year \$3.00. Details free. Berberich, Box A6527, Pittsburgh 12, Penna.

BUY Nylons direct from mill. Make good profits on fast selling nylons. Quick delivery on any quantity. Write for confidential wholesale price list. Joy Hosiery Mills, Delawanna 13, New Jersey.

MAKE Seamless billfolds at home. Good income. No experience needed. Write to Max Products, HEM 805 East Walnut, Louisville 4, Ky.

RAISE Your business value, standing, as state notary public. Information. Stationers, Helotes 50, Texas.

MONEY Made easily at home. Details and free copy of trade publication. 25c. A Sales, 18-A City Terrace, Newburgh, N. Y.

PUBLISH Your own magazine. Hand-some 52 page format, well edited, illustrated. Cost low as \$1.00 month. Brings you prestige, profits. 25c brings sample, details. National, Ord, Nebr.

ELECTROPLATE. Brass, nickel, chrome, baby shoes. Free information. Electroplate, Box 293, Red Lion, Penna.

READ Progressive Mailtrade, the magazine that tells how to make money by mail. Dime brings sample and special offer. Progressive Mailtrade, Box 357, Sheboygan, Wisconsin.

EARN Money at home! Home mail order plan shows how. Details free. Chambers Enterprises, Box 871, Augusta 1, Ga.

DISTRIBUTORSHIPS Open — Motor tuneup, tremendous profit possibilities, full or spare time. Deco, Box 463, La Crosse, Wisconsin.

MONEYMAKING Opportunities! Read mailorder man's magazine PMT. Sample 25c. Southwest Associates, 1309 N. Princeton, Albuquerque, New Mexico.

\$35 WEEKLY! Home! Two hours daily! Twenty seven unusual ways! Walsh, 894 Main, Buffalo 2, N. Y.

EARN Extra cash! Get quick profits. Make pearl and rhinestone jewelry! It's easy! It's fun! Sells on sight! For complete instructions and illustrated catalog send only 10c to cover mailing and handling to Immerman & Sons, 1812 C3 E. 13th St., Cleveland 14, Ohio.

NEW—Unusual opportunities in "Backyard Profits!" Interesting booklet free. Pickett's, Florence, Kentucky.

WIN Contest money. General Contest Bulletin gives hundreds of tips. Lists current contests and rules. Sample 25c. General Contests, 1609½ East 5th, Duluth, Minn.

INDEPENDENT Income! Make leather belts, billfolds, purses. Big catalog and genuine steerhide keyholder, 10c. Tandy Leather Box 397E Tulsa, Okla.

LEARN How others earn money at home! Write—A. Sizemore, 4917 Kostner, Chicago 30, Ill.

PROFITABLE Fertilizer factory! Domesticated earthworms convert garbage. Huge garden harvests. Valuable booklet 10c. Aviry, 112-P Elizabeth, Wichita 12, Kansas.

10,000 NYLONS, Rayons, cottons, 9c pair, up. Sample razor blades, complete stock. List, 25c. Sibert Warehouse, Chattanooga 4, Tenn.

\$250 WEEK Reported! Free book "505 Odd, Successful Businesses." Work home! Expect something odd! Pacific-EE, Ocean-side, California.

QUICK Profits taking magazine subscriptions, handling greeting cards. Cassell Publishers Service, Westfield, N. J.

DOLLARS Make sense. Sell card table advertisement, receive \$130.00. 12 tables free. Unique Gift Club, Pine Hill, New Jersey.

DEFENSE Welding jobs pay. Welders needed. Train quickly. V. A. contract. Hobart Welding School, Box M-317, Troy, Ohio.

MAKE Money at home. Let me show you how to get \$1 to \$20 checks in your daily mail doing simple, spare time writing. Experience unnecessary. Details free. Herwell, 7016 Euclid, Cleveland 3, Ohio.

RESURFACE Butcher's chopping blocks with easy, fast-working, portable electric machine. Unique service in wide demand with little competition. Large steady profits from full or part-time work. Hill Machine Company, Box 677B, Rockford, Ill.

EARN Money evenings, copying and duplicating comic cartoons for advertisers. Adservice, Argyle 1, Wisconsin.

FORMULAS, PLANS, ETC.

REAL Manufacturing formulas. Lists free. Cummings, Chemist, Gordon Ave., Syracuse 4, N. Y.

WATERLESS Hand cleaner. (No ammonia.) Easily made. Good profit. 2 dependable formulas \$1.00. Nelko Chemical Service, Box 3462HC, Chicago 54, Ill.

MAKE—Sell cleaners, soaps, polishes, flavors, cosmetics. No machinery. Formula literature free. Kemico, Park Ridge 16, Illinois.

FORMULAS, Trade secrets, for nearly everything. Catalog free. Creative Publishers, Winnetka 6, Illinois.

FREE Formula catalog, anything analyzed \$20.00. Western Chemical, Salem, Oregon.

10,000 FORMULAS And trade secrets. Free literature. Stillman, 555 Kingston Ave., Brooklyn 3, N. Y.

CHEAP Automobile polish. Information 10c. Write James Lamont, Beacon, New York.

TESTED Formulas. Interesting descriptive booklet free. Pont, Box 635-PM, Terre Haute, Indiana.

WRITE For Miller's Messenger listing newest 1951 formulas. Fifty years supplying the best. Miller, Chemist, Desk 1517, Tampa, Florida.

COLD Light! Simple formula makes brilliant glowing liquid. Instructions 25c. United Manufacturing Associates, 3605 Canyon Ridge, Fort Worth 3, Texas.

PLASTICS

PLASTICS—Wholesale, retail. We make our own full-color carving dyes. Casting plastic, jewelry findings, mold materials. Catalog, bargain lists, instructions, 10c. 25c airmailed. Gem-O-Lite, Box 686B, North Hollywood, Calif.

NEW Liquid plastic. Clear, colors. Cast without heat. Embed flowers, insects, coins. Saw, drill, carve. Free folder. "Liquid Magic," shows fine things you can make and sell. Write today. Castolite, Dept. C-101, Woodstock, Illinois.

LUCITE. Plexiglas. Any size sheets, masked. Square foot (12 x 12) cost, 1/16". \$1.20; 1/8". \$1.40; 3/16". \$1.75; 1/4". \$2.08. Colors add 10%. Include 10% postage. Almac Plastics, 230 Fifth Ave., New York 1, N. Y.

PLASTIC, Sheets, rods, tubes, etc. Free list. Plastic Supply Co., 2901 N. Grand Blvd., St. Louis 7, Mo.

HI-PROFITS. Internally hand carved plastics. Gift-jewelry. Free catalog. Pilot Plastics, 67 C, New York City 7.

PLASTIC: Sheets, cut pieces, and scrap in clear and colors. Rod, tubing, acetate, dies, jewelry findings. Send \$1.50 for 4 pound scrap assortment and fabricating manual. Regal Plastic Supply, 720 Main, New York 17, N. Y.

MOLDED Plastic letters for signs, house numbers, etc. Samples 25c. Plastic Exchange, Box 302, Bradenton 3, Fla.

LEARN Plastics at home. Small cost—Spare time. Complete experimental outfit and full instructions furnished. Details free. Plastic Projects, Box 5151-C, Detroit 35, Michigan.

CHEMISTRY

ILLUSTRATED Catalog: Chemistry, mineralogy, biology. 10c. Tracey Laboratories, Evanston, Illinois.

SAVE Money, chemicals, supplies. Catalog 10c. Laboratory Sales, Box 161, Brighton, Mass.

NEW Idea chemical and apparatus outfits for home experimenting. Photo-scales, microscopes, chemicals, biological and laboratory supplies in small quantities. Catalog 15c. Established 1931. John H. Winn, 124A West 23rd Street, New York 11, N. Y.

CHEMICALS And apparatus for industrial, analytical, and private laboratories. Catalog 15c. Dept. M-50, Biological Supply Co., 1176 Mt. Hope Ave., Rochester 20, N. Y.

OH Boy! New Book of Science. Experiments, formulas, secret processes, together with catalog of laboratory supplies, only 25c. National Scientific Company, Dept. 16, 2204 W. North Avenue, Chicago 47, Illinois.

LABORATORY Apparatus, chemicals, microscopes, complete chemistry sets, minerals, uranium ore. 10c brings catalog. Porter Chemical Company, Hagerstown 1, Maryland.

URANIUM Ore sample, weighing scale, catalog of chemicals, apparatus, kits. \$1.00. Catalog only, 10c. Rex Laboratories, 2849-A Birchwood, Chicago 45, Illinois.

HELP WANTED

\$5 HOUR Easy! Sell name plates for houses. Free sample, order blanks. Write: National, 214 Summer, Boston, Mass.

AGENTS WANTED

MAKE Money calling on friends! Show nationally advertised greeting card assortments—new all-occasion assortment and laugh-packed barrel-of-fun assortment. Sells for \$1.00—up to 50c profit for you! Also personal notes, gift wrappings, stationery, gift items, others! Get two assortments on approval. Write Wallace Brown, 225 Fifth Ave., Dept. T-4, New York 10.

SELL Du Pont nylon uniforms. Complete line famous exclusive Hoover styled nylon uniforms for beauty shops, nurses, doctors, waitresses, others. Best quality, splendid values. Exceptional income. Real future. Equipment free. Write fully, Hoover, Dept. M-100, New York 11, N. Y.

FREE Samples. Big profits showing amazing "Glow-in-the-dark" specialties. House numbers, pictures, plastic novelties, ashtrays, keyholders, religious and nursery objects, etc. Madison Plastics, 303 Fourth Ave., New York 10, N. Y.

SELL Wood photograph albums. 50% profits. Catalog free. Wood Album Co., 54 Jefferson St., Brooklyn, N. Y.

BE A money maker. Use your home as magazine headquarters. Liberal commissions. No experience—No capital needed. Everything furnished. Write for free catalog. McGregor Magazine Agency, Dept. 500A, Mount Morris, Ill.

YOUR Own business selling army surplus, new clothing. Lowest prices. Enormous profits. Catalog free. Moro, 558-J Roosevelt, Chicago 7.

MAGIC Cleaner—Laundry soap deal. Hotter than a firecracker. Big profits. Sample free. Bestco, 4642 No. Central, Chicago.

PHOTO—Salesmen, agents. Sell beautiful hand colored plastic enlargements and sensational new photo compacts, rings, bracelets, lockets, etc. Collect deposit, we deliver. Profitable sideline. Send card, for free sample kit. Novel Portrait Co., 3343 North Ave., Chicago, Ill.

EXCELLENT Sideline for printing and advertising salesmen. Decalcomania name plates in small quantities. Great demand. Also, make money with our line of automobile initials and sign letters. Free samples. "Ralco" XL-Roxbury, Boston 19, Mass.

SELL Arcadian cigars. 100% imported Havana tobacco. Hand made. Steady, repeat profits. Free folder. Seco Cigars, 87 South Drive, Rochelle Park, New Jersey.

SCHOOL Seniors—Earn sensational profits selling classmates America's most beautiful graduation name cards. Largest selection. Outsells all others. Free sample kit. Printcraft, Dept. M, 1425 E. Elm St., Scranton 5, Penna.

EXTRA Money! Free gift offers! Sell friends extraordinary 21 for \$1.00 metallic, humorous greeting cards. Gift wrappings, novelties. Big profits. Bonus. Experience unnecessary. Request feature all-occasion assortments on approval. Free samples name imprinted stationery, napkins, towels and free catalog. New England Art Publishers, North Abington 420-A, Mass.

CALENDARS, Advertising novelties, matches. All styles, including religious, varnished, 12 sheet, girls. Hundreds of advertising novelties, book matches, etc. Fleming Calendar Co., 6539 Cottage Grove, Chicago 37, Ill.

POSITIVELY New—Over 100% profit. Two sided reversible neckties. Free details. Farrell Company, Dept. P-20, 1377 Van Zandt, Cincinnati 31, Ohio.

SIDELINE Salesmen. Power mower \$59.50. Sensation. Sales kit free. Rotacut, RM-2013, Excelsior Springs, Mo.

JEWELRY Factory desires salesmen, distributors, jobbers. Pickcraft, 19 Bank Street, Attleboro, Mass.

EXTRA Cash—Easy! Sell friends newest design 21 for \$1.00, dark card, novelty all-occasion greeting card assortments, gift wraps, animated books. Profits to 50c per \$1.00 box. Special offers. Bonus. Prompt service. Experience unnecessary. Write today for free samples name imprinted scented stationery, napkins, book matches, feature assortments on approval. Free catalog, selling plans. Elmira Greeting Card Co., 2309, Elmira, New York.

PERFUME Beads. Sensational sellers. Big profit. Particulars free. Mission, 2328P West Pico, Los Angeles 6, Calif.

FREE Sample and information: Sensational new fisherman's article. Nelson Company, Dept. F, St. Paul 2, Minnesota.

MEXICAN Feather pictures. Sell on sight; 200% profit! Free details; sample 10c stamps. Sylvia-PJ, Apartado 9036, Mexico City.

FREE Uniforms as bonus! Biggest commissions! Sell famous direct-from-factory nylon uniforms to housewives, waitresses, nurses, others, full or part time. Exclusive styles. No experience or investment needed. Write today for free style book, sales guide. Upland Uniforms, 255 West 28th Street, Dept. G-4, New York.

GOLD Lacquered window sign letters. Large sizes penny each. New foils. Absolutely beautiful. Free samples. Atlas, 544 W. 79th, Chicago 20.

EVERYDAY Cards. Earn \$5.00 with every ten \$1.00 boxes of everyday cards you sell. Also imprinted stationery, note paper, wrappings. Send for samples today. Howard P. Ellis, Dept. PM-3, Pitman, N. J.

55 HOUR Easy! Sell name plates for houses. Free sample, order blanks. Write: National, 214 Summer, Boston, Mass.

NEW Sponge wall cleaner. Erases dirt like magic. Wallpaper, painted walls, ceilings. Saves redecorating. Lightning seller. Samples sent on trial. Kristee 125, Akron, Ohio.

EASIEST Money you ever made! Big commissions selling work shoes guaranteed six months, exclusive cushioned shoes. Free outfit. Concordian Shoe, 8-B West Concord, Mass.

AT Last! Something new and sensational in everyday cards, 21 for \$1. Make extra money fast! Show satin, velour, metallic cards. Get orders easy. Big line \$1 assortments, scented stationery, personal matches, kiddie books. Imprints free. Two \$1 boxes on approval. Puro Co., 2801 Locust, Dept. 140-C, St. Louis 3, Mo.

FREE Water and our concentrates make flavors, lotions, shampoos, perfumes, cleaners, polishes. 125 products, free catalog. Qualco, E-20030 Russell, Detroit 3.

DO You need money? \$40.00 is yours for selling only 50 boxes of our 200 greeting card line. And this can be done in a single day. Free samples. Other leading boxes on approval. Many surprise items. Experience unnecessary. Free samples personalized stationery, napkins. Write today. It costs nothing to try. Cheerful Card Co., 177 White Plains, N. Y.

HIDE-A-KEY Ends lockouts! Everybody buys! \$1.00. Sample 50c. Merit, 6560 Sheridan, Chicago.

FREE Mexican novelty curiosities. Fast selling. Exceptional profits. Panamericana, Apartado 9318, Mexico City.

TAKE Large unit orders with wool and cotton uniforms, initial buckles, belts, badges. Choice 3,000 emblems. Prospects everywhere. Write Hook-Fast, Box 480-PM, Roanoke, Va.

AGENTS: Stamping names on key protectors. Sample 25c. Stamping outfits, checks, social security and name plates. Hart Mfg. Co., 303 Degraw St., Brooklyn, N. Y.

STRANGE "Dry" window cleaner. Sells like wild. Replaces messy rags, liquids. Simply glide over glass. Samples sent on trial. Kristee 126, Akron, Ohio.

NYLON Uniforms. Immediate delivery, immediate profits. Sell to doctors, dentists, nurses, waitresses, beauticians, housewives. Free sales kit. Superior Fabrics, Dept. P-3, 3936 Market, Philadelphia 4, Penna.

ABSOLUTELY Free! Big package actual sample fabrics and style presentation of dresses, lingerie, hosiery, etc. Take orders. Commissions big. Send no money. Melville Co., Dept. 7005, Cincinnati 25, Ohio.

AGENTS—300% Profit selling genuine gold window letters; stores and offices. Free samples. Metallic Letter Co., 438-B North Clark, Chicago.

DRESSES, 18c; Coats \$1.00, blouses 35c. Free catalog. Crown, 164-P Monroe Street, New York.

WONDERFUL Invention brings new relief to foot sufferers! Sell two pairs a day, make up to \$5.00 daily in spare time! Free demonstrator outfit for serious men, write to Owen Mason, "Velvet-eez," Chippewa Falls, Wisconsin.

WANTED—Purchasing agents. No money or experience required. Write Dept. C, Purchasing Manager, 2719 Lawrence, Chicago, Ill.

NYLONS Direct from mill. Free sample stocking. Guaranteed against runs. New process 100% DuPont nylon gives great strength and elasticity. Proportioned to fit, width and length to your size. That's why not all "51-15" are the same. Just show the stocking, you get orders. We deliver and collect. Advance cash plus 40% bonus. All year you sell our nylon hosiery, slips, gowns, neckties. Become crew manager, earn more money. Ergim Hosiery Mills, 992 Columbus Ave., New York City.

SUMMER Money maker. 1½ million dollars worth sold in 3 months last summer. Every lawn owner wants this product. Sales samples and complete sales kit supplied. Product approved by four leading universities. Barclay Co., Box 883, Plainfield 4, New Jersey.

BUY Thousands of nationally advertised products direct from manufacturers and distributors. Write for "Buy Direct and Save." Service Publishing, 1420-A Investment Bldg., Pittsburgh 22, Penna.

SELL New automatic floor waxer. Trigger on handle. Hands never touch floors or wax. Retail \$2.95. Profit 125%. Write Smith, Inc., Greenfield 34, Mass.

100% PROFIT Plus. Colette, patented wire device that automatically retracts and coils the telephone cord into a neat roll by the telephone. Eliminates all kinking and twisting. Quickly installed and a first class demonstrator. Also a model for electric ironing cords and other appliances. Over fifty thousand sold direct last six months. Send one dollar for two wholesale samples and selling details. Huff Sales Company, 911 Western Avenue, Seattle 4, Washington.

BIG Profits. Sell fast moving tarnish remover, cleans silverware and jewelry, no polishing. Agents sample \$1.00. 206 Corona, Long Beach, California.

COSTUME Jewelry, gifts, novelties; sparkling fast sellers. Watson, Barry 5, Illinois.

AMAZING New Telechron-timed defroster. Eliminates messy defrosting nuisance of electric refrigerators. Sell part or full time. Pleasant, fast, easy sales without canvassing. Big profits. Tremendous market. Send postcard for free information on this and other fast-selling Telechron-timed appliances. Miller-Harris, Dept. P3, 836 N. 4th St., Milwaukee 3, Wis.

WHERE To buy 800,000 articles direct from manufacturers. Including hundreds of scarce items. Sent free, "Your Profits Under the Spotlight." Glass Publishing Co., Ellwood City, Penna.

SELL Big money-maker to men and women. Easy handwork makes fast-selling useful articles. Sunmade Company, Brockton 64, Mass.

BIG Spring sales! Scat Wick Deodorant gets rid of unpleasant odors quickly. Sample Scat and Kitty \$1.00. Write for 16-page catalog of household items. Sunshine

FREE Sample nylon stocking of world's only nationally advertised hosiery line actually guaranteed against runs, snags or excessive wear, regardless of cause! It's amazing but true. Every weight from sheerest 15 denier to heavy 70 denier—all gauges to luxury 60 gauge. Amazingly low prices, starting at \$1.08 prepaid for sheerest 15 denier 51 gauge. Not sold in stores. Good Housekeeping guarantee seal. Also complete line men's hosiery guaranteed one full year or replaced free. Full variety lingerie in crepe, satin and nylon, featuring all nylon slip at \$2.95, satin slip at \$1.58, etc. Housecoats and robes. Kendex sales people will earn one million dollars this year. Get your share. No money or experience needed. Pay nothing now or later. Just show free outfits. Write orders. We deliver and collect. Advance cash plus huge bonus. Earn money spare or full time. Become manager; appoint others to sell for you; earn steady income on their sales. Man or woman—young or old, you can earn more money than you ever thought possible. Everything you need is furnished free and prepaid, including nylon stocking, samples of materials, sales books, 36-page salesmanual, color cards, etc. Simply write your name and address on postcard and mail to Kendex Corporation, Babylon 33, N. Y.

PAINTS—All kinds. 65c gallon up. Private label. Big profits. Certified Products, Louisville, Ky.

FREE Sample ultra-blue stock sign! 6c, sell 35c. 1000 slogans, 7"x11", comedy, religious, general. Lowy, 812-MM Broadway, New York 3.

SELL Amazing petal action floral everyday cards. Profits to 100%; send 65c for sample. Collins Sales Company, 5914 Hodgman, Parma Hts. 29, Ohio.

EXTRA Cash selling shoes direct in spare time. Advance commissions. Bonus. No investment. Experience unnecessary. Free outfit. Samples. Paragon Shoes, 739 Columbus, Boston, Mass.

FAST Profits—No investment. Send for big, free catalog. Plastic aprons, tablecloths, etc. 150 sure-fire items. We guarantee sales. Write The Holiday Company, Dept. M-3, 15-19 Pennington Ave., Passaic, N. J.

HIGH-GRADE SALESMEN

GET A line on this one. Hook up with real money-maker! Sell revolutionary, new Getzem Fish-Bait-Odors that lure fish by smell! Fish really "go for" Getzem. So do fishermen. That's why Getzem practically "sells itself." Fat profit for you on every sale! Plenty repeat business, too! Big season ahead. Act now! Send 50c for \$1.00 tube, or write for free money-making facts. Getzem, Dept. 27-C, 117 W. 67th Terrace, Kansas City, Mo.

HOTTEST Money-maker out! New idea ironing pad pays you up to 100% profit. Saves housewives time, labor, money. Minute demonstration. Fully guaranteed. Plastic clothes line, other sensational sellers. Free sample offer. Sheldon, 1223 South 23rd, Dept. 540, Milwaukee, Wis.

\$2600 NEXT 9 Weeks—Season starting. Sell calendars, specialties, matches. Prospects everywhere. Advanced commissions. Experience unnecessary. Samples free. Continental Calendar, 542-A South Dearborn, Chicago.

EARN Spare time extra money. Show amazing cushion comfort shoes. To \$3.25 commission per pair, plus big cash bonus. Experience unnecessary. Write for free catalog, full information. Tanners Shoes, 778 Boston, Mass.

SELL Art and commercial calendars. Advertising specialties. Over 1000 goodwill items. Diversified line. Highest commissions. Territorial protection. Send \$1.00 refundable deposit for prepaid initial set of samples. Standard Calendar Company, Madison, Illinois.

IS \$210 A week worth a penny postcard to you? Then rush card with name and address for special free trial plan that sells amazing new automatic refrigerator defroster "like hot cakes!" Write to Mr. Lewis, D-Frost-O-Matic Corp., Dept. PMC-3, 6 N. Michigan, Chicago 2, Ill.

SALESMEN—Sell our "Leader Specials," America's finest, biggest line of advertising specialties. Sensational sellers to all types of business. Big commissions advanced. Sensational sales plan nets you top earnings. Free outfit. Charms & Cain, 407 South Dearborn, Dept. 300, Chicago.

ADVERTISING Book matches—Cash in on big demand; sell union label matches. Cuts for all businesses and political parties. Free powerhouse selling kit, low prices, protection guaranteed on repeat orders. Cash commissions. Superior Match Co.

BIG MONEY taking orders. Shirts, ties, socks, pants, jackets, sweaters, shoes, uniforms, etc. Sales equipment free. Experience unnecessary. Nimrod, 4922-AN Lincoln, Chicago.

A Fine income, your own nylons free! Show nylons, lingerie, men's socks with amazing free replacement guarantee against runs, snags, tears. Write for free sales kit. Group organizers invited. Rosalee Hosiery Co., Clifton 58, N. J.

AMAZING Discovery, Master Glaze, puts brilliant glass-like surface on cars. Free sample, information. Big commissions. Master Glaze, Dept. 704, 7720 Harwood, Milwaukee, Wis.

EARN Big money fast! Sell finest-quality advertising work uniforms to garages, factories, filling stations, etc. Free selling kit. Topps, Dept. 533, Rochester, Ind.

\$5 HOUR Easy! Sell name plates for houses. Free sample, order blanks. Write: National, 214 Summer, Boston, Mass.

NEW Jobs open in selling! Send name, address for five free issues of Opportunity Magazine's money-making guide, listing hundreds of companies who'll pay you well, full or part-time. No experience needed. Opportunity, 28 E. Jackson, Dept. 17, Chicago 4, Ill.

WANT To make real money? You can positively make \$50.00 a day and up selling a brand new item going to every type of food and beverage store, factories, laboratories, hospitals, etc. First time advertised. Write for free details today. Johnson-Hartmann, 53 West Jackson Blvd., Dept. PM-3, Chicago 4, Illinois.

WANTED. Man to earn \$85 week and up. Long needed invention. Advertised in Saturday Evening Post. Full or part time. Exclusive territory. No investment. Free sample outfit. Write Red Comet, Inc., Dept. 889, Littleton, Colorado.

DISTRICT Mgr. calendars and specialties. Klingstedt's, 424-509 Schroyer S.W., Canton, Ohio.

SALESMEN Wanted in every state. Sell flying saucers, real recreation for the teenagers. Send one dollar for prepaid sample which will be deducted first dozen order. Mars Novelty Co., 117-5th St., Turlock, Calif.

NEW. Much needed auto specialty fills a great need. Every auto and truck owner will want. Whirlwind seller. Pays excellent profit. Literature free. See display ad on page 268 this issue. Bock Mfg. Co., 711 West Lake St., Minneapolis 8, Minn.

AD Matches! Sell amazing designs—20, 30, 40 and 240-light book matches. Big spot cash commissions; every business a prospect. Low prices for high quality. Repeats. Start without experience; men, women; full, part time. Buy nothing! Sales kit furnished. Match Corp., Dept. PM-15, Chicago 32, Illinois.

WRITE 3 Words—Collect \$7.65 on 10-second demonstration to merchants. Write on glass with amazing magic crayon—Presto! 5 color advertising message takes fire, glows like brilliant neon. Three sales daily bring \$22.95 profit. Rush postcard for details. Complete sales kit, free! Maxilume Co., 125 W. Hubbard, Dept. CL-83, Chicago 10, Ill.

BIG Cash profits for men and women introducing Flexiclogs, sensational new flexible footwear. Experience unnecessary. Nationally advertised styles for women, children, men. Excellent sideline, no investment. Easy to average hundreds of dollars weekly. Free sales helps and sample offer. Get details now! Flexiclogs, Dept. L-3A, New Holstein, Wisconsin.

EDUCATIONAL AND INSTRUCTION

PIANO Tuning pays. Learn this profitable profession at home. Our Tomometer and mechanical aids make learning easy. No knowledge music necessary. Diploma granted. Largest and oldest school—53rd year. G.I. approved. Write for booklet. Niles Bryant School, 78 Bryant Bldg., Washington 16, D. C.

BE A real estate broker through home study or classroom instruction. Write for free book. Approved for veterans. Weaver School of Real Estate, 15 E. Pershing Rd., Box CP-3, Kansas City 8, Missouri.

LEATHER Carving. Fascinating, highly-paid art; age-old secrets now taught for first time in home study course. For hobby, profession or profitable business, write: Baird School of Leather Carving, Box 1367-M, Dept. 13, Manitou Springs, Colo.

ACHIEVE Business and financial success in your own collection-credit agency business. Home or office. Quickly learned. Free folder. Write Cole & Associates, Syracuse 2, N. Y.

BOOKKEEPERS. Male or female. Study practical credit management with an experienced credit man. J. Cooke, 116 St. Stephen St., Boston, Mass.

ATTENTION! Army needs trained dental laboratory technicians. Inquire about big, illustrated ten lesson training course or send \$1.00 for first lesson. Grant Dental Laboratory, 219 W. 7th, Los Angeles 14, Calif.

WELDING Training pays at Hobart Welding School, Box M-313, Troy, Ohio. VA contract. Best equipment. Catalog free.

"HOW To Break and Train Horses"—A book every farmer and horseman should have. It is free; no obligation. Simply address Beery School of Horsemanship, Dept. 1103, Pleasant Hill, Ohio.

LEARN Piano tuning, repairing — At home in 30 days. Unlimited income. Phonograph recordings, tools and instructions furnished. Write Capitol City Tuning School, Department 334, 129 East Michigan, Lansing 16, Michigan.

MAKE Up to \$35-\$45 week as a trained practical nurse! Learn quickly at home. Booklet free. Chicago School of Nursing, Dept. M-3, Chicago.

BOOKKEEPERS! Increase your earnings! Operate your own simplified "dollar-a-week" bookkeeping and tax service. Full or spare time. Details free. No obligation. Ellis, Box 200, Cedar Grove, North Carolina.

LEARN Linotype (machine typesetting). Good pay, steady work. Booklet "X" free. N. Y. Mergenthaler Linotype School, 244 West 23rd, New York.

EARN \$10,000 Annually! Learners \$2,700. Unlimited opportunities in Merchant Marine. Instruction-Employment Manual \$1.00. Refundable. Titan Company, 45 Clinton St., Newark 2, N. J.

SHORTHAND In one week. EZ longhand system \$1.00. Self instructor. Returnable. Zinman, 215 West 91, New York 24, New York.

INVESTIGATOR Training. Phillips Secret Service System, 1917-B North Kenneth, Chicago 39.

USED Correspondence courses and books sold and rented. Money back guarantee. Catalog free. Courses bought. Lee Mountain, Pisgah, Alabama.

MEDICAL Laboratory Technicians in great demand. We train you in your own home. Catalogue free. Imperial Technical Institute, Box 973-J, Austin, Texas.

SECRET Investigation. Experience unnecessary. Investigators particulars free. George Wagner, M 125 West 86th, New York.

BECOME A Doctor of Psychology or Metaphysics. Teach secret of contentment, happiness. Win degree of Ps.D. or Ms.D. Solve mental worries. Free book. College of Universal Truth, 5153-C North Clark, Chicago.

DEFENSE Welding jobs pay. Welders needed. Train quickly. V.A. contract. Hobart Welding School, Box M-316, Troy, Ohio.

IT'S Fun learning a language by Lingua-phone. At home, in leisure time, quickly, easily, correctly master Spanish, French, German, Russian, Oriental—any one of 29 languages through Lingua-phone Conversational Method. Add to service, job, travel opportunities. Send for free book. Lingua-phone Institute, 8303 Rockefeller Plaza, New York City.

HOME Study course, drugless therapy. Free literature. Institute of Drugless Therapy, Tama, Iowa.

PHOTOGRAPHY For pleasure or profit. Learn at home. Practical basic training. Long established school. Write for free booklet. American School of Photography, 835 Diversey Parkway, Dept. 3431, Chicago 14.

USED Correspondence courses and educational books bought, sold, rented. Catalog free. Educational Exchange, Summer-ville, Ga.

HIGH School—No classes. Study at home, spare time. Diploma awarded. Write for free catalog HF-5. Wayne School, 2527 Sheffield, Chicago 14, Ill.

ANNOUNCING Home study course in commercial baking. Practical basic training. Good field for those with aptitude. Nearly depression proof. Send for free booklet. "Opportunities in Baking Industry." National Baking School, 835 Diversey Parkway, Dept. 3431, Chicago 14, Ill.

HAWAII. Lava specimens, appr. 4"x4"x2", from Mauna Loa 1950 eruption, world's largest active volcano, amazing, educational, useful. Post paid \$1.00. Volcanic Curio Service, P.O. Box 854, Honolulu, Hawaii.

READ With speed! New amazing method! Save hundreds of hours yearly. Free home test. No obligation. Rush post card. Speed-Reading, 9111-A, Hoyne, Chicago 20.

STUDY To be a doctor of psychology or metaphysics. Obtain Ps.D., Ms.D., D.D. or Ph.D. degree. Chartered by state. Write for free book telling how. The Neotarian Fellowship, Desk 8, Dwight Building, Kansas City 6, Missouri.

AMAZING New scientific way to remember. Free details. H. Kaye, P.O. Box #261, Staten Island #1, N. Y.

EARN While you learn. Day or night classes. Thorough courses in: Automobile mechanics, diesel mechanics, motor tune-up, auto body and fender, welding, refrigeration, radio, etc. Living accommodations. Veterans may earn \$210 to \$290 per month while in school including subsistence. Fully accredited to train veterans. Thirty-two years' experience training men. Nashville Technical College, Dept. #256, Y.M.C.A. Bldg., Nashville 3, Tennessee.

WAKE Up your personality with practical psychology home study. Many helped. Free booklet and plan. President Ballard, 1008 Washington Bldg., Louisville 2, Ky.

MEMOROLOGY. Science of memory simplified, makes memory work easy, 84 page book. Money back guarantee. Memorology Studio, 2016 Sunnyside, Chicago, Illinois.

LEARN Sewing machine repair. Electricity, rent, trade, sell. Big profit home setup. I show you how. Motor kits, new machines, etc. supplied wholesale. Free particulars. Taylor Service Co., Hamilton PM-3, Ohio.

HOME Study course in drafting. Monroe Institute, PM-3, Alton, Illinois.

RADIO Amateur license preparation. Learn theory at home to pass government examinations. Low cost. Personal coaching. Federal Electronics Institute, 45 E. Putnam, Dept. B, Greenwich, Conn.

HERE Is real chance to learn upholstery at home; it will make you prosperous. Important. P.O.B. 1544, Oakland, Calif.

VOICE Secrets! Free information. Studio 14356B, Jersey Ave., Norwalk, California.

WELDING Training profitable. Learn quickly. Magnificently equipped non-profit school. V.A. contract. Hobartweld, Box M-318, Troy, Ohio.

PLAYS, STORIES, MANUSCRIPTS

EARN \$10 Hour writing! Free information. Progressive Enterprises, 105-E Seminoles, Catonsville 28, Md.

WRITERS, Composers: Your name on penny card brings price list. Magdalene Kuhlman, 184 South Point Drive, Avon Lake, Ohio.

SUCCESSFUL Writer reveals "Tips for Beginning Authors." Booklet 10c. Send to: Career Aids, Dept. PM2, 204 East 81, New York 28, N. Y.

BUSINESS SERVICE

HAVE A Chicago mail address. Information free. Schultz House, 3116 Seminary, Chicago 13.

SPECIAL SERVICES

ENGRAVING On nameplates, trophies, medals, etc. Free catalogue. Ackerman, Malden-on-Hudson, N. Y.

ADVERTISING AGENCIES, LETTER WRITERS, FOR ADVERTISERS

ADVERTISERS! Reach nearly 18,000,000 readers. 25 Sunday national key newspapers. 18 words, \$59.00. "Terrific pullers." 20 popular newspapers, \$11.50. Free booklet. Special—One inch display 2, -821,198 circulation, \$51.10. Newmark's Advertising Agency, (Established 1893), 217-7th Ave., New York 11.

ADS Placed in out of town newspapers and magazines. Low rates. Catalogue free. Ideas that pay. Baker Advertising Agency, Successors Ankrum Agency, 189 W. Madison, Chicago 2.

FREE! 1950 Advertisers Rate and Data Directory. 52 pages! E. H. Brown Advertising Agency, 20 N. Wacker, Chicago 6.

MAILING Lists; \$5.00-1000 up. Write Dixie Service, King, N. C.

24 WORDS In 50 weeklies, \$4.96. J. Darrell, 730 Hays, Jackson, Tenn.

ADVERTISE! 24 Words, 40 newspapers \$3.50. Lists free. Advertising Bureau, 10511-C Springfield, Chicago 43.

FREE Copy, layout service. Mailorder ad, 1,700,000 nationwide circulation, \$25.90 inch. 24-word classified, 20 big Sunday newspapers, \$30.00. Advertising ratebook free. Chicago Advertising Agency (established 1900), Chicago 4.

CARTOONING, COMMERCIAL ART, SHOWCARD WRITING, SIGN PAINTING

"HOW To Make Money With Simple Cartoons"—A book everyone who likes to draw should have. It is free; no obligation. Simply address Cartoonists' Exchange, Dept. 93-C, Pleasant Hill, Ohio.

LEARN Sign painting, 152 lesson course. Results guaranteed. Stewart Sign Co., Box 287M, Pasadena, California.

CHALK Talks. Laugh producing program, \$1.00. Catalog 10c. Balda The Cartoonist, Oshkosh, Wisconsin.

FREE Strok-o-graph shows correct method for brush lettering plus money making opportunities. Home study course in Showcard art. Midwest School of Art, 103 E. Main St., Fort Wayne 2, Indiana.

TYPEWRITERS, DUPLICATORS, OFFICE DEVICES

PRINTOMATIC Selffeeding post card printing duplicator \$13.50. Envelope addressing machines \$24.50. Pittsburgh Typewriter Company, 336-R Fourth Avenue, Pittsburgh 22, Penna.

RECONDITIONED Typewriters, printing devices. Write Dixie Service, King, N. C.

TYPEWRITER Sale. Up to 50% discount from original price. Catalogue free. Apple, 993c Westchester Ave., New York 59, N. Y.

RUBBER STAMPS AND OFFICE SUPPLIES

RUBBER Stamps. Send for catalog. Excello, Box 500, Shreveport, Louisiana.

RUBBER Stamps, illustrated catalog 10c. Williams, Box 648, Plainfield 3, N. J.

3 LINES 50c; Pads 35c; signature \$2.00; notary seals. Stampright, Wauwatosa, Wis.

PRINTING, MULTIGRAPHING, MIMEOGRAPHING GUMMED LABELS

110 HAMMERMILL Letterheads, 100 envelopes \$2.00 postpaid. Samples, prices free. Don Johnson, 410-PM East Oklahoma Place, Tulsa 6, Oklahoma.

QUALITY Printing. We specialize in publications, newspapers, tabloids. Send copy for estimate. Bagby Printing Co., Georgetown, Ohio.

SEND 10c Now for our 48 page 1951 price list—refunded first order. McCall Press, 1326 South 27th, Omaha, Nebraska.

QUALITY Printing—Circulars, catalogs, publications, stationery; free catalog. Adams Printing, 30 West Washington, Chicago 2, Illinois.

MIMEOGRAPHING—Letters, pricelists, formulas, instructions. Lowest prices. Lem's Letter Shop, 5710 Stanton, Detroit 8.

PHOTO-Offset special, 5000-8½ x 11 \$14. Samples free. Reiffe, 160-P Monroe St., New York 2.

500 ¾x2¼ FOUR Line gummed stickers 50c. Red border \$1.00. Moritz Printery, Saginaw, Mich.

DISTINCTIVE Quality printing postpaid. Free estimates. Henry, 2815 Blvd., Jersey City 6, N. J.

1000 BUSINESS Cards \$2.50 prepaid. Samples free. Reliable Print Shop, 905 East Jefferson, Louisville 6, Ky.

COMPLETE Printing line. \$1.00 up. Samples. D'Yarmett Printing, Newark, Ohio.

NEED Printing? Get my samples, prices. Gooch, 202PM, Hernando, Miss.

BUSINESS Printing. Samples, prices free. Howprint, 723-M Eunice, Webster Groves 19, Missouri.

LETTERHEADS, 1000 Attractively printed, bond, \$4.95 postpaid. Samoset Press, Plymouth, Mass.

THREE Day service on printing, multi-graphing, mimeographing. Prices, samples free. Progressive, 270c Burkhart, Cincinnati 15, Ohio.

HAMMERMILL Individually designed 8½ x 11 business letterheads, envelopes, cards, 500 each postpaid \$15. Fisher Print Shop, 2112 Middlefield Street, Middletown, Connecticut.

100 8½ x 11 Hammermill and 100 envelopes \$1.95. H. Hudson, Centredale, R. I.

MIMEOGRAPHING. Letterheads, letters, envelopes. Martin Mimeographing, 3212 Harper, Saint Louis, Missouri.

48-HOUR Mimeographing service! Samples, prices, free. Thompson, Loganville, Wisconsin.

100 LETTERHEADS (8½ x 11 Hammermill) \$1.00 postpaid. Envelopes same. Race Printers, Hudson, New York.

GUMMED Labels, stationery. Free list. Reed, Box PM-135, Spiro, Okla.

BUSINESS Stationery. Letterheads, envelopes, cards. Samples dime. Refunded first order. Crow, 533 18th St., Huntington 3, West Virginia.

MIMEOGRAPHING—Reasonable. Any copy. Mailers Service, Box 606-T, Chicago 90, Ill.

5,000 6¾ ENVELOPES Printed \$3.10 per thousand, price list free. 1,000 simulated engraved business cards \$4.00. Michel, Box 76F, New York 16.

100 ENVELOPES. Printed 2-colors \$1.25. Samples. Box 523, Rochester 2, N. Y.

250 8½x11 WHITE Bond letterheads \$2.00 postpaid. 5 lines. Envelopes same. Cards or statements 250—\$1.85. L. & F. Printers, Box 5531-A, Chicago 80, Ill.

MIMEOGRAPHING—Any copy. Free samples. Zorn Mimeo Service, Brillion, Wisconsin.

PRINTING OUTFITS AND SUPPLIES

PRINT Your own cards, stationery, circulars, advertising. Save money. Simple rules. Print for others, nice profit. Raised printing like engraving too. Have home shop. Details free. Kelsey Presses, L-11, Meriden, Conn.

PRESSES, Supplies, paper. Catalog 10c. Printers Supply, 211, Springfield, Missouri.

PRINTING Presses, type, supplies. Lists 3c. Turnbaugh Service, Loysville, Penna.

PRESSES, Bought, sold, list 3c. Exchange, 212 Curtis, Meriden, Conn.

BARGAINS—Presses, type. Lists 5c. Garza, 98 Pleasant, Cambridge 39, Mass.

MAKE Your own printing cuts. Self-molding process. Plexirubber, Argyle 1, Wisconsin.

PRESSES, Cutters, typecases, galleys, cabinets, automatics, requirements? Bulletins 3c. Box 918, New York 8.

PRESSES, Type, cabinets, supplies. List for stamp. Lincoln Press Company, 220-T Hartwell, Fall River, Mass.

PATENT ATTORNEYS

INVENTORS: Learn how to protect your invention. Unless the inventor is familiar with patent matters, he should engage a competent registered patent attorney or agent to represent him. We are registered to practice before the U. S. Patent Office and prepared to serve you in handling your patent matters. "Patent Guide for the Inventor" containing detailed information concerning patent protection and procedure with "Record of Invention" form will be forwarded to you upon request—without obligation. Clarence A. O'Brien & Harvey Jacobson, Registered Patent Attorneys, 11B-A District National Building, Washington, D. C.

INVENTORS—If you believe you have an invention, you should find out how to protect it. The firm of McMorrow, Berman & Davidson with offices in Washington, D.C., is qualified to take the necessary steps for you. Send for copy of our patent booklet "How to Protect Your Invention." We will also send you an "Invention Record" form. No obligation. They are yours for the asking. McMorrow, Berman & Davidson, Registered Patent Attorneys, 134-R Victor Building, Washington 1, D. C.

INVENTORS: When you are satisfied that you have invented something of value write me, without obligation, for information as to what steps you should take to secure a patent. Write Patrick D. Beavers (Formerly Randolph & Beavers) Registered Patent Atty., 935 Columbian Bldg., Washington 1, D. C.

PATENT Practice before U. S. Patent Office. Validity and infringement investigations and opinions. Booklet and form "Evidence of Conception" forwarded upon request. Lancaster, Allwine & Rommel, Registered Patent Attorneys, Suite 411, 815-15th Street, N.W., Washington 5, D. C.

INVENTORS—If you consider your invention to be something of importance, take steps to protect it with a United States Patent which gives you the right to exclude others from making, using and selling your invention as claimed. "Patent Protection for Inventors" outlines steps to take to secure patent protection. Mailed promptly without obligation. Victor J. Evans & Co., Merlin M. Evans, Registered Patent Attorney, 631-C Merlin Building, Washington 6, D. C.

PATENTS. "Proof of Invention" folder mailed without obligation. E. E. Vrooman, Registered Patent Attorney, 507 McKim Building, Washington 5, D. C.

INVENTORS: Write for free brochure "Evidence of Invention." Labiner, World Building, New York 38.

C. A. Snow & Co.—M-427, Snow Building, Washington 1, D. C. Registered Patent Attorneys. Write for information.

INVENTORS—For "Record of Invention" form, contact Carl Miller, Registered Patent Attorney, Woolworth Building, New York.

INVENTORS: Without obligation, write for information explaining the steps you should take to secure a patent. John N. Randolph, Registered Patent Attorney, 203 Columbian Bldg., Washington 1, D. C.

PATENTS—Irrving L. McCathran, 315 McLachlen Bldg., Washington 1, D. C. Registered Patent Attorney.

CANADA—Ramsay Company Registered, 273 Bank Street, Ottawa, Canada.

REGISTERED Patent attorney offers services. Sanders, 6430 Evans, Chicago 37, Ill.

"INVENTOR'S Guide" free on request. Frank Ledermann, Registered Patent Attorney, 154 Nassau St., New York City.

FOR INVENTORS

INVENTORS—If you believe you have an invention, you should find out how to protect it. The firm of McMorrow, Berman & Davidson with offices in Washington, D. C., is qualified to take the necessary steps for you. Send for copy of our patent booklet "How to Protect Your Invention." We will also send you an "Invention Record" form. No obligation. They are yours for the asking. McMorrow, Berman & Davidson, Registered Patent Attorneys, 134-P Victor Building, Washington 1, D. C.

INVENTORS: Learn how to protect your invention. Unless the inventor is familiar with patent matters, he should engage a competent registered patent attorney or agent to represent him. We are registered to practise before the U. S. Patent Office and prepared to serve you in handling your patent matters. "Patent Guide for the Inventor" containing detailed information concerning patent protection and procedure with "Record of Invention" form will be forwarded to you upon request—without obligation. Clarence A. O'Brien & Harvey Jacobson, Registered Patent Attorneys, 11A-A District National Building, Washington, D. C.

INVENTORS—If you consider your invention to be something of importance, take steps to protect it with a United States patent which gives you the right to exclude others from making, using and selling your invention as claimed. "Patent Protection for Inventors" outlines steps to take to secure patent protection. Mailed promptly without obligation. Victor J. Evans & Co., Merlin M. Evans, Registered Patent Attorney, 632-C Merlin Building, Washington 6, D. C.

SEARCHES—Put your patent searches in the hands of a registered patent attorney or agent, as he qualifies to give a worthwhile patentability report. Record of invention form upon request and information on patent protection. Patrick D. Beavers, Registered Patent Attorney, 936 Columbian Bldg., Washington 1, D. C.

INVENTORS. For "Record of Invention" form, contact Carl Miller, Registered Patent Attorney, Woolworth Building, New York.

INVENTORS: Without obligation, write for information explaining the steps you should take to secure a patent on your invention. John N. Randolph, Registered Patent Attorney, 202 Columbian Bldg., Washington 1, D. C.

INVENTORS—Our free booklet "Reaching Your Invention Markets" gives recommended marketing procedure for patented, unpatented inventions. Mailed on request without obligation. Market Contacting & Data Service, 11106-W2 Longwood, Chicago 43.

PATENT Owner representative. Years of experience. Can I help you? Charles A. Scott, 773PM Garson Avenue, Rochester 9, N. Y.

WE Specialize in developing patents on articles made from rubber or plastics. Complete development laboratories with limited manufacturing facilities. Over 25 years experience. Rublab, 2706 Tower Bldg., Akron, Ohio.

INVENTORS: If you have an invention for sale, patented or unpatented, write Institute of American Inventors, Dept. 40A, 631-E St. N.W., Washington 4, D. C.

CASH For your idea, 280 manufacturers need inventions, patented or unpatented. List free. Invention Bureau, 208M Clinton, Oak Park, Ill.

PATENT Searches, \$5.00, including patent copies. Same reliable search as conducted for patent attorneys. Free protection forms, 48 hour service. Patent Service Institute, 945-A Pennsylvania Avenue, Washington 4, D. C.

PATENTED, Unpatented inventions promoted. M. Joyce Humphries, 1424 Landtitle, Philadelphia 10, Penna.

PRINTING Plates, hand engraved. Graphic, 230 So. Church, Clyde, Ohio.

COLD Cash for your invention! Sell it by mail. Patent unnecessary. Professional engineer's complete instructions \$1.00. Moneyback guarantee. Previews, Eight Drummond St., Boston, Mass.

INVENTORS! For complete services write: Industrial Patent Reports, Box 1081, Massachusetts and North Capitol, Washington 13, D. C.

PATENT Searches \$5.00. Same reliable searches we conduct for patent attorneys. 48 hour service. Protection forms free. Write Capitol Patent Service, P.O. Box 664, Washington 4, D. C.

INVENTORS Having patented or patent pending inventions for sale or lease, request our free book. No obligation. U. S. Patent Exchange, Dept. 1-P, 406 South Spring St., Los Angeles 13, Calif.

PATENT Searches by former patent office examiners \$5.00. 48-hour service. Protection forms free. Write Patent Engineering Service, 1404 New York Avenue, Washington 5, D. C.

PATENT Searches \$5.00. 48-hour service. Patent copies included. Protection forms free. Write Raymond L. Smith, Patent Searcher, 410 Bond Building, Washington 5, D. C.

PATENT Searches \$5.00. Reports airmailed within 48 hours. Invention protection forms free. Write Miss Ann Hastings, Patent Searcher, P.O. Box 176, Washington 4, D. C.

INVENTIONS WANTED

SKILSAW, Inc., leading manufacturer of portable electric and pneumatic tools seeks patented or patentable ideas suitable for manufacture in our modern production plant. Address: Engineering Department, 5033 Elston Ave., Chicago 30.

INVENTORS—What have you, patented, unpatented to offer manufacturers? Request free booklet without obligation. Market Contacting & Data Service, 11106-A2 Longwood, Chicago 43.

PRACTICAL Inventions wanted. Inventors Patent Exchange, Dept.-B, Hartford 1, Connecticut.

INVENTIONS Promoted. Patented or unpatented. Write Adam Fisher Company, 61 Enright, St. Louis, Mo.

INVENTORS: Hundreds of manufacturers have requested our assistance in locating marketable new products. Complete information free. Institute of American Inventors, Dept. 40-D, 631-E St. N.W., Washington 4, D. C.

CASH Or royalty: Our unusual service sells inventions, patented, unpatented, because alert manufacturers constantly ask us for ideas. Also, we make special calls on live manufacturers, promoters, agent-houses, mail order houses, etc., in rich Chicago industrial area. List of needed ideas free. Inventors Sales Bureau, 208-N Clinton, Oak Park, Illinois.

INVENTORS Having patented or patent pending inventions for sale or lease, request our free book. No obligation. U. S. Patent Exchange, Dept. 1-W, 406 South Spring St., Los Angeles 13, Calif.

PATENTS FOR SALE

REVOLVING Desk telephone stand. Pat. No. 2512933. Outright or royalty. Write for information. Mrs. Leo J. Murray, 21

INVENTORS: Test the commercial value of your patented or unpatented inventions, quickly and inexpensively. Write for free information. Institute of American Inventors, Dept. 40-B, 631-E St. N.W., Washington 4, D. C.

MANUFACTURING

MODELS — Small lot manufacturing. Metals, plastics, etc. Milburn, Burlington, Kentucky.

COMPLETE Inventors' model construction services. Mechanical Development Company, Salem, Virginia.

MODELS, MODEL SUPPLIES

LIONEL Trains, accessories, switches. Tremendous stock; fast delivery. Guaranteed repairs. Authorized Lionel Train Station, 72 West Washington, Chicago 2.

SHIP And yacht model fittings; blueprints. Send 25c for illustrated catalog No. 26—listing hundreds of items. A. J. Fisher, 1002-1 Etowah Ave., Royal Oak, Mich.

SHIP Models and yacht supplies complete. Large 64 page catalogue 30c. Bill Wild's, 510 East 11 St., New York City 9.

BUILD Historic ship models, complete kits 39c to \$9.00. Catalog 10c. Ideal Models, 19 W. 18th, New York 11, N. Y.

BRASS Gears and model supplies for the inventors. Send 10c for catalog. Pierce Model Works, Tinley Park, Ill.

BUILD, Fly, world's most authentic model aircraft. Kits, motors, supplies. Airplane catalog, 10c. Clevemodel, 4507TC-25 Lorain, Cleveland, Ohio.

RECEIVE 1/2 Class A gasoline engine and model airplane practically as a gift. Details free. Hobbycraft, Box 104-A, Brooklyn 30, New York.

RAILROADERS—50c Gets new Catalog Reference Manual. State O or HO gauge. Walthers, 247 Erie, Milwaukee 2, Wis.

STEAM Locomotives, 1 1/2", 1", 3/4", 1/2", 1/4" scales. Castings, rail, steam fittings! Thorough drawings with instructions. Catalog 50c. Little Engines, Wilmington, California.

HOME CRAFTSMEN

LEATHERCRAFT. Everything needed by beginners, advanced hobbyists and professional leatherworkers. Largest stock of supplies in U. S. Moderate-priced tooling leathers, top quality calfskins, tools, supplies, kits. Send 10c for big catalog. J. C. Larson Co., 820 S. Tripp, Dept. 875, Chicago 24.

NEW Leathercraft catalogue. Pleasure and profit. New styles, belts, purses, shoes. Largest leathercraft school in U.S.A. G. I. approved. Send 10c for catalogue. Dept. PM, Apache Leather Co., 2804 E. Washington St., Phoenix, Arizona.

KNOCKDOWN Cedar chests. Lumber and veneers. Free price list. Giles & Kendall Company, Huntsville, Ala.

JIGSAW Owners attention! Start earning money at home cutting out wooden novelties and souvenirs. Write H. Cook, Dept. A, 4407 S. Normal Ave., Chicago 9, Ill.

89 FULL Size jig saw patterns of beautiful shelves, ornaments, toys, novelties. Plus "How, Where to Sell." Only \$1.00. Mastercraft 34M, 7041 Olcott, Chicago 31, Illinois.

LEATHERCRAFT Supplies, leather and tools, low prices. Send 10c for catalog. Jonas Handicraft Co., Dept. 3-M, 30 Frankfort St., New York 7.

OZARK Wood samples. Eleven varieties prepaid. \$1.50. Davis Lumber, Cabool, Missouri.

LEATHERCRAFT Supplies, leather, tools, lacing. Catalogue 10c. Mail orders. Crown Leather Co., 22 Spruce Street, New York 7.

WHOLESALE Shellcraft Book 15c. Large shellcraft kit \$1.69 postpaid. Shell-Art Novelty, Dept. PM, 5th and Moore, Philadelphia 48, Penna.

SHELLS, Plastics, findings. Lowest prices. Catalog 5c. Frances Jones, Box 251, Sarasota, Fla.

16 NEW Lawn chairs, 22 picnic tables, benches, trellises, etc. All 38 plans with necessary full size patterns, \$1.00. Mastercraft 33M, 7041 Olcott, Chicago 31, Illinois.

LEATHERCRAFT Bargains! Lacing. Francis Byrd, 3406 Montrose Ave., Richmond, Va.

8 BEAUTIFUL Full-size whatnot patterns 35c. Joanness, P.O. Box 141-M,

90 ALL New, full size lawn ornament and novelty patterns, up to 20" high. Only \$1.00. Mastercraft 32M, 7041 Olcott, Chicago 31, Illinois.

SHELLCRAFT! Make beautiful seashell jewelry and novelties; income or hobby. Supplies, instructions \$2.00, deluxe \$3.00 prepaid. Gift Center, Hollywood, Fla.

DECORATE Chinaware by decalcomania process. Beginner's professional kit \$4, postpaid. Supplies, 2 china blanks, 1 finished sample, directions. Seastrom, 203 Ivy, Arlington, New Jersey.

SHELLCRAFT For hobby or profit. Giant illustrated catalogue showing many new designs for jewelry, plaques, etc., with instructions. Send 25c. Southern Shellcraft Supply, Clearwater, Florida.

WALNUT — Beautiful select straight grain "squares". Average 2 1/2"x3"x14". Clear 4 sides, 2 ends. Kiln dried. End coated. Perfect for hundreds of uses. Bundle of 4 only \$1 postpaid or c.o.d. (plus few cents postage). Dept. PM, Bishop Industries, Warsaw, Missouri.

NEW 96 Page leather and craft catalog. 1000's of items. Send 10c. Russo Handicraft Supplies, Dept. C-2, 245 South Spring, Los Angeles, California.

PROFESSIONAL—Type furniture finishing and refinishing supplies. New illustrated catalog and simple instructions 10c. Refunded. Colorall, 515 Cedar Lane, Teaneck, N. J., Dept. M.

LEATHERCRAFT Supplies. In leather business over 40 years. Tremendous stock, leather and accessories. Send 10c today for big catalog. Sax Bros., Inc., 1111 No. 3rd St., Dept. PM, Milwaukee, Wis.

30 LAWN Ornament patterns, ready cut. Full size, color indicated. \$1.00 postpaid. Lincoln Craft Studio, Farmington, Conn.

CRAFT Supplies for hobby or profit. Send 10c for complete illustrated catalogue featuring metal, cork, felt, shellcraft, paint, leather, plastic, and over 30 new crafts. University Hobby Crafts, 1701-C, Macombs Road, New York 53, N. Y.

MAKE Leather belts, billfolds, purses. Big catalog and genuine steerhide keyholder, 10c. Tandy Leather, Box 397C, Tulsa, Okla.

LEATHERCRAFT, Copper tooling, textile painting. Make spare time, profitable time. Free illustrated catalog shows everything you need. Kit Craft, 7377 Melrose, Hollywood 46, California.

LEATHER, Tools, lacings, supplies. Free catalog. National Handicraft, 199 William St., New York 7.

MAKE IT YOURSELF

BUILD Your own tractor. Plans. Walking, riding. Free information. Ellsworth Tractor Co., D-I, Camptonville, Calif.

FREE Literature describing needed farm and home machinery, easily built by you, from salvage materials. Kenneth Reeves, Box 3557-A, El Paso, Texas.

"CONCRETE Block Homes." 32 page booklet on how to build. \$1.00. H. G. Lightfoot, Civil Engineer, Richboro 1, Penna.

BUILD Your own concrete blockmaker. Easy. Inexpensive. Motor or hand. Make block per minute. Write, C. Lee, Mountain View, Okla.

STREAMLINED, Built-in kitchen cabinets to fit any kitchen. Illustrated manual describes designing and construction. All for \$1.00. Thombert Company, Newton, Iowa.

GRANDFATHER Clock easily built. Big savings. See ad on page 247.

BEAT Shortages ahead, save money. Build lathes, sawmills, tractors, scooters. Over 100 farm, home, workshop machines from junkyard materials. Rush 25c now for descriptive handbook (refundable). Kimo Plans, RCS, New York 19.

FOLDING Breakfast nook—Pat. No. 245-0515. Folds to wall out of way, facilitating the work of mopping and sweeping. Wonderful space saver. Easy to make. Send name and address for specifications and drawings with \$1.00 to Ken-Craft, 319 E. Jackson Blvd., Elkhart, Indiana.

PROFITABLE Hobby. Plans for hand weaving loom \$4. Englewood Weavers, 447 West 60th Place, Chicago 21, Ill.

MAKE Your own desk, end table, bookcase, buffet, vanity. 5 big plans. Only \$1.00. Craft-Plan, Box 581, Los Angeles 43, Calif.

WATCHES, OLD GOLD, JEWELRY

HIGHEST Prices paid for old gold, silver, platinum, diamonds, watches, gold teeth, spectacles. Cash immediately. Goods returned if offer unsatisfactory. Government licensed. United Smelting Works, (The Old Reliable), 39-J South State, Chicago 3.

HIGHEST Cash paid for old, broken jewelry, gold teeth, watches, silverware, diamonds, spectacles, platinum. Free information. Satisfaction guaranteed. Government licensed. Rose Smelting Company, 29-A East Madison, Chicago.

RHINESTONES, Jewelry settings, cameo, sequins, beads. Catalog free. J & M Novelties, Dept. CC-3, Griffith, Ind.

WATCHMAKERS', Jewelers', hobbyists', tools—supplies. Catalogue! Bengal Company, Culver City, California.

DIAMONDS Lowest wholesale prices. Airmail for price list. Joachim Goldenstein Diamond Club, Antwerp, Belgium.

WATCHMAKERS' Tools, materials, supplies, watches, Catalog. Gales, Box 1000, Chicago 90, Ill.

LEARN Watch-clock repairing at home. While learning we fix all watches for you. Inquire Modern Technical Supply, 55PM West 42 St., New York 18, N. Y.

GOLD Plated jewelry supplies. Rhinestones, pearls. Illustrated catalog, only 10c. Barry's, 47-N Branford Place, Newark 2, N. J.

TOBACCO, SMOKERS' SUPPLIES

FREE "Pipemaking" instructions. Exciting new hobby. Carvape, 2829-L Dixie, Hamilton, Ohio.

FREE Color catalog, fine pipes. Terrific bargains, bonuses. Write Gaylords, 522, Brockton, Mass.

PIPE Lovers—For an aromatic smoke use my bouqueting and aromatizing agents. Information free. Cozza, Manufacturing Pharmacist, Pequannock, N. J.

FOR THE HOME

WINDOW Devices. Prevent heat escape. Controls ventilation. Substantial fuel savings. Inexpensive, durable. Instructions, blueprints, \$1.50. Polokoff, 26 Milford Ave., Newark, N. J.

OF INTEREST TO WOMEN

START A pleasant hobby that can become profitable. Make artificial flowers, decorative novelties for friends and relatives. Proposition, crafts catalog, 10c. Chenille bride doll kit, \$1.89. CleveModel, 4507TC26 Lorain, Cleveland, Ohio.

\$30 WEEKLY. Spare time, making studio roses at home. Easy. Looks, smells real. Complete illustrated instructions, patterns, scent formula, send only 25c. Studio Rose, Col4, Greenville, Penna.

BIG Profits. Make fast-seller chenille holiday flowers, monkey trees, dolls. Literature free. Velva, Bohemia 16, N. Y.

FOR SALE—MISCELLANEOUS

MISSING Heirs. Are you one? Long list of names; former address. \$1.00. L. Wornall, 166 Vernon, San Francisco 25, Calif.

HANDSIGHTING Levels, improved, new model, used for grading land, contouring and laying out fences, piers, roads and gardens, price \$2.00 postpaid. Public Sport Shops, 11 S. 16th Street, Philadelphia 2, Penna.

SAVE Money on army, navy and factory surplus. Write today for new 60-page illustrated catalog. Tennusa Sales Co., Dept. AE, 1451 Market, Chattanooga, Tenn.

DRESSES 18c; Coats \$1.00; blouses 35c. Free catalog. Crown, 164-PA Monroe Street, New York.

VONSCHRADER Rug cleaning machine for sale. Less than half price. Good as new. Dorsett, 2215 So. Walnut, Muncie, Ind.

FREE Catalog! War surplus clothing. Amazing bargains. N. Y. Clothing Co., New York 29A.

WANTED—MISCELLANEOUS

WANTED Scrap solder, nickel, cadmium, mercury, tantalum, tungsten. Beacon Smelting Co., 93 Federal Street, Boston, Mass.

I Buy old comics, magazines, for quick cash. Whatcha got? Wilson, 1425 Roscoe, Chicago, Ill.

WANTED. Patents or exclusive sales for marine or fishing items. National distribution. L. & S. Marine, Box 548, Jackson, Michigan.

AIRCRAFT Wire rope, to 1/4", on spools, any quantity. Send sample, price. Aero Parts Supply, 8102 Lockheed, Houston, Texas.

PERSONAL

BORROW By mail. Loans \$50 to \$300 to employed men and women. Easy, quick. Completely confidential. No endorsers. Repay in convenient monthly payments. Details free in plain envelope. Give occupation. State Finance Co., 210 State Finance Bldg., Dept. U-14, Des Moines 8, Iowa.

VALUABLE Big mails, four months listing, 25c. Wright Publications, 2270-J Hubbard, Memphis 8, Tenn.

MAKE Money in 1951 by mail. Particulars 3c. Swaty, Box 1466-P, San Diego, Calif.

GLOBAL Remailing service; free particulars. Travelpost, Box 1250, Albuquerque, New Mexico.

LETTERS Remailed 25c each. Edward Nadell, Box 345, Los Angeles 53, Calif.

MYSTIFY Friends. Six San Francisco postcards \$1.00. You address. We remail. Martin, Box 414, Alameda, California.

MEXICAN Legal matters reliably handled. Box 1736, El Paso, Texas.

LETTERS Remailed 25c each. Green, Box-6761, East Los Angeles 22, Calif.

MEXICAN Law. General practice. Attorney, 1203 Arizona St., El Paso, Texas.

RUPTURED? Positive comfort, no understraps, no steel, no elastic. Write Smith Manufacturing Co., Preston, Ont.

"HOW Can I find out?" You can! Information discreetly developed. Any matter, person, problem, anywhere. Worldwide. Officially licensed, bonded service. Established 1922. Reasonable. Confidential. William Herman, 170 Broadway, New York.

HERE'S How and where to borrow \$50.00 to \$300.00 by mail. Confidential. Free particulars. Postal Finance Company, Dept. 45, Sioux City, Iowa.

MISCELLANEOUS

INCREDIBLE! Unprecedented! Become a mental superman overnight! Floor everybody! No studying! "Memoprop" does all your thinking! It's uncanny! Revolutionary! Write: Bijou, Box 1727-M9, Hollywood 28, California.

GENUINE Diamond-like zircons, wear them for good luck, good looks, good style. Brilliant, perfect half carat sample \$1.00 or one carat \$3.00. Field Bros., Importers, 39-B South State, Chicago, Illinois.

FORTUNE May be yours. Detect uranium, gold, silver, precious metals, minerals. America's finest Geiger counters, metal and mineral detectors and mineralights. None finer at any price. Factory guaranteed. Write manufacturer for free information. Detectron Co., 5631 Cahuenga, North Hollywood, California.

VENETIAN Blind tape and cord. Repair your own average size, two strap blind, eggshell or wine color, instructions included \$1.59. Give slat width, 2 inch or 2 3/4 inch. Fixit Blind Shop, 1537 Winton Avenue, Lakewood 7, Ohio.

RECEIVE Hundreds of valuable items absolutely free. Supply source directory 25c. Nelko Service, 3462 Merchandise Mart Sta., Dept. FR-3, Chicago 54, Ill.

SAVE Money on paint brushes. Buy direct. Post card brings descriptions and prices. Kenmore Brushes, P.O. Box 53, Kenmore 17, N. Y.

TREASURE Finders for gold, silver and minerals. Money back guarantee, best available. Also Geiger counters for uranium prospectors, free information. Write Goldak Company, 1541 West Glenoaks, Glendale 1, Calif.

"RECEIVE Mail." Moneymaking offers, opportunities, catalogs. Name listed 10c. Ideal Service, Park Ridge 10, Ill.

RESEARCH: We find, locate buyers, or sellers for anything of value. Registration and listing, \$1.00. Refundable. Wright Publications, 2270-F Hubbard, Memphis 8, Tenn.

HAND Controls wonderfully improve poor penmanship in three hours. Write, "OZ," Box 665 (34P), St. Louis, Mo.

PANNING Gold lesson and catalogue. Beginners supplies, books, "maps where to go" free. Old Prospector, Box 729D1, Lodi, Calif.

SEEK Gold, uranium, buried treasure! Latest low cost super-sensitive equipment. Free literature. Glen Scientific, Box 151-B, Glen Ellyn, Illinois.

LABELS, Carton. Send 10c. Smith Labels, 890 Logan, Denver, Colorado.

SQUARE Dance instructions. 40 dances, \$1.00. Wesley Rader, 1922 Grant, Denver 5, Colorado.

INTERESTING Mails. 25c keeps name on mailing list three months. Bentz, Desk C/84, Chatawa, Mississippi.

RESILVER Mirrors at home. Formula 25c. Ideal Service, Park Ridge 6, Illinois.

DRESSES 18c; Coats \$1.00; blouses 35c. Free catalogue. Crown, 164-PM Monroe Street, New York 2.

\$5 HOUR Easy! Sell name plates for houses. Free sample, order blanks. Write: National, 214 Summer, Boston, Mass.

ADD Spice to home projection shows with colorful old-time Nickleodeon slides. 2x2. Write for free list. Nickleodeon Co., New Fleidner Bldg., Portland 5, Oregon.

OUTDOOR Toilets, cesspools, septic tanks cleaned, deodorized with amazing new product. Just mix dry powder with water; pour into toilet. Safe, no poisons. Save digging, pumping costs. Postcard brings free details. Burson Laboratories, Dept. C-16, Chicago 22, Illinois.

TREASURE—M-Scope Geiger counters, mineral locators. Why buy something inferior when you can buy the best at a lower price? Backed by years of experience. Fully guaranteed by factory. Detects minerals, metals, gold, silver, coins. Payment plan available. Proven superior performance. Free 16 page illustrated booklet. Fisher Research Lab., Inc., Palo Alto, California.

TATTOOING Outfits, supplies. Illustrated list free. Zeiss, 728 Leslie, Rockford, Illinois.

URANIUM Prospecting information free. Prospector, Box 142-D, North Battleford, Saskatchewan, Canada.

URANIUM Detection by government approved fluorescent method. Expensive equipment not necessary. Send only \$3.75 for test outfit. Free particulars. Central States Laboratories, 947 N. Avers Ave., Chicago 51, Ill.

TEN Transparent ball pens sent for \$1. Adar Nissan, 400 East Tremont Ave., New York 57, N. Y.

UP To 20% on radios, electric appliances, cameras. Retail catalog \$1.00, refundable. Points Mail Order House, Box 331, Middletown, Penna.

PRESS Cards for auto, hat, pocketbook, \$1. Wellman Printers, 123 W. Third, Williamson, W. Va.

PER-CAL-CO Method of figuring, mentally, "day of week" for any month, any year. You can learn in a few minutes. You will amaze your friends and find it entertaining and useful. Per-Cal-Co Method plus four patented, pocket-size 101 year calendars, in colors, sent postpaid for \$1.00. Perpetual Calendar Co., Milford, Michigan.

RECIPE To make syrup with corn cobs. Taste like maple. \$1.00. A. J. Ross, 1129 E. Taylor St., Phoenix, Arizona.

BUY Wholesale and save! Plumbing, heating, roofing, building samples, tools, paints, etc. Rush 25c for price lists, catalogs, samples, other details. Dept. E, Handy Man—Wholesale Buying Plan, 1009 E. Cheltenham Avenue, Philadelphia 24, Pennsylvania.

BUY 550,000 Articles wholesale. Directory 10c, refundable. Publishers, Box 1302-P3, Detroit 31.

CARTOONS. The kinds you'll like. Samples 25c. Verret, Raceland, Louisiana.

CESSPOOL-Septic action supplied. Saves pumping \$2.50. Descriptive literature. Chemical Cesspool Cleaning Company, Allston 34, Mass.

YOUR Leather jacket renovated expertly. Free circular. Berlew Mfg. Co., Dept. 8, Freeport, N. Y.

PLASTIC Garment cover, \$1.00 postpaid. P. Cerone, 6222-P Grays Avenue, Philadelphia 42, Penna.

1000 POSTCARDS \$10.00. Reproduced from photograph, negative or picture. 15 word advertisement, name and address. Samples 10c. Tuclaw Art, Stanhope, New Jersey.

HAIRCUT Satisfaction. Shaving technique. Booklet tells how. 25c. Mastrolia, 51 1/2 R. Jane, New York 14.

DOLLAR Gift for women. Send 50c. Behm, 3635 Roosevelt, Chicago 24.

EARN Up to \$200 month, inventing toys, games, gadgets. Write, Hendrickson, Argyle

Earn Big Money

WRITING ORDERS

AMAZING NYLONS

Guaranteed Against

RUNS AND SNAGS

Regardless of Cause!

The world's **ONLY** complete, nationally advertised nylon hosiery line actually guaranteed against runs, snags or excessive wear, **REGARDLESS OF CAUSE!** It's amazing, but true! No matter what the cause—hard use or deliberate abuse—Kendex nylons are replaced **FREE** if they run, snag or become unfit for wear within entire guarantee period! Every weight from sheerest 15 denier to heavy 70 denier—all gauges up to luxury 60 gauge—all sizes, lengths, popular shades, fancy heels, black seams—full fashioned and seamless. Nothing is missing to make sure every woman is pleased. In spite of the amazing guarantee, retail postage prepaid prices are no higher than comparable quality national brands. Should free replacement be necessary, actual cost is cut in half! How could any woman possibly resist saving money and solving her hosiery problems? **NOT SOLD IN STORES.** Men and women wanted **NOW**, spare or full time, to write orders and earn big money. You can get orders even if you never sold a thing in your life!

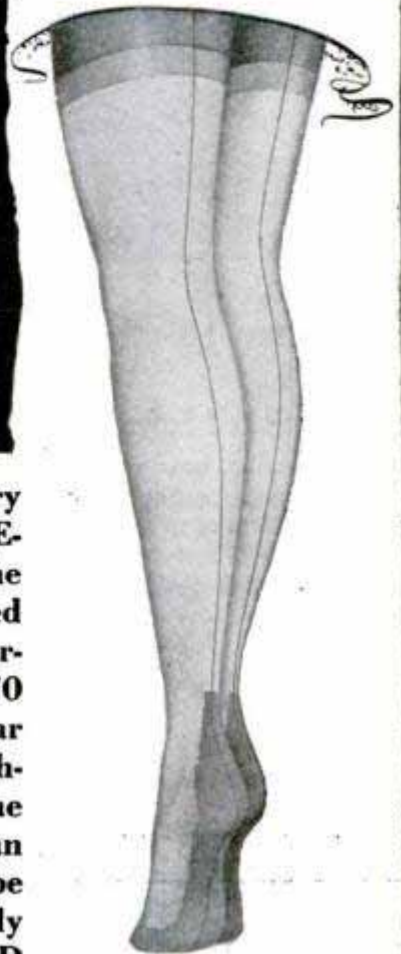

FREE SAMPLE STOCKING

Man or woman—young or old, **YOU** can easily earn steady income, spare or full time. No money or experience needed. We supply **EVERYTHING** free and set you up in business at **OUR** expense. Nothing to buy or deliver. Write orders. We deliver and collect. Big advance pay plus huge cash bonus that increases your earnings up to **40%**! Your name and address on postcard will bring you sample stocking; self-selling sales books with **FULL COLOR** illustrations; 32-page sales manual showing you easy steps to success; color cards, free "door openers" worth \$1 each but which you give away free; special plan to have others sell for you, etc., etc. You can start making money the minute you receive the complete **FREE** outfits!

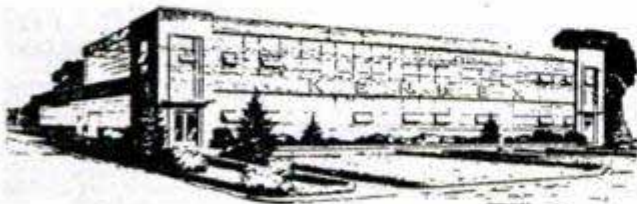

YOUR COST ONE CENT!

SEND NO MONEY. Pay nothing now or later. No obligation. Not even a promise to return outfits. Simply write your name and address on a penny postcard and mail to us. We'll immediately rush you everything you need **FREE** and postage prepaid. **WRITE TODAY!**

KENDEX CORPORATION

● BABYLON 846, N. Y.

NEW Transvener



PLASTIC VENEER

★
Wood Grain Veneer
in Transfer Form!

- ✓ Refinish Old Furniture Like New!
- ✓ Finish Unfinished Furniture!

Miraculous new veneer applies as easily as a decal. Choice of world's richest wood grains, marbles, leathers. Permanently covers any smooth surface—wood, metal, glass. Dries fast, Inexpensive.

FREE! Write today for free sample folder showing TRANSVENEER selections.



Transvener
DIVISION OF

THE DI-NOC CO.
1302 Public Sq. Bldg. Cleveland 13, O.

CONDENSERS • DISTRIBUTOR HEADS
COILS • VOLTAGE REGULATORS
(ALSO FUEL PUMPS)

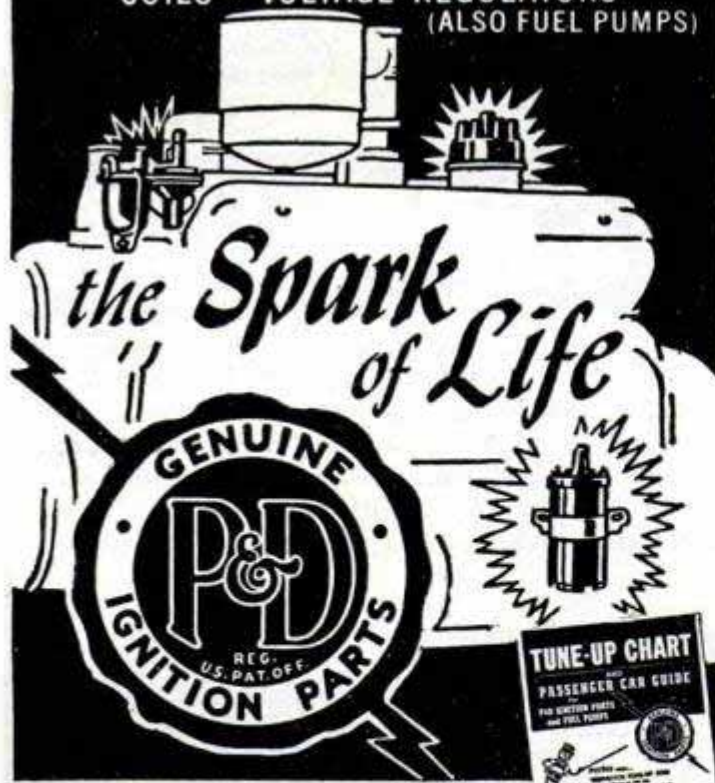

Send a postcard to Dept. M1 for the P.&D. TUNE-UP CHART for P.&D. ignition parts and fuel pumps...tune up specifications for the various makes and models of autos.

P. & D. Manufacturing Company, Inc.
19-02 Steinway Street, Long Island City 5, N. Y.

GO PLACES
LEARN ANOTHER LANGUAGE
by World's Standard
Linguaphone METHOD
IN 20 MINUTES A DAY

FRENCH
SPANISH
GERMAN
RUSSIAN
- any of 29 Languages

Are you letting interesting job, travel, armed services, opportunities and a whole new world of social advantages pass you by because you speak only one tongue? Speak French, Spanish, German — any of 29 languages, including the Oriental — quickly, easily by the one and only LINGUAPHONE CONVERSATIONAL METHOD. You listen—you learn—you understand—you SPEAK. World-wide educational endorsement; over a million delighted home-study students. FREE BOOK gives fascinating facts. Write TODAY! State if Veteran.

LINGUAPHONE INSTITUTE
143-03 Rockefeller Plaza, New York 20, N. Y.

TELESCOPE

NEW HI-POWER

For Shooting
Star Study
Watching
Birds
Etc.



Only
\$24.75

New Principle—Out-Performs
More Expensive Scopes!

Here's a powerful, rugged telescope for every kind of use at a common sense price. It's the brand new SUPER-LITE—22-Power—2 1/2 inch diameter. Entirely new principle gives more light and better resolving power than very expensive scopes of this size. Has coated achromatic lenses, fully corrected. No ghosts or internal reflections. Length, extended, 16 in., closed 13 in. Field view 2 3/4 feet at 100 yards. Tapered eyepiece. Built-in sight and sunshade. All-metal, permanent black finish. Order today under money-back guarantee. Send only \$24.75 for prepaid delivery to your home.

Projection Optics Co. Inc., Dept. 13
330 Lyell Ave., Rochester 6, N. Y.



Bar Bells
Buy Direct From Factory \$8.95 up
Write for free booklet and price list
INDEPENDENT IRON WORKS
2416 East 23rd Street, Dept. B
Los Angeles 58, Calif.

ELECTRIFY your **SEWING MACHINE**
NEW LOW PRICE!
\$12.50 1 YR. GUARANTEE
Buy direct from manufacturer and save! Kit comes fully wired, installed in a jiffy. Fits all machines! You get these all-new parts:
• Motor & Bracket
• AC-DC 115v 60c
• Multi-speed foot control
• Cord set & block
• Easy instructions
• Steel pulley & belt
FREE . . . reg. \$2.95 chrome SEWLITE given with every kit.
10 DAY FREE TRIAL — ORDER NOW!
Send no money, pay COD or send money order and we'll pay postage. Please state whether wheel on your machine turns toward you or away from you. Shipping wt. 6 lbs.
SENIOR SEWING MACHINE CO.
1046 BEDFORD AVENUE Dept. PM-24 Brooklyn 5, N. Y.

LIFETIME WRITTEN GUARANTEE
17-JEWEL WRIST WATCH **4.95**
PLUS \$1.50 TAX

ORIGINAL PRICE \$59
INCABLOC— Shock Protected
WATER-DUST PROOF
 Worn by Army, Navy & Marines During War

YOU SAVE \$44



Luminous dial . . . Sweep second hand . . . Super Accurate . . . Imported Swiss precision movement and case. You get these men's New Lifetime Guaranteed Watches now for a small fraction of the original price. You save \$44, because we bought-out surplus stock! Don't delay!

Order now . . . while they last.

TRIAL OFFER! Wear at our risk!
 Money back in 5 days if not delighted. SEND ONLY \$1 down payment with order. Pay balance to postman on arrival plus postage. Or we pay postage if you include full payment, plus tax with your order. Return this ad with your order.

FREE! Handsome Expansion Band included. ORDER NOW!
MARYLAND DISTRIBUTORS, Dept. 236
 501 EAST BALTIMORE STREET, BALTIMORE 2, MARYLAND
 Free Watch & Diamond Ring Catalog.
 Practically Wholesale Prices to User Direct.

Get into Good Paying AUTO BODY and FENDER WORK



BIG DEMAND in Auto Body and Fender work. Start training now in your spare time at home for good pay work. Practical shop experience included. U. E. I. Training covers metal work, welding, painting, etc. Placement service—or we will show you how to start your own shop. Behind U. E. I. TRAINING is a large national organization founded 1927. Write today for **FREE FACTS**—No obligation.

Write For Free Facts

AUTO-CRAFTS DIVISION • UTILITIES ENGINEERING INSTITUTE
 2523 SHEFFIELD AVE., DEPT. XC-9, CHICAGO 14, ILLINOIS

Fly this famous model!
 Big 43" Luscombe SILVAIRE model kit *and* tiny, powerful, .049 "CUB" gas motor *and* gas tank *and* propeller
 All for **\$9.50** postpaid
CLEVELAND MODEL & SUPPLY CO.
 4507TD4 Lorain, Cleve. 2. Ohio
 Send it today!

1/2" ELECTRIC DRILL ADAPTER
 Fits any small 1/4" Drill—in a SECOND!
 Takes all larger size drills—Sturdy—A Mighty Handy Tool.
DANIELS PRODUCTS CO.
 M3-822W 22nd, Kearney, Nebraska
\$2.95 Postpaid in USA

Earn up to \$6,000 a year!
MORE JOBS THAN WE CAN FILL
METAL TRADES BACKBONE OF INDUSTRY
 Men who are mechanically inclined have a wide open field to choose employment in the Metal Trades Industry. Jobs are going begging for lack of qualified trained men. You need no previous experience to start your training at this school.

SHORT COURSES TO MEET PRESENT JOB DEMAND. **INDICATE YOUR PREFERENCE—RESIDENT or HOME STUDY TRAINING**

ALLIED SCHOOL OF MECHANICAL TRADES, Inc.
 1338-1340-1342 S. MICHIGAN AVENUE
 403 ALLIED BUILDING, CHICAGO 5, ILL. Write for FREE BOOKS
 A 1¢ Postcard will do.



LET US PUT THIS MAMMOTH NEW 1951 MIDWEST TELEVISION 19 1/2-Inch CONSOLE IN YOUR HOME ON 30 DAYS MONEY BACK TRIAL

Be your own judge! See and hear Midwest Television in your own home. Then decide whether to keep or return it and have your money refunded. Low factory prices. Factory authorized service available.

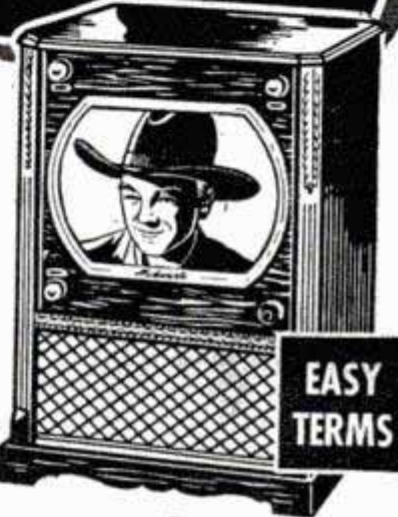

EASY TERMS

FACTORY-TO-YOU



Midwest offers a complete line of 19" and 16" Television models in beautiful consoles or ready-to-use chassis.

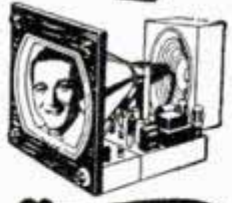

Also Available on 30 DAYS TRIAL
The NEW 1951 MIDWEST RADIOS
 Beautiful Consoles • Complete Chassis

Send This COUPON on 1c Post Card for NEW 1951 FREE 4 Color MIDWEST CATALOG

MIDWEST RADIO & TELEVISION CORP.
 Dept. 25-K, 909 Broadway, Cincinnati 2, Ohio

NAME _____
 ADDRESS _____
 CITY _____ ZONE _____ STATE _____



FREE! ROOSEVELT STAMP

This beautiful postage stamp, issued by the Republic of Cuba in memory of President F. D. Roosevelt, sent absolutely free! Our supply is limited—please do not request more than one. We'll also include other interesting offers for your inspection plus a **FREE** copy of our booklet "How To Collect Stamps".



Mail coupon today!

ALSO FREE BOOK

LITTLETON STAMP CO.
Box 815, Littleton, N. H.

LITTLETON STAMP CO.,
Box 815, Littleton, N. H.

Please rush items described. (Print Plainly)

Name

Address

City..... State.....



We Agree..

"INVENTORS ARE LAZY PEOPLE"

Take Thomas Edison; tired of gas lamps, he invented electric lights. Or Henry Ford, he'd rather ride than walk—result, the Model "T." George Eastman wanted a picture without painting, so . . . the science of photography advanced.

For our money we're betting on the lazy inventor. Lazy or enterprising, we in Rochester know American industry cannot progress without inventors. That's the reason for the Rochester Plan. It's the inventor's link to manufacturing and marketing.

For further details on the Rochester Plan write to:

DIVISION OF PUBLIC RELATIONS
54 Court St., Rochester 14, N. Y.

ROCHESTER DEPT. OF COMMERCE
ROCHESTER, NEW YORK

"In Rochester, Government Helps Business"

New! PRINT YOUR OWN ADVERTISING POST CARDS

ROTO-PRINT STENCIL DUPLICATOR prints and illustrates Advertising Announcements and Club Notices on 1c Government Postal Cards. Also Price Lists, Labels, Order Forms, etc. Easy to use. Gets amazing results in sales and inquiries. Hundreds of uses for every type business and organization. **GUARANTEED FOR LIFETIME!** Comes complete with necessary supplies, instructions, **FREE** Book of money-making ideas.



complete outfit
only
\$9.95

FREE TRIAL OFFER! Write and a ROTO-PRINT will be sent you postpaid. Try 10 days—then send only \$9.95 (Low, Direct-to-You Price), or return ROTO-PRINT with no questions asked. Write NOW! **AGENTS WANTED!**

ROTO-PRINT CO., 211 North 7th St., Dept. B-4, St. Louis 1, Mo.

POWERFUL

Interchangeable rifled barrels for 5 types of ammunition. .22 or .177 Cal. Hy-Score Pellets & Darts, & BB's. Small game HUNTING, indoor and outdoor TARGET shooting. The perfect gift. At your dealer now or write Dept. P-2



NO PUMPING
HY-SCORE
5 in 1
AIR PISTOL
ONLY
\$19.95

HY-SCORE ARMS CORP., 25 Lafayette St. Brooklyn 1, N. Y.

LAW

STUDY AT HOME for Business Success and **LARGER PERSONAL EARNINGS**. 40 years expert instructions—over 114,000 students enrolled. LL.B. Degree awarded. All text material furnished. Easy payment plan. Send for **FREE BOOK**—"Law and Executive Guidance"—**NOW!**

AMERICAN EXTENSION SCHOOL OF LAW
Dept. PM-36, 646 N. Michigan Ave., Chicago 11, Ill.

TRAIN

Your VOICE!

RESULTS GUARANTEED
STRENGTHEN your voice this tested, scientific way. Yes—you may now be able to improve the **POWER** of your speaking and singing voice . . . in the privacy of your own room! Self-training lessons, mostly silent. No music required. Write TODAY for Eugene Feuchtinger's great booklet "How to Develop a Successful Voice." It's absolutely **FREE!** You must state your age. Booklet mailed postpaid in plain wrapper. No salesman will call. Send your name and age **RIGHT NOW!** Perfect Voice Institute, 210 S. Clinton St., Studio C-2, Chicago 6, Ill.

EARN MONEY IN UPHOLSTERING

Professional home training—tools, supplies, equipment included. Business of your own or a good job. Upholster your own furniture at fraction of cost. Valuable booklet free. Write now. General Trades Schools, 3810 Broadway, Dept. PM-3, Chicago 13, Ill.

Say You Saw It in
POPULAR MECHANICS

FOAM RUBBER

FOR HOBBYISTS, CRAFTSMEN, EXPERIMENTERS



Lowest Prices—SAVE 50%	AUTO SEAT TOPPER PADS
16 x 16 x 1 1/2" . . . ea. 51.35	Place under seat cover.
16 x 22 x 1 1/2" . . . ea. 1.75	24" x 60" x 1 1/2" . . . ea. \$6.45
18 x 24 x 1 1/2" . . . ea. 2.00	24" x 60" x 2" . . . ea. 7.95
24 x 24 x 1 1/2" . . . ea. 2.95	12" x 14" x 1 1/2" . . . ea. 1.25

Use for furniture cushion fillers, mattresses, mattress pads, cushions. Foam Rubber is available in any size or thickness. Send For Free Price List. Immediate delivery. No C.O.D.'s. Add 10% for Postage & Handling to Above Prices. Please print.

RIOR RUBBER COMPANY, Dept. P-15
50 East 22nd St. Chicago 16, Ill.

WANTED!

MEN AND WOMEN TO EARN SPARE TIME MONEY

Many Popular Mechanics neighborhood representatives are making extra cash for easy, after-hours work. A few more are needed.

For details, write:

POPULAR MECHANICS
ROOM 408
200 E. ONTARIO STREET
CHICAGO 11, ILLINOIS



30 DAY FREE TRIAL

High Power BINOCULARS

Finest Precision Optics
Featherlight
Money Back Guarantee
Easy Pay Plan
Leather Case Incl'd.
Free! Catalog & Book
"How to Select Binoculars"
Dealer Inquiries Invited

Bushnell Bldg., Dept. M-23,
Pasadena 1, Calif.

BRAND NEW
33 MODELS
\$14⁹⁵
up
BUSHNELL Binoculars

LEARN WATCH REPAIRING



AT HOME. By our modern and original system of instruction you can learn every part of the **WATCH REPAIRING TRADE AT HOME.** Prepare yourself for a well-paying position or start in business after completing our course of instruction. Good watch repairers are in demand and generally earn very good salaries. For particulars apply to the **WISCONSIN SCHOOL OF WATCH REPAIRING**
759 North Milwaukee St., Milwaukee 2, Wis.

SAY YOU SAW IT IN POPULAR MECHANICS

READY CUT HOMES

Order Now.

Homes \$2132 and up, freight paid. Orders filled in order received. Save up to \$1,000 on modern production method homes. Much more compared with builders' prices. Anyone can assemble with simple plans furnished. Complete, including paint, hardware, roofing, glass, nails, etc. Send 25¢ in coin for full color catalog showing 57 modern low priced homes and floor plans. Complete building plans ready for filing at low cost. Sold separately if desired.
Five Easy Payment Plans.



NEW COLOR CATALOG FOR ONLY 25¢

Dept. P.M. 351
INTERNATIONAL MILL & TIMBER CO.
Bay City, Mich.



NEW! HULA DIVER



"BEST BAIT BY A DAM SITE"—say Toby Shopper (left) and Hank Werner, who took these beauties at Fontana Dam, N. C., on the new Hula Diver. You control amazing new wiggling action by speed of retrieve. Sinks slowly at rest. You control running depth by length of cast and sinking time allowed. Red-hot open-water bait for Bass, Walleyes, and other game fish. Ideal for trolling.



EACH
\$1.25

AT YOUR DEALER

5/8 oz.

Choice 7 body colors

FREE WRITE TODAY FOR BIG FREE 1951 ARBOGAST COLOR CATALOG—FULL OF PICTURES OF CATCHES

FRED ARBOGAST & CO., INC.
2263 WEST NORTH STREET • AKRON 3, OHIO

Don't Envy The PLUMBER—Be One

Make \$15 to \$50 a Day

Every skilled workman will tell you Plumbers have the best of it. WINTER and SUMMER the Plumber is busy at top wages. No skilled Plumber is ever out of a job. Compare his opportunities with any trade. To the man with know how, Plumbing means profit. Investigate Universal Plumbing School. Not a "war born school," but a plumbing school developed and operated by plumbers since 1923.



The Plumber Protects the Health of the Nation

Own Your Own BUSINESS

Have your own business and big profits with little other than training and a kit of tools.

JOURNEYMAN Gets Good Salary

Master Plumbers own their own shop. A Journeyman works for a Master. With this training journeymen can depend on high wages.

BE A PLUMBER IN JUST 32 WEEKS

Learn With Tools—Not Books

No need ever serve an apprenticeship. Don't envy the plumbers big profits—enjoy them. Learn every trick of the trade—Leadwork—Blueprint for plan reading, etc. under Licensed Master Plumbers.

Over 7,000 Successful Plumbers Recommend This School

This system has made more than 7,000 plumbers. Investigate our past performance. If you like to work with tools this is your opportunity. Become a Plumber in America's largest and only school devoted exclusively to plumbing. Write today for FREE information.

G. I. Approved. Established 1923

UNIVERSAL PLUMBING SCHOOL

877 Holmes Street

Kansas City, Mo.



**OVER 700%
PROFIT!**
WITH THE
**PDQ CHAMPION
PHOTOMASTER**

**Makes Finished Pictures
in 2 MINUTES!**

**Complete Portable
Photo Studio**
Size 4½" x 5" x 10".
Weighs about 6 lbs.
No experience required.
Simple directions teach
you quickly.

- Beautiful, everlasting photos—black and white or sepia, size 2½x3½ in.
- Guaranteed not to fade.
- No darkroom needed.
- Photos are taken **DIRECT** on "SUPER-SPEED" direct positive paper.
- Leads enough paper for 50 shots in half a minute — in broad daylight.

BE A P.D.Q. PHOTOGRAPHER

Work at home or travel. Make expenses plus extra profits. Pictures cost you only 2c. Sell for 15c to 25c. Folks just grab for 'em. They are amazed to see their own photos come to life in broad daylight. Photomaster "shoots" any subject—individuals or groups—buildings and scenes. This new and fascinating business offers unheard-of money-making opportunities everywhere—every day throughout the year. Write quick! Get **FREE INFORMATION** about the great PDQ CHAMPION PHOTOMASTER.

P D Q CAMERA COMPANY

1161 N. Cleveland Ave., Dept. PM-3, Chicago 10, Ill.

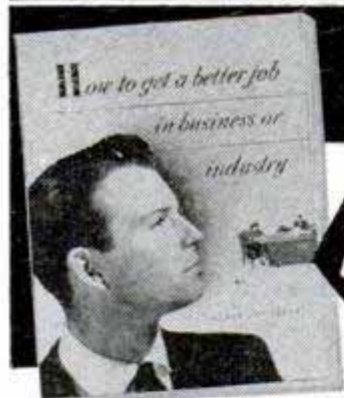

**HOW TO GET A
BETTER JOB**

In Business or Industry

FREE BROCHURE...

shows how to advance
yourself with
self-training in
effective Leadership

Leaders aren't born—they're *trained*—many of them *self-trained*. Industry is mobilizing for defense and you should make a decision quickly! See how the present shortage of *qualified* leaders—supervisors, foremen, and managers—can be to your advantage. Our catalog describes the methods used by thousands of successful men whose spare-time training got them better jobs at much higher pay. Get your copy now—without cost or obligation. Please check your fields of interest. **ACT TODAY!**

HOLMES INSTITUTE Home Study Dept. MP-1
3308 - 14th ST., N. W., WASHINGTON 10, D. C.

Send free illustrated brochure "How to Get a Better Job in Business or Industry." I'm interested in following subjects:

- | | |
|--|--|
| <input type="checkbox"/> Production Control | <input type="checkbox"/> Technique of Handling People |
| <input type="checkbox"/> Business Organization and Practices | <input type="checkbox"/> Moving Ahead on the Job |
| <input type="checkbox"/> Reading Blueprints in the Machine Age | <input type="checkbox"/> Principles of Industrial Organization |
| <input type="checkbox"/> Salesmanship | <input type="checkbox"/> Simplified Accounting |

NAME
STREET
CITY
ZONE STATE AGE

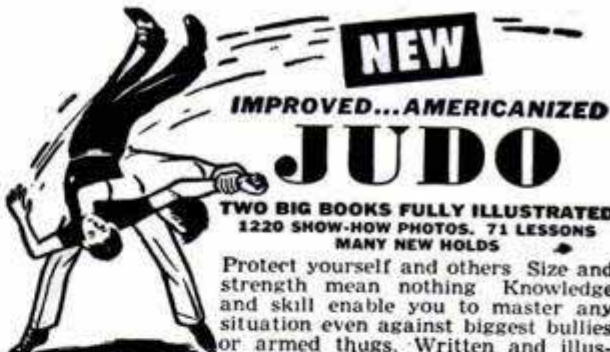

NEW
**IMPROVED...AMERICANIZED
JUDO**

TWO BIG BOOKS FULLY ILLUSTRATED
1220 SHOW-HOW PHOTOS. 71 LESSONS
MANY NEW HOLDS

Protect yourself and others. Size and strength mean nothing. Knowledge and skill enable you to master any situation even against biggest bullies or armed thugs. Written and illustrated by one of the world's great Judo experts. Volume 1, basic and advanced holds. Volume 2, very advanced. Each volume \$1.50.

**Big Combination
Offer!
SAVE...**

BOTH BOOKS \$2.50 POSTPAID
OR C.O.D. PLUS POSTAGE
5-day Money Back Offer. ACT NOW!

DEPT. PM-3

IMPROVED JUDO, INC. P.O. Box 7355, Sta. L, Los Angeles, Calif.



**TEACH YOURSELF
OR YOUR CHILDREN**

to play piano from notes, at home. Save money and see what our professional self-taught piano course and a few enjoyable minutes a day will do for you. Check: I want to learn myself, want to teach children myself; want your help to improve my present playing; you put music to my songs. Rush for free facts today: **MUSIC TEACHERS' ASSOCIATES, 26 POTTERS LANE, GREAT NECK, N.Y.**

TRAIN in Our SHOPS -

in **AIR CONDITIONING, REFRIGERATION,
ELECTRICITY, MAJOR APPLIANCES, AUTOMOTIVE
MECHANICS, BODY and FENDER REBUILDING**

If interested write or wire

COMMERCIAL TRADES INSTITUTE Inc. of Ala.

200 S. 20th ST.
BIRMINGHAM, ALA.

254 IVY ST. N.E.
ATLANTA, GA.

VETERANS ASK ABOUT G I TRAINING

Use Easter Seals

DUST RESPIRATORS FOR HOME USE



NEW! GOV'T SURPLUS — Don't breathe germ laden dust when sanding, grinding or sweeping. These respirators are easy to use and inexpensive. Excellent for furnace cleaning and all dusty jobs around home or shop. Get several today at this bargain price. Made of grey felt and moulded rubber.

59c each

1 for \$1.50 FPD unless COD

WRITE FOR **FREE GOV'T SURPLUS CATALOGUE**

BEN'S SURPLUS 549 Kleiman Bldg., Grand Rapids, Mich.

**GET A FINE SUIT
AND START IN BUSINESS**

Get your made-to-measure suit without cost taking orders from friends at direct-from-factory prices. Pocket-big commission on all orders. Get splendid demonstration outfit and tested plans **FREE**. Work from home or office, full or spare time. Top men make up to \$12,000 in a year. Famous 38-year-old firm. Write



BUSINESS MANAGER, Dept. 171,
Box 23, Cincinnati 6, Ohio

PAY US NOTHING



**RE-STRING RACKETS
AT HOME — EARN MONEY**

FREE
Write today for our Catalog and Instruction Sheet.

Earn Money at home in Spare time. It's pleasant, profitable work. No experience or skill required. Easy to learn. Full line of guaranteed **Stringing Tools, Frames, Gut and Nylon Strings**. Every item high quality.

W. A. BICKEL & CO., 803 So. Boulevard, Dept. PM-3, Oak Park, Ill.

Learn PHOTOGRAPHY at Home

Splendid opportunities. Prepare in spare time. Practical basic training. Long-established school. Send for free book, "Opportunities in Photography." No obligation.

American School of Photography, 835 Diversey Parkway, Dept. 1353, Chicago 14, Ill.

**It's So Easy to Make
FALSE TEETH FIT TIGHT**
For Life of Plate
the **LINO-DENT** WAY



Professionally Developed

Why put up with the embarrassment and discomfort of loose plates. Now, with no fuss or bother—looseness and slipping vanish—gum soreness heals and disappears—forever. Talk with ease, eat anything. Thousands of satisfied users enjoy complete mouth comfort.

NOT MESSY! NOT STICKY! Not paste — not powder but an amazing plastic. The same material modern dentures are made of. That's why we can guarantee perfect plate comfort permanently with one application.

ABSOLUTELY SAFE. Lino-Dent is pure, non-toxic, non-irritating, harmless, tasteless, pleasant. Needs no heat. Easy to use!

MONEY BACK IF NOT SATISFIED

SEND NO MONEY—Full size package only \$1.25 plus postage. Specify upper or lower. Both \$2.25 plus postage. C.O.D. Enclose payment and save postage.

LINO-DENT, Inc.
Dept. C-4, 507 5th Ave.
New York 17, N. Y.

LOWER YOUR CAR
CALIFORNIA STYLE

with the Original Clark Lowering Blocks

- Far greater safety at high speed
- Less body rolling in turns
- Less front end dip on quick stops
- Lowers rear end to front end level

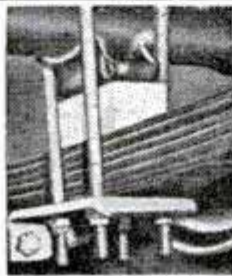

Complete kit only \$3.00, includes parcel post chg., 30 minutes to install—state make & year of car. Special kit for Ford & Merc 1932 to 1948 \$1.00

Over One Million In Use

CLARK HEADER CO.

6980 E. Firestone Blvd., Downey, Calif.

ARRO-PING —the Original Arrow

Slingshot has accuracy and power for small game or target with swift ping of an arrow. Sturdy, smoothly-made wood stock, metal-guided barrel, slender metal-tipped 12-inch arrows. Powerful rubber propulsion sends arrow 300 feet. Try skill in a new hunting thrill.



Postpaid, with three Arrows, \$1. Or Arrows alone 30 for \$1.

ARRO-PING CO.

Box 25H West End Station, Colorado Springs, Colo.

Build the "Golden Hind" In Just A Few Short Hours

You'll get plenty of solid satisfaction out of putting the "Golden Hind" together! Another historic IDEAL model ship, she's easy to assemble, comes complete with carved wood hull, simple plans, many finished parts. The "Golden Hind", Sir Francis Drake's Flagship, 13" model, only \$1.50 plus 15c postage for complete kit. Send 15c for catalogue of various models.



IDEAL MODELS

26 West 19th St., New York 11, N. Y.

Say You Saw It in
POPULAR MECHANICS

Learn Show Card Writing

For a Year 'Round Good Income in Big White Col- lar Field . . . Get This Master Authority.



For Beginners and Experienced Sign Men

Learn Show Card Writing for profitable employment, a spare time or full time business of your own or for a fine hobby. It's easy with this brand new book by E. J. Duvall. Size 8 1/2 x 11 inches, 158 pages and 115 illustrations.

Tells How to get started—How to letter—Shows Lettering practice strokes—Spacing and layout—19 full page plates of alphabets—How and what colors to use—Describes and illustrates equipment and materials—and includes 86 illustrations of actual show cards. Get your copy today. Only \$4.00 postpaid. Sent COD if you prefer. Order on 5-day money back guarantee.

FREDERICK J. DRAKE & CO., Dept. 13
117 Green Bay Road Wilmette, Ill.

PRACTICE FOR THE ARMY TESTS

GET THE RATING YOU WANT IN THE ARMY — NAVY — OR AIR FORCE!



To be sure of the job you want, officer training, success and advancement in the Army, Navy or Air Force—you must get a high mark on the Classification Intelligence Test you take on induction. **PRACTICE FOR THE ARMY TESTS** contains complete, simplified material along the line of the questions given on the test—shows you how to answer them quickly and easily. Crammed with hundreds of questions and answers on Arithmetic, Cube Counting, Reading Interpretation, etc.—it prepares you for this test—and helps you get the Army, Navy or Air Force job you want!

EXAMINE IT 7 DAYS FREE!

This book has helped over 500,000 men and women to bigger, better Armed Forces jobs—and it can help you! Send for your copy at once! Just mail coupon. On arrival, pay postman only \$2.00, plus postage and handling. If not completely satisfied, return it within 7 days for refund. Order NOW.



Arco Publ. Co., 480 Lexington Ave., N. Y. C.

ARCO PUBLISHING CO., Dept. 100
480 Lexington Ave., New York 17, N. Y.

Rush me my copy of "Practice for the Army Tests." On arrival, I will pay postman only \$2.00 plus postage and handling. If not satisfied, I may return book within 7 days for \$2.00 refund.

Name _____

Address _____

City _____ Zone _____ State _____

Check here if you enclose \$2.00. We pay postage. Same money-back guarantee.

DIRECT FROM CAN TO MOTOR
No Dirty Funnels or Containers

Use this new dispenser to handle all weight oils, gasoline, pour greases, etc. Delivers a quart of fluid to every four strokes, and a pound to every two. No waste. Fits any five-gallon kerosene-type can.



Steel cylinder, aluminum nozzle, four feet of oil-resistant hose, and pour-spout cap. Can, not included. Guaranteed.

Order Direct

ONLY \$6.00

Shipped PP if check with order. Add charges for C. O. D.

STELLO PRODUCTS CO.
HUTCHINSON, KS.



REPAIRS

Furniture, Toys,
Luggage, Dishes



It's transparent, waterproof,
flexible and durable.
Get a tube
today.



DUCO CEMENT

REG. U. S. PAT. OFF.

**PLEASE
SEND ME**



for the
time checked.

I am enclosing . . .

1 year \$3.50

2 years \$6.00

name

address

city

zone

state

C-3

Hand this order to your newsdealer or send it to

POPULAR MECHANICS

200 East Ontario St.

Chicago 11, Ill.

YOU CAN MAKE THESE WITH POPULAR MECHANICS PLANS AND BLUEPRINTS

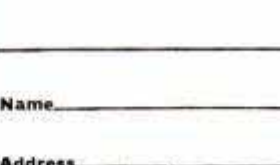
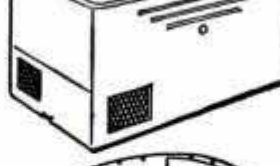
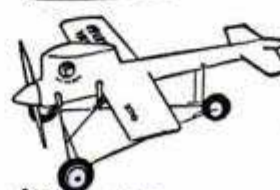

- 501—Colonial Grandfather's Clock. 25c
- 507-508—Doll-House, 5-Rooms, Open staircase, fireplace.50c
- 526—Queen Anne Coffee Table: True replica of antique.25c
- 528—Duncan-Phyfe Console Table: 30 in. high.25c
- 529—Lawn Chair: Southern style.25c
- 593—Three Attractive Corner Shelves: Scroll-sawed.25c
- 596—Three Hanging Type Shelves: Hold books, china, etc.25c
- 661—Rocking Horse: Scroll-sawed from plywood.25c
- 707—12 Ft. Rowboat: Flat-bottom, four seats.25c
- 795—Two Handsome Cedar Chests. 25c
- 811-812—16 Ft. Canoe: Canadian type, cedar planking.50c
- 813-814—Pops Outboard Racers: 10 ft. long, stepped bottom.50c
- 828-835—Sovereign of the Seas: English warship model. \$2.00
- Book: Sovereign of the Seas: Instruction Book. \$1.00
- 836—12 in. Bandsaw: Uses plywood, cuts two in. stock.25c
- 839—Melrose Corner Cabinet: Old Colonial design.25c
- 846-848—Governor Winthrop Desk: True copy of original.75c
- 896-897—Three Easily Made Workbenches—Simplified construction. 50c
- 906-909—Midget Auto: 58 in. wheelbase, 1/2 to 3/4 h.p. \$1.00
- 910—Circular Saw Table: Hardwood, 24" x 36", Stationary.25c
- 917—Outdoor Fireplaces: Several simple but practical.25c
- 920-922—Lawn and Garden Furniture: Swings, arbors, tree seat.75c
- 923—Indoor Fireplaces: Standard Sizes.25c
- 926-927—Venetian Blinds: Three different styles.50c
- 930—Hooked Rug Frame—Quilting Frame.25c
- 933—Cape Cod Cupboard: 4 ft. wide, 5 ft. 8 in. high.25c
- 935—Knee-Hole Desk: 40 in. long, 30 in. high, 31 1/2 in. wide.25c
- 936—Modern Coffee Table: 24 in. long, 15 in. wide.25c
- 952—Child's Crib in Maple.25c
- 958—Colonial Corner Cupboard: 6 ft. 8 in. high.25c
- 961—Hanging China Cabinet: 38 in. long, 40 in. high.25c
- 969—Combined Chest and Writing Desk: 35 1/4 in. high.25c
- 970—Modern Clothes Chest: Built of Plywood.25c
- 977—Bookcase in Chippendale Style: 47 in. high, 10 in. wide. 25c
- 978—Lawn Chair on Wheels: Lightweight, easy to wheel.25c
- 981—Colonial Wall-Shelf: 30 in. high, 19 in. wide.25c
- 984—Duncan-Phyfe Drop-Leaf Table: Reproduction of historic piece.25c
- 986-987—Utility Trailers: Built of old auto parts.50c
- 989-990—Speedy Motor Scooter: Gas engine, 40 to 60 miles on gal. of gas.50c
- 991—Gun Cabinet: Handy cabinet includes rack for rifles.25c
- 993—Twin-Deck Beds: 6 ft. 4 in. long, 31 1/2 ft. wide.25c
- 1106-1112—SEACRAFT—25 FT. CABIN CRUISER: Adaptable as sport fisher, express cruiser, or utility boat. Cruises at 15 knots with marine engine or converted auto engine. Cabin sleeps four. Galley has fresh-water tank, sink, and cook stove. Set of seven large-sized blueprints scaled 1 in. per ft. plus 40-page two-color illustrated booklet, only. \$10.00
- 1011—Fireplace Fittings: Andirons, log rack, etc.25c
- 1080-1081—Banta: 12 Ft. Plywood Runabout: Vee-Bottom, 3-passenger.50c
- 1086—Black Forest Corner Shelf: Scroll-sawed.25c
- 1089-1090—Home-Constructed Freezing Unit: reaches 30 degree temp.50c
- 1091-1096—17 ft. trailer, 7 ft. wide. Steel chassis. \$1.50
- 1102-1105—Midget Trailer: "Teardrop" body. Sleeping quarters for two. \$1.00
- 1113-1114—Gold Rush of '47: The A.M.A. Open Class B Record Holder Plane Model. \$1.00

FILL OUT AND MAIL THIS COUPON NOW

POPULAR MECHANICS COMPANY, Dept. 19
200 E. Ontario St., Chicago 11

Please send the following plans _____

I am enclosing \$ _____

Name _____

Address _____

FLASH Your Turns



**ELIMINATE HAND SIGNALLING
S & L DIRECTIONAL SWITCH
THE LOWEST PRICED DIREC-
TIONAL SWITCH THAT MEETS
ALL S.A.E. REQUIREMENTS**

Here is a safe, comfortable way of signalling your intention to make a left or right turn. Flashes from 60 to 80 times per minute. No need to roll down window to signal turns in cold winter weather. Kits furnished with all necessary material for perfect installation. No outside mounting of any kind. Uses your present parking and tail lights. Either of our two models fits most cars from 1942 to 1950.

**Specify year and make of car.
Money-back guarantee.**

**A PERFECT GIFT FOR MOTORISTS
S & L AUTO SALES
Box 6414, Dept. 4, Chicago 7, Ill.**

\$6.95
postpaid
in U.S.A.

SEND
CHECK
OR
MONEY
ORDER.

POSTAGE
EXTRA
ON
C.O.D.'s

OUT OF PAWN SAVE UP TO 50% AND MORE

GENUINE DIAMONDS

Approx. 1/2 Carat
\$95 Tax Incl. \$200 Value

SAVE ON DIAMONDS FROM ESTATES, BANKS AND UNREDEEMED PLEDGES

MONEY BACK GUARANTEE

SEND FOR FREE ILLUSTRATED Catalog

All diamonds reset in brand new modern mountings. Values from \$10.00 to \$10,000.

BERMAN'S DIAMOND LOAN BANK
DEPT. P—BERMAN BLDG., BALTO. 1, MD.

Our Ref. Your own bank or any mercantile agency.

HELPFUL BOOKS

Send post card asking for FREE catalog
Popular Mechanics Press, 200 E. Ontario, Dept. 601, Chicago 11

HELP CRIPPLED CHILDREN

1951

WAR SURPLUS AND OTHER BARGAINS

"BALTIC" SWEDISH TOOLMAKERS VERNIER CALIPER

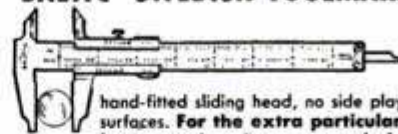

ULTRA PRECISION—0-6" in .001 graduations. Quick, accurate depth, inside and outside measurements, fine engraving. Extra heavy rule, hand-fitted sliding head, no side play. Rockwell C-60, lapped measuring surfaces. For the extra particular mechanic who must have the best—used and recommended by most critical experimental and research machinists at Lockheed • Douglas • Bendix • GM • RCA • General Electric. Save 50%! A \$37.50 value—only \$17.25—Leather case incl. Also a standard grade Mauser Design Caliper • made in Germany • For the production machinist, 0-6" in thousandths, the most accurate caliper of this type on the market, thousands of satisfied users—only \$12.95—Leather case included.

These are both guaranteed buys. Your money back if not entirely satisfied. Order now!

INSIDE MICROMETER 2" to 8"

Precision made of tool steel. Hardened tips on all six measuring rods. One 1/2" spacer. Chrome finish. Complete with case. **\$6.95**



MICROSCOPE 100 and 150 POWER



A fine precision instrument... not a toy. Highly ground and polished lenses. Overall height 8 1/2 inches. Designed for easy portability and yet stable enough for laboratory use. Microscope, leather case for barrel, four slides and hardwood carrying case box **\$9.95** postpaid.

MICROMETERS



Chrome plated, precision engineered and carefully tooled to give long life. All new.

0-1" capacity . . . each **\$2.25**
1-2" capacity . . . each **3.50**
2-3" capacity . . . each **5.50**
3-4" capacity . . . each **6.50**

DRILL GRINDER

... Sharpens round, square or tapered drills up to 6" long. Even an amateur mechanic can get a new, factory finish on a drill in 25 seconds. New protractor feature gives every drill sharpening angle, with 5 convenient angles already marked off. Usable with hand or power stone. A brand new development, manufactured by Ten Eyck. Shipped postpaid



All New.
\$2.80 each.

HIGH SPEED DRILLS

All New. Fractional & numbered. Orig. Val. \$15. Nationally known brand. Ast'd. sizes. Set 30, **\$3.50**

EXTENSION DRILLS

High Speed Steel, like new. Ass't'd sizes from No. 1/4 to 40. Lengths from 6" to 12". Approximately \$20 value. Set of 12 **\$3.75**



ELECTRIC BELLS—Vibrating type, high pitch. 115 V., 60 Cycle. Ideal for use indoors or outdoors—on ranches, for schools, plant installations, as signal systems, burglar alarm systems, etc. Nationally known Mfr. ALL NEW in orig. Pkgs. Solid brass clapper & 8 1/2" gong. Wt. 8 lbs. Govt. cost about \$67.50. **Close out at . . . \$7.95**

Send check, money order or cash. 25% deposit required on C.O.D. orders. All prices F.O.B. Culver City, California, unless otherwise stated.

Send 25c for Illustrated Catalog.

AIRBORNE SALES CO., INC. DEPT. PM 3-51 CULVER CITY, CALIF.

BLOOD PRESSURE GAUGE



for HOME USE. **\$5.98**
Keep check on yourself! Prevent strokes, kidney damage, etc. Manual has full details on what is prescribed in 95% of ALL high blood pressure cases. You get a Blood Pressure Gauge, Arm Bandage, Sleeve, 2 Valve Bulb, Base, Stethoscope and 25 Grams of MERCURY. Complete outfit sent prepaid for \$5.98 or simply send name and address and pay \$5.98 plus C.O.D. and postal charges on arrival.

JOY SPECIALTY COMPANY
Scientific Instrument Department
2320-A W. Hubbard St. Chicago 12, Ill.
Additional information upon request

MAGIC-SCREEN INCOME PLAN OFFERS BIG MONEY, AT HOME, SPARE OR FULL TIME



Reproduce any painting, design, trade-mark, picture, printing, in full color, on any surface! Proven new method enables you to cash in on established business where Profits up to \$5.00 or more an hour are being made, right now! Examine complete Plan and equipment without risk!



Write today for free sample — Complete free details! **Send NOW!**

CALIF. ACADEMY OF SCREEN PROCESS DEPT. 23, 5100 SO. VERMONT AVE., LOS ANGELES 37, CALIF.

**RELIEVES
HEADACHE
NEURALGIA
NEURITIS PAIN**

FAST



Here's Why...

Anacin® is like a doctor's prescription. That is, Anacin contains not one but a combination of medically proved active ingredients. Anacin is specially compounded to give **FAST, LONG LASTING relief.** Don't wait. Buy Anacin today.

FREE BERRY'S NEW POULTRY BOOK



DAY-OLD and 4 WEEK CHICKS—52 varieties and 7 cross-breeds. B.W.D. tested. Sexed or Non-Sexed. Chickens, Ducks, Geese, Guinea, mature fowls and hatching eggs. **LOW PRICES. ORIGINAL BERRY FARM,** over 50 years service. **Beautiful Book Free.** Stamps appreciated. **BERRY'S POULTRY FARM, Box 29, Clarinda, Iowa**

LEARN MONEY-MAKING CARTOONING

IN SPARE TIME—by Easy Picture Chart Method Same Simplified Method that has helped train creators of "Terry & Pirates," "Freckles," "Out Our Way," "Winnie Winkle," "Reg'lar Fellers," "Strange As It Seems," "The Neighbors," and many others. Earn while learning. Send 10c for Picture Chart (to test your ability), and full details. (State age.)



THE LANDON SCHOOL, 5103 Cleve. Transit Bldg., Cleveland, O.



GIANT BALLOONS

U. S. Govt. Surplus, Genuine Neoprene. Used by Govt. for weather & Target Balloons. Loads of fun for yards, pools, gym, parties. Wonderful for Advertising; Attracts immediate attention.

Postage paid on pre-paid orders.

3 Ft. dia.	39c
6 Ft. dia.	79c
13 Ft. dia.	1.39

AIR CORPS

ZOOM GLASSES

High speed, blue clear-vision Sunglasses with ground and polished lens. Favored by the Air Force. Eliminates harmful glare, protects your eyes, gives clearer vision. Lifetime guarantee. A \$7.50 value, with case **\$2.79**

GENUINE U. S. NAVY Stanley UNBREAKABLE LIFE-TIME SUPER-VAC VACUUM BOTTLE

Brand new. Stainless steel. Holds one quart. For autoists, Sportsmen. Will last life-time. It's unbreakable! **\$5.95**

Dept. M-351 War Assets Div.

VOLUME SALES COMPANY

3828 Sunset Blvd., Los Angeles 26, Calif.

Holds one quart

Postage paid on pre-paid orders. Calif. res. add sales tax

PLYMOUTH SAVE MONEY!

Owners



Learn How to Make Your Car Run Better . . . Last Longer . . . and Save Hundreds of Dollars!

Get this book, written especially for you, without one penny of risk and get more out of your car. Mail coupon for **MANUAL FOR PLYMOUTH OWNERS** today. When the book comes, skip through the pages and see how your investment in one of America's most popular automobiles can be even a better investment than you thought. If you don't agree, send the book back and you'll get your money back.

A Popular Mechanics Book Written Just for You

Not a re-hash of service manuals. A complete new Popular Mechanics book written for the Plymouth owner by an outstanding automotive authority with the full cooperation of Plymouth engineers and service directors. It will save you money on repairs and service; make your Plymouth last longer; give you safe, economical and trouble-free motoring. And this is true whether you take your Plymouth to a regular service station or service it at home.

Prevents Trouble. Cuts Down on Repair Bills

Nothing like this manual anywhere. It covers all phases of operation, service and maintenance. It has entire chapters on the individual parts of your Plymouth—battery, ignition, starter, generator, regulator, lighting, fuel system, engine, lubrication, gasoline qualities, cooling systems, transmission, differential, rear axle, brakes, wheel alignment, tire care, body maintenance, trouble shooting on the road, etc. It covers your Plymouth, new and older models, step by step—bumper to bumper—showing you how parts operate; what can go wrong; how repairs and adjustments should be made and how to avoid all types of troubles.

Money Back if Not Satisfied

Mail the coupon today. Send only \$3.50 or you can pay postman. Money back guarantee protects you.

Official, Authoritative, Practical Information

Written by C. E. Packer, formerly service school instructor and auto show lecturer for automobile manufacturers, Member Society of Automotive Engineers, Special Services Editor of Automobile Digest, contributor to leading magazines, author of some of the biggest selling books on Automotive subjects. Prepared with the full authority and active cooperation of the Plymouth Division of the Chrysler Corporation.

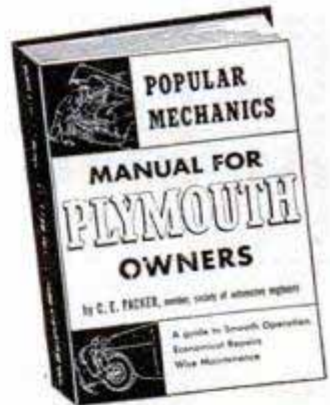

288 Pages. Hundreds of How-To-Do-It Illustrations and Diagrams

The entire book follows Popular Mechanics famous easy-to-read and easy-to-understand style. While primarily intended for the Plymouth owner, to help him get more out of his car at lower cost, it can be worth its weight in gold to the auto mechanic and service station operator who works, not only on Plymouths, but on all other makes as well, to which the information in the book can be easily applied.

Order on this Handy Coupon

POPULAR MECHANICS PRESS, Dept. 17 200 E. Ontario St., Chicago 11, Ill.

Send Manual for Plymouth Owners at once. If not satisfactory I will return it within 5 days and you will refund full purchase price.

Remittance for \$3.50 enclosed. Send C.O.D.

Name _____

Address _____

City _____ State _____

WAR SURPLUS BARGAINS

WAR SURPLUS BARGAINS

\$500,000.00 INVENTORY for QUICK LIQUIDATION

Surplus items—hundreds of them for home, shop, factory, farm and outdoor use. New items, used items, reconditioned items—all at tremendous savings—all priced for quick sale.

Page After Page of Values

This big catalog shows page after page of amazing money saving values. Write for your copy today. Send 10c to cover postage, mailing, etc. Write today!

SEND TODAY FOR YOUR COPY **10c**

STARK'S Dept. 509 So. STATE STREET CHICAGO 5, ILLINOIS

DRIVE 3 TO 6 DAYS A MONTH Gas Free!

Amazing discovery, Dept. of leading U. S. University, reduces gasoline consumption as much as 20%—gives you up to 6 days a month gas free driving—may actually pay for itself in cash savings. Also better performance, more power, quicker starts, faster acceleration, on all cars, light trucks, tractors—any age, make or model! It can help keep you rolling if emergency gas restrictions come.

TEST IT 30 DAYS ON YOUR OWN CAR BEFORE DECIDING

No one can appreciate the astounding benefits of this new miracle development without actual day-by-day experience on the road—so we want you to try it for 30 days on your own car at our risk. Write or wire today for complete FREE details, technical explanation and 30-Day Examination Request Blank.

G. B. SCHUYLER, Dept. 43
1665 Mission St. San Francisco 3, Calif.

SEND NO MONEY

EASTER SEALS HELP CRIPPLED CHILDREN

BRAND NEW NAVY PHONES

Voice powered, no batteries or electricity needed. Mfd. by RCA. 1 mile range. Govt. cost \$99. pair. Simple hook-up, splice 2 wires and talk. Complete, no extras to buy. Each phone has headset, adjustable transmitter, chest plate, switch (on mike)—PLUS 24 ft. rubber covered cable. All new. For farms, mills, mines, warehouses, contractors & home use. Extra cable available. Money-back guarantee. Send cash, check, M.O. COD's pay postage.

\$13.95 ppd.

2 complete phones

GRAND-HAWTHORNE SURPLUS
1439 S. E. GRAND Dept. PM-31 PORTLAND, OREGON



Be a DANCING Teacher

Become a certified dance instructor. Remarkable home study course trains you for professional career teaching all modern dances: Fox Trot, Waltz, Bumba, etc. Men, Women, 18 to 56, learn to be popular teachers quickly even if you've never danced before. Quality for well paid position or open your own dance studio. Write for FREE catalog. Give age.

PRINCETON INSTITUTE OF DANCING
119 W. NORTH ST. LIMA 1, OHIO



CHRONOGRAPH WRIST WATCH

Lifetime Guarantee (Exclusive of Parts)

3 DIALS — \$9.95 Tax Inc.

5 HANDS — 2 BUTTONS

Multi-purpose watch that measures distance, speed, time, moving objects. Used as Stop Watch or Timepiece. Has Sweep-Second Hand for full 60 Second count. Second Dial records up to 45 minutes. Third Dial then records up to six hours. The movement of this fine Swiss Made watch continues to run when sweep hands are stopped. For sportsmen, professional men and women—timekeeper works when other hands and dials are stopped—separate movements permit dual use at same time.

RUGGED CONSTRUCTION

Precision workmanship and shock resistant features are added to enhance the value of this watch. Sold elsewhere for as high as \$17.00. Our low introductory price is only \$9.95 tax inc. (Gold plated \$12.95.) Send check or money order and we prepay postage. Or sent C.O.D. plus charges.

MARDO SALES CORP., 480 Lexington Ave., Dept. P-12, N.Y. 17, N.Y.



The NEW Model 50 UTILITY TESTER

FOR REPAIRING ALL ELECTRICAL APPLIANCES-MOTORS

an all-around electrical trouble shooter



- Measures A.C. and D.C. Voltages, A.C. and D.C. Current, Resistances, etc.
- Will measure the current consumption while the appliance under test is in operation. The appliance or utility may be plugged directly into the front panel receptacle. A special pair of insulated clip-end leads is included for motors, etc.
- Incorporates a sensitive direct-reading resistance range which will accurately measure all resistances commonly used in electrical appliances, motors, etc. This range will enable continuity checks and tests for shorts and opens.
- Will test thermostats, radio tube filaments, bulbs, fuses, fluorescents, condensers, switches, field coils, circuit breakers, lighting systems, etc.

Handsome round cornered molded bakelite case 3 1/8" x 5 7/8" x 2 1/4". Complete with all test leads and instructions.

\$13.90

SHIPPED ON APPROVAL

Send \$3.90 with order and pay \$10.00 balance on receipt of merchandise. Try it for ten days. If not completely satisfied — return for refund. No explanation necessary.

SUPERIOR ELECTRONIC CO., INC.
Dept. C-2 • 227 FULTON STREET • NEW YORK 7, N. Y.

SCIENCE DISCOVERS THE SECRET OF MAN-MADE GEMS

NOW! MORE BRILLIANT Than

DIAMONDS

AT LESS THAN **5%** THE COST OF DIAMONDS

LOOK PROSPEROUS—IMPRESS YOUR FRIENDS—WEAR BIG BEAUTIFUL TITANIA BRILLIANTS—more SPARKLING THAN DIAMONDS, 57 perfectly cut and polished facets. Ideal for ENGAGEMENT RING, LADIES EARRINGS, LAVALIERES, BRACELETS, MEN'S SOLITAIRE, REPLACEMENTS FOR YOUR DULL STONES. New man-made gem of incomparable brilliance and fire; only gem on earth MORE BRILLIANT than DIAMOND. 1 CARAT unmounted Titania Brilliant ONLY \$19.20; 2 CARATS \$38.40; 3 CARATS \$57.60; MOUNTED IN 14K GOLD RING as low as \$52—all prices include Federal Tax.

10 DAY RETURN PRIVILEGE If not thrilled and delighted, you may return within 10 days for refund if in same condition as when received. Enclose remittance and we send prepaid or send 25% deposit and pay, balance on arrival, plus postage. Deal with 35 YEAR OLD COMPANY. SEND CHECK OR MONEY ORDER. ASK FOR FREE BOOKLET M.

BRADLEY MARTIN CO. 495 WASHINGTON AVENUE BROOKLYN 16, N. Y. DEPT. M



"It Measures As It Rolls"

ROLLER RULE

HANDY MECHANICAL PENCIL

Measures Curves and Straight Lines. Any Shape. Any Distance. Any Surface.

\$1.29 POST PAID

Roll head over surface. Inches and fractions record accurately on "Inch-O-Meter". Excellent pencil tool! Order Now! 10 Day Money Back Guarantee! C.O.D. (postage extra). In Calif. add 3% Sales Tax.

PENCIL SALES CO., Dept. PM3
Room 6, 1213 E. Ocean Blvd., Long Beach, California



BUILD YOUR OWN RADIO CONTROLLED DOOR OPENER

... and 23 other electronic labor-savers

● This book gives complete instructions for building an electronic door lock, a charger for small dry batteries, a radio-controlled relay, pocket stroboscope, remote control for model trains, doorbell "booster", a photoelectric relay, photographic interval timer, simple crystal radio and a dozen other valuable gadgets.

All you need is some inexpensive Sylvania Crystal Diodes and a few everyday materials. Book gives easy-to-follow, illustrated how-to-do-it instructions.

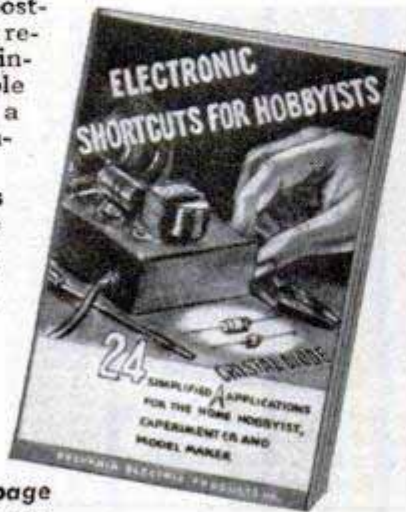

Get Sylvania's 40 page book, "Electronic Shortcuts For Hobbyists" today.

Only 25¢

Send coin or stamps to: Sylvania Electric Products Inc., Department E-1203, Emporium, Pa.

cars and trucks START INSTANTLY in any weather with a STEWART-WARNER Electric Fuel Pump!



Save your battery with quick, sure starts every time, in any weather. Stewart-Warner's Electric Fuel Pump feeds a steady, even flow of fuel to your carburetor the second you turn on the ignition. Outperforms, outlasts other pumps now in use.

Easy to install on any car or truck. Complete fittings supplied. Do it yourself or see your local Carburetor Shop or Service Garage.

FREE—Illustrated Booklet on Request

Stewart-Warner Corp., Dept. N-31
1840 Diversey Parkway, Chicago 14, Ill.

Name _____
Address _____
City _____ Zone _____ State _____
 For Cars For Trucks

YOU CAN BUILD Beautiful Furniture for every room of your home

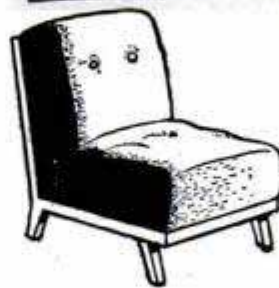

LIVING ROOM



DINING ROOM



BEDROOM



No Experience Needed
Suites for Living,
Dining and Bedroom
Exclusive Designs
Modern and
Traditional Styles
Scaled Diagrams

Now you can build beautiful furniture for every room of your home—charming, graceful furniture that will give your house an air of elegance and be the envy of your neighbors and friends.

For the Man with Few Tools and Limited Experience

Take your choice from a wastebasket to a complete suite. Choose any one of 100 beautiful articles. Start with a simple project and end up by refurbishing every room in your home. Step-by-step instructions from the Editors of Popular Mechanics and scaled diagrams make building easy.

Save Hundreds of Dollars

Why pay skyhigh prices for furniture when with a few evenings' spare time you can build a desk, dresser, bookshelf or even a complete suite and save as much as 67% of the cost? And the furniture you build will be even more attractive and sturdily constructed than the furniture you could buy. Several designs are exclusives by John Bergen, famous furniture designer.

160 Pages
16 Full Color Plates
Hundreds of Illustrations,
Photographs, Diagrams

Start building your furniture now. Send only \$3.00 for your copy of "100 Beautiful Pieces of Furniture You Can Build," or you can pay the postman if you prefer. Money back in five days unless you are completely satisfied.

Order on this Handy Coupon

POPULAR MECHANICS PRESS, Dept. 39
200 E. Ontario St., Chicago 11, Ill.

Gentlemen:

Send at once my copy of "100 Beautiful Pieces of Furniture You Can Build" at \$3.00. Unless it is entirely satisfactory I may return it within five days for a full refund.

NAME _____

ADDRESS _____

CITY _____ ZONE _____ STATE _____

Remittance Enclosed Send C.O.D. (Postage Extra)

WAR SURPLUS OPTICAL BARGAINS

SLIDE PROJECTOR SETS Consists of all unmounted lenses you need to make the following size projectors:

- Stock #4029-H—35 mm. \$2.85 Postpaid
- Stock #4038-H—2 1/4" x 2 1/4" \$3.35 Postpaid
- Stock #4039-H—2 1/4" x 3 1/4" \$3.35 Postpaid

MAKE A MICROSCOPE Get wonderful results. Own an instrument worth many times the cost to you. Simply convert a U. S. Govt. Rifle scope (Govt. cost over \$65.00). It's easy! We show you how. No machining required. Get up to 40 Power. Scope we furnish is used but good condition . . . sent complete with extra lenses and direction sheet.

Stock #959-H \$7.90 Postpaid

10 POWER SPOTTING SCOPE —A WONDERFUL BUY! Pocket-Size! Complete with tripod and swivel head. Only 5 1/2" long—8 1/2" high on tripod. Adapted from Army telescope and worth many times our price. Has prism erecting system, achromatic objective, Ramsden Eye-Piece. Lenses low reflection coated.

Stock #955-H \$14.95 Postpaid

SIMPLE LENS KITS —Include plainly written, illustrated book-let showing how you can build lots of other uses in experimental optics, building TELESCOPES, low power Microscopes, etc.

- Stock #2-H—10 lenses \$ 1.00 Postpaid
- Stock #5-H—45 lenses 5.00 Postpaid
- Stock #10-H—80 lenses 10.00 Postpaid

We Have Literally Millions of War Surplus Lenses and Prisms for Sale at Bargain Prices. Numerous Types of Instruments, Too! Write for FREE CATALOG-H

EDMUND SALVAGE CO., Barrington, New Jersey

FREE HOT ROD AND POWER HANDBOOK given with each catalog! Send only 25c New! Covers everything in HOT RODS



ALMQUIST ENGINEERING — Milford 32P, Pa.

LOCKSMITHING & Key Making

PRACTICAL UP-TO-DATE COURSE—ONLY \$4.95
Easy-to-learn modern information for self-instruction. How to work on locks, de-code, make master-keys, repair, install, service, etc. For every handyman, home owner, carpenter, mechanic, service station operator, fix-it shop, hardware dealer, gunsmith. 53 plain illustrated lessons. **FULL PRICE ONLY \$4.95. SEND NO MONEY.** Just pay postman plus C.O.D. postage. Or send \$4.95 with order, we'll ship postpaid. Satisfaction guaranteed or refund.
NELSON-HALL CO., 210 S. Clinton St., Dept. C-2, Chicago 6, Ill.

HELPFUL BOOKS

Send post card asking for **FREE catalog**
Popular Mechanics Press, 200 E. Ontario, Dept. 601, Chicago 11

MINUTE-DEMONSTRATION AMAZES BUSINESS AND PROFESSIONAL MEN

While other lines are standing still our men are making sales running into the hundreds of dollars. Earnings start the very first day and continue to grow with amazing rapidity. Your name and address on a post card is all that is necessary, complete information is **FREE**. Facts that can easily turn the tide of fortune in your direction.

Perpetual Profits Year Round Free Proof Write Today
I. C. A. Corp'n, Dept. P-3, 2801 Sheffield, Chicago 14

EXTRA INCOME THE YEAR 'ROUND

Earn additional income and have fun at the same time! Popular Mechanics **MONEY MAKING HOBBIES** shows you how to make 132 different projects at home in your spare time! Complete instructions with over 600 illustrations, photographs, drawings and diagrams. Projects for everyone regardless of experience. Excellent resale value. State making your hobby pay a profit by ordering a copy of **MONEY MAKING HOBBIES** today from
POPULAR MECHANICS PRESS \$2.00
200 E. Ontario Street Chicago 11



Learn WOOD PRODUCTION ENGINEERING

At Home In Your Spare Time

Veterans
You must enroll in training before July 1st to get it free under the G. I. Bill. Act Now!
NON-VETERANS
Money Back Trial Offer

Prepare now for a top pay position in the furniture and woodworking industry . . . with **KLOK SPECIALIZED TRAINING**. Teaches you the arts of Sketching—Drafting—Rod Making—Time Study—Cost-Production Scheduling in our Home Study Course or Resident Course at Grand Rapids. An aid to hobbyists . . . to the successful operation of your own shop.
WRITE TODAY—for **FREE** Booklet that gives you **ALL** the fascinating facts. State age, veteran, non-veteran, Home Study or Resident Course preference, occupation.

from **THE ONLY SCHOOL OF ITS KIND**

FREE Booklet



JOHN H. KLOK, Pres. Woodworking Industry Training Since 1928
KLOK INSTITUTE, C, Louis St. N.W., Grand Rapids 2, Mich.

BOAT KITS Easy To Build

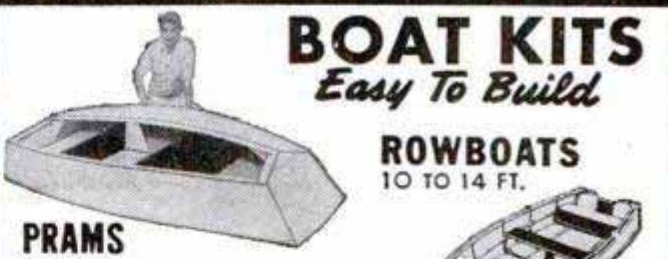

ROWBOATS
10 TO 14 FT.

PRAMS
\$39⁶⁰ up

8 TO 11 FT. ALSO WITH SAILS



OUTBOARDS
12 TO 16 FT.

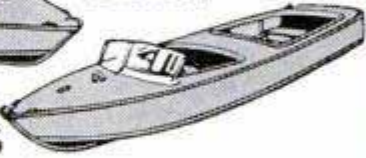

INBOARDS & CABIN CRUISERS
16 TO 23 FT.



NEW CATALOG
MOST COMPLETE EVER OFFERED

- 1 - BOAT KITS—26 MODELS
- 2 - MARINE HARDWARE
- 3 - MARINE ENGINES
- 4 - MARINE CONVERSIONS
- 5 - PAINTS & COLOR CHARTS



► All For Only 35c, SEND COIN TODAY
U-MAK-IT PRODUCTS 703P-WHITTIER ST. New York 59, N. Y.

It's Smart ... AND THRIFTY TO PLAN YOUR HOME THIS EASY WAY

Now you can see your home before it's built! Have loads of fun and prevent costly mistakes at the same time. See just how the inside of your home will look laid out to exact scale with your furniture in every room. New giant **ARC-I-TEX Kit**, containing exact scaled layout sheet and more than 100 cutouts of furniture, doors, partitions, walls, windows, fireplaces, stairs and a host of other building features including a complete master furniture layout adaptable to any home, makes your home planning simple and accurate. **SPECIAL**—Included at no extra charge is a collection of valuable hints on planning your home just the way you want it. Send for this amazing value-packed kit today. Only \$1.50 postpaid, Money back guarantee.

POPULAR MECHANICS PRESS
200 East Ontario Street Chicago 11, Ill.

Prepare Now for YOUR Tomorrow "3 TRADES IN 1 CAREER"

Engraving • WATCH REPAIRING • Jewelry

Big Demand for "Combination Men" in these 3 Trades. We cannot fill requests. **YOU CAN EARN MORE—LONGER**. Also learn **CHRONOGRAPH REPAIRING**, newest phase of watchmaking. Write for **FREE CATALOG**, and ask about our Correspondence Courses.

Name _____
Address _____

KANSAS CITY SCHOOL OF WATCHMAKING
1218 Admiral Blvd. — Kansas City 6, Missouri



Recipro Register CHRONOGRAPH

WORLD FAMOUS SPLIT-SECOND TIMER

10 DAY FREE EXAMINATION A handsome wristwatch of incredible accuracy! Precision made in the highest traditions of Swiss craftsmanship. Thoresen's new RECIPRO-REGISTER CHRONOGRAPH automatically computes speeds and distances down to 1/5th second tolerances! RECIPRO-REGISTER system HOLDS the result indefinitely. It remembers for you while movement continues to keep time. Compare with other stop-chronographs and you will never be satisfied with anything less than this truly precision timepiece.

OVER 25 HIGH QUALITY FEATURES!

- Times Planes
- Times Races
- Times Sports
- Times Photography
- Times Lab experiments
- Times Shop Work
- Shock-Resist
- It "remembers"
- 17 Ruby Jewels

Three multi-function dials automatically coupled and synchronized for hours, minutes, seconds & 1/5th seconds. Contact clutch to start computation and brake clutch to freeze Recipro-Register result. Erases back to zero. Halftime sweep-second. Radium-active dial. Unbreakable crystal. Sturdy, yet thin case with stain-less steel back. Its 17 Jewel Ruby movement is electronically time tested for accuracy. A smart, thin timepiece of functional beauty. The pride of every owner. **SAVE \$50.00—ORDER YOURS DIRECT!** Recent list price 79.95. Now reduced for quick sales to \$29.95 tax paid... while supply lasts. Featured in Esquire and leading magazines. Instructions and gift case included. Price subject to change without notice because of international crisis. Remit 29.95, or order C.O.D. plus postage. Money Back in 10 days if not delighted. **THORESEN DIRECT SALES, Dept. 6C-233, 131 West 33rd Street, (Phones: LA 4-5996 & 7) New York 1, N. Y.**

UNLIMITED SERVICE GUARANTEE

Exclusive of Parts
FREE repair service ANYTIME if needed by skilled watchmakers. NO COST EVER for labor, "hand-dling" or adjustment, provided watch is returned with all parts. FREE: Anting oiling, cleaning & makes lifetime friends!

Buy Direct



Try this

FREE TO THE RUPTURED

6 WEEKS' SUPPLY TRUSS EASER POWDER
Don't throw your present truss away. Famous Easer powder will let you wear it with solid comfort. This soothing medicated powder helps prevent chaffing, rubbing and gouging. It soothes tender skin—helps prevent inflammation. Six months' supply only \$1.00 postpaid. Generous 6 weeks' supply absolutely free. Write today! **Truss Easer Labs, 2335-P Cottage Gr., Chicago 16**



Three Authoritative Books Every Fan Needs!

AUTOMOBILE RACING

Famous for authoritative, detailed information on auto racing, every type race car, rules, specifications, duplication. Every book is different. Money back if not satisfied.

AUTOMOBILE RACING, 6th Ed.

★ Championship cars, big cars, midgets, roadsters, Offenhauser dirt track car. Specifications on Indianapolis cars, four-wheel drive details, front drive drawings. Plans for Ford 60 midget, roadster racer, data on engines, gear boxes, clutches, axle ratios, compression ratios, etc. Indianapolis rules and regulations. More than 100 illustrations. Only \$2.00.

AUTOMOBILE RACING, 5th Ed.

★ Tells you—Why the Fast Ones are **POPULAR MECHANICS PRESS, Dept. 350, 200 E. Ontario St., Chicago**

information on auto racing, every working drawings, plans, etc. No Money back if not satisfied. Past—How to Make Them Fast—How to Build Engines—How to Build Chassis—How to Build Bodies—Who Holds What Records—What the International Formula Is—What Midget Racing Rules Are—How World's Record Cars are Built—How to Speed Up Ford V8 Cars! Only \$1.00.

AUTOMOBILE RACING, 4th Ed.

★ Gives information on midgets, including three sets of working drawings and complete building instructions. Miller-Ford V8 Front Drive Racers are illustrated and described, also other big-time data featured. Only \$1.00.

BE YOUR OWN BOSS

Make Hundreds of \$ Spare or Full Time Work

NO EXPERIENCE NEEDED

Here is the ideal business with no previous experience or large investment required and no high-priced equipment to buy. A business that will return dollars for the pennies you invest.

YOU CAN CAST ANYTHING

With *Flexible Mold Making and Ornamental Casting*, an amazing fact-packed book, you learn how you can cast practically any article in concrete, plaster, imitation marble or any other casting material using a marvelous new process. You can make ash trays, novelties, garden and lawn ornaments and hundreds of other highly profitable items that cost you but a few cents and sell for as much as \$5.00 and more. Why you can even make true-to-life full-sized busts of your neighbors and friends.

NO EXPENSIVE MOLDS TO BUY

Why buy high-priced molds from others? Learn how you can make your own molds quickly, easily and inexpensively with materials that can be used over and over. You get copyrighted formulas, complete instructions and detailed how-to-do-it photographs as well as complete sources of supply for the few inexpensive materials you need. This is the only book printed in America today that contains instructions for making profitable papier-mache casts.

MONEY BACK GUARANTEE

Start on your road to extra income and independence today. Send only \$3.00 for your copy of *Flexible Mold Making and Ornamental Casting*. Complete satisfaction guaranteed or your money refunded within seven days.

POPULAR MECHANICS PRESS, Dept. 46
200 E. ONTARIO ST., CHICAGO 11, ILL.

You can make simply and cheaply



YOU CAN'T LOSE GAS!

DEFIANCE Keyless-Locking Gas Tank Cap

Protects against siphoning, loss or theft.



Save precious gas without nuisance of gas tank key. The Defiance Gas Tank Cap is self locking, no key is necessary. It's theft-proof too, as the cap can't be removed from car or left at station. Grids at bottom of cap prevent siphoning of gas from your tank. Speeds filling. Beautiful chrome finish, fits all cars. 10-second installation. If dealer can't supply, order direct. **Send \$2.75** (or C.O.D. plus postage) Money-back guarantee.

Defiance Mfg. Co., 1556 N. Wilcox, Los Angeles 28, Calif.

Electricity From A to Z!

At A Fraction Of Cost Of Average Home Study-Reference Course!

Get into the big-pay fields of Electricity and Electronics. Coyne's great 8-volume set "APPLIED PRACTICAL ELECTRICITY" gives you the practical "know-how" you need, easy to understand. Amazing Self-Study Guide included. Hundreds of charts, examples, pictures, diagrams make every fact crystal-clear. Thoroughly covers more subjects than courses costing many times more. Easy terms. Write now for facts and Trial Offer—mailed absolutely FREE. Send postcard today.

COYNE ELECTRICAL & TELEVISION-RADIO SCHOOL
500 S. Paulina St., Dept. 31-R6, Chicago 12, Ill.



3000 Subjects

- Fundamentals
- Appliance Repair
- Electronics
- Automotive
- Diesel Engines
- Refrigeration
- AC & DC Motors
- Construction
- Lighting

MAKE A "Stradivarius" VIOLIN
 —For Pleasure
 —For Profit
 —For Your Own Use

BOOK AND PLANS ALL YOU NEED



**You Can Do It at Little Cost!
 It's Easy! It's Fun!**

Here is the "tops" of all home crafts projects. Make a violin—a replica of a famous "Strad"—the original of which sold for \$80,000.00. Joe Reid who has made hundreds of fine violins makes the job so easy—so inexpensive—in his new book "You Can Make a 'Stradivarius' Violin." You don't need any tools. Reid shows you how to make all the tools you need from old table knives, worn out files, sheet metal, etc. Eight full-size plans, 16x23 inches, folded into the book give you every detail in actual size.



**Complete Instructions
 8 Actual Size Plans
 How to Make the Tools You Need
 Where to Get the Materials**

You trace or work direct from actual size plans. No measurements to translate or confuse you. You see the entire violin in the plans. You read the how-to-do-it instructions in the book.

Violins Bring High Prices

Make a violin and you probably will never want to sell it. But good tone modern violins bring terrific prices. Yet the materials cost comparatively little. With Reid's plans and step-by-step instructions you can make such a violin for yourself. 15 chapters guide you in selection of wood, fashioning the belly, back, sides, mold, lining, neck, scroll, purfling. Other chapters cover varnishing, finishing, stringing. Others show how to make tools and clamps at little or no cost.

**Order Book Today.
 Money Back if Not Satisfied.**
 Make your own violin for pleasure or profit. Get book and plans now. Clip this ad and mail with check, money order or cash for only \$3.50 or we will send C.O.D. Money back in 5 days if not satisfied.

POPULAR MECHANICS PRESS Dept. 30
 200 E. Ontario St., Chicago

SEND ME

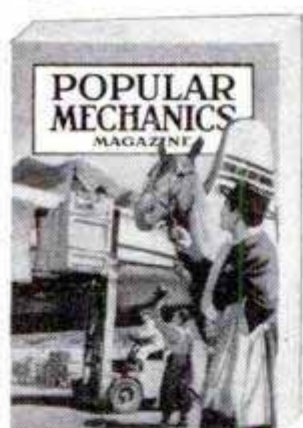

every month so I am sure to see each new issue. Here's

\$3.50 for 1 year
 \$8.00 for 3 years

name _____
 address _____
 city _____ zone _____ state _____

Hand this order to your newsdealer or send it to

POPULAR MECHANICS PRESS
 200 East Ontario St. Chicago 11, Ill.

THE AMAZING NEW GANE-O-MATIC
 Overdrive Control



ONLY \$995
 POSTPAID & INSTALLED
 (We pay your garage or gas station)
 Dealer inquiries invited

- ✓ SAVE GAS, BRAKES & TIRES
- ✓ GET AUTOMATIC HILL HOLDER
- ✓ USE SIX FORWARD SPEEDS
- ✓ ENJOY NO-CLUTCH SHIFTING

THE GANE-O-MATIC PUTS TO WORK HIDDEN ADVANTAGES OF YOUR PRESENT OVERDRIVE. FINGER-TIP CONTROL GETS OVERDRIVE OR REGULAR RANGE . . . AT ANY SPEED . . . IN ANY GEAR.

A. Save gas as Gane-O-Matic allows using overdrive 100% of the time. Get down-hill compression when in overdrive thus braking your car . . . saving tires and brakes when stopping.

B. The Gane-O-Matic hill holder holds your car on any incline without the use of your hand or foot brake.

C. Utilize more of your motor's power with six forward speeds . . . three each in regular and overdrive range.

D. Enjoy the speed and ease of gear shifting at any speed . . . up or down . . . without touching your clutch pedal.

THE GANE-O-MATIC IS EASILY INSTALLED IN A FEW MINUTES ON ALL FORD, MERCURY, LINCOLN, STUDEBAKER, CHRYSLER, DODGE, DESOTO, NASH, HUDSON, KAISER-FRAZIER, JEEPSTER AND OTHER CARS WITH OVERDRIVE.

MONEY BACK GUARANTEE If you are not fully satisfied with your Gane-O-Matic, we will refund the entire purchase price if it is returned within 30 days.

FREE LITERATURE. Comes complete with illustrated installation instructions plus free installation certificate, redeemable for cash by your garage or gas station. Send cash, check, money order or \$1 deposit on C.O.D.

NATIONAL AUTOMOTIVE RETAIL CO.
 Dept. Y-3, 350 West Washington Blvd., Venice, Calif.

PRACTICAL BOOKS ON HOME PLANNING BUILDING · REPAIRS



MAIL ORDER TODAY Plan Now—Build When You Can
 Books Sent C.O.D. Anywhere in U.S.A.

Select from this list of helpful books. In U. S. books sent postpaid if remittance accompanies order. Outside U. S. include 15% extra for shipping charges.

- How to Plan a House. \$5.00
- Your Home and How to Build It Yourself. \$3.00
- Painting, Decorating. \$1.75
- Carpentry. \$2.50
- Painting, Furniture Finishing and Repairing. \$1.50
- Includes floor renewal. \$1.50
- How to Remodel a House. Complete, practical. \$5.00
- Building Insulation. \$4.50
- Concrete Handbook. Do work for yourself, others. \$2.00
- Blueprint Reading for Building Trades. \$1.50
- Practical Bricklaying. \$2.00
- Primer for Home Builders. \$2.50

FAMOUS PLAN BOOKS
 Books contain floor plans, photos, descriptions of homes.

- AMERICA'S BEST LOW COST HOMES. 125 designs. \$1.00
- DE LUXE SMALL HOMES. 210 designs. \$1.00
- OUR FUTURE HOME. Wide selection of residences, summer homes, garage apartments. \$1.00
- MODERN HOME & GARDENING. 42 popular designs. Improvements, garden short-cuts, etc. .50c

Set of Four Books \$3.50

Stair Building \$2.50

POPULAR MECHANICS PRESS
 DEPT. 24 • 200 E. ONTARIO STREET, CHICAGO 11

TITANIUM Rutile

The New WONDER GEM of the century

For the first time in history and as a result of intensive experimentation and research on a vital military project brilliant scientists of one of America's largest corporations suddenly hit upon the solution of the ages. The secret of how to crystallize in the laboratory a gem with a refractive index higher than and a dispersion factor greater than a DIAMOND was DISCOVERED. The discovery is TITANIUM RUTILE so widely acclaimed by leading reportorial mediums such as Readers Digest and The Saturday Evening Post.

REFRACTIVE INDEX ABOUT 10% HIGHER THAN DIAMONDS

Compare: Refractive Index of Rutile is between 2.62 and 2.90 as compared to the diamond's 2.42. Dispersion of Rutile ranges between 0.155 and 0.205 in comparison to the diamond's 0.025.



(Actual Photograph of Our Product)

You are living in an age of miracles. As you know, atoms are being split. Actual basic materials are being re-arranged. Fantastic as it may seem to the layman, the secret of what has formerly been referred to as the DIAMOND is now known beyond a shadow of a doubt. YOU PROFIT. No longer need you invest large sums of money in a tiny stone the value of which is determined largely by scarcity and control. YOU can enjoy the beauty and prestige and the envy of your friends with a stone that no one of lesser ability than a REAL JEWELER working with a magnifying glass in his eye under good light can detect as not being a real DIAMOND. A handsome engagement ring made of our remarkable gem presented to any girl will inspire her devotion. The hundreds of dollars thus saved will go far towards building a happy, permanent home. Hudson Gem Co. sells RUTILE only in the cut stones. Each stone is perfectly cut with full 58 facets per BRILLIANT stone. By law we cannot refer to our products as DIAMONDS so we ask you to order them in the three most popular DIAMOND shapes namely the round or BRILLIANT, the oblong or EMERALD and the oval or MARQUISE cuts. You may order these stones for setting by your local, friendly, trusted jeweler who will be glad to verify your purchase. We do not sell mountings nor do we go in for costly catalogues nor expensive time payment plans. You get the benefit of direct to consumer possession of a valuable product which you can then have mounted and SAVE THE MONEY YOURSELF. PAWNBROKERS—ATTENTION! We suggest that you order a sample of this amazing product to have in your shop for comparison. Some pawnbrokers have paid out money under the impression that they were loaning on DIAMONDS when in reality people were offering titanium rutile. Lapidarists can make money buying cut stones from us and setting and selling complete rings. UNCONDITIONAL MONEY BACK GUARANTEE, 30 DAY TRIAL IN YOUR HOME. You are the SOLE JUDGE. In this advertisement you are assured that if for any reason whatever you are dissatisfied with your purchase from us you may, within 30 days, return your purchase for 100% CASH REFUND WITHOUT QUESTION. Order with confidence. Select the shape you want, either BRILLIANT or EMERALD or MARQUISE shapes. Then select the number of carats you want, either 1, 2, 3, 4 or 5. Remember each BRILLIANT is full 58 facets. Check this with your trusted jeweler. Price \$10.00 per carat. Add 20% Fed. Tax. Send Check or Money Order (do not send cash). Reference Farmers National Bank of Hudson or your local bank. Everything sent postpaid. WRITE DEPT. PM-5.

HUDSON GEM CO., HUDSON, N. Y.

BURN WATER OR ALCOHOL OR BOTH IN YOUR CAR!

FOR ALL CARS, TRUCKS & TRACTORS
 "...New high compression automobile engines which increase gasoline mileage up to 30% with alcohol-water gasoline fuels"

says U. S. Dept. of Agriculture.

WRITE FOR FREE LITERATURE
 Illustrated—Interesting—Descriptive
 YOU'LL BE GLAD YOU DID

NEWHOUSE
 AUTOMOTIVE INDUSTRIES

Dept. 51 5805 E. BEVERLY BLVD.
 LOS ANGELES 22, CALIF.

MODEL BUILDERS!

NEW 1951 CATALOG

MODEL AIRPLANE ENGINES • GLOW
 PLUGS • MARINE ENGINES • FUELS
 MODEL RACERS • ACCESSORIES

CUT OUT AND MAIL TODAY

OHLSSON & RICE, INC.
 3344 Emery St., Los Angeles 23, Calif.
 Los Angeles 23, California

Please RUSH _____ copies of the NEW 1951 O&R Catalog at 15c each for which I am enclosing _____ in stamps or coins to cover handling and mailing.

Name _____

Address _____

City _____ Zone _____ State _____

PAY RAISING—EXTRA MONEY BOOKS

Use these books to prepare for a better job—bigger pay—to start a profitable spare time or full time business of your own, improve your home, or start a hobby. Popular Mechanics specializes in supplying outstanding self-help books on many subjects. Send for our FREE catalog.

- Outdoor Sports Manual
 Hunters, Fishermen, Trappers, Campers, Archers, Boatmen, here is your book! . . . \$2.00
- Shop Notes Library
 5 Vols.—1951, 50, 49, 48, 47 (No Dup. Matter) . . . \$3.98
- Shop Notes 1951 . . . \$1.00
- Money From Ideas. Patent and sell your invention . . . \$2.50
- Photo Handbook
 An entirely new and different book from our Popular Photo Guide. It's a complete guide to better pictures and dark-room technique, and features dozens of handy gadgets you can make yourself. . . \$2.00
- Automatic Transmissions Simplified. How to locate trouble, service all types. . . \$4.00
- Dykes Auto Encyclopedia. (World's Greatest Auto Book) New 1950 Edition . . . \$7.50
- Garden Book
 Build own trellises, lawn furniture, fireplaces, ornaments, etc. . . \$1.50
- Diving, Cutting and Welding in Underwater Salvage Operations. Only book of its kind . . . \$2.00
- Picture Framing
 Modern methods for making and painting picture frames. Fully illustrated . . . \$2.75
- Radio-TV and Electronics Handbook. How to service radio and TV sets; build receivers, phonographs, portables, student sets, etc . . . \$2.50
- Money Making Hobbies. 132 ways to make money . . . \$2.00
- 210 Deluxe Small Homes \$1.00 into the Freezer and Out
 A complete handbook on the home freezing of foods \$2.50
- Concrete Handbook
 New book on using concrete around home, garden, farm . . . \$2.00
- Leather Art by Baird
 Leathercraft is a wonderful hobby whether for pleasure or for pay. Get this beautifully illustrated, clearly detailed book at once. Tells you each step and furnishes actual designs . . . \$3.00
- Welding, Brazing and Soldering 1950 Ed. How to build your own equipment and how to use it effectively . . . \$1.75
- Modern Electric and Gas Refrigeration. New 1950 Ed. includes sealed units—home freezers. . . \$5.00
- Complete Book of Home Repair and Improvements. Radio's famous "Fix-It" book. Everything about repairing and improving your home. Cloth Ed. \$2.98; DeLuxe Binding \$3.98
- You Can Make A "Stradivarius" Violin. Instructions. 8 full scale plans . . . \$3.50
- Oil Burner Handbook . . . \$2.50
- 23 Boats You Can Build. Rowboats, canoes, sailboats, 25 foot cabin cruiser. Working diagrams, material lists. \$2.00
- House Wiring (No. 89) . . . \$2.50
- Turn Scrap Into Money
 Convert old auto generators into motors, welders, etc. . . \$1.00
- Popular Mechanics Farm Manual
 Packed with practical ideas and usable information that can easily be worth hundreds of dollars to every farm family and to homeowners everywhere. Send for free descriptive folder giving complete contents! . . . \$3.00
- Woodworking for Everybody . . . \$2.75
- Sheet Metal Work . . . \$3.00
- Tool and Saw Sharpening (No. 92) . . . 25c
- Forging Practice . . . \$1.50
- Action Toys (No. 66)
 Plans for 21 easy-to-make toys . . . 25c
- Foundry Work . . . \$2.25
- Pattern Making
 Wood, metal . . . \$2.25
- For Power Tools
 Build own saw, drill, lathe, sander, etc., from scraps save money . . . \$1.50
- Carpentry . . . \$2.50
- The Young Craftsman
 Over 450 things boys can make . . . \$2.00
- Five Acres and Independence
 How to make money on small farm . . . \$2.50
- Your Home and How to Build It Yourself. Step-by-step construction of the famous POPULAR MECHANICS house. Wonderfully illustrated. \$3.00
- Manual for Plymouth Car Owners
 How to get the most from your Plymouth and save on repair bills . . . \$3.50
- 100 Beautiful Pieces of Furniture You Can Build. Complete suites for living room, dining room, bedroom shown in brilliant color. Exclusive styles by John Bergen. Working diagrams . . . \$3.00
- Motorist's Handbook
 Popular Mechanics scores again. A 160 page guide to automotive happiness . . . \$2.00
- Planning Your Home Workshop
 How to use every inch of space. Build cabinets, benches, etc. How to wire . . . \$2.50
- What to Make for Children
 Junior tough on toys? Build him playthings that will last. . . \$2.00
- LeJay Manual of Homemade Electric Equipment. How to construct 50 items that are scarce and valuable . . . \$1.50
- How to Estimate for the Building Trades: Material and labor costs for masonry, plumbing, electricity, carpentry, heating, hardware, painting, etc. 620 pages . . . \$5.50
- Rabbits for Food and Fur \$2.50
- Tool Making . . . \$4.00
- Tool Design . . . \$4.50
- Plumbing Installation & Repair . . . \$2.00
- Ropp's Calculator
 Figuring made easy . . . 75c
- Slide Rule Simplified . . . \$2.75
- Drake's Refrigeration Service Manual . . . \$2.00
- Power Tools and How to Use Them. Tools to start with; tools to add; how to use them and where to buy them \$2.50
- America's Best Low Cost Homes
 125 popular practical designs . . . \$1.00
- Toys You Can Make of Wood . . . \$2.50
- A.B.C. of Poultry Raising \$2.50
- Ice Cream for Small Plants
 Some technical formulas for ice cream, ices and frozen desserts on a commercial scale . . . \$2.50
- Furniture Joinery . . . \$2.00
- Essentials of Upholstery . . . \$3.25
- Radio Physics Course
 A thorough training in radio fundamentals . . . \$5.00
- Lessons in Ornamental Penmanship. You can easily learn to write beautifully. Delight and amaze your friends with the skill you can acquire by using this book—Only . . . \$1.50



MAIL THIS COUPON TODAY

Check the books you want, write your name and address below, and mail this advertisement with money order or check. Outside U. S. A. include 15% additional for shipping charges.

Books selected will be mailed promptly on our "money back if you're not entirely satisfied" guarantee.

Name _____

Address _____

City _____ State _____

Mail to POPULAR MECHANICS PRESS
 DEPT. 15 — 200 EAST ONTARIO ST., CHICAGO 11, ILL.



TURN WOOD, SCRAP AND WASTE INTO PRACTICAL POWER SHOP TOOLS

Don't limit your workshop fun to use of hand tools. Get the new edition of "Forty Power Tools You Can Make" with many new tools, and make your own power machines. Step up your fun and production. Do a better job with power tools. Make them yourself from wood and old discarded materials at small cost.

This book gives every detail in plain language you can understand and follow. Hundreds of pictures and plans show every step to follow. Mail coupon with \$1.50 today. Even though you have the old edition get this new book with 20 new tools. Money back if not satisfied.

40 Power Tools

You Can Make at Little or No Cost

Some of the 40 Tools You Can Make

- | | |
|--------------------------------|---------------------------|
| Table Saw with Tilting Arbor | Wood Lathe |
| Saw Sander Unit | Power Hacksaw |
| Drill Press from pipe fittings | Double Duty Sander |
| Bending Brake | Jig Saws |
| Thickness Planer | Band Saws |
| | 40 Different Tools in All |

NOW! BECOME EXPERT AT Radio-Television

IN 4 EASY STEPS!

Complete Self-Training Course in RADIO and TV by Famous Experts—Takes You BY SIMPLE STEPS From Basic Theory to Problems of Repair, Installation, Color TV, etc.

NOW you can do ANY Radio-TV installation, service, or repair job like an expert; operate field-testing equipment; understand problems of TV, FM-AM transmission, etc. Step into a good-paying job—or start your own service business. Train yourself AT HOME . . . IN SPARE TIME . . . with the McGraw-Hill Basic Course in Radio and TV.

2296 Pages—
1611 Illustrations

Complete 4-volume course by outstanding experts. Every detail clearly explained. Over TWO THOUSAND PAGES of step-by-step instruction. SIXTEEN HUNDRED "how-to-do-it" illustrations, cross-section diagrams, etc. "Trouble-shooting" charts show how to diagnose any radio or TV breakdown, how to repair it expertly and quickly.

Pays for itself many times over. Can qualify a beginner for FCC's 1st-Class License test; shows experienced technician new tricks.

SEND NO MONEY

Mail coupon to examine complete four-volume course FREE for 10 days. No obligation. WITH course, you get ABSOLUTELY FREE (to keep whether or not you keep course) valuable illustrated book, "Successful Soldering." (reg. price: \$2.00)

Or you may examine individual books FREE for 10 days by checking proper boxes in coupon. Mail coupon at once!

ABSOLUTELY FREE

(whether or not you keep course)
"Successful Soldering"
(reg. price: \$2)

Soldering coppers; fluxes; Tinning; sweating; stainless-steel; other special solders . . . heating methods. Illustrated.

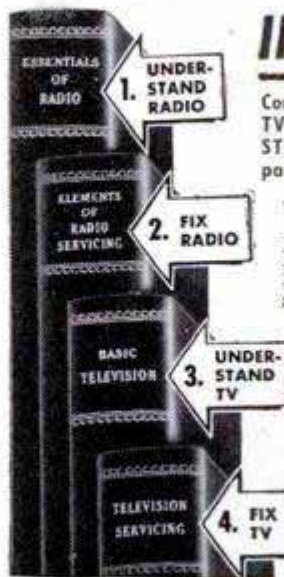

PARTIAL CONTENTS

ESSENTIALS OF RADIO, 800 pages, 433 illus.

Circuit Analysis • Vacuum Tubes • Circuits: Detector • Amplifier • Tube Oscillator • Power Supply • Transmitting, Receiving • Test Equipment

ELEMENTS OF RADIO SERVICING, 475 pages, 375 illus.

Multimeters • AC Power Supply • Speakers • Antennas • Auto Radios • Push-Pull Output Stage

BASIC TELEVISION, 592 pages, 415 illus.

Scanning • Synchronizing • Video Signal • Brightness Control • D-C Reinsertion • Picture • FM Alignment • Picture Tubes • VHF and UHF transmission • Reception

TELEVISION SERVICING, 429 pages, 388 illus.

Antennas • Transmission Lines • Test-pattern and Picture Analysis • Localizing Reception Troubles • Interference Remedies • Deflection Circuits . . . AND MUCH MORE!

FREE 10-DAY TRIAL COUPON

McGRAW-HILL BOOK CO., Inc., Dept. PM-3,
327 West 41st St., New York 18, N. Y.

Send me for 10 days' FREE EXAMINATION:

McGRAW-HILL's Basic Course in Radio & TV . . . including Essentials of Radio, Elements of Radio Servicing, Basic Television, Television Servicing (Total retail price of four books \$22.50 — Special Course Price: Only \$19.95 in easy installments). Also send ABSOLUTELY FREE, "Successful Soldering." If not satisfied, I will return books; pay nothing; and keep "Successful Soldering" free. Otherwise, I will send only \$1.95 plus postage then; and balance in 6 monthly installments of only \$3.00 each.

If you wish to examine books individually, check below the ones you wish for 10 days' FREE EXAMINATION:

- Essentials of Radio, \$6.00
 Elements of Radio Servicing, \$4.50
 Basic Television, \$6.50
 Television Servicing, \$5.50

For each book I keep, I will send \$2.00, plus postage, within 10 days; balance in easy monthly installments.

Name _____
Address _____
City _____ State _____

WE PAY POSTAGE if you enclose first payment of \$1.95 when ordering course, or full price of book when ordering individual books (prices above). Same 10-Day Return-Refund Privilege.

POPULAR MECHANICS PRESS, Dept. 33
200 E. Ontario St., Chicago 11

Send the new edition of "Forty Power Tools You Can Make."

Remittance for \$1.50 enclosed.

Name _____

Address _____

City _____ Zone _____ State _____



NEW POPULAR MECHANICS MAGAZINE LIBRARY FILE

Brand New, Grand New
Way to Preserve Each and Every
Issue of Popular Mechanics

Now you can preserve every treasured issue of Popular Mechanics in these ingenious, custom-built storage files. Constructed to look like an attractively bound book, Popular Mechanics Magazine Library Files afford neat, orderly, flick-of-the-finger convenience. Handy reference index printed on back records the exact location of selected articles, diagrams, etc. A "must" for every reader of Popular Mechanics Magazine. A sensational Popular Mechanics value scoop. Order yours today. Use the handy coupon.

Only
70c

PER SET OF 2
(set holds 12 issues)
POSTAGE PAID

5 sets only \$3.10

10 sets only \$6.00
POSTPAID

USE THIS COUPON . . . MAIL TODAY

Popular Mechanics Magazine, Dept. PL P3-51
200 East Ontario Street, Chicago 11, Illinois

Please rush PREPAID _____ set Popular Mechanics Magazine Library Files. (QUANTITY)

Remittance for \$ _____ is enclosed. (AMOUNT)

Name _____

Address _____

City _____ Zone _____ State _____

Double the Life

**TOP
COMPRESSION RING**
Plated with Solid Chrome

**NEW CHROME
OIL STOPPER**

Optional HiPressure
spring packed with
every Chrome Oil
Stopper, for use in
badly worn engines
—at no extra cost!

of cylinders and rings with
Perfect Circle's amazing new

2in1 Chrome Piston Ring Set!

IT'S A FACT! The new 2-in-1 Chrome Piston Ring Set is actually *two sets in one* . . . because solid chrome plating on the top compression ring and the steel rails of the oil ring assures *twice the life* of ordinary sets!

Yes, Perfect Circle's 2-in-1 Piston Ring Set establishes a new high standard of piston ring performance, even in dustiest, heavy-duty conditions. Whether cylinders are slightly or badly worn, tapered or straight, round or out-of-round, the new 2-in-1 Chrome Set provides genuine oil economy and sustained power for thousands of extra miles.

Your Doctor of Motors, your favorite mechanic, will respect your judgment when you request him to install a new 2-in-1 Chrome Piston Ring Set. Or, if you handle your own repair work you'll find the 2-in-1 Set gives improved performance in every installation.



Perfect Circle

The Most Honored Name in Piston Rings

IF YOU COULD squeeze a navigator, a radar operator and a bombardier into one uniform you'd have a composite picture of America's newest kind of airman.

Together with a pilot and copilot he makes up the entire crew of a superspeed jet bomber.

He does all the navigation on a mission, locates and identifies the target, bombs it and navigates the aircraft home again. He can do all this without one glance outside, without one look at the ground.

He can find his way, and bomb, by radar alone. He operates the azon-razon and other secret equipment on board. He can set a course by pressure patterns to stretch his range and is expert at polar navigation.

POPULAR MECHANICS

MARCH
1951

WRITTEN SO YOU CAN UNDERSTAND IT
VOL. 95 NO. 3

For the speedy new warplanes that can't afford to carry a surplus ounce, the USAF is training one man to navigate, bomb and operate the radar

SSN 1037-TRIPLE-THREAT MAN of the JET BOMBERS

By Thomas E. Stimson, Jr.



Three-man crew of a Boeing B-47 Stratojet, with triple-threat man in nose, a pilot in the overhead canopy and a copilot behind him

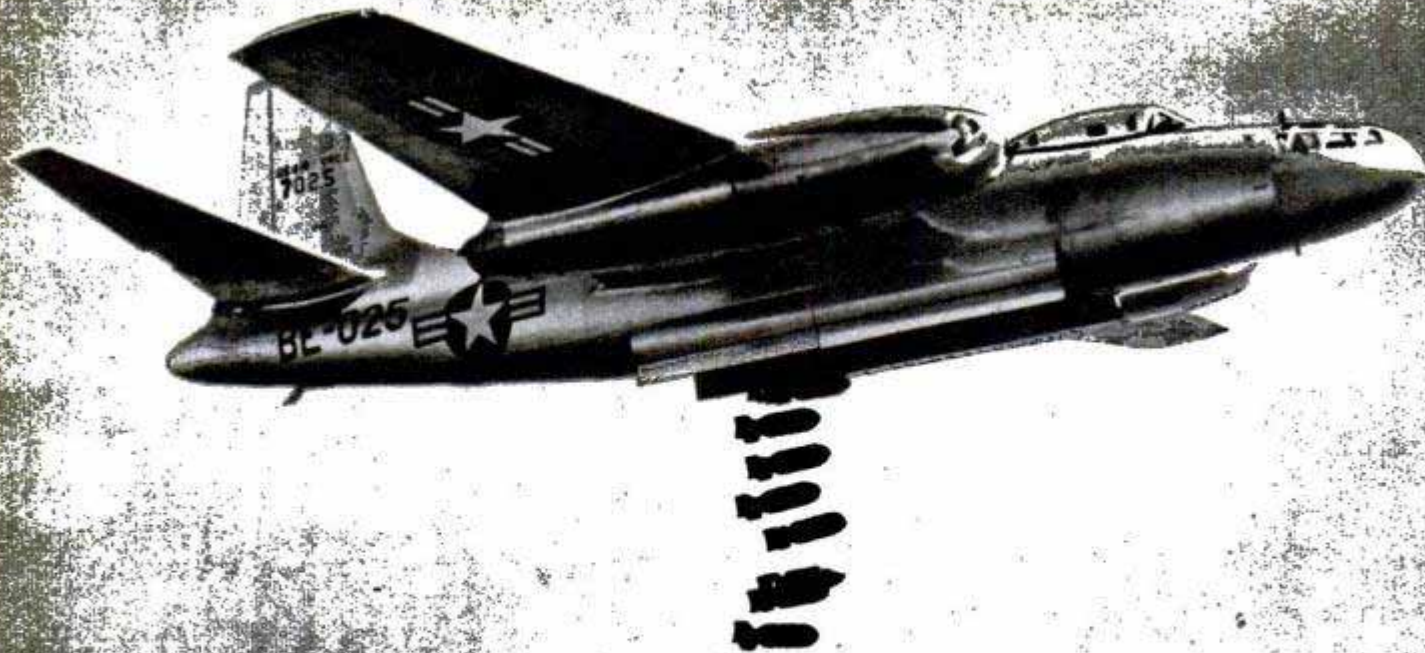

North American Aviation Co., photo

On the B-45, the bomb-bay doors retract into the fuselage, instead of swinging open in the air stream

In between times he makes photographs of the ground and, when necessary, fires defensive guns. He's one of the busiest men in the Air Force.

His friends sometimes call him a three-headed monster in token of his three main jobs. He's an SSN 1037 on the roster, the prosaic service rating that designates a highly trained graduate of the bombardment-radar-navigation school at Mather Air Force Base near Sacramento, Calif.

His three jobs were tied together because the big new jets can't afford to carry a surplus ounce. In a Boeing B-47 he sits in the

transparent nose, with the pilot above and behind him in the cockpit bubble. The co-pilot sits behind the pilot and serves as flight engineer and radio operator, in addition to helping fly the plane. The pilot is still nothing more than a pilot, though there's talk of calling him the "pilot-pilot-pilot" just to help his morale.

The triple-threat 1037s also are being assigned to the slower piston-engine bomber craft because there's no point, now, in carrying three men when one expert can handle all three jobs. Nearly all the new specialists are being assigned to the Strategic Air Command.

Most of the 1037s are veteran bombardiers or navigators with 1500 hours of flight time behind them when they enter the Mather school. There they get a brush-up in their specialty and then months of instruction and coaching in other subjects.

Their training is complete and intensive because of the need to make them the best bomb aimers in the world. In jets the aiming problem is especially tough. In fact, all kinds of problems that hardly exist at slow speeds become very serious at, say, 450 miles per hour.

There's less time for navigation even though navigation must be done much more precisely than in slow aircraft. Each slight error is magnified with distance. As navigator, the 1037 must remember that some of his instruments are subject to error just because they are flying fast. The reaction time of a bubble-type instrument.

Crouched over a Norden sight, in a mobile compartment similar to his station in an airplane, a bombardier simulates an actual run. A motion picture of target area is slowly moved across the panel in front of him

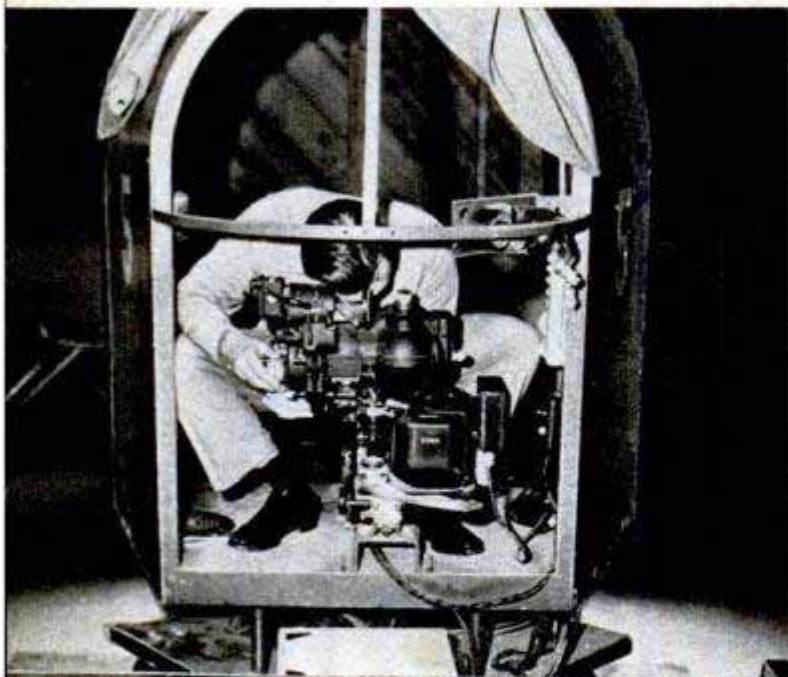



Bombing problems that barely exist at low speeds mushroom to become critical in 450-mile-an-hour jets

for instance, is just the same in a fast aircraft as in a slow one, and at high speed the fast aircraft covers more ground per unit of time.

In his capacity as bombardier, the triple-threat man has to work at top speed during the approach to the target, for he can be over the target and gone almost before he realizes it. During his approach he must identify the target, set the aircraft on the proper bombing course, train his sighting device on the target, and start the operation of the bomb-release mechanism—all before it's too late.

The time element is so acute that North American Aviation, Inc., engineers, to mention one group, are trying to devise electro-mechanical thinking machines that would automatically solve many of the bombardier's problems faster and more accurately than is possible by a human brain.

They are working toward automatic flight and bomb-control systems that would function almost without human guidance. The final military bombing goal, of course, is to be able to dispense with the airplane entirely and to mount on any big rocket a control system that could be told, in effect: "Deliver and explode this in a certain munitions plant, at such and such a street address, in such and such a city, on a certain continent."

A control system like that may be achieved in the future; meanwhile the jet bombardier has his hands full.

Another problem accentuated by high speed is that of getting the bombs to fall cleanly and immediately, as soon as they

have been released. A bomb that hangs in the bay even for an instant after being released may land beyond the target. And if it leaves the bay sideways or tail first it may be deflected to one side and veer away from the normal trajectory. Missiles weighing up to 500 pounds are apt to hang or tumble even at slow speed because of the uprush and turbulence of the air stream into the bomb bay after the doors are opened.

One suggested remedy has been to eject the bombs by shooting them out of the bay, another has been to open a scoop in



Specially built as flying classrooms, Convair T-29s carry the triple-threat airmen aloft for schooling

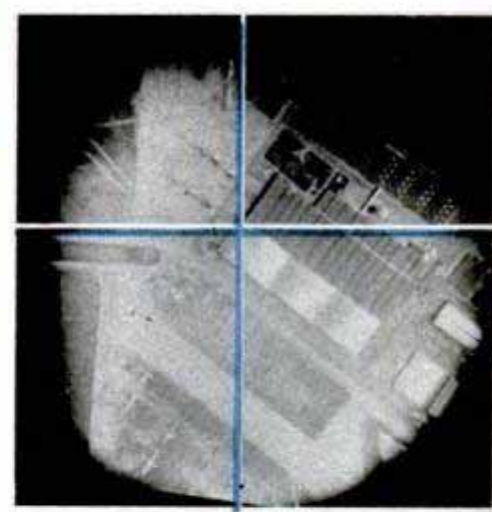
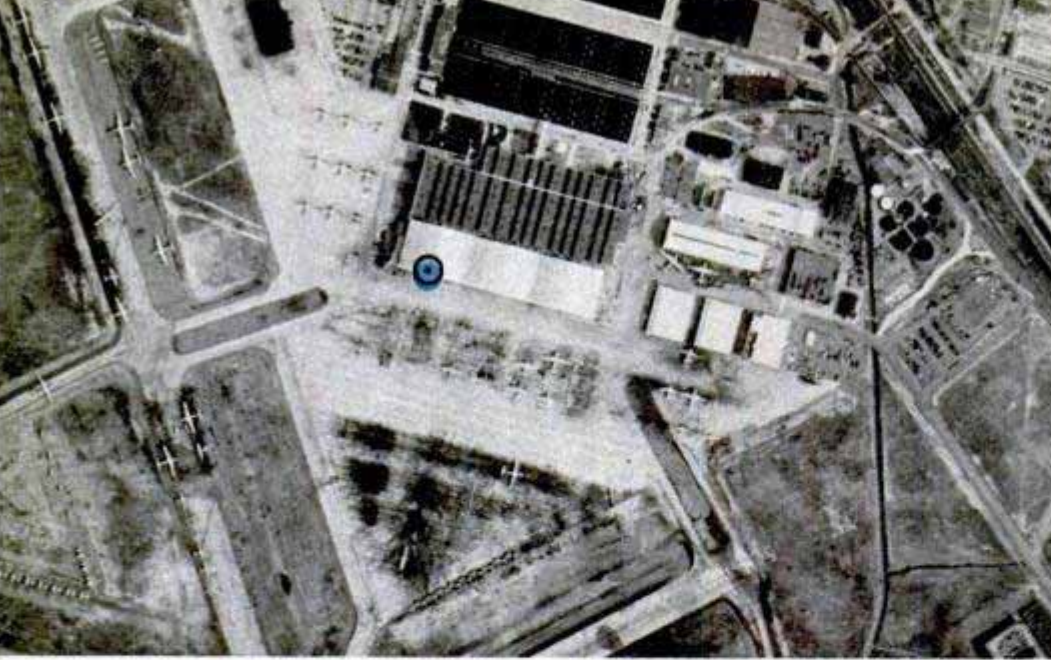

Aiming point circled in photo at left was radar bombed. The cross hairs, above, reveal hit would have been 165 feet off

the top of the fuselage so that the missiles would be blown down by the blast of air. A third has been to use a "spoiler" grid work at the front of the bay to control the turbulence. North American planned a spoiler for its jet B-45 and then solved the problem instead by retracting the bomb-bay doors up into the fuselage instead of allowing them to hang open.

Some armament men point out the need to reshape the bomb cases themselves. They assert that it's stupid to drop stubby, old-fashioned bombs out of fast, modern aircraft. A streamlined and even needle-nosed bomb should fly truer, avoid any tumbling with the attendant risk of mid-air collision and detonation, and land closer to the mark. The bomb shapes we are using now are 25 years old and were designed for 200-mile-per-hour aircraft.

One company that has an answer is Douglas Aircraft. Engineers at their El Segundo, Calif., plant have created a streamlined shape that is fitted with large swept-back tail fins and that is stable and flies

true at speeds up to 1500 miles per hour. It was first used for external fuel tanks on the Douglas A2D Skyshark, built for the Navy, and is entirely suitable as a case for bombs, rockets, torpedoes, depth charges and other external stores that are carried under a wing or that are released from a bomb bay. About 30 miles an hour greater speed could be made by another Douglas aircraft, the Skyraider, if the pair of 2000-pound bombs that it carries under its wing on some missions were simply reshaped to the new design.

As a matter of fact, the whole idea of a bomb bay is out of date. A bombing aircraft would have greater range with the same load if the bomb bay were eliminated and if streamlined bombs were carried under the wing or fuselage. Not only would the aircraft be aerodynamically cleaner, its cost would be reduced by about six percent. External bombs would create a little more drag on the way to the target, to be sure, but this would be more than offset by the decreased drag after they were

Substituting streamlined bomb shapes for the typical stubby ones now carried under the wing and fuselage, as indicated by broken lines, would reduce drag enough to give some jets 40 miles an hour greater speed

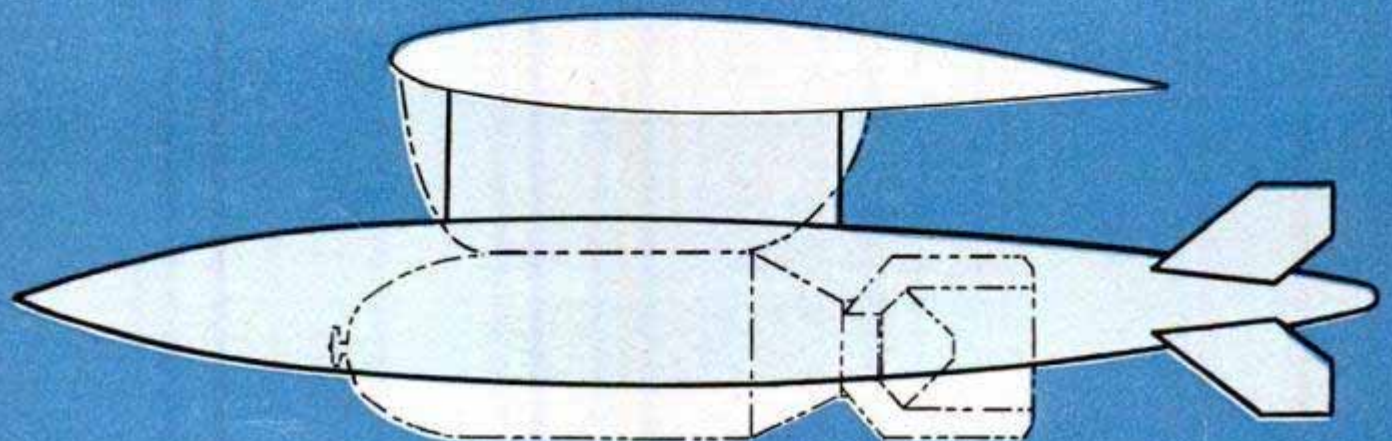

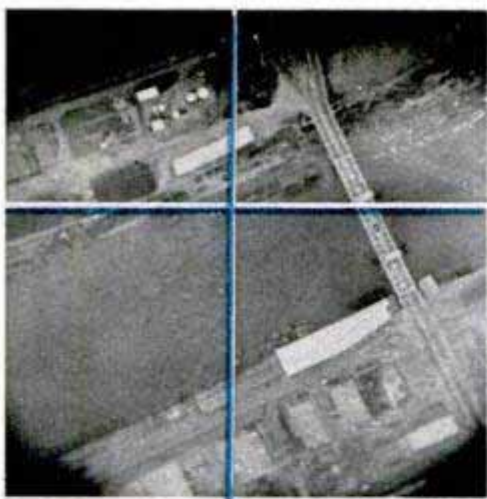

Cross hairs, above, show radar bombing of bridge, from altitude of 20,000 feet, was a clean miss—460 feet away



dropped. The net result would be a greater striking range.

One of the newest instruments that helps the jet bombardier do his job is a radar set which can be described as a bombsight that looks down through clouds or darkness. This AN-APQ-23 instrument is also a valuable navigation aid. It is a complicated mass of electronic equipment that spreads over several parts of the aircraft. It operates in part on the principle of the World War II Norden bombsight, still the best in the world for visual bombing.

The bombardier feeds information into his radar controls similar to the way he adjusted his Norden to compensate for ground speed, altitude, time of fall of the bomb, expected wind effect and other data. He sets up the one point in space at which the bomb must be dropped to score a hit, and then carefully watches the picture that appears on his radarscope, ready to make adjustments if the cross hairs stray away from the target. The bombs drop automatically when the release point is reached.

Scanner, or antenna, of radar that allows bombardier to watch ground through either clouds or darkness



The 1037 students first attain proficiency in visual bombing before learning to operate the radar bombsight. One training aid is a wheeled vehicle built to duplicate a bombardier's compartment which can be maneuvered in front of a large white panel on the floor of a darkened room.

A motion picture of the ground is projected onto the panel so that the bombardier seems to see, spread out in front of him, the cities, rivers and other landmarks that he would see from a plane. He positions his compartment on the correct bombing run and then uses his Norden to hit a particular target when it moves into place before him. An automatic scoring device tells him how close he comes on each simulated bomb run.

Graduating to the radar bombsight, the student "flies" simulated radar missions in another classroom. Here with a so-called supersonic trainer, the student is required to guide himself to the target and bomb it by radar alone.

(Continued to page 246)

Using the supersonic trainer, a student simulates a mission of bombing and navigating entirely by radar





Jack-in-Bumper

Wheel jacks are hidden inside the bumper guards of one new German car. The jacks, developed by a Berlin inventor, are built into each of the four bumper guards. The motorist merely turns a crank in the bumper guard nearest the wheel he wishes to raise. All four wheels can be lifted if necessary.

Flying "Raincoats"

"Raincoats" to protect the plastic radomes on jet planes are being tested by the Air Force. While flying 400 or more miles an hour the rain hit has an eroding effect on plastic. One of the best possibilities is neoprene, a synthetic rubber made by Du Pont, that can be sprayed on as a coating 10 to 12 thousandths of an inch thick. The radomes house radar equipment and cannot be made of metal because metal blocks the radar signal.

Silent Sound Spots Flaws in Rails

Cracks and defects hidden by joint bars on railroad tracks are spotted quickly and accurately by ultrasonic detection. A quartz crystal vibrates at a frequency ranging between $\frac{1}{2}$ million and 10 million cycles per second, sending these vibrations into the metal of the rail. When these vibrations, which travel across the metal much as light travels across space, strike the opposite side of the track they are reflected back to the instrument. If there's a break in the metal, such as a crack or flaw, the vibrations bounce back more quickly. By watching the cathode-ray screen on which the "pips" of the reflected sound waves are seen, the operator spots defective rail joints. The new system,

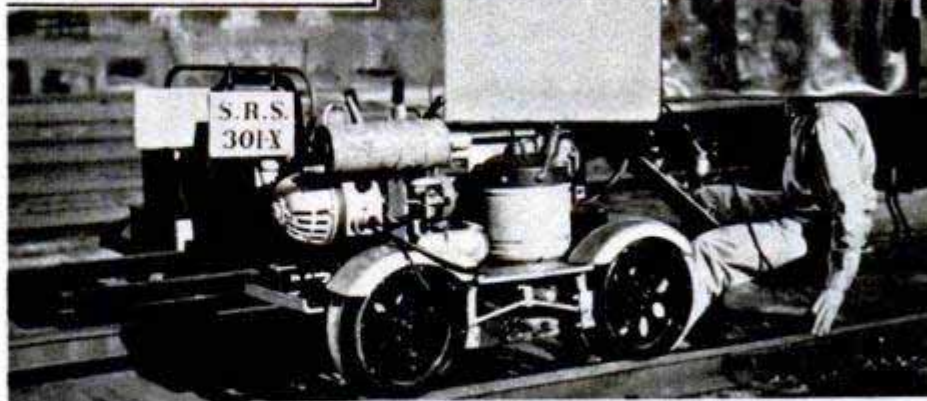
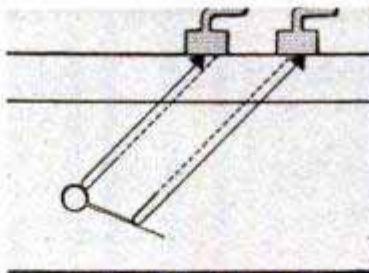

Sperry Rail Service, Sperry Products, Inc., Danbury, Conn.

Rail defects show up on cathode-ray screen under hood. Sound waves are reflected by bolt-hole crack, top, making twin "pips" on circular screen

mounted on a powered car, cuts down inspection time considerably because it permits inspection of the rail joints without removal of the joint bars.



Cargo Model of B-36 Sets Tonnage Record

In one mission, an XC-99 has flown a record 200,000 ton-miles of cargo that would formerly have required 20 C-47s, the twin-engine "work horses" of the last war. A ton-mile is one ton flown one mile. The load, consisting mainly of 42 airplane engines weighing 2300 pounds each, was hauled from San Antonio, Tex., to Spokane and Tacoma, Wash., to Sacramento, Calif., then back to San Antonio, nearly 4000 miles. The XC-99 is Consolidated Aircraft's military-transport version of the B-36. The double-decked freighter has a 230-foot wingspan and is 182 feet long.

Surrounded by some of the cargo hauled on her record flight is the XC-99. The plane's gross weight at take-off was over 300,000 pounds. Below, some of the 42 engines being unloaded

U. S. Air Force photos

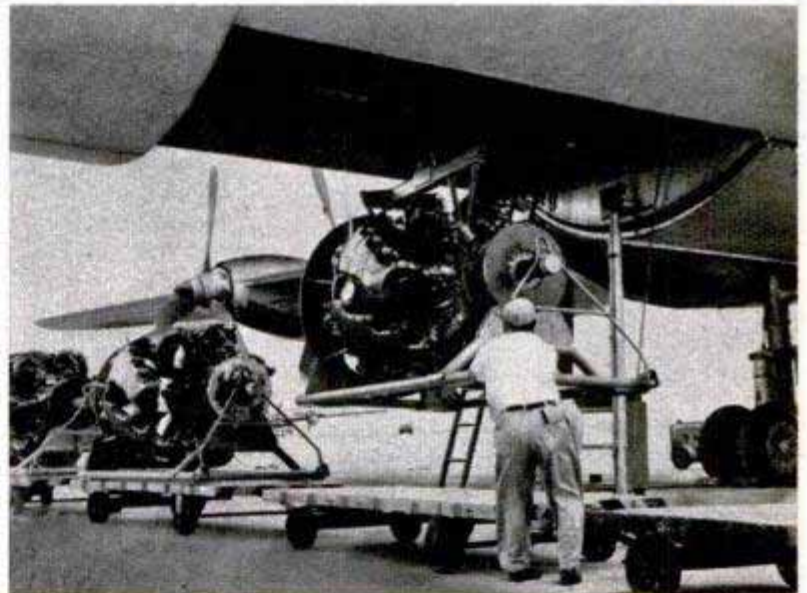

U. S. Navy photo

Alertness Indicator

Electronic pickups, strapped to the head of a test subject, relay a running tabulation of the individual's degree of alertness. Designed for Navy research into monotonous tasks of long duration, it has already been tried in aircraft and trucks and will soon be tested aboard a submarine. The indicator flashes a warning when the alertness level falls dangerously low.

"No Hands" Helicopters

Easing the helicopter pilot's constant two-hands and two-feet job, automatic controls have proved successful for both flying and hovering rotary-wing craft. Vertical landings and take-offs were made during the Piasecki Helicopter Corp., Morton, Pa., experiments, as well as automatic landing approaches through low ceilings.

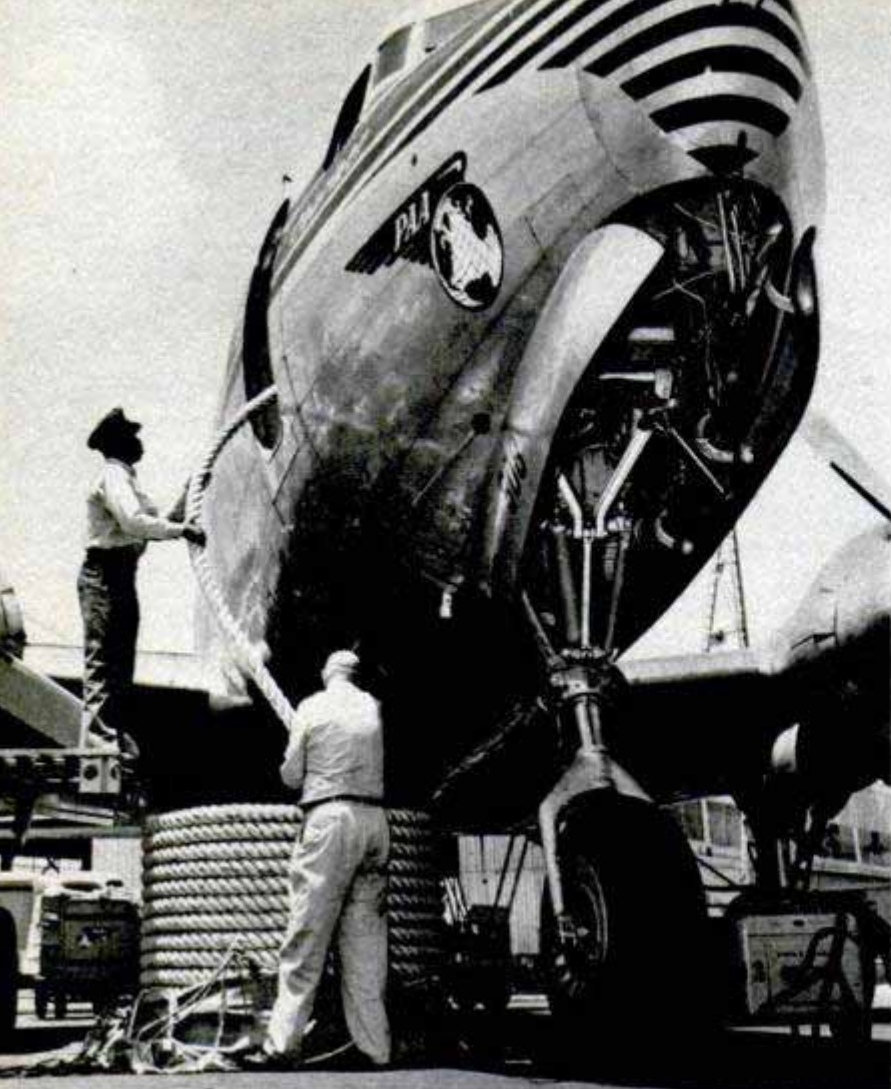

CAPTAINS Quentin "Q-Ball" Pearson and Bill Nash hauled their big C-46 off the runway with a shattering roar. From the control tower at Maiquetia, serving Venezuela's capital city of Caracas, operators watched the pointed nose and deep bulging belly of the ship's fuselage shimmer as it caught the red rays of a rising tropical sun, giving her the mean look of a tiger shark against the coastal mountains.

In that belly was a fortune—in perishable orchids. Unless the dispatcher at San Juan or Miami crackled in over the radio at one of the plane's scheduled check points across the Caribbean and diverted the flight to some forgotten jungle strip to pick up a load of bananas, mine machinery, horses, monkeys, anteaters or gold dust, the fresh orchids would be in Miami by midafternoon. In any case, they'd be there in 24 hours, fresh as when they left the orchid-grower's garden in Caracas, their stems stuck in tiny food-laden test tubes with sponge-rubber collars.

For Pearson, Nash and some 50 other pilots flying the 10-plane



"Tropical

Pan American's pioneer freighters roam the skies between two continents toting a weird assortment of cargo—orchids and anteaters, race horses and cars

*By
Richard F. Dempewolf*

Cargo loaders have their problems. Bulky coils of 3-inch hawser, above left, had to be uncoiled, then recoiled inside the plane



Because they can't stand heat, a shipment of 20 penguins crossing the equator had to be given ice-water baths at every stop



Crating costs and time were saved when 200,000 pounds of furniture were flown to Puerto Rico to equip a hotel opening there

fleet of Pan American World Airways' Latin American Cargo Division, nothing is surprising; orchids, automobiles or boa constrictors—they've carried them all.

Ten years ago, air freight was an interesting dream for emergency shipment of small parcels. Heavy international cargo was pure fantasy. In 1949, however, Pan Am's "tropical tramps" hauled 34 million pounds of international revenue cargo a total of 20 million ton-miles. If you think it was automatic, it wasn't.

In Miami, where most cargo funnels through, Capt. Vic Wright, chief of the Latin freight runs, and Gus Alfonso, cargo trouble shooter, continually cudgel their ingenuity for new cargo ideas and ways to handle it when they've got it. It's one thing to take a Havana shipment order for a stone crusher, pronounced too big for an ocean freighter to handle because of inadequate stevedore facilities (which they did) and quite another to fit it through an airplane cargo hatch and fly it to its destination (which they also did). Toughest problem of all, though, has been to ferret out and pick up return cargoes from dollar-short Latin America, so the planes don't make expensive deadhead trips home.

To turn this trick, Wright and Alfonso have set up the most glamorous, incredible "tramp" freight operation going. Here's how it works:



No desk-bound executive, Pan Am's Capt. Vic Wright follows the tough air-cargo problems the whole way

When Pearson and Nash lift their big Clipper from fields in Miami, New Orleans or Brownsville, Tex., they are on a scheduled hop. They'll be loaded to the astrodome with anything from the six-ton propeller shaft that was rushed to a stranded ship in Panama, to cigarettes, clothes, furniture, or the 210,000 false teeth recently shipped

Tramps" Link the Americas

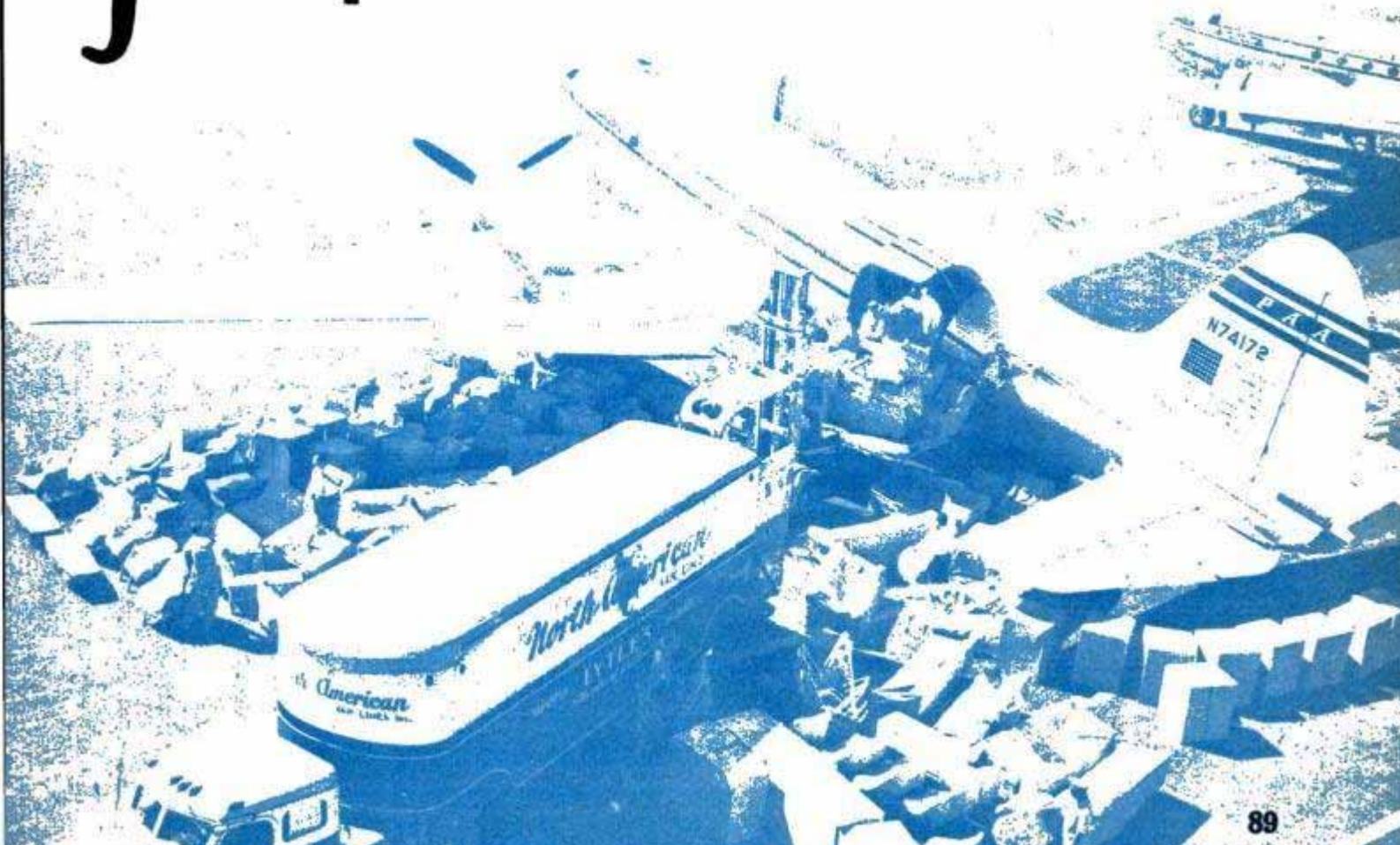



Before orchids are put in tissue and boxed, below, their stems are inserted in tubes of liquid plant food, left. A sponge-rubber collar clasps the stem without pressure and seals the tube top



to an optimistic wholesaler in Brazil. Down they go over a scheduled course, dropping and picking up cargoes in Cuba, Puerto Rico, Trinidad and Caracas.

Once delivery is made, though, Pearson's plane disappears from Pan Am's roster of scheduled flights. He becomes a roving tramp of the airways, dropping in on palm-lined jungle-town air strips to pick up catch-as-catch-can cargoes for return to the States—gold and diamonds from the Guianas, race horses from Argentina, coffee from Brazil, bananas from almost anywhere.

Secret of the operation is a complex communications setup between cargo agents and the planes in flight—known simply as "O-X". At a huge nerve center in Miami, Teletypes are clacking an incessant barrage of cargo tip-offs from Pan Am agents throughout Latin America. If the agent in Bolivar, Venezuela, for instance, has unearthed a shipment of diamonds from the interior, he immediately radios Miami.

Pearson, meanwhile, has made his last delivery and is homeward bound. But everyone knows exactly where he is. At designated check points (there are eight between Caracas and Miami) he goes out over two-way radio to the nearest Pan Am radio center. Between Caracas and Cuba, his man is in San Juan.

From the clattering Teletype room the cargo message is rushed to operations, where a radio operator sits before a board with cards

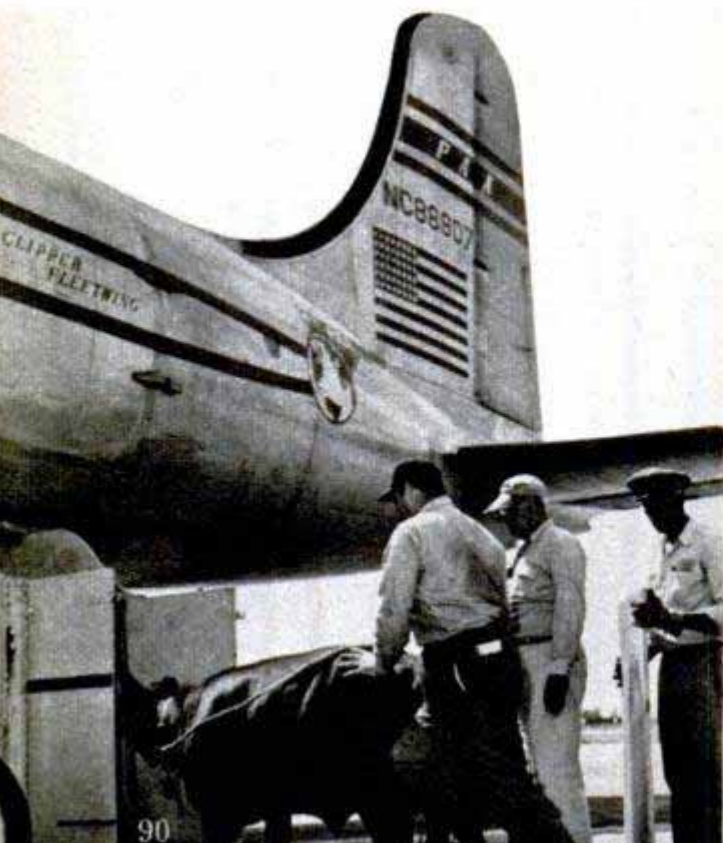

Cattle ride easily on cargo Clippers, but coaxing them on board, left, sometimes develops into a difficult problem

Ropes between them and across their rumps are enough to keep cattle from bumping each other and getting excited

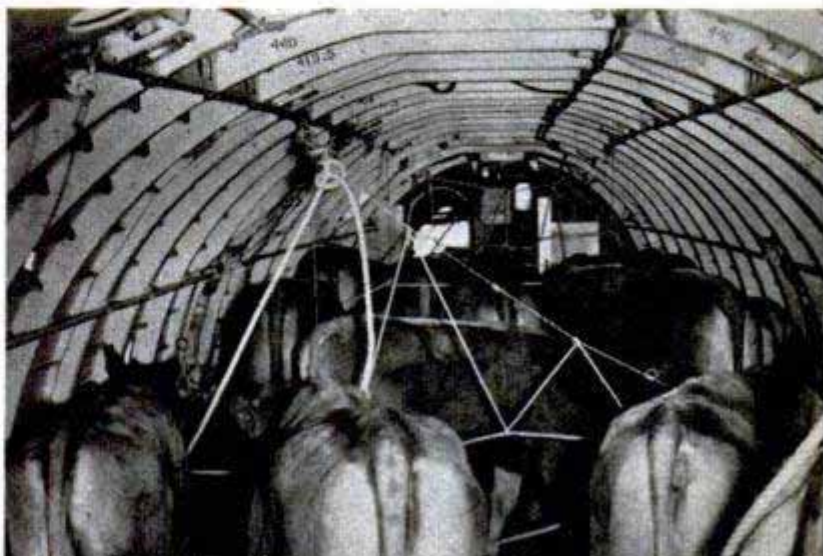

in sliding tracks. Each card represents a freighter in the sky at a specific check point—radioed to the Miami board by operators who have been in regular voice contact with the freighter pilots.

A glance at the board and near-by map tells Miami that Pearson's flight is closest to Bolivar. The O-X cargo message is immediately whipped to the San Juan radio operator, who will be talking with Pearson shortly. Within half an hour, Pearson, winging over the Caribbean, gets the news that he's been diverted, must return to Maiquetia for fuel and head for Bolivar to pick up a cargo.

Because there's no telling where or how often a plane will be diverted, the tropical tramps carry two or three pilots who will relieve each other along the way, so that no one exceeds the eight flying hours a day allotted by the Civil Aeronautics Administration. Though it's often rough going, these khaki-clad men wouldn't swap seats with "plush seat" passenger pilots. "We graduated from the plush runs," says Nash. "This is informal. We get more time at home after long hauls. Furthermore, we never know what's coming next."

Besides knowing how to fly, a freight pilot has plenty to think about. On a single round trip he may have to convert his plane from a box car to a cattle car to a fruit wagon to a refrigerator car, in order to accommodate the cargo of the moment.

One typical run left Miami recently with two pilots and 12,000 pounds of brassieres, cigarettes, electrical equipment, stoves, refrigerators, etc., for Caracas. Cargo delivered, they ferried to Trujillo where they picked up a load of wild animals. They were on their way home when O-X cut in:

"Go to San Juan for rush shipment," it said.

Around they turned, rigged up a stall and picked up a race horse. Then they were ordered to Buenos Aires to pick up seven more race horses. Wild animals and race



Map showing south-bound scheduled paths of Pan American Clippers. On way back they hit any point that has a northbound cargo, such as bananas, diamonds

horses delivered, they got another O-X to pick up a load of bananas in Colombia. So they stowed the stalls, scrubbed down the plane, and it became a fruit carrier back to Miami.

Good cargo pilots keep their ears open for business, and have authority to use initiative and judgment to carry anything anywhere. They've got to know customs forms, import licenses as well as cargo loading, stowing and unloading.

The technique of flying a loaded cargo plane has its own particular brand of hazard. Shifting cargo can break up the structure of a plane. In bumpy weather, one loose, heavy carton will knock more loose.

In their cardboard "apartment houses," a load of baby chicks moves up to the plane on a conveyor tractor





Like a waiter carrying a tray, the fork-lift truck moves a furniture shipment to a waiting cargo craft, where it'll be hoisted to the exact height of the loading hatch. Below, their speed and smooth riding make cargo airplanes popular carriers for animals like this husky alligator

If enough weight shifts to the tail, the pilot will stall out and go into a flat spin. "It happened in transport during the war," says Nash, "when men rushed to the tail for mattresses during take-off. The planes just nosed up and spun in. For a long time, no one knew why until finally one man survived a wreck and told authorities."

Of all cargoes, animals give the boys the most fun—and problems. Despite all precautions, they'll sometimes get loose. "Like the time," recalls Nash, "when we had a plane full of monkeys, birds and snakes. A boa constrictor in the belly compartment got out. We just locked the hatch, gave it the run of the plane, and let the woman trainer in Miami go in after it."

Even more staggering was the load of 300 monkeys coming in from South America in cages. One got out, unbeknownst to the crew. Then a dozen were loose, and were helping their friends out. In ten



minutes, the whole plane was a screaming bedlam of loose monkeys. The crew locked themselves in the cabin in self protection. "When the plane arrived," says a man who saw it, "there were monkey faces peering from every window watching the landing. It took the ground crew an hour to catch and cage them."

Horses are standard cargo to and from the race tracks and breeding farms between the Americas. They used to go in heavily padded wooden box stalls, into which they were marched from their vans, and hoisted aboard on a fork lift. Some race horses still go this way, if the shipper insists. "But we found out," says Nash, "that such elaborate equipment isn't necessary. As long as they don't have to look at each other, they'll behave." Now, most big livestock goes in canvas stalls. It's safe, keeps them from nipping each other and gives them a confined feeling. Furthermore, it cuts weight and saves the shipper money. The overhead is padded so highstrung steeds don't bash their heads when they toss.

Occasionally, a problem lands right in the skipper's lap. One plane load of 17 Holstein-Friesian cattle going from Toronto to Montevideo required watering at every stop. On the take-off at Belem, the plane staggered down the runway and the pilot barely got it off. He couldn't understand how the load got so heavy, until he did some paper work and found the cattle had taken



Only chicken wire prevented the escape of 10 macaws and five parrots who chewed their cartons to shreds

on several hundred gallons of water and quantities of feed—and all of it was still aboard! Since then, the straw and sawdust are changed at every stop.

Getting the animals on and off presents problems. It has taken 12 hours to coax a persnickety horse up or down a ramp. At the big Miami terminal, if they won't go

Special ramps that are easy to position have replaced fork lifts as the fastest method of loading automobiles

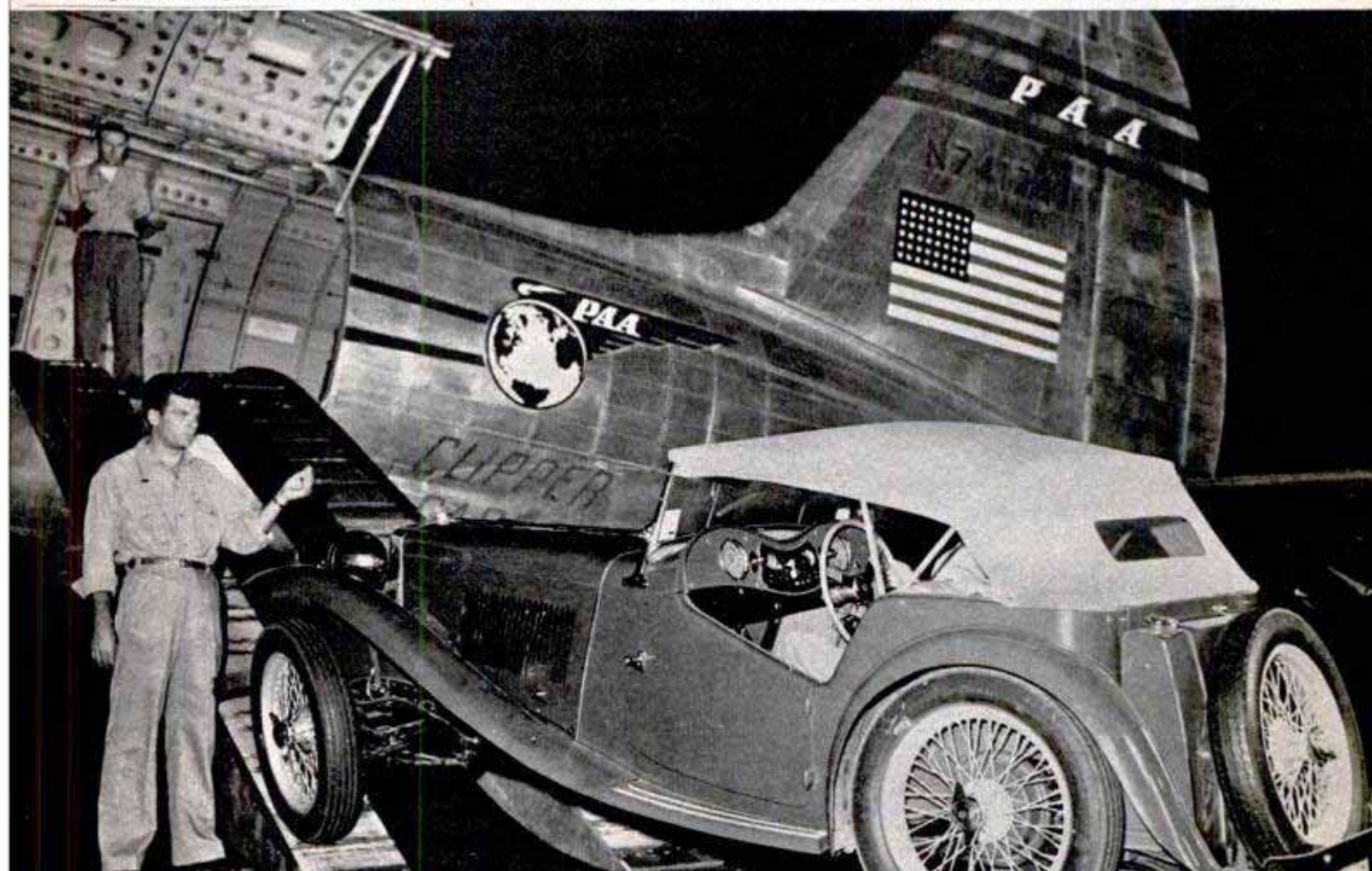

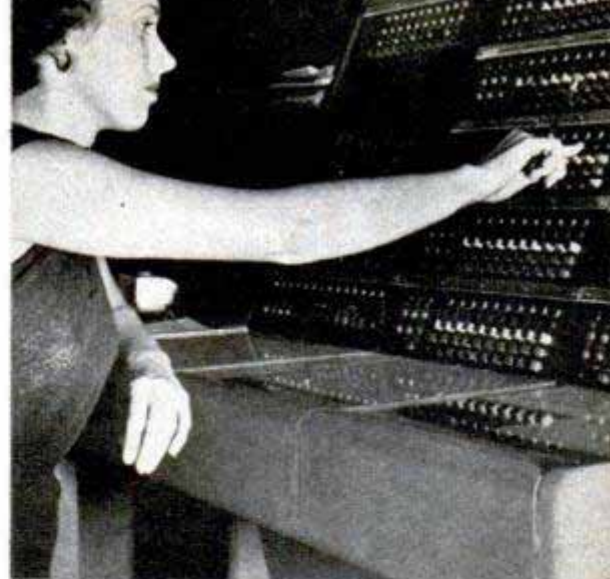

While the man at left checks schedule of an en-route craft, a co-worker finds its location on map. Right, the big switchboard at Pan Am's headquarters controls Teletypes handling orders from all over Latin America



up ramps, there's always the fork lift. But in the early days of air cargo, down in remote Latin airports, this wasn't always true. Sometimes there weren't even people around to help. "We finally got one horse off after dark at Maiquetia," recalls Nash. "Everything was shut by that time, but we found the door to the Post Office open, so left him there. I've often wondered what the postmaster thought next morning . . ."

Another pilot, who arrived at a jungle 'port after dusk with a cow to unload, found no one around—and no ramps, either. So he let the cow out on a 15-foot-high mobile-engine scaffold, which came just to the level of the hatch sill, and took off, leaving

(Continued to page 234)

At the operations desk, left, a man with a voice headset sends out orders diverting "tramp" freighters to new assignments. Cards in front of him represent C-46 planes and points from which they will next report in



Illustrating example in the story, diagram shows flight path and the sequence of orders when a Caracas-Miami bound plane got instructions in flight to switch back to Bolivar to pick up a shipment of diamonds

Snow-Cycle

Roaring up the snow-covered mountain slopes of Bavaria is a unique snow-cycle. Invented by Dr. Fritz Riemerschmid, the little vehicle has a miniature tank-type track which spins beneath the chassis. The snow scooter is guided by two rudders which extend like outriggers along the sides.

Super-Smooth Elevators

Passengers hardly know when the car has stopped if an elevator is controlled by a super-smooth landing system that reduces travel time between floors. The new Westinghouse system permits cars to delay slowing down for a stop until they are only 20 inches from the floor. The car slows down so rapidly and smoothly that during the last half inch of travel it is moving only seven feet a minute—so slowly that passengers have difficulty detecting when the car has stopped. Another feature of the new system that speeds service is an automatic door opener that opens the doors simultaneous with the arrival of the elevator. By the time the elevator has stopped, the doors



are three-quarters open and passengers can move in and out immediately. Travel time between floors is cut $1\frac{1}{2}$ seconds which increases passenger-handling capacity by 10 percent.

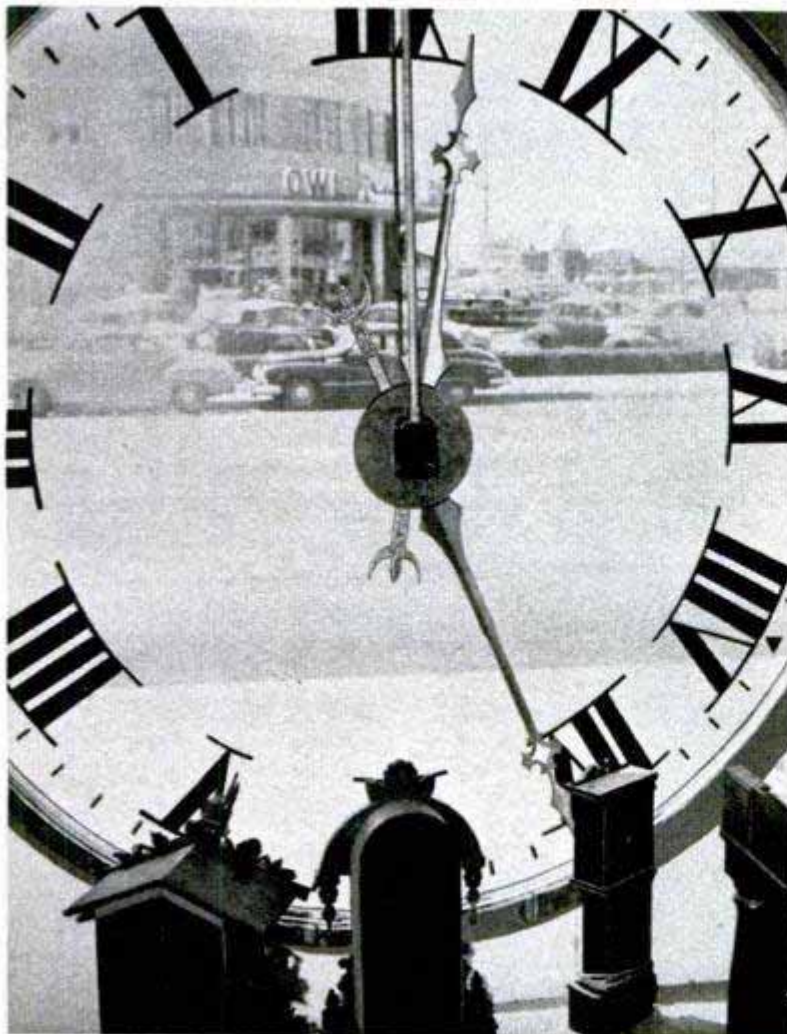

Show Window Is Clock

You can look right through a huge clock into a store in Los Angeles because the clock face is the store's show window. Built as an attention-getter by the proprietor, a watchmaker, the giant clock is electrically operated. The dial is $6\frac{1}{2}$ feet in diameter but the works measure only $2\frac{1}{2}$ by 5 inches. Counterbalanced so they can be moved by the small motor, the $4\frac{1}{2}$ -foot hands weigh 3 pounds each, yet require almost no effort to turn them.

U. S. Has More Than Half Of World Crude-Oil Output

In contrast to the United States' 52 percent, Russia and her satellites have only eight percent of the world's crude-oil production, according to Dr. Gustav Egloff of the Universal Oil Products Company. The western nations control 75 percent of the ultimate reserves. Of the world's present refining capacity, the U. S. has 6.7 million barrels daily.



Army "Task Force" In Wood

After just one look at an Army vehicle, Leo Helmer of San Jose, Calif., can duplicate it in wood right down to the leaf springs and rivets. Helmer's battle fleet includes guns, Jeeps, radar trucks, tanks and tank destroyers. He spent 100 hours in building a radar truck alone. Its fittings include gears, brakes, a movable signal arm and wheels that are controlled by the steering wheel. Helmer bound tongue depressors together to form springs which will withstand 30 pounds of pressure. The fleet is made from pine scraps, welding rod and ten-cent store items.

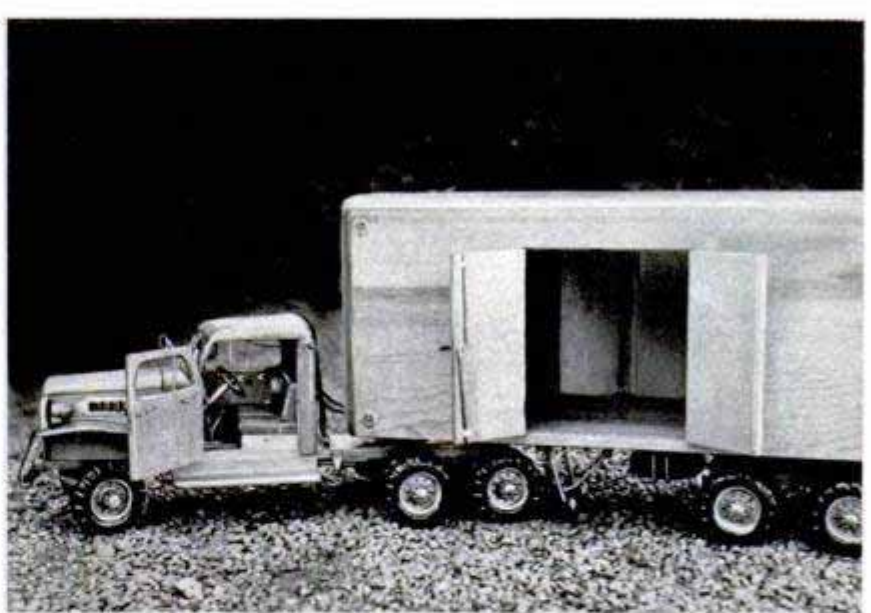

Left, Helmer holds half-track tank destroyer made of sugar pine scraps. Above, into the radar truck went only \$2 worth of materials but 100 hours of work. Below is just part of realistic battle fleet

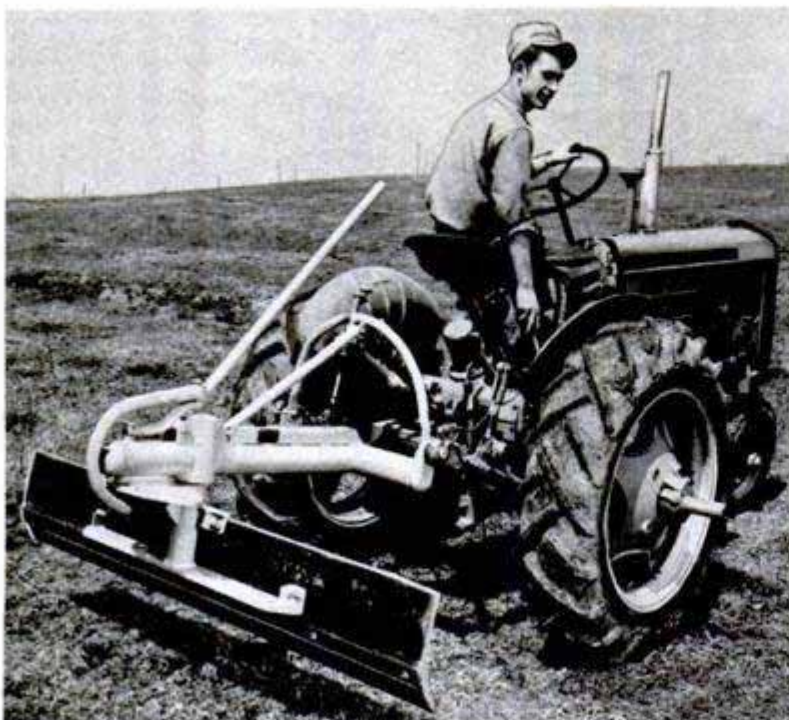
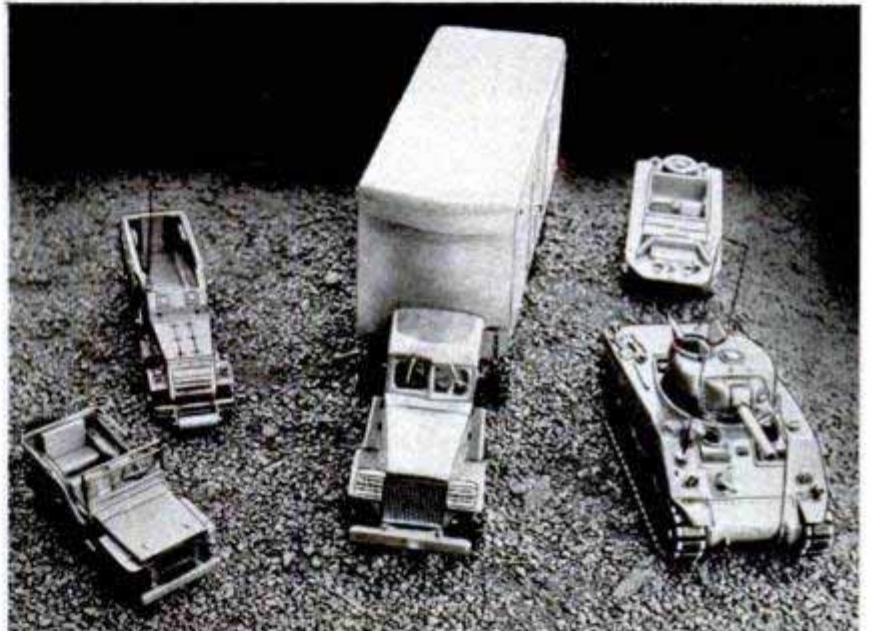

Danuser Machine Co., Fulton, Mo.

Bulldozer Blade For Farm Tractor

Hydraulically operated, a tandem-mounted blade converts a farm tractor into an earth-moving machine for terracing, ditching, grading, scraping and numerous other operations. Designed for one-man operation, the blade can be raised and lowered from the tractor seat. It swings in a full circle, can be shifted to the right or left, or given a half-turn for backfilling and bulldozing.

☐ Plane-to-plane refueling time is halved by a hydraulically operated pump that does the work of eight electric pumps now used by tanker aircraft and weighs 550 pounds less.

George Marchand is shown working on the large mastodon diorama that he made for the University of Michigan. It features a lighting system he developed that "paints" a realistic sunrise on the background

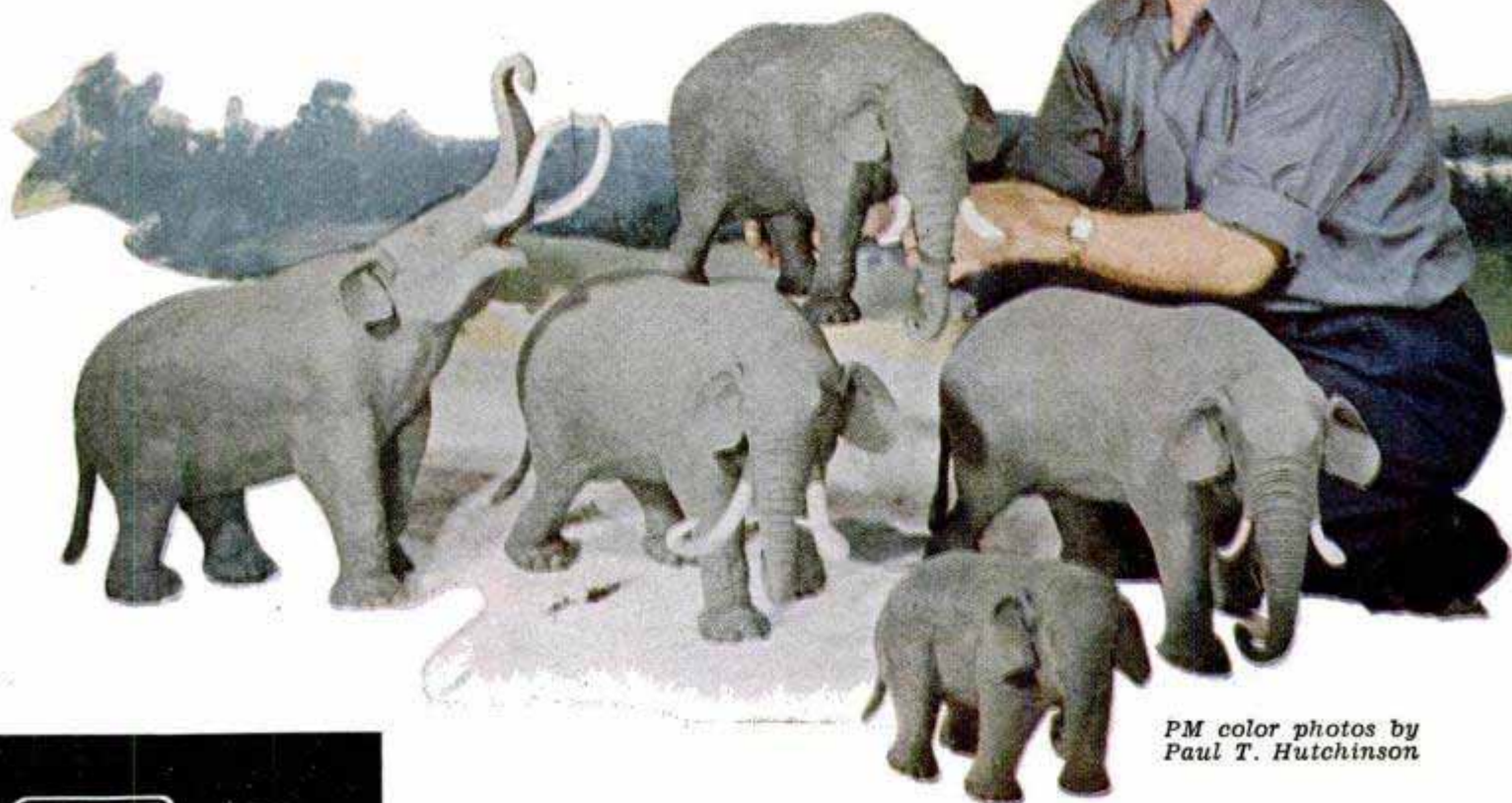

PM color photos by Paul T. Hutchinson



sculptor of a prehistoric world

TO MOST OF US, fossils are strange, uninteresting rocks with tongue-twisting names like *Michelinoceras* and *Terataspis*. But George Marchand, the artist of fossils, can "re-create" the world of millions of years ago, making models of fossils as fresh and beautiful as a Technicolor movie. Under his skilled hands, the dull, lifeless fossil has become the "glamor girl" of the museum.

"Just because the fossil is dead and has been for many centuries," says Marchand, "is no reason for making the exhibit dull. We try to give the museum visitor an accurate picture of life as it was millions of years ago—and life is never dull."

Working with Irving G. Reimann, paleontologist at the University of Michigan, Marchand has turned out many dioramas of prehistoric life for the best known museums of the nation. Reimann does the research while Marchand converts the data

into plant and animal models with amazing realism.

Right now, these two experts are working on a series of 10 dioramas for the Chicago Natural History Museum. Each diorama shows life as it was during a different period of prehistoric time. These 10 exhibits represent more than three years of work and study, and when completed will provide a realistic view of life as it progressed from a period 300,000,000 years ago down to the comparative "yesterday" of a mere 75,000,000 years ago!

But the Chicago exhibits are only a few of the scores that Marchand has produced. He inherited his skill and interest in museum work from his father. Always on the search for new ideas in display methods, Marchand has brought many new techniques (some of which he guards with understandable secrecy) into the work and has become internationally known among

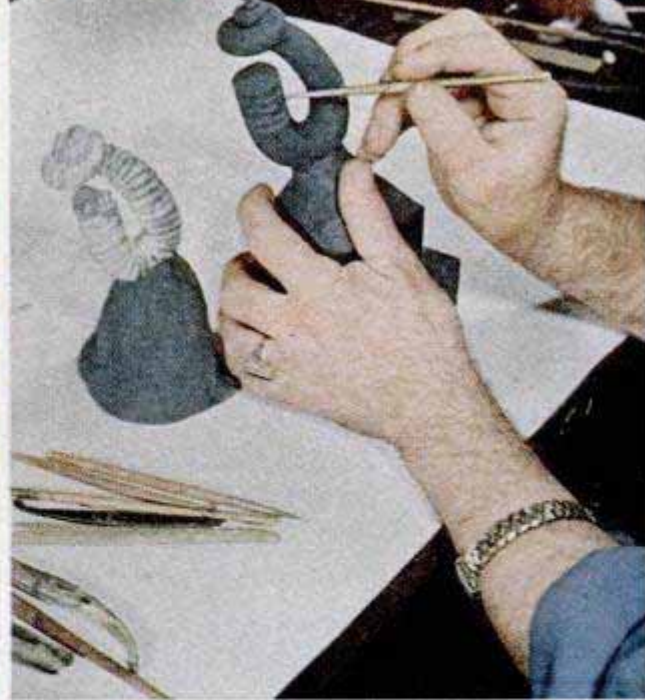

Left, Marchand makes a wax model of the coral fossil in foreground. Right, he shapes a fossil in clay

museum staffs. Universities like Harvard, Yale, Princeton and Michigan are customers of the fossil artist. Museums in Rochester and Buffalo, N. Y., Toronto and Chicago, to mention only a few, are proud to display his work. Despite what amounts to a seven-day week of work, it seems he can't keep ahead of orders for his displays.

In the construction of models of fossils and long-extinct creatures, Marchand and Reimann sometimes have to rely entirely on a few fragments found in fossil form. Often a mere imprint of the body in rock, preserved for millions of years, is the only clue available. But by drawing on a broad knowledge of paleontology, they are able

A coral reef of 350,000,000 years ago. Colors used are based on those of the fossils' modern relatives



to make accurate replicas of ancient life.

Marchand's techniques are varied. He uses rubber and wax for most of his models. Wire stiffeners are required for many of them. His best work is often in rubber, which he stains to any color desired. A talented painter as well as sculptor, he uses oils for most of his brush work. The backgrounds, painted on a curved backdrop, blend in so smoothly with the models in the foreground that the scene seems to stretch far, far into the distance. He produces an eerie, murky effect with his paints that heightens the underwater illusion in many dioramas.

Colleges find Marchand's rubber reproductions of small fossils excellent for classroom use. They can be handled without danger of breakage and eliminate the need for handling original specimens, which are sometimes fragile and often so rare as to be priceless.

But it is in the diorama field where Marchand is at his best. He has given new life to the fossil-display techniques of museums. Not many years ago, the fossil display was just that—some lifeless rocks with hard-to-understand labels pinned under them. Today, in many museums, persons who don't know the difference between a Placenticas and a Silurian coral reef are attracted to Marchand's colorful displays which show, clearly and realistically, how the creatures that we know only by fossil remains lived millions of years ago. Museum directors of the nation know how important this interest is and are keeping Marchand busy with orders for his work.

Only on the subject of colors do Marchand and Reimann become slightly apologetic. There they admit they're guessing—there is no way to discover the colors of the original plants and animals. Fossils have no pigments, of course. So these two experts have carefully selected colors for their models after a study of the colors found today in the nearest known relatives of the fossils.

"We may be right or we may be wrong," explains Reimann. "But we do know that prehistoric creatures had color and we don't feel we should show them in dull monochrome. The colors we use are, we feel, reasonably close to what the plants and animals had long ago."

But not all of Marchand's work is with fossils. He has made many copies of modern plants and animals. A strict perfectionist, he challenges anybody to show him where his models are not true to life.

His test for quality is simple. He places one of his artificial flowers in a vase with several natural specimens. If anyone can tell which is Marchand's and which is Nature's without touching them, he considers

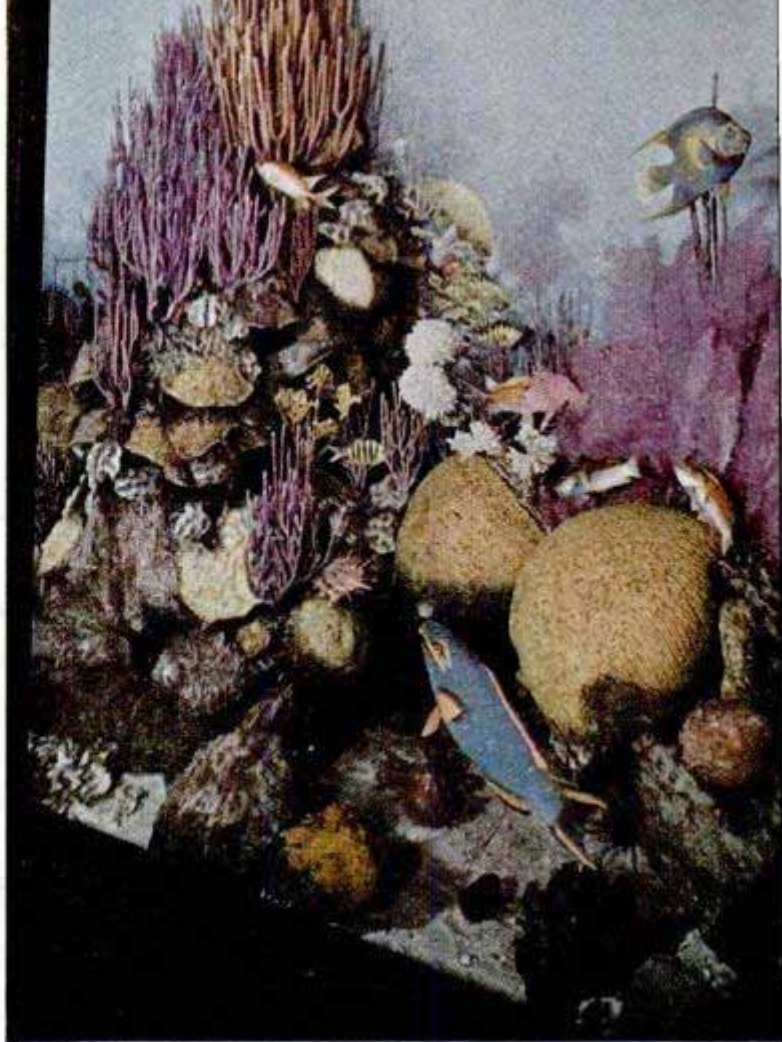

Above, Marchand went underwater to get the data for this modern coral-reef diorama. Below, this pair of rubber moccasin flowers is exactly like Nature's own





Reimann, paleontologist of the team, replaces a weird animal in this diorama of life 125,000,000 years ago

his work not satisfactory and rejects it.

One day he had a collection of his flowers on his workbench when a bee flew in through an open window. The bee headed straight for the flowers. After perching on the flowers for a few seconds the bee flew away in disgust. A friend who was visiting Marchand at the time was amazed.

"I've seen everything now," he said. "When you can fool a bee with your flowers, you've reached perfection!"

Marchand admits that this was a lucky accident. He knows that bees are attracted as much by scent as by sight and that the bee was not really fooled. But it's a good story and it does illustrate the superb quality of his work.

In his striving for perfection, Marchand often goes to extremes. When he was commissioned to reproduce a modern coral reef, he decided that he'd better get a first-hand view of one. So he packed his bags

Left, these are rubber mushrooms. Those with the skull are poisonous. Right, painting the wax Placenticerias



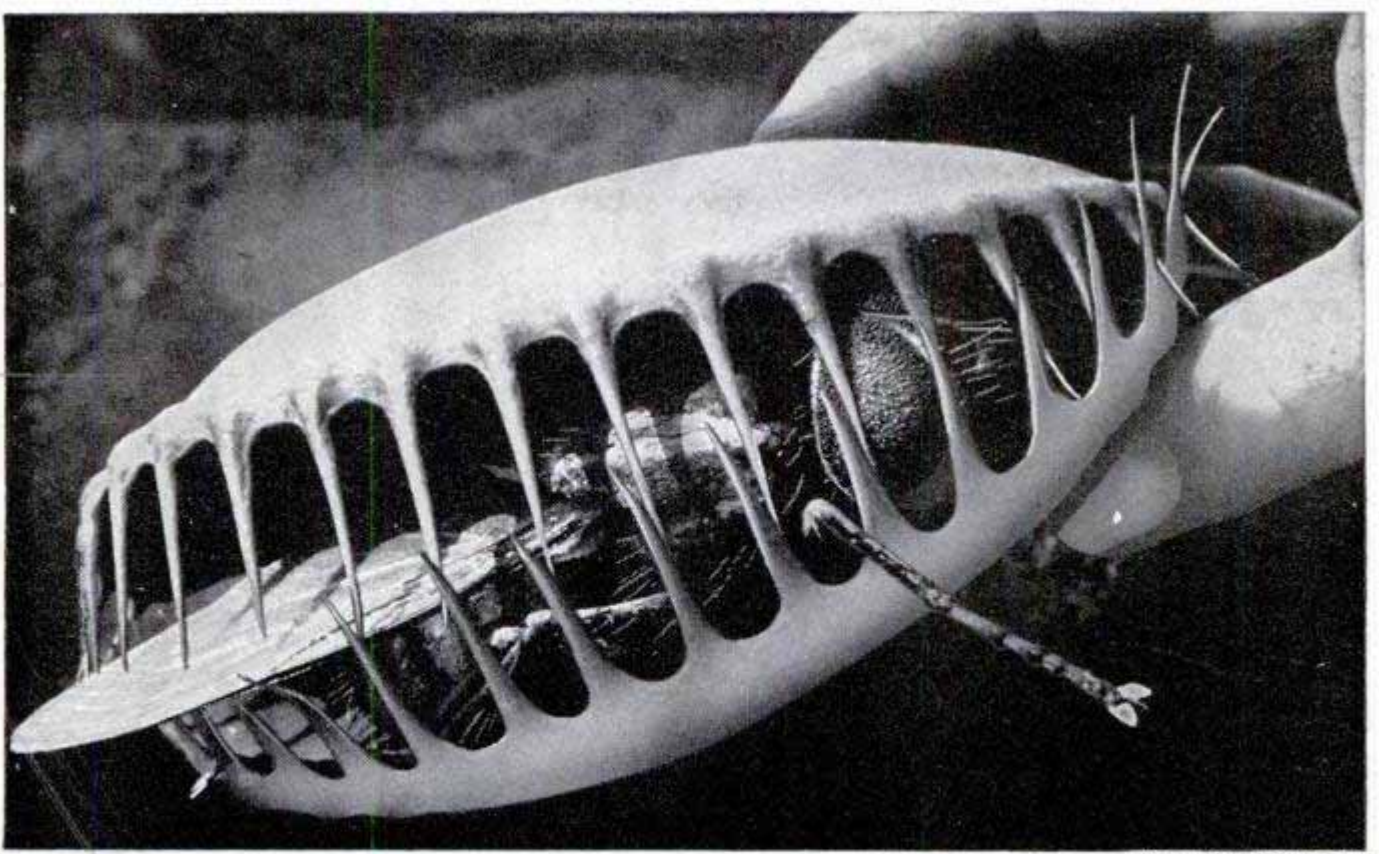

Photos by Alfred Eris

This enlarged model is of the Venus flytrap, a plant found in North Carolina. Note the details on the fly

Marchand works on a model of a snake that he cast in mold at right. A real snake was the pattern for the mold

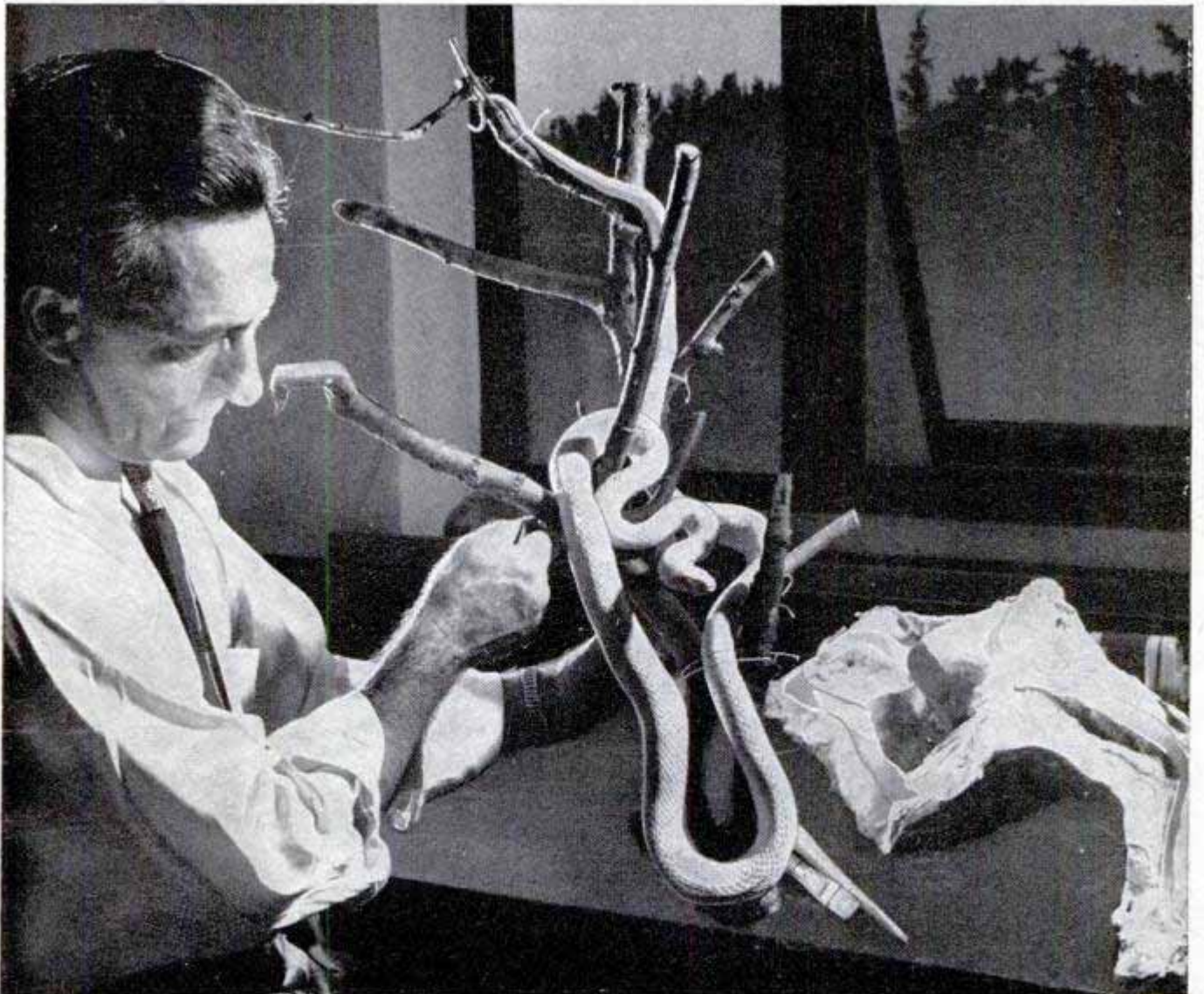

and went to Bermuda. Donning a diving helmet, weighted belt and shoes, he went down to the bottom to see for himself. With oil paints and weighted brushes, he sketched the scene on a zinc "canvas" right there on the bottom.

"The sketch was nothing wonderful," he admits. "Painting underwater is mostly a matter of impressions. But I was able to take down enough of the scene so I could make an accurate coral-reef diorama."

That diorama is on display at the University Museum of the University of Michigan at Ann Arbor where visitors exclaim over its beauty.

Because Marchand's models are so natural in appearance, they are used frequently by photographic studios in New York and Chicago. Out-of-season fruits and flowers are a specialty with him. When a color photographer wants a wild flower in the middle of January, Marchand comes to his rescue.

In reproducing a flower, Marchand always starts with the original blossom. A plaster mold is made of each tiny filament, pistil and stamen. Then each part is cast in wax, celluloid or plastic. Delicate wax petals are reinforced with cotton fiber and hair-thin wires. The many parts are then assembled and colored to match the beauty of the original. Some "simple" flowers, such as daisies, require only 15 molds, but a milkweed, much more complex to reproduce, requires 45 different molds!

One valuable trick that Marchand discovered is an automatic method of enlarging molds. He pours the mold, using a liquid rubber. When the rubber

(Continued to page 234)



Photo by Alfred Eris

The two fossil experts look over a model of the *Terataspis*, which is a particular favorite of paleontologist Reimann. Below, the mold for this strange animal is made up of 26 pieces, some of which can be seen here

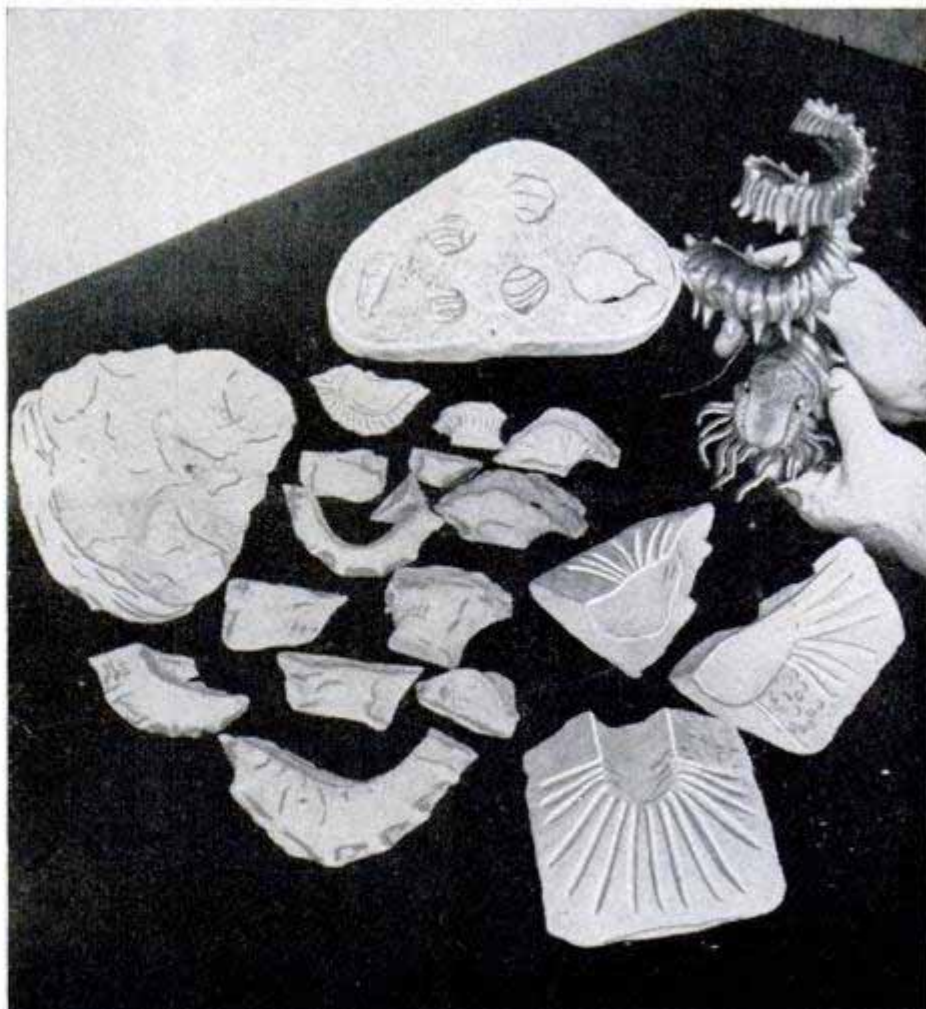



Detroit Listening Post

By Siler Freeman

THE ROUND of new-car introductions has now been completed by the manufacturers, with Chrysler and Oldsmobile the last to show their new lines. Chrysler's new engine was the big feature but the lack of large production will restrict it to the two highest-priced models at first. The schedules on the high-powered V-8 are set to go as high as 80 an hour but it will be some time before that is reached.

Buick's emphasis on the Special indicates that it is after the big market which it bracketed last year. The new body in that series, plus the higher-powered engine which it took on this year, should make it a big seller.

From an over-all viewpoint of the 1951 models, the trend toward a better ride seems to be the all-important feature in all lines and makes. Springing is emphasized and the Chrysler-made cars go even further than this in the new shock-absorber system.

Oldsmobile has changed from coil springs in the rear to leaf springs. This was brought about as much by cost considerations as by a better ride claimed for the flat springs. Buick, however, retains the coil springing in the rear, as does Nash. All the rest have gotten away from it in favor of the flat leaves.

Some high officials of automotive companies look for continued production of cars and trucks throughout the year. Some will only estimate it at "most of the year." But predictions of a goodly output the first six months and slightly more than a trickle afterward have now been modified by a "30 to 33½ percent reduction from the 1950 rate" and spread over the year. Only an all-out war, which few can foresee, would change this estimate.

As for the retail end of the business, the dealers are pictured by most of the factories as starting a new round which will lead to more of the prosperity which has made fortunes for most since the end of the last war. With schedules cut and new cars getting scarcer, both new and used-car merchants are enjoying a return of the seller's market.

"Bootlegging," which stirred the industry a year ago when production got ahead of sales, is now replaced by the "black" and "gray" market. With the spring sales rush just coming in, this is expected to reach its peak. Scare buying was noticeable as long as a month ago and the profits of the dealers may climb to new heights.

The reduction in the number of cars and trucks to be made this year for civilian use has focused attention on the service side of the business. With the larger number of cars now in the field, this would be profitable except for the manpower problem which the dealers are already facing. Those in areas where airplane contracts have been placed report raids on their ranks for skilled mechanics. Many have been forced to boost wages to retain their staffs of workmen and bring back some of the over-age mechanics.

The parts problem is expected to get acute as defense programs cut into materials and production. It was a serious one in the last war, and dealer groups have been alerting Washington not to get into that fix again. They are said to have some sympathetic ears in the National Resources Board where ex-dealers have been put in key spots. Meanwhile, the expected "black-outs" of the new models are already showing up. One manufacturer has been shipping cars with veneered bumpers. A tangle with the car in front or back results in disappearance of the gleam. The rims of headlights are already a thing of the past, and other bright work will be coming off more and more.

Some sales managers have been trying to figure how the more somber look of the cars will affect sales. With good production and a lot of the older cars, with chrome intact, this may become a problem, they admit.

Substitutions are very much in order. Many parts now made of aluminum are being changed to cast iron. The Ford Company, which only last year changed from cast-iron pistons to aluminum, will probably soon go back to the old style, at a great cost.

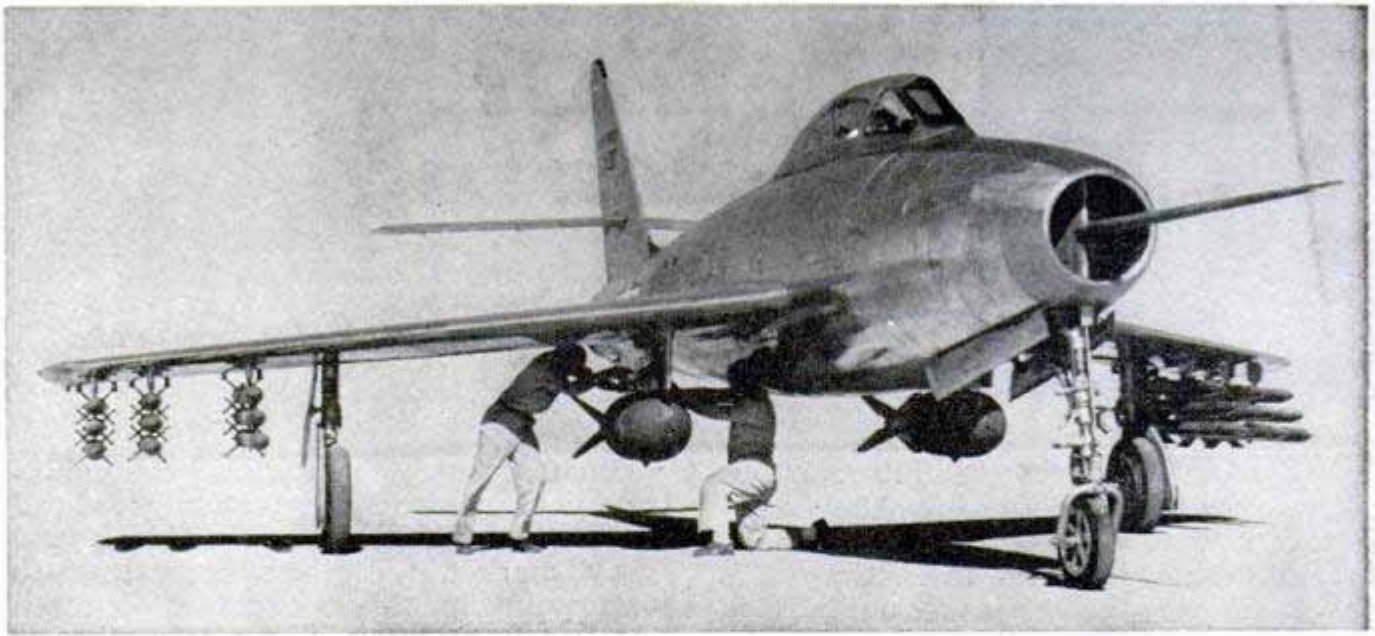

Armorer's attaching a 1000-pound bomb beneath swept wing of new Thunderjet. Below, underside view of 450-gallon fuel tanks

Swept-Wing Thunderjet

Packing 24 five-inch rockets beneath its wings, a new swept-wing version of Republic's F-84 Thunderjet has a secret top speed estimated at well over 625 miles an hour. Depending on the mission, it can also carry either two 450-gallon underwing fuel tanks or two 100-pound bombs and 18 five-inch rockets. Its fixed armament consists of six 50-caliber machine guns. With external fuel tanks, the F-84F has a combat radius of over 1000 miles and a service ceiling above 45,000 feet. An earlier Thunderjet, the "E" model, has fought in Korea since December.

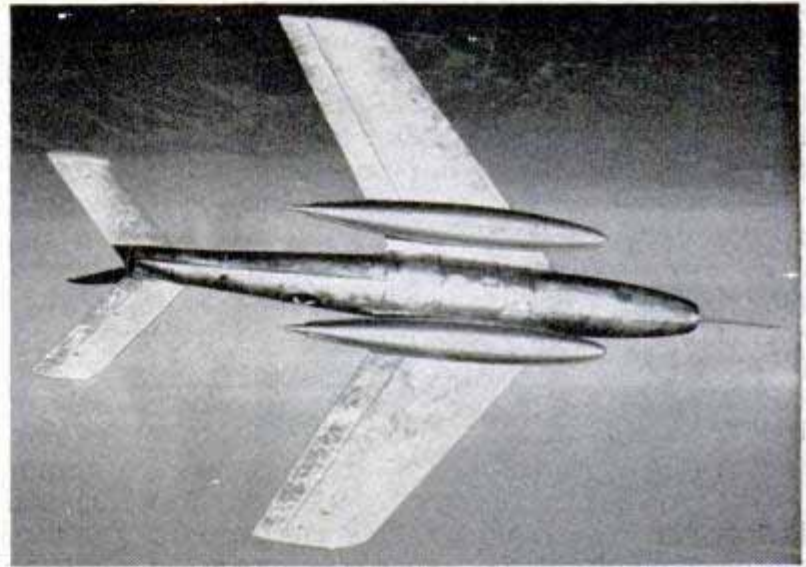

Allied Mfg. & Sales Co., 4700 Rice St., Chicago 51.

Hand-Operated Lift Truck

One man can lift, move and stack a 500-pound load easily with a hand truck that has a lever-operated hydraulic lift. Each stroke of the lever raises the lift more than an inch and it takes less than a minute to elevate the load to the maximum height of 54 inches. A foot pedal controls the lowering action which can be stopped instantly by releasing the pressure on the pedal.

Seaweed Indicator Aids Jet Tests

By detecting seaweed, a simple instrument in Lynn, Mass., is aiding in the testing of jet engines. When engines are under test, the laboratory uses 4,800,000 gallons of water per hour, drawn from a tidewater stream near by. This torrent of water carries seaweed which piles up on the inlets. Engineers have devised a seaweed indicator to solve the problem—lights flash on and bells ring when the inlet screen starts filling with underwater growth.



180-Hp. V-8 Engine For Big Chryslers

CHRYSLER has joined the growing list of automobile manufacturers who are using the torque-converter principle in an automatic transmission. Coupled with its new V-8 180-horsepower engine, Chrysler's 1951 line provides an unusual array of mechanical innovations. The Chrysler V-8 is the most powerful engine now in use on any mass-produced passenger car. It will be used at first only in the big New Yorker and Imperial models. The V-8 is the result of eight years of development. Its secret lies in the hemispherical combustion chamber, with overhead lateral-valve arrangement. The shape of the chamber is said to give better fuel utilization. The new engine has a compression ratio of 7.5 to 1 but uses regular fuel. Although it has only 2.3 percent more displacement than Chrysler's eight in-line engine, it develops 33 percent greater horsepower and 16 percent more torque. However, its weight is 8 percent under the former eight. Easy cold starts, smoother operation during warm-up period and improved hot starting are other features of the new engine. A newly developed heat-retainer plate permits the use of a more active thermostatic coil and also stores heat to allow the choke to cool down with the engine. Another feature of the new Chrysler line is power steering, another "first." The pressure of one finger and guidance with the thumb are all that is required to rotate the wheel with Hydra-guide power steering. Like the new engine, it is only available now on the Imperial and New Yorker models. Oriflow shock absorbers are another "first" on the 1951 Chrysler. This reduces driver fatigue and increases safety and comfort. For the first

The Chrysler '51 Imperial six-passenger sedan presents a lower silhouette and improved rear visibility. Below, cutaway of the new 180-hp. V-8 engine

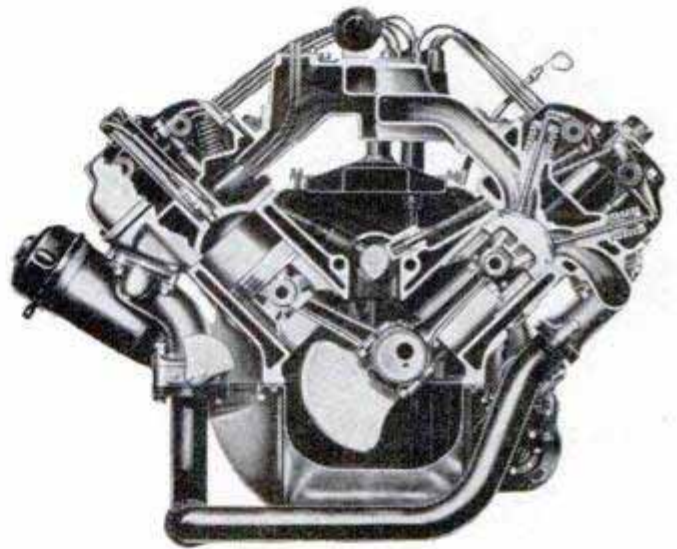

time, too, forced-air cooling is used on disk-type brakes. This feature is available only on the 1951 Imperials. It reduces internal brake temperatures up to 35 percent, according to the Chrysler engineers. As a result, brake lining wear is reduced up to 50 percent.

The new torque converter is available on all but the Imperial Eight sedan and limousine. In combination with the V-8 engine, it is said to have the most powerful starting and acceleration on the road. Driver operation is the same as with the regular fluid coupling and automatic transmission except that most of the driving is done in high range. Low range, however, is still available for engine braking, push starts and other emergency requirements. The Chrysler torque converter is of the four-element type. Impeller and turbine are hydrogen-braced assemblies of stamped-steel parts. The two stators are cast aluminum. The housing is welded on after the assembly of the elements. Thus, the converter is serviced as a complete assembly.

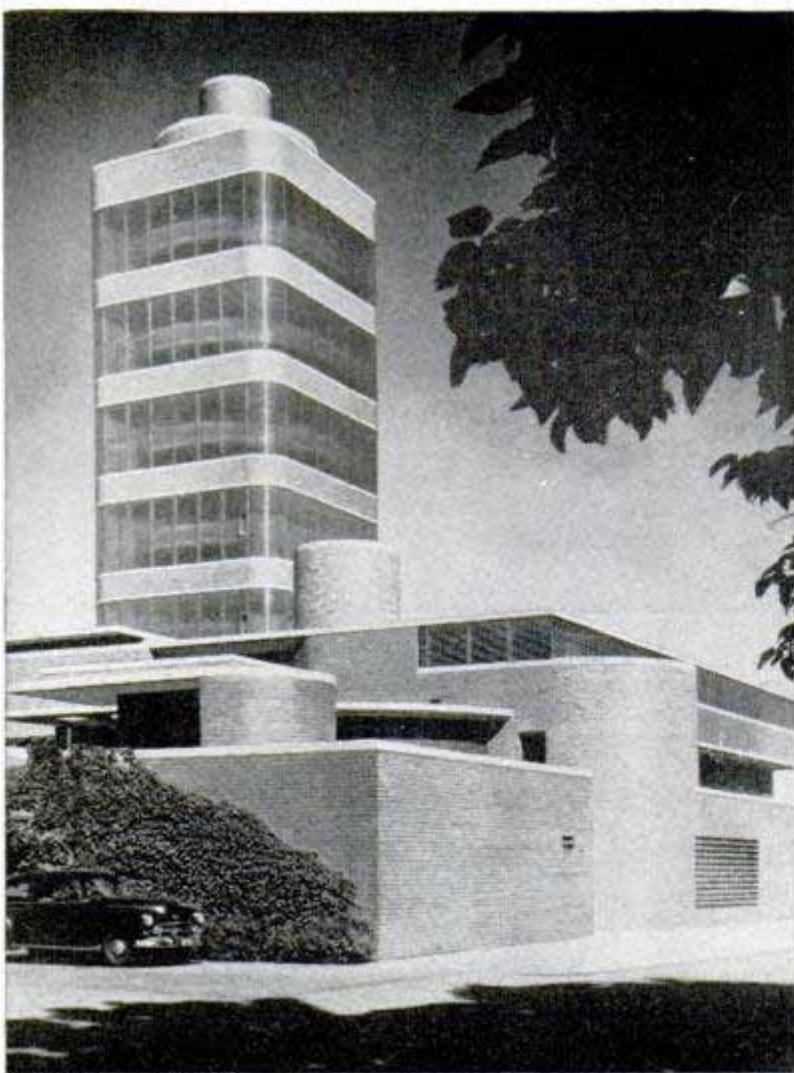

Johnson Wax Co. photo

Unique "stem" base of tower, in background, is not visible from street. Right, skeletonized view of building

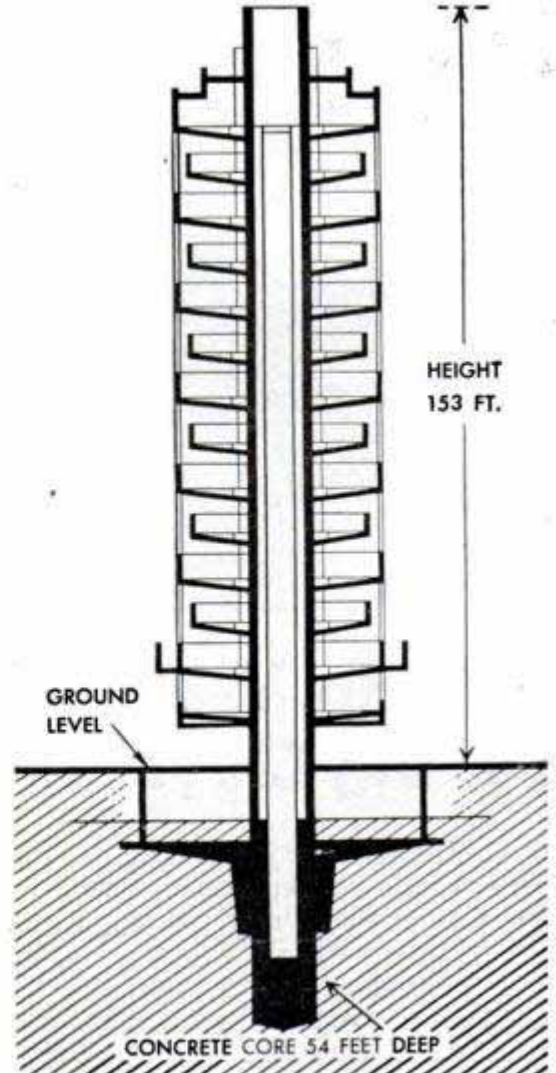

Tower on a "Stem"

Resembling a giant chalice, a 15-story tower at Racine, Wis., rests on a hollow concrete "stem" only 13 feet wide. There is no other foundation under its hanging walls of brick and horizontal glass tubing. It was designed by Frank Lloyd Wright for a wax firm's research and development facilities. The central core, of steel-reinforced concrete, has channels for the ele-

vator shaft, a circular stairway, pipes, wiring, fume exhausts and ventilating ducts. Forty-foot-square floors alternate with smaller circular floors, leaving space for tall laboratory equipment around the perimeter. Narrow strips of brickwork marking the square floors provide the only breaks in the glass outer surface, which consists of two-inch-wide tubing separated by rubber strips. The glass tubes would extend 21 miles if laid end to end.

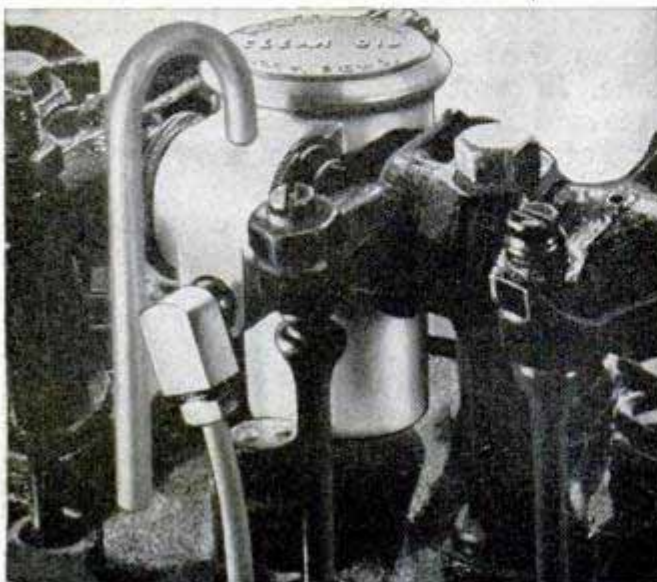

Wolfer Corp., 3723 Wilshire Blvd., Los Angeles 5, Calif.

Oil Filter for Overhead-Valve Engine

Mounted directly on the rocker-arm shaft of the overhead-valve system, a small oil-filtering unit cleans the oil at the point of wear. The filter element stops particles as small as 39 microns in diameter and is easily replaced when dirty. At present, the filter is made only for Chevrolet engines.

Underwater Ear

Underwater sounds above the human-ear's range can be detected by wire with a porous coating. Scientists at Western Reserve University, Cleveland, made the discovery, which has possible application to submarine detection.

Nash **BUILDS** **A SPORTS CAR**

IF AMERICA'S new sports car, the 1951 Nash Healey, has a nautical line or two in its low, racy body there is a good reason. The car first saw the light of day on a tablecloth in mid-Atlantic. Bent over the tablecloth were the heads of two ocean-liner passengers: George W. Mason, president of Nash Motors, and Donald Healey, the noted British custom sports-car builder.

Healey told Mr. Mason he was coming to America to find an automobile engine for a sports-car body. The Nash president told him to look around, and drop in on Nash. Healey looked around and came back to the Nash plant in Detroit.

The chance meeting of these two automotive tycoons has resulted in the first American sports car to be introduced by a major auto maker since the

Low and luxurious, the two-passenger Nash Healey sports car has an estimated speed of 125 m.p.h. It stands only 38 inches from road to top of hood

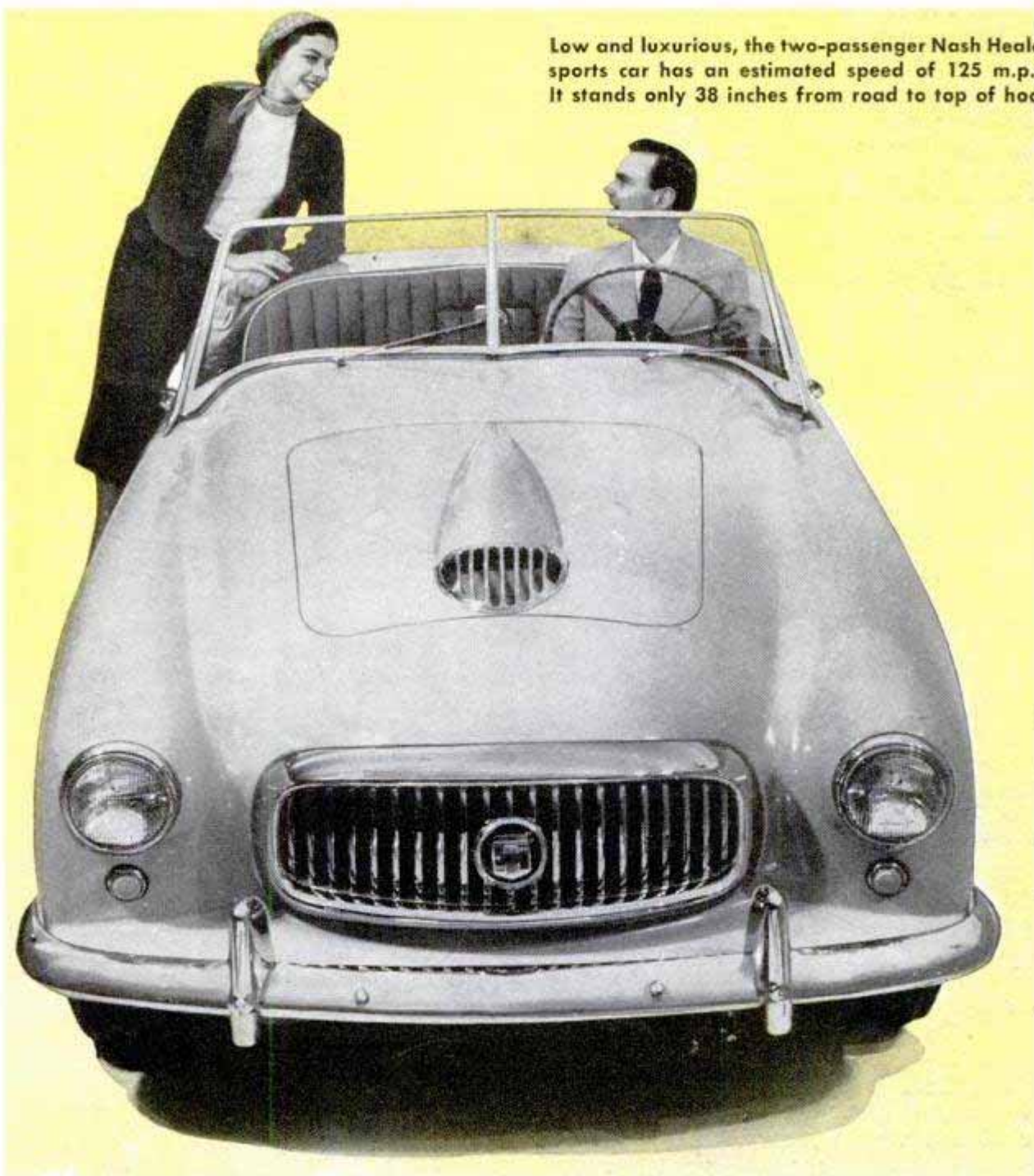

mid-'20s. (Remember the Stutz Bearcat and the Jordan Playboy?) The two-passenger Nash Healey will also be strictly a luxury item and according to reports will sell for "\$3500 and up." It has an estimated speed of 125 miles per hour.

The front grille of the Nash Healey follows the familiar Nash Airflyte design. Its low streamlining is accentuated by a broad hood and car-long horizontal lines that flow gracefully from front to rear. The car measures only 38 inches from road to hood top. Body panels as well as many structural parts are made of aluminum. The car has a curb weight of about 2600 pounds, a wheelbase of 102 inches, over-all length of 170 inches and width of 66 inches. It has a turning radius of 17½ feet and road clearance of 7 inches. The instrument panel is of functional design with leather finish and the adjustable single seat is upholstered in high-grade English leather over latex foam cushions. Because of the low seat, the steering wheel is adjustable.

Bodies for the Nash Healey will be built by the Donald Healey Company in England which has been catering to the taste of European sportsmen for years. The engine (basically Nash Ambassador) and other mechanical parts are being built by Nash in

the U. S. The engine is a six-cylinder overhead-valve, high-compression job specially equipped with an aluminum racing head and other major modifications for high speeds. The new aluminum cylinder head offers a compression ratio of 8.1 to 1 with developed power of 125 horsepower at 4000 revolutions per minute. There are two S.U. horizontal British carburetors working in conjunction with an oversized sealed-in intake manifold. Passages of the latter are found directly in the main engine castings, water cooled on two sides, providing even gasoline distribution and improved temperature control. This temperature control makes it possible to use the more efficient higher compression ratios and thus squeeze the maximum power from the gasoline. The crankshaft is 100 percent counterbalanced, providing uniform load-carrying ability to meet the increased thrusts of the higher compression ratios on main bearings.

Another major feature of the car is its chassis utilizing the Healey "trailing arm" front-end suspension. This was developed by Healey to help his fast, low sports cars hold the road on curves and aid the driver in steering at all times. The front wheels are mounted on "swinging arms" pivoted ahead of the wheel center line. This arm is

The instrument panel of functional design is finished in fine English leather like the seat which is 53 inches wide. A folding fabric top is concealed behind seat. Side windows of hard plastic lower into the narrow door panels

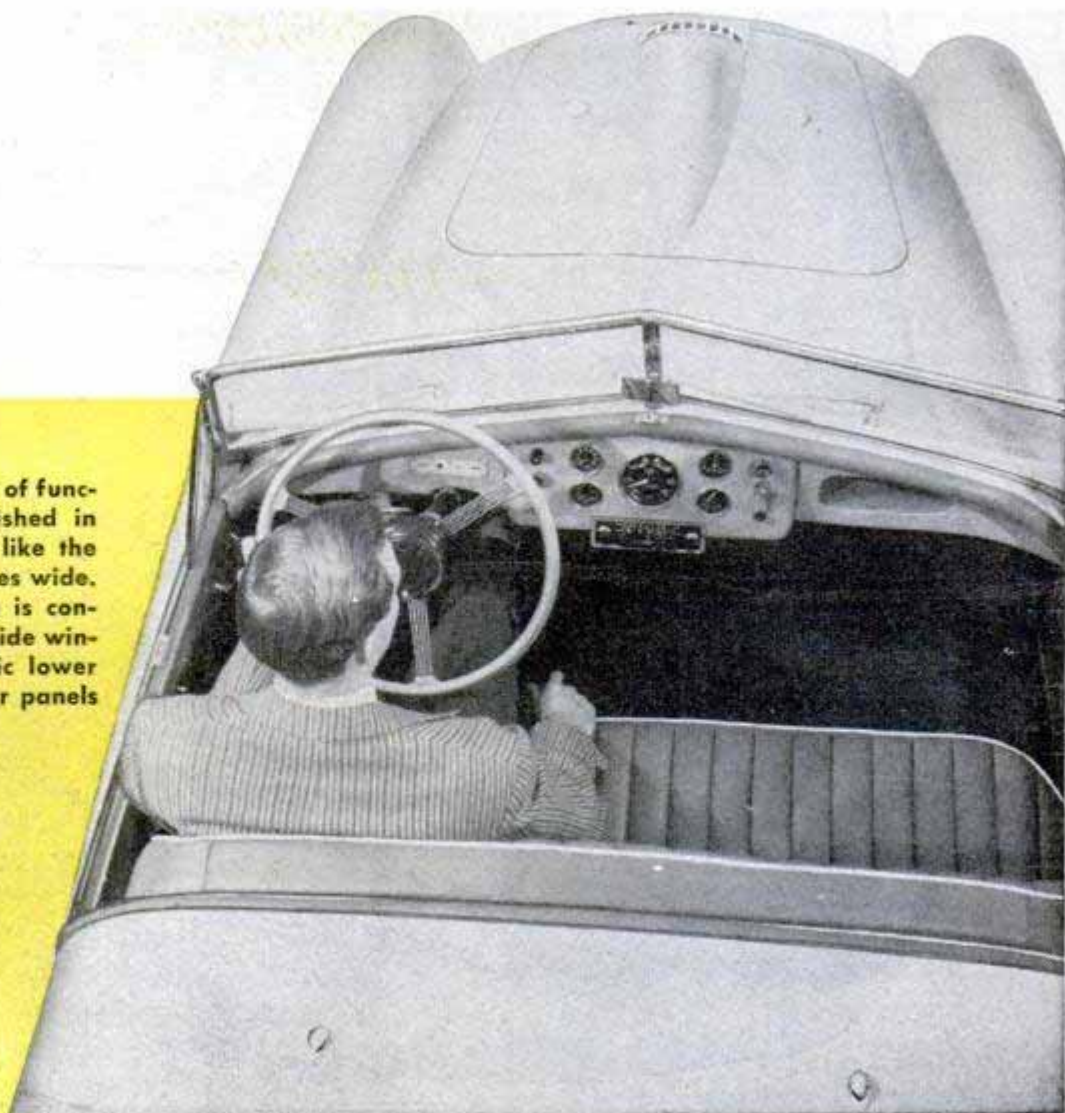

Long hood of Nash Healey gives continental look to the sports car which has an over-all length of 170 inches. The body panels and many structural parts are aluminum



cushioned against a coil spring. In taking bumps, each wheel deflects vertically in an arc without change to tread or camber.

Rear suspension of the Nash Healey also employs coil springs combined with direct-acting shock absorbers mounted in towers attached to the chassis frame. This suspension is similar to that used in the Nash Ambassador with modifications in spring design and shock-absorber calibration to accommodate the weight and operating characteristics of the Nash Healey. It has a torque-tube-type drive, making it possible to use coil-spring suspension at the rear. Torque tube and propeller shaft of the Nash Healey are shorter than those used in the Ambassador due to the sports car's shorter wheelbase. With a rear tread of 53 inches, the rear-axle shafts and tubes are shorter. The car is equipped with hydraulic Duo Servo brakes and 6.40 x 15 white sidewall tires. Overdrive permits high road speeds with moderate engine speed. Structural members of the chassis frame, typical of English sports cars, are massive to withstand extreme stresses.

The Nash Healey has a folding fabric top located behind the seat with soft plastic rear window. The side windows are of hard plastic and lower into the door panels. Spare tires and luggage compartment are reached through a nearly horizontal rear deck.

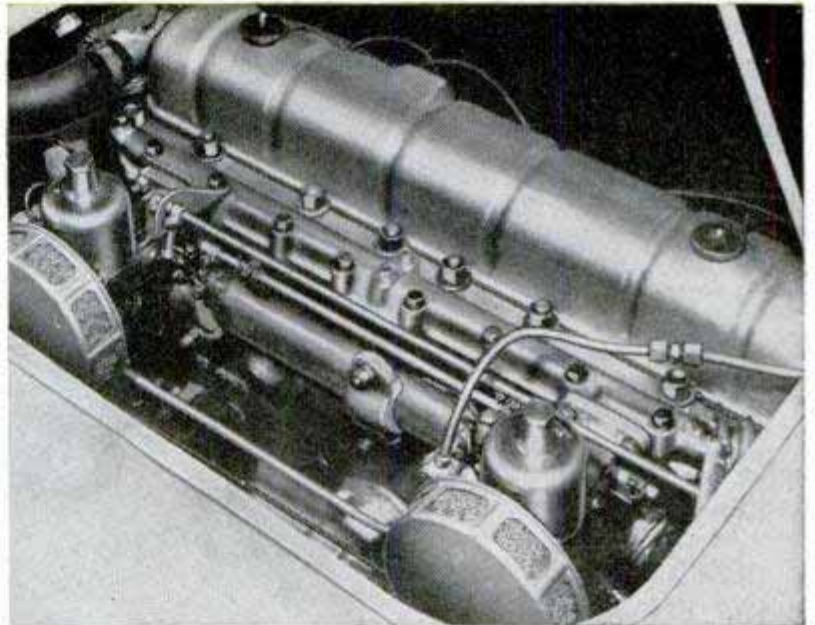

Power plant of the sports car is the Nash Ambassador six-cylinder overhead-valve, high-compression engine equipped with two S.U. horizontal British carburetors. Below, experimental setup shows how front wheels are suspended on "trailing arm"

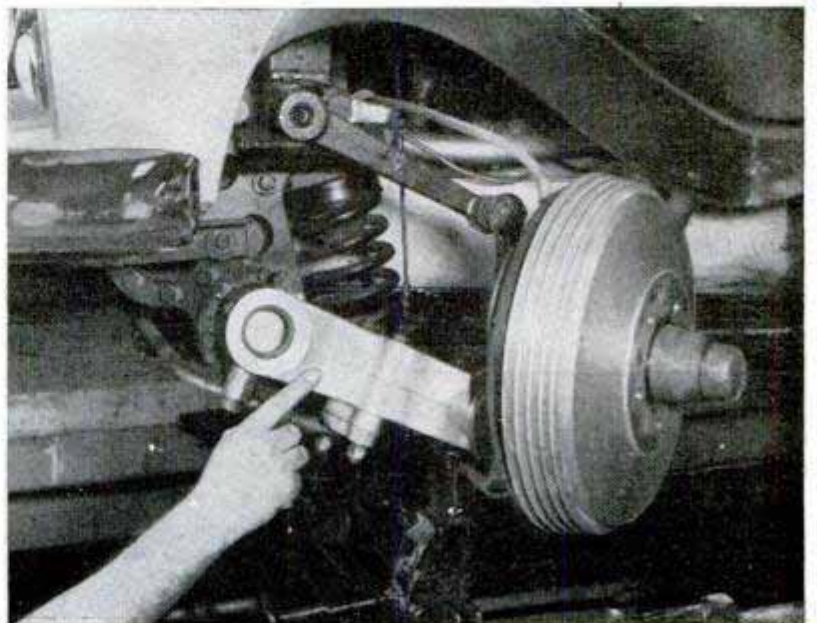



Bradley University photo

Each Player's Totals On Lighted Cage Scoreboard

Individual scoring and fouls by the powerful Bradley University basketball team registers on a lighted scoreboard. A red light flashes when any of his figures change. The board records field goals, free throws, total points and fouls.

Bearings That Run on Air

Question: What's the world's best lubricant? Answer: Air! Engineers at North American Aviation, Inc., lubricate bearings with a film of air $\frac{1}{1000}$ inch thick. A shaft mounted on these air bearings turns at the touch of a feather. It continues to turn long after a shaft on conventional bearings has been stopped by friction. The air is forced into the bearing race through tiny capillaries, $\frac{1}{3000}$ inch in diameter, causing the shaft literally to float on air. These air bearings are used in the engines of guided missiles.

Expandable Ladder For Packplane

Built like a collapsible gate, a portable folding ladder enables crewmen to get up into the Packplane's flight deck 15 feet above ground. The new plane applies the trailer-truck principle to air transport, with a detachable cargo-carrying fuselage below the flight deck. Special hooks on the end of the ladder fit any one of 10 pair of keyholes near the fins, tail booms, oil tanks, rudder and windshield. It folds to three feet for easy storage under the navigator's table where it is kept when the plane is in flight.



Fairchild Aircraft Division, Hagerstown, Mo.

Information not listed on articles in the index often is listed in the WHERE-TO-FIND-IT LIST, available without charge from Bureau of Information, Popular Mechanics, 200 E. Ontario St., Chicago 11



Fertilizing With Gas

Gas is being sprayed as a fertilizer in Cypress, Tex. Equipment rigged up by Chester Turner, shreds the soil several inches deep while hoses attached to the tiller's claws spew out almost pure nitrogen gas, which is quickly absorbed into the soil. The gas is anhydrous ammonia, a refrigerant that comes as a liquid in high-pressure containers but changes to gas when released into ordinary pressure. Though estimated to cost about half as much as commercial fertilizer, the gas is dangerous unless properly handled and it should not be employed without supervision by experienced operators.

Snow Packer for Ski Slopes

Snow on ski slopes is kept smooth and compacted by a slatted roller invented by Steve Bradley of Winter Park, Colo. Insuring an even, firm surface on snow-covered ski areas has always been an expensive operation because of the large number of skiers required to compact fresh snow by sidestepping up or down the hill. Bradley's roller enables one man to do the work of 10 such ski packers. An adjustable blade in front of the roller shaves off bumps and scatters the snow before the roller compacts it. This blade also acts as a brake. If the operator releases the blade-control lever, the blade digs into the snow, stopping the roller. This prevents runaways which could be dangerous on a steep ski slope.

Plans have been drawn for the world's longest suspension bridge to connect Italy and Sicily across the Straits of Messina.

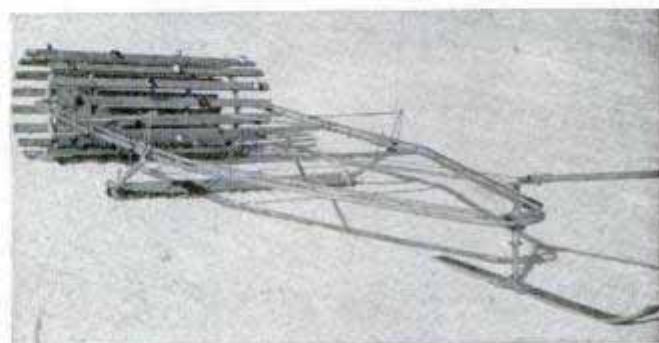

Folks around Puget Sound can't hide from Bill Cheney's camera. With its far-seeing eye he takes . . .

CLOSE-UPS FROM MILES AWAY

By Rafe Gibbs

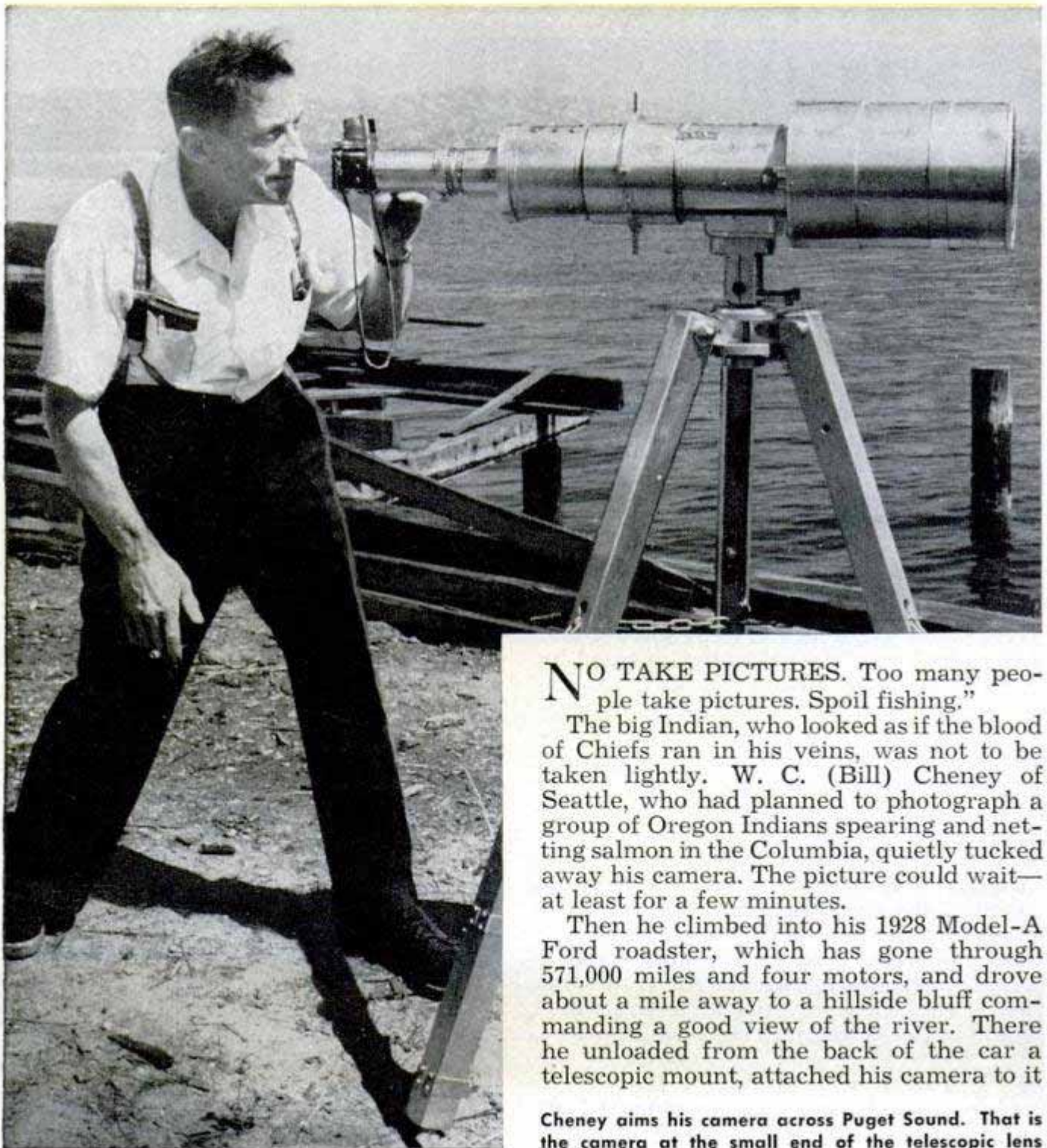

NO TAKE PICTURES. Too many people take pictures. Spoil fishing."

The big Indian, who looked as if the blood of Chiefs ran in his veins, was not to be taken lightly. W. C. (Bill) Cheney of Seattle, who had planned to photograph a group of Oregon Indians spearing and netting salmon in the Columbia, quietly tucked away his camera. The picture could wait—at least for a few minutes.

Then he climbed into his 1928 Model-A Ford roadster, which has gone through 571,000 miles and four motors, and drove about a mile away to a hillside bluff commanding a good view of the river. There he unloaded from the back of the car a telescopic mount, attached his camera to it

Cheney aims his camera across Puget Sound. That is the camera at the small end of the telescopic lens

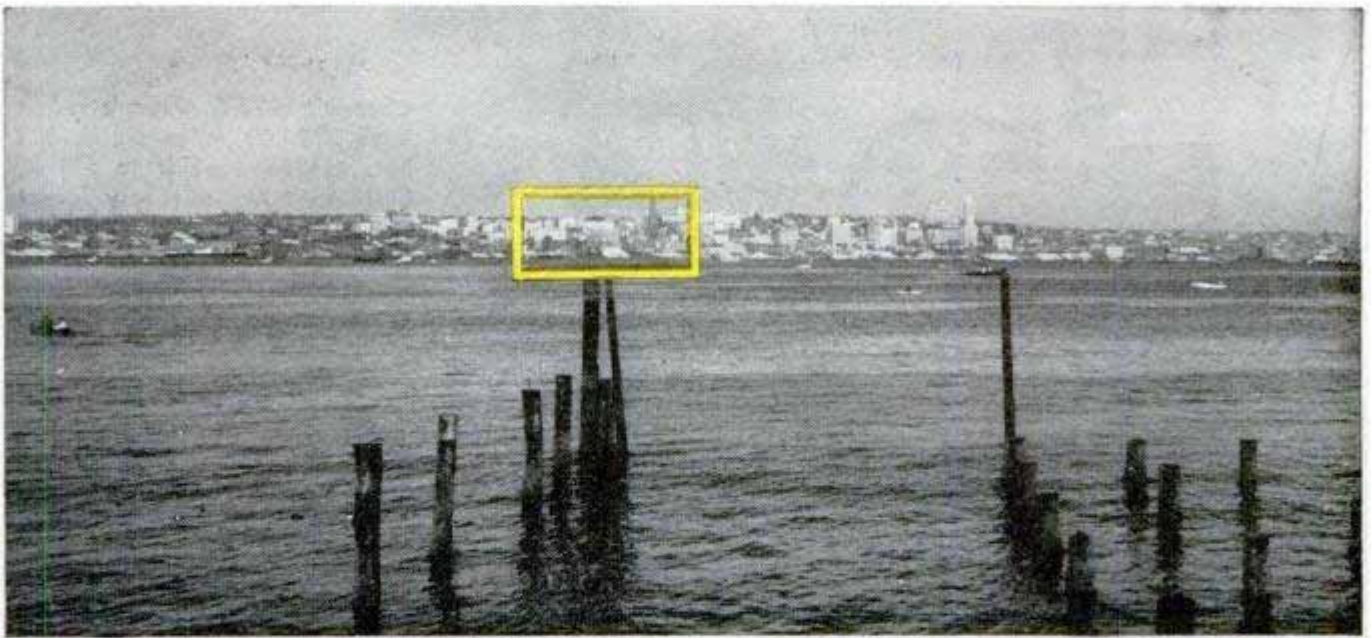

Here's what the author's camera shot when aimed across Puget Sound at Seattle. Notice the outlined area

Here is the section outlined above as Cheney's telescopic camera saw it from a slightly different position

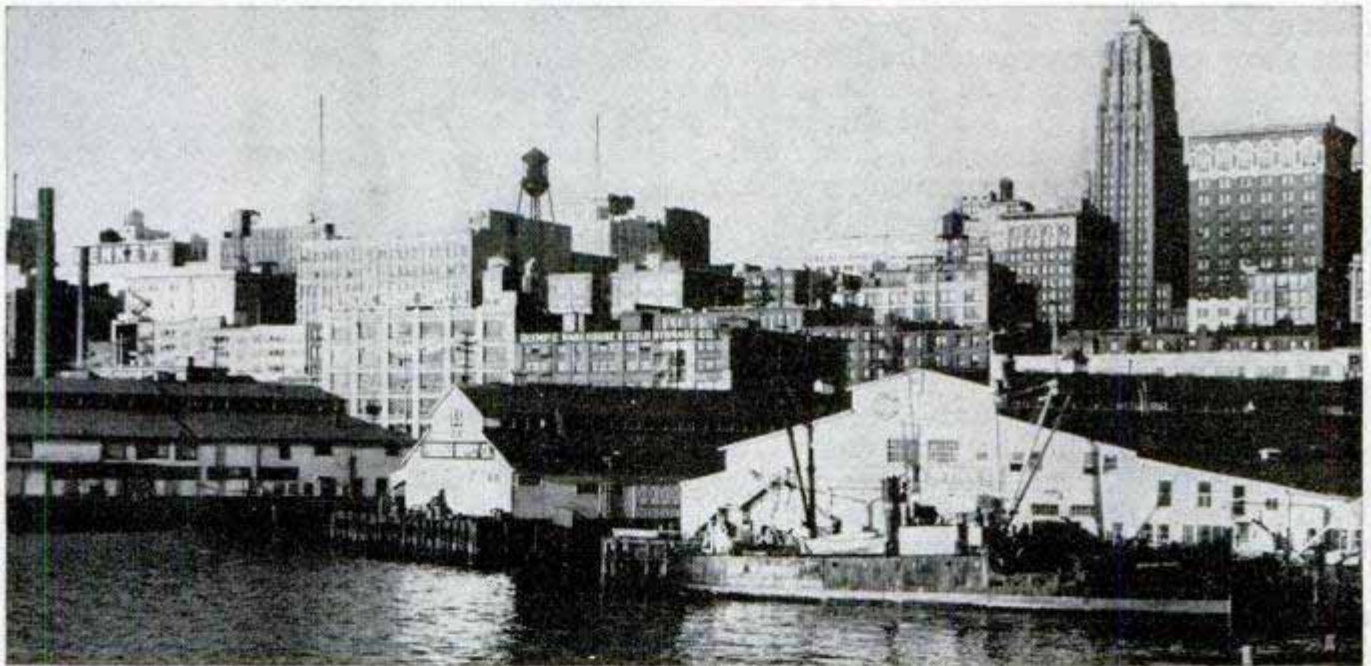

and proceeded to take detailed pictures of the fishing Indians.

Close-up photography at a mile is just a warm-up for Cheney. He gets good detail at three miles.

A machine-shop operator and manufacturer of custom-built furnaces and torches, 53-year-old Cheney has his establishment on the water's edge of Puget Sound. Across the sound, approximately three miles away, is the port side of Seattle. To the unaided eye, the scene is just a gray-blue-white melange of ships, docks and buildings. But peering through his telescopic camera, Cheney has been able on a clear day to pick out the headlines on a newspaper being scanned by a man on a street corner.

"Couldn't quite read the headlines, though," said Cheney modestly.

Watching a ship one day, two miles distant, he even spotted loose rivets. The looseness was not serious enough to merit a call to the captain of the ship, but Cheney figured—miles away—that the craft could do with a dry docking soon.

He has pictures of wild life, particularly motion pictures, which could only have been taken miles away when the subjects were utterly unaware that the eyes of man were upon them. His probing camera has reached from one mountain to another into an osprey's craggy nest and photographed the mother hawk feeding fish to her young. Also on motion-picture film are bald eagles swooping down upon jackrabbits and seals teaching the small fry to swim. In taking motion pictures of sea gulls feeding on herring in Puget Sound, Cheney has taken



Cheney's 1928 Ford roadster has over 570,000 miles on it, but he's too fond of it to sell it. Besides, it has a roomy locker he built into the rear to haul the photo equipment he requires

Below, here's a Cheney shot of the moon on a movie camera with the 14-inch lens. He prefers to shoot astronomical photos

close-ups from two miles away—close-ups that show even the eyes of the birds.

At night, the man with the far-seeing camera eye goes right out of this world. He photographs astronomical bodies. Actually, this is the primary purpose for which Cheney constructed his telescopic camera. Viewing and photographing earthly life and objects from great distances, he considers incidental—but fascinating.

He has no idea how many times he has photographed the moon or how often he has picked up one of a dozen magnifying glasses lying about his shop and studied the pictures in detail. Professional astronomers have declared that some of his moon pictures are the clearest taken on 16-mm. film.

"No," Cheney shook his head, "I have never observed any sign of life on the moon. But stillness is interesting, too. There is much to be learned from studying pictures of the moon. Here . . . notice these lines on this picture."

And Cheney pointed to lines on the moon which looked like the sectional markings on the outside of a cantaloupe.

"Ever place iron filings on a piece of paper, and hold a magnet beneath the paper?" he asked. "Well, then you know that the filings will quickly form into magnetic lines of force. I am convinced that the lines which radiate from the pole of the moon are caused by magnetic force acting on dust with magnetic properties. These lines, you will note, show no shadows. Therefore, they do not have great height. They appear, however, to be formed by grains set end to end—drawn into line by magnetic force."

Unhampered by astronomical theories and procedures of study handed down from



one professional astronomer to the next for many centuries, Cheney hopes some day to discover "something really big." And he may. Folks around Seattle who know him will tell you that quiet-mannered, philosophical man is a genius—and perfectionist.

Primarily to obtain better astronomical pictures, he has climbed to the peaks of major Western mountains 113 times. He has gone up 9671-foot Mount St. Helens in Washington 50 times. Once, on the spur of the moment, he drove to North Dakota to snap a picture of an eclipse of the sun.

The desire for perfection has kept Cheney refining and adding to his equipment for years. He figures he now has at least \$8500 in equipment. And that does not include the hundreds of hours of personal labor. Much of the equipment Cheney builds himself. He even constructs his own camera solenoids.

His first interest in photography came as a boy of nine in Oregon City, Ore. For convincing half the youths in Oregon City—or their parents—that they should subscribe to the "Youth's Companion," young Cheney received a box camera, kerosene darkroom lantern, developing kit, printing frame, roll of film and package of paper. He was started on Hobby No. 1.

Then a few years later he acquired

Hobby No. 2—probing the boundless mysteries of the universe. Utilizing an old camera lens and magnifying glass, he built his own telescope and continued with both hobbies throughout college and later years. Son of an engineer, he studied electrical engineering at Oregon State College and was also a student teacher there.

In 1946, he decided to merge the two hobbies. Using standard photographic lenses, he built a telescope unit to which he could attach a camera. That first telescopic camera was pretty simple—but it worked.

Its shell consisted primarily of two 30-cent cardboard mailing tubes. Cutting one tube lengthwise, Cheney "shrank" it, then taped it so it would fit snugly—yet slide—inside the other tube. Lens holders to fit inside the tubes were cut from soft-pine boards of apple boxes. Then came the lenses. They were not so primitive. At the front end was a 14-inch Ektar f:6.3 lens and at the rear a highly corrected 1 $\frac{3}{8}$ -inch f:0.9 six-element lens from a war-surplus range finder.

This equipment, with camera attached, was then fastened to a wooden 2 by 4, and Cheney started shooting the moon . . . with complications. The trick was determining the right location of the front lens to the rear lens. This required a lot of experimenting, sliding the rear lens back and forth until the best focus was obtained. The two photographic lenses, when properly adjusted, formed a compound lens and produced great magnification.

Cheney obtained some surprisingly good moon pictures through his cardboard tubes, but once a man like Cheney is able



This series of three shots was taken from some motion pictures Cheney made across Puget Sound. Above, this is how the scene was photographed by a standard 25-mm. movie lens. The fishing parties are scarcely visible



Above, with the 14-inch lens on the movie camera, the fishing boats are seen in more detail, but they still appear some distance away. Below, a real close-up is possible with the 38-inch lens on the camera. Cheney says that the boat was about three miles away when the photograph was taken



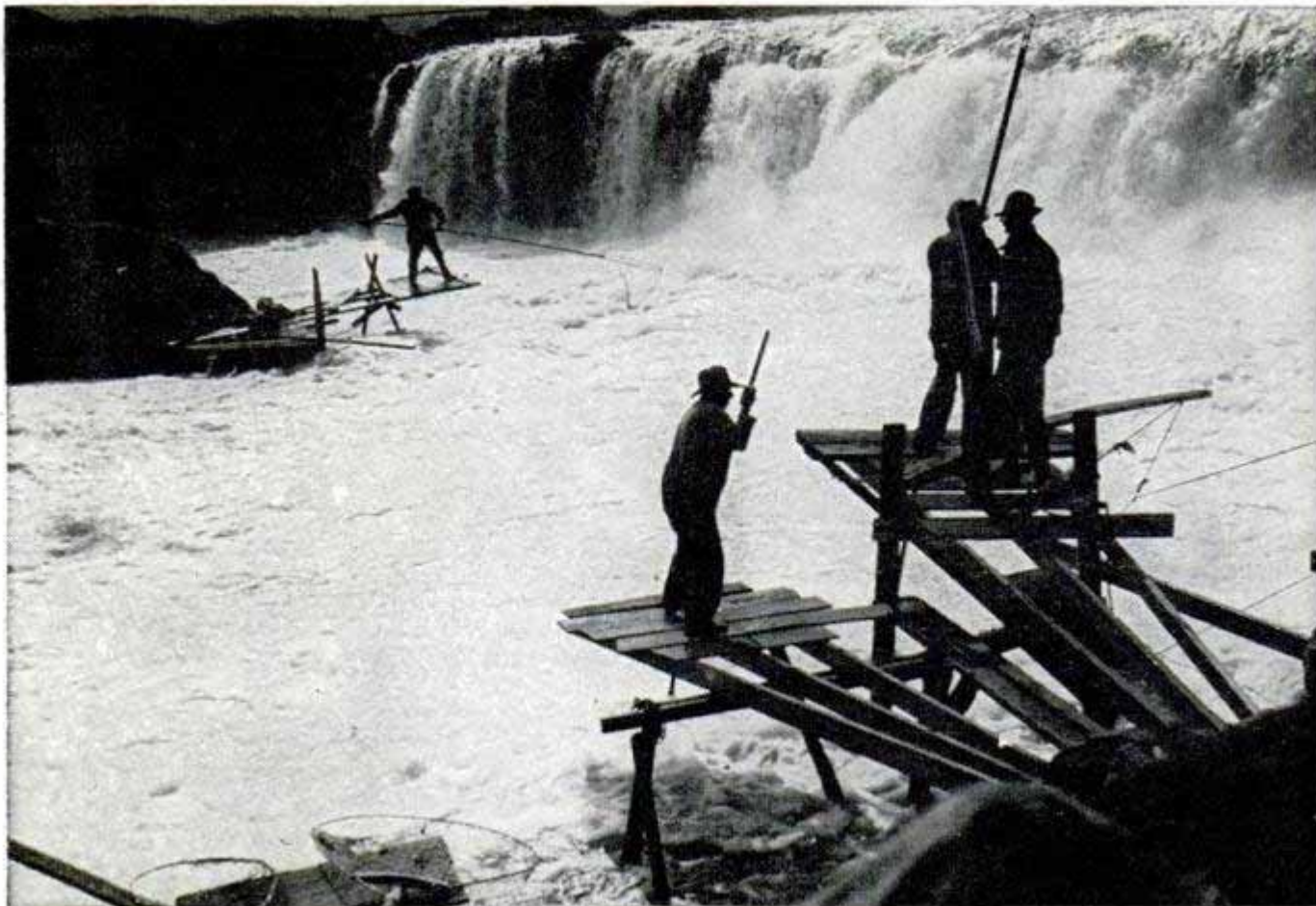

Photographs like this one can be taken without the subjects becoming aware if you are using telescopic equipment

Below, never satisfied, Cheney is now constructing this new telescopic camera mount for making 140-diameter enlargements

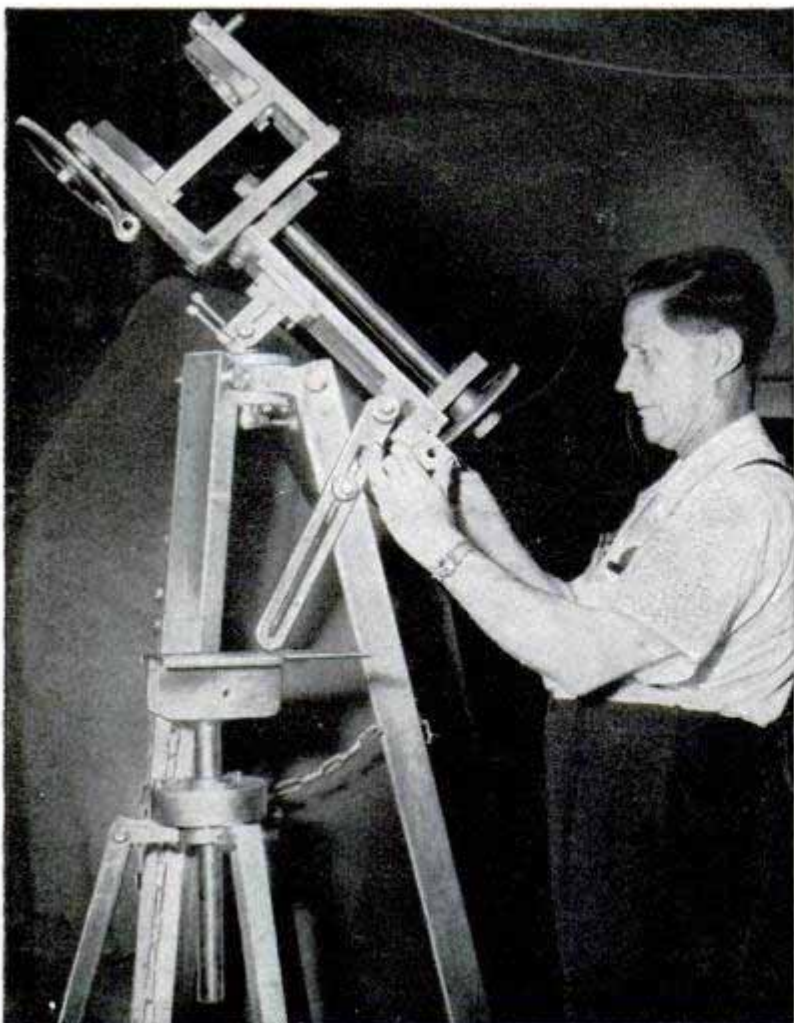

to photograph the giant craters on the moon—miles deep, miles wide—he wants to photograph the craters within craters. Tossing the cardboard tubes into the ash heap, Cheney set to work on a new telescopic camera.

Into the new equipment went the best material and thought. To avoid jerking in making adjustments, the tripod was provided with a ball thrust bearing. The ability to make quick adjustments easily is particularly valuable in taking distant shots of animals.

Utilizing in the new telescope a 24-inch Ektar f:6.0 lens for the front unit and the old range-finder lens for the rear unit, Cheney produced a device which enlarges images 72 times. You would think he would be satisfied with this, but he isn't. He is now building a new telescope to enlarge images 140 times.

"I feel that a man should build his hobby as near perfect as possible," said Cheney. "If perfection costs too much, he should get another hobby."

Cheney's hobby has been expensive, all right. That's one reason, he says, why he hasn't bought a new car in 22 years. The other

(Continued to page 258)



Standard Mfg. & Sales Co., Lebanon, Ind.

Pint-Size Tractor

Big enough to do a day's work, yet small enough to be a child's plaything, a tiny tractor that weighs only 154 pounds is simple and safe to operate. It cannot be upset or tilted on a pull. There are no belts, gears or hot exhaust pipes to injure youngsters. The two-horse-power engine operates through a reducing gear and differential to power both rear wheels. Its top speed is a safe $4\frac{1}{2}$ miles an hour.

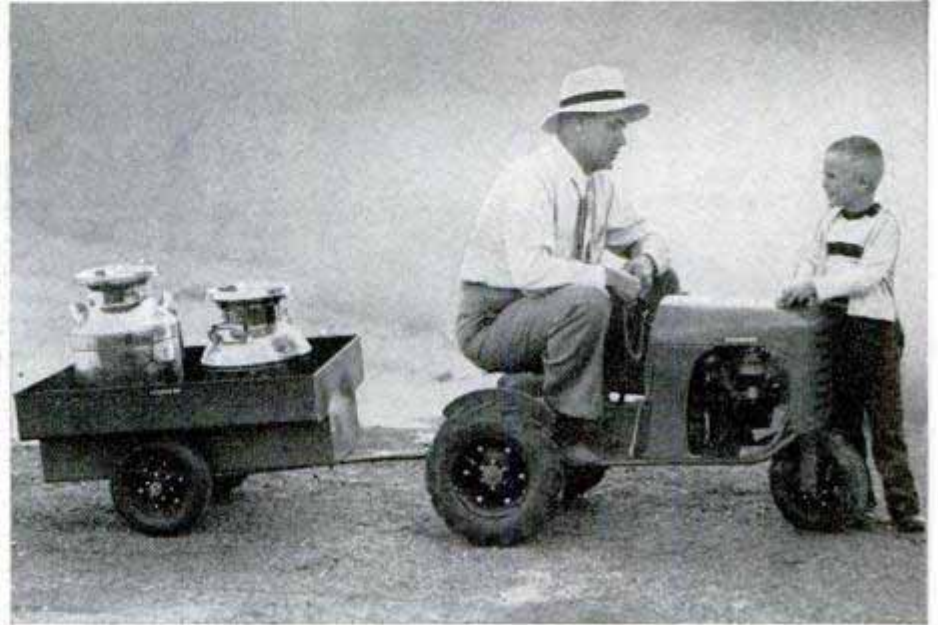

Unexploded Bombs Are Defused by Remote Control

Bombs are defused from the safety of a foxhole with a defuser used by West Berlin police to make unexploded bombs harmless. The defuser is fastened to the fuse at

one end of the bomb. Then, the bomb-disposal officer withdraws to a foxhole and pulls a steel wire that rotates a drum on the device, unscrewing the fuse.



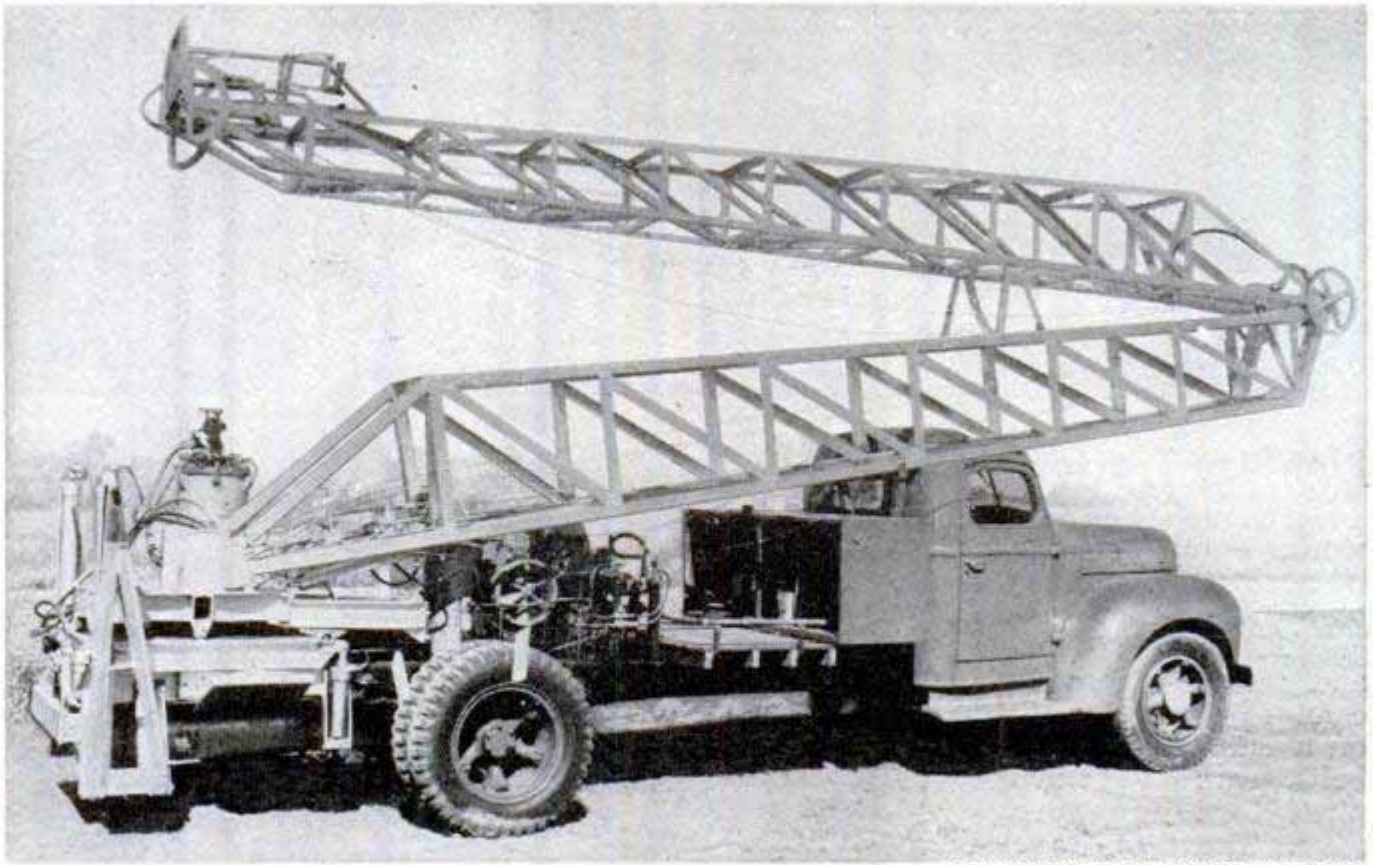

Lester L. Myers, Rt. 10, Ft. Wayne, Ind.

"Sky Hook"

Riding a platform at the end of a long mechanical arm, a painter can cover one entire side of a 50-foot building, including the roof, without moving from his perch. The arm is built in two 24-foot sections, hinged together and to a turntable on the truck on which the "sky hook" is mounted. Hydraulic controls on the platform permit the operator to swing the booms at wide angles and swivel the turntable. The operator has a working range of 50 feet vertically and a horizontal swing of more than 60 feet at a height of 25 feet. A four-cylinder engine on the truck powers a hydraulic pump as well as an air compressor for paint spraying. Paint is piped under pressure to the operator's platform.

With his mechanical arm, the painter has a vertical reach of 50 feet and a sidewise span of more than 60 feet. The seat is always kept level and paint is piped under pressure to user

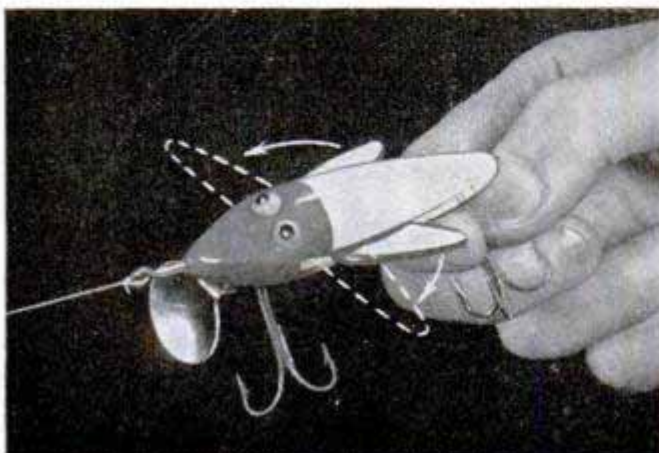
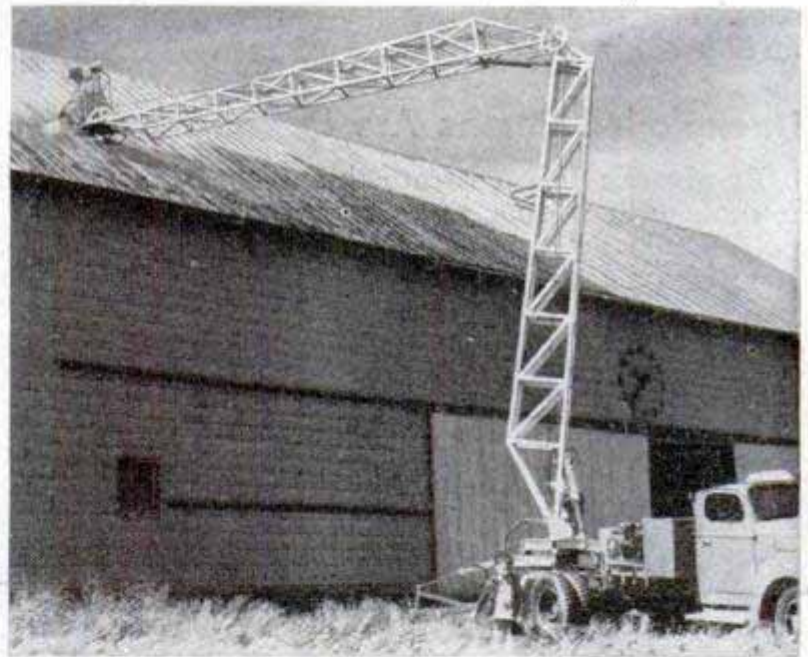

Kentucky Bait Co., 2528 Greenup Ave., Ashland, Ky.

Flutter Bait

Large bass are said to be unable to resist snapping at a fluttering lure with movable wings that creates considerable commotion in the water as it is reeled in. As the line is jerked, it pulls forward on the wings, causing them to flip back as if doing the breast stroke. The lure is available in any of six colors.

Three of America's oldest houses, built about 3000 years ago, were unearthed at the foot of the Sierra Nevada in California.

Storm-Belt Microwave Keeps Trains Running

COMMUNICATIONS are as important to a railroad as locomotives. When they go dead, trains don't run on time. That's why the Rock Island Railroad, with tracks crisscrossing the midwestern sleet-storm belt, is turning to radio to eliminate wires that stretch and snap when coated with ice.

Tests are being run on a 105-mile section between Norton and Goodland, Kans., a storm-infested, ready-made proving ground. Frequent are heavy snow and sleet storms and extremely high winds, occasionally of tornado velocity. Electrical storms occur almost daily in summer. If microwave works here, it will work almost anywhere.

Because microwaves, like radar and television waves, travel in a straight line, they have to be "bent" to follow the curvature of the earth. To do this, four relay stations are used. These stations are automatic, requiring no attention. They also are switch centers, hooking into ground circuits for calls to stations between the relay points.

At each station a dishpan-shaped antenna is mounted at the base of the 100-foot pole. Signals from the antenna shoot straight up to strike a reflecting panel at the pole top. This panel reflects the signal at right angles, sending it horizontally toward the next station.

The system provides one local and four through telegraph channels, plus two voice channels for telephone. It can be expanded to handle up to 32 voice channels.

Cost is about \$600 a mile, compared with about \$1600 for an equivalent wire system. However, for reliable communications a dual system is required, raising the cost to about \$1000 a mile—still a substantial saving. When maintenance costs are added with allowances for sleet storms, microwave looks like the answer to a railroader's prayer.

Right, reflectors atop poles bounce signal horizontally as shown in diagram. Below, lower line represents (exaggerated) earth's curvature; wavy line is profile of terrain

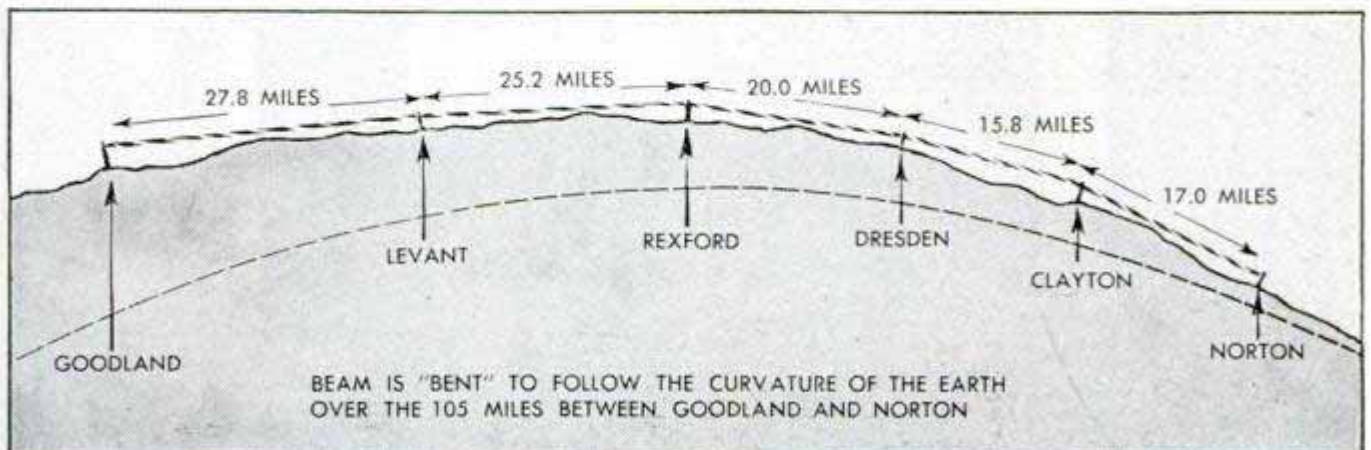
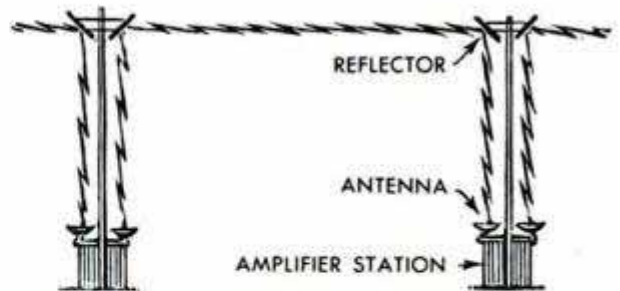
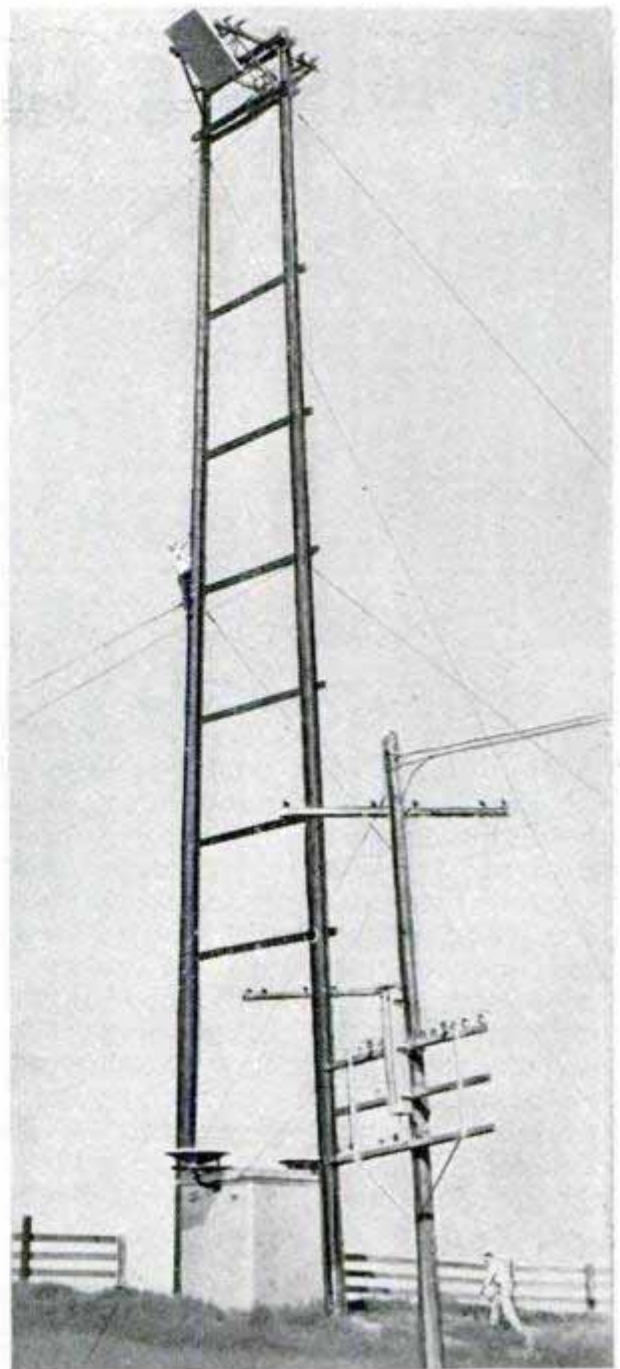

I'm building the

Popular Mechanics PLYWOOD ranch house



Part V

By Tom Riley

A CONTRACTOR would say that the Ranch House is now almost through the period of sub-trades. I have done the sub-trades myself—the wiring, plumbing, concrete finishing, furnace work and the like—your editors having insisted that this rank amateur try all of them to see if just anyone can do them in the modern way. I find the modern methods of doing the various sub-trades are actually the simplest for the amateur. Contractors and manufacturers alike have been working for speed of installation and this has resulted in simplified methods which are a great help to us amateurs.

Since his house lacks a basement, Riley assembles a soil-pipe section before placing it under the house

I also find that this is where you put modern convenience—livability—into your new home. In the sub-trades you can save money by using the latest materials. And the modern style will increase the value of your home.

The electrical wiring of the Ranch House is a good example. Look closely at most homes and you will find that they are wired in almost the same way as they were 25 years ago. But today you can use what electricians call the touch-plate or two-

Troweling the concrete floor of the garage is no trick—it's just hard work that is rough on your back

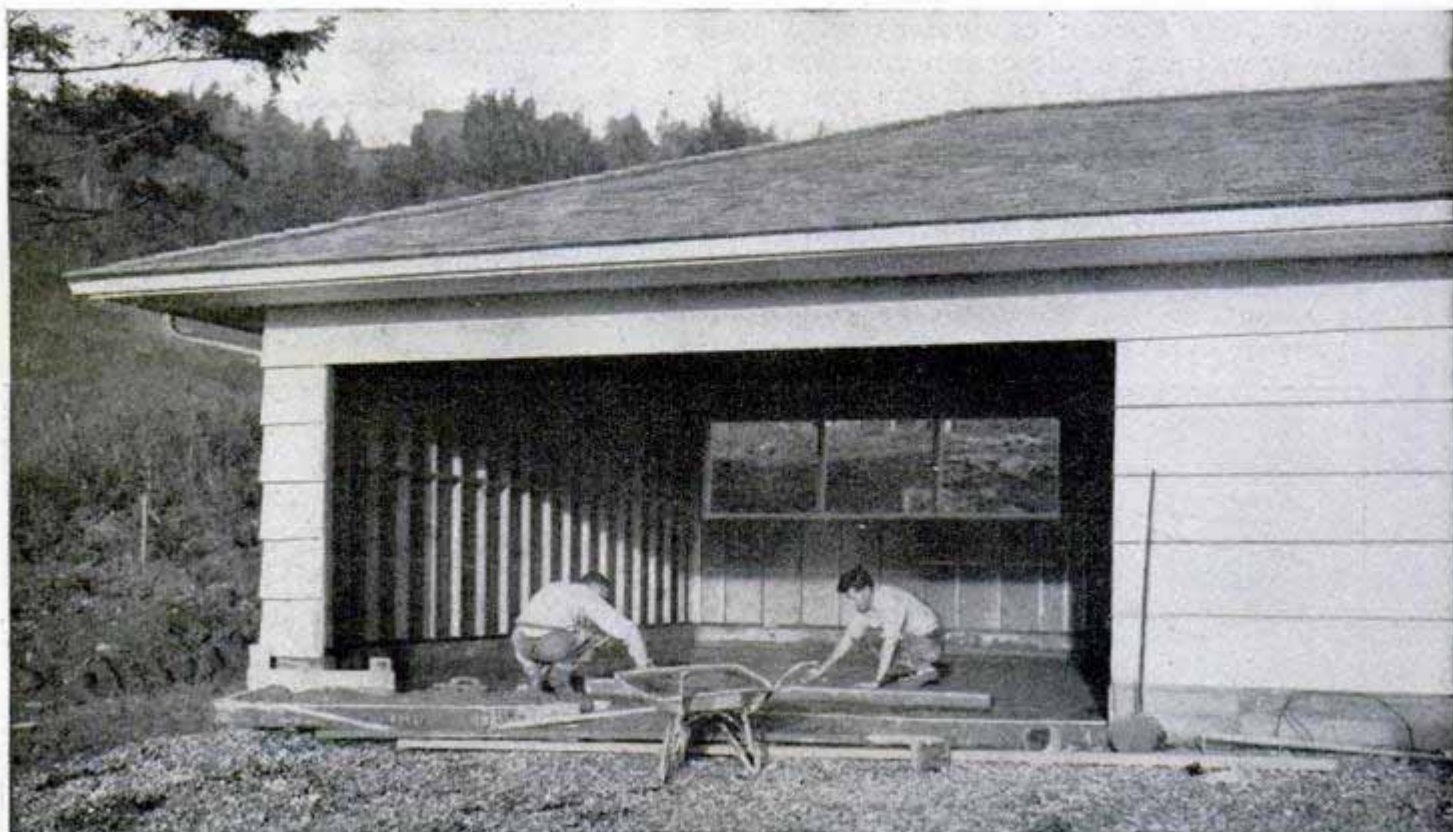

wire low-voltage system. This eliminates complicated switching circuits and gives you truly adequate light control.

In a low-voltage system, the lights in the various rooms are switched on and off by relays in a metal box up in the attic. The relays are activated by low-voltage current and push-button switches on the walls—it's as simple as a doorbell circuit. You run 115-volt wiring only to the light fixtures themselves. You string inexpensive doorbell wiring across the walls to the touch-plate switches, running it anywhere to have a switch at every entrance to every room in the house.

All switches are low voltage and non-shocking. You can have at every door double touch plates which, when you brush both buttons with a finger or elbow, turn off the light behind you and turn on the one ahead. I have installed a master panel in the large bedroom, a small panel with tiny buttons and indicator lights for each relay in the Ranch House. This means that I can turn any or all lights in the house off or on from my bed, and the indicator lights will tell me if any light has been left on.

The new wiring also means that such luxuries as turning on the coffee pot and radio from the bed can be had simply and inexpensively. I placed a small doorbell button alongside the telephone to turn off the radio when I'm talking. And, although you must buy a relay for each room's lights, the low-voltage system is not an expensive luxury because you save by not running heavy 115-volt wiring to the switches and

Riley saws narrow openings for floor registers that "wash" the windows with warm air for added comfort



Tom can always find work for his wife. Here, **Vinita** staples insulation on the kitchen-dining-room wall

not using metal switch boxes and their necessary accessories.

Finishing the concrete floors of the garage and breezeway is another job most contractors delegate to specialists. This is hard work but little more. In the *Popular Mechanics* book on how to build the Ranch House you will have a choice of two concrete floors for the garage, the smooth "stepped" finish and the rougher "floated" finish. The latter is less slippery when wet,

(Continued to page 256)

This attic relay box controls all the house lights, turning them on through low-voltage switch circuits





Arthur A. Allen, 3322 S.E. Concord Rd., Milwaukie 22, Ore.

Loom Can Be Folded for Storage With Work Intact

- Measuring 36 inches deep when in use, a new hand loom can be collapsed to 14 inches thick for storage or movement from room to room. It also can be folded small enough to be carried in a car. Work need not be removed from the loom when it is

collapsed. The folding loom, weighing only 50 pounds, is of the four-harness type and permits the weaving of materials from 30 to 50 inches wide. Supplied with the loom are long shuttles that carry enough yarn for the weaving of 10 inches of cloth.

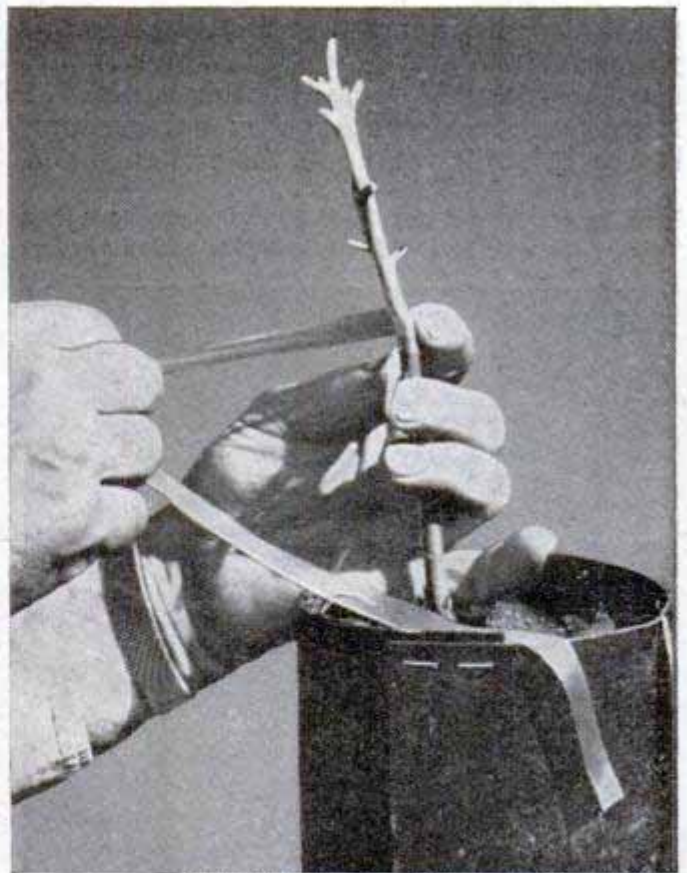

Resin Industries, Box 1589, Santa Barbara, Calif.

Plastic Tape Grafts Seedlings

Tip grafting of seedlings is accomplished more easily with a Vinylite plastic tape that holds the seedling and budwood in alignment until union is completed. The

tape is also used to seal the cut made when the budwood is trimmed. The wraps are removed in about five weeks. Used in grafting young avocado trees, the method enables the grower to select fruit best suited to the land and climatic conditions.

HORSE-HOUSE TRAILER

THERE'S nothing like a trusty cow pony for giving a man a close-up look at grazing land, according to Lloyd Bruce, custodian of 750,000 acres for Uncle Sam. On the other hand, Bruce realizes that no horse can run from Denver to Dillon and back in a day, a feat that Bruce's job as range-management expert for the Department of the Interior often demands. So the ingenious horseman has come up with a novel idea—a horse-trailer house-trailer that fits the bed of a standard pickup truck. Not only does the vehicle carry Bruce's horse and duffle, but it is replete with hot and cold running water, a cooking stove, electric lights and bunk beds for four. Bruce loads his horse into the vehicle and drives to the area he wants to inspect. Then he saddles the still fresh pony and trots across the range. At night he folds down one or more of the bunk beds, depending upon the number of persons present. He cooks his meals over an insulated stove. The cabin can be lifted off the truck as a unit.

Top, Dillon serves a meal, cooked on cabin stove, to bunk mates. Right, unit fits on a standard pickup truck. There's space for the horse's head above the truck cab. Below, bunks fold down—when Dobbin is outside

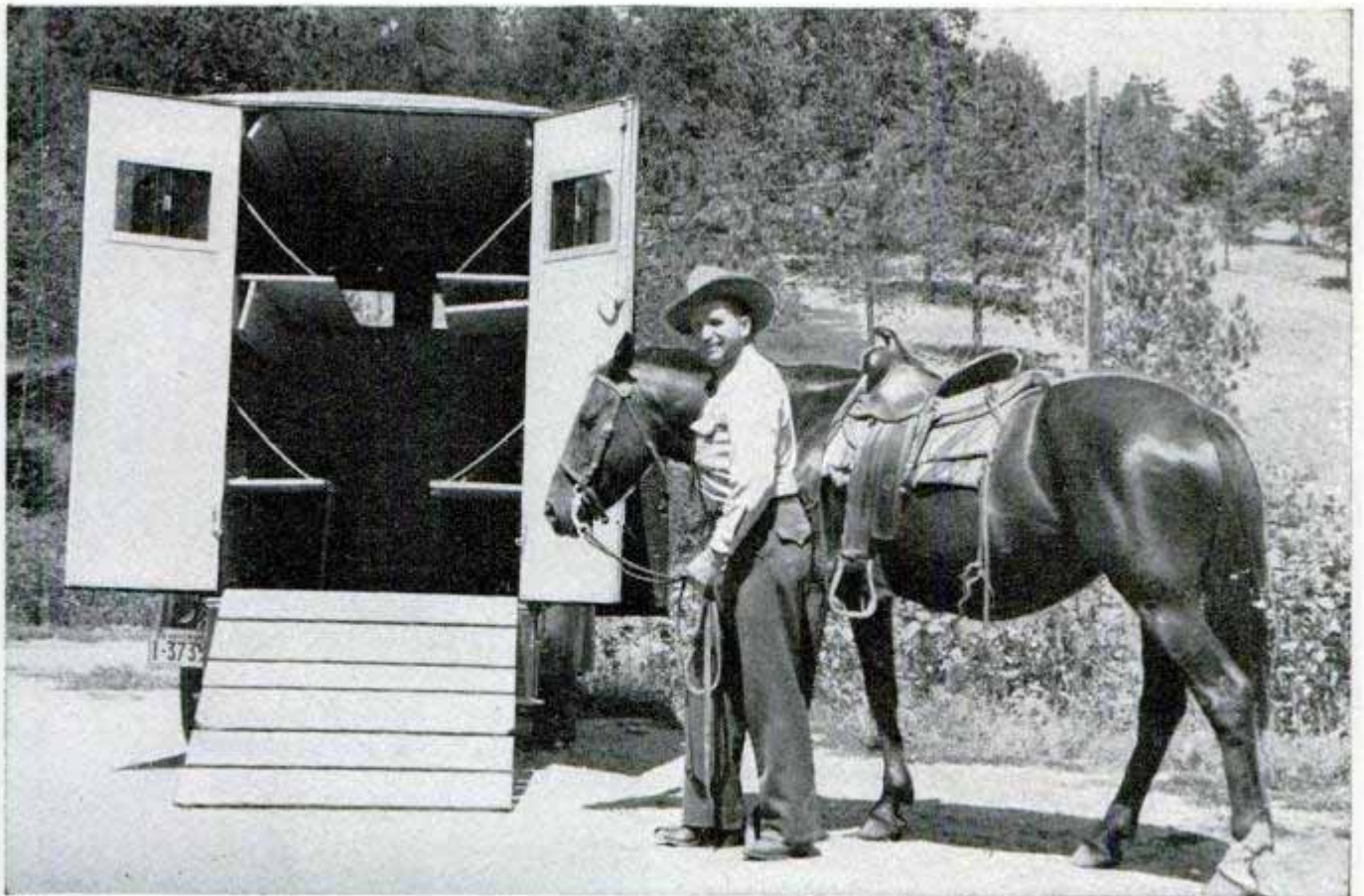
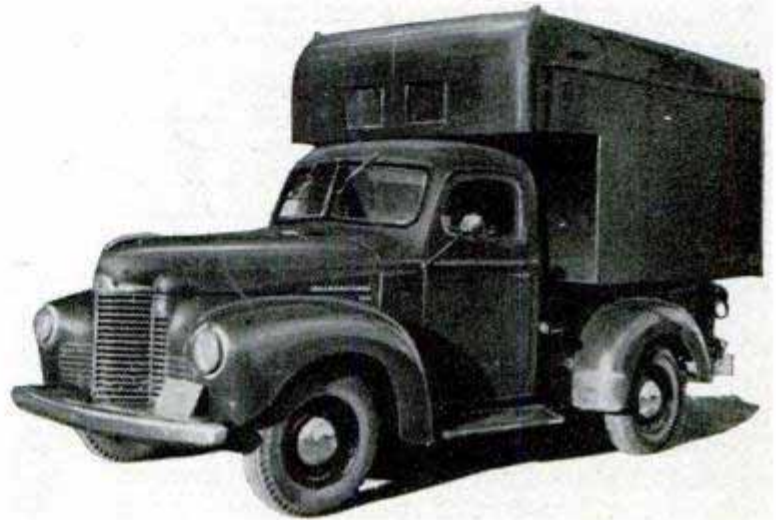

FIVE MILES UNDER THE SEA

By Hakon Mielche

TAKE A LOOK at the globe. You will discover that only a small part of it is covered by land—only about one third of the surface of the earth. Looking at the remaining two thirds, the oceans, it soon becomes apparent that more than half of these wide oceans are deeper than 12,000 feet. That means an area as great as all the continents and islands put together is totally unexplored.

The exploration of those vast areas of the earth which are covered with water was first started about 70 years ago. It is expensive to equip seagoing expeditions. Completely new instruments had to be constructed and progress was slow toward further exploration of the deep seas—even to comparatively modest depths.

Although in our day we have quite a good knowledge of the sea and what lies at the bottom of it, to a depth of 6000 to 9000 feet, there is still a long way to the greatest depression measured on the floor of the sea—32,400 feet.

That which lies between 9,000 and 32,400 feet is—and this is said without exaggeration—just as unexplored as the continent of America was in A.D. 1493.

The very few attempts which have been made to send instruments down to these depths have had no greater influence upon our knowledge than the reports given by Columbus and his men after their first trip to the New World. But the "New World" in the sea, which as yet guards its mysteries in eternal darkness, is more extensive than all the continents and islands of the world put together.

What a playground for imagination!
What a wide field of activity for a modern

Main nerve of the Danish deep-sea expedition ship is the big winch (right) which holds 36,000 feet of steel wire. This wire will lower bronze sphere (on opposite page) to bottom of sea for making tests on earth magnetism. The sphere weighs one ton and will be lifted to Galathea (inset) by 10-ton winches

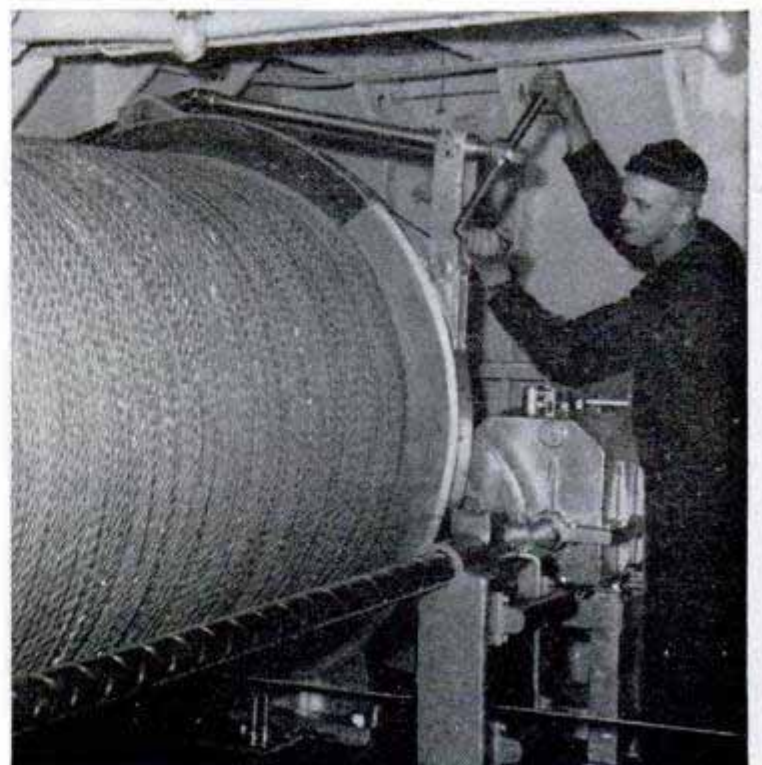



Power from the automobiles' rear wheels drives ferries above. They are steered by turning the car wheel, which brakes a propeller at the rear on the side of the turn and makes the one beside it run faster

Metal strips pressed against rear tires transmit drive from wheels through gearboxes to propellers

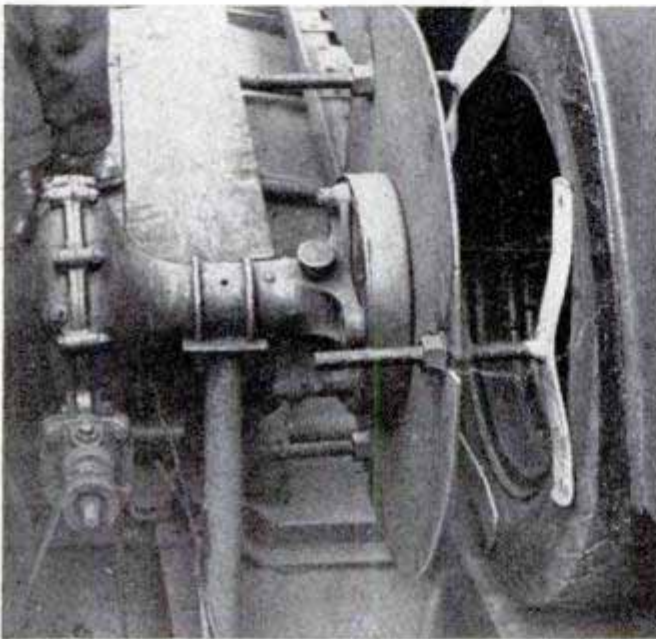

Turning of Auto's Rear Wheels Propels Ferry on the Thames

When A. H. G. Burgess of Putney, England, says he is going driving on the Thames, he means just that. Burgess built two ferries that rely entirely on the automobiles they carry for power and steering. After the vehicle is driven aboard, its rear wheels are jacked up clear of the deck and three metal strips are pressed against the sides of the rear tires. Each set of strips is bolted to a disk and linked by a shaft to one of two propellers at the rear of the craft. When the auto engine runs, the power is transferred from the rear wheels to the propellers. Cables lead from the front wheels to a brake drum in the driving mechanism. When the car wheel is turned, the brake is applied to the propeller on that side.

Drive-In Library

Library patrons can return books without stepping from their cars in Racine, Wis., where the public library has installed a "mailbox" on a convenient curb. The operator pulls back a handle to open a door, deposits his book and pushes back the handle. A spring-controlled platform then lowers the book gently to the bottom of the box. Another innovation at the Racine library is a private Teletype wire to the neighboring Milwaukee library. It places 1,000,000 books in Milwaukee at the disposal of the Racine reader. If a Milwaukee book is requested, the librarian orders it immediately by Teletype.

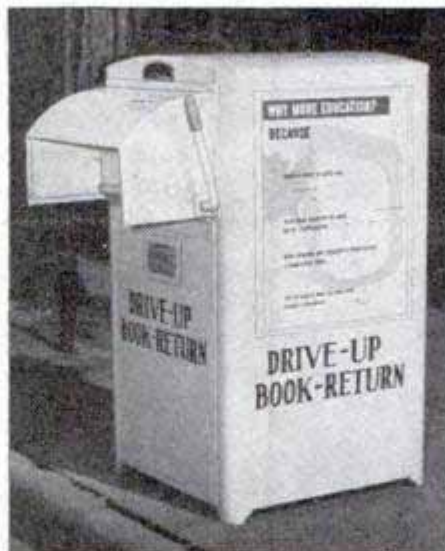

Patrons can reach through car window to return books. Right, Teletype instrument gives reader access to additional 1,000,000 books in Milwaukee

Answers to research questions also are sent by Teletype. During the first six months of operation, nearly 2000 messages were sent on the private wire.

WHAT'S NEW For Your Home



Selfix Products Co., 30 E. Adams St., Chicago 3.

SELF-STICKING HOOKS are as simple to use as a postage stamp. Just moisten the adhesive back and press in place. It will hold 15 pounds and sticks permanently to plaster, wood, glass, tile or metal



Argyle Mfg. Co.,
806 Coal St., Colchester, Ill.

DRYING HAMPER, right, is the fast way to dry towels and lingerie in the bathroom. Its fan and heating unit force the warm air past the wet articles

ADJUSTABLE SHOWER, at left, can be raised or lowered to suit the user. It replaces any fixed shower head. A wall rack holds the nozzle securely

ICE-CREAM FREEZER, below, fits in a refrigerator's freezer. A motor-driven dasher blends the mix as it freezes. It makes a quart in 30 minutes



Lylton Distributing Co., 508 "E" St., San Bernardino, Calif.

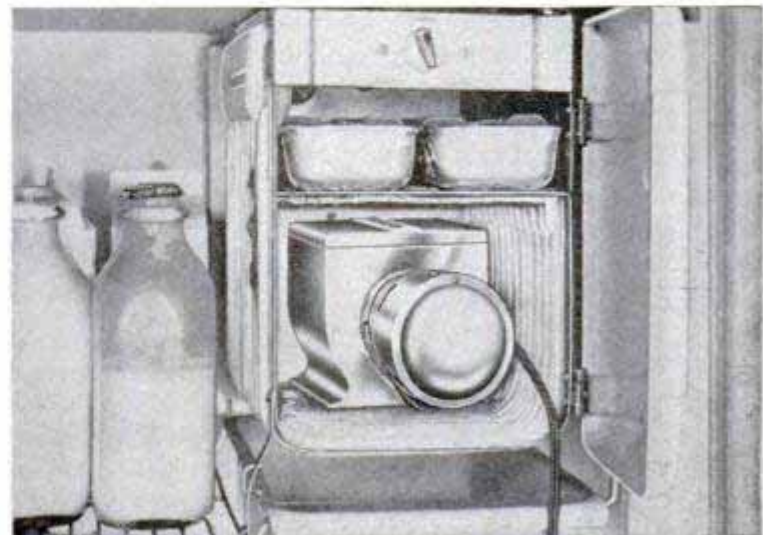

Louisville Electric Mfg. Co., 3010 Magazine St., Louisville 11, Ky.

POPULAR MECHANICS

In quest of knowledge of the earth's last unexplored frontier and the weird life existing there, as deep beneath the ocean as Mt. Everest rises above it, a party of Danish scientists has embarked on a two-year voyage. This story was written by a Scandinavian author (right) as he sailed with the expedition

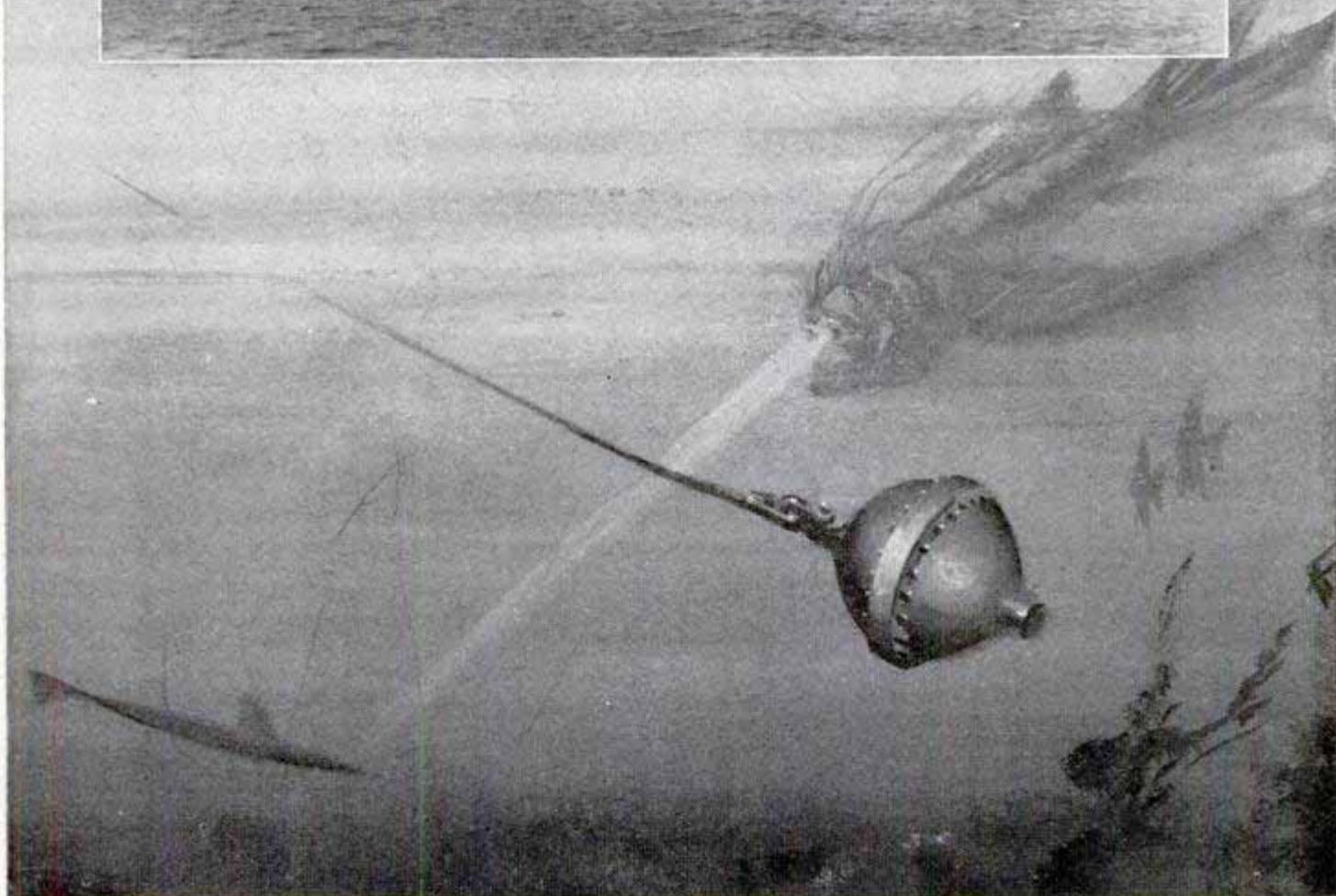



Expedition photographer uses life jacket with lung attachment which allows him to stay under 20 minutes

expedition, specially equipped for exploring the great depths!

For the first time in history a deep-sea expedition has started — on the 14th of October, 1950 — with the special purpose of visiting the ocean where it is deepest, and equipped with instruments which can penetrate to the hitherto impenetrable darkness at depths of over 30,000 feet.

It is not by chance that this expedition is Danish. Denmark has a tradition for exploring the seas. The first Danish sea expedition sailed round the world in 1845 on board the original Galathea. Since then many expeditions have crossed the oceans and brought home results which have become known far beyond scientific circles all over the world. Thus, for instance, when Prof. Johannes Schmidt solved the problem of the eel in 1928-30, and discovered that the Northern European eel swims all the way to the Sargasso Sea in the middle of the Atlantic to propagate there and die, whereafter the young immediately set out on the same trip back to the very lake or river from which the parents started out.

And now, a hundred years after the first Galathea unfolded its white sails, a new Galathea has gone forth under the red and white flag of the Danish marine, manned

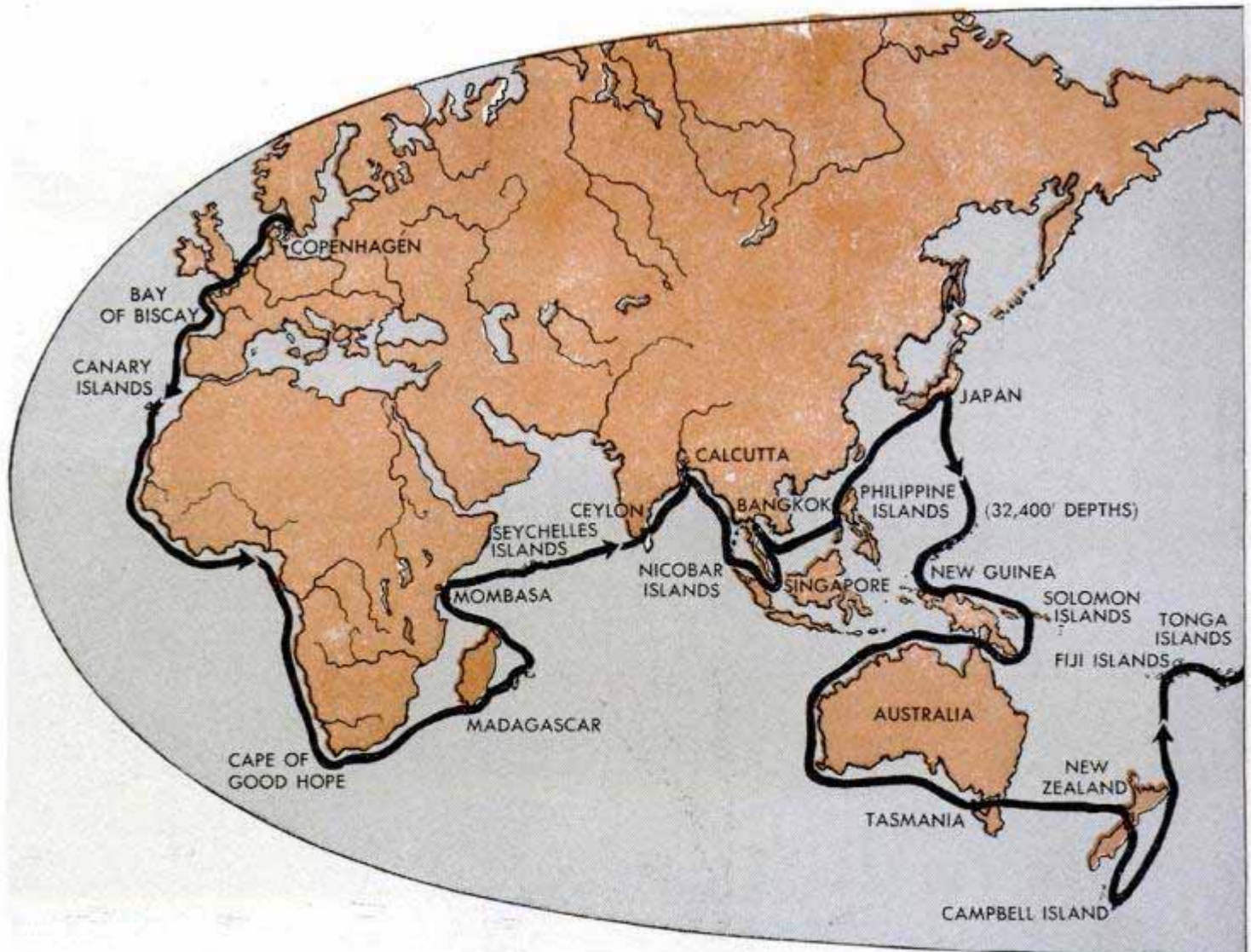

by Danish sailors and scientists from all parts of the world, and with representatives from the press, radio and films on board. There are 100 men on the ship and they expect to return to Copenhagen in about two years.

The route is planned from Copenhagen via the Bay of Biscay and the Canary Islands to the west coast of Africa, to be followed down to the Cape of Good Hope. From here sail is set towards the waters of Madagascar, Reunion and Mauritius. After a visit to Mombasa, course is set towards the Seychelles Islands, Ceylon and Calcutta, and further to the Nicobar Islands, Singapore and Bangkok. From Bangkok the trip goes to the Philippines, where the 32,400-foot grave, the deepest abyss measured anywhere in the world, will be thoroughly examined before proceeding further to Japan.

From Japan the Galathea will make for Indonesia, New Guinea, the Solomon Islands, and Australia, around which she will sail before visiting Tasmania and New Zealand.

After a detour to Campbell Island the good ship sets course for the South Sea Islands, visits Fiji, and the great depths outside the Tonga Islands are due for an



Bronze ball holds instruments for measuring earth magnetism to determine if it increases with depth

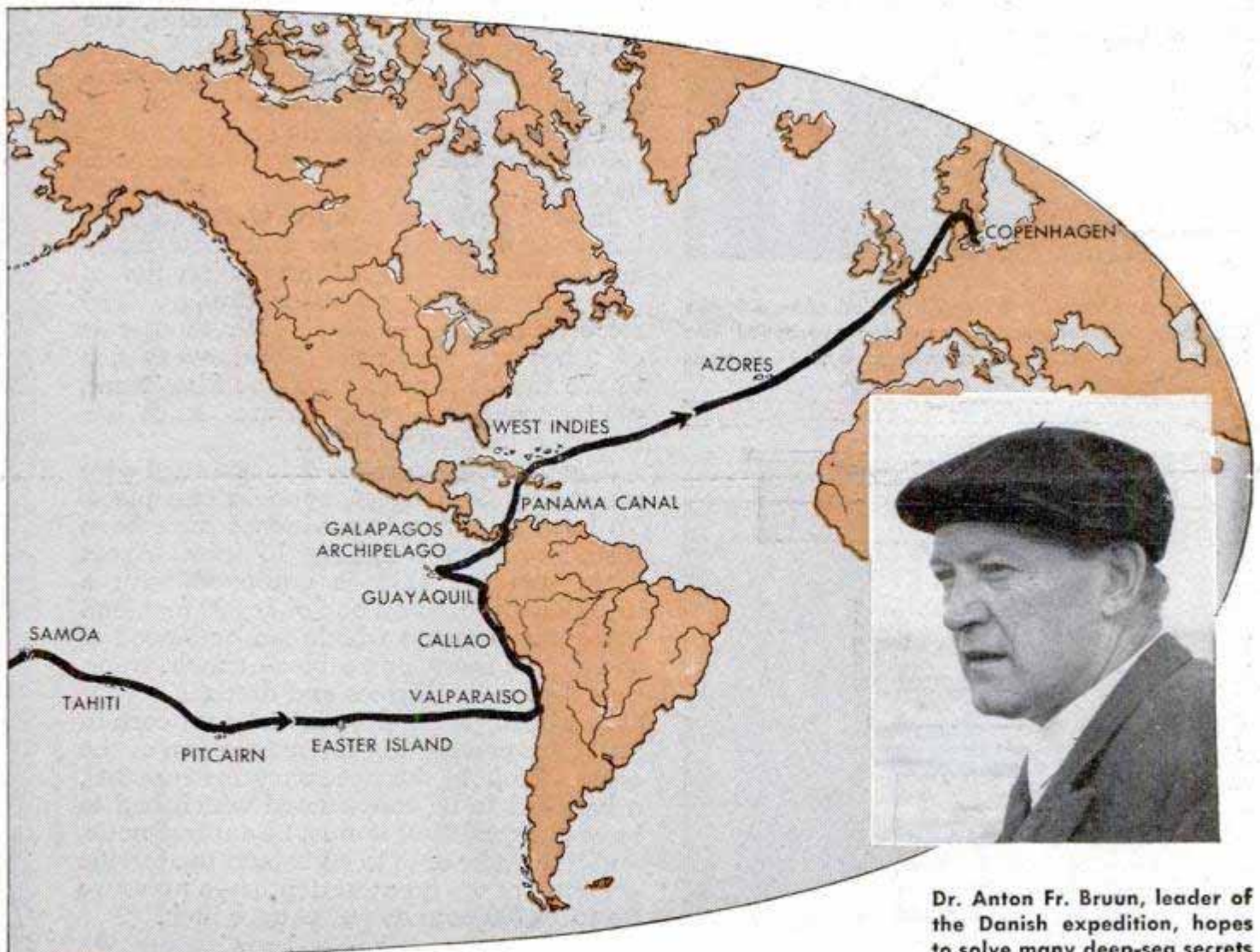

Dr. Anton Fr. Bruun, leader of the Danish expedition, hopes to solve many deep-sea secrets

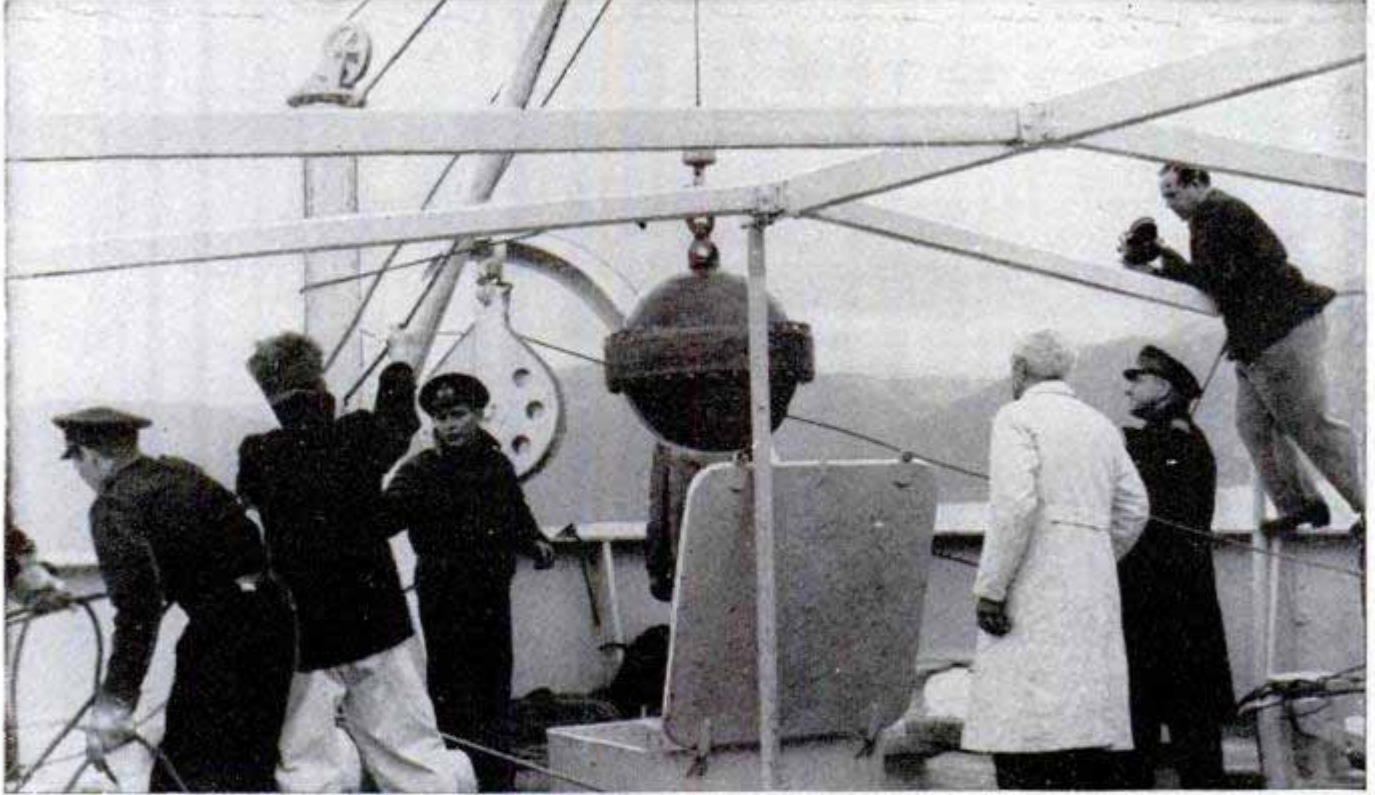

Preliminary to world cruise, bronze sphere built for magnetism studies is tested off Norway shore



When a monster of the deep is pulled alongside the Galathea, a photographer can step overboard into floating tank which has camera port of thick glass

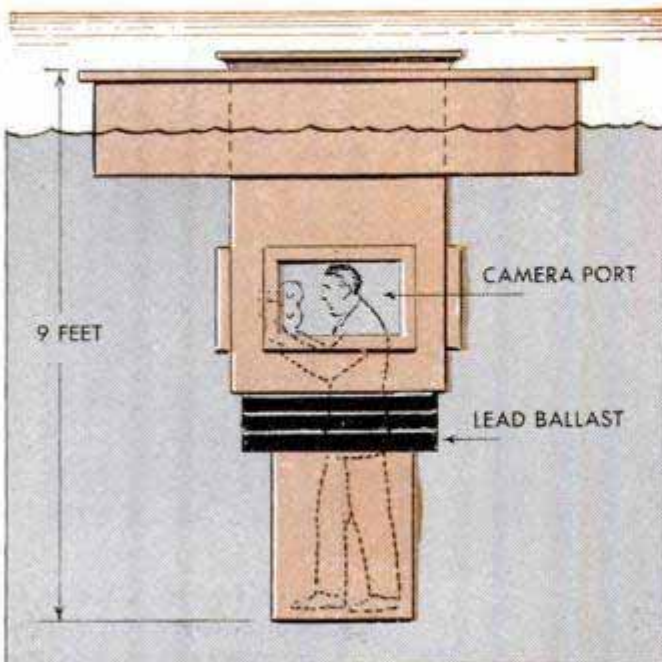

examination before the west coast of South America is reached via Samoa, Tahiti, Pitcairn and Easter Island. Visits are also paid to the ports of Valparaiso, Callao and Guayaquil. Then it is the Galapagos Archipelago's turn, and only then through the Panama Canal to the West Indies, the Azores and home to Copenhagen.

Before the return of the expedition, sensational news may be expected from it. There is no doubt that living things will be raised from the depths, never before seen in history.

In the ship's modern and well-equipped laboratory, the scientists and their many assistants will investigate the results of every draw with trawl or dredge. The storerooms will be filled with thousands of tubes of preparations, and every fish to see the light of day will be filmed and photographed in color before death has bleached its natural tones.

The main nerve of the ship is a steel wire measuring 36,000 feet, spun in one piece. To haul this wire two winches have been installed, each weighing 10 tons. Apart from this the ship is equipped with a 24,000-foot wire and one of 12,000 feet, and many instruments which can be placed at the ends of these long cables—trawls, traps, nets, hooks in all sizes and dredges.

It is also planned to investigate certain problems concerning the magnetism of the earth. To hold the necessary instruments, a ball had to be constructed which had to have two qualities; it must be antimagnetic, and it must be able to withstand the terrific pressure at the greatest depths—a pressure up to 14,700 pounds per square inch.

(Continued to page 250)



Fresh'nd-Aire Co., 221 N. LaSalle St., Chicago 1.

BATHROOM HEATER, above, does any one of four jobs. It's a hair drier, left, or a clothes drier, right. It will heat the room on cool days and cool it with its fan on warm ones. It is held firmly on the wall by an adhesive-backed bracket

EMERGENCY HINGES provide a quick method of entering a locked room. A sharp push on the hinged side of the door separates the two halves of the hinge, enabling you to remove door without damage.

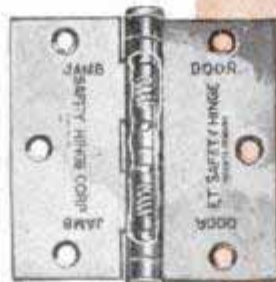

Safety Hinge Corp.,
Box 111, Cranford, N. J.



MILK-BOTTLE RACK holds four bottles up off the porch floor where they often are kicked over and broken. Hanging on two screws, the rack slips off easily to become a carrier when you take the milk inside. It holds any glass milk bottle

AUTOMATIC PRESSURE COOKER is kept at desired pressure by electric stove that shuts off heat when preset time elapses

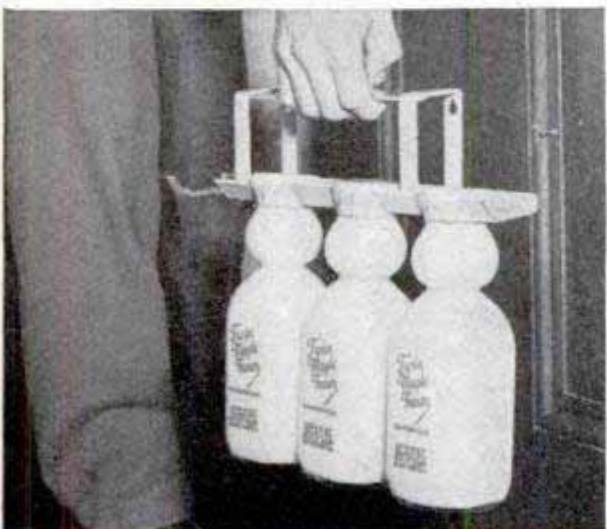

G. E. Trombley & Associates, 58 Front St., Worcester, Mass.

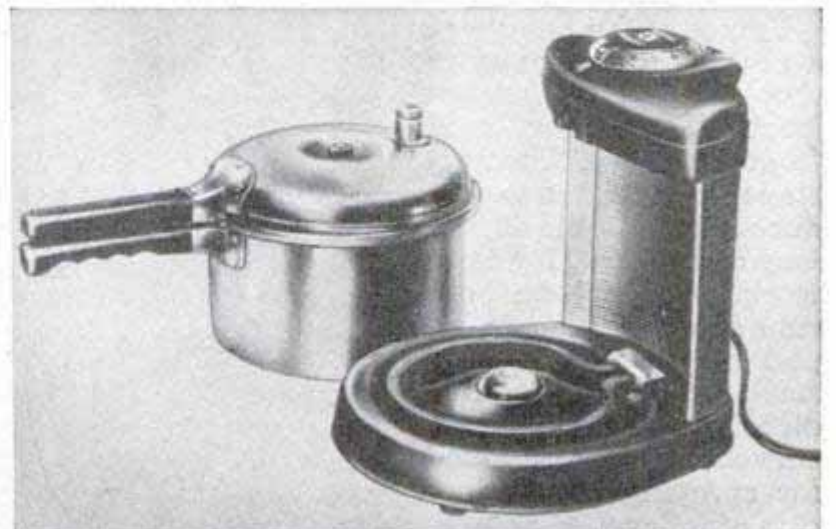

Proctor Electric Co., 480 Lexington Ave., New York City 17.

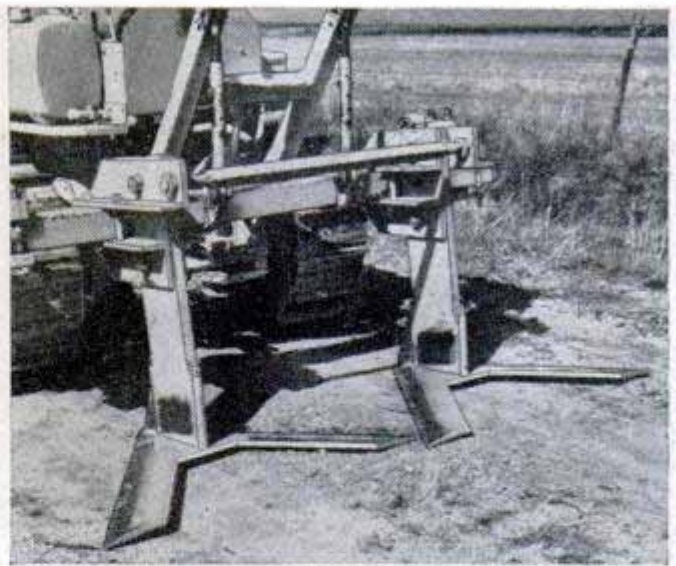

Caterpillar Tractor Co., Peoria 8, Ill.

Brush Cutter

Slicing off unwanted brush just below the bud ring, a new brush cutter eliminates undergrowth and insures that there will be no new growth from a cut bush. The cutter, which is attached to a tractor, has twin,

V-shaped sweeps that combine to cut a 100-inch swath. The cutting edges are adjustable to protect grass roots, yet cut brush stalks to the ground. The attachment is designed for clearing big areas of Western range, but it can also be adapted for tillage of summer fallow.



E. Leitz, Inc., 304 Hudson St., New York 13, N. Y.



"Folding Fan" Flash Reflector

Folding compactly like an old-fashioned fan, a new reflector for flash bulbs can be carried in the pocket. The reflector is part of a new flash unit designed for a Leica camera. Made of dull-finish aluminum, it diffuses light evenly and can be used with all sizes of focal-plane bulbs. The complete unit, including batteries, weighs 9½ ounces.

Hand Pump Operates Garden Sprayer

Pumping the handle of a new garden sprayer shoots a controlled mist of insecticide or other liquid from the nozzle. The nozzle can be adjusted to produce a jet of liquid 40 feet long or a fine fog for close work. A neoprene hose runs from the pump to the pail of insecticide, or a small jar can be attached directly to the handle. A curved nozzle is supplied for spraying the underside of foliage.



Earl L. Chadwick Co., Box 480, Houston, Tex.

STUNT DRIVERS WILL DO ANYTHING TO PLEASE



In "Dive Bomber," a stunt man zooms his car up a ramp, through the air and crashes it smack on top of another

By Andrew Hamilton

SEVERAL MILLION spectators shriek their way into a pleasant state of delirium each year watching Joie Chitwood and his stunt drivers ram cars head-on, break through blazing barricades and skid a hundred feet on two wheels. The most amazing part of the show is not a particular stunt, but the fact that some day these death-defying feats may save your life.

Chitwood and his drivers present head-on collisions, scheduled in advance. These

crack-ups give science an opportunity to assemble data on the impact which a human body withstands during a highway accident.

Herman P. Roth, U.C.L.A. physiologist, is working with the Chitwood daredevils in a research project. With high-speed motion-picture cameras and other instruments, he is recording forces involved in a collision between two speeding automobiles.

From these experiments has come detailed information on the safety of the

Daredevils drop backward off a car speeding 50 miles an hour and slide along the track on special corsets





With a resounding crash, two cars collide head-on. Such scheduled "accidents" are providing data on auto safety features



Late-model car was mangled into a heap of twisted metal by a collision with a solid wall of ice. There was a driver inside!

Motorcycle driver crashes through a blazing barricade. He earns about \$200 a week for defying death with such stunts

modern automobile. Tomorrow's passenger cars may have revolutionary safety features because Roth's grinding cameras are recording crack-ups today.

Meanwhile Chitwood and his drivers, subjects of the research, go about the everyday business of risking their necks to earn a living.

Which is tougher—stunt driving before a thrill-hungry crowd or racing automobiles in big-time track competition? Chitwood, three-time Eastern AAA champion, has done both.

Joie gingerly feels a facial injury that required 50 stitches not long ago and says: "Stunt driving—every time!"

The reason?

"When you slide behind the wheel of a racing car, you plan to do everything possible to avoid a crash. But when you're stunting—jumping ramp-to-ramp, busting through blazing barricades, skidding on two wheels—you know for sure that a crash is coming sooner or later."



There are several automobile stunt troupes in the United States. Best known, probably, are the five Chitwood units that appear at carnivals, racing tracks and county and state fairs from coast to coast.

Chitwood and his daredevil drivers have also made several motion pictures, the latest being M.G.M.'s new "To Please a Lady," starring Clark Gable and Barbara Stanwyck in the story of a stunt driver who wouldn't quit the game.

There's a saying among throttle jockeys of the crash circus: "You don't have to be crazy in this racket, but it sure helps."

Stunt driving probably got started that way. One or two screwballs with more nerve than brains risked their lives for a few bucks to give the crowds a spine-tingling thrill. But Chitwood has put automobile stunting on a businesslike basis.

Before the war this 200-pound ex-football player, a full-blooded Cherokee, did a lot of driving on dirt tracks in the Midwest and East, competing seven times in the 500-mile Memorial Day classic at Indianapolis. In 1939, 1940 and 1942 he was Eastern AAA champion.

In 1940 Chitwood joined Lucky Teter's "Hell Drivers" as an understudy driver. Teter's luck ran out in 1942 while performing at an Army-Navy benefit show in Indianapolis. His car failed to negotiate a ramp-to-ramp jump and he was killed.

In 1945 Chitwood acquired some of Teter's equipment, hired some of his drivers and started the show afresh, naming it the "Auto Daredevils." He added showmanship, zip and dash. He combined chills



Show's clown "relaxes" the audience by wandering straight into path of oncoming cars, which pass on ramp with inches to spare



Chitwood, standing center among his drivers, has put courage on a business basis. Drivers wear colorful outfits designed by a Hollywood costumer. Below, finish of a motorcycle stunt shows driver, head down, escaping from blazing barricade of boards



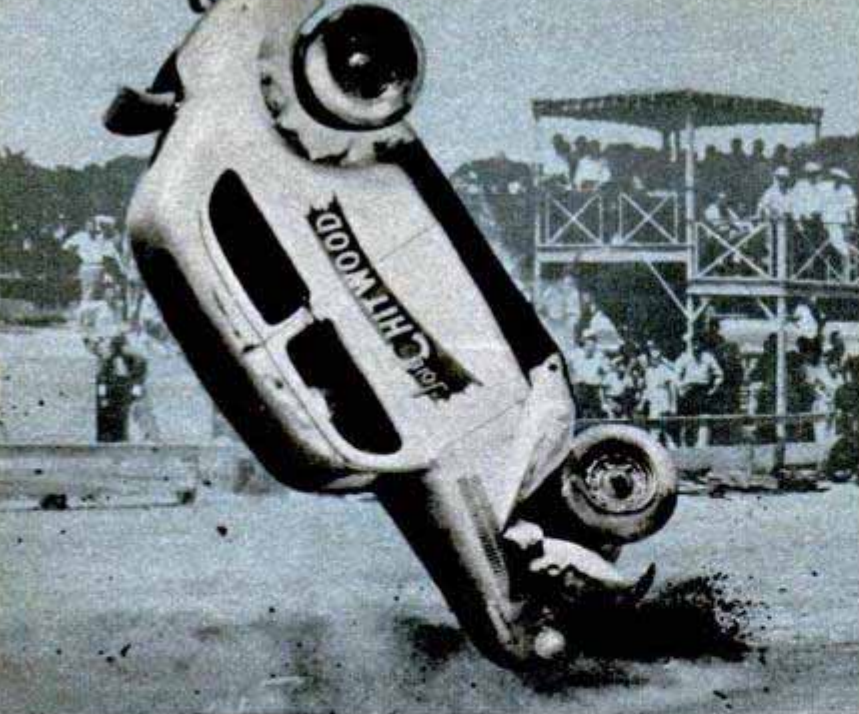

One of Chitwood's drivers does a snap roll-over in an older car, which can usually survive six or seven crashes. His only protection in the car is a crash helmet and safety belt

and thrills with businesslike acumen in publicizing and running the organization. In four years, he has parlayed such ideas into the outstanding automobile stunt show in the United States.

Today, he has more than \$100,000 invested in equipment. His shows are as carefully planned as a three-ring circus. Drivers are costumed by a leading Hollywood designer. Stunts are worked out with blueprint accuracy. And the route of five units is plotted as carefully as a railroad train schedule.

Each of the Chitwood troupes is a self-contained unit of 60 men—20 drivers and 40 helpers, mechanics and promotion men. Three huge trucks are used to haul the ramps and other equipment; the stunt cars proceed under their own power. Each unit also contains a mobile machine shop for repair work.

The units move around the country from

early spring to late fall giving as many as three shows a day. Longest overnight hop ever made was a 700-mile jump from Indiana to Maryland.

"Automobile stunting requires a combination of courage, precision planning and split-second timing," Chitwood says. "Courage is a fine thing—but you can't get very far on nerve alone."

For example, in the hair-raising number called the "High Ski" or "Wingover," a driver comes roaring down the track at 50 miles an hour. The car's right or left wheels run up on a long, narrow ramp (30 feet long, three feet high at the far end). The car is thrown up on the opposite two wheels—remaining in delicate balance for 200 feet or more before settling down on four wheels again. The driver is able to control the car about 75 percent of the time by pressure on

the steering wheel.

Then there's the stunt called the "Reverse Box." A wooden frame, a mere inch and a quarter larger than the car itself is placed on the track. The stunt driver approaches the frame, in reverse gear, at 30 miles an hour and skims through as neatly as you please.

One of the biggest thrills of the crash circus is the ramp-to-ramp jump in which Teter lost his life—thus giving Chitwood his start. Joie isn't at all superstitious about this stunt. In fact, he is so sure of his timing that he sometimes carries his six-year-old son, Joel, in the front seat with him as he "rides the ramps."

Two ramps (five feet wide and five feet high at the far end) are spaced from 40 to 80 feet apart, depending upon the kind of a track and the speed of the car before making the jump. Ramps are checked and re-

In one stunt a car hurtles up a ramp, soars across another car and lands on another ramp 80 feet away



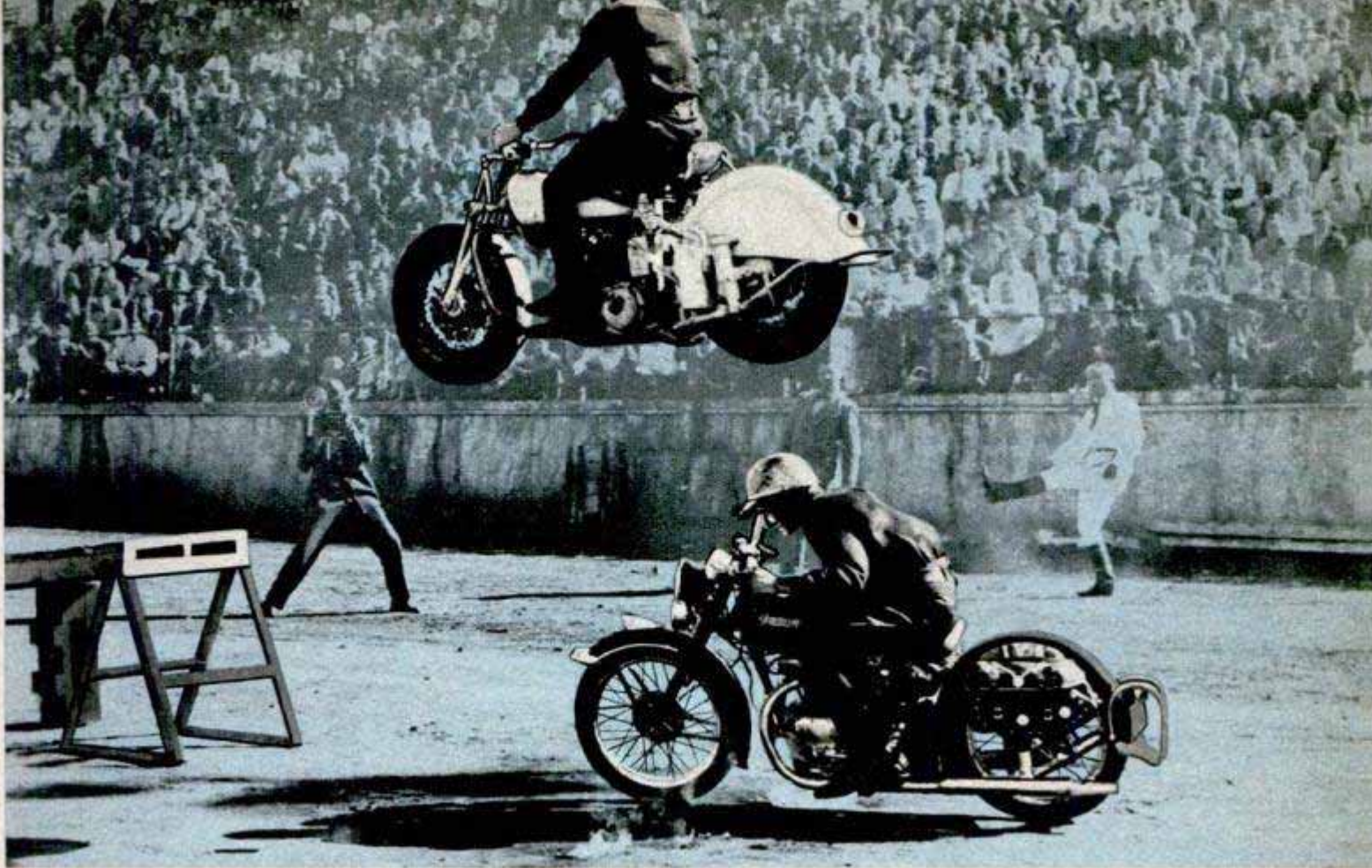

Ramp-to-ramp by motorcycle is even trickier than by car. Rider must be perfectly balanced to avoid disaster

checked so that they will be correctly spaced and aligned for the speed at which the driver will hit them. One car comes zooming down the track at full throttle, roars up the ramp, hurtles through the air, thuds to the ramp at the other end. Just to complicate matters, a second car scoots between the ramps while the first is leap-frogging over it.

Chitwood drivers usually drive late-model Fords. They're stock sedans, just as they came off the assembly line.

The only concessions to safety are three: hub caps are removed so they won't pop off and "bean" somebody; a special metal

apron protects the front bumpers from gouging the wood of the ramps; and the gas tank is placed inside the trunk compartment to lessen the danger of fire.

Like the gruelling tests of men and equipment in the 500-mile race at Indianapolis, the night-after-night performances of Joie's thrill drivers tell automobile manufacturers wherein the new models may be improved. Design men and engineers at the Ford plant base future planning on monthly damage and repair reports.

"People just can't believe that an ordinary car, such as we use, will take such

(Continued to page 242)

Driver hits ramp at 50 miles an hour and careens 200 feet on two wheels before other two touch earth again





"Casey Jones" Auto

More than one citizen of Washington State has been amazed to see an automobile rolling across the countryside on the railroad tracks. It's a special car converted to rail use by the Great Northern Railway. Officials use it for quick inspections of the track between Seattle and Wenatchee, Wash. The rail-auto is capable of safe high speeds and gives inspectors a good view of the track. Special pneumatic tires, flanged on the inside, permit the conventional car to ride along the rails.

Copying "Lucy" Has Six Lenses

Enlarging or reducing the image as the artist wishes, a new camera "lucy" has six lenses mounted on a turret for quick and easy changing. With one eye the artist looks at the copy through a prism as the other eye looks down at the pencil. The two images are superimposed in the brain, enabling the artist to reproduce the original accurately. There are six lenses on the turret, each designed for a certain enlargement or reduction. Moving the eyepiece up increases the size of the image, lowering it decreases the image size.

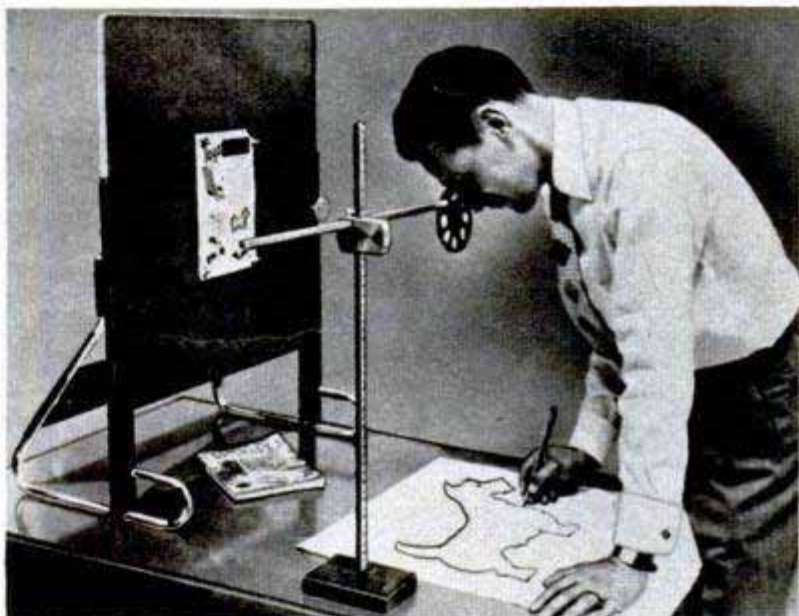

Prisma-Scope Laboratories, 3151 East Colorado Blvd., Pasadena 8, Calif.

"Eye" on Cutter Follows Pattern

Irregularly shaped metal parts are cut automatically to the shape of a drawing by a contour-following machine that uses an electric eye to trace the pattern. The electric eye "looks" at the line to be followed through a microscope placed only a fraction of an inch away. As the scanning head moves along the lines of the drawing, the position of the cutting tool changes to reproduce the outline in metal to an accuracy within .003 inch.

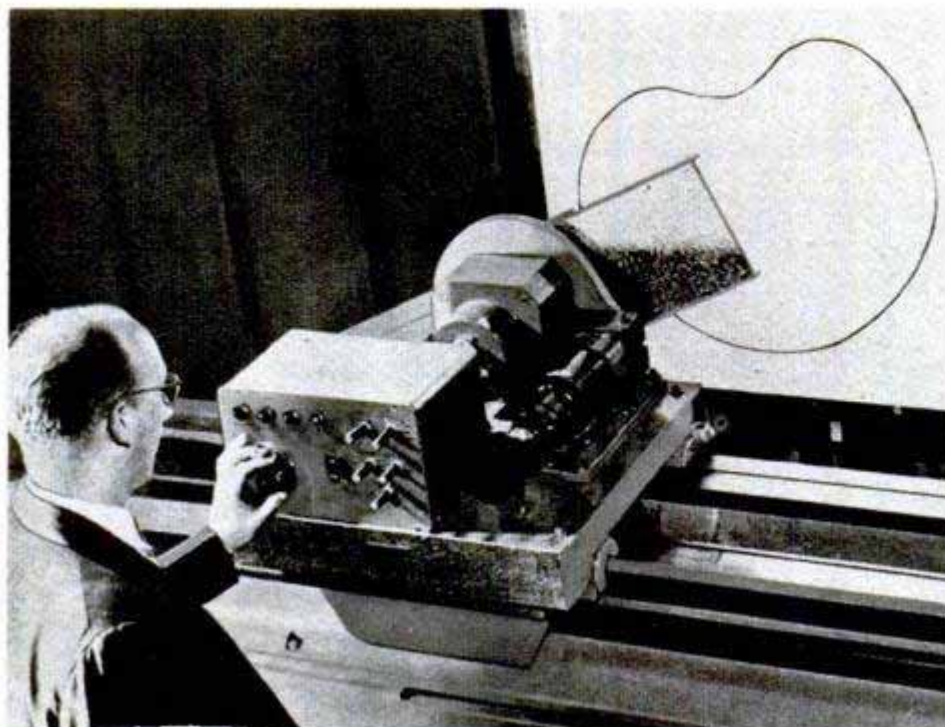

General Electric Co., Schenectady 5, N. Y.



Telanserphone, 224 East 38th St., New York City.
Above, this transmitter automatically calls doctors by radio when the triggering slides, below, are inserted in it. Right, the small battery-operated receiver looks like a hearing aid



Radio Calls the Doctor

New York doctors who are relaxing at the beach or ball game are kept on continuous call by means of a new radio service. Each doctor who subscribes to the service is given a code number and a small receiver that looks like a hearing aid. When the doctor's office wants to talk to him his secretary merely notifies the call service. An audio slide (there's one for each number) is placed in a transmitting machine that broadcasts the code number automatically once each minute until the doctor responds by telephone. The small battery operated receiver will pick up the code signal within 25 miles of the transmitter, which is presently located atop a New York hotel.

Convertible Lure

Fishermen make their own lures with a kit that can be made into more than 100 different bait combinations. Several detachable plastic parts, including a hollow body with seven interchangeable colored inserts, make up the kit. The four different heads provide any desired fishing action—top water, wiggler, popper, darter, underwater and others. When assembled, the lure is watertight for running on the surface. It can be made to run deeper by filling it with water.

What is probably the second oldest camera produced for photographic use—a Voigtlander made in Vienna in 1841—has been placed on display at George Eastman House at Rochester, N.Y.

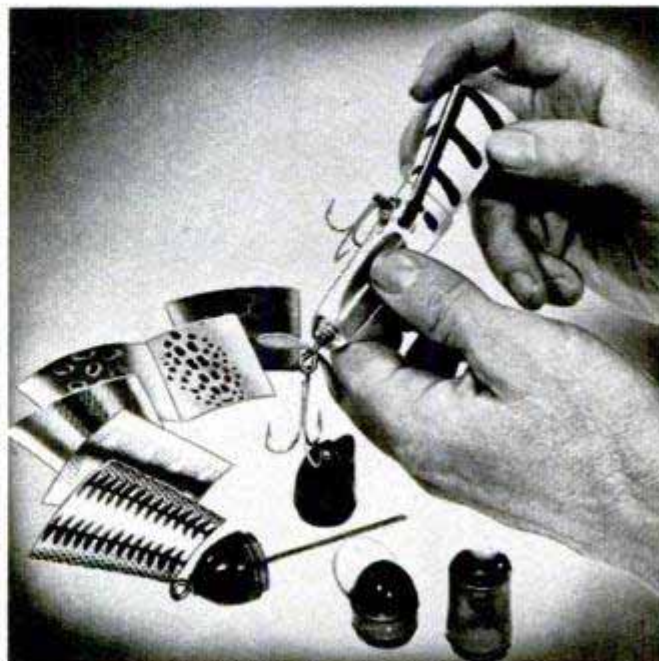

Nickel Tackle Co., Box 1827, Jacksonville 1, Fla.

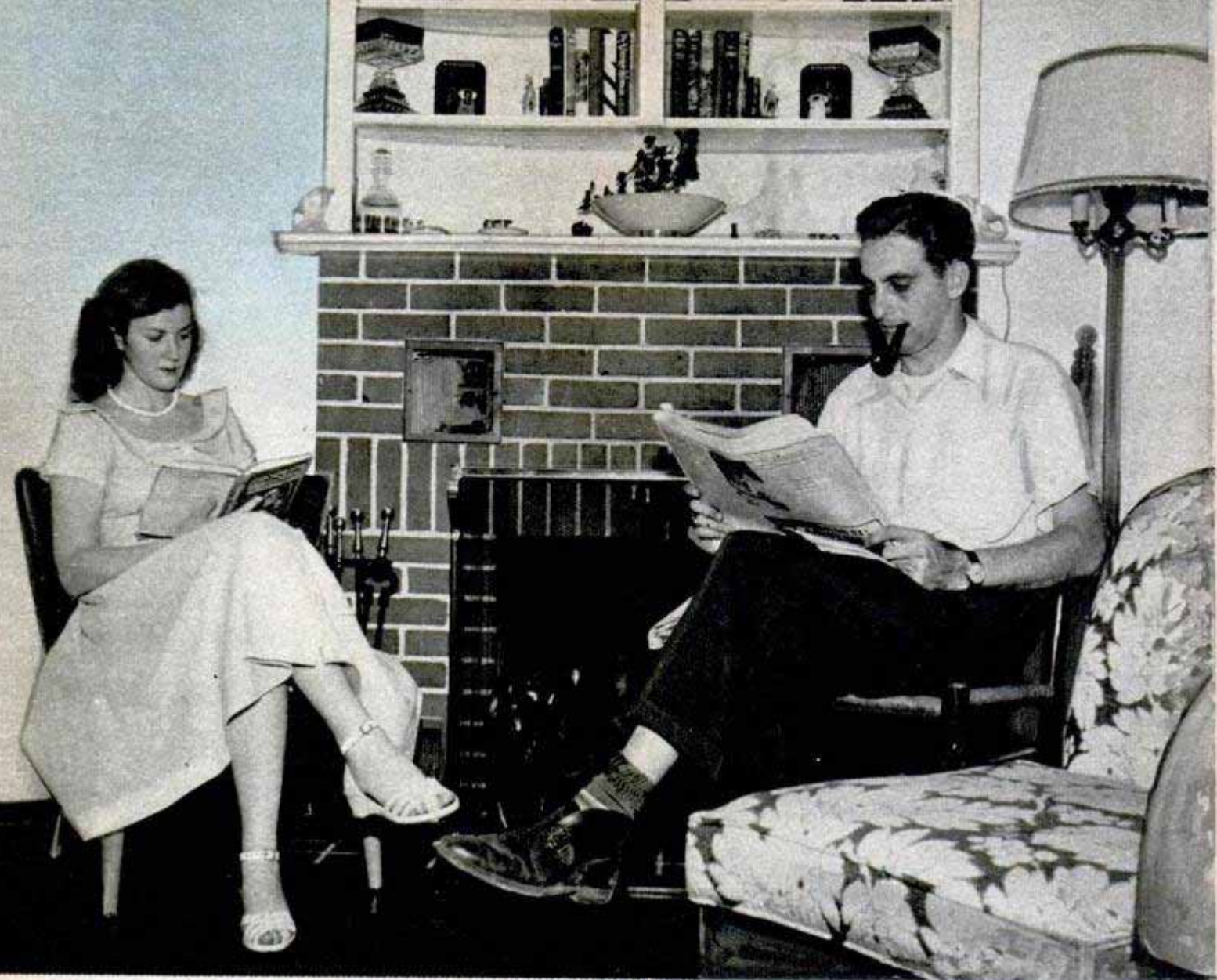

Working fireplace along wall is the center of attention in the circular living room, which is 14 feet in diameter

Lighthouse-like circular staircase leads from first floor to the kitchen and bedroom on the two top floors

Buff rolls past his \$3200 house on his way to work again. Figure includes cost of kitchen equipment

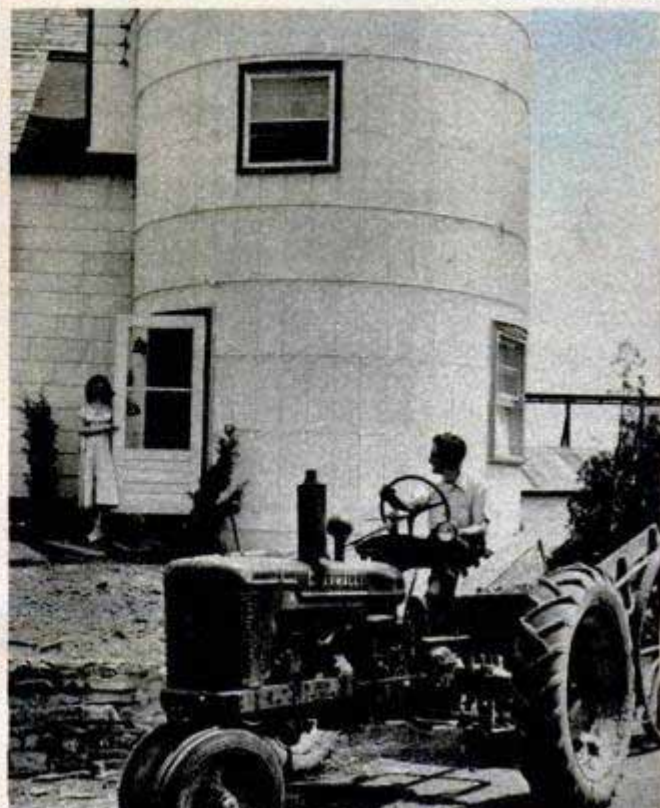

AT HOME IN A SILO

By Albert Pione

FACED with the not uncommon dilemma of the high cost of setting-up house-keeping, Mr. and Mrs. Albert Buff, imaginative newlyweds of Quakertown, Pa., solved their housing problem by converting a silo into an unusual apartment.

The silo, located on the farm of Mrs. Buff's father, has been remodeled into a three-room apartment complete with basement and fireplace. For this conversion, the Buffs spent a total of \$3200 which included labor, materials, copper piping throughout, an all-electric kitchen, oil heater, hot-water heater and an aluminum roof. The cost was kept low by the Buffs who did most of the unskilled labor. They cut all the lumber, nailed the plaster-board and did the painting.

The silo-apartment is 32 feet high and 14 feet in diameter. It contains three rooms—a living room 14 feet in diameter, with a working fireplace on the first floor, an all-electric kitchen neatly arranged on the second floor and a bedroom on the third floor. There is an aluminum-tile shower stall on the second floor. In the kitchen the stove, cupboards and other equipment are arranged in a circular pattern and some items are recessed into the silo wall. The dwelling is warmed by an oil heater located in the five-foot-high basement. A circular, lighthouse-like, stairway leads to the second and third-floor rooms.

The Buffs, pleased with their silo-apartment, are planning to complete it by installing a sun deck leading from their second-story window to the barn roof.

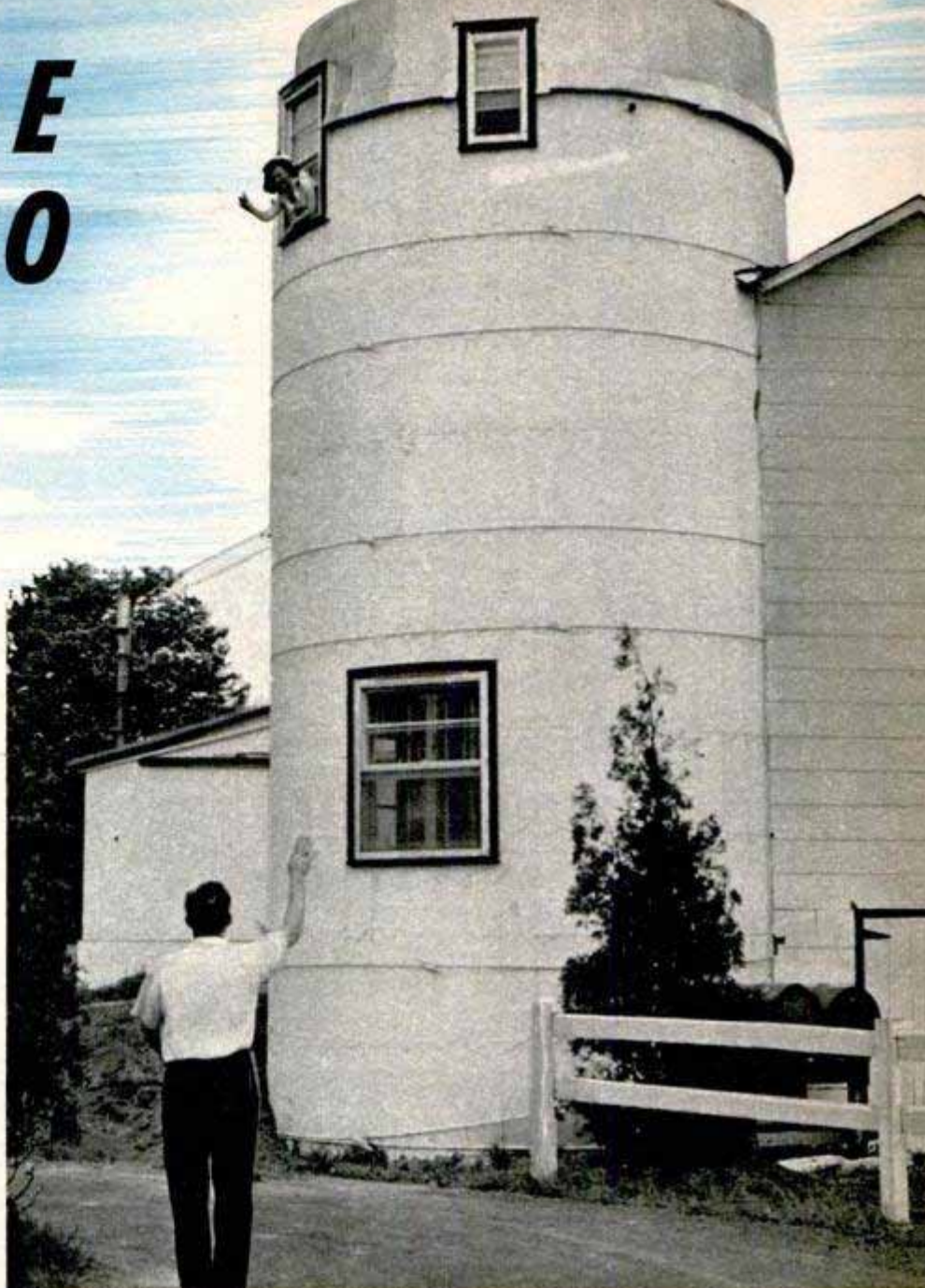

Mrs. Buff is probably the only housewife in the world who welcomes her husband home from work with a gay wave through a silo wall. Below, kitchen is all-electric with cabinets arranged in a circle



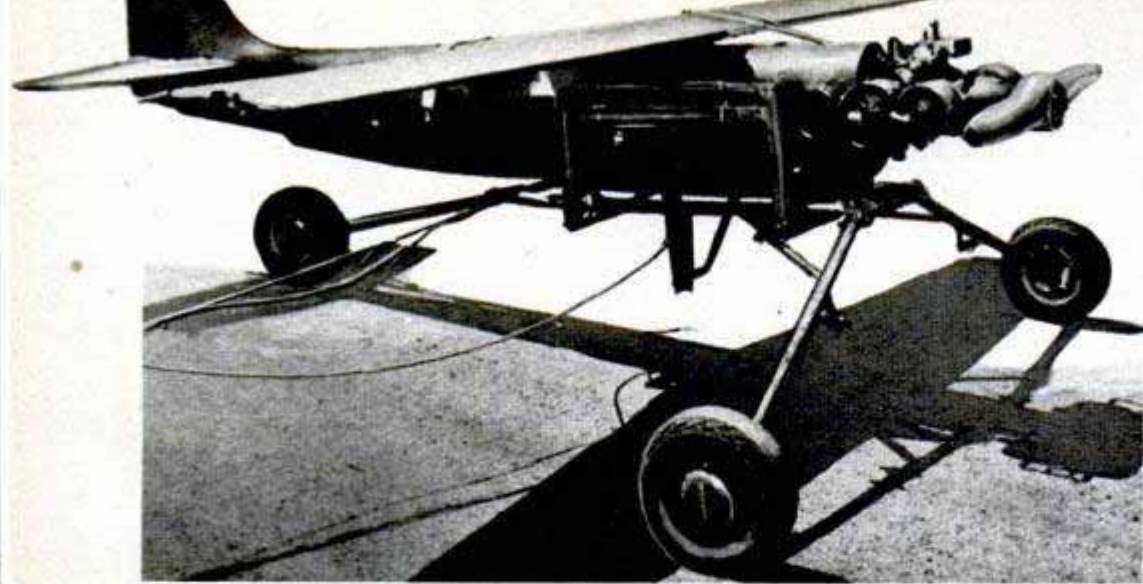

Power for the 300-pound target plane comes from a four-cylinder engine. Separated from its undercarriage at take-off, the plane lands by parachute

Radar "Eyes" for Target Planes

RADAR and a new automatic pilot now enable pilotless target planes to fly beyond the operator's sight. Designed to simulate a fighter plane for antiaircraft and flexible gunnery practice, the OQ-19 can make remotely maneuvered high-speed dives, steep turns and travel 220 miles an hour. The miniature craft, with wings spanning only 138 inches, is also pioneering a new launching technique. Instead of a rocket boosting it to take-off speed along a 60-foot ramp, the craft moves in a circle on a detachable wheeled carriage under its power and attains flying speed in less than five round trips. A 150-foot cable from the carriage to a center post holds the plane down until it is remotely released

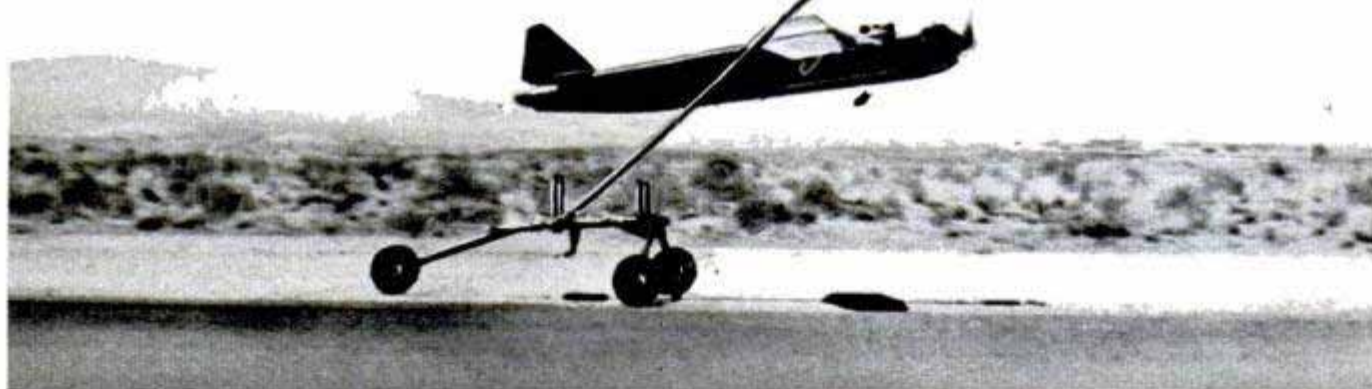

USAF Air Materiel Command photos

Seconds after reaching its take-off speed of about 80 miles an hour, the pilotless craft, above, moves away from its undercarriage. A 150-foot cable to the center post holds plane on ground until it reaches flying speed

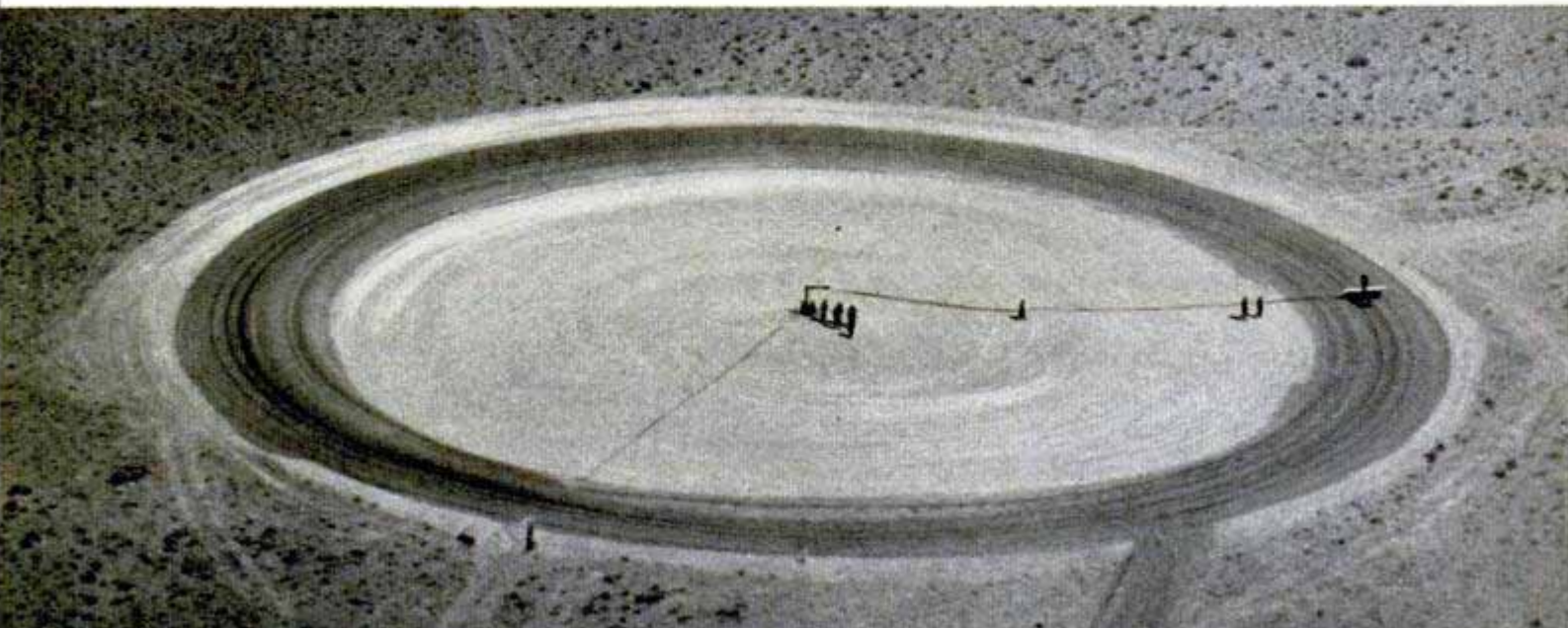

Pump Drains Engine Oil Through Dip-Stick Hole

Portable and fast acting, a new pump changes engine oil in less than two minutes. The device, which fits any five-gallon pail, can be used without crawling under the car. A metal tube is inserted in the dip-stick hole and 12 strokes on the pump handle draws out the oil and sludge. The pump hose is transparent to permit a visual check of the oil's condition. Producing a strong vacuum, the device can also be used to clean oil and fuel lines, as well as to drain oil from oil filters, water from radiators and gasoline from tanks.

Forest-Killing Disease Stopped by Knife or Poison

Oak wilt, rapid-spreading forest killer, can be stopped in its tracks with poison or a tractor-drawn knife, according to plant pathologists at the University of Wisconsin. By using radioactive iodine as a tracer, the scientists discovered that the disease often moves underground from tree to tree through natural grafts in a forest root system. The disease can be controlled by poisoning a ring of healthy trees around an infected stand or by cutting the



Chisholm Industries, Inc., 109 Central Ave., Lynn, Mass.

interlocking root systems with a tractor-drawn knife. Still a mystery, however, is the manner in which the disease jumps great distances. It has spread throughout the Middle West and as far east as central Pennsylvania.



Microwave "Interphone" Aids Motorist

Invented by an Italian engineer, a microwave communications system enables an automobile driver to "talk" to the people in the car in front of him. If a driver wishes to pass another, he simply presses a button on the dashboard control box. A microwave signal lights up a light on the dash of the car ahead and its driver responds by turning on a green taillight if it is safe to pass, a red taillight if not. Another modification of the device will automatically depress the headlight beams of approaching cars at the proper distance and lift them when the cars have passed.

Information not listed on articles in the index frequently is listed in the WHERE-TO-FIND-IT LIST, which is available to readers without charge from Bureau of Information, Popular Mechanics, 200 E. Ontario St., Chicago 11, Ill.

By Jack B. Kemmerer

THOUGH supersonic jets and sizzling rocket planes may be flashing through the skies, one of the most unusual planes in the United States today is a converted, wartime PBY-5A Catalina.

Ever hear of an airplane with a shower bath? Or one with French phones in every compartment?

Or an aircraft with a fully equipped galley having a 10-cubic-foot electric refrigerator and frozen-food unit? Or a plane that has hot and cold running water with automatic pumps for drainage?

Or one that carries two 14-foot boats complete with 10-horsepower motors, fishing gear and walkie-talkies?

This luxurious sky-yacht—literally an apartment with wings—was designed and built by the Southern California Aircraft Corporation, Ontario, Calif. Glenn E. Odekirk, special assistant to Howard Hughes and also the executive vice-president of the new corporation, is the man responsible for building it.

In theory, of course, the Landseaire is still a PBY-5A Catalina with a completely new interior and a few changes made to the exterior.

The forward gun turret and the bombardier's window have been replaced by a graceful clipper bow.

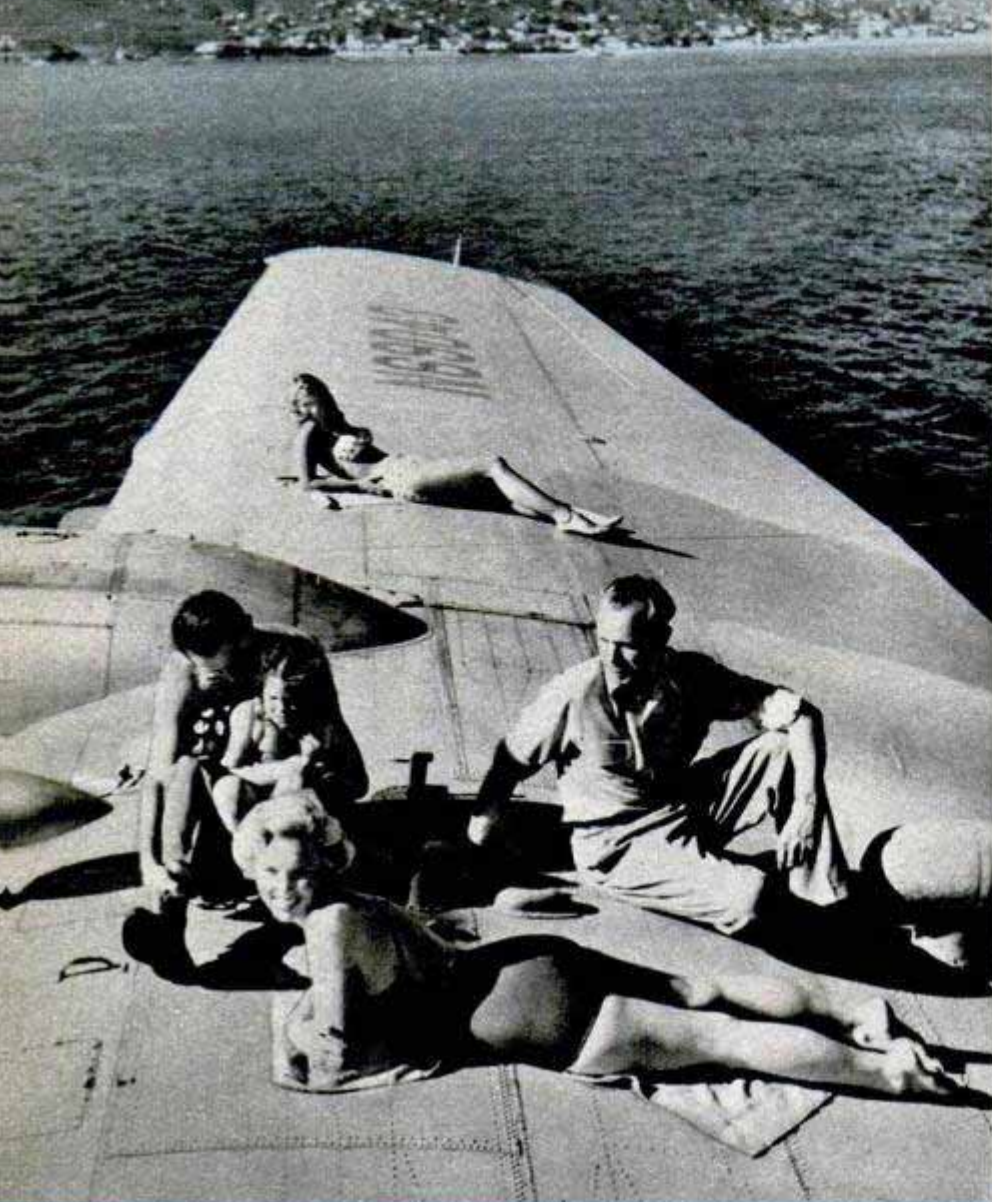

Big wing, 104 feet long and about 15 feet wide, doubles as an exclusive sun deck when the luxurious sky-yacht rides at anchor

PBY penthouse

Clipper-bow replaces the forward gun turret and bombardier's window on the former war-plane, which has been converted into an apartment on wings



Changing the airflow over the vertical and horizontal stabilizers made a balanced-type rudder, thus giving improved directional control. Also, the trim tabs on the rudder are double their former size.

Other additions that amaze Navy flyers are the 14-foot boats attached under each wing where bombs and torpedoes used to hang. Each boat, fitting into a streamlined fairing near the leading edge of the wing, is raised or lowered from the plane's interior by an electric hoist.

A new stainless-steel firewall increases the fire safety of the engines. A single switch in the cockpit cuts off all fuel, lube oil and hydraulic fluid forward of this wall.

The flight engineer's controls in the tower were moved to the cockpit, making it possible for only the pilot and copilot to handle the airplane.

The airplane's interior rivals that of any modern seagoing yacht. Little remains that would be recognized by Navy pilots who flew the PBVs for hours upon hours patrolling the sea lanes in World War II.

Colorfully styled in blue, russet, tan and gray, the Landseaire has an observation compartment with the former gun blisters converted into wide, curved sight-seeing windows. In the compartment are a special bar, foam-rubber cushions, flight instruments, radio and French-phone intercom.

The special blister cost approximately \$3500. Excellent optical qualities without distortion were achieved by free-blowing the blister. It is as thick as the blisters used for military airplanes and is attached in the same manner as the plastic canopy on our latest jet aircraft.

Located in various compartments of the ship are three double beds and two singles. Standard equipment for the beds includes individual bed lights, radio switches and speakers, curtains, vents for an air-condi-



Curved blister made of plastic forms a big picture window for a long, undistorted view of the horizon

tioning system, and more French phones.

During the day the single beds in the observation compartment serve as lounge seats. In the combination dining and lounge room, one double bed converts into a large lounge and the other folds into two seats with a table between for card playing or work. The double bed in the forward compartment also folds into individual seats.

The shower bath, in waterproof plastic, runs hot and cold from the ship's tanks.

Finished in white porcelain and stainless

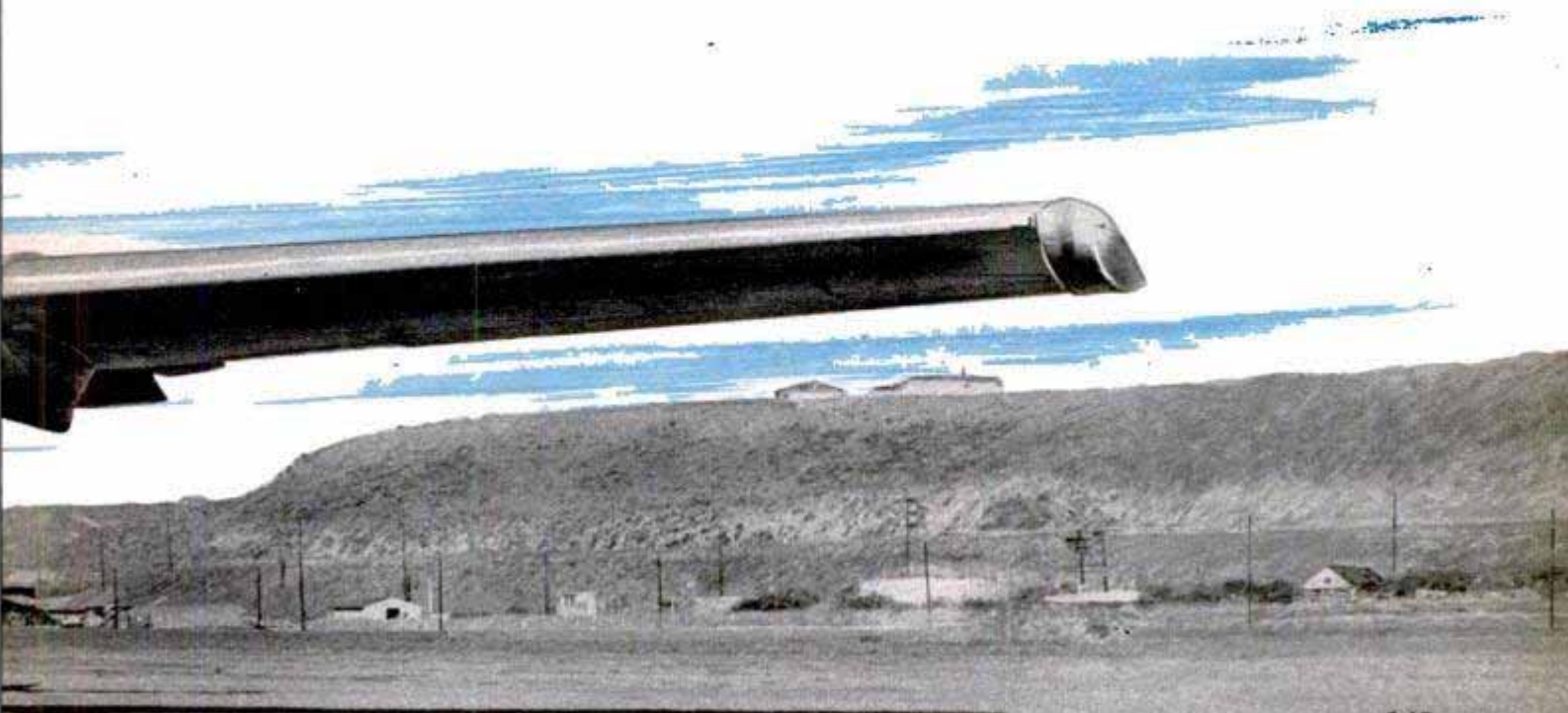

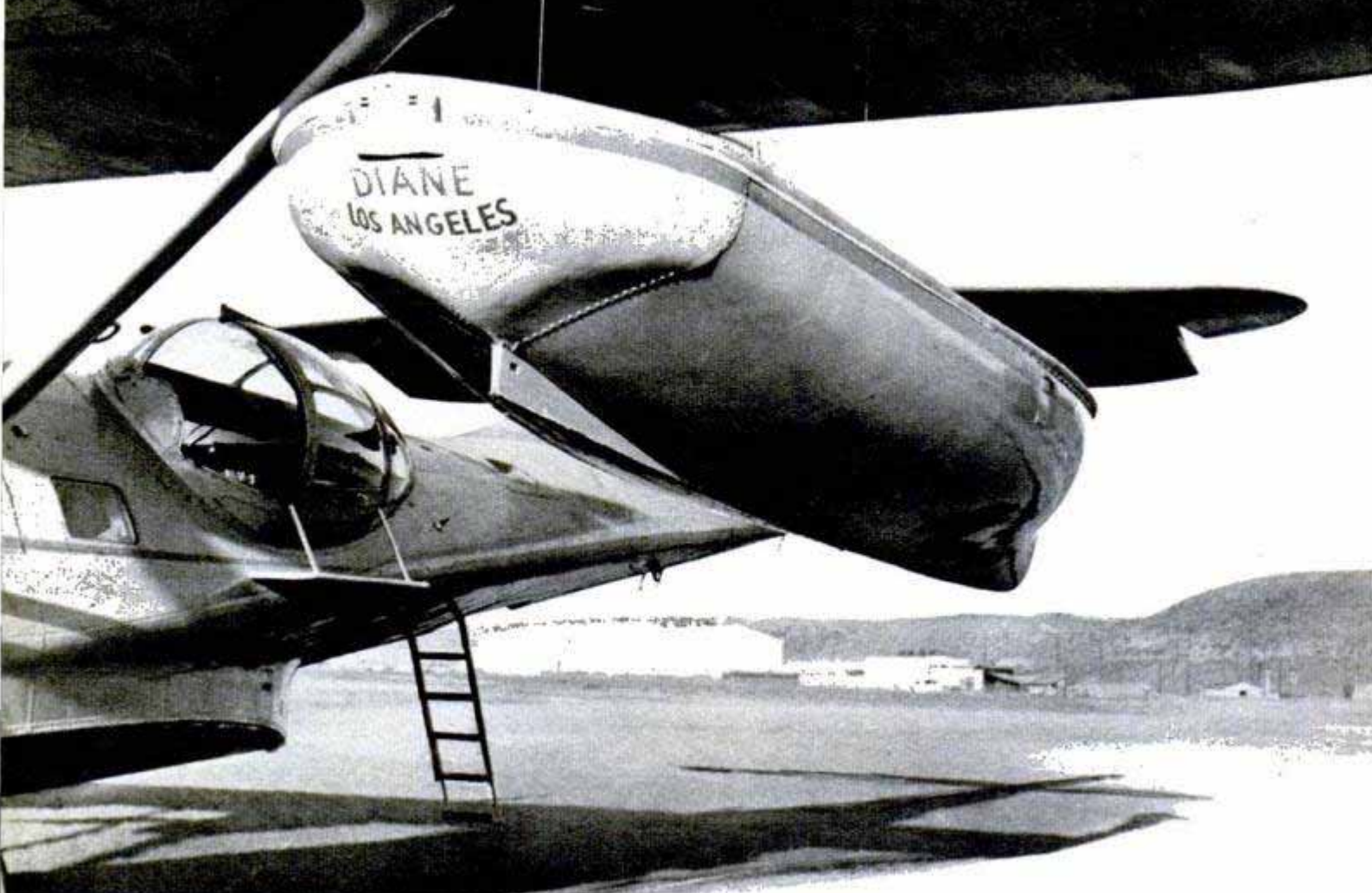

Outboard motorboats, attached under each wing, are raised and lowered by hoists operated from inside plane

steel, the compact galley rivals most modern home kitchens. The equipment consists of a three-plate range, oven, 10-cubic-foot refrigerator and frozen-food unit, ample cupboards with storage space and a stainless-steel sink with hot and cold running water. When the plane is airborne, the sink drains overboard, and at anchor it drains into a sump tank which is automatically pumped over the side when full.

The water for the sink is fed from a 10-gallon pressure tank. When the water reaches a low level, causing the pressure to drop below 20 pounds, a pump automatically refills it from large storage tanks.

Both the refrigerator and range have dual wirings and operate on 24 or 110 volts. These voltages are cut in and out by auto-relay switches. The 110-volt, 6000-watt, gas-driven, generating plant is located in the nose of the ship in the space formerly occupied by the bombardier and forward gunner. The compartment has been made fumeproof, soundproof and is insulated. With the exhaust of the engine discharging underwater, the operation of the plant is noiseless. All of the ship's equipment operates on 24 volts in the air but power is shifted to the 110-volt plant at anchor. A remote-control panel in the galley operates the plant and the sealed compartment remains closed except when the engine is

fueled. An exterior connection, installed in the wheel-well, provides a hookup for outside power when the ship is in the hangar.

The plane is equipped with the latest navigation and radio features, including a marine ship-to-shore telephone. And, to top it all off, the 104-foot wing, 15 feet wide, doubles for a sun deck when at anchor.

Off-duty, the pilot pours himself a cup of coffee in the galley while conferring on the French intercom



The Landseaire is equipped with Pratt and Whitney engines developing 1200 horsepower. The normal cruising speed at 10,000 feet is 160 miles per hour and fast cruising at the same altitude is 172 miles per hour. Maximum range of 3000 miles is possible if the plane is flown at 150 miles per hour. On a recent flight to Canada, the ship averaged 162 miles per hour at a fairly low altitude.

Additional planes of the Landseaire type will be equipped with Pratt and Whitney engines developing 1350 horsepower, and will have a normal cruising speed of 172 miles per hour.

Odekirk, a veteran pilot of more than 4000 hours, has his own ideas of what an executive-type private airplane should be able to do. After numerous flights, under almost every type of weather, he thinks this airplane is the answer.

"It seemed to us," Odekirk explained, "that no one has been getting real utility out of a private airplane. Normally, it's just a means of transportation in which you ride from here to there with varying degrees of comfort.

"So we decided to build a cruiser—an aerial luxury yacht—in which you can fly and land and live almost anywhere in the world with all the comforts of home."

The Landseaire is an ideal airplane for private flying because it is so versatile. Amphibious, it can land almost anywhere. The Southern California Aircraft Corporation has purchased 30 of the surplus "Cats"

Master radio has a speaker in every compartment. Later planes will be equipped with television sets



Inside or out, the plane is a luxury craft. The metal rack in the blister holds cameras for taking aerial snapshots

and is converting them into executive airplanes for individual and corporation use. The production line now converts one per month but this can be stepped up.

Interested in buying one? The luxurious land-sea-air yacht can be purchased, f.o.b. Los Angeles, for approximately \$225,000 completely equipped, including bed linen.

Complete fishing tackle, walkie-talkie and 10-horsepower outboard motor are standard boat equipment

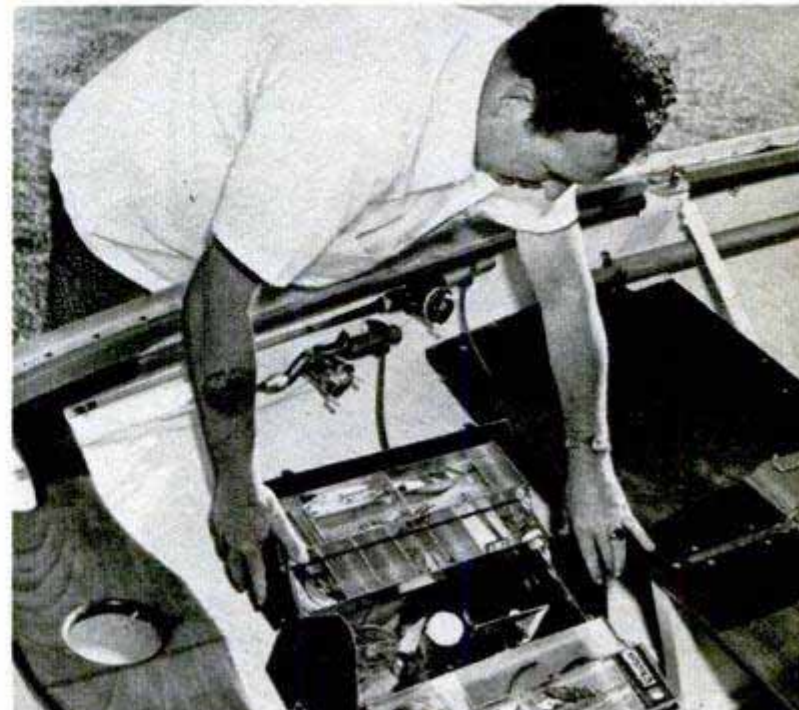

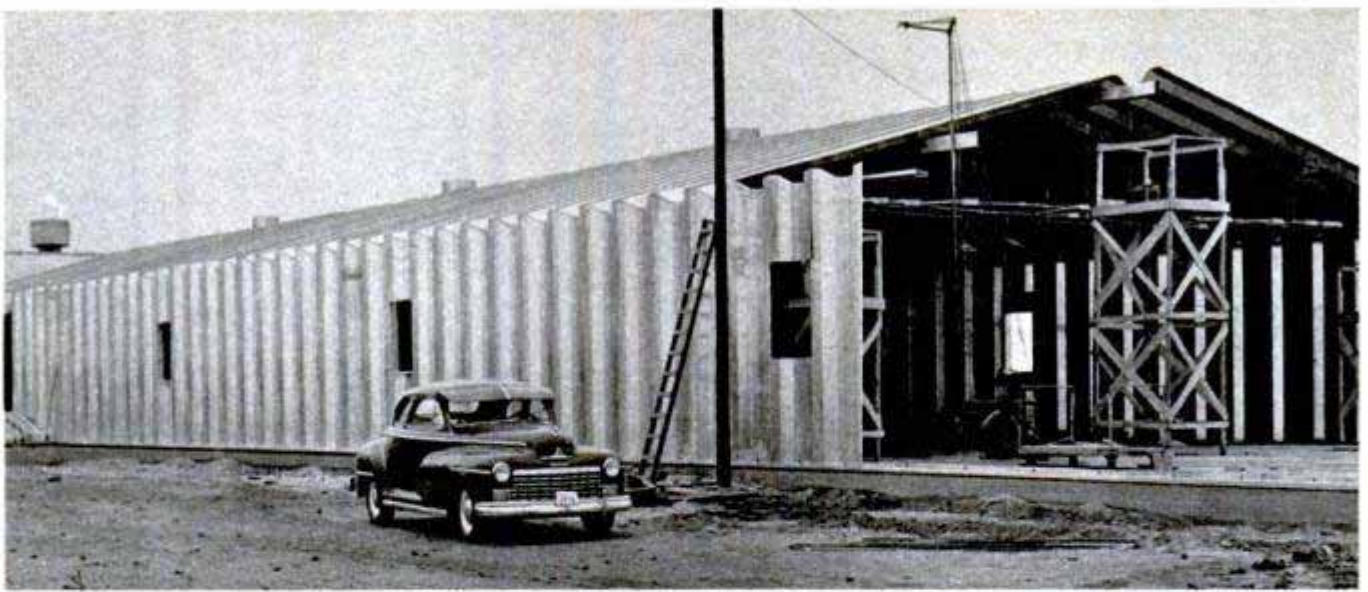

Behlen Mfg. Co., Columbus, Neb.

Steel Building Requires No Frame

So strong that 40 tons of tractors suspended from the roof did not cause any sag, a corrugated sheet-steel building supports itself with no frame or trusswork necessary. The steel is approximately $\frac{1}{16}$ inch thick, yet the $7\frac{1}{2}$ -inch-deep corrugations add so much rigidity that each panel becomes a support arch. The vertical panels and roof panels are bolted or welded together. There is virtually no limit to the size that buildings can be made with the corrugated steel.

Corrugated sheet-steel panels eliminate framework in building, above, because wall and roof panels are joined to form a continuous arch that supports itself. Below, roof holds up 40 tons of tractors with no sag

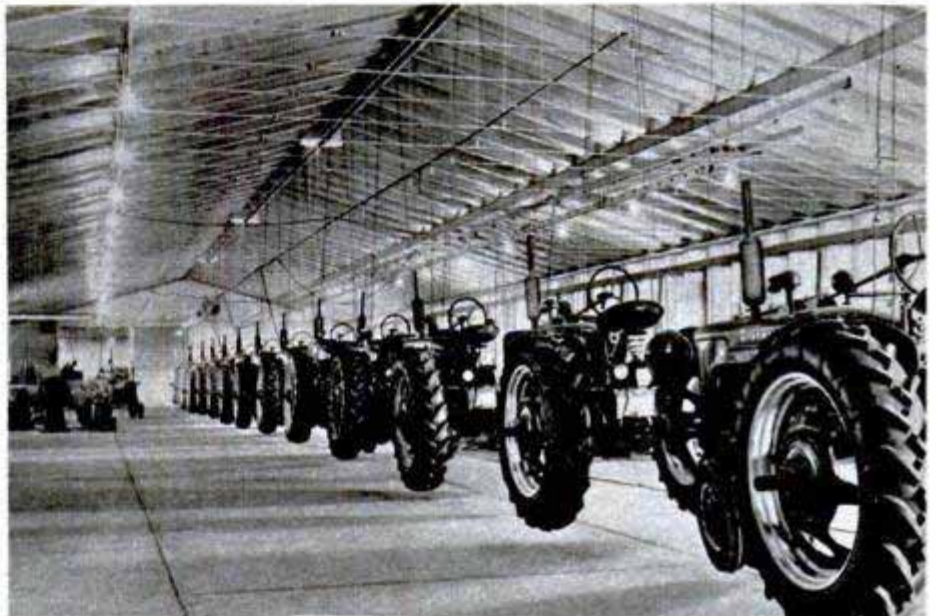

Little Giant

It took a veteran Kansas shovel operator 11 years of his spare time to make an exact scale model of a giant coal-mining electric shovel. The model, built to a scale of one inch to the foot, operates precisely as the real shovel does. It can be moved back and forth on its rails and is supported by four hydraulic jacks that keep it level at all times. There is even a workshop inside the model and on the workbench there's a miniature vise! About 30,000 rivets hold the model together. Five electric motors drive the shovel.

☐ Experiments indicate that Israel may soon be getting its oil supplies by processing sunflowers that grow wild in the Negev Desert.

Power Digger

Lightweight and easy to handle, a new power digger bridges the gap between slow hand labor and the job done by giant shovels. It is especially suited to limited spaces and can be used for excavating trenches, graves, culverts and for moving stones. The digger unit can be attached to the rear end of a tractor in 20 minutes, and its independently mounted hydraulic pump operates from the tractor's power take-off shaft. It reaches eight feet below ground.

141 Mold Remedies

Since 1942, when there wasn't enough penicillin to treat one patient, the number of mold remedies has grown to 141 and the monthly output to 16 trillion units. The basic seven on the list of antibiotics certified by the U. S. Food and Drug Administration are penicillin, streptomycin, chloramphenicol (also known as chloromycetin), aureomycin, bacitracin, ty-

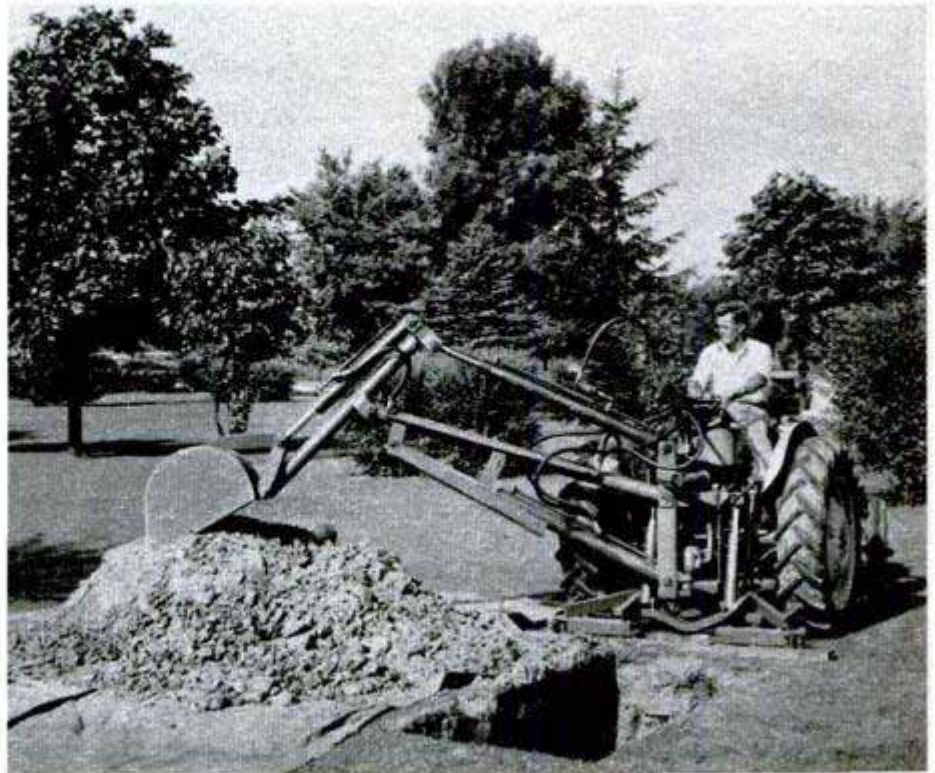

Sherman Products, Inc., Royal Oak, Mich.

rothricin and terramycin. Certification means that the FDA examines each batch of the drug produced for identity, strength, quality and purity before it is shipped in interstate commerce.

Versatile Farm Implement Does Five Jobs at a Time

In one operation, a new farm implement does five or more jobs, leaving sod or grazing crops undisturbed. Some of the simultaneous operations are disking, harrowing, cultipacking, spreading slag, seeding with spreader and spreading ammonium nitrate. Oats have been the main crop planted in tests, but the machine will successfully

plant millet, peas, corn and other field crops as it is adjustable for depth of planting. In a test, the machine did a complete job of renovating, applying fertilizer and planting oats on 10 acres in 18 hours with a two-man crew. The machine was announced by the Agriculture Extension Service of Mississippi State College.

Left, close-up of the compartmented boots. Right, only a narrow furrow is left as the feet cut into the soil

Taylor Machine Works, Louisville, Miss.



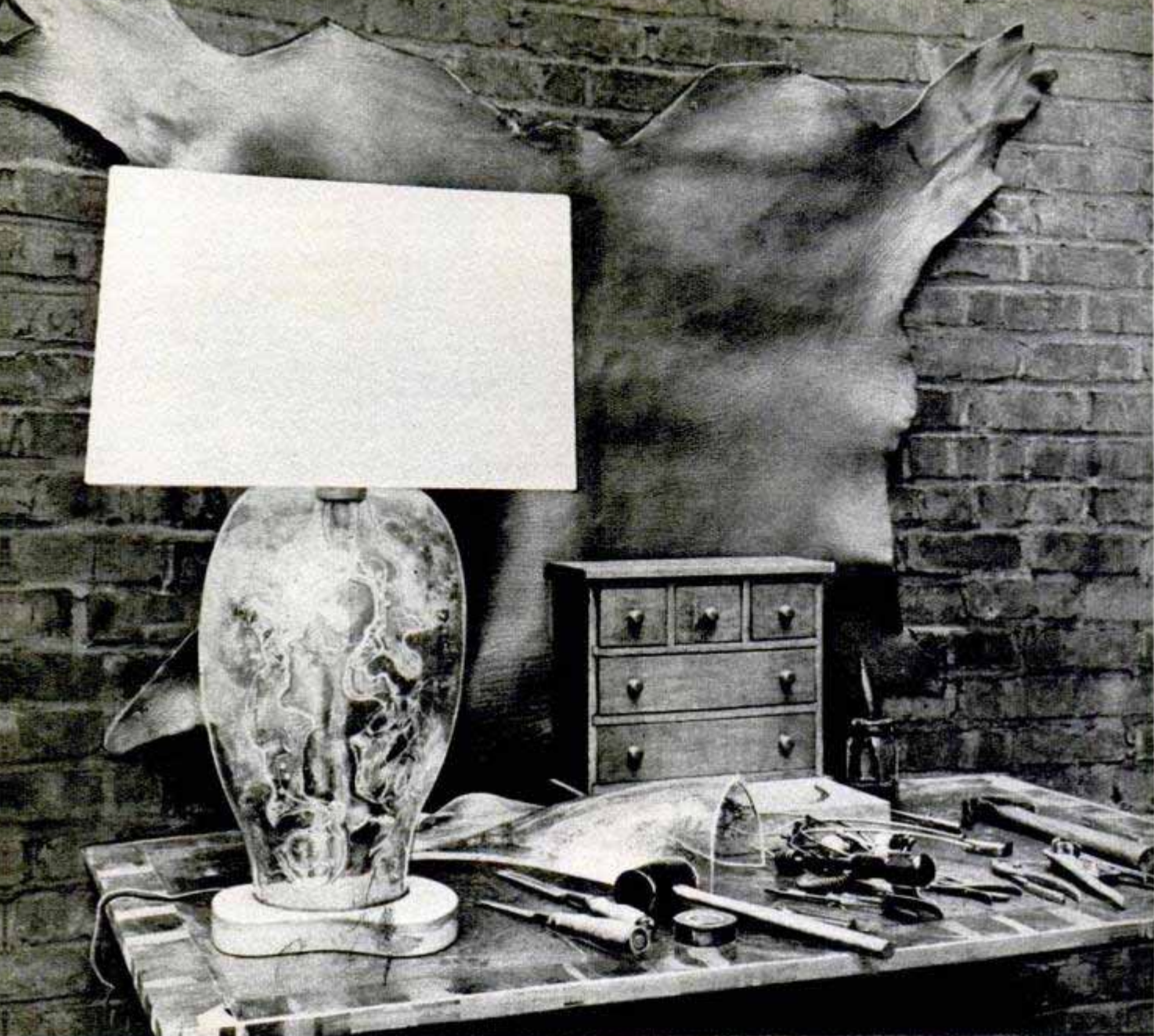

Above, that surrealistic-looking lamp is made of glass, coated on the inside to form nebulous patterns. On the wall is a steer hide that will be converted into scores of unusual items by the craftsmen. Below, when lighted from within, this plastic lamp produces a weird effect

HANDICRAFT

Even this old chemistry flask will be converted into something attractive by the Manhattan craftsmen

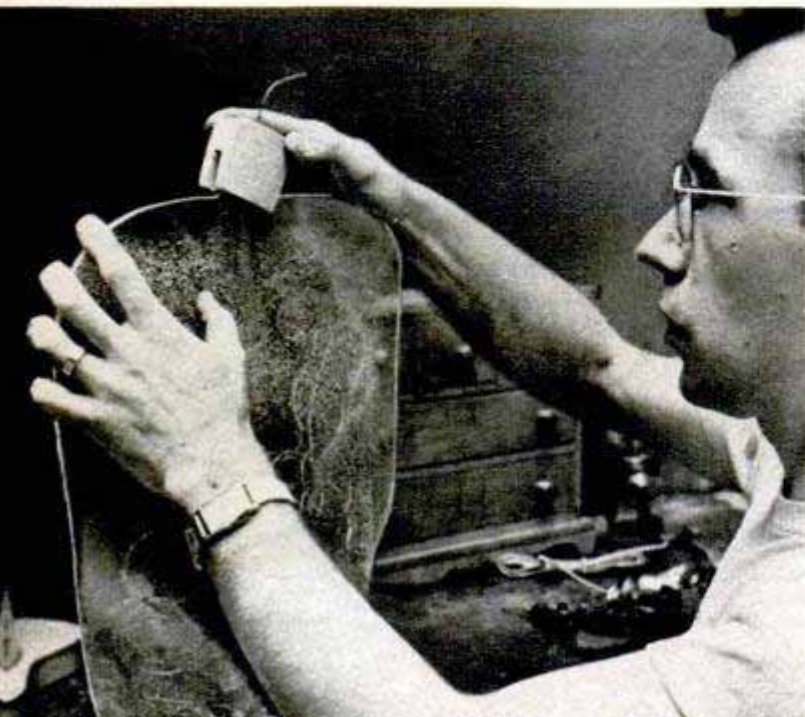



Rollers once used to print patterns on wallpaper are "raw material" for these experts who make them into lamp bases

Right, a finished wallpaper-roller lamp ready for a shade and a customer. The raised parts that once printed the design are gold leafed

Below, right, this is a bird in flight as fashioned by a modern sculptor. The materials used are wire and strips of aluminum. Suspended in air, it is supposed to provide the feeling of flight



ON MANHATTAN

TUCKED away on Manhattan, heart of America's mass-production system, is a small shop where a craftsman's skill and imagination are as essential as they were in the days before production lines. Formed by several veterans, the shop has never hired a professional! Each worker was an amateur, who practiced his craft simply as a hobby, before joining the group. By pooling their skills, these hobbyists now produce furniture and decorative pieces that appeal to New Yorkers who prefer the unusual.

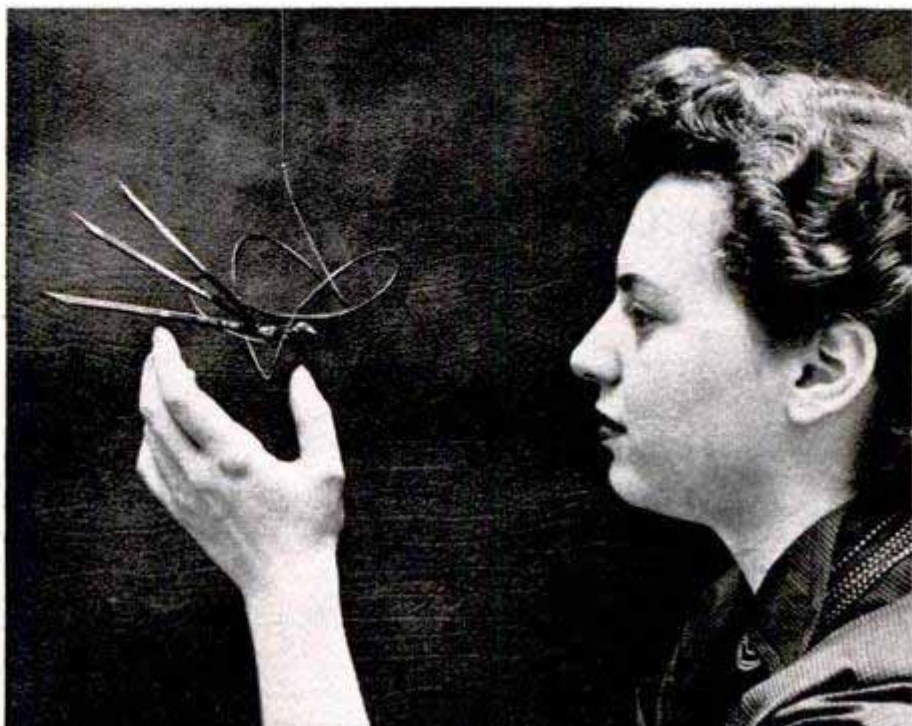

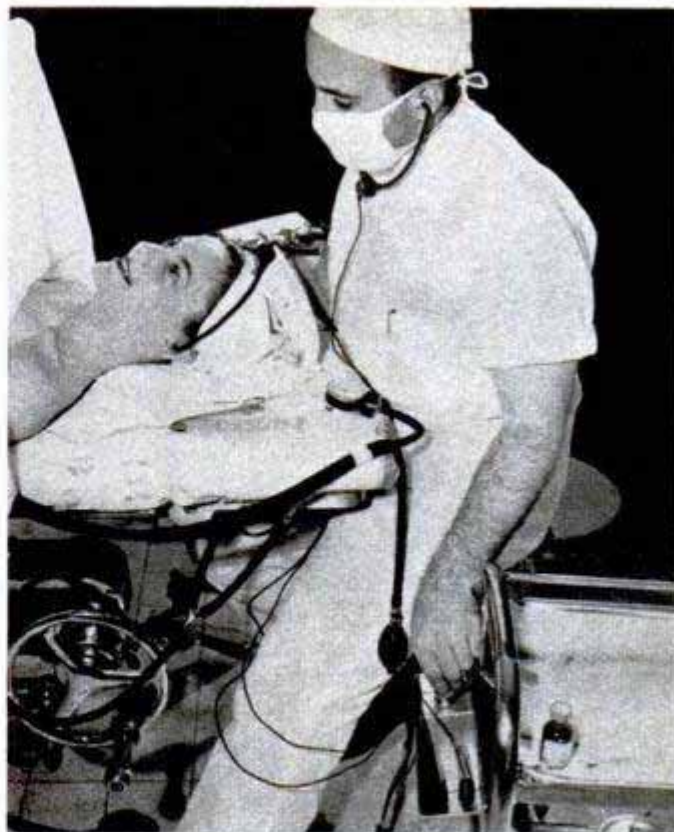
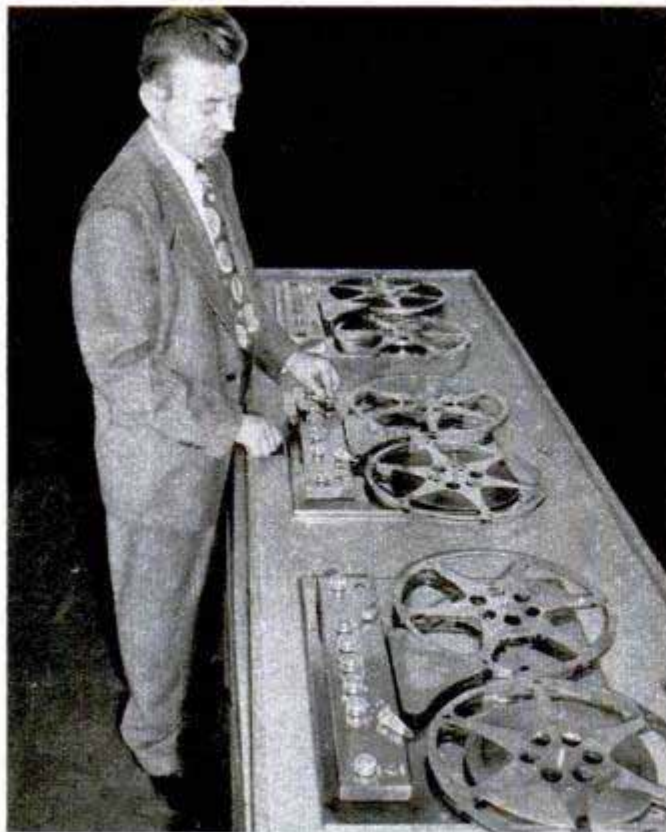

Joel Willard, 1959 W. 59th St., Chicago 36

Left, these tape-recording machines play relaxing music to calm the patient, right, in the operating room

Music in the Operating Room

Surgical patients relax before and during operations to soothing music that is "piped" directly to them through lightweight earphones. Used with spinal, local or regional anesthesia, the music occupies the patient's attention, lessening his worry and reducing tension. It also prevents him from hearing the clicking of instruments and the conversation of the doctors, two factors which cause apprehension when general anesthesia is not used. Designed

for the University of Chicago hospitals, the music-with-anesthesia system uses three magnetic-tape recorders to provide classical, popular or children's music, according to the patient's desire. These recorders operate all day in a special room, remote from the operating rooms. Control switches in each operating room regulate the type of music and volume. With 4800 feet of double-channel magnetic tape, each recorder plays for four hours without repeating any selection. The operating-room controls are handled by the anesthetist.

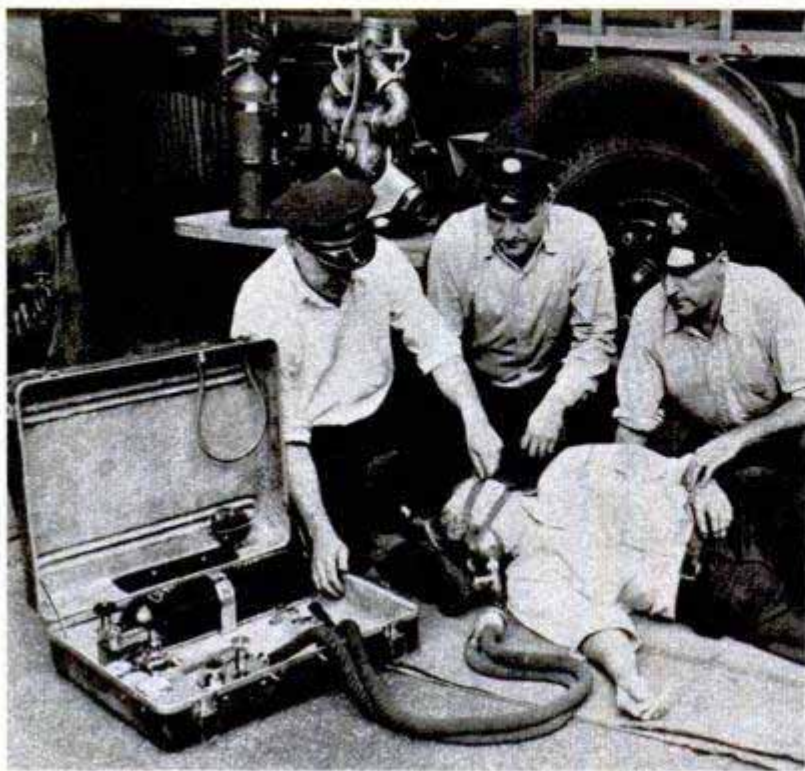

Mine Safety Appliances Co., 230 N. Braddock Ave., Pittsburgh 8, Pa.

Automatic Breather

Victims of any kind of asphyxiation can be treated with a new automatic breathing instrument which pours oxygen into the lungs in two different ways. A facepiece is connected by two tubes and dual valves to an oxygen tank. One valve, which administers oxygen under pressure at regular intervals, is designed for treatment of victims whose breathing has stopped. The other valve passes oxygen only when the patient inhales, and stops the flow when he exhales. The valves interchange automatically as needed. The two tubes make the apparatus suitable for use in any emergency in which a victim's breathing has been stopped or impaired.

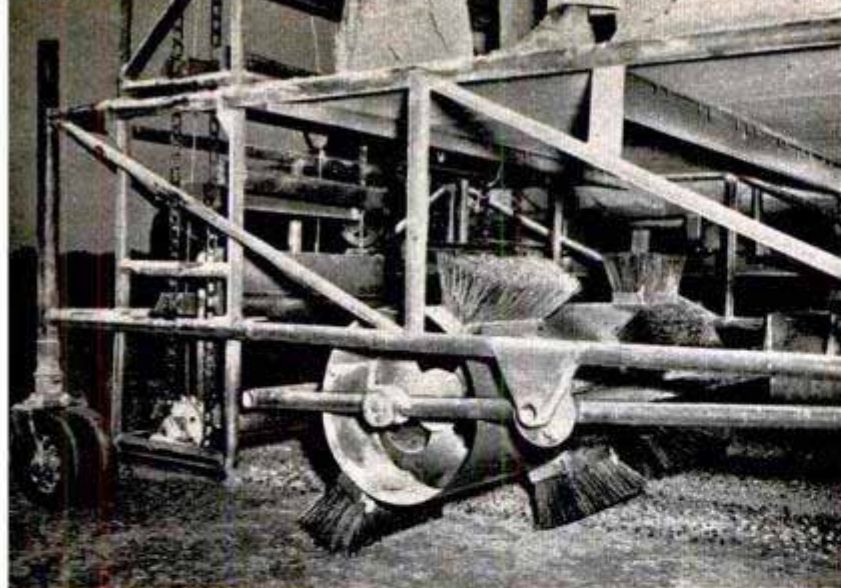

Powered by a small air-cooled engine, sweeper brushes push dried potatoes toward elevator buckets that lift them into truck

In two weeks the combined elevator-sweeper, right, and another machine processed 17,500 hundred-pound bags of potatoes



Chopper Converts Potatoes Into Animal Feed

POOR-GRADE POTATOES are mass processed for animal and poultry feed by two machines built by Harry Stafford and Ferris Talmadge of Easthampton, L.I. One chops the potatoes into small pieces and spreads them to dry.

Three or four days of sun reduces their weight 80 percent and they can be fed to cattle without further processing. Wire-mesh drums separate the tubers from debris. The other machine sweeps the dehydrated potatoes into elevator buckets that hoist them into a truck.

Revolving wire-mesh drums on cutter-distributor remove stones and debris before tubers are spread to dry

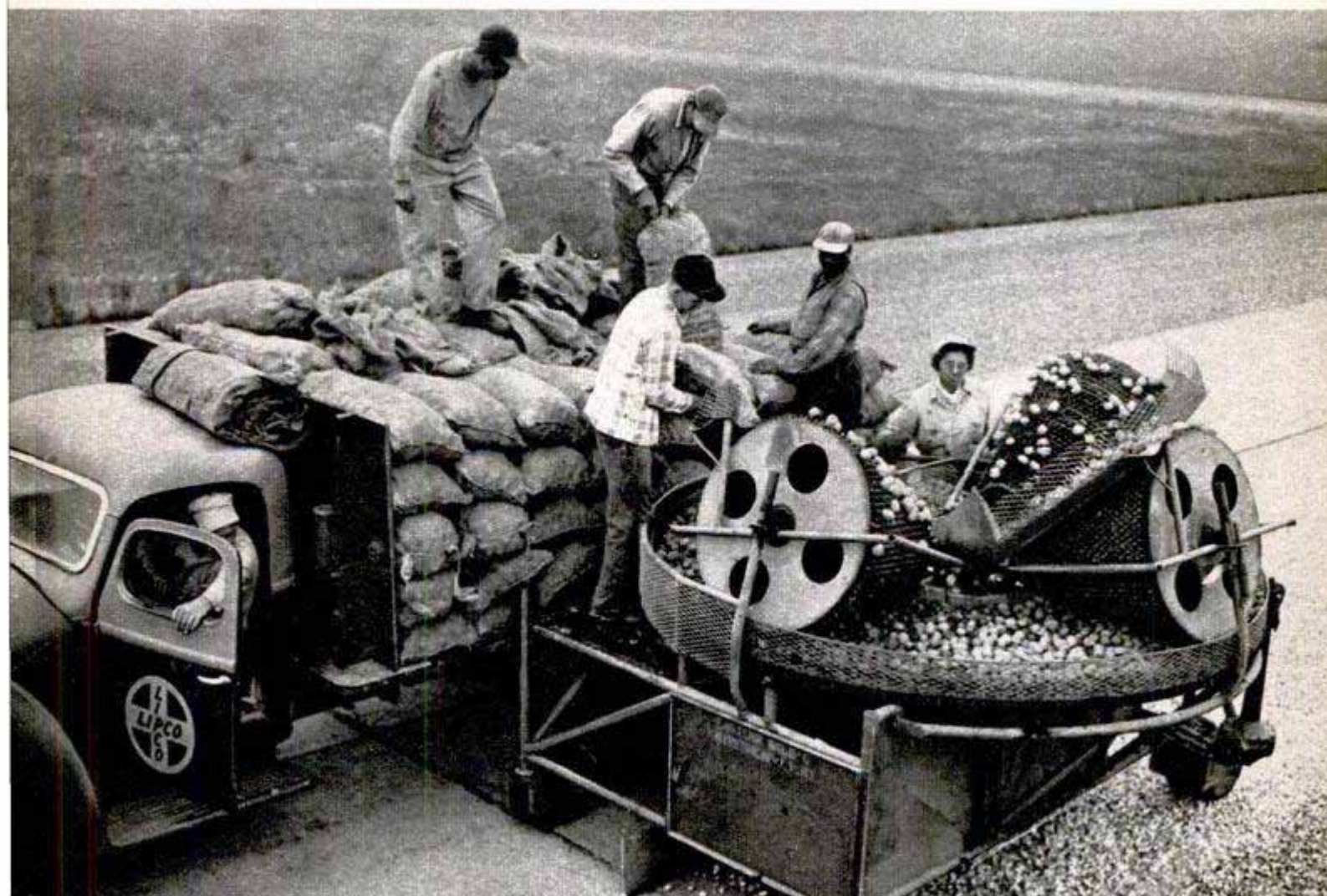

ONE RIVER BORROWS FROM ANOTHER

OUT IN CALIFORNIA engineers are going to pump water from one river, move it 117 miles south and dump it into another river so it can flow back north to its starting point! The amount of water involved would supply the needs of three cities the size of New York.

This watery merry-go-round may sound like so much wasted effort, but actually it's a long-distance water transfusion that will mean added fertility to thousands of acres of Central Valley farmland. Receiving the mammoth transfusion is the San Joaquin River that flows northward through Central Valley. This supplementary water is needed because far upstream the river diverts most of its water to two long-distance irrigation canals at Friant Dam, leaving only a comparative trickle for Central Valley farms.

Bureau of Reclamation engineers, seeking a source of water, knew that the Sacramento River poured billions of gallons into the ocean at San Francisco. Why not use this abundance as the remedy for the shrunken San Joaquin and thirsty Central



Arrows on drawing trace roundabout route taken by the water from Sacramento River as it is used to irrigate Central Valley. Inset shows the pumping plant

Valley? In a long-range program, which is scheduled for completion by July of this year, the bureau began the work of moving water from one river into another.

Heart of the project is a huge pumping plant on an inlet canal connecting to the Sacramento River. Six pumps will lift two million gallons a minute from the

Laying concrete for the Delta-Mendota Canal is a big job. It is 100 feet wide, 40 feet deep, 117 miles long

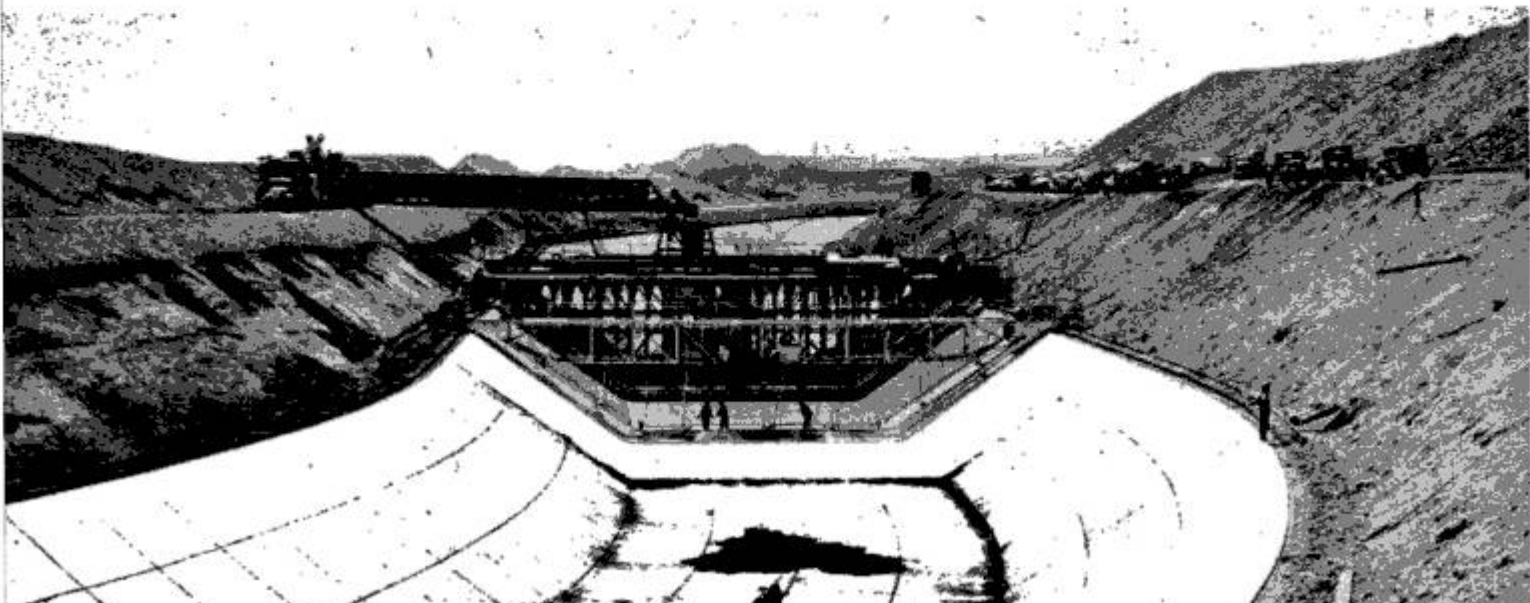

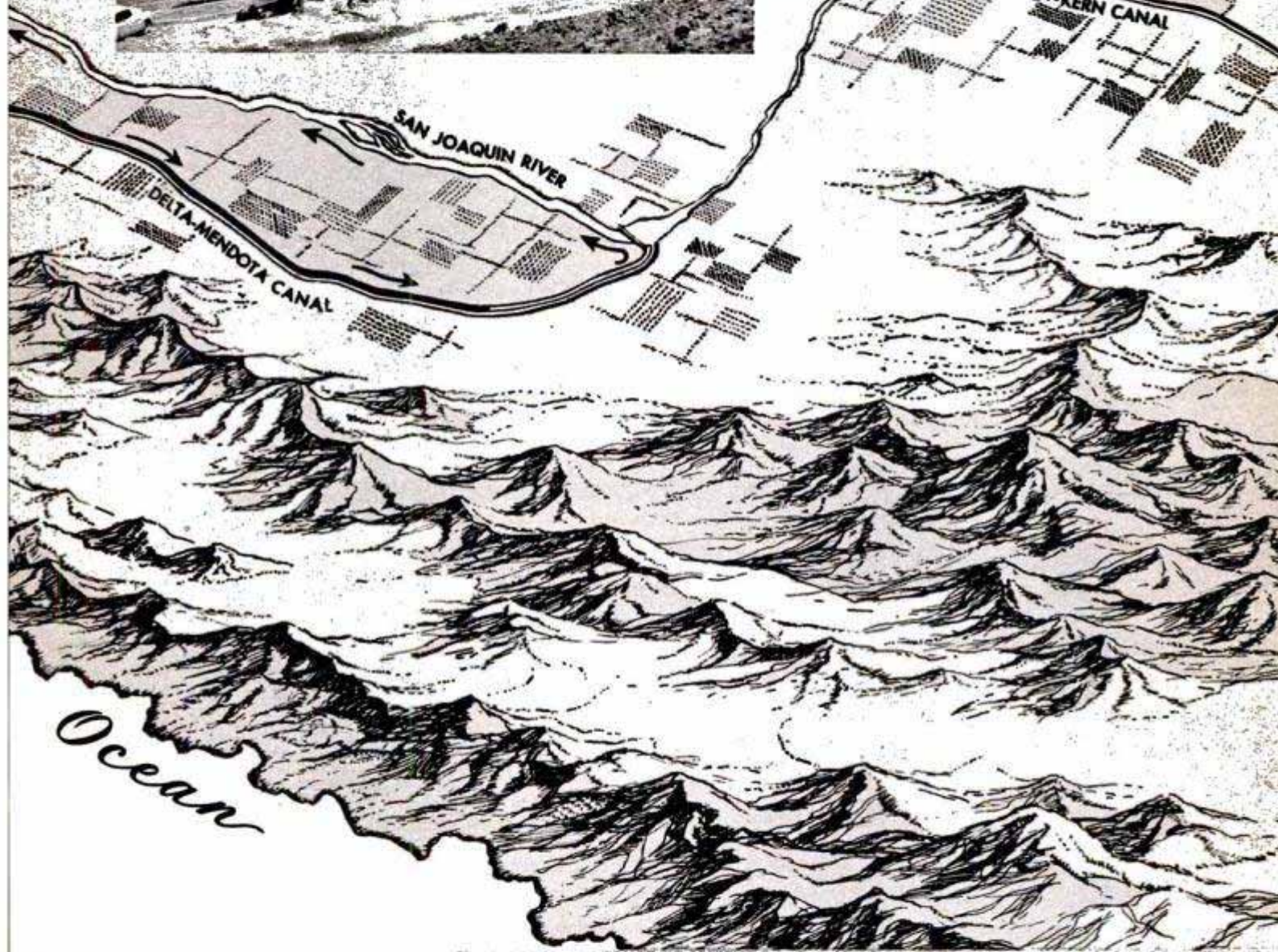
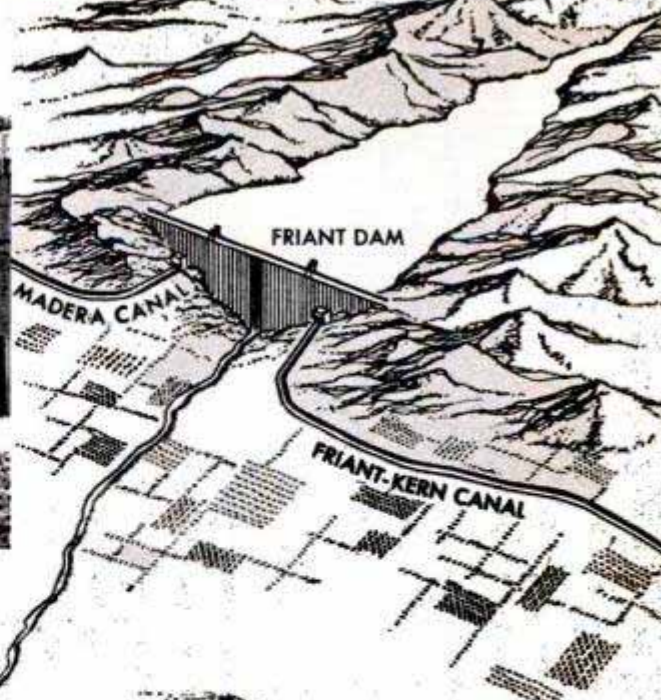
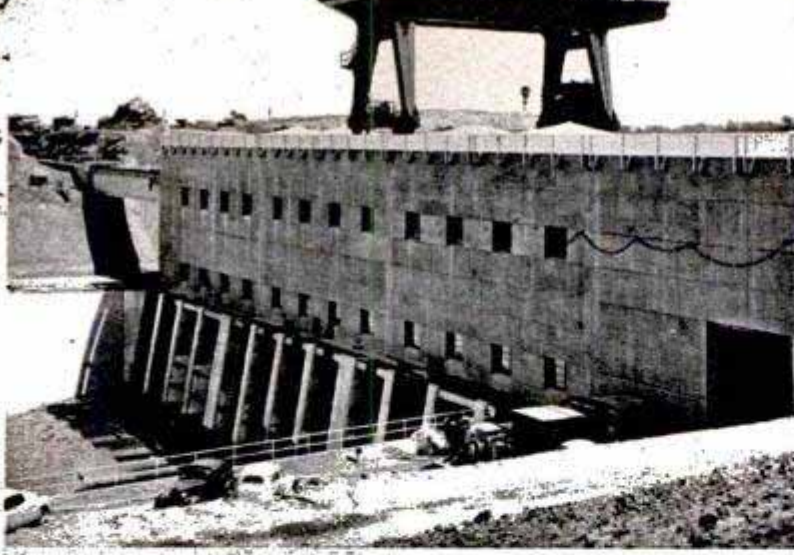

These three pipes carry the water from the river to the outlet works where it is dumped into the Delta-Mendota Canal

Sacramento, raising the water through 5000-foot-long concrete pipes to an outlet works atop a 197-foot hill. There the water will pour into the Delta-Mendota Canal in which it will flow south by gravity the 117 miles to the entry point on the San Joaquin. Entering the river, the water from the Sacramento will swell the San Joaquin, enabling it to irrigate Central Valley as it rolls north to the sea.



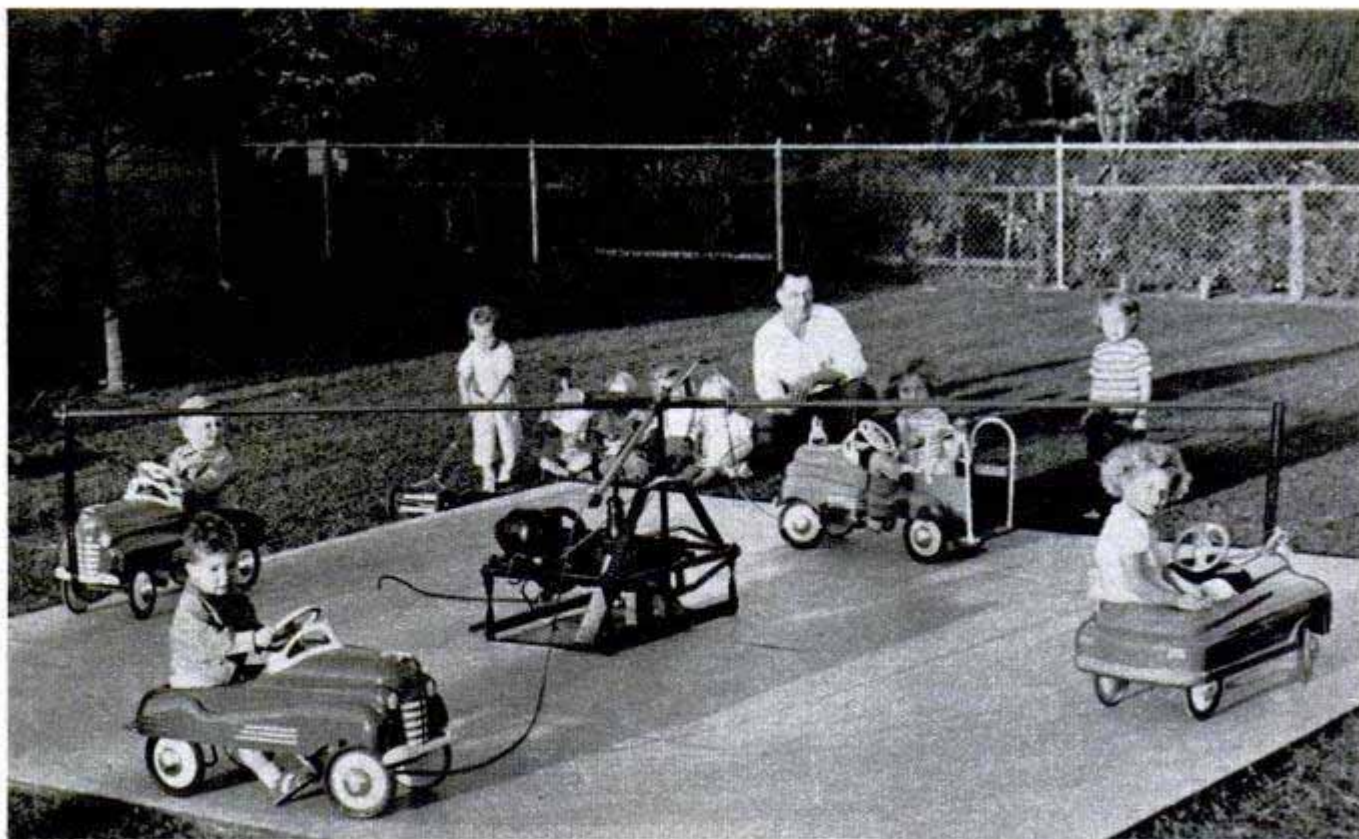

Back-Yard Merry-Go-Round

Toy automobiles, parts from cast-off machinery, an electric motor and pieces of pipe were used by Donald Giannini of Burlington, Wis., in making a miniature merry-

go-round for his three-year-old son, Dennis, and the neighborhood children. An old automobile transmission and threshing-machine gears serve as vital parts. It took Giannini and a helper four months to complete the job in their spare time.

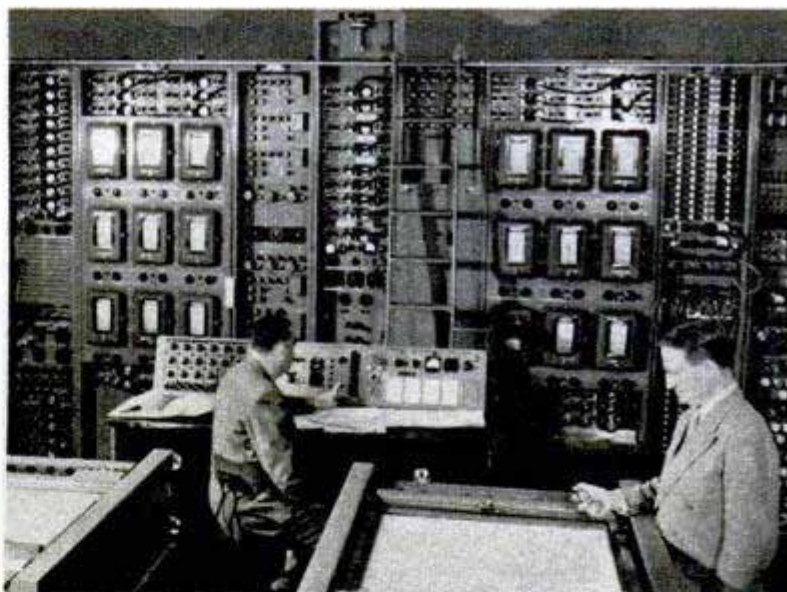

Radio Corp. of America photos

Sensitive Computer Speeds Missile Design

Costly trial-and-error tests to determine how proposed guided missiles, airplanes and ships will perform are by passed by a new electronic computer. It permits the design of equipment, with only a minimum of experiments with small scale models, that would otherwise require expensive apparatus such as actual missiles, airplanes and ships. In less than 60 seconds it solves

problems that would take two mathematicians six months. Built by the Radio Corporation of America for the Navy, it has 4000 electron tubes, several miles of intricate wiring and parts accurate to better than one part in 25,000. Each of more than 600 electric relays in the multipliers operates in 1/10,000 second. The computer is so sensitive that it has to be housed in an air-conditioned room kept at a constant temperature of 75 degrees Fahrenheit and a relative humidity of not more than 50 percent.



PLASTIC IGLOO

Top, new plastic shelter designed for soldiers and equipment can be easily packed and delivered on small truck

Top, right, igloo is assembled from 12 identical and interchangeable panels. Shelter goes up in 30 minutes

Right, panels interlock to form the dome. Walls are $\frac{1}{8}$ in. thick and have stiffener ribs for strength

Below, right, handle is pushed in and turned to lock panels together. This squeezes neoprene gaskets at joints

Below, completed 20-foot shelter accommodates 12 men comfortably. It is strong, lightweight, virtually airtight



East Coast Aeronautics, Inc., 896 S. Columbus Ave., Mount Vernon, N. Y.

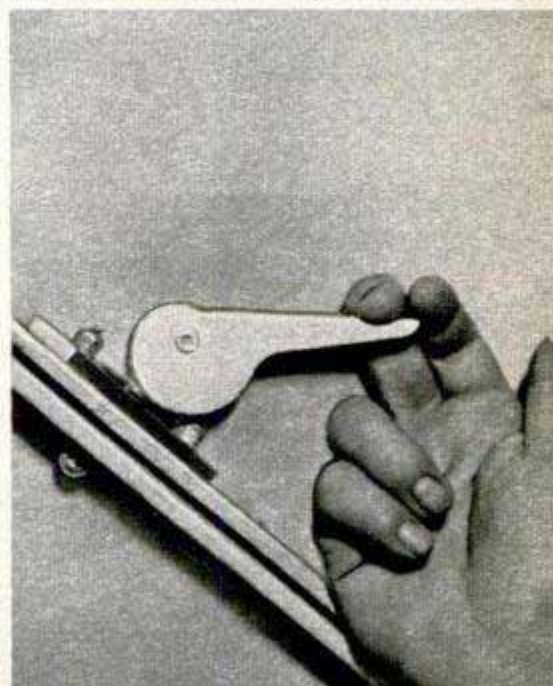
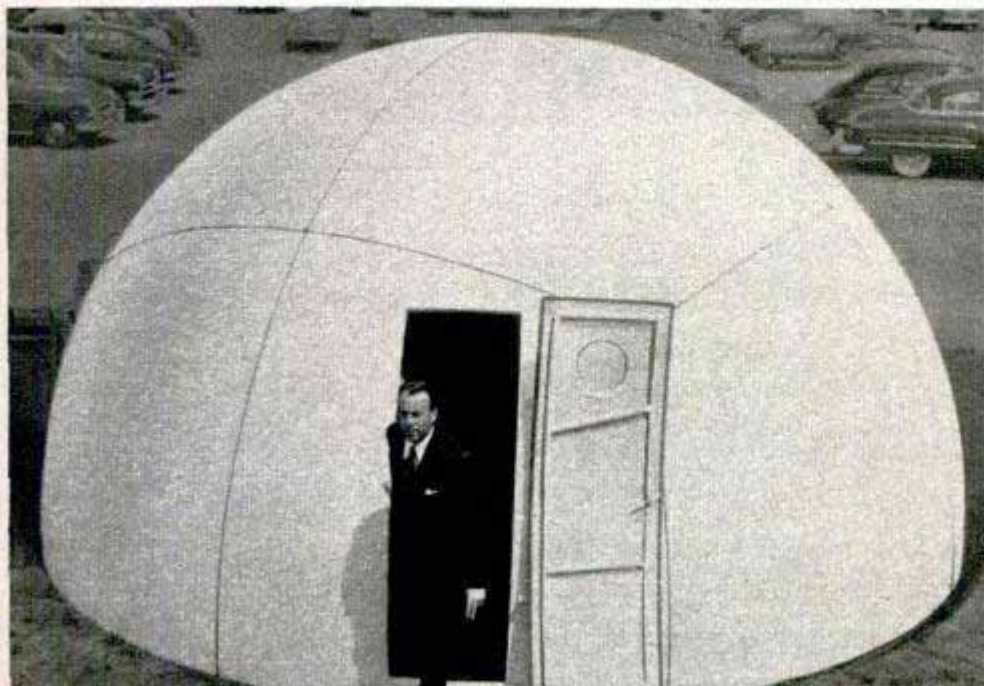

YOU SPEND six months or a year perfecting a can opener that not only works, but seems to have every similar device beat by a mile. You test it. Your wife and your friends test it. Everyone is enthusiastic and you begin dreaming about bundles of green bills. You spend another few hundred dollars and many hours perfecting your invention so that nothing can possibly go wrong.

Then—wham! You come down to earth with a bang. You discover that someone patented the exact device 39 years and 5 months before you thought of it!

That's the sad story that occurs all over the United States almost daily. Is there a way to prevent it? You bet there is—Uncle Sam's Search Room at the Patent Office in Washington is always "eager and willing" to save you time, money and heartaches. If you feel the urge to apply for a patent on the greatest can opener of all time, then don't do it before a search has been made through the files of the Patent Office. There are just about 1000 patents on can openers in the Search Room files and chances are that your brain child is a pretty old hag even if you think it's flushed with youthful freshness!

The Search Room, a monument to American ingenuity, is a high-domed chamber in Washington's Commerce Building. Its stacks today bulge with over 2,500,000 U. S. patents, with more being added weekly. Next to the inventor's own workshop, no other room in the world is quite so important to him as the Search Room. Here, he can learn how to avoid pitfalls and how to spot the paths along which the "pot of gold" may be found.

Head of the Search Room is soft-spoken Elton H. Brown, who has been on the job some 27 years, and has seen over 1,000,000 patents filed in that time. He warns inventors that, before applying for a patent, they should have a search made to make certain the alleged invention is not shown in some prior patent.

But even with the help of Brown and his staff, the job of looking for a particular device can be an all-day or all-week proposition. Take bottle openers, for example. About 1000 patents have been granted in 22 subclassifications. By the way, the Patent Office calls them "Receptacle Closure Removers."

If it's a wonderful idea for a spark plug that you have, take it easy—there are 1500

First stop of inventors is the Search Room of the U. S. Patent Office. Join the parade of inventive genius and you'll find that . . .

SOME

Number of patents issued yearly rose rapidly from 1849 to 1932. Downward trend of depression and war was reversed in 1948

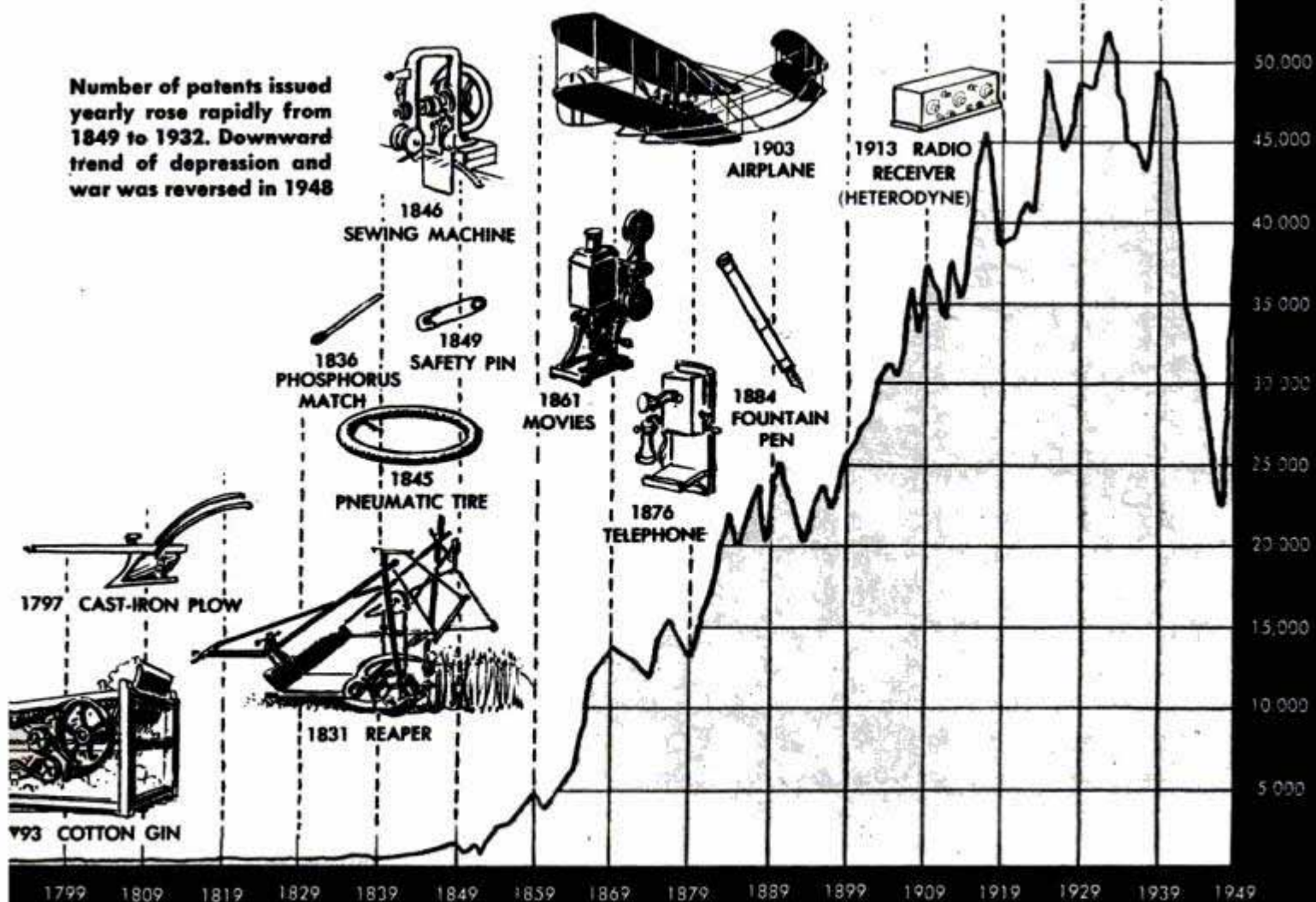



Elton H. Brown, the head of the Search Room for 27 years, is consulted by inventor Ralph Holcombe, right

GET RICH, SOME DON'T

By Alfred Eris

Patent agents and inventors study pages and pages of words and drawings in the Patent Office Search Room

patents on spark plugs. If you want to look over the 1000 patents on can openers, you look for them under Class 30—Cutlery, Subclassification 3, where you'll find openers of the sweep-cutter type, shear, right and left-hand types, fulcrum-type side cutters and many others.

Gasoline-saving devices are favorites with inventors even though there are several hundred patents in this category already. Most involve putting water into the carburetor, and come under Class 123—Internal Combustion Engines, Subclassification 25—Water and Hydrocarbon. You must also check under 261—Gas and Liquid Contact Apparatus, Sub 126, for all sorts of carburetors, aerated nozzles, carbonizers and such devices.

If this sounds bewildering, you can understand why patent officials counsel inventors to hire patent agents or attorneys. Washington patent agents and attorneys usually fill most of the hundreds of seats in the Search Room each day. They work for free-lance inventors, for research departments of large firms, for small manufacturers and for patent lawyers all over the





Above, in the filing room each of 2,500,000 patents is indexed by classification and subclassification and can be located quickly by an expert. Below, government draftsmen who make drawings for inventors

country. All day long, harassed-looking patent agents and inventors trudge over to Brown's desk and ask for help in finding the right classification.

"I've got a new baby leash, Brownie," says one lawyer, "and—." Before he can finish the sentence, Brown answers "Fire Escapes — 227, Body Harness Sub — 49." That's all the lawyer needs to start his search.

Inventors new to the Search Room are bewildered by this business, but the old-time patent agents accept such pronouncements as just another sign of Brown's phenomenal memory for classifications. He has to know, for example, that Yo-Yos are tethered aerial tops, shoe trees are formers, safety pins are resilient pin fasteners. Ball-point pens are brushing and scrubbing instruments (they were originally developed for marking wet laundry). Playpens are fences, panel, inclosure! The most confusing of all are ice crushers, which you find under reciprocating, cooperating, comminuting surfaces!

Inventors come in all shapes and sizes and, the Patent Office will reluctantly confess, in all temperaments, too. Brown is regularly accused of theft by suspicious inventors, who regard the entire adult population of the country with cautious eyes. "An inventor will sidle over and guardedly inquire about certain classifications," one official stated. "To help him, you ask what his invention is and he throws up his hands in horror! 'Oh, I couldn't tell

(Continued to page 248)



Propellers Tested In Buried "Spin Pit"

Propellers will be tested at supersonic speeds in an underground "spin pit" at Dayton, Ohio. First of its kind, it is a steel cylinder approximately 13 feet in diameter and 8 feet high, sunk below ground and sealed to a concrete base. It was built by the Aeroproducts Division of General Motors. The propeller will whirl horizontally on a shaft extending vertically through the cylinder's dome to a right-angle gearbox. In turn, the gearbox is driven by a shaft extending to the engine, which has a propeller mounted on it to act as engine load, cooling fan and governor. Ninety-nine percent of the air will be pumped from the test chamber so that relatively low horsepower engines will be able to rotate experimental propellers at extremely high speeds.

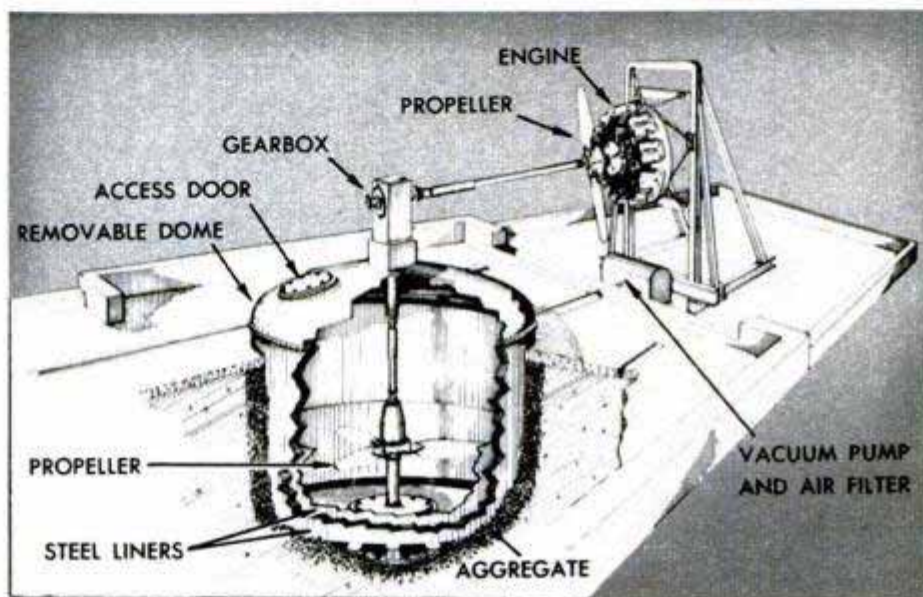
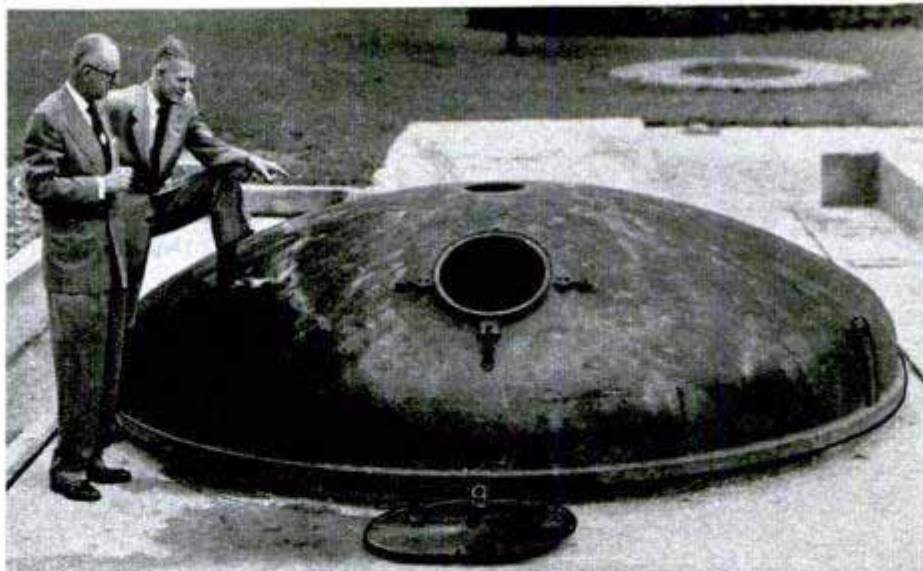

Plastic Filler Makes Wood Boats Leakproof

Sandwiched between the inner and outer planking of a new line of boats is a plastic core which prevents the craft from leaking no matter how dry the wood is. The core will not rot nor cause rot in the wood to which it is applied. No calking or puttying

is required to keep water from penetrating the hull, according to Penn Yan Boats, Inc., Hammondsport, N.Y. Unless pierced by something sharp, the plastic core will stay watertight even if the planking is stove in by an accident.

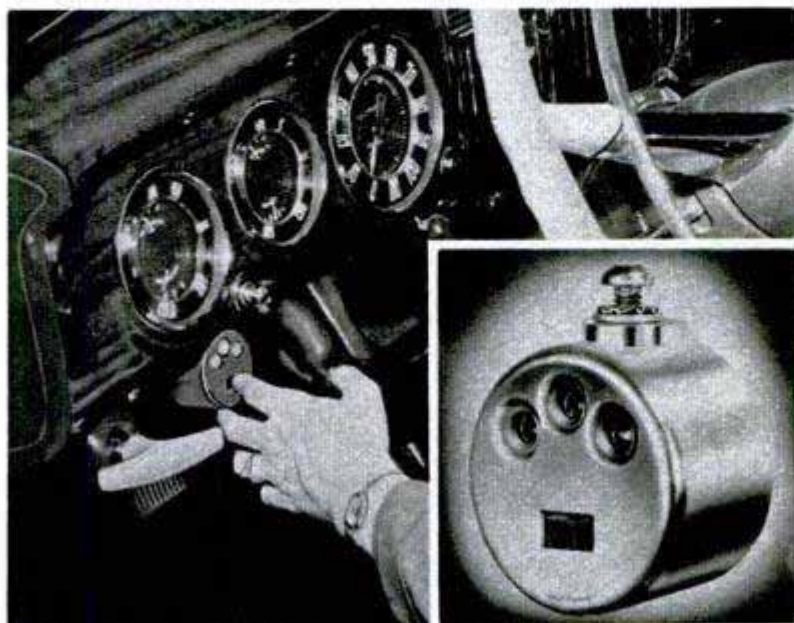

Myriatron Corp., Pontiac, Mich.

Battery Checker On Dashboard

Providing a continuous check on battery condition, a dash-mounted indicator shows water level, strength of charge and condition of each cell. By watching three lights, one for each cell, the motorist can tell the condition of his battery at all times. Installation is simple and the instrument draws less current than a clock.

☞ Average age of passenger cars on the road is 8.5 years compared with 5.5 years in 1941, according to a recent survey by the Automobile Manufacturers Association.

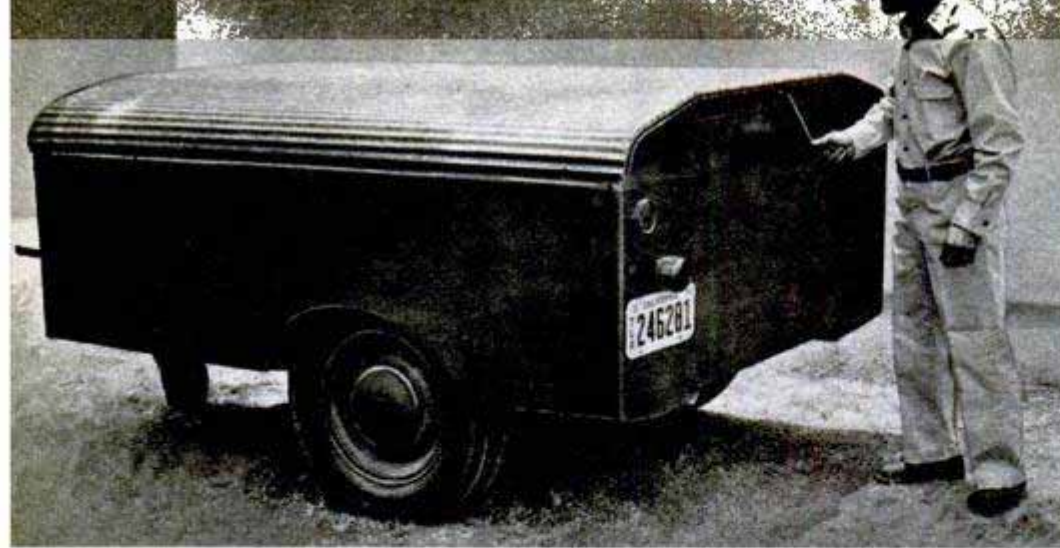

Before Sandage gives the crank a few turns, the trailer looks like an ordinary two-wheeler. The top is corrugated aluminum and the frame is made of angle iron, covered with a light-gauge sheet steel

**Photos from
Jack B. Kemmerer**

CAMP KITCHEN on Two Wheels



A TWO-WHEEL trailer that becomes a covered cook shack in a few minutes has been built by Ned Sandage of Los Angeles, Calif. In addition to a complete kitchen, it includes a folding steel table and a steel floor for the tent.

Sandage, his wife and five-year-old daughter are ardent outdoor enthusiasts and take every opportunity to go hunting and fishing. One of their biggest headaches was carrying and setting up an efficient kitchen. The trailer looks like an ordinary one, with a solid top, until Sandage turns a crank. Operating a sprocket and chain-drive system, it raises the top of the trailer to a height of six feet.

The trailer tail gate is removable and is quickly transformed into a sturdy table by unfolding legs attached to the inner side. Surplus air-

When top is lifted to six feet, above, both the tail gate and center of the floor are removed

Unfolding four legs hinged to tail gate's inner side quickly converts it into a dining table

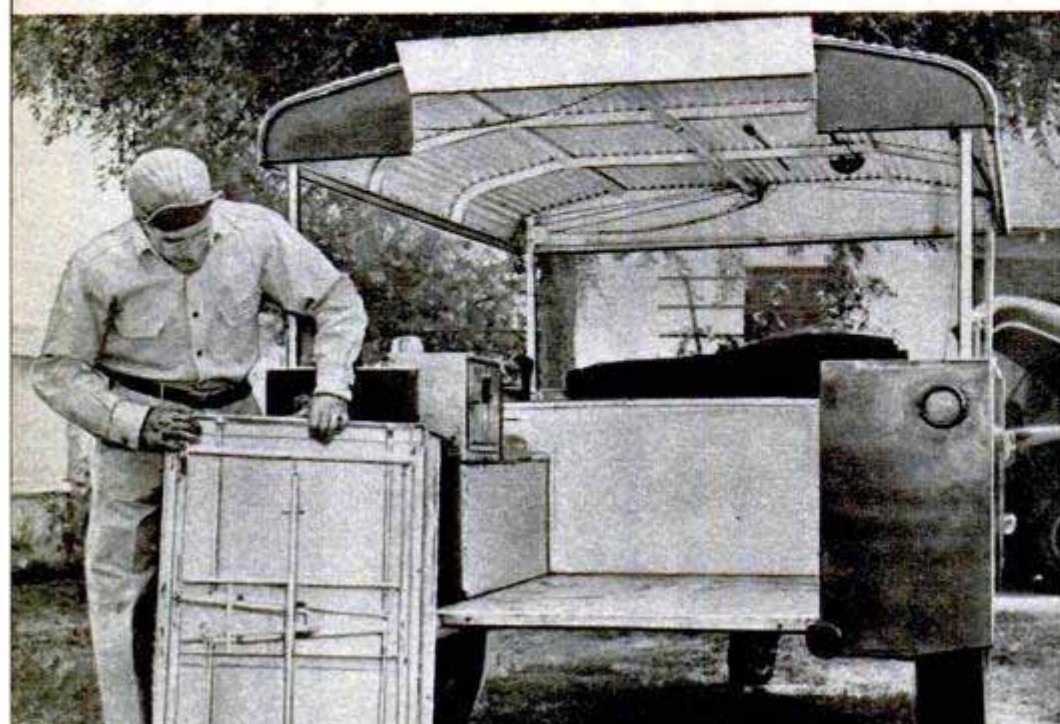



With the trailer floor out there is plenty of room in the cook shack for an adult. Mounting the wheels on aircraft suspension units does away with need for an axle

craft suspension units were used to hang the wheels, making them independent of each other and eliminating the need for an axle. The center section of the trailer floor can be removed to provide a floor between the two cots in the tent. In transit, the space beneath the trailer floor is used for storing the cots, the tent and extra luggage. With the center section removed, an adult can walk upright in the trailer, which has a complete camping kitchen, a stove, oven, icebox and built-in cupboards. Special racks hold three five-gallon cans for fuel and water. A tent hooks on one side of the trailer and the open ends and opposite side

have canvas covers in case of bad weather. The body frame is made of angle iron, covered with light-gauge sheet steel, and the top is corrugated aluminum. Weighing 800 pounds empty, the trailer is 5 feet wide, 7 feet long and 52 inches high when the top is lowered. An airplane tail wheel on the front keeps the trailer on even keel and makes it easier to move when unhitched from the car. It is small and light enough to be taken into areas where a standard large trailer would have to be left behind. By purchasing all the materials, except tires, from surplus stores, Sandage was able to keep the total cost to \$125.

Close-up, below, of the wheel-suspension system. Right, camping outfit is completed by hooking a tent to one side of trailer. The open ends and opposite side of trailer are fitted with canvas covers





Lightning-Proof Boat

Boatowners can protect their craft from lightning with one or two short pieces of aluminum tubing and a few feet of copper wire, according to J. M. Wallace, Westinghouse engineer. Wallace experimented in a high-voltage laboratory to discover how much protection was needed for his own 32-foot pleasure boat. He built a three-foot model of the craft and hit it with 3,000,000-

volt man-made thunderbolts. Unprotected, the craft caught fire. When he added aluminum tubing to the mast and stern light, and connected these lightning rods by copper wire to the propeller shaft, the lightning was harmlessly grounded. Wallace points out to boatowners that a lightning rod provides a cone of protection with a base diameter equal to its height. This rule can be used to figure the number of rods required to protect a boat of any size.

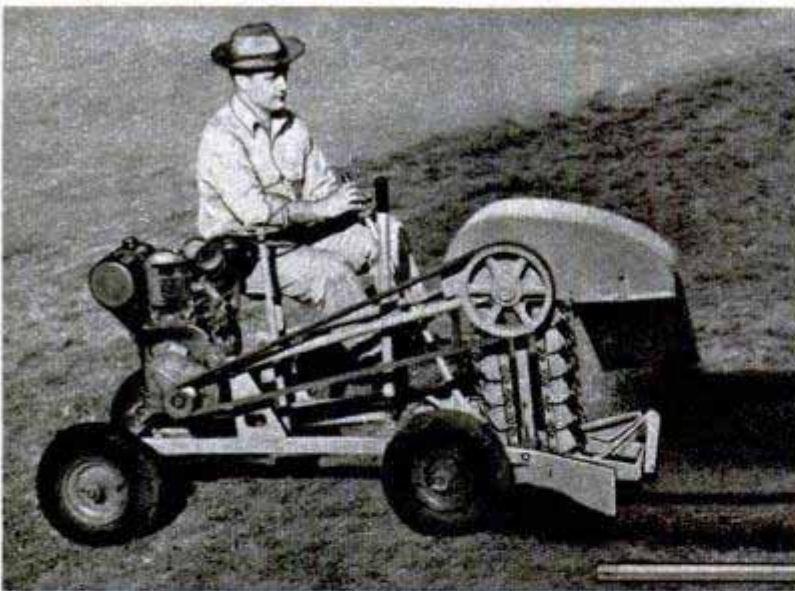

Charlie's Machine Works, 625 Birch St., Perry, Okla.

Compact Ditch Digger Weighs Only 550 Pounds

Weighing only 550 pounds, a compact ditching machine digs trenches 4½ inches wide and 30 inches deep on a single pass. Wider ditches can be dug with multiple cuts. Powered by a six-horsepower gasoline engine, it does the work of five men and it will operate within a foot of fences and buildings. Its steel buckets are self-cleaning and empty into a chute which deposits the spoil on either side of the trench. The digging mechanism is raised and lowered hydraulically.

Three-Decker Paint "Sandwich" Resists Worst Weather

Use of a three-decker paint "sandwich" wards off Nature's toughest blows including sub-zero cold, desert heat and salt spray. Developed by Westinghouse to protect outdoor transformers, it consists of a special primer base coat, followed by a layer of mica flakes embedded in a syruplike plastic. The flakes resist attacks of moisture and oxygen, principal causes of rust, and

increase the middle coat's heat resistance as much as 10 times. A finishing coat shuts out ultraviolet light from the sun's rays. The triple coating withstood 10,000 hours of continuous salt-water spray exposure before showing any signs of deterioration. Ordinary finishes were 50 percent gone after only 2000 hours of continuous exposure under the same spray.

the

POPULAR
MECHANICS

CRAFTSMAN

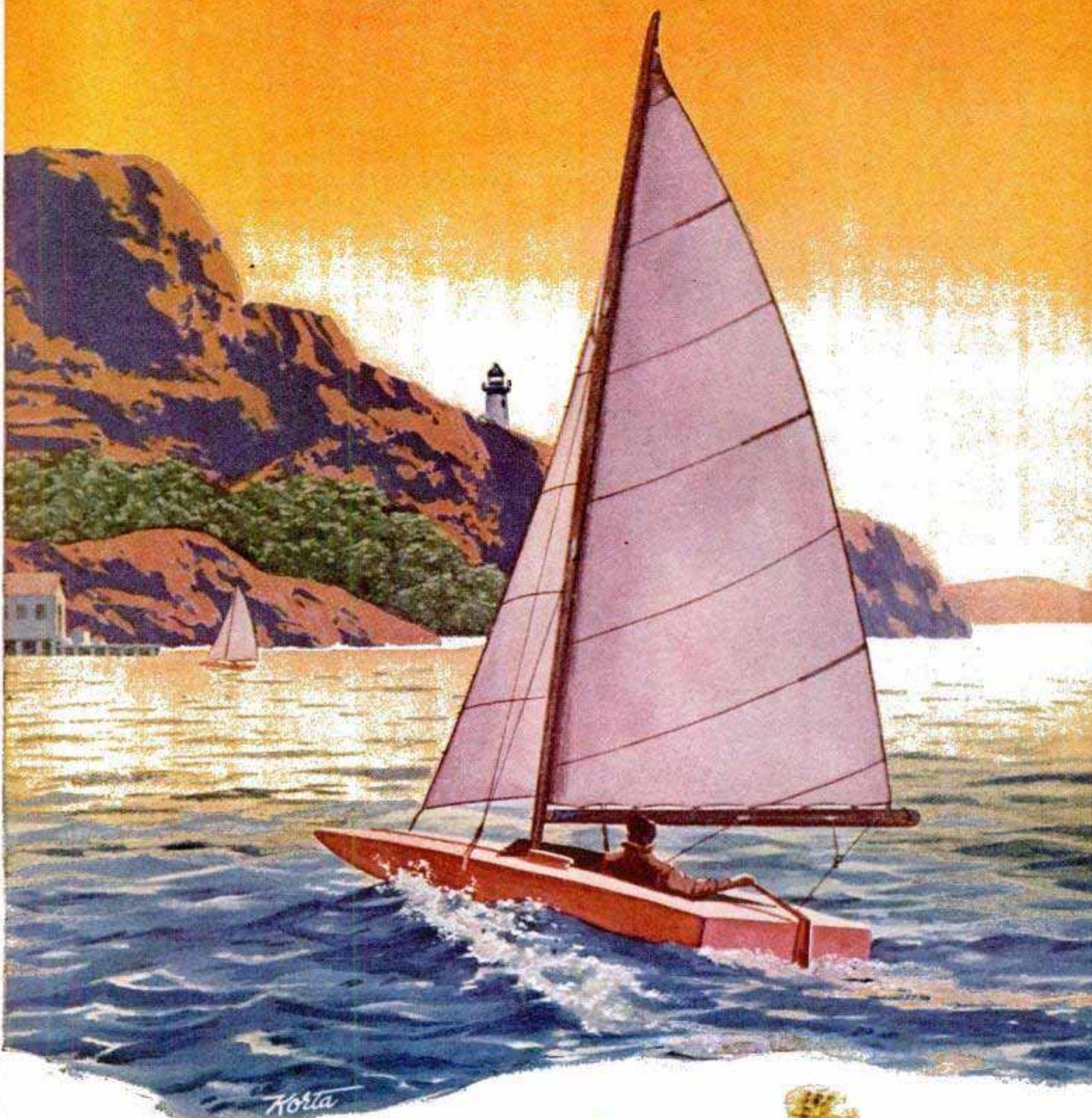

Yours to enjoy when the lake breezes blow, this trim 16-ft. sailing scow is a simple plywood boat which you can build in your garage. Get an early start by beginning now. For construction details turn to page 194

Announcing the new "'51 Kidster"—sleek sidewalk runabout for car-minded youngsters. Plans on page 190 show you how to build it





CANDY DISH

TRY YOUR HAND

EVEN THOUGH your hobby may be woodworking, just take a look at what can be made with metal. We're sure you'll be eager to try your hand at duplicating some of these beautiful and practical items. This fascinating hobby of metalcraft still requires some woodworking tools, such as a jigsaw, hand grinder and vibrating tool. To get you started, patterns and details for both etched and pierced work are given for some of the projects shown but you'll soon be working up your own ideas and designs.

Etched tray: An important step in duplicating the etched aluminum fruit tray pictured below is to see that the metal is thoroughly clean after it is cut to shape. There are several cleaning agents that can be used, depending on the finish desired. Fine

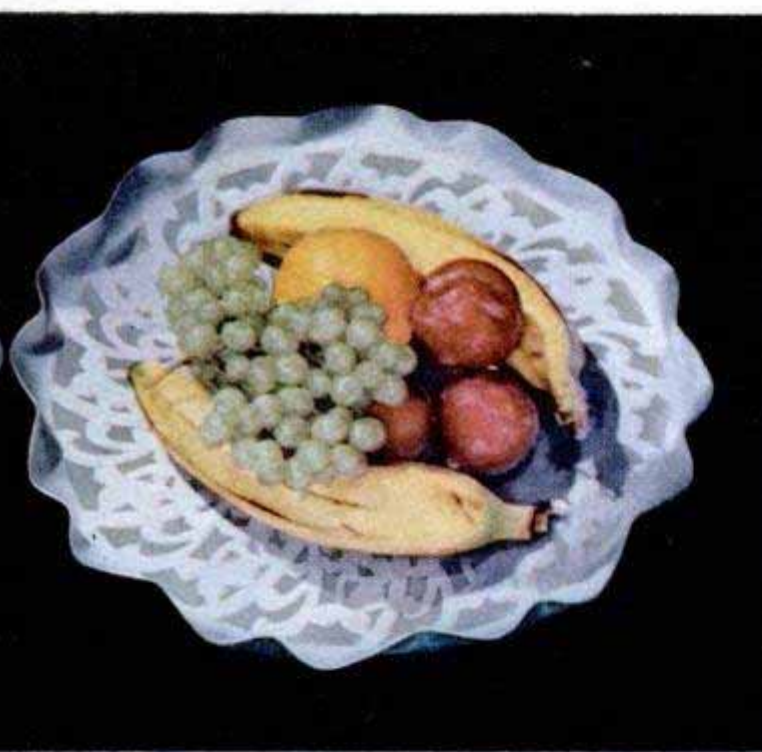

ETCHED FRUIT TRAY



SERVING TRAY



PHOTO ALBUM

By Clifford B. Hicks

YOU'RE in for a look even before you open the cover of this unusual photo album, for what you see through the windows is actually the title page. Tempered hardboard is used for the front and back covers, the outer surfaces of both being padded and covered with the new quilted plastic material. Details show how the front cover is first hinged, drilled for ledger bolts and the windows jigsawed. Acetate is cemented over the windows and a filler of cardboard is fitted before the inner surface is covered with plain sheet plastic. Corners of the covers are protected with metal, crimped as shown

AT METAL WORK

steel wool gives a shiny finish, while caustic soda produces a pleasing satin finish, but you can even use common scouring powder. A wire scratch brush, provided it is very fine, also can be used to clean the metal, the important thing being that you avoid touching the surface after it is clean.

Next in importance is the type of asphalt paint that is used to block out the design. Ready-mixed screen paint can be used but better results can be expected if you mix your own. Screen paint has a tendency to dry hard and chips easily in scraping off any overruns. Also, as the paint is brittle, the heat set up by the etching acid is apt to cause it to peel off the metal. A good homemade asphalt paint consists of powdered asphalt, 1 part, wax, 1 part, turpentine, 1

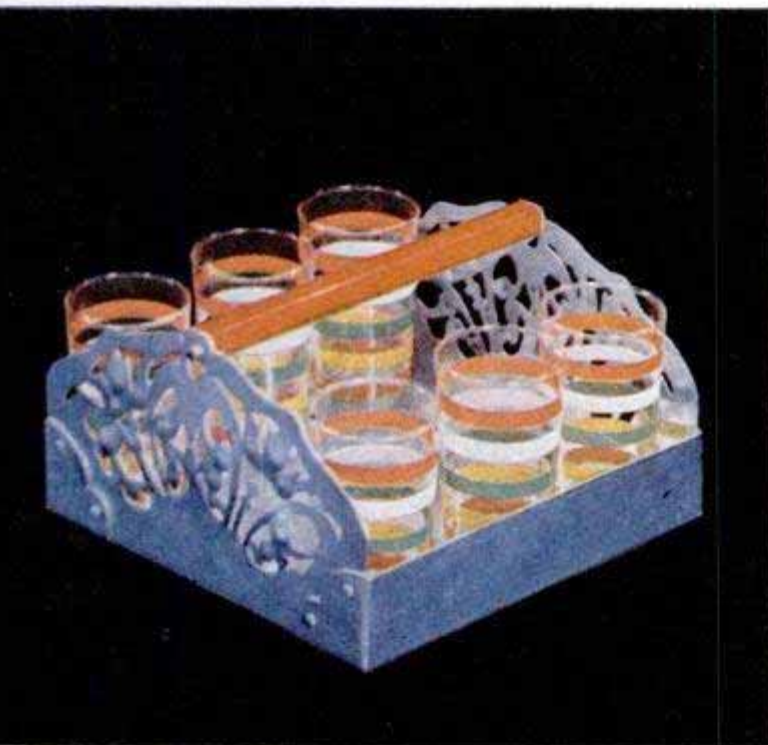

BEVERAGE TRAY

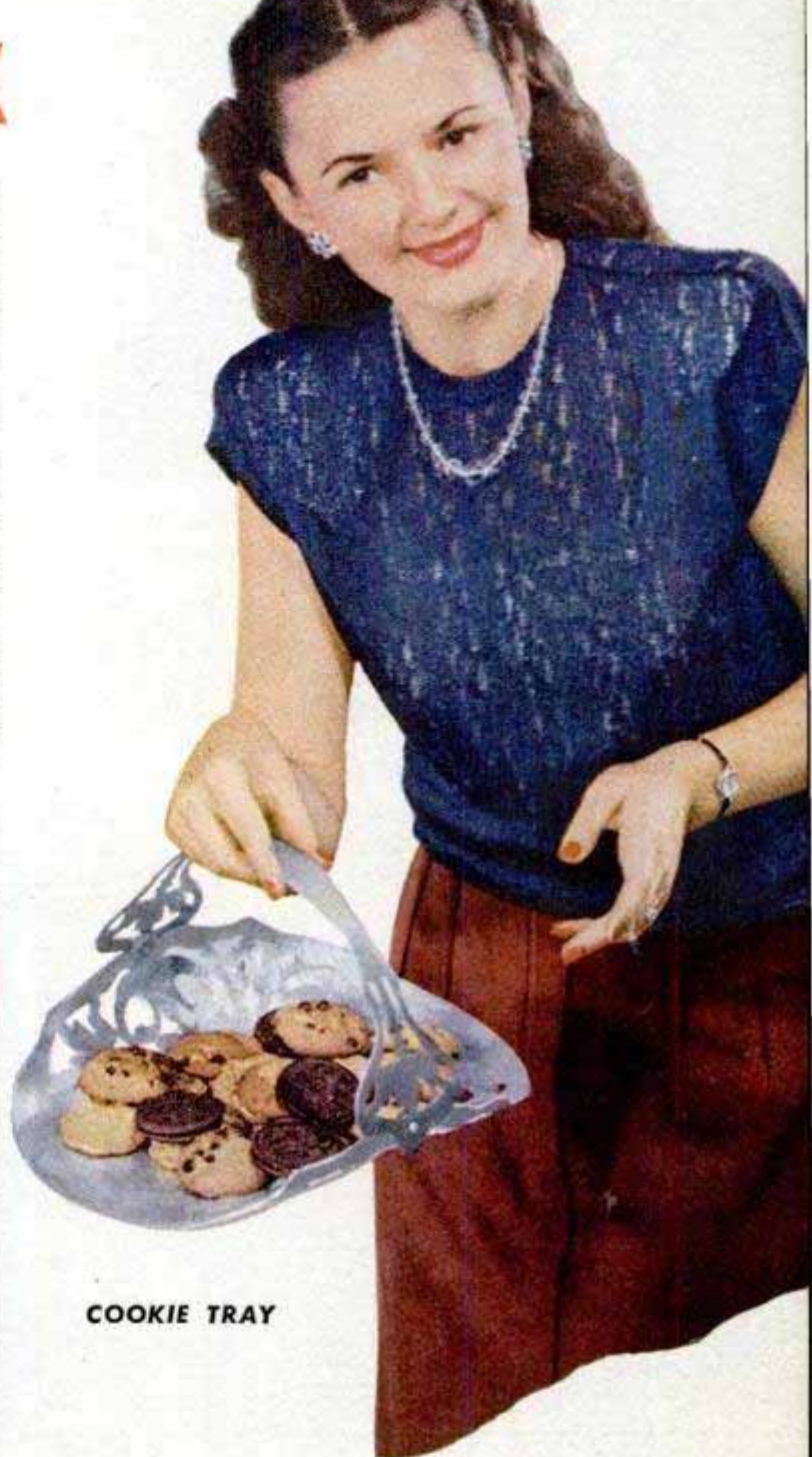

COOKIE TRAY

PM color photos by Paul T. Hutchinson

By Albert P. Belanger

in PLASTIC

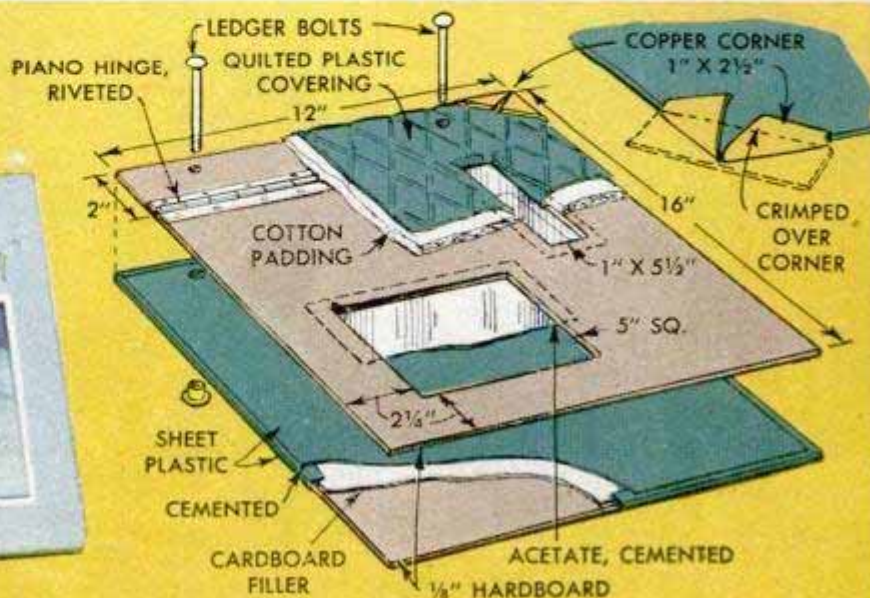



Scalloped brass plate shows how "etching" can be done with vibrating tool. Embossed flower in copper plate is raised by dishing background. Same pattern is used in aluminum plate as brass one, except it is jigsawed

part, and varnish, $\frac{1}{10}$ part. Heat the wax to the boiling point. Then add the powdered asphalt and stir. While stirring, add the turpentine and varnish. When mixed well, set aside to cool. Store the paint in a tight container until ready to use. If you find it too thick, a little turpentine on your brush will thin it to the proper working consistency. Best work can be done with camel-hair brushes, which come with round, square or pointed tips in many sizes.

Transferring the design: Carbon paper is used to transfer the design to the metal. A full-size segment of the complete tray pattern is given on page 170. This, as well as patterns for all the other projects, can be purchased completely drawn if you do not care to make your own. Ordinary typewriter carbon paper is not recommended, as it prevents the paint from adhering and does not permit a fine-line impression. For this reason, it is imperative that you use

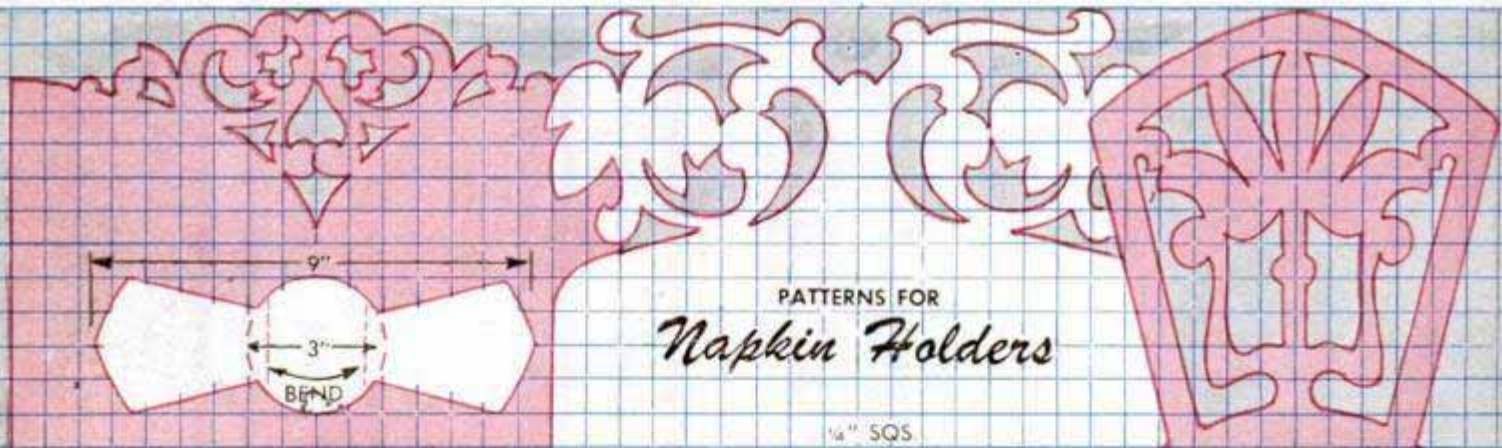

These half patterns for napkin holders are enlarged on paper ruled in an equal number of $\frac{1}{4}$ -in. squares



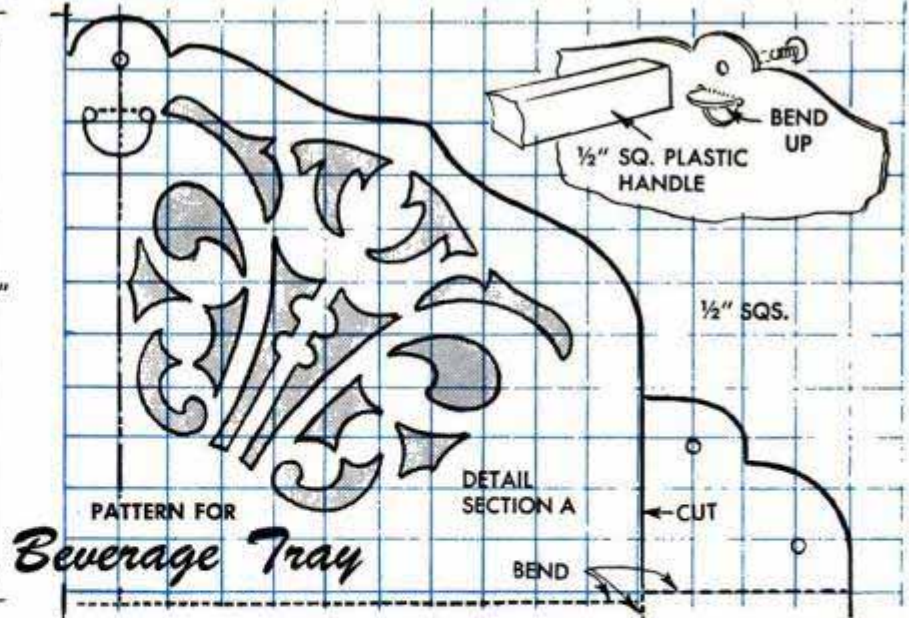
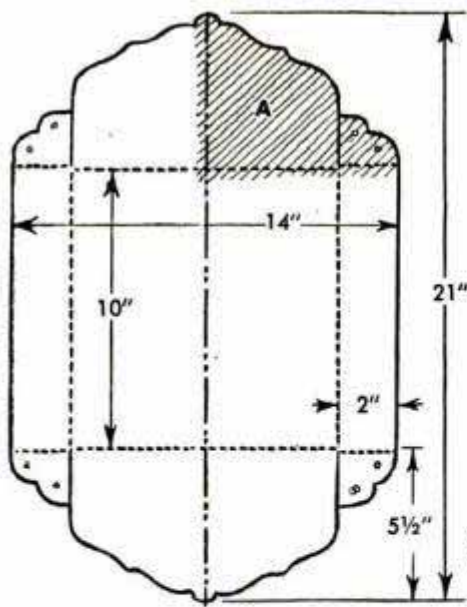

the type of paper used by china painters. In tracing the design, avoid touching the clean metal, as any finger marks will prevent the etching acid from working properly. Pressure from the hand should also be avoided. To keep the hand off the work, make a steady rest like the one shown in the series of etching steps on page 171.

Applying the asphalt paint: The paint should be applied evenly but not too thin, so that the acid will not lift the paint. There are two types of etching—in one the background is etched, in the other the design is etched. In the case of the fruit tray, the background is etched, which means that the paint is applied to the design. The back of the tray, of course, must also be completely painted. While not pertaining to the particular design of the fruit tray, there are several stunts worth knowing in applying the asphalt paint. Instead of using a brush to make small dots, use the round end of the brush handle, dipping it in paint applied to a piece of glass and bringing it straight down onto the metal. Similarly, a square dot is applied with a square stick. A spatter pattern may be applied by dipping a toothbrush

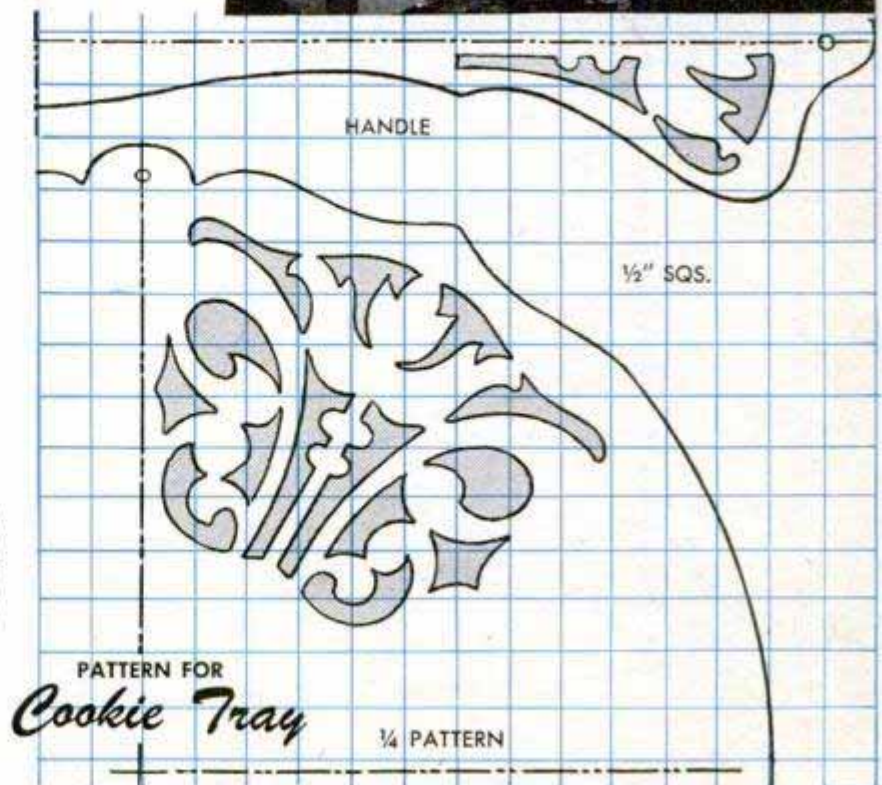

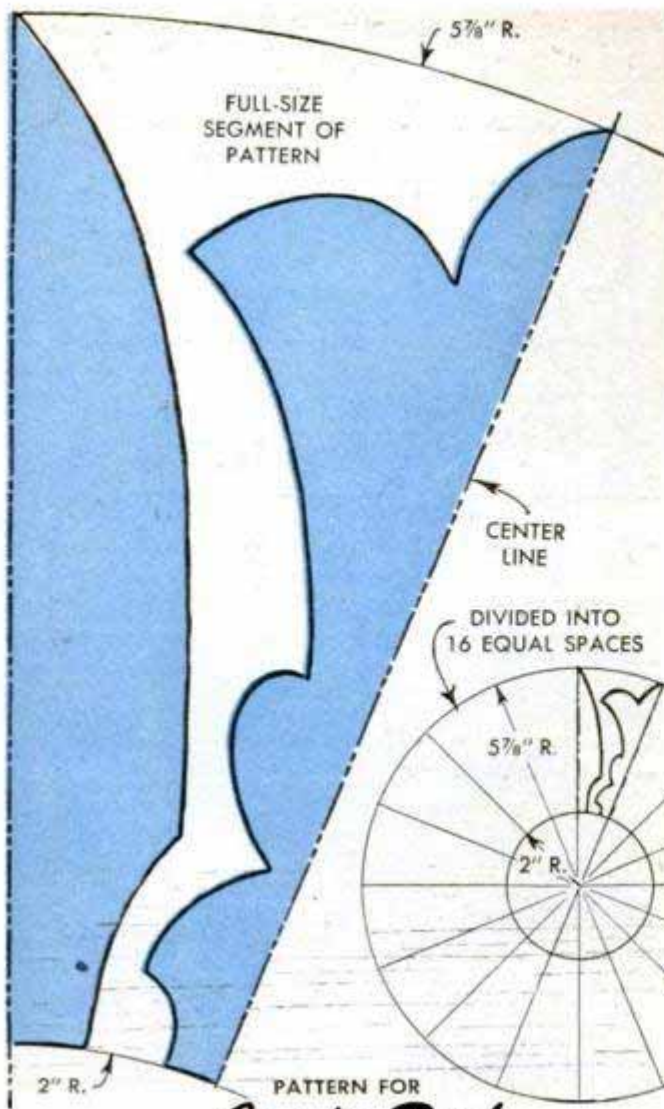

PATTERN FOR
Candy Dish

These segment patterns of the candy dish and etched tray are presented full size, ready for tracing directly from the magazine page. In each case, the complete pattern is made by merely stepping off the segment pattern on a circle divided into the proper number of divisions. Carbon paper is used to transfer the pattern lines

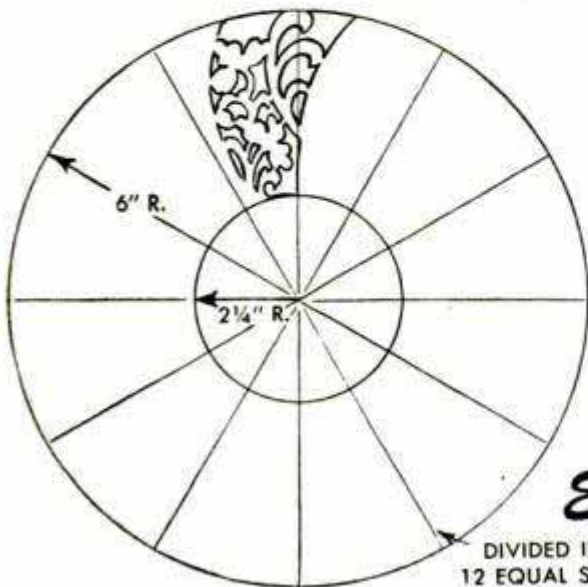

PATTERN FOR
Etched Tray



in asphalt paint and flicking it onto the metal by rubbing a stick over the bristles. Coarse lace, starched and pressed flat and then coated lightly with paint, produces an interesting border pattern when pressed onto the metal.

Etching the metal: Hydrochloric (muriatic) acid is used to etch aluminum. Nitric acid is used to etch brass, while a combination of nitric and sulphuric acid (nitric, 2 parts, sulphuric, 1 part) is used to etch copper. *Caution: as these acids are highly injurious to both skin and clothing, handle them carefully and play safe by wearing rubber gloves.* Hydrochloric acid in its full strength works too fast and overheats the metal to a point of boiling off the paint. Therefore, it must be diluted to the proportions of acid, 1 part, and water, 1/2 part.

Even these proportions may be found to be too strong, and it is well to have water handy to add to the acid to slow it down. Where there are fine details in the design, it is better to etch the metal slowly. If you do not have a glass or hard-rubber tray large enough to hold the metal disk,

you can make a suitable tray of wood and coat it with asphalt paint to make it leak-proof. The design should not be etched too deeply, and the acid should be agitated so that it will work evenly. A large turkey feather is excellent to keep the acid in motion, but avoid touching the work as it will leave marks. When etched to your satisfaction, the acid is poured off and flushed safely down the basement drain. Then the metal is washed in running water for at least 15 minutes.

Cleaning after etching: The asphalt paint is removed from the metal by rubbing with a cloth saturated in turpentine, kerosene or carbon tetrachloride. The metal can be left as is or polished with fine steel wool or pumice stone, depending on the finish desired. Completing the tray by crimping the edges is done with a wooden tool which is merely placed over the edge of the metal and pulled upward.

Jigsawing metal: Patterns are given for the napkin holders, candy dish, beverage tray and cookie tray, all of which are jigsawed from aluminum. The same blades are used as in cutting wood, although the secret of attaining a smooth cut is to keep the blade oiled and be sure not to force it. Paraffin oil has been found to be the best lubricant for sawing aluminum but any light machine oil is recommended for metals in general. The design can be drawn on paper and cemented directly to the metal with rubber cement or it can be transferred, as before, with carbon paper. If a vibrating-type tool fitted with a small ball-point tip is available, go over the lines on the metal with the tool. This overcomes the possibility of rubbing off the lines when sawing and makes the lines easier to follow. If the metal is of light gauge, a piece of cardboard cemented to the underside of the metal will help considerably in preventing burrs from catching on the edge of the saw table. Waxing the underside of the cardboard aids in controlling the saw cut.

As detailed, the cookie tray is sawed from a 12-in. disk and is given a hammered finish with a ball-peen hammer. Two opposite edges are bent upward for a distance of about 2 in. and the tray handle is fastened to the upturned edges with $\frac{1}{8}$ -in. aluminum rivets. In the case of the beverage tray, the jigsawed fretwork on the ends is embossed after being cut. This is done by placing the cutout ends on a rubber kneeling pad or a piece of thick felt and hammering the design outward. Use a round-nose punch, which can be improvised by using a hinge pin. The corners of the tray are held with small rivets.

The pattern for the candy dish is laid out complete by dividing a circle into 16 equal

Etching Steps

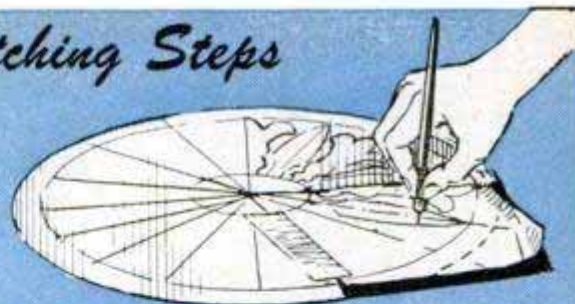

1st APPLY THE DESIGN WITH CARBON PAPER

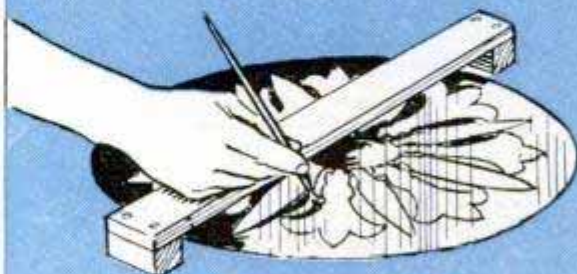

2nd BLOCK OUT DESIGN WITH ASPHALT PAINT

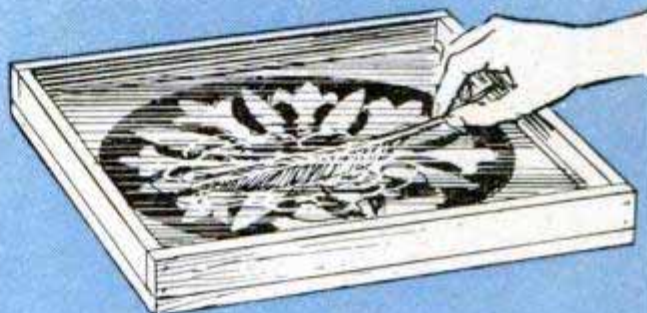

3rd AGITATE ACID WITH A TURKEY FEATHER

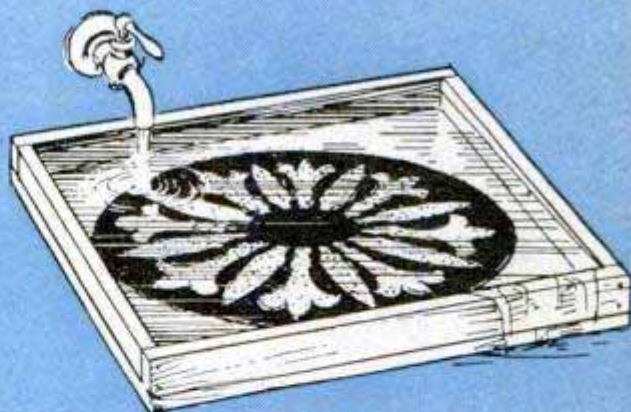

4th RINSE ETCHED PLATE IN RUNNING WATER



5th REMOVE THE ASPHALT WITH TURPENTINE

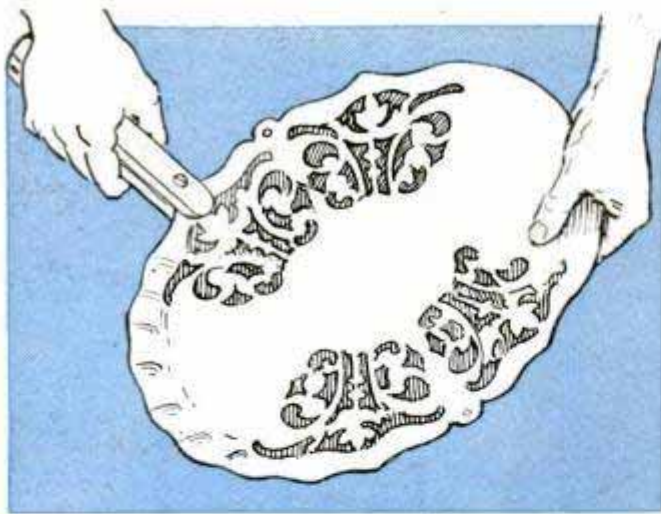

Crimping Tray

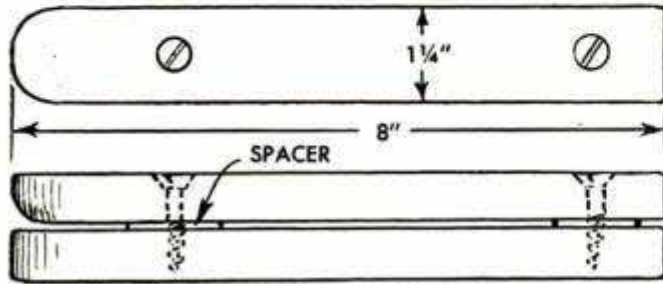

WOODEN CRIMPING TOOL

divisions, as indicated, and then tracing the full-size segment pattern 16 times on the circle pattern. Then the metal is cut, and the leaves of the design are "tooled" on the inner surfaces with a ball-peen hammer to emboss or raise the metal on the outside. Finally the leaves are bent upward, leaving a 2-in. radius at the center of the disk to serve as the bottom of the bowl. Overlapping edges of the leaves are riveted to-

gether and the points are curled downward as shown in the color photo.

Decorative ceramic tiles can be combined with copper or other metals to produce many attractive and useful items, such as the wall plaque shown in the color photo at the bottom of page 168. The tiles, which may be purchased at most large department stores, come in a variety of designs and sizes and range from inexpensive domestic tiles to the more costly Italian, Mexican, Dutch and other imported varieties. If preferred, plain glazed tile can be used and decorated with ceramic-type paints sold at most dime stores. The over-all dimensions of the plaque depend on the size of the tile and the width of the border desired. The plaque pictured was made by framing a 6-in. tile with a sheet of copper 10 in. square. Brass or aluminum also can be used, 20-ga. being about right. The recess for the tile should equal its thickness, and one way of forming the recess is to cut a square block of wood about $\frac{1}{16}$ in. larger all around than the tile. Then, after the corners of the sheet metal are mitered to leave a tab for soldering, the block is clamped in position and the metal is bent up around it. When three sides have been formed, the clamp is removed to permit bending the other. The sides are flared outward to the point where the corners meet neatly and then the tabs are bent over on the back and soldered. The tile is held in the recess with a white mortar which is allowed to ooze up around the four sides. As in the original plaque, the mortar also can be run up the mitered corners of the metal to emphasize the flare of the sides.

Pendulum Controls Model-Airplane Elevators to Avoid Steep Dives

After watching my 6-ft. model airplane suddenly nose over into a steep dive and crash on several occasions, I hit upon an idea of using a pendulum to stabilize the plane. The pendulum is linked to the elevators and swings forward whenever the nose of the plane drops, thus pulling the elevators upward and raising the nose of the plane. This, in turn, causes the pendulum to return to a vertical position with relation to the fuselage and allows the elevators to lower to a neutral position. Note in the detail that the pendulum is suspended from the top of the fuselage just to the rear of the nose. It is made by attaching a 2-oz. fishing sinker to a length of wire and pivoting the wire to the top of the fuselage with a staple. L-shaped wire brackets are cemented to the top surfaces of the elevators and these are linked to the pendulum with lengths of string or fine wire passed through holes in the fuselage.

Herbert E. Fey, New Braunfels, Tex.

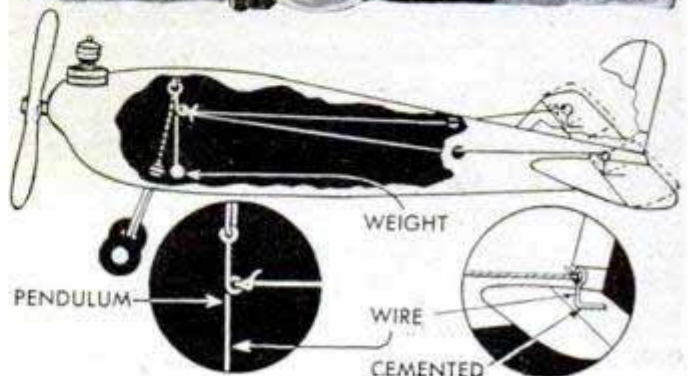
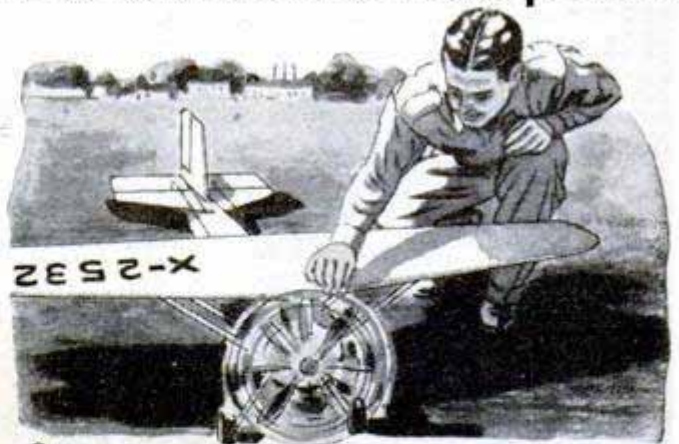

Functional END TABLE

By Roland Cueva

NO POWER TOOLS required—that's the story on this striking modern end table. Assembled from standard widths of 2-in. pine, the table features an offset side as well as a straight side, so that it fits snugly against a sofa or easy chair having either straight, slanted or flared arms. The top of the table is cut to length from a 2 x 12 while the bottom is made from a 2 x 15. If the 15-in. stock is not available, two lengths of narrower stock can be doweled and edge-glued together to attain the desired width. The slanting uprights, the outer ones of 2 x 4 and the inner ones of 2 x 8-in. stock, are all cut at an 80-deg. angle. The uprights are assembled with finishing nails or countersunk screws driven through the inner faces of the 2 x 8s and through the underside of the bottom. The base of the table is made in picture-frame fashion with miter joints at the corners that are reinforced with plywood splines. The table top is mounted on two cleats which are fastened to the uprights. All joints are glued, and visible nail or screw holes are filled with wood putty or plugged.



This modern end table fits neatly against either a straight or slanted chair arm. The table is made of pine and finished in the natural color with clear shellac and wax, or it can be lacquered as desired.

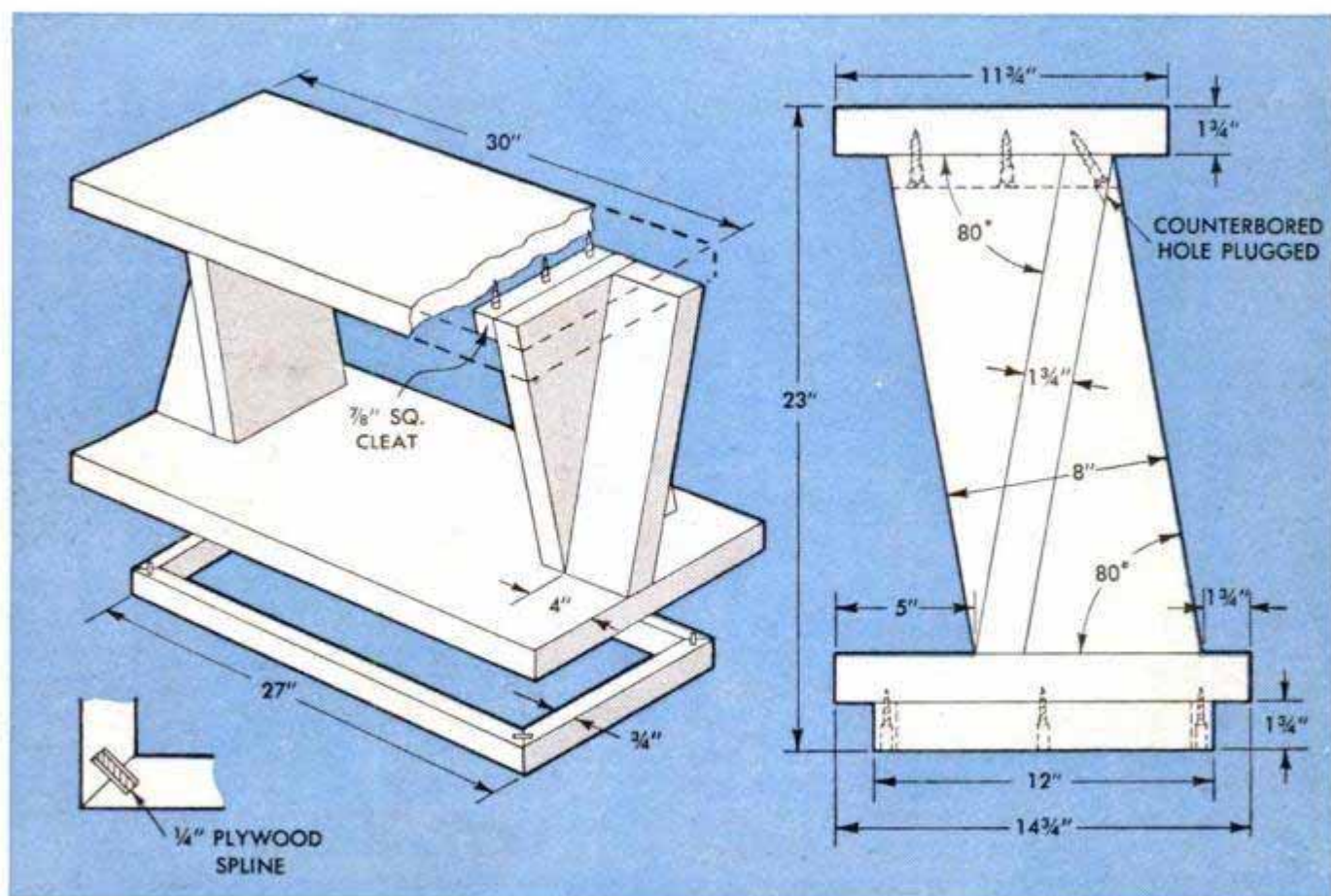

Attractive Youth Bed for Growing Child Built Sturdily to Withstand Rough Use

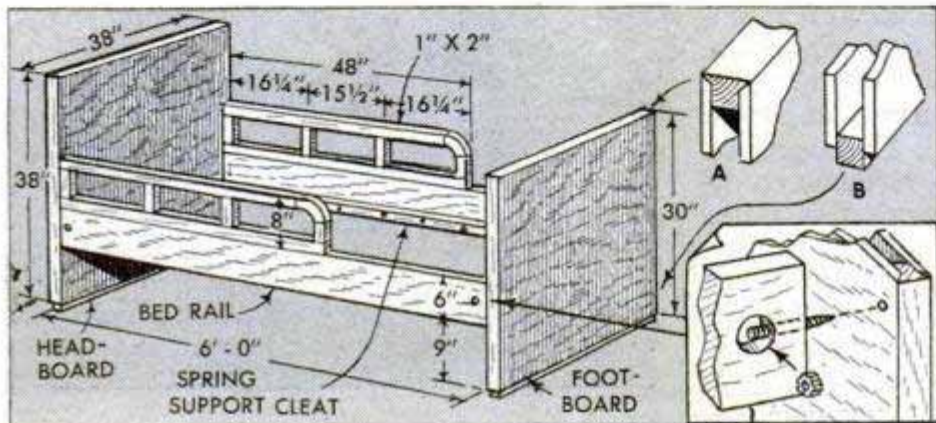
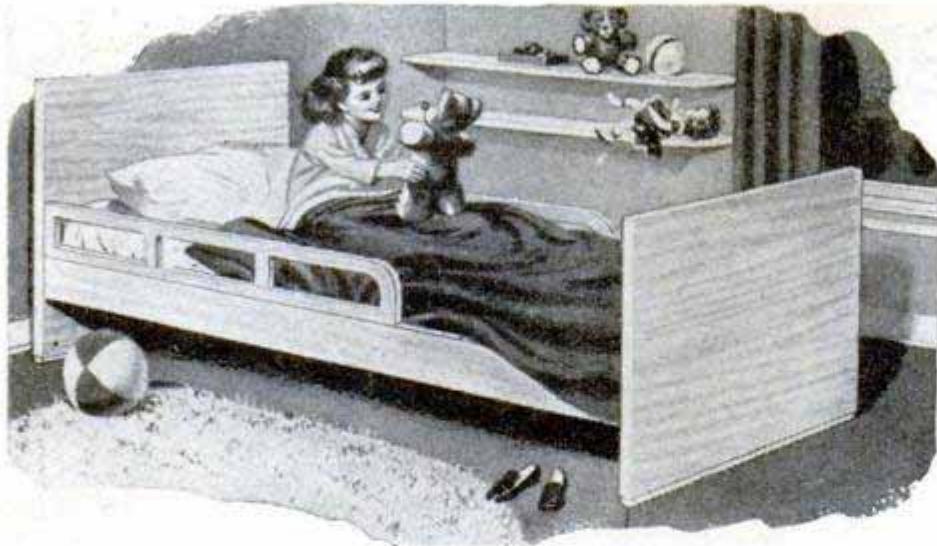

Designed to take a standard spring and mattress, this inexpensive, ruggedly built bed will give your youngster sleeping comfort well into his teens. Both the headboard and footboard are made by covering wooden frames with $\frac{1}{4}$ -in. plywood. Note in detail A how the top and side frame members are miter-rabbeted to conceal the end grain of the plywood. Miter joints are used at the corners. Detail B shows how the bottom frame member projects to form a base. The 1 x 6-in. bed rails are attached to the head and foot boards with hanger bolts, as in the lower right-hand detail. The guard rails are made up in sections of 1 x 2-in. stock, doweled and glued together. Each guard rail is screwed to the bed rail and headboard for easy removal.—Wallace W. Buffmire, Evanston, Ill.

Water-Color Pellets Mark Trail on Unfamiliar Waterway

Splattering shore-line rock formations with bright-yellow water color is a stunt used by one fisherman to aid in finding his camp without difficulty when venturing out on unfamiliar waters. This is particularly helpful when fishing lakes which are dotted with islands and have their shores broken with numerous small inlets, thus providing few natural check points and tending to confuse the newcomer. Several glass pill vials are filled with the paint and tightly corked, the number of vials being estimated by the distance to be traveled. Then, as the boat passes an island or rounds a point, one of the vials is thrown at a prominent rock on the shore. Although the vials can be thrown by hand, a sling-shot will fire them with sufficient force to insure breakage and, after a little practice, with surprising accuracy. Water colors are



used instead of oil-base paints because the rain will wash them from the rock, leaving the scenery unmarred.

Sprinkling With DDT Powder Rids House Wall of Wild Bees

Ridding a house of wild bees that have established a honeycomb inside one of the walls can be done by sprinkling a pound of 50-percent DDT powder between the studs. If access to the area between the studs cannot be had at the top of the wall,

it then may be necessary to remove a section of the siding. This should be done well above the point where it is thought the bee colony, or swarm, is located. After you are reasonably sure that the bees are dead, attempt to remove the honeycomb.

Improvised Duplicator for Printing Club Notices

Just the thing to print announcements for the small club where the cost of a duplicating machine is prohibitive, this little duplicator is made at the expense of only a few pennies. The drum is fashioned from a fruit-juice can, both ends of which are left intact. The side is cut along the seam and the ends and sides are cut away as shown in the upper detail and bent along the dotted lines, the sides being formed into U-shaped channels as in the lower detail. The tabs at the ends are folded to provide handles. With a $\frac{1}{16}$ -in. bit, holes are

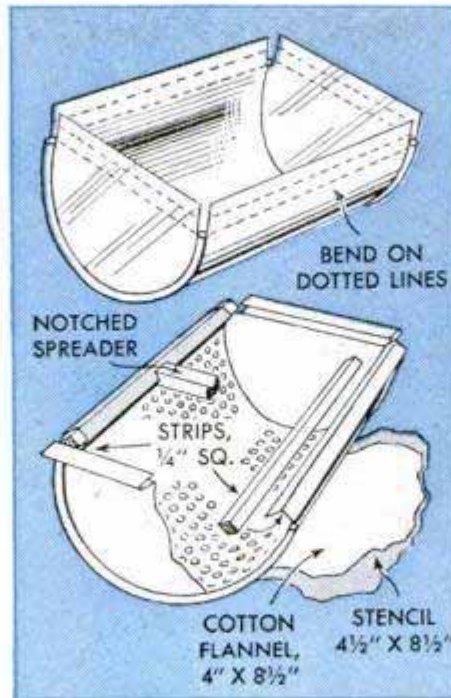

drilled from the inside through the sides of the drum, spacing them $\frac{1}{4}$ in. apart and ending the series of holes about $\frac{5}{8}$ in. from the ends of the drum. After the burrs on the outside of the drum have been filed smooth, a piece of cotton flannel is stretched over the outside and the ends are held in the U-shaped channels with $\frac{1}{4}$ -in.-square wooden strips. The flannel is painted on the outside with duplicator ink until it nearly shines, and the stencil, which has been cut previously, is stretched over the flannel. The wooden strips are removed from the channels, the ends of the stencil inserted and the strips replaced. Then the

parts are locked in place with a small wooden spreader which is notched at each end. To provide a smooth base for printing the paper, use a piece of plywood slightly larger over all than the sheet or card. First, try out the duplicator on scrap paper, printing a few sheets with a rolling motion of the drum. If the impression is too heavy, keep running trial copies until the excess ink is used. If the printing is too light, apply additional ink to the inside of the can so that it will soak through the flannel. It is a good idea to wrap the duplicator in wax paper before storing it for any length of time.—Ted Houk, Seattle, Wash.

Baling Wire Quickly Cuts Sheets of Corrugated Roofing

Having to cut a number of sheets of corrugated metal roofing, I found that a length of baling wire did a faster and easier job of

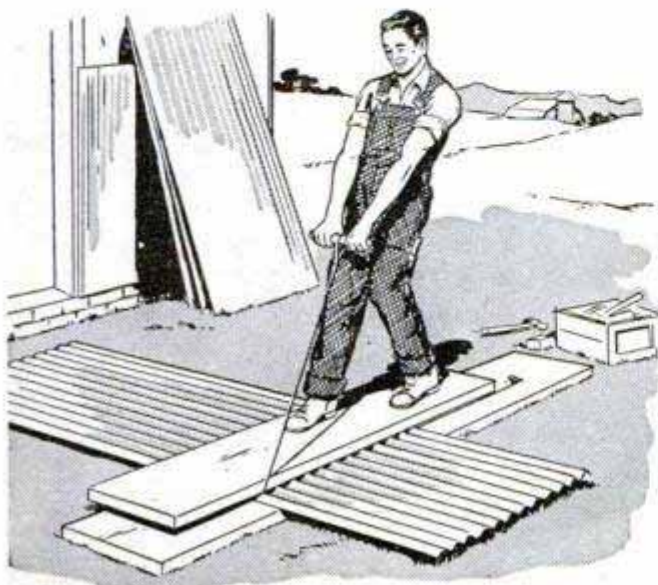

cutting the metal than ordinary tin snips, although the cut edges may not be as smooth. First, one end of the wire is tied securely to a 10d nail driven in a plank and the other end of the wire is fitted with a wooden handle. This can be done by twisting the wire around a short length of 1-in. dowel or broom handle. After the wire is stretched flat, lengthwise along the plank, the roofing is laid over the wire. Then a second plank is placed on top of the roofing with one edge along the cutting line. By standing on the plank while pulling upward and back on the baling wire, I sheared the roofing along the edge of the plank. Keep your weight on the roofing when nearing the end of the cut, pulling the wire almost directly upward at this point. The edge of the roofing should be at least 1 ft. from the nail which anchors the baling wire to the bottom plank.

M. W. Willsey, Vandevort, Ark.



PAPER BAG

CURTAIN STRETCHERS ARE STORED compactly and free from dust by inserting them in a cardboard cylinder of the type used to ship linoleum rugs. Ends of the cylinder are covered with paper bags

LOOSE HANDLE ON HOUSEHOLD BRUSH can be tightened easily by removing it and spreading twisted wire of the brush tang with a punch or large nail. When replaced, the handle will fit snugly over the tang

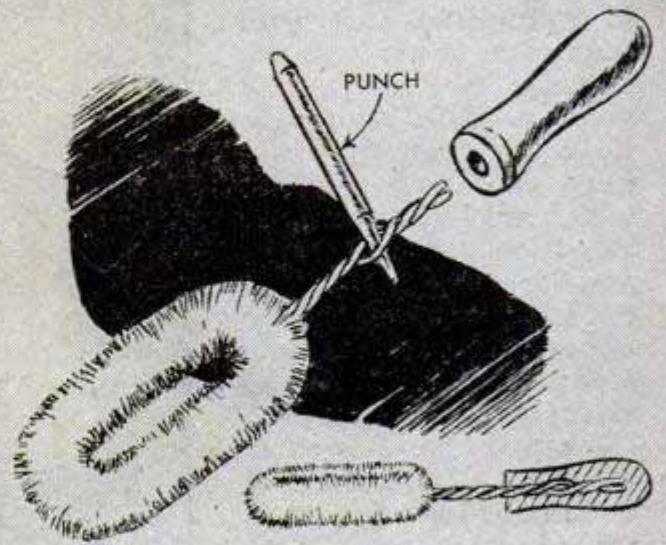

PUNCH

Solving HOME



SCRAP BOARDS NAILED TOGETHER provide long-burning fireplace "logs." With one or two nails, fasten together several pieces of lumber which otherwise would be suitable only for kindling



EMERY CLOTH

OPENING A STUBBORN JAR CAP is done in a jiffy with the aid of an emery-cloth "clamp." Just wrap a strip of emery cloth around the jar cap, grasp end of strip with pliers and twist jar to loosen the cap

DON'T SPOIL A PAINTBRUSH by standing it vertically in turpentine. Instead, select a tin can having a lid and bend it to support the can at an angle, so the brush will lie flat and keep bristles straight

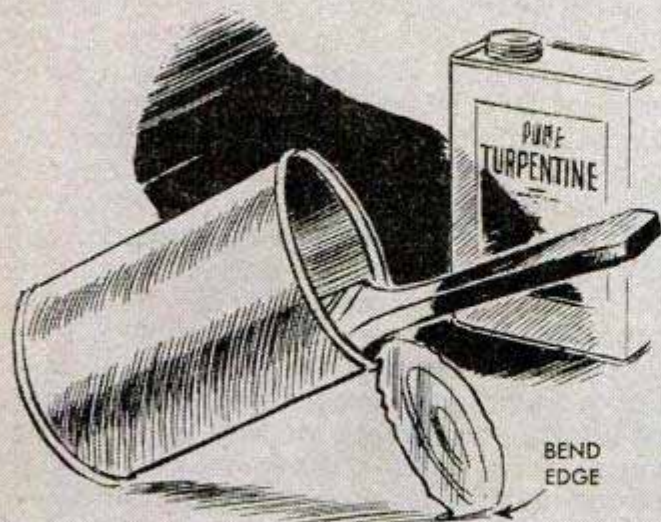

PROBLEMS

CLOSET-SHELF CAPACITY is increased considerably by stringing cord or clothesline between screw eyes driven into walls. Rope shelves are handy for hats, dress boxes and other small items

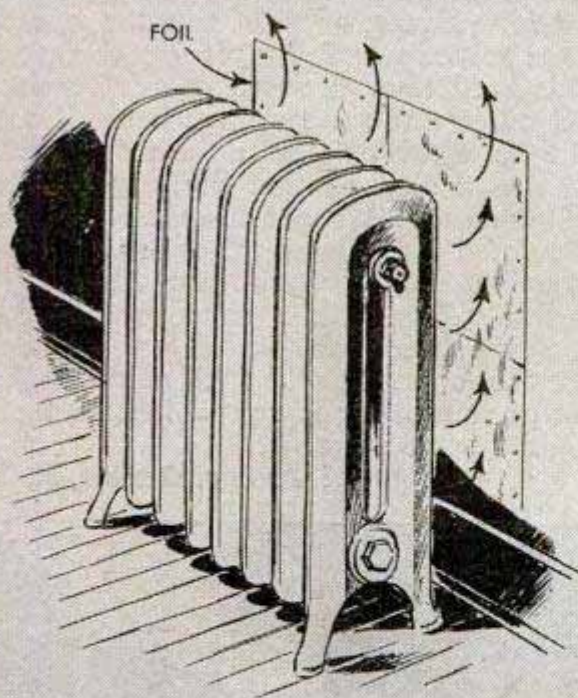

TO REFLECT MORE HEAT FROM RADIATORS, tack or glue aluminum-foil sheets to the walls directly behind them. Heat which normally would be lost through the walls is reflected into the room by the aluminum

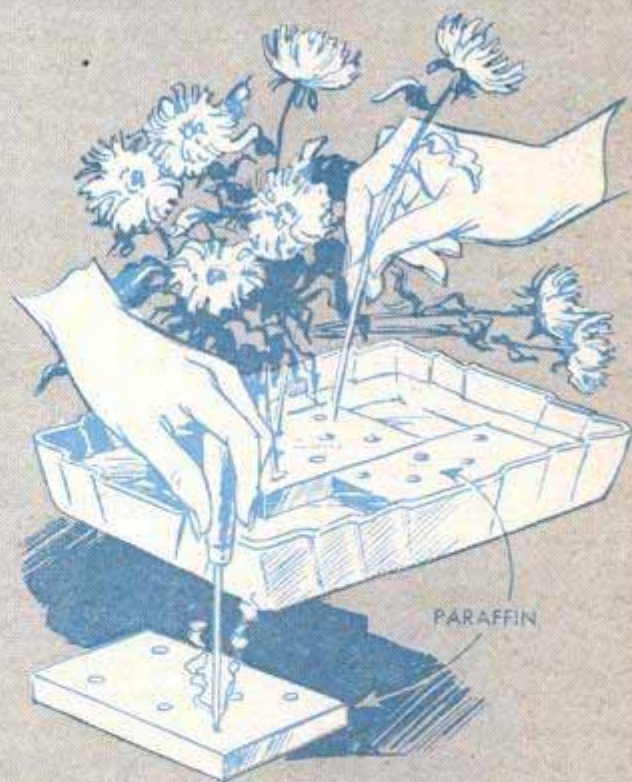

FLOWER FROGS OF PARAFFIN form a substantial base and can easily be cut to any desired size and shape for a particular vase or tray. Punch holes through cake with heated end of ice pick

High Beams Tilted Downward For Emergency Driving

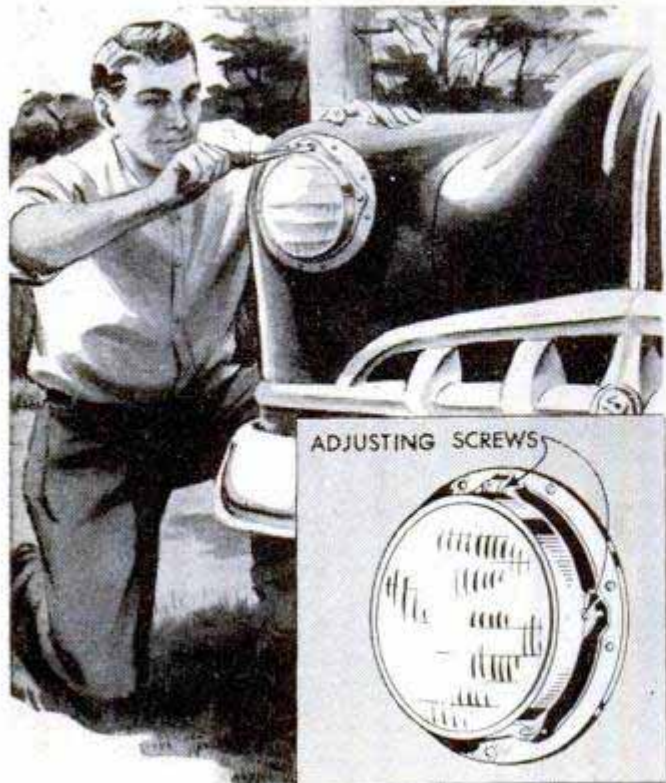

When one of the low beams on your car headlights burns out on the road, it isn't necessary to risk driving with one headlight or blinding an oncoming motorist with the high beams. Instead, temporarily tilt both headlights downward so the high beams will serve as low beams, thus allowing you to drive safely until a replacement for the burned-out light can be obtained. To tilt the beams downward, remove the headlight rim from each light and back out the top adjusting screw. Check the beams to make sure that they are low enough and, if desired, set the side adjusting screws to throw the beams slightly to the right.

Paths of Atomic Particles Observed With Continuous Cloud Chamber

A continuous cloud chamber which permits you to observe the paths of atomic particles is an interesting experiment that can be set up at home or in the school physics lab in just a few minutes. The particles form "vapor trails" in artificially produced "clouds" within a glass chamber which is essentially the same as a device now used by physicists. To make the chamber, first obtain a glass jar having a screw top. The common refrigerator jar in which some foodstuffs are sold will serve the purpose but, if possible, the diameter of the jar should be greater than its height. Also, it is preferable that the lid of the jar contain a rubber ring to form a positive, efficient seal. Cement a strip of $\frac{1}{4} \times \frac{1}{2}$ -in. felt to the inside of the jar to form a ring

around the bottom, fitting the felt in the corner where the bottom joins the sides and fastening it in place with rubber cement. Cement a black-velvet disk to the inside of the jar lid and screw the lid tightly on the jar. The velvet should cover most of the inner surface of the lid. Next, pour rubbing alcohol (containing propyl alcohol) in the jar to cover the felt in a pool $\frac{1}{4}$ to $\frac{1}{2}$ in. deep. Then set the jar upside down on a cake of Dry Ice which is larger than the diameter of the lid, and warm the glass bottom of the jar with the hands, from time to time, so the alcohol in the felt will vaporize. The alcohol vapor moves downward from the warm upper surface until it meets the colder air caused by the Dry Ice, thus producing a supersaturated atmosphere. It is through this atmosphere that atomic particles, traveling at speeds approaching that of light, form streaks of tiny droplets, or vapor trails. To see the vapor trails, train a strong light from a movie projector or powerful flashlight on the black velvet. Sometimes the trails can be seen best through the sides of the jar and at other times through the end of the jar. Operation of the chamber can be maintained for an hour or so with a slab of Dry Ice 1 in. thick. When the alcohol has evaporated from the felt ring, the jar is simply inverted so the alcohol again saturates the ring.

Planing Board Holds Small Pieces

The problem of holding small pieces of wood for planing or light sanding operations is solved neatly by placing the work on this sandpaper-covered board. The latter is made like an ordinary bench hook, having a cleat on the underside which serves as a stop against the edge of the workbench top. A sheet of coarse sandpaper is glued to the top surface of the board to keep the work from sliding while light cuts are taken with a sharp plane. Although the board may be made to any desired size, one that will take about half a sheet of sandpaper is convenient to handle and easy to store.

John M. Avery, Dexter, N. Y.

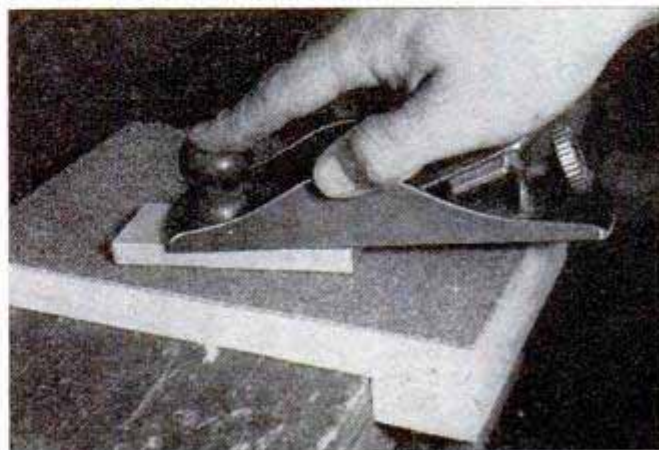

WALL PIPE RACK

combines humidior

By Bertram Brownold

THIS combination pipe rack and humidior solves the storage problem for pipe smokers. There's a glass humidior behind a false drawer front, a single drawer for accessories and a rack for six pipes combined in a small cabinet. The drawer fronts are ornamented with copper overlays having diamond-shaped cutouts and a hammered finish. The finish is applied with the point of a wood screw held by a twisted wire as in the lower right-hand detail. Either copper-foil stock or colonial (red) brass may be used. Lay out the pattern for each overlay on $\frac{1}{4}$ -in. squares. Use a high-grade cabinet wood such as cherry, birch or mahogany for all wooden parts. The two members which, when assembled, form the pipe rack are notched to suit the individual stems and bowls of the pipes. The notches are cut on a jigsaw after which the side

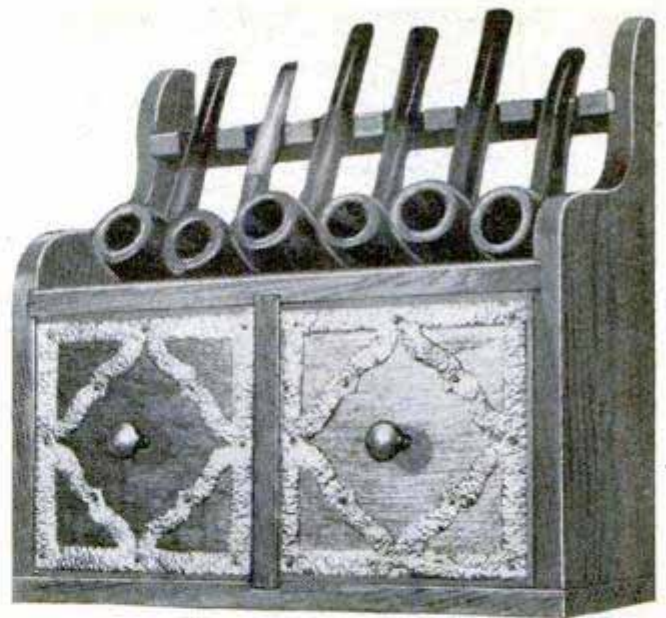

The back of each drawer compartment is drilled to permit attaching the rack to the wall with screws

members are scrolled and grooved to take the top of the cabinet. The top is grooved at the center to take the divider between the drawers. Clamp the parts as in the upper right-hand detail until the glue is dry. Attach the lid of a large screw-top jar to the back of the right-hand drawer front.

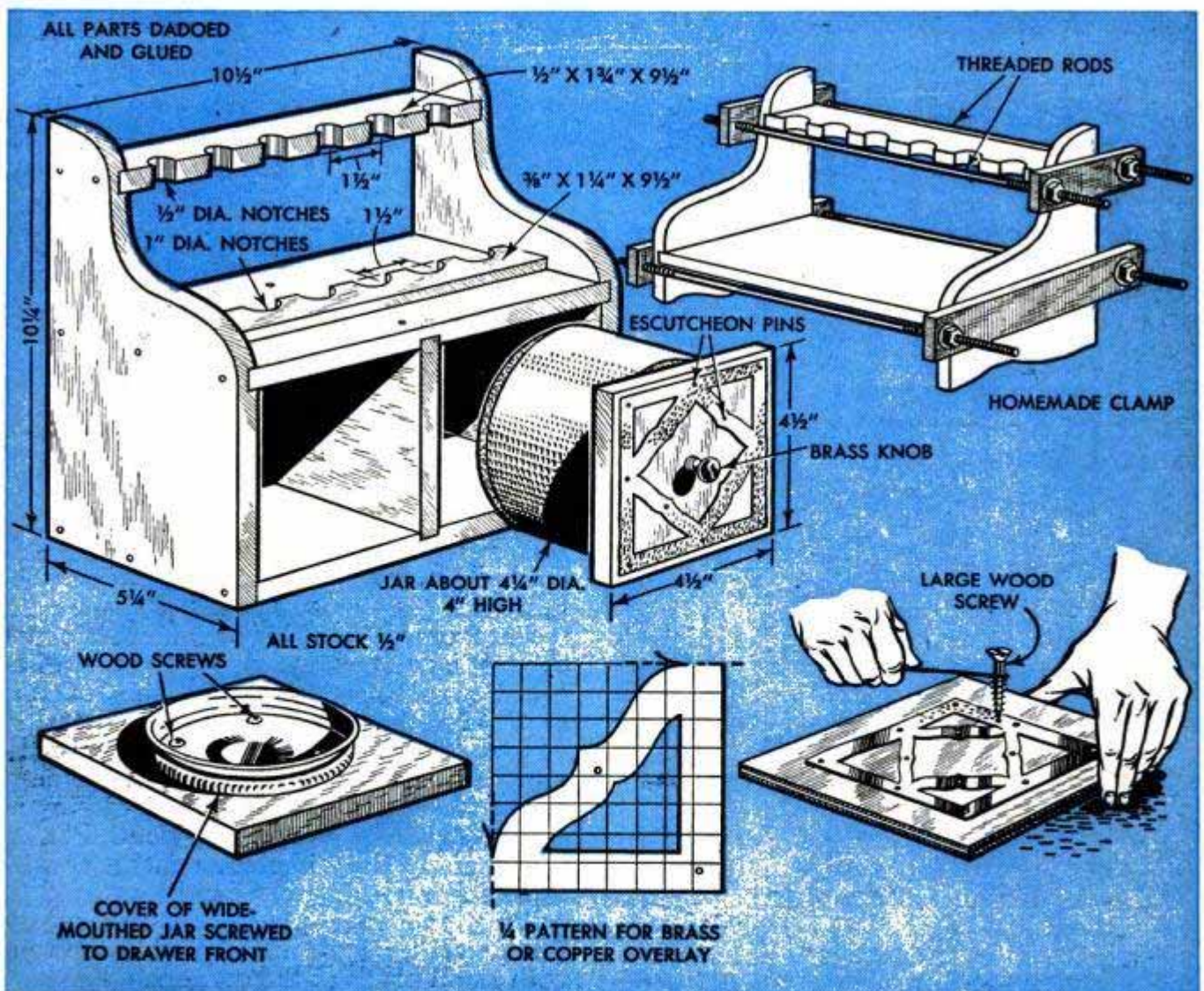

1 EVENING PROJECTS



Ticktacktoe

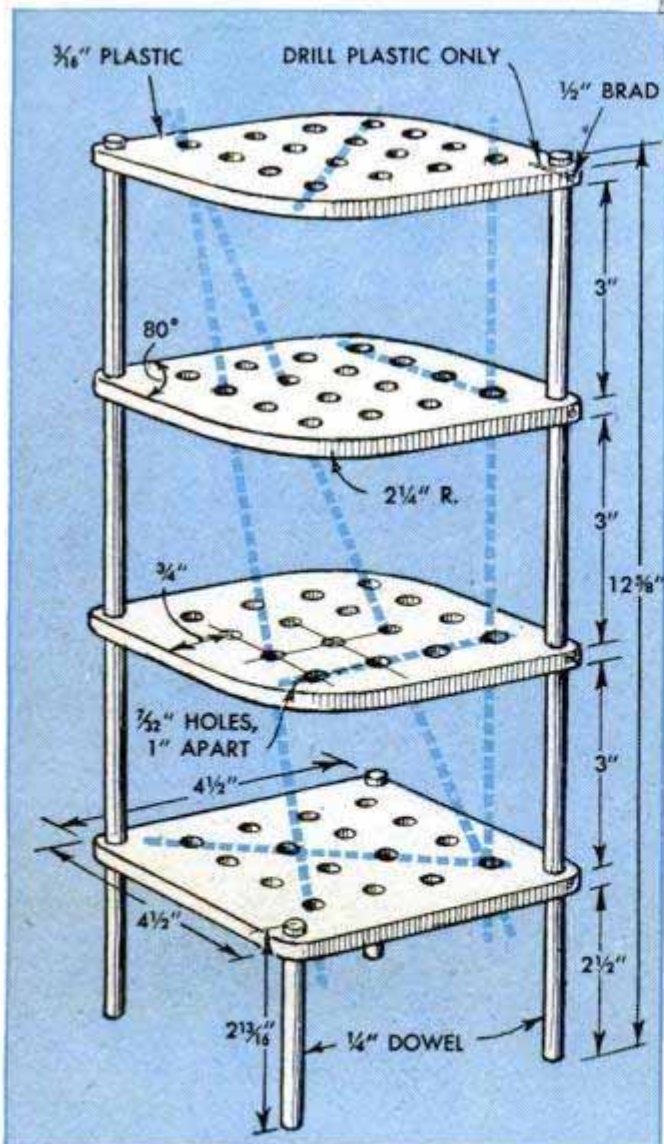

CRAFTSMEN who like relatively simple projects that can be completed in an evening, or over a week end at the most, will find these six projects ideal. Five of the items are highly suitable for gifts or party prizes and all of them can be made from materials which are readily available.

TICKTACKTOE

This four-in-one version of a children's popular game is a good example of a project that provides an excellent gift. The object of the game is to align four pegs in a row, using any combination similar to the ones indicated by the dotted lines at the left. Each player has 32 pegs of a color different from those of his opponent. Wooden or plastic golf tees will do for the pegs. The four tiers of the board can be made of clear or colored transparent plastic. The tiers may be cut square or diamond shape, making the acute angles 80 deg. The diamond shape facilitates inserting the pegs in the center holes of the lower tiers. Perfect alignment of the 16 holes in each tier with those in the other tiers can be assured by drilling the four pieces simultaneously. The dowel uprights are pinned to the tiers with small brads at the corners.

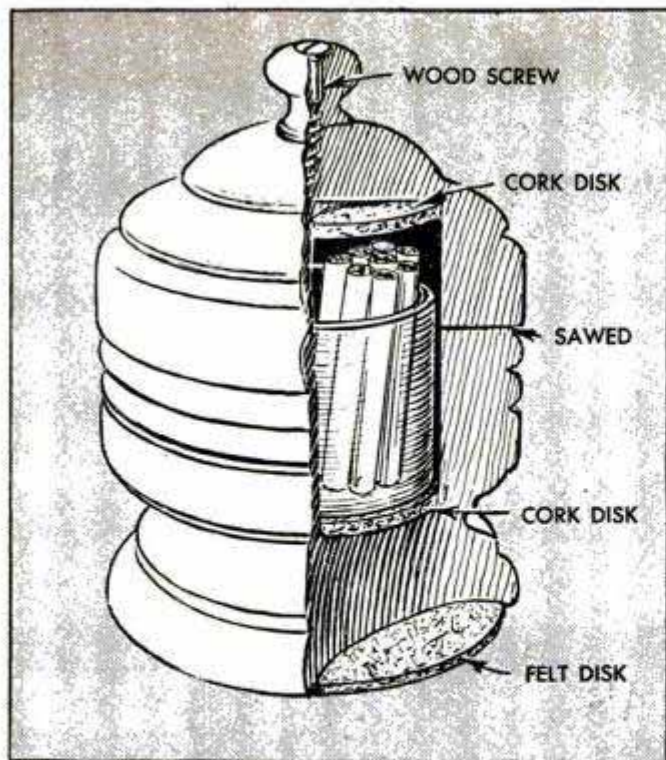

CIGARETTE HUMIDOR

A crown finial, removed when modernizing a stairway newel, or a similar turning cut from an old pedestal table, forms an unusual cigarette humididor. After the turning is sawed in two, as shown in the detail, use an expansive bit to drill both the top and bottom sections to receive a glass container. The latter is simply a jar or tumbler which has been cut slightly shorter than the length of the cigarettes. The rim of the container, which should extend about $\frac{1}{4}$ in. above the edge of the hole in the bottom section, is ground smooth.

BAKING HOT PAD

Just the thing for cooling cakes and pies or for setting hot casseroles on the table, this hot pad is made from wire mesh, linoleum seam binding and a few scraps of sheet metal. The wire mesh is cut to size and all edges bent downward $\frac{1}{4}$ in. Then the seam binding, or strips of sheet metal $\frac{3}{4}$ to 1 in. wide, are folded double and drilled for riveting to the legs. The sheet-metal legs are bent to the shape indicated, the joint being mitered at the top of the flange and soldered, if desired.

COMBINATION BASKET AND BOWL

Here's an interesting lathe project that consists of a bowl-shaped turning cut in half along its diameter and held together in two different ways by an interlocking ring. It can be used as a fruit bowl when the halves are locked in their normal, edge-to-edge, position, and will serve as a basket for artificial flowers if the halves are set on end and locked face to face with the ring. To shape the bowl, turn a wooden disk 2 in. thick to a suitable diameter—9 in.

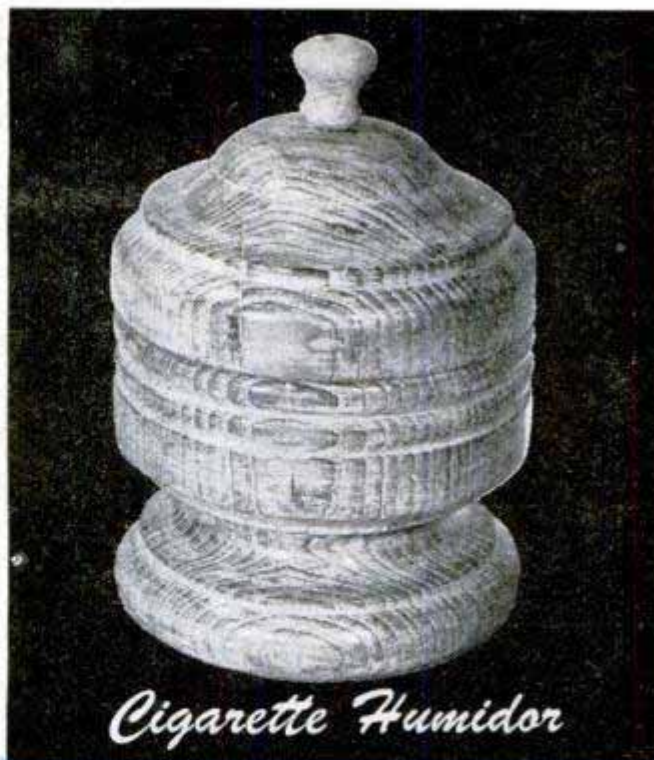

Cigarette Humidor

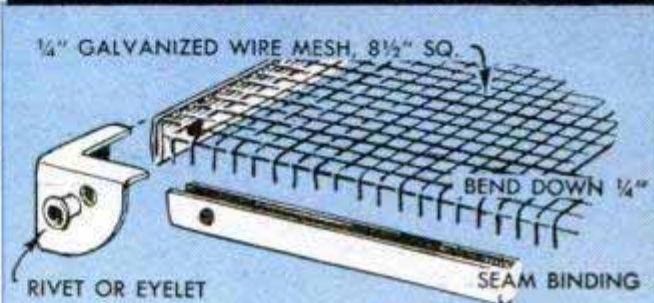

Baking Hot Pad





*Combination
Basket-and-Bowl*

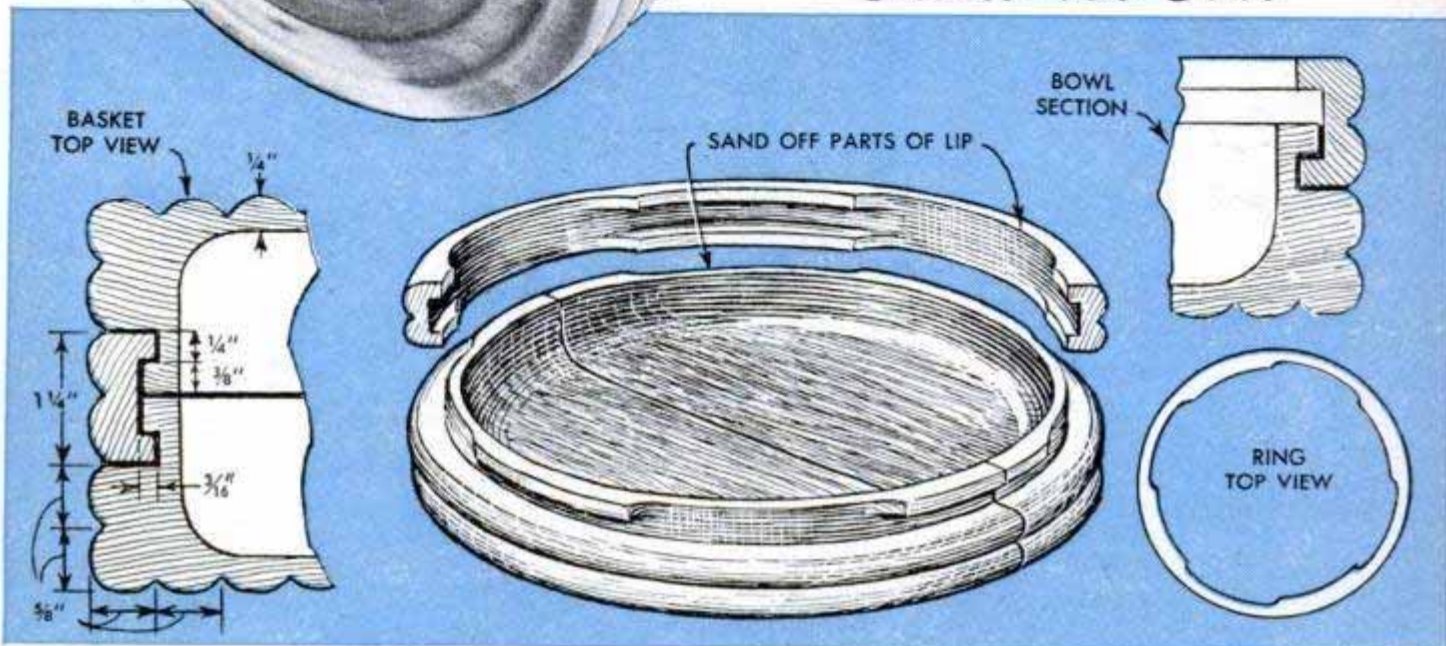

was used for the original—and then turn beads on the edges and face. The $\frac{3}{16} \times \frac{3}{8}$ -in. lip around the top of the bowl is also turned at this time. Remove the turning and temporarily glue the beaded side to a piece of waste stock with paper between. Remount on the faceplate and dish out the center. Portions of the lip are sanded off as shown in the center detail, and the bowl is cut in half. To make the ring, a disk of $1\frac{1}{4}$ -in. stock is screwed to the faceplate and turned to fit over the lip of the bowl. Note that sections of the ring lips are sanded off to match those of the bowl lip.

POP-OUT SPICE SHELF

Attractively enameled to match your kitchen, and possibly enhanced with decorative decals, this little shelf conveniently dispenses six or more spice cans. Housed in a soldered sheet-metal cabinet, each can is set on an individual tilting rest which brings it outward and into your hand when you push on the tab at the bottom of the rest. A channel bent on the lower edge of

the cabinet back provides a stop for the rests, which are pivoted on a length of rod or tubing. Tenons turned on the rod allow inserting the ends through the sheet-metal sides of the cabinet and peening them over to hold the rod in place. If tubing is used, the ends are simply inserted through holes in the sheet metal and swaged.

PLAY TABLE

Apple boxes combined with two table tops, a permanent one of plywood and a removable one of hardboard, provide an inexpensive play table that includes generous storage space for toys, a permanent layout for a toy train and a play top. The boxes are assembled on a base made of 1×3 -in. wooden strips and fitted with six large casters. Hardboard is used to back the center shelves and also to cover the table-top frame. Note how the latter rests on corner blocks and fits over the edge of the plywood. If desired, the center portion of the hardboard can be supported with blocks or cleats which rest inside the track oval.

Pop-Out Spice Shelf

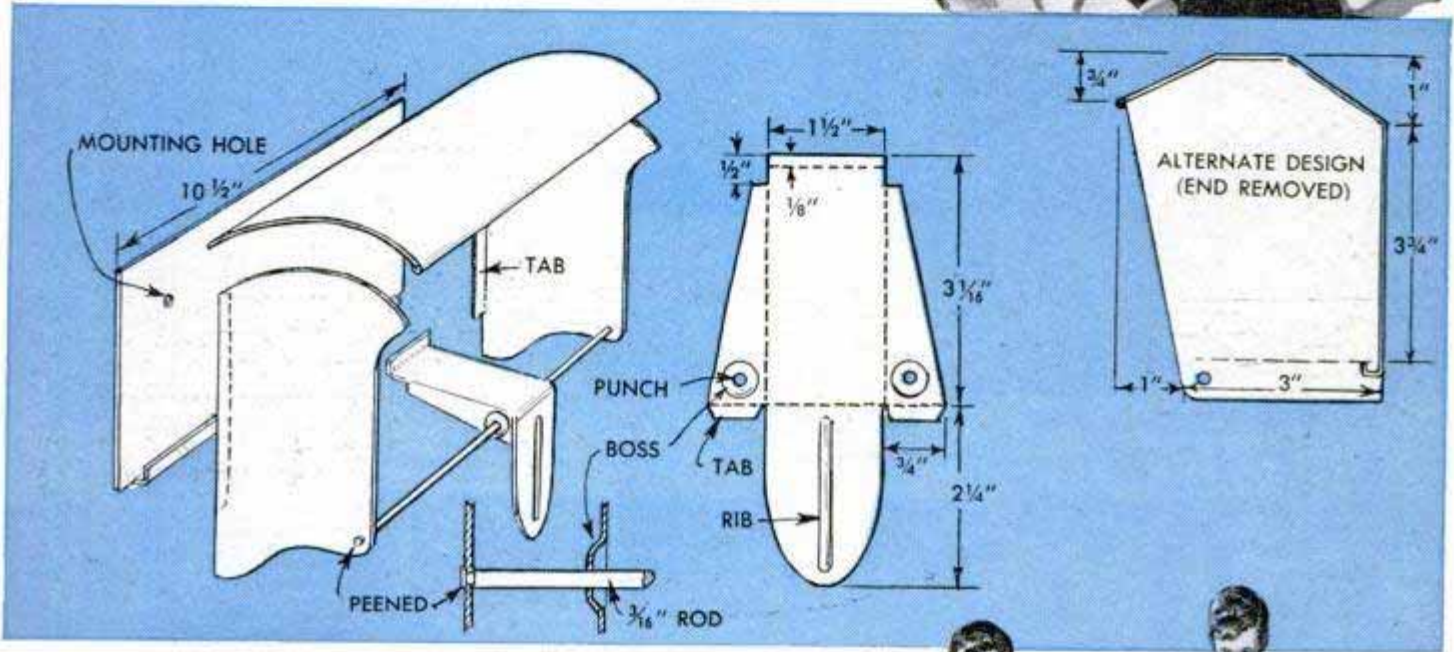
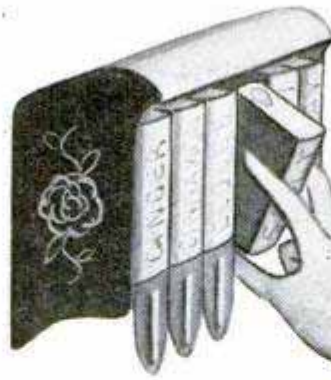
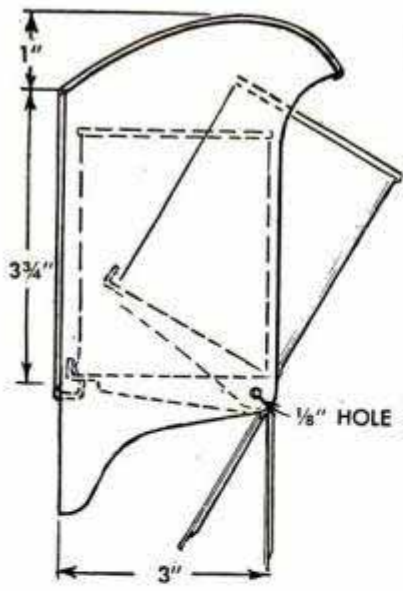

Play Table

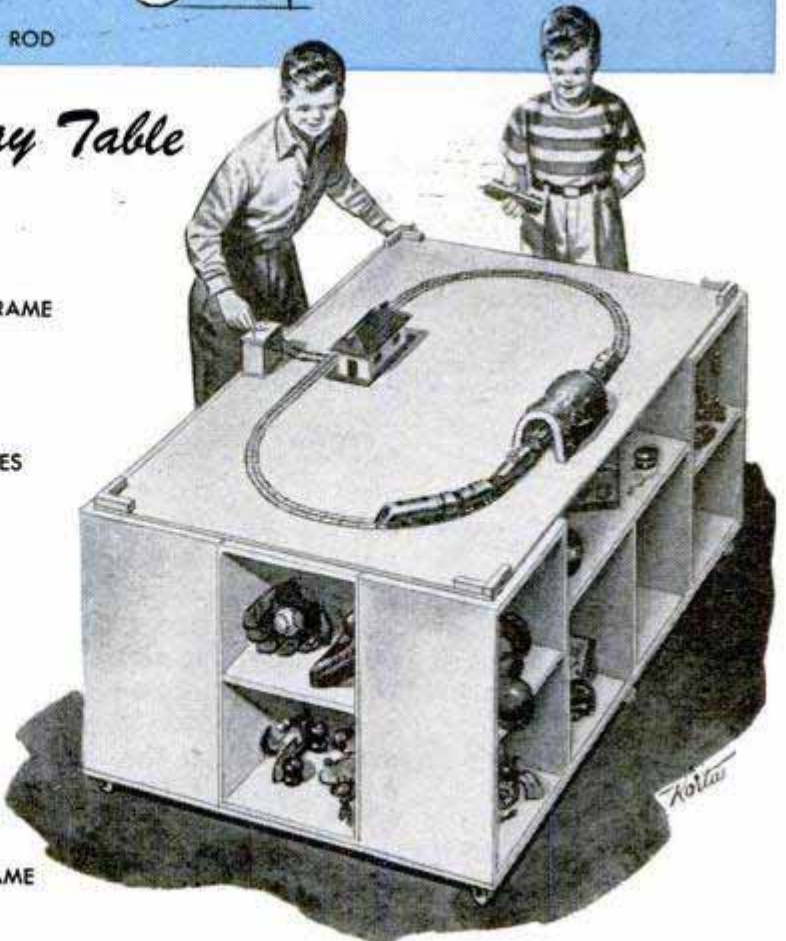
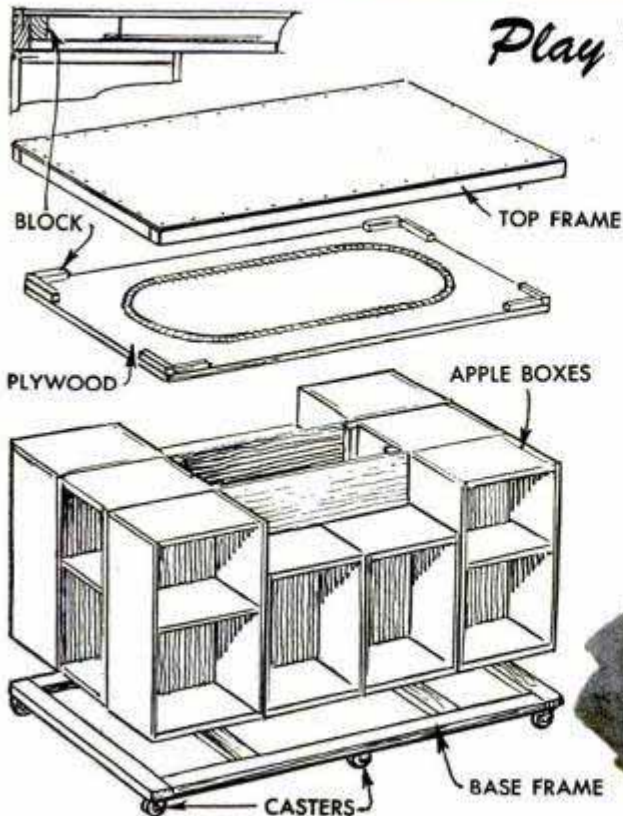

Portable Bleacher Seat With Canvas Back Adds Comfort to Plank-Type Bench

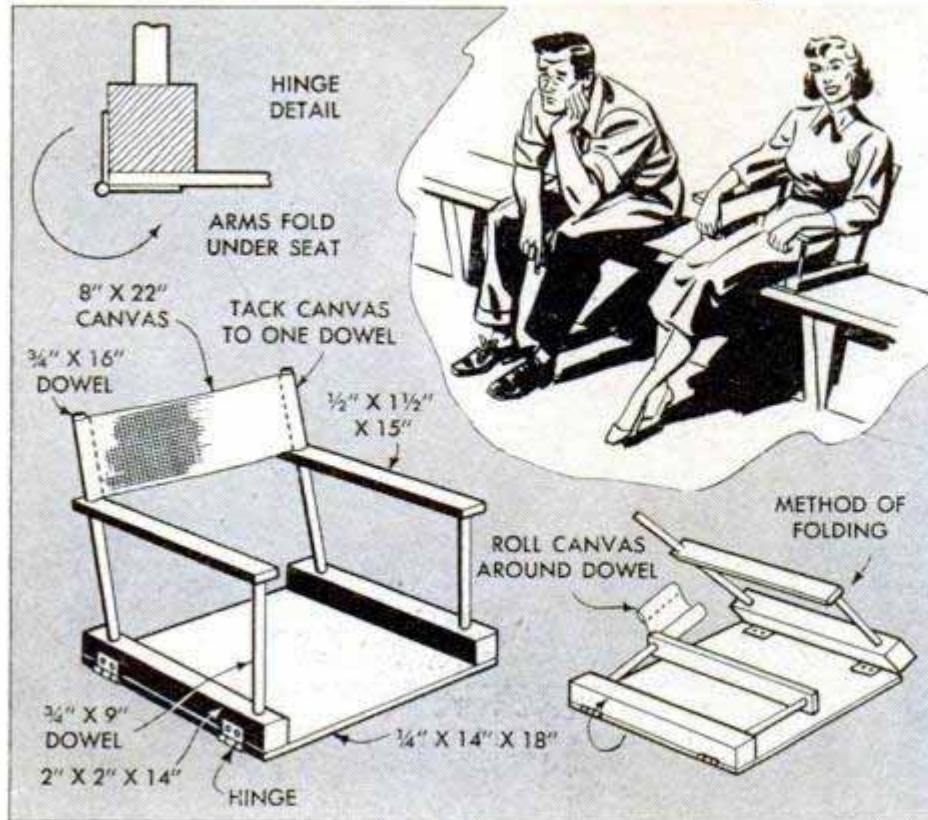

You will be sure of comfort at sports events if you come outfitted with one of these folding seats. The seat, which is simply set on top of the usual plank-type bleacher bench, consists of a plywood bottom having two hinged arms and a canvas back. The arms, which fold outward and under the seat, are made by drilling a length of 2 x 2-in. stock to take two dowel uprights, the longer, or rear, one at about an 80-deg. angle. The armrest is drilled to fit over both dowels and is nailed flush with the top of the front upright. The canvas back is hemmed to slip over the rear dowels and is rolled around one of them when folding the seat. — Sumner Veazey, Santa Barbara, Calif.

Switch on Dashboard Reduces Noise of Twin Horns

One motorist, who found that the twin horns on his car were so loud that they startled rather than merely warned pedestrians, installed a switch in the horn circuit to cut out one of the horns for city driving. When on the open highway, the switch is closed to obtain the full blast of both of the horns. As shown in the wiring diagram, a toggle switch is wired in the lead which connects one of the horns to the relay. The switch is mounted in a convenient location on the dashboard, preferably near the ignition switch, so that it can be snapped quickly to either position.

A. J. Seymour, Jr., Salmon Falls, N. H.

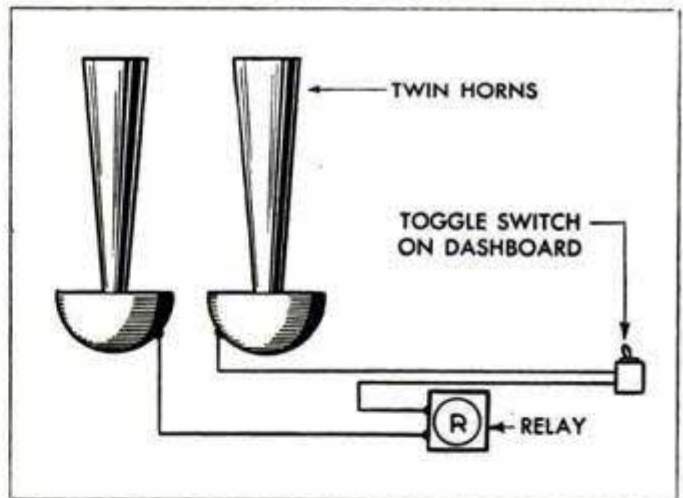

Chimney Blocks Form Piers for Supporting Small Buildings

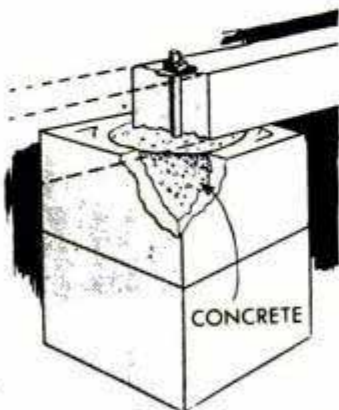

desired height and fill the center hole with crushed stone and concrete. It is not necessary to use mortar between the blocks, as

concrete piers for supporting small buildings can be had without going to the trouble of making wooden forms if chimney blocks filled with concrete are used to support the sill. Just build the block pier to the

the concrete fill will hold them in place. The anchor bolt for the sill should be set in place before completely filling the hole.

Victor H. Lamoy, Upper Jay, N. Y.

Gasolineproof Aluminum Paint

For painting outboard motors and other parts that are exposed to spilled gasoline, ordinary aluminum-paint preparations usually will be washed away within a short time. A paint that will withstand the effects of gasoline for a considerable length of time and also a maximum amount of exposure to the weather can be had by mixing aluminum powder or paste with lacquer.

MODERN TEACART



A modern take-off on the conventional large-wheel tea wagon, this modified version retains all the features of its prototype—including lift-off tray, portability and pull-out shelves. The shelves slide on a half-lapped frame which is edge-screwed to the side members $\frac{5}{8}$ in. below the plywood top of the cart. The latter, which is rabbeted to fit grooves in the side members, is notched to fit over the slanting, half-lapped legs

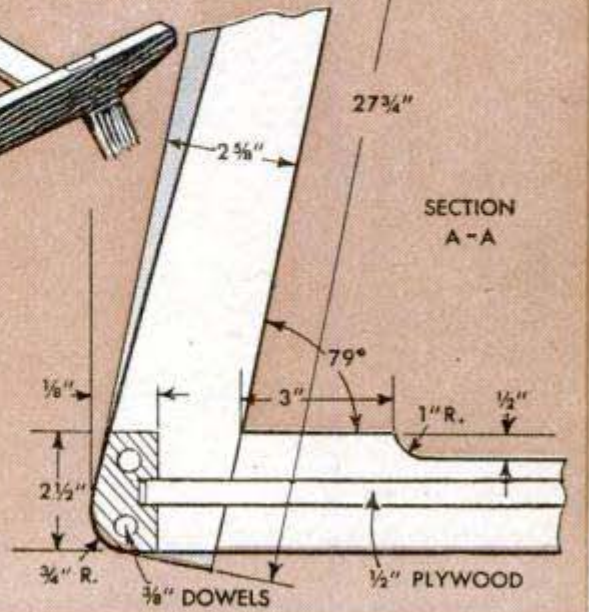
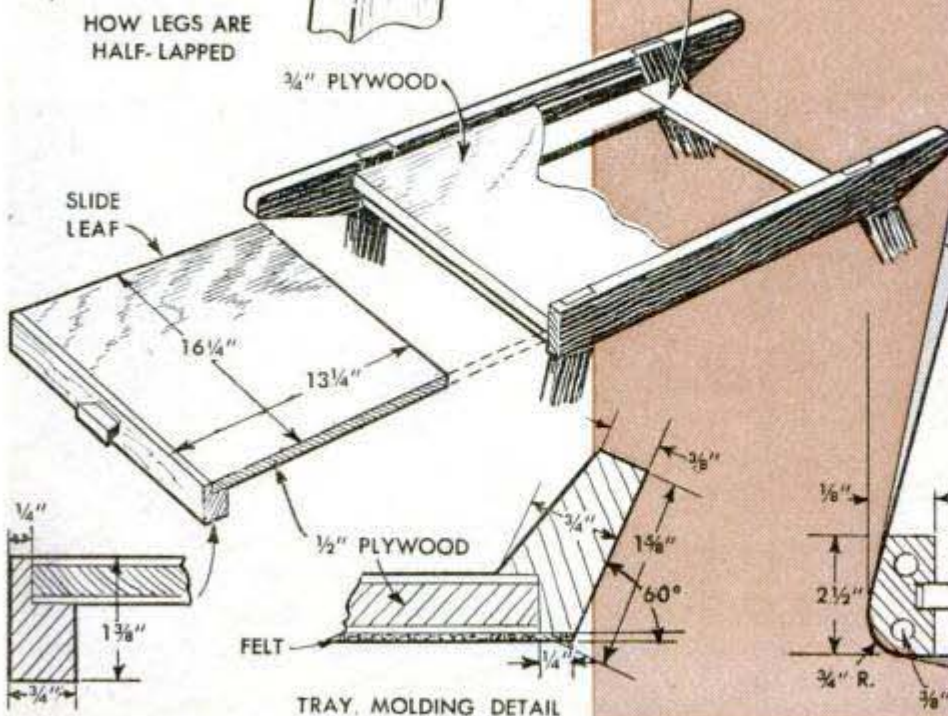
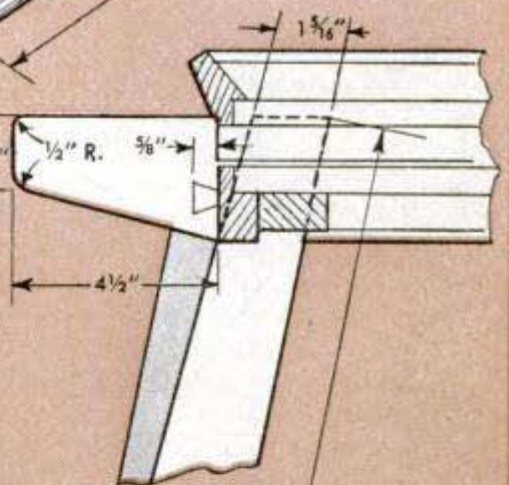
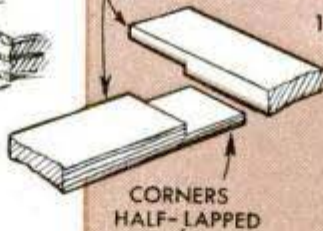
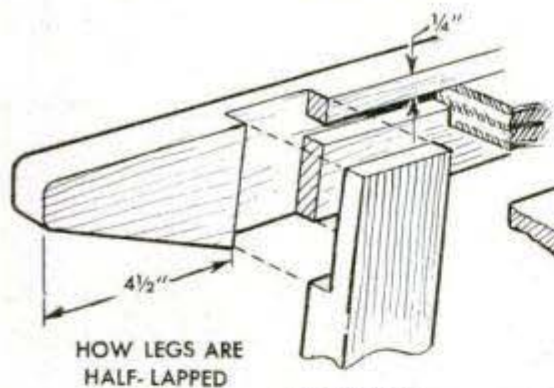
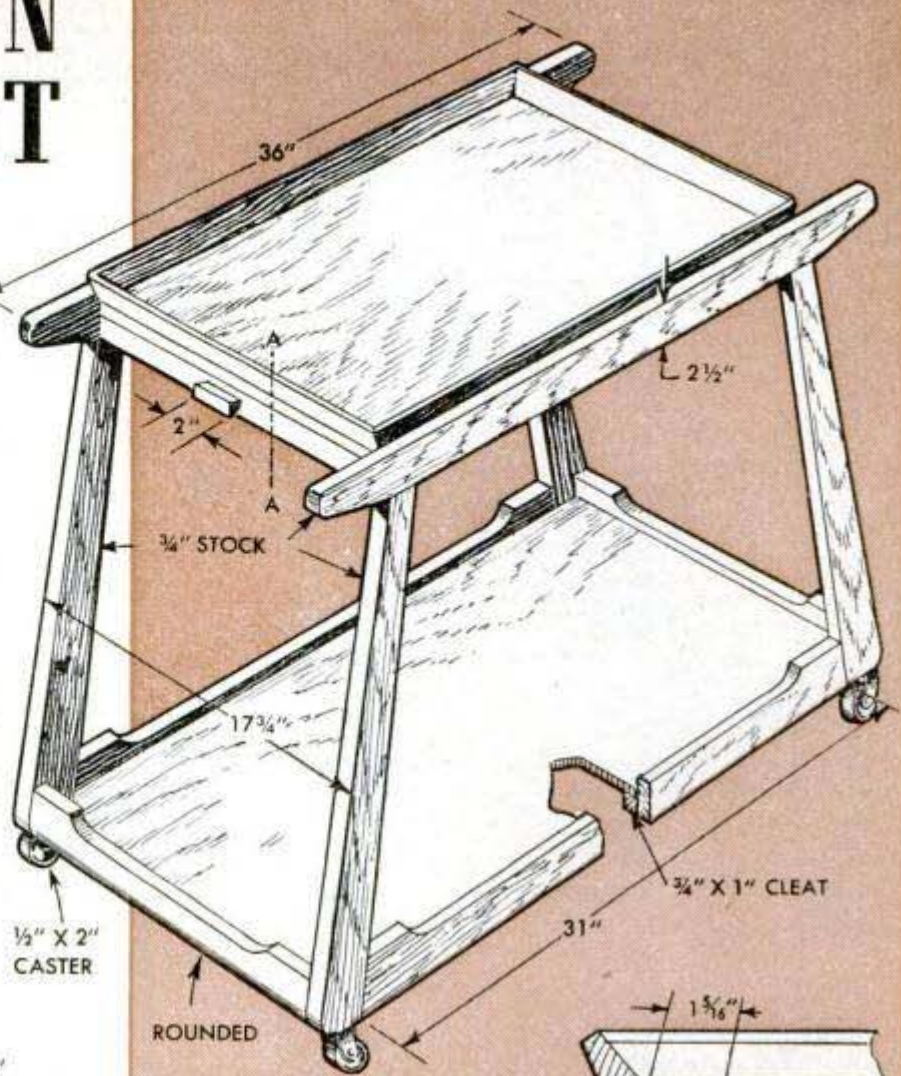

How to Make

ONE OF THE most practical home-workshop projects is making your own storm sash and screens. In addition to the cash saving, there are several other advantages to be gained by doing the job yourself. For example, you can make the convenient divided storm sash with a hinged lower section, sealed inside storm sash which prevent condensation on metal casements and screens with sturdy, durable frames. All homemade storm sash can be sealed with various types of weather stripping to prevent air leakage. These special features are not ordinarily available in the regular product.

The details at the lower left show six different methods of corner-joining sash frames. Of course, the same methods can be used in joining screen frames of either the full or half-length type. Of all the types of joints suggested, the doweled joint, the splined miter and the miter joined with corrugated fasteners get the highest recommendation. Material for the stiles (vertical members) is available ready-cut to recommended sizes, usually $1\frac{1}{8}$ x $2\frac{5}{8}$ -in. sectional size, in clear white pine. By ripping the bottom and top rails and the center muntin of screen frames from standard $1\frac{1}{8}$ -in. stock lumber, you can obtain a stronger, more rigid frame at less cost per unit. This is done simply by making the bottom rail 3 to 5 in. wide instead of the usual $2\frac{5}{8}$ in. The lower left-hand details on the facing page show average sectional sizes of the three cross members with $\frac{1}{2}$ x $\frac{1}{2}$ -in. glass rabbets. Rabbets of the same size are cut on the stiles. Now, note in the circled detail how the rabbeted parts are joined at the corners, using dowels and waterproof glue. The raised section between the inner

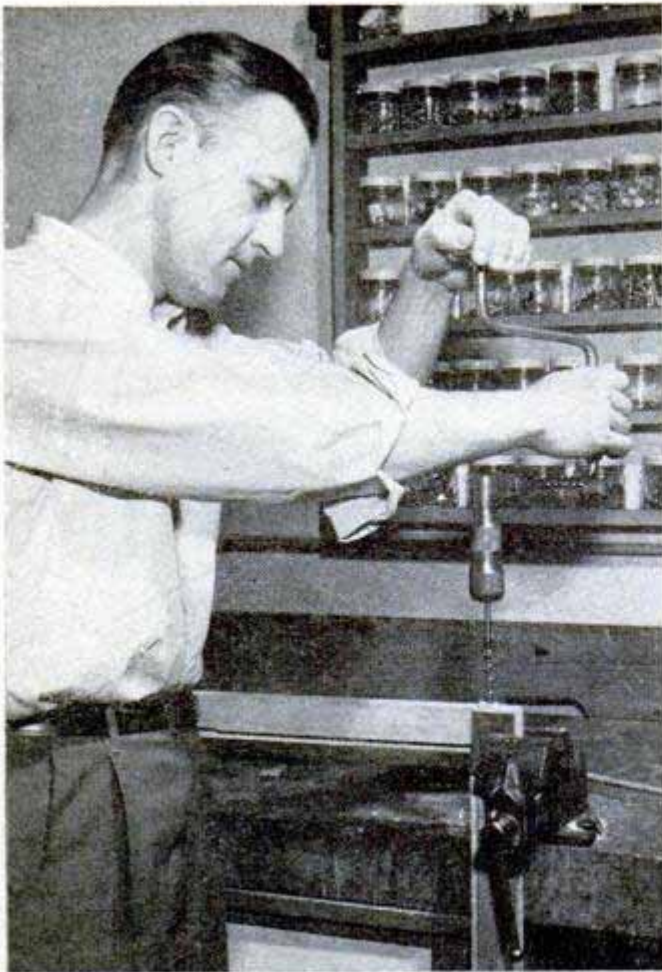

Typical corner joints

PREFERRED METHOD
 $\frac{1}{4}$ " X 5" DOWELS
GLUED

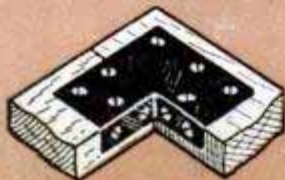
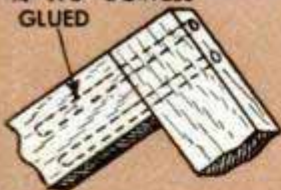

METAL CORNER BRACES
RECESSED FLUSH
(T-BRACES USED TO
JOIN MULLION)

3" No. 12 F.H. SCREWS
OR $3\frac{1}{4}$ " 12d BARBED
BOX NAILS



BUTT JOINT USING
SCREWS OR NAILS
AS FASTENERS

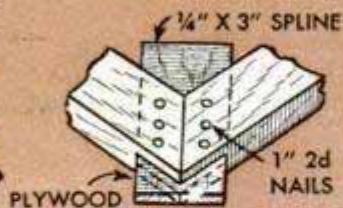

SPLINED MITER JOINT,
USE WATERPROOF GLUE

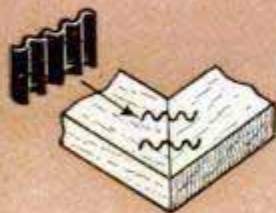

MITERED FRAME
JOINED WITH
CORRUGATED FASTENERS

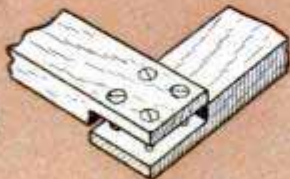

HALF-LAP JOINT GLUED
AND FASTENED WITH 1"
No. 7 SCREWS

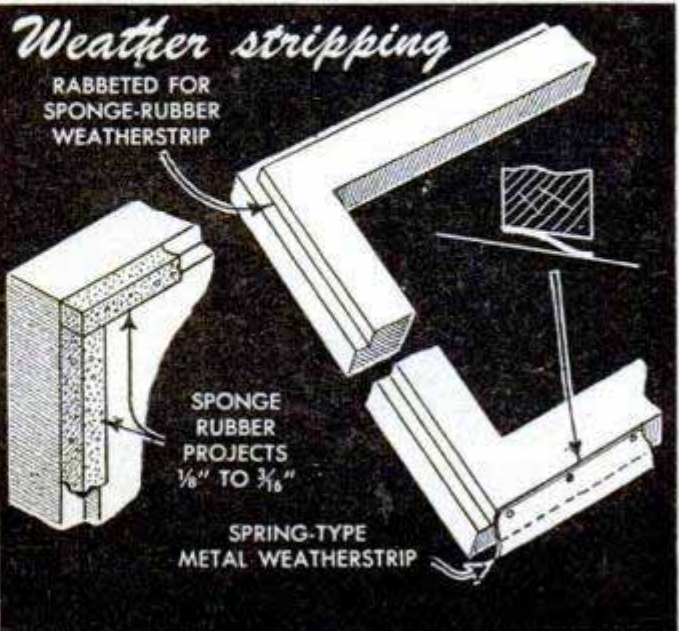

STORM SASH and SCREENS

face of the rabbet and the back face of the stock is cut away to permit the rail to butt against the stile. The same method of joining can be used when making screen frames which are rabbeted for the screen molding, as will be seen from the sectional details on the following page.

Pictured and detailed at the right is the special storm sash with a lower section pivoted on hangers, or hinges. As you can see, it is quite simple to make and on second-floor windows the use of a hanger permits installing and removing the lower half from the inside. By making a matching screen frame, it is not necessary to remove the upper half of the outer sash during the summer season. Be sure to use a sponge-rubber or a spring-type metal weather strip between the upper and lower sash as shown in the detail. This prevents seepage of water at the open

SPONGE-RUBBER STRIP IN GROOVE. SPRING-TYPE WEATHERSTRIP ALSO USED

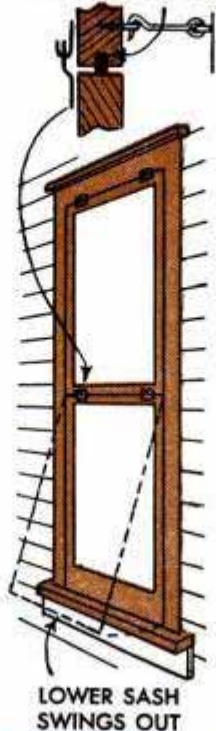

LOWER SASH SWINGS OUT

Storm-sash hardware

STORM-SASH HANGERS (SIMILAR ONES ON SCREENS FIT THE SAME HOOKS)

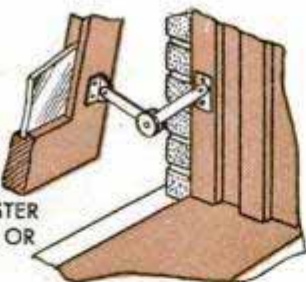

FRICTION-TYPE STORM-SASH ADJUSTER HOLDS SASH OPEN OR CLOSED

Hanging divided storm sash

A divided storm sash arranged so that it may be removed and installed from the inside is a great convenience. By attaching the lower half with hangers and making an interchangeable screen frame, it will not be necessary to remove the upper half of the sash during the summer season

Casement storm sash

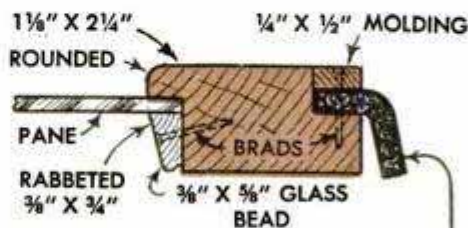
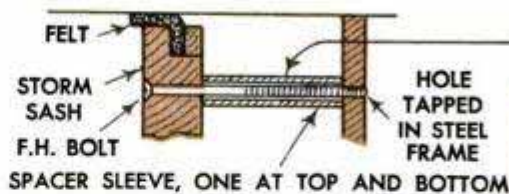

1/4" X 1 1/2" FELT STRIP ALL AROUND

STORM SASH MUST HAVE 5/16" CLEARANCE ALL AROUND

Frame sizes

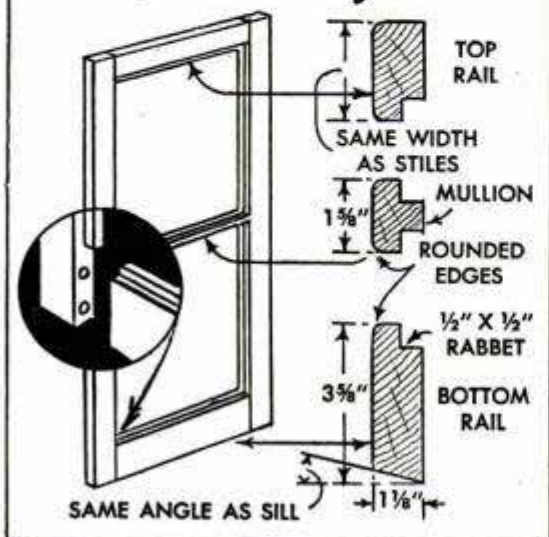

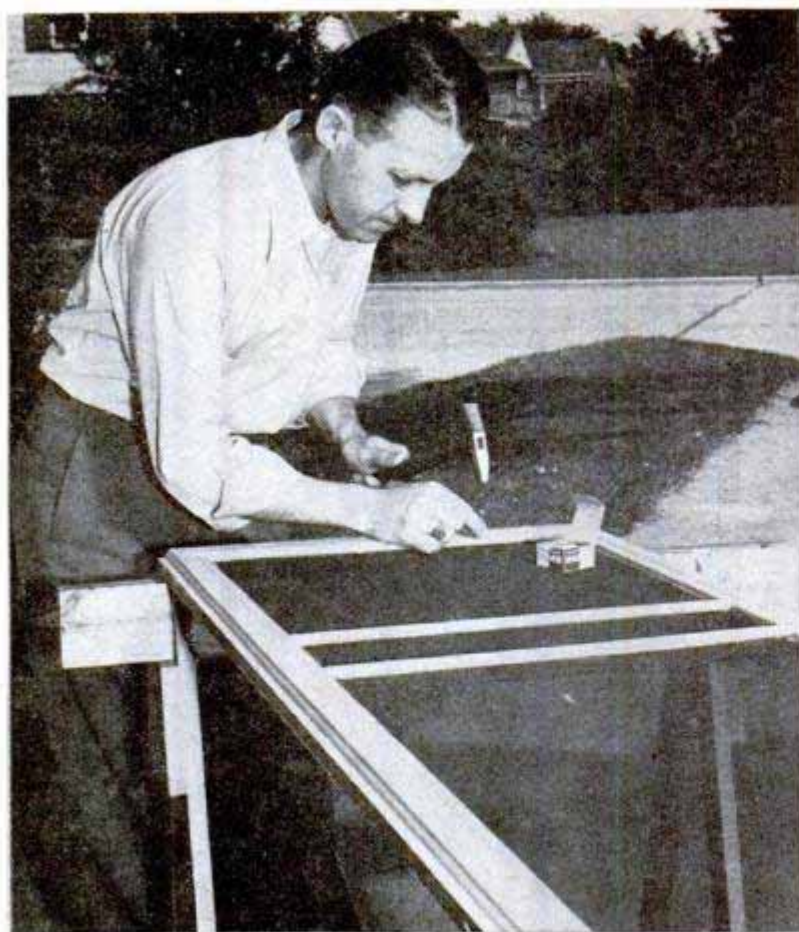

joint. Also, it's a good idea to install the friction-type sash adjuster on the lower half of the sash so that it may be opened and held at any desired angle during mild winter weather. This special mild type of sash adjuster is shown in one of the details on the preceding page.

It is usually possible to fit storm sash over metal casement windows by installing them on the inside of the frame as in the lower right-hand details on the preceding page. Note that the special sash is attached with spacer sleeves and long bolts which turn into holes tapped into the casement muntin. The edges of the storm-sash frame are trimmed down to allow $\frac{5}{16}$ -in. clearance all around then rabbeted to permit the installation of a felt weather stripping. This is held in place with $\frac{1}{4} \times \frac{1}{2}$ -in. molding strips attached with small brads. The glass is held in place by a bead instead of putty, as shown in one of the cross-section views.

After outside storm-sash frames have been finished and assembled, apply a priming coat of paint and permit it to dry thoroughly before installing the weather stripping and glass panes. The latter should be cut to fit in the rabbets with clearance all around. Lay a thin line of putty in the corner of the rabbet, set the pane, drive glazier's points spaced 6 to 8 in. apart and then putty the joint. Be sure, before applying the finishing coats of paint, that the putty is thoroughly dry, as otherwise the paint will peel. The details at the left show the procedure in making full-length screen frames. The method of making the half frame is the same except that the center muntin is omitted, of course. Although making and fitting the doweled joint takes more time, this type of joinery is by far the most durable on woodwork exposed to weathering. Note that in the detail of the assembled frame, the width of the lower rail is given as the same as that of the stiles and top rail. A stronger and more rigid frame will result if the lower rail is ripped at least 3 in. wide. Details A, B and C show how to attach screen wire to the frames. Priming and painting procedures are the same as outlined for storm sash.

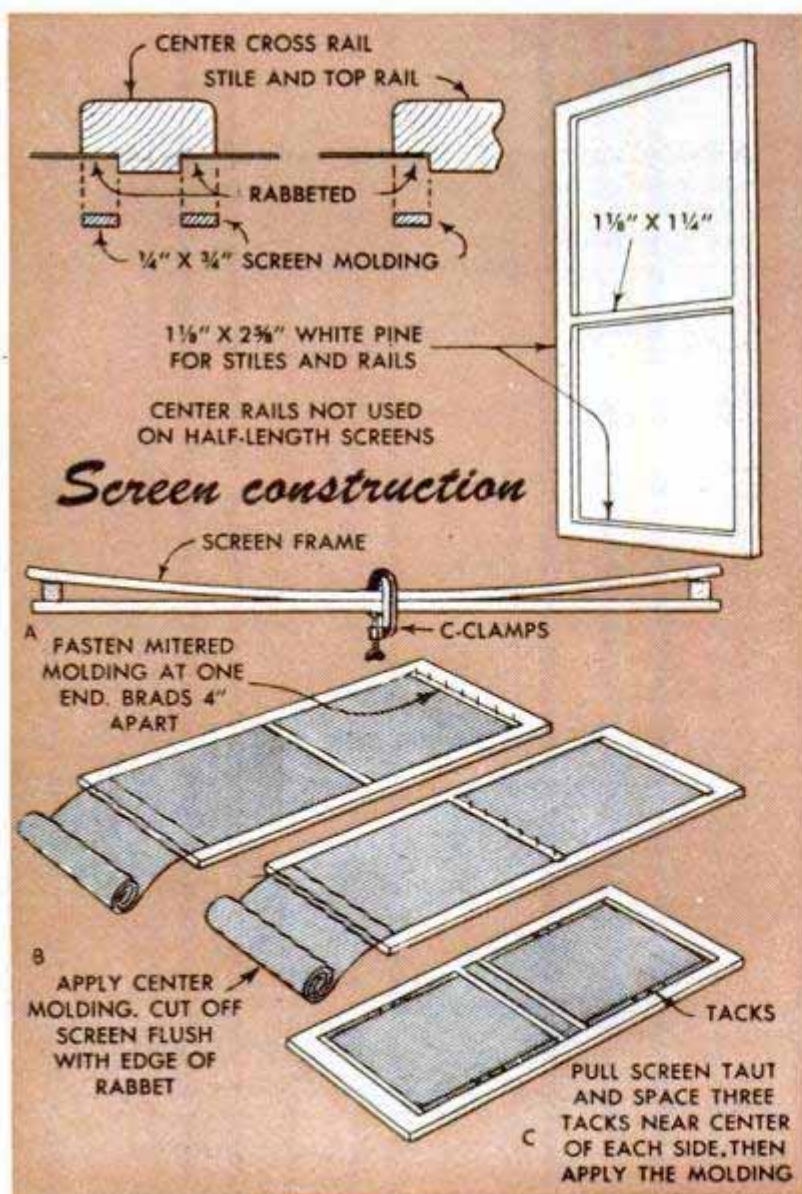

Loose-Pin Hinges Provide Motor Mount for Driving Power Tools

If you drive several power tools with a single motor, here is an inexpensive floating-type motor mount that permits shifting the motor from one tool to another in a few seconds. A 4 x 4-in. loose-pin hinge is needed for each tool to be driven by the motor, although not all of the hinge leaves will be used. Select identical leaves from two of the hinges and weld small flat-iron tabs to the ends of the leaves. Drill and countersink holes in the tabs to permit fastening the hinge leaves to both sides of the motor base with flat-headed machine screws. Then screw matching hinge leaves to the top of the workbench or table, locating them so that the motor pulley will be in line with the machine pulley when the motor is set in the mount. The weight of the motor provides floating tension on the belt as shown in the illustration.

Nathan Green, Silver Spring, Md.

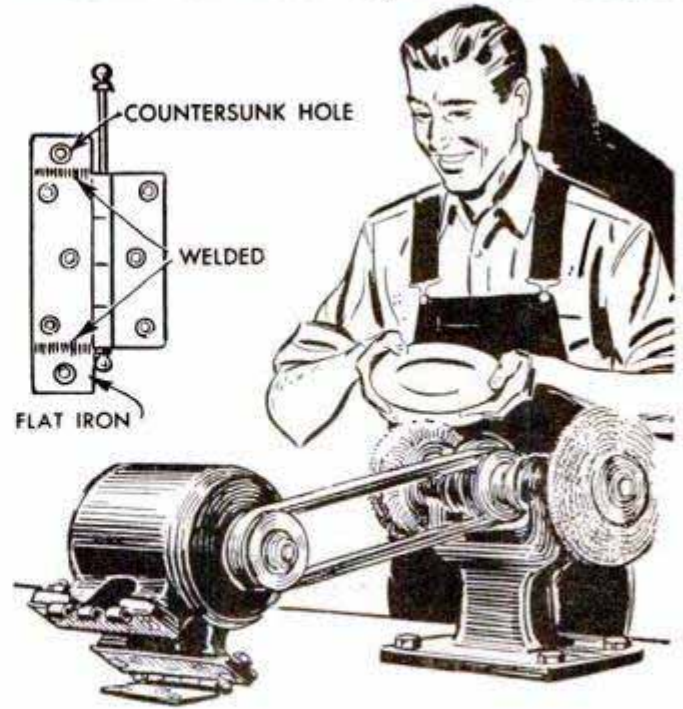

Sponge Fitted to Hose Speeds Bathing Dog



With the aid of a garden hose and a large sponge, you can bathe a dog quickly with little danger of getting your clothes wet. First, cut a narrow slit part way through the sponge and press the sponge over the garden-hose nozzle. After applying a liberal amount of soap to the sponge, turn on the water and adjust the nozzle for a gentle spray. The sponge is removed before rinsing the dog.—Bess Ritter, Yonkers, N. Y.

Garden Gate Closed Automatically By Sash-Weight Balance

Attached to a gate with a length of chain guided by two V-pulleys, an ordinary sash weight automatically closes a yard or garden gate. The pulleys are bolted loosely to a wooden block which is mounted on the gatepost, one of the pulleys being fastened to the top of the block and the other to the side. Then the sash-weight chain is attached to the gate and drawn across the pulleys.

A. M. Wettach, Mt. Pleasant, Iowa.

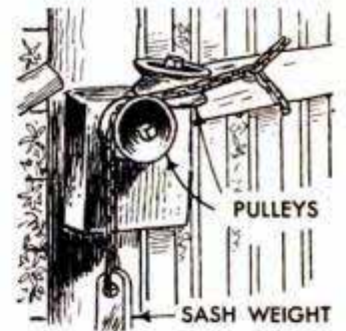

Tape Marks Hand-Drill Depth

When using a hand drill to bore a number of holes to the same depth or a single blind hole to a predetermined depth, use cellulose tape as a guide. Wrap the tape around the bit so that the lower edge of the tape is the desired distance from the tip of the bit. Then simply drill until the edge of the tape is flush with the surface of the work.

Harrison Neustadt, Miami Beach, Fla.

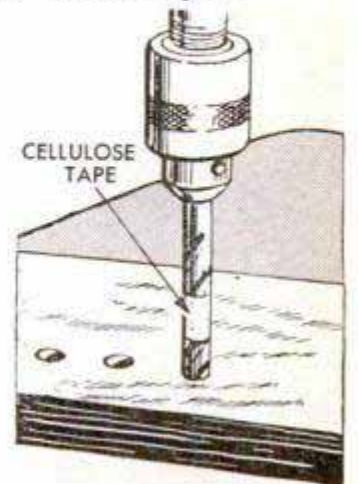

"KIDSTER"

By Marvin Hartley

DAD WILL have little trouble "selling" the family small fry on the features of this sporty, pedal-driven auto—one look will be enough. They'll be quick to see the real headlights, plastic windshield, rubber tires and airplane-type steering wheel. Built from common parts and stock lumber, the car features a chain drive, using a standard tricycle sprocket bolted to a pipe support.

Fig. 1 gives the dimensions for laying out the sides on 1 x 12-in. pine stock. Cleats for supporting the sheet-metal hood and rear deck are screwed and glued to the inner faces of the sides $\frac{1}{2}$ in. down from the top edge. Mounting cleats for the pillow blocks which carry the rear axle are centered in the wheel openings. Remember to make a right and left-hand assembly. The sides are joined together at the front with a heavy cross member, to which the pipe support is bolted, and at the back with a 1 x 6 board. Long flat-headed screws are used to fasten these cross members, the rear member being 16 in. long, and the front one 14 $\frac{1}{2}$ in. long. The seat board and back are also screwed in place at this time. The final wooden piece to be added is the 1 x 6-in. board that supports the windshield and steering-column bracket. However, you may find it more convenient to fasten this in place after the pillow blocks for the steering assembly are installed.

Fig. 2 shows the chassis assembly at a glance. The $\frac{3}{4}$ -in. pipe support for the car is drilled at the points indicated for mounting the tricycle sprocket, the eyebolt for the steering column and the bolts which anchor the pipe to the body. A U-shaped yoke, bent from flat iron, is used to fasten the rear end of the pipe to the bottom of the seat.

Lengths of $\frac{1}{2}$ -in. cold-rolled shafting are used for the steering assembly, the steering column and the front and rear axles. Details in Figs. 2 and 3 show how "knuckles" for the front wheels are improvised from $\frac{1}{4}$ -in. pipe tees. These are drilled or reamed out and then cross-pinned to lengths of $\frac{1}{2}$ -in.

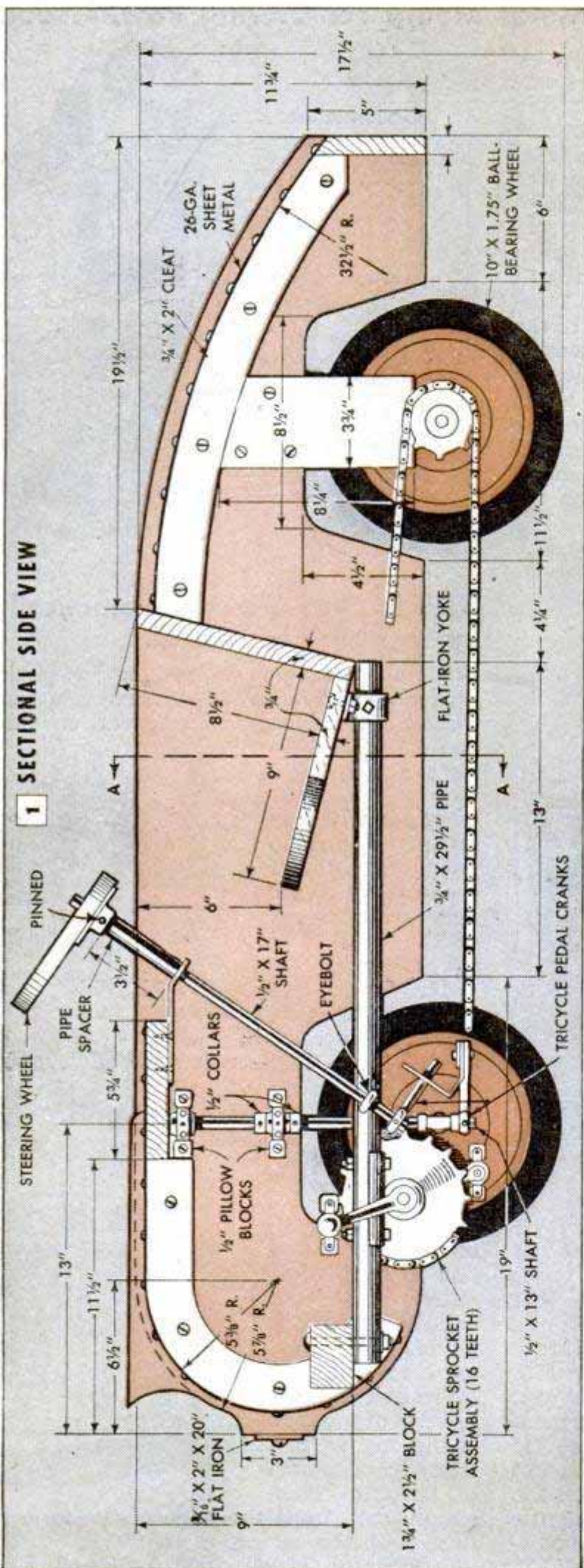

PEDALMATIC

FOR '51

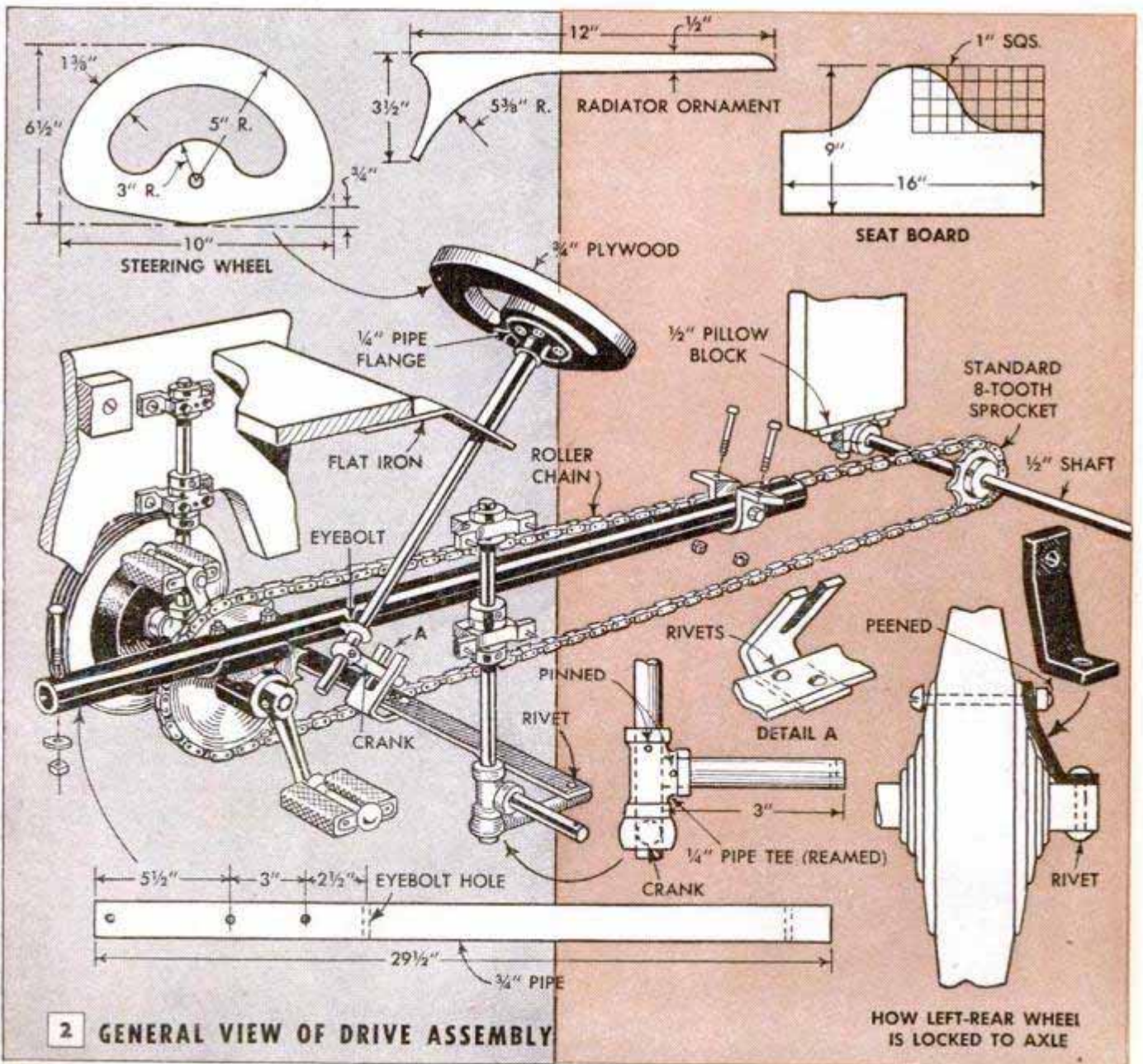

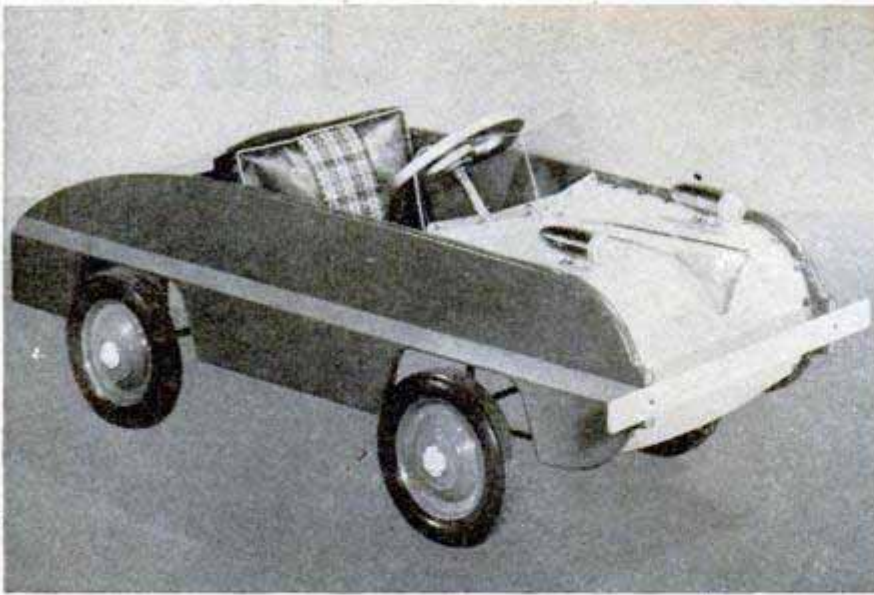

The wooden radiator ornament is screwed to the hood from the underside, while two roundheaded screws hold the flat-iron bumper in place

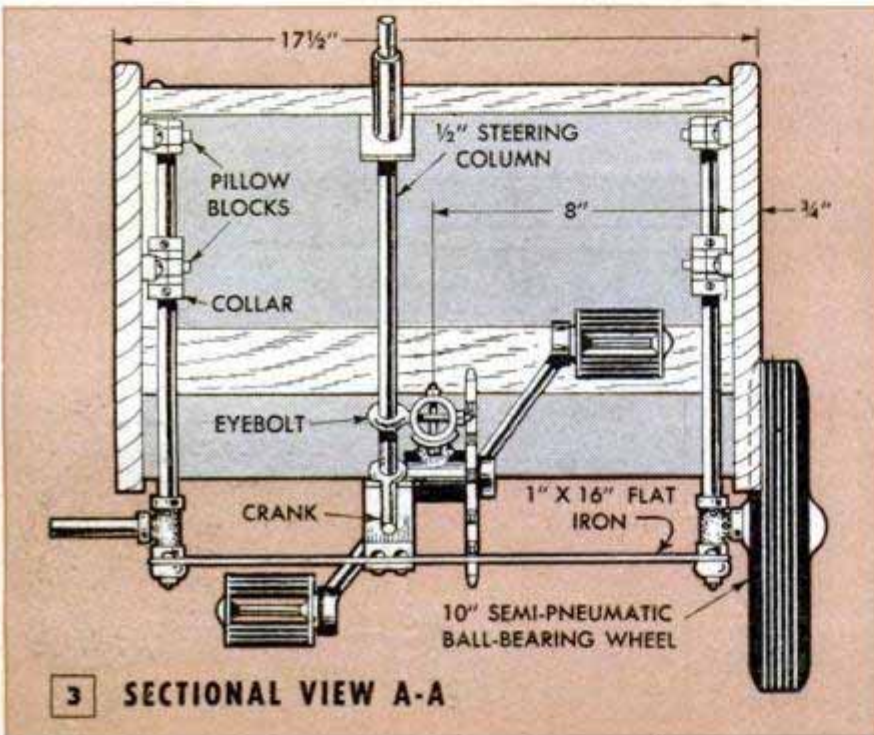

Like a tricycle, braking is done with the pedals, and if the driver has difficulty reaching the pedals, a back cushion can be provided

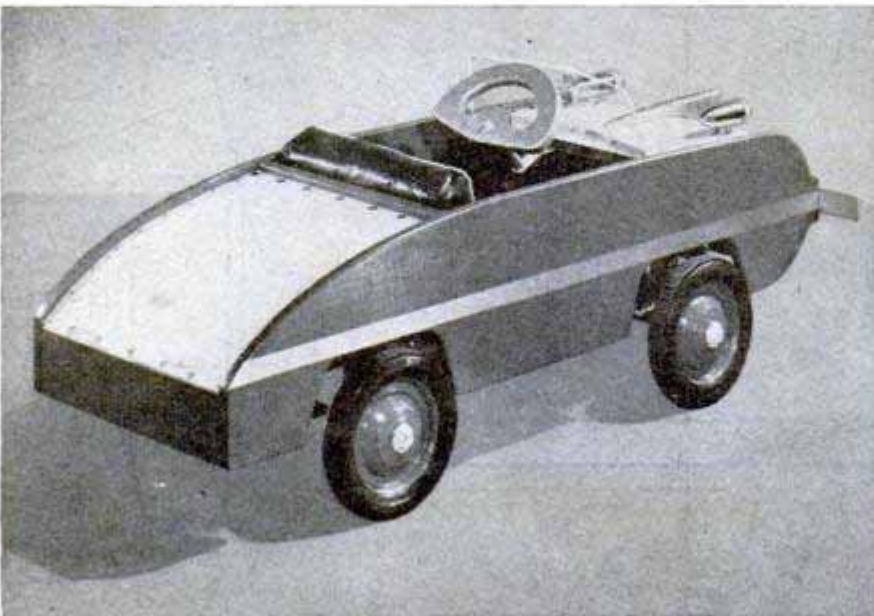

rod, 3-in. lengths being provided for the wheel axles. Note that the tees are pinned about $\frac{3}{4}$ in. from the ends of the vertical lengths to permit attaching radius arms to the lower ends. Cranks taken from tricycle pedals were used for these on the original car, although you can make them from bar stock, drilling and tapping each one for a setscrew. Note that a third crank is used on the steering column to engage a slotted bracket riveted to a flat-iron radius rod. Two collars, one above and one below the lower pillow block on each side of the car, hold the steering assembly in place. The lower end of the steering column is supported by an eyebolt, while the upper end is held by a flat-iron bracket. A pipe spacer placed over the upper end of the shaft holds the column in place. The pipe flange, to which the steering wheel is fastened, is drilled out and pinned to the column. Pillow blocks, which provide bearings for the rear wheels, are screwed securely to the ends of the mounting cleats provided, and an 8-tooth standard sprocket is fitted to the axle in line with the tricycle sprocket. Slotted mounting holes in the latter provide takeup of the roller chain. Any 10-in. semi-pneumatic, ball-bearing wheels can be used. Details in Fig. 2 show how the left wheel is locked to the rear axle.

The sheet-metal hood and deck covering are attached to the cleats with oval-headed screws and cup washers, spaced about 2 in. apart. The windshield consists of two pieces of clear plastic 5 x 8 in. which are fastened to the body at about a 2-in. slant with pieces of metal angle. The lights used are battery-operated headlights purchased at a bicycle shop, and are attached to the hood by driving the mounting screws into wooden blocks fitted under the sheet metal.

Plastic Food Bags Shield Sockets While Cleaning Ceiling Fixture

When one housewife cleans the rather ornate ceiling fixture in her living room, she covers each of the lamp sockets with a plastic food bag. This insures that no soap and water will remain to short-circuit the sockets when the fixture is turned on or cause corrosion which would, in time, be likely to damage the sockets and wiring. With the sockets completely protected by the plastic bags, plenty of cleaning solution can be used to do a quick and thorough job. However, it still is necessary to make sure that the wall switch is turned off to prevent any possibility of electric shock.

Ed Packer, Chicago.



Wire Under Exhaust Deflector Prolongs Tail-Pipe Life

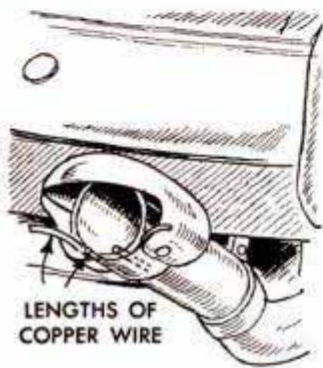

As most exhaust deflectors clamp tightly to the end of the tail pipe, moisture collects between the two parts with little chance for evaporation. This frequently causes the end of the tail pipe

to rust off within a comparatively short time. To prolong the life of the tail pipe, insert four lengths of copper wire between the deflector and the tail pipe when attaching the former. The wires serve as spacers which hold the metal surfaces apart, thus permitting sufficient air circulation between the two parts to keep the area reasonably free from moisture and, in this way, minimize rusting.

Clinton R. Hull, Costa Mesa, Calif.

Block Simplifies Pulling Nails

Pulling rusted nails and spikes from old lumber is no problem if this stepped block is used as a rest under the hammer. Each step raises the hammer $\frac{1}{2}$ in. and, if the nail is too long to be pulled straight out with the hammer on the first step, the second or third step is simply slipped under the hammer. A hole drilled through the first step will permit hanging the block from a nail when it is not in use.

Archie N. Brunton, Gisborne, N. Z.

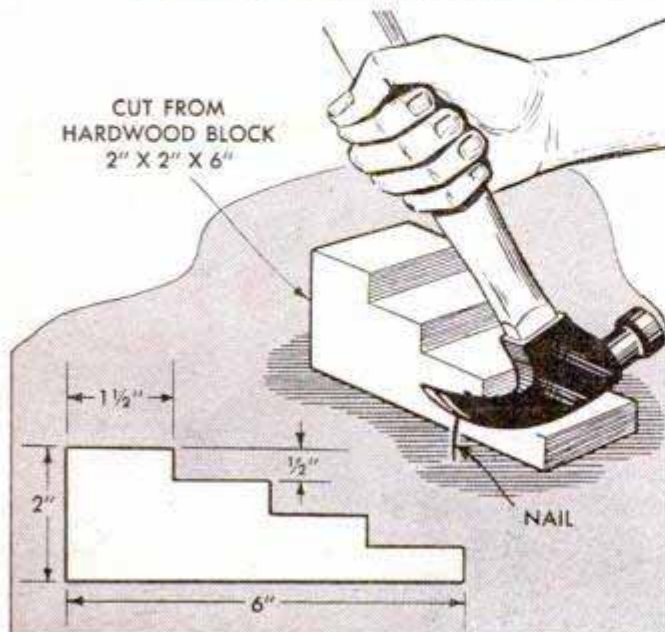

Tubing Holds Eye Glasses in Place

Those who wear shell-rim glasses while working or participating in sports will find that a length of rubber tubing temporarily fitted to the glasses will keep them from slipping out of place or falling to the ground. A



length of $\frac{3}{8}$ -in. tubing is pressed over the end of one bow of the glasses. Then the tubing is stretched lightly around the back of the head and pressed over the other bow.

Robert A. Groff, Elmira, N. Y.

Determining Amount of Seed

If directions tell you to plant so much seed per acre, here is how to find the area of your garden in fractions of an acre. Just multiply the length of the land by the width, and multiply the answer by .000023. Thus, if the garden is 100 ft. long by 100 ft. wide, its area is .23 acre. Then multiply the number of pounds of seed per acre by .23 to arrive at the quantity needed.

W. F. Schaphorst, Newark, N. J.

Solution

A 16-FT. PLYWOOD SAILING SCOW

By R. Howell

DESIGNED especially for those who want a practical, unpretentious sailboat which is easily and quickly built at low cost, Solution is simply a scow with hull refinements that enable it to carry a 21½-ft. stepped mast and about 140 sq. ft. of sail. The plywood bottom curves in a long, unbroken sweep from the stem block to the transom, while the sides curve out to the beam width back of midships and then fair in to the transom in a smooth, flat curve. Because of these construction refinements, the hull rides easily and planes smoothly when you pick up a good breeze on the long reach of the tack. The unbroken curve at the gunwale adds to its trim, seaworthy appearance.

Selected fir or spruce is used for the frames, and all fir plywood used in the hull should be of the waterproof marine grade. The solid stock for the

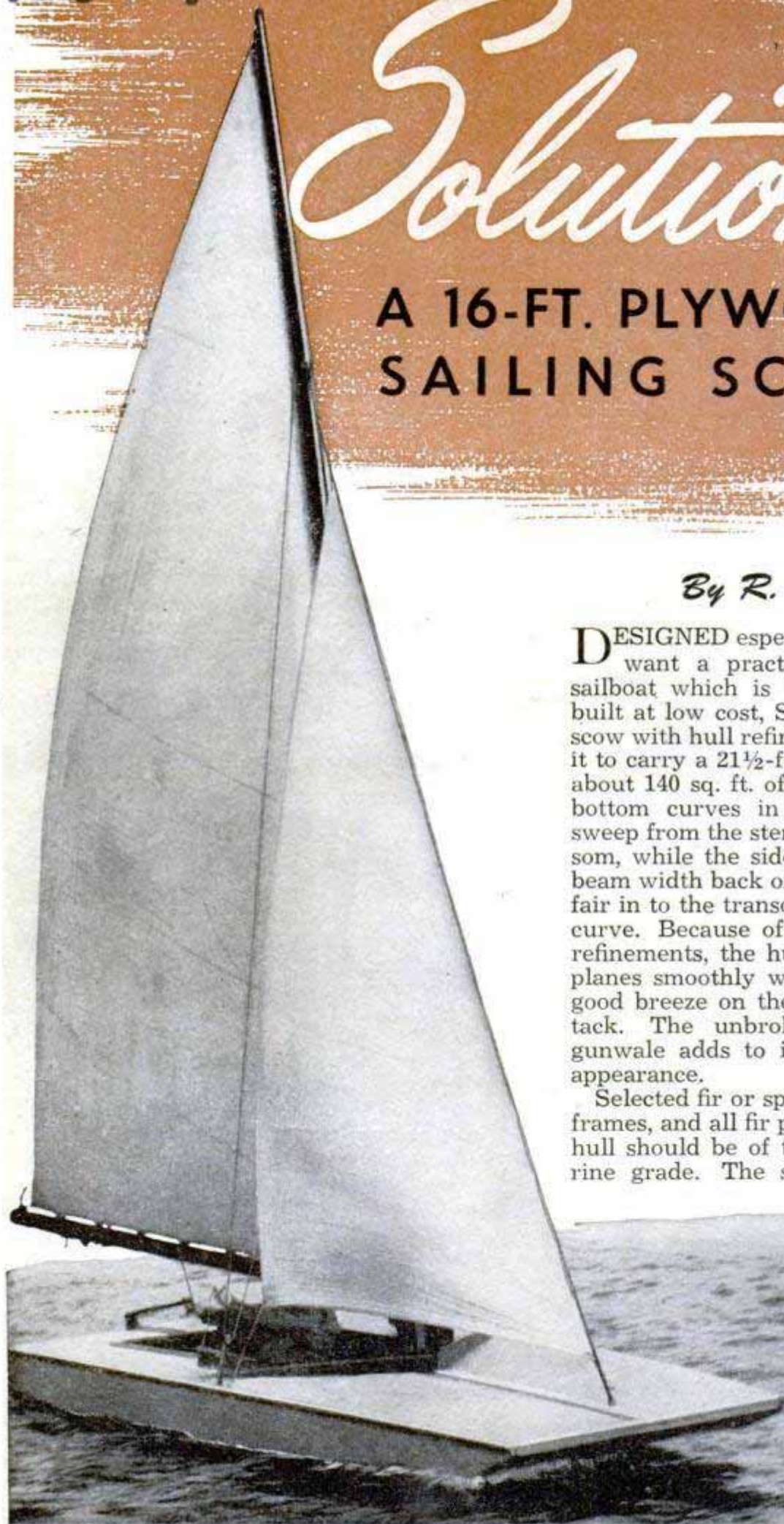

structural members should be clear and straight grained.

The first step is to lay out and cut the side panels, Fig. 3. Note that both side and deck panels are cut from four 4 x 9-ft. sheets of 1/4-in. plywood. To lay out the sides of the hull, two sheets are laid on the floor, end to end, and marked according to the drawing. Stations for the eight frames also are marked. The deck panels, Fig. 4, are laid out from the waste plywood after cutting the sides. To do this, it is necessary to flip over the panels, end for end. Being made up of two separate pieces, the deck and side panels are butted together and joined with butt blocks, as indicated, gluing and screwing them in place. Be sure to assemble the side panels so that one is right hand and the other left. After the glue is dry, clamp the panels together and plane the edges so that both units are identical in size and shape.

Fig. 1 details assembly of the frames. Scrap plywood left from the panels is used to serve as gusset plates in covering the frames. In the case of the mast frame, both sides of the frame are completely covered to give sufficient strength to support the mast. The headstay frame is a solid 8-in. board, notched top and bottom. Note that

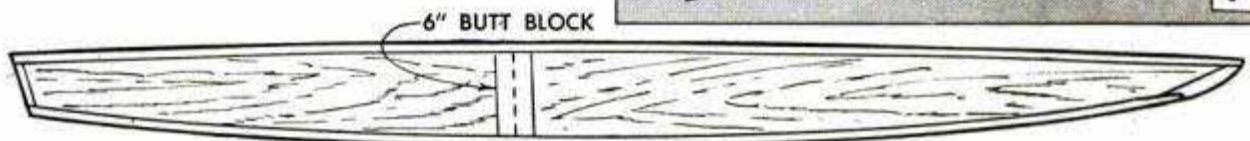
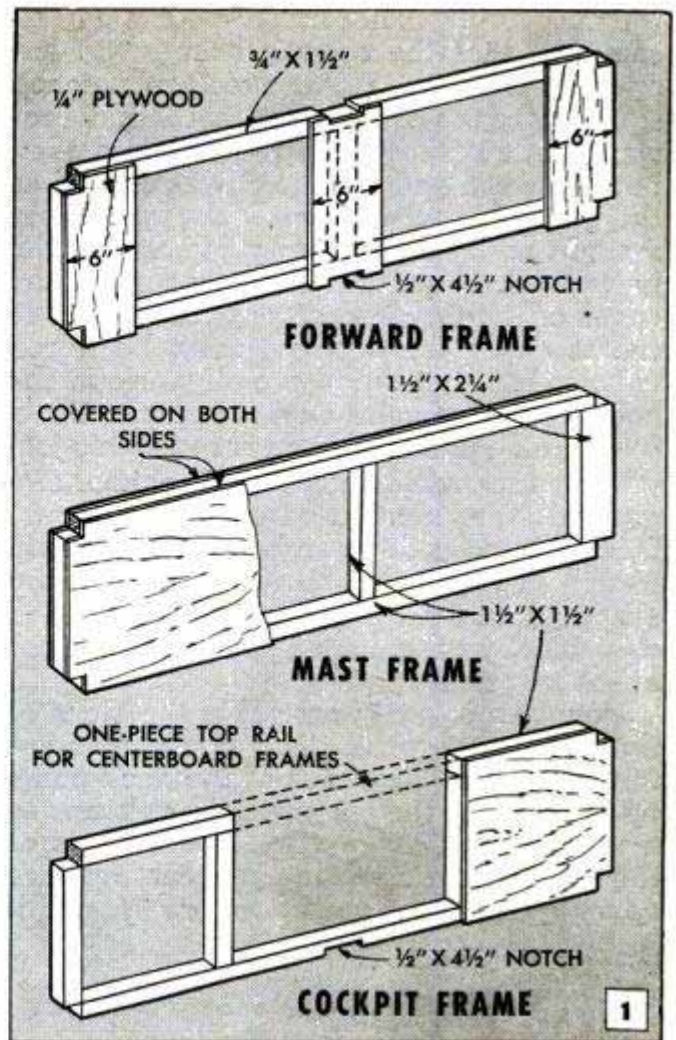

2 SIDE-PANEL ASSEMBLY

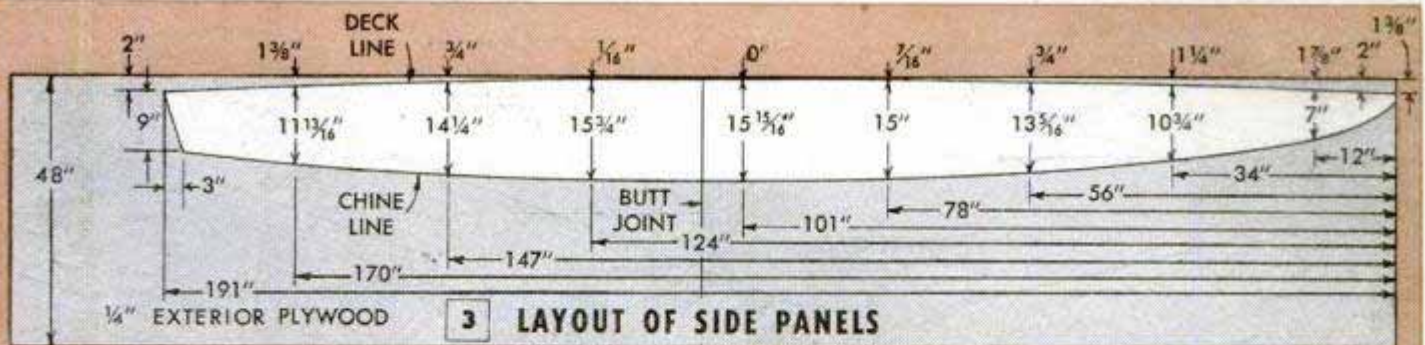

3 LAYOUT OF SIDE PANELS

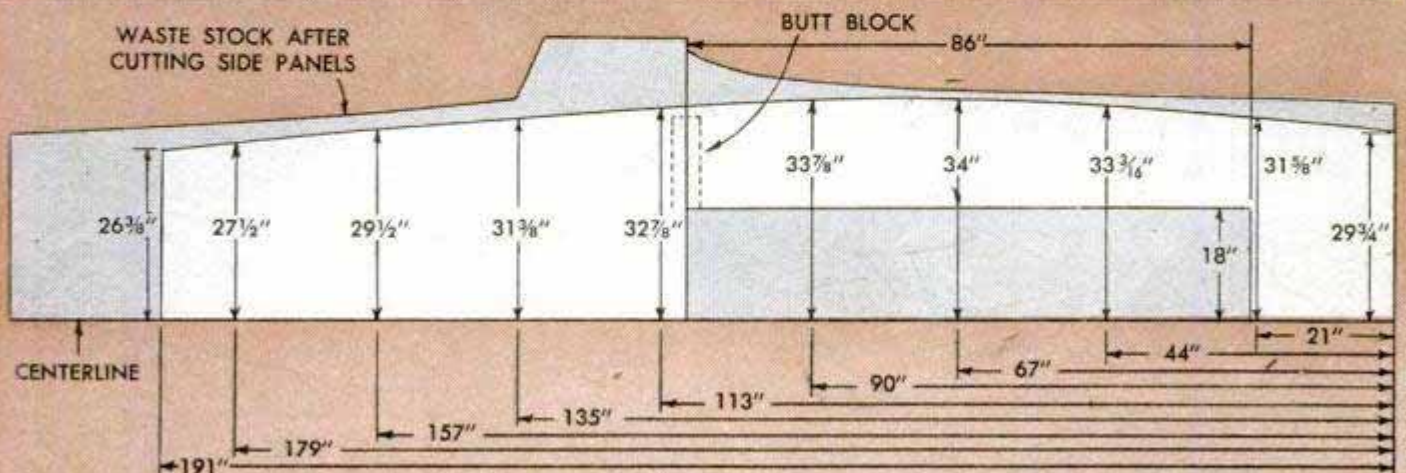

4 LAYOUT OF DECK PANELS

the mast frame is not notched for the keelson, and that the cockpit frames are left open at the top. All frames are notched squarely at the corners for chines and gunwales, but it should be remembered that, both forward and aft, the chines as well as the gunwales actually meet the notches at a slight angle because of curvature of the parts at these points. For this reason, the edges of the fore and aft frames, including the faces of the notches, must be faired (planed) so that the plywood panels fit the chines and gunwales on a flat plane. Use a block plane and fine wood rasp for this job.

With the frames completed, chines and gunwales are next fitted to the inner surfaces of the side members of the hull. Notice in Fig. 2 that these conform to the shape of the sides and are fitted with a nose block at the stem and a vertical cleat at the transom.

Now, temporarily assemble the sides of the hull to the deck. The side panels are forced to take the curve of the deck panel by drawing in the ends with bar clamps or a twisted rope loop. The lower edges of the panels are held the correct distance apart by clamping a strip across the width

at a point directly under the deck butt block. In this way, the butt block and the strip act as spreaders which force the side panels to take a uniform bend in each direction from this point. When this is done, the frames can be fitted to the chines and gunwales individually.

After fitting the frames and the keelson, the bottom panels can be installed. First, turn the assembly over, place on a level floor and block up the stem and transom until these parts check square and true. Plane all exposed surfaces and edges so that the curves are uniform, then locate the bottom panels with the edges centering on the keelson. Plane the edges to get a tight fit. Remove the panels and apply marine glue to all joining surfaces. Then replace the panels in the order removed and fasten with screws driven in flush. After the glue is dry, attach the keel and turn the hull over. Remove the deck panel so that you can install the deck beams, intermediate frames and the filler block between the headstay and stem piece. After these parts are installed as in the cutaway view shown below, cut the opening for the centerboard and fit the parts of the centerboard well as

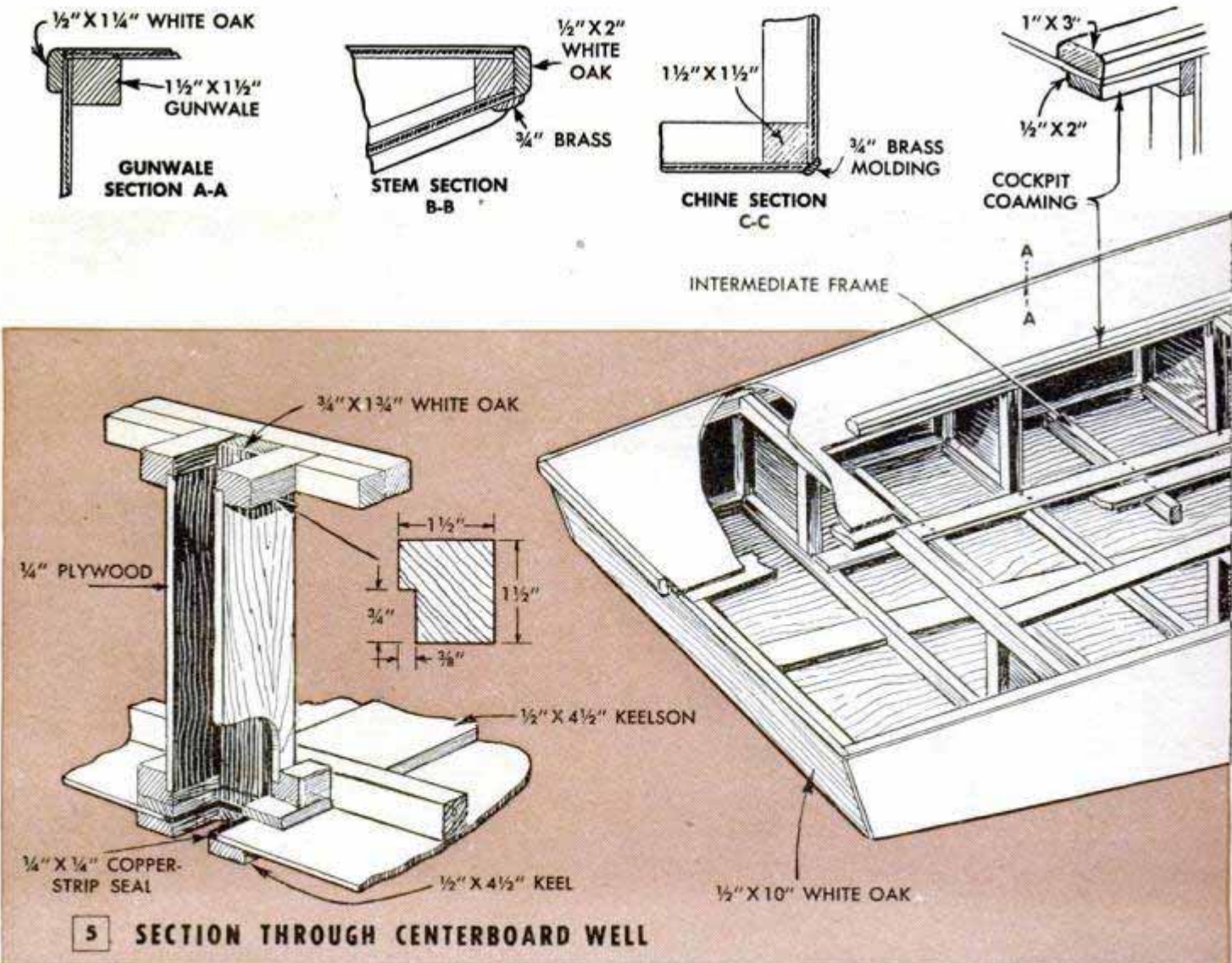

5 SECTION THROUGH CENTERBOARD WELL

in Fig. 5. Special care must be taken to build a watertight joint around the lower opening of the well. Set all the joining parts in marine glue and be sure that all joints fit tightly. The copper sealing strip, Fig. 5, serves the dual purpose of providing a watertight seal at the joint and also protecting the wood against wear from the centerboard. Finish the hull by adding the oak transom, cockpit coaming, deck splashboards, mast step, Fig. 7, rudder and centerboard, Fig. 6, and the moldings and rub rails as shown in sections A-A, B-B and C-C, Fig. 5.

The mast, Fig. 11, is of box-section construction with filler blocks spaced as indicated. Sides of the mast are faced with $\frac{3}{8}$ -in.-thick stock, which is applied with cold resin glue. The mast has a 6-in. rake aft from a point 16 ft. above the deck. Figs. 8 and 10 show the method of attaching the mast stays to the mast and to the deck tangs. Fig. 9 details the gooseneck which carries the boom. To anchor each stay to the tangs, first insert the end through the hole in the tang and seize it tightly, using several turns of No. 16-ga. copper wire at a point about $1\frac{1}{2}$ in. from the end, as in

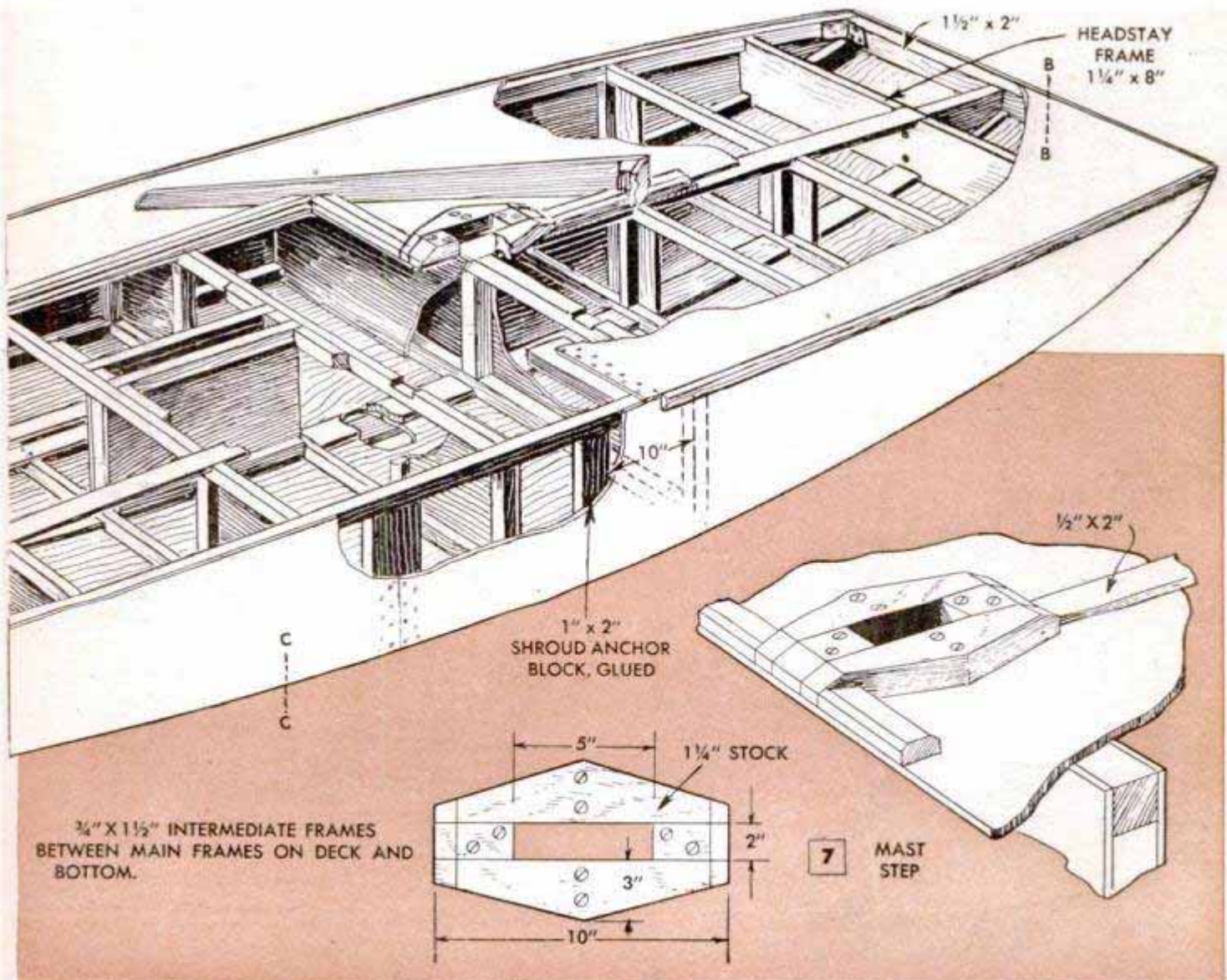
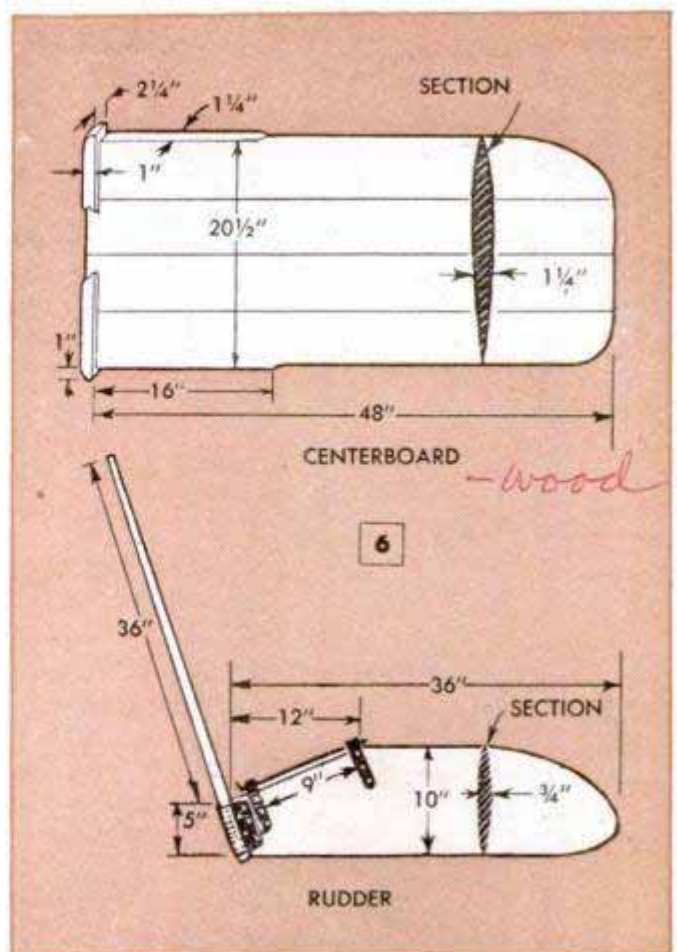

detail A. Next, the strands of the stay are raveled down to the seizing, as in detail B, and brought down over the seizing to form a knob considerably larger than the hole in the tang. Then the raveled ends are passed through the hole in the tang and finally seized to the stay by wrapping the strands with serving wire, as in detail C. A drop of solder will prevent the servings from loosening. Over-all dimensions for the jib and mainsail are given in Fig. 11. These require 22 yds. of 36-in., 4-oz. sail cloth and about 100 ft. of $\frac{5}{16}$ -in. Manila rope. Unless funds are strictly limited, it's best to have the sails made by an experienced sailmaker as, above all, you'll want them to be the best part of the boat.

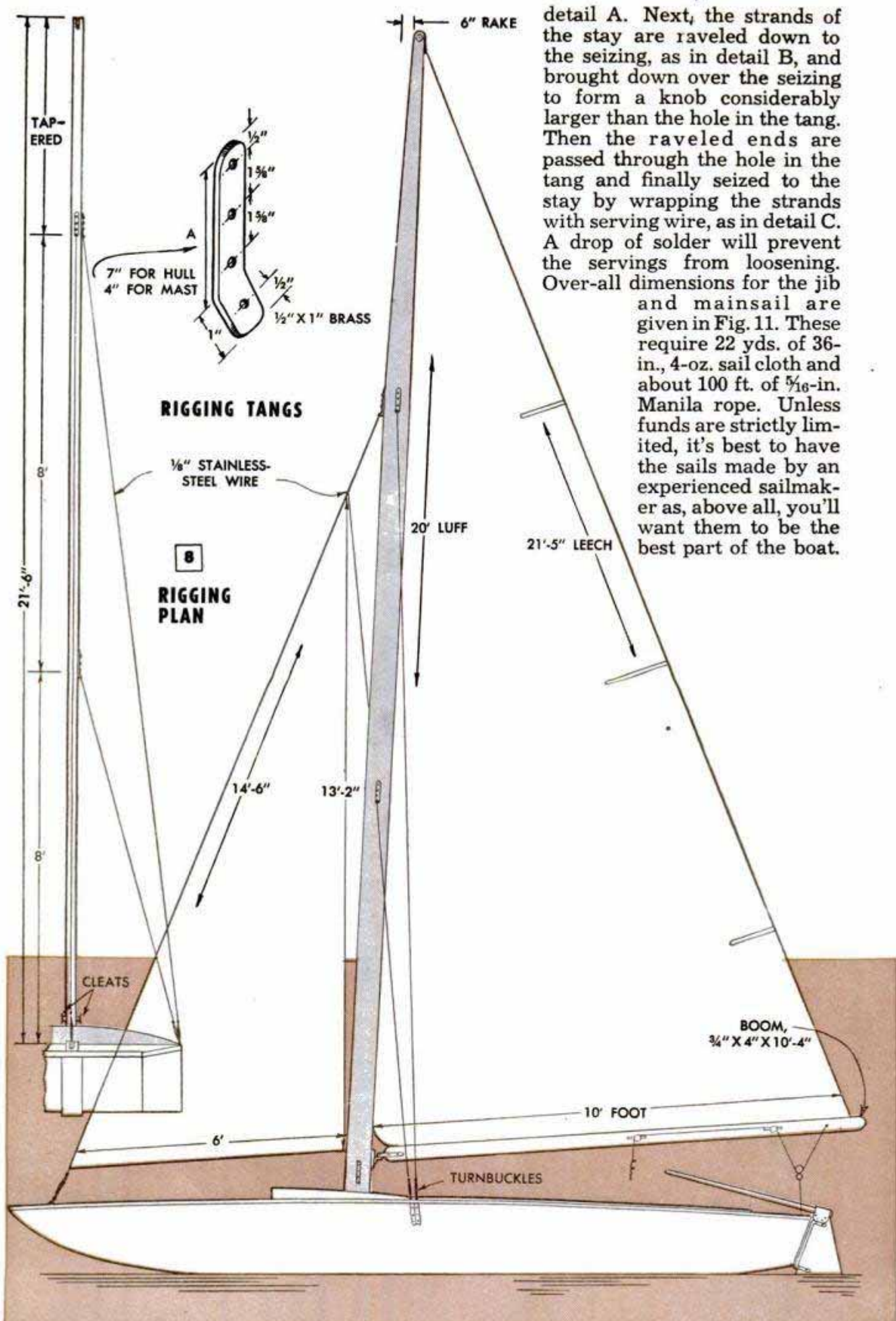

Kitchen Range Set on Even Keel By Means of Carpenter's Level

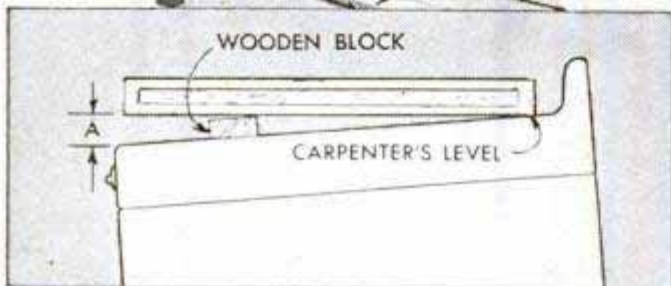

As it is important that a kitchen range be level, particularly when it comes to baking cakes and pies, much time and effort are spent in trying to level the range. Often this is done by a hit-and-miss method of slipping blocks of various thicknesses under the legs. To take guesswork out of leveling the range, just set a carpenter's level on top of the range and prop it with a piece of wood as shown. Move the wood inward or outward until the bubble is centered in the glass and measure the distance, A, between the top of the range and the underside of the level. Then cut a wooden prop to this thickness and insert it under the low leg.—James E. Cronin, Ferguson, Mo.

Hacksaw-Blade Straightedge For Cutting Paper



When cutting paper with a stencil knife, try using an ordinary hacksaw blade as a straightedge. The teeth of the blade tend to grip the surface of the paper to provide a

nonslip straightedge, and the knife cannot accidentally cut into the hard steel of the blade. If the straightedge is held firmly in place, several sheets of paper can be cut simultaneously without danger of their slipping out of line.

Walter Gabriel, Omaha, Neb.

Replacing Rubber Hood Cushions

If the rubber tabs that cushion the hood of your car have deteriorated to the point where they are no longer suitable, they can be replaced satisfactorily with small squares of sponge rubber. Mount the squares several inches apart along both sides of the hood, as shown, fastening them in place with gasket or tire cement.

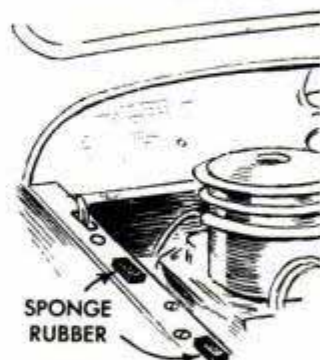

Yardstick Tacked to Level Provides Handy Tool

Tacking a yardstick to one side of a carpenter's wooden level combines a rule and level in a single timesaving tool. After cutting off the yardstick to the desired length, tack it slightly above the lower edge of the level so that it does not interfere with the operation of the instrument.

Jack Hatfield, Pasadena, Calif.

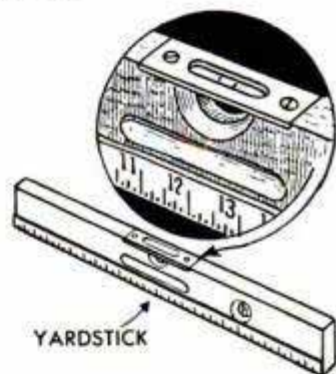

Flashlight Fitted With Mirror "Sees" Around Corners

Clamped to a flashlight, a bicycle mirror directs the beam at an angle and also reflects the object at which it is directed. Thus, it is ideal for working on plumbing and making repairs on the car, as you can see exactly what you are doing even though the work ordinarily would be hidden from view. The mirror, of course, is easily adjusted to the desired angle.—H. Leeper, Canton, Ohio.

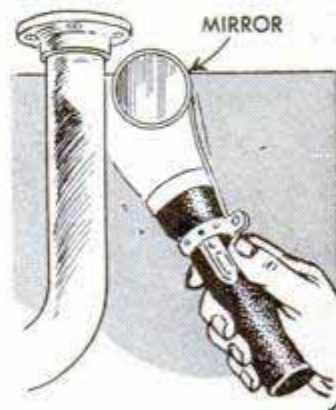



BACK-YARD EGG AND FRYER PLANT

By Hi Sibley

EGG AND MEAT production in a minimum of space is permitted by this compact back-yard poultry plant. The wire-floored structure is fitted with roosts, feed hoppers, nests and a sanitary dewdrop watering system so that the chickens can practically take care of themselves in the outdoors during the warmer months. In cold weather they should be protected with a tarpaulin spread over the exposed parts of the structure, or the unit can be moved inside the garage or other outbuilding. Details of the fittings and framing show that construction is a simple carpentry job. The corner and center uprights and the floor frame are of 2 x 4-in. stock. Other framing members and rafters are 2 x 2s. Coat wooden parts with a creosote solution.

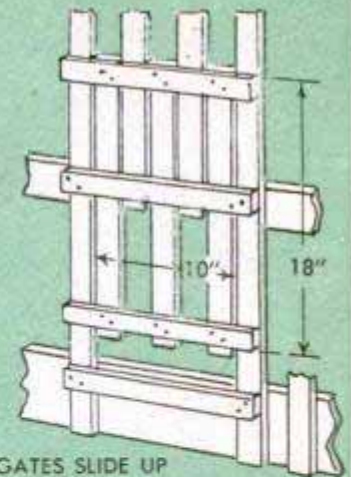

GATES SLIDE UP

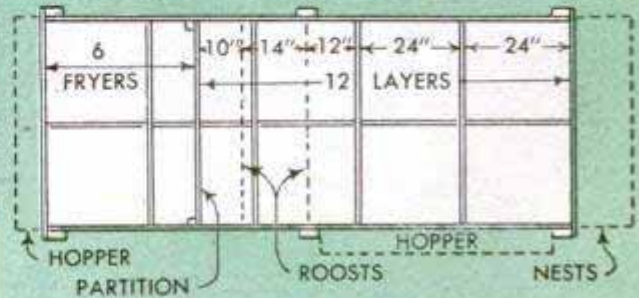

FLOOR PLAN

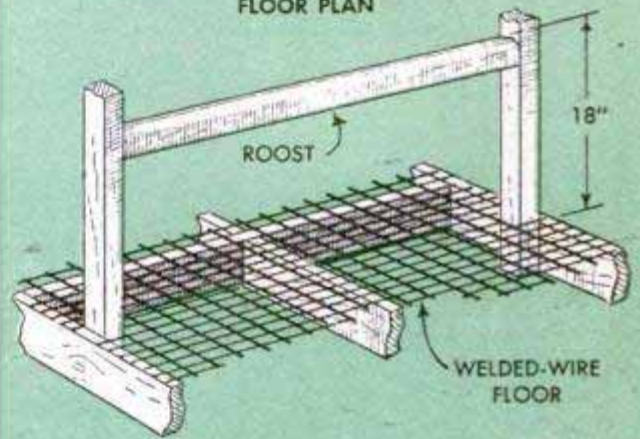

ROOST

WELDED-WIRE FLOOR



DEWDROP NIPPLE

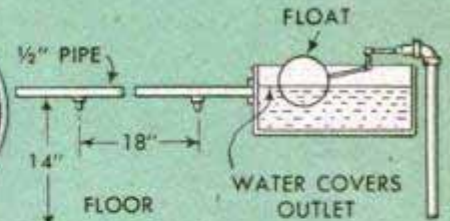

AUTOMATIC WATERING SYSTEM

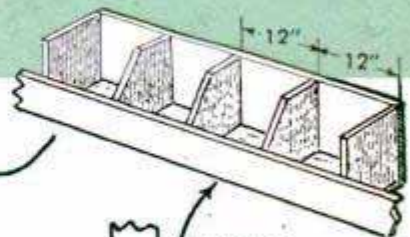
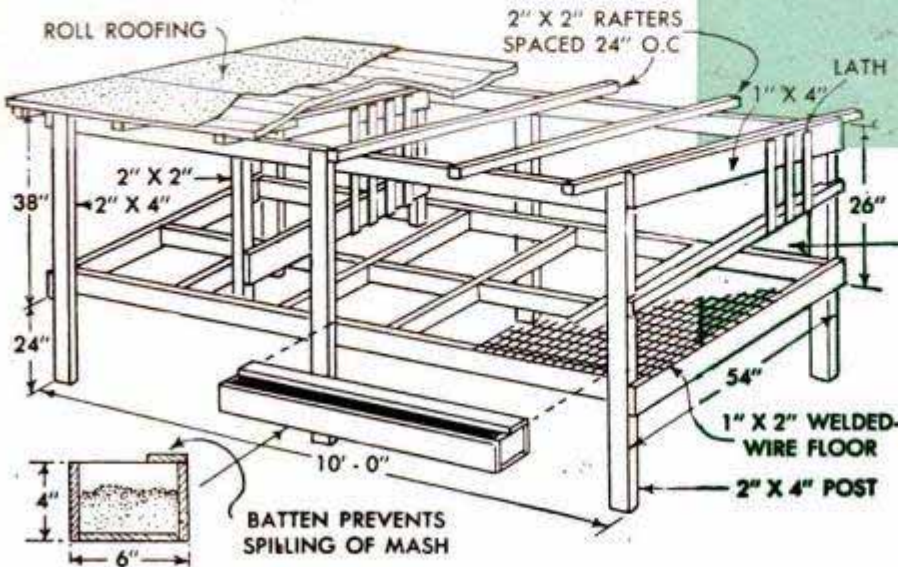

NEST SECTION

Handy Carrier for Bicycle Lock Fits Under Horizontal Bar

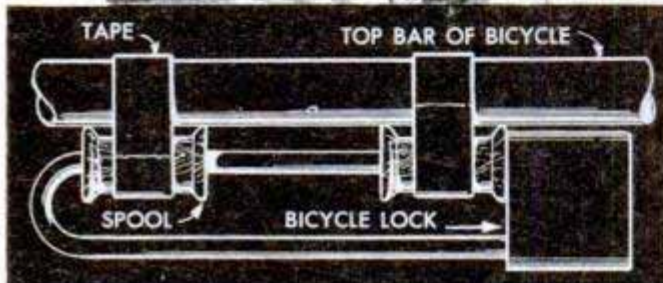
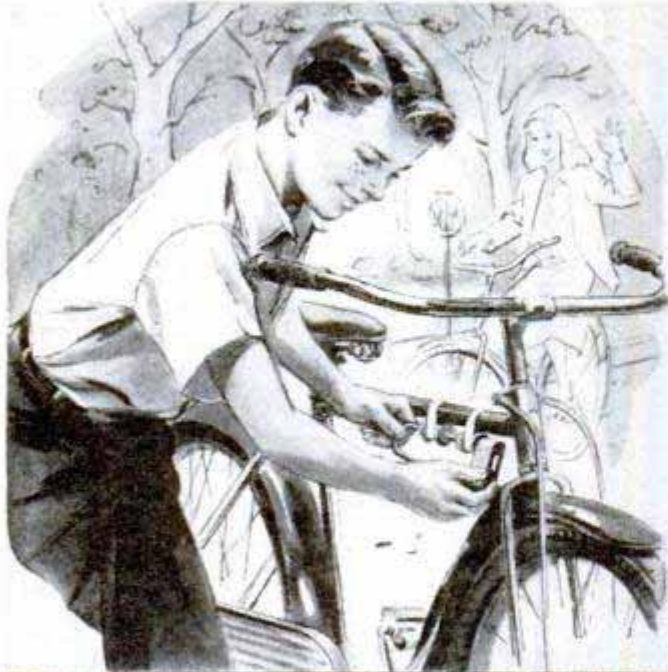

A bicycle lock won't rattle and scratch the frame if it is carried in this convenient rack when not in use. To make the rack, tape two wooden thread spools to the underside of the horizontal frame bar. Then slip the shackle through both spools and snap the lock closed to hold it in place. If the holes in the spools are too small for the lock shackle they can be enlarged by drilling with a twist drill.—W. P. Augustine, Walkerville, Ont., Can.

Boiling Prevents Dish Cracking

Crazing of earthenware dishes frequently is prevented or at least minimized by placing the new dishes in a pan of cold water and bringing the water to a boil. Allow it to boil for a minute or two.

Correcting Car-Door Rattle

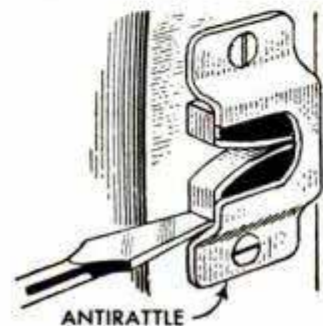

If a car door rattles and does not seem to fit as well as it originally did, the trouble may be due to worn anti-rattles. If the anti-rattles are of the type shown in the drawing, the in-

serts can be interchanged to renew their grip on the door. Remove the inserts with a screwdriver blade by pushing inward and prying them out. Then simply replace them with the bottom insert on top.

Charles Wesley Shutt, Alma, Mich.

Cork Provides Fishhook Holder

Large corks of the type used on vacuum bottles form safe and compact holders for several fishhooks fitted with leaders. Draw evenly spaced lines lengthwise on the sides of the cork, spacing them about $\frac{1}{2}$ in. apart. Then, with a razor blade, cut slits along the lines to a $\frac{1}{2}$ -in. depth. To use the holder, merely embed the barbs of the hooks in the top of the cork and press the leaders into the slits.

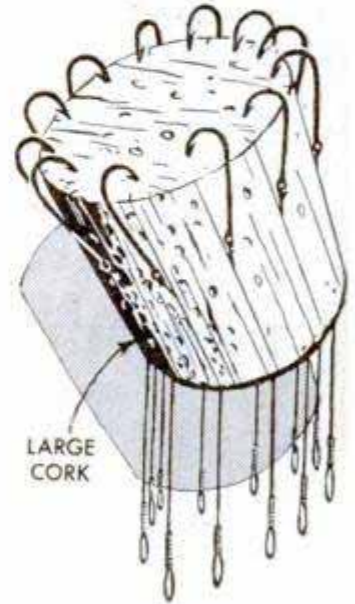

Homer E. Lee, Bedford, Ind.

Retaining Appearance of Suede

To keep suede shoes and accessories looking like new, it is best to clean them frequently. Before putting the items away after wearing them, go over the suede with a cloth moistened in vinegar. Then rub with a stiff brush or sponge.

Blanche Campbell, Las Vegas, Nev.

Improved Bottle Opener

When you are unable to find a bottle opener, you can improvise one quickly by using a common nail and a piece of wood. Drive the nail into the wood so that the head projects about $\frac{1}{4}$ in.



and hammer over the end so it won't pull out. Remove the cap by hooking the nail-head under the edge of the cap and pressing downward on the end of the wooden handle.

Federico Strasser, Santiago, Chile.

☐ Dropping a piece of lemon peel into the dishwater will soften the water, remove traces of fish or onion odor, and result in a high luster on china and glassware.

UNDERINFLATION & OVERINFLATION OF

Tires

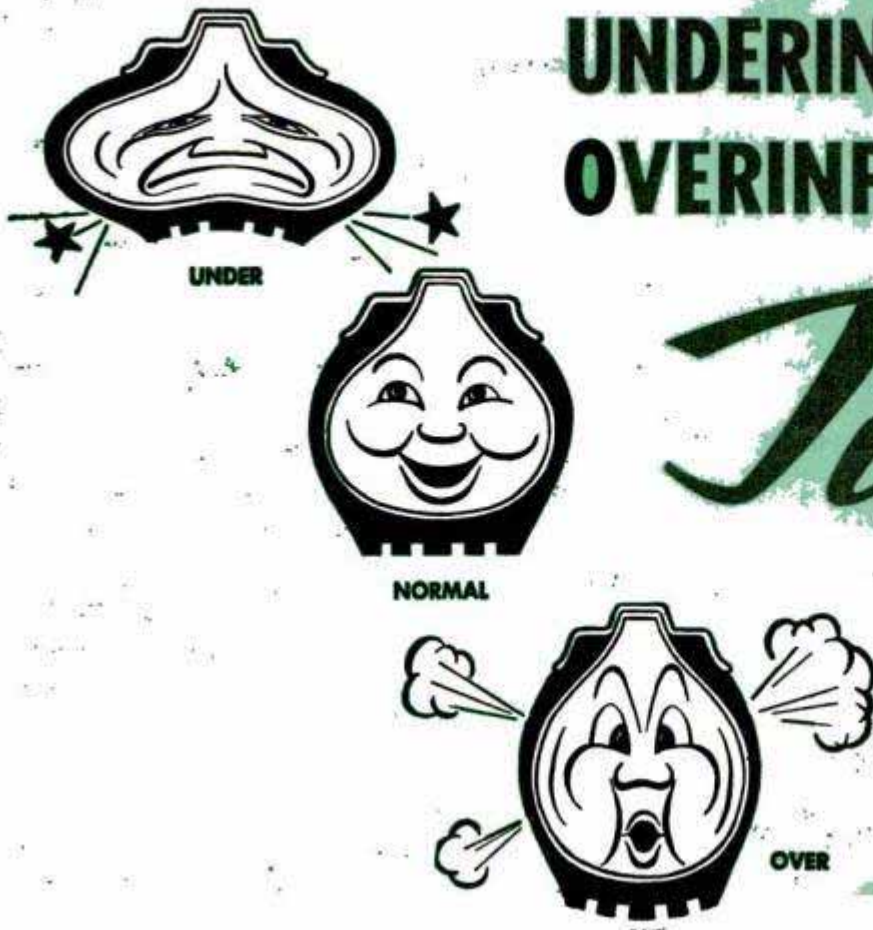

By S. V. Neibardt

Tire failure resulting from under or over inflation can be both costly and dangerous. Save money by making it a habit to check your tires once a week the year 'round

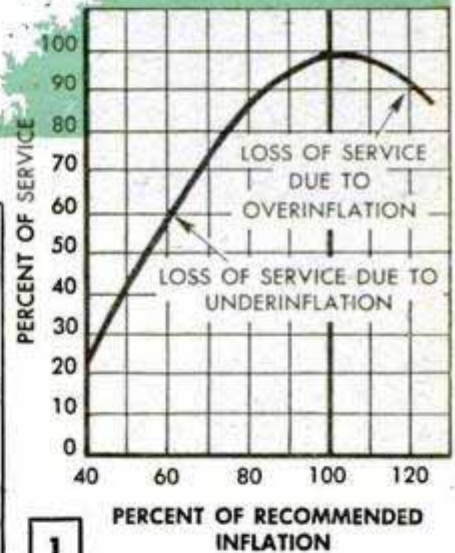
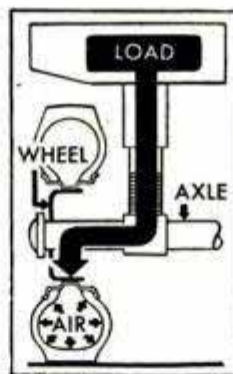

DID YOU ever have a tire suddenly go flat without any apparent reason, or experience a bad blowout that endangered you and your family, and then wonder what caused it? Punctures, stone bruises, glass cuts and other causes of external tire damage are readily observed, but serious fabric breaks and tread separations due to under or over inflation rarely show on the outside of the tire. A study of the simple graph in Fig. 1 will emphasize the importance of checking the air pressure in the tires at regular intervals. Careful drivers carry a tire gauge as a standard item in the tool kit, so that regular checks can be made at the proper time when the tires are cold. Driving at a fast clip generates considerable heat in the tires because of the flexing of the sidewalls and road friction at the treads. The heat expands the air in the tube and may raise the reading on the gauge as much

as 3 lbs. if the reading is taken while the tire is still warm. Never deflate the tire under these conditions, however, as the pressure will return to normal when the tire cools. A slow leak in the valve, often difficult to detect by ordinary methods, may cause a loss of 2 to 4 lbs. pressure in a few hours. In some tires a loss of 2 to 3 lbs. pressure may not cause a noticeable deflection of the sidewalls and for this reason the owner should never rely on a casual examination of the tires to detect a condition of underinflation. It's always best to use a reliable tire gauge.

Fig. 2 shows graphically what happens to the tread of a tire when it is run for a time underinflated. What you see is the almost complete absence of wear at the center of the tread. What you don't see are the separation of the fabric layers and the breaks which may develop at the center of



This tread wear is caused by running the tire under-inflated. Note the absence of wear at center of tread

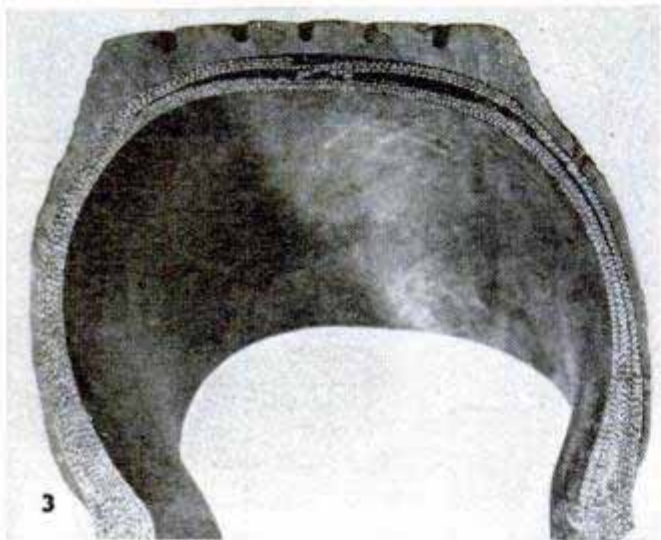

From the outside, you can't see ply separations and breaks in fabric that result from running tire under-inflated. Ply separations are costly to repair

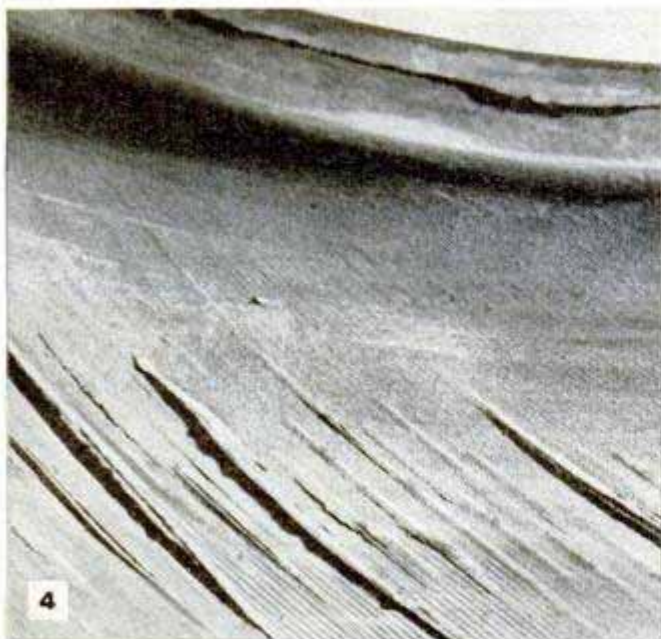

Flex breaks and ply separations in inner sidewalls often cause hazardous blowouts which can occur without warning. Note diagonal direction of the breaks

the tread, Fig. 3, and also flex breaks in the sidewalls, Fig. 4. The latter are a common cause of serious blowouts which may occur without any warning to the driver. When an underinflated tire is forced to fold over an obstruction as in Fig. 5, the sidewall break shown in Fig. 6 may result. In an older tire the damage may appear on the outside of the sidewall as in Fig. 7. A sharp fold in the sidewall, such as that pictured in Fig. 5, also may pinch the inner tube sufficiently to cause an immediate break, or one that is delayed only a short time.

In overinflated tires, the tread gradually takes on a high crown due to abnormal wear and stretching of the fabric. Only the center of the tread contacts the road, reducing the load-carrying area and greatly accelerating wear at the point indicated by the arrow in Fig. 8. Such a condition greatly reduces the ability of the tire to dissipate road shock, as the normal resiliency is reduced by the undue tension caused by over-inflation. Also, the tread and sidewalls are more easily cut and snagged by sharp objects. The tire cannot flex and fold over ordinary road irregularities. The possibility of serious fabric breaks, due to the inability of a "hard" tire to absorb impact, is greatly increased, as is the wear on other parts of the car, such as shock absorbers, kingpins and wheel bearings. The most costly and hazardous breaks resulting from continued overinflation are those pictured in Figs. 9 and 10. It's a good idea to examine the treads of older tires closely at regular intervals to detect the type of break shown in Fig. 9. The end result of such a break in the tread is the dangerous blowout pictured in Fig. 10. If you discover this type of tread break in time there is a good chance that it can be repaired at reasonable cost by a reliable tire-repair shop. But when the escaping air blasts away a portion of the tread as in Fig. 10, the cost of the repair may be more than the cost of a new tire.

It should also be kept in mind that other precautions against excessive tire wear, such as periodic checks of wheel alignment, cross changing of the wheels and good driving practices, will be largely offset by costly wear resulting from continued under or over inflation. All these special precautions must be carried out on schedule if tires are to give maximum service. It's a good idea to replace the valve cores and dust caps after the tires have gone 15,000 to 20,000 miles, or before, if there is reason to suspect slow leaks. When replacing the valve core, be sure to screw the new one down far enough so that the top end of the plunger will clear the dust cap when the latter is tightly in place. Use a valve-core wrench for this purpose and, after inflating the tires, don't forget to replace the caps.

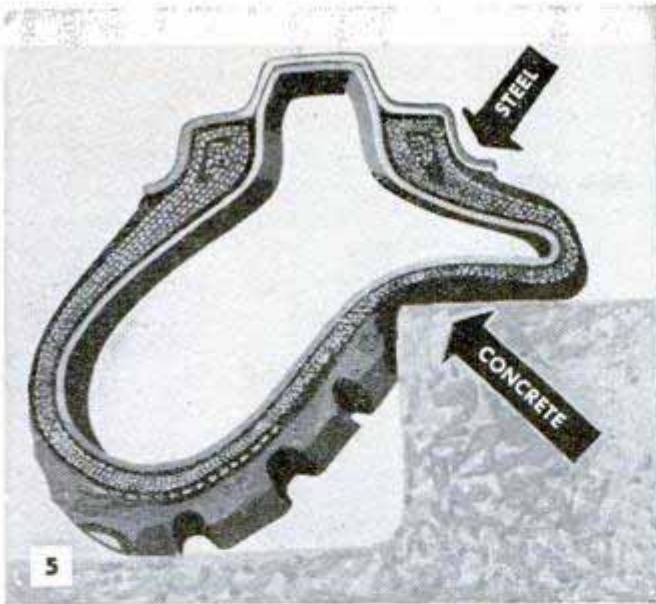

5 Don't drive over curbs, railroad tracks or any other straight-sided obstruction, especially with old tires



6 Here's what may happen inside the tire when you drive over a high obstruction or back onto the curb



7 In older tires, breaks may appear on outer sidewall. A sharp fold in sidewall may also pinch the tube, causing an immediate break, or at best a delayed one

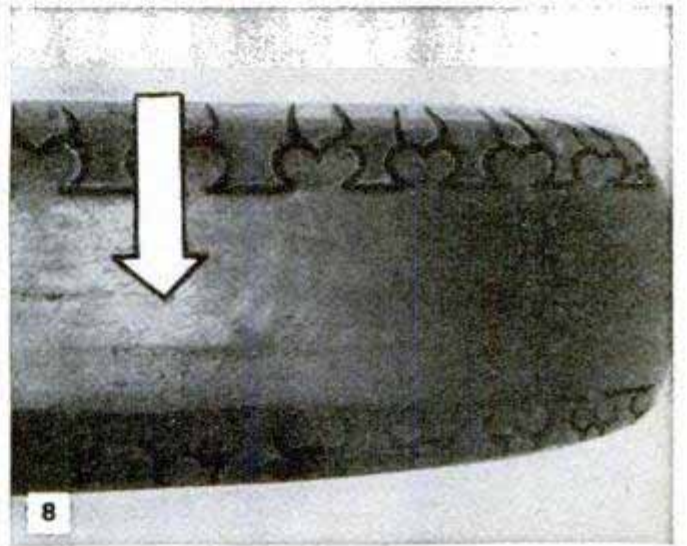

8 Overinflated tires gradually take on a high crown, because of abnormal wear and stretching of fabric. Arrow indicates point where wear usually is greatest

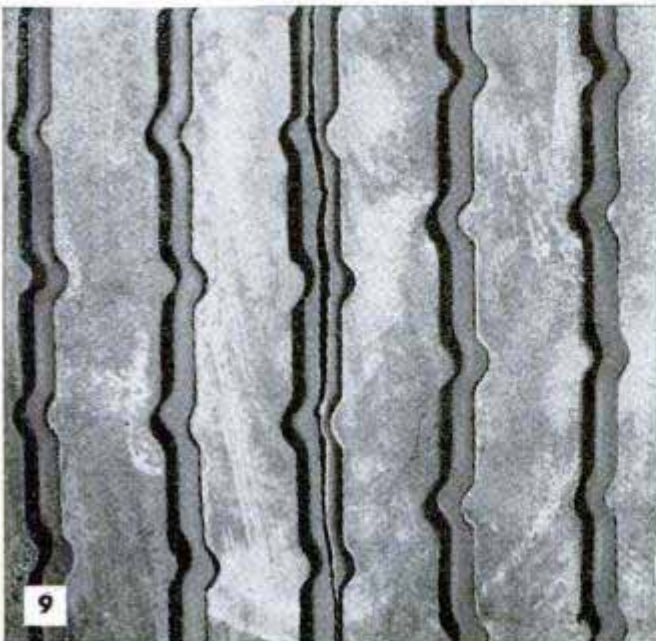

9 Continued overinflation results in tread breaks like that shown above. It is extremely hazardous to drive on crowded highways with tires in this condition

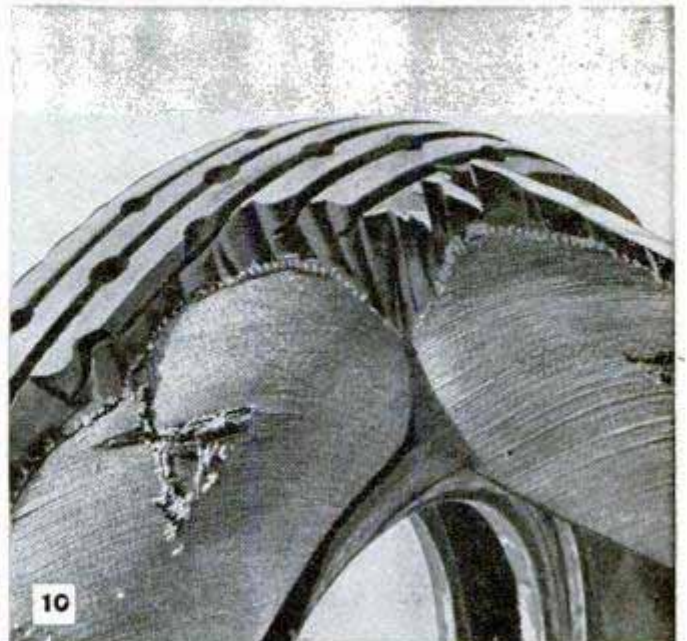

10 The inevitable end result of a tread break like that pictured at the left is a blowout like this. Sudden escape of the air has torn away a part of the tread

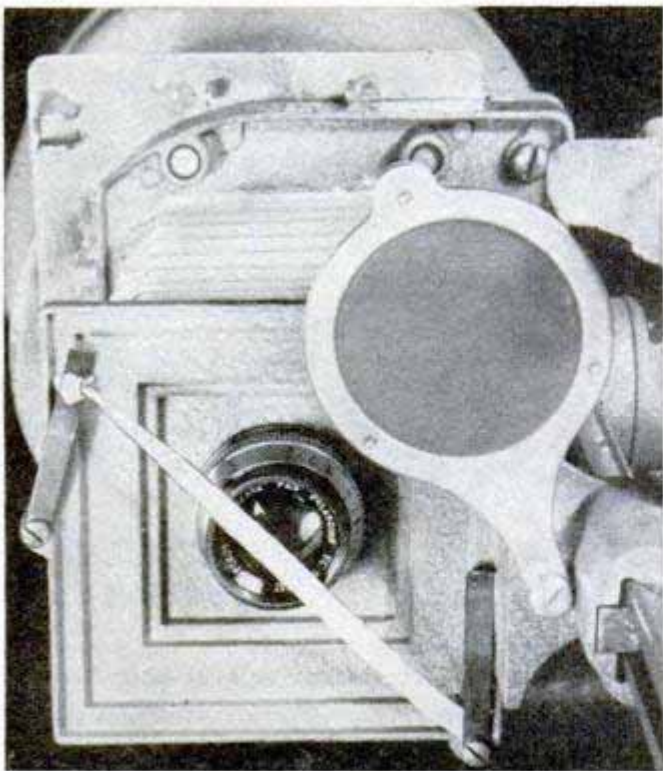

Rubber Band Across Enlarger Lens Facilitates Sharp Focusing

Fastened to the lens board of an enlarger so that it bisects the lens, a large rubber band forms an excellent focusing aid. When the rubber band casts a double image on the easel, the enlarger is out of focus. After focusing, the rubber band is simply moved alongside the lens barrel where it will remain until again pulled over the lens.

H. Klein, Pittsburgh, Pa.

Storing Spare Photoflood Bulbs In Individual Wall Racks

By using metal lamp-shade holders to provide individual racks, one home photographer safely stores his extra photoflood bulbs on the darkroom wall.



Each holder is bolted to an angle bracket which, in turn, is screwed to the wall. The bulb is simply set in the holder as pictured. For storing reflector-type photofloods, a larger angle bracket is used so the holder will be far enough from the wall to allow sufficient clearance for the top of the bulb.

For storing reflector-type photofloods, a larger angle bracket is used so the holder will be far enough from the wall to allow sufficient clearance for the top of the bulb.

John J. Rea, Urbana, Ill.

Spoons Measure Photo Chemicals

When mixing photo solutions, it is not necessary to weigh each powdered chemical if the same formula is frequently used. To save time, equip your darkroom with plastic measuring cups cut to hold the desired weight of each chemical.



Grind or cut the edges of the cup until it holds the exact quantity by weight. Each spoon should be labeled to identify it.—Hugh Lineback, Stillwater, Okla.

Staples Identify Print Paper

Selecting the right print paper is easy if each box is marked with staples to designate the size and grade of the contents. Work out your own identification code, and drive the staples through the front of the box cover, positioning them horizontally, vertically and diagonally in various combinations.

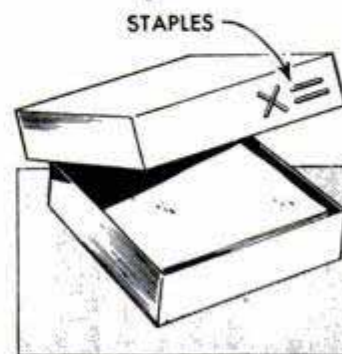

Warning on Loaded Film Tank

Sometimes film processing is interrupted when the tank is loaded and ready for the developer, and it may be a day or two before you get back to the darkroom. When this happens, it is easy to forget that the tank is already loaded, and opening it with the darkroom lights on will result in spoiling the film. Next time you have to set aside a loaded film tank, don't take chances. Just tear a section from the paper film backing, and press the paper over the agitator spindle to serve as a reminder that there is undeveloped film in the tank.

C. A. Lewis, Saskatoon, Sask., Can.



If investing in a standard copying easel does not seem worth while, an inexpensive one can be made quickly by fitting an ordinary picture frame with a hinged back. Although an 18 x 24-in. frame is detailed, any convenient size can be used. The back is made in two sections which are hinged at the center as well as at the bottom of the easel. In this way, the upper section may be dropped to permit inserting the work or the entire back may be opened for cleaning. Half-round molding is nailed to the three outer edges of the plywood or hardboard back panels, and the butting edges are joined with a length of piano hinge. The lower panel is hinged to the bottom rail of the frame with two butt hinges, small cleats being fastened to the rail to shim out the lower hinge leaves. Wooden turn buttons at the sides lock the lower panel in place, and a single turn button at the top holds the upper panel closed. A knob or small drawer pull is mounted on the upper panel. If you wish to set up the easel permanently, it can be held upright with two angle brackets screwed to the

Picture Frame Fitted With Hinged Back Provides Inexpensive Copying Easel

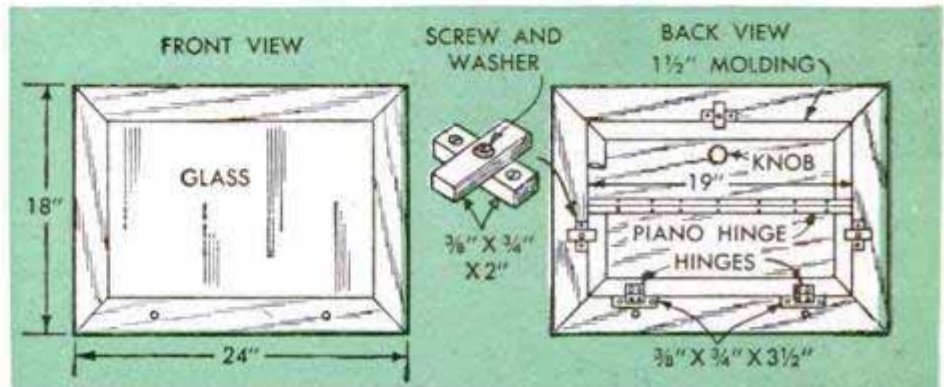
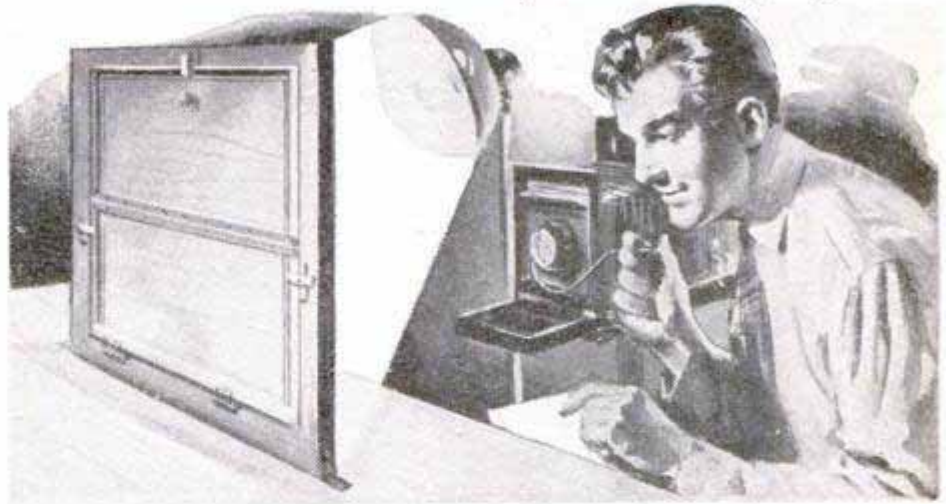

edges of the frame and to the table top. However, if you want to store the easel after each use, simply drill the lower frame rail to permit bolting two lengths of angle iron or other suitable base to the bottom of the easel. A coat of flat-black paint or lacquer applied to the inside surfaces of the hinged back will minimize reflection.

Pocket Fastened to Camera Case Holds Tab for Quick Film Identification

There is no danger of forgetting the type of roll film with which your camera is loaded if the tab from the end of the film package is kept with the camera. To do

this, sew or cement a leather pocket to one side of the camera case. The pocket, about $\frac{1}{2}$ in. larger over all than the cardboard tab, is cut out, as shown in the photo, so the identification on the tab can be seen at a glance. The cutout at the bottom of the pocket aids in removing the tab when another type of film is used.

Walter E. Burton, Akron, Ohio.



Safe Lens-Cleaning Methods

Before cleaning a lens with tissue, a camel's-hair brush or an air syringe should be used to remove all grit particles which rubbing might grind into the lens. Then, if you use lens cleaner, apply it to the tissue or a soft, lintless cloth, rather than to the lens, as otherwise the fluid is liable to run into the lacquer or cement of the lens mount, causing it to loosen. Use care in reassembling unscrewed lens elements as slight damage may result in costly repairs.

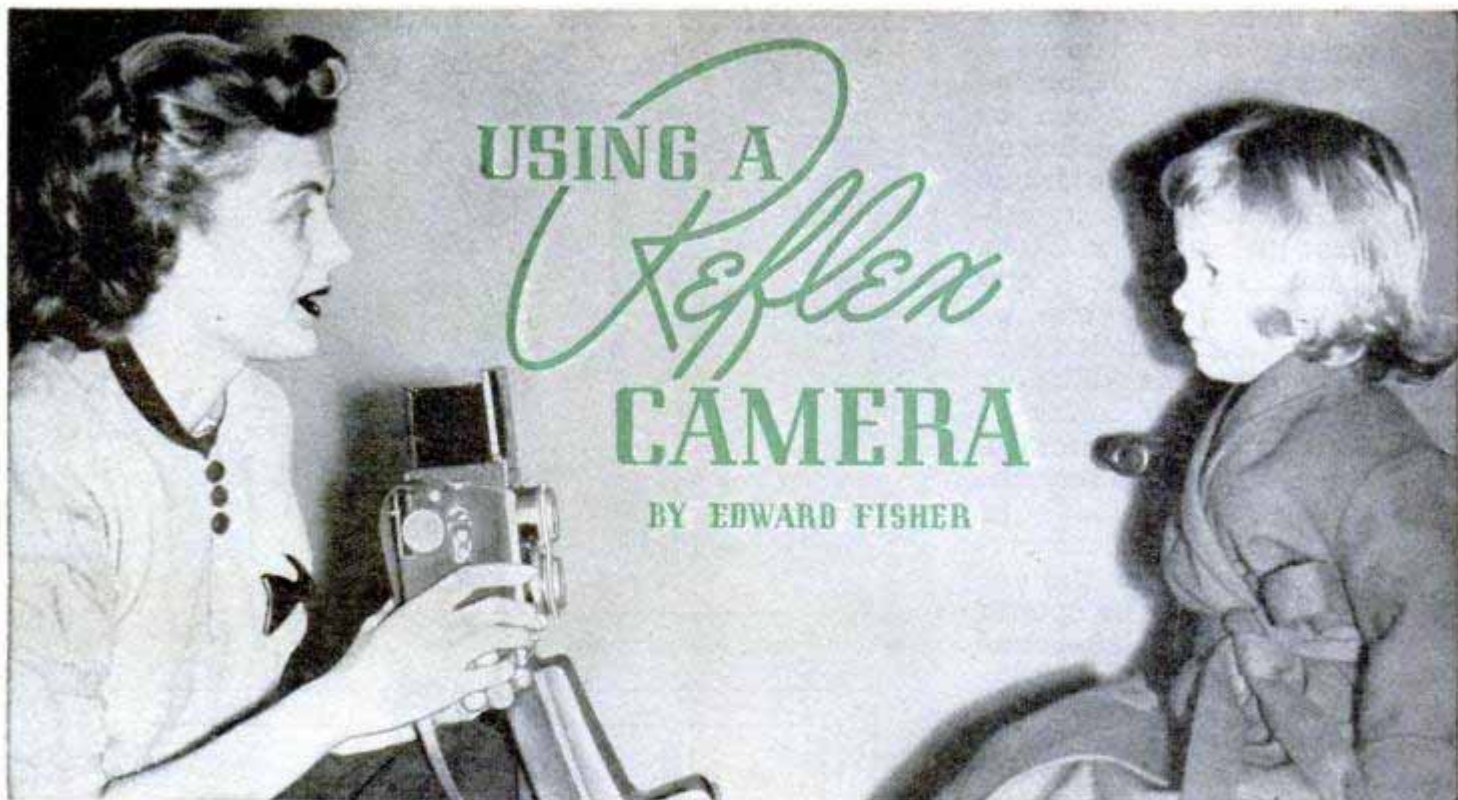

USING A Reflex CAMERA

BY EDWARD FISHER



1

Above, follow directions in all details for loading camera and be sure that film is properly aligned so that it will not jam in the guides. Below, most photos can be taken with the reflex camera still in its case



2

USUALLY, the instruction pamphlet furnished with any new camera points out its features and explains, in general, its basic operation. But, from there the amateur is left on his own. However, there are a number of camera techniques, not covered in manufacturers' instructions, that will prove helpful in getting the most from the camera. If you are just becoming acquainted with the use of a reflex-type camera, the following tips are worth knowing and can be put to good use as you become more proficient and more shutter-minded. Popularity of the twin-lens reflex is due largely to the fact that the picture can be viewed on a ground glass to the very moment the shutter is snapped. This, together with the opportunity of viewing the shot right side up, although reversed, makes it easy for the beginner to get good composition right at the start, as is not often the case when the picture must be viewed in an upside-down position.

It is important to remember that the correct way to load your reflex is to attach the leader to the takeup spool first and load from top to bottom as shown in Fig. 1. In this way, there is less chance of later jamming the film in winding it onto the takeup spool, as you can align it properly between the guides before closing the back.

Not always realized by the amateur photographer is the fact that the leather neck strap on the camera case has a definite part in the taking of a picture. Adjusted to support the camera at the most convenient viewing distance, the strap serves as a means of steadying the camera against the body. Forming the habit of pressing down

lightly on the camera case, Fig. 2, at the moment the shutter is clicked pays off in sharp, clear pictures. To provide a more convenient means of pulling down on the camera, some photographers equip their reflexes with a short handle (one similar to a wooden file handle) that has a threaded stud to fit the camera tripod socket. The drop front on the camera case also plays a part in getting the best possible shot by serving as a lens shade when the picture is made in sunlight above reflective surfaces.

A trick sometimes used for critical focusing and also when the subject is dimly lighted, is to remove the ground glass and rub a little castor oil on the underside of the glass, Fig. 3. This produces a transparent spot on the opaque glass which intensifies detail in the image.

A good stunt worth remembering when taking overhead "periscope" shots is illustrated in Fig. 4. Here, the camera is merely held in an inverted position while it is focused and clicked in the usual manner.



Above, to obtain an image of greater brilliance, coat ground glass with castor oil. Below, to shoot over the heads of people, or to get dramatic composition in high-angle shots, camera is held in this position

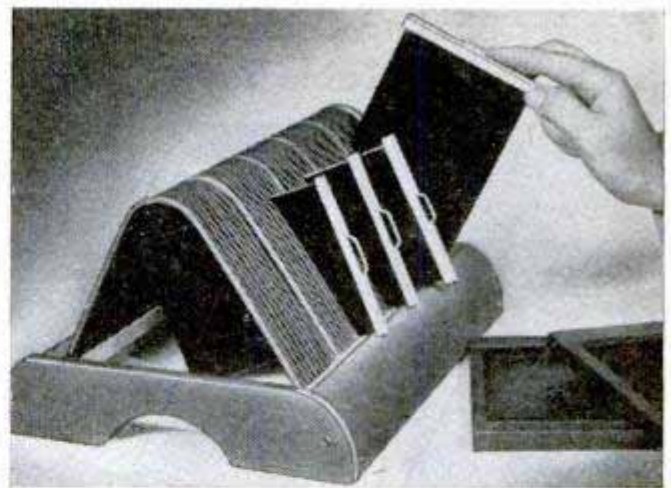

Film-Holder Slides Easy to Find When Kept in Record File

One photographer found that a vertical phonograph-record file provides a handy addition to his darkroom. When unloading film holders, he simply drops the slides between the wires of the record rack so they are within easy reach for replacing in the holders. In addition to its convenience, the rack holds the slides off the table top where they are less likely to be contaminated by spilled darkroom chemicals.

Bamboo Provides Overflow Drain For Washing Prints

A short section cut from a bamboo fish pole forms an inexpensive and easily made overflow drain for washing negatives and prints in an ordinary sink. The bamboo, which should be about the same length as the depth of the sink, is whittled at one end to fit snugly in the sink drain. A series of holes is drilled around the upper end of the bamboo and a single hole for flushing out the hypo is drilled at the lower end, level with the bottom of the sink basin.



J. A. Leason, St. Paul, Minn.

Dusting Color Transparencies

Objectionable dust particles are quickly removed from color slides with the aid of a vacuum cleaner. Fit the crevice attachment to the cleaner hose and pass the tool slowly over both sides of the slide. Be careful that the tool does not touch the film. The vacuum cleaner also comes in handy for dusting the slide projector.

Henry Perina, Berwyn, Ill.

Vise for Binding Color Slides Is Clamped to Table Top

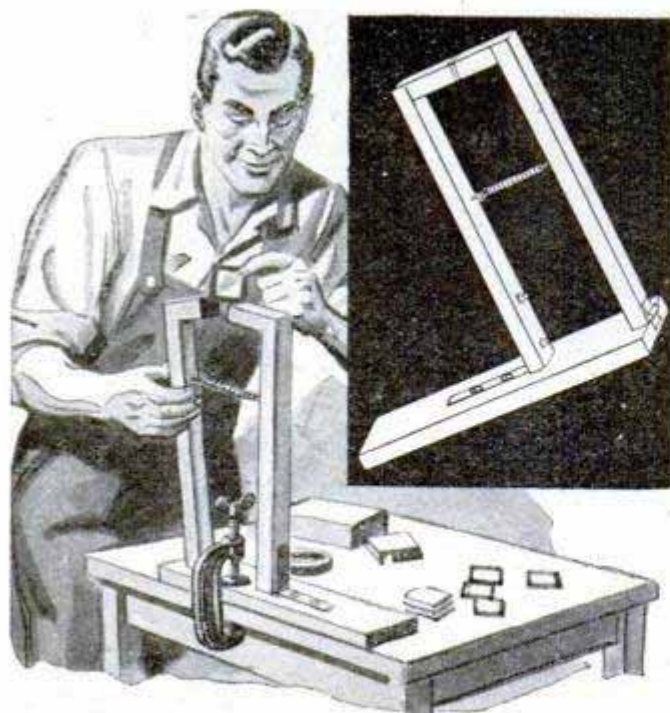

As inexpensive as it is easy to build, this slide-binding vise clamps to the top of a table or workbench where it holds the slide members in a convenient working position. The arms of the vise are of 1-in.-sq. stock, and the jaws are held closed with a short length of screen-door spring. Only the outer arm is hinged to the base, the inner arm being rigidly mounted with an angle bracket. The faces of the jaws are covered with felt to prevent marring the slide

glasses. The original vise was made about 14 in. high with a clearance of several inches between the jaws and spring, thus allowing plenty of room for wrapping the binding tape around the slide members.

Karl H. Goldman, Marenisco, Mich.

Accessories Hung From Pan Head

Hanging a camera case from a pan-head handle provides an out-of-the-way container for storing film packs and accessories. This is especially handy when shooting outdoors where there is no place to keep these items except in your pockets. Just

tighten a small C-clamp over the pan-head handle and use the handle of the clamp as a hook for the camera-case strap.

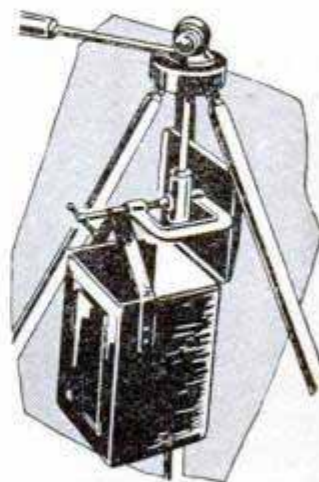

Bath-Spray Hose Washes Negatives

One photographer uses a bath-spray hose to wash roll film without taking it from the developing tank. With the hose nozzle removed and the cover off the tank, the hose is simply inserted in the tank stem and the water turned on.

John C. Malocsay, Denver, Colo.

The Craftsman Book Shop

It matters not whether you are merely planning to start a home workshop, already have one equipped with a few hand tools, or own one complete with power tools, *Popular Mechanics* how-to-do-it books will bring you large returns in pleasure or profit for the small amount invested.

Our Craftsman series, which consists of books entitled **PLANNING YOUR HOME WORKSHOP**, **POWER TOOLS AND HOW TO USE THEM**, **100 BEAUTIFUL PIECES OF FURNITURE** and **RADIO-TV AND ELECTRONICS HANDBOOK**, is a must for every home craftsman.

If you are just setting up your shop, **PLANNING YOUR HOME WORKSHOP** will get you started correctly. It shows how to lay out a shop, how to light it and what tools to get first. A remittance of \$2.50 will bring it to your home. The book **POWER TOOLS AND HOW TO USE THEM** will help the most inexperienced person use power tools safely and get the most work from them. It's written by one of *Popular Mechanics* craftsman

editors who is an experienced wood and metal worker. He knows the problems of beginners in these crafts and explains the use of power tools so that anyone can get much pleasure and profit from them. Price \$2.50.

The book **100 BEAUTIFUL PIECES OF FURNITURE** is the last word in furniture construction. It shows how to build modern bedroom, dining-room and living-room suites and matched occasional pieces, as well as period furniture. Many pieces are shown in full color, and all are carefully detailed so that even persons with little experience can duplicate them. This beautiful book is yours for \$3.00.

If your craft interest is in the field of radio and electronics, *Popular Mechanics* **RADIO-TV AND ELECTRONICS HANDBOOK** is a must for your technical library. It shows how to make many radio repairs and build your own radio sets, amplifiers and other electronic devices. From it you can also learn how to install TV and FM antenna systems and adjust and tune TV receivers. Price \$2.50.

All books available from *Popular Mechanics* Book Dept., Dept. 210, 200 E. Ontario St., Chicago 11

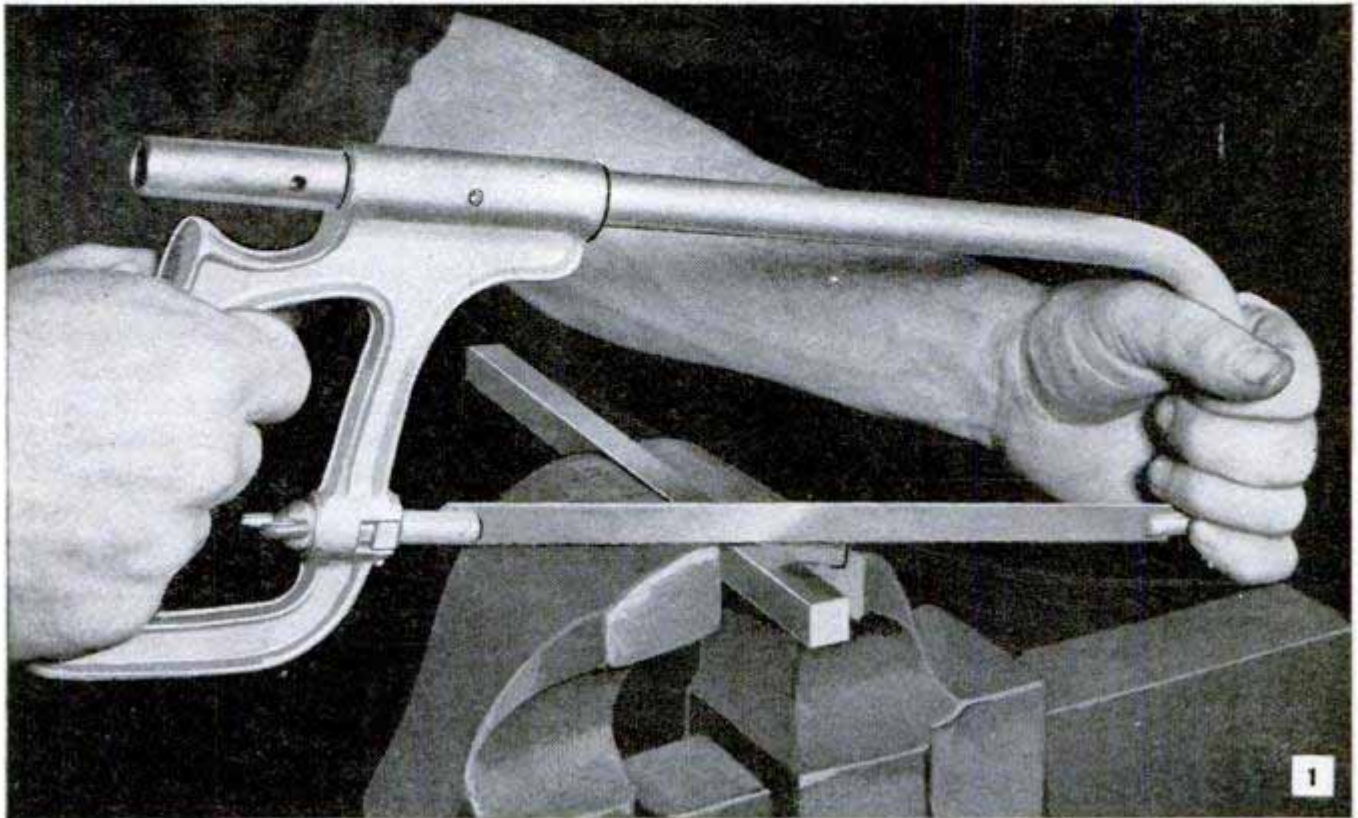
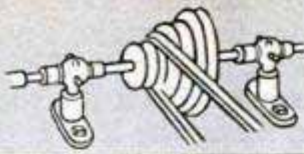

Better Results With **HAND HACKSAWS**

Select the right hacksaw blade
for the job and use it in a
frame of approved design

By E. R. Haan

ACCURATE alignment of the frame and positive control of the direction of cut are the two essential requirements in hand hacksawing. That's why choice of a good-quality hacksaw frame of proper construction and proportions is important. The standard hand-hacksaw frame, one type of which is pictured in Fig. 1, must have all the features of proper balance, ample work clearance and a pistol-type grip contoured to give a natural easy handhold. The studs and pins which take the blade ends should be adjustable to face the blade in at least four directions and there should be provision for drawing the blade to the correct tension, either by means of a wing nut or

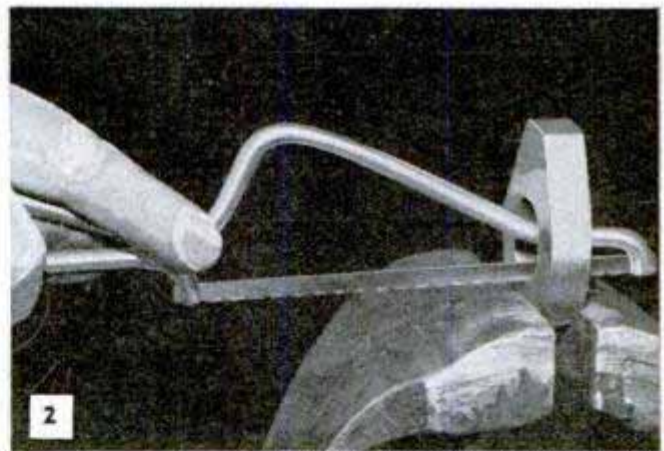

Photos courtesy W. O. Barnes Co., Inc.

a cam arrangement in the frame. For best results on average work, the lower end of the handle should be on the cutting line of the blade or slightly below it. This position of the handle utilizes the natural thrust of the arm to the fullest advantage on the cutting stroke and also facilitates positive control of the direction of cut. In addition to a variety of frames that are more or less standard, there also are a number of special frames designed for various purposes. One of these, made for working in drilled holes, is shown in Fig. 2. Similar hacksaw frames are available for working in holes as small as $\frac{5}{8}$ in. in diameter.

Inserting blade in frame: Most hacksaw blades are $\frac{1}{2}$ in. wide, .025 in. thick, and are available in 10 and 12-in. lengths.

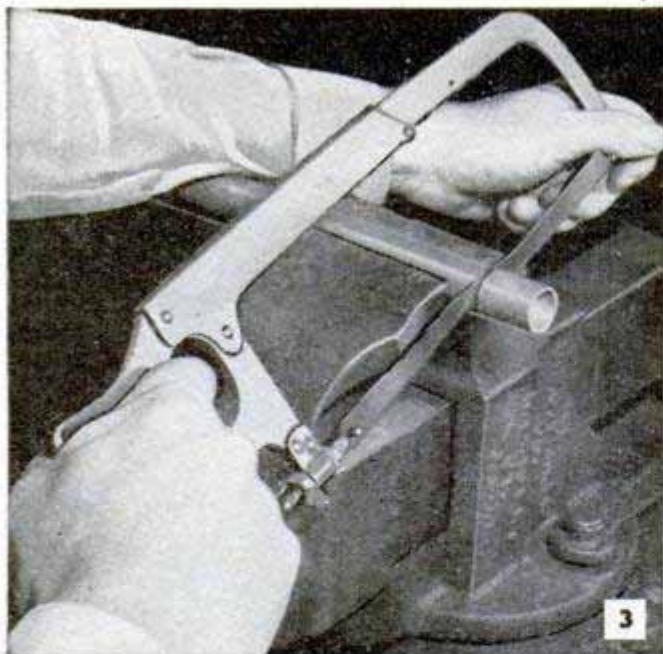

Blades are inserted in the frame so that the teeth point away from the handle, Fig. 4. Tension on the blade should be sufficient to hold it true in the cut. When the blade warms it will expand along the length and lose some of its original tension. Before tightening the tension nut, or the cam, be sure that the blade rests flat against the milled sides of the studs and that the pins are fully engaged.

Types of blades: Hacksaw blades are made for a variety of purposes and differ in toughness, hardening and tooth spacing. Ordinary blades are edge-hardened along the line of the teeth to a point just below the gullets (spaces between the teeth), leaving the back of the blade softer and more flexible. Blades of high-speed steel generally are more wear resistant and capable of cutting much harder metals. They also are more resistant to breakage of the blade itself.

Blade hardness: Besides the flexible, general-purpose blade, there are all-hard, stiff-backed blades of various gauges which many mechanics and toolmakers prefer. Although these blades are capable of making smooth cuts in very hard metals, they are rather brittle and break easily in materials that tend to flex. Both flexibility and hardness are combined in some blades made for special purposes. This type of blade is shown in Fig. 3. It is the best one to use where the cutting strains are severe.

Tooth spacing: Tooth spacing is one of the important points in job selection of hand-hacksaw blades. Common blades come in four general tooth spacings: 14, 18, 24, and 32 teeth per in., Fig. 5. The coarser blades are usually recommended for cutting work of fairly large cross section in mild steel, cast iron, brass and bronze, and also for cutting aluminum, copper, hard rubber, fiber and certain other materials requiring ample chip clearance. Blades of 18-tooth spacing are advised for cutting hard materials such as tool steels, bronze, drill rod, etc. Blades of 24 and 32-tooth spacings are used to cut metals of thin cross section such as $\frac{1}{8}$ -in. angles, tubing and pipe. The finest blades are used to cut thin-walled tubing, conduit, sheet metals less than 18 gauge in thickness, and small rounds, such as $\frac{1}{8}$ -in. drill rod. In choosing a blade for the job, the important thing to remember is that at least three teeth should engage the metal simultaneously as in Fig. 6. This avoids stripping the teeth, or damaging the work, and gives a smooth cutting action similar to that of a file, Fig. 10. For solid rounds and bars, use the coarser blade, Figs. 11 and 12.

General cutting technique: Grip the work in a vise and scribe the cutting line close to the vise jaws, Fig. 7, to prevent the work

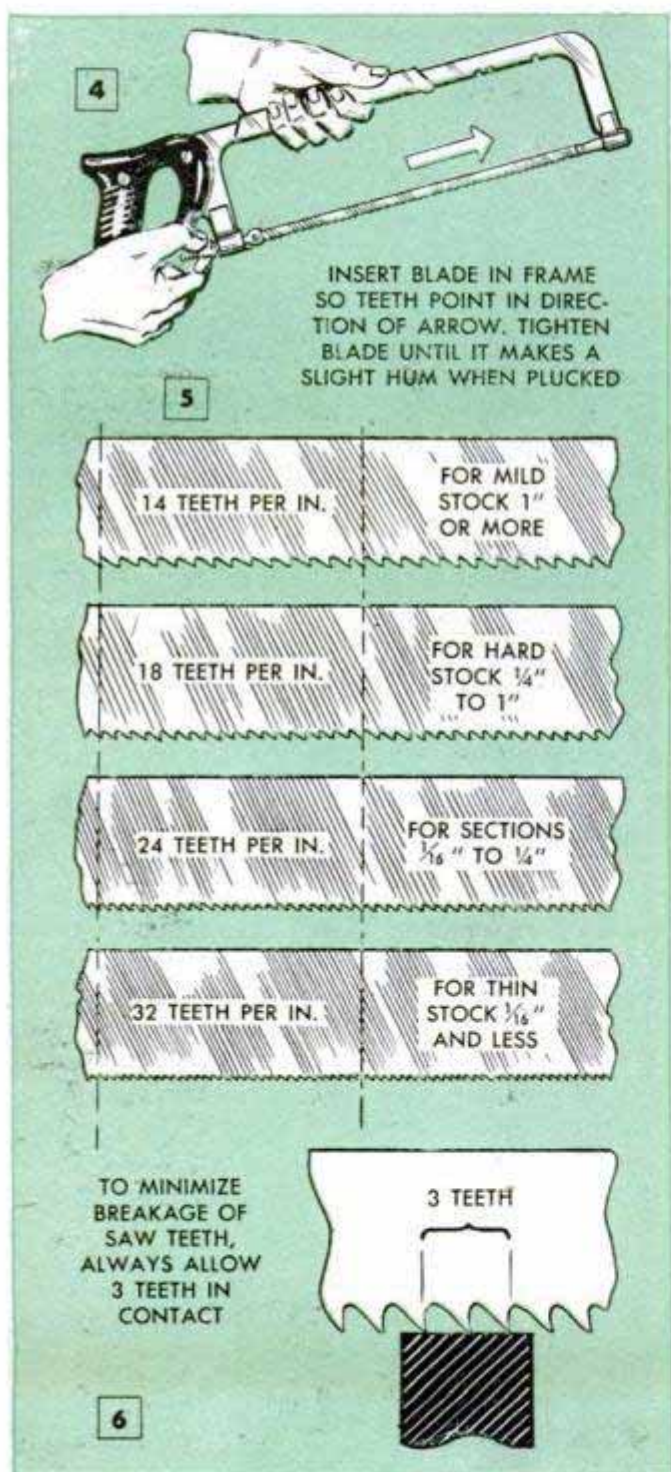

from flexing and pinching the blade. Notch the edge at the scribed line with a file so that the cut can be started easily on the line. Don't start the cut across the entire surface of flat work, as the blade will skid sidewise because of the large number of teeth engaged. Start the cut at a slight angle with the surface as in Fig. 9. Hold the saw with both hands as in Fig. 1, and apply sufficient pressure on the cutting (forward) stroke to cause the teeth to engage uniformly. Relieve the pressure on the back stroke. To hold the cut to a scribed line use a long, sweeping, straight-line stroke that utilizes nearly the full length of the blade for cutting. Timing of the cutting speed should be about one forward and one return stroke in one second. Faster sawing with ordinary blades may produce sufficient heat to draw the temper from the teeth. Short, fast strokes increase the risk of breaking the blade and make it more difficult to follow the scribed line. When a blade breaks after long use, don't try to complete the cut with a new blade. It will bind because the teeth have a wider set than that of the worn blade. Turn the piece over and finish the cut from the opposite side. In cutting angles the job will be done faster if each leg (side) of the angle is cut separately as in Fig. 8. By sawing each leg individually, you can use a coarser blade than could be used if the legs were sawed straight through edgewise. Use the same technique when sawing flat stock up to 1/4 in. thick. Grip the piece in the vise with the jaws bearing against the edges, not the flat sides, and start the cut by notching the edge of the stock at the scribed line with a file. Don't neglect this step whenever the cut must be started on a corner. It also is helpful when starting the cut on a round, as the notch serves to guide the blade on the first few strokes until it has cut deeply enough to be guided by the sides of the cut itself. The notch will also help to prevent the blade from skidding and damaging the surface of the material adjacent to the cut.

Use very light pressure when sawing thin materials. To cut thin sheet metals, it's a good idea to clamp the work between two pieces of wood as in Fig. 13, and saw through all three pieces as shown. This eliminates bending of the thin stock, as well as vibration, and breakage of blades. To make a cut along the edge of a large piece of flat stock, where the total depth of the cut will be deeper than the distance from the edge of the blade to the frame, set the blade holders, or studs, at right angles to permit the saw frame to clear the edge of the stock. This same position is used where there is insufficient clearance above the cut. Slots can be cut by using two or more blades side by side in the saw frame.

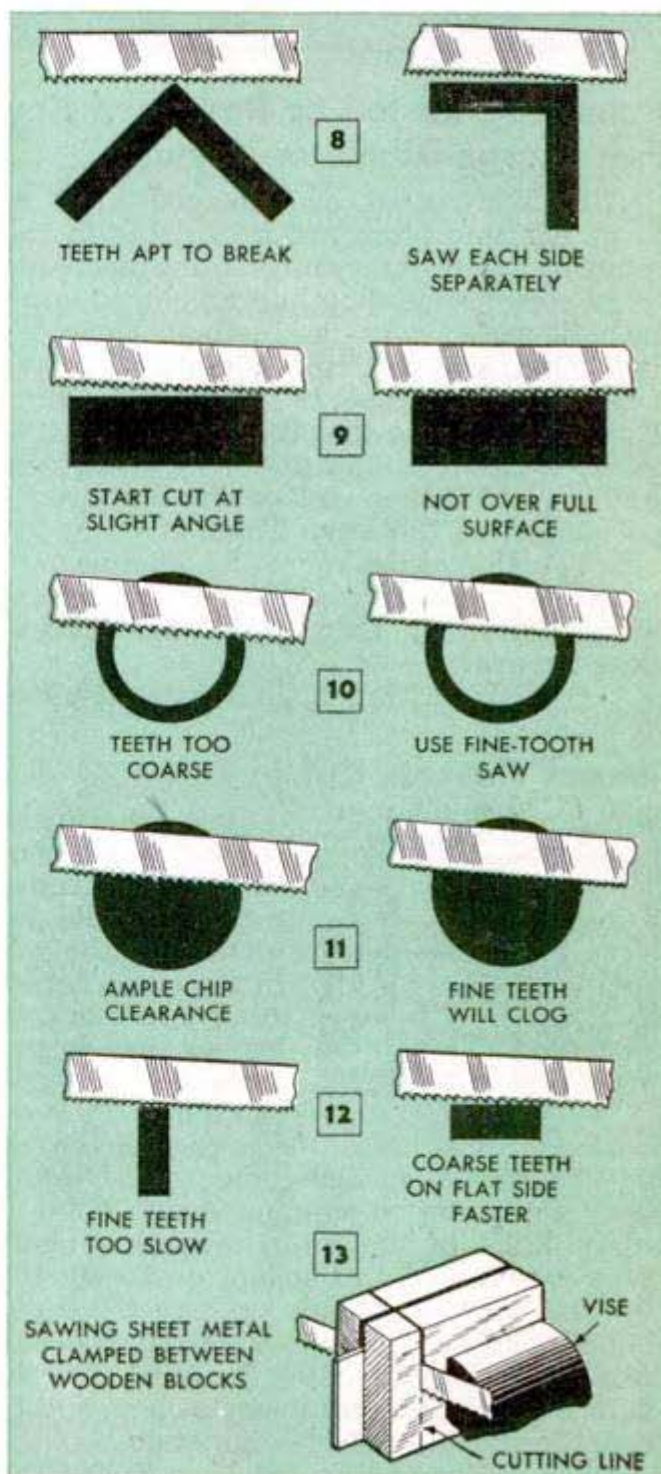



Removing Rusted or Damaged Key From Large-Diameter Keyway

Although rusted or damaged keys in large shafting often are impossible to remove by any ordinary means, one mechanic in a farm service shop has developed what he believes is a sure-fire method. He welds two lengths of flat steel together edge to edge to form an offset bar about 36 in. long. Note in the photo that the shorter piece is wider than the longer one. The end of the longer piece is then tack-welded to the exposed end of the key. Thus, striking the offset portion of the bar with a hammer removes the most stubborn key without damaging the shaft. Usually one sharp blow does the trick.

L. H. Houck, Jefferson City, Mo.

Round Gaskets Cut in Lathe

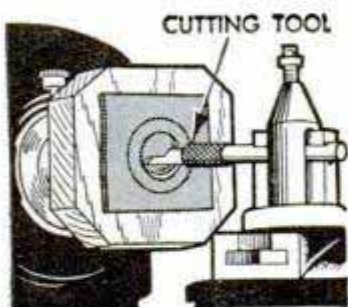

One mechanic solves the problem of cutting true, round gaskets by setting up the job in the shop lathe. A square block of hardwood is attached to the faceplate and the gasket material is cemented to the face of the block with the special cement used to attach sandpaper to sanding disks. Then a sharp knife of the interchangeable-blade type is mounted in the tool post with the bevel edge of the blade up, and the knife handle perpendicular to the surface of the work. By simply feeding the knife straight in, it is possible to cut gaskets clean and to exact inside and outside diameters.

Norman Fraser, New York City.

Norman Fraser, New York City.

Spring Water Cleaned of Sediment By Utilizing Perforated Milk Can

To obtain clean, clear water from an open spring, one farmer made a simple, efficient filter from a milk can. First, he punched three rows of equally spaced holes near the bottom of the can with a 10d nail, and then filled the can with small rocks to a point just below the top row of holes. He poured clean sand on the rocks and the weight of sand and rocks caused the can to sink to the bottom of the small pool at the edge of the spring. While such a filter cannot remove

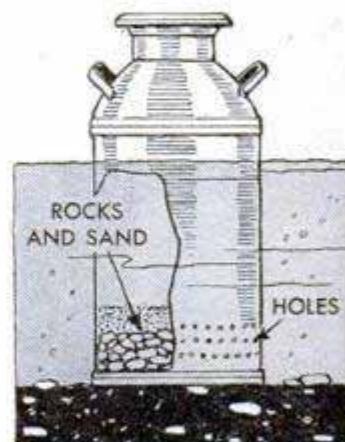

chemical impurities from the water, it does filter out all sediment, dust, leaves and twigs which tend to collect in open springs. The can cover is always replaced after dipping water from the container.

Counterbalanced Pump Jack For Deep-Well Operation

By counterbalancing a conventional pump jack, one farmer found that a 1/4-hp. electric motor would operate a cylinder-type deep-well pump without overloading. As a counterweight, he used a 30-gal. oil drum filled with small stones and attached to one end of a hardwood walking beam. The beam is pivoted at the center on a 1-in. rod passing through two posts which are set in the ground side by side and spiked to a spacer. The opposite end of the beam is attached to the metal crossarm of the pump-jack lift by means of a clevis. The latter is passed through a ring welded to the lift crossarm and fastened to the end of the beam with a clevis pin secured with a cotter key. Several holes are drilled through the bottom of the drum so that rainwater will drain out.

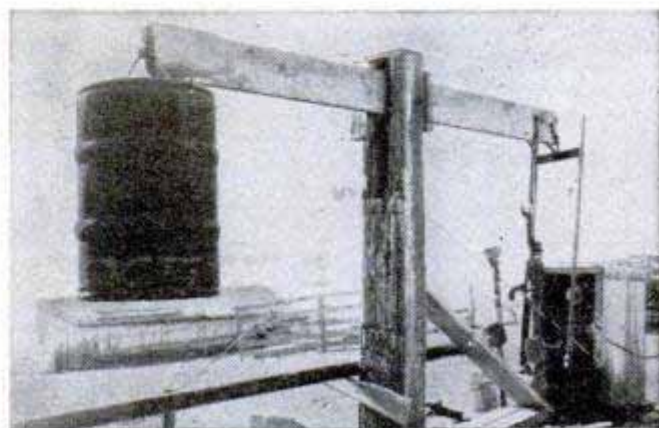

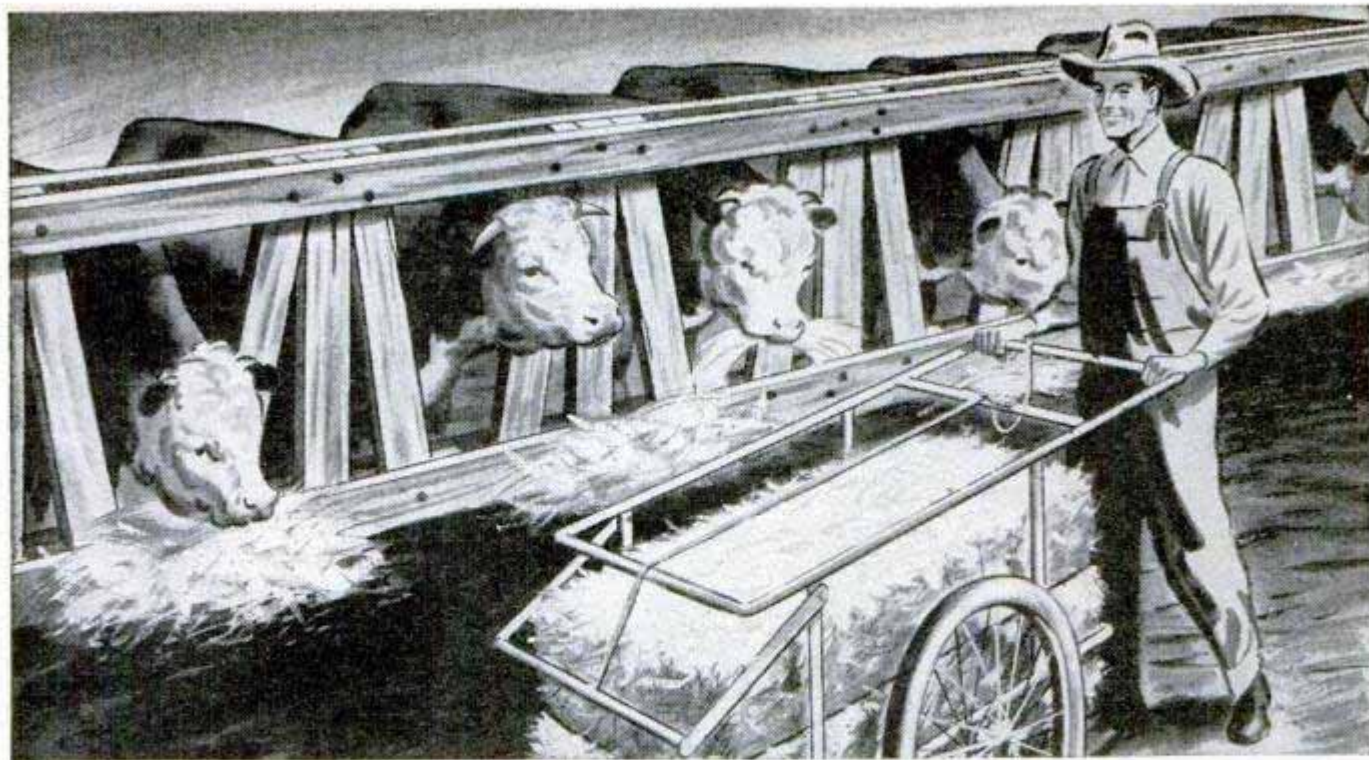

BALED-HAY CART saves heavy lifting

FARMERS, poultrymen and feed dealers who have occasion to transport individual bales of hay or straw will have regular use for this unusual bale cart. It straddles the bale and carries it suspended in a welded frame in a manner similar to a lift truck. The method of loading the bale is pictured in Fig. 1, and construction details and dimensions of the cart are given in Fig. 2. Note that the complete frame is made from $\frac{3}{4}$ -in. pipe with all joints welded and that it consists of two similar frames, one above the other with pipe spacers welded between. The lower frame has one open end, permitting the cart to straddle the bale when loading. While it is possible to mount bicycle wheels on stub axles as indicated, a stronger straddle-type mounting is shown in the lower left-hand detail. Note that the sharpened metal spurs on the hinged bracket at the front of the frame are welded on at an angle of about 30 deg. so that when the bracket is lowered the spurs will engage the bale and support it in the horizontal position with ample ground clearance when the cart is tilted for transport, as in one of the illustrations at the right.



Portable Buzz Saw Is Gasoline Powered For Cutting Cordwood or Building Cabin



Here is a portable 10-in. buzz saw that can be carried in the car right to the job. It is ideal for cutting firewood and also is an excellent tool when building a cabin where electricity is not available. The saw, which weighs about 60 lbs., is powered by a 1½-hp. gasoline engine. The engine is mounted in an angle-iron frame with the saw-arbor bearings bolted to the top members of the frame. The blade rotates between two lengths of angle iron which provide a suitable rest for cutting cordwood. The saw can be chained to a tree trunk, as shown in the photograph, or it can be bolted to the underside of a table for crosscutting lumber. — Keats K. Vining, Grand Rapids, Mich.

Finishing Bushings Speeded by Locking on Special Shouldered Mandrel

Confronted with the problem of finishing a quantity of oversize bronze bushings in a limited time, one machinist devised a special mandrel on which the work is held by end pressure instead of internal pressure

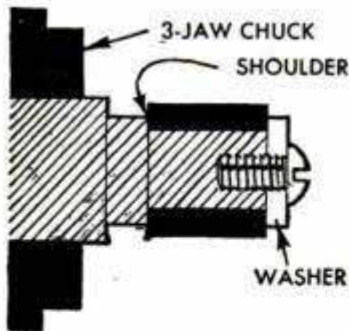

as on an expanding or tapered mandrel. The mandrel is made by running two shoulder cuts on a short piece of cold-rolled steel which has a diameter slightly larger than the outside

diameter of the work. On bushings and similar work, the first shoulder cut should be of a diameter somewhat greater than the inside diameter of the bore. This provides clearance for the cutting tool at the finish end of the cut. The second shoulder cut is made about .005 in. less than the over-all length of the work and is undercut approximately 1 deg. The diameter of this cut is finished to a smooth, slip fit in the work. The outer end of the mandrel is tapped for a machine screw which holds a faced washer of a diameter slightly greater than the inside diameter of the work. In use, the mandrel is held in a three-jaw chuck.—Harry J. Morris, New York City.

Sled-Type Platform Holds Hog-Feeding and Oiling Equipment

To achieve easy portability of his hog-feeding and oiling equipment, one farmer mounted oilers and also self-feeders for both minerals and dry feeds on the same platform. The latter is fitted with four heavy skids so that it may be moved from one lot to another with a tractor. Heavy clevises for attaching a pull chain are bolted to the two center skids. A 2 x 10-in. plank is spiked across the skids at the front and rear ends of the platform to give added strength and rigidity for towing.

☐ Rubber stamps are cleaned quickly by pressing modeling clay against the type.

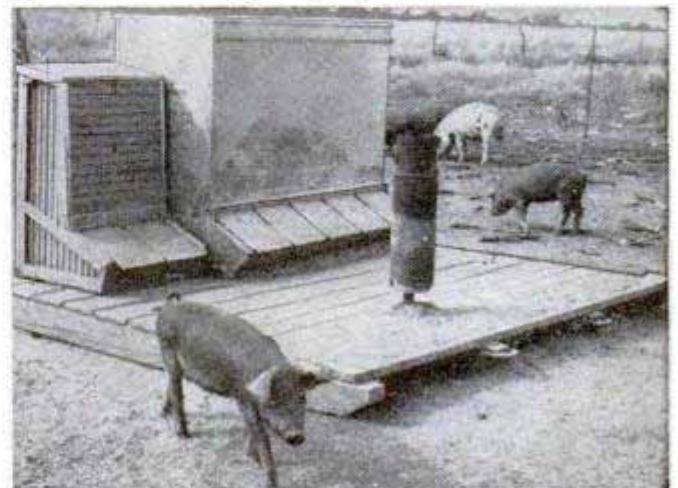

5/11/52

Weatherproof Self-Feeder Handles Small Grain

Just the thing for ground feed, this large-capacity hog feeder has 12 individual feed hoppers each of which is fitted with a hinged self-closing door. A heavy lid that runs the full length of the bin protects the feed from weather. The lid swings sidewise on pivot arms of flat iron. This arrangement permits it to be opened easily by hand, but prevents it from being blown open by high winds. As the hogs push open the hopper doors, long spikes driven through the lower portions of the doors automatically agitate the feed. A triangular-shaped divider set in the center of the bin floor directs the flow of feed toward the feed hoppers. The divider, which is not fastened to the floor, can be removed easily to facilitate cleaning out the bin. The feeder is mounted on skids, and the lid,

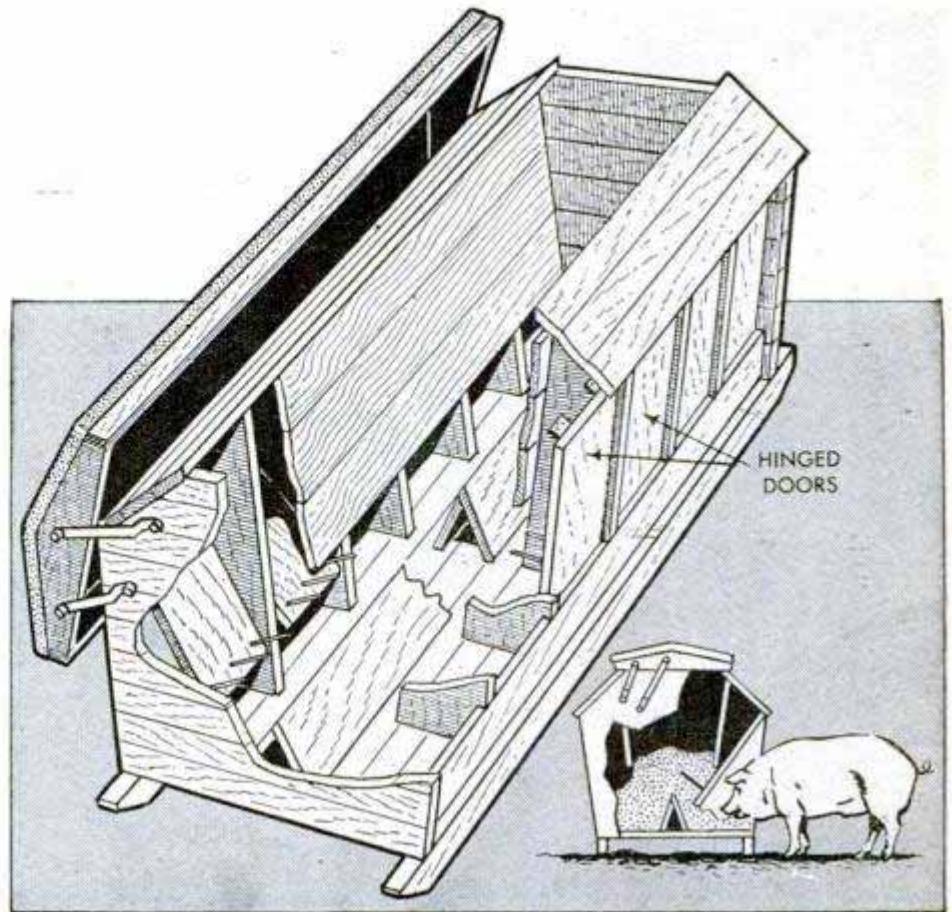

which can be covered with galvanized sheet metal or roll roofing, may be fitted with two sash handles on the front edge if desired.

Floor Plate on Farm Tractor Provides Nonslip Platform

Made from one piece of steel floor-plate stock, this nonslip platform makes it easier to mount to the tractor seat, and also provides space for a toolbox, small drums of lubricating oil, grease guns, etc. The rear edge of the platform is cut away at the center to allow movement of a power-take-off shaft and to permit the drawbar to swing without interference. The supporting flat-iron brackets are bolted to mounting pads on the tractor-axle housings and can be easily removed.



Pointing Ends of Generator Bolts Helps Starting in Bracket

To save time when reassembling car generators, one mechanic grinds a point on the ends of the long through bolts. This aids in aligning and starting the bolts in the end bracket which otherwise is a tedious job. A very shallow point ground or filed on the end of the bolt usually will do the trick.

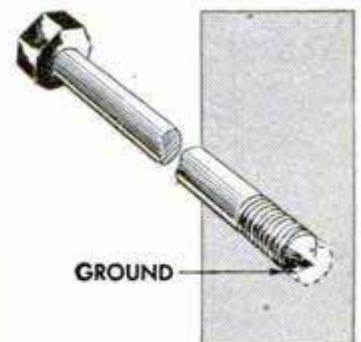

Sharpening Disk Harrow

By welding a nut to a pulley and then turning the pulley onto the threaded end of a disk-gang shaft, the disks can be rotated slowly for sharpening while the gang is raised off the ground. The gang is simply anchored in the up position and the pulley is belted to the tractor drive. The disks are sharpened individually by holding an emery wheel against the edge of each one while the gang is rotating.

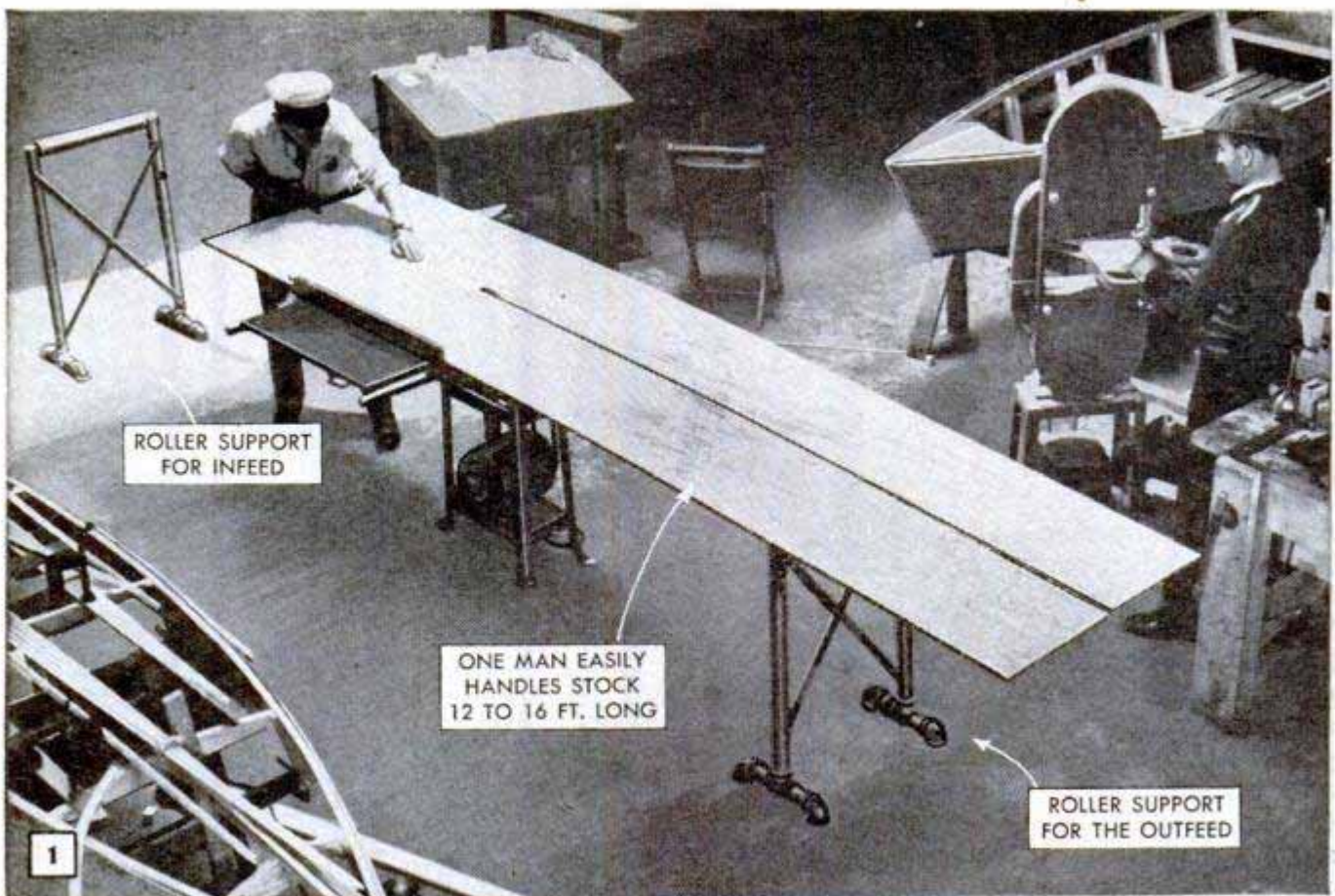

ROLLER SUPPORT FOR INFEED

ONE MAN EASILY HANDLES STOCK 12 TO 16 FT. LONG

ROLLER SUPPORT FOR THE OUTFEED

1

INFEED AND OUTFEED ROLLER SUPPORTS ARE A PRACTICAL SOLUTION TO HANDLING BIG WORK ON SMALL SAW TABLES. A TYPICAL SETUP IS SHOWN ABOVE, AND A UNIT EASY TO MAKE IS SHOWN BELOW. SAME SUPPORT CAN BE USED WITH A SIDE ROLLER FOR CUTOFF WORK AS IN FIG. 11

HANDLING BIG

By Sam Brown

WHILE the small table on the average circular saw provides adequate support for most of the work done in the basement workshop, occasionally there are times when an extra-large panel or long board must be ripped or crosscut. Trying to do this singlehandedly in cramped quarters is not only difficult but hazardous. However, there are improvised setups which give big-saw capacity to home-shop machines with the added features of convenience and safety for the operator.

Along with these setups, however, there are a few important points to remember when handling oversized work in either crosscutting or ripping. First, use a blade with standard ripping or combination teeth which have been correctly sharpened and set. Never use a hollow-ground (planer) blade because of the danger of a kickback should the blade suddenly bind in the cut. Also, wherever possible, use both the guard and the splitter with which the machine is equipped. Finally, it is important to adjust the blade so that it projects no more than $\frac{1}{2}$ in. above the top of the stock. This helps to hold the cut open and prevent binding, and aids in steadying the blade in heavy cuts.

Ripping long boards: Fig. 1 shows how

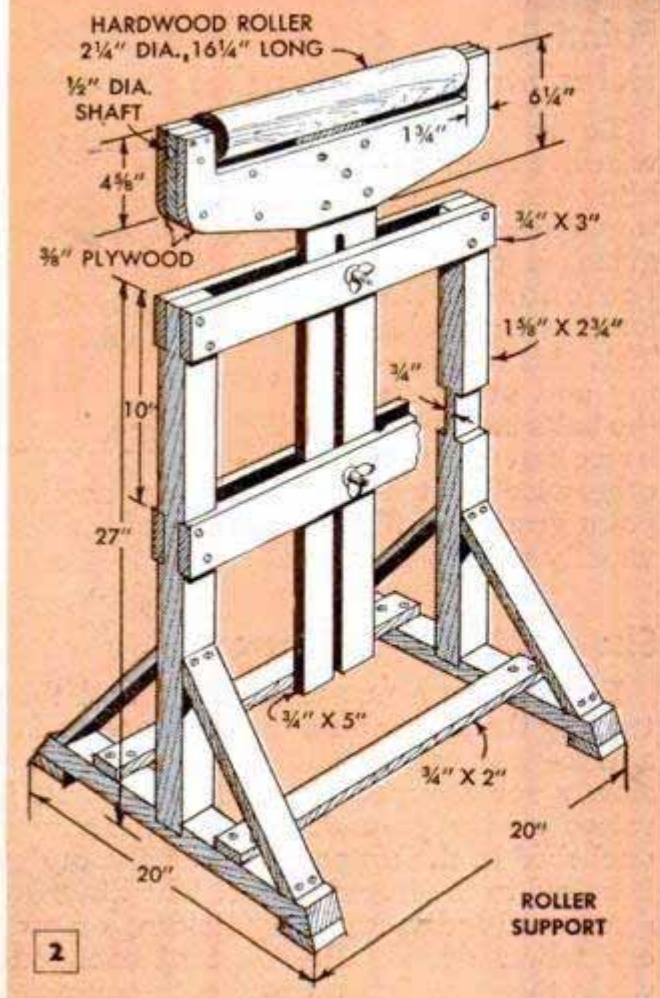

2

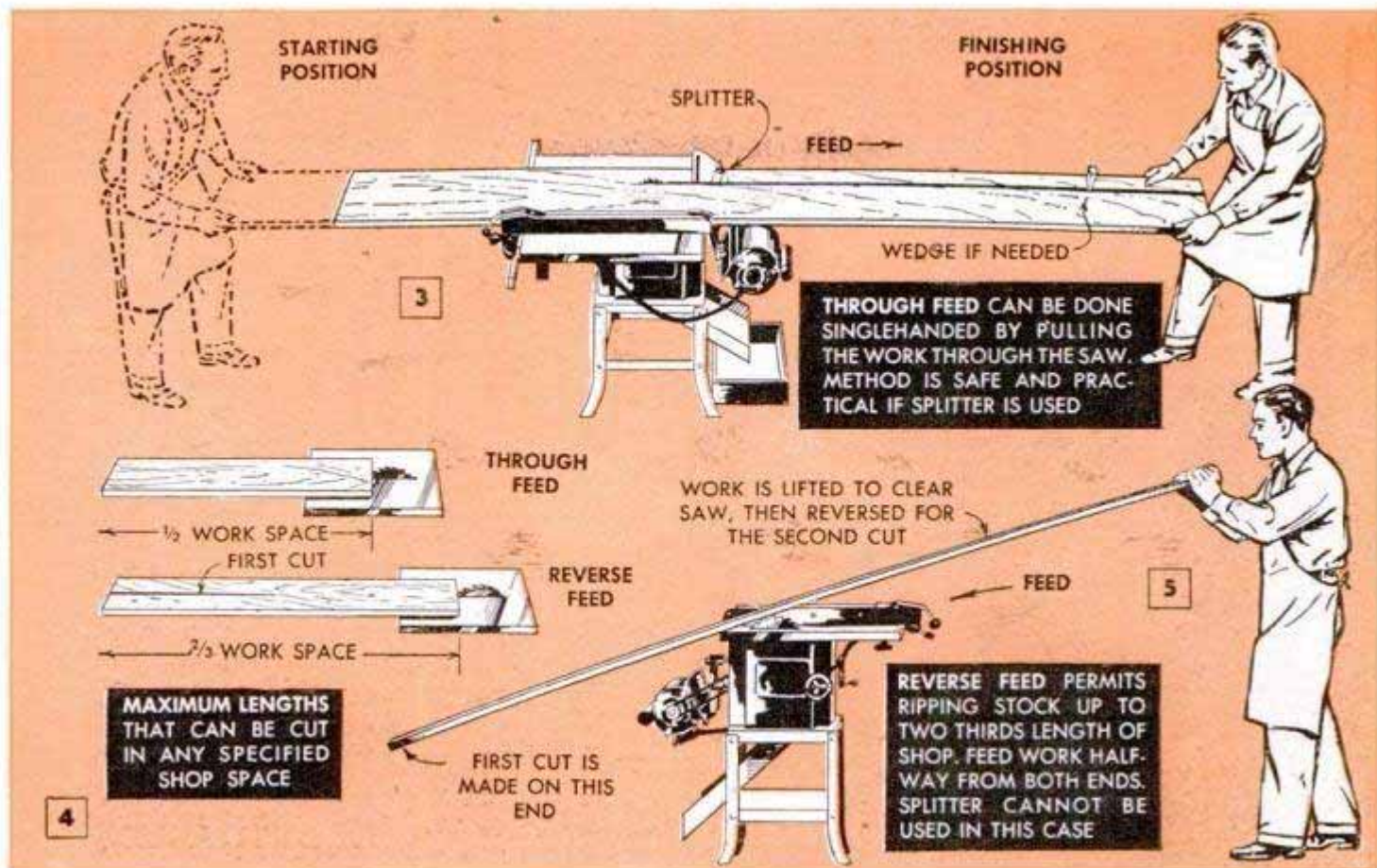

WORK ON YOUR CIRCULAR SAW

two simple roller supports build big-saw capacity into the small machine. Although the infeed and outfeed supports in this setup are made from pipe and fittings, adjustable supports to serve the same purpose can be made from stock lumber as in Fig. 2. Ripping long stock without any supports can be done in two ways. One is the infeed-and-pull-through method detailed in Fig. 3. The other method is the reverse feed, Fig. 5, where the ripping cut is run half the length from both ends of the stock. Fig. 4 shows the maximum lengths which can be cut with these methods. When accurate work is desirable or necessary, a straight-through feed with both the infeed and out-

feed ends of the board supported, as in Figs. 1 and 6, is the most practical, especially when it is necessary to rip duplicate pieces in long lengths. When making a support such as that in Fig. 2, it's a good idea to make allowance for sufficient range of adjustment to accommodate long work on the bandsaw and jointer as well. A short outfeed table, or a roller, attached directly to the saw table, as in Figs. 7, 8 and 9, is helpful not only for ripping long stock but for dadoing and molding operations. On

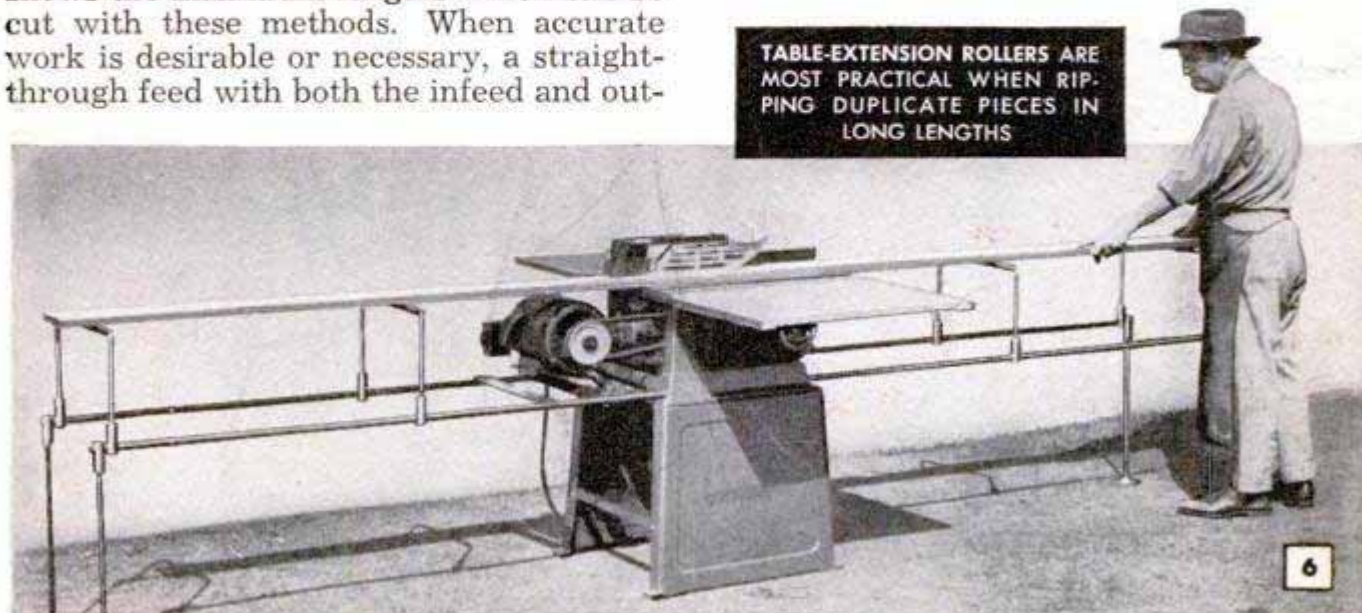

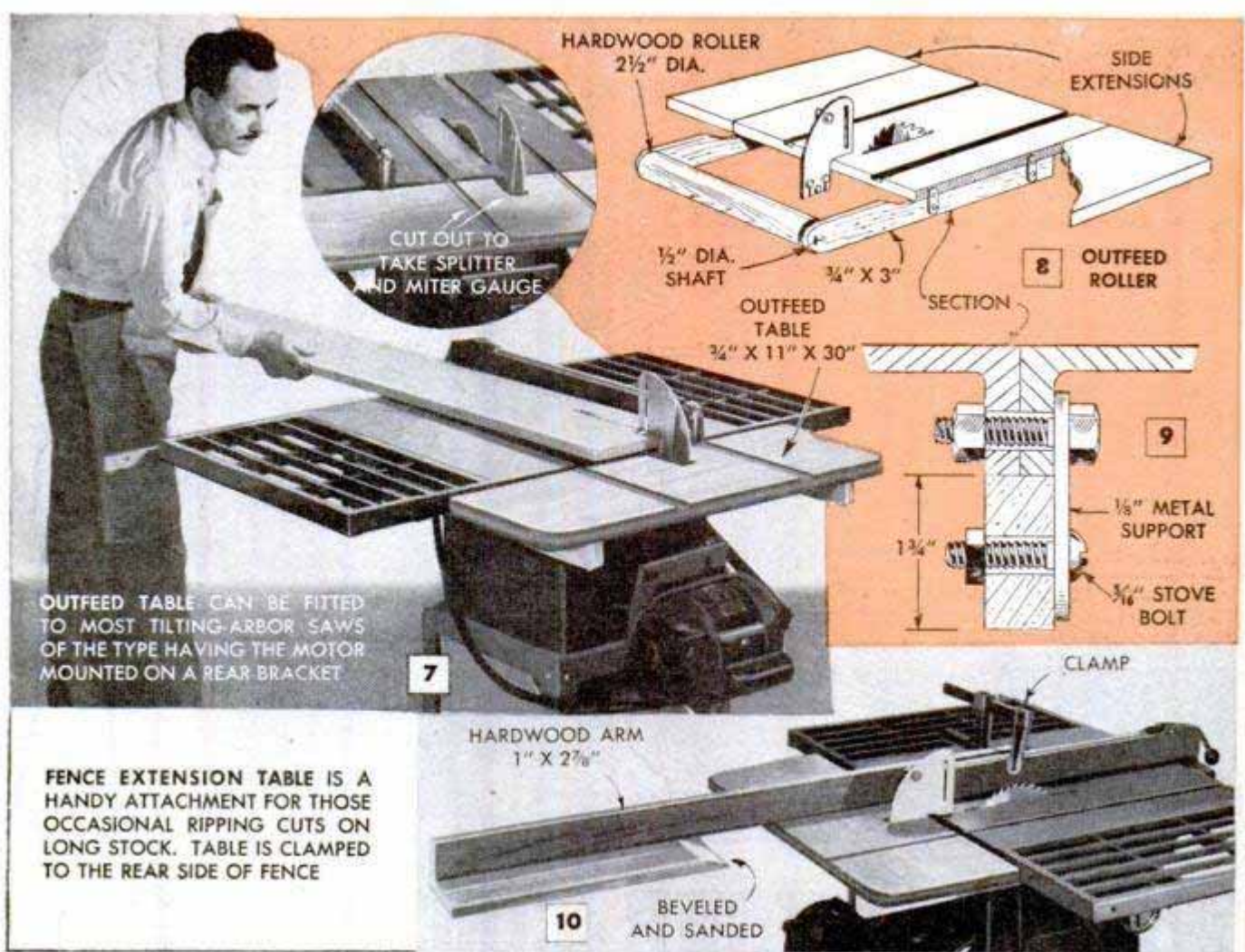

OUTFEED TABLE CAN BE FITTED TO MOST TILTING-ARBOR SAWS OF THE TYPE HAVING THE MOTOR MOUNTED ON A REAR BRACKET

FENCE EXTENSION TABLE IS A HANDY ATTACHMENT FOR THOSE OCCASIONAL RIPPING CUTS ON LONG STOCK. TABLE IS CLAMPED TO THE REAR SIDE OF FENCE

tilting-arbor saws having the splitter support back of the table, it will be necessary to cut an opening in the auxiliary table to permit the splitter to swing with the blade through the tilt range. Both the table and roller can be mounted in various ways, depending to some extent on the type of saw table. Another type of outfeed support, which is especially useful for ripping an occasional piece of long stock, is pictured in Fig. 10. It is clamped to the ripping fence in the manner shown.

Crosscutting long stock: This is somewhat more difficult, especially where the cutoff must be made near the end of wide stock. Clamping a supporting strip to the drill-press table as in Fig. 12 offers a simple solution to the problem of cutting an occasional long piece. A better method is use of the roller unit detailed in Fig. 11 and pictured in use in Fig. 13. This unit is designed to interchange with the roller support detailed in Fig. 2. An extra-long miter gauge with a ball-bearing roller to support the overhang makes it easy to handle long pieces when the cutoff is made near the end as in Fig. 15. This unit consists of a long guide board fitted with two miter gauges and an outboard roller that rides on the under edge of the saw-table extension as in Fig. 14. Of course, the length and construction of the unit must be

adapted to the machine on which it is to be used. Care should be taken to position the miter gauges with the guide bars exactly the same distance apart so that they do not bind in the table grooves. Another adaptation which will work out satisfactorily on some small saw tables is providing an outboard miter-gauge groove, or slot, by attaching a rabbeted strip to the outer edge of the table, or the table extension, as in Fig. 16. Screw a long guide board to the miter gauge and you have the setup pictured in Fig. 17, which enables the operator to stand well to the left of the saw table and crosscut long boards without any additional support. If the edge of the saw table is not machined, then cut a full-width groove in the center of the strip for the miter-gauge bar.

Trim cuts: Ordinary supports of the type already described are suitable only for ripping and cutting off stock of medium standard widths. On bench-type saw tables the length of the miter-gauge grooves will permit cutting off stock up to 12 in. wide. In some cases you can cut off stock up to 18 in. wide by reversing the miter gauge and placing the back edge of the material against it. But when wider stock, such as plywood panels or solid stock glued up to wide widths, must be trimmed, the miter gauge cannot be used. Figs. 18, 19 and 20

Outboard Support Is Needed For Long Cutoffs

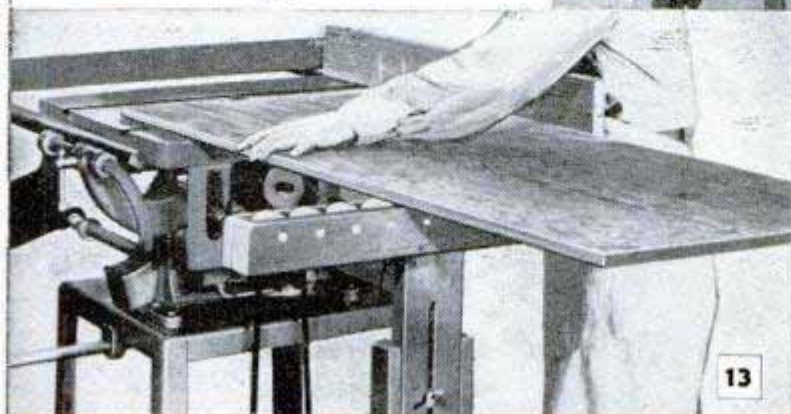
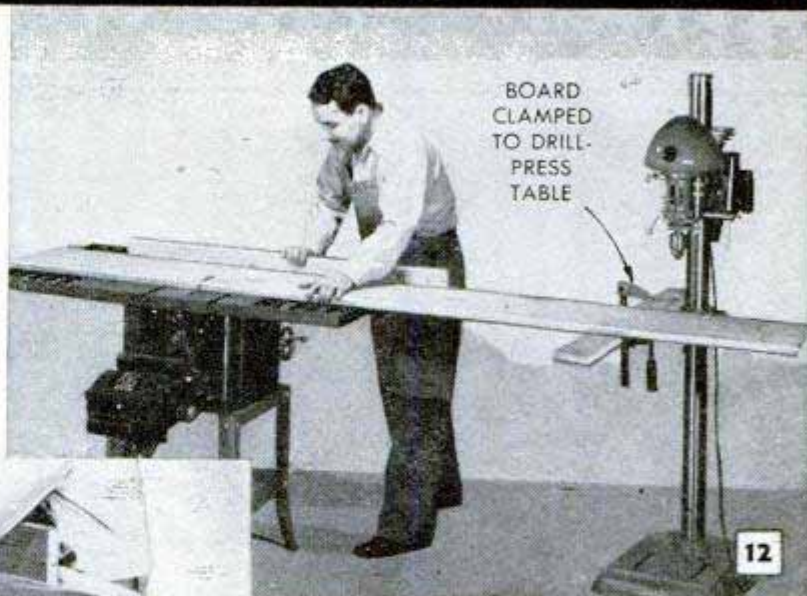
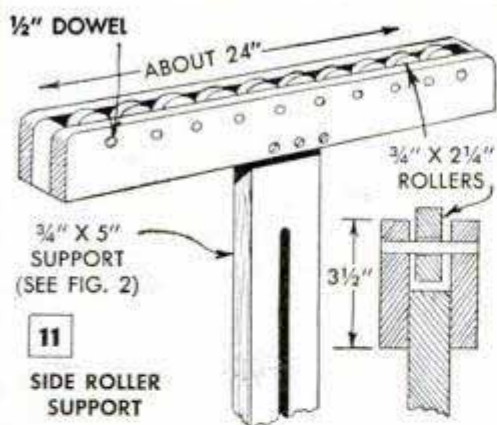

FOR OCCASIONAL JOBS A BOARD CLAMPED TO THE DRILL-PRESS TABLE PROVIDES A SUITABLE OUTBOARD SUPPORT. THE SIDE ROLLER, LEFT, IS BETTER AND CAN BE MADE INTERCHANGEABLE ON BASE DETAILED IN FIG. 2 BY USING SAME SIZE SUPPORT

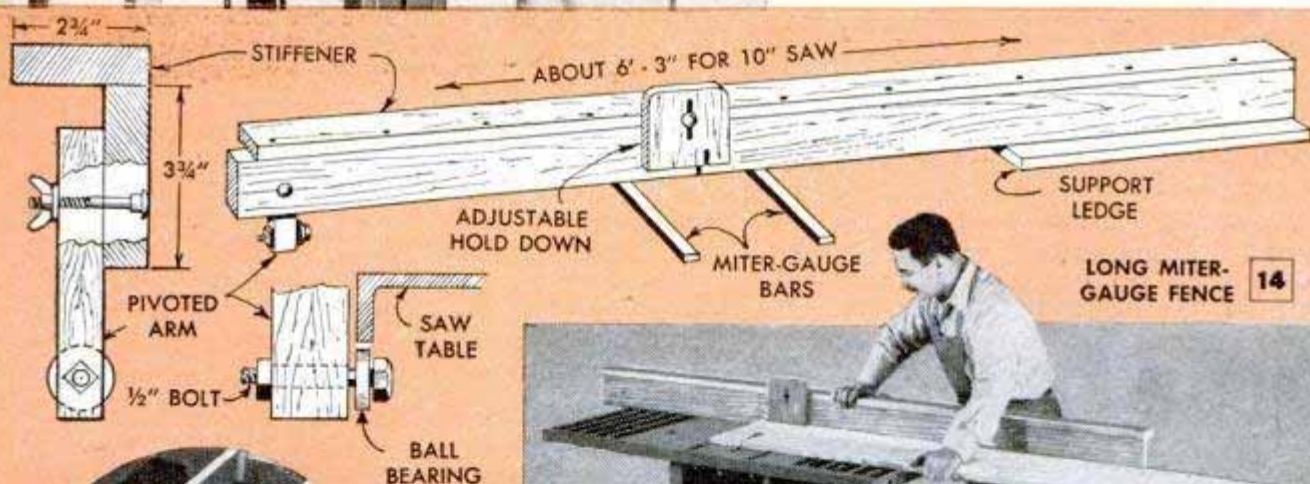

ABOVE, LONG MITER GAUGE WITH SUPPORTING LEDGE AND HOLD-DOWN TAKES A 6-FT. OVERHANG WITHOUT USE OF ADDITIONAL SUPPORTS. TWO MITER GAUGES ARE NEEDED FOR ACCURACY

LEFT, OUTBOARD MITER-GAUGE SLOT ENABLES OPERATOR TO CUT OFF LONG BOARDS WITHOUT OTHER SUPPORT. CENTRAL LOCATION OF MITER GAUGE PERMITS OPERATOR TO STAND AT LEFT OF SAW TABLE TO GUIDE WORK WITH EASE

3 Ways To Make Trim Cuts

SAWING WITH A PATTERN BOARD IS A GOOD METHOD OF MAKING TRIM CUTS ACROSS ENDS OF WIDE PIECES. THE GUIDE IS FLUSH WITH THE SAW BLADE, AND THE PATTERN BOARD IS TACKED TO WORK WITH EDGE ALONG PENCIL LINE. NOTE THAT GUIDE IS WIDER THAN WASTE STOCK

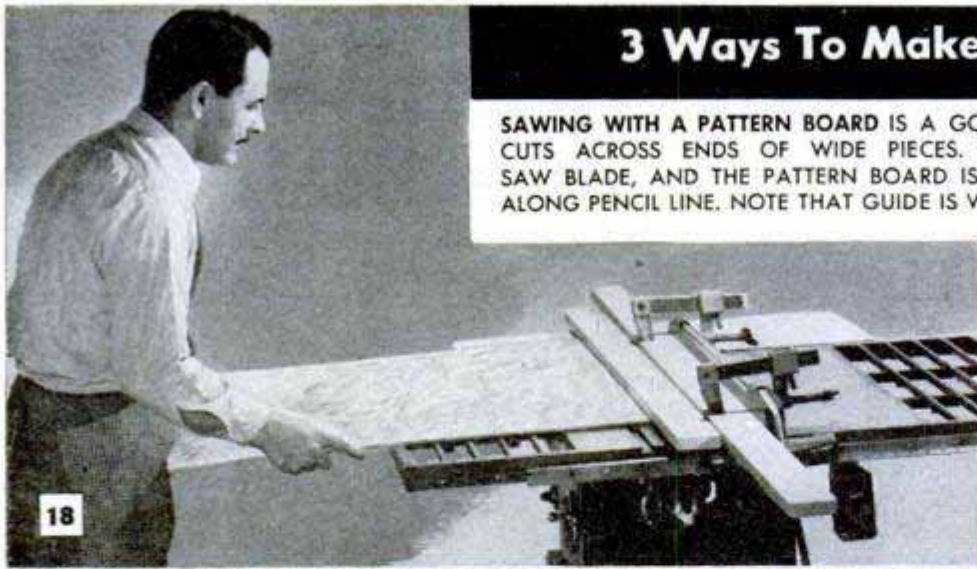

18

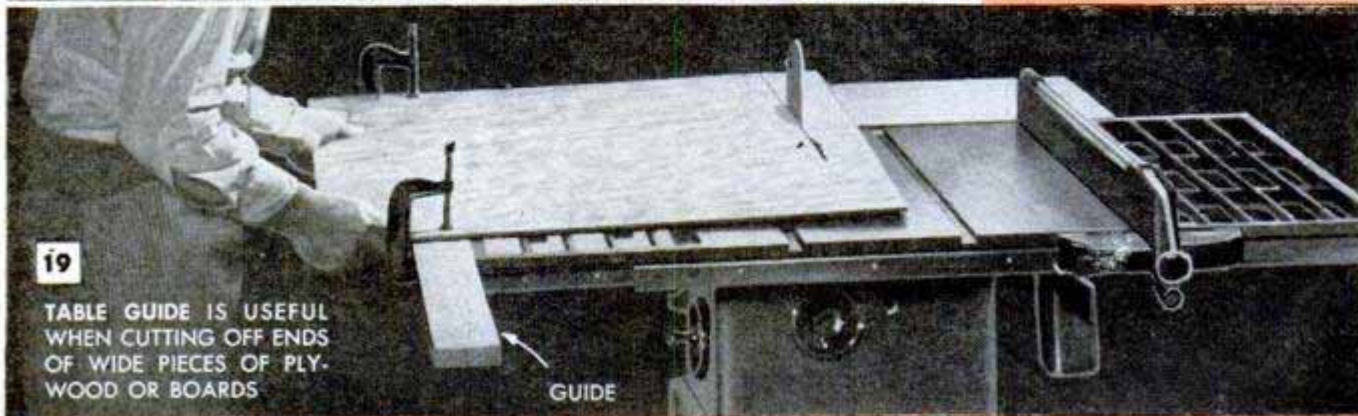
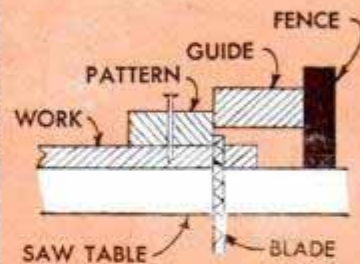

19

TABLE GUIDE IS USEFUL WHEN CUTTING OFF ENDS OF WIDE PIECES OF PLYWOOD OR BOARDS

GUIDE

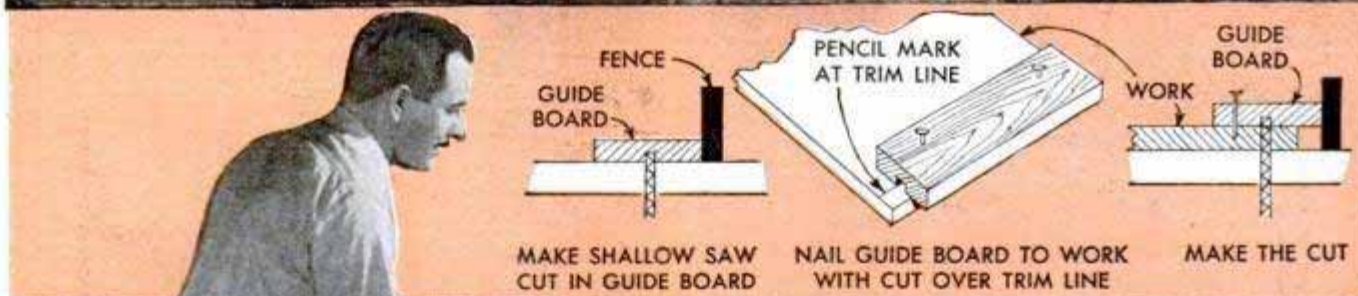

MAKE SHALLOW SAW CUT IN GUIDE BOARD

NAIL GUIDE BOARD TO WORK WITH CUT OVER TRIM LINE

MAKE THE CUT



20

USE OF THE GUIDE BOARD IS SIMILAR TO PATTERN SAWING. LENGTH OF THE GUIDE IS SLIGHTLY LESS THAN WIDTH OF WORK

show three ways to solve this problem. The procedure is similar to pattern sawing in that a pattern or guide board is used on top of the stock. This is guided either by a strip clamped to the ripping fence, Fig. 18, or by a strip clamped to the work which rides along the left-hand edge of the saw table as in Fig. 19, or simply by a strip attached to the work as in Fig. 20. Of the three methods, the first is the most commonly used as it produces the most accurate work and is best for duplicating a number of pieces. Of course, the limited width of the guide, Fig. 18, makes it possible to trim only narrow widths from the ends of the stock. For making cuts across

the ends or near the center of wide panels, the table guide, Fig. 19, generally gives the best results. Always use the splitter with the table guide, and hold the work firmly against the edge of the table to prevent it from twisting or being thrown upward by the saw blade. The splitter cannot be used with either of the other methods, so make sure that the teeth are sharp and have a medium-wide set. The procedure in Fig. 20 requires a separate guide board for each piece of varying width. A shallow groove, or a saw cut, is made lengthwise on one face of the guide. Then the guide is attached to the work with one edge of the groove flush with the trim line at both ends.

Spinner Chucked in Electric Drill Drives Truck Wheels for Balancing

Truck tires can be easily balanced by the use of this simple spinner tool which is chucked in a portable electric drill. The driving member is made from flat cold-rolled steel bent as shown in the detail and notched to engage the lug nuts on the wheel knob. A $\frac{1}{2}$ -in. rod is welded to the spinner for chucking in the electric drill which will rev up the wheel to about the equivalent of a speed of 60 m.p.h. At this speed any out-of-balance condition is easily detected and, by adding balancing weights on the light side of the wheel, it is easily corrected. Spinning the jacked-up wheels at this speed also discloses any tendency to shimmy resulting from loose kingbolts or slack tie rods connecting the wheels with the steering gear.

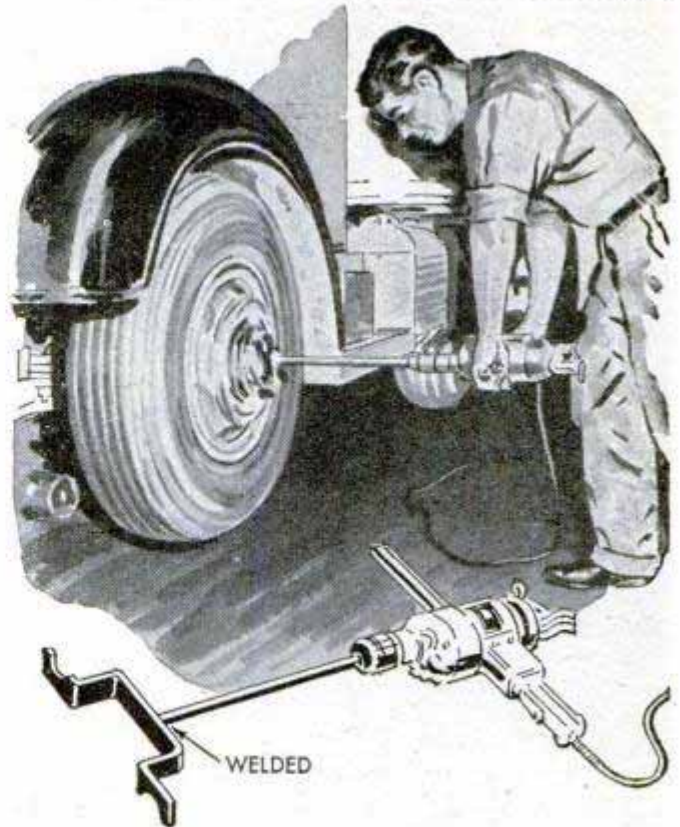

Portable Farm Anvil



This lightweight anvil is just the thing for field repairs and small jobs on the farm, as one man can easily carry it short distances or readily load it on a pickup truck for longer hauls. The anvil is a short length of railroad rail which is fitted with a horn, the latter being made by welding a section of automobile axle to one end of the rail. Lengths of channel and angle iron welded together provide a stand for the anvil, and a piece of wide channel welded between the two legs forms a tool tray.

latter being made by welding a section of automobile axle to one end of the rail. Lengths of channel and angle iron welded together provide a stand for the anvil, and a piece of wide channel welded between the two legs forms a tool tray.

Improved Barn-Door Latch

A serviceable barn-door latch can be improvised quickly from a strap hinge and screw hook of the type used to hinge heavy gates. Loosely bolt the strap hinge to the door, as shown in the drawing, and drive the screw hook into the frame so that the loop at the end of the hinge can be dropped over the hook to hold door closed.



Dusting Zip-A-Tone With Talc Permits Loose Brush Effect

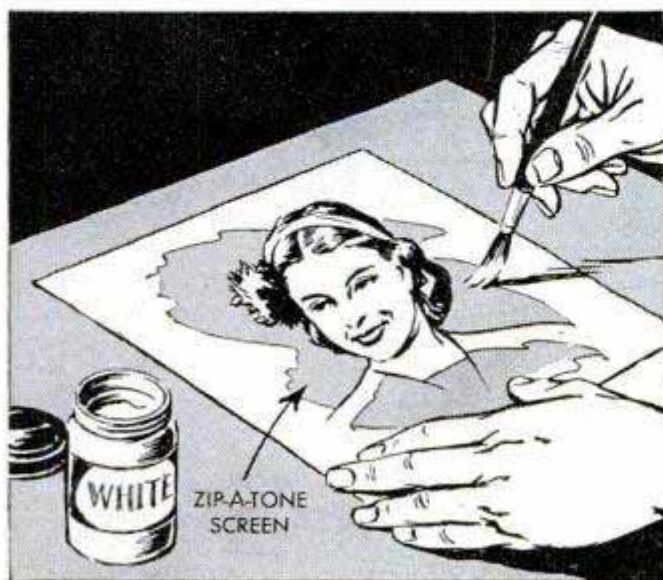

To obtain "free flowing" brush effects on Zip-A-Tone, or similar overlay screens, rub down with burnisher in the usual manner and dust the surface with talc. The dusting process permits the use of water color directly on the Zip-A-Tone where dry-brush or other effects may be obtained, or the background or other areas can be blocked out with white paint.

Lacquer Protects Car Wiring

Try applying a coat or two of clear lacquer to the exposed wiring in your car, particularly near the engine. The lacquer will prevent acids and moisture from damaging the insulation, thus prolonging the life of the wiring.

SHOPPING

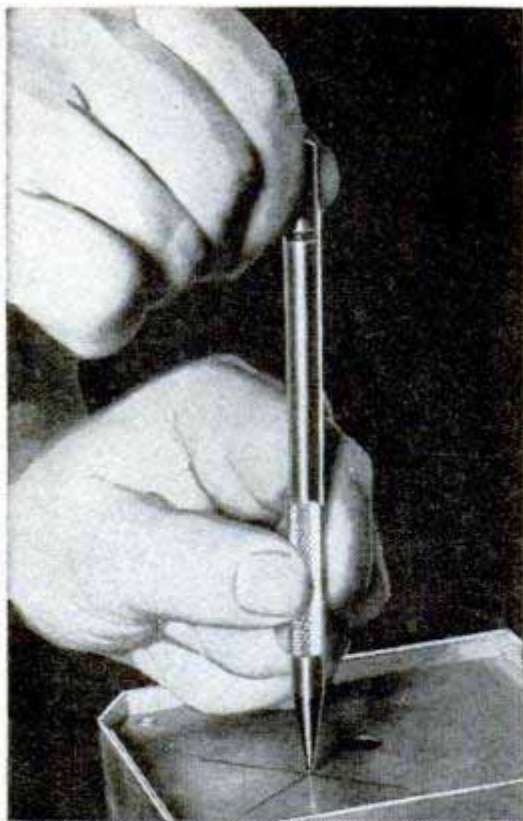

Lakelin Products Co., 2316 Rugby Rd., Dayton, Ohio.

PRECISION CENTER PUNCH has been especially designed for modelmakers, tool and diemakers, machinists and others who do precision layout work on small parts. Only slightly larger in diameter than an ordinary pencil, it can be located on fine layout lines with extreme precision. The point is driven by raising the spring-loaded head and releasing it. The degree of indentation is determined by distance the head falls

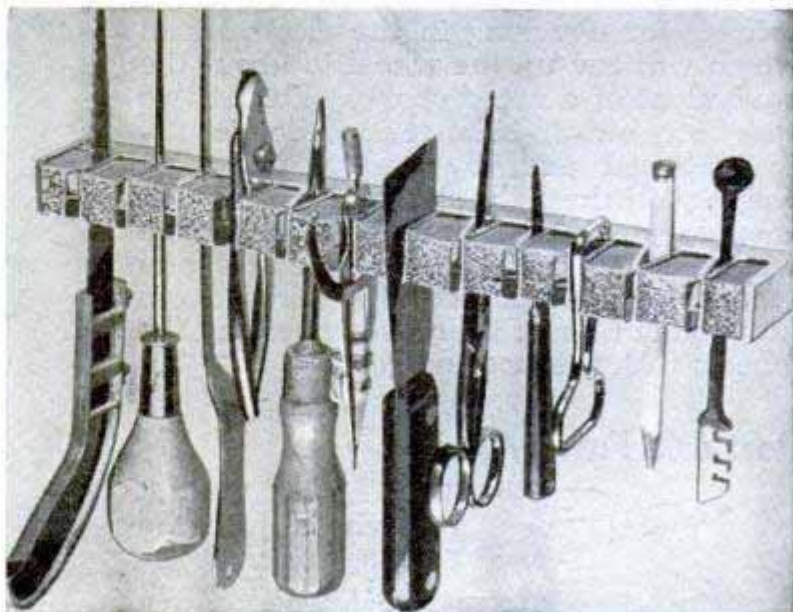

R. K. Products Co., Dept. P-4, 731 S. W. Front Ave., Portland, Ore.

SELF-ADJUSTING TOOLHOLDER is just the thing in small home workshops where storage space is limited and hand tools must be stored on wall racks. Not only can tools be stored in this holder, but also a variety of kitchen utensils, each item being held securely and always in full view. Sponge-rubber "springs," held in U-shaped clips which slide in a channel, provide constant grip and easy release for various tools from putty knives to pliers

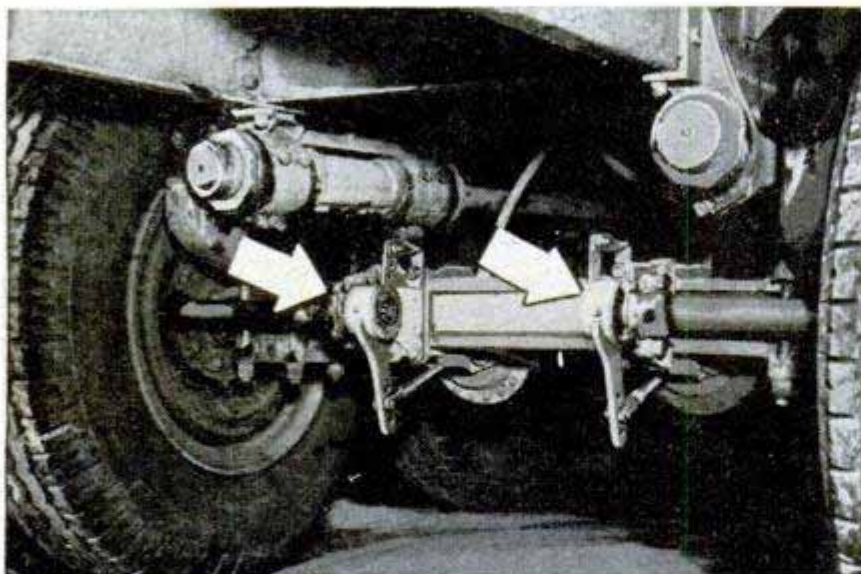

Brakemaster Corp., 205 W. Wacker Dr., Chicago 6.

AUTOMATIC BRAKE ADJUSTER maintains equalized braking action on heavy trucks, trailers and busses, and reduces tire-tread wear by as much as 25 percent. The unit, one of which is attached to each wheel, advances brake shoe automatically to compensate for lining wear, thus eliminating frequent inspection and adjustment. The unit is mounted on the splined camshaft of cam-actuated air brakes, and the power arm is connected to the push rod from the air-brake diaphragm. As the brake lining wears, a ratchet mechanism takes up slack



General Scientific Equipment Co., 2700 W. Huntington St., Philadelphia 32, Pa.

HEADREST GOGGLES, designed for welding, cutting, and brazing operations where complete eye coverage is unnecessary, are extremely lightweight and comfortable to wear for long periods of time. The novel headrest feature distributes the weight uniformly. Adjustments permit the goggles to be worn over glasses and also adjusted so that the lenses are the correct distance from each eye

FOR TOOLS

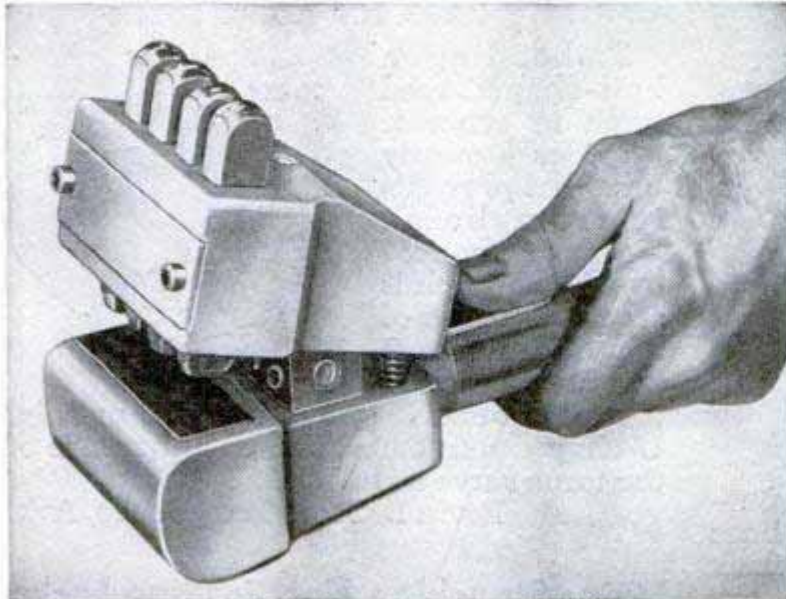

M. E. Cunningham Co., 83 E. Carson St., Pittsburgh 19, Pa.

METAL STAMP HOLDER that operates like a small edge clamp has a multiple holder for individual metal stamps, which can be arranged in any combination desired. Specially designed springs retain the stamps in the holder, but permit rapid changing. When unit has been placed in position over edge of sheet metal, each individual stamp is struck a light blow with a hammer. Because of unique design, the impressions cause minimum distortion



Speed Specialty Co., 5314 Mt. Royal Dr., Los Angeles 41, Calif.

VACUUM-SEALED UNIT that supplies moist air to your auto-engine carburetor is said to give more miles per gallon of fuel and also a smoother operating engine as a result of better fuel-air mixtures. No water ever is added to the chemicals in the container as they are continually reactivated by moisture from the air. The unit is mounted on the carburetor in such a way as to replace the idling-adjustment pin, or screw, found on most types of cars



Gabb Mfg. Co., Windsor Locks, Conn.

SPARK-PLUG SOCKET WRENCH has been especially designed for removing spark plugs from deep seats, such as those found on modern aircraft and industrial engines. By a novel application of the ordinary snap-ring retainer, a holder is provided for lifting the plug clear after it has been unscrewed. This feature speeds up plug changing and minimizes the possibility of dropping and damaging plugs when removing or inserting them from deep seats in the cylinder head. Unit comes in several sizes and fits ordinary square-nosed socket drivers either of regular or ratchet type

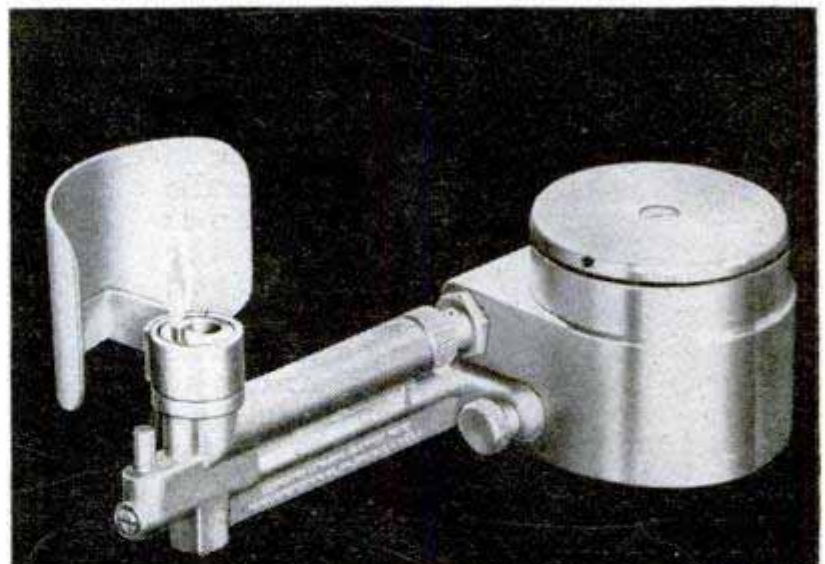

Hanau Engineering Co., 1231-33 Main St., Buffalo 8, N.Y.

AUTOMATIC BUNSEN BURNER with a pilot unit lights at a touch to a full, regulated flame. The on-off valve is controlled by a hand rest which makes it possible to use both hands to support the work over the flame. When the hand is lifted from the rest, the flame goes out, leaving only the pilot burning when burner is not in use. This feature reduces fire hazard to the minimum and will prove especially valuable in shops and laboratories where burners of this special type get intermittent use

Vertical Lines on Drawing Board Speed Sign Painter's Work

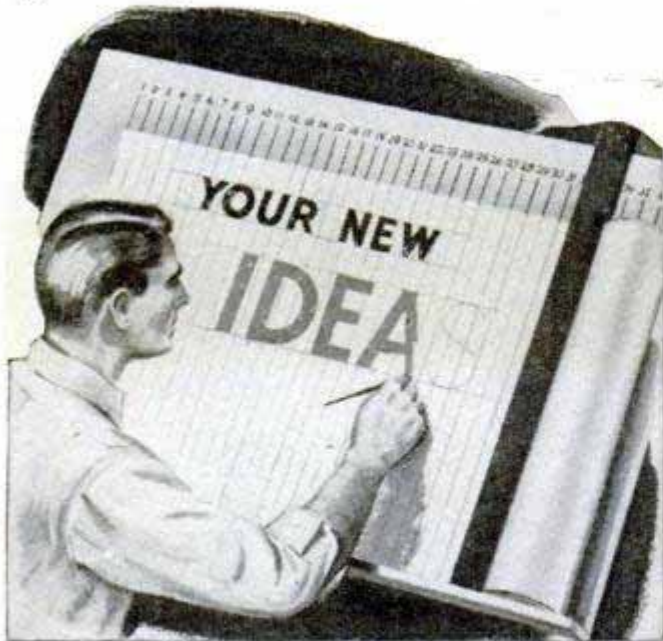

One sign painter increased his work output considerably by ruling vertical lines on his drawing board. The heavy black lines, which are spaced 1 in. apart, are numbered along the top of the board to provide a permanent yardstick for measuring the length of paper to be cut from the roll. In addition, the lines form a series of vertical guides for laying out lettering, as they can be seen faintly through the paper. A 2-in.-wide cleat nailed along the lower edge of the board holds the roll of paper in place.—Paul H. Will, Chicago.

Clothespin Holds Rubber Stamp

Fastened to a shelf, a spring-type clothespin forms a convenient holder for a rubber stamp. A wood screw driven through the

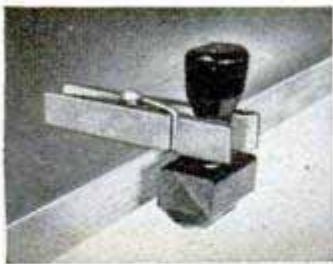

spring coil holds the clothespin in place. The handle of the stamp is gripped by the clothespin jaws, which extend over the edge of the shelf, and the stamp is released

by pressing together the arms of the clothespin. Several clothespins fastened to a shelf in this way will provide a rack for a number of different stamps.

Fast-Cutting Router Bits Made From Broken Drills

The next time you break a drill bit close to the top end of the flutes, don't throw it away, as you can make an excellent router bit from the shank end of the broken drill. Simply grind away one flute and then grind

a straight cutting edge across the end at an angle of about 5 deg. with the axis of the drill. When grinding, dip the bit frequently in water to prevent overheating. To do good work, a router bit made in this way should be rotated at a speed not less than 5000 r.p.m.

W.T.M. Concrete Concrete Base for Road Torch

Embedding a ball-shaped road torch in concrete provides a sturdy base that prevents it from being blown or knocked over. The torch is set in the center of a wooden form and the concrete is poured around it to a depth of 2 or 3 in. U-shaped rods embedded on either side of the torch serve as handles.

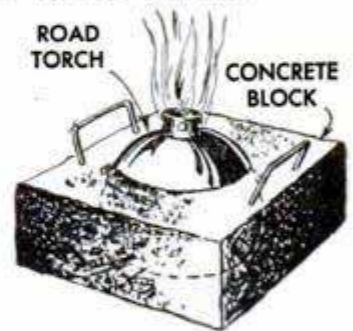

Ervin L. Strayhorn, Beebe, Ark.

Dairy Stanchion Has Positive Lock

Swinging on a pivot at the bottom, this homemade dairy stanchion is locked in place by raising the flat-iron locking bar which is pivoted at the top of the movable stanchion member. When in the raised position, the top end of the locking bar slips over the offset at the top of the stationary bar. The stanchions are made of 2 x 2-in. oak, with the inside edges well rounded, and supported by a 2 x 6-in. piece suspended from the barn ceiling. The entire stanchion turns easily, giving the cow plenty of feeding movement.

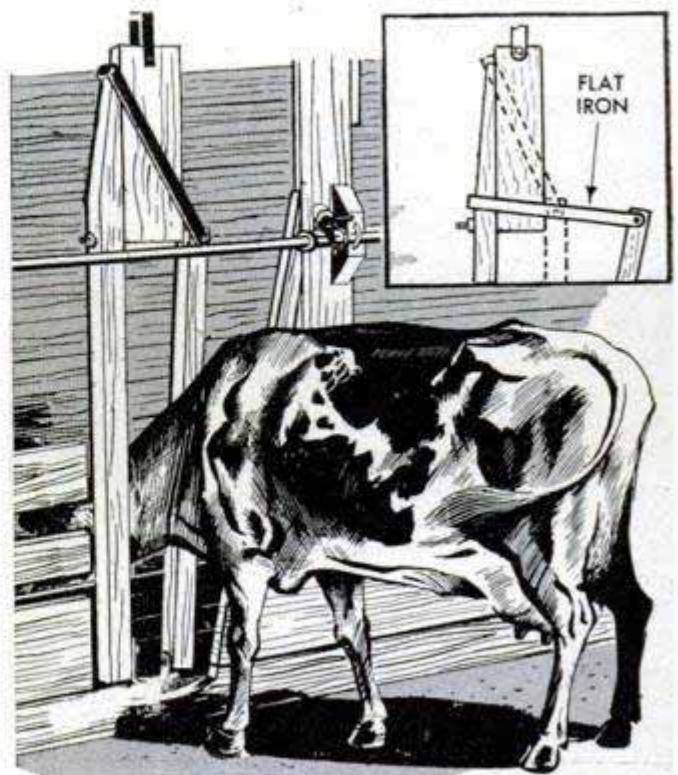

TELEVISION IN ENGLAND

THERE are no private broadcasting stations in England; all stations are operated by the government as a state monopoly. However, sound-relay companies have been licensed, paying a yearly fee for permission to relay the B.B.C. radio-broadcast programs. The subscribers pay a small fee and the radio-program service goes to them by means of coaxial cables and relay stations. TV service is relayed at present to selected subscribers at Hayes, Middlesex, only until the government permits relayed TV service all over the country.

The service is transmitted to the subscriber's home by means of two coaxial cables. With the new E.M.I. Relays Ltd. service, which includes TV programs, photo A, the subscriber has a choice of either the TV programs or any of the four regular sound-broadcast programs. Each town will have its own master receiver, amplifier and relay system as illustrated in photo B. The system provides trouble-free reception as the master receiver is in a selected location.

British TV set owners recently had a grandstand seat at an important experiment in air-to-ground TV transmissions conducted by the Bristol Airplane Company Ltd. Photo C shows the TV transmission equipment in the Bristol freighter during one of the flights. Photo D was taken as the freighter flew over Ascot.

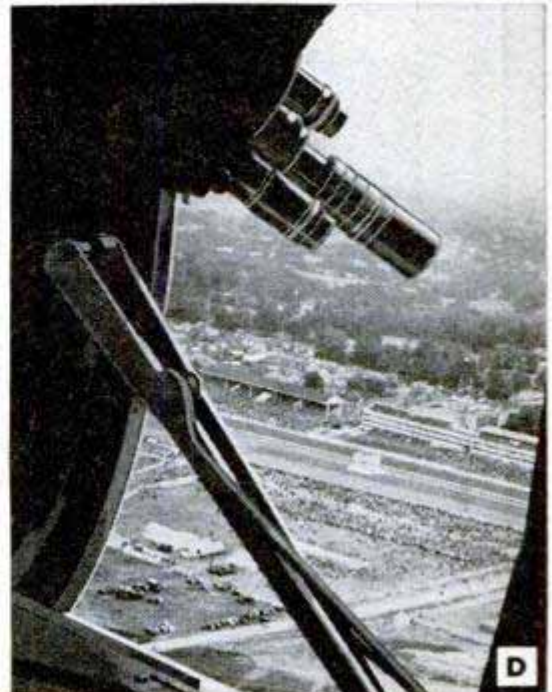
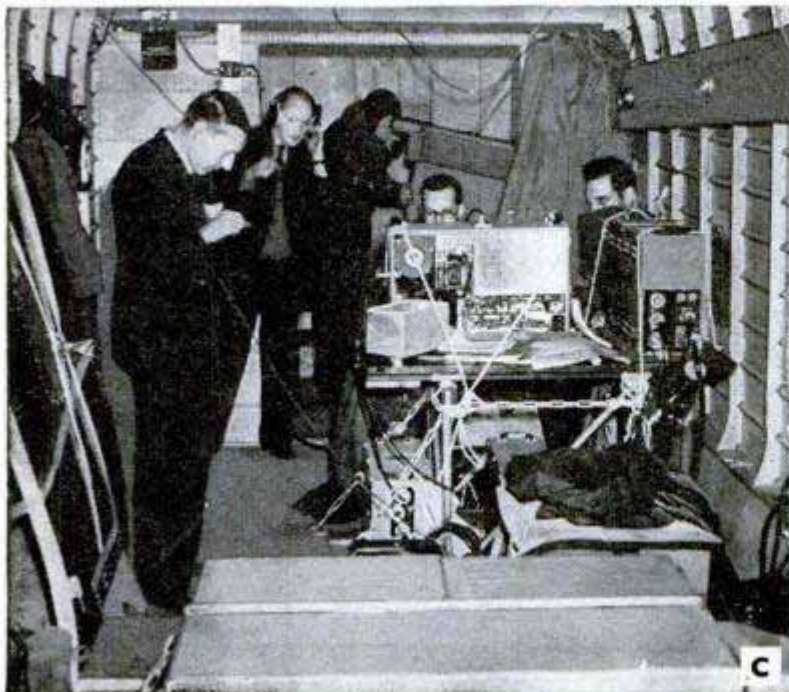
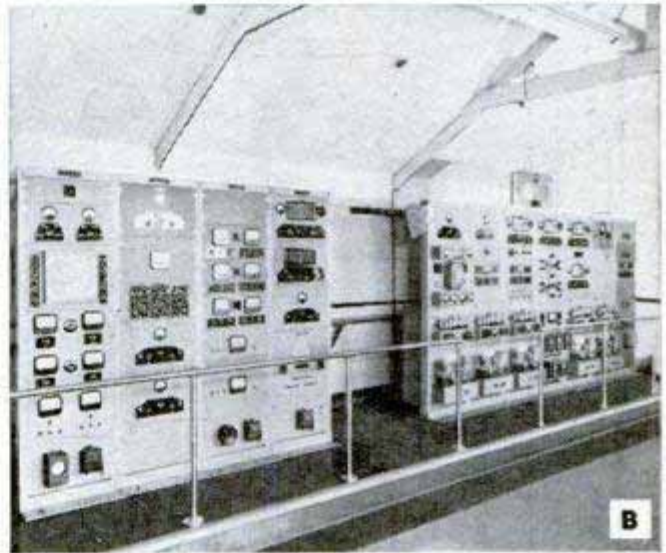
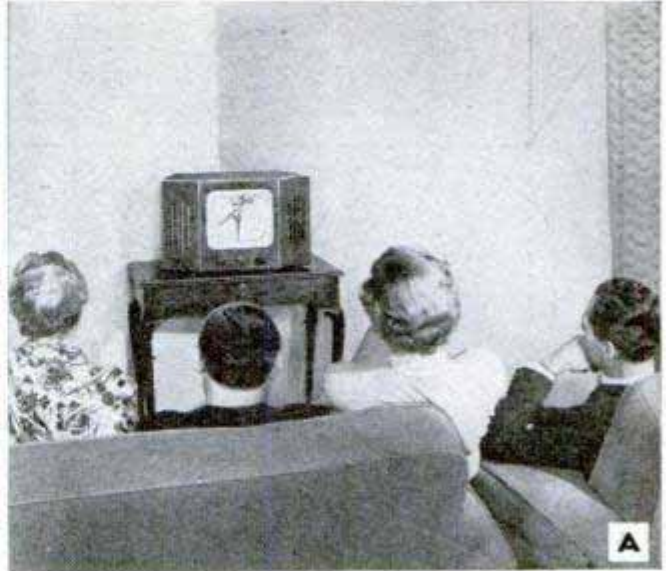

T.R.F. BROADCAST RECEIVER

By L. M. Dezettel

FOLLOWING a trend of increasing interest in high-fidelity sound reproduction, this new model of the popular annual Little Giant student receiver is designed to meet the requirements of students and experimenters with limited pocketbooks. A complete home high-fidelity system involves several expensive components such as a special audio amplifier, speaker and a tuner. However, very satisfactory high-quality reproduction of broadcast music can be achieved inexpensively with just a specially designed receiver. The receiver described here approaches the high-fidelity results obtained from more expensive equipment but is easy to build from standard parts available from any radio supply house at a cost of about \$30.00.

This receiver will pick up the standard broadcast signals, pass the full band width of the transmitted signal and reproduce the audio portion of it through a push-pull power amplifier stage, with an order of fidelity not ordinarily found in the average receiver today. It can be installed in a cabinet, or made a part of a custom installation. It needs only a short external antenna and a good quality 10 or 12-in. PM speaker to be complete.

The simplified wiring diagram is given in Fig. 1, and the standard-size chassis-base details are shown in Fig. 2. Photos A, B and C show various views of the completed receiver. The schematic circuit diagram appears in Fig. 3. The dial is a standard Crowe assembly. This assembly includes a combination broadcast and short-wave dial scale. However, a dial scale with the broadcast band only is available separately. The Meissner coils are of standard construction and available almost anywhere. These coils are designed for 365 mmfd. variable condensers. As two-gang variable condensers of this value are now difficult to obtain, use the new standard two-gang 498.8 mmfd. variable condenser with trimmers, for C1 and C2, and merely remove four of the rotor plates from the

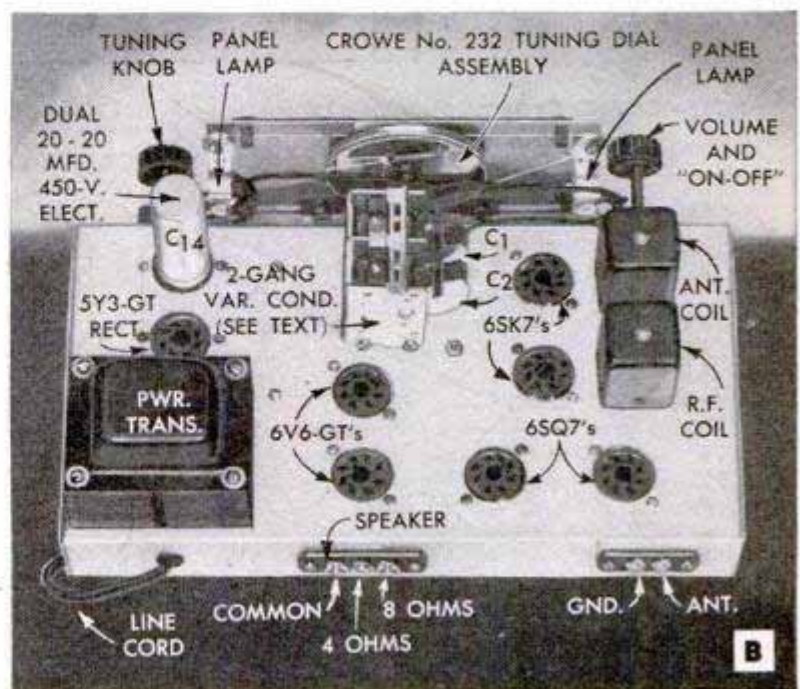
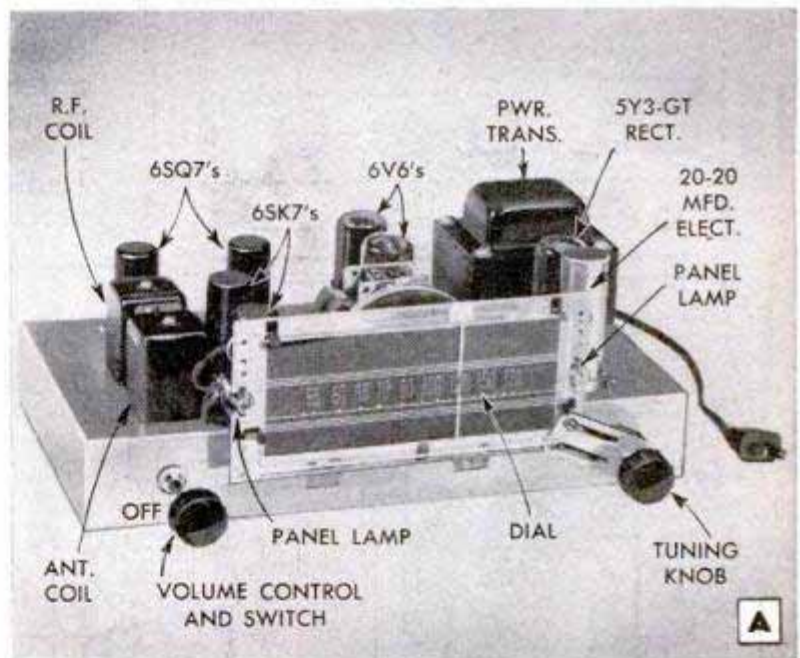
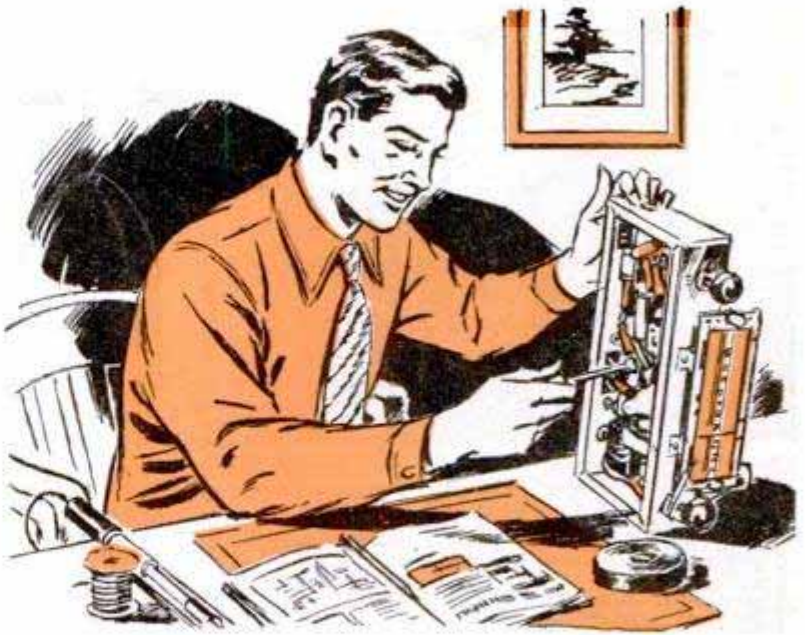

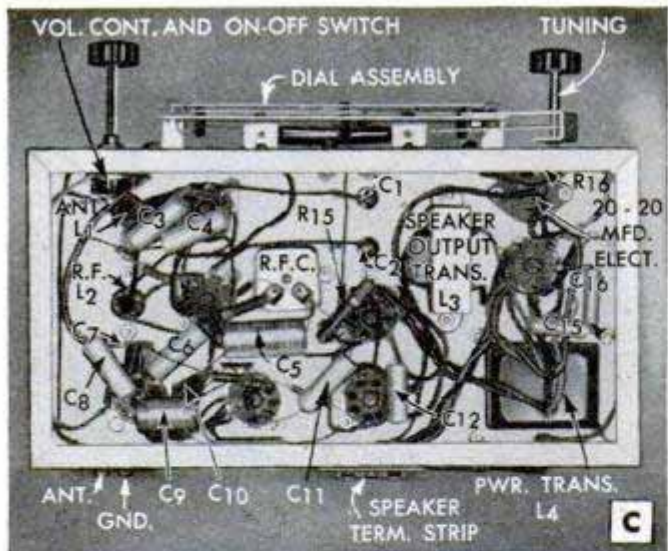

front and rear sections with a pair of pliers, beginning from the outer ends. Remove rotor plates only. Move each plate back and forth gently near the brass crossbar until it falls out of its groove in the rotor shaft. Output transformer L3 can be either a Thordarson T-22S56, or a Stancor A-3870.

Use rosin-core wire solder only, and keep all leads as short as possible. The power transformer L4 can be a Thordarson TS-24R04 or a Stancor P-6012. Final adjustment of the receiver is very simple. The two trimmer condensers on the two-gang variable condensers are used to adjust at the high-frequency end of the band. The low end of the band will track very close without any adjustment. Adjust the trimmers for obtaining the correct reading on the tuning scale and place the traveling pointer for approximately correct calibration. Tune in a station at the high-frequency end of the band and adjust both trimmers for maximum volume. In or near large cities where there are several broadcasting stations, use a 10 or 15-ft. indoor antenna for best selectivity and to prevent overloading. Detailed student material list R-399 is available from Popular Mechanics Radio and Electronics department upon receipt of ordinary letter postage.

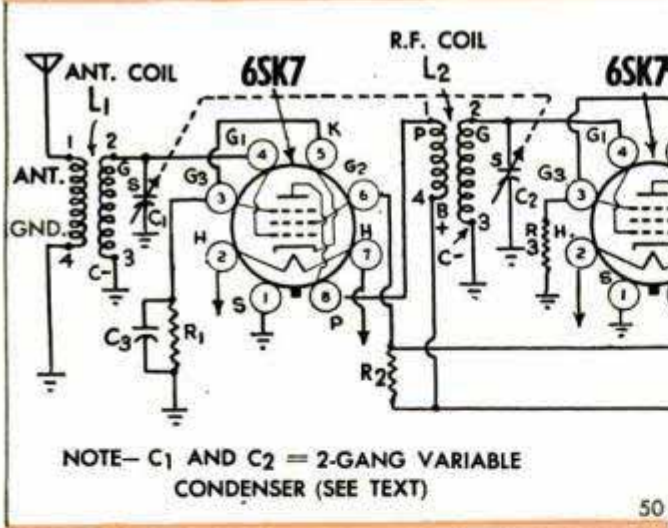
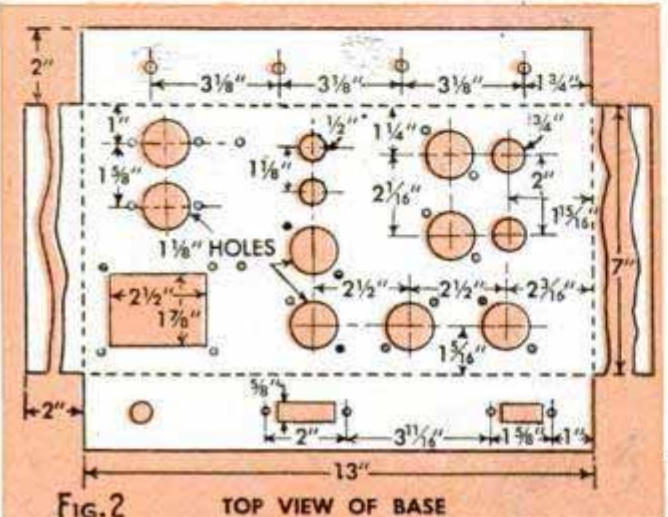

RESISTOR CHART

R1	1000 ohms, 1/2-watt carbon
R2	12,000 ohms, 1/2-watt carbon
R3	1500 ohms, 1/2-watt carbon
R4	18,000 or 20,000 ohms, 1-watt carbon
R5	220,000 ohms, 1/2-watt carbon
R6	4700 ohms, 1/2-watt carbon
R7	28,000 ohms, 1/2-watt carbon
R8	1- megohm volume control (audio taper)
R9	220,000 ohms, 1/2-watt carbon
R10	470,000 ohms, 1/2-watt carbon
R11	22,000 ohms, 1/2-watt carbon
R12	4700 ohms, 1/2-watt carbon
R13	220,000 ohms, 1/2-watt carbon
R14	470,000 ohms, 1/2-watt carbon
R15	270 ohms, 2-watt carbon
R16	1800 ohms, 2-watt carbon

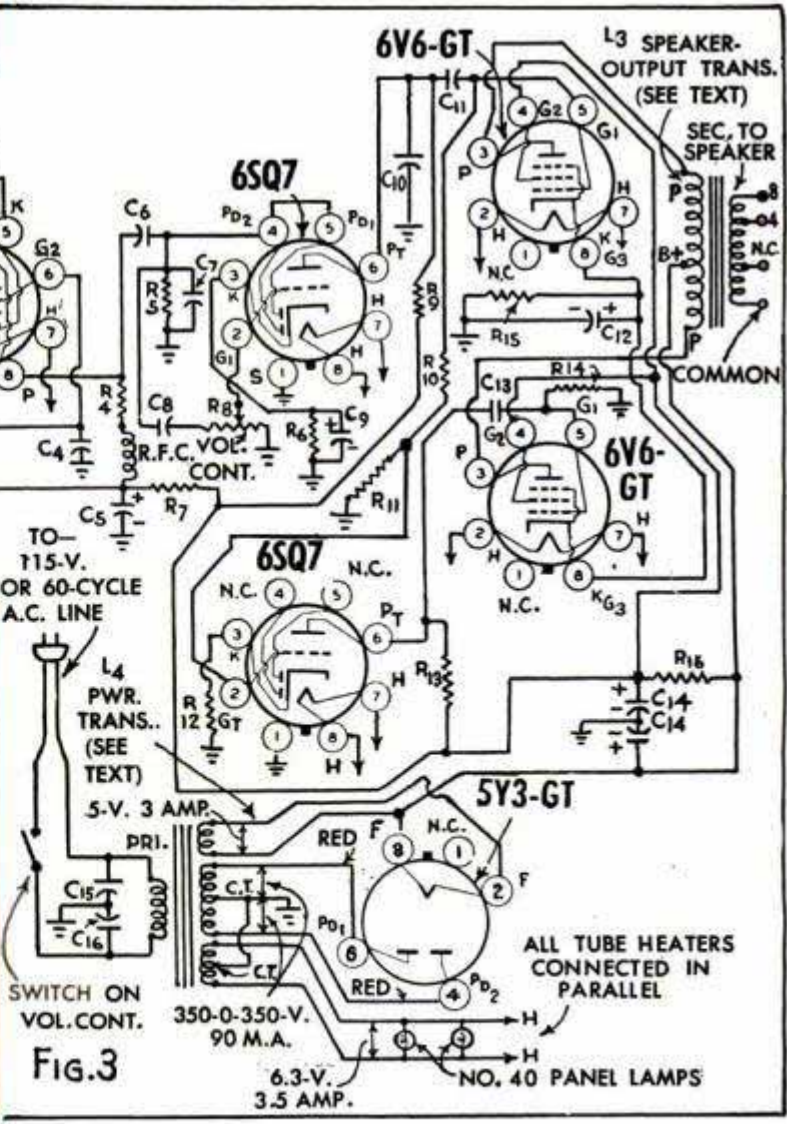

FAULTY INSTALLATIONS OF TV-ANTENNA SYSTEMS

By **George MacDonald**

Senior Safety Engineer, National Safety Council

WHEN TV SETS first came on the market, the dealer made arrangements as part of the purchaser's contract for an engineered antenna installation. In fact, this was almost mandatory before a set could be sold.

In the past two years, competition has become greater in this field. Originally handled by specialty appliance-radio-TV dealers, television receivers are now also sold by department stores, hardware stores, music stores and even drugstores. Through some of these mediums—unless the work is turned over to a service organization—the set is sold with an outdoor-antenna kit without installation charges, a condition which appealed to the general public. As comparatively few new owners had the necessary experience to cope with the TV-antenna-installation problem, accidents began to occur.

Unlike ordinary outdoor radio-antenna systems, TV antennas are of special design and in many locations, especially in fringe areas, they must be higher than ordinary radio antennas. Until recently very little information on TV-antenna installation has been available to the general public. Installers, who had never been on a roof before, fell off ladders and otherwise injured themselves. As a result of faulty installations, TV antennas fell on power lines and caused interruption of service. In locations where it was necessary to elevate the antenna considerably, extensions were added to the masts provided in the kits without adding the necessary guy wires to support

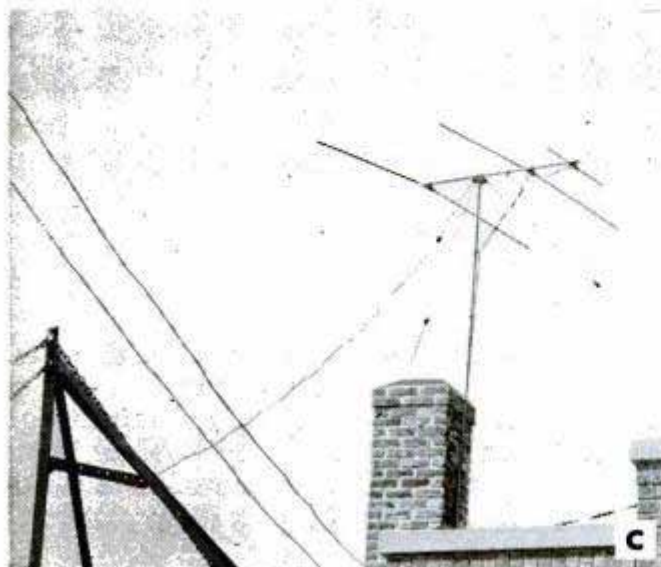
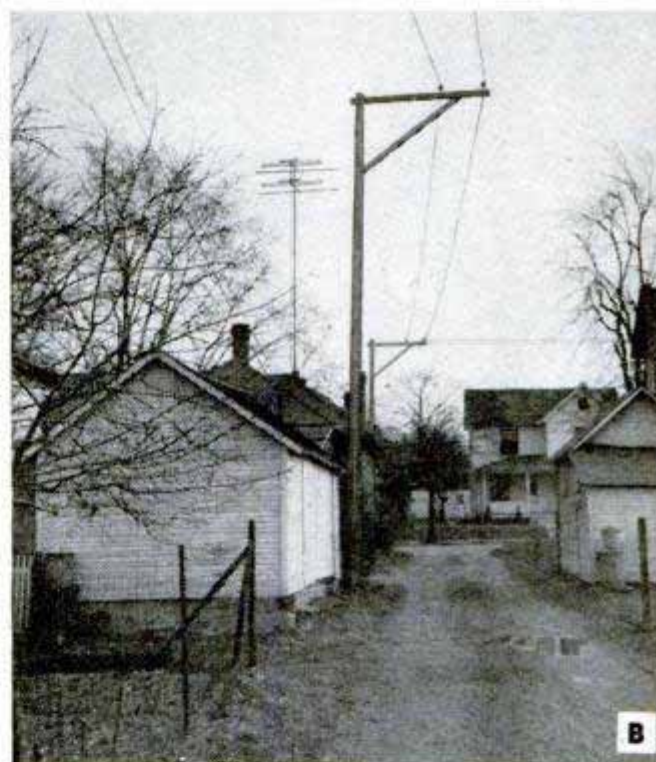
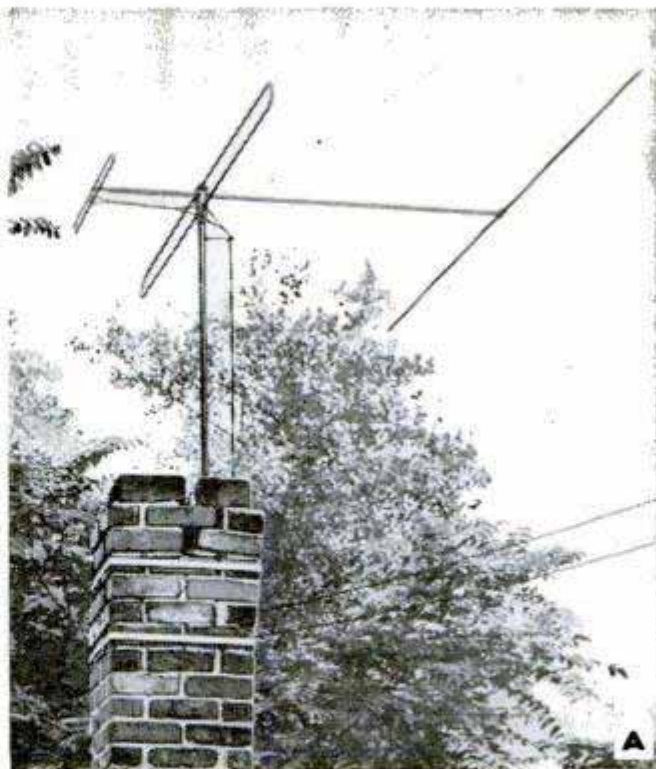

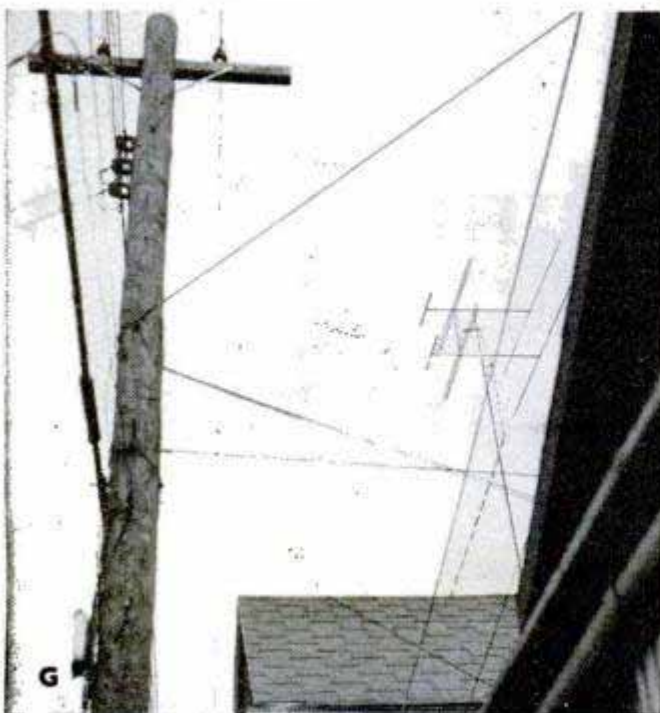
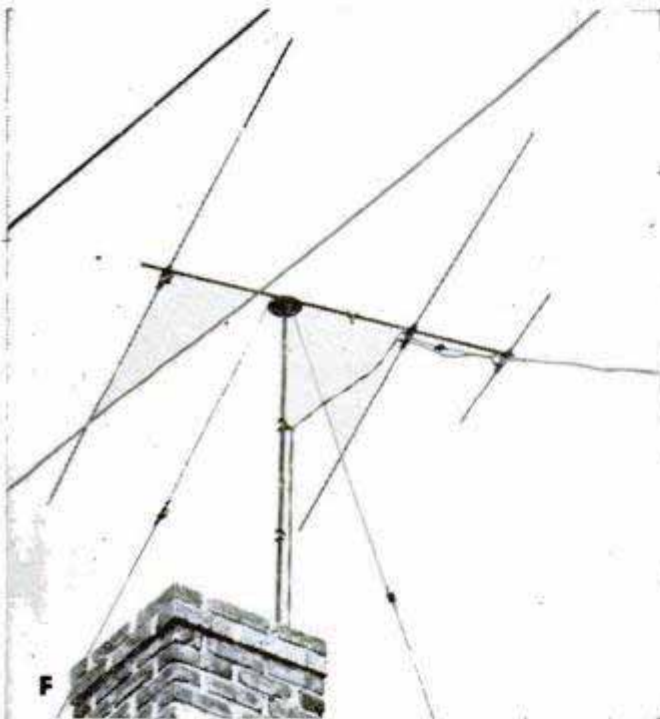

the higher masts. Others made the mistake of trying to strap the antenna mast to a chimney that was badly in need of repairs as illustrated in photo A.

Some of these hazards can be eliminated by sizing up the job before actual operation. For example, the installer should note the type of antennas on adjacent buildings, the relative height of the masts, how they are oriented, and the type of guying or support needed relative to the wind and other local weather conditions. In addition to the physical conditions of the working area, the installer should carefully check the immediate area for energized wires and should determine the most usable spot for the antenna as far away from contacts as possible. With this same thought in mind, he should route the transmission line from the antenna accordingly. Local building-code provisions dealing with structures and electrical installations must be observed.

Photo B shows where the power-and-light company relocated its high-tension wires to extend beyond the arc of the high TV-antenna mast should it fall. Photo C illustrates how a loose guy wire can fall across power lines. Photos D and G show examples of high antenna masts erected with no thought to measuring clearances from power lines. The same condition exists in photo F, even though the antenna is only a few feet above the chimney.

Accidents, personal and otherwise, can be avoided by using common sense. The installer in photo E is just asking for trouble. For elevation while erecting the antenna, he apparently intends to stand on a stool on the edge of the chimney. When installing a rotating device on a TV-antenna mast always check to see that there is sufficient clearance for the elements at all points of the compass. Don't fail to secure eyebolts and make sure that you use enough guy wires. In some cases, the installer failed to use good mechanical judgment and over-tightened nuts, bolts, and guy wires so that the threads were stripped. In one location, the installer failed to secure the guy-wire turnbuckles by threading a wire through them. Becoming unscrewed as result of vibration caused by the wind, they released the guy wires and permitted the antenna mast to fall.

The installation of television antennas is no more hazardous or difficult than installing any other type of roof antenna, but it does require some thought and attention to details in order to avoid the mistakes described and illustrated in this article. Every experienced set owner, radio amateur and serviceman knows that any roof-antenna job requires the observance of safe practices. Ladders must be carefully placed to prevent falls.

How to make wide- and narrow-beam flood shots with one lamp

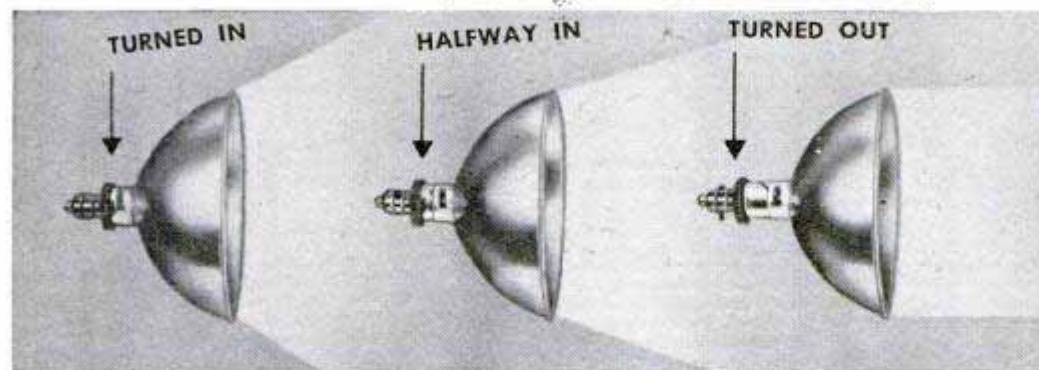

wide beam for general still work

moderately narrow beam for your movies

extra-narrow beam for glamour shots

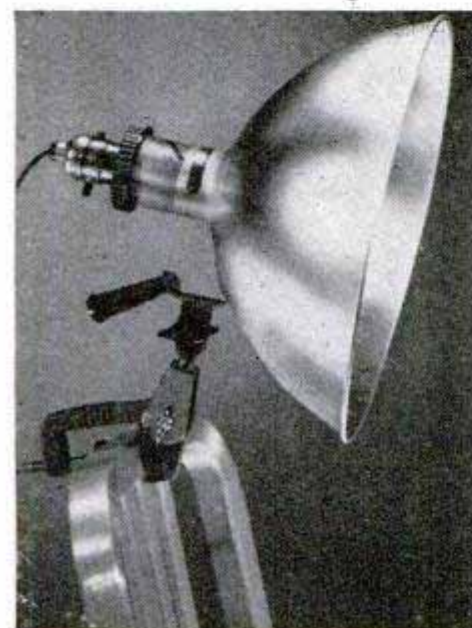

Kodak Vari-Beam Standlight (right)

As you see above, the versatile Kodak Vari-Beam system is mighty handy. 12-inch reflector with a #2 flood lamp gives powerful illumination . . . convenient handle aims the lamp . . . telescopic column adjusts height from 3 to 5½ ft. . . special rubber rim on heavy base protects furniture. \$15.

Kodak Vari-Beam Clamplight (left)

Lamp unit has all the features of the Vari-Beam Standlight unit, but is mounted on flexible bracket. Padded clamp attaches quickly and securely to chair backs, table tops, and tubular surfaces. \$9.75.

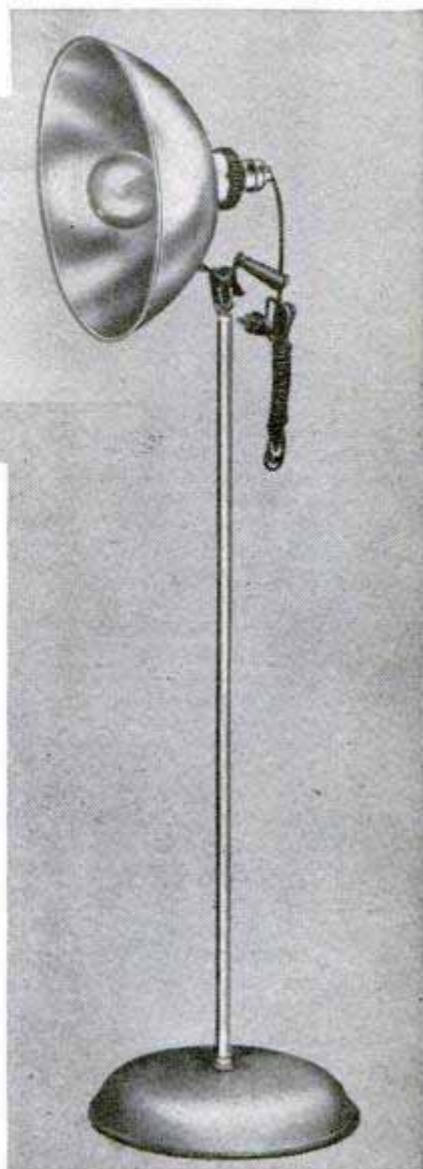

Why 2 flash units are better than 1

Flash pictures taken with multi-flash illumination have a more pleasing, natural look. You eliminate possibility of burned-out highlights and dense shadows in flash shots this easy way:

Start with the KODAK FLASHHOLDER connected to camera—easy to attach. New model with handy data on back of reflector, \$11.50.

Then connect a KODAK FLASHHOLDER EXTENSION UNIT, MODEL B. Attach to a chair for side lighting. More than one unit can be used. \$12.75.

Prices include Federal Tax where applicable

Prices subject to change without notice. Consult your dealer.
EASTMAN KODAK COMPANY, ROCHESTER 4, N. Y.

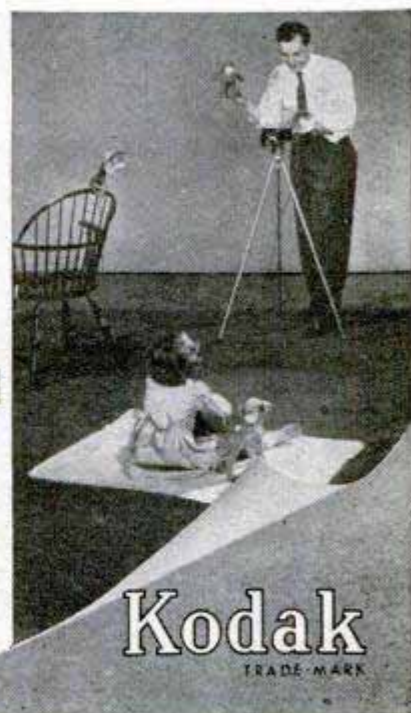

Kodak
TRADE-MARK

Here's why Cars that WASTE OIL
are headed for

PREMATURE OLD AGE

OIL WASTE warns you that
rocking chair pistons
are wearing out
cylinder walls



INSIDE FACTS



ON EXCESSIVE
OIL CONSUMPTION

SEND NOW FOR FREE BOOKLET:

"Inside Facts on Excessive Oil Consumption" brings you the facts about the 10 ways engines start to premature old age when you neglect to replace worn rings at first sign of oil pumping.

RAMCO RE-POWERING

with 10,000 Mile (or 1 Year) Guaranteed
Piston Rings actually
CURBS WEAR



Rameco's
"NO-GAP"
Spiro-Seal steel section on the 10-Up oil ring develops a special compensating action that minimizes friction on the power stroke. Then, as the piston rises in cylinder, Spiro-Seal lessens its contact thus insuring adequate wall lubrication for exceptionally long life. This is one of many Rameco originations which make possible the control of oil in worn engines through STABILIZATION rather than pressure. See your repair shop displaying the RE-POWERING Sign... or write for free booklet. Send postcard to Ramsey Corporation, Dept. 3764, St. Louis 8, Missouri.

Copyright 1951, Ramsey Corporation 5409

Sculptor of a Prehistoric World

(Continued from page 102)

has set, he soaks it in kerosene and, for some reason which he can't explain, it doubles its size in every detail. Even the tiniest portion of the mold expands to twice its original size. By repeating the process, pouring a new mold and soaking it, he can enlarge the original mold any number of times he desires. Using this technique, he can enlarge an acorn to pumpkin-size with no loss of detail.

He often uses live animals as models. When he makes a mold of a frog, he anesthetizes the animal and slaps a plaster kimono around it. When the anesthetic wears off, the frog struggles out of the hardened plaster and scampers away no worse for wear, leaving an accurate impression of its body. Marchand uses the same technique with snakes and other small animals.

"So far as we know," says Marchand, "Reimann and I are the only free-lance team in the country doing this sort of work. It's highly specialized, of course. Others reproduce nature scenes, but they usually feature taxidermy. We do no taxidermy. Instead, we try to reconstruct the life of geological periods so ancient as to be almost unbelievable. In our modern exhibits, we require that the models be indistinguishable from the living counterparts."

Next time you visit your favorite museum, look around for Marchand's work. He needs no signature or by-line—if you find a fossil diorama that is so real that you can't believe your eyes, then it's a good bet that Marchand made it!

"Tropical Tramps" Link the Americas

(Continued from page 94)

the animal standing there. How the field attendants got it down the next morning has never been adequately explained.

How to load, carry and care for all kinds of cargo are constant worries of Alfonso and Wright. It's still a trial-and-error business, they point out. But already an amazing array of machinery and techniques facilitates the moving of tons of freight through the big terminal.

No longer do the chicks and cigarettes go in heavy crates. Chicks, which must be freshly hatched so no food will be required (they'll be delivered in 24 hours), go in light cardboard "apartment houses." Cigarette packs go in featherweight net bags.

Heavier items like mine machinery or

(Continued to page 240)

HARLEY-DAVIDSON *HYDRA-GLIDE*® FOR SPORT FOR WORK FOR CIVIL DEFENSE

Have fun . . . save money . . . be useful to your community. You can do all three, with a Harley-Davidson Hydra-Glide. This big, smooth-riding streamliner takes you comfortably to distant points at low cost. It saves money on daily trips to work. It makes you a "buddy" at exciting race meets, sightseeing tours and other motorcycling fun events. With it you can join your local civil defense program. See your dealer. Mail coupon now.



HARLEY-DAVIDSON MOTOR CO.
Dept. PM, Milwaukee 1, Wisconsin

Send me free copy of ENTHUSIAST Magazine filled with motorcycle action pictures and stories; also literature on new models.

Name.....
Address.....
City..... State.....

OPPORTUNITY: Valuable franchises available for the full line of famous Big Twins and 125 model. Write today.



Care and Feeding of Engines

BY S. P. CORP

FINDING THE MISS

High speed misses are not always corrected by new coils. A stone bruise or dirt in the gas line may let through enough gas for low speeds but not for continued high speed driving. These two tests are then indicated:

Pressure Test: Disconnect fuel line at carburetor and connect pressure gauge as shown. Idle engine until maximum pressure shows—from 3 to 5 lbs. Stop engine and if pressure falls quickly, check fuel pump valves and diaphragm.

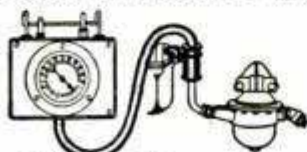

PRESSURE TEST

Capacity Test: Connect short hose to fuel line; place other end of hose in a pint measure. Then crank engine enough to prime pump and fill hose. Pour out fuel in measure and crank engine for 15 strokes of the pump. It should deliver 5 to 6 ounces of fuel if pump is O. K. and fuel line is clear. If not, check for restriction in line between gas tank and fuel pump.

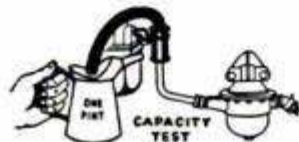

CAPACITY TEST

STOPPED AT FRONT LINE

If Old Man Winter has fouled up your cooling system, the first warm weather will usually reveal this sad fact. To locate the trouble, remove top and bottom hose from radiator and fit wooden plugs as shown, after draining radiator. Fill radiator and leave cap off. Then remove bottom plug and see how high water squirts. It should be 5 or 6 inches if core is not clogged. If radiator is clogged, give it a thorough reverse flush and use a good radiator cleaning solution. Be sure to drain the radiator immediately before the loosened sediment has a chance to settle. There's nothing more annoying than to be miles from home on a vacation trip and have overheating trouble. Guard against it now!

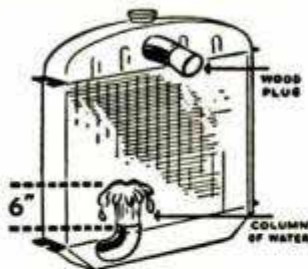

WOOD PLUG
COLUMN OF WATER
6"

GET SET FOR SPRING!

When warm days come and birds return and buds bust forth with surging power—what about your car? Will it surge with power—or go pfft? Get set for spring with new Sealed Power Piston Rings—the best rings built! Sealed Power MD-50 Steel Oil Ring is the world's finest—the only ring with the Full-Flow Spring—controls oil even in badly tapered and out-of-round bores! Ask for free booklet, "7 Ways to Save Oil." A card will bring it—just address Sealed Power Corporation, Dept. G-3, Muskegon, Michigan. For triple wear, get Sealed Power Chrome-Faced Rings.

Clinic



for Homemakers

As a service to our readers in solving the hundreds of problems pertaining to a home—inside or out—the editors of *Popular Mechanics* invite you to present your problems to The Clinic Editor for help and advice. Address your questions to The Clinic Editor, *Popular Mechanics Magazine*, 200 East Ontario Street, Chicago 11, Ill.

Shotgun "Sweats"



Q—I know this question is a little out of line with home problems, but last fall when bringing my shotgun inside the house after a day's hunting in cold weather, the metal parts became coated with moisture and rust spots appeared. What caused this and how can I prevent it?
L.A., Huron, S.D.

A—After carrying your shotgun for several hours in temperatures below freezing, the metal becomes very cold. When you bring the gun indoors, into warmer air, moisture in the warm air condenses on the cold metal surfaces; just as it does on the surface of a glass tumbler filled with cold water on a warm summer day. It is not safe to rely on the ordinary gun case to prevent the entrance of warm, moisture-laden air, that is, under these particular conditions. A better way is to make a full-length plastic cover with all seams folded in and sewed with two rows of stitching. The seams can be cemented, of course, but two rows of stitching will serve equally well. Fit a long drawstring at the open end so that the cover can be slipped over the muzzle, pulled tightly about the gunstock just back of the grip, and tied securely to prevent the entrance of warm air. Placing the cover over the gun before taking it inside and tying the drawstring tightly around the stock will prevent condensation of moisture on the bare metal. Use a thin, flexible plastic of the type used for draw curtains and window draperies.

Old Furniture Finishes

Q—What kind of finish was used on the home furnishings made by our early American colonists? How did they achieve that unusual reddish-brown color on pieces made of pine? I'm not referring to painted pine, but to the clear finish which colored the wood without hiding the grain. How long has white lead been used?—A.Y., Albany, N.Y.

A—The type of finish used varied with the period. One of the earliest finishes known to have been used on pine was made by mixing a small quantity of Venetian red with fresh skimmed milk. It is quite possible that this produced the reddish-brown finish you are referring to, although it should be remembered that nearly all woods change color, and, to some extent, grain characteristics, in

(Continued to page 238)

want better results
in your workshop...

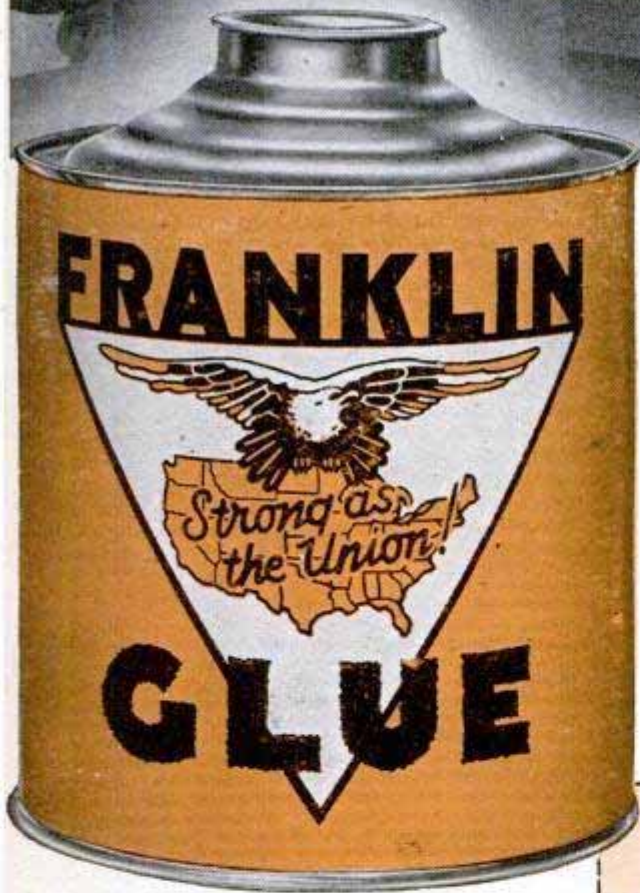
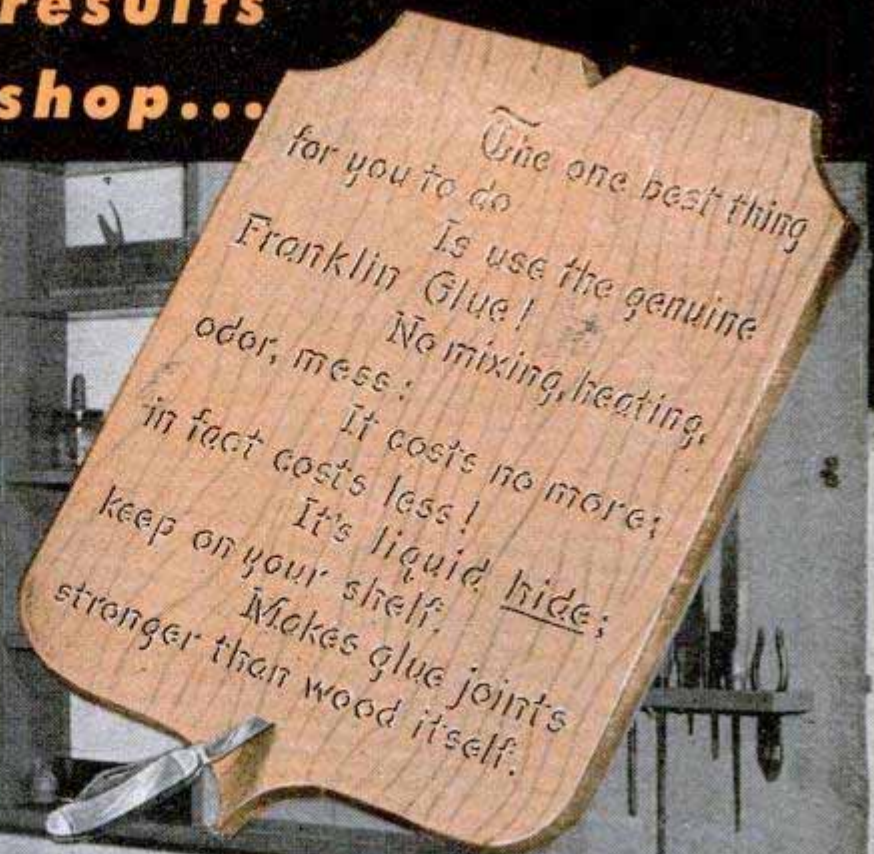
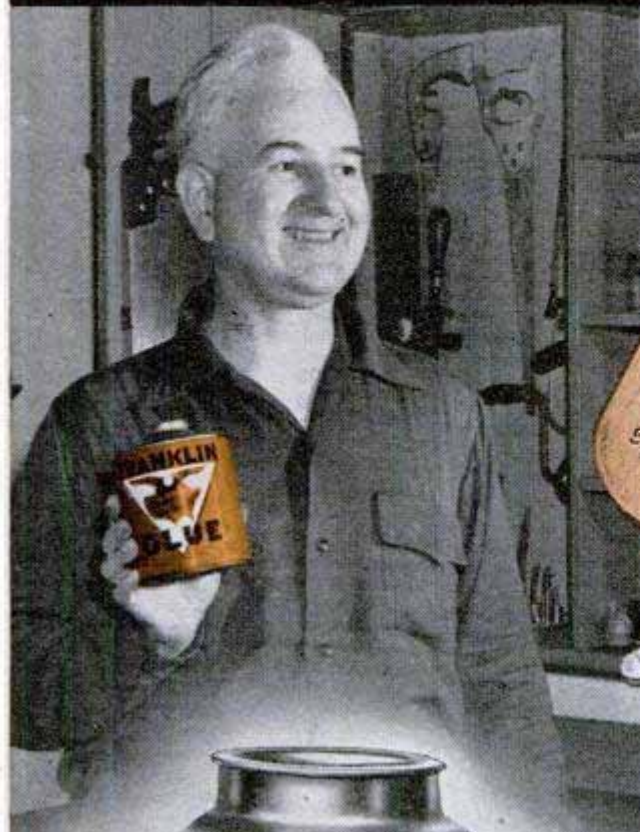

FRANKLIN GLUE IS BEST FOR ALL WOODWORK

Genuine HIDE glue, strongest known. Easy to use . . . no mixing, no heating. No odor. Eliminates chilled joints. Actual laboratory tests prove Franklin Glue holds more than 4000 lbs. per sq. in. and shows 100% wood failure. Spreads thin, goes farther. Costs no more than ordinary glues. Ideal for all home uses. If your dealer cannot supply you, send this coupon with 20¢



The FRANKLIN GLUE CO., 113 W. CHESTNUT ST.
Columbus 15, Ohio

Enclosed 20c (15c plus 5c postage and handling charge) for trial tube of Franklin Liquid Hide Glue.

NAME.....

ADDRESS.....

SIX SIZES: Available in tubes 15c; quarter pints 50c; half pints 85c; pints \$1.50; quarts \$2.65; gallons \$7.50.

HOME CRAFTSMEN

Send for this Money-Saving
Introductory Offer of...

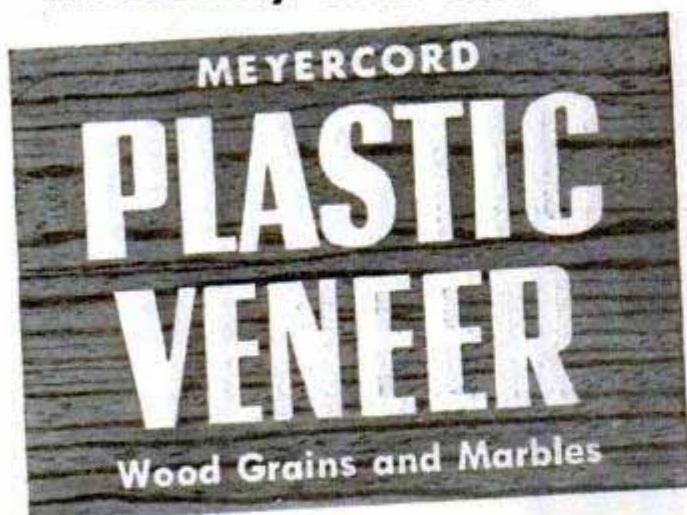

FEATURED IN FULL COLOR • JANUARY
AND FEBRUARY POPULAR MECHANICS

Here's the Big Offer!

- 1 3 sheets of Meyercord Plastic Veneer
—Any Pattern (Check Coupon Below)
- 2 with Cement
- 3 and Squeegee

COMPLETE ONLY
\$5.00
POSTAGE PAID

Now—exact reproductions of rare woods and marbles are available in PLASTIC VENEER sheet form to beautify the articles you make. Easy to apply on flat or simple curved surfaces of wood, metal, glass or composition. Durable, workable. Can be rubbed, top-coated, waxed. Order the special 3-in-1 package today. Check woods or marbles desired. Sheets contain 5 to 6 sq. ft.

CLIP COUPON—MAIL TODAY

THE MEYERCORD CO., 5325 W. LAKE ST., CHICAGO 44, ILL.

Please send me your \$5.00 introductory offer of 3 sheets of Meyercord Plastic Veneer, squeegee, cement, and complete instructions. Patterns are checked below. Enclosed find check M.O. for \$5.00. Plus \$_____ for _____ additional sheets, @ \$1.50 for wood, \$1.60 for marble.

- | | |
|--|--|
| <input type="checkbox"/> Italian Walnut | <input type="checkbox"/> Macassar Ebony |
| <input type="checkbox"/> Circassian Walnut | <input type="checkbox"/> Salinwood |
| <input type="checkbox"/> Butt Walnut | <input type="checkbox"/> Straw Stump |
| <input type="checkbox"/> Walnut Crotch | <input type="checkbox"/> Blonde Harewood |
| <input type="checkbox"/> French Walnut | <input type="checkbox"/> Brazilian Rosewood |
| <input type="checkbox"/> Walnut Stump | <input type="checkbox"/> French Rosewood |
| <input type="checkbox"/> Quartered Walnut | <input type="checkbox"/> Black & Gold Marble |
| <input type="checkbox"/> Rhododendron Burl | <input type="checkbox"/> Breche Rose Marble |
| <input type="checkbox"/> Mahogany Crotch | <input type="checkbox"/> Jaune Benou Marble |
| <input type="checkbox"/> Mahogany Stump | <input type="checkbox"/> Mexican Onyx |
| <input type="checkbox"/> Striped Mahogany | <input type="checkbox"/> Brazilian Onyx |
| <input type="checkbox"/> Straw Zebra wood | <input type="checkbox"/> Rose de Brignole Marble |
| <input type="checkbox"/> Carpathian Burl | <input type="checkbox"/> Skyros Marble |
| <input type="checkbox"/> Grey Prima Vera | <input type="checkbox"/> Verdi Antique Marble |

NAME _____

ADDRESS _____

CITY _____ ZONE _____ STATE _____

(Offer good in continental U.S.A. only)

(Continued from page 236)

the aging process. This is especially true of white pine, which darkens on exposure to light and air. Over long periods the reds and browns in this wood greatly intensify, resulting in the aged patina so highly prized by collectors. In a later day, a form of liquid wax was quite widely favored by cabinet-makers. In your reference to the use of white lead we assume you mean its use as a pigment in paint. Although industrial production of white lead for this purpose is only a little over 200 years old, the basic pigment, or basic carbonate of white lead, has been in use for centuries.



Finishing Plywood Edges

Q—I'm building a simple project of $\frac{3}{8}$ and $\frac{3}{4}$ -in. fir plywood, and I'm having trouble getting a smooth varnish finish. How can I seal the surfaces so that the liquid finishing materials will not absorb and leave some areas flat and others shiny? Also, how does one finish the exposed edges smooth and square?
W.B., Scarsdale, N.Y.

A—This wood requires a special sealer to provide a surface for building a satisfactory varnish or enamel finish. After sanding the wood smooth—don't use a coarse sandpaper on fir, as the scratches are difficult to remove—apply the sealer according to the directions on the container. After the sealer is thoroughly dry, apply finishing coats of varnish, or enamel, as desired. In cabinet construction and in some other types of work where this wood is used, it is a common practice to design the unit so that there will be no exposed edges of plywood in the completed product. However, if the design of the project is such that certain edges must be exposed, they will require a special finishing treatment. First, the edges are sanded perfectly smooth and a sealer is applied and allowed to dry. Follow the sealer with a natural wood filler (if the wood is stained, the filler must be colored to match) rubbing the material into the grain and openings between the several plies with a coarse cloth. Certain types of crack fillers and paste white lead also can be used for this job, depending, of course, on the type of finish that is to be applied. After the filler is dry, sand lightly with fine sandpaper and apply the finish.



Efflorescence On Masonry

Q—My home is about one year old and recently I have noticed a peculiar, crystallike substance or "growth," forming on the surface of the basement wall. Surface of the blocks seems to be crumbling as a result. What is this, and what can I do about it? Can I paint or plaster over it?
F.F., Akron, Ohio.

A—If we judge correctly from your description, the crystallike coating "growing" on your basement wall is what is known as efflorescence. It appears on the surface of brick, concrete-block and monolithic-concrete walls when certain salts contained in the masonry are activated in the presence of moisture and force their way to the surface. There are a number of suggested remedies, none of which can be considered a positive cure in all cases, but which have been reported to give fairly satisfactory results. Perhaps the simplest of these is to remove all the coating and loose particles with a stiff wire brush, then coat the affected surfaces with a zinc-sulphate solution. Homeowners who have used this method report that it has proved quite reliable as a cure for the trouble.



WHATTA MAN! HE USES THE 3-purpose hair tonic!

1. Wakes Up Scalp!

The appearance of your hair depends upon the health of your scalp. So try Lucky Tiger. See how it relieves itching scalp, removes loose dandruff, and gives your scalp a keen, zesty tingle!



Sold at all
toilet goods
counters

3. Grooms Hair Perfectly!

Lucky Tiger keeps hair in place easily . . . without making it look greasy. For that natural look, use Lucky Tiger.



2. Kills Dandruff Germs*

Lucky Tiger goes farther than the hair tonics that merely remove loose dandruff. Lucky Tiger actually kills on contact the germ *pityrosporum ovale**, a common cause of infectious dandruff.

LUCKY TIGER Hair Tonic

WHAT LASTS FOREVER?



THIS DEAD BLADE still looks new but it blurs rain, smears muck, streaks glass. DEAD blades make dead drivers!



THIS LIVE ANCO BLADE wipes clean, clears rain, clears road muck . . . lets you SEE. Protects your loved ones.

WHAT LASTS FOREVER? Nothing does. This is especially true with Windshield Wiper Blades—even though made of finest natural rubber. Corrosive windshield film, wind burn and hot sun BAKE the life out of wiper blades, often in six months or less. DEAD blades cause dangerous windshield smear. DEAD blades make dead drivers. Make sure your car has live, new windshield wipers.

Change Your Wiper Blades

Next time you buy gas, change to LIVE,

NEW ANCO BLADES . . . RAIN-MASTER for Flat windshields . . . CLEAR-FLEX for Flat or Curved windshields. They fit all cars—wipe quicker and cleaner than any other blades.

Mr. Dealer: Anco Wiper Motors give lots more power, lots less stall. Controlled wiping arc prevents blade slap. Only six models give COMPLETE replacements for ALL Cable Linkage, Bar Linkage, and Direct Drive original equipment vacuum wiper motors.

**THE ANDERSON COMPANY
GARY, INDIANA**

More Hours of FUN with this NEW Outdoor Light



Model 200

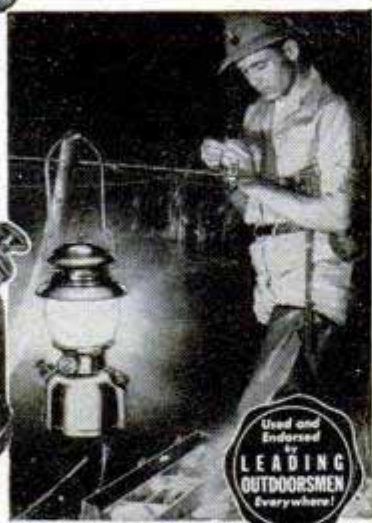

Used and
Endorsed
by
**LEADING
OUTDOORSMEN**
Everywhere!

NEW Coleman FLOODLIGHT LANTERN

You can fish and hunt longer, have plenty of light on the trail or in camp at night with this great new all-purpose Coleman Floodlight Lantern. Superior in structure, appearance and service; more compact in design; sturdier built for hard use. Improved burner. Larger fuel fount (1½ pints) gives 8 to 10 hours lighting service. New attractive red porcelain ventilator top. Instant lighting. Floodlights 100 ft. area. Stormproof. Safe. See it lighted—ask your dealer.



Big Outdoor Spotlight

Easily attached Coleman Reflector makes a powerful spotlight of your lantern. Concentrates a flood of brilliant light wherever wanted. Made of high luster steel; adjustable handle.

Easy Meals Quick... More Fun Coleman FOLDING CAMP STOVE

Cooks like a city gas range. Lights instantly; easily regulated. Folds up and carries like a suitcase. Durably built for long service. See your dealer.



The Coleman Company, Inc., Wichita 1, Kansas

MAIL COUPON TO The Coleman Co., Inc., Dept. 102-PM
Wichita 1, Kans.

Please send me free literature about Coleman Lanterns,
Camp Stoves and other Coleman Appliances.

NAME _____

ADDRESS _____

CITY _____ STATE _____

refrigerators are put on a big pallet in the warehouse, hoisted on a fork truck and driven out to the deck level of the plane like a waiter would carry a tray. Automobiles and animals may go up ramps under their own steam, or be loaded by the fork lifts. For four-legged layovers in Miami, Vic has even arranged what he calls the "horse hotel" where the animals can be bedded down, fed and watered. Valet service includes currying and rub downs in a private stall. "But you have to be a horse to stay there," he says.

Alfonso is continually looking for new tricks that will eliminate packaging weight. Furniture can go without crating. The plane is rigged with pads like a super moving van, the furniture is hauled up from the store, is loaded as is, and delivered the same way. Alfonso sent a single shipment of 200,000 pounds of beds, dressers, vanities, chairs, sofas and floor lamps to outfit the entire Caribe Hotel in San Juan, saved the owner the extra cost of crating and uncrating, plus valuable time.

Orchid growers were leery of planes, since their valuable plants "go to sleep" if they're chilled and wither if they're out of water. Up came the boys with the idea of slipping the stems in test tubes of liquid plant food, which is retained in the tube by a sponge-rubber collar that fits over the stem and caps the tube. Today, Gonzalez-Lugo, a single grower in Caracas, ships 30,000 of the plants that way each year. The pilots don't fly too high when they carry orchids, so the delicate flowers are not chilled.

Occasionally, the boys gnash their teeth over a job they've taken on—but that is becoming an increasingly rarer situation.

The most recent barrage was leveled at Alfonso when he accepted a shipment of 2364 feet of three-inch hawser which had to be rushed to a tugboat en route to Venezuela with a valuable tow. The hawser arrived in Miami in two massive coils, neither of which would have gone through a barn door, let alone a cargo-plane hatch.

Chagrined cargo handlers had to uncoil every inch, pass it through the hatch and recoil it inside. At the delivery point in Kingston, Jamaica, the same process was repeated in reverse.

Whatever the cargo, the tropical tramps can probably handle it. They have boomed the business from nothing to a point where thousands of tons of anything that will go through a cargo hatch is pouring through the southern gateways to any place south of the Gulf with a landing strip big enough to take a C-46. And now they're bringing substantial cargoes back home.

Here is something you don't know about your own automobile

Let's say you're driving your car on a level road at 40 miles per hour. Do you know that *half* the power generated by your motor never reaches the rear wheels; doesn't help your car go farther or faster or climb a steeper hill?

And do you know why? Because automotive engineers have proved that 50% of that motor's power is used to overcome *friction*.

Therefore any lubricating oil which further *reduces* this internal friction can't help but deliver the same power with *less* gasoline.

That's exactly what Macmillan Ring-Free Motor Oil does. And we don't just think it's true — we *know* it's true. Here's how we proved it beyond question:

There is a machine called the Dynamometer. It is a scientific way to measure the power an engine delivers to the rear wheels. Cars of all makes, models and ages — cars that had been using *every* nationally known brand of motor oil — were used in this nation-wide test. Hundreds and hundreds of them! And what was the result?

The same thing happened every time: When the oil in these cars was changed

to Macmillan, *the same power was developed with an average of 8% less gasoline.*

That means, at an average price of 25¢ per gallon, you can save 2¢ on every gallon of *gas* — simply by changing your motor *oil*.

What's more, 1094 certified road tests proved that, when the *oil* in an average car is changed to Macmillan, you get 1.3 more miles to the gallon of *gasoline*.

You can't laugh off proof like that — proof that makes dollars-and-sense! Especially when, on top of all this, Macmillan Oil actually *removes carbon from your motor* — cleans your motor as you drive.

Ask for this fine motor oil at any one of the more than 35,000 dealers in America where you see the sign of the big red "M." It means Money in your pocket, Mileage in your car.

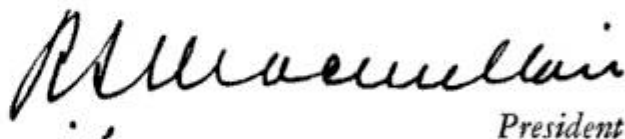

R. Macmillan
President

MACMILLAN PETROLEUM CORPORATION
530 W. 6TH STREET, LOS ANGELES
50 W. 50TH, NEW YORK • 624 S. MICHIGAN, CHICAGO

YOU CAN TELL A GOOD ELECTRIC DRILL BY ITS CHUCK



JACOBS

*If it's a JACOBS
It bears the name...look for it!*

Jacobs Rubber-Flex Hex-Key Chucks on home workshop power tools prove that their makers put quality first.

Jacobs Plain Bearing Key Chucks... the most widely used drill chuck in the world.



Jacobs Rubber-Flex Hand-Tite Chuck. One-piece RUBBER-FLEX jaw assembly holds tools true and tight. No loose jaws or springs.

IF IT'S A

JACOBS

IT HOLDS

The Jacobs Manufacturing Company
West Hartford 10, Connecticut

Stunt Drivers Will Do Anything To Please

(Continued from page 137)

punishment," Chitwood says. "After each show, hundreds of curious men, women and kids pour down to the track to inspect our rolling stock—to be sure it's what we claim it is."

In other types of stunts, however, in which cars are deliberately crashed, rolled over or demolished, older prewar models are used. They are purchased in the city where the Chitwood troupe happens to be appearing. Fenders are removed, glass is taken out of the windows and doors are tied shut.

In a number called the "Roll Over," the stunt man wears a crash helmet and safety belt. He guns the car down the track and hits a ramp slightly higher than that used in the "Wingover" stunt. The ramp throws the car clear over on its side. From then on, it's a crashing, twisting, end-over-end mass of metal hurtling through the air. The driver throws himself flat on the seat, grips the steering wheel with one hand, the glove compartment with the other.

Old cars are crashed in this manner until their motors won't fire any more. Most cars cannot take more than six or seven consecutive crashes in one performance. One tough old buggy in Salem, Ind., lasted for 15 crashes.

When two cars have been reduced to smoking junk they are stacked approximately 50 feet from one end of a broad ramp. This is the spectacular "Dive Bomber" stunt. A third old car zooms up the ramp, sails through the air and lands on the other two.

Where do the men come from who risk their necks night after night in this fashion? Many of them are veterans of the automobile racing tracks, some are Hollywood stunt men and circus performers, some are high-school youngsters with a thirst for thrill and adventure.

Joie Chitwood started out as a welder; Pierre Armand was a fighter in the French underground; Hal Kent was a student at the University of Virginia; "Snooks" Wentzell was a Hollywood stunt man; and "Flash" Wardlow was a motorcycle racer.

A couple of years ago a beardless youth followed one of the Chitwood troupes all over Pennsylvania, begging to be allowed to join up with them. He'd do anything, he said—grease the cars, help move ramps, change tires.

"You finish high school, get your mother's permission and then we'll see," Chitwood

(Continued to page 244)

THIS 5 ROOM ALADDIN READI-CUT HOUSE \$1642 FREIGHT PAID

SAVE 4 PROFITS ON LUMBER, MILLWORK, HARDWARE & LABOR

The Aladdin Read-Cut System of Construction enables you to save 18% lumber waste and up to 30% labor costs, and guarantees you will receive the highest quality dry lumber and a COMPLETE house as specified. You can buy your **COMPLETE HOUSE, ALL IN ONE SHIPMENT**, direct from our mills and save the in-between profits.



HOW TO BEAT THE HIGH COST OF BUILDING

Every hour you can put in on the construction of your Aladdin home means a saving to you of from \$2.00 to \$3.00 per hour on its cost. That means a **SAVING** of from \$15.00 to \$18.00 for every day you work on it! . . . Depending on the size of the house, the carpenter work sums up to from three hundred hours to twelve hundred hours. . . . **WITH MOST**

OF THE SKILLED LABOR ALREADY PERFORMED when you receive your Aladdin Read-Cut, what an opportunity you have to bring down the cost of your new home to practically a pre-war level. Our drawings and instructions cover everything from the foundation up, so you can save any part, or even all labor costs.

BUILD IT YOURSELF AND PAY YOURSELF THOSE HIGH WAGES



WHAT YOU GET WHEN YOU BUY AN ALADDIN HOUSE

You get **ALL THE LUMBER** cut to fit by fast machinery-production line methods—marked and numbered, ready to erect practically without the use of a saw; also siding, flooring, interior trim, all millwork,

doors, windows, mouldings, glass, hardware, nails, roofing, paint and complete drawings with instructions. Many Aladdin home buyers erect their own houses.



ALADDIN HOUSES ARE NOT PREFABRICATED

71
DESIGNS
TO CHOOSE
FROM

Send 25 CENTS for New 1951 4-Color Catalog No. LM-5

THE ALADDIN CO.
BAY CITY, MICHIGAN

ALADDIN GUARANTEE—
Satisfaction
or Your
Money Back

Say You Saw It in Popular Mechanics

CRESCENT TOOLS
Give Wings to Work

ASK YOUR
HARDWARE
DEALER

PISTON TYPE
COMPRESSOR



EASY PROFIT IN PAINT SPRAYING

Paints walls, ceilings, screens, furniture and machinery faster, better. All complete as shown less motor. Carry anywhere. Fully guaranteed. Could be used with 1/4 H.P. motor or less. Price **\$35.00** less motor F.O.B. Chicago. \$5.00 deposit balance C.O.D. or see your dealer. With motor \$55.00.

IDEAL AUTOMATIC PUMP CO., Dept. P.M.8
801 W. Washington Blvd. Chicago 7, Ill.



New Tricks You Can Do

with these **Wizards with Wood**

Do you get a kick out of making things with wood? You'll rave about the dandy new effects you get with these time-tested products. . . .

A MUST for Finishing Fir Plywood



Tame that wild grain with FIRZITE. It tight-seals the pores . . . virtually prevents grain rise or checking . . . readies the surface satin-smooth for paint, stain or enamel. (For blond, pickled, wiped or tinted effects use White Firzite).

FIRZITE

Newer than Shellac or Varnish



For "natural wood" finishes on furniture or woodwork, there's nothing like Satinlac. Brings out the natural grain and color beauty of any plywood or solid wood. Avoids that "built-up" look, and will never turn yellow or darken with age. "Water-white", easy to brush or spray, dries ready for next coat in 2 or 3 hours.

SATINLAC

Glue That's Stronger than Wood



To make things or fix things, use Weldwood Glue for all wood-to-wood bonds. Makes joints stronger than the wood itself. Mixes easily with water. Stain-free, rot-proof . . . highly water-resistant! 15¢, 35¢, 65¢, 95¢ and larger sizes.

WELDWOOD PLASTIC RESIN GLUE

Ask for Weldwood Glue, Firzite and Satinlac at hardware, paint or lumber dealers.

Send post card for interesting glue and finishing leaflets.

UNITED STATES PLYWOOD CORPORATION
Dept. 201, 55 West 44th St., New York 18, N.Y.

said, thinking he'd given the lad a polite brushoff.

Last summer the boy showed up again with a diploma and his gray-haired mother. Now he's one of the youngest members of the Chitwood troupe and has learned to perform some of the stunts.

He does the "Slide for Life." Buckling on a corsetlike arrangement, he stands on the rear bumper of a car as it speeds down the track at 50 miles an hour. Slowly he lowers himself to the track by a rope and then skids along on the corset. It's tricky and dangerous—but crowd-pleasing. In another stunt he lies on the hood of a car as it crashes through a blazing barricade. Now he's working on a motorcycle ramp-to-ramp jump.

Most stunt men belong to the International Stunt Men's Union of America and are paid wages to scale. A man working on the ramps earns \$65 a week. A stunt man gets \$200 a week and up.

An important factor in the success of Chitwood's crash-and-smash shows has been his combining of thrills with humor. When a crowd gets all keyed up over a spine-tingling stunt, it needs a safety valve to relieve the tension. Chitwood's troupe includes "Crash" Roberts, one of the world's most famous outdoor clowns.

He has a small car which blows up. He pretends to get his foot caught in one of the ramps as two cars whiz by. He falls down in front of a speeding car—and scrambles to safety in the nick of time. The crowd eats it up.

One of the newest and most spectacular stunts is the "Ice Wall Crash." This is usually done at night for maximum effectiveness—and only before the largest crowds because it is expensive.

The rear end of a car is fitted with rockets, which spew out colored fire. The speeding car also knocks down a row of electrical switches which set off ear-splitting dynamite caps. As a climax, the car plunges head-on into a solid wall consisting of a triple row of 100-pound ice slabs.

The spectacular CR-R-UNCH as metal meets frozen water always brings "ohs" and "ahs" from the crowd. It ruins the car.

Chitwood is continually seeking ways to improve his show. His latest idea—and it's a thriller—is a ramp-to-ramp jump with a full twist in the air. Lucky Teter had the original idea, Chitwood has improved it. Soon you'll see it performed.

A madman as a stunt driver, Chitwood is a model motorist on the highway.

"I take no chances with the crazy driver you meet on the road," he says. "Why a man could get killed if he isn't careful!"

**MORE FISHERMEN — BY FAR —
OWN JOHNSON OUTBOARD MOTORS
THAN ANY OTHER MAKE**

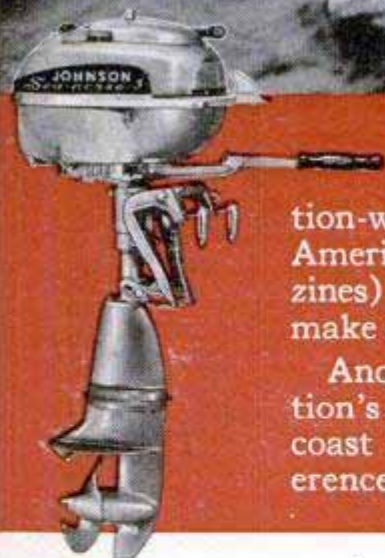

Yes, by actual count among fishermen in a nation-wide survey (subscribers to America's leading outdoor magazines) Johnson leads any other make of outboard motor by 76%.

Another survey, among the nation's automotive engineers from coast to coast, also shows preference for Johnson. In this case

Johnson leads by 82%!

Take a tip from the experts — the men who know *fishing* and the men who know *engines*. Buy Johnson DEPENDability!

FREE HANDY CHART. Describes the four versatile Sea-Horses for 1951. Your copy sent free. WRITE today!

JOHNSON MOTORS
400 Pershing Road, Waukegan, Illinois
In Canada: Johnson Motors, Peterborough

**Fisherman's
Favorite —
SEA-HORSE 5**

4 GREAT SEA-HORSES FOR 1951

- SEA-HORSE 25:** 25 H.P. Only 85 lbs.! With Gear Shift, Synchro Twist-Grip Speed Control, six-gallon Mile-Master Fuel Tank Only \$390.00*
- SEA-HORSE 10:** 10 H.P. 58 lbs. With Gear Shift and separate Mile-Master Fuel Tank (6 gals.) . . \$295.00*
- SEA-HORSE 5:** 5 H.P. 44 lbs. Neutral Clutch . . No Shear Pin. World's favorite fishing motor . . \$187.50*
- SEA-HORSE 2½:** 2.5 H.P. 31 lbs. World's lightest Alternate Firing Twin \$137.50*

JOHNSON
SEA-HORSES
for DEPENDability

 *Prices, f.o.b. factory, subject to change without notice. Ratings, OBC Certified brake h.p. at 4000 r.p.m.

SURE AS SHOOTIN'*
YOU CAN'T BEAT A
SAVAGE

*SAVAGE Lawn Mowers are precision-built by the makers of famous SAVAGE sporting arms.

IT'S A TRIUMPH
 OF SAVAGE
 CRAFTSMANSHIP!
 THE GREAT NEW
SAVAGE
Yard Chief
 21-inch POWER MOWER

In this great power mower you get the same precision workmanship, the same skilled engineering, the same finer steel quality that have made Savage rifles and shotguns famous the world over.

The new Savage Yard Chief brings you easier handling, better performance, greater dependability than you ever thought possible! Powered by Briggs & Stratton 1.6 h.p. 4-cycle engine. Famed Timken bearings. "Sta-Temp" blades that stay sharp longer. Totally enclosed chain drive. Convenient finger-tip controls. Protective grass guards to prevent grass from winding at ends of reel. Free floating handle. Over-size heavy duty tires. See it at your dealer's today!

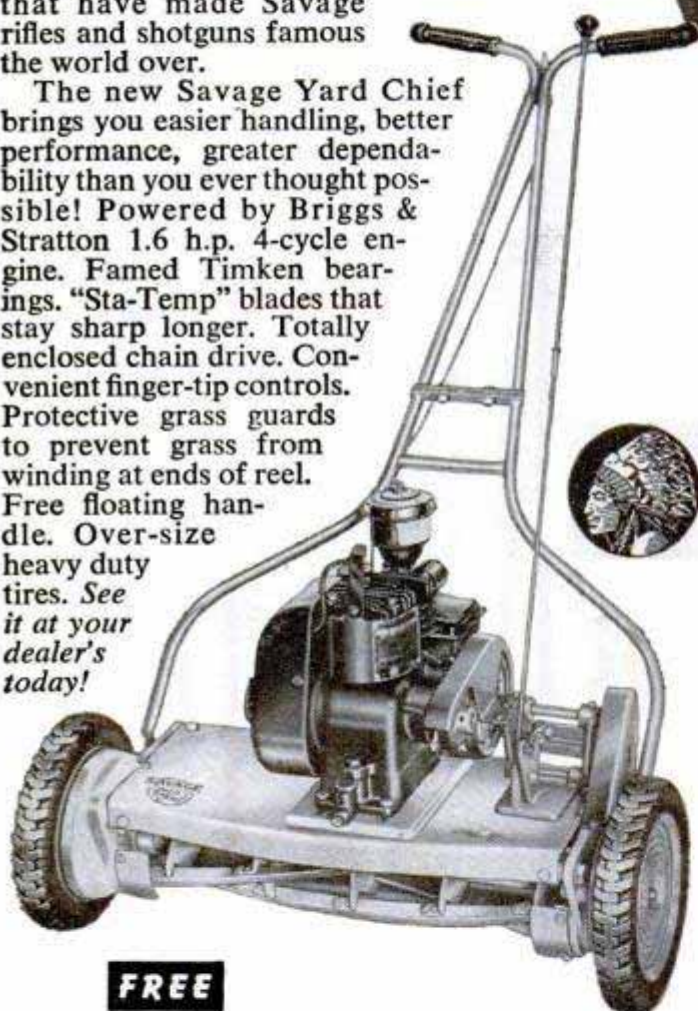

FREE

Mail the coupon today for the new SAVAGE lawn mower folder with its valuable guide on lawn care.

SAVAGE ARMS CORPORATION

Lawn Mower Division, 99 Broadway, Chicopee Falls, Mass.

Please send me free the new Savage lawn mower folder with its informative section on lawn care.

NAME _____

ADDRESS _____

TOWN _____ ZONE _____ STATE _____

SSN 1037—Triple-Threat Man

(Continued from page 85)

The trainer consists of the complete radar apparatus with the student seated in front of it, plus a large shallow tank of water on the bottom of which rests a scale model of the terrain over which the practice mission is conducted. Projecting down into the water from a movable carriage is a scanning head that radiates supersonic waves. These are reflected back to the head by the surfaces of the model, producing the same image as would radar itself. The scanner moves over the model in keeping with the way the student "flies" his course. Thus the changing picture that the student sees in his scope is virtually what he would see in his scope in a real aircraft.

Before a Mather student is graduated he makes 25 actual flights as navigator, 25 as bombardier and 16 flights on which he navigates and bombs solely by radar.

Training flights are flown in B-25s and C-54s and in the new, specially designed 240-mile-an-hour Convair T-29 that is built from the wheels up as a flying classroom. Radar, radio and navigation can be taught simultaneously to different groups in the plane. Equipment on board includes four astrodomes, 14 navigator tables and half a dozen complete sets of controls for loran, radio compass and radio altimeter.

Previously, a student bombardier got flight training by dropping practice bombs on a target marked out on the ground. Mather students drop a few such practice bombs, just so that they can watch them hit, but most of their missions are flown against actual military or strategic targets.

The Mather school uses 48 military and industrial targets in all. Seven are in nearby Sacramento, often referred to as the most-bombed city in the world.

It's much more realistic, and better training, to tell a triple-threat student that he is to bomb a certain air base, bridge, or chemical plant located in a particular city. The student has to navigate to the proper area, identify his target, and bomb it just as he would on a wartime mission. His visual or radar bombsight doesn't drop a bomb when the release point is reached; it trips the shutter of a camera that is trained on the target. Cross hairs on the film show where the bomb would have landed if it actually had been dropped.

This year the Mather school is trying something new. Having determined that a student can be competent in three specialties, it is beginning to train a few groups of accomplished pilots. They will be superspecialists, able to take over almost any job on a long bombing mission.

“As a Scientist,
I say we must
destroy it or it
will destroy us!”

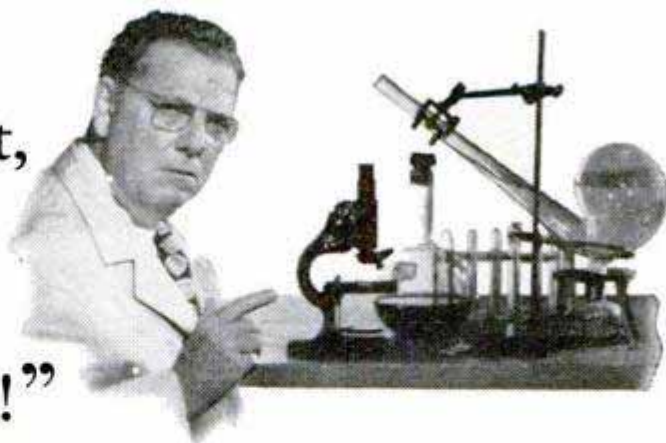

THE THING

from Another World!

HOWARD HAWKS' *Daring* MOVIE!

R K O
RADIO
PICTURES

MONEY for MEN ALL DATA FREE

THE PLASTEX Industry needs manufacturers on small scale and for big production of Lamp and Clock Stands, Art Goods and Novelties in Plastex and Marble imitation. Experience unnecessary. $\frac{1}{2}$ ¢ material makes regular 10¢ store sellers. Rubber moulds furnished for speed production. Small investment brings good returns. We are now placing big Chain Store Orders with manufacturers. Ambitious men have chance for real prosperity. Our Free booklet will interest and benefit you.

PLASTEX INDUSTRIES, Dept. A

3400 Third Ave. New York 56, N. Y.

BUILD FINE GRANDFATHER CLOCK NOW

The simple sensible Red-i-Kut way as thousands have—**SAVE HALF. SHOP TESTED PLANS** “SPIRIT OF THE CENTURY” Narrow waist, 83” tall or stately straight side “SPIRIT OF AMERICA.” **EASY-to-FOLLOW photopack PLANS** tell all — plus **BROCHURE** of heavy brass weight Westminster, tube chime, movements, *gorgeous* dials, $\frac{3}{4}$ ” solid mahogany case kits. **Send \$1.00 today — Both Plans \$1.50 NOW.**

KUEMPEL CHIME CLOCK CO., #8 Kuempel Bldg., Minneapolis 16, Minn.

SAY YOU SAW IT IN POPULAR MECHANICS

ARC WELDING FOR PROFIT OR PLEASURE

60 LBS. OF READY MADE PARTS

Only
\$24.95

BUILD YOUR OWN HEAVY DUTY WELDER

SAVE
Buy Only
NECESSARY
PARTS

All necessary parts Ready-Made and easy to assemble. You can do all around welding on steel, cast iron and other metals after only a few hours practice. Illustrated instruction manual included. Free plans for building case. Sold on 30-Day Money-Back Guarantee!

FREE: Write today for fully illustrated Pamphlet P-3

ATOMIC ARC WELDER CO.
1037 So. 19th St. OMAHA, NEBR.

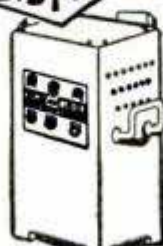

Gives 100% penetration. Welds are stronger than original metal. Operates on 110 or 220 AC.

brand NEW just off the press



**CONSTANTINE'S MANUAL
FOR WOODWORKERS
HOBBYISTS
HOME OWNERS
116 PAGE BOOK**

a complete catalog!

AND REFERENCE BOOK OF WOODS,
VENEERS, LEATHER, METAL, PLASTICS, ETC.

This is the biggest, most complete manual we ever published. More new items, on leathercraft, decorative metals, wood finishing, hard to get items of all kinds . . . In addition to our power and hand tool sections, upholstery, picture frame mouldings, rare and domestic woods, veneers, lumber, inlay panels, 83 inlay designs, inlay borders, all in full natural color, plus a full color wood identification panel of 60 different woods suitable for framing. All items at lowest prices from America's Biggest Supplier to Craftsmen.

Send today for your copy of the hobbyist's most helpful book.

SEND FOR YOUR COPY TODAY

FREE

With each copy of our Master Manual, you get a year's subscription to Chips and Chats, a breezy bimonthly to keep you up-to-date on what craftsmen are doing.

ALBERT CONSTANTINE & SON, INC., DEPT. PM-3
797 East 135th St., New York 54, N. Y.

Enclosed find 25¢ for a copy of your “Master Manual” and a FREE one year's subscription to Chips and Chats.

NAME _____

ADDRESS _____

CITY _____ STATE _____

Some Get Rich, Some Don't

(Continued from page 160)

you that. I don't have it patented yet!"

"Then there's another type," says another member of the staff, "who won't ask directly about his invention. He beats around the bush until he's sure you're reasonably trustworthy. Then he divulges his great secret, nervously asking, 'Aaaah, this won't go any further, will it?'"

Inventions seem to run in batches—like epidemics. Suddenly there are scores of applications for card shufflers (brought about by the Canasta craze) or Christmas-tree holders, fishing-pole holders, electrical switches or insulating bags. Often an important event or a public figure will stimulate inventors. When Lindbergh, in 1927, mentioned the trouble he had with ice forming on his wings, there resulted a wave of ideas for de-icing—most of them impractical.

"It's amazing," remarked one agent, "how many inventors rush into making models and machines without a prior search. They then find out, later, that they must almost completely revise or scrap their models. A search would have revealed similarities and given them hints which they could incorporate in a model. I don't think anyone should ever file for a patent without a prior search."

Another agent, asked if he could detect foolish and worthless inventions, sadly shook his head.

"I wish I could tell which inventions would click and which wouldn't. I've seen it happen again and again—someone shows me a device that, in my opinion, wouldn't amount to a row of beans. It would work all right, but, in my opinion, just wouldn't sell. And then I've seen it sell a million right after that!"

In his 27 years at the Patent Office, Brown has seen some of America's "greats" come and go, gaining valuable information from the Search Room. He recalls Glenn Martin, coming in to check his early ideas many years ago. There was Charles Duryea, inventor of the automobile. Oscar Ulysses Zerk, who scored an outstanding success with his lubrication fittings, was another. But perhaps the most successful of them all is William S. Gubelmann of Convent Station, N. J.

Virtually every typewriting, calculating and bookkeeping machine in use today owes some of its design to the ideas of the little-known Gubelmann, who has an awesome string of victories in the courts. He began working on a model of the typewriter in 1884 and five years later made his

(Continued to page 250)

PEEL OFF PAINT

WITH KLEAN-STRIP

**Amazing new-type remover
is fast, safe, easy-to-use**

Klean-Strip changes any finish into loose, wrinkled film. Use only a brush or putty-knife to peel off all layers of the old finish at one time.

Klean-Strip leaves the surface clean, smooth and dry. No sticky mess to wash off, no waxy residue to scrape. And Klean-Strip is absolutely safe: will neither burn nor explode.

Klean-Strip is brand new . . . not like any paint remover you've ever used. Takes all the danger and drudgery out of refinishing. Buy Klean-Strip whenever you buy paint. Available at better paint, hardware and department stores, everywhere.

Product of
W. M. BARR & CO.
2352 S. Lauderdale
Memphis, Tennessee



**New! No-Wash!
Non-Inflammable!**



**Send for this
BIG NEW
Hunt's
WOODWORKERS
CATALOG NO. 18**

ONLY 15c

NEW LOW PRICES

Offers greatest selection of fine domestic and imported woods—and hundreds of woodworkers items at bargain prices!

You'll save time and money with this big, new catalog. Contains everything wood craftsman needs. Shows 32 rare and fancy woods in color...43 veneer designs...275 scroll patterns...multicolor inlays, overlays, bandings...all kinds of tools, machinery, cabinet hardware, ornaments, mouldings...and pages of valuable tips, ideas, information, instruction. Send for your copy NOW. Only 15c—refundable on your first order.

- 144 PAGES
- **QUICK DELIVERY**
- on maple, poplar, oak, mahogany, red cedar, cherry, walnut, and many others—
- all properly seasoned and kiln dried.

MAIL THIS COUPON—TODAY!

CRAFTSMAN WOOD SERVICE CO.
2729 S. Mary St., Dept. A3
Chicago 8, Illinois

Send me the big, new, money-saving Catalog No. 18. Enclosed is 15c—refundable on my first order.

Name _____

Address _____

City _____ Zone _____ State _____

Here's a Dependable
Spring Tonic For Your Car

NEW

CHAMPION

Spark Plugs



BE A CHAMPION DRIVER... *Re-Vitalize Your Car's Performance!*

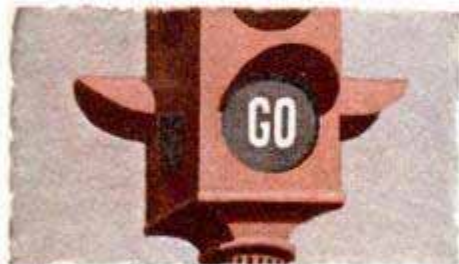

When your car gets the green light does it really get up and "GO"? Follow the experts and install a new set of clean, crisp, hard-hitting Champion Spark Plugs!

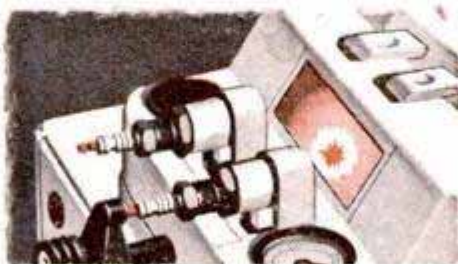

See with your own eyes how your old plugs compare to new Champions! Have your Champion dealer check them on his scientifically designed cleaner and tester.



Your best assurance that Champion represents the ultimate in quality, value and dependability is that it has been America's favorite for over a quarter century!

CHAMPION SPARK PLUG COMPANY, TOLEDO 1, OHIO

Listen to the CHAMPION ROLL CALL . . . Harry Wismer's fast sportscast every Friday night, over the ABC network

Actionrod

MAKES IT A
'MILLION-DOLLAR'
VACATION
FOR ONLY \$7⁹⁵



● Actionrod is the glass rod with *live* action. It's fast enough to cast your lightest lures, strong enough to handle the heaviest.

You don't have to throw the plug . . . don't have to push your casts. The tip does all the work.

Pick the Actionrod model to fit your fishing. Your sporting goods store has your favorite length, your favorite model—in bait casting, spinning, trolling and fly rods. And they're priced from only \$7.95 to \$25.00.

ORCHARD INDUSTRIES, INC.
DETROIT, MICHIGAN



ACTION where you want it!
STRENGTH where you need it!

NOW IN THE NEW TUBULAR GLASS!

Now Actionglas brings you tubular glass—in bait casting, spinning and fly rods, plus an entirely new salt water series. \$9.45 to \$32.50.

"TARPON FISHING with Actionrod"—a 15-minute movie with color and sound for Sports Clubs. Write for it.

Actionrod

"NATION'S BEST-SELLING GLASS ROD"

first patent application. Since then, his patents have been challenged literally thousands of times. The Patent Office has approved as many as 800 claims on just one of his patents and he has had to cope with 350 disputes on a single patent. Altogether, Gubelmann today holds some 5000 claims granted on his patents, making him the father of all calculating machines in use today. His income has been derived for about 50 years from royalties on the licensing of his patents by such firms as International Business Machines and it has totaled, to date, many millions of dollars.

Gubelmann, you see, is one of those who got rich. For every one like him, there are thousands whose dreams are shattered because somebody has beaten them to the draw! A careful study in the Search Room will help prevent such heartaches and may also guide you to a success as fabulous as that of William S. Gubelmann.

Five Miles Under the Sea

(Continued from page 128)

Such a metal did not exist. The scientists turned to leading experts in the U. S. A., England and Sweden, but without result. There was therefore only one thing to do: invent a metal with the required qualities. This was done by a Danish engineer, Boerge Lunn. Of this new metal—Galathea-bronze—a ball was cast with a diameter of 36 inches, weighing about one ton and with four-inch-thick walls. It was cast in two halves which, when fitted together, are completely waterproof. The instruments will be fixed in this ball before it is lowered to 30,000 feet below the surface to register the oscillation of the magnetic needle on photographic paper.

There is great doubt as to the results of this investigation. The magnetism of the earth is an unsolved problem. No one knows positively whether magnetism increases or decreases nearer the center of the earth. The English Nobel prize winner, P. M. Blackett, has formed the theory that earth magnetism decreases towards the center. To prove his theory, Blackett has carried out measurements in mines as deep as 6000 feet, but because of the ore content in the ground, these measurements cannot be relied upon. In the great depths of the open sea, however, there is still hope for exact results. These will be of the utmost importance to theoretical physics. Blackett's theory is in strict opposition to ordinary opinion, according to which earth magnetism should increase nearer the center of the earth.

(Continued to page 254)

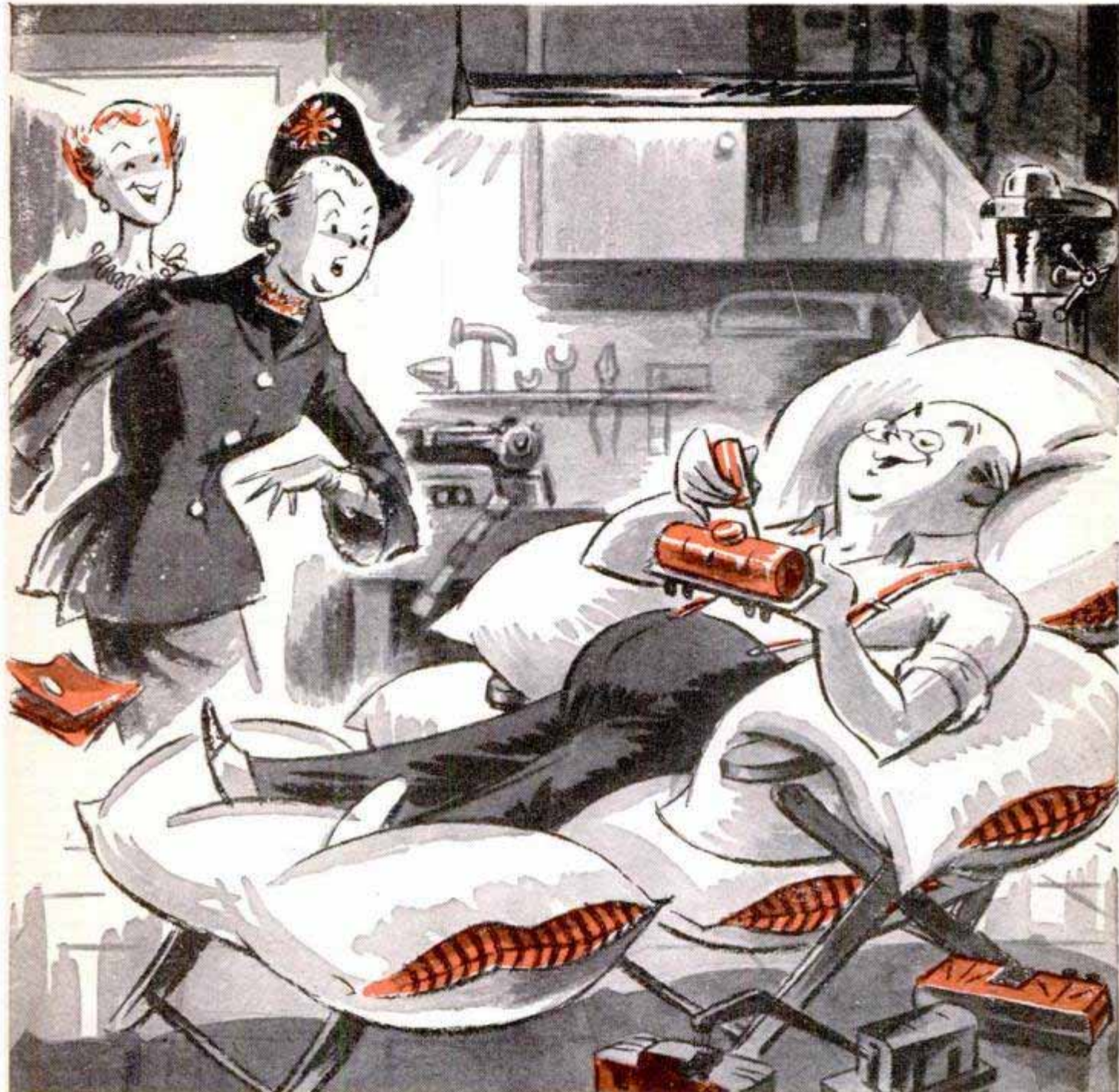

"MARFAK MADE HIS CAR RIDE SO CUSHIONY HE'S SPOILED"



That "cushiony" feeling lasts far longer—with *Marfak* chassis lubrication. *Marfak* is scientifically compounded to resist jar-out and squeeze-out. It *clings* right to vital chassis points when the going's wet. *Marfak* lasts 1,000 miles or more! Today, get *Marfak* lubrication from your Texaco Dealer, *the best friend your car ever had.*

THE TEXAS COMPANY
TEXACO DEALERS IN ALL 48 STATES

Texaco Products are also distributed in Canada and in Latin America



TUNE IN . . . TEXACO STAR THEATER starring MILTON BERLE on TV every Tuesday night. See newspaper for time and station.

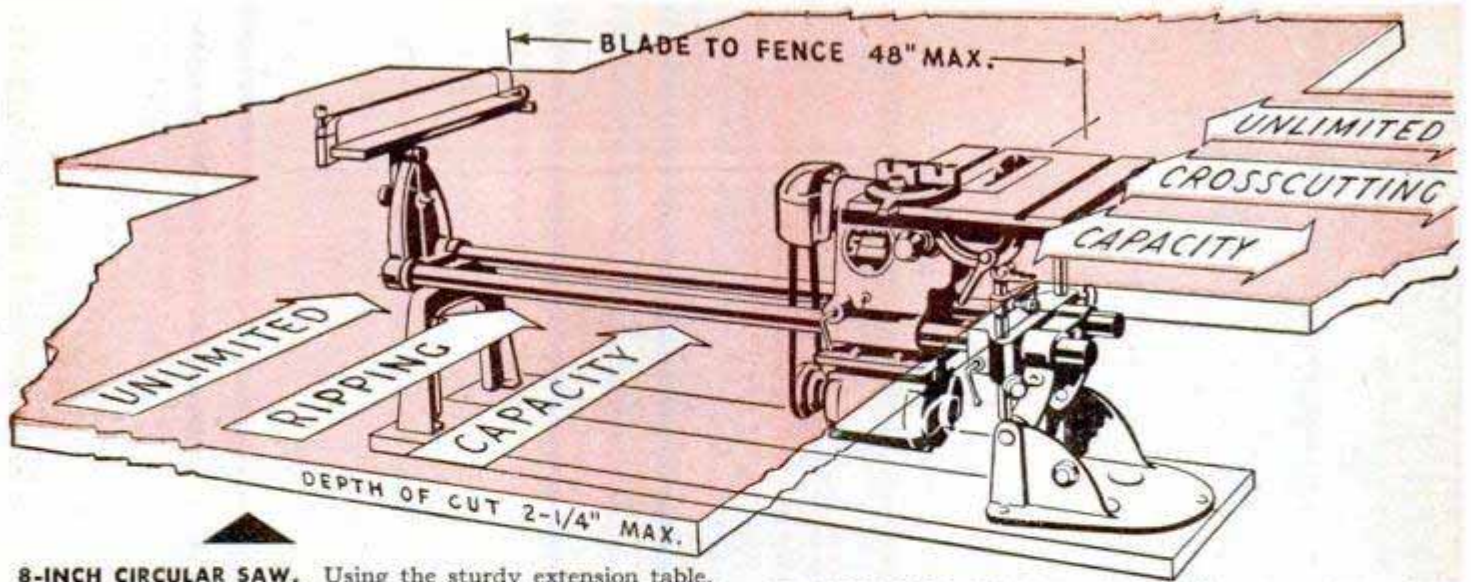

8-INCH CIRCULAR SAW. Using the sturdy extension table, you get an effective table area of 54" x 17"—twice that of the finest saws. Maximum blade to fence distance is 48"—the exact center of full-size plywood panels. Maximum depth of cut, 2-1/4". When table is tilted, crosscutting capacity extends from floor to ceiling.

12-INCH DISC SANDER. Only 12" sander with quickly changeable discs for different sanding grits. Disc can be fed into the work for maximum accuracy, speed and safety—can be set to stop on a hairline. Jointing to precise widths is easily done by slightly cocking rip fence and feeding work through from side.

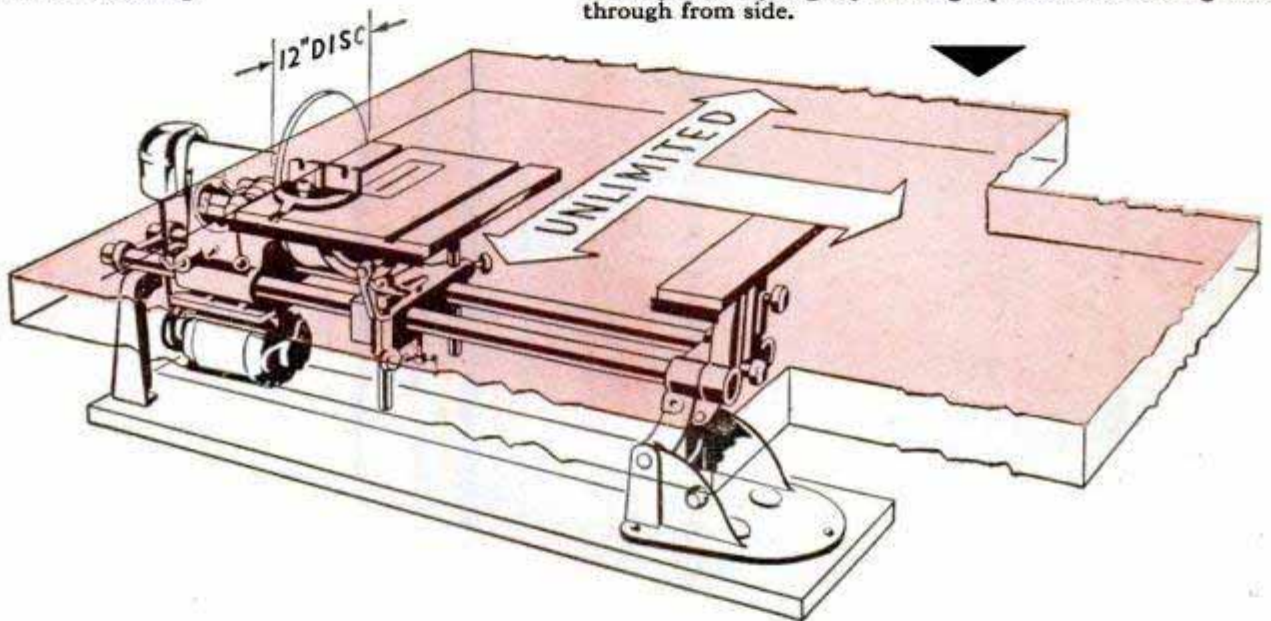

It's Shopsmith for CAPACITY

THE diagrams on these pages present dramatic proof of SHOPSMITH's tremendous capacity. They show you how SHOPSMITH, in each of its five basic positions, is designed to handle your biggest projects. How SHOPSMITH saws, sands, drills and turns with little or no restriction on the size of your work. How it converts—in less than sixty seconds—to the right tool for the job complete with time-saving jigs and extensions.

What does SHOPSMITH's great work-capacity mean to you? It means there is virtually no limit to the size work you can handle quickly and easily. You can saw to the center of full-size plywood panels . . . trim doors, screens, storm sash . . . accurately sand or joint room-length boards . . . drill or mortise oversize furniture or cabinet frames . . . turn table legs, bowls, lamp

bases, table tops up to 50" in diameter . . . spin metal bowls up to 15" in diameter . . . do your own remodeling jobs...*build your own home.*

Yet for all its capacity, SHOPSMITH is compact—occupies only 2' x 5' of shop space. It's extremely accurate—has precision features and micro-adjustments found only in production-type tools. It's precision engineered to watchmakers' tolerances. It's completely flexible, exceptionally sturdy and rugged, weighs 200 pounds. It's no wonder, then, that SHOPSMITH is America's largest-selling power tool!

See SHOPSMITH demonstrated—at leading hardware and department stores or any Montgomery Ward store. And send today for your free copy of the information-packed, 16-page SHOPSMITH booklet.

\$189.50
 COMPLETE
 5-TOOL UNIT
 WITHOUT MOTOR*

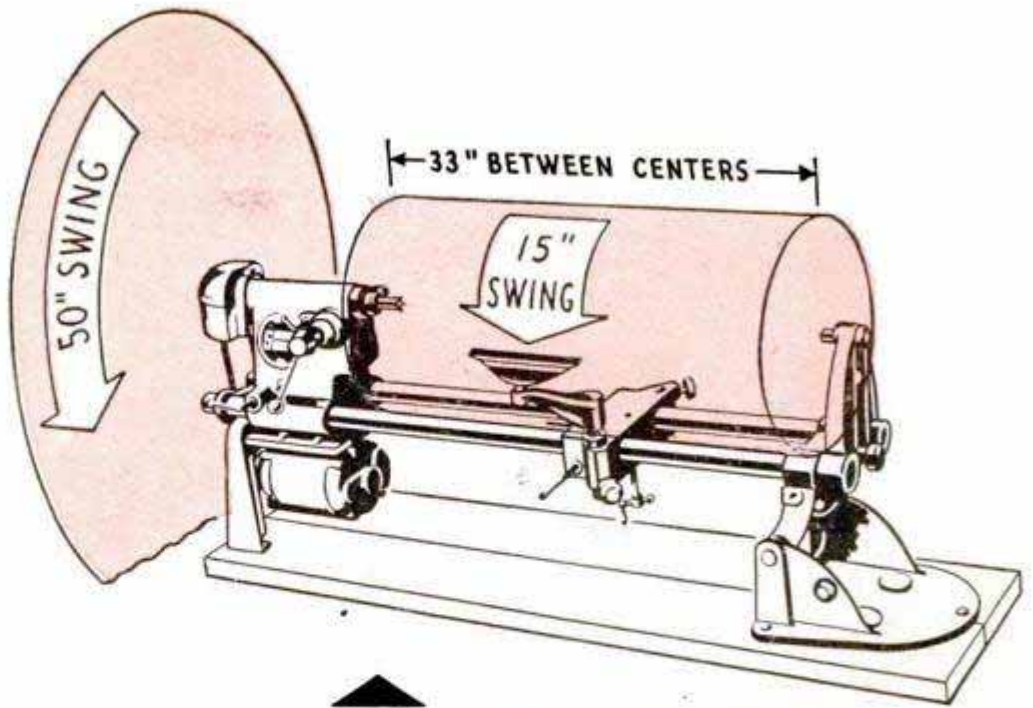

33-INCH WOOD LATHE. Capable of turning work up to 15" in diameter—4" more than most other heavy-duty lathes. 33" between centers. Headstock can be reversed for large-diameter outboard faceplate turning. Tool rest always slides parallel to work. Only lathe that lets you face your work while hollowing bowls or turning flat pieces.

VERTICAL DRILL PRESS. It's a bench model! It's a floor model! Drill to the center of a 15" circle. Jacobs key chuck takes drills up to 1/2" in diameter. Right or left-hand quill feed. Easy to read, adjustable depth scale. Spindle floats on four grease-sealed ball bearings. Rip fence and miter gauge provide convenient jigs.

HORIZONTAL DRILL PRESS. Makes easy work of drilling or mortising pieces too large or too awkward for vertical drill press. Just lay the work on the table, feed drill horizontally. Handy, too, for drilling flat pieces for doweled joints. Accuracy is automatic, since fence and table serve as jigs.

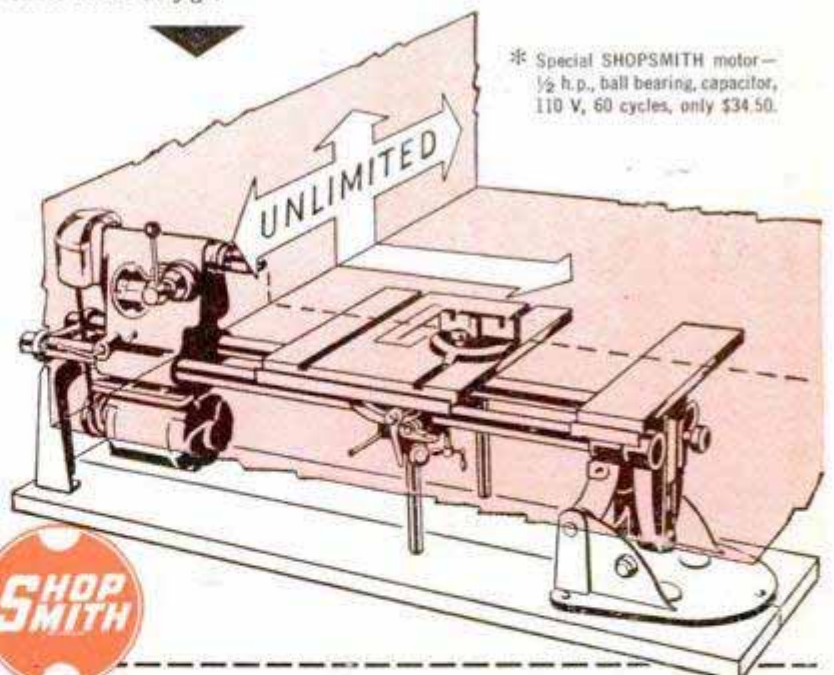
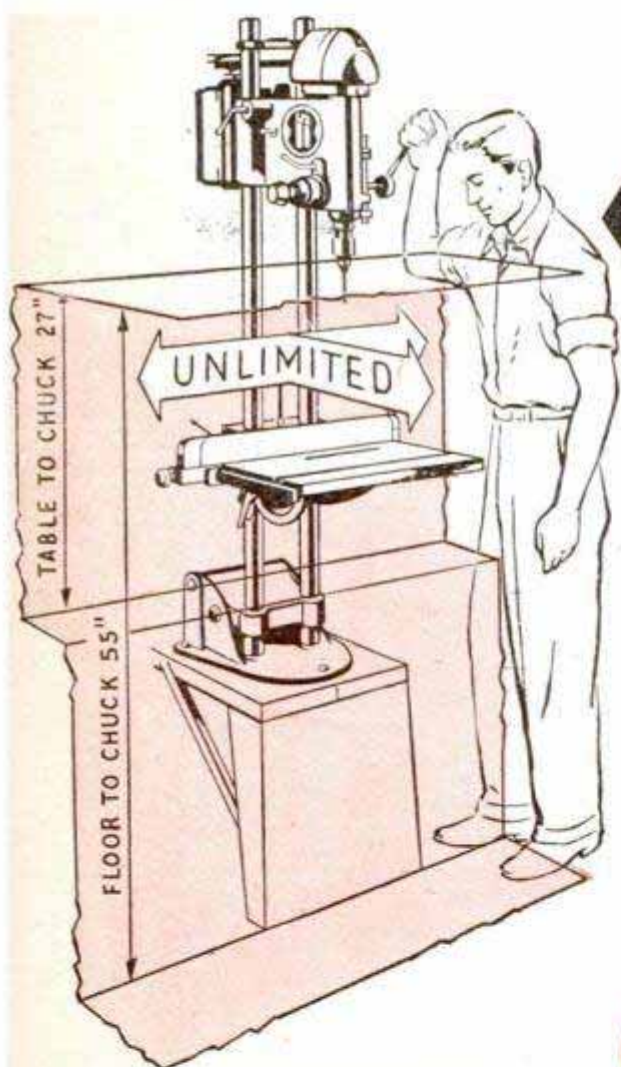

* Special SHOPSMITH motor—
 1/2 h.p., ball bearing, capacitor,
 110 V, 60 cycles, only \$34.50.



NEW RETRACTABLE CASTERS

increase SHOPSMITH's already great flexibility. They're easily mounted on any wood or metal bench. Easy to set, too, with three-stage foot levers that raise or lower unit. Your SHOPSMITH dealer has them. Complete set... **\$11.95**

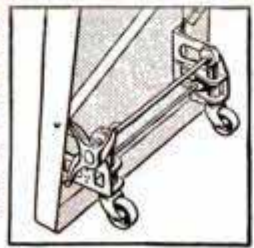

SHOPSMITH, Dept. 154-B, at factory nearest you:
 12819 Coit Road, Cleveland 8, Ohio, OR
 417 Montgomery Street, San Francisco 4, Calif.
 Please send me the free SHOPSMITH booklet.

Name _____
 Address _____
 City _____ State _____

PINCOR



Never a dull moment...

Sharp . . . and they stay sharp always. Every Pincor sharpens itself. No more expensive bills. No more annoying "time-out."

What's more, Pincor blades have a proven toughness not found in any other mower. Ready for the roughest going without *nicking*—without *breaking*.

Model illustrated is the famous P-22



Step out behind a Pincor and see, hear, feel the difference. Enjoy the featherweight ease of handling . . . admire the smart design that's made Pincor America's "best-dressed" power mower . . . thrill to the husky engine so simply controlled. Yes . . . see them all . . . then try Pincor and you'll know.

See your Classified Telephone Directory for the name of the Pincor dealer nearest you or mail coupon for full information.

PINCOR'S OUT FRONT—NOT BY CLAIM, BUT BY COMPARISON
America's Leading Power Lawn Mower

PINCOR PRODUCTS

Manufactured by Pioneer-Gen-E-Motor Corporation
Power Lawn Mowers • Hand Lawn Mowers • Electric Trimmers • Gasoline Engines • Electric Generating Plants
Battery Chargers • Generators

USE COUPON—GET FREE FOLDER!

PIONEER GEN-E-MOTOR CORPORATION
5853 West Dickens Avenue, Chicago 39, Illinois

Please send, ABSOLUTELY FREE, complete information on all Pincor models.

Name _____

Address _____

The main purpose of the expedition is zoological research. Does life exist at the greatest depths? If so, what form of life? Is it possible the deep oceans cover secrets which are the answer to recurring reports of sea monsters, seen now here, now there?

About all this we can only guess. Science cannot give an answer yet, because no one has been able to penetrate to the greatest depths with instruments which could bring anything but the smallest living things to the surface.

Twice before things have been brought up from the sea—but from much shallower depths—which have caused an uproar in scientific circles. The first time was in 1930 when the Dana expedition caught an eel larva measuring 73 inches. Normally, an eel larva is two to three inches long. The grown eel is not often longer than three feet. But here a larva was found, double the size of a grown eel. It does not take much imagination, just a little calculation, to realize the size of the larva as a full-grown fish. Could not the thing be called a sea monster?

In 1938, an ordinary trawler, off the southeastern coast of South Africa, caught a sparkling blue fish, three feet long. Its like had never been seen before. And that was not so strange, for on closer inspection, scientists discovered that our only knowledge of this rare fish was from fossils, and that it had been regarded as extinct 80,000,000 years ago. But here came *Latimeria* swimming fresh and fit into the net of a modern fishing boat, an effective protest against its own obituary notice! There is no doubt that the deep seas have many more secrets such as these hidden in their waves. It will be the job of the *Galathea* expedition to unveil them.

At the same time all sides of life and possibilities for life will be examined. Samples will be taken from the bottom of the sea, radioactive isotopes will be used to locate the production of organic stuff by plants in the deep seas, the quantities and distribution of creatures in the water and on the floor of the sea will be examined down to microbe size, physical and chemical investigations of conditions for life, temperature, salt content, etc. The streams of the sea will be registered, profiles of the bottom drawn by means of an echo sounder.

But if you ask the scientists what they expect to find, they will not be able to answer. This is a pioneer job, an explorers' trip to quite virgin parts of the world. Darkness has loomed over them since the beginning of time, and it is the job of this expedition to send the first struggling ray of light into the darkness, and almost anything can be expected.



EARN \$25 AND MORE A DAY!
NO SCHOOLING!

STEADY ALL-YEAR
WORK!
THOUSANDS
ARE SUCCESSFUL!

MAKE BIG MONEY BE YOUR OWN BOSS!

WANTED—men with ambition and desire to get ahead and *make money* in something for themselves. *Act now*—do as thousands of successful men have done—start on your own in floor surfacing with American Machines!

Take advantage of this opportunity if you want steady year 'round work—earnings of \$25 and more a day—pleasant indoor working conditions—and a lifetime of comfortable living for yourself and your family. No schooling—no experience needed. Sanders are easy to operate. Hundreds of prospects—new and old homes. Send coupon for "money-making" booklet entitled "Opportunities in Floor Surfacing"—enclose 25c in coin or stamps to cover handling.

AMERICAN FLOOR MACHINES



The American Floor Surfacing Machine Co.
535 So. St. Clair St., Toledo 3, Ohio

Enclosed find 25c in stamps or coin for booklet "Opportunities in Floor Surfacing", telling me how I can start my own floor sanding business.

Name _____
Street _____
City _____ State _____

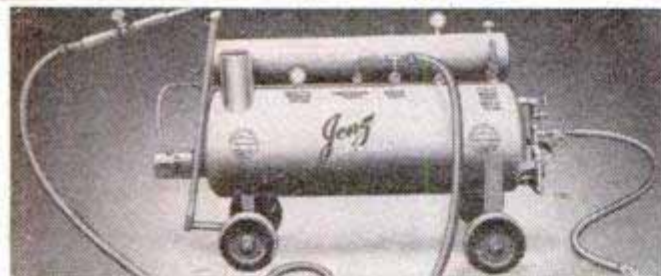

EARN \$6.00 PER HOUR

At a cost of 20c with the NEW JENZ SUPER CHIEF STEAM CLEANER. Portable—No moving parts—Cleans anything—Any place—Motors—Chassis—Machinery—Floors—Buildings—Oil Rigs, etc.—Oil fired—Economic—Fully tested and warranted. 75 lbs. steam in ten min.—Model 80, Complete as illustrated..... **\$315.50**

F.O.B. shipping point

HI-PURE LABORATORIES, Evansville, Ind.



FAST—Old Town Lapstrake Boat

SMOOTH lines of this lapstrake outboard boat help you start in a hurry—and get there fast! She's roomy, too, with wide cross seats (folding backs) and long seats on both sides at the stern. Handles easily, with deep bow to fight stormy waves! Built of handsome woods for strength and service. Upkeep is easy.

FREE CATALOG shows just the model you need. Write for one today! Also rowboats, sailing dinghies, sailboats, canoes.

OLD TOWN BOATS

Old Town Canoe Co., 743 Elm St., Old Town, Maine
PLEASE SEND ME FREE CATALOG

Name _____
Address _____
City _____ State _____

EVERYTHING IN LEATHERCRAFT

For Beginners - For Professionals
For Advanced Hobbyists

America's Most Complete Stock of Kits, Leathers, Tools, Supplies

It will pay you to get acquainted now with LARSON Leathercraft. Easy-to-Assemble kits for beginners require no tools or experience to make belts, billfolds, purses, gloves, woolskin animals, etc. Complete stock of moderate-priced tooling leathers, top-quality calfskins, tools, supplies for advanced hobbyists and leatherworkers. Send 10c TODAY for new 24-page catalog.

J. C. LARSON CO., 820 So. Tripp Ave.
Dept. 618, CHICAGO 24, ILLINOIS



Make \$3.00 AN HOUR AND MORE
IN FULL OR SPARE TIME!
SHARPENING LAWN MOWERS
IN YOUR GARAGE or BASEMENT!

READ WHAT THIS CUSTOMER SAYS:

"I am buying a home and my Universal is going to be a tremendous help paying for it." Another Universal owner says, "I have taken in last season **more than \$3500.00.**" Another "During this year I sharpened 602 mowers." Spare time or full time, **you, too,** can make big money in your own business and be your own boss. No other lawn mower sharpener has the advantages that Universal offers. That's why owners tell glowing success stories in this profitable business. Write today for full details of our proved success plan.



ONLY ON THE UNIVERSAL LAWN MOWER GRINDER

can the inside face and edge of the stationary blade, and all reel blades, be ground to proper clearance

ALL IN ONE SET-UP

WITHOUT REMOVING ANY BLADE FROM THE MOWER

Men with 20 and 30 years of experience have tried them all and acclaim the UNIVERSAL Grinder best.

OUR PLAN GIVES ALL THE PROVED SHORT-CUTS TO SUCCESS

SHOWS YOU HOW STEP BY STEP
 From the successful experience of hundreds of our customers, we have evolved a basic plan, simple and easy to follow, which leads you to quick success in either spare or full time.

ROGERS MFG. CO.
 DEPT. M-31, LINDSEY, OHIO

SEND THIS COUPON NOW

ROGERS MFG. CO., Dept. M-31 Lindsey, Ohio
 Please send me full details about the profit possibilities of Lawn Mower Sharpening.

NAME _____

ADDRESS _____

CITY _____ STATE _____

I'm Building the Popular Mechanics Plywood Ranch House

(Continued from page 121)

but I chose the steeled finish because it is easier to sweep and more resistant to staining caused by oil and grease.

Plumbing is not difficult when planned properly, and you can save considerable here as I have done by renting a few tools and doing it yourself. The plumbing of the Ranch House has been designed throughout by architect John Whelan so that you can now or later on install all modern appliances such as a garbage-disposal unit, dishwasher or automatic clothes washer without any complications.

The plumbing plan allows you to add the luxury of an extra half-bath in the full version of the Ranch House. I have already installed it in my Ranch House because, by doing it myself, a second bathroom costs only \$100, including the toilet and wash-basin fixtures. Realtors say the extra half-bath will add \$500 to the value of the house.

Insulating your new home is inexpensive if done during construction and especially so if you do it yourself. The cost will be paid back in fuel savings in a few years. We rented two stapling guns for a dollar a day and installed the balsam-wool blanket insulation on walls and ceilings. It was so easy to do that my wife took this job over and completed it all by herself.

For heating the Ranch House I am using General Electric's new furnace, taking advantage of the fact that it requires only the simplest of duct work. Warm-air ducts to the various rooms are small galvanized or aluminum stovepipe and stovepipe fittings which anyone can assemble. And I find that modern wall registers, which give even temperatures by "washing" the windows with warm air, are the utmost simplicity to install. Sheet-metal work is required only for the furnace plenum, a standard item that you can buy. This meant that I could have a good oil or gas furnace and yet save so much by doing my own duct work that the total cost was kept very low.

We are also showing something in heating here that could not be done five years ago. We are placing the furnace right in the kitchen! Five years ago furnaces were too noisy and bulky to do this—today they sound and look like a second refrigerator. If you prefer, you can install the furnace in the basement or utility room of the Ranch House—there are three possible locations. I chose the kitchen installation because it centralizes the duct work of a basementless ranch house.

Scientists Create "TAILORED LIGHTNING" For Better Motoring

In the great engineering laboratories of The Electric Auto-Lite Company in Toledo, Ohio, a group of Auto-Lite Ignition Engineers have been probing inside engine cylinder walls, peering at "blow-by-blow" spark performances, charting the behavior characteristics of man-made "lightning" across the spark plug gap. From endless tests they've determined what your engine's ignition system needs most, and then set about producing spark plugs to fill the bill. Net result: Ignition Engineered Auto-Lite Spark Plugs . . . the spark plugs that are *world famous* for quality and performance.

ELECTRICITY LEAPS from storm clouds to top of Empire State Building as shown in this dramatic night photograph. Engineers harness electrical energy like this to "fire" gasoline in your engine.



FRANKLIN'S KITE experiment was first demonstration of electrical nature of spark discharges between clouds. Date: 1752.



"FIRING PIN" of the car engine. Your spark plugs fire as many as 15,000 fuel charges per minute with tailored precision.



RELIABLE STARTING is one important benefit resulting from Auto-Lite research to assure correct materials, dimensions and design.



RIVER CUTTING CANYON resembles way surging of electricity wears away electrodes. For solution see next picture.



TINY UNIT called a "Resistor" permits wider initial gap setting, makes possible these advantages of Resistor Spark Plugs:

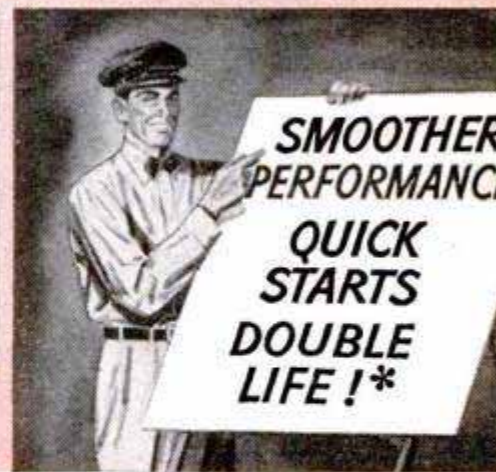

**SMOOTHER
PERFORMANCE
QUICK
STARTS
DOUBLE
LIFE!***

All car, truck and tractor owners benefit from the exhaustive research performed by Auto-Lite Ignition Engineers . . . the men who design the coil, distributor, spark plugs, wire and all the other parts of the complete ignition system used as original factory equipment on many leading makes of America's finest cars and trucks. *You're Always Right With Auto-Lite.*

THE ELECTRIC AUTO-LITE COMPANY

Ignition Engineered
AUTO-LITE
SPARK PLUGS

For **SMOOTHER
MOTORING**

**INSIST ON
BOWES**



**DEPENDABLE
SPARK
PLUGS**

*Here's
Why -*



★ **Every Bowes Plug is Individually Tested**—tested at higher voltage than is ever encountered in your car.

★ **Oversize Special Alloy. Electrode . . .** welded construction assures positive connection.

★ **Extra Large Ground Electrode** assures longer life for plug.

★ **Husky Aluminum Oxide Type Insulator** assures against porosity—sure proof against shorting.

★ **One-Piece, Leak-Proof Construction.**

★ **Patented Engine Gasket Retainer Ring** assures better contact and better heat transfer.

BOWES PLUGS

are tailored to YOUR car's motor

If your favorite SERVICE STATION does not handle Bowes Spark Plugs, write us direct for further information.

BOWES "SEAL FAST" CORPORATION
INDIANAPOLIS 7, INDIANA

Close-Ups From Miles Away

(Continued from page 116)

reason is that "I've become so fond of the old jalopy I couldn't bear to part with it now. Besides, I've got the rear end specially rigged to carry my equipment."

Cheney has his own darkroom in the machine shop. He even develops his own color films. Stacked around the shop among drills and presses are more than 8000 slides of scenes he has snapped. And the cameras . . . well, there are three 16-mm. motion-picture cameras, two 35-mm. cameras, a 3¼ by 4¼ press-type camera, and special 3¼ by 4¼ and 2 by 2 cameras Cheney built himself for astronomical work. All cameras attach to the telescopic equipment, and in addition there are 71 different lenses, many of which are used on several cameras.

"Actually, the camera itself is not so important in taking long-distance pictures," explained Cheney. "A box camera would do. The secret is in the optical system and the mounting. And unless the very best mounting can be obtained, the beginner would do well to try cardboard tubing and a 2 by 4."

Cheney has another theory on his hobby—or anybody's hobby.

"It should be shared," he said.

All photography fans turn out a lot of extra prints. Usually, these prints are dropped into the wastebasket, or tucked away in corners to gather dust. But not in Cheney's case. He sends all extra prints to the county tuberculosis sanitarium.

"The bedridden patients are able to travel through the pictures to different parts of the country—even to the moon," said Cheney. "Knowing the photographer, they take an interest in the pictures."

Cheney has made friends all over the nation with his picture taking, because he is one photographer who, when asked by a picture subject to "send me a print," never forgets to do so. Besides the case of the Indian fisherman, he recalls only one other instance when he has run into difficulty in taking pictures. That was the time he set up his telescopic camera and a drunk stood squarely in front of it, refusing to budge.

"This is a free country," declared the drunk, "and I've got a perfect right to stand here if I want to!"

Cheney feels that a man is missing nine tenths of photography—without a telescopic camera.

"It's the details that are most interesting," he said. "Of course, I see things upside down through my ground glass, but sometimes I think that's the best way to get a proper perspective on this topsy-turvy world."

Buy **CRAFTSMAN** Drill Presses for dependabable low-cost drilling!

REG. U. S. PAT. OFF.

NOW equipped with Improved Jacobs "Safe-Lock" Chuck!

Another SEARS "First"! CRAFTSMAN "100" Drill Presses are now *exclusively* equipped with the new Jacobs "Safe-Lock" chuck for **absolute SAFETY!** Threaded lock-collar positively prevents chuck flying off tapered spindle (regardless of speed or type of load); yet changes easily! Ends need for using special collet chucks. Here's PROOF of the "extras" you get with CRAFTSMAN!



Drills to center of 15-in. circle

CRAFTSMAN flexibility makes possible dozens of operations like these!



Typical gang drill press set-up for tapping. CRAFTSMAN flexibility can save you money in hundreds of similar industrial applications like this!

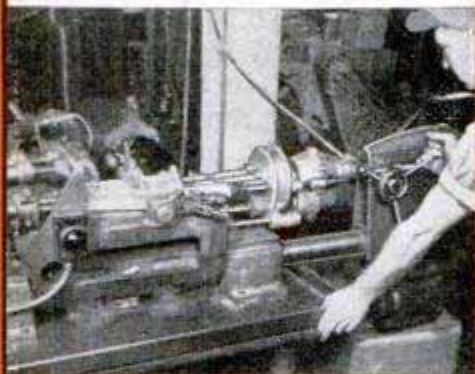

Drill press head used horizontally in special multiple drill-and-tap set-up. CRAFTSMAN is "tops" for versatility in dozens of such industrial set-ups!

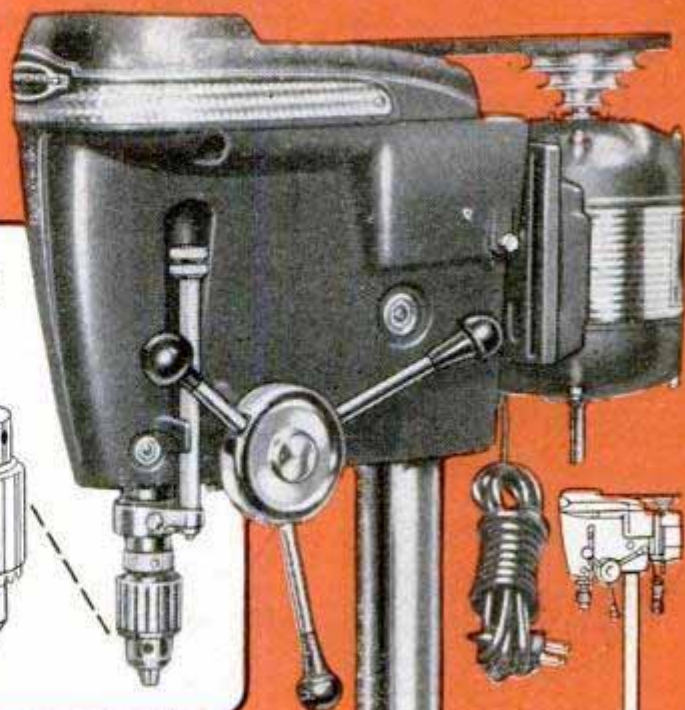

CRAFTSMAN "100" Bench Model

\$82.50* Without motor
Cash Only \$8.50 Down

CRAFTSMAN "100" Floor Model

\$92.50* Without motor
Cash Only \$9.50 Down



Big .. Rugged! Exclusive Features! Outstanding for Industrial Accuracy!

Superb CRAFTSMAN dependability! Only industrial-type drill presses we know of with ALL these features . . . **at anywhere NEAR these prices!** Exclusive Jacobs SAFETY key-chuck (described above); 1/2-in. capacity; No. 33 taper. Precision ball bearings; *lubricated for life!* Longer lasting spiral "Perma-Coil" quill-return-spring. Pre-loaded bearings reduce spindle end-play. 11 speeds; 4-in. spindle travel. See them at (or call) your nearest Sears Retail Store TODAY! Or write Dept. 609, Sears, Roebuck and Co., Chicago 7, Illinois.

* Prices slightly higher south of Ohio and west of Mississippi rivers

CRAFTSMAN Hand and Power Tools by **SEARS, ROEBUCK and CO.**
Famous for fine quality . . . precision performance . . . low price!

new! 1951 ALLIED RADIO & TV CATALOG

→ free!

COMPLETE
UP-TO-DATE
•
EVERYTHING
IN RADIO & TV
AT LOWEST
PRICES!



212 PAGES
OF VALUES

Everything for
Experimenters, Builders,
Amateurs, Servicemen,
Engineers and Soundmen..

Save money on every Radio and TV need! Get the big 212-page 1951 ALLIED Catalog featuring the world's largest stocks of top-quality equipment at low, money-saving prices! See the latest TV releases, home radios, radio-phonos, Amateur equipment, P.A. systems and Hi-Fidelity Custom Sound, recorders, test instruments, builders' kits—plus thousands of parts, tools, books and diagrams. Get more for your money from the World's Largest Radio Supply House. Send today for your FREE 1951 ALLIED Catalog!



TV, HOME RADIOS
& RADIO-PHONOS



SERVICE SUPPLIES
BUILDERS' SUPPLIES



AMATEUR GEAR



P.A. SYSTEMS
RECORDERS

free
CATALOG
Send For It!

ALLIED RADIO

ALLIED RADIO CORP., Dept. 5-CC-1
833 W. Jackson Blvd., Chicago 7, Ill.

Rush FREE 212-Page Catalog No. 126

Name _____

Address _____

City _____ Zone _____ State _____



Homemade Safety-Belt Tester

From scrap materials, Staff Sgt. Guy J. Gear of the Military Air Transport Service has built a machine to test parachute harnesses and safety belts. It is powered by an electric hoist and pulls up to 1000 pounds, using 50-pound weights on a 10 to 1 ratio lever and fulcrum. A Plexiglas door protects the user if a belt or harness breaks under test.

Electric "Eyes" Watch Modern Ship Break Apart During Tests

Seven hundred electric "eyes" were on watch as the British Navy deliberately broke a modern warship in half. Purpose of the research was to test the stresses and strains as a sinking ship breaks up. The *Albuera*, an uncompleted destroyer was chosen for the test. Put in drydock, the craft was supported only amidships. The 700 instruments were installed at various places throughout the hull and then the craft was slowly filled with water until its back was broken. From a building on the dock the research men watched their instruments and calculated the strain on each part of the ship.

No-Rub Furniture Wax

All the housewife has to do to apply a new furniture wax is to spread it on, let it dry, then wipe it lightly. The wax, manufactured by S. C. Johnson and Son, Inc., of Racine, Wis., dries to a luster that needs no rubbing. The resulting surface is hard and dry, with no stickiness to catch dust.

*Better Engine Performance
Starts Here!...*

Scientifically Engineered



MARVEL MYSTERY OIL

More than thirty years of constant scientific research and experimentation by Emerol Engineers have made Marvel Mystery Oil the best specialized automotive lubricant—a must in modern high-compression engines!

- Stops dry firing in upper cylinder area
- Protects rings, valves and pistons
- Quiets high compression ping
- Provides smoother engine performance

Use Marvel Mystery Oil in your crankcase, in your gas tank, or with a Marvel Top Cylinder Oiler.



Marvelize your car at your dealer today
or write for free information. Dept 115

EMEROL MANUFACTURING CO., INC.

242 West 69th Street, New York 23, N. Y.

CONVERT HAND MOWERS to POWER MOWERS

Takes less than 3 hours

The Handy-Dandy Lawn Mower Kit fits any hand mower from the 16 to the 20 inch size. Complete with all necessary parts. Kits can be purchased separately, complete with engines or complete with Pennsylvania mower.



Also manufacturers of complete power mowers and garden cultivators.

DEALERS WANTED

LE CLAIRE MFG. CO., Le Claire, Iowa, Dept. PM

MODERN LAWN MOWER SHARPENER

**FOR LAWN MOWER SHOPS
FIX-IT SHOPS**

GOLF COURSES • PARKS
101 OTHER JOBS

Sharpens All Reel Type Mowers • Hand, Power or Gang
• 10 to 20 Minutes • No Dismantling • No Extra Attachments Needed.

All reel type mowers, from 5-inch edgers to 36-inch power mowers, are quickly sharpened to extreme ends of both left and right twist blades.

Handle, wheels, roller and motor remain in place when sharpening is in process. Bed knife is sharpened in same brackets. Grinding head rides on five ball bearing races. Easy to operate. Also sharpens chisels, jointer knives, planer blades. Big profit maker. Own your own business. Send Today for FREE Illustrated Bulletin No. 10-C. Prices Subject To Change Without Notice

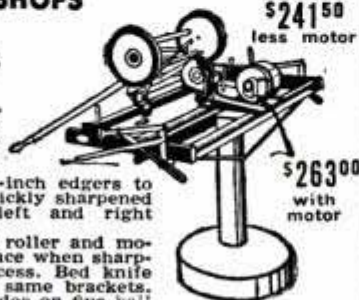

PRICE
\$241.50
less motor

\$263.00
with motor

ORDER NOW
Immediate Delivery

MODERN MFG. CO. 108 N. FAIR OAKS AVE
PASADENA, CALIFORNIA

CAMPBELL-HAUSFELD Spray Painting Outfits



SAVE time, materials
and money

PAINT buildings, tractors, trucks. Refinish furniture and fenders. Inflate tires; lubricate motors and implements.

Destroy weeds. Rid live stock and pens of pests and parasites

First job pays for the outfit. Then it is yours for a lifetime of trouble-free service. 4 models at 4 money-saving prices. If your dealer does not have them, write for literature and prices, giving his name.

pressure queen

The only 4 cylinder portable. Outperforms them all for spray painting without pulsation.

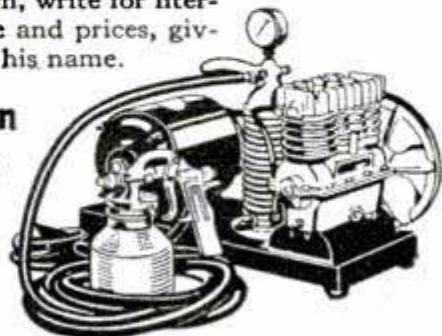

THE CAMPBELL-HAUSFELD CO.

1046 RAILROAD AVE. HARRISON, OHIO

For Casting that's out of
this World — a STEPGLASS® Rod!



South Bend STEPGLASS® ROD *Sensational - New*

There's nothing like it! Step-tapering the solid glass tip gives amazing casting action that can't be attained any other way. Live action for distance with light lures. Plenty of backbone for accuracy and to set hooks solidly. New chuck-type collar locks reel and tip in place, aligns guides. Choice of 4', 4½', 5', 5½' or 6' lengths, \$19.95.

New! SMOOTHCAST® REELS
Nylon Gears!
Direct Drive!
Smoother, easier
casting. \$12



New! FISH DECEIVER®
Casting Line
Camouflaged!
50 yds. \$1.20 up.



FREE

New '51
book on tackle, fish-
ing, etc. Write for it now.
SOUTH BEND BAIT CO.
891 High St., South Bend 23, Ind.



SOUTH BEND

A Name Famous in Fishing

New! Ex-
clusive step-
taper tip. No
rot, rust or set.



W. J. Ruseoe Co., 2170 W. Market St., Akron 13, Ohio.

Hand-Hit "Bird"

Only a sponge-rubber ball with feathers attached to its neck is required to play a new game resembling handball and badminton. The object is to keep the ball in the air, and opponents use bare hands to bat it back and forth or against a wall.

A Little Terramycin Makes a Lot of Pork

*Dr. J. H. Brown
Shenandoah, Pa.*

Terramycin, newest of the earth-mold "wonder" drugs, makes pigs grow bigger and faster. Used in very small amounts (less than a third of an ounce for each ton of feed), terramycin was given to pigs in a test on animal-feed supplements. Swine fed the terramycin gained 18 percent more weight than the control animals. Other wonder drugs were used and all proved beneficial, although terramycin was the most effective. Nobody knows why more nourishment is taken from food when these drugs are added, but they appear to be effective for humans as well as for animals and poultry.

During 1950 the scheduled airlines in the U. S. flew more than 17 million passengers nearly 8 billion passenger miles with only five fatal accidents.

Announcing "MOTO-MOWER"

I N C L U D I N G
first

fundamental improvement
in Power Lawn Mowing

now available on

NEW MODELS
Nineteen Hundred Fifty-One

Featuring an Idler
and Control that
allows a free
handle . . . and
in addition to the

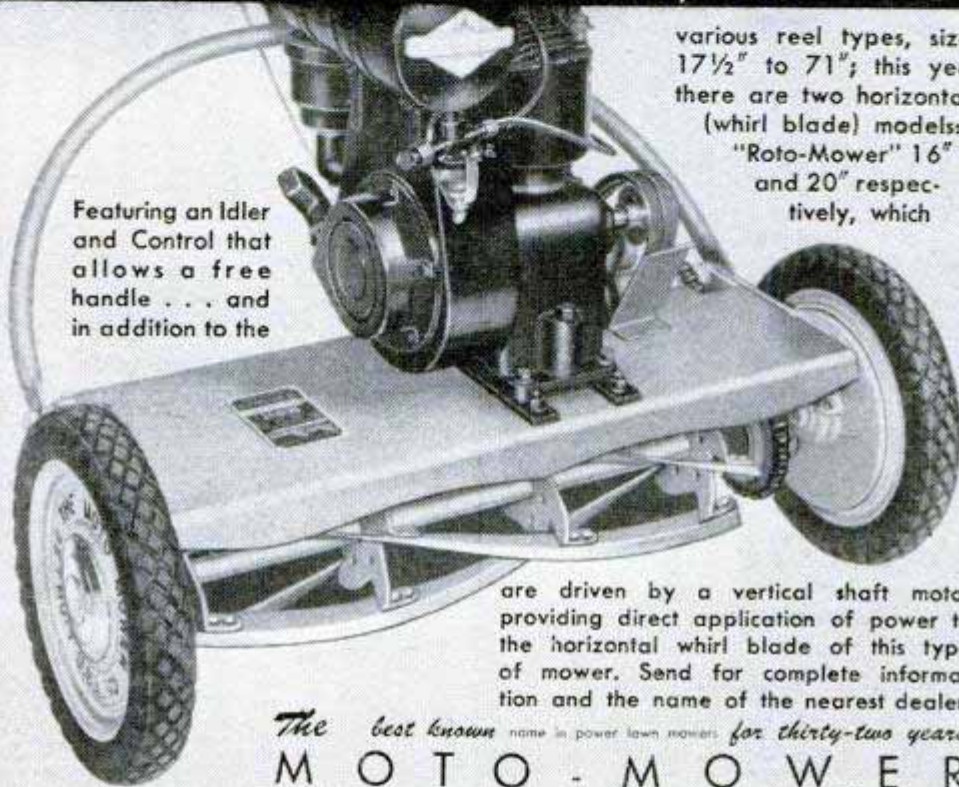

various reel types, sizes
17½" to 71"; this year
there are two horizontal
(whirl blade) models:
"Roto-Mower" 16"
and 20" respec-
tively, which

are driven by a vertical shaft motor
providing direct application of power to
the horizontal whirl blade of this type
of mower. Send for complete informa-
tion and the name of the nearest dealer.

The best known name in power lawn mowers for thirty-two years

MOTO-MOWER
4615 Woodward Ave. Detroit 1, Michigan Company

New
MIRACLE WALL CLEANER

Saves Costly Redecorating!
AMAZING INVENTION. Banishes old-style housecleaning mess and mud. No tags—no sticky "dough"—no red, swollen hands. No more dangerous stepladders. Literally erases dirt like magic from walls, ceilings, window shades, upholstered furniture, etc. **Ends drudgery! SAVES REDECORATING!**

SAMPLES TO INTRODUCE Sample offer sent immediately to all who send name at once. A penny postal will do. **SEND NO MONEY—just your name.** KRISTEE CO., Dept. 687, AKRON 8, OHIO

COMPARE THIS !! **\$39.95**
300 AMP. - D.C. - WELDER KIT
ASSEMBLE YOUR OWN - SAVE HALF!

Never Before at Such an
Unbelievable Low Price!

Now you can make your own welder using any aircraft generator and save many dollars. Only a pair of pliers and a few minutes are needed to assemble this kit into a sturdy welder giving you many years of useful service. Satisfaction guaranteed.



HERE'S WHAT YOU GET: No. AW5-Kit includes Special Hook-up Leads, Amperage control with leads, Mounting Plate, Pillow Bearings, Bearing Supports, Shaft Extension, Flexible Coupling splined to fit your generator, Triple Groove "B" Type Pulley, Plan included.
No. AW5-Kit Complete — \$39.95.
No. AW6 includes AW5-Kit above plus Arc Stabilizer — \$49.95.
No. AW7 includes AW6-Kit plus R-1-300 Amp. Generator — \$67.90 (R-1 Generator Cost Gov't. approx. \$400.00).

EXTRA! A \$15.95 Accessory Kit Complete for only \$12.95! Includes Welding Helmet, Electrode Holder, 5 lbs. Ass't. Rods, Two 10 ft. Welding Leads with Terminals and ground clips, plus Audel's Welding Guide. Sold with any Welder Kit . . . Special Price **\$12.95**



PLANS 35c LeJay's proven plan for building your own Welder using aircraft generator. Catalog included.

Order Direct from This Ad
FREE! BIG NEW CATALOG OF ELECTRICAL BARGAINS — WRITE FOR IT!

LEJAY MFG. CO. 947 LEJAY BUILDING - MINNEAPOLIS 8, MINN.

FOR BIG MEN ONLY!

SIZES 10 to 16 WIDTHS AAA to EEE

We SPECIALIZE in large sizes only—sizes 10 to 16; widths AAA to EEE. Loafers, Wing Tips, Moccasins, Dress Oxfords, High and Low Work Shoes, House Slippers, Rubbers, Overshoes, Sox. Extra quality at popular prices. Satisfaction guaranteed. Sold by mail only. Write for FREE Catalog.



SEND FOR FREE CATALOG

KING-SIZE, Inc., 515, Brockton, Mass.



the plane with the Golden Cutter*

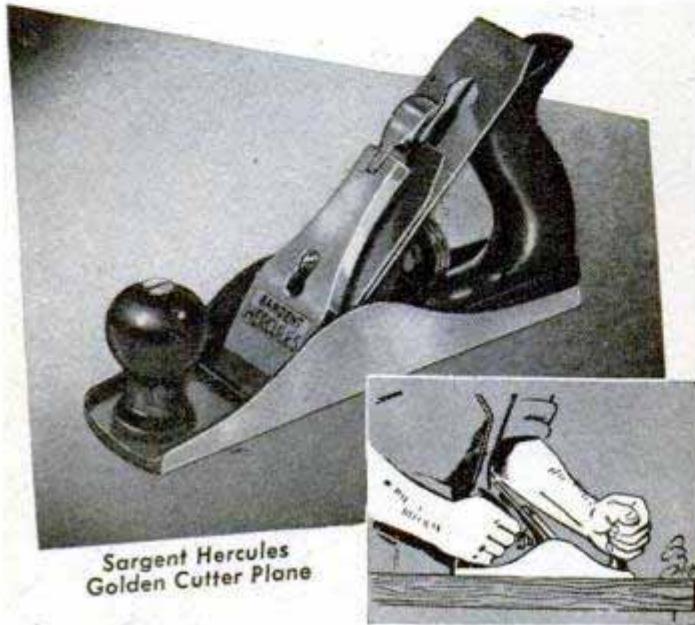

Sargent Hercules
Golden Cutter Plane

— never before such a blade

in a professional plane at a popular price.

*Precision honed from vanadium tool steel.

The Sargent Hercules Plane has a large brass nut for easy adjusting to cut paper-thin or coarse shavings. Steel spring under clamp toggle for firm seat. Knob and easy grip handle are second growth hardwood. Precision machined frog, bed and throat prevent chatter. Fully guaranteed.

Next time you pause at a tool display, check up on the 12 certified advantages of this fine tool.

A better tool by —



Sargent and Company

New York, New Haven, Conn., Chicago

Builders Hardware and Fine Tools since 1864

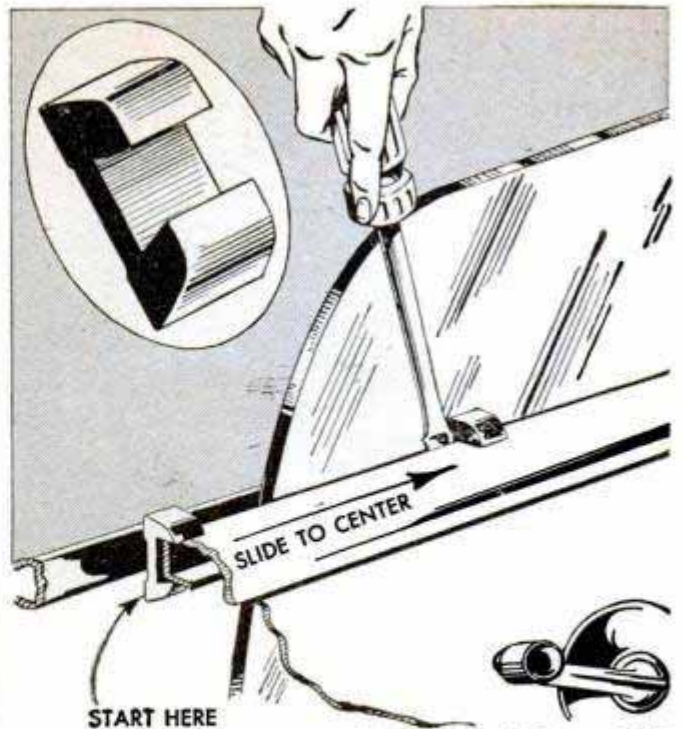

Rolexco, Box 11, Orange, N. J.

Rattle-Stopper for Car Windows

Slipped on the inner sill of a car window, a one-piece rubber buffer stops annoying rattles. There are no springs, clips or screws to catch on the clothing. Even when the window is lowered until it is flush with the sill, the rattle-stopper still does its job. It fits virtually all cars except convertibles and some station wagons.

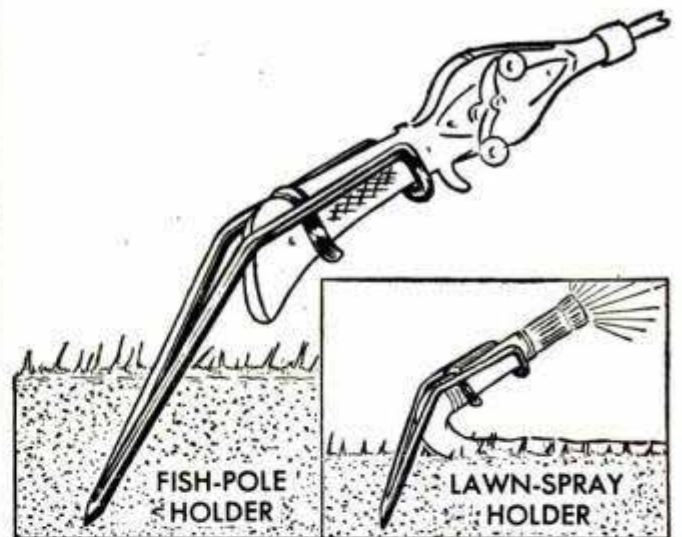

Bassett & Clark Industries, Vinton, Iowa

Pole Holder

Fishermen can now turn the chore of pole holding over to a dependable metal stake that can be pushed into the ground or wedged in an oarlock receptacle of a boat. The stake is bent to support the pole at the correct angle. When not used for fishing, the stake will hold the garden hose.

Among recently patented items is a "snore stopper" which fits under the chin and prevents open-mouth breathing.

GROBANS' WAR SURPLUS SPECIALS

ALL BRAND NEW ALL FULLY GUARANTEED

GENERAL MOTORS-ALLISON

CENTRIFUGAL PUMP

200 GALLONS PER MINUTE

- For Draining Basements • Fire-Fighting • Irrigation • Fuel Transfer • Swimming Pools • Home Water Systems • Dewatering

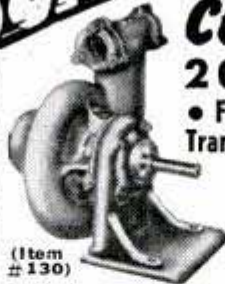

(Item #130)

This General Motors-Allison Centrifugal Pump—designed for use on U. S. Air Force Mustang fighters, now converted for commercial, home, and industrial high volume pumping applications. Inlet, 2 1/2" standard pipe thread, twin outlets with 1/4" pipe thread, ball bearing supported 3/4" shaft. Easy, fast simple priming. Rotation, counter-clockwise facing shaft. Shipping wt. 35 lbs. Gov't. acq. cost \$145.00. F.O.B. Chicago Now Only...

Suction Lift	Head Pressure	Gal. Per Min.	H.P.	R.P.M.
10'	65'	200	5.2	3500
10'	80'	40	1.5	2500
10'	50'	140	5.0	3500
10'	30'	100	3.0	2500

39.50

SELF PRIMING ALL PURPOSE PUMP

IDEAL FOR:

- Draining Basements
- Insecticides
- Fuel Oil
- Vacuum Pump—25" for Milk- ing Machines, Lab use, etc.
- Air Compressor—for Paint Spraying, etc. Delivers 4.5 CFM at 40 PSI with 1725 RPM
- Home Water Systems
- 4-Ball Bearings—1/2" Shaft—3/8" Ports
- Rotate in either direction
- Rated up to 6 GPM, 50 PSI
- Use with 1/4 HP motor or larger, speeds from 200 to 1800 RPM
- Useful for hundreds of applications in the home, farm and factory
- Built by Pesco—Div. of Borg-Warner, Gov't. acq. cost \$45.00. Shpg. wt. 12 lbs. Free: Complete instructions and performance data with each pump. F.O.B. Chicago NOW ONLY.....

16.50

HYDRAULIC CONTROL VALVES

- ITEM #24. Four-way control valve with built-in relief valve, for use with one double action hydraulic cylinder, may be used with 1500 P.S.I. hydraulic system to open and close hydraulic cylinders. Ship. wt. 8 lbs. A \$38.00 value, postpaid..... 9.95
- ITEM #26. Four-way control valve for use with two hydraulic double-action cylinders. Each cylinder may be operated independently of the other or in conjunction with the other. Oil may be locked in any of the cylinders to hold the piston at any required position. Ship. wt. 6 lbs. A \$60.00 value, postpaid..... 12.95



(ITEM #24)

NEW! STATIONARY OR PORTABLE

D. C. ARC WELDER

FOR ANY WELDING JOB, LIGHT OR HEAVY

Stop Costly Repair Bills, Weld It Yourself and Save One or two jobs will pay for entire welder. Designed for many years of trouble-free service. This precision-engineered Direct Current ELECTRIC ARC WELDER is offered at but a fraction of its original value. It can be mounted permanently or easily transported for portable use. Does the job instantly where and when you need it. Has dial type rheostat for easy pinpoint control and a high-low range switch. Run welder at 2500 RPM from drive pulley or power take-off of tractor, a 7 1/2 HP electric motor or a 10 HP gas engine. Use two V belts or flat belt (on pulley). Now at a fraction of its value. Price includes double V or flat belt pulley and instruction book. Shpg. wt. 107 lbs.....

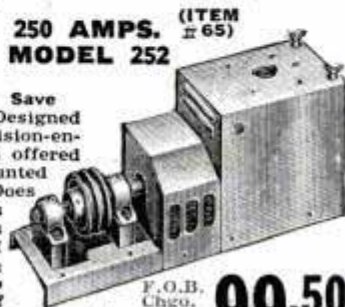

F.O.B. Chgo.

99.50

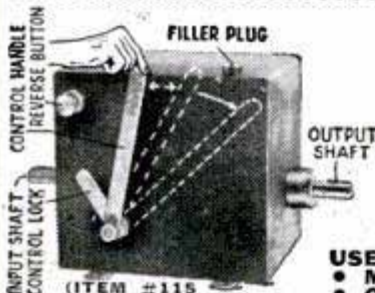

HYDRAULIC SPEED REDUCER

WITH FINGERTIP CONTROL

- USE FOR: • Reamer Drives
- Midget Cars • Feed Mills
- Canning Machines • Conveyors
- Lathes • Milling Machines • Motor Boats
- Cream Separators • Garden Tractors • Pumps

Variable output speeds ranging from 0 to input speed now available. Merely move control handle until desired speed is attained. Then turn locking handle to maintain the setting. Internal relief valves prevent overloading. Use input power of 1/4 to 1 1/2 H.P. This Westinghouse-Oil Gear Unit converted to commercial use from 40 MM anti-aircraft traversing mechanisms consists of a variable displacement hydraulic pump feeding a fixed displacement hydraulic motor. These components are contained in a crackle-finish steel oil reservoir (capacity 2 qts.). Adjustable relief valves set at factory for 100 inch pounds of torque may be reset up to 180 inch pounds. Independent reverse control allows full output power and speed selection in either direction of rotation. Both input and output shafts measure 5/8" diam., include keyway. Input rotation is counter-clockwise facing shaft. Recommended input speeds not to exceed 750 R.P.M. Over-all dimensions 7 1/2"x7 1/2"x11 1/2". Gov't. acquisition cost, \$428.00. Shipping weight 26 lbs. Complete with 2 qts. of oil and full instructions. F.O.B. Chicago

54.50

DIRECT CURRENT GENERATORS



For welders, plating, truck and marine use, D. C. appliances, lights, etc. Aircraft quality—lifetime grease sealed ball bearings. Heavy duty.

- Item #131 — Brand new Electric Auto-Lite 12 volt Direct Current electric generators, rated 18 amps. Complete with blower and pulley. Use for trucks, tractors, boats, battery chargers, etc. Part No. GEF-4805A. In original sealed U. S. Army cartons. \$40.00 value. Shpg. wt. 27 lbs. F.O.B. Chicago. Now Only..... 15.00
- Item #90—Type P-1, rated 200 Amps.—28 Volts, 2500 RPM. Mfd. by General Electric, Ford, Delco-Remy and Westinghouse. Gov't. Acq. Cost \$300.00. Shpg. wt. 70 lbs. F.O.B. Chicago..... 22.50
- Item #91—Type R-1, rated 300 Amps.—30 Volts. Mfd. by Jack & Heintz. Gov't. Acq. Cost \$380.00. Shpg. wt. 70 lbs. F.O.B. Chicago. Each individually packed in wooden box..... 35.00
- Item #73—Allis Chalmers MOTOR GENERATOR, 120 volt, 60 cycle AC, 7.82 amps. output. Input—24 volts DC, 63 amps. 3600 RPM. Ideal for marine and aircraft installations, farm and factory use where AC is desired and DC available. Run unit off DC Welder for handy 120 volt AC current for emergency power for oil burners, incubators, electric motors, etc. Shipping wt. 200 lbs. F.O.B. Chicago..... 79.50

Hydraulic Cylinders—Air or Oil

Large supply of new labor-saving, economical hydraulic equipment in many types and sizes. Use these positive, highly efficient smooth pressure hydraulics on presses, arbors, lifts, loaders, power control, positioning, brakes, plastic dies, auto frame alignment, etc., etc.

- ITEM #4—All steel double action hydraulic cylinder, 1 1/4" bore, 2 7/8" stroke. Clevis mounting. Will lift 1000 lbs. with 1000 P.S.I. line pressure. Perfect for positioning and feeding movements. Shpg. wt. 4 lbs. Postpaid..... 4.95
- ITEM #33C—Double action hydraulic cylinder, 1 1/2" bore, 4 1/2" stroke. Clevis mountings at both ends. Uses 1/2" pipe fittings. Postpaid..... 8.95
- ITEM #32—Double action, 1 1/2" bore, 9" stroke, will lift 1760 lbs. with 1000 P.S.I. line pressure. Wt. 4 lbs. A \$45.00 value. Postpaid..... 10.95
- ITEM #41—Double action hydraulic cylinder, 2" bore, 6" stroke, clevis mounting at base and end of shaft. Over-all length closed 12 1/2". Has 3/4" stainless steel shaft, uses 1/4" tube fittings. Will lift up to 3100 lbs. with 1000 P.S.I. line pressure. Weight 7 lbs. Postpaid..... 12.50
- ITEM #16C—Double acting hydraulic cylinder, 1 1/2" bore, 26" stroke. Will lift 1760 lbs. with 1000 PSI line pressure. Weight 8 lbs. A \$55.00 value Now Only, Postpaid..... 16.95
- ITEM #103—Double acting hydraulic cylinder, 2 1/2" bore, 17" stroke. Clevis mounting. Will lift 4900 lbs. with 1000 PSI line pressure. 1 1/4" diam. shaft. 3/8" tubing thread ports. Overall length closed 28". Shpg. wt. 11 lbs. F.O.B. Chicago..... 21.50
- ITEM #31C—Double action hydraulic cylinder, 3 1/2" bore, 11" stroke. Aluminum alloy cylinder wall and all steel 1 1/2" piston rod. Clevis mounting at base and shaft, 19 1/2" overall length closed. Will lift 9625 lbs. using 1000 PSI from Logan Heavy Duty Hydraulic Pump. Uses 3/8" tubing fittings. Value \$102.00. Ship- ping wt. 11 lbs. F.O.B. Chicago..... 22.50
- ITEM #6-A—Double action hydraulic cylinder, 3" bore, 25" stroke, will lift 7070 lbs. with 1000 PSI line pressure. Steel barrel, 1 1/2" stainless steel shaft. Gov't. acq. cost \$176.00. Shpg. wt. 26 lbs. F.O.B. Chicago..... 28.00
- ITEM #42—Double action hydraulic cylinder, 4" bore, 18" stroke. Rated lift capacity with 1000 PSI line pressure is 12,500 lbs. Ship. wt. 30 lbs. F.O.B. Chicago..... 32.50



16.95

LOGAN HEAVY DUTY HYDRAULIC PUMP

For operating hydraulic cylinders and hydraulic motors on tractors, bulldozers, construction machinery, lift trucks, industrial applications, etc. Delivers 10 GPM at 1200 RPM at 1000 P.S.I. using 6 HP. Has a 3/4" inlet, 1/2" outlet, 3/4" shaft with flat and keyway for direct or pulley drive. Has flange with 4 bolt holes for convenient mounting. Ship. wt. 22 lbs. Overall dimen.: 7" L x 5 1/2" H x 5 1/2" W. A \$105.00 value FOR ONLY..... 22.50 F.O.B. Chicago



(ITEM #29)

FREE: NEW 1951 48-PAGE CATALOG. You save on everything. Write today.

ORDER DIRECT FROM AD — SEND PAYMENT OR PURCHASE ORDER, TODAY — SATISFACTION GUARANTEED

GROBAN SUPPLY CO., Inc., 1507 S. MICHIGAN AVE., Chicago 5, Ill., Dept. PM-3

a "Must" for every mechanic
FREE, NEW CATALOG of those

"doggone good"

DURO-CHROME TOOLS



Soon to be released—a new Duro-Chrome Mechanic's catalog. Crammed with pictures and detailed descriptions of the latest ideas in tools. Shows the right Duro-Chrome Quality Tool for every mechanic's needs, PLUS hard-to-find and "special job" tools your dealer has or can get for you.

Explains why Duro-Chrome Tools have been preferred by professional shop men for over 30 years. Tells what to look for in picking good tools; how Duro puts

Extra quality into every tool; for example, gets 25% more wear on Sockets, by exclusive Hot Broaching process.

Shows Duro-Chrome Tool Sets from 5-pc Punch and Chisel Sets up to 114-pc DeLuxe Workshops Sets. Reserve your copy of this "cyclopedia" of fine tools.



USE THIS COUPON NOW TO GET FREE COPY

SEND IT TO DURO METAL PRODUCTS COMPANY

2651 Kildare Avenue, Chicago, Ill.

Write your name and address in margin space below

ALL-PURPOSE, LOW-PRICED



HI-STANDARD
Sport-King

For only \$44 you can have this value-packed light-weight 22 long rifle automatic with either the 6 3/4" target barrel or the 4 1/2" all-sport barrel. Get both these precision-broached barrels for only \$8 more. Instantly interchangeable without tools. No other pistol has this feature.

Ideal for hunter, fisherman, trapper or camper. Just the gun for plinking or shooting varmints or small game, or as light-weight target pistol. Nothing else available of this quality for anywhere near this low price.

Equipped with diamond-checked molded grips with comfortable thumb rest. Or you can add the finest carved black walnut grips for only \$8.50 more.

Accurate glareproofed fixed sights. Easily installed rear adjustable sight with positive click adjustments for windage and elevation, and compensating front sight, available in a kit for \$6 additional.

Ask your dealer about the Sport-King and the heavier target automatics—used by the world's leading target shooters—the Olympic for 22 shorts and the Supermatic for 22 long rifle cartridges. Write for free folder about all Hi-Standard pistols.

HIGH STANDARD MANUFACTURING CORPORATION
Dept. 16C Dixwell Ave., Hamden, Connecticut

Thompson
BEATS
the World
on BOATS



Better Built
Lower Prices

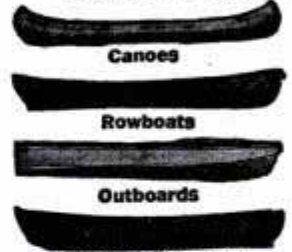

Safe Boats With
Full Length Spray Rails

Keep passengers perfectly dry—even at high speeds. Catalog also shows two new models of "Take-Along" Boats. Two big factories—save you freight.

CATALOG FREE
Write for your copy. State kind of boat in which you are interested.

THOMPSON BROS. BOAT MFG. CO. (151)
213 Ann St. PESHIGO, WIS. (Write to either place)

Light Boat for Auto
113 Elm St. CORTLAND, N.Y.

B-M POWER MOWERS

CUT HOURS OF WORK into
MINUTES of PLEASURE!

- Prompt Shipment
- ★ Low Factory Prices
- ★ Fully Guaranteed
- ★ Model D-3



For a quick, slick job and a smooth-as-velvet lawn, you can't beat a B-M Power Mower. Three Models of fine rotary mowers available for your special cutting needs. The D-3 (pictured here), the self-propelled P.D. models, or our light VD-1 Mower with vertical shaft engine and direct blade drive. Quick starting, dependable 1 1/2 to 3 h.p. Clinton engines. Safety features. Easy adjustments. Low factory-to-you Price. Write for FREE LITERATURE.

B-M MOWER CO., Box 66-PM, Blue Mound, Kansas



BRONZE FOUNDRY

Schools and Home Workshops

Make your own castings of aluminum, copper, bronze, silver. Foundry sets are available in three sizes including 2400 Deg. F. blast Furnaces. \$22.50; \$29.50; and \$42.00. f.o.b. Kansas City. Free Circular.

KANSAS CITY SPECIALTIES CO. P. O. BOX 6022, DEPT. P-3 KANSAS CITY, MO.



FREE SAMPLES!
GLOW IN THE DARK!

BIG PROFITS showing amazing Luminous Specialties—house numbers, pictures, plastic novelties, religious and nursery objects, ash trays, key-holders, etc. Large manufacturer. Enormous demand. Sell on sight. WRITE AT ONCE for FREE samples. Madison Mills, 303 4th Ave., Dept. W-4, New York 10, N.Y.

KINKADEE GARDEN TRACTOR

and Power Lawnmower
A Practical Power Plow and Cultivator for Suburbanites, Gardeners, Florists, Estates, Fruit, Nursery & Poultrymen.

Easy Terms - Write Today
American Farm Machine Co.
1058 33rd Ave. S. E. Minneapolis, Minn.



Catalog Free

NEW

POWER
AUGER BIT

ORDER TODAY!

\$1⁰⁰/₃ SIZE

Entirely NEW design. Drills fast and perfectly in any wood. Six sizes, from 3/8" to 1" will fit any 1/4" electric drill or press. Knots and nails won't damage keen hardened cutting edges. Hexagon shank can't slip in chuck.

Sizes 3/8", \$1.00; 1/2", \$1.05; 5/8", \$1.10; 3/4", \$1.15; 7/8", \$1.20; 1", \$1.25. Set is \$6.50. Order set of six and save.

Money back guarantee. Cash with order. We pay the postage.

BARCLAY COMPANY, P. O. Box 883, Plainfield 3, N.J.

CHOOSE THE MODEL BEST FOR YOU!

Two DREMEL Electric SANDERS with STRAIGHT LINE Action for Guaranteed SCRATCH-FREE Surfaces

BEFORE YOU BUY ANY SANDER—BE SURE YOU WILL GET A SCRATCH-FREE FINISH



ORBITAL Action
Partial cross-grain motion

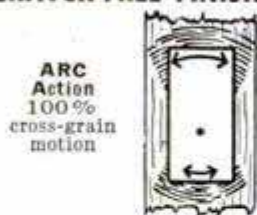

ARC Action
100% cross-grain motion



ROTARY Action
About 50% cross-grain motion

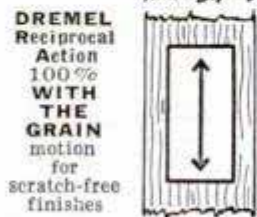

DREMEL Reciprocal Action
100% WITH THE GRAIN motion for scratch-free finishes

(Patented)



Model 2000
\$24.50

14,400
SANDING STROKES
PER MINUTE

Model "A"
\$14.85

FOR HEAVY-DUTY CRAFT AND WOOD WORKING PROJECTS

The new Model 2000 is a fast-cutting production sander. It has the added stroke and power required for furniture and cabinet making, boat building or refinishing, resurfacing large area table-tops, sanding plastic, leather, etc. Great for building operations in sanding woodwork, stair treads, dry wall joints, siding and other exterior surfaces. Does a superb wax polishing job, too! Weighs only 5 lbs. yet has 21 sq. in. sanding surface. Over-all size 3½"x4½"x7". Model 2000 price includes steel carrying case shown, with 25 assorted sheets abrasive paper and 1 sheepskin polishing pad.

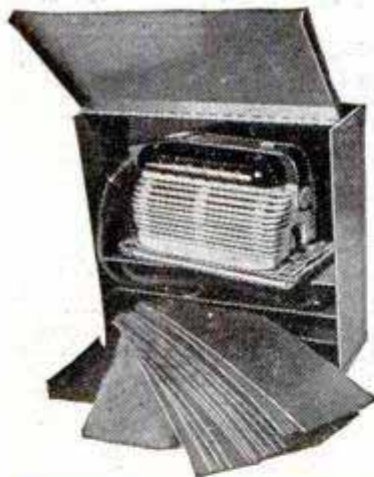

IMPORTANT

Before buying just any make of power tool, compare Dremel, feature for feature, with all competitive products. If you are not thoroughly convinced of Dremel superiority, we are sincere in saying we don't want you to buy.

WHERE TO BUY DREMEL TOOLS



Dremel Tools are sold everywhere. If your dealer cannot supply you, send remittance in full and we will ship postpaid. Or send only \$2, and pay postman balance plus postage and C.O.D. fee. Money back if not delighted after 5 days' trial.

DREMEL MFG. CO. Dept. 111-C, RACINE, WIS.

FOR HOBBY WORK, REFINISHING AND REDECORATING . . .

Dremel Model "A" Sander saves time and labor for hobbyists, homeowners and housewives. Over a quarter million now in use for sanding woodwork, cabinets, wood and plastic models, unfinished furniture, workshop projects, etc. Easy to handle—weighs only 2½ lbs. Takes all the drudgery out of polishing any waxed surface. Sanding pad 2¼"x5½". Furnished with 6 sheets sandpaper, 1 sheepskin, 1 felt pad.

FUN FOR BOYS FROM 8 TO 80

DREMEL Electric COPING SAW

CUTS SCROLLS LIKE MAGIC—SANDS AS IT SAWS

BLADE FACES 4 WAYS

FREE PROJECT PLANS

JUST GUIDE IT!

Only \$5.85 with 3 saw blades

SAFE AS A HANDSAW

For home, hobby, repair work—no other tool pleases so much for so little cost. Works in any direction—delivers 7,200 strokes per minute smoothly, effortlessly. Saws through ¾" medium-hard wood at a foot-a-minute speed. Touch-of-the-trigger, foolproof action. Only 2 moving parts, never needs oiling. Uses 110-120 v. A.C.

make your own Gems 29.50 F.O.B.

All necessary lapidary equipment is furnished, including a super-charged diamond blade for sawing, and all wheels for grinding, shaping and polishing; also complete instructions. The complete equipment as shown, less motor and belt, for only \$29.50, f.o.b., Burlington, Wisconsin. Write today for information and literature.

B&I MANUFACTURING CO.
Dept. S Burlington, Wis.



BOYS—IT'S FREE!

"THE WONDERS OF CHEMISTRY"

This exciting new book shows how to amaze your friends with chemical magic, describes many fascinating home experiments, tells of fun, thrills and big future opportunities for boys who know chemistry. Special atomic energy feature. Send today!

THE PORTER CHEMICAL COMPANY
46 Prospect Avenue, Hagerstown, Maryland





**Make Money
with Spare-Time
Plowing &
Mowing!**

5-HP

GRAVELY Tractor

OFFERS 20 MONEY-MAKING TOOLS!

Make good money this spring plowing gardens with the powerful Gravely Tractor! Perfect seedbed in one operation. It's easy to earn \$30 to \$40 a week—*extra!* The tractor does the work—you collect the fee. After plowing season, use Sickle or Lawn Mower attachments for cutting brush, weeds, lawns. Remember, with 20 tools, Gravely does *every* lawn, garden and field job! All-gear drive, power reverse; moderate investment. . . . An easy way to get a Gravely of your own—and make a profit besides!

"Power vs Drudgery" tells you how to put Power to work making money for you! Spring's almost here—write today!



GRAVELY MOTOR PLOW & CULTIVATOR CO.
BOX 363 DUNBAR, W. VA.

SPECIAL Fishing Line YOUR CHOICE FOR \$1.00

500' 2-PLY NYLON	25 lb. T
250' 3-PLY NYLON	45 lb. T
150' 3-PLY NYLON	85 lb. T
500' Linen Line	24 lb. T

BRAIDED NYLON LINE

200 ft.	15 or 20 lb. Test
175 ft.	35 lb. Test
150 ft.	50 lb. Test
125 ft.	75 lb. Test
100 ft.	100 lb. Test
50 ft.	100 lb. Test

Imported FLIES, Assorted . . .10 for \$1.00
Level Fly Line, size E & D, 75 ft. \$1.00
All lines available in longer lengths. Send Check, Money Order. We pay Postage.

MAC-MILLS, Dept. K-3, Pleasant Valley, New York

Save Point Repair Costs

with **"PRESTO"**
POINT SHIELD

Shields and protects ignition points. Serves as excess current regulator—prevents "Blue Points". Particularly efficient in cold weather starting as well as all ordinary driving. Saves cost of several sets of points. Easily and quickly installed—merely connect in series between coil and distributor.

If your service station or dealer can't supply, order direct—only \$1.85 postpaid.

BOCK MFG. CO. 711-A WEST LAKE STREET
MINNEAPOLIS 8, MINN.



If it is accuracy you want
ROAD-MISER has it!!

Any vacuum operated gas mileage indicator or tune-up tester can be made to fit your car to an accuracy within 1 mile per gallon at maximum level road economy with a Road-Miser Dial. We supply a set of Road-Miser sectional dials to cover all probable variations in cars of the same specifications. You easily attach the correct dial strip to your indicator after making a short mileage check by simple instructions. Road-Miser leaves all present dial numbers exposed on most indicators. The best index to your car's condition is a constant reading of its maximum mileage. Test it anytime with a Road-Miser equipped indicator. Money refunded if not satisfied. (Please give make, year, and model of car. Also, indicator name and dial size.)

\$1.50 in check or money order pays for set of Road-Miser Dials and airmail postage.

ROAD-MISER DIALS 4198 Sunnyside Drive
Riverside, California

WOOD FASTENERS



Don't split Wood—Use "CHEVRONS" hardened steel FASTENER. Draws wood together eliminating doweling, mortising, nailing. Hammer in—"Presto"—a firm joint! No wobble, no distortion. Lends artistic appearance. Easily counter-sunk and concealed with wood fillers. For hard and soft woods. For mill workers, artisans, HOME CRAFTSMEN, for making and repairing screens, doors, sash, frames, cabinets, furniture, moulding. 3/8" depth, for thickness wood up to 1 1/2". At your dealer or send only \$1.00 NOW for GIANT box, postpaid. Money back if not delighted.

E. B. PACKARD CO., Inc.
Dept. M3 139 Cedar St. New York 6, N. Y.

Print Your Own

Cards, stationery, circulars, tags, labels, photo and movie titles, advertising, etc. Save money. Print for Others, Good Profit; easy rules sent. Raised Printing like Engraving, too. Sold direct from factory only. Write for free catalog of outfits and all details. **KELSEY PRESSES, M-37, Meriden, Conn.**

GOLD-SILVER-COINS

Easily located with new Lightweight M-Scope Detector. Superior performance, lowest price, monthly payment plan.

FREE LITERATURE
FISHER RESEARCH LAB., INC.
PALO ALTO CALIF.

LAWN ORNAMENT-NOVELTY PATTERNS

28 Lawn Ornament Patterns, 25¢. Other Patterns; 15-20" high; Dutch Girl, Dutch Boy, Pirate, Bull Terrier, Mexican Girl, Mexican Boy, Dwarf, Penguin, Flower Girl, 10¢ each. 25 Novelty Patterns, 30¢. All 62 Full Size Patterns, \$1.00 Postpaid. Strother Pattern Service, Dept. CD-8, Box 128, Belington, W. Va.

AUTOMATIC RETOOTHER

MAKES NEW PROFITS

for HAND SAWS

Cuts new teeth in 50 seconds—any size 4 to 16 points. Old teeth fall off as chips. Easy to operate. A perfect job.

IMMEDIATE DELIVERY
WRITE DEPT. 3
BURR MFG. CO.
8933 VENICE BLVD.
LOS ANGELES 34, CALIFORNIA

VALUABLE BOOK
25¢
Order Burr's Blue Book of Coast to Coast prices for saw shop services

FOR **SPEED TO SPARE**



MAN A *Martin* "45"

WITH

SYNCHRO-TWIST CONTROL

FACE FORWARD
WHILE YOU
CONTROL SPEED
AND DIRECTION



MARTIN "45"
"Synchro-Twist"
4.5 H.P.
Alternate
Firing Twin
36 lbs.

Other MARTIN MOTORS not illustrated are:

- MARTIN "200" with full "Twist-Shift" 17 H.P.
 - MARTIN "200" Hi-speed "P-T" 17 H.P.
 - MARTIN "100" with neutral "Twist-Shift" 10 H.P.
 - MARTIN "100" with "Aquamatic Control" 10 H.P.
 - MARTIN "75" with neutral "Twist-Shift" 7.5 H.P.
 - MARTIN "75" with "Synchro-Twist" 7.5 H.P.
 - MARTIN "20" 2 1/2 H.P. Single
- ... priced from \$114.75 F. O. B. Factory

FREE! Complete, illustrated literature with descriptions of the 8 Great MARTIN MOTORS for 1951. Sent on request. Write: MARTIN MOTORS, Dept. 5123, Eau Claire, Wis.

Put more *pleasure* in your outboarding hours . . . man *any one* of the 8 Great MARTIN MOTORS for 1951 . . . They're tops for fishin', for goin' places fast or for "just cruisin'"! Only MARTIN MOTORS give you these "Performance Tested" features . . . **✓ Mechanically-Controlled Intake Poppet Valves for Automotive Smoothness** **✓ Patented Vertical Stern Adjustment** **✓ Full 360 Degree Steering** **✓ Improved Carburetion and Cooling Systems** . . . plus many others.

"Best Outboards Ever Built!"

MARTIN MOTORS

Division: National Pressure Cooker Co., Eau Claire, Wis.

Canadian Sales by: MARTIN MOTORS

Division: National Pressure Cooker Co. (Canada) Ltd., Wallaceburg, Ontario

Martin
OUTBOARD MOTORS

© 1951, M. M.

"BECAUSE SHOOTING'S
MY GAME—I KNOW

*You'll Shoot
BETTER
with a Marlin .22!"*



says JASPER HAYNES of Millinocket
One of Maine's Most Famous Hunting Guides

"Good shooting isn't just a matter of pride with us Maine guides—it's our living!" says Jasper Haynes, like his father before him, an internationally famous guide.

"That's why my Pa taught me on a Marlin way back in 1914. And that's why I shoot a Marlin today. So I can tell you from experience—you shoot a Marlin .22 and you'll shoot better."

*Prices subject to change without notice.
Slightly higher west of the Rockies.

THE NAME
FOR GAME

Marlin

FINE GUNS SINCE 1870



- ★ **AMERICA'S ONLY LEVER-ACTION .22 REPEATER**—The Marlin 39-A—The best all 'round .22 made. Loads 25 short, 20 long or 18 long-rifle cartridges—regular or high-speed, without adjustment. Solid top receiver and side ejection provide for lowest central 'scope mounting.
- ★ **SENSATIONAL NEW. 22 AUTOMATIC**—The Marlin 88-C. No-jam action. To load, you simply "funnel" ammunition thru the butt-plate. Loads 15 long-rifle cartridges (any standard type, regular or high velocity).

MARLIN BOLT-ACTION .22 REPEATERS FROM \$25.80*—At your sporting goods dealer's now—Marlin Guns and sensational new Marlin *Magnetized* Razor Blades are available in the U. S. A. and Canada.

—VALUABLE COUPON—MAIL TODAY—

The Marlin Firearms Company
Dept. PM-3, New Haven, Conn.

Send me catalogue with full information and photo-illustrations of Marlin Guns. I understand you will also send me pack of (please check)single ormagnetized double-edge Marlin Blades. I enclose 10¢ for postage.

Name

Street

City Zone State

best
white tape
made

ONLY
98¢*



The new "Evans White-Tape" has everything you'll find in tapes costing over \$1.50—plus.

- snow-white blade with bold, legible, jet-black numerals and graduations. Graduated in 32nds for first 6 inches.
- sturdy die-cast case heavily chrome-plated, calibrated for quick reading inside and outside measurements.
- blade 1/2" wide made of finest high carbon steel—tempered—Bonderized—enamelled—baked.
- blade replaceable in seconds—without tools—without even opening case. And Evans replacement blades cost far less.
- every "Evans White-Tape" is unconditionally guaranteed.
- exclusive Evans automatic brake gives smoother push-pull action with absolutely no "creeping" of tape into case.
- underside is white, too. Mark with ordinary pencil, remove mark with flick of thumb.
- unheard-of low price*: 10-ft. \$1.49; 8-ft. \$1.19; 6-ft. 98¢. Prices higher in far west and Canada.

Evans & CO. • Newark 5, N. J. 7429
Makers of Evans 6 ft. Folding Rule and "Folding Yardstick"

NOW YOU CAN HAVE A
Beautiful Lawn
EASILY, QUICKLY

MOW-MASTER not only does a beautiful job of mowing grass and cutting tall weeds, it also pulverizes autumn leaves. It keeps the lawn fresh and clean looking spring, summer and fall. Just think—a powerful 2 H.P. Engine—direct drive—easy operation—triple duty and long season use. All in one machine. No wonder MOW-MASTERS are popular.

PROPULSION ENGINE CORP.
7th St. & Sunshine Rd.
Dept. PM-3
Kansas City 15, Kansas

DELUXE MODEL SHOWN



AMERICA'S
FINEST POWER
MOWER

Write for illustrated folder at once.

Gentlemen: Please send me your illustrated folder, describing the MOW-MASTER Line of Power Mowers and Grind-a-Leaf attachments.

NAME _____
ST. ADDRESS _____
CITY _____ STATE _____

HOLD-E-ZEE

The Original
**AUTOMATIC GRIP
SCREWDRIVERS**

Hold, start and set up screws in unhandy places. Gripper instantly released by SPRING ACTION, sliding up out of way when not in use. Highest quality throughout.

New Models FOR RECESSED HEAD SCREWS \oplus \oplus



UPSON BROS., INC., ROCHESTER 4, N. Y. At Leading Dealers Everywhere

Plane it SQUARE!

with **SQUAR-EZY** guide

Attach to YOUR plane quickly & easily for perfect JOINING & EDGING. • Rugged, Roller Spindle Accurately Machined. • Model 7 fits Block & Smooth Planes Nos. 3, 4, \$2.98. • Model 11 fits No. 5 Jack (14") & larger \$3.98. • Order now. Literature available. Dealer inquiries invited.



Satisfaction or money back



THE BRATTON COMPANY

Dept. 323

Edwardsville, Kansas

Reduce RADIO NOISES

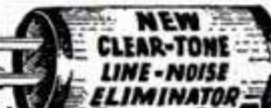

SIMPLY PLUG Radio or Appliance cord into Noise Eliminator & plug into wall socket. Enjoy reception FREE from many distracting noises. Send No Money, pay postman \$1 ea. (2 for \$1.75) plus postage or send cash & we'll mail postpaid. Try 5 days, money back if not delighted. Merit Sales, 6560 Sheridan Rd., Dept. P-30, Chicago 26, Ill.



\$2.95

NOW! GRIND YOUR OWN DRILLS

Sharpen 3/32" to 1" drills like an expert in 30 seconds. Precision lock insures factory accuracy. No experience necessary. Full instructions. Use with any hand or power grinder to keep drills extra sharp and true cutting. Guaranteed. Order Today \$2.95 postpaid (COD postage extra)

Another Speedcor Tool

THE SPEED CORP., PM-1
512 N.E. 73 PORTLAND 16, OREGON

AGENTS 300% Profit SIGN LETTERS

For Store Fronts and Office Windows. Anyone can put them on. Free samples. Liberal Offer to General Agents.

METALLIC LETTER CO., 430 N. Clark, Chicago 10

Precision Caliper

**M. Z. B. MAUSER-TYPE
VERNIER CALIPER**

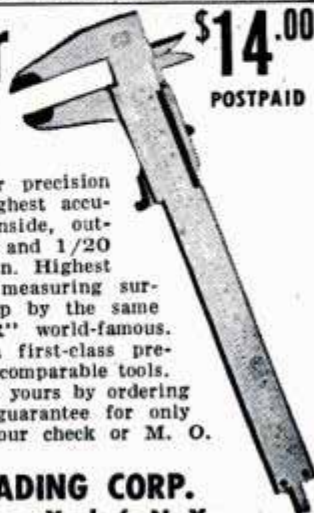

\$14.00
POSTPAID

An indispensable measuring tool for precision work in any trade or workshop. Highest accuracy and dependability. Measures inside, outside, thread and depth to 1/1000" and 1/20 millimeter. 8" overall, 6" graduation. Highest quality throughout with glass-hard measuring surfaces. M.Z.B. Calipers are made up by the same men who made the old "MAUSER" world-famous. This is your opportunity to buy a first-class precision tool at about half the price of comparable tools. Shipment from stock. Be sure to get yours by ordering it now. Sold with a money back guarantee for only \$14.00 postpaid if you send us your check or M. O. You pay postage on C.O.D.

INTER-CONTINENTAL TRADING CORP.
90 West Street New York 6, N. Y.

Choose your
WHIZZER NOW!

**NEW '51
WHIZZERS...**

are better than ever!

UP TO
100 MILES PER GALLON

5 TO 40
MILES PER HOUR

3 H.P. 4-CYCLE,
138 C.C. MOTOR

The NEW
AMBASSADOR

A **BIG** fully-equipped
motor bike

- 24" Heavy Duty Wheels
- Positive, E-Z-Glide Clutch
- Quick Starting Kick Starter
- Whizzer 5" Expander-Type Rear Brake, Pedal Controlled
- Hi-Low Beam Headlight, Tail Light, and Generator
- Dual Coil Telescopic Spring Fork



Newest, finest motorbike on the road! The big, rangy, and rugged Whizzer Ambassador—a great motorbike for comfort, beauty, power and dependability. You'll like its full size and its flashing performance. Be first in your crowd to own a Whizzer Ambassador!

\$249⁵⁰

plus tax,
F.O.B. Pontiac

The Pacemaker

Complete, low priced
motorbike



You'll get mile after mile after mile of riding pleasure out of Whizzer Pacemaker! Heavy-duty frame, dual coil telescopic front fork, big 5" Whizzer expander-type rear brake, special 3-point mounted saddle. **\$199⁵⁰**
Complete for only.....

plus tax, F.O.B. Pontiac

The Sportsman

Star of the
Lightweights



It's long, low, and lively! All the features of the Ambassador on a heavy-duty frame with 20" wheels and motorcycle-type tires. Whizzer Sportsman has a distinctive style and appeal that will make you **\$249⁵⁰** proud to own it. Only.....

plus tax, F.O.B. Pontiac

Whizzer Motor



makes your bike a motorbike

Fits any standard heavy-duty man's bike. 138 c.c., 3 h.p., 4-cycle motor sets the pace for dependability and economy. America's finest bike motor. **\$109⁹⁷**

F.O.B. Pontiac, attachments included

SEE YOUR
DEALER . . .

OR WRITE FOR
LITERATURE

WHIZZER MOTOR COMPANY
354 S. Sanford St., Pontiac, Michigan

"I'll take the **WHITE** one every time!"



WYTEFACE Steel Tapes, with their jet black markings on a white background, are easier to read in any light. They are rust-resisting, hard to kink and easy to clean.

Protected by U. S. Patent 2,089,209

WYTEFACE

TRADE MARK

STEEL TAPES

KEUFFEL & ESSER CO.

NO MORE
**GARDENING
CHORES —**
I'VE GOT A
Bready



BREADY GARDEN TRACTOR turns backbreaking work into fun! You just guide this easy-handling tractor through the toughest jobs. Use Bready to plow, disc, cultivate. Let Bready mow your lawn and cut weeds, too. Choice of 5 tractor models and 17 all-purpose implements for year 'round use. See powerful, economical BREADY TRACTORS at your dealer's. Write today for free folder.

THE BREADY TRACTOR & IMPLEMENT CO.
BOX 230 SOLON, OHIO.



**Removing Paint
is no problem now!**

Just apply WONDER-PASTE with a paint brush, and it completely transforms thick, resistant paint and other finishes to a soft slush. Strips off cleanly and easily with a putty knife—no sanding, no hard scraping. Let Wonder-Paste do the job!

At paint and hardware stores everywhere

WONDER-PASTE

● Wonder-Paste leaflet shows how simple it is to remove paint—write for it today.

Wilson-Imperial Company
119 Chestnut Street, Newark 5, N. J.

NEW! OIL BURNER
SWEEEPING THE COUNTRY!

**SALESMEN
BIG MONEY**
SLIPS INTO ANY COAL RANGE, STOVE OR FURNACE. Amazing quick, intense heat. By finger-tip control. Cheaper than coal. No more shoveling coal or ashes. **SENT ON TRIAL.** Prove it pays for itself quickly by what it saves. \$1 bonus for testing. We'll let you try one in your own home for one month. Write for details today. Northwest Mfg. Co., Dept. 207, Mitchell, S. Dak.

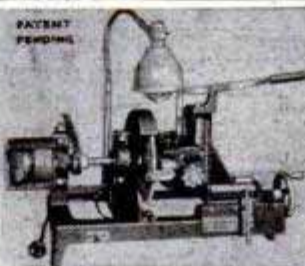

Start a NEW BUSINESS!
or Add to your present Repair Business

SHARPEN DULL PIPE WRENCHES

PIPE TAPS & DIES
"GUM" CIRCULAR SAWS

Write for Information

J. C. MOORE INDUSTRIES
BOX M 276 FREDONIA, PA.

Build your own JET ENGINE!

Order these plans today
1. JET PROPELLED BICYCLE. Assemble your own. Photo and instructions, \$1.00.
2. HOW TO MAKE EXPERIMENTAL JET ENGINES. Seven sheets drawings with information and instructions \$2.95.
3. BOTH OF ABOVE in one order \$3.75. SEND NO MONEY. Order both at once \$8.75 C.O.D. in USA plus c.o.d. postage. Send check or Money Order and we pay postage. Get other information too. Rush Order.

J. HOUSTON MAUPIN, Dept. 55, Tipp City, Ohio



GERSTNER Tool Chests

Machinists and Toolmakers may prove the convenience of one of these better chests on their own bench. Free catalog.

GERSTNER TOOL CHESTS

451 Columbia St. Dayton 7, Ohio

Ball-Bearing SPEED WHEELS



JUVENILE WHEELS (No bearing, solid tires)
4" 40¢ 6" 65¢
5" 45¢ 7" 75¢
(Semi-pneumatic tire, ball bearing)
8 x 1.25... 1.85 10 x 1.25... 2.20
8 x 1.75... 1.95 10 x 1.75... 2.30
8 x 2.00... 2.20 10 x 2.00... 2.65
12 x 1.75... 3.45

INDUSTRIAL WHEELS
Lug Base, Semi-Pneumatic tire
5 x 1.75... 3.65 10 x 2.00... 6.10
6 x 2 SW... 3.45 10 x 2.75... 5.15
6 x 2.00... 4.00 12 x 2.00... 6.90
8 x 2.00... 5.20 12 x 3.00... 9.20
8 x 2.50... 5.40 16 x 4.00... 15.15
Smooth Base, Pneumatic tire and tube
8 x 3.00... 11.00 12 x 4.00... 12.10
10 x 2.75... 6.80 4.00 x 8... 13.10
10 x 3.50... 10.55 14 x 4.50... 13.40

Dealers, Jobbers, and Manufacturers! Our new prices will interest you.

No c.o.d. orders.

JIM BROWN TOY COMPANY
1093 HOME AVENUE AKRON 10, OHIO

STILL AVAILABLE!



THE WORLD'S FINEST LOW-COST POWER TOOLS!

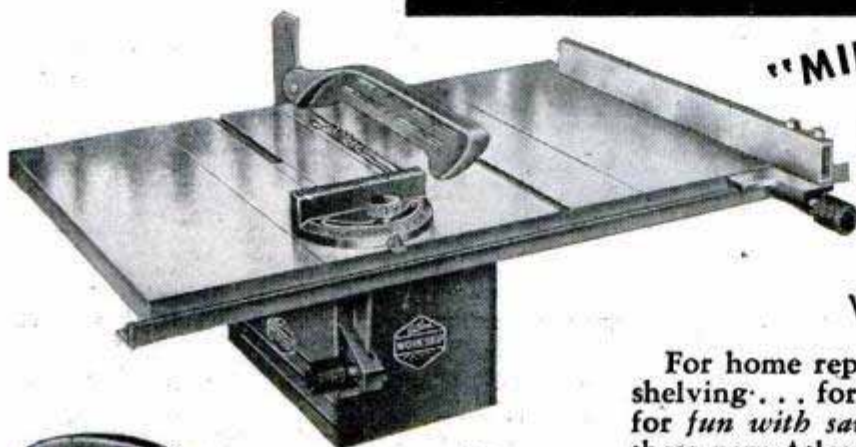

"MILES AHEAD IN VALUE!"

8" BENCH SAW Only **\$33⁹⁵!**

With two extensions, as shown, **\$38.90**

For home repairs and improvements, furniture, cabinets, shelving... for hobby work of dads and teen-age sons... for *fun with savings*... there's nothing to compare with these new Atlas Workshop tools. Each tool is backed by 40 years of Atlas precision engineering. They give your shop greater versatility *at less cost* than any tools or combination tool you can buy! Equip your shop now for the years ahead. Stocks are still available, but don't delay. See your Atlas or Atlas-Power King dealer today. Prices are the current ones, F.O.B. Kalamazoo. Send coupon for catalog with full details.

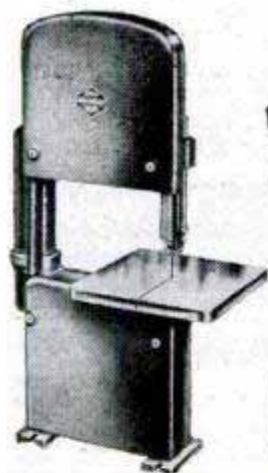

10" BAND SAW
ONLY . . . \$42.50

**5 TOOLS
POWERED BY
1 MOTOR**



13" JIG SAW
ONLY . \$18.50

Fast! Rugged! Accurate! Precision Designed and Engineered Throughout. Every Feature You Need for "Factory Quality" Workmanship!



11 1/4" DRILL PRESS
ONLY \$37.50



4" JOINTER PLANER
ONLY \$28.75

SEND FOR FREE CATALOG



Shows you all the Workshop tools and illustrates how to use them for special work.

NAME _____

ADDRESS _____

CITY, STATE _____



ATLAS PRESS CO.

343-W. N. PITCHER ST.
KALAMAZOO, MICHIGAN

DEPENDABLE QUALITY TOOLS

Keep Brushes like New

BEFORE



AFTER



DICA DOO PAINT BRUSH BATH

Clean and Restore PAINT BRUSHES

• 10c
• 25c

Perfect for NYLON BRUSHES, too!

At Paint, Hardware, Dept., and 5 & 10c Stores

Patent Cereals Co. Geneva, N. Y.

NEW SENSATION IN LOW-COST TRANSPORTATION the CUSHMAN EAGLE

WRITE FOR RIDER-AGENT PLAN



OPERATES FOR ONLY 3/4¢ PER MILE

Your new Cushman EAGLE will give you these famous Cushman features: automatic disc-type clutch; selective gear transmission; silent action shock-absorbing springs; doubly-dependable heavy duty brakes; special heavy-duty tires for added safety and comfort. Powered by the famous Cushman "Husky" engine, the EAGLE has rapid pick-up, quick acceleration, cruises up to 60 m.p.h. — over 75 miles per gal.

WRITE FOR FREE FOLDER AND PRICES TO DEPT. 6M

Cushman MOTOR WORKS, INC.
LINCOLN, NEBRASKA

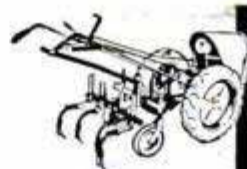

NEW '51 LINE!

PAGE GARDEN TRACTORS

RIDING AND WALKING MODELS!

NO CHEAP BELTS OR CHAINS!

2 TO 6 H. P. WITH COMPLETE GEAR DRIVE AND REVERSE

SAVES LABOR!

LOW PRICES EASY TERMS

BENEFIT FROM OUR 25 YEARS EXPERIENCE FREE 24 PAGE CATALOG SHOWS ALL ATTACHMENTS

WRITE PAGE FARM EQUIPMENT

1904 S. 81st St. • Milwaukee 14, Wisconsin

STARRETT "Tools and Rules" BOOK

Describes and illustrates the precision methods skilled mechanics use. Only one dime. Write Dept. AP.

THE L. S. STARRETT CO., Athol, Mass., U. S. A.

VARIABLE SPEED HYDRAULIC POWER TRANSMISSION



It has Infinite Speeds 0 to 550. Reverse. Automatic Overload Protection; Adjustable Torque up to 180 inch pounds. 5/8" Input and Output Shafts. It will handle 1/4 to 1 1/2 H.P. Motor. Case measures 7 1/2" long 7" high 6 1/2" wide. VALUE OVER \$300. Shipping Wt. 25#. On C.O.D. Orders we require a 10% only Deposit.

\$54.50

Fob. Chicago

DIRZIUS MACHINE SHOP "L" 1423-25 So. 52nd Ave., Cicero 50, Ill.

HAUCK FLAME GUN KILLS WEEDS



KILL WEEDS, crab grass, Canada thistle — stalks, seeds and roots. Destroy brush, caterpillar nests, diseased trees, grasshoppers, chinch bugs, etc. Clear irrigation ditches, split rocks, burn tree stumps — Sterilize poultry houses, kennels, barns. Use as portable home forge. Melt ice, thaw pipes. Safe, inexpensive. Burns only 6% kerosene, 94% air! Thousands satisfied users. 7 models. Write for FREE CATALOG.

HAUCK MFG. CO., 77 Tenth St., Brooklyn 15, N. Y.

Genuine MAHOGANY Wood

Large Batch \$1.00 Postpaid. Other Usable Scrap Bargains Postpaid

Sample 25c — Price List 3c

S. R. MARKS CO., Inc., Dept. C, Montgomery 5, Ala.

POWER HACKSAW \$52.75

LESS MOTOR

F. O. B. Benton Harbor



● Rugged cast iron construction. Wt. 56 lbs. bronze bearings. Draw cut. Auto. return lift. Auto. shut-off. Vise swivels 45°. Cap. 4"x4".

Send for full details and name of nearest dealer.

Dept. PM-31

EXCEL MACHINE TOOLS BENTON HARBOR, MICHIGAN

Use Easter Seals

NEW PACKAGED BOATS

EASY TO BUILD KITS

23 Models—Kits. Semi-finished. Custom-finished boats shown in big 16 page catalog.

SEND 35c FOR CATALOG

Catalog and booklet "Plywood Hints", \$1.00

BOAT PATTERNS-BLUE PRINTS

New 1951 catalog. Over 70 modern plans and full size patterns. Racing classes, cruisers, inboards, outboards, sail. By famous Designers. 6' to 30'. CATALOG 35c. Catalog and boat building handbook, \$1.00.

MARINE MART-DEPT. 24-BUFFALO 7, N. Y.

SURPLUS MACHINE SHOP TOOLS AT PRICES YOU CAN AFFORD

HIGH SPEED STRAIGHT SHANK DRILLS

SET 1L 30 Selected High Speed Straight Shank Drills from 1/8" to 1 1/4". \$15 value. New and slightly used surplus. Priced at only..... **\$2.95**

SET 2L 10 Different Size High Speed Straight Shank Drills from 1/4" to 1". Extra Long Drills. \$40 value. New and slightly used surplus..... **\$6.95**

HIGH SPEED MORSE TAPER SHANK DRILLS

SET 3L 20 Different Size High Speed Morse Taper Shank Drills from 1/4" to 1". \$70 Value. Priced at only..... **\$12.95**

SET 4L 10 Different Size High Speed Morse Taper Shank Drills from 1/2" to 1 1/4". \$50 Value. Priced at only..... **\$9.95**

SET 5L 8 Different Size High Speed Morse Taper Shank Drills from 1" to 2" with No. 3, 4 and 5 tapers. \$125 Value. Priced at only..... **\$29.95**

High Speed Taper Shank Chucking Reamers

SET 6L 20 different size High Speed Morse Taper Shank Chucking Reamers up to 1 1/2" with No. 1 and 2 tapers. Priced at only **\$6.95**

SET 7L 8 Different Size High Speed Morse Taper Shank Chucking Reamers from 1/4" to 1". Priced at only..... **\$4.95**

SET 8L 10 Different Size High Speed Morse Taper Shank Chucking Reamers from 1/2" to 1 1/8". \$65.00 value. Priced at only..... **\$9.95**

HIGH SPEED STRAIGHT SHANK CHUCKING REAMERS

SET 9L 20 Different Size High Speed Straight Shank Chucking Reamers up to 1 1/2". Priced at only..... **\$6.95**

SET 10L 10 Different Size High Speed Straight Shank Chucking Reamers from 1/2" to 1 1/8". Priced at only..... **\$9.95**

SET 11L 15 Different Size High Speed Straight Shank Chucking Reamers from 1/4" to 1". Priced at only..... **\$6.95**

SLITTING SAWS

SET 12L 7 Different Size High Speed Slitting Saws 2 3/4" dia. x 1" arbor. Thickness from .040 to .071. Cuts wood, aluminum, brass, steel, etc. \$25 Value. Priced at only..... **\$4.95**

HIGH SPEED HAND TAPS

SET 13L 10 Different Size High Speed Standard Thread Hand Taps up to 3/4", including 2 std. High Speed Pipe Taps..... **\$2.95**

Hand Reamers & Tap Handle

SET 14L 10 Different Size Hand Reamers from 1/4"-1". Majority Brand New Plus No. 6 Tap Handle (5/32"-3/4" Cap.). \$30 Value. Only..... **\$9.95**

SET 15L 20 Different Size Hand Reamers as above with Same Tap Handle. Only..... **\$16.95**

8 BRAND NEW CARBON HAND REAMERS

SET 16L From 1" to 1-13/16" including 1 No. 11 Taper Pin Reamer and 1 Large Carbon Expansion Reamer. \$19.95 all for..... **\$19.95**
F.O.B. Tulsa

COMBINATION DRILL AND COUNTERSINKS

SET 17L 8 Different Size from C2 to M1 (1/16 drill x 13/64 body to 7/32 drill x 5/8 body). 60 degree of Countersink. These New Countersinks Sell New from 75c to \$2.50 each. Your price for this set of 8, while they last,..... **\$3.95**

BRAND NEW ROTARY FILES

SET 18L 7 Different pcs. High Speed 1/4" Shanks. (Complete Set for Less Than Cost of 1 Rotary File)..... **\$4.19**

SET 19L 14 Different pcs. as above..... **\$7.49**

BRAND NEW GRINDING WHEEL SET

SET 20L Ideal for 1/4" Electric Drill. Includes one 2" x 1/4" and one 4" x 1/4" Polishing Wheel; six 3/4" x 1/4" 60-grit Grinding Wheels; Six 3 1/2" Sanding Discs. Set includes one Uniform 1/4" arbor to Fit All Items. 16 pcs..... **\$3.95**

BRAND NEW TAPER PIN REAMER SET

SET 21L 4 Taper Pin Reamers, sizes from No. 21L 4 to 0 plus 1/4" Capacity Tap Wrench..... **\$2.95**

SET 22L 2 1/2 FT. FLEX. SHAFT For 1/4" Drill. With 5/16" NF Arbor. Ball Bearing Handle and Arbor..... **\$3.19**

SET 23L 4 Taper Pin Reamers, sizes from No. 21L 4 to 0 plus 1/4" Capacity Tap Wrench..... **\$2.95**

SET 24L 10 Different Size High Speed Morse Taper Shank Chucking Reamers from 1/2" to 1 1/8". Priced at only..... **\$9.95**

SET 25L 15 Different Size High Speed Straight Shank Chucking Reamers from 1/4" to 1". Priced at only..... **\$6.95**

SET 26L 7 Different Size High Speed Slitting Saws 2 3/4" dia. x 1" arbor. Thickness from .040 to .071. Cuts wood, aluminum, brass, steel, etc. \$25 Value. Priced at only..... **\$4.95**

SET 27L 10 Different Size High Speed Standard Thread Hand Taps up to 3/4", including 2 std. High Speed Pipe Taps..... **\$2.95**

SET 28L 10 Different Size Hand Reamers from 1/4"-1". Majority Brand New Plus No. 6 Tap Handle (5/32"-3/4" Cap.). \$30 Value. Only..... **\$9.95**

SET 29L 20 Different Size Hand Reamers as above with Same Tap Handle. Only..... **\$16.95**

SET 30L 30 Selected High Speed Straight Shank Drills from 1/8" to 1 1/4". \$15 value. New and slightly used surplus. Priced at only..... **\$2.95**

SET 31L 10 Different Size High Speed Straight Shank Drills from 1/4" to 1". Extra Long Drills. \$40 value. New and slightly used surplus..... **\$6.95**

SET 32L 20 Different Size High Speed Morse Taper Shank Drills from 1/4" to 1". \$70 Value. Priced at only..... **\$12.95**

SET 33L 10 Different Size High Speed Morse Taper Shank Drills from 1/2" to 1 1/4". \$50 Value. Priced at only..... **\$9.95**

SET 34L 8 Different Size High Speed Morse Taper Shank Drills from 1" to 2" with No. 3, 4 and 5 tapers. \$125 Value. Priced at only..... **\$29.95**

SET 35L 20 different size High Speed Morse Taper Shank Chucking Reamers up to 1 1/2" with No. 1 and 2 tapers. Priced at only **\$6.95**

SET 36L 8 Different Size High Speed Morse Taper Shank Chucking Reamers from 1/4" to 1". Priced at only..... **\$4.95**

SET 37L 10 Different Size High Speed Morse Taper Shank Chucking Reamers from 1/2" to 1 1/8". \$65.00 value. Priced at only..... **\$9.95**

BRAND NEW PUMP & MOTOR

Pump has 1" connections, built-in relief valve, adjustable, up to 1500 lbs. 1 1/2 H. P. 24-volt motor. Can be used on 12 or 36 volts. 500 units available at quantity discounts. Both pump and motor only..... **\$12.95**
F.O.B. Tulsa

MOTOR 2 H. P., 90 amp., 4000 RPM, 24 volt, ball bearing throughout. Double shaft. Adaptable to 12 or 36 volts. Ea..... **\$4.98**
F.O.B. Tulsa

HYDRAULIC HOSE 10 Ft. length of high-pressure hose with 1/4" pipe thread fittings.... **\$3.25**
5 pcs., 14" length, with 5/16" connections, all 5..... **\$1.95**

HYDRAULIC PANEL COMPLETE ONLY..... **\$54.95**
F.O.B. Tulsa

A complete hydraulic mechanism, compactly mounted, connected, ready to go! Includes: 2 1/4 H.P., 4000 RPM, 90 Amp., 24 volt, precision built, ball-bearing throughout electric motor, attached to 1000 PSI, 6 GPM, Pesco or Vickers Pump; one 4-way Vickers Hydraulic Valve; one Vickers Unloading Type Relief Valve; one 1000 PSI Accumulator; one Cuno Oil Filter; one 3-gal. Hydraulic Tank with Visual Gauge; Plus Dozens of fittings and connections, Government cost over \$300. Shipping Wt. 75 lbs. Limited Quantity.

GEAR BOX BARGAINS

Excellent for small hoist or winch, 3/8" sq. for hand crank with 15:1 gear ratio and 1/2 spline for motor drive with 20:1 gear ratio. Large gear 10" in dia. Throw-out type clutch..... **\$9.49**

15:1 GEAR BOX with 1/2" drive spline and throw-out type clutch..... **\$5.49**

8:1 GEAR BOX with 1/2" drive spline and throw-out type clutch..... **\$5.49**

90° HEAVY DUTY GEAR BOX ball-bearing throughout with 1/2" drive spline, excellent for hot rod, power mowers, etc. **\$4.95**

NOTE: All above gear boxes are precision built to stand up to 6 H.P. and some cases much more.

BRAND NEW REX HIGH SPEED TOOL STEEL BITS

1/4 x 1/4 x 2 1/4"	10 pieces	\$2.29
5/16 x 7/16 x 4"	6 pieces	\$1.85
3/8 x 3/8 x 3"	6 pieces	\$1.85
1/2 x 1/2 x 4"	4 pieces	\$1.95
3/4 x 3/4 x 4 7/8"	2 pieces	\$2.49
7/8 x 7/8 x 5 7/8"	1 piece	\$1.95

CUT OFF BLADES

1 1/8 x 3/4 x 6"	\$1.49 ea.
1 1/8 x 7/8 x 8"	\$1.49 ea.
3/16 x 1 x 8"	\$1.79 ea.
3/16 x 1 1/8 x 8"	\$1.89 ea.
1/4 x 1 1/4 x 10"	\$1.95 ea.

HIGH SPEED MILFORD HACK SAW BLADES
These blades are so slightly used that they are practically new. Sold with usual money-back guarantee.

14 x 1 1/4 x .065 x 6 Tooth	Price Ea.	Doz.
18 x 1 1/2 x .072 x 6 Tooth	\$.50	\$5.75
21 x 2 x .072 x 4 Tooth	.75	8.00
24 x 2 x .072 x 5 Tooth	1.00	11.00
	1.25	13.00

COUNTER
Counts up to 9,999,999. Has direct 1:1 ratio worm gear drive. Units are used and were taken from precision gasoline meters. Contains a host of other worm and drive gears. **\$4.49**

PESCO HYDRAULIC GEAR TYPE PUMP
Rated at 3 GPM @ 3750 RPM @ 1000 PSI. Female type drive..... **\$8.98**
Discounts on Quantities

GOOD USABLE HIGH SPEED MILLING CUTTERS

SIDE MILLING CUTTERS				STAGGER TOOTH CUTTERS			
Dia.	Width	Arbor Hole	Price Each	Dia.	Width	Arbor Hole	Price Each
5	3/32	1	2.75	4	5/16	1	\$3.50
5 1/2	5/32	1 1/4	3.50	6	5/8	1 1/4	8.95
7	1	1 1/4	9.95				

PLAIN SLITTING SAWS

45° Angle Cutter - 2 1/2" dia. 5/8" arbor	1	1.50
	4	1.95
	6	3.00

PLAIN MILLING CUTTERS

Dia.	Width	Arbor Hole	Price Each
2 1/2	2	1	\$ 3.00
4	3	1 1/4	9.95
6	3 1/8	1 1/4	26.50
7	3 3/4	1 1/4	39.50
7	5 1/2	1 1/4	49.50

Money-Back Guarantee—All Mds. Mixture of New and Reconditioned Tools Unless Specified Brand New—All Orders (Except Those Specified F.O.B. Tulsa) Are Shipped Post Paid, saving you up to 25% on total delivered cost.

Write for Free Catalog Describing Thousands of Bargain Cutting Tools.

T & T TOOL 221 W. SECOND TULSA, OKLA.

**STRIKES
HARD
AND
FAST**



Light and speedy, the destroyer is built to strike hard and fast—to hit with force and accuracy.

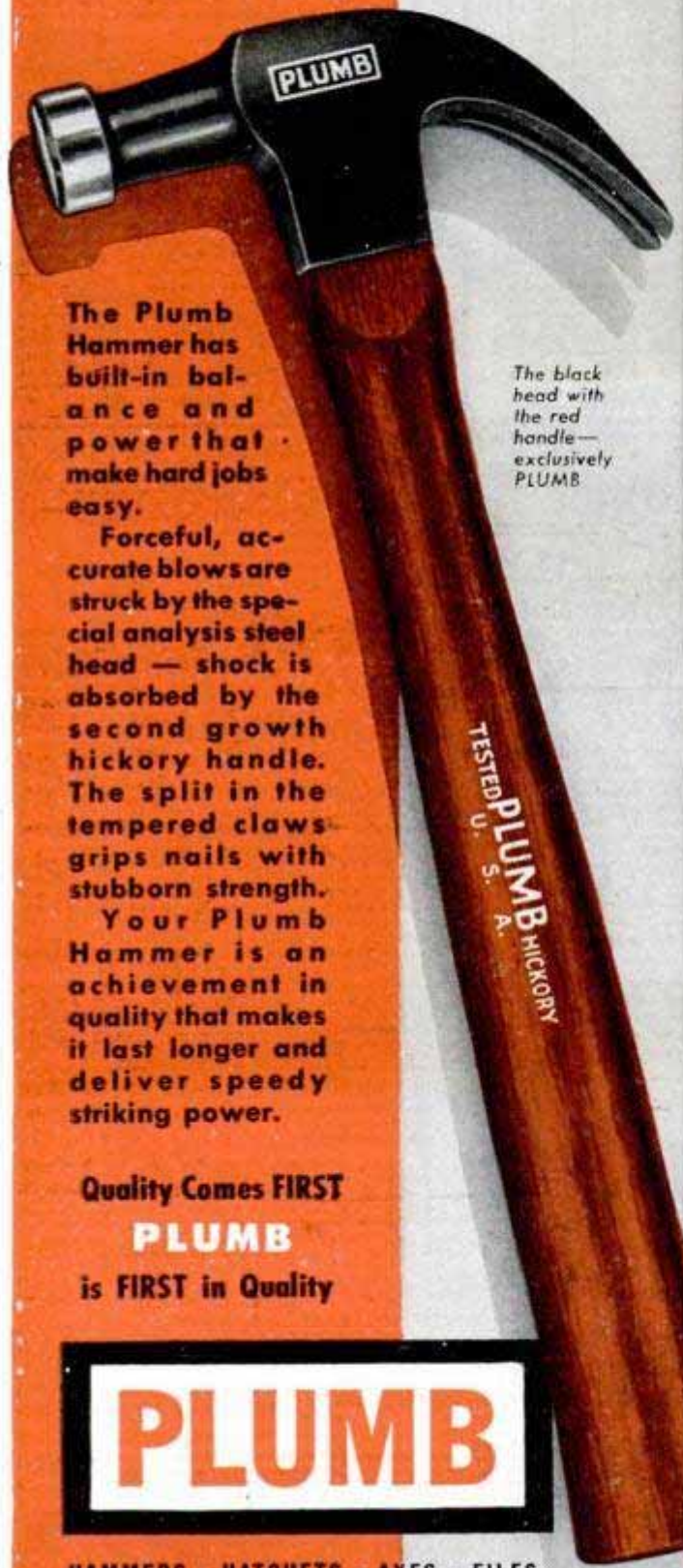

The Plumb Hammer has built-in balance and power that make hard jobs easy.

Forceful, accurate blows are struck by the special analysis steel head—shock is absorbed by the second growth hickory handle. The split in the tempered claws grips nails with stubborn strength.

Your Plumb Hammer is an achievement in quality that makes it last longer and deliver speedy striking power.

Quality Comes **FIRST**

PLUMB

is **FIRST** in Quality

PLUMB

HAMMERS • HATCHETS • AXES • FILES

The black head with the red handle—exclusively PLUMB

LAWN MOWER SHARPENER



lawn mower sharpening at low cost!

Now only **\$34.95** less motor.

turn spare time into dollars

Order direct from **QUAD CITY PRODUCTS Company, Inc.** Box 42, Rock Island, Ill.



**CAPE COD CHAIRS
TRELLISES • ARBORS
DUTCH WINDMILLS**

Chairs style B-C-A PLANS 50c Ea., all 3 only \$1.00. 12 different trellis designs PLAN of all 12 only 50c. Authentic 40" high Dutch Windmill Detailed PLAN only 75c. Unique 40" high Light-house having copper lantern, ideal for garden or on lake shore of summer home. Large detailed PLAN 75c.

SPECIAL ALL PLANS ABOVE \$3.00 VALUE ONLY \$2.50

SEND 10c for catalogue of many fine projects. Dept. P26 **CRAFTSMAN'S MODEL CO. DELAFIELD, WISCONSIN**

MARCOT KEY MACHINE



MARCOT No. 8 KEY MACHINE, less motor... \$110.00
Auto Code Book and Depth Keys... 12.50
75 Dz. Popular Key Blanks... 60.00
Set — Key File, Follow-Through Rods, Lock Picks, Bit Key Gauge, Thimble, Pins, Springs... 10.50
"Locksmith Trade Books"... 6.75
How to Open Locks without Keys or Picks; Secret of Locksmithing; How to Make Keys by the Impression Method; Master Key Systems.

TOTAL COST... \$199.75
A. J. MARCOTTE CO., 1200 N. Kedzie Ave., Dept. PM, Chicago 51, Ill.

LIQUID MARBLE COMPOSITION FLOORS FLEXIBLE MOLDS

Mold, Brush, Trowel, Spray It! MOLD novelties, Statuary, Art Goods in Flexible Plastic Molds; 5c material makes \$1 seller. Make Marbleized floors, Tile Walls. Colorful, glossy, amazing! Easily learned; start in garage or basement. Particulars free. **MARBLEIZING SERVICE, Dept. 10-F, Edwardsville, Ill.**

BUILD HEAVY DUTY MACHINES

SAVE UP TO 90%— You can build, using read plans, all kinds of machines, for home, farm or shop — scooters, portable sawmills, metal working machines, concrete machinery of all kinds, printing equipment, woodworking machines, midget autos, dish washers, farm equipment, freezers, tractors.

FREE CATALOG HANDBOOK 183 SETS OF PLANS VALUABLE INFORMATION

NICHOLS EQUIPMENT COMPANY, D-11 PURVIS, MISS.

DRILL PRESS OWNERS!

HERE'S 1 TOOL WITH 5 DISTINCT USES



THE BARRON MULTI-PURPOSE ROTARY WOOD PLANER

PLANES & SURFACES • PANELS & BEADS **\$7.50**
ROUTS & GROOVES • RABBETS • TENONS COMPLETE

Finest precision performance—certainty of skilled workmanship—time-saving, money saving short cuts—yours with world famous Barron Drill Press Tools. Fifteen important operations—all available on any standard drill press—with Barron Accessories. Equip your shop with these versatile exclusively designed tools—and save up to \$500. 200,000 Barron owners have bought on our liberal 10 day full money back guarantee. Order, or write for catalog. **BARRON TOOL CO. INC. 305 Architects Bldg., Detroit 1, Mich.**

FREE Workshop Guide & Catalog

DELTA
MILWAUKEE

World's standard for quality power tools!

DELTA
UNISAW

— the world's best
10" tilting-arbor saw



- Cuts 3 1/8" thick
- Rips to center of 50" panel

\$254⁰⁰

Without motor or switch
Price subject to change without notice

Extra-plus Delta features like these mean MORE PROFITS to you!



Massive table is heavily ribbed to prevent warping.



Large hand-wheel controls easy to reach and operate.



High motor mounting permits use of safe, narrow saw slot.



Quick-acting table inserts fit in machined openings.



Auto-Set Miter Gage has individually adjustable index stops.



Rip fence locks at both ends for perfect alignment.

... PLUS Super-safe saw guard . . . true-running arbor . . . completely machined saw-carriage trunnions . . . easy-running raising mechanism . . . vibrationless 3-belt drive . . . cabinet-type base . . . other more-for-your-money features.

HERE are reasons why the Delta Unisaw is your best long-range investment. Modern design and precision manufacturing make every Delta Unisaw consistently accurate on continuous operation.

The Unisaw is safe and easy to operate — changes quickly from one job to another — low initial cost.

These 5 Delta Quality Features make every Delta Unisaw "Trouble Free"

1. Lubricated-for-life Ball Bearings. Double-sealed against harmful dust. No oiling necessary.
2. Pre-loaded Bearings. "End-play" is taken out, for greater accuracy, longer bearing life.
3. Precision-bored Bearing Seats.
4. Precision-ground Shafts. Run without "wobbling," assure accuracy.
5. Dynamically-balanced Pulleys. Run without damaging vibration.

See your Delta Dealer. He is listed under "Tools" in the classified section of your phone book.

Free!

Tear out coupon and mail today!

DELTA POWER TOOL DIVISION

Rockwell
Manufacturing Company

803 E. Vienna Ave., Milwaukee, Wis.

Send me free catalogs and bulletins on the complete Delta line of tools and accessories.

Name _____

Address _____

City _____ State _____

B-17



For 1,000,000 HOME OWNERS

UTICA
MagneKit
with
Magnetic
Tool Holder

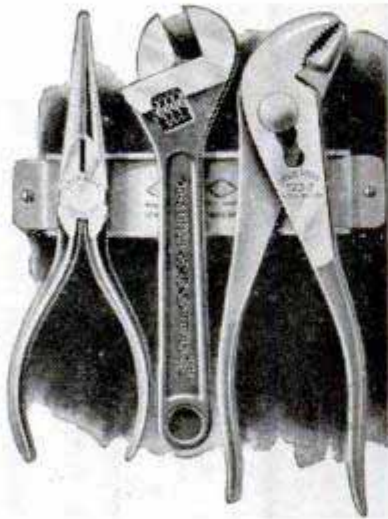

3 high quality tools, on permanent magnetic holder, that should be in every home. A carefully selected trio that performs a multitude of jobs. For workshop, garage, tool house, kitchen, etc. A bargain at \$5.85.

At your hardware dealer's. If he can't supply you, write us.

Utica Drop Forge and Tool Corp., Utica 4, N. Y.



It pays to buy quality tools

And the world's best tools are made in U. S. A.

MOTORISTS—FARMERS—SPORTSMEN
—and for use around the home!

Get a **Big Beam**

Model No. 211



It's the Best
Anywhere...
Any Time...

**For Powerful
Brilliant Light**

Quality built, sensibly priced, long lasting. Has 5" polished chrome lamphead with triple-plated reflector. Weather-proof, rustproof.

HOLD DOWN ACCESSORY
for securely fastening lamp in car trunks, on prows of boats, etc.

See your dealer or write for folder

U-C LITE MFG. CO., 1066 W. Hubbard St., Chicago 22, Ill.

65 KW. 225 Volt D.C. DIESEL ELECTRIC GENERATING UNIT

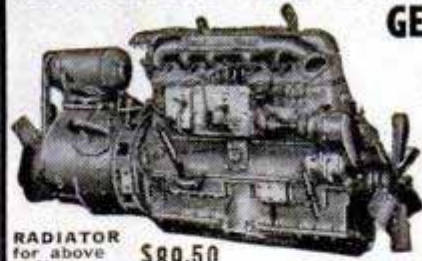

RECONDITIONED

Equipped with 6 cyl. DRXC Hercules DIESEL engine, 4 1/2" bore, 5 1/4" stroke, 133 H.P. at 2000 R.P.M. Complete with injector, pump, nozzles and electrical equipment. Generator attached to engine. Complete as shown.

RADIATOR for above unit..... \$89.50

Ea. \$1375.00
Lots of 2 \$1295.00
ea.....

Write for price on DIESEL ENGINE only.

60 HP. Jeep Engine Reconditioned, tested & Guaranteed in perfect order, ready to run. \$192.50

SEND 25% CASH WITH ORDER, BALANCE C.O.D.

1951 EDITION! It's New! It's Different! Get World's Largest Auto Accessory & Parts Catalog and Save Money! Over 50,000 items— including Hollywood Accessories, Hi-Speed Equipment, Rebuilt Engines, all parts & accessories for all cars & trucks. We have that Hard-To-Get Part! Jam packed with Bargains. Completely illustrated. Send 25c (refundable).

J. C. WHITNEY & CO.

1917SP ARCHER AVE.

CHICAGO 16, ILL.

NU-WAY HEAVY DUTY CUTTING UNIT

with Timken Roller Bearings

PRICE

\$16.50

WHY PAY MORE



Build your own rotary type lawn or weed cutter.

Take the hard work out of weed cutting. Build yourself an up-to-date weed and lawn mower with the Nu-Way heavy duty unit.

Write for Free Circular—We Supply Cutting Unit Complete
TRACTOR-LITE MFG. CO., Spirit Lake, Iowa



The FIFTH Essential Instrument HULL AUTOMOBILE COMPASS

Like your other important instruments, a Hull Automobile Compass gives you... quickly, easily, accurately... a vital fact about your car—the DIRECTION it is going. Know your way, anywhere, with a HULL. Proved dependable for 18 years.

Write for local dealer's name and free literature.

HULL MFG. CO.
P. O. BOX 246-D3, WARREN, O.

Beaconlite[®] \$6.95
Illuminated
STREAMLINE \$4.95
Standard (not ill.)

Have fun! BUILD YOUR OWN CHAMPION



Do what hundreds of others are doing! Build your own sleek racing boat or comfortable pleasure craft in spare time!

Have fun and save a lot of money! Send 25c today for new illustrated catalogue of tested boat plans. 18 trim styles ranging from midget outboards to 20 ft. cabin cruisers. Don't wait. Write now to

CHAMPION BOATS, P.O. Box 7006 15-C, Long Beach 7, Calif.

V-PLEX
AUTOMATIC
TRANSMISSION CLUTCHES

for... POWER LAWNMOWERS,
MOTOR SCOOTERS, GARDEN
TRACTORS, MOTORBIKES, ETC.

The Way to transmit Power Smoothly

WRITE FOR FREE FOLDER

V-PLEX CLUTCHES automatically tighten drive belt as throttle is opened, eliminate belt slippage, cut wear, permit idling engine. Easily installed on any gas engine; practically indestructible. Fit 1/2, 5/8, 3/4" drive shafts. See dealer or write.

MFD. BY V-PLEX CLUTCH DIVISION
LIGHT INSPECTION CAR WORKS — HAGERSTOWN, INDIANA

PRESTO! ANYONE CAN MASTER GLAZE



LEAVES HARD GLASS-LIKE FINISH
SEALS THE PORES OF THE SURFACE
EASY TO APPLY
WILL NOT FINGER-MARK
NO OILY FILM AS WITH POLISH
EASY TO KEEP CLEAN
NO SMEAR OR STREAKS AS WITH WAX
LASTS SIX MONTHS TO A YEAR
SAVES YOU MONEY

Car Owners! Meet Master Glaze—the sensationally different luster for new and used cars! Not a wax—not an oil polish—not a paint!—nothing that “smears” over the surface.

MASTER GLAZE is a unique discovery—a creamy liquid—quick and easy to apply! Gives a hard, glass-like surface. Even gasoline cannot dull it! Lasts six months to a year! Amazing luster—beautiful, sparkling clean and brilliant! Doesn't finger-mark—doesn't smear! A match box full glazes an entire car. Seals the pores—protects! NOTHING LIKE IT!

AGENTS

An unusual opportunity! Quick, flashy demonstrator. Big profits. Good territory. Write today!

FREE SAMPLE

Just send your name and address to
MASTER GLAZE CO., 7720-701 W. Harwood Ave., Milwaukee, Wis.

STOPS LEAKS PERMANENTLY

Cut your fixture replacement, water and fuel bills with Economy Renewable Seats. Make economical, permanent repairs quickly and easily with the Junior Kit (illus.). Repair bathroom, kitchen and laundry fixtures. Everything you need included in steel box. This is a natural for the “Fixit” shops—get extra income from making permanent repairs on your customers' faucets.

Senior Master Kit also available—repairs faucets and valves up to 1" pipe. Write for illustrated circular and prices.

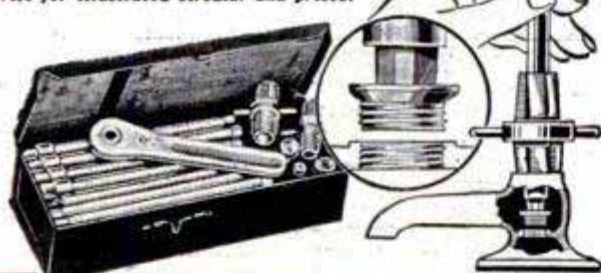

ECONOMY VALVE SEAT CO.

1430 N. Keating Ave. Chicago, Ill.

NEW Coprion SEAMLESS BELL



MAKES YOUR PLAYING Easier! Better!

First and only seamless bell, of superior new metal, made by electro-mechanical process. Impossible to overblow or crack a note! Gives amazingly greater flexibility, richer tone quality, easier response. Exclusive on Conn trumpets, cornets and trombones. Most important development in years. Preferred by the leading artists. See your Conn dealer or write us. Please mention instrument. Conn Band Instrument Div., C. G. Conn Ltd. 331 Conn Bldg., Elkhart, Ind.

Write FOR FREE FOLDER



Quality and Precision
yet Low in Price
that's **Shopmaster** tools

12" Drill Press \$46.95
12" Floor Model Drill Press \$54.00

8" Tilting Arbor Bench Saw . . . \$72.95
Also
7" Tilting Arbor Bench Saw . . . \$45.45
8" Tilting Table Bench Saw . . . \$51.50
10" Tilting Arbor Bench Saw . \$86.95
10" Floor Model Tilting Arbor Saw . . . \$105.00

6" Jointer-Planer . \$79.95
4" Jointer-Planer . \$47.95

15" Jig Saw (Tilting Table) \$27.95

12" Band Saw . \$79.95
10" Band Saw . \$46.95

Saber Saw . \$17.95

Belt and Disc Sander . \$51.50
Spindle Shaper . . \$45.95
10" Wood Turning Lathe . \$45.95

Zone 2 prices, slightly lower in Zone 1.

Write today for full color catalog.



SHOPMASTER, INC.

1214 Third St. S., Minneapolis, Minn.

BUILD YOUR OWN TILTING ARBOR SAW!

Exclusive GIL-BILT Build-It-Yourself Features

- No machining—build easily with hand tools only
- No blueprint reading—step-by-step pictorial plans, full scale patterns, actual photographs
- Sturdy wood, aluminum, and steel construction
- Capacity and performance of commercial saws selling for \$80 and up

SAVE
\$50
OR MORE

GIL-BILT 10-INCH TILTING ARBOR SAW



- 27x28 in. table, 13 1/2 in. capacity in front of blade
- 10 in. blade cuts 3 1/4 in. deep, tilts full 45 degrees
- Floor model 34" high, table always stays level
- New Departure ball bearing arbor, 3/4" precision shaft turned down for 5/8" bore blades, alum. housing, shipped ready to run
- Jackscrew and 4 1/2 in. dia. handwheel lowers and raises blade
- Cast aluminum miter gauge and self-aligning rip fence guide

GIL-BILT Metal Parts Kit includes Plans, ball bearing arbor, miter gauge and bar, rip fence guide, dado insert, lock knobs, jack screw mechanism and handwheel, and all other metal parts (less blade)..... \$20.95
Same Kit with 10" Combination Blade \$24.90
Same Kit with 8" Combination Blade \$23.90

GIL-BILT 8-INCH TILTING TABLE SAW

- 21x27 in. table tilts full 45 degrees, 13 in. capacity in front of blade
- 8 in. blade cuts from 0 to 2 1/2 inches
- New Departure ball bearing arbor, 5/8" precision shaft turned down for 1/2" bore blades, alum. housing, ready to run
- Cast aluminum miter gauge and self-aligning rip fence guide (same as above)



GIL-BILT Metal Parts Kit includes Plans, Ball Bearing Arbor, Miter Gauge and Bar, Rip Fence Guide, Machined Lock Knobs, Tilt Support Segments and All Other Metal Parts (less blade)..... \$15.95
Same Kit with 8" Combination Blade..... \$18.90

GIL-BILT 12-INCH BAND SAW

- Cuts to center of 24 inch circle
- Handles stock up to 6 inch thick
- 18x18 inch table tilts 45 degrees
- Lower wheel and drive pulley runs on sealed New Departure Ball Bearings; Upper wheel runs on two 5/8" bore Oilite Bronze bearings.
- Upper wheel tension and tilt mechanism of cast aluminum, completely assembled.
- Upper and lower blade guides. Each has ball thrust bearing, self-lub bronze jaws
- Rigid cast aluminum wheels fully machined ready-to-install. Heavy rubber tires.
- Uses standard 78 inch blades up to 3/8 in. wide.
- Fully enclosed mechanism for utmost safety.



GIL-BILT Metal Parts Kit includes Plans, rubber tires, aluminum wheels, 1/4 in. blade, ball bearing spindle, tilt mechanism, blade guides, table tilt segments, and all other metal parts..... \$20.95

GIL-BILT BELT SANDER

- 84 sq. in. sanding surface. Over 4 times the effective area of a 10 in. disc sander.
- Belt operates in either vertical or horizontal position, does all sanding operations.
- Driver drum and pulley turn on sealed New Departure ball bearings; tension drum turns on Chrysler Oilite bronze bearings.
- Spindle and tension mechanisms of cast aluminum, completely machined and assembled.
- Belt travels 1800 ft. per min. Over a MILE of straight sanding action every three minutes. Saves more "elbow grease" than any other tool.



GIL-BILT Metal Parts Kit includes Plans, ball bearing spindle, 4 in. driver drum, 3 in. tension drum, tension mechanism, table tilt segments, rubber tires, cloth sanding belt, and all other metal parts..... \$16.95

NO DEALERS—ONE LOW FACTORY PRICE! Return in 10 days for refund of purchase price if not satisfied. Prices include postage within 600 miles. Over 600 miles add 5%. Send cash, check, or money order for parts kit, or send \$1.00 for Step-by-Step Plans and order kit later less cost of Plans. Plans sent postpaid anywhere in the world.

GILLIOM POWER TOOLS

P.O. Box 1-PC, Lambert Field, St. Louis 21, Missouri

COMPLETE
PLANS
only
\$1.00
EACH

TOOLS AT WHOLESALE

DIRECT FROM FACTORY
Full line of top quality, fully guaranteed, chrome, factory-new mechanics hand tools. You save **HALF REGULAR PRICE** for tools of this quality. Our Permanent Price Protection Plan guarantees you wholesale prices.



WRITE TODAY FOR FREE CATALOG

MECHANICS CO-OP

Dept. A OAKLAND 8, CALIFORNIA

GARDEN TRACTORS



SPEEDEX

YOUR CHOICE OF TWO TYPES

8 H.P. RIDING

2 1/2 H.P. WALKING

Exceptionally Low Prices Still in Effect

New catalog gives you full details on the famous Speedex. Illustrates many labor-saving uses. Complete descriptions.

SEND POSTCARD FOR YOUR FREE COPY OF NEW CATALOG TODAY

SPEEDEX GARDEN TRACTOR CO.

BOX 216D1C

RAVENNA, OHIO

P-251-32

DRAINS Cellars, Laundry Tubs; CIRCULATES Oil; IRRIGATES Gardens

Original "Type P" Pump has 2400 GPH capacity. 360 GPH 75' high, or 1500 GPH from 25' well. Use any 1/8 to 1/2 HP motor. DOES NOT CLOG.

Only \$6.95 postpaid if cash with order. (West of Mississippi, add 50c.)

SATISFACTION GUARANTEED OR MONEY BACK!

LABAWCO PUMPS, BELLE MEAD 7, N. J.



DEPENDABLE CRAFT SUPPLIES

WRITE FOR CATALOG SINCE 1928

LEATHER CRAFT • PLASTICS • POTTERY
CRAFT • BLOCK PRINTING • BELT CRAFT •
TEXTILE COLORS • POWER TOOLS • WOOD
BURNING • INSTRUCTION BOOKS • ETC.

DWINNELL CRAFT SHOP

Dept. PM-351—Wheeling, W. Va.



MAKE YOUR OWN FOLDING TABLES • BENCHES • HORSES

WITH **FOLD-A-WAY...**
CHANNEL STEEL LEGS!



Shipped complete, ready to fasten to your top in a minute. **FOLDS** flat for easy carrying or storage. Rubber tipped. Used on the job, in homes, workshops, ping pong tables, camps, boats, trailers, banquet halls, lodges, churches, etc.

SEND FOR FREE CIRCULAR

THE DIAMOND MFG. CO., Dept. PM 1100 ALTAMONT AVE. • SCHEMECTADY 7, N.Y.

\$600 BUILDS 4 ROOMS & BATH!

WHY PAY RENT?

For Six Hundred dollars and 30 days of your spare time you can build yourself this Beautiful Home.



Living room 9x15. Front bedroom 9x10. Back bedroom 10x11. Kitchen 8x10. Bath 5x7. Hall 3x4. Wind out steel Casement windows. Concrete block, stuccoed. \$1.00 brings you Step-by-Step Instructions, Blueprint & Material List.

L. H. FARROW, Dept. C
Box 645 Columbus 16, Ohio



The Modern PLASTIC for lasting Home Repairs

PERMANENTLY mends cracks or holes in wood, tile, stone or plaster. Sticks and stays put—Does not chip, shrink or fall out. Easy to use. Economical. Mold it, chisel it, polish or paint it. If unobtainable from your lumber, paint or hardware dealer, the big 4-lb. can will be sent you postpaid (in U.S.) for only \$1.15. Full money-back guarantee, order now.

DONALD DURHAM CO.
Box 804-O, Des Moines, Iowa

MILLER ROTARY

Hi-Speed / OPE-SAW / DRILL-BIT
ITS SAWS & CUTS REAMS

Presents The Big 3

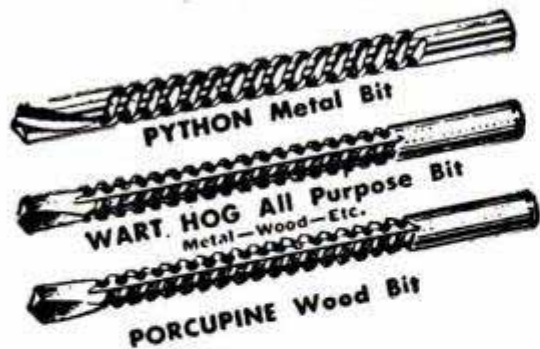

Each \$3.95 ^{Post-paid} 3 for only \$11.50 ^{Post-paid}
Each Bit Performs its own Function Specify Which

SAWS, CUTS, REAMS sheet metal, angle iron, pipe, wood, plastic, Transite, etc. Amazing high-speed combination bit and saw fits any 1/4" or 1/2" electric drill or slow drill press. Drills own starting hole to quickly cut, saw or ream opening. Easy to operate. Ideal for carpenters, auto mechanics, electricians, plumbers, hobby workers, many others. Abrasive resistant high speed steel. No breaking. Will withstand severe continuous use. Resharpener at no charge. 1/4" diameter. Conventional Drill length 3 1/2" with 2" cutting section. Junior Drill length 2 3/8" with 1" cutting section. Router Bit length 1 3/4" with 1" cutting section. Ground from solid. Shipped same day—money back guarantee. Discounts on quantity orders from dealers. Takes place of up to \$50 in tools. SEND CASH, CHECK OR M. O.

Manufactured and distributed by
INTERNATIONAL TWIST DRILL CORP.
624 Wyandotte Rm. 261 Kansas City 6, Mo.
"Pioneers in break resistant short drills"

PYTHON Conventional

Junior

Router

WART HOG Conventional

Junior

Router

SETS WITH
1 Conventional
1 JUNIOR
1 ROUTER
\$8.50
SPECIFY TYPE
PYTHON
WART HOG
PORCUPINE

PORCUPINE Conventional

Junior

Router

ALL NEW 1951 KING MIDGET AUTO

World's Lowest Priced 2 Passenger Car

Drive it for 75c per week. Amazing performance. Surprising comfort. All steel construction. Full accessories, top and heater. Ready to run or assemble it with our bolt together parts. Rider agents wanted, earn your car free. Send 25c for detailed literature or \$1 (refunded first order) for actual assembly book and service manual filled with photos, drawings, specifications, etc.



MIDGET MOTORS MFG. CO.,
ATHENS 1, OHIO

POWER TOOL USERS



don't lose an eye!

There's no second helping when it comes to eyes. Don't gamble with 'em. Save yours from flying wood or metal particles—chips, sawdust, sparks. Wear this MonoGoggle when you are drilling, sanding, grinding. The MonoGoggle gives you complete eye protection. One-piece, wide vision,

plastic lens has high impact strength. The molded frame is flexible—fits your face comfortably. The MonoGoggle weighs only about an ounce and you can wear it, even over prescription glasses, for long periods. Get yours now. Fast delivery from the factory. Send check or money order to

each \$2²⁵

MAIL TODAY!

WILLSON PRODUCTS, INC.
Box 31, Reading, Pa.

I enclose \$____. Send me _____ MonoGoggle (s) postpaid. _____ Send descriptive bulletin.

Name _____

Address _____

City & Zone _____ State _____

MAKE YOUR OWN!

WITH

Griffin READCUT LEATHER PROJECTS

Over 100 KITS in every kind of Tooling and Carving Leather, accurately cut, all parts included. Only Top Grade Leathers used. You do the choosing. You do the tooling, carving, stamping, the punching and assembling.



SEND 25c FOR COMPLETE CATALOG 116 pages, shows all hand craft supplies. 25c refund with first order.

OUT OF THE WEST, THE HOME OF LEATHER CARVING

Griffin CRAFT SUPPLIES
Since 1924 5626-A TELEGRAPH AVE.
OAKLAND 9, CALIFORNIA

EVERYTHING FOR THE LEATHER WORKER

Largest, most complete stock of Leathercraft Tools and Accessories in U.S.A.



HIDES AND SKINS of Craft Leathers of every kind if you prefer to cut your own.



FAMILY AFFAIR... yours and ours

Atkins saws constitute a family — a family of merchandise priced to give the best value, the most satisfaction. In the Atkins family there is a saw for every purpose — and for every person in your family! . . . The Atkins family includes big saws and little saws, pruning saws and crosscuts, band saws and circular saws — saws to cut metal and saws to cut wood! . . . Every family needs one or more good saws. And when it comes to good saws, it will pay your family to ask your hardware dealer for Atkins "Silver Steel" saws, the best values that money can buy!

E. C. ATKINS AND COMPANY
Indianapolis 9, Indiana

irha
HARDWARE WEEK
APRIL 12-21, 1951
QUALITY! VALUE!

Only **ATKINS** makes
"Silver Steel"
products

ATKINS



THE UTILITY TRACTOR OF 1000 USES

Gibson provides you a tractor to do a thousand jobs faster, better, more economically. Rugged simplicity... low maintenance... versatility for every need produce sustained and consistent profits.

WRITE FOR FREE GIBSON SPECIFICATIONS AND CATALOG OF IMPLEMENTS

DEPT. PM-151

GIBSON MANUFACTURING CORPORATION
LONGMONT, COLORADO

BRUSH PLATING OUTFITS

for re-plating articles in the home and shop. No tanks necessary. Free particulars.
GUNMETAL CO., AVE. M, DECATUR, ILLINOIS



BARGAIN! BRAND NEW! SPINNER!

only **\$57⁵⁰** Save **\$25!** REG. \$82.50
7-in. disc

While They Last — Direct From Manufacturer
Uses 7-in. or 9-in. disc — Sands, grinds, wire brushes, etc. Makes tough jobs easy. 3/4 h.p., Heavy Duty Motor. 10-day, money-back guarantee. No C.O.D. Send check or M.O. TODAY — while they last! Californians add 3% State Sales Tax

HOLT MFG. CO. 651 20th Street | 272 Badger Avenue
Oakland 12, Calif. | Newark 8, New Jersey

ONE-MAN SAWMILL LOW \$50⁰⁰ AS... \$50⁰⁰ DOWN



Take **BELSAW** Portable Sawmill right to the trees — turn out valuable lumber for local yards — do "custom sawing" for neighbors. **BELSAW** lasts a lifetime. No crew needed. Power with old auto engine. Beginners get excellent results. Send postcard for **FREE BOOK**, "How To Make Lumber."

BELSAW MACHINERY CO
8116 Field Bldg., 315 Westport Rd., Kansas City 2, Mo.



2 DRILLS IN 1

This attachment gives you two drills in one. It converts any 1/4 inch electric drill to 1/2 inch capacity. Reduction gears reduce the drill speed 5 to 1, the average speed of a 1/2 inch drill, and thereby increases the power. Absolutely indispensable for all shop work and home craftsmen. Satisfaction guaranteed. Order yours now.....

Send check or Money Order with order. Jobbers write for special information. **\$11.95** post paid

G. M. CO. MANUFACTURING, INC.
1308 43rd AVE. LONG ISLAND CITY 1, NEW YORK

Sale! WAR SURPLUS BARGAINS Sale!

BUY NOW and SAVE BRAND NEW! WAR SURPLUS LIGHT PLANTS

BE PREPARED

for any emergency!

Use for: Farms, cottages, stores, garages, floodlighting, drilling rigs, refineries, house trailers, fire departments, sound trucks, yachts, tugs, construction, airports, police radios, etc.

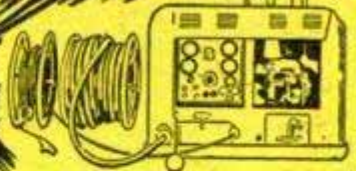

SENSATIONAL BUYS at 50 to 75% savings

LIGHT PLANT BUYERS, in emergency telephone collect —unit shipped same day!

300 WATT, 110-220 volt AC, 60 cycle light plant powered by 1 HP gas engine, direct drive. Mounted base, weight 40 lbs., just right for bomb shelter or P. A. system. New Stock #409 \$99.00

750 WATT, AC 110 volt, 60 cycle, direct drive, air cooled, Briggs & Stratton gas engine, Model AP, Pioneer generator, radio filter, self exciter, rope start, 190 lbs., 20" long, 17" wide, 16 1/2" deep with carrying handle. New, Stock #573 \$232.00

2500 WATT, AC 115 volt, 60 cycle, single phase. ENGINE: Briggs & Stratton, air cooled. 6 1/2 HP. GENERATOR: Kurts & Root or Leland, belt drive. Complete with \$30.00 worth of spare tools, instructions and fully GUARANTEED. Was formerly priced at approximately \$710.00. Now priced for you NEW. War surplus, at only \$345.00. Reconditioned \$295.00. Plants built in 1951 \$426.00. To make plant 110-220 add \$48.00 for transformer.

3000 WATT CONTRACTOR'S PORTABLE, Briggs & Stratton 5 to 7 HP gas engine with Devo generator and rubber tired wheels. Rope start, weight 275 lbs. Used like new at \$220.00. NEW \$279.00

5000 WATT, 120 volt, 60 cycle AC. HERCULES 4 cycle gas engine. Generator mfr'd

by Hobart Bros. Unit includes remote control cable, 150' 2-wire #6 and 150' 3-wire #18, exhaust pipe, power cable plug, KVA at 80% power factor, radio and television filtered. Unit is completely automatic. List price today \$1910.00. Now priced for you at \$675.00 used. NEW \$895.00. To make plant 110-220 add \$72.00 for transformer.

7500 WATT, 110 volt AC, 60 cycle, powered by a VE 4 Waukesha 4 cyl. gas engine. Continental or Hollinsworth generator. Remote control starting. Complete with switch board. NEW \$995.00. To make plant 220 volt, 3 phase, add \$76.00 for transformer.

10,000 WATT, 110-220 volt AC, 60 cycle. Remote control. Powered by a Jeez 4 cyl. gas engine. Used but like new \$1195.00. NEW \$1495.00.

25,000 WATT, 220 volt AC, 3 phase, or 110-220 volt single phase. Used but like new and GUARANTEED \$1995.00. NEW \$2495.00.

35,000 WATT, 110-220 volt, Diesel. Rebuilt, \$2995.00.

50,000 WATT, Cummins Diesel generator, 240 volt, 3 phase, 60 cycle, AC, 1200 RPM, 150 amps. Rating 50% continuous exciter. NEW. GUARANTEED \$8900.00.

SPECIAL! HOT ROD SUPERCHARGER

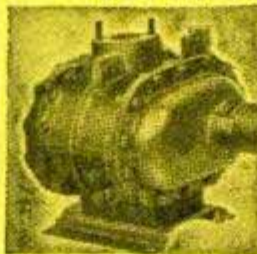

Here's a hot rod supercharger at a price you can't afford to miss. SEE HOW THIS TYPE SUPERCHARGER IS USED IN PICTURE and ARTICLES on Page 67 AUG. Issue of POPULAR MECHANICS. Mfg. by Borg & Warner. S P C P I. A. TIONS: 7 1/2" wide, 5" deep, 7" high. Weight 17 lbs. Compact and sturdy, 4 base mounting holes, 3/4" outlet, 5/8" shaft. Includes female Lovejoy coupling. Priced today at \$85. OUR SPECIAL SALE PRICE ONLY \$19.95

sturdy, 4 base mounting holes, 3/4" outlet, 5/8" shaft. Includes female Lovejoy coupling. Priced today at \$85. OUR SPECIAL SALE PRICE ONLY \$19.95

HEAVY DUTY ELECTRIC CABLE

Electric rubber cable, 16 cond., No. 18, solid, 100 feet or more, per foot \$.16
Electric rubber cable, 10 cond., No. 18 solid, 100 feet or more, per foot \$.10
Electric rubber cable, 4 cond., stranded, No. 18, water and oil resistant; run in parallel No. 16; 100 ft. \$6.25; 250 ft. \$12.50; 500 ft. \$25.00; 1320 ft. reel \$56.00
Electric rubber cable, 3 wire, stranded, No. 10; 65 ft. with lugs, Val., \$46.00 \$26.00
Electric rubber cable, 3 wire, stranded, No. 10, submarine cable, underwater, underground, overhead—50 ft., \$20; 100 ft. \$40; 250 ft. \$100; 500 ft. \$200.00
Electric rubber cable, 3 wire, stranded, No. 6—150 ft. reels, with 1 male connector; 2 female, crouse hinds connectors— \$125.00
Value \$300.00
Electric rubber cable, 2 wire, No. 4—75 ft. lengths, male & female connectors \$75.00

HORNS and HOWLERS



Motor driven, (not a vibrator). Heavy duty with great power and long life. Adjustable for high, medium or low tone. 110 volt AC current. Weather proof. For alarm or signal horn on boats, school yards, factories, air raid siren, etc. List price \$47.00. NEW. Stock #302. Your price \$15.45.

STAINLESS STEEL TUBE

HALF PRICE — 6' to 10' Lengths

SIZE	O.D.	WALL	MILL PRICE	OUR PRICE
1/4	3/16	01508	51c Ft.	Ft. 25c
3/8	11/32	01301	63c Ft.	Ft. 32c
7/16	13/32	01508	70c Ft.	Ft. 35c
1/2	15/32	01205	72c Ft.	Ft. 36c
3/4	11/16	05001	91c Ft.	Ft. 46c
7/8	1-3/16	03125	1.01 Ft.	Ft. 50c
2 1/2	2-7/16	05000	2.74 Ft.	Ft. 1.37



"MALL" PORTABLE Flexible Shaft Grinder

1/2 HP, 3450 RPM 110 or 220 volt dustproof motor mounted on universal swinging trunion. Heavy base has a convenient tool tray and large, easy rolling casters. Flexible shaft is equipped with both full speed, angle spindle and straight spindle. List price \$172.00. Your price with all attachments \$99.00.

AIR COMPRESSORS

Gas or electric. Awarded from government.

1/2 HP	12 gal. tank	\$ 99.00
1 HP	50 gal. tank	\$239.00
1 1/2 HP	50 gal. tank	\$265.00
2 HP	50 gal. tank	\$295.00
3 HP	60 gal. tank	\$410.00
5 HP	60 gal. tank	\$485.00
7 1/2 HP	80 gal. tank	\$675.00
10 HP	80 gal. tank	\$775.00

and other bargain items

HEAVY DUTY GRINDER 1 HP, 1800 RPM, 3 phase, 220 Volt 60 cycle, 20 ft. cord, 24" Long. GUARANTEED. Mfg. by Thor & Chicago Pneu. Special SALE PRICE.....\$29.50

BLOWER and MOTOR. Enclosed squirrel cage type for cooling, heating, suction or blowing. Ball bearing Redmond Motor, 1550 RPM. Discharge 3"x3". Intake 5". Weight 9 lbs. \$11.95

PORTABLE HEATERS for Contractors, Lauson gas engine with supercharger blower \$179.00

PREVENT FROZEN WATER PIPES! Thermostat with 60 ft. of flexible, (wrap around) lead heating cable \$19.95

HEATING SPECIALS! HEAT CONTROL



Made by Minneapolis-Honeywell—a name known for the best in controls. 1000 watts—115 to 220 volts. Element length 10 ft. Range 70° to 212° Fahrenheit. Control fans, motors, furnaces. This control makes an ideal automatic combination when hooked up to the heat boosters below! List price \$16.00. Your price \$4.95

HEAT BOOSTERS



Fits any 8", 9", 10" furnace pipe. 1500 RPM motor with 6" cord, mounting frame, 7" blade. Motor 110 volt 60 cycle 1550 RPM. Easy to install. Silent operation. Warm those rooms with long runs. Stock #583. Regular \$11.95. Your price \$6.95

10" ball bearing fan Mfg. by Redmond. Can be run vertically or horizontally. 110 volt AC 60 cycle motor with plug and cord. New in original box. Use it for the kitchen as an exhaust fan, heat booster, etc. High pitch blade, 1/25 HP 1550 RPM. only \$11.95



Automatic Control Ventilator

For BARNs, ATTICS or BASEMENTS. Increases cows milk production.

20" fan driven by 1/4 HP motor. Switches and thermostat similar to heat control at upper left included \$89.50

Available in other sizes.

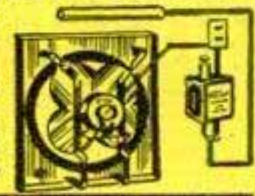

GEAR REDUCER

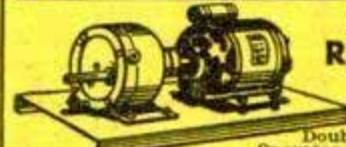

Double reduction. Operates on any 1/6 to 1/2 HP electric motor.

22 RPM. Can be used as winch, barbecue, dummy elevator, operate turntable, electric garage door opener, television antenna. REGULAR \$45.00 NOW ONLY \$22.00

JARVIS GRINDER



Three phase, 220-440 volt, with flexible shaft; 3450 RPM Totally enclosed motor. 1 HP List \$165 Now \$65.00 1 1/2 HP List \$195 Now \$75.00 2 HP List \$225 Now \$85.00 1/2 HP, 110 Volt stand & shaft. \$39.50

ELECTRIC WATER HEATER

IMMERSION TYPE—Heats water for shaving, washing; keeps tanks, troughs from freezing, etc. Mfr'd by Westinghouse or Calrod—110 volt AC, interchangeable 312—625—1250 WATTS. List price \$21.00. Your price \$3.95.

CLUTCHES

For Motor-scooters, Motor-bikes, Lawn Mowers, etc. Mercury centrifugal clutch for use with any small gas engine. 3" "A" belt pulley, 5/8" bore. Brand new only. Stock #400. 3/4" bore. NEW \$9.95 1" bore \$11.95



ROCKFORD CLUTCH Manual bronze throw yoke 1 1/2" bore, 1" female spline; 5" long, 5 1/2" OD. Takes to 25 HP. PRICE ONLY \$20.00

BALL BEARING ARBORS



Grinding and saw arbor, has 1/2" double end shaft, 1 1/4" long with 2" center pulley. New Departure double roll ball bearings. Right and left hand thread. Self aligning Dodge pillow block. 10,000 RPM. Bearings alone list at \$10. Complete arbor new. Stock #305 only \$6.95

GENERATORS



300 Watt, RPM 3400, 110 and 220 volt, 1/2" shaft \$40.00; 2500 Watt, RPM 1800, 115 volt AC \$235.00; 3000 Watt, RPM 2800, 110 volt DC Delco ball bearing, 1" shaft. List \$343.00 to you at only \$99.00

ALL ITEMS GUARANTEED C & H ELECTRIC Co. AS REPRESENTED

434 W. JUNEAU AVE. MILWAUKEE 3, WISCONSIN

All prices F.O.B. Milwaukee, 25% deposit required on all C.O.D. orders. No C.O.D.'s under \$10.00. Use stock number when ordering. Many other bargain items not listed—write for our free circulars.

AMAZING TOOL BARGAINS!

ALL BRAND NEW MERCHANDISE

SURPRISE VALUE

100 Pieces \$1.00

FOR ELECTRIC GRINDERS



Grinding Wheels, Cut-off Wheels, Sanding Discs, Mounted Stones, Sharpening and Honing Stones, Rotary Cutting Burs, Abrasive Cartridges, Mandrels, and many other items.

Post Paid in U.S.A.

2 CIRCULAR SAWS \$1.50

ON 2 MANDRELS— ALL AT ONE LOW PRICE

1" diameter saws on 3/8" Mandrels. For cutting wood, plastic, or soft metals. Order at once! Send Check or Money Order.

7 HIGH SPEED STRAIGHT SHANK DRILLS \$1.00

15 Drills for only \$2.00! Order Today! Postpaid in U.S.A.

7 Popular Sizes— up to 1/4". Brand new, ideal for home or shop use. Fits all standard chucks.

12 MINIATURE CUTTERS \$1.00

FOR CUTTING WOOD, PLASTIC, or METAL

Actual size. Asst. shapes on 3/32" shank. For die makers, home workshop, etc.

2 DRUM SANDERS \$1.50

With 12 Bands in Assorted Grits. 1/2" dia. x 1" long on 1/8" arbor with 12 bands.

ONE DRUM, 1" DIA. x 1" LONG ON 1/4" ARBOR WITH 6 EXTRA SLEEVES \$1.00

P.P. in U.S.A.

12 MOUNTED WHEELS \$2.95

and points on 1/8" Mandrel. For grinding on plastic, wood, soft and hard metals. Regular \$8.40 List Val. ONLY

ADAPTER CHUCK \$1.50

With 2 interchangeable collets, opening from 3/32" to 0, on 3/32" mandrel. Price each, only

112 Piece Assortment for Electric Grinders \$7.50 VALUE... ONLY \$3.95

Here's what you get! 6 mounted stones on 1/8" mandrel, 1 Drum Sander, 6 sanding sleeves for sander, 3 Rotary Cutters, 1 wire scratch brush, 2 bristle brushes, 1 circular saw, 1 Buffing Wheel, 1 Grinding Wheel, 1 Rubber Polishing Wheel, 6 cut-off wheels, 1 rubber cylinder, 6 mandrels to fit above tool. 75 asst'd sanding discs, 1 sharpening stone.

SCHUPACK SUPPLY CO., 7331 Cottage Grove, Dept. M-16, Chicago 19, Ill. ILLUSTRATED BARGAIN CATALOG 10c

Say You Saw It in Popular Mechanics

WELD

BRAZE, SOLDER, and CUT →

ONLY \$11.95 F.O.B. complete!

EASILY... QUICKLY!

FOUR-WAY WELDER

ORDER NOW 10 DAY TRIAL

No experience needed. Follow simple instructions, weld on iron, steel, bronze, brass, aluminum, and other metals. Plugs into any properly wired 110 volt A.C. or D.C. line. Make or save time and money doing repair work for yourself and others. Repair men, farmers, tinsmiths, home and auto owners, hobbyists, etc., say FOUR-WAY pays for itself over and over. Order today or send for Free details.

FOUR-WAY WELDER COMPANY, Dept. F2-CB
2326 So. Michigan Ave. • Chicago 16, Illinois

EASY AS A-B-C...

... to make furniture for your home, or for gifts, with Rogers how-to-do-it woodworking plans. They're easy to follow!

You also get a full size bottle of Rogers famous Gorilla Grip glue—all for only 10c! Your furniture will last a lifetime with Rogers. It has a ton of strength in every drop. Ask for Rogers at your local Hardware Store.

Don't miss this great offer! Send 10c today to Rogers Isinglass and Glue Company, Gloucester, Mass.

The Glue With the Grip of a Gorilla!

ROGERS
the best LIQUID FISH GLUE
GLOUCESTER, MASS

CARBURETOR TOO RICH MAKES MOTORIST TOO POOR

Car owners who are wasting money and not getting proper gas mileage due to over-rich mixtures will be pleased to learn how to save gasoline by VACU-MATING over-rich mixtures. VACU-MATIC fits all cars, trucks, and tractors. It is automatic and operates on the supercharge principle. Easily installed in a few minutes.

SALESMEN WANTED! Big Profits! Send name, address on penny postcard for free particulars and how to get yours for introducing.

VACU-MATIC CO., 7617-1725 W. State St., WAUWATOSA, WIS.

GREENLEE
HANDY CALCULATOR

HANDY CALCULATOR FOR WOODWORKERS.. ONLY 10c

Just set dial, quickly solves countless problems. Converts linear to board feet, compares workability of various woods, shows bit sizes, nail specifications. Also tool sharpening tips, etc. 6" diameter heavily varnished cardboard. Send 10c to Greenlee Tool Co. 2103 Columbia Av., Rockford, Ill.

Dico BUFFS and COMPOSITIONS

FOR USE IN THE HOME WORKSHOP

INTRODUCTORY KIT • Contains 2 big 6" Buffing

ONLY \$2.59

- Wheels, 2 tubes composition, 4 spindle flanges, Buffing Manual.
- AT YOUR HARDWARE STORE, OR ORDER DIRECT FROM

Cash or Money Order: **DIVINE BROTHERS CO., Dept. B-351, UTICA 1, N.Y.**

Easy and Cheap to Operate

PLOW

CULTIVATE

SHAW MFG. CO.

SAVE TIME, WORK, MONEY!

SHAW

DU-ALL

and "PEPPY PAL" TRACTORS

These rugged walking or riding tractors are ideal for farm, truck garden, orchard, poultry farm. Operate on a few cents an hour. A child can handle them.

DO DOZENS OF JOBS Both riding and walking tractors quickly and easily plow, cultivate, harrow, disk, bulldoze, spray, haul, grind, saw wood, etc.

LOW FACTORY PRICES Buy direct or through your dealer. Year's guarantee!

RIDING TRACTORS 4 models from 5 to 12 1/2 H.P., 58 in. wheelbase, 36 to 52 in. wide, 24 in. plant clearance. Hand or electric starter. Walking Tractors 1 1/2 to 5 H. P.

FREE Illustrated folders giving complete details and price lists—write today!

4503 FRONT ST., GALESBURG, KANS.
668G NORTH 4TH ST., COLUMBUS, O.

**MAKE MONEY
SAVE MONEY
BUY
SUPERSHOP**

**15 DAY
TRIAL**



8" TILTING
TABLE SAW

GRINDER

SANDER

30" LATHE

HORIZONTAL
DRILL PRESS

BUY SMART — \$59.95
FACTORY TO YOU

SUPERSHOP offers you a lifetime of power tool pleasure and profit. 100% ball bearing. RUGGED. Accurate. Big capacity. 15 day FREE trial. Money back guarantee. Mail postcard for FREE catalog.

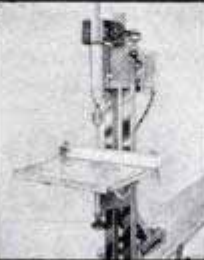

POWER TOOLS, INC.

121 YATES AVENUE
BELOIT, WISCONSIN

VERTICAL
DRILL PRESS

TUBELESS Personal RADIO

POCKET SIZE! GUARANTEED to play on local stations

- No Tubes
- No Batteries
- No Electricity



Costs nothing to run, lasts indefinitely. Range up to 25 miles (some users report up to 50 miles on 50,000 Watt stations). New Germanium Diode crystal detector—same as used in Army, Navy Radar sets. Extra sensitive stethophone. Designed, mfgd. by an internationally known electronic engineer. Beautiful red plastic case with green trim. Single-control tuning, has rich, mellow tone. Just hook it up on simple instructions—it plays instantly, never turns off. Nothing to wear out; should last years. Everything complete. \$5.

Send \$1 plus small C.O.D. cost & postage.
Pay postman \$4 balance

Patrick Laboratories, Inc.

2450 E. 52nd St., Indianapolis, Indiana — Dept. PM-3

**EVERY ELECTRIC DRILL
A PORTABLE SAW**

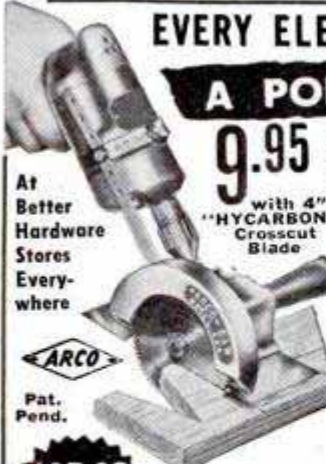

At Better Hardware Stores Everywhere

ARCO

Pat. Pend.

'ARCO SAW'

9.95 Can Be Used With One Hand!
Any 3/4" or 3/8" Drill a Powerful Saw in ONE MINUTE

"ARCO-SAW" is a rugged tool with right angle gear drive (no clumsy, dangerous, direct drive with drill sideways). Works like a high priced Portable Saw.

CUTS 1-5/16", or 2x4 by turning over ONLY ARCO GIVES YOU ALL THESE FEATURES: Safety-yoke assures rigid connection and absolute safety—Big handle affords firm grip for two-hand operation—Precision one-piece gear box—Self-lubricating lifetime bearings—Visual guide and wide shoe-plate for straight, square cuts—Lowest priced, quality Replacement Blades.

"HYCARBON" 4" Crosscut or 4" Combination Blade . . \$2.00 ea.

90-day Factory Guarantee

ORDER TODAY at your dealer or send us check or M.O. (Postpaid). C.O.D.'s—Postage extra

UNCONDITIONAL 10-DAY MONEY BACK GUARANTEE

DEALERS—Write for nearest jobber.

ARROW METAL PRODUCTS CO.

DEPT. PM-3, 140. WEST BROADWAY, NEW YORK 13, N. Y.

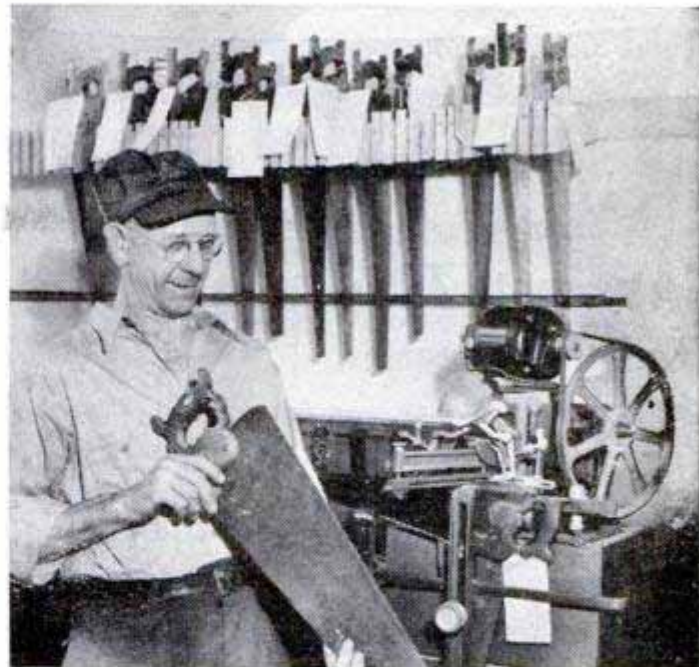

**OWN
YOUR BUSINESS**

**Start in Spare Time with a
FOLEY SAW FILER**

Here is a steady repeat CASH business you can start at home in your basement or garage, while you are working at your regular job. No experience is necessary to turn out perfect cutting saws—"the first saw I sharpened came out 100%. I think the Foley Saw Filer is a marvel of perfection," writes Clarence E. Parsons. Every saw you sharpen will bring you new customers. You will find you can make up to \$2 or \$3 an hour—\$20 to \$30 a week in your spare time as a starter.

With a Foley Saw Filer you can file all hand saws, also band and cross-cut circular saws. It is easy to operate—simple adjustments—no eye-strain. Patented jointing principle evens up all irregular teeth and makes an old saw cut just like new.

**This Free Book
Shows How to Start**

"INDEPENDENCE AFTER 40!" shows you how to get plenty of saws to file without canvassing, and how you can develop into a general repair shop that will be your own business. This is a helpful, practical book that tells just what to do—send for your free copy today. No salesman will call.



Send For FREE BOOK

FOLEY MFG. CO., 316-1 Foley Bldg.
Minneapolis 18, Minn.

Send me free book "INDEPENDENCE AFTER 40!"

Name _____

Address _____

Gigantic "Warehouse Remodeling" MAIL SALE

SAVE up to 70%!

Check these bargains:



Power Plants and Generators

• Homelite 115-v, 400-c Light Plant. Complete. Brand new, with tools, parts, manual. Ideal for lights, heaters, radio campers, contractors, etc. Cost Gov't. \$645. **\$129.60**

• Army Portable Power Plant. 600-800-w, 115-v, 60-c. Push-button start. Nearly new. Cost \$390. **\$172.90**

• D-C Arc Welder. 0-250 amps. Drive with tractor, engine, etc. Ready to use. Built-in controls, reactor. Brand new. **\$99.50**

• Build Welding Generator. Delco-Remy, 200 amps, 30-v. Full instructions. Includes control, fan, etc. Cost \$296. **\$29.89**

(Power plant bargains—500-w to 25 k.w.—write)

We Pay Shipping Charges



Winches, Clutches, Transmissions, Engines

• Gas Engine. 2-cycle, 1 h.p. Finest design. **\$26.90**

• Gas Engine. Briggs 1.5 h.p. Model N. **\$36.90**

• Power Winch. 80-to-1 ratio, 5000-lb. cap. Mounts on front trucks, jeeps, cars. Cost over \$175. **\$24.95**

• Hand Winch. Finest steel. Powerful. Complete with 3,000-lb. 50' cable. 1 to 3 ratio. **\$29.95**

• Same Winch, dual ratio 1-3, 1-9. **\$39.50**

• Winch Snatch Block. 3,000 lb. cap. Roller Bearings. **\$ 5.50**

• Utility Clutch. Engine end takes 1" shaft. Drive end, 3/4". Handles engines or motors up to 6.5 h.p. **\$13.95**

• V-Belt Clutch. 1/2", 3/8" or 3/4" shaft size. Up to 1.5 h.p. **\$ 7.50**

• Speed Reducer. Drive at 1750. Gives any speed 0 to 450 RPM. **\$19.95**

• Pulley Clutch. 3 h.p., 4 1/2" pulley, easy release. A buy! **\$ 7.95**

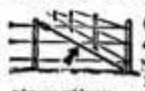

SPECIAL! FLEXIBLE GUY and TURNBUCKLE GUY

New 12-ft. 48-strand, 1/8" galv. steel cable, 1000-lb. strength, 14-in. turnbuckle. Guy, strengthen . . . gates, fences, buildings, wagons, television towers, etc. Cost Gov't. \$1.10 each. Special . . . 10 for **\$3.89**; 50 for **\$16.47**; 100 for **\$29.32**.



Water Pumps and Systems

• Bronze Rubber Rotor, All-Purpose Water Pumps. Stainless steel shaft. Pipe thread. Self priming. High efficiency.

1/2", up to 25 PSI, up to 6 GPM. **\$12.75**

3/4", up to 25 PSI, up to 10 GPM. **16.95**

1", up to 25 PSI, up to 19 GPM. **22.95**

• Bronze Nylon Roller Pressure Pump. Stainless steel shaft. Pipe thread. Self priming. Positive displacement.

1/2" up to 100 PSI, over 5 GPM. **\$14.50**

3/4" up to 150 PSI, over 8 GPM. **20.95**

1" up to 150 PSI, over 17 GPM. **27.95**

• Low Cost Centrifugal Pump, over 15 GPM. **\$6.85**

• Hi-Efficiency Cent. Pump. Garden hose thread, over 15 GPM **\$11.95**

• Fadden Centrifugal Pump, bronze, stainless steel shaft. 3/4"x1 1/2", 30 GPM, **\$28.80**; 1x3/4", 45 GPM **\$37.60**; 1 1/4"x1 1/2", 60 GPM **\$46.50**

• Water System. Automatic, finest 110-v, 60-c motor. 22' lift. 300 GPM. 30 lbs. Fresh water instantly. No tank needed. For cabins, cottages, farm homes, etc. **\$69.50**

(Write for free pump circular. Give details your problem.)



Air Compressors and Spray Equipment

• DeLux Air Compressor. Pressures to 150 lbs. Capacity to 3 c.f.m. Single cylinder. 2" bore, 1.75 stroke. **\$18.15**

• Build Your Own Compressor. 1-cyl. piston compressor, stainless 13"x25" tank, 160-lb. gauge, paint spray gun, blow gun, tire chuck, 1 1/2" hose, fittings and manual. **\$36.90**

• Stainless Steel Air Tank, brand new, not used, 13"x25", 400 lbs. **\$ 8.95**

• Brass Check Valve, (dash pot non-chatter type). **\$ 3.75**

• Brass Adjustable Pop Off Valve, 25 to 250 lbs. **\$ 1.49**

• Automatic Pressure Regulator (0 to 150 lbs.). **\$ 2.49**

• Automatic Pressure Motor Switch, on 115, off 150 lbs. **\$ 5.87**

• Finest Pressure Gauges (air or water) specify pressure—60, 100, 160, 300 lbs. **\$ 1.89**

• DeVilbiss Air-Solvent Engine Cleaner, \$14.95 value. **\$ 8.96**

(Write for paint spray equipment bulletin.)



Weed Spray Unit

• All-brass 14-foot boom, 4-row, tee jets, bronze direct-drive gear pump, etc. Cost \$139.50. **\$69.90**

Mechanical — Electrical — Electronics

• Rural Phone. Magneto, 5-bar, 1600-ohm, wall type. **\$12.40**

• Private Phone. Magneto, desk, many uses. **\$11.60**

• Field Telephones, EE-8. Latest type. **\$15.90**

• Army Switchboard, 12-line, small hotels, factory, etc. **\$33.50**

• Insulated Wire. Twisted pair, outdoor type (100-ft.). **\$ 1.39**

• Stone Job Lot. 12 finest Norton wheels, 1" to 4". **\$ 3.89**

• Mounted Stone Job Lot. 4 mounted stones, 1 wire brush (3/4"). **\$ 2.19**

• Rotary File Kit Lot. (1/4") 8 Assort. tool steel units. **\$ 3.26**

• Electric Water Heater. 5 1/2 gal 110-v. 1200-w Guar. **\$49.50**

• Tractor Weed Spray Unit. Complete, finest 17 ft. outfit. **\$99.50**

• Motor 2 H.P. 24-v. D-C. Double shaft. 4000 RPM. **\$10.89**

• MotorGyro, 24-v, D-C, 10,000 RPM. Fascinating! **\$ 1.98**

(Hundreds other electrical-radio-mechanical bargains.)

ORDER DIRECT FROM AD or Write for Free Catalog!

BURDEN SALES COMPANY

805 "O" ST. LINCOLN, NEBR.

FREE CATALOG

YOU DOUBLE THEIR VALUE

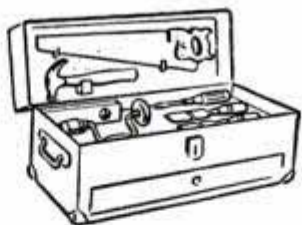

Because your vise is really a multi-purpose tool—used as a "partner" with so many other hand and power tools—it's important that you buy the vise that gives you the most durability and convenient features.

WITH THIS BASIC SHOP TOOL

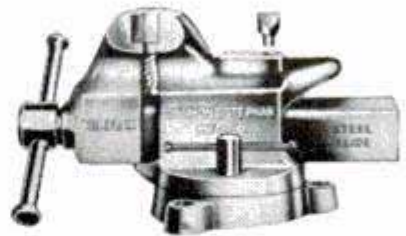

The Desmond Simplex utility vise will make all your tools more useful. Steel jaw inserts, shielded screw, cut-off tool, anvil, swivel base, built-in pipe jaws and other features increase for you the utility of this basic workshop tool. See it at your dealer's,

or write for new valuable folder on vise applications to Desmond-Stephan Mfg. Co., Urbana, Ohio

DESMOND-SIMPLEX VISES BINOCULARS TELESCOPES



Big Bargain Catalog Free

BROWSCOPE CO.
Dept. 3M,
24 WEST 45th ST.
NEW YORK 19, N. Y.



DUST-O-VAC FOR ALL MACHINES

For Home Workshops & Industry. DUST-O-VAC collects & bags wood & plastic chips, wood & metal dust, wood shavings. Free Bag. Attaches to circular saw, planer, band saw, grinder, belt or disc sander, shaper, drill press with shaper or sander attachment, spindle shaper, wood lathe, jig saw, 110 A.C., D.C. Send for mounting instr. for all machines. **\$19.95**

HEAVY CAST ALUMINUM BLOWER — ONLY \$11.25
For workshop, lab., kitchen, cellar, app. 100 CFM. Send for circular.
UNIVERSAL YONKERS CORP., 137 Alexander St., M-3, Yonkers 2, N. Y.



TRAILER PARTS

BULL DOG Hitches, Parking Jacks and Axles for all types of trailers!

Write for FREE Catalog
Hammer Blow Tool Company
Wausau 13, Wisconsin



"RED-E" GARDEN TRACTORS

Gear Driven! No Belts! No Chains!—New 1951 Models Now Available!

You'll like the smooth, powerful, gear-driven, easy operating action of the 4-cycle gasoline engine-equipped Walking Model with power turning clutch for each wheel or the Riding Model with automotive type differential. Dozens of attachments for plowing, sowing, cultivating, harrowing, mowing, raking, wood-sawing, snow-plowing. EASY TERMS — with Pays-For-Itself-Plan. SPECIAL Discount to User Agents.

Buy Direct from Manufacturer and SAVE

WALKING MODEL
2-3-4 1/2-6 H.P.
RIDING MODEL
6 H.P.
Fully Guaranteed

Write for FREE Catalog!

RED-E TRACTOR CO. Richfield 93, Wis.

LIFETIME CHRONOGRAPH, STOP-WATCH

CALENDAR WATCH



It's also a
**TELEMETER &
TACHOMETER**

NEW LOW PRICE
895
with
Steel
Expansion Band
Plus 10% Tax (90c)

**FULLY
GUARANTEED
for One Year**

**Plus Lifetime
Service Certificate
5-Day Free Trial.**

31-Day Calendar
Changes dates automatic-
ally! For Sportsmen,
Scouts, Photographers, En-
gineers, Chemists, Navi-
gators, Doctors.

Remarkable Import Buy—these ideal all-around timepieces and chrono-
graphs at an unbelievable low, low price. Imported Swiss jeweled move-
ment, Radium Glow 1" dial, red sweep-second hand, shock-resistant case,
unbreakable crystal. And—included is the handsome, rich-looking steel
expansion wristband. Complete instructions included together with guar-
antee and service certificate. White, Pink or Black dial face, specify color.

GAYLORD Dept. PC-7, Fifth & Hamilton, Pittsburgh 6, Pa.
I enclose Check Money Order Send C.O.D.
Send _____ Chronograph watches at 8.95 (Postpaid), plus 10% tax on
5-day free trial. **Money Back Guarantee.** Name & Address on Margin.

ALNICO MAGNETS LIFT 125-lb.

AMAZING PERMANENT MAGNETS — WILL NOT WEAKEN! NON-ELECTRIC. Retrieve guns, tackle, tools and other steel items from lake, river, plating tanks, drains or other hard-to-reach spots. Recover drills, lugs, etc. from floor sweepings. Clear alley of harmful tacks, nails. Many other uses listed. Pays for itself quickly. **GUARANTEED:** Try any magnet one week. Money refunded if you are not well-pleased. Cat. No. 125 (has a pull of 125 lbs. on a flat steel block) . . . \$7.50
Cat. No. 40 (40 lb. pull) \$2.79. Cat. No. 7 (10 lb. pull) \$1.35
Cat. No. 20—Hobbyists assortment of seven medium magnets \$1.25
MIAMI MAGNET CO.,
3240 N.W. 27th Ave., Aviation Bldg. No. 43, Miami, Florida



WITH SPEED NUTS

SPEED NUTS—the fasteners that won't vibrate loose—now available in handy kit. Ten popular sizes with matching screws. Replace threaded nuts and lock washers in repairing all types of metal, wood, plastic products. Over 100 parts for only \$1. Send cash, money order, check—no stamps—no C. O. D.



TINNERMAN PRODUCTS, INC.
Dept. 13, Box 6688, Cleveland 1, Ohio

Got a new glass rod?
Get the new **COXE** reel!

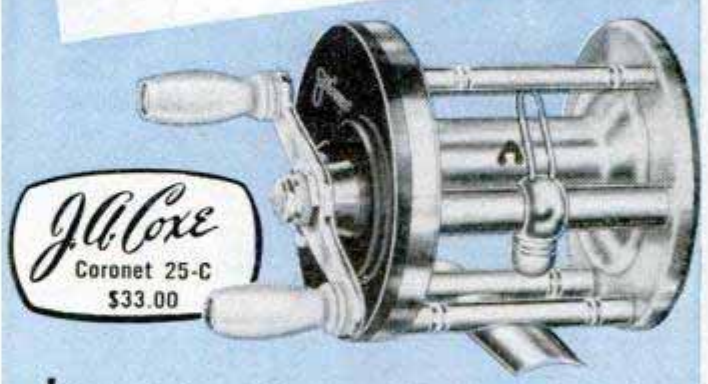

J.A. Coxre
Coronet 25-C
\$33.00

It's the right reel for any rod—the perfect reel for the new glass rods. It's the J. A. Coxre Coronet 25-C—with the new one-piece spool.

This is the reel you've known for years as the world's only automatic free spool reel. You get the same Coxre craftsmanship, the same basic features—cross-bolt construction, 10-second take-down, perfect spool alignment. But now it's completely re-designed—with the weight cut in half!

If you're ready for the finest reel money can buy, ask for the new J. A. Coxre Coronet 25-C.



LIGHTER—it's all aluminum.
RUGGED—it's made in one piece.
BALANCED—it's machined both inside and out! Featured on four Coxre reels, starting at . . . \$11.00



Bronson
GREEN HORNET
\$5.95

Here's the reel that packs premium features into a popular price—the Bronson Green Hornet. Beautifully designed with green anodized head and tail plate. Bronson's easy-to-set drag button lets you pinpoint the correct tension with one simple turn. Just set the dial before you cast—the reel does the rest! If you want the finest reel for the money, ask for the Bronson Green Hornet.

BRONSON REEL COMPANY, BRONSON, MICHIGAN
Division of Higbie Manufacturing Co.



MILL IT... ON YOUR LATHE!
PALMGREN
MILLING ATTACHMENT
3 SIZES
 No. 250 Illustrated
2 1/2" JAW
Only \$24.75
CONVERT LATHE IN 10 SECONDS

Now you can Mill, Slot, Grind, Groove, Square Shafts, Saw at Angles, Recess and many other important jobs. **SAVE TIME and MONEY!** Why send work out or use costly methods when a **PALMGREN MILLING ATTACHMENT** will solve your problem. Precision built, it has accurate graduations for rotary angle adjustments, also graduated vertical feed screw. Fits South Bend, Atlas, Craftsman, Logan, Sheldon and all other lathes. Thousands now in use in small and large machine shops, repair shops, railroads, schools, home work shops, etc. **ORDER SIZE NEEDED TODAY!**—It will quickly pay for itself.

IMMEDIATE DELIVERY

Nos.	Width Jaws	Depth Jaws	Jaws Open	Weight Pounds	Fits Tool Post	Price F.O.B. Factory
150	1 1/2"	1"	1 5/8"	6 1/2	1" Dia.	\$18.75
250	2 1/2"	1-7/16"	2 1/2"	11	1 1/4" Dia.	24.75
400	4"	1 1/2"	4"	25	2" Dia.	39.75

Order From Your Dealer or Jobber: Write for Circular No. 353
 Mfrs. of **PALMGREN PRODUCTS** Since 1915

CHICAGO TOOL and ENGINEERING CO.

8365 South Chicago Ave. Chicago 17, Ill.

JUST A FEW OPERATIONS YOU CAN DO ON YOUR LATHE!

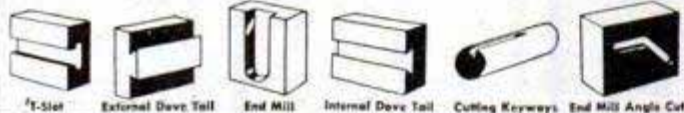

Sharpens 1,000 MOWERS per Season
 in spare time with the **FOLEY LAWN MOWER SHARPENER**

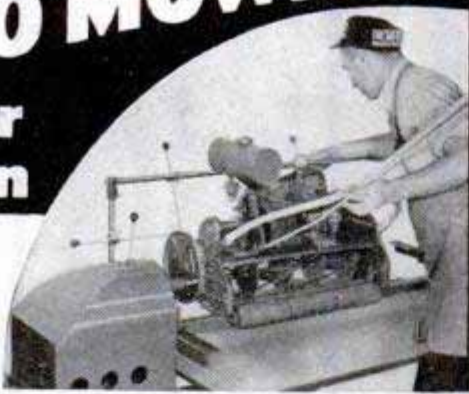

"I have sharpened over 10,000 mowers in my Foley Lawn Mower Sharpener in the last 10 years—only repairs needed were new belts."—Charles H. Smith, From Ralph Rand—"The first month's business paid for my machine." The Foley sharpens all sizes and types of mowers in 15 or 20 minutes (with handles on). Prices run from \$1.50 to \$2.00 for hand mowers, and \$5.00 to \$8.00 for power mowers. This is the way to make money!—99c out of each dollar you take in is profit!

FREE BOOK—"How to Sharpen Power Mowers" with the Foley Lawn Mower Sharpener. Prices \$97.50 to \$159.50—easy payment terms available. **FREE PLAN** shows how to start. Mail coupon today—no salesman will call.

Send for FREE PLAN

FOLEY MFG. CO., 307-1 Foley Bldg., Minneapolis 18, Minn.
 Send **FREE PLAN** and **FREE BOOK** on the Foley Lawn Mower Sharpener business.

Name.....
 Address.....

New POWER MOWER
Build It Yourself And Save. Amazing new invention makes whirl-blade mower pull and steer itself as well as cut grass and weeds. **BUILD IT YOURSELF.** Send name and address on 1c postcard for **FREE** building instructions... **NO OBLIGATION.**
T & H Mfg. Co., Dept. MPC-3, 811 E. 31 St., Kansas City, Mo.

PULLS ITSELF, STEERS ITSELF



WANT \$10,000?

Earn the government Super Sensitive P.R.I. bonus. Locate **GEIGER COUNTER** Uranium with a



Also get one for Atom Bomb Defense! Find gold, silver, and other valuable ores with a P.R.I. Treasure Locator. World's finest instruments. **FREE** catalog. Write!

PRECISION RADIATION INSTRUMENTS
 4113PM W. Jefferson, Los Angeles 16, Cal.

Dealer Inquiries Invited

\$ Free Course! Big Profits! \$ Flocks & Sandblasts



Dual Purpose Spray Gun! Uses only 25 lbs. Air Pressure • Thousands of uses in Home, Shop, Industry: Makes Auto Interiors Clean & New, Lines drawers, Marproofs lamp bases, Refinishes any object. All in colorful Flock. Etch & Frost windows, glassware, etc. Removes Paint & Rust from Autos, Tools. Guaranteed! Send \$24.75 or write for free information. Flocking supplies!
BLASTO SPRAY GUN MFG.
 Dept. PM-3, 7007 Haas Avenue, Los Angeles 47, Calif.

Low Cost Way To Brighten Your Home

New free illustrated booklet shows easy, low-cost ways to brighten cellars, attics. Use aluminum paint—the right kind. We don't make paint, but offer this book to help you get best results. Write for free booklet "Paint it Bright."



Aluminum Company of America, 1718C Gulf Bldg., Pittsburgh 19, Pa.

SHEET METAL BRAKES

Forms angles, flanges and Pittsburgh locks. 26 gauge steel, heavier aluminum. Cam locking. Portable, can be bolted to bench, or clamped to edge of truck. All steel, reinforced. Shipped Exp. Coll. 30" size. Wt. 54 lbs., \$26.50. 36" Wt. 66 lbs. \$31.00. 48" Wt. 100 lbs., \$45.00. Floor mountings, portable, 32" high, \$7.00 12" BRAKE. Fits in vise to form difficult compound bends, up to 20 gauge steel. Not illustrated..... \$12.50 P.P.
 24" CURVE FORMER. Capacity—16 gauge steel..... \$10.00
IRON BENDER. 1/4x2" capacity, 9 parts. All steel..... \$10.00 P.P.
 Immediate Delivery. Order direct, cash or C.O.D. or send for folder.
VYKE BRAKE CO., P-1116 So. 27th St., Omaha 5, Nebr.



KEEP THOSE EDGES IN YOUR PLANE BLADES RAZOR SHARP AND CHISELS

With This New, Proven, Carpenter's Accessory That Assures a Straight, Sharpened Edge Always at a Right Angle to the Sides.



PLANE BLADE AND CHISEL SHARPENER

by Marsh

\$1.50 POSTPAID (plus tax in Calif.)

SMALL, COMPACT, READY FOR IMMEDIATE USE—WING SCREW IN THE HOLDING CLAMP IS THE ONLY ADJUSTMENT.
 • Holds blade at correct angle for sharpening • A few strokes back and forth on stone keeps the edge razor sharp • No guesswork • No round corners • 14 Ga. steel construction • Wt. only 8 oz. • For the bench or on the job • Satisfaction guaranteed or your money refunded.

BE SHARP! START SHARP - STAY SHARP
 SEND YOUR CHECK OR MONEY ORDER TO:
Sportsmens Specialties
 47 E. WALNUT ST. PASADENA 1, CALIF.

ANNOUNCING

NOT ONE—NOT 12—BUT 40 DIFFERENT CUTS!

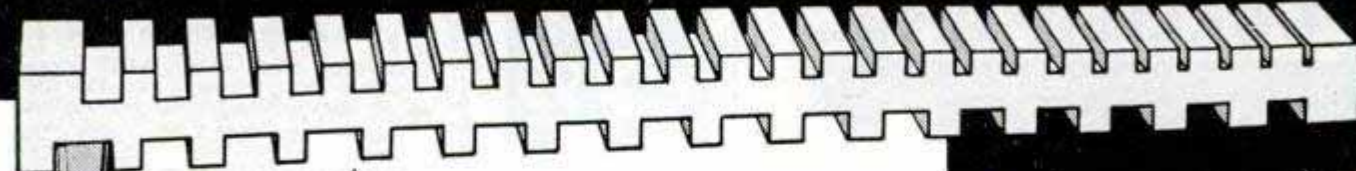

NEW **Warren** DADO SAWING WASHERS



Multiply the uses of your circular saw with sensationally improved Warren Dado Sawing Washers! Make smooth, parallel dados or grooves in 40 different widths with your present saw blade! Dial the width with Micromatic adjustment—in 15 seconds you're making the cut. Four simple washers—precision-made in matched sets—no vibration, no gadgets to get out of alignment. No burning, chewing—no sanding. Four sizes 1/2", 3/8", 3/4", 1"—fit all popular saw arbors. See your dealer or send coupon today—ABSOLUTELY GUARANTEED!

ONLY
\$4.95
per set

NO INCREASE IN PRICE!

WARREN DADO SAWING WASHERS CO., Dept. 23,
70 Medbury, Detroit 2, Mich.

Enclosed (check or M.O.) \$4.95 for one set of NEW Warren Washers. My arbor size is 1/2" 3/4" 3/8" 1". Send free booklet. (PLEASE PRINT)

Name _____
Address _____
City _____ State _____

NEW POWER TOOL UNITS

Amazing
Values

Write for
Details

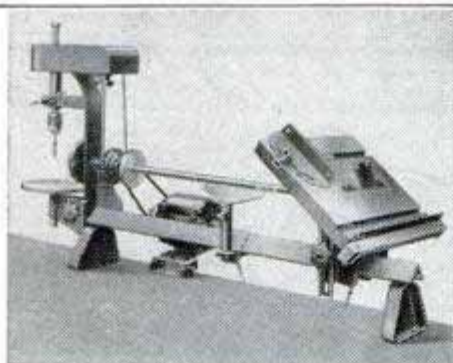

EMRICK, INC., 131 Clinton, Kalamazoo, Mich.

NEW 1951 OUTBOARDS SHIFT LIKE A CAR



SCOTT-ATWATER'S COMPLETE SHIFT. Shift lever (1) controls selection of neutral, forward, reverse. Rugged gearshift mechanism—only 3 new major parts (2)—is foolproof. Scott-Atwater owners say it's "the greatest improvement since the outboard was invented." On five models, 4 to 16 HP.

FREE OUTBOARD BOOKLET shows Shift, latest Scott-Atwater improvements, automatic controls. Packed with action pictures, detailed motor facts. Explains easy plan for buying your outboard.

MAIL COUPON NOW!

Dept. 53, Scott-Atwater Mfg. Co., Inc.,
Minneapolis 13, Minn.

Please send FREE OUTBOARD BOOKLET.

Name _____
Address _____
City _____ State _____

Export Dept. - American Steel Export Co., 347 Madison Ave., N. Y. 17, N. Y.

MAN, O MAN! WHAT POWER!



VISE-GRIP WRENCH

LOCKS
With
TON-GRIP



Jobs that used to take hours now take minutes—because you always have the right tool with VISE-GRIP, the tool with 1000 uses! LOCKS to work with a grip that can't slip. Turns battered nuts, bolts, screws, broken studs—holds anything! With Cutter —No. 7W, 7", \$2.25; No. 10W, 10", \$2.60. Without Cutter —No. 7C, 7", \$1.95; No. 10C, 10", \$2.25. No. 7, 7", \$1.85; No. 10, 10", \$2.15.

Order From Your Dealer

PETERSEN MFG. CO., Dept. P-3, DeWitt, Nebr.

CROSLLEY WINS COLLIER RACE



A Crosley car that was in regular use as a passenger car and not tuned up for racing, ran off with the coveted Sam C. Collier Memorial Grand Prix at Sebring, Florida. Against a highly competitive field of foreign sports cars costing up to \$20,000, the Crosley led the field all the way in the gruelling 6-hour endurance race sponsored by the Sports Car Club of America. The Crosley had such stamina that it made only one pit stop—to take on gasoline! No water or oil was added during the race. Despite the high speed (52 m.p.h. average for the six hours) the car gave typical Crosley economy—over 35 miles to the gallon!

That's the kind of performance you can count on when you're driving the winner, the Crosley for 1951. Still the lowest new car price, lowest down payment, lowest monthly payments, lowest upkeep—35 to 50 miles on a gallon of regular gasoline—and didn't you wish your car could do that the last time gasoline was rationed? See your Crosley dealer. Test-drive the new 1951 Crosley—America's most improved car!

FREE! 1951 Crosley Catalog! Write Crosley Motors, Inc., 2530-HX Spring Grove Ave., Cincinnati 14, Ohio.



a FINE car

"You see them everywhere"

ALL EQUIPMENT FOR LITTLE COST

george tractor

only \$107.50 f.o.b. Sullivan, Illinois

You can still get the George Tractor for only \$107.50, f.o.b. Sullivan, Illinois. It's ruggedly built for lawn and garden work. Has 2 HP Briggs or Clinton Engine with handle bar gas and clutch control. Attachments for all garden work cost little. Plow \$14.50... Disc Harrow \$15.95... Cultivator \$14.50... Sickle Bar Mower \$39.75... Tool Hitch for lawn mower \$4.50... Bulldozer Blade \$10.75... all prices f.o.b. Sullivan, Illinois. This year don't be without a tractor. ORDER NOW when supply is still available. Write direct or see your dealer. Complete information will be mailed... ask for George Tractor and Attachments bulletin. Write today.

GEORGE GARDEN TOOL DIVISION
COMMUNITY INDUSTRIES ASSOCIATION

SULLIVAN ILLINOIS

\$\$\$ extra profits for you each month with..

Hobart 200 Amp. Portable Gas Drive D.C. Welder goes right to the job.

Set up your own welding business... get the big pay, extra profit jobs with this rugged, versatile welder that can't be beat for speed, durability, or performance.

Special features include 1,000 combinations of welding heat, positive control at or away from machine, outlet for supplying emergency power. Send for data.

HOBART BROTHERS CO., Box M-31, Troy, Ohio, "One of the world's largest builders of arc welders"



Handy Flexible SHAFT

With 1/8 Inch Adjustable Chuck

ONLY \$3.95

Converts any motor, drill press, electric drill, electric fan (10 inch or larger) into a handy rotary tool.

Attach ROTA-SHAFT in a jiffy. Use for grinding, polishing, sharpening, cleaning, engraving, making tools, carving on metal, plastic, wood, leather, glass. Handles tools from zero to 1/8 inch diameter. 40-inch overall length. Complete with buff and sanding disc ready to use in a drill press chuck. ORDER TODAY!

SEND NO MONEY! Mail your order. Pay postman only \$3.95 plus postage on delivery. Try 10 days — if not delighted return for money back. For use on motor—35c extra for Special Coupling. Give exact size of motor shaft diameter.

STRADER PRODUCTS CO., Dept. C-101
259 Strader Ave. Cincinnati 26, Ohio

OLD FAN MOTOR



VACUUM CLEANER MOTOR



SPECIAL OFFER!

LOCK-STITCH SEWING AWL

\$1. Postpaid

Famous, patented lock-stitch sewing awl complete with needles, waxed thread and direction folder. Hundred uses — sewing, repairing leather goods, canvas, belting, harness, saddles, gun cases, awnings, golf bags. Extra needles and thread available. Satisfaction guaranteed or money back. Send currency, check or money order. Yates Mfg. Co., 611-H Main St., Lake Geneva, Wisconsin

SHARPEN CIRCULAR SAWS LIKE AN EXPERT



THE SUPER GADGET FOR HOME WORKSHOP

Two simple adjustments. Gets hollow-ground, cross-cut or combination saw blades true and sharp. Fits 6" to 12" blades 1/2" to 13/16" centers. Includes file, complete instructions. \$6.95 postpaid. (C.O.D. postage extra.) Guaranteed—Money back if not satisfied after 10-day trial. Soon pays for itself. Order today. Free Folder. SURE SHARP MFG. CO., Dept. M-31 P. O. Box 24 Santa Ana, Calif.

BATTERIES!—START

—a factory at home and re-cast junk batteries into new; latest achievement. We supply complete instructions and everything needed. Big Profits!



BATTERY LABORATORIES, Dept. PM, Minneapolis 4, Minn.

Say You Saw It in Popular Mechanics

DO MORE PLANING JOBS WITH LOW-COST BELSAW \$215.00



AMAZING 12 1/4-IN. PLANER Does All Ordinary Planing Mill Jobs. Provides attachments for Jointing, Rabbeting, Tongue, Groove, Matching. 12 1/4 x 6-in. capacity, 3-knife solid round all-steel cutterhead. Power feeds at 24 feet per minute, 42 cuts per inch. Provides for full line of accessory attachments—Grind and Joint knives IN THE CUTTERHEAD WITHOUT REMOVING.

FREE BOOK

BELSAW MACHINERY CO

1018 Field Bldg., 315 Westport Rd., Kansas City 2, Mo.

Simplified arc welding

HOBART 200 Amp Gas Drive...world's best welder buy!



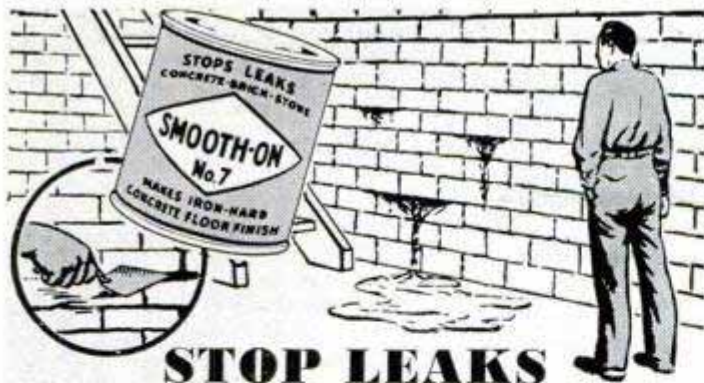

STOP LEAKS IN CELLAR WALLS

Do it with Smooth-On No. 7 Cement! Apply with trowel or stiff brush to leaky cracks, holes, porous spots, seams or other leaks in concrete, brick or stone walls and floors. The leaking will stop and Smooth-On will "stay put"; for it expands slightly as it hardens. May be applied to wet or dry surfaces, indoors or outside. Use Smooth-On No. 7, too, to seal openings around pipes passing through walls. Buy Smooth-On No. 7 by name and number in 1-, 5-, 25- or 100-lb. size. If your hardware store hasn't it, write us.

FREE Leaflet and Handbook

We'll send you leaflet showing No. 7 uses, also the famous 40-page Smooth-On Repair Handbook describing other Smooth-On Cements and showing many helpful home repairs. 170 illustrations. Write today.

SMOOTH-ON MFG. CO., Dept. 37C
570 Communipaw Ave., Jersey City 4, N. J.



Do it with
SMOOTH-ON
NO. 7 CEMENT

New kind of SAW BLADE



*Takes the Danger
Out of Circular Sawing*

New PTI Safety Saw Blade is the original safety saw blade that eliminates all dangerous "kick-backs" from circular sawing—as proven by extensive tests at government and university laboratories in the United States and Europe. Thousands of delighted users in industrial, school, government and home shops—hail this as greatest circular saw improvement!

New PTI Safety Saw Blade Cuts on Entirely New Principle

Each PTI Saw Blade has only 8 teeth instead of the customary 100. These teeth project only 20/1000" above a non-cutting edge. Thus the cut of each tooth is "controlled" by the non-cutting edge, in contrast to the ordinary saw blade where each tooth cuts right down to its base. This basic change revolutionizes performance of the saw blade.



Offers Many Advantages

1. Complete Safety from Kick-backs;
2. Reduced possibility of direct injuries;
3. Cuts Chips, not Sawdust;
4. 30% to 40% Power Saving;
5. Longer Life Without Sharpening;
6. Smoother Cutting;
7. Quieter Running;
8. Less Danger of Blade Cracking.

Ask For Demonstration

If your dealer cannot supply you — you can order direct. Prices are for special Vanadium Steel blades, combination rip and cross cut, delivered, postpaid.

7" dia. blade \$4.95 12" dia. blade \$ 9.40
8" dia. blade \$5.90 14" dia. blade \$11.40
10" dia. blade \$7.50 16" dia. blade \$14.00

(Prices on carbide tipped blades furnished on request.)



INCORPORATED Dept. PM3
401 Broadway, New York 13, N. Y.

Gentlemen: Send me the following units:

Quantity	Blade Diameter	Blade Bore

Please check:

_____ Money order or check for \$ _____ _____ Send C.O.D.

Name _____

Address _____

City _____ Zone _____ State _____

SAY YOU SAW IT IN POPULAR MECHANICS



**USE
YOUR
ATTIC**

Install the
PRECISION
folding stairway
YOURSELF

Fits all ceilings. Just saw the hole in your ceiling—frame the hole with 2x6's, nail the stairway in place and cut off the stairway at the calibrated ceiling height. The Precision Stairway is simple and easy to operate. No springs, actuated by counterweights, it's perfectly balanced, raising or lowering easily with one hand. Composition safety treads on steps. Insulated door panel. Requires no attic space. Made of No. 1 kiln dried poplar with cast brass hinges, heavy cast aluminum rocker arms and brackets. Approved by F.H.A. everywhere

See your local lumber dealer or write direct today.

Manufactured by

PRECISION PARTS CORP.
Nashville 7, Tennessee

for YOUR "22"

A Mossberg 4-POWER SCOPE



NEW MODEL #2M4
with improved CAST mount.
For high or low position.

NEW MODEL #4M4
with dovetail mount specially designed
for Mossberg rifle models 142, 142M,
144, 146B, 151K, 151M, 152 and 152K.

*Mossberg scopes fit almost
all makes of rifles up to 25-20 cal.*

Patented
Internal
Adjustments.
Easier
and quicker.

All lens surfaces
hard coated—to
assure sharp image.

All scopes \$9.95

PREVENT FOREST FIRES

Carelessness can destroy timber,
game, property and human
lives. Snuff out matches and
smokes. Quench fire embers
carefully.

Ask for
MOSSBERG SCOPES
at your dealer's.

No sales at factory.

FREE catalog
write for it!

O.E. Mossberg
® & SONS, INC.

19703 St. John St., New Haven 5, Conn.

Say You Saw It in POPULAR MECHANICS

BUILD a "Schneider" SPEEDSTER

Have Fun! Save 1/2 the Cost!



Complete plans with FULL SIZE
details for America's finest de-
signed and engineered outboard
speedsters, sailing dinks, row-
boats and skiffs... ALSO...
easily assembled cut-to-fit KITS.

SEND 10c for illustrated literature

SCHNEIDER BOAT CO.

Dept. 131, 1913 W. VLIET ST.
MILWAUKEE 5, WIS.

STOP CHANGING MOTOR OIL!

End this needless
expense forever with

RECLAIMO Today's Most
Advanced OIL RE-REFINING filter
FOR CARS, TRUCKS,
TRACTORS & DIESELS

Continuously cleans and RE-
REFINES motor oil as you drive
(by utilizing motor heat)—keeps
oil in high grade lubricating
quality at all times!

- "RECLAIMO"
- REMOVES SOLIDS (by filtration)
 - REMOVES WATER (by distillation)
 - PREVENTS Excess Fuel Dilution
 - PREVENTS Acid and Sludge Formation
 - ADDS Thousands of Miles to Engine Life

MAINTAINS Stable Viscosity **ELIMINATES** All Oil Changes
FREE 32-PAGE BOOK "OIL FACTS" (with bono-
fide \$1000.00 offer on page 30), gives you the
complete "Reclamo" story and details of our
extraordinary 90-DAY NO-RISK TRIAL OFFER!
Write for your copy TODAY!

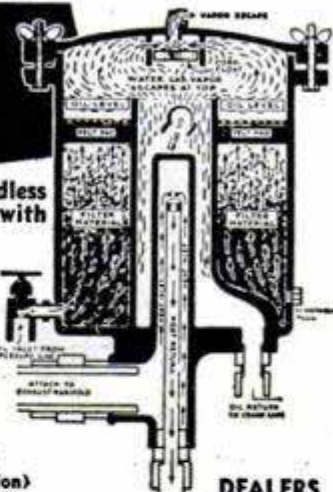

**DEALERS
WANTED**

U.S. BUREAU
OF STAND-
ARDS, Bul. 86
States. "Oil
does not wear
out - mechan-
ically."

**MONEY-BACK
GUARANTEE**

Reclamo Sales Div., Inc.

4508 S. Logan, Dept. M-5, Lansing, Mich.

ACE TOOLS



Be permanently
tooled-up for every operation
on your Metal Cutting Lathe.

No. 8-A Ace Tool Set
for 9" and 10" Swing
Lathes—fits shank size
3/8" x 3/4". Includes Turning,
Cutting-off, Boring,
Knurling and Threading
Tools with high speed cutters,
blades and wrenches. 8 complete tools
in fitted steel case—nothing else to buy
See your local dealer or order direct.

ARMSTRONG BROS. TOOL CO.
5268 W. Armstrong Ave., Chicago 30, Ill.

\$26⁹⁵



Build it Yourself!

TRAILER COACHES

Complete Trailer Book
and Construction Data
for 10, 16 and 22 Foot
Trailers — Only \$1.50

Here's everything you want to know
about trailers, with plenty of pictures
and plans and instructions for build-
ing three different types. Covers
also, history of trailers, trailer parks,
camps and overnight-stops informa-
tion, furniture, furnishings, materi-
als and engineering data. If you
want to build a trailer, live in a
trailer, or just want to know more
about trailers, get this book. Only
\$1.50 postpaid. Rush order to:

Partial Contents

Trailer Parks—Living in a
Trailer—Towing a Trailer—
Floor Plans—Service—Classi-
fications—Balance—Dollies
— Jacks — Weight Distribu-
tion—Construction—Working
Drawings for a Two-Place,
Standard Travel and Stand-
ard Dwelling Trailers. Size
8 1/2 x 11 1/4 inches.

POPULAR MECHANICS PRESS ● Dept. 350, 200 E. Ontario St., Chicago

THE BIGGEST
VALUE
ON THE MARKET
DIRECT FACTORY TO YOU

DYNAMIC SUPER-CHARGED ARC-WELDER

DOES WELDING, BRAZING, SOLDERING, CUTTING

It's the finest, precision built heavy duty transformer-welder avail-
able for home, farm, or shop use. Does work you'd expect from
costlier machines. EASY TO OPERATE. Do expert work; follow
simple instructions. Works on iron, steel, brass, bronze, aluminum
and other metals. Operates from any properly wired 110 volt 50/60
cycle AC line. Save time, Make money—Build or repair auto, home,
farm or shop equipment, etc. for yourself and others in spare or full
time. Comes complete Ready-To-Operate. Order today for 10 day
trial on money back guarantee or write for Free Particulars.

DYNAMIC WELDER CO., Dept. D2-CB6, 15 E. 23rd St., Chicago 16, Ill.



OVER 50,000 SATISFIED USERS

\$41.80 Only \$33⁵⁰ F.O.B. COMPLETE
VALUE



New DURO 12" BAND SAW

... Combines

RUGGEDNESS, SAFETY and CONVENIENCE

Offers features you'd expect only on models selling for much more, including: Duro ball bearing blade guides above and below table, that keep blade running truer and smoother; cast one-piece wheel guard that unlocks quickly for blade changes; heavy cast-iron extra rigid frame; double trunnion table supports; rubber-tired disc wheels mounted on needle-type bearings—and many other features.

3 MODELS TO FIT ALL BUDGETS

Duro now offers 10", 12" and 15" band saws—a model to fit every need and budget. A speed convertor for metal cutting available for 12" and 15" models. All models incorporate special DURO features that mean extra band-saw value for you.



Write Today
for details, prices
and specifications
on these new Duro
10", 12" and
15" Band Saws.

DURO METAL PRODUCTS CO.
2697 N. Kildare Ave., Chicago 39, Ill.

Please send me: Full details about the new line of Duro Band Saws.

Name.....
Address.....
City..... Zone..... State.....
Dealer's Name.....

P&C Hot Forged Tools

Stay on the Job longer

Really tough jobs—in industry or at home—prove that special analysis alloy steel and scientific heat treating make P&C tools last longer. More than 300 P&C tools are easier and faster in everyday use or on special jobs. Your hardware dealer recommends P&C hot forged tools; ask him for the P&C tools you need.

Write for the new folder on P&C tools —"the BEST tools money can buy".

P&C HAND FORGED TOOL COMPANY
PORTLAND 22, OREGON

Start a Business in Your Backyard

MANUFACTURE BUILDING BLOCKS

General Concrete Vibrator BLOCK MACHINE
CAPACITY 1000 BLOCKS A DAY

only \$218 LESS MOTOR F.O.B. PLANT
SHIPPING WEIGHT 400 LBS.

Here is a business you can start on small capital—in your own backyard—that earns 100 to 150% profit, with unlimited opportunities. Make concrete or cinder blocks. Millions used for homes, factories, public buildings, garages. Sell all you make to building trade. Do it with a General—and you've headed for success.

1000 BLOCKS A DAY

The General is a high speed, power-driven block machine at amazingly low cost. Rugged all-steel construction. Simple to operate indoors or outdoors. Makes superior 3 core type block meeting all code requirements. Produces up to 1000 blocks per day. Full operating instructions and mixing formulas supplied. Write for FREE details.
Dealer inquiries invited

Wonderful Book Written & Illustrated by Experts

HOW TO BUILD YOUR OWN CONCRETE BLOCK HOME
Only 1 Prepaid

GENERAL ENGINES CO.
DEPT. P-18 • 307 HUNTER ST. • GLOUCESTER, N. J.

Includes floor plans for 6 beautiful, easy to build concrete block bungalows. Shows ways to save money. How to lay blocks, lay out building lines, mix concrete, build steps, porches and concrete floors. Mail coupon at once with \$1.

Name.....
Address.....
City..... Zone..... State.....

HANDEE®

tool of 1001 Uses

FINEST IN POWER TOOLS PLUS 51 ACCESSORIES

Complete . . . designed for every hobbyist and mechanic! Grind, drill, polish, carve, sand, saw, etc. Packs plenty of power in the 25,000 r.p.m. motor, with approved 7-segment commutator. Handsome fitted steel carrying case.

Complete, with liberal 10-day money back trial offer **\$27.50**

with 7 accessories . . . **\$19.95**



HANDEE WORKSHOP

"Tornado-Powered"
with NEW HANDEE "85"

Versatile, with 41 accessories . . . suitable for shop or home use. For novice or expert . . . precision routing, molding cuts. HANDEE "85" a production wizard . . . automatically air-cooled, pin-point accuracy. Sensational power!

Complete, packed in handsome case,

\$29.95

Chicago Wheel & Mfg. Co., Dept. PM

1101 West Monroe St.

Chicago 7, Ill.

WAR SURPLUS BARGAINS

BRAND NEW WAR SURPLUS!



GENERATORS 115V-AC

FOR AUXILIARY LIGHT PLANTS

NOW . . . here's the buy of the year. Brand new Eclipse Generators in the original box.

These generators have an AC output of 115 volts, 10.4 amps, 1200 watts, single phase, 800 cycles at 2400 R.P.M. They also have a DC output of 28.6 volts, 60 amps. The unit has a spline drive shaft and is self excited. It will serve as a dependable 115 V-AC auxiliary light plant when driven by a gasoline engine for farms, cottages, flood lighting, trailers, boats, or wherever power is not readily accessible. Shipping wt. 55 lbs. Govt. cost more than 10 times selling price. F.O.B. Pasadena

ONLY
\$19.95

BLACK LIGHT KITS

FOR ULTRA-VIOLET FLUORESCENCE

NOW . . . you can build your own black light equipment at a new low cost with these easy-to-assemble components. Geologists, mineral prospectors and hobbyists can easily make laboratory black lights for mineral identification. Signs, posters, pictures, fabrics, house numbers . . . anything painted with fluorescent paint glows with eye appealing fluorescence under black light. Kit contains: Ultra-Violet tube, brackets, ballast, starter, wire, plug and wiring diagram.

Special! 4 Watt Kit—(5 1/4" tube) **\$3.00**
8 Watt Kit—(12" tube) **\$4.00**

postpaid
Enclose full amount with order

C and H Sales Company

BOX 356-E EAST PASADENA STATION • PASADENA 8, CALIFORNIA

ELECTRIC MOTOR BARGAINS!



Every Motor
Fully
Guaranteed

1/4 HP 1750 RPM 110 Volt 60 Cy. Split Phase Type . . . **\$ 8.50**
1/2 HP 3450 RPM 110V 60 Cy. Cap. Type Double Shaft . . . **24.50**
3/4 HP 3450 RPM 110-220V 60 Cy. Repulsion Induction . . . **33.50**
1 HP 1750 RPM 110-220V 60 Cy. Capacitor Type **52.50**

DOUBLE SHAFT MOTORS AT 50% SAVINGS

1/6—\$11.00 **1/4 HP—\$12.00**

1750 RPM Split Phase — 1/2"x3" Shafts

1/3—\$14.00

1750 RPM Split Phase — 5/8"x3" Shafts

All new, Resilient mounted for quiet operation on 110-V 60-Cy. AC current. Ideal for Blowers, Grinders and Tool layouts.

Write for 32-Volt Bargain List

ROBERTS ELECTRIC CO., 7232 Madison, Forest Park 14, Ill.



ALL PRICES F.O.B.

SET-UP - KNOCKDOWN SAWHORSE with Jiffy BRACKETS



No nails or bolts . . . use 2x4's for legs, 2x4 or wider for crossbar. Easy to move, saves storage space. Buy at hardware or building material dealers, or direct.

GRAND HAVEN STAMPED PRODUCTS CO., Grand Haven, Mich.

STRAIGHT TRAILER AXLES CHROME and 4" DROP TRAILER AXLES STEEL

with heavy duty
ELECTRIC BRAKES

Comes complete with finger tip control unit and two 20" truck wheels, springs and fittings.

Two ton load capacity. Easy to build your own trailer. For heavier load use dual wheels. Other new surplus truck and trailer parts. Write for free circular. 25% deposit with all orders.

STRAIGHT AXLE

\$88.00

F.O.B. COMPLETE

BROADWAY TRAILER CENTER

31-23 Vernon Blvd., Astoria, L.I. 6, N.Y.

Use Easter Seals

STANDARD GARDEN AND SMALL FARM TRACTORS

Plow
Seed
Cultivate
Mow Hay
and Lawns

Powerful Gas Tractors for Small Farms, Gardeners, Florists, Poultrymen, Fruit Growers, Suburbanites.

1 & 2 Cylinders

High Wheels. Rubber or Steel Tires. Walk or Ride.

Easy Terms — Free Catalog

STANDARD ENGINE CO.

MINNEAPOLIS, MINN.

3221 Como Avenue

NEW YORK, N. Y.
617 West 26th Street



CLEAN with Jack-Hi Waterless Cream. A new, waterless hand cleaner developed especially for mechanics, printers, painters, welders, plumbers, etc. Cleans any substance from hands quickly, thoroughly. Softens skin, callouses. Contains Lanolin. Order your supply today! **DEALERS WANTED!** 3 lb. Can: \$1.50, 5 lb. can: \$2.00 postage paid. Available with or without ammonia—please specify. **COSMOPOLITAN PRODUCTS CO., Dept. P, 3408 Emery Street, Los Angeles 23, California**

ELECTRICITY Anywhere

FOR PORTABLE, EMERGENCY OR HOME USE

ONAN Electric Plants furnish modern city-type electric service for homes, farms, cabins and resorts beyond the high-line. Lightweight, portable A.C. and D.C. plants serve contractors, estates, fire departments, etc. Automatic standby plants protect hospitals, radio stations, hatcheries. Over a hundred models—400 to 55,000 watts. Gasoline or Diesel powered

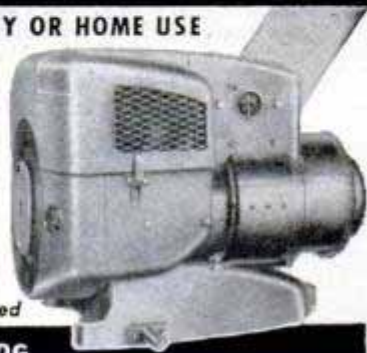

WRITE FOR CATALOG

D. W. ONAN & SONS INC.

5843 ROYALSTON AVE. • MINNEAPOLIS 5, MINN.

It's easy to sharpen any tool



Take a gouge,

for instance. Here's the fine INDIA® Gouge Slip with varying inside and outside curves that will give you a razor-keen edge on any gouge or other curved-edge tool. It's just one of several NORTON ABRASIVES stones that are a must in any shop—stones that are pre-filled with oil at the factory to save you time and give you far better edges.

Send for "HOW TO SHARPEN"

Contains 32 pages of illustrated instructions on sharpening. Send 10¢ to Dept. PM-3.



BEHR-MANNING

TROY, N. Y.

ALSO MANUFACTURERS OF COATED ABRASIVES

MAKE BIG MONEY SHARPENING MOWERS!



Model 300 Ideal Sharpener complete with bed knife grinder and "lapping-in" reconditioner.

IDEAL LAWNMOWER SHARPENER

The economical, profitable way for you to "set up shop!" Ruggedly built to last for years; designed for fast, precision sharpening of hand and power mowers without disassembling. Many new features based on 49 years of research and experience building sharpening equipment. Compare the Ideal; you'll recognize its superior features, its extra earning capacity. Send today for free catalog.

THE FATE-ROOT-HEATH COMPANY

DEPT. M-3, PLYMOUTH, OHIO

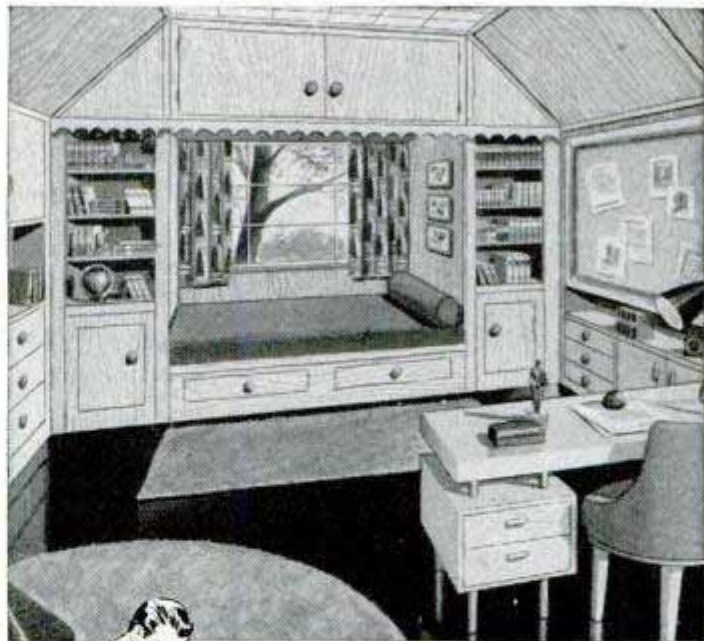

"How I built this \$1425 room

for only \$421* with my

SKIL

HOME SHOP SAW

You too can build a beautiful room like this—quickly, easily—with a SKIL Home Shop Saw. You'll save construction costs and a lot of tedious, time-wasting work in cutting lumber too.

A SKIL Home Shop Saw is portable, lightweight, perfectly balanced. It's got the power, speed, and accuracy you need. Instantly adjustable for bevel angles and depth of cut. Safe too . . . with trigger switch and telescoping guard.

At the low price of \$59.50 your SKIL Home Shop Saw quickly pays for itself in savings.

*For materials only, including desk, for 10½' x 15' room depending upon where you live.

SKIL Home Shop Saw model 520.

57/8" diameter blade. Weight 10½ pounds. Depth adjustment from 3/4" to 17/8". Quickly adjusts for bevel cutting any angle up to 45°. \$59.50.

Prices subject to change without notice.

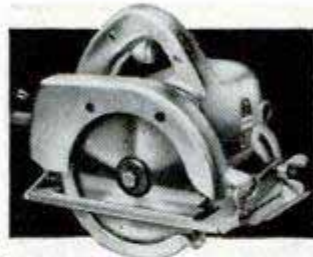

SKIL home shop Tools

Made only by Skilsaw, Inc., Chicago

In Canada: 66 Portland St. Toronto, Ontario

FREE! SKIL-Chart shows you how to buy materials and build a room like this. We'll also send you full information on the complete line of SKIL Home Shop Tools. Mail coupon today! Skilsaw, Inc., Dept. C-3, 5033 Elston Ave., Chicago 30, Ill.

Name _____

Street _____

City _____ State _____

MOST POWERFUL 6" ELECTRIC SAW YOU CAN BUY!

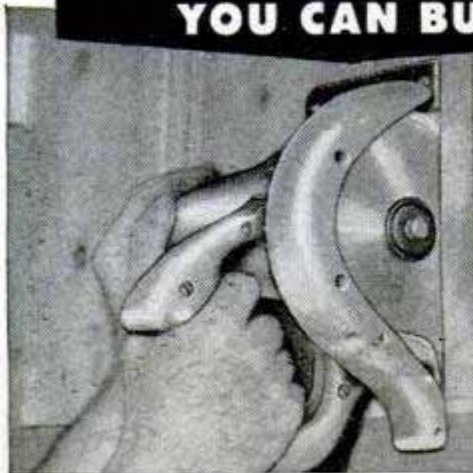

6"
Heavy-Duty
LECTRO-SAW
only
\$56⁵⁰

Cuts to 2" depth

Also 8"
Heavy-Duty
LECTRO-SAW
\$92.50
Cuts to 2 13/16"
depth

Saves Time, Money in Building, Altering

HERE'S PROOF: The 6" Heavy-Duty LECTRO-SAW so outclasses other 6" saws that we matched it against two competitive 8" electric saws in a mechanically-controlled speed ripping test. The other saws cost \$30 more. Yet LECTRO-SAW matched the speed and power of one and conclusively beat the other!

RESULT: The LECTRO-SAW speeds up general carpentry, home construction and alterations, farm building and maintenance. Ten times faster than hand sawing. Power, speed and ease of handling almost unbelievable in a low-priced Saw!

REMEMBER: LECTRO-SAWS are quality-built by BLACK & DECKER, world's largest Portable Electric Tool maker. So you can count on them for long service. See one demonstrated today at your hardware, building, electrical or implement dealer!

Products of HOME-UTILITY Div.,
The BLACK & DECKER Mfg. Co.,
Dept. H3M, Towson 4, Maryland

Professional Saws at Popular Prices



Crosscutting



Cutting Tile,
Transite, Slate



Ripping



Angle Cutting

Make Ur-Own ROTARY TYPE POWER MOWER

THIS IS NOT A KIT
But A Complete Mower Assembled
As Illustrated

Model 50M KEEN MOWER. Just add your electric motor or gas engine, concealed blade for safety, 3 cutting heights, 1 1/2" to 3 1/2". Ball bearing rubber tired wheels. 18" cut. Cuts to within 1/2" of sidewalk. Wght. 48 lbs. America's Greatest Power Mower Value. Order **\$44.95** today.....

Send check or money order
Write for FREE Folder for information on "Make Ur-Own" and other models with gasoline engines or electric motors.

ATLAS KEEN MOWER
Dept. MP3 KANSAS CITY, MO.

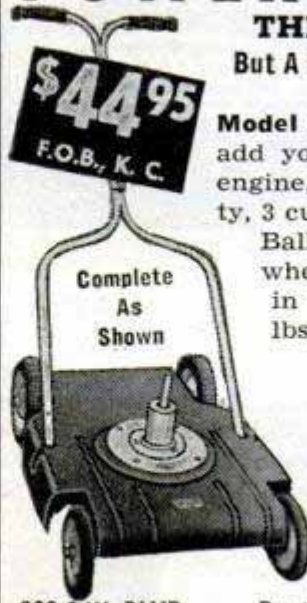

229 S.W. BLVD.

Dept. MP3

KANSAS CITY, MO.

BRIKCRETE



Local Manufacturing of this Modern Masonry Has High Earning Power

Several hundred territories are being opened up for local Brikcrete manufacture by men of vision and aggressiveness. Brikcrete ties in with today's huge building program. Makes possible better construction at lower cost. Truly better than brick; actually cheaper than lumber. Combines strength, safety, insulation value, colorful beauty that fits today's styling.

Brikcrete is made in locally owned plants, using local materials and local labor. That's why high quality and low price still permit a 100% to 150% mark-up. We supply complete equipment; easy terms if required. Generous co-operation. Exclusive manufacturing privileges in protected territory. Write for information.

Brikcrete Associates, Inc.
4679 Division Ave. S
Grand Rapids 8, Mich.

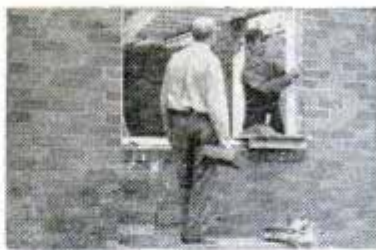

New MOTOR BARGAINS for Home, Farm & Industry



New General Electric
1/2 H.P. Induction Type
3450 RPM 110 V. 60
cy. 1 Ph. A.C. Motor
#GEH-5.....**\$21.75**

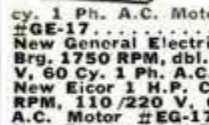

New General Electric
1/2 H.P. Cap/Ind. Ball
Brg. 1750 RPM, double
1/2" shaft. 110 V. 60
cy. 1 Ph. A.C. Motor
#GE-17.....**\$26.50**

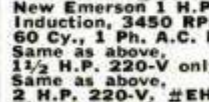

New General Electric 3/4 H.P. Cap/Ind. Ball
Brg. 1750 RPM, dbl. 1/2" shaft. 110 V. 60
cy. 1 Ph. A.C. Motor #GE-75.....**\$34.50**
New Eicor 1 H.P. Capacitor Induction 1750
RPM, 110/220 V. 60 Cy. 1 Ph.
A.C. Motor #EG-17.....**\$45.00**
New Emerson 1 H.P. Heavy Duty, Repulsion
Induction, 3450 RPM, 110/220 V.
60 Cy., 1 Ph. A.C. Motor #EH-1.....**\$45.00**
Same as above,
1 1/2 H.P. 220-V only #EH-15.....**\$57.50**
Same as above,
2 H.P. 220-V, #EH-20 only.....**\$67.50**

The above prices are F.O.B. Chicago. Order by number. We have large stock of special & standard motors, ALL SIZES. Write for prices on the motor you need.

C. MARSHALL SALES, 3546 W. Fullerton Av., Dept. P-3, Chicago 47

General Utility Motors

1/50 H.P., shaded pole motor, brushless, non-radio interfering, 1550 R.P.M., 110 volt, 60 cycle A.C. for light machinery duty, exhaust fans, furnace fans, oil heater blowers and many practical purposes. Handles (in 10 or 12 inch fan blade. Special at \$4.50

No. UM-50, 1/50 H.P. Mtr. & Speed Controller (\$1. val.) both postpaid.....**\$4.50**
No. F-10, 10 inch fan blade to fit above motor, Postpaid.....**\$1.00**
No. F-12, 12 inch fan blade to fit above motor, Postpaid.....**\$1.50**
No. B-4, 4 inch, Sirocco Blower Wheel to fit above motor **\$1.50**

TOY MOTOR BARGAIN



1/250 H.P., shaded pole motor, 110 volt, 60 cycle, A.C., for powering toys, display and experimental work. Only **\$2.75.**

No. TM-12, 1/250 H.P. A.C. Motor & Speed Controller (\$1 val.) both postpaid **\$2.75.**

BARGAIN RHEOSTAT SPEED CONTROLLER. Small 2-inch dia. rheostat for 1/50 H.P. and smaller motors gives approximately 30% speed reduction, light dimmer, etc.
No. RHEO-1, Rheostat complete with instructions. Postpaid.....**\$1.00**
WRITE FOR BIG BARGAIN MOTOR CATALOG & ELECTRICAL GOODS AND SAVE MONEY.

BACKGEAR MOTOR



110 V. 60 cycle, A.C. slow speed motor. Sturdy Gears & Bearings. Drives window displays, Toys & useful experimental work.
#8 - 8 R.P.M. Only **\$5.95** Postpaid
#22 - 22 R.P.M. Only **\$5.95** Postpaid
#90 - 90 R.P.M. Only **\$5.95** Postpaid

BUY DIRECT-BRAND NEW-UP TO 85% DISCOUNT



Portable LIGHT PLANT

PUSH BUTTON START
500-700 watts 110-120 v. — 60 cyc. A.C. Powered by a sturdy dependable, easy starting, air cooled 1 1/4 hp. gas engine. No wiring necessary, just plug in and operate. Plenty of current for most oil burners, emergency lights, freezer, radio, incubator, etc. Ideal for trailers or camping. Complete with Voltmeter and built-in winding to charge 6 v. auto batteries. Wt. 85 lbs. Fully guaranteed. Be prepared if war or storm knocks out power lines. Reg. \$275.00 value. **\$143.50**

GIANT 2000-2500 WATT PLANT

110-120 v. 60 cyc. A.C. Absolutely the best made because its heavy windings develop up to 5000 watt overload for motor starting. Skid-mounted—portable. Powered by 5 h. p. easy starting Briggs engine—complete with all accessories: engine easily disconnected for other uses. Big outlet box, voltmeter, no wiring necessary. Ample current for all purposes. Factory warranty and instructions included. Wt. 220 lbs. Reg. \$585.00. Spec. at **\$299.50**
GENERATOR ONLY and control box. Drive it with your engine or tractor. **\$169.50**

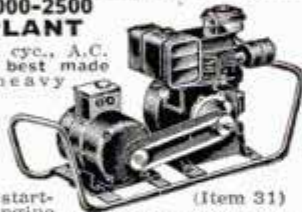

EXTENSION CORD

(Item 16) 40 ft. heavy duty, made of specially insulated No. 14 2-conductor wire. So tough that you can drive over it and yet amazingly flexible and easy to handle. Resists oil, grease or water. Extends electricity up to 400 ft. without voltage drop. Use indoors or out. Complete with heavy rubber plug and outlet. Wt. 2 1/2 lbs. Usually \$4.50—Special 40 ft. **\$1.99**
Comb: 2-40 ft. and 1-20 ft. (total 100 ft.) **\$4.95**

PRESSURE SWITCH

(Item 30) Penn Electric Model 110 BPO2, best made. For pumps and air compressors. Heavy duty. Will handle up to 250 lbs. press. and up to 5 h. p. Autom. unloader valve, for easy starting. 110-220 v. A.C. or D.C. 2 pole. Wt. 5 lbs. Reg. list \$17.50. Our Spec. **\$8.95.**



HOT WATER HEATER

(Item 26) Immersion type, heavy duty, 115v. A.C. 300w. Does not require watching. Thermostat shuts off at 185°. Keeps water hot for shaving, washing dishes, etc. Also good for keeping water from freezing in big troughs or tanks. Made by Cities Service. Wt. 4 lbs. Worth \$9.50. Our Spec. **\$4.50.**

GAUGE TESTER

(Item 27) Precision made of solid bronze by Star Brass Co. Calibrated weights (incl.) acting against hydraulic piston, provides quick accurate testing of all pressure gauges up to 3000 lbs. per sq. in. Brand new in hardwood cases. Wt. 100 lbs. Reg. \$435.00. Our Spec. **\$135.00.**

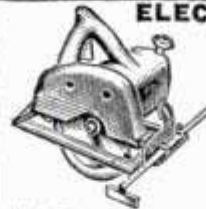

ELECTRIC HAND SAW

(Item 36) Most perfectly balanced and smoothest running saw made. Advanced design provides max. power and light weight. Easily adjusted for all angles, depth and width of cut. Comes complete with 6 1/4" comb. blade, ripping guide and 10 ft. hvy. duty cord. Built-in saw-dust blower. Autom. telescoping guard. 110-120 v. AC-DC. Depth of cut 2 1/8". 1 year written guar. Wt. 12 lbs. Drastically reduced. **\$39.95.**



ANGLE DRILL

(Item 25) Fits into chuck of any electric or pneumatic drill or flex. shaft. Operates at any angle in a full 360° arc. Makes possible drilling, grinding, carving, routing, etc. in close cramped quarters. Makes impossible jobs easy. Made by Kett Tool Co. Complete with built-in chuck (1/4" capacity) and adjusting key. Hardened alloy gears. Precision built for heavy duty. Lists at \$39.95 — while they last **\$9.95.**

CARRY-AIR

Stainless steel tank — capacity 500 cu. in. at 400 lbs. press. complete with inlet and shut-off valves, press. gauge, detachable air hose, tire chuck. Fill at any service station. Carry air for tire inflation, blowing out lines, spray painting, insecticides, etc. One emergency pays back cost. Wt. 13 lbs. Worth \$20.00. Our price — **\$8.95.** (Item 32).



SPRAY OUTFIT

(Item 37) Twin cyl. piston type compressor direct-connected to powerful 110-120 v. AC-DC motor. Built-in air tank eliminates pulsation and provides steady flow of air at 25-30 lbs. Sprays lacquers, enamels, insecticides, etc. Does beautiful work on autos, furniture, farm equip. 1 qt. spray gun, relief valve and 10 ft. air hose incl. Full instructions and 1 year guar. Wt. 11 lbs. Easily worth \$50. Spec. **\$22.95.**

PARTS WASHER

(Item 20) Store gas or carbon tet. in 5 gal. safety can. Valve releases just the right amount into washing compartment. Parts are washed and drained on a "dunking" screen — no fishing for parts. Eliminates fire-danger, waste, spillage, evaporation. Wt. 14 lbs. Reg. \$19.50—Special **\$5.95.**



RUBBER HOSE

New genuine Neoprene Hose — outlasts ordinary rubber 5 to 1. Reinforced with super tough cotton cord piles. Flexible. Easy Flo brass couplings with standard pipe threads for quick connections, included. Pump water for irrigation, stock tanks, home, barn, fire fighting, etc. Pump Gas or Fuel Oil. Save more than 60%. (inside Diam.) 1 1/4" 1 1/4" 1 1/2" Length 25 ft. 40 ft. 30 ft. Price 9.25 14.75 14.75 If specified we will send special hose for gas or oil at same prices.



TERRIFIC VALUES!

HEATING & VENTILATING FAN

(Item 10) Easily installed in furnace pipes. Forces even heat to all rooms. Over range, removes kitchen smoke and odors. Powerful continuous duty motor, 110-120 V. A.C. Quiet, super efficient fan moves huge volume of air (400 to 600 c.f.m.) 8" Fan (6" blade), wt. 5 lb. **\$6.35;** 9" Fan (6" blade), wt. 6 lbs. **\$7.45;** 10" Fan, (8" blade), wt. 7 lb. **\$8.45;** 12" Fan (10" blade), wt. 8 lbs. **\$9.45.**



1/2" DRILL

(Item 33) DeLuxe model — powerful, smooth running, precision built. Handles toughest jobs. Cutler-Hammer switch, Jacobs key chuck. 110-120 v. AC-DC 300-450 rpm. Alum. alloy case for high strength and easy handling. Built-in blower assures cool operation. Cap. 1/2" in steel. 1 year written guar. Wt. 11 lbs. Compares with \$65 drills. Special **\$34.50**



1/4" DRILL

(Item 34) Hi-power, long-life, smooth running. Alloy steel gears; built-in blower, Cutler-Hammer switch, Jacobs hand-miter chuck. 110-120 v. AC-DC 1000-1600 rpm. Cap. 1/4" in steel. 1 year guar. Wt. 4 lbs. Terrific value at **\$12.95.**



38 Pc. DRILL KIT

(Item 35) Includes above illus. guar. drill, buffers, polishing bonnet, sanding discs, grinding wheels, wood bits, steel bits, wire wheels, bench stand, paint mixer burrs. Complete in heavy steel case. Wt. 13 lbs. 38 pc's., all highest quality. Complete kit worth \$38.50. Our Spec. only **\$19.85**



FRAM OIL FILTER

(Item 12), Model F21, Big 73 cu. in. size. Ample capacity for all cars, trucks, tractors. Universal bracket, standard openings. Fram filters are tops. Easy to install. Wt. 8 lbs. Usually \$7.95—now **\$3.75.**

HYDRAULIC HOSE

High pressure, heavy duty, complete with swivel fittings. Pipe thread connections. Ideal for farm equip., bulldozers, grease guns, airbrakes, etc. Any length. Minimum \$1 per lgth. **INSIDE DIAMETER,** 1/4" 50¢ per ft. 3/8" 60¢, 1/2" 80¢, 5/8" 90¢.

CLIP BOARD

(Item 17) Heavy Masonite, with self-adjusting spring hinge to hold up to 100 sheets of 8 1/2 x 11 paper. Push back cover for instant release. Flip cover shut and notes or drawings are protected. Perfect for pilots, engineers, students, artists, truck drivers. Wt. 2 1/2 lbs. Usually \$2.95. Spec. **\$1.10, 2 for \$2.00.**



MANUFACTURERS AND JOBBERS — write us about your surplus items

All items brand new. Prices f.o.b. Chicago area. Money back guarantee. Send check or M. O.

MASTER MECHANIC MFG. CO., Dept. 37, Burlington, Wis.

Aladdin Tools

Make These Cuts — And Hundreds More With Aladdin Shapers for Circle Saw and Drill Press!

CIRCLE SAW WOODSHAPER, MODEL #5A-10. (left) Solid steel. Absolutely safe—blades locked in position with screws all the way through. In ordering, state diameter of your circle saw shaft. Complete, as pictured, with 6 pair blades and tool rack. **\$14.95**

DRILL PRESS WOODSHAPER MODEL #60. (right) Heavy-duty shaper. Exclusive pilot bearing eliminates side thrust, chatter, vibration—assures smooth cutting action. Complete as pictured with 6 pair blades. **\$12.95**

ALL ALADDIN TOOLS ARE GUARANTEED
Send Cash, Check, or Money Order today.

Nationally Distributed by

BERTRAM E. ENGINEERING & SUPPLY CO.

3121 MAIN STREET

KANSAS CITY, MO.

Get Your POWER KING Saw NOW-WHILE YOU CAN!

"America's Finest 8" Saw Value"



ONLY... \$6175!

F.O.B. Kalamazoo, Mich. Price includes motor rail, belt, pulley, mitre gauge, fence, splitter, guard—less motor.

POWER KING
8" TILT/ARBOR SAW

BIG! FAST! RUGGED! ACCURATE!

Steel is scarce! Don't delay a day longer in buying a good, dependable power saw for your shop. This fine Power King 8" tilt/arbor model is today's outstanding buy. It's priced low, has every feature you need for "factory-quality" work in your home shop. Pays for itself on shelves, cabinets, cupboards, furniture, home repairs.



POWER KING
7" TILT/ARBOR SAW

ONLY \$4475

F.O.B. Kalamazoo, Mich. Price includes same as above, less motor.

"KING OF THE 7" SAWS"

No other 7" saw even close to this value! *Big capacity—big saw features*—yet priced so low it pays for itself on one or two projects alone! Fast, accurate, lasts a lifetime. See these fine saws today at your Power King dealer's, or send postcard for details.

ATLAS PRESS CO.

335 N. Pitcher St. • Kalamazoo, Mich.



SAY YOU SAW IT IN POPULAR MECHANICS

AMAZING NEW

WOOD-TURNING TOOLS!

Outlasts Steel Up to 50 to 1!



SHARPEN ONCE IN 12-YEARS! (UNDER NORMAL USE)

These remarkable tools tipped with TUNGSTEN CARBIDE will astound you with their performance. They work FREE HAND equally well in wood, plastic or soft metals—and at the same time hold their razor-like edge almost indefinitely. Tests show that they will turn wood or plastic for days and days CONTINUOUSLY without showing any signs of dulling. They are the finest tools available at any price. Beautifully finished 5" blade—flush ground, polished tip—finest brass tube ferrule—9" hardwood handle—over all length 14"—25 tools to choose from: round & square nose from 1/8" to 1/2"—1/8 and 3/16 cut off; 1/2"x30 skew, spear, r. & l. skew, turning and parting. Amazingly Low Prices! Write at once for free literature.

JOHNS MFG. CO., DUNELLEN 6, N. J.

Our 372nd Advertisement

REAL DIESEL ENGINE

\$2.95

- for planes, boats, midget cars
- 7500 RPM; 1/7 HP; ht. 3 1/2"; wt. 5 oz.
- comes completely assembled

You just can't beat this price for a complete precision diesel engine! Streamlined, rugged, compact. Starts quickly, easy to install, runs for years. Fast delivery if you ORDER TODAY! Send \$2.95 plus 25c postage.

GOTHAM HOBBY CORP. Dept. P, 107 E. 126 St. New York 35

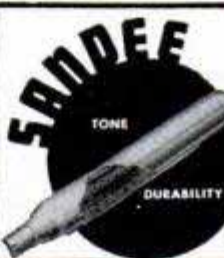
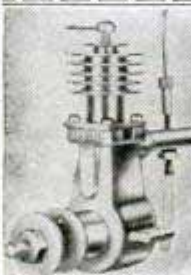

SPORTONE MUFFLERS

- Ford & Chevrolet.....\$ 4.45
 - All other popular cars..... 5.45
 - V-8 Dual Sets..... 15.95
 - Chromed Silentips..... 2.95
- (Please state make & year of car on all orders.)

SANDEE MUFFLER CO.
5643 Corryne Place • Culver City, California

Make Your Own LOW COST POWER TOOLS

Use Wood, Scrap, Discarded Materials—Make Practical, Proven Machines

Order today the new "Forty Power Tools You Can Make." Even though you have the older edition, get this new book with twenty brand new tools—40 in all. Make your own motorized lathe, drill press, sander, shaper, circular, band, scroll and jig saws from old auto and other discarded parts. Make forty different tools following simple instructions, diagrams and photos and have an efficient, up-to-date shop. Save money, time and hard work and do a better job with low-cost power tools. Sent postpaid for only \$1.50 with order. Avoid high C. O. D. charges.

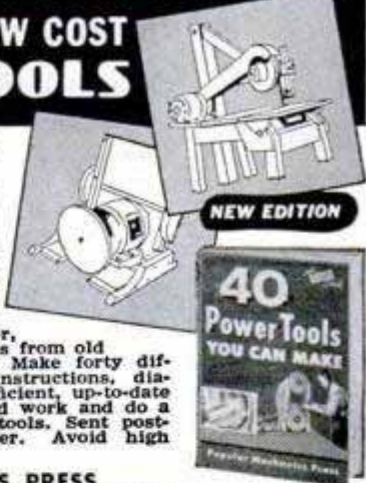

POPULAR MECHANICS PRESS
200 E. ONTARIO ST., CHICAGO 11, ILLINOIS

GRIND YOUR OWN CIRCULAR SAWS

BETTER THAN NEW WITH "TRU-CIRCLE" (Pat. Pend. R)

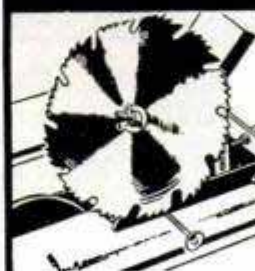

USE YOUR OWN saw table. Sharpen combination, rip and hollow ground saws from 8" to 10". Makes hand filing obsolete. Saws last twice as long—and stay round—with correct tooth bevel—for cleaner work.

PRECISION JIG
Give arbor size and distance arbor A to saw edge B. and instructions. Buy now. Steel is scarce. Guaranteed.

Only \$8.95. At your dealer's or postpaid. Sent complete with \$3.00 grinding wheel.

"Tru-Circle" Automatic Saw Set. Sets saw teeth at 10° or more. Only \$2.95. At dealers or postpaid.



A. D. McBURNEY, 317 E. 4th Street, Los Angeles 14, Calif. Dept. A-3

POPULAR MECHANICS



The COASTER BRAKE
with
SELF-ALIGNING
BRAKE SHOES



Ride
a Bike
it's
Fun!

Self-aligning brake shoes give quicker stops, longer life, easier pedaling. It's another Bendix feature that makes the Bendix* Coaster Brake the outstanding performer in its field. Your dealer will put on the brake you want—so just say "Bendix Coaster Brake." *REG. U.S. PAT. OFF.

DOUBLE THE FUN
WITH A **Bendix**
COASTER BRAKE

ECLIPSE MACHINE DIVISION of
Elmira, New York



Ask Your Hardware Store for
FULLER'S
Unbreakable Amber Handle
SCREW DRIVERS

America's most popular line of moderately-priced screw drivers! Wide range of sizes.
FULLER TOOL COMPANY, Inc.
911 Faile St. New York 59
World's largest makers of Amber-Handle Tools



FEDCO get this
**Saw-Rite WONDER-WORKING
DRILL SAW**

Fits any
3/4" drill

FINEST YET MADE... ZIPS THROUGH
WOOD, PLASTICS, WALLBOARD, ETC.

You'll never use a handsaw again after you try this light-weight, fast-cutting beauty. Careful design, rugged, precision manufacture and a better blade make this an outstanding buy. Quick-acting, worm-drive, patented clamp gets it on and off your drill in seconds. Combination blade is chrome nickel alloy steel, precision ground, correctly heat treated, balanced and fitted. Cuts grooves, dados, crosscut, rip, hour after hour without sharpening. Depth of cut fully adjustable from 1/8" to 1 1/4", cuts plywood, shelving, wallboard, 2x4's to 2x10's in two cuts, one from each side. Special sighting notch enables you to follow line. Lifetime Oilite bearings, finest quality hardened steel gears, shafts. One or two hand operation with hand-fitting knob. Use coupon to order at once for immediate delivery. Try it for 10 days, full refund if not completely satisfied.

Fedco also makes Saw-Rite Jr. at \$7.75 and
Zanzall at \$2.95 . . . ask for FREE literature

FEDCO \$10⁹⁵
Saw-Rite
Attachment

COMPLETE WITH COMBINATION BLADE
ELECTRO SPECIALTY CO.
128 Church Street, N. Y. 7, N. Y.

Electro Specialty Co.,
128 Church St., N. Y. 7
Send me _____ Saw-Rite #600 Saw Attachment(s) @ \$10.95; _____ Additional blades @ \$2.00; _____ metal cutting blades @ \$3.00; _____ FREE literature.
(Write name and address on margin)
(All prices postpaid except C.O.D.'s)

tame

the most stubborn

nuts

as the experts do

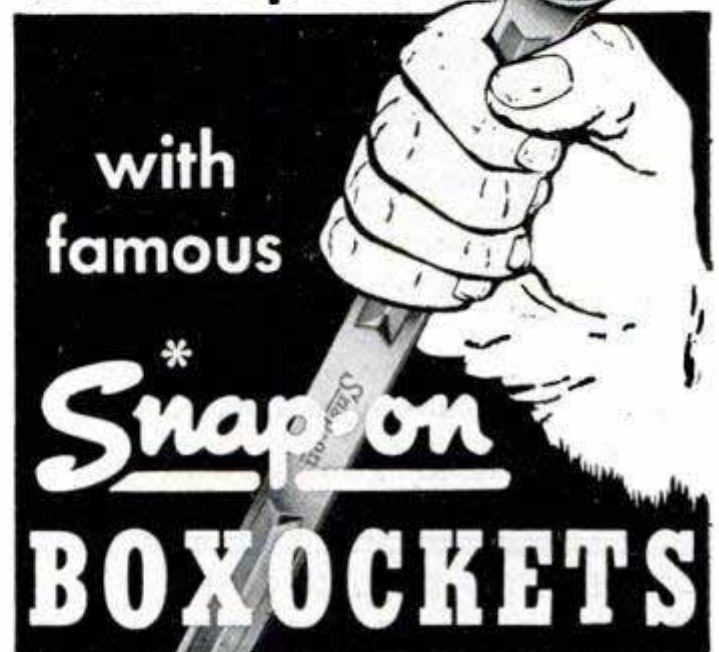

Tens of thousands of mechanics in plants and service shops rely on famous Snap-on professional tools in earning their livings. Snap-on Boxockets are special favorites. Drop-forged, heat-treated. Incredibly strong, with machined openings, "streamlined" for close work. Properly offset for knuckle clearance. Beautifully finished, as fine tools deserve. Snap-on Boxockets will serve you for years. Make you proud of your kit. Make you sure and confident on any job. If you are a user of quality tools, send for free 104-page catalog.

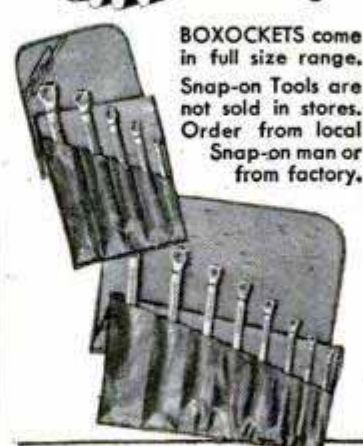

BOXOCKETS come in full size range. Snap-on Tools are not sold in stores. Order from local Snap-on man or from factory.

SNAP-ON TOOLS CORPORATION
8062-C 28th Avenue
Kenosha, Wis.

*Snap-on is the trademark of Snap-on Tools Corporation.



SAVE ON REMODELING



IT'S easy and inexpensive to build an extra bedroom, bathroom, game room, photography darkroom or what-have-you with Gold Bond Gypsum Wallboard. Just nail the

sturdy, fireproof panels right to lumber framework or over an old wall or ceiling. Joints can be completely concealed with Gold Bond Perforated Tape Joint System. Decorate with Gold Bond Sunflex—the one hour wall paint. Or, if you prefer papered walls, Gold Bond Gypsum Wallboard takes wallpaper beautifully. It's moisture resistant, won't warp, swell or contract. For further details, write Div. W., Dept. PM-31

Available at your local Gold Bond lumber and building materials dealer!

NATIONAL GYPSUM COMPANY
BUFFALO 2, NEW YORK

GEARED TOOLS FOR THIS ATOMIC AGE

.. Are Saving USERS \$s — Energy
Making **BIG MONEY** for AGENTS ..
.. Eifel-Line Super-Tools

with the Amazing
4X, EXPANDO-Jaw



The NEW '4X' Jaw
Above Composite Cut shows 2 Positions.
• The Exclusive Parallel EXPANSION-Grip has countless new uses.



• A 3-Jaw, 7" Plierenich KIT and 8 1/2" PRIME and MASTER KITS with 3 to 8 Jaws, etc.: Universal, Pipe, Wire; for a Million Sizes 0"-1 3/4", and
• GIANT UNIV.. '4X' and PIPE Jaws (Range 1" to 3 1/2")
• Tub'g Ctr., Grip-Clamp, etc. . . . 1-Oz. to 1-TON grips!
• Do Thousands of Jobs, Quicker, Better and Easier.
• 8 1/2" Items FIT EIFEL-GEARED Plierenichs . . . '33 and later. Sold SINGLY or in ANY Combination.



GET the Most Amazing Gripping-tool Facts Ever

This is Your LAST CHANCE for a Long Time.

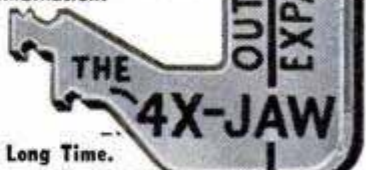

MAIL this COUPON TODAY . . .

(ON A POSTCARD WILL DO) . . .
Print your Address . . . Get FREE
1) The 115-Picture MANUAL — M,
2) The 120-Picture CATALOG — C,
With OFFER as marked —
PART-TIME AGENT USER
FULL-TIME DISTRIBUTOR



AMERICAN PLIERENCH CORP'N
4611 N. RAVENSWOOD AVE.,
CHICAGO 40, ILL., DEPT. PM-1-3

3) Also FREE (in U.S.A.) this 3", 6-Edge, End-and-Angle Screwdriver, etc. . . . often more Valuable, Useful than a Pocketknife!

PRESENTING THE ONLY SANDER With
POWER UNIT GUARANTEED

All During Your Ownership

AGAINST BURN-OUT . . . or REPLACED

Free!

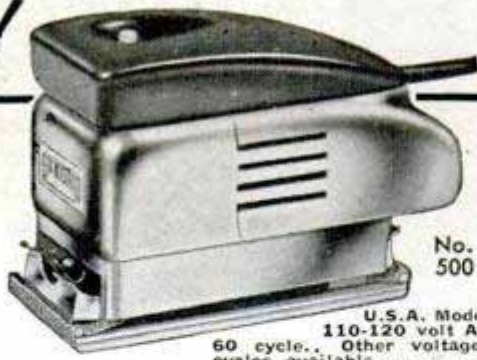

Listed by

ONLY
\$16.95

No. 500

U.S.A. Model, 110-120 volt AC, 60 cycle. Other voltages, cycles available. . . .

SYNCRO

ELECTRIC

SANDER—POLISHER—MASSAGER

Looking for a "light finishing" sander and high polisher plus a relaxing massager? Here it is — made by dependable SYNCRO . . . and the only sander of its kind that guarantees its Power Unit against burn-out A L L DURING YOUR OWNERSHIP—or replaces it Free.

Also, the ENTIRE sander (not just the cord) is LISTED by Underwriters' Laboratories, Inc. Let the new, improved SYNCRO do the work at 240 strokes per second—just guide it. COMPLETE with BUILT-IN Fractional Horsepower Reactor Type Electric MOTOR, 10 sandpapers, lamb's wool and fabric pads, \$16.95 at dealers. If none near, send \$16.95 direct—we'll ship Sander postpaid. Syncro Corporation, Dept. D-31, Oxford, Mich. U.S.A.

SAW SHARPENER



Table model, gums and sharpens rip saws, combination saws & cut-off saws. Ideal for "Skill-saw" blades. Cap. 4" to 20" diam. Complete with 1/4 h.p. motor & 1 grinding wheel & cord — \$64 f.o.b. Portland. Shipping weight, 63#. SEND FOR FREE LITERATURE.

8375 N. Interstate,

P. T. HOBBS MACHINERY
Dept. PM-52, Portland 17, Ore.



Clark EXPANSIVE BIT
CUTS BETTER • COSTS LESS! Accurate, fast; cuts smooth holes in hard or soft wood. Chrome vanadium steel blades, all chrome body. No. 250, 1/2"-1 1/2", \$1.89; No. 251, 7/8"-3" \$2.19 GUARANTEED. At your dealer or write ROBERT H. CLARK COMPANY, Beverly Hills, Calif.

PARTS FOR MILITARY TRUCKS

At A Savings New FREE Catalog
For Jeep, Dodge, Chev., G.M.C., Studebaker—4x4 - 6x6. Drive

Brand New — Not War Surplus — Complete
JEEP TOPS and SIDE CURTAINS
Fits all Military Jeeps. Also adaptable to some Civilian Jeeps. Waterproof O.D. . . . **\$59.50**

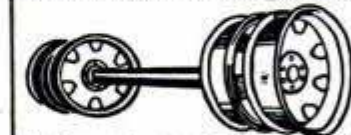

TRAILER AXLE
Heavy duty trailer axle suitable for many types of trailer construction. Also excellent for building of heavy farm trailers and wagons. It is a 12,000 lb. capacity square type straight trailer axle complete with Timken roller bearings, hubs, and 6 hole 750 x 20 Budd Wheels. Without brakes. Axle is 2 inches square and 69 inches between wheel mounting flanges. Std. width.

With Single Wheels. \$59.50 With Dual Wheels. \$69.50
Hundreds of Other Truck & Jeep Parts and Supplies
All prices quoted good 30 days FOB, Kansas City
25% DEPOSIT REQUIRED ON ALL ORDERS

American AUTO PARTS CO. INC.
1830 LOCUST—DEPT. PM
KANSAS CITY, MISSOURI

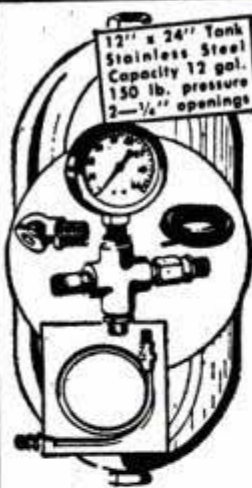

WESTINGHOUSE Air Compressor

Reg. \$60.50 Only
Model T-1 Brand New
— 2 CYLINDER \$21.50
PISTON TYPE.
 Operates with 1/2 H.P. Motor or equivalent gas engine
 Compressor has 2" bore, 1 1/2" stroke, ball bearing, 3.27 CFM at 600 R.P.M. Capacity up to 6.54 CFM. Size 9"x 11 1/2"x6 5/8". Wt. 26 lbs.

BRAND NEW
 Compressor, pressure tank, air gauge, air chuck, 20-ft. hose, pop valve, copper tubing with 4 brass flared fittings for connecting compressor to tank, 4-way cross and 3 nipples.

COMPLETE OUTFIT, wt. 52 lbs. \$32.50
EQUIPMENT LESS COMPRESSOR, \$12.50
COMPRESSOR SEPARATELY, \$21.50

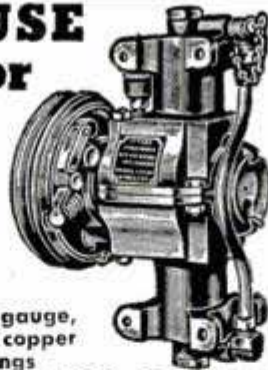

LIGHT PLANTS

Brand New!
War Surplus

Signal Corps Power
Unit PE 197

115 volt 60 cycle A.C. single phase 5 K.W. Hobart, water cooled, 14 h.p. 4 cylinder Hercules engine. **Remote Control,** complete panel board with instruments, 150 ft. automatic remote control cable with reel; 150 feet #6 heavy duty wires with reel; housed in metal case with replacement parts and tools. Cable with reels alone worth \$400. Regular price of unit \$1900. Shipping wt. 1250 lbs. Our price, **\$895.00** complete. f.o.b. Chicago

Same unit, slightly used. Reconditioned, less cable. Fully guaranteed **\$595.00**

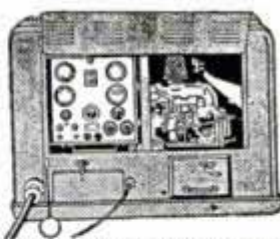

RED SEAL CONTINENTAL GAS ENGINE

BRAND NEW. 1 1/2 HP with 6 to 1 reduction gear. Operates at 450 R.P.M. For lawn mowers, scooters, garden tractors, pumps, compressors, generators, etc. List Price \$79.50. Shipping weight 54 lbs.

SPECIAL PRICE \$47.50

Same engine furnished at 2600 RPM.



\$46.50



Chicago Pneumatic
 CP4X Pistol grip handle. Takes up to 3/16" rivet. Weight 6 lbs. List price \$73.00
Brand New \$32.50
 Used, like new, gurr. **\$17.50**

AUTOMATIC PRESSURE SWITCH



For Air or Water

20 to 40 lbs. **\$6.50**

LIGHT PLANT

Brand New 1 Year Guarantee
Portable Light Weight

1500 watts, 110-120 volt, 1 phase 60 cycle, A.C. 12 Volt starting and charging 30 watts, 2 receptacles for plug in. Rheostat for voltage control. Voltmeter. Complete with Briggs & Stratton or Wisconsin Air Cooled engine. Shipping wt. 220 lbs. **\$325.00**
SPECIAL PRICE.

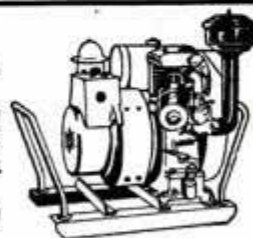

GENERATORS

500 to 750 watt, A.C., 110-120 volt, 60 cycle, 1 phase output. Also 100 watt D. C. battery charging output. May be used at the same time. Voltmeter, 2 outlet boxes. **\$99.50**
 Wt. 55 lbs. Price
 Furnished with 1 1/2 HP Engine with drive **\$149.50**
 2000 Watt, 110-120 volt, 60 cycle, A.C. 1 phase, 35 amperes. Starting, overload capacity up to 51 amps. Voltmeter, 2 plug-in receptacles. Wt. 75 lbs. Complete instructions furnished. Special Price **\$169.50**
 Furnished with 6 1/2 HP. **\$295.00**
 —B & S Z Engine.

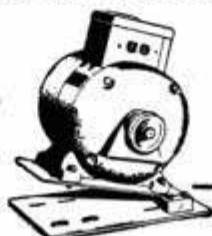

WELLWORTH V-BELT CLUTCH



Takes starting load off engines or motors. When speed is reached, a flip of handle shifts clutch from idling to driving position. Handles "A" belts, 2.35" pitch diameter, 5/8" bore. Ideal for use with lawn mowers, garden tractors, home workshop motors, etc. 3 1/4" long. Safe, easy to mount, sealed bronze bearings, positive action. Shpg. wt. 3 lbs. **\$7.50**
BUSHING FOR 1/2" SHAFT, 15c
BRAND NEW SAME CLUTCH FURNISHED WITH 3/4" BORE \$8.50

Portable ELECTRIC HAND SAW



The Zip Sawyer With ALL the Features
 6 1/4" Diameter saw blade, 1/2" square arbor hole. Maximum depth of cut 2 1/8". (At 45°, 1 3/4".) Minimum depth of cut 0". Angular adjustment 90° to 45°. No-load speed, 5200 r.p.m. Full load speed, 3200 r.p.m. Amperes, full load 8.0. Universal AC-DC motor, 110/220 volt. Dimensions: 11 1/4" long; 9 1/2" wide (ripping guide removed); 7 1/8" high (without blade). Furnished complete with 6 1/4" diameter combination blade and 10 ft. cord and plug. Wt. 11 1/2 lbs. Price **\$39.95**

6 Ft. Stow FLEXIBLE SHAFT

BRAND NEW
 3/8" Core. Ball bearing handle and arbor. Operates on 1/4 H.P. Motor at 1725 or 3450 r.p.m. \$29.00 value. Wt. 8 lbs. **\$16.50**



AIR REGULATOR and EXTRACTOR
 1/4" Air Regulator, Gauge and filter. Wt. 5 lbs. **\$8.95**



New
 Regulator and Gauge only **\$5.95**
 Air Filter only **\$3.25**

"Wellworth" BLOWER BARGAIN



BRAND NEW
 Quiet operating. Double wheel inlet, double width blower. For heating, ventilating, cooling, air washing, exhausting and forced draft. DIMENSIONS: 10" wheel; outlet 13 1/2" x 11 3/8"; inlet 8 3/4". Height 19". Width 18". Depth 16 1/2"; C.F.M., 1/4" S.P. 1600; outlet vel. 1575; wt. 45 lbs. **\$27.50**
BLOWER LESS MOTOR AND DRIVE \$2.50
 with belt and variable speed pulleys extra. (Motor required, 1/4 h.p.)

AUTOMATIC COMPRESSOR UNIT

1/2 H.P. heavy duty capacitor motor. AC 110/220 volt, 60 cycle, 2x1 3/4 inch piston type compressor, splash feed lubrication, 12x24 inch tank, automatic pressure switch. CFM 2.8 at 100 lb. pressure, or 150 lbs. pressure for intermittent duty. Check valve, safety valve, air regulator with gauge and filter, 20 ft. air hose with air chuck for inflating tires. V. belt drive. Mounted on 2 wheels, ball bearing, with 2"x10" pneumatic tires. Portable with handle. Shipping wt. 90 lbs. **\$98.50**

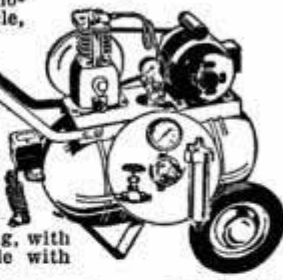

Brand New
SPECIAL PRICE \$98.50 Same unit with Gas Engine **\$107.50**

Prices f. o. b. Chicago. Money back guarantee. Send check or money order today. Prompt shipment.

NEW CATALOG

Motor guide, air compressors, home and factory workshop tools, light plants, luggage bargains. Send 10c for postage.

WELLWORTH TRADING CO.

1831 S. STATE ST. DEPT. D-3 CHICAGO 16, ILL.

Detectron GEIGER COUNTERS • TREASURE DETECTORS



LOW COST BATTERIES • LIGHT WEIGHT • 3-WAY SIGNAL • GTD. 1-YEAR

Detectron GEIGER COUNTERS
 Sensational new models; low cost operation, light weight, sensitive to all uranium minerals. We have a model in YOUR price range.

Detectron TREASURE DETECTORS
 Lightweight, portable, sensitive. Model 711 (right) is most powerful made. New model 27 for nuggets, rings, small objects. Also mineralights.



Detectron co. Write Today for Free Descriptive Literature 5631 CAHUENGA, NORTH HOLLYWOOD, CALIF.

now! Foredom offers a
POWER-PACKED 14000 RPM
 1/15 H.P.
FLEXIBLE SHAFT MACHINE
 YOU can afford

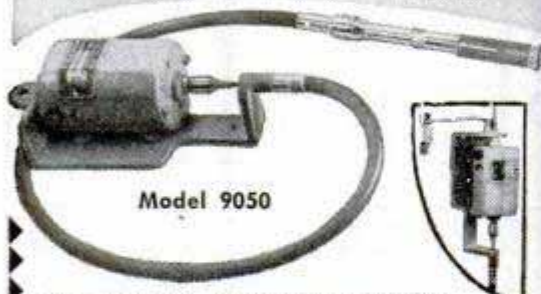

Model 9050

ONLY
\$29.60

including
6-STEP
FOOT
RHEOSTAT

3-WAY USEABILITY

- Hang it up
- Set it on Bench
- Mount under Bench

Foredom's Model 9050 gives you industrial quality at a popular price. Here is what you get: a 14000 rpm 1/15 H.P., air-cooled universal motor • precision-made pencil-size, quick-detachable handpiece • flexible shaft of extra good flexing qualities running in a metal sheath covered with tough, long-lasting Neoprene. Here's a small power grinder with the kind of power, speed, stamina and all-around versatility you have been waiting for. **TOPS THEM ALL.** For commercial users and home users who insist on industrial quality in their tools. Use it to grind, polish, drill, saw, sand, carve, mill, clean, rout, etch, engrave, etc. on all metals, wood, plastics, glass and linoleum. Includes your choice of 3/32" or 1/8" capacity collet. Add 85c if you want both. Backed by Foredom's 28-year old reputation for quality and workmanship. Other motor-driven models for as little as \$17.75, all precision-made.

Catalog 1139-E on request.

FOREDOM ELECTRIC CO.

27 PARK PLACE Dept. 1139-E NEW YORK 7, N.Y.

In a tight spot?
"YANKEE"
Offset Screw Driver
Drives . . . draws screws
in close quarters!

Get 'em out or drive 'em easily in tight places with a "Yankee" Offset Ratchet Screw Driver! Lever action gives more power than a regular 8" screw driver. No. 3400 illustrated has 1/4" and 3/8" blades for slotted screws; other models for Phillips Recessed Head Screws. At your Stanley dealer's. Write for free "Yankee" Tool Book.

"YANKEE" TOOLS **STANLEY** THE TOOL BOX OF THE WORLD
 NOW PART OF Reg. U.S. Pat. Off.

NORTH BROS. MFG. CO., Philadelphia 33, Pa.

POSTPAID ANYWHERE IN U.S.A. WE FURNISH ALL MACHINED METAL PARTS, EVERY SCREW, NUT, BOLT, WASHER, AND COMPLETE PLANS FOR THIS . . .



BIG 10" POWER SAW

\$10.95 FULL REFUND IF NOT SATISFIED IN 10 DAYS
 LESS GUARD & WOOD

ASSEMBLE IT YOURSELF WITH SIMPLE HOUSEHOLD TOOLS!

COMPLETE PLANS 10c
MARCUS-POLLAKE
 DEPT. N, ROYERSFORD, PA.

SpeedWay



SpeedDrills

Advanced designs, new all-die-cast (aluminum) construction and bigger motors. Lighter, handier, yet faster-drilling than more expensive, more cumbersome old style drills. Drill steel, wood, concrete or stone rapidly and efficiently.

No. 400 1/2" capacity—more power than drills costing almost double. Jacobs Geared Chuck, removable top handle. **\$39.50**

See these new Speed-Drills before you buy; for more drill per dollar and more power per lb.



No. 200 1/4" capacity. Fast-drilling with added power. **\$16.50**
 With Jacobs Geared Chuck. **\$19.50**

No. 79 3/8" capacity—power of ordinary 1/2" drill. **\$22.50**
 With Jacobs Geared Chuck **\$27.50**



Write for Circular on drills, grinders and sander

SpeedWay MANUFACTURING CO.
 1863 So. 52nd Ave., Cicero 50, Illinois

STOP GENERATOR TROUBLE



WITH THE AMAZING NEW INVENTION THE WATTAGE REGULATOR
 THE GREATEST NEW DEVELOPMENT IN AUTO IGNITION SINCE THE SELF STARTER
YOU CAN DRIVE WITHOUT BATTERY
 It's Thermo-Automatic for Better All-Weather Performance
Guaranteed 100,000 Miles or One Year
SCIENTIFIC ELECTRIC CO. P. O. BOX 2162-G STA. H CLEVELAND 8, OHIO

BUILD AN ARC WELDER FROM OLD GENERATOR

For Light or Heavy Work. 75-200 amps. No previous experience needed. Complete **PLANS** and valuable **Catalog 35c**. Send today.
LEJAY MANUFACTURING CO.
 1347 LeJay Bldg., Minneapolis 8, Minn.



584 Page Novelty Catalog Now Ready!

Rush Coupon **584 Pages; 7500 Amazing Novelties**
 Send 10c for mammoth new catalog of 7500 novelties. (Each copy costs us over 50c—10c helps pay postage.) More fascinating than World's Fair. Thousands of things you never knew existed—never knew where to get. Includes novelties, tricks, jokes, live animals & pets, scientific supplies, den novelties, hobby supplies, planes & boats, looms, magic, unusual seeds, gadget time savers, camera & optical goods, movies, projectors, lucky jewelry, religious novelties, telegraph sets, magnets, disguises, easy musical instruments, stamps, coins, puzzles, fortune tellers, radios, experimental sets, auto & bike accessories, Western belts & wearing apparel, telescopes, magnifiers, compasses, banks, smokers' gadgets, artists' supplies, printing sets, engines & motors, electric shockers, knives, billfolds, weird articles, archery, swimming helps, 1000 fascinating books, games, locks, live chameleons, barometers, rings, watches, charms, imported novelties, exercisers, money savers, handy tools, Indian novelties, etc., etc., etc. Jammed & packed with sensational funmakers & useful articles. Big catalog—over 1 inch thick. 6 color cover. Rush Coupon to Johnson Smith & Co.

Johnson Smith & Co., Dept. 369, Detroit 7, Mich.
 Here's My 10c. Send Big Catalog to:

Name & Address _____



SAVE UP TO 85% IN WAR SURPLUS

NOW! MAKE YOUR OWN ARC WELDER

Here's a Real Buy! Finest precision built R-1 Generators, used on B-29's, cost the Government approximately \$400.00. Gives from 300 to 400 amps at 27 volts. Ideal for all welding, light and heavy up to 5/8" thickness, FREE complete instructions for conversion of this Generator to welding unit. R-1 NOW AVAILABLE AT



27 95

Other AIRCRAFT GENERATORS

P-1	27 Volts	200 Amps	1595	E-5A	12 to 15 Volts	50 Amps	1295
127J-1A	27 Volts	75 Amps	1595	03	27 Volts	100 Amps	2500

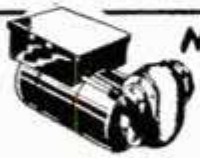

NEW! GEAR HEAD MOTOR

GHM-607 - Originally designed to drive large Aircraft Tow-Target reels. Powered by 24 VDC, 95 amp, compound wound motor. Rated at 2 HP. Turns 4,200 RPM and is geared down to 136 RPM at the power take-off shaft. 60 foot pound torque at take-off. Power drive is 3/4" female adaption. Unit has magnetic clutch for instant stop control. Comes complete with operating switches and control box.

3750



FIRE EXTINGUISHER

Kiddie Lux CO₂ Type. Built to Gov't spec. Shatter-proof, heavy case. Fully recharged. with horn.

No. 602A - 7 1/2 lb. \$35 Value. **19.25**

No. 603 - 10 lb. A \$65 Value. **25.75**

No. 601 - 4 lb. Wheel Control Type. **14.25**

No. 605-B - 15 lb. Wheel Control Type. **32.95**

No. 605-C - 15 lb. New Squeeze Grip Type. \$85 Value. **39.95**



LEAR ELECTRIC MOTOR

24 volt, 6 amps, series-wound reversible motor with over-load clutch. Motor turns 11,000 R.P.M. Has 11 to 1 gear reduction box turning 1000 R.P.M. at take-off. Adaptable to flex or rigid drive. Limit switch box. Size 10" x 4".

\$795



SAMSELL MOTOR

27 volts, 16 amps 1/5 H.P. reversible, series wound on motor. 3800 R.P.M., shaft 9/32" diameter. 12-spline. 4-1/8" x 2-3/8".

395

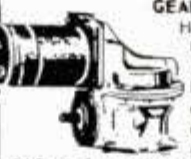

GEAR HEAD MOTOR

Heavy Duty G.E. Gear Head Motor. 1 1/2 H.P., 24 volt DC, 125 amp reversible motor will drive reduction gear box unit 44.5 to 1, resulting in 168 R.P.M. at 5/8" diameter take-off shaft. Motor contains electro magnetic break.

495

UNIT COMPLETE **1095**

GEAR BOX ALONE **795**

ELECTRIC ACTUATOR



Hundreds of uses for any mechanical device needing controlled 2-way action, opens, closes, raises or lowers doors, windows, gates, valves.

CTU-2 Foote linear actuator. 24 Volt A.C. or D.C., 8500 R.P.M., 1/6 H.P. Series wound motor, 4 1/2" stroke in 1 1/2 seconds. Compression and tension. Loads up to 750 lbs. Adjustable micro switch for limits of travel. Overall length retracted 11" **Only 695**

TACHOMETER - TYPE C-11

Operates on direct drive with flexible shaft. Range is 0 to 4500 RPM. Ideal for use on single engine planes or boats, autos, etc. Drives direct from camshaft or at 2 to 1 reduction from crankshaft. **\$475**

AUTO PULSE PUMP

Ideal for fuel pump for auto or boat. 24 Volt D.C. Can be adapted to 6 Volt D.C. 1/8" standard pipe ports. **550**

Sperry Aircraft Directional CYRO COMPASS

Dial is 360° swing, calibrated 1/10° (6 min). Panel mounted. Face is 4 1/2" square with 3" luminous dial. Can be used in autos, planes or boats by attaching one tube to intake manifold for required vacuum. Has external set knob. Government overhauled and ready **\$495**

D. C. METERS

AMMETERS		VOLTMETERS	
0-30-0	0-30	0-120	0-300
60-0	60	0-240	
120-0	120	0-300	

Your choice 3.95 ea.

COMBINATION VOLTMETER - AMMETER

30V - 30 AMP **\$4.95**

30V - 60 AMP

All meters 2" face except 0-300 which is 3" face.

SHUNTS - Required for use with D.C. Ammeters 30-60-120-240

SOLD ONLY WITH METERS. **\$1.00**

NEW ELECTRIC MOTORS

No. 500 - New 1/2 HP - 27 Volt DC-AC. This motor can be readily adapted to deliver up to 1/2 HP on 110 Volts AC by the simple method of rearranging armature brush-leads. Free diagram with each order. A sensational Value **\$5.95**

No. 500-A - Converted to 110 Volts-AC Equipped with plug and 3/16" Heavy Duty Cord **\$8.49**

GEAR BOXES VTG-1 - 90°

bevel gear 1 1/2 to 1 reduction, size 7" x 6". A Life-time Value. **\$3.95**

VTG-2 - In-line spur gear 16 to 1 reduction, thru 4 gears. Final take-off 4 1/2" dia 26 teeth. 1/4" Alum. spur gear. **\$6.49**

Both above gear boxes have lever control for engaging & disengaging positive clutch, dust proof housing. Pre-lubricated bearings. Both can be adapted in Vickers Transmission.

ELECTRONIC TRANSMISSION GEAR TRAIN

GT-1, approx. 50 Bronze Spur & Pinion Gears - 1/8" to 4" dia., 5 sets of 7 cluster gears, 2 complete worm and worm gear drive sets, 40 N.D. ball bearings 1/2" to 1 1/2" dia., watch springs, bushings posts, face plates, housings - Micro Switches, 2 miniature controlled clutches, etc. Gears in multiple size & sequence, identical teeth ratio, giving 100's of gear reduction combinations. **899**

Wt. 10 lbs.

NEW! 1951 CATALOG

PACKED WITH BARGAINS!!! Just Off The Presses! Bigger Than Ever! 200 Pages of NEW and SURPLUS Clothing, Tools, Camp Equipment, Electrical Supplies, Hydraulics, Motors, Pumps, Valves, Raw Stock, etc. AT UNHEARD OF LOW PRICES! Send 50c Today! (refunded with your initial order of \$1 or more).

HYDRAULIC CYLINDER SPECIAL



Gives 20,000 lb. thrust (push pull) using 1500 PSI line pressure as obtained from our hyd. pumps. Or will produce 40,000 lb. thrust with 3,000 lb. line pressure. CAN ALSO BE OPERATED ON LOW PRESSURE AIR SYSTEMS, 4" Bore, 1 1/2" dia. piston shaft, 18" stroke, length 30 1/2". Equipped with ball bearing loaded clevis type mounting and swivel type high pressure steel pipe bracket for easy use. Ideal for roof, farm & shop machinery, presses, etc. Cost Gov't \$390.00 **295**

We carry the World's Largest Supply of New Hydraulic Equipment featuring over 20,000 Cylinders in 61 Sizes & Types. Can also supply all accessories such as Pumps, Fittings, Valves, Tanks, Hose Fittings. Let us solve your Hydraulic problems. Write for information.

No. 9-E HYDRAULIC CYLINDER Double action cylinder. Has a bore of 1-3/8" and shaft of 1". Stroke is 9". Overall length 15 1/2". Built for 1500 lbs. continuous duty, 3000 lbs. intermittent duty. Will lift or push up to 2300 lbs. Can be adapted to hundreds of jobs. **895**

No. 3 HYDRAULIC CYLINDER - Double action. Bore is 1". Shaft 3/4". Has a stroke of 2 1/2" to 4". Stroke can be adjusted with internal sleeve stops. Overall length is 8 1/2". Will take 1500 lbs. continuous duty, 3000 lbs. intermittent. Will lift or push up to 1100 lbs. **475**

P-3 STRATO POWER PUMP With built-in variable flow control valve in head. Positive displacement piston type. Displaces 450 cu in. per revolution. 2 gal. per min. cap. at 1500 RPM at 1250 PSI. Pressure limit, 1250 PSI continuous. 1400 PSI for 15 sec. Operates at 3750 RPM, intermittent maximum, 4500 RPM. Rotation either direction without adjustments. **1950**

GEROTER TYPE PUMP Logan Geroter type. For operating hydraulic systems on trucks, tractors, etc. Delivers 8 GPM at 1200 RPM at 1000 PSI with 5HP. Can also be used as hydraulic fluid motor. 3/8" stand pipe ports, 1/2" splined shaft for pulley or direct attachment. 5 1/2" dia., 7" long. Used but condition guaranteed. **2150**

VICKERS HYDRAULIC Transmission Self contained, 2 H.P. constant torque at all speeds with variable volume reversible piston pump (controlled by outside lever) supplying piston hydraulic motor. Automatic pressure, dash pot for smooth control. Power output R.P.M. - 0 to 1/3 input R.P.M. in both directions. Input R.P.M. 1800 continuous 4000 intermittent. Dash pot can be removed for greater R.P.M. Ideal for Lathes, Duplicator Setup on Mills, Conveyors, Small Cars, Drives, Gearing, etc. **3250**

4" Spline Shafts for input & power take-off. **250 PR.**

TWO HEAT SOLDERING IRON World's Hottest Iron Value! Two soldering irons in one with button heat control. Push the button - Select 150 or 300 Watt heat for light or heavy work. Complete with tip, bench holder, 5' asbestos cord. U.L. approved. 110V AC. A \$15.00 Value For... **449**

PALLEY FAMOUS MIXES!!

Prepared especially for the HOME CRAFTSMAN, HOBBYIST, INVENTOR, GADGETEER or SHOP MECHANIC.

GADGET MIX - Rivets, Spacers, Bolts, Screws, Gears, Wheel Bearings, Springs and Clamps. No. 106, 5 lbs. **1.19**

BEARING MIX, No. 170A. Approx. 20 needle, Ball & Roller Bearings, New & Used. Sizes: 1/2" to 4". Some of these cost Gov't \$10 a piece. Never such a value! 5 lbs. ONLY **1.59**

HINGE MIX, No. 170H. 12 pairs of Strap and butt hinges, Hasps, 1 1/2" x 1" to 7/8" x 10" in length and 8" strap, 2 lbs. **1.09**

ABRASIVE AND GRINDING WHEEL MIX - 50 pieces including hona stone, pencil rolls, wheels, etc. A sharp value. No. 170AG **99c**

SPRING MIX, No. 206 - Torsion, Compression & Tension Springs. Ass'd. sizes. A treasure trove for emergencies. Scores of springs. 5 lbs. for ONLY **1.69**

RIVET MIX - 3 POUNDS - Consisting of sizes from 1/4" long to 3" long in many diameters & alloys. **1.19**

FILE MIX - Ten assorted Files, 4" to 12", includes 3 Vixens, half rounds bastards, mills, etc.; in seconds and used but in good condition. 1 Vixen alone worth our price for entire mix. F-1 **99c**

PULLEY MIX, No. PM-1 - You'll want this one around. 10 micarta & metal pulleys ranging from 1" to 5" with ball and one piece bearings. These are aircraft pulleys, the best made with 100's of uses. A WONDERFUL BUY!!! **2.95**

SCREW MIX - 5 lbs., including assortment of wood and machine screws. Many sizes. Save dollars and always have plenty of screws on hand. **1.39**

NUT MIX NM-1 - 3 lbs. approx. 500 nut. Anchor, Lock, Castle, Hex, Elastic Stop Nuts, etc. You'll always have plenty of Nuts in the shop. NM-1 **1.39**

SUPER COMBO MIX - No. SC2. Here's a real bargain. All eleven above mixes for ONLY **14.95**

REAMER MIX - No. 168. Reamer assortment Special Taper line finish Reamers. High Speed Steel. Slightly used but in excellent condition. Ten assorted sizes ranging from .168x.165 & .244x.215 to .425x.385 & .432x.403. One alone worth our selling price of ten. **4.49**

AIRCRAFT CABLE

Rust resistant alloyed steel, extra flexible, preformed - 7 x 19 strand on reels.

1/16" ... 4 1/2 ft.	7/32" ... 9 ft.
5/64" ... 5 ft.	1/4" ... 10 1/2 ft.
3/32" ... 5 1/2 ft.	9/32" ... 11 1/2 ft.
1/8" ... 6 ft.	5/16" ... 13 1/2 ft.
5/32" ... 6 1/2 ft.	3/8" ... 15 1/2 ft.
3/16" ... 8 ft.	1/2" ... 18 ft.

Stainless Steel - Not pre-formed

1/8"9 ft.	1/4"31 ft.
-----------------	------------------

Bronze Cable - Not pre-formed

1/16"5 ft.	3/16"23 ft.
1/4"17 ft.	1/2"38 ft.

PIANO HINGE

Overall Width	Length	Price Ea.
1 1/2" (5/8" side)	72" alum.	\$1.00
2" (1" side)	9" alum.	\$1.75
2 1/2" (1-3/4")	54" st. steel	\$1.69

BRASS HINGE - 1 1/2" (5/8" side). 040 Any length at ... **29c per ft.**

Order from this Ad. All sales final. All Prices F.O.B. Los Angeles. Pay by M.O. or Check. P.O.'s Accepted from D&B firms. 1/2 deposit with C.O.D.'s.

PALLEY SUPPLY COMPANY
6321 SAN FERNANDO RD.
DEPT. PM-3 GLENDALE 1, CALIF

Fast—Accurate—Efficient

ON SMALL PARTS

SOUTH BEND SERIES 1000
PRECISION TURRET LATHE

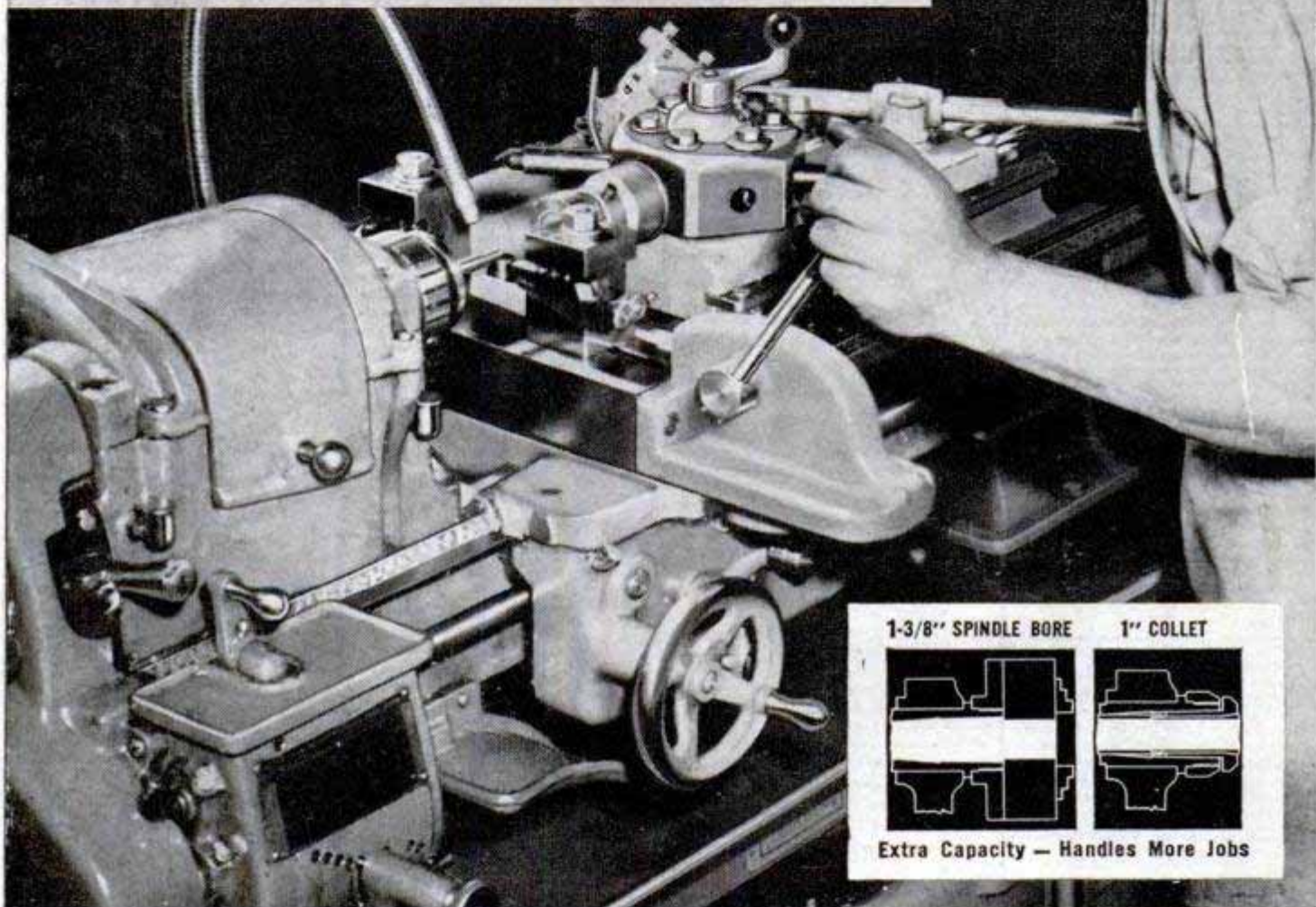

1-3/8" SPINDLE BORE

1" COLLET

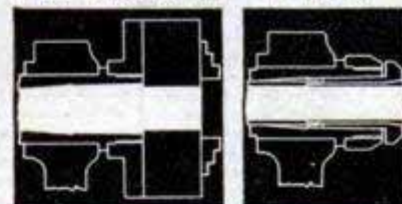

Extra Capacity — Handles More Jobs

This precision turret lathe is highly practical for machining small, precision parts. It meets the demand for fast, efficient production; yet is easily adaptable to many classes of work. It has the accuracy for exacting, close-tolerance operations; ample power for smooth performance; the rigidity for producing fine finish. It is especially suitable for second-operation work.

SPECIFICATIONS: Collet Capacity 1". Spindle Bore 1-3/8". Swing over bed 10-1/8", over double tool slide 3-9/16". Turret Tool Feed 4". Spindle to Turret 19-3/8", maximum. Thread Cutting Feeds (48) 4 to 224 per inch. Carriage Longitudinal Power Feeds (48) .0015" to .0836". Cross-Slide Power Feeds (48) .0006" to .0309". Spindle Speeds (12) 55 to 1340 r.p.m., approximate.



SOUTH BEND LATHE

SOUTH BEND 22, IND. • Building Better Tools Since 1906

Send Information on:

LATHE ATTACHMENTS

TURRET LATHE

TIME PAYMENT PLAN



9" and 10" BENCH LATHES

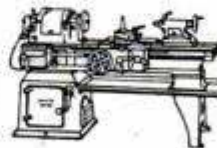

10" to 16-24" FLOOR LATHES



14" DRILL PRESSES

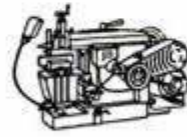

7" BENCH SHAPERS

NAME _____ COMPANY _____

STREET _____ CITY & STATE _____

Printed by Popular Mechanics Company, Chicago, Ill., U. S. A.

NOW! Professional-quality sandpaper pre-cut to fit your home power tools

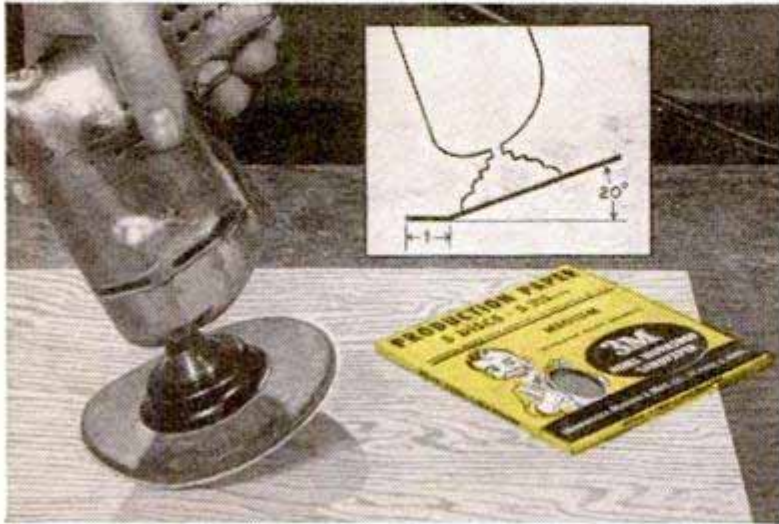

SANDING TIP: for more efficient disc sanding hold the machine at a 20° angle to the work. Use only the outer 1" of disc surface for grinding. And to get even better results, use the new 3M Home Workshop Sanding Discs with aluminum-oxide mineral coating. For ¼" to 1" arbor, 5" and 6" diameters. 5 sheets to a pack.

Tough aluminum-oxide mineral coating lasts ten times as long as ordinary sandpaper—cuts faster, gives cleaner results on metal, wood or plastics.

Yes, 3M Home Workshop Sandpaper is the same "production" type sandpaper with the same tough aluminum-oxide mineral coating used in wood-working plants. It's tougher than flint or garnet—many times tougher than emery!

Never before has this fast-cutting, professional sandpaper been available to you in handy packs for home use. But now you can get discs, belts and sheets of aluminum-oxide pre-cut to fit everything from the popular 3M Sanding Block to most home power tools.

Your hardware dealer has 3M Home Workshop Sandpaper now. Ask him for it and you'll see the difference. Try it and you'll feel the difference.

Get "production" type 3M Sandpaper NOW from your hardware dealer!



3M Sanding Block



"Production" Paper Sheets



"Production" Paper Discs



"Production" Cloth Belts



"Production" Paper Face Plate Discs

Made in U.S.A. by MINNESOTA MINING & MFG. CO., St. Paul 6, Minn. also makers of "Scotch" Brand Pressure-sensitive Tapes, "Scotch" Sound Recording Tape, "Underseal" Rubberized Coating "Scotchlite" Reflective Sheeting, "Safety-Walk" Non-Slip Surfacing, "3M" Adhesives. General Export: Durex Abrasives Corp., New Rochelle, N. Y. In Canada: Canadian Durex Abrasives Ltd., Brantford, Ontario.



3M Rubber Sanding Block takes pre-cut sandpaper



THE FAVORITE sanding block of professional finishers is now available for home use with convenient packs of pre-cut sheets. Block is solid rubber, 2¾" wide, 5" long. 3M Home Workshop Sandpaper is coated with aluminum-oxide mineral for longer life, faster cutting. 10 sheets to pack in fine, medium and coarse grits.

How MILD can a Cigarette be.?

MAKE THE 30-DAY CAMEL MILDNESS TEST—SEE WHY...

MORE PEOPLE SMOKE CAMELS than any other cigarette!



"The roles I play in movies are far from easy on my voice—I can't risk throat irritation. So I smoke Camels—they're mild"

John Wayne
POPULAR, HANDSOME
HOLLYWOOD STAR

"I've been around movie sets enough to know how important mildness is to an actor. So when it came to deciding what cigarette was right for my throat—I was particular. I made a *sensible* test—my own 30-Day Camel Mildness Test!

"I gave Camels a real tryout for 30 days. The most pleasure I ever had from smoking. My own 'T-Zone' told me just how mild a cigarette can be!"



MAN'S IDEA OF A MOVIE HERO. And the women agree! 6 feet 4 inches, John Wayne has smashed his way to fame in dozens of motion pictures!

*Make your own
30-Day Camel
MILDNESS Test
in your "T-Zone"*

(T for Throat,
T for Taste)



Not one single case of throat irritation *due to smoking* **CAMELS!**

Yes, these were the findings of noted throat specialists after a total of 2,470 weekly examinations of the throats of hundreds of men and women who smoked Camels — and only Camels — for 30 days.

E. J. Reynolds Tob. Co.,
Winston-Salem, N. C.