

ANC



POPULAR MECHANICS

MAGAZINE

WRITTEN SO YOU CAN UNDERSTAND IT

REG'D. TRADE MARK, GREAT BRITAIN, No. 410426

REG. U.S. PAT. OFF.



See page 118



White sidewall tires and wheel trim rings extra cost.

*Studebaker again
amazes America!*

A great new V-8

1951 STUDEBAKER

COMMANDER

Priced lower than you expect!

**New peaks of power! New driving thrills!
A real gas saver! Needs no premium fuel!**

*Studebaker Automatic Drive gives you
truly marvelous "no clutch-no gearshift" motoring
Available at extra cost*

Studebaker, South Bend 27, Indiana, U.S.A.

2 BELOW!

-but no cause for alarm!

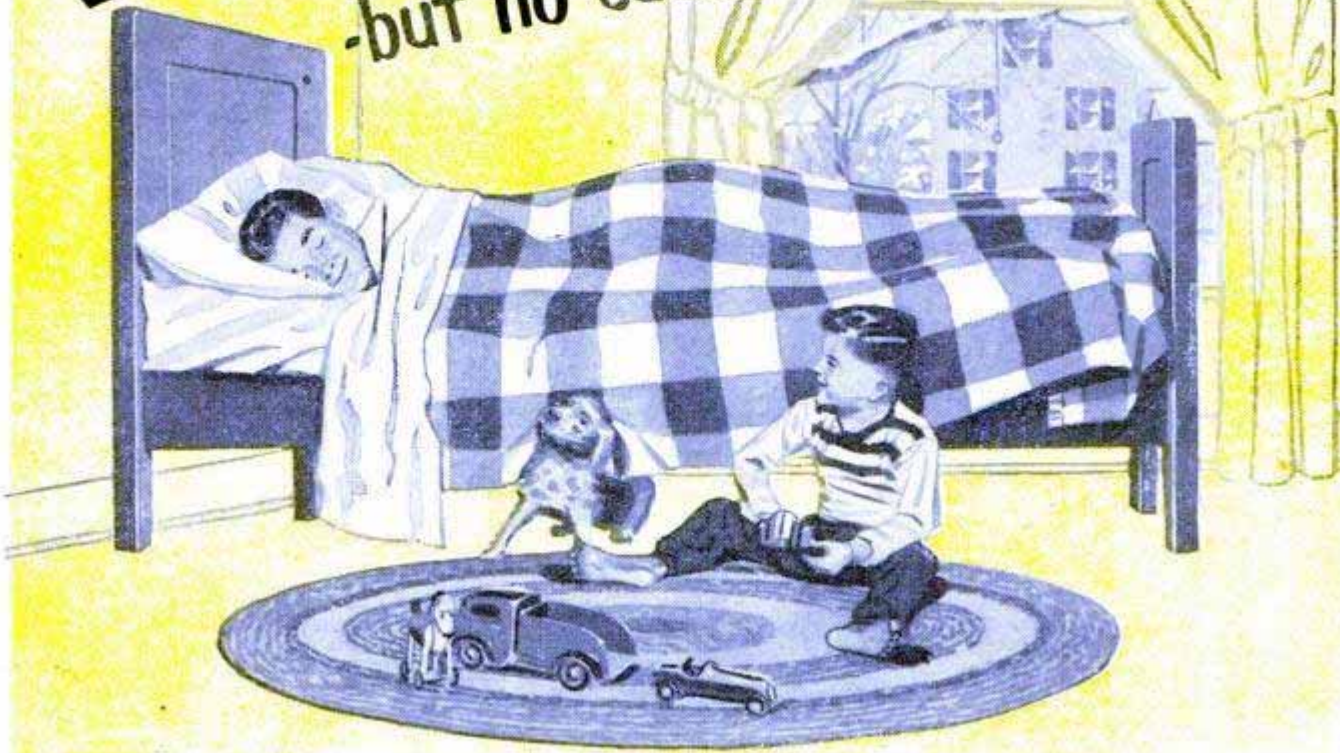

You'll enjoy an extra measure of *both* fuel economy and comfort—year after year—when you've installed Timken Silent Automatic Heat in your home. Hundreds of thousands of proud owners have learned from experience that investing in quality-built, experience-backed heating equipment pays big dividends of *extra* comfort, convenience and fuel economy. The famous

wall-flame burner found in dependable Timken Silent Automatic units is only one feature of their advanced design throughout. When you buy, make the right buy! Phone your nearest Authorized Timken Silent Automatic dealer today. He's listed in the "yellow pages." You'll find him a friendly, capable person who takes real pride in his work.



Timken Silent Automatic Wall-Flame Oil Burner installed in coal burning heating plant. Other products include gas-fired conversion burners for existing heating plants, oil- and gas-fired boiler and furnace units, and oil-fired water heaters, all in a complete range of capacities for every home. Easy terms—10% down, 30 months to pay.

TIMKEN Silent Automatic HEAT

OIL • GAS • COAL

TIMKEN SILENT AUTOMATIC DIVISION
The Timken-Detroit Axle Company • Jackson, Michigan
The Timken-Detroit Axle Company of Canada, Ltd., Toronto, Ont.



MAIL THIS COUPON TODAY FOR ILLUSTRATED LITERATURE!

Timken Silent Automatic, Jackson, Michigan:
Please mail illustrated literature. I am interested in:

(type of equipment)

NAME _____

STREET ADDRESS _____

CITY and STATE _____

If you are a student, please check here () for special information.



PM-251

This One



MORE JOBS EASIER, QUICKER

With Gear Driven

WALKING AND RIDING "RED-E" GARDEN TRACTORS NO BELTS! NO CHAINS!

Proven For Over 28 Years!

Buy Direct
From Manufacturer
and **SAVE**

WALKING
MODEL
2-3-4½
and
6 H. P.

**A Time and Money Saver For Farmers,
Truck Gardeners, Nurseries, Suburbanites,
Estates, Cemeteries, Golf Courses!**

If you want the best in a Garden Tractor . . . buy the "RED-E" . . . proven by thousands of satisfied users for over 28 years. You'll like the smooth, powerful, gear-driven action of this modern tractor that does more jobs, easier, quicker, better. Offered in the Walking Model with power turning clutch for each wheel in 2, 3, 4½ and 6 H. P. Offered in the Riding Model with automotive type differential in 6 H.P. Two models to meet your needs, with dozens of attachments for plowing, sowing, cultivating, discing, mowing, raking, wood sawing, snow plowing, etc.

NEW 1951
MODELS
NOW
AVAILABLE

Easy to Operate

You'll find the "RED-E" Tractor, with its air-cooled 4-cycle gasoline engine, surprisingly easy to operate, with less time required to do the job. For economical operating efficiency—the "RED-E" should be your choice.

Fully Guaranteed

"RED-E" Tractors are quality built of tested materials under precision engineering methods for years of dependable service. And they're fully guaranteed against any defect in material and workmanship. We even guarantee the power turning clutch and worm drive against any defects for three years.



RIDING
MODEL
6 H. P.



Order With Convenience From Our Catalog

Easy Terms With Pays-For-Itself-Plan

Get the full facts about "RED-E" Tractors—and judge for yourself. Just mail Coupon for our big FREE CATALOG—and order conveniently by mail right from your home.

FREE CATALOG COUPON-MAIL NOW

RED-E TRACTOR CO.
Richfield 54, Wis.

Kindly send me your FREE "RED-E" 1951 GARDEN TRACTOR CATALOG, postpaid.

Name _____

Address _____

R.F.D. _____

City _____

Zone State _____

Our Catalog presents the exciting facts and exclusive features of the new, 1951 "RED-E" Tractors in Walking and Riding Models—with actual photographic reproductions of both tractor models and attachments—backed by our surprisingly low prices and easy terms with our Pays-For-Itself-Plan. **SPECIAL:** Discount to User Agents.

Mail-Coupon Now!

RED-E TRACTOR CO. RICHFIELD 54, WIS.

Popular Mechanics Magazine

Registered in U. S. Patent Office and Canada

H. H. WINDSOR, Founder

H. H. WINDSOR, JR., Editor and Publisher



this month's cover

ROOM IN YOUR garage for this little helicopter? It's the new Hiller "Hornet," a two-place, inexpensive fly-bug. Western Editor Tom Stimson was the first man, except for designers, to see and cruise in the craft. It's powered by watermelon-size ramjets. His flight begins on page 118

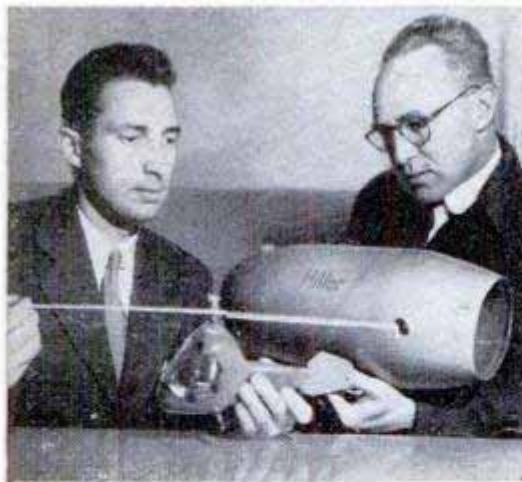

Published monthly by Popular Mechanics Company, 200 E. Ontario St., Chicago 11, Ill. H. H. Windsor, Jr., president; William Harrison Fetridge, vice president; D. P. Windsor, vice president and secretary-treasurer; Clover L. Perkins, advertising manager; Alan M. Deyoe, circulation manager. Single copy in the United States and Canada, 35 cents; subscription rates in United States and possessions, Canada, Philippines and countries of the Pan-American Postal Union, 1 year \$3.50; 2 years, \$6.00; 3 years \$8.00. To all other countries add \$1.00 a year over United States prices for overseas postage. If you plan to move, notify us at least 30 days in advance so you will not miss an issue. Give both your old and new addresses.

Entered as Second Class Matter, September 15, 1903, at the Post Office at Chicago, Illinois, under Act of March 3, 1879. Entered as Second Class Matter at Post Office Dept., Canada. Registered as Second Class Matter at the Post Office at Mexico, D. F., Mexico, June 20, 1950.

Copyright 1951 by Popular Mechanics Company. Copyright under International Copyright Union. Copyright in France. All rights reserved under Pan-American Copyright Union. Printed in the United States of America.

Volume 95 FEBRUARY 1951 Number 2

Managing Editor.....Roderick M. Grant
 Assistant Managing Editor.....Wayne Whittaker
 Shop Notes and Crafts Editor.....James R. Ward
 Radio-Television, Electronics Editor.....Frank L. Brittin
 Associate Editor, Aviation.....Aubrey O. Cookman, Jr.
 Associate Editor.....Clifford B. Hicks
 Associate Editor.....Donald R. Brooks
 Automotive Editor.....Siler Freeman
 Art Director.....Frank Beatty
 Director, Bureau of Information.....Allan Carpenter

Assistant Editors
 Dorothy E. Hoffmann Arthur R. Railton H. H. Windsor III
 Assistant Editors, Shop Notes and Crafts
 W. Clyde Lamme Wayne C. Leckey Frank N. Stephany
 Chester W. Woodson

Eastern Editor.....Richard F. Dempewolf
 Empire State Bldg., Room 2906, New York 1, N. Y.

Western Editor.....Thomas E. Stimson, Jr.

Representative in Great Britain.....Douglas W. Wedderspoon
 77 Baker St., London W. 1, England

IN THIS ISSUE

Digging Deeper for Red Metal - - - - -	81
A Swiss Wood Carver Brings Back Hawaii's Lost Art - - - - -	88
Balloon Man - - - - -	97
Rangers Patrol the Everglades - - - - -	102
The Owners Report on the '51 Kaiser - - - - -	108
What's New for Your Home - - - - -	114
Here's Your Helicopter Coupe - - - - -	118
I'm Building the P.M. Ranch House—Part IV - - - - -	126
Hollywood's Antique Auto Livery - - - - -	133
High Ride on a Cable - - - - -	140
If the A-Bombs Burst—Part II - - - - -	144
The House That Works on a Dial System - - - - -	156
A Railroad Comes Out of Hibernation - - - - -	160

For the Craftsman

Beautiful Finishes With Plastic Veneer—Part II	166
Pottery From Your Back Yard - - - - -	180
A Wet Basement Is Lost Space - - - - -	188
Fish Trophy in Plaster - - - - -	202
Pipe Fitting at Home - - - - -	209
Mounted Tractor Mower - - - - -	214
Smooth It With a Portable Belt Sander - - - - -	218
Shopping for Tools - - - - -	224
Radio-Television, Electronics - - - - -	227
Clinic for Homemakers - - - - -	236

Other items, and manufacturers of available products described, are listed on pages 14, 16 and 18

A Top Job

IN THE ARMORED FORCE!

Only the latest and best technical equipment . . . like this new General Patton tank . . . is good enough for the U.S. Army's Armored Force . . . the slugging outfit good men are proud to serve in.

Only the best men move up to the top jobs in the Armor, as in all other Army branches. The Sergeant commanding a Patton is a good man in a good job . . . with good pay.

That's the way it is in the Army

. . . only the best for the best men . . . whether you're in the Armored Force . . . or the hard-hitting Artillery . . . the seven-league-booted Airborne . . . the building Engineers . . . or the "queen of battles" Infantry.

Visit your nearest U. S. Army and U. S. Air Force Recruiting Station for the proof that it's a man's Army . . . and that there's a good job in it for you.



The Mark of a Man . . . the Army Uniform!

U. S. ARMY

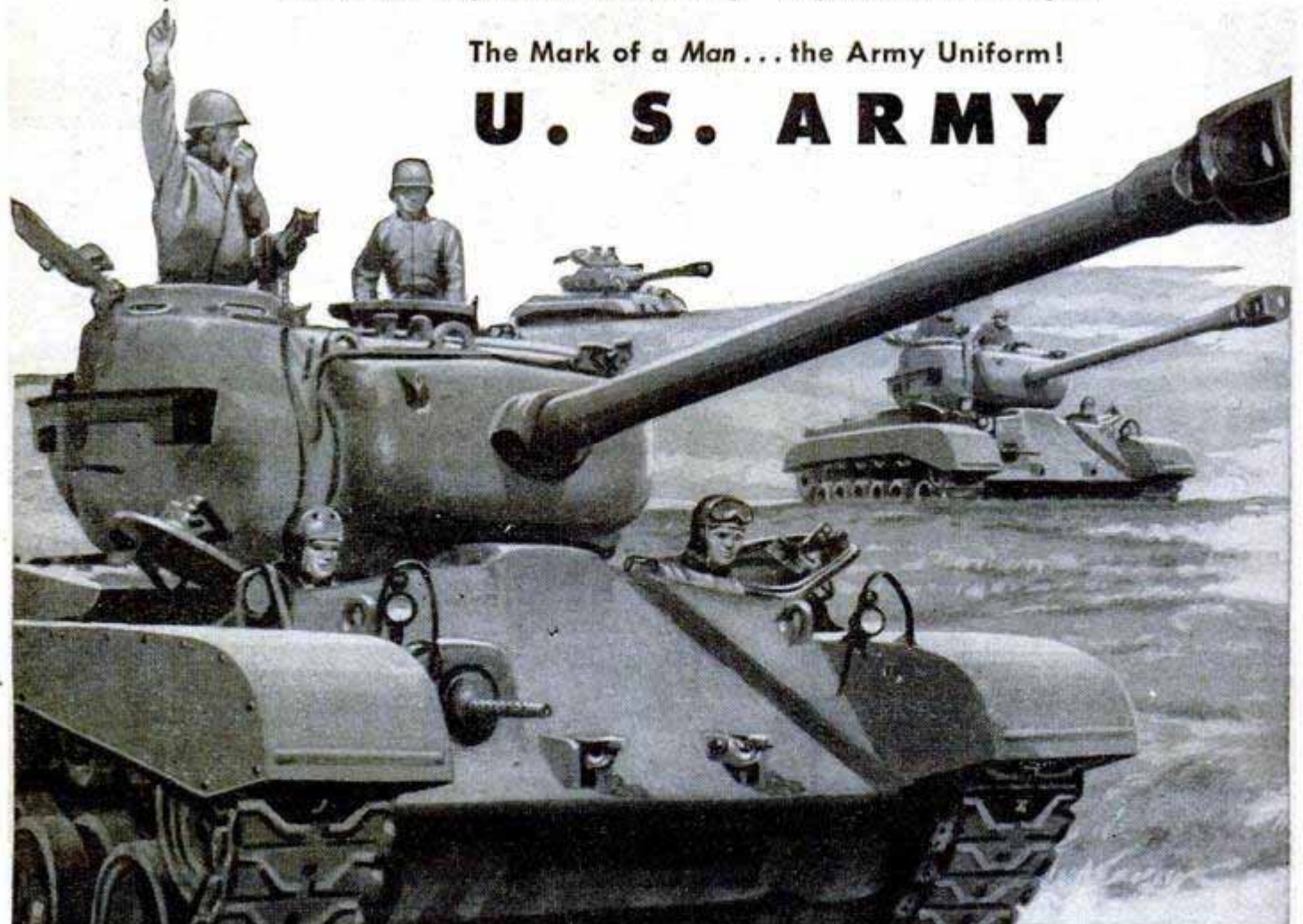



You'll always have lots of fun
with a

HARLEY-DAVIDSON

HYDRA-GLIDE®

Thrills and adventure are all around you, when you ride the exciting, super-smooth Harley-Davidson Hydra-Glide! It's your all-season ticket to endless good times, on delightful gypsy tours, sightseeing trips, at races, runs, and other motorcycling pleasure-events. Easy to buy on convenient terms, so why not join in the fun? See your dealer today. Mail coupon now.

OPPORTUNITY: Valuable franchises available for full line of Big Twins and 125 Model. Write today.



HARLEY-DAVIDSON MOTOR CO.
Dept. P. Milwaukee 1, Wisconsin
Send me free copy of ENTHUSIAST
Magazine filled with motorcycle action
pictures and stories; also literature on
new models.

Name.....

Address.....

City.....State.....

STOP

Winter wear with Pyroil

Wintertime is wear-and-tear time on your car—unless you give your motor added lubrication protection. It's easy and economical to do this with Pyroil. Pyroil improves winter lubrication because it gives low viscosity oil the special added property of adhering to vital metal surfaces at all times. This clinging film of oil protects piston rings and cylinder walls. It assures "quick starts". It prevents damaging rust. It frees the engine of sludge and gummy deposits.

To stop costly winter wear, start using Pyroil—start adding miles to your car.

Pyroil for Aircraft Engines

Use Aircraft Pyroil B for lubricating oil, Aircraft Pyroil A for gasoline.

GIVEN! An attractive Pyroil metal savings bank, takes coins up to 50c pieces. **MOTORISTS**, it's yours for the asking — sent postage paid.



Manufactured and Guaranteed by Pyroil Company, 112 Pyroil Bldg., La Crosse, Wisconsin.

Canadian Distributors: Central Purchasing Agencies, Ltd., Toronto, Ontario

PYROIL COMPANY
112 Pyroil Bldg., La Crosse, Wisconsin

I want my car to last and run properly. Please tell me more about Pyroil and how it can accomplish this for me.

Name _____

Address _____

City or Town _____ State _____



in this corner.....

THE EDITORS

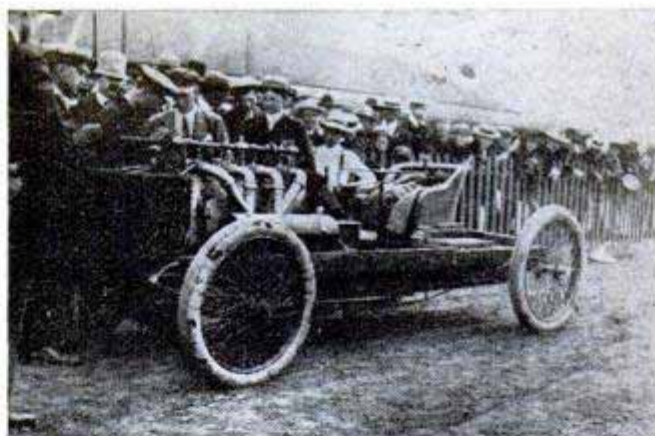

Letter to the Editor

Re your article on page 131 of the September issue of PM wherein you state that the two keel beams of fir 18" x 20" x 97'-0" were the longest timbers ever handled by an old-time Washington mill, may I inform you that a Washington mill in 1903 furnished six timbers 24" x 24" x 100'-0" that were shipped to St. Louis and used in the construction of the Washington State building at the Louisiana Purchase Exposition in 1904? As proof I am inclosing herewith a picture of this building taken while I was a Jefferson Guard (Badge #375) at this, the greatest of all "World's Fairs." Your publication of this would be very

(Continued to page 8)

5 reasons why ACCOUNTANCY

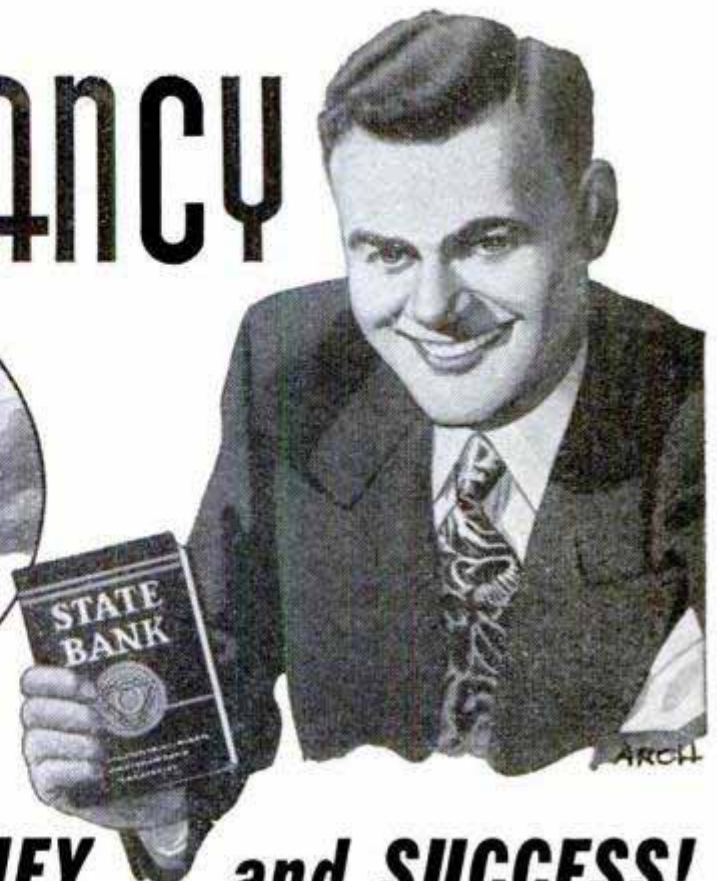
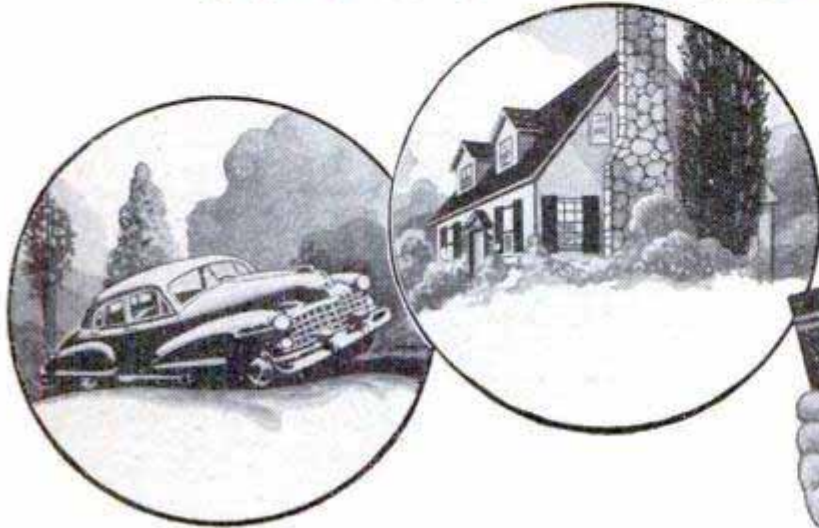

offers you MORE MONEY... and SUCCESS!

REASON #1. If you were an expert accountant right now, chances are you would find yourself among the highest-paid of all professional men and women. Even back in "depression years," surveys showed that accountants earned more on the average than men in other major professions.

REASON #2. The demand for accountants is great—everywhere. All businesses must have trained accountants to cope with ever-growing requirements. It's a profession offering wide opportunity—always—to the man who knows.

REASON #3. You can fit into any business, anywhere in the country—because accounting principles are universal. Think what this means in terms of security and independence!

REASON #4. Accountancy is open to all. Any man or woman of good intelligence, who enjoys figure work and is willing to follow LaSalle's systematic "problem method" plan, can rapidly qualify for a highly profitable, enjoyable

lifetime career... and he doesn't have to finish his training before beginning to "cash in."

REASON #5. Without losing a day from your present work, you can prepare in spare hours at home, at low cost, under LaSalle's step-by-step "Problem Method" of "learning by doing." This famous plan accounts for LaSalle's remarkable record of having trained nearly 10 per cent of all Certified Public Accountants in the U. S. . . . and of having put many thousands of others into high-paying careers.

Send today for LaSalle's interesting booklets, "Accountancy, the Profession That Pays," and "Success Reports." Learn about the five great fields of opportunity... and LaSalle's time-tested plan for helping men and women to rapid advancement, higher income, greater prestige and professional standing. The coupon below will bring these fact-filled booklets to you—without cost or obligation. Mail the coupon NOW.

LaSalle Extension University A Correspondence Institution

Dept. 264H, 417 S. Dearborn St., Chicago 5, Ill.

Please send me, free of all cost or obligation, your 48-page illustrated book "Accountancy, the Profession That Pays," and the booklet "Success Reports"—send also "Ten Years' Promotion in One"—a book which has helped many men.

Name.....Age.....

Address.....

City, Zone, State.....

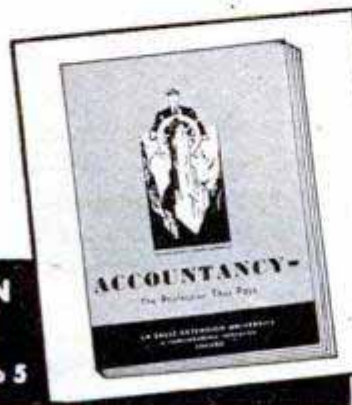

**LASALLE EXTENSION
UNIVERSITY**

417 S. Dearborn St., Chicago 5

AVIATION TRAINING



A MESSAGE TO YOUNG MEN... AND PARENTS

We have an urgent demand for Embry-Riddle graduates. Aircraft manufacturers and operators need thousands of properly trained young men for essential positions in civilian aviation.

SAVE TIME

Now, more than ever before, you need maximum school training in minimum time. Embry-Riddle offers complete eight-month to two-year aeronautical engineering, master A & E mechanic, flying and specialist courses, backed by a quarter-century experience in training today's aviation leaders.

BE PREPARED

No one can safely predict the course of events today. Be assured, however, that no matter what happens, you will be one step ahead of the crowd with up-to-date, intensive Embry-Riddle aviation training. Write, wire or call today for catalog and full information.



Wherever planes fly, men know Embry-Riddle . . .
A Famous Name in Aviation.

Dean of Enrollments - Dept. 99
Embry-Riddle School of Aviation
Miami 30, Florida

Please Print

NAME _____

ADDRESS _____

City _____

State _____ Age _____

I am interested in...

- A.&E. Mechanic
- Commercial Pilot
- Engineering
- A.&E. Combined with Commercial Pilot
- Flying Mechanic
- Drafting & Design

Check One Veteran Non-Veteran

TRAIN IN MIAMI--AIR CAPITAL OF THE WORLD

(Continued from page 6)

much appreciated as it might enable me to get in touch with some of the few surviving guards. Thanking you, I am

Owen Hawkins,
2623 White Oak Dr.,
Houston 9, Tex.

P. S. You might also be interested in the other picture I am inclosing which was taken at the Lexington, Ky., race track in 1903 and shows Barney Oldfield (with cap) standing immediately behind the radiator and tinkering with some part of his car—maybe cleaning a spark plug—of his "BIG 999" built and financed—if I remember correctly—by Henry Ford.

Letter to the Editor

The picture of the Porsche car on page 163 of the October *Popular Mechanics* is of special interest.

This is the postwar version of the German Volkswagen and has been described by an English source as the one good thing that came out of the war.

It is a rear-engine car, with the engine weight over the rear wheels. This is a most important point, not incorporated as yet in our American cars.

For over a hundred years, our railroads have accepted the principle of weight over driving wheels. Shipbuilders would never think of constructing a ship that would be "down by the head." Any 10-year-old kid knows better than to try to row a boat with his weight in the bow. Yet millions of front-end-heavy passenger autos are turned out from our assembly lines year after year.

Depressing the height of today's cars to the point where one has to crawl down into them is another proof of the impossibility of stabilizing a decelerating front-end-heavy car.

It is high time that American cars be built with the engine in the rear.

Sincerely,
Arthur W. Stevens, President,
Automobile Safety Association,
Boston, Mass.

China Church Bells

Church bells made of china have been installed in a rebuilt church in Leipzig, Germany. They are small—about the size of a man's hat—and give out sweet and pure tones when lightly tapped with mechanical hammers. They are made of famed Meissen ware. The small china bells can be heard all over the city by means of an amplification system.

(Continued to page 10)

Put yourself in the I. C. S.

HALL of FAME*

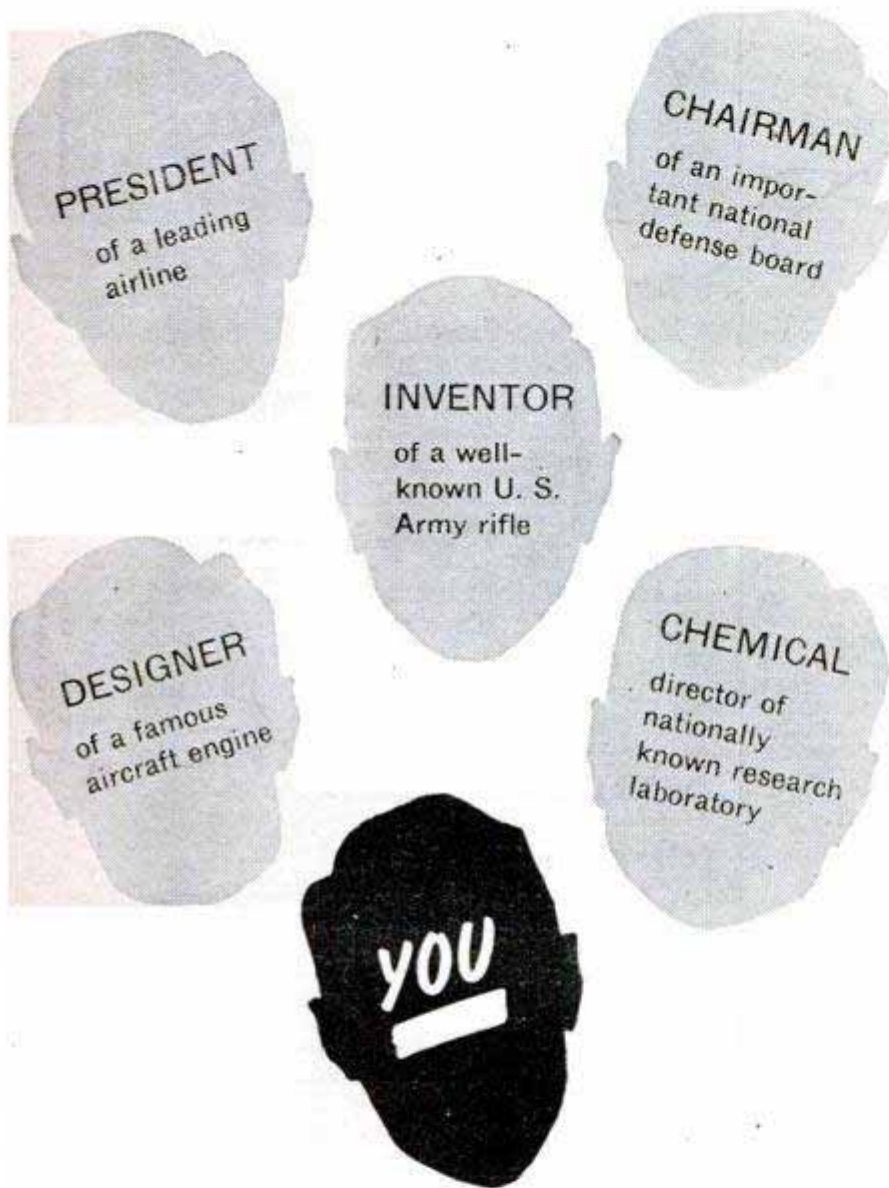

Join these men who have made their mark!
Men who by dint of ambition, intelligence and sound, practical I. C. S. training now enjoy positions of leadership in business, industry and government.

The sooner you start, the better your chances of making the grade. Today, with the critical shortage of skilled labor, trained men are becoming leaders overnight. Hundreds of I. C. S. students are reporting promotions and pay increases, earning greater security for themselves and their families. How about marking and mailing the coupon today?

*Names and positions sent on request.

INTERNATIONAL CORRESPONDENCE SCHOOLS

BOX 5693-K, SCRANTON 9, PENNA.

Explain fully about your course marked X:

Air Conditioning and Plumbing Courses

- Air Conditioning Heating Plumbing
 Refrigeration Steam Fitting

Chemical Courses

- Chemical Engineering Chemistry, Analytical
 Chemistry, Industrial
 Chemistry, Mfg. Iron & Steel
 Petroleum Refining Plastics
 Pulp and Paper Making

Civil Engineering, Architectural and Mining Courses

- Architectural Drafting Architecture
 Civil Engineering Coal Mining
 Contracting and Building Highway Engineering
 Reading Structural Blueprints
 Structural Drafting Structural Engineering

Communications Courses

- Electronics Radio General
 Practical FM and Television
 Radio Operating Radio Servicing
 Telephony Telegraph Engineering

Electrical Courses

- Electrical Drafting Electrical Engineering
 Power House Electric Practical Electrician

Internal Combustion Engines Courses

- Automobile Aviation
 Diesel Engines Gas Engines

Mechanical Courses

- Aeronautical Engineer's, Jr. Aircraft Drafting
 Forging Foundry Work
 Heat Treatment of Metals
 Industrial Engineering Industrial Instrumentation
 Industrial Metallurgy Machine Shop
 Mechanical Drafting Mechanical Engineering
 Patternmaking—Wood, Metal
 Reading Shop Blueprints Sheet-Metal Worker
 Ship Drafting Toolmaking

Railroad Courses

- Air Brake Car Inspector Diesel Locomotive
 Locomotive Engineer Locomotive Fireman
 Locomotive Machinist Steam-Diesel Loco. Engineer

Stationary Engineering Courses

- Marine Engineering
 Power Plant Engineering Steam Engineering

Textile Courses

- Cotton Manufacturing
 Loom Fixing Rayon Weaving
 Textile Designing Woolen Manufacturing

Business and Academic Courses

- Accounting Advertising
 Bookkeeping Business Administration
 Certified Public Accounting Business Law
 Commercial Art Cost Accounting Federal Tax
 Foremanship French Good English
 High School Illustration—Lettering
 Industrial Supervision Postal Civil Service
 Retailing Retail Business Management
 Salesmanship Secretarial
 Spanish Stenography
 Traffic Management Typing

Name _____ Age _____

Home Address _____

City _____ State _____

Present Position _____

Working Hours _____ A.M. to _____ P.M.

Employed by _____

Length of Service in World War II _____

Enrollment under G.I. Bill approved for World War II Veterans. Special tuition rates to members of the Armed Forces.

DON'T PATENT YOUR INVENTIONS

—until you examine this new kit which offers complete protection, and possible sale before you even apply for patent



This new organization "Inventors-for-Industry" (recently created to stop abuses against inventors) has just designed a new device which can save you hundreds of dollars on patent fees and costly models. It enables anyone to make 3-dimensional "pictorial models" of ideas. No talent or instruments needed. You may use it to improve ideas, establish priority, get top selling price . . . before you spend a cent on patent or model.

Also included in this IFI "Successful Inventor's Kit" is a 70-page guide book, "How to Win Sales and Make Better Inventions." Describes how to protect and promote inventions before you patent; how to improve design; how to think up "trade-marks" and slogans that sell on sight. Also included in this kit: 3 exclusive IFI secret self-registering records of invention . . . a safe method of establishing priority.

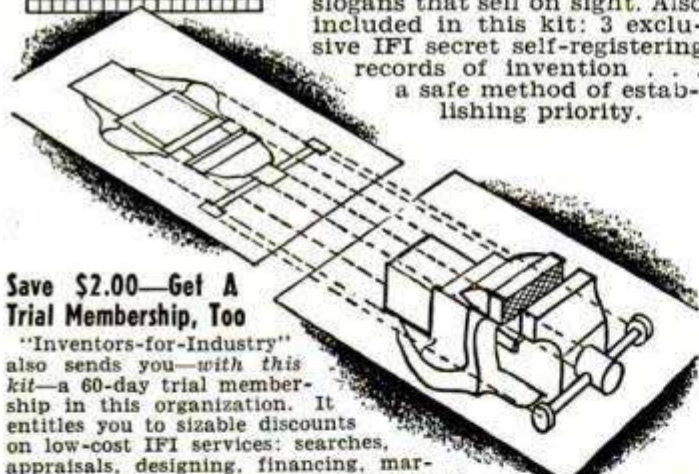

Save \$2.00—Get A Trial Membership, Too

"Inventors-for-Industry" also sends you—with this kit—a 60-day trial membership in this organization. It entitles you to sizable discounts on low-cost IFI services: searches, appraisals, designing, financing, marketing, etc. Membership also includes: monthly publication, special reports, member identification card.

Regular price of kit is \$4.75. But on this introductory offer, you get entire kit—plus a scientific "Inventive Aptitude Test" (worth \$1.00)—plus 60-day membership in IFI—all for \$3.75.

SEND NO MONEY: Just mail coupon for 7-day examination Inventors-for-Industry, Dept. 512, 1947 Broadway, New York 23, N. Y.

FREE!

A scientific "Inventive Aptitude Test" shows how inventive you really are! Amazingly high degree of accuracy. Self-correcting; so it's easy to measure yourself. Offered free with kit for a limited time only.

how to win SALES and make better inventions

INVENTORS-FOR-INDUSTRY, DEPT. 512, 1947 BROADWAY, NEW YORK 23, N. Y.

Please send me for 7-day home examination the complete "Successful Inventor's Kit" (reg. \$4.75)—plus a scientific "Inventive Aptitude Test" (worth \$1.00)—plus 60-day Trial Membership in this organization. When the package arrives, I will deposit with postman only \$3.75 plus C.O.D. and postage charges. After 7-day examination, if not completely satisfied with kit, I may return it for full refund of my \$3.75.

Name _____
 Address _____
 City _____ State _____
 SAVE C.O.D. AND POSTAGE CHARGES. Enclose \$3.75 WITH coupon and WE will prepay all C.O.D. and postage charges. Return kit for full refund if not satisfied.

(Continued from page 8)



What's New?

Remember the old saw "there's nothing new under the sun"? Magazine editors never get a chance to forget it. A case in point is the mechanical elephant we described on page 113 of our October issue. It looked like a novel idea to us. It did, that is, until we got a letter from L. F. Adams of Opp, Ala., describing a mechanical elephant that he saw in Hollywood, Fla., back in 1937. Two small gasoline engines powered the 11-foot beast. It could walk, run, dance, flap its ears, wave its trunk and blink its eyes! Some repertoire for a mechanical elephant. Here, 14 years late, is the Florida mechanical elephant.

Letter to the Editor

I have read with considerable interest Part I of the article concerning the Military Air Transport Service which appeared in the December 1950 issue of *Popular Mechanics Magazine* under the title "I Rode the Airlift to the Orient." It made excellent reading.

I deeply appreciate your publication's interest in MATS as evidenced by your sending Mr. Richard Dempewolff to Japan at the cost of considerable time and effort to obtain the complete factual material about our command.

On behalf of all personnel in MATS, I wish to extend my thanks to you for presenting the MATS story in such a readable, interesting and factual manner. We are all looking forward to the publication of Part II of this article.

Sincerely,
 Laurence S. Kuter,
 Major General, USAF,
 Commanding,
 Military Air Transport Service.

Alaska has some frigid spots where the earth is permanently frozen down to a depth of 1020 feet below the surface.

WHAT Every MECHANIC Wants to Know

AUDELS CARPENTERS & BUILDERS GUIDES—(4 Book Set).....\$6

A practical illustrated trade assistant on modern construction for carpenters, joiners, builders, mechanics and all woodworkers. 4 vols., 1600 pages, 3700 illustrations. Fully indexed, flexible covers. Each volume sold separately \$1.50 a vol.

AUDELS PLUMBERS & STEAMFITTERS GUIDES—(4 Book Set).....\$6

A Practical Trade Assistant & Ready Reference. Explains in plain language & by clear illustrations, diagrams, charts, graphs, pictures principles of modern plumbing practice including Marine Pipe Fitting and Air Conditioning. 4 Vols.—1670 Pages—3642 Diagrams & Illustrations. Each Vol. Sold Separately \$1.50 a Vol.

AUDELS OIL BURNER GUIDE.....\$1

384 Pages Covering Installation, Servicing & Repairs All Types Domestic & Industrial Burners. Illustrated. Highly Endorsed.

AUDELS HOUSE HEATING GUIDE.....\$4

1000 Pages Covering Working Principles, Installation, Service of All Modern House Heating, Ventilating & Air Conditioning Systems. Explains New Radiant Heating. Fully Illustrated & Indexed.

AUDELS REFRIGERATION & AIR CONDITIONING GUIDE.....\$4

New from Cover to Cover—1280 Pages, Fully Illus. Covering basic principles, servicing, operation & repair of household, commercial & industrial refrigeration & air conditioning. A gold mine of essential important facts for engineers, servicemen, users.

AUDELS SHEETMETAL WORKERS HANDY BOOK.....\$1

Practical inside information. Fundamentals of Sheet Metal Work. 388 pages. Illustrated. 11 sections. Clearly written. Essential & important facts, figures, pointers in everyday language. Ref. Index.

AUDELS SHEETMETAL PATTERN LAYOUTS.....\$4

Developed by Experts for Sheet Metal Workers, Layout Men & Mechanics. A Practical Encyclopedia in 10 Sections, size 7 x 10 x 2—1125 Pages—350 Layouts—1600 Illustrations. 1001 Key Facts. Fully indexed for ready reference in answering your layout problems. Covers all phases of sheet metal work including Pattern Cutting, Pattern Development & Shop Procedure.

AUDELS BLUE PRINT READING.....\$2

For Mechanics & Builders. Covers all types of blue print reading including ship & airplane. 416 pages, fully illustrated.

AUDELS MATHEMATICS & CALCULATIONS FOR MECHANICS \$2

Mathematics for home study or reference. 700 pages, 550 illus. Practical mathematics from beginning. How to figure correctly. Easy, correct methods covering complete review. Illus. & Indexed.

AUDELS AUTOMOBILE GUIDE.....\$4

A practical quick ready reference book for auto mechanics, service men, operators & owners. Explains theory, construction & servicing of modern motor cars, trucks, buses & auto type Diesel engines. 1100 pages, fully illustrated. 55 chapters. Indexed. A standard book for mechanics. New Hydraulic drive covered.

AUDELS DIESEL ENGINE MANUAL.....\$2

A practical, concise treatise with questions and answers on the theory, operation and maintenance of modern diesel engines. Over 400 pages, fully illus. All details plainly brought out, this book is of extreme value to engineers, operators & students.

AUDELS WELDERS GUIDE.....\$1

A concise, practical text on operation & maintenance of all welding machines for all mechanics. Over 400 pages, illustrated. Covers all methods of electric and acetylene welding including airplane work.

AUDELS MACHINIST & TOOLMAKERS HANDY BOOK.....\$4

Covers modern machine shop practice in all its branches. Tells how to set up & operate lathes, screw and milling machines, shapers, drill presses & all other machine & hand tools. 1600 pages, fully illustrated. Indexed. 5 sections. 1—Modern Machine Shop Practice. 2—Blue Print Reading & How to Draw. 3—Calculations & Mathematics for Machinists. 4—Shop Physics. 5—How to Use the Slide Rule. 60 chapters. Easy to read and understand. A shop companion that answers your questions.

AUDELS ELECTRIC MOTOR GUIDE \$4

Practical Information Covering Construction, Control, Maintenance & Wiring Hookups of All Types Electric Motors also Armature Winding. 1000 Pages Fully Illustrated & Indexed.

AUDELS ELEC. WIRING DIAGRAMS \$1

210 Pages. Illustrated. Gives practical facts on wiring of electrical apparatus. It shows clearly how to wire apparatus for practically all fields of electricity. Each diagram is complete & self-explanatory. Highly Endorsed Pocket Companion.

AUDELS PRACTICAL ELECTRICITY \$4

A key to a practical understanding of Electricity. For maintenance engineers, electricians & all electrical workers. 1440 Pages, 2600 Illus. Covers important electrical information in handy form—including wiring for Light & Power. Indexed.

AUDELS RADIOMANS GUIDE.....\$4

A key to the practical understanding of radio including Frequency Modulation, Television, etc., Aircraft & Marine Radio. For radio engineers, servicemen, amateurs, 914 Pages, 633 Illustrations & Diagrams. Photos. Review Questions & Answers. Reference Index.

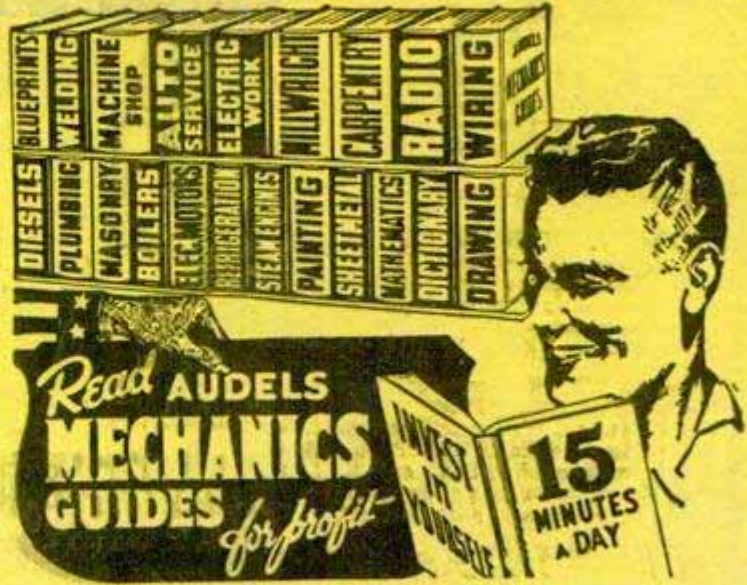

AN AUDEL GUIDE IS A GOOD FRIEND!
Step Up Your Own Skill with the Practical Facts and Figures of Your Trade. Save time and money with right methods, short cuts, labor saving ideas. CHECK NOW! You can look over any Audel Guide in your home. Start the Easy Payments if satisfied.



Check NOW!

Audels List Of Time Tested Practical Handy Books For Mechanics That Will Answer Your Questions — Highly Endorsed

MAIL THIS TODAY

CUT HERE MAIL ORDER

AUDEL, Publishers, 49 W. 23 St., NEW YORK 10, N. Y.
Please send me postpaid for FREE EXAMINATION books marked xx below. If I decide to keep them I agree to mail \$1 in 7 Days on each book or set ordered and further mail \$1 monthly on each book or set until I have paid price, otherwise I will return them.

- MACHINISTS HANDY BOOK . . . 1650 Pgs. . . \$ 4
- WELDERS GUIDE, 400 Pages 1
- BLUE PRINT READING, 416 Pages 2
- MATHEMATICS & CALCULATIONS, 700 Pages. . . 2
- SHEET METAL PATTERN LAYOUTS, 1100 Pages . . . 4
- SHEET METAL WORKERS HANDY BOOK, 388 Pgs. . . 1
- MECHANICAL DRAWING GUIDE, 160 Pages 1
- MECHANICAL DRAWING & DESIGN, 480 Pages . . . 2
- AUTOMOBILE MECHANICS GUIDE, 1800 Pages . . . 4
- DIESEL ENGINE MANUAL, 575 Pages 2
- AIRCRAFT WORKER, 240 Pages 1
- RADIOMANS GUIDE, 914 Pages 4
- ELECTRONIC DEVICES, 216 Pages 2
- ELECTRIC MOTOR GUIDE, 1000 Pages 4
- ELECTRIC WIRING DIAGRAMS, 272 Pages 1
- ELECTRICIANS EXAMINATIONS, 250 Pages 1
- ELECTRIC POWER CALCULATIONS, 425 Pages. . . . 2
- HANDY BOOK OF ELECTRICITY, 1440 Pages. 4
- ELECTRIC DICTIONARY, 9000 Terms 2
- ELECTRIC LIBRARY, 7000 Pages (12 Book Set) . . . 18
- MARINE ENGINEERS HANDY BOOK, 1258 Pgs. 4
- SHIPFITTERS HANDY BOOK, 250 Pages 1
- REFRIGERATION & Air Conditioning, 1280 Pgs. . . 4
- MILLWRIGHTS & MECHANICS GUIDE, 1200 Pgs. . . 4
- POWER PLANT ENGINEERS GUIDE, 1500 Pages . . . 4
- ENGINEERS & FIREMANS EXAMS, 525 Pages 1
- PUMPS, Hydraulics & Air Compressors, 1658 Pgs. . 4
- ENGINEERS LIBRARY (3 Book Set) 9
- MECHANICAL DICTIONARY, 950 Pages 4
- GARDENERS & GROWERS GUIDES (4 Book Set) . . . 6
- CARPENTERS & BUILDERS GUIDES (4 Book Set) . . . 6
- PLUMBERS & Steamfitters Guides (4 Book Set) . . 6
- MASONS AND BUILDERS GUIDES (4 Book Set) . . . 6
- PAINTERS & DECORATORS MANUAL, 450 Pgs. . . . 2
- HOUSE HEATING GUIDE, 1000 Pages 4
- OIL BURNER GUIDE, 384 Pages 1

Name _____
Address _____
Occupation _____
Employed by _____

I Trained These Men



E. J. STREITBERGER, New Boston, O., says, "After finishing course, I made a week fixing sets in spare time. Now set up Television sets."



PHILLIP G. LOUISVILLE, Louisville 8, Ky., says, "I have been operating Servicing business 3 years I did \$14,000 business; net profit \$2,000."



S. W. DINWIDDIE, Chicago, Ill., writes, "After finishing course, we started servicing shop. No. 1 Engineer of WCUN Police Radio Installation."



A. HERR, New Castle, Pa., writes, "Have doubled my salary since starting in Radio full time. Am employed by Station WKBO as transmitter operator. Future looks bright to me."



L. HAUGER, San Bruno, Calif., tells us, "I accepted a position as Radio and Television Technician . . . promoted to manager of Television Service and Installation."



LEANDER ARNOLD, Pontiac, Mich., says, "While learning, made \$5 to \$10 a week repairing Radios in my spare time. Now I have a spare time shop in my home."



NORMAN H. WARD, Ridgefield Park, N. J., writes, "4 years ago, I was a bookkeeper with a hand-to-mouth salary. Now I am employed by a key ABC station."

I'll Train You RADIO-

PRACTICE SERVICING OR COMMUNICATIONS with kits you get—Read how

For both my Servicing Course and my Communications Course, I send you many Valuable Kits of Parts for PRACTICAL EXPERIENCE. They "bring to life" theory you learn in my illustrated texts. Some equipment from both courses is shown below. As part of my Servicing Course, you build a complete, powerful Radio Receiver, a Multitester useful in earning extra spare time money, an A.M. and F.M. Signal Generator, etc. In my Communications Course, you assemble a low-power Broadcasting Transmitter that shows how to put a station "on the air," a Wavemeter, and an Electronic Multitester for measuring voltage, current, resistance, impedance, etc. This and other equipment you build with Kits I send is yours to keep.

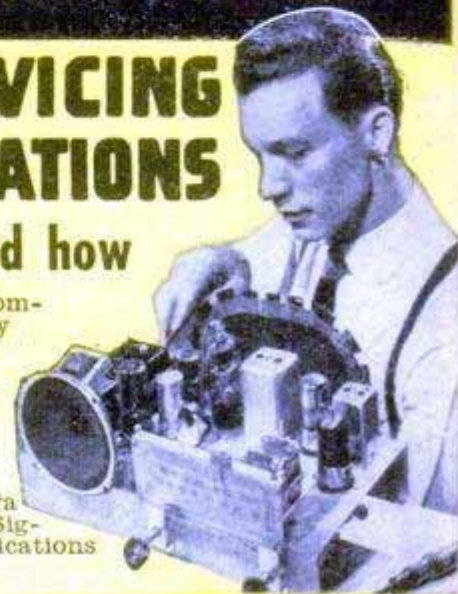

NOW! Advanced Television Practice

New, special TV kits furnished to build high-definition SCOPE . . . RF OSCILLATOR with flyback power supply . . . complete TV SET . . . many other units. You see pulse, trapezoidal, saw-tooth wave forms. Get valuable PRACTICAL EXPERIENCE locating and correcting TV troubles. Mail card for facts and pictures.

Make Extra Money in Spare Time While Learning

Many of my students earn money fixing neighbors' Radios in their spare time while learning, often average \$5, \$10, a week. I send you SPECIAL BOOKLETS that show you how to do it . . . and I send parts to build a Multitester that helps you do it.

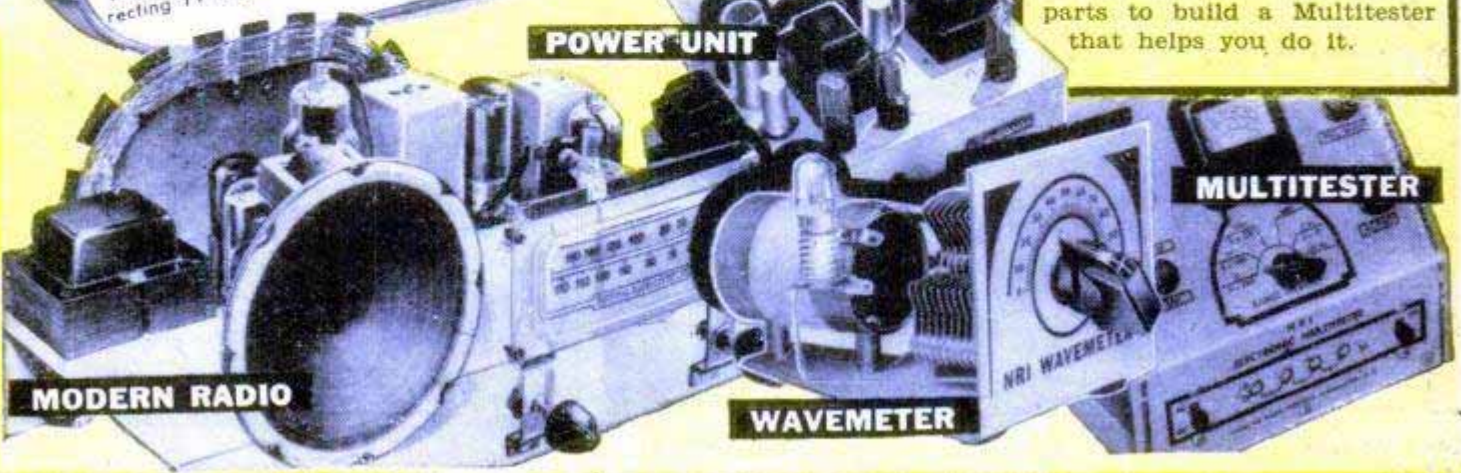

AT HOME for Good Jobs in TELEVISION

There is Success--Good Pay--Security for You in America's Fast Growing Industry

Veterans

Get this training under G. I. Bill

Mail Coupon Now

Want Your Own Business?

Many N. R. I. trained men operate successful Radio-Television sales and service businesses. Let me show you how, starting with spare time earnings as their capital, they build good incomes from their own shops.



TRANSMITTER

Do you want good pay, a job with a bright future and security? Would you like a profitable shop of your own? The fast growing prosperous RADIO-TELEVISION industry is making these opportunities for you. Radio alone is bigger than ever. 90 million homes and auto Radios, 3100 Broadcasting Stations, Two-Way Radio for buses, taxis, etc., are making opportunities for Servicing and Communications Technicians and FCC-Licensed Operators.

Television is TODAY'S Good Job Maker

In 1946 only 6,000 TV sets sold. In 1950 over 5,000,000. By 1954, 25,000,000 TV sets will be in use, according to estimates. Over 100 TV Stations are operating in 35 states. Authorities predict there will be 1,000 TV Stations. This means new jobs, more jobs, good pay for qualified men.

Many Soon Make \$10 A Week Extra in Spare Time

Keep your job while training at home. Hundreds I've trained are successful RADIO-TELEVISION TECHNICIANS. Most had no previous experience; many no more than grammar school education. Learn Radio-Television principles from illustrated lessons. Get PRACTICAL EXPERIENCE. See on the opposite page some of the devices my students build from Kits of Parts I furnish; also prac-

tice servicing Radios or operating transmitters—experiment with circuits common to Radio and Television. You keep all equipment. Many students make \$5, \$10, a week fixing neighbors' Radios in spare time. SPECIAL BOOKLETS start teaching you the day you enroll.

Send Now for 2 Books FREE — Mail Coupon

Act Now! Send for my FREE DOUBLE OFFER. Coupon entitles you to actual lesson on Servicing; show how you learn Radio-Television at home. You'll also receive my 64-page book, "How to Be A Success in Radio-Television." You'll read what my graduates are doing, earning; see photos of equipment you practice with at home. Send coupon in envelope or paste on postal. J. E. Smith, President, Dept. 1BA, National Radio Institute, Washington 9, D. C. OUR 38TH YEAR.

Actual Lesson and 64 page Book BOTH FREE

The ABC's of SERVICING

Mail Coupon Now!

MR. J. E. SMITH, President, Dept. 1BA National Radio Institute, Washington 9, D. C.

Mail me Sample Lesson and 64-page Book, "How to Win Success in Radio-Television"—both FREE. (No salesman will call. Please write plainly.)

NAME.....AGE.....

ADDRESS.....

CITY.....ZONE.....STATE.....

Check if Veteran Approved Under G. I. Bill

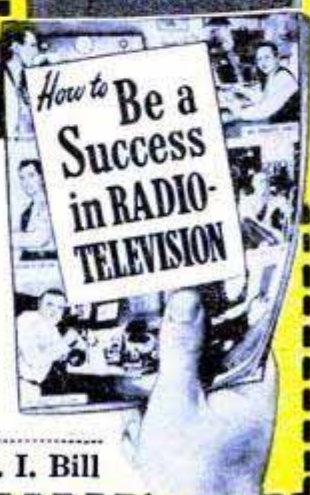

NOW!

BRIGGS SMOKES 3 WAYS BETTER*



1. Stays lighted longer ... by 19%



2. Cleaner burning ... by 16.4%



3. Less tar ... by 21.6%

So today ...

Put this
in your
pipe



and smoke it!

*Yes, our new process makes Briggs better by actual test! Better even than the swell-smoking Briggs that proved so fine and friendly in your pipe before. And remember this: when tobacco burns steady, free and clean, that's when you enjoy *all* the goodness of Briggs' fine tobacco, aged and mellowed in oaken casks. Today—try 3-ways-better Briggs!

Also available in Canada

WHERE-TO-BUY-IT INDEX

Source of supply appears after items commercially available

AUTOMOTIVE

Detroit listening post	101
Style czar of GM gets custom-built car	116
Buick features special series for '51	117
'51 Cadillac	122
'51 Plymouth	123
'51 Dodge	123
'51 DeSoto gets new look	124
Reflective license plates	125
Rain shield for windshield (A. N. McCreight, 301-303 W. Washington Ave., DuBois, Pa.)	125
Antifreeze "boot"	125
Custom sportster (Boardman Motors, Inc., 701 Reynold St., Augusta, Ga.)	132
Automatic car laundry (Jetomatic, Inc., Ansonia, Conn.)	132
Corrugated carport	143
Portable spotlight (Arrow Safety Device Co., Mount Holly, N. J.)	151
Add your own back-up lights (Yankee Metal Products Corp., Norwalk, Conn.)	151
Road run	152
Car exhaust kills rats (Meyer Chemical & Supply Co., 515 W. 7th St., Sioux City, Iowa)	152
"Buckets of bolts" car	163
Brake for accelerator (Accela-Brake Sales, 6201 Santa Monica Blvd., Hollywood, Calif.)	163

AVIATION

Faster flying with less fuel	14
Flying chuck wagon	8
Jet engines rely on "hot noses" to halt icing	124
Helicopter "wind" shakes fig trees	130
Muffler for jets	150

FARM

Hydraulic chain saw powered by tractor (Von Ruden Mfg. Co., Claremont, Minn.)	8
Dump-truck post driver	8
Homemade elevator for baled hay	11
Walnut picker	153

HOUSE AND HOME

Multicolor paint (United Lacquer Mfg. Corp., 1001 W. Elizabeth Ave., Linden, N. J.)	10
Bath spray (Chicago Specialty Mfg. Co., 2954 W. Lawrence Ave., Chicago)	11
Springless mattress (Susquehanna Mills, Inc., 404 Fourth Ave., New York City)	11
Wire "porcupine" (Flour City Brush Co., 301 5th Ave., S., Minneapolis, Minn.)	11
Convactor for living room (Modine Mfg. Co., Racine, Wis.)	11
Strip opener (Jiff Sales Co., Box 5946, Milwaukie, Ore.)	11
Shirt caddy (Selector Co., Box 1440, Grand Central P.O., New York City)	11
Shoe tree (Fortner & Perrin, Inc., 731 W. Wilson St., Glendale 3, Calif.)	11
Poison lock (Bob Baker, 4943 Biloxi Ave., North Hollywood, Calif.)	11
Stationary iron (Frank Meier, Inc., Box 934, Menlo Park, Calif.)	11
Push-button shave cream (Carter Products, Inc., 53 Park Place, New York City)	16
Fold-down metal edging (R. D. Werner Co., Inc., 295 5th Ave., New York City 16)	16
Frame locks sink in place (B & T Metals Co., 425 W. Town St., Columbus 16, Ohio)	25

INDUSTRY

Scoop dumps load over its shoulder (Bradford Iron Works, Longmont, Colo.)	10
"Tracer" splits petroleum in pipe line	10
Road-or-rail switcher (Whiting Corp., Harvey, Ill.)	13
G. E.'s hall of knowledge	15
Concrete roadway laid on swamp	15

MILITARY

Cream repels land leech	9
Wind-tunnel simulator uses water instead of air	10
Jeep-mounted rifle can knock out biggest tank	12
Torpedo retriever	15

OUTDOOR RECREATION AND SPORTS

Sea scooter	9
Baseball with rackets! It's called "Wiskit"	9
Basketball referee goes aloft to get bird's-eye view of game	13
One-wheel school for bullfighters	13
Tiny telescope gun sight mounted in two seconds (Tinsley Laboratories, 2526 Grove St., Berkeley, Calif.)	15

PHOTOGRAPHY

"Extras" give surplus camera that professional touch (Hollywood Camera Exchange, 1600 N. Cahuenga Blvd., Hollywood 38, Calif.)	10
Nonrewind reel for movie fans (Borroughs, Inc., Box 252, Greene, Iowa)	11
"Deep" photo film resists heat	12
Photo cart (Eastman Kodak Co., Rochester, N. Y.)	16

MISCELLANEOUS

Cable-operated dump truck (Schonrock Equipment Mfg. Co., Box 1543, San Angelo, Tex.)	8
"Spider" cart for roofers	8
Noise stopper (Sigma Sales Corp., 1491 N. Vine St., Los Angeles 28, Calif.)	9

(Continued to page 16)

INVENTORS

Learn how to protect your invention. The U. S. Patent Laws provide that any new and useful art, machine, article of manufacture, or composition of matter, or any new and useful improvement thereof, may be patented if the act of invention is involved. Therefore, every inventor with a valuable invention should take advantage of the Patent Laws and proceed for patent protection in order to safeguard his rights.

A patent gives the inventor the exclusive right to prevent others from making, using, or selling the invention claimed in the patent for a period of seventeen years.

The Patent Laws were enacted for the benefit of the inventor to give him protection for the features of his invention which are patentable. These features must be properly and concisely set forth and claimed in a formal application for patent, in order to comply with the requirements of the Patent Laws. For that reason, unless the inventor is familiar with patent matters, he should engage a competent registered patent attorney or agent to represent him. We are registered to practice before the U. S. Patent Office and are prepared to serve you in the handling of your patent matters.

A specially prepared booklet entitled "Patent Guide for the Inventor", containing detailed information with respect to patent protection and procedure, together with a "Record of Invention" form will be promptly forwarded to you without obligation upon request.

CLARENCE A. O'BRIEN & HARVEY JACOBSON

Registered Patent Attorneys

11-B DISTRICT NATIONAL BUILDING

WASHINGTON 5, D. C.

Which of these 2 one time WEAKLINGS PAID only a Few Cents to become an All-Around HE-MAN at Home?

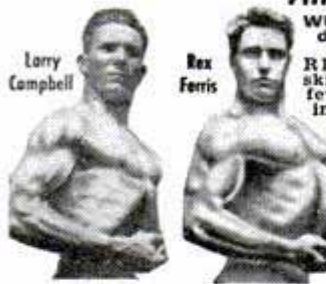

Which One Paid Hundreds of Dollars to Train at My Side? REX FERRIS, was a skinny weakling, paid a few cents to start building into a Champion All Around the Man! LARRY CAMPBELL paid me hundreds of dollars to train at my side years ago. Start to become an All Around He Man at home with these same secrets—like Rex Ferris did!

Amazing get-acquainted offer—YOURS for only 10c Instead of \$1 For all 5 Courses plus FREE Photo Book!

Be A Winner at Anything You Tackle with Progressive Power—SPORTS! JOB! SCHOOL! FRIENDS!

Let's Go, Pal! I'll prove I can make YOU an "ALL-AROUND" HE-MAN FAST—OR NO COST! says George F. Jowett World's Greatest Body Builder



George F. Jowett "Whom experts call 'Champion of Champions.'" World's wrestling and weight lifting champ at 17 and 19. World's Strongest Arms. 4 times World's Perfect Body—plus other records.

Enjoy My "Progressive Power" Strength Secrets! Give Me 10 Easy Minutes a Day—Without Strain! I'll teach you the "Progressive Power Method" through which I rebuilt myself from a physical wreck the doctors condemned to die at 15, to the holder of more strength records than any other living athlete or teacher! "Progressive Power" has proven its ability to build the strongest, handsomest men in the world. And I stand ready to show you on a money back basis—that no matter how flabby or puny you are I can do the same for you right in your own home. Let me prove I can add inches to your arms, broaden your shoulders, give you a man-sized chest, powerful legs and a Rock-like back—in fact, power pack your whole body so quickly it will amaze you! Yes, I'll jam you with power and confidence to master any situation—to win popularity—and to get ahead on the job! Through my proven secrets I bring to life new power in you inside and out, until YOU are fully satisfied you are the man you want to be.

PROVE IT TO YOURSELF IN ONE NIGHT Send only 10c for my 5 easy-to-follow, picture-packed courses now in 1 complete volume "How to Become a Muscular He-Man." Try it for one night! Experience the thrilling strength that surges through your muscles. 10 DAY TRIAL! Think of it—all 5 famous courses in one picture-packed, muscle-building volume only 10c. You must actually FEEL results in ONE WEEK, or your money will be promptly refunded!

FREE!

PHOTO BOOK of Famous Strong Men!

HOW TO MOLD MIGHTY LEGS

HOW TO MOLD A MIGHTY BACK

HOW TO MOLD A MIGHTY ARM

HOW TO MOLD A MIGHTY CHEST

HOW TO MOLD A MIGHTY GIP

How to BECOME A MUSCULAR HE-MAN

With these 5 Complete Courses on Molding a Muscular He-Man: 1. A Mighty Grip 2. A Mighty Chest 3. A Mighty Arm 4. A Mighty Back 5. A Mighty Leg

FREE GIFT COUPON!

Jowett Institute of Physical Training DEPT. PMA-12
230 Fifth Avenue, New York 1, N.Y.

Dear George:—Please send by return mail, pre-paid, FREE Jowett's Photo Book of Strong Men, plus all 5 Muscle Building Courses. 1. Molding a Mighty Chest. 2. Molding a Mighty Arm. 3. Molding a Mighty Grip. 4. Molding a Mighty Back. 5. Molding a Mighty Leg—Now all in One Volume "How to Become a Muscular He-Man." Enclosed find 10c for postage and handling. No C.O.D.'s.

George F. Jowett
Champion of Champions

NAME _____ AGE _____

ADDRESS _____

CITY _____ ZONE & STATE _____

(Continued from page 14)

Scissors scaffold	94
"Eggshell" on wheels challenges motorcycle speed mark	95
Mosquito nemesis—paddle-wheel style	106
Automatic orange juicer (Automatic Orange Juicer Corp., 22 Park Place, New York City)	113
Bricklayer's mobile shop	123
Synthetic pepper	124
Underwater swimmer's lung (Rene Sports of Westwood, 1045 Broxton Ave., Los Angeles 24, Calif.)	125
Model newspaper press	129
Mountain mast for TV antenna (General Electric, Electronic Dept., Syracuse, N. Y.)	138
Frigid cylinder is food locker	138
Soil pulverizer	139
Midget auto	143
Coming or going? Train's not sure	143
Unique Bikini fish	152
Hottest railroad	155
Radioactive cortisone	159
Midget road marker (Beaver Tractor Co., Inc., Stratford, Conn.)	159
Pocket-size sun lamp (Cooper-Hewitt Electric Co., Hoboken, N. J.)	159
Silting of reservoirs is groundless fear	164

Craftsman and Shop Notes Index

AUTOMOTIVE	
Tab depresses car-door switch to turn off interior lights	186
Auto-wiring insulation renewed by using friction tape and lacquer	196
Bags mask lights for painting cars	222
ELECTRICAL	
Improved armature test stand	216
Air locates conduit outlet	223
Improved coil-winding form	223
FARM	
Increasing throw of seeder	212
Handy mash cart from oil drum	213
Guide protects sliding door	216
Wooden partitions for hog troughs prevent crowding at feeding time	216
Gutter on floor of temporary crib eases shoveling corn	223
Strips nailed across range-shelter roof provide roosts	223
Floor-type grinder for farm shop accommodates heavy work	226
Large stock tank supplies float-controlled hog waterer	226
Eliminating exhaust sparks	226
Handy barnyard snowplow is assembled from odds and ends of metal	226
HOBBIES AND MODELS	
HO train case	166
Pencil holds sandpaper strip for finishing narrow grooves	186
Turntable pivoted on caster speeds painting figurines	197
HOUSE AND HOME	
Rubber ball serves as patching-plaster container	176
Toy chest made from old trunk	176
Novel photo frames	176
Outlet openings in wall laid out quickly	176
Toy bank is container for used razor blades	177
Straightening warped phonograph records	177
Clothesline for bathroom	177
Egg-gathering basket aids in washing vegetables	177
Easier way to install glass-block "windows"	179
Storm sash opened from outside to free sticking window	183
Toaster improvised from hot plate	184
Adding life to electric clock	184
Eaves-trough howling reduced by metal wind deflectors	194
Cleaning yellowed piano keys	194
Canvas shield protects house while near-by shrubs are sprayed	200
Improvements in Colonial homes are applicable to modern construction	204
OFFICE, SHOP AND STORE	
Fountain pen set in wooden base is converted to desk model	174
Slitting pencil-eraser edge increases efficiency	174
Two notebooks fastened together with length of stiff wire	174
Wire wrapped around ink dropper reduces formation of bubbles	178
Stamp moisteners of chamolins	186
Sidewalk display panel	212
Emery board cleans eraser	212
PHOTOGRAPHY	
Roll-film adapter for view camera	205
Identical cameras held by dual mount take photos for use with stereoscope	207
Unmounted optical lenses stored in coin cards	207
Roughening plastic clips keeps negatives from slipping	207
Light shield clamped to reflector with spring-type clothespins	208
Mailing tube flattens prints	208
Clipping corners of film prevents binding in tank reel	208

(Continued to page 18)

IMPORTANT NOTICE—It is the intention of this magazine to provide its readers with information regarding the latest developments in the mechanical arts. We take no responsibility as to whether the disclosures contained in our articles are covered by patents and advise readers to investigate this subject before making, using, or selling any of the products, machines, or processes described in order to avoid possible liability for patent infringements.

INVENTORS

If you believe that you have an invention, you should find out how to protect it. The first step is to have a search made of the prior pertinent U. S. patents. If a report on this search indicates that the invention appears patentable you can apply for a patent, and the specifications and claims should be prepared.

The firm of **McMorrow, Berman & Davidson**, with offices in Washington, D. C., is qualified to take the necessary steps for you. We can make a preliminary search on your invention, advise you whether we think it can be patented, and prepare your application for patent.

Unless you are fully familiar with the U. S. Patent Laws, we recommend that you engage the services of a Registered Patent Attorney to protect your interests. The patent laws are *your* laws. A patent gives you the right to prevent others from making, using or selling the invention claimed in your patent for a period of 17 years.

Use these patent laws for your protection. Investigate whether your invention can be patented. If you have what you believe to be an invention, we suggest that you have this firm make a search for you.

Send for a copy of our Patent Booklet entitled "How To Protect Your Invention," containing information about patent protection and patent procedure. Along with this we will also send you an "Invention Record" form, for your use in writing down and sketching details of your invention. We will mail them promptly. No obligation. They are yours for the asking.

McMORROW, BERMAN & DAVIDSON

Registered Patent Attorneys

PATENTS • COPYRIGHTS • PATENTS

135 - P VICTOR BUILDING, WASHINGTON 1, D. C.

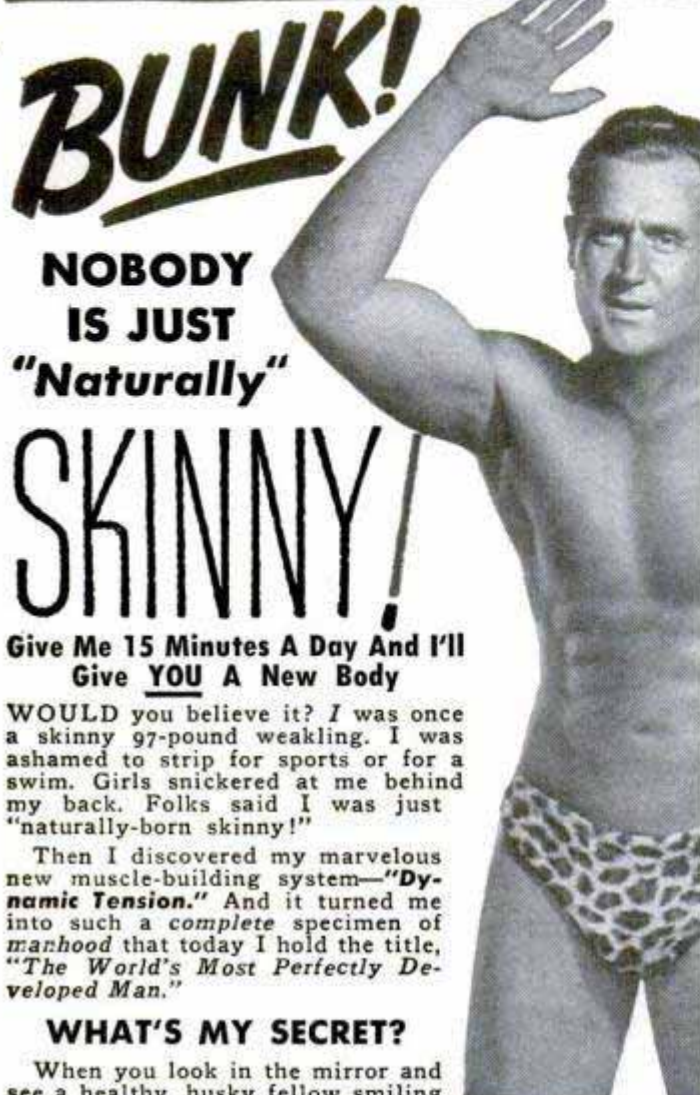
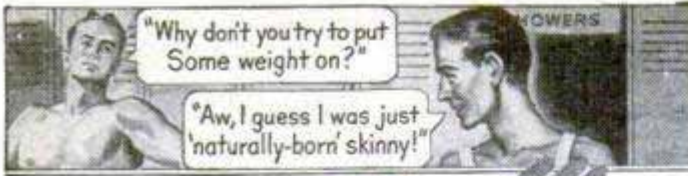

BUNK!
NOBODY IS JUST "Naturally" SKINNY!

Give Me 15 Minutes A Day And I'll Give YOU A New Body

WOULD you believe it? I was once a skinny 97-pound weakling. I was ashamed to strip for sports or for a swim. Girls snickered at me behind my back. Folks said I was just "naturally-born skinny!"

Then I discovered my marvelous new muscle-building system—"Dynamic Tension." And it turned me into such a complete specimen of manhood that today I hold the title, "The World's Most Perfectly Developed Man."

WHAT'S MY SECRET?

When you look in the mirror and see a healthy, husky fellow smiling back at you—then you'll be astonished at how fast "Dynamic Tension" gets results! And you'll be using the method which many great athletes use for keeping in condition—prize fighters, wrestlers, baseball and football players, etc.

"Dynamic Tension" is the easy natural method that you can practice in the privacy of your own room—just 15 minutes each day—while your scrawny chest and shoulder muscles begin to swell . . . those spindly arms and legs bulge . . . and your whole body starts to feel full of zip, self-confidence, new energy!

My Illustrated Book is Yours
—Not for \$1.00 or 10c—But FREE

Send NOW for my famous book, "Everlasting Health and Strength." 48 pages, packed from cover to cover with actual photographs, valuable advice, answers to many vital questions. Page by page it shows what I can do for YOU. This book is a real prize for any fellow who wants a better build. Yet I'll send you a copy absolutely FREE. Just glancing through it may mean the turning point in your whole life! Rush the coupon to me personally: Charles Atlas, Dept. 8B, 115 East 23rd St., New York 10, N. Y.



Charles Atlas
Awarded the title of "The World's Most Perfectly Developed Man."

CHARLES ATLAS, Dept. 8B, 115 East 23rd St., New York 10, N. Y.
Send me—absolutely FREE—a copy of your famous book, "Everlasting Health and Strength"—48 pages, crammed with actual photographs, answers to vital health questions, and valuable advice to every man who wants a better build. I understand this book is mine to keep, and sending for it does not obligate me in any way.
Name.....Age.....
(Please print or write plainly)
Address.....
City.....State.....

TOOLS

- Rubber tip on screwdriver handle increases gripping surface. 184
- Wrench doubles as screwdriver. 193
- Magnet kept with toolbox picks up scattered nails. 194
- Do your shaping on contour wheels. 195
- Precision filing done in home workshop with roller guide mounted on bench top. 196
- Spring hold-down fits wooden shaper fence. 197
- Socket adapted for short bolts. 212
- Ratchet die stock from bit brace. 212
- Drill-press speed attachment. 217
- Four-in-one socket-key wrench. 223
- Giant end wrenches (Owatonna Tool Co., Owatonna, Minn.). 224
- Explosive rivet gun (Ripley Co., Inc., Middletown, Conn.). 224
- Ignition-wiring repair kit (Vaco Products Co., 317 E. Ontario St., Chicago 11). 224
- Shaper and drill-press fence (J. T. Lloyd, Bourse Bldg., Philadelphia 6, Pa.). 224
- Inexpensive grade gauge (Pitchrite Grade Gauge Co., Box 26, Arlington Heights, Ill.). 225
- Novel drive point (Model Patent Mfg. Co., 209 16th St., Denver, Colo.). 225
- Gearless, nonhydraulic speed changer (Revco, Inc., 415 Thorpe Bldg., Minneapolis, Minn.). 225
- Ratchet-type open-end wrench (Thorsen Tools, 5321 Horton St., Emeryville, Calif.). 225

TOYS AND NOVELTIES

- Simple blinker light. 175
- "Toadstool" yard umbrella supported by tree trunk. 178
- Wooden toy wheels made quickly. 178
- Toy wheels from tin cans. 185
- Toy drum made from coffee can has drafting-paper heads. 186
- Porch lamp in copper. 187

WOODWORKING

- Scribing guide for wood trim assures close-fitting joints. 184
- Corner hook for wood carving has right-angle stop. 196
- Two unusual tables for magazines. 198
- Novel footstool includes utility drawer for mending, slippers or magazines. 204

MISCELLANEOUS

- Fly-tying vise from pipe fittings mounted on workbench. 174
- Wrist watch works kept clean after breaking crystal. 178
- Determining pipe diameter for main water line. 178
- Solution of DDT and fuel oil keeps termites away from wooden posts. 183
- Broken figurine repaired quickly by reinforcing with bobby pin. 184
- Screen wire stretched taut on simple table-top jig. 194
- Copper tubing provides rivets for assembling knife handle. 194
- Removing shoe-polish stains. 200
- Screws stored with extra hinges cannot be mislaid. 200
- Scrap leather pulled through cutter to produce lacing. 200
- Car-crib stroller. 201
- Waterproof case improvised from film container holds safety matches. 204
- Truck body fitted with rain shields. 216
- Stopping water hammer. 216
- Using red ochre on chalk line. 216

Radio-Television, Electronics

- Television in the home (Earphone attachment, Skinner & Pelton, Inc., 100 N. La Salle St., Chicago 2; TV polish, Jim Robbins Co., 1555 E. Eight Mile Road, Hazel Park, Mich.; flat TV antenna, Video Associates, 1865 Adams St., Toledo, Ohio; twin-driven, corner antenna, Technical Appliance Corp., Sherburne, N. Y.; portable television seats, Plasticronics, Inc., 54 Greene St., New York City). 227
- Super-fidelity amplifier has hum-reduction feature. 228
- Hams ready for emergency (Ultra-high frequency receiver, National Co., Inc., 61 Sherman St., Malden, Mass.; mobile transmitter and receiver, Motorola, Inc., 4545 Augusta Blvd., Chicago 51). 231
- Hints for radio set owners. 232

Faster Flying With Less Fuel

Nonstop airline flights between Chicago and London are made possible by a new turbosupercharger for piston engines. Compared with a current type in tests on the same engine, the CH9 developed by General Electric boosted power one third and used 20 percent less fuel. Turbosuperchargers help engines "breathe" at high altitude by compressing the rarefied air to sea-level pressures before it enters the cylinders. The CH9 supplies the highest air flow of any turbosupercharger, 350 pounds a minute, and eliminates the conventional geared supercharger working off the engine shaft, which drew up to 500 horsepower from the engine.

WILL YOU BE CLIMBING? OR STUCK?

WHAT you'll be doing *one year* from today depends on what you do *today*.

Take advantage of today's opportunities and you're sure to move ahead. Put off doing anything about them and you chance being left behind.

The opportunities open to trained men are greater today than at any time in the past five years. Skilled technicians and specialists are the *men of the hour*. And thousands of them are I. C. S. students.

The chance for World War II veterans to train under the G. I. Bill is another of today's great opportunities. But the offer is due to expire. To qualify, you must enroll before July 25, 1951!

Start now! Study at home, in your spare time, with the world's largest school—I. C. S. Mail the coupon today for full information. It may be later than you think!

INTERNATIONAL CORRESPONDENCE SCHOOLS



BOX 5694-K, SCRANTON 9, PENNA.

Without cost or obligation, please send me full particulars about the course BEFORE which I have marked X:

- | | | | |
|---|--|---|--|
| <p>Business and Academic Courses</p> <ul style="list-style-type: none"> <input type="checkbox"/> Accounting <input type="checkbox"/> Bookkeeping <input type="checkbox"/> Business Administration <input type="checkbox"/> Bus. Correspondence <input type="checkbox"/> Certified Public Accounting <input type="checkbox"/> Commercial <input type="checkbox"/> Cost Accounting <input type="checkbox"/> Federal Tax <input type="checkbox"/> First Year College <input type="checkbox"/> Foremanship <input type="checkbox"/> Good English <input type="checkbox"/> Higher Mathematics <input type="checkbox"/> Industrial Supervision <input type="checkbox"/> Motor Traffic <input type="checkbox"/> Retailing <input type="checkbox"/> Salesmanship <input type="checkbox"/> Sign Lettering <input type="checkbox"/> Spanish <input type="checkbox"/> Typing <p>Air Conditioning and Plumbing Courses</p> <ul style="list-style-type: none"> <input type="checkbox"/> Air Conditioning <input type="checkbox"/> Heating <input type="checkbox"/> Refrigeration | <p>Chemical Courses</p> <ul style="list-style-type: none"> <input type="checkbox"/> Chemical Engineering <input type="checkbox"/> Chemistry, Analytical <input type="checkbox"/> Chemistry, Industrial <input type="checkbox"/> Chemistry, Mfg. Iron & Steel <input type="checkbox"/> Petroleum Refining <input type="checkbox"/> Pulp and Paper Making <p>Civil Engineering, Architectural and Mining Courses</p> <ul style="list-style-type: none"> <input type="checkbox"/> Architecture <input type="checkbox"/> Building Estimating <input type="checkbox"/> Civil Engineering <input type="checkbox"/> Contracting and Building <input type="checkbox"/> Highway Engineering <input type="checkbox"/> Lumber Dealer <input type="checkbox"/> Reading Structural Blueprints <input type="checkbox"/> Sanitary Engineering <input type="checkbox"/> Structural Drafting <input type="checkbox"/> Structural Engineering <input type="checkbox"/> Surveying and Mapping <p>Communications Courses</p> <ul style="list-style-type: none"> <input type="checkbox"/> Electronics <input type="checkbox"/> Prac. FM and Television <input type="checkbox"/> Prac. Telephony <input type="checkbox"/> Radio, General <input type="checkbox"/> Telegraph Engineering | <p>Electrical Courses</p> <ul style="list-style-type: none"> <input type="checkbox"/> Electrical Drafting <input type="checkbox"/> Electrical Engineering <input type="checkbox"/> Electric Light and Power <input type="checkbox"/> Lighting Technician <input type="checkbox"/> Practical Electrician <input type="checkbox"/> Power House Electric <input type="checkbox"/> Ship Electrician <p>Internal Combustion Engines Courses</p> <ul style="list-style-type: none"> <input type="checkbox"/> Auto Technician <input type="checkbox"/> Diesel-Electric <input type="checkbox"/> Diesel Engines <p>Mechanical Courses</p> <ul style="list-style-type: none"> <input type="checkbox"/> Aeronautical Engineer's, Jr. <input type="checkbox"/> Aircraft Drafting <input type="checkbox"/> Forging <input type="checkbox"/> Heat Treatment of Metals <input type="checkbox"/> Industrial Engineering <input type="checkbox"/> Industrial Instrumentation <input type="checkbox"/> Industrial Metallurgy <input type="checkbox"/> Machine Shop <input type="checkbox"/> Machine Shop Inspection <input type="checkbox"/> Mechanical Drafting <input type="checkbox"/> Mechanical Engineering | <p>Railroad Courses</p> <ul style="list-style-type: none"> <input type="checkbox"/> Air Brake <input type="checkbox"/> Diesel Locomotive <input type="checkbox"/> Locomotive Engineer <input type="checkbox"/> Locomotive Fireman <input type="checkbox"/> Locomotive Machinist <input type="checkbox"/> Railroad Section Foreman <input type="checkbox"/> Steam and Diesel Loco. Eng. <p>Stationary Engineering Courses</p> <ul style="list-style-type: none"> <input type="checkbox"/> Boilermaking <input type="checkbox"/> Combust. Engrg. <input type="checkbox"/> Marine Engineering <input type="checkbox"/> Power Plant Engr. <input type="checkbox"/> Steam Engineer <p>Textile Courses</p> <ul style="list-style-type: none"> <input type="checkbox"/> Cotton Manufacturing <input type="checkbox"/> Rayon Weaving <input type="checkbox"/> Woolen Manufacturing |
|---|--|---|--|

Name _____ Age _____ Home Address _____

City _____ State _____ Working Hours _____ A.M. to _____ P.M.

Present Position _____ Employed by _____

Length of Service in World War II _____ Enrollment under G.I. Bill approved for World War II Veterans. Special tuition rates to members of the Armed Forces. Canadian residents send coupon to International Correspondence Schools Canadian, Ltd., Montreal, Canada.

INVENTORS

If you consider your invention to be something of importance — if you have invented any new and useful art, machine, manufacture or composition of matter or improvement thereof — you are advised to protect your invention by applying for a U. S. patent.

This firm is registered to practice before the U. S. Patent Office and is available to assist in the preparation and prosecution of your patent application.

The "Evidence of Invention" form mentioned below is offered as a convenience to you in making your disclosure to us for search purposes.

You should date and sign your disclosure and have it witnessed by two or more persons who are capable of understanding your invention.

Your disclosure should be mailed to us together with a letter authorizing us to conduct a preliminary search among previously granted U. S. patents for similar types of invention.

We then make this search and prepare a report of the probable patentability of your invention. If such report is favorable, we recommend the further course for you to take.

The "Evidence of Invention" form and booklet are suggested as conveniences to you and us in starting action on your invention.

VICTOR J. EVANS & Co. *Merlin M. Evans*
REGISTERED PATENT ATTORNEY

630-B MERLIN BUILDING, WASHINGTON 6, D. C.

PATENTS

COPYRIGHTS

We shall be glad to send you promptly and without obligation, an instructive booklet, "Patent Protection for Inventors", which was prepared to give inventors detailed information and steps to take toward patent protection—also our convenient "Evidence of Invention" form. Use address Victor J. Evans & Co., 630-B Merlin Building, Washington 6, D. C.

TRY HOME STUDY WATCHMAKING

FREE Sample Lesson

Famous Sweazey System shows how to master watchmaking . . . expertly, quickly, successfully . . . right in your own home. No previous experience needed to learn one of the highest paid trades. Try it without obligation.

G. I. APPROVED RESIDENT COURSES

. . . in Watchmaking, Engraving, Jewelry Repair, Diamond and Stone Setting at our modern, fully-accredited resident school. Founded 1908. Write for FREE CIRCULAR.

CHICAGO SCHOOL OF WATCHMAKING

1608 N. Milwaukee Avenue Dept. 121 Chicago 47, Ill.



Make BIG MONEY!

RAISE CHINCHILLA RABBITS!

Cash Markets Supplied for Your Production

FREE - Illustrated Booklet - WRITE TODAY!

ROCK HILL RANCH, SELLERSVILLE 36, PA.

World's Largest Breeder of Chinchilla Rabbits

CARPENTRY BRICKLAYING

APPROVED FOR VETERAN TRAINING • FREE CATALOG

PENNSYLVANIA INSTITUTE SCHOOL OF TRADES
30th & MARKET STS. PHILA. 4, PENNA.



TOOTHACHE?

Ask your Druggist for

DENT'S

TOOTH GUM
TOOTH DROPS
POULTICE

"How to Make Money with Simple Cartoons"

A book everyone who likes to draw should have. It is free; no obligation. Simply address

FREE BOOK

CARTOONISTS' EXCHANGE
Dept. 92D Pleasant Hill, Ohio

STAMMERER?

New booklet, "Stammering, and How to Stop It," sent free to any stammerer upon request. Write today. **BENJAMIN N. BOGUE**, Dept. 514, Circle Tower, Indianapolis 4, Ind.

GET THIS
FREE BOOK!

Say You Saw It in POPULAR MECHANICS

TUBELESS Personal RADIO

POCKET SIZE! GUARANTEED to play on local stations

- No Tubes
- No Batteries
- No Electricity



Costs nothing to run, lasts indefinitely. Range up to 25 miles (some users report up to 50 miles on 50,000 Watt stations). New Germanium Diode crystal detector—same as used in Army, Navy Radar sets. Extra sensitive stethophone. Designed, mfgd. by an internationally known electronic engineer. Beautiful red plastic case with green trim. Single-control tuning, has rich, mellow tone. Just hook it up on simple instructions—it plays instantly, never turns off. Nothing to wear out; should last for years. Sent postpaid—cash, check or money order. No C.O.D.'s. Complete—nothing else to buy—\$5.00.

Pat. Appl. for
Patrick Laboratories, Inc. 2450 E. 52nd St., Indianapolis, Indiana — Dept. PM-2

Prepare in our
Big Training
Shops for these

GREAT OPPORTUNITY FIELDS!

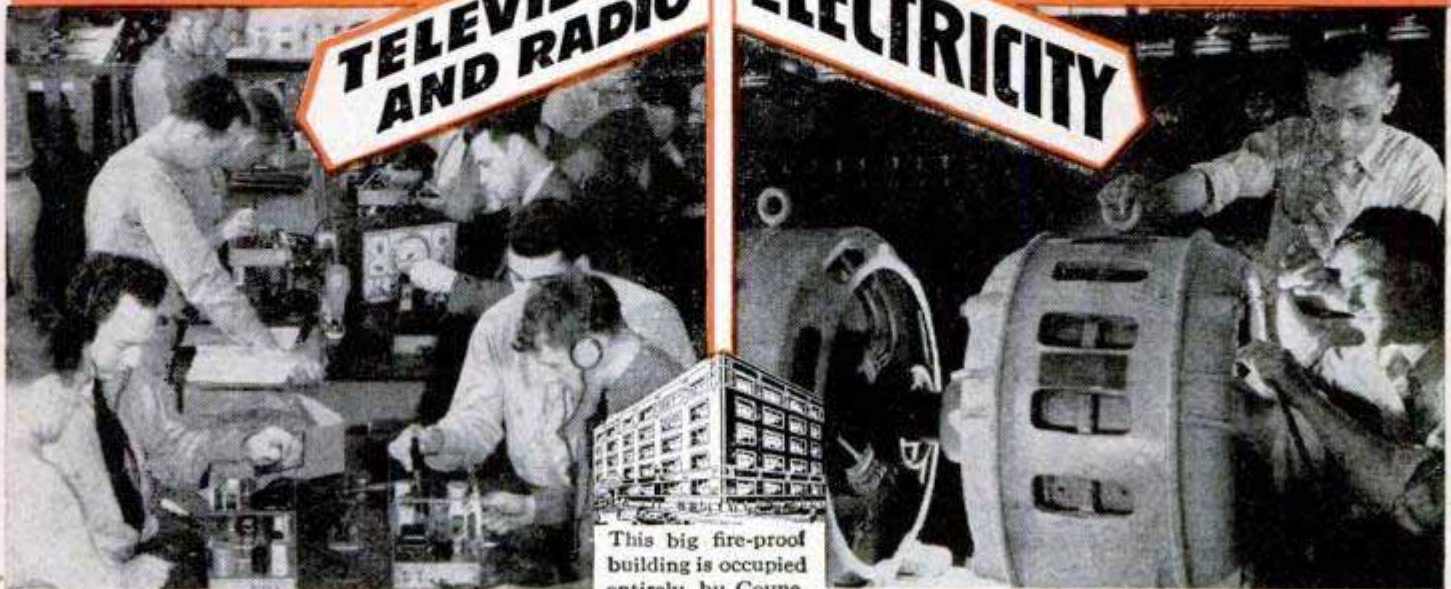

This big fire-proof building is occupied entirely by Coyne.

FIVE BIG FLOORS PACKED WITH MASSIVE EQUIPMENT

Thousands of men and young men have come to our big training shops where we have floor upon floor packed with massive equipment. Here they prepare for good jobs and real futures in the opportunity fields of Television-Radio and Electricity. For many years, these fields have offered great opportunities to trained men. With new developments, including Electronics and Television, they will continue to grow and offer even greater opportunities. Why be satisfied with a "no future" job? Many "one operation" jobs that exist today will not last. Prepare for a good job with a real future for steady pay and advancement by training NOW in the great training shops of COYNE in Chicago.

NOT "HOME-STUDY" COURSES

Our famous Television-Radio Practical-Technical method gives you practical experience on a massive outlay of equipment. Not by correspondence, but actual shop work plus necessary technical training. You are trained right here in the great Coyne shops that have been training men and young men for over 50 years.

TELEVISION-RADIO ELECTRICITY

A great field now, even greater growth ahead. Here at COYNE you're trained for Construction, Testing, Troubleshooting on Radio, Public Address, Sound Units. Training includes FM, Television Installations, Servicing, etc. Many Coyne trained men in good jobs or own well paying Television-Radio businesses of their own.

INCLUDING INDUSTRIAL ELECTRONICS

Big future in Power Plant Work, Motors, Armature Winding, Home and Factory Wiring, Appliances, Refrigeration, Maintenance, Illumination, etc. Electricians are in demand everywhere —lifetime job service to Coyne graduates. Send for BIG FREE BOOK.

LARGEST, OLDEST, BEST EQUIPPED SCHOOL OF ITS KIND IN THE U.S.

Mail Coupon for
Big FREE Book!



Whether you prefer Television-Radio or Electricity, train on actual equipment at Coyne. We will send you a Big, fully Illustrated Book, if you will indicate below, which course interests you. No salesman will call. Mail coupon TODAY.



START NOW—PAY LATER

Don't let lack of money hold you back. You can finance most of your tuition and pay for it later, in easy monthly payments. We'll help you get part time work, if you need it, to help pay living costs while at Coyne.

G. I. APPROVED

B. W. COOKE, President

COYNE ELECTRICAL AND TELEVISION-RADIO SCHOOL
An Institution not for Profit
500 So. Paulina St., Dept. 21-72H, Chicago 12, ILL.

B. W. Cooke, President
COYNE ELECTRICAL AND TELEVISION-
RADIO SCHOOL, 500 S. Paulina St.,
Dept. 21-72H, Chicago 12, Ill.

Send me your Big Free book, and details of your training offer. I am interested in the course checked below. This does not obligate me.

TELEVISION-RADIO ELECTRICITY

NAME.....

ADDRESS.....

CITY..... STATE.....



NOW ANY AUTO REPAIR JOB

CAN BE A "Push-Over" for You!

IN LESS TIME —
WITH LESS WORK —
AND MORE PROFITS!

Used by
U. S. Army
and Navy



NOW, tackle anything from carburetor to rear end on ANY car built from 1935 thru 1950! Fix it quick, easy, right the FIRST time! Just look up make, model, and job in quick index of MoToR's brand-new 1950 Edition AUTO REPAIR MANUAL. Clear, illustrated instructions—you just can't go wrong! 7-DAY FREE TRIAL!

Earn More Money! Win Prestige!

Boiled down in one BIG handy 750-page book — the complete "dope" from 150 Official Factory Manuals. 200,000 service, repair, tune-up facts, 35,000 essential dimensions!

Covers 741 car models. Includes all new automatic transmissions, GM Rochester carburetors. 2100 cut-away photos, diagrams, charts show what the clear text tells. Used by Army, Navy, Tech Schools, thousands of auto-repairmen. Makes every operation so easy, you'll tackle jobs you wouldn't think of doing before. You'll win added prestige, more money!

SEND NO MONEY

Mail coupon—without money! When book arrives—make it show you what it's got! Unless you agree it's the greatest time and work saver you've ever seen—return it in 7 days, pay nothing. Mail coupon NOW! MoToR Book Department, Desk 12A, 250 West 55th Street, New York 19, N. Y.

COVERS ANY CAR BUILT SINCE 1935!

- | | |
|-----------|------------|
| Auburn | Kaiser |
| Austin | Lafayette |
| Bantam | La Salle |
| Buick | Lincoln |
| Cadillac | Mercury |
| Chevrolet | Nash |
| Chrysler | Oldsmobile |
| Cord | Packard |
| Crosley | Pierce |
| De Soto | Arrow |
| Dodge | Plymouth |
| Ford | Pontiac |
| Frazer | Reo |
| Graham | Studebaker |
| Hudson | Terraplane |
| Hupmobile | Willis |

Same FREE Offer On MoToR's Truck and Tractor Manual

BRAND-NEW! Covers EVERY job on EVERY popular make gasoline truck, tractor made from 1936 thru 1949. FREE 7-Day Trial. Check proper box in coupon.



PRINT YOUR OWN POST CARDS!

FREE

10 DAY TRIAL

The GEM STENCIL DUPLICATOR saves money... gets results quickly! Hundreds of uses for every type of business and organization. We ship the GEM complete with all supplies, Guide Board for accurate printing and 60-page Book of Ideas at the special low price of only \$8.50 (a \$15.00 value)

FREE TRIAL OFFER: Use the GEM FREE at our expense! SEND NO MONEY. Write and complete GEM outfit will be sent you postpaid. After ten days, send us only \$8.50 or return the GEM. You must be satisfied!

BOND EQUIPMENT CO. Dept. 62
6633 Enright St. Louis 5, Mo.



WHAM-O SPORTSMAN*

45-LB. PULL \$1.00 POSTPAID

HITS LIKE A .22 RIFLE—KILLS RABBITS, SQUIRRELS. Powerful, silent, accurate. For hunting, target, routing pests.

Sportsman's choice sold world over!

HUNTING SLINGSHOT

Heavy duty 7" ash stock. 40 steel balls, extra rubber straps. GUARANTEED—at dealers, or send \$1. to Wham-O Mtg. Co., Box 21, South Pasadena, Calif. *Professional model of Nat'l Slingshot Assn



Bar Bells

Buy Direct From Factory \$8.95 up

INDEPENDENT IRON WORKS
2416 East 23rd Street, Dept. B
Los Angeles 58, Calif.



LEARN MEAT CUTTING At Home—In Spare Time

Get into the vital meat industry. Concise, practical Home Training based on 25 years proven instruction methods used at National's famous resident school. Prepares you for bigger pay as Meat Cutter, Supervisor, market manager or more money in your own store. Go as rapidly as your spare time permits. Diploma. Start NOW to turn your spare hours into money. Send for FREE bulletin today. No obligation.

NATIONAL SCHOOL OF MEAT CUTTING, INC., Div. U-125, Toledo 4, Ohio

Model Railroading is more fun than you imagine, and less expensive than you think!



● 250,000 people can't be wrong. They are having real fun with the world's fastest growing hobby. Get this picture-packed book that tells how simple it is to start... and how surprisingly little money is needed.

Fully illustrated, this book tells how constructive this hobby is. Enjoyed by anyone from 7 to 70. Send 10c today

for your copy of "Model Railroading for You," written by a well-known authority.

MODEL RAILROADER MAGAZINE

Dept. 1550 — Milwaukee 3, Wis.

MAIL COUPON NOW FOR 7-DAY FREE TRIAL

MoToR BOOK DEPT.
Desk 12A, 250 W. 55th St., New York 19, N.Y.

Rush to me at once (check box opposite book you want):

MoToR's New AUTO REPAIR MANUAL. If O.K., I will remit \$1 in 7 days (plus 35c delivery charges), \$2 monthly for 2 months and a final payment of 95c one month after that. Otherwise I will return the book postpaid in 7 days. (Foreign price, remit \$8 cash with order.)

MoToR's New TRUCK & TRACTOR REPAIR MANUAL. If O.K., I will remit \$2 in 7 days, and \$2 monthly for 3 months, plus 35c delivery charges with final payment. Otherwise I will return book postpaid in 7 days. (Foreign price, remit \$10 cash with order.)

Print Name.....Age

Address

City.....State

Check box and save 35c delivery charge by enclosing WITH coupon entire payment of \$5.95 for Auto Repair Manual (or \$8 for Truck and Tractor Repair Manual.) Same 7-day return-refund privilege applies.

GET INTO

RADIO-TELEVISION ELECTRONICS By

Shop-Method Home Training

GOOD JOBS AWAIT THE TRAINED RADIO-TV TECHNICIAN

There is a place for you in the great Radio-Television-Electronics industry when you are trained as National Schools will train you at home!

Trained technicians are in growing demand at good pay—in manufacturing, broadcasting, television, communications, radar, research laboratories, home Radio-TV service, and other branches of the field. National Schools Master Shop-Method Home Training, with newly added lessons and equipment, trains you in your spare time, right in your own home, for these fascinating opportunities. OUR METHOD IS PROVED BY THE SUCCESS OF NATIONAL SCHOOLS TRAINED MEN, ALL OVER THE WORLD, SINCE 1905.

EARN WHILE YOU LEARN

Many National students pay for all or part of their training with spare time earnings. We'll show you how you can do the same! Early in your training, you receive "Spare-time Work" Lessons which will enable you to earn extra money servicing neighbors' and friends' Radio and Television receivers, appliances, etc.



Signal Generator

Audio Oscillator

T. R. F. Receiver

National Schools Training Is All-Embracing

National Schools prepares you for your choice of many job opportunities. Thousands of home, portable, and auto radios are being sold daily—more than ever before. Television is sweeping the country, too. Co-axial cables now under construction will soon bring Television to every city, town, and farm! National Schools' complete training program qualifies you in all fields. Read this partial list of opportunities for trained technicians:

Business of Your Own • Broadcasting
Radio Manufacturing, Sales, Service • Telecasting
Television Manufacturing, Sales, Service
Laboratories: Installation, Maintenance of Electronic Equipment
Electrolysis, Call Systems
Garages: Auto Radio Sales, Service
Sound Systems and Telephone Companies, Engineering Firms
Theatre Sound Systems, Police Radio
And scores of other good jobs in many related fields.

TELEVISION TRAINING

A complete series of up-to-the-minute Television lessons is an important part of your course. They cover all phases of Television repairing, servicing and construction. The same lesson texts used by resident students in our own modern and complete Television broadcast studios, laboratories and classrooms!

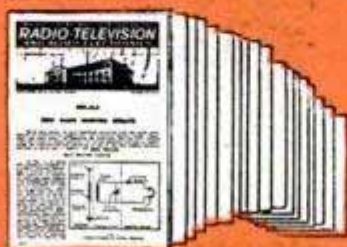

MASTER ALL PHASES!

Get Master Shop-Method Home Training from an Established Practical Resident School with its own



Training Shops, Laboratories, and Studios—and almost 50 Years of Successful Experience in Training Ambitious Men.

We Bring National Schools To You

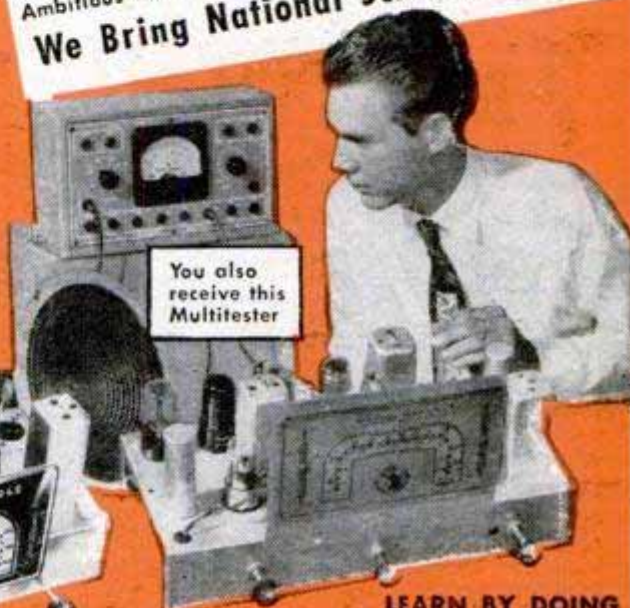

You also receive this Multitester

LEARN BY DOING

You receive and keep all the modern equipment shown above, including tubes and valuable, professional quality Multitester. No extra charges. You build the fine Superheterodyne Receiver with parts we send you.

FREE! These 2 Free Books give you all the facts. Send today for National Schools' new, illustrated Book of Opportunity in Radio-Television-

Electronics, and an actual Sample Lesson. No cost—no obligation. Use the coupon now—we'll answer by return airmail.

APPROVED FOR VETERANS AND NON-VETERANS
Check coupon below

Both Resident & Home Study Courses offered



NATIONAL SCHOOLS

LOS ANGELES 37, CALIF. • EST. 1905

FIND OUT NOW...MAIL COUPON TODAY

National Schools, Dept. 2-PM
4000 South Figueroa Street
Los Angeles 37, California

Mail in envelope or paste on penny postal.

Send me your FREE book "Your Future in Radio" and the sample lesson of your course. I understand no salesman will call on me.

NAME _____ AGE _____

ADDRESS _____

CITY _____ ZONE _____ STATE _____

Check here if Veteran of World War II

**NOW
FOR THE
FIRST
TIME**

Combined Experience and
KNOW HOW
of World's BEST
AUTO MECHANICS

AUTO Repair Kinks

by
Bill Toboldt

Editor Motor
Service
Magazine

Only
\$3.00

Postaid to your
Home



ZIP THRU Auto Repair Jobs

Bill Toboldt's AUTO REPAIR KINKS, the entirely new and different guide to "doctoring up" ailing autos, describes hundreds of out-of-the-ordinary but practical time and money-saving repair kinks that have helped auto mechanics out of tough spots... tells How to Step Up Speed, Power; Save Fuel, Cure High Oil Consumption, Trouble Shoot Engine Knocks, Service Cooling Systems... brings you the combined experience and KNOW HOW of World's Best Auto Mechanics. Also, complete Mechanical and Tune-Up Specifications 1938-1950 models on: Buick, Chrysler, Dodge, Hudson, Mercury, Packard, Studebaker, Cadillac, Crosley, Ford, Kaiser, Nash, Plymouth, Willys, Chevrolet, DeSoto, Frazer, Lincoln, Olds, Pontiac. Only \$3.00.

SEND NO MONEY - MAIL COUPON



**Check
Titles
Wanted**

**Examine
Books In
Your Own
Home
Without
Obligation**

Goodheart-Willcox Co., Dept. 151
1321 S. Michigan Ave., Chicago 5, Ill.

Send at once books checked below. I agree to remit price indicated plus 25c per book postage and handling, or return books within 7 days and owe nothing.

Check here if you remit with order and save postage and handling charges. If books are returned within 7 days we will refund full purchase price.

AUTO REPAIR KINKS.....	\$3.00
AUTOMATIC TRANSMISSIONS Simplified (new book covers all types).....	4.00
DYKE'S Auto Encyclopedia (new 22nd edition)..	7.50
AUTO Body & Fender Repairs.....	3.50
DYKE'S Carburetor Book.....	3.50
AUTOMOTIVE Service Management.....	5.00
MODERN Electric & Gas Refrigeration.....	5.00
MODERN Welding Practice.....	4.00
HOUSE WIRING.....	3.00
D. C. POWER WIRING.....	4.00
PLUMBING & Pipe Fitting.....	2.50
SHEET Metal Layout.....	3.50
STORAGE Battery Simplified.....	3.00
BAILEY'S Handbook for Engineers and Firemen..	2.00

Name _____ (Please Print)

Street _____

City _____ State _____

Employed By _____

LIFETIME WRITTEN GUARANTEE 17-JEWEL WRIST WATCH \$4.95 PLUS TAX

ORIGINAL PRICE \$59
INCABLOC— Shock Protected
WATER-DUST PROOF
Worn by Army, Navy & Marines During War

YOU
SAVE
\$44



Luminous dial... Sweep second hand... Super Accurate... Imported Swiss precision movement and case. You get these men's New Lifetime Guaranteed Watches now for a small fraction of the original price. You save \$44, because we bought-out surplus stock! Don't delay!

Order now... while they last.
TRIAL OFFER! Wear at our risk!

Money back in 5 days if not delighted. SEND ONLY \$1 down payment with order. Pay balance to postman on arrival plus postage. Or we pay postage if you include full payment, plus tax with your order. Return this ad with your order.

FREE! Handsome Expansion Band included. ORDER NOW!

MARYLAND DISTRIBUTORS, Dept. 217
501 EAST BALTIMORE STREET, BALTIMORE 2, MARYLAND
Free Watch & Diamond Ring Catalog.
Practically Wholesale Prices to User Direct.

LAW FREE BOOK



Your FREE copy of "The Law-Trained Man" shows how to gain prestige and greater earnings through Blackstone home law study. All instruction material furnished including 18-volume Law Library written by 65 well-known law authorities. Lawyers, Judges among our graduates. LL.B. degree. Low cost; easy terms. Write today.
BLACKSTONE COLLEGE OF LAW Dept. 52, Chicago 1, Ill.

A Correspondence Institution Founded in 1890

BECOME AN EXPERT IN TRAFFIC

Traffic men earn \$4,000 to \$10,000 and up. Thousands of firms need experts on rates, tariffs, regulations. We train you thoroughly in spare time at home for executive traffic jobs. Personal training under traffic authorities. Placement counsel and help. Write for free 48-page book "Traffic Management—the Fast Growing Profession."

LASALLE Extension University, 417 So. Dearborn St.
A Correspondence Institution Dept. 264T Chicago 5, Ill.



AJAX LIGHT BRAHMAS

Wonderlay Strain Egg—show winners. Gigantic size. Quick growing. Heavy layers. Exceptional big capons. U. S. Approved—Pullorum Controlled. Thousands hatching weekly. Low farm prices. Catalog FREE. Write TODAY.
AJAX HATCHERY, BOX 916, QUINCY, ILL.

FREE AMAZING NEW BOOK "HOW TO ANSWER ADS"



Never before have you seen anything like this. Tells you in simple language the correct way to answer ads. Gets you quicker replies—better results, and greater satisfaction. Will save you time and money and it's ABSOLUTELY FREE. No obligation whatever. Every reader of advertising should have this booklet. Send a postcard for your copy NOW. Advertising Department, Popular Mechanics Magazine, Room 600, 204 East Ontario Street, Chicago 11, Ill.

SAY YOU SAW IT IN POPULAR MECHANICS

Now Many Wear FALSE TEETH

With More Comfort

FASTEETH, a pleasant alkaline (non-acid) powder, holds false teeth more firmly. To eat and talk in more comfort, just sprinkle a little FASTEETH on your plates. No gummy, gooey, pasty taste or feeling. Checks "plate odor" (denture breath). Get FASTEETH at any drug store.

Now IN YOUR OWN HOME Learn

TELEVISION RADIO

the Amazingly Effective

D.T.I. WAY

—with the aid of **BOTH HOME EQUIPMENT and HOME MOVIES**

What will mailing the coupon below *do for YOU?* Just this! You'll find out about one of today's most remarkable... practical ways to prepare to get into America's amazing billion dollar opportunity field of TELEVISION-RADIO-ELECTRONICS. You'll see how to get into fascinating work that pays well... that offers one of America's most promising futures... that enables you to start your own business almost "on a shoe string," if you prefer this to a job opportunity.

And above all, you'll get some **GOOD NEWS** especially welcomed by men anxious to earn **REAL MONEY** in this thrilling field. For you'll see that **NOW** you can get the kind of practical, laboratory-type training so desirable for making real progress in Television-Radio-Electronics... and **WITHOUT LEAVING HOME.**

You'll see that DeForest's Training, Inc. sends everything needed to set up your own **HOME LABORATORY.** You get and keep the same type of basic electronic equipment used in our modern Chicago Training Laboratories. You get home training that includes the knowledge and experience gained from training thousands of students first hand in Chicago. And to top it all, you use DTI's amazingly effective and exclusive home training aid—**INSTRUCTIVE MOVIES.** But why not get the complete story? Mail coupon today for information-packed literature.

MODERN LABORATORIES

If you prefer, get all your preparation in our new Chicago Training Laboratories—one of the finest of its kind. Ample instructors, modern equipment. Write for details!

SEE FOR YOURSELF
Mail Coupon Today

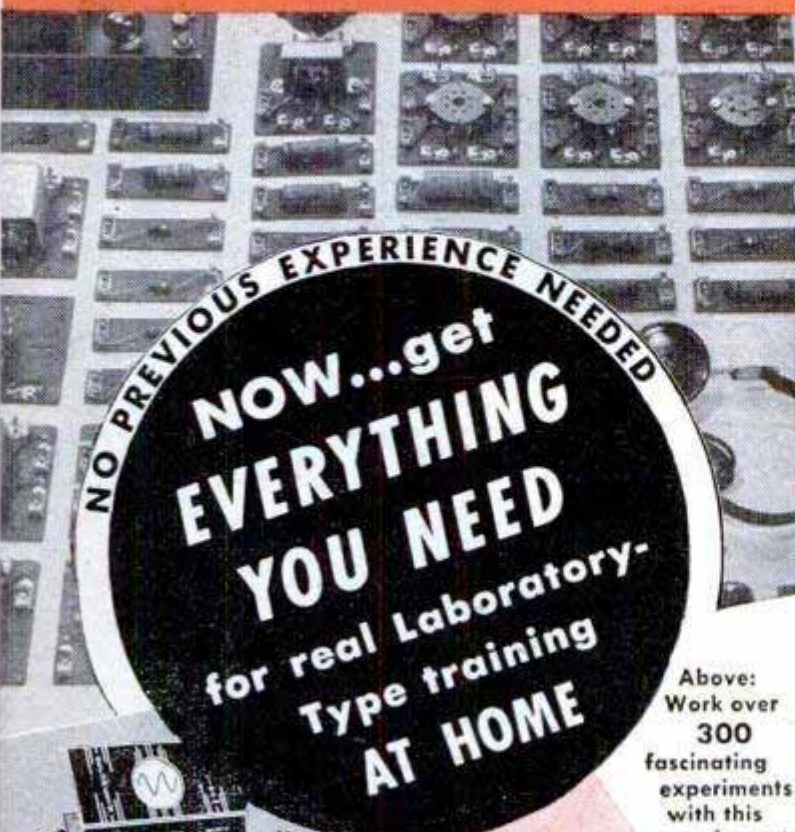

NO PREVIOUS EXPERIENCE NEEDED
NOW...get EVERYTHING YOU NEED
for real Laboratory-Type training **AT HOME**

Above: Work over **300** fascinating experiments with this equipment



1. Build over 300 fascinating experiments from 16 **BIG SHIPMENTS** of Electronic-Radio parts which you **KEEP.**

2. Build valuable commercial-type test equipment—as shown to the left—which you **KEEP.** This includes a quality **OSCILLOSCOPE**—a must for Television work.

3. Use a 16 mm. movie projector and new series of Hollywood produced instructive movies—a wonderful aid to help you grasp important fundamentals faster...easier...better.

4. Enjoy well-illustrated, easy-to-read lessons with handy **FOLD-OUT** diagrams.

5. Get an honest-to-goodness **EMPLOYMENT SERVICE** to help you get a good job after graduating—or assistance in starting your **OWN SALES AND SERVICE BUSINESS.** Mail coupon today for the complete details.

Build and Keep this **16-INCH TV RECEIVER**—OPTIONAL after completing regular training.



New "black" **RECTANGULAR TUBE**

Get **BOTH** of these colorful, information-packed folders **FREE**



DeFOREST'S TRAINING, INC. Dept. PM-H-2
2533 N. Ashland Avenue, Chicago 14, Ill

Without cost or obligation, I would like valuable, information-packed folders showing how I may get started toward a good job or my own business in Television-Radio-Electronics.

Name _____ Age _____
Street _____ Apt. _____
City _____ Zone _____ State _____

DeFOREST'S TRAINING, INC.

Chicago 14, Illinois
A DeVry Institution



KNOWLEDGE
THAT HAS
ENDURED WITH THE
PYRAMIDS

A SECRET METHOD FOR THE MASTERY OF LIFE

WHENCE came the knowledge that built the Pyramids and the mighty Temples of the Pharaohs? Civilization began in the Nile Valley centuries ago. Where did its first builders acquire their astounding wisdom that started man on his upward climb? Beginning with naught they overcame nature's forces and gave the world its first sciences and arts. Did their knowledge come from a race now submerged beneath the sea, or were they touched with Infinite inspiration? From what concealed source came the wisdom that produced such characters as Amenhotep IV, Leonardo da Vinci, Isaac Newton, and a host of others?

Today it is known that they discovered and learned to interpret certain *Secret Methods* for the development of their inner power of mind. They learned to command the inner forces within their own beings, and to master life. This secret art of living has been preserved and handed down throughout the ages. Today it is extended to those who dare to use its profound principles to meet and solve the problems of life in these complex times.

This Sealed Book—FREE

Has life brought you that personal satisfaction, the sense of achievement and happiness that you desire? If not, it is your duty to yourself to learn about this rational method of applying natural laws for the mastery of life. To the thoughtful person it is obvious that everyone cannot be entrusted with an intimate knowledge of the mysteries of life, for everyone is not capable of properly using it. But if you are one of those possessed of a true desire to forge ahead and wish to make use of the subtle influences of life, the Rosicrucians (not a religious organization) will send you A Sealed Book of explanation without obligation. This Sealed Book tells how you, in the privacy of your own home, without interference with your personal affairs or manner of living, may receive these secret teachings. Not weird or strange practices, but a rational application of the basic laws of life. Use the coupon, and obtain your complimentary copy.

The ROSICRUCIANS

SAN JOSE

(AMORC)

CALIFORNIA



AMENHOTEP IV
Founder of Egypt's
Mystery Schools

Use this
coupon for
FREE
copy of book

SCRIBE X.S.Y.
The Rosicrucians (AMORC)
San Jose, California

Please send free copy of Sealed Book
which I shall read as directed.

NAME.....

ADDRESS.....

CITY.....

HERE'S A READY-MADE FUTURE FOR YOU

MILLIONS OF HOMES IN U.S. HAVE 6-12 SMALL APPLIANCES YEAR - MILLIONS MORE SOLD EVERY YEAR - MILLIONS NEED REPAIR NOW WITH THE NEED INCREASING DAILY!

Start Your own Business IN

ELECTRICAL APPLIANCE REPAIRING

EARN WHILE YOU LEARN

Only had your course a few short weeks and have already made \$800.00. Going to quit my job paying \$250.00 straight salary to operate my own business. — J. D. S., St. Louis, Mo.

Make \$15.00 Saturdays and more. Am only able to operate in my spare time. It is just what a mechanical minded man needs. — G.O.F., Thomasville, Ga.



IN YOUR OWN KITCHEN, BASEMENT OR GARAGE

Learn at home in your spare time this fascinating big paying profession.

If you are mechanically inclined, can hold and use tools, we can give you the training and time saving kits that will enable you to . . . Command More Money At Work . . . A Better Paying Job Elsewhere . . . Or A Business Of Your Own!



3 EASY STEPS

- 1 We send You An **ELECTRONIC KIT**.
- 2 We teach you Electrical Appliance Repairing.
- 3 We show You How To Get Business.

New Shop Method Home Training teaches you both the technical and practical side of Electricity by having you work with your hands, Building, Testing, Repairing. All instruction manuals are written in easy-to-understand language chock full of hundreds of detailed photos and drawings.

We show you how to quickly locate the trouble, how to fix it and what to charge. ALSO, how to solicit business and keep business coming to you!

\$5.00 to \$6.00 AN HOUR

Often charged for making ordinary repairs. We show you how to repair refrigerators, vacuum cleaners, washing machines, motors, etc.



WE GIVE YOU THIS **ELECTRONIC KIT TROUBLE FINDER**



SEND FOR FREE BOOK!

CHRISTY TRADES SCHOOL, Dept. D-9003
4432 N. Kedzie Ave., Chicago 25, Ill.

Please send me **FREE** Illustrated Book on Electrical Appliance Repairing and special form for paying later from earnings.

NAME _____ Age _____

ADDRESS _____

CITY _____ Zone _____ State _____



YOU
can
acquire

LAW NIGHTS AT HOME! L. L. B. DEGREE

LaSalle's famous Law Library—used as reference in many Law libraries and Law offices—has enabled thousands to master Law surprisingly fast, in spare hours at home, for business and professional advancement.

These 14 remarkable volumes, compiled by leading professors and lawyers, cover the whole basic field of Law in condensed, orderly, simplified manner.

You advance rapidly with this great library, plus special lectures furnished. We guide you step-by-step with personalized Problem Method of instruction . . . you learn by doing—handling legal problems—not by memorizing rules.

Send for two FREE 48-page booklets, "Law Training for Leadership," and "Evidence," answering questions about Law and its value to you, and telling how LaSalle Law graduates are winning rapid advancement in business and public life. Mail coupon below. No obligation.

LA SALLE EXTENSION UNIVERSITY A Correspondence Institution

417 S. Dearborn St., Dept. 264L, Chicago 5, Ill.

Send me your two FREE booklets described above, without obligation.

Name..... Age.....

Street.....

City, Zone & State.....

ENGINEERING DEGREE IN 27 MONTHS

Big Demand for Graduates

Aeronautical, Chemical, Civil, Electrical, Mechanical and Radio Engineering (including Television)

Hundreds of young men are earning engineering degrees in this recognized institution each year—continuous operation. New terms start quarterly. Many students earn a major part of their college expenses in this large industrial center.

Low tuition. Competent instruction. Thorough, intense, practical program. Modern laboratory facilities including new physics lab. and modernized wind tunnel. Individualized instruction emphasized.

Approved for Veterans. Engineering preparatory courses. Students from 48 states and 21 foreign countries. Enter March, June, September or December. Send coupon for free catalog and full information. Enroll now.

SEND COUPON TODAY

INDIANA TECHNICAL COLLEGE

521 E. Washington Boulevard
Fort Wayne 2, Indiana

Please send me free information on B.S. Engineering Degree in 27 months as checked.

Aeronautical, Chemical, Civil, Electrical,
 Mechanical, Radio-Television

Name.....

Address.....

MAKE EXTRA
MONEY

PLASTICS

LEARN
AT HOME

LEARN HOW
TO MAKE
fast selling
PLASTIC
NOVELTIES
FURNITURE
JEWELRY
SIGNS
TOYS
LAMPS



There are RICH OPPORTUNITIES for MEN and WOMEN with "know-how" in Plastics. Interstate's amazing new Plastics course tells and shows how to make hundreds of fast selling items out of Plastics. Gives complete training in fabrication, casting, lamination, molding, etc., in simple, easy, step-by-step language and pictures.

START A PLASTICS BUSINESS OF YOUR OWN. No other industry holds such promise for the future. You can make big money manufacturing novelties, toys, signs, etc., in your own home in spare or full time. Don't wait! Learn NOW how Interstate's Plastics Training qualifies you for success in the plastics field.

Write for FREE Information Today!

INTERSTATE TRAINING SERVICE

School of Plastics
PORTLAND 13, OREGON

(Dept. 3-B)

A "GOOD HAND" HELPS YOU SUCCEED!

LEARN TO WRITE WELL

Your Name

beautifully
written, plus
special pen-
point for
shaded
writing.

Only 10¢

Handwriting quickly improves with our easy-to-understand picture lessons! Put your spare time to good use; send today for FREE BOOK, "How to Become a Good Penman", or check volumes wanted below at \$1 each: Business Writing Artistic Writing Card Writing Bird & Design Flourishing Engrossing Alphabets. COMPLETE SET \$4.50

TAMBLYN SCHOOL of PENMANSHIP
S. A. Ziller, Pres. 442 Ridge Bldg., Kansas City, Mo., USA

HAWAIIAN WIGGLER #1

Deep runner. No snag-up in pads and brush. Easy to cast. Rubber Hula Skirt acts alive. At your dealer 5/8 oz. or 1/4 oz., \$1.15 each.



WORLD-FAMOUS
FISH-GETTER

FRED ARBOGAST & Co., Inc.
2212 W. North St., Akron 3, Ohio

FREE WRITE TODAY FOR BIG FREE 1951 ARBOGAST COLOR CATALOG—FULL OF PICTURES OF CATCHES

REAL ESTATE BE A BROKER

PAYS BIG! SEND FOR FREE, BIG, ILLUSTRATED CATALOG NOW! No obligation. Graduates report making substantial incomes. Start and run your own business quickly. Men, women of all ages, learn easily. Course covers Sales, Property Management, Appraising, Loans, Mortgages, and related subjects. STUDY AT HOME or in our classrooms in big cities. Diploma awarded. G.I. approved. Nationally known.

WEAVER SCHOOL OF REAL ESTATE (Est. 1936)
15 E. Pershing Road Dept. PM Kansas City, Mo.

FREE
BOOK
TELLS
HOW

BOYS! MAKE YOUR OWN RADIO



Make your own simple, tubeless, batteryless Crystal Radio. SEND 25c for a GENUINE MELOMITE CRYSTAL with complete illustrated instructions for making your own set. Crystal sent postpaid with instructions and our own publication, "THE MAGIC CRYSTAL" which is full of news, diagrams, questions and answers of interest.

SEND 25c FOR YOUR CRYSTAL TODAY!

ALVA ALLEN RADIO Dept. 156 Clinton, Mo.

Say You Saw It in Popular Mechanics

WATCHMAKING

★ Watch Repairing ★ Jewelry Engraving ★ Jewelry Repairing
Combination men earn top pay. Learn in school fully accredited by Horological Institute of America in Washington, D. C. and United Horological Association of America. Approved for veterans. Receive tools, tuition and subsistence while learning.

Established 1935. Write for FREE booklet



The Baronian School, Inc.

2116 WALNUT ST. (DEPT. C) PHILA. 3, PA.

GET INTO

DIESEL-AUTO MECHANICS

Master All Phases

JOB LIKE THESE ARE AVAILABLE TO **TRAINED MECHANICS**. CHOOSE THE FIELD YOU LIKE BEST

Get Complete Training

- Diesel Fuel Injection
- Automotive Motor Tune-up
- Diesel Engine Rebuilding
- General Garage Mechanic
- Agricultural Implements
- Auto Engine Rebuilding
- Auto Elec. Service
- Public Utilities
- Parts Dealers
- Bus & Truck Lines
- Industrial Maintenance
- Contracting & Excavating
- Business of Your Own
- AND MANY other similar openings

As a National Schools graduate, you are trained for ALL opportunities in the Diesel & Auto Industries

EARN WHILE YOU LEARN

With our practical Master Shop-Method Home Training, you study at home in your spare time. You receive Spare Time Work Lessons, which show you how to earn while you Learn . . . for extra money and experience. You Learn by DOING.

TOOLS AND EQUIPMENT

To make your training complete, we give you selected mechanic's tools and equipment, illustrated below, including all-metal toolbox — as a regular part of your instruction.



Shop-Method Home Training by an Established Resident School Prepares you for Many Good Jobs

Opportunity is everywhere for the trained Diesel-Auto Mechanic. Highways throng with cars, busses, trucks, tractors. Garages and Service Stations are kept busy. Factories, ships, farms, railroads, general industry, are dependent upon engine power. Here's a dynamic, fast-growing field that needs trained men who know ALL phases: installation, operation, maintenance and repair. Now—National Schools offers you a practical, all-embracing Diesel-Auto Mechanic's Course, including all of these advantages:

Complete training, covering—Diesels, High Speed and Heavy Duty; Semi-Diesels, Gasoline and Special Fuel Engines AND Allied Mechanics.

- Basic Lesson Texts
- Diesel Installation
- Operation-Maintenance
- Diesel Chart Manual
- Spare Time Lessons
- Engine Service Manuals
- Engine Repair
- Drive Systems
- Diesel Electric Power
- Thermodynamics

TOOLS AND EQUIPMENT

INVESTIGATE
Secure Full Information

NEW, ILLUSTRATED BOOK & SAMPLE LESSON SHOW HOW WE TRAIN YOU . . . SEND FOR THEM TODAY!

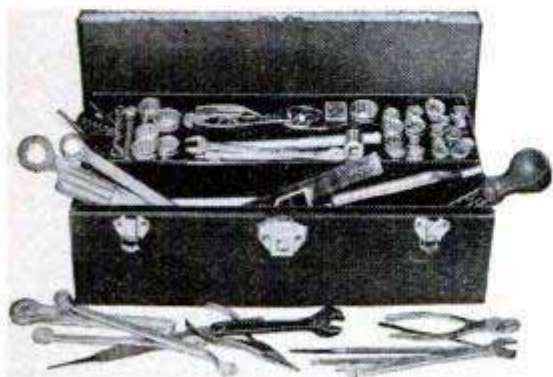

WE GIVE YOU TOOLS OF YOUR TRADE

NATIONAL SCHOOLS

LOS ANGELES 37, CALIF. • EST. 1905



FIND OUT NOW... MAIL COUPON TODAY

NATIONAL SCHOOLS, DEPT. 2-PMD
4000 South Figueroa Street
Los Angeles 37, California

(Mail in envelope or paste on penny postcard)

Mail me FREE the book, YOUR FUTURE IN DIESEL-AUTO MECHANICS, together with the Sample Lesson. I understand I may keep and use the information with no obligation.

Name _____ Age _____

Address _____

City _____ Zone _____ State _____

Check here if Veteran of World War II

I'LL TRAIN YOU for **RADIO**



**MEET
A FEW OF MY
GRADUATES**



**Appreciates Sprayberry
Personal Interest**
"Before completing
your course I had
a good paying job.
I appreciate the per-
sonal interest you
gave me."—Leon-
ard Petrus, Arkan-
sas



**Best Investment
He Ever Made**
"Began fixing ra-
dio sets after first
few lessons. Your
course is one of the
best investments
I've ever made."
—A. R. Foronda,
Hawaii

**I Send You
18 BIG
KITS
OF RADIO-
TELEVISION
EQUIPMENT**

EXTRA MONEY

**Earn While You Learn
In Your Spare Hours!**
You do all your training
with me AT HOME in
spare hours. Keep right on
with your present job and
income while learning—and
earn extra cash besides! The
day you enroll I begin send-
ing you plans and ideas for
doing profitable spare time
Radio-TV work. Many of
my Sprayberry students
pay for their entire Radio-
TV training this way!



YOU KEEP THIS VALUABLE EQUIPMENT

The many big kits of Radio-Television parts and equipment are sent to my students "for keeps." Nothing need be returned—it is YOURS! There is absolutely nothing else to buy!

AT HOME IN SPARE TIME TELEVISION



Training Leads To Good Radio Job
"Got a job in local radio shop soon after enrolling. Very satisfied with training"—Stanley Clemmons, Kansas



Lucky To Be Sprayberry Trained
"I consider myself lucky I chose your training in preference to others I considered. Here's thanking you again."—Paul White, Ohio



Radio Profits Pay Cost of Training
"I have more than taken in the cost of your training doing spare time radio repair work. See bright future ahead!"—Thomas Shearer, N. Y.



Earns Easy Spare Time Cash
"While training I made about \$180.00 in spare time. Thank you for wonderful Radio-TV training!"—Herbert Burroughs, W. Va.

My Proved Training System—Backed by a Quarter Century of Experience—Prepares You FAST for a Good Job or Your Own Profitable Radio-Television Business!

Radio-Television is now America's greatest opportunity field. Correctly trained men are needed NOW—more than ever—to fill good jobs and handle the profitable Radio-Television Service work. I have trained hundreds of successful men for Radio-Television—and I stand ready to train YOU too—even if you have no experience or knowledge of this field. My training is modern—right up to the second—with all the newest developments included! This is 100% practical training that eliminates the frills that only waste your time and progress. Sprayberry Training provides the all-important practical knowledge and skill you need to start making money in Radio-Television in the shortest possible time. You can start at once and be earning welcome spare time cash in a few short weeks. Upon completion of my Training you will be ready to handle any practical Radio-Television job.

You receive all the equipment I have illustrated on the opposite page—and MUCH MORE besides! In addition to your fascinating Sprayberry home study lessons, I send you a total of 18 kits of quality parts and equipment with which you do over 300 practical demonstrations, experiments and construction projects. You build a complete television set that you can use in your shop or at home—you build a powerful TWO-BAND superheterodyne radio set—a multi-range test meter—signal generator and other valuable test equipment—a cathode ray oscilloscope—everything needed to set up your own Radio-Television Service Shop! All equipment I send you is yours to keep. In addition I send you many valuable service manuals, books and reference material to help you in your day-to-day Radio-Television work. I firmly believe I offer the ambitious man the most outstanding training value of its kind in America today!

Be Ready for Top Paying Radio-Television Jobs!

Radio-Television is growing with amazing speed. More than 2000 broadcasting stations PLUS an additional 102 Television stations are now on the air! Radio sets and TV receivers are being made and sold in record breaking numbers. If you enjoy working with your hands . . . if you like interesting and varied work . . . YOU BELONG IN RADIO-TELEVISION. But you MUST have good Training to "cash in" . . . the training that starts with basic fundamentals and carries through every circuit and problem of Radio-TV.



No Previous Experience Needed to Succeed

My Training in Radio-Television is so complete, so down-to-earth that previous experience is not necessary. I start you with basic fundamentals and carry you in easy, practical steps through one Radio-Television subject after another. You will be amazed at your rapid progress and your knowledge of Radio-Television. Best of all, you put this knowledge to work making spare time cash soon after you enroll! You may train as fast or as slowly as suits your convenience. Each of my students receives individual training!

VETERANS

My Radio Training is approved for Veterans under the G. I. Bill.

If you are Experienced...

in radio . . . I'll qualify you for Television in 4 to 8 weeks. Check coupon for special details.



FREE 3 Big Radio and Television Books

I want you to have ALL the facts about my complete system of Radio-Television Training! Act now! Rush the coupon for my three big Radio-Television books: "How To Make Money in Radio-Television," PLUS my new illustrated Television bulletin PLUS an actual sample Sprayberry Lesson—all FREE with my compliments. No obligation and no salesman will call on you. Send the coupon in an envelope or paste on back of post card. I will rush all three books at once!

Mail Coupon Today!

**NO OBLIGATION
No Salesman
Will Call**

SPRAYBERRY ACADEMY OF RADIO, Dept. 10-T
111 North Canal St., Chicago 6, Ill.

Please rush to me all information on your Radio-Television Training plan. I understand this does not obligate me and that no salesman will call upon me.

Name..... Age.....

Address.....

City..... State.....

Please Check Below About Your Experience

Are You Experienced?

No Experience

**Sprayberry Academy
of Radio, Dept. 10-T**

111 North Canal St., Chicago 6, Ill.



Good Luck - Fishing Fly - Personal Initial Key Tags

These unusual and very useful key chain tags were made by embedding a four leaf clover, a fishing fly and gold-plated personal initials in Castolite Liquid Casting Plastic. You can also embed real flowers, butterflies, coins, photos, shells, etc. to make distinctive necklaces, pins, brooches, buttons, coasters, tiles, trays, book ends, other objects. Have a happy hobby or make big money in spare-time. Use home tools. Follow simple instructions. Information FREE. Just write for new illustrated folder "Liquid Magic."

THE CASTOLITE CO., DEPT. B-1, WOODSTOCK, ILL.

AERONAUTICAL ENGINEERING



Design Aircraft & Components—Study with Jets & Rockets—Great Future—Advanced Aeronautical Subjects—World-Wide Enrollment—Fully Accredited—Established 1929—Approved for Vets—CAL-AERO grads in heavy demand.
WRITE TODAY for Special Information. PM-2

NAME _____ AGE _____
ADDRESS _____
CITY _____ ZONE _____ STATE _____

CAL-AERO TECHNICAL INSTITUTE
GRAND CENTRAL AIR TERMINAL • GLENDALE 1, CALIFORNIA

TECHNICIANS WANTED

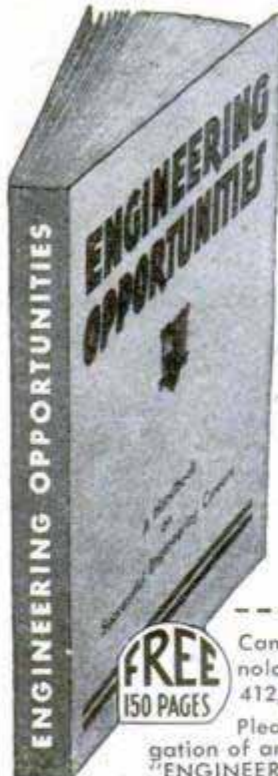

GAPS IN INDUSTRY MUST BE FILLED BY MEN TRAINED TO HIGH STANDARDS . . .

The man who really has the "know-how" will win the best rank and position and the highest pay.

"Engineering Opportunities" lists many specialized home study courses written by world authorities in: Aeronautical, Civil, Mechanical, Mining, Petroleum, Structural, Electrical, Radio, Television and Plastics, etc. Send today for your free copy of "Engineering Opportunities" to Canadian Institute of Science and Technology Limited, 511 Century Building, 412, 5th Street, N.W., Washington, D.C.

Canadian Institute of Science & Technology Limited, 511 Century Building, 412, 5th Street, N.W., Washington, D.C.

Please forward free of cost or obligation of any kind your 150-page handbook, "ENGINEERING OPPORTUNITIES".

Name _____
Address _____
Course interested in _____ Age _____

Canadian enquiries: 263 Adelaide St. W., Toronto 1



FREE TO HOME PLANNERS

Our color folder showing 5 popular home designs sent FREE to demonstrate our MONEY SAVINGS home planning service. Over 1,250 Tested Designs of homes already built shown in beautiful illustrated books. Floor Plan shown with each design. Blue Prints, material lists, specifications available at LOW COST. Mail request today or order new 1951 Plan Books below.

1 TO 4 BEDROOMS — ALL TYPES CONSTRUCTION

America's Best Home Plans	50c	ALL Books POSTPAID Order 2 or more and get "Little Red Book" of 29 designs at nothing extra.
125 Designs, many in color.		
Ranch and Suburban	50c	
158 Designs, many moderate cost.		
All American Homes	50c	
120 Designs, varied types, sizes.		
Our Future Home	\$1.00	
149 Designs, all sizes, styles.		

L. F. GARLINGHOUSE CO., INC., Box PM-8 TOPEKA, KANSAS

Rupture Troubles Ended

Advanced method has healed thousands. No leg straps, no elastic, no plasters. No pressure on hips or spine. Flexo-pad. Entirely different. Endorsed by doctors, mechanics, clerks. Very light. **INEXPENSIVE. GUARANTEED.** Write for information and trial.

SMITH MANUFACTURING COMPANY
EST'D 1893 DEPT. PM PRESTON, ONTARIO

Learn **ACCOUNTING BOOKKEEPING**

This nationally renowned school has demand for graduates in good salary positions thru Nationwide recognition and placement service. Write Department PMU today for Big 32 page Success Book to be sent to you **FREE**

Hills **BUSINESS UNIVERSITY AND EXTENSION SCHOOL**
619 W. MAIN ST. OKLAHOMA CITY 2, OKLAHOMA

Aptitude Tests for men, women, boys, girls, discover the kind of work or studies best for your success! You get a personal report—a guide for life—more happiness—more prosperity. . . . Write for complete facts. . . .
VOCATIONAL COUNSELORS, 5057 Woodward Avenue, Detroit

LEARN WATCH REPAIRING

This highly skilled, well paid trade offers unusual opportunities today. Watch repair men are in great demand for repairing watches and for working with the many new, delicate instruments of industry and re-armorment. Study at G. I. approved resident school or by low-cost, home study course in your own home. Thorough training. Catalog free. Write Dept. C-22 today.

American Institute of Specialized Watch Repair
1014 Franklin Southeast, Grand Rapids 7, Mich.

SAY YOU SAW IT IN POPULAR MECHANICS

Thrilling Work **COLORING PHOTOS**

Fascinating vocation learned at home by those with aptitude. Thrilling pastime. National method brings out life-like colors. Free booklet.

NATIONAL PHOTO COLORING SCHOOL
EASY TO LEARN
835 Diversey Pkwy., Dept. 1352, Chicago 14



**TO HELP YOU PREPARE FOR
ONE OF THE BETTER JOBS
IN BUSINESS or INDUSTRY**

**You can take subjects which have *Real Job Value*
and still earn graduation!**

• This is *your* opportunity to make completion of high school *work* for you. Your AMERICAN SCHOOL home study course can include high school subjects closely related to your present job or the kind of work you want to do later. Not only can you qualify for your high school course diploma but you can benefit from course subjects that will aid greatly in winning promotions.

**50 Job Help Subjects
from Which to Choose**

Our FREE, 44-page book of detailed information lists 100 high school subjects, of which 29 are technical and 21 are commercial. Whether you work in a shop, factory, garage or office you will find subjects of practical benefit in your climb toward better jobs at better pay. Some of these are Blueprint Reading, Mechanical and Machine Drawing, Tool Making, Foundry Work, four Automotive subjects, Electricity, Carpentry—and Bookkeeping, Accounting, Secretarial Practice, Office Machines, Salesmanship.

Turn Spare Time Into Money

During more than 50 years American School has helped thousands to reach higher job goals by profitable use of spare time at home—and it can help *you*. Others have prepared for college entrance. If you have not completed high school, check that subject on the coupon below, add your name and address and mail it *right now*. Or if you are a high school graduate and are ambitious to succeed in the vocation of your choice, check that subject. Your coupon will bring you the book of information, without obligation of any kind. Mail it *now*.

PRACTICAL, EFFECTIVE HOME - STUDY TRAINING SINCE 1897
Take This First Easy Step

CHECK, CLIP AND MAIL COUPON NOW

AMERICAN SCHOOL, Dept. G245, Drexel at 58th, Chicago 37, Ill.
Without obligation, please send me FREE information on training course checked below.

- | | | |
|---|--|---|
| <input type="checkbox"/> HIGH SCHOOL COURSES | <input type="checkbox"/> Bookkeeping | <input type="checkbox"/> Plastics Engineering |
| <input type="checkbox"/> Accounting | <input type="checkbox"/> Business Management | <input type="checkbox"/> Plumbing—Practical |
| <input type="checkbox"/> Air Conditioning | <input type="checkbox"/> Contracting | <input type="checkbox"/> Private Secretary |
| <input type="checkbox"/> Architecture & Building | <input type="checkbox"/> Diesel Engineering | <input type="checkbox"/> Radio Operating & Servicing |
| <input type="checkbox"/> Automotive Engr. | <input type="checkbox"/> Drafting & Design | <input type="checkbox"/> Railway Training |
| <input type="checkbox"/> Aviation—Practical | <input type="checkbox"/> Electrical Engineering | <input type="checkbox"/> Refrigeration |
| <input type="checkbox"/> Aviation Drafting & Design | <input type="checkbox"/> Electricity—Practical | <input type="checkbox"/> Sheet Metal Pattern Drafting |
| <input type="checkbox"/> Better Foremanship | <input type="checkbox"/> Electronics, Industrial | <input type="checkbox"/> Shop Management |
| | <input type="checkbox"/> Machine Shop Operations | <input type="checkbox"/> Tool Making |
| | <input type="checkbox"/> Mechanical Engineering | |

Name _____ Occupation _____

Address _____ Age _____

City & Zone _____ State _____

AMERICAN SCHOOL
Dept. G245, Drexel at 58th Street, Chicago 37

new 1951 ALLIED

RADIO and TV CATALOG



free

SEND FOR THIS
212-PAGE
Value-Packed
CATALOG
•
COMPLETE
UP-TO-DATE

SAVE ON EVERYTHING IN RADIO & TELEVISION

Get Radio's Leading Buying Guide

Save money on every purchase you make from the world's largest radio supply house! Send for ALLIED's 212-page 1951 Catalog, the value-packed guide to *everything* in Radio and Television. Biggest selections of home radios, TV equipment, radio-phonos, Amateur equipment, P.A. systems, Hi-Fidelity Sound, recorders, test instruments, builders' kits—plus thousands of parts, tubes, tools, books and diagrams. Get more for your money—send today for your FREE 1951 ALLIED Radio and TV Catalog!

EVERYTHING FOR:
Servicemen
Engineers
Experimenters
Builders
Amateurs



**FREE
CATALOG**

ALLIED RADIO

ALLIED RADIO CORP., Dept. 5-B-1
833 W. Jackson Blvd., Chicago 7, Ill.

Rush FREE 212-Page Catalog No. 126.

Name _____

Address _____

City _____ Zone _____ State _____

FUN!

MAKE THIS Squirrel Lamp
Yes sir, out of a real squirrel! Also make ash-trays, book-ends, etc., using rabbits, frogs, etc. LEARN AT HOME TO MOUNT BIRDS, ANIMALS & FISH; tan skins and make rugs. Decorate your room.
It's FUN! BIG profits in spare time!
Free book tells how.
FREE BOOK! Write TODAY for beautiful free book telling how to learn this fine hobby. Book is free. Contains many fine pictures. **STATE YOUR AGE.**

N.W. SCHOOL OF TAXIDERMISTRY, Dept. 2502, Omaha, Nebr.

USE the POLICE METHOD to

The bigger they come, the harder they fall when the Commanding knowledge of POLICE JIU JITSU IS YOURS! Brute strength, giant size and bulging muscles will not beat you when You master Police Jiu Jitsu. A complete course easy to read and learn in one illustrated volume. JUST PIN \$1 to this ad and we will send Police Jiu Jitsu to you POST-PAID. Satisfaction guaranteed or money refunded.

handle wise guys and bullies

BOOKS PUBLISHING CO. 56 W. 24 St. New York 10

Learn WOOD PRODUCTION ENGINEERING

FREE Booklet IN SPARE TIME AT HOME

Prepare for top wood-working positions or for more profitable shop ownership with KLOK TRAINING. Covers all woodworking arts in a Home Study Course or Resident Training Course at Grand Rapids. Free G.I. instruction. Money back trial for non-veterans. Write for FREE BOOKLET. State Age, veteran, non-veteran, Home or Resident Course, occupation. JOHN H. KLOK, Pres. KLOK INSTITUTE
B. Louis St. N.W. Grand Rapids 2, Mich.

from THE ONLY SCHOOL OF IT'S KIND

LOCKSMITHING & KEYMAKING

HOME TRAINING OUTFIT INCLUDES KEY MACHINE, SUPPLIES AND TOOLS TO GET STARTED IN BUSINESS

Professional outfit. Get practical training from Master Locksmiths. Learn to cut keys by code, master locks, change combinations, quickly identify key blanks, many profitable "tricks of the trade." Booklet of Information FREE. Write today. UNITED SUPPLY & SERVICE, 3327 Madison St., Dept. PM-2, Chicago, Illinois.

ENGINEERING DEGREE IN 27 MONTHS

INDIANA TECHNICAL COLLEGE

B. S. DEGREE. Aeronautical, Chemical, Civil, Electrical, Mechanical and Radio Engineering (inc. television). Drafting, 1-yr. Gov't approved for G.I.'s. Low rate. Earn board. Large industrial center. Students from 48 states, 21 countries. Demand for graduates. Enter March, June, Sept., Dec. Write for catalog. 1621 E. Washington Blvd., Fort Wayne 2, Indiana.

SAY YOU SAW IT IN POPULAR MECHANICS

READ ABOUT TRAILERS BEFORE YOU BUY

TRAILER TOPICS MAGAZINE

Brings you the latest in Trailer Coaches—Equipment—Accessories—Trailer Trips—Trailer Parks and many other interesting features at only—\$3.00 for 2 years.

(6 month trial subscription \$1.00)

Send your subscription to
TRAILER TOPICS MAGAZINE, (Room 1511B)
28 EAST JACKSON BLVD. CHICAGO 4, ILL.

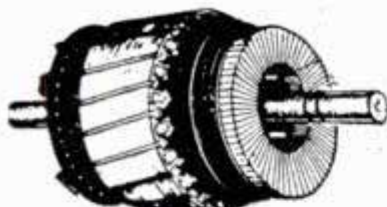

NOW! you can LEARN ELECTRIC MOTOR REPAIR

... A good-paying, modern profession



OPPORTUNITIES EVERYWHERE

Don't drift into a rut! Don't train for something that everybody and his brother are studying! Consider the facts. . . . The average small home has at least 11 electric motors! Big homes have many more—in phonographs, recorders, oil burners, refrigerators, washers, fans, clocks, mixers, cleaners, air conditioners, etc., etc. Millions more in office, industrial, mining, and transit equipment. Be the well-paid expert who can keep them working!

... for only \$5 FOR THE COMPLETE TRAINING (while the present low-cost supply lasts)

Every day, more and more electric motors and motor control systems are being used BOTH in industry and in home appliances. The expert who can install, repair and keep them working properly is a valuable man in this Electrical Age. The pay is surprisingly good. The field is tremendous—and growing rapidly. Trained men find opportunities everywhere for full or part time work. **ELECTRIC MOTOR REPAIR**, the big 500-page training course book teaches you the work step by step—quickly and easily—at home in spare time. There is no other book like it. Ideal for beginners or for actual bench use in busy shops. Thousands of copies are already in use in leading vocational schools, shops, and, most important of all, home study.

SHOWS YOU HOW... Every Step of the Way!

Based on what you can learn quickly at home from **ELECTRIC MOTOR REPAIR**, you can train for prompt, profitable installation, servicing, repairing and complete rewinding of practically any motor in use today. You learn fast! You learn right! Every subject is clearly and simply explained by text AND ALSO by more than 900 clear-cut illustrations and diagrams. You not only read what to do—you actually SEE how it is done. Quick reference guides tell you how to handle specific jobs. When a certain motor comes in for repairs, just look it up. **ELECTRIC MOTOR REPAIR** tells you what to do—and exactly how to do it.

ELECTRIC MOTOR REPAIR is designed for use right at the service bench. Unique Duo-Spiral Binding divides the book into two sections so that both text and related diagrams can be viewed together. An instructor standing by your side could hardly do better! **ELECTRIC MOTOR REPAIR** covers the entire field—from alternating- and direct-current motors and generators, etc., to mechanical and electrical and electronic control systems. Right down the line, it explains every detail of trouble diagnosing, repair, rewinding and maintenance in a way you can easily understand.

FREE STUDY GUIDE

A unique Study Guide booklet of 500 practical motor study questions—priced and sold separately at 25c—is yours FREE with your request to examine **ELECTRIC MOTOR REPAIR** book. Makes learning easier—speeds up the work! See coupon.



LAST CHANCE AT THIS AMAZINGLY LOW PRICE!

Due to much higher costs of producing this big training book, the price of **ELECTRIC MOTOR REPAIR** must be raised to \$6, effective April 1, 1951. However, orders received from this advertisement before that date will be filled at the \$5 price. So rush coupon today and save \$1. Practice from **ELECTRIC MOTOR REPAIR** for 10 days at our risk! If not more than satisfied, return book to us and we will refund your \$5 promptly.



LEARN FAST... No Lessons to Wait for!

If sold as a course and sent to you in lesson form, **ELECTRIC MOTOR REPAIR** would be a bargain at 10 times the price! You get it all at once. You learn rapidly. Here are just a few of the subjects covered:

- Split-Phase Motors
- Capacitor Motors
- Repulsion-type Motors
- Polyphase Motors
- Alternating-Current Motor Control
- Direct-Current Armature Winding
- Direct-Current Motors
- Direct-Current Motor Control
- Universal, Shaded-pole, and Fan Motors
- D-C Generators; Synchronous Motors and Generators
- Electronic Motor Control
- ... and essential motor data



10 DAY MONEY-BACK GUARANTEE

Dept. PM-21, RINEHART BOOKS, INC., Technical Division
232 Madison Ave., New York 16, N. Y.

Send me a copy of **ELECTRIC MOTOR REPAIR** book for which I enclose \$5 (\$5.50 outside U.S.A.); or send C.O.D. for this amount plus postage. If this book is not what I want, I'll return it within 10 days and you guarantee to return my \$5. It is also understood that you will include a FREE copy of the electric motor **STUDY GUIDE** which is mine to keep, whether or not I decide to keep the **ELECTRIC MOTOR REPAIR** book.
(Cash only outside U.S.A.—same return privilege.)

Name _____

Address _____

City & Zone _____ State _____

NOTE: Price after Apr. 1, 1951 will be \$6.00 (\$6.50 foreign.)

TRAIN FOR GOOD PAY IN A FIELD THAT ISN'T CROWDED!

INVENTORS

Before you make any effort to market your invention, you should take the first steps toward proceeding for patent protection.

The usual first step is to have a search of the U. S. patent records conducted, so that I can report to you on the question of patentability.

I shall be pleased to furnish you with information relative to patent procedure, upon request from you, and this will be without any obligation on your part.

PATRICK D. BEAVERS

(Formerly RANDOLPH & BEAVERS)

Registered Patent Attorney

934 Columbian Building Washington 1, D. C.

Watch Repairing Pays Big Money Learn at home

Free Literature Tells How

Watchmakers in big demand. You train step-by-step under experts. You learn to take a watch apart—repair and put in perfect working order. 10 easy lessons. We furnish all tools, and a 15 jeweled watch. Practicemovement with first lesson.



Turn spare time into cash—perhaps a business of your own. A licensed school. Students 18 to 65 have profited by our training. Low cost.

Write Today for All the Facts—No Obligation

WATCH REPAIRING Dept. PM-21, 2870 Elston Ave. Chicago 18, Ill.

INVENTING

-FOR PROFIT! If you have an inventive turn of mind, write for free 28-page booklet explaining how the Institute of American Inventors is helping inventors pre-test the profit possibilities of proposed devices to fill today's unprecedented demand for useful new inventions.

INSTITUTE of AMERICAN INVENTORS

Dept. 4, 631-E St., N.W., Washington 4, D. C.

INVENTORS

IF YOU WISH TO PROTECT YOUR INVENTION, You should take steps to protect it by a U. S. Patent. Write me for "RECORD OF INVENTION" form.

CARL MILLER

REGISTERED PATENT ATTORNEY

WOOLWORTH BLDG., 35th FLOOR, 21A
NEW YORK CITY

NEON SIGN SCHOOL

Learn Neon in 12 1/2 weeks. Many jobs open. Start at \$1.50. \$2.00 hour. We train you in Glass Blowing, Neon Tube Bending, Color Gassing. Glass Blowers often deferred. ACME TRAINING G. I. APPROVED. Course also open to Non-Vets. FREE FOLDER explains. Write. ACME NEON INSTITUTE, Dept. B-3, 330 South Paulina St., Chicago 12, Ill.

ing, Color Gassing. Glass Blowers often deferred. ACME TRAINING G. I. APPROVED. Course also open to Non-Vets. FREE FOLDER explains. Write. ACME NEON INSTITUTE, Dept. B-3, 330 South Paulina St., Chicago 12, Ill.



PATENTS

C. A. SNOW & CO.

REGISTERED PATENT ATTORNEYS
WRITE FOR INFORMATION TO
428 SNOW BUILDING, WASHINGTON 1, D. C.



INVENTORS

Whether an invention is patentable can be substantially determined by a search of the U. S. Patent records. Without obligation, write for information explaining the steps you should take to secure a patent.

JOHN N. RANDOLPH

Registered Patent Attorney

201 Columbian Building, Washington 1, D. C.

PATENTS PATENT LAWYER

GUSTAVE MILLER

REGISTERED PATENT ATTORNEY
21-PM WARNER BLDG.
WASHINGTON 4, D. C.

ASSOCIATE EXAMINER
U. S. PATENT OFFICE 1922-1929
Patent Attorney and Advisor
U. S. NAVY DEPT. 1930-1947
Send for PATENT INFORMATION book and "INVENTOR'S RECORD" without obligation

Say You Saw It in Popular Mechanics

INVENTORS

If you have a **PATENTED** or **PATENT PENDING** Invention **TO SELL** or **LEASE**

Request our **FREE** book

(No Obligation)

U.S. PATENT EXCHANGE

406 SOUTH SPRING STREET (Suite M)

LOS ANGELES 13, CALIF.



DISCOVERED...

BY OVER 850,000 PEOPLE

AN EASY WAY TO LEARN MUSIC!

Thousands Now Play Who Never Thought They Could!

"I NEVER DREAMED I WOULD EVER PLAY. BEFORE I TOOK YOUR COURSE, I DIDN'T KNOW 'ONE NOTE!'"

From a letter written to us by Mrs. Dallas B. Kerk, Lodgepole, Nebraska



"I DIDN'T KNOW ONE NOTE! Three months later I started to play for dances. Have been invited to many parties and made people happy with my music." —Miss Rosie Montemurro, Vancouver, B. C., Canada.

"I bet some friends that I could learn to play the piano quickly. They didn't believe me — because I am slow learning. Imagine their surprise last night when I played for them. One said, 'Why, Louise, it sounds like you've been playing for years!'" — Louise Gomez, Oakland, Cal.

"How easy it is to learn to read notes and play an instrument this 'teach yourself' way! You did so much for me that I've enrolled my 2 daughters." — Lawrence Welk, famous orchestra leader.

Even if you don't know one note from another NOW—you can easily learn to play piano, guitar, accordion, or any instrument you choose. No boring exercises to do—no "talent" needed. And this simple method HOLDS your interest and your enthusiasm—because you progress so rapidly! FREE BOOK tells about it.

Yes, during the last 53 years 850,000 people in all parts of the world have turned to this famous way to learn music — as the tried-and-proven means of making their dreams of playing their favorite instrument come true!

Yet there are millions more to whom it can bring a lifetime of joy. The joy of having your phone give that welcome ring—and of finding yourself whisked away to one gay party after another. With you as the center of attraction — because you can play. The fun of having a happy group clustered around you, "singing their hearts out" as you play one asked-for song after another. The thrill of having them dancing to your liting music. The rich, restful happiness of being able to renew and refresh your mind and your spirit with music, after a work-filled day!

No, It's NOT a "Dream"

How often have you said to yourself, "If I could only play!" But you can. Thousands now play who never thought they could. They didn't know a single note of music. They had no special "talent." They had very little spare time. They were in modest circumstances.

But they learned to play, and to play well—easily, confidently, and properly, by note. As for having "talent"—they found that they didn't need it. As for spare time—they learned in the spare time of their own choosing; free from the rigid schedule imposed by a teacher. And as

for cost—their lessons cost only a few cents each; and that included sheet music which alone would have cost more than that!

It WORKS — Because It's FUN

This famous method starts you out on delightful pieces—right from the very first lesson. No tiresome exercises; no dreary scales. And you stay with it because your progress is so rapid, so interesting, and so satisfying—makes learning music fun.

Many of our 850,000 students didn't know a single note when they started; others had "given up" their music many years ago and were eager to get back to it. Today they are enjoying the happiness which only music can give. Now YOU can too.

FREE BOOK and Free Instruction-Sample

Send for our Free Book—and also a Free Instruction-Sample showing how interesting and simple our method really is. Then you will realize why it has been so successful for the last 53 years. No obligation, no salesman will call



Why Deny Yourself This Joy!

So MANY people needlessly deprive themselves—all their lives—of the pleasures of playing! They imagine that learning requires some mysterious "musical talent" and long hours of practicing scales. That's not true any more—and it's a pity more people don't realize it!

upon you. So mail coupon at ONCE, U. S. School of Music, Studio 72, 225 Fifth Avenue, New York 10, N. Y. (Special Reduced Prices on instruments to our students.)

U. S. School of Music, Studio 72, 225 Fifth Avenue, New York 10, N. Y.

I am interested in learning to play, particularly the instrument checked at right. Please send me your free illustrated booklet, "How to Learn Music at Home"—also the free Instruction-Sample of your simplified words-and-pictures teaching method. NO SALESMAN IS TO CALL UPON ME.

Mr. _____
Mrs. _____
Miss _____ (Please Print Carefully)

Address _____

City _____ State _____
(Insert Zone Number, If Any)

NOTE: If you are under 18 years of age parent must sign coupon.

- Piano
 - Guitar
 - Hawaiian Guitar
 - Violin
 - Piano Accordion
 - Saxophone
 - Trumpet, Cornet
 - Pipe, Hammond, Reed Organ
 - Tenor Banjo
 - Ukulele
 - Clarinet
 - Trombone
 - Flute
 - Piccolo
 - Modern Elementary Harmony
 - Mandolin
 - Practical Finger Control
- Do you have the instrument? _____

the
new
**CUSHMAN
EAGLE**
truly a
TRIUMPH
in
low-cost
transportation!



**WRITE FOR
RIDER-AGENT PLAN**

gives you ALL THESE FEATURES:

- Automatic disc-type clutch; selective gear transmission!
- Silent action shock-absorbing springs!
- Doubly-dependable heavy duty brakes—BOTH front and rear wheels!
- 75 miles PLUS per gallon!
- Special heavy duty tires for added safety and comfort!
- Powered by the famous 4-cycle CUSHMAN "Husky" engine, acclaimed by thousands of users.
- Rapid pick-up, quick acceleration!
- Cruises up to 50 m.p.h.

All these plus CUSHMAN quality, dependability and design, make the new CUSHMAN "Eagle"—the ONE to buy in '51!

Write for free folder and prices to Dept. 4M

Cushman MOTOR WORKS, INC.
LINCOLN, NEBRASKA

WORK FOR THE



**GOVERNMENT
START AS HIGH AS
\$3,450.00 YEAR**

Veterans Get Special Preference

MEN—WOMEN

Railway Mail Clerks
Postoffice Clerks, Carriers
Storekeeper-Gaugers
Stenographers-Typists
Meat Inspectors
Many Other Jobs

**PREPARE
IMMEDIATELY
FOR NEXT EXAMS**

Common Education
Often Sufficient

Mail
Coupon
TODAY



COUPON

Franklin Institute
Dept. N-83,
Rochester 4, N. Y.

(Not Government Controlled)

Gentlemen: Rush to me, FREE of charge, list of U. S. Government big pay jobs. Send FREE 40-page book describing salaries, vacations, hours, work. Tell me how to qualify for one of these jobs.

Name.....
Street.....
City..... Vet?.....

Ride it
for ONLY
 $\frac{3}{4}$ ¢
per mi.

SHORTHAND IN 6 WEEKS AT HOME

Write 120 Words
Per Minute
Age no obstacle

Famous Speedwriting System. No signs; no symbols; no machines. Uses ABC's. Easy to learn and use. Fast preparation for a position and a sound future.

Nationally used in leading offices and Civil Service; also by executives, speakers, writers, lawyers, students at college, scientists. Over 100,000 taught by mail. The very low cost will surprise you. Also classroom instruction and typing. 28th Year.

Write for Free Booklet to

Speedwriting
Dept. 1502-1, 55 W. 42d St., N.Y. 18



"Speedwriting was as easy to learn as their ad claimed, and I did so in 40 hours of study. I was able to go out and secure a new job with more money and better opportunities." — Miss Ruth E. Rubinow, Norwalk, Conn.



NEW EYEGGLASS POLISHER Eyeglasses cleaned and polished — instantly! Amazing new polishing cloth removes steam, mist, blur, dust, dirt specks, fingermarks. Quick! Simply wipe over glasses. Stops fogging in changing temperatures. **Sells like wild!** **SAMPLES FOR TESTING** Sample offer sent immediately to all who send name at once. Hurry—postcard will do. **SEND NO MONEY** KRISTEE CO., Dept. 684, Akron 8, Ohio

How to win an Executive's JOB and PAY

Only one thing stands between you and a top executive's pay—the right kind of ability. You may be skilled in your work, yet if not trained in management you are not likely to be promoted to important executive jobs. Thousands win promotions thru LaSalle's Executive Training—and YOU too can gain tremendous advantage over others by knowing management principles. Write today for FREE 48-page book, "14 Steps to Executive Leadership."

LASALLE Extension University, 417 So. Dearborn St.
A Correspondence Institution Dept. 264BM, Chicago 5, Ill.

LEARN POULTRY BUSINESS AT HOME!

Thorough knowledge can mean greater success in this \$3½ billion business. Our interesting, practical, home-study courses have trained thousands during past 30 years. For full information on courses, methods, opportunities—Write Today to Dept. 50



NATIONAL POULTRY INSTITUTE Adams Center, N.Y.

SAY YOU SAW IT IN POPULAR MECHANICS

"It Measures As It Rolls"

ROLLER RULE

HANDY MECHANICAL PENCIL

Measures Curves and Straight Lines. Any Shape. Any Distance. Any Surface.

Roll head over surface. Inches and fractions record accurately on "Inch-O-Meter". Excellent pencil tool! Order Now! **10 Day Money Back Guarantee!** C.O.D. (postage extra). In Calif. add 3% Sales Tax.

PENCIL SALES CO., Dept. PM2
Room 6, 1213 E. Ocean Blvd., Long Beach, California

\$1.00
POST PAID

WANTED! DRAFTSMEN!

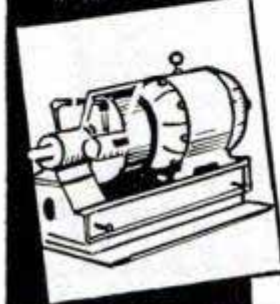

LEARN THIS BIG PAY PROFESSION AT HOME IN YOUR SPARE TIME

The need for more skilled draftsmen continues to grow. Essential jobs await trained draftsmen in every major industry. The war emergency has increased an existing shortage. Machines will never replace the draftsman. Before production can start plans must be drawn. Draftsmen are the first to be hired. Drafting is light, pleasant work, in pleasant surroundings and leads to top managerial position.

CTS OFFERS NEW TRAINING PROGRAM

A program that teaches you the hows and whys of production planning while studying at home. You learn by making actual drawings. CTS sends you a set of professional drafting instruments, portable drafting table, drafting supplies, etc., everything you need at no extra cost.

**EVERYTHING
IN THE
FIELD
OF**

• ARCHITECTURE •
ELECTRONICS • MACHINERY

MAIL COUPON FOR FREE BOOK!

CHRISTY TRADES SCHOOL, Dept. DB-603
4432 N. Kedzie Ave., Chicago 25, Ill.

Mail me at once your big FREE book on Drafting and Blue Printing. How your Home Training and Professional Drafting Instruments, Equipment, etc. can be had on PAY AS YOU LEARN PLAN.

NAME..... Age.....

ADDRESS..... CITY..... STATE.....

BE A PHOTO-ENGRAVER

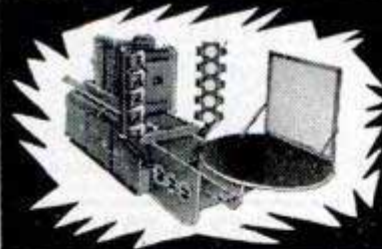

We furnish complete equipment and supplies. Learn at home or in our modern, friendly APPROVED school in MISSOURI. Get into this big demand, high profit, high wage field. You can start your own profitable, full time or part time PHOTO-ENGRAVING business right in your own home.

Be independent, be your own boss or pave the way to a high pay job with experience gained in your own shop.

TASOPÉ TRAINING and TASOPÉ EQUIPMENT has enjoyed world wide recognition since 1931. Write for descriptive literature today. No obligation.

THE AURORA SCHOOL OF PHOTO-ENGRAVING, DEPT. 9PM., TASOPÉ BLDG., AURORA, MO.

LEARN MEAT CUTTING AT NATIONAL Pay After Graduation



The steady dependable trade of Meat Cutting taught easily in 8 short weeks. YOU LEARN BY DOING under actual meat market conditions in big modern school at Toledo.

For beginners or men with experience. Get a profitable store of your own. Remember, PEOPLE MUST EAT! Big pay jobs. Free employment help. Thousands of successful graduates.

Buying, cutting, percentage, pricing, advertising, selling, etc. A complete retail meat education. National School established over 25 years. Get National training NOW. Pay your tuition in easy weekly payments

after you graduate. G. I. approved. Send coupon for FREE 52 page school catalog — TODAY.

National School of Meat Cutting, Inc., Dept. 50-P, Toledo 4, Ohio

Send me your FREE school catalog on National Training at Toledo in Meat Cutting, Meat Merchandising and Self Service Meats. No obligation. No salesman will call.

Name.....

Address.....

City..... State.....

() Check here if Veteran of World War II

MACHINE SHOP MEN

Needed Now!

TODAY shop men are in big demand. Don't miss the chance to get into the big money class and to qualify for promotions to high pay positions. Opportunities are open to men who add to their "know how" day by day. Equip yourself without delay.

8 BIG BOOKS ON APPROVAL

Modern Shop Practice, 14th edition, is the 8-volume set for the use of ambitious men. It contains 4,000 pages of vital information—3848 illustrations—167 tables. Written simply and clearly by 41 experts in tool making, pattern making, foundry work, forging, mechanical drawing, blueprint reading and many other skills. With the set we include a special binder of 860 profusely illustrated pages covering machine shop operations step by step, and 293 actual job tickets. 9 books in all! See also our gift offer at the left.

DICTIONARY OF MACHINE SHOP TERMS

Pocket Size

Included as gift if you act NOW, whether you keep or return the set.

Send the coupon NOW. Examine these books and note their great help to you. If you want to keep the set, pay on the very easy terms. If not, return the 9 books and owe us nothing. Remember—we now give a year's consulting privileges with our engineers without charge.

PUBLISHERS SINCE 1898

AMERICAN TECHNICAL SOCIETY, Dept. 5219
Drexel at 58th St., Chicago 37, Illinois

Send me the 8 big books and special binder on approval. I will pay delivery charges only. If I decide to keep the books I will send \$3.00 in ten days and \$4.00 per month until the total price of \$34.80 is paid. If I return them in 10 days I can keep the dictionary and owe you nothing. You also agree to send me a certificate entitling me to consulting privileges without extra charge.

Name _____

Address _____

Please attach a letter stating age, occupation, employer's name and address and name and address of at least one business man as reference. Men in service, also please give home address.



**START AS HIGH
AS \$3,450.00 YEAR**

Many early Examinations Expected. Prepare NOW! Veterans Get Special Preference! 40-Page Civil Service Book FREE

Franklin Institute
Dept. N-84,
Rochester 4, N. Y.
(Not Gov't Controlled)

Mail Coupon Today SURE

Gentlemen: Rush to me FREE of charge, list of U. S. government big pay jobs. Send FREE 40-page book describing salaries, vacations, hours, work, etc. Tell me how to qualify for one of these jobs.

Name _____

Street _____

City _____ Vet? _____

BUILD FAST STOCKS!
RACERS! HOT RODS!



SPEED & MILEAGE

"Get This Famous POWER MANUAL . . ."

COVERS ALL MAKES—Double power and mileage of your car! Racing Tricks! Souping! Speed Tuning! Customizing! 100 Gas Saving Secrets! SAVE MONEY—Build Superchargers, Dual Manifolds, High Compression Heads, Racing Cams, Dual Mufflers, Water Injectors! Covers Racers, Sports Cars, Stock Car Racer, California Roadster Construction—Engine Rebuilding, Frames, Bodies, Fuel Formulas, Ratios, Offys, Speed Shop Methods! Photo Section on HOLLYWOOD CUSTOM RESTYLING! 320 Illus.! Satisfaction Guaranteed.



YOU GET: "California HOT ROD HANDBOOK & BUILDERS KIT" free with BIG MANUAL—All For (p.p.d. or C.O.D.) \$1.98.

(Racing Catalog without above books 25¢)

ALMQUIST Engineering, Milford 22P, Penna.

I WANT EVERY READER of this Paper to have my big new SENSATION TOMATO



"KING OF THE EARLIES"

Big solid, scarlet fruit, disease resistant, heavy yielder. Ideal for table or canning. Send 125 SEED postal today for 125 seed

FREE and copy of Seed and Nursery Catalog. R.H. SHUMWAY SEEDSMAN, Dept. 725, Rockford, ILL.

LEARN AT HOME LOCKSMITHING

YOU CAN EARN BIG MONEY ALL YEAR ROUND IN FULL OR SPARE TIME!

Locksmiths are always in big demand! Age or physical handicap is no disadvantage in this respected, permanent field. Learn how to make keys, fix locks, make duplicates, etc. Practical, illustrated lessons by experts show you how! All materials and special tools supplied. Send for FREE booklet. INSTITUTE OF LOCKSMITHING, Dept. P-15, 55 Park Ave., Rutherford, N. J. Licensed & Approved by State of New Jersey

AMERICA'S BIGGEST KAYAK VALUES!

Complete Kits Ready-to-Assemble Light—Speedy—Safe \$18.75 up Easy-to-build, no steaming or bending
FREE DETAILS: Dept. PM-2
DEDHAM KAYAKS, DEDHAM, MASS.



Learn PHOTOGRAPHY

There's big money in PHOTOGRAPHY—and an action-packed career for you. Our HOME STUDY COURSE is your spare-time SHORT CUT TO SUCCESS! Or, if you wish—PERSONAL ATTENDANCE TRAINING at our famous New York School is available with subsistence under the G. I. Bill. Our 41st year. Write immediately!

NEW YORK INSTITUTE OF PHOTOGRAPHY

Dept. "49," 10 West 33 Street, New York 1, N.Y.

AMAZING OFFER—\$50 IS YOURS

- for selling only 100 boxes of MERIT'S outstanding 21 for \$1 All-Occasion cards. No experience necessary, costs nothing to try.
- Write for Selling Plan and Samples on Approval now.
- MERIT, Dept. 78, 370 Plane St., Newark 2, N. J.

Also Free Samples PERSONALIZED STATIONERY, NAPKINS, BOOK MATCHES

IS \$21000 A WEEK Worth a Penny Post Card?

Then RUSH postcard with name and address. Get FREE details of amazing full-and-spare-time PROFITS made by ambitious men handling new Automatic Defroster for refrigerators on FREE TRIAL basis. Learn how housewives hand you big profits when you just plug in the D-Frost-O-Matic to end defrosting mess forever. Send card for Special Offer TODAY.

D-FROST-O-MATIC

Dept. PM-2
6 N. Mich. Ave.
Chicago, Ill.

NOW is the time to ENTER ENGINEERING

Thru This Plan 

CAREER OPPORTUNITIES in Electronics and Electrical Power are at an all-time high. Young men trained in Electronics enter a science of tremendous growing value. The power industry faces an 80% expansion of its generating capacity by 1960. This 47-year-old school offers the following *proven* plan whereby the young man can prepare *realistically* for these opportunities.

BECOME A TECHNICIAN IN 12 MONTHS — Prepare for a wide range of career objectives with a Certificate as an Electro Technician, Electronic or Radio Technician. As a radio technician you can become a Radio-Television Technician in 6 additional months. All courses are complete in themselves.

B.S. DEGREE IN 24 ADDITIONAL MONTHS — All Technician courses apply as a full year of credit toward your degree in Electrical Engineering, majoring in either Power or Electronics. Scientific guidance helps you choose additional specialized preparation for design and research — manufacturing and production — or engineering sales and management.

- Over 2300 students annually enrolled from all states and 23 foreign countries. More than 35,000 alumni. Faculty of 85 specialists. TERMS OPEN APRIL, JULY, OCTOBER, JANUARY.



reprinted from
MILWAUKEE JOURNAL
Nov. 15, 1950

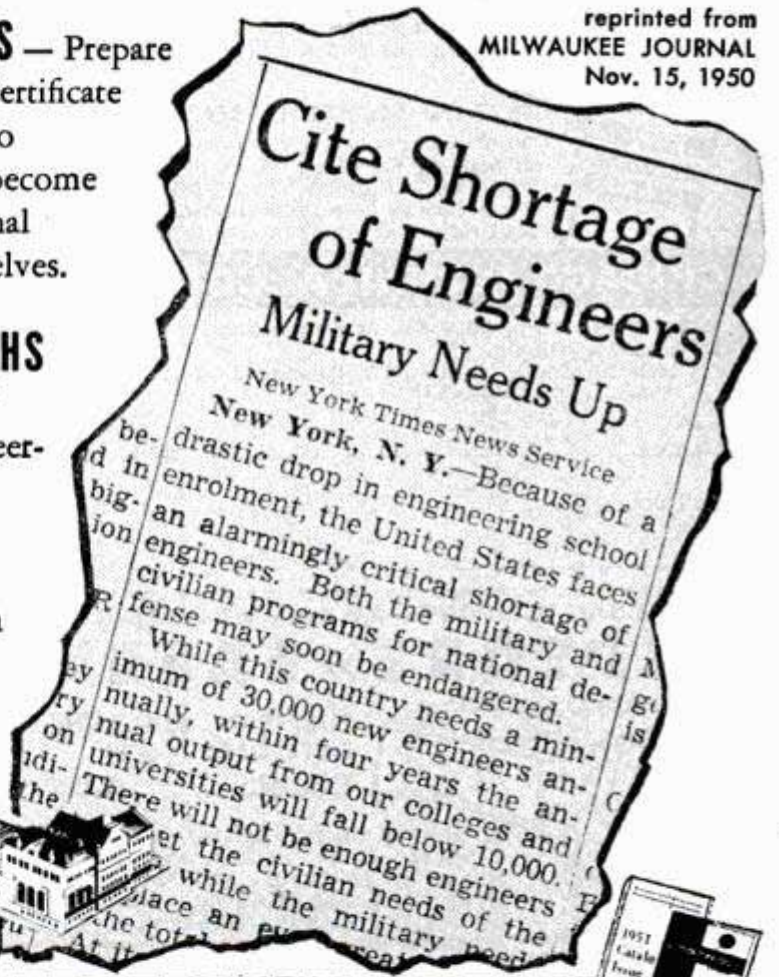

MILWAUKEE SCHOOL of ENGINEERING

Technical Institute • College of Electrical Engineering

- Military, practical or prior academic training evaluated for advanced credit. Preparatory and refresher courses available.
- If you have only 6 months to train — Ask for full details on the intensive, practical ELECTRICAL SERVICE course — complete in itself.

MILWAUKEE SCHOOL OF ENGINEERING

Dept. PM-251, 1020 N. Broadway, Milwaukee, Wis.

Without obligation, mail:

- 110-page 1951 Catalog for Electrical Engineering, B.S. Degree Electronics or Power. Occupational Guidance Manual on Electrical Power Radio-Television Refrigeration, Heating, Air Conditioning Welding

Name..... Age.....

Address.....

City..... Zone..... State.....

Check if World War II Veteran



EARN MORE IN DRAFTING



More Opportunities for Employment and Promotion

"Here I am at work making good money as a draftsman. I'm glad I sent the coupon to Chicago Tech for that Free Trial Lesson and found out how easy it is to learn Drafting in spare time at home. Today I feel secure in my job because the draftsman's work comes first on any new project. And, in addition, draftsman can't be replaced with machines. What's more, I feel I'm slated for promotion and more pay, because I see so many draftsmen advancing to high-pay jobs."

LEARN IN SPARE TIME—AT HOME!

(or at the College in Chicago)

A few hours of pleasant home study every week—that's all. No interference with your present job. All the tools you need; drawing outfit included. With Chicago Tech's help, you train yourself step by step. This tested method—developed over 46 years of C.T.C. progress—prepares men quickly for good positions in industry.



FREE INFORMATION—SEND COUPON

To prove to you how easy it is to learn Drafting at home by the Chicago Tech method, we will send you this FREE TRIAL LESSON. No charge for this lesson, now or later. Fill out and mail coupon, or send post card today.

CHICAGO TECHNICAL COLLEGE

B-214 Tech Bldg., 2000 So. Michigan Ave., Chicago 16, Illinois

Mail me FREE Lesson with information about big opportunities in DRAFTING.

Name _____ Age _____

Address _____

City _____ Zone _____ State _____

AMAZING COMFORT—NO SPECIAL FITTING

RUPTURE - EASER

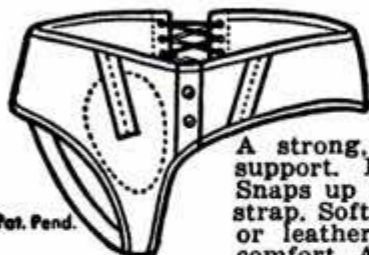

Pat. Pend.

Right or Left Side **\$3.95**
Double **4.95**

A strong, form fitting washable support. Back lacing adjustable. Snaps up in front. Adjustable leg strap. Soft, flat groin pad. No steel or leather bands. Unexcelled for comfort. Also used as after operation support. For men, women and children. Mail orders give measure around the lowest part of the abdomen. Specify right or left side or double. We Prepay Postage Except on C.O.D.'s.

10 DAY TRIAL OFFER

Money-back guarantee if you don't get blessed relief.

Piper Brace Company, Dept. PM-21, 308 E. 12th St., Kansas City 6, Mo.

Please send my RUPTURE-EASER by return mail.

Right Side \$3.95 Left Side \$3.95 Double \$4.95

Measure around lowest part of my abdomen is INCHES.

We Prepay Postage Except on C.O.D.'s

Enclosed is: Money Order Check for \$..... Send C.O.D.

Name

Address

City and State

RUSH THIS COUPON NOW!

AMAZING POCKET ALARM

You've always wanted one of these sturdy, accurate, 7-jewel alarm watches, Swiss made... so here it is—at tremendous savings. Check these value extras.

It Rings

- Loud Alarm
- Fits Watch Pocket
- Stands on table
- Unbreakable crystal
- White, pink or black luminous dial
- All Chromium case

ONLY **\$8.95** Post Paid

Check or money order plus 10% Federal Tax. 10 day return privilege—1 year guarantee.

FRANKLIN SALES CO.

Dept. PM-1
17 John Street, New York, New York



EASY TO LEARN CODE

Learn or increase speed with an Instructograph—the Radio-Telegraph Code Teacher that takes the place of an operator-instructor and enables anyone to master code without further assistance. Available tapes from beginners alphabet to typical messages on all subjects. Speed range 5 to 40 WPM. Always ready—no QRM. Thousands have "acquired the code" with the Instructograph System. Write today for convenient rental and purchase plans.



INSTRUCTOGRAPH COMPANY

4701-V Sheridan Road, Chicago 40, Illinois



ITALIAN ACCORDIONS

Hand Made. Very Best. Buy Direct from Factory Representative at lowest wholesale prices and Save Money. Send Name and Address for FREE catalog.

ITALIAN ACCORDION MFG. CO.

7600 Cottage Grove Ave., Dept. PM-2, Chicago 19, Ill.

GROW YOUR OWN SALAD, 10 DAYS



You can taste the results of this fascinating hobby. Plant Vita-Green seeds in your home—harvest a salad crop in 10 days. A year's supply, complete details..... **\$1.** post-paid

GILBERT & COMPANY

3535f ENTERPRISE ST., SAN DIEGO 10, CALIF.

BE A CRIMINOLOGIST

WORK HOME or TRAVEL. Experience unnecessary.

CRIMINOLOGY Particulars FREE. Write to **GEO. C. R. WAGNER**, 125 W. 86th St., N. Y.

LEARN RADIO-ELECTRONICS



Train for an important job in Radio, Television and Radar—with unlimited future. Spartan resident study is backed with actual construction and operation. Write Department PM-21

SPARTAN SCHOOL of RADIO-ELECTRONICS
MUNICIPAL AIRPORT • TULSA, OKLAHOMA

NOW GET PERFECT ELECTRIC SHAVES!



Amazing New Compound Sharpens Any Make Shaver

Better Than New!

For the smoothest, closest electric shaves ever, sharpen your shaver with Marino's Compound. Simple as 1-2-3. Takes only a few minutes time. Puts miracle cutting edge on any shaver, new or old. Actually sharpens better than new. Send only \$1 and be convinced—or return unused portion of tube and get your dollar back.



Dealer Inquiries Invited

WORLD'S OLDEST & LARGEST EXCHANGE & REPAIR FOR ALL MAKES

ELECTRIC SHAVES EXCHANGE

DEPT. PM-2

17 N. STATE ST.

CHICAGO 2, ILL.

BE AN ARTIST



Here's the Amazing Way You Learn to Draw
— Step by Step — at Home in Spare Time

DRAW FOR MONEY

TWO BIG ART OUTFITS GIVEN

Upon enrolling, we send you the first of TWO complete Artists' Outfits, including all the material you need to start this fascinating training. Later in the course you receive the second, advanced outfit. All at no extra cost!

Read What These Graduates Say:

TRAINING PAYS OFF—Fred B. Chott of Cicero, Illinois, says, "I have turned your teaching into profit very quickly." (1-49)

STAFF ARTIST AND CARTOONIST—G. W. Thomas, Los Angeles newspaper artist, says, "WSA is Number One School in U. S. A." (1-48)

FREE BOOK GIVES DETAILS

"Art for Pleasure & Profit" tells about our course of instruction and commercial opportunities for you—also about WSA students, reproductions of their artwork, and results enjoyed by our graduates.

G. I. APPROVED Est. 1914
FOR VETERANS



Enjoy a pleasant, profitable Art career. **COMMERCIAL ART, DESIGNING, CARTOONING**—all in one complete, modern home study course. Trained Artists are capable of earning \$65, \$80, \$100 and more a week. Good Art positions await you in this great field. Become your own boss—work at home on your own time. Many students earn extra money while learning by designing posters, doing simple artwork, lettering, etc. WSA is now in its 37th year of training successful men and women. No previous Art experience necessary. We teach you from the beginning. Qualify for professional Art jobs in advertising, television, newspaper and magazine publishing, department stores, printing, art studios, etc. Get the exciting facts now in free, illustrated book. Low cost, easy terms.

MAIL COUPON FOR FREE BOOK



WASHINGTON SCHOOL OF ART
Studio 122A, Washington 5, D.C.

Send me without obligation your Free Book, "Art for Pleasure & Profit", with full information. No salesman will call. (Please print).

Name..... Age.....

Address.....

City..... Zone..... State.....

I am entitled to training under G. I. Bill.

WASHINGTON SCHOOL OF ART

HULA POPPER • GETS BIG BASS

Surface popping lure. Ideal combination of noise, action, casting and hooking qualities. Pops, plunks, jerks, twitches—obeys your slightest wrist command. Rubber Hula Skirt imitates live bug. At your dealer 5/8 oz. or 1/4 oz., \$1.25. Fly rod size, 75c.



FRED ARBOGAST & Co., Inc., 2252 W. North St., Akron 3, Ohio

FREE WRITE TODAY FOR BIG FREE 1951 ARBOGAST COLOR CATALOG—FULL OF PICTURES OF CATCHES

Become a Doctor of PSYCHOLOGY

Win the degree of Ps.D. Teach the secret of contentment, happiness. Solve mental worries. Experience the revelation of truth. Chartered college. Individual help. Write for FREE book. **COLLEGE OF UNIVERSAL TRUTH, 5153-B North Clark St., Chicago.**

Say You Saw It in Popular Mechanics

STUDY AT HOME

WITH AN EDUCATIONAL INSTITUTION

Courses in ARTS AND SCIENCES: Philosophy; Education; Letters; Public Health; Medical Jurisprudence; Psychology; Sociology; Physics; Chemistry; Geology; Pol. Science; Theology; Law; Business and Commerce; Accounting; Mathematics; Statistics, Agriculture. **Courses in ENGINEERING:** Electrical, Civil, Mechanical, Drafting, Architectural, Automotive, Steam, Diesel, Aeronautical, Radio, Structural, Mining, Industrial. Petroleum, Marine, Refrigeration, Air Conditioning, Chemical. Send for free catalog.

McKinley-Roosevelt Incorporated, 4610-K3, Sheridan Rd., Chicago 40, Illinois

Your YOUNGSTER WILL LOVE IT!



Give your youngster a TRACTALL for the joy-ride of a lifetime! Looks just like a man-size Tractor. The perfect gift for boys, girls, up to 12 years old. Chain Drive. Sold only direct from factory. Write for Literature, FREE trial offer.

INLAND MFG. CORP., Dept. PM-2 164 Ellicott St., Buffalo 3, N. Y.



Men!

Reading This Message Could Be the Most Important 40 Seconds In Your Life

From every indication Auto Body and Fender Repair work will continue to be one of America's Big Income fields. Here at U.E.I. we're training men for it—a proven plan that combines spare-time, home study and actual shop practice. Men from coast to coast have successfully completed the U.E.I. course in Auto Body and Fender Repair—many earned money while learning—many now have their own shops. What about you? Isn't this the time for you to see what this big-pay field offers you? Do this: Mail the coupon below and we'll send you our big, descriptive book, "Opportunities." It's Free—Mail the Coupon.

UTILITIES ENGINEERING INSTITUTE, Chicago 14, Illinois
Founded 1927

UTILITIES ENGINEERING INSTITUTE,
2523 Sheffield Ave., Dept. XC-8, Chicago, 14, Illinois

Please send, Free, Your Book "Opportunities".

NAME (print) AGE.....

ADDRESS

CITY..... (Zone).... STATE.....

Check here for information if you are under 17.

PLASTICAST

THE GREATEST THING IN PLASTICS!



A NEW HOME INDUSTRY and HOBBY!



We have started THOUSANDS of people in a wonderful new kind of business! Here are 4 reasons why: (1) The work is pleasant and very easy . . . actually as easy as pouring water out of a glass! (2) VERY LITTLE investment is required; imagine, less than \$5.00 is required in order to start you off in your own manufacturing business! (3) Can be started ANYWHERE . . . at home, garage, basement, etc. and most important (4) The things you can make in QUANTITY PRODUCTION are not only exceptionally attractive and useful but are always in big demand every season of the year!

VAST QUANTITIES OF PLASTIC COMPONENTS NOW NEEDED BY ARMED FORCES!

YOU CAN MAKE ANYTHING!

What is this new business? It is CASTING . . . Casting with liquid plastics. CASTING is a method of production manufacturing WITHOUT MACHINERY OR TOOLS! CASTING is the exceedingly simple process of pouring liquids into molds . . . it is as simple as that! Like making Jello, only these liquid plastics SOLIDIFY in a few minutes after mixing into extremely HARD, DURABLE and ATTRACTIVE articles such as Jewelry, Novelties, Giftware, Figurines, Statuary, Knick-Knacks, Baby Shoes, Souvenirs, Ceramics, Imitation Marble, Bookends, Lamps, Pen sets, Cigarette Lighters, Toys, Dolls, Banks, Fishing Lures, Tools . . . A THOUSAND USEFUL THINGS! The field is really unlimited. We supply EVERYTHING . . . Casting Materials, Molds, Accessories and Instructions.



1000 GOLDEN OPPORTUNITIES!



Regardless what you are doing now you can get into the CASTING BUSINESS in your spare time or evenings. We assure you, once you do, you will be eagerly devoting all of your time to this very easy, fascinating and HIGHLY PROFITABLE OCCUPATION until it leads into a dependable business all your own! BUT LET US PROVE IT. Send only 25c for our big 40 page Catalog of Casting Materials, hundreds of Molds, etc. We will also send you FREE an attractive CASTING to show you what can be done with liquid plastics in a few minutes! We will also send you FREE a valuable book giving you details on the ART AND BUSINESS OF CASTING which shows you how to cast and get started! All this for only 25c, but write for it today. This may be the lucky coin that will start the most fascinating and profitable phase of your life!

10 VALUABLE MOLDS FREE!



If you want to get started at once without delay then send for our big SENIOR PLASTICAST OUTFIT . . . here is what you receive! TEN VALUABLE MOLDS for making extremely beautiful and useful TRANSPARENT crystal-clear or colored plastic articles as illustrated directly above! Make unusual Penholders, Cigarette Lighters, Ash Trays, Perfume Sets, Pendant Hearts, Imbedded Flowers and Photos, Buttons, Key Chain Fobs and countless other attractive items! Outfit also includes 1 qt. PLASTICAST liquid casting plastic and hardener which will make about \$100. worth of material, pipette, measuring glass, colorful imbedding material, polishing material, 2 dyes and Instruction Manual. OUTFIT No. 646, price postpaid \$7.50

Our MASTER OUTFIT contains 4 molds, pint of PLASTICAST and hardener, pipette, measuring glass, imbedding material and Manual. OUTFIT No. 4 Price, postpaid . . . \$3.50 C.O.D. orders filled (not postpaid) if \$1.00 deposit sent with order.

FREE



An attractive Casting and valuable BOOK shown at the right sent FREE with our Catalog! See 3rd paragraph above.

PLASTICAST COMPANY (DEPT. C)

170 N. Halsted St. (Write to P. O. Box 987 Chicago 6, Ill. nearest address) Palo Alto, Calif.

CANADIAN CUSTOMERS, please order directly from: CANADIAN INDUSTRIAL PLASTICS, LTD., 1056 1/2 Pender West, Vancouver, B.C.

SPEED AND POWER 1951 HANDBOOK



Direct from the Dry Lakes of California comes authentic information to thrill the most sedate motor enthusiast.

BIG LIBRARY EDITION . . . 128 PAGES ILLUSTRATIONS 300

Tens of thousands of copies have been sold— Shows by photos and drawings how to build fast stock cars! California Roadsters! 225 M.P.H. Rods! Covers ALL MAKES. Build your own Dual Manifolds! Superchargers! Hot Cams! Water Injectors! Hi-Compression Heads! Mileage Devices! Get up to ten more miles per gallon! Get racing speed, lightning acceleration, dynamic power increases from any make passenger automobile! Get construction secrets! Tuning techniques! Speed tricks! Economy secrets! Ingenious formulas! Covers "Racing Frames"—"Reciprocating Masses"—"Jet Engines"—"Wheel Geometry"—"Dynamometers"—"Re-Styling"—"Customizing"—"Dual Pipes, Gears, Fuels, Porting, Relieving, Lowering! Balancing, 50 breathtaking chapters! GREATEST VALUE EVER OFFERED! Also get 40 page "DRIVING ECONOMY BOOK" plus big "1951 SPEED EQUIPMENT CATALOGUE", plus "WATER INJECTION", plus "MILEAGE INFORMATION", plus purchase of 128 page "SPEED & POWER"—5 items \$1.98 postpaid.



SPEED SHOP METHODS

BIG CATALOGUE (Without Books) 25c NEWHOUSE AUTOMOTIVE INDUSTRIES 5805 EAST BEVERLY BLVD., DEPT. B-24, LOS ANGELES 22, CALIF.



FREE BOOKS

Play GUITAR in 10 DAYS



OR GET YOUR MONEY BACK! Let Ed Sale teach you to play with his famous diagram photo system. Book contains 53 photos, 43 diagrams, showing exactly how to place your fingers. Gives you 110 popular songs, words and music—along with complete, easy to learn instructions. Imagine your joy when you find after only two weeks you are playing beautiful music! Amaze your friends! Be the life of the party! SEND NO MONEY. Pay Postman \$1.95 Plus Postage. ED SALE, Dept. PM-2, Point Pleasant, N. J.



Money In Hamsters

The new wonder animals from Syria. Often called Toy Bears. Delightful pets. Everyone wants them. Laboratories use thousands. Clean, odorless. Raise anywhere. NOW, spotted and golden breeds. We furnish breeders, equipment and manual of instructions. Write today for free illustrated literature.

GULF HAMSTERY 1536 BASIL ST., MOBILE 17, ALA.

Print Your Own

Cards, stationery, advertising, etc. Save money. Print for others, good profit! easy rules sent. Raised printing like engraving, too. Sold direct only. Write for free details. Kelsey Presses, F-37 Meriden, Conn.

BE A LANDSCAPE CONTRACTOR

or a Landscape Architect. Make \$15 to \$50 a day. Compare the competition in this field to others & you'll see why we have hundreds of employed graduates from coast to coast. Course includes practical instruction here in addition to approved home study work. Write for free information.



NATIONAL LANDSCAPE INSTITUTE Dept. P-2, 310 So. Robertson Los Angeles 48, Calif.

MEN! WOMEN!

TAKE ORDERS FOR NATIONALLY ADVERTISED WATERLESS COOKWARE

Big Money Full or Spare Time Starting a Carlton Cookware Club

Big earnings daily taking fast orders for amazing new kind of Stainless Steel Waterless Cookware under Sensational Plan that makes it easy for every housewife to buy. Club privileges permit your customers to get Matched Sets of CARLTON WARE without missing the money—on sensational new Easy Payment "ADD-A-PIECE" Plan—PLUS up to \$8.00 worth of gift bonuses. No experience needed. We show you everything—supply everything FREE. Earnings start at once. Rush name and address. Be First!



FREE! 20-Use Set of Stainless Steel Cookware Given As a Bonus

CARLTON OF CARROLLTON, Dept. 33-B Carrollton, Ohio

\$200 GROSS IN MY FIRST WEEK!



Some Make More, Some Less... Start This Business for **YOUR OWN**

Would YOU like to own a permanent, year-round business in which it is possible to take in as much as \$200 gross the first week, as did L. A. Eagles? R. E. Traynor says, "I made \$62 gross in one day." R. R. Newlin reports, "I have averaged \$173 gross per week." Others report gross from \$100 per week to \$12,000 per year.

Surely YOU will want to investigate a golden opportunity like that. You need not have any special skill or experience, but if you are ambitious, honest and courteous, we will help you to start and succeed in YOUR OWN money-making business where net profits are high.

No Shop Necessary

Our Electric Rug Washer cleans rugs and carpets like new right on the customer's floor. This quick, thorough and highly efficient method removes dirt and grime, thus restoring the natural, fresh beauty of floor coverings. Anyone can do it. Rugs and carpets are not harmed.

There are hundreds of possible customers in YOUR vicinity. Most of the have several rugs needing regular cleaning. To get a quick start,

VON SCHRADER MFG. CO.
210 PL, Racine, Wis.

Send at once (no obligation) your FREE booklet containing information about your Electric Rug Washer and how I can own my own permanent profitable business.

Name _____

Address _____

City _____ (Zone) _____ State _____

shampoo a few rugs or carpets. These customers tell their friends and soon you should have an independent, prosperous business, and you should be able to keep it growing. Send the coupon RIGHT NOW for booklet that explains everything.

Every Machine Guaranteed and Easy to Own

You take no risk. These wonderful, fully guaranteed machines have been used and endorsed by largest hotels, railroads—also used by U. S. Government. Many individuals have built up successful businesses that made big profits. Mail the coupon TODAY and we will send complete information, including how to start and succeed in YOUR business without a large investment. Don't delay your BIG opportunity. Send the coupon AT ONCE.



MAIL COUPON TO

VON SCHRADER MFG. CO., 210 PL, RACINE, WIS.

You are in demand if you can draw!



Make Money with your brush and pen! If you like to draw, sketch, or paint, take the Free Talent Test. No fee. No obligation. Mail this coupon TODAY!



ART INSTRUCTION, INC., Dept. 2131

500 S. 4th Street, Minneapolis 15, Minnesota

Please send me your FREE Talent Test.

Name _____ Age _____

Address _____ Phone _____

City _____ Zone _____ County _____

State _____ Occupation _____

WE TRAIN YOU AT HOME FOR RADIO TELEVISION JOBS

Prepare now for high-pay jobs with SECURITY. Big demand for trained men! Get to the top faster through practical shop-training methods! You earn big money at home while learning; start your own business! Fastest growing industry in the country!

**RTTA FURNISHES
EVERYTHING -
TUBES,
BATTERIES,
LARGE TV
PICTURE TUBE**



**YOURS
TO KEEP
AND ENJOY**

**YOU KEEP
ALL
EQUIPMENT!**

**YOU BUILD THIS
LARGE SCREEN
TELEVISION RECEIVER**

YOUR CHOICE OF 10, 12½, OR 16 INCH
PICTURE TELEVISION TUBE

**CAN BE CONVERTED
FOR COLOR TELEVISION**



**STUDY
AT HOME
IN YOUR
SPARE
TIME**

**FREE...At No Extra Cost...
YOU GET A ROUND TRIP
TO NEW YORK CITY**

After completing home study training, your transportation both ways from any point in U.S. or Canada will be paid by RTTA. At our affiliated training shops in New York City you get 2 solid weeks of laboratory work on newest equipment.

**NO PREVIOUS
EXPERIENCE NECESSARY
FREE EMPLOYMENT HELP**

RTTA helps you earn while you learn. Open to men of all ages! RTTA prepares you for BIG PAY and to open your own shop.

DRAFT AGE MEN

Special "SPEED-UP" Radio Communications program helps you get BETTER SERVICE RATING—BETTER PAY! You can find out by return mail! Send Coupon TODAY!

FREE "SPEED-UP OFFER" COUPON

RADIO TELEVISION TRAINING ASSOCIATION
972 Broad Street Dept. 242, Newark 1, N. J.

Rush me FREE Sample Lesson & Catalog "How to Make Money in Television," in spare time. AT HOME, while learning; also () Special Home Plan for Men over Draft Age. () "Speed-Up" Service Rating Plan for Draft Age Men. No obligations! I understand no salesman will call.

Name.....Age.....

Address.....

Prepare Now!
ENGINEERING
B.S. DEGREE IN 27 MONTHS
WORLD FAMED SCHOOL - ESTABLISHED 1884

Mechanical, Civil, Electrical, Chemical, Aeronautical, Radio (Television) Engineering; Business Administration and Accounting. Also 36-weeks diploma courses in Surveying and Drafting.

Personalized instruction. Accelerated courses. For ambitious earnest students. Preparatory department. Approved for veterans.

Heavy demand for Tri-State graduates; hold positions of responsibility the world over. Placement service. Serious shortage of engineers indicated for immediate future. Prepare now for the opportunities ahead. Technical training helpful in military assignments.

Extensive campus. Well equipped, new and modernized buildings; up-to-date labs. Low cost. New terms start quarterly. Enter March, June, September, January.

Write today for free catalog and special information.

TRI-STATE COLLEGE
421 COLLEGE AVENUE ANGOLA, INDIANA



**USE OUR
CAPITAL**

NO SALES EXPERIENCE NEEDED

The biggest opportunity ever, to quickly establish a money-making, lifetime business, now awaits you as a McNeess Dealer. Sell things farmers need and use up. Serve same families year after year. Pleasant work--no bosses--easy to do. We supply capital to work on. Also provide offers--advertising--premiums and trade secrets that bring sales.

First to apply get best trading areas. Don't wait--write us today for McNeess proposition. Tell us county and state you want to serve. Ask for free McNeess Book.

The McNEESS CO., 111 Adams St., Freeport, Ill.

MAKE MONEY with Bostonian SHIRTS

TAKE orders for old, reliable line finest quality dress and sport shirts. All styles...fabrics...colors...sizes. Sensational LOW PRICES. No experience needed.

FREE Samples of actual fabrics and big Style Kit waiting for you! Send no money, but rush name NOW! **BOSTONIAN MFG. CO.,** 89 Bickford St., Dept. B-40, Boston 30, Mass.



SAY YOU SAW IT IN POPULAR MECHANICS

BECOME A BETTER PAID MAN BY BEING A WELL TRAINED MAN

Learn a profitable trade--the Eastern Technical School way. Enroll now for an eight month course in Radio or Refrigeration. New classes beginning every April--August--December. Veterans--Nonveterans. Write for free catalogue. Graduates successfully placed from Coast to Coast.

EASTERN TECHNICAL SCHOOLS
888 PURCHASE STREET NEW BEDFORD, MASSACHUSETTS

MONTH AFTER MONTH, YEAR AFTER YEAR, YOU SEE OUR AD.
REMEMBER IT'S DANGEROUS to pay less if you want the finest matched USED tires.

GOOD YEAR Firestone

GOODRICH, UNITED STATES, GENERAL & OTHERS, NOT RECAPS

Our policy is to select your tires so carefully, as if our very future depended on the service given by that particular tire.

FREE TUBE WITH "ALL" BLATT'S GOOD GRADE TIRES

GOOD GRADE, 16 MONTHS GOLDEN RULE GUARANTEE BOND.			
600-16 \$4.17	700-15 \$4.57	650-20 \$7.97	32x6(8) \$8.67
650-16 4.67	670-15 4.77	700-20 8.57	32x6(10) 9.97
700-16 5.07	710-15 4.97	750-20 8.67	900-20 13.97
650-15 4.47	550-17 4.67	825-20 13.97	1000-20 13.97

FINEST GRADE, 26 MONTHS GOLDEN RULE GUARANTEE BOND
THIS GRADE MADE THE BLATT NAME "WORLD FAMOUS."

MATCHED BALANCED TIRES		MATCHED BALANCED TRUCK TIRES	
600-16 \$5.37	650-15 \$5.97	600-20 \$9.97	900-20 \$17.57
650-16 5.97	670-15 6.27	650-20 9.97	1000-20 18.57
700-16 6.57	700-15 6.57	700-20 10.97	1100-20 18.57
750-16 7.77	710-15 6.37	32x6(8) 10.57	1000-22 17.37
550-17 5.97	760-15 6.57	32x6(10) 11.97	1100-22 18.57
525-18 5.57	820-15 7.07	750-20 14.57	750-16 8) 8.97
650-18 6.97	475-19 5.97	825-20 17.57	1100-24 21.57

Military Xtra-Traction Guar. 45,000 Miles (Reg. 16 Mos.)

750-16 Reg. \$11	900-16 Reg. \$11	750-20 Reg. \$10.47
XTRA-TRACTION \$14	XTRA-TRACTION \$14	XTRA-TRACTION \$16.67
1000-22 Reg. \$22	1100-20 Reg. \$22	
XTRA-TRACTION \$38	XTRA-TRACTION \$39	

BLATT BLATT BLDG., GIRARD & LANCASTER AVES., DEPT. PM, PHILADELPHIA 31, PA.
Send check or money order and this ad for rush shipment. We won't ship a tire we wouldn't use. The name to trust in rubber. Shipments RUSHED down south, up north and far west.

"A FASCINATING...MONEY-MAKING art career can be yours

America's **12** Most Famous Artists Show You How!"



says **NORMAN ROCKWELL**

We show you our successful methods and art secrets...you learn them at home, in your spare time. Write for our big, handsomely illustrated free booklet that tells how you can have a great new art career! **WRITE TODAY!**

• FAMOUS ARTISTS COURSE •

Dept. 6-N, Westport, Conn.

FREE

Please send book about your home study art course.

Mr. Mrs. _____ Age _____
Miss _____

Street _____

City, Zone, State _____

FACULTY

Norman Rockwell	Al Parker
Jon Whitcomb	Ben Stahl
Stevan Dohanos	Robert Fawcett
Peter Helck	Austin Briggs
Harold Von Schmidt	John Atherton
Fred Ludkens	Albert Dorne

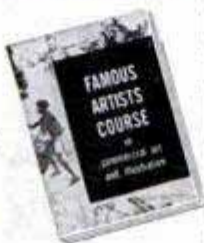

AUTO WASHER

Your car sparkling clean—in a jiffy—Amazing "Suction" Auto Washer. Simply glide over car. PRESTO! Dust, grease, dirt, and grime disappear like magic. Leaves finish clear, lustrous. Auto gleams like a mirror.

SAMPLES for AGENTS

Sample offer sent immediately to all who send name at once. Hurry, postal will do. **SEND NO MONEY**—Just your name. KRISTEE Co., Dept. 685, Akron 8, Ohio



EXTRA MONEY FOR YOU!

Sell Friendship Greeting Cards to Friends Easy way to get extra income in your spare time. Lovely new 21-card Assortment for Birthdays, other occasions sells on sight at \$1. You make up to 100% profit. Super Value \$1 Box pays you up to 55c. Many other fast sellers double your earnings. **EXTRA CASH BONUS.** Samples ON APPROVAL. Imprint Samples FREE. Write! **FRIENDSHIP STUDIOS, INC., 442 Adams St., Elmira, N.Y.**

A HIGH SCHOOL DIPLOMA the EASY WAYNE WAY

• The quick, low-cost WAYNE way to a High School education. No classes; pleasant, spare-time home training; college preparatory; standard texts; credit for past schooling. If you have finished 8th grade and are over 17 years of age, write for free catalog.

WAYNE SCHOOL
2527 SHEFFIELD AVENUE
Catalog HF-3 CHICAGO 14, ILL.



GLIDE TO THE HAUNTS OF THE BIG ONES

• Smoothly and quietly you reach the best spots when your canoe is an easily handled Old Town. Strong yet light, Old Towns are built to give years and years of pleasurable, reliable service. Every canoe is backed by half a century of skilled experience in building water-wise craft.

FREE CATALOG shows all kinds of canoes for paddling, for sailing, for outboards. Also sailboats, outboard boats, dinghies, rowboats.

OLD TOWN CANOES

(Old Town Canoe Co., 742 Elm St., Old Town, Maine)

PLEASE SEND ME FREE CATALOG

Name _____

Address _____

City _____ State _____

BE A LICENSED* RADIO-TELEVISION BROADCAST OPERATOR!

*First Class License issued by the Federal Communications Commission of the United States Government.

This is your opportunity to get into an **ESSENTIAL**, exciting, fast-moving job. Be a licensed Radio-TV Broadcast Operator. Be the man in the studio control room . . . meet famous people . . . earn **BIG MONEY** for interesting work.

No need to quit your job! You can qualify for your First Class FCC License at home . . . learning in your spare time. **BIG HOME LABORATORY EQUIPMENT KITS!** Clear modern instructions. **FREE** placement to help you secure a top pay job. Get full information today.

CENTRAL RADIO AND TELEVISION SCHOOLS, INC.

Dept. T, 1644 Wyandotte, Kansas City, 8, Mo.

Tell me how I can qualify at home, for a big pay job in Radio & TV. This does not obligate me.

NAME _____ AGE _____

ADDRESS _____

CITY _____ ZONE _____ STATE _____

5 YEAR WRITTEN GUARANTEE BENRUS 15 & 17 JEWEL

YOUR CHOICE
only

\$14.95

Originally Sold Up To **\$59.50**

OFFICIAL SHOCK-PROOF WATCH OF FAMOUS AIRLINES Choice of MEN'S OR LADIES'

In latest style Yellow gold Cases. You get these unredeemed 5-year guaranteed lifetime quality **FAMOUS BENRUS WATCHES** now at only \$14.95 because we bought out **SURPLUS STOCKS** of leading N.Y. and Md. jewelers. Order now. Order men's or ladies'.

TRIAL OFFER! WEAR AT OUR RISK!

Money back in 5 days if not delighted. SEND ONLY \$1 with order. Pay balance COD, plus postage. Or we pay postage if you enclose \$14.95, plus \$1.50 tax.

FREE! Handsome Expansion band included with Prepaid Orders. Order now.

MARYLAND DISTRIBUTORS
501 E. BALTIMORE ST. DEPT. 226
BALTIMORE 2, MD.

Free Watch & Diamond Ring Catalog. Practically Wholesale Prices to User Direct. War or no war, no inflation on our prices.

Lifetime Guaranteed 17 JEWEL Military Style

WRIST WATCH

Originally \$59 while they last

\$14.95 plus \$1.50 tax

New Incublock Shock-Protected WATER-DUST PROOF



FREE BOOK



WOULD UP TO \$400 PER MONTH INTEREST YOU?



It is easily possible to earn up to \$400 a month raising Guaranteed Thoroughbred **ANGORA RABBITS**. No experience required. Wool brings top price. Plenty of markets. **WRITE TODAY** for **FREE INFORMATION**, prices and where to sell.

WHITE'S RABBITRY
NEWARK 10 OHIO

WHY DON'T YOU WRITE?

Writing short stories, articles on business, sports, hobbies, travel, shop crafts, local and club activities, etc., will enable you to earn extra money. In your own home, on your own time, the **New York Copy Desk Method** teaches you how to write the way newspaper men learn—by writing. Our unique "Writing Aptitude Test" tells whether you possess the fundamental qualities essential to successful writing. You'll enjoy this test. Write for it, without cost or obligation.

Veterans: Course approved for Veterans' Training.

NEWSPAPER INSTITUTE OF AMERICA
SUITE 5591-B, ONE PARK AVENUE, NEW YORK 16, N. Y.

EASY START COMPOUND

All welding rods start instantly. Just dip end of the rod in compound. Liberal Jar \$1.00. Send check or money order, for postpaid shipment. Satisfaction Guaranteed. **STRADER PRODUCTS, Dept. A-175, 259 Strader Ave., Cincinnati 26, Ohio.**

Do You Make These Mistakes in English?

MANY persons say "between you and I"—use "who" for "whom"—don't know whether to use one or two "e's" or "m's" or "r's." Every time you speak or write you show what you are. A command of effective English brings you added advantages, better opportunities.

You can improve your English through Sherwin Cody's 100% self-correcting invention. If you are ever embarrassed by mistakes in grammar, spelling, punctuation, or pronunciation, write for **FREE** book "How You Can Master Good English in 15 Minutes a Day." No obligation. **SHERWIN CODY COURSE IN ENGLISH, 52 B & O Bldg., Rochester 14, N. Y.**

There's BIG MONEY in

UNIFORMS and Work Clothes that ADVERTISE!

Every business and businessman is swinging over to employee uniforms and work clothes, embroidered with company name, trademark, sales message, etc. The field is new. Prospects are everywhere—garages, service stations, factories, coal dealers, dairies—and hundreds more. Profits are huge. You take orders by the dozen and gross! One man made over \$800.00 on a single deal! You get the business everytime because you offer latest style and finest fabrics. Big selling kit sent **FREE!**



TOPPS, Dept. 612, Rochester, Indiana

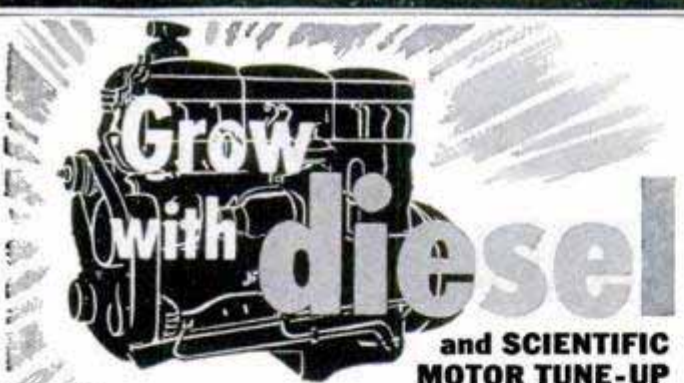

and SCIENTIFIC MOTOR TUNE-UP —One of America's Fast-Growing Big-Pay Industries!

● Lay the foundation now for something bigger and better—get into the fabulous Diesel industry. The U.E.I. Plan for learning Diesel and Scientific Motor Tune-Up is simple, practical and is based upon the principle of learning-to-do-by-doing. Essential fundamentals are gained through spare-time home-study, followed by actual shop practice. Competent instructors guide you step by step—you learn the **HOW** and **WHY** of Diesel operation, service and maintenance. Get all the facts—mail the coupon and we'll send you a free copy of "Earning Power in Diesel." Mail coupon today!



UTILITIES ENGINEERING INSTITUTE
Chicago 14, Illinois Founded 1927

UTILITIES ENGINEERING INSTITUTE, Dept. DC-12
2525 Sheffield Ave., Chicago 14, Illinois

Please send me, without obligation, your book "Earning Power in Diesel."

NAME (print).....AGE.....

ADDRESS

CITY..... Zone..... State.....

Check here for information if you are under 17



CARVE LEATHER

*Easy to Learn in Spare Time.
Fascinating, Profitable HOBBY.*

Have fun and make money too! Carve handsome bags, billfolds, belts, moccasins, key cases, etc. from our huge and varied stock of Leather Projects that come **READY TO CARVE AND ASSEMBLE**. To select what you need, write for complete, fully-illustrated catalog. Contains over 200 photographs of projects, leathers, tools and accessories. Learn this fascinating hobby—start small and experiment. Write for catalog today, include 25c to cover printing and mailing.

BURTONS LEATHERCRAFT
Dept. PM-2
1755 1/2 Glendale Blvd.
Los Angeles 26, Calif.

WRITE NOW FOR COMPLETE LEATHER-CRAFT CATALOG!

CAR OWNERS! Here's HANDILITE

Ideal emergency light for night breakdowns. **WORKS 3 WAYS**... red flasher, red flasher with white floodlight, white floodlight only. Use for home, hunting, etc. Waterproof, 12" high, aluminum construction, rotates in complete circle; 1000 ft. beam.

only **\$7.95** postpaid complete with batteries



FLASHDRIVER

Lets you work in dark corners. Both a flashlight and a screwdriver. Quality steel blades. Shockproof handle. Complete with bulb, battery, 4 interchangeable blades including one that fits 4 slot heads.

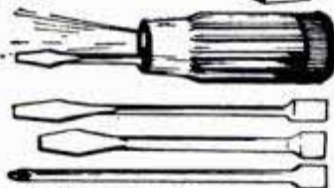

only **\$2.98** Postpaid

SEND CHECK OR M. O. NO C.O.D.'S
L. B. SALES, 16 E. 17th St., N. Y. 3, N. Y.

SAY YOU SAW IT IN POPULAR MECHANICS

CAN YOU EQUAL THIS HOME for \$2915



Save 30% to 40%

Shipped Direct from Our Mill

DON'T PAY several hundred dollars more than necessary when you build a home! Buy direct from our mill at our low factory price. We ship you the lumber cut-to-fit, ready to erect. Paint, glass, hardware, nails, etc., all included in the price—no extra charges. Plans furnished—also complete building instructions. No wonder our customers write us that we saved them 30% to 40%. Easy terms—monthly payments.

Handsome Big CATALOGUE

Pictures wonderful homes in colors at money-saving prices. Designs to suit everyone. Send 25c for catalogue today.

LEWIS MANUFACTURING CO.
912 Lafayette Ave., Bay City, Mich.

BIG BOOK
of
House Plans
in Colors
25¢

FOR EASY HOME ASSEMBLY 20 MODELS U-MAK-IT BOAT KITS

PRAMS \$39⁶⁰
8 TO 11 FT.

ROWBOATS
10 TO 14 FT.

OUTBOARDS
12 TO 16 FT.

INBOARDS & CABIN CRUISERS
16 TO 23 FT.

SEND 25c (coin) TODAY NEW CATALOG
SHOWING ALL 1951 MODELS, MOTORS AND ACCESSORIES
703P-WHITTIER ST. New York 59, N. Y.

U-MAK-IT PRODUCTS

BUILD THE BEST U-MAK-IT KITS

Can a Man MY Age Become a HOTEL EXECUTIVE

Even Though He Has No Previous Hotel Experience?

Would you like to step into a well-paid position as Hotel, Club, Restaurant or Inn Manager, Purchasing Agent, Social Director or Assistant Manager? Would you like to look forward happily to the future? The success of Lewis graduates from 18 to 50 **PROVES** you can — though you have no experience in hotel work.



Harry E. Roorbach,
Veteran Wins Success
as
Hotel Executive

"While I was in the hospital awaiting discharge from the U. S. Navy, I enrolled for Lewis Training. Shortly after I had completed the course, the Lewis National Placement Service informed me of an opening near my home. "At present, I am Night Manager in the largest hotel in Rochester. I owe my success to the Lewis Course."

Step Into a Well-Paid Hotel Position FREE Book Gives Fascinating Facts

Our **FREE** Book, "Your Big Opportunity," explains how you can qualify for a well-paid position at home, in leisure time; tells how you are registered **FREE** of extra cost in the Lewis National Placement Service. Most important, it shows how you can be a Lewis Certified Employee—certified to "make good" when placed in a position. Mail the coupon **NOW!**

Course Approved for Veterans' Training

LEWIS HOTEL TRAINING SCHOOL
Room TB-324, Washington 7, D. C.

35th SUCCESSFUL YEAR

Send me the Free Book, "Your Big Opportunity," without obligation. I wish to know how to qualify for a well-paid position at home, in my leisure time.

Name _____
(Please Print Name & Address)

Address _____

City _____ Zone _____ State _____

Check here if eligible under G. I. Bill of Rights.

MORE PAY through HOME-STUDY TRAINING in SPARE TIME

Do you want a better position—a larger salary? They are within your reach—now. LaSalle experts will guide you step by step in gaining business training which leads to greater earnings.

The time-saving, interesting LaSalle Problem Method helps you prepare at home, without interference with your present duties.

Simply mark on the coupon the field in which you desire success, and we will mail you a valuable book describing the opportunities in that field—plus "Ten Years' Promotion in One"—a book which has helped many men. Let us tell you how we have started thousands of average men and women on the high road to success and more money. Check and mail the coupon now.

LASALLE EXTENSION UNIVERSITY

A Correspondence Institution

417 S. Dearborn St., Dept. 264-R, Chicago 5, Ill.
Send me full information regarding the course I have marked—without obligation—plus "Ten Years' Promotion in One."

- | | |
|--|---|
| <input type="checkbox"/> Higher Accountancy | <input type="checkbox"/> Salesmanship |
| <input type="checkbox"/> C.P.A. Coaching | <input type="checkbox"/> Traffic Management |
| <input type="checkbox"/> Bookkeeping | <input type="checkbox"/> Foremanship |
| <input type="checkbox"/> Law: LL.B. Degree | <input type="checkbox"/> Industr'l Management |
| <input type="checkbox"/> Business Management | <input type="checkbox"/> Stenotypy |
| | (Machine Shorthand) |

Name.....Age.....
Address.....
City.....Zone.....State.....

Which of these 2 one time WEAKLINGS PAID only a Few Cents? to become an All-Around HE-MAN at Home!



WHICH ONE PAID HUNDREDS OF DOLLARS TO TRAIN AT MY SIDE?

Rex Ferrus mailed a coupon and paid only a few cents. Larry Campbell paid me hundreds of dollars.

LET ME PROVE I CAN MAKE YOU TOO an "ALL-AROUND" HE-MAN FAST — or it won't cost you a cent — says George F. Jowett—World's Greatest Body Builder

Just as I did Rex Ferrus, I'll teach you, at home, the "Progressive Power Method" through which I rebuilt myself from a wreck at 15, to holder of more strength records than any other living teacher!

BUILD A BODY YOU WILL BE PROUD OF . . .

Send only 10c for my 5 easy-to-follow, picture-packed courses now in 1 volume, "How to Become a Muscular He-Man."

10 DAY TRIAL! If these 5 courses do not PRODUCE results in ONE WEEK, send them back and I'll return your dime.

FREE! Jowett's Photo Book of Famous Strong Men!

JOWETT INSTITUTE, Dept. PM-12
230 Fifth Avenue, New York 1, N. Y.

Dear George: Please mail to me prepaid FREE Jowett's Photo Book of Strong Men, plus all 5 Muscle Building Courses, "How to Become a Muscular He-Man." ENCLOSED FIND 10c in complete payment for EVERYTHING.

NAME.....AGE.....
(Please Print Plainly, Include Zone Number)
ADDRESS.....NO C.O.D.'s
CITY.....ZONE & STATE.....



POWER MOWERS & KITS

FREE PLANS

LOW FACTORY PRICES DIRECT TO YOU

3 & 4 Wheel Model



4 Wheel Direct Drive



Build your own quality mower with our LOW COST KITS. Parts, Engines. Free Plans guide you. 3 and 4 Wheel Kits, complete. Parts precision finished, ready to use. Write TODAY for Free Plans, Low Prices, Parts List and Guarantee.

3-WHEEL KIT NO. T-80C



America's Finest Power Mowers completely assembled in 3 and 4 wheel models. Belt or direct drive. 18" and 20" sizes. Nationally known make engine optional. Latest improved features, sturdy construction and money back guarantee fully described in color folder. Write today.

TRIANGLE MANUFACTURING CO., Dept. M-3, Fort Scott, Kansas

HISTORY-MAKING TANKS

Accurately scaled, exact replicas by

Authenticast



Send for the Authenticast catalogue, now only 25c.

Miniature models that are the duplicates of the ones used in pre-combat and recognition training and that are scaled replicas of the EXACT SAME American and Russian Tanks currently used in combat fighting. Full line of miniature fighting equipment including: Sherman, Gen. Scott and Stalin Tanks, Jeeps, Armored Cars, Tank Destroyers, Landing Vehicle Tanks.

Scaled 1" to 108"

COMET METAL PROD. CO., INC.

91-04 132nd ST.

RICHMOND HILL 18, N. Y.

LEARN MONEY-MAKING CARTOONING

IN SPARE TIME—by Easy Picture Chart Method

Same Simplified Method that has helped train creators of "Terry & Pirates," "Freckles," "Out Our Way," "Winnie Winkle," "Rep'lar Fellers," "Strange As It Seems," "The Neighbors," and many others. Earn while learning. Send 10c for Picture Chart (to test your ability), and full details. (State age.)

THE LONDON SCHOOL, 5102 Cleve. Transit Bldg., Cleveland, O.



GOLD-SILVER-COINS

Easily located with new Lightweight M-Scope Detector. Superior performance, lowest price, monthly payment plan.

FREE LITERATURE
FISHER RESEARCH LAB., INC.
PALO ALTO CALIF.



X.L. RUBBER MOLDS

Will realize your great profits quickly!

WRITE FOR NEW FREE CATALOG

YOU can EASILY learn to cast thousands of perfect plaques, book ends, figurines, ash trays, etc. IT'S EASY, FUN, PROFITABLE! X.L. Rubber, Pts. \$2.00; Qts. \$3.50; Models and enough rubber for 3 molds \$1.30 postpaid.



SEND FOR FREE FACTS

GREAT PROFITS
MAKE YOUR OWN RUBBER MOLDS

PLASTIC ARTS STUDIO Address Dept. 2
3403 S. Madison St.

Muncie, Ind.

AJAX WHITE GIANTS



FAMOUS MEAT-EGG PRODUCERS. Extra big profit breed. Contest - show winners. Massive capons, quick maturing. U. S. Approved-Pullorum Controlled. Low farm prices. Colored catalog FREE. Write TODAY. AJAX HATCHERY, BOX 915, QUINCY, ILL.

BOYS-IT'S FREE!

"THE WONDERS OF CHEMISTRY"

This exciting new book shows how to amaze your friends with chemical magic, describes many fascinating home experiments, tells of fun, thrills and big future opportunities for boys who know chemistry. Special atomic energy feature. Send today!

THE PORTER CHEMICAL COMPANY
45 Prospect Avenue, Hagerstown, Maryland



SAY YOU SAW IT IN POPULAR MECHANICS

Learn BAKING At Home

Baking is one of America's high industries in wages. Nearly depression-proof. Thorough basic home course lays sound foundation. If you have aptitude, write for FREE BOOKLET, "Opportunities in Commercial Baking."

NATIONAL BAKING SCHOOL
835 Diversey Pkwy. Dept. 1352 Chicago 14, Ill.



MEN! WOMEN!

New Car given as Bonus!



TAKE ORDERS for Nationally Advertised

NYLONS

GUARANTEED NINE MONTHS

Sensational Guarantee creating a tremendous demand for Wilknit Nylons! If they run, wear out or even snag from any cause whatever... within NINE MONTHS... depending on quantity... they are replaced FREE OF CHARGE. No wonder it's easy to quickly build up fine, steady, year-round income. Earnings start immediately. Look at these exceptional figures—Ralph Shearer made \$67.11, first week—Mrs. Paul Estes, \$42.92—Mrs. Ivey Gentry, \$43.37. Doris Jensen in addition to making as much as \$17.00 in a single day, earned two cars as EXTRA BONUSES. Learn how you can make money in your full or spare time without a bit of previous experience.

EARNED TWO NEW CARS

... and as much as \$120.00 in one week

That's the exceptionally fine record of Chas. Mills with the famous Wilknit hosiery line. Offer of New Chevrolet as a bonus open to EVERYONE. Send name for facts FREE.

SEND NO MONEY... Just Hose Size

When you send for Selling Outfit, I also send your choice of Nylons or Socks for your personal use. Don't lose a minute. Rush name on penny postcard for full money-making facts on Sensational Sales Kit. Send hose size, too. **Lowell Wilkin, WILKNITHOSIERY CO., 302 Midway, Greenfield, Ohio**

EARN MONEY IN UPHOLSTERING

Professional home training—tools, supplies, equipment included. Business of your own or a good job. Upholster your own furniture at fraction of cost. Valuable booklet free. Write now. General Trades Schools, 3810 Broadway, Dept. PM-2, Chicago 13, Ill.

WAR SURPLUS OPTICAL BARGAINS

SLIDE PROJECTOR SETS Consists of all unmounted lenses you need to make the following size projectors:
 Stock #4029-H—35 mm. \$2.85 Postpaid
 Stock #4038-H—2 1/4"x2 1/4"..... \$3.35 Postpaid
 Stock #4039-H—2 1/2"x3 1/2"..... \$3.35 Postpaid

MAKE A MICROSCOPE Get wonderful results. Own an instrument worth many times the cost to you. Simply convert a U. S. Govt. Rifle scope (Govt. cost over \$65.00). It's easy! We show you how. No machining required. Get up to 40 Power. Scope we furnish is used but good condition... sent complete with extra lenses and direction sheet.

Stock #959-H..... \$7.90 Postpaid

10 POWER SPOTTING SCOPE—A WONDERFUL BUY! Pocket Size: Complete with tripod and swivel head. Only 5 1/2" long—8 1/2" high on tripod. Adapted from Army telescope and worth many times our price. Has prism erecting system, achromatic objective, Ramsden Eye-Piece. Lenses low reflection coated.
 Stock #955-H..... \$14.95 Postpaid

SIMPLE LENS KITS—Include plainly written, illustrated booklet showing how you can build lots of optical items. Use these lenses in photography and for dozens of other uses in experimental optics, building TELESCOPES, low power Microscopes, etc.

Stock # 2-H—10 lenses..... \$ 1.00 Postpaid
 Stock # 5-H—45 lenses..... 5.00 Postpaid
 Stock # 10-H—80 lenses..... 10.00 Postpaid

We Have Literally Millions of War Surplus Lenses and Prisms for Sale at Bargain Prices. Numerous Types of Instruments, Too! Write for FREE CATALOG-H

EDMUND SALVAGE CO., Barrington, New Jersey

SPRAYING MADE EASY

BECKER Self-Contained PRESSURE GUN

Saves Cost of Compressor and Motor

TAKE IT ANYWHERE—the first completely portable spray gun. Needs no compressor, motor, or electrical outlet. Pressure-powered with an inexpensive CO2 cartridge that sprays up to 21 liquid ounces, depending on viscosity. Extra cartridges, 10 for \$1. postpaid, or buy from your dealer.

PAINTS • VARNISHES • ENAMELS MOTH-PROOFS • INSECTICIDES

Every home needs a Becker Spray Gun for dozens of jobs in the house, workshop, garden or garage. Complete instructions furnished for effective results. Order yours today for the season ahead.

HOW TO ORDER—If your dealer can't supply, send \$15.95 and we ship postpaid—or \$2 now and pay postman balance plus postage and fee. Money back if not delighted after 5 days' trial.

SULLIVAN-BECKER CO. Dept. 111-B, Kenosha, Wisc.



ONLY \$15.95 with 3 cartridges



Now! The Most Fabulous Road Racer In Auto History!



Our scale model from the original "Old 16" now owned by Peter Helck, the well-known artist. Build this Vanderbilt Cup Winner! Length 10" when completed — newest "Old Timer" Antique Auto Set! Below we show 12 other famous "Old Timers":



Check "OLD TIMERS" You Want

- | | |
|--|--|
| <input type="checkbox"/> 1911 Maxwell \$2.50 | <input type="checkbox"/> 1911 Buick \$2.50 |
| <input type="checkbox"/> 1904 Olds \$1.95 | <input type="checkbox"/> 1903 A Ford \$2.50 |
| <input type="checkbox"/> 1910 T Ford \$2.50 | <input type="checkbox"/> 1910 Internat. |
| <input type="checkbox"/> 1909 Stanley \$2.95 | <input type="checkbox"/> 1903 Harvester \$2.95 |
| <input type="checkbox"/> 1909 T Ford \$2.95 | <input type="checkbox"/> 1903 Cadillac \$2.50 |
| <input type="checkbox"/> 1903 Rambler \$2.50 | <input type="checkbox"/> 1900 Packard \$2.50 |
| <input type="checkbox"/> 1911 Mercer \$3.95 | <input type="checkbox"/> 1914 Stutz Bearcat \$3.95 |
| <input type="checkbox"/> 1906 "Old 16" Locomobile \$3.95 | |

Mail order to us for your favorites. Add 25c for postage and handling. No C. O. D.'s please

HOBBYISTS and Collectors want these nostalgic Antique Autos—each one easy to assemble with pre-fabricated parts! Actual 1/4" scale models, they're decorative and authentic. 6 1/2" to 10 1/2" in length. See them at hobby, toy or department stores. They're the cutest things on wheels! Or write to us. Prompt delivery. Guaranteed satisfaction.

Hudson Miniatures' "OLD TIMERS"

SCRANTON HOBBY CENTER, Dept. 14, Scranton 10, Pa.

TRADES THAT PAY OFF In Defense & In Industry



Jewelry- WATCHMAKING Engraving Stone Setting & Chronograph

"3 High-Paying Trades in 1 Career"

Serve in Emergency — Profit in Industry

Increasing needs in industry—defense—the trades—for thoroughly trained men.

Write for catalog and full information—also inquire about correspondence courses.

MAIL THIS COUPON TODAY

KANSAS CITY SCHOOL OF WATCHMAKING
 1218 Admiral Blvd.
 Kansas City 6, Missouri

Please send me, without obligation, complete information on training in the above courses.

Name _____
 Street _____
 City _____ State _____
 Check if Veteran G. I. Approved

BUILD ONE OF THESE *Popular Mechanics Homes* YOURSELF... Save Thousands of Dollars!

Build This 5-Room Concrete Block House **\$3650** for Only

Popular Mechanics Build-It-Yourself Concrete Block House is 26'-8" deep by 32'-8" wide. It has 675 square feet of comfortable living space—living room, two bedrooms, cabinet kitchen, utility room, bath and three closets, concrete block walls, poured concrete floors. Insulated ceiling, hot air heating, gas or oil. Hot air ducts in ceiling, cold air ducts laid under floor. Its total cost was less than \$3650 including all material, heating, plumbing and electrical equipment and outside labor for installing the equipment and plastering all rooms.



Build This 5 Room 1 1/2 Story Frame House for **\$7000**

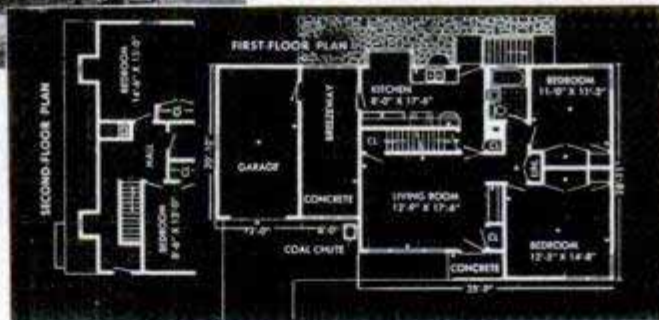

This beautiful, modern home, with breezeway and garage, as pictured, has been built in many locations at an average cost of \$7000 for all materials, equipment and some outside labor. It is 1 1/2 stories with basement, recreation room, living room, kitchen, dining nook, two bedrooms, bath, plenty of closets and space

for 2 additional bedrooms on the second floor. It has an unusually large amount of good, usable living space that can easily be increased to meet the needs of a growing family. The house itself is 35'-9" x 28'-11"; the breezeway is 20'-10" x 8', and the garage is 20'-10" x 12'.

Beat the High Cost of Home Building! Get Book and Plans Now! No Previous Experience Needed!

If you can mix a batch of concrete and saw a board straight you can build either of these Popular Mechanics Build-It-Yourself houses, yourself. Yes Sir! In a few months of spare time you can laugh at the housing shortage and save several thousand dollars while acquiring a home you will be proud to own.

The big, basic idea behind the design of the Build-It-Yourself Houses is ease of construction (so a man could do the job himself with very little assistance) and get the most living at the least cost, considering attractiveness and suitability for any neighborhood. Either is a home anyone can enjoy and be proud to own.

A detailed Build-It-Yourself Book and a set of 10 full-size building blueprint plans are available for each house. Every part of the construction is simplified and thoroughly explained in the Build-It-Yourself Books from the turning

of the first shovel full of earth to the last flick of the paint brush. Every paragraph is written in plain, understandable terms and over half of each book is pictures and diagrams, some in two and four colors, that make every construction detail simple as ABC. The Concrete Block House book also tells how to make your own concrete blocks, how to select and buy a lot and how to build a house of bricks. The Frame House Book includes lumber and mill lists and design variations. Book and set of ten working blueprint plans are all you need to get started and enjoy the thrills of home owning, doing the job yourself and saving thousands of dollars.

If you want to hire a contractor or builder, instead of doing the job yourself, you can still enjoy a tremendous saving by working from the Build-It-Yourself Book and Plans.

POPULAR MECHANICS PRESS, 200 E. ONTARIO ST., CHICAGO 11, ILL.

**WORLD'S
BEST
WANT AD
MEDIUM**

CLASSIFIED Advertisements



Advertisements in this section 75 cents per word, each insertion, minimum 10 words, payable in advance.

**NEW RATE
MAY 1951 ISSUE
85c PER WORD**

To be inserted under proper classification, copy must be in our office the
20th of the second month preceding date of issue
F. W. Johnson, Manager, Classified Advertising
Popular Mechanics Magazine, 200 East Ontario Street, Chicago 11, Illinois

YOU'LL PROFIT

By reading and answering the classified ads in this section. Hundreds of opportunities for you to make and save money

AUTOMOBILES, MIDGET CARS

WIGLESWORTH-Chasteen's Automobile History Scrapbook #1 just published! Over 250 ads and illustrations of antique and vintage automobiles dating back to 1901. Money-back guarantee. \$1.50. Wiglesworth-Chasteen, 7134-PM2 Alhambra, Mission, Kansas.

CALIFORNIA Custom accessory headquarters. Buy direct from original designers and save. Chrome dash panels, push button door, trunk conversions, chrome motor accessories, lowering kits, speed-dress-up equipment. 1951 catalog, 40 pages, hundreds of photos—25c. Eastern Auto, 3319A South Grand, Los Angeles 7, Calif.

WATER Injection. Also economy, power, methods. Free illustrated information. Neher Industries, La Verne, California.

MEXICAN Road Race Book just out! Complete history 2135 mile race across Mexico. 132 stock cars. Articles by famous authorities, drivers, personalities. Rules, leg by leg description. Travelogue over Mexico's famous new highway. 152 pages, 300 photographs. Postpaid, \$2.00. Deluxe edition \$3.50. A. Clymer, 1268 S. Alvarado, Los Angeles 6, Calif.

NON-Profit organization for automobile collectors, mechanics and hobbyists now distributes old car literature, new car information, engineering papers, shop manuals, data books, free magazines. Fraternize with world's foremost automobile nuts. Write today; get on free mailing list. Auto Maniacs, Inc., Stockbridge, Mich.

SPARK Intensifier—Gives more power, quicker starting, better mileage all cars, trucks, tractors. Only \$2.00. See ad page 280.

LIFE Doubled in new batteries—Extended in old ones! One package Jolly's Battery Aid added to water, gives more power; permanent treatment. Guaranteed. \$1 post paid. Hayden Institute, Dept. PM-1, St. Helena, California.

NEWHOUSE Now offers the world's greatest automotive book deal. See page 44 for details.

SPEED & Mileage, world's #1 power manual! Championship methods, all cars. Shows speed tuning, souping, racing tricks, customizing, 100 gas saving secrets! Double your power, gas mileage, acceleration! Covers racers, stock cars, California roadsters, sports car construction, engine rebuilding, frames, bodies, fuels, formulas, ratios, speed shop methods! How to build superchargers, dual manifolds, high compression, racing cams, dual mufflers, water injectors, economizers! Photo-section on California custom cars, body restyling, streamlining, sports conversions! Working plans! Catalogs! 320 illustrations! Includes free California Hot Rod Handbook and Custom Builders Kit! Books plus kit \$1.98 postpaid or c.o.d. Alquist Engineering, Milford 21P, Pennsylvania. (See page 40.)

THOUSANDS of speed equipment items now ready for all makes of cars. See big catalogue offer on page 44.

MOTORISTS—Stop wasting gas! New automatic vaporizer injects water vapors into combustion chambers. Fits all cars. List make, year and number cylinders. Only \$5.95 postpaid. Send cash or money order. Literature sent free. Vaporizer Company, Box 7033, Station G, Los Angeles, California.

1950 SUPERIGNITIONITER—Starting, pep, mileage. \$4.50. EG Mfg., Elmsford, N. Y.

BIGGEST Racing and hot rod catalog in world, just out! Lowest prices. Hollywood mufflers \$4.50, duals \$15.90, chrome megaphones \$1.55, dual manifolds \$9.95, racing cams \$29, heads \$23.50, water injectors \$12.95, superchargers, bargains! Free Power Calculator included. 25c coin or stamps. Alquist Engineering, Milford 23P, Pennsylvania. Dealers wanted.

DON'T Bang that door! Brand new Pressur-Vent—expels interior auto pressures, permits easy closing of doors. Works on any make car. Easy installation. Only \$1.00 postpaid. Cundiff Mfg. Co., Saybrook, Ill.

FREE Books. Don't miss the world's greatest automotive book offer by Newhouse. See page 44.

MODERN Motor Car Magazine—Facts, figures, photographs and features on all cars. Sample copy 25c; \$3.00 yearly. Crestline Publications, Box 581-A, Holliston, Mass.

PHOTOGRAPHS. World's finest automobiles. List, sample, 25c. Box 1028, Minneapolis, Minnesota.

SILENCE Overhead-valves, attachments unnecessary. \$2.00. Derderian, Box 542, Sandston, Virginia.

SMITHYS Mufflers for all automobiles. Free list. Buck's Auto Parts, Box 1296H, Merced, California.

FROM Speedway to roadway! Track-proved hi-speed heads and manifolds now available for your passenger car! No special tools needed! Increase horsepower 25%! Astounding getaway! Free illustrated catalog. Speedsport, 6215P Diversey, Chicago 39.

AUTO SUPPLIES AND EQUIPMENT

FOR Free descriptive literature on alcohol-water injection for cars, trucks, tractors write Shade, Webster, New York.

AUTO Conversions and parts. Marine manifolds for all engines. Your transmission converted to marine gear, propellers, shafts, struts, couplings, etc. Everything you need for your boat. Money back guarantee. Conversion Parts Company, 278 Adams St., Boston 22, Massachusetts.

WATER Vapor injector system. Increases gas mileage and performance. Inexpensive to build. Plans \$1. Vapo, Box 462, Kearney, Nebraska.

NEW Economy, power, methods. Free information. Neher Industries, La Verne, California.

CONVERTIBLE Top covers. Plastic fabric. Tailored. \$24. Vassar, Cleveland 5, Ohio.

1951 EDITION! It's new! It's different! Get world's largest auto accessory and parts catalog and save money! Over 50,000 items, including Hollywood accessories, hi-speed equipment, rebuilt engines, all parts and accessories for all cars and trucks. We have that hard-to-get part! Jam packed with bargains. Completely illustrated. Send 25c (refundable). J. C. Whitney, 1919 Archer, Chicago 16.

MOTORIST Save gasoline by Vacu-mating overrich mixtures. Fits all cars. For free particulars write Vacumatic, Dept. 1711, Wauwatosa, Wis.

AUTO Parts and accessories. Briggs Automotive Engineering of Chicago, P.O.B. 3454 Merchandise Mart, Chicago 54, Ill.

JEEP Body plans \$1.00. Photo circulars 20c. Motorized Vehicle Manual \$1.00. Craftsmann Books, Box 1153, Milwaukee 1, Wis.

TAKE Advantage of the complete new range in driving with the Overdrive Selector. Automatic hillholder, full engine compression, optional free wheeling. Six selective forward speeds. Eliminates use of clutch. Now available for Ford, Mercury, Lincoln, Nash, Kaiser, Frazer, Hudson, Studebaker, Jeepster. Easily installed. When ordering specify year and make. Sent postpaid with check or money order for \$9.95. Send 25c for over 70 page illustrated catalog of auto accessories and speed equipment. Auto Accessories Co., 1272 West Washington, Los Angeles 15, California.

GARAGEMEN Build your own generator and/or magneto tester. Free literature. Abbott Supply Co., Quincy, Ill.

NEWHOUSE—One of the world's largest speed equipment distributors, now makes amazing offer. See page 44.

INCREASE Gasoline mileage! Three to five miles per gallon. Guaranteed Turb-O-Vane Vaporizer, increases power; reduces carbon. \$3.50 each. Agents wanted. Turb-O-Vane, Box 1167, Stockton, Calif.

PRACTICAL! Winter-parking windshield cover. 6 feet (colored plastic). Money-back guarantee. \$1.20. Witzell, Valley Cottage, N. Y.

CUSHMAN High compression heads, \$6.95. Speed cams, \$7.50 exchange. Weber Tool Company, 4200 Whiteside, Los Angeles 33, California.

FROZEN Batteries are out—When Jolly's Battery Aid is in the water! Extends life. Adds power. One package treats permanently. Protects to 35" below. Guaranteed. \$1.00 post paid. Hayden Institute, Dept. PM-2, St. Helena, Calif.

LACHAPELLES 100,000 Miles motor and motor fuel treatment, (patented), makes any gasoline motor better. \$3.00 postpaid. Ferns Products, 8120 Walnut Dr., Los Angeles 1, Calif. (Data on request.)

CHAMPION, A-C, Auto-Lite spark plugs. Rebuilt. Guaranteed 10,000 miles. 25c each. 23c sets of 6. Postpaid. Wholesale discounts available. State brand, type, quantity. Philip Minor, 5707 Arnsby Place, Cincinnati 27, Ohio.

BUICK Parts—Enjoy new-car pep and power in your old Buick. Same day service from world's largest stock of new (not rebuilt) Buick parts and engines. Ship anywhere. Write today. Robertson Buick Co., 1001 S. Wabash Ave., Chicago 5, Ill.

AUTO And truck parts. New and used. Lowest prices. Complete stock. Prompt replies. Babbitt Auto Parts, 2833 Chicago Ave., Chicago 22, Ill.

NEW Government surplus. Low voltage circuit tester in steel box cost \$202. Our price \$27.50. Will test batteries, starters, generators, voltage regulators, grounds, short circuits. Wilt Electrical Company, 7829 S. Racine Ave., Chicago 20, Ill.

CHEVROLET Parts. Scarce motor, body, sheet metal parts. Grossman Chevrolet, Minneapolis, Minnesota.

BRUSH Plating outfits connect to a battery. No tanks or shop required. Free particulars. Gunmetal Co., Avenue J, Decatur, Illinois.

AUTO TRAILERS

BUILD Your own trailer! Plans for all kinds. Illustrated catalog 10c. Jim Dandy, 125-M. Wausau, Wisconsin.

MOTORCYCLES, BICYCLES, MOTORSCOOTERS AND SUPPLIES

MOTORCYCLE Handbook listing reduced prices on Indian and Harley new and used parts, batteries, accessories. Motor rebuilding. Send 15c. Bootz, 1700 East University, Des Moines (16), Iowa.

MIDGET Racer, less motor \$10; 1946 Whizzer \$15; 1938 Cushman \$35; James motorcycle \$45; Indian \$30; Smith motorwheel \$8; motorbike conversions \$5; 2 h.p. engine \$5. Four balloon tires \$3 (mail-order only). Send 25c for catalogue Number Thirty-Nine just out listing these and hundreds of other bargains, in new and used machines, parts, plans, war surplus, etc. (35c by first class mail). Midget Motors Directory, Athens, Ohio.

MOTORCYCLE Magazine—Worldwide coverage. Yearly subscription \$2.00. Sample 20c. Motorcycle News, 5424-A Sawyer, Chicago 25.

MOTORCYCLES, Lightweights, guaranteed, reconditioned, late models, \$98.00 f.o.b. New Orleans. Servi-Cycle Distributors, New Orleans, La.

WHIZZER In Schwinn bike \$20; good motorscooter (twist grips) \$22.50; midget racer \$40; Shaw bicycle motor \$15. Send 25c (35c first class mail) for catalog #17 jammed with other sensational bargains in wheels, motors, clutches, motorscooters, midget cars, motorettes, motorbikes, etc. Gail, 538 Erie, Toledo, Ohio.

REBUILT Gasoline engines \$9.00 to \$30.00. Cauffiel Motor Industries, Temperance, Mich.

WHIZZER (All attachments) \$25; Cushman motorscooter, extra tires, \$20; Indian motorcycle \$30 complete; midget car \$35. Rush 25c (35c first class mail) for catalog #947 listing these and scores of other amazing bargains in motors, midget cars, motorscooters, motorbikes, motorcycles, etc. Associated, Box 1764-CS, Toledo, Ohio.

TIRES And industrial wheels. All sizes. Bicycles and accessories. Send dime for list. Cycle Transport Company, 1241 So. Michigan Ave., Chicago 5, Illinois.

RECONDITIONED Motorcycles and motors. Chromium accessories. Complete stock Indian parts. Expert rebuilding. Fast service. Indian Motorcycle Sales, Kansas City 1, Mo.

AVIATION

LIGHT Planes. Design, build yourself. Large manual \$2.00. Circular illustrates plans, motors 20c. Craftsmann Books, Box 1153, Milwaukee 1, Wis.

PROPELLERS, Plans, supplies, for ice sleds, snow sleighs, air boats. Catalog 20c. Banks-Maxwell, Box 3301E, Ft. Worth.

PROPELLERS—For sleds, airframe boats. Literature. Standard Aircraft, Box 387, Ft. Worth, Texas.

BATTERIES, GENERATORS

REAL Edison batteries. Long unconditional guarantee. 37 to 600 ampere sizes. Free interesting literature. Hawley Smith Co., Croton Falls 1, New York.

ELECTRICAL SUPPLIES

BE Independent, be secure, have your own profitable business—earn \$20.00 and more a day making beautiful, fast-selling lamps at home. No equipment needed. Illustrated course teaches you quickly. Course, parts catalog, wholesale price list—only \$2. Gearon Co., Dept. 200-B2, 27 S. Desplains, Chicago 6, Ill.

4½ INCH GE 6 volt Sealbeam lamps, red or clear 50c each. 6 volt double shaft 1/30 hp. 4000 r.p.m. motors \$5.00. Balford Corporation, Brookler, Florida.

LAMPS—Build own originals, parts wholesale, any amounts. Catalogue 10c. Brown Lamp Co., Box 501, Wellston, St. Louis 12, Mo.

MAGNETWIRE, Insulation, varnish, repair supplies, Morton Electrical Service, Maywood, Ill.

FREE—New catalog. Bargains in welders, motors, generators, surplus equipment. Or, build your own kits—save. LeJay Company, Minneapolis, Minnesota.

LEARN Automotive generator, regulator, battery rebuilding. Introductory manual \$1.00. Modern Technical Manuals, Box 4704, Kansas City, Mo.

LAMP Parts—Sockets, wire, harps, cords, bases, pipes—all parts to build and repair. 64 page catalog with charts and instructions 25c. Gyro Lamps, 5402P Clark, Chicago 40.

MOTORS—1/100, 1/25, 1/4, 1/3 hp. Nationally known make. All a.c. At a sacrifice price. Write Mercury Electric Corporation, 719 Wyandotte, Kansas City 6, Mo.

LAMPS—Electrify oil lamps, vases, bottles, etc. Instructions 10c. Fisher Lamp Supplies, 3825P Eastern Avenue 26, Cincinnati, Ohio.

ELECTRIC Pencil: Engraves all metals \$1.25. Beyer Mfg., 10511-H Springfield, Chicago 43.

WELDING, SOLDERING, PLATING

ACETYLENE Welding outfits, new \$45.00; used \$25.00; arcwelders \$46.50. Eagle Welding, Dept. PM, 5085 Broadway, Chicago 40, Ill.

BUILD Your own portable arc welder. Hobart generator plus your auto engine. Saves hundreds, gets big paying jobs. Catalog free. Hobart Welders, Box M-212, Troy, Ohio.

200 AMP. Welding generators. Brand new. \$25.00. Free literature. Thorndyke Mfg. Co., Pipestone, Minn.

BUILD Your own 100 ampere electroplating rectifier at a low cost. Starkweather, Ottawa, Kans.

RADIATOR Repairing books, supplies, equipment, gasoline torch. Write, Curfman Co., Maryville, Mo.

BUY Direct from factory. Welding and cutting equipment. All makes of equipment repaired. Established 1913. Box 331, Hamilton, Ohio.

RADIATOR Repairing, cleaning, reconditioning. How to equip small shop at low cost. Supply sources, trade secrets, instructions. Now only \$3.50 postpaid. Radiator Service, McBain, Mich.

MACHINERY, TOOLS, SUPPLIES

WATCH Makers' lathe, gov't surplus, complete with motor and foot pedal. Value \$225.00, like new, \$87.50. Public Sport Shops, 11 S. 16th Street, Philadelphia 2, Penna.

10" BANDSAW. Special \$34.00! Latest design, rugged construction. Investigate! Free literature. Write today! American Machinery, 323 Russell North, Minneapolis 5, Minnesota.

PRECISION Cast small parts, jewelry, etc., in your own shop. Be a subcontractor. Lost wax process. Free equipment price list. Southwestern Specialty Co., Box 3506, Station A, El Paso, Texas.

FREE Particulars explaining workshop, farm, home machinery you build from salvage. Rush 25c (refundable) descriptive handbook. Kimo, Box 307MD, New York 19.

AUGER Bit. Sensational new design. See Barclay Co. advertisement on page 280.

DI-ACRO Hand tools, slightly used, punch press, brake, shear. Prolarger, Conover, Ohio.

ONLY \$3.95. 2" Universal lathe chuck, \$14.00 value, check or money order. Har-Mur, 2349 Devon Ave., Chicago 45, Ill.

DRILL Grinder for twist drills, \$2.95. See ad on page 280.

CIRCULAR Saw blades. Longer runs without sharpening. 8" diameter \$2.95. Satisfaction guaranteed. Van Dick, Little Falls, New Jersey.

POWER Tools. Build your own with Lewis castings. Save up to 80%. Complete castings, material and blueprints supplied for 23 woodworking and metalworking tools. 32 page catalog 10c. Write today. Lewis Machine Tool Co., 3217 Union Pacific Avenue, Dept. M, Los Angeles 23, Calif.

CHUCKS, Independent, universal; threaded 1½"-8, 1"-8, 1"-10, 1"-12, or with adapter recess. Other chucks to 16" diameter. Write for quotation and free literature. No obligation. Westcott Chuck Co., 3600 Walnut, Oneida, N. Y.

WE Make low cost forced circulation electric industrial ovens. 1001 uses; 10 cubic feet, 110 volts, only \$69.50. Fully guaranteed. Write Dept. PM, Grieve-Hendry Company, 1101 Paulina, Chicago.

ENGINES, MOTORS, DYNAMOS

MOTOR Winders, free bulletins, winding and testing equipment. Motor Industries, Quincy, Illinois.

MOTORS ½ Horse \$15, ¾ \$22, 1 \$35. Compressors \$17.50. Other bargains. State your needs. Butler, 1885 Milwaukee, Chicago 47.

REBUILT Gasoline engines \$9.00 to \$30.00. Cauffiel Motor Industries, Temperance, Mich.

WINDING Data, listing 225 motors, single and three phase. \$1.00. Motor Data Co., Box 7631, Kansas City 3, Mo.

ONE Horsepower "Fly Weight" gasoline engine complete, new \$23.00, reconditioned \$17.00 (January Page 289). Airmerchant, Springfield 9, Mass.

BOATS, OUTBOARD MOTORS

OUTBOARD Motor parts, new—used, all makes. Rebuilt outboards. Standard and oversize pistons any make regardless of age. Our boring bar rebore cylinders 1½" to 2¾" diameter. Outboard motor magneto specialists. Estimates given, no charge. Outboard Motor Mart, Inc., 309 Atlantic Avenue, Boston 10, Mass.

FASTEST Boats in the world—Build now. Complete plans available for sleek three point racing hydroplanes, runabout and others. Send 25c immediately for illustrated catalogue. Champion Boats, P.O. Box 7006, Dept. 22-B, Long Beach 7, Calif.

SAVE ½ Cost. Assemble your own boat. We furnish parts. No experience necessary. Rowboats, cruisers. Illustrated catalogue 25c. Midwest Boat Company, Menomonee Falls, Wisconsin.

CONVERT Fords and Jeep to 100% marine engines with Osco's world famous Convo-Kits. Deluxe catalogue 25c (coin). Oscomotors, 3627B Lawrence, Philadelphia 40, Penna.

BOAT Kits: Outboards, inboards, hydroplanes, sail. A cinch to assemble. Minimum expense. Catalog, specifications, prices. 25c. Brooks Boat Company, Carrollton, PM, Michigan.

220 PAGE Marine hardware catalog, beautifully illustrated for \$1.00. Money refunded with first order plus 10% discount. Marine Products, 7 Longfellow St., Baldwin, Long Island, New York.

FORD and Jeep marine conversion kits. Request catalog. Arthur Gershel, Dept. O, 51 Chambers St., New York 7, N. Y.

P38 BELLY Tanks, steel \$9.95. Free picture. Bucks Auto Parts, Box 89, Merced, Calif.

EXPRESS Cruiser or open utility, 20'. Prefabricated. Mahogany, oak, bronze. 15 to 40 m.p.h. Easy terms! Complete illustrated information 25c, refundable. Bay City Boats, Inc., Bay City 202, Michigan.

OUTBOARD Motor bargains—\$35.00 up. Send for free list! Save big money! Used parts for most makes and models. Crandall-Hicks, 911 Commonwealth, Boston, Mass.

NEW. Used, rebuilt marine motors. Marine conversions, fittings. Free catalog. Stokes Marine Supply, Dept. 24, Coldwater, Michigan.

MARINE Conversions for Ford and Jeep engines. Catalog 10c. Lehman Manufacturing Company, Department D, Newark 2, New Jersey.

FULL Size, cut to shape boat patterns, blueprints, 7½"-38 feet. Illustrated "Build a Boat" catalog. 25c (coin). "How to Build Boats" book, \$1.00. PolyWog houseboat plans \$10. Marine catalog \$1.00. Marine Specialty Mfg. Co., 3107 Detroit Ave., Cleveland 13, Ohio.

ATHLETIC EQUIPMENT, BODY BUILDING COURSES

BODY Building. Massive proportions. Personal course, Barbells. Catalog 50c. EG, Elmsford, N. Y.

TALLER! Be one to three inches taller. A new scientific method for permanent height increase has now been developed. Free information. Natural Methods, Box 453, Briggs Station, Los Angeles.

DEADLY Judo—Fiercest fighting technique. Trick knockouts. (Over 200 illustrated pictures.) Expert instructions; three volumes. Complete \$2.25. Variety House, Box 46-B Wall Station, New York 5.

BARBELLS. Exercise equipment. Courses. Free booklet. Good Barbell Co., Reading, Penna.

TAXIDERM Y

MODERN Taxidermist Magazine, Greenfield Center 2, N. Y. Devoted entirely to taxidermy, photos, articles, methods. Trial year's subscription, \$1.00.

BINOCULARS, TELESCOPES, MICROSCOPES, MAGNIFIERS

MICROSCOPES, pocket pen type, 20 power, \$2.95; 40 power, \$4.95 postpaid. Pocket pen telescope, 6 power, coated lens, \$9.95. Public Sport Shops, 11 S. 16th Street, Philadelphia 2, Penna.

SAVE 50% On new binoculars! Free catalog. Free book, "How to Select Binoculars." Write today! Bushnell's 43-M22 Green, Pasadena 1, California.

GIANT Night binocular, 20 power, stand, tripod \$500. Photos. J. Holeman, 77 Newcomer, Richland, Wash.

WAR Surplus bargains, binoculars, telescopes, sextants, millions of lenses, prisms, reticles, eyepieces, objectives, etc. Mail 10c for big "Catalog CH." Send \$1.00 for Stock CH—10-piece lens kit and big instruction booklet. Edmund Salvage Co., Barrington, N. J.

IMPORTED Binoculars, save 75%. Free catalog and book. Far Eastern, Dept. PM-2, 2251 West Pico, Los Angeles 6, California.

REFLECTOR Telescope kits, refractors. Free illustrated bulletin. Rake Instrument Laboratory, 612 Adams, Hoboken, N. J.

ASTRONOMICAL Telescopes, binoculars, microscopes, bought, sold, repaired. Books. Lists 10c. Rasmussen-Reece, Amsterdam, N. Y.

GIANT Astronomical telescope with 6 ft. tripod \$15.00, f.o.b. factory. 100 power. (10,000 area magnification). Clear vision, full power guaranteed. Ready for use. Suffolk Science Service, Dept. BT, Riverhead, N. Y.

REFLECTING Telescopes, 60X, completely assembled \$25.00. Guaranteed observatory clearness. Free information. Skyscope, 475 Fifth Avenue, New York 17.

TELESCOPES, Binoculars, microscopes, big bargain catalog free. Brownscope Company, 24 West 45th Street, New York.

POWERFUL Astronomical telescopes easily made. Perfect lenses and instructions; 100X \$3.00; 100X and 200X \$4.00; 100X, 200X and 400X \$6.00. Full power, clear vision guaranteed. Instructions alone 10c. Suffolk Science Service, Riverhead, N. Y.

SPORTING GOODS, GUNS, FISHING TACKLE, ARCHERY, TRAPPING

NEW Book—Antique gun prices. Lists 2000 American revolvers \$1. Pioneer Press, Harriman, Tenn.

SNORKELS Now \$6.95. Manufacturers clearance. Dealers inquiries invited. F.O.B. Foner Machine Company, 2826 Penn, Pittsburgh 22, Penna.

FISHING Rods. Make them right. It's easy with our detailed, illustrated booklet. Only \$1.00. Dreis-Davis Co., 419 Ocean Center Bldg., Long Beach 2, Calif.

YOUR Poster troubles solved. Send \$1.00. Harry Haisma, Wadsworth, Ill.

LEARN Gunsmithing! Details, copy Guns and Gunsmithing, plus 50 page gun catalog, 25c. We buy, sell, trade. Gunsmith, Palatine, Illinois.

NEW! Free catalog. Complete, easy-to-build glass rod kits, other fine fishing tackle values. Valuable free offer. Write today Trimline Tackle Co., Dept. Z, 508 Tinton Avenue, New York City 55.

WAR Surplus 2X gun sight; 4 1/2" long, circle and dot aiming point, can be mounted on rifle, \$5.50. Surplus Distributors, 928 N. Plankinton, Milwaukee, Wis.

SEND 10c For list either, rifles, ammunition, shotguns, handguns, or send 25c for all lists. Frayseth's, Willmar, Minn.

WANTED—Firearms (antique or modern), swords, arrowheads, war relics. Send complete description, prices. Garinger, Liberty Center, Ohio.

FISHERMEN—Make your own sinkers with our molds. Free illustrated booklet. Reading Instrument Co., Box 78, Reading, Penna.

"FREE," Crow hunting information, calling, Decoys, Toad Woodward, Lamar, Missouri.

190 PROFUSELY Illustrated pages antique and modern pistols, swords, daggers, armor, etc. 50c. Robert Abels, A860 Lexington Ave., New York 21.

5000 BARGAINS. Firearms, binoculars, war relics. Catalog 40c. Smith Firearms, Runnemed, New Jersey.

PETS—DOGS, BIRDS RABBITS, HAMSTERS, ETC.

BOXERS, St. Bernards, Hof Kennels, 5136 Cascade Rd. S.E., Grand Rapids 6, Mich.

NATURALISTS Catalog 10c. Reptile bulletin 5c. Chameleon 45c. Turtle 45c. Quivira Specialties, Topeka 51, Kansas.

RAISE Guinea pigs. Money makers. Booklet free. Taylors, B426A, Hapeville, Georgia.

HAMSTERS. Hardy northern bred, harmless, clean, odorless, money makers. Cute pets. Write for prices. Empire Hamstery, 1124 East Colvin St., Syracuse, N. Y.

BEAUTIFUL Pure white pedigreed police puppies. Ansonia Kennels, Mose, N. Dak.

GENUINE Chinchillas Payment plans. Booklet on raising 25c. Kyhis Chinchilla Ranch, Britt, Iowa.

RABBIT Raising, profitable business. Request literature. Tayco Rabbitry, Hapeville, Georgia.

ZOOLOGICAL And pet animals for sale. Illustrated catalogue, literature, 25c. Trails End Zoo-5, St. Stephen, S. C.

SEE Gulf Hamstery ad on page 44. Shows picture of hamster.

RACCOONS—Minks. Bred females. Baby skunks. Catalog, 25c. Shady Fur Farm, Springfield, Minnesota.

"TREATISE On Breeding and Raising Canaries"—\$1.00. American Canary Magazine, 3449 North Western Ave., Dept. PM, Chicago 18, Illinois.

HAMSTERS—Best breeding stock available, \$3.00 pair. Buy from us and save high advertising costs. Write for free information. Lakeview Hamster Colony, Newfield, N. J.

BRED Female mink. Booklet, pen plans, \$1.00. Lake Ontario Mink Ranch, Gravel Road, Webster, N. Y.

MAKE Big money! Raise Chinchilla rabbits. Cash markets supplied for your production. Write today! Rockhill Ranch, Sellersville 15, Penna.

EARN Up to \$400 monthly. Raise Angora rabbits! Experience unnecessary. Wool brings \$5 pound. Plenty markets. Folder free. White's Rabbitry, Newark 38, Ohio.

A Practical beginning to successful rabbit raising. 48 page illustrated booklet. Dime. American Rabbit Breeders Association. 36 AR & CBA Bldg., Pittsburgh, Penna.

MINK Raising information free. Complete. Lake Superior Mink Farm, Superior, E.E. Wisconsin.

INCREASE Your income by raising domestic rabbits. Small space needed. Ready market for delicious meat, fur and wool. Largest magazine in the industry tells you how. \$1.50 per year. Sample 15 cents. No stamps. Small Stock Magazine, Lamoni 20, Iowa.

RAISE Pedigreed rabbits for us. We buy all you raise. Literature free. Grinsteeds, Edwardsville, Illinois.

PLANTS, SEEDS, NURSERY AND GARDEN SUPPLIES

TREES And shrubs. Raise your own from seed for ornament, windbreak, snow fence, erosion control, Christmas trees, spruce, firs, pines, birch, others. Free planting guide—price list. Woodlot Seed Co., Norwary, Zone 4, Michigan.

GLADIOLUS—Spring special. Delicious yellow strawberries. Glad Haven, Sebastopol, California.

FARMS, FARM LANDS, REAL ESTATE

NEW Free spring catalog just off press! Farm and country real estate bargains, good pictures, many states, easy terms, many equipped, growing crops included. For special service, state requirements, desired location. United Farm Agency, 220-PM South State St., Chicago 4, Ill.

CANADIAN Tax sale lands for two dollars an acre and up. Small monthly payments. Farms, timber, hunting and fishing camps, minerals. Limited number of properties. Write at once for free catalogue. Tax Sale Service, Room 105, 120 Bloor St. W., Toronto 5, Canada.

MASSACHUSETTS Land. Summer resort area. Recreation, profit-making, retirement. \$50 per acre. Year to pay. Free literature. Windsor Development Company, Kimball Building, Boston, Mass.

WEST'S New digest of farms and country real estate—free! Values galore—Maine to Florida. West's, CK-2, Pittsburgh 17, Penna.

\$5 MONTHLY Buys 40 acres; near town; price \$200; free list. Box 425-P, Carthage, Mo.

GOOD Farms—Ranches. Washington, Minnesota, Montana, Idaho, Oregon, North Dakota. Dependable crops, favorable climate. Write for literature, lists describing typical farm opportunities. Specify which state. J. W. Haw, 119 Northern Pacific Ry., St. Paul 1, Minn.

GOVERNMENT Lands \$2.00 acre up. Information all states twenty-five cents. National Tax Service, 901-A Majestic Bldg., Detroit.

FLORIDA. Beautiful homesites in new Lake County development. \$245 at \$10 monthly. Near Ocala National Forest, many pretty lakes, streams, pavement. World's best bass fishing, wonderful hunting. Folder free. Howard Vernor, DeLand, Florida.

STROUT'S Catalog—Farms, homes, country businesses. World's largest! 3029 outstanding bargains, 31 states. Mailed free. Buy now and save thru Strout, 7 So. Dearborn St., Chicago 3, Ill.

POULTRY, FARM SUPPLIES

POULTRY Farmers, broiler growers, turkey raisers read the new American Poultry Journal for latest ideas and greater profits. 12 months, 50c. Special offer, 4 years, \$1.00. American Poultry Journal, 565 South Clark, Chicago.

BABY Chicks, champion mated. 52 varieties, 7 crosses, licensed inspected, bloodtested. Rush postal, large colored book free, low prices. Berry's Farm, Route 12, Clarinda, Iowa.

KNOW How to raise poultry for profit. Read Poultry Industry. Every issue packed with helpful hints and practical suggestions. Latest articles on breeding, feeding and management. Subscribe now. 1 year 65c. 2 years one dollar, foreign subscriptions \$1.00 a year. Poultry Industry, Dept. P.M., 376 Boylston St., Boston 15, Mass.

RAISE Turkeys the new way. Write for free information explaining how to make up to \$3,000 in your own backyard. Address—National Turkey Institute, Dept. 3, Columbus, Kansas.

PROFITABLE OCCUPATIONS

TURN Your spare time into cash. Make quick-selling, highly profitable lamps—every home a prospect. No experience or special tools required. New 1951 56-page illustrated catalog shows shades, shade frames, figurines and bases, oil lamp converters, boring compounds, and dozens of similar items. Also all kinds of sockets, cords, pipes, harps, finials, bases, and hundreds of other parts—everything you need. Special 8-page section shows 6 beautiful lamps in kit form ready to assemble. You buy wholesale, sell at retail—make big profits. Hundreds doing it. You can, too. Send 25c today for catalog and wholesale price list. Refundable first order. Gearon Co., Dept. 500-B2, 27 S. Desplaines, Chicago 6, Ill.

RAISE Pheasants on the \$100 week plan. Little capital and space can make you independent. Free details. Great Central Game Management System, Columbus 1, Kansas.

WANT A diesel job? Our approved, up-to-the-minute diesel training program can help you qualify for steady, big pay jobs or specialized military training. Covers diesel, tractor, heavy equipment. Easy to master. No loss of present income. Job placement advisory service. Investigate! Write for information today. Interstate Training Service, Dept. 3B, Portland 13, Oregon.

RAISE Fishworms, free literature, complete instructions 10c. Huffmans Ranch, Rives Junction 2, Michigan.

100,000 NYLONS, Rayons, cottons, \$2 doz., up. Sample razor blades, complete stock list, 25c. Sibert Co., Chattanooga 4, Tenn.

NEW Backyard income. Write Kramer, 1309 South Cheyenne, Tulsa 14, Okla.

EARN Money in spare time in radio and television. Send for full information. Receive free copy of Radio Trouble-Shooting Guide. Progressive Electronics Co., 497 Union Ave., Dept. PM-100, Brooklyn 11, N. Y.

EARN Up to \$400 monthly raising rabbits. Free particulars. White's Rabbitry, Newark 61, Ohio.

FREE Book "How to Make Money With Home Workshop" describes amazing methods used by hundreds of successful craftsmen. Tells what to make, how to sell workshop output spare time. Write at once for details. Remember it's free! Craftsman, 115-A2 Worth St., New York City.

MUSHROOMS Grown. Boxes, barrels. Instructions 50c. Spawn \$1.00. Manureless process. \$2.00. Gordons, 553 William, Winnipeg, Manitoba.

FOREIGN Employment. Construction men, building trades, mechanics, helpers, Office men. Good workers interested in foreign development projects. Pipe lines, dams, power plants, roadways, shipping, oil refineries, etc. Transportation and quarters furnished; High wages. Listings of firms actively working on projects in Arabia, Persian Gulf, Africa, Alaska, Canada, South America, Europe, etc. Send \$1.00 for Foreign Construction Compendium and application forms. Foreign Service Bureau, Dept. PM-2 (Employment) P.O. Box 295, Metuchen, N. J.

START Own business. Make polishes, cleaners, flavors, etc., in basement workshop. Details free. Monde, Pulaski, Wis.

\$46 FROM Square foot plywood. Jigsaw necessary. Write, Woodarts, Bridgewater, Mass.

\$5 HOUR Easy! Sell name plates for houses. Free sample, order blanks. Write: National, 214 Summer, Boston, Mass.

ALASKA—America's frontier. \$1.00 brings 1951 business directory, large government map giving up-to-date construction projects, current employment information, homestead and highway facts; hunting, fishing, game rules; firm's hiring and application forms. Alaska Opportunist, P.O. Box 883-P, Hollywood 28, Calif.

RESILVER Mirrors at home. Formula 25c. Ideal Service, Park Ridge 9, Illinois.

"FROG Raising!" New book tells how! Illustrated literature free. Marlboro-A, Box 7002, New Orleans 19, Louisiana.

FOREIGN And Latin American employ, ment. 1951 "Foreign Service Directory" gives up-to-minute facts on military and civilian construction, government jobs, major oil listings, aviation, transportation, steamship lines, mining, importers, exporters, how-when-where to apply, application forms, hot list firms hiring. \$1.00 postpaid. Global Reports, P.O. Box 883-P, Hollywood 28, Calif.

\$250 WEEK Reported! Free book "505 Odd, Successful Businesses." Work home! Expect something odd! Pacific-E, Ocean-side, California.

TYPISTS, Profitable business at home. Complete copyrighted information 50c. Rosdahl Industries, 4901 Elston Avenue, Chicago 30, Illinois.

HAVE Fun! Make money! "Working With Leather"—64-page booklet tells how. Send 25c for copy. Free catalog and valuable information included. Wilder-Craft, 1039 Crosby, Chicago 10.

MAKE Flexible molds! Cast plaques, bookends, figurines! Free sample! H. Tooker, 630-M Chestnut, Hamilton, Ohio.

LIFETIME Income as notary public. Appointment assistance. Stationers, Helotes 50, Texas.

BE The Popular Mechanics representative in your neighborhood and earn big profits in your spare time. Write Popular Mechanics Magazine, Room 408M, 200 E. Ontario St., Chicago, Ill.

\$40.00 WEEKLY Made growing mushrooms, fresh, dried. Dominion patent 331583. Free spawn. North American, 169P Yonge, Toronto, Canada.

BOOKS, PERIODICALS, PICTURES POSTCARDS

BASTOGNE. Photo postcard of Main Street 50c each. J. Anthony, 602 Elderts Lane, Brooklyn 8, New York.

WHAT Every Mason wants. We have Masonic books for Blue Lodge, Chapter, Commandery, Scottish Rite and Shrine. Our rituals are used the world over. Send for free catalog of books and rituals for Masons, Odd Fellows, Knight of Columbus, etc. Ezra A. Cook, Publisher, P.O. Box 796-PF, Chicago 90, Ill.

BOOKS—Encyclopedias, arts, crafts, Jiu-Jitsu. Novels four \$1.00. Catalogs 10c. Kogan, 1032-PM Church Annex, New York 8.

BARGAIN! Three used novels, our selection. \$1.00 postpaid. Book Center, 719 West Sixth St., Los Angeles 17, Calif.

RENT Fiction, non-fiction. Catalog 10c. Santens, 2700-A Ann. St. Louis 4, Missouri.

SAVE Through subscriptions. Free list. Rural Magazine Agency, Grenada-1, Miss.

BOOKHUNTERS! All subjects, all languages. Send wants! Atlantic Book Service, Lawrence Ave., Charlestown 29, Mass.

FREE Novelty lists! "Police Jiu-Jitsu," 50c! 130 Main, Spring Valley, N. Y.

HARD-To-Find Books supplied. Send wants. Pierce's, Winthrop, Iowa.

SELF-Explaining Bible: Illustrated circular free. Box 446-P, Minneapolis, Minn.

BOOKHUNTERS! All subjects. Send wants! Jaher Book Service, 620-P East 178 Street, New York 57.

GAMES AND ENTERTAINMENT

FASCINATING Football card game. Rules to make and play. 50c. Dorco Specialties, Box 22, Highland Station, Denver 11, Colorado.

MAGIC TRICKS, PUZZLES, JOKER NOVELTIES

TRICKS, Jokes, novelties. Catalogue 15c. Furr, Box 1882-D, Norfolk, Va.

VENTRILOQUIST Dummies. Catalogue 25c. Be a ventriloquist. Free literature. State age. Maher, Box 36-M251 Kensington Station, Detroit 24, Mich.

TRICK For February. \$1.00. Refund if dissatisfied. Fun. Vee-PM, Avalon, Calif.

PLASTIC Ventriloquist dummy with instructions 25c. Roalex, 32 West 39th St., New York City 18.

SHOCKING Bubble dancer 50c. Tupler Bros., 216 W. Jackson, Chicago.

FREE Trick and catalog 25c. Lerro's Magic, 509 80th Street, Brooklyn 9, N. Y.

THE Mystic Hindu vase. Mysteriously remains suspended in mid-air. It fooled Houdini. Send \$2.00. Stratton Murrell Tricks, Dept. H-3, 6417 N. 13th St., Philadelphia 26, Penna.

LEARN Magic, ventriloquism, mind-reading. Write for particulars. Fasic, Big Flats, N. Y.

584 PAGE Catalog, 7500 novelties, jewelry, funmakers, gadgets, hobbies, sports, tricks, jokes, timesavers, radios, animals, music, guns, etc. 10c. Johnson Smith Company, Dept. 314, Detroit 7, Michigan.

200 ELECTRIC Stunts, 110 volts, \$1. Kutting Sons, Los Altos, Calif.

500 TRICKS, New 1950 edition now ready! Send only 10c for your copy, containing latest in good magic for pocket, parlor, stage. Unequaled service to magicians for 30 years. Douglas Magicland, Dept. 1, Dallas, Texas.

BE A magician. Large professional magic catalog of latest tricks, 35c. Ireland, C-109 North Dearborn, Chicago 2.

PROFESSIONAL Catalog, 124 pages, 25c. Williams, 900 Plymouth, Ellwood City, Penna.

MAGIC Tricks, puzzles, books, cards, punch boards. Catalog 10c. Specialty, Box 671, St. Louis 1, Mo.

512-PAGE Catalogue of 2500 tricks, pocket, parlor, stage. World's finest magic. Send \$1.50 for catalogue (refunded first \$6.00 order). Kanter's, M-1311 Walnut, Philadelphia 7.

16 CARD Tricks and catalog 25c. Sterling Magic, Royal Oak, Mich.

WORLD'S Largest professional magic shop. keeps you in touch with latest tricks. To receive mailings, send 50c for new catalog. Holden's, M220 West 42nd St., New York.

VENTRILOQUISM Taught. 3c stamp bringing particulars. Smith, 801 Bigelow, Peoria 5, Ill.

OLD STAMPS WANTED

I Will pay \$100.00 each for 1924 1c green Franklin stamps, rotary perforated eleven (up to \$1,000 each unused). Send 10c for large illustrated folders showing amazing prices paid for old stamps, coins and collections. Vernon Baker, PM-12, Elyria, Ohio.

COINS, TOKENS, CURRENCY

JAPANESE Invasion notes, 1c to \$1,000.00, \$2.00. Burma note and catalogue 25c. Shultz, Salt Lake City 10, Utah.

LARGE List of lots, sets and individuals with foreign set 10c. Globe, 3238 Orange, Chicago 34, Illinois.

FORTY Different coins, \$1.00, 100 different bills, \$1.00, 20 coins, bills 25c. Oddehon, Box 482, St. Louis, Mo.

COIN Collectors big magazine, just out, and two wooden nickels 10c. Lawrence Brothers, Anamosa, Iowa.

10 DIFF. Coins 25c, 20 diff. 50c. Box 2201, Bischoff, Kansas City, Mo.

COINS For collectors, G. D. Ridings, Melvina Hill, N. C., Dept. D.

4 DIFFERENT Whitman coin albums \$1.00; 254 page U. S. Coin Guidebook \$1.50; 126 page handbook 75c. Giant bargain list 10c. Olson, 5800 Lake, Chicago 44.

RARE Collections 45 different dates Indian cents \$5.00, 20 different \$1.00, 1864 L cent \$2.00, 40 different dates large cents \$10.00, 15 different \$3.00, 28 different liberty head nickels \$4.00, 10 different \$1.00, 20 different half cents \$15.00; 5—\$3.00. Complete buying-selling catalogue 25c. Worthy Coin Corporation (D-406), Boston 8, Mass.

HOLY Year Vatican set 4 coins \$1.00. 1932-D quarter \$1.00. 1932-S quarter \$1.00. 1951 giant bargain catalogue 25c. Bebee's, 1180 East 63rd, Chicago 37, Illinois.

OLD Money wanted. Do you know that coin collectors pay up to \$100.00 for certain U. S. cents? And high premiums for all rare coins? We buy all kinds. Send 4c for large coin folder. May mean much profit to you. Numismatic Co., Dept. 20, Fort Worth, Texas.

FOREIGN Bills, 10 different 15c; foreign coins, 10 different 25c. Lists. O. Arnold, Macon, Mo.

50 ASSORTED Indian pennies, \$1.50; 1892 Columbian half-dollar, 75c; Whitman coin album, 25c; 1863 Civil war cent, 15c; 25 foreign coins, \$1.00; check list, 3c; large catalog, 15c; 100 2 x 2 coin envelopes, 25c. Coin Shop, 31 North Clark, Chicago 2.

COINS Wanted, will pay up to \$2000 for certain coins, send 25c for catalogue. Burton's, 111 So. Third, Columbus, Ohio.

FREE! Foreign coin, banknote and coin collectors illustrated catalog to approval service applicants. Send 3c postage. Tatham Coinco, Springfield 30, Mass.

GET Profit and pleasure in collecting old coins. Send 10c for 56 page illustrated coin catalog. You'll be delighted with it. Send for it now. B. Max Mehl, 370 Mehl Bldg., Fort Worth, Texas. Largest rare coin establishment in U. S. Established 50 years.

STAMP COLLECTING

PREMIUMS, Prices, and service that satisfy. U. S. approvals at rock bottom prices. Foreign, from 1/10 to 1/2 catalogue, mounted in books and sheets. No matter how large or small your collection is, we can help. References appreciated. Roseland Stamp Co., Dept. 10B, Spring Lake, Michigan.

FREE—Famous Americans set, Flag set, National Parks set, and Presidential set to \$5.00. A total of 90 stamps free to customers for our unsurpassed U.S. and foreign selections. Send 3c for 15 of the above stamps and full particulars. Triboro Stamp Co., 145 Nassau St., Dept. 102, New York.

100 LARGER U. S. commemoratives, used, all different, mounted, numbered; fine or better; \$1.50 postpaid by air. Jess T. Green, P.O. Box 698, Mountain View, California.

TRAINS! Trains! Trains! 12 train stamps and packet of 100 different stamps only 10c with approvals. Reich Stamp Company, 4647 Kenmore, Dept. M20, Chicago 40, Illinois.

YOUR Own printed letterheads and envelopes without charge. Full information sent on request for foreign stamps approvals. Frank L. Hock, 1909-P N. 3rd Street, Milwaukee 12, Wis.

FREE! Super set offer. Armenia set 16 stamps picturing animals, etc., Italian Social Republic set 15 stamps, picturing churches, drummer, etc., Monaco set 3 large, bicolored pictorials, with approvals. C. Moublow, 740 Hegney, Bronx 56, New York.

UNITED States bargain! It sounds unbelievable, but nevertheless it's true: "50 different United States stamps, face value as high as \$5.00 for only 10c" to approval applicants, but only one per person. Please state whether approvals shall consist of only U. S. or foreign also. Globus Stamp Company, 268 Fourth Ave., New York 10, N. Y., Dept. 219.

SAN Marino collection free—25 different old and new issues. Airmails, Commemoratives. High values—Absolutely free with approvals. Viking, 130-ZZ Clinton St., Brooklyn, N. Y.

UNITED States stamps nearly 100 years old, Roosevelt set, others, 40c value—only 5c to applicants United States approvals. Wakonda, Box 272K, Jackson Heights, N. Y.

LOOKING For bargains? Try our 1 and 2c approvals mounted in books of 1,000. We believe in both quantity and quality. First try will satisfy. Clark, Box 544P, Muskegon, Mich.

FREE! Canadian sets, royal visit, George VI, George V, coronation, jubilee, others to approval applicants. Ensign, Box 118-M, South Orange, N. J.

WHOLESALE Lists to dealers. 3c postage. Grossman, 100 West 42nd, New York 18.

EXCHANGE Stamps universe. Particulars free. "Exchangers," Bry 126, Seine, France.

ZANZIBAR, Pitcairn Islands, Turks, Caicos, Gilbert, Ellice, Solomon, Borneo, Gambia, Tanganyika and others. Complete collection free. Send 5c for postage. Gray Stamp Company, Dept. PM, Toronto 5, Canada.

LOOKING For better U. S. on approval? Write New-Way Stamp, Lawrence, Mass.

COMPLETE Army, Navy set only 10c with United States approvals. Locust Stamp Co., Box 390T, Peekskill, N. Y.

DEALERS—Wholesale list. Postage 3c. Frank; 5031 Queensberry, Baltimore 15, Md.

NORTH Borneo 25 different postwar \$1.00; 15 Brunel \$1.00; 25 Sarawak \$1.00. Douglas Voon, Sandakan, North Borneo.

FINE Approvals. Fast, personal service. What countries do you prefer? I'll send their stamps. Skinner, 438 Locust, Long Beach 12, Calif.

FREE—30 Different United States with approvals. Tauber, 708 E. Tremont Ave., Bronx, N. Y.

PENNY Approval bargains—Write Department PM, 1267 Tutwiler, Memphis 7, Tennessee.

1000 DIFFERENT World \$1.50; U. S. foreign approvals. Packet list. Keating, 4820 Reservoir Road, N.W., Washington 7, D. C.

SERBIA, Silesia, Wurttemberg free! Approvals. Colonial, Box 326A, Passaic, N. J.

WORLDWIDE Stamps. All different. 200, 25c; 500, 50c; 1000, \$1.00; 2000, \$2.50; 5000, \$12.50. Beacon Sales, Maynard, Massachusetts.

CANADA Scarce error set 10c. attractive approvals. Rheume, 8591 11th Ave., Montreal 36, Canada.

50 DIFFERENT U. S. 10c. No approvals. Seidenberg, 944, Appleton, Wis.

UNUSED U. S. bargain! 33 different unused U. S. commemoratives: \$1.00. Unused U. S. approvals accompany. Patrick Agencies, 3650D Central, Indianapolis 5, Indiana.

ILLUSTRATED Stamp magazine, 26 weeks 25c. Stamp Journal, Kalamazoo, Michigan.

FREE! Big illustrated catalog listing everything for the stamp collector. Harrisco, 202 Transit Bldg., Boston 17, Mass.

SUPER! 100 Different Japan 5c. Approvals. Potomac Stampco, Washington 15, D. C.

FREE! Big worldwide collection! Commemoratives, high values, etc. Approvals. Concord, Box 23-D, Beeville, Texas.

LIBERIAN Triangulars, 10c with approvals. Vargo Stamps, 6044 South Fairfield, Chicago 29, Illinois.

FREE! Triangle, diamond, midget, giant, Roosevelt, Hitler stamps to new customers. Thrifty Stamp Service, Silver Spring, Maryland.

500 DIFFERENT! With approvals—25c! Gateway Stamps, Box 662, La-Crosse, Wis.

100 DIFFERENT Worldwide, 5c! Approvals. Stearns, Box 602-B, Inkster, Michigan.

SOUVENIR Sheet free if you request approvals. Knight, Box 3770, Portland 8, Oregon.

NEWEST Issues, world-wide approvals. McQueen, 185 Puritan, Highland Park 3, Mich.

GOYA Nude 3c, approvals accompany. Royal Stamp Company, Tamaqua, Penna.

ZOUNDS! Amazing "queer countries" packet—Free with approvals! Saxon, Vista, California.

MONACO Nudes set—10c. Approvals accompany. Atlas, 3210-M Republic, Racine, Wisconsin.

SPECIAL Bulgaria 1941 set of 12. Complete 10c to approval applicants. Kingman, Highbridge, Box 42, New York 52.

VALUABLE U. S. illustrated catalog free. Stone, Box 52-P, Dorchester 24, Mass.

1/2c—1c APPROVALS! 12,000 Bargains! Cole, 43-A Rinewalt, Buffalo 21, N. Y.

LIBERIAN Triangles free with approvals. Ottervik, Box 75, East McKeesport, Penna.

STAMP Magazine! Copy free! Stamp Post, South Catalina, Pasadena, Calif.

START Your own stamp business. Send for free circular. Donald Shepard, Box 1147, Chicago.

1863 SAXONY Included with 193 different, 33 countries, 38 19th century 10c. Approvals. Brooks, 2352B East 23rd Street, Brooklyn 29, New York.

TOPS In value. U. S. approvals. Jarr, 309 Taft Road, River Edge, N. J.

NEW Approval plan: 10 stamps 1c! Dimond, 3152 Cuthbert, Oakland, Calif.

BOX Of foreign. Pick at 2c each. G. E. Stamps, Springfield 15, Mass.

205 AUSTRIA—All different only 10c! Beautiful commemoratives, pictorials, airmails, high values. Catalog price nearly \$6.00! Approvals included. Garcelon, Calais 111, Maine.

FREE! \$10,000 Airmail! Madagascar! Nigeria! Philippines! Approvals. Keating, 637-P Bergen, Jersey City, New Jersey.

FLAG Stamp—Free with hygrade U. S. approvals. Wenigman, 1933 Patterson, Chicago 13.

40 RUSSIA—All different, only 10c with dandy approvals! Sapphire, Box 44, Times Square Station, New York 18.

STAMP Magazine. 1 year, 50c, copy 10c. Holmes, Kings Highway, Independence, Mo.

GIANT Approvals book 500 penny stamps, 40 stamps 1 1/2c up. 5 sets. Wahl's Stamp Exchange, 7008P Farragut, Chicago 31, Ill.

GIGANTIC Triangle, pictorials, free! Buza, Stevens Point 99, Wisconsin. (1,012 stamps, 50c).

ROOSEVELT Memorials: 14 different 10c. Approvals. Robert Wilks, Beverly, Massachusetts.

INTERNATIONAL Specials. 1000, \$1.00; 3000, \$5.50. 5000, \$12.25. No approvals. Hale Stamps, 7609 Grand, Minneapolis 19, Minn.

U.S. Used—Good to fine. Approvals. Glades Stamp Company, Box 2842-M, Miami 18, Florida.

\$28.50 FOR \$1.00! Collection of 1017 different stamps cataloging \$26.00—Plus valuable A.M.G. collection retailing \$2.50! Both for \$1.00! Bargain approvals accompany. Stampex, 116-G Nassau St., New York City.

FREE! Big United States catalog! Invaluable guide and check list. Hundreds of illustrations. Harrisco, Boston 17-W, Mass.

U.S. Commemoratives, 200, \$4.75; regular, 300, \$5.50. Hale Stamps, 7609 Grand, Minneapolis 19, Minn.

"HOW TO Recognize Rare Stamps." Free book illustrated! Kenmore, Richford, H-57, Vermont.

100 DIFFERENT Free, 10% discount on all approvals. Hofstra Stamps, West Midway, Mass.

FREE—Illustrated catalog! Kenmore, Richford, C-57, Vermont.

500 STAMPS For only 10c! This mammoth value includes airmails, pictorials; stamps from strange countries, cataloging up to 25c each! Also approvals. Mystic Stamp Company, Camden 80, New York.

FREE "Stamp Finder." Tells instantly country to which any stamp belongs. 32 pages profusely illustrated. Garcelon, Calais 17, Maine.

GIGANTIC Penny approval selections. Resch, 3739 N. Wilton, Chicago 13, Ill.

307 ALL Different—Only 15c! Beautiful collection: commemoratives, triangles, high values, bicolored stamps, etc. Garcelon, Calais 400, Maine.

50,000 STAMP Grabbags 25c each. Anderson, 630B, Bingham, Reading, Penna.

OLD Scarce U. S. seconds on approval. Slight imperfections, lowest prices. Hernefield, Clintonhill Sta., Newark 8, N. J.

500 EXOTIC Japan stamps—10c. Kenmore, Richford, J-57, Vermont.

COLUMBIANS, Trans-Mississippi, Pan Americans, Pan Pacific, ten other different commemoratives. All 10c with your request for U.S. approvals. Moda Stamps, Box 251-X, C.S.A., New York 8.

300 DIFFERENT Foreign 15c to approval applicants. McKinney, Elsie, Michigan.

TOPS! Our book "How To Collect Stamps." Send for your free copy today! Littleton Stamp Co., Littleton 37, N. H.

PORTUGAL 30 Different 10c. Reidenbach, 88 Lexington Ave., Troy, New York.

FREE Commemoratives, airmails, pictorials. World wide approvals. Wisehart, 900 Second, Frankfurt, Ohio.

AMAZING Offer! 500 United States stamps—including commemoratives, airmails, high values to \$5.00. Only 10c to approval applicants! Illustrated bargain lists free. Mystic Stamp Co., Dept. 80, Camden, New York.

OVER 1,000,000 Sold; 200 different stamps 10c with approvals. Carlton's, Tujunga, Calif.

SPORTS Set plus four others 5c. Approvals. Wirth, Norwichtown, Conn.

FREE, Five foreign sets. Approvals. Stoll, 2632 Burnett, Louisville 10, Ky.

BARGAIN Borneo, Norfolk, largest stamp, Virgins, Iceland, old U. S. 100 different others; everything 10c with approvals. Satra, Valentine, Nebr.

200 U. S. Commemoratives, old and new. \$1.00. Weatherby, Medina, Ohio.

TERRIFIC Approval selections with free gifts. Hutchinson's, 3463 "T" Street, Philadelphia 34, Penna.

750 FRANCE And colonies stamps 10c. Littleton Stamp Co., Littleton 25, N. H.

U. S. Complete price list free. Lush, 47 Tyler, Detroit 3, Mich.

10,000 PENNY Approvals waiting for you. Many from exotic countries, pictorials, airmails, new issues. Tilbury, Box 862, Newark 1, N. J.

FREE! Surprise packet. Penny approvals. Pioneer, Box 414, Pasadena 18, Calif.

FIRST U. S. (1847) government reissues 5c, 10c, plus giant bargain U. S. collection—only 5c to applicants U. S. approvals. Metropolitan, Box 312G, Jackson Heights, N. Y.

FREE Collection—Over 100 different stamps of the world—commemoratives, she-wolf, camels, giraffes, ships, rare Austria race horse, others all to approval buyers; also Scott International Albums, stamp catalogs. Bell Stamp Service, Dept. S-2, Bell, California.

FREE U. S. price list, postage 3c. Mark Hanna, 335 5th Ave., Pittsburgh 22, Penna.

U. S. All different: 100, 40c; 200, \$1.00; 300, \$2.50; 100 commemoratives, 80c. Pat Knowles, 1626 North Harvard, Hollywood 27, Calif.

GIPT Nicaragua baseball airmails, 5 to approval applicants. Deane Stamps, Box 87, Miami 35, Florida.

10 ASSORTED U. S. Commemorative 15c. Five U. S. Air Mail 15c. 10 Famous Americans 25c. All for 50c. Ideal Stamp Shop, Box 179, Park Ridge, Illinois.

POSITIVELY Greatest free offer—Latest Scott's international \$6.00 stamp album, covering entire world, contains 36,000 illustrated descriptive spaces. Scott's New Standard \$7.00 catalogues "Philately's Encyclopedia"—absolutely free to applicants for foreign approvals becoming customers. Plymouth Specialty Co., Dept. A-9, Box 510, Bell, California.

FREE! Powerful magnifying glass. Jamestown Stamp, Jamestown 202, New York.

TRY "Gold Nugget" approvals: U. S., Americas, British Colonies, world. Nothing like them! 312 mixed U. S. only 10c to approval applicants. Kessel's, Folsom, California.

UNUSUAL—Unheard of. Cancelled sets of Roosevelts and Washington bicentennials complete. All yours for fifteen cents. Bargain approvals accompanying. Park Stamp Co., Box 191, New York 21, N. Y.

FREE. Scott's International Album. Other big premiums. Full particulars with approvals. Raymax, 123-Z William St., New York City 7.

WOW! 203 All different Germany 10c! Zeppelins, semipostals, airmails, high values, etc. to new customers. Jamestown Stamp, Jamestown 512, New York.

FREE! 50 Different Japanese stamps! Approvals. Star Stamps, 225 Willard, Jamestown, New York.

300 DIFFERENT Given free with approvals. Postage 3c. Windsor Stamps, 1435 East 67th Place, Chicago 37.

110 DIFFERENT Hitlers, Roosevelt, Liberia, Haiti, etc. 10c. Buckey, 208 Ludlow Bldg., Dayton 2, Ohio.

FREE—Cuba Roosevelt issue and illustrated catalog. Littleton Stamps, Littleton 12, N. H.

10,000 DIFFERENT 1c Each! Gordon Davison, Box 1019S, Manchester, N. H.

FREE Philatelic supply list. Penny approvals on request. Reed, Box 980, Chicago 90, Illinois.

PENNY Approvals that satisfy. Neil Gronberg, Box 5441-P, Philadelphia 43, Penna.

U. S. Price list. Send postage. State Stamp Service, 1225 Park Building, Pittsburgh 22, Penna.

STAMPS Wanted. Collections, duplicates, surplus stock, mint and used. Trade for printing; buy outright if bargain. What have you, what's wanted. Vanroy Shirk, Lebanon, Penna.

WORLD'S Largest stamp (7 1/2 x 14 inches). A real curiosity! Retail for 50c, only 3c to approval applicants. Tatham Stamp Co., Springfield 30, Mass.

FREE! 100 Worldwide different stamps to approval buyers. Big U.S. and illustrated bargain lists sent with approvals. Bookman, Maplewood, N. J.

200 DIFFERENT Including Roosevelt triangle, 5c to approval applicants. M. Avalon Stamp Company, Springfield, Mass.

MAGNIFIER, Big stamp magazine; first U. S. commemorative; plus unused \$5000 Foreign Legion, diamond, giant, and other worthwhile stamps. Everything free to approval buyers. Capital Stamp Company, Little Rock 2, Arkansas.

ANTIQUES, RELICS, INDIAN GOODS, CURIOS

INDIAN Relics, guns, books; thousands items; catalog 25c. Frontier Bookshop, 1813 Main, Houston, Texas.

INDIAN Beadwork, buckskin, beads, feathers, moccasins, wigs, supplies; buying direct from Indians; prices reasonable; free list. Pawnee Bill's Indian Trading Post, Box 35-P, Pawnee, Okla.

PRECIOUS STONES, MINERALS

TEN New Mexico mineral specimens \$1.50. Six fluorescents \$1.00. Fool's gold 2c. Free literature. Prospector, Winston, New Mexico.

AGATES, Gems, free list. North West Gems, Box 305, Tacoma 1, Washington.

MINERAL Specimens, cutting material, slabs, and gems. Send for free price list. Warren's Minerals and Gems, 1969 Abbott St., San Diego 7, Calif.

MINERAL—Treasure locators, Geiger counters. Superior performance, lowest prices. Payment plan available. Free literature. Fisher Research Lab., Inc., Palo Alto, California.

ROSE Quartz, jasper, agate and catalogue. Quarter. Gemco, Elkhart Lake, Wisconsin.

GEMSTONES, Mineral specimens. Every variety. Lowest prices. Postcard brings free booklet. Plummer's, 2183C Bacon, San Diego 7, California.

HOBBIES AND COLLECTIONS

START A profitable and fascinating hobby. Learn radio and television at home at a minimum cost. Send for full particulars. Receive free copy of Radio Troubleshooting guide. Progressive Electronics Co., 497 Union Ave., Dept. PM-200, Brooklyn 11, N. Y.

50 DIFFERENT Army embroidered patches \$1. Other bargains. Insignia Mart, 703A Broadway, New York 3, N. Y.

COLLECTORS—Old railroad pictures. U. S. Write Carl Smith, Concord, N. H.

WHAT Are your old stamps worth? Look them up in our price guide. 128 pages. 1,000 illustrations. 10,000 prices. Only 25c—satisfaction guaranteed. Harrisco, 801 Transit Bldg., Boston.

U. S. Army insignia patches. Ten assorted outfits, \$1.00. C. B. Bishop, 29 Stanford St., Gaspee Plateau 5, R. I.

NEW—15 Different match covers 10c. Box 202, Rochester 1, N. Y.

UNUSED Matchbook covers—100 different \$1.00. Catalog 25c. Charles Edelman, 1311C East 84, Cleveland 3, Ohio.

INVENTING Can be an interesting and profitable hobby. Write for complete particulars. Institute of American Inventors, Dept. 40-E 631-E St. N.W., Washington 4, D. C.

CAMERAS, PHOTO SUPPLIES

NATURAL Color Processes, by Dunn. Fifth edition of the famous book outlining all instructions you need to produce color prints through any process in use today. \$5.00. Photographic Facts and Formulas—Wall & Jordan. Every photographic formula worth knowing and how to make best use of it. Best darkroom guide and general reference. Special \$5.00. Cash with orders. Amphoto Dept. A, 421 Fifth Avenue South, Minneapolis 15, Minnesota.

SEND For literature on panorama operator for taking panoramic pictures with your roll film camera. 9456 Ben Nevis Blvd., Riverside, Calif.

FREE Photographic bargain book packed with hundreds of sensational values in still and movie cameras, lenses and latest accessories. Super savings for you in new and used equipment. Liberal trade-in allowances, too, on your equipment. Write now for your free copy to Central Camera Company, Dept. 9B, 230 S. Wabash Ave., Chicago 4. (Photographic headquarters since 1899.)

PHOTOCOPY Anything—Papers, books. No darkroom. 8½" x 11" complete \$6.95. Fotoflek, 8555 Plainfield Lane, Cincinnati 36, Ohio.

YOU Can take real glamour photographs, with eye appeal, if you know the secrets. Glamour Guide by Eugene Hanson, the book on how to photograph girls, gives you the answers. For classical study of figure photography, Pictorial Figure Photography is the book. Cash with order. Glamour Guide—\$5.00. Figure Photography—\$2.00. Amphoto Dept. A, 421 5th Avenue South, Minneapolis 15, Minn.

BASS Says: Trading cameras a national habit since 1910. Write to Bass the old "horse trader." A postcard will do. Simply say: "Bass, I have and I want. How much will you allow me?" It's fun to trade with Bass. Satisfaction guaranteed. Bass buys, sells, and trades. Bass Camera Company, Dept. AG., 179 W. Madison St., Chicago 2.

PHOTOMURALS. Your negatives or ours. Catalogue 25c. Photomammoth Murals, 12048 Vanowen St., North Hollywood, Calif.

PICTORIAL Figure photography illustrated by 6 full color 2x2 or Stereo slides \$2.00. Includes data on exposure and use of filters in color photography. Free literature on full set of 24 free to adults only. Sid Klein, Inc., 7916 Beverly Blvd., Los Angeles 48, Calif.

PHOTO FINISHING

OIL Coloring photographs can be a fascinating hobby or profitable sideline for those with artistic talent. Learn at home. Easy simplified method. Send for free booklet. National Photo Coloring School, 835 Diversey Parkway, Dept. 3441, Chicago 14, Illinois.

JUMBO Prints. 30c 8 exposure roll; 40c 12 exposure; 50c 16 exposure. Overnight service. Satisfaction guaranteed. Photocraft of Superior 3, Wis.

FREE Price list on quality developing, printing, enlarging. Write for it today. Bryan's Photo Shop, Dept. M, Panama City, Florida.

16 PRINTS Or 8 jumbos from roll, 25c with this ad. S. Skrudland, River Grove, Ill.

FREE 5 x 7 Enlargement with each roll developed and printed. 6 or 8 picture roll 35c. 12 or 16 picture roll 55c. Send coin with roll. No c.o.d. If you fail to get pictures on your roll of film, we will mail a new roll to you at no additional cost. Overnight service. Mailers sent free on request. Deluxe Film Service, Box 1268-A, Shreveport, Louisiana.

MAIL Us your films. Prompt service. 8 exposures developed and printed 30c. Free enlargements. Foto Art Studio, Box 406, San Francisco, Calif.

MOTION PICTURES AND SOUND EQUIPMENT

NEW 1-Reel 16mm. sound films low as \$3.98, formerly \$17.50; new 1-reel 16mm. silents, \$1.98 up, formerly \$8.75; all first quality prints in original cartons. Used Panoram 100' 16mm. musicals, \$9.95 per dozen. Equally attractive bargains in good used feature pictures, cartoons, sports, comedies, musicals, travels. Big selection of used 16mm. sound projectors. Save on new and used reels and cans, projection lamps, and other supplies. We have the biggest stock of 16mm. films in the world; over 100,000 prints on hand! Write today for your copy of Blackhawk's big catalog 5-F. "Sixteen's Super Market." Blackhawk Films Inc., Davenport, Iowa.

THE World's greatest story. "Entire Life of Christ;" 8mm., 16mm. Sound and silent. Rent or purchase. Hemenway Film, 33 F Melrose Street, Boston 16, Mass.

THRILLS! Action! In exciting 8-16mm. movie film subjects. Big movie and equipment catalog with sample film, 25c. National Film Supply, Toledo 9-H, Ohio.

LEARN Professional motion picture technique at home. Free catalog. Motion Picture Institute, Birmingham 4, Mich.

16MM. Sound films. Guaranteed condition. Waverly, 5707 So. Christiana, Chicago 29.

FREE Movies. Hundreds of subjects, interesting, entertaining, fascinating. Latest directory, only 50c. National Cine Society, 126 Lexington Avenue, New York 16, N. Y.

ADD Spice to home projection shows with colorful old-time Nickleodeon slides. 2x2. Write for free list. Nickleodeon Co., New Fieldner Bldg., Portland 5, Oregon.

ALASKA, Mexico, and wild white rapids canoeing. Rare original 16 mm. koda-chrome adventure movie film surplus shots. Select what you want 40c foot. Neil Douglas, Explorer, Lecturer, Box 664, Meriden, Conn.

FILM Exchange—16mm. sound, silent. Your 400' reel and \$1.00 brings different reel, equal value. Postpaid. Estes Record Shop, Brunswick, Missouri.

FILM With free processing 100 foot 16mm \$2.95, 25 foot 88mm. \$1.29. Fromaders, Box 637A, Davenport, Iowa.

CLEARANCE Sale of 16mm. films. Want a real buy in 16 mm. sound films? Take advantage of the I.C.S. 1951 clearance sale of 16 mm. sound features: Comedies, cartoons, novelties, musicals, new, used. Specify: Send for our giant list "A" today stating machine you own (make and model). Institutional Cinema Service Inc., 1560-PM Broadway, New York 19, N. Y.

8-16MM. Silent-sound films. Complete rental library. All latest subjects. Free catalogue, sample film 10c. Garden Film, 317 West 50th, New York 19.

GUARANTEED Fresh 8mm. roll, magazine; 16mm. roll, magazine movie films. Color, b&w. Free catalog. ESO-S, 47th Holly, Kansas City 2, Missouri.

UNUSUAL 8 MM. and 16mm. films used by many art students. Catalog free to adults or send 25c for sample strip. Sid Klein, Inc., 7916 Beverly Blvd., Los Angeles 48, Calif.

BASS Says: Leadership since 1910 guarantees satisfaction. Finest Cine equipment: 8mm., 16mm., and 35mm., silent and sound. Write the old "horse trader." Satisfaction or your money back always! Bass Camera Company, Dept. A, 179 W. Madison St., Chicago 2.

"CINE-VOICE" Sound-on-film camera shoots your own 16mm. color talking pictures. \$695. Write for free illustrated folder. Berndt-Bach, Inc., 7345 Beverly Blvd., Hollywood 36, California.

1000' 16MM. Silent-sound projection film \$7.50. International, 2120 Strauss, Brooklyn 12, N. Y.

BETTER 8MM. and 16mm. movie camera film. Free equipment catalog. Better Films, 742 New Lots, Brooklyn 7, N. Y.

UNUSUAL 8 And 16mm. films, used by many art students. Write for free catalogue. Send 25c for sample strip. Priart, 140-A Liberty Street, New York 6.

RENT 16MM. sound films, 50c reel. Large selection; free catalog. Film Service, 128 Chestnut St., Roselle Park, N. J.

GUARANTEED Fresh anti-halo outdoor movie film! Weston 16! Daylight loading! Processing free! Three spools double 8 mm. \$4.50! Six single 8 mm. for Univex, \$4.60! Postpaid! Catalog. ESO-S, 47th Holly, Kansas City 2, Missouri.

MUSIC AND MUSICAL INSTRUMENTS

REAL Composer of music will cooperate in song production. Fine publication proposition. Recordings by fine artists on nationally advertised label. Record recent release \$1.00 prepaid. C. Isabel Mayer, Box 3896, Portland 8, Oregon.

WHOLESALE—Popular used jukebox records, 100-\$15.00 f.o.b. No catalogs. Milner's, 204 Griffin, Atlanta, Ga.

POEMS Wanted. Broadcast consideration. Sooner Song Co., 22 PM North West 8th, Oklahoma City 2.

UKULELE Fans. It's simple as A B C to play every chord in popular music with the Uke-Master Chord Chart. Complete 144 easy-to-play chord diagrams with instructions—only 25c. Send coin only, to Churchill Publications, Hackensack, New Jersey.

PIANISTS (Adult). Greatly improve technic, accuracy, sightreading. Quick results. Also, composition, harmony, song-writing studies. Also, complete classical or popular piano studies. Also, arranging, criticism, how to sell songs. Free booklet. Write Broadwell Studios, Dept. 51B, Covina, California.

1951 ACCORDIONS—Wholesale. Free catalog. American Accordion Center, 5329 Belmont, Chicago.

POEMS Wanted for musical setting. Send poems for free examination. Five Star Music Masters, 630 Beacon Bldg., Boston, Mass.

YOUR Voice made loud, clear and powerful with my diaphragm exerciser. Write, Inventor "Oz," 34V, Box 665, St. Louis, Mo.

PHONOGRAPH Records cheap. Catalogue. Paramount, FQ-313 East Market, Wilkes-Barre, Penna.

ACCORDIONS—All brands. New and used. Save 50%. Wholesale to every one. Del Principe, 307 So. Wabash, Chicago, Ill.

WANTED! Poems for musical settings. Write Songwriters' Service, Clifton, N. J.

SONGWRITERS! Send poems, songs. Music Service, 243 West 72nd St., PM, New York 23.

WRITE Songs. Big money and reputation. Write for information. J. Gordon Pub. Co., 4790 South California Avenue, Chicago.

POEMS Wanted to be set to music. Free examination. Send poems. McNeil, Master of Music, 510-PM S. Alexandria, Los Angeles, California.

RADIO AND TELEVISION

BUILD 15 Radios at home, only \$1.30 each. Experience unnecessary. Home radio course includes trouble-shooting and servicing, lessons, quizzes, and all parts and instructions. Nothing else to buy. Earn money doing radio and television repairs while learning. Prepare for profitable future. Free trouble-shooting tester with each course. Send for full particulars and receive absolutely free a copy of the Progressive Trouble-Shooting Guide. Progressive Electronics Co., 497 Union Ave., Dept. PM-10, Brooklyn 11, N. Y.

FREE—Send for new 1951 Buyer's Guide. Has thousands of top values in television, radio, electronic supplies. Concord Radio Corp., Dept. LB-51, 901 W. Jackson, Chicago 7, Illinois.

FREE! 212 Page radio and television catalog! World's largest stocks, lowest prices. Complete supplies for builders, experimenters, amateurs, servicemen. Latest radios, phonos, television, recorders, sound equipment. Thousands of parts, tubes, test instruments, books, diagrams. Top quality money saving values. Get it now! Allied Radio Corp., 833 W. Jackson Blvd., Dept. 34B1, Chicago 7, Illinois.

FIX Any radio. Amazing new instrument locates radio troubles double quick. Simple instructions show you how. Thousands now in use. Free. Write today for 32-page illustrated technical manual. "The Inside Story." Feiler Engineering Co., Dept. 2PM1, 1601 S. Federal St., Chicago 16, Ill.

COLOR Tone your television! Free information. Harvard Laboratory, 657 Fulton Street, Brooklyn, N. Y.

"RAPID Radio Repair." Refreshing, unorthodox, practical book. \$1.25. John D. Burke, 168-08 90th Ave., Jamaica 3, N. Y.

24 PAGE Plans 18 Long Distance Crystal Sets, 25c; including Radiobuilder, catalog. Laboratories, 411-C Capitol Hill, Reno, Nevada.

MAKE Simple, tubeless, batteryless, distance-getting crystal radios. Crystal and illustrated instructions 25c postpaid. Allen, 427-P, Clinton, Mo.

PICTORIAL Instructions, midget one tube radio, all-purpose tester. 25c. Arthur Alena, Wall Street Station, Box 271, New York 5.

EARN While building radios. Learn television. Experience unnecessary. Parts, tools, instructions supplied. Free details. Federal, 176-71 Union Turnpike, Flushing 3, New York.

RADIO And television tubes. We have all numbers. They're all new at good discounts. Write us for your needs. Immediate response. Beacon Stores, Inc., Anderson Avenue, Grantwood, New Jersey.

BUSINESS OPPORTUNITIES

A BUSINESS In your own home! Our chemicals, plus free water and cheap "grocery store" materials can bring you over \$500 monthly earnings. Plans and formulas free. Western Aircraft, Dept. B, Los Angeles 19.

MIRROR Resilvering. Wonderful home business. Complete formula 25c. Magic two-way mirrors. You can see out—no one can look in. Formula 50c. How to make coppered mirrors, vases, glasses. Formula 50c. All three \$1.00. Nelko Chemical Service, Box 3462-MB, Chicago 54, Ill.

\$85.00 WEEKLY Possible. Amazing homework plan. Details free. Frank Graham, Gen. Del., Oklahoma City, Okla.

CASH For your idea, 280 manufacturers need inventions, patented or unpatented. List free. Invention Bureau, 208-M Clinton, Oak Park, Ill.

"WATERLESS (Lanolin) Hand Cleaner." (Oil base.) Make, sell. No machinery. Build profitable business. Complete formula \$1.00. Ideal Service, Park Ridge 1, Ill.

EARTHWORM Breeding. Valuable bulletins on successful methods mailed free. Earthmaster System, Dept. 14, El Monte, Calif.

MEN And women grow mushrooms. Celar, shed. We pay \$3.00 lb. We paid O. Babbitt \$4,165 in few weeks. Send \$2.00 for 40-page illustrated manual and start mushrooms. Dept. 122, Washington Mushroom Ind., 2954 Admiral Way, Seattle, Wash.

START Your own business on credit. Always your own boss. 1559 dealers sold \$5,000 to \$28,000 in 1949; their average \$6,834. We supply stocks, equipment on credit. 200 home necessities. Selling experience unnecessary to start. Wonderful opportunity to own pleasant profitable business backed by world-wide industry. Write Rawleigh's, Dept. BU-PPM, Freeport, Ill.

IMPORT, Export! Men, women. Learn from established world trader. Your own profitable world-wide business by mail order from home without capital; or travel abroad. Experience unnecessary. Free details. Mellinger, C-4, Los Angeles 24.

EASY To make expensive perfume with low cost "essential concentrate base." Fast, tremendous profits. Write post card. H. May, Box 4473-PF, Coral Gables 34, Fla.

TO \$35.00 Weekly. Spare time, home operated mail order business. Successful small "beginner's" plan. Everything supplied. Lynn, 5710-M Bankfield, Culver City, California.

START Home manufacturing business making cleaning compounds, soaps, insecticides, cosmetics, polishes, food flavors. No machinery. Literature free. Kemix, Park Ridge 2, Ill.

TRADE Magazines help you to success. Get latest copies through our easy-to-get-acquainted service. More than 1200 business, professional, farming, investment, educational, sport, hobby, music, radio, etc. List free. Commercial Engraving Publishing Company, 34C North Ritter, Indianapolis 19, Indiana.

BUY Wholesale—Million articles. Supply source directory, dime. Nelko, Box 3462-DB, Chicago 54, Ill.

AMAZING Patented screw-holding screw drivers! Removes, inserts screws hard-to-get-at places! Urgent mechanics tool. Also non-skid rug underlay that prevents accidents in home. Tremendous profits, exclusive territories. Toolco, 90B Summit Ave., Brookline, Mass.

MAKE Tough, durable plastic; 1c pound. Makes attractive floors, walls, built-ins, roofs. Build good home, \$150.00 room. Bays Laboratory, Oklahoma City 9.

MAKE Perfume. Big profits. Mailorder. Expect secrets. Write Imasco, 6347 Parnell-PM-2, Chicago 21, Illinois.

BIG Money in your own business. Sharpen circular saws for builders, lumber yards, farmers, others—with new Belsaw complete circular saw shop. Low cost, no experience needed. Write Belsaw Machinery Co., 24 Field Bldg., Kansas City 2, Mo.

BIG Money! Spare or full time in your home. No selling! Spray new miracle finishes, plush and suede, on signs, radios, automobiles, figurines, lamps, toys, etc. Our business is booming. Help us fill huge demand. New easy Flok-Kraft methods. Material costs few pennies. You get dollars. Free samples, complete powerful money-making plan free. Write now! Coast, 1002B S. Los Angeles St., Los Angeles 15, Calif.

BE Independent — Operate America's lowest price penny vending machine. Big profits. Immediate shipments. Write for bulletin and prices. Fielding Mfg. Co., Desk 20, Jackson, Mich.

EXCEPTIONALLY Profitable making finest perfume. Sample fragrance, full particulars free. Genmerco, Box 142-L, Dorchester 24, Mass.

ESTABLISH Profitable home mail business with your exclusive proposition. Idea to mailbox service. Booklet free. NMD Agency, Box 88-W, Dorchester 22, Mass.

\$35 WEEKLY! Home! Two hours daily! Invisible Textile Reweaving Course \$2. Twenty-seven other methods! Free details! Walsh, 894 Main, Buffalo 2, N. Y.

SPECIAL Rubber for making molds. Literature and sample free. Universal, Box 1076-A, Peoria, Ill.

TOOTH Brite removes tobacco stain, film, from teeth, dentures. Liberal profits. Cumulative, 1505 Race St., Philadelphia, Penna.

"GOOD News!" Opportunity seekers! Sample copy dime. Heidorn, Box 184, New York 25.

MANUFACTURE Automobile and furniture polish at home without machinery. Complete instructions \$3. Information free. Henry, 2815 Boulevard, Jersey City, N. J.

WORK At home. Get orders by mail. Everything supplied at low cost. Big earning possibilities. Write: Edmondson, Box 4865-P, Atlanta 2, Ga.

BOOKKEEPERS Boost income operating simplified bookkeeping service. Kern, 4942 Vineland Avenue, No. Hollywood, Calif.

BRONZE Baby shoes. Great home business. Amazing profits. No machinery. Very simple. Guaranteed process, formula \$1.00. Nelko Chemical Service, 3462-BB Merchandise Mart Sta., Chicago 54, Ill.

RAISE Earthworms. Easy, profitable. Send for free literature or send dollar bill for illustrated book. Money back guarantee. Earthworm Culturists, Box 710, Atlanta 1, Ga.

THOUSAND Articles wholesale. "Supply Source Directory" 10c. Ideal Service, Park Ridge 30, Illinois.

RUBBER Molds! 50 different! Dollar up! Illustrated lists free! Castcraft Studios, 508-P Marion St., Brooklyn 33, N. Y.

BUY It wholesale! Manufacturers, distributors offer 850,000 items. Literature free. Olsen, 1231-A East Third St., Duluth 5, Minn.

MAKE Perfumes at home. Write, Carey Laboratories, 1914 Chouteau PM-2, St. Louis 3, Missouri.

OUR Patented machine creating new service business in fast growth field. Free booklet "Aiming at a First Year \$15,000 Profit" and letter of introduction to one of 60 successful plants operating near you. New yet proven. Price \$6750 in 24 payments. E. M. Co. Inc., 101 S. 44 St., Philadelphia 4, Penna.

START New easy moneymaking home business. No selling. Free details. Southwest, 1309A North Princeton, Albuquerque, New Mexico.

"ELECTROPLATING — Know-How" includes baby shoe metallizing, brush plating, chrome plating; learn easily. Free particulars. Joseph B. Kushner Electroplating School, Stroudsburg 51, Penna.

"HOW To Build Your Own Mail Order Business" new edition 25c. Satisfaction guaranteed. H. Sullivan, 6168 Westminster, St. Louis 12, Mo.

SAWDUST. Turn it into cash. Six methods. Instructions 25c. Charles Co., 12-BWD, Norwood, Ohio.

LIFE-Time security! Manufacturing chemical specialties! Extremely profitable! Formula lists free. Thermolab, Peoria 4, Ill.

BE Income happy. New local and mail selling opportunities. Free literature. L. Mallory, 2666 South Court, Neillsville 2, Wisconsin.

BEAT Inflation. Wartime plans! Free book "372 Unusual Worldwide Businesses." Work home. Start sparetime! \$800 month reported. Publishers-PM, Carlsbad, Calif.

TIN-Cans. Turn them into cash. Nine methods. Instructions 50c. Charles Co., 12-BWE, Norwood, Ohio.

CASH In on loose money at construction camps, or follow vacation trade. Especially good for vet. dis. vet. Portable self-service laundry. Mobilandry, 344 S. 7th, Corvallis, Oregon.

FREE Inside information. 101 new successful home businesses. Unlimited possibilities. Research Bureau, Stanton 49, California.

PART-Time business, full-time profits. Metallizing (plating) equipment, supplies, hard-to-get chemicals and anodes. Complete assemblies for plating baby shoes, jewelry, novelties and industrial products; copper, bronze, gold, silver, nickel, chrome, etc. Home workshop to production shops priced from \$79.50 complete. World's largest line of metal, onyx and marble mounts for bronzed baby shoes. Instructions furnished. Buy direct from manufacturer. Write for free catalog and address of local branch. Hollywood Bronze Supply, Technical Dept., 1624 East First St., Los Angeles 23, California.

MAKE Money at home. Ideas galore to choose from. All fully illustrated and described. Spens Distributors, Box 5511-N, Chicago 7, Ill.

HAVE Profitable home business. Get 101 ideas in new booklet only 25c. Argo Sales Co., 505 W. 26 St., Chicago.

SPIN Angora wool into yarn at home. House of Angora, PM, Springfield, Illinois.

START Manufacturing, selling, artificial flowers, corsages, wreaths, novelty dolls. Profit 100%-300%. Sell on sight everywhere. Everything furnished. 500 woodfibre \$3.75 dozen, all colors. H-14 catalog 10c. Clevemod, 4507T5 Lorain, Cleveland 2, Ohio.

LIQUID Rubber. Make flexible molds. Free sample. Chaney, 1130 E. 16th St., Jacksonville 6, Fla.

OPERATE Profitable mailorder business. Particulars free. George Lenhoff, Lincoln 8, Nebraska.

OWN Exclusive mailorder business. 100% profit plan. Write for details. Sample copy 25c. Mail order News, 1041 South Garfield, Alhambra, California.

HUNDREDS Of mail, local opportunities. Clinton Sales, 88 Weaver Ave., Buffalo 6, N. Y.

MAKE Big money making modern national demand products from chemist-created formulas. Fifty years supplying the best. Write Miller, Chemist, 1517, Tampa, Florida.

REFRIGERATION And air conditioning. Complete, illustrated course. Free booklet. Mechanics School, 7219 South Broadway, Los Angeles 3.

OPERATE Profitable mail order business. Write Universal, 24-B Main, Tangier, Virginia.

MAKE Money at home as renewal headquarters for all magazines. Liberal commissions. No experience — no capital needed. Supplies furnished. Write for free catalog. McGregor Magazine Agency, Dept. 500B, Mount Morris, Ill.

AMAZING New formulas. Dr. Hertstein, 511 Thomas, Grand Rapids, Michigan.

FABULOUS Earnings—Fascinating pastime. Growing genuine, living miniature (mim) tree. New sensational business or hobby. Astounding information free. Dwarf Gardens, Box 355B, Briggs Station, Los Angeles 48, Calif.

LEARN Professional candy making profitable home business. Details free. Pate, Kissimmee, Florida.

\$46 FROM Square foot plywood; jigsaw necessary. Write, Woodarts, Bridgewater, Mass.

FIX Typewriters—Home study course quickly trains you for own business. Factory methods taught. Write: Typewriter Repair, 1915 Corbet, Tarentum, Penna.

POPCORN And potato chip equipment. Long Eakins Company, 5160 High, Springfield 99, Ohio.

EARN Money at home with your typewriter! Spare time! Details free. Edwards, Publisher, 3915-PM, 12th, Des Moines 13, Iowa.

OUR Representatives make big money at home. So can you, if you ask us about this new, highly respectable business. We'll tell you how to be your own boss. M. T. Associates, 26 Potters Lane, Great Neck, N. Y.

DOLLARS In personalized baby record books. Sell by mail. Use same literature we do. No-Co-Ro, Oakland 6, Calif.

MADE Big money. So can you. Wamsteker, Box 34-A, Wynberg, Cape, South Africa.

REVOLUTIONARY Conception of public bookkeeping! \$5.00 hourly. Simple instructions. Full, spare time. Systems, shortcuts, obtaining clients. Auditax, 10775-8 Tabor, Los Angeles 34.

\$5 HOUR Easy! Sell name plates for houses. Free sample, order blanks. Write: National, 214 Summer, Boston, Mass.

SELL By mail; free booklet, instructions. Manhattan House, P.O. Box 50-M, New York 28, N. Y.

EARN While building radios. Learn television. Experience unnecessary. Parts, tools, instructions supplied. Free details. Federal, 176-71 Union Turnpike, Flushing 4, New York.

ELIMINATE Financial worries, with the biggest money making opportunity you've ever seen. Ages, West Liberty, Iowa.

WOULD You pay 3%—first \$350 made? Book "505 Odd Successful Businesses" free! Work home. Expect something odd! Pacific-PM, Oceanside, Calif.

HOW And where to obtain capital. Small and large loans. Free particulars. Star Service, Wapekoneta, Ohio.

UNPAINTED Bookends, plaques, statues, figurines. List, Haverly Products, 822-17th St., Altoona, Penna.

MAKE Money spare or full time, casting metal toys and novelties. Big wholesale and chain store demand for cast metal autos, soldiers, ashtrays, banks, etc. keeps manufacturers busy. Production molds furnished for up to 100 and more castings per hour. No experience or special place necessary. Write for information and illustrations of patterns needed. Metal Cast Products Co., Dept. A, 1696 Boston Road, New York 60, N. Y.

MAKE Rubber stamps, metalize baby shoes, repair dolls, silver mirrors, make beautiful figurines. Catalogue of "30 ideas" free! Universal, Box 1076-A, Peoria, Ill.

WANTED! Home producers by manufacturers in our clearing house service. Become a sub-contractor, casting plastic products for these companies. Thousands of easy to make items required. Cash in at home without previous experience. For details write Plastic Service Guild, Dept. PM, 233 Condon St., E. Boston 28, Mass.

YOUR Own profitable home business. Preserve live flowers to last for years. New simple discovery. Enormous demand all year 'round. Tremendous profits! Light fascinating work. Send \$2.00 for working equipment, instructions, and valuable sales plans. Satisfaction guaranteed or money promptly refunded. Alfred Hermansen, 210 Fifth Ave., Suite 1102A, New York 10, N. Y.

BOOKKEEPERS Earn \$100.00 weekly operating simplified "bookkeeping and tax service." Details free. Universal Bookkeeping, Box 664-M, Springfield, Missouri.

NEW Profitable home business repairing zippers. Thousands of customers waiting. No experience required. We furnish everything. Write Texas Specialty Company, 204-B Texas, Texarkana, Texas.

MINK Raising information free. Complete. Lake Superior Mink Farm, Superior, EEL, Wisconsin.

MOLD Makers—Attention! Genuine natural latex for reproduction of figurines, statuary, plaques, etc. Instructions free. B. M. Barron, 77 Francis St., Everett, Mass.

MEN—Women. Everybody likes candy. Learn to make professionally. Our 40th year. Ragsdale Candies, D5, East Orange, New Jersey.

EARN At home casting novelties. Free instructions using latex molds. Major Chemical Company, 164 Portland Street, Cambridge 39, Mass.

VENTING Machines earn big money! An investment as low as \$10.50 will start you in this fascinating, profitable business that can lead you to the road of success and independence. Routes can be established and operated in either full or spare time with no experience needed. Write for full details and our free catalog illustrating our nut, candy, gum and stamp vendors; also pin ball machines, music boxes, etc. Write immediately to Parkway Machine Corporation, Dept. 7, 715 Ensor Street, Baltimore 2, Maryland.

DRESDEN Craft figurine molds and many others, natural liquid rubber, statuary plasters, flock finishes, etc. Illustrated catalog and "Plastercraft" manual free. Blue Rapids Supply, Blue Rapids, Kansas.

MAIL Order opportunities galore. Sanchez, Box 66-P, Chelsea Station, New York 11.

OWN A printing business. Good profit printing cards, stationery, etc. in spare time. Easy rules furnished. Have home shop. Send dime for complete printer's supply book and samples. Kelsey, Inc., Z-24, Meriden, Conn.

COPUBLISH Leading m.o. paper. Latest copy Mail Sale Advertiser, details, dime. Vanroy Shirk, Lebanon, Penna.

MADE \$24,500 Using money making plans from Schemer Magazine, world's oldest mailorder publication. Box 775M, Alliance, Ohio. Year \$2.00. Sample 20c.

MAKE Flexible molds! Cast plaques, bookends, figurines! Free sample! H. Tooker, 630-R Chestnut, Hamilton, Ohio.

\$25 WEEKLY Working two hours daily. No canvassing. No manufacturing. Lycke, Box 2471-A, Cleveland 12, Ohio.

CO-PUBLISH And advertise in The Central Mail Advertiser. Sample copy 10c. Low rates. Large circulation. Bagby Printing Co., Georgetown, Ohio.

RECAST Old batteries into new. Latest achievements. Battery Laboratories, Minneapolis.

EXTRA Money. No selling; operate vendors. Amazing profits, details free. Silver King, Suite B, 622 Diversey, Chicago 14.

READ "Advance"—The voice of mail order. Offers money-making opportunities, sources of supply, personal guidance, etc. Issued monthly. Sample copy 25c. Yearly subscription \$2.00. Advance Publishing Company, 313 East 21st Street, Suite 450, New York 10, N. Y.

MAKE Money making new greaseless doughnuts at home on electric machine. Wholesale to grocers, drug stores, cafes, hamburger shops. Send for free recipes and plans. M. Ray Company, 3605 South 15 Ave., Minneapolis 7, Minnesota.

START Mailorder bookshop — Everything furnished. 25c brings booklet, samples, exciting ideas. General Publications, Ossining, N. Y.

OPERATE Profitable mail order business. Write Walter Service, 4159-A East 112th, Cleveland 5, Ohio.

MAILING Postcards selling repeat merchandise is profitable. Everything supplied. Details free. Gordan Publishers, Box 23, Pawtucket, R. I.

137 WAYS To make money, in home or office, business of your own. Full particulars free. Elite Co., 220 Grand St., New York 13.

BRUSH Plating outfits connect to a battery. No tanks necessary. Good paying business at home plating autoparts, bathroom fixtures, bicycles, reflectors, silvering mirrors. No shop or experience required. Outfits furnished. Free booklet. Gunmetal Co., Ave. H, Decatur, Ill.

COLORGLAZED Concrete pottery made without molds. Patented method. Cemetery products, novelties, tiles. Basement leak-sealing. Money-making projects. Booklet, details free. Men only. National Potteries Company, Grand Rapids, Minnesota.

BE Appointed state notary public now! Details. Stationers, Helotes 50, Texas.

COMMERCIAL Deep frying course. Mock chicken legs, potatoes. New and proven methods. Learn about this money-making field. \$2.50 p.p. Concession, Toledo 13, Ohio.

NATURAL Molding Latex. Extra thick. Free sample. W. Wooley, 115-A Donald, Peoria, Ill.

LIQUID Marble—Colorful, glossy! Molded, brushed, sprayed! Cast novelties, statuary, colored tiles. Flexible molds. Composition floors. Particulars free. Marbleizing Service, Edwardsville, Illinois.

MONEYMAKING OPPORTUNITIES

RESURFACE Butcher's chopping blocks with easy, fast-working, portable electric machine. Unique service in wide demand with little competition. Large steady profits from full or part-time work. Hill Machine Company, Box 677B, Rockford, Ill.

SELL! Buy! Trade! Anything! Read, Trading Post Magazine 15c. Thorne's, 525 Dewey, Jackson 30, Michigan.

ELECTROPLATE Brass, nickel, chrome, baby shoes. Free information. Electroplate, Box 293, Red Lion, Penna.

BUY Nylons direct from mill. Make good profits on fast selling nylons. Quick delivery on any quantity. Write for confidential wholesale price list. Joy Hosiery Mills, Delaware 13, New Jersey.

MAKE Silhouette portraits at home. Easily learned. Fascinating work. Offers good moneymaking opportunity. Sample, details, free. J. Odell, Route 4, Warren, Ohio.

WIN Cash, cars in prize contests! Write for copy filled with current contests, winning hints and tips. Send only 25c. Wright Contest Digest, Dept. 17-B, P.O. Box 2266, St. Louis 9, Mo.

WE Need more song poems. Ritas Service, Mt. Carmel, Ill.

WHAT Are your old stamps worth? Look them up in our price guide. 128 pages, 1,000 illustrations, 10,000 prices. Only 25c—satisfaction guaranteed. Harrisco, 802 Transit Bldg., Boston.

NEW—Unusual opportunities in "Backyard Profits!" Interesting booklet free. Pickett's, Florence, Kentucky.

PUBLISH Your Own Magazine. Well edited, illustrated. Brings you prestige, profits. 25c brings sample, details. Sullivan, Pub., 6168 Westminster, St. Louis 2, Missouri.

UNPAINTED Plaques, book ends, novelties free. List. Plastercraft Arts, 1611 E. Fifteenth, Cheyenne, Wyo.

EARN Money evenings, copying and duplicating comic cartoons for advertisers. Adservice, Argyle 1, Wisconsin.

\$25.00 PROFIT A day. Complete plan with working sample, 50c. Holmes, Kings Highway, Independence, Missouri.

INDEPENDENT Income! Make leather belts, billfolds, purses. Big catalog and genuine steerhide keyholder. 10c. Tandy Leather, Box 397E, Tulsa, Okla.

MONEY Made easily at home. Details and free copy of trade publication, 25c. A & A Sales, 18-A City Terrace, Newburgh, N. Y.

NEW Sure fire method of making big money with small camera. Free information. Spicers, D-22, 1834 Milburn, Indianapolis 2, Indiana.

SHELLCRAFT! Make beautiful seashell jewelry and novelties, income or hobby. Supplies, instructions. Pace's, Cortez-M, Florida.

EARN Money at home! Thousands do! "Home Worker Magazine" tells how. Sample, 25c. Sizemore, Box 7, 4917 Kostner, Chicago 30, Ill.

MAKE Seamless billfolds at home. Good income. No experience needed. Write to Max Products, HEM 805 East Walnut, Louisville 4, Ky.

CHURCHES Organizations, receive \$130. 12-Tables, sell advertisements for tops. Unique Gift Club, Pine Hill, New Jersey.

DOLLARS Three ways with "Kitty-Kat" read-cut baby shoes. Complete local and mail order plans. Write No-Co-Ro, Oakland 6-K, California.

PROFITABLE Mail order 10c. Copper Hill Sales Service, Copper Hill, Va.

BOOKKEEPERS: Earn up to \$520 month part or full time serving small firms. Simplified system; free details. Tax Saver System, Dept. B, Fort Worth 2, Texas.

MAKE Money! Raise birds in spare time. "Parakeet Breeding For Profit" and copy of cage-bird magazine, \$1.50. American Canary Magazine, 3449 N. Western Ave., Dept. PM, Chicago 18, Illinois.

YOU Can buy thousands of articles wholesale. "Supply Source Directory" 10c. Ideal Service, Park Ridge 40, Illinois.

WOULD You pay 3%—first \$350 made? Book "505 Odd Successful Businesses" free! Expect something odd! Pacific-PM, Oceanside, Calif.

QUICK Profits taking magazine subscriptions, handling greeting cards. Cassell Publishers Service, Westfield, N. J.

RAISE Your business value, standing, as state notary public. Information. Stationers, Helotes 50, Texas.

PUBLISH Your own magazine. Handsome 52 page format, well edited, illustrated. Cost low as \$1.00 month. Brings you prestige, profits. 25c brings sample, details. National, Ord, Nebr.

READ Progressive Mailtrade, the magazine that tells how to make money by mail. Dime brings sample and special offer. Progressive Mailtrade, Box 357, Sheboygan, Wisconsin.

CHEMISTRY

OH Boy! New book of science. Experiments, formulas, secret processes, together with catalogue of laboratory supplies, only 25c. National Scientific Company, Dept. 16, 2204 W. North Avenue, Chicago 47, Illinois.

SAVE On chemicals, supplies. Catalog 10c. Laboratory Sales, Box 161, Brighton, Mass.

URANIUM Ore sample, weighing scale, catalog of chemicals, apparatus, kits, \$1.00. Catalog only, 10c. Rex Laboratories, 2849-A Birchwood, Chicago 45, Illinois.

LABORATORY Apparatus, chemicals, microscopes, complete chemistry sets, minerals, uranium ore. 10c brings catalog. Porter Chemical Company, Hagerstown 1, Maryland.

CHEMICALS And apparatus for industrial, analytical, and private laboratories. Catalog 15c. Dept. M-50, Biological Supply Co., 1176 Mt. Hope Ave., Rochester, 20, N. Y.

ILLUSTRATED Catalog: Chemistry, mineralogy, biology. 10c. Tracey Laboratories, Evanston, Illinois.

NEW Idea chemical and apparatus outfits for home experimenting. Photo-scales, microscopes, chemicals, biological and laboratory supplies in small quantities. Catalog 15c. Established 1931. John H. Winn, 124A West 23rd Street, New York 11, N. Y.

PLASTICS

NEW Liquid plastic. Clear, colors. Cast without heat. Embed flowers, insects, coins. Saw, drill, carve. Free folder. "Liquid Magic" shows fine things you can make and sell. Write today. Castolite, Dept. B-101, Woodstock, Illinois.

LUCITE Plexiglas. Any size sheets, masked. Square foot (12 x 12) cost, 1/16", \$1.20; 1/8", \$1.40; 3/16", \$1.75; 1/4", \$2.08. Colors add 10%. Include 10% postage. Almac Plastics, 230 Fifth Ave., New York 1, N. Y.

HI-PROFITS, Internally hand carved plastics. Gift jewelry. Free catalogue. Pilot Plastics, 67C Fulton St., New York City 7.

LUMINESCENT Plastics, casting liquids, rods, sheets. Send 25c for list and samples. Storn Plastics, Box 324, Niagara Falls, New York.

PLASTIC, Sheets, rods, tubes, etc. Free list. Plastic Supply Co., 2901 N. Grand Blvd., St. Louis 7, Mo.

PLASTIC: Sheets, cut pieces, and scrap in clear and colors. Rod, tubing, acetate, dies, jewelry findings. Send \$1.00 for 4 pound scrap assortment and fabricating manual. Regal Plastic Supply, 720 Main, Kansas City, Missouri.

PLASTICS—Complete line. Wholesale, retail. We make our own full-color carving dyes. Casting plastic at quantity prices. Catalog, bargain lists, ideas, instructions, 10c. Gem-O-Lite, Box 686B, North Hollywood, Calif.

FORMULAS, PLANS, ETC.

ANTI-Freeze and nearly 500 other moneymaking formulas 50c. Nelko Chemical Service, 3462-BA Merchandise Mart Sta., Chicago 54, Ill.

FREE Formula catalog, anything analyzed \$20.00. Western Chemical, Salem, Oregon.

WATERLESS Hand cleaner. (No ammonia.) Easily made. Good profit. 2 dependable formulas \$1.00. Nelko Chemical Service, Box 3462HC, Chicago 54, Ill.

MILLER'S Modern post-war formulas make products that get the business and pay. Fifty years supplying the best. Literature free! Miller, Research Chemist, Tampa, Florida.

OVER 100 Profitable formulas only \$1.00 postpaid. Charlow Company, Box 223, State Capitol, Albany, New York.

CHEAP Automobile polish. Information 10c. Write James Lamont, Beacon, New York.

MAKE—Sell cleaners, soaps, polishes, flavors, cosmetics. No machinery. Formula literature free. Kemico, Park Ridge 16, Illinois.

FORMULAS, Trade secrets, for nearly everything. Catalog free. Creative Publishers, Winnetka 6, Illinois.

10,000 FORMULAS And trade secrets. Free literature. Stillman, 555 Kingston Ave., Brooklyn 3, N. Y.

TESTED Formulas. Interesting descriptive booklet free. Pont, Box 635-PM, Terre Haute, Indiana.

REAL Manufacturing formulas. Lists free. Cummings, Chemist, Gordon Ave., Syracuse 4, N. Y.

HELP WANTED

SAIL Ho! Be a merchant seaman. Enjoy good pay—world travel. Bonuses now being paid. Write for free information. Seaways, Box 47, Old Chelsea Sta., New York City 11.

\$5 HOUR Easy! Sell name plates for houses. Free sample, order blanks. Write: National, 214 Summer, Boston, Mass.

AGENTS WANTED

WIN Real cash. Even beginners make handsome profits selling new 21 for \$1.00, 3-dimension everyday greeting card assortments. Novelties, gift wraps, household items. Free samples imprinted stationery, napkins, notes. Deluxe all-occasion samples on approval. Bonus. Special offers. Write Pilgrim Greetings, 111 Summer, Dept. AN-7, Boston, Mass.

BUY Wholesale, earn big money selling thousands nationally advertised products at big discount. No stocks to carry. Sent free "The Wholesale Plan." American Buyers Service, 629P Linden, Buffalo, N. Y.

ABSOLUTELY Free! Big package actual sample fabrics and style presentation of dresses, lingerie, hosiery, etc. Take orders. Commissions big. Send no money. Melville Co., Dept. 7004, Cincinnati 25, Ohio.

SELL Razor blades. Sample 100, \$1.00 prepaid or c.o.d. Mack's Distributor, Mt. Vernon, Illinois.

NO Experience needed to make money fast for yourself or organization. Sell gorgeous new all-occasion assortments. 21 cards \$1.00. Valentines, Easter cards, religious, novelties, unusual gifts. Scented stationery, notes, wrappings. Over 100 items. "Get Started" plan. Write for samples on approval. Hedenkamp, 361 Broadway, Dept. PM-11, New York.

FREE Samples, and amazing plan, giving you gorgeous dress without penny cost. Rush name today with dress size. Harford, Dept. 335, Cincinnati 25, Ohio.

TIRE Whistle—Blows when you have a puncture; easily installed on valve stem. Agents sample set \$2.98. R. J. Hall Co., 240 E. 19th Ave., Denver 5, Colorado.

STRANGE "Dry" window cleaner. Sells like wild. Replaces messy rags, liquids. Simply glide over glass. Samples sent on trial. Kristee 124, Akron, Ohio.

AGENTS Wanted. One in each larger city. Employed teachers, ministers, librarians preferred. Receive telephone inquiries for USA's oldest and largest exclusive restorers of paintings. Helzer, Box 333 GPO, New York 1, N. Y.

GREETING Card salespeople. \$50 without risk. Sell America's leading 21 card everyday boxes; samples on approval. Amazing newest gift items. Free samples 150 for \$1.00 personalized stationery. Write today. Lorain Art Studios, Dept. F-44, Vermillion, Ohio.

BRAND New! Amazingly different and smart everyday cards, 21 for \$1. Magic window designs. Take easy orders. Make up to 100% cash profit. Big line \$1 assortments, personal stationery, imprinted matches. Free imprint samples. Assortments on approval. North Star, 31 Glenwood, Dept. R-18, Minneapolis, Minn.

\$3.00 AN Hour selling cushioned shoes direct. Advance commissions. Bonus. No investment. Experience unnecessary. Free outfit. Samples. Paragon Shoes, 739 Columbus, Boston, Mass.

AMAZING New way to earn money quickly and easily with gifts, stationery, cards. No experience necessary. Send now for free home demonstrator and all else needed. 2 best sellers on approval. Terry Studios, 501 Westfield, Mass.

NEW "Sponge" wall cleaner. Erases dirt like magic. Wallpaper, painted walls, ceilings. Saves redecorating. Lightning seller. Samples sent on trial. Kristee 123, Akron, Ohio.

JUST Out! New thrilling sensation in everyday cards. Rich foils, satins, velours sell on sight, 21 for \$1. Make up to 100% profit. 50 assortments, imprint stationery and book matches, gift items. Two \$1 assortments on approval, imprints free! Joy Greetings, 507 N. Cardinal, Dept. G-60, St. Louis, Mo.

YOUR Own business selling army surplus, new clothing. Lowest prices. Enormous profits. Catalog free. Moro, 558-J Roosevelt, Chicago 7.

OUR Agents make big money selling all-occasion greeting cards. Terrific box of 21 only \$1.00. Over 75 other boxes. Profits to 100% plus bonus. Free samples. Kit on approval. Regal Greetings, Hazel Park 55, Michigan.

MAKE Perfume. Big profits. Mailorder. Expect secrets. Write Imasco, 6347 Parnell-MA-2, Chicago 21, Illinois.

DO You need money? \$40.00 is yours for selling only 50 boxes of our 200 greeting card line. And this can be done in a single day. Free samples. Other leading boxes on approval. Many surprise items. Experience unnecessary. Free samples personalized stationery, napkins. Write today. It costs nothing to try. Cheerful Card Co., 117 White Plains, N. Y.

MEXICAN Feather pictures. Sell on sight; 200% profit! Free details; sample 10c stamps. Sylvia-P1, Apartado 9036, Mexico City.

EXTRA Cash—easy! Sell friends newest design 21 for \$1.00, dark card, novelty all-occasion greeting card assortments, gift wraps, animated books. Profits to 50c per \$1.00 box. Special offers. Bonus. Prompt service. Experience unnecessary. Write today for free samples name imprinted scented stationery, napkins, book matches, feature assortments on approval, free catalog, selling plans. Elmira Greeting Card Co., 2209 Elmira, New York.

SELL Du Pont nylon uniforms. Complete line famous exclusive Hoover styled nylon uniforms for beauty shops, nurses, doctors, waitresses, others. Best quality, splendid values. Exceptional income. Real future. Equipment free. Write fully, Hoover, Dept. L-100, New York 11, N. Y.

YOURS For free trial—everything you need to make extra money! Experience unnecessary. Big profits. Bonus. Request feature all-occasion greeting card assortments on approval, free samples name imprinted stationery, napkins, towels, free catalog, selling guide and surprise gift offer. New England Art Publishers, North Abington 418B, Mass.

NYLON Uniforms. Immediate delivery, immediate profits. Sell to doctors, dentists, nurses, waitresses, beauticians, housewives. Free sales kit. Superior Fabrics, Dept. P-2, 3936 Market, Philadelphia 4, Penna.

EASIEST Money you ever made! Big commissions selling work shoes guaranteed six months, exclusive cushioned shoes. Free outfit. Concordian Shoes, 8-A West Concord, Mass.

MAKE Money calling on friends! Show nationally advertised greeting card assortments—new all-occasion assortment and laugh-packed barrel-of-fun assortment. Sells for \$1.00—up to 50¢ profit for you! Also personal notes, gift wrappings, stationery, gift items, others! Get two assortments on approval. Write Wallace Brown, 225 Fifth Ave., Dept. S-4, New York 10.

FREE—Mexican novelty curiosities. Fast selling. Exceptional profits. Panamericana, Apartado 9318, Mexico City.

NYLONS Direct from factory to wearer. Only way you get fresh nylon, that's why can guarantee against runs. Sample free. Pay high comm. Advance cash plus 40% bonus. Sell women necessities needed all year; nylon slips, panties, gowns, robes. Also Ergim gold chains and religious medals. Become manager, have your own salesmen. We pay 40% comm. on salesmen's earnings. Ergim Co., 992 Columbus Ave., New York.

125 RAZOR Blades \$1.00 postpaid in America. Warren Wallace, Kittell Road D, Fayetteville, N. Y.

BUY Direct. Extra discount. Power mowers, 11 models. Delivered. Rotacut, R-2012, Excelsior Springs, Mo.

CASH Profits handling most attractive greeting cards. Amazing values. Complete line. Samples free. Arro, 2749 Garrison, St. Louis 6, Mo.

UP To \$50.00 in a week spare time, and tailored suit for yourself without paying one cent. Write for plan, and free sample case. Stonefield Corp., 532 S. Throop, Dept. P-817, Chicago 7, Ill.

NEED Extra cash? Take orders for personal initialed belts and buckles, cap badges, tie holders, etc. Choice of 3000 emblems. Free sales kit. Hook-Fast, Box 1425PM, Providence, R. I.

BUY Thousands of nationally advertised products direct from manufacturers and distributors. Write for "Buy Direct and Save." Service Publishing, 1420-A Investment Bldg., Pittsburgh 22, Penna.

SELL Wood photograph albums. 50% profits. Catalog free. Wood Album Co., 54 Jefferson St., Brooklyn, N. Y.

AT Last! Something new and sensational in everyday cards, 21 for \$1. Make extra money fast! Show satin, velour, metallic cards. Get orders easy. Big line \$1 assortments, scented stationery, personal matches, kiddie books. Imprints free. Two \$1 boxes on approval. Puro Co., 2801 Locust, Dept. 140-B, St. Louis 3, Mo.

PAINTS—All kinds. 65¢ gallon up. Private label. Big profits. Certified Products, Louisville, Ky.

FAST Profits—No investment. Send for big, free catalog. Plastic aprons, tablecloths, etc. 150 sure-fire items. We guarantee sales. Write The Halliday Company, Dept. M-2, 15-19 Pennington Ave., Passaic, N. J.

POSITIVELY New—Over 100% profit. Two sided reversible neckties. Free details. Farrell Company, Dept. P-19, 1377 Van Zandt, Cincinnati 31, Ohio.

SELL Arcadian cigars. 100% imported Havana tobacco. Hand made. Steady, repeat profits. Free folder. Seco Cigars, 87 South Drive, Rochelle Park, New Jersey.

FREE Water and our concentrates make flavors, lotions, shampoos, perfumes, cleaners, polishes, 125 products, free catalog. Qualco, E-20030 Russell, Detroit 3.

FREE Samples. Big profits showing amazing "Glow-in-the-dark" specialties. House numbers, pictures, plastic novelties, ashtrays, keyholders, religious and nursery objects, etc. Madison Plastics, 303 Fourth Ave., New York 10, N. Y.

BE A money maker. Use your home as magazine headquarters. Liberal commissions. No experience—No capital needed. Everything furnished. Write for free catalog. McGregor Magazine Agency, Dept. 500A, Mount Morris, Ill.

\$5 HOUR Easy! Sell name plates for houses. Free sample, order blanks. Write: National, 214 Summer, Boston, Mass.

SCHOOL Seniors! A postal will bring you our wonder, Kwick-Sell Cardalog of popular graduation name cards. Biggest profits! Only firm giving free Golden Memory Book and Souvenir Chest. Don't miss out. Hurry that postal! Craftcards, Box 235 (L), Pittsburgh 30, Penna.

SCHOOL Seniors—Earn sensational profits selling classmates America's most beautiful graduation name cards. Largest selection. Outsell all others. Free sample kit. Printcraft, Dept. M, 1425 E. Elm St., Scranton 5, Penna.

FREE Sample nylon stocking of world's only nationally advertised hosiery line actually guaranteed against runs, snags or excessive wear, regardless of cause! It's amazing but true. Every weight from sheerest 15 denier to heavy 70 denier—all gauges to luxury 60 gauge. Amazingly low prices, starting at \$1.08 prepaid for sheerest 15 denier 51 gauge. Not sold in stores. Good Housekeeping guarantee seal. Also complete line men's hosiery guaranteed one full year or replaced free. Full variety lingerie in crepe, satin and nylon, featuring all nylon slip at \$2.95, satin slip at \$1.58, etc. Housecoats and robes. Kendex sales people will earn one million dollars this year. Get your share. No money or experience needed. Pay nothing now or later. Just show free outfits. Write orders. We deliver and collect. Advance cash plus huge bonus. Earn money spare or full time. Become manager; appoint others to sell for you; earn steady income on their sales. Man or woman—young or old, you can earn more money than you ever thought possible. Everything you need is furnished free and prepaid, including nylon stocking, samples of materials, sales books, 36-page salesmanual, color cards, etc. Simply write your name and address on postcard and mail to Kendex Corporation, Babylon 23, N. Y.

PHOTO-Salesmen, agents. Sell beautiful hand colored plastic enlargements and sensational new photo compacts, rings, bracelets, lockets, etc. Collect deposit, we deliver. Profitable sideline. Send card, for free sample kit. Novel Portrait Co., 3343 North Ave., Chicago, Ill.

MAGIC Cleaner—Laundry soap deal. Hotter than a firecracker. Big profits. Sample free. Bestco, 4642 No. Central, Chicago.

DRESSES, 18¢; Coats \$1.00, blouses 35¢. Free catalog. Crown, 164-P Monroe Street, New York.

JEWELRY Factory desires salesmen, distributors, jobbers. Pickcraft, 19 Bank Street, Attleboro, Mass.

SELL Big money-maker to men and women. Easy handwork makes fast-selling useful articles. Sunmade Company, Brockton 64, Mass.

GOLD Lacquered window sign letters. Large sizes penny each. New foils. Absolutely beautiful. Free samples. Atlas, 544 W. 79th, Chicago 20.

AGENTS: Stamping names on key protectors. Sample 25¢. Stamping outfits, checks, social security and name plates. Hart Mfg. Co., 303 Degraw St., Brooklyn, N. Y.

WHERE To buy 800,000 articles direct from manufacturers. Including hundreds of scarce items. Sent free. "Your Profits Under the Spotlight." Glass Publishing Co., Ellwood City, Penna.

AGENTS—300% Profit selling genuine gold window letters; stores and offices. Free samples. Metallic Letter Co., 438-B North Clark, Chicago.

EXCELLENT Sideline for printing and advertising salesmen. Decalcomania name plates in small quantities. Great demand. Also, make money with our line of automobile initials and sign letters. Free samples. "Ralco" XL-Roxbury, Boston 19, Mass.

HIGH-GRADE SALESMEN

EXTRA Money easy, taking orders for world-famous Stark-Brand apple, pear, peach, other fruit trees, grapes and berries. Gorgeous flowering shrubs, roses, etc. Sensational patented, hardy, quick-growing varieties. Enormous demand for yards, small plots, farms. No experience needed. Rush name for free plate book and sales kit. Stark Bro's., Dept. 961, Louisiana, Mo.

BIG Cash profits for men and women introducing Flexiclogs, sensational new flexible footwear. Experience unnecessary. Nationally advertised styles for women, children, men. Excellent sideline, no investment. Easy to average hundreds of dollars weekly. Free sales helps and sample offer. Get details now! Flexiclogs, Dept. L-2A, New Holstein, Wisconsin.

RICH Opportunity for men in their 50's. Healthful, pleasant occupation. No investment needed. 150 of our men made \$500 to \$3,000 in one month; many just beginners. Heckman made \$104 first 2 hours. Crowley made \$224 first day; exceptional earnings. Openings available. Write President, Box 711, Dept. PM, Fort Worth 1, Texas. (If you live in Canada write: President, 25 Industrial St., Dept. PM-2, Leaside [Toronto], Ontario.

FREE Sample and information: Sensational new fishermen's article. Nelson Company, Dept. F, St. Paul 2, Minnesota.

MAKE Money with Merritt. Sell Davis Air Cushioned Shoes, dress, work, heavy duty. Popular priced. Advance commissions. Cash bonuses. Experience unnecessary. Write to Geo. Merritt Shoe Co., C52, Brockton, Mass.

GET Into big profit leather jacket business. Horsehide, suede, capeskin, all fine quality leathers, low factory prices. Write Mason S100, Chippewa Falls, Wisconsin.

SALESMEN—Sell our "Leader Specials," America's finest, biggest line of advertising specialties. Sensational sellers to all types of business. Big commissions advanced. Sensational sales plan nets you top earnings. Free outfit. Charms & Cain, 407 South Dearborn, Dept. 300, Chicago.

EARN Big money fast! Sell finest-quality advertising work uniforms to garages, factories, filling stations, etc. Free selling kit. Topps, Dept. 532, Rochester, Ind.

ADVERTISING Book matches—Cash in on big demand; sell union label matches. Cuts for all businesses and political parties. Free powerhouse selling kit, low prices, protection guaranteed on repeat orders. Cash commissions. Superior Match Co., Dept. M-251, 7530 Greenwood, Chicago.

AMAZING Discovery, Master Glaze, puts brilliant glass-like surface on cars. Free sample, information. Big commissions. Master Glaze, Dept. 703, 7720 Harwood, Milwaukee, Wisc.

IS \$210 A week worth a penny postcard to you? Then rush card with name and address for special free trial plan that sells amazing new automatic refrigerator defroster "like hot cakes!" Write to Mr. Lewis, D-Frost-O-Matic Corp., Dept. PMC-2, 6 N. Michigan, Chicago 2, Ill.

EARN Spare time extra money. Show amazing cushion comfort shoes. To \$3.25 commission per pair, plus big cash bonus. Experience unnecessary. Write for free catalog, full information. Tanners Shoes, 778 Boston, Mass.

MEN 30 Or older. Top earnings. C. H. Libbey made over \$7,081.25 last year, even more this year. Call on building owners, schools, etc. with famous maintenance product. 30% commission. Write in detail. Vice President, Dept. MC, Box 789, Fort Worth 1, Texas.

AD Matches! Sell amazing designs—20, 30, 40 and 240-light book matches. Big spot cash commissions; every business a prospect. Low prices for high quality. Repeats. Start without experience; men, women; full, part time. Buy nothing! Sales kit furnished. Match Corp., Dept. PM-14, Chicago 32, Illinois.

SELL Art and commercial calendars. Advertising specialties. Over 1000 good-will items. Diversified line. Highest commissions. Territorial protection. Send \$1.00 refundable deposit for prepaid initial set of samples. Standard Calendar Company, Madison, Illinois.

WANT To make real money? You can positively make \$50.00 a day and up selling a brand new item going to every type of food and beverage store, factories, laboratories, hospitals, etc. First time advertised. Write for free details today. Johnson-Hartman, 53 West Jackson Blvd., Dept. PM-2, Chicago 4, Illinois.

A Fine income, your own nylons free! Show nylons, lingerie, men's socks with amazing free replacement guarantee against runs, snags, tears. Write for free sales kit. Group organizers invited. Rosalee Hosiery Co., Clifton 58, N. J.

SELL Our waterproofings, floor mastic, cement hardener, etc. (30 items) to maintenance men, building owners, contractors. Can start part time. Commission. Territory. Write Haynes Products Co., Desk 6, Omaha 3, Nebr.

\$5 HOUR Easy! Sell name plates for houses. Free sample, order blanks. Write: National, 214 Summer, Boston, Mass.

NEW Jobs open in selling! Send name, address for five free issues of Opportunity Magazine's money-making guide, listing hundreds of companies who'll pay you well, full or part-time. No experience needed. Opportunity, 28 E. Jackson, Dept. 17, Chicago 4, Ill.

BIG Money taking orders. Shirts, ties, socks, pants, jackets, sweaters, shoes, uniforms, etc. Sales equipment free. Experience unnecessary. Nimrod, 4922-AN Lincoln, Chicago.

BOOKS on every subject. Written in Popular Mechanics famous easy-to-understand style. Profusely illustrated. Subjects include workshop planning and practices, projects, hobbies, household repairs, motoring, outdoor sports, photography, home building and many others. Also booklets on specific topics. Illustrated catalog free. Popular Mechanics Press, 200 E. Ontario, Chicago 11, Ill.

EDUCATIONAL AND INSTRUCTION

TEACH Yourself to play piano quickly, right at home. Professional method, easily learned. Ingeniously arranged guide for teaching children included. Amazing proof free. Write today. Music Teachers' Associates, 26 Potters Lane, Great Neck, N. Y.

ANNOUNCING Home study course in commercial baking. Practical basic training. Good field for those with aptitude. Nearly depression proof. Send for free booklet, "Opportunities in the Baking Industry." National Baking School, 835 Diversey Parkway, Dept. 3431, Chicago 14, Ill.

YOU For president of your own credit-collection business. Many who answered our ads now have their names on office doors. Franklin Credit, Roanoke 7, Va.

BOOKKEEPER, Male or female. Study practical credit management with an experienced credit man. J. Cooke, 116 St. Stephens Street, Boston, Massachusetts.

HAWAII, Lava specimens, appr. 4"x4"x2", from Mauna Loa 1950 eruption, world's largest active volcano, amazing, educational, useful. Post paid \$1.00. Volcanic Curio Service, P.O. Box 854, Honolulu, Hawaii.

PHOTOGRAPHY For pleasure or profit. Learn at home. Practical basic training. Long established school. Write for free booklet. American School of Photography, 835 Diversey Parkway, Dept. 3431, Chicago 14.

FREE Bible correspondence courses—Adult, junior, offered by world-wide radio Bible broadcasters. Write: Voice of Prophecy, Box 55, Los Angeles 53, California.

ACHIEVE Business and financial success in your own collection-credit agency business. Home or office. Quickly learned. Free folder. Write Cole & Associates, Syracuse 2, N. Y.

LEATHER Carving, Fascinating, highly-paid art; age-old secrets now taught for first time in home study course. For hobby, profession or profitable business, write: Baird School of Leather Carving, Box 1367-M, Dept. 12, Manitou Springs, Colo.

"HOW To Break and Train Horses"—A book every farmer and horseman should have. It is free; no obligation. Simply address Beery School of Horsemanship, Dept. 1102-C, Pleasant Hill, Ohio.

LEARN Piano tuning, repairing—At home in 30 days. Unlimited income. Phonograph recordings, tools and instructions furnished. Write Capitol City Tuning School, Department 234, 129 East Michigan, Lansing 16, Michigan.

MAKE Up to \$35-\$45 week as a trained practical nurse! Learn quickly at home. Booklet free. Chicago School of Nursing, Dept. M-2, Chicago.

BE A real estate broker through home study or classroom instruction. Write for free book. Approved for veterans. Weaver School of Real Estate, 15 E. Pershing Rd., Box CP-2, Kansas City 8, Missouri.

HIGH School, No classes. Study at home, spare time. Diploma awarded. Write for free Catalog HF-4, Wayne School, 2527 Sheffield, Chicago 14, Ill.

LEARN Auctioneering by mail or working with successful auctioneer. \$100.00 daily often earned! Revolutionary new method gives you actual experience at home. Advance Auction School, 5944-H, North Newark, Chicago 31, Ill.

INCREDIBLE! Unprecedented! Look under "Miscellaneous"! Bijou, Box 1727-M8, Hollywood 28, Calif.

U. S. Gov't jobs! Men—women. Emergency program creating 125,000 new openings. Start high as \$3,450.00 year! Regular advancements! Qualify now. Experience usually unnecessary. Free 40-page book shows jobs, salaries, sample tests. Write: Franklin Institute, Dept. P-24, Rochester, N. Y.

WELDING Training pays at Hobart Welding School, Box M-213, Troy, Ohio. VA contract. Best equipment. Catalog free.

READ With speed! New amazing method. Save hundreds of hours yearly. Free test. Speed-Reading, 9111-X Hoyne, Chicago 20.

USED Correspondence courses and educational books bought, sold, rented, catalog free. Educational Exchange, Summerville, Ga.

TUNE Pianos—Easy homestudy course. Goldstein, 2162 Brighton Street, Philadelphia 24, Pennsylvania.

SHORTHAND In one week. EZ longhand system. \$1.00. Self instructor. Free literature. Zinman, 215 West 91, New York 24, New York.

VOICE Secrets! Free information. Studio 14356B, Jersey Ave., Norwalk, California.

EARN While you learn. Day or night classes. Learn automobile mechanics, diesel mechanics, motor tune-up, auto body and fender, welding, refrigeration, radio, etc. Living accommodations. Veterans may earn \$210 to \$290 per month while in school including subsistence. Fully accredited to train veterans. Thirty-two years' experience training men. Dept. #256, Y.M.C.A. Bldg., Nashville 3, Tennessee.

3800 LATEST Used correspondence courses. Catalog 50c. EG, Elmsford, N. Y.

LEARN Linotype (machine typesetting). Good pay, steady work. Booklet "X" free. N. Y. Mergenthaler Linotype School, 244 West 23rd, New York.

LEARN A trade: Midland Linotype School, Charles City, Iowa. Immediate enrollment, civilian courses since 1909. G.I. Bill for 346 and 16 since 1945. Keyboard operation and maintenance, printing. Practical courses. Nine machines. Day and night classes. Free placement bureau. Write, call or wire for free information.

EARN \$10,000 Annually! Learners \$2,700. Unlimited opportunities in Merchant Marine. Instruction-Employment Manual \$1.00. Refundable. Titan Company, 45 Clinton St., Newark 2, N. J.

PIANO Tuning pays. Learn this profitable profession at home. Our Tonometer and mechanical aids make learning easy. No knowledge music necessary. Diploma granted. Largest and oldest school—53rd year. G.I. approved. Write for booklet. Niles Bryant School, 78 Bryant Bldg., Washington 16, D. C.

BOOKKEEPERS! Increase your earnings! Operate your own simplified "dollars-a-week" bookkeeping and tax service. Full or spare time. Details free. No obligation. Ellis, Box 200, Cedar Grove, North Carolina.

USED Correspondence courses and books sold and rented. Money back guarantee. Catalog free. Courses bought. Lee Mountain, Pisgah, Alabama.

STUDY To be a doctor of psychology or metaphysics. Obtain Ps.D., Ms.D., D.D. or Ph.D. degree. Chartered by state. Write for free book telling how. The Neotarian Fellowship, Desk 8, Dwight Building, Kansas City 6, Missouri.

MEDICAL Laboratory Technicians in great demand. We train you in your own home. Catalogue free. Imperial Technical Institute, Box 973-J, Austin, Texas.

HOME Study course, drugless therapy. Free literature. Institute of Drugless Therapy, Tama, Iowa.

INVESTIGATOR Training, Phillips Secret Service System, 1917-B North Keneth, Chicago 39.

SECRET Investigation, Experience unnecessary. Investigators particulars free. George Wagner, M 125 West 86th, New York.

PLAYS, STORIES, MANUSCRIPTS

SUCCESSFUL Writer reveals "Tips for Beginning Authors." Booklet 10c. Send to: Career Aids, Dept. PM2, 204 East 81, New York 28, N. Y.

I Want new writers to cash checks of \$1 to \$100 offered daily. The easiest way to write for pay. No previous experience necessary. Free details. Saunders M. Cummings, 468-11 Independence Bldg., Colorado Springs, Colo.

BUSINESS SERVICE

CHICAGO Address for your mail. Business or personal. Schultz House, 3116 Seminary, Chicago 13.

SPECIAL SERVICES

WHAT Can I do for you in Belgium? Representation, purchasing, investigation, mail forwarding \$5 monthly, \$50 yearly. Schmit, 25 Rue Vangaver, Brussels.

INFORMATION

"DIRECTORY"—1951 Stepping Stone to Success" free. Box 3542 Station-B, Winnipeg, Manitoba, Canada.

QUESTIONS Answered completely, any subject, 25c. Shay Publications, Special Information Dept., 1132 West Kensington Road, Los Angeles 26, Calif.

CARTOONING, COMMERCIAL ART, SHOWCARD WRITING, SIGN PAINTING

"HOW To Make Money With Simple Cartoons"—A book everyone who likes to draw should have. It is free; no obligation. Simply address Cartoonists' Exchange, Dept. 92-C, Pleasant Hill, Ohio.

BE Smart. Get in art. Let me start you free. Nick Nichols Arts, 39 W. Adams, Chicago 3, Ill.

2 CARTOON Drawing courses \$3.95. Catalog 50c. EG, Elmsford, N. Y.

LETTER patterns produce professional signs, catalogue dime, refundable. Tracing folios, 12 alphabets, ten numerals \$1.10, three different \$3.00. Demonstrators, 639-P Paulina, Chicago 12.

FREE Strok-o-graph shows correct method for brush lettering plus money making opportunities. Home study course in Shocard art. Midwest School of Art, Fort Wayne 2, Indiana.

SIGN Painting taught at home. Test lesson free. Ben Kerns, Box 812-T, Greenville, S. C.

CHALK Talks, Laugh producing program, \$1.00. Catalog 10c. Balda The Cartoonist, Oshkosh, Wisconsin.

LEARN Sign painting, 152 lesson course. Results guaranteed. Stewart Sign Co., Box 287M, Pasadena, California.

ADVERTISING AGENCIES, LETTER WRITERS, FOR ADVERTISERS

ADVERTISERS! Reach nearly 18,000,000 readers. 25 Sunday national key newspapers, 18 words, \$59.00. "Terrific pullers." 20 popular newspapers, \$11.50. Free booklet. Special—One inch display 2,-821,198 circulation, \$51.10. Newmark's Advertising Agency, (Established 1893), 217-7th Ave., New York 11.

MAILORDER Advertisement, 2,000,000 nationwide circulation, \$32.90 inch. 24-word classified, 20 Sunday newspapers, \$25.00. Instructive Ad-Guide—ratebook magazines, newspapers, mail-lists—10c. Ideas developed. Ads prepared free. Chicago Advertising Agency, (Established 1900), Chicago 4.

FREE! 1950 Advertisers Rate and Data Directory, 52 pages! E. H. Brown Advertising Agency, 20 N. Wacker, Chicago 6.

24 WORDS in 50 weeklies, \$4.96. J. Darnell, 730 Hays, Jackson, Tenn.

ADVERTISE: 24 Words, 40 newspapers \$3.50. Lists free. Advertising Bureau, 10511-C Springfield, Chicago 43.

MAILING Lists: \$5.00-1000 up. Write Dixie Service, King, N. C.

ADS Placed in out of town newspapers and magazines. Low rates. Catalogue free. Ideas that pay. Baker Advertising Agency, Successors Ankrum Agency, 189 W. Madison, Chicago 2.

RUBBER STAMPS AND OFFICE SUPPLIES

RUBBER Stamps, simplified bookkeeping records. Catalog 10c. Williams, Box 648, Plainfield 1, N. J.

RUBBER Stamps. Send for catalog. Excelsior, Box 500, Shreveport, Louisiana.

TYPEWRITERS, DUPLICATORS, OFFICE DEVICES

PRINTOMATIC Selffeeding post card printing duplicator \$13.50. Envelope addressing machines \$24.50. Pittsburgh Typewriter Company, 336-R Fourth Avenue, Pittsburgh 22, Penna.

RECONDITIONED Typewriters, printing devices. Write Dixie Service, King, N. C.

PRINTING, MULTIGRAPHING, MIMEOGRAPHING GUMMED LABELS

\$1.00—50 LETTERHEADS With envelopes. Benneville, Box 1931, Pittsburgh 30, Penna.

100 LETTERHEADS, 8½x11 Hammermill \$1.00 postpaid. Envelopes, business cards, same. Race Printers, Hudson, New York.

100 PLAIN 6½x9½ Kraft envelopes—\$1.00 postpaid. Lincoln, Box 449, Irwin 4, Penna.

125 LETTERHEADS, 125 Envelopes, \$2.00 postpaid. Going, Box 1544, Muskogee 1, Okla.

BUSINESS Printing. Samples, prices free. Howprint, 723-M Eunice, Webster Groves 19, Missouri.

1000 EMBOSSED Business cards \$3.00. Ortiz, 1050 Fox Street, New York.

COMPLETE Printing line. \$1.00 up. Samples. D'Yarmett Printing, Newark, Ohio.

5,000 6 3/4 ENVELOPES Printed \$3.00 per thousand, price list free. 1,000 simulated engraved business cards \$4.00. Michel, Box 76F, New York 16.

1000 EMBOSSED Business cards, wallet. \$3.00. Averl, 112-MP Elizabeth, Wichita 12, Kansas.

GUMMED Labels, stationery. Free list. Reed, Box PM-135, Spiro, Okla.

500 3/4x2 1/4 FOUR-Line gummed labels 35c. Woodprint, Romeo 183, Mich.

1000 SIMULATED Engraved business cards \$3.00 postpaid. Choice 24 types layouts. Immediate delivery. Free samples. ABC, 728 West Peachtree, Atlanta, Ga.

1000 3-COLOR Embossed business cards \$6.50 pp. Zenith Print, 5114 Beeman, Dallas, Tex.

OFFSET Printing, mimeo prices! Samples. Athins, 2815-F Vaughn, Ft. Worth 5, Texas.

MIMEOGRAPHING, Vari-typing. Prompt service. Free price list. Loyal Brush, 3712 Walnut, Kansas City 2, Mo.

MIMEOGRAPHING—45c Hundred. You cut stencil. Save money. Details. McCann's, Fleetwood, R.D. 3, Penna.

SEND 10c Now for our 48 page 1951 price list—refunded first order. McCall Press, 1326 South 27th, Omaha, Nebraska.

1000 BUSINESS Cards \$2.50 prepaid. Samples free. Reliable Print Shop, 905 East Jefferson, Louisville 6, Ky.

PHOTO-Offset special, 5000-8 1/2 x 11 \$14. Samples free. Reiffe, 160-P Monroe St., New York 2.

100 8 1/2 x 11 HAMMERMILL Letterheads and 100 envelopes \$1.95. H. Hudson, Centredale, R. I.

MIMEOGRAPHING. Any copy. Trial hundred \$1. Parker, Box 1674, New Haven 7, Conn.

500 3/4x2 1/4 FOUR Line gummed stickers 50c. Red border \$1.00. Moritz Printery, Saginaw, Mich.

100 ENVELOPES, Printed 2-colors \$1.25. Samples. Box 523, Rochester 2, N. Y.

MIMEOGRAPHING—Reasonable. Any copy. Mailers Service, Box 606-S, Chicago 90, Ill.

QUALITY Printing. We specialize in publications, newspapers, tabloids. Send copy for estimate. Bagby Printing Co., Georgetown, Ohio.

MIMEOGRAPHING—Letters, pricelists, formulas, instructions. Lowest prices. Lem's Letter Shop, 5710 Stanton, Detroit 8.

PRINTING OUTFITS AND SUPPLIES

FINE Inks—Every printing process. Send trial order to Laketime Corp., Box 224-W, R. 1, DesPlaines, Ill.

PRESSES, Type, cabinets, supplies. List for stamp. Lincoln Press Company, 220-S Hartwell, Fall River, Mass.

MAKE Your own printing cuts. Self-molding process. Plexirubber, Argyle 1, Wisconsin.

PRINT Your own cards, stationery, circulars, advertising. Save money. Simple rules. Print for others, nice profit. Raised printing like engraving too. Have home shop. Details free. Kelsey Presses, L-11, Meriden, Conn.

PRESSES, Supplies, paper. Catalog 10c. Printers Supply, 211, Springfield, Missouri.

PRINTING Presses, type, supplies. Lists 3c. Turnbaugh Service, Loysville, Penna.

PATENT ATTORNEYS

REGISTERED Patent attorney offers services. Sanders, 6430 Evans, Chicago 37, Ill.

PATENTS, "Proof of Invention" folder mailed without obligation. E. E. Vrooman, Registered Patent Attorney, 507 McKim Building, Washington 5, D. C.

INVENTORS: When you are satisfied that you have invented something of value write me, without obligation, for information as to what steps you should take to secure a patent. Write Patrick D. Beavers (Formerly Randolph & Beavers) Registered Patent Atty., 935 Columbian Bldg., Washington 1, D. C.

INVENTORS—If you believe you have an invention, you should find out how to protect it. The firm of McMorro, Berman & Davidson with offices in Washington, D. C., is qualified to take the necessary steps for you. Send for copy of our patent booklet "How to Protect Your Invention." We will also send you an "Invention Record" form. No obligation. They are yours for the asking. McMorro, Berman & Davidson, Registered Patent Attorneys, 134-M Victor Building, Washington 1, D. C.

INVENTORS—If you consider your invention to be something of importance, take steps to protect it with a United States Patent which gives you the right to exclude others from making, using and selling your invention as claimed. "Patent Protection for Inventors" outlines steps to take to secure patent protection. Mailed promptly without obligation. Victor J. Evans & Co., Merlin M. Evans, Registered Patent Attorney, 631-B Merlin Building, Washington 6, D. C.

INVENTORS: Learn how to protect your invention. Unless the inventor is familiar with patent matters, he should engage a competent registered patent attorney or agent to represent him. We are registered to practise before the U.S. Patent Office and prepared to serve you in handling your patent matters. "Patent Guide for the Inventor" containing detailed information concerning patent protection and procedure with "Record of Invention" form will be forwarded to you upon request—without obligation. Clarence A. O'Brien & Harvey Jacobson, Registered Patent Attorneys, 11B-A District National Building, Washington, D. C.

PATENTS—Irving L. McCathran, 315 McLachlen Bldg., Washington 1, D. C. Registered Patent Attorney.

CANADA—Ramsay Company Registered, 273 Bank Street, Ottawa, Canada.

C. A. SNOW & Co.—M-427, Snow Building, Washington 1, D. C. Registered Patent Attorneys. Write for information.

"INVENTOR'S Guide" free on request. Frank Ledermann, Registered Patent Attorney, 154 Nassau St., New York 7, N. Y.

INVENTORS: Write for free brochure "Evidence of Invention." Labiner, World Building, New York 7.

INVENTORS: Without obligation, write for information explaining the steps you should take to secure a patent. John N. Randolph, Registered Patent Attorney, 203 Columbian Bldg., Washington 1, D. C.

PATENT Practice before U. S. Patent Office. Validity and infringement investigations and opinions. Booklet and form "Evidence of Conception" forwarded upon request. Lancaster, Allwine & Rommel, Registered Patent Attorneys, Suite 411, 815-15th Street, N.W., Washington 5, D. C.

INVENTORS. For "Record of Invention" form, contact Carl Miller, Registered Patent Attorney, Woolworth Building, New York.

FOR INVENTORS

INVENTORS—If you consider your invention to be something of importance, take steps to protect it with a United States patent which gives you the right to exclude others from making, using and selling your invention as claimed. "Patent Protection for Inventors" outlines steps to take to secure patent protection. Mailed promptly without obligation. Victor J. Evans & Co., Merlin M. Evans, Registered Patent Attorney, 632-B Merlin Building, Washington 6, D. C.

PRINTING Plates, hand engraved. Graphic, 230 So. Church, Clyde, Ohio.

PATENT Searches, \$5.00, including patent copies. Same reliable search as conducted for patent attorneys. Free protection forms, 48 hour service. Patent Service Institute, 945-A Pennsylvania Avenue, Washington 4, D. C.

INVENTORS—If you believe you have an invention, you should find out how to protect it. The firm of McMorro, Berman & Davidson with offices in Washington, D. C., is qualified to take the necessary steps for you. Send for copy of our patent booklet "How to Protect Your Invention." We will also send you an "Invention Record" form. No obligation. They are yours for the asking. McMorro, Berman & Davidson, Registered Patent Attorneys, 134-L Victor Building, Washington 1, D. C.

CASH For your idea, 280 manufacturers need inventions, patented or unpatented. List free. Invention Bureau, 208M Clinton, Oak Park, Ill.

INVENTORS! For complete services write: Industrial Patent Reports, Box 1081, Massachusetts and North Capitol, Washington 13, D. C.

WANTED! By large manufacturer of light metal products. New products, new ideas, new inventions. For production, distribution, sales on a national basis. Will consider royalty basis, leasing or outright purchase. Sales Craft, Inc., 70 Fourth Street, N.W., Atlanta, Ga.

INVENTORS: Learn how to protect your invention. Unless the inventor is familiar with patent matters, he should engage a competent registered patent attorney or agent to represent him. We are registered to practise before the U.S. Patent Office and prepared to serve you in handling your patent matters. "Patent Guide for the Inventor" containing detailed information concerning patent protection and procedure with "Record of Invention" form will be forwarded to you upon request—without obligation. Clarence A. O'Brien & Harvey Jacobson, Registered Patent Attorneys, 11A-A District National Building, Washington, D. C.

INVENTORS—Our free booklet "Reaching Your Invention Markets" gives recommended marketing procedure for patented, unpatented inventions. Mailed on request without obligation. Market Contacting & Data Service, 11106-W2 Longwood, Chicago 43.

SEARCHES—Put your patent searches in the hands of a registered patent attorney or agent, as he qualifies to give a worthwhile patentability report. Record of invention form upon request and information on patent protection. Patrick D. Beavers, Registered Patent Attorney, 936 Columbian Bldg., Washington 1, D. C.

WE Specialize in developing patents on articles made from rubber or plastics. Complete development laboratories with limited manufacturing facilities. Over 25 years experience. Rublab, 2706 Tower Bldg., Akron, Ohio.

ACTION, Action, action. Inventors with patented and patent pending inventions for sale or lease request free book. No obligation. Dept. 1-P, U. S. Patent Exchange, 239 Hellman Bldg., Los Angeles 13, Calif.

PATENT Owner Representative. Years of experience. Can I help you? Charles A. Scott 773PM Garson Avenue, Rochester 9, N. Y.

INVENTORS: If you have an invention for sale, patented or unpatented, write Institute of American Inventors, Dept. 40A, 631-E St. N.W., Washington 4, D. C.

PATENT Searches by former patent office examiners \$5.00. 48-hour service. Protection forms free. Write Patent Engineering Service, 1404 New York Avenue, Washington 5, D. C.

PATENT Searches \$5.00. 48-hour service. Patent copies included. Protection forms free. Write Raymond L. Smith, Patent Searcher, 410 Bond Building, Washington 5, D. C.

INVENTORS: Without obligation, write for information explaining the steps you should take to secure a patent on your invention. John N. Randolph, Registered Patent Attorney, 202 Columbian Bldg., Washington 1, D. C.

INVENTORS. For "Record of Invention" form, contact Carl Miller, Registered Patent Attorney, Woolworth Building, New York.

PATENT Searches \$5.00. Reports air-mailed within 48 hours. Invention protection forms free. Write Miss Ann Hastings, Patent Searcher, P.O. Box 176, Washington 4, D. C.

INVENTIONS WANTED

ARMY, Navy, airforce inventions urgently needed. Detailed list of 97 inventions needed by our armed forces. Compiled from latest official government sources. Send one dollar to Texall Corporation, Bedell Building, San Antonio, Texas.

CASH Or royalty: Our unusual service sells inventions, patented, unpatented, because alert manufacturers constantly ask us for ideas. Also, we make special calls on live manufacturers, promoters, agent-houses, mail order houses, etc., in rich Chicago industrial area. List of needed ideas free. Inventors Sales Bureau, 208-N Clinton, Oak Park, Illinois.

PRACTICAL Inventions wanted. Inventors Patent Exchange, Dept.-B, Hartford 1, Connecticut.

INVENTIONS Promoted. Patented or unpatented. Write Adam Fisher Company, 61 Enright, St. Louis, Mo.

SKILSAW, Inc., leading manufacturer of portable electric and pneumatic tools seeks patented or patentable ideas suitable for manufacture in our modern production plant. Address: Engineering Department, 5033 Elston Ave., Chicago 30.

INVENTORS—What have you, patented, unpatented to offer manufacturers? Request free booklet without obligation. Market Contacting & Data Service, 11106-A2 Longwood, Chicago 43.

ACTION, Action action. Free book to inventors with patents and patent pending inventions for sale or lease. No obligation. Dept. 1-W, U. S. Patent Exchange, 239 Hellman Building, Los Angeles 13, Calif.

INVENTORS: Hundreds of manufacturers have requested our assistance in locating marketable new products. Complete information free. Institute of American Inventors, Dept. 40-D, 631-E St. N.W., Washington 4, D. C.

PATENTS FOR SALE

COMBINED Roaster and barbecue oven for sale. Charcoal grate may be removed and electric heat put on. Electric power with gear used. Fire-proof glass may be used. E. Bocchino, 58 Yerance Ave., Clifton, N. J.

AUTOMATIC Butter fly safety fire door. Most modern fire door on the market. Convenient and practical for house furnaces, boilers, bakers' ovens, heat treating furnaces. Operated by foot pedal. Some territories left open. Apply to P. H. Rutledge, Box 180, Mission City, British Columbia, Canada.

NEW Novelty flash light mirror, pocket size. Royalties or outright. Frank Novak, P.O. Box 368, Rahway, N. J.

NO. 2,459,458. Double-action trailer hitch. Philip Schmitz, Sleepy Eye, Minn.

INVENTORS: Test the commercial value of your patented or unpatented inventions, quickly and inexpensively. Write for free information. Institute of American Inventors, Dept. 40-B, 631-E St. N.W., Washington 4, D. C.

MODELS, MODEL SUPPLIES

PRIME Kits and fittings for sail, steam and diesel. Send 25c for useful 1951 catalog. Model Shipways, Folio 66, 476 Main Street, Fort Lee, N. J.

SHIP And yacht model fittings; blueprints. Send 25c for illustrated catalog No. 26—listing hundreds of items. A. J. Fisher, 1002-1 Etowah Ave., Royal Oak, Mich.

POWER Models. Unusual steam, gasoline and traction engines. Metals, tools, accessories. Catalog 50c. Chas. Cole, Ventura, Calif.

STEAM Locomotives, 1½", 1", ¾", ½" ¼" scales. Castings, rail, steam fittings! Thorough drawings with instructions. Catalog 50c. Little Engines, Wilmington, California.

RAILROADERS—50c Gets new Catalog Reference Manual. State O or HO gauge. Walthers, 247 Erie, Milwaukee 2, Wis.

BRASS Gears and model supplies for the inventors. Send 10c for catalog. Pierce Model Works, Tinley Park, Ill.

BUILD Historic ship models, complete kits 39c to \$9.00. Catalog 10c. Ideal Models, 19 W. 18th, New York 11, N. Y.

SHIP Models and yacht supplies complete. Large 64 page catalogue 30c. Bill Wild's, 510 East 11 St., New York City 9.

LIONEL Trains, accessories, switches. Tremendous stock; fast delivery. Guaranteed repairs. Authorized Lionel Train Station, 72 West Washington, Chicago 2.

MANUFACTURING

MACHINE Work: tools, dies, jigs, patterns, aluminum castings. Special work to order. Ricardo Co., Adel, Iowa.

COMPLETE Inventors' model construction services. Mechanical Development Company, Salem, Virginia.

MODELS—Small lot manufacturing. Metals, plastics, etc. Milburn, Burlington, Kentucky.

HOME CRAFTSMEN

89 FULL Size jig saw patterns of beautiful shelves, ornaments, toys, novelties. Plus "How, Where to Sell." Only \$1.00. Mastercraft 24M, 7041 Olcott, Chicago 31, Illinois.

12 FULL Size lawn ornament patterns \$1.00. These ornaments sell like "hot cakes" for us. Continental Homecrafters, 907 Birch, Eau Claire 3, Wisconsin.

GARDEN Figures, lawn chairs, furniture, novelties, toys, etc. 68 popular plans, with full size patterns, \$1.00. Mastercraft 21M, 7041 Olcott, Chicago 31, Illinois.

LEATHERCRAFT Supplies, leather and tools, low prices. Send 10c for catalog. Jonas Handicraft Co. (Dept. 2-M), 30 Frankfort St., New York 7.

16 NEW Lawn chairs, 22 picnic tables, benches, trellises, etc. All 38 plans with necessary full size patterns, \$1.00. Mastercraft 23M, 7041 Olcott, Chicago 31, Ill.

JIGSAW Owners attention! Start earning money at home cutting out wooden novelties and souvenirs. Write H. Cook, Dept. A, 4407 S. Normal Ave., Chicago 9, Ill.

90 ALL New, full size lawn ornament and novelty patterns, up to 20" high. Only \$1.00. Mastercraft 22M, 7041 Olcott, Chicago 31, Illinois.

SAVE On leather items. Make easy-to-assemble belts, purses, gloves, woolskin toys, etc., as gifts or to sell. Send 10c for big catalog. 100 money-making ideas. Largest leathercraft stock in U. S. J. C. Larson Co., 820 S. Tripp, Dept. 775, Chicago 24.

70 LAWN-Ornament, and novelty patterns only \$1. Write at once for new, free, price-list. Mosbro Patterns, 44-M, Victor, Mimico, Ontario.

CACTUS Wood, lamp size sample, 60c postpaid. 214D East Yavapai, Tucson, Arizona.

VIOLINMAKERS. Amateurs, professionals. Fine tone European wood, materials, supplies, instructions, patterns. Illustrated catalogue 10c, refunded. Premier Violin Supplies, 430 South Broadway, Los Angeles 13, California.

KNOCKDOWN 16 Drawer chest solid wood, no veneer. Ask for illustrated price list. Henry E. Piltz, Box 148, East Orange 2, N. J.

MAKE Leather belts, billfolds, purses. Big catalog and genuine steerhide keyholder, 10c. Tandy Leather, Box 397C, Tulsa, Okla.

NEW 96 Page leather and craft catalog, 1000's of items. Send 10c. Russo Handicraft Supplies, Dept. C-1, 245 South Spring, Los Angeles, California.

8 BEAUTIFUL Full-size whatnot patterns 35c. Joanness, P.O. Box 141-M, Omaha 7, Nebr.

HOBBYCRAFT Booklet and catalog 10c. Leisure Hour Products, 416 Rose, West Hazleton 3, Penna.

TURN Workshop into cash. Send dime for new 32-page catalog describing hundreds things to make for fun, profit. Craftplans, 1321-A South Michigan, Chicago 5.

LEATHERCRAFT Bargains! Lacing. Francis Byrd, 3406 Montrose Ave., Richmond, Va.

LEATHERCRAFT Supplies, leather, tools, lacing. Catalogue 10c. Mail orders. Crown Leather Co., 22 Spruce Street, New York 7.

NEW Leathercraft catalogue. Pleasure and profit. New styles, belts, purses, shoes. Largest leathercraft school in U.S.A. G. I. approved. Send 10c for catalogue. Dept. PM, Apache Leather Co., 2804 E. Washington St., Phoenix, Arizona.

SHELLS, Plastics, findings. Lowest prices. Catalog 5c. Frances Jones, Box 251, Sarasota, Fla.

LEATHERCRAFT, Copper tooling, textile painting. Make spare time, profitable time. Free illustrated catalog shows everything you need. Kit Kraft, 7377 Melrose, Hollywood 46, California.

LEATHER, Tools, lacings, supplies. Free catalog. National Handicraft, 199 William St., New York 7.

80 FULL Sized patterns. Lawn ornaments, toys, novelties \$1.00. Modern Woodcraft, Saginaw, Mich.

KNOCKDOWN Cedar chests. Lumber and veneers. Free price list. Giles & Kendall Company, Huntsville, Ala.

MAKE IT YOURSELF

STREAMLINED. Built-in kitchen cabinets to fit any kitchen. Illustrated manual describes designing and construction. All for \$1.00. Thombert Company, Newton, Iowa.

HOW To build farm, home and workshop machines. Free list and sample. Write Clearprint Plans Company, Box 2-265, Muskegon, Michigan.

PROFITABLE Hobby. Plans for hand weaving loom \$4. Englewood Weavers, 447 West 60th Place, Chicago 21.

BUILD 21" Heavy duty band saw, cast aluminum parts, full ball bearing. Parkraft, 246 Reo, Warren, Ohio.

BUILD Your own furniture. Send dime for illustrated folder. Craft-Plan, Box 581, Los Angeles 43, Calif.

GRANDFATHER Clock easily built. Big savings. See ad on page 260.

FREE Literature describing needed farm and home machinery, easily built by you, from salvage materials. Kenneth Reeves, Box 3557-A, El Paso, Texas.

BUILD Your own tractor. Plans. Walking, riding. Free information. Ellsworth Tractor Co., D-1, Camptonville, Calif.

BUILD Your own concrete blockmaker. Easy. Inexpensive. Motor or hand. Make block per minute. Write, C. Lee, Mountain View, Okla.

WATCHES, OLD GOLD, JEWELRY

RHINESTONES, Jewelry settings, camoes, sequins, beads. Catalog free. J & M Novelties, Dept. CB-3, Griffith, Ind.

WATCHMAKERS' Jewelers', hobbyists', tools, Supplies. Catalogue! Bengal Company, Culver City, California.

KLONDIKE Novelty and jewelry findings! Swept from manufacturers' tables. Parts for bracelets, pins, earrings, finished and unfinished chains, rings, stones, clips, beads, many others. Sample pound assortment \$2.00, 5-pound lots, \$7.50. Also unset stones, for rings, jewelry; all colors, sizes, designs, 1,000 assortment \$5.00, sample 100 assortment \$1.50. Also beads, assorted colors, sizes, 5-pound lots \$3.00, sample pound \$1.00. Prepaid only. Merchandise Distributing Company, 19 East 16th Street, Dept. 12, New York 3, N. Y.

WATCH And Clockmakers Handbook. Bitten \$4.95. Free catalog. Engineers' Book Service, 19 W. 44th St., New York City 18.

WATCHES—Promptly, completely, expertly, reconditioned, \$4. Fifty-three years experience backs guarantee. No-Stop Watch Shop, Glenwood, Arkansas.

WATCHMAKERS' Journal contains instructive articles on watch repairing. \$1.00 year. Sample copy 20c. Dean Co., 116-K Nassau St., New York 7, N. Y.

WATCHES Wanted. Any condition. Also broken jewelry, spectacles, dental gold, diamonds, etc. Cash sent promptly. Mail articles today or write for free shipping container. Lowe's, Dept. POM, Holland Bldg., St. Louis 1, Mo.

WATCHMAKERS' Beginners! Watches; movements; descriptive list. Box 150, Chicago 90, Illinois.

DIAMONDS Lowest wholesale prices. Airmail for price list. Joachim Goldstein Diamond Club, Antwerp, Belgium.

HIGHEST Cash paid for old, broken jewelry, gold teeth, watches, silverware, diamonds, spectacles, platinum. Free information. Satisfaction guaranteed. Government licensed. Rose Smelting Company, 29-A East Madison, Chicago.

TOBACCO, SMOKERS' SUPPLIES

FREE—Valuable pipemaking instructions! Exciting new hobby. Carvape, 2829-K Dixie, Hamilton, Ohio.

RAZORS, BLADES, SHARPENING

FREE. Tube of Gillette Brushless Shaving Cream with 100 chrome steel double edge razor blades \$1.00 postage paid. Fast Dime Harry, 1549 Harrison Ave., Cincinnati 14, Ohio.

OF INTEREST TO WOMEN

WHAT Are your old stamps worth? Look them up in our Price Guide. 128 pages, 1,000 illustrations, 10,000 prices. Only 25c—satisfaction guaranteed. Harrisco, 803 Transit Bldg., Boston.

PROFITABLE Home business. Make fast-selling Easter, Mother's Day flowers, monkey trees, dolls. Literature free. Velva, Dept. M, Bohemia, N. Y.

FOR SALE—MISCELLANEOUS

HANDSIGHTING Levels, improved, new model, used for grading land, contouring and laying out fences, piers, roads and gardens, price \$2.00 postpaid. Public Sport Shops, 11 S. 16th Street, Philadelphia 2, Penna.

FREE Catalog! War surplus clothing. Amazing bargains. N. Y. Clothing Co., New York 29A.

SAVE Money on army, navy and factory surplus. Write today for new 60-page illustrated catalog. Tennusa Sales Co., Dept. AE, 1451 Market, Chattanooga, Tenn.

DRESSES 18c; Coats \$1.00; blouses 35c. Free catalog. Crown, 164-PA Monroe Street, New York.

WANTED—MISCELLANEOUS

WHAT Are your old stamps worth? Look them up in our Price Guide. 128 pages, 1,000 illustrations, 10,000 prices. Only 25c—satisfaction guaranteed. Harrisco, 804 Transit Bldg., Boston.

WANTED—Saw filing machines. Box 194, Park Ridge, N. J.

PERSONAL

BORROW By mail. Loans \$50 to \$300 to employed men and women. Easy, quick. Completely confidential. No endorsers. Repay in convenient monthly payments. Details free in plain envelope. Give occupation. State Finance Co., 210 State Finance Bldg., Dept. T-14, Des Moines 8, Iowa.

FREE Aptitude testing booklet. Find right career. Write Vocational Center, Executive, 2227 DeLancey, Philadelphia 3, Penna.

LOW Cost hearing device. No battery, no wires. Simple ear plug that carries sound to the ear drum. Beaudry, 4337—30th Avenue South, Dept. H, Minneapolis 6, Minn.

"**BIG** Mail" directory that is different! Write for free offer. Dougherty Directory, Box 12, Phillipsburg, N. J.

MEXICAN Legal matters reliably handled. Box 1736, El Paso, Texas.

INTERESTING Mails. 25c keeps name on mailing list three months. Bentz, Desk C/77, Chatawa, Mississippi.

ADVENTURE Mails. Unusual. Name listed 3 months, 25c. McCann's, Fleetwood, RD3, Penna.

VALUABLE Big mails, four months listing, 25c. Wright Publications, 2270-J Hubbard, Memphis 8, Tenn.

MEXICAN Mailing service. Your letters remailed, received 20c. Mystify friends. Photographic postcards 10c. Tillotson, Apartado 1405, Guadalajara, Jalisco, Mex.

MAKE Money in 1951 by mail, particulars 3c. Swaty, Box 1466-P, San Diego, Calif.

MEXICAN Law. General practice. Attorney, 1203 Arizona St., El Paso, Texas.

HERE'S How and where to borrow \$50.00 to \$300.00 by mail. Confidential. Free particulars. Postal Finance Company, Dept. 45, Sioux City, Iowa.

"**HOW** Can I find out?" You can! Information discreetly developed. Any matter, person, problem, anywhere. Worldwide. Officially licensed, bonded service. Established 1922. Reasonable. Confidential. William Herman, 170 Broadway, New York.

LETTERS Remailed 25c each. Edward Nadell, Box 345, Los Angeles 53, Calif.

MISCELLANEOUS

FORTUNE May be yours. Detect uranium, gold, silver, precious metals, minerals. America's finest Geiger counters, metal and mineral detectors and mineralights. None finer at any price. Factory guaranteed. Write manufacturer for free information. Detecron Co., 5631 Cahuenga, North Hollywood, California.

URANIUM Detection by government approved fluorescent method. Expensive equipment not necessary. Send only \$3.75 for test outfit. Free particulars. Central States Laboratories, 947 N. Avers Ave., Chicago 51, Ill.

RECEIVE Hundreds of valuable items absolutely free. Supply source directory 25c. Nelko Service, 3462 Merchandise Mart Sta., Dept. FR-2, Chicago 54, Ill.

CHINESE Division. Amaze by quickly doing long division backwards writing only the answer. 25c tells how. Many other new unusual tricks. Montl, 219 Tinton, Eatontown, N. J.

NOVELTY Key tags. Real bees in plastic 35c each, three for \$1.00. Earl Knebel, Raymond, Iowa.

ALUMINUM Nails—Never stain, never rust. All sizes. Large assortment \$1.00. W. W. Sales, 503 Deming P-1, Chicago, Ill.

INCREDIBLE! Unprecedented! Become a mental superhero overnight! Floor everybody! No studying! "Memoprop" does all your thinking! It's uncanny! Revolutionary! Write: Bijou, Box 1727-M8, Hollywood 28, California.

RESEARCH: We find, locate buyers, or sellers for anything of value. Registration and listing, \$1.00. Refundable. Wright Publications, 2270-F Hubbard, Memphis 8, Tenn.

HAIRCUT As you like it. Booklet tells how. 25c. Mastrolia, 5½-L Jane, New York 14.

WHAT Are your old stamps worth? Look them up in our Price Guide. 128 pages, 1,000 illustrations, 10,000 prices. Only 25c—satisfaction guaranteed. Harrisco, 805 Transit Bldg., Boston.

GEIGER Counter, skeleton, \$16 postpaid. Metal detectors. Mineralights. Western Radiation Laboratory, 1107 W. 24th Street, Los Angeles 7, Calif.

EARN Up to \$200 month, inventing toys, games, gadgets. Write, Hendrickson, Argyle 1-A, Wisconsin.

INSTRUCTIONS For building Radio Treasure Finder, \$1.00. Wyss, 104½ Francis, St. Joseph, Mo.

YOUR Leather jacket renovated expertly. Free circular. Berlew Mfg. Co., Dept. 8, Freeport, N. Y.

SEEK Gold, uranium, buried treasure! Latest low cost super-sensitive equipment. Free literature. Glen Scientific, Box 151-B, Glen Ellyn, Illinois.

PANNING Gold lesson and catalogue. Beginners supplies, books, "maps where to go" free. Old Prospector, Box 729D1, Lodi, Calif.

SPIT-FIRE Guaranteed world's hottest, most dependable alcohol blow torch. Write Robert Livingston, 1425 Scott, Williamsport, Penna.

VERMONT Maple syrup, sugar, cream. 100% pure. 1950 crop. Butternuts. List. H. Marshall, Poultney, Vt.

LABELS, Cartons. Send 10c. Smith Labels, 890 Logan, Denver, Colorado.

OUTDOOR Toilets, cesspools, septic tanks cleaned, deodorized with amazing new product. Just mix dry powder with water; pour into toilet. Safe, no poisons. Save digging, pumping costs. Postcard brings free details. Burson Laboratories, Dept. C-16, Chicago 22, Illinois.

\$5 HOUR Easy! Sell name plates for houses. Free sample, order blanks. Write: National, 214 Summer, Boston, Mass.

SAVE Money on paint brushes. Buy direct. Post card brings descriptions and prices. Kenmore Brushes, P.O. Box 53, Kenmore 17, N. Y.

TREASURE—M-Scope Geiger counters, mineral locators. Why buy something inferior when you can buy the best at a lower price? Backed by years of experience. Fully guaranteed by factory. Detects minerals, metals, gold, silver, coins. Payment plan available. Proven superior performance. Free 16 page illustrated booklet. Fisher Research Lab., Inc., Palo Alto, California.

20% DISCOUNT On radios, television, electric appliance, mixers, binoculars. Catalog \$1.00 (refundable). Points Mail Order House, Box 331, Middleton, Penna.

URANIUM Prospecting information free. Prospector, Box 142-D, North Battleford, Saskatchewan, Canada.

TREASURE Finders for gold, silver and minerals. Money back guarantee, best available. Also Geiger counters for uranium prospectors, free information. Write Goldak Company, 1541 West Glenoaks, Glendale 1, Calif.

TATTOOING Machines, outfits. Free catalogue. Jensen, 120 West 83rd Street, Los Angeles 3.

"**RECEIVE** Mail." Moneymaking offers, opportunities, catalogs. Name listed 10c. Ideal Service, Park Ridge 10, Ill.

SQUARE Dance instructions. 40 dances, \$1.00. Wesley Rader, 1922 Grant, Denver 5, Colorado.

TATTOOING Outfits, supplies. Illustrated list free. Zeiss, 728 Leslie, Rockford, Illinois.

NEW Beautiful distinctive gifts for all occasions. Highest quality. Maker's name and guarantee. Your great opportunity. Crane Merchandise Sales, 1651 Park Ave., Racine, Wis.

GET THE FACTS ABOUT FISHING RODS FREE!

• What kind should you buy? Solid steel, tubular steel or glass? What are the advantages of each? Which gives best action—most sport—best value? A new "True Temper Fact Folder" explains the merits of each. It describes world's finest, most complete line of rods—including the new True Temper Dynalite laminated glass fiber rod. No obligation—write today for free copy.

USE THIS COUPON PLEASE

TRUE TEMPER Corporation
MAKERS—THE ROD OF CHAMPIONS

Sporting Goods Division, Dept. 8
Geneva, Ohio
Please send your new True Temper Fact Folder to—

Name _____
Street _____
City _____
State _____

BRAND NEW **30 DAY FREE TRIAL**
High Power BINOCULARS
Finest Precision Optics
Featherlight
Money Back Guarantee
Easy Pay Plan
Leather Case Incl'd.
Free! Catalog & Book
"How to Select Binoculars"
Dealer Inquiries Invited
Bushnell Bldg., Dept. M-22,
Pasadena 1, Calif.



33 MODELS
\$14⁹⁵
up
BUSHNELL Binoculars

Remarth
MANUFACTURING COMPANY
AUTOMATIC GAS INJECTOR

WILL CUT YOUR GAS BILL—OR MONEY REFUNDED IN FULL

Use Remarth 30 days at our risk. Must save you substantial gas, give quicker starts, faster pick-ups, more power, better car performance, or return for full refund. SAVES MANY \$\$\$ A YEAR. One Fleet owner says, "Have Remarth on 8 cars. Saves 1 gallon of gas in every 6, get increased power under full throttle." Order today. Give car make, model, year No. of cylinders.

\$995
POST PAID

WESCO Dept. 42, 12, 1665 Mission St. San Francisco 3, California

You Can Install It



Earn Big Money

WRITING ORDERS

AMAZING NYLONS

Guaranteed Against
RUNS AND SNAGS
Regardless of Cause!

The world's **ONLY** complete, nationally advertised nylon hosiery line actually guaranteed against runs, snags or excessive wear, **REGARDLESS OF CAUSE!** It's amazing, but true! No matter what the cause—hard use or deliberate abuse—Kendex nylons are replaced **FREE** if they run, snag or become unfit for wear within entire guarantee period! Every weight from sheerest 15 denier to heavy 70 denier—all gauges up to luxury 60 gauge—all sizes, lengths, popular shades, fancy heels, black seams—full fashioned and seamless. Nothing is missing to make sure every woman is pleased. In spite of the amazing guarantee, retail postage prepaid prices are no higher than comparable quality national brands. Should free replacement be necessary, actual cost is cut in half! How could any woman possibly resist saving money and solving her hosiery problems? **NOT SOLD IN STORES.** Men and women wanted **NOW**, spare or full time, to write orders and earn big money. You can get orders even if you never sold a thing in your life!

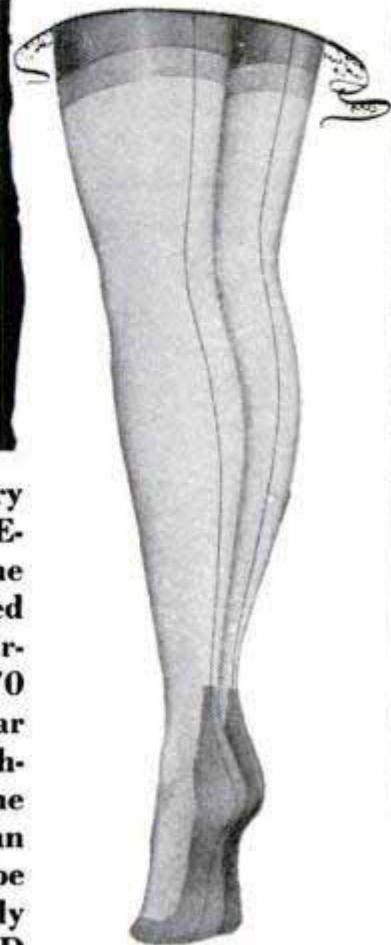

FREE SAMPLE STOCKING

Man or woman—young or old, **YOU** can easily earn steady income, spare or full time. No money or experience needed. We supply **EVERYTHING** free and set you up in business at **OUR** expense. Nothing to buy or deliver. Write orders. We deliver and collect. Big advance pay plus huge cash bonus that increases your earnings up to **40%**! Your name and address on postcard will bring you sample stocking; self-selling sales books with **FULL COLOR** illustrations; 32-page sales manual showing you easy steps to success; color cards, free "door openers" worth \$1 each but which you give away free; special plan to have others sell for you, etc., etc. You can start making money the minute you receive the complete **FREE** outfits!

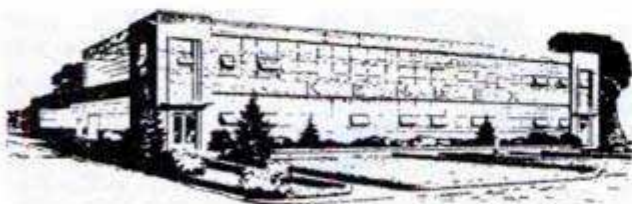

YOUR COST ONE CENT!

SEND NO MONEY. Pay nothing now or later. No obligation. Not even a promise to return outfits. Simply write your name and address on a penny postcard and mail to us. We'll immediately rush you everything you need **FREE** and postage prepaid. **WRITE TODAY!**

KENDEX CORPORATION

● BABYLON 746, N. Y.

Listen
to this
Record!



SPEAK FRENCH-SPANISH

RUSSIAN - GERMAN
ITALIAN - BRAZILIAN - JAPANESE

"Learn by Listening" to CORTINA RECORDS, at home,
the NATURAL way—quickly, easily, cheaply.

Only 15 Minutes a Day!

THOUSANDS have found it the most fascinating, most
effective way to learn languages for Pleasure, Business,
Travel, Culture. INVESTIGATE!

Send For FREE BOOK!

Illustrated 32-page book, "The Cortinaphone Short-Cut"
sent FREE. Tells just what you want to know. Interesting.
Get it!

Write Today--NOW

CORTINA ACADEMY (Est. 1882)
Suite 642, 105 W. 40 St., N.Y. 18, N.Y.

Please send me—without obligation—your free book,
I am interested in (check)

French Spanish German Italian Brazilian
 Russian Japanese

Name.....
Address.....
City..... State.....
 Check here if you are a VETERAN

**VETS! FRENCH OR SPANISH COURSE
AVAILABLE UNDER G. I. BILL**



WRITTEN GUARANTEE SENT WITH EVERY TIRE YOU BUY

PLEASE NOTE: Our Tires are NOT Retreaded or Re-Capped We serve TRUCKS — BUSES — PASSENGER CARS

GOOD USED TIRES

WE PERSONALLY SELECT YOUR TIRES A TRIAL OF ONE TIRE WILL CONVINCE YOU.

ONE QUALITY
ONE PRICE
OUR BEST!

Why Pay More!

SEND CHECK OR MONEY ORDER IN FULL WITH THIS AD NOW — AND YOU MAY TAKE **20%** DISCOUNT ON EVERY TIRE SAVE TIME & MONEY

ALSO TUBE GIVEN WITH EACH PASSENGER & TRUCK TIRE AT NO EXTRA COST — SEND THIS AD!

550-15	\$6.40	670-15	\$7.00	710-15	\$7.75	760-16	\$8.45
600-16	6.40	700-15	7.75	750-16	8.40	820-15	8.50
650-15	6.50	700-16	6.95	750-17	10.95	825-18	6.50
650-16	6.60	700-17	10.00	760-18	7.75	850-17	6.50



600-20	\$10.90	32x6(8)	\$12.50	1000-20	\$20.40
650-20	11.50	32x6(10)	14.65	1100-20	20.40
700-20(8)	12.50	825-20	19.40	1000-22	20.40
750-20	15.00	900-20	19.40	1100-22	20.40

Thousands of tires shipped all over U.S.A. All tires shipped F.O.B. Phila. Send Check or M.O. with this ad. Dept. 2. If your size is not listed write for prices. 17 YEARS AT THIS ADDRESS.

STANDARD 834 N. Broad St., Philadelphia 30, Pa.



SEND FOR THIS FREE!

Make money. Know how to break and train horses. Write today for this book FREE, together with special offer of a course in Animal Breeding. If you are interested in Gaiting and Riding the saddle horse, check here () Do it today—now.

BEERY SCHOOL OF HORSEMANSHIP
Dept. 1102-D Pleasant Hill, Ohio



AJAX AUSTRALORPS

SENSATIONAL WORLD CHAMPION LAYERS. Black Australorps mature fast. Excellent roasters — capons. Massive size. U. S. Approved — Pullorum Controlled. Low farm prices. Catalog FREE. Write TODAY. **AJAX HATCHERY, BOX 914, QUINCY, ILL.**

LEARN WATCHMAKING JEWELRY REPAIRING

Start your training now for a better paying job or your own profitable business. Our training is nationally recognized, outstanding and supervised by expert craftsmen. Write for free catalogue.

APPROVED FOR VETERANS

SCIENTIFIC SCHOOL OF WATCHMAKING, Dept. PM-2
3923 San Fernando Road Glendale 4, California

Say You Saw It in Popular Mechanics

ELECTRIFY your SEWING MACHINE

NEW LOW PRICE!
\$11.50 1 YR. GUARANTEE

Buy direct from manufacturer and save! Kit comes fully wired, installed in a jiffy. Fits all machines! You get these all-new parts:

- Motor & Bracket
- AC-DC 115v 60c
- Multi-speed foot control
- Cord set & block
- Easy instructions
- Steel pulley & belt

FREE . . . reg. \$2.95 chrome SEWLITE given with every kit.

10 DAY FREE TRIAL — ORDER NOW!
Send no money, pay COD or send money order and we'll pay postage. Please state whether wheel on your machine turns toward you or away from you. Shipping wt. 6 lbs.

CONTINENTAL SALES CO.
1046 BEDFORD AVENUE Dept. PM-23 BROOKLYN 5, N. Y.

The Steady Pay Profession Good Times or Bad!

SCIENTIFIC CRIME DETECTION



FREE! OVER 800

"BLUE BOOK OF CRIME"

This book is full of exciting information on scientific crime detection. It will show how You can get started in a grand career. Now, at amazingly low cost. Clip coupon Now...Mail it today.

It Is Easy to Learn!

I will teach you this fascinating science during your spare time at home. It pays to be an expert in Finger Printing, Firearms Identification, Police Photography and Criminal Investigation. I have trained hundreds of men and women now successfully serving in identification bureaus throughout America. You, too, may quickly prepare yourself to become a well-paid valued officer of the law, often sharing in the generous rewards offered for wanted criminals.

of all Identification Bureaus in the U. S. employ students and graduates of I. A. S. A majority of these men are heads of Bureaus. Many of them knew nothing about crime detection before training with me. Now they have steady jobs, good salaries and a fine future. Write today for full particulars and free book. Give age. Nosalesman will call.

INSTITUTE OF APPLIED SCIENCE
(A Correspondence School since 1916)
1920 Sunnyside Ave., Dept. 1352, Chicago 40, Ill.

INSTITUTE OF APPLIED SCIENCE
1920 Sunnyside Ave., Dept. 1352, Chicago 40

Gentlemen: Without any obligation on my part, send me the "Blue Book of Crime," and complete list of Identification Bureaus employing your students or graduates, together with your low priced and Easy Terms Offer. (Literature will be sent ONLY to persons stating their age.)

Name..... Age.....
Address..... R. F. D.....
City..... State.....

Save Point Repair Costs

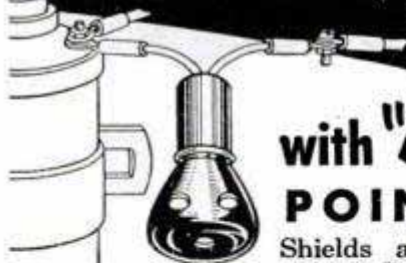

with "PRESTO" POINT SHIELD

Shields and protects ignition points. Serves as excess current regulator—prevents "Blue Points". Particularly efficient in

cold weather starting as well as all ordinary driving. Saves cost of several sets of points. Easily and quickly installed—merely connect in series between coil and distributor.

If your service station or dealer can't supply, order direct—only \$1.85 postpaid.

QUICK STARTS IN COLD WEATHER—with **MARVEL STARTER COIL!** Replaces standard equipment coil for year around use. Delivers thru "built in booster" the high frequency sparks needed for quick cold weather starting. No additional batteries nor connection with plug-in electrical currents needed. Price \$19.85—send for descriptive circular.

BOCK MFG. CO. 711-A WEST LAKE STREET
MINNEAPOLIS 8, MINN.

WANT TO Write Stories

FREE LESSON
shows how you learn at home

Articles
Mysteries?



The demand for writers is creating great new opportunities and it's not as hard to succeed as you may imagine. At home, you may learn fiction writing, best basis for all fields; short stories, radio & TV, articles, business items. Palmer training is endorsed by famous authors, scores of successful graduates. Complete instruction, professional coaching. **FREE** book and lesson show how you may enjoy an ideal part-time or full-time career. Write **TODAY** (no salesman will call). Approved for veterans; advise if eligible.

PALMER INSTITUTE OF AUTHORSHIP, Since 1917
1680 N. Sycamore, Hollywood 28, Calif., Desk T-21

SAY YOU SAW IT IN POPULAR MECHANICS

DRIVING RELIEF! New LEFT-FOOT ACCELERATOR

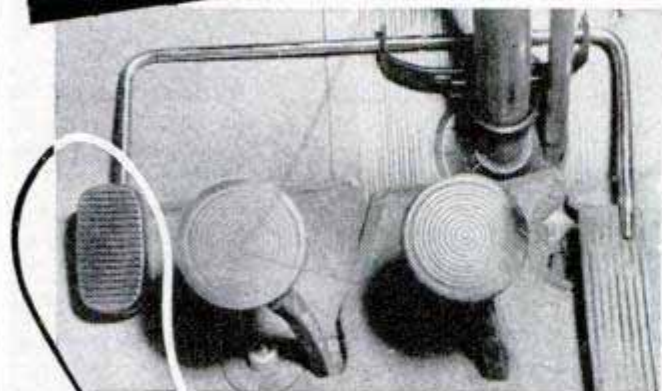

Dealer inquiries invited.

Cut driving fatigue in half with Lefty! Install this new left foot accelerator yourself in 60 seconds with just a wrench—no alterations to your car are necessary. Enjoy relaxed comfort on long drives. Lefty lets you feed the gas with your left foot when you desire, relieves tension and fatigue in leg, back, and foot. Safe, positive and convenient. Swings out of way when not in use. Brings your car up to date. \$5. ppd. Specify year and make. No COD's please.

INVENTOR'S MARKETING LAB.

1210 De Young Bldg., 690 Market St., San Francisco, Calif.

DRAW ME!



COPY THIS GIRL

\$1,275.00 IN PRIZES!

5 Prizes! 5 Complete \$255 Art Courses, including Drawing Outfits!

Here's your big chance, if you want to become a commercial artist, designer, or illustrator! An easy-to-try way to win **FREE** art training!

Whether you win or not we send you our comments on your work, if your drawing shows promise! Trained illustrators, artists and cartoonists now making big money. Find out now if YOU have profitable art talent. You've nothing to lose—*everything to gain*. Start your drawing now. Mail it today.

Amateurs Only! Our students not eligible. Make copy of girl 5 ins. high. Pencil or pen only. Omit the lettering. All drawings must be received by March 31, 1951. None returned. Winners notified.

Latest Winner List! Free course winners in previous contest— from list just released: R. Lambert, 3206 Eastern, York, Pa.; H. Koch, Jr., 2339 N. Park, Philadelphia, Pa.; Mrs. M. Palsce, 916 Culbertson, Worland, Wyo.; R. Freiheit, 4261 N. 29th, Milwaukee, Wisc.; R. Hunt, Rt. 2, North Tazewell, Va.

Art Instruction, Inc.

MINNEAPOLIS • NEW YORK • CHICAGO
MEMBER NATIONAL HOME STUDY COUNCIL

ART INSTRUCTION, INC., Dept. 2131-C
500 S. 4th St., Minneapolis 15, Minn.

Please enter my attached drawing in your March drawing contest. (PLEASE PRINT)

Name _____ Age _____

Address _____ Phone _____

City _____ Zone _____ County _____

State _____ Occupation _____

"I'M MAKING MORE THAN \$1000 a Month Haven't Touched Bottom Yet!"



—reports Charles Kama, Texas, one of many who are "cleaning up" with orders for PRESTO, Science's New Midget Miracle Fire Extinguisher. So can YOU!



A MAZING new kind of fire extinguisher. Tiny "Presto" (about size of a flashlight!) does job of bulky extinguishers that cost 4 times as much, are 8 times as heavy. Ends fires fast as 2 seconds. Fits in palm of hand. Never corrodes. **Guaranteed for 20 years!**

Show it to owners of homes, cars, boats, farms, etc. and to stores for re-sale—make good income. H. J. Kerr reports \$20 a day. Wm. Wydallis, \$15.20 an hour. Write for **FREE Sales Kit**. No obligation. **MERLITE INDUSTRIES, Inc.**, Dept. 52, 201 East 16th St., New York 3, N.Y. **IN CANADA: Mopa Co., Ltd.**, 371 Dowd St., Montreal 1, P.Q.

Science's New Midget Miracle "PRESTO"

(If you want a regular Presto to use as a demonstrator, send \$2.50. Money back if you wish.)

"I'M EARNING \$300 A MONTH!"



... says Leonidas Burgoyne of Chicago, Illinois, "Expert individual instruction in the fully equipped shops of Greer Shop Training gave me the right start to get my good paying job."

GREER SHOP TRAINING . . . established 1902, is one of America's largest trade schools. Over 48,000 successful graduates. You learn by tearing down, repairing and rebuilding. Day and evening classes. Mail this coupon today!

LEARN A TRADE NOW!

GREER SHOP TRAINING, Desk 211, 460 S. State St., Chicago, Ill.

Gentlemen: Please send me information about trade I have checked below. (Specify if you are VET or NON-VET .

- IN OUR CHICAGO SHOPS**
- | | |
|---|--|
| <input type="checkbox"/> AUTO MECHANICS | <input type="checkbox"/> BODY, FENDER REPAIR |
| <input type="checkbox"/> DIESEL | <input type="checkbox"/> WELDING—ARC, GAS |
| <input type="checkbox"/> REFRIGERATION | <input type="checkbox"/> MACHINIST |
| | <input type="checkbox"/> PIANO TUNING |

Above courses approved for Vets and Civilians.

ALSO THE FOLLOWING HOME STUDY COURSES

- | | | |
|--|---------------------------------|-----------------------------------|
| <input type="checkbox"/> REFRIGERATION | <input type="checkbox"/> DIESEL | <input type="checkbox"/> PLASTICS |
|--|---------------------------------|-----------------------------------|

Name _____ Age _____

Address _____

City _____ State _____

GREER SHOP TRAINING

Earn up to \$6,000 a year!

MORE JOBS THAN WE CAN FILL METAL TRADES BACKBONE OF INDUSTRY

Men who are mechanically inclined have a wide open field to choose employment in the Metal Trades Industry. Jobs are going begging for lack of qualified trained men. You need no previous experience to start your training at this school.

SHORT COURSES TO MEET PRESENT JOB DEMAND.

PARTICIPATE IN THE PREPAREDNESS AND REARMAMENT PROGRAM.

ALLIED SCHOOL OF MECHANICAL TRADES, Inc.
1338-1340-1342 S. MICHIGAN AVENUE
402 ALLIED BUILDING, CHICAGO 5, ILL.

Write for **FREE BOOKS**
A 1c Postcard will do.

TV ANTENNA KIT **INSTALL IT YOURSELF**

SAVE UP TO 65%—IT'S QUICK-EASY **12⁹⁵**

NO "TV" KNOWLEDGE REQUIRED

Special: For WEAK SIGNAL AREAS
Stacked Twin Antenna & Bars. \$13.95

EVERYTHING YOU NEED
ANTENNA • MAST • LEAD SUPPORTS • BRACKET
Complete Simple INSTRUCTIONS

SEND NO MONEY—SATISFACTION GUARANTEED
SORMANI ELECTRONIC CO. 1068 63rd St. Brooklyn, N. Y.

COLOR PHOTOGRAPHY

Natural Color Processes—by Dunn
Fifth edition of the famous book outlining ALL you need to produce COLOR prints through any process in use today. **\$5.00**

PHOTOGRAPHIC FACTS Photographic Facts & Formulas, Wall-Jordan
Every photographic formula worth knowing and HOW TO make best use of it. Best darkroom guide and general reference. **SPECIAL, \$5.00**

CASH WITH ORDERS
Amphoto Dept. 111, 421-5th Av. S., Minneapolis 15

Say You Saw It in POPULAR MECHANICS

Learn CARTOONING

HAVE FUN! MAKE MONEY! Cash in on your sense of humor at HOME—BY MAIL. No experience needed to start. Write today for **FREE TRIAL LESSON** and full particulars.



MOON Gag Cartoon School, Dept. F, Fall Creek, Wis.

CHAPMAN CHINCHILLAS

The originator of the first Chinchilla Farm in the United States. For information on purchasing the finest, selected breeding stock of these aristocratic animals that were virtually trapped to extinction write or visit—

Established 1919 **Chapman Chinchilla Farm**
"P. O. BOX 221" 4957 West 104th Street
Inglewood, California



MAKE MONEY POLISHING FLOORS . . .

You can when you have your own Floor Polishing & Maintenance Service. Write for free plans and ideas on how you can easily get started in this money-making business. Send a postcard to:

McCANNA SUPPLY CO., 148A East 40 Street, New York 16, N.Y.



STUDY AT HOME for Business Success and **LARGER PERSONAL EARNINGS**. 40 years expert instructions—over 114,000 students enrolled. LL.B. Degree awarded. All text material furnished. Easy payment plan. Send for **FREE BOOK**—"Law and Executive Guidance"—NOW!

AMERICAN EXTENSION SCHOOL OF LAW
Dept. PM-35, 646 N. Michigan Ave., Chicago 11, Ill.

TREMENDOUS WATCH VALUES WITH A LIFETIME GUARANTEE!



MARDO QUALITY!

We offer —
TOP-QUALITY PRECISION MADE TIMEPIECES
 • Money Back Guarantee
 • Lifetime Guarantee
 • Accuracy Guarantee
 You can buy with complete faith and confidence. We sell direct, eliminating the storekeeper and his profit and pass along these savings to you.

SHOCK-WATER PROOF

Full 17 Jewel. Protected by water tight screw back and balance gasket. Give it hard treatment, IT CAN TAKE IT.

Luminous Dial, Sweep Second Hands, Unbreakable Crystal, Stainless Steel Case. Incl. Tax. \$19.75

*FLYBACK REGISTER CHRONOGRAPH!

VALUE! Amazingly accurate 1/5 seconds, 3 dials keep record of elapsed time as time-piece operates. Computes Speed, Distance, Time. Great for Sports, Races, Doctors, Photographers, Workroom experiments, tests, etc. **DIALS** record hours, minutes, seconds — automatically coupled for split second accuracy. *FLYBACK (Sweep Hand and Automatic Recorder Reset to Zero).
17 JEWELS Inc. Tax. \$26.35
***GOLD FILLED MODEL** \$36.85

SHOCK PROOF

Hardy Chromed Case that can take knocks. 7 Jewel Movement — Luminous dial, Sweep Second Hand and also second computations. Handsome in appearance — a real watch for active people.

Inc. tax \$8.75

3 DIAL CHRONO

Swiss Made. Second, minute and hour dials that are automatically coupled to give dependable, accurate readings. Sportsmen, Doctors, Technicians, Army and Navy men need this dependable timekeeper and recorder. Measures Speed, moving objects, distance and elapsed time. Unbreakable Crystal. Sweep Second Luminous numerals & hands. **WHAT A VALUE!**

(Tax Inc.)... \$9.95

*Same as above in Gold Plate..... \$14.95

10-DAY MONEY BACK GUARANTEE

*Charge for Broken parts only.

You have nothing to lose with our three way, triple GUARANTEE. Order Now. Enclose Check or Money Order for the watches of your choosing (Tax is included) and we prepay postage. C.O.D. orders are accepted. You Pay Postman plus charges.

MARDO SALES CORP., 480 Lexington Avenue, Dept. CW-2, New York 17, N. Y.

RADIO ENGINEERING

Broadcasting, Television, FM, Servicing, Electronics, Aviation, Marine & Police Radio taught thoroughly. Engineering course equivalent to 3 years' college radio work. Approved Veteran Training. Catalog free.
VALPARAISO TECHNICAL INSTITUTE, Dept. D, Valparaiso, Ind.

Say You Saw It in
POPULAR MECHANICS

TRAIN

Your VOICE!

RESULTS GUARANTEED
 STRENGTHEN your voice this tested, scientific way. Yes—you may now be able to improve the POWER of your speaking and singing voice. . . in the privacy of your own room! Self-training lessons, mostly silent. No music required. Write TODAY for Eugene Feuchtinger's great booklet "How to Develop a Successful Voice." It's absolutely FREE! You must state your age. Booklet mailed post-paid in plain wrapper. No salesman will call. Send your name and age RIGHT NOW! Perfect Voice Institute, 210 S. Clinton St., Studio B-2, Chicago 6, Ill.



george
 2 HP
32" SICKLE BAR MOWER
 Only \$139.50 f.o.b.
 Sullivan, Ill.

QUALITY FEATURES at one low price

Buy George 32" Sickle Bar Mower for the best that can be built! Check these top quality features:

1. "Vibration tingle" eliminated from handle bars by rubber shock absorption mounting.
2. Independent clutch to sickle knife for ease of operation.
3. Clutch at handle for all-weather traction drive.
4. 12x3.00 balloon tire wheels with roller bearings.
5. Clinton or Briggs 2 HP motor.
6. Forward travel 1 1/2 to 2 MPH.
7. Balanced . . . easy to control. Weighs only 139 lbs. for easy handling and back-up.

Write for complete details.
GEORGE TRACTOR DIVISION
 Community Industries Ass'n.
 SULLIVAN • ILLINOIS

Amazing Attachment MAKES OLD REFRIGERATORS INTO MODERN Automatic Defrosters!

Thirty Million Prospects. Sell without "selling pressure" on sensational Free Trial Plan. Just plug it in and leave it. Frees women from drudgery and mess of defrosting. Saves electricity. Keeps food longer, better. Gives longer life to refrigerator. Secret "follow-up" Plan often brings five additional sales by making every user your agent. Big season now on!
SENT FREE . . . JUST SEND NAME!

Don't send a cent—just your name on penny postcard. We'll send you the biggest money-maker you ever got your hands on and guarantee your sales at profits as high as \$5.00 on each sale. Rush your name!

MAXILUME COMPANY, 125 West Hubbard Street, Dept. D-82, Chicago 10, Illinois

Women buying by the thousands!
 Salesmen Cleaning up on "Free Trial" Sales Plan Sent Free with Instructions. Make as high as \$5 on Every Sale!





HORNS WITH VOLUME CONTROL for the man who has everything

Buell Air Horns are softer than standard horns for city driving. Give miles of volume for highway emergencies. Also a complete range in between instantly available with convenient foot control.

Chromed band instrument horns sound a pleasing, true-pitch chord. Case histories prove Buell Air Horns increase driving security and avoid accidents. Very popular with traveling executives.

Under-hood as well as outside mountings are available in several models and tones. Write now for literature, prices and name of your dealer.

BUELL MFG. CO., 925 W. 49th Place, Chicago 9, Ill.

Learn this Profitable Profession

**IN 90 DAYS
AT HOME**

Money-Making Career Open to Men and Women, 18 to 60

Hundreds of men and women between 18 and 60 make \$10 to \$20 in a single day giving scientific Swedish Massage and Hydro-Therapy treatments. There is big demand from doctors, hospitals, sanatoriums and clubs. Graduates earn large full time incomes from these or in private practice in their own offices. Others make good money from home treatments given in spare time. Learn this interesting, money-making profession in your own home, through our home study course. Same instructors as in our nationally known resident school. You can win independence and prepare for future security by qualifying for your Diploma. Course can be completed in 3 to 4 months. Many earn while they learn. Begin your training at once.



Anatomy Charts & Booklet FREE

Enroll now and we will include, at no extra cost, many needed supplies. Fit yourself to help meet growing demand for Scientific Swedish Massage. Send the coupon at once for complete details. Anatomy Charts and 32-Page Illustrated Booklet, FREE, postpaid.

THE COLLEGE OF SWEDISH MASSAGE
Dept. 164-B, 41 E. Pearson, Chicago 11, Illinois
Please send me FREE and postpaid, Anatomy Charts, 32-page Booklet and complete details on Home Training.

Name _____ Age _____
Address _____
City _____ State _____

HERE'S A REAL BUY!



FACTORY SURPLUS Motor Bike!

Wholesale Price! Buy Now and Save
Regular Price \$198.50
While Limited Quantity Lasts! **\$124.50**

Famous Continental Style SPORTSTER

Amazing!—Continental style Sportster at cost! Surplus at factory allows us to make this startling offer! Sensational Sportster gives amazing fuel economy—up to 100 miles per gallon at speeds up to 30 miles per hour! Safe, low center of gravity, 56" wheelbase. Briggs-Stratton or Clinton 1 1/2 h.p. motor (3 1/2 h.p.—\$15 additional). Smart blue finish. Money back guarantee. Parts always available. Send money order or 10% down with C.O.D. Remember—quantities are limited. Order today!

MERX Products, Inc.

1214 THIRD STREET SO., MINNEAPOLIS, MINNESOTA

Say You Saw It in Popular Mechanics

LEARN WATCH REPAIRING



AT HOME. By our modern and original system of instruction you can learn every part of the **WATCH REPAIRING TRADE AT HOME.** Prepare yourself for a well-paying position or start in business after completing our course of instruction. Good watch repairers are in demand and generally earn very good salaries. For particulars apply to the **WISCONSIN SCHOOL OF WATCH REPAIRING**, 759 North Milwaukee St., Milwaukee 2, Wis.

Learn CARPENTRY BRICK LAYING

Get into the billion dollar building trades. Learn now while opportunities are greatest. Train in our completely equipped shops under expert instructors. G.I. Approved. Enroll now. Limited classes. Write for FREE Catalog.

MIDWEST SCHOOL OF BUILDING TRADES, Dept. PM-2
411 N. Center St. Bloomington, Ill.



ILLUSTRATED COMIC BOOKLETS

**THE KIND MEN LIKE!
THE GIRLS LIKE IT TOO!!
(VEST POCKET SIZE)**

They are loaded with rare cartoons. Full of Fun and Humor. **20 DIFFERENT** booklets sent for \$1 in sealed wrapper. No C.O.D.

GRAYCO, Dept. 2128, Box 520, G.P.O., N.Y.C. 1

Learn PHOTOGRAPHY at Home

Splendid opportunities. Prepare in spare time. Practical basic training. Long-established school. Send for free book, "Opportunities in Photography." No obligation.

American School of Photography, 835 Diversey Parkway, Dept. 1352, Chicago 14, Ill.

WANT TO SAVE GAS?

BE PREPARED IF RATIONING RETURNS.

1/4 MILLION
NOW IN USE

TRY **FREE**
IT
IN YOUR CAR

TEST FOR

- ✓ MORE MILEAGE ✓ FASTER PICK-UP
- ✓ EASIER STARTING ✓ BETTER IDLING

You can install it easily in a few minutes.

Many Gane Needle users report up to 25% more mileage, faster pick-up, easier starting and smoother idling.

Try a Gane Needle in your car for ten days at our expense, then compare your mileage and performance. If fully satisfied, send only \$1.50 per needle (8 cylinder cars take 2). If not satisfied, just return it—FAIR ENOUGH? Since authorities differ on merits and some users report no improvement, TRY BEFORE YOU BUY!

WRITE TODAY • ENCLOSE NO MONEY • PAY POSTMAN NOTHING. Send us your name, address, make and year of car—and the make of carburetor if convenient.

THE AMAZING
GANE

AIR
FLOW
NEEDLE

Gane replaces the idling adjustment screw in gasoline carburetors.



Holes for Air Flow

BOOK SENT FREE! This auto economy manual is sent *absolutely free*, to all who try Gane Needles. It tells how to save gas, tires, brakes and tells how you can gain more power, speed and better performance from your car. This combination manual-catalog also introduces many new and ingenious economy products.

NATIONAL AUTOMOTIVE RETAIL CORP., Dept. J-2
350 West Washington Blvd. Venice, California

How to MAKE MONEY with Simple CARTOONS



A book everyone who likes to draw should have. It is free; no obligation. Simply address

FREE BOOK

CARTOONISTS' EXCHANGE
Dept. 92A Pleasant Hill, Ohio

MAGIC-SCREEN INCOME PLAN OFFERS BIG MONEY, AT HOME, SPARE OR FULL TIME

Reproduce any painting, design, trade-mark, picture, printing, in full color, on any surface! Proven new method enables you to cash in on established business where Profits up to \$5.00 or more an hour are being made, right now! Examine complete Plan and equipment without risk! Write today for free sample — complete free details! Act NOW!

CALIFORNIA ACADEMY OF SCREEN PROCESS — Dept. 22
5100 S. VERMONT AVE., LOS ANGELES 37, CALIF.

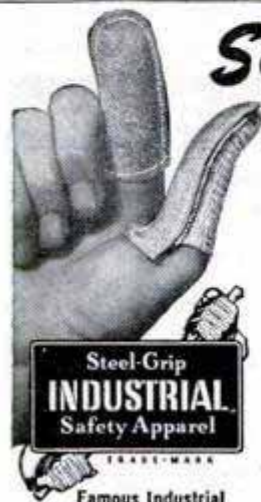

Steel-Grip
INDUSTRIAL
Safety Apparel

Famous Industrial
Safeguards Since 1910

Save Fingers with Industrial Finger Guards

Lower Your Hand Protection Cost

Hundreds of factories save time and injuries by protecting workers with Industrial Finger Guards. Used for handling rough or sharp articles, for buffing, grinding, sanding, polishing and punch press work and hundreds of other jobs. Protect fingers or thumbs, front or back, from cuts, abrasions or blisters. Various designs made in several leathers and other materials, with elastic web back for snug, cool, comfortable fit. Sizes for men or women. Send 10c each for samples. Catalog of Safety Apparel Free. Write.

INDUSTRIAL GLOVES CO.
1413 Garfield, Danville, Illinois
(In Canada: Safety Supply Co., Toronto)

I need 500 Men to wear SAMPLE SUITS



Pay No Money—
Send No Money

My values in made-to-measure suits are so sensational, thousands of men order when they see the actual garments. I make it easy for you to get your own suit to wear and show—MAKE MONEY IN FULL OR SPARE TIME THIS EASY WAY!

My Plan is AMAZING!

Just take a few orders at my low money-saving prices—that's all! Get your own personal suit to wear and show—make money fast taking orders. No experience needed. Spare time pays big. You pay no money, now or any time.

MAIL COUPON!

Rush this coupon today for full facts and BIG SAMPLE KIT containing more than 100 fine woollens in all popular weights and shades. Be one of the 500 top-notchers I need to wear, show, and take orders for my suits. Act now!

W. Z. GIBSON
500 S. Throop St., Chicago 7, Ill.

FREE
Costly Sample
Kit containing
over 100 actual
fabric samples.

W. Z. GIBSON
500 S. Throop St., Dept. P-516, Chicago 7, Ill.

Dear Sir: I WANT A SAMPLE SUIT TO WEAR AND SHOW, without paying 1c for it. Rush Valuable Suit Coupon and Sample Kit of actual fabrics, ABSOLUTELY FREE.

Name

Address

City..... State.....

Say You Saw It In
POPULAR MECHANICS

High School
at Home

Many Finish in 2 Years

No classes. No time wasted going to and from school. Progress as fast as your time and abilities permit. Standard H. S. texts supplied. Thousands enroll each year in this 53-year-old school. Send for FREE descriptive booklet.

AMERICAN SCHOOL, Dept. H-245
Drexel at 58th St., Chicago 37, Ill.

Without obligation, please send FREE descriptive booklet.

Name

Address

LET US PUT THIS MAMMOTH NEW 1951 MIDWEST 19 1/2-Inch TELEVISION CONSOLE

IN YOUR HOME
ON 30 DAYS
MONEY
BACK TRIAL

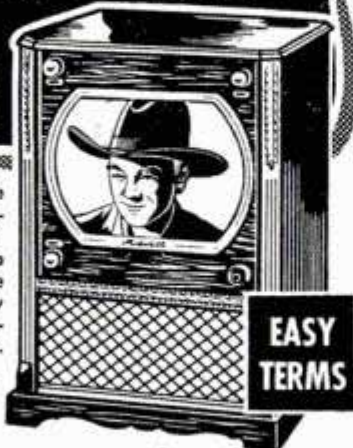

EASY
TERMS

Be your own judge! See and hear Midwest Television in your own home. Then decide whether to keep or return it and have your money refunded. Low factory prices. Factory authorized service available.

FACTORY-
TO-YOU



Midwest offers a complete line of 19" and 16" Television models in beautiful consoles or ready-to-use chassis.



Also Available on 30 DAYS TRIAL
The NEW 1951
MIDWEST RADIOS
Beautiful Consoles - Complete Chassis

SEND THIS
COUPON
ON 1c POST
CARD FOR
NEW 1951
FREE 4 COLOR
MIDWEST
CATALOG

MIDWEST RADIO & TELEVISION CORP.
Dept. 25-H, 909 Broadway, Cincinnati 2, Ohio

NAME _____

ADDRESS _____

CITY _____ ZONE _____ STATE _____

SAVE \$150 MAKE YOUR OWN
3-Dimensional Camera
ALL YOU NEED IS YOUR
OLD CAMERA AND THE
STEREO-TACH



No costly stereo camera is needed to take realistic 3-D slides and prints. Use your present camera and a Stereo-Tach outfit. Changes practically any camera to a 3-D camera instantly. See your dealer or write

For 35 MM cameras, outfit #101 (Stereo-Tach & 3-D slide viewer) **17.70**
For larger cameras #100 or for Polaroid Cameras #100 PL (Stereo-Tach and print viewer) **16.25**
plus 2.09 fed. tax

ADVERTISING DISPLAYS, INC.
Dept. PM2 COVINGTON, KY.

MODEL BUILDERS!

NEW 1951 CATALOG



MODEL AIRPLANE ENGINES • GLOW
PLUGS • MARINE ENGINES • FUELS
MODEL RACERS • ACCESSORIES

CUT OUT AND MAIL TODAY

OHLSSON & RICE, INC.
3344 Emery St., Los Angeles 23, Calif.
Los Angeles 23, California

Please RUSH _____ copies of the NEW 1951 O&R Catalog at 15c each for which I am enclosing _____ in stamps or coins to cover handling and mailing.

Name _____

Address _____

City _____ Zone _____ State _____

YOU CAN BUILD Beautiful Furniture for every room of your home



LIVING ROOM



DINING ROOM



BEDROOM



No Experience Needed
Suites for Living,
Dining and Bedroom
Exclusive Designs
Modern and
Traditional Styles
Scaled Diagrams

Now you can build beautiful furniture for every room of your home—charming, graceful furniture that will give your house an air of elegance and be the envy of your neighbors and friends.

For the Man with Few Tools
and Limited Experience

Take your choice from a wastebasket to a complete suite. Choose any one of 100 beautiful articles. Start with a simple project and end up by refurbishing every room in your home. Step-by-step instructions from the Editors of *Popular Mechanics* and scaled diagrams make building easy.

Save Hundreds of Dollars

Why pay skyhigh prices for furniture when with a few evenings' spare time you can build a desk, dresser, bookshelf or even a complete suite and save as much as 67% of the cost? And the furniture you build will be even more attractive and sturdily constructed than the furniture you could buy. Several designs are exclusives by John Bergen, famous furniture designer.



160 Pages
16 Full Color Plates
Hundreds of Illustrations,
Photographs, Diagrams

Start building your furniture now. Send only \$3.00 for your copy of "100 Beautiful Pieces of Furniture You Can Build," or you can pay the postman if you prefer. Money back in five days unless you are completely satisfied.

Order on this Handy Coupon

POPULAR MECHANICS PRESS, Dept. 39
200 E. Ontario St., Chicago 11, Ill.

Gentlemen:

Send at once my copy of "100 Beautiful Pieces of Furniture You Can Build" at \$3.00. Unless it is entirely satisfactory I may return it within five days for a full refund.

NAME _____

ADDRESS _____

CITY _____ ZONE _____ STATE _____

Remittance Enclosed Send C.O.D. (Postage Extra)



Recipro Register CHRONOGRAPH

WORLD FAMOUS SPLIT-SECOND TIMER

TO DAY FREE EXAMINATION A handsome wristwatch of incredible accuracy! Precision made in the highest traditions of Swiss craftsmanship. Thoresen's new RECIPRO-REGISTER CHRONOGRAPH automatically computes speeds and distances down to 1/5th second tolerance! RECIPRO-REGISTER system HOLDS the result indefinitely. It remembers for you while movement continues to keep time. Compare with other stop-chronographs and you will never be satisfied with anything less than this truly precision timepiece.

OVER 25 HIGH QUALITY FEATURES!

- Times Planes
- Times Races
- Times Sports
- Times Photography
- Times Lab experiments
- Times Shop Work
- Shock-Resist
- It "remembers"
- 17 Ruby Jewels

Three multi-function dials automatically coupled and synchronized for hours, minutes, seconds & 1/5th seconds. Contact clutch to start computation and brake clutch to freeze Recipro-Register result. Erases back to zero. Hairline sweep-second. Radium-active dial. Unbreakable crystal. Sturdy, yet thin case with stainless steel back. Its 17 Jewel Ruby movement is electronically time tested for accuracy. A smart, thin timepiece of functional beauty. The pride of every owner. **SAVE \$50.00—ORDER YOURS DIRECT!** Recent list price 79.95. Now reduced for quick sales to \$29.95 tax paid . . . while supply lasts. Featured in Esquire and leading magazines. Instructions and gift case included. Price subject to change without notice because of international crisis. Remit 29.95, or order C.O.D. plus postage. Money Back in 10 days if not delighted. **THORESEN DIRECT SALES, Dept. 6B-233, 131 West 33rd Street, (Phone: LA 4-5996 & 7) New York 1, N. Y.**

UNLIMITED SERVICE GUARANTEE

Exclusive of Parts
FREE repair service ANY TIME if needed by skilled watchmakers. **NO COST EVER** for labor, "hand-dling" or adjustment, provided watch is returned with all parts. **FREE:** Antimaging service, cleaning & makes lifetime friends!

Buy Direct



Trades that pay off!

Here's a great chance to learn a high paying skilled trade when the need for craftsmen is urgent. Get actual practical experience in our complete shops. No home study. Approved for veterans. A Post Card brings the story



**CARPENTRY
 CABINET MAKING
 UPHOLSTERING**

ENROLL NOW

THE TERRACE SCHOOL FOR CRAFTSMEN

TERRACE AVE.,
 NEW CASTLE, PA.

PHONE
 6699

POWERFUL

Interchangeable rifled barrels for 5 types of ammunition. .22 or .177 Cal. Hy-Score Pellets & Darts, & BB's. Small game HUNTING, indoor and outdoor TARGET shooting. The perfect gift. At your dealer now or write Dept. P-2



NO PUMPING
HY-SCORE
 5 in 1
AIR PISTOL

ONLY \$19.95 with 2 barrels & asst. ammo

HY-SCORE ARMS CORP., 25 Lafayette St. Brooklyn 1, N. Y.



CARTOON SCHOOL

ONLY SCHOOL TEACHING CARTOONING EXCLUSIVELY
 Billy Hon nationally known cartoonist director. Draw comic strips, gag cartoons, editorials, sports, commercial cartoons and caricaturing. Cartoonists needed for television. Approved for Vets.
 2921 Beverly Blvd. BILLY HON Los Angeles 4, Calif.

LOCKSMITHING & Key Making

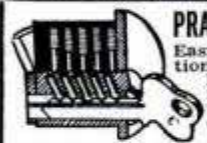

PRACTICAL UP-TO-DATE COURSE—ONLY \$4.95

Easy-to-learn modern information for self-instruction. How to work on locks, de-code, make master-keys, repair, install, service, etc. For every handyman, home owner, carpenter, mechanic, service station operator, fix-it shop, hardware dealer, gunsmith, 53 plain illustrated lessons. **FULL PRICE ONLY \$4.95. SEND NO MONEY.**

Just pay postman plus C.O.D. postage. Or send \$4.95 with order, we'll ship postpaid. Satisfaction guaranteed or refund.
 NELSON-HALL CO., 210 S. Clinton St., Dept. B-2, Chicago 6, Ill.

Say You Saw It in
POPULAR MECHANICS

TRAIN in Our SHOPS - -
 in **AUTOMOTIVE MECHANICS**
BODY and FENDER REBUILDING

If interested write or wire

ATLANTA MOTIVE TRADES INSTITUTE
 Dept. PM 254 IVY St., N.E. Atlanta, Georgia
 Member of the Southern Association of Private Trade Schools
VETERANS ASK ABOUT GI TRAINING

Now!

Be a Well-Paid Expert

ON ALL ELECTRICAL

REPAIRS and MAINTENANCE

Defense Program Means
 Bigger Pay in Essential Field for
 Top Electrical Repair Men

Prepare NOW for a good-paying, ESSENTIAL job. Defense plants need expert electrical repair, maintenance men. Get the "know-how" from this Electrical Maintenance and Repair Library.

5 Volumes; 2072 Pages; 1834 Pictures

Starts at beginning, takes you step by step through every phase of connecting, altering, testing, repairing all types of equipment. How to install motors, generators, rewind motors; inspect, repair starters; locate trouble; test induction motors, and MUCH MORE! One entire volume crammed with trouble-shooting charts. Simple diagrams make everything crystal-clear. Gives best-on-the-job practices of experts. Will



help to put you in big-pay class and to rate as an ESSENTIAL worker.

FREE 10-DAY TRIAL

Send no money. Mail coupon for FREE 10-DAY TRIAL. Note special price, easy payments.

McGraw-Hill Book Co., Dept. PM-2
 327 West 41st St., New York 18, N. Y.

Send me for FREE 10 days' examination the Electrical Maintenance and Repair Library. If not satisfied I will return books. Otherwise I will send \$3.50, plus postage, then send \$4 a month for 4 months (a saving of \$2 under regular price of \$21.50).

Name _____

Home Address _____ PM-2

City & State _____

WE PAY POSTAGE if you enclose \$3.50 first payment WITH coupon. Same return privilege for full refund.

YOU CAN BE AN EXPERT in RADIO-TELEVISION ELECTRONICS



Get ahead in today's fastest growing field with The RADIO & TELEVISION LIBRARY SET

Gives you the fundamentals, complete ground work, understanding of all types of radio, television, electronic gear and their circuits, including theory of operation.

Shows you expert methods of planning, building, installing, operating, testing, adjusting, and servicing. The know-how of radio, television and electronics presented in plain language and simple terms with easy to understand pictures and working diagrams.

You get 1800 pages of the basic knowledge, methods and data of radio, television and electronics completely illustrated with over 2000 pictures, drawings, diagrams, codes, charts and graphs.

Written by the Boyce-Roche experts who make electronic manuals for the U. S. Signal Corps. Over 25,000 in use.

SPECIAL OFFER Save one dollar—Send for the RADIO & TELEVISION LIBRARY SET and get The RADIO & ELECTRONICS HANDBOOK and The VIDEO HANDBOOK in handsome slip case as

\$10.90

(Regularly \$11.90)
RADIO & ELECTRONICS HANDBOOK provides instruction and reference on fundamentals, parts, tubes, circuit elements, receivers, transmitters, amplifiers, systems, power supplies, antennas, meters, test equipment, and accessories, with complete Data Section. **\$5.95**

VIDEO HANDBOOK teaches television and provides complete handbook reference on all phases with full sections on principles of television, receivers, antennas, test equipment, servicing, pattern interpretation, transmitters, show production and more. **\$5.95**

SEND NO MONEY

10-DAY FREE EXAMINATION COUPON

(Good only while special Library Set offer lasts)

BOYCE-ROCHE BOOK CO.

CALDWELL, NEW JERSEY

Send Library Set @ \$10.90 (I save \$1.00)

Video Handbook @ \$5.95

Radio & Electronics Handbook @ \$5.95

In ten days I will send you price plus postage or I will return book(s) postpaid. (Offer good only in U.S.)

Name _____

Address _____

City, Zone, State _____

Employed By _____

Save Postage! We pay postage if you enclose full price(s) now. Money back on same return privilege.

Thousands Handicapped by Poor English and don't know it!



Dr. Stratton

Formerly English Director, Cleveland High Schools; University lecturer, noted author

MAKE THIS TEST NOW

Is your English holding you back from bigger pay? Do embarrassing errors bar you socially? Send at once for self-scoring Test with Sealed Key. Also free booklet "The Magic of Words;" explains new easy way to improve your speech and writing through the Funk & Wagnalls STANDARD COURSE IN PRACTICAL ENGLISH by Dr. Stratton, famous educator. Works wonders in few minutes a day. Write or mail coupon NOW for Test and Booklet.

FREE English Test with Sealed Key and Booklet, "The Magic of Words"



FUNK & WAGNALLS CO., Dept. PM-1
 153 EAST 24th STREET
 NEW YORK 10, NEW YORK

Please send me FREE English Test and booklet, "The Magic of Words."

Name _____

Address _____

Town _____ Zone _____ State _____

BE YOUR OWN BOSS

Make Hundreds of \$ Spare or Full Time Work

You can make simply and cheaply

NO EXPERIENCE NEEDED

Here is the ideal business with no previous experience or large investment required and no high-priced equipment to buy. A business that will return dollars for the pennies you invest.

YOU CAN CAST ANYTHING

With *Flexible Mold Making and Ornamental Casting*, an amazing fact-packed book, you learn how you can cast practically any article in concrete, plaster, imitation marble or any other casting material using a marvelous new process. You can make ash trays, novelties, garden and lawn ornaments and hundreds of other highly profitable items that cost you but a few cents and sell for as much as \$5.00 and more. Why you can even make true-to-life full-sized busts of your neighbors and friends.

NO EXPENSIVE MOLDS TO BUY

Why buy high-priced molds from others? Learn how you can make your own molds quickly, easily and inexpensively with materials that can be used over and over. You get copyrighted formulas, complete instructions and detailed how-to-do-it photographs as well as complete sources of supply for the few inexpensive materials you need. This is the only book printed in America today that contains instructions for making profitable papier-mache casts.

MONEY BACK GUARANTEE

Start on your road to extra income and independence today. Send only \$3.00 for your copy of *Flexible Mold Making and Ornamental Casting*. Complete satisfaction guaranteed or your money refunded within seven days.

POPULAR MECHANICS PRESS, Dept. 46

200 E. ONTARIO ST., CHICAGO 11, ILL.



YES! SEND



directly to my door every month

I am enclosing

\$3.50 for 1 year

\$8.00 for 3 years

name _____

address _____

city _____

zone _____

state _____

A-2

Hand this order to your newsdealer or send it to

POPULAR MECHANICS
 200 East Ontario St. Chicago 11, Ill.

ATTENTION: HOME HOBBYISTS
VOCATIONAL INSTRUCTORS
WITH LATHES

**FINISH YOUR OWN SALAD BOWLS
OR PLATES AND SAVE \$12.00 DOZ.**

Wonderful Class Projects

FOR \$6.50 POSTPAID YOU RECEIVE . . .

12 Salad Bowls

Finest Select

Solid Maple

5½" x 1¾"

75% Rough Cut



OR:

12 Eight inch plates
cut to size ready for
sanding on face; trim
cut needed on back
only



Including 1 - completely
finished Salad
Bowl or Plate with full
instructions for final
trimming & finishing.

\$18.00 retail value for
\$6.50 by doing it yourself
. . . Order one or both of
these sets and get on ur
mailing list for future
projects.

NO Discount for Quantity
C.O.D., Please.

Send Orders To:

MARGARET STUDIOS, INC. ANTIGO, WIS.

Creators of America's Finest Woodenware

\$100 "MIRACLE" CAMERA

can be Yours for **\$3.95**
Only



Make your own High-Speed Camera—En-
larger—Slide Projector—Movie Film
Viewer—Shadowgraph—Burglar Alarm
Lights—Engraving Spot—Telescope—Signal
Light—Magnifier—Code Blinker Light.

ALL OF THESE and many more useful things can
be made with this fine precision made piece of
optical equipment.

Contains color corrected anastigmat lens 2¼ inches in diameter,
3½ inch focal length, Cast Aluminum Case, Water-Tight Cover Glass,
Front Surface Reflecting Mirror, Reticle, Lamp Socket, 28-Volt Lamp
Bulb, Bull's-Eye, etc. Booklet of instructions showing how to make
many of the above items included. This offer may never be repeat-
ed. Shipped Postpaid. Rush check or money order today to

ELECTRONIC PRODUCTS CO., Dept. PM-3, St. Charles, Ill.

NEW "PAINT PEN"

PAINT STRIPING TOOL

Works like a Fountain Pen

Stripes with Paint instead of Ink!

This amazing new "PAINT PEN" is a Paint
Striping Tool that makes it easy to do expert
striping on furniture, bikes, model planes,
autos, signs, toys, linoleum, wall board, etc.
Makes plain, painted walls look like tile. Paint
straight, curved, circular or evenly spaced par-
allel lines the same way a professional painter
does. Simply fill Tubular Glass Paint Fountain
with any color paint and wheel tip feeds paint
evenly. Tip: interchangeable—jaws split
apart for easy cleaning. Tool complete with
tip for 1-16 inch strip only \$1.00 postpaid.
Other complete tools with 1-64, 1-32, 3-64,
1-16, 5-64, 3-32, 1-8 inch tips, \$1.50.
Separate tips, 75c each. Complete KIT
with 7 tips, \$5.00. C.O.D.'s postage
collect. Here's the handiest tool in
your whole painter's kit. Get
yours today.



Paint
STRAIGHT,
CURVED OR
PARALLEL LINES

Home Craftsmen

Just the tool you've been waiting for!
New Paint Striping Tool gives "pro-
fessional" results every time, yet
simple and easy to use as a fountain
pen. Adjustable guide keeps lines
straight as an arrow. Just as easy to
make curves or free hand designs.
Adds new beauty and finished look to
everything you paint. Send \$1 now!

WENDELL MFG. CO., Dept. 32,
4234 LINCOLN AVENUE, CHICAGO 18, ILL.

DEALERS
PAINT STRIPING TOOL
packed in display cartons
of 1 doz. Fast, profitable
seller. Write for illus-
trated circular, discounts

Only
\$1.00

23 MODELS-SAVE 50%

**FREE
CATALOG**



16' Sport Cruiser
\$330

★ **EASY TO
ASSEMBLE**

**PACKAGED
BOAT KITS**

WORLD'S BEST BOAT BUY!

CUSTOM-CRAFT

★ SEMI-FINISHED BOATS
(READY TO PAINT)
★ CUSTOM-FINISHED BOATS
(READY FOR THE WATER)
FACTORY TO YOU

Racers 12'-14'



\$135. up

Dinghies 8'-10'

\$37. up



Skiffs 10'-14'

\$55. up



Runabouts

12'-16'

\$137. up



Outboards 12'-16'

\$125. up

Exclusive
features. Top-
grade materials.
Precision cut and
pre-assembled parts.
Advanced de-
sign. Top
performance.

Kit prices approx. - F.O.B. Buffalo

BOAT PLANS - PATTERNS

Over 50 modern plans and full size pat-
terns. Racing classes, cruisers, inboards,
outboards, sail — by famous designers.
6'-30'. CATALOG 35c. Catalog and
boat building handbook, \$1.00

BOAT HARDWARE

Send 10¢ for literature on small boat
hardware, paints and finishing mate-
rials. Literature and book "How to
paint your boat" 35¢.

**MARINE
MART**

Dept. 52

BUFFALO 7, N. Y.

New
**Advertising
Machine**



**Prints &
Illustrates**

1¢ Post Cards

FREE Learn how thousands of business
men, in every line, are boosting
sales in spite of conditions—with
1¢ messages—printed and illustrated in a few
minutes on gov't post cards — with amazing
new patented **CARDMASTER**. Your "today's"
ideas, read by your prospects next morning.
Not a toy, but a sturdy advertising machine,
built to last for years. Low price, sold direct.
Guaranteed for five years. Send name today.

SEND NAME We'll send **FREE** illustrated book of money-
making **IDEAS** for your business and com-
plete, unique advertising plans. **RUSH YOUR NAME TODAY.**
CARDMASTER COMPANY
1920 SUNNYSIDE, Dept. 132, CHICAGO 40, ILL.

Don't Envy The PLUMBER·Be One

Make \$15 to \$50 a Day
(and work every day)

Every skilled workman will tell you Plumbers have the best of it. WINTER and SUMMER the Plumber is busy at top wages. No skilled Plumber is ever out of a job . . . compare his opportunities with any trade, and decide where your opportunity is.



The Plumber
Protects
the
Health
of the
Nation

Own Your Own PLUMBING BUSINESS

No other business offers you the opportunity of starting in your own business, and making good profits, with little other investment than Universal's training and a kit of tools.

JOURNEYMAN PLUMBER Gets Good Salary

Master Plumbers own their own shop. A Journeyman works for a Master. With Universal's training a journeyman can depend on high wages from the start.

G. I. Rights EXPIRE July 25, 1951

A veteran must have eligibility certificate and be enrolled before this date. This school limits students, thus giving better training. Few openings available before G. I. Rights expire. Write Universal Plumbing School, K. C., Mo. for reservations.

Plumbing, to the man with know how, means profit. Investigate Universal's unique "Shop Method" system . . . This system, developed over a quarter century ago by a master plumber, offers you the opportunity to quickly get into the plumbing business. This is not a "war born school" . . . but a plumbing school developed and operated by plumbers since 1923.

BE A PLUMBER In Just 32 Weeks

Now, just 32 weeks of intensive training equips you to be a plumber. No need ever serve an apprenticeship. Don't envy the plumber's big profits . . . enjoy them.

System Shows How With Tools . . . Not Books

Universal's highly developed method makes plumbers by a special developed system showing how to use plumbing tools . . . not books. Every instructor is a Licensed Master Plumber capable of showing every trick of the trade . . . Lead Work . . . Blueprint for plan reading, etc. This offers a wonderful opportunity for the man who likes to work with tools.

Over 7,000 Successful Plumbers Recommend This School

This system has made more than 7,000 plumbers. Each will testify it was the Universal Plumbing School that started him on the road to profits. Investigate our past performance . . . then decide. Universal is the largest and only school in America devoted exclusively to plumbing. It was established in 1923 under a system developed by a plumber and is owned and operated by licensed plumbers.

Don't waste your time looking over "war born schools" . . . Investigate this system . . . then get into the profitable plumbing business.

JUST MAIL COUPON

Send me FREE details about the plumbing business and tell me how to make profits as a plumber . . . I understand there is no obligation.

Name _____

Address _____

City _____ State _____

G. I. Approved. Established 1923

UNIVERSAL PLUMBING SCHOOL
877 HOLMES KANSAS CITY, MO.

Say You Saw It in Popular Mechanics



IS YOUR FUTURE WORTH **1¢?**
that's all it costs to find out about
correspondent courses in

FREIGHT TRAFFIC MANAGEMENT

\$60 a week is the average starting salary . . . others earn up to \$20,000 a year in this uncrowded field.

Courses: General, Advanced, Air Freight, Export and Import, Motor Carrier. Practical training given as well as theory — by men daily engaged in Traffic Management. Get the facts today.

Send a penny card for **FREE BOOKLET**
Co-educational Veterans Inquiries Invited

RESIDENT CLASSES: Hartford, Bridgeport, Trenton, Rochester, New Haven, Buffalo, Erie, Baltimore. Booklet P

TRAFFIC MANAGERS INSTITUTE

154 Nassau Street, New York

Branches: 294 Washington St., Boston, Mass.; 10 South 18th St., Phila., Pa.

A Famous, Fascinating Hobby!

Build Your Own Authentic Miniature Ships
Anyone can build an IDEAL ship model . . . just a few hours of simple, satisfying work and you've a completed historic miniature you'll proudly display! No work-room, no tools necessary — kit contains simple plans, many finished parts. ORDER TODAY!

THE BOUNTY only \$1.50

plus 15c postage for complete kit.

Send 15c for complete catalog of various models.

IDEAL MODELS 26 W. 19th St. New York 11, N.Y.



EXTRA INCOME THE YEAR 'ROUND

Earn additional income and have fun at the same time! Popular Mechanics MONEY MAKING HOBBIES shows you how to make 132 different projects at home in your spare time! Complete instructions with over 600 illustrations, photographs, drawings and diagrams. Projects for everyone regardless of experience. Excellent resale value. State making your hobby pay a profit by ordering a copy of MONEY MAKING HOBBIES today from

POPULAR MECHANICS PRESS \$2.00
200 E. Ontario Street Chicago 11



SEND ME



every month so I am sure to
see each new issue. Here's

- \$3.50 for 1 year
 \$8.00 for 3 years

name _____

address _____

city _____ zone _____ state _____

Hand this order to your newsdealer or send it to

POPULAR MECHANICS
200 East Ontario St. Chicago 11, Ill.

Look AHEAD...be AHEAD...



MAN A **Martin "75"**

WITH **SYNCR-TWIST CONTROL**

FACE FORWARD
WHILE YOU
CONTROL SPEED
AND DIRECTION!



REVERSE
FULL
360°
STEERING
WITHOUT SHIFTING

"Go '75'!"

... with one of the 8 great MARTIN MOTORS for '51! Precision-built, "Performance-Tested" by expert craftsmen, MARTIN offers incomparable power, speed and maneuverability! EXCLUSIVE features put control of speed and direction RIGHT IN THE PALM OF YOUR HAND!

ONLY MARTIN GIVES YOU: ✓ "SYNCR TWIST" ✓ "TWIST-SHIFT" ✓ "AQUAMATIC CONTROLS" ✓ Mechanically-controlled intake poppet valves ✓ Vertical stern adjustment ✓ Full 360-degree steering ✓ Improved carburetion and cooling systems, and many others!

FREE! Complete, illustrated booklet with descriptions of The 8 Great Martin Motors for 1951. Sent on request. Write: Martin Motors: Dept. 5113, Eau Claire, Wisconsin

8 GREAT MARTIN MOTORS:

- MARTIN "200" with full "Twist-Shift" 17 H.P.
- MARTIN "200" Hi-speed "P-T" 17 H.P.
- MARTIN "100" with neutral "Twist-Shift" 10 H.P.
- MARTIN "100" with "Aquamatic Control" 10 H.P.
- MARTIN "75" with neutral "Twist-Shift" 7.5 H.P.
- MARTIN "75" with "Synco-Twist" 7.5 H.P.
- MARTIN "45" with "Synco-Twist" 4.5 H.P.
- MARTIN "20" 2 1/3 H.P.

MARTIN MOTORS are priced from \$114.75 F.O.B. Factory

MARTIN "75" with "Synco Twist" 7.5 H.P. Twin 44 lbs.



"Best Outboards Ever Built!"



MARTIN MOTORS
Division: National Pressure Cooker Co., Eau Claire, Wis.
Canadian Sales by: MARTIN MOTORS
Division: National Pressure Cooker Co. (Canada) Ltd., Wallaceburg, Ontario



I MADE **\$14 PER DAY**
While still learning!

T. E. H.—WEST VIRGINIA



I MADE **\$800 IN 3 MONTHS**
While taking your course!

F. V.—NEW YORK

Get into the **ELECTRIC APPLIANCE REPAIR & SERVICE BUSINESS**



OPEN YOUR OWN SHOP
As soon as you enroll, I send you my New Book "How to Open Your Own

SPARE OR FULL TIME

You can actually increase your income while still learning—spare or full time **ACT NOW**

Want a good-paying business—a job in a fast-growing industry? Send now for your **BIG FREE BOOK**—"My Plan for your Success." Get started **NOW**

EASY TO LEARN

Men of all ages, yes, even the man of 69 can get into this expanding field. A **REAL OPPORTUNITY** for the practical man who wants the **BETTER THINGS IN LIFE**. The easy PTS Home Study Plan prepares you for greater earnings **NOW!**

I SEND YOU A **BIG KIT of TOOLS at No Extra Cost**



H. T. ARMSTRONG

Business" at no extra cost. PTS training is more than a home study course in electric appliance repair and service. It gives you the "know how" on the operation of your shop from a business standpoint: What to charge, how to get customers. Everything possible is done to start you on the road to success.

WE TEACH YOU:

Electric motors, house wiring, refrigerator, auto ignition, automatic washers, garbage disposals, fluorescent lights, irons, cleaners, etc., at home. **FULL OR SPARE TIME**

SEND FOR THIS FREE BOOK



MAIL THIS COUPON TODAY

PACIFIC TRAINING SCHOOL H. T. ARMSTRONG
7219 So. Broadway, Dept. P-512, Los Angeles 3, Calif.
Please send me, without obligation, your free booklet and details.

Name _____

Address _____

City _____ Zone _____ State _____

"Go to the head of the class!..."



That's what my Economics teacher said when I showed him how to solve his problem.

THE PROBLEM:

Find the true economical way to make a high-mileage Ford run like new again.

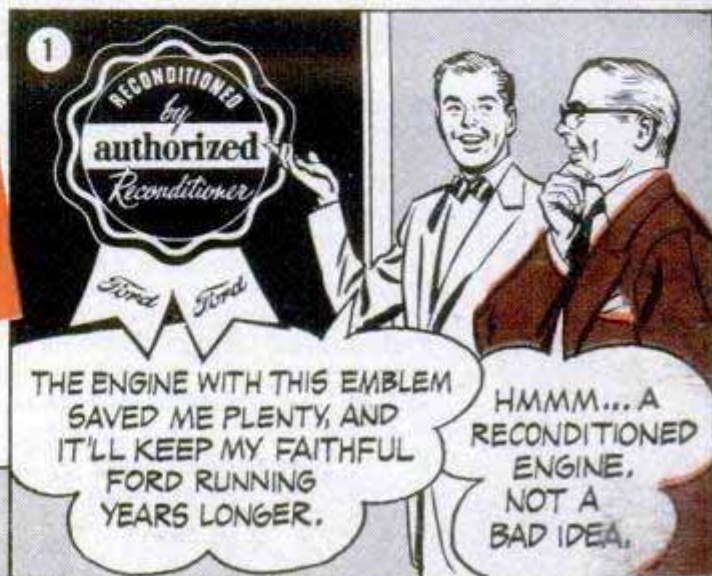

1 THE ENGINE WITH THIS EMBLEM SAVED ME PLENTY, AND IT'LL KEEP MY FAITHFUL FORD RUNNING YEARS LONGER.

HMMM... A RECONDITIONED ENGINE, NOT A BAD IDEA.



2 **Completely Reconditioned and Guaranteed**

RIGHT—IF IT'S AN **AUTHORIZED** RECONDITIONED FORD ENGINE, IT'S **COMPLETELY*** RECONDITIONED AND GUARANTEED.

HIGH QUALITY... **GUARANTEE**—BOTH GOOD ECONOMICS.



3 PROFESSOR, HERE'S A LESSON IN PRACTICAL ECONOMICS—AN **AUTHORIZED** RECONDITIONED FORD ENGINE PROMISES YOU "LIKE NEW" PEP AND POWER, AND EVEN I CAN AFFORD THE PAYMENTS!

LAD, YOU GET AN "A" FOR THE DAY! WHERE CAN I BUY?



ASK YOUR FORD DEALER OR INDEPENDENT GARAGE. WHEN THE ENGINE YOU BUY HAS THIS EMBLEM—IT'S YOUR ASSURANCE OF QUALITY AND VALUE.

AUTHORIZED RECONDITIONED FORD ENGINES and ENGINE ACCESSORIES

*Crankshaft, camshaft, bushings, valve guides, timing gears, pistons, rings, bearings, rods, valves, gaskets, studs, nuts—all completely reconditioned or replaced with Genuine Ford Parts. All work done to exacting Ford standards by authorized experts.

RECONDITIONER'S GUARANTEE
90 DAYS OR 4,000 MILES

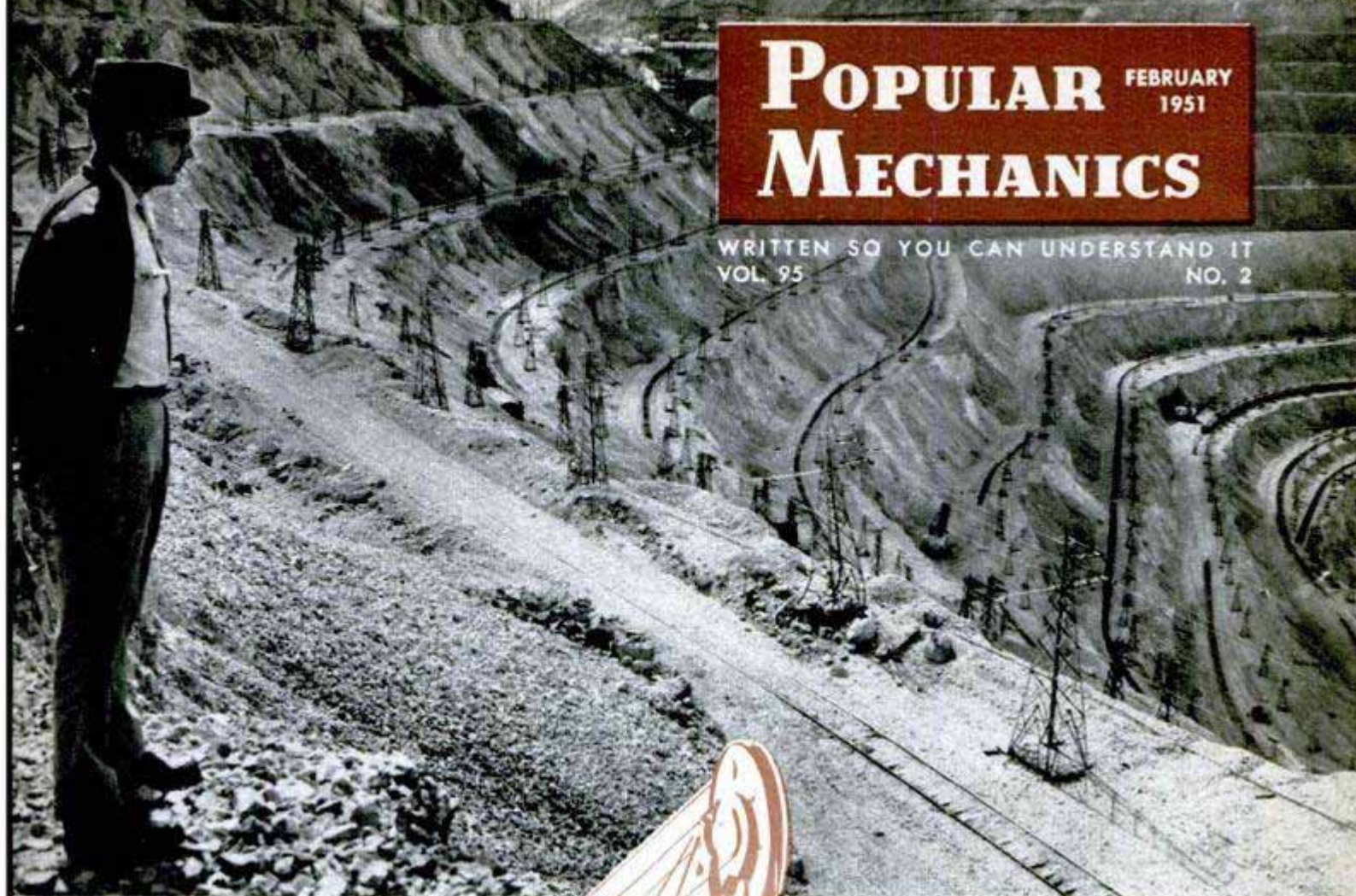

So vast that its ore trains look like scale models, Bingham Canyon produces nearly one third of our copper

By Thomas E. Stimson, Jr.

Digging Deeper For RED METAL

ALMOST LIKE the cut-rate merchant who claims that he loses money on every sale but makes it up by the volume of business, mining engineers can make a profit from virtually worthless copper ore if there is enough of it.

You'd starve to death if you tried all by yourself to extract the copper from a low-grade deposit that ran, say, one percent in metal. After a full day of treating 10 pounds of rock you'd get about an ounce of copper, worth less than two cents.

But when you put 4500 skilled men on the job and give them plenty of heavy equipment, including a full-size railroad, a miracle occurs. Instead of one ounce per man, production jumps to almost 250 pounds per man per day. Working together, the men can produce some 200,000 tons of copper per year.

That's what happened at the largest open-pit copper mine in the world, the Bingham Canyon

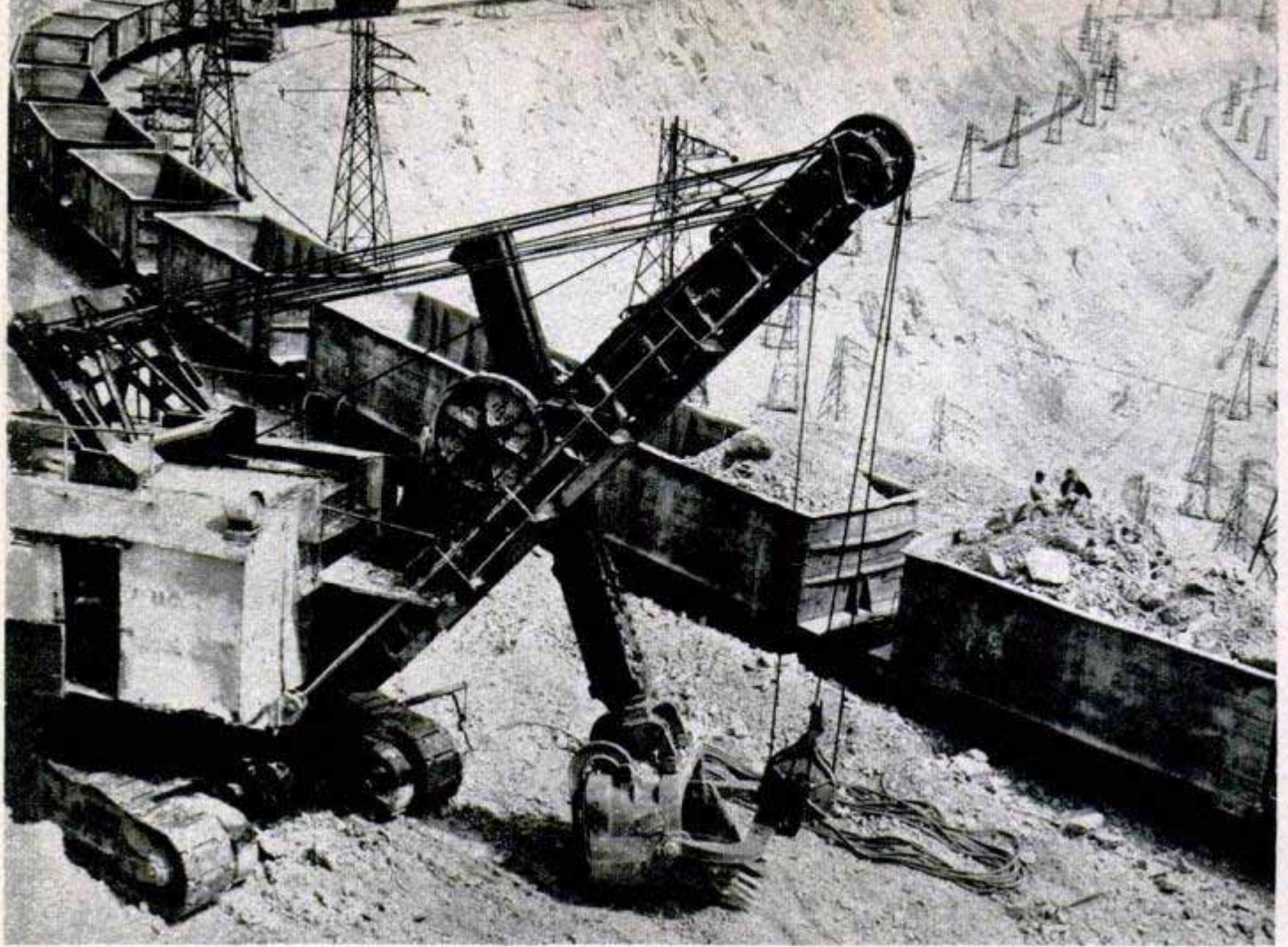

Each electric shovel takes a five-cubic-yard bite. Multiply that by 45 terraces and you've got Bingham Canyon

operation of the Kennecott Copper Corporation near Salt Lake City.

Pound by pound the Bingham Canyon ore isn't worth the trouble of stooping over to pick up, and yet this one mine produces nearly a third of all the newly mined copper that the United States produces, a twelfth of the entire world's production.

More than a billion tons of ore and waste have been removed from Bingham in the last 45 years and today it's hard to tell where the original canyon used to be. An

entire mountain that overlooked one side has completely vanished and even its roots have disappeared. The enormous pit where the mountain once stood measures 1960 feet from top to bottom.

This amphitheater is one of the man-made wonders of the world. It is so big that some of the shovel operators, powder men and other miners ride passenger trains to work; so vast that, from a public observation point, the numerous ore trains on the different working levels seem as tiny as the cars of a model railroad.

As canyon walls are gnawed away, this machine shifts the rails with them



Every year thousands of tourists from all parts of the country drive the 19 miles from Salt Lake City to have a look at the big hole. The tourists steer their cars up the narrow, twisting road to Bingham, negotiate a 6988-foot curved tunnel that pierces one wall of the amphitheater, and drive out onto an observation area.

Above their heads the walls of the pit slope back in a series of terraces or

steps. There are 45 levels on the walls of the pit, approximately 70 feet apart, and each is from 70 to 250 feet wide. Each level is widened by blasting the cliff that forms its wall. The loosened ore is loaded by electric power shovels onto the ore cars that are spotted on temporary trackage. The level is subsequently narrowed again by the blasting that takes place on the level below it. By this process the ore is mined in an economical manner and the amphitheater continues to widen.

The thing that impresses most visitors is the ore trains, constantly on the move. There are approximately 140 miles of trackage in the mine area and the transportation equipment includes sixty-seven 750-volt electric locomotives. The mine trains consist of 12 to 20 ore cars. A loaded train moves downhill out of the mining area to the near-by town of Copperton, where the cars are joined with others into 70 to 90-car trains for the 15-mile trip to the mills at Arthur and Magna on the shores of the Great Salt Lake. Two 125-ton electric locomotives handle the cars on this run. Traffic is heavy. In the mine area, there are flagmen in watch towers at the numerous curves to signal a clear track to the oncoming trains. On another part of the system, the operation of the trains is controlled by the same kind of centralized traffic control that is used by the major railroads.

At the mills the ore cars are turned up-

side down and dumped, and the ore then travels through a series of grinding and crushing machines. Water, lime and reagents are added to the pulverized material and a copper concentrate is extracted by the standard flotation process. At a near-by reduction plant this concentrate is smelted and cast into anode shapes of better than 98-percent-pure copper.

The milling and refining operations are so huge that it's difficult to appreciate the tonnages involved, but a single fact gives you an idea of the work that is done: 50 tons of two-inch iron balls are worn out every day in the ball mills that help grind the ore. A special foundry is always busy casting more balls for tomorrow's use.

Bingham's ore averages less than one percent copper, with traces of molybdenum, silver and gold. There's enough of it left for many more years of mining, even though tremendous quantities of waste overburden must be shoveled into the ore cars and hauled away from the mine area and dumped.

The Bingham ore body was first explored during the last century but no one could figure out a break-even way of extracting its copper until Daniel C. Jackling, a Missouri farm boy who was schooled and trained as a mining engineer, proposed the bulk handling of the material with heavy equipment. His idea sounded like a wildcat scheme but it worked and the method has since been applied to other huge low-grade

Below, left, a battery of ball mills, rotating at high speed, grinds the ore to a powder. Right, electric locomotives draw their current from an overhead wire hung at one side of the track to avoid shovel booms

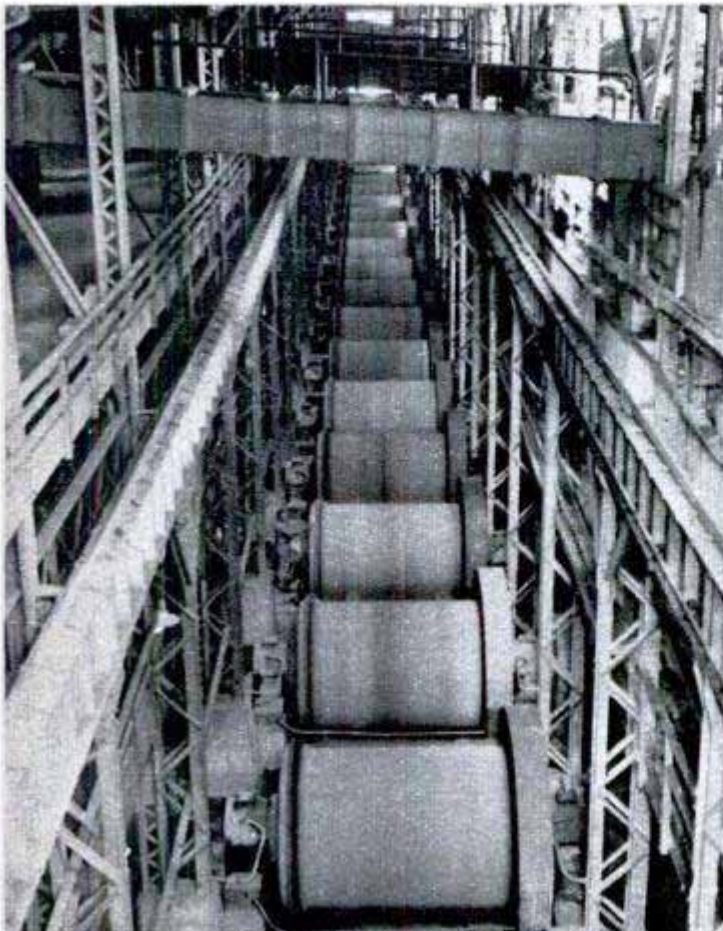

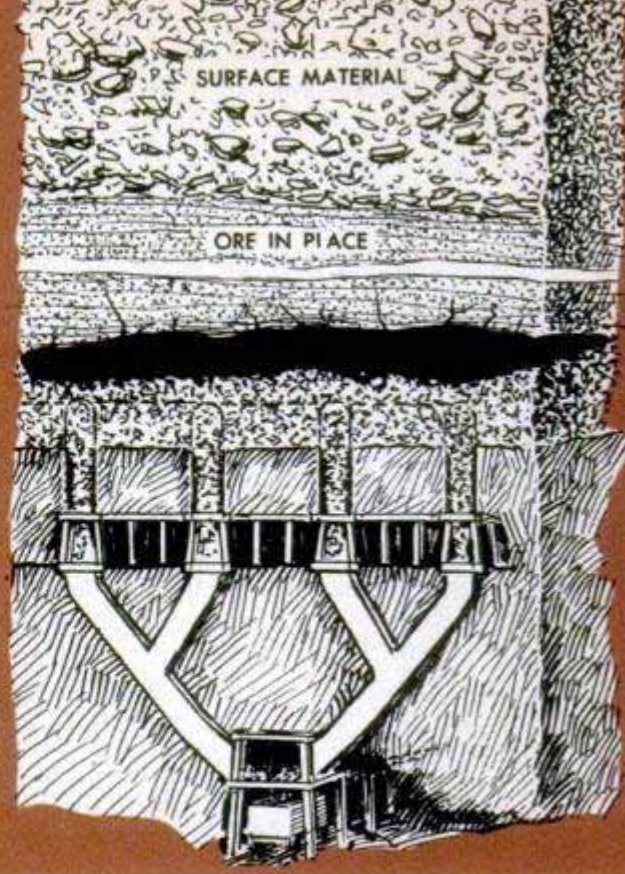
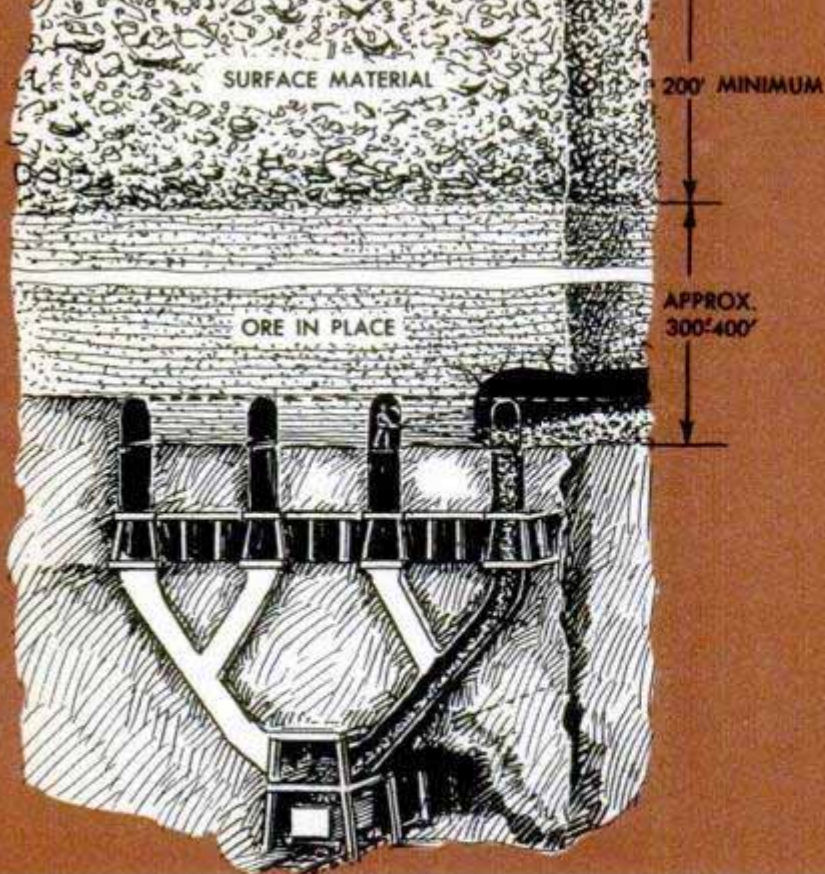

Block-caving mining of underground ore at Butte uses finger chutes. One is being drilled by a miner here

When support pillars are blasted away, roof of ore caves in, falling through chutes to mine cars below

copper bodies that lie at or close to the surface.

feet long, located from 700 feet below the surface to 3400 feet below, possibly deeper. One shallower zone is only 200 feet below the surface.

One of these is the Morenci open-pit mine of Phelps Dodge in Arizona. Here 200,000,000 tons of waste capping are being removed so that an equal amount of ore that contains only a fraction more than one percent of copper can be worked. Even so, estimates are that 2,500,000 tons of pure copper will be extracted before the deposit is worked out. Like the Kennecott operation at Bingham Canyon, Morenci uses huge electric shovels on a series of terraces for lifting ore into railroad cars. Electric and diesel-electric locomotives haul the ore trains to the near-by mill. Train movements are controlled by a central dispatching office.

In the past, the poor ore wasn't consid-

Up in Butte, Mont., the Anaconda Copper Mining Company likewise has blocked out a tremendous body of low-grade ore, fabulously rich in the aggregate but worth only a cent or two per pound.

This miner fuses the explosive charges in a vein of Butte ore so they'll go off in rapid-fire succession

Butte's low grade can't be handled by the open-pit method because it lies far underground, deep inside the "richest hill on earth" that has already yielded millions of tons of copper, zinc and manganese.

Most of the rich veins in the hill already have been worked out. Since 1910, in fact, more than 2200 miles of shafts, drifts and crosscuts have been dug to mine the high-grade material.

The low-grade ore that remains occurs in several zones about 400 feet wide by 2000



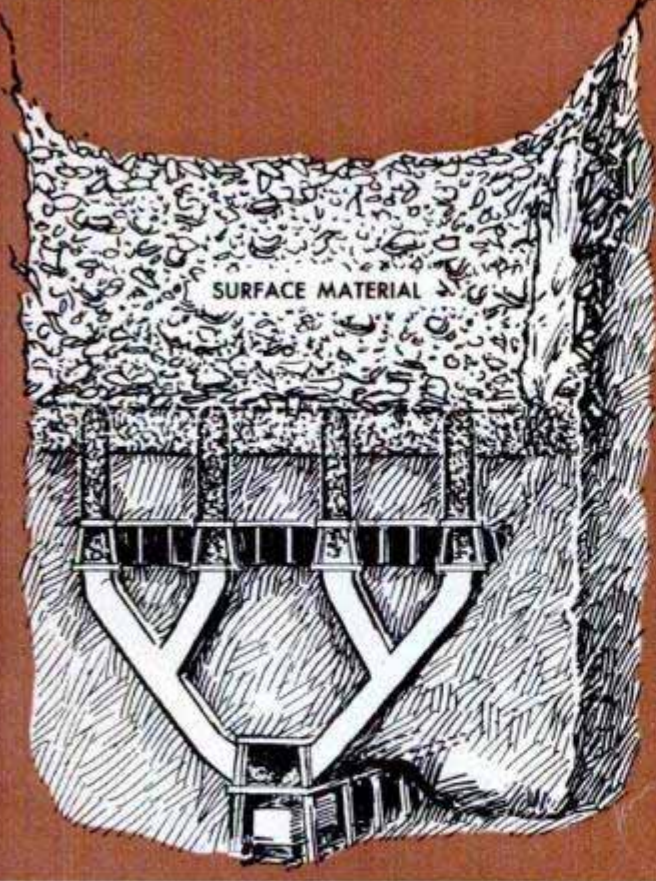

With the ore almost all removed through the chutes, surface material above it has settled to fill hole

ered worth the trouble of working; now the Anaconda engineers have developed a "block caving" method of mining it that appears to be sound. More than \$20,000,000 are being spent in preparation. This Greater

Looking down on roaster furnace at Anaconda where the ore from the Butte mines is refined into copper

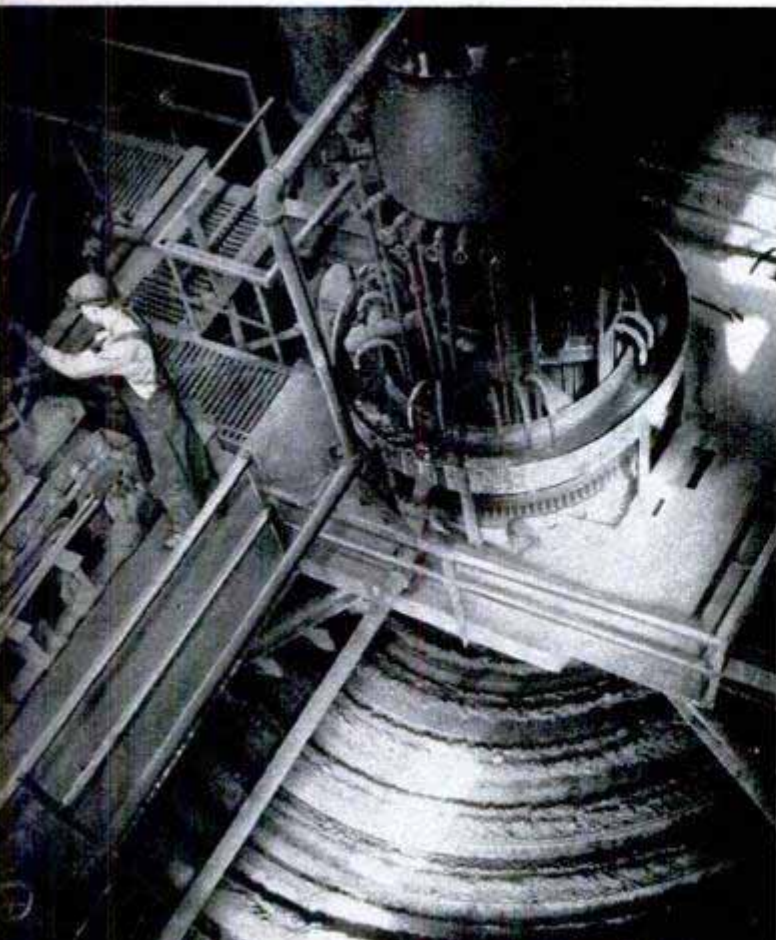

Butte Project is expected to maintain Butte as a major copper producer for decades to come. At maximum production, about 15,000 tons of ore will be raised to the surface every day.

The engineers are going to attack the ore zones from below. They will excavate a void deep in the earth and let the ore cave down and fall into strings of empty ore cars. That's a simple way of describing a very exacting operation.

The first step, almost finished, has been to excavate a deep shaft some distance away from the deposit. Named the Kelley Shaft, this bore is being excavated to 2200 feet and eventually will be deepened to 4200 feet. The shaft will be 9 by 38 feet in cross section and will contain several compartments, one of which will be occupied by a cage for raising or lowering men and supplies, and two of which will be occupied by ore skips of 12 tons capacity each. When hauled up into the headframe, each skip will discharge its load through a bottom dump into a hopper, which in turn will discharge into railroad cars that will haul the material to the mill at Anaconda, Mont.

The ore skips will travel up and down the shaft at a speed approaching 30 miles per hour.

Haulage drifts that will accommodate trains of five-ton capacity side-dump ore cars are to be blasted through the rock at various levels from the shaft. From these

(Continued to page 242)

Refined copper is discharged from an Anaconda converter furnace to be poured into molds to form bars

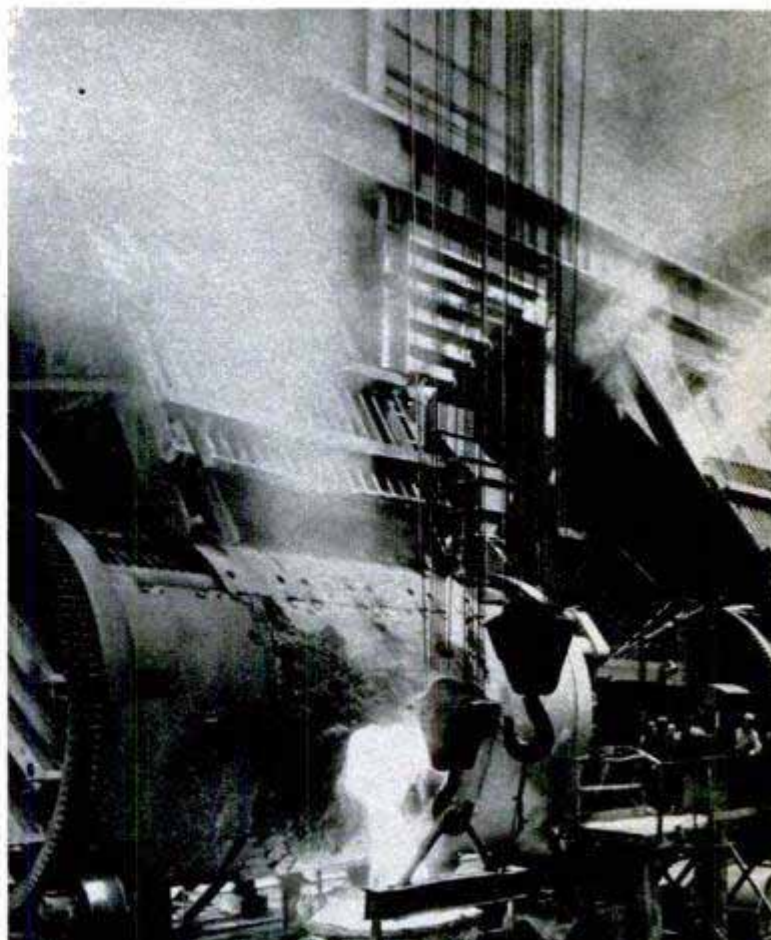

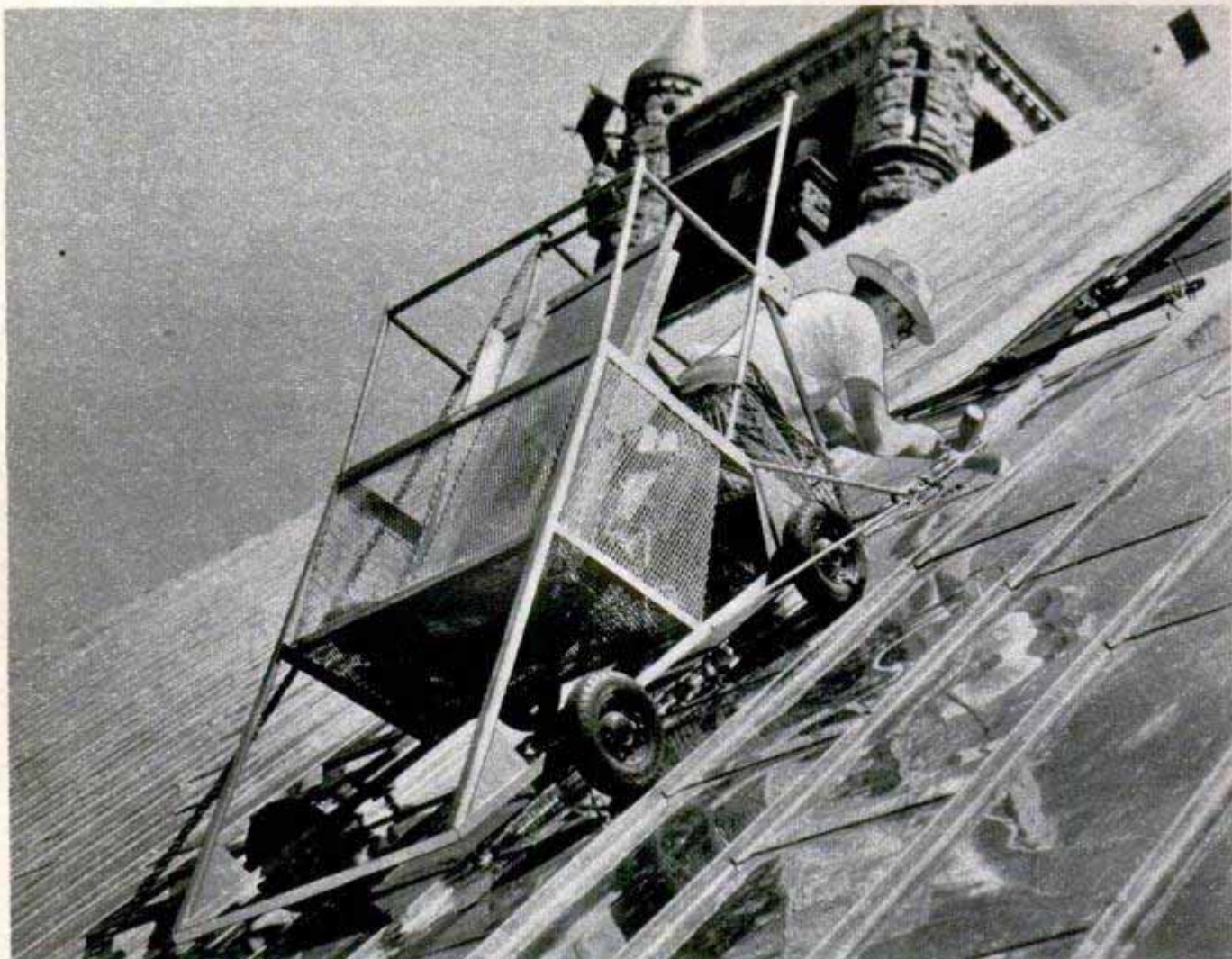

"Spider" Cart for Roofers

Roofers working on the Hennepin County courthouse at Minneapolis, Minn., pooled their ideas and built a "spider" cart to solve a knotty problem. The courthouse has a high-pitched roof which was to be covered with 120,000 square feet of cold-rolled copper. Hauling the copper sheets into place and then installing them was a difficult and

dangerous job until the workers developed their cart. It is built to the pitch of the roof, giving the operator a level platform on which to stand. Four rubber-tired wheels provide good traction without damaging the soft metal. A "caboose" on the cart hauls the roofing materials. The workman moves the cart up and down the roof by operating block pulleys and ropes secured to the roof peaks.



Cable-Operated Dump Truck

Through a block-and-tackle arrangement, a single cable elevates a new truck trailer, thereby dumping the load. The winch-operated cable eliminates the need for a heavy understructure. The new trailers are operated with standard traction units and the driver handles all controls from the cab. Two lift arms are pivoted to a "fifth wheel" and to the trailer chassis. When the winch is operated, the cable draws the trailer toward the truck, elevating the front end to dump the load. Spot-dumping is accomplished by locking the trailer wheels, which causes the mechanism to draw the tractor unit backward.

Dump-Truck Post Driver

Fence posts are driven at a rate of 100 an hour by a driver that uses the hydraulic lift of a dump truck to force the post into the ground. The driver mechanism bolts to the frame of the truck between the cab and body. The drive cable hooks to the front edge of the truck body. A cap at the end of the cable slips over the top of the fence post. As the dump body is raised, the cable is pulled up, driving the post into the ground.

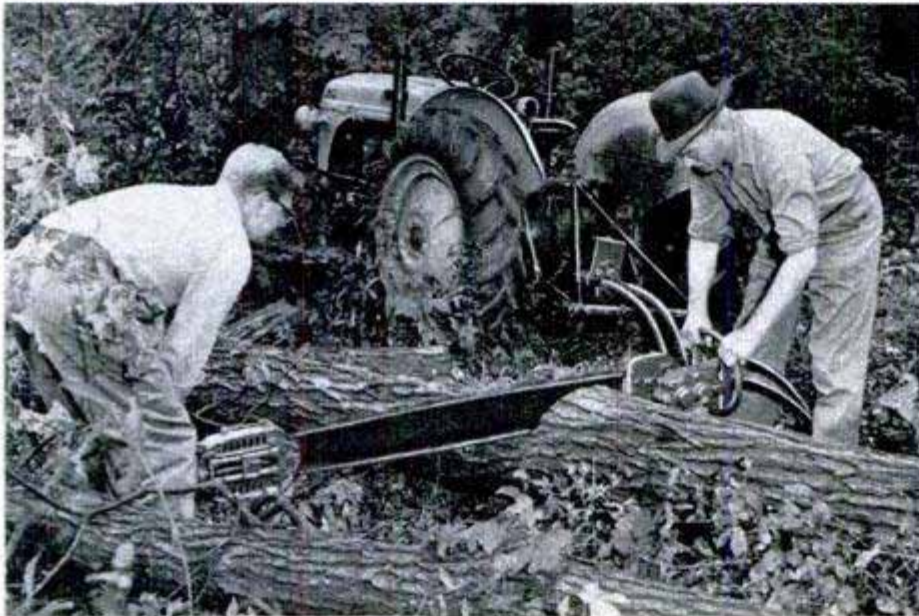
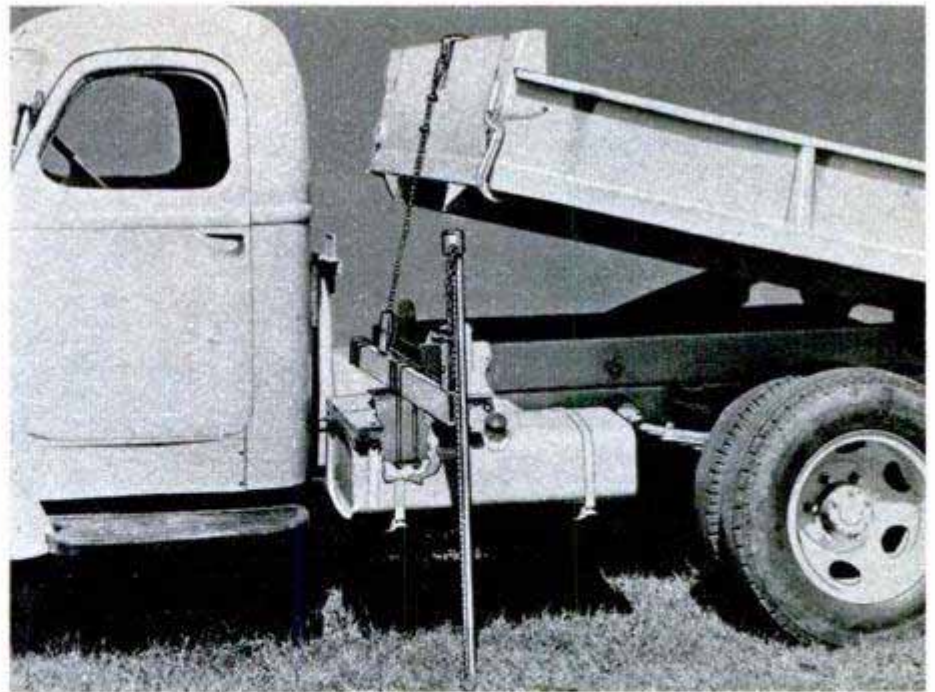

Hydraulic Chain Saw Powered by Tractor

Hydraulically operated, a fast-cutting chain saw is light in weight because it is driven by the power take-off of a tractor or truck. Long hoses allow the operators to work at a considerable radius from the tractor. The saw can be started or stopped, by a control lever convenient to the operator, without stopping the tractor engine and it cuts equally well at any angle and in any position.

Flying Chuck Wagon

Meals for Northwest Airlines passengers are being speedily hoisted up into the planes by a hydraulic-lift chuck wagon. The steel truck body is 6 feet high, 8 feet wide and 12 feet long. Carrying enough food to load several planes, it can be elevated to the level of the galley door for any of the several sizes of planes being serviced.

☐ There are more than two billion tons of high-grade iron ore in the Quebec-Labrador area, according to the most recent conservative estimate.



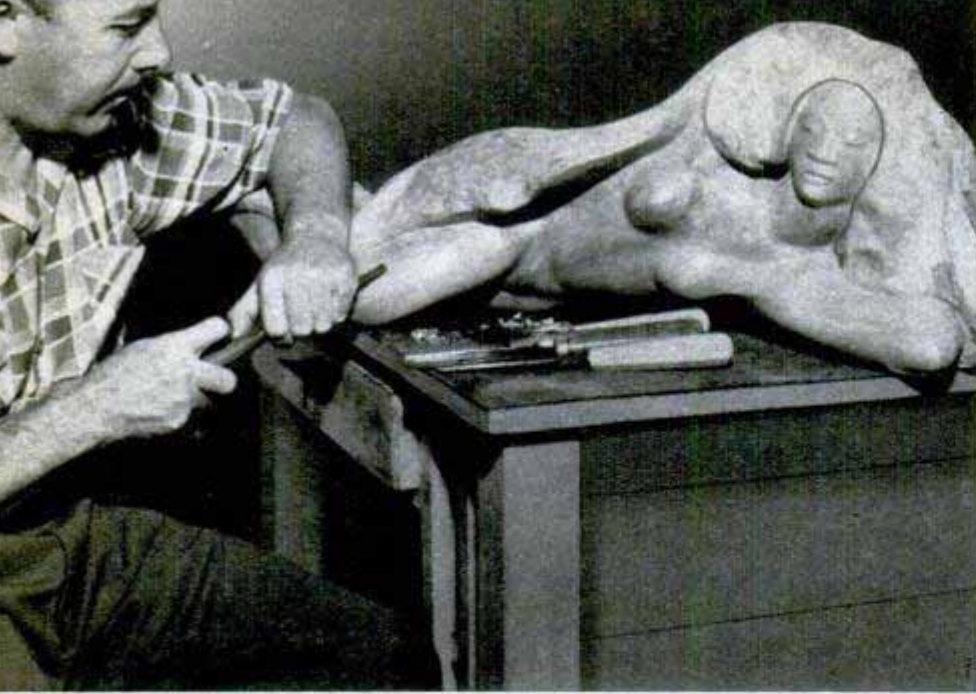

Here's the Swiss wood carver with an example of his work on driftwood, a specialized type of wood carving for which he is best known in Hawaii

Once essential to the Polynesians, the art of wood carving had almost vanished in Hawaii until a man from far-away Switzerland revived it

By Richard M. Botts

A Swiss Wood Carver Brings Back Hawaii's Lost Art

This driftwood face illustrates clearly how Abplanalp allows the shape of the eroded wood to influence his art

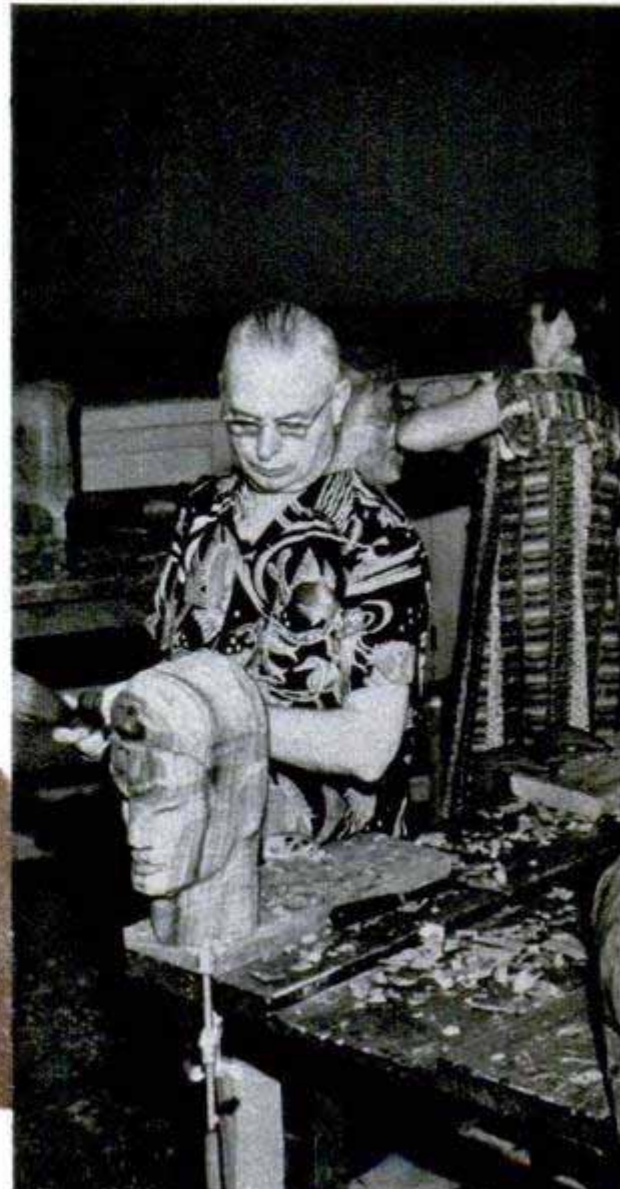
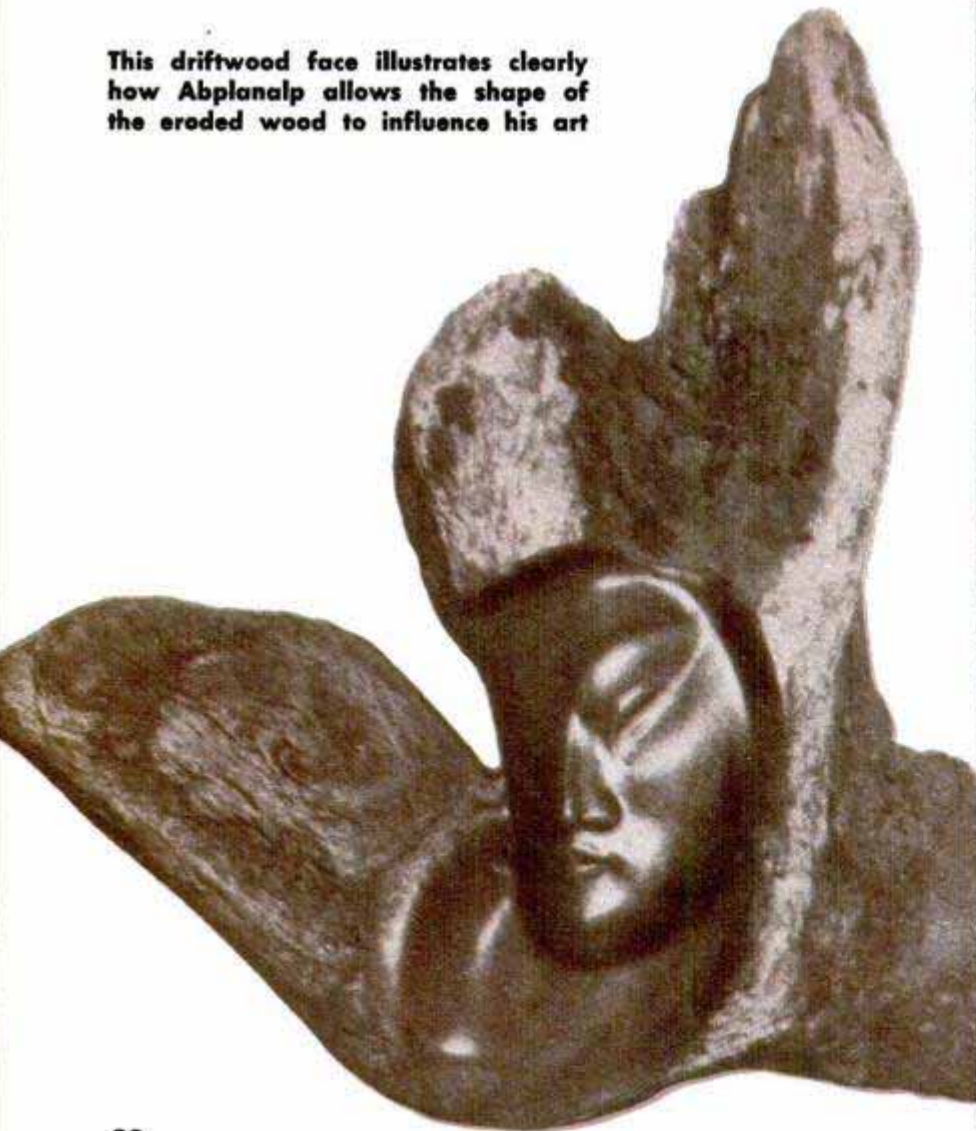

TAP ALMOST ANY Honolulu on the shoulder and you're apt to find a wood carver!

"The wood-carvingest place I ever saw," declares Aubrey Price, one of Hawaii's many wood-carving instructors. "Why, tots in grade school as well as their grandparents think nothing of carving salad bowls, coffee tables, lamps, plates, cigarette boxes or even sculpture in half a dozen rare Hawaiian woods."

The roots to this popular Island hobby can be traced back to a Swiss wood-carving genius who landed on these Pacific shores about 15 years ago and liked it well enough to stay.

Fritz Abplanalp is his name and wood carving's been his game ever since he was old enough to swing a mallet. In that time, he's carved everything from tropically designed wooden perfume containers to the interior of an Ohio church.

The Ohio church took him six years of constant work and is to date his most ambitious project. But he's still very proud of a life-size nude he carved from a two-ton Hawaiian monkeypod log that was nine feet long and three feet in diameter. This piece of sculpturing took three years to complete and required 283 hours of work.

Fritz was born in the Swiss Oberland, which is known for its fine wood carvers who've handed down the art for centuries. He received a "formal" education in wood carving from one of the Swiss masters and had advanced to such a point at the age of 18 that he was picked from over 50 veteran wood carvers to



Above, another fine driftwood specimen. Most carvers have their own secrets for finishing wood, but basically they use a sealer, oil or wax, and lots of rubbing



Left, here are just a few of the hundreds who have studied wood carving with Fritz Abplanalp. This is the advanced section where students carve figures and heads

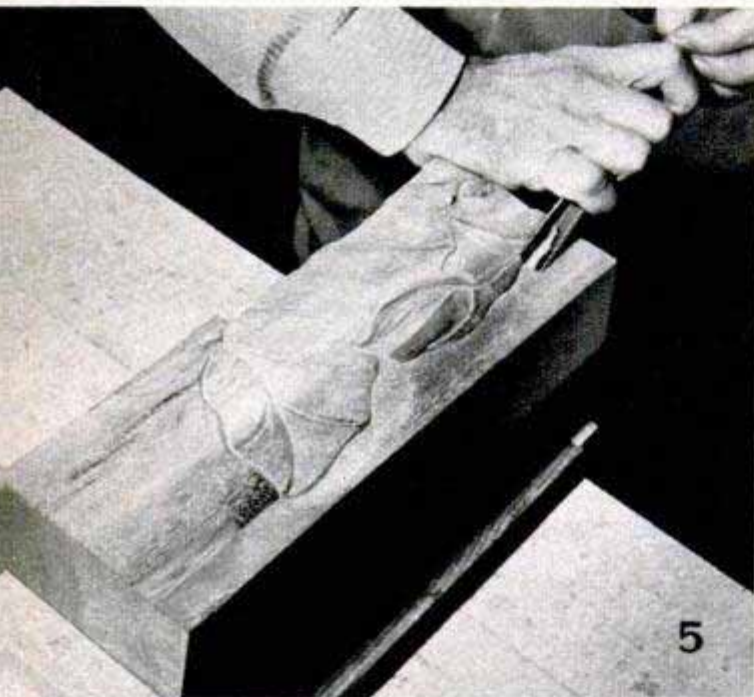
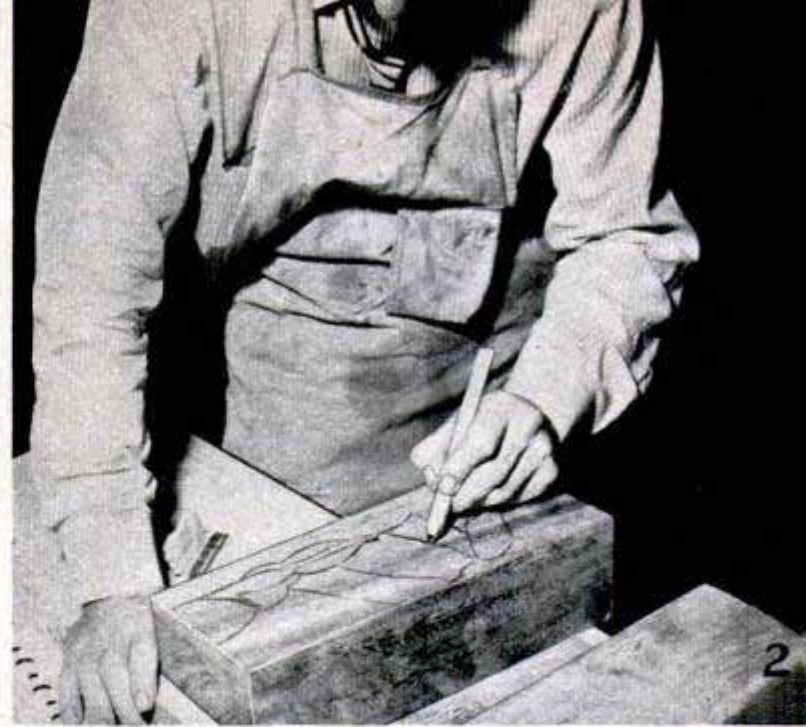
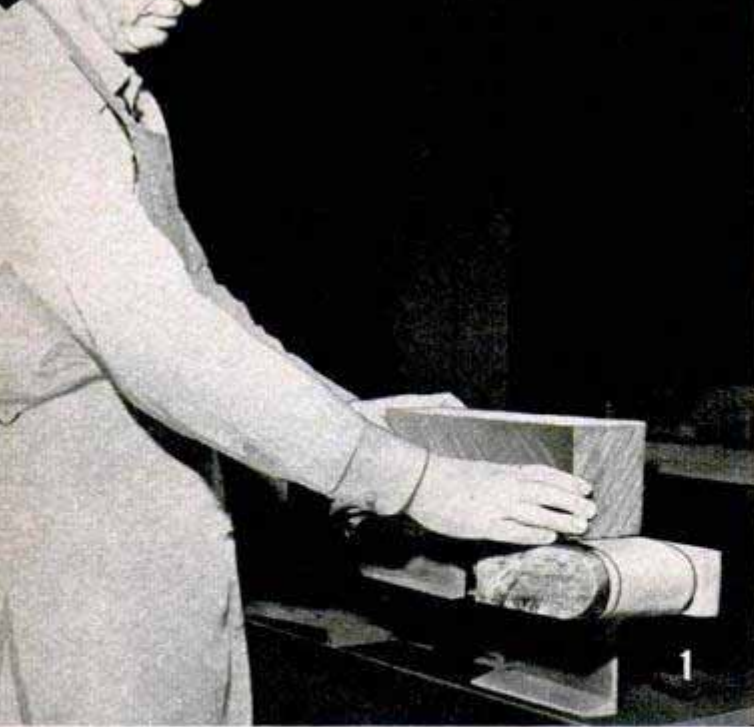

1. First step in carving a block of wood is sanding it. Aubrey Price uses a power sander on block of monkeypod

2. Next, Price, who is an artist, quickly sketches the design on the wood. Many carvers resort to tracing here

3. The first tool the wood carver uses is the narrow V-tool. With it he carves along the lines he has sketched

4. As soon as he has entirely outlined the pattern with the V-tool, the carver uses a gouge to deepen the design

5. Now a larger V-tool is used to cut the design deeper into the wood. Note the L-shaped stop holding the block

6. When the design has been cut down to the right depth, the carver removes the adjacent wood with a flat chisel

7. When finished carving, Price uses fine sandpaper to smooth rough edges of the design and remove tool marks

8. After adding lamp attachments, Price applies a sealer to the carved block of monkeypod wood, then waxes it

9. Mounted on a dark wood base and topped with a shade, the attractive carved block becomes this lamp

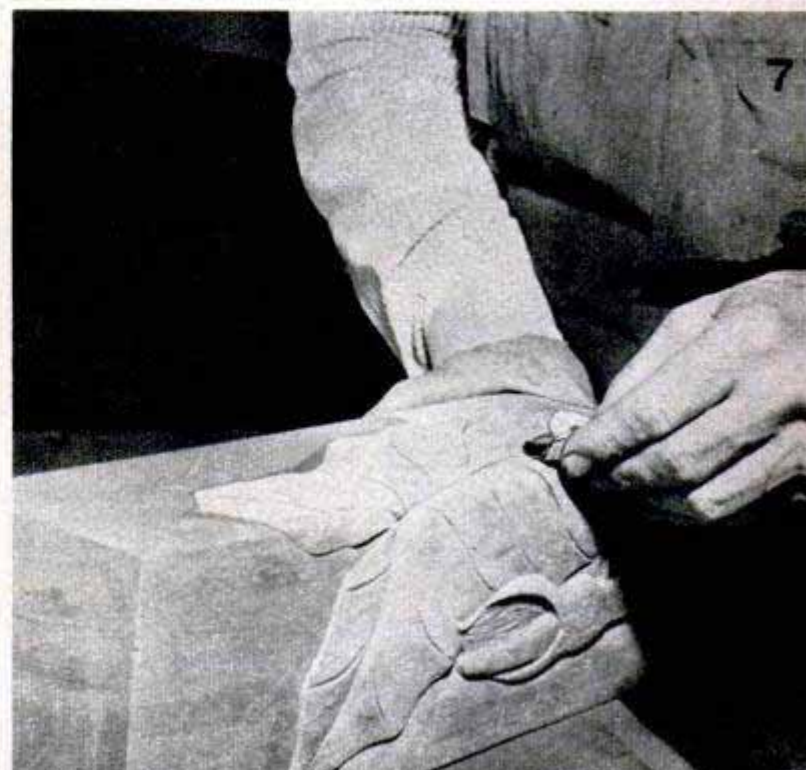
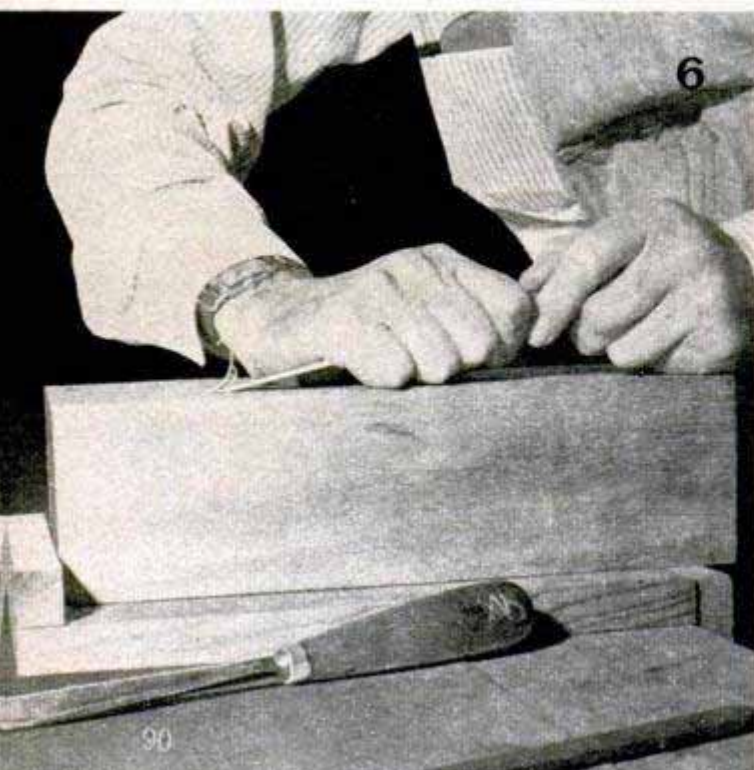

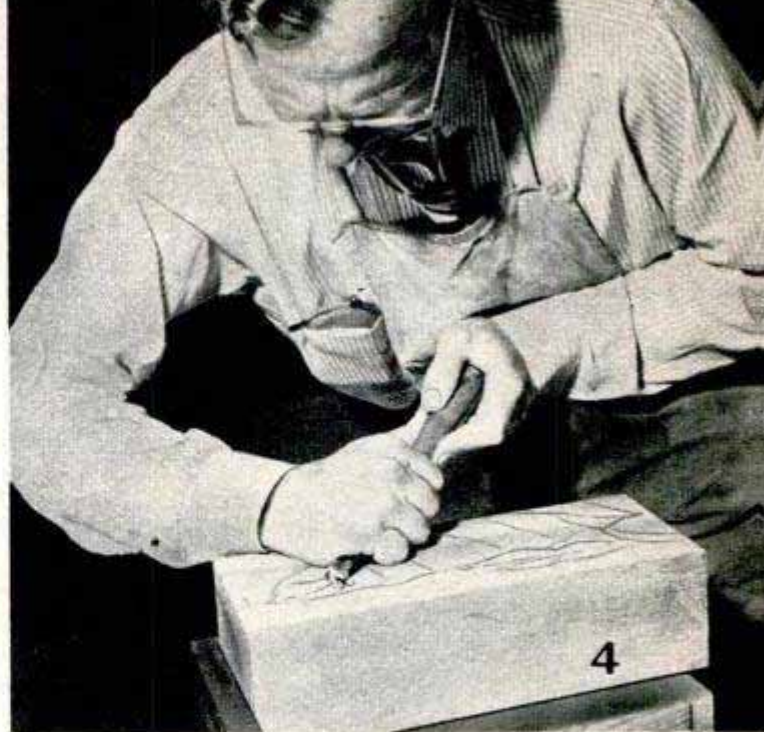

carve a church located in Glendale, Ohio.

In 1935, when his Ohio contract was finished, Fritz leaped across the Pacific to take a "special order" wood-carving job with Gump's in Honolulu. "I saw at once that Hawaii was a natural for wood carvers," Fritz said. "It has over 32 different types of wood—some extremely rare and found nowhere else in the world—and it has hundreds of typically Polynesian objects such as flowers, tropical fish and Hawaiian gods that could be used as subjects. But it had no wood carvers."

This may surprise those who know that the ancient Polynesians were excellent wood carvers. Wood carving, however, became a lost art after Western civilization was introduced to the Islands. The natives found the Western world's pottery and steel far superior. Prior to that time, however, the Polynesians made everything—

bowls, utensils, spears and idols—of wood. They had to as the volcanic soil did not produce suitable clay or metal.

"The Polynesians were real craftsmen," Fritz says. "They did beautiful wood carving with extremely crude stone tools. Some of their idols were 10 feet high and their bowls and spears show marks of real artistry."

Fritz decided to bridge this gap between the ancient Polynesian wood carvers and the present day. He began teaching classes in wood carving; he preached the use of Hawaiian woods and Hawaiian motif. His classes grew until today he estimates he's taught over 600 pupils since arriving in Hawaii.

From his classes other teachers developed. They are among the 10 percent who Fritz believes have enough manual dexterity and creative ability to go far in wood

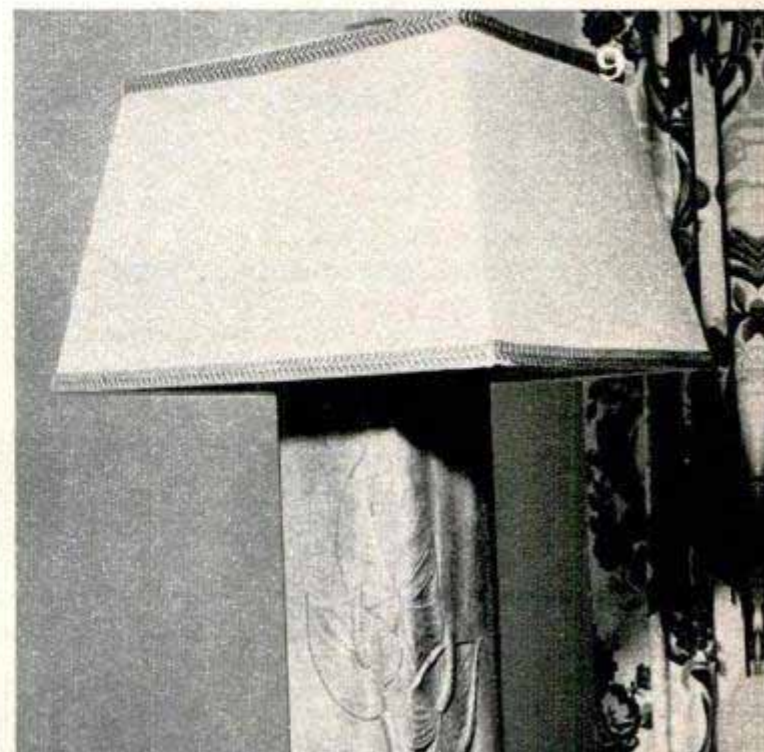
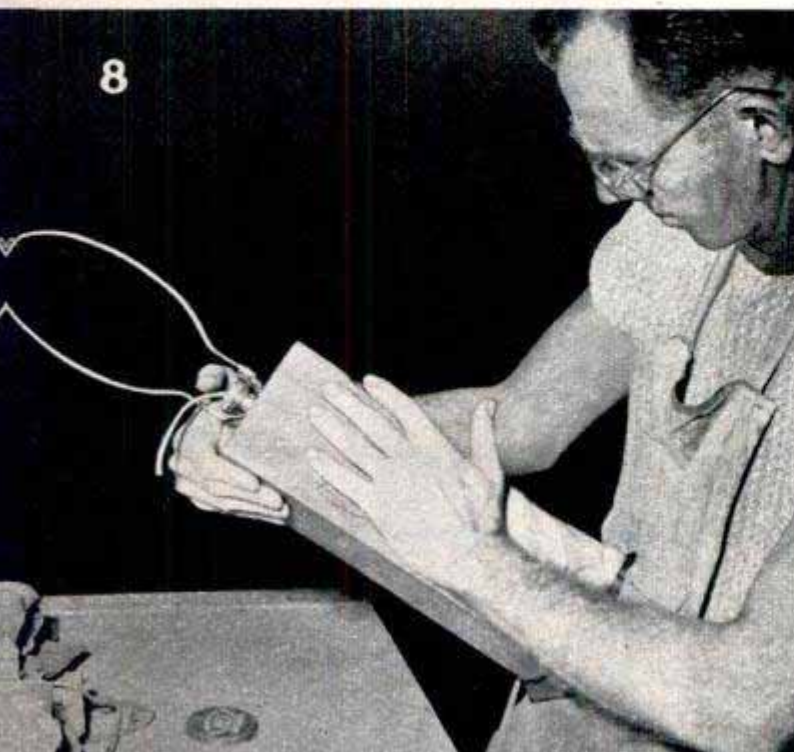



Left, Ian Cameron, one of Hawaii's wood carvers, is holding monkeypod hors d'oeuvre dish that he made. Above, a matching set that includes a canape tray and salad bowl in leaf pattern. Below, a statuette in its early stage. The worker has just completed roughing out the design with his chisel and mallet

carving. They taught beginner classes themselves and added to the growing popularity of wood carving.

Hawaiian wood carvers are unique in many ways from their brother carvers around the world. They have a myriad of excellent instructors; an abundance of beautiful and unusual tropical designs, and fine Hawaiian woods.

The rarest wood which is indigenous to Hawaii is koa. Some call it "Hawaiian mahogany." It is a hard wood, polishes to a dark, rich color and is very popular with wood carvers.

Milo is another rare wood. It is found only in volcanic soils and generally on inaccessible beaches. It is a small tree about 12 inches in diameter. Only the center portion of the log is used and the wood must be aged for at least two years. Milo has a beautiful grain, polishes to an ebony and retains a satinlike sheen. It is used mostly for dining tables and perfume containers.

Fritz, along with many of his students, likes monkeypod as the best all-purpose wood. It is not only indigenous to Hawaii but may be found in other parts of the world. Monkeypod is easily obtainable and does not take long to season. Monkeypod comes in a wide variety of colors which range all the way from the dark brown of the male tree to the tawny shade of the female tree. In the young wood, the color is a golden yellow.

Other Hawaiian woods are coffeewood and sandalwood, which is now extremely rare but at one time flourished in great



quantity throughout the Islands. The Chinese liked it so well that Hawaii over the years has been almost depleted of this wood.

Another popular wood is hau, which comes in many shades. Those who do sculpturing like the grayish-blue tone of some hau wood.

Finding pieces of rare wood takes on the semblance of a treasure hunt at times. Most wood carvers in the islands are secretive about their source of supply. Some scour the beaches—especially after a heavy storm. Others obtain their wood from an

old prison up on the slopes of the active volcano, Mauna Loa. Lumber dealers sell a few types of wood. Still others find their wood in the heavy mountain forests of the Islands. Most of this forest area is under protection of the Forest Rangers and woodworkers keep mum on this source of supply. When you question them too closely, they'll drift onto another subject.

Whatever the source of supply, the wood must be well seasoned before carving. Generally, wood is aged a year for each inch of thickness. Aging may be quickened by boring a hole in the bottom of the block, thus giving the inside a better chance to age. Fritz has so many pieces of wood aging in his garage there is hardly room for his car. The fireplace is stuffed with wood and every spare corner has a favorite piece or two aging.

Fritz teaches advanced as well as beginners' classes in wood carving. The beginners start out by carving simple trays in some Polynesian leaf form.

"It's not so important what a student attempts as his first project," Fritz says. "It's learning the use of the tools that counts. Too many try to use force. That's tough on them as well as the tools."

Most instructors in beginners' classes supply their own tools. It takes almost as much skill to sharpen these tools as it does to do a neat piece of wood carving.

Students decide what they will carve and Fritz helps them with the design. Sometimes they design directly on the block of wood; at other times they will trace a suitable drawing on thin tracing paper and then transfer the tracing to the block. The light lines are darkened with a carpenter's pencil and the student is ready to go to work.

The instructor sees that the student chooses the right tools. For lamp bases, for instance, the beginner starts off with a V-tool. The V-tool is used to make outline cuts around the sketch on the block and then other tools are brought in as needed.

Most wood carvers use a carver's vise. A great many students, however, just use a regular bench vise to keep the block of wood steady.

(Continued to page 242)

FEBRUARY 1951

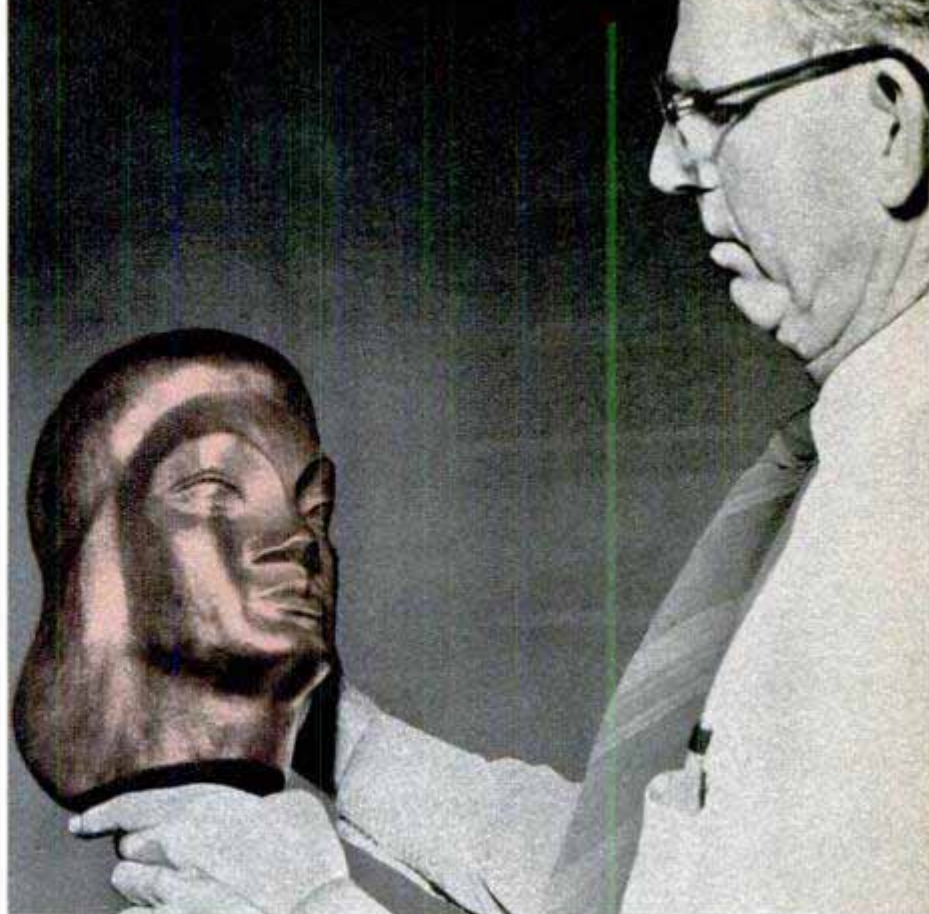

Above, Price holds a female Polynesian head he carved from a koa block and rubbed to a deep mahogany. Below, a typical set of advanced wood-carver's tools. From top to bottom: V-tools, deep gouges, shallow gouges, straight chisels and skew chisels



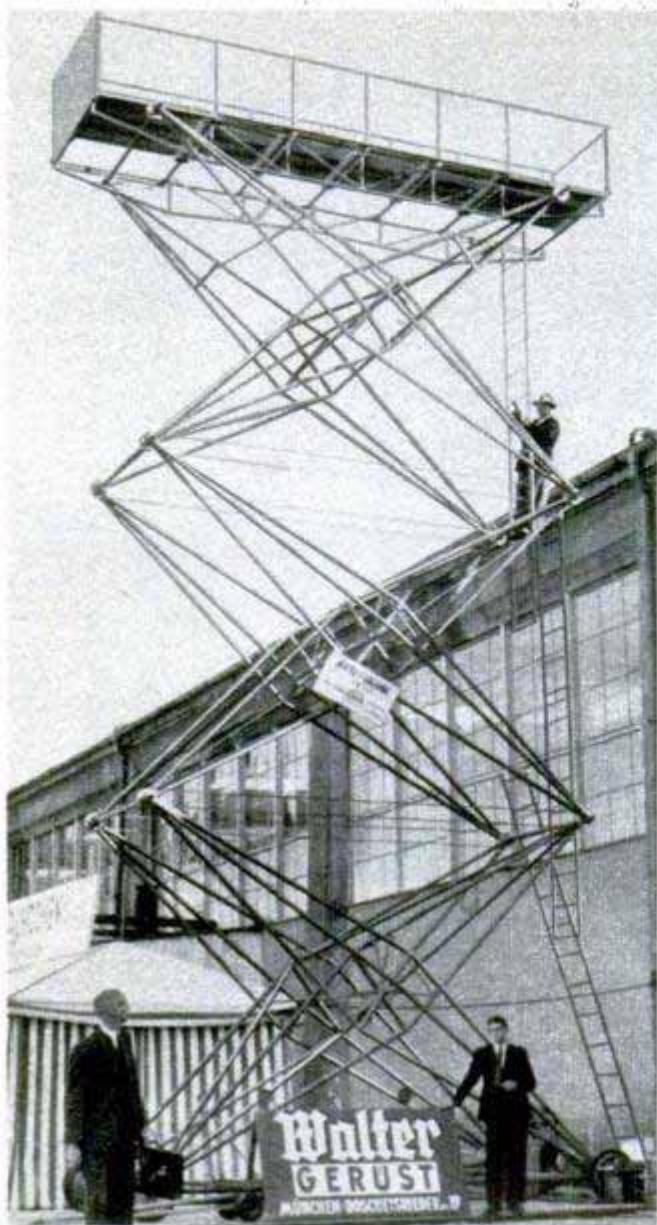

Scissors Scaffold

Weighing little more than a ton, a German scaffold can be set up at any height from 10 feet to 46 feet. The tubular-steel framework, which pivots like a lazy tongs, is raised and lowered by an electric motor. It is mounted on wheels so it can be moved easily into any position.

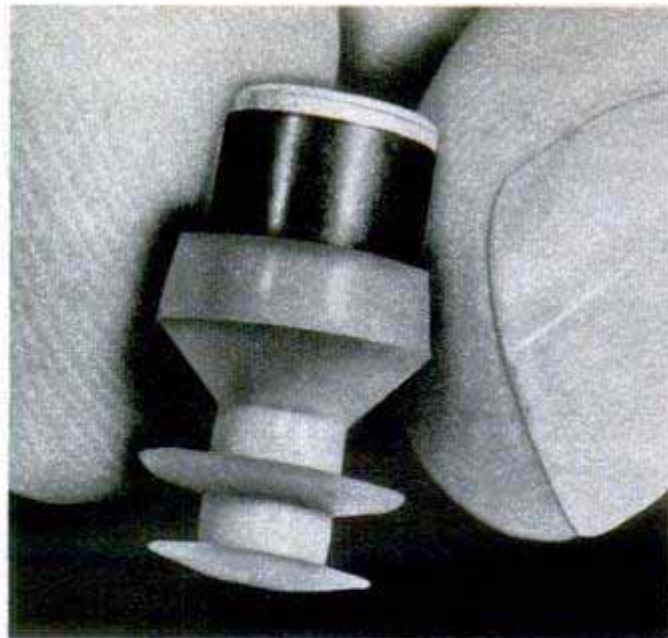

Noise Stopper

Intended for use in boiler factories, on firing ranges and in other noisy places, a new ear valve shuts out all dangerously loud noises and yet allows its wearer to hear ordinary speech and other sounds. It is a rubber plug with a tiny aluminum cylinder and plastic valve that is held open by a weak spring. Any sound of 80 decibels or greater closes the valve momentarily. The valve is also said to be effective in reducing the discomforts caused by abrupt changes in altitude while flying.

Cream Repels Land Leech

One of jungle warfare's most serious plagues, the land leech, will find the soldier of the future a less tempting victim. A light covering of a creamy chemical substance, dimethyl phthalate, on footwear and the lower leg is offensive enough to discourage the parasite. The cream, which also repels mosquitoes, was compounded by a British scientist, Dr. F. M. G. Stammers, and tested in Ceylon's jungles.



Sea Scooter

Motor-scooter fans in Italy now are amphibious—a "sea scooter" boat with its trailer is available as a companion piece to the little land vehicle. The trailer, which carries the boat, is towed to the water's edge. There the craft can be lifted by two men, as it weighs only 220 pounds. The tiny boat travels eight miles an hour and will run five hours on a tank of fuel.

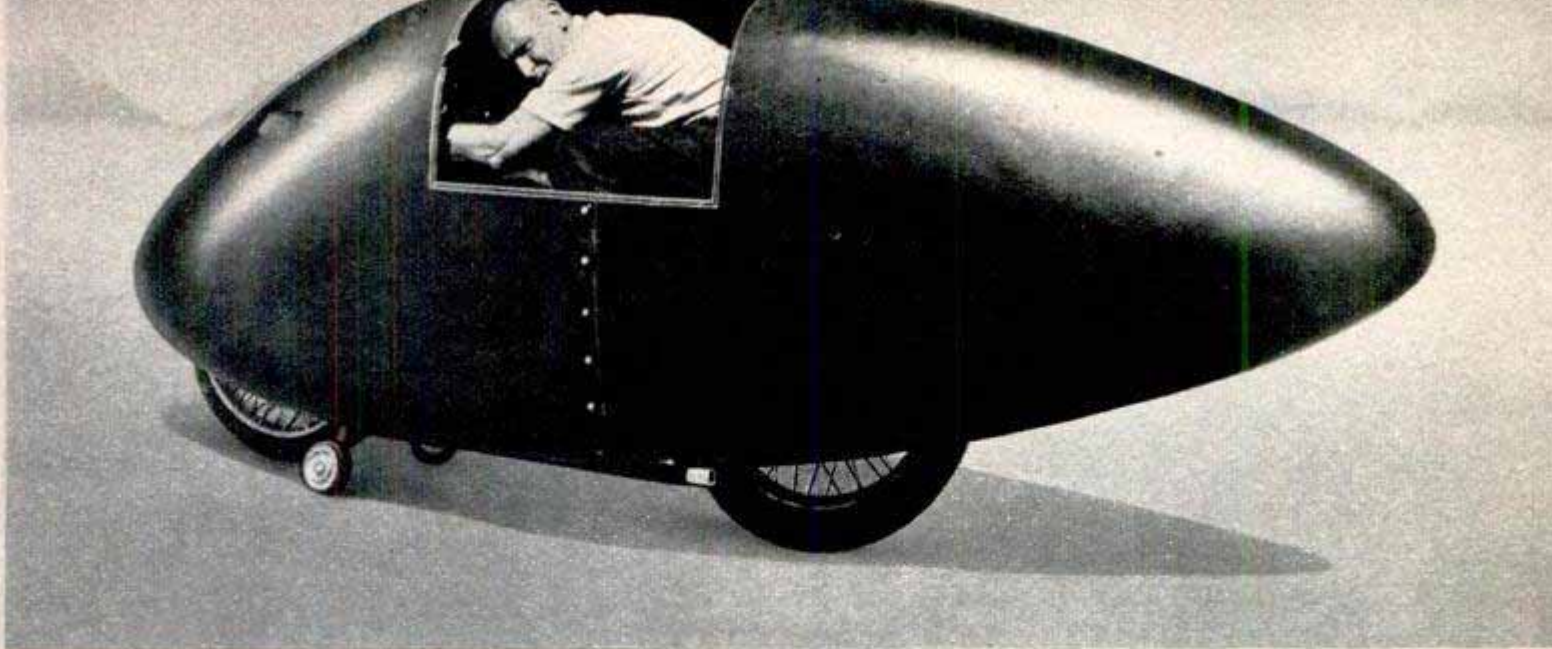

There's so little room inside the shell that Free has to look under the handle bars to see where he's going

"Eggshell" on Wheels Challenges Motorcycle Speed Mark

CROUCHED inside a plastic "eggshell," 50-year-old Roland Free of Los Angeles hopes to zoom to a new speed record for motorcycles over a mile course. He'll have to beat the 172-mile-an-hour mark set in 1937 by Ernest Henne of Germany. Free plans to make the bid on the Bonneville Salt Flats this summer, using his British Vincent racer that develops more than 80 horsepower. The eggshell cuts air resistance and holds the machine on the ground at high speeds. Last year, Free set the American record for the mile (156 miles an hour), using the same machine minus the shell.

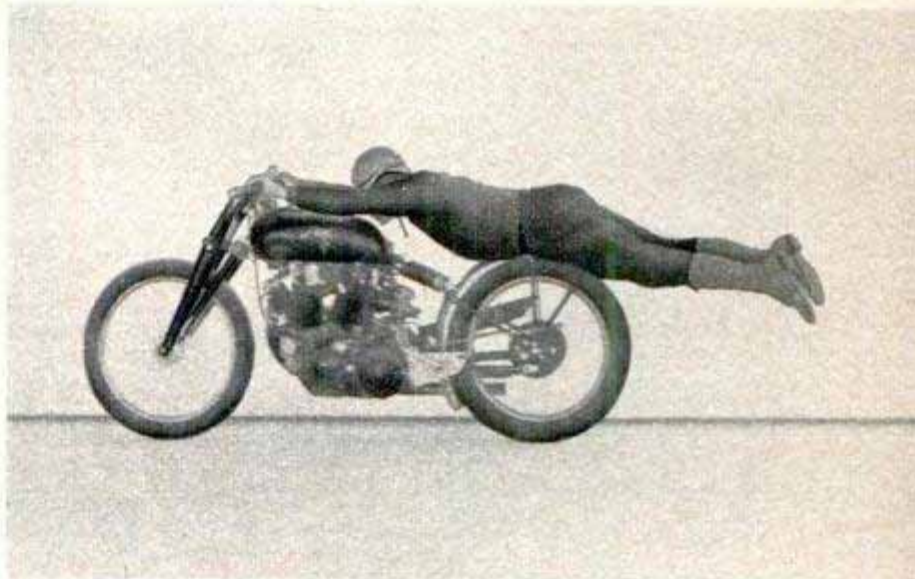

Center, Free set the American record last year in this position! Below, left, with the shell removed, Free and cycle look like this. Right, head-on view shows air slots, windshield and retractable "landing gear"

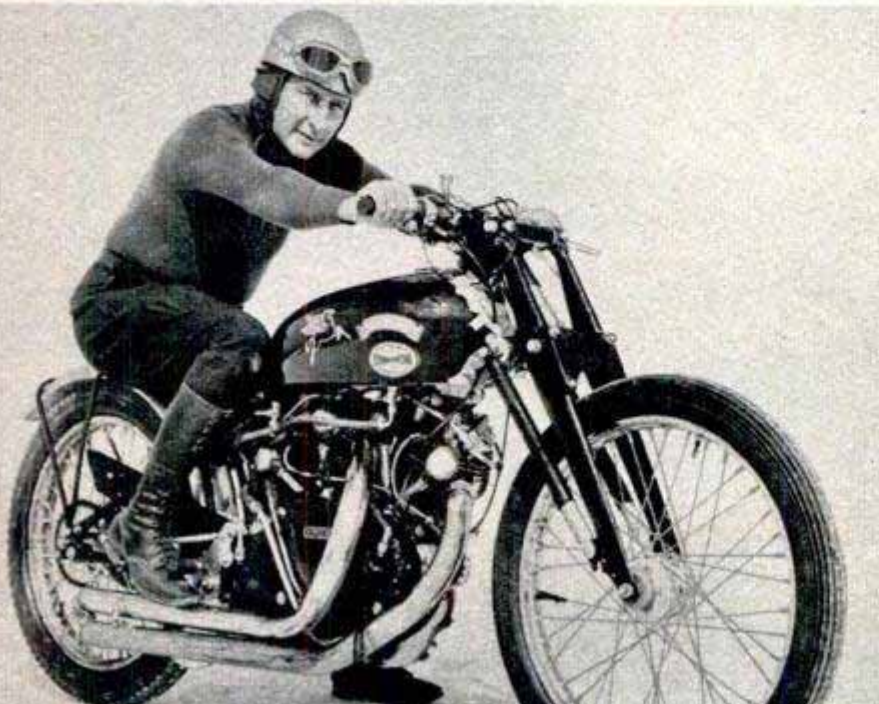



Left, the ball stays in a wire pocket at the base of the racket until it's thrown. Right, a short handle on the racket helps snare the high ones



Baseball With Rackets! It's Called "Wiskit"

BASEBALL seasoned with tennis, lacrosse and softball—that's the new sport of the Northwest. Called "Wiskit," it is played on a baseball diamond, according to baseball rules, except that: 1. the ball is han-

dled only by a lacrosse-type racket; 2. the ball is larger than a baseball, smaller than a softball; 3. a softball bat is used; 4. base runners are tagged out with the free hand, not the ball.

Wiskit looks like baseball except that catching and throwing are done with a racket. You can't use your hands

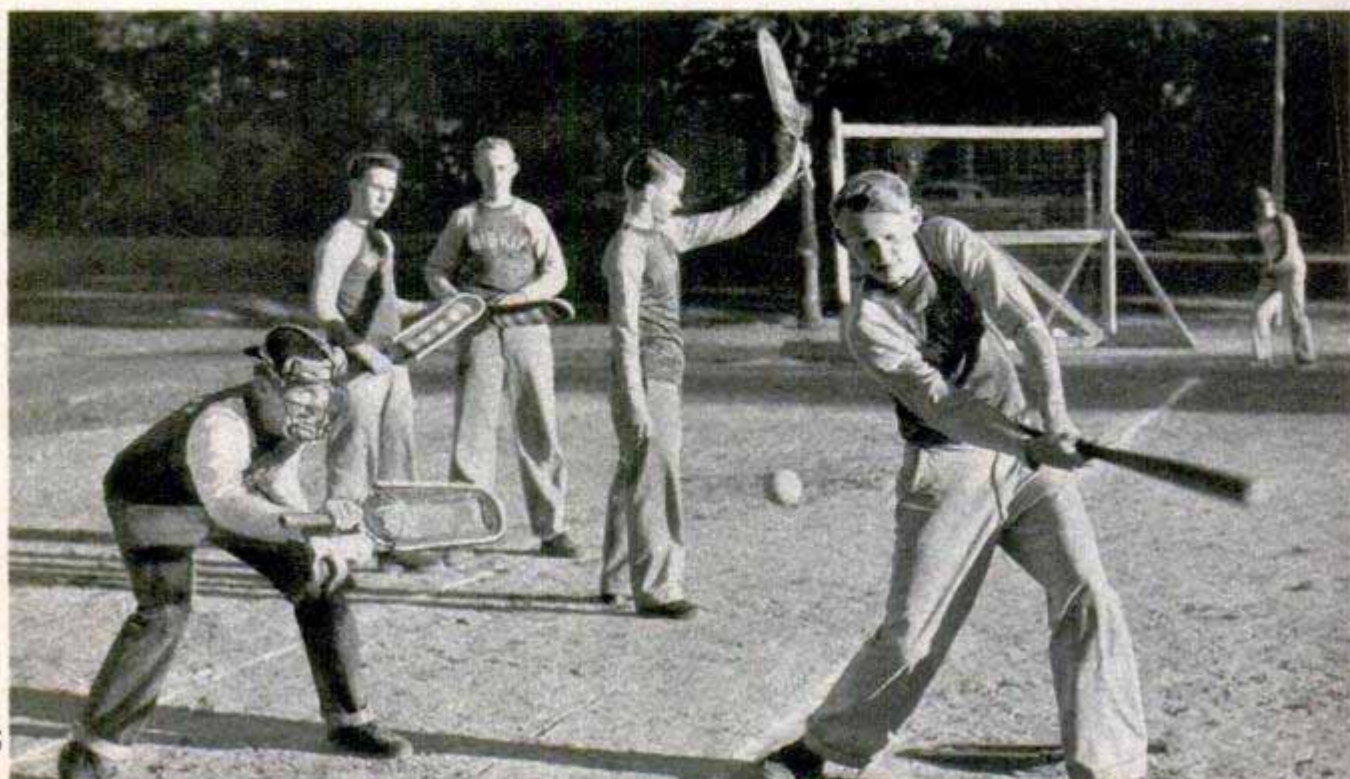

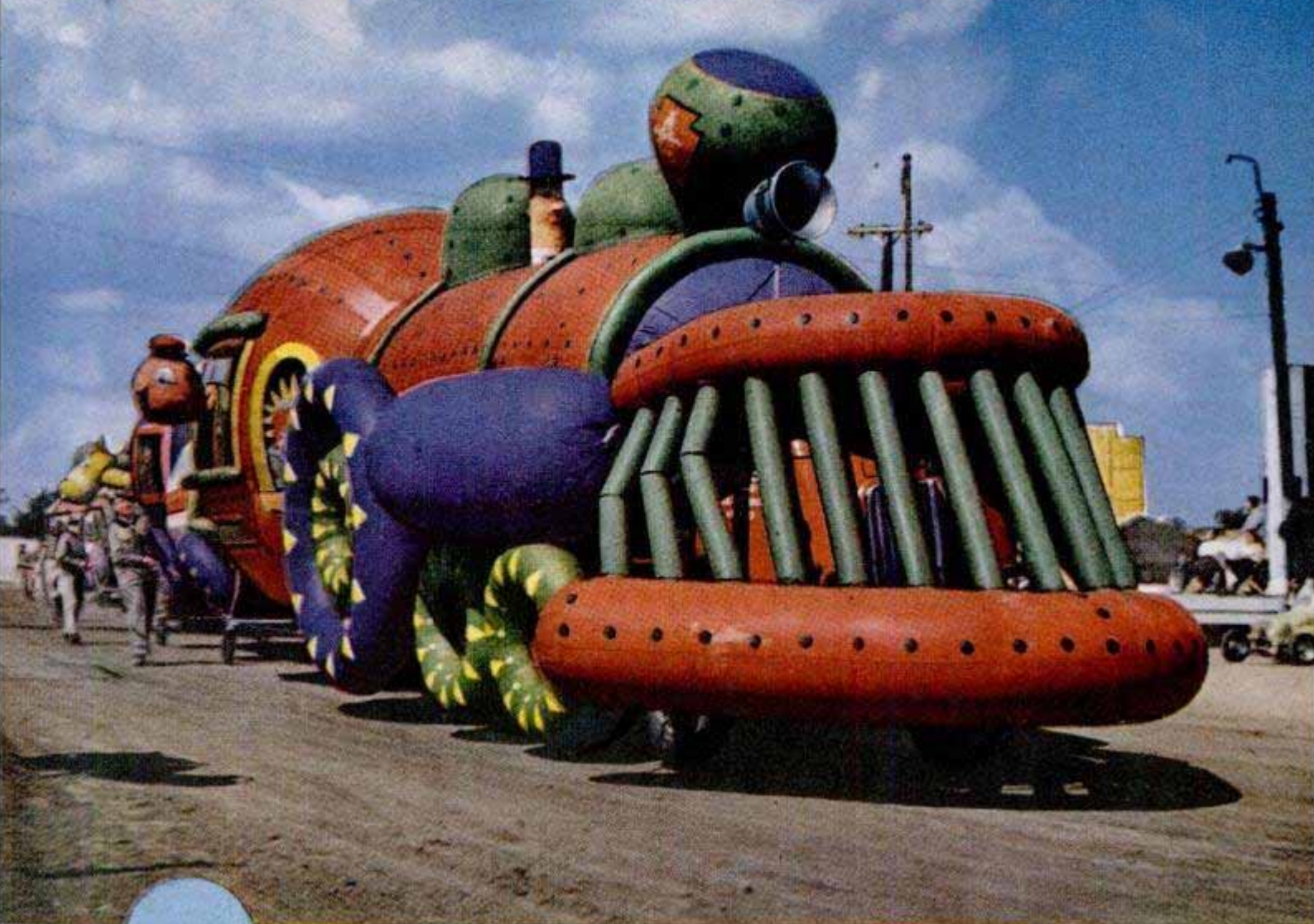

(M) Jean Gros Inc.
4614 Forbes St., Pittsburgh, Pa

BALLOON MAN

By Marjorie and Grant Hellman

JEAN GROS doesn't believe in nightmares. Not even when he sees 50-foot dachshunds, gigantic prehistoric animals, 25-foot kangaroos, or bright green dragons with 100-foot bodies which writhe and twist.

To Gros these creatures and scores of others are no figment of an overworked imagination, for he is a builder and exhibitor of giant balloon figures. The balloons have delighted youngsters in cities throughout the country, from El Paso to Boston.

Gros' balloon figures are certainly one of the country's oddest industries and their design and building has called for a spectacular amount of artistic imagination and engineering ingenuity.

Although Gros has spent most of his life in the United States, he is of French origin and was very early impressed with the

pageantry of European mummers' parades. He wondered whether something similar wouldn't be popular in the United States. But the usual papier-mache figures of the mummers, Gros realized, were much too fragile and unwieldy to be carried from one city to another.

Inflated figures made of rubberized fabric seemed the answer, and Gros studied the famous Macy parades in New York City. His balloons, he discovered, would have to be considerably different. First, they would often be used in cities which had overhead wires—the balloons therefore couldn't be more than 15 feet high and would have to stay on the ground. Second, they must be air inflated because helium was far too expensive when the balloons were being used every day. And third, the balloons had to be designed to be easily



Once in Minnesota bitter cold contracted air inside horse and refill was in order before parade could go on

It took many gallons of paint to decorate the popular pig of the Gros parade. Appendages, such as the forelegs, are made separately and then zipped on

The Indian lady is mounted on an aluminum frame and small wheels on base help trundle her through the streets. She supports a papoose on her ample back

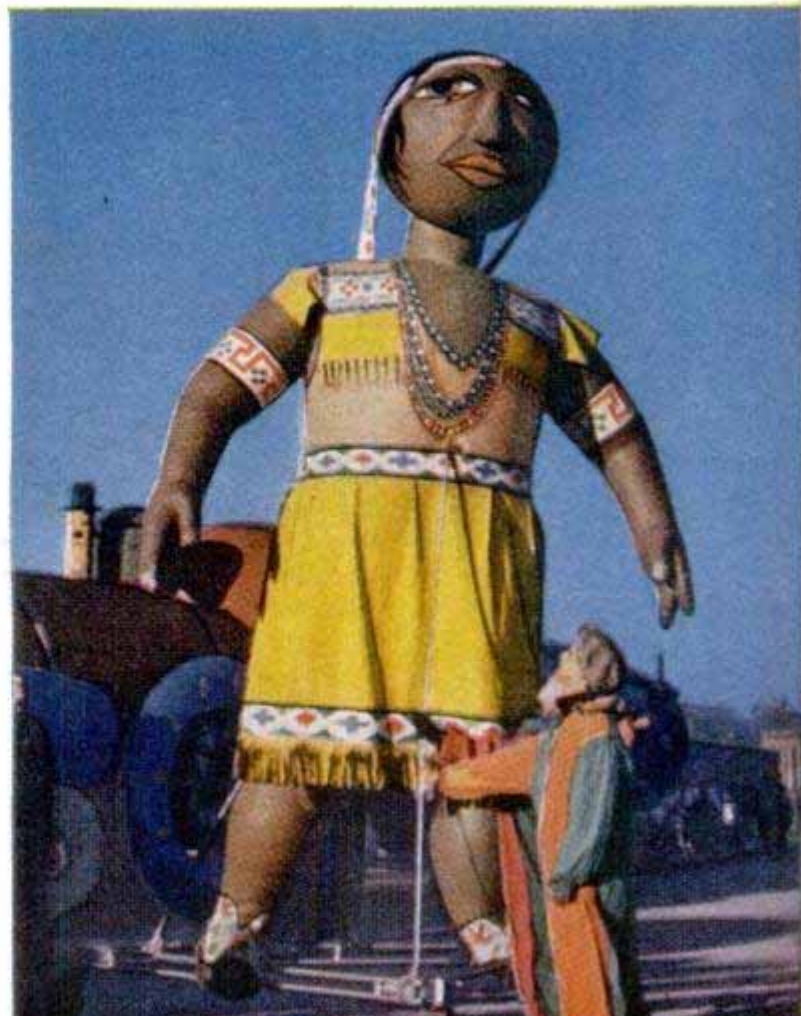

inflatable, quickly packed and simply transported.

That Gros has succeeded in meeting these requirements and has produced an exciting show is quite evident to the many millions of people who have jammed the streets in any of the hundreds of towns in which Gros' characters have strutted their stuff. The parades, usually sponsored by chambers of commerce or other local promotional groups, have on occasion attracted as many as half a million people to a single outing.

Building the balloons has been a large-scale undertaking, and is a continuing process, for Gros is always adding new figures to his stock. The Oomph Express has been his most ambitious single project to date. It took 10 men more than six months to design and build the 300-foot train, and during the building they used more than 4000 square yards of rubberized fabric and about 18 miles of tape. The original paint job required almost a thousand gallons of paint, and the figures must continually be returned to the Gros shop in Pittsburgh for refurbishing and repainting.

The train is made of so many separate balloon pieces zipped or tied together that no one has actually counted them all. And yet the train can be deflated, packed and transported on a 2½-ton truck. The train reputedly cost \$50,000.

When Gros gets an idea for a balloon, or for a series of balloons, he and his assistants make up rough sketches. Then a designer begins to translate the sketches into more definite plans. The engineering problems are surprising.

The entire secret of balloon construction, Gros explains, lies in what he calls "roundness." The air pressure which inflates the balloons causes trouble when it is forced into corners. So the balloons are designed with as few corners as possible. This means that the basic shapes Gros uses most are combinations of cylinders and spheres, or parts of spheres. By cleverly combining these simple shapes, Gros produces his complicated balloon figures. Individuality and variety are increased by adding appendages in odd shapes.

The question of pressure again accounts for the use of several separately inflated balloons or sections in a single figure. When Gros designed a 14-foot ice-cream cone, the cherry on top, being only about a foot in diameter, was constructed as a separate balloon. It is permanently cemented to the rest of the cone, but is inflated separately. Many of these smaller appendages are zipped on and off the larger balloons to make packing simpler and safer.

Once the designers feel all of the kinks have been worked out of the engineering

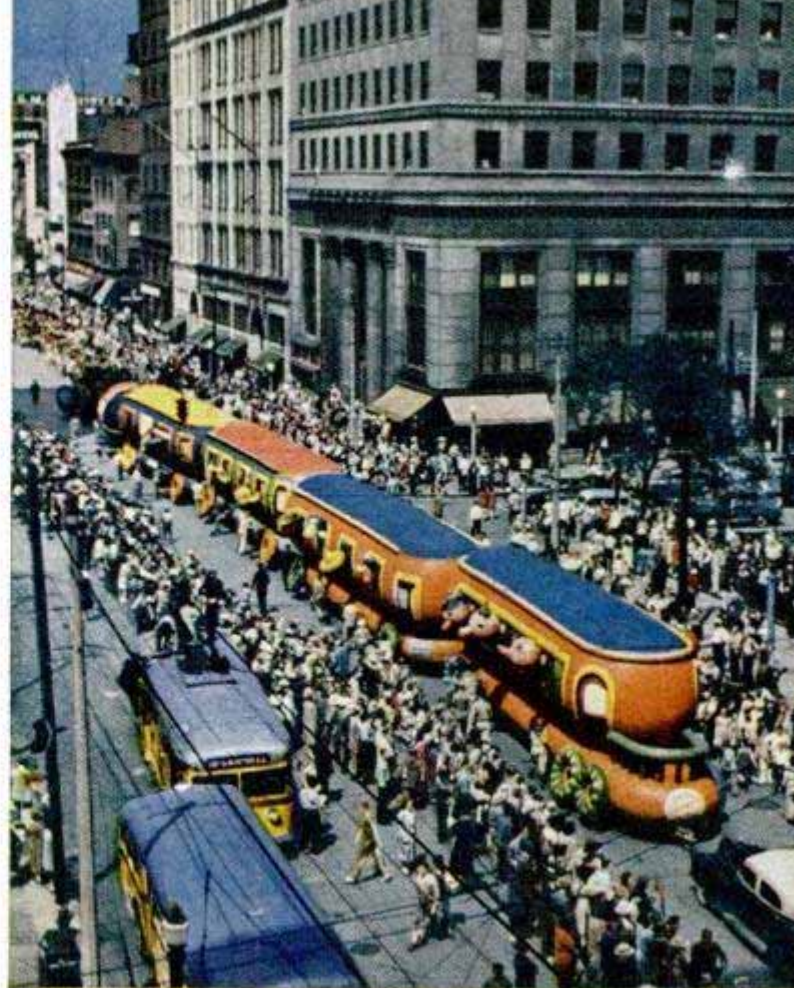

Three-hundred-foot train attracts a large crowd as it moves through downtown Youngstown, Ohio. It took over six months to build; cost about \$50,000

Krazy Kat sports a gaudy paint job—and not just for show. The paint on all the Gros balloon figures is rubberized and adds strength to basic fabric

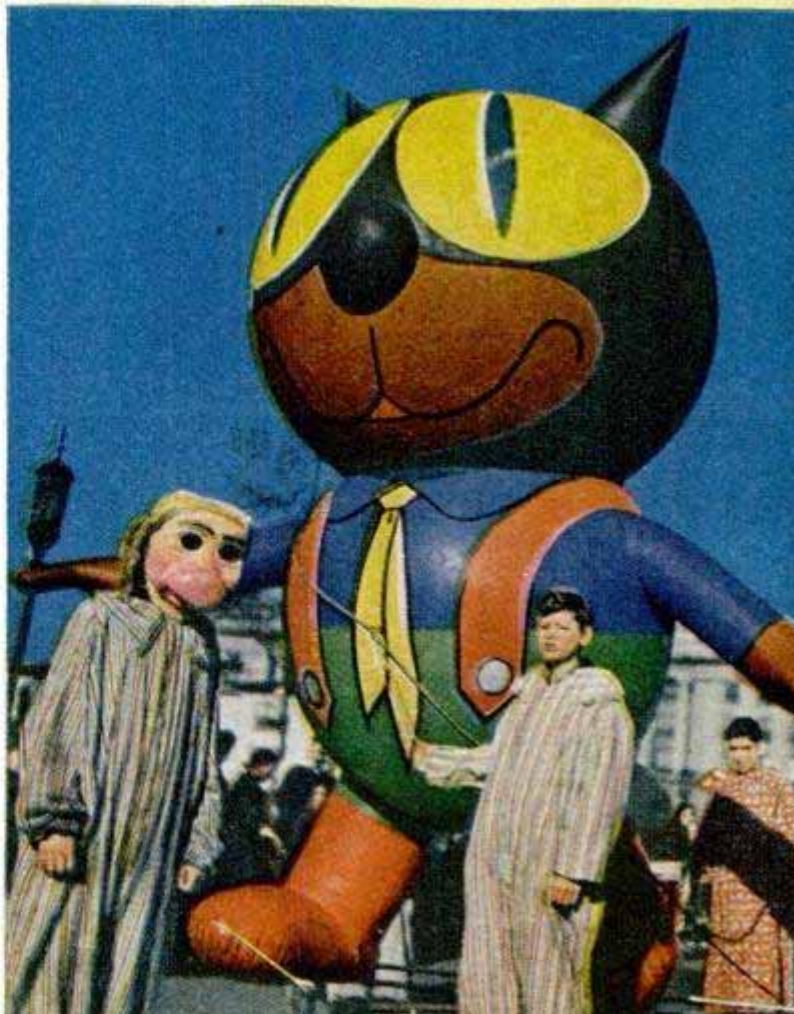



problems in any particular piece, cardboard templates are made up for each of the sections of the figure and the rubberized fabric is marked out.

The fabric having been cut either by scissors or by a standard cloth-cutting machine, the workmen begin assembly. The fabric is cemented with regular rubber cement, the pieces having about an inch overlap. And to make the seams doubly secure, latex tape is added after the pieces have been cemented. The final paint job of rubberized paint also adds a strengthening skin to the figure.

Although the cement is ordinarily almost impossible to loosen once it has set, Gros has discovered that it is readily soluble in benzol. When the construction men make errors, therefore, they can easily loosen the cement by squirting a few drops of benzol onto the seam from an oilcan.

The air intakes on the balloons are sleeves of fabric attached to a fabric base cemented to the balloon. The sleeve, after the balloon has been inflated, is tied off to prevent air escape. A clever zipper cover goes over the intake valve, protects it and helps preserve the balloon shape.

The average Gros parade has 50 to 60 pieces in it, and getting the show under way is a matter of hard work and careful timing. Gros usually has about six of his own experts in a crew, and recruits the same number of local laborers. Seventy-five to a hundred local youngsters handle the balloons during a parade.

If the Gros crew arrives in a city early in the morning, it can have a parade inflated and ready to go by noon. Vacuum-cleaner blowers inflate the figures in a matter of minutes. The same blowers, incidentally, are used to deflate the figures after a parade. Deflation without the help of the blowers would take many hours.

Some of the larger balloons are mounted on aluminum frames which have small wheels and are trundled along the streets. Others are light enough to be carried. The 100-foot dragon is carried by 10 to 20 boys dressed in clown costumes and can be made to writhe and swing back and forth along the street.

The largest pieces are pulled by truck. The engine of the train, for example, conceals a 2½-ton truck which pulls the 300-foot train. In the truck, Gros has built an amplifier and a tape-recording unit which

(Continued to page 234)

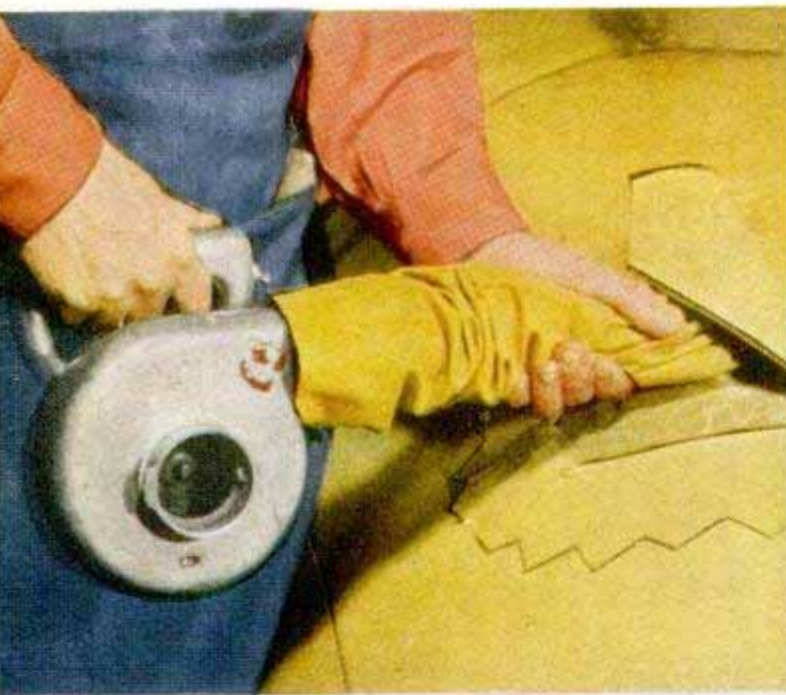

Top, templates are used to outline balloon pieces on rubberized fabric used in all Gros masterpieces

Middle, the balloons are inflated through a fabric sleeve which is tied and hidden with zipper cover

With a long-handled brush "portrait artist" strives for realism on biggest grinning whale in captivity



Detroit Listening Post

By Siler Freeman

THE CHRYSLER CORP., long noted for its engineering contributions to better and safer automobiles, has incorporated two outstanding improvements in its 1951 cars. One has been made available to all its divisions; the other is an exclusive feature of its two highest-priced cars in the Chrysler line. The first is a new hydraulic shock absorber, which smooths out the roughest roads and permits speeds at 50 miles an hour on surfaces which would throw other cars out of control. The other is a hydraulic steering aid called Hydroguide which takes the effort out of driving a modern car.

The auto industry is walking a tightrope. It is trying to balance itself between civilian production of 1951-model cars and trucks and an increasing volume of defense orders that may change into strategic war orders at a moment's notice. Meantime it is proceeding with its 1951-model production and has a good start on its 1952 planning.

If 1952 models are to be brought out according to schedule, most of the planning must be translated into machine-tool requirements very soon. A lot of the ordering on such far-off items as new engines and transmissions was done last year but the machine-tool industry is hopelessly behind in its schedules.

One of the big programs that hangs in the balance is Ford's new engine to be built in the new plant near Cleveland. This overhead-valve, high-compression V-8 is being planned for the 1952 Ford, Mercury and Lincoln models. All will use the same engine block. The big difference among the three engines for the divisions will be bore and stroke. It will make for much better interchangeability of parts.

Many car builders have additions to their lines which they deferred until this year and about which there is some doubt. For instance, Packard's 1951 line was brought out last September but, while it showed a convertible, it did not plan to bring it out until this year. Its hard-top coupe was slated for production this spring.

The 100-inch wheelbase car may be another casualty of present-day conditions. Both Nash, with its small Rambler line,

and Kaiser-Frazer with its Henry J, had planned to extend them into varied body styles. Another manufacturer was about to venture into the 100-inch wheelbase class. But materials are scarce and all are inclined to sit tight.

But outside of the individual companies, the picture which is emerging promises to take in everyone. For instance, the chrome that has been sprinkled so liberally on 1951 models may be slated for a dim out. Tires will be more and more synthetic.

The rubber situation makes it extremely doubtful that the fifth tire will continue as part of a new car's equipment.

Scarcity of materials has emphasized the industry's salvage job. The material-saving techniques go beyond just collection of scrap. Full-time staffs of engineers, researchers and specialists devote their efforts to counteract shortages.

The program received its early emphasis in the postwar era when materials were almost as tight as they promise to be now. Costs were also spiraling as they have been doing ever since, and price increases weren't balancing them. One company found that in making a hood, the metal sheared off could be put to good use in stamping out washers, caps, flanges, brackets, cover plates and other small parts.

Now the program has become so important that one firm even installed two-way television equipment so that one man could load the freight cars better. But it is not entirely reclamation of scrap which the technicians seek. Materials are saved at the outset by new methods.

For instance, Buick found a way to save 90 percent of its chromic-acid consumption in its chrome-plating process. Another firm which used a special stone for deburring now uses ordinary gravel, saving the company a half-million dollars a year.

Even designs must yield in the efforts to save materials and money. One car builder changed an exhaust-pipe flange so he could use a thinner gauge of steel without sacrificing strength. As the pinch gets tighter on materials, the salvage program becomes more important.

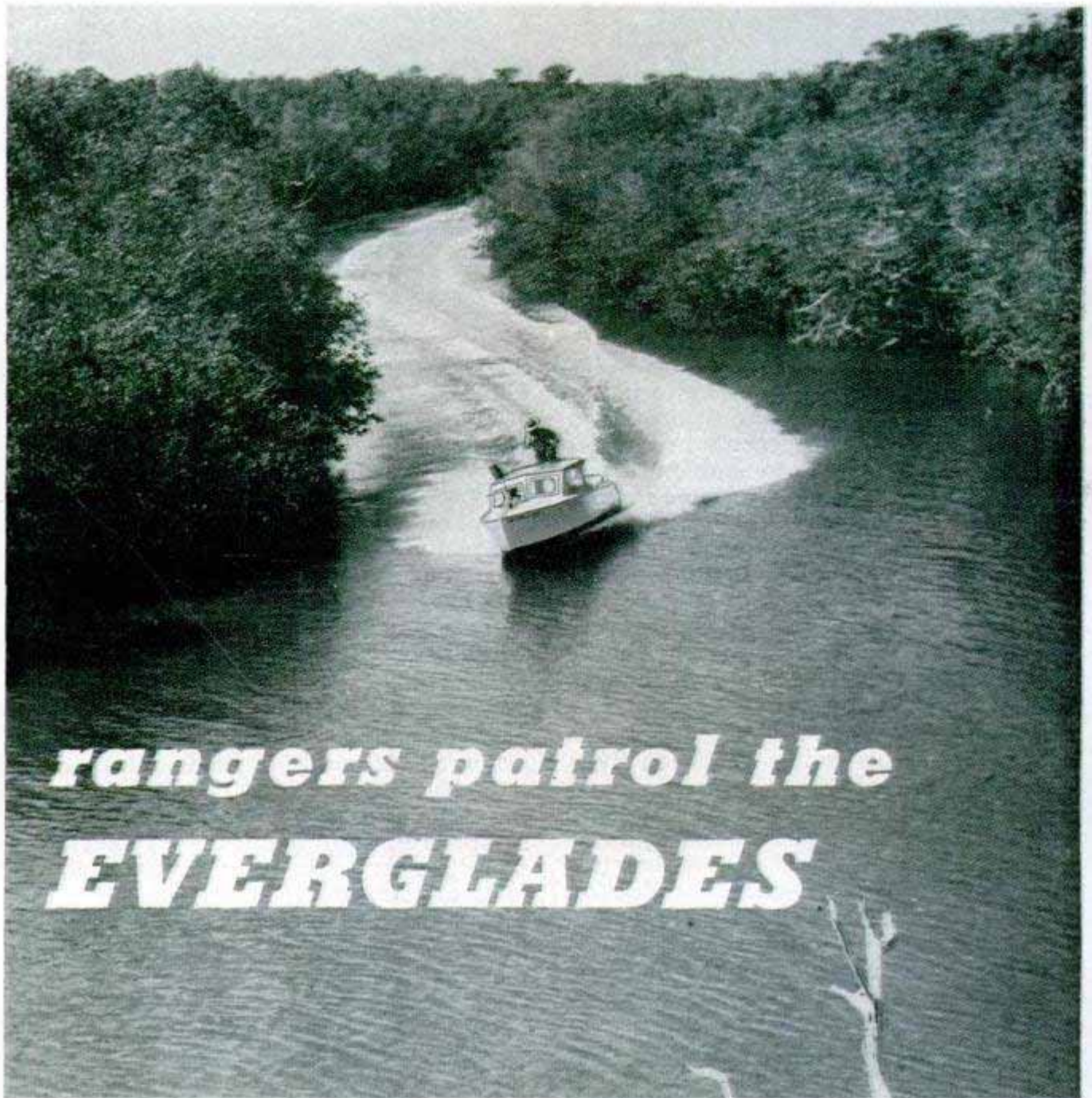

rangers patrol the **EVERGLADES**

By Verne O. Williams

A NEWLY TRANSFERRED RANGER, fresh from service in a northern park, was spending his first night in a lonesome patrol cabin built over the mangrove roots at Coot Bay in Florida's Everglades National Park. About midnight he awoke to hear the crunching of bones under the cabin.

"Hey," he whispered, shaking the old-timer who shared the cabin. "I think a panther has dragged a deer or something under the floor."

The old hand listened a moment, then snorted and told him to go back to sleep. "It's just our old pet 'gator having his nightly snack of crabs," he said.

The ways of alligators, the labyrinth of mangrove-lined waterways on the coast, and the vast prairies of sawgrass and water, dotted with junglelike hammocks, come as a surprise to rangers transferred to the

Everglades from other U. S. national parks.

Veterans of snowy mountain rescues find themselves sweating through a jungle of mangroves to catch alligator poachers. Experts in battling forest fires in the Rockies are soon standing in ankle-deep water to fight strange wind-driven flame-storms that sweep the sawgrass land in the dry season.

The Everglades are like nothing else. That's why, of course, this "last frontier" of subtropical wilderness was selected for preservation. Its backers waged a 20-year battle with hostile hunters, jealous politicians and oil interests before President Truman, in 1947, dedicated it as the twenty-eighth in our system of national parks.

That fall, rangers setting up patrol stations in the new park received a boisterous initiation into Florida weather. "Prepare for tropical disturbance with winds over



Above, busy rangers putting up one of the boundary signs around 100-mile perimeter of park to protect wildlife



Top, right, rangers prepare to fight sawgrass prairie fires with back-pack pumps which are trucked to the scene

Right, ranger Ed Stephanic is pointing out alligators to tourists near the Royal Palm ranger station in park



Below, right, ranger David E. Bogart uses an FM walkie-talkie to send in report on wood ibis to district chief

100 miles an hour," warned the Miami weather bureau. The park area was smack in the path of a howling hurricane.

Park-service men who knew how to take shelter from a mountain blizzard were happy to take hurricane cues from the fishermen who lived in isolated shacks on stilts along the shores of Florida Bay. The fishermen ran their boats far up the narrow canals between the mangroves. Then they piled their most valued possessions in their fish trucks and headed up the one narrow road for towns on the mainland.

While the gusts ripped into the lower Florida peninsula





Ranger Ralph Maxwell and mechanic Jim Parker attach rudder of airboat after overhaul job. The boat has a sledlike hull with airplane engine and propeller

Boats for rangers are kept in station at Coot Bay and include cruisers, skiffs and airboats. Radio tower in background is for the park's FM network

like the teeth of a great circular saw, the rangers worried about the dock piling stacked at Coot Bay; even worried about the birds and animals huddling helpless in the mangroves or sawgrass.

When the winds subsided, the rangers hopped aboard their neat green pickups and started back. They found a literal convention of wildlife assembled on the marl-clay road, the only high spot in the flooded marshes. Rabbits and raccoons walked warily around moccasins. Deer splashed away at the trucks' approach. A wet wildcat, drying his fur in the sun, waited unhappily until a truck almost touched him before jumping off into the canal.

Lower down, sections of the road were under water and alligators waddled hastily away across the shallows. Finally, the rangers had to take to skiffs to reach the station at Coot Bay.

There, district ranger Paul Barnes found that the high waters, driven up from Florida Bay by the wind, had floated off many of his construction materials. The next several days he spent in the park speedboat picking up his planks and creosoted piling, scattered far up the flooded road.

The need for a speedboat, even without a hurricane, is a good example of the new means of transportation the rangers from "dry" northern parks had to master. A man who had saddled horses all his life found himself learning how to dock a motor cruiser instead.

(Continued to page 252)



Scoop Dumps Load Over Its Shoulder

Large quantities of material are loaded rapidly by an overshot loader for crawler-type tractors that makes it unnecessary to turn the tractor around to unload its scoop. Instead, the loader simply swings the scoop up and to the rear, dumping the load behind it. The scoop can be dumped either forward or backward and dumping clearance is standard. In operation, the tractor operator simply runs the scoop into the material, raises it and backs up to the truck or unload pile. The scoop is then swung up and over, dumping the load. The tractor is then driven forward for the next load.



Multicolor Paint

That age-old trick of magicians — spreading polka-dot paint in one coat — now is virtually possible for everyone. A new multicolor paint applies two or more colors in one coat. On walls and furniture it produces a speckled surface that appears to be a base coat sprayed with another color. The paint is available in 16 color combinations and requires no primer except when used on

metal. It can be applied with either a brush or a spray gun. Costing slightly more than conventional enamels, the paint may be obtained for flat, semigloss or gloss finish.



Automobile Water Filter

Scale deposits inside an automobile radiator are retarded by a new water-cleaning unit. The cleaner softens the water, inhibits corrosion and filters rust and foreign particles from the cooling system. Water, drawn into the unit, contacts chemicals which soften it. The water then passes through a filter where solids are eliminated and re-enters the cooling system. The cleaning unit is harmless to antifreeze.

Canadian Mine 7850 Feet Down

Gold is where you find it and up in Canada miners are finding it 7850 feet below the surface in the Lake Shore mine, the deepest mine working in North America. This is an extension of 500 feet below the previous working levels.

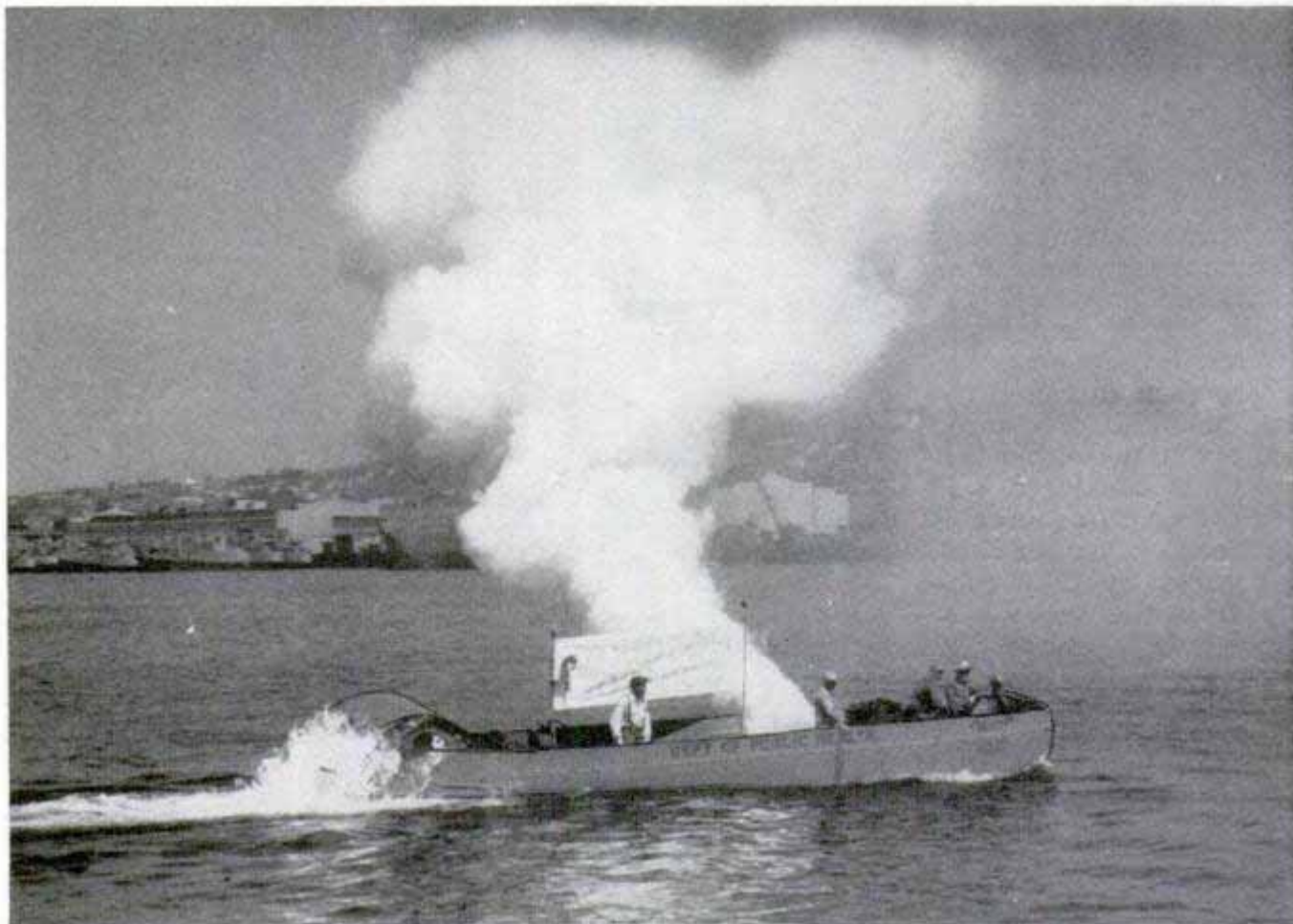

Mosquito Nemesis— Paddle-Wheel Style

Plying the harbor and marshes around Seattle, Wash., is a strange craft that spells death to mosquitoes. The boat, powered by two stern paddle wheels, is owned by the city's Department of Public Health and carries equipment to spray insecticide over mosquito-breeding areas. Made of a 10-ton aluminum bridge pontoon, the boat draws but 12 inches of water when fully loaded. It is steered by changing the drive of the two paddle wheels.

"Tracer" Splits Petroleum In Pipe Line

Radioactive material supplied by the Atomic Energy Commission now serves to divide and trace petroleum materials through a pipe line. Various petroleum products are pumped down the pipe line one after the other, and it is essential for men at the delivery point to know the "interface" or dividing point between the materials. Now, each time the pumping station changes products, a fraction of an ounce of diluted tracer liquid is added to the oil stream be-

Insecticide fog billows out across the harbor to cover mosquito-breeding areas. Below, two stern paddle wheels propel the craft



tween the products. Sensitive instruments respond to the arrival of this liquid. The amount of radiation present is less than that emitted by a luminous watch dial.



Lens turret and side-mounted adjustable view finder give the professional touch to a war-surplus camera



Also available is this plastic pistol grip with its built-in trigger for quick filming of action shots

"Extras" Give Surplus Camera That Professional Touch

Motion-picture photographers who use war-surplus 16-mm. movie cameras of the GSAP type can now increase the versatility of their equipment with a professional-type lens turret. Four lenses of different focal lengths and a side-mounted optical view finder are used with the turret. The view finder adjusts to the focal length of the lens being used. Another accessory is a pocket view finder which enables the photographer to select and compose his shots without moving the camera. It is available for 16 and 35-mm. cameras and is adjustable for various focal lengths.

Photographers plan their shots without having to set up their cameras when they use a pocket view finder



Wind-Tunnel Simulator Uses Water Instead of Air



Wind-tunnel tests are accurately demonstrated for students and workers on a training device developed by the Navy that uses fast-moving water instead of air. The water is pumped continuously in a closed system and flows past a stationary object at a controlled speed. The water forms waves which correspond approximately to those created in air by an object flying at supersonic speeds. Although it is not accurate enough for precise testing, the machine is compact and does show the student air-flow principles.

☐ With the 21,116 gallons of gasoline in a big bomber's wing tanks, an automobile could travel a distance equal to 16 times around the earth and still have enough fuel left to tour the United States.

RESULTS OF THE POPULAR MECHANICS SURVEY OF 1951 KAISER OWNERS

(Percentages from Poll)

Owners who bought overdrive.....	63%
Average gasoline mileage (in country)	21.9 m.p.g.
Average gasoline mileage (in city).....	18.5 m.p.g.
Owners using regular gas.....	79%
Owners who change oil.....	73%
Average mileage for change of oil.....	1180
Owners who add oil.....	39%
Average mileage for adding oil.....	1070
Owners who liked length of wheelbase.....	92%
Owners satisfied with road and curb clearance	92%

BEST-LIKED FEATURES

Style, appearance, roominess.....	65%
Visibility, window area.....	61%
Maneuverability, handling	48%
Seating, riding qualities.....	48%
Interior details, dash, etc.....	35%
Gas and oil economy.....	31%
Acceleration, pickup	18%

(These percentages are based on the fact that some owners commented on more than one feature)

RATINGS OF CAR

Excellent	58%
Good	33%
Average	8%
Poor	1%

GENERAL INFORMATION

Prefer in-line engine.....	68%
Prefer V-type engine.....	32%
Prefer six cylinders	68%
Prefer eight cylinders.....	32%
Prefer four cylinders.....	0%
Prefer automatic transmission	45%
Prefer Hydra-Matic	68%
(The above figures mean 68% of the 45% preferring automatic transmission)	
Prefer makes other than Hydra-Matic.....	22%
Undecided about automatic transmission.....	10%
Owners who like low-pressure tires.....	79%
Previous Kaiser owners.....	44%
Will buy another Kaiser.....	80%
Might buy another Kaiser.....	13%
Will not buy another Kaiser.....	7%
Dealer service good.....	63%
Dealer service average.....	24%
Dealer service poor.....	13%

Most disliked features—Body and window leakage. Rattles.

THE OWNERS

This is the second report from the owners of 1951 cars based on a detailed questionnaire sent by PM to 1000 Kaiser drivers. The survey is conducted by Floyd Clymer and the percentages both for and against give the reactions of the man who drives one

THE ENTHUSIASTIC response to our first owners' report published last month proves that if there is anything in the world a man likes to talk about it's his car. As one man said, "Buying a car is like getting married and you take what you drive away with for better or worse. You never really know 'til the honeymoon is over what you've got."

Many state frankly that never before have they filled out a questionnaire, but when it comes to reporting on their cars—well, that's different. One man from Wheelersburg, Ohio, wrote: "As a rule I never fill out any of these forms, just ignore them, so if this information is of any benefit just feel grateful." His favorite adjectives for his four-door Kaiser sedan which he has driven 2400 miles were "wonderful" and "just right." He did complain, though, about "loose bolts, screws and leaks around the front and back glass."

For many owners the questionnaire is

Kaiser owners in the survey failed to comment on new recessed tire well in trunk floor. Many complained of lack of space and leaks in compartment

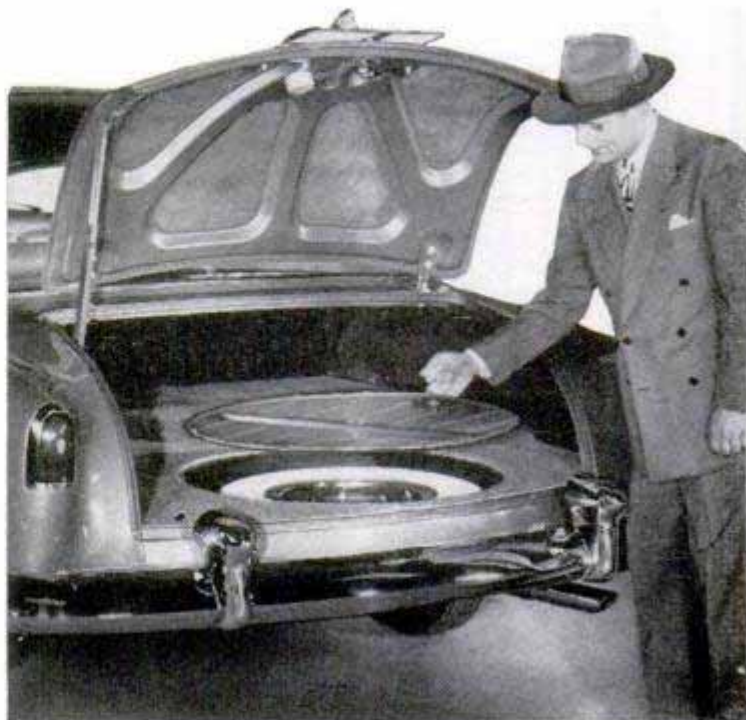

REPORT on the '51 KAISER



not nearly long enough and they turn it over and write their own detailed report on the back, filling it with much interesting and valuable data. They tell about trips they have taken, accidents they have survived and many quirks in their car experiences that could never be covered in a questionnaire. A man from Villa Park, Ill., wrote: "Last month's Motor Trend listed the top speed of the '51 Kaiser at 84 miles per hour. Time and again I have walked around my buddy's new '50 _____ when his speedometer read close to 95. I've never yet read an article that gave Kaiser an even break. It seems they only knock him as much as possible. Here's hoping the *Popular Mechanics* article gives Kaiser just a bit of credit where it's due." (Any credit in this series is not the voice of the magazine but the reaction of an owner.)

This month's Kaiser survey pretty generally covered the nation, city owners, farmers, doctors, mountain drivers, night drivers, day drivers, owners from the Deep South to northern Minnesota and from coast to coast. Their story is told in

The '51 Kaiser De Luxe shows here what owners go all out in approving —good style and appearance. Eighty percent will buy another Kaiser

Below, a typical questionnaire received in the survey of 1000 Kaiser '51 owners. Many turned over sheet and filled back with information

THE POPULAR MECHANICS MOTOR SURVEY
as conducted by Floyd Clymer

I am the owner of a 1951 Kaiser. Model De Luxe Body Style 4 door
Hydra-Matic Overdrive? No Yes Have owned it about 4 months Mileage is now 5035 miles.

My approximate gas mileage in the city is 18 MPG. Country driving 22 MPG.

Do you have to use premium gasoline to eliminate knocking? Yes Do you change or add oil? Yes
If you add oil, about how many miles do you drive before adding one quart? Do not add any

How does the car handle on the road? It holly the road better than any other car I have driven.

What about maneuverability? It is of the best, according to American standards.

What is your opinion of the wheelbase? I like it about where it is now.

Do you have good passing pickup at cruising speed? Very good (not like '47)

Do you have sufficient curb and road clearance? yes

What features about the car do you like? The body styling, that is low hood, better visibility etc. Also its handling ability that is holding the road at high speeds.

What do you dislike about the car? I would like more powerful engine with greater torque.

Have you ever owned a Kaiser car before? Yes If so, how many? 1 (1947)

Would you buy another Kaiser car? Yes Do you secure good dealer service? Yes

How would you rate the Kaiser car? Excellent Good Average Poor

GENERAL INFORMATION

What type of engine would you prefer in your car of the future? In-line V-type

Cylinders: 4, 6 or 8 8 Valves: Side Overhead

Automatic Transmission? Yes If so, what type do you prefer? Hydra-Matic

Do you like the new low pressure super-cushion tires? Yes

Do you carry recommended pressure? Yes If more pressure, how much more lbs.

You are under no obligation and your reply will be held in strict confidence

My name is [Redacted]
Address [Redacted]
City and State New Orleans La

PLEASE MAIL PROMPTLY TO:
FLOYD CLYMER
1268 So. Alvarado Street
Los Angeles 6, California

(Use other side for additional remarks if you wish)



Turns on a dime? That is, if you can find a 36-footer. Owners like the '51 Kaiser's fine maneuverability

the percentages from the poll listed on these pages. Perhaps the most glowing compliment to Mr. Kaiser & Co. is the fact that 80 percent of 1951 Kaiser owners would like to buy another Kaiser. Not quite half of those who reported were previous Kaiser owners. Also, only two persons expressed any concern about trade-in value when buying from an "independent." This is, indeed, a tribute and obviously based on faith in the car's future.

1951 KAISER (Special and De Luxe)

Condensed Specifications

ENGINE

6-cyl. L-head. Bore—3-5/16 in. Stroke—4 3/8 in. Displacement—226.2 cu. in. Brake hp.—115. Compression ratio—7.3 to 1. Transmission—3-speed conventional. Optional: Overdrive or Hydra-Matic.

GENERAL

Weight—Special, 3126 lbs.; De Luxe, 3171 lbs. Wheelbase—118 1/2 in. Tread—front, 58 in.; rear, 58 3/4 in. Height—60 1/2 in. Over-all width—74 in. Length—Special, 208 1/2 in.; De Luxe, 210 3/8 in. Tires—6.70 x 15. Recommended pressure—24 lbs. Road clearance—7 1/2 in. Turning radius—18 ft. Steering wheel, lock-to-lock—4 3/4 turns. Steering ratio—18.2 to 1.

CAPACITIES

Oil—5 qts. Water—13 qts. Gasoline—17 gallons.

The best-liked features of the car—style, appearance and roominess — show the things people look for first and appreciate most in a car. Many seem to take for granted that the average American-built car will provide them with a good engine. Maneuverability also got a good bill of health in the Kaiser survey, and the owner of a two-door Special sedan in New Orleans credited that factor with possibly saving his life and that of his family. He reported that "coming back through Mississippi on our return from a vacation trip to Illinois, the driver of an old car pulled onto the pavement and was crossing it without looking in either direction. I was doing 50 miles per hour. I slammed on my brakes and turned the wheel to the right. The car skidded and bounced when the front wheels hit the shoulder. Immediately, I spun the wheel in the direction of the skid and on the first bounce the car swung into line, missing the other car by a hair. My two boys in the back were thrown to the floor but not hurt and my wife and small baby in front were just scared, as I was. We feel mighty thankful for a SAFE automobile."

By far the most complaints against the Kaiser were directed at rattles and body

(Continued to page 270)

One owner reported frankly that his only reason for buying a '51 Kaiser Traveler was to sleep in

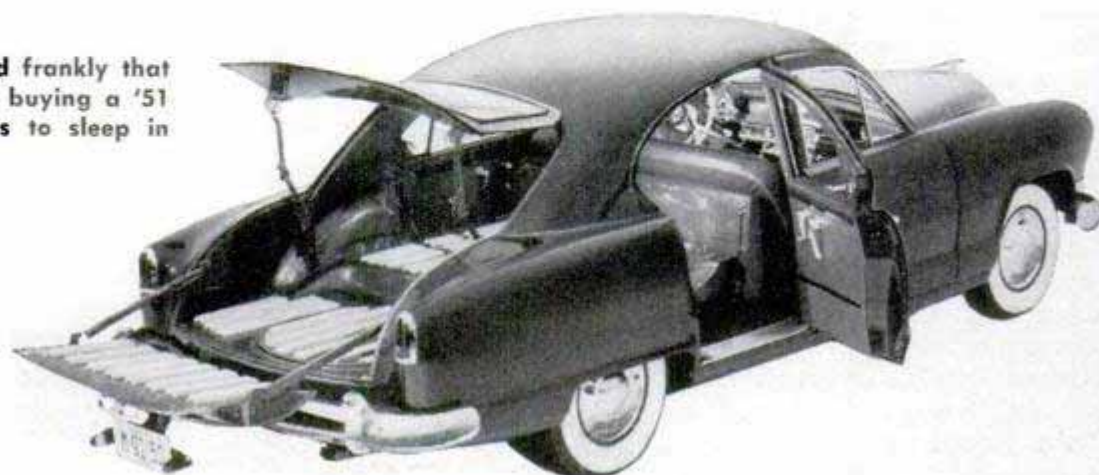

CLYMER TESTS the HENRY J

By Floyd Clymer

HERE IS A REPORT on another 100-inch-wheelbase car—Kaiser's new Henry J, which I drove from Detroit to Los Angeles and many miles around southern California in a 4500-mile test under every conceivable driving condition. It was the six-cylinder job, equipped with overdrive, which I highly recommend in a light car such as the Henry J.

Unlike the Nash Rambler, in which all accessories are included in the price of the car, the Henry J is at the opposite extreme, with nearly every possible gadget or accessory eliminated.

To cut first costs, the Henry J is built with no window vent panes, no lock on the left door or glove compartment (which is actually a pouch on the side), an unglamorous interior finish including plain fabric seat cushions, and a plain but practical instrument panel. The rear-deck space cannot be reached from the back of the car, as there is no trunk lid, but one may be ordered as special equipment, as may the extra locks and vent panes.

The Henry J is not revolutionary in any sense: engine by Willys, differential by Spicer, a Borg & Beck



The Henry J's six-cylinder engine built by Willys is only an 80-horsepower job but plenty powerful for weight of car. Below, this high power-to-weight ratio gives the car good maneuverability, especially on rough and winding highways



CLYMER'S ECONOMY TEST OF THE HENRY J

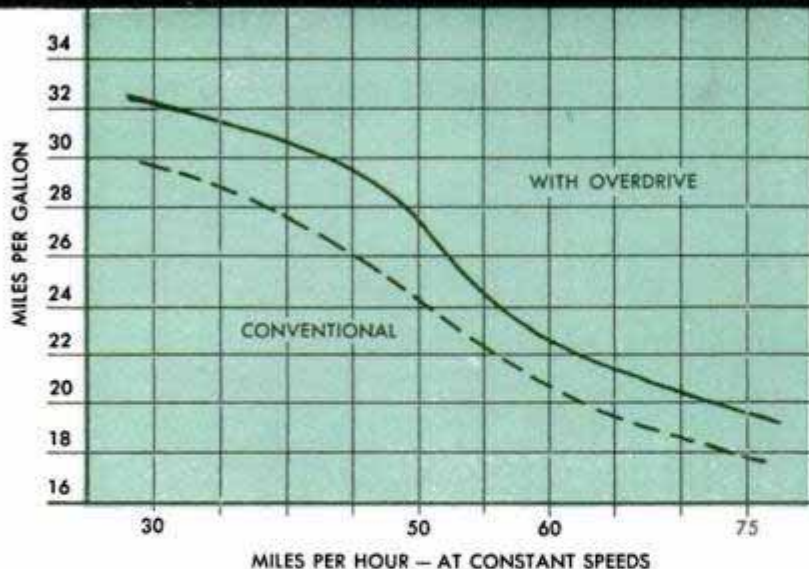

clutch, Young radiator, Auto-Lite electrical system and Warner transmission and overdrive units are used. All are names famous for their quality products.

I beat the Henry J over all kinds of roads, through rain and mud, and over rough detours and winding back trails, seriously trying to find the "bugs." After completing the test, I have a high respect for this new Kaiser model.

The car will take punishment mile after mile with no sign of overheating. In overdrive, 80 miles an hour is a cinch. On long, level stretches, the speedometer several times showed 85, 90, 95 and even 100 miles per hour, but like most speedometers the speeds are from two to six percent fast as compared with stop-watch timing.

The Henry J's acceleration is terrific. Performance of the Henry J can be at-

tributed to a very high horse-power-to-weight ratio . . . it might well be called a "hard-top hot rod"!

Like the Nash Rambler, this car has a wide hood in front, offering the driver a sense of security and no feeling of being in a small car. The 100-inch wheelbase proves handy in parking and cornering, and the front suspension is as soft and easy riding as in several higher-priced cars; in fact, it was a little too soft to suit me, in fast and hard cornering. I liked the easy steering and the soft

yet effective brakes which don't seem to "fade" or lose their braking effect when used often at high speeds. Gas mileage is excellent, as shown on my test chart.

On the other hand, the car does have some things that could be improved. During a severe rainstorm, water leaked in around the windshield and one window. The plastic knob on the gearshift lever is pushed on, and tends to work loose quickly; it should be threaded. Although it wasn't serious, I noticed a steering-column vibration between 65 and 70 miles per hour, apparently due to the method of anchoring the steering column to the cowl. Vibration is not noticeable at any other speed. In fact, the engine is unusually smooth.

A few rattles and squeaks were evident; the body could stand a bit more sound-proofing. Generally, the body is light, the doors operate easily and the car "turns on a dime." Visibility is excellent. The instrument panel is neat and attractive, although I prefer an ammeter and oil gauge instead of the simple red warning lights for generator and oil pressure, as used in the Henry J.

In my personal survey on the Henry J, I talked to a number of owners. About a third had overdrive, and all were pleased with OD for use in the light car. Average gas mileage reported in the city was 24.1 miles per gallon, and in the country, 27.3 miles per gallon. Nearly all of them liked the size of the car and found it ideal for their particular use. Most owners praised the visibility, the riding qualities in so light a car (2448 pounds), the performance and the fuel economy.

(Continued to page 274)

Luggage compartment of standard Henry J is reached by folding rear seat down, but rear deck that can be opened is optional



Automatic Juicer Counts Oranges

Oranges are automatically counted, cut and squeezed by a push-button juicer designed for restaurants and juice bars. Sixty large oranges can be stored in a bin at the top of the machine. The waitress pushes a button to denote how many oranges she wants juiced, and that number rolls down a wire ramp into the squeezing chamber. Here the oranges are cut and lowered into position to be squeezed. The fresh juice flows through a strainer and out into a container. The juicer can squeeze oranges at the rate of one every three seconds.

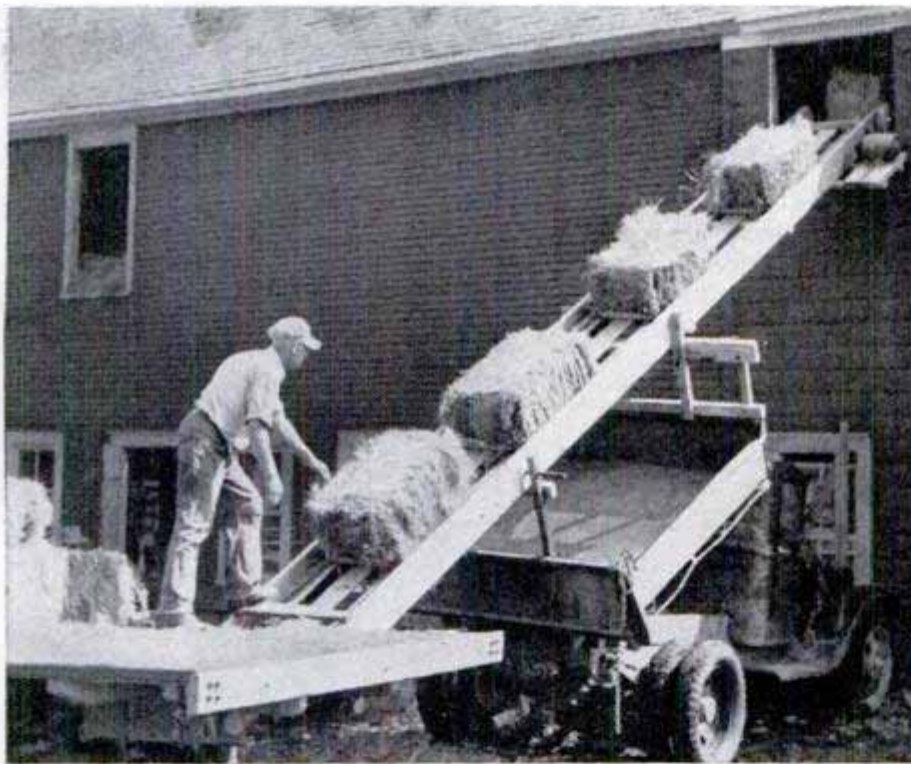

Homemade Elevator For Baled Hay

Several feet of implement chain and some spruce lumber cut from the farm wood lot have been fashioned into an elevator for hoisting baled hay into the barn. James Leach, Jr., of Pawlet, Vt., who built the elevator, mounted it on an old dump truck which carries it from farm to farm and supports it at work. The conveyor is 27½ feet long and is powered by a ¾-horsepower motor. The angle of elevation can be adjusted by raising or lowering the dump-truck body.

Nonrewind Reel For Movie Fans

Movie fans don't have to take time out to rewind film after each showing when they use nonrewind reels that make it possible to remove the film from the center. The reels act in the usual manner on the takeup side, but when mounted on the supply spindle they do not revolve. Instead, rollers in the reel hub allow the film to revolve within the reel as it is withdrawn through the center slot. An adapter holds the supply reel at the correct angle to feed the film in a straight line to the film-feed mechanism of the projector.

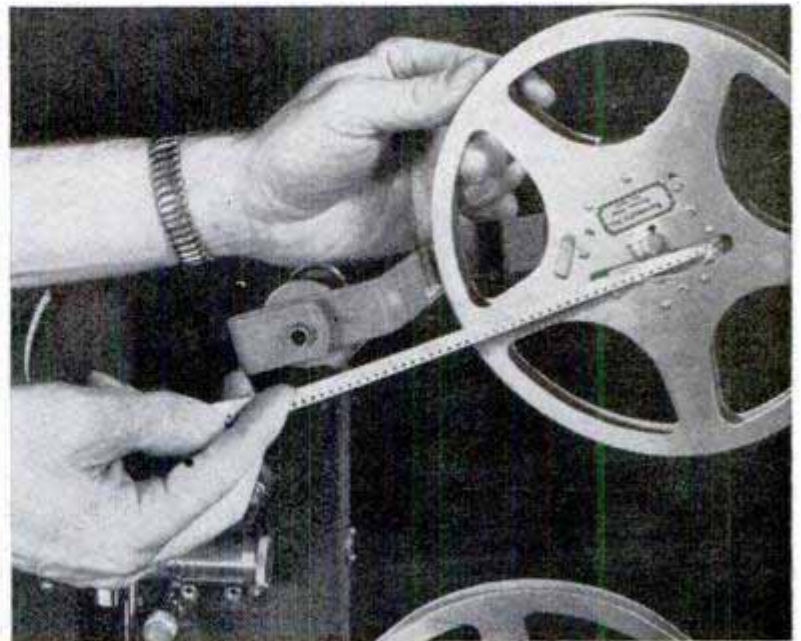

WHAT'S NEW

For Your Home



BATH SPRAY, above, has a two-way nozzle. It delivers a nonsplashing stream of aerated water or, if you like, it's a stimulating needle spray when the aerator cap is removed. It is attached to a rubber hose and can be used with any faucet

SPRINGLESS MATTRESS, below, has a permanently sealed pneumatic core, formed by 136 air-filled cubes. Each plastic cube is individually sealed. The mattress has only half the weight of the standard innerspring type

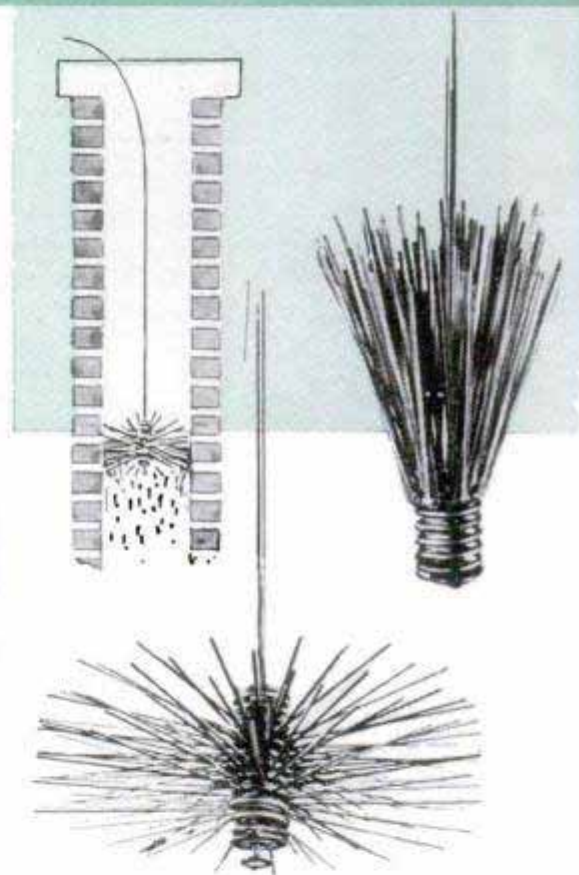

WIRE "PORCUPINE," above, is a chimney brush that can be used from the top or bottom. You can force it down from the top or, if you prefer, you can fold it and push it up from any flue opening. When it reaches the top, it opens up like an umbrella to scrape off soot as it is pulled down



CONVECTOR for the picture-window living room is a long, low model that hides as it heats the room

STRIP OPENER, below, for vacuum cans removes the metal strip neatly and ejects it when finished



SHIRT CADDY, above, hangs on a door and holds six shirts. It is transparent for quick selection

SHOE TREE, below, keeps the shoe in shape by hooking on sole. It doesn't stop air circulation



POISON LOCK, below, prevents accidents. Cap can't be removed until the combination is dialed

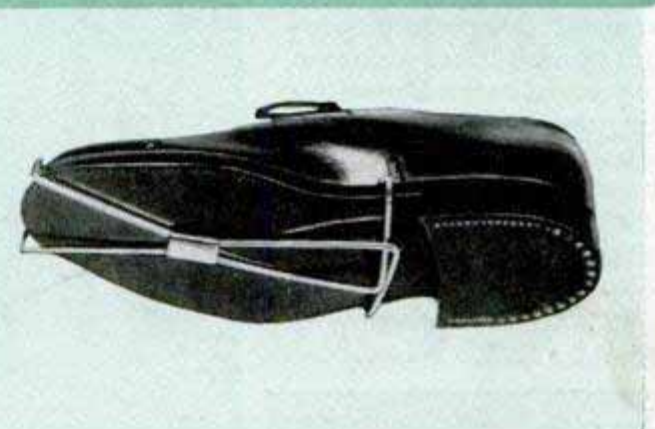

STATIONARY IRON, below, is simple to use. You merely slide the material across the egg-shaped hot surface. It's designed for fancy ironing on ruffles, shirring or pleats. It has a thermostatic control



Style Czar of GM Gets Custom-Built Car

WHEN Harley J. Earl, General Motors vice-president in charge of styling, steps out in a new experimental car the automotive industry pricks up its ears. His last experimental job was the "proving ground" for such innovations as electrically controlled convertible top and windows, curved-glass windshield and push-button door latches. His newest experimental model, called Le Sabre, is now under construction and will be powered by a high-compression (10 to 1) V-8 engine plus supercharger. Its dual fuel system will use current premium fuels and methyl alcohol, the latter to be injected into combustion chambers through the carburetor for extra power boost. The engine will develop 300 horsepower. The engine weight is expected to be about 500 pounds, providing a high horsepower-to-weight ratio. Dynaflo transmission will be housed near the rear of the stationary drive shaft, just ahead of the differential. The body is only 36 $\frac{1}{4}$ inches high at the cowl and 50 inches with the top raised. Wheelbase

is 115 inches and over-all 200. Ground clearance is six inches. The top section of the front grille is part of the lighting system and when the front lamps are turned on the grille moves out of sight. Two sets of three tail lamps are mounted on the trailing edge of the rear fins. These also operate as directional signals. Housed in the twin fins are aircraft-type 20-gallon rubberized fuel cells, one for gasoline and the other for methyl alcohol. Hydraulic jacks operate from the instrument panel. If rain falls on sensitized spots between the seats, the top and windows automatically go up.

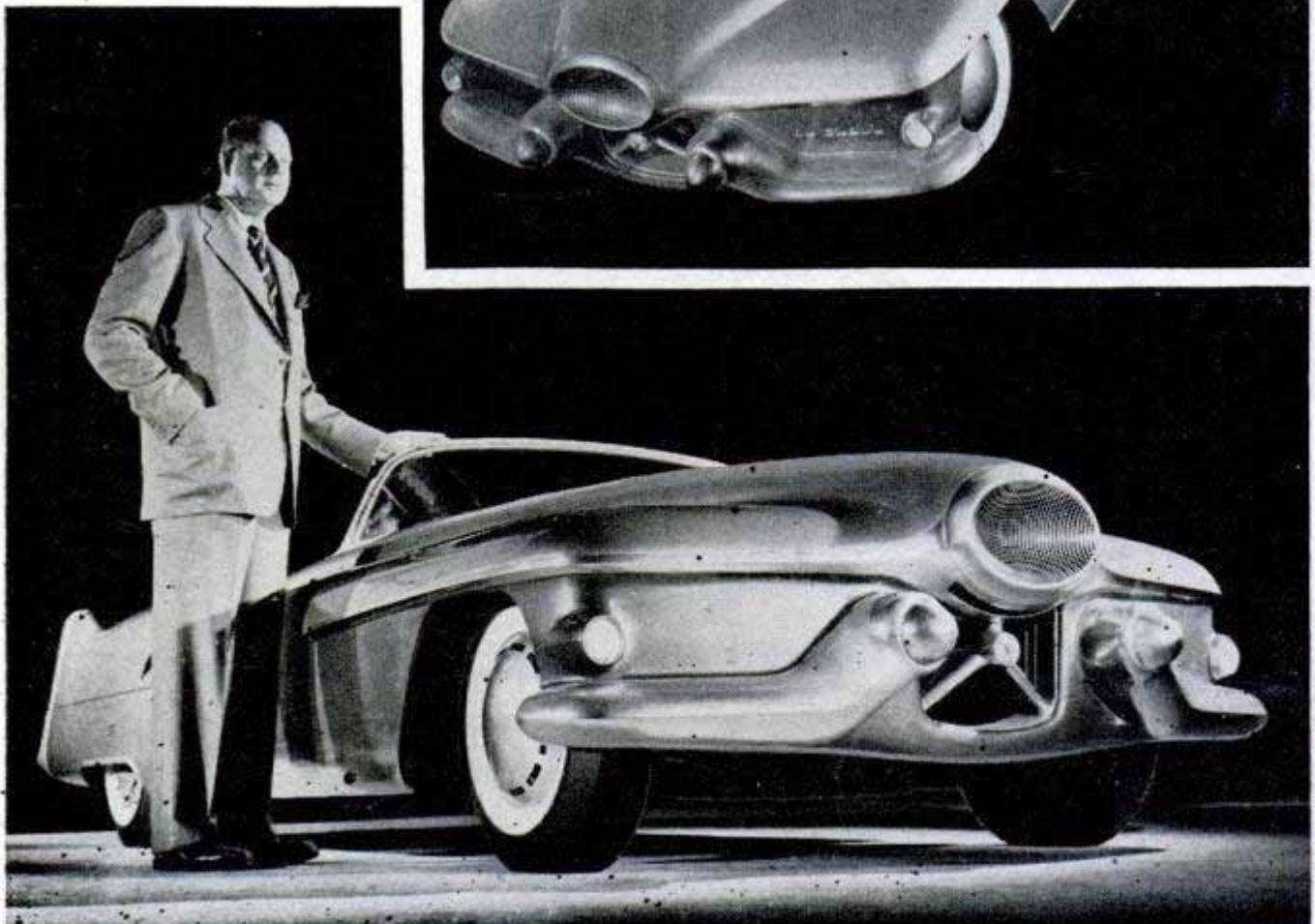
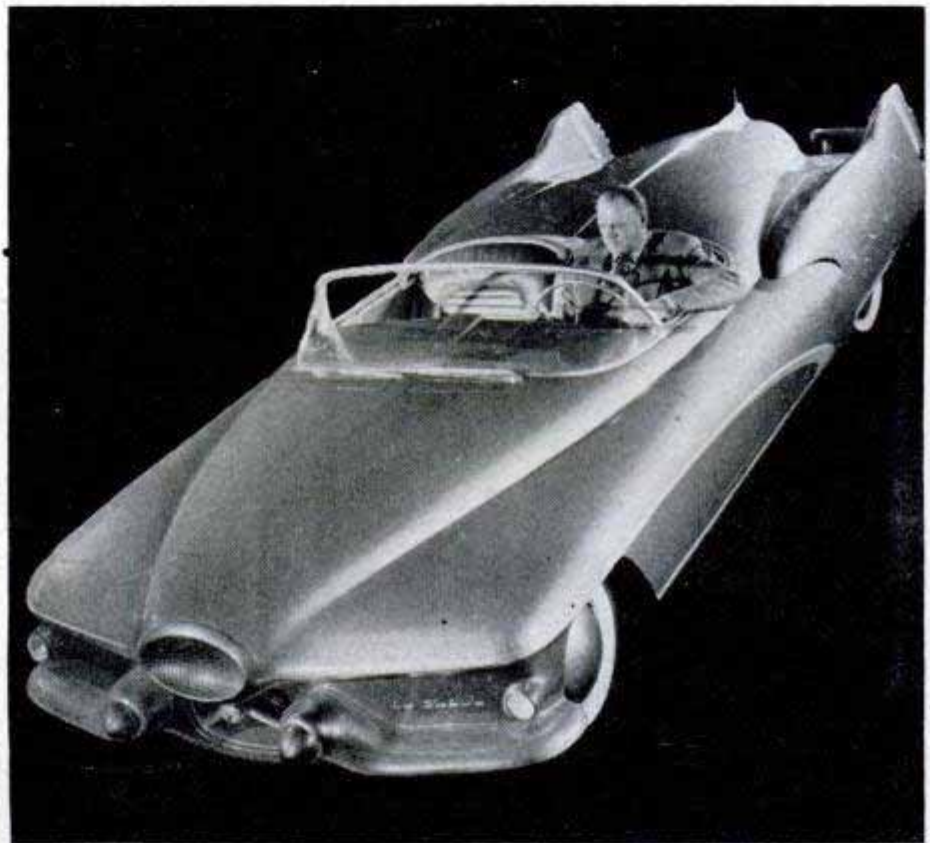



Four-door '51 Buick Special has new chassis and body including the Roadmaster's distinguishing "sweepspear"

BUICK FEATURES SPECIAL SERIES FOR '51

BUICK for 1951 is emphasizing its Special series. It has the distinction of being one of the two General Motors divisions to bring out an entirely new body and has given it to the Special to enlarge the choice of styles in that series. Buick is also introducing a Custom Special with which it will challenge its lower-medium priced competitors. The '51 Special series has the new F-263 engine which was introduced last year in the Super. The engine develops 128 horsepower with Dynaflow and 120 with

the synchromesh. The Special has a 121½-inch wheelbase with 204.8 inches over-all. Riviera styling has been extended to both the Special and Custom Special in both two and four-door models. A convertible is also available in this line for the first time, as well as a low-priced three-passenger coupe. An outstanding mechanical change on the Roadmaster is new brakes. Linings are segmented and cemented to the drum. The Roadmaster's distinguishing "sweepspear" is available on all '51 models.

Buick's sleek '51 convertible displays new grille and chrome trim with flowing restyled fender lines



Stanley Hiller, Jr., its designer, enters the two-place, jet-powered helicopter. It weighs 340 pounds empty, has a maximum speed of 85 miles an hour and a ceiling of 12,000 feet

Here's Your HELICOPTER COUPE

By Thomas E. Stimson, Jr.

DO YOU WANT a helicopter that's small enough to land on your lawn and big enough to carry two people? A simple, practical, foolproof machine?

It's in production.

Stanley Hiller took me for a ride in one just in time to beat the presses for this issue of *Popular Mechanics*. Hiller is the 26-year-old president of Hiller Helicopters, the Palo Alto concern that in the last year has out-sold commercially all other helicopter manufacturers combined. His big "Hiller 360" is a weight carrier, a workhorse that dusts crops, flies the power lines and helps fight forest fires.

The new "Hiller Hornet" is a small, personal vehicle. It's priced under \$5000, one fifth the cost of an ordinary helicopter. Eventually, that price can be cut in half, at least. Except for Korea it would be ready for the civilian market this month. Right now military orders alone are being filled.

Hiller drove me from his modern factory to an old, ramshackle farmhouse to see the new vehicle. The farm looks like it has been abandoned for years and here, away from prying eyes, he conducts secret tests on advanced designs.

"You are the first person beside my own

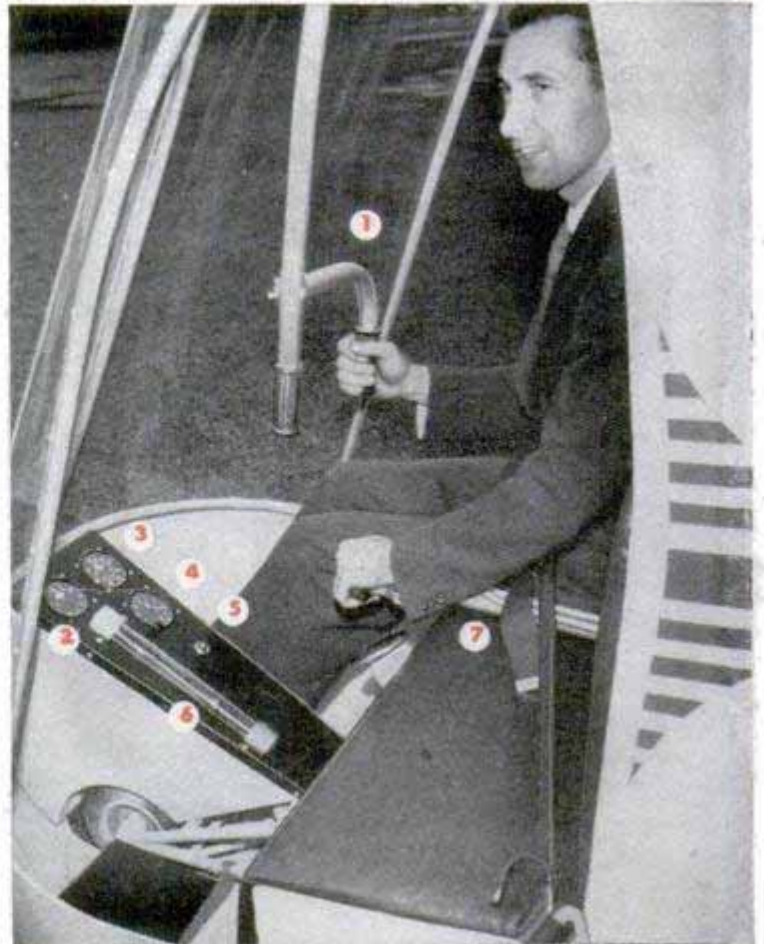

Pilot and passenger sit on a seat above fuel tank. (1) Cyclic control stick guides direction of travel, (2) rotor r.p.m. register, (3) air speed, (4) altimeter, (5) starter button, (6) fuel-flow gauge and (7) is the throttle and "up and down" collective pitch control

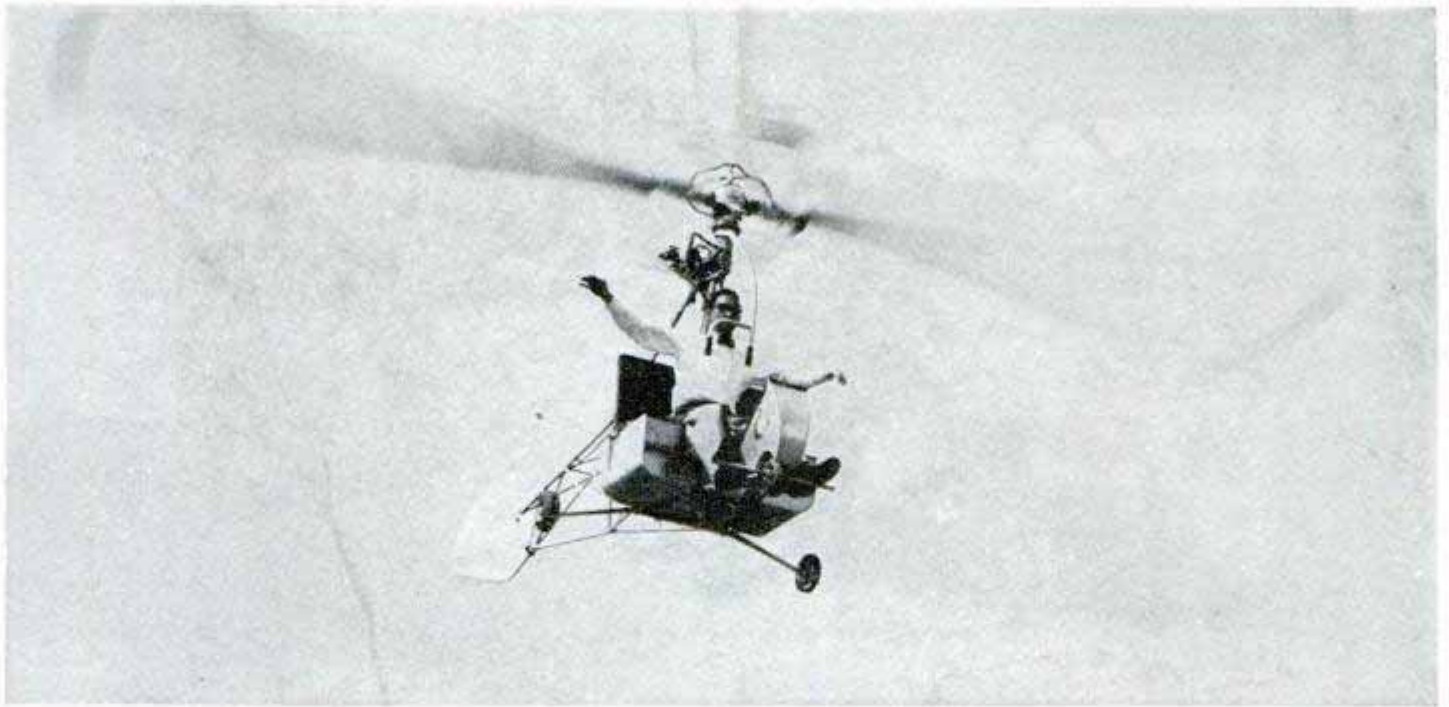

Stable control system of "Hornet" permits "hands off" flight in any attitude

engineers to see this new baby," he said as he swung open a garage door and went inside. "I'll pull it out and we'll fly it." With one hand he towed outside a little fuselage that was 152 inches long and had a long, thin rotor blade above. The whole thing was small enough to rest on a pool table.

My eyes were attracted to a short, fat tube at each end of the rotor. "Ramjets," Hiller explained. "No moving parts. Nothing to go wrong. Each motor weighs 11 pounds and together they develop 70 horsepower."

We sat down, side by side, on the padded fuel tank and he explained the controls. "This horizontal stick on the seat between us is the collective pitch control,

New jet helicopter, right, is tiny compared to standard-size Hiller "360" model beside it. The latter has a conventional piston engine

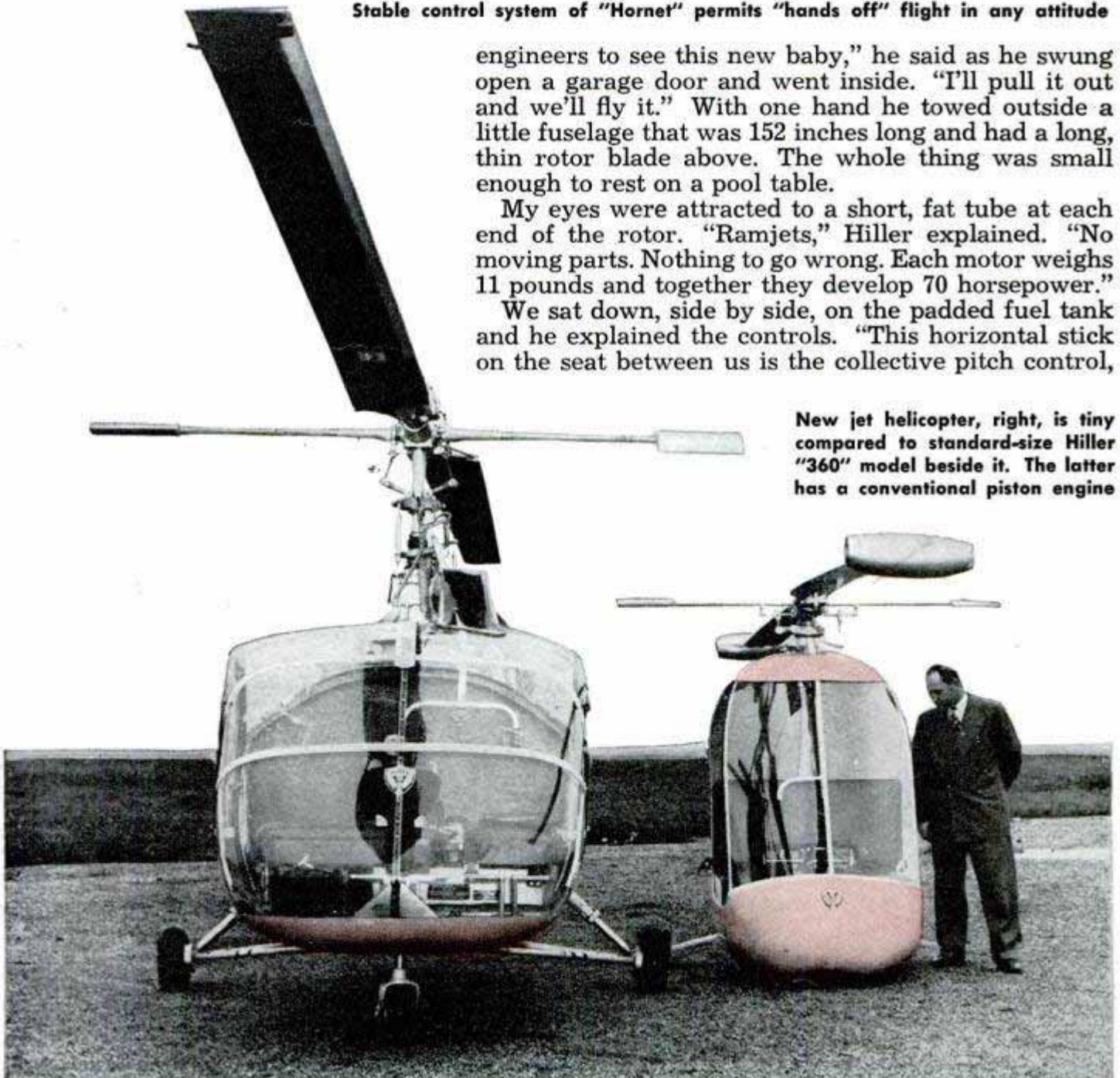

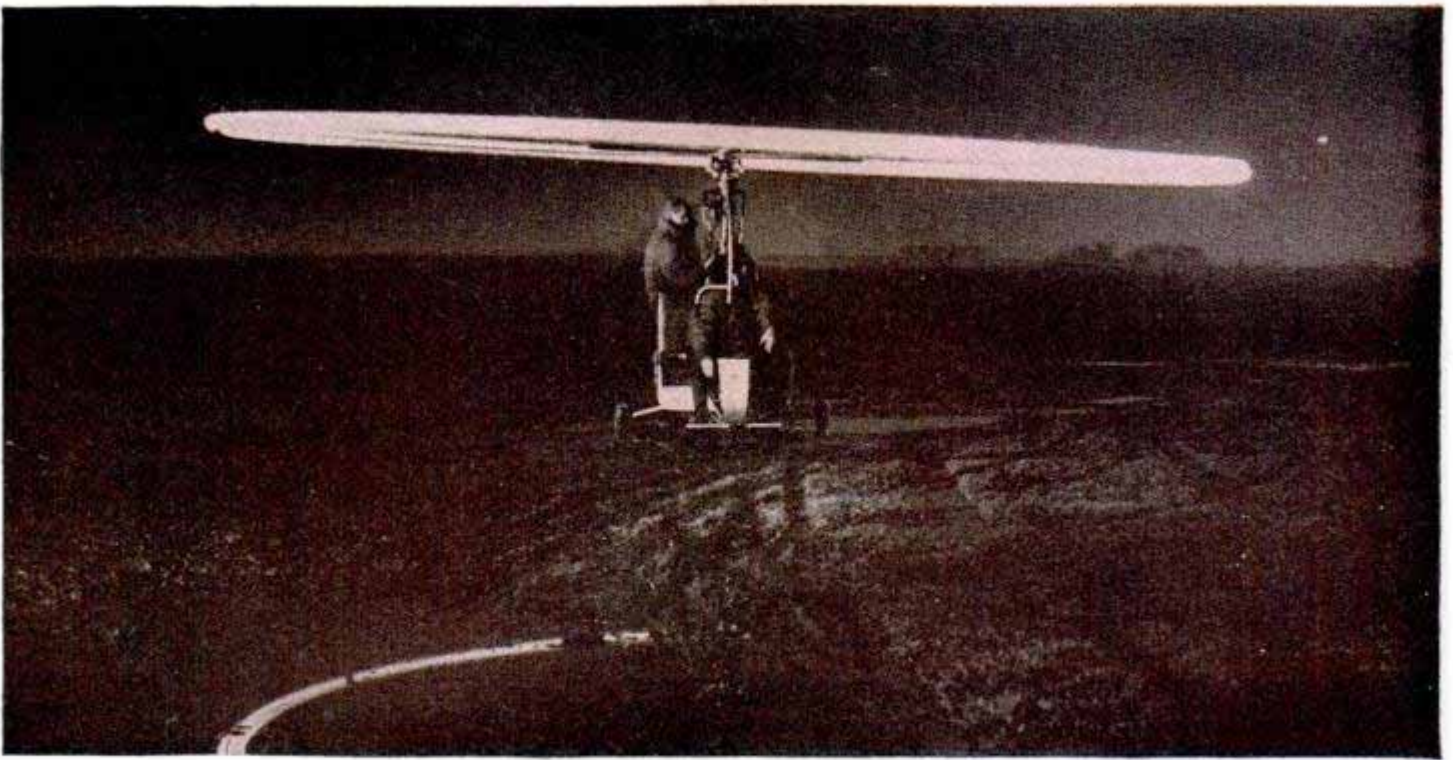

Running smoothly, the ramjets at a tip speed of 450 miles an hour produce a halo like this after dark

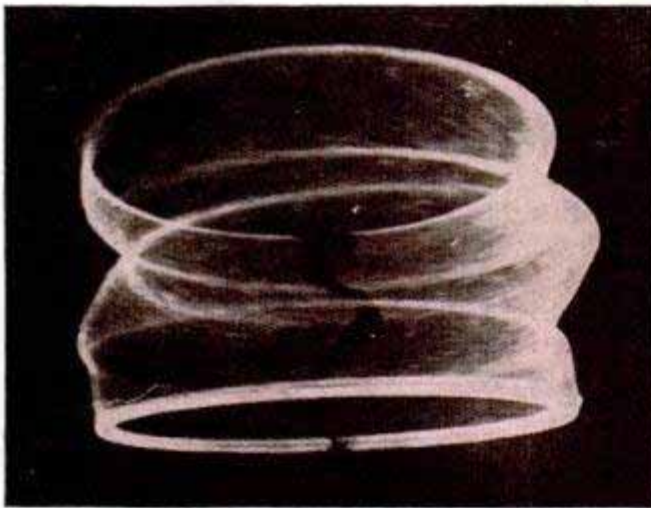

Night photograph by the author shows pattern of fire created by short, slow climb of jet helicopter

the up-and-down stick. Pull it up and we climb, push it down and we descend. Push it to one side and you rotate the fuselage. That's for lining up in the direction you are traveling. You'll notice that there are no foot pedals.

"This cyclic pitch control, the bar that curves down from overhead, governs the direction of flight. Push it forward to move ahead, pull it back to fly in that direction. If you want to turn, push to the left or right. That's all there is to it."

Between our feet was a small instrument pedestal on which were mounted a rotor tachometer, air-speed indicator, altimeter and fuel-flow gauge. There was an ignition button as well, and the handle of a wobble pump for starting the flow of fuel to the motors. Hiller pumped up the fuel and then twisted around to turn a hand-crank that was geared to the rotor.

In production, he explained, three kinds of starters will be optional equipment; the hand crank, an electric motor



Facilitating storage, tail can be taken off in three minutes



In one of the versions now being built, the jet rotary-wing craft carries a pilot and one litter patient

connected to a battery, or a tiny air-cooled gasoline engine that you'll start by pulling a cord. They get the rotor sweeping around at a speed of 50 revolutions per minute, after which the ramjets can be fired.

Hiller pressed the ignition button and immediately a gob of flame shot out from the tip motors, then died away as the excess fuel was consumed. In the daylight the engines were running without any visible fire

or smoke. After-dark photographs, however, reveal that the engines create a thin blue halo of exhaust flames when operating at peak efficiency. Surprisingly, the roar of the jets was not as loud as I'd expected. We could talk without too much trouble.

There was no warm-up delay. Hiller simply pulled up on the collective pitch stick and we rose straight up. There was

(Continued to page 266)

Rudder, below, is sloped so as to be affected by downdraft from the rotor blades. Fuel for the jets flows up mast, right, and into pipes contained inside the rotating blades

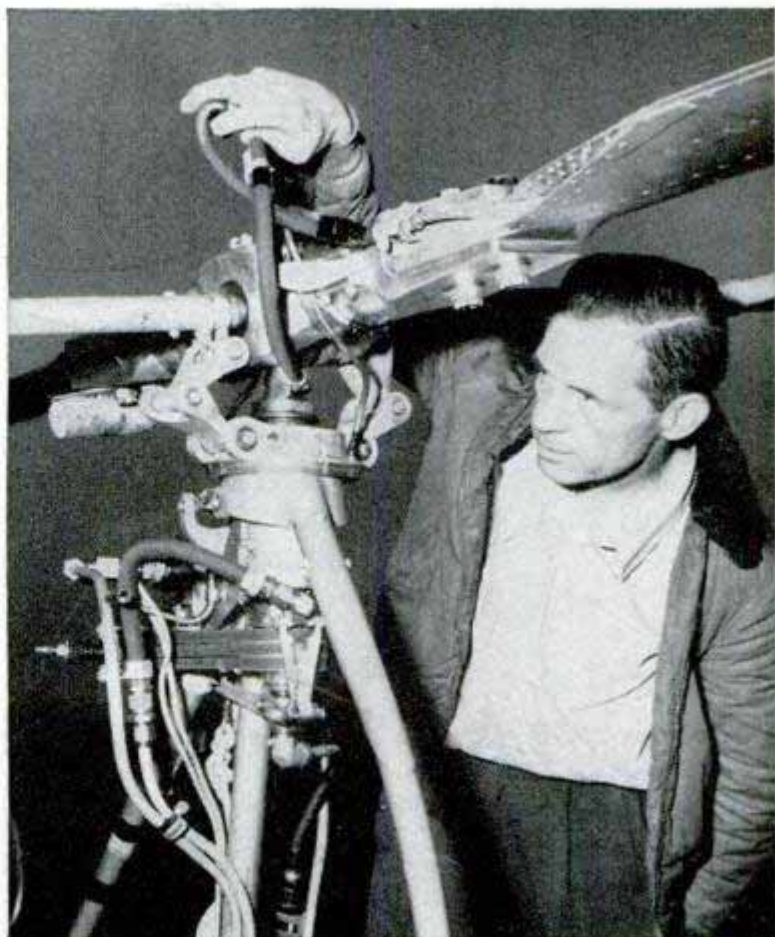



'51 Plymouth Improves Visibility

Wider windshield and rear window with narrower side pillars and a sloping hood on the '51 Plymouth provide greater visibility. A new grille and smooth lines give the car a lower streamlined appearance. Mechanical improvements include new shock ab-

sorbers featured throughout the Chrysler line, electrically operated windshield wipers and a pressure-vent radiator cap. The car is powered with the same 97-horsepower engine and the transmission is conventional. On the inside, Plymouth has a new instrument grouping and other refinements of interior design.



'51 Cadillac

Cadillac stylists have concentrated on the interior in the 1951 model. The instrument panel has been redesigned and the fittings and upholstery made more luxurious, especially in the 61 series. The Hydra-Matic transmission has a new "finger tip" control for reverse, which makes it

possible to rock the car. On the outside the front bumper has a new flare design and the rear fenders are more sweeping than ever. There is a new modified circle headlamp ring and a broader V-emblem on the hood. The Cadillac engine is said to be smoother than ever and more economical on gasoline. One new model for '51 was added in the 75 series, a business sedan.



The 1951 Dodge Coronet four-door sedan has a wider windshield and massive bumper. Wide rear window (below) affords driver excellent visibility



'51 Dodge Hugs Ground

Styling in the 1951 Dodge line shows a trend toward modern contours in grille, hood and front fenders with an over-all streamlined and ground-hugging appearance. Larger windshields and rear windows provide better driver vision. Mechanical improvements are topped by the new, more comfortable riding Oriflow shock absorbers. The cooling system has a six-blade pump impeller for greater efficiency.

Bricklayer's Mobile Shop

All the tools he requires for bricklaying are stored in a mobile workshop built by Malcolm Dinsmore, a mason contractor of Hebron, Ind. Just above a platform on one end is mounted an electrical brick-cutting machine. Other tools are stored on racks and in drawers inside the shop, which is mounted on auto tires. When Dinsmore leaves a job, he folds up the platform and padlocks it.





'51 DeSoto four-door sedan presents changed appearance with new body lines, grille and bigger windows

Oriflow shock absorbers on '51 Chrysler line operate with fluid-filled tubes instead of shock valves

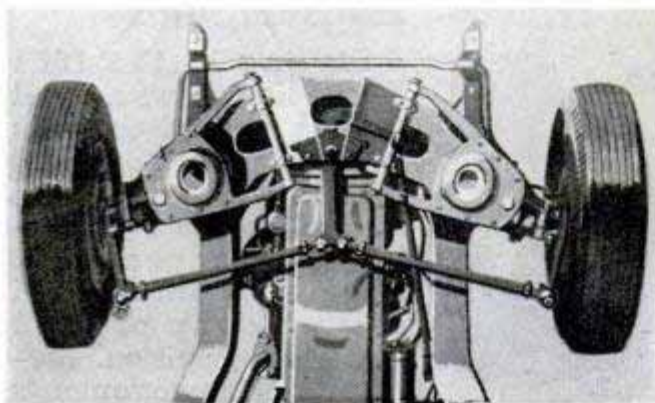

'51 DeSoto Gets New Look

Streamlined fenders, sloping hood and a new grille give the 1951 DeSoto a lower and racier look. Length is emphasized by a fender line which extends back onto the front-door panel. Visibility has been improved with a wider windshield and rear window. While the wheelbase remains the same, the over-all is two inches longer due to an increase in the front overhang. The power rating of the DeSoto engine has been boosted from 112 to 116 horsepower and a new carburetor-choke unit makes starting easier. Comfort has been improved with the new Oriflow shock absorbers. The instrument panel has been redesigned.

Basketball Referee Goes Aloft To Get Bird's-Eye View of Game

Perched above each basket, officials at basketball games will be able to do a better job, according to Sax Elliott, coach of Los Angeles State College. Elliott says that 90 percent of the fouls are committed in the zone around the basket and from the elevated perch the referee will see every movement as the players move in for shots at the hoop. A third official will be on the floor to handle jump balls and out-of-bound plays, but fouls will be called by the officials above the backboards.

Synthetic Pepper

Chemists at the Army Quartermaster General Laboratories in Philadelphia have made a synthetic pepper that goes under the chemical name of piperazonium salts. These salts dissolve in water and their pungent taste is like that of the piperine of black pepper.





Underwater Swimmer's Lung

Swimmers can now descend to depths of more than 100 feet with a breathing apparatus that does not hinder movements. There is no heavy suit or air tube, the swimmer breathing compressed air that equalizes his internal pressure with the pressure of the water. One or two cylinders are strapped to his back, providing enough air for one hour per cylinder at 75-foot

depth. Also designed for the well-dressed underwater swimmer are a pair of trunks and sweater over which a thin rubber suit is worn for retaining body temperature. A lead-weighted belt, swimming fins, a faceplate with attached flashlights and a depth gauge that straps on the wrist are also recommended. For sportsmen who like to hunt their fish, a harpoon gun that is actuated by rubber cords can hit an underwater target 75 feet away.



Reflective License Plates

Delaware license plates for 1951 have reflective numerals which pick up the rays of approaching headlights more than a quarter of a mile away. Not only will the plates provide additional protection from collisions, but they will also be easier to read at night. Another safety aid is a pair of reflective driving gloves which make hand signals easier to see.

Sources of available products described in this issue are listed in the index, starting on page 14. Sources of further information on other articles are listed in the WHERE-TO-FIND-IT LIST, which is available from Bureau of Information, Popular Mechanics, 200 E. Ontario St., Chicago 11

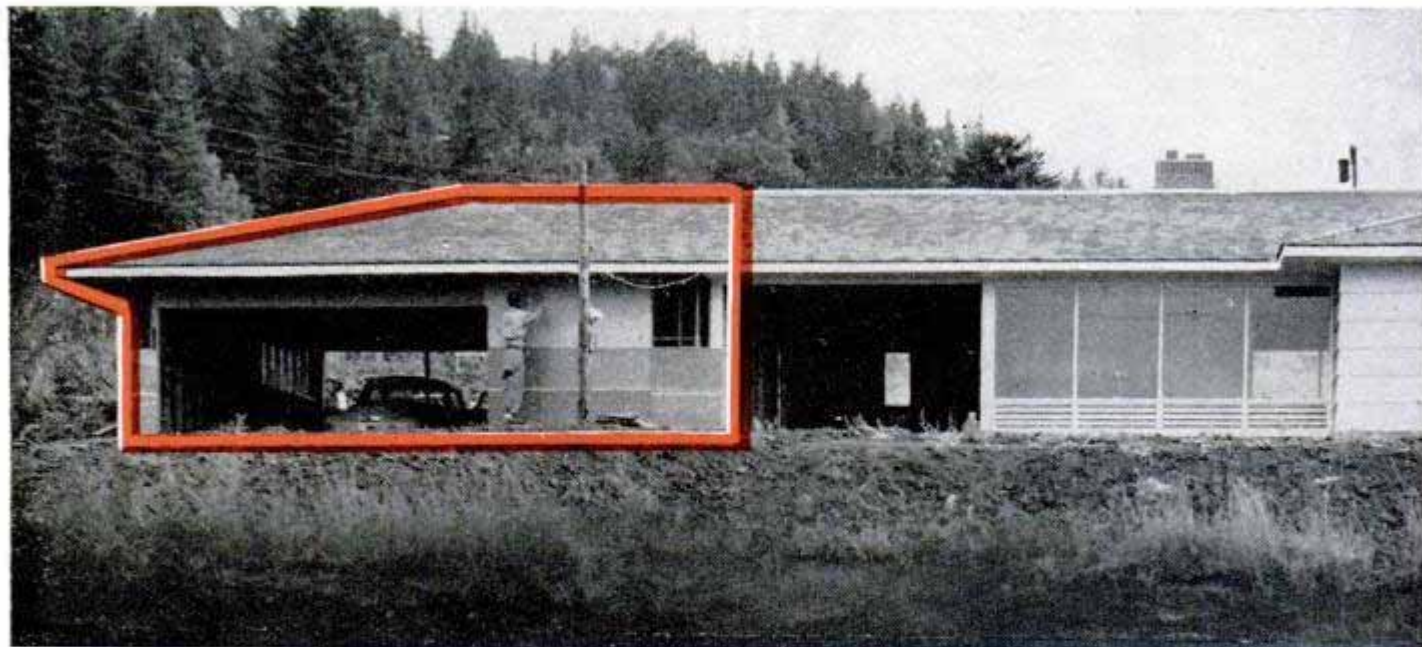

Red outline shows new addition. Original carport, center, will be closed in with more full-length windows

I'm Building the Popular Mechanics

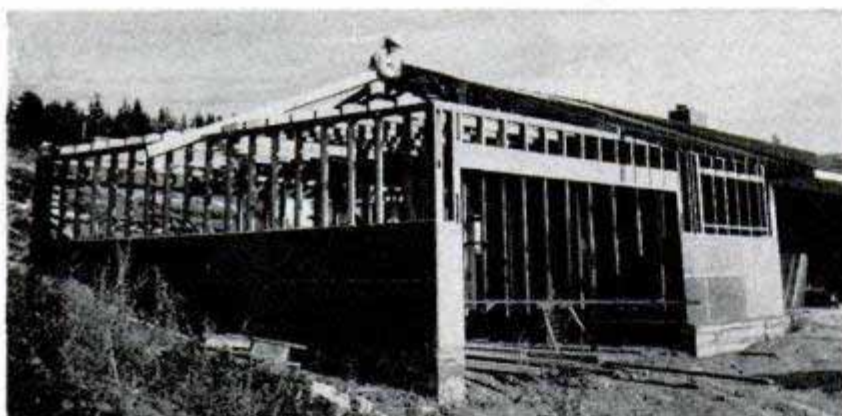

Above, setting end rafters for the two-car garage. To the right of the garage, the enclosed breezeway can be seen. Below, Riley uses a power saw to cut the plywood sheets into lengths of lapped siding



OUR DREAM home, the model of the *Popular Mechanics* ranch house, is now well past its basic stage.

As you may remember from the November issue, this modern house can be built in two stages. First, the basic house, then, at a later date, the breezeway-garage addition makes it a full-sized home. Or, it can be built all at once. Or, if you prefer, it can be left in the small stage and it's still a good home. What we are doing in the scenic Bridlemile area of Portland, Ore., is building the exterior of the basic house and then going right on, immediately expanding it into the larger version to discover any problems that may be involved in the expansion.

One of the requirements that the editors made of architect John Whelan was that this house be expandable without any complications. You asked for that—probably because you've seen homes that were expanded by tearing out walls or moving kitchens and bathrooms elsewhere—with all the problems of carpentry, plumbing, wiring and heating that crop up. Such complications are not only expensive but



Vinita Riley helps with shingling—a big job on the long house

Plywood Ranch House

By Tom Riley
Part IV

often result in your never having the time to complete your expanded home. There's no such problem with the P.M. house.

Frankly, this amateur builder didn't realize the simplicity of the expansion of the ranch house until he tried it. Even with all the advance planning, I thought it was inevitably somewhat difficult to add to a house. But, Whelan proved me wrong! Here we tear down and rebuild nothing in the basic house. Best of all, if you build this home in two stages, it will be completely livable before and while the expansion is being done.

The key to the simplicity is the carport of the basic house and the fact that a breezeway is attached to it in the larger version. The roof merely continues on. The carport, being open on the front of the house, is simply studded in to form a wall of the larger home. The exterior siding of the utility room (that siding is already in place) is not removed; it forms one wall of the enclosed breezeway. The carport becomes your den or third bedroom and also has ample space for a half-bath, storage room or whatever you wish.

Many of us desire to make some special room arrangements in our home and here, in the enclosing of the carport, is the easiest place to do that. Of course, with the modern construction of the *Popular Mechanics* ranch house you can change any room willy-nilly because of its engineering (no interior walls support the roof). But by putting your special ideas to work in the carport area you will not lose the traffic

pattern, the open living area, the savings in hall space, plumbing and the like that Jim Ward and John Whelan have so carefully planned into the basic house. This amateur builder, most of the time, claims to be a writer and has always wanted a study or den with an adjacent photographic darkroom. So I am placing one in the carport

(Continued to page 256)

Plywood strips overlap to form siding. The wooden shingles beneath siding provide the correct slant



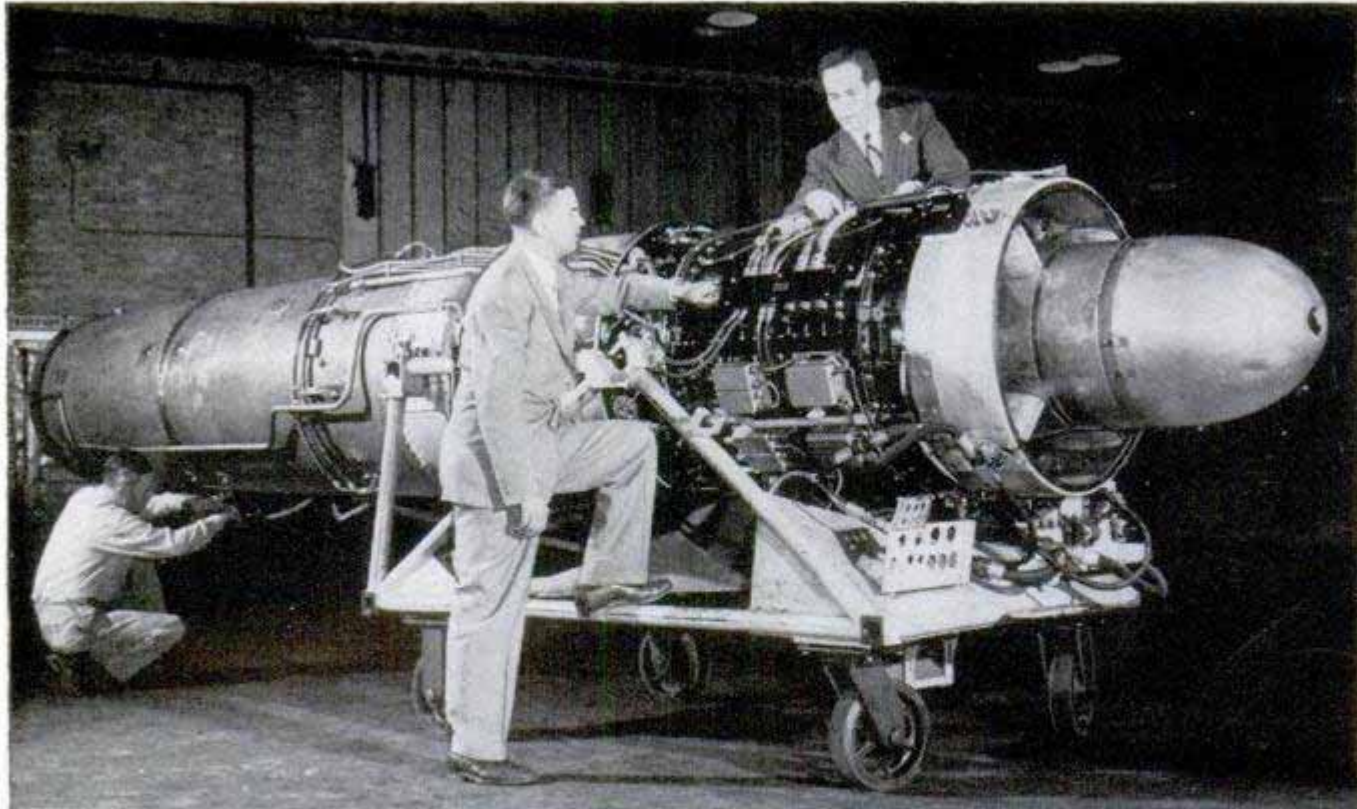

Jet Engines Rely on "Hot Noses" to Halt Icing

"Hot noses" enable two of the new Air Force jet engines to avoid icing, one of their knottiest operational problems. Super-cooled water droplets, striking the air inlet, form into ice crystals that within seconds block air entering the engine. On the General Electric units, the most powerful the company has built, hot air from the compressor is bled to hollow parts of the nose to prevent ice forming. Both engines also have special ignition systems that make starts possible at altitudes up to 50,000 feet.

In steel cylinder, right, jet compressors are tested at a simulated 70,000 feet

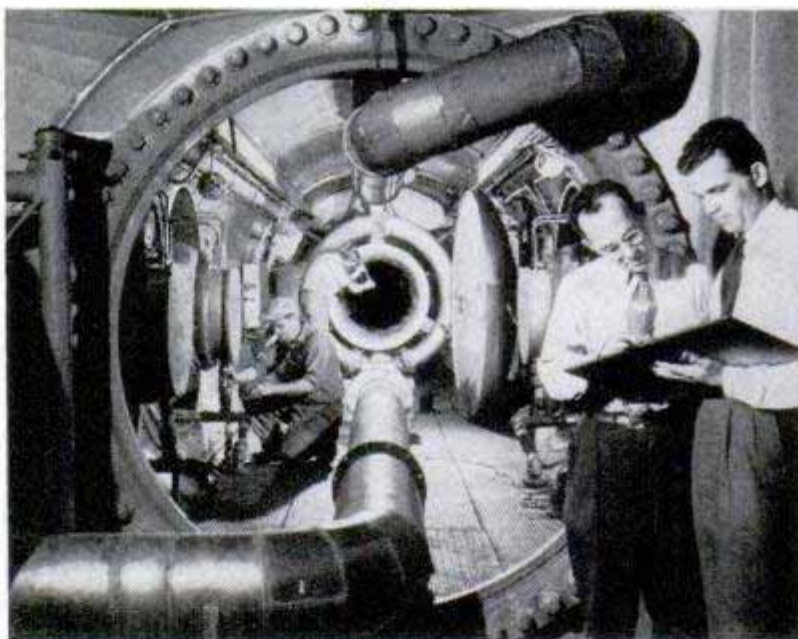

Rain Shield for Windshield

Patrons of drive-in theaters now can see the show even during a rainstorm without turning on their windshield wipers. A new plastic hood stretches across the windshield to prevent rain from striking the glass. The car doors are closed on the ends of the hood to hold it in place. A wire runs from the front of the shield to the car ornament to hold the hood in the open position. A stiffening hem along the front edge forms a trough which carries the water to the sides of the car.

☐ A motor road crosses the main range of the Andes at 15,889 feet near Lima, Peru.



Jeep-Mounted Rifle Can Knock Out Biggest Tank

According to the Army, its new Jeep-mounted rifle is capable of knocking out the biggest foreign tank known today. The

105-mm. weapon has no recoil. One man in the Jeep sights the rifle while another loads it from behind.

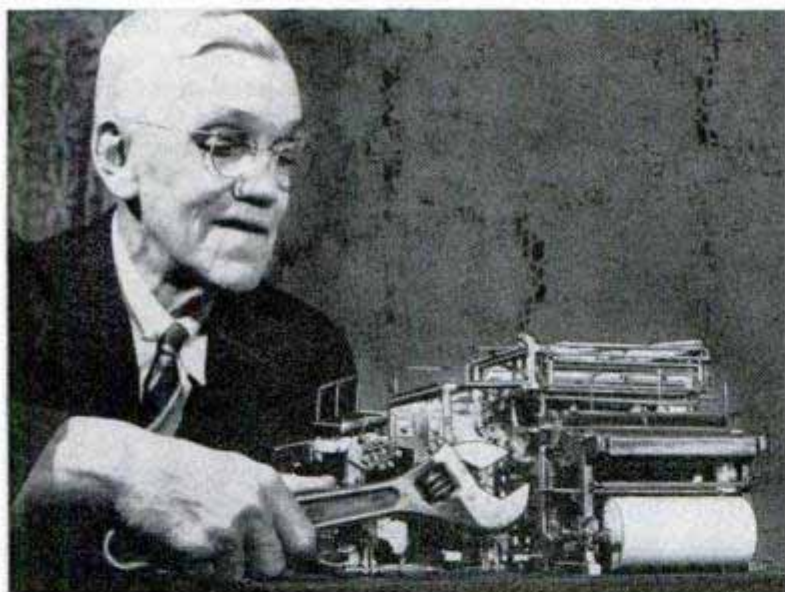

Model Newspaper Press Built From Memory

When Henry Showers became a pressman for the Portland "Oregonian" more than 50 years ago he took a fancy to the newspaper's big press. Now Showers has completed a foot-long model of that press, built entirely from memory. Most of the parts are small pieces of brass, held together with more than a thousand tiny watch and clock screws. Although the press is not a working model, it can be completely taken apart. Showers spent more than six years of spare-time work on it.

"Deep" Photo Film Resists Heat

Photographic film is normally supersensitive to heat, but Eastman Kodak has developed a new film that will take pictures three miles beneath the earth's surface where temperatures reach 325 degrees. Oil-well drillers need such a film so they can photograph instrument readings at the drill point far underground. From this photographic record, technicians determine the angle and direction that the drill is taking. The film comes in 16 and 35-mm. widths.

Antifreeze "Boot"

Easily installed on any late-model General Motors automobile, a new synthetic-rubber "boot" prevents frozen locks and door handles. The boot covers the entire push-button assembly, preventing water from entering. Four of the boots can be installed in five minutes.

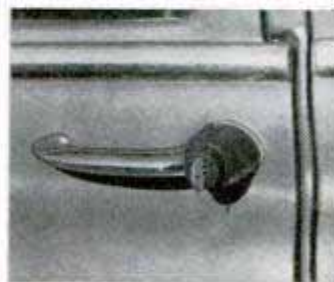

One-Wheel School for

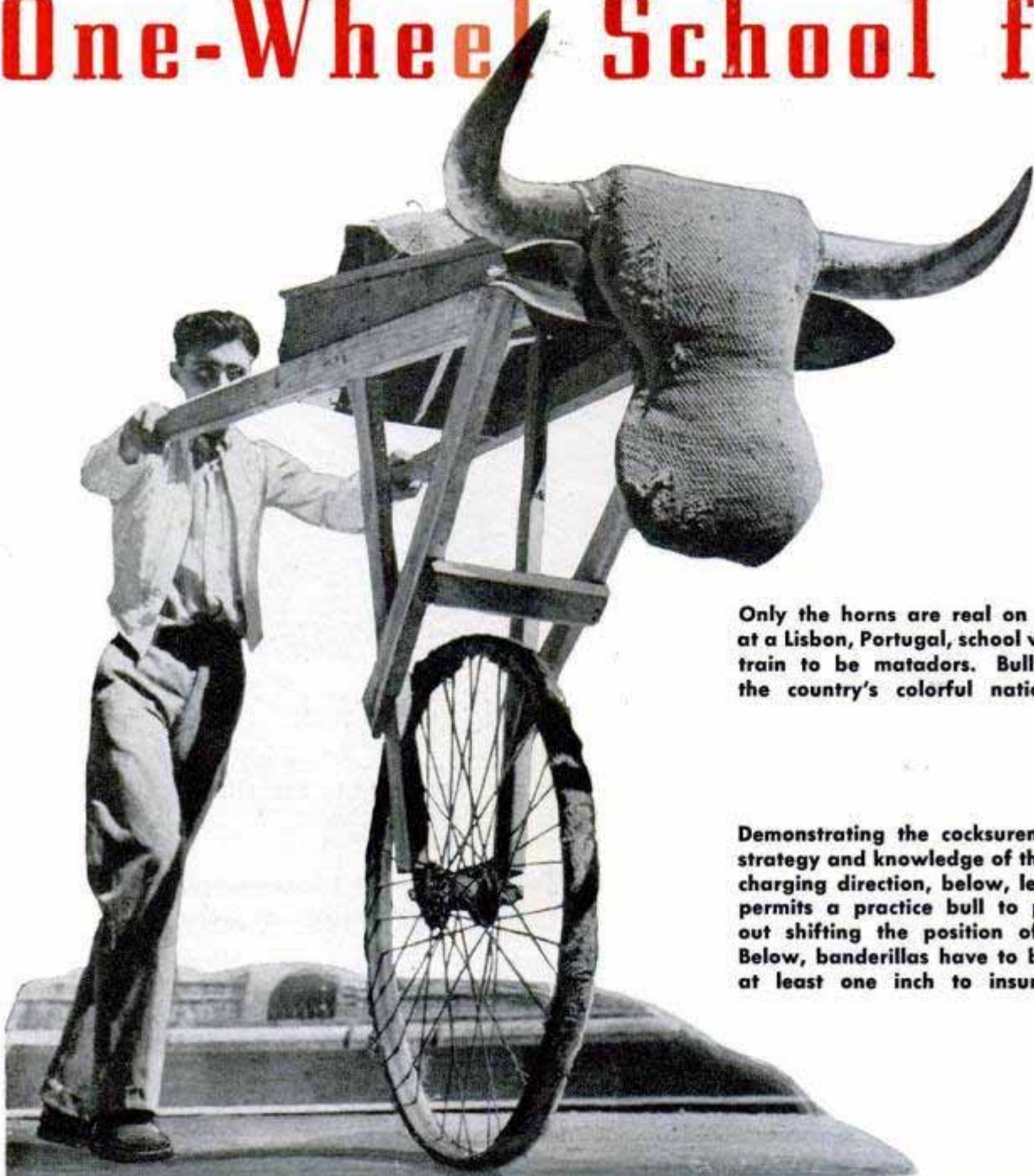

Only the horns are real on the "bull" at a Lisbon, Portugal, school where boys train to be matadors. Bullfighting is the country's colorful national sport

Demonstrating the cocksureness of his strategy and knowledge of the animal's charging direction, below, left, student permits a practice bull to pass without shifting the position of his feet. Below, banderillas have to be inserted at least one inch to insure sticking



Bullfighters

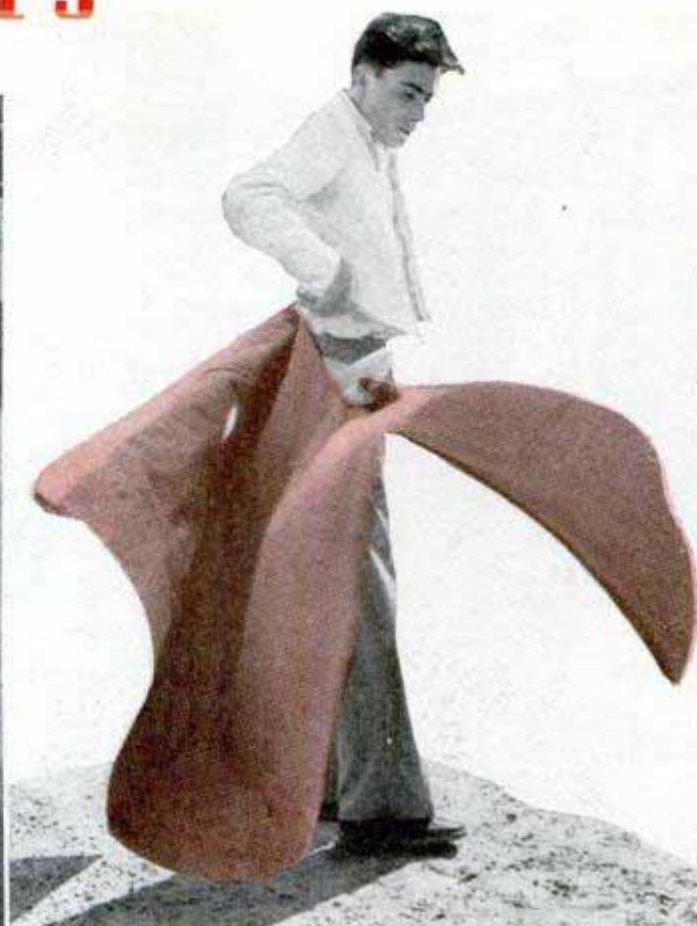
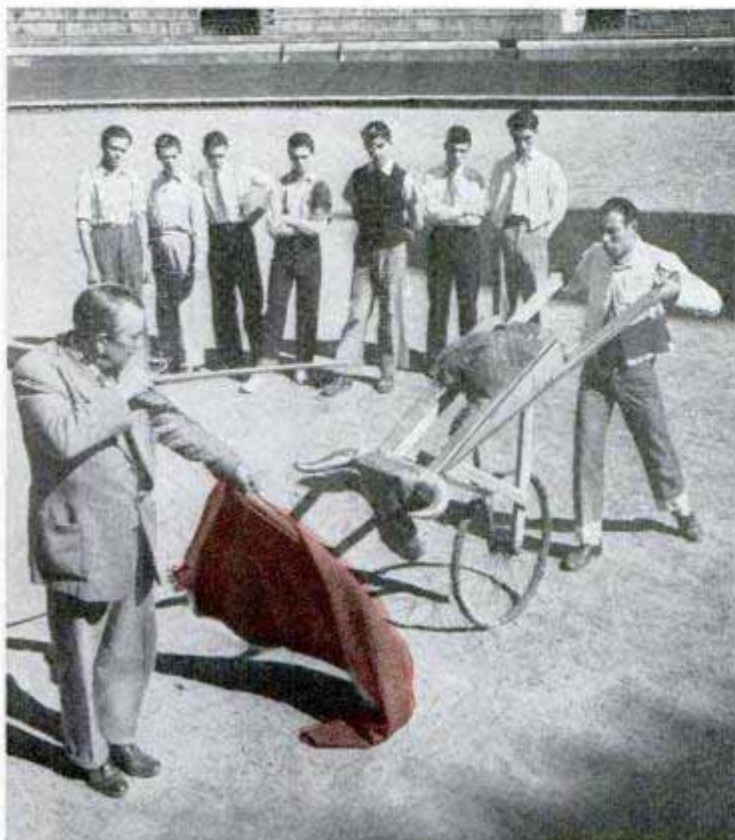

While the class watches, above, left, the instructor demonstrates the correct stance and method for killing a bull or planting a banderilla. An advanced student, above, right, illustrates difficult butterfly figure with a cape. If the bull gets control of the situation, below, it is well to know the quickest way to leave the ring

THERE is no gore or death in the ring in Lisbon, Portugal, when the bullfighting class is in session. Instead, empty stands look down upon a group of serious teen-agers training to become heroes of their native land, the matadors of tomorrow. Many are from the finest families in Portugal. Their practice "bull" is a high, one-wheel cart, with a pair of bull's horns extending from the front end. Between demonstrations and lectures, while a classmate pushes the cart at them in imitation of an angry bull's charges, the students rehearse fighting maneuvers. They learn the elaborate processional and pageantry connected with the fights, techniques of inciting the bull to charge with flourishes of a bright-colored cape, and the correct stance and method of killing the animal. Padding on top of the cart, where the bull's shoulders would be located, serves as a "pincushion" into which they can practice thrusting banderillas, 18-inch darts used to madden the bull.



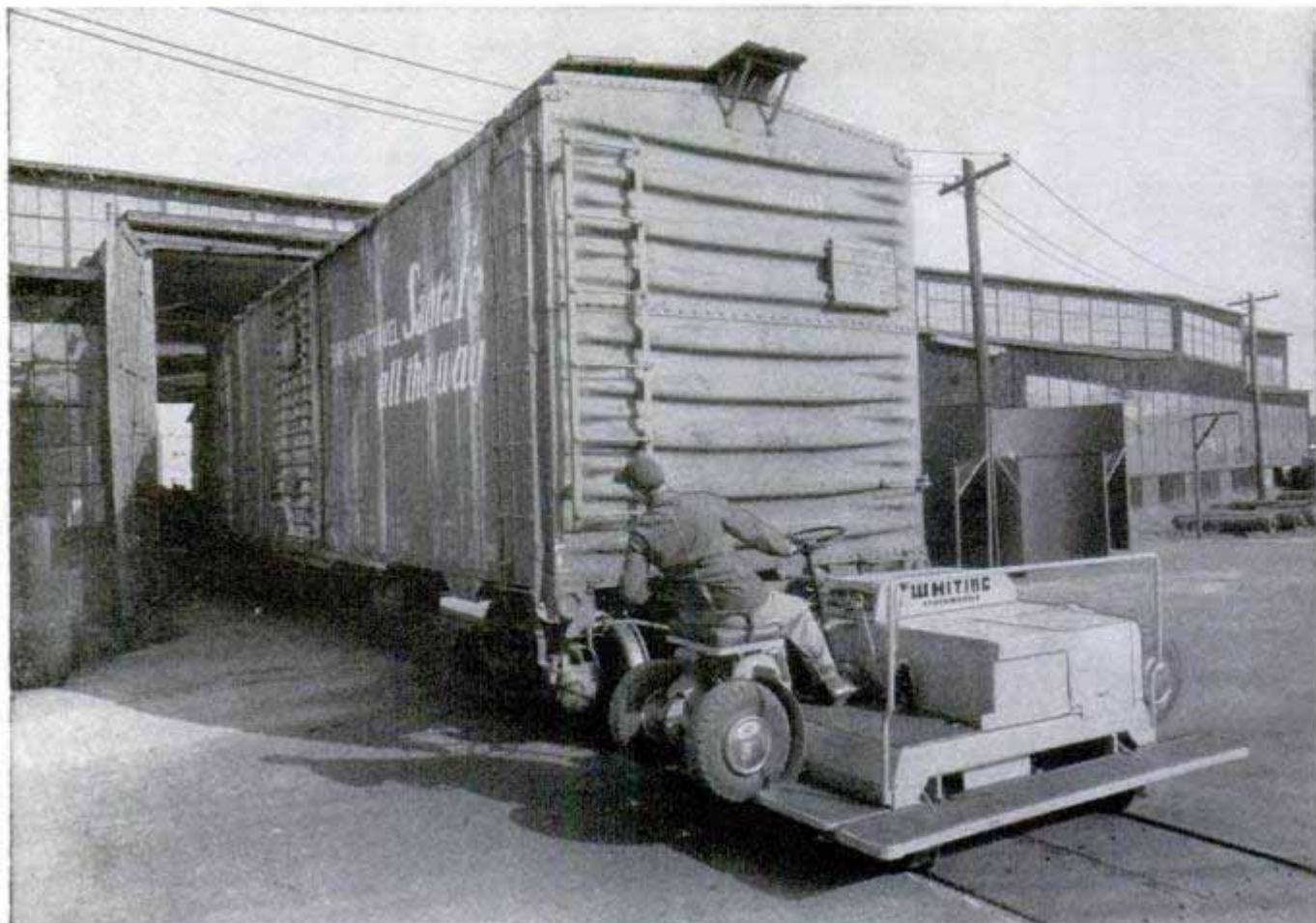

Road-or-Rail Switcher

At home on rails or road, a tiny "locomotive" switches freight cars without becoming "bottled up" on the track. The vehicle is gas-driven and has two sets of wheels—four steel wheels for track travel and four rubber-tired wheels for ground travel. The road wheels are retracted by a hydraulic jack when the switcher is operated on the tracks. The operator drives onto the tracks at right angles and then moves down the track sideways. When coupled to a freight car, the jack raises a special coupler, transferring part of the car's weight onto the switcher and thus increasing the adhesive force against the track. The vehicle can attain a drawbar pull of 7350 pounds and can pull or push four loaded freight cars.

Vehicle moves down the track sideways, pushing or pulling freight cars into position. Below, job on tracks done, the operator swings down the rubber wheels with hydraulic jack and drives to another job

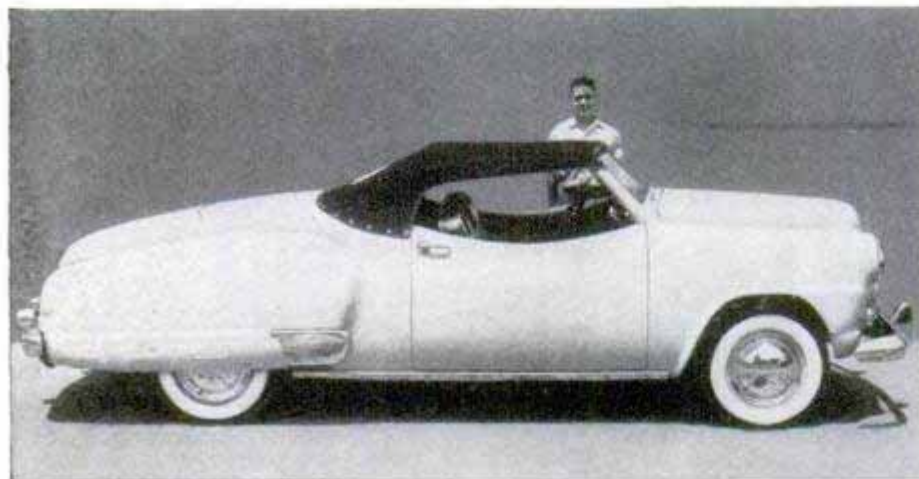

Custom Sportster

If you're an expert on motorcars, you will recognize the ancestry of a custom-made sport car. It was originally a 1947 Studebaker Champion coupe. In five months of spare-time work, Harold Boardman, Jr., of Augusta, Ga., and several friends rebuilt the car into a sporty runabout with a high-compression engine.



In the movie "Sunset Boulevard" Gloria Swanson rides in a 1930 Isotta Fraschini from Pacific Auto Rentals

HOLLYWOOD'S ANTIQUE AUTO LIVERY

By George Finneran

BACK IN 1926, John W. DeNoria came down to Hollywood from Portland, Ore., to open a car-rental business which would cater to people who would rather rent than buy a car. After the first few months in business as Pacific Auto Rentals, Inc., he found that the black Dodge sedans and gray Chevrolet coupes would sit in the garage with their original 00000 mileage, while a Stutz Bearcat or an Isotta Fraschini phaeton hardly ever got a minute to itself. He also discovered a demand for liveried chauffeurs behind the wheels of wickerwork-body Duesenberg town cars or Minerva landaulets. So Mr. DeNoria began to stock up on these items even though the initial cost and upkeep were terrifically high on this stuff in the rental business.

Brush Surrey with the fringe on top is one of rarest cars in collection. A cord belt drives the wheels



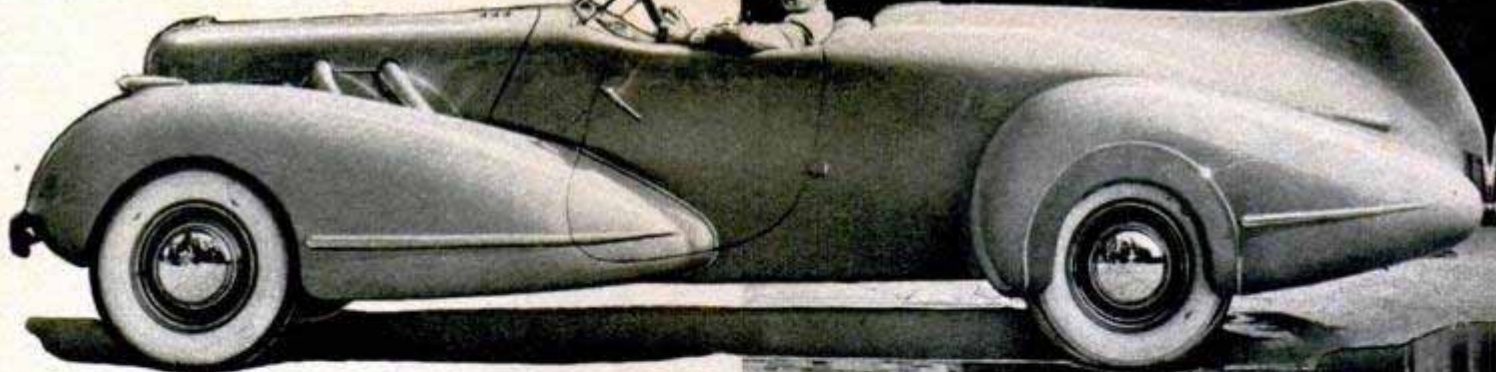

"Topper" car (above and at right) was made for the movie of that name and was built on a Buick chassis

In 1928, one of the major studios heard of DeNoria's automobile stock pile, and began renting movie cars from Pacific Auto. By 1938, the firm had expanded to such an extent that Dr. George Schweiger was able to purchase a half-interest in the business. When John DeNoria died in 1943, his capable, auto-expert widow (Dorothy Forster) and Dr. Schweiger's son, George Schweiger, Jr., continued the management of the company.

You have to know your cars to be able to rent them to the studios. For instance, some cars bought by Pacific Auto Rental haven't been in a picture in over five years. When you consider that the purchase price of the 167 cars in the collection ranged from \$10 to almost \$10,000 (in one case), you can see that a bad investment can tie up quite a lot of capital. This seems to be particularly true of antique cars, as movies based on the early 1900s are few and far between. The Pacific Auto collection is based, therefore, on what the studios have needed in the past and what they probably will need in the future. Right now the collection represents autos from every country including taxis, military vehicles, race-track jobs, delivery trucks and even "hopped up" cars commonly known as hot rods.

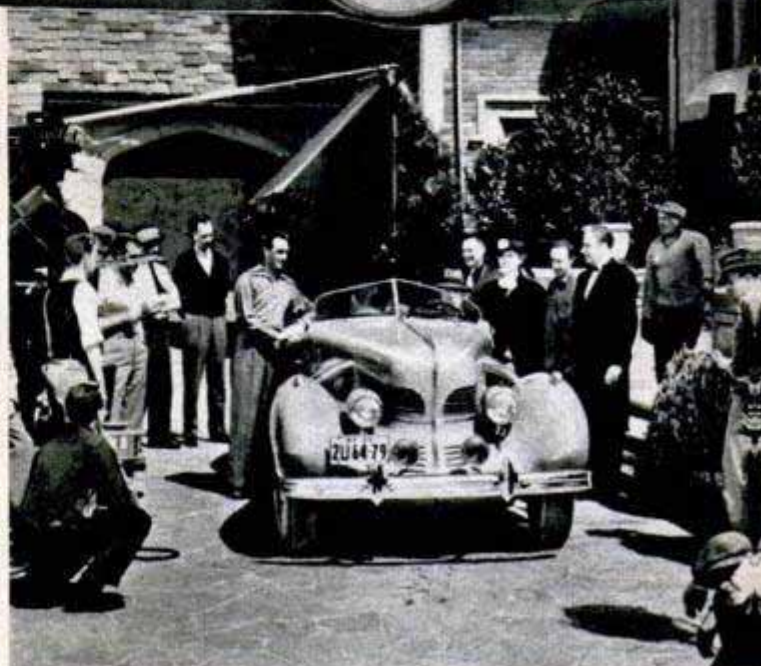

Let's follow a rental through from start to finish and see how the business operates. In 1946 Pacific Auto bought a 1935 Packard V-12 convertible for \$400. The car was in fair shape—good tires, leather upholstery not torn or badly worn, paint and top not too good, and the engine not too bad. The car was brought into the garage, the engine tuned and worked over, a new top and paint job given it, and the car stored in one of the two large storage garages. Along about 1947, a studio decides that it needs an impressive-looking convertible to be

In "The Great Gatsby," Alan Ladd drives this 1933 Duesenberg coupe (325 horsepower) supplied by the agency

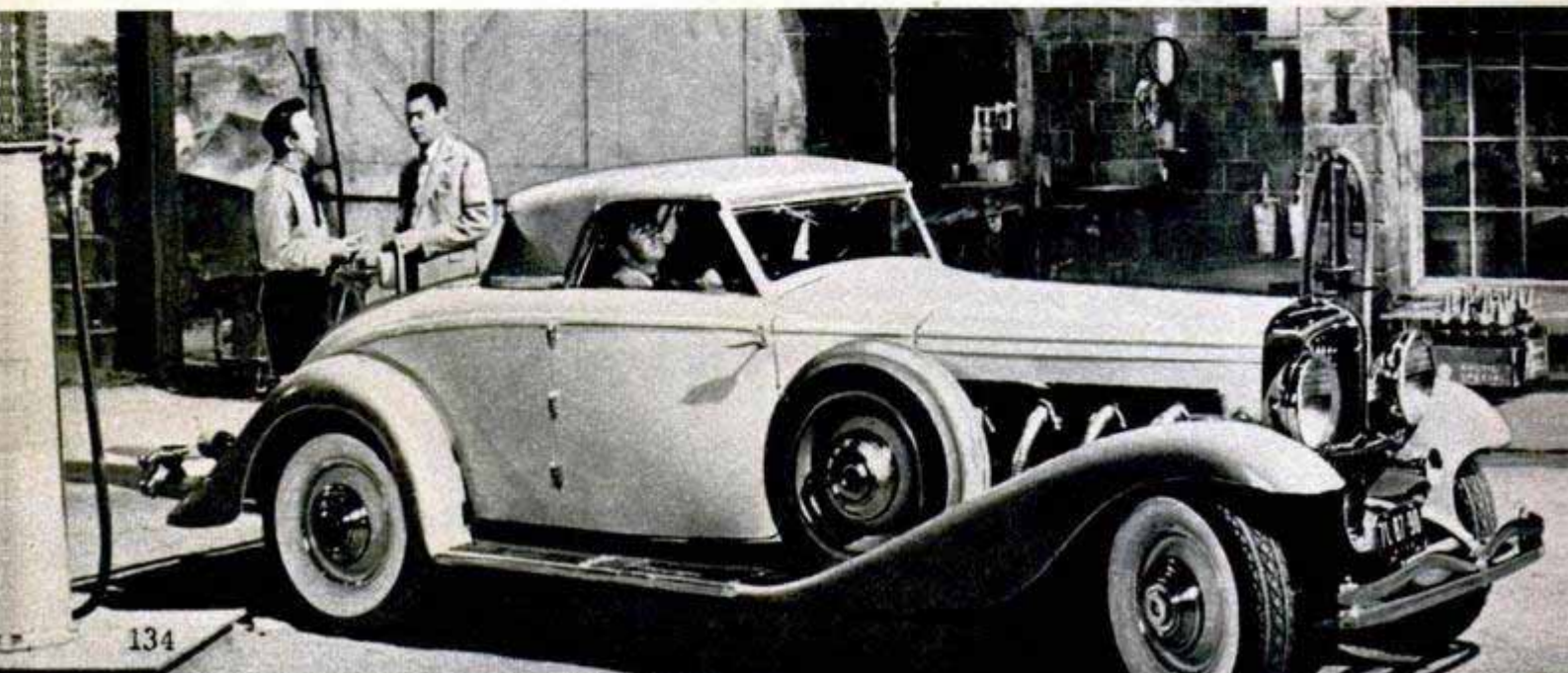

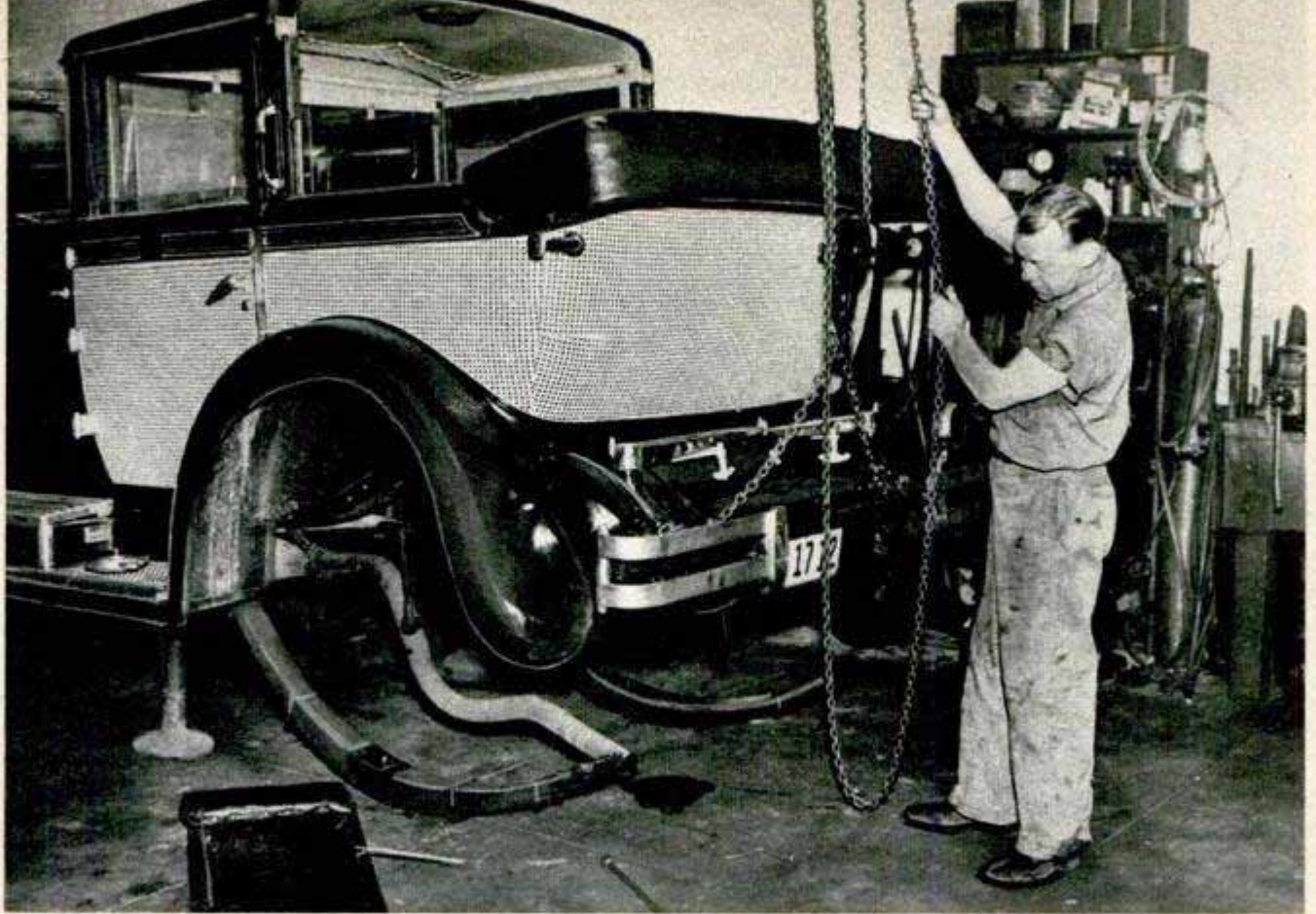

Jack Booth, master mechanic, at work on rear-end assembly of Isotta Fraschini used in "Sunset Boulevard"

used as a government official's car in a picture about prewar Washington. Pacific sends the studio several pictures of cars that would be suitable because of year and model. The Packard gets the job. By now, it is in the back row of the garage in which it was stored, so 10 cars must be moved in order to get it out. Then a charged battery must be installed, the gas tank filled, the oil replaced, the interior and exterior cleaned and polished and the engine tuned. The car was painted a light gray, but the studio wants a sleek black job so the car must be sent out and repainted (expense

of repainting to be paid by the studio).

In perfect shape and ready to go on the lot or on location, the car is loaded on a trailer and taken to its destination. Pacific Auto's insurance must cover the car up to the moment of delivery; then it goes under a studio policy. A man from Pacific stands by all the time the car is on the lot to give driving instructions to the actors (also necessary where some foreign jobs are concerned), replenish the gas and oil, or to make repairs and adjustments (this is necessary on many of the antique cars). When the car is finished on the lot, it is

This 1917 Renault roadster is in good condition and is in demand for pictures with a European background

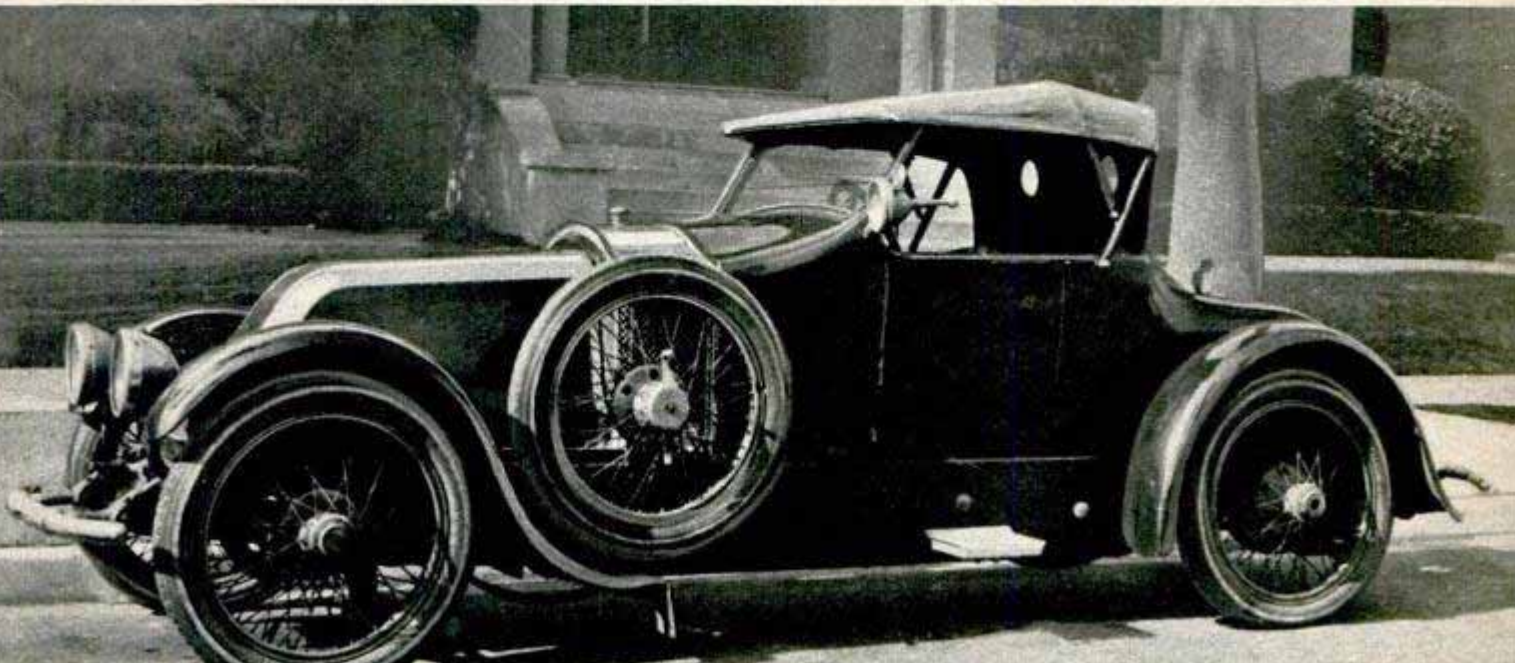

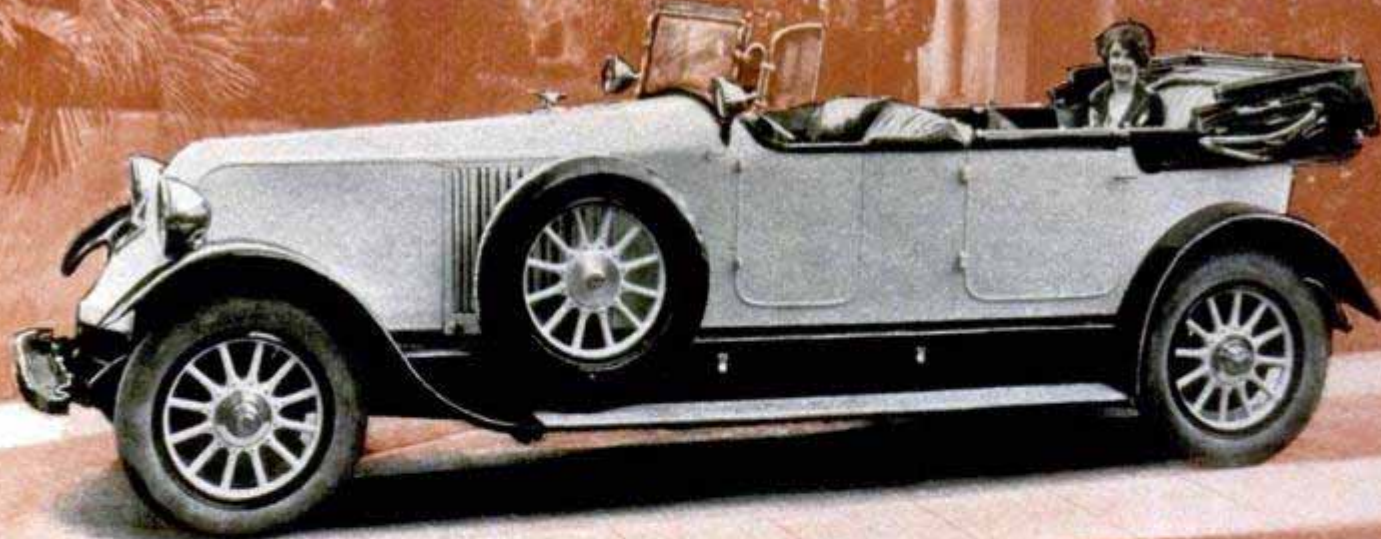

Largest machine in Pacific Auto collection is this French Renault touring car used in European scenes, 1922

loaded on the trailer and brought home. But—its job is not over yet. The car cannot be rented out on another job until the studio, under the rental contract, releases its "retake rights"; in other words, the car must be held available for retaking any shots in which it may have been used. When this period has expired, the car is either restored to its original color, at studio expense, or left as is, the oil and gas drained, battery dismounted and the car returned to its storage place.

Still using the Packard as an example, let's say the total rental on the car for a period of five days was \$250—it actually might be quite a bit lower on this type of car. This is applied against the original cost of the car, storage for two years, gas, oil, labor on moving, cleaning, repairing, transporting to location, services of attendant on the lot, insurance and restoring. Some cars are in almost continual demand and have paid off their own mortgage and carried a few of the wallflowers.

Besides the cars owned outright by Pacific Auto, there are approximately two or three hundred others for which the firm acts as agent. Let's suppose that you own a snazzy looking Duesenberg roadster, vin-

tage 1934. Like any proud parent, you're not against the idea of the car getting into pictures. So you send Pacific Auto a photo of your baby, and include the following data: year, model, color, general condition, special features and anything else that's applicable. This photo and the information are filed by the firm. If your Duesenberg is chosen for a picture by a studio, Pacific Auto will pick up your car, get it ready for production, deliver and return it, take care of all the details, and then pay you 20 percent of the rental fee. They can use listings even now, but only of extraordinary looking cars or first-class antique cars in top shape—no 1938 Ford business coupes or 1941 Olds sedans, thank you.

Don't worry too much if your Duesenberg is rented for a Dillinger-type movie and used in a cops-and-robbers chase sequence. Every skidding turn, screeching stop and supposedly flat-out straightaway race is carefully laid out by the studio engineers and the stunt drivers who will drive the cars. Then, the camera speed is set down a notch, the scenes filmed, and your precious Duesenberg has probably never registered over 35 to 40 miles per hour on its speedometer while on the lot.

Swanky 1938 Mercedes Benz is typical of the cars listed by owners with the agency for rental to the movies

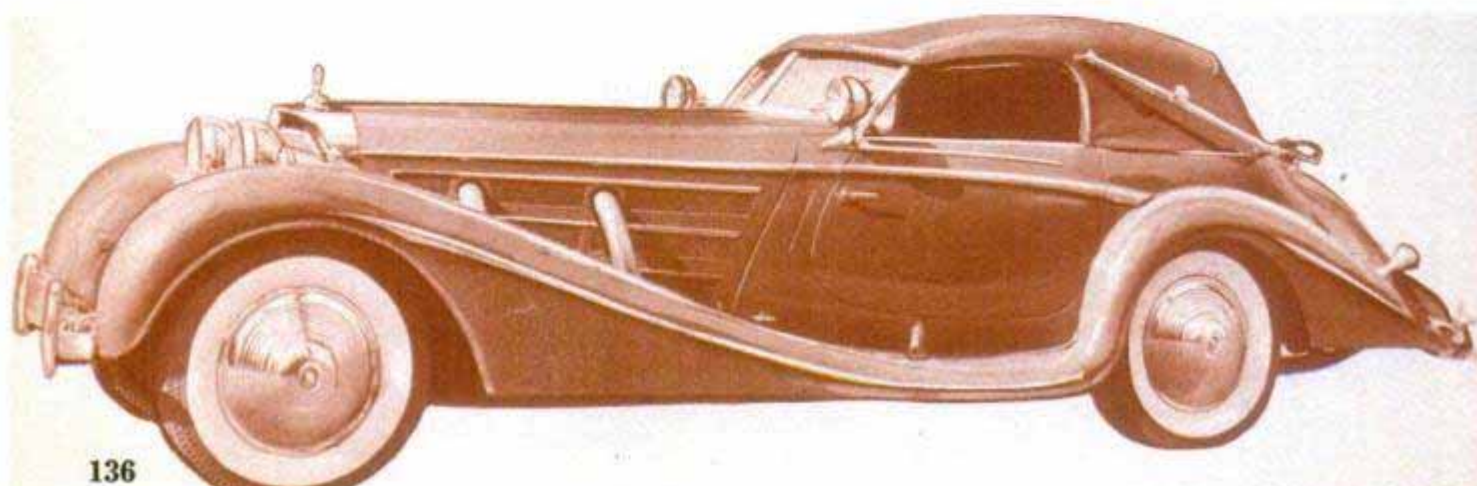

If your car is supposed to end up in the ditch, or over a cliff, a scale model or a wooden mockup will go through the actual crackup and your car will be carefully laid on its side, the wheels set spinning, the scene shot and the car righted without a scratch on its shiny surface.

One versatile mechanic does all the maintenance and repair work on the 167 cars in Pacific's collection. His name is Jack Booth, and a day's work might include an engine job on a 1910 Cadillac town car, a tune-up on a 1939 Lagonda Rapide, or a brake job on a 1948 Ford. Locating tires for the cars in his care is an important part of his job—and you should see what some of these wagons use for rolling rubber! A 1910 Baker Electric is a problem child de luxe because of the age and precarious condition of its many batteries. Recently, a very fine Duesenberg convertible coupe became "camera shy" and was sadly sold down the river to a Duesenberg enthusiast. Camera-shy cars, because of their good looks or uniqueness, have been in a great many pictures and are rejected by the studios because they are too familiar to many moviegoers. Pacific Auto now has about five cars for sale because of this and other reasons, including two 1914 Renaults, two 1929 touring cars (a Buick and a Packard), and a rakish 1916 Mercedes Benz touring car, all in excellent shape.

Pacific Auto cars used in recent movies are a leopard-skin upholstered Isotta Fraschini town car carrying Gloria Swanson in "Sunset Boulevard"; the twin Duesenbergs in "The Great Gatsby"; a 1906 Mitchell 8 used in "I Remember Mama"; and a very famous job, the 1932 Chrysler LeBaron Imperial phaeton with a Mercedes Benz grille, appearing as Hitler's car in Charlie Chaplin's "The Great Dictator." In regard to this last item, Miss Forster wants it plainly understood that this rarely indulged in piece of chicanery was not the work of Pacific Auto. The car belonged to a competitor at the time of its rental, and it was not acquired by Pacific until after this film was completed.

Some of the more intriguing cars in the collection beside those already mentioned include a 1934

(Continued to page 250)

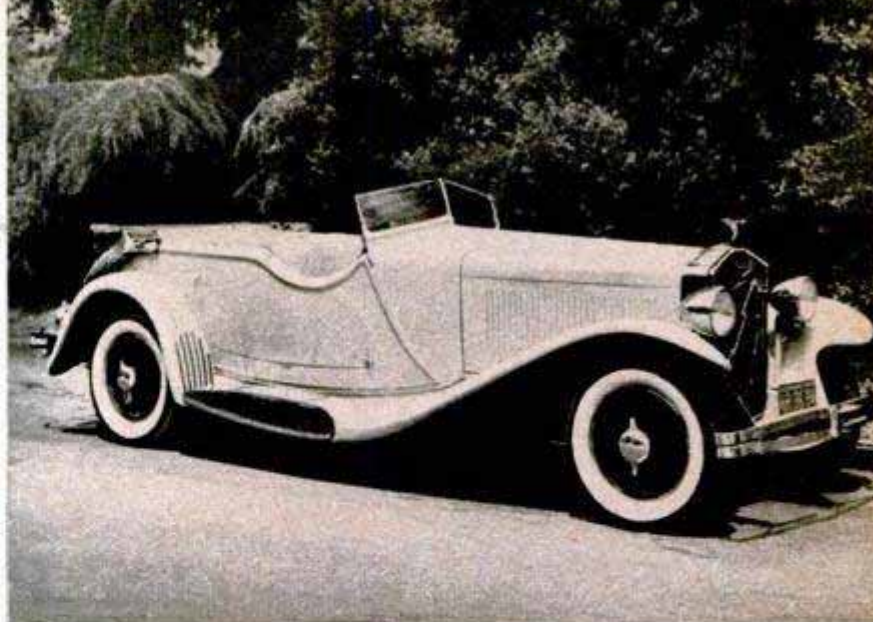

The 1937 Isotta Fraschini phaeton is in demand for movies with foreign setting. Pontoon-shaped running boards are not wing stubs but provide storage space for tools and odd items

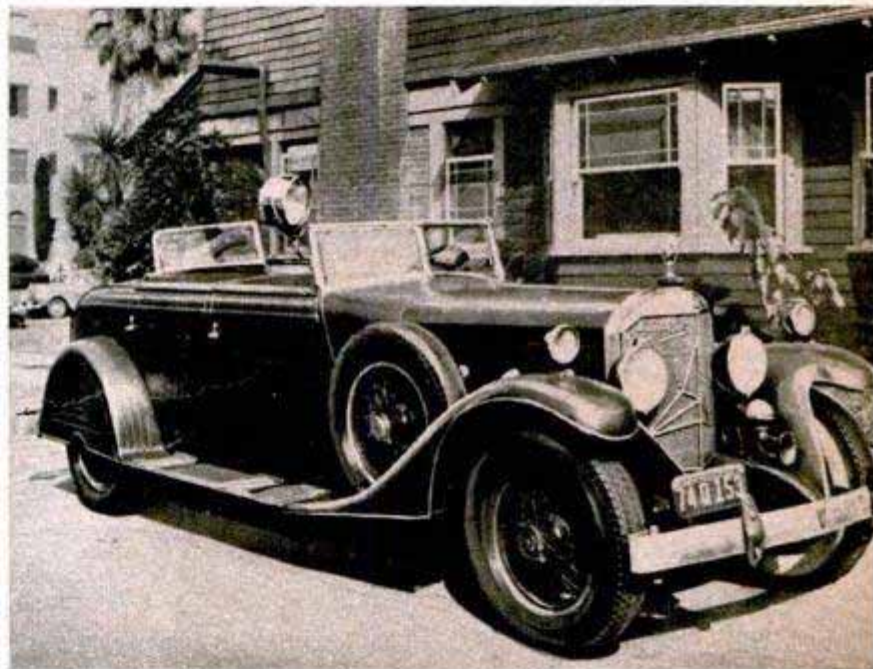

Makers of movie thrillers like to use this Mercedes Benz as a Gestapo chase car. It was built during World War I. Below, Aston-Martin English taxi is handy in London street scenes and has been used in many pictures to lend foreign atmosphere

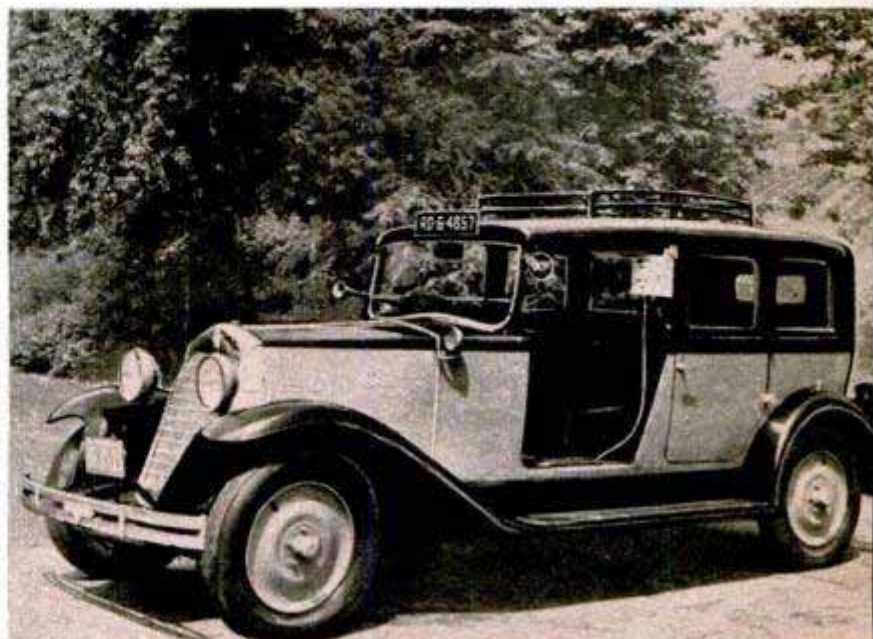

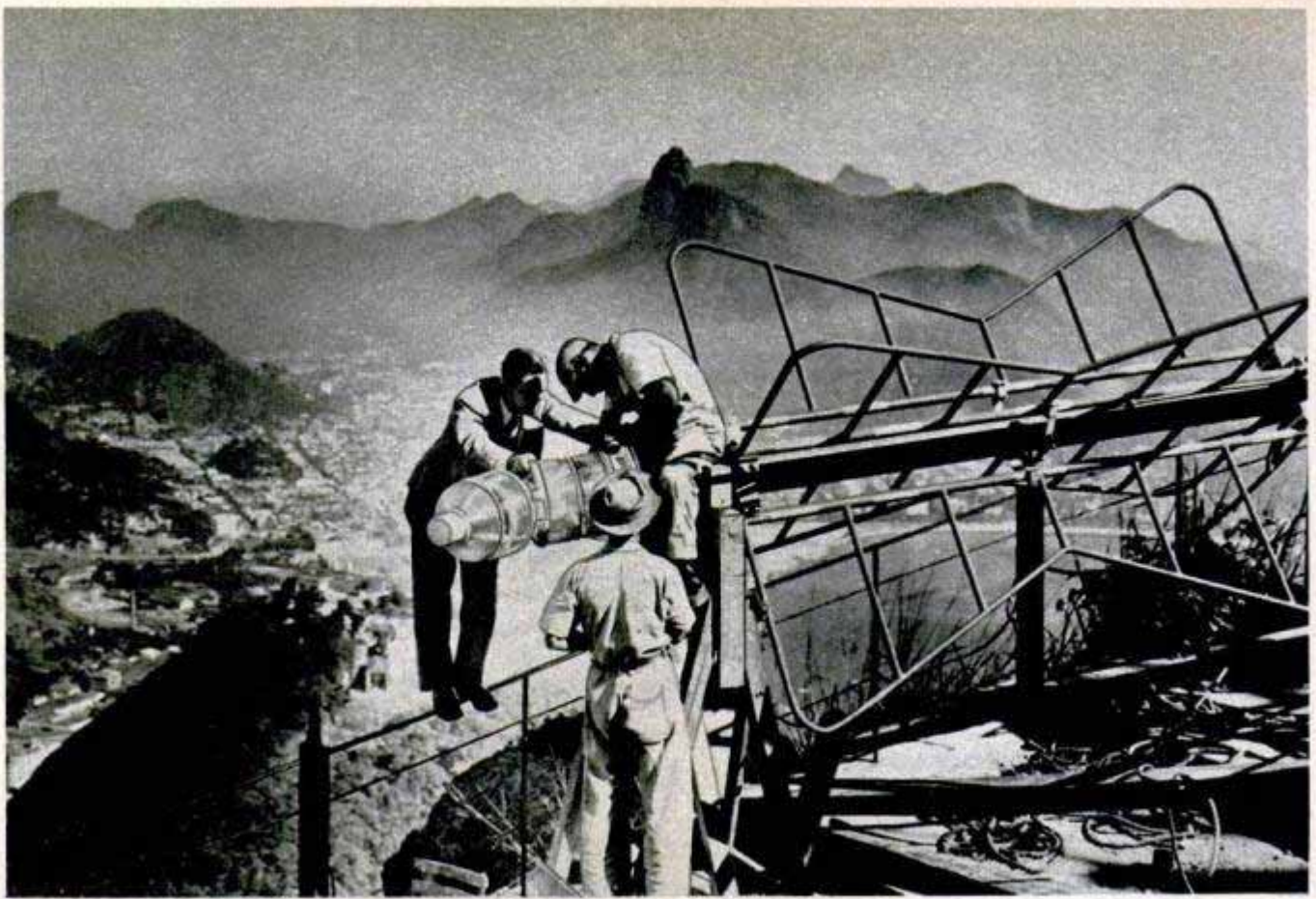

Mountain "Mast" for TV Antenna

Rio de Janeiro's television station has a ready-made "mast" to support its antenna—famed Sugar Loaf Mountain that towers 1300 feet above the city. The several tons

of transmitting equipment, including the 150-foot antenna, had to be hauled by cable car, mule and hand to the lofty summit. Brazil is the first South American country to have regularly scheduled commercial television programs.

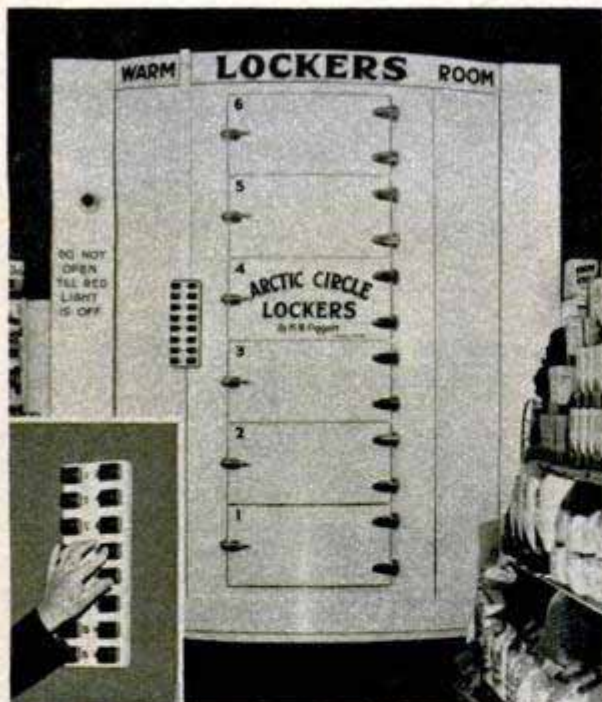

Frigid Cylinder Is Food Locker

Occupying six square feet inside the store, a round cold-storage locker enables a store to install 96 rental lockers without loss of valuable counter space. The cylinder is 9 feet tall and 11½ feet in diameter.



The only part of the locker unit that extends into the store is the door panel, the rest being located behind the wall. Locker baskets, stacked six high, are mounted on a rotating core. The customer presses a button and the core rotates until his locker is behind the door.

Automatic Car Laundry

All it takes to wash a car with an automatic washer is the flip of a switch. The car is parked between two parallel tracks and the U-shaped spray rack makes three passes over the car, first spraying it with water, then with soap and finally with a clear rinse under high pressure. Because of its automatic operation, the machine enables the station attendant to make oil changes, pump gasoline or perform other duties while the car is being washed. It takes only about five minutes to wash a car. The machine has a

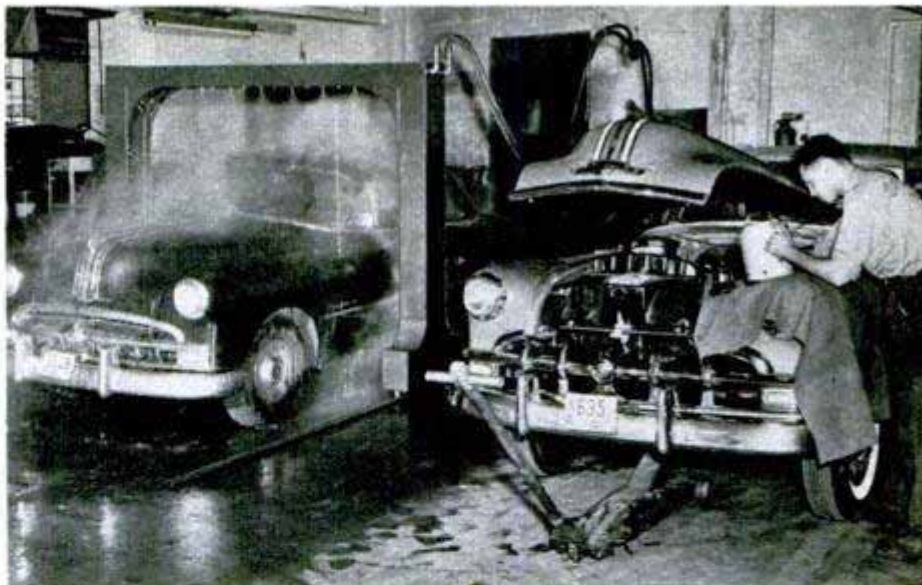

turbine-type pump that produces the pressure required for thorough cleaning of passenger cars and trucks.



Helicopter "Wind" Shakes Fig Trees

Helicopters, already widely used for seeding and spraying, now complete the growing cycle by helping with the harvest. Robert Forkner of Fresno, Calif., has a low, slow-flying helicopter "wind shake" for fruit from fig trees on his 56-acre fig farm. Though slightly more expensive than hand-knocking fruit from the trees, wind from the machine helps clear away leaves, which aids in picking up the figs.

Soil Pulverizer

Mounted on rubber tires so it can be hauled to the field, a soil pulverizer built by a Minneapolis nurseryman handles five cubic yards in less than 10 minutes. The nurseryman built the machine when the housing boom brought tremendous demands for pulverized soil. The only equipment available was too small to turn it out in quantity, so he built his own machine. The hopper is filled by a tractor with a front-mounted shovel.



A high-angle photograph of a person in a metal cage ziplining over a deep, rocky canyon. The canyon walls are rugged and layered, with a river visible in the distance. The text "HIGH RIDE" is overlaid on the right side of the image.

HIGH RIDE



Hanging in the vastness of the canyon is the longest unsupported cable in the world. Arrow indicates terminal

ON A CABLE

By Joyce R. Muench

Photos by Josef Muench

UNCLE SAM has another tool to help him in his job of taming the cantankerous old Colorado River. It's a slender steel cable that looks like a spider strand sloping down the vast side of the river canyon. As a matter of fact, it's the longest unsupported cable in the world, located at the proposed Marble Gorge Dam site in northern Arizona.

The Bureau of Reclamation, in its long-range program for development of water resources and power in the Southwest, has been surveying the old Colorado for possible future dam sites. This spot, about 30 miles below

↓ Cable takes men and supplies down a 2200-foot vertical drop. It ends on a ledge 350 feet above the Colorado

Right, terminal on the rim of the canyon is a steel tower, here viewed from cable car. The trip takes 15 minutes

Lees Ferry, in the middle of the Colorado's steepest canyon, was nominated for further study.

Engineers who are scrutinizing the site first built a narrow trail from the rim of the canyon down to the water's edge. It took them eight hours to hike the trail, even after it was built. So they set to work



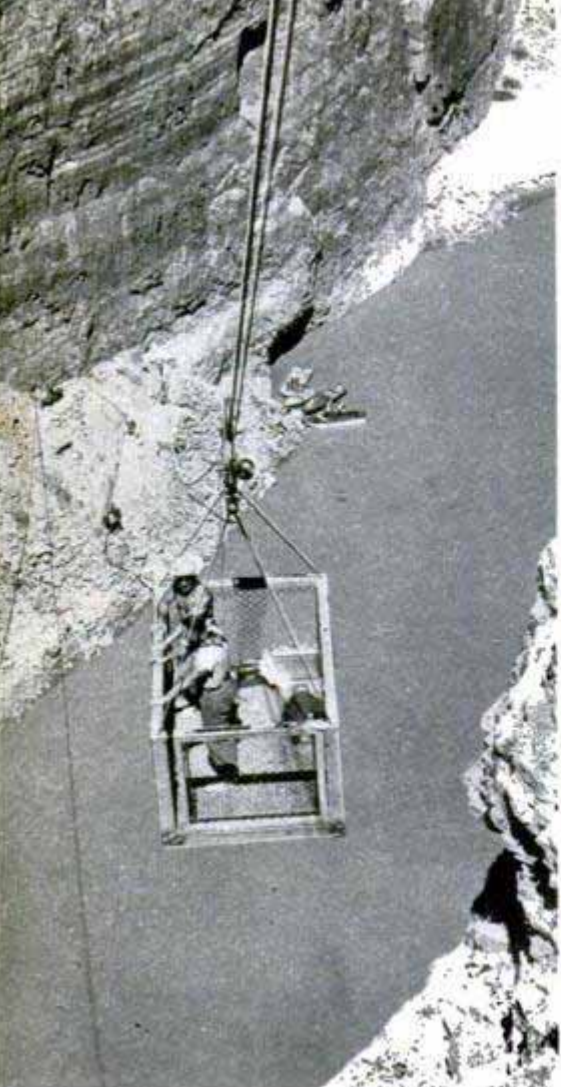

Here's the final drop—350 feet from the tent camp on the ledge to the river channel in Marble Gorge

rigging a temporary cable to span the dizzying drop.

Climbing down ropes, hanging over precipices, drilling at strange angles they finally drew a thin wire over the distance. Then they fastened the heavy cable to the wire and drew it down the face of the canyon to terminal towers set in concrete.

The result is a 3700-foot thread of steel that curves down into the canyon, making a vertical drop of 2200 feet. It ends on a ledge at the front door of the tent camp where the engineers live. Another cable, 800 feet long, finishes the drop from the ledge down to the water's edge.

Now, when an engineer wants to climb out of the prehistoric canyon, he telephones the hoist man up on the rim. The hoist man switches on a compression engine and up the steel strand climbs a cage with the engineer inside. It's a 15-minute ride.

At one point in their work the research men needed two big steel pontoons down on the river. The pontoons were negotiated over the rough edge of the cliff and dropped down the cable to the water. They were anchored by guy wires in the middle of the 380-foot-wide stream.

No one is sure that a dam will ever be

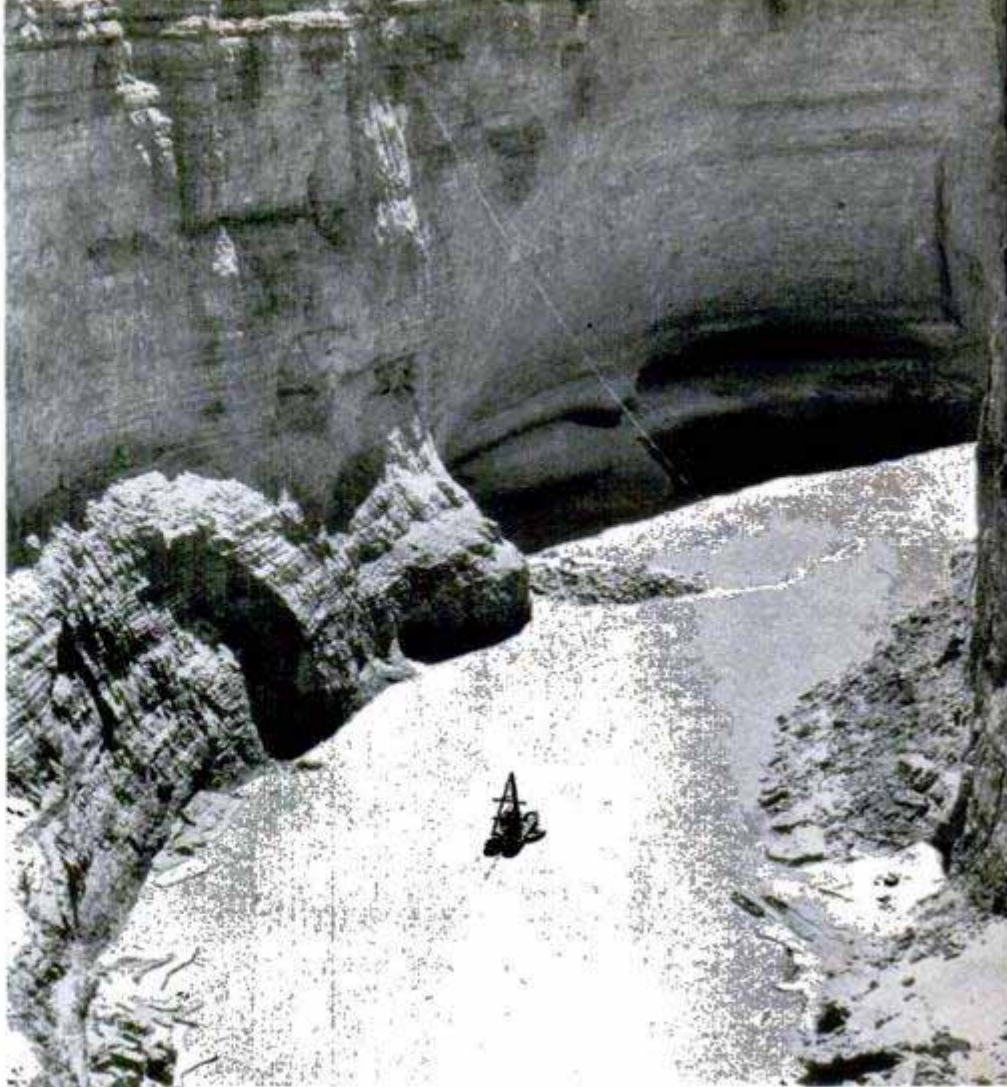

Drilling rig is mounted on pontoons anchored in the river. Shorter cable seen here is 800 feet long

built here. Reclamation Bureau crewmen merely are gathering data which Congress will need to decide whether a birth certificate should be issued for Marble Gorge Dam. The crewmen dig out cores of rock which are sent to the Denver office of the bureau for study. Such cores indicate whether the rock formation of the mighty canyon will support a dam. Fossils tell the age of the formation and numerous chemical and mechanical tests indicate its condition and strength.

Hoist man operates levers to control the engine. He's connected by telephone with the engineers far below





Coming or Going? Train's Not Sure

On a stretch of railroad in Texas there's a horseshoe curve so severe that when the locomotive of a freight train is heading north, the caboose is still going south!

Nearly a mile long, the curve is a few miles west of Sierra Blanca. Southern Pacific Railroad officials say the curve was laid back in 1881.



Corrugated Carport

If you're looking for an inexpensive method of protecting your car, you will do well to copy James J. Moore of Logansport, Ind. His carport cost him only \$35. A framework of piping is set in concrete. Bolted to the piping are strips of corrugated metal roofing. An old canvas protects the front end of the car.

Midget Racer

About \$250 and 500 hours of skillful work combined to produce a torpedo-shaped midget racer that is driven by a motorcycle engine. Built by John W. Ladd of Williams Bay, Wis., the car combines parts of a P-38 airplane (body), a 1938 Willys (front axle), a motorcycle (engine and front spring), a Model-T Ford (steering mechanism) and a V-8 Ford (driveshaft). It weighs 550 pounds and has a 72-inch wheelbase. The engine, mounted in the rear, drives the car at 55 miles an hour.

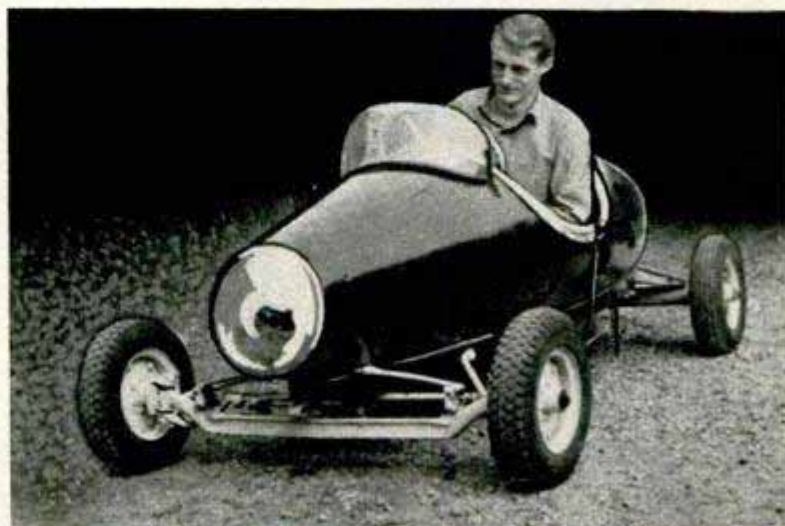



FIRST AID

IF THE A-BOMBS BURST--

By Clifford B. Hicks

Part II

THIS MINUTE, in New York, the shriek of a siren means an air raid—no fooling.

Sirens on squad cars, ambulances and fire engines have been silenced, with no exceptions. If the New Yorker hears a wail, he knows instantly that the Air Force has alerted the city for a genuine enemy raid. No one is crying "wolf" in Manhattan.

Plans already have been drawn up to mobilize the city's 11,800 taxicabs and 35,700 drivers to furnish emergency transportation if an attack comes. And initial steps have been taken toward construction

of a walloping \$450,000,000 worth of dual-purpose atom-bomb shelters and underground parking areas.

New York just isn't kidding itself about A-bombs.

In San Francisco more than 100,000 school children probably will be issued military-type dog tags.

In Chicago there's a plan afoot to make every resident a walking blood bank; each person's blood type would be tattooed in small letters in an inconspicuous spot beneath his arm.



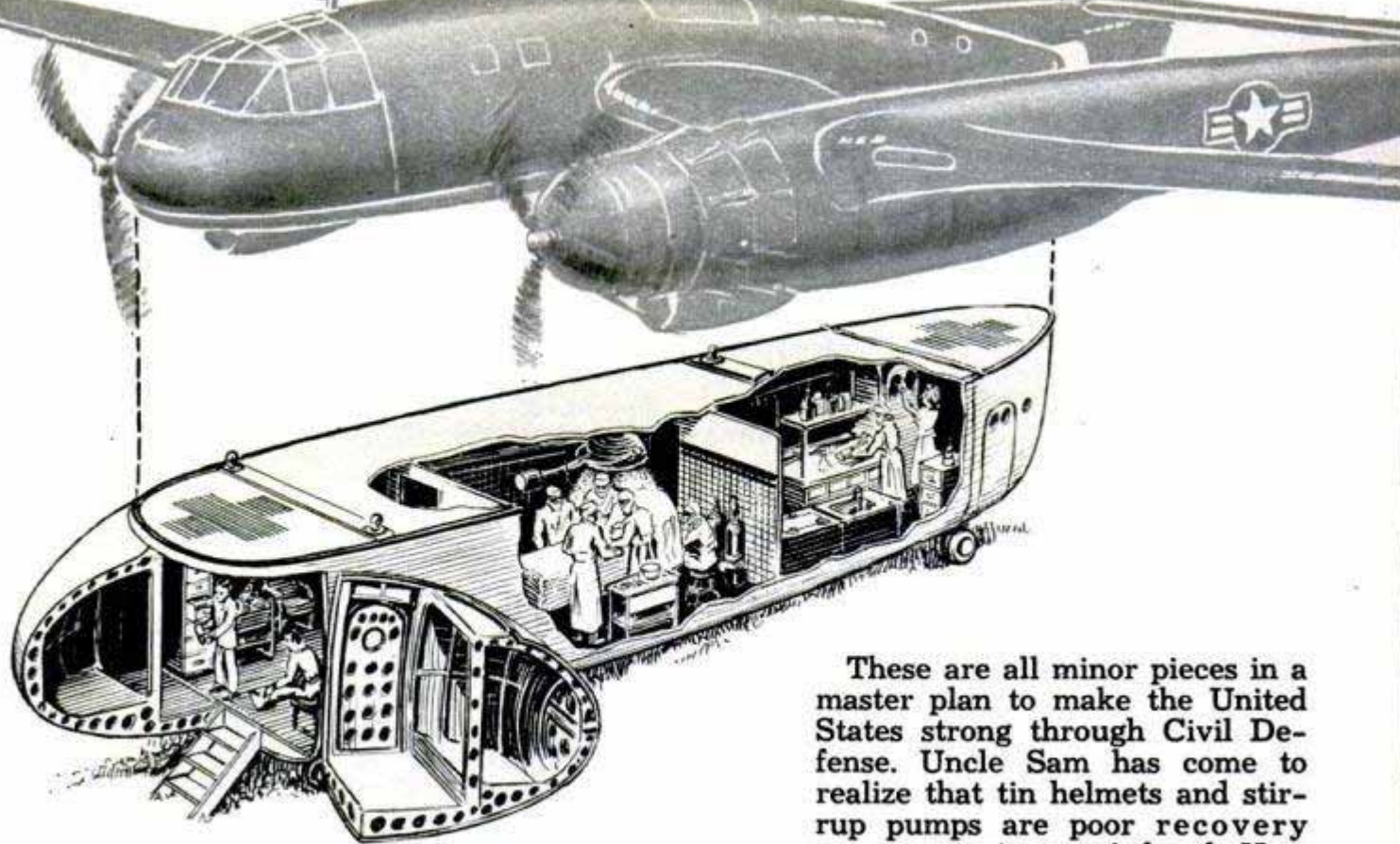

"Pod" units of the new Fairchild Packplane may be available as emergency hospitals for Civil Defense. Pod attaches under belly of the plane, can be flown anywhere and disengaged for use

Civil Defense volunteers already are manning air-raid filter centers. This one is at Pasadena, Calif. On the plotting board, civilians coordinate reports from air observers for Air Force use



These are all minor pieces in a master plan to make the United States strong through Civil Defense. Uncle Sam has come to realize that tin helmets and stirrup pumps are poor recovery weapons against an A-bomb. Now he's trying to replace them with 15,000,000 alert citizens trained in Civil Defense.

The federal government hopes to enlist, in the United States Civil Defense Corps, all types of people from clubwomen driving cars to Boy Scouts serving as runners.

CD is no longer a stepchild. The government recently distributed "United States Civil Defense," an over-all plan which spells out the role the national government, the states and the cities will play in this home-front army.

The number of volunteers needed is virtually a roll-call of able-bodied, nonmilitary Americans. Each will serve according to his particular abilities. How can 50,000 wardens be trained? In Chicago, many of the 14,000 school-teachers will be trained first; they in turn, will help teach the wardens how to handle the job.

The Chicago postmaster has announced a plan to deposit first-aid supplies in the city's 5000 storage mailboxes. If the plan is carried through, 22,000 mailmen will be trained in first aid. A thousand postal vehicles will become an emergency-ambulance fleet.

Ham-radio operators will weave a communications network. Civil aviation, with its 500,000 private pilots and 90,000 aircraft, will air-lift supplies and men.



Right, British workmen repair telephone cables damaged during past war. Quick recovery is major job of CD

Center below, photo taken in England shows a worker tucking children into hammocks. Just another job for CD

According to the national plan, the federal government will establish a staff college of CD. Uncle Sam will pump out informational material, will donate part of the essential equipment and will stock-pile medical and other supplies.

States, in turn, become the "field armies" of CD. They'll have to allocate as much money as necessary to keep alert teams—hundreds of thousands of workers—on split-second disaster notice. The state will help its cities through "mobile support."

Mobile support means just that—aid which can be dispatched on a moment's notice to any point in the state, or outside of it if necessary. Citizens of the state will be enrolled in many types of units from field hospitals to troop and engineering battalions. And here the small towns and villages must play their part. A medical unit, for example, might be organized in a small town under the supervision of local doctors.

From the target city itself must come the thousands of volunteers needed as wardens and rescue teams, auxiliary firemen and police guards, first-aid teams and monitoring crews, decontamination men and aircraft spotters.

Only two things can save a bombed city. The first is its own CD preparations and the other is the help that will arrive from the outside. Mobile support from the state is one type of outside help. Another—and just as important—is "mutual aid." Each critical target area will become the bull's-eye of a mutual-aid circle.

Mutual aid means that neighboring communities help each other. If a conflagration sweeps Chicago after an air raid, all suburbs and near-by cities, possibly as far away as Gary, Ind., will send firemen and equipment. Conversely, if the Gary steel mills are hit, Chicago manpower and equipment will race to Gary's rescue.

Simple? Yes, on paper. But mutual aid, unless backed by legislation, could tie communities into controversial knots. Suppose Gary sends equipment to help Chicago. Who pays the Gary fireman's wages while he works in the Windy City? And suppose a Gary fireman is killed and an engine destroyed. Is the fireman's insurance still in effect? Which city pays for the engine?

When the United States is completely organized—when all volunteers are trained

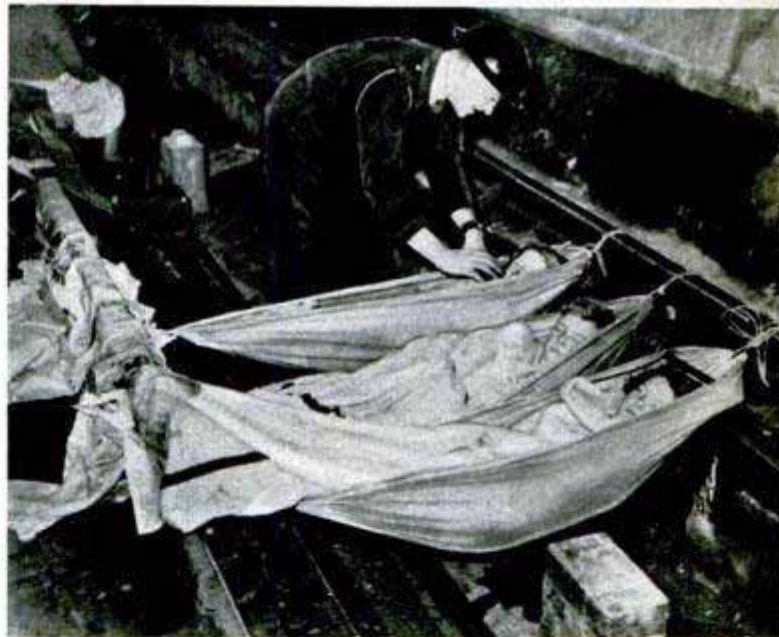
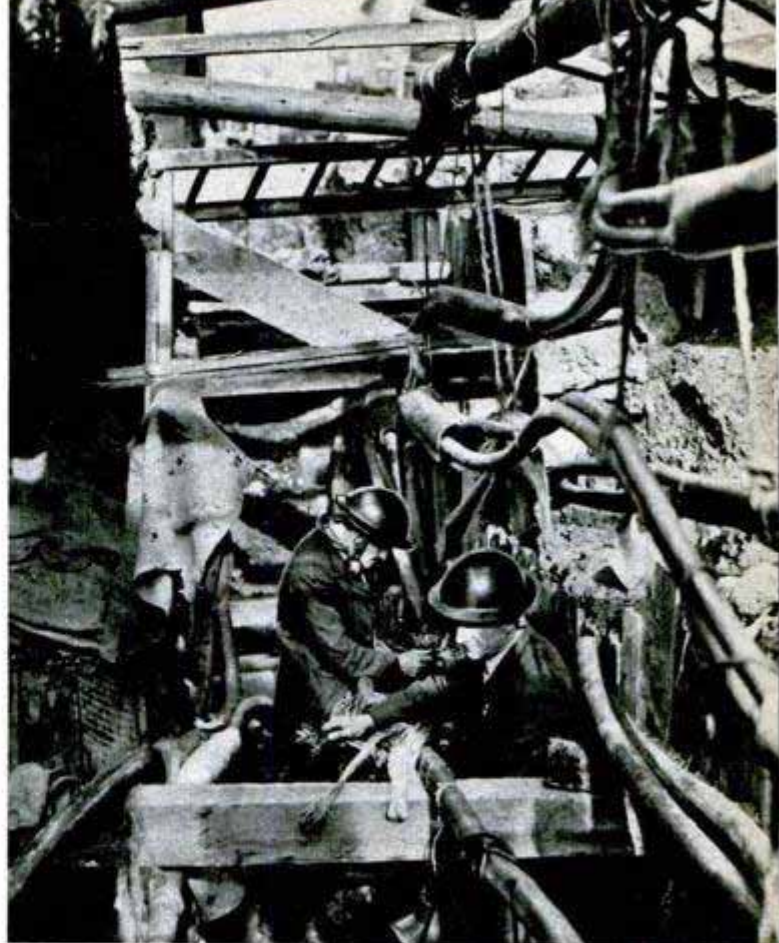

New type Geiger counter, not much larger than a hearing-aid case, is designed expressly for civilian use



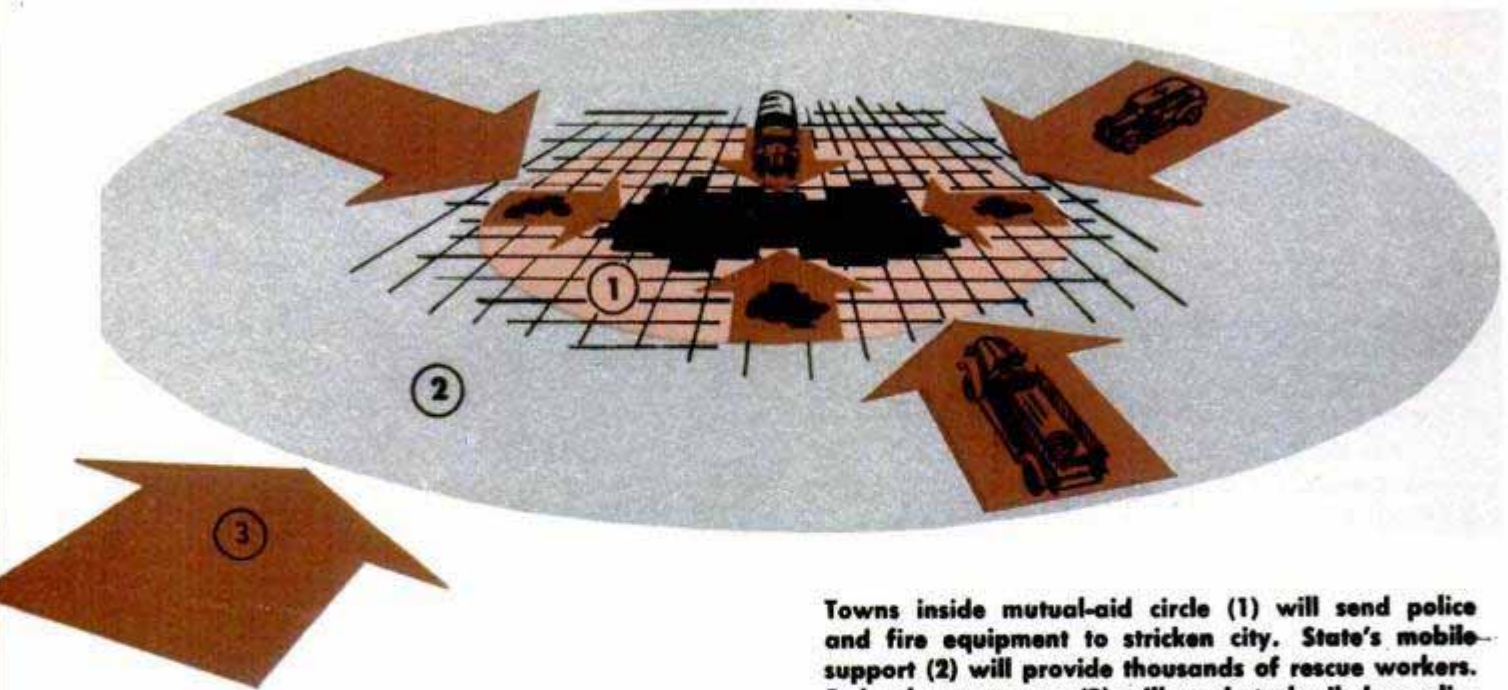

Towns inside mutual-aid circle (1) will send police and fire equipment to stricken city. State's mobile support (2) will provide thousands of rescue workers. Federal government (3) will send stock-piled supplies

—an air raid or disaster anywhere in the country will throw the switch to start the huge CD machine into operation. To be sure, there'll be a grinding of gears here and there, for some key cogs in the machinery will disappear in the atomic cloud. But the civil strength of the whole nation will move to the aid of the stricken city.

The National Civil Defense Office has dropped hypothetical bombs on three cities—Washington, D. C., Seattle and Chicago—to test local civil defenses. Each “bombing” was a pencil-and-paper test. Local officials merely were handed a narrative which told them the events leading up to the raid, where the bombs exploded and what damage was done. Then they were asked, “How will you save your city?”

If the Chicago test had been a terrible reality instead of a fiction, and if the Windy City, the State of Illinois and the federal government had been fully organized in line with the national plan, here's what might have happened:

AT MIDNIGHT the phone rang. Martin H. Kennelly, Mayor of Chicago, sleepily picked up the receiver.
“Yes?”

“The Governor calling, sir. One moment please.”

Ten seconds later the Mayor was standing wide awake beside the bed. Governor Adlai Stevenson's voice was crackling out the most important—and most frightening—message the Mayor had ever received. The Governor had just been informed that northern cities could expect enemy air attacks that night.

It was a sleepless night for Mayor Kennelly and for Anthony J. Mullaney, the city's director of Civil Defense. The two men set to work arousing key personnel. Fire engines rumbled through the streets, their sirens silent as they relocated.

Early in the morning the Air Force transmitted a “Yellow” alert to key city and CD officials. Chicago could expect an attack within an hour. CD teams began assembling at designated points.

Several minutes later an air observer at one of the 330 civilian observation posts in northern Illinois heard the sound of planes overhead. Immediately he reported by phone to the Filter Center, which relayed the information to the Air Force. His call, plus calls from other observers, enabled the Air Force to keep track of the invaders

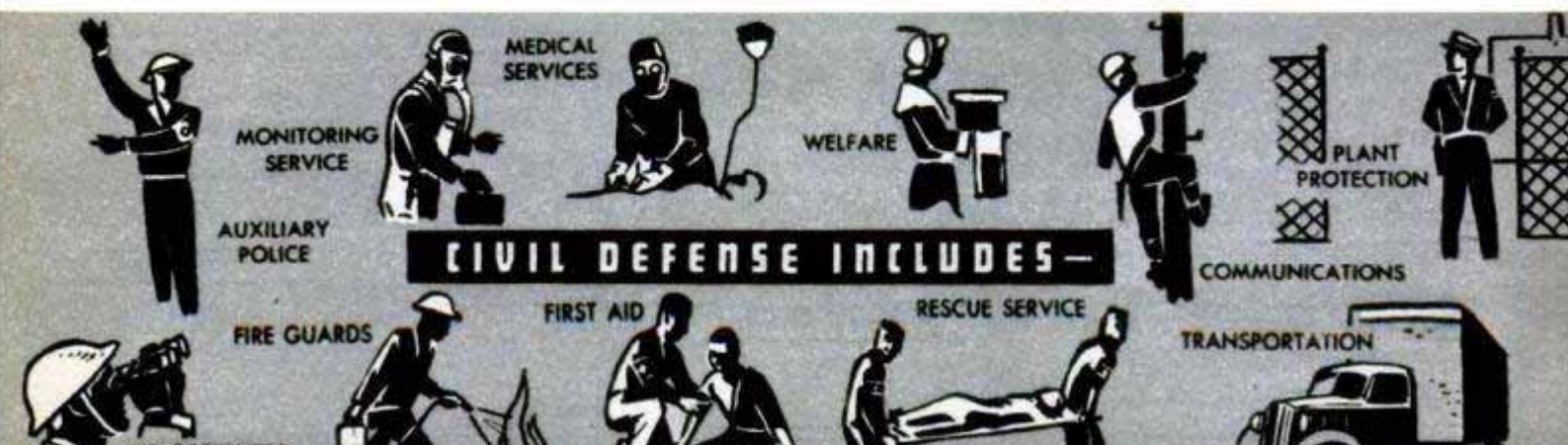



In a recent Chicago demonstration, 100 auto trailers were assembled in 11 minutes to provide emergency housing

even when planes evaded the radar "fence."

No identification of the planes ever was made, so the Air Force alerted the Air Raid Warning Service in Chicago, which instantly transmitted the signal to buildings with sirens. The alert wailed across the city at 6:10 a.m. It was the first public warning. Chicago's 3,600,000 sleepy citizens started scurrying for their shelters.

At 6:26 an atom bomb exploded high above the North Side. Apartment buildings and stores, railroad tracks and sidewalks boiled upward in a geyser of rubble.

Millions of tons of debris were still mushrooming toward the sky when another A-bomb lashed out above the South Side.

Between 45,000 and 55,000 Chicagoans were killed within a few seconds.

Minutes after the second explosion, the "All Clear" sounded. In one rubble-strewn block along Western Avenue, $\frac{3}{4}$ mile from ground zero, there was no movement except the swirling dust. A weakened wall suddenly collapsed. Then a man crawled slowly up what remained of the basement steps in an apartment building. Choking

and gasping through the dust cloud, Al White, the Block Warden, heaved a timber out of the way and stood up.

White coughed until he vomited, steadied himself and then clawed his way to the top of a mound of brick and steel beams. From here he surveyed what remained of

(Continued to page 246)

Battered buildings have become classrooms for the British Civil Defense School. In this country, federal government will form a staff college for CD

British Information Service photo



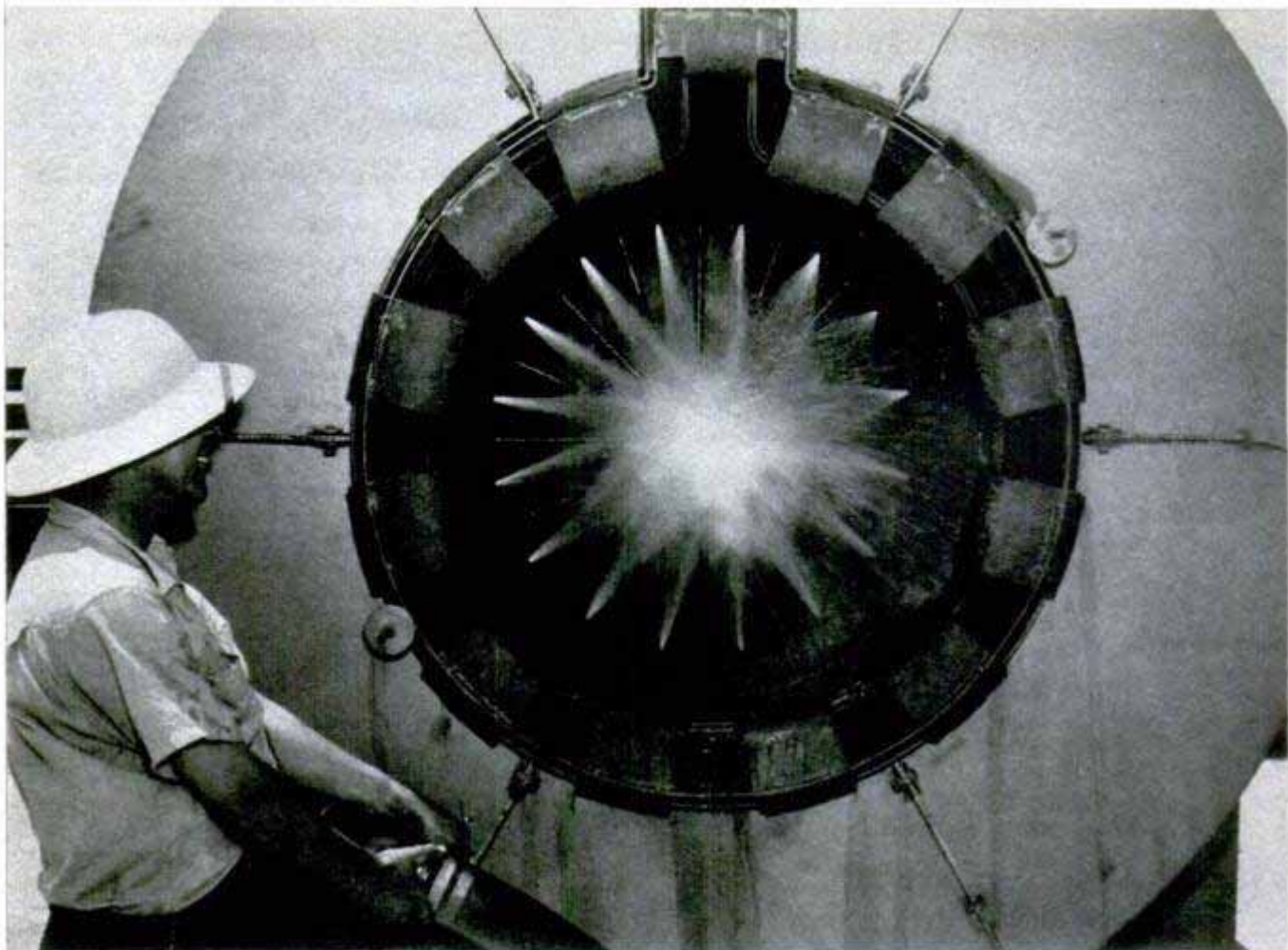

Water spraying from ring of nozzles cools jet-plane exhaust blast from 3500 down to a few hundred degrees

MUFFLER FOR JETS

ENGINEERS at Lockheed Aircraft soon hope to have jet-engine "warm up" noise down to a growl, if not a purr. Within 100 feet of an F-94, when its afterburner roars at full blast, the sound approaches 150 decibels, about 100 times louder than inside a boiler factory. To quiet it, they are using a Maxim Silencer, a giant muffler 7 feet wide and 23 feet long, and a specially designed adapter that connects to the plane's

tail pipe. In the adapter, a ring of nozzles fed from a six-inch water main literally floods the 3500-degree exhaust blast, slowing it and cutting the temperature to only a few hundred degrees. The passage through the adapter being larger than the tail pipe lessens the pressure. In the silencer itself, where an eight-inch copper-wool lining and baffles help dissipate the sound, the exhaust roar is lowered 30 to 40 decibels. With adjustments, the engineers expect to get it down to a sound level scarcely above that of a loud radio.

Front section of installation behind F-94 is the Lockheed-designed adapter. Silencer, at rear, is longer



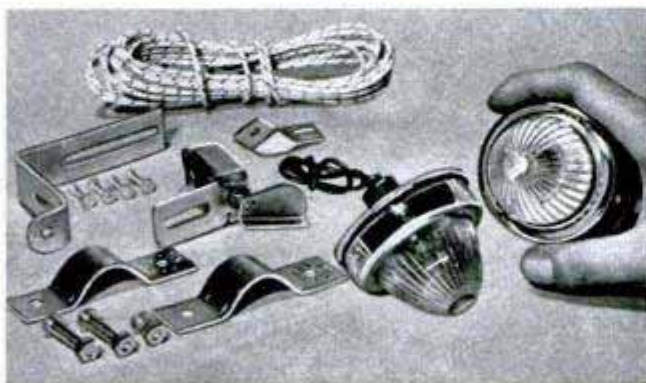
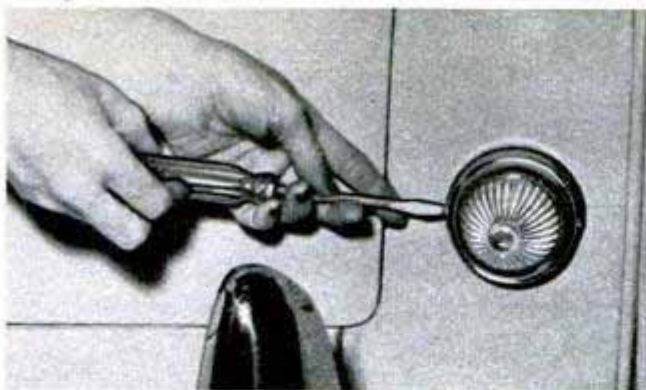

Everything needed to install a pair of flush-mounted back-up lights is provided in the kit, above. You just drill several holes in the body, upper, right, and screw the lamps in place, top. Right, the wiring diagram

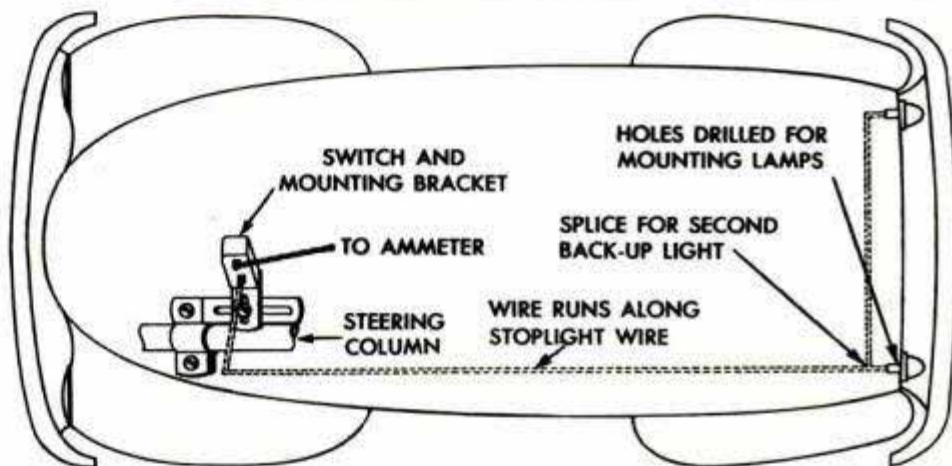

ADD YOUR OWN BACK-UP LIGHTS

You can install a pair of back-up lights on your car in a few hours and the finished job will look like a factory installation. The lights are set in neat flush mountings, protected against water and dirt by rubber gaskets, and look like original equipment.

An automatic switch fastens to the steering column to turn the lights on and off, the action of the shift lever operating the switch. The pair of lights can be mounted on almost any make of car produced from 1939 to date.

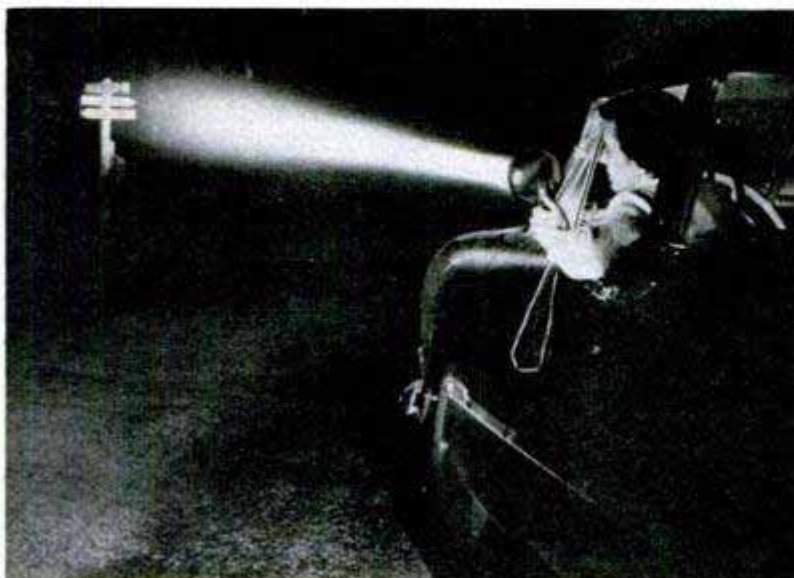

Portable Spotlight Throws 1000-Foot Beam

Small enough to slip into the glove compartment of your car, a baby spotlight throws a 1000-foot beam. It comes with 14 feet of wire so you can use it as a trouble light as well. You simply plug it into the cigarette-lighter socket. There are no holes to drill or installation costs to pay.

☐ An antibiotic called Netropsin, which shows promise as a weapon against clothes moths and carpet beetles, has been reported by the American Chemical Society.



Walnut Pickup

Walnut gathering is made faster and easier on the back by a pickup devised by Wally Buckingham of Reseda, Calif. It consists of a short handle attached to an aluminum cone with two taut coil springs across the bottom. When pressed down on a walnut, the springs spread and the nut pops into the container. The pickup is lightweight and fills to the top.

Unique Bikini Fish

Scientists at the Smithsonian Institution are still finding new species of fish in a collection made at Bikini atoll during the 1946 atom-bomb tests. Seventy-nine of the 481 forms already identified at the National Museum are being described for the first time. One is only 15 millimeters long. Another, a shallow-water oddity, is a flathead the exact color of the sand that covers all but its mouth.

Car Exhaust Kills Rats

Attached to the exhaust pipe of a passenger car, truck or tractor, a handy fumigator kills rats and delouses chickens or animals. The exhaust gas goes through a condenser, where excess moisture is removed, then flows through a generator where it combines with a powder that converts into a lethal chemical gas. The gas is then driven into rat holes and corn or grain cribs for instant killing of rodents. One hundred cubic feet of space can be treated for five cents.



Road Runt

European motorists who like small cars for their economy and maneuverability have a new model to look over—a tiny two-seater Rolux. This baby roadster has a top speed of about 50 miles an hour and its gas tank holds only seven pints! The Rolux weighs 300 pounds and that's usually less than the combined weight of its two passengers.

Information not listed on articles in the index, starting on page 14, frequently is listed in the WHERE-TO-FIND-IT LIST, available to readers without charge from Bureau of Information, Popular Mechanics Magazine, 200 East Ontario Street, Chicago 11, Illinois



With recovered torpedoes strapped in its skids, a retriever ship heads home

TORPEDO RETRIEVER

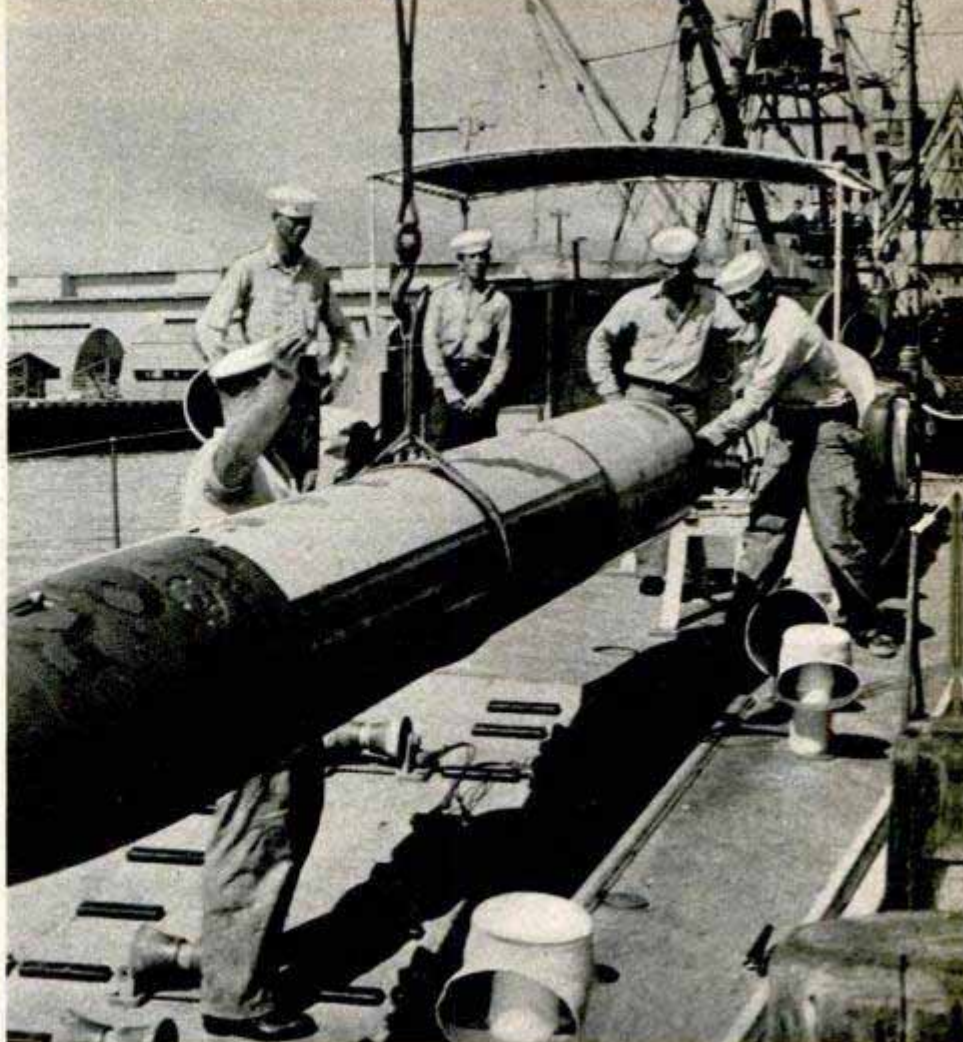

Unloading the day's "catch" of practice missiles at Pearl Harbor

TWO OCEAN-GOING oddities have been added to the U. S. Navy. For the difficult job of retrieving practice torpedoes fired by submarines off Pearl Harbor, the Navy redesigned two crash boats into the most unusual craft in the Pacific. These torpedo retrievers had their aft ends cut away and are open to the sea. An inclined deck replaced the former deck from about the pilot

house to the stern. On it the Navy constructed a series of torpedo skids and set up four hand-operated winches. The retrievers jump into action whenever a submarine has firing practice. They chase a torpedo as it nears the end of its run, toss a lasso over it and wiggle the missile aboard. Two sailors can haul in a 3000-pound torpedo with the winches.

While aft end is cut away, the retriever's downward-sloping deck won't ship water in even a heavy sea

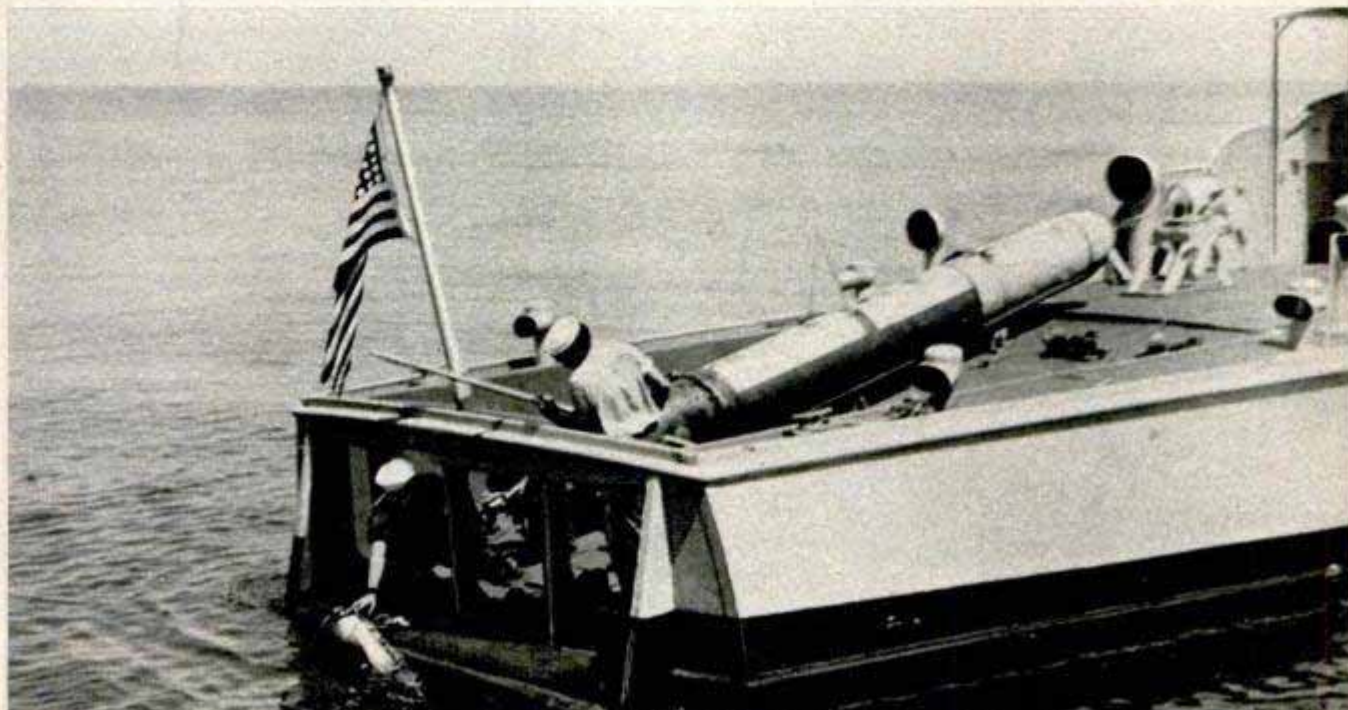



Left, a scientist studies crystal structure. Right, weather experts create a "snowstorm" inside a freezer

G. E.'s HALL OF KNOWLEDGE

General Electric and research are old friends — they've been together for years. Since 1900, in fact, when G. E. set up the nation's first industrial research laboratory

in a Schenectady, N. Y., barn. In less than a year, the lab had outgrown the barn stage and it's still growing. It has just moved into a new five-story, 107-room laboratory where top-flight scientists do basic research in metallurgy, chemistry, electronics and mechanics.

G.E. also conducts atomic research. These scientists are working on the lab's 300-million-volt synchrotron

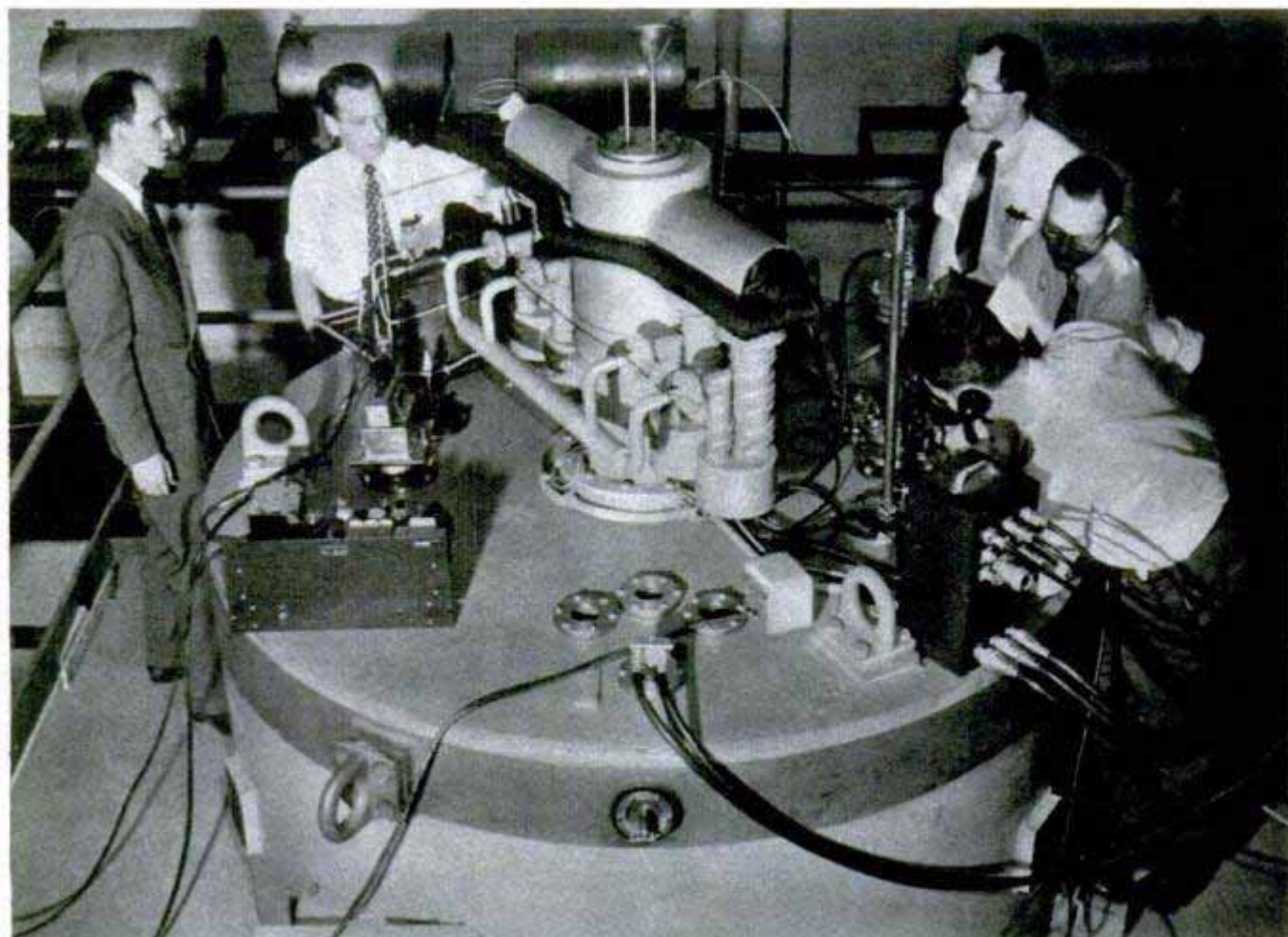

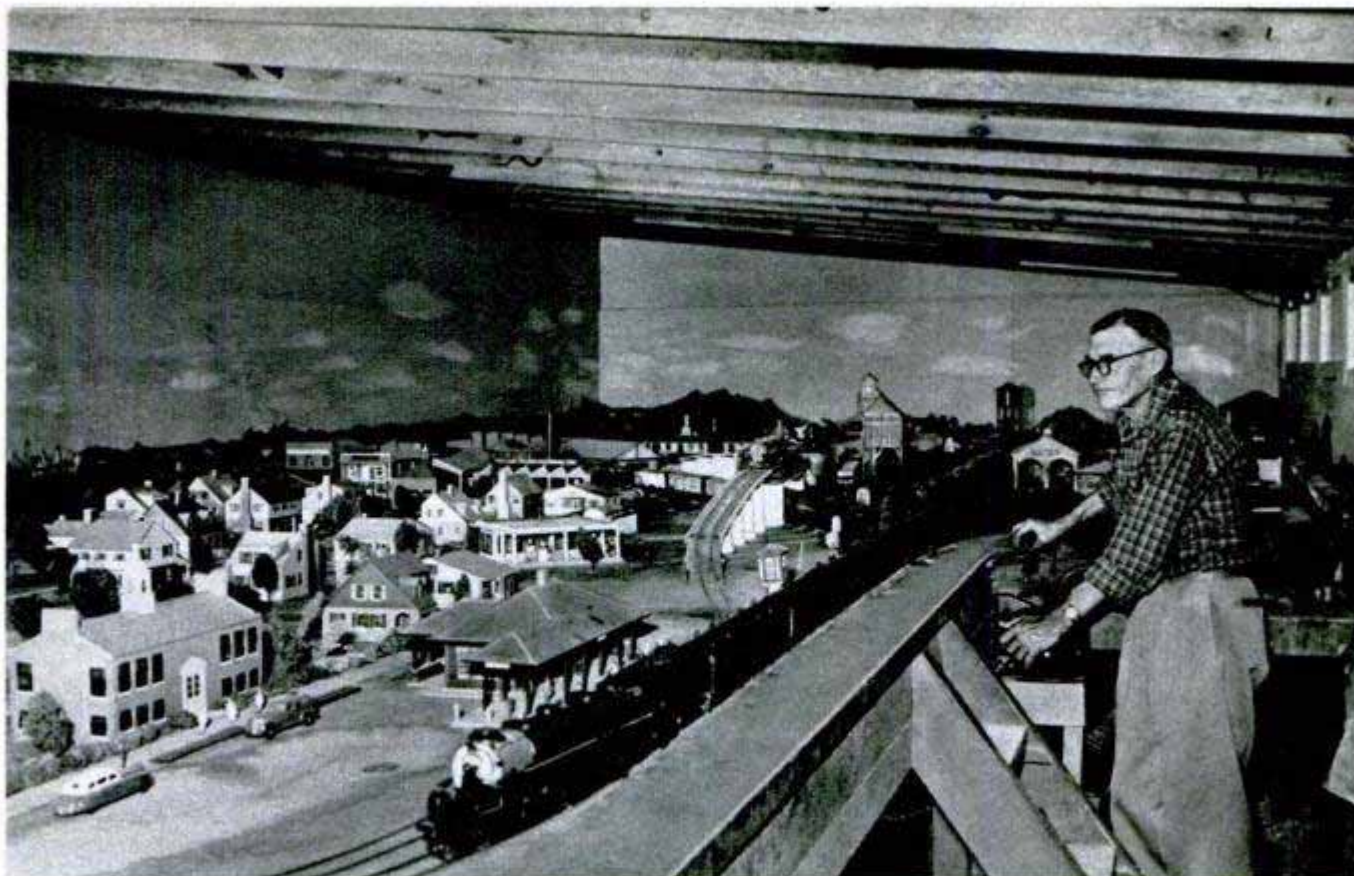

Hottest Railroad

How hot is too hot to operate a model railroad? When the temperature reaches 160 degrees it's time to close down even the hottest line, according to T. R. Goodwin, superintendent of Death Valley National Monument. Goodwin is a model-railroad fan who keeps his rail line running in a

low-ceiling shed even when the temperature edges up to 130 degrees. But at 160 degrees Goodwin closes down the 16 by 34-foot layout and heads for the cooler area on the western boundary of Death Valley. The layout includes six steam locomotives, one diesel, passenger and freight cars and 40 electrically lighted houses and factories.



Concrete Roadway Laid on Swamp

Poured directly on the surface of a swampy bog, a cellular-concrete roadway supported a 5750-pound truck only six hours after pouring was completed. The bog was soft enough so that it could not be walked on without sinking to the waist. No attempt was made to drain the land under



the roadway or to build it up with fill. Wire mesh was laid over the marsh and two rows of logs served as forms for the shoulders. The cellular concrete, which expands $2\frac{1}{2}$ times as it sets, was mixed and pumped into the form through a hose to make a slab about eight inches thick. The roadway was poured as an experiment by Higgins Resources, Inc., developers of the lightweight cellular concrete.

the HOUSE that WORKS on a DIAL SYSTEM

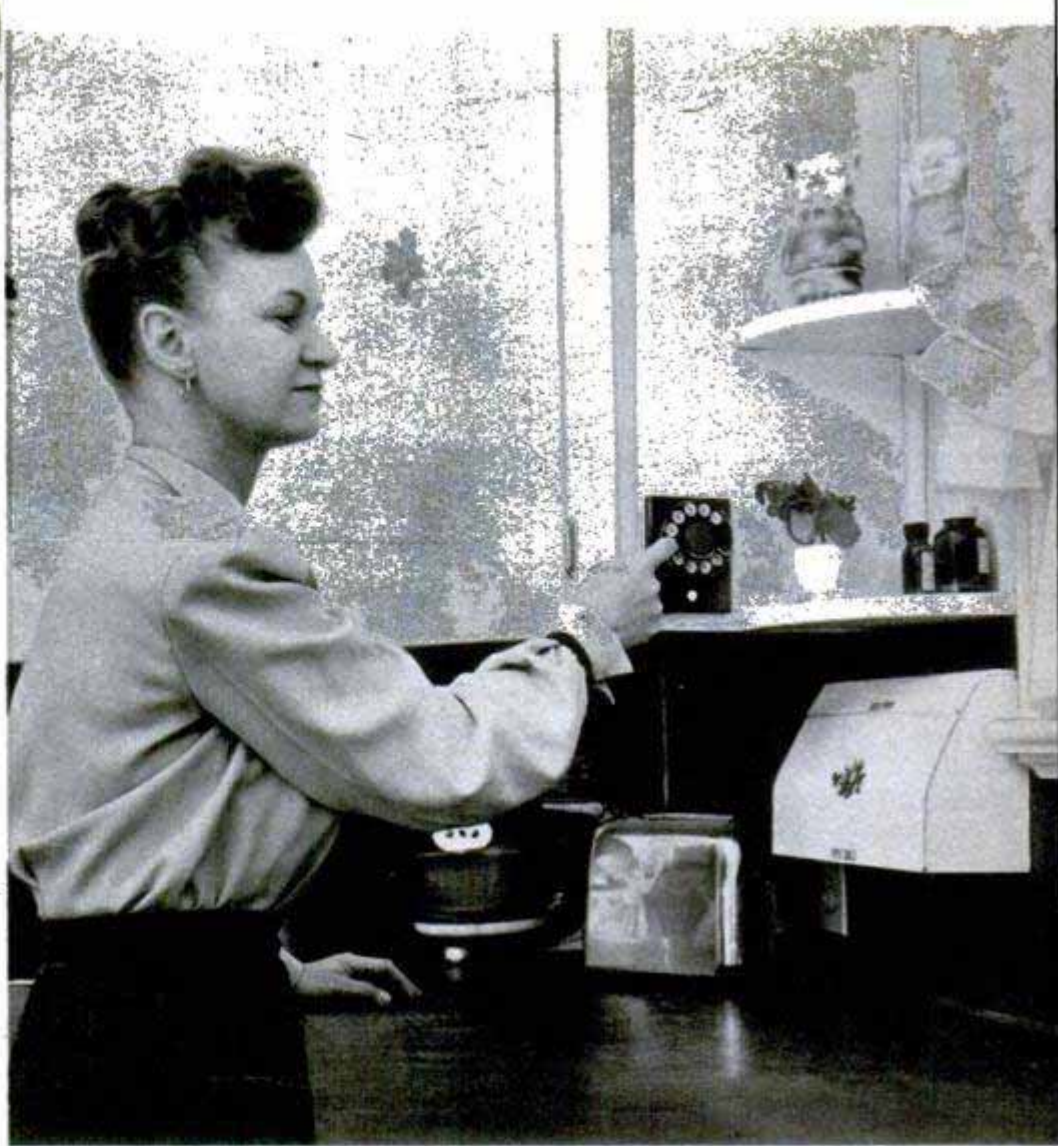

By
Richard Dempewolff

There's one of the "magical" dials in the kitchen. When Mrs. Bassett sees her husband swing his car into the driveway, she dials a number and . . .

WHEN Merton Bassett returns to his Schenectady house late at night, he doesn't fumble around for light switches like the average man groping his way along dark halls and stairways. Instead, he reaches for what looks like a telephone dial fastened to the entry wall, dials two or three numbers and starts walking. One by one lights flick on ahead of him in the house—first in the hall, then on the stairway, then upstairs.

Bassett, control engineer for General Electric, has rigged the dials all over his house, and once you sit in a Bassett chair, there's seldom any need to get out of it for minor chores. Just pick up the nearest dial and start flipping numbers as you would on a telephone. If the family car is coming in the driveway, dial 8106 and the garage door opens; 8107 closes it. Another number turns the radio on; buttons at the base of each dial raise or lower the volume. A total of 14 lights in every room in the house can be turned on and off individually from any of the dials. Special numbers work various combinations.

You dial 9 and every light in the house

comes on. Dial 0, and they all go out. At bedtime, the engineer dials 8192 on the night-table dial. The radio stops playing and the furnace shuts down for the night.

The secret of Bassett's remote-control house is a 24-volt wiring system. Its beauty lies in the fact that it does not require heavy cable for the switch circuits. Wiring to control operation of lights and appliances throughout the house is thin, lightly insulated, single strand. It's threadlike, and hides easily. It carries the low voltage which operates relays, turning on the 110-volt current.

In Bassett's house, the 24-volt current, controlled by dials, activates a selector switch in the basement. If you were dialing 16, for instance—which would turn on the kitchen light—the "1" would bring the selector switch up one notch. The "6" would send it scuttling across six notches sideways. At that point it would make its contact with the proper relay, the current would be carried to a magnetic switch installed in the outlet of the kitchen light, the switch would make contact and the light would go on.



... presto, the garage door opens! Bassett is now working on a radio control so he can dial in the car

Below, the system's "brain" is the selector switch. It's the switch used in many dial-telephone systems

Besides the dials, Bassett is also experimenting with push buttons which do the same thing but are smaller and less noticeable. Instead of turning a dial, you simply press a tiny button set in a neat plastic case. The button is pushed the proper number of times, with a pause between digits. Down in the cellar the selector switch clucks away like an old mother hen, stops at the right contact, and bingo—something happens two rooms away.

The G.E. engineer is building up his circuits gradually. Right now he can turn lights on and off in any room from any one of four dials and two push buttons spotted at strategic places around the house. Besides those already mentioned, he has numbers that will turn on or shut off one, two or all three of the loudspeakers of his central radio set. Number 51 will turn off the overhead lights in the living room and turn on two small table lamps instead. The garage door can be opened, closed or stopped in the middle of its ascent or descent by numbers that control a $\frac{1}{8}$ -horsepower electric motor with a magnetic clutch.

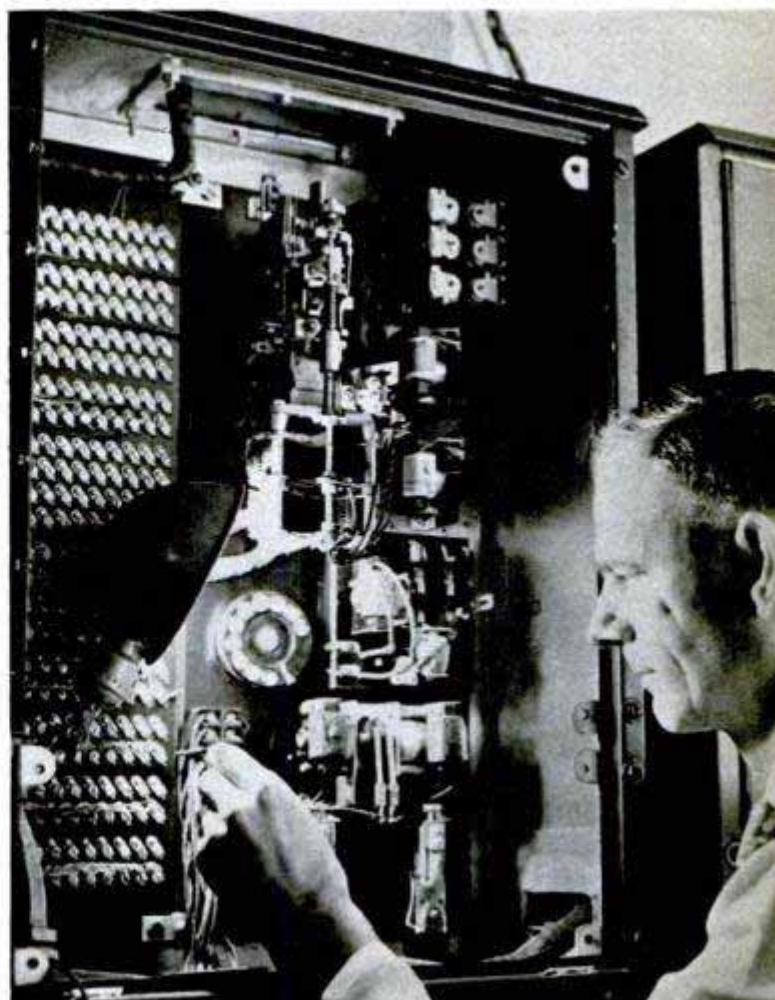



When Bassett leaves the house at night, he doesn't have to check each room for burning lights. He just dials "0" at the door and all lights are turned off

Convenient push buttons do the same thing dials do. Just tap out the number and the system goes to work



"I'm busy rigging a radio receiver that will be hooked to the system," says Bassett. "The sending set will be installed in the car. There will be a dial on the car dashboard and I'll be able to broadcast a dialed number from about three blocks away. The receiver will pick up the impulses, transfer them to the selector switch and by the time I roll into the driveway the garage door will be open and any light that I need in the house will have been turned on and waiting for me."

Probably the most startling thing about Bassett's dial-system house is the effect it produces on neighbors. When combination numbers are dialed, for all lights off, for instance, the house doesn't plunge into instantaneous darkness. The lamps plink off one at a time until all the relays have done their duty. This can look mighty queer from across the street. "We get lots of odd looks from the neighbors," smiles Mr. Bassett. They've seen my wife and me leave the house with all the lights going. They know no one's home, but they see those lights click off one at a time until we're halfway down the block. They probably think we're haunted. But if I told them I did it by dialing '0,' they'd think I was crazy as well."

Midget Road Marker

So versatile it can be used equally well on long stretches of open highway or short crosswalks in town, a compact road-marking machine is ridden and operated by one man. The paint is sprayed on the road for greatest economy. Five gallons of paint will mark up to a mile of roadway. The machine rolls along at about six miles an hour.

Radioactive Cortisone

Cortisone, the powerful drug which provides relief in some cases of arthritis, leukemia and other diseases, now has been made radioactive. Scientists expect that the radioactive drug will help them determine just how cortisone acts inside the body. The new form of cortisone contains tritium, an isotope of hydrogen which is so radioactive that it can be traced in extremely small amounts through the body, according to the



Sloan-Kettering Institute for Cancer Research, which first synthesized radioactive cortisone.



Tiny Telescopic Gun Sight Mounted in Two Seconds

Hardly a handful, a tiny rifle telescope designed around ground front-surface mirrors provides more accurate shooting even during early morning and twilight. The new optical system loses no light and permits accurate aiming against the sharply defined crossed hairlines. It easily fits in a hunter's inside pocket and can be mounted in two seconds. A coin turns the one screw holding it in place.

Pocket-Size Sun Lamp

So compact it takes up little space in a suitcase, a small sun lamp is ideal for travelers who don't want to miss their daily session under the ultraviolet. The lamp combines both ultraviolet and infrared rays and can be used without goggles because harmful radiations are screened out. The lamp plugs into any 110-volt a.c. outlet and weighs 1½ pounds.

☐ Montana's 222 billion tons of easy-to-mine coal reserves, though generally below good industrial quality, hold great promise for synthetic liquid fuel.



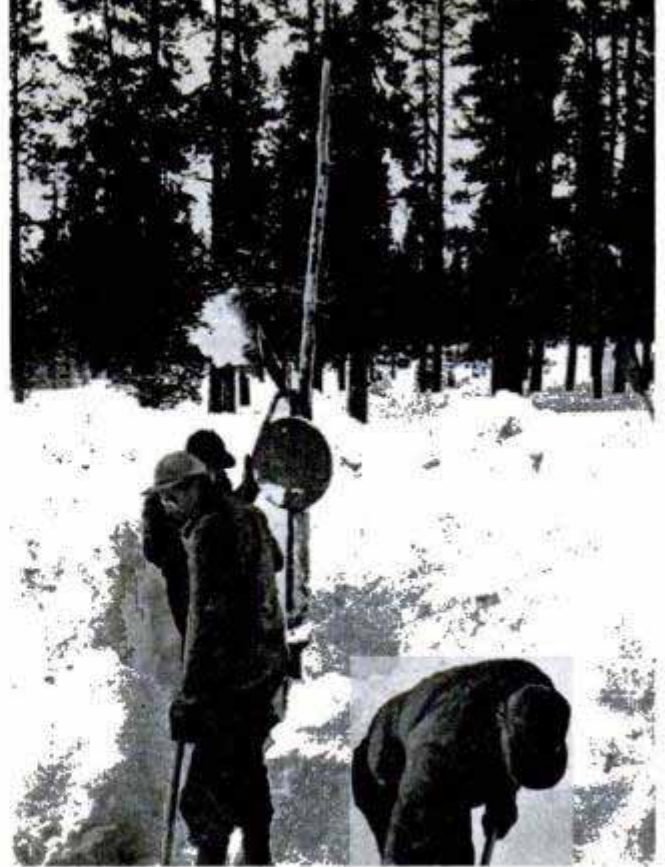

Top, left, water tanks along the railroad are empty so tank cars that feed water to the locomotives are filled from mountain streams along the right of way



Above, switches have to be dug out by hand when the railroad shakes loose from winter's grip. Note that the switch stand was marked by lashing a tree trunk to it so that it could be located beneath deep snow



Left, your eyes are not deceiving you! That is the top of a crossing sign that can be seen sticking up through eight feet of snow as the plow moves along

Below, here's the new Lima-Hamilton diesel rotary snowplow that will get its final test this spring over the track between Ashton and West Yellowstone

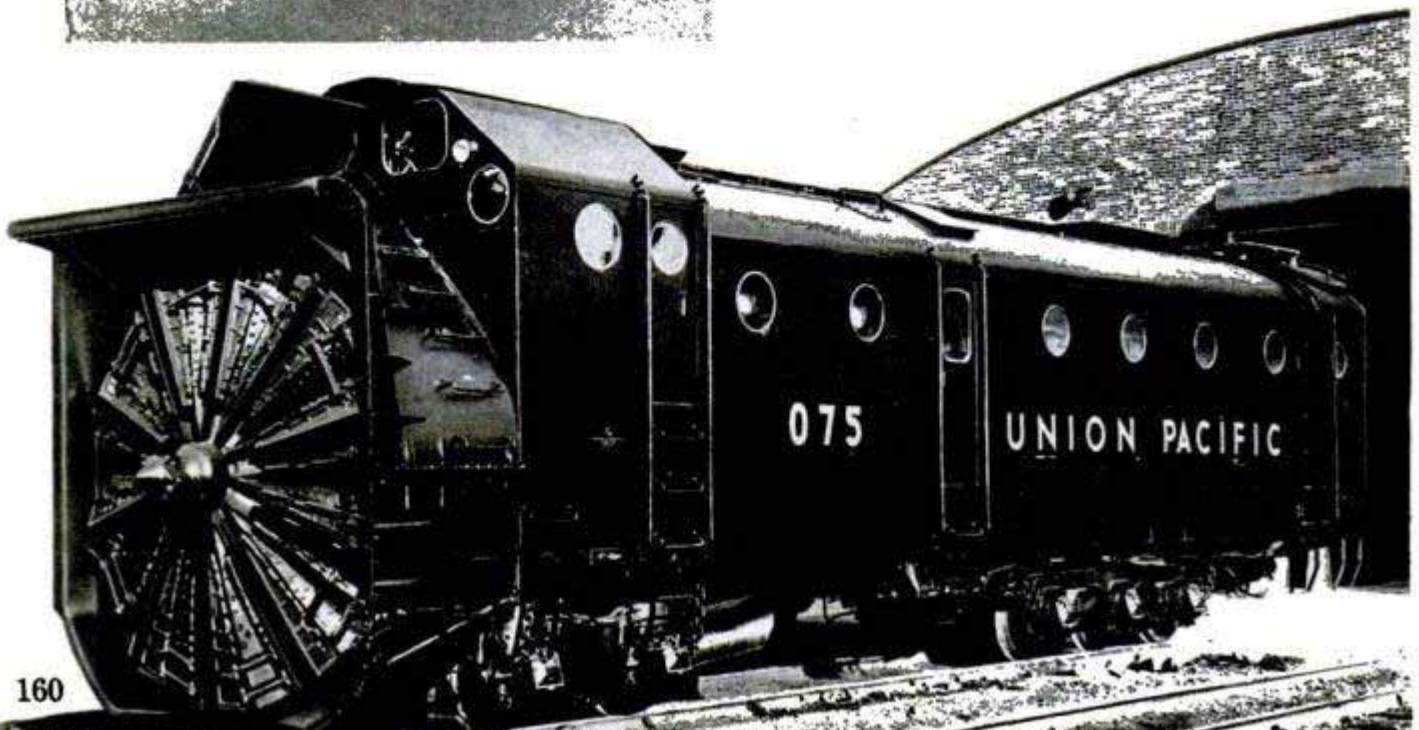

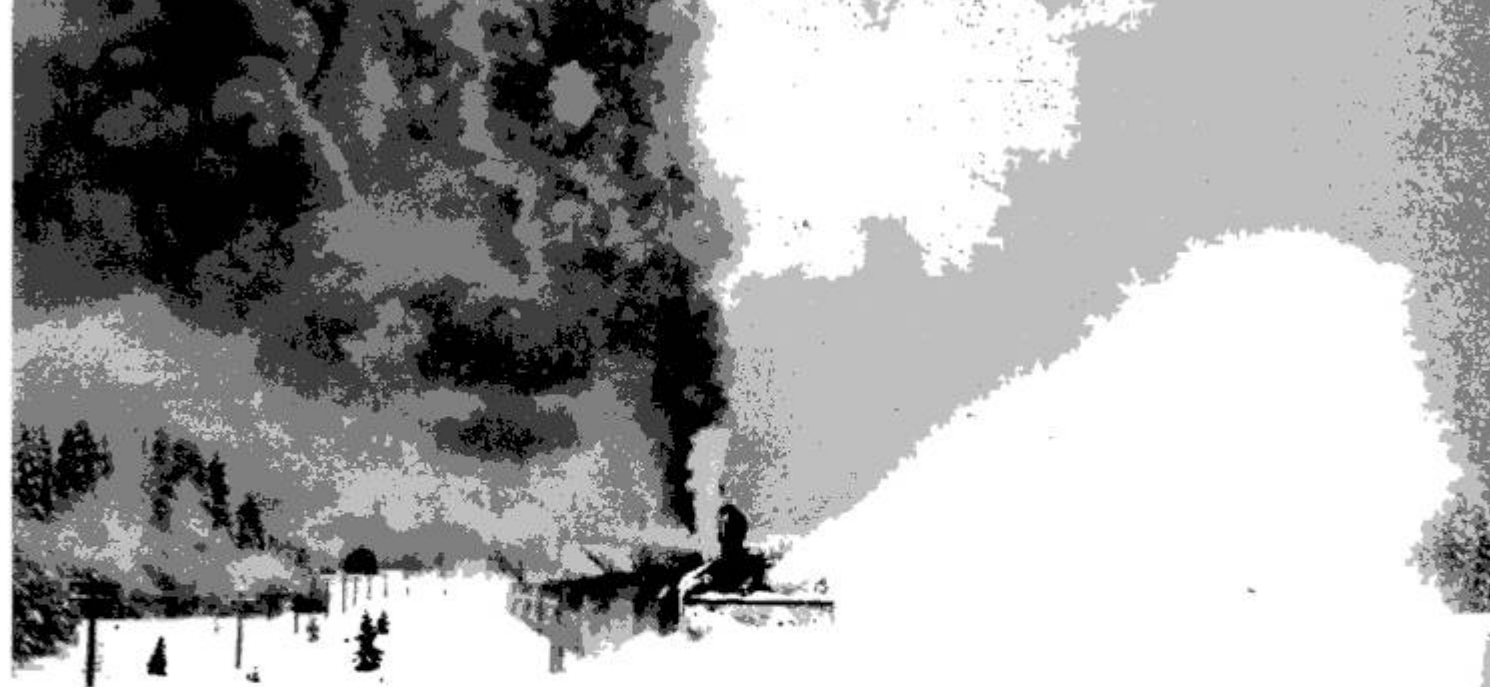

Pushed by two steam locomotives, the diesel snowplow tosses the snow off the track during its initial tests

A Railroad Comes Out of Hibernation

By Ewart Thomas

A RAILROAD that hauls 25,000 passengers each summer and then hibernates through the winter provides a natural testing ground for snowplows every spring when it shakes off its thick coat of snow.

The line is Union Pacific's 56-mile branch between Ashton, Idaho, and West Yellowstone, Mont., gateway to Yellowstone Park. The winding single track crosses the continental divide at 6934 feet above sea level and has an average grade of two percent. Tourists grow scarce come mid-September and the railroad shuts down tight.

Plowing the road open again in March or April before the winter snows have melted is one of the toughest assignments that a plow can be given. It would be no chore with fresh snow, but this snow has been settling and consolidating for months. In addition to buried crusts there are considerable ice and layers of dirt and gravel that drifted in with the wind. Railroaders expect to find five feet of packed snow over the rails in the open stretches in the spring, and as much as 20 feet in the drifts and cuts.

The opening requires a special task force of men, plows and motive power. The expedition may consist of four steam locomotives, three rotary plows that will be tested on different parts of the line, 20 other units of rolling stock and as many

as 75 men including engine crews, track workers, observers from other railroads and observers from the plow manufacturers. Years ago a whole week was needed to clear the line; today almost any modern rotary plow can do the job in two or three days.

This coming spring a new Lima-Hamilton oil-burning diesel rotary plow will lead the parade for its final tests after having been tried out for the first time last year. The big plow is rated at 1500 horsepower, a third more than older steam rotaries, and it weighs 303,000 pounds. All of its power is used to spin its 12-foot-bladed head-end rotor and to toss the snow as far as 150 feet to one side of the tracks. The unit is pushed from one to six miles per hour by a pair of coal-burning Consolidation locomotives. Its operator can spin the rotor up to 150 revolutions a minute and he uses a throttle control to keep the blades whirling at the right speed in varying depths of the drifts.

As the expedition slowly moves along, track walkers inspect the cleared track and the bridges behind the train, and electricians check the telegraph lines. Extra water for the locomotives is carried in tank cars, but at least once each day additional water must be pumped into the tank cars from a stream. Not until warm weather



It may not look like it to you, but when this snowplow breaks through, spring has come to West Yellowstone

are the water towers filled with water.

Clearing the snow from America's rail lines actually takes several kinds of special equipment, depending on the conditions that exist. An ordinary locomotive with no extra equipment except a small flanger mounted in front can break through drifts of fresh snow five or six feet high without danger of derailing. Wedge plows that split the snow and toss it 25 feet away are ideal in open country where a speed of 25 miles

an hour can be maintained, if the snow isn't too deep. The big rotaries rarely move faster than six miles an hour but they can handle snow of any depth and they can clear the snow from lines on which high speeds are impossible. They are ideal for mountain country. And, the railroaders remark, if a rotary proves its worth in cleaning the snow from Union Pacific's West Yellowstone branch, it can handle any fall of snow, anywhere.

When there are only three or four feet of fresh snow, a flanger blade on the locomotive handles it easily

Even when the summer tourist season starts, there is still snow at the West Yellowstone railroad station





Brake for Accelerator

Through a brake mechanism which fits on the accelerator, a motorist can use the same pedal for speeding up or stopping his car. The mechanism eliminates the need for a brake pedal, though it does not affect the operation of the standard brake pedal in any way. It is activated by a slight pressure of the driver's heel—when he wants to speed up he presses with his toe and when he desires to stop he pushes with his heel. The attachment, which fits any car equipped with hydraulic brakes, is installed under the hood and connected to the brake system between the master cylinder and wheels. The mechanism can be installed by any mechanically inclined person in a few hours.

Push-Button Shave Cream

Now the man of the house can push a button and get a handful of creamy shaving lather. The new form of shaving soap is pressure-packed inside a can. When the shaver pushes a button, the lather flows out a nozzle. There's enough lather for about 50 shaves inside the small container.



Official MATS photo

"Bucket of Bolts" Car

For only \$36.80, M/Sgt. Murray Miller, Jr., of the Air Force built himself a three-wheel car, bought a license and insured the vehicle. Stationed in Hawaii, Sergeant Miller invested his money in surplus parts and a "bucket of bolts" which he fashioned into a small auto. He spent about 50 hours of off-duty time in joining the parts with the bolts. The resulting auto has front-wheel coil springs, a two-speed gear system and travels 65 miles on a gallon of gasoline. Furthermore, there's room for his baby daughter in a special compartment up front.

Fold-Down Metal Edging

All the fastenings of a new type metal edging for table or sink tops are concealed by the covering material. When the material is in place, the molding's lip is folded down with a hammer handle or a wood block to make a waterproof joint.

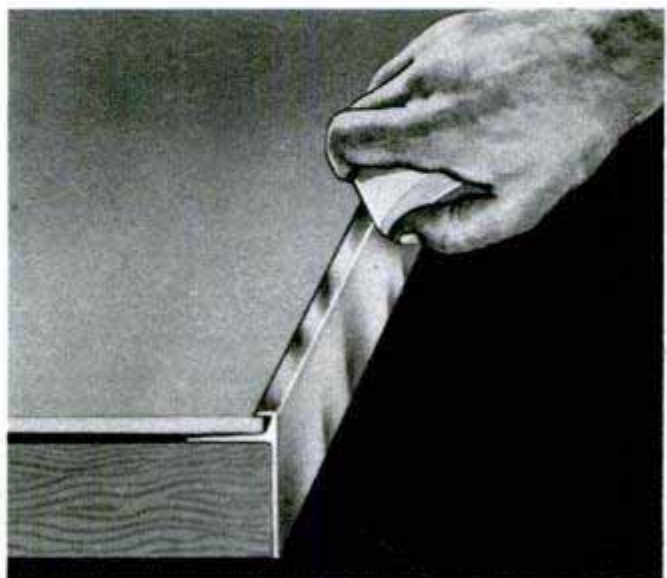



Photo Cart

Press photographers of the Chicago Tribune, determined to catch all the excitement of a night football game, have developed a special cart which holds a bank of speedlamps. The cart makes it possible to wheel all lamps up and down the side lines to follow the action. The photographers wanted to portray the crowd in the background as well as the action on the field. Ordinary lights will not carry far enough to illuminate such a background. The speedlamps are mounted on the wheeled cart along with their power packs. A special support makes it possible to swivel all lamps in the same direction simultaneously.

Silting of Western Reservoirs Is Groundless Fear

Fears that our Western reservoirs will become filled with silt in a comparatively short time have been determined groundless, according to Oscar L. Chapman, Secretary of the Interior. Lake Mead won't become completely filled with material carried by the Colorado River for another 275 years even if no upstream dams are

built meanwhile. Studies reveal that Hoover Dam has trapped about 105,500 acre-feet of silt each year since it was built in 1935. This is just 500 acre-feet more than was predicted before the dam was built. Taking all factors into consideration, engineers say Lake Mead will be useful for water storage until the year 2380.

the

POPULAR
MECHANICS

CRAFTSMAN

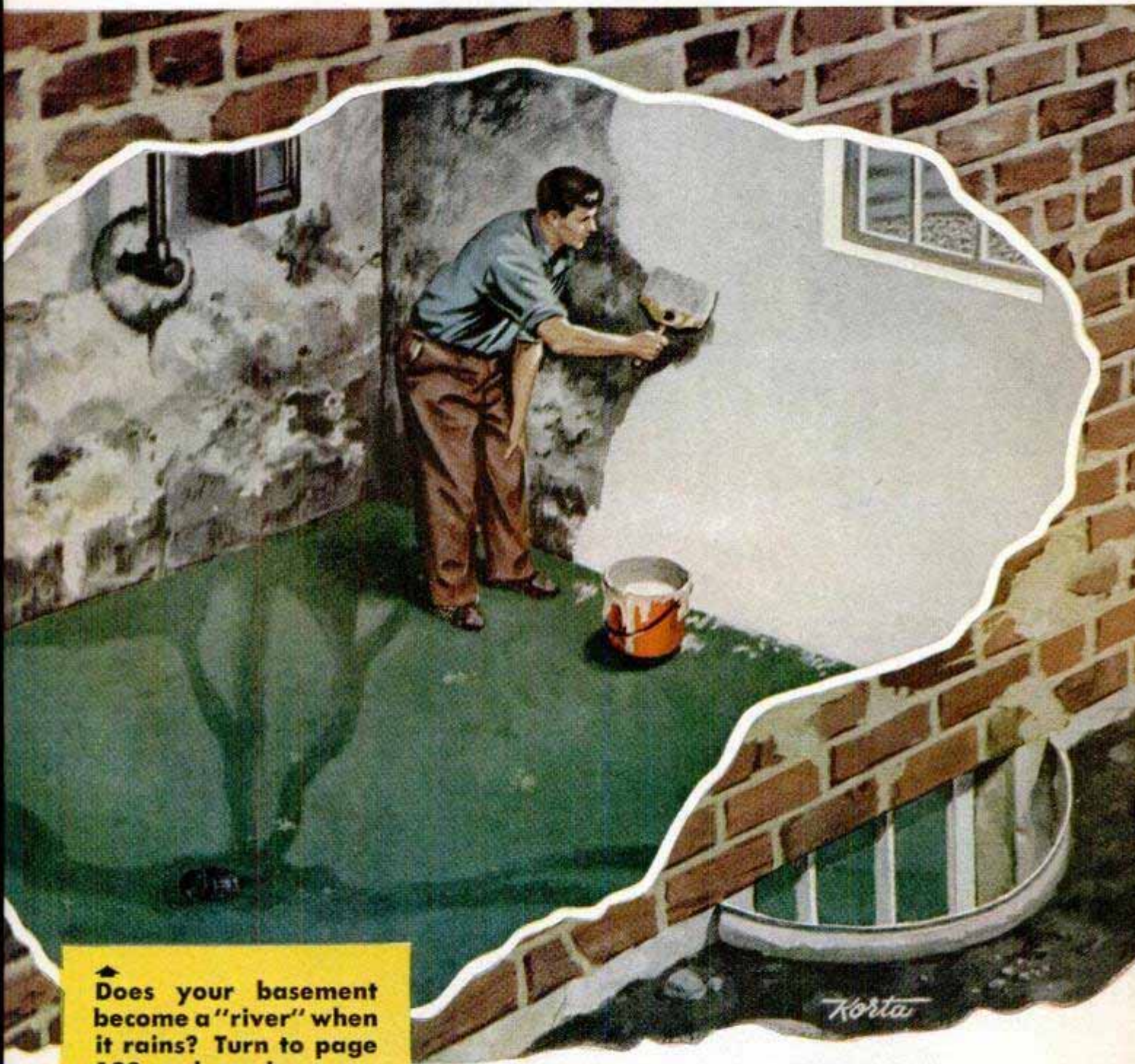

↑ Does your basement become a "river" when it rains? Turn to page 188 and see how you can keep the water out and make the basement really "belong" —not a damp, musty hole under your house

♦ Farmers will welcome this tractor-mounted mower. See page 214



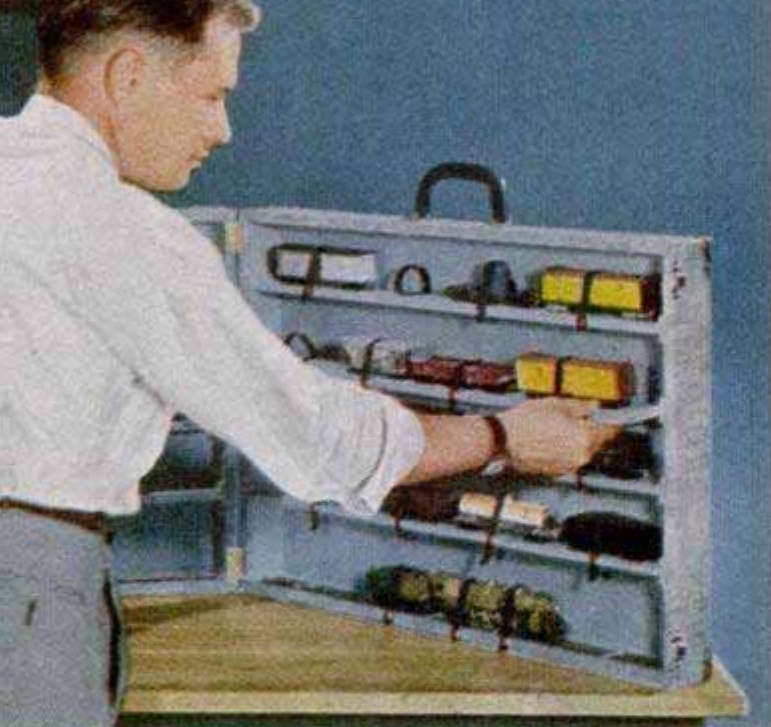

HO TRAIN CASE

MODEL RAILROADERS of the HO class who visit and operate their rolling stock on the track systems of fellow enthusiasts will go for this neat carrying case. Built by Frank Beatty, art director of Popular Mechanics and himself an avid HO fan, the case is designed to hold up to 36 cars and as many as 4 locomotives. Consisting of two parts hinged at one end, the case opens wide to reveal two storage compartments, each one being fitted with four removable shelves. Bands of elastic tape held with thumbtacks anchor the cars to the shelves. The case is made as a single box, complete with top and bottom, and then sawed in half edgewise. Both sections are covered with imitation leather, after which suitable suitcase fittings, handles and metal corners are attached to complete the case

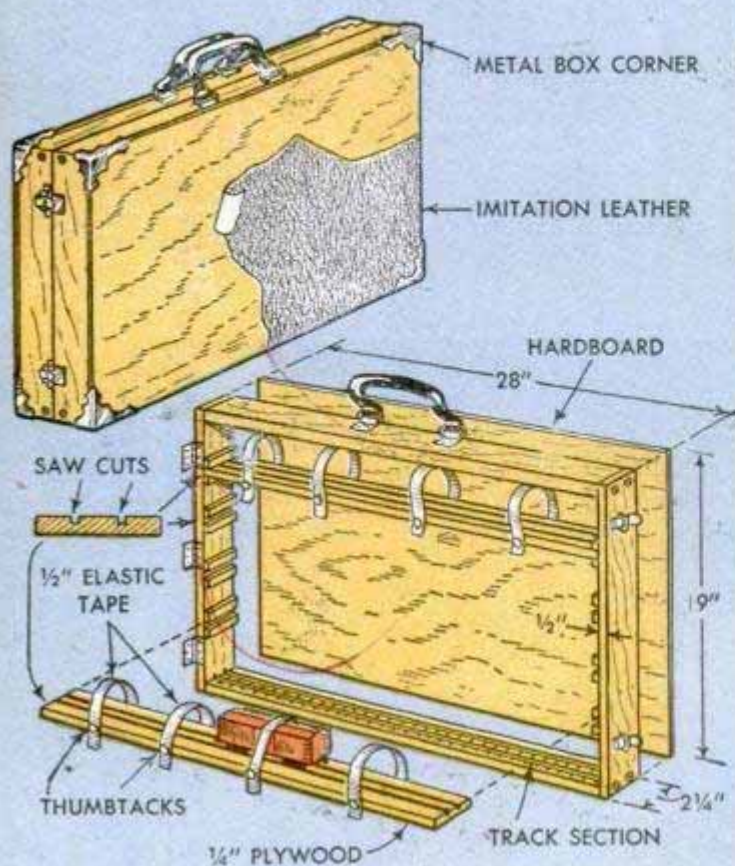

Beautiful Finishes with
PLASTIC



PM color photos by Paul T. Hutchinson

The two companion pieces pictured here, step table and commode, and also the desk on the opposite page, show how veneers of contrasting wood grains can be combined effectively to relieve plainness



VENEER

By Wayne C. Leckey

NOW THAT you, perhaps, have had opportunity to become acquainted with the application of plastic veneer—the new marble and wood-grain material described last month—several additional pieces together with constructional details are presented here to show further possibilities of this amazing material. Like the others presented in Part I, these pieces were designed and built exclusively for *Popular Mechanics* from inexpensive poplar plywood. Then, with the cooperation of The Meyercord Co., one of the manufacturers of plastic veneer, the plain poplar

Part II



If made of the rare woods represented, this beautiful desk would cost a fortune and, yet, when covered with inexpensive plastic veneer, it's difficult to tell it from the real thing

The massive top of this stunning planter cocktail table is built-up, but when covered with plastic veneer, all joinery is concealed and the top appears to be made from a solid plank of rare and expensive wood

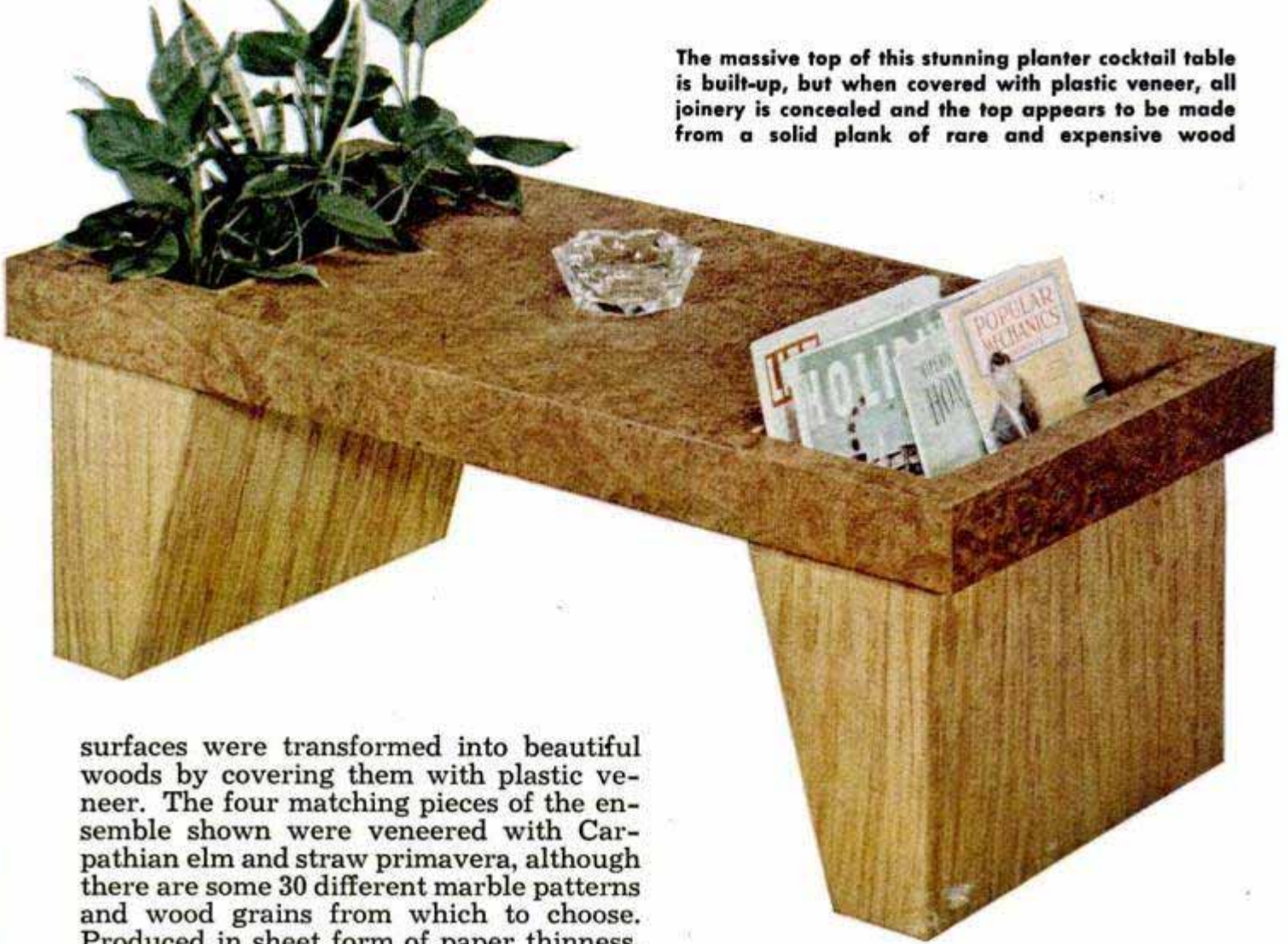

surfaces were transformed into beautiful woods by covering them with plastic veneer. The four matching pieces of the ensemble shown were veneered with Carpathian elm and straw primavera, although there are some 30 different marble patterns and wood grains from which to choose. Produced in sheet form of paper thinness, the veneer resembles a decal in some respects in that it has a paper carrier that is removed by soaking. But, unlike a decal, it is cemented to the surface with a special slow-drying adhesive. The examples at the bottom of the page picture two excellent uses for black-and-gold marble veneer; one simulates a real marble top on

a wall console table, while the other example shows how the veneer can be used to form marbleized mats for wall prints. Here, the veneer, when cut, is merely cemented to the back side of a piece of plate glass and, of course, requires no finishing whatever. Normally, the veneer,

Like the cocktail table above, the top of the console table below, when covered with black-and-gold marble veneer, appears to be cut from a solid slab of marble, when actually it's merely wood. The plate-glass wall picture, below right, shows how marble veneer can be applied to form unusual mats for the prints



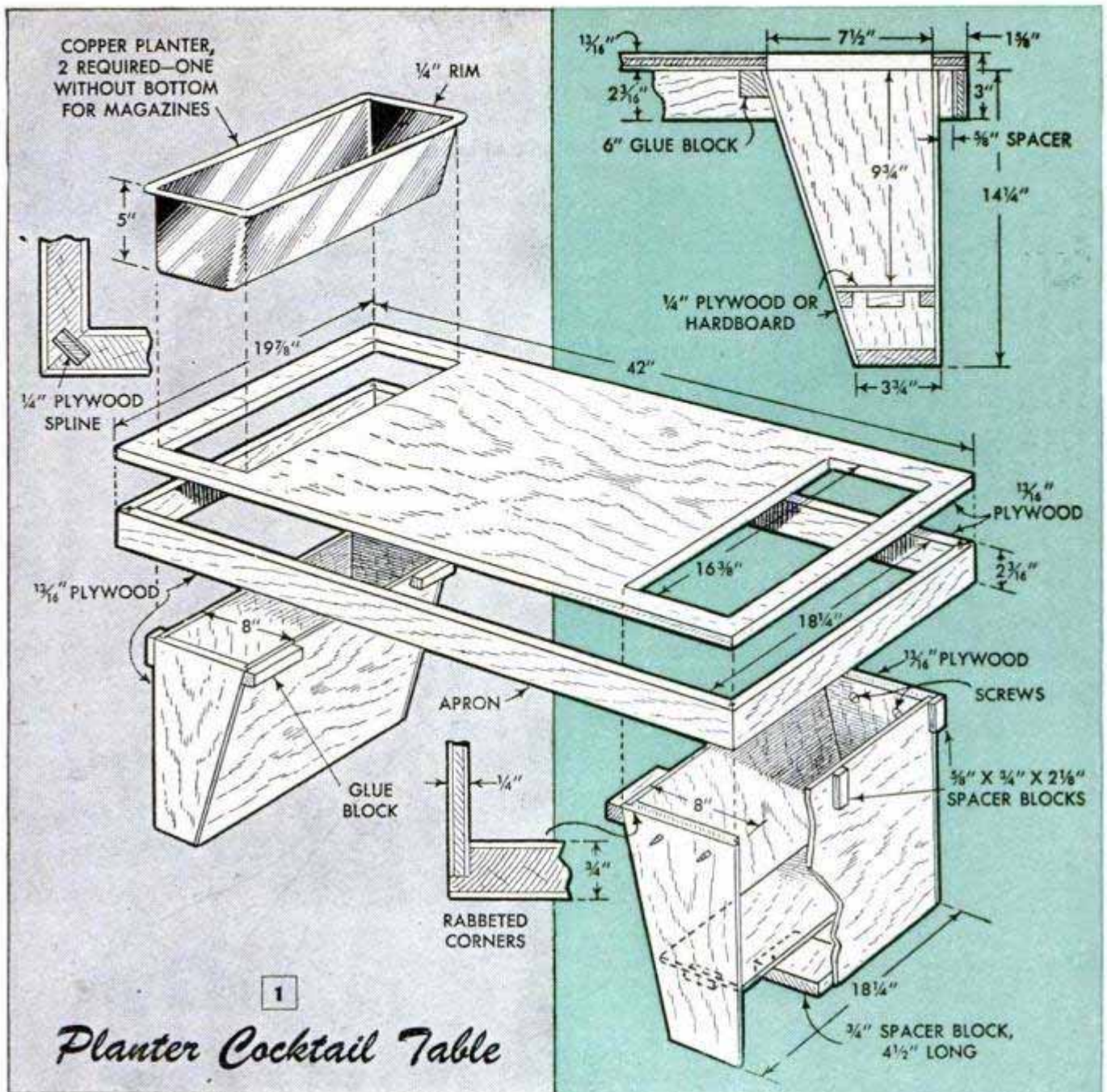

1
Planter Cocktail Table

after application, is either sprayed with a protective finish of satin or flat-drying lacquer, or finished with several coats of varnish—no staining, sealing or filling being necessary. However, whether varnish or lacquer is used, each coat should be rubbed smooth with No. 10/0 waterproof sandpaper before applying the next coat.

In addition to covering new work, plastic veneer offers great possibilities in the transformation of old furniture and, once you have worked with this amazing material, other applications will suggest themselves. Part I described how easy it is to apply plastic veneer, and the results of your first job are sure to surprise you.

Concealing the laminations of plywood has always presented a problem. While the only practical solution has been to cover the plies with wood veneer, this requires a clamping job often difficult for the average craftsman. However, as plastic veneer requires no clamping, it truly provides the

answer to finishing plywood furniture, for it not only hides the plies but also the joints.

Planter cocktail table: If you are interested in duplicating any of the original samples, Fig. 1 details the construction of the smart-looking planter cocktail table. Either lumber-core ($1\frac{3}{16}$ -in.) or seven-ply ($\frac{3}{4}$ -in.) plywood may be used. The "plank" top is formed by gluing an apron around the edge of the top board, mitering the corners and grooving the ends for $\frac{1}{4}$ -in. plywood splines. A fast way to cut the openings in the top for the copper planters is to set the saw fence in position and then lower the work carefully down over the rotating saw blade. The fact that the cuts will run past the corners of the openings on the underside is unimportant as the planters will hide the cuts.

Plywood, $\frac{1}{4}$ and $\frac{3}{4}$ in. thick, is combined to make the legs for the table. These are made hollow, fitted with bottoms and then attached to the table top with screws and

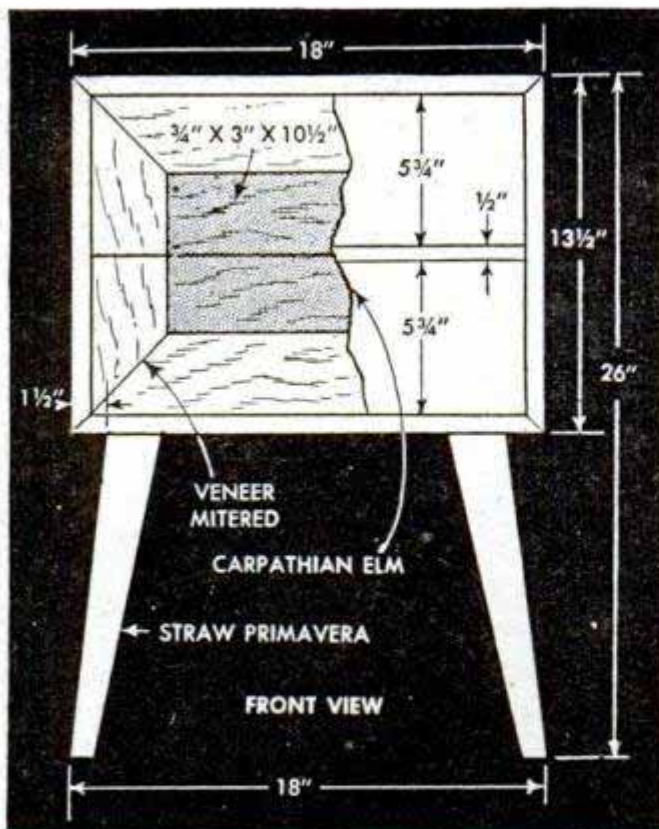

glue blocks. If one opening is to serve as a magazine compartment, one of the copper planters should be made without a bottom. In covering the top of the table with plastic veneer, the veneer is brought down over the edges to create the illusion of a 3-in.-thick slab, as shown in the color photo. In the case of the legs, the grain of the veneer is applied vertically, covering each face with a separate piece of veneer.

Two-drawer commode: Construction of this piece is apparent from the drawings in Fig. 2. Half-lapped members form the bottom frame of the drawer compartment, and the sides and top are built around it. Note that just the upper corners are actually mitered and that only the veneer is mitered at the lower corners. If you find it particularly difficult to saw the upper corners on a miter, butt joints can be used here also. The legs, which are built up similarly to those of the cocktail table, are glued and screwed to the half-lapped frame before adding the upper assembly. The drawer fronts are lipped (the bottom of one and the top of the other) so that they lap the center plywood frame. In applying the veneer, cover the laminated edges of the plywood separately. Note that the edging strips are mitered at the corners. Run the veneer vertically on the legs and in the same direction

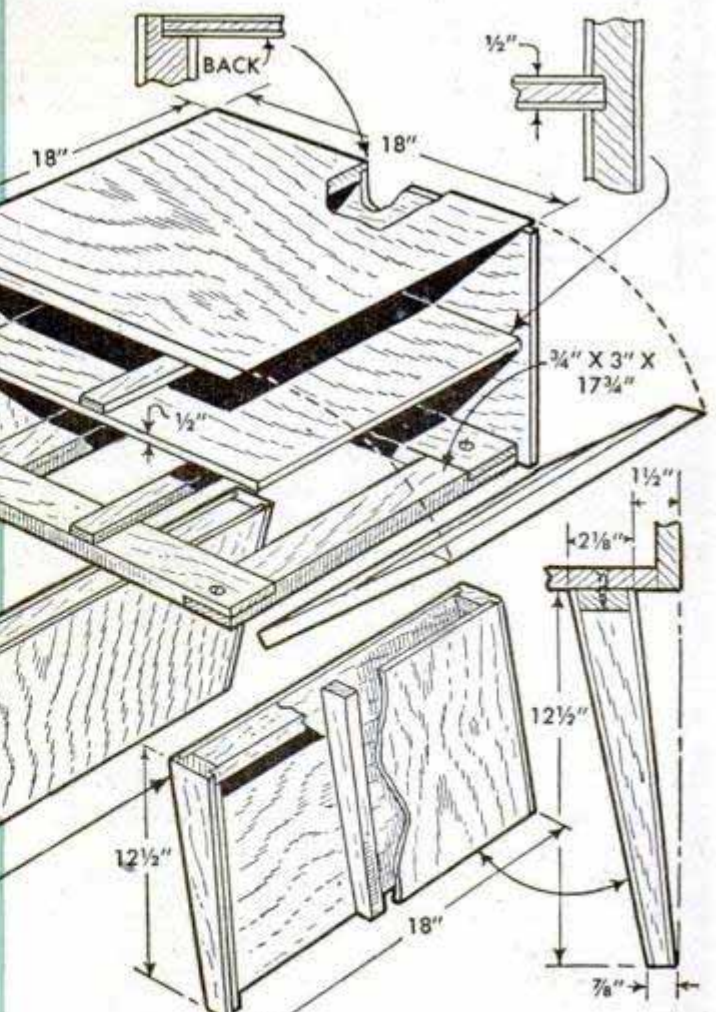
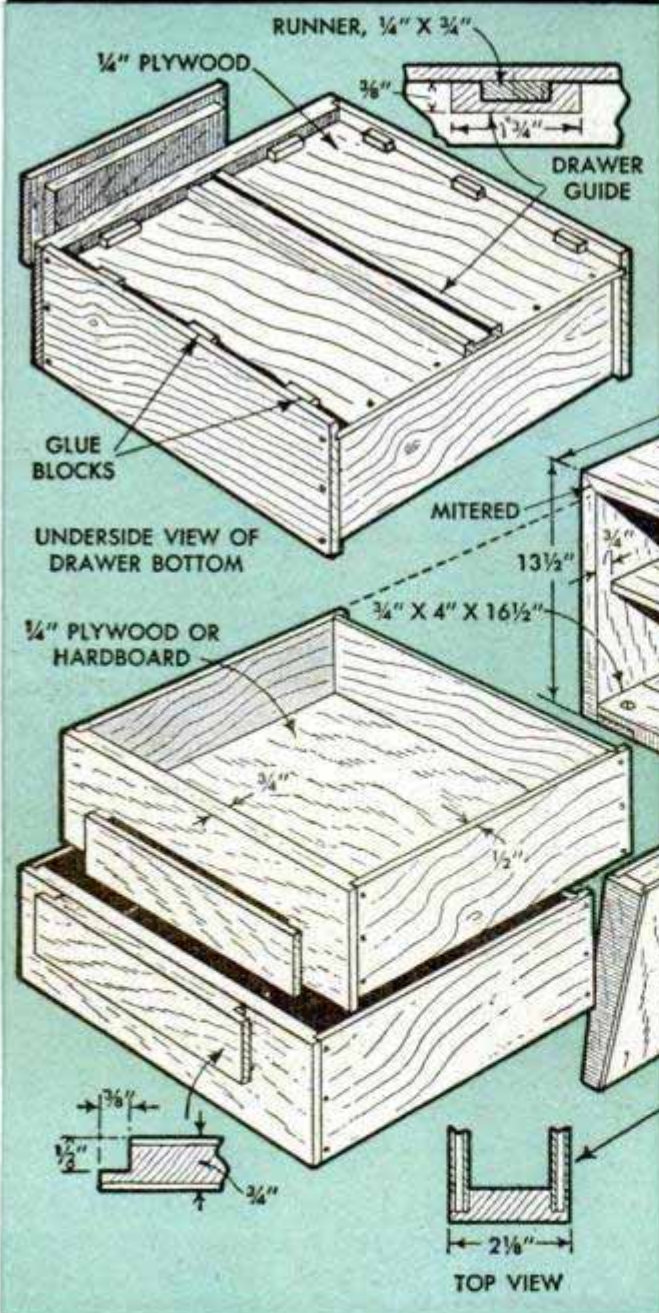

2 Two-Drawer Commode

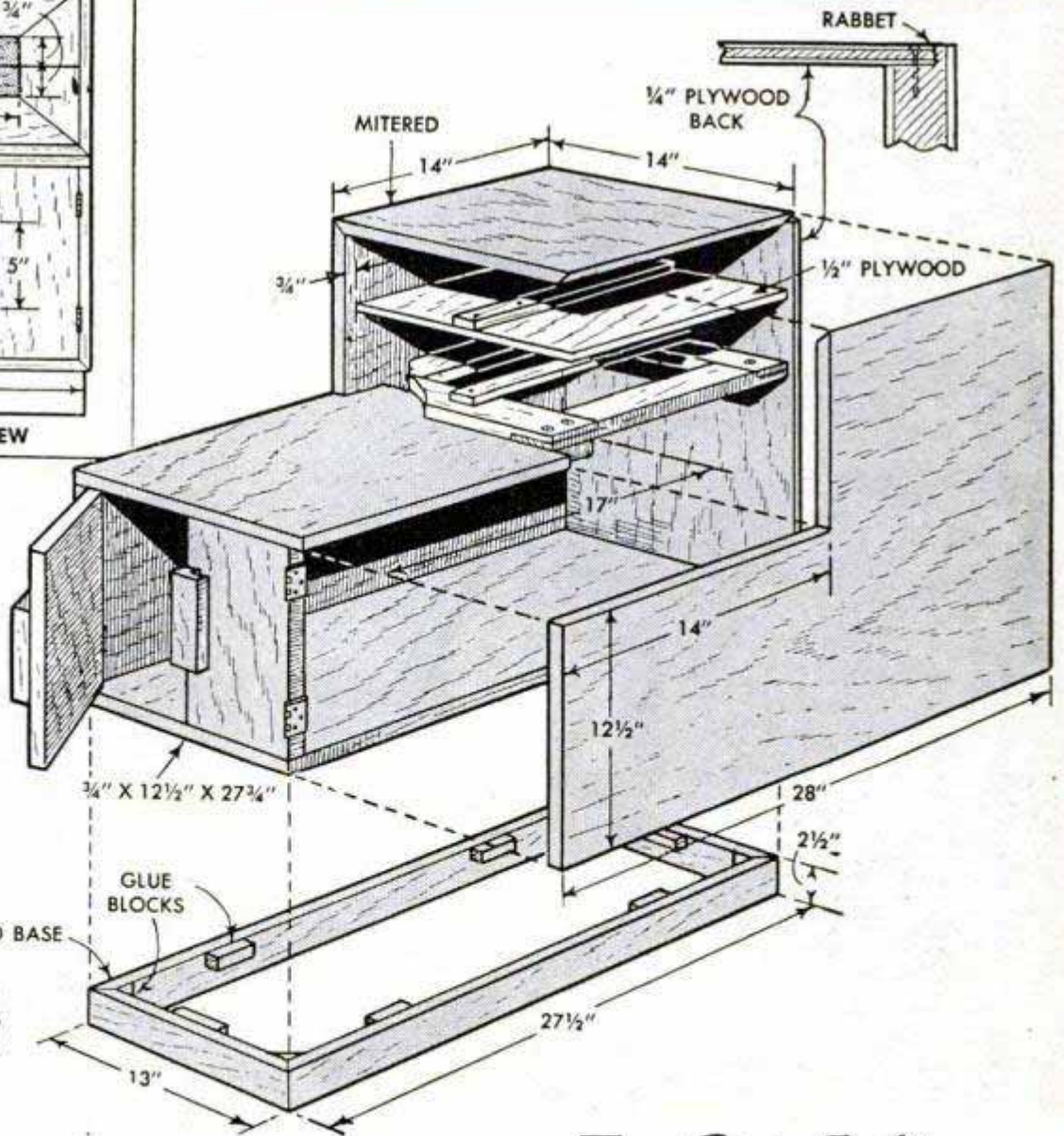
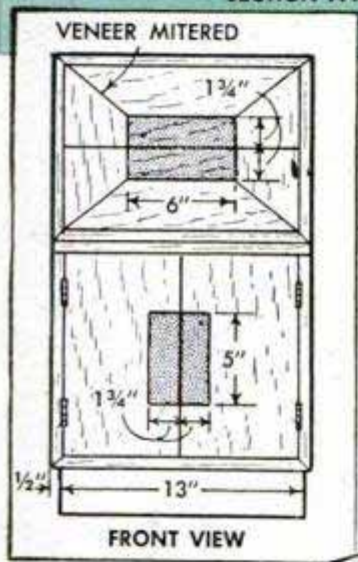
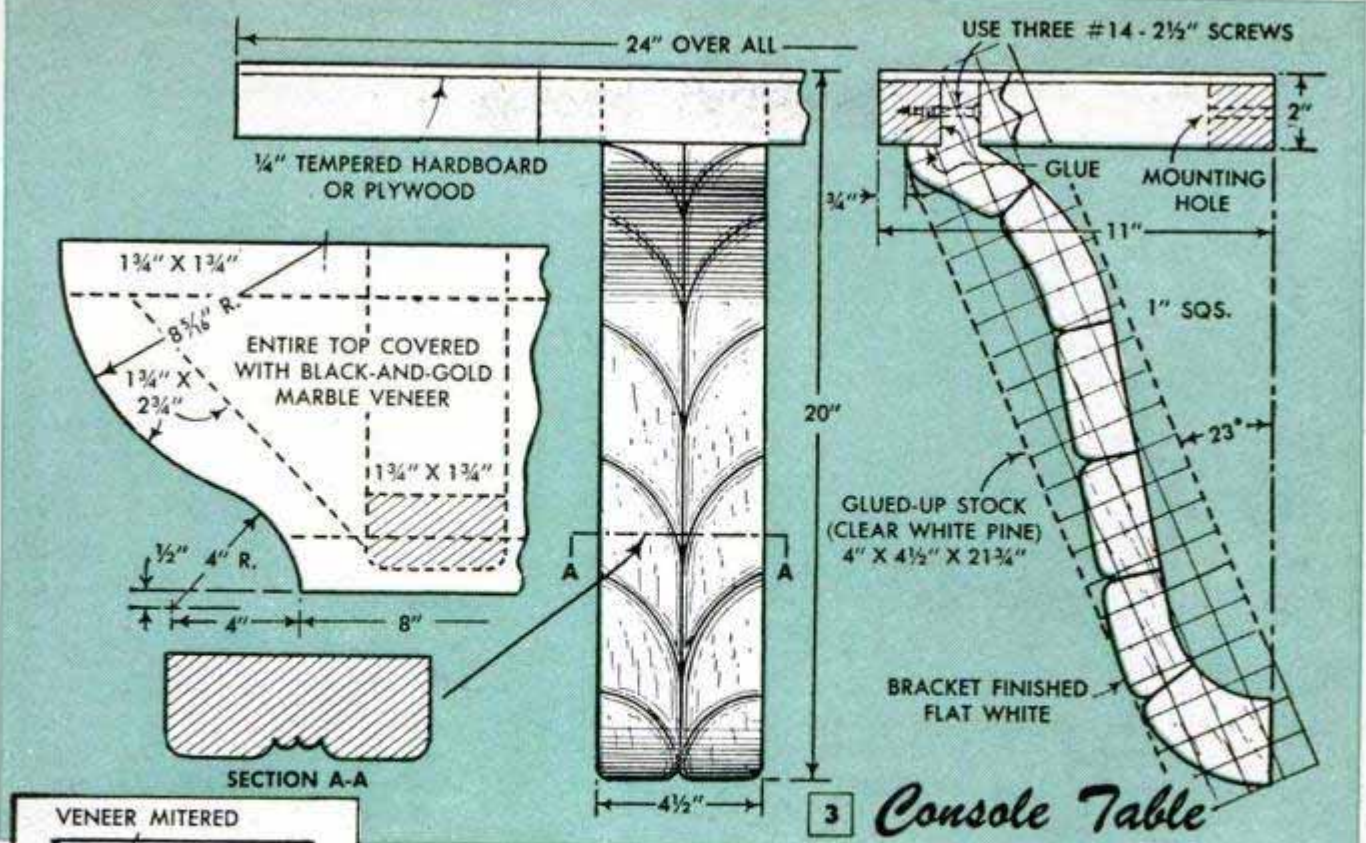

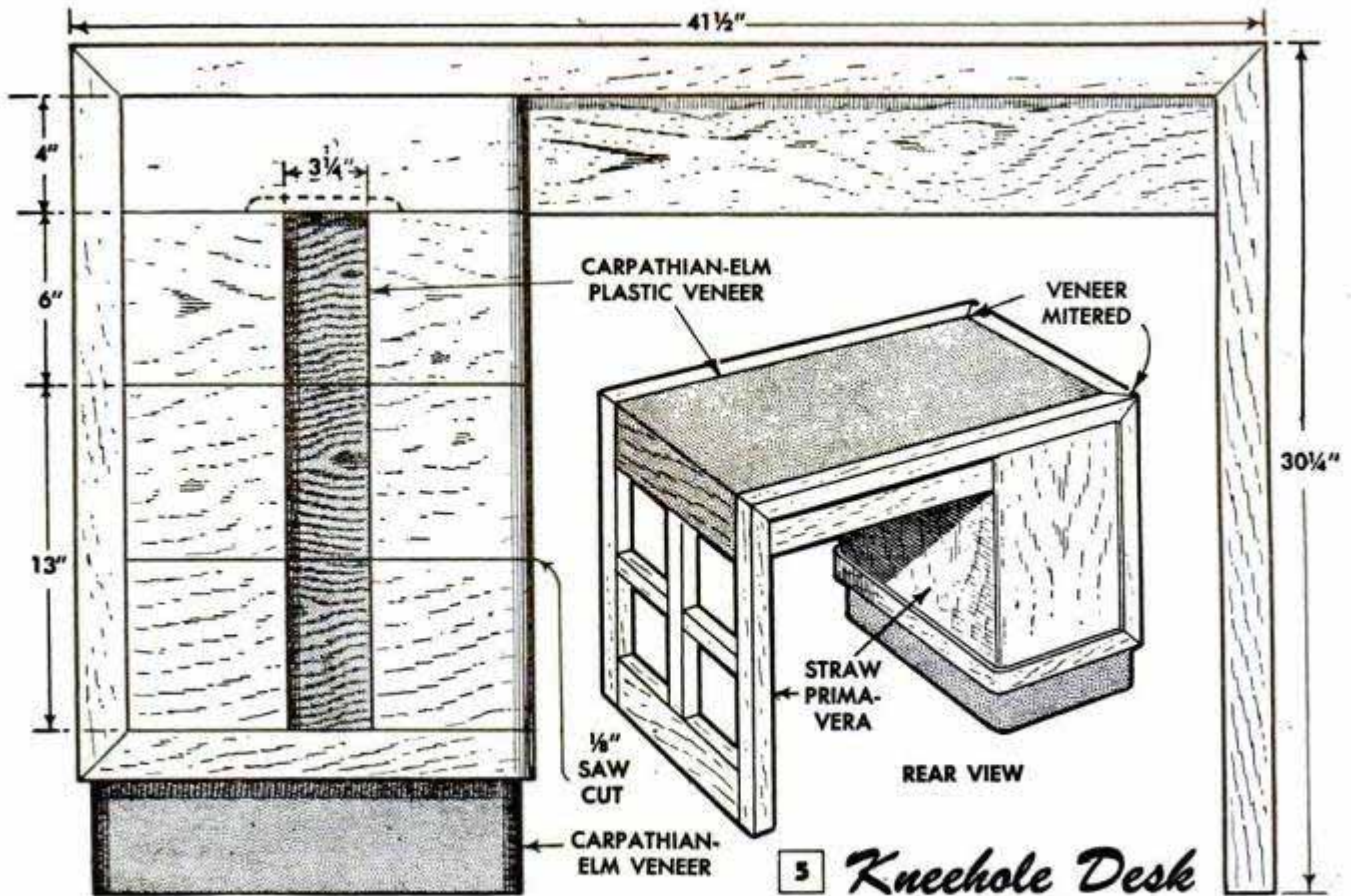

3 *Kneehole Desk*

6 **TYPICAL DRAWER CONSTRUCTION**

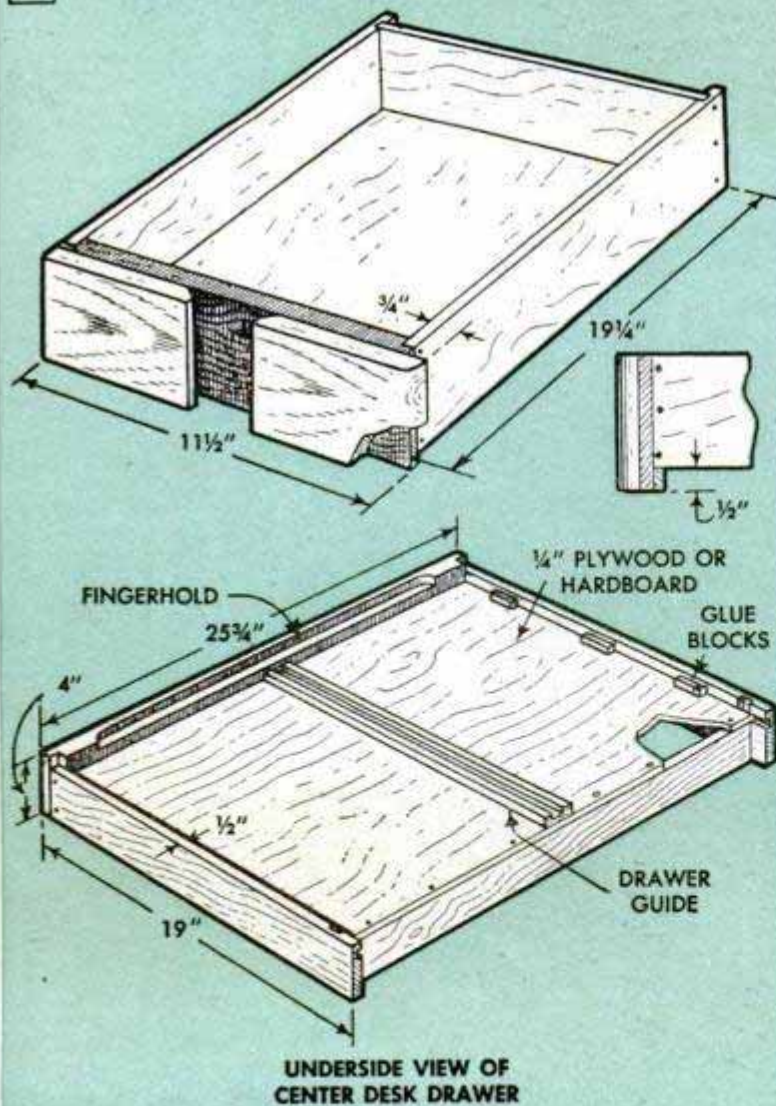

on the sides and top of the cabinet. The veneer on the drawer fronts is mitered according to the front-view detail, and a contrasting veneer is used on the handles.

Console table: Only the top of this smart wall table is covered with veneer (black-and-gold marble), the rest being painted flat white. Fig. 3 shows how the top is built up of 1 3/4-in. stock and then covered with hardboard or plywood. Pieces of ponderosa pine are glued up to form the block for the carved bracket. This is band-sawed, following a pattern made from the squared drawing. The spray design on the bracket is carved 1/4 in. deep with a veining tool or V-chisel and the edges of the cuts are rounded both on the face and edges of the work. Obviously, gloss lacquer or varnish should be applied in finishing marble veneer, rather than satin or flat coats to obtain the luster of the real thing.

Step table: Construction of this piece needs little explanation, the pull-apart drawing in Fig. 4 showing clearly how it goes together. In referring to the color photo of the original table, you'll notice that the top surfaces have a border of veneer around a contrasting center veneer, although this is optional. The drawer fronts are

Fly-Tying Vise From Pipe Fittings Mounted on Workbench

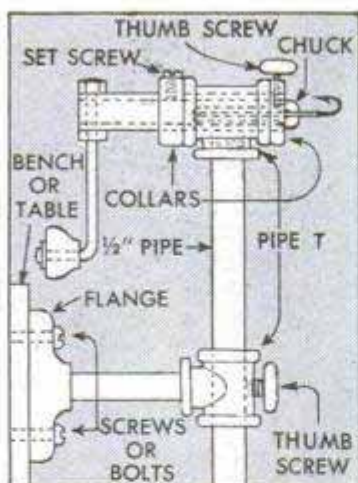

Assembled from pipe fittings and mounted on a table or workbench, this fly-tying vise holds the hook at a convenient position for tying and allows the hook to be rotated or held stationary as desired. The vertical member of the vise is adjusted for height with a thumb screw turned in a tapped hole in the side of a pipe "T." The short length of pipe which forms the chuck spindle is held in the top pipe "T" by two collars cut from pipe or made from pipe couplings. The spindle is turned with a handle bent from a length of rod. The end of the rod is threaded and passed through a hole drilled in the pipe, the rod being held in place with a nut tightened against both sides of the pipe. The collar at the chuck end of the spindle is drilled and tapped for a thumb screw which passes through both collar and spindle to close the jaws of the chuck. The latter is a piece of steel bar which is slotted lengthwise to receive the fishhook and slipped inside the spindle.

Harlan Houk, Lamoni, Iowa.

Fountain Pen Set in Wooden Base Is Converted to Desk Model

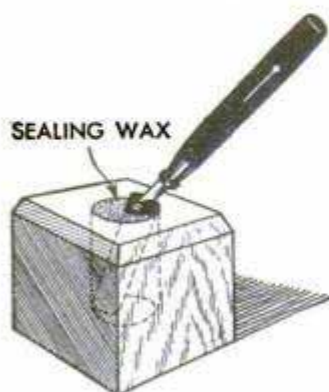

An extra fountain pen is easily converted for use as a desk pen by mounting the cap permanently in a wooden base. The pen is held simply by setting it in the cap which seals the point sufficiently to keep the ink from evaporating. First, a 1¼-in. hole is drilled in a 2½-in. cube of softwood, making the hole deep enough so that the open end of the

cap will project slightly when it is placed in the hole at an angle as shown. After inserting the cap in the hole, fill the hole with plaster of paris or sealing wax. If desired to conceal the wax, cover the top of the block with opaque plastic. This is drilled for the pen cap and cemented to the block. Finish the sides of the block in the natural color of the wood or paint it to suit. The edges of the plastic may be beveled and the corners of the block chamfered.

W. H. McClay, Pasadena, Calif.

Slitting Pencil-Eraser Edge Increases Efficiency

Erasers will remove pencil marks and smudges faster without increasing rubbing pressure if a series of slits has been cut in the edge being used. On soft erasers, cut the slits about ⅜ in. deep and space them about ⅜ in. apart. On harder ones, cut the slits closer together.



Edward A. Lasko, Glendale, Calif.

Two Notebooks Fastened Together With Length of Stiff Wire

Two spiral-bound notebooks which contain related information can be bound together for future reference with a length of fine, stiff wire. Place the notebooks

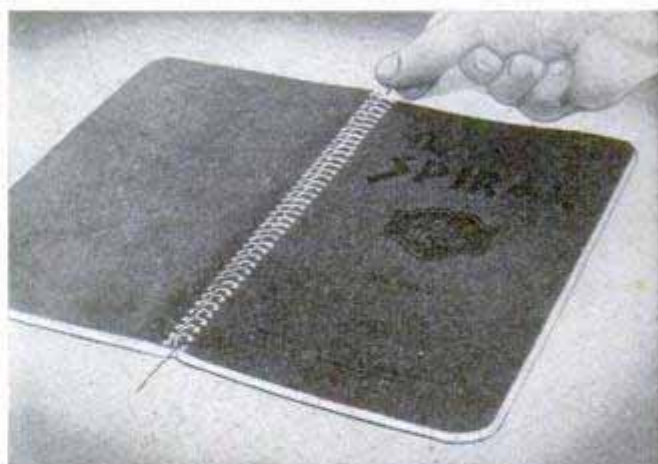

back to back so that the spirals interlock and then slip the wire through both spirals. Simply bend over the projecting ends of the wire to hold it in place.

John J. Rea, Urbana, Ill.

Galoshes and rubber floor mats will last longer and look better if they are coated with liquid floor wax.

SIMPLE BLINKER LIGHT

By John M. Avery

YOUNGSTERS engaged in back-yard war games will enjoy using this safe blinker light to work out a winning strategy. A floodlight bulb of the reflector type used in lighting show windows serves as a light source. A normally open microswitch is actuated by an improvised telegraph key to control the light, making it easy to transmit messages in blinker code. Details below show how to mount the light socket and connect the wiring from the power source to the socket and switch. Note that the switch is shielded so there is no possibility of a finger coming in contact with the open terminals on the switch. The wooden block that supports the socket is drilled at A, and hole B is drilled through the bottom, meeting hole A. Finally, hole C is drilled through into hole B. This makes it possible to fish the wiring through the block to the socket and switch. For easy operation the distance from the key knob to the pivot should be about twice that from pivot to switch button.

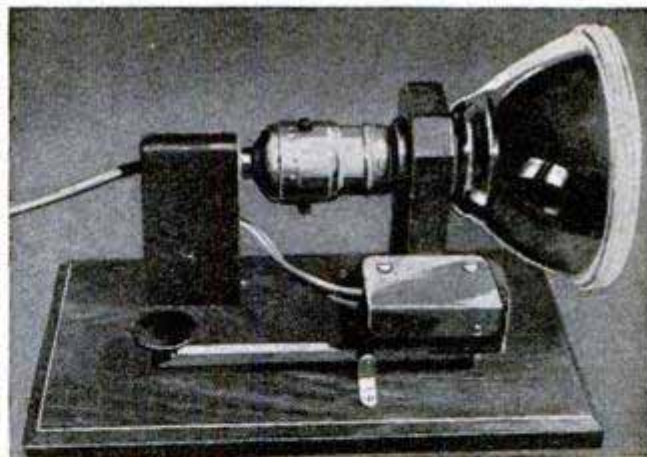

This safe blinker light utilizes a floodlight bulb of the reflector type used in show-window lighting

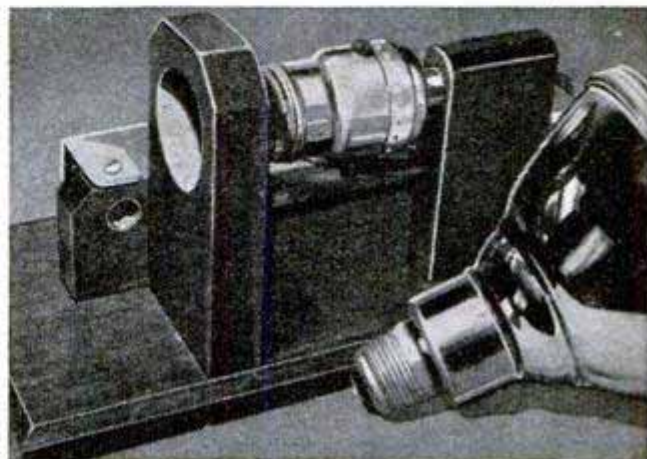

The socket and bulb are supported at a uniform height in separate wooden blocks attached to base

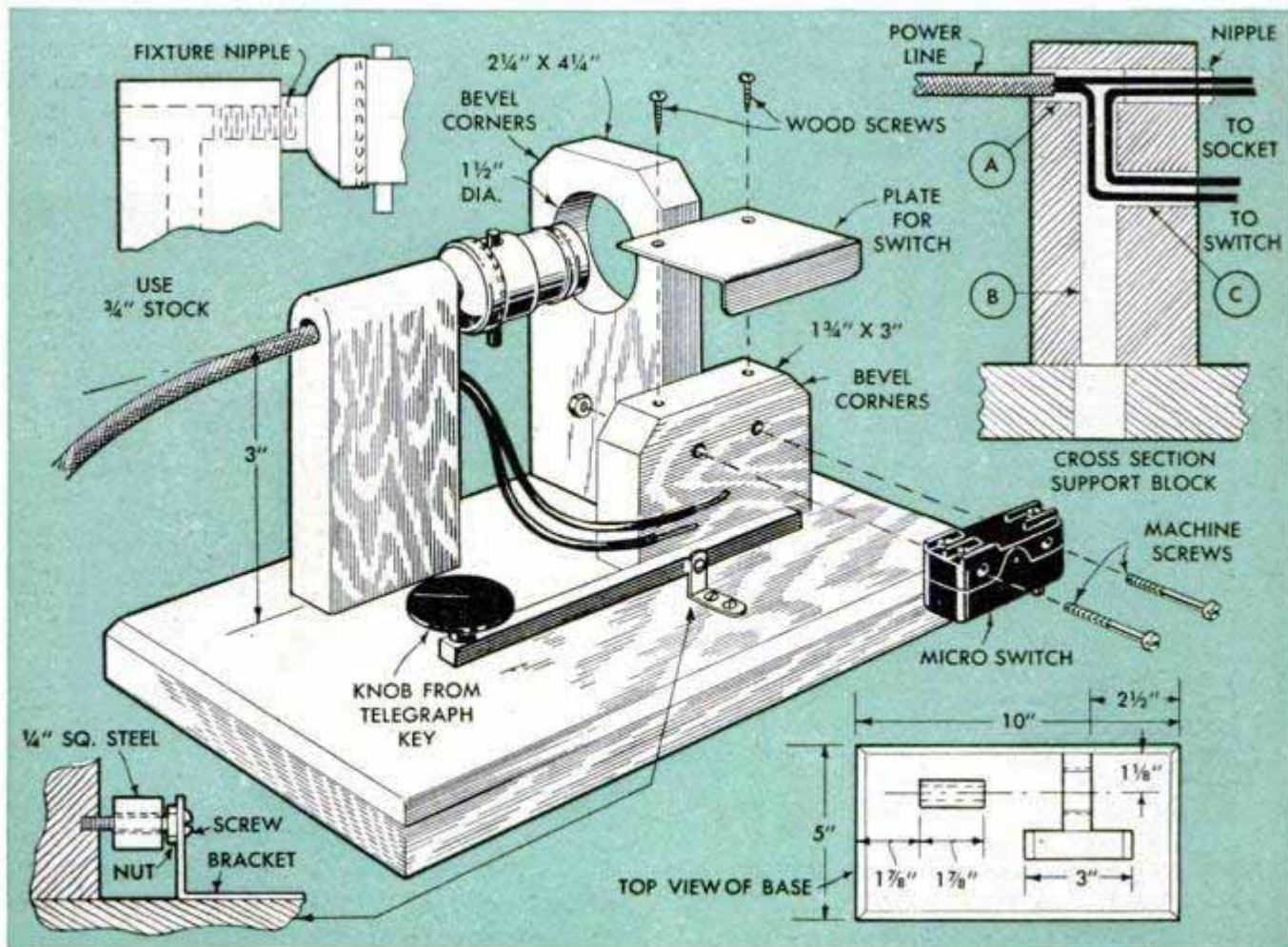



HALF OF A RUBBER BALL serves as handy patching-plaster container which is cleaned simply by bending rubber to free sections of dried plaster. This is especially useful when several evenings are needed to finish a wall



OLD TRUNK OR FOOT LOCKER makes an inexpensive toy chest that will hold many of the youngster's playthings. Cover inside of trunk with wallpaper in a nursery design and paint the outside with bold, colorful stripes

NOVEL PHOTO FRAMES can be improvised from clear-glass dinner plates and hung from the wall with plate hooks. The photograph is carefully cut to fit the bottom of the plate and fastened face down on the inside of the plate with cellulose tape



Solving HOME

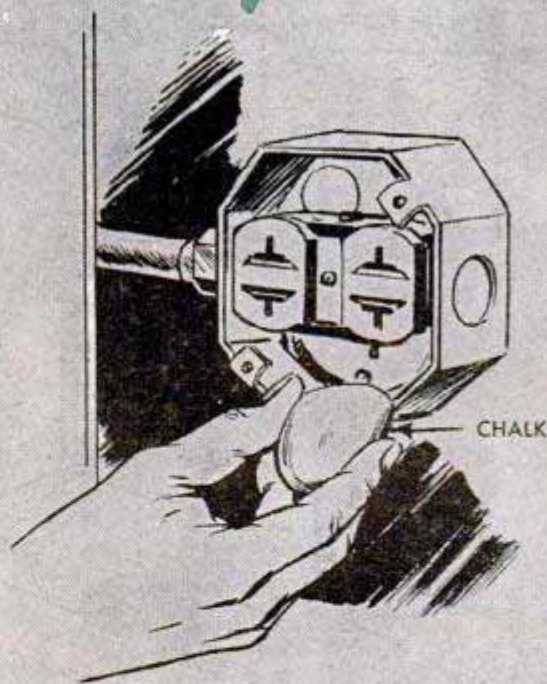

WHEN PANELING A WALL, openings for outlet boxes are laid out quickly with the aid of a piece of chalk. Just rub the chalk on the edges of the box, set panel in position and press it against the box. This leaves an outline of the box on the panel

A **TOY BANK** set on a medicine-cabinet shelf provides a safe and handy receptacle for used razor blades, which are simply dropped in the coin slot. Some banks lend themselves to mounting on the inside of cabinet door where they are out of the way

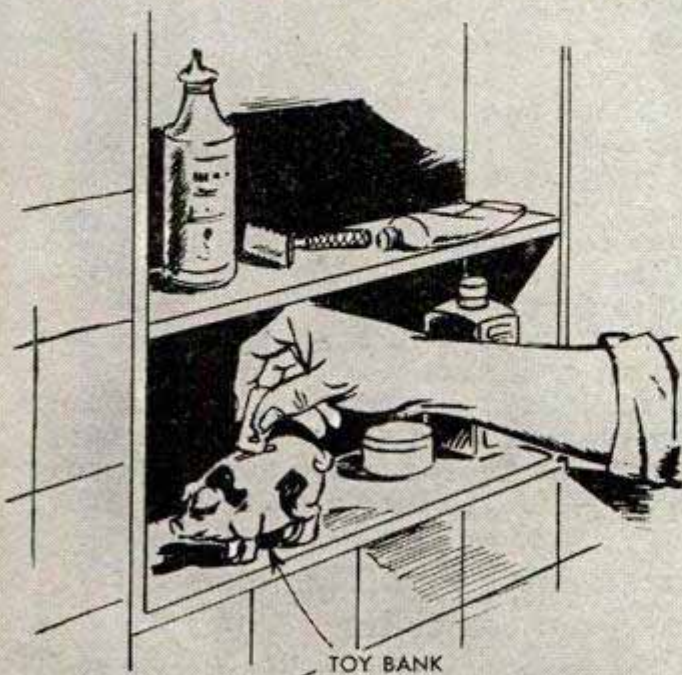

TOY BANK

PROBLEMS

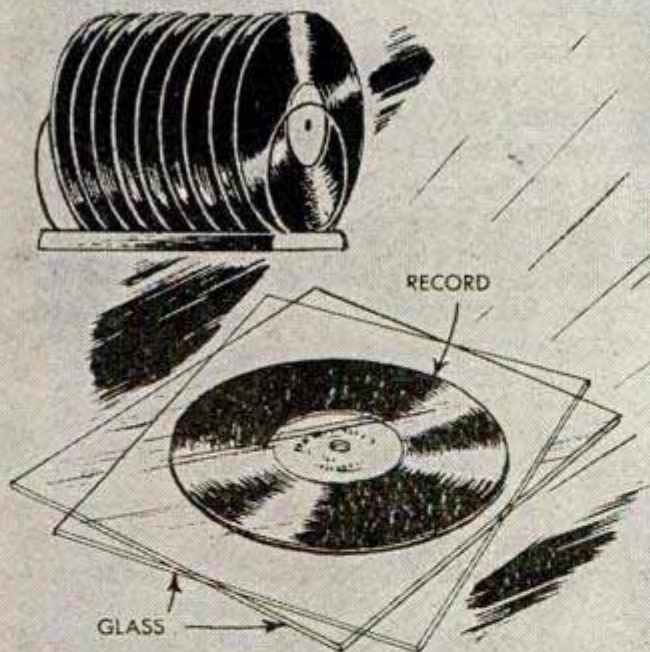

WARPED PHONOGRAPH RECORD is straightened without endangering the tone quality by sandwiching it between two sheets of glass and setting in the sun. Heat from the sun will soften the record and the weight of the glass will flatten it



BATHROOM CLOTHESLINE suspended over the bathtub is out of the way and easy to remove when tub is to be used. Just string line from screw hooks turned into two wooden strips which are held to the walls with suction cups



NEWLY DUG GARDEN VEGETABLES, such as carrots, beets and potatoes, are washed quickly and thoroughly by placing them in a wire egg-gathering basket and spraying with hose. Basket holds generous quantity of vegetables

"Toadstool" Yard Umbrella Supported by Tree Trunk

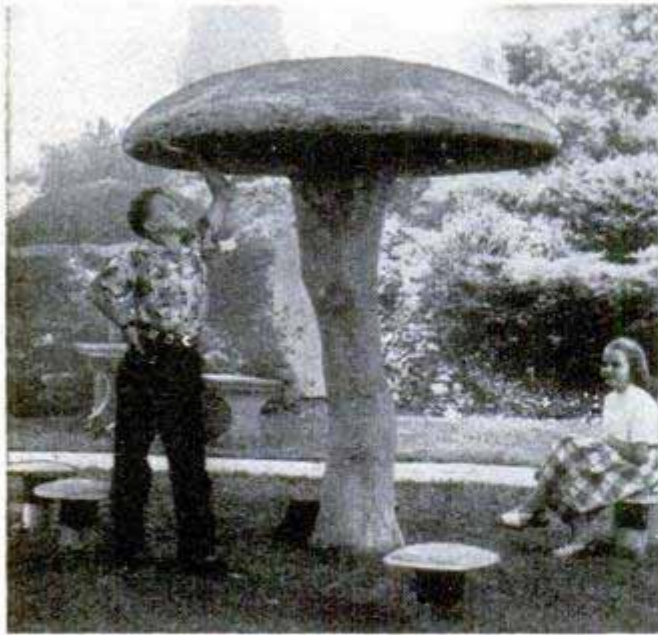

A novel lawn ornament which affords a welcome spot of shade can be achieved by disguising the trunk of a dead tree to look like a giant toadstool. The trunk is cut off straight across at a height of about 5 or 6 feet from the ground and stripped of its bark. Then a bandsawed wooden framework for the toadstool-shaped umbrella is nailed to the top of the trunk and covered with wire mesh. Both the trunk and the wire-mesh top are coated with a mortar-like cement mixture to give a stucco effect.

Grover Brinkman, Okawville, Ill.

Wooden Toy Wheels Made Quickly

Wooden wheels for toy cars and trains can be made in a jiffy by cutting them out of plywood with a hole saw. Select a twist drill of the same diameter as the axle to be used on the toy. Then insert the drill through the hole saw and chuck it in the drill press. In this way, the disk is cut out and the hub drilled simultaneously.

William Bernard, Cincinnati, Ohio.

Wrist Watch Works Kept Clean After Breaking Crystal

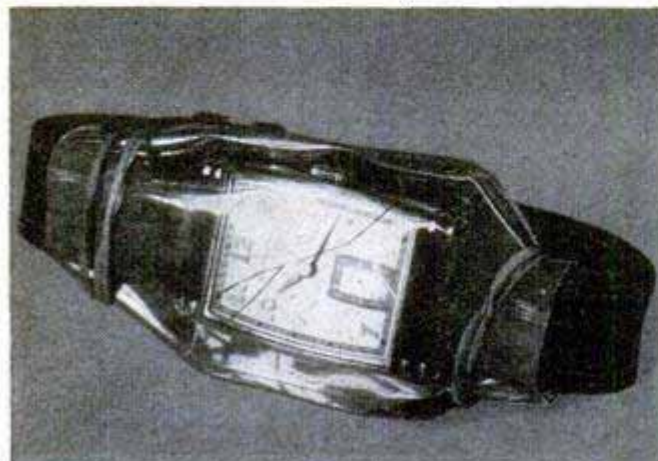

Wire Wrapped Around Ink Dropper Reduces Formation of Bubbles

Using the dropper from a bottle of drawing ink to fill a ruling pen or compass often results in transferring ink bubbles from the dropper to the pen where they burst and sometimes splatter the drawing with ink. These bubbles can be eliminated entirely or at least reduced in size by wrapping the end of the dropper with a short length of No. 23 bare copper wire. Insert about $\frac{1}{8}$ in. of the wire into the tip of the dropper and wind the rest of the wire around the tapered end of the dropper as shown.—Herb L. Brown, Columbus, Ohio.



Insert about $\frac{1}{8}$ in. of the wire into the tip of the dropper and wind the rest of the wire around the tapered end of the dropper as shown.—Herb L. Brown, Columbus, Ohio.

Determining Pipe Diameter For Main Water Line

The size of pipe required for a main water line which is to handle the flow from two branch lines is easily determined by means of a steel framing square. As indicated in the upper

detail, measure the inside diameters of both branch pipes and then mark the diameter of one pipe on one arm of the square and the diameter of the other pipe on the other arm, using the graduations on the inner edge. Then, carefully measure

between the two marks, as in the lower detail, to determine the inside diameter of the pipe which is needed for the main line.

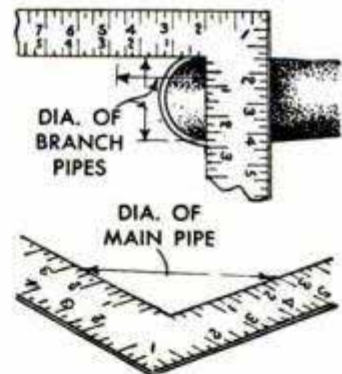

Whenever the crystal of a wrist watch is broken there is danger of dust entering the case and damaging the delicate mechanism before the crystal can be replaced. To be sure that the works will stay clean until you can get the watch repaired, wrap the watch with cellophane removed from a package of cigarettes. Sealing the ends of the wrapper with rubber bands as shown allows you to continue wearing the watch.

Ed Packer, Chicago.

☐ Rinsing in an alum-and-water solution restores stiffness to hairbrush bristles.

Easier Way To Install GLASS-BLOCK "WINDOWS"

HOMEOWNERS planning to install small decorative glass-block panels in an exterior wall will be happy to know that the manufacturers of structural glass block have developed a simplified method of installation which eliminates the need of expansion strips and wall ties. Instead, an asphalt emulsion is used, and an expansion space is allowed above the top row of blocks as in the upper detail. The opening must be framed in the same way as for a double-hung window, with adequate lintel support at the head, and it should be not more than 5 ft. wide or 7 ft. high, including a maximum of 25 sq. ft. The first step is to brush a heavy coat of asphalt emulsion onto the wooden frame, applying it in a strip about 3½ in. wide across the sill, lower detail, and up the jambs, center detail. The blocks are laid up in ¼-in.-thick mortar joints consisting of portland cement, 1 part, hydrated lime (high-calcium type), 1 part, and graded plastering sand, 4 to 6 parts. Trowel the joints neatly and, when finished, scrub the panel to remove all excess mortar. Scrape out any loose mortar from the expansion space at the head and finally run a line of calking completely around the opening.

CROSS SECTION OF GLASS-BLOCK WINDOW

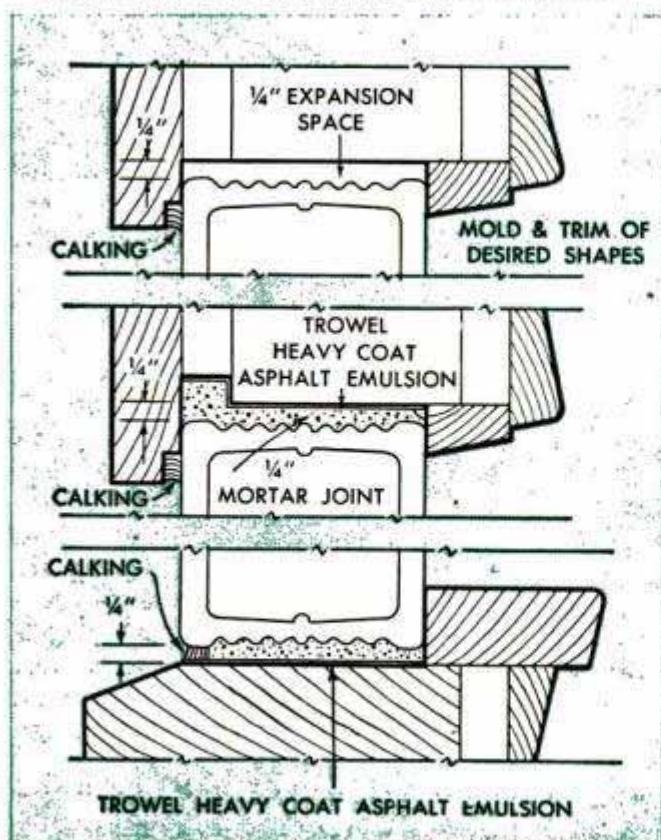

Apply a heavy coating of asphalt emulsion to the sills and jambs. The coating should be at least 3½ in. wide



Above, lay the blocks in mortar joints troweled to a uniform thickness of ¼ in. Below, run a line of calking compound all around the completed panel



Pottery

FROM YOUR BACK YARD

By Betty Thompson

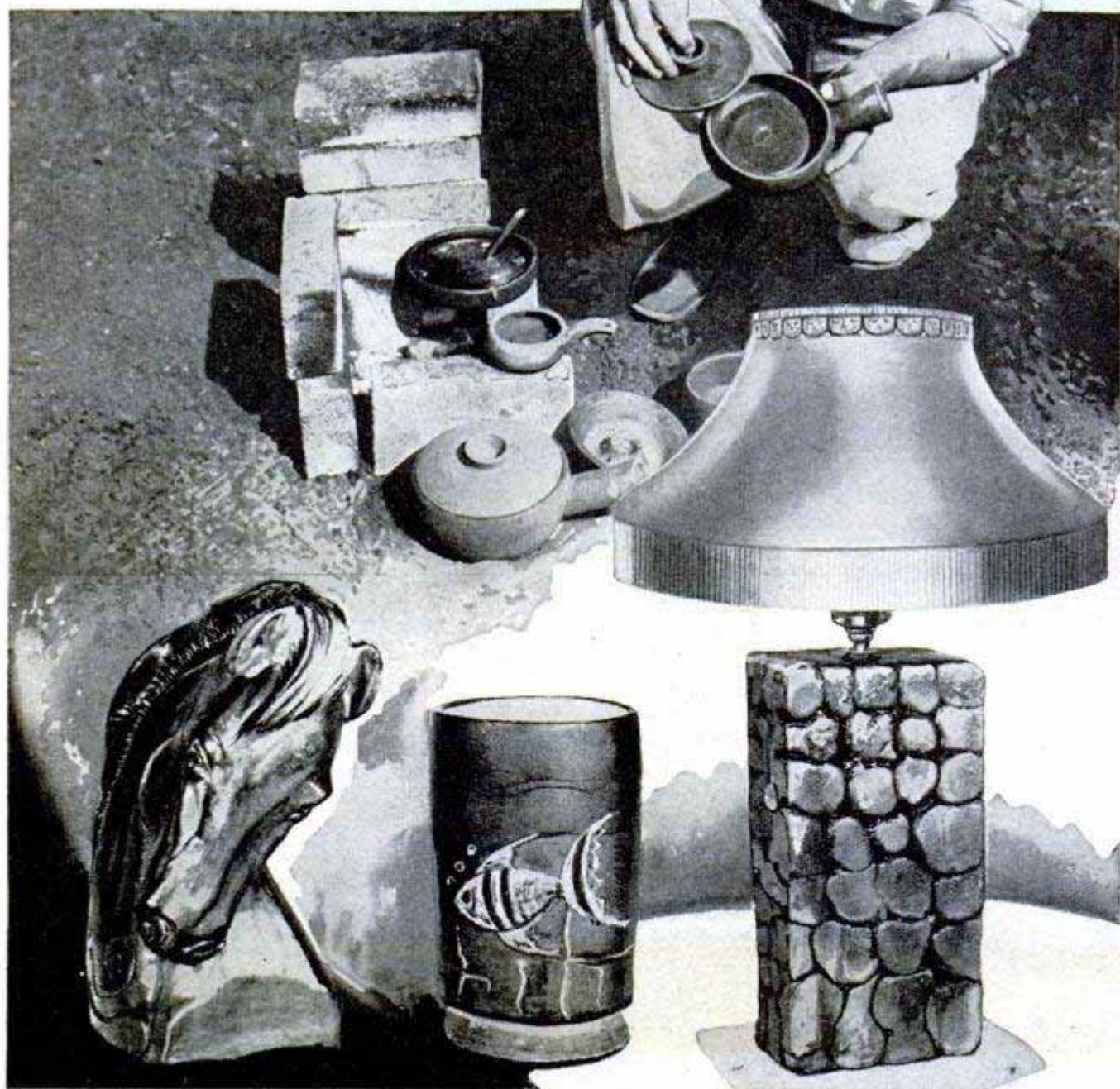
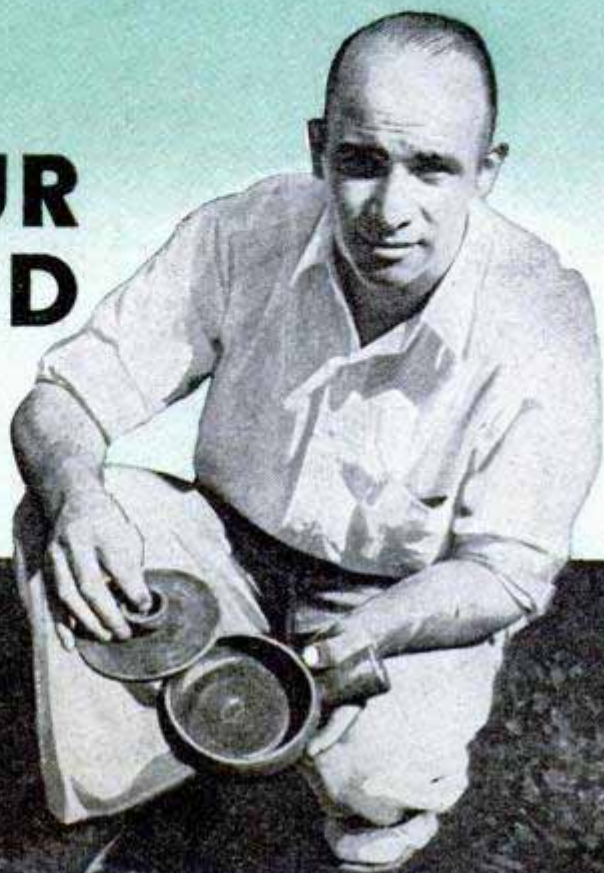

DID YOU KNOW that you can make fine clay pottery at practically no cost for materials or equipment? The clay usually can be had for the digging, right in your own back yard, and a quart or two of fresh milk will produce that soft, velvety glaze you've admired on fine pottery. There's no need to worry about intricate glazing processes or critical firing temperatures in ovens or kilns. The sun will take care of the drying process and firing is done in a charcoal fire built in an outdoor kiln made from a few loose bricks. Suitable clays are almost universally available. In its natural state, common clay will be found in a variety of colors ranging through shades of tan, green, blue and even black. However, as a rule, all ordinary clays turn a reddish brown when fired because of the presence of iron.

Art objects in clay, such as lamp bases, figurines, ash trays and vases are formed in various ways. Some can be thrown on a potter's wheel, while others, like the horse's head illustrated, must be modeled free-hand. The straight-sided vase, pictured on the opposite page, was made by simply pressing clay inside a cardboard carton. The base was added later. The rectangular lamp base was formed in a similar fashion, except that the clay was first worked into balls of a fairly uniform size and then pressed against the sides and ends of a cardboard shoe box.

Now, to carry out the simple process from the beginning, first locate the clay and test it by moistening a small amount with water, working until pliable. Then rub be-

tween the palms until it forms a long roll about $\frac{1}{2}$ in. in diameter. Coil the clay around the index finger. If the clay will roll easily around your finger without breaking, it is suitable for pottery making. Next, dig a pailful, or so, and place in a container, leveling off the top of the clay. Pour in an equal quantity of water, by measure, and allow to stand overnight. Then pour off the water slowly and skim off the soupy mass which has formed. Strain this through a fine-mesh screen to remove any foreign matter and allow to dry until it is once more cohesive. Now the clay is put through the kneading process known to potters as wedging. The purpose of this is to remove all the air bubbles and reduce the clay to a tight, compact mass that is neither so wet that it sticks to the fingers, nor so dry that it tends to crack while being kneaded or wedged. To get a good modeling clay of the proper working consistency, it is necessary to do a thorough job of wedging. After a period of wedging, slice the clay into thin strips with a fine wire held taut, then press the strips together again and repeat. In each wedging stroke, use the palms of both hands side by side, and apply sufficient pressure to flatten the mass of clay. After flattening in this manner, some potters pound the clay mass alternately with the palms. In reforming the clay mass after each stroke, care should be taken not to fold it so as to entrap air. After a thorough wedging, the clay is ready for immediate use.

To further illustrate the process, a simple "one egg" skillet has been selected.



First step in making a pottery skillet is to mold the clay in a small pie tin as shown above



Roll the clay to a uniform thickness and then cut and bend a strip to form the skillet handle



Skilled potters would either pat the clay mass into the shape required, or throw it on a wheel, but a simpler method is to mold the clay in a small pie tin into which a soft paper napkin has been pressed, Fig. 1. Build up the thickness in the tin to about $\frac{1}{2}$ in. and then smooth with the fingers and the back of a large spoon until the surface comes to the shape and degree of smoothness desired. Dry in the sun until the clay is sufficiently stiff to hold its shape. Then carefully tip it out onto a board, upside down. Smooth the bottom and flared edge with the back of a spoon. If the surface is too dry to smooth easily, just wet the spoon slightly to soften the surface of the clay.

Now, to make a handle, roll a small quantity of the clay to a uniform thickness. This can be done by placing the clay between two wooden strips of uniform thickness and rolling with a short length of 1-in. dowel, the ends of the dowel bearing on the

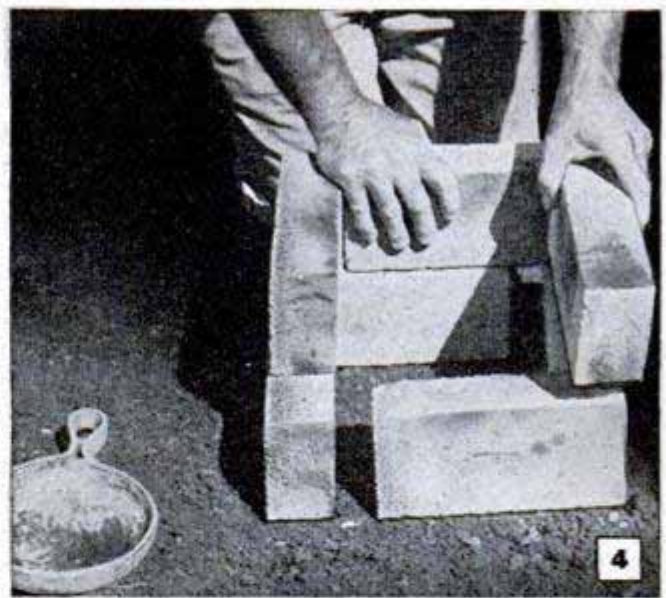

strips. Then cut a strip from the clay 2 in. wide and fold it to form the handle as in Fig. 2. Joining the handle to the body of any piece of pottery calls for special care. The body still should be moist on the surface but, as potters describe it, "leather hard." The handle should be of a somewhat softer consistency as it will dry more quickly. Place the handle on the body of the skillet in the required position, press it firmly in place and smooth the joint with the tips of the fingers until you form a uniform fillet at the joint, Fig. 3. Again set the work in the sun to dry.

Now, build a simple furnace, or kiln, for firing, using several bricks placed loosely on edge as in Fig. 4. Or, if you have one, an outdoor fireplace is just the thing. Use wood and charcoal for fuel. Before placing the work in the kiln, however, make sure that it is thoroughly dry, as otherwise it may crack during the warming-up pe-



The work to be fired should be placed inside the improvised kiln, partly in the red-hot coals



Fill the skillet with fresh milk and simmer for eight hours to form a glaze on all the surfaces

riod. In any case, place the work in the improvised kiln before kindling the charcoal so that it will warm gradually to the maximum temperature. The time of firing averages about six hours, and it is necessary to keep the coals red hot during this period of time. The work should be directly in or on the bed of coals, Fig. 5, not above it. At the end of six hours of maximum heat, the work is removed and allowed to cool.

Now comes the glazing process and that's simplicity itself. Just fill the skillet brimful of fresh milk and let it simmer on the kitchen stove, or on the fireplace, for about eight hours. Then immerse the work in boiling milk for about 30 minutes, and there you are, ready for frying an egg as in Fig. 7. For art pottery, a novel color variation can be produced by using sweetened condensed milk instead of fresh milk. Coat the surface of the fired object with condensed milk and bake for an hour in an oven at 550-deg. temperature. This process results in an unusual bronze-black finish, very similar to the most costly art glazing. Not only art pieces can be finished in this latter type of glaze, but nearly all ornamental pieces are good subjects. The fresh-milk glaze does not color the clay, nor does it change the reflective properties of the surface appreciably.



If you purchase clay from dealers in art supplies be sure to get genuine clay, and not the product manufactured especially for low firing temperatures. Three to five pounds of clay should be ample for experiments. Keep the clay wrapped in a damp cloth until ready for use. If it hardens when unused over long periods, moisten with warm water and don't neglect to do a thorough job of wedging before using. This is the most important step to success in this process of pottery making.

Storm Sash Opened From Outside to Free Sticking Window

Regardless of how fast a lower window sash seems to be stuck it usually can be freed quickly by driving a small wooden wedge between the bottom sash rail and

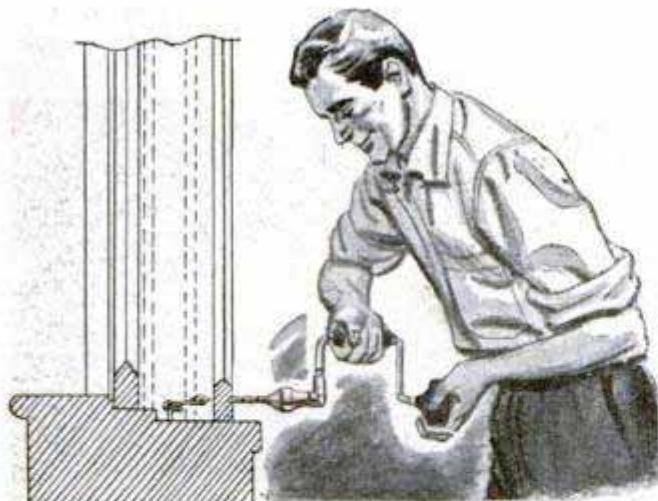

the window sill from the outside of the house. However, as this cannot be done until the storm sash is removed, a hinged storm sash fastened with hooks and eyes from the inside complicates the problem. To remove this type of storm sash from the outside with a minimum of damage, use a $\frac{1}{8}$ -in. bit to drill straight into the end of the screw hook. The bit will glance off the tip of the hook and bore through the wood to one side of it. Repeat this procedure all the way around the hook (or hooks) until it is cut from the sash. Then screw a sash lift to the lower rail of the storm sash to permit pulling it outward in order to gain access to the window sash. The screw hook, of course, is installed in a new location on the sash rail, and the hole formed by removing the hook is either drilled out and plugged or filled with wood putty.

Solution of DDT and Fuel Oil Keeps Termites Away From Wooden Posts

Applied to the soil surrounding posts, pillars and foundations, a fuel-oil solution containing 5 percent DDT discourages infestation of termites for at least five years. About 1 qt. of the solution should be added to each cubic foot of soil. This solution can also be used to control termites after they

are in the structure; however, it is more effective when applied to new construction.

J. F. Carter, Pearlinton, Miss.

☞ To remove hot pies from an oven, use a small coal shovel, the turned-up edges of which have been hammered flat.

Scribing Guide for Wood Trim Assures Close-Fitting Joints

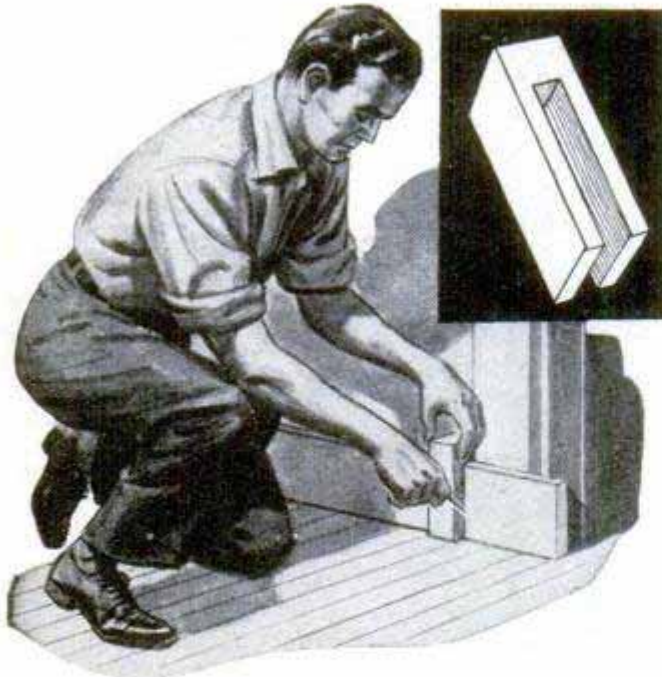

Baseboard, window trim and other woodwork where the over-all appearance of the job depends upon accurate joinery, are fitted easily by using this scribing guide to mark the work for cutting. The guide shown was made by cutting a 1 x 5-in. notch in a 2 x 2 x 6-in. wooden block, thus producing a U-shaped jig which fits over the edge of most standard stock. Instead of being built up of three pieces, the jig is cut from a solid block to insure that the faces of both arms are in perfect alignment. This is essential to the accuracy of the guide. The illustration pictures the guide being used to mark a length of baseboard for cutting the joint at a door casing. The baseboard is set in place temporarily and the guide is slipped over the top edge. Then, with the guide held firmly against the edge of the door casing, the saw cut is scribed on the outer face of the baseboard.

Roland H. Moore, Akron, Ohio.

Toaster Improved From Hot Plate

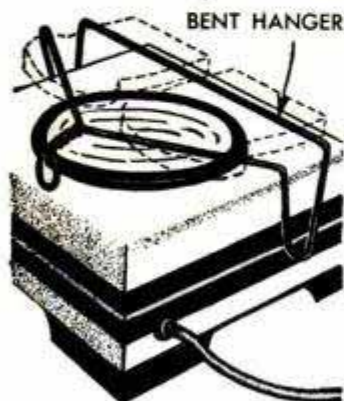

to rest on the top. Then lay the pieces of bread on the wire rack and turn them over after they have browned on one side. Be

sure, however, to burn the paint from the coat hanger before using it. This method also can be used to hold the toast over the coil of an electric range.

Ray M. VanHook, Chicago.

Rubber Tip on Screwdriver Handle Increases Gripping Surface

If it is difficult to get sufficient grip on a screwdriver handle when driving large screws into hardwood, try fitting the handle with a rubber tip of the type used



on the ends of metal chair legs, canes and crutches. The tip increases the size of the handle and thereby affords additional gripping surface. If the tip does not fit the handle tightly enough to prevent slipping, it can be cemented in place.

R. K. Beal, Independence, Kans.

Adding Life to Electric Clock

Sometimes an electric household clock stops running because the gears are worn and do not mesh properly. If this is the case, the clock can be restored for many more years of service simply by turning the works upside down and replacing them in the case in this inverted position.

George C. Updegraff, Arlington, Va.

Broken Figurine Repaired Quickly By Reinforcing With Bobby Pin

When the head has been broken from a ceramic figurine, a lasting repair can be made quickly with a bobby pin and some plaster. After mixing a small quantity of patching plaster to the consistency of heavy syrup, pour a little of the mixture into the neck of the figurine.

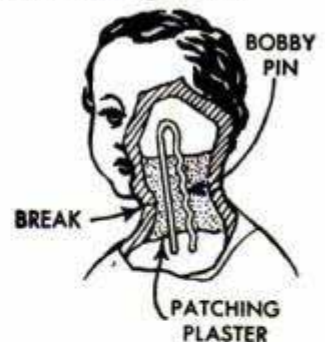

Then spread the arms of the bobby pin slightly and insert them into the plaster, allowing about $\frac{1}{4}$ in. of the pin to project above the neckline. Next, place some plaster in the head of the figurine and press the two parts together, positioning them carefully so that the broken edges match. Finally, wipe off any excess plaster squeezed out of the joint and set the figurine aside to dry. If the line of the joint is still apparent, touch it up with paint.

Charles F. Patrick, Philadelphia, Pa.

TOY WHEELS from tin cans

By Al Stephenson

BUILDING or repairing pull toys for the children can be simplified greatly by using these easily constructed tin-can wheels. They may be made in practically any size, complete with rims and tires. From two cans of the desired diameter, cut off the lower sections approximately $\frac{1}{2}$ in. from the bottoms. The exact size will depend on the desired width of the rim. Next, accurately locate and punch the axle holes. Then serrate (cut a series of notches) the edge of one section and join the two sections as shown in the center detail. Alternate the serrations inside and outside over the edge of the plain section and solder for added strength. Also solder a washer on each side of the wheel to form a hub.

A piece of rubber tubing of the desired diameter can be made into a serviceable tire. The ends are cut at an angle, as in the drawings, and joined with rubber cement. The tires also can be cemented to the rims with rubber cement. Painting the wheels and hubs with colorful enamels adds a gay touch to the completed toy.

The realistic milk trailer, shown below, was made with a block of wood, a sardine can, two soup cans, a toothpaste cap and the top section of a beverage can. The wheels were made up as described above, enameled and fastened to the trailer body with finishing nails for axles. Tin cans and their various parts were soldered together and mounted on the trailer. The entire toy was then painted in bright colors to harmonize with a ready-made toy tractor. Note that the sardine can also may be made into a realistic dump-truck body.

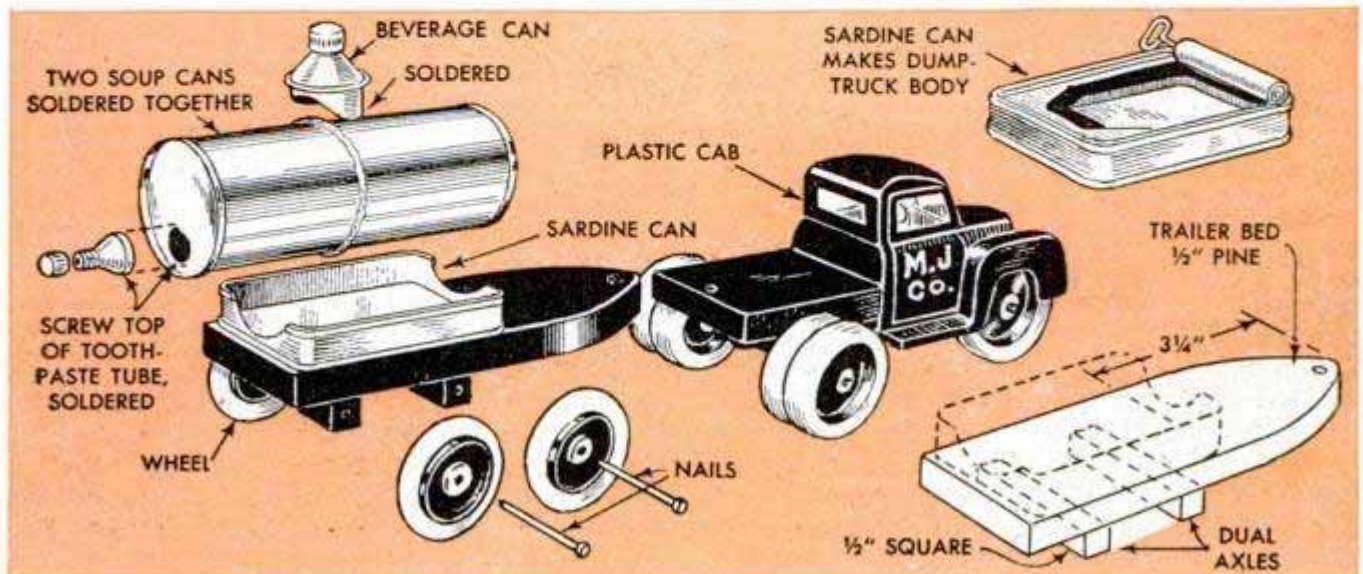
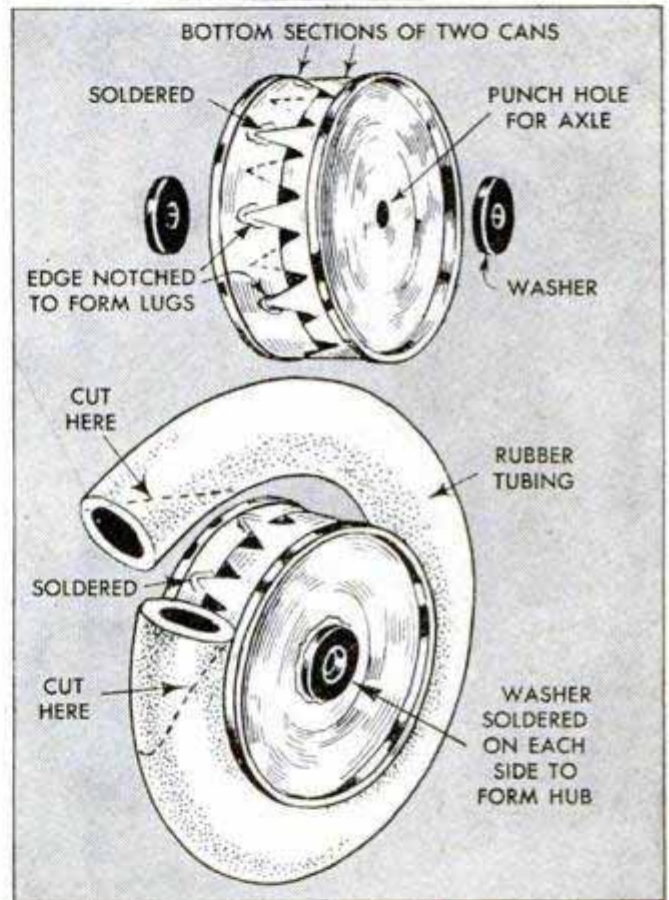
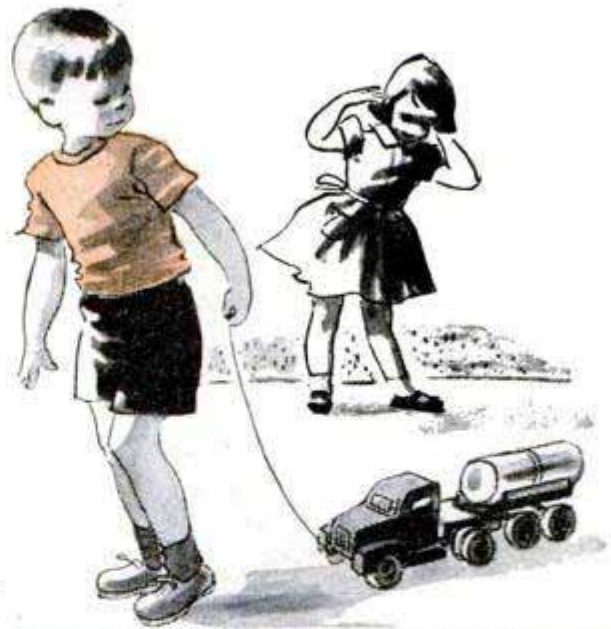

Toy Drum Made From Coffee Can Has Drafting-Paper Heads



By utilizing a 1-lb. coffee can for a shell and vellum drafting paper for the heads, it is easy to make a sturdy toy drum for the little soldier. The can is opened with the key in the usual way and the bottom is removed with a rotary-type can opener. Then two disks are cut from the drafting paper, their diameter being about an inch greater than that of the coffee can. To stretch each disk over the shell rim, dampen the paper with water, position the disk over the shell while still wet and slip a rubber band over the rim to hold the paper in place. Then pull the edge of the paper downward all around the shell to remove the wrinkles, and immediately wrap two turns of string around the paper overhang just under the can bead, tying the string tightly. The paper will become taut upon drying. After both heads are in place trim the edge of the paper to the rubber bands with a sharp knife and tie a length of string around the shell for a neck loop. Two eraser-tipped pencils will provide suitable drumsticks.

Elmer O. Spargo, Santa Ana, Calif.

Stamp Moisteners of Chamois

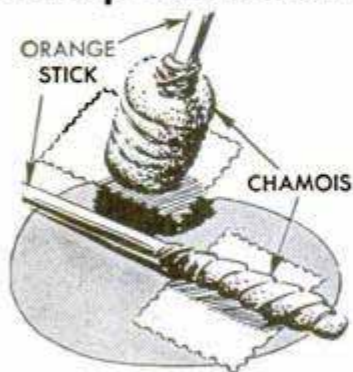

If you don't like the taste of the mucilage on postage stamps and envelope flaps, here are two moisteners that will do the job and can be stored neatly in the corner of a desk drawer. Both moisteners are

made from chamois and orange sticks, the difference being that one can be used vertically, moistening the stamp with the end, and the other horizontally. The moistener shown at the top of the drawing utilizes a 5 x 5-in. piece of chamois. This is folded

lengthwise so that one layer is about $\frac{3}{8}$ in. wider than the other, thus allowing a single thickness for tying to the orange stick. The latter is inserted between folds of the chamois to cover the tip and then the chamois is wrapped tightly around the stick. Colored string or a rubber band is wrapped around the chamois and also is used to tie the single layer at the top of the chamois to the orange stick. The moistener pictured at the bottom of the drawing is made similarly from a $\frac{3}{4}$ x 6-in. strip of chamois. However, this is wrapped spirally and tied to the stick only at the top. If desired, pieces of dowel or pencils can be used instead of the orange sticks.

Helen Lemberger, Chicago.

Tab Depresses Car-Door Switch To Turn Off Interior Lights

Having a car equipped with door switches for automatically turning on the interior lights when the doors are opened, one car owner fitted each switch with a

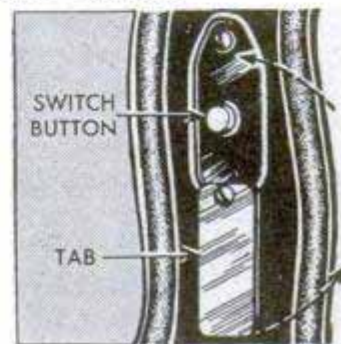

sheet-metal tab which can be swung upward to keep the switch depressed. This allows the interior lights to be turned off while the doors are kept open when working on the car, thus saving drain on the battery over a prolonged period of time.

R. C. Schneelock, Tulsa, Okla.

Pencil Holds Sandpaper Strip For Finishing Narrow Grooves

Modelmakers who are confronted with the problem of sanding the bottoms of narrow grooves and small recesses will find that an eraser-tipped pencil provides a handy tool for inserting the sandpaper into

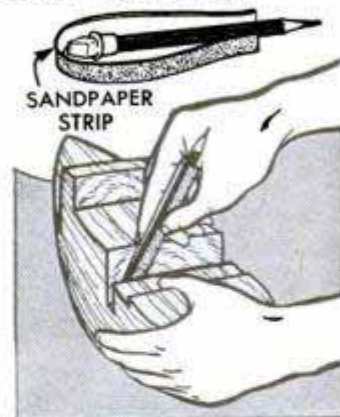

hard-to-reach places. A narrow strip of sandpaper or abrasive cloth is drawn over the eraser and held against the sides of the pencil with the fingers.—A. H. Waychoff, Phoenix, Ariz.

☐ Absorbent cleaners such as fuller's earth, powdered magnesia, cornmeal and cornstarch are safe and easy to handle and do not injure the fabric.

PORCH LAMP IN COPPER

By Marvin Hartley

ATTACHED to the house wall under a porch roof or a door canopy, this lamp will make the house number easy to read and add individuality to your home. As the lamp is not weatherproof, it is necessary to mount it under a roof to keep out the rain. However, it can be made weatherproof if desired by installing suitable electrical fixtures and sealing the glass panes and metal joints with putty or other waterproof compound. The metal parts are copper, but brass, aluminum or even galvanized sheet iron may be used. If the latter is used, it should be protected with two coats of metal enamel or lacquer. The rear panel of the lamp is of $\frac{3}{4}$ -in. waterproof plywood or solid stock, this thickness being necessary to permit driving screws into the end grain for attaching some of the metal members.

The center detail shows the assembly. As the sheet metal is soft, the various parts can be bent to shape in a vise or between two hardwood strips clamped tightly over the metal. Roundheaded rivets or self-tapping metal screws can be used for assembling the lamp, or the parts may be soldered together. If screws or rivets are used, false rivetheads are soldered along the simulated seam in the top. Patterns for the two-part top section are shown in the lower detail, the parts being bent as indicated by the dotted lines. Sheet-metal strips are used to hold the glass panes in place. The upper and lower strips are mounted inside the panes to form channels between the top and bottom lamp sections, while the center strips are fastened to the upright members on the outside of the panes.

In wiring the original lamp, a candle-type socket from an old ceiling chandelier was used. However, you can use any suitable socket, being sure that it is installed safely to prevent short circuits. Weatherproof fixtures should be purchased at your local electrical store if the lamp cannot be protected from the rain.

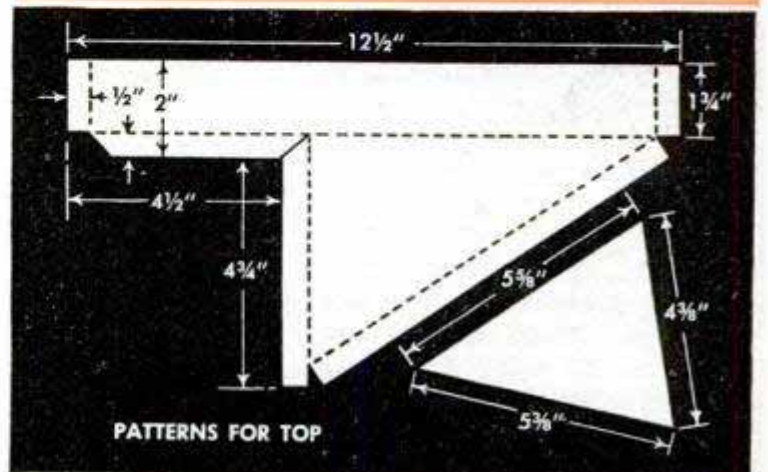
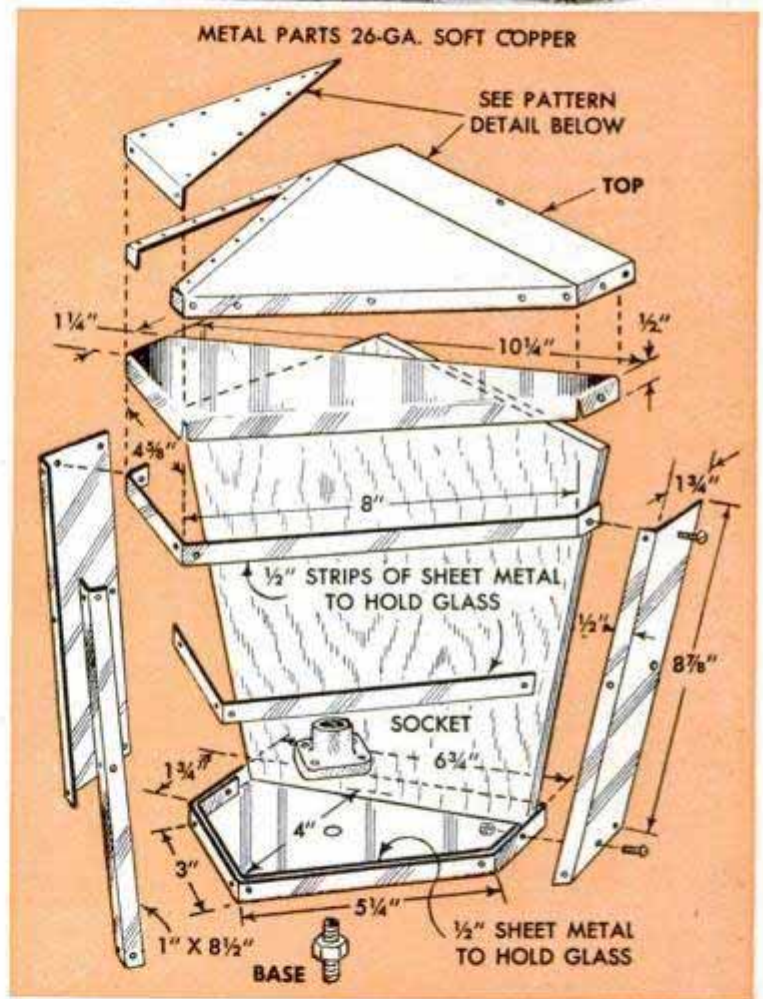
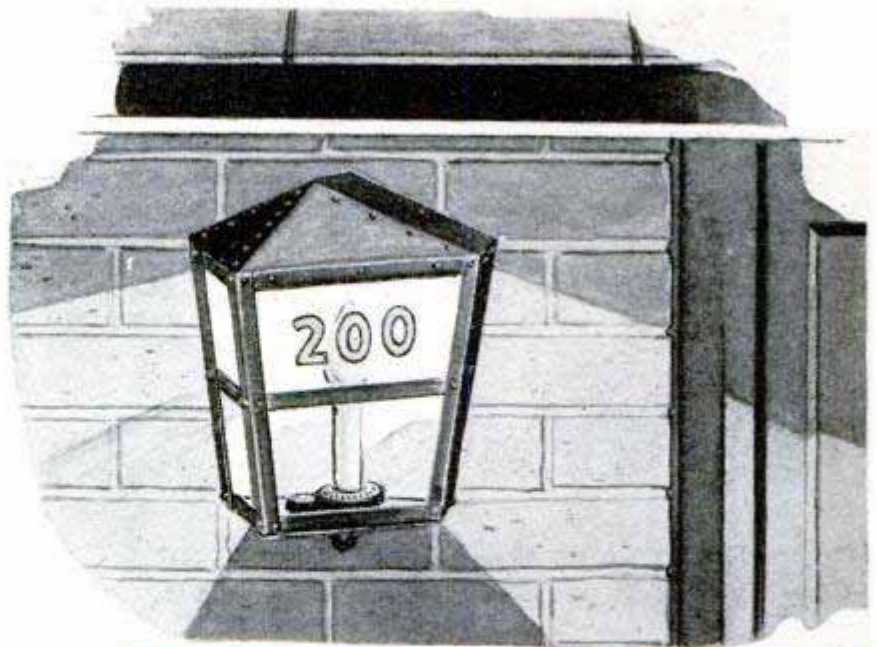



If your basement is leaky or so damp and musty that you cannot get the benefit of this desirable space for recreation or other purposes, it is not too difficult to eliminate these conditions by waterproofing

A WET BASEMENT IS LOST SPACE

IS YOUR HOUSE one of many in which valuable basement space—often equal to almost 100 percent of the living area upstairs—is practically unused and wasted because of water leaks and dampness? All of this space can be used by applying preventive or corrective measures to keep it dry. Preventive measures, which should be taken at the time a house is built, are much less expensive than corrective measures taken later. If you are planning to build where there is any possibility of water leakage through basement walls and floors, insist on having waterproof concrete. Also be sure to have waterproof cement-plaster coatings over walls of concrete, concrete blocks, brick, tile or stone. In prepared waterproof cement mixtures a waterproofing agent is added in correct proportions and interground with the cement. If the ready-made product is not

available, good results can be had by adding waterproofing powder to regular cement. Concrete walls should be no less than 8 in. thick and basement floors no less than 4 in. thick. Concrete in wall forms should be tamped or spaded next to the forms immediately after pouring in order to release entrapped air and prevent porous honeycomb spots that are particularly vulnerable to leakage. Where floors meet walls, a continuous tar joint is recommended. To provide an “undercut” keyway to retain the tar, three thicknesses of beveled siding, well-oiled or soaped, are placed next to the wall, as shown in the upper detail of Fig. 2, before the floor is poured. Many contractors apply a coating of hot tar or asphalt cement to the outside surface of foundation walls, as in Fig. 1, to seal the pores against water entrance. This is put on in one or more applications after the concrete

is thoroughly dry. Other contractors apply a $\frac{3}{4}$ -in. coat of waterproof cement plaster to the outside of foundation walls—sometimes also to the inside surface—to assure resistance to dampness. Such coatings are put on in two $\frac{3}{8}$ -in. layers.

Although a building site may be dry during summer months, it can be very wet during spring and also after severe and prolonged rainstorms. When the water table—height of standing underground water—is high, there is often considerable pressure which forces water through cracks and imperfections in basement walls and floors. Before building, you can determine the extent of the water table from the experience of others in the neighborhood. If the building site is on a hillside or slope, water may run against the foundation. Or, the grade may be flat and the soil so compact that the water seeping down from the surface does not drain away quickly. In any case where water tends to collect under and around foundation walls, and natural drainage is insufficient, artificial drainage by tiling is advisable, in addition to waterproofing the walls and floor.

Installing drainage tile: To carry away water, 6-in. drainage tile should be laid entirely around the foundation. The method of installation is shown in Fig. 2. The tile is laid at a slight slope— $\frac{1}{8}$ to $\frac{1}{4}$ in. per ft. is sufficient—with the high point at the top of the footing. Pieces of tar paper are laid over the joints of the tile as shown in Fig. 3 to prevent soil from getting inside, and the tile then is covered with an 18 to 24-in. layer of crushed stone or gravel. Often it is advisable to lay drainage tile under the basement also, which is a simple matter if done before the floor is poured. The sub-floor lines connect with those around the walls as shown in the lower detail of Fig. 2. Then the outside line is brought at a slight but constant slope to the discharge points at opposite corners of the building. In many localities it is permissible to make connections to the sewer. If this is not possible, you can provide one or two dry wells, as shown in Fig. 3, which should be located at least 15 ft. from the house.

Sealing basement with membrane: If water cannot be drained away quickly or completely with tile, a membrane waterproofing job may be necessary. This consists of two or more layers of asphalt-saturated felt, overlapped at the edges and cemented together with hot tar or cutback asphalt cement, placing the strips in the lower layer at right angles to those in the upper layer. The membrane is located between a two-layer concrete floor, and it should continue unbroken up the outside of the wall as shown in Fig. 4. Note how

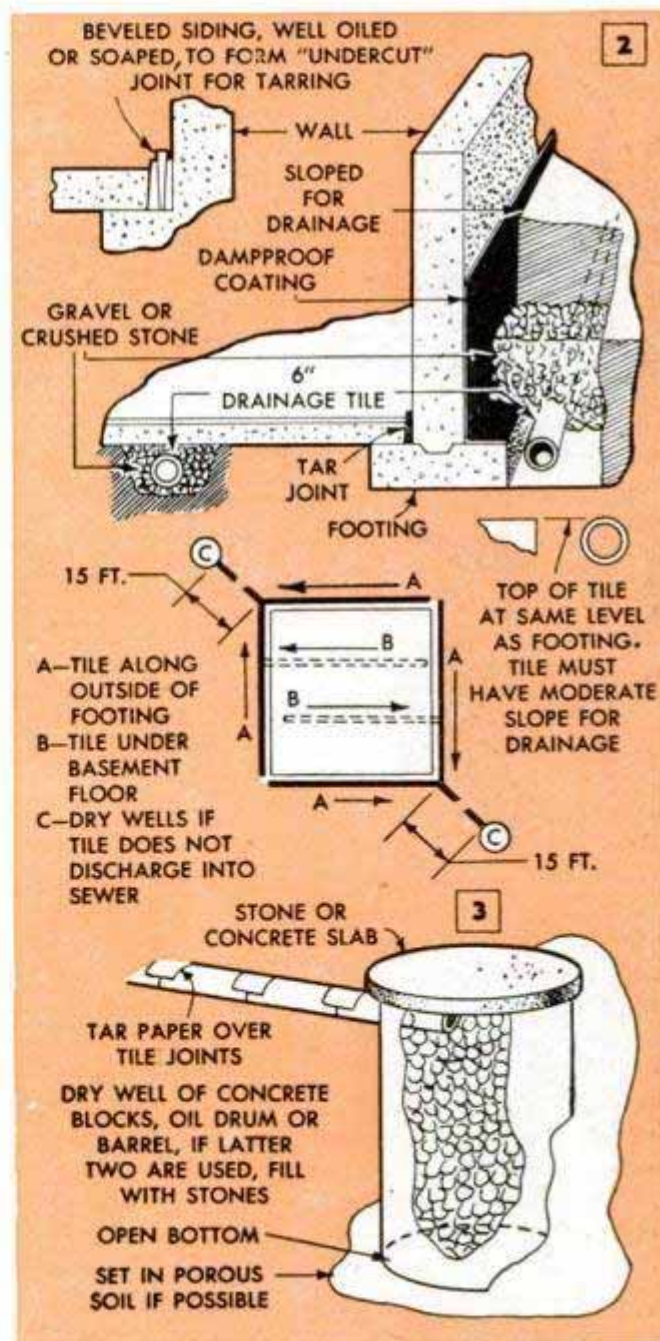

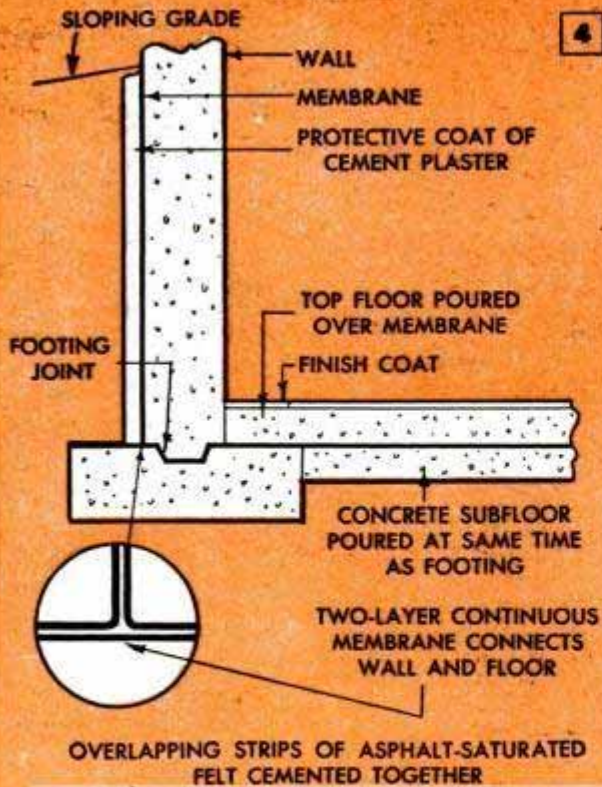

OVERLAPPING STRIPS OF ASPHALT-SATURATED FELT CEMENTED TOGETHER



HOT TAR OR ASPHALT ON CONCRETE

SECOND LAYER OF FELT CEMENTED TO FIRST AT RIGHT ANGLES, THEN COATED WITH CEMENT

HOT TAR OR ASPHALT-MASTIC SEAL

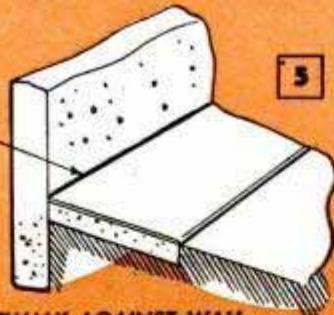

SIDEWALK AGAINST WALL SHOULD BE SEALED AT JOINT AND HAVE A DRAINAGE SLOPE

DENSE TURF HELPS TO SHED WATER ON SLOPING GRADE

SLIGHTLY SLOPING GRADE SHOULD EXTEND ABOUT 10 FT.

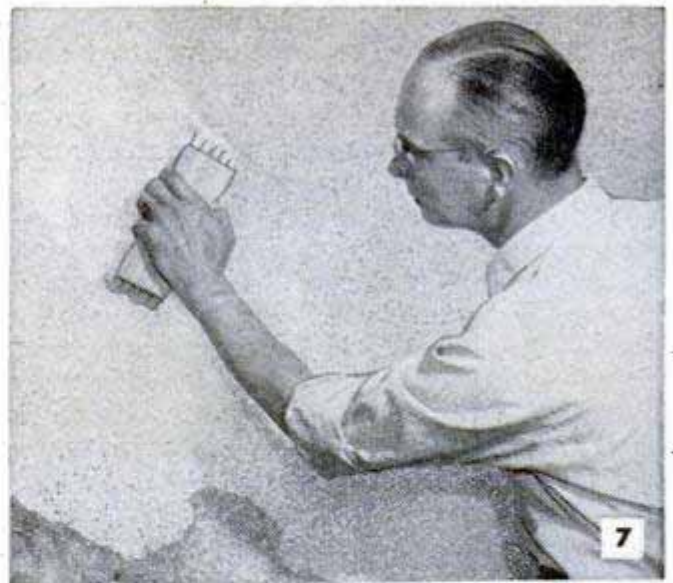

the membrane seals the joint between wall and footing. To protect it against mechanical injury on the outside of the wall, a $\frac{3}{4}$ -in. coat of cement plaster can be applied in two $\frac{3}{8}$ -in. layers.

General precautions: If roof drainage water cannot be directed into a sewer system, it should be led away from the house as indicated in Fig. 6. When filling in around an excavation, waste lumber, mortar and rubbish should be removed in order to avoid water pockets. The earth fill should be rammed down tightly after soaking it to minimize further settling. For drainage purposes, it is best to have the ground around a house slope slightly away from it, preferably for a distance of about 10 ft. Good, thick turf on this slope will also help shed water. A sidewalk that butts against a house wall and slopes away from it slightly as in Fig. 5 aids in keeping the wall dry. Too dense a planting of shrubs along foundation walls tends to retain moisture in the soil.

Waterproofing from the inside: Until recently, waterproof coatings applied to the inside surface of basement walls were not generally successful. However, a relatively new waterproofing powder, which will effectively stop seepage, is now available. The powder is dissolved in water to form a solution which is scrubbed onto clean, uncoated masonry as in Fig. 7. After filling the pores it expands upon curing to form a firm bond with the masonry, completely sealing it against the passage of water. The masonry surface must be saturated with water before the waterproofing solution is applied. As soon as the solution has hardened—6 to 12 hrs. after application—it is kept moist by repeated applications of a fine spray for at least 48 hrs. Generally, only a single coat is required. Besides stopping water seepage, it produces a snow-white surface which can be painted when dry. Figs. 8 and 9 show a corner of a basement before and after such waterproofing

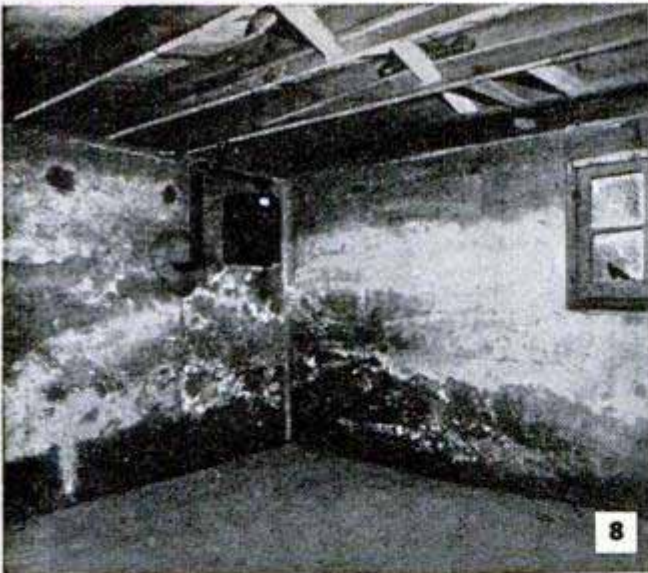

8

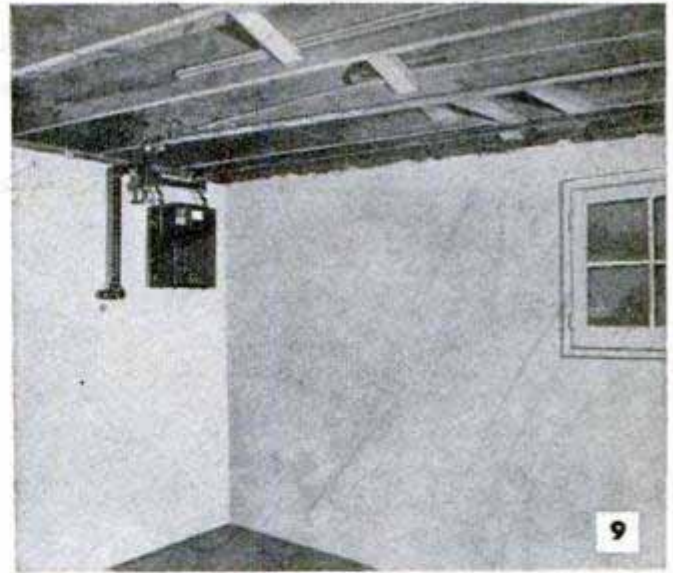

9

These photos courtesy Aquella

treatment. Note the improved appearance.

Small cracks and holes in masonry can be sealed watertight by filling them with a putty made from this powder and a small amount of water. For large cracks, equal amounts of fine, sharp sand and portland cement are added in the same volume as the powder, with enough water to form a heavier putty.

When floors are to be treated with this waterproofing solution, they must first be tested for porosity. This is done by pouring a small amount of water on the floor and observing whether the water is absorbed within a few minutes. If not, the floor is etched with a solution of muriatic acid, 1 part, to 5 parts of water, mixed by slowly adding the acid to the water. *Caution:* Avoid getting the acid or solution on flesh or clothes. The etching solution is applied to the floor with a fiber or rubber brush. After half an hour, the floor is hosed off with water and the waterproofing solution is applied. Floors thus treated should be painted or otherwise covered to protect them from abrasion. Special attention should be given to the joint where the floor meets the walls since this is the place where leakage is most likely to occur. Force the waterproofing solution well into minute cracks; if they are wide enough, force the putty into them. Leakage at joints between floor and walls also can be stopped by having a narrow groove cut in the floor (this can be done quickly with an air hammer) and filling the space with hot tar after the concrete has been dried thoroughly with a blowtorch, Fig. 10.

Keeping water away: Where there is considerable hydrostatic pressure because of a high water table, water may still enter if any cracks develop after a waterproofing job of the kind just described. Also, water may enter through imperfect joints at floor drains, or defective joints in the soil pipe. Waterproofing the inside surface of a basement wall does not prevent the wall from

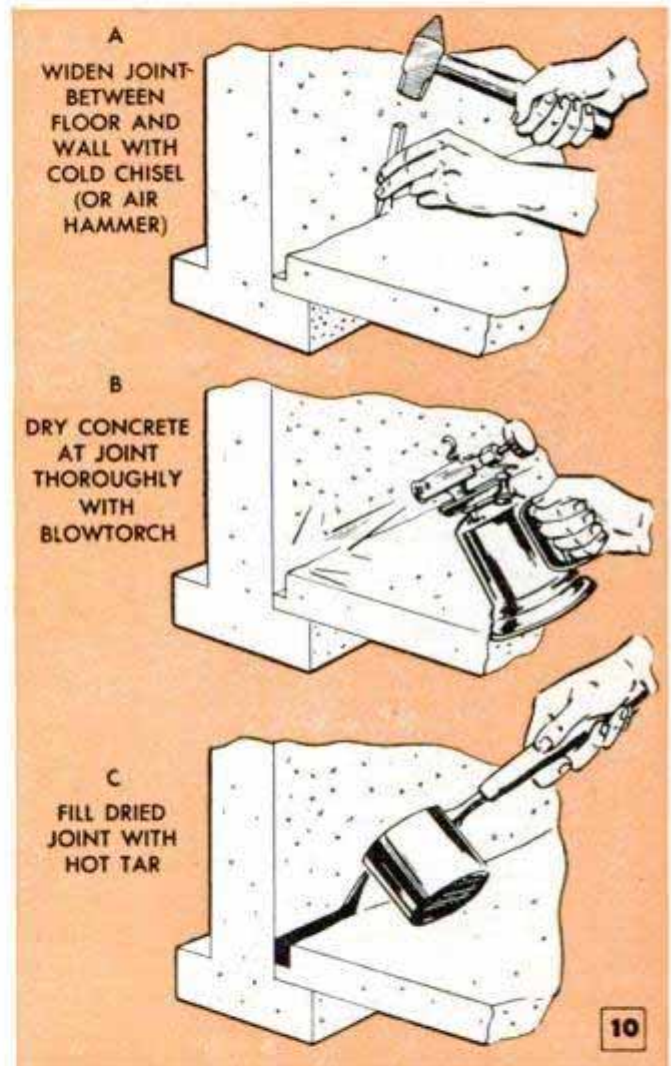

retaining moisture, which may evaporate continuously under the sill causing it to rot. The moisture then may also get into the house walls causing paint peeling and other troubles. Excessive water around foundation walls may be responsible for an unstable condition that is conducive to continued settling of a building. Because of these conditions excessive water should always be drained away from a foundation. With old buildings this involves digging a trench alongside the walls and installing drainage tile as explained and illustrated

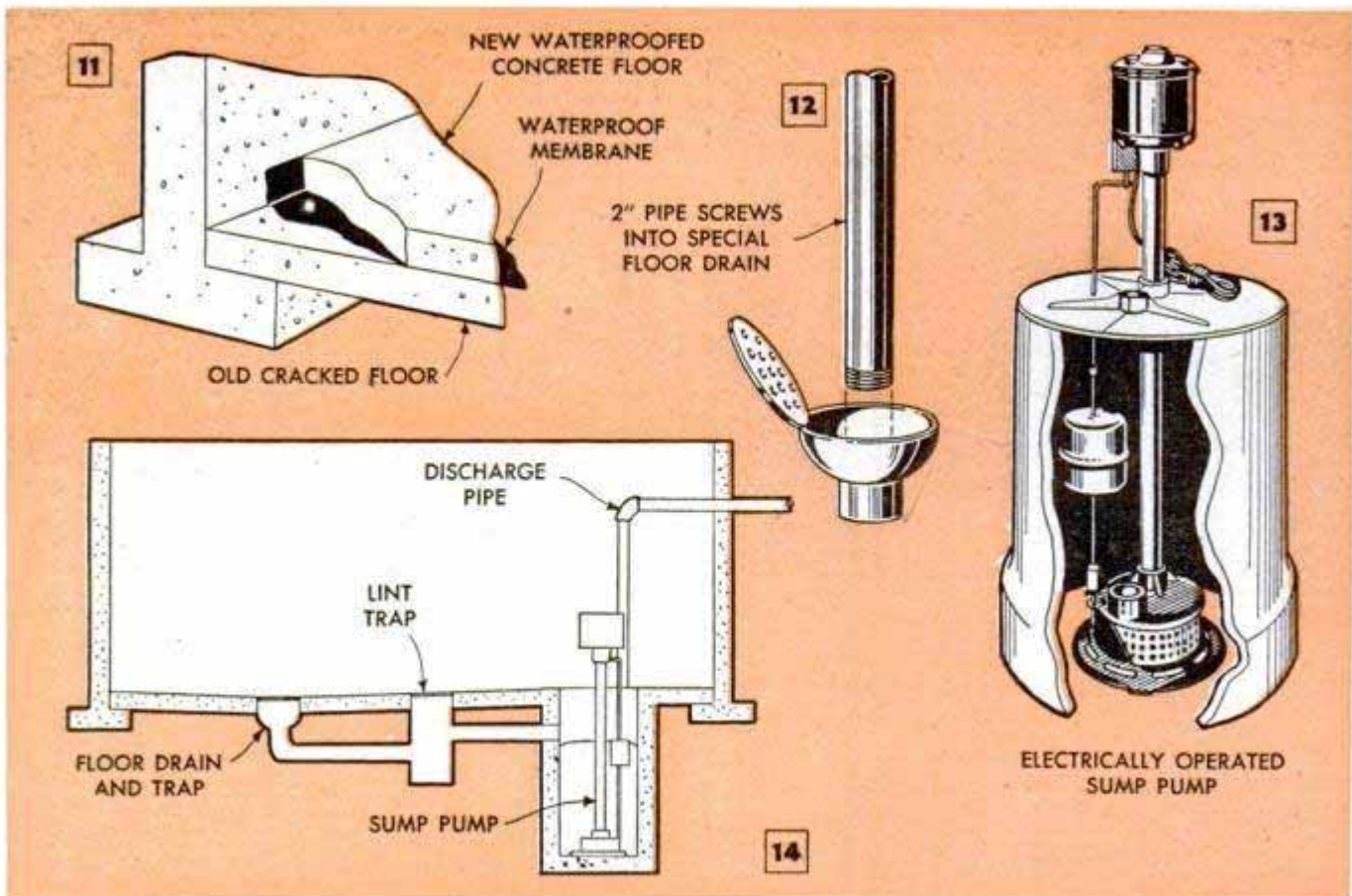

in Fig. 2, which details correct procedure.

In cases where floors are badly cracked and there is considerable leakage, a new floor of waterproof concrete can be laid over the old one, with a watertight membrane between them as shown in Fig. 11. This is easier, quicker and more positive than attempting to fill the cracks. The membrane consists of two or more layers of asphalt-saturated felt overlapped at right angles and cemented together.

Sewer-backup control: When sewers are overloaded, as when carrying away storm water, the water often backs up into basements, which makes them unsanitary as well as unfit for storage. Even if the flooding is of short duration and the water level does not rise over a few inches, a deposit of silt and dirt is left. To stop sewer water from getting into basements, backwater traps and valves can be installed, or drain caps or plugs used. If either of the latter are used, joints in the sewer under the floor must be tight and strong, otherwise pressure of the restricted water will cause leaks at the joints. Caps or plugs are applied manually when trouble is expected, and removed later.

A better and simpler method of preventing sewer-backup water from spreading over a floor is to use a standpipe. Floor drains, threaded for attachment of pipe, Fig. 12, are available. The height that the water will rise will seldom be over 2 or 3 ft. In case there is a toilet in the basement, the bowl can be plugged securely against backup water with a sack of sand, if the

water is likely to rise above the rim of the bowl.

Sump pumps: In some cases where basements are located below the sewer level and natural drainage is impossible, a sump pump, Fig. 13, is required to raise the water out of the basement to discharge it. Such a pump is used also to remove water from old cellars that are leaky and which would have to be rebuilt completely to make them watertight. A sump pump is installed in a small pit, as in Fig. 14, to which drain water from tubs and floor drains is directed. Most sump pumps are electrically operated, being controlled by a float-operated switch which makes operation entirely automatic.

Window-well drainage: Wells around basement windows often become filled with snow and sometimes accumulate water during heavy rainstorms, with the result that water gets into the basement through the window. Usually the reason for this is heavy, compact soil under the well, which does not absorb water quickly, or the well may not have a good drainage outlet. The quickest remedy is to dig out the compact earth about 18 to 24 in. below the well and substitute gravel or sand as in Fig. 15 if the basement gravel wall is tiled. But if the wall is not tiled, it is better to dig a trench 4 to 6 ft. long from the well, as shown in Fig. 18, and install a few lengths of tile to lead the water away from the house.

Moisture condensation: When warm, humid air gets into a cool basement, moisture is deposited on cool surfaces such as walls, floors and especially cold-water

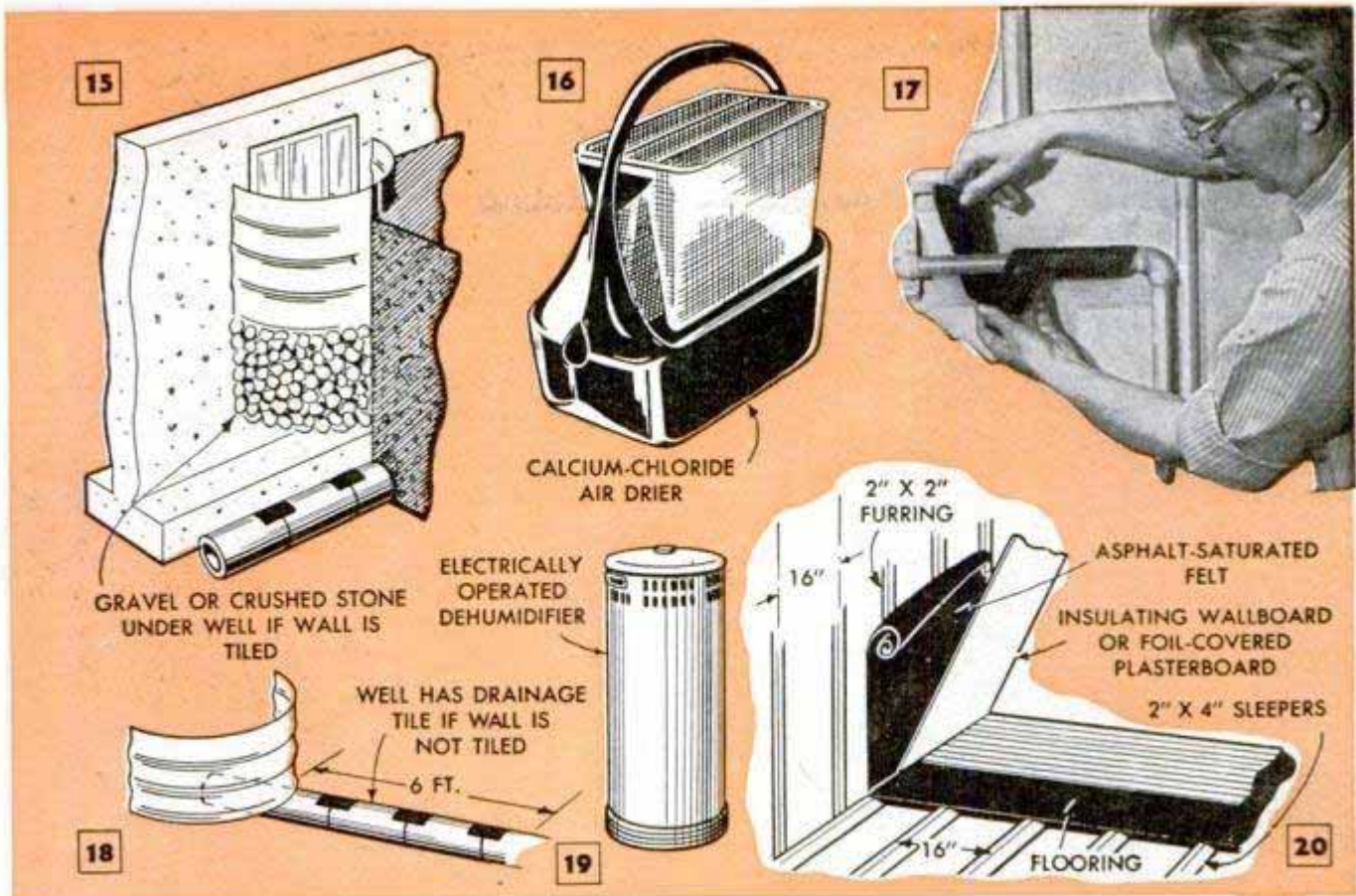

pipes. Often this condition is mistaken for water leakage through walls. The simplest way to prevent condensation in basements is to prevent the entrance of air that is warmer than the basement air, allowing outside air to enter only when it is cooler and drier than the basement air. Cool night air could sometimes be admitted to freshen the basement air, but warm day air should be kept out. However, because of the constant air leakage through windows and doors as well as through the floor and ceiling over the basement, such control is seldom possible.

In closed basements where air change can be held to a minimum, moisture may be extracted from the air by means of calcium-chloride driers. Those with a large area of absorption, as the one in Fig. 16, are best. Using a fan to direct air against them permits them to function faster. Also there are electrically operated dehumidifiers as shown in Fig. 19. However, neither device can perform at its best when the air in a room is constantly being replaced with humid air. Sometimes a hot-water heater is sufficient to raise basement temperature above the dew point where condensation occurs.

If, after waterproofing basement walls and floor, it is desired to minimize condensation, the cold-water pipes should be covered with insulating material designed for this purpose, Fig. 17. Even the valves in the water line can be partly covered. Cool concrete walls that sweat when exposed to warm, humid air can be covered with in-

insulating type of wallboard over a layer of asphalt-saturated felt, which serves as a vapor barrier. Or, the covering can be plasterboard coated on the inside with metal foil. In either case, the wall covering is applied to wooden furring strips as shown in Fig. 20, and special care must be taken to make all joints at the floor, corners and ceiling practically airtight in order to retard air change in the space between the covering and the concrete-wall surface. Similar treatment for sweating floors consists of flooring and asphalt-saturated felt nailed to 2 x 4-in. sleepers also shown in Fig. 20. These may be tapered on one edge to produce a level wood floor over the concrete floor.

Wrench Doubles as Screwdriver

A small screwdriver for mounting accessories on the spindle of a hand grinder is always at hand if a screwdriver blade is filed or ground on the handle of the spanner chuck wrench which is furnished with the unit. Grind off the end of the handle



as indicated by the dotted lines and taper the metal to fit the slot of the spindle screw.

Andrew Vena, Philadelphia, Pa.

Screen Wire Stretched Taut On Simple Table-Top Jig



Merely replacing the wire of a window screen is simple enough, but stretching it evenly to eliminate unsightly bulges is another story. One homeowner, who had a single screen to re-cover, found that this table-top jig would do a neat job of holding the wire taut while it is tacked to the frame. The jig consists of two cleats and a wooden turnbutton nailed to the top of an old table or workbench. After one of the cleats has been nailed in place several inches from the edge of the table top, the screen frame is placed against the cleat to locate the wooden turnbutton. Next the wire is tacked securely to the frame member nearest the turnbutton and pulled toward the cleat to raise the end of the frame an inch or two. With the frame propped up with a block, a second cleat is nailed or clamped to the table top and over the wire. Then the raised end of the frame is pressed downward and held flat against the table top with the turnbutton while tacking the wire to the frame is completed. The excess wire is trimmed off after nailing.

Herbert E. Fey, New Braunfels, Tex.

Eaves-Trough Howling Reduced By Metal Wind Deflectors



High winds whipping across the eaves trough at the corners of the house frequently cause an annoying howling sound. In most cases, this noise can be eliminated

by installing sheet-metal wind deflectors at the corners of the eaves trough. Make the deflector for each corner in two 18-in. pieces, 3 or 4 in. wide. These are fastened to the eaves trough with sheet-metal screws and bent to deflect the wind upward. Note that the corner is mitered so the two pieces fit together tightly.

Frank M. Butrick, Jr., Alma, Mich.

Copper Tubing Provides Rivets For Assembling Knife Handle

Substituting short lengths of copper tubing for rivets results in a fast, neat job of assembling a knife blade and handle. Position the handle over the blade and drill two or three holes through the assembly, using a bit of the same size as the outside diameter of the tubing. Countersink

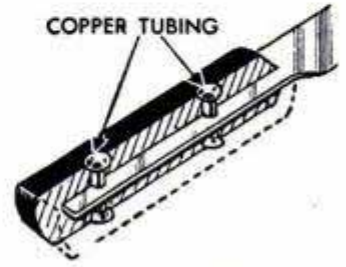

both ends of the holes, slip the tubing in place and then swage the ends of the tubing with a center punch to lock the handle to the tang of the blade.

Cleaning Yellowed Piano Keys

Ivory piano keys which have yellowed with age can be restored to their original finish by scrubbing them with a mixture of hydrogen peroxide and very fine pumice. Depending on the depth of the discoloration, the operation may have to be repeated several times to restore the color. However, if the keys are of plastic and the discoloration extends completely through them, it cannot be removed in this way.

Magnet Kept With Toolbox Picks Up Scattered Nails

After finishing a carpentry job, scattered nails, tacks and brads can be retrieved in a fraction of the usual time if they are picked up with a magnet. A horseshoe magnet of the type used on radio speakers or one taken from an old magneto is excellent for this purpose as it can be hung over the handle of the toolbox, where it is always handy.

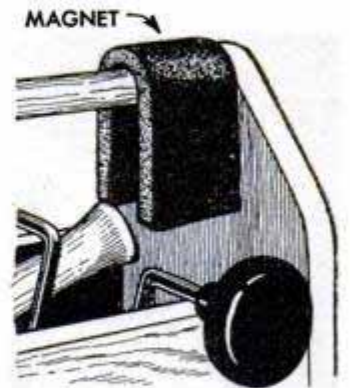

☐ Candy stains are removed by scrubbing with strong laundry soap and hot water.

DO YOUR SHAPING ON

Contour Wheels

By Dick Hutchinson

FOR OCCASIONAL jobs of sanding moldings in the home workshop these abrasive contour wheels eliminate a lot of tedious handwork and produce as good a job as a ribbon sander on moldings of average size. Also, it is possible to rough the molding to shape and finish it on a contour wheel made especially for the purpose.

The wheel is turned from hardwood on a lathe to a square-edged disk about 7 or 8 in. in diameter. Then the edge is shaped in the reverse, or negative, of the molding shape desired. Of course, for each molding shape a disk must be selected of a thickness equal to the width of the molding. Coat the contoured edge of the disk with liquid glue and allow the glue to set to the tacky stage. Next, roll the disk over a layer of loose abrasive grains spread in the bottom of a shallow box or tray. Tap the wheel lightly with a mallet to knock off excess abrasive and hang on a wire or hook until the glue is dry. For sanding wood, use garnet abrasive grains in the fine, medium or coarse grade, depending on the type of finish desired. For grinding or polishing

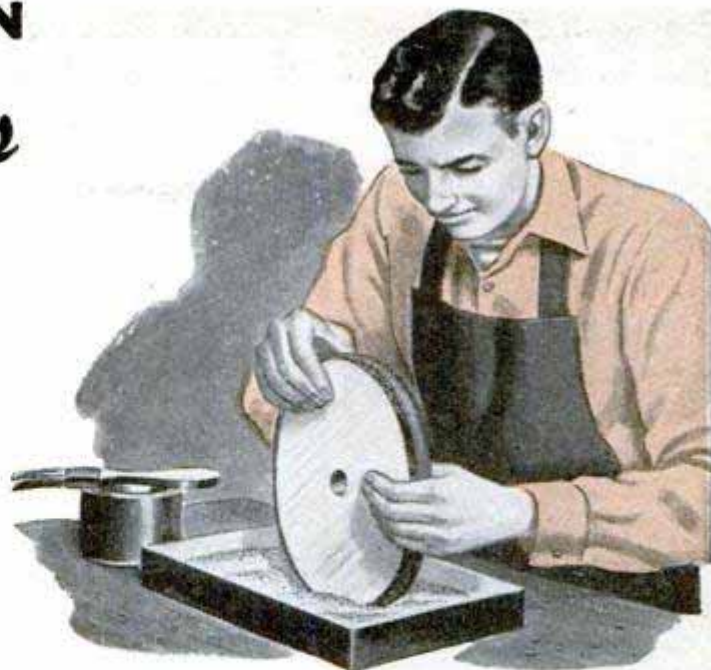

metal, coat the wheel with aluminum-oxide grains. For finishing straight moldings, the contour wheel is mounted on the circular-saw arbor. Thus you have the advantage of the ripping fence in guiding the stock. For freehand operations, such as rounding curved edges, make a small wheel with a concave edge contoured to suit the work and mount it in a lathe chuck. As you can see, in addition to making and finishing moldings, it is possible to make wheels for almost any ordinary job in contouring. The wheels will polish or grind irregular shapes in metals as well as wood.

TURNUED WOODEN SANDING WHEELS

PICTURE MOLDING

Profiles shown at left are suggested shapes of contour wheels. Photo below shows samples of the work produced. The hardwood wheels are turned, contoured and coated with abrasive grains to suit the job. They finish stock to almost any shape

MOLDINGS SHAPED WITH SANDING WHEELS

EDGE MOLDING

MOLDING ROUGHED OUT ON CIRCULAR SAW

The complex block contains several diagrams and a photograph. At the top left, there are two diagrams of turned wooden sanding wheels with different profiles. To the right of these is a diagram of a 'PICTURE MOLDING' profile. Below the top diagrams is a photograph showing several finished moldings of various shapes. To the right of the photograph is a diagram of an 'EDGE MOLDING' profile. At the bottom left is a diagram of a 'MOLDING ROUGHED OUT ON CIRCULAR SAW'. At the bottom right is a photograph of two circular sanding wheels mounted on a lathe arbor, with a wooden tray containing abrasive grains in front of them.

Precision Filing Done in Home Workshop With Roller Guide Mounted on Bench Top

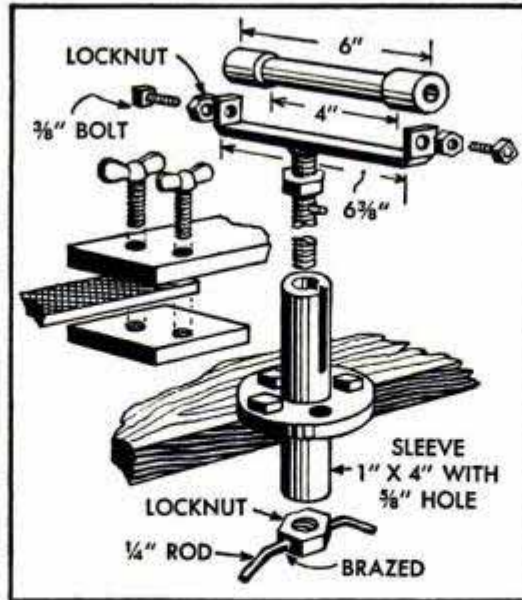
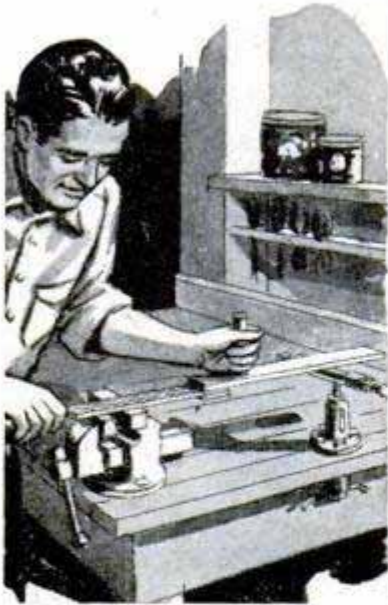

Using this roller guide permits accurate filing of flat surfaces by hand. A flat-iron extension clamped to the file rides on a roller consisting of a length of rod which is turned as shown or fitted with a sleeve at each end. A short handle of pipe is welded to the extension. The threaded shaft is adjusted with the top nut and clamped with a locknut at the lower end. A pin driven into the side of the shaft drops into a slot in the pipe sleeve to keep the roller from turning.—Walter G. Fisher, New Haven, Conn.

Corner Hook for Wood Carving Has Right-Angle Stop

Handy for low-relief carving and making linoleum-block cuts as well as assembling small parts that are easier to handle if they can be crowded into a corner, this small-size bench hook fits over any square corner of a table or bench top. The hook consists of a 5 x 5-in. piece of 1/4-in. plywood and four 1/2-in.-sq. cleats. Two of the cleats are nailed along adjacent edges on one face of the plywood and two are nailed along opposite edges on the other face. In this way, either side can be hooked over the bench corner. When assembling, be sure that the cleats on one side square with each other and with those on the opposite side.

Harry H. McIntyre, Midland, Mich.

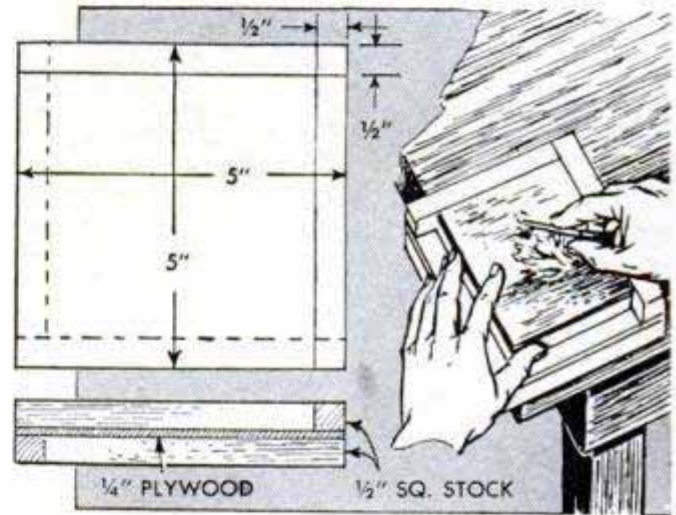

Auto-Wiring Insulation Renewed by Using Friction Tape and Lacquer

In older cars where the insulation on the wiring has become worn and frayed, grounds and short circuits are likely to occur along with the ever-present possi-

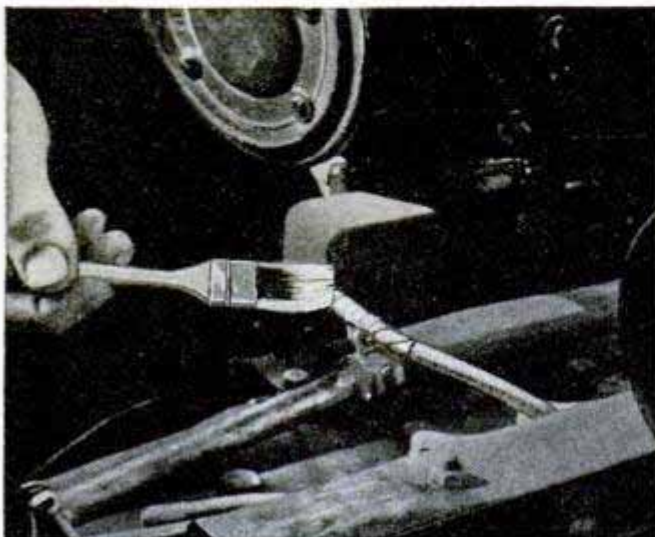

bility of fire. Low-voltage wires leading to the lights, horns and other accessories can be reinsulated with friction tape and lacquer. Trace each wire individually from the accessory to the point where it enters a sheathed cable, or loom, inspecting the wire with special care under the metal clips which fasten it to the car body. If the insulation at the cable is doubtful, remove as much of the sheathing as necessary. Then, tape the wire tightly, using a long spiral and overlapping each turn about one third its width. When all the leads have been taped, coat them with clear lacquer. Tape the opened end of the cable, secure loose wires to other leads or a firm support and tape them together. Finally, apply lacquer to all taped joints to seal the tape from dust and moisture and prevent its coming loose.

☐ Replacing a broken window pane usually is easier if the sash is first removed.

Spring Hold-Down Fits Wooden Shaper Fence

This spring-loaded hold-down can be used on either a homemade or commercial shaper, or it can be used in connection with a drill-press shaper attachment. The top block of the hold-down is mounted on the fence by means of an L-shaped bracket bent from sheet metal. This bracket is slotted so the hold-down can be raised or lowered for different sizes of work, final adjustment being made automatically by two compression springs which "float" the pressure foot on the top surface of the work. The foot, which is rounded at both ends, is connected to the top block with two bolts. These are a sliding fit in holes drilled through the block and are turned into tapped holes in the foot. Note

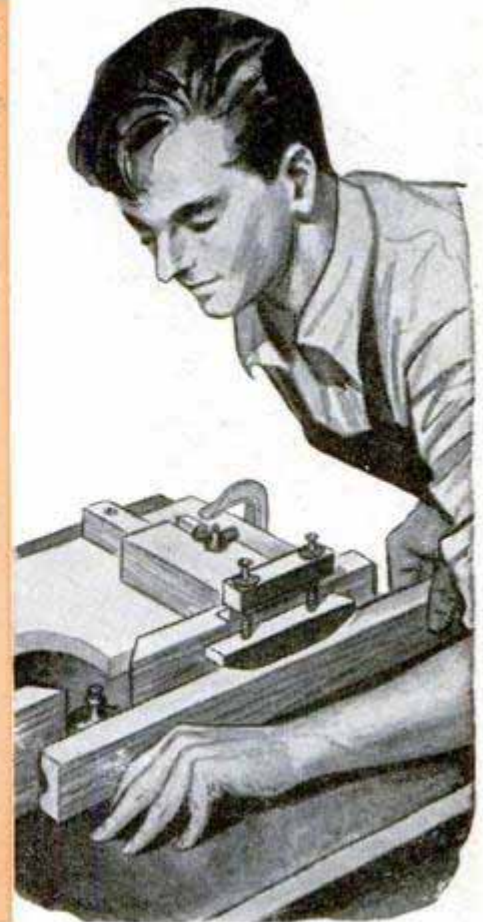
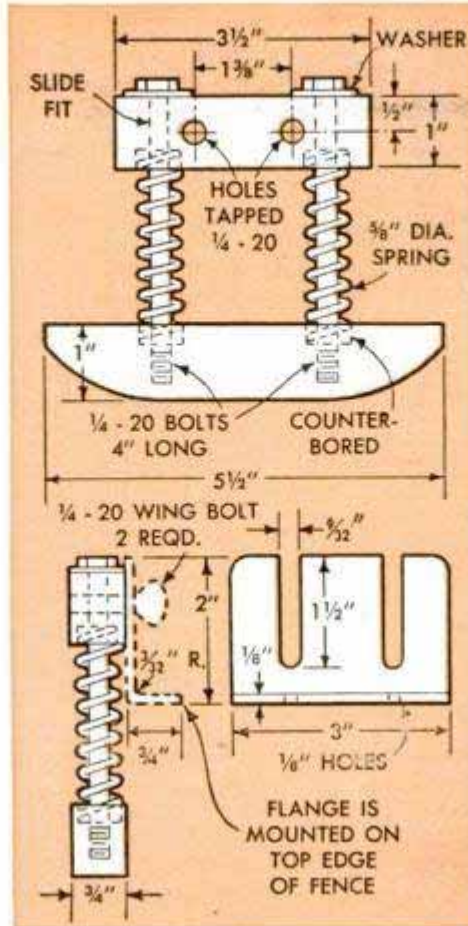

that the holes in both the block and foot are counterbored to provide seats for the coil springs. The hold-down can be made of aluminum, as shown in the details, or hardwood can be used for the top block and foot. In the latter case, the mounting holes for the top block are not tapped, and

bolts and wing nuts are used instead of wing bolts. Also, the bolt holes are drilled completely through the foot and counterbored on the underside so the nuts which hold them in place will not come in contact with the work.—John Kenneth Kapus, East Hempstead, N. Y.

Turntable Pivoted on Caster Speeds Painting Figurines

If your hobby is figurine painting or shell crafting, you will find this miniature turntable just the thing to permit quick



and easy manipulation of the small pieces for fine work. Obtain a ball-bearing plate caster of the type that is fastened with screws and remove the wheel from the caster. Next cut a block of wood to fit in the caster yoke (the one used in the original was $\frac{3}{4} \times 1 \times 2$ in.) and glue this to the face of a piece of $\frac{1}{4} \times 2\frac{1}{2} \times 2\frac{1}{2}$ -in. stock. Then set the block in the caster yoke and fasten in place with two wood screws which are driven through the wheel-mounting holes. The caster plate can be screwed to the top of your worktable or mounted on a wooden base as desired. A 6-in. disk of $\frac{1}{4}$ -in. wood, covered with felt, provides a base for painting figurines, and a square of sheet glass cemented to the top of the $2\frac{1}{2}$ -in. turntable base forms an excellent surface for shell crafting. When you intend to work on figurines, simply set the felt-covered disk loosely on top of the glass.

R. E. Hancock, Portsmouth, Va.

Two UNUSUAL

By Norbert Engels



IF YOU have a flair for Early American furniture, you'll surely find a place among your furnishings for at least one of these charming little magazine tables. Embodying characteristic spool-turning in their design, both tables provide opportunity to try your hand at lathe work. Although the magazine compartment of only one of the tables is designed to rotate, both can be made to feature this point or the tops can be made stationary. In either case, it is important to true up the top end of the column in the lathe so that the compartment will be square with the column when assembled.

Walnut, birch, maple or cherry are appropriate woods to use. The method of doweling the three legs to the turned column is the same for both tables, the legs being spaced 120 deg. apart. Figs. 1, 2 and 3 detail the table with the rotating top. The bottom of the magazine rack is cut to size, the edge molded on three sides and the blind dadoes are cut for the scrolled front-piece and the center divider. One simple way to form the blind dadoes on a small piece, such as the bottom of the rack, is to run the grooves clear through, then rip a strip from the same wood as the bottom to the sectional size of the groove. Cut off two short lengths and glue these into the ends of each groove. Sand flush after the glue is dry.

Fig. 3, left-hand sectional detail, shows how the pivot is assembled. A tap hole for a No. 5 wood screw is drilled in the top end of the column and filled half full of glue. Then a hole is drilled through the bottom of the rack, centered in the groove. After inserting the screw, a large 1/8-in.

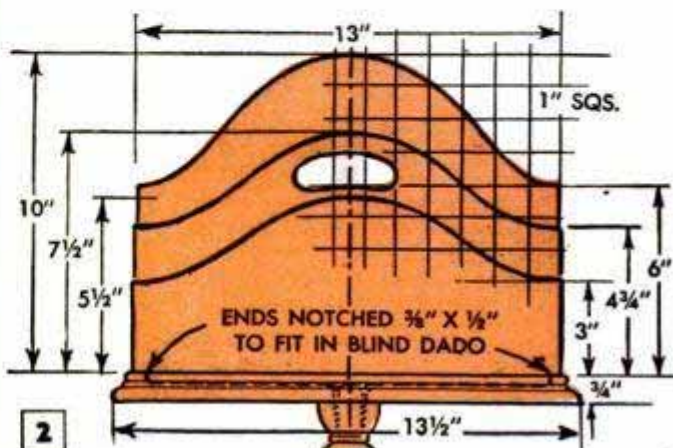
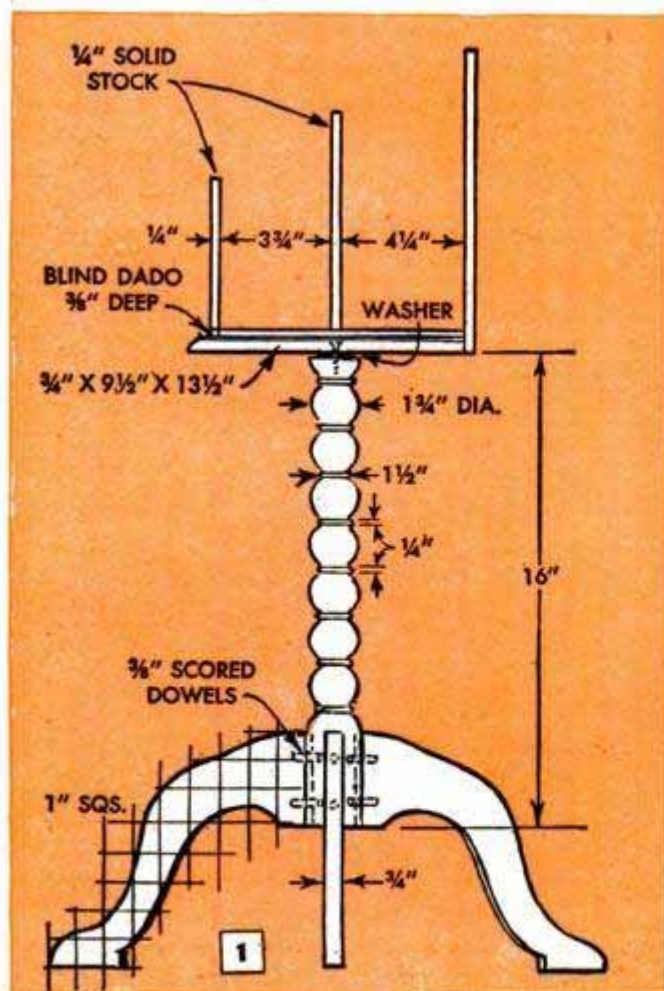

TABLES for Magazines

fiber washer is placed between the bottom and the top of the column. Draw the screw up fairly tight. Notch the lower corners of the center partition to fit in the blind dado and glue in place. In fitting the curved legs, the ends are sanded or filed to a concavity with a radius equal to that of the lower end of the column. This permits them to fit snugly against the curved surface. After bandsawing the legs, smooth the sawed edges and round the top edges to a radius by sanding. Do the same with the top edges of the front and back pieces as well as the center partition of the magazine rack. This done, the assembly is ready for finishing.

The hopper-type rack, pictured at the right and detailed in Fig. 4, is simply a tray with a handhole in each end. The sloping sides and ends are assembled with compound miters, or "hopper" joints, at the four corners. A special feature of the handholes is that they are bandsawed from the edge, that is, you simply saw in and saw out. After the miter cuts have been made on all the pieces, the corners are joined, one at a time, with screws and glue. The screw holes are countersunk and fitted with wooden plugs cut from the same wood as that from which the tray is made. Then the edges of the bottom are beveled and the sides joined with screws and glue. Sand all parts smooth and round the corners slightly. Then join to the column as in the right-hand detail in Fig. 3.

Methods of applying a finish depend on the kind of wood used and the type of finish desired. If an open-grained wood, such as walnut is used, then a filler must be applied. After staining and filling the grain, apply a sealer and follow this with shellac or two coats of varnish or lacquer. Maple and birch do not require a filler, but many craftsmen apply a filler to cherry as it helps to bring out the beauty of the grain.

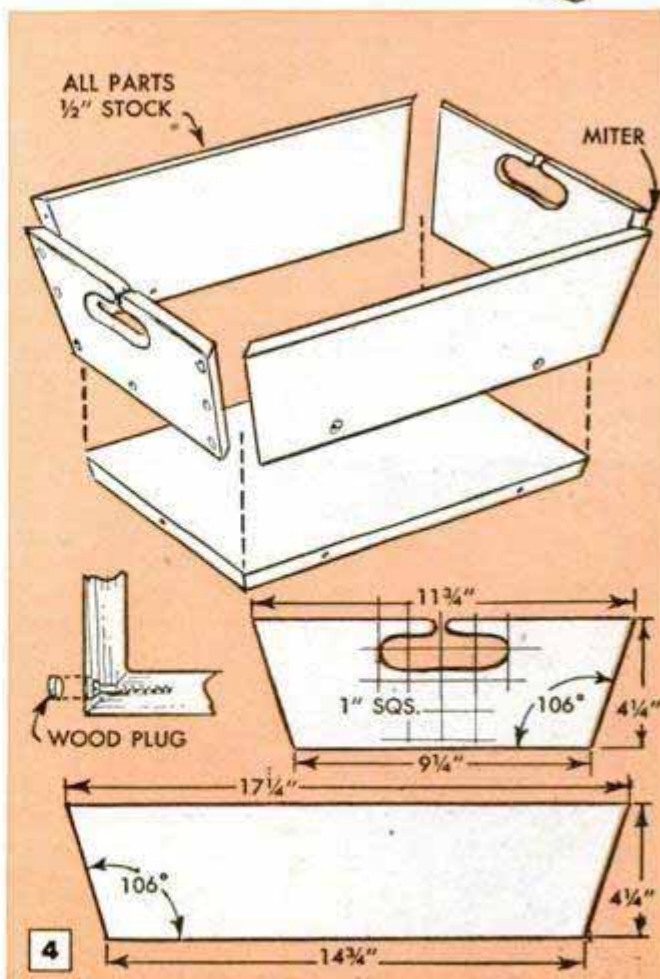
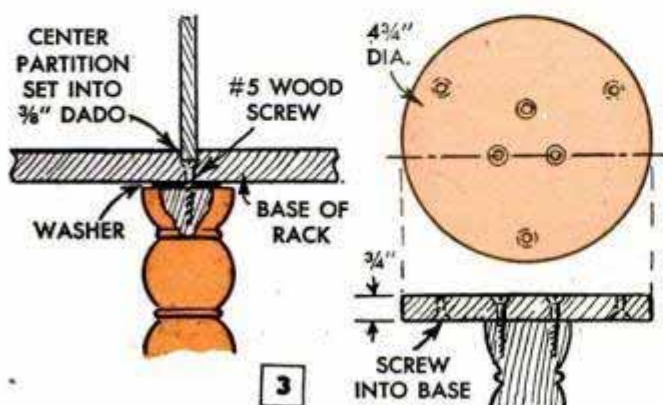

Canvas Shield Protects House While Near-By Shrubs Are Sprayed



Chemicals used to spray shrubs frequently blow against a near-by house where they stain the windows and sometimes leave hard-to-remove discolorations on the walls. This can be avoided simply by having one man hold a 6-ft.-square section of waterproof canvas between the shrub and the house. The canvas is moved along with the sprayer in order to deflect the spray being blown toward the house.

Removing Shoe-Polish Stains

Clothing stained with black shoe polish can be cleaned by washing the stained portion in soap and water or by applying turpentine directly to the stain. Alcohol or vinegar can be used to remove stains caused by tan or brown shoe polish.

Screws Stored With Extra Hinges Cannot Be Misaid

When extra hinges are kept in the home workshop for future use, often the screws are mislaid if they are stored loosely in a drawer or on a shelf. To be sure that there will be a complete set of screws for each hinge when it is needed, here are two ways of storing the screws right with the hinge so that there is no chance of their being lost. One way is to insert the screws in the holes in the hinge leaves, close the leaves fully, as shown, and then slip a rubber band over them to hold them together. The other way is to place the screws in the holes and

merely stick a strip of cellulose tape over the heads to keep them from falling out of the hinge leaves.

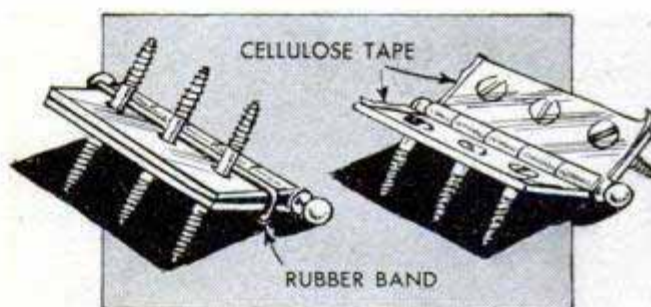

Scrap Leather Pulled Through Cutter to Produce Lacing

Lacing of almost any desired length and reasonable width can be made quickly by rotating a piece of scrap leather on this easy-to-make cutter. A razor blade held at a slight rake by a sheet-metal bracket provides the cutter, and a slotted wooden base receives the lower end of the blade. Note that the metal guide, which controls the

width of the lacing, is inserted between the mounting bracket and metal base plates. The latter are set flush with the surface of the wood. The guide is adjusted by loosening the blade-bracket screw and the guide screw, and the blade is moved to renew the cutting edge simply by loosening the machine screw which holds it to the bracket.

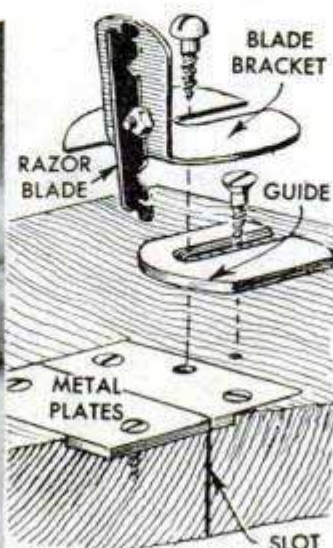
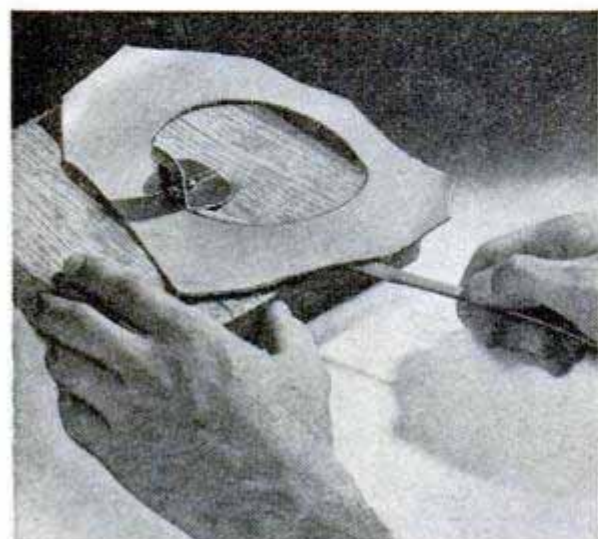

To cut the lacing, first cut a small disk from the center of the leather scrap and place the scrap over the blade bracket. Then insert the edge of the leather under the lip of the blade bracket, bring it in contact with the blade and slowly rotate the leather counterclockwise. When the lacing projects from under the leather, grasp the end and pull until the desired length is attained. —C. Mendendorp, Grand Rapids, Mich.

CAR-CRIB STROLLER

By Orwin Westwick

BUSY MOTHERS with daily shopping and visiting schedules will appreciate the convenience of this dual-purpose car crib because it doubles as crib and sidewalk stroller without any alteration or adjustment. The sturdy frame is made from stock sizes of aluminum, $\frac{1}{4}$ x $\frac{3}{4}$ in. in sectional size, and is joined with aluminum rivets where indicated in the details below. Note, in detail A, that an opening is allowed between the frame members to take short axles, which can be lengths of threaded $\frac{3}{8}$ -in. rod or common machine bolts. Two nuts, one on each side of the frame, lock the axles in place. If bolts are used as axles, the wheels are mounted beforehand. After riveting together the parts which form the basket frame, seat hooks and front rests, the handle is bent from thin-walled conduit and attached to the spacer and to the basket frame as in the assembly details. Although not shown, a rubber handle-bar grip of the type used on bicycles can be fitted over the upper end of the handle. The semi-pneumatic wheels are held on the axles with cotter pins and washers. Care should be taken in the assembly to make sure that the wheels track straight ahead, as otherwise the cart may not roll freely. The basket is made from heavy muslin or light canvas with four buttoned flaps which loop over the basket frame as shown. Note that the flaps are cut away and hemmed separately to clear the corners and handle.

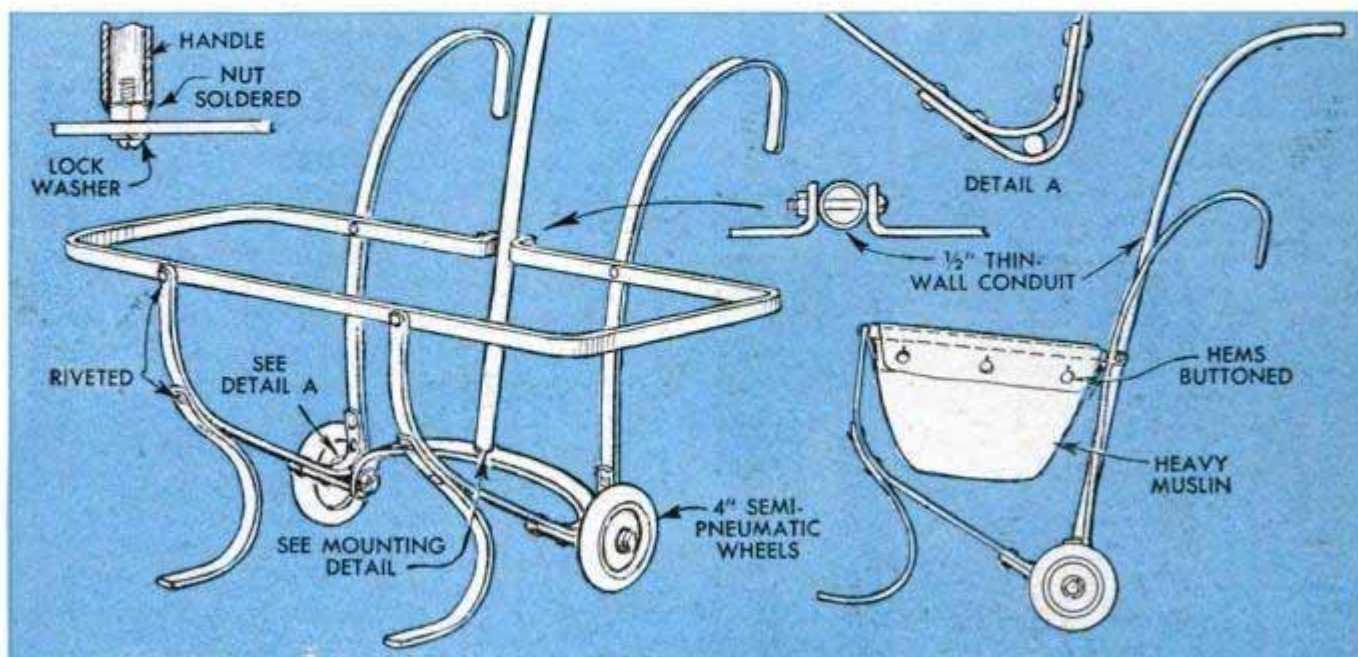
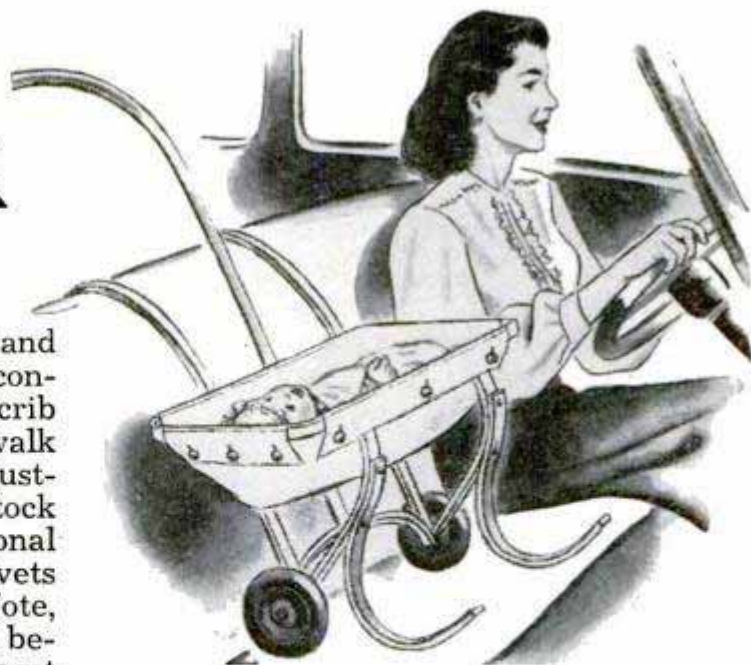

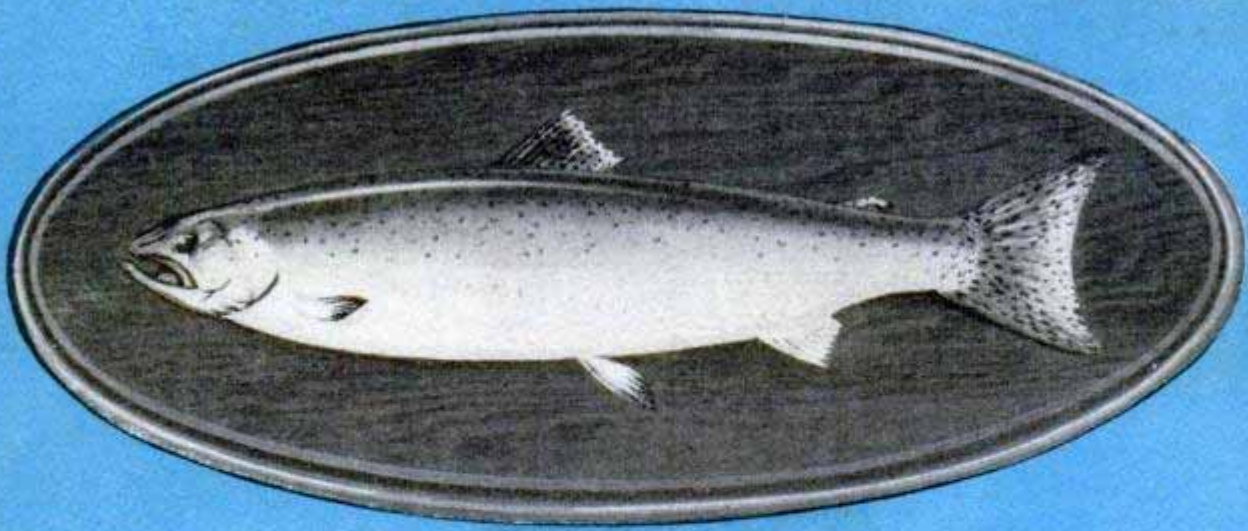

FISH TROPHY

By Eric Cameron

THAT amazing fishing yarn about the big one that *didn't* get away will leave little doubt among fellow anglers when you proudly show them proof of your catch—a true-colored replica in plaster. The first step in “preserving” a fish is to jot down its natural coloring for reference when painting. Do this before the colors fade, preferably as soon as the fish is landed. Make a plaster-of-paris impression of the fish right on the spot, using a cardboard box filled with sand as a form. Level out the sand, dampen it if dry, and sponge off the fish with a solution of alum and water to remove the mucus film. After this, use petroleum jelly, cooking oil or melted lard to coat the side of the fish that is to be duplicated. This will keep the plaster from sticking. If the mouth is to be left open slightly, plug the throat with plaster of paris and oil it so that it will not interfere later with removing the plaster mold. Next, press the fish firmly into the sand until it is embedded half its thickness. Spread out the tail and fins in a lifelike manner as shown at the right, detail A, holding them in position with common pins, which are pressed in all the way. Note the oiled pieces of cardboard placed under the fins.

The first coating of plaster of paris is made thin, about the consistency of thick cream, and is poured over the fish as soon as mixed, detail B. This is followed with a second coating of a slightly heavier consistency and is reinforced by embedding tow, fibers or fine excelsior in the wet plaster. Thickness of the plaster impression mold depends on the size of the fish, but it is best to make it extra heavy to prevent cracking.



First step in making a plaster mold is to coat one side of the fish with oil to keep the plaster from sticking and then press the fish into bed of sand



Plaster of paris is poured over the fish to make an impression mold as shown above. Below, the impression mold is oiled before the plaster casting is poured



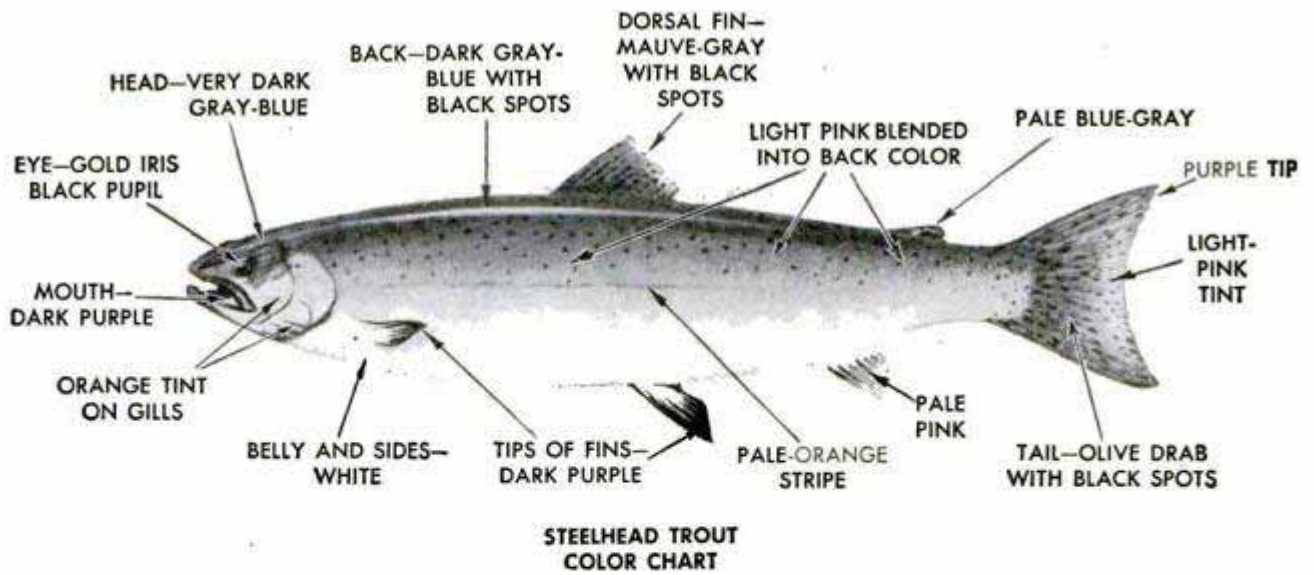

IN PLASTER

After the mold is thoroughly dry, the fish is removed and the inside of the mold is wiped with benzine or alcohol. If you find that the impressions of the tail and fins are not clear-cut, these can be deepened with the point of a knife.

The plaster mixture used in making a casting from the master mold must be uniform in texture and it is therefore best to sift the plaster to remove any lumps before mixing it. Oil the inside of the mold and then fill it with plaster, patting it into all depressions and smoothing off excess plaster, flush with the top of the mold. Before the plaster has time to set, stove bolts are embedded in the soft plaster, head downward, to provide a means of attaching the casting to a wooden plaque, detail C. After the casting is thoroughly hard and removed from the mold, wipe off the oil as before and give the casting two coats of clear shellac to seal the plaster. Any rough spots or pitted places, of course, should first be sanded down or filled.

Oil colors are used to paint the fish. The best and most lifelike results are obtained by using a "dry" brush. The white underparts look more natural when applied in two thin coats instead of a single thick coat. Blend the colors by deft strokes of the brush, and work the transparent colors down over the opaque ones. If desired, a coat of gold or silver-colored paint can be applied after shellacking the fish to produce an underlying sheen characteristic of fish scales. A good job of painting requires practice, and it is best to have several castings on hand with which to experiment until you have a lifelike replica of that prize catch.

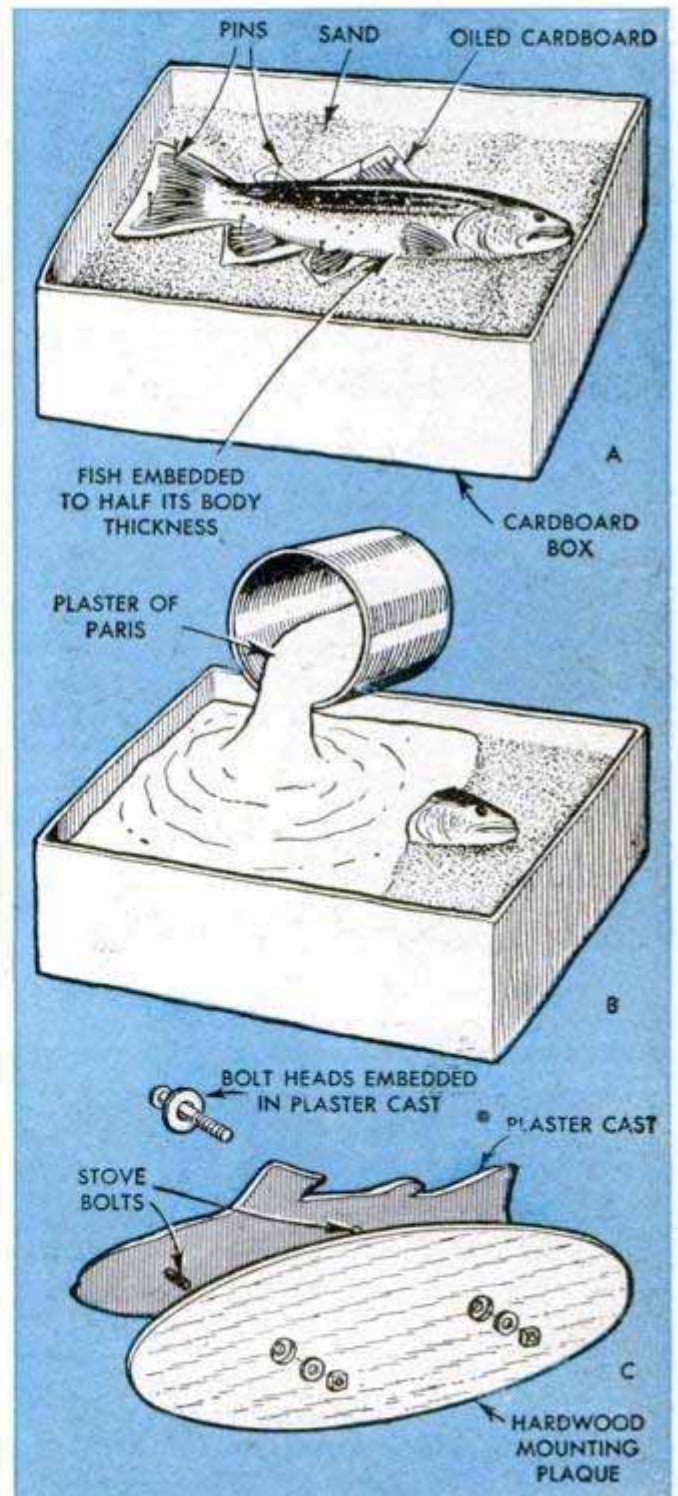

Novel Footstool Includes Utility Drawer For Mending, Slippers or Magazines

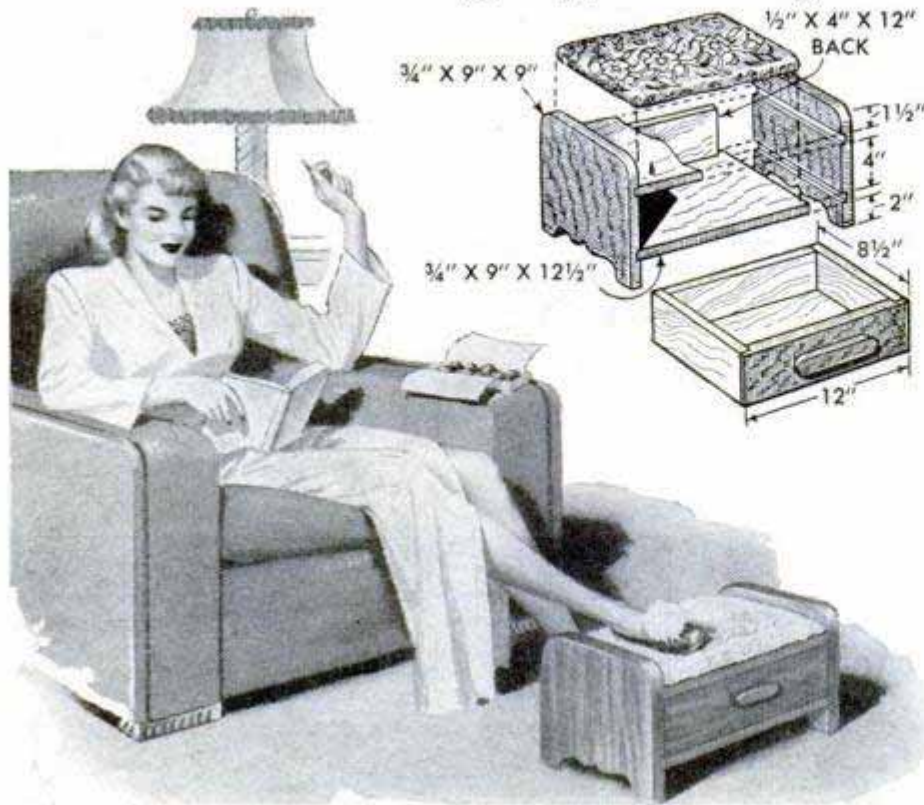

Easy to build and upholster, this attractive little footstool incorporates a convenient drawer for keeping slippers, mending, smoker's needs, etc. The stool is made from solid stock or plywood to the dimensions indicated, grooving the inside faces of the end members for the top and bottom members. The drawer bottom is a piece of $\frac{1}{8}$ -in. plywood or hardboard fitted in grooves cut in the front, sides and back. The cushion, which is screwed in place, is made by covering $\frac{1}{4}$ -in. plywood with cotton padding and sheet plastic or fabric. After completion, the footstool can be stained and waxed or painted a suitable color. —Bertram Brownold, Cedarhurst, N. Y.

Improvements in Colonial Homes Are Applicable to Modern Construction

Two ideas taken from the restored area of Williamsburg, Va.—the barred basement window and brick-lined foundation ditch shown in the photograph—are just as applicable to new construction as they were to homes built in Colonial days. The window bars, which can be either rod or tubing of round, square or hexagonal cross section, are set in sturdy wooden frames to deter potential burglars and also to protect the window glass from accidental breakage. The shallow brick ditch, which extends completely around the outside of the foundation wall, drains water from the eaves directly into the sewer line. This type of ditch can be constructed of concrete or asphalt instead of brick. It serves to keep water from soaking into the ground adjoining the foundation of the house and,

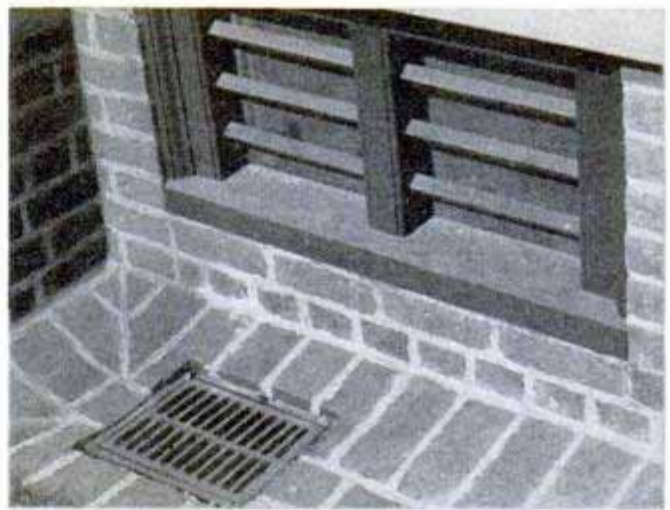

being shallow, it also doubles as a walk. The sewer openings are covered with iron grids. Walter E. Burton, Akron, Ohio.

Waterproof Case Improvised From Film Container Holds Safety Matches

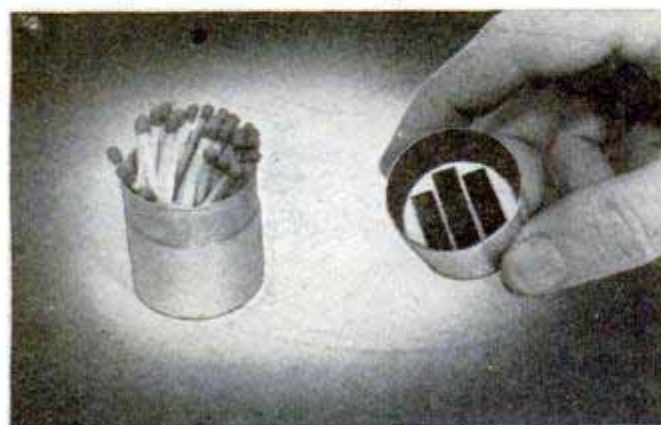

The metal container from a roll of 35-mm. film provides a handy waterproof case for carrying safety matches on hunting or fishing trips. Two or three abrasive strips removed from the sides of matchboxes are cemented inside the lid of the container and, after it is filled with matches, the container is sealed with cellulose tape.

☞ One machinist uses a single toolbox for all tools needed on the various machines he might operate. He carries this with him to the different machines.

ROLL-FILM ADAPTER *for view camera*

By Louis Hochman

OWNERS of view cameras will be quick to appreciate the economy and convenience of this roll-film adapter with its side-by-side placement of the film holder and focusing hood on a single sliding panel. This arrangement not only keeps both units constantly in the focal plane, but provides the quickest possible means of shifting the position of the units without the necessity of removing one and inserting the other. As will be seen from Figs. 1 and 2, the unit can be placed on the camera in either the vertical or horizontal position. The dimensions of the parts adapt the unit for use on a 4 x 5-in. view camera but, of course, sizes can be varied to suit film holders and cameras of other types. The details in Fig. 6 show the construction of the three basic units, camera-back adapter, sliding-panel bed and the sliding panel, on which the film adapter and ground-glass focusing hood are mounted. The sectional views show how these various parts are grooved, rabbeted, and tongued to permit movement and to provide light traps, or baffles, where required. The camera-back adapter, Figs. 3 and 6, is simply a rectangular frame joined with open mortise-and-tenon joints and fitted to the back of the camera as shown. The sliding-panel bed is permanently attached to the camera back with the openings centered. Strips of velvet are glued into shallow recesses cut in the outer face of the panel bed on each side of the opening to provide light traps.

Now, refer to the corner detail at the lower right in Fig. 6 and note that the top and bottom edges of the bed panel are rabbeted to take the tongued guide strips, but that the vertical end, or closure, strips are fitted against the flat face of the panel. These strips are attached with screws only, so that they may be removed. Note also, in the top view of the sliding panel, lower left-hand detail in Fig. 6, that three equally spaced strips of velvet are glued into shallow recesses cut into the back face of the sliding panel. In this way, regardless of the position of the sliding panel, velvet strips on the slide will be in contact with corresponding ones on the bed panel to trap



Above, the roll-film adapter in position for taking a horizontal picture. Panel has been moved down to bring film holder in position for exposure. Below, the camera-back adapter being checked for correct fit

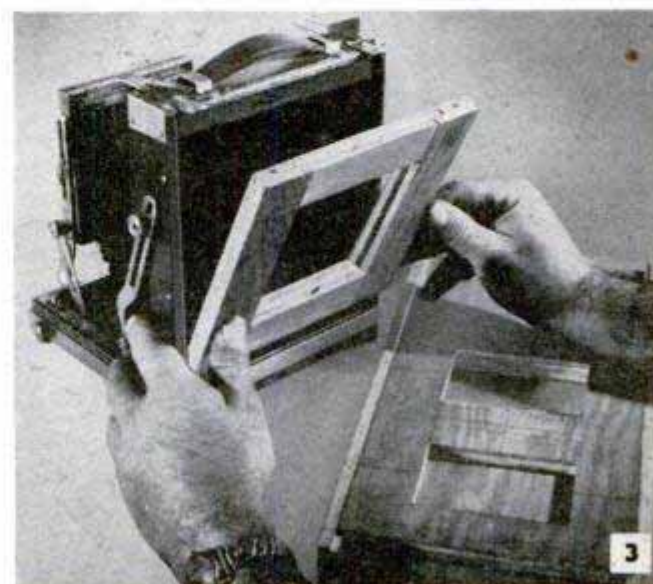

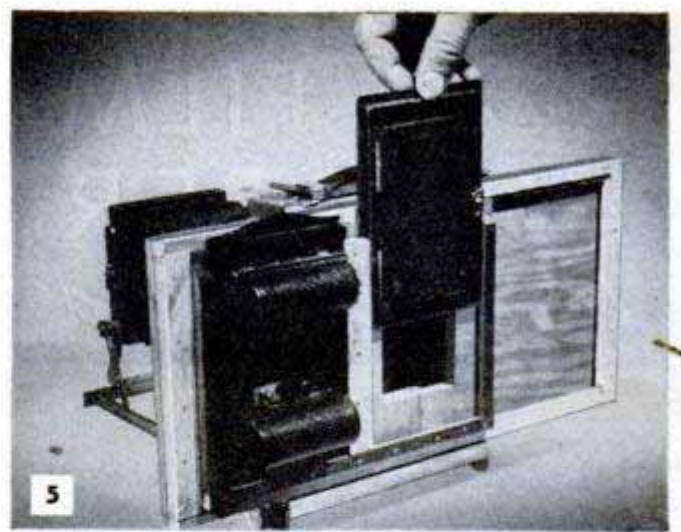

light. A single velvet strip is glued to the back face of the sliding panel above the opening over which the film holder fits. This must be positioned to register with the strip on the back of the holder, so that when the parts are in position a light trap will be formed at this point.

The edge of the sliding panel is grooved to take the tongues of the guide strips in a snug, sliding fit. Care should be taken in laying out and cutting the openings in the sliding panel to make sure that they register in the two positions with the opening in the bed panel. Rabbeled strips attached

to the back of the sliding panel form slides for the film holder and the focusing hood. When the rabbeled bottom strip is in place, glue a strip of velvet or felt into the bottom of the rabbet to trap extraneous light that might otherwise leak past the bottom of the film holder when it is in position. Figs. 4 and 5 picture the completed parts assembled on the camera. After the assembly has been made and checked for proper fitting of all parts, sand lightly to round the exposed corners and smooth the wood. Then apply a sealer and follow with two coats of flat-back enamel.

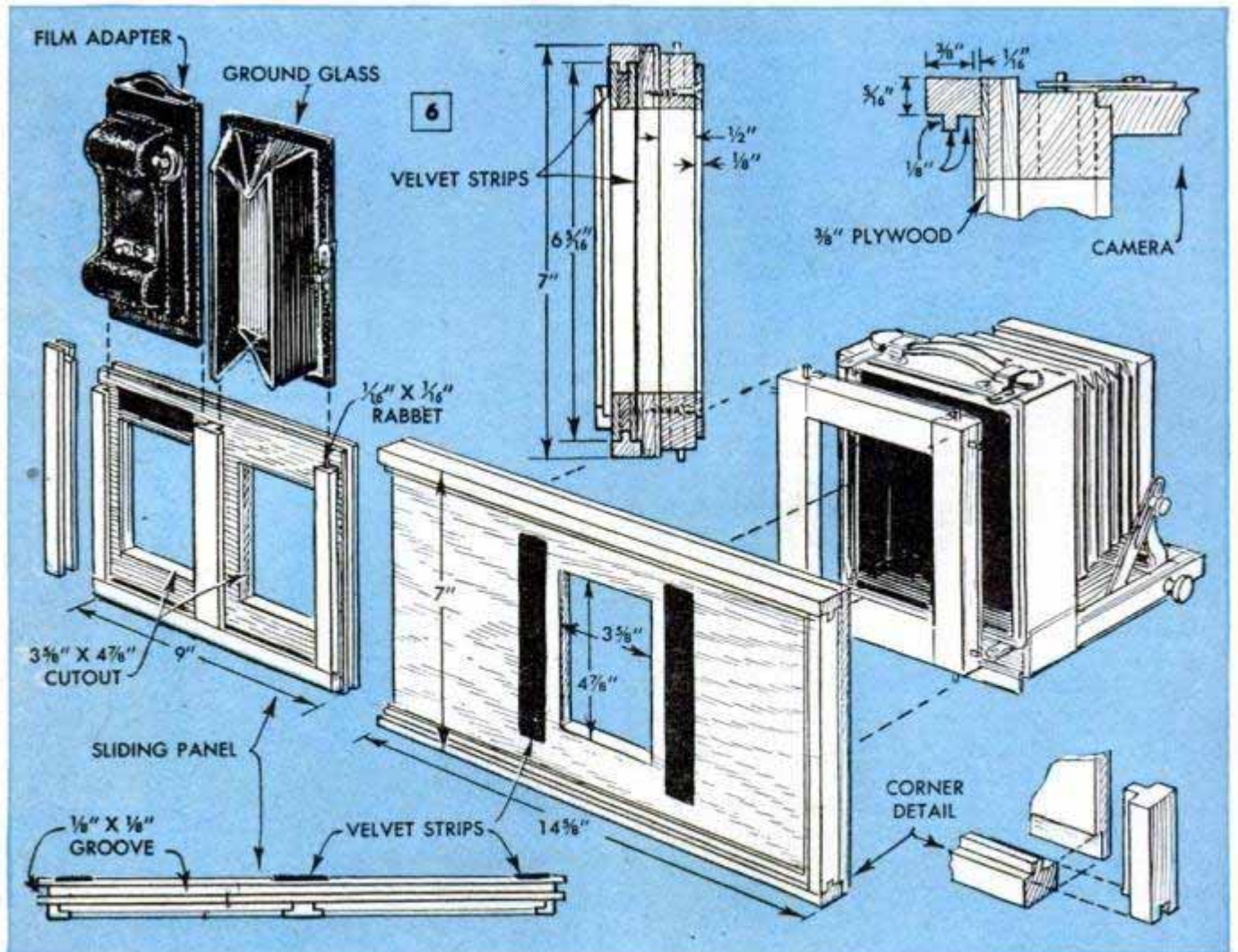

Taking your own photographs for viewing in a stereoscope can be done by using two identical cameras held in a dual mount. The important thing to remember is that the cameras must be fired simultaneously. This, of course, is somewhat tricky to do by hand, but it can be accomplished with satisfactory results. Each shutter should be rotated to position the release lever for the most convenient operation. After focusing, carefully move both levers to a point just short of actual release, as pictured. A slight resistance can be felt at this point. Then, a gentle push with both fingers will release the two shutters simultaneously. Using cable releases, if possible, simplifies synchronizing, as the ends of the cables can be taped together and both plungers depressed with the thumb. Don't shoot slower than $\frac{1}{50}$ second. The two cameras are joined with a machine screw having the head cut off and are kept from shifting by the clamp shown in the detail. Dimensions are not given as these

Identical Cameras Held by Dual Mount Take Photos for Use With Stereoscope

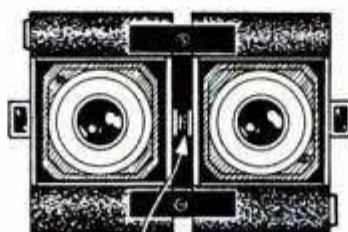
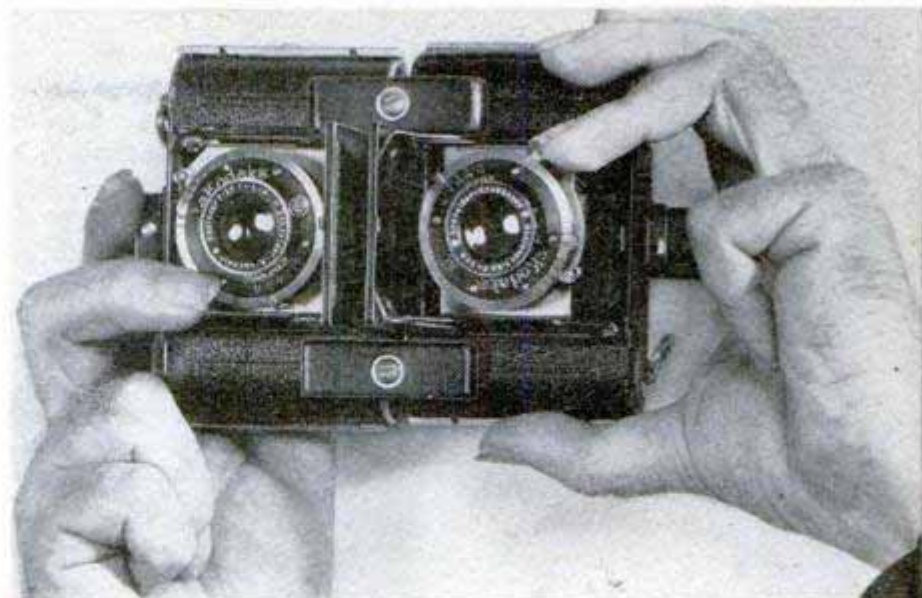

TRIPOD SOCKETS
JOINED WITH $\frac{1}{4}$ - 20
MACHINE SCREW

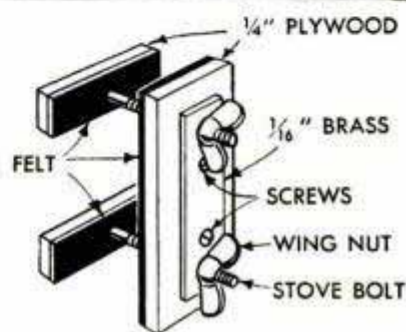

must be varied to suit the particular type of camera used. It takes only a few seconds to remove the cameras from the mount for individual usage or to reassemble them.

George Lauer, Chicago.

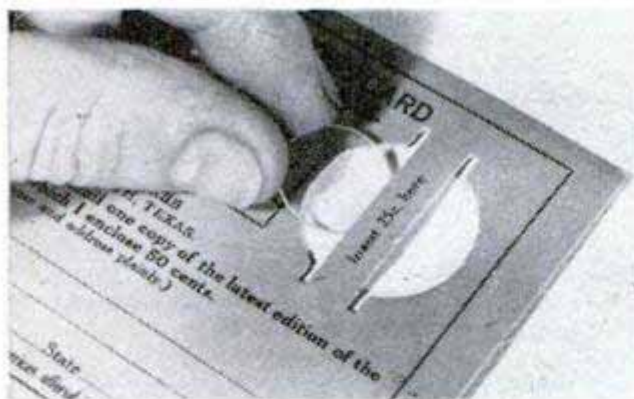

Unmounted Optical Lenses Stored in Coin Cards

Small unmounted lenses used by the hobbyist for optical experiments, or as photographic supplementary lenses, are safely and conveniently stored in 3 x 5-in. coin cards of the type used for sending money through the mail. The cards may be filed in a box or held together with a rubber band. Identification, or other pertinent data, may be written on the card.

Roughening Jaws of Plastic Clips Keeps Negatives From Slipping

When plastic clips are used to hang sheets of cut film for drying, the emulsion sometimes causes the negative to slip from the jaws and fall to the floor. To keep your negatives from being damaged in this way, just roughen the faces of the clip jaws with a small file to assure a tight grip on the film. A fingernail file will do the trick.

☐ Plastic-coated window screen provides an excellent light diffuser for covering the photoflood reflector of a flash gun.

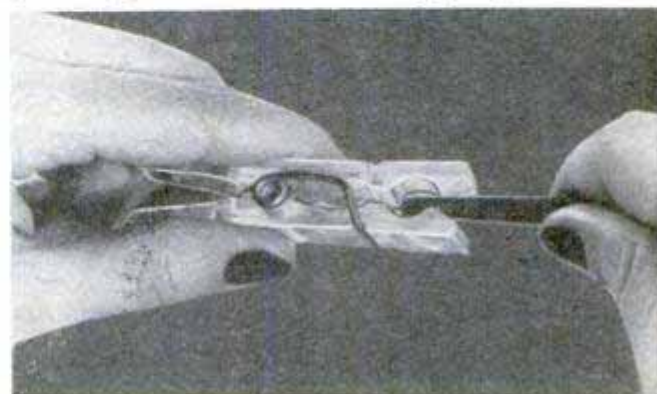

Light Shield Clamped to Reflector With Spring-Type Clothespins

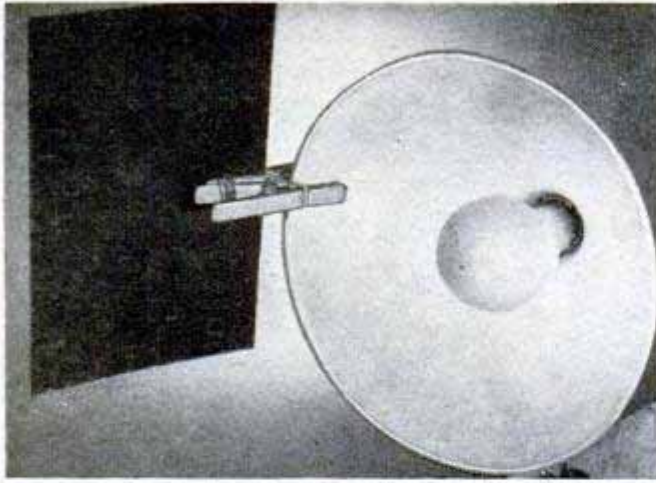

Mounting a sheet of cardboard on a photoflood reflector with two spring-type clothespins provides an effective light shield to protect the camera lens from the direct glare of the lamp or to shade a particular portion of the subject. Fasten the jaw of one of the clothespins to the handle of the other with a rubber band as in the bottom photo. Then clip one pin over the rim of the reflector and clamp the cardboard in the jaws of the other pin.

Mailing Tube Flattens Prints

To flatten badly curled prints, roll them in a reverse direction to the curl and insert the rolled prints in a cardboard mailing tube. Use a 3-in.-diameter tube and leave the prints in the tube for a half hour. — Louis Hochman, Sherman Oaks, Calif.

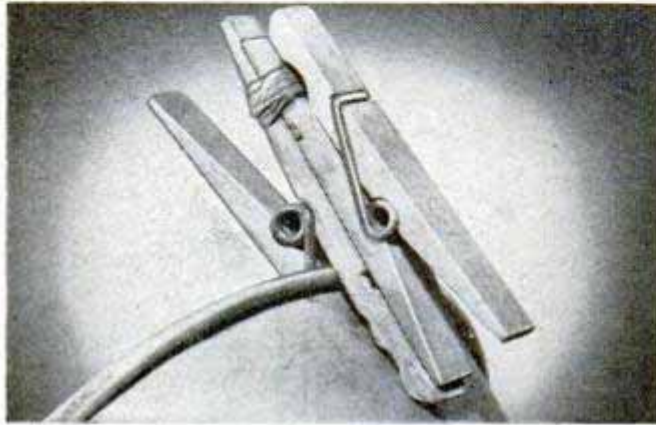

Clipping Corners of Film Prevents Binding in Tank Reel

Feeding a roll of film into a developing tank becomes a chore that tries one's patience when the edges of the roll invariably seem to bind in the grooves of the tank reel. To lessen the chances of the film stick-

ing in the reel, clip off the front corners of the roll before starting it in the groove. An ordinary fingernail clipper is just the tool for this purpose.

John C. Malocsay, Denver, Colo.

Build Your Own Home and Save Money

The weather now may be anything but suitable for building a home, but these long February evenings can be spent to good advantage in discussing and planning so that you will be ready to start building when the weather becomes suitable. If you feel that a new home poses an insurmountable problem, *Popular Mechanics* has the answer—build the home yourself. You can save over half the cost. We have two Build-It-Yourself homes now, and a third one will be ready about September 1. One, a frame house, is described in a book called **YOUR HOME AND HOW TO BUILD IT YOURSELF**, and the other, a concrete-block house, is detailed in a book called **POPULAR MECHANICS' CONCRETE BLOCK HOUSE**. The third house is a ranch home having many unusual features.

The frame home has four rooms downstairs plus garage and breezeway in addition to space upstairs for three large rooms. Also, it can be built in four different styles. The concrete-block home is a one-story house con-

sisting of five rooms. It was built two years ago at a cost for materials of less than \$4000. Both of these houses were constructed by inexperienced persons. The frame home was built by two boys, 18 and 23 years of age. One of the artists employed by *Popular Mechanics* constructed the concrete-block house. If these inexperienced people could do it, you need not hesitate. While the houses were being constructed, books and blueprints were prepared to guide the inexperienced builder in duplicating the homes. The book on each house, by means of photos, diagrams and descriptive text, takes you through the construction step by step. Like the 52,680 other people who have purchased these books and the 2800 who have purchased blueprints, why don't you order now and get your new home started? The book on the frame house, **YOUR HOME AND HOW TO BUILD IT YOURSELF**, is \$3.00 and a set of blueprints is \$12.50. For the book on the concrete-block house, send \$2.00. Blueprints are \$12.00 a set.

Books and blueprints are available from Popular Mechanics Book Dept., 208 E. Ontario St., Chicago

SHOP NOTES

PIPE FITTING AT HOME

It's easy when you know the right way to measure pipe and how to cut, thread and assemble it

By E. R. Haan

DO YOU want to replace a section of water pipe, change the location of a hot-water tank, or install a new plumbing fixture? Often you can save time and money by doing these simple plumbing jobs yourself. All you need are a few inexpensive tools and a knowledge of the essentials of pipe-fitting practice.

Correct measurements: Center-to-center measurements, which are necessary to lay out the job, are determined as shown in Fig. 1. The actual pipe lengths must be shorter than the center-to-center dimensions to allow for fittings and for the portion of the pipe that enters them. To determine exact lengths, subtract dimension A (center-to-face distance) of fittings from the center-to-center dimensions. Then add dimension C, Fig. 2.

Tools needed: Either of the vises shown in Fig. 6 will do, or you can use a machinist's vise fitted with detachable pipe jaws. You'll need two pipe wrenches for the average home plumbing jobs, an 8-in. and a 10-in. wrench. Using too large a wrench may result in buckling the pipe. The proper size wrenches for various pipe sizes are given in Fig. 6. You'll also need a pipe cutter, a reamer and a die stock with threading dies of the

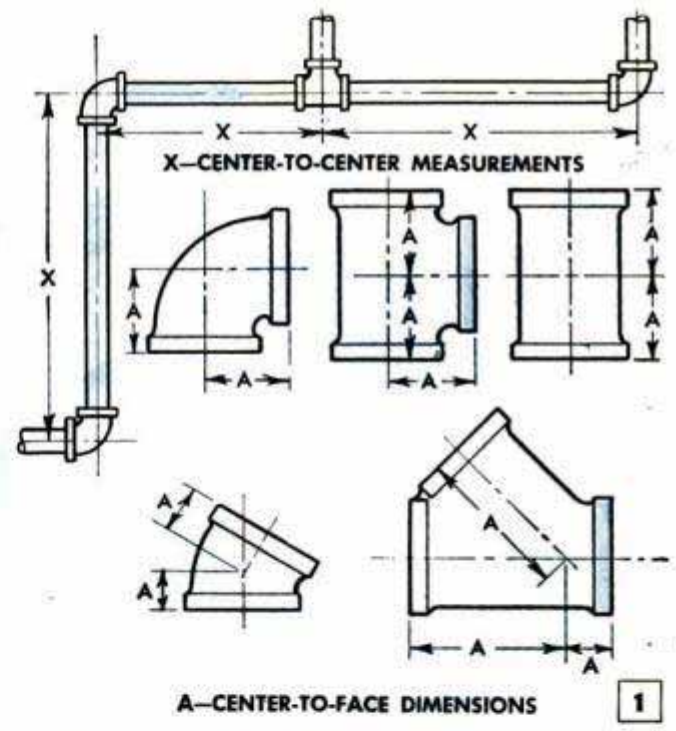
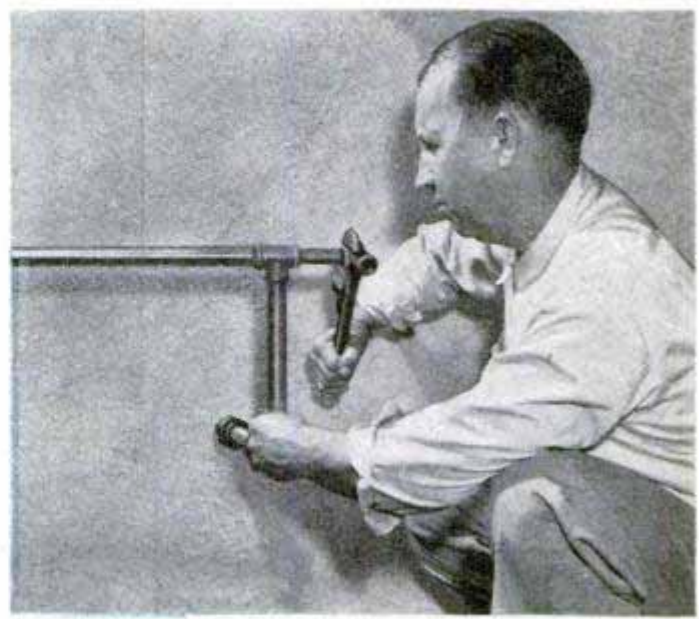

2 CORRECT MEASUREMENTS

THREAD DATA FOR STANDARD-WEIGHT PIPE

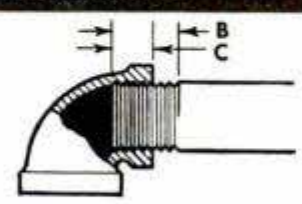

Size Pipe	1/4"	3/8"	1/2"	3/4"	1"	1 1/4"	1 1/2"	2"
Thread Lgth. "B"	3/8"	3/8"	13/16"	13/16"	1"	1"	1"	1 1/16"
Thread Screwed Into Fitting "C"	3/8"	7/16"	5/8"	5/8"	1 1/16"	1 1/16"	3/4"	3/4"
No. of Threads Per Inch	18	18	14	14	11 1/2	11 1/2	11 1/2	11 1/2



CUTTING

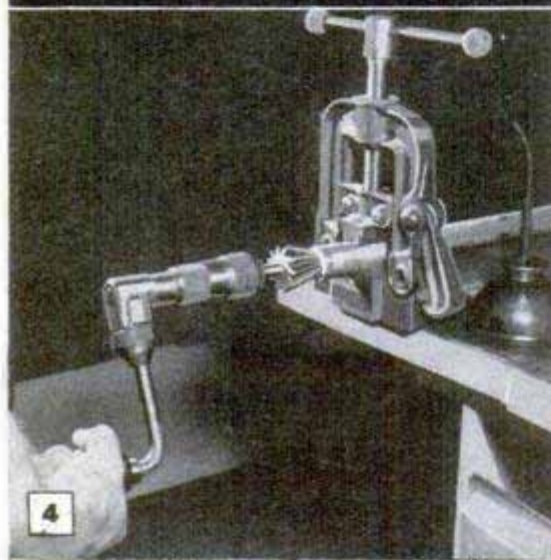

REAMING



THREADING

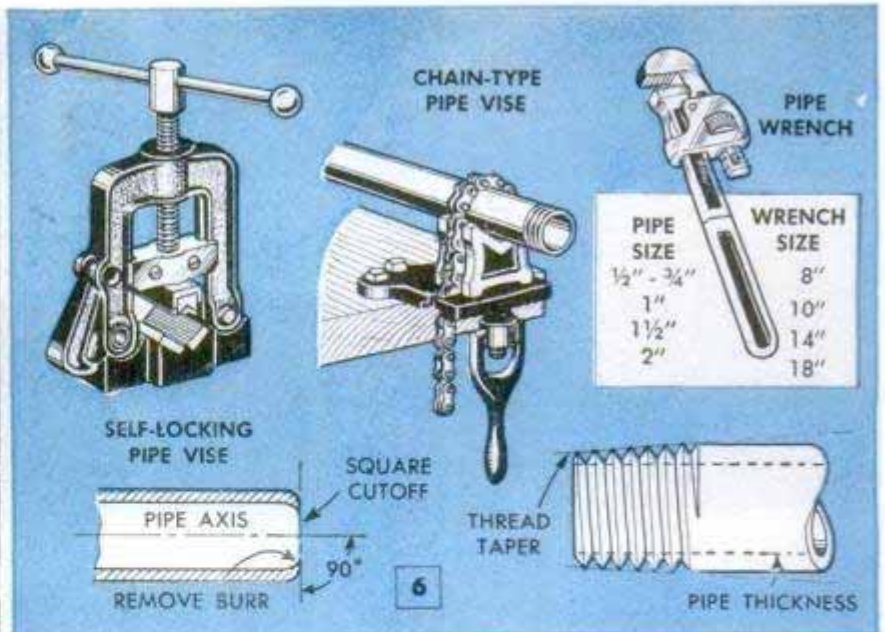

sizes required. Cutting oil is used for lubrication and also to dissipate heat caused by the cutting action of the die.

Cutting off and reaming: Good pipe joints have the ends of the pipe cut off at 90 deg. to the axis, Fig. 6. It's best to use a regular pipe cutter, Fig. 3, rather than a hacksaw. First mark the pipe for cutting, not less than 1 in. from the end. Then grip it in the vise so that the mark extends far enough to permit the cutter and threading tool to clear the bench. Set the cutting wheel on the mark and screw the handle down so that the rollers rest firmly on the pipe. Apply cutting oil and proceed, screwing down the handle a little each time the cutter is rotated. When cut, use a reamer chucked in a carpenter's brace, as in Fig. 4, to remove the burr formed inside the pipe.

Threading: Pipe dies, Figs. 5 and 7, are held in a stock, which is fitted with handles for turning. The ratchet-type stock has only one handle. Ordinary pipe stocks hold dies of several different sizes. There are two types of dies—the solid, non-adjustable type and the split die, which is adjustable for wear and cutting depth. A different die is required for each size of pipe. In a stock-and-die assembly there also is a guide bushing—one for each pipe size within the capacity of the die stock, or one that is adjustable for size. The bushing slips on the pipe first and lines up the die on the end of the pipe. Pipe dies cut tapered threads

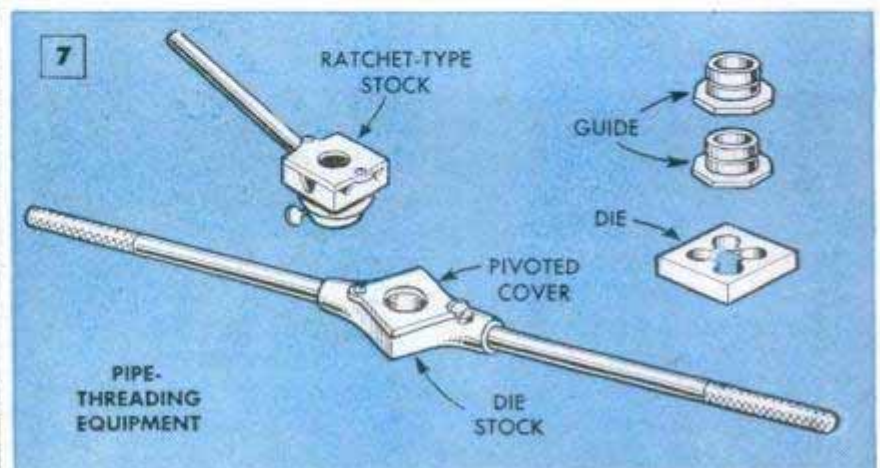

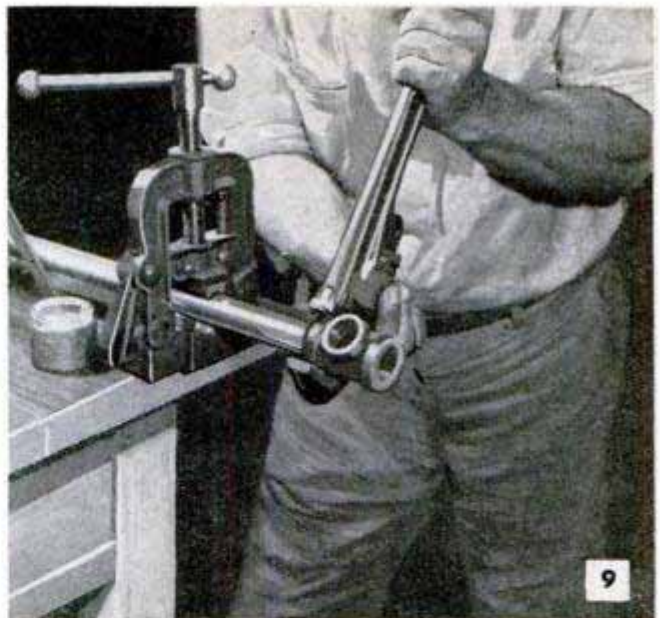
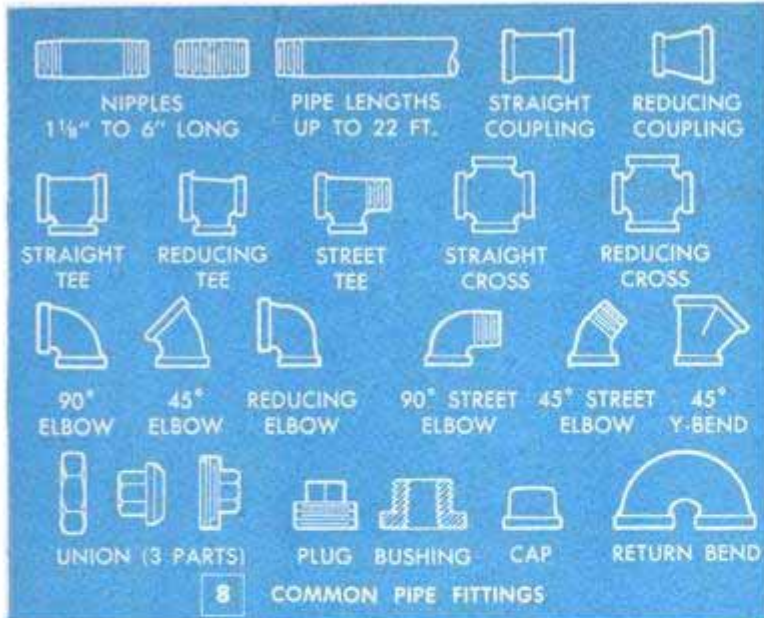

as in Fig. 6, and for this reason it is necessary to make sure that the die is placed in the stock so that the largest diameter faces the guide.

After slipping the guide bushing over the pipe, press the die teeth on the pipe slightly while turning the stock slowly to the right. Keep the handle at right angles to the pipe and apply a steady pressure until the die engages. Apply cutting oil liberally. Then start the thread by turning the stock forward a half turn and then back a quarter turn to break the chips. Now turn the stock slowly to avoid excessive heating, and apply cutting oil every two or three turns. Stop threading when the end of the pipe projects slightly beyond the small end of the die. This distance indicates that a thread of approximately standard length (dimension B of Fig. 2) has been cut.

Assembling pipe and fittings: Fig. 8 shows common pipe fittings you will use in an ordinary pipe assembly. Before assembling pipe and fittings, clean the threads with a wire brush to clear them of chips. Then spread pipe-joint compound on the threads of the pipe—never apply it to the internal threads of a fitting as it will be forced inside the pipe and may start an obstruction or taint the drinking water. Turn on a fitting by hand for three or four threads, after which a few more turns with a pipe wrench will draw it up snugly. Tighten the fitting on the pipe while it is still held in the vise, Fig. 9, and before threading the opposite end. This prevents accidental damage to threads and keeps the dirt out. It is not necessary to draw the fitting unduly tight. A moderate pressure on the wrench is sufficient. Excessive wrench pressure may distort the fitting or even strip the threads.

Replacing part of pipe: When a defective pipe is replaced, or when a new branch line is cut into an existing one, Fig. 10, it

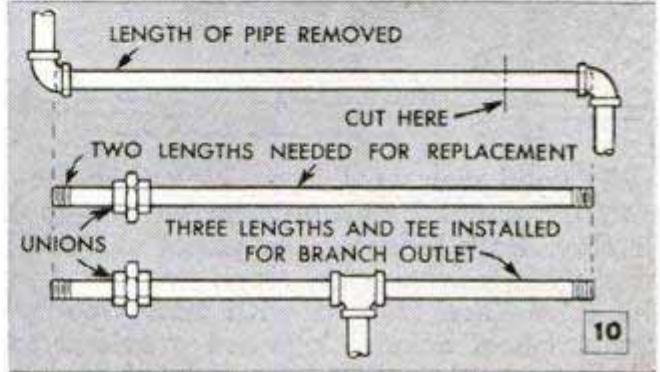

generally is necessary to saw the latter to permit unscrewing it except, of course, when there's a union to "break" the line. First shut off the water supply and drain the system by opening a faucet. Cut the pipe about 4 in. from a joint, never less if avoidable, and unscrew both pieces. The new section is made up of two lengths and a union, the total length of which should be equal to that of the old pipe. The same method is followed in installing a branch line, three lengths of pipe, a tee and a union being required. When tightening a union, Fig. 11, you'll need two wrenches to prevent the pipe from turning.

Sidewalk Display Panel



Plywood was used in making this eye-catching panel for an outdoor garden-tool display. Both sides of the panel are covered with bright grass-green matting and the edges are framed with thin wooden strips. Short curved legs are provided to hold the panel upright. A variety of garden tools attractively arranged on both sides of the board are wired securely in place. The display is then set up on the sidewalk.

Opie Read, Jr., Chicago.

Emery Board Cleans Eraser

Your typewriter eraser can be cleaned quickly by rubbing it against an ordinary emery board. Fastened with cellulose tape to the side of the typewriter or to an out-of-the-way spot on the desk, the emery board is always at your fingertips.

I. M. Fenn, Chicago.

Increasing Throw of Seeder

By welding fins and a hub to the concave side of an 11-in. harrow disk, and substituting it for the original disk of a broadcast

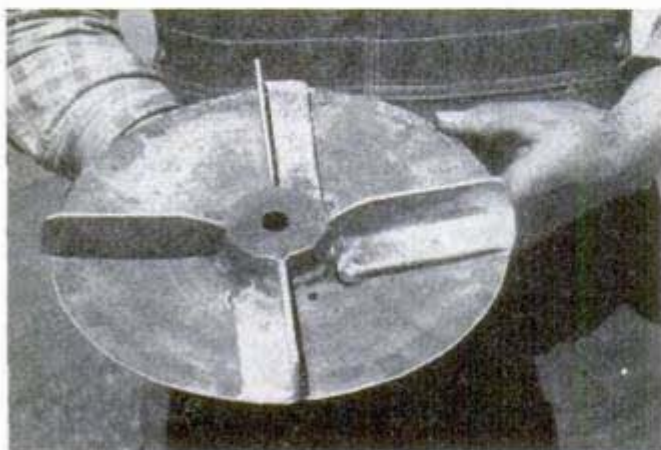

seeder, one farmer increased the throw of his seeder 15 to 25 ft. Because of the concavity of the harrow-disk slingers the seed is thrown at a higher angle than normal, which causes it to travel farther even when seeding against a side wind.

L. H. Houck, Jefferson City, Mo.

Socket Adapted for Short Bolts

It sometimes is difficult to start short bolts with a socket wrench as the depth of the socket does not allow enough of the bolt thread to be exposed. When this is the case, drop a hex nut in the bottom of the socket before inserting the bolt. This adds the thickness of the nut to the distance the bolt threads will project from the socket.

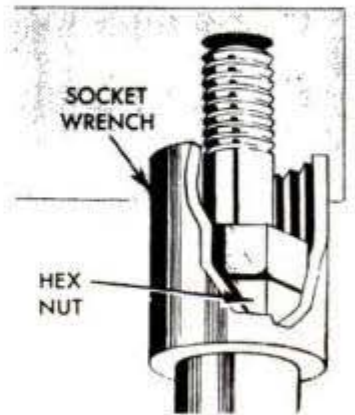

Ratchet Die Stock From Bit Brace

A ratchet die stock for threading work in hard-to-get-at places can be made from a bit brace by removing the universal jaws and welding a holder for a button die to the chuck sleeve. To make the holder, a short length of steel bar stock, slightly larger in diameter than the die to be used, is chucked in the lathe and a 1/2-in. hole is drilled clear through. This is counterbored

to an easy sliding fit for the die and is just deep enough so it sets flush with the surface. After reversing the stock in the chuck, the opposite end is counterbored and bevel-shouldered to a depth of 1/8 in. so that it fits over the tapered end of the drill-chuck sleeve. This permits the die holder to be accurately centered on the sleeve when being welded. The weld is ground to a smooth fillet and the job is finished by drilling and tapping a hole for a setscrew transversely through the rim of the holder.



This permits the die holder to be accurately centered on the sleeve when being welded. The weld is ground to a smooth fillet and the job is finished by drilling and tapping a hole for a setscrew transversely through the rim of the holder.

D. C. Marshall, Manhattan, Kans.

Printing can be removed from flour bags by soaking them in kerosene for 24 hrs. and then boiling them for 30 min. in a strong solution of laundry soap and water. Repeat the process if necessary.

HANDY MASH CART

from oil drum



By Hi Sibley

ALTHOUGH designed and built especially for a poultryman's needs by Loren Salkeld of Nuevo, Calif., this cart also is well adapted for use in the dairy barn and farrowing house where it is necessary to pass through narrow feeding alleys. It consists of an oil drum mounted on a bicycle-wheeled truck having a tread width of only 26 in. Handles welded to each end of the drum make it unnecessary to turn the cart around in narrow alleys when it has been unloaded. Cut a full-length opening in the side of the oil drum and fit a hinged sheet-metal lid with a latch. *Caution:* If you use a torch for cutting the drum, be sure to steam-clean the drum first to avoid the

danger of an explosion. Then form handle frames from pipe, tubing or conduit and weld lengths of pipe across the free ends to provide handles. Weld the units to the ends of the drum. Note that one handle frame extends below the drum to form a foot on which the cart rests when stationary. The bicycle wheels are mounted in improvised forks, the inner member of each one being welded to the side of the drum as detailed. The outer members of the forks are held in place with bolts so that they may be removed. Details A and B show two methods of mounting wheel axles. Although most wheels can be mounted as in A, some will require the other method.

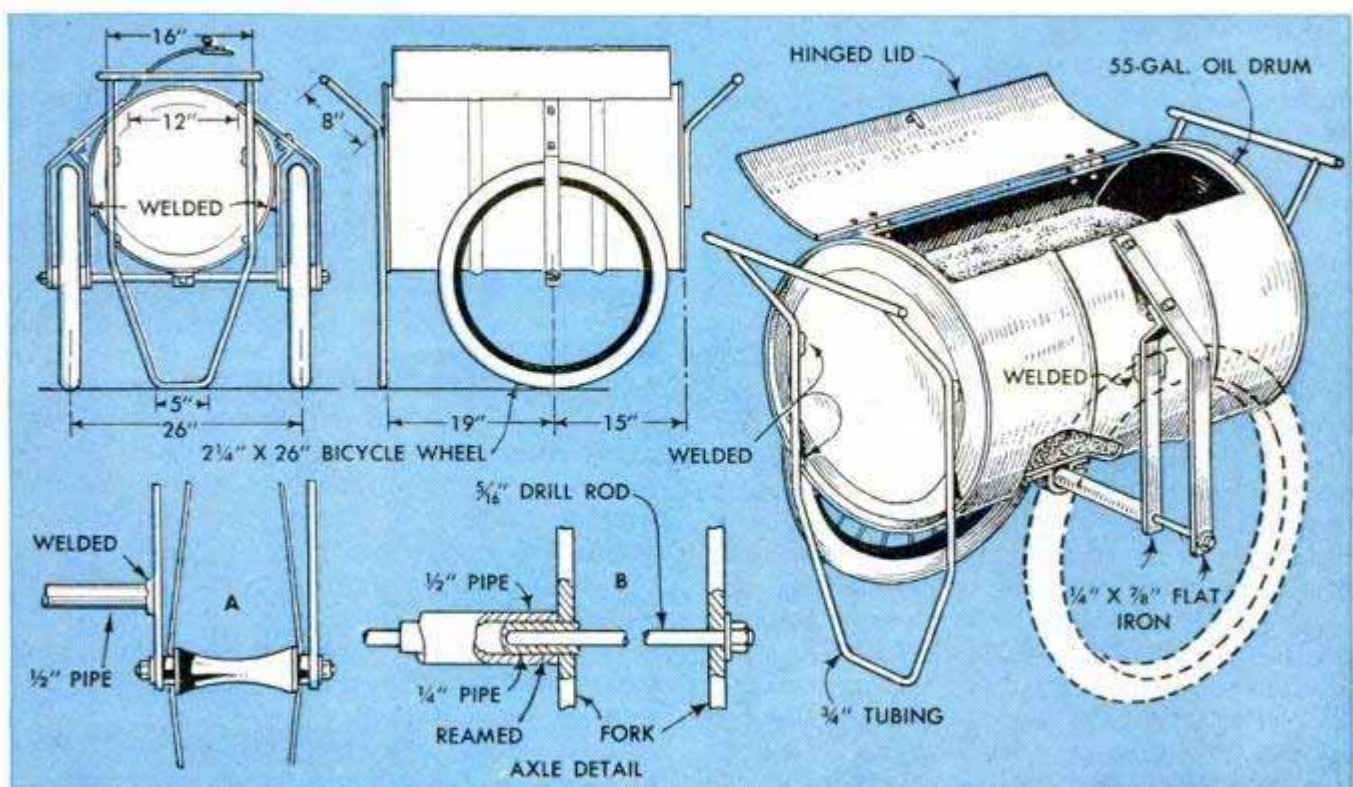

July

Farm Manual

MOUNTED TRACTOR MOWER

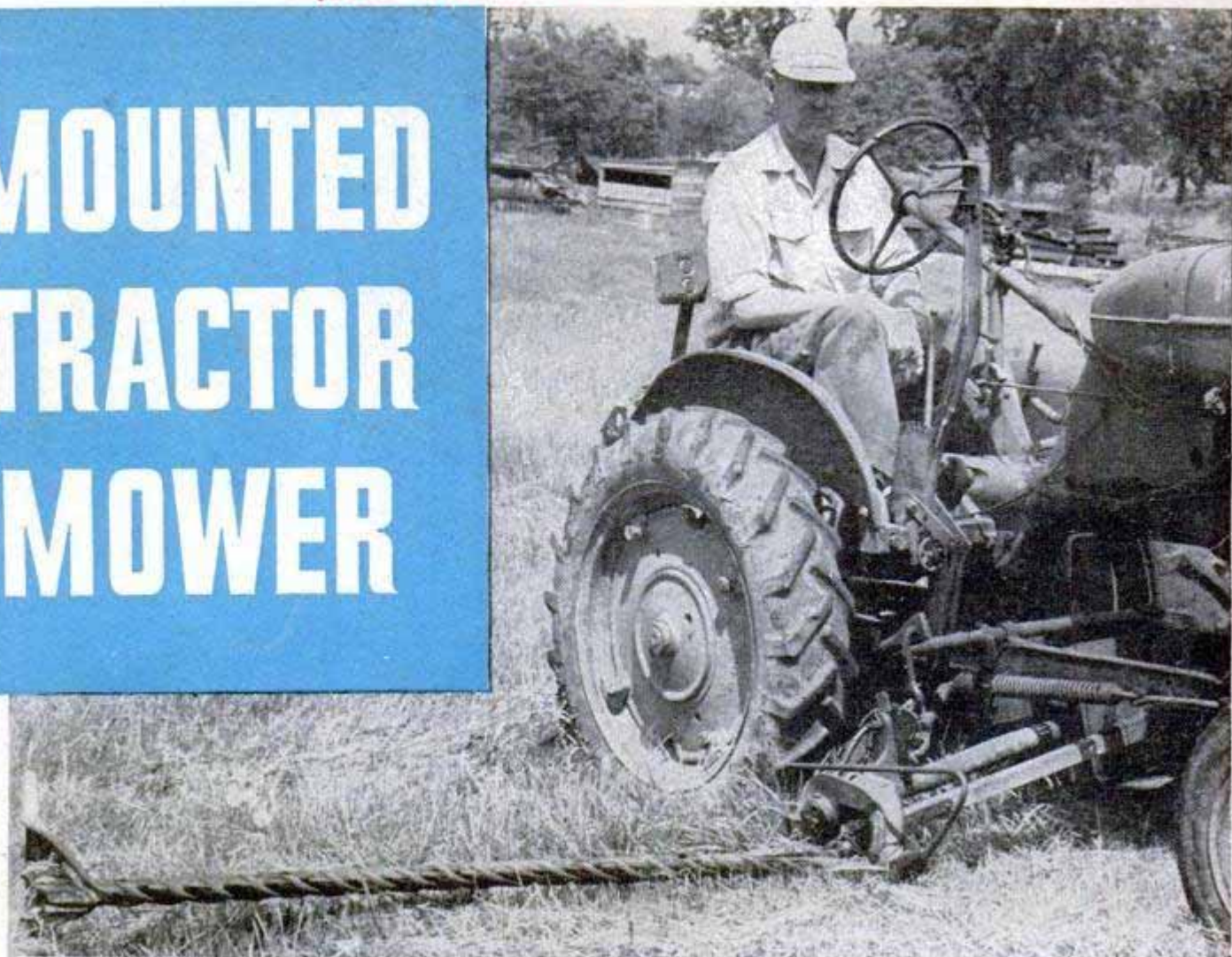

By L. H. Houck

MOST FARMERS prefer a tractor-mounted mower to a towed one because of the convenience of operation and the ability of the self-contained unit to operate over rough ground. It is especially suitable for mowing irregularly shaped fields and pastures where it is necessary to make short turns and where a clear view of the sickle is essential. The mower pictured above and on the facing page was built in the farm workshop by utilizing parts from a horse-drawn mower, the side members of a car frame, a Chevrolet drive shaft and miscellaneous pieces of flat steel and steel bar stock. As designed and detailed, it fits an Allis-Chalmers Model B tractor. Of course, some changes in the dimensions and shape of the parts will be necessary to adapt the mower unit for use on tractors of other makes, such as changing the width and perhaps the length of the underslung frame slightly, as well as relocating the mounting brackets. In some instances it also may be necessary to weld an X-brace between the side frames either at the front or back end of the frame unit. Only sections of the side members of the car frame are used and these must be cut to a length to suit the tractor. Note that a

flat steel stiffener is welded lengthwise in each car-frame channel and that four of the spacers are cut from flat steel stock. Holes are cut in the spacers with a cutting torch to provide openings through which the Chevrolet drive-shaft housing is inserted. The spacers are welded between the frames as shown but, before you weld them in place, it's a good idea to take careful measurements to see that there is plenty of clearance under the tractor. On some tractors it will be necessary to mount the drive-shaft housing somewhat higher in relation to the frame than is shown in the detail. On others it can be mounted proportionately lower with good results. The front cross member is a piece of $\frac{1}{2}$ -in. flat steel welded between the ends of the frame members. The upper end of the pitman guard is welded to the lower edge of this cross member, and the lower end of the guard is welded to the forward spacer directly under the pitman eccentric. The guard should be cut from heavy, flat steel, not less than $\frac{1}{4}$ in. thick and at least 12 in. wide.

Some machining may be necessary in fitting the V-pulley and the pitman eccentric on the Chevrolet drive shaft. As the drive-shaft housing is slid into place before welding, telescoping rings are slipped over

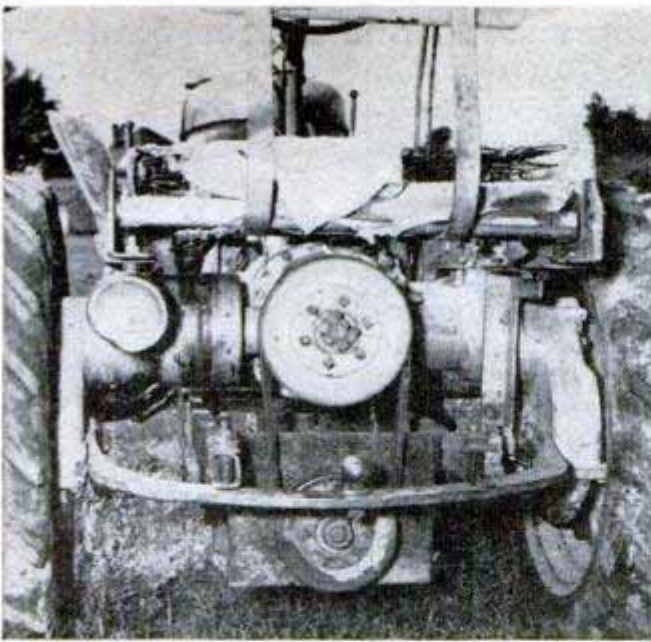

This rear view of the tractor mower shows the power take-off drive and how rear end of the mower frame is bolted to the tractor drawbar. Note V-belt drive

the end as it passes through the space between the second and third, and the third and fourth spacers. The end of the sickle support arm and the support brace are welded to these rings, which are then welded to the drive-shaft housing. Note that the brace is in two parts and that it is fitted with a heavy turnbuckle. A lifting linkage, consisting of a ratchet-type implement lever mounted on the tractor frame and connected to the sickle head through a series of flat-iron links, is easily worked out to suit the tractor on which the mower is mounted. The lower links are connected to an arm welded to the shaft which supports the sickle head. This shaft turns in



Spring-loaded raising and lowering linkage is operated by a ratchet-type implement lever mounted on tractor frame. Parts are connected by flat-iron links

bearings mounted on the mower frame and the outer end is flattened, bent and drilled to take an eyebolt which is attached to the sickle head. A tension spring, attached with eyebolts to the forward end of the frame and to a short arm on the raising shaft, "floats" the sickle, and aids in raising it to clear an obstruction. Note that the bolts holding the center L-brackets are welded on top of the frame. This method of assembly was found to be easier than drilling the holes through the frame and heavy stiffeners. The diameter of the drive pulley on the power take-off must be worked out in accordance with the normal speed of the power take-off shaft.

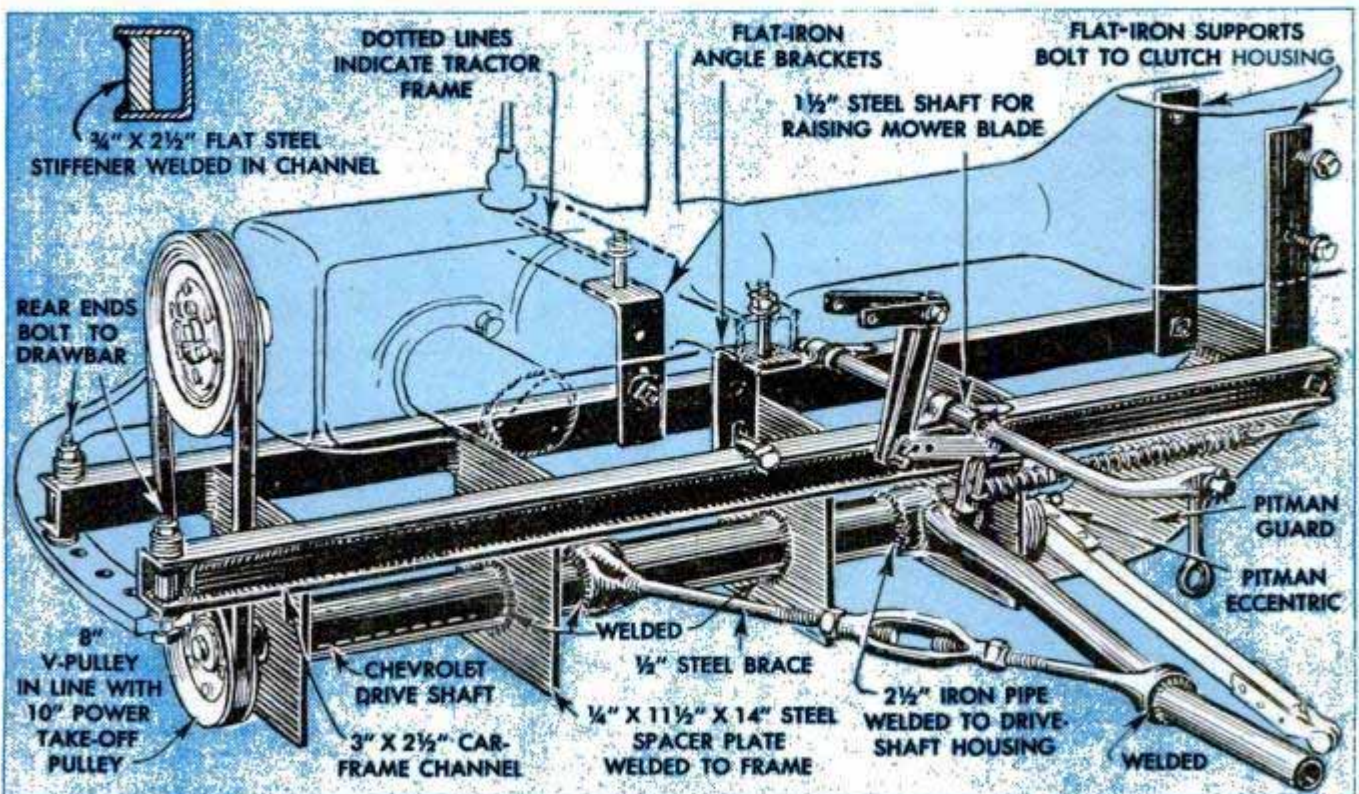

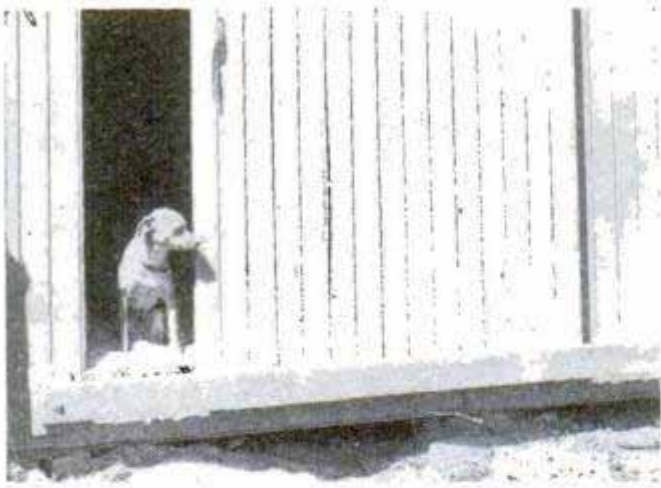

Guide Protects Sliding Door

A 2 x 4 bolted to the granary wall just outside and slightly above the lower edge of the door will keep the latter from blowing outward in the wind and prevent livestock from working the door open.

A. M. Wettach, Mt. Pleasant, Iowa.

Stopping Water Hammer

The annoying hammer in water pipes can be eliminated by fitting a 1-ft. length of pipe vertically in the line to provide an air cushion. Use a tee to install the air cushion in the line at any connection of two lengths of pipe, making sure that the 1-ft. length is vertical and tightly capped.

Truck Body Fitted With Rain Shields

Rainwater running down the sides of a closed body mounted on the bed of a pickup truck sometimes accumulates on the floor of the truck bed. This can be prevented by installing rain shields on each side of the closed body as pictured. The shields are cut and bent from heavy galvanized sheet metal and are wide enough to extend beyond the rolled and flared edges of the pickup bed. The shields are attached to the sides of the closed body with screws and the joints are sealed with calking compound to make them watertight.



Improved Armature Test Stand

Mounting two neon-tubing insulators on a board provides an excellent test stand for small armatures. Locate the insulators in line, spacing them to take both ends of the armature shaft and blocking them up, if necessary, to gain the desired height above the board. Because complete insulation is obtained, the stand is especially suitable for using test prods on commutator segments.

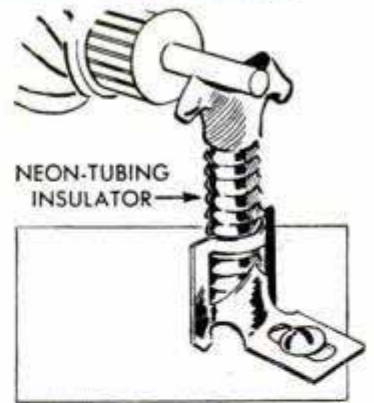

C. W. Philpot, Laurens, S. C.

Wooden Partitions for Hog Troughs Prevent Crowding at Feeding Time

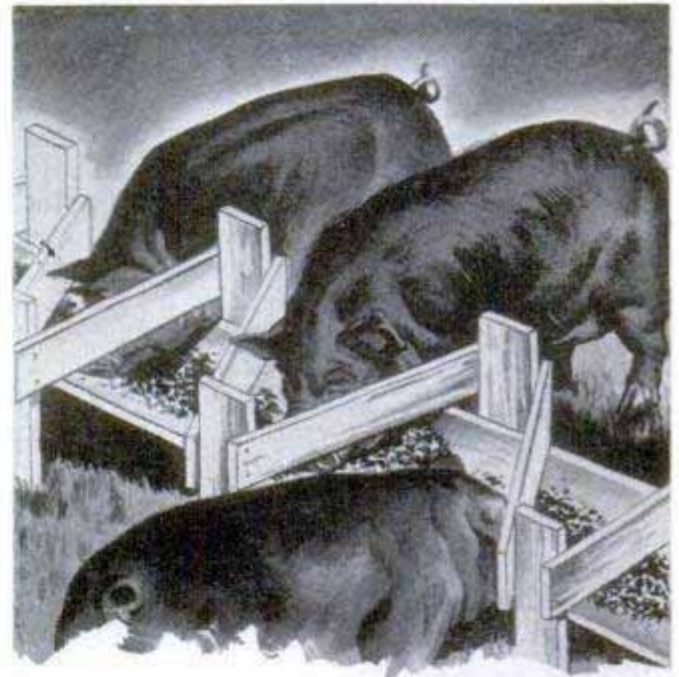

Partitioning the hog trough as pictured will assure that smaller pigs get their full share at feeding time. Built of 1 x 4-in. stock, with the uprights fitted into notches cut in the sides of the trough, the zigzag partitions are spaced 18 in. apart. This allows plenty of room for each hog and prevents crowding as milk, grain or other feed is poured into the trough.

Using Red Ocher on Chalk Line

When you wish to use a chalk line to snap several lines consecutively, use a solution of red ocher and water instead of chalk. Soak the line in the solution and use as with chalk. The easily seen mark will not rub off readily and the line can be reused without soaking until the moisture dries out.—G. L. Shahan, Santa Ysabel, Calif.

NAME SIZE OF PORTABLE BELT SANDERS IS THE WIDTH AND LENGTH OF BELT. SANDERS WEIGHING 8 TO 12 LBS. ARE BEST FOR AVERAGE LIGHT WORK. THE 3 X 27-IN. MACHINE IS FITTED WITH A DUST-COLLECTING MECHANISM

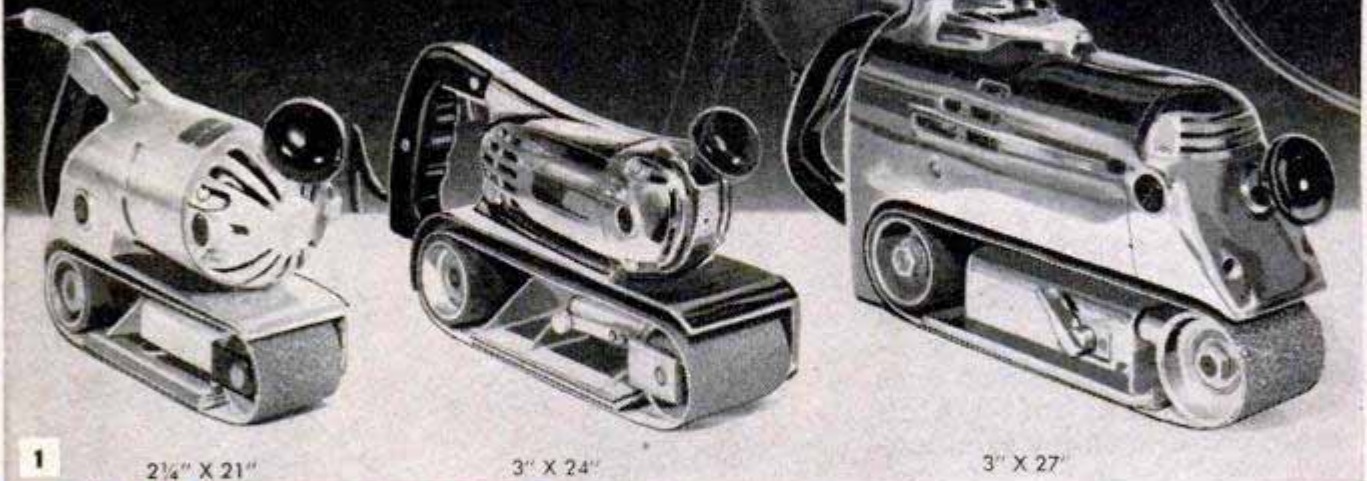

1 2 1/4" X 21"

3" X 24"

3" X 27"



SHORT, STRAIGHT STROKES OVERLAP TO COVER WHOLE SURFACE UNIFORMLY



ARM MOVEMENT IS PARALLEL WITH THE GRAIN



SANDING ACTION IS ALWAYS PARALLEL WITH BELT



CROSS SANDING IS FIRST OPERATION IN LEVELING WIDE WORK

DROP DOWN



HEEL OF SANDER TOUCHES FIRST. FRONT IS THEN LOWERED AS SANDER MOVES FORWARD ON THE SURFACE

SMOOTH IT WITH

By Sam Brown

PORTABLE belt sanders make sanding a fast, easy job on nearly all types of woodworking projects. Finishing will improve, too, because half of the work of applying a good paint or varnish job is in surface preparation of the wood. Straight-line sanding with fine abrasive belts produces a surface that is ideal for the application of the various finishing materials. Belt sanders also are used for removing paint, and for grinding and polishing metals and plastics.

Machine sizes: The width and length of the belt in inches is the name size of the portable belt sander, Fig. 1. About the smallest practical unit has a 2 x 21-in. belt and the largest, 4 1/2 x 26 in. For surface sanding on large pieces, big machines weighing about 25 lbs. will sand much faster than the smaller, lighter machines, but either kind will produce a top-rate finish on any cabinet wood. Holding large sanding machines against the side of a boat is a difficult, tiresome job,



6 9-LB. PORTABLE SANDER IS EASY TO HANDLE ON VERTICAL WORK



7 25-POUNDER CUTS ABOUT TWICE AS FAST AS LIGHTWEIGHT UNIT

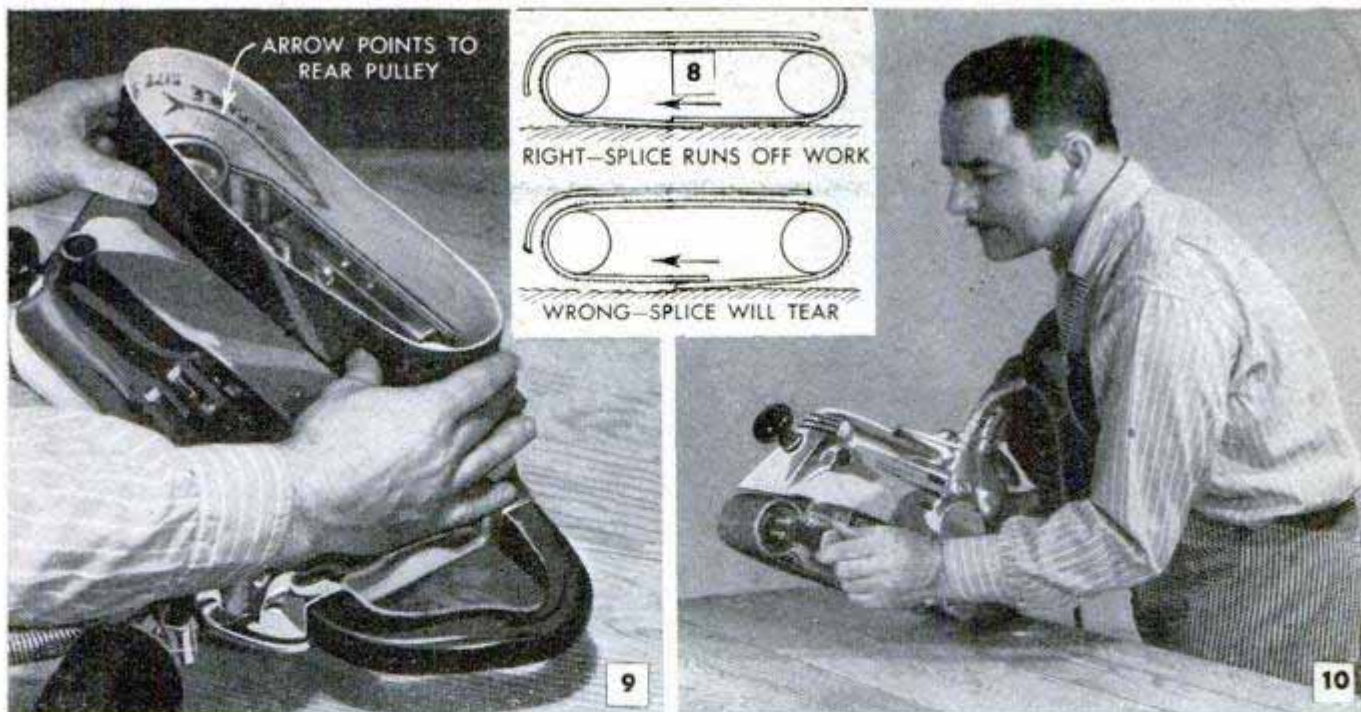

A PORTABLE BELT SANDER

but the 8 to 12-lb. machines make this work simple and fast, Fig. 12. In the home workshop, smaller machines in a size range from 2 x 21 to 3 x 24 in. probably are the best all-around choice. The dust-collector type, like the 3 x 27-in. size, Fig. 1, is often preferred, as the efficient collecting mechanism prevents fine dust from being distributed over the shop. However, on occasional sanding jobs the small amount of dust produced is not so objectionable, as most of it can be brushed onto the floor and collected with sweeping compound.

Belt adjustment: Sander belts are spliced and should be put on the machine so that the splice runs off the work as in Fig. 8. An arrow stamped on the back of each belt indicates the direction in which it should run, Fig. 9. After the belt is in place on the pulleys, it is tracked as in Fig. 10.

Sanding stroke: Operating a sander is very easy and Fig. 5 shows how to start the stroke. Most belt sanders have a trigger switch of the momentary-contact type, which means that you have to hold the trigger to keep the switch "on." The machine automatically stops



ALUMINUM-OXIDE BELT IS BEST FOR SANDING WOOD OR METAL



BELT SANDER IS A MUST FOR SUCH JOBS AS SANDING BOAT PLANKING

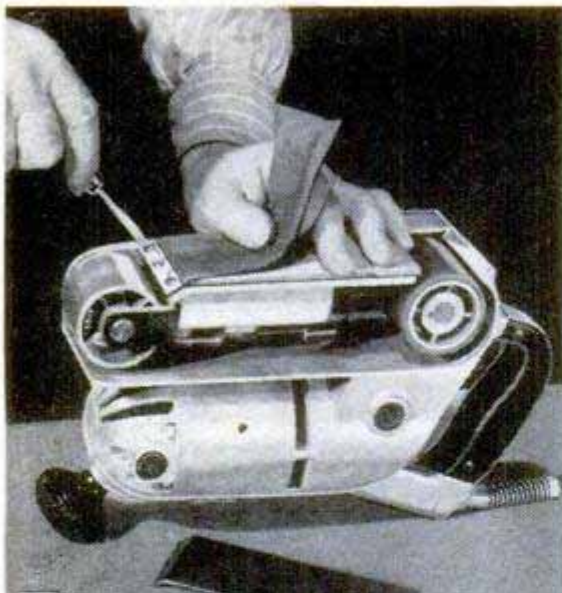

14

SOFT SHOE IS USED ON UNEVEN SURFACES SUCH AS PLASTER. ALSO FOR FINISHING

when the trigger is fully released. In starting the stroke, tilt the machine backward so that it rests on its heel plate and the belt clears the surface, and then pull the trigger switch. Lower the sander slowly to the horizontal position and immediately move it forward. After becoming familiar with starting the sander, practice the faster "airplane" stroke by merely bringing the heel of the belt in contact with the work and then leveling out in a sweeping forward motion. Ordinarily, the sanding stroke is straight back and forth, Fig. 2, gradually working the sander sidewise to cover the width of the work. In rough sanding, the sander is held at an angle, Fig. 3, while the arm movement is parallel to the grain. In the case of exceptionally wide work, the initial operation is done across the grain as in Fig. 4. When rough sanding open-grain woods with a coarse belt, never sand with the grain.

Special sander shoes: The standard backing shoe supplied with the portable belt sander is a



15

HUMP SHOE IS FAST FOR SPOT-SANDING JOINTS OR OTHER RAISED AREAS



16

SPOT SANDING WITH TOE

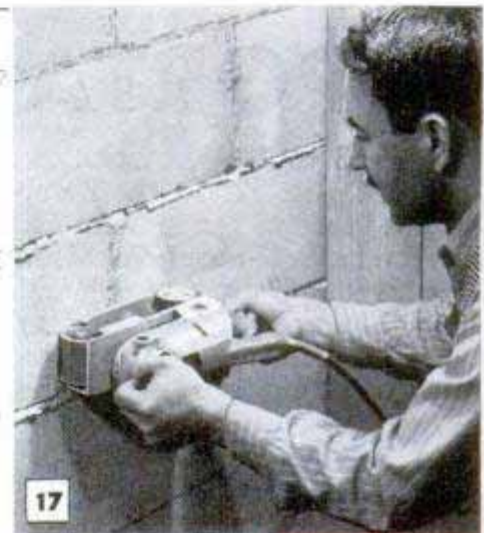

17



19

18 BELT SELECTION

Material or Job	Rough	Finish	Fine	Remarks
Hardwoods	2	1/0 (6)	3/0 (6)	Coarse Belt Electro-Coated Alum.
Softwoods	1½	1/0 (6)	2/0 (G)	Oxide, Use At Angle To Grain Of Wood
Aluminum	40	60-80	100	A.O. Open. Use Quick Short Strokes
Steel	24 - 30	50-80	100	A.O. Standard Closed Coat
Boats	2 (A.O.) (E.C.)	½ (G)	1/0 (G)	Use Soft Shoe For Finishing
Oak Floors	2	½	1/0	A.O. Or Garnet. Rough With Diag- onal Stroke
Plastic	60	120	240	Use Cloth Belt And Compound For Finishing
Plaster	½	1/0	2/0	A.O. Or S. Use Soft Shoe For Finishing
Concrete	3½ (S)	1 (S)	½ (S)	Hard Materials. Abrasives Are Not Fast Cutting
Slate Blackboard	80 (S)	120 (S)	150 (S)	
Toothing Paint			2/0 - 3/0	E.C., A.O. Use Soft Shoe
Removing Paint	2½ - 3½	1½		Open A.O. Lift Sander At End Of Each Stroke

G - Garnet E.C. - Electro Coated S - Silicon Carbide
A.O. - Aluminum Oxide Open - Open Coat

CONVERSION TABLE
"O" SERIES
TO GRAINS
PER INCH

3½ - 20
3 - 24
2½ - 30
2 - 36
1½ - 40
1 - 50
½ - 60
1/0 - 80
2/0 - 100
3/0 - 120
4/0 - 150
5/0 - 180
6/0 - 220
7/0 - 240
8/0 - 280
9/0 - 320
10/0 - 400

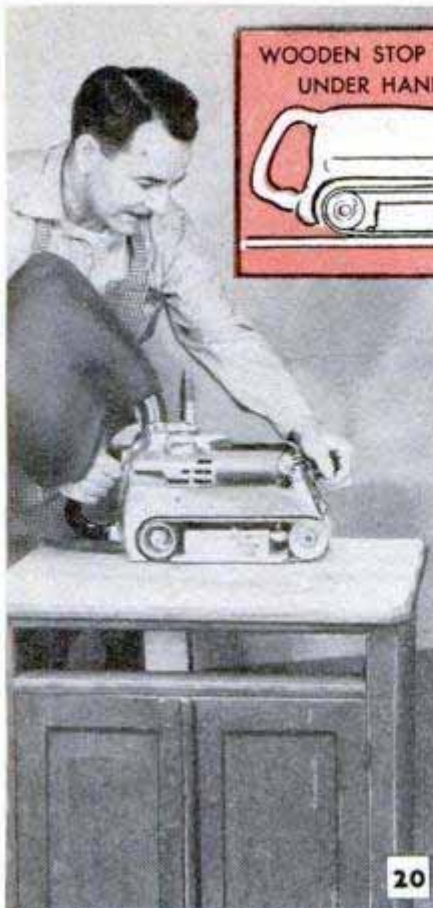

20

REMOVE PAINT WITH QUICK STROKES TO AVOID OVERHEATING



22

FLUSH RIGHT SIDE OF MACHINE PERMITS SANDING INTO CORNERS

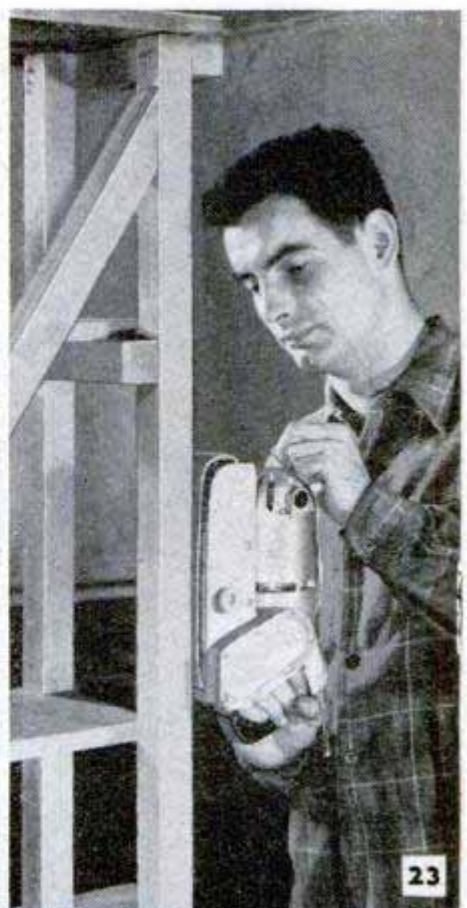

23

VERTICAL SURFACES ARE SANDED BY STARTING STROKE AT THE TOP

flexible sheet-metal plate cushioned with sheet cork or other soft material. This shoe is satisfactory for all common surfacing operations, but there are instances where special improvised shoes can be used to adapt the machine to a wider range of work. An example of this is the soft shoe, Fig. 14, that conforms to slight irregularities in the surface without digging in on the high spots. The hump shoe, Fig. 15, is especially useful for spot sanding on a large surface, or cutting down glue or mortar joints as in Fig. 17. Another way to cut down mortar joints is shown in Fig. 16, but the work is not as smooth as that done with a hump shoe.

Sanding vertical surfaces: Methods of sanding vertical, or near-vertical, surfaces are shown in Figs. 6, 12, 13, 17, 19, 23 and 24. Except when using a balance reel, Fig. 13, or an improvised counterbalance as in Fig. 19, the heavier machines are not satisfactory for use on vertical work. It's better to use the smaller machines weighing 10 lbs., or less, as in Figs. 6 and 23. Most of this work is done with an up-and-down stroke, which is started as in Fig. 24 by angling the machine slightly so that you can see the right edge of the belt. As the stroke is started, tilt the machine so as to bring the right edge of the belt into contact, then level the machine and simultaneously sweep the stroke to the left. This procedure will offset the tendency to dig in at the beginning of the stroke.

Removing paint: This job is done effectively with the belt sander, but you have to take special precautions to avoid gumming, or loading, of the abrasive surface of the belt. Use of an open-coated belt specially made for coarse-sanding operations and paint removal will help to prevent this trouble. Heat generated by the abrading action of the belt softens paint quickly, so the trick is



24

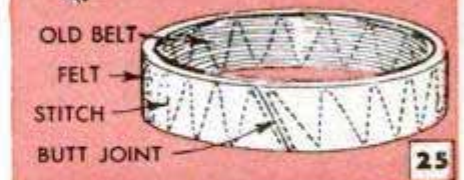

25



26

POLISHING BELT OF FELT CAN BE USED WITH COMPOUND ON PLASTIC



STATIONARY MOUNTING ON AUXILIARY TABLE MAKES PRACTICAL SETUP FOR EDGING WORK

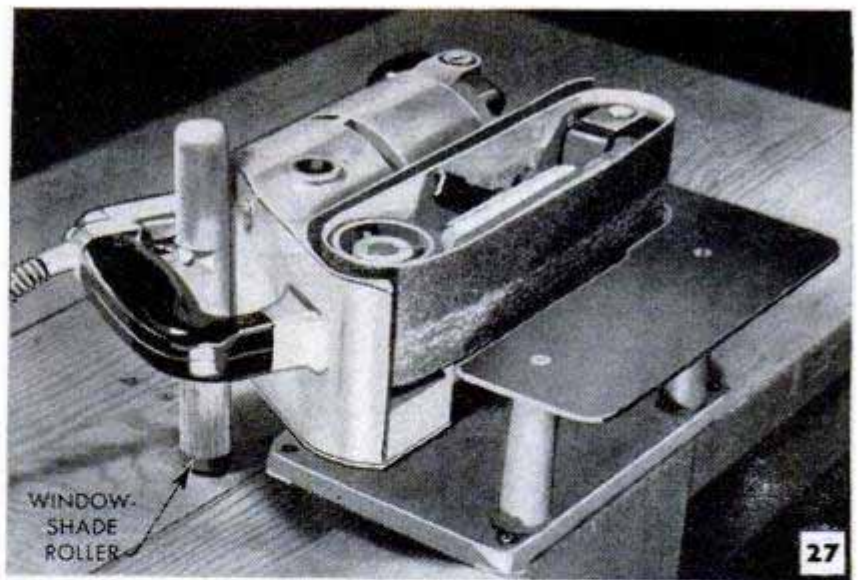

to use a short, backward stroke, Fig. 20, lifting the machine at the end of each stroke. Sometimes a hump shoe works advantageously by reducing the contact area. Where the paint film is thick, consisting of several heavy coats, move the machine to a new area after each stroke to avoid heating the paint unduly.

Belt selection, special procedures: The table, Fig. 18, gives the data on belt selection for various uses. If you can't stock all the belts listed, then use No. 1 aluminum oxide for all jobs except paint removal. A No. 2/0 belt is just right for finish sanding. Finer belts tend to heat unduly on some cabinet woods. When sanding a door, as in Fig. 7, or a cabinet end as in Fig. 22, work to the edge with the right side of the machine, from which the edge of the belt is visible. In door sanding, this is especially important to avoid sanding into the cross grain where the rail meets the stile, Fig. 7. Also, the right side of the machine is flush, enabling you to work up to a baseboard, or into a corner as in Fig. 22. When working on floors or on housed panels, attach a stop to the front of the machine as in Fig. 21, to guard against overrunning and damaging the panel frame or the baseboard. In sanding floors with a portable sander, use essentially the same procedures as described for use on flat surfaces. Because of the small

contact area of the shoe, it is not practical to attempt to sand large floors with this type of sander. The regular floor-sanding machine is much faster and more satisfactory. Grinding and polishing metals and plastics are done as in Figs. 11 and 26. For finishing a wood or metal surface, use a fine aluminum-oxide belt. For polishing metals and plastics, use a felt polishing belt made as in Fig. 25. Most manufacturers of portable belt sanders also supply specially made belts for polishing operations. As a rule the belts are used with a polishing rouge or compound. Do not use oil or other liquids with a polishing belt as this may cause clogging.

Stationary sander table: Nearly all manufacturers of portable sanding machines supply a stationary sanding table as an accessory. Figs. 27 and 28 show a typical stationary table in use. The table is fitted with a special cradle in which the machine is supported on its side as shown, exposing the belt at a right angle to the table surface. This inexpensive unit adds considerably to the versatility of the machine, as a great variety of flat sanding and edging operations can be performed on small parts that must be finished to precise dimensions. Fig. 27 suggests a way of holding the switch in the "on" position by means of a short length of dowel, notched to take the switch knob.

Bags Mask Lights for Painting Cars

Fog lights, spotlights and other exposed accessories can be protected while spray-painting the car body if they are covered with paper bags or Manila envelopes. Small envelopes can be used to shield the outside mirrors. The bags are slipped over the accessories and secured with strips of masking tape. The coverings are easily removed when the job is finished.

Russell L. Card, Tweed, Ont., Can.

Gutter on Floor of Temporary Crib Eases Shoveling Corn

Difficulty in shoveling corn from temporary cribs was overcome by this farmer who installed a shovel gutter across the floor of the crib. The gutter, which is about 5 in. deep and 24 in. wide, projects 15 in. outside the crib. Corn is easily shoveled out of this smooth-bottomed gutter and is constantly replaced by gravity until the crib is almost empty.

Four-in-One Socket-Key Wrench

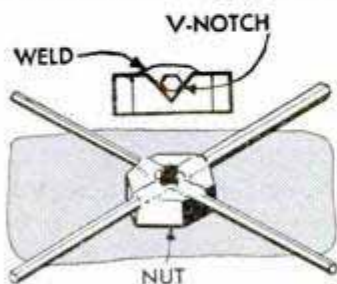

Welding the long arms of four socket-key wrenches to a V-notched nut provides a four-way speed wrench for driving socket-head screws. Select four socket

keys in the most widely used sizes and cut off the long arms just before the bend. Then clamp a 1-in. hex nut in the vise and with a hacksaw cut two vees across the face of the nut, making them at right angles to each other. Set the ends of the socket keys in the vees, tack-weld them in place and tap with a hammer to straighten them if necessary. After they are aligned, weld the keys in the V-slots, covering the vees and filling the center hole of the nut. Finish the wrench by grinding the welds flush with the face of the nut.

Roy Carlson, Kenosha, Wis.

Air Locates Conduit Outlet

To trace a particular conduit in the maze usually found in shop buildings, use compressed air to locate the outlet. With an air hose, blow a stream of air into the starting end of the particular conduit while a helper passes his hand over the ends of the conduits in the other part of the building. The emerging air stream will quickly identify the conduit in question.

John Krill, North Lima, Ohio.

Strips Nailed Across Range-Shelter Roof Provide Roosts

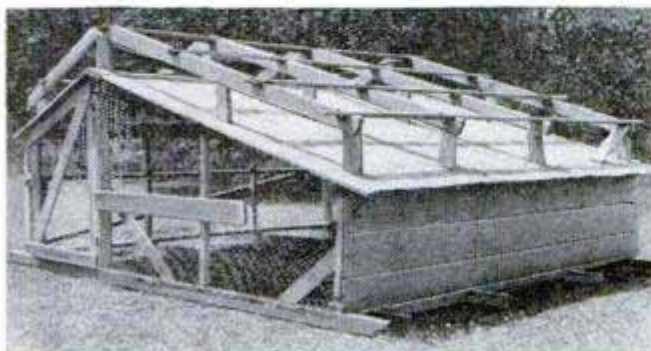

Improved Coil-Winding Form

When winding coils for radios or other apparatus, a flashlight cell with a cardboard covering can be used as a form. Space four strips of cellulose tape at regular intervals around the cell, placing them lengthwise with the adhesive side up. The length of the tape strips

should be slightly more than twice the width of the proposed coil. When the desired number of turns has been tightly wound over the tape, the loose ends of the tape are folded back over the coil and pressed firmly down to keep the winding in shape while it is being handled.

The finished coil can be removed by slipping the cardboard cover off the cell and collapsing it enough so that it may be easily withdrawn from the coil.

Warren W. Howe, Longview, Wash.

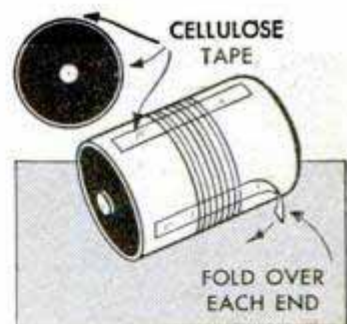

In order to provide ample roosting space for growing poults, one turkey raiser built additional roosts on the roof of each of his range shelters as shown in the photograph. The roost strips are nailed across several false rafters which are supported on posts about 18 in. above the roof surface. The same type of structure can be adapted to the use of range-grown chickens simply by spacing the roost strips somewhat closer together than those for the turkeys.

SHOPPING



TWO GIANT END WRENCHES now available are designed to take the place of as many as 29 ordinary end wrenches made for use on large nuts. These new wrenches are adjustable to nonslip positions by means of a bolt and nut rather than a screw. To change the adjustment, the user simply removes the nut and bolt and slides the movable jaw to the required position. Registering holes in the movable jaw and wrench frame are located to position the jaws for various sized nuts within the capacity of the wrench. The smaller of the pair, 24 in. long over all, adjusts from $1\frac{3}{8}$ to $2\frac{7}{8}$ in. The larger, 36 in. long, adjusts to sizes ranging from $2\text{-}15/16$ to $4\frac{3}{4}$ in.

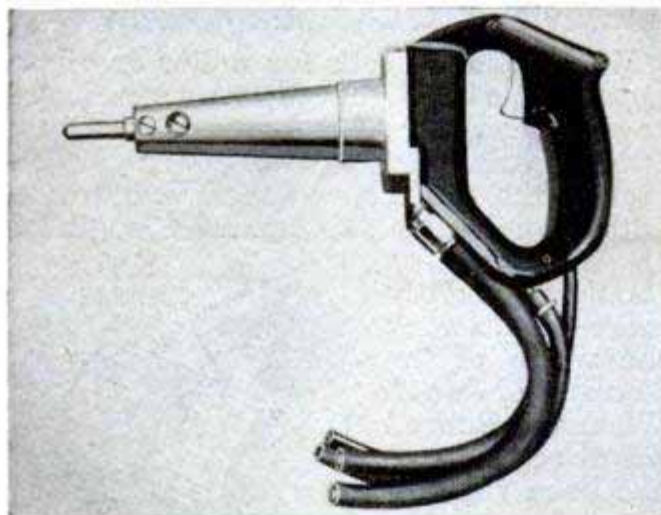

EXPLOSIVE RIVET GUN for high-speed operation in those blind, hard-to-get-at places has recently been announced. Special design of the gun eliminates need for back-up. No hammers or bucking bars are required. The gun is always ready for instant use on blind riveting and for maintenance and repair work. One operator handles gun for average riveting operations on sheet-metal work, radios, refrigerators, etc.



IGNITION-WIRING REPAIR KIT containing everything needed to make repairs on ignition wiring of auto, aviation and marine engines, includes distributor-cap terminals, spark-plug terminals of both straight and angle types, and also plastic distributor-hood caps. A combination tool for crimping, cutting and wire stripping is included with the kit, which is packed complete in a plastic container having 11 separate compartments



SHAPER AND DRILL-PRESS FENCE has several special features of interest to craftsmen who have small shapers, or do this work on a drill press. Big feature is the unusual combination guard and circular guide. This is adjustable in and out, and up and down, and is on the face side of the fence instead of on the back, as in the ordinary design. After the guard has been positioned as required by the work, it is locked firmly in place with two knurled spin nuts which are turned onto the threaded ends of the studs. In this position, the work passes under the guard and the shaper cutter is completely enclosed, giving maximum safety to the operator

FOR TOOLS



INEXPENSIVE GRADE GAUGE attaches to a level for checking roof pitch, setting drain tile and gutters at the proper inclination, and for checking pipe pitch in plumbing installations. It consists of a short level, or "bubble," mounted on a movable arm which is laid out as a protractor having graduations from 0 to 90 deg. and also for slopes from 0 to 6 in. per ft. In addition, the end of the movable arm has an expanded scale of 0 to 2 in. per ft. for setting long slopes quickly and accurately

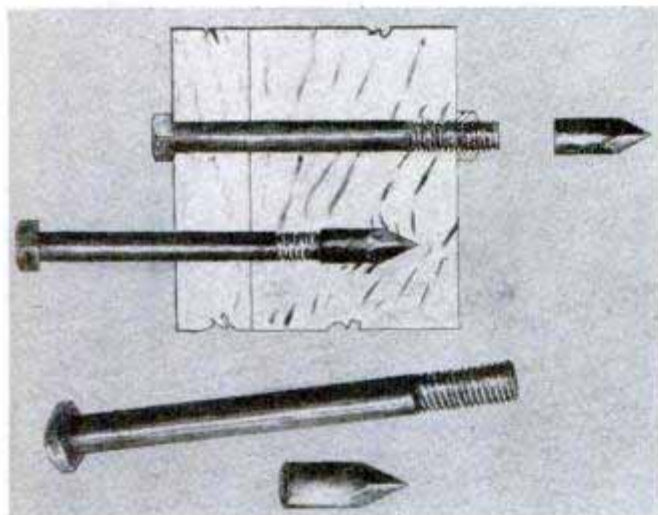

NOVEL DRIVE POINT is available for driving small bolts through two or more pieces of wood in the same manner as a large spike is driven. In use, the adapter, or drive point, is slipped over the threaded end of the bolt, which is then driven through the wooden members to be joined. After the bolt has been driven through the wood, the point is removed and the nut turned onto the threaded end. This procedure entirely eliminates the necessity for drilling clearance holes for bolt. Points are available in sizes from $3/16$ to $3/8$ in.

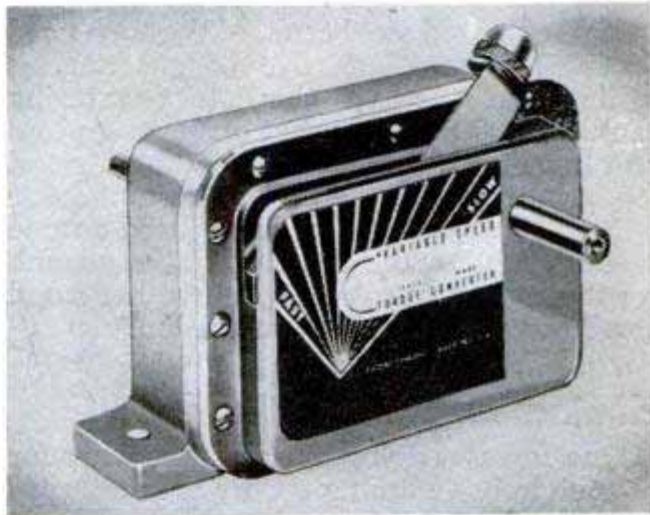

GEARLESS, NONHYDRAULIC SPEED CHANGER for light drives requiring torque conversion through a wide range of variable speeds gives an even flow of power and reverses without stopping, thus making it easy to incorporate the unit into the design of any product requiring this type of drive. Drive is through a cam-driven connecting rod on the input shaft. This imparts motion to a connecting link which, in turn, actuates an overriding clutch driving output shaft. No time lag occurs when increasing or decreasing speed



RATCHET-TYPE OPEN-END WRENCH having no moving parts is now available to users. Ratchet feature of this new wrench is unique in that all advantages of the conventional ratchet mechanism are gained by a simple basic design of the jaw. Lack of moving parts permits working in limited spaces where even the ordinary open or closed-end wrenches cannot be used. The conventional wrench at the right must be lifted clear of the nut at the end of each tightening or loosening stroke, while the new wrench shown at the left simply ratchets back to the original position without being lifted from the nut which is being tightened or loosened

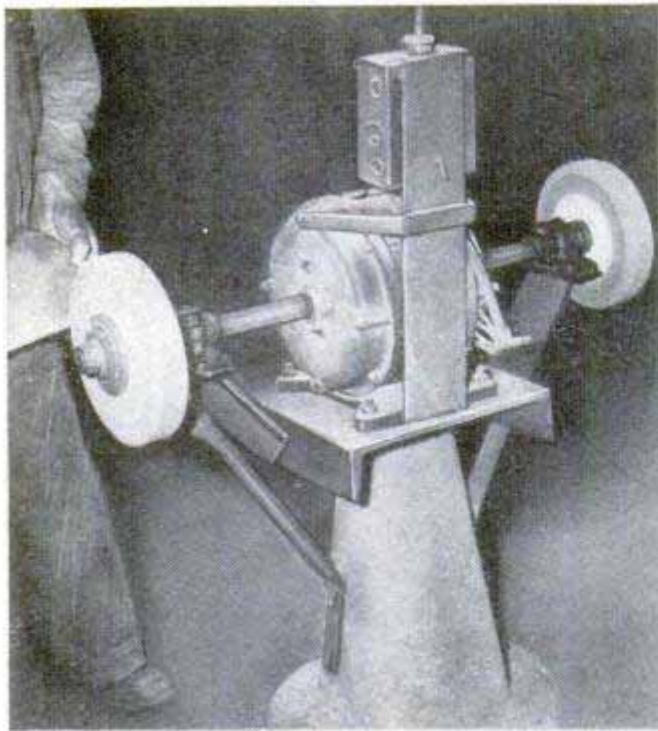

Floor-Type Grinder for Farm Shop Accommodates Heavy Work

Needing a floor-type grinder for coarse and fine grinding on large irregularly shaped parts, one farmer built a shop grinder from a double-shaft stock motor which met his requirements. First he welded 14-in. extensions to each motor shaft. The extensions are shouldered, threaded and fitted with wheel flanges, and the outer ends are carried in split pillow-block bearings supported on pads welded to angle-iron brackets. The lower ends of the brackets are welded to steel channel which forms a base for the motor. Note also that additional pipe supports extend down to the grinder pedestal from each bearing. No tool supports are used, as most of the grinding is done freehand. To eliminate vibration and inaccurate work, the wheels should be trued occasionally with a wheel dresser.

Large Stock Tank Supplies Float-Controlled Hog Waterer

Half of an old steel tank, of the type used for underground storage of gasoline, is utilized in making this stock-watering tank. The tank half is set on level ground and kept from tipping by wedging a small log lengthwise on each side. An automatic waterer, with float control, is fitted on one end of the tank and set close to the ground for the convenience of hogs and other small stock, as shown in the illustration.

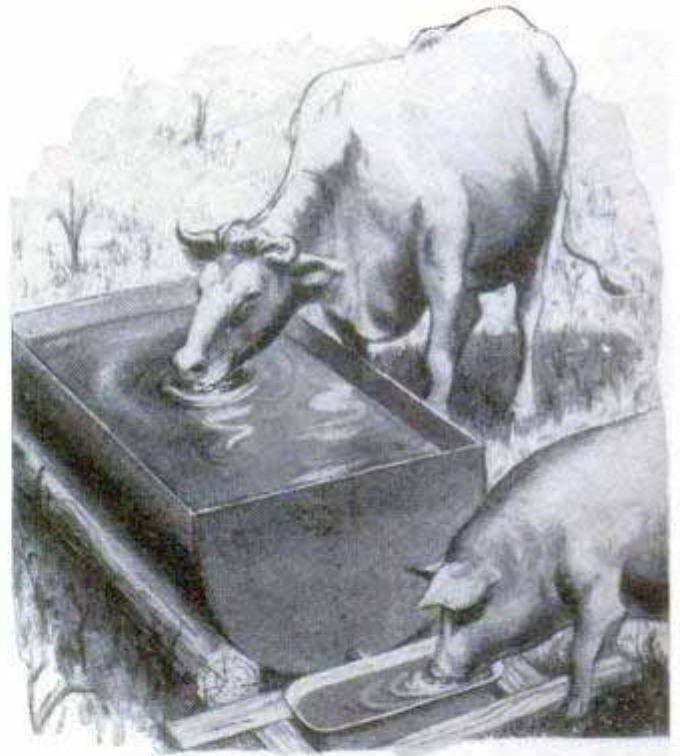

Eliminating Exhaust Sparks

One farmer, doing custom threshing for his neighbors, eliminated the spark hazard from the tractor exhaust by running a short length of copper tubing from the radiator tank to the exhaust manifold. A valve at the tank permits adjusting the flow of water to a trickle. This generates sufficient steam in the hot manifold to snuff, or deaden, any sparks originating either in the manifold or the muffler of the tractor.

Handy Barnyard Snowplow Is Assembled From Odds and Ends of Metal

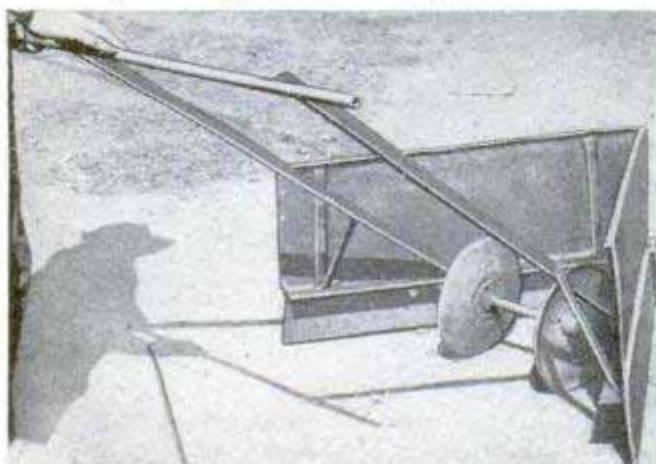

This handy snowplow for clearing paths and the feeding floors in the barnyard is assembled from metal scrap found around the farm. The wheels are automobile hub caps, and the plow itself is made from two pieces of sheet metal. The frame and handle bar are built up from odds and ends of pipe, angle iron and flat steel, which are cut to length and welded together.

☛ To remove iron rust from pails, apply some lemon juice to the rusted portions of the metal and allow to remain for a few hours before rinsing.

TELEVISION IN THE HOME

AS TELEVISION interests all members of the family group, its enjoyment has not been an unmixed blessing in many homes. Individual choice of programs presents a problem when youngsters are in the midst of a bang-up session with "Two-Gun Pete" just when Dad wants a little peace before dinner, or when Mother is trying to carry on a phone conversation. An earphone attachment shown in photo A solves the problem by permitting the speaker to be cut out when quiet is desired. The headphone device also serves so that children can sleep while grownups enjoy their evening programs.

A television seating problem is solved with the inflatable seats made of colorful and sturdy Vinylite plastic. The seats are made for children and are decorated with cowboy, Indian and circus figures, as illustrated in photos B. They are easily inflated with a hand pump. When deflated, each one folds into a small 8 x 10-in. package. Photo C shows an improved twin-driven corner antenna for all-channel coverage that is claimed to minimize "ghosts" caused by reflected signals in critical locations.

By using a new TV polish as illustrated in photo D, Mother can now clean the plastic television outer screen without fear of scratching the soft optical surface. Figs. 1 and 2 in sketch E show two applications of an inexpensive, flat, nondirectional, indoor TV antenna that can be used in apartments.

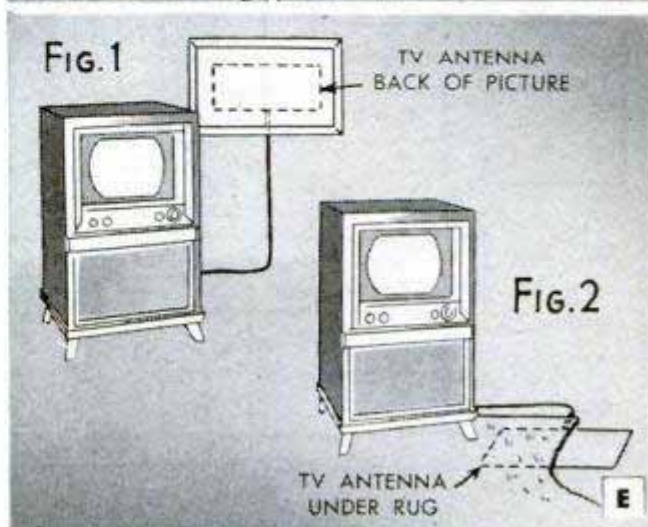
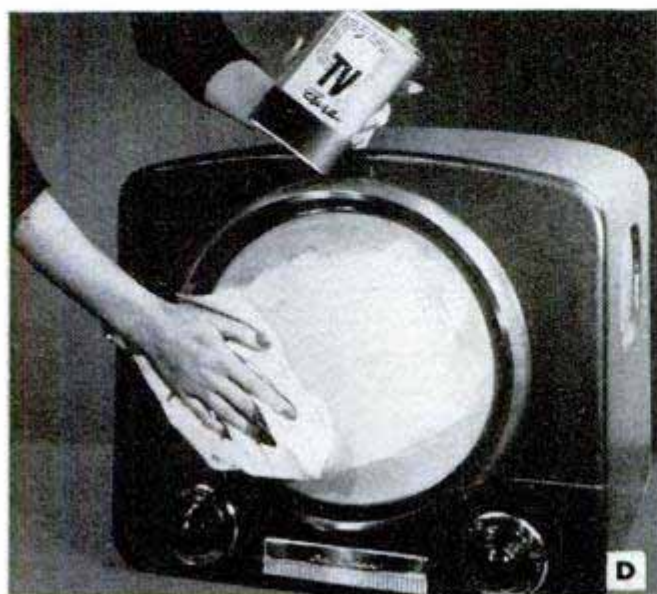
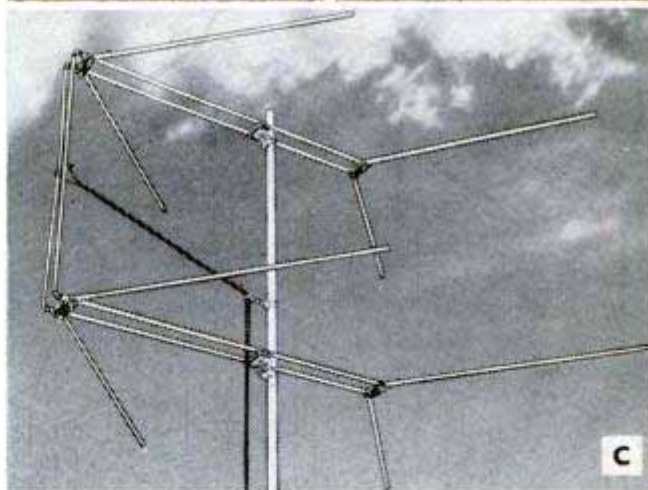
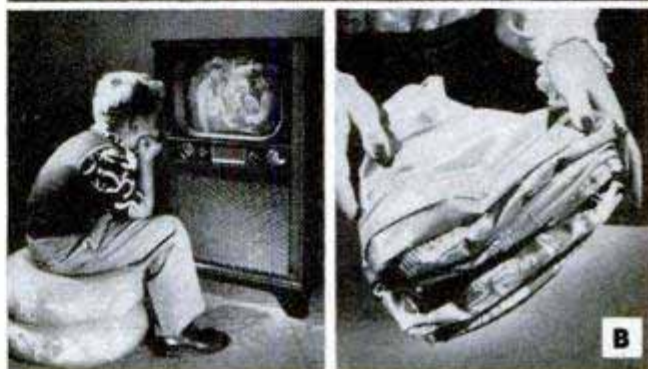

SUPER-FIDELITY AMPLIFIER

By Dr. Richard C. Hitchcock

(Eng. Westinghouse Research Laboratories)



THIS IS a highly satisfactory general-purpose audio amplifier that any radio or electronic experimenter can build. There are two high-impedance inputs, a low-gain for phonograph, and a high-gain for microphone. Output is up to 10 watts, with very little distortion.

The voltage-amplifier stages are 6SJ7 pentodes, triode-connected. A special feature is the use of grid 3 as a hum reducer for each of the three input tubes. The driver is a twin-triode 6N7 tube; the output is a twin-triode 6V6 tube; the output 6V6

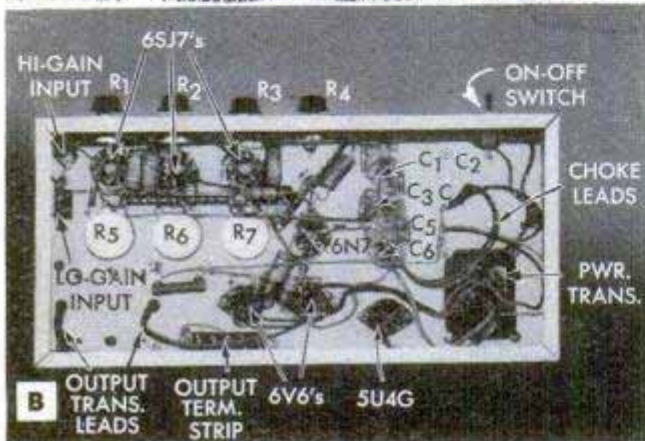

RESISTOR CHART

- R1, R2, R4—.5 MEG. POTENTIOMETERS (MALLORY MR-48 #1T)
- R3=1-MEG. POTENTIOMETER (MALLORY MR-53 #1T)
- R5, R6, R7=100-OHM POTENTIOMETERS (MALLORY M100PX)
- R8=250-OHM WIRE-WOUND, 10-WATT
- R9, R10, R11, R12=5,000-OHM, 1-WATT CARBON
- R13, R14=200-OHM, 1/2-WATT CARBON
- R15=1,500-OHM, 1/2-WATT CARBON
- R16=2,200-OHM, 1/2-WATT CARBON
- R17=4,700-OHM, 1/2-WATT CARBON
- R18, R19=10,000-OHM, 1/2-WATT CARBON
- R20=22,000-OHM, 1/2-WATT CARBON
- R21, R22=56,000-OHM, 1/2-WATT CARBON
- R23, R24, R25, R26, R27=100,000-OHM, 1/2-WATT CARBON
- R28, R29=150,000-OHM, 1/2-WATT CARBON
- R30, R31=270,000-OHM, 1/2-WATT CARBON
- R32, R33, R34, R35=1-MEG., 1/2-WATT CARBON

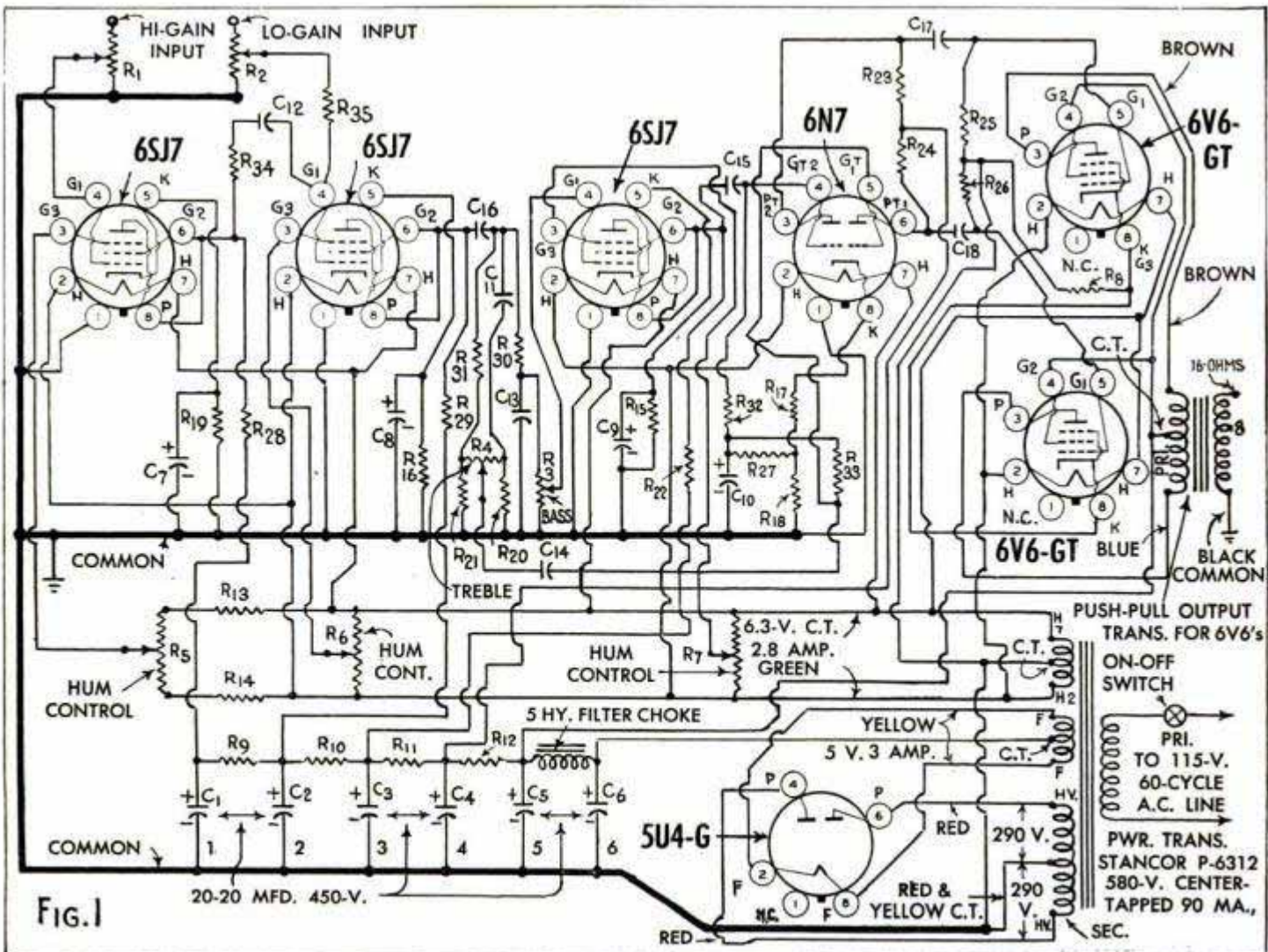
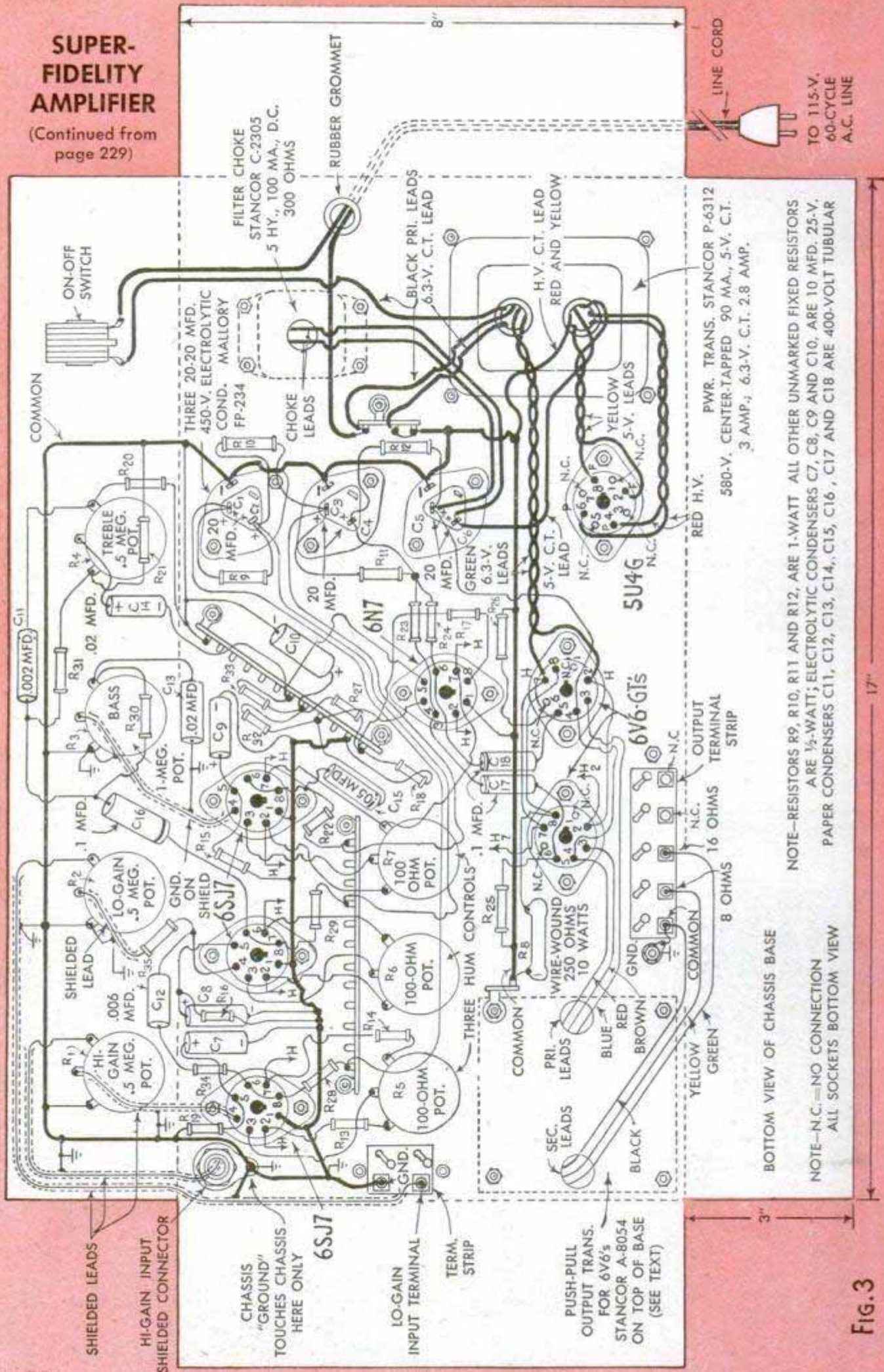

FIG. 1

SUPER-FIDELITY AMPLIFIER

(Continued from page 229)



NOTE—RESISTORS R9, R10, R11 AND R12, ARE 1-WATT ALL OTHER UNMARKED FIXED RESISTORS ARE 1/2-WATT; ELECTROLYTIC CONDENSERS C7, C8, C9 AND C10, ARE 10 MFD. 25-V. PAPER CONDENSERS C11, C12, C13, C14, C15, C16, C17 AND C18 ARE 400-VOLT TUBULAR

NOTE—N.C.—NO CONNECTION ALL SOCKETS BOTTOM VIEW

NOTE—RESISTORS R9, R10, R11 AND R12, ARE 1-WATT ALL OTHER UNMARKED FIXED RESISTORS ARE 1/2-WATT; ELECTROLYTIC CONDENSERS C7, C8, C9 AND C10, ARE 10 MFD. 25-V. PAPER CONDENSERS C11, C12, C13, C14, C15, C16, C17 AND C18 ARE 400-VOLT TUBULAR

NOTE—RESISTORS R9, R10, R11 AND R12, ARE 1-WATT ALL OTHER UNMARKED FIXED RESISTORS ARE 1/2-WATT; ELECTROLYTIC CONDENSERS C7, C8, C9 AND C10, ARE 10 MFD. 25-V. PAPER CONDENSERS C11, C12, C13, C14, C15, C16, C17 AND C18 ARE 400-VOLT TUBULAR

NOTE—RESISTORS R9, R10, R11 AND R12, ARE 1-WATT ALL OTHER UNMARKED FIXED RESISTORS ARE 1/2-WATT; ELECTROLYTIC CONDENSERS C7, C8, C9 AND C10, ARE 10 MFD. 25-V. PAPER CONDENSERS C11, C12, C13, C14, C15, C16, C17 AND C18 ARE 400-VOLT TUBULAR

NOTE—RESISTORS R9, R10, R11 AND R12, ARE 1-WATT ALL OTHER UNMARKED FIXED RESISTORS ARE 1/2-WATT; ELECTROLYTIC CONDENSERS C7, C8, C9 AND C10, ARE 10 MFD. 25-V. PAPER CONDENSERS C11, C12, C13, C14, C15, C16, C17 AND C18 ARE 400-VOLT TUBULAR

Fig. 3

Hams Ready for Emergency

NETWORKS of amateur radio stations are being formed for operation on the VHF two-meter amateur band for emergency work. A typical group can be heard testing almost nightly in the city of Chicago, covering the area between Milwaukee, Wis., and South Bend, Ind. They operate on 147.5 megacycles, using wide-band FM.

This group, which is typical of many throughout the United States and Canada, is being organized by several well-known amateurs including William E. McNatt, W9NFK, Harry Harrison, W9LLK and Charles R. Waller, W9QIO, who is operating his station and equipment shown in the accompanying photos. The aluminum antenna tower illustrated in photos A and B is 85 ft. high. The National model HFS receiver shown in photos C and D tunes the very high frequencies from 27 to 250 megacycles. W9QIO also operates a mobile Motorola FM, TRU5V rig in his car. There are several mobile units in the group; most of these use retired police equipment.

Perhaps no atomic bomb will ever fall on Chicago, or on any of our metropolitan areas. However, everybody knows that this could happen, knocking out power facilities and paralyzing immediately all ordinary means of communication. Outside help would have to be brought in at once. Following Presidential approval, the National Security Resources Board recently released its Civil Defense Plan. One separate paragraph states in part, "Amateur radio operators and networks will be used in Civil-Defense communications."

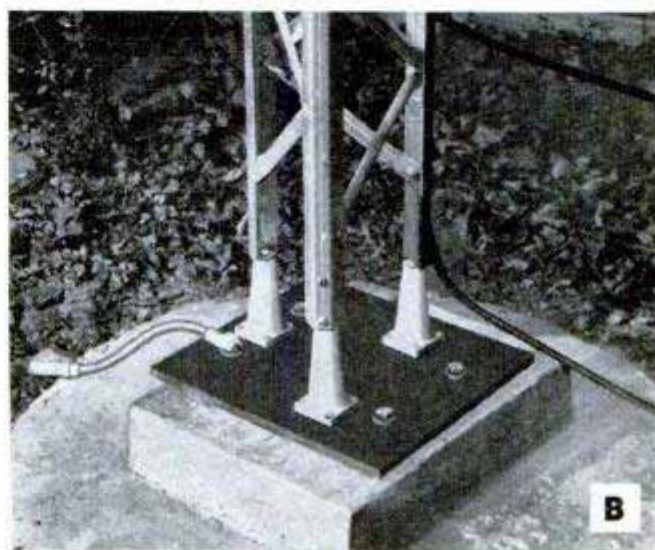
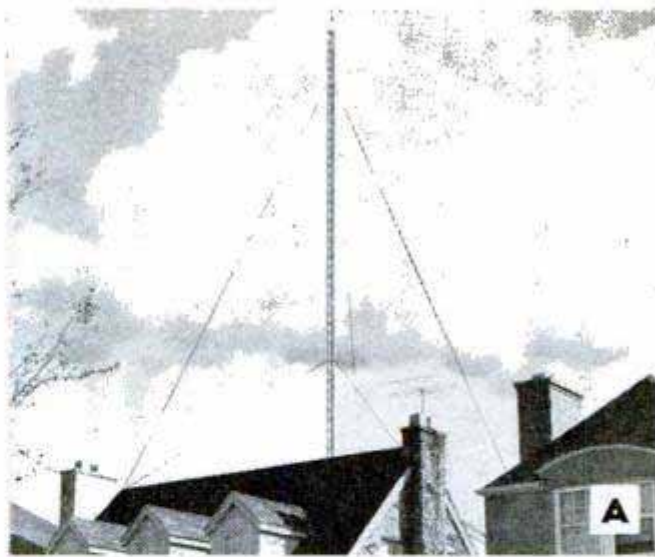

HINTS FOR RADIO SET OWNERS

A—Wax from warm condensers and transformers often runs down into tube sockets and causes poor contact when tubes are replaced. By heating terminals and inserting pipe cleaner, wax may be removed

B—Case for sun glasses used to carry spare miniature tubes. A partition that protects the glasses from breakage also provides protection for the tubes when they are wrapped in paper for carrying

C—Plastic toy scissors, available at dime stores, can be made to serve as a handy insulated radio tool. By filing notches near the ends as shown, the suspected loose wiring can be pulled for testing

D—Clear plastic box, obtainable at hardware stores, has seven partitions convenient for spare fixed resistors, machine screws, nuts and small parts. Makes a handy transparent container for workbench

E—Breaks or cracks in white plastic radio cabinet may be repaired as shown. The first step is to apply liquid plastic cement to edges of the break; second, hold cemented edges tightly together, binding with friction tape until the cement sets, and third, paint the break line with a standard golf-ball lacquer

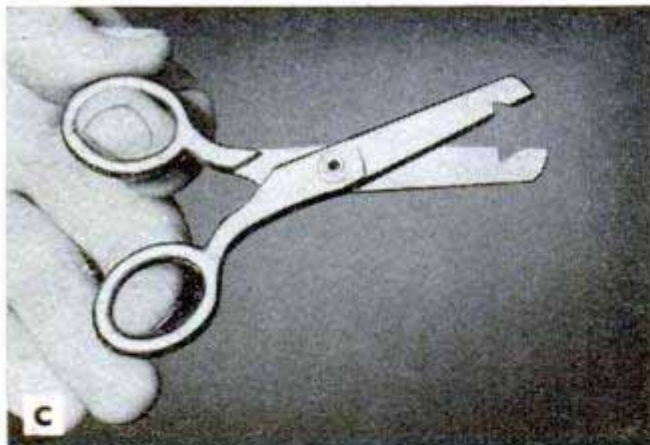
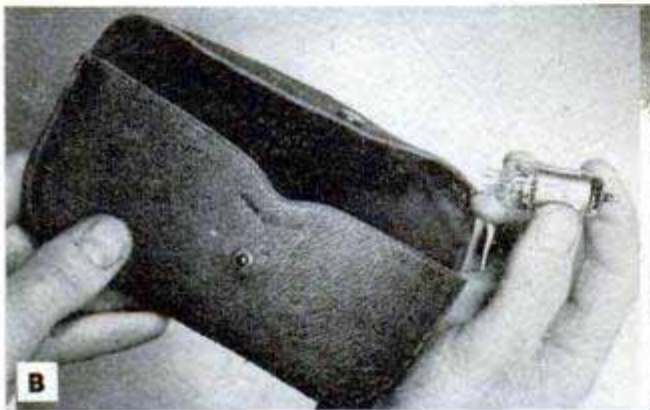

BLUEPRINTS covering radio and electronic construction articles in past issues are available for 25c each. Latest list can be obtained without charge from Popular Mechanics Radio and Electronics Dept. Our new **RADIO-TV and ELECTRONICS HANDBOOK**, now available at your bookstore and from Popular Mechanics Press, is today's 160-page guide for millions of radio and television set owners, students and experimenters. Price \$2.50

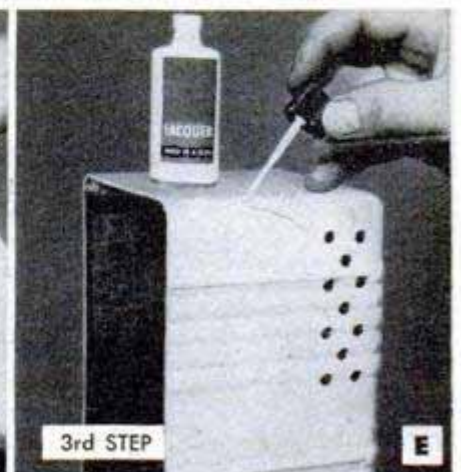
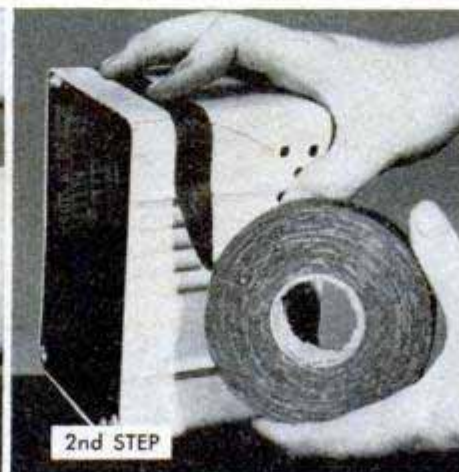
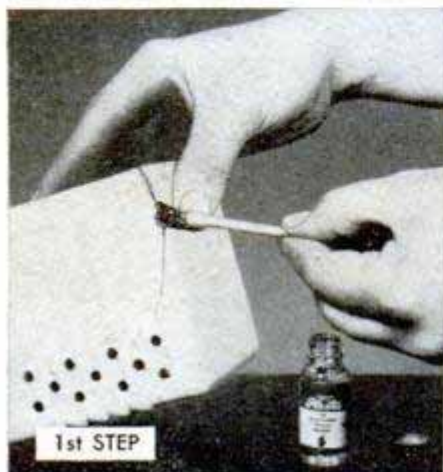
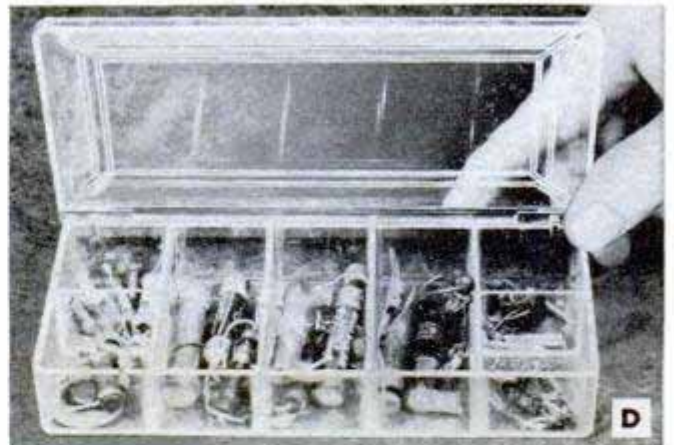

SPECTACULAR NEW

"SAFETY-FLOW RIDE"

ON DISPLAY
NOW

new Plymouth



A new driving experience

New "Safety-Flow Ride" provides extra shock-resistance when you run upon a sudden bump or hole—keeps you gliding with a steady motion. You enjoy new freedom from tension and fatigue—new comfort and steering ease. New steadiness too—an important safety feature. Learn more about this great new kind of ride at your Plymouth dealer's.

Introducing

THE CONCORD Two-door Sedan • Three-passenger Coupe

THE CAMBRIDGE Four-door Sedan • Club Coupe

THE CRANBROOK Four-door Sedan • Club Coupe
Convertible Club Coupe

Plus that famous all-purpose car, the "Suburban," and its still more luxurious version, the "Savoy."

Exciting new styling

A new grille of graceful yet massive form. Heavy bumpers of sleek, wrap-around design. New-style rub rails, moulding and scuff guards. Completely new interiors with a new variety of rich fabrics. New colors. New trim. New dash. Other style improvements you'll want to see!

Other new features

Greater all-around vision with narrower front corner posts and wider rear window. Constant-speed electric windshield wipers. More headroom. New easy-action hand brake. Waterproof ignition system. New by-pass thermostat for faster warm-up, now standard on all models. Many other mechanical advances.

NEW
INSIDE

OUTSIDE

PLYMOUTH
BUILDS GREAT CARS

See it at your Plymouth dealer's

PLYMOUTH Division of CHRYSLER CORPORATION, Detroit 21, Michigan



Care and Feeding of Engines

BY S. P. CORP

ABOUT CYLINDER SLEEVES

When you have to repair an engine with a cracked cylinder, or with walls scored too deeply to rebore, the answer is, "Sleeve 'em and save 'em!" "Wet" or "dry" cylinder sleeves will make that engine work again. A *wet sleeve* replaces the entire cylinder wall and comes in direct contact with the cooling liquid. A *dry sleeve* is pressed into a bored-out cylinder. Fig 1 shows how a dry sleeve is fitted into a cracked cylinder to provide a new cylinder wall. Write Sealed Power, Muskegon, Mich., for complete instructions.

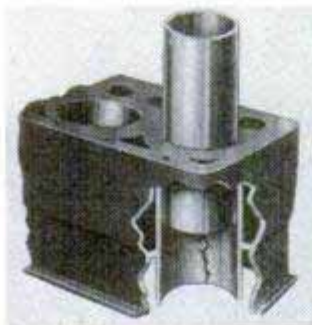

Fig. 1—Dry sleeve

WHY 3.1 TO 1 GEAR RATIO?

Ever wonder why transmission and rear axle gear ratios should be such odd figures as 3.3 to 1 or 4.1 to 1, when a straight 3 to 1 or 4 to 1 is so much easier to figure? You can discover the answer easily by taking a 2 to 1 timing gear set, marking opposite teeth, and seeing how often they meet—every second revolution. Now take a 4.1 to 1 set from a rear axle and repeat the step. The ring gear has 41 teeth, the pinion 10 teeth, and the marked teeth meet only once in 41 revolutions. If something chips a tooth, the wounded teeth won't mesh again until they have had a chance to be smoothed off by other teeth.



ALWAYS REMOVE PISTON PINS

Two shopmen were recently hurt severely while machining pistons because they didn't remove the pins. Always be sure to do this before putting a piston in a lathe or grinder. Otherwise, as heat is generated, the piston will expand and the pins will loosen. Nothing is gained by leaving the pins in, as they have to be removed later to attach the rod.

Now about rings: Always use Sealed Power Piston Rings when re-ringing. The Sealed Power MD-50 Steel Oil Ring does the world's best job of oil control, even in badly tapered and out-of-round bores. Your dealer has Sealed Power Rings or can get them for you. They save gas, save oil, restore original power to your engine and lengthen its life. A postal to "Sealed Power, Dept. G-2, Muskegon, Mich.," will bring you free a helpful book, "7 Ways to Save Oil."

Balloon Man

(Continued from page 100)

emits real locomotive sounds to heighten the realism.

The giant balloon pipe organ, which is almost a block long, also carries its own sound equipment, including two power generators. The resulting blast of music can be heard for two miles.

There are plenty of tricks to the balloon trade, Gros has learned. At one parade all the figures were lined up, ready to go, when the engine of the locomotive suddenly exploded. The balloon had been inflated too high, then had been put into the sun. As the air inside the balloon warmed, it expanded and the increased pressure finally burst the balloon. Fortunately, the crews carry complete repair gear and temporary patches can be made in a matter of minutes.

Out in Minnesota for a winter carnival, Gros encountered the opposite trouble. The balloons were inflated in a heated auditorium, then were moved outside just before the parade began. The Indian lady almost dropped her papoose, the pig staggered, the three-headed monster sagged and the horse dragged on the pavement. The bitter cold had contracted the air inside the balloons. A quick injection of additional air put them in shape again. Now the Gros crews make sure there will be no serious temperature changes, or make allowance for any changes that they know will occur.

The balloons, being the unbelievable things they are, have been the butt of enough practical jokes to make Jean Gros prematurely gray. Once a Gros elephant disappeared from a lagoon down in Georgia where it had been floated to promote a local fair. It turned up three days and many columns of newspaper publicity later, guarding a farmer's field.

And out in St. Paul the police radio cars were startled one night to hear their announcer broadcast: "Be on the lookout for a 100-foot dragon with green spiked ear and a bright red tongue. Known affectionately as Igor, the dragon is not believed to be dangerous!"

The errant dragon, worth several thousand dollars, had been kidnapped by pranksters and showed up later that night, its partially deflated figure decorating the bar of a local tavern.

Production of aluminum nails, a postwar product, reached 1400 tons in 1949 and is increasing as the nonferrous nail loses the status of a substitute and becomes a special-purpose product.

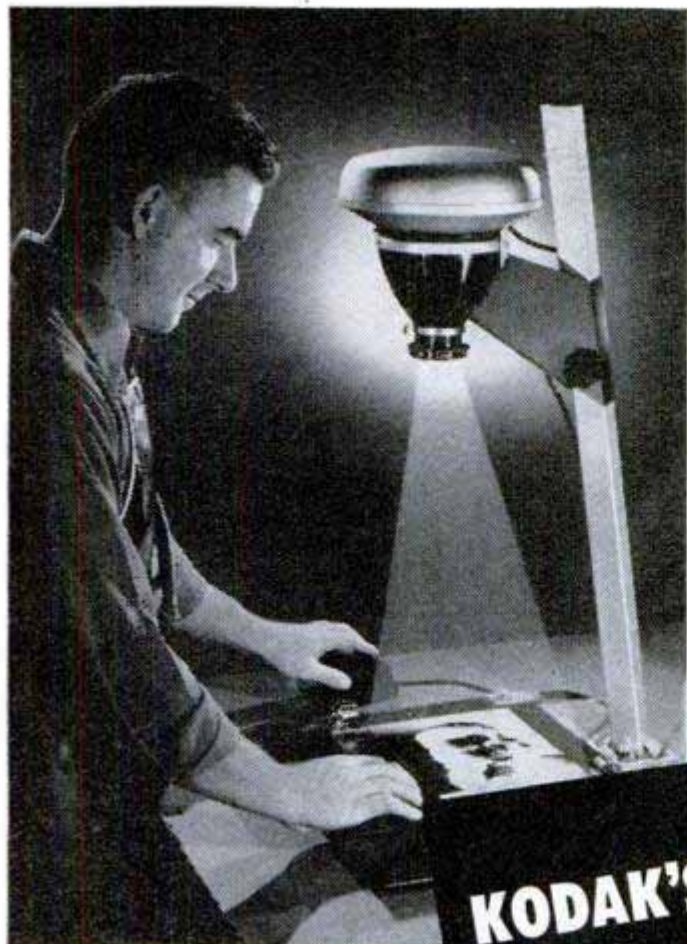

Looking for a down-to-earth price tag?

KODAK HOBBYIST ENLARGER—\$49.50

Complete with lens! New-type lamphouse designed so all light reaching negative is *reflected* light. New-type interior reflective coating gives remarkably *even* light distribution. Newly designed negative carrier for easier loading. Locking knobs for both elevation and focus. Enlarges up to 7 times. Kodak Enlarging Ektanon Lens, $f/6.3$, with click stops.

**KODAK'S MODERN
"COLD-LIGHT"
ENLARGERS**

Want magnificent enlarging PLUS?

KODAK FLUROLITE ENLARGER

Circular cold-light fluorescent lamp, integrated with a new reflector design, gives you the speed and brilliance of a condenser system. Light is instant-on, instant-off . . . negative carrier tilts and rotates for control of distortion . . . base has big (17 x 21¼ x 5-inch) light-tight paper cabinet. Assembly can be used for cine-titling, photomicrography, and as view camera. Without lens—\$112.50.

Kodak Enlarging Lenses for the Flurolite range from the Kodak Enlarging Ektanon Lens, 2-inch $f/4.5$ (for negatives up to $1\frac{3}{8}$ x $1\frac{9}{16}$ in.)—\$22.50 . . . to Kodak Enlarging Ektar Lens, 4-inch $f/4.5$ (for negatives up to $2\frac{1}{4}$ x $3\frac{1}{4}$ in.)—\$56.00.

Prices include Federal Tax

Prices subject to change without notice. Consult your dealer.

EASTMAN KODAK COMPANY, ROCHESTER 4, N. Y.



Kodak
TRADE-MARK

Now it's **EASY**
to have modern
oak floors

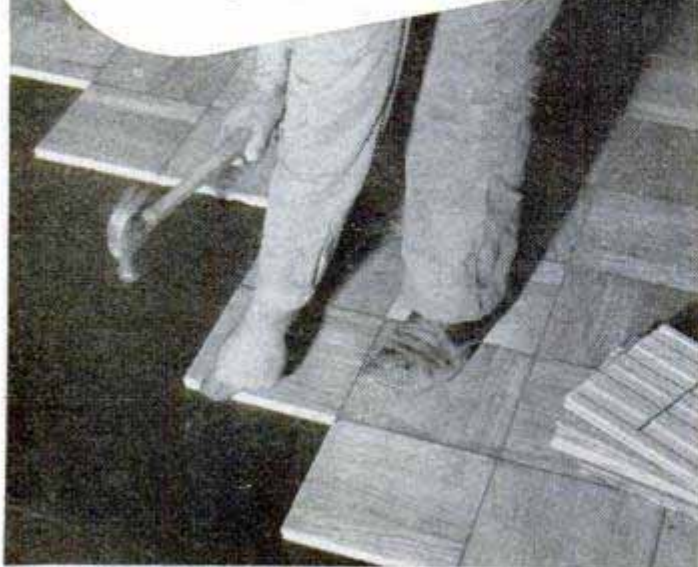

Your choice of block or strip design

Just lay prefinished Bruce oak flooring right over your old floors...no sanding or finishing

You can give your home new beauty at low cost with a prefinished Bruce Hardwood Floor. Completely finished—even waxed—at the factory, this highest quality oak flooring can be nailed right over old floors. No sanding or finishing...no mess or smell. Ready for use as soon as laid. Made in strip or block (parquet) design.

"Scratch Test" Finish — The Bruce factory-applied finish is baked into the pores of the wood.



The "Scratch Test" (left) will prove to you that this durable finish does not scratch or chip or mar like an ordinary floor finish.

Moderate in cost — A new Bruce Hardwood Floor will cost you less than a good rug or carpet. Easy to keep clean and beautiful, too. It's just the thing to use in fixing up or adding a room. Let your lumber dealer give you an estimate. Mail coupon below for colorful literature.

MAIL FOR FREE LITERATURE

E. L. Bruce Co., Box 397-H, Memphis 1, Tenn.
Send complete information on prefinished Bruce Hardwood Floors.

Name.....

Address.....

City..... State.....



Bruce Hardwood Floors

Product world's largest hardwood flooring maker

Clinic



for Homemakers

As a service to our readers in solving the hundreds of problems pertaining to a home—inside or out—the editors of *Popular Mechanics* invite you to present your problems to The Clinic Editor for help and advice. Address your questions to The Clinic Editor, *Popular Mechanics Magazine*, 200 East Ontario Street, Chicago 11, Ill.



Spray Painting

Q — What are the advantages and disadvantages of spray painting a house as compared with brush painting? I have two painting bids and the spray-paint job is cheaper, both being estimates on two-coat work. Why is one quotation so much lower?
S.S., Ft. Smith, Ark.

A—Probably your spray-painting contractor figures that he can do the work in less time and with less help, perhaps, than doing the job by hand with a brush. The manner of applying the paint, whether by brushing or spraying, is not nearly so important as is a thoroughgoing knowledge of the techniques to be employed. If the spray painting is done in accordance with approved practices, there is no reason why the job should not prove to be as durable and attractive as a painstaking brush job. The best exterior spray-painting practice requires that windows, doors and all other areas not to be painted be masked effectively and that the paint be of the best quality and mixed according to the directions of the manufacturer for spray application. On the average outside job, spray painting is much faster than brushing.

Power-Saw Speeds

Q—I have an 8-in. circular saw of the home-shop type on which I would like to use a 6-in. cross-cut blade, but somewhere I have read that 6-in. blades should be operated at a speed of over 7000 r.p.m.; 7600 r.p.m. as I recall. This seems excessively high and to obtain it I would have to replace my present motor pulley with one of much larger diameter. Is this recommendation correct? And what about speeds of dado and molding heads?
G.T., Santa Fe, N. Mex.

A—For operation of a 6-in. circular saw blade, the speeds you give are correct, as a general recommendation, as the small-diameter blades are tensioned for these speeds. However, it is not at all necessary to drive the blade at this high speed in order to obtain satisfactory results in intermittent operation. In fact, a 6-in. crosscut blade (with crosscut teeth) will operate satisfactorily at speeds as low as 2500 r.p.m. on light work. Dado heads of the separable type consisting of two outside cutters, or saws, and several inside chipper, should never be operated on small home-shop machines at excessive speeds, as they may set up damaging vibrations as a result of the difficulty

(Continued to page 238)

TRY THIS TUBE

you'll be convinced!

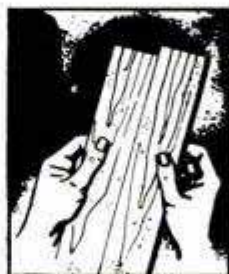

It is the best glue for all fine woodwork. It makes joints so strong they cannot be opened without wood failure, yet so thin you cannot see them when grain is matched. Long lasting, hide glue was used in museum pieces centuries old. This hide glue is the easiest to use, yet the finest glue for all home craftsmen.

It's genuine HIDE glue . . . strongest known
That's the secret of Franklin popularity. Once a craftsman realizes that this is the same glue as he has used, but without any of the trouble of heating, mixing, etc., it's the only glue for him from then on.

No mixing or heating . . . ready-to-use
That means no danger of chilled joints, no waste, uniform from first drop and every drop works.

Economical—no waste
Actually costs less than any ordinary glue because it spreads so thin and goes farther.

No odor—no muss
Unbelievably pleasant to use. A favorite in furniture factories, schools and at home.

15¢ AT ALL HARDWARE STORES



SIX SIZES . . .

Available in tubes, 15c; ideal for a trial; quarter pints, 50c; half pints, 85c; pints, \$1.50; quarts, \$2.65; and gallons, \$7.50 at most good hardware stores. If your dealer cannot supply you

SEND THIS COUPON

with 20¢

Send 20c for the large tube (15c plus 5c for postage and wrapping).



THE FRANKLIN GLUE CO., 113 W. Chestnut St.
Columbus 15, Ohio

Enclosed 20c (15c plus 5c postage and wrapping charge) for a trial tube of Franklin Liquid Hide Glue.

NAME _____

ADDRESS _____

SEND THIS COUPON

Variety is the spice of filing

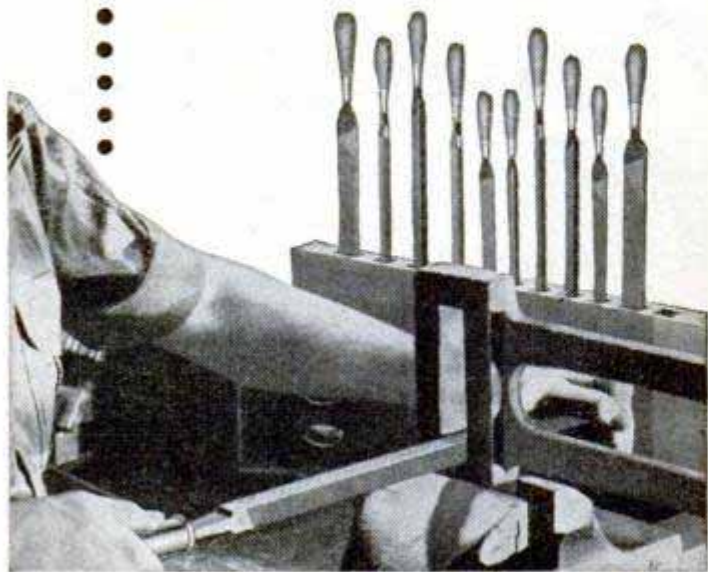

A VARIED assortment of Nicholson or Black Diamond files is as much a part of the complete home workshop as a good assortment of bits, taps or chisels. For one thing, it means you always have exactly *The right file for the job*. For example: Mill (single cut) files for sharpening and smoothing. Flat files (double cut) for fast stock removal. X.F. Swiss Pattern files for precision work. Taper files for saw sharpening.

Equally important, Nicholson and Black Diamond quality means top performance. You can't buy files that are more accurately cut, more expertly hardened—more widely accepted by expert filers because of their fast, uniform cutting, and their extra-long life.

Your hardware dealer will be glad to help you work up an assortment of these famous files to fit your needs.

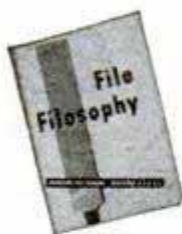

FREE—"FILE PHILOSOPHY"

—a home-workshop manual on files. Its 48 illustrated pages cover the kinds, care and use of files. Send for your copy today. No obligation.



NICHOLSON FILE COMPANY

22 Acorn St., Providence 1, R. I.
(In Canada, Port Hope, Ont.)



NICHOLSON FILES

FOR EVERY PURPOSE

(Continued from page 236)

of placing the separate units on the saw arbor in such a way that the assembled head will be in perfect balance. A speed of 3600 to 4000 r.p.m. is a good, safe average for 6-in. saw blades, dado heads and molding heads of the type used on saw arbors.

Tinting Wood Fillers

Q—I have tried tinting natural wood fillers without satisfactory results. When I try to match a stained surface it ends up either too dark or too light. What ingredients are used and what procedure is followed to produce the desired results?

B.T., Holyoke, Mass.



A—One of the simplest ways of solving your problem is to use colored fillers. These are available in standard colors for use on open-grained woods, such as oak, mahogany, and walnut. For ordinary finishing of these woods the colored fillers give excellent results. However, there are cases where shades are desired which are not available in the ready-made product. The usual practice in this work is to tint a natural filler to the shade desired with an oil stain. The trick in mixing just the shade you want is to mix a small quantity of stain with filler, then spread this thinly on a piece of cardboard and allow it to dry flat. In this way you can determine the true color. If the test shows that the filler is too light, add a little more stain and test again. If, on the other hand, the mixture is too dark, add more filler. By working and testing in this way you can produce a filler of almost any shade desired.

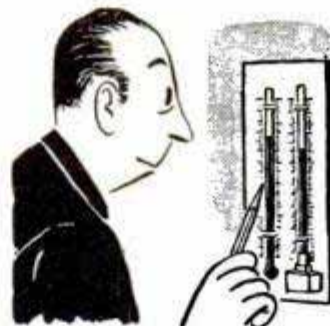

Humidity

Q—How can I determine accurately the amount of humidity in the air in my home at any given time? What is important for me to know in this connection—the absolute humidity, or the relative humidity? What is relative humidity, that is, how is it defined?

R.E., Green Bay, Wis.

A—One fairly accurate way of determining this is to use a comparatively inexpensive wet-dry bulb hygrometer. By comparing the reading with a chart furnished with the instrument you can obtain values for both relative and absolute humidity. One type of wet-dry hygrometer is made for wall mounting and contains two thermometers with a small water container and wick to keep the bulb of one thermometer wet. Evaporation of the water cools the wet thermometer. When readings are taken from both thermometers, reference to the chart will show the relative humidity of the air at that particular time. Absolute humidity of the air, or atmosphere, is the mass, or amount, of water contained per unit volume. Relative humidity is the ratio of the quantity of water vapor present to that which would be necessary to bring about a condition of saturation.

Loss of Heat Through Glass

Q—My question is, what is the resistance of ordinary glass to the passage of heat? D.F., Chicago.

A—We assume you are referring to a window pane. Most of the resistance to passage of heat is not in the glass itself, but rather in static air films that lie close to the two surfaces. In a recent test by a well-known glass manufacturer, it was shown that with an air temperature of 70 deg. F. on one side of a pane of glass, and -30 deg. on the other side, there was less than 3 deg. difference in the temperatures of the two surfaces. Of course, these figures are for a test made in still air. On a windy day the protective air film probably would be blown off the exposed side, resulting in a considerable loss of resistance.

EAR NOISE MISERY?



If you are missing many of the joys of living because you have Ear Noises or are Hard of Hearing due to Catarrh of the head WRITE US TODAY and learn of the blessed relief our simple Home Treatment has brought many others suffering from the same cruel handicap. Many were past 70! NOTHING TO WEAR. Treatment easily used right in your own home. SEND TODAY FOR PROOF AND AMAZING 30-DAY TRIAL OFFER.

ELMO CO., Dept. 814, Davenport, Iowa

MONEY for MEN ALL FREE
DATA

THE PLASTEX Industry needs manufacturers on small scale and for big production of Lamp and Clock Stands, Art Goods and Novelties in Plastex and Marble imitation. Experience unnecessary. Vge material makes regular 10c store sellers. Rubber moulds furnished for speed production. Small investment brings good returns. We are now placing big Chain Store Orders with manufacturers. Ambitious men have chance for real prosperity. Our Free booklet will interest and benefit you.

PLASTEX INDUSTRIES, Dept. A
3400 Third Ave. New York 56, N. Y.

Say You Saw It in
POPULAR MECHANICS

MIRACLE TOMATO
Yields **2 BUSHELS**
To a Vine

Now—You can grow the world's most amazing Tomato right in your own garden and get from 2 to 3 bushels of delicious, ripe tomatoes from every vine.

BURGESS CLIMBING TRIP-L-CROP

TOMATO grows 16 to 20 feet high. Huge, meaty, solid fruit, wonderful flavor. Some weigh as much as 2 pounds each. Unsurpassed for canning and slicing. Blight free—drought and disease-resistant. Grows in any garden. Outyields all other varieties.

TRIAL PACKET 10c
3 For 25c POSTPAID
ORDER TODAY

Write for **FREE** complete Catalog listing many unusual Seeds, Plants and Bulbs.
BURGESS SEED & PLANT CO.
217 B. Galesburg, Mich.

Walworth
GENUINE
Stillson teeth
keep their
bite!

Compare the Walworth *Genuine* Stillson with any other similar wrench regardless of price. Compare its good, sound design features . . . its teeth that receive an extra treatment, rendering them so hard and tough that long service is assured. Make all these comparisons; then you'll agree that the Walworth *Genuine* Stillson is the best wrench your money can buy.

Get a Walworth *Genuine* Stillson from your local hardware store today!

*No shop is complete without
Genuine Stillson Wrenches*
The Stillson Diamond Trademark
identifies the
Walworth Genuine Stillson

WALWORTH

New York, N. Y.

VALVES . . . PIPE FITTINGS . . . WRENCHES



FOR ACCURACY



\$189.50

for complete 5-tool unit without motor. Includes geared Jacobs chuck, 12" sanding disc, 8" saw blade, arbors, lathe centers, etc.

TAKE another look at the photo above. See those paper-thin strips? All four were sliced from the same piece of wood in sixty seconds *without changing the rip fence setting*. How? It's easy with SHOPSMITH. You can shift the *saw blade* as well as the fence—using SHOPSMITH's exclusive micro-feed blade adjustment.

There's not much you can do with wood strips. What's important is the speed and extreme accuracy of SHOPSMITH's fence-to-blade settings. And this is just one of SHOPSMITH's many precision features.

The disc sander, for example, feeds into the work, can be set to stop on a hairline.

The vertical and horizontal drill presses have built-in jigs, unique micro-settings. The centerless ground steel ways are stress-tested at over a ton, assure absolute rigidity and accuracy in lathe work as well as in other operations.

Add 'em all up—accuracy, capacity, flexibility, rugged construction and precision features—and you'll begin to see why SHOPSMITH is America's most popular power tool. See SHOPSMITH demonstrated at leading hardware and department stores or any Montgomery Ward store. And for complete details and specifications, mail the coupon.

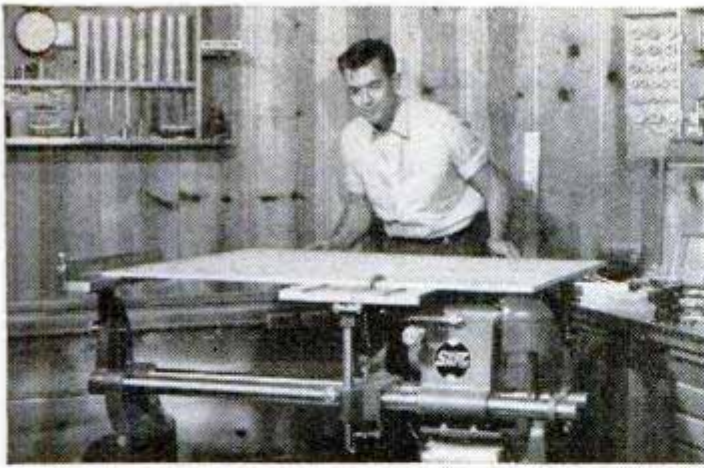

BLADE TO FENCE—48". You won't find many saws under \$200 that offer capacity like this. It means you can cut to the center of 8' plywood panels, handle extra-long boards, trim doors, screens, storm sash. Table tilts, raises, lowers. Maximum depth of cut 2¼".

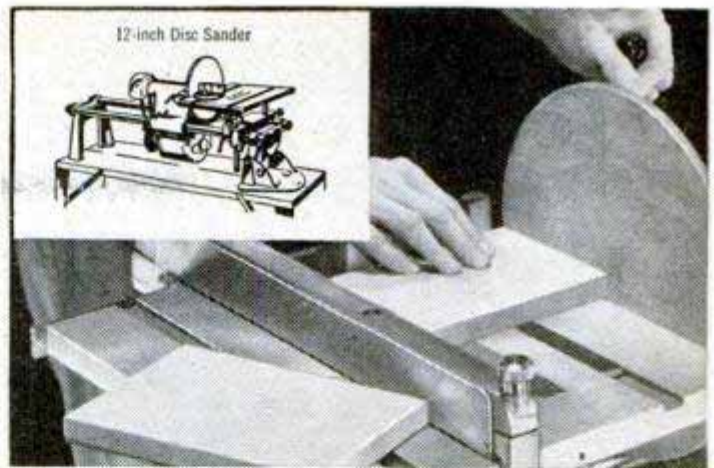

90° ON THE NOSE. SHOPSMITH as a disc sander is so accurate you can forget about your try square. Can be used as a jointer too. Work fed through at a slight angle (by cocking fence) comes out with a beautifully jointed edge. Sandpaper discs easily replaced.

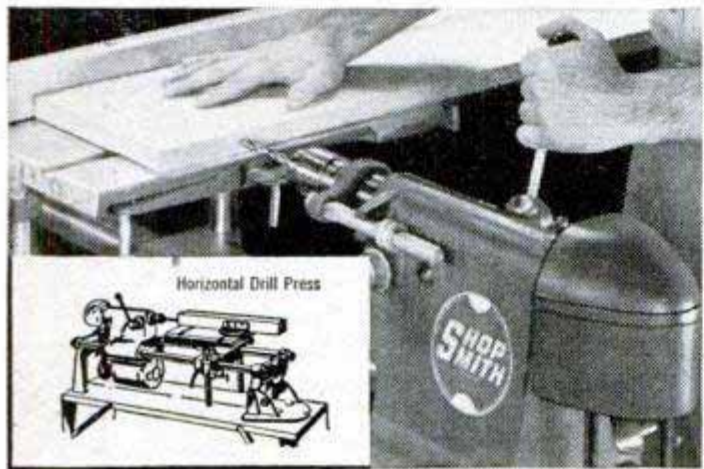

PERFECT DOWELED JOINTS. No jigs required. Just lay the work flat on the table, feed drill from side. Dowel holes match perfectly. Horizontal drill is especially useful when drilling large, awkward work. Its capacity is limited only by the length of your workshop.

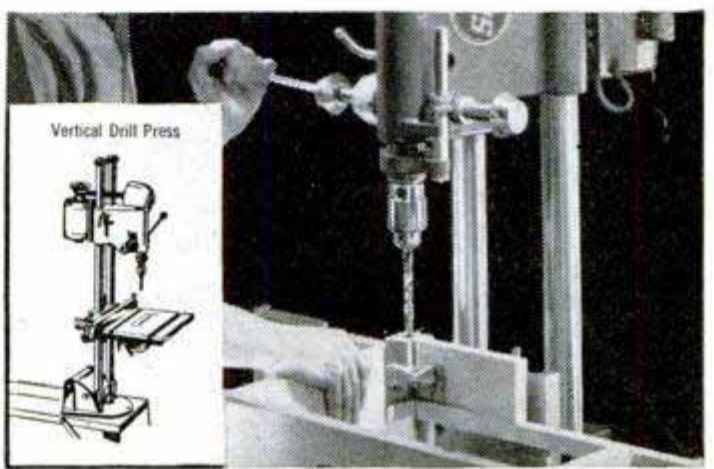

FLOOR MODEL, TABLE MODEL. SHOPSMITH as a drill press is both. Maximum clearance, table to chuck, 27", floor to chuck, 55". Jacobs key chuck takes drills up to ½" diameter. Speeds range from 875 to 3500 rpm. 4" quill feed. Easy to read, adjustable depth scale.

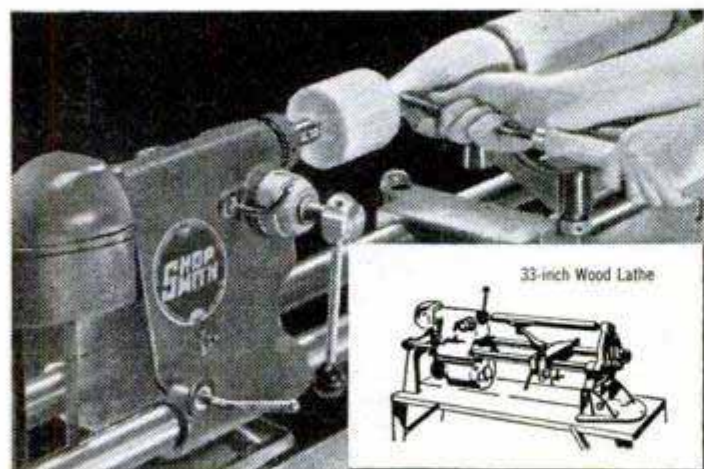

ROOM TO TURN IN. SHOPSMITH as a lathe has a 15" swing—4" more than most other heavy-duty lathes. It has a quick-set tool rest that always moves parallel to your work-piece. And it's the only lathe that lets you face the work while face-plate turning.

NEW RETRACTABLE CASTERS

... increase SHOPSMITH'S already great flexibility. They're easily mounted on any wood or metal bench. Easy to set, too, with three-stage foot levers that raise or lower unit. Your SHOPSMITH dealer has them. Complete set ... \$11.95.

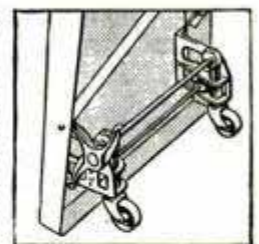

ADDRESS:

SHOPSMITH, Dept. 152-B, at factory nearest you:

12819 Coit Road, Cleveland 8, Ohio, OR
417 Montgomery Street, San Francisco 4, Calif.

Please send me the free SHOPSMITH booklet.

Name _____
Address _____
City _____ State _____

MAKE BIG MONEY *Sharpening* LAWN MOWERS

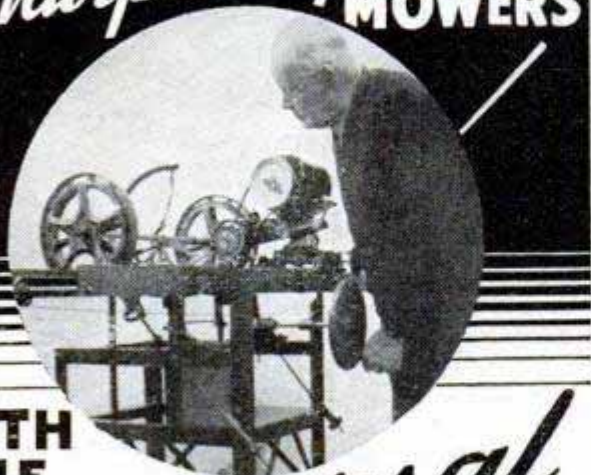

WITH THE *Universal* LAWN MOWER GRINDER!

Enjoy a profitable full or spare time lawn mower sharpening business of your own. No previous experience necessary. Place a hand or power mower on the UNIVERSAL GRINDER. With only **one set-up** you grind both the stationary blade and all of the reel blades to proper clearance. No need to remove a single blade from mower! No need for extra attachments. The UNIVERSAL is complete. Gives precision adjustment for every desired angle, bevel or clearance. The UNIVERSAL does a faster, more accurate grinding job. You save time . . . you give greater customer satisfaction. Thousands of owners in all parts of the country acclaim the UNIVERSAL the best lawn mower grinder on the market. A big money maker!

PROOF "I am doing a fine business with the Universal Grinder. One customer sends another. I spent 40c for a newspaper ad and have done nearly \$500.00 of business." —C. E. Hardy, Miss.

PROOF "Thank you for getting me started in this wonderful business . . . I averaged \$100.00 a week in May, and made \$1000.00 spare time this season." —J. L. Peterman, Pa.

PROOF "I am 70 years young. I sharpened mowers all my life and have had all kinds of grinders. But the Universal tops them all." —A. J. Tuttle, N. H.

Only on the UNIVERSAL LAWN MOWER GRINDER can the inside face and edge of the stationary blade, as well as all the reel blades, be ground to proper clearance ALL IN ONE SET-UP without removing a single blade from mower.

ROGERS MANUFACTURING CO., Dept. M-21, Lindsey, Ohio

SEND FOR FREE FACTS NOW!

ROGERS MFG. CO., Dept. M-21, Lindsey, Ohio

Please send me full facts about the Universal Lawn Mower Grinder and its big money making opportunities.

NAME _____

ADDRESS _____

CITY _____ STATE _____

A Swiss Wood Carver Brings Back Hawaii's Lost Art

(Continued from page 93)

When the student feels he is stuck, the instructor helps him on the next step and again instructs him in the use of the right tool. A beginner may use only a few chisels and gouges, while an experienced carver may use up to 80 different tools.

"The help of competent instructor's guidance, plus the inspiration of other wood carvers, keeps the student moving along," Fritz says.

When a student completes his carving, he rubs it with steel wool or sandpaper. Luckier students use a sanding machine. When this is done, there are many ways of polishing the wood. Most popular, however, is to use a sealer base followed by a high-grade wax. The clear wax is rubbed on with a cloth and "elbow grease" is used to produce the desired polish. When using koa wood, some students pour linseed oil and white shellac on their palms and then rub the wood well. This makes koa glow with a dark mahogany sheen. Many students dislike using shellac in the finishing process as they find it gums up the fine lines in their carvings.

Fritz teaches the only advanced wood-carving class in the Islands. The better students and teachers attend these classes. Here wood carving turns from craftsmanship to art. These classes are strictly limited to 18 students who generally go in for carving figures and heads—usually having Polynesian features.

With a host of instructors, fine-grained woods and never-ending subject matter, Hawaii is fast turning out a new generation of wonder workers in wood.

Digging Deeper for Red Metal

(Continued from page 85)

tunnels a system of finger chutes will be excavated upwards into the ore to the level that is to be undercut.

The miners will leave numerous pillars to support the ore while they are undercutting, then the pillars will be blasted away a few at a time. Unsupported, the roof will begin to slough and spall. Once this caving-in process has started, it is self-sustaining and the fallen ore will be drawn off through the finger chutes and dropped into the cars of the ore trains that are spotted below.

The process will continue until all the ore has fallen and is hauled away. No underground void will remain because the

(Continued to page 244)

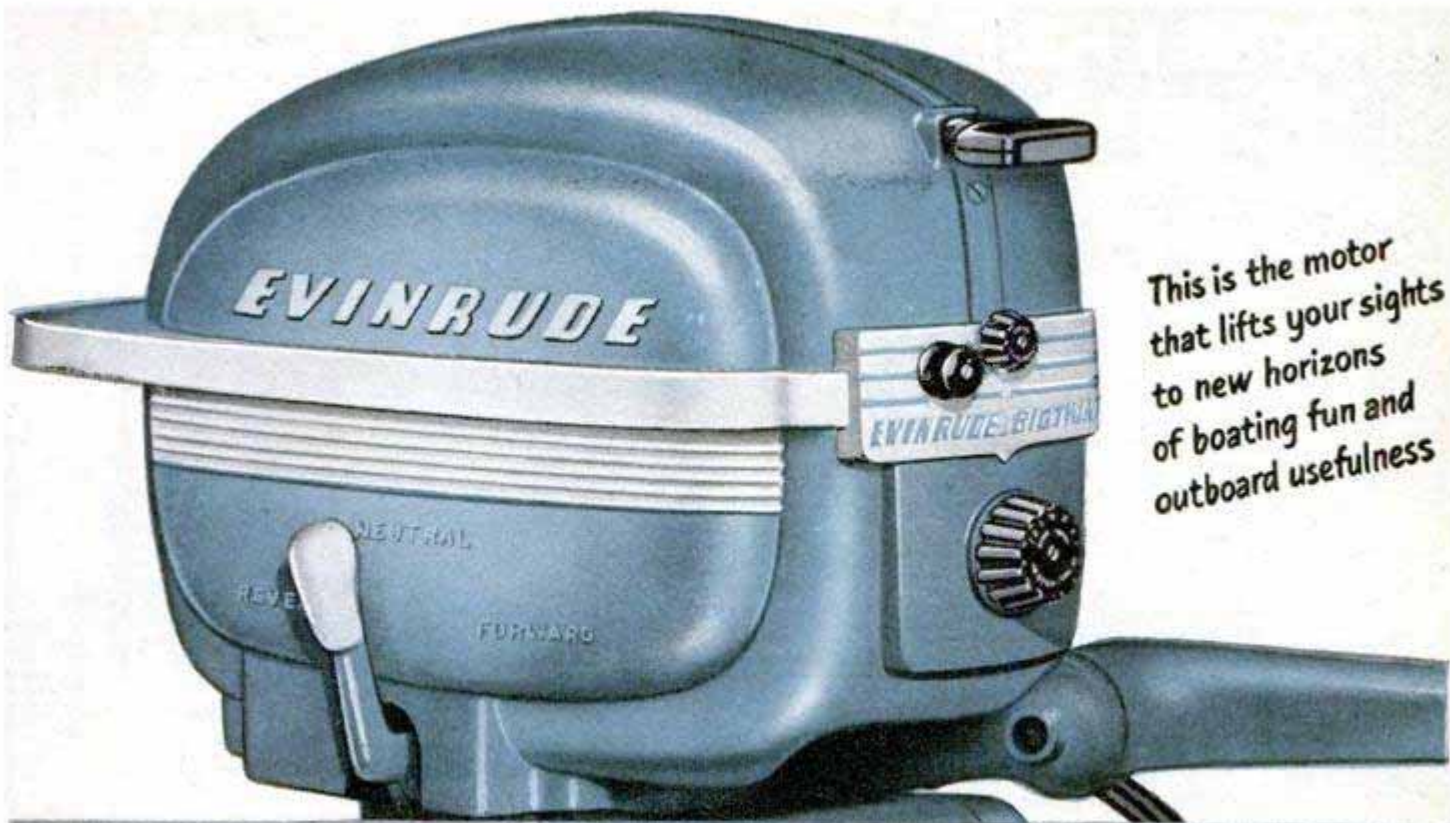

This is the motor
that lifts your sights
to new horizons
of boating fun and
outboard usefulness



BIG TWIN
by **EVINRUDE**

25 HORSEPOWER*
only 85 POUNDS
new HANDLING EASE
ROTO-MATIC CONTROL
GEARSHIFT
CRUIS-A-DAY TANK

... it's years ahead! You've heard about

a great new Evinrude... a motor that packs the wallop of 25 sharp and solid horsepower *in only 85 pounds*... a motor that thrusts the thrill of exhilarating speed into big boats, heavy loads... the one that takes off like a scared cat, trolls like a sweetheart, handles like a dream... and is *excitingly priced* within the reach of all! This is the one... **BIG TWIN**... it's years ahead! **BIG TWIN** gives you Simplex Starter for starting ease—and Roto-Matic Control—every speed right in your hand! Gearshift with Neutral, Forward, Reverse! Separate, big-capacity Cruis-A-Day Fuel Tank! Full range performance—less than 2 to over 30 miles an hour on able boats! SEE THE **BIG TWIN**—see the complete 1951 line at your Evinrude dealer! Look for his name under "Outboard Motors" in the yellow pages of your phone book. **CATALOG FREE**—write for it today! Address **EVINRUDE MOTORS**, 4602 N. 27th St., Milwaukee 16, Wis. In Canada, Evinrude Motors, Peterborough, Ontario

\$390⁰⁰



*O.B.C. Certified brake H.P. at 4000 R.P.M.

F. O. B. Factory, Milwaukee, subject to change without notice.

CAMPBELL - HAUSFELD Spray Painting Outfits

*Outperform
them all!*

WITH a Campbell-Hausfeld Spray Painting Outfit you can paint a house or barn in less time than it now takes to paint a chicken coop by hand. Make a better job of it, too.



Four Models . . . moderately priced!



The same compressor will save you many a trip to the service station. It does everything from inflating tires and lubricating chassis to complete refinishing of your car, truck, tractor or farm implements.

All Campbell-Hausfeld air compressors are piston type, precision built with deep cooling fins cast integral with cylinder block. Cylinders are honed to mirror finish. Crank shaft is drop forged automobile steel, heat treated. Valves are disc type, stainless steel.

Every C-H compressor is rechecked by run-in on test line before shipment. Lasts a life-time.

PRESSURE QUEEN
the only 4-cylinder
portable outfit.

No Pulsation

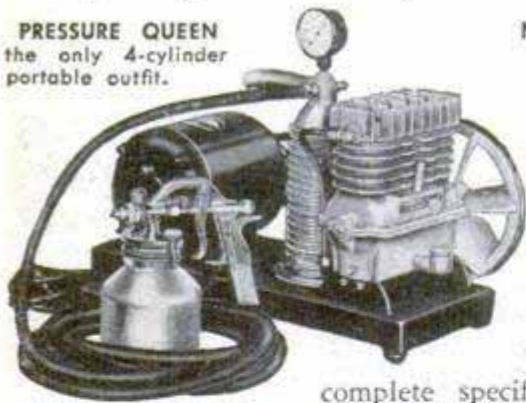

Write for
complete specifications and
price list.

THE CAMPBELL-HAUSFELD CO.

1046 Railroad Avenue

Harrison, Ohio

Send literature and prices on complete line

Name _____

Address _____

Post Office _____ State _____

My dealer is _____

At _____

ground above the mined area will slowly subside and fill up the hole.

The ore body is to be mined by caving one block of ore at a time, each block being a cube some 300 or 400 feet in each dimension. Ore in the top zone will be removed first, then the process will begin all over



Mine executives ride on a motor-driven rail scooter as they check various workings in the Bingham area

Below, a radio-telephone in the rail scooter keeps the executives in communication with their offices



again at a lower level and will continue at increasingly deeper levels until the ore is exhausted.

The undertaking is a daring one because nothing like it has ever been attempted on so large a scale before. Yet it is the best way that has been devised so far for working buried deposits of low-grade material at a profit. It's an assurance, too, that so far as copper and some other metals are concerned, the United States is going to be self-sufficient for all of its needs for a long time to come.

☐ New strains of guayule, America's best natural - rubber - producing shrub, yield from 25 to 40 percent more rubber than those produced during World War II.

"BETTER CUTTING" BUILT INTO CRESCENT SNIPS

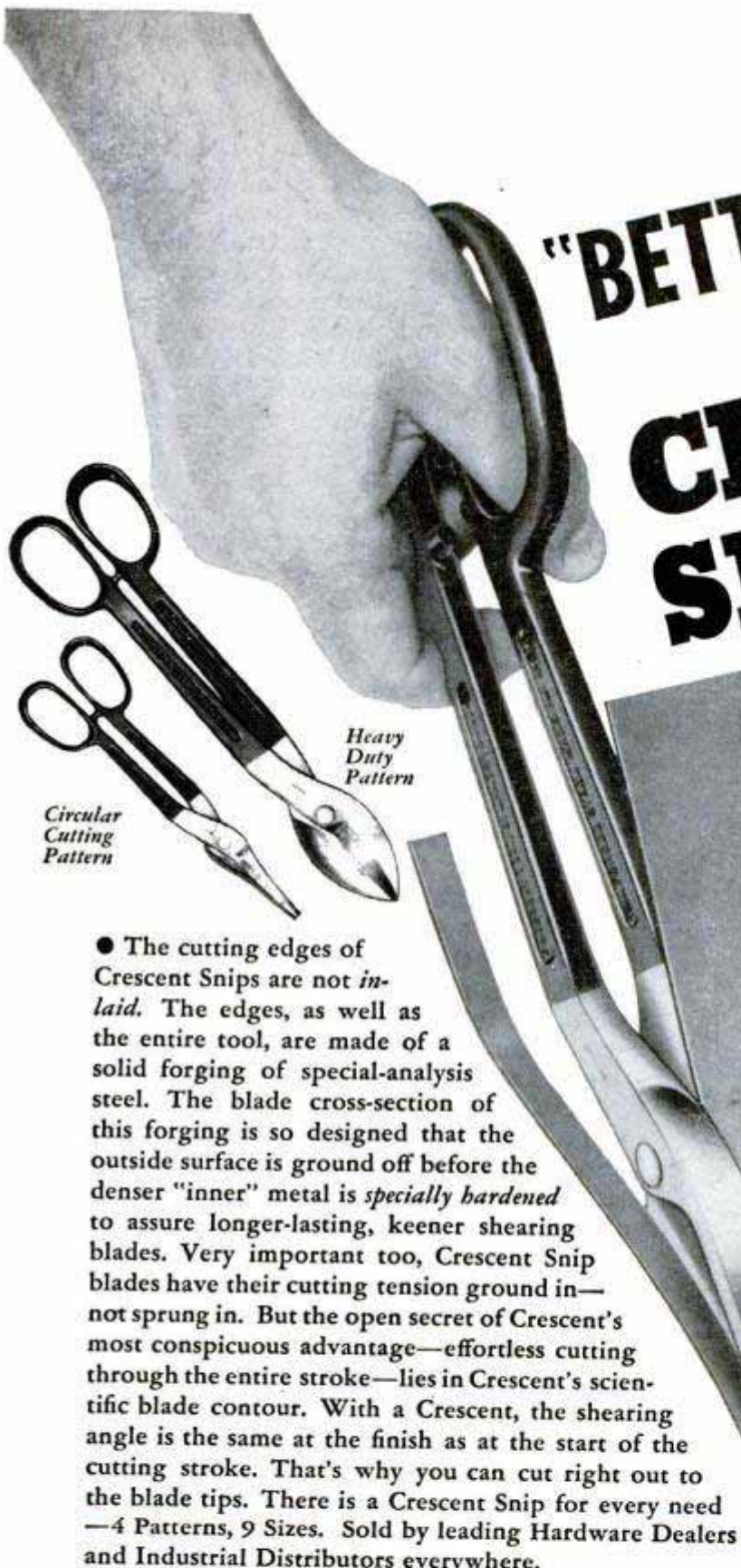

Heavy
Duty
Pattern

Circular
Cutting
Pattern

● The cutting edges of Crescent Snips are not *in-laid*. The edges, as well as the entire tool, are made of a solid forging of special-analysis steel. The blade cross-section of this forging is so designed that the outside surface is ground off before the denser "inner" metal is *specially hardened* to assure longer-lasting, keener shearing blades. Very important too, Crescent Snip blades have their cutting tension ground in—not sprung in. But the open secret of Crescent's most conspicuous advantage—effortless cutting through the entire stroke—lies in Crescent's scientific blade contour. With a Crescent, the shearing angle is the same at the finish as at the start of the cutting stroke. That's why you can cut right out to the blade tips. There is a Crescent Snip for every need—4 Patterns, 9 Sizes. Sold by leading Hardware Dealers and Industrial Distributors everywhere.

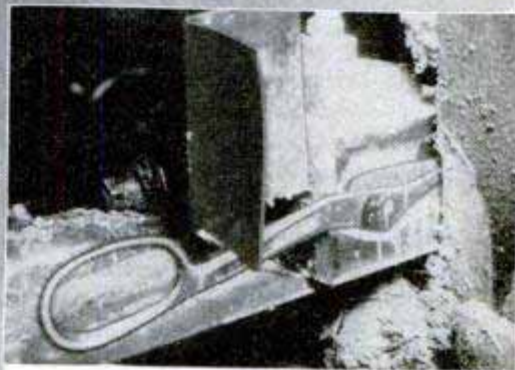

Above: Crescent Snips are ground on automatic machines thus assuring absolute uniformity.

Below: The Shearing angle of Crescent blades remains the same throughout the entire cutting stroke.

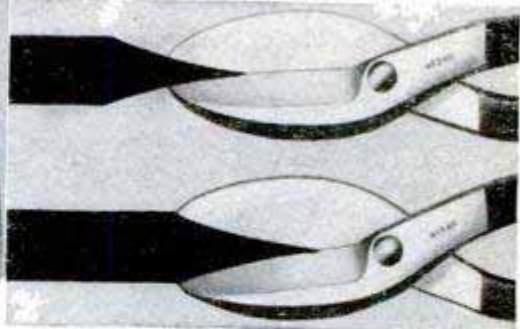

CRESCENT TOOL COMPANY, JAMESTOWN, N. Y.

"Crescent" is our trade-mark, registered in the United States and abroad, for wrenches and other tools. Sold by leading distributors and retailers everywhere and made only by Crescent Tool Company, Jamestown, N. Y.



CRESCENT TOOLS

Give Wings to Work

*Sign of the Artisan
Symbol of Excellence*



make your *HANDS* **MORE CREATIVE** with **X-acto Knives and Tools**

Creative hands can be your greatest asset... X-acto knives and tools help the intelligent coordination of active minds and agile fingers... they can develop skill and dexterity in any art or handicraft you select.



Whether it's boat whittling, model airplanes, wood-carving, leathercraft, model railroads or any other handicraft, you can make your hands more creative with "designed-for-the-job" precision-engineered X-acto knives, tools and handicraft kits.



X-acto offers the complete line of handicraft knives, interchangeable blades, tools and attractive kits



From 25¢ to \$25.—at dealers everywhere.



No. 82
X-ACTO KNIFE CHEST
\$4.20



Send 10¢ to cover postage
for our new illustrated
28-page Catalog.



X-acto Crescent Products Co., Inc.
440 Fourth Avenue, New York 16, New York

If the A-Bombs Burst—

(Continued from page 149)

his block. Somewhere beneath his feet he heard the muffled scream of a woman.

A neighborhood lad came scrambling up the pile of rubble and stood by his side. White previously had trained the boy as a messenger. Now the Block Warden told the lad precisely what to report. The boy scurried off through the rubble, reached the fringe of the blasted area and slipped past the tilted door of a store. He tried the phone inside. Luckily all the phone lines weren't out, and he gave the message to a voice at the Zone Warden's headquarters.

At the other end of the line the Zone Warden coordinated the message with other information that was coming in by phone and foot runner. Deciding that White's block needed help badly, he put in a call to the Chief Warden's office.

By this time help was already racing toward White from outer Chicago. First to arrive was a monitoring crew from the Health Services. The men climbed through the debris toward ground zero, watching the dials of instruments they carried. White moved with them across his block, and heaved a sigh of relief when they indicated that there was little lingering radiation.

Behind the monitoring crew came the first team from the Rescue Service. White told the team's chief where shelters could be found. Three men started tunneling down to the basement of an apartment shelter, cutting through steel beams with an acetylene torch. Others guided or carried the dazed and wounded residents out toward the edge of the damaged area where a team of a dozen doctors and nurses already had set up a first-aid station in a schoolhouse. Stretcher teams were fanning out from the station.

White moved off to investigate the numerous small fires which had broken out in his block. Near one blaze he spotted the man who had been trained in the Fire Guard Group. It was about this time that the first fire engine moved up behind a bulldozer, and the Fire Guard told the company officer which fires were threatening people still trapped in shelters. Behind the fire apparatus crowded a bus and two mail trucks, converted into ambulances.

The Zone Warden arrived, along with a man from the Chief Warden's office. White gave his two superiors a report of what had been done, and estimated how many people still were trapped. Many of the evacuees had been guided by police past one intersection, and beside it stood an Assistant Warden writing on a sheet of paper

(Continued to page 248)

Now
10 FEET long!



Yes, here it is—that extra length you've always wanted... 120 inches of accurate, more useful measuring ease. Jet black markings on a wear-resistant, acid-resistant snow white blade.

Carlson quality throughout with famous 10-second blade change economy and the new convenient swing-tip... a real value at YOUR HARDWARE DEALER. Just be sure it's the White Chief by Carlson.

P.S. And don't forget to get an extra blade to keep on hand as a "spare."

Blade produced under patents 2089209, 2510939

CARLSON STEEL TAPE RULES

CARLSON & SULLIVAN, INC.

MONROVIA, CALIFORNIA

CARLSON

MAKE YOUR OWN!
WITH



Griffin READYCUT LEATHER PROJECTS

Over 100 KITS in every kind of Tooling and Carving Leather, accurately cut, all parts included. Only Top Grade Leathers used. You do the choosing. You do the tooling, carving, stamping, the punching and assembling.

SEND 25c FOR COMPLETE CATALOG 116 pages, shows all hand craft supplies. 25c refund with first order.

OUT OF THE WEST, THE HOME OF LEATHER CARVING

Griffin CRAFT SUPPLIES

Since 1924 5626-A TELEGRAPH AVE. OAKLAND 9, CALIFORNIA

EVERYTHING FOR THE LEATHER WORKER

Largest, most complete stock of Leathercraft Tools and Accessories in U.S.A.



HIDES AND SKINS of Craft Leathers of every kind if you prefer to cut your own.

EASY TO PLAY

"EXTRA-VALUE"

PA



New!

PAN-AMERICAN Super BRASSES, SAXOPHONES

Sensational Pan-American instruments, used in bands and orchestras everywhere! Fully guaranteed. Exclusive features. See your dealer, or write for literature. Mention instrument. Address Dept. 203.

Write FOR FREE FOLDER

PAN-AMERICAN BAND INSTRUMENTS
Division of C. G. CONN Ltd., Elkhart, Ind.



A "COMPLETE HOME WORKSHOP" IN ONE COMPACT UNIT!

Patent No. 161025

NEW and IMPROVED

atkins

ELECTRIC MOTOR DRIVEN

3 in 1

JIGSAW! SANDER! FILER!

Cuts 1/2" wood, 1/4" plywood, thin metal, plastic.

ONLY \$14.95 POST PAID

Complete with built-in Motor — 3 Project Patterns — 3 Blades — 2 (4" x 9") Pieces of Wood and Allen Wrench!

POWER PLUS—ABSOLUTELY SAFE—MADE OF LIGHT WEIGHT CAST ALUMINUM!

POWERFUL ELECTRIC MOTOR (do NOT confuse with ordinary, less powerful vibrator type motors.) 3000 revolutions per minute! SAW cuts to center of 16" circle... adjustable SAW GUIDE permits cutting ANY length material. Strokes 3000 per minute. 110 V - A.C. TILTING and ROTATING TABLE TOP (6"x8") cuts at any angle. SANDING TABLE tilts through 45°. FOR FAST, EASY FILING simply remove saw blade, chuck and saw guide... insert 1/4" diameter standard file.

Guaranteed 1 Year against defects in materials and workmanship

Try it FREE for Five Days—Money Back if Not Satisfied!

Wonderful PROJECT PATTERNS. It's Simple To Make Most Anything! Household Items, Toys and Many Others!



All pattern parts are actual size for finished projects. All you do is paste them down or trace them right on the wood! **FOR \$1**

GROUP 1... 10 patterns for beginners
GROUP 2... 10 patterns for the advanced
GROUP 3... 10 patterns for the skilled

Sold in leading Department, Hardware and Hobby Stores.

If your dealer cannot supply, send coupon direct: **FREE 5 day trial... MONEY BACK if not satisfied!**

atkins INDUSTRIES, inc., Dept. PM2
5823 N. Ravenswood Ave., Chicago 26, Ill.

- Enclosed is \$14.95 (check or M.O. in full.) Rush, 3-in-1 Jig Saw POST PAID.
 - Enclosed is \$2.00 part payment. I will pay postman balance plus postage on C.O.D. delivery.
 - Enclosed is \$.....(check or M.O. in full.)
- Rush Group No's.....Project Patterns at \$1.00 each POST PAID.

Name.....

Address.....Zone.....

City.....State.....

NEW!

Klean-Strip Remover Peels Off Paint



Throw away messy, dangerous solvents! Klean-Strip, the new-type remover, needs no

after-wash, will neither burn nor explode. Just apply with brush, or spray gun . . . then slide off the loose film. That's all there is to it!

Klean-Strip actually breaks the bond between wood or metal and the finish you want to remove. Peels off any paint, enamel, varnish, synthetic or lacquer. Works fast, leaves the surface clean, smooth and dry, ready for a perfect refinish job.

The next time you buy paint, get a can of Klean-Strip, too! Available at better paint, hardware, and department stores everywhere.

W. M. BARR & CO.
2354 S. Lauderdale
Memphis, Tenn.



Clean · No-Wash
Non-Inflammable

POWER at your
fingertips!



Bredy makes
GARDENING and
LAWN CARE *easy*

A touch of your hand on the throttle sends BREDY GARDEN TRACTOR through the toughest gardening and lawn care chores. You'll use Bredy to plow, disc, harrow, cultivate . . . mow the lawn, cut weeds . . . even plow snow in winter! Take your choice of five different Bredy tractors and 17 all-purpose implements. Why do it by hand? Let Bredy do the work! Write today for free folder and name of nearest dealer.

THE BREDY TRACTOR & IMPLEMENT CO.

BOX 230 ● SOLON, OHIO

the name of each person he spotted. Checking the list, White suddenly discovered that not one of the 25 persons in a building a half block away had been seen. CD officials quickly sent a rescue crew to the building.

The fires had become dangerous, so the Zone Warden ordered White to make his way to the evacuation station. Along the cleared road streamed thousands of people, many of them wounded.

At the evacuation station, White was told to wait for transportation. A man, still shivering in his pajamas, was issued inexpensive clothing by the Welfare Service. At a makeshift desk near by, a young woman wrote down the name of every evacuee and his probable destination. From her, White learned that he would go to a private home in a northwest suburb.

All the time he waited, a voice blared down from the sky. A small private plane, equipped with a loudspeaker, circled overhead. An observer aboard the plane droned instructions to the workers and the wounded, and guided the drivers of heavy equipment through the debris.

By now, mutual aid and mobile support had proved their worth. Converging on Chicago's two ugly scars came fire engines and policemen from the suburbs, rescue teams and medical units from the state.

At 7:30 that evening, exhausted firemen were still trying to confine the fire storms which swept through the damaged areas. Rescue crews working under portable lights were still picking the rubble clean of human beings. Suddenly, without warning, another bomb burst—this one on the ground southwest of the Loop. There wasn't even any rubble left around this explosion—just an ugly, radioactive saucer.

It was the same heartbreaking story all over again. Some CD teams were switched to the new area. Still more aid came from surrounding communities and the state. And by now an airlift, called into action by the federal government, was shuttling blood, equipment, medical supplies and men into the Chicago area.

Within one week rail lines to Chicago were restored, temporary bridges were built, main thoroughfares cleared and dangerous structures demolished. Chicagoans could stream to work once more, though their city never would be the same again. Thousands upon thousands of people owed their lives to their alert CD organization.

The United States needs 15,000,000 CD volunteers. They'll be trained to lift a community by its bootstraps in any kind of disaster—atomic or otherwise.

Russia, according to one estimate, is training 5,000,000 people each year in Civil Defense. Can we afford to do less?

Can You Equal This Home for 2915

Shipped
Direct
from Our
Mill



Save 30% to 40%
on Your New Home.. **Act Now!**

Don't pay several hundred dollars more than necessary when you build a home! Buy direct from our mill at our low factory price. We ship you the lumber cut-to-fit, ready to erect. Paint, glass, hardware, nails, etc., all included in the price—no extra charges. Plans furnished—also complete building instructions. No wonder our customers write us that we saved them 30% to 40%. Easy terms — monthly payments.

BIG BOOK
of
House Plans
in Colors
25¢

Handsome Big CATALOGUE

Pictures wonderful homes in colors at money-saving prices. Designs to suit everyone. Send 25c for catalogue today.

LEWIS MANUFACTURING CO.
1212 Lafayette Ave., Bay City, Mich.

TOOLS AT WHOLESALE

DIRECT FROM FACTORY

Full line of top quality, fully guaranteed, chrome, factory-new mechanics hand tools. You save

HALF REGULAR PRICE

for tools of this quality. Our Permanent Price Protection Plan guarantees you wholesale prices.

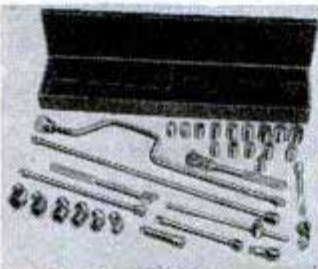

WRITE TODAY FOR FREE CATALOG

MECHANICS CO-OP

Dept. A OAKLAND 8, CALIFORNIA

PRESTO! ANYONE CAN MASTER GLAZE

LEAVES HARD GLASS-LIKE FINISH
SEALS THE PORES OF THE SURFACE
EASY TO APPLY
WILL NOT FINGER-MARK
PROTECTS THE SURFACE
NO OILY FILM AS WITH POLISH
EASY TO KEEP CLEAN
NO SMEAR OR STREAKS AS WITH WAX
LASTS SIX MONTHS TO A YEAR
SAVES YOU MONEY

Car Owners! Meet Master Glaze—the sensationally different luster for new and used cars! Not a wax—not an oil polish—not a paint!—nothing that “smears” over the surface.

MASTER GLAZE is a unique discovery—a creamy liquid—quick and easy to apply! Gives a hard, glass-like surface. Even gasoline cannot dull it! Lasts six months to a year! Amazing luster—beautiful, sparkling clean and brilliant! Doesn't finger-mark—doesn't smear! A match box full glazes an entire car. Seals the pores—protects! NOTHING LIKE IT!

AGENTS
An unusual opportunity!
Quick, flashy demonstrator.
Big profits.
Good territory.
Write today!

FREE SAMPLE

Just send your name and address to

MASTER GLAZE CO., 7720-700 W. Harwood Ave., Milwaukee, Wis.

MECHANICS! Buy THE BEST!
STARRETT PRECISION TOOLS
Made By The World's Greatest Toolmakers

See this New Starrett® Universal Precision Gage

Designed for machinists, tool and diemakers and inspectors, Starrett No. 995 Universal Precision Gage combines the unique features of fine adjustment with universal adaptability to countless gaging, scribing, measuring and leveling operations.



PLUS MORE THAN 60 OTHER
NEW STARRETT TOOLS
AT YOUR STARRETT DISTRIBUTOR

Ask your distributor to show you these and many more important new tools — or write for Starrett New Tools Booklet.

<p>No. 354 Vernier Height Gage With Slotted Base. Reads Direct 0-6"</p>	<p>No. 449 Micrometer Depth Gage With Flat Rods</p>	<p>No. 1010 Pocket Dial Indicator. Reads in .001"</p>
<p>No. 231 Satin Chrome Micrometer. No Glare Readings</p>	<p>No. 11 Improved Combination Square With Reversible Lock Bolt</p>	<p>No. 1025 Pocket Slide Caliper—Stainless Steel</p>

SPECIAL OFFER TO MECHANICS

GET THESE TWO HANDY MECHANICS AIDS — ONLY 10¢

"Dial Type Decimal Equivalent and Tap Drill Calculator" plus "Decimal Equivalents of Letter and Number Size Drills"—both for only ten cents. Send coupon with one dime to cover handling and mailing.

THE L. S. STARRETT CO.
Dept. AP, Athol, Mass., U.S.A.
Here's my 10¢ for 2 calculators

Name _____ Position _____
Address _____
City _____ Zone _____ State _____

Heike's 1951 Hobby Catalog

16 — 35c

Collector's Catalog of historical and scientific items.— Selling: 450 historical fire-arms — 20,000 Indian Relics — Collectors Cartridges — Coins — Confederate Money — Revolutionary, Civilwar, Indian Wars, Flintlocks, percussion muskets, Swords, Bayonets, Pistols, Revolvers, Ramrods, Bullet Molds, Percussion Caps, Powder Flasks, Powderhorns, Blunderbusses, Civilwar Handgrenades, — Stagecoach Carbines, Winchester Rifles, Kentucky Rifles, Pepperboxes, Gun Barrels — Locks — Nipples. — **ARROWHEADS**, Tomahawks, Battle Axes,

Gempoints, Spearheads, Peace Pipes, Arrow making stones, Discoidals, Bannerstones, Gorgets.— **Steerhorns**, Buffalo Horns, Eagle Feathers, Deer Horns, Elk Antlers, Bo-wood, Blohorns, Mounted Squirrels, Pheasants, Ducks, Owls, Quails.— **AGATES**, Fossils, Minerals, Marine Shells, Violin Wood — Daguerreotypes, Ambrotypes, Scalping Knives, Duelling Pistols, Gold Dollars, etc., too numerous to mention.

SPECIAL:—8 arrowheads \$1.46—Tomahawk \$2.75—Battle Axe \$3.88 — Hammerstone \$1.65 — Civilwar Musket \$28.00—Civilwar Sword \$8.88—Powder Horn \$8.40—Civilwar Bayonet \$1.98—Scalping Knife \$1.65—25 Indian-head Cents \$2.45 — Agate \$.48 — Fossil \$.48 — Rattler Geode \$.48.

Write today for your profusely illustrated catalog. Send 35c to cover handling.

R. HEIKE, 251 M. Street, WENONA, ILLINOIS

Hollywood's Antique Auto Livery

(Continued from page 137)

Duesenberg town car, formerly the property of Dolores Del Rio; a 1930 Isotta Fraschini town car allegedly presented to Samuel Untermyer, the lawyer, by Mussolini at the cost of \$25,000; a rare Cadillac town car, vintage 1910; a 1935 Packard phaeton used by Madame Chiang Kai-shek during her visit to California; three Mercedes Benzes, three Isotta Fraschinis, two Minervas and seven Rolls Royces, in various body styles. The oldest car in the collection is the 1890 Pillion steamcar, and the newest is any one of the 1950 American or foreign stockcars—Pacific has them all. The smallest is a tiny (60-inch wheelbase) 1936 English Austin, and the largest is a monster seven-passenger Renault touring car, vintage 1922.

Sometimes actors expect too much from the old cars. Recently, a famous cowboy star was making a picture in which he was to drive Pacific Auto Rental's 1898 Holsman Surrey—a one-lunged, belt-driven job, complete with fringe on top. When a cameraman sped by in a 1949 Buick Roadmaster, the actor shouted angrily, "Whazza matter with this heap? This thing ain't got no pickup at all!"

Tighten Loose Handles

TO STAY

Use the "repairman's standby" — Smooth-On No. 1 Iron Cement — to anchor loose tool and cutlery handles, knobs, pulls, casters, clothes-hooks, bolts, screws, etc. You apply it like putty — no heat required. It hardens like metal. And because Smooth-On expands slightly as it sets, your repairs *stay tight*. Buy Smooth-On No. 1 in 1¾-oz., 7-oz. or 1-lb. size at your hardware store. If they haven't it, write us.

FREE Repair Ideas

40 pages of time-saving, money-saving ways to stop leaks, seal cracks, tighten loose parts. 170 illustrations. Clear, simple directions. Send now.

SMOOTH-ON MFG. CO., Dept. 37B,
570 Communipaw Ave., Jersey City 4, N. J.

Do it with

SMOOTH-ON

THE IRON CEMENT OF 1000 USES

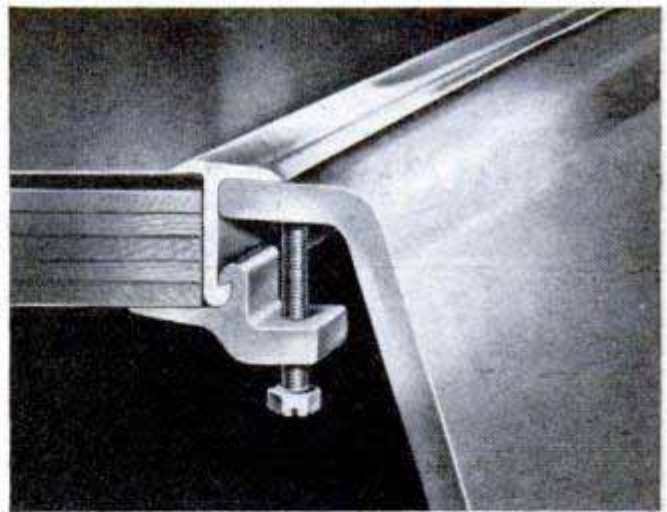

Frame Locks Sink in Place

For cabinet-top sinks, a new frame not only serves as a trim but also seals the joint and supports the sink itself. The frame overlaps the edges of the covering materials ¼ inch, preventing them from pulling loose. A clamp attached to the trim holds up the sink. With the new frame there is no need for mortising or any other special preparation of the cabinet-top opening.

☐ The United States, largest producer of titanium ores, has the world's largest titanium mine in the Adirondack Mountains.

Never before - SO MUCH SAW for SO LITTLE MONEY!

*Prices subject to change without notice.

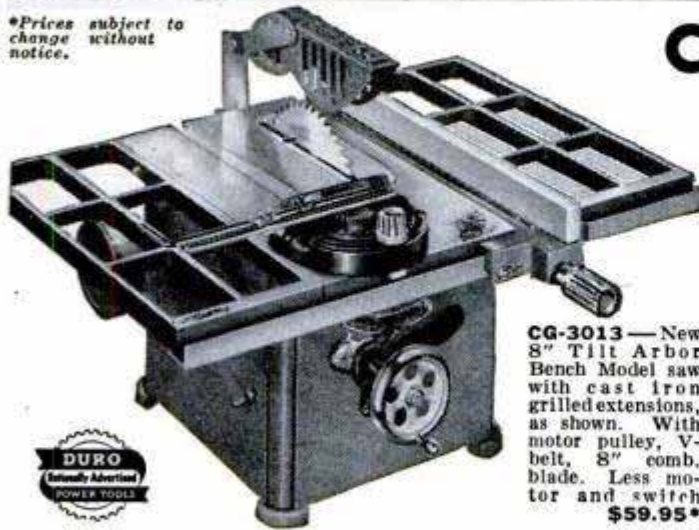

CG-3013 — New 8" Tilt Arbor Bench Model saw with cast iron gridded extensions, as shown. With motor pulley, V-belt, 8" comb. blade. Less motor and switch **\$59.95***

Completely NEW DURO 8" Ball Bearing Tilt Arbor Saw

\$52⁹⁵*

C-3013 — New 8" Tilt Arbor Bench Model saw. With motor pulley, V-belt and 8" comb. blade. Less extensions, switch and motor. **\$52.95*** retail.

Enjoy the thrill of working with a husky, extra-capacity *tilting arbor design* saw . . . for little more than you'd expect to pay for an ordinary saw! This new ball bearing saw is BIG in everything but price. There is a full 7³/₈" ahead of the blade, it makes cuts up to 2³/₈" in depth. With gridded extensions the work table measures 26" x 17¹/₈". The new Duro arbor lock tilts and locks the blade just where you want it . . . instantly, safely.

EXCLUSIVE NEW DURO MOTOR PULLEY allows the belt to adjust itself to the angle of the saw blade. You get more positive drive . . . less belt twist . . . longer belt life. In addition, an interchangeable sleeve permits use of this new pulley on either 1/2" or 5/8" motor shafts.

Write Today!

for details and specifications on this new Duro 8" Tilt Arbor Saw.

DURO METAL PRODUCTS CO.

2669 N. Kildare Ave., Chicago 39

DURO METAL PRODUCTS CO.

2669 N. Kildare Ave., Chicago 39, Ill.

Please send me: Full details about the new Duro 8" Tilt Arbor Saw.

Name

Address

City..... Zone... State.....

Dealer's Name.....

KINKADE GARDEN TRACTOR and Power Lawnmower

A Practical Power Plow and Cultivator for Suburbanites, Gardeners, Florists, Estates, Fruit, Nursery & Poultrymen.

Easy Terms - Write Today

American Farm Machine Co.
1058 33rd Ave. S. E. Minneapolis, Minn.



Catalog Free

RUPTURE!

An amazing Air-Cushion Invention allows body freedom at work or play. Light, neat, cool, sanitary.

Durable, cheap. Day and night protection helps Nature support weakened muscles gently but surely. No risk. **Sent on Trial!** Write NOW for free Booklet and Proof of Results. All correspondence confidential.

Brooks Company, 161-H State St., Marshall, Mich.



SAY YOU SAW IT IN POPULAR MECHANICS

ARC WELDING FOR PROFIT OR PLEASURE

60 LBS. OF READY MADE PARTS

Only \$24.95

BUILD YOUR OWN HEAVY DUTY WELDER

SAVE
Buy Only
NECESSARY
PARTS

All necessary parts Ready-Made and easy to assemble. You can do all around welding on steel, cast iron and other metals after only a few hours practice. Illustrated instruction manual included. Free plans for building case. Sold on 30-Day Money-Back Guarantee!

FREE: Write today for fully illustrated Pamphlet P-2

ATOMIC ARC WELDER CO.
1037 So. 19th St. OMAHA, NEBR.

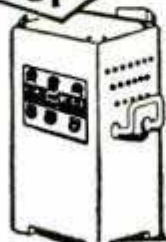

Gives 100% penetration. Welds are stronger than original metal. Operates on 110 or 220 AC.

AMAZING SHIFT OUTBOARDS HAVE NEUTRAL, FORWARD, REVERSE

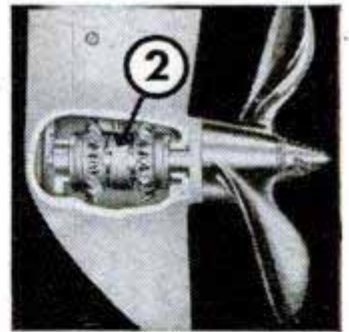

HOW SCOTT-ATWATER SHIFT WORKS. Shift lever (1) moves gear selector (2) to the left to engage forward gear, right for reverse. When selector is in between, motor is in neutral.

FREE OUTBOARD BOOKLET shows Shift, latest Scott-Atwater improvements, automatic controls. Helps you pick the right shift motor for your boat. Explains easy plan for buying your outboard. Packed with pictures, detailed motor facts.



MAIL COUPON NOW!

Dept. 49, Scott-Atwater Mfg. Co., Inc.,
Minneapolis 13, Minn.

Please send FREE OUTBOARD BOOKLET.

Name

Address

City..... State.....

Export Dept. - American Steel Export Co., 347 Madison Ave., N. Y. 17, N. Y.

Make it yourself with STANLEY TOOLS

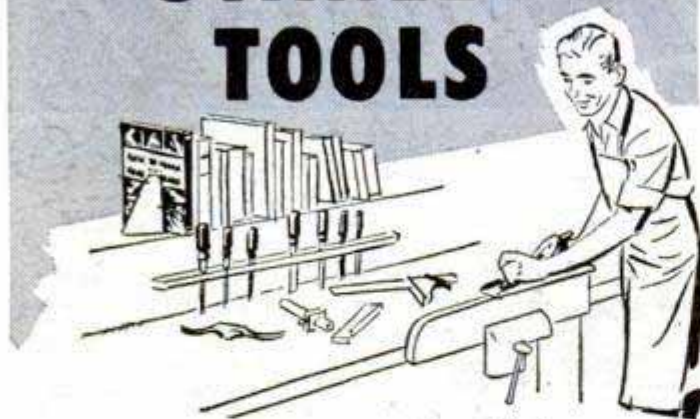

Make it yourself with Stanley Tools . . . the choice of experts. The Vise, Rule and Plane shown here are prominent in the Stanley Tool line, designed for artisans, yet priced to appeal to the woodworking hobbyist. Look for the famous trade-mark at your hardware dealer's.

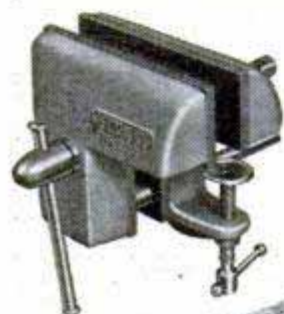

No. 700 Woodworker's Vise
Can be quickly attached to bench, table, sawhorse, almost any place where there's a small projection.



No. 106 Zig-Zag Rule
Accurate, easy-to-read, handy-to-use. Good for long life without "stretch".



No. 5 Plane
The world's most popular plane . . . the choice of 9 out of 10 woodworkers.

New Projects for Your Shop

EARLY AMERICAN DESIGNS Easy to follow — fun to make. Two sets of 15 plans, 25c each, postpaid.

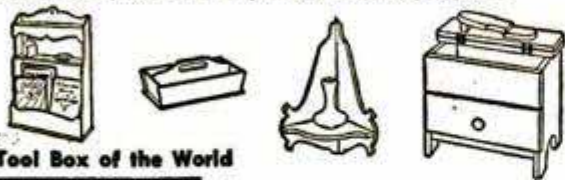

The Tool Box of the World



Hardware • Tools • Electric Tools
Steel Strapping • Steel

ORDER YOUR PLANS NOW

Stanley Tools, 121 Elm St., New Britain, Conn.
(In Canada: Send to Stanley Tool Co. of Canada, Ltd.,
112 Stanley St., Roxton Pond, Quebec.)

Please send me Series A () and Series B ()
of the new Early American Project Plans. I enclose
25c for each set.

Name.....
Street.....
City..... State.....

Rangers Patrol the Everglades

(Continued from page 104)

And this was simple compared to mastering the whims of a 40-mile-per-hour airboat, which was capable of pitching out its driver in a tight turn and leaving him stranded in the Glades. These sledlike craft, powered by a small airplane engine and propeller, were developed by frog hunters for skimming over shallow sawgrass sloughs.

One crew that set to work driving posts for boundary signs across 50 miles of the wildest area in the southern United States had to use a "swamp buggy." This clanking contraption is built up either from a tractor or a stripped auto frame with huge airplane tires.

There's plenty for tourists to see in the Glades—the rare sea cow, or manatee, poking her nose up in the mangrove waterways, age-old bird rookeries with their thousands of nesting ibis or egret, Amazonian gumbo-limbo hammocks filled with wild orchids. The difficulty is getting to them in this watery wilderness.

A paved highway, the Tamiami Trail, spans the Everglades at the upper edge of the park. But most tourists drive over it and the marl road to Coot Bay, in the heart of the park, too fast to see anything.

As park superintendent Dan Beard puts it, "Going through the Everglades is not like watching a football game; it's more like listening to a symphony."

The spectacular island-bird rookeries are reached by one-day boat trips. In cooperation with the park service, the Audubon Society offers guided boat tours at a nominal cost.

The rangers find it exceedingly easy to please another class of visitors. Fishermen, who in other national parks have spent days whipping mountain streams before catching a trout over 12 inches long, are in anglers' heaven when big silver tarpon hit their flies or plugs. Other salt-water battlers, with odd names like snook, jack, chiro and redfish, lure skiffs far into the vast labyrinth of waterways.

Ever since the "opening" of Florida, a few ruthless men, some hiding out from the law in the fastnesses of the Glades, have always considered it their right to plunder the wild jewels of this land. Even today, the rangers must patrol by airboat, swamp buggy, speedboat and skiffs, linked by an FM radio system, against poachers.

Working with the old hands, the new rangers learned where alligator hunters had burned off the protective tangle around a "gator hole" in order to jacklight the

(Continued to page 254)

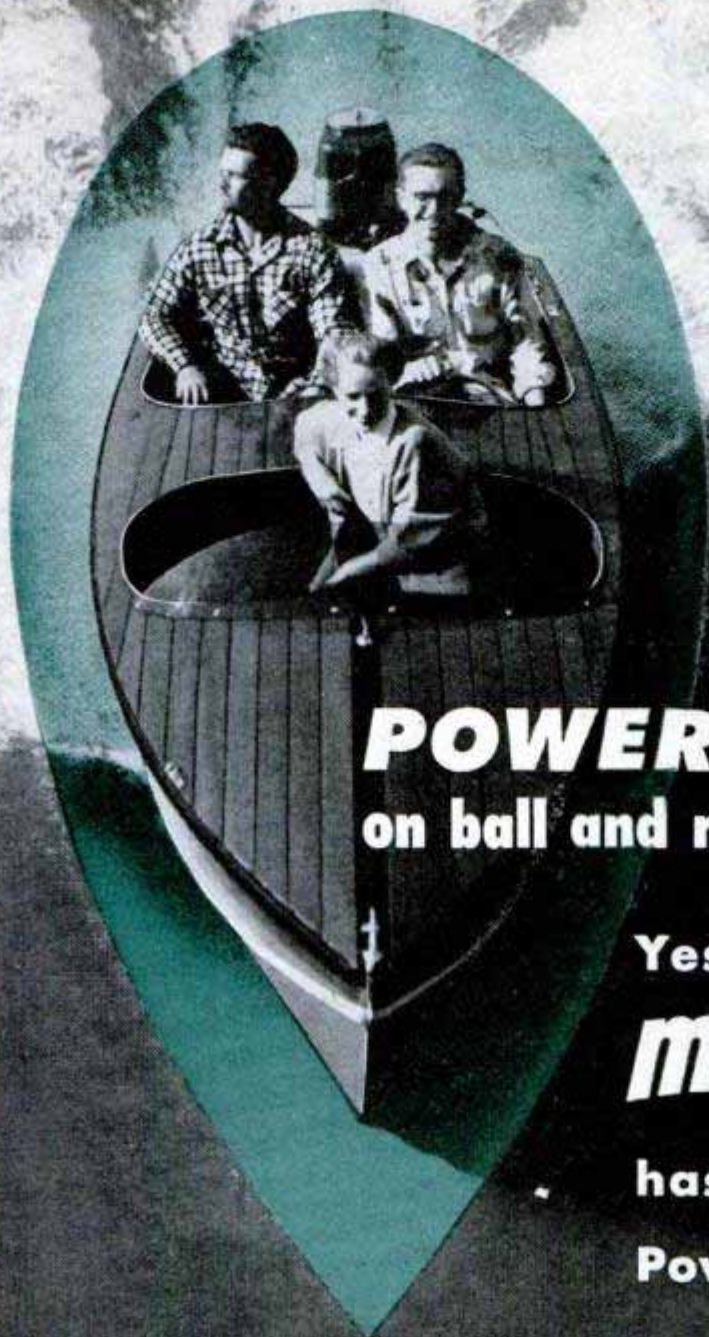

POWER
on ball and roller bearings

Yes, every Kiekhaefer

MERCURY

has Full Jeweled

Power*

It's one of many big engineering differences pioneered by MERCURY that sets MERCURY apart from ordinary outboards. Full Jeweled Power means ball and roller bearing construction that gives *all* vital moving parts of the engine an anti-friction ride.

To you it means easier starts, smoother operation, more power, slower trolling and longer engine life. You get it in *every* MERCURY—and *only* in MERCURY!

*Ball and Roller Bearings Throughout



Write for FREE folder—"PICK OF THE PILOTS"

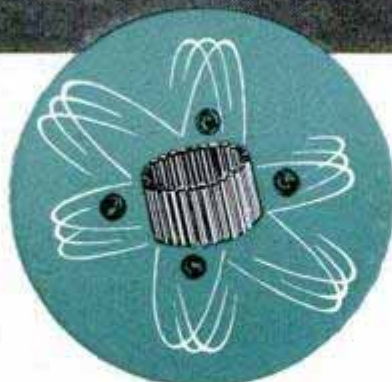

NEW HURRICANE SERIES

See your dealer for a demonstration of the sensational new MERCURY HURRICANES, the outboards that shattered endurance and speed records everywhere. Never before such ease of control, such smooth steady troll—all combined in a light outboard.

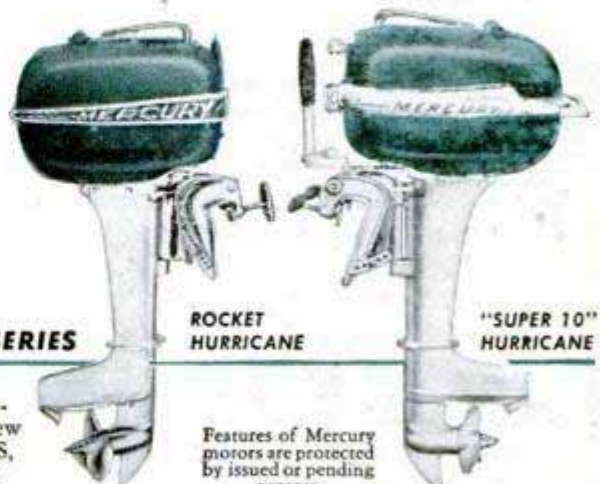

ROCKET HURRICANE

"SUPER 10" HURRICANE

Features of Mercury motors are protected by issued or pending patents.

KIEKHAEFER CORPORATION, Fond du Lac, Wis., U. S. A.



A Beauty in looks



and oh,
such
power!

Flashlight Batteries



The streamlined beauty of BURGESS Flashlight Batteries covers amazing power. You enjoy many more hours of dependable service because Chrome Protection guards against power loss when flashlight is idle. It curbs internal action and allows more complete battery recovery. Get the most for your money! Buy BURGESS Flashlight Batteries.

- SEALED IN STEEL AND PLASTIC
- GUARANTEED
- PLAINLY DATED
- IMPROVED ENGINEERING DESIGN

BURGESS *Flashlight*
BATTERIES
 BURGESS BATTERY COMPANY
 FREEPORT, ILLINOIS

saurians at night. Here commercial orchid hunters had once despoiled a hammock. And, as flights of snowy egret and white ibis rose from a rookery in their nuptial plumage, it was easy to picture again the ghastly slaughter that once threatened the plume birds with total extinction.

Unlike enforcement work in long-established parks, where the chief violations are keeping an undersized trout or building a campfire without a permit, an Everglades patrol can be dangerous. Every advantage is with the poacher whose boat skims in swiftly at night.

As in most parks, the rangers have to patrol the accessible borders during hunting season. Predators such as wildcat and panther get the same protection in a national park as do the birds or deer on which they feed. Making this clear to local hunters who had never heard of the idea was difficult at first.

The Glades is literally a river of grass, and yet—as new rangers soon learned—the greatest man-caused destroyer is fire. During the dry winter months weird, wind-driven flame-storms may sweep over the sawgrass prairies and consume hammocks that have been centuries in the making.

Here was a difficult teaching job for the park service, for Floridians were used to seeing the Glades burn. Hunters, farmers and cattlemen started most fires just outside the park's borders. Few appreciated the havoc visited on wildlife when feeding and nesting grounds went up in smoke.

The rangers and fire guards found Glades fire fighting a new experience. They stood in ankle-deep water and "flapped out" small sawgrass fires with a sort of giant fly swatter. But when one of these little blazes sprang before a wind into a conflagration covering thousands of acres, equipment ranging from airplanes for spotting to bulldozers for trenching was brought into play. Then, in 24 hours it might be under control. In the north a five-acre forest fire meant a week-long job.

It's been only three years since the park service took over this strange wilderness, but its "tropical rangers" are now veterans who can give a Seminole Indian a pointer or two on the Glades. And already they can see the value of their protection. The birds venture closer to the lone marl road and alligators once more sun themselves on the bank. Here, where such species as the American crocodile and the Florida panther are making their last stand, peace is returning to the wilderness.

☐ About one out of every seven patents issued in the United States is an automotive patent.

Thompson BEATS the World on BOATS



**Better Built
Lower Prices**



**Safe Boats With
Full Length Spray Rails**
Keep passengers perfectly dry—even at high speeds. Catalog also shows two new models of "Take-Along" Boats. Two big factories—save you freight.

CATALOG FREE
Write for your copy. State kind of boat in which you are interested.

THOMPSON BROS. BOAT MFG. CO. (151)
213 Ann St. PESHIGO, Wis. (Write to either place.) 113 Elm St. CORTLAND, N.Y.

Light Boat for Auto

New WOOD SAMPLE KIT

Only
\$8.50

The only wood study kit on the market. Contains 54 wood and wood products specimens size 3/8" x 2 1/4" x 5", an 84-page identifying manual with 51 magnified cross sections; a 10-power hand lens and knife. Send this ad and only \$8.50 today for delivery any place in continental U.S.

TIMBER ENGINEERING COMPANY
1319 18th ST., N. W., WASHINGTON 6, D. C.

Cracked Block? BLOCK SAVER

Pour BLOCKSAVER copperized powder into block. Finds all cracks. Permanent metallic repair guaranteed. Cars, Trucks, Tractors. \$3.00 postpaid. No. C.O.D.'s.
ZO-TITE PRODUCTS, Box 373, Lindenhurst, N.Y.

DRAINS Cellars, Laundry Tubs; CIRCULATES Oil; IRRIGATES Gardens

Original "Type P" Pump has 2400 GPH capacity. 360 GPH 75' high, or 1500 GPH from 25' well. Use any 1/8 to 1/2 HP motor. DOES NOT CLOG.

Only \$6.95 postpaid if cash with order. (West of Mississippi, add 50c.)

\$6.95

SATISFACTION GUARANTEED OR MONEY BACK!



LABAWCO PUMPS, BELLE MEAD 7, N. J.

FREE AMAZING NEW BOOK "HOW TO ANSWER ADS"



Never before have you seen anything like this. Tells you in simple language the correct way to answer ads. Gets you quicker replies—better results, and greater satisfaction. Will save you time and money and it's ABSOLUTELY FREE. No obligation whatever. Every reader of advertising should have this booklet. Send a postcard for your copy NOW. Advertising Department, Popular Mechanics Magazine, Room 602, 204 East Ontario Street, Chicago 11, Ill.

SAY YOU SAW IT IN POPULAR MECHANICS

Easy and Cheap to Operate

SHAW DU-ALL

and "PEPPY PAL" TRACTORS

PLOW

CULTIVATE

SHAW MFG. CO.

SAVE TIME, WORK, MONEY!

These rugged walking or riding tractors are ideal for farm, truck garden, orchard, poultry farm. Operate on a few cents an hour. A child can handle them.

DO DOZENS OF JOBS Both riding and walking tractors quickly and easily plow, cultivate, harrow, disk, bulldoze, spray, haul, grind, saw wood, etc.

LOW FACTORY PRICES Buy direct or through your dealer. Year's guarantee!

RIDING TRACTORS 4 models from 5 to 12 1/2 H.P., 68 in. wheelbase, 36 to 52 in. wide, 24 in. plant clearance. Hand or electric starter. Walking Tractors 1 1/2 to 5 H.P.

FREE Illustrated folders giving complete details and price lists—write today!

4502 FRONT ST., GALESBURG, KANS.
668G NORTH 4TH ST., COLUMBUS, O.

FISHERMEN!



FREE Beautiful Colorful Shakespeare 1951 Tackle Book and Fishing Calendar

FEATURING:

- Joe Godfrey's Fishing Calendar—Shows Best Days to Fish!
- Casting lessons, fishing tips, "Balanced Tackle" suggestions by U. S. Champion Ben Hardesty.
- "Fitting the Tackle to the Man—or Woman"—by Jason Lucas, famous angling authority.
- New Shakespeare Direct Drive Reels with LQT NYLON Gears—the tackle sensation of the year.
- Genuine Shakespeare Howald-Process Fiber Glass Wonderods. New Low Prices!
- Wexford Wonder Line, Black and "Invisible".
- The Shakespeare President—NOW built with 3 miracle materials—Carboloy, Nylon and "78-8" Stainless Steel.
- Famous Shakespeare Wondereels that Make You a Fisherman in 5 Minutes.



Shakespeare

Shakespeare Company, Dept. PM-2
Kalamazoo 2, Michigan

Please send me your FREE 1951 Tackle Book and Fishing Calendar.

Name _____

Address _____

City _____ State _____

MODERN LAWN MOWER SHARPENER

**FOR LAWN MOWER SHOPS
FIX-IT SHOPS
GOLF COURSES • PARKS
101 OTHER JOBS**

Sharpens All Reel Type Mowers • Hand, Power or Gang • 10 to 20 Minutes • No Dismantling • No Extra Attachments Needed.
All reel type mowers, from 5-inch edgers to 36-inch power mowers, are quickly sharpened to extreme ends of both left and right twist blades.

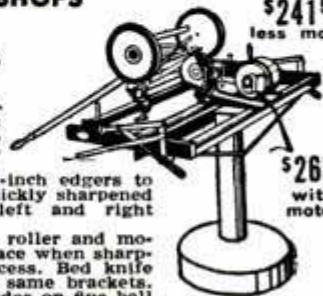

PRICE
\$241.50
less motor

\$263.00
with motor

ORDER NOW
Immediate Delivery

Handle, wheels, roller and motor remain in place when sharpening is in process. Bed knife is sharpened in same brackets. Grinding head rides on five ball bearing races. Easy to operate. Also sharpens chisels, joiner knives, planer blades. Big profit maker. Own your own business. Send Today for FREE Illustrated Bulletin No. 10-C. Prices Subject To Change Without Notice

MODERN MFG. CO. 160 N. FAIR OAKS AVE. PASADENA, CALIFORNIA

**USE
YOUR
ATTIC**

**Install the
PRECISION
folding stairway
YOURSELF**

Fits all ceilings. Just saw the hole in your ceiling—frame the hole with 2x6's, nail the stairway in place and cut off the stairway at the calibrated ceiling height. The Precision Stairway is simple and easy to operate. No springs, actuated by counterweights, it's perfectly balanced, raising or lowering easily with one hand. Composition safety treads on steps. Insulated door panel. Requires no attic space. Made of No. 1 kiln dried poplar with cast brass hinges, heavy cast aluminum rocker arms and brackets. Approved by F.H.A. everywhere

See your local lumber dealer or write direct today.

Manufactured by

**PRECISION PARTS CORP.
Nashville 7, Tennessee**

**DU-FAST
OSCILLATING MOTION
SANDER**



... BEST VALUE BAR NONE!

Where in the world can you get FULL 1/2" OSCILLATING MOTION . . . LARGE 3-2/3" x 7" FAST-WORKING SURFACE THAT USES INEXPENSIVE STANDARD CUT PAPERS . . . LIGHT WEIGHT FOR EASY CONTINUOUS USE?

Where in the world can you get the economy and convenience of a powerful sander and polisher that attaches in 10 seconds to any Home Utility Black & Decker 1/4" Electric Drill? Or (another Du-Fast model) that attaches just as easily to any Skill Home Shop 1/4" Electric Drill?

Where can you get the safety that permits you to sand or polish with absolutely no chance of gouging, maring, scuffing or burning? YET GIVES A PERFECT FINISH EVERY TIME!

See your nearest hardware dealer carrying either Skill or Black & Decker tools. ASK TO SEE AND TRY A DU-FAST UNIT . . . YOU'VE GOT A PLEASANT SURPRISE COMING!

DU-FAST OSCILLATING SANDER powered by Home Utility B & D 1/4" Electric Drill.

ONLY **\$14.95**
FOR ATTACHMENT!



DU-FAST OSCILLATING SANDER powered by Skill Home Shop 1/4" Electric Drill.

ONLY **\$14.95**
FOR ATTACHMENT!



*Pat. Applied For

MANUFACTURED BY **DU-FAST, INC.**

32 East Fourth Street

New York 3, N. Y.

I'm Building the Popular Mechanics Plywood Ranch House

(Continued from page 127)

area—there is ample room for it, even including a half-bath.

The second stage of the ranch house consists of the breezeway attached to the former carport and a double garage. The breezeway, besides simplifying the expansion and being extremely popular today, is the most inexpensive way of adding that extra living space to your home. Basically, it is just an addition to the roof, the house and garage walls forming its two sides. For outdoor living, it can be closed off at one end or left open at both. It can be glassed in to form a sunroom or part of it can be closed off to become an extra bedroom or rumpus room—it can be refitted to your family's needs at any time.

You may notice that the garage of the ranch house now extends back the full width of the house, 25 feet. As the architect has proved, this full length costs you no more and it simplifies roof construction.

My friend, Norm Chapman, and I are now completing the exterior of the garage and breezeway. Its framing and roof are the same as the rest of the house and in the garage the plywood sheathing gives another advantage—its large panels provide the inside walls of an unlined garage with a smoother finish.

The last thing we did on the exterior of the basic house was to nail on the siding. The siding can be any standard material, but that being used here on the model probably provides one of its most striking construction features.

We are using 3/8-inch exterior fir plywood in the latest method of installation, applied horizontally as wide, lapped boards. This siding application is receiving wide attention from builders as it answers many problems and is already fully approved by FHA and other agencies.

It cuts the current high cost of lapped siding to nearly one half. It gives a very strong exterior, forms an extra air space in the wall for insulation and allows "breathing" to reduce the problem of moisture condensation. Architecturally, the extra-wide, lapped boards add length and lowness to the ranch-house design.

I enjoyed the ease of making this siding. We simply set up my multipurpose shop tool as an 8-inch table saw and ripped each standard 4 by 8-foot panel of 3/8-inch plywood into three 16-inch-wide panels. These are the lapped "boards" that form the broad siding.

(Continued next month)

Here's 50% MORE POWER . . . for Dozens of those Production Jobs!



DEBURRING. CRAFTSMAN Rotary Electric Tool, on the "line", deburring castings. It also cleans, wire-brushes, sands.

7 1/4 in. long,
over-all.



Rotary Tool Only

\$23⁹⁵*
Cash

Complete 54-pc. Set

\$28⁹⁵*
Cash

Only \$3 Down



POLISHING work, with rubber bonded polishing wheel. And the CRAFTSMAN Rotary Tool can buff, rout, and drill, too!



GRINDING on die work. CRAFTSMAN also sharpens, engraves and etches . . . and it is invaluable for tool-room use.

CRAFTSMAN Rotary Electric Tool . . . NEW! Fast! Handy! Most powerful tool of its type we've ever seen!

These Features make it a "Better Buy"!

- 50% more power than any other tool in its class!
- Coolest-running rotary tool we've ever seen! Temperature rise scarcely noticeable even after hours of continuous use!
- Exclusive 3-jaw chuck adjustable from 1/64 to 1/8-in.; takes not only 3/32 and 1/8-in. shank tools, but also wire gauge drills, without special adapters!

A superb tool to speed your production-line and tool-room work; and to lower costs! Has dozens of uses; on metals, plastics, wood, glass, leather, etc. Precision-built, big-tool construction. Shaft straddle-mounted on two large bearings; large ball thrust bearing. "Natural-position" finger rest; convenient off-on switch. Strong aluminum housing. Extra-powerful 15,000 R.P.M. motor for 110-120 volt, 25-60-cycle, AC-DC use; 6-ft. cord and plug. See this sensational tool at (or call) your nearest Sears Retail Store TODAY! Or write Dept. 609, Sears, Roebuck and Co., Chicago 7, Illinois.

*Prices slightly higher south of Ohio and west of Mississippi rivers.

CRAFTSMAN Hand and Power Tools by **SEARS, ROEBUCK and CO.**
Famous for fine quality . . . precision performance . . . low price!



**Make Money
with Spare-Time
Plowing &
Mowing!**

5-HP

GRAVELLY Tractor

OFFERS 20 MONEY-MAKING TOOLS!
Make good money this spring plowing gardens with the powerful Gravelly Tractor! Perfect seedbed in one operation. It's easy to earn \$30 to \$40 a week—*extra!* The tractor does the work—you collect the fee. After plowing season, use Sickle or Lawn Mower attachments for cutting brush, weeds, lawns. Remember, with 20 tools, Gravelly does *every* lawn, garden and field job! All-gear drive, power reverse; moderate investment. . . . An easy way to get a Gravelly of your own—and make a profit besides!



"Power vs Drudgery" tells you how to put Power to work making money for you! Spring's almost here—write *today!*

GRAVELLY MOTOR PLOW & CULTIVATOR CO.
BOX 263 DUNBAR, W. VA.

SAY YOU SAW IT IN POPULAR MECHANICS

BEAUTIFIES natural wood, pine paneling

POLISHES furniture, woodwork

IMPROVES paint jobs

PROTECTS wood and metal surfaces

KEY CONTENTS ONE QUART

Guaranteed by Good Housekeeping

ATTACHMENT OR A REFUND OF MONEY IF NOT AS ADVERTISED THEREIN

49¢ PINT 89¢ QUART

AND 101 HANDY HOME USES

101 HANDY HOME USES!

Every home, every workshop, needs Pol-mer-ik BOILED Linseed Oil. Available at all stores. Free folder tells you how to use it. Write Dept. 603 . . .

ARCHER-DANIELS-MIDLAND CO., Minneapolis 2, Minn.

BeMoCo Dependable

AUTOMATIC SAW SET

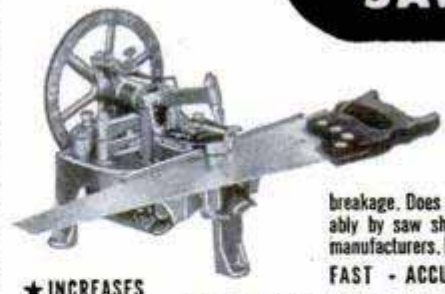

Sets 400 teeth per minute on hand or band saws 4 to 16 point. Hammer and anvil action sets teeth accurately and uniformly. . . . No tooth breakage. Does a perfect job. Used profitably by saw shops everywhere and saw manufacturers. Every machine guaranteed!

★ INCREASES PROFITS

BEAVER MFG. CO.

Saw Machine Div. #4M
800 SO. 1515 AVE. INGLEWOOD, CALIF.

RUPTURE



RELIEF...OR YOUR MONEY BACK
Simple, easy to wear truss made by old surgical house. You risk nothing. Write for free booklet. Don't delay.

WEB TRUSS CO., Dept. M-2, Hagerstown, Md.



**FREE SAMPLES!
GLOW IN THE DARK!**

BIG PROFITS showing amazing Luminous Specialties—house numbers, pictures, plastic novelties, religious and nursery objects, ash trays, keyholders, etc. Large manufacturer. Enormous demand. Sell on sight. WRITE AT ONCE for FREE samples. Madison Mills, 303 4th Ave., Dept. U-4, New York 10, N.Y.

make your own Gems

All necessary lapidary equipment is furnished, including a super-charged diamond blade for sawing, and all wheels for grinding, shaping and polishing; also complete instructions. The complete equipment as shown, less motor and belt, for only \$29.50. f.o.b. Burlington, Wisconsin. Write today for information and literature.

29.50
f.o.b.

B&I MANUFACTURING CO.
Dept. S Burlington, Wis.

OWN A Printing Business

Cards, Tickets, Stationery, etc. Good profit in spare time. PRINT YOUR OWN greeting cards, movie titles, church work, etc. Save money. Easy rules supplied. Raised printing like engraving too. Have home shop. Sold direct from factory only. Pays for itself in short time. Write for free catalog of outfits, and all details.

KELSEY PRESSES, 0-37, MERIDEN, CONNECTICUT

LAWN MOWER SHARPENER

turn spare time into dollars

lawn mower sharpening at low cost!
Now only **\$34.95** less motor.

Order direct from **QUAD CITY PRODUCTS Company, Inc.**
Box 42, Rock Island, Ill.

IT'S Sensational!

25 HORSEPOWER!

...YET IT TROLLS!

ONLY 85 POUNDS!

AND ONLY \$390*

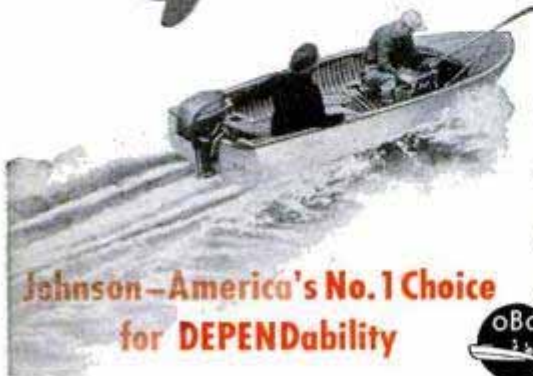

THE NEW

JOHNSON

SEA-HORSE 25

WITH GEAR SHIFT . . . SYNCHRO TWIST-GRIP SPEED CONTROL . . . SEPARATE MILE-MASTER FUEL TANK. A *super-powered* motor that handles *easily*. A smooth-running motor with an unbelievable range of performance. A Gear Shift motor with Neutral-Forward-Reverse. A long-cruising motor with separate Mile-Master Fuel Tank. Ideal for speed (over 30 m.p.h.) —“big” waters—outboard cruisers—water sports—and *fishin'*! See it! Drive it! Look for your Johnson dealer's name under “Outboard Motors” in your classified phone book.

FREE! NEW HANDY CHART. Full details on the 4 versatile Sea-Horses for 1951 . . . a motor for every outboard need. Write today! It's free!
 JOHNSON MOTORS, 400 Pershing Road, Waukegan, Illinois
 In Canada: Johnson Motors, Peterborough

FOUR VERSATILE MOTORS FOR 1951

- | | | |
|-----------|-----------|--|
| SEA-HORSE | 25 | 25 H.P. 85 lbs. \$390.00* |
| | | With Gear Shift, Synchro Twist-Grip Speed Control, six gallon Mile-Master Fuel Tank. |
| SEA-HORSE | 10 | 10 H.P. 58 lbs. \$295.00* |
| | | With Gear Shift, separate Mile-Master Fuel Tank (6 gal.) |
| SEA-HORSE | 5 | 5 H.P. 44 lbs. \$187.50* |
| | | World's fishing favorite, Neutral Clutch, No Shear Pin. |
| SEA-HORSE | 2½ | 2.5 H.P. 31 lbs. \$137.50* |
| | | World's lightest Alternate Firing Twin. |

**Johnson—America's No. 1 Choice
 for DEPENDability**



*All prices f.o.b. factory. All prices subject to change without notice. All h.p. ratings are OBC Certified brake h.p. at 4000 r.p.m.

**BUILD 'EM YOURSELF
IT'S EASY - - - IT'S FUN!**

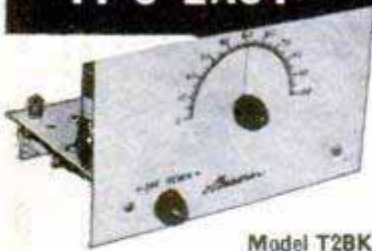

**Meissner
RADIO KITS**

Model T2BK

You'll have a world of fun assembling a MEISSNER Radio Kit, and what's more you'll have a REAL radio at an amazing low cost.

Step-by-step instructions with pictures and diagrams make it easy as ABC. All you need is a screw driver and soldering iron.

MEISSNER Radio Kits carry a written guarantee — your assurance of complete satisfaction!



Model T6BK

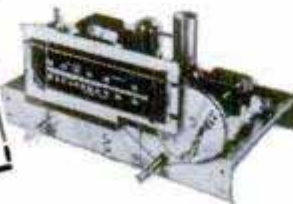

Model T8CK

**Write Today for
Free Kit Catalog**

You'll Be Glad You Did!

MEISSNER MFG. DIVISION
Maguire Ind., Inc.
Mt. Carmel, Illinois

brand NEW just off the press



**CONSTANTINE'S MANUAL
FOR WOODWORKERS
HOBBYISTS
HOME OWNERS
116 PAGE BOOK**

a complete catalog!

**AND REFERENCE BOOK OF WOODS,
VENEERS, LEATHER, METAL, PLASTICS, ETC.**

This is the biggest, most complete manual we ever published. More new items, on leathers, decorative metals, wood finishing, hard to get items of all kinds... In addition to our power and hand tool sections, upholstery, picture frame mouldings, rare and domestic woods, veneers, lumber, inlay panels, 83 inlay designs, inlay borders, all in full natural color, plus a full color wood identification panel of 60 different woods suitable for framing. All items at lowest prices from America's Biggest Supplier to Craftsmen.

Send today for your copy of the hobbyist's most helpful book.

SEND FOR YOUR COPY TODAY

FREE

With each copy of our Master Manual, you get a year's subscription to Chips and Chats, a breezy bimonthly to keep you up-to-date on what craftsmen are doing.

ALBERT CONSTANTINE & SON, INC., DEPT. PM-2
797 East 135th St., New York 54, N. Y.

Enclosed find 25¢ for a copy of your "Master Manual" and a FREE one year's subscription to Chips and Chats.

NAME _____
ADDRESS _____
CITY _____ STATE _____

GARDEN TRACTORS



**NEW CATALOG
IN COLOR**

It's New! The finest broadside on garden tractors ever issued gives you full details on the famous Speedex 2 1/2 H.P. walking Model C, and on the heavy-duty 8 H.P. riding Model 23. Illustrates many labor-saving uses, shows wide range of implements for plowing, discing, cultivating, mowing, snow removal, lawn mowing, etc. Gives you complete descriptions... full information. Supply limited—write today!

SEND A POSTCARD FOR YOUR FREE COPY
SPEEDEX GARDEN TRACTOR CO.
BOX 216-D1B RAVENNA, OHIO
P-1150-42

**Are You Interested In
SHOOTING?**

Send 6¢ in stamps for sample copy 96-page 35¢ monthly magazine. The AMERICAN RIFLEMAN, exclusively about guns and shooting. Or send \$4.00 for subscription next 12 issues, and receive 2 back numbers, free.

NATIONAL RIFLE ASSOCIATION
1605-F Rhode Island Ave., N.W., Washington 6, D.C.

SPECIAL Fishing Line YOUR CHOICE FOR \$1.00

500' 2-PLY NYLON 25 lb. T	200 ft. 15 or 20 lb. Test
250' 3-PLY NYLON 45 lb. T	175 ft. 35 lb. Test
150' 3-PLY NYLON 85 lb. T	150 ft. 50 lb. Test
500' Linen Line 24 lb. T	125 ft. 75 lb. Test
	100 ft. 100 lb. Test
	50 ft. 100 lb. Test

Imported FLIES, Assorted... 10 for \$1.00
Level Fly Line, size E & D, 75 ft. \$1.00
All lines available in longer lengths. Send Check, Money Order. We pay Postage.

MAC-MILLS, Dept. K-2, Pleasant Valley, New York

ONE-MAN SAWMILL LOW \$50.00 AS... 50.00 DOWN

Take BELSAW Portable Sawmill right to the trees—turn out valuable lumber for local yards—do "custom sawing" for neighbors. BELSAW lasts a lifetime. No crew needed. Power with old auto engine. Beginners get excellent results. Send postcard for FREE BOOK, "How To Make Lumber."

BELSAW MACHINERY CO
8115 Field Bldg. 315 Westport Rd, Kansas City 2, Mo.

BUILD FINE GRANDFATHER CLOCK NOW

The simple sensible Red-i-Kut way as thousands have—SAVE HALF. SHOP TESTED PLANS "SPIRIT OF THE CENTURY" Narrow waist 83" tall or stately straight side "SPIRIT OF AMERICA." EASY-TO-FOLLOW photopack PLANS tell all—plus BROCHURE of heavy brass weight Westminster, tube chime, movements, gorgeous dials. 3/4" solid mahogany case kits. Send \$1.00 today—Both Plans \$1.50 NOW.

KUEMPEL CHIME CLOCK CO., #8 Kuempel Bldg., Minneapolis 16, Minn.

SAY YOU SAW IT IN POPULAR MECHANICS

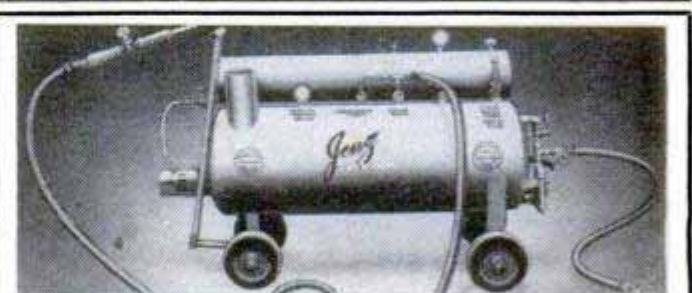

EARN \$6.00 PER HOUR

At a cost of 20¢ with the NEW JENZ SUPER CHIEF STEAM CLEANER. Portable—No moving parts—Cleans anything—Any place—Motors—Chassis—Machinery—Floors—Buildings—Oil Rigs, etc.—Oil fired—Economical—Fully tested and warranted. 75 lbs. steam in ten min.—Model 80, Complete **\$315.50** as illustrated... F.O.B. shipping point

HI-PURE LABORATORIES, Evansville, Ind.

MOST PRACTICAL TOOL YOU COULD EVER OWN! DREMEL *Electric* MOTO-TOOL



The "Pocket-Size
Machine Shop"

Grinds, Drills,
Routs, Carves, En-
graves, Cleans,
Polishes, Finishes

Approx.
27,000 RPM

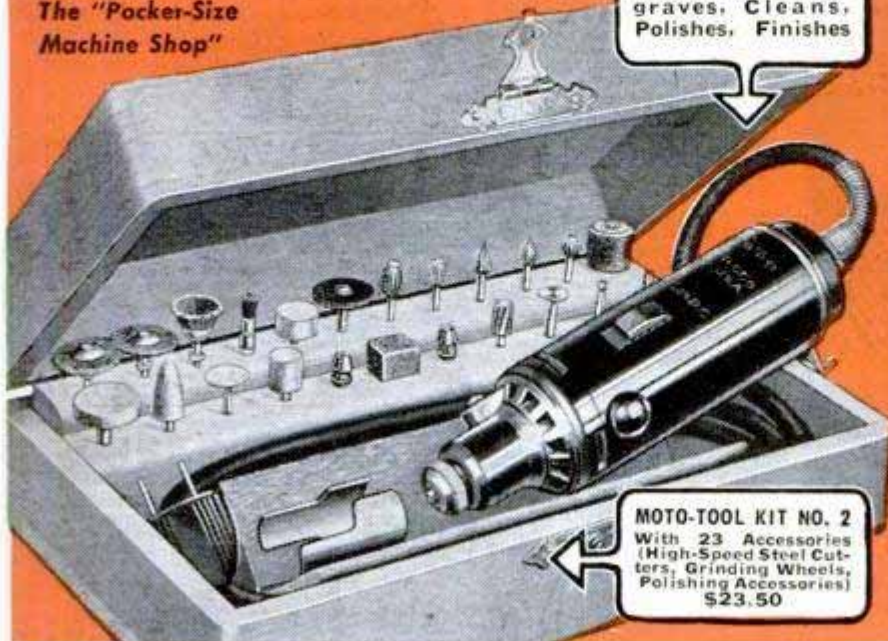

MOTO-TOOL KIT NO. 2
With 23 Accessories
(High-Speed Steel Cutters,
Grinding Wheels,
Polishing Accessories)
\$23.50



MOTO-TOOL NO. 2
with one emery wheel point
\$16.50



Great for
Hobbyists

Saves Time
and Labor

Only Dremel Model 2 Gives Approx. 27,000 R.P.M. — Conserves Cutters

It's the fastest, most powerful tool of its kind! Preserves cutters by cutting cleaner—faster. Works well in wood, plastics, metal—for drilling, carving, engraving, buffing, etc. For model-making it's a must. For home maintenance and repair jobs you'll wonder how you ever got along without it. And for general all-round workshop operation it's a tool every crafts-

man finds indispensable. We urge that you try Moto-Tool on Dremel's 5-day money-back offer. Buying the complete Kit No. 2 saves money and opens the door to years of profitable results.

CHECK THESE MOTO-TOOL FEATURES

- Oil-less, sealed bearings . . . Pat'd. automatic chuck lock pin . . . Oversize armature shaft, hardened, ground, polished . . . Shockproof, bakelite housing.
- Dust filtered, air cooling system . . . Dynamically balanced armature . . . Handy hanger hook.
- Sturdy 110-120 V. AC-DC motor . . . weight only 13 oz.
- A precision tool widely used in industries like Ford, G-E, Remington-Arms, Nash-Kelvinator, etc.

IMPORTANT

Don't confuse Moto-Tools and Accessories with so-called "bargain offers". Compare Dremel, feature for feature, with any make. If Dremel products are not superior in every way, we don't want you to buy.

Portable DRILL PRESS

Add further versatility to your Moto-Tool with this 12" high drill press. Just right for creating costume jewelry, model making, carving, routing, etc. Utilizes No. 2 Moto-Tool, which can be raised, lowered or swung in any direction. Weighs 3½ lbs.



ONLY
\$9.95

(Less Moto-Tool)

BIG VALUE!

MOTO-TOOL KIT NO. 1

Contains the lighter Model No. 1 Moto-Tool and 34 practical accessories (steel cutters, grinding wheels, etc.) in attractive lacquer-finish wood case. . . . \$17.50

MOTO-TOOL NO. 1 with one emery wheel point. . . \$9.85

WHERE TO BUY DREMEL TOOLS



Dremel Tools are sold everywhere. If your dealer cannot supply you, send remittance in full and we will ship postpaid. Or send only \$2. and pay postman balance plus postage and fee. Money back if not delighted after 5 days' trial.

DREMEL MFG. CO., Dept. 111-B, RACINE, WIS.

FUN FOR BOYS FROM 8 TO 80 DREMEL *Electric* COPING SAW

CUTS SCROLLS LIKE MAGIC—SANDS AS IT SAWS



BLADE
FACES
4 WAYS

Only
\$5.85

JUST
GUIDE IT!

SAFE AS A HANDSAW

For home, hobby, repair work—no other tool pleases so much for so little cost. Works in any direction—delivers 7,200 strokes per minute smoothly, effortlessly. Saws through ¾" medium-hard wood at a foot-a-minute speed. Touch-of-the-trigger, foolproof action. Only 2 moving parts, never needs oiling. Uses 110-120 v. A.C.

... for 6 useful projects packed with each saw



NEW! "WIGGLE" GETS BIG FISH HULA DIVER

POSITIVE CONTROL OF DEPTH AND ACTION

New big lip and rear paddle for amazing results. Ideal open-water lure for deep-feeding game fish. 5/8 oz.

FRED ARBOGAST & Co., Inc., 2262 W. North St., Akron 3, Ohio

WRITE TODAY FOR BIG FREE 1951 ARBOGAST COLOR CATALOG—FULL OF PICTURES OF CATCHES



DEPENDABLE CRAFT SUPPLIES



LEATHER CRAFT • PLASTICS • POTTERY CRAFT • BLOCK PRINTING • BELT CRAFT • TEXTILE COLORS • POWER TOOLS • WOOD BURNING • INSTRUCTION BOOKS • ETC.

DWINNELL CRAFT SHOP
Dept. PM-251—Wheeling, W. Va.



RELIEVES PAIN OF HEADACHE • NEURALGIA NEURITIS

FAST

The way
thousands of
physicians
and dentists
recommend



Anacin® relieves headache, neuralgia, neuritis pain fast because Anacin is like a doctor's prescription—that is, Anacin contains not just one, but a combination of medically proven, active ingredients in easy-to-take tablet form. Thousands have been introduced to Anacin through their own dentist or physicians. If you have never used Anacin, try these tablets yourself for incredibly fast, long-lasting relief from pain. Don't wait. Buy Anacin today.

PISTON TYPE COMPRESSOR



EASY PROFIT IN PAINT SPRAYING

Paints walls, ceilings, screens, furniture and machinery faster, better. All complete as shown less motor. Carry anywhere. Fully guaranteed. Could be used with 1/4 H.P. motor or less. Price \$35.00 less motor F.O.B. Chicago. \$5.00 deposit balance C.O.D. or see your dealer. With motor \$55.00.

IDEAL AUTOMATIC PUMP CO., Dept. P.M.8
801 W. Washington Blvd. Chicago 7, Ill.



Better Sights FOR BETTER "SHOTS"

Sheard "Gold"
Front Sight
\$1.75



Standard
Front Sight
\$1.25



Marble's
Flexible
Rear Sight,
with automatic
spring joint.
Can be locked
down. With 2
discs. Price \$5.50.

At your dealer, or
write for Catalog

Marble Arms & Mfg. Co.
578 Delta Ave. Gladstone, Mich.

For faster, more accurate sighting
equip with a combination of

MARBLE'S SIGHTS



Flat Top Rear. Price \$2.00



Semi-Buckhorn Rear
Price \$2.00

No. 69
Flat Top
Sporting
Leaf.
\$2.00



(1952)

ALL NEW 1951 KING MIDGET AUTO

World's Lowest Priced 2 Passenger Car

Drive it for 75c per week. Amazing performance. Surprising comfort. All steel construction. Full accessories, top and heater. Ready to run or assemble it with our bolt together parts. Rider agents wanted, earn your car free. Send 25c for detailed literature or \$1 (refunded first order) for actual assembly book and service manual filled with photos, drawings, specifications, etc.

MIDGET MOTORS MFG. CO.,
ATHENS 1, OHIO



Have fun! BUILD YOUR OWN CHAMPION



Do what hundreds of others are doing! Build your own sleek racing boat or comfortable pleasure craft in spare time! Have fun and save a lot of money! Send 25c today for new illustrated catalogue of tested boat plans, 18 trim styles ranging from midget outboards to 20 ft. cabin cruisers. Don't wait. Write now to

CHAMPION BOATS, P.O. Box 7006 M-2, Long Beach 7, Calif.

HAUCK FLAME GUN KILLS WEEDS



KILL WEEDS, crab grass, Canada thistle—stalks, seeds and roots. Destroy brush, caterpillar nests, diseased trees, grasshoppers, chinch bugs, etc. Clear irrigation ditches, split rocks, burn tree stumps. Sterilize poultry houses, kennels, barns. Use as portable home forge. Melt ice, thaw pipes. Safe, inexpensive. Burns only 6% kerosene, 94% air! Thousands satisfied users. 7 models. Write for FREE CATALOG.

HAUCK MFG. CO., 76 Tenth St., Brooklyn 15, N.Y.

MARCOT KEY MACHINE



MARCOT No. 8 KEY MACHINE, less motor \$ 95.00
Auto Code Book and Depth Keys 12.50
75 Dz. Popular Key Blanks 60.00
Set — Key File, Follow-Through Rods, Lock Picks, Bit Key Gauge, Thimble, Pins, Springs 10.50
"Locksmith Trade Books" 6.75
How to Open Locks without Keys or Picks; Secret of Locksmithing; How to Make Keys by the Impression Method; Master Key Systems.
TOTAL COST \$184.75

A. J. MARCOTTE CO., 1200 N. Kedzie Ave., Dept. PM, Chicago 51, Ill.

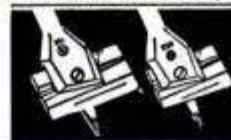

Clark EXPANSIVE BIT
CUTS BETTER • COSTS LESS! Accurate, fast; cuts smooth holes in hard or soft wood. Chrome vanadium steel blades, all chrome body. No. 250, 1/2"-1 1/2", \$1.89; No. 251, 3/8"-3" \$2.19 GUARANTEED. At your dealer or write ROBERT H. CLARK COMPANY, Beverly Hills, Calif.

CASH IN YOUR SPARE TIME



BIG MONEY IN OWN BUSINESS
YOU CAN MAKE UP TO \$40 A DAY sharpening and setting circular saws for factories, builders, lumber yards — with NEW BELSAW COMPLETE CIRCULAR SAW SHOP. LOW COST, Sharpens 4 to 5 saws per hour, no experience needed, complete instructions. Send today for FREE Catalog.

BELSAW MACHINERY CO
3703 Field Bldg. Kansas City 2, Mo.

Say You Saw It in POPULAR MECHANICS

Plane it SQUARE!

with the **SQUAR-EZY** guide
..fast, accurately...easily

Attach it to YOUR plane quickly and easily for perfect JOINING and EDGING.
• Rugged Construction, Roller Spindle Accurately Machined. • Model 7 guide fits Block & Smooth Planes Nos. 3, 4, \$2.98 • Model 11 guide fits No. 5 Jack (14") and larger \$3.49. • Order Direct or Ask Your Dealer: Literature Available, Satisfaction Guaranteed



THE BRATTON COMPANY

Dept. 123

Edwardsville, Kansas



EARN \$25 AND MORE A DAY!
NO SCHOOLING!

STEADY ALL-YEAR
WORK!

THOUSANDS
ARE SUCCESSFUL!

MAKE BIG MONEY BE YOUR OWN BOSS!

WANTED—men with ambition and desire to get ahead and *make money* in something for themselves. *Act now*—do as thousands of successful men have done—start on your own in floor surfacing with American Machines!

Take advantage of this opportunity if you want steady year 'round work—earnings of \$25 and more a day—pleasant indoor working conditions—and a lifetime of comfortable living for yourself and your family. No schooling—no experience needed. Sanders are easy to operate. Hundreds of prospects—new and old homes. Send coupon for "money-making" booklet entitled "Opportunities in Floor Surfacing"—enclose 25c in coin or stamps to cover handling.

AMERICAN FLOOR MACHINES



The American Floor Surfacing Machine Co.
535 So. St. Clair St., Toledo 3, Ohio

Enclosed find 25c in stamps or coin for booklet "Opportunities in Floor Surfacing", telling me how I can start my own floor sanding business.

Name _____
Street _____
City _____ State _____

ATHEARN
authentic
scale model
RAILROAD
CARS

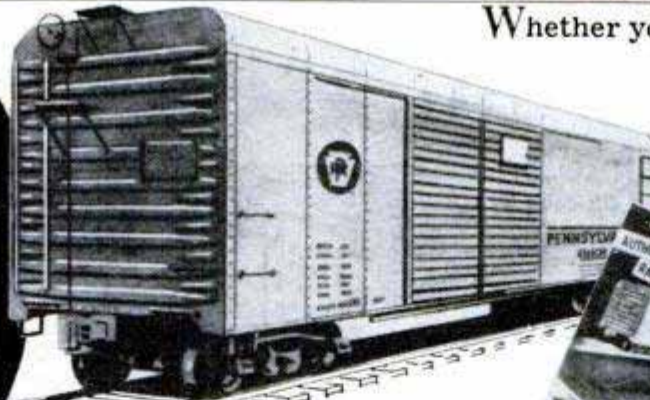

Whether you want an evening's mantel piece project or a complete scale model railroad, ATHEARN car kits give you more realism. Each model is exactly scaled, down to the last rivet from the actual car...even the trucks have real springs! ATHEARN kits are so easy to build that beginners get professional results.

Send 10c
for Athearn's
big catalog



Build one tonight. On sale at all hobby shops.
IRVIN R. ATHEARN CO.
11129 Van Buren Ave.
Los Angeles, Calif.

CUT-TO-FIT HOMES CUT BUILDING COSTS

CHOICE
OF
57
DESIGNS

ORDER NOW

SAVE UP TO $\frac{1}{3}$



Build your own home and save the builders' profit—plus savings in lumber and labor with Sterling Ready-Cut-Homes. Anyone can assemble with simple, easy to follow plans furnished. Every house complete with all lumber, roofing, nails, glass, hardware, paint, doors and windows marked ready to erect. Freight paid. Complete building plans ready for filing at low cost. Sold separately if desired. Write today!

PRICED FROM \$2132 UP
Five Easy Payment Plans

INTERNATIONAL MILL AND TIMBER CO.
DEPT. P.M. 251 BAY CITY, MICHIGAN

Send 25c for NEW COLOR CATALOG

HANDEE®

tool of 1001 Uses

FINEST IN POWER TOOLS PLUS 51 ACCESSORIES

Complete . . . designed for every hobbyist and mechanic! Grind, drill, polish, carve, sand, saw, etc. Packs plenty of power in the 25,000 r.p.m. motor, with approved 7-segment commutator. Handsome fitted steel carrying case.

Complete, with liberal 10-day money back trial offer **\$27.50**

with 7 accessories . . . **\$19.95**



HANDEE WORKSHOP

"Tornado-Powered"
with NEW HANDEE "85"

Versatile, with 41 accessories . . . suitable for shop or home use. For novice or expert . . . precision routing, molding cuts. HANDEE "85" a production wizard . . . automatically air-cooled, pin-point accuracy. Sensational power!

Complete, packed in handsome case,

\$29.95



FREE! New 64-page Manual

Chicago Wheel & Mfg. Co., Dept. PM
1101 West Monroe St. Chicago 7, Ill.



PAGE GARDEN TRACTORS

WITH PRECISION TRANSMISSION!

RIDING AND WALKING MODELS
TO DO MORE JOBS AT LESS COST! 1951 LINE!

New, low-cost 1951 line with extra features! Riding, walking models, 2 to 6 HP. **NO BELTS OR CHAINS!** Complete gear drive with reverse on every model, no cheap belts or chains. Running parts in oil, no slippage or wear. We have over 25 years of tractor experience.

JACK OF ALL JOBS! The Page cuts weeds, harrows, plows, moves snow—does dozens of other important jobs.

WRITE TODAY — 24 PAGES
100 ILLUSTRATIONS Shows All ATTACHMENTS

FREE CATALOG

PAGE FARM EQUIPMENT

1904 S. 81st St., Milwaukee 14, Wis.

EAT ANYTHING WITH FALSE TEETH!

Corn-on-the-cob, hard candy, nuts . . . you can eat them all! Simply lay soft strip of Brimms Plasti-Liner on upper, lower or partial plate. Bite and it molds perfectly. Your plate fits snugly and stays that way because Brimms Plasti-Liner hardens permanently to your plate. Even on old rubber plates get good results six months to a year or longer.



EASY TO REFIT OR TIGHTEN FALSE TEETH

One application gives instant relief from slipping, rocking plates that cause sore gums. You can talk without embarrassment. Forget temporary "stickums" to hold plates in. Tasteless, odorless, harmless to you and your plates. Removable according to directions. Money back if not completely satisfied.

SEND NO MONEY Order a \$1.25 package to reline one plate. Sent in plain wrapper. Pay postman when delivered. Or send money and save C. O. D. charges. Also available at leading drug stores. Sample of plate cleaner free if you act now.

PLASTI-LINER COMPANY, Buffalo 11, N. Y., Dept. 43-P

Brimms PLASTI-LINER

The Permanent Denture Reliner

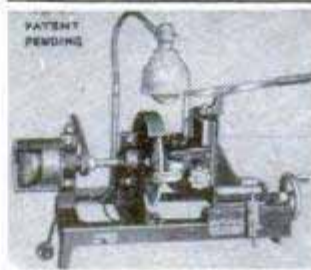

Start a NEW BUSINESS!

or Add to your present
Repair Business

SHARPEN DULL PIPE WRENCHES

PIPE TAPS & DIES
"GUM" CIRCULAR SAWS

Write for Information

J. C. MOORE INDUSTRIES
BOX M 276 FREDONIA, PA.

BUILD HEAVY DUTY MACHINES

SAVE UP TO 90%— You can build, using our practical, easy-to-read plans, all kinds of machines, for home, farm or shop — scooters, portable sawmills, metal working machines, concrete machinery of all kinds, printing equipment, woodworking machines, midget autos, dish washers, farm equipment, freezers, tractors.

FREE CATALOG HANDBOOK
183 SETS OF PLANS
VALUABLE INFORMATION

NICHOLS EQUIPMENT COMPANY
D-11 PURVIS, MISS.

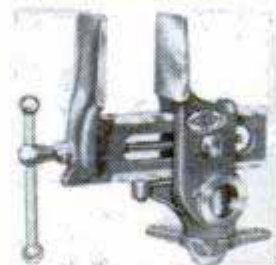

DESIGNED FOR THE HOME WORKSHOP

A penny postcard will bring you a folder showing in use the most versatile wood-working vise (the Versa-Vise) you ever imagined. Use it upright, flat on its side, turned to any angle! Mail a card now.

THE WILL-BURT CO.
DEPT. PM-5, ORRVILLE, OHIO.

Pioneers

Leaders

AIR RIFLES BENJAMIN AIR PISTOLS

SHOOT WITH SAFETY

BE SAFE—SHOOT WITH COMPRESSED AIR—ALWAYS READY No Cartridges or Tanks to Replace or Recharge. If you want the most PRACTICAL GUN to use anywhere—inside or outdoors—get a SAFE—CLEAN—ECONOMICAL BENJAMIN with Adjustable Power and Amazing Accuracy. Send for Free Folder of Latest Models Today. BENJAMIN AIR RIFLE CO., 890 MARION ST., ST. LOUIS 4, MO.

ALL BRAND NEW

WAR SURPLUS BARGAINS!

ALL FULLY GUARANTEED

HYDRAULIC CYLINDERS AIR or OIL

Large supply of new labor-saving, economical hydraulic equipment in many types and sizes. Use these positive, highly efficient, smooth pressure hydraulics on presses, arbors, lifts, loaders, power control, positioning, brakes, plastic dies, auto frame alignment, etc., etc.



ITEM #70—Purolator hydraulic oil filter. Permanent element type, 3/8" female pipe thread ports. Capacity, 16 gallons per minute. A \$13.00 value. Now **Postpaid..... 4.95**

ITEM #4—All steel double action hydraulic cylinder. 1 1/2" bore, 2 3/8" stroke. Clevis mounting. Will lift 1000 lbs. with 1000 P.S.I. line pressure. Perfect for positioning and feeding movements. Shpg. wt. 4 lbs. **Postpaid.... 4.95**

ITEM #33C—Double action hydraulic cylinder. 1 1/2" bore, 4 1/2" stroke. Clevis mountings at both ends. Uses 1/4" pipe fittings. **Postpaid..... 8.95**

ITEM #32—Double action, 1 1/2" bore, 9" stroke, will lift 1760 lbs. with 1000 P.S.I. line pressure. Wt. 4 lbs. A \$45.00 value. **Postpaid..... 10.95**

ITEM #41—Double action hydraulic cylinder. 2" bore, 6" stroke, clevis mounting at base and end of shaft. Over-all length closed 12 1/2". Has 3/4" stainless steel shaft, uses 1/4" tube fittings. Will lift up to 3100 lbs. with 1000 P.S.I. line pressure. **Weight 7 lbs. Postpaid..... 12.50**

ITEM #16C—Double acting hydraulic cylinder. 1 1/2" bore, 2 3/8" stroke. Will lift 1760 lbs. with 1000 PSI line pressure. Weight 8 lbs. A \$55.00 value **Now Only, Postpaid..... 16.95**

ITEM #103—Double acting hydraulic cylinder. 2 1/2" bore, 17" stroke. Clevis mounting. Will lift 4900 lbs. with 1000 PSI line pressure. 1 1/4" diam. shaft. 3/8" tubing thread ports. Overall length closed 28" Shpg. wt. 11 lbs. **F.O.B. Chicago..... 21.50**

ITEM #31C—Double action hydraulic cylinder. 3 1/2" bore, 11" stroke. Aluminum alloy cylinder wall and all steel 1 1/4" piston rod. Clevis mounting at base and shaft. 19 1/2" overall length closed. Will lift 9625 lbs. using 1000 PSI from Logan Heavy Duty Hydraulic Pump. Uses 3/4" tubing fittings. Value \$102.00. Shipping wt. 11 lbs. **F.O.B. Chicago..... 22.50**

ITEM #6-A—Double action hydraulic cylinder. 3" bore, 25" stroke, will lift 7070 lbs. with 1000 PSI line pressure. Steel barrel, 1 1/2" stainless steel shaft. Gov't acq. cost \$176.00. Shpg. wt. 26 lbs. **F.O.B. Chicago..... 28.00**

ITEM #42—Double action hydraulic cylinder. 4" bore, 18" stroke. Rated lift capacity with 1000 PSI line pressure is 12,500 lbs. Ship. wt. 30 lbs. **F.O.B. Chicago An Excellent Buy for..... 32.50**

HI-PRESSURE FITTINGS for cylinders and valves available at 50c ea. for 3/8" pipe and 65c ea. for 1/2" pipe.

HYDRAULIC SPEED REDUCER with Fingertip Control

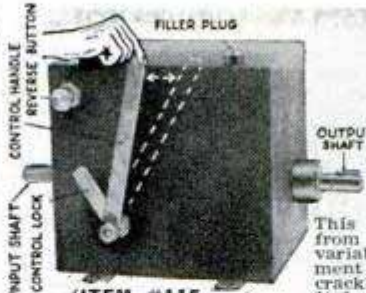

(ITEM #115) reset up to 180 inch pounds. selection in either direction of rotation. Both input and output shafts measure 5/8" diam., include keyway. Input rotation is counter-clockwise facing shaft. Recommended input speeds not to exceed 750 R.P.M. Over-all dimensions 7 1/2" x 7 1/2" x 11 1/2". Gov't acquisition cost, \$428.00. Shipping weight 26 lbs. Complete with 2 qts. of oil and full instructions **Postpaid..... 54.50**

- USE FOR:**
- Reamer Drives
 - Midget Cars
 - Feed Mills
 - Canning Machines
 - Conveyors
 - Lathes
 - Milling Machines
 - Motor Boats
 - Cream Separators
 - Garden Tractors
 - Pumps
 - Blowers, etc.

Variable output speeds ranging from 0 to input speed now available. Merely move control handle until desired speed is attained. Then turn locking handle to maintain the setting. Internal relief valves prevent overloading. Use input power of 1/4 to 1 1/2 H.P. This Westinghouse-Oil Gear Unit converted to commercial use from 40 MM anti-aircraft traversing mechanisms consists of a variable displacement hydraulic pump feeding a fixed displacement hydraulic motor. These components are contained in a crackle-finish steel oil reservoir (capacity 2 qts.). Adjustable relief valves set at factory for 100 inch pounds of torque may be Independent reverse control allows full output power and speed

NEW! STATIONARY OR PORTABLE D. C. ARC WELDER

250 AMPS. MODEL 252 FOR ANY WELDING JOB, LIGHT OR HEAVY STOP COSTLY REPAIR BILLS, WELD IT YOURSELF AND SAVE

Only one or two jobs will pay for entire welder. Designed for many years of trouble-free service. This precision engineered Direct Current ELECTRIC ARC WELDER is offered at but a fraction of its original value. It can be mounted permanently or easily transported for portable use. Does the job instantly where and when you need it. Has dial type rheostat for easy pinpoint control and a high-low range switch. Run welder at 2500 RPM from drive pulley or power take-off of tractor, a 7 1/2 HP electric motor or a 10 HP gas engine. Use two V belts or flat belt (on pulley).

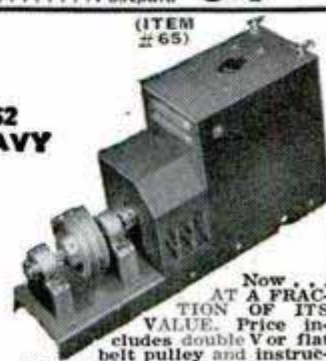

Now... AT A FRACTION OF ITS VALUE. Price includes double V or flat belt pulley and instruction book. Shpg. wt. 107 lbs. **F.O.B. Chicago..... 99.50** If more information is desired write for welder circular.

GENERAL MOTORS-ALLISON CENTRIFUGAL PUMP

200 GALLONS PER MINUTE

- For Draining Basements • Fire-Fighting • Irrigation • Fuel Transfer • Swimming Pools • Home Water Systems • Dewatering



(Item #120)

This General Motors-Allison Centrifugal Pump—designed for use on U. S. Air Force Mustang fighters, now converted for commercial, home, and industrial high volume pumping applications. Inlet, 2 1/2" standard pipe thread, twin outlets with 1/4" pipe thread, ball bearing supported 3/4" shaft. Easy, fast simple priming. Rotation, counter-clockwise facing shaft. Shipping wt. 35 lbs. Gov't acq. cost \$145.00. **F.O.B. Chicago Now Only..... 39.50**

Success Lift	Head Pressure	Gal. Per Min.	H.P.	R.P.M.
10'	65'	200	5.2	3500
10'	80'	40	1.5	2500

DIRECT CURRENT GENERATORS



For welders, plating, truck and marine use, D.C. appliances, lights, etc. Aircraft quality—lifetime grease sealed ball bearings. Heavy duty.

Item #89—Type M-2, rated 50 Amps.—24 Volts. Mfd. by Lece-Neville Co. Shpg. wt. 32 lbs. Gov't Acq. Cost \$176.00. **F.O.B. Chicago. Now Only..... 16.50**

Item #90—Type P-1, rated 200 Amps.—28 Volts, 2500 RPM. Mfd. by General Electric, Ford, Delco-Remy and Westinghouse. Gov't Acq. Cost \$300.00. Shpg. wt. 70 lbs. **F.O.B. Chicago..... 22.50**

Item #91—Type R-1, rated 300 Amps.—30 Volts. Mfd. by Jack & Heintz. Gov't Acq. Cost \$380.00. Shpg. wt. 70 lbs. **F.O.B. Chicago..... 35.00**

Each individually packed in wooden box. **Item #73**—Allis Chalmers MOTOR GENERATOR. 120 volt, 60 cycle AC, 7.82 amps. output. Input—24 volts DC, 65 amps, 3600 RPM. Ideal for marine and aircraft installations, farm and factory use where AC is desired and DC available. Run unit off DC welder for handy 120 volt AC current for emergency power for oil burners, incubators, electric motors, etc. Ship. wt. 200 lbs. **F.O.B. Chicago..... 79.50**

SELF PRIMING ALL PURPOSE PUMP

IDEAL FOR:

- Draining Basements
- Insecticides
- Fuel Oil
- Vacuum Pump — 28" for Milking Machines Lab use, etc.
- Air Compressor—for Paint Spraying, etc. Delivers 4.5 CFM at 40 PSI with 1725 RPM
- Home Water Systems
- 4-Ball Bearings—1/2" Shaft—3/4" Ports
- Rotate in either direction
- Rated up to 6 GPM, 50 PSI
- Use with 1/4 HP motor or larger, speeds from 200 to 1800 RPM
- Useful for hundreds of applications in the home, farm and factory
- Built by Pesco — Div. of Borg-Warner. Gov't acq. cost \$45.00. Shpg. wt. 12 lbs. Free! Complete instructions and performance data with each pump. **F.O.B. Chicago. NOW ONLY..... 16.50**



(ITEM #31A)

HYDRAULIC CONTROL VALVES

ITEM #24. Four-way control valve with built-in relief valve, for use with one double action hydraulic cylinder, may be used with 1500 P.S.I. hydraulic system to open and close hydraulic cylinders. Ship. wt. 8 lbs. A \$38.00 val. **9.95 postpaid.....**



ITEM #26. Four-way control valve for use with two hydraulic double-action cylinders. Each cylinder may be operated independently of the other or in conjunction with the other. Oil may be locked in any of the cylinders to hold the piston at any required position. Ship. wt. 6 lbs. A \$60 value, **postpaid..... 12.95**

LOGAN HEAVY DUTY HYDRAULIC PUMP

For operating hydraulic cylinders and hydraulic motors on tractors, bulldozers, construction machinery, lift trucks, industrial applications, etc. Delivers 10 GPM at 1200 RPM at 1000 P.S.I. using 6 HP. Has a 3/4" inlet, 1/2" outlet, 3/4" shaft with flat and keyway for direct or pulley drive. Has flange with 4 bolt holes for convenient mounting. Ship. wt. 22 lbs. Overall dimen.: 7" L. x 5 1/2" H x 5 1/2" W. A \$105.00 value **FOR ONLY..... 22.50**



(ITEM #29)

FREE: NEW 1951, 48-PAGE CATALOG Listing Brand New War Surplus bargains including Aircraft Quality hydraulics, A.C. generators, pumps, welders, tanks, and many, many others. You save on everything! Write today!

ORDER DIRECT FROM AD — SEND PAYMENT OR PURCHASE ORDER, TODAY — SATISFACTION GUARANTEED

GROBAN SUPPLY CO., Inc., 1507 S. MICHIGAN AVE., Chicago 5, Ill., Dept. PM-2

HOME CRAFTSMEN

Send for this Money-Saving
Introductory Offer of...

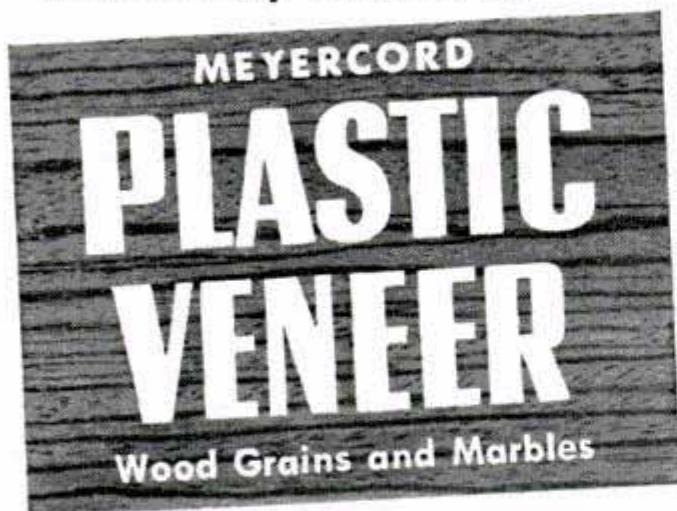

FEATURED IN FULL COLOR
IN JANUARY POPULAR MECHANICS

Here's the Big Offer!

- 1 3 sheets of Meyercord Plastic Veneer
—Any Pattern (Check Coupon Below)
- 2 with Cement
- 3 and Squeegee

COMPLETE ONLY
\$5.00
POSTAGE PAID

Now—exact reproductions of rare woods and marbles are available in PLASTIC VENEER sheet form to beautify the articles you make. Easy to apply on flat or simple curved surfaces of wood, metal, glass or composition. Durable, workable. Can be rubbed, top-coated, waxed. Order the special 3-in-1 package today. Check woods or marbles desired. Sheets contain 5 to 6 sq. ft.

CLIP COUPON—MAIL TODAY

THE MEYERCORD CO., 5323 W. LAKE ST., CHICAGO 44, ILL.

Please send me your \$5.00 introductory offer of 3 sheets of Meyercord Plastic Veneer, squeegee, cement, and complete instructions. Patterns are checked below. Enclosed find check M.O. for \$5.00. Plus \$_____ for _____ additional sheets, @ \$1.50 for wood, \$1.60 for marble.

- | | |
|--|--|
| <input type="checkbox"/> Italian Walnut | <input type="checkbox"/> Macassar Ebony |
| <input type="checkbox"/> Circassian Walnut | <input type="checkbox"/> Satinwood |
| <input type="checkbox"/> Butt Walnut | <input type="checkbox"/> Straw Stump |
| <input type="checkbox"/> Walnut Crotch | <input type="checkbox"/> Blonde Harewood |
| <input type="checkbox"/> French Walnut | <input type="checkbox"/> Brazilian Rosewood |
| <input type="checkbox"/> Walnut Stump | <input type="checkbox"/> French Rosewood |
| <input type="checkbox"/> Quartered Walnut | <input type="checkbox"/> Black & Gold Marble |
| <input type="checkbox"/> Rhododendron Burl | <input type="checkbox"/> Breche Rose Marble |
| <input type="checkbox"/> Mahogany Crotch | <input type="checkbox"/> Jaune Benou Marble |
| <input type="checkbox"/> Mahogany Stump | <input type="checkbox"/> Mexican Onyx |
| <input type="checkbox"/> Striped Mahogany | <input type="checkbox"/> Brazilian Onyx |
| <input type="checkbox"/> Straw Zebra wood | <input type="checkbox"/> Rose de Brignole Marble |
| <input type="checkbox"/> Carpathian Burl | <input type="checkbox"/> Skyros Marble |
| <input type="checkbox"/> Grey Prima Vera | <input type="checkbox"/> Verdi Antique Marble |

NAME _____

ADDRESS _____

CITY _____ ZONE _____ STATE _____

(Offer good in continental U.S.A. only)

Here's Your Helicopter Coupe

(Continued from page 121)

no vibration, no special sense of being airborne. We sat there, six feet in the air, and a mechanic walked in under us to give one of the wheels a tug. He could move us around, but it took a hard push, demonstrating the machine's inherent stability.

Hiller pushed the cyclic control forward and we started to move, climbing slowly to rise over a brushy fence. We flew toward his factory at roof height, then descended to the ramp area where mechanics were making adjustments to some "360s."

On the way back to the experimental area I took over the controls and found that just a touch was required to guide the helicopter in changing altitude or direction. There was no sharp, rapid change of attitude; the helicopter answered the controls slowly and smoothly. "Put her on course and let go of everything," Hiller suggested, and I did. The machine moved along as steadily as if I had both hands clutched on the controls. "She'll stay in any attitude you put her, hands off!" Hiller told me.

Hiller has been trying to build a simple, cheap rotary-wing aircraft ever since he got into the business in 1939—when he was 15. The big obstacle has been that until recently the most practical engine was the conventional internal-combustion engine. This is expensive to begin with and requires expensive gears, cooling systems and auxiliaries.

The wartime development of gas turbines, pulsejets and ramjets suggested new low-cost possibilities and Hiller experimented with or studied 17 different applications of these power plants. He settled on the ramjet as offering the best possibilities and he spent a year and a half working out his own version of this "flying stovepipe" engine.

The ramjet is inefficient and gulps fuel in prodigious amounts; on the other hand it is light, cheap and foolproof. It has no carburetor to ice up, no ignition system to fall apart or misfire. It works beautifully in heavy rains that would ground a helicopter powered with an ordinary engine. Hiller's engine is the size of a small watermelon and can be bolted onto a rotor tip in a couple of minutes. It burns any kind of fuel from dime-a-gallon stove oil or kerosene up to aviation gasoline. A ramjet unit costs less than \$200 and can be thrown away at 500 hours.

Hiller spent a quarter of a million dollars reworking the basic ramjet and came up with a design that is somewhat quieter and more efficient than the original. He

(Continued to page 268)

HERE'S HOW YOU DO MORE JOBS

With a DELTA[®] DRILL PRESS

Only Delta offers so many extra-job accessories!

A SPINDLE FOR EVERY JOB

You can change the spindle on your Delta Drill Press, equip it to do more jobs.



No. 972 — with Jacobs chuck and key.

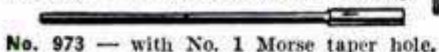

No. 973 — with No. 1 Morse taper hole.

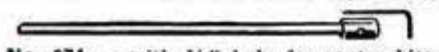

No. 974 — with 1/2" hole for router bits.

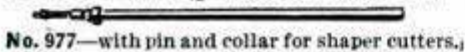

No. 977 — with pin and collar for shaper cutters.

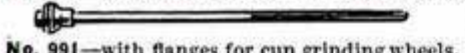

No. 991 — with flanges for cup grinding wheels.

DRILL IN WOOD

Delta gives you a wide variety of sizes of chisels, bits, bushings for mortising; plug cutters, for cutting dowels, etc. Do straight boring, angle boring, counter-sinking.



DRILL IN METAL

Using standard holding and clamping fixtures, you can countersink, tap, drill large holes, small holes — in round stock, thin or heavy metal.



CUT THOUSANDS OF SHAPES

Delta No. 980 Three-Lip Cutter Set makes your drill press a Shaper. You can cut mouldings, picture frames, thousands of shapes.



DO ROUTING

Using Delta No. 974 Spindle with Delta Router Bits, you can rout curved work, rout with pattern, cross-rout, rabbet, make round-end mortises, flute, cut rosettes.

SAND CURVES ACCURATELY

Delta offers a big selection of sanding drums and sleeves for pattern sanding and freehand sanding of irregular curves.



Look for the name of your Delta dealer under "Tools" in the classified section of your telephone directory.

Free!

Catalogs and bulletins on complete Delta line.

DELTA POWER TOOL DIVISION
 **Rockwell**
 Manufacturing Company
 MILWAUKEE 1, WISCONSIN



Shown is a Delta 17" Drill Press, one of 144 different models Delta offers in 14" and 17" sizes.



MAKE MORTISE AND TENON JOINTS

Delta No. 976 Mortising Attachment converts your drill press into an accurate mortising machine that saves time and money.

"HOW-TO" BOOKS

suggest what to make, tell how to make it — in clear words and pictures. Available from your nearby Delta dealer, as part of his complete "one-stop" service on power tools and accessories. See him, to get the most out of your power tools — take on new jobs — have more fun — make new profits!



DO MANY OTHER JOBS

Drill glass, slate, marble, paper. Mill, carve, surface, spin rivets, flute and reed turnings, cut disks, cut tenons, mix paint, do engine finishing, point dowel rods, polish and buff, etc.

TEAR OUT COUPON AND MAIL TODAY!

DELTA POWER TOOL DIVISION
 Rockwell Manufacturing Company
 802B E. Vienna Ave., Milwaukee 1, Wis.

Send me free catalogs and bulletins on the complete Delta line of tools and accessories.

Name.....
 Title.....
 Company.....
 Address.....
 City..... (.....) State.....

B-16



AMAZING...worn Connecting Rod Bearings Fouled this Valve!

Amazing, yes—but logical when you consider it. Normally, connecting rod bearings meter oil flow for proper engine lubrication. When bearings are worn, increased clearances let excess oil reach combustion chambers. It burns to carbon, fouling spark plugs, valves, pistons and rings. Moreover, one badly worn bearing can oil-starve other bearings until they fail, too! When the complaint is oil-pumping, check for worn bearings. Replace in sets with Genuine Federal-Mogul Bearings, engineered for the job of oil-control!

FEDERAL-MOGUL SERVICE

DETROIT 13, MICHIGAN

Division of Federal-Mogul Corporation



**Control Oil Pumping
where it starts...replace with
FEDERAL-MOGUL
OIL CONTROL BEARINGS**

plans further improvements. When better engines are available, you can unbolt the old ones, attach the new ones, and the change-over is complete.

The "Hornet" was designed around this power plant. The first machine was flown last spring and since then has piled up hundreds of flying hours. The Hiller organization tooled up for production, prepared the way for CAA licensing and was all ready to start sales this spring. Then the war postponed civilian production.

Here are the "Hornet's" specifications: fuselage length, 152 inches; tread, 60 inches; height, 80 inches; rotor blade, 23 feet long. The helicopter has an empty weight of 340 pounds, carries a pay load of two people plus 25 pounds of baggage, and has a range of 50 miles at 70 miles per hour. Its maximum speed is 85 miles per hour, it has a ceiling of 12,000 feet, and a rate of climb of 1200 feet per minute. At cruising speed its rotor makes some 520 revolutions per minute. No tail fan or other torque-compensating mechanism is required. The tail rudder is used for directional trim and is sloped so that it is affected by the rotor downdraft.

The rotor has a solid leading edge, consisting of an aluminum extrusion with a built-up magnesium trailing edge. The cockpit is walled in transparent Plexiglas and the fuselage itself is Fiberglas and plastic laminate.

I asked Stanley how long it would take for me to be checked out as a "Hornet" pilot and what troubles I could get into with the machine.

"Well," he said, with a twinkle, "it might take you, personally, a couple of years to learn how to fly this helicopter. Actually, a couple of hours instruction at most would teach the average person the rudiments of flying it. However, I don't think that the CAA will relax its present requirements for solo flight in any kind of aircraft. There's a lot more to flying than just learning to coordinate a couple of controls. You have to know flight patterns, something about weather, your responsibilities and a lot of other things.

"As for getting into trouble with the 'Hornet,' I can't see how you could hurt yourself unless you deliberately flew into a building or a power line. You can always slow down to a halt in the air and think things over. You can creep along at walking speed if you like, and you can set down on any clear patch of ground. You don't need an improved airport for this craft."

So, there's your personal helicopter. Hiller will deliver one to you just as soon as circumstances permit.

amazing new

SAFE

circular saw blade!



What the PTI "Cut Control" Blade Is:

Each PTI Saw Blade has only 8 teeth instead of the customary 100. These teeth are entirely different from the conventional saw tooth — they project only 20/1000" above the non-cutting edge. Thus the cut of each tooth is "controlled" by the non-cutting edge, in contrast to the ordinary saw blade where each tooth cuts right down to its base. This relatively simple alteration in design actually works miracles in the performance of the blade.



patent pending

CUT CONTROL

TESTED and APPROVED

The PTI Cut Control Saw Blade is the first and original blade of this type. (Patent Pending) Developed by one of the world's foremost saw makers — it has been thoroughly tested in leading laboratories and shops of both Europe and U.S.—with favorable reports in every instance. Letters from delighted users crowd our files:

O.M.W., Lima, Ohio: "Without question the finest saw blade I have ever seen! Makes sawing a pleasure. Here's my check for two more."

L.B.E., Winnipeg, Man., Canada: "Was unable to cause a kick-back with it."

R.E.O., Bainerd, Minn.: "Never saw a blade cut wood like this. Will never use any other blade."



Takes the DANGER out of circular sawing

Here is the greatest improvement in circular sawing — since the invention of the circular saw. It's the sensational new PTI Cut Control Saw Blade that brings long-needed safety and remarkable new efficiency to this important power tool. Never before has a saw blade been subjected to such gruelling, thorough tests, to such careful checking and re-checking by leading laboratories, government agencies, universities, and industrial concerns. And never before has a saw blade made such astounding records in safety and cutting efficiency. No other saw blade today can offer you so many exclusive advantages, including:

- 1 Complete Safety From Kick-backs" — Since the teeth are only 20/1000" high — they cannot grab the wood and throw it against the operator — eliminating one of the most serious causes of circular saw injuries.
- 2 Reduced Direct Injuries — Cut Control teeth do not drag the hand into the saw. The non-cutting edge acts as an effective stop to cuts and limits their depth.
- 3 Cut Chips — Not Sawdust — Unique cutting action produces chips. Easier to clean. Eliminates fire hazard of spontaneous combustion.
- 4 30% to 40% Power Saving — Fewer teeth mean fewer cuts

to achieve same results — hence less power consumption.

- 5 Longer Life Without Sharpening — When cutting off chips — the wedge action of the tooth does most of the work — which means less wear on the cutting edge of the teeth.
- 6 More Efficient Cutting — Each tooth is backed up better against body of blade. It is therefore more rigid, less likely to vibrate — and cuts more smoothly.
- 7 Quieter Running — Fewer teeth makes saw practically noiseless when running true.
- 8 Blade Does Not Crack — Blades are made of special Vanadium Steel. In addition — controlling of cut prevents overloading of teeth, a common cause of blade cracking.

ORDER TODAY

SATISFACTION GUARANTEED!
OR MONEY BACK!

Here are the prices and sizes, delivered, postpaid. All blades are combination rip and cross cut. In ordering, be sure to give the diameter and bore of the blade. Send check or money order or we will ship C.O.D.

7" diameter blade \$4.95
8" diameter blade \$5.90
10" diameter blade \$7.50
12" diameter blade \$9.40
14" diameter blade \$11.40
16" diameter blade \$14.40

(Prices on carbide tipped blades furnished on request.)



INCORPORATED

Dept. PM-2

401 Broadway, New York 13, New York

Gentlemen: Rush me the following units:

Quantity Blade Diameter Blade Bore

Please check:

Money order or check for \$_____ Send C.O.D.

Name _____

Address _____

City _____

Zone _____ State _____

new! 1951 ALLIED RADIO & TV CATALOG

→ free!

COMPLETE
UP-TO-DATE
•
EVERYTHING
IN RADIO & TV
AT LOWEST
PRICES!



212 PAGES
OF VALUES

Everything for
Experimenters, Builders,
Amateurs, Servicemen,
Engineers and Soundmen..

Save money on every Radio and TV need! Get the big 212-page 1951 ALLIED Catalog featuring the world's largest stocks of top-quality equipment at low, money-saving prices! See the latest TV releases, home radios, radio-phonos, Amateur equipment, P.A. systems and Hi-Fidelity Custom Sound, recorders, test instruments, builders' kits—plus thousands of parts, tools, books and diagrams. Get more for your money from the World's Largest Radio Supply House. Send today for your FREE 1951 ALLIED Catalog!



TV, HOME RADIOS
& RADIO-PHONOS



SERVICE SUPPLIES
BUILDERS' SUPPLIES



AMATEUR GEAR



P.A. SYSTEMS
RECORDERS

free
CATALOG
Send For It!

ALLIED RADIO

ALLIED RADIO CORP., Dept. 5-BB-1
833 W. Jackson Blvd., Chicago 7, Ill.

Rush FREE 212-Page Catalog No. 126

Name _____

Address _____

City _____ Zone _____ State _____

The Owners Report on the '51 Kaiser

(Continued from page 110)

and window leakage. An owner in Tacoma, Wash., prefaced his critical remarks by saying that he would definitely buy another Kaiser. He has a De Luxe model four-door sedan and has driven it 8000 miles in four months. His gas mileage in the city is 14 miles per gallon and in the country 18. (Both considerably lower than the poll average which was 18.5 for city and 21.9 for country.) He likes the maneuverability and wheelbase but finds the pickup at cruising speed is "not as much as I would expect for 110 horsepower." Then he warms up to his criticism: "The brake pedal is too close to the accelerator. The overdrive cutout switch should be mounted either for the left foot or steering-wheel operation. This would give smoother operation to change and wouldn't cause motor to load up and hit the rear end so hard. Kaiser used too many metal screws. They jar loose. A bolt now and then would help. Not enough attention is paid to the weatherproofing of the cars—trunk, windshield and doors leak."

On the other side of the ledger there is the man from St. Cloud, Minn., who reported the car's "vision is the best on market, I believe," and the mechanic from Green Bay, Wis., who said: "I've been a mechanic for 30 years and owned everything that was made and a few they are not making any more. I cannot think of a thing I dislike about the Kaiser."

An interesting figure in the survey shows that 44 percent of the '51 Kaiser owners who filled out the questionnaires were previous owners. Also, despite the widespread interest in V-type engines, both in the industry and among motorists in general, the survey shows only 32 percent preferring the V engine. In regard to the number of cylinders, the preference for six cylinders was twice as great as for eight, and four cylinders drew a blank.

A Minneapolis driver told of a 3000-mile trip on which he averaged 21.2 miles per gallon and used only two quarts of oil. At 85 miles per hour, he figured he got 18.9 miles per gallon and at 35 miles per hour, 26 miles per gallon. He found the car to be excellent on the road, but was bothered by the hand brake and reported the "appointments very ordinary." Another owner from Green Bay (Somebody must be boosting Kaisers there!) says: "Wonderfully designed automobile but not tied together very well. I have driven a dozen automobiles over 500,000 miles and like this one the best. It's fun to drive." A fellow in

(Continued to page 272)

CHANNELLOCK *Belongs*



Wherever
PLIERS ARE USED!



When Mom or the kids get in a fixin' mood you can bet they'll do a better job when Channellock pliers are handy. Channellocks are easy to use, simple to adjust and—well, darn good pliers. They are made by Champion DeArment who for nearly 3/4 of a century have been making and selling highest quality tools. The next time you're shopping for tools ask to see Channellock pliers. Heft 'em, use 'em, test 'em—then buy 'em. On almost every job requiring tools, you'll find a use for Channellock. And remember, Only Champion DeArment makes Channellock. Send for Catalog D15 Today.

CHAMPION DEARMENT TOOL CO. • Meadville, Pa.

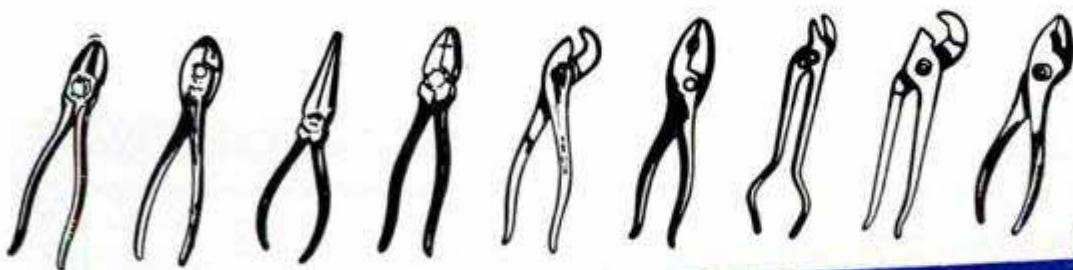

Channellock pliers are listed in the Yellow Pages of most Telephone Directories under "Tools"



Only CHAMPION DEARMENT...
makes **CHAN NEL LOCK**

CARTER



FUEL PUMPS

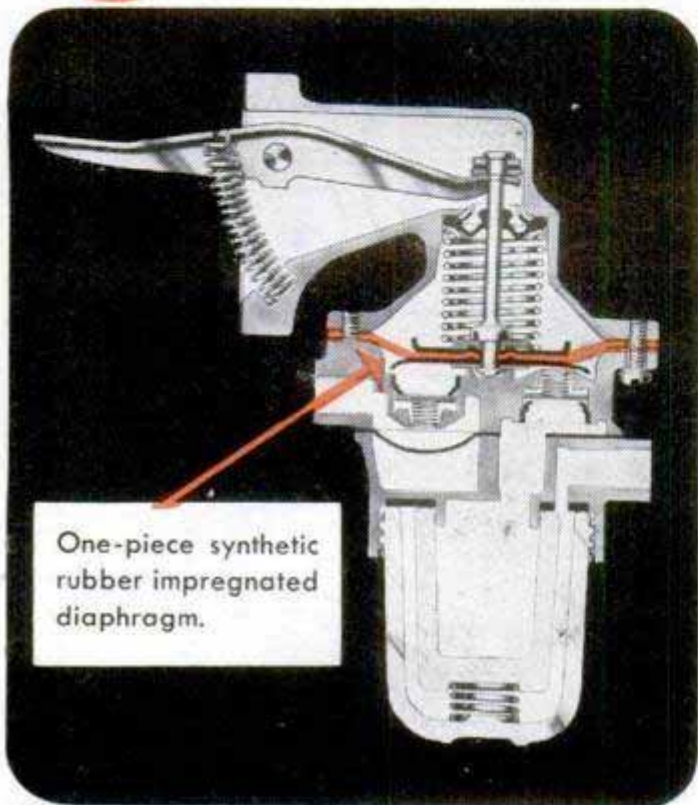

One-piece synthetic rubber impregnated diaphragm.

**Last Longer Because
They're Designed
Better -**

Look at the Diaphragm . . .

For a
**LIBERAL
TRADE-IN
ALLOWANCE**

on your old pump,
see your garage, car
dealer or service
station.

. . . This one-piece synthetic rubber impregnated unit is unharmed by gasoline and gasoline blends. It is built to operate under temperature extremes far in excess of those encountered in normal driving conditions.

CARTER CARBURETOR CORPORATION

St. Louis 7, Missouri

Division of American Car and Foundry Company



Fort Lewis, Wash., reports that he is proud of his '51 four-door sedan, but dislikes the glove compartment ("too many rattles") and adds that the trunk compartment is too flat to take ordinary luggage conveniently. He also found the master brake cylinder difficult to service.

A Louisiana driver with 10,000 miles on his De Luxe sedan gives one of the most glowing reports of any received. Everything about the Kaiser with him is tops and after the question in regard to dealer service he wrote: "Excellent!" In almost every case where an owner is completely sold on the car he reports good dealer service. On the other hand, a gloomy report on the car invariably includes the word "lousy" after the dealer service question. This was found not only in the Kaiser survey but also in the Nash Rambler poll taken last month. One owner who said his dealer service was "the poorest possible" wrote on the back of his questionnaire: "In all my life I have never seen such a poor excuse . . . for a dealer." He indicated that he will not buy another Kaiser. Despite the occasional loud squawks about dealers, 63 percent of the polled Kaiser owners reported service "good," 24 percent "average."

An Illinois farmer gave the car a good report and then added: "I don't want you to think that I am just putting on . . . the 1951 K is tops . . . Just take a ride and drive one." His only objection was to dust gathering in the trunk. Another man said, frankly, that he bought a Kaiser Traveler just for the bed. He sleeps there on weekend trips.

There were a few kicks about the ignition-key arrangement which makes it possible to remove the key without turning off the engine. One man left his engine running all day parked in front of his office.

Many owners commented on the car's low center of gravity and approved of the way it takes curves. One surprise of the survey was that 55 percent reported they would prefer NOT to have an automatic transmission.

Infrared Lamps Keep Chicks Warm

With infrared lamps as their only source of heat, baby chicks will thrive even in a refrigerated room 12 degrees below zero. Lamps were placed 19 inches above the ground in experiments at a new 20,000-chicken broiler house in Delaware and were raised as the baby chicks grew and required less heat. A thermostat regulated the heat. The new method eliminates firing and stoking of coal stoves, formerly needed, removes the danger of fire and insures a more consistent temperature.

The Most Practical Watch in the World!



HANDSOMELY STYLED 17 JEWELS!

WRIST ALARM

IMPORTED SWISS MOVEMENT with LUMINOUS DIAL

1995 PLUS 10% TAX

WITH METAL EXPANSION BAND OR LEATHER STRAP
Never before available at less than \$71.50



ALARM ON-OFF SWITCH FINGER-TIP CONTROL



REMINDS YOU OF APPOINTMENTS



AWAKENS YOU ON TIME



AMAZES & SURPRISES YOUR FRIENDS

The ideal business man's watch that serves double-duty at office or home. A guaranteed accurate fine timepiece that becomes a precision ALARM Watch when you set the dial for it. Merely set the alarm indicator to ring at the time you want—that's all—no complicated extras. This exclusive Gaylord Wrist Alarm features thin, smart chrome and stainless steel case; red sweep-second hand; choice of black or white face; single winding principle for both alarm bell and watch spring; leather or metal expansion band. It's neat, smart, wonderfully-convenient—handy just when you need its help, will be a great convenience to any man in ANY work.

INCREDIBLE ACCURACY

Guaranteed FOR ONE YEAR

Precision movement in the best Swiss craftsmanship; moisture and shock resistant; time-tested; alarm bell integral with movement.



GAYLORD

Dep't. PB-2 Fifth & Hamilton, Pittsburgh 6, Pa.

Please send me.....Wrist Alarm Watches @ 19.95 + 10% Tax (2.00) with Black Dial; White Dial; Wristband in Metal or Leather. I enclose Check, Money Order, Send COD. Money-Back Guarantee! PRINT NAME & ADDRESS IN MARGIN

\$600 BUILDS 4 ROOMS & BATH!

WHY PAY RENT?



For Six Hundred dollars and 30 days of your spare time you can build yourself this Beautiful Home.

Living room 10x15, Front bedroom 9x10, Back bedroom 10x11, Kitchen 8x10, Bath 5x7, Hall 3x4, Wind out steel Casement windows, Concrete block, stuccoed. \$1.00 brings you Step-by-Step Instructions, Blueprint & Material List.

L. H. FARROW, Dept. C Box 645 Columbus 16, Ohio

SAY YOU SAW IT IN POPULAR MECHANICS

NU-WAY HEAVY DUTY CUTTING UNIT with Timken Roller Bearings

PRICE

\$16.50

WHY PAY MORE



Build your own rotary type lawn or weed cutter.

Take the hard work out of weed cutting. Build yourself an up-to-date weed and lawn mower with the Nu-Way heavy duty unit.

Write for Free Circular—We Supply Cutting Unit Complete
TRACTOR-LITE MFG. CO., Spirit Lake, Iowa



The Right Tool for a Right Job
IN YOUR WORKSHOP
EMPIRE LEVELS



Get more value for less money! Make Your Choice an Empire Level

No. 151 Aluminum Level. Extremely accurate with adjustable-interchangeable vials. Has 2 levels, 2 plumbs, and a choice of 2 45° vials or 2 additional plumbs. Beautifully finished, easy to work with. A tool you can be proud to own.

18" ... \$6.40 24" ... \$6.80 28" ... \$7.80

Order EMPIRE Levels from your local dealer, or write for complete information.



EMPIRE LEVEL MFG. COMPANY

Dept. PM

10930 W. Potter Rd., Milwaukee 13, Wis.

Make \$20 to
\$30 a Week
**EXTRA
MONEY**



MACHINE SAW FILING PAYS UP to \$2 or \$3 an HOUR

Turn your spare time into CASH—sharpening saws with a Foley Automatic Saw Filer pays up to \$2 or \$3 an hour. You will find you can make \$20 to \$30 a week in your spare time as a starter.

You can work in your basement or garage—no experience necessary. "The first saw I sharpened with my Foley Filer came out 100%"—writes Clarence E. Parsons. No canvassing—"I advertised in our local paper and got in 93 saws"—says M. L. Thompson. The Foley is the only machine with which you can file all hand saws, also band saws and cross-cut circular saws.

SEND FOR FREE BOOK "INDEPENDENCE AFTER 40!"

Shows how you can get business from home owners, farmers, carpenters, schools, factories, etc. With a small investment, no overhead, no stock of goods to carry, you can get right into a cash business—and possibly later on develop into a full-time repair shop. Send coupon today for Free Book. No salesman will call.

"Each saw I filed got me six more and business has been picking up that way since a year ago. If it keeps up I will have to buy another Foley Saw Filer." — William C. Baldwin

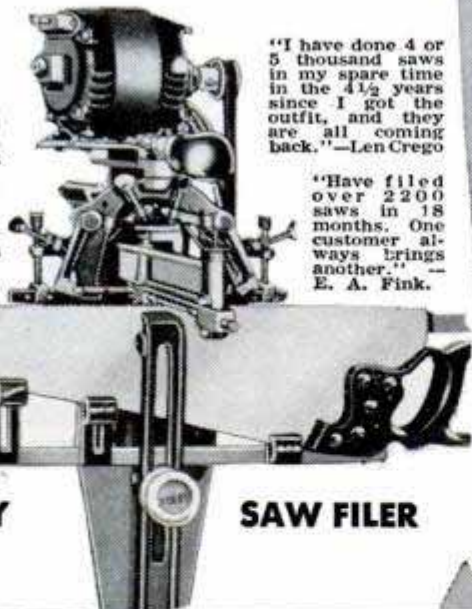

"I have done 4 or 5 thousand saws in my spare time in the 4½ years since I got the outfit, and they are all coming back." — Len Crego

"Have filed over 2200 saws in 18 months. One customer always brings another." — E. A. Fink.

FOLEY

SAW FILER



SEND COUPON FOR FREE BOOK

FOLEY MFG. CO.
216-1 Foley Bldg., Minneapolis 18, Minnesota
Send FREE BOOK — "Independence After 40."

Name _____
Address _____

Clymer Tests the Henry J

(Continued from page 112)

Few owners were dissatisfied, but about half of them wanted a rear-deck trunk lid, side-window vent panes, locks on both doors and better interior finishing. Most owners said that even though the upholstery is very plain, the seat springing and comfort compared with that in more expensive cars. Ninety percent said they had ample head and leg room. Three fourths said they bought the Henry J because they wanted a lighter, more economical car which would be easier to park and handle in traffic. Of the owners to whom I talked, more than three fourths declared they would buy a Henry J again.

1951 HENRY J

Condensed Specifications

ENGINE

	6-Cyl.	4-Cyl.
Type.....	L-head	L-head
Bore and stroke.....	3½" x 3½"	3½" x 4¾"
Displacement.....	161 cu. in.	134 cu. in.
Brake hp.....	80	68
Compression ratio.....	7.0 to 1	7.0 to 1
Transmission.....	3-speed conv. (O.D. optional)	3-speed conv. (O.D. optional)

GENERAL

Weight—2448 lbs. Wheelbase—100 in. Tread—front, 54 in.; rear, 54 in. Height—59½ in. Overall width—70 in. Length—174½ in. Tires 5.90 x 15. Recommended pressure—24 lbs. Road clearance—7 in. Turning radius—17 ft. 6 in. Steering wheel, lock-to-lock, 4½ turns. Steering ratio—18.2 to 1.

CAPACITIES

Oil—6-cyl., 5 qts.; 4-cyl., 4 qts. Water—6-cyl., 10 qts.; 4-cyl., 11¾ qts. Gasoline—13 gallons.

Here are some favorable comments of Henry J owners:

"Handles well, easy to park, economical. It is too high priced, but I sure save on gas and oil."

"The car has amazing power and top speed. Surprises everyone who rides with me. Good in mountains and on sharp curves. Brakes are fine. I get 25 miles per gallon in mountain driving."

"I like the Henry J for its vision, steering, brakes and economy."

"The Henry J, while overpriced like most cars today, serves my needs better than any car I ever owned. As a salesman, the space for samples is very useful."

"I bought the Henry J for my wife, but now I let her drive the big car, because the Henry is so easy to park and maneuver

(Continued to page 276)

Take a Tip
From American Airlines!

USE DEPENDABLE

CHAMPION

Spark Plugs

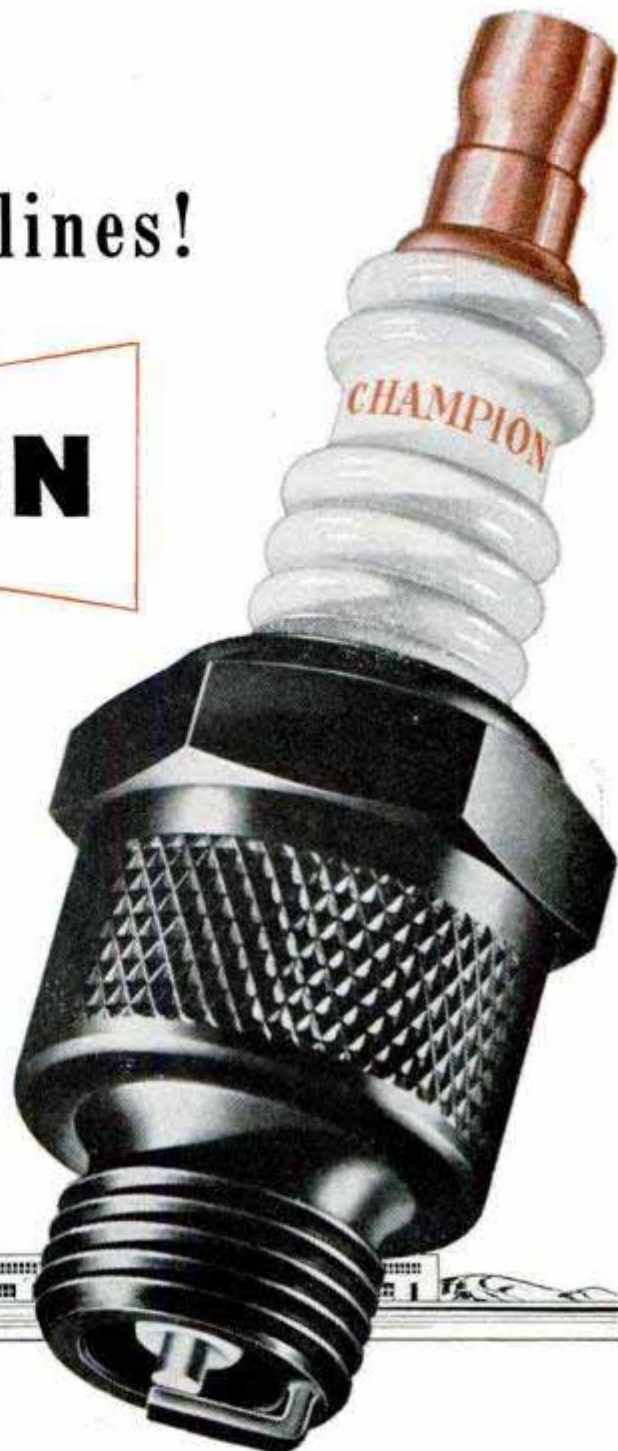

BE A CHAMPION DRIVER

... Good Spark Plugs are the Key to More Power!



Airline pilots know that the ability to get maximum engine power at a given moment is the greatest single safety factor they have. That's why 95% of the airlines fly with Champions!



Maximum engine power for passing is also a safety factor in driving. If your car lacks power, take American Airlines' word for it and install new Champion Spark Plugs.



"AMERICAN AIRLINES requires spark plugs that give maximum power, economy and dependability. Naturally, then, dependable Champion Spark Plugs are the approved standard for our fleet."

(signed) M. G. BEARD
Chief Engineer
American Airlines

CHAMPION SPARK PLUG COMPANY, TOLEDO 1, OHIO

Listen to the CHAMPION ROLL CALL . . . Harry Wisner's fast sportscast every Friday night over the ABC network



Handy Hank says:

"Every man's a handyman with PLASTIC WOOD"

Reset loose drawer pulls-

Replaces splintered wood . . . makes loose screws firm!



Seal drafty cracks-

Fills openings easily . . . dries tight and hard! Resists weather!

Repair loose tiles-

Holds tiles firm on wall! Easy!



Also useful in filling cracks in floors, nail and screw holes, repairing broken toys. *Handles like putty . . . hardens into wood!*

PLASTIC WOOD
A CELLULOSE FIBRE FILLER

IN CANS OR TUBES



WEATHER RESISTANT

through traffic in downtown Los Angeles. I like it—all but the interior."

"Climbs a hill near my home in high gear faster than any car I've owned. It is like a jack rabbit. Should be better finished, but performance is wonderful!"

"Henry J is snappy, comfortable, a pleasure to drive. It deserves better appointments, for it is really a fine job."

And here are some comments not so favorable:

"Far overpriced, body too light, rattles, cheap interior."

"In spite of a few bugs such as poor assembly on the first cars, it has many good features. Tires should be popular 6.00 x 16 size, window leaks water, needs glove compartment and window vents. Needs better inside upholstery and seat material."

"Disappointed in my Henry J. Too 'cheesy' in appearance. Partially offset by its economy and performance, which are surprising for a light car."

"In spite of lightness and lack of needed essentials, the Henry J does perform and gives no trouble. Body too light, choppy rear end due to short wheelbase."

"Although many things could be improved, appearance-wise, the Henry J is O.K. I have a lot of fun beating bigger cars on the hills and on the highway. I can do 95 in overdrive."

Voice Stopper

When speaking interrupts music, a new device turns off the radio until about one minute after the voice stops. Then it turns it on again. The unit works because of a fundamental difference between music and speech. Speech is full of extremely short pauses, like the one between "s" and "t" in "stay." They are much more frequent and abrupt than they are in music. What the instrument does is to "listen" for these pauses, remember how many pauses there were during the preceding few seconds, and then make a "decision."

Garage-Door Operator

Simple to install and operate, a magnetic garage-door opener goes to work when you press a button on the dashboard of your car. The button energizes a magnetic unit underneath the car and this, in turn, actuates a magnetic switch buried in the driveway. The switch not only opens the motor-operated door, but also turns on the garage and yard lights. When the door is closed, the lights go off automatically. The actuating mechanism in the driveway uses only low-voltage wiring, thus making the installation a simple matter.

Here is something you don't know about your own automobile

Let's say you're driving your car on a level road at 40 miles per hour. Do you know that *half* the power generated by your motor never reaches the rear wheels; doesn't help your car go farther or faster or climb a steeper hill?

And do you know why? Because automotive engineers have proved that 50% of that motor's power is used to overcome *friction*.

Therefore any lubricating oil which further *reduces* this internal friction can't help but deliver the same power with *less* gasoline.

That's exactly what Macmillan Ring-Free Motor Oil does. And we don't just think it's true — we *know* it's true. Here's how we proved it beyond question:

There is a machine called the Dynamometer. It is a scientific way to measure the power an engine delivers to the rear wheels. Cars of all makes, models and ages — cars that had been using *every* nationally known brand of motor oil — were used in this nation-wide test. Hundreds and hundreds of them! And what was the result?

The same thing happened every time: When the oil in these cars was changed

to Macmillan, *the same power was developed with an average of 8% less gasoline.*

That means, at an average price of 25¢ per gallon, you can save 2¢ on every gallon of *gas* — simply by changing your motor *oil*.

What's more, 1094 certified road tests proved that, when the *oil* in an average car is changed to Macmillan, you get 1.3 more miles to the gallon of *gasoline*.

You can't laugh off proof like that — proof that makes dollars-and-sense! Especially when, on top of all this, Macmillan Oil actually *removes carbon from your motor* — cleans your motor as you drive.

Ask for this fine motor oil at any one of the more than 35,000 dealers in America where you see the sign of the big red "M." It means Money in your pocket, Mileage in your car.



R. Macmillan
President

MACMILLAN PETROLEUM CORPORATION
530 W. 6TH STREET, LOS ANGELES
50 W. 50TH, NEW YORK • 624 S. MICHIGAN, CHICAGO

BUILD YOUR OWN TILTING ARBOR SAW!

Exclusive GIL-BILT Build-It-Yourself Features

- No machining—build easily with hand tools only
- No blueprint reading—step-by-step pictorial plans, full scale patterns, actual photographs
- Sturdy wood, aluminum, and steel construction
- Capacity and performance of commercial saws selling for \$60 and up

SAVE
\$50
OR MORE

GIL-BILT 10-INCH TILTING ARBOR SAW



- 27x28 in. table, 13 1/2 in. capacity in front of blade
- 10 in. blade cuts 3 1/4 in. deep, tilts full 45 degrees
- Floor model 34" high, table always stays level

- New Departure ball bearing arbor, 3/4" precision shaft turned down for 5/8" bore blades, alum. housing, shipped ready to run
- Jackscrew and 4 1/2 in. dia. handwheel lowers and raises blade
- Cast aluminum miter gauge and self-aligning rip fence guide

GIL-BILT Metal Parts Kit includes Plans, ball bearing arbor, miter gauge and bar, rip fence guide, dado insert, lock knobs, jack screw mechanism and handwheel, and all other metal parts (less blade).....\$20.95
Same Kit with 10" Combination Blade \$24.90
Same Kit with 8" Combination Blade \$23.90

GIL-BILT 8-INCH TILTING TABLE SAW

- 21x27 in. table tilts full 45 degrees, 13 in. capacity in front of blade
- 8 in. blade cuts from 0 to 2 1/2 inches
- New Departure ball bearing arbor, 5/8" precision shaft turned down for 1/2" bore blades, alum. housing, ready to run
- Cast aluminum miter gauge and self-aligning rip fence guide (same as above)



GIL-BILT Metal Parts Kit includes Plans, Ball Bearing Arbor, Miter Gauge and Bar, Rip Fence Guide, Machined Lock Knobs, Tilt Support Segments and All Other Metal Parts (less blade).....\$15.95
Same Kit with 8" Combination Blade.....\$18.90

GIL-BILT 12-INCH BAND SAW



- Cuts to center of 24 inch circle
- Handles stock up to 6 inch thick
- 18x18 inch table tilts 45 degrees
- Lower wheel and drive pulley runs on sealed New Departure Ball Bearings; Upper wheel runs on two 5/8" bore Oillite Bronze bearings.

- Upper wheel tension and tilt mechanism of cast aluminum, completely assembled.
- Upper and lower blade guides. Each has ball thrust bearing, self-lub bronze jaws
- Rigid cast aluminum wheels fully machined ready-to-install. Heavy rubber tires.
- Uses standard 78 inch blades up to 3/4 in. wide.
- Fully enclosed mechanism for utmost safety.

GIL-BILT Metal Parts Kit includes Plans, rubber tires, aluminum wheels, 1/4 in. blade, ball bearing spindle, tilt mechanism, blade guides, table tilt segments, and all other metal parts.....\$20.95

GIL-BILT BELT SANDER

- 84 sq. in. sanding surface. Over 4 times the effective area of a 10 in. disc sander.
- Belt operates in either vertical or horizontal position, does all sanding operations.
- Driver drum and pulley turn on sealed New Departure ball bearings; tension drum turns on Chrysler Oillite bronze bearings.
- Spindle and tension mechanisms of cast aluminum, completely machined and assembled.
- Belt travels 1800 ft. per min. Over a MILE of straight sanding action every three minutes. Saves more "elbow grease" than any other tool.



GIL-BILT Metal Parts Kit includes Plans, ball bearing spindle, 4 in. driver drum, 3 in. tension drum, tension mechanism, table tilt segments, rubber tires, cloth sanding belt, and all other metal parts.....\$16.95

NO DEALERS—ONE LOW FACTORY PRICE! Return in 10 days for refund of purchase price if not satisfied. Prices include postage within 600 miles. Over 600 miles add 5%. Send cash, check, or money order for parts kit, or send \$1.00 for Step-by-Step Plans and order kit later less cost of Plans. Plans sent postpaid anywhere in the world.

GILLIOM POWER TOOLS

P.O. Box 1-PB, Lambert Field, St. Louis 21, Missouri

COMPLETE
PLANS
only
\$1.00
EACH

CONVERT HAND MOWERS to POWER MOWERS

Takes less than 3 hours

The Handy-Dandy Lawn Mower Kit fits any hand mower from the 16 to the 20 inch size. Complete with all necessary parts. Kits can be purchased separately, complete with engines or complete with Pennsylvania mower.



Also manufacturers of complete power mowers and garden cultivators.

DEALERS WANTED

LE CLAIRE MFG. CO., Le Claire, Iowa, Dept. PM

WONDERFUL WAY to remove paint



Here's a really EASY way to remove any paint, enamel, varnish, shellac or lacquer from any kind of surface. Just apply

WONDER-PASTE

with a paint brush, and the thickest, most time-hardened finish quickly turns to a soft sludge. Then watch how easily it peels off with a putty knife! The surface is left so clean, no tedious scraping or sanding is needed. Safe for wood, metal, fabric or your hands. Try WONDER-PASTE—it works wonders on the toughest finish.

Write to us for Wonder-Paste leaflet
At paint and hardware dealers everywhere

Wilson-Imperial Company, 119 Chestnut Street, Newark 5, N. J.

CAN YOU MAKE \$100 A DAY?

DEMONSTRATION SELLS GARDEN TRACTORS

Spare time operators make up to \$100 a day demonstrating and selling UNIVERSAL GARDEN TRACTORS. Some make money doing garden work. Introduced by Fairbanks-Morse; highest quality UNIVERSAL TRACTORS have been nationally known for years. Full line of implements and parts available for repeat business. If you have the spare time and ability to make demonstrations...



write for factory prices, full details on direct factory supply and a demonstrator. Write Don Hirschberger, President, today!

UNIVERSAL MACHINERY CORP.
1815 N. W. NORTHRUP • PORTLAND 9, OREGON

WANT \$10,000?

Earn the govern- Super Sensitive P.R.I. ment bonus. Locate Uranium with a GEIGER COUNTER

Also get one for Atom Bomb Defense!
Find gold, silver, and other valuable ores with a P.R.I. Treasure Locator. World's finest instruments. FREE catalog. Write!



PRECISION RADIATION INSTRUMENTS, Inc. Dealer Inquiries Invited
4113PM W. Jefferson, Los Angeles 16, Cal.

WOOD FASTENERS



Don't split Wood—Use "CHEVRONS" hardened steel FASTENER. Draws wood together eliminating doweling, mortising, nailing. Hammer in—"Fresto"—a firm joint! No wobble, no distortion. Lends artistic appearance. Easily countersunk and concealed with wood fillers. For hard and soft woods. For mill workers, artisans, HOME CRAFTSMEN, for making and repairing screens, doors, sash, frames, cabinets, furniture, moulding, 3/8" depth, for thickness wood up to 1 1/2". At your dealer or send only \$1.00 NOW for GIANT box, postpaid. Money back if not delighted.

E. B. PACKARD CO., Inc.
Dept. M2 139 Cedar St. New York 6, N. Y.

Light!



800 ft. spotlight—brilliant floodlight—from one electric lantern, Delta POWERlite! Convenient. Safe. Economical. Uses one 6-volt dry battery. Buy at hardware, sport, or electrical stores. Try one!

DELTA ELECTRIC CO., MARION, IND.
Delta POWERlite 2-LITE ELECTRIC LANTERN

MARVEL MYSTERY OIL and INVERSE OILER

THIS GREAT COMBINATION KEEPS PERFORMANCE UP
RING, PISTON AND VALVE WEAR DOWN

MARVEL INVERSE OILER—Feeds Marvel Mystery Oil to critical upper cylinder area in proportion to acceleration. Visible supply in 1 qt. glass container functions on the exclusive Marvel principle.

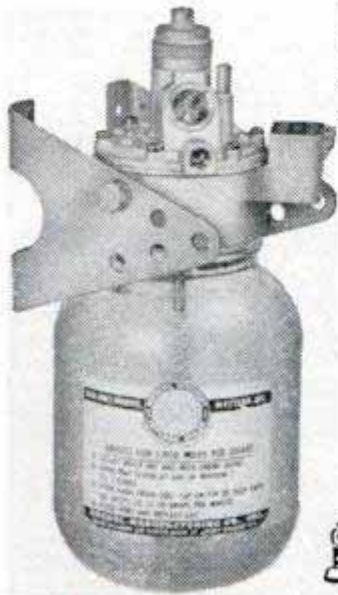

UNEQUALED
FOR NEW CAR
BREAK-IN!

MARVEL MYSTERY OIL—Protects rings, valves and pistons and produces highly-polished, wear-resistant finish on cylinder wall and parts. Can be used in Marvel oiler, crank case or gas tank.



Have your car Marvelized at your dealer today, or write for free information. Dept. 114

EMEROL MANUFACTURING CO., INC.
242 West 69th Street, New York 23, N. Y.

ANNOUNCING NOT ONE—NOT 12—BUT 40 DIFFERENT CUTS!

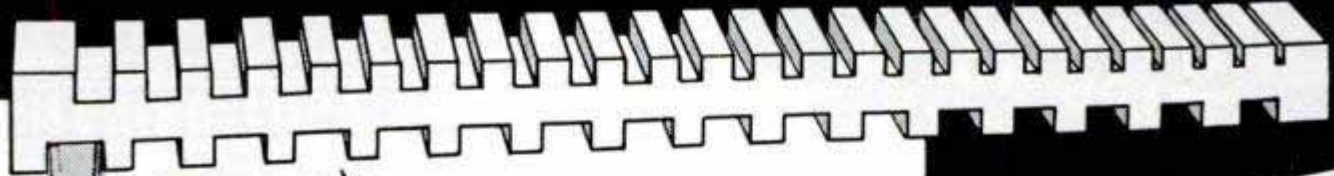

NEW *Warren*
DADO SAWING WASHERS

Multiply the uses of your circular saw with sensationally improved Warren Dado Sawing Washers! Make smooth, parallel dados or grooves in 40 different widths with your present saw blade! Dial the width with Micromatic adjustment—in 15 seconds you're making the cut. Four simple washers—precision-made in matched sets—no vibration, no gadgets to get out of alignment. No burning, chewing—no sanding. Four sizes 1/2", 3/8", 3/4", 1"—fit all popular saw arbors. See your dealer or send coupon today—ABSOLUTELY GUARANTEED!



ONLY \$4.95 per set

NO INCREASE IN PRICE!

WARREN DADO SAWING WASHERS CO., Dept. 22.
70 Medbury, Detroit 2, Mich.

Enclosed (check or M.O.) \$4.95 for one set of NEW Warren Washers. My arbor size is 1/2" 3/8"
 3/4" 1". Send free booklet. (PLEASE PRINT)

Name _____

Address _____

City _____ State _____

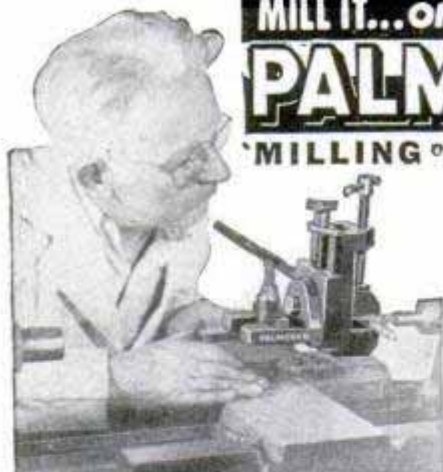

MILL IT... ON YOUR LATHE!

PALMGREN

MILLING ATTACHMENT

3 SIZES

No. 250 Illustrated

2 1/2" JAW Only

\$24.75

CONVERT LATHE IN 10 SECONDS

Now you can Mill, Slot, Grind, Groove, Square Shafts, Saw at Angles, Recess and many other important jobs. SAVE TIME and MONEY! Why send work out or use costly methods when a PALMGREN MILLING ATTACHMENT will solve your problem.

Precision built, it has accurate graduations for rotary angle adjustments, also graduated vertical feed screw. Fits South Bend, Atlas, Craftsman, Logan, Sheldon and all other lathes. Thousands now in use in small and large machine shops, repair shops, railroads, schools, home work shops, etc. ORDER SIZE NEEDED TODAY!—it will quickly pay for itself.

IMMEDIATE DELIVERY

Nos.	Width Jaws	Depth Jaws	Jaws Open	Weight Pounds	Fits Tool Post	Price F.O.B. Factory
150	1 1/2"	1"	1 5/8"	6 1/2	1" Dia.	\$18.75
250	2 1/2"	1-7/16"	2 1/2"	11	1 1/4" Dia.	24.75
400	4"	1 1/2"	4"	25	2" Dia.	39.75

Order From Your Dealer or Jobber: Write for Circular No. 353 Mfrs. of PALMGREN PRODUCTS Since 1915

CHICAGO TOOL and ENGINEERING CO.

8365 South Chicago Ave. Chicago 17, Ill.

JUST A FEW OPERATIONS YOU CAN DO ON YOUR LATHE!

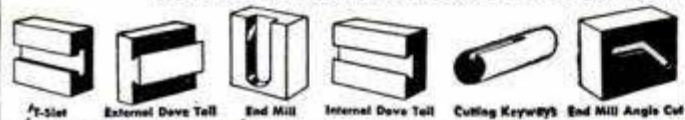

T-Slot External Doves Tail End Mill Internal Doves Tail Cutting Keyways End Mill Angle Cut

Send for this BIG NEW Hunt's WOODWORKERS CATALOG NO. 18

NEW LOW PRICES

ONLY 15c

Offers greatest selection of fine domestic and imported woods—and hundreds of woodworkers items at bargain prices!

You'll save time and money with this big, new catalog. Contains everything wood craftsman needs. Shows 32 rare and fancy woods in color...43 veneer designs...275 scroll patterns...multicolor inlays, overlays, bandings...all kinds of tools, machinery, cabinet hardware, ornaments, mouldings...and pages of valuable tips, ideas, information, instruction. Send for your copy NOW. Only 15c—refundable on your first order.



- 144 PAGES
- QUICK DELIVERY
- on maple, poplar, oak, mahogany, red cedar, cherry, walnut, and many others—all properly seasoned and kiln dried.

MAIL THIS COUPON—TODAY!

CRAFTSMAN WOOD SERVICE CO.

2729 S. Mary St., Dept. A2
Chicago 8, Illinois

Send me the big, new, money-saving Catalog No. 18. Enclosed is 15c—refundable on my first order.

Name _____
Address _____
City _____ Zone _____ State _____

PARTS FOR MILITARY TRUCKS

At A Savings New FREE Catalog
For Jeep, Dodge, Chev., G.M.C., Studebaker—4x4 - 6x6. Drive

Brand New — Not War Surplus — Complete
JEEP TOPS and SIDE CURTAINS
Fits all Military Jeeps. Also adaptable to some Civilian Jeeps. Waterproof O.D... **\$59.50**

TRAILER AXLE
Heavy duty trailer axle suitable for many types of trailer construction. Also excellent for building of heavy farm trailers and wagons. It is a 12,000 lb. capacity square type straight trailer axle complete with Timken roller bearings, hubs, and 6 hole 750 x 20 Budd Wheels. Without brakes. Axle is 2 inches square and 69 inches between wheel mounting flanges. Std. width.

With Single Wheels. \$59.50 With Dual Wheels. \$69.50
Hundreds of Other Truck & Jeep Parts and Supplies
All prices quoted good 30 days FOB, Kansas City
25% DEPOSIT REQUIRED ON ALL ORDERS

American AUTO PARTS CO. INC.
1830 LOCUST—DEPT. PM
KANSAS CITY, MISSOURI

NEW POWER AUGER BIT

Entirely NEW design. Drills fast and perfectly in any wood. Six sizes, from 3/8" to 1" will fit any 1/4" electric drill or press. Knots and nails won't damage. Keen hardened cutting edges. Hexagon shank can't slip in chuck.
Sizes 3/8", \$1.00; 1/2", \$1.05; 5/8", \$1.10; 3/4", \$1.15; 7/8", \$1.20; 1", \$1.25. Set is \$6.50. Order set of six and save.
Money back guarantee. Cash with order. We pay the postage.

BARCLAY COMPANY, P. O. Box 883, Plainfield 2, N.J.

Say You Saw It in Popular Mechanics

LIQUID MARBLE COMPOSITION FLOORS FLEXIBLE MOLDS
MOLD novelties, Statu-
Mold, Brush, Trowel, Spray It! Art Goods in Flex-
ible Plastic Molds; 5c
material makes \$1 seller. Make Marbleized floors,
Tile Walls. Colorful, glossy, amazing! Easily learned;
start in garage or basement. Particulars free.
MARBLEIZING SERVICE, Dept. 10-F, Edwardsville, Ill.

NONE BETTER! SUPER DRILL GRINDER

Sharpens round shank drills from 3/32" to 1/2" in diameter, up to 6" long. Grinds old drills like new in 4 different point angles, using hand or power grinding wheels. Money-back guarantee.
Price only \$2.95
At Dealers or Postpaid
CRANDALL MFG. CO. 1512 W. Slauson, Dept. FA-55, Los Angeles 34, Calif.

Auto Spark Intensifier Gets ROCKET Performance

MORE POWER **MORE SPEED**
BETTER MILEAGE **QUICKER STARTING**
The ELECTRONIC SPARK INTENSIFIER is an efficient, scientifically developed automotive device which can be easily installed in the center hole of the distributor cap of all autos, trucks and tractors in sixty seconds. By boosting the high voltage current passing through the distributor, it gives a "hotter spark" permitting a wider spark gap... thus reducing "misfiring", ring and cylinder wear and allowing all-around better performance. FREE TRIAL, send \$2.00 cash, check or money order... if not fully satisfied after 10 day trial, return for immediate refund.
ELECTRONIC DEVELOPMENT CO. DEPT. PM-2
LOS ANGELES 34, CALIF.



QUICK-ON, STAY-ON, SPEED NUTS®
NOW IN HANDY TINKER KIT

SPEED NUTS—famous throughout industry—now ready for home use. Ideal for repairing or attaching sheet metal parts on toys, appliances, etc. Kit contains over 100 parts—10 popular size nuts and matching screws. Replace threaded nuts and lock washers this fast, sure way. Tinnerman Products, Inc., Dept. 13 — Cleveland 1, Ohio.

ONLY \$1.00
 Including Postage
CASH or CHECK ONLY

tough
as they come!



FAMOUS
Snap-on Vacuum Grip
pliers

● Pick any Snap-on Vacuum Grip Pliers and you're set for years of faithful service. The way these professional pliers are designed, hammer-forged, oil-tempered, finished, inspected and tested, has just one purpose . . . to make them the finest pliers a man can buy. They handle better. They grip, twist, bend or cut better. They don't slip, in your hand or on the work. They last longer, because close-grained strength is forged and tempered into them. They're tougher.

31 types and sizes
to choose from

Heavy-Duty Gripping Pliers ● Combination Pliers ● Lineman Pliers ● Diagonal and End Cutters ● Pin and Needle-Nose Pliers ● Midget Pliers ● Duck-Bill and Ignition Pliers ● Brake Spring, Brake Key, Battery, Water Pump, Snap-Ring and Cotter-Pin Pliers ● Pliers in sets, in leatherette kits, varied sizes. If you are a user of quality tools, send for the free, 104-page Snap-on catalog.

Not sold in stores. Buy from your local Snap-on man or order from factory.



SNAP-ON TOOLS CORPORATION
 8062-B 28th Avenue
 Kenosha, Wisconsin



Make Money
 SELLING
 Eshelman
 Tractors
 and DOING
 GARDEN
 WORK

RAKES
 SEEDS
 CULTIVATES
 HARROWS
 HAULS
 SPRAYS
 SAWS
 DOZER
 MOWS
 CUTS
 ROLLS
 PLOWS

ESHELMAN FOR BETTER
LAWNS
 and **GARDENS**
 also **POWER MOWERS**
 and **RIDING TRACTORS**
 Women can operate it.



As low as
\$95
 Plus tools

Free Catalog, Write
ESHELMAN CO.,
 Dept. 127
 119 Light St., Balto. 2, Md.

SPARE TIME at home
SEWING
MACHINE
BUSINESS

HANG OUT YOUR SHINGLE

WRITE YOUR OWN PAY CHECK. YOU PROFIT FROM MY 19 YEARS EXPERIENCE.

EASY—Hundreds of our men making big money. I show you how to Repair, Rebuild, Electrify, Trade, Rent and Sell at big profits. Motor Kits, New Machines, and Supplies wholesale. FREE details.

TAYLOR SERVICE CO., Hamilton PM-2, Ohio

WAR SURPLUS BARGAINS



GENERATORS 115V-AC

FOR AUXILIARY LIGHT PLANTS

NOW . . . here's the buy of the year. Brand new Eclipse Generators in the original box

These generators have an AC output of 115 volts, 10.4 amps, 1200 watts, single phase, 800 cycles at 2400 R.P.M. They also have a DC output of 28.6 volts, 60 amps. The unit has a spline drive shaft and is self excited. It will serve as a dependable 115 V.-AC auxiliary light plant when driven by a gasoline engine for farms, cottages, flood lighting, trailers, boats, or wherever power is not readily accessible. Shipping wt. 55 lbs. Govt. cost more than 10 times selling price. F.O.B. Pasadena

ONLY
\$19.95

BRAND NEW POLE CLIMBERS

Buckingham pole climbers in their original package. (Without Straps) **ONLY \$2.95 PER PAIR**



LINEMAN'S TOOL & SAFETY BELT

Brand new web-type belts in their original box. **SPECIAL \$3.95**

C and H Sales Company

BOX 356-5 EAST PASADENA STATION • PASADENA 8, CALIFORNIA

A complete shop in one precision machine!

The IDEAL LAWNMOWER SHARPENER

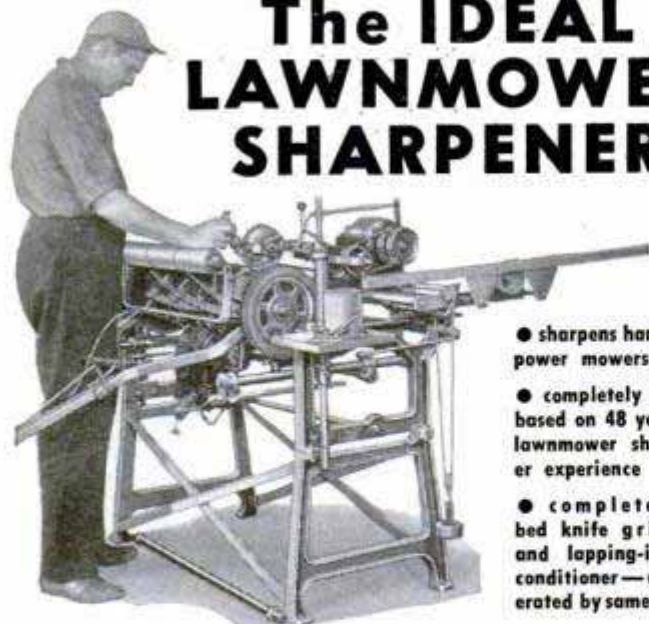

- sharpens hand and power mowers
- completely new—based on 48 years of lawnmower sharpener experience
- complete with bed knife grinder and lapping-in Reconditioner—all operated by same motor

You can do precision lawnmower sharpening faster and easier than ever before on the Model 300 Ideal Sharpener. No disassembling needed, place the entire mower in the machine. You can make more money and do better work with an Ideal. Get all the facts, compare, no other sharpener offers as much as the Model 300 Ideal.

Write Today For Free Catalog

THE FATE-ROOT-HEATH COMPANY
DEPT. H-3, PLYMOUTH, OHIO

AIRCRAFT INVENTION

ROLLS YOUR CAR
INTO THE AIR

LIFTS AND LIFTS—

There is no other automobile jack like it. This Saginaw super-jack literally rolls a car into the air. Ball-bearings, rolling between the raceway-shaped threads, reduce effort through increased efficiency—give you remarkable lifting power.

EXTRA SENSIBLE—

There's common sense in buying a Saginaw jack. Added to safety and ease of operation, there is real economy in a jack built to last for years. One good jack is worth more—costs less—than several poor ones.

GET YOURS NOW—

See your nearest United Motors service station.

UNITED MOTORS SERVICE, DEPT. S-31
General Motors Building, Detroit 2, Michigan
Send me more information about the new Saginaw jack and where I can buy it.



SAGINAW Recirculating-Ball BUMPER JACK

LASTS AND LASTS—

Tested and proved, this exclusive principle actuated bomb bay doors and wing flaps in thousands of warplanes. The heavy base is permanently attached—can't come loose. The rugged steel construction is built to outlast your car.

EXTRA SAFE—

Won't slip, won't spin, no fluid to leak, no notches to wear. Recirculating balls hold your car where you want it. No kneeling or stretching to prop it under your car. It fits every bumper. Safety like this can mean more than money to you.

AMAZING NEW

WOOD-TURNING TOOLS!

Outlasts Steel
Up to 50 to 1!



SHARPEN ONCE IN 12-YEARS!
(UNDER NORMAL USE)

These remarkable tools tipped with TUNGSTEN CARBIDE will astound you with their performance. They work FREE HAND equally well in wood, plastic or soft metals—and at the same time hold their razor-like edge almost indefinitely. Tests show that they will turn wood or plastic for days and days CONTINUOUSLY without showing any signs of dulling. They are the finest tools available at any price. Beautifully finished 5" blade—flush ground, polished tip—finest brass tube ferrule—9" hardwood handle—over all length 14"—25 tools to choose from: round & square nose from 1/8" to 1/2"; 1/8" and 3/16 cut off; 1/2"x30° skew, spear, r. & l. skewers, turning and parting. Amazingly Low Prices! Write at once for free literature.

JOHNS MFG. CO., DUNELLEN 4, N. J.

JITTERBUG • CATCHES MORE FISH

The old favorite. Noisy surface bait. World's best hooker—day or night. Gurgling, paddling action of the double-lobed lip makes fish strike hard. At your dealer 5/8 oz. or 3/8 oz. \$1.25. Musky size \$2.00.



FRED ARBOGAST & Co., Inc., 2242 W. North St., Akron 3, Ohio

FREE WRITE TODAY FOR BIG FREE 1951 ARBOGAST
COLOR CATALOG—FULL OF PICTURES OF CATCHES

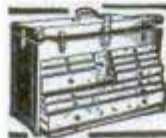

Gerstner TOOL CHESTS

Machinists — Toolmakers — Don't worry about your good tools. Keep them safely in a GERSTNER Chest. Free Catalog.

GERSTNER TOOL CHESTS

451 Columbia St. Dayton 7, Ohio



Only
\$19.75
Com-
plete

\$ Free Course! Big Profits! \$ Flocks & Sandblasts

Dual Purpose Spray Gun! Uses only 25 lbs. Air Pressure

• Thousands of uses in Home, Shop, Industry: Makes Auto Interiors Clean & New, Lines drawers, Marproofs lamp bases, Refinishes any object. All in colorful Flock. Etch & Frost windows, glassware, etc. Removes Paint & Rust from Autos, Tools. Guaranteed! Send \$19.75 or write for free information. Flocking supplies!

BLASTO SPRAY GUN MFG.

Dept. PM-2, 7007 Haas Avenue, Los Angeles 47, Calif.

BATTERIES!—START

—a factory at home and re-cast junk batteries into new; latest achievement. We supply complete instructions and everything needed. Big Profits!

BATTERY LABORATORIES, Dept. PM, Minneapolis 4, Minn.



FILE your own SAWS... easy!



A SPEEDCOR TOOL!

Do expert saw filing without experience. Keep your hand saws extra sharp, true-cutting. Easy to use. Money back guarantee. Cash COMPLETE with order, prepaid. (COD \$2.95 postage extra.) WITH FILE

THE SPEED CORP. PM-2

512 N.E. 73 Ave., Portland, Oregon

Safer Night Driving

When Visibility Is Low



Don't take chances. Luma-Rim, the red circle, reflects light from all angles, throwing off bright red glow. Colorfast, made from finest reflective material. Precision cut. Easy to apply. Lasts for years.

Be sure to state if for 15 or 16 inch rims. Postage prepaid, per set (for 4 wheels) ONLY \$2.95

LUMA-RIM Corporation

Pacific Bldg.

Oakland 12, Calif.

*See article page 98 December 1950 Popular Mechanics

Sale! WAR SURPLUS BARGAINS Sale!

HEATING SPECIALS! HEAT CONTROL



Made by Minneapolis-Honeywell—a name known for the best in controls. 1000 watts—115 to 220 volts. Element length 10 ft. Range 70° to 212° Fahrenheit. Control fans, motors, furnaces. This control makes an ideal automatic combination when hooked up to the heat boosters below! List price \$16.00. Your price \$4.95

HEAT BOOSTERS



Fits any 8", 9", 10" furnace pipe. 1500 RPM motor with 6" cord. Mounting frame, 7" blade. Motor 110 volt 60 cycle 1550 RPM. Easy to install. Silent operation. Warm those rooms with long runs. Stock #583. Regular \$11.95. Your price \$6.95



10" ball bearing fan Mfg. by Redmond. Can be run vertically or horizontally. 110 volt AC 60 cycle motor with plug and cord. New in original box. Use it for the kitchen as an exhaust fan, heat booster, etc. High pitch blade, 1/25 HP 1550 RPM. only \$11.95

Automatic Control Ventilator

For BARNs, ATTICS or BASEMENTS. Increases cows milk production.

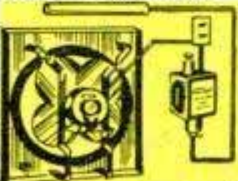

20" fan driven by 1/4 HP motor. Switches and thermostat similar to heat control at upper left included \$89.50

Available in other sizes.

GEAR REDUCER

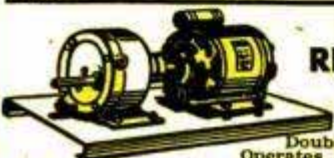

Double reduction. Operates on any 1/8 to 1 1/2 HP electric motor. 22 RPM. Can be used as winch, barbercutter, dummy elevator, operate turntable, electric garage door opener, television antenna. REGULAR \$45.00 NOW ONLY \$22.00

TELEPHONE SETS

Not a toy—but the real McCoy! Magneto-bell ringing set; operates 2 stations or 101 2 telephones with 200 ft. wire \$19.95

AIR COMPRESSORS

Gas or electric. Awarded from government.

1/2 HP	12 gal. tank	\$69.50
1 HP	50 gal. tank	\$229.00
1 1/2 HP	50 gal. tank	\$237.00
2 HP	50 gal. tank	\$264.00
3 HP	60 gal. tank	\$325.00
5 HP	60 gal. tank	\$385.00
7 1/2 HP	80 gal. tank	\$558.00
10 HP	80 gal. tank	\$642.00

CLUTCH

For Motor-scooters, Motor-bikes, Lawn Mowers, etc. Mercury centrifugal clutch for use with any small gas engine. 3" "A" belt pulley, 3/8" bore. Brand new only. Stock #400 \$8.95
1" bore NEW \$9.95
1 1/2" bore \$10.95
ROCKFORD CLUTCH Manual, bronze throw yoke 1 1/2" bore, 1" female spline; 5" long, 5 1/2" OD. Takes to 25 HP. PRICE ONLY \$15.00



BALL BEARING ARBORS

Grinding and saw arbor, has 1/2" double end shaft 1 1/4" long with 2" center pulley. New Departure double roll ball bearings. Right and left hand thread. Self aligning Dodge pillow block. 10,000 RPM. Bearings alone list at \$10. Complete arbor new. Stock #305 only \$5.95

GENERATORS

300 Watt, RPM 3400, 110 and 220 volt, 1/2" shaft \$40.00; 2500 Watt, RPM 1800, 115 volt AC \$225.00; 3000 Watt, RPM 2800, 110 volt DC Delco ball bearing, 1" shaft. List \$343.00 to you at only \$99.00



BUY NOW and SAVE BRAND NEW! WAR SURPLUS LIGHT PLANTS

BE PREPARED for any emergency!

Use for: Farms, cottages, stores, garages, floodlighting, drilling rigs, refineries, house trailers, fire departments, sound trucks, yachts, tugs, construction, airports, police radios, etc.



SENSATIONAL BUYS at 50 to 75% savings
LIGHT PLANT BUYERS, in emergency telephone collect—unit shipped same day!

300 WATT, 110-220 volt AC, 60 cycle light plant powered by 1 HP gas engine, direct drive. Mounted base, weight 40 lbs. New Stock #409 \$89.50

750 WATT, AC 110 volt, 60 cycle, direct drive, air cooled, Briggs & Stratton gas engine, Model AP, Pioneer generator, radio filter, self exciter, rope start, 190 lbs., 20" long, 17" wide, 16 1/2" deep with carrying handle. New, Stock #573 \$199.50

2500 WATT, AC 115 volt, 60 cycle, single phase. ENGINE: Briggs & Stratton, air cooled. 6 1/2 HP. GENERATOR: Westinghouse or Leland, belt drive. Complete with \$30.00 worth of spare tools, instructions and fully GUARANTEED. Was formerly priced at approximately \$700.00. Now priced for you NEW at only \$345.00. Reconditioned \$275.00. To make plant 110-220 add \$48.00 for transformer.

3000 WATT CONTRACTOR'S PORTABLE, Briggs & Stratton 5 to 7 HP gas engine with Delco generator and rubber tired wheels. Rope start, weight 275 lbs. Used like new at \$220.00. NEW \$279.00

5000 WATT, 120 volt, 60 cycle AC. HERCULES 4 cycle gas engine. Generator mfr'd by Hobart Bros. Unit includes remote control

cable, 150' 2-wire #6 and 150' 3-wire #18, exhaust pipe, power cable plug, KVA at 80% power factor, radio and television filtered. Unit is completely automatic. List price today \$1900.00. Now priced for you at \$675.00 used. NEW \$895.00. To make plant 110-220 add \$72.00 for transformer.

7500 WATT, 110 volt AC, 60 cycle, powered by a VE 4 Waukesha 4 cyl. gas engine. Continental or Hollingsworth generator. Remote control starting. Complete with switch board NEW \$995.00. To make plant 220 volt, 3 phase, add \$76.00 for transformer.

10,000 WATT, 110-220 volt AC, 60 cycle. Remote control. Powered by a Jeep 4 cyl. gas engine. Used but like new \$1095.00. NEW \$1395.00.

25,000 WATT, 220 volt AC, 3 phase, or 110-220 volt single phase. Used but like new and GUARANTEED \$1995.00. NEW \$2495.00.

35,000 WATT, 110-220 volt, Diesel. Rebuilt, \$2995.00.

50,000 WATT, Cummins Diesel generator, 240 volt, 3 phase, 60 cycle, AC, 1200 RPM, 150 amps. Rating 50% continuous exciter. NEW. GUARANTEED \$5900.00.

SPECIAL! HOT ROD SUPERCHARGER



Here's a hot rod supercharger at a price you can't afford to miss. SEE HOW THIS TYPE SUPERCHARGER IS USED IN PICTURE and ARTICLE on Page 67 AUG. Issue of POPULAR MECHANICS. Mfg. by Borg & Warner. SPECIFICATIONS: 7 1/2" wide, 5" deep, 7" high. Weight 17 lbs. Compact and sturdy, 4 base mounting holes. 3/4" outlet. 5/8" shaft. Includes female Lovejoy coupling. Priced today at \$85. OUR SPECIAL SALE PRICE ONLY \$16.95

sturdy, 4 base mounting holes. 3/4" outlet. 5/8" shaft. Includes female Lovejoy coupling. Priced today at \$85. OUR SPECIAL SALE PRICE ONLY \$16.95

HEAVY DUTY ELECTRIC CABLE

Electric rubber cable, 16 cond., No. 18, solid, 100 feet or more, per foot \$.16
Electric rubber cable, 10 cond., No. 18 solid, 100 feet or more, per foot \$.10
Electric rubber cable, 4 cond., stranded, No. 18, water and oil resistant; run in parallel No. 16; 100 ft., \$6.25; 250 ft., \$12.50; 500 ft., \$25.00; 1320 ft. reel \$56.00
Electric rubber cable, 3 wire, stranded, No. 10; 65 ft. with lugs. Val., \$26.00 \$19.50
Electric rubber cable, 3 wire, stranded, No. 10, submarine cable, underwater, underground, overhead—50 ft., \$15; 100 ft. \$30; 250 ft. \$75; 500 ft. \$125.00
Electric rubber cable, 3 wire, stranded, No. 8—150 ft. reels, with 1 male connector; 2 female, crutch binds connectors— \$75.00
Electric rubber cable, 2 wire, No. 4—75 ft. lengths, male & female connectors. \$60.00

HORNS and HOWLERS



Motor driven, (not a vibrator). Heavy duty with great power and long life. Adjustable for high, medium or low tone. 110 volt AC current. Weather proof. For alarm or signal horn on boats, school yards, factories, air raid siren, etc. List price \$47.00 N.E.W. Stock #302. Your price \$15.45.

STAINLESS STEEL TUBE

HALF PRICE — 6' to 10' Lengths

SIZE	O.D.	WALL	MILL PRICE	OUR PRICE
1/4	3/16	01506	51c Ft.	Ft. 25c
3/8	11/32	01301	63c Ft.	Ft. 32c
7/16	13/32	01508	70c Ft.	Ft. 35c
1/2	15/32	01205	72c Ft.	Ft. 36c
3/4	1 1/16	05001	91c Ft.	Ft. 46c
7/8	1-3/16	03125	1.01 Ft.	Ft. 50c
1	1-3/16	105	1.10 Ft.	Ft. 55c
1 1/2	1-3/8	05015	1.74 Ft.	Ft. 87c
2	1-15/16	05003	2.20 Ft.	Ft. 1.10
2 1/2	2-7/16	0500	2.74 Ft.	Ft. 1.37

JARVIS GRINDER

Three phase, 220-440 volt, with flexible shaft; 3450 RPM. Totally enclosed motor.
1 HP List \$165 Now \$65.00
1 1/2 HP List \$195 Now \$75.00
2 HP List \$225 Now \$85.00
1/2 HP, 110. Volt stand & shaft \$39.50

BLOCK AND TACKLE

70-Foot 3/4 rope, 1 double block, 1 single block—both have swivel hooks, galvanized tensile strength, 4000 lbs.; No. 6 block, 3 1/2" wheel; weight 27 lbs. Value, \$27.00. Price \$9.95

and other bargain items

HEAVY DUTY GRINDER 1 HP, 1800 RPM, 3 phase, 220 Volt 60 cycle, 20 ft. cord, 24" Long, GUARANTEED, Mfg. by Thor & Chicago Pneu. Special SALE PRICE \$29.50
BLOWER and MOTOR. Enclosed squirrel cage type for cooling, heating, suction or blowing. Ball-bearing Redmond Motor, 1550 RPM. Discharge 3"x3". Intake 5". Weight 9 lbs. \$11.95
PORTABLE HEATERS for Contractors. Lauson gas engine with supercharger blower \$149.00
PREVENT FROZEN WATER PIPES! Thermostat with 60 ft. of flexible, (wrap around) lead heating cable \$19.95

Automatic Oil Tank Watchman

No risk of oil tank going empty. Pilot light turns on when fuel level gets down to danger or minimum point. \$11.95

ALL ITEMS GUARANTEED AS REPRESENTED C & H ELECTRIC Co. 434 W. JUNEAU AVE. MILWAUKEE 3, WISCONSIN

All prices F.O.B. Milwaukee. 25% deposit required on all C.O.D. orders. No C.O.D.'s under \$10.00. Use stock number when ordering. Many other bargain items not listed—write for our free circulars.



**Speed Way
Speed Sander**

\$34.50



**Sands,
Cleans,
Smooths, Polishes Electrically**



Designed for industry, for professional work, this light, beautifully balanced, orbital-motion, SpeedSander is rapidly becoming a standard home appliance. With its powerful electric motor and all-ball-bearing construction, anyone can easily re-surface and refinish furniture, woodwork, metal surfaces or walls. It will quickly remove old paint, stain, or enamel down to the bare wood or metal; will sandpaper to a "piano finish"; remove rust and corrosion or "feather edge" a scraped fender. It will burnish pots and pans or with lambs wool bonnet, delicately polish fine furniture. It makes

tedious, tiresome jobs fun—saves hands! In design, convenience and efficiency it is today's finest sander regardless of price. Ask your local dealer to demonstrate it.

Write for Catalog

Speed Way MANUFACTURING CO.
1863 So. 52nd Ave., Cicero 50, Illinois

**NEW HIGH QUALITY - NEW LOW PRICES!
MIDGET COMBINATION**

**9 pc.
WRENCH
SET**



• For Carburetor, Timers, Generators, Radios, TV Sets, Electrical Equipment and all Home Handy Work.

• Combination wrenches with open end angled at 15° for better efficiency, box end has 12 point opening. Broached to accurate tolerance in graduated sizes for quick sure fit. Heads plated to high lustre, handles panelled for firm grip. In strong, tough chrome molybdenum alloy steel, heat treated and hardened. Unconditionally guaranteed. At your dealer or order direct from factory.

$\frac{13}{64} \times \frac{7}{32}$ $\frac{7}{32} \times \frac{1}{16}$ $\frac{15}{64} \times \frac{1}{4}$
 $\frac{1}{4} \times \frac{9}{32}$ $\frac{9}{32} \times \frac{3}{16}$ $\frac{9}{16} \times \frac{11}{32}$
 $\frac{11}{32} \times \frac{3}{8}$ $\frac{3}{8} \times \frac{1}{2}$

Snapped in Pocket Size Plastic Kit 2½" x 4½"

**ONLY
\$1.50**

METEOR MFG. CORP. 1441 MAIN ST. BUFFALO 9, N. Y.

Enclosed is check _____, money order _____ for \$1.50
Send Meteor Midget Wrench Set to:

Name _____

Address _____

City _____ State _____

65 KW. 225 Volt D.C. DIESEL ELECTRIC GENERATING UNIT

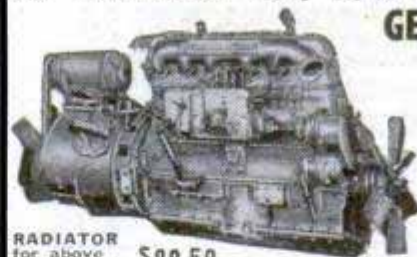

RECONDITIONED

Equipped with 6 cyl. DRXC Hercules DIESEL engine, 4½" bore, 5¼" stroke, 133 H.P. at 2000 R.P.M. Complete with injector, pump, nozzles and electrical equipment. Generator attached to engine. Complete as shown.

RADIATOR for above unit..... \$89.50

Ea. \$1375.00
Lots of 2 ea. **\$1295.00**

Write for price on DIESEL ENGINE only.

60 HP. Jeep Engine Reconditioned, tested & Guaranteed in perfect order, ready to run. **\$192.50**

SEND 25% CASH WITH ORDER, BALANCE C.O.D.

1951 EDITION! It's New! It's Different! Get World's Largest Auto Accessory & Parts Catalog and Save Money! Over 50,000 items including Hollywood Accessories, Hi-Speed Equipment, Rebuilt Engines, all parts & accessories for all cars & trucks. We have that Hard-To-Get Part! Jam packed with Bargains. Completely illustrated. Send 25c (refundable).

J. C. WHITNEY & CO.

1917SP ARCHER AVE. CHICAGO 16, ILL.

SAW SHARPENER



Table model, gums and sharpens rip saws, combination saws & cut-off saws. Ideal for "Skil-saw" blades. Cap. 4" to 20" diam. Complete with ¼ h.p. motor & 1 grinding wheel & cord — \$64 f.o.b. Portland. Shipping weight, 63#. SEND FOR FREE LITERATURE.

P. T. HOBBS MACHINERY
Dept. PM-51, Portland 17, Ore.

8375 N. Interstate,

HARDWARE TOOLS AND DIES WANTED

Established builders' hardware manufacturer interested in purchasing existing tools to expand present line. Must be an item that fits a hardware line—perhaps one that did not produce profitable volume marketed by itself. Tools must be suitable for efficient production. In writing please send blueprint or illustration of article. P.O. Box #1, Birmingham, Mich.



10 SHELF PLANS

ACTUAL SIZE, easily built, beautiful wall shelf plans, ready to trace on lumber for cutting out. Corner and wall racks with 1 to 3 shelves. Stores charge as high as \$75.00 for these shelves. Make money selling them. PLUS BONUS of 48 other novel cutouts, Dutch Boys, Girls, Toys, etc. PLUS FREE HOBBY BOOK. Send only \$1.00 to JACKSON STUDIO, 7900 Milw. Ave., Milwaukee 13, Wis.

\$1.00



**If it is accuracy you want
ROAD-MISER has it!!**

Any vacuum operated gas mileage indicator or tune-up tester can be made to fit your car to an accuracy within 1 mile per gallon at maximum level road economy with a Road-Miser Dial. We supply a set of Road-Miser sectional dials to cover all probable variations in cars of the same specifications. You easily attach the correct dial strip to your indicator after making a short mileage check by simple instructions. Road-Miser leaves all present dial numbers exposed on most indicators. The best index to your car's condition is a constant reading of its maximum mileage. Test it anytime with a Road-Miser equipped indicator. Money refunded if not satisfied. (Please give make, year, and model of car. Also, indicator name and dial size.)

\$1.50 in check or money order pays for set of Road-Miser Dials and airmail postage.

ROAD-MISER DIALS 4198 Sunnyside Drive
Riverside, California

**EVERY ELECTRIC DRILL
A PORTABLE SAW**



At Better Hardware Stores Everywhere

9.95 Can Be Used With One Hand!
Any 1/4" or 3/8" Drill a Powerful Saw in ONE MINUTE

with 4" "HYCARBON" Crosscut Blade
"ARCO-SAW" is a rugged tool with right angle gear drive (no clumsy, dangerous, direct drive with drill sideways). Works like a high priced Portable Saw.
CUTS 1-5/16", or 2x4 by turning over ONLY ARCO GIVES YOU ALL THESE FEATURES: Safety-yoke assures rigid connection and absolute safety—Big handle affords firm grip for two-hand operation—Precision one-piece gear box—Self-lubricating lifetime bearings—Visual guide and wide shoe-plate for straight, square cuts—Lowest priced, quality Replacement Blades.
"HYCARBON" 4" Crosscut or 4" Combination Blade . . \$2.00 ea.
90-day Factory Guarantee



ORDER TODAY at your dealer or send us check or M.O. (Postpaid). C.O.D.'s—Postage extra

UNCONDITIONAL 10-DAY MONEY BACK GUARANTEE

DEALERS—Write for nearest jobber.

ARROW METAL PRODUCTS CO.

DEPT. PM-2, 140 WEST BROADWAY, NEW YORK 13, N. Y.

BUILD YOUR OWN ARC-WELDER



For Light or Heavy Work
No rewinding necessary—use coils taken from old auto generators. Works on 110 or 220 A.C. Has 20 different heats. Complete plans and BIG Catalog 35c.

LEJAY MFG. CO. 3347 LeJay Bldg. Minneapolis, Minn.

MAKE EXTRA MONEY with Larson Leathercraft



Easy-To-Assemble Kits No Experience Needed

Get started now. LARSON Beginners' Kits of ready-cut projects require no tools or experience. Free instructions included. Make belts, gloves, moccasins, billfolds, woolskin animals and mittens, other attractive leather items. Also America's most complete stock for advanced hobbyists and professional craftsmen. SEND 10c TODAY for newest 24-page catalog. J. C. LARSON CO., 820 So. Tripp Ave. Dept. 518, CHICAGO 24, ILLINOIS

FINE TOOLS NEED FINE OIL!



- Lubricates
- Prevents Rust
- Cleans • Polishes

SOLD EVERYWHERE

3-IN-ONE Oil

Tips FOR YOUR COLD WEATHER DRIVING



HOW TO START FAST

Get quick starting every morning—no matter how cold the weather—with Casite in the crankcase. Casite retards congealing of oil, lets the engine turn over and go, even in sub-zero temperatures. Casite guarantees Quick Starting or Double-Your-Money-Back!



HOW TO GET NEW POWER

Casite conditions your engine for winter. A pint through the air-intake gets rid of gum and goo, frees sticky valves and rings, lets the power zoom through. Casite guarantees Better and Smoother Motor Performance or Double-Your-Money-Back.

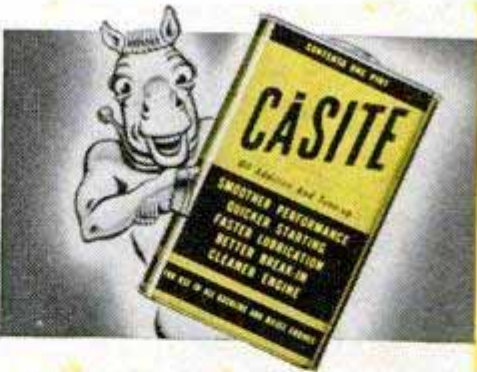

HOW TO CUT ENGINE WEAR

Every time you start your car, metal scrapes against metal because cold oil can't get around fast enough. Casite, however, makes cold oil move fast—speeds the flow of No. 10 oil 24.3% at 50°F, more when colder. Casite sees that enough oil gets to the right places at the right time—to give you long and economical engine life.

Get Casite today from your garage, service station or car-dealer.

Write for FREE "Facts of Engine Life" Booklet.
THE CASITE CORPORATION • HASTINGS, MICHIGAN
Casite Division, Hastings Ltd., Toronto

NOW COMPOST BY MACHINE Right in Your Garden Itself!



After over 20 years of experiment and research, we have perfected a revolutionary new machine, the Model T ROTO-ETTE, that completely prepares your seed-bed for planting IN ONE SIMPLE OPERATION. No more changing from plow to disc to harrow. It does the work of all these at the same time! It also mixes into your top-soil with ease—any cover crop, manure, mulch, plant or animal waste! It will even knock down, chew up and mix standing cornstalks into your soil! The secret of this amazing performance is in the new Roto-miller (pat. pending), illustrated below.

No more hauling, turning and watering the compost pile. The Model T ROTO-ETTE composts by machine right in your garden itself! Enthusiastic users tell us it does a day's garden work in an hour!

Does Other Yard and Garden Jobs, Too

Through use of quick-change attachments the Model T ROTO-ETTE is also convertible to a power lawn mower, field mower, snowplow and power sawer in a jiffy. Yet the cost of this amazing, all-around, "automatic handy man" is so low that it often pays for itself the very first year! Anyone can operate it and it's as easy to service as any power lawn mower.



FREE Book Tells All — Write Us Today for It



Ed Robinson, famous author of "The Have-More Plan," waxed so enthusiastic about the ROTO-ETTE he bought that he wrote a big 68-page book about it for us. It is called "Power Gardening and Power Composting." In it, complete with scores of action-pictures, is the whole exciting story—and it's your FREE for the asking. (Simply enclose 10 cents in stamps or coin to cover postage and handling.) Address Dept. 202, Rototiller, Inc., Troy, New York.

BE INDEPENDENT!

START YOUR OWN BUSINESS installing the lifetime **BELCO BALL BEARING FAUCET WASHER**. Every home, apartment, factory, public building and all types of institutions are prospects. Satisfied customers because you save them money on water, fuel and costly maintenance. Start small with a modest investment, expand on your earnings. Steady profits. Light weight **BELCO CONVERTER MACHINE** makes short work of converting standard faucets to BELCO.

STOP THIS WITH BELCO

WRITE TODAY FOR YOUR FREE SAMPLE AND DETAILS OF OUR EXCLUSIVE PLAN.

ECONOMY VALVE CO.
5919 TIREMAN AVE. • DETROIT 4, MICH.

SEND THIS COUPON NOW!

ECONOMY VALVE COMPANY
5919 TIREMAN AVE. • DETROIT 4, MICH.

NAME _____
ADDRESS _____
CITY _____ STATE _____



FULLY GUARANTEED TIRES COST LESS!

Nationally famous FIRESTONE, GOODRICH, U.S. ROYAL, GOODYEAR, and other makes. Every tire selected and inspected for your safety.

NEW TREAD TIRES GUARANTEED 24 MONTHS					
600x16	8.98	650x16(6)	13.98	650x15	11.48
600x16(6)	10.98	700x16	12.98	700x15	12.48
650x16	11.98	550x17	8.98	700x15(6)	14.48
700x15	4.64	700x20(8)	8.94	750x20(10)	9.94

GOOD TIRES GUARANTEED 12 MONTHS					
600x16	4.14	700x16	5.14	32x6(8)	8.84
650x16	4.54	670x15	4.74	32x6(10)	10.84
650x15	4.34	650x20	7.84	750x20(8)	8.54
700x15	4.64	700x20(8)	8.94	750x20(10)	9.94

AAA PREMIUM GRADE GUARANTEED 18 MONTHS					
600x16	5.28	710x15	5.68	650x20	9.88
650x16	5.88	600x16(6)	5.88	700x20	11.88
650x15	5.68	700x15(6)	6.98	32x6(8)	10.48
700x15	5.88	760x15	6.28	32x6(10)	12.48
700x16	6.18	550x17	5.68	750x20(8)	12.98
820x15	6.98	600x20	8.88	750x20(10)	14.98

MILITARY SPECIAL		AA GUARANTEED 12 MONTHS		New Tread Guar. 24 Mo.	
900x16	11.98	1000x20	18.98	600x16	9.98
750x20	12.89	1100x20	19.98	600x16(6)	11.93
				750x20	28.98

AAA GUARANTEED 18 MONTHS	
900x16	14.98
750x20	16.48

Largest stock of used tires in the East. Thousands of satisfied customers. Write for sizes not listed.
MONEY ORDER OR CHECK WITH ORDER.

PENNA'S LARGEST STOCK

PENNA'S LARGEST STOCK

PYRAMID TIRE CO.
1333-35 North 5th St.
Dept. M, Phila. 22, Pa.

CARBURETOR TOO RICH MAKES MOTORIST TOO POOR



Car owners who are wasting money and not getting proper gas mileage due to over-rich mixtures will be pleased to learn how to save gasoline by VACU-MATING over-rich mixtures. VACU-MATIC fits all cars, trucks and tractors. It is automatic and operates on the supercharge principle. Easily installed in a few minutes.

SALESMEN WANTED! Big Profits! Send name, address on penny postcard for free particulars and how to get yours for introducing.

VACU-MATIC CO., 7617-1708 W. State St., WAUWATOSA, WIS.

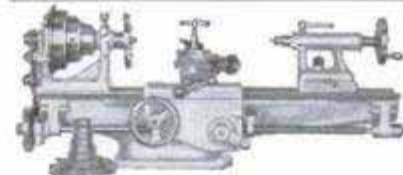

CASTINGS BLUE PRINTS BUILD YOUR OWN MACHINE, TOOLS!

Catalogue with complete construction drawings of this 8 inch lathe with milling, grinding and hand shaper attachments, 25 cents postpaid, or send one dollar for drawings of three lathes, two milling machines and six inch crank shaper—refund on castings order.

DAVID JONES MACHINE CO.,

1828 STRATFORD AVE.

BRIDGEPORT, CONN.



BRONZE FOUNDRY

Schools and Home Workshops
Make your own castings of aluminum, copper, bronze, silver. Foundry sets are available in three sizes including 2400 Deg. F. blast Furnaces, \$22.50; \$29.50; and \$42.00. f.o.b. Kansas City. Free Circular.

KANSAS CITY SPECIALTIES CO. P. O. BOX 6022, DEPT. P-2 KANSAS CITY, MO.



MUCH MORE SPEED FOR OUTBOARDS!

of all makes from 7½ to 50 HP on racing runabouts is provided with the famous Michigan "AQUA-JET" propellers. No rebuilding of lower unit is necessary. Each propeller is specifically engineered for the motor on which it is to be used. Other propellers for superior performance for practically every outboard in every application. Write for 1951 catalog, the "Outboarder's Bible," FREE. Michigan Wheel Co., Dept. 1-2 Grand Rapids 3, Michigan.

SURPLUS MACHINE SHOP TOOLS AT PRICES YOU CAN AFFORD

HIGH SPEED STRAIGHT SHANK DRILLS



- SET 1K** 30 Selected High Speed Straight Shank Drills from 1/8" to 1/4" \$1.5 value. New and slightly used surplus. Priced at only... **\$2.95**
- SET 2K** 10 Different Size High Speed Straight Shank Drills from 1/4" to 1/2". Extra Long Drills. \$30 value. Priced at only... **\$3.95**



BRAND NEW

STRAIGHT SHANK DRILLS

These high quality carbon drills are of extra length as follows: drills 21/64 to 33/64 are 4.5 to 6.25 inches long; drills 37/64 to 1-5/16 are 8.75 to 14.75 inches long.

- 21/64"—\$.38 37/64"—\$.75 25/32"—\$1.05 57/64"—\$1.40
 3/8"—.40 39/64"—.80 51/64"—1.10 29/32"—1.45
 7/16"—.50 41/64"—.85 53/64"—1.20 31/32"—1.85
 33/64"—.65 21/32"—.90 27/32"—1.25 1-1/8"—2.25
 Discounts on Quantity 1-5/16"—2.75

HIGH SPEED MORSE TAPER SHANK DRILLS



- SET 3K** 15 Different Size High Speed Morse Taper Shank Drills up to 9/16" with No. 1 and 2 Tapers. \$50 Value. Priced at Only... **\$6.49**
- SET 4K** 20 Different Size High Speed Morse Taper Shank Drills from 1/4" to 1". \$70 Value. Priced at Only... **\$12.95**

- SET 5K** 10 Different Size High Speed Morse Taper Shank Drills from 1/2" to 1 1/4". \$50 Value. Priced at Only... **\$9.95**

- SET 6K** 10 Different Size High Speed Morse Taper Shank Drills from 1" to 2" with No. 3, 4 and 5 Tapers. \$180 Value. Priced at Only... **\$39.95**

HIGH SPEED TAPER SHANK CHUCKING REAMERS



- SET 8K** 20 Different Size High Speed Morse Taper Shank Chucking Reamers up to 1 1/2" with No. 1 and 2 tapers. Priced at only... **\$6.95**
- SET 9K** 8 Different Size High Speed Morse Taper Shank Chucking Reamers from 1/4 to 1". Priced at only... **\$4.95**

- SET 10K** 10 Different Size High Speed Morse Taper Shank Chucking Reamers from 1/2" to 1 1/2". \$65 value. Priced at only... **\$9.95**

HIGH SPEED STRAIGHT SHANK CHUCKING REAMERS



- SET 11K** 20 Different Size High Speed Straight Shank Chucking Reamers up to 1 1/2". Priced at only... **\$6.95**
- SET 12K** 10 Different Size High Speed Straight Shank Chucking Reamers from 1/2 to 1 1/4". Priced at only... **\$9.95**

- SET 13K** 15 Different Size High Speed Straight Shank Chucking Reamers from 1/4 to 1". Priced at only... **\$6.95**

HIGH SPEED HAND TAPS



- SET 14K** 10 Different Size High Speed Standard Thread Hand Taps up to 3/4". Plus No. 6 Tap Handle (5/32-3/4" Cap). Priced Complete at only... **\$5.79**

HAND REAMERS & TAP HANDLE



- SET 15K** 10 Different Size Hand Reamers from 1/4" - 1". Majority Brand New Plus No. 6 Tap Handle (5/32"-3/4" Cap) \$30 Value. Only... **\$9.95**

- SET 16K** 20 Different Size Hand Reamers as above with Same Tap Handle, only... **\$16.95**

BRAND NEW HIGH SPEED COMBINATION DRILL AND COUNTERSINKS

- SET 17K** 8 Different Size from C2 to M1 (1/16 drill x 13/64 body to 7/32 drill x 5/8 body; 60 degree of countersink. These new countersinks sell new from 75c to \$2.50 each. Your price for this set of 8, while they last, only... **\$3.95**

HIGH SPEED WOODRUFF KEY SEAT CUTTER

- SET 18K** 5 Different Size Cutters. Can be used as mounted milling cutter or circular saw. All with 1/2" shanks, widths up to 1/4", diameters up to 1 1/2". Priced at only... **\$3.95**

SELF PRIMING ELECTRIC PUMP

Oil Burner or Coolant Pump, Tool Post Grinder



Black & Decker electric motor. 24 Volt AC or DC 1 Amp. 1/30" H.P. Double Ball-Bearing. Series Wound. Attached To Pump Manufactured by Weidon Tool Co. Standard 1/4" Pipe Conn. Rated at 2 G.P.H. Also included Transformer 50 Motor Can be Used on Standard 110 Volt AC. Applications Are: Oil Burners, Aquariums, Fuel Pumps, Etc. Skinner Cleanout Type Filter as Pictured Above also included. Pump—Motor—Transformer—Filter, All for Only... **\$9.98**

PESCO HYDRAULIC GEAR TYPE PUMP

Rated at 3 GPM @ 3750 RPM, @ 1000 P.S.I. Female type Drive... **\$8.98**
 Discounts on Quantities



Money Back Guarantee—All Mdse. Mixture of New and Reconditioned Tools Unless Specified Brand New—All Orders Shipped Post Paid saving you up to 25% on total delivered cost. Write for Free Catalog Describing Thousands of Bargain Cutting Tools.

T & T TOOL 101 W. ARCHER TULSA, OKLA.

Bass WEEJUNS
 ... for leisurely comfort

Bass QUAIL HUNTERS
 ... for field and stream

Bass SKI BOOTS
 ... for extra control

Bass SPORTOCASINS
 ... for better golf
 G. H. BASS & CO.
 60 Main Street
 Wilton, Maine

Say You Saw It in Popular Mechanics

\$\$\$ extra profits for you each month with..

Hobart 200 Amp. Portable Gas Drive D.C. Welder goes right to the job.

Set up your own welding business... get the big pay, extra profit jobs with this rugged, versatile welder that can't be beat for speed, durability, or performance. Special features include 1,000 combinations of welding heat, positive control at or away from machine, out-let for supplying emergency power. Send for data.

Simplified
arc welding

HOBART 200 Amp Gas Drive... world's best welder buy!



HOBART BROTHERS CO., Box M-21, Troy, Ohio, "One of the world's largest builders of arc welders"

AT THE TOP OF THE CLASS



**THE
1951**

Cushman
MOTOR WORKS



Ride it for only 3/4¢ per mile!

Beat expensive transportation, save your car, with a low-cost CUSHMAN. Hundreds of practical uses—ride to work, school, shop, play! Ideal for light deliveries. Easy to park, quick in traffic. Get up to 85 mi. per gal. Low purchase price, low maintenance, low operating cost—that's CUSHMAN economy.

Write for free folder and prices—Dept. 3M

Write for it!
RIDER-AGENT PLAN

Cushman MOTOR WORKS, INC.
LINCOLN, NEBRASKA

DEALER INQUIRIES INVITED

**Made \$2,600
LAST SEASON**



99¢ Profit On Each Dollar

It costs less than 1¢ per mower for electricity and material. The Foley sharpens all blades and cutter bar together just like lawn mower manufacturers do it. Start in spare time in basement or garage. The Foley handles up to 3 or 4 mowers per hour—prices run \$1.50 to \$3.00 for hand mowers—\$5.00 to \$8.00 for power mowers.

PRICES \$97.50 to \$159.50—easy payment terms available. **FREE BOOK** shows how to sharpen all power mowers. **FREE PLAN** tells how to start—no canvassing. Send coupon today—no salesman will call.

SEND FOR FREE BOOK

FOLEY MFG. CO., 207-1 Foley Bldg., Minneapolis 18, Minn.

Send **FREE BOOK** and **FREE PLAN** on Foley Lawn Mower Sharpening business.

Name _____

Address _____

**with
FOLEY
LAWN MOWER
SHARPENER**

"Last year we sharpened and repaired about 1000 lawn mowers for a net profit of \$2600," says E.G. "In 1939 I bought a Foley Lawn Mower Sharpener," writes W. T. J., "the best investment I ever made. I have made a good living for my wife and self, and have put money in the bank besides."



**POWERFUL! PORTABLE!
POCKET-SIZE!
BULL
HACK SAW
only \$4.95**

Fits any 1/4" electric drill or drill press. Weighs only 11 ozs.; small in size—easy to carry, easy to use. 2-to-1 ratio of drill speed to saw speed for extra power! No gears, no bearings, nothing to wear out. Full chip clearance on any wood, metal or plastic stock up to 3/4". Powerful, portable, pocket-size—a must for every home craftsman, only \$4.95.

LIFETIME GUARANTEE: At any time, we guarantee to put this tool in perfect working order for a handling charge of 75¢.

BERTRAM F. ENGINEERING & SUPPLY CO.

3121 Main Street

Kansas City, Mo.

MAGNETS OF ALL TYPES—10¢ UP
AMAZINGLY POWERFUL!
4 oz. Alnico Magnet, lifts 10 lbs. \$1.00. Our Leader, 15 oz. Magnet, lifts 40 lbs. \$2.50. New alloy—will not weaken! Useful for lifting valuables from tanks, lakes, or rivers easily! 7 small magnets \$1.10 with list of many shop and home uses. Satisfaction guaranteed.
R. EYRICH, 2566 N. 49TH ST., MILWAUKEE 10, WIS.

ACE TOOLS



Be permanently tool-ed-up for every operation on your Metal Cutting Lathe.

No. 8-A Ace Tool Set for 9" and 10" Swing Lathes—fits shank size 3/8" x 3/4". Includes Turning, Cutting-off, Boring, Knurling and Threading Tools with high speed cutters, blades and wrenches. 8 complete tools in fitted steel case—nothing else to buy. See your local dealer or order direct.

ARMSTRONG BROS. TOOL CO.
5268 W. Armstrong Ave., Chicago 30, Ill.

\$26.95

NEVERSLIP PULLEY

Transmits more power with less belt wear, unaffected by weather. No pulley covering, no belt dressing required. Replace troublesome pulleys with NEVERSLIP. All sizes. Money-back guarantee. Ask for NEVERSLIP Pulleys on ALL power machinery you buy. Write for folder and prices.



ROSENTHAL CORN HUSKER CO.
Box 16 Milwaukee, Wisconsin



SILVER SOLDER TORCH & KIT \$6

JOINS ALL METALS PERMANENTLY

Do your own repairing. KIT includes one tube silver solder flux and 10 5-in. lengths silver solder alloy. Hottest ALCOHOL TORCH known. 2700° F. flame. Operates in any position, indoors or out. Torch alone \$5. KIT alone \$1.50.

AMERICAN PRODUCTS CORP.
422 S. Dearborn St. Dept. 3-B Chicago 5, Ill.



**\$500,000.00 INVENTORY
for QUICK LIQUIDATION**

Surplus items—hundreds of them for home, shop, factory, farm and outdoor use. New items, used items, reconditioned items—all at tremendous savings—all priced for quick sale.

Page After Page of Values

This big catalog shows page after page of amazing money saving values. Write for your copy today. Send 10¢ to cover postage, mailing, etc. Write today!

SEND TODAY FOR YOUR COPY

10c

STARK'S Dept. 509 So. STATE STREET
PM-2 CHICAGO 5, ILLINOIS

ONE Tool Does 1000s of Jobs . . .

Original-Genuine
WISE-GRIP
WRENCH



Another of 1000 Uses

LOCKS to work with Ton-Grip! Not a gadget, but a professional tool with 1000 uses. Turns rounded nuts, bolts, screws with worn slots—grips anything, even in close quarters. Insist on the genuine VISE-GRIP with Involute Jaw Curve that holds all shapes. Knurled Jaw Tips that grip to the very tip. Thin Nose, Super Wire-Cutter. With cutter—No. 7W, 7", \$2.25; No. 10W, 10", \$2.60. Without cutter—No. 7C, 7", \$1.95; No. 10C, 10", \$2.25. No. 7, 7", \$1.85; No. 10, 10", \$2.15.

Order from your dealer.

PETERSEN MFG. CO., Dept. P-2, DeWitt, Nebr.



7x50
\$36
Illustrated

**BINOCULARS
TELESCOPES**

Big
Bargain
Catalog
Free

BROWNSCOPE CO.
Dept. 2M,
24 WEST 45th ST.
NEW YORK 19, N. Y.

D. C. ARC WELDER
\$300 VALUE — ONLY \$97.50

200 Amperes Continuous Duty. Up to 250 amps. intermittent duty. Easily mounted on your tractor. Welding range from 0-up by dial type control. 1-yr. guarantee with money back 10-day trial period. Write for FREE literature. OR send 35c for PLAN "Build Your Welder from Aircraft Generator." Write today.

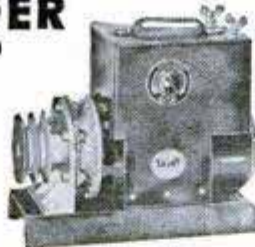

LEJAY MFG.

847 LeJay Bldg., Minneapolis 8, Minn.

SAY YOU SAW IT IN POPULAR MECHANICS

**NEW
ELECTRICAL
TESTER**

New principle
makes testing easy.

- TESTS—110-220-440, AC, or DC.
- TELLS—3 phase from 1 phase.
- CHECKS—phase-rotation on 220-440 V. AC.
- LOCATES—blown fuses, shorts, opens, and grounds.
- TESTS—all home appliances, motors, generators, elec. stoves, auto elect. system, etc.

Furnished FREE with tester. (if ordered from this ad), a special 5 foot safety POWER CORD and instruction sheets, telling HOW TO MAKE ELECTRICAL TESTING EASY.

GUARANTEE—Use tester for 10 days, if not satisfied, will refund your money.

COMPLETE \$5.95 pp.

Send money order, cash or check . . . and get FREE offer.

SPICERS PRODUCTS

1834 Milburn St.

Indianapolis 2, Ind.

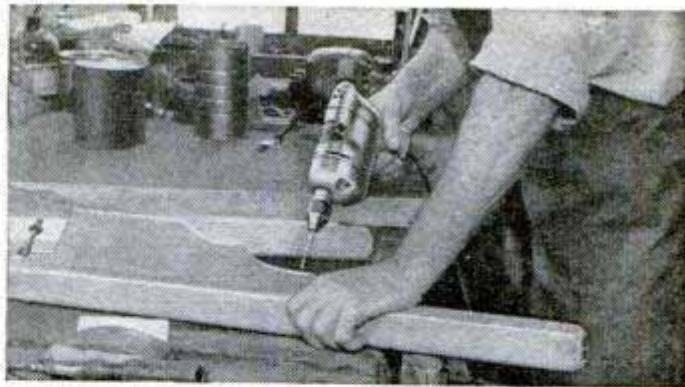
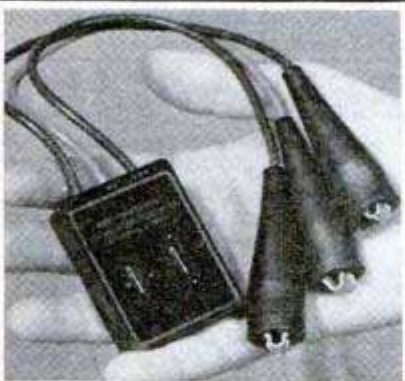

Drilling Wood, Metal, Plastics

**Zip through these home jobs
with a HOME-UTILITY 1/4" Electric Drill
only \$22.95 (complete)**



Sharpening
Cutlery



Refinishing
Furniture



Shining
Pots, Pans

MR. FIXITS, HOUSEWIVES:

This Home-Utility 1/4" Drill is the workin'est tool you've ever seen! It's a handy fistful of power for installing hardware and fixtures; sanding down furniture; sharpening cutlery and tools; polishing cars, silverware and woodwork; shining up pots and pans; waxing furniture; knocking off old paint and rust; light grinding! Drives scores of attachments. Weighs only 3 1/4 lbs. Over a million sold. Quality-built by BLACK & DECKER, world's largest electric tool maker! Sold at leading hardware, appliance, implement, department stores. *Try One Today!*

Products of HOME-UTILITY Div.,
The BLACK & DECKER Mfg. Co.
Dept. H2M, Towson 4, Md.

**ELECTRIC
HOME-UTILITY
TOOLS**

SANDER-POLISHERS • BENCH GRINDERS
1/2" DRILLS • TOOL KITS • LECTRO-SAWS

OIL FILTER REFILLS . . . 10c



10,000
Sq. In. of
Filtering
Surface

Filters Oil
the full
length of
the Pack

Plates Last
Indefinitely

Here's News! Ordinary toilet paper makes an ideal oil filter. Laboratory tests prove it cleans oil faster and better than popular makes of filter elements. All you need is a simple set of RETLIF ADAPTER PLATES . . . and you can start using ordinary toilet paper rolls in your present oil filter. For proof and descriptive literature, send name and address to:

RETLIF CORPORATION, Dept. 67

1239 No. Highland Ave., Los Angeles 38, Calif.

now! Freedom offers a **POWER-PACKED** 14000 RPM 1/15 H.P. **FLEXIBLE SHAFT MACHINE** YOU can afford



Model 9050

ONLY \$29.60 including 6-STEP FOOT RHEOSTAT

3-WAY USEABILITY

- Hang it up
- Set it on Bench
- Mount under Bench

Freedom's Model 9050 gives you industrial quality at a popular price. Here is what you get: • 14000 rpm 1/15 H.P., air-cooled universal motor • precision-made pencil-size, quick-detachable handpiece • flexible shaft of extra good flexing qualities running in a metal sheath covered with tough, long-lasting Neoprene. Here's a small power grinder with the kind of power, speed, stamina and all-around versatility you have been waiting for. **TOPS THEM ALL.** For commercial users and home users who insist on industrial quality in their tools. **Use it to grind, polish, drill, saw, sand, carve, mill, clean, rout, etch, engrave, etc. on all metals, wood, plastics, glass and linoleum.** Includes your choice of 3/32" or 1/8" capacity collet. Add 85c if you want both. Backed by Freedom's 28-year old reputation for quality and workmanship. Other motor-driven models for as little as \$17.75, all precision-made.

Catalog 1138-F on request.

FOREDOM ELECTRIC CO.

27 PARK PLACE Dept. 1138-F NEW YORK 7, N.Y.

SET-UP - KNOCKDOWN SAWHORSE with *Jiffy* BRACKETS



(\$1.60 in West)

No nails or bolts... use 2x4's for legs, 2x4 or wider for crossbar. Easy to move, saves storage space. Buy at hardware or building material dealers, or direct.

GRAND HAVEN STAMPED PRODUCTS CO., Grand Haven, Mich.

STOP CHANGING MOTOR OIL!

End this needless expense forever with

RECLAIMO Today's Most Advanced OIL RE-REFINING filter FOR CARS, TRUCKS, TRACTORS & DIESELS

Continuously cleans and RE-REFINES motor oil as you drive (by utilizing motor heat)—keeps oil in high grade lubricating quality of all times!

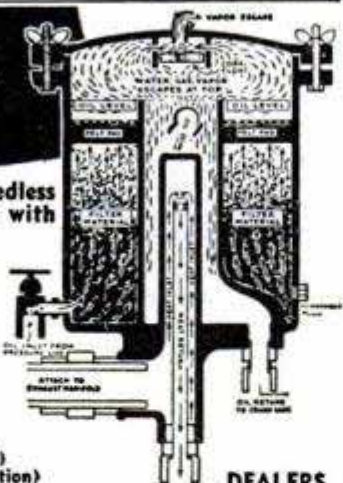

- "RECLAIMO"**
- REMOVES SOLIDS (by filtration)
 - REMOVES WATER (by distillation)
 - PREVENTS Excess Fuel Dilution
 - PREVENTS Acid and Sludge Formation
 - ADDS Thousands of Miles to Engine Life

MAINTAINS Stable Viscosity **ELIMINATES** All Oil Changes
 FREE 32-PAGE BOOK "OIL FACTS" (with bonafide \$1000.00 offer on page 30), gives you the complete "Reclamo" story and details of our extraordinary 90-DAY NO-RISK TRIAL OFFER! Write for your copy TODAY!

DEALERS WANTED

U.S. BUREAU OF STANDARDS, Bul. 86 States, "Oil does not wear out—mechanically."

MONEY-BACK GUARANTEE

Reclamo Sales Div., Inc.

4508 S. Logan, Dept. M-5, Lansing, Mich.

Big 6 HORSEPOWER ROTARY TILLER

\$349

No Extras to Buy



The Mulsifier Rotary Soil Tiller! Unsurpassed for tilling and cultivating. Makes it easy to work 1 to 20 acres. Prepares the soil in one operation. Nothing to do but guide it. High-powered—adequate for all soils. Unbreakable tines. Gives you more horsepower per dollar than any other garden tractor. Attachments available. Money-Back Guarantee. Send postcard for circular.

MULSIFIER IMPLEMENT CO.

7758 HAMILTON, DETROIT 2, MICH.

*Trade Mark Reg. U. S. Pat. Off.



Mulsifier ROTARY SOIL TILLER

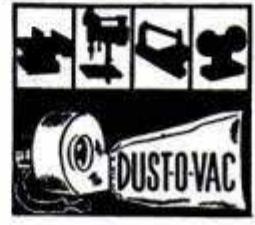

DUST-O-VAC FOR ALL MACHINES

For Home Workshops & Industry, **DUST-O-VAC** collects & bags wood & plastic chips, wood & metal dust, wood shavings. *Free Bag.* Attaches to circular saw, planer, band saw, grinder, belt or disc sander, shaper, drill press with shaper or sander attachment, spindle shaper, wood lathe, jig saw. 110 A.C., D.C. Send for mounting instr. for all machines.

\$19.95

Free Ship. east of Miss. West of Miss., add \$1. Check. M.O.

HEAVY CAST ALUMINUM BLOWER — ONLY \$11.25
 For workshop, lab., kitchen, cellar, app. 100 CFM. Send for circular. UNIVERSAL YONKERS CORP., 137 Alexander St., M-2, Yonkers 2, N. Y.

LAWN ORNAMENT-NOVELTY PATTERNS

28 Lawn Ornament Patterns, 25c. Other Patterns; 15-20" high; Dutch Girl, Dutch Boy, Pirate, Bull Terrier, Mexican Girl, Mexican Boy, Dwarf, Penguin, Flower Girl, 10c each. 25 Novelty Patterns, 30c. All 62 Full Size Patterns, \$1.00 Postpaid. Strother Pattern Service, Dept. CB-8, Box 128, Belington, W. Va.

1951 BUZZ MASTER

8 MODELS — \$99 up

More cutting — "Tomorrow's BUZZ MASTER Today!" See the de luxe riding model. Nothing else like it. Made by the oldest firm in the business—now in our 47th year. Many special features used only on Ottawa Saws. Write today for FREE DETAILS. OTTAWA MFG. CO., 1-127 Brush Ave., OTTAWA, KANS.



NOTE THIRD WHEEL

BRUSH PLATING OUTFITS

for re-plating articles in the home and shop. No tanks necessary. Free particulars. GUNMETAL CO., AVE. M, DECATUR, ILLINOIS

START INSTANTLY IN WINTRY WEATHER

"QUICK START" Carburetor preheater starts your car instantly in cold-est weather—saves battery—gas—trouble. Press starter and you're off. Install yourself in 10 minutes. "QUICK START" electrically warms cold gasoline—starts engine instantly. EVEN AT 30° BELOW ZERO. Send check or M. O. Only \$3.95. Give make and year of your car. If C.O.D. you pay postage.



UNITED SALES CO. 4643 NORTH 13th ST. PHILA. 40, PA., DEPT. 150

1951 Models



CROSLLEY

You have to drive a '51 Crosley to know the car as it is today. Bigger, sturdier, heavier. Powerful engine with 7.8:1 compression ratio, hundreds of mechanical improvements. New interior and exterior features and styling. Crosley gives you 35 to 50 miles per gallon. And Crosley is still the only new car you can buy for less than \$1,000. Lowest price, lowest down payment, lowest monthly terms. So see your dealer—test drive the new 1951 Crosley—the most improved car!



FREE! 1951 Crosley Catalog! Write Crosley Motors, Inc., 2530-HY Spring Grove Ave., Cincinnati 14, Ohio.

CROSLLEY

a FINE CAR
"You see them everywhere"

WELD BRAZE, SOLDER, and CUT →

ONLY \$11.95 F.O.B. complete!

EASILY... QUICKLY!

No experience needed. Follow simple instructions, weld on iron, steel, bronze, brass, aluminum, and other metals. Plugs into any properly wired 110 volt A.C. or D.C. line. Make or save time and money doing repair work for yourself and others. Repair men, farmers, tinsmiths, home and auto owners, hobbyists, etc., say FOUR-WAY pays for itself over and over. Order today or send for Free details.



ORDER NOW
10 DAY TRIAL

FOUR-WAY WELDER COMPANY, Dept. F2-BB
2326 So. Michigan Ave. • Chicago 16, Illinois

AGENTS 300% Profit SIGN LETTERS

For Store Fronts and Office Windows. Anyone can put them on. Free samples. Liberal Offer to General Agents.

METALLIC LETTER CO., 430 N. Clark, Chicago 10

Say You Saw It in Popular Mechanics

Local Colorcretors Can Earn High Incomes

COLORCRETE is today's biggest business opportunity in the building field. High returns from a low investment. Easy, fascinating work. Large waiting market because Colorcrete is applied over all kinds of old and new masonry surfaces — exterior and interior.

Beautifies and Protects All Types of Buildings



Pneumatic pressure sprays plastic-like Colorcrete to give enduring beauty and water-resistant values. Range of 30 gleaming colors; many textures. Easy to wash. Smartly modern. Write or wire today for Opportunity Portfolio, which gives complete story.

COLORCRETE INDUSTRIES, INC.
570 Ottawa Ave., Holland, Mich.

SHOPMASTER

America's Finest Tools at Amazing Low Prices



12" Drill Press \$46.95
12" Floor Model Drill Press \$54.00

8" Tilting Arbor Bench Saw . . . \$72.95

Also

7" Tilting Arbor Bench Saw . . . \$45.45

8" Tilting Table Bench Saw . . . \$51.50

10" Tilting Arbor Bench Saw . . . \$86.95

10" Floor Model Tilting Arbor Saw . . . \$105.00

6" Jointer-Planer . \$79.95

4" Jointer-Planer . \$47.95



15" Jig Saw (Tilting Table) \$27.95

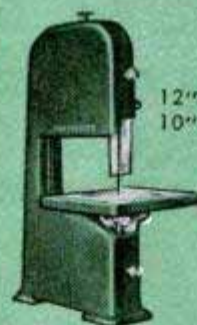

12" Band Saw . \$79.95

10" Band Saw . \$46.95

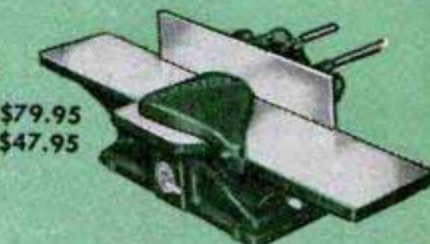

Saber Saw . \$17.95

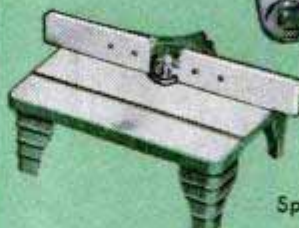

Spindle Shaper . . \$45.95



Belt and Disc Sander . \$51.50



10" Wood Turning Lathe . \$45.95

Zone 2 prices, slightly lower in Zone 1.

Write today for full color catalog.



SHOPMASTER, INC.

1214 Third St. S., Minneapolis, Minn.

FIXES

Toys, Dishes,
Books, Furniture



It's transparent, waterproof,
flexible and durable.
Get a tube
today.



DUCO CEMENT

REG. U. S. PAT. OFF.

Start a Business in Your Backyard



MANUFACTURE BUILDING BLOCKS

General Concrete Vibrator
BLOCK MACHINE
CAPACITY 1000 BLOCKS A DAY

only \$218 LESS MOTOR
F.O.B. PLANT
SHIPPING WEIGHT 400 LBS.



Wonderful
Book Written
& Illustrated
by Experts

HOW TO
BUILD
YOUR OWN
CONCRETE
BLOCK
HOME
Only 1 Prepaid

Here is a business you can start on small capital—in your own backyard—that earns 100 to 150% profit, with unlimited opportunities. Make concrete or cinder blocks. Millions used for homes, factories, public buildings, garages. Sell all you make for building trade. Do it with a General—and you're headed for success.

1000 BLOCKS A DAY

The General is a high speed, power-driven block machine at amazingly low cost. Rugged all-steel construction. Simple to operate indoors or outdoors. Makes superior 3 core type block meeting all code requirements. Produces up to 1000 blocks per day. Full operating instructions and mixing formulas supplied. Write for FREE details.
Dealer inquiries invited

GENERAL ENGINES CO.

DEPT. P-17 • 307 HUNTER ST. • GLOUCESTER, N. J.

Includes floor plans for 6 beautiful, easy to build concrete block bungalows. Shows ways to save money. How to lay blocks, lay out building lines, mix concrete, build steps, porches and concrete floors. Mail coupon at once with \$1.

Name.....
Address.....
City.....Zone.....State.....



MEN! send for this MONEY- MAKING OUTFIT

MAKE \$15.00 IN A
UP TO DAY

Do you want to make more money in full or spare time... as much as \$15.00 in a day? Then write for this BIG OUTFIT, sent you FREE, containing more than 150 fine quality fabrics, sensational values in made-to-measure suits and overcoats. Take orders from friends, neighbors, fellow-workers. No experience needed. You'll say it's the greatest way to make money you ever saw.

SAMPLE SUITS TO WEAR

Pay No Money! Send No Money!

Our plan makes it easy for you to get your own personal suits and overcoats without paying 1c, in addition to your big cash earnings. This offer is limited. Rush your name and address for big FREE OUTFIT—today!

PIONEER TAILORING CO., Dept. P-1116
Congress & Throop Streets, Chicago 7, Illinois

Expert's Painting Tips—FREE

Lifetime of experience with aluminum paint, yours free—write for free 24-page illustrated book. Tells how to buy and apply right kinds of aluminum paint. We don't make paint but have prepared this to help you get best results. Just write for "Paint it Bright."

ALUMINUM COMPANY OF AMERICA,
17188 GULF BLDG., PITTSBURGH 19, PA.



VARIABLE SPEED

HYDRAULIC POWER
TRANSMISSION



It has Infinite Speeds 0 to 550. Reverse, Automatic Overload Protection; Adjustable Torque up to 180 inch pounds. 3/8" Input and Output Shafts. It will handle 1/2 to 1 1/2 H.P. Motor. Case measures 7 1/2" long 7" high 6 1/2" wide. VALUE OVER \$300. Shipping Wt. 25#. On C.O.D. Orders we require a 10% only Deposit.

\$54.50
Fab. Chicago

DIRZIUS MACHINE SHOP "K" 1423-25 So. 52nd Ave., Cicero 50, Ill.

Only \$498

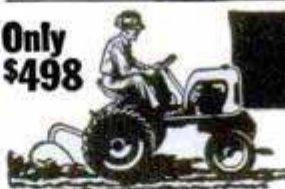

OTTAWA Mule Team Tractor

Finest low-cost tractor. Costs too little to do without. Engines burn gasoline. Seven models. Starter and lights available. Other larger Models to choose from. Over 4,000 in world-wide use. Time-proved and tested. At low cost they easily mow, plow, disc, harrow, plant, cultivate, etc. Sold only direct to user. Write for FREE details.

OTTAWA MFG. CO., 2-127 Garden St., Ottawa, Kansas

ELECTRICITY Anywhere

FOR PORTABLE, EMERGENCY OR HOME USE

ONAN Electric Plants furnish modern city-type electric service for homes, farms, cabins and resorts beyond the high-line. Lightweight, portable A.C. and D.C. plants serve contractors, estates, fire departments, etc. Automatic standby plants protect hospitals, radio stations, hatcheries. Over a hundred models—400 to 55,000 watts. Gasoline or Diesel powered



WRITE FOR CATALOG

D. W. ONAN & SONS INC.

5842 ROYALSTON AVE. • MINNEAPOLIS 5, MINN.

BRAND NEW SURPLUS UP TO 85% DISCOUNT

Portable LIGHT PLANT

PUSH BUTTON START
500-700 watts 110-120 v. — 60 cye. A.C. Powered by a sturdy dependable, easy starting, air cooled 1 3/4 hp. gas engine. No wiring necessary, just plug in and operate. Plenty of current for oil burner, emergency lights, freezer, radio, incubator, etc. Complete protection against current failure. Ideal for hunting or camping. Complete with Voltmeter and built-in winding to charge 6 v. auto batteries. Wt. 85 lbs. Fully guaranteed. Be prepared if electric power fails. Reg. \$275.00 value. **\$138.50**

(Item 24)

GIANT 2000-2500 WATT PLANT

Absolutely the best made because its heavy windings develop up to 5000 watt overload for motor starting. Skid-mounted — portable. Powered by 5 h. p. easy starting Briggs engine — complete with all accessories; engine easily disconnected for other uses. Big outlet box, voltmeter, no wiring necessary. Ample current for all purposes. Factory warranty and instructions included. Wt. 220 lbs. Reg. \$585.00. Spec. at **\$299.50**. 110-120 V.—A.C. **GENERATOR ONLY** and control box. Drive it with your engine or tractor. **\$169.50**

(Item 31)

HOT WATER HEATER

(Item 26) Immersion type, heavy duty. 115v. A.C. 300w. Does not require watching. Thermostat shuts off at 165°. Keeps water hot for shaving, washing, dishes, etc. Also good for keeping water from freezing in big troughs or tanks. Made by Cities Service. Wt. 4 lbs. Worth \$9.50. Our Spec. **\$4.50**.

GAUGE TESTER

(Item 27) Precision made of solid bronze by Star Brass Co. Calibrated weights acting against hydraulic piston, provides quick, accurate testing of all pressure gauges up to 3000 lbs. per sq. in. Brand new in hardwood cases. Wt. 100 lbs. Reg. \$435.00. Our spec. **\$125.00**.

EXTENSION CORD

(Item 16) 40 ft. heavy duty, made of specially insulated No. 14 2-conductor wire. So tough that you can drive over it and yet amazingly flexible and easy to handle. Resists oil, grease or water. Extends electricity up to 400 ft. without voltage drop. Use indoors or out. Complete with heavy rubber plug and outlet. Wt. 2 1/2 lbs. Usually \$4.50—Special 40 ft. **\$1.99** Comb: 2-40 ft. and 1-20 ft. (total 100 ft.) **\$4.95**

PRESSURE SWITCH

(Item 30) Penn Electric Model 110 EPD, best made. For pumps and air compressors. Heavy duty. Will handle up to 250 lbs. press. and up to 5 h.p. Autom. unloader valve, for easy starting. 110-220 v. A.C. or D.C. 2 pole. Wt. 5 lbs. Reg. list **\$17.50**. Our Spec. **\$8.95**.

HYDRAULIC HOSE

High pressure, heavy duty, complete with swivel fittings. Pipe thread connections. Ideal for farm equip., bulldozers, grease guns, airbrakes, etc. Any length. Minimum \$1 per lgh. **INSIDE DIAMETER**, 1/4" 40c per ft. 3/8" 50c, 1/2" 70c, 5/8" 90c.

PARTS WASHER

(Item 20) Store gas or carbon tet. in 5 gal. safety can. Valve releases just the right amount into washing compartment. Parts are washed and drained on a "dunking" screen — no fishing for parts. Eliminates fire-danger, waste, spillage, evaporation. Wt. 14 lbs. Reg. \$19.50—Special **\$5.95**

RUBBER HOSE

New genuine Neoprene Hose —outlasts ordinary rubber 3 to 1. Reinforced with super tough cotton cord plies. Flexible. Easy Flo brass couplings with standard pipe threads for quick connections. included. Pump water for irrigation, stock, tanks, home, barn, fire fighting, etc. Pump Gas or Fuel Oil. Save more than 60%. (inside Diam.) 1 1/4" 11 1/4" 1 1/2" Length 25 ft. 40 ft. 30 ft. Price 9.25 14.75 14.75 If specified we will send special hose for gas or oil at same prices.

HEATING & VENTILATING FAN

(Item 10) Easily installed in furnace pipes. Forces even heat to all rooms. Over range, removes kitchen smoke and odors. Powerful continuous duty motor, 110-120 V. A.C. Quiet, super efficient fan moves huge volume of air (400 to 600 c.f.m.) 8" Fan, wt. 5 lb. **\$6.35**; 9" Fan, wt. 6 lbs. **\$7.45**; 10" Fan, wt. 7 lb. **\$8.45**.

ANGLE DRILL

(Item 23) Fits into chuck of any electric or pneumatic drill or flex. shaft. Operates at any angle in a full 360° arc. Makes possible drilling, grinding, carving, routing, etc. in close cramped quarters. Makes impossible jobs easy. Made by Kett Tool Co. Complete with built-in chuck and adjusting key. Hardened alloy gears. Precision built for heavy duty. Lists at \$39.95 — while they last **\$9.95**.

CARRY-AIR

Stainless steel tank—capacity 500 cu. in. at 400 lbs. press. complete with inlet and shut-off valves, press. gauge, detachable air hose, tire chuck. Fill at any service station. Carry air for tire inflation, blowing out lines, spray painting, insecticides, etc. One emergency pays back cost. Wt. 7 lbs. Worth \$20.00. Our price—**\$8.95**. (Item 32)

FRAM OIL FILTER

(Item 12), Model F21. Big 73 cu. in. size. Ample capacity for all cars, trucks, tractors. Universal bracket, standard openings. Fram filters are tops. Easy to install. Wt. 8 lbs. Usually \$7.95—now **\$3.75**.

CLIP BOARD

(Item 17) Heavy Masonite, with self-adjusting spring hinge to hold up to 100 sheets of 8 1/2 x 11 paper. Push back cover for instant release. Flip cover shut and notes or drawings are protected. Perfect for pilots, engineers, students, artists, truck drivers. Wt. 2 1/2 lbs. Usually \$2.95. Spec. **\$1.10**, 2 for **\$2.00**.

All items brand new. Prices f.o.b. Chicago area. Money back guarantee. Send check or M. O. **MASTER MECHANIC CO., Dept. 34, Burlington, Wis.**

1/2" ELECTRIC DRILL ADAPTER

Fits any small 1/4" Drill—in a SECOND! Takes all larger size drills—Sturdy—A Mighty Handy Tool.

DANIELS PRODUCTS CO.
M2-822W 22nd, Kearney, Nebraska

\$2.95
Postpaid in USA

CHECK BATTERY CONDITION

without leaving the driver's seat!

DETECTO-CELL

Amazing, instant visual check on battery strength, condition of cells, need for service!

Saves Money by Prolonging Battery Life . . .

Add as much as 70% to battery life! DETECTO-CELL shows instantly — in glowing lights — battery strength, condition of each cell, water levels, warns of battery weakness in time to prevent failure. No more unexpected dead batteries, no more needless, costly replacements! Works with any 3 cell battery, on any car. Simple installation, takes just a few minutes and ordinary hand tools. No moving parts, fool-proof operation. Will last life of your car, or longer. Send check or money order today!

MYRIATRON CORP., Pontiac, Mich.
Dept. 22

\$6.95 complete.

DEALERS • JOBBERS
Write—We've got a good deal for you!

GEARED TOOLS FOR THIS ATOMIC AGE

.. Are Saving USERS \$s — Energy Making BIG MONEY for AGENTS ..

Eifel-Line Super-Tools

with the Amazing **4X, EXPANDO-Jaw**

The NEW '4X' Jaw

Above Composite Cut shows 2 Positions.

- The Exclusive Parallel EXPANSION-Grip has countless new uses.
- A 3-Jaw, 7" Plierench KIT and 8 1/2" PRIME and MASTER KITS with 3 to 8 Jaws, etc.; Universal, Pipe, Wire; for a Million Sizes 0"-1 3/4", and
- GIANT UNIV. '4X' and PIPE Jaws (Range 1" to 3")
- Tub'g Ctr., Grip-Clamp, etc. . . 1-Oz. to 1-TON grips! Do Thousands of Jobs. Quicker, Better and Easier.
- 8 1/2" Items FIT EIFEL-GEARED Plierenches . . . '33 and later. Sold SINGLY or in ANY Combination.

GET the Most Amazing Gripping-tool Facts Ever

This is Your LAST CHANCE for a Long Time.

MAIL this COUPON TODAY . . .

(ON A POSTCARD WILL DO) . . .

Print your Address . . . Get FREE

- 1) The 115-Picture MANUAL — M,
- 2) The 120-Picture CATALOG — C.

With OFFER as marked —

PART-TIME AGENT USER

FULL-TIME DISTRIBUTOR

AMERICAN PLIERENCH CORP'N
4611 N. RAVENSWOOD AVE.,
CHICAGO 40, ILL., DEPT. PM-1-2

FREE OPENER

3) Also FREE (in U.S.A.) this 3", 6-Edge, End-and-Angle Screwdriver, etc. . . often more valuable. Useful than a Pocketknife!

OUTSIDE GRIP 0" TO 3" EXPANDING GRIP 1/2" TO 2 1/4"

THE 4X-JAW

**PRECISION
PRACTICE MAKES PERFECT!**

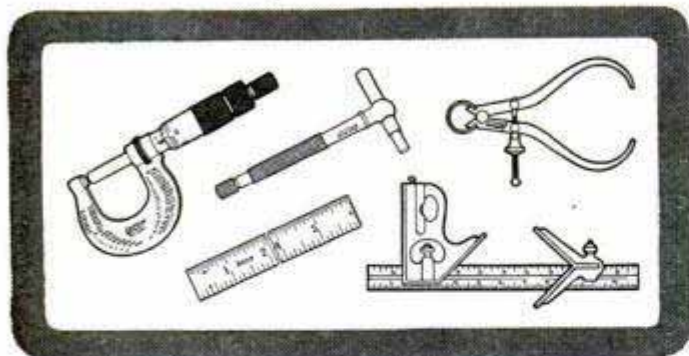

Without good precision tools, all the practice in the world won't accomplish the perfect job. But, you will get accurate measurements at workshop or homeshop with precision-made *Lufkin* tools. No matter what type of precision tools you need—thousands of machinists agree on this—the perfect choice for perfect work is *Lufkin*.



TAPES • RULES
PRECISION TOOLS
FROM YOUR DEALER

110

THE LUFKIN RULE CO.

SAGINAW, MICH. • New York City • Barrie, Ontario

Our 362nd Advertisement

**REAL DIESEL
ENGINE!**

\$2.95

You just can't beat this price for a completely assembled precision diesel engine!

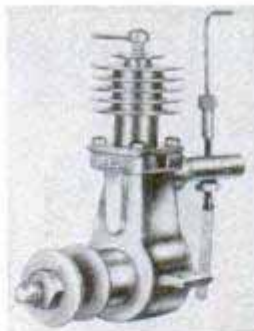

- Ideal for planes, boats, midget cars
- Actually runs at 7500 RPM, produces 1/7 HP
- Height a full 3 1/2 inches; weight 5 ounces
- Comes to you completely assembled, ready for operation

MAYBE WE'RE CRAZY, giving away a precision diesel engine, complete with cylinder and piston, carburetor, crankshaft, connecting rod, etc. for **ONLY \$2.95**. But we're selling thousands of **DEEZILS** all over the world, and that keeps our production costs down. **DEEZIL** is streamlined, compact, rugged, Starts quickly, easy to install, runs for years! Fast delivery if you **ORDER DEEZIL TODAY!**

Send \$2.95 plus 25c postage

GOTHAM HOBBY CORP. Dept. P, 107 E. 126 St. NEW YORK 35, N. Y.



**2
DRILLS
IN 1**

This attachment gives you two drills in one. It converts any 1/4 inch electric drill to 1/2 inch capacity. Reduction gears reduce the drill speed 5 to 1, the average speed of a 1/2 inch drill, and thereby increases the power. Absolutely indispensable for all shop work and home craftsmen. Satisfaction guaranteed. Order yours now.....

Send check or Money Order with order. Jobbers write for special information.

\$11.95 post paid

G. M. CO. MANUFACTURING, INC.
1308 43rd AVE. LONG ISLAND CITY 1, NEW YORK

New POWER MOWER

Build It Yourself And Save.

Amazing new invention makes whirl-blade mower pull and steer itself as well as cut grass and weeds. Build it yourself. Send name and address on 1c postcard for FREE building instructions . . . NO OBLIGATION.

PULLS ITSELF, STEERS ITSELF

FREE Building Instructions

T & H Mfg. Co., Dept. MPC-2, 811 E. 31 St., Kansas City, Mo.



SPECIAL OFFER!

LOCK-STITCH SEWING AWL

\$1. Postpaid

Famous, patented lock-stitch sewing awl complete with needles, waxed thread and direction folder. Hundred uses — sewing, repairing leather goods, canvas, belting, harness, saddles, gun cases, awnings, golf bags. Extra needles and thread available. Satisfaction guaranteed or money back. Send currency, check or money order. **Yates Mfg. Co., 611-H Main St., Lake Geneva, Wisconsin**

MACHINE SHOP EQUIPMENT

• The No. 49 edition of the famous Center Tool Co. Catalog is now ready! Every workshop owner should have a copy. 240 pages full of illustrations, descriptions, and prices of the latest tools made by best known manufacturers in U. S. You pay the cost of printing—50c. We refund your 50c with your first order of \$10.00 or more. Prompt delivery on most tools. Send check or money order today!

CENTER TOOL CO.

153 Centre Street, Dept. C, New York 13

SAVE YOUR TOOLS — TEMPER — TIME

with this special **ALL LEATHER TOOL KIT**

only **\$2.95** postpaid
8" x 11"

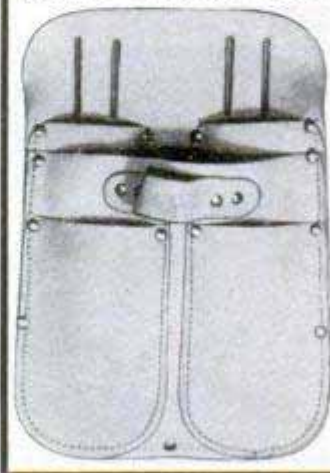

Genuine chrome leather, sturdy stitching, re-enforced with rivets to last a lifetime. One large pocket for drivers, cutters, pliers, chisels—two medium pockets for knives, markers, rules, etc. Large pocket accessible to very bottom without digging hands. Small pockets hold tools without dropping. Worn on belt to make tools easy to get at—always in place, as you need them! **SATISFACTION GUARANTEED.**

Order direct today—Send for free catalog.

WESTERN TOOL KITS
516 Allen Avenue, Glendale, Calif.

WHERE DID IT COME FROM? HOW DID IT GET HERE?

WHAT IS IT?

THE THING

from Another World!

HOWARD HAWKS' *Amazing* MOVIE!

R K O
RADIO



NEW! CHEAP! **OIL BURNER**
SWEEPING THE COUNTRY!

SALESMEN BIG MONEY!

SLIPS INTO ANY COAL RANGE, STOVE OR FURNACE. Amazing quick, intense heat. By finger-tip control. Cheaper than coal. No more shoveling coal or ashes. **SENT ON TRIAL.** Prove it pays for itself quickly by what it saves. \$1 bonus for testing. We'll let you try one in your own home for one month. Write for details today. Northwest Mfg. Co., Dept. 206, Mitchell, S. Dak.



ATTENTION MANUFACTURERS INVENTIONS FOR SALE

BOILER TOOL, Labor Saver. Needed in War or Peace by Marine and Stationary Personnel.

AUTOMOBILE SAFETY DEVICE. Aids in parking. Big sale appeal. Money maker.

KNIFE SHARPENER, really sharpens knives. Write to **SPENCER & HEIL, INC., 34 Valentine Road, Bloomfield, N. J.**

BE A HIGH-PAID MAN IN YOUR COMMUNITY WITH THIS LONG NEEDED INVENTION

Earn up to \$10,000 or more per year! U.S. Pat. D 153853
Nothing to invest! Be your own boss! D 153854

A worldwide product needed by every home, business and farm . . . priced to sell quickly! Automatic Red Comet goes into action as soon as fire starts . . . smother's fire without human aid. It's a sales 'natural'!

FREE SALES KIT
Demonstrator units, sales literature, etc., furnished you FREE. Handsome leather-type kit. Tried and proved, it will make you an independent businessman. **ACT NOW!** Someone in your community will be appointed soon. Write for details, today!

RED COMET, INC.
872 R. C. Bldg. Littleton, Colorado



For the ultimate in KEEN EDGES there's nothing like





HARD ARKANSAS*
a **NORTON** abrasives
"NATURAL" STONE

For generations the selection of surgeons, dentists, wood-carvers, engravers, for the final refinement in edges. HARD ARKANSAS is purely a finishing stone. It takes over where other stones leave off — and what an edge it gives you! . . . In slips and bench sizes. HARD ARKANSAS Round Edge Slip #HS-4, 4" x 1 3/4", \$2.70, and HARD ARKANSAS Bench Stone #HB-6, 6" x 2", \$9.00, at most hardware stores.

GET THE "HOW TO SHARPEN" BOOK
32 pages of pictures and data on professional tool sharpening. Send 10c to Dept. PM-2.

*Trade Mark

BEHR-MANNING
TROY, N. Y.
Also Manufacturers of Abrasive Paper and Cloth

New, High-Speed ELECTRIC PLANE



PORTER-CABLE
Guild

Weights
8 lbs.



WORKS AS
A JOINTER



FITS DOORS
AND SASHES



SHAPES EDGES,
MOULDING

A Work-Horse For Any Home Shop Only \$65.00

Try it. You'll agree that as a labor-saving device it's more than the equal of any tool in your shop. It does jobs your other tools cannot do, in real professional manner. And the hardened, razor-sharp spiral cutter is F-A-S-T—20,000 rpm. Zips off the shavings, leaving a straight, smooth, non-fuzzy surface with or against the grain, with no bumps, no gouges. Enables you to do perfect surfacing, fit doors, windows, drawers, screens, storm sash, trim of every kind. Ideal for hobby projects—built-in furniture, cabinets, bookcases, benches.

Special Jointer-Shaper Cutters

Yes, you can even use this plane as a bench jointer-shaper, or as a moulding plane. Spiral cutter for jointing work; variety of shaper cutters for decorative edging, grooving and channeling. Optional Sharpener (extra) puts keen edge on plane cutter in 3 minutes.



Same Motor Powers 2 Other Guild Tools: Motor of your Guild Power Plane is interchangeable with the versatile new Guild Router—one of the most valuable tools for advanced home-craft projects; also with the Guild Shaper, adapted from the Router. Router base only (using Plane motor), \$7.50. Router complete, \$47.50. Shaper Table only, \$24.00; complete with Router, \$71.50.

At your dealer's—or mail coupon.

Send me full information about the Guild Power Plane and attachments . . . Also name of nearest Guild Tool dealer.

Name.....

Street.....

City..... State.....

PORTER-CABLE MACHINE COMPANY
6062 N. Salina St. Syracuse 8, N. Y.

AUTOMATIC RETOOTH

MAKES NEW
PROFITS

for HAND SAWS

Cuts new teeth in
50 seconds—any
size 4 to 16 points.
Old teeth fall off
as chips. Easy to
operate. A perfect
job.

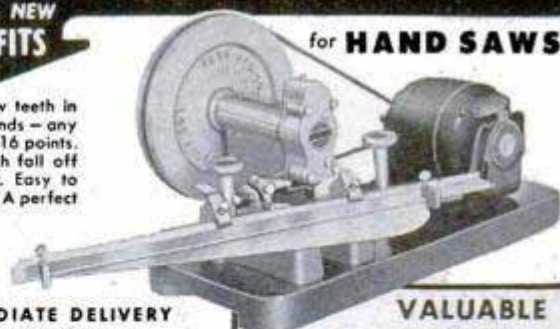

IMMEDIATE DELIVERY
WRITE DEPT. 2

BURR MFG. CO.
8935 VENICE BLVD.
LOS ANGELES 34, CALIFORNIA

VALUABLE
BOOK

25¢

Order Burr's Blue
Book of Coast to
Coast prices for
saw shop services.

ALNICO MAGNETS LIFT 125-lb.

AMAZING PERMANENT MAGNETS — WILL NOT WEAKEN! NON-ELECTRIC. Retrieve guns, tackle, tools and other steel items from lake, river, plating tanks, drains or other hard-to-reach spots. Recover drills, taps, etc. from floor sweepings. Clear alley of harmful tacks, nails. Many other uses listed. Pays for itself quickly. **GUARANTEED:** Try any magnet one week. Money refunded if you are not well-pleased. Cat. No. 125 (has a pull of 125 lbs. on a flat steel block) . . . \$7.50 Cat. No. 40 (40 lb. pull) \$2.79. Cat. No. 7 (10 lb. pull) \$1.33 Cat. No. 20—Hobbyists assortment of seven medium magnets \$1.25

MIAMI MAGNET CO.,
3240 N.W. 27th Ave., Aviation Bldg. No. 43, Miami, Florida



(ACTUAL SIZE)

WORLD'S SMALLEST LIGHTER \$1.00

Smaller than a postage stamp! Not a toy, but a precision-built imported lighter covered with alligator in shades of red, green, blue, brown or black. Takes ordinary flints and fuels for a sure light every time! Order several today for yourself and friends in your favorite colors.

COLUMBIA WHOLESALE SUPPLY HOUSE
3803-A Van Patten Rd. Hampton, Va.

Find HIDDEN TREASURES



GEIGER COUNTERS for Uranium Detection. (see at left). **TREASURE DETECTORS** for gold, silver, etc. Lightweight, ultra sensitive. None finer at ANY PRICE. Information FREE.

Detectron Co. Dept. 2-B
5631 Cahvenga, No. Hollywood, Calif.

HELPFUL BOOKS

Send post card asking for FREE catalog
Popular Mechanics Press, 200 E. Ontario, Dept. 601, Chicago 11

CALENDAR WATCH

CHRONOGRAPH & STOP WATCH

Only **8.95** + 10% TAX

31-Day Automatic Calendar

A precision timepiece and chronograph at an unusual low price. Imported Swiss jeweled movement, Radium Glow 1" dial, red sweep-second hand, shock resistant case, metal expansion wristband. 1 Year Guarantee, 5-day Free Trial. Choice of white, black dial.



Fully
Guaranteed

GAYLORD DEPT. PB-7, Fifth & Hamilton, Pittsburgh 6, Pa.

Send..... Watches @ 8.95 + 90¢ tax. Enclose Check, Money Order, Send C.O.D. Print name, address & dial color in margin.

ENTIRELY NEW!

TAKE THE GUESSWORK OUT OF MOTOR PROTECTION!

Watch the Glass Dome

ONLY
\$2.98



IT TELLS THE STORY!

Dirty oil—abrasive muck and sludge lead to excessive wear and costly motor repairs. **VISOLATOR** shows you at a glance, while the motor is running, when an oil change or a new filter cartridge is necessary. **VISOLATOR** has no moving parts. Aluminum base. Brass fitting screws into bottom of all conventional filters for easy installation. Overall length, 4 3/4". Send check or money order today.

VISOLATOR CORP.

807 E. Sacramento St. Dept. A2 Altadena, Calif.



"OKAY, SO YOU'RE

A KNIGHT IN SHINING ARMOR
—BUT HE USES MENNEN BRUSHLESS"

Keeps You
Presentable Longer!

Gives Cleaner Shaves with

No Burning!
No Stinging!



New-Formula Hair Conditioner

KEEPS HAIR NEATLY IN PLACE!

Gives Natural Good Looks

- Not Greasy . . . Not Sticky!
- Fortified with LANOLIN, That's So Like the Natural Oils of Your Scalp!
- No Alcohol to Make Hair Dry!
- It's So Economical, Too!



Buy Early — SAVE !!
POWER MOWERS

Rotary — Reel Types

\$44.95 to \$129.95

Write for Illustrated Booklet

ATLAS KEEN-MOWERS

229 Sw. Blvd. Dept. P.M. Kansas City, Mo.



CAPE COD CHAIRS
TRELLISES • ARBORS
DUTCH WINDMILLS

Chairs style B-C-A PLANS 50c Ea., all 3 only \$1.00. 12 different Trellises Detailed PLAN only 75c. Unique 40" high Light-house having copper lantern, ideal for garden or on lake shore of summer home. Large detailed PLAN 75c.

SPECIAL ALL PLANS ABOVE \$3.00 VALUE ONLY \$2.50

SEND 10c for catalogue of many fine projects.

Dept. P25

CRAFTSMAN'S MODEL CO. DELAFIELD, WISCONSIN

IT'S PLEASANT MOTORING!!

With Amazing New Scientific Development to End Generator & Battery Trouble

THE WATTAGE REGULATOR

TO REPLACE YOUR CAR OR TRUCK VOLTAGE REGULATOR It's THERMO-AUTOMATIC to give top performance required under various climatic conditions. HIGH-VOLTAGE output for higher battery charge, brighter lights and more battery life. On your vacation or extended trips, EMERGENCY DRIVE WITHOUT BATTERY.

Guaranteed 100,000 Miles or One Year

Send for beautifully illustrated, FREE bulletin 50A today

SCIENTIFIC ELECTRIC CO. CLEVELAND 8, OHIO



EASY-TO-BUILD "OLD-TIMERS"

EXQUISITELY
DETAILED,
COLLECTORS'
MINIATURES

FIRE
ENGINES

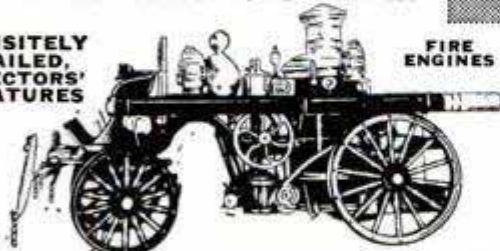

PRE-FAB PARTS! Featured in Dec. P. M. CATALOGS

Detailed, colorful old-time fire "ma-shreens!" Complete, easy-to-assemble kits make up into fascinating, decorative & welcome gift pieces for home, office, den, club or museum.

8 POPULAR 'OLD-TIMERS' ENGINES

Steamer (illus.)	\$6.50	Ladder Truck	\$4.00
Comb. Hose Wagon	3.50	Chem. Reel Carts (2)	2.25
Aerial Ladder	5.25	Comb. Chem. Wagon	3.50
Hosewagon	2.50	Hose-Reel	2.00

Also Scranton "OLD-TIME" Autos!

POLKS Hobby Department Store
314 5th Ave., N Y C 1 (Dept. PM-51)

Model Airplanes, Trains, Ships, Handcraft & Art Materials

WAR SURPLUS AND OTHER BARGAINS



PNEUMATIC RIVETER & CHIPPING HAMMER

Mfr'd by Ingersoll-Rand, Chicago Pneumatic and Ther
Pistol grip. Ideal for fender, brake lining, concrete breaking work. Weight 5 lbs. Like new. Price each
2X - \$6.95 3X - \$7.50 4X - \$8.50

INSIDE MICROMETER 2" to 8"

Precision made of tool steel. Hardened tips on all six measuring rods. One 1/2" spacer. Chrome finish. Complete with case. **\$6.95**



MICROMETERS

Chrome plated, precision engineered and carefully tooled to give long life. All new 0-1" capacity ea. **\$2.25**.
1-2" cap. **\$3.50**. 2-3" cap. **\$5.50**. 3-4" cap. **\$6.50**.



DRILL GRINDER

Sharpens round, square or tapered drills up to 6" long. Even an amateur mechanic can get a new, factory finish on a drill in 25 seconds. New protractor feature gives every drill sharpening angle, with 5 convenient angles already marked off. Usable with hand or power stone. A brand new development, manufactured by Ten Eyck. Shipped postpaid



All New **\$2.80** each.

HIGH SPEED DRILLS

All New Fractional & numbered. Orig. Val \$15 Nationally known brand. Ast'd sizes. Set 30, **\$3.50**



EXTENSION DRILLS

High Speed Steel, like new. Asst'd sizes from No. 1/4 to 40. Lengths from 6" to 12". Approximately \$20 value. Set of 12..... **\$3.75**

ELECTRIC BELLS—Vibrating type, high pitch 115 V., 60 Cycle. Ideal for use indoors or outdoors—on ranches, for schools, plant installations, as signal systems, burglar alarm systems, etc. Nationally known Mfr ALL NEW in orig. Pkgs. Solid brass clapper & 8 1/2" gong. Wt. 8 lbs. Govt cost about \$67.50 **Close out at... \$7.95**



Send check, money order or cash. 25% deposit required on C.O.D. orders. All prices F.O.B. Culver City, California, unless otherwise stated.

Send 25c for Illustrated Catalog.

AIRBORNE SALES CO., INC. DEPT. P M 2-51 CULVER CITY, CALIF.

SAY YOU SAW IT IN POPULAR MECHANICS

WHOLESALE BY MAIL

GOOD USED TIRES with a GOLD BOND GUARANTEE

Goodyear • Firestone • Goodrich • And Others

FREE Tube With Every Passenger Tire
12 Month GOLD BOND GUARANTEE

600-16	\$4.16	700-15	\$4.56	650-20	\$7.96	32x6(8)	\$8.66
650-16	4.66	670-15	4.76	700-20	8.56	32x6(10)	9.96
700-16	5.06	710-15	4.96	750-20	8.66	900-20	13.96
650-15	4.46	550-17	4.66	825-20	13.96	1000-20	13.96

24 Month GOLD BOND GUARANTEE

600-16	\$5.56	650-15	\$5.96	600-20	\$9.96	900-20	\$16.56
650-16	5.96	670-15	6.26	650-20	9.96	1000-20	17.56
700-16	5.96	700-15	6.56	700-20	10.96	1100-20	17.56
750-16	6.96	710-15	6.36	32x6(8)	10.56	1200-20	18.56
550-17	5.96	760-15	6.56	32x6(10)	11.96	1000-20	15.56
525-18	5.56	820-15	7.06	750-20	12.56	1100-22	17.56
650-18	6.96	475-19	5.96	825-20	16.56	750-15	9.96

MILITARY MUD AND SNOW TIRES 12 Month GOLD BOND GUARANTEE

600-16	900-16	750-16	750-20
Special \$6.46	Special \$9.66	Special \$9.96	Special \$10.46

When ordering give make and year of vehicle
10% discount on 2 or more tires if you send this ad with this order
Send check or money order to

GOLD BOND TIRE COMPANY, Dept. PM24
512 North 1st Street, P. O. Box 2175
Richmond, Virginia

WANTED!

MEN AND WOMEN TO EARN SPARE TIME MONEY

Many Popular Mechanics neighborhood representatives are making extra cash for easy, after-hours work. A few more are needed.

For details, write:

POPULAR MECHANICS
ROOM 408
200 E. ONTARIO STREET
CHICAGO 11, ILLINOIS

HELPFUL BOOKS

Send post card asking for FREE catalog
Popular Mechanics Press, 200 E. Ontario, Dept. 601, Chicago 11



AUTO RACING TRAILER Coaches

Four Books Every Fan Needs

Famous for authoritative, detailed information on auto racing, every type of race car, rules, specifications, working drawings, plans, etc. No duplication. Every book different. Money back if not satisfied.

AUTO RACING • 6th Edition

Championship cars, big cars, midgets, roadsters, Offenhauser dirt track car. Specifications on Indianapolis cars, four-wheel drive details, front drive drawings, etc. Plans for Ford 60 midget, roadster racer. Data on engines, gear boxes, friction and dog clutches, axle ratios, compression ratios, independent suspensions, Indianapolis rules and regulations, etc. More than 100 illustrations. \$2.00.

TRAILER COACHES

By Ray F. Kuns. Contains information on the history of trailers, trailer parks and camps; materials, furnishings, trailer chassis, engineering, etc. Construction data on 10, 16 and 22 foot trailers which you can build yourself. 100 illustrations. \$1.50.

AUTO RACING • 5th Edition

Tells you—Why the Fast Ones are Fast—How to Make Them Fast—How to Build Engines—How to Build Chassis—How to Build Bodies—Who Holds What Records—What the International Formula Is—What Midget Racing Rules Are—How World's Record Cars Are Built—How to Speed Up Ford V8 Cars. \$1.00.

AUTO RACING • 4th Edition

Includes eight working drawings and complete building instructions for standard midget racers, drawings for midget road cars, Miller-Ford V8 front-drive racers are illustrated and described and other big-time data given. Technical pictures give the inside dope on these cars, together with authentic descriptions. 50 pages. 66 illustrations. \$1.00.

ORDER ON COUPON

POPULAR MECHANICS PRESS, Dept. 31, 200 E. Ontario St., Chicago
Remittance for \$_____ enclosed. Send books checked, postpaid.
 Auto Racing, 6th Edition Trailer Coaches
 Auto Racing, 5th Edition Auto Racing, 4th Edition
 Send C.O.D., postage extra.

NAME _____
ADDRESS _____
CITY _____ ZONE _____ STATE _____

SAVE UP TO 60%! GIGANTIC MAIL SALE!

COMPLETE BARGAIN CATALOG
Order from ad. Satisfaction guar.
Or, rush card for big free catalog.

Power Plants · Welders · Pumps · Compressors · Tools

WE PAY SHIPPING COSTS



FLEXIBLE GUY and TURNBUCKLE UNITS

- New 12-ft. flexible steel cable with 14-in. turnbuckle.
 - 7-strand 1/4" galv. steel wire cable, 1000-lb. strength.
 - Hundreds uses on farms, for business, contractors, etc.
 - Guy — strengthen — gates, fences, buildings, wagons, etc.
 - Ideal guy for television towers, many other uses.
 - Cost Gov't. \$1.10 ea.
- SALE, 10 for \$ 3.89
50 for 16.47
100 for 29.32

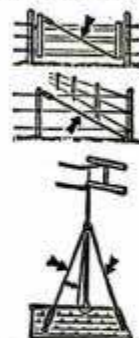

WATER PUMPS and SYSTEMS

Genuine brand new Burdex bronze self priming all purpose water pumps. Std. pipe threads. Will lift up to 22 ft. Pressures to 30 lbs. Up to 22 g.p.m. Other pumps up to 150 lbs.

- 1/2" BRONZE \$12.75
- 3/4" BRONZE 16.95
- 1.0" BRONZE 22.95
- 3/4" CENTRIFUGAL 6.85



D-C ARC WELDER

0-250 amps. Easy to drive with tractor, engine, etc. Professional outfit. Ready to use. Built-in controls. reactor..... **\$99.50**
• Unit with G.E. helmet, rod holders, rods, cables, clamps, etc. **\$104.50**
\$300.00 value **\$104.50**



TRACTOR WEED SPRAY UNITS

• Wonderful buy in weed spray equipment. Bankrupt dealer's and excess inventory stock. Top quality units. Latest type. Less than factory cost. All units fully guaranteed.
• Weed spray equipment already hard to get. Buy at once. Or send for Weed Spray Bargain Catalog.

LOT NO. 130 All brass bottom assembly. 4-row, 14-ft. size, with 9 genuine T-jets, filter, hose, tractor mounting brackets, pressure gauge. **\$32.90**
Standard cost, \$71.50. SALE.....

LOT NO. 131 Direct drive, 3/4" bronze tractor pump, **\$26.95**
SALE.....

LOT NO. 132 Weedmaster complete spray outfit. 5-row, 17 ft. Complete tractor with pump, jets, valves, gauge, hose, tractor mounting brackets, etc. **\$99.95**
List, \$150.00. SALE.....

Send for Weed Spray Bargain Circular. **COMPLETE WATER SYSTEMS** low as \$69.00 Write for Pump Circular

POWER & HAND WINCHES

• Amazing Values. Jeep winches, 80 to 1 ratio, 5,000 lb. capacity. Mounts on front trucks, jeeps, cars. Cost over \$150.00..... **\$21.95**
• Finest Steel Hand Winch. Powerful unit complete with 50 ft. 3,000 lb. cable. Complete with crank. **\$29.95**
\$50.00 value.....

• Everything new, unless otherwise stated. Satisfaction guaranteed.
• Write for free amazing bargain catalog — hundreds of electronic, radio, mechanical, tool, pump, other bargains.



MISCELLANEOUS BARGAINS

- "We pay shipping costs on everything"
- A. Utility Clutch up to 6.5 h.p. **\$13.95**
 - B. V-belt Clutch up to 1.5 h.p. **7.49**
 - C. Hand Gas Pump 10 g.p.m. **15.90**
 - D. Army Field Telephone EE-8. **11.25**
 - E. Rural Phones (5 bar)..... **12.40**
 - F. City Desk Phones (Com. Batt.) **4.99**
 - G. Briggs 3.5 h.p. Engine..... **75.50**
 - H. 2 sta. phone inter com..... **11.60**
 - I. 110-v. Electric Chain Saw... **94.50**
 - J. Auto Compression Tester.... **3.94**

Burden Prepays All Shipping Charges! except on 3500-watt plant.

BURDEN SALES COMPANY

804 "O" ST. LINCOLN, NEBR.

A-C POWER PLANTS (3500-watt)

- Brand new 110-volt, 60-cycle, 3000-4000-watt. Complete with tools, spare parts, battery, full instructions.
- Push-button start. Easily made for automatic start.
- Genuine Hercules 4-cyl. 15 H.P. eng.
- Finest Hobart generator. Complete instrument panel.
- Ideal emergency (or full time) plant. For farmers, city homes, resorts, etc. 770 lbs. 19x30x48-in.
- Today's cost, over \$1,400.00.



SPECIAL..... \$485 Frt. Collect

AIR COMPRESSOR KIT

Build portable hi-pressure (up to 150 lbs.) air unit. Basic kit consists best 1-cyl. piston compressor, stainless 12"x24" tank, 160-lb. gauge, genuine Brown paint spray gun, dust blow gun, tire chuck, 15' hose, fittings and manual "How to build." Guaranteed. **\$36.90**



AIR COMPONENTS

- Compressors. Sing. Cyl. Smith. Pressures to 150 lbs. at 3 c.f.m. Top quality. **\$18.15**
- Regulators. Adjustable 20 to 150 lbs. **\$2.49**
- Hose (15') Finest Rubber 1/4" fittings..... **\$1.99**
- Tanks 12"x24" 400 lb. stainless 12"..... **\$8.95**
- Guns. Planet dust blow. **\$1.21**
- Guns. Heavy Duty paint. **\$8.95**
- Switch. Automatic pressure, adjustable..... **\$4.95**



HANDY CALCULATOR FOR WOODWORKERS.. ONLY 10c

Just set dial, quickly solves countless problems. Converts linear to board feet, compares workability of various woods, shows bit sizes, nail specifications. Also tool sharpening tips, etc. 6" diameter heavily varnished cardboard. Send 10c to Greenlee Tool Co. 2102 Columbia Av., Rockford, Ill.



PROTECTIVE UNBREAKABLE EYESHIELDS

U. S. ARMY APPROVED

- FOR SHOPWORK—Protects your eyes from flying particles, chemical sprays, etc.
 - FOR SPORTS—Protects against sun, snow glare or wind—while skiing, hunting, driving, etc. Fits over Glasses. With snug, adjustable headbands. Money-back guarantee. Mail check or money order to: **BENDAR IMPORTING CO., 520 SURF ST., CHICAGO 14, ILL.**
- One clear shield, one smoked shield; set, **\$1.00** postpaid



BUILD a "Schneider" SPEEDSTER

Have Fun! Save 1/2 the Cost!



Complete plans with FULL SIZE details for America's finest designed and engineered outboard speedsters, sailing dinks, rowboats and skiffs... ALSO... easily assembled cut-to-fit KITS. SEND 10c for illustrated literature

SCHNEIDER BOAT CO. DEPT. 121, 1913 W. VLIET ST. MILWAUKEE 5, WIS.

SET JOINTER KNIVES in PERFECT ALIGNMENT

only **\$1.75** Postpaid

New Belsaw Setting Gauge

- Accurate • Quick • Easy True alignment of your jointer and planer knives is easy with BELSAW Knife Setting Gauge. Set your knives equal to original factory accuracy... in just 30 seconds per knife! Money back GUARANTEE by makers of famous BELSAW wood-working equipment. Send check or money order today.



BELSAW MACHINERY CO 211 Field Bldg., Kansas City 2, Mo.

Mall POWER TOOLS
THE RIGHT "FOUNDATION" ON WHICH TO BUILD YOUR WORKSHOP!

★A Complete line of "matched" tools, attachments and accessories, engineered to work together. ★World-wide service, 37 Factory Branches, 100% interchangeable parts. ★Thirty years experience in building Power Tools for American Industry, Railroads and Contractors.



(A) Mall Drill Model 149 perfect for home or workshop use, has the speed and power to drill any material. Capacity 1/4" in metal to 1/2" in wood. Sintered bronze bearings, aluminum alloy housing, powerful universal type motor gives spindle speed of 2000 rpm. Weighs only 3 1/2 lbs. Genuine Mall dependability at extremely low price. Complete with hand-tight chuck, \$16.50. Complete with Jacobs' geared chuck, \$19.50.

PARTIAL LIST OF ATTACHMENTS

- (B) Sanding Pad Kit** includes 4" pad, 6 abrasive discs and assembling wrench. For fast, all-purpose sanding. No. 35555, \$4.20.
- (C) Belt Sander.** Cuts sanding time to a minimum. Gives smooth finishes on all woods. No. 38170. Price \$14.95.
- (D) Slitting Saw.** Attachment that will cut wood, non-ferrous metals and plastic. Saves hours of tedious hand sawing on any job. No. 32940. Price \$7.50.
- (E) Mall Electric Hand Chain Saw** is ten times faster than hand sawing. Power to outlast 10 men cutting timber to 12" dia. with one cut; 24" dia. with two cuts. Light weight, but sturdy (only 11 lbs.). In a tree or on a scaffold or ladder it can be operated with one hand. Universal electric Motor, 115-230 volt AC, or DC, current. Heavy duty Mall construction. Model 1E12, Complete Price \$95.00.

Order from your dealer or direct from us. Send for free "Magic Power" Bulletin 2311-2

MALL TOOL COMPANY
7805 South Chicago Ave. • Chicago 19, Ill.

SAY YOU SAW IT IN POPULAR MECHANICS

NEW Low Cost QUALITY Tools!

ANNOUNCING



AMERICA'S NEW
VALUE STANDARDS

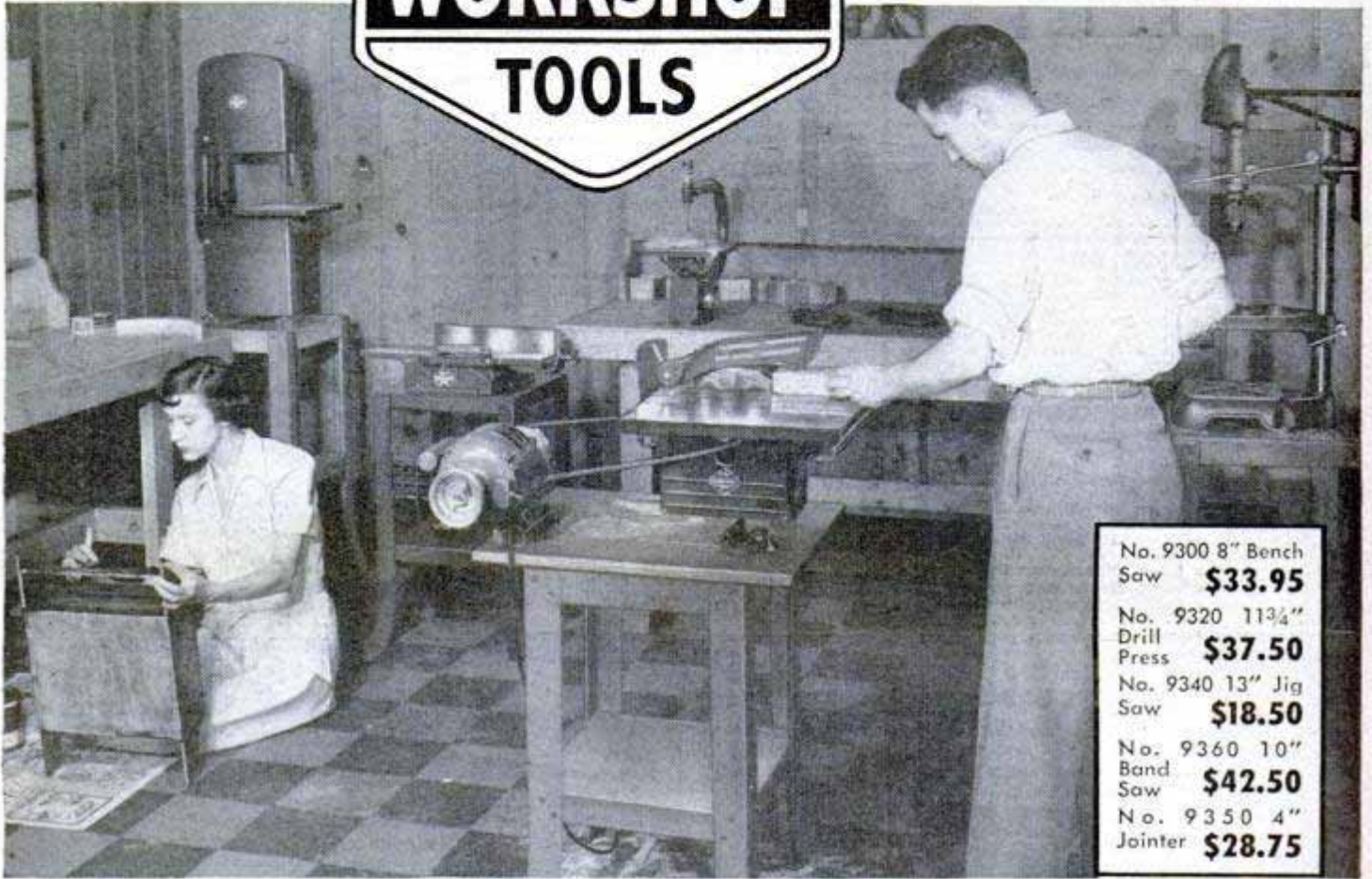

No. 9300 8" Bench Saw	\$33.95
No. 9320 11 $\frac{3}{4}$ " Drill Press	\$37.50
No. 9340 13" Jig Saw	\$18.50
No. 9360 10" Band Saw	\$42.50
No. 9350 4" Jointer	\$28.75

Now Every Family Can Enjoy the Fun and Savings of a Power Tool Home Shop!

FREE



These are the first low-cost *quality* tools. If you have long wanted precision tools for your shop, but haven't wanted to spend the money for large machines, these Atlas Workshop tools will suit you to perfection. All the skill of Atlas' 40 years of precision engineering has gone into the development of Workshop tools. They give your shop *greater* versatility at *less cost* than any tools or combination tool on the market — *and all 5 can be powered with 1 motor!* See them today at the store of any Atlas or Atlas-Power King dealer. Send the coupon for complete catalog.

ATLAS PRESS CO.

243-W N. Pitcher St., Kalamazoo, Mich.
Please send your Workshop Tool catalog.

Name _____

Address _____

City, State _____



ATLAS PRESS CO.

243-W N. PITCHER ST., KALAMAZOO, MICH.

DEPENDABLE QUALITY TOOLS

Announcing "MOTO-MOWER" I N C L U D I N G first

fundamental improvement
in Power Lawn Mowing
now available on
NEW MODELS
Nineteen Hundred Fifty-One

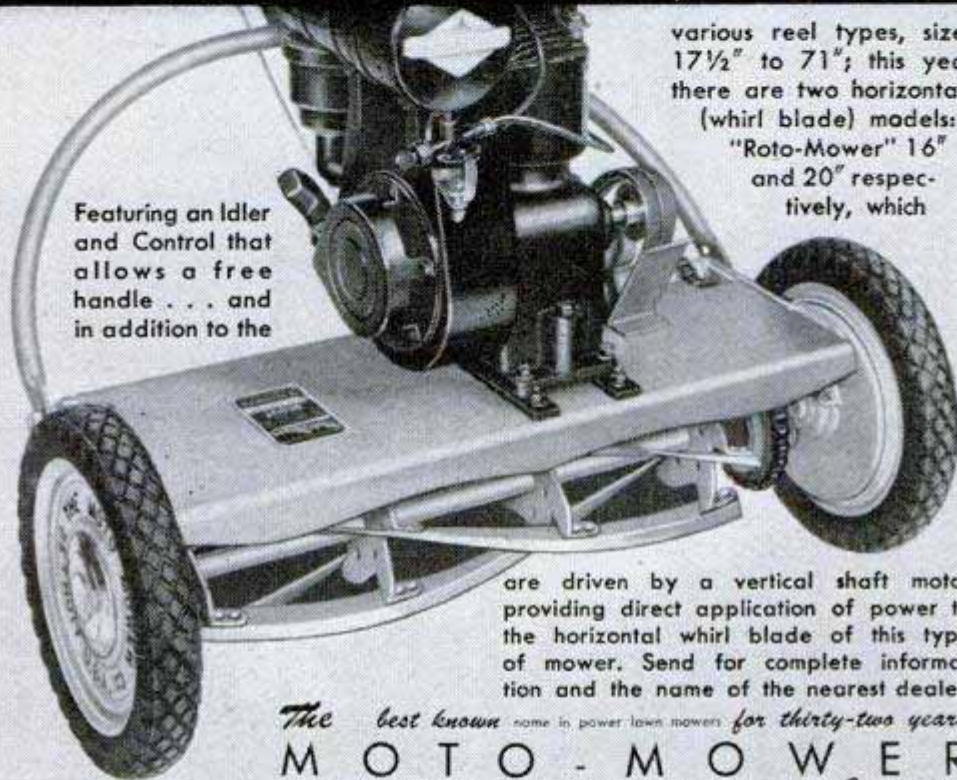

Featuring an Idler and Control that allows a free handle . . . and in addition to the

various reel types, sizes 17½" to 71"; this year there are two horizontal (whirl blade) models: "Roto-Mower" 16" and 20" respectively, which

are driven by a vertical shaft motor providing direct application of power to the horizontal whirl blade of this type of mower. Send for complete information and the name of the nearest dealer.

The best known name in power lawn mowers for thirty-two years
MOTO-MOWER
4615 Woodward Ave. Detroit 1, Michigan Company



SPORTONE MUFFLERS

- Ford & Chevrolet.....\$ 4.45
 - All other popular cars..... 5.45
 - V-8 Dual Sets..... 15.95
 - Chromed Silentips..... 2.95
- (Please state make & year of car on all orders.)

SANDEE MUFFLER CO.
5643 Corryne Place • Culver City, California

Make Personalized HOUSE, LAWN MARKERS For Fun Or Profit



17 new silhouette cutouts (3 shown plus 14 other novel designs) complete alphabet and numbers, ready to trace onto wood. Sawing is easy. Marker with name or address is distinctive personalized gift or addition to your own home. Make markers for fun and to sell. Set of 17 full-size, ready-to-use patterns, alphabet, numbers, only \$1.00, postpaid. Money Back Guarantee.

Clip This Ad and Mail With **CRAFTPLANS** 1321 S. Michigan Ave. Dollar Bill or Check TODAY Dept. P-184, Chicago 5, Ill.

New MOTOR BARGAINS for Home, Farm & Industry



- New General Electric 1/2 H.P. Induction Type 3450 RPM 110 V, 60 cy. 1 Ph. A.C. Motor #GEH-5 . . . \$21.75
- New General Electric 1/2 H.P. Cap/Ind. Ball Brg. 1750 RPM, double 1/2" shaft. 110 V, 60 cy. 1 Ph. A.C. Motor #GE-75 . . . \$26.50
- New General Electric 3/4 H.P. Cap/Ind. Ball Brg. 1750 RPM, dbl. 1/2" shaft. 110 V, 60 Cy. 1 Ph. A.C. Motor #GE-75 . . . \$34.50
- New Eicor 1 H.P. Capacitor Induction 1750 RPM, 110/220 V, 60 Cy. 1 Ph. A.C. Motor #EG-17 . . . \$45.00
- New Emerson 1 H.P. Heavy Duty, Repulsion Induction, 3450 RPM, 110/220 V, 60 Cy., 1 Ph. A.C. Motor #EH-1 . . . \$42.50
- Same as above, 1 1/2 H.P. 220-V only #EH-15 . . . \$57.50
- Same as above, 2 H.P. 220-V, #EH-20 only . . . \$67.50

General Utility Motors

- 1/50 H.P., shaded pole motor, brushless, non-radio interfering, 1550 R.P.M., 110 volt, 60 cycle A.C. for light machinery duty, exhaust fans, furnace fans, oil heater blowers and many practical purposes. Handles any 10 or 12 inch fan blade. Special at \$4.50
 - No. UM-50, 1/50 H.P. Mtr. & Speed Controller (\$1. val.) both postpaid . . . \$4.50
 - No. F-10, 10 inch fan blade to fit above motor, Postpaid . . . \$1.00
 - No. F-12, 12 inch fan blade to fit above motor, Postpaid . . . \$1.50
 - No. B-4, 4 inch, Sirocco Blower Wheel to fit above motor \$1.50
- The above prices are F.O.B. Chicago. Order by number. We have large stock of special & standard motors, ALL SIZES. Write for prices on the motor you need.

TOY MOTOR BARGAIN



- 1/250 H.P. shaded pole motor, 110 volt, 60 cycle, A.C., for powering toys, display and experimental work. Only \$1.75.
- No. TM-12, 1/250 H.P. A.C. Motor & Speed Controller (\$1 val.) both postpaid \$1.75.

BARGAIN RHEOSTAT SPEED CONTROLLER

- Small 2-inch dia. rheostat for 1/50 H.P. and smaller motors gives approximately 30% speed reduction, light dimmer, etc.
- No. RHEO-1, Rheostat complete with instructions . . . Postpaid . . . \$1.00

THE VAPORITE

Automatic HUMIDIFIER for Warm Air Furnaces. THERMOSTATICALLY controlled water supply puts more moisture in the air. Easily installed in bonnet of air furnace. Complete with THERMOSTAT Water Control Valve. Tubing and parts for complete installation. GIVES HEALTHIER AIR. \$15. Value ONLY \$7.50 POSTPAID.



WRITE FOR BIG BARGAIN MOTOR CATALOG & ELECTRICAL GOODS AND SAVE MONEY.

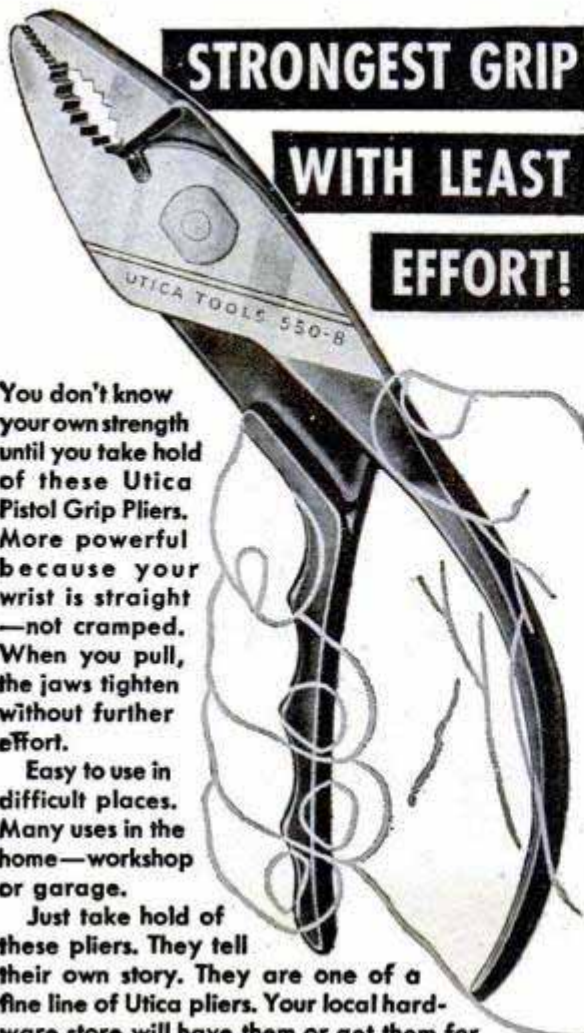

**STRONGEST GRIP
WITH LEAST
EFFORT!**

You don't know your own strength until you take hold of these Utica Pistol Grip Pliers. More powerful because your wrist is straight—not cramped. When you pull, the jaws tighten without further effort.

Easy to use in difficult places. Many uses in the home—workshop or garage.

Just take hold of these pliers. They tell their own story. They are one of a fine line of Utica pliers. Your local hardware store will have them or get them for you. **FREE—descriptive folder on request.**



#550
\$2.20

Utica Drop Forge & Tool Corp. • Utica 4, New York

Jointer Owners!

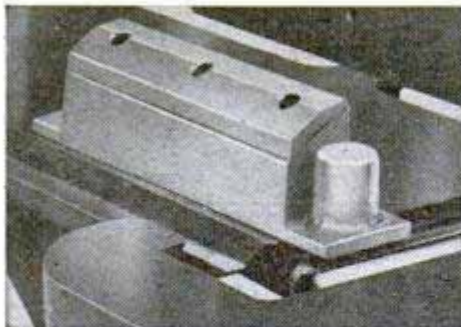

sharpen and
reinstall your
own jointer
knives quickly
and accurately

Jig-gauge in place on back table

This combination sharpening jig and reinstallation gauge makes it easy for you to grind and reinstall your 4 and 6" jointer knives in fifteen minutes. All you need to do is install the grinding wheel in your drill press, put each knife in the jig, and pass it under the special cupped grinding wheel several times. Reinstallation is easy. The gauge—mounted on one end of the jig—tells you quickly and easily when the edge of the knife is exactly even with the top of the back jointer table.

Satisfaction GUARANTEED or your money back.

Sharpening jig with gauge, and grinding wheel complete with arbor.....

\$12⁶⁵

See your dealer or order direct. Postage paid on pre-paid orders.

HARTMEISTER MFG. CO., 2020 W. Barbary Pl., Denver 4, Colorado

Packed with Fun, Fascination and Profit for Everyone

WHAT TO MAKE AND HOW TO MAKE IT

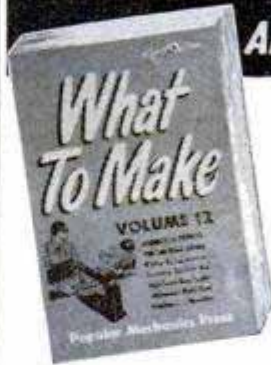

**Popular Mechanics Annual
Workshop and Hobby Guide
for
HOME CRAFTSMEN —
HOBBYISTS**

New 1951 Volume Ready

250 projects including—On-the-Spot Darkroom, Leathercraft Novelties, Outdoor Gym, Telescope Tripod, Molded Hands to Hold Your Books, Kiddie Roller Coaster, Camera Enlarger, Inexpensive Windows, High-Speed Boat Trailer and others—250 in all.

EXTRA SPECIAL! New Articles Never Before Published! "Carving and Rigging a Miniature Ship," by Raymond H. Biggs. "Projects From Scrap Wood," by Amy E. Jensen.

Cloth Bound \$1.75



START YOUR OWN WHAT TO MAKE LIBRARY

VOLUME 1 — 152 Projects

Including—Modernizing Kitchen Sinks, Attic Ventilator Fan, Folding Table and Benches, Porch Mail Boxes, Hammock on wheels.

VOLUME 2 — 201 Projects

Including—Lighting Fixtures, Bird Cages, Plywood Facing on Old Doors, Porch Furniture, Folding Picnic Table, Telephone Stand.

VOLUME 3 — 291 Projects

Including—Home Improvements, Basement Playrooms, Garden Fences, Quilting Frame, Dog Houses, Tables, Magazine Racks, Tubular Steel Furniture.

VOLUME 4 — 325 Projects

Including—Utility Kitchens, Doorbell Chimes, New Windows Modernize Old Homes, Using Glass Blocks.

VOLUME 5 — 273 Projects

Including—Closet Fittings, Attic Rooms, Storm Sash and Doors, Colonial Corner Cupboard, Breakfast Table, Nested Tables.

VOLUME 6 — 380 Projects

Including—Colonial Bed, Dog Bed, End Table and Vanity, Telephone Shelves, Game Table, How to Hang a Door.

VOLUME 7 — 249 Projects

Including—Tea Cart, Twin Studio Beds, Smoking Stand, Boy's Desk, Pull-up Chair, Bookends.

VOLUME 8 — 271 Projects

Including—Plywood Picture Frames, Craftwork in Plastics, Marbelized Finishes, Jewelry From Sheet Metal, Rustic Furniture.

VOLUME 9 — 378 Projects

Including—Costume Jewelry, Carved Desk Set, Decorative Wall Plaques, Heat Forming Plastics, Colonial Chair, Chessmen.

VOLUME 10 — 389 Projects

Including—Table-Top Loom, Eight-foot Duckboat, Built-in Studio Couch, Synchro-Flash for Box Cameras, Plastic Lamps, Sidewalk Jeep.

VOLUME 11 — 205 Projects

Including—Modern Bedroom Furniture, Coffee Table From Log, Kneehole Desk, Fishing Tackle Mending Kit, Barbecue Cart.

**SINGLE VOLUMES \$1.75 EACH NO DUPLICATION
ENTIRE 12 VOLUME SET AT SPECIAL PRICE OF \$18.00**

HANDY ORDER BLANK

POPULAR MECHANICS PRESS, Dept. 37
200 E. Ontario St., Chicago 11, Ill.

Send at once volumes of What to Make circled at \$1.75 each:

1 2 3 4 5 6 7 8 9 10 11 12

Send complete twelve volume set at special money saving price of \$18.00.

Name _____

Address _____

City _____ Zone _____ State _____

Remittance enclosed Send C.O.D. (Postage extra)

SAY YOU SAW IT IN POPULAR MECHANICS

MILLER ROTARY

HI-SPEED / OPE-SAW / DRILL-BIT
IT / SAWS & CUTS / REAMS

Presents The Big 3



Each Bit Performs its own Function
Specify Which

SAWS, CUTS, REAMS Sheet metal, angle iron, pipe, wood, plastic, Transite, etc. Amazing high-speed combination bit and saw fits any 1/4" or 1/2" electric drill or slow drill press. Drills own starting hole to quickly cut, saw or ream opening. Easy to operate. Ideal for carpenters, auto mechanics, electricians, plumbers, hobby workers, many others. Abrasive resistant high speed steel. No breaking. Will withstand severe continuous use. Resharpener at no charge. 1/4" diameter, over-all length 3 1/2", cutting section 2" long with flutes ground from solid. Shipped same day—money back guarantee. Discounts on quantity orders from dealers. Takes place of up to \$50 in tools.

SEND CASH, CHECK OR M. O.

Each \$3.95 ^{Post-paid} 3 for only \$11.50 ^{Post-paid}

Manufactured and distributed by

INTERNATIONAL TWIST DRILL CORP.

624 Wyandotte Rm. 262 Kansas City 6, Mo.
"Pioneers in break-resistant short drills"

SHEET METAL BRAKES

Forms angles, flanges and Pittsburgh locks. 26 gauge steel, heavier aluminum. Cam locking. Portable, can be bolted to bench, or clamped to edge of truck. All steel, reinforced. Shipped Exp. Coll. 30" size. Wt. 54 lbs., \$26.50. 36" Wt. 66 lbs. \$31.00. 48" Wt. 100 lbs., \$45.00. Floor mountings, portable, 32" high, \$7.00 12" BRAKE. Fits in vise to form difficult compound bends, up to 20 gauge steel. Not illustrated. 24" CURVE FORMER. Capacity—18 gauge steel. \$12.50 P.P. \$10.00
IRON BENDER, 1/4x2" capacity. 9 parts. All steel. \$10.00 P.P.
Immediate Delivery. Order direct, cash or C.O.D. or send for folder.
VYKE BRAKE CO., P-1116 So. 27th St., Omaha 5, Nebr.



STANDARD GARDEN AND SMALL FARM TRACTORS

RIDE-WALK Powerful Gas Tractors for Small Farms, Gardeners, Florists, Suburbanites, Fruit and Poultrymen.
1 & 2 Cylinders
Rubber or Steel Tires.
Easy Terms — Free Catalog

Plow Seed Cultivate Mow Haul Belt Work

STANDARD ENGINE COMPANY
MINNEAPOLIS, MINN. NEW YORK, N. Y.
3221 Como Avenue 617 West 26th Street

HELPFUL BOOKS

Send post card asking for FREE catalog

Popular Mechanics Press, 200 E. Ontario, Dept. 601, Chicago 11

Saw, Drill & Grind

without stopping, lifting machine or changing set-ups; only one change for lathe work and sanding. No heavy lifting. Basic Emrick 5-in-1 Machine still only \$39.95. 10-day Free trial; Money-Back Guarantee. Write for FREE Catalog of entire line.



EMRICK, INC., 121 Clinton, Kalamazoo, Michigan

Make Your Shop More Useful

WITH Atlas

PRECISION TOOLS

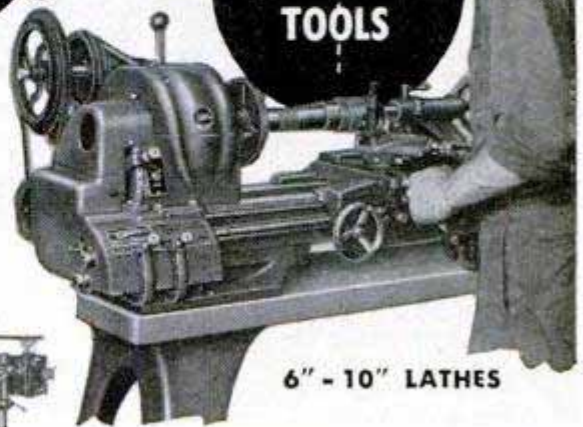

6" - 10" LATHES



DRILL PRESSES



MILLING MACHINES

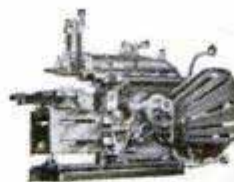

SHAPERS

Opportunities are opening up again for sub-contracting on defense production. If you have the skill for such work, Atlas precision tools will help you equip for it at low cost.

Atlas lathes, for example, give you wider speed selection and greater versatility than any other low cost metalworking lathe. And the Atlas is Timken bearing equipped for dependable production and accuracy. Atlas drill presses (50 models), millers, and shapers have also fully proved their worth in all types of precision operations.

America needs machining skill and all-out production from small and large shops as never before. Now is the time to get started if you have such ability. Send the coupon today for catalog.

Send For New FREE Catalog

ATLAS PRESS COMPANY

243 N. Pitcher St. Kalamazoo, Mich.



ATLAS PRESS CO., 243 N. Pitcher St., Kalamazoo, Mich.

Please send latest information on Atlas tools.

10" lathe; 6" lathe; drill press; miller; shaper; woodworking tools.

NAME _____
ADDRESS _____
CITY, STATE _____

This Emblem on Your Engine Means that You Have the World's Quickest-Starting Most Reliable Small Gasoline Engine



Look for the Clinton Emblem when you buy your garden tractor or power equipment. You'll find Clinton Engines on leading garden tractors—such as this Bolens Power-Ho Garden Tractor.

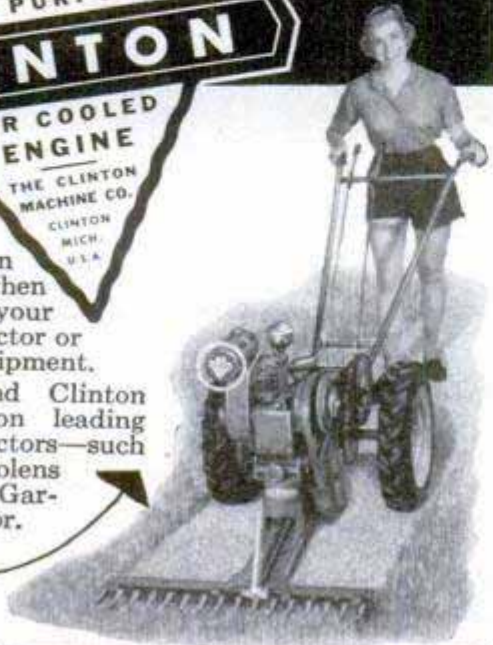

CLINTON ENGINES

DO MORE PLANING JOBS WITH LOW-COST BELSAW \$215.00

AMAZING 12 1/4-IN. PLANER Does All Ordinary Planing Mill Jobs. Provides attachments for Jointing, Rabbeting, Tongue, Groove, Matching. 12 1/4 x 6-in. capacity, 3-knife solid round all-steel cutterhead. Power feeds at 24 feet per minute, 42 cuts per inch. Provides for full line of accessory attachments—Grind and Joint knives in THE CUTTERHEAD WITHOUT REMOVING.

BELSAW MACHINERY CO.
1017 Field Bldg., 315 Westport Rd., Kansas City 2, Mo.

FREE BOOK

Hardened Steel HAND PUNCHES

—5 widely used sizes—**\$2.95** set
Low factory prices on clean-cutting WAGNER punches. Make washers, gaskets, etc. Punch paper, leather, felt, plastics accurately and fast. Five sizes for \$2.95: 3/8", 1/4", 1/2", 5/8", 3/4". Length: 3". Send cash, check or money order—postage prepaid in U. S. A.

F. WAGNER & SON, Inc. 603 S. Palm Ave. Alhambra, California

HOT RUNNING WATER!

Attaches easily, quickly to any standard faucet. Regulates temperature by turning faucet. Operates AC or DC. Comes with 8-ft. rubber cable and plug. Our DELUX heater has delighted many thousands of users. Send \$3.95 cash, check, or M.O.—we will ship prepaid or, if you wish, we will ship C.O.D.—you pay postman \$3.95 plus few cents postage. Order 3 for \$10—save \$1.85.

METROPOLITAN ELECTRONICS CO.
Dept. 199, 106 Fifth Ave., New York 11, N.Y.

TRY WATER-INJECTION 30 DAYS AT OUR RISK!

Add zip to your car with "Vapo-Jet." Automatically combines water, oil vapors, with fuel, to help give smoother performance, more power, faster get-away, better pickup, fuel economy. Complete. Nothing else to buy.

LIMITED SUPPLY Rush order today! Give car make, model, no. of cyl. Remittance with order saves postage!

BANTEL MFG. CO., 757-L Venice Blvd., Los Angeles 15, Cal.

YOU CAN BUILD A VIOLIN FOR PLEASURE OR PROFIT

Now you can build a rich toned mellow violin modeled after a famous "Strad." **YOU CAN MAKE A STRADIVARIUS VIOLIN** contains 8 full scale plans plus complete instructions. You work directly from the plans with no confusing scale of dimensions to translate. Detailed instructions for each step including varnishing and stringing—even shows how to build your own tools. Cloth bound. Order today from

POPULAR MECHANICS PRESS \$3.50
200 EAST ONTARIO STREET, CHICAGO 11, ILLINOIS

Say You Saw It in POPULAR MECHANICS

Make Your Own LOW COST POWER TOOLS

Use Wood, Scrap, Discarded Materials—Make Practical, Proven Machines

Order today the new "Forty Power Tools You Can Make." Even though you have the older edition, get this new book with twenty brand new tools—40 in all. Make your own motorized lathe, drill press, sander, shaper, circular, band, scroll and jig saws from old auto and other discarded parts. Make forty different tools following simple instructions, diagrams and photos and have an efficient, up-to-date shop. Save money, time and hard work and do a better job with low-cost power tools. Sent postpaid for only \$1.50 with order. Avoid high C. O. D. charges.

POPULAR MECHANICS PRESS
200 E. ONTARIO ST., CHICAGO 11, ILLINOIS

FEDCO Saw-Rite get this WONDER-WORKING DRILL SAW

Fits any 1/2" drill

FINEST YET MADE... ZIPS THROUGH WOOD, PLASTICS, WALLBOARD, ETC.

You'll never use a handsaw again after you try this light-weight, fast-cutting beauty. Careful design, rugged, precision manufacture and a better blade make this an outstanding buy. Quick-acting, worm-drive, patented clamp gets it on and off your drill in seconds. Combination blade is chrome nickel alloy steel, precision ground, correctly heat treated, balanced and fitted. Cuts grooves, dados, crosscut, rip, hour after hour without sharpening. Depth of cut fully adjustable from 1/4" to 1 3/4", cuts plywood, shelving, wallboard, 2x4's to 2x10's in two cuts, one from each side. Special sighting notch enables you to follow line. Lifetime Oilite bearings, finest quality hardened steel gears, shafts. One or two hand operation with hand-fitting knob. Use coupon to order at once for immediate delivery. Try it for 10 days, full refund if not completely satisfied.

Fully adjustable

Fedco also makes Saw-Rite Jr. at \$6.95 and Stanzall at \$2.95... ask for FREE literature.

FEDCO \$10.95
Saw-Rite Attachment

COMPLETE WITH COMBINATION BLADE

ELECTRO SPECIALTY CO.
128 Church Street, N. Y. 7, N. Y.

Electro Specialty Co., 128 Church St., N. Y. 7
Send me _____ Saw-Rite #600 Saw Attachment(s) @ \$10.95; _____ Additional blades @ \$2.00; _____ metal cutting blades @ \$3.00; _____ FREE literature.
(Write name and address on margin)
(All prices postpaid except C.O.D.'s)

**YOUR WORK
DESERVES . . .**

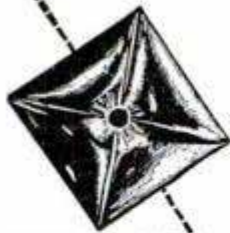

**FIND YOUR NEAREST
DEKTUFT RETAILER
BELOW**

Cain-Sloan Co., Nashville, Tenn.; Gimbel Bros., Philadelphia, Pa.; Goldblatt Bros., Inc., Chicago, Ill.; Hale's, Oakland, Calif.; Hecht Co., Washington, D.C.; Higbee Co., Cleveland, O.; J. L. Hudson Co., Detroit, Mich.; F. & R. Lazarus & Co., Columbus, O.; Leonards, Fort Worth, Texas; R. H. Macy & Co., New York City; May Co., Cleveland, O.; Milwaukee Boston Store, Milwaukee, Wisc.; Mandel Bros., Chicago, Ill.; Rich's Inc., Atlanta, Ga.; Rike-Kumler Co., Dayton, O.; Sears-Roebuck & Co., Drapery Dept. and Sears mail order div.; John Shillito Co., Cincinnati, O.; Stix, Baer & Fuller, St. Louis, Mo.; John Wanamaker, Philadelphia, Pa.; Montgomery Ward, Jamaica, N.Y.



DEKTUFTS!

Yes, your craftwork deserves these luxurious 4-inch square, leather-like tufts. They add a colorful, professional finish to headboards, home bars, toy chests, tables, wall surfaces, and hundreds of other home decorating projects. So easy to use a child can mount them, dektufts* attach to any wooden surface . . . last for years. Available in 7 handsome colors at retailer nearest you.

LITERATURE AND SAMPLE

If there is no retailer in your vicinity, send 25c to cover cost of handling and mailing to Deks, Inc., Dept. PM-2 for sample Dektuft and free literature.



*Pat., U.S. & For. Pat. Off.

DEKS, inc. 482 Broome St., New York 13, N. Y.



**NEW POPULAR
MECHANICS
MAGAZINE
LIBRARY FILE**

**Brand New, Grand New
Way to Preserve Each and Every
Issue of Popular Mechanics**

Now you can preserve every treasured issue of Popular Mechanics in these ingenious, custom-built storage files. Constructed to look like an attractively bound book, Popular Mechanics Magazine Library Files afford neat, orderly, flick-of-the-finger convenience. Handy reference index printed on back records the exact location of selected articles, diagrams, etc. A "must" for every reader of Popular Mechanics Magazine. A sensational Popular Mechanics value scoop. Order yours today. Use the handy coupon.

**Only
70c**

PER SET OF 2
(set holds 12 issues)
POSTAGE PAID

5 sets only **\$3.10**

10 sets only **\$6.00**
POSTPAID

USE THIS COUPON . . . MAIL TODAY

Popular Mechanics Magazine, Dept. PL
200 East Ontario Street, Chicago 11, Illinois

P1-01

Please rush PREPAID _____ set Popular Mechanics Magazine Library Files.

(QUANTITY)

Remittance for \$ _____ is enclosed.

(AMOUNT)

Name _____

Address _____

City _____ Zone _____ State _____

**NEW SAFE SAW
CUTS ONE INCH WOOD
50% FASTER WITH
70% LESS NOISE!**



**ARM
ADJUSTS TO
PERMIT SAWING
ANY LENGTH
MATERIAL**

No. 201
\$22.95

Arm in normal position



**SYNGRO
ELECTRIC** **NEW IMPROVED
JIG SAW**

Here's the largest, most powerful jig saw of its kind . . . yet SAFE for children! A "must" for Dad's workshop. Now 70% quieter operation with 50% more power. Cuts any length 1" wood, thin metal, plastic. Precision built to last a lifetime. Portable. Perfect for even apartments! 14,400 Safety Strokes a minute! ENTIRE Saw listed by UL—not just the cord! Built-in Power Unit guaranteed against burn-out all during your ownership or replaced Free! COMPLETE with

BUILT-IN Fractional Horsepower Reactor Type Electric MOTOR, Blades, Cord — only \$22.95.

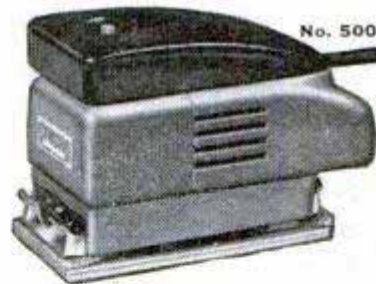

No. 500

**New Improved
SYNGRO SANDER
POLISHER and
MASSAGER**

Comparison proves it best! Exclusive Double Arc Motion. For all light sanding, high polish jobs in tight places, corners, etc. Marvelous massager. 240 strokes a second — just guide it. UL-Listed.

COMPLETE with BUILT-IN Fractional Horsepower Reactor Type Electric MOTOR, 10 sandpapers, lamb's wool and fabric pads, \$16.95

**SYNGRO POWER UNITS
GUARANTEED
AGAINST BURN-OUT
ALL DURING YOUR
OWNERSHIP—or Re-
placed FREE!**

**That's the Name
to Ask For!**

**SYNGRO
QUALITY TOOLS**



U.S.A. model, 110-120 Volt, AC only, 60 cycle. Other voltages, cycles available. Buy at hardware, department stores. If none near, send article price, we'll ship POSTPAID.

SYNGRO CORPORATION
Dept. D-21, Oxford, Michigan, U.S.A.

How to **SAVE MONEY**
on your
POWER TOOLS



8" TILTING TABLE SAW

Compare

SUPERSHOP
FEATURE for FEATURE
DOLLAR for DOLLAR

Buy SUPERSHOP direct from factory and save 47.96%. Lifetime lubricated ball bearings. Precision-built. RUGGED. Handles BIG jobs. Complete line of accessories available. 15 day FREE trial. Money back guarantee. Mail postcard for FREE CATALOG.

FACTORY TO YOU

\$59⁵⁰

POWER TOOLS INC.

120 YATES AVENUE
BELOIT, WISCONSIN



DRILL PRESS



SANDER



LATHE



GRINDER

SHARPEN CIRCULAR SAWS
LIKE AN EXPERT



\$6⁹⁵

THE SUPER GADGET FOR HOME WORKSHOP

Two simple adjustments. Gets hollow-ground, cross-cut or combination saw blades true and sharp. Fits 6" to 12" blades 1/2" to 13/16" centers. Includes file, complete instructions. \$6.95 postpaid. (C.O.D. postage extra.) Guaranteed—Money back if not satisfied after 10-day trial. Soon pays for itself. Order today. Free Folder.

SURE SHARP MFG. CO., Dept. M-21
P. O. Box 24 Santa Ana, Calif.

SAY YOU SAW IT IN POPULAR MECHANICS

RIFLE BARREL BLANKS
ALL WEIGHTS ALL TWISTS

Two Week Delivery Guaranteed on Blanks — Pretuns — Finish Contoured Barrels in Calibres .22, .25, .270, 7mm, .30
Above calibres also fitted to customers action—2 week delivery

OTHER CALIBRES AVAILABLE

6 mm, 6.5 mm, .35, .38 S. & W. Spec., .375, .38-55
.45 Rifle (Slightly later delivery required on above)

ALL ORDERS
PREPAID
IN U.S. AND
TERRITORIES

Write for New Price lists & discounts
PFEIFER RIFLE CO. INC.
11252 PENROSE ST. — SUN VALLEY, CALIF.

MAGNIFIERS
Special Price

FULL TWO INCH DIAMETER READY
LENS—Swivel mounted on heavy cast base
A HIGH GRADE PRACTICAL INSTRUMENT. Just
right for close machine work, model building, fly
tying, etc. C.O.D. orders accepted. Don't delay,
send your order today.

TRAILSIDE MERCANTILE COMPANY, Dept. M
RIVER FOREST, ILLINOIS

Money back guarantee on our merchandise.



ONLY
\$2⁹⁵

DRIVE BEHIND A FRIEND
WHO KNOWS EVERY TURN



Ever been out of town and had a friend lead you through confusing turns and intersections until you were on the right road home? Sure is welcome help—the kind you get EVERY DAY with a Hull Automobile Compass. At your dealer's. Write for literature.

See Hull quality before you buy

Beaconlite
Illuminated **\$6⁹⁵**
STREAMLINE **\$4⁹⁵**
Standard (Not Imit.)

HULL MFG. CO. P. O. Box 246-D2,
Warren, Ohio



Build your own JET ENGINE!



SEND
NO
MONEY

Order these plans today

1. JET PROPELLED BICYCLE, Assemble your own. Photo and instructions, \$1.00.
2. HOW TO MAKE EXPERIMENTAL JET ENGINES. Seven sheets drawings with information and instructions \$2.95.
3. BOTH OF ABOVE in one order \$3.75. SEND NO MONEY. Order both at once \$3.75 C.O.D. in USA plus c.o.d. postage. Send check or Money Order and we pay postage. Get other information too. Rush Order.

J. HOUSTON MAUPIN, Dept. 55, Tipp City, Ohio

Got an Idea? An Inventive Mind? . . .
Want to Cash In on It? . . .

THEN GET

CLOTH
BINDING

\$2.50

MONEY
from **IDEAS**

MONEY FROM IDEAS by Myron P. Laughlin, is a down to earth, informative and useful book for every man with an active, inventive mind, who believes he has ideas that can be patented.

Get this book to determine what inventions are needed for today's market, and how to go about inventing them; how to get a patent, protect it, sell it and make money out of it.

144 pages, well illustrated, indexed, and contains an appendix of patent forms, most valuable for the sale, assignment or licensing of patents.

Vital, Informative and Practical Help!

Inventions and How They Are Patented—What Inventions Can Do For You—The Growth of an Idea—Let Others Experiences Guide You—An Invention, How It Was Developed—An Invention, How It Was Protected—An Invention, How It Paid Its Way in the World—How to Make Money From Inventions—Invention is a Business—Specialization—Sources of Information. A Where-to-Find-It Index—Records of Progress—Development Work—Starting a Business—Selling Patent Rights—Selecting a Patent Attorney—Patent Forms—Form of Assignment and Royalty Agreement—Form of License—Helpful Books.



POPULAR MECHANICS PRESS
DEPT. 28 — 200 E. ONTARIO ST.
CHICAGO 11, ILL.

The easy way to paint!

Speedy Sprayer

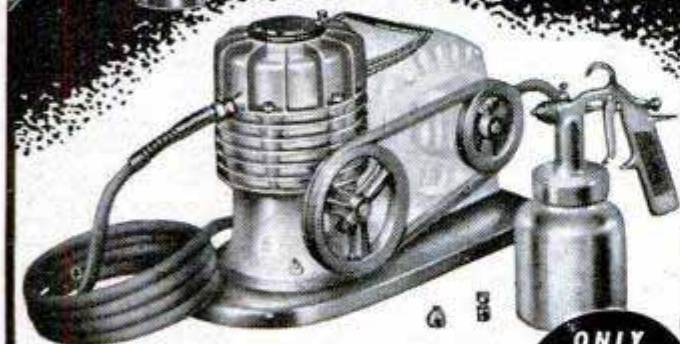

Favorite of home owners and craftsmen for 20 years! SPEEDY SPRAYER gives your work that professional paint finish everyone admires. Sprays paint, enamel, varnish, lacquer, etc. . . . 4 to 7 times faster than hand brushing! Lightweight, portable, uses any 1/4 H.P. motor. Improved diaphragm principle assures clean, oil-free air. You'll find dozens of time and money saving uses for SPEEDY SPRAYER, including spraying insecticides 2-4-D and DDT. Complete outfit, without motor, only \$32.50.

ONLY \$32.50 LESS MOTOR

At leading hardware, lumber, and auto supply dealers. FREE—write for handy booklet "How to Spray."

W. R. BROWN CORPORATION

5717 Armitage Ave. • Chicago 39, Ill.

MAKE A "Stradivarius"

VIOLIN

—For Pleasure
—For Profit
—For Your Own Use

BOOK AND PLANS ALL YOU NEED



You Can Do It at Little Cost!
It's Easy! It's Fun!

Here is the "tops" of all home crafts projects. Make a violin—a replica of a famous "Strad"—the original of which sold for \$80,000.00. Joe Reid who has made hundreds of fine violins makes the job so easy—so inexpensive—in his new book "You Can Make a 'Stradivarius' Violin." You don't need any tools. Reid shows you how to make all the tools you need from old table knives, worn out files, sheet metal, etc. Eight full-size plans, 16x23 inches, folded into the book give you every detail in actual size.



Violins Bring High Prices

Make a violin and you probably will never want to sell it. But good tone modern violins bring terrific prices, yet the materials cost comparatively little. With Reid's plans and step-by-step instructions you can make such a violin for yourself. 15 chapters guide you in selection of wood, fashioning the belly, back, sides, mold, lining, neck, scroll, purfling. Other chapters cover varnishing, finishing, stringing. Others show how to make tools and clamps at little or no cost.

Order Book Today.

Money Back if Not Satisfied.

Make your own violin for pleasure or profit. Get book and plans now. Clip this ad and mail with check, money order or cash for only \$3.50 or we will send C.O.D. Money back in 5 days if not satisfied.

Complete Instructions
8 Actual Size Plans
How to Make the Tools You Need
Where to Get the Materials

You trace or work direct from actual size plans. No measurements to translate or confuse you. You see the entire violin in the plans. You read the how-to-do-it instructions in the book.

POPULAR MECHANICS PRESS

Dept. 30
200 E. Ontario St., Chicago



NOW! YOU CAN EASILY
Fix ANY Car
IN LESS TIME . . .
and do a better job too!



BRAND-NEW Edition of Famous MoToR's Manual Shows You How To Repair — Quickly and Easily—Any Car Built from 1935 THROUGH 1950!

FREE 7-DAY TRIAL

NO job is too tough when you've got MoToR's brand-new AUTO REPAIR MANUAL. Shows how to save work on "ornery" jobs. Helps you make MORE MONEY by doing more jobs in less time! Now covers 1950 models; up-to-date information on all new automatic transmissions and carburetors.

COMPILED FROM 150 OFFICIAL FACTORY SHOP MANUALS!

This great book—750 BIG 8 1/2"x11" pages — brings you the complete "dope" from 150 Official Factory Shop Manuals, boiled down in simple easy-to-understand language. 2100 cut-away photos, diagrams, drawings show WHAT to do, HOW to do it. 200,000 service and repair facts! 741 car models! Now YOU can try it FREE—for 7 days.

COVERS ANY CAR BUILT SINCE 1935!

- | | |
|-----------|------------|
| Auburn | Kaiser |
| Austin | Lafayette |
| Bantam | La Salle |
| Buick | Lincoln |
| Cadillac | Mercury |
| Chevrolet | Nash |
| Chrysler | Oldsmobile |
| Cord | Packard |
| Crosley | Pierce |
| De Soto | Arrow |
| Dodge | Plymouth |
| Ford | Pontiac |
| Frazer | Reo |
| Graham | Studebaker |
| Hudson | Terraplane |
| Hupmobile | Willys |

Same FREE Offer On MoToR's Truck and Tractor Manual

BRAND-NEW! Covers EVERY job on EVERY popular make gasoline truck, tractor, stock engine made from 1936 thru 1949. 961 big pages, 300,000 facts, 1,400 pictures. Check proper box in coupon for FREE 7-Day Trial.



SEND NO MONEY

Mail coupon below — without money! When your book arrives—make it show you what it's got! Unless you agree it's the greatest time and work saver you've ever seen—return book in 7 days, pay nothing. Mail coupon NOW! MoToR Book Department, Desk 12B, 250 West 55th Street, New York 19, N. Y.

MAIL COUPON NOW FOR 7-DAY FREE TRIAL

MoToR BOOK DEPT.
Desk 12B, 250 W. 55th St., New York 19, N. Y.

Rush to me at once (check box opposite book you want):

MoToR's New AUTO REPAIR MANUAL. If O.K., I will remit \$1 in 7 days (plus 35c delivery charges), \$2 monthly for 2 months and a final payment of 95c one month after that. Otherwise I will return the book postpaid in 7 days. (Foreign price, remit \$8 cash with order.)

MoToR's New TRUCK & TRACTOR REPAIR MANUAL. If O.K., I will remit \$2 in 7 days, and \$2 monthly for 3 months, plus 35c delivery charges with final payment. Otherwise I will return book postpaid in 7 days. (Foreign price, remit \$10 cash with order.)

Print Name.....Age.....

Address.....

City.....

Check box and save 35c delivery charge by enclosing WITH coupon entire payment of \$5.95 for Auto Repair Manual (or \$8 for Truck and Tractor Repair Manual.) Same 7-day return-refund privilege applies.

AMAZING TOOL BARGAINS!

SURPRISE VALUE
100 Pieces \$1.00
FOR ELECTRIC GRINDERS
 Post Paid in U.S.A.
 Grinding Wheels, Cut-off Wheels, Sanding Discs, Mounted Stones, Sharpening and Honing Stones, Rotary Cutting Burs, Abrasive Cartridges, Mandrels, and many other items.

2 CIRCULAR SAWS
 ON 2 MANDRELS—
ALL AT ONE LOW PRICE \$1.50
 Post Paid in U.S.A.
 1" diameter saws on 1/4" Mandrels. For cutting wood, plastic, or soft metals. Order at once! Send Check or Money Order.

18 ROTARY CUTTERS
\$5.85
 Post Paid in U.S.A.
 \$13.50 Value
 Assorted sizes cutter on 1/8" or 3/32" shank. Will fit all hand grinders. Ideal for cutting wood, metal, or plastic. Brand new.

2 DRUM SANDERS \$1.50
 With 12 Bands in Assorted Grits. 1/2" dia. x 1" long on 1/8" arbor with 12 bands. P.P. in U.S.A.
ONE DRUM, 1" DIA. x 1" LONG ON 1/4" ARBOR WITH 6 EXTRA SLEEVES \$1.00
 P.P. in U.S.A.

ADAPTER CHUCK
 With 2 interchangeable collets, opening from 3/32" to 0 on 3/32" mandrel. Price each, only. **\$1.50**
 P.P.

SCHUPACK SUPPLY CO., 7331 Cottage Grove, Dept. M-15, Chicago 19, Ill.
 ILLUSTRATED BARGAIN CATALOG 10c

SAY YOU SAW IT IN POPULAR MECHANICS

MAKE IT BETTER, FASTER, EASIER... WITH

BURGESS electric JIG SAW SANDER FILER

Only \$14.75 Complete

Amazing New Power Tool with Built-In Rotary Motor . . . Perfect for Every Home Project

You'll be delighted with the smooth, clean lines, the accurate edges and the speed with which you turn out difficult projects when you own a Burgess Jig Saw. This fine, low-cost tool saws, sands, files easily and safely in half the time it takes by hand. Not a vibrating saw! Fractional h.p. rotary motor powerful enough to cut 1/2" wood, any length, to file metal up to 1/8" thick. A "must" for every work bench. Fully guaranteed. Descriptive literature on request.

See Your Dealer, or Write: Dept. Z

BURGESS VIBRO-CRAFTERS, INC.
 180 N. WABASH AVE. • CHICAGO 1, ILL.

Built-In Rotary Motor • "Every Direction" Saw Blade • Large, 45°-Tilt Saw Table • 3500 RPM Sanding Disc • Tilting Sanding Table • Built-In Sawdust Blower • Completely Portable. Comes with 3 Extra Saw Blades, 3 Extra Sanding Discs • 110-125 volt, 50-60 cycle, A.C.

POWER HACKSAW \$52.75

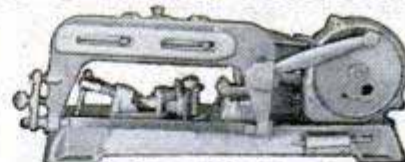

LESS MOTOR
F. O. B. Benton Harbor
 • Rugged cast iron construction. Wt. 56 lbs. bronze bearings. Draw cut. Auto. return lift. Auto. shut-off. Vise swivels 45°. Cap. 4"x4".

Send for full details and name of nearest dealer.

EXCEL MACHINE TOOLS Dept. PM-21 BENTON HARBOR, MICHIGAN



HAVE A BIGGER — MORE EFFICIENT HOME WORKSHOP
 Popular Mechanics PLANNING YOUR HOME WORKSHOP shows you how to make use of every inch of space in your workshop; detailed floor plans, wiring layouts and power tool hookups plus actual photographs of famous home workshops you can use as models. Save money by building your own shop furniture. Special Where-to-Buy-It Guide, 450 Illustrations. Cloth Bound. Working Diagrams. Order your copy today from **\$2.50**
POPULAR MECHANICS PRESS
 200 E. Ontario Street Chicago 11



Build it Yourself!

TRAILER COACHES

Complete Trailer Book and Construction Data for 10, 16 and 22 Foot Trailers — Only \$1.50

Here's everything you want to know about trailers, with plenty of pictures and plans and instructions for building three different types. Covers also, history of trailers, trailer parks, camps and overnight-stops information, furniture, furnishings, materials and engineering data. If you want to build a trailer, live in a trailer, or just want to know more about trailers, get this book. Only \$1.50 postpaid. Rush order to:

Partial Contents
 Trailer Parks—Living in a Trailer—Towing a Trailer—Floor Plans—Service—Classifications—Balance—Dollies—Jacks—Weight Distribution—Construction—Working Drawings for a Two-Place, Standard Travel and Standard Dwelling Trailers. Size 8 1/2 x 11 1/4 inches.

POPULAR MECHANICS PRESS • Dept. 350, 200 E. Ontario St., Chicago

PLEASE SEND ME

POPULAR MECHANICS MAGAZINE

for the time checked.
 I am enclosing . . .

1 year \$3.50
 2 years \$6.00

name _____
 address _____
 city _____ zone _____ state _____ C-2

Hand this order to your newsdealer or send it to
POPULAR MECHANICS
 200 East Ontario St. Chicago 11, Ill.

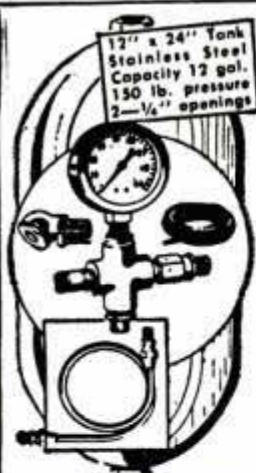

WESTINGHOUSE Air Compressor

Reg. \$60.50 Only
Model T-1 Brand New
— 2 CYLINDER \$21.50
PISTON TYPE.
 Operates with 1/2 H.P. Motor or equivalent gas engine
 Compressor has 2" bore, 1 1/2" stroke, ball bearing, 3.27 CFM at 600 R.P.M. Capacity up to 6.54 CFM. Size 9"x 1 1/8"x6 5/8". Wt. 26 lbs.

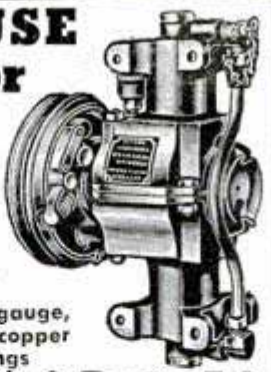

BRAND NEW
 Compressor, pressure tank, air gauge, air chuck, 20-ft. hose, pop valve, copper tubing with 4 brass flared fittings for connecting compressor to tank, 4-way cross and 3 nipples.

\$32.50

COMPLETE OUTFIT, wt. 52 lbs.
 EQUIPMENT LESS COMPRESSOR, \$12.50
 COMPRESSOR SEPARATELY, \$21.50—TANK ONLY \$6.95

LIGHT PLANTS

Brand New!
War Surplus

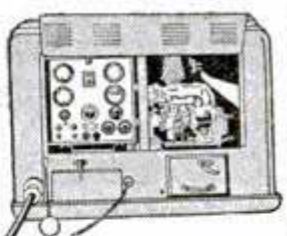

Signal Corps Power Unit PE 197
 115 volt 60 cycle A.C. single phase 5 K.W. Hobart, water cooled, 14 h.p., 4 cylinder Hercules engine. Remote Control, complete panel board with instruments. 150 ft. automatic remote control cable with reel; 150 feet #6 heavy duty wire with reel; housed in metal case with replacement parts and tools. Cable with reels alone worth \$400. Regular price of unit \$1900. Shipping wt. 1250 lbs. Our price, complete. f.o.b. Chicago

\$895.00

Same unit, slightly used. Reconditioned, less cable. Fully guaranteed
\$495.00
 2 1/2 K.W. LELAND POWER PLANT. **\$295.00**

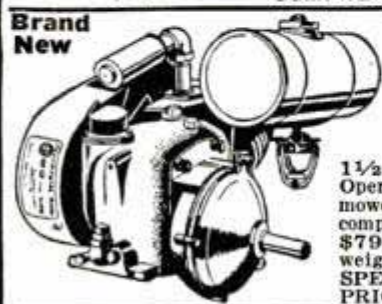

Save nearly 1/2 on Gas Engines!

Red Seal Continental 6 to 1 REDUCTION GEAR 1 CYLINDER — 4 CYCLE

1 1/2 HP with 6 to 1 reduction gear. Operates at 450 R. P. M. For lawn mowers, scooters, garden tractors, pumps, compressors, generators, etc. List Price \$79.50. Shipping weight 54 lbs.
SPECIAL PRICE \$47.50

AUTOMATIC COMPRESSOR UNIT

1/2 H.P. heavy duty capacitor motor. AC 110/220 volt, 60 cycle, 2x1 3/4 inch piston type compressor, splash feed lubrication. 12x24 inch tank, automatic pressure switch. CFM 2.8 at 100 lb. pressure, or 150 lbs. pressure for intermittent duty. Check valve, safety valve, air regulator with gauge and filter, 20 ft. air hose with air chuck for inflating tires. V. belt drive. Mounted on 2 wheels, ball bearing, with 2"x10" pneumatic tires. Portable with handle. Shipping wt. 90 lbs.



Brand New
SPECIAL PRICE \$98.50 Same unit with Gas Engine **\$107.50**

WELLWORTH V-BELT CLUTCH



Takes starting load off engines or motors. When speed is reached, a flip of handle shifts clutch from idling to driving position. Handles "A" belts, 2.35" pitch diameter, 5/8" bore. Ideal for use with lawn mowers, garden tractors, home workshop motors, etc. 3 1/4" long. Safe, easy to mount, sealed bronze bearings, positive action. Shpg. wt. 3 lbs.
BUSHING FOR 1/2" SHAFT, 15c
\$7.50

BRAND NEW SAME CLUTCH FURNISHED WITH 3/4" BORE **\$8.50**

Portable ELECTRIC HAND SAW



The Zip Sawer With ALL the Features
 6 1/4" Diameter saw blade, 1/2" square arbor hole. Maximum depth of cut 2 3/8". (At 45°, 1 3/4".) Minimum depth of cut 0". Angular adjustment 90° to 45°. No-load speed, 5200 r.p.m. Full load speed, 3200 r.p.m. Amperes, full load 8.0. Universal AC-DC motor, 110/220 volt. Dimensions: 11 1/4" long; 9 1/2" wide (ripping guide removed); 7 1/4" high (without blade). Furnished complete with 6 1/4" diameter combination blade and 10 ft. cord and plug. Wt. 11 1/2 lbs. Price **\$39.95**

AUTOMATIC Pressure Switch



For Air or Water
 20 to 40 lbs.
\$6.50

125 to 150 lbs. with unloader. . . . \$13.75
 1/4" check valve . . . \$3.25
 1/2" check valve . . . \$4.75

AIR REGULATOR and EXTRACTOR

1/4" Air Regulator, Gauge and filter. Wt. 5 lbs. NEW.
\$8.95
 Regulator and Gauge only . . . \$5.95
 Air Filter only \$3.25



Chicago Pneumatic RIVETER & CHIPPING HAMMER

CP4X Pistol grip handle. Takes up to 3/16" rivet. Weight 6 lbs. List price \$73.00 Brand New. **\$32.50**
 Used, like new, guar. **\$17.50**

Chicago Pneumatic Lever Type AIR DRILL

With 1/4" Jacob Chuck. Wt. 2 lbs. List price \$55.00 Only. **\$17.95**

6 Ft. Stow FLEXIBLE SHAFT

BRAND NEW
 3/8" Core. Ball bearing handle and arbor. Operates on 1/4 H.P. Motor at 1725 or 3450 r.p.m. \$29.00 value. Wt. 8 lbs. **\$16.50**

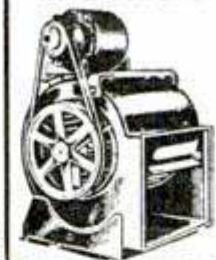

"Wellworth" BLOWER BARGAIN

BRAND NEW
 Quiet operating. Double wheel inlet, double width blower. For heating, ventilating, cooling, air washing, exhausting and forced draft. DIMENSIONS: 10" wheel; outlet 13 1/8"x11 3/8"; inlet 8 3/4". Height 19". Width 18". Depth 16 1/2". C.F.M., 1/4" S.P., 1600; outlet vel. 1575; motor 1/4 H.P. with overload relay; cord & plug. 110 v. 60 cy. A.C. Ship. wt. 67 lbs. Special price. **\$47.50**
 BLOWER LESS MOTOR AND DRIVE **\$27.50**

Prices f. o. b. Chicago. Money back guarantee. Send check or money order today. Prompt shipment.

NEW CATALOG
 Motor guide, air compressors, home and factory workshop tools, light plants, luggage bargains. Send 10c for postage.

WELLWORTH TRADING CO.
 1831 S. STATE ST. DEPT. D-2 CHICAGO 16, ILL.

THE BIGGEST VALUE ON THE MARKET DIRECT FACTORY TO YOU DYNAMIC SUPER-CHARGED ARC-WELDER

DOES WELDING, BRAZING, SOLDERING, CUTTING
 It's the finest, precision built heavy duty transformer-welder available for home, farm, or shop use. Does work you'd expect from costlier machines. EASY TO OPERATE. Do expert work; follow simple instructions. Works on iron, steel, brass, bronze, aluminum and other metals. Operates from any properly wired 110 volt 50/60 cycle AC line. Save time, Make money—Build or repair auto, home, farm or shop equipment, etc. for yourself and others in spare or full time. Comes complete Ready-To-Operate Order today for 10 day trial on money back guarantee or write for Free Particulars. DYNAMIC WELDER CO., Dept. D2-BB6, 15 E. 23rd St., Chicago 16, Ill.



OVER 50,000 SATISFIED USERS
\$41.80 Only \$33.50 F.O.B. VALUE COMPLETE

SAVE UP TO 85%

IN WAR SURPLUS from "GADGETEERS" HEAVEN

NEW 1951 CATALOG

PACKED WITH BARGAINS!!!

Just Off The Presses! Bigger Than Ever! 200 Pages of NEW and SURPLUS Clothing, Tools, Camp Equipment, Electrical Supplies, Hydraulics, Motors, Pumps, Valves, Raw Stock, etc.

AT UNHEARD OF LOW PRICES! Send 50¢ Today! (refunded with your initial order of \$1 or more)

SHEEPSKIN LINED LEATHER JACKET
 These Navy Arctic jackets are fully lined with the finest quality sheepskin obtainable. Comes with storm tabs and fur collar. Two deep patch pockets, adjustable waist and heavy duty zipper. Sizes 36 thru 44 in excellent cond. Cost Gov't approx. \$80. **ONLY 27.50**

NEW! STATIONARY or PORTABLE D.C. ARC WELDER
 300 Amps Continuous. 350 - 400 Amps Intermittent. For ALL WELDING - LIGHT or HEAVY!!
 This rugged air-cooled precision built electric ARC WELDER - designed to weld for hours comes complete with pulley reactor, output controls, Hi-La switches, rheostat. The heart of this unit is the famous R-1 generator, specially developed for B-29 Bombers, and with features no other generator has. Heavy steel frame, easily adapted to mounting on Jeep, Tractor or other power supply (10 H.P. gas or electric). Never before offered at this low price.
97.50

FLYING HELMET
 Fine grade leather - Chamois lined with chin cup on strap. Intermediate weight - Ideal for summer wear. **NEW ONLY 1.59**

All New! Winter type with fleece or chamois lining. Has ear puffs & chin cup. Ideal for pilots cycle - drivers sportsmen, etc. **1.95**

NAVY WADING SUIT
 Here's a suit that will make surf fishing a pleasure. Made of rubberized canvas, with vulcanized seams. It will keep you absolutely dry. Has built in rubber gloves and 1/2 length rubber boots. Air tight Buoyancy pockets inside keep you balanced in deep water. Has 100% waterproof liner. **16.95**
 Guaranteed condition. Small, Medium & Large

FLYING SUIT or Blue Bunny SUIT
 For hunting, winter sports skiing or "bundling". As coveralls for cold outdoor, or farm work, 100% woven wool with extra flannel inner lining for double warmth & utility. Wiring so fine, flexible it does not interfere with movement. Can be used with or without heating or can be plugged into car, tractor, or truck battery. Sizes 36 thru 44. **\$34.99**

AAF CASE
 Genuine top grade leather. Multi-compartment. Lock and Straps. Ideal for Artists, Students, Salesmen, etc. Used, good condition. **7.95**

#180 RIVET GUNS
 Gooseneck Type \$8.95
 E-2--CLEVELAND--Pistol, \$12.95
 E-3--CLEVELAND--Pistol, \$14.50
 4-X--CLEVELAND Pistol, \$15.40

LINEMAN'S KIT - Type used by U.S. Army Signal Corps. Consists of pair of heavy duty lineman's pliers with pipe jaws & side cutters - a fine quality 2 bladed wire-skinning knife. In reg. Signal Corps leather pouch. **2.39**

AIR CORPS BRIEF CASE
 This is a genuine piece of AAF equipment. Made of best grade Brown Leather in a handsome Pebble finish with a light canvas liner. Has two full length map or paper compartments and three smaller pockets. An ideal case for students, salesmen, artists, etc. Full heavy duty zipper closure. 12" x 16" Shpg. Wt. 3 lbs. **ONLY 2.95**

NEW WATCH
 Here's a real Shock Absorbing watch. Has jewel movement. Sweep second hand, luminous dial, chrome case. Guaranteed for one year. Ideal for young and old. **16.95**
WALTHAM NAVIGATION WATCH (Type A-8). An ideal timer for followers of horse racing, boating or any other sports event where split-second timing counts. Large dial with sweep second hand counts the seconds in 1/10ths. Small dial records up to 5 minutes. Originally designed for aircraft navigation. **THIS IS A TREMENDOUS VALUE AT 22.50**
17 JEWEL Chronograph. One of the finest made anywhere. Cased in Switzerland. Sweep second hand, stop and re-set buttons. Measures distance, air speed, ground speed, races. Ideal for the sportsman. **\$23.95**

NEW ELECTRIC MOTORS
 No. 500 - New 1/2 HP - 27 Volt DC-AC. This motor can be readily adapted to deliver up to 1/2 HP on 110 Volts AC by the simple method of rearranging armature brush-leads. Free diagram with each order. A sensational value... **\$5.95**
 No. 500-A - Converted to 110 Volts-AC Equipped with plug and 3/4" Heavy Duty Cord. **\$8.49**

CHEMISTRY SET
 Made for Chemical Warfare Division for testing water, etc. A handy addition to the chemistry lab. or an exciting experiment for the amateur. Set includes test tubes, complete instructions, 15 different items. Packed in attractive lucite box with cover & dividers. **Set \$1.39**

17 JEWEL AUTOMATIC WRIST WATCH... Swiss made men's wrist watch. A real self-winding watch... winds itself while you wear it. Incabloc (shock protected). Swiss movement. Sweep second hand, luminous dial and hands. Silver white or black face. Waterproof nickel chrome case. Stainless steel back. Hours marked in numerals. Genuine leather strap. Red second hand with arrow tip... **GUARANTEED**

PLEXIGLASS & Noscilite clear plastic shts.
 N-ASCILITE - Full sheets app. 1/8" x 37 1/2" x 49 1/2", app. 10 1/2 lbs. each **\$14.25**
PLEXIGLASS - Full Sheet 3/16" x 36" x 48" Per Sheet **\$17.95**
 5/16" x 36" x 48" . . . Per Sheet **\$27.50**
 Fabricators write in for our special quantity prices, all above are new & marked. Also inquire about other large stocks of Plastics

PLEXI DOME
 Overall length 21" - Width at widest point 11" - at base 4". 6" deep. For Fish & Flower Bowls - Cab Roof - Lights. **1.89**

NEW TARPS - HEAVY CANVAS
 Mildew & Flame Resistant. Cheap outside storage! They are really moving at these prices.
 9' x 16' \$11.95
 5' x 7' 3.95
 16' x 16' 25.60
 Rubberized Nylon Tarp 7' x 11' **6.95**

AAF FLEECE LINED JACKET
 Will keep you warm & comfortable in the roughest weather. Fur lined thru-out sleeves & body. 2 slash pockets & heavy duty zipper. Ideal for Farmers Ranchers, Hunters and Mechanics. **9.95**

PLASTIC PARALLEL
 with knobs and rubber pads for non-slippage on each section. A must for navigators, mechanics, draftsmen and engineers. You've never seen 'em at... **97¢ ea.**

GOOSENECK LAMP
 Consists of 24 volt control box with dimmer switch, 18" flexible extension & frosted glass shade. Can be used on 110 volt current. **2.49**

New Rubberized Linen Tarp - 7' x 11'
 Waterproof, weighs only 3 lbs. Ideal for outside car storage. **5.95**
18 OZ. TARP - 6' x 6' - O.D. Duck
 Can be used as a tent floor covering or storage protector. A terrific buy! Used - but in excellent condition... **3.95**

RE-CONDITIONED and in WONDERFUL CONDITION! **9.95**

PRESSURE TANKS
 Stainless Steel, Shatterproof & Rustless. Ideal for painting, cooking, spraying, ocean buoys, underwater fishing, or diving.
 G-1-12 1/2 x 24 inches. 2100 Cu. In. capacity - Stainless Steel **4.75**
 F-1-10 x 18 inches. 1000 Cu. In. capacity - Stainless Steel **4.19**
 F-2-6 x 45 inches. 1000 Cu. In. capacity - Stainless Steel **4.95**
 F-2-Same as F-2 but in Corrosion resistant steel **3.95**
 D-2-6 1/2 x 24 inches. 500 Cu. In. capacity. Stainless Steel Construction **3.49**
 D-2A-Corrosion resistant steel. Same as D-2 **2.49**
 A-4-5" x 8" (104 cu. in. capacity) Stainless Steel **1.69**
 A-4A-Same as A-4 but in Corrosion resistant steel **1.35**

NAVIGATORS LAMP
 A handy light for desk, work bench, chart table, engine room, etc. Can be used on 6-12-24-110 V by changing bulb. 3 ft. shaft has 4 joints to adjust position... **ONLY 2.95**

Aviators (AN-6530) Windproof & Dustproof GENUINE GOGGLES
 Rubber or chamois covered frame. Clear or Green GROUND LENSES are inter-changeable. Adjustable nose bar. Ideal for flying, motor cycling, etc. **\$1.69**
GO-1 GOGGLE KIT
 NEW! U.S. Navy - Has soft sponge rubber frame. 4 Polaroid lenses 2 green, 1 red, 1 clear. Perfect for racing, cycling, etc. **89¢**

MICROPHONE
 Telephone type - Highly Sensitive with excellent, clear tone. This was the Signal Corps favorite. An ideal instrument for the radio "ham" and professional recording studio, broadcasting, home recording, public address, etc. A Sensational Buy! Complete with cord and plug. **ONLY 2.29**

TANK Dural with welded seams, 2" filler with cap, two standard pipe parts for hookup. Visible liquid level gauge on side. Ideal for Gas, Oil, Water, or "spare" on auto, tractor, truck or boat. Sturdy, light. Capacity 6 gal. **14.95**

Sealed Beam LAMP
 U.S. Navy Portable Pistol Grip light. Has sealed beam and aiming sight. Ideal for search, spot or Emergency light on auto, boat, farm etc.
 12 Volt light, 4" lens **2.85**
 24 Volt, 5" lens & carry case **3.49**
 Set of 3 filters, Red, Gen, Amber (specify type lamp) **99¢**

RADIO HEADSET
 Low impedance. Ideal for amateur radio, crystal sets, or professional use. Adjustable ear phones. Used and in excellent condition. **1.69**

SHOE PACS
 Assures complete foot and shoe protection in the coldest weather. Specially designed to keep the feet warm & comfortable & the shoes dry. Has 14" leather boot top, rubber shoe & sole - felt inner sole. **3.95**

RUBBER BOOTS
 A sturdy boot of the finest pliable rubber. Completely water-proof with adjustable strap. Can be worn with or without shoes. A REAL BUY **3.95**

PALLEY SUPPLY CO
 Dept. PM 2 GLENDALE, CALIF.

LARGEST FIRM OF ITS TYPE IN THE WORLD

Draw from this Ad. All sales final. All Prices F. O. B. Glendale. Pay by M.O. or Check. P.O.'s Accepted. from D. & B. firms. Deposit with C.O.D.'s.



**Hoot
Mon!**

LOOK WHAT THIS LATHE WILL DO!

With this lathe and a few accessories you can turn, bore, face, thread, drill, ream, file, polish, mill, and saw all kind of metal, plastic, wood, fibre, and other materials. It is the most versatile tool you can put in your shop.

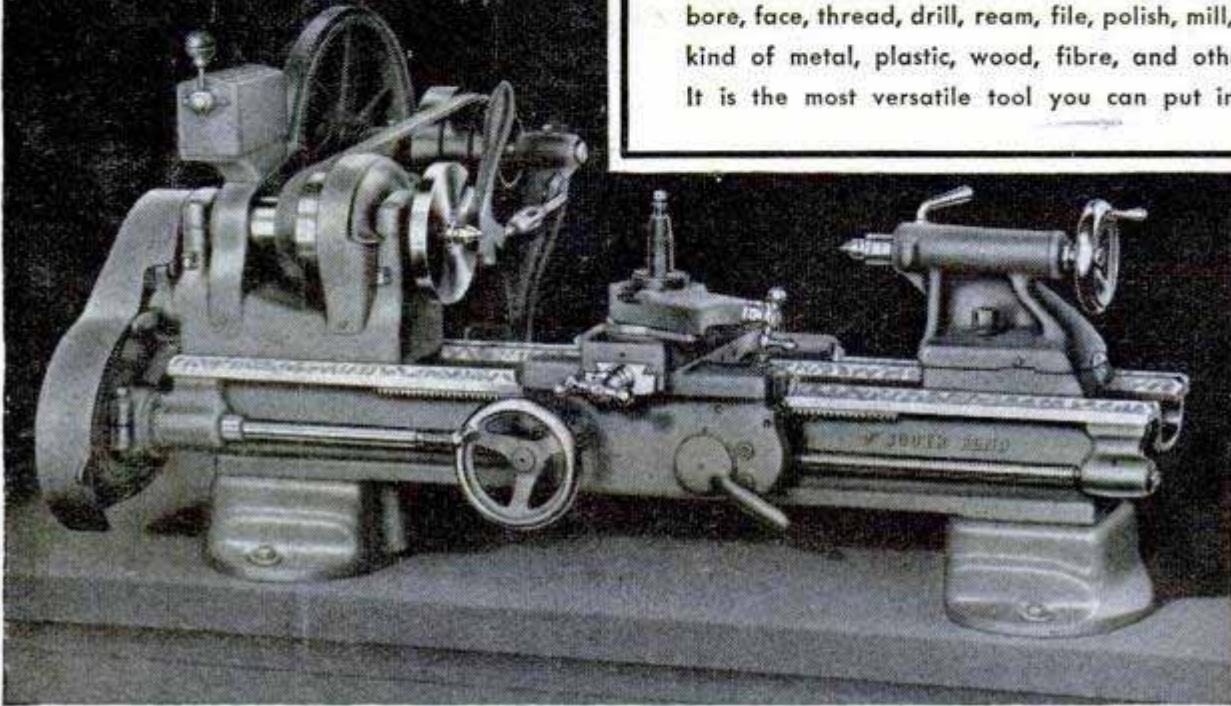

Install this fine lathe in your shop now and let it help pay for itself. Capable of a wide variety of operations, this lathe is ideal for general machine work in the small shop and for machining small parts in the large shop. A complete line of practical attachments and accessories simplify the tooling of this lathe for many special classes of work.

All sizes of South Bend Lathes, 14" Drill Presses, and 7" Bench Shapers are available on time payment terms: 25% down, balance in 12 monthly payments. Reasonable finance charges.

Building Better Tools Since 1906

SOUTH BEND LATHE

SOUTH BEND, INDIANA

Send for Information:

- 9" BENCH LATHES
- LATHE TOOLS AND ATTACHMENTS
- TIME PAYMENT PLAN

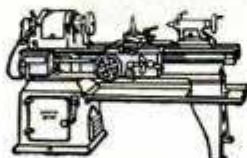

- 10" TO 16" FLOOR LATHES

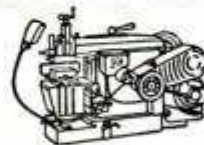

- 7" BENCH SHAPER



- 14" DRILL PRESSES

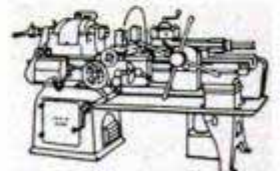

- 1/2" and 1" Collet TURRET LATHES

Name _____

Street _____

City _____ Zone _____ State _____

Printed by Popular Mechanics Company, Chicago, Ill., U. S. A.

Now! YOU CAN MAKE MONEY...

**TURNING WORTHLESS OBJECTS INTO GOLDEN TREASURES—
... BY METALIZING!**

HERE ARE JUST A FEW OF THE HUNDREDS OF ARTICLES THAT CAN BE RESTORED BY REPLATING—INCREASED IN VALUE—OR “ETERNALIZED” AS KEEPSAKES WITH A COATING OF EVERLASTING BRONZE, STERLING SILVER, OR 14 KARAT GOLD.

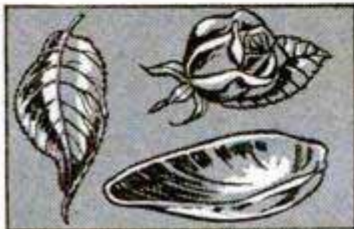

Costume Jewelry from flowers, insects, shells, and leaves.



Ash trays, paper weights, from leaves, fruit, vegetables.



Metalize busts, figure, from plaster cast or wood carvings.



Metal plate object of glass, cloth, leather, plastic or rubber.



Eternalize Baby Shoes, Toys, and other sentimental mementoes.



Metalize baskets, plates, ceramics and other non-metallic objects.



Preserve sports and war trophies in solid Bronze, Silver or Gold.

YES—ANY MAN OR WOMAN CAN DO WORK LIKE THIS IN ONE CORNER OF THE KITCHEN OR IN ANY SPARE ROOM!

Make \$5⁰⁰ An Hour For Your Spare Time!

Amazing book tells you how

HOW to do the work—how to get customers coming to you—how to set up the simple equipment—how and where to buy the materials—what to charge—how to start in spare time—how to expand into a full time business whenever you wish. Shows you in pictures and words how to put a coating of pure metal on such things as flowers, leaves, insects, shells, wood carvings, plaster castings, busts, statues, religious figures, buttons, baskets, feathers, base balls, golf balls, mementoes of all kinds, such as, baby shoes, party and wedding favors and decorations. Operating a home metalizing business is one of the greatest insurance policies a man could ask for his future. Read about it without risking a penny.

OWN YOUR OWN HOME-OPERATED BUSINESS

Think of turning 56 cents worth of materials into a profit of \$5.00 and over for just a few minutes of easily learned handiwork. Sounds fantastic? . . . Yet it is absolutely true . . . **AS YOU CAN QUICKLY PROVE TO YOURSELF.**

AN EXCITING NEW OPPORTUNITY

Just at a time when hundreds of men and women would like to make an extra \$35.00 to \$50.00 a week in spare time home work, the old—established—and highly profitable Metalizing Business has been turned into a home-work money-maker. Where in the past a few big companies have been making fortunes, now hundreds of smaller home operators can become independent. I have ready to send you a complete set of simple instructions by which anyone—regardless of age or education—can learn the fascinating art of metalizing.

By this process you can replate worn objects in silver, copper, or real gold—you can change silver to gold by overplating—you can even deposit a heavy coating of solid metal on non-metallic objects such as baby shoes, golf balls, toys and other precious keepsakes—or you can take inexpensive articles and make them worth 10 to 20 times their cost by jewel plating with precious metals.

ALL THIS INFORMATION IS FREE

The information is free. A stamp brings you the details of the exact plan by which hundreds are NOW MAKING EXTRA MONEY EVERY WEEK. Study it over. Analyze the possibilities. Then if you don't think it's made to order for you—your only loss is your 3c stamp. You can read every fact, every secret, every step of the instructions—all at my risk.

**NO "CATCH" TO THIS OFFER DON'T SEND ME A PENNY
... Just Your Name!**



Learn about this wonderful "Ace in the hole". See how you can start without risking job or pay check—how you can turn spare hours into \$5.00 bills—how you can actually have fun making money in a business that all the family can help with. No charge now or at any time for the

complete facts about this permanent lifetime business that has now opened its door to home operation. Scores of men and women have already started . . . Plenty of opportunity for hundreds more. **BUT DON'T PUT IT OFF.** Send your name and address **TODAY . . .** It may open new horizons in your life.

R. E. Brandell, Warner Electric Co., 1512 Jarvis, Dept. 32, Chicago 26, Ill.

R. E. Brandell, Warner Electric Co.
1512 Jarvis, Dept. 32, Chicago 26, Ill.

Rush complete facts showing how the old and profitable Metalizing Business has now been converted into a homework money-maker for full or spare time. No charge or obligation for the information you send.

Name

Address

City..... Zone..... State.....

HOW MILD CAN A CIGARETTE BE?

"How Mild? I found the answer
when I changed to **CAMELS**
—they agree with my throat!"

Dick Powell

STAR OF FILMS AND RADIO



"Being in show business, I can't risk throat irritation. That's why I was so careful in choosing my cigarette. I didn't decide on one puff or one sniff. A fast inhale and exhale wasn't enough proof for me.

"I made what I think is the *sensible* test... my own 30-Day Camel Mildness Test. I smoked Camels regularly for 30 days and found that Camels agree with my throat. Now I know why more people smoke Camels than any other cigarette!"

NOTED THROAT SPECIALISTS REPORT
ON 30-DAY TEST OF CAMEL SMOKERS...

**Not one
single case of
throat irritation**

due to smoking

CAMELS!

Yes, these were the findings of noted throat specialists after a total of 2,470 weekly examinations of the throats of hundreds of men and women who smoked Camels — and only Camels — for 30 consecutive days.



STAR of over 40 Hollywood musicals, Dick Powell's versatility has won him hard-hitting dramatic roles.



R. J. Reynolds Tobacco Co., Winston-Salem, N. C.

**Make your own 30-Day Camel MILDNESS Test
in your T-Zone (T for Throat—T for Taste)**