

# POPULAR MECHANICS

## MAGAZINE

WRITTEN SO YOU CAN UNDERSTAND IT

REG'D. TRADE MARK, GREAT BRITAIN, NO. 410426





Commander State 4-door sedan.

White sidewall tires and wheel trim rings optional at extra cost.

*Presenting*

## **THE NEW 1951 STUDEBAKER**

A grand new

*Studebaker Champion*

**in the lowest price field!**

**One of the 4 lowest price  
largest selling cars in America!**

A brand new V-8

*Studebaker Commander*

**A truly great car  
that sparkles with brilliant  
new performance!**

Stop in and see these styled ahead, engineered ahead, enduringly built new 1951 Studebakers! They're on view now—at a nearby Studebaker showroom!

*Studebaker Automatic Drive or overdrive available on all models at extra cost*

**STUDEBAKER...THE THRIFTY ONE FOR '51**

# IT'S HERE! 3-Speed Bicycling!

Now you can shift gears  
on your bike just as  
you would in a car!

NOW, with a flick of your finger you can change from low, to second, to high—quickly and smoothly.

This amazing new development, called Tripspeed, marks the greatest advance in cycling since the invention of the coaster brake. Tripspeed gives you a choice of three different gear ratios, quick sure braking, smooth free-wheeling, constant control at all speeds and at all times. Bicycling now becomes safer, easier, more fun with...



## TRIPSPEED

HERE'S HOW IT WORKS

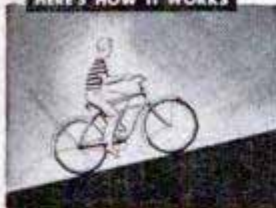

1. **LOW** (a 25 percent reduction) for hill climbing, bad roads, etc.



2. **SECOND** for all normal riding on good roads, level stretches.



3. **HIGH** (a 33 percent overdrive) for far greater speed.

**BEST NEWS OF ALL**, you don't have to buy a new bike! Tripspeed can be installed right in the hub of your present New Departure Coaster Brake.

Your dealer, your bicycle repair man, has Tripspeed right now. Ask him to show you how easy it is to have the best hill climber, the speediest, safest bike in town!

**FREE BOOKLET . . .** The exciting story of Tripspeed—how it works and how you too can get one. Just fill in and mail the coupon at right.

1892



Fingertip Shift,  
Gives You Safe,  
Constant Control  
at all times.

ANOTHER "NEW DEPARTURE" BY

**New Departure**  
DIVISION OF **GENERAL MOTORS**

### Just Look at these Great Features

TRIPSPEED is compact and weatherproof.

TRIPSPEED is sturdy, durable, easy to install.

TRIPSPEED converts any New Departure coaster brake to three speeds.

TRIPSPEED has a back-pedaling brake with each gear.

TRIPSPEED has "synchromesh" action. Gears can be shifted at any time.

TRIPSPEED has handle-bar control. Your hands never have to leave the handle-bars.

### MAIL THIS COUPON

Dept. P, New Departure Division  
General Motors, Bristol, Connecticut

Please send me the FREE booklet about Tripspeed, the great new conversion unit that makes bicycling easier, safer, more fun!

Name.....

Address.....

City..... Zone..... State.....

This One



DECEMBER 1950

1

The "ALL-GLASS" headlamp gives most light when new  
... most light throughout life



"ALL-GLASS"  
sealed beam  
HEADLAMPS



**General Electric headlamps are**

**ALL-GLASS** ..they do not grow dim!

Road and laboratory tests prove the average G-E Sealed Beam headlamp gives 99% of original light output right up to the end of lamp life. They do not grow dim, because:

**1** "All-Glass" seal makes possible the one-piece construction that

keeps out dirt and moisture.

**2** Rugged filament supports—filaments won't shake loose.

**3** Reflector *stays* mirror-bright.

**4** Hard-glass lens gives accurate beam pattern.

Check your lights . . . and replace burnouts with General Electric "All-Glass" headlamps!

*You can put your confidence in—*

**GENERAL**  **ELECTRIC**



# TAKE TO THE AIR FORCE



## There's a Man's Job for YOU in the U. S. AIR FORCE

When you choose the U. S. Air Force as your service, you're choosing top technical training for war or peace in 42 career fields. You'll enjoy good pay, with additional pay for flying. You'll be assigned to specific duty according to your aptitudes. And you'll know the pride that goes with being *one of the best*, in a topflight outfit!

Take to the Air Force . . . for an interesting, rewarding and exciting life. Come war or peace . . . choose the Air Force way. Visit your nearest U. S. Army and U. S. Air Force Recruiting Station today for complete information.

**GET ON TOP...STAY ON TOP...  
WITH THE U. S. AIR FORCE**



### AIR FORCE TRAINED SPECIALISTS:

If you're a former Air Force specialist, with one or more of 200 most essential MOS skills, you can re-enlist in the Reserve for three years in your old grade at last honorable discharge . . . for direct assignment to a year of active duty. Reservists can go back on active duty in present grades. Civilian jobs are protected under Selective Service. You are needed . . . NOW!

**THE U. S. AIR FORCE NEEDS MEN  
for these and other fields:**

RADIO AND RADAR MAINTENANCE  
AIRCRAFT AND ENGINE MAINTENANCE  
WEATHER • ARMAMENT SYSTEMS

# American Flyer

3/16" SCALE  
AND HO GAUGE

WORLD'S MOST REALISTIC TRAINS



## REAL SMOKE AND "CHOO-CHOO" SOUNDS

**No. 4904T Pacific 3-car Freight**—The faster your train goes, the more smoke it puffs, the louder are the "choo-choo" sounds. Powered by famous Gilbert motor. Complete with real, 2-rail track, making 140" oval, 3 realistic cars, transformer, \$29.95. Denver and west, \$31.50.



## SUPERB NEW SANTA FE PASSENGER

**No. 5008 Santa Fe 3-car Passenger**—Built-in Electronic Horn. Authentic scale model. Over 5 feet long. 3 ultra modern aluminum cars, including Vista Dome Pullman. Locomotive powered by two Gilbert motors. Real 2-rail track, making 160" oval, \$62.50. Denver and west, \$65.00.

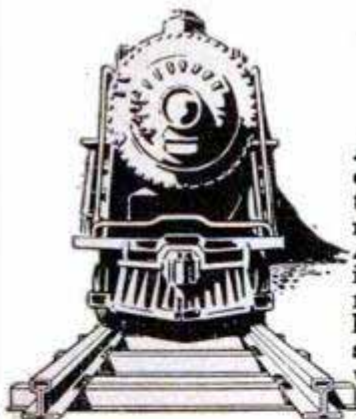

## REAL 2-RAIL TRACK

American Flyer track looks like the track of a real railroad. There's no old-fashioned third rail in the middle. For further realism, track can be mounted in new American Flyer Rubber Roadbed, finished to resemble real ballast. Reduces noise. Non-slip back holds tracks securely in place without tacks. Curved or straight sections, each, 30¢. Denver and west, 35¢.

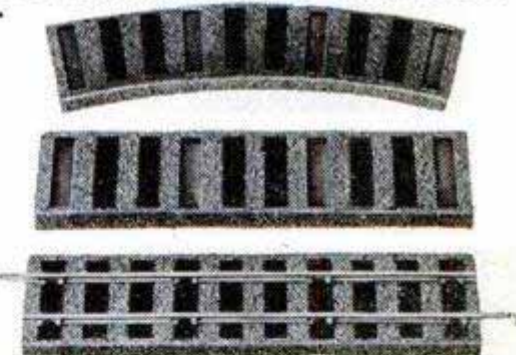

## TALKING RAILROAD STATION

Produces voice of train announcer and other true-to-life sounds of busy station. Stops train by remote control—starts it automatically. \$16.95. Denver and west, \$17.80.

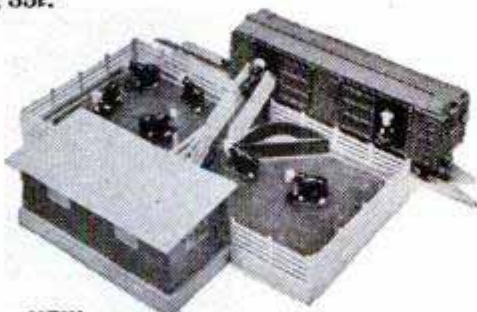

## NEW OPERATING STOCK YARD AND CAR

An exclusive American Flyer sensation! Watch the steers mill around when you press remote control button. See them climb up ramp and enter car. Most amazing of all, you can make them file, one by one, out of car and down to stock pen again. \$14.95. Denver and west, \$15.70.

## GET THIS GIANT TRAIN CATALOG



Cost over \$125,000.00 to produce!  
56 big full-color pages.

Illustrates and describes all American Flyer train sets—locos—cars and spectacular equipment. Free at stores selling American Flyer or send 10¢.

Gilbert Hall of Science,  
152 Erector Sq., New Haven, Conn.  
Rush Giant Train Catalog.  
I enclose 10¢.

Name.....  
Street.....  
City.....State.....  
This offer good only in U.S.A.

# PYROIL fights these enemies of your car . . .

- DRY STARTS
- FRICTION WEAR
- GUM AND SLUDGE
- BATTERY DRAIN
- CORROSION

There's no need to let the first cold snap find your car vulnerable to attack on vital engine parts. Now is the time to add Pyroil, to protect your car against the extra risk of cold-weather driving.

Pyroil contains the special property of making motor oil cling to cylinder walls and piston rings. That's why Pyroil eliminates "dry starts"—it keeps engines free of sludge and reduces wear due to friction, rust and corrosion.

Pyroil is economical ammunition for fighting these enemies of your car. You'll find Pyroil at your nearest gas station. Just ask the attendant to add Pyroil—add miles to your car.

### Pyroil for Aircraft Engines

Use aircraft Pyroil B for lubricating oil, Aircraft Pyroil A for gasoline.

**GIVEN!** An attractive Pyroil metal savings bank, takes coins up to 50c pieces. **MOTORISTS**, it's yours for the asking—sent postage paid.

Manufactured and Guaranteed by  
Pyroil Company, 110 Pyroil Bldg.,  
La Crosse, Wisconsin

Canadian Distributors: Central  
Purchasing Agencies, Ltd.,  
Toronto, Ontario



**PYROIL COMPANY**  
110 Pyroil Bldg.,  
La Crosse, Wisconsin

I want my car to last and run properly. Please tell me more about Pyroil and how it can accomplish this for me.

Name \_\_\_\_\_

Address \_\_\_\_\_

City or Town \_\_\_\_\_ State \_\_\_\_\_



## in this corner..... **THE EDITORS**



### Helicopter Ambulance

"This war is the first time that helicopters have been used to evacuate wounded men from the front lines," writes Lt. Comdr. Arthur L. Schoeni as a postscript to his story of the "Handy-Andy Eggbeaters," appearing on page 73 of this issue. This photograph from the war front in Korea shows a Marine helicopter dropping in to pick up casualties. The wounded are carried in metal "pods" attached to each side of the fuselage below the doors. On one day press reports told of 18 Americans saved by the "windmill" ambulances, including two fighter pilots who were snatched from behind the enemy lines.

### They Did As They Were Told . . .

Mr. Milburn is snowed under, but digging out. Last June we published an article titled "Bring on Your Inventions," which proved to be a very compelling headline. It told of a development service for inventors, operated by the Milburn Manufacturing Company at Burlington, Ky. Mr. Milburn tells what happened in this letter to the editor:

"I have been wanting to write you for some time, as I thought you might be interested to know the effects of your story. . . .

"As of September 1st, we have received 8476 letters from the story. I am proud to say that all of these letters have been answered personally. Many of them were people who wanted advice about their invention. Some of them had patents and wanted to know how to sell them. . . .

People visiting us here number 512 to

(Continued to page 8)



# 5 reasons why ACCOUNTANCY

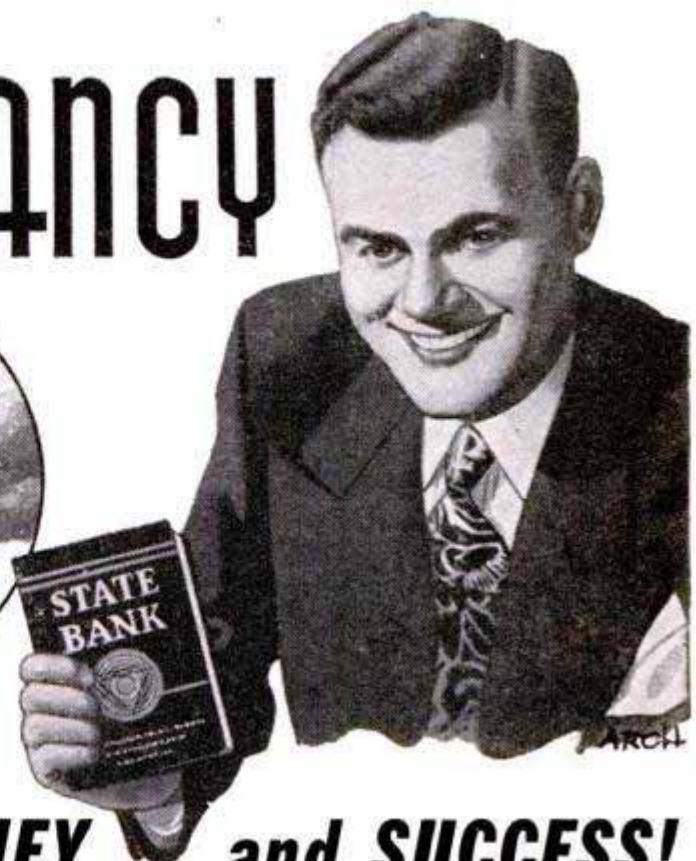
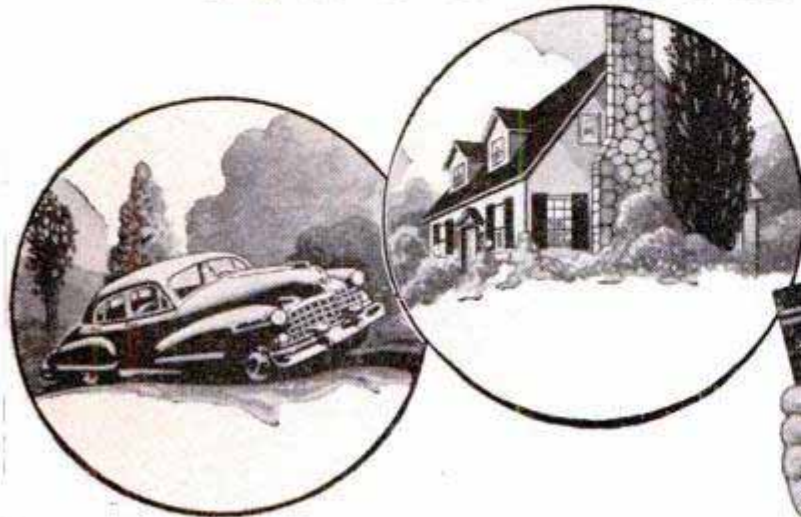

**offers you MORE MONEY... and SUCCESS!**

**REASON #1.** If you were an expert accountant right now, chances are you would find yourself among the highest-paid of all professional men and women. Even back in "depression years," surveys showed that accountants earned more on the average than men in other major professions.

**REASON #2.** The demand for accountants is great—everywhere. All businesses must have trained accountants to cope with ever-growing requirements. It's a profession offering wide opportunity—always—to the man who knows.

**REASON #3.** You can fit into any business, anywhere in the country—because accounting principles are universal. Think what this means in terms of security and independence!

**REASON #4.** Accountancy is open to all. Any man or woman of good intelligence, who enjoys figure work and is willing to follow LaSalle's systematic "problem method" plan, can rapidly qualify for a highly profitable, enjoyable

lifetime career... and he doesn't have to finish his training before beginning to "cash in."

**REASON #5.** Without losing a day from your present work, you can prepare in spare hours at home, at low cost, under LaSalle's step-by-step "Problem Method" of "learning by doing." This famous plan accounts for LaSalle's remarkable record of having trained nearly 10 per cent of all Certified Public Accountants in the U. S. . . . and of having put many thousands of others into high-paying careers.

Send today for LaSalle's interesting booklets, "Accountancy, the Profession That Pays," and "Success Reports." Learn about the five great fields of opportunity... and LaSalle's time-tested plan for helping men and women to rapid advancement, higher income, greater prestige and professional standing. The coupon below will bring these fact-filled booklets to you—without cost or obligation. Mail the coupon NOW.

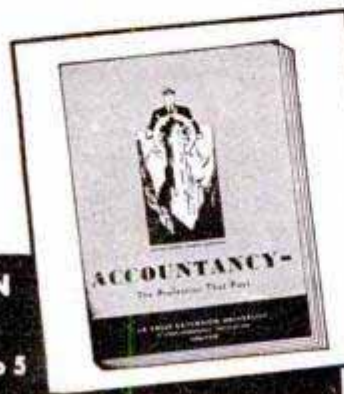

## LaSalle Extension University A Correspondence Institution

Dept. 1264H, 417 S. Dearborn St., Chicago 5, Ill.

Please send me, free of all cost or obligation, your 48-page illustrated book "Accountancy, the Profession That Pays," and the booklet "Success Reports"—send also "Ten Years' Promotion in One"—a book which has helped many men.

Name..... Age.....  
Address.....  
City, Zone, State.....

**LASALLE EXTENSION  
UNIVERSITY**  
417 S. Dearborn St., Chicago 5

# AVIATION



## ESSENTIAL

**in peace or war**

**A MESSAGE TO YOUNG MEN...  
AND PARENTS**

We have an urgent demand for Embry-Riddle graduates. Aircraft manufacturers and operators need thousands of properly trained young men for essential positions in civilian aviation.

### SAVE TIME

Now, more than ever before, you need maximum school training in minimum time. Embry-Riddle offers complete eight-month to two-year aeronautical engineering, master A & E mechanic, flying and specialist courses, backed by a quarter-century experience in training today's aviation leaders.

### BE PREPARED

No one can safely predict the course of events today. Be assured, however, that no matter what happens, you will be one step ahead of the crowd with up-to-date, intensive Embry-Riddle aviation training. Write, wire or call today for catalog and full information.



Wherever planes fly, men know Embry-Riddle . . .  
A Famous Name in Aviation.

Dean of Enrollments - Dept. 99  
Embry-Riddle School of Aviation  
Miami 30, Florida

Please Print

NAME \_\_\_\_\_

ADDRESS \_\_\_\_\_

City \_\_\_\_\_

State \_\_\_\_\_ Age \_\_\_\_\_

I am interested in . . .

- A.&E. Mechanic
- Commercial Pilot
- Engineering
- A.&E. Combined with Commercial Pilot
- Flying Mechanic
- Drafting & Design

Check One  Veteran  Non-Veteran

**TRAIN IN MIAMI -- AIR CAPITAL OF THE WORLD**

(Continued from page 6)

date. Some of these people have driven from California, Texas, New York, etc. There have been 372 long-distance calls responding to the story.

"We are still receiving about 20 letters per day and a few calls and visits. You may be sure that for a few weeks they almost covered us up with mail, but at this point is well under control.

"I felt that you might like to know the figures on your story and what a punch your magazine carries. . . ."

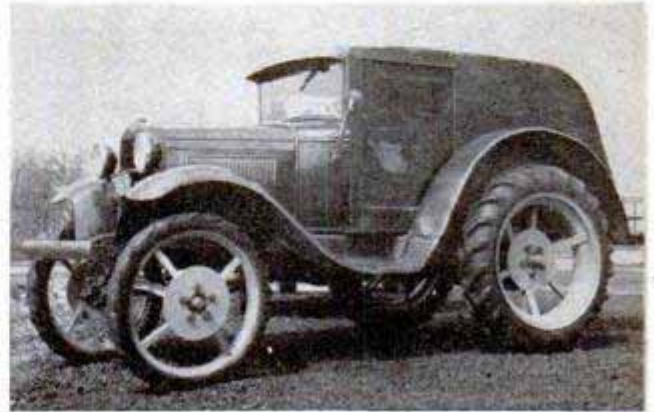

### Letter to the Editor

Imagine my surprise upon reading your August, 1950 issue when on page 127 I saw described the "Mail Buggy."

That designation, "Mail Buggy," used to be right. This "weird vehicle" is what used to be a stilt-mobile and was manufactured somewhere in Wisconsin. The machine is the same in every respect as it was when originally manufactured for mail carriers excepting that I replaced the back wheels, which were much larger in circumference and had a smaller tire in diameter; by that I mean to say that the tire used to be about a 6-inch tire whereas the one I have on now is about a 15-inch tire. The fact is, it is a tractor tire. I took off the original wheels and replaced them with smaller wheels but carrying a tractor tire. My reason for doing that was that I am using this outfit to take me from the place that it was photographed at Bartelso, Ill., and where I keep the machine, to my clubhouse down in the wildest and most inaccessible part of Clinton County. This machine has long ago served its purpose as a "Mail Buggy." It now serves, to my way of thinking, a much better purpose. It is a "Fishing Buggy."

Last Sunday we were down at my clubhouse, and one of the boys wanted to take a trip down to the river which is about a quarter of a mile south of my lake, which is a very large lake. He said though that he felt that we probably couldn't get through because of some of the sloughs which he

(Continued to page 10)

**"Impossible," they say**

**M**AYBE they're right about money growing on trees. But here's a success-proved fact: a career firmly rooted in good, practical *training* bears rich and wondrous fruit. Money, promotions, prestige, security—many of the things you really want in life.

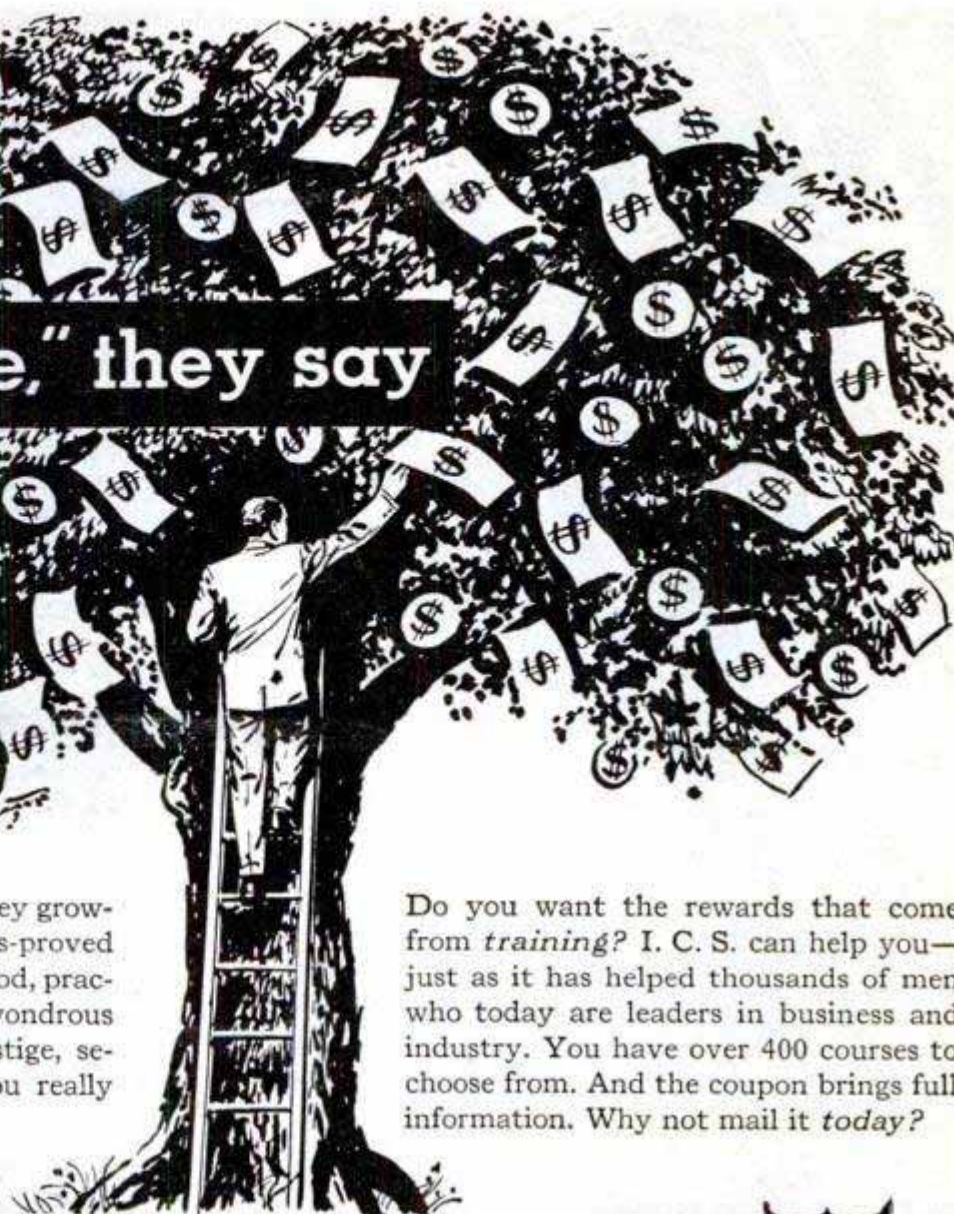

Do you want the rewards that come from *training*? I. C. S. can help you—just as it has helped thousands of men who today are leaders in business and industry. You have over 400 courses to choose from. And the coupon brings full information. Why not mail it *today*?

**INTERNATIONAL CORRESPONDENCE SCHOOLS**

**APPROVED**  
under the  
**G.I. BILL**

**BOX 5689-K, SCRANTON 9, PENNA.**

Without cost or obligation, please send me full particulars about the course BEFORE which I have marked X:

- |   |  |   |  |
|---|--|---|--|
| <p><b>Business and Academic Courses</b></p> <ul style="list-style-type: none"> <li><input type="checkbox"/> Accounting</li> <li><input type="checkbox"/> Bookkeeping</li> <li><input type="checkbox"/> Business Administration</li> <li><input type="checkbox"/> Bus. Correspondence</li> <li><input type="checkbox"/> Certified Public Accounting</li> <li><input type="checkbox"/> Commercial</li> <li><input type="checkbox"/> Cost Accounting</li> <li><input type="checkbox"/> Federal Tax</li> <li><input type="checkbox"/> First Year College</li> <li><input type="checkbox"/> Foremanship</li> <li><input type="checkbox"/> Good English</li> <li><input type="checkbox"/> Higher Mathematics</li> <li><input type="checkbox"/> Industrial Supervision</li> <li><input type="checkbox"/> Motor Traffic</li> <li><input type="checkbox"/> Retailing</li> <li><input type="checkbox"/> Salesmanship</li> <li><input type="checkbox"/> Sign Lettering</li> <li><input type="checkbox"/> Spanish</li> <li><input type="checkbox"/> Typing</li> </ul> <p><b>Air Conditioning and Plumbing Courses</b></p> <ul style="list-style-type: none"> <li><input type="checkbox"/> Air Conditioning</li> <li><input type="checkbox"/> Heating</li> <li><input type="checkbox"/> Refrigeration</li> </ul> | <ul style="list-style-type: none"> <li><input type="checkbox"/> Advertising</li> <li><input type="checkbox"/> Bus. Law</li> <li><input type="checkbox"/> Commercial Art</li> <li><input type="checkbox"/> French</li> <li><input type="checkbox"/> High School</li> <li><input type="checkbox"/> Illustration</li> <li><input type="checkbox"/> Postal Civil Service</li> <li><input type="checkbox"/> Retail Bus. Management</li> <li><input type="checkbox"/> Secretarial</li> <li><input type="checkbox"/> Stenography</li> <li><input type="checkbox"/> Traffic Management</li> </ul> <p><b>Chemical Courses</b></p> <ul style="list-style-type: none"> <li><input type="checkbox"/> Chemical Engineering</li> <li><input type="checkbox"/> Chemistry, Analytical</li> <li><input type="checkbox"/> Chemistry, Industrial</li> <li><input type="checkbox"/> Chemistry, Mfg. Iron &amp; Steel</li> <li><input type="checkbox"/> Petroleum Refining</li> <li><input type="checkbox"/> Pulp and Paper Making</li> </ul> <p><b>Civil Engineering, Architectural and Mining Courses</b></p> <ul style="list-style-type: none"> <li><input type="checkbox"/> Architecture</li> <li><input type="checkbox"/> Building Estimating</li> <li><input type="checkbox"/> Civil Engineering</li> <li><input type="checkbox"/> Contracting and Building</li> <li><input type="checkbox"/> Highway Engineering</li> <li><input type="checkbox"/> Lumber Dealer</li> <li><input type="checkbox"/> Reading Structural Blueprints</li> <li><input type="checkbox"/> Sanitary Engineering</li> <li><input type="checkbox"/> Structural Drafting</li> <li><input type="checkbox"/> Structural Engineering</li> <li><input type="checkbox"/> Surveying and Mapping</li> </ul> <p><b>Communications Courses</b></p> <ul style="list-style-type: none"> <li><input type="checkbox"/> Electronics</li> <li><input type="checkbox"/> Prac. FM and Television</li> <li><input type="checkbox"/> Prac. Telephony</li> <li><input type="checkbox"/> Radio, General</li> <li><input type="checkbox"/> Telegraph Engineering</li> </ul> | <p><b>Electrical Courses</b></p> <ul style="list-style-type: none"> <li><input type="checkbox"/> Electrical Drafting</li> <li><input type="checkbox"/> Electrical Engineering</li> <li><input type="checkbox"/> Electric Light and Power</li> <li><input type="checkbox"/> Lighting Technician</li> <li><input type="checkbox"/> Practical Electrician</li> <li><input type="checkbox"/> Power House Electric</li> <li><input type="checkbox"/> Ship Electrician</li> </ul> <p><b>Internal Combustion Engines Courses</b></p> <ul style="list-style-type: none"> <li><input type="checkbox"/> Auto Technician</li> <li><input type="checkbox"/> Diesel-Electric</li> <li><input type="checkbox"/> Diesel Engines</li> </ul> <p><b>Mechanical Courses</b></p> <ul style="list-style-type: none"> <li><input type="checkbox"/> Aeronautical Engineer's, Jr.</li> <li><input type="checkbox"/> Aircraft Drafting</li> <li><input type="checkbox"/> Forging</li> <li><input type="checkbox"/> Heat Treatment of Metals</li> <li><input type="checkbox"/> Industrial Engineering</li> <li><input type="checkbox"/> Industrial Instrumentation</li> <li><input type="checkbox"/> Industrial Metallurgy</li> <li><input type="checkbox"/> Machine Shop</li> <li><input type="checkbox"/> Machine Shop Inspection</li> <li><input type="checkbox"/> Mechanical Drafting</li> <li><input type="checkbox"/> Mechanical Engineering</li> </ul> | <ul style="list-style-type: none"> <li><input type="checkbox"/> Mold-Loft Work</li> <li><input type="checkbox"/> Patternmaking—Wood, Metal</li> <li><input type="checkbox"/> Reading Shop Blueprints</li> <li><input type="checkbox"/> Sheet-Metal Drafting</li> <li><input type="checkbox"/> Ship Drafting</li> <li><input type="checkbox"/> Ship Fitting</li> <li><input type="checkbox"/> Tool Designing</li> <li><input type="checkbox"/> Toolmaking</li> <li><input type="checkbox"/> Welding—Gas and Electric</li> </ul> <p><b>Railroad Courses</b></p> <ul style="list-style-type: none"> <li><input type="checkbox"/> Air Brake</li> <li><input type="checkbox"/> Diesel Locomotive</li> <li><input type="checkbox"/> Locomotive Engineer</li> <li><input type="checkbox"/> Locomotive Fireman</li> <li><input type="checkbox"/> Locomotive Machinist</li> <li><input type="checkbox"/> Railroad Section Foreman</li> <li><input type="checkbox"/> Steam and Diesel Loco. Eng.</li> </ul> <p><b>Stationary Engineering Courses</b></p> <ul style="list-style-type: none"> <li><input type="checkbox"/> Boilermaking</li> <li><input type="checkbox"/> Combust. Engrg.</li> <li><input type="checkbox"/> Marine Engineering</li> <li><input type="checkbox"/> Power Plant Engr.</li> </ul> <p><b>Textile Courses</b></p> <ul style="list-style-type: none"> <li><input type="checkbox"/> Cotton Manufacturing</li> <li><input type="checkbox"/> Rayon Weaving</li> <li><input type="checkbox"/> Woolen Manufacturing</li> </ul> |
|---|--|---|--|

Name \_\_\_\_\_ Age \_\_\_\_\_ Home Address \_\_\_\_\_

City \_\_\_\_\_ State \_\_\_\_\_ Working Hours \_\_\_\_\_ A.M. to \_\_\_\_\_ P.M.

Present Position \_\_\_\_\_ Employed by \_\_\_\_\_

Length of Service in World War II \_\_\_\_\_ Enrollment under G.I. Bill approved for World War II Veterans. Special tuition rates to members of the Armed Forces. Canadian residents send coupon to International Correspondence Schools Canadian, Ltd., Montreal, Canada.

# NEW LOW PRICE!

LARGE-SIZE TUBE

NOW ONLY

27¢

MENNEN  
brushless  
SHAVE

Giant  
Tube  
43¢

NO LATHER

NO BRUSH



**MORE DOCTORS**

Who Specialize in Care of the Skin

**USE MENNEN BRUSHLESS**

Than All Other Brands Combined

• Helps Make Beards Up to 47% Softer for Shaving

(Continued from page 8)

thought we would not be able to cross. He was very much surprised when we "walked" through the sloughs and mud just as if they weren't there. Then to be a little more cocky I had him chain his boat on the back end, and when we went back to the clubhouse we dragged the boat from the river through high weeds and again through the sloughs which he thought we would not be able to navigate.

These machines are not being manufactured any more, and I am very careful with this machine because, as some of the boys say, they feel that I prize it much higher than I do my pleasure car. I think that is right, because I can replace my pleasure car, but I would have a hard time replacing this machine.

In closing I want to say that I certainly got a big kick out of seeing this in your magazine. I would have gotten a much greater kick had it been described belonging to the proper person and also for what it now is being used.

Very truly yours,  
D. L. Schaeffer,  
President,  
Farmers Bank of Trenton,  
Trenton, Ill.

### Apologies

An article in our July 1950 issue, "Patterns in Tile," in describing colorful concrete tile, gave as examples the tile work appearing in the Ambassador Hotel and Union Station in Los Angeles. The article failed to state that tile work on these buildings was done by the Valencia Tile Company, predecessors of the present California Spanish Tile Company.

### Letter to the Editor

A word of congratulations to you for the oil-tanker story which appeared in your August 1950 issue. (A Super-Tanker Feeds Oil-Thirsty America, by Richard F. Dempewolf.) This article will go a long way towards helping to inform the American public of the tremendous amount of work and expense which goes to providing them with petroleum products which they have come to accept as an everyday need.

The wide readership which your publication enjoys is serving well the American public in giving them the facts on our American way of life which I, among millions of others, feel is a good way of life.

Very truly yours,  
H. B. Miller,  
American Petroleum Institute,  
50 West 50th Street,  
New York 20.

# WHAT Every AUTO MECHANIC Wants to Know

A motor vehicle is a machine of many parts, each part designed and constructed for its own special function.

All good mechanics, like good doctors, should know the working theory and operation of each part and understand what causes trouble and how to remedy it.

## LET AUDELS AUTO GUIDE SOLVE YOUR PROBLEMS

Every auto mechanic, helper, serviceman and operator can use AUDELS AUTO GUIDE. The information it gives saves time, money and worry. Highly endorsed by all users. It presents the whole subject of auto mechanics from A to Z in plain language and simple terms.

This Big Practical Book gives full information with working diagrams covering the principles, construction, ignition, service and repair of modern cars, trucks and buses.

A complete Guide of 1800 pages, with over 1500 illustrations showing inside views of the working parts, with instructions for service jobs. Diesel engines, Fluid and Hydra-matic drives fully explained.

## IT PAYS TO KNOW HOW TO

How to fit pistons—How to locate engine knocks—How to fit connecting rod bearings—How to service main bearings—How to recondition valves—How to time valves—How to adjust fan belts—How to adjust carburetors & chokes—How to rebuild a clutch—How to service automatic transmissions—How to service brakes—How to adjust steering gear—How to cope with ignition troubles—How to service distributors—How to time ignition—How to "tune up" an engine.

## INFORMATION IN A HANDY FORM

73 INTERESTING CHAPTERS—Read this partial list of subjects on which practical information is fully given for quick reference under the headings as shown below. Ready Reference Index.

All Parts of an Automobile—Automotive Physics—The Gas Engine—Gas Engine Principles—Multi-Cylinder Engines—Horse Power—Automobile Engines—Stationary Parts—Moving Parts—Pistons—Piston Rings—Connecting Rods—Crank Shafts—Valves—Valve Gear—Cams and Cam Action—Valve Timing—Cooling Systems—Fuel Feed Systems—Dual Fuel Feed—Mixture—Carburetors—Carburetor Service—Automatic Choke—Super-Chargers—Transmissions—Special Transmissions—Fluid and Hydra-matic Drives—Clutches—Universals and Propeller Shafts

A Ready Reference

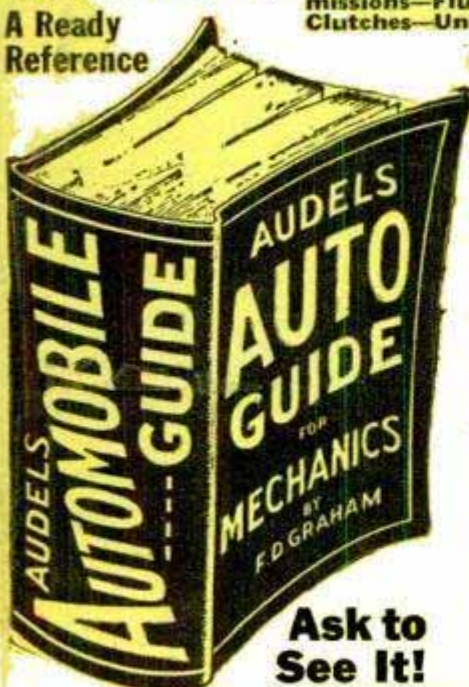

—The Differential—Rear Axles—Rear and Front Suspension—Running Gear—Brakes—Wheel Alignment—Knee Action—Steering Gear—Tires—Lubricants and Lubrication—Automotive Electricity—Ignition Systems—Magneto Ignition—Spark Plugs—Ignition Coils—Distributors—Automatic Spark Control—Ignition Timing—Generators—Starters—Generator and Starter Testing—Lighting Systems—Storage Batteries—Charging and Testing—Diesel Engines and Trouble Shooting.

**7 DAYS' FREE TRIAL**  
TO GET THIS ASSISTANCE FOR YOURSELF SIMPLY FILL IN AND MAIL COUPON TODAY.

**\$4 COMPLETE PAY \$1 A ONLY 1 MO.**

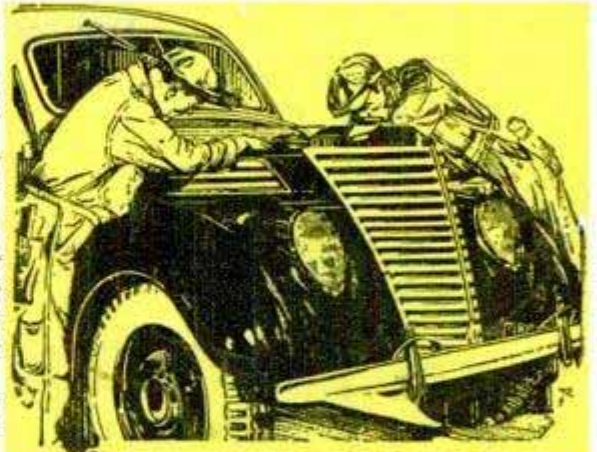

## Sent on 7 Days Approval

Step up your own skill with the facts and figures of your trade. Audels Mechanics Guides contain Practical Inside Trade Information in a handy form. Fully Illustrated and Easy to Understand. Highly Endorsed. Check the book you want for 7 DAYS FREE EXAMINATION. Send No Money. Nothing to pay postman.

## CUT HERE MAIL ORDER

AUDEL, Publishers, 49 W. 23 St., NEW YORK 10, N. Y.

Please send me postpaid for FREE EXAMINATION books marked below. If I decide to keep them I agree to mail \$1 in 7 Days on each book or set ordered and further mail \$1 monthly on each book or set until I have paid price, otherwise I will return them.

- AUTO GUIDE, 1800 Pages . . . \$4**
- DIESEL ENGINE MANUAL, 400 Pages . . . 2
- WELDERS GUIDE, 400 Pages . . . 1
- MACHINISTS Handy Book, 1600 Pages . . . 4
- POWER PLANT ENGINEERS Guide, 1500 Pages . . . 4
- ENGINEERS & FIREMANS EXAMS, 528 Pages . . . 1
- PUMPS, Hydraulics & Air Compressors, 1658 Pgs. . . 4
- MARINE ENGINEERS Handy Book, 1280 Pages . . . 4
- ENGINEERS & Mechanics Guides (8 Book Set) . . . 12
- Answers on Practical ENGINEERING, 254 Pages . . . 1
- ELECTRIC WIRING DIAGRAMS, 210 Pages . . . 1
- ELECTRICIANS EXAMINATIONS, 250 Pages . . . 1
- ELECTRICAL DICTIONARY, 9000 Terms . . . 2
- ELECTRIC MOTOR GUIDE, 1000 Pages . . . 4
- HANDY BOOK OF ELECTRICITY, 1440 Pages . . . 4
- ELECTRICAL POWER CALCULATIONS, 425 Pgs. . . 2
- RADIOMANS GUIDE, 914 Pages . . . 4
- ELECTRONIC DEVICES, 216 Pages . . . 2
- ELECTRIC LIBRARY, 7000 Pages (12 Book Set) . . . 18
- Vols. I, II, III, IV, V, VI, VII, VIII, IX, X, XI, XII \$1.50 Ea.
- OIL BURNER GUIDE, 384 Pages . . . 1
- HOUSE HEATING GUIDE, 1000 Pages . . . 4
- CARPENTERS & Builders Guides (4 Book Set) . . . 6
- PLUMBERS & Steamfitters Guides (4 Book Set) . . . 6
- MASONS & Builders Guides (4 Book Set) . . . 6
- BLUE PRINT READING, 416 Pages . . . 2
- PAINTERS & DECORATORS MANUAL, 450 Pgs. . . 2
- GARDENERS & GROWERS Guides (4 Book Set) . . . 6
- REFRIGERATION & Air Conditioning, 1280 Pgs. . . 4
- SHEET METAL WORKERS Handy Book, 388 Pgs. . . 1
- SHEET METAL PATTERN LAYOUTS, 1100 Pgs. . . 4
- AIRCRAFT WORKER, 240 Pages . . . 1
- MECHANICAL DRAWING GUIDE, 160 Pages . . . 1
- MECHANICAL DRAWING & DESIGN, 480 Pgs. . . 2
- MATHEMATICS & CALCULATIONS, 700 Pgs. . . 2
- MECHANICAL Dictionary, 968 Pages . . . 4
- MILLWRIGHTS & Mechanics Guide, 1200 Pgs. . . 4

Name \_\_\_\_\_  
Address \_\_\_\_\_  
Occupation \_\_\_\_\_  
Employed by \_\_\_\_\_ 15A

AUDEL, Publishers, 49 W. 23 St., New York 10, N. Y.



Makes \$10

Shop Specializes in Television



\$5 to \$8 Week In Spare Time



Calls N.R.I. His "Stepping Stone"

# BE A SUCCESS IN RADIO-

## Learn by Practicing

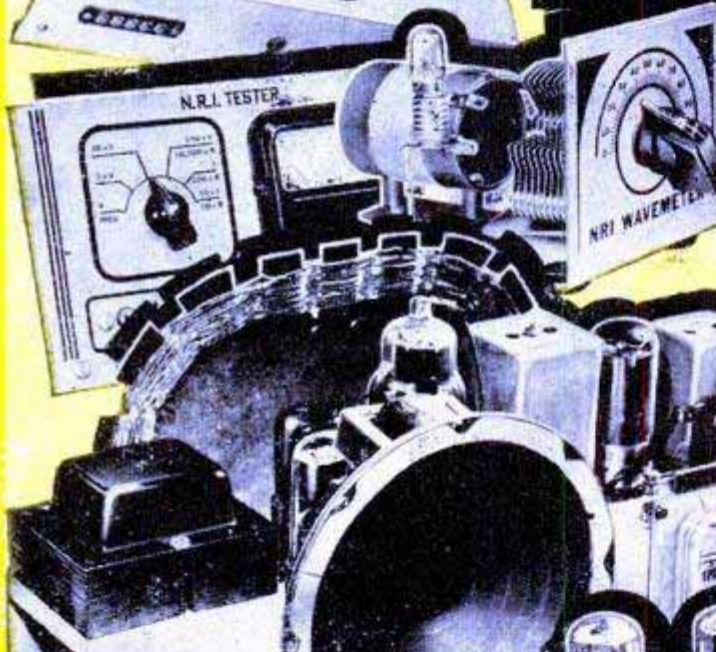

### Build Radio Equipment Like This With Kits of Parts I Send

I give you PRACTICAL EXPERIENCE with many Valuable Kits I send that "bring to life" my illustrated texts. In my Servicing Course, you build a modern Radio, Set Tester, AM Signal Generator, etc. In my Communications Course, you assemble a low-power Broadcasting Transmitter, Wavemeter, Electronic Multitester, etc. Some equipment from both the courses is shown on this page. All of the equipment that you build is yours to keep.



### MAKE EXTRA MONEY WHILE LEARNING

I show you how to earn \$5, \$10 a week, or more, in spare time fixing Radios. I send you parts to build the SET TESTER you use to do it. Frank Lhotsky, Cicero, Ill., above, one of my many students who earned while training, writes, "when I enrolled, I didn't know the difference between a power transformer and a condenser. Your outstanding course made a new, prosperous man of me."

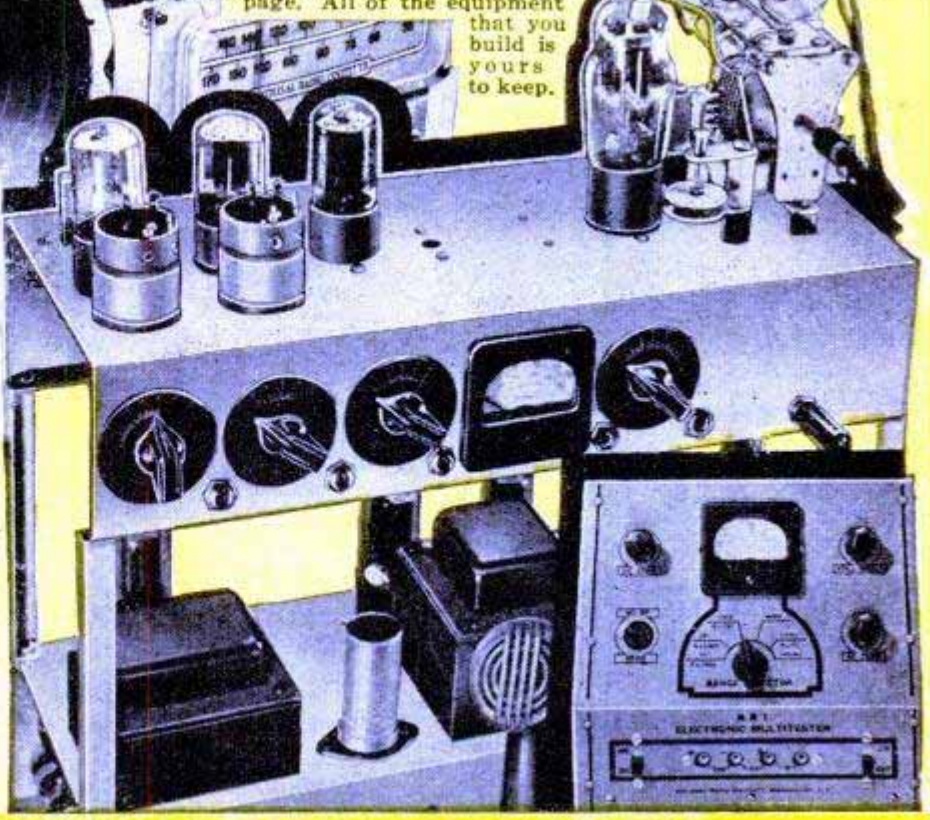



**NRI-Graduate Doubles Salary**

"I am employed by Station WKBO as transmitter operator. Have more than doubled salary since starting in Radio full time."—A. Herr, New Cumberland, Pa.



**Manager Radio and Television Dept.**

"From Radio and Television Technician... was promoted to Manager of Television Service and Installation. Thanks to N.R.I."—L. Hauger, San Bruno, Calif.



**Gets First Job Through N.R.I.**

"My first job was operator with KDLR, obtained for me by your Graduate Service Dept. Am now Chief Engineer Police Radio Station WQOX."—T. S. Norton, Hamilton, Ohio.

**I TRAINED THESE MEN**



# TELEVISION

## at Home in Spare Time

**Get a Good Job--Have a Bright Future in America's Fast Growing Industry**

Do you want good pay, a job with a bright future and security? Would you like a profitable shop of your own? The fast growing, prosperous RADIO-TELEVISION industry is making these opportunities for you. Radio alone is bigger than ever. 81 million home and auto Radios, 2,700 Broadcasting Stations, expanding use of Aviation and Police Radio, Micro-Wave Relay, Two-Way Radio for buses, taxis, etc., are making opportunities for Servicing and Communications Technicians and FCC-Licensed Operators.

**Television is TODAY'S Good Job Maker**  
 In 1946 only 6,000 TV sets sold. In 1949 almost 3,000,000. By 1954, 20,000,000 TV sets will be in use, according to estimates. 100 TV Stations are operating in 35 states. Authorities predict there will be 1,000 TV Stations. This means new jobs, more jobs, good pay for qualified men.



**HAVE A BUSINESS OF YOUR OWN**  
 Let me show you how to have a good, steady income from your own Radio-Television shop. Many N.R.I.-trained men each year start without capital, like Robert Bohmen, New Prague, Minn., above. He writes, "Am now tied in with two television outfits."

**VETERANS HURRY!**  
 To get this valuable training under G. I. Bill. Time is running out.  
**Mail Coupon NOW!**

**Many Soon Make \$10 A Week Extra in Spare Time**

Keep your job while training at home. Hundreds I've trained are successful RADIO-TELEVISION TECHNICIANS. Most had no previous experience; many no more than grammar school education. Learn Radio-Television principles from illustrated lessons. Get PRACTICAL EXPERIENCE—build valuable multimeter for conducting tests; also practice servicing Radios or operating transmitters—experiment with circuits common to Radio and Television. You keep all equipment. Many students make \$5, \$10 a week extra fixing neighbors' Radios in spare time. SPECIAL BOOKLETS start teaching you the day you enroll.



**FREE ACTUAL LESSON AND 64 PAGE BOOK**

Act Now! Send for my FREE DOUBLE OFFER. Coupon entitles you to actual lesson on servicing; shows how you learn Radio-Television at home. You'll also receive my 64-page book, "How to Be A Success in Radio-Television." You'll read what my graduates are doing, earning; see photos of equipment you practice with at home. Send coupon in envelope or paste on postal. J.E. SMITH, President, Dept. ONP, National Radio Institute, Washington 9, D.C. OUR 37TH YEAR.

**MAIL THIS NOW**

**Good For 2 Books FREE**

**MR. J. E. SMITH, President, Dept. ONP**  
**National Radio Institute, Washington 9, D. C.**  
 Mail me Sample Lesson and 64-page Book about How to Win Success in Radio-Television. Both FREE. (No salesman will call. Please write plainly.)

NAME.....AGE.....  
 ADDRESS.....  
 CITY.....ZONE.....STATE.....  
 Check if Veteran. Approved Under G. I. Bill.

# NOW!

## BRIGGS SMOKES 3 WAYS BETTER\*



1. Stays lighted longer ... by 19%



2. Cleaner burning ... by 16.4%



3. Less tar ... by 21.6%

So today ...

Put this  
in your  
pipe



and smoke it!

\*Yes, our new process makes Briggs better by actual test! Better even than the swell-smoking Briggs that proved so fine and friendly in your pipe before. And remember this: when tobacco burns steady, free and clean, that's when you enjoy *all* the goodness of Briggs' fine tobacco, aged and mellowed in oaken casks. Today—try 3-ways-better Briggs!

Also available in Canada

## WHERE-TO-BUY-IT INDEX

Source of supply appears after items commercially available

### AUTOMOTIVE

Hinged fender speeds repairs (Federal Motor Truck Co., Detroit 9, Mich.)	78
Aligner sets exact wheel toe-in while car is assembled (Oldsmobile Div. General Motors Corp., Lansing 21, Mich.)	82
Detroit listening post	93
Reflector rims on auto wheels shine warning (Luma-Rim Corp., Pacific Bldg., Oakland 12, Calif.)	98
1951 Lincoln with the long look (Lincoln-Mercury Co., 6200 W. Warren Ave., Detroit 32, Mich.)	98
Chrome "skin" doubles life of piston rings (Perfect Circle Corp., 552 S. Washington St., Hagerstown, Ind.)	99
Car rugs (Wooster Rubber Co., Wooster, Ohio)	100
Hudson features new six (Hudson Motor Car Co., 12601 E. Jefferson Ave., Detroit, Mich.)	100
V-8 for Studebaker (Studebaker Corp., South Bend, Ind.)	107
Portable one-end lift speeds work on cars (Automatic Steel Products, Inc., Canton 6, Ohio)	118
"Rough roads" in laboratory check auto vibrations (Fisher Body Div., General Motors Bldg., Detroit, Mich.)	136

### AVIATION

Flying messenger	78
Homemade sweeper cleans hangar floor	115
Fuel pours into Jetliner at rate of 200 gallons per minute (A. V. Roe Canada, Ltd., Malton, Ont., Can.)	119
Plane anchor is shot into ground	124
Pump pops up to fuel planes (Todd Shipyards, Corp., 81-86 45th Ave., Elmhurst, Queens, L.I., N.Y.)	134
Wheels on wing	141

### FARM AND GARDEN

Shower for pineapples	78
Illuminated garden ornaments (Franco-British Electrical Co., Ltd., 180 Corporation St., Birmingham, England)	82
Dust jackets for grain prevent insect damage (U. S. Industrial Chemical, Inc., 1910 Lincoln Bldg., New York City 17)	106
Parcel-post garden (Magic Gardens, Inc., Box 4635, Jacksonville, Fla.)	130

### HOUSE AND HOME

Aluminum screen is radiant heater (Radiant Electric Co., 1981 W. Slauson Ave., Los Angeles 47, Calif.)	79
Telescoping trailer homes	80
Aluminum window has screen and storm sash (Fleet of America, Inc., 421 Dun Bldg., Buffalo, N.Y.)	88
TV floor chair (R. Bruce Wight, T-V Loafers, Box 342, Waukegan, Ill.)	140
Snap-in washer for faucets (Snap Products Corp., 153 W. Hubbard St., Chicago 10)	142
Cord cage (J. E. Pricke Co., 40 N. Front St., Philadelphia, Pa.)	142
Tension tester (Miller Belt Co., Peoria, Ill.)	142
Handle holder (Bassick Co., Bridgeport, Conn.)	142
Washers fit any opening (Flexrock Co., Filbert & Cuthbert, Philadelphia 4, Pa.)	142
Stretchers for curtains (Quaker Stretcher Co., Merchandise Mart, Chicago)	142
Electric Oven (Thermador Electric Mfg. Co., 5119 District Blvd., Los Angeles 22, Calif.)	143
Rubber molding (The Cassidy Co., 5659 N. Lincoln Ave., Chicago)	143
All-purpose furniture for youngster (Juvenile Furniture Co., 406 Elm St., Cincinnati 2, Ohio)	143
Electric channel installed in strips (National Electric Products Corp., Chamber of Commerce Bldg., Pittsburgh 19, Pa.)	144
Balance bar for stepladder (MacLeod Safety Device, Libertyville, Ill.)	144
Twelve-hour concrete house (L. E. Town, Construction Engineer, Conair Sales, Inc., Van Nuys, Calif.)	151

### INDUSTRY

Machine pits 1000 pounds of cherries per hour (U. S. Rubber Co., Public Relations Dept., Rockefeller Center, New York City 20)	88
"Radiant" cloth holds heat (Deering, Milliken & Co., 450 7th Ave., New York City)	106
Old railroad rails serve many uses	115
Turbine-powered truck (Boeing Airplane Co., Seattle 14, Wash.)	118
"Piano roll" operates four lathes simultaneously (Arma Corp., 254 36th St., Brooklyn 32, N. Y.)	144
Paper-pulp waste makes rubber	150

### MODELS

Radio-guided ship model tows miniature barge	114
Spare-time railroader	116
"Workin' on railroad" by remote control (Lionel Corp., 15 E. 26th St., New York City)	123

### PHOTOGRAPHY

Daylight tank develops movies (Micro Record Corp., 30 E. 10th St., New York City 3)	79
Bayonet tripod	100
Camera caddy	134
Plastic shield diffuses flash (Eastman Kodak Co., Rochester 4, N. Y.)	141

(Continued to page 16)





# INVENTORS

**L**earn how to protect your invention. The U. S. Patent Laws provide that any new and useful art, machine, article of manufacture, or composition of matter, or any new and useful improvement thereof, may be patented if the act of invention is involved. Therefore, every inventor with a valuable invention should take advantage of the Patent Laws and proceed for patent protection in order to safeguard his rights.

A patent gives the inventor the exclusive right to prevent others from making, using, or selling the invention claimed in the patent for a period of seventeen years.

The Patent Laws were enacted for the benefit of the inventor to give him protection for the features of his invention which are patentable. These features must be properly and concisely set forth and claimed in a formal application for patent, in order to comply with the requirements of the Patent Laws. For that reason, unless the inventor is familiar with patent matters, he should engage a competent registered patent attorney or agent to represent him. We are registered to practice before the U. S. Patent Office and are prepared to serve you in the handling of your patent matters.

A specially prepared booklet entitled "Patent Guide for the Inventor", containing detailed information with respect to patent protection and procedure, together with a "Record of Invention" form will be promptly forwarded to you without obligation upon request.

**CLARENCE A. O'BRIEN & HARVEY JACOBSON**

*Registered Patent Attorneys*

**01-M DISTRICT NATIONAL BUILDING**

**WASHINGTON 5, D. C.**



CAN LEAD TO A BETTER JOB IN BUSINESS or INDUSTRY

You can take subjects which have Real Job Value and still earn graduation!

This is your opportunity to make completion of high school work for you. Your AMERICAN SCHOOL home study course can include high school subjects closely related to your present job or the kind of work you want to do later.

50 Job Help Subjects from Which to Choose

Our FREE, 44-page book of detailed information lists 100 high school subjects, of which 29 are technical and 21 are commercial.

Turn Spare Time Into Money

During more than 50 years American School has helped thousands to reach higher job goals by profitable use of spare time at home—and it can help you.

AMERICAN SCHOOL

DEPT. G-945, DREXEL AT 58th, CHICAGO 37

Form with text: PRACTICAL, EFFECTIVE HOME - STUDY TRAINING SINCE 1897. Take This First Easy Step. CHECK, CLIP AND MAIL COUPON NOW. AMERICAN SCHOOL, Dept. G-945, Drexel at 58th, Chicago 37, Ill. Without obligation, please send me FREE information on training course checked below.

RECREATION
Sulky pulled by dog 118
Watercycle (William Dein, 22 Nostrand St., Farmingdale, L. I., N. Y.) 119
Quick-change mount for sportsmen's rifle sights (Mykrom Co., 1335 S. W. Morrison, Portland, Ore.) 123
Portable sun screen (Draper & Vaughn, Phoenix, Ariz.) 130
Florball (Florball, Inc., Salem, Conn.) 136
Human-fly whirligig 149

MISCELLANEOUS
Zip-on coating stops corrosion (Dresser Mfg. Div., Dresser Industries, Inc., Bradford, Pa.) 79
Mechanical note writer (Keaton Music Typewriter Co., 461 Market St., San Francisco 5, Calif.) 79
Rope splicer (Dorham Specialties, Box 212, Noroton, Conn.) 82
Sewing pictures 83
Snow blower (Gravelly Motor Plow & Cultivator Co., Dunbar, W. Va.) 98
Christmas-tree holder (K&V Automatic Stand Co., 543 Peck St., Muskegon, Mich.) 106
Mobile X-ray for animals 115
Rear wheel motor powers bicycle (Cyclemaster, Ltd., 26 Old Brompton Road, South Kensington, London S.W. 7, England) 124
Striking strip for matches resists moisture (Universal Match Corp., St. Louis 3, Mo.) 130
Fishing with a ladder 131
Emergency door lock (Hunter Lock Co., 1109 S. Robertson Blvd., Los Angeles 35, Calif.) 134
Unlighted decorations glow in dark (Sheeting: Minnesota Mining & Mfg. Co., St. Paul 6, Minn.) 135
Traffic light on bus protects children 136
Age of sturgeon told by rings in fins 140
Dinghy hoist (Diamond Mfg. Co., 1100 Altamont Ave., Schenectady 7, N. Y.) 141
Rowboat with wheel is its own trailer 150
Radar "measures" rainfall over 200-mile area 150
Man recaptures Sardinia from mosquitoes 156

Craftsman and Shop Notes Index

AUTOMOTIVE
Car freed from icy pavement with nonslip rug mats 166
Refinishing taillight lenses with red fingernail polish 183
Tray slipped under car seat holds maps and sundries 192
Lubricating car-window channels prevents binding of glass 192
Special brackets for spark-plug wires help reduce lcx-speed missing 203
T-wrenches align oil pan when bolting in place 215

CHRISTMAS SPECIALS
Decorated stationery for the holiday season 177
Fluorescent fixtures decorated with Christmas trimmings 192
Christmas-tree ornaments cut from paper simulate giant snowflakes 194
Unusual Christmas-tree display seems to project through store window 218

FARM
How to weigh cattle with a length of string 203
Binder canvas rolled in tar paper is protected from rodents 208
Portable bench and toolbox 208
Eaves trough fitted to side of coop provides poultry feeder 209
Two-wheel trailer safely hauls farm tractors 215
Rump strap for dairy cow stops switching of tail 215
Laying nests made from oil can are fitted with wooden perches 218
Chicken feeder handles wet mash 218
Self-dumping trailer operated by tractor carries heavy load 218

HOUSE AND HOME
Can lowered through flue removes chimney soot 164
Under-shelf rack for rolling pin 166
Corrugated-rubber scrub brush 168
Preventing loss of packaged seed 168
Drying rack for hose 168
Tie stretcher from coat hanger 168
Water pipes plugged temporarily 169
Can tops kept from dropping in food 169
Paint-can opener 169
Covering drawer-pull fastenings 169
Spools screwed to cabinet door provide kitchen-knife holder 170
Handleless cabinet door is opened easily with plumber's force cup 172
Towel draped across door edge prevents accidental slamming 178
Hanging clothes from lazy tongs saves space in small closet 183
Double-hung clothesline conserves space in yard or basement 184
Hydrometer measures salt content of water-softener brine tank 208

METALWORKING
Tubing bent around pulley to prevent kinking 183
Shafting holds disk blanks between centers for accurate multiple turning 202
Drilling holes in duplicate parts 203
Forming press for sheet-metal parts improvised from bench vise 207
Removing rust from metal scrap 209

(Continued to page 18)

# INVENTORS

If you believe that you have an invention, you should find out how to protect it. The first step is to have a search made of the prior pertinent U. S. patents. If a report on this search indicates that the invention appears patentable you can apply for a patent, and the specifications and claims should be prepared.

The firm of McMorow, Berman & Davidson, with offices in Washington, D. C., is qualified to take the necessary steps for you. We can make a preliminary search on your invention, advise you whether we think it can be patented, and prepare your application for patent.

Unless you are fully familiar with the U. S. Patent Laws, we recommend that you engage the services of a Registered Patent Attorney to protect your interests. The patent laws are *your* laws. A patent gives you the right to prevent others from making, using or selling the invention claimed in your patent for a period of 17 years.

Use these patent laws for your protection. Investigate whether your invention can be patented. If you have what you believe to be an invention, we suggest that you have this firm make a search for you.

*Send for a copy of our Patent Booklet entitled "How To Protect Your Invention," containing information about patent protection and patent procedure. Along with this we will also send you an "Invention Record" form, for your use in writing down and sketching details of your invention. We will mail them promptly. No obligation. They are yours for the asking.*

**McMORROW, BERMAN & DAVIDSON**

*Registered Patent Attorneys*

**PATENTS • COPYRIGHTS • PATENTS**

**135-L VICTOR BUILDING, WASHINGTON 1, D. C.**

# GET THE WORLD'S GREATEST RADIO & TELEVISION CATALOG!

# FREE

**ALLIED'S**  
212-PAGE GUIDE  
TO EVERYTHING  
IN RADIO & TV AT  
LOWEST PRICES



SAVE ON  
EVERYTHING  
IN RADIO AND TV

Save money on every purchase you make from the world's largest radio supply house! Send for ALLIED'S 212-page 1951 Catalog packed with everything in Radio and Television. Widest selections of home radios, TV equipment, phono-radios, Amateur equipment, P.A. systems, Hi-Fidelity music systems, recorders, test equipment, builders' kits—plus thousands of parts, tubes, tools, books and diagrams. Get more for your money—send today for your FREE 1951 ALLIED Radio and TV Catalog!



Everything for:  
Servicemen  
Engineers  
Experimenters  
Builders  
Amateurs

Get Radio's Leading Buying Guide!

## ALLIED RADIO

FREE  
CATALOG

ALLIED RADIO CORP., Dept. 5-M-O,  
833 W. Jackson Blvd., Chicago 7, Ill.

Rush FREE 212-Page ALLIED Catalog

Name.....

Address.....

City.....Zone.....State.....

(Continued from page 16)

### MODELMAKING

Doorstop forms small hammer .....	170
Plastic container dispenses fuel to model gasoline engines	172
Improvising small caliper from spring-type clothespin.....	202

### OUTDOOR RECREATION

Pipe fitted with wooden handle forms spud for chopping ice	164
Safety panel on bicycle wheel guards foot from spokes.....	167
Improvised tipup for ice fishing made from three-pronged branch .....	184
Simulated pork-rind bait .....	184
Caster cups support cot legs .....	194

### PAINT AND PAINTING

Unfinished furniture painted easily by using shellac as undercoat .....	170
Rubber band around paint can indicates level of contents	184
Glass fuses provide paint cups .....	192

### PHOTOGRAPHY

Negative and print filed in one packet.....	195
Wire recorder saves time by handling data on photographs..	195
Pipe rack holds darkroom items.....	195
Glossy prints dried quickly with fan and heat lamp.....	199
Enlarger lens illuminated with red plastic rod .....	200
Book end doubles as stand for clamp-on reflector.....	200

### TOOLS

Hooked can-opener blade provides linoleum knife.....	172
Sanding block from softboard results in better work .....	172
Vise clamps small work between wooden blocks.....	177
Fence fastened to plane provides mitering guide.....	177
Level anchored to straightedge .....	178
Clay shields glass cutter .....	178
Spectacle case clamped on saw muffles sound of filing.....	183
Old putty removed from sash with altered plane blade.....	186
Two-speed radial saw (Consolidated Machinery & Supply Co., Los Angeles, Calif.) .....	216
Auto-set template (Eliason Tool Co., 2117 E. 56th St., Minneapolis 17, Minn.) .....	216
Magnetic driver (Magna Tool Corp., Buffalo 3, N.Y.).....	216
Circular-saw accessory (Federal Engineering Co., 37 Murray St., New York City 7) .....	217
Floor jack (R. M. Products, Box 171, Rochester, Mich.).....	217
Self-contained tamper (Barco Mfg. Co., 1801 Winnemac Ave., Chicago 40) .....	217
Slide-set vise (Dodge Mfg. Corp., Mishawaka, Ind.) .....	217

### TOYS AND NOVELTIES

Have fun with this chariot-type tricycle trailer.....	165
Hanging ornamental flowerpot.....	166
Personalized laundry bag for child's room.....	167
Centerpiece for dining table utilizes angel-cake pan.....	170
Child's glider swing .....	171
Making wooden blocks for children .....	178
Holders for earrings .....	179
Garden urns molded in concrete .....	185
Walnut phonograph top forms modern hopper-type picture frame .....	186
Weather vanes .....	193

### WOODWORKING

Hardboard kerfed on underside is bent to small radius.....	164
Reflection in saw squares board .....	194
Making box joints on your circular saw.....	209

### MISCELLANEOUS

Electrical wires kept from fraying by applying fingernail polish .....	164
Calculating roof pitch in degrees .....	166
Removing wristwatch back .....	170
Reinforcing vacuum-bottle filler lessens chance of breakage	172
Plastic liner protect shirt pocket from damage by pencils.....	178
Ice cube numbs injured finger .....	178
Rubber hose slipped over ball forms comfortable handgrip.....	183
Trap improves trailer icebox by forming water seal.....	184
Cork backs plaster patch .....	184
Asphalt roofing laid on ground provides temporary walk.....	186
Varnish aids in patching plaster .....	186
Venting outdoor fuel drums .....	192
Boards fastened to block wall with hammer and nails.....	194
Gang valve lifter saves time .....	208
Carpenter's chalk holder prevents soiling hands.....	215

### Radio-Television, Electronics

TV mirrors "see" only one color (Westinghouse Laboratories, Pittsburgh, Pa.) .....	219
Three germanium diode crystal receivers for beginners.....	220
TV antenna installation with minimum roof attachments.....	222
Radio-television and electronics today (Geiger counter, James A. Batson Electronics, Inc., 1031 S. 27th St., Omaha, Neb.; record changer, V. M. Corporation, 280 Park St., Benton Harbor, Mich.; Jack-up tower, Camburn Sales and Mfg. Co., Battle Creek, Mich.; FM receiver, Fred W. Ahrbecker Co., 1916 N. Meridan St., Indianapolis 2, Ind.; Radio-TV and Electronics Handbook, Popular Mechanics Press, 200 E. Ontario St., Chicago 11).....	224

**IMPORTANT NOTICE**—It is the intention of this magazine to provide its readers with information regarding the latest developments in the mechanical arts. We take no responsibility as to whether the disclosures contained in our articles are covered by patents and advise readers to investigate this subject before making, using, or selling any of the products, machines, or processes described in order to avoid possible liability for patent infringements.

# DEFENSE and what it means to you!

**1** If you are of draft age—you may or may not be called to service. But either way, I. C. S. training can give you the skills that mean a more important job. You can't lose—if you are inducted, your I. C. S. payments may be stopped and your studies suspended if you wish.

**2** If you want to get into defense work—you'll have a better chance of landing a job... a better chance of getting ahead... if you have training. And you can get that training at home in your spare time from I. C. S.

**3** If you want to stay in your present field—there will be new job vacancies as the demands of the services and defense industries are stepped up. The men who move into these better jobs will be trained men. One of them might be you... with the help of I. C. S.

Any way you look at it, I. C. S. training will fit you for the demands of today, will help put you in a position of importance. So mail the coupon...today!

## INTERNATIONAL CORRESPONDENCE SCHOOLS



BOX 5690-K, SCRANTON 9, PENNA.

Without cost or obligation, please send me full particulars about the course BEFORE which I have marked X:

- |  |  |  |  |
|--|--|--|--|
| <p><b>Air Conditioning and Plumbing Courses</b></p> <p><input type="checkbox"/> Air Conditioning      <input type="checkbox"/> Heating</p> <p><input type="checkbox"/> Refrigeration      <input type="checkbox"/> Plumbing</p> <p><input type="checkbox"/> Steam Fitting</p> <p><b>Chemical Courses</b></p> <p><input type="checkbox"/> Chemical Engineering</p> <p><input type="checkbox"/> Chemistry, Analytical</p> <p><input type="checkbox"/> Chemistry, Industrial</p> <p><input type="checkbox"/> Chemistry, Mfg. Iron &amp; Steel</p> <p><input type="checkbox"/> Petroleum Refining      <input type="checkbox"/> Plastics</p> <p><input type="checkbox"/> Pulp and Paper Making</p> <p><b>Civil Engineering, Architectural and Mining Courses</b></p> <p><input type="checkbox"/> Architecture</p> <p><input type="checkbox"/> Architectural Drafting</p> <p><input type="checkbox"/> Bridge and Building Foreman</p> <p><input type="checkbox"/> Building Estimating</p> <p><input type="checkbox"/> Civil Engineering</p> <p><input type="checkbox"/> Coal Mining</p> <p><input type="checkbox"/> Contracting and Building</p> <p><input type="checkbox"/> Highway Engineering</p> <p><input type="checkbox"/> Lumber Dealer</p> <p><input type="checkbox"/> Reading Structural Blueprints</p> <p><input type="checkbox"/> Sanitary Engineering</p> <p><input type="checkbox"/> Structural Drafting</p> | <p><input type="checkbox"/> Structural Engineering</p> <p><input type="checkbox"/> Surveying and Mapping</p> <p><b>Communications Courses</b></p> <p><input type="checkbox"/> Electronics</p> <p><input type="checkbox"/> Practical Telephony</p> <p><input type="checkbox"/> Radio, General      <input type="checkbox"/> Radio Operating</p> <p><input type="checkbox"/> Radio Servicing      <input type="checkbox"/> Television</p> <p><input type="checkbox"/> Telegraph Engineering</p> <p><b>Electrical Courses</b></p> <p><input type="checkbox"/> Electrical Drafting</p> <p><input type="checkbox"/> Electrical Engineering</p> <p><input type="checkbox"/> Electric Light and Power</p> <p><input type="checkbox"/> Lighting Technician</p> <p><input type="checkbox"/> Practical Electrician</p> <p><b>Internal Combustion Engines Courses</b></p> <p><input type="checkbox"/> Auto Technician      <input type="checkbox"/> Aviation</p> <p><input type="checkbox"/> Diesel-Electric</p> <p><input type="checkbox"/> Diesel Engines      <input type="checkbox"/> Gas Engines</p> <p><b>Mechanical Courses</b></p> <p><input type="checkbox"/> Aeronautical Engineer's, Jr.</p> <p><input type="checkbox"/> Aircraft Drafting      <input type="checkbox"/> Flight Engineer</p> <p><input type="checkbox"/> Forging      <input type="checkbox"/> Foundry Work</p> <p><input type="checkbox"/> Heat Treatment of Metals</p> <p><input type="checkbox"/> Industrial Engineering</p> <p><input type="checkbox"/> Industrial Instrumentation</p> | <p><input type="checkbox"/> Industrial Metallurgy</p> <p><input type="checkbox"/> Machine Shop      <input type="checkbox"/> Mech. Drafting</p> <p><input type="checkbox"/> Mechanical Engineering</p> <p><input type="checkbox"/> Mold-Loft Work</p> <p><input type="checkbox"/> Patternmaking—Wood, Metal</p> <p><input type="checkbox"/> Reading Shop Blueprints</p> <p><input type="checkbox"/> Sheet-Metal Worker</p> <p><input type="checkbox"/> Sheet-Metal Drafting</p> <p><input type="checkbox"/> Ship Drafting      <input type="checkbox"/> Ship Fitting</p> <p><input type="checkbox"/> Tool Designing</p> <p><input type="checkbox"/> Toolmaking</p> <p><input type="checkbox"/> Welding—Gas and Electric</p> <p><b>Railroad Courses</b></p> <p><input type="checkbox"/> Air Brake      <input type="checkbox"/> Car Inspector</p> <p><input type="checkbox"/> Diesel Locomotive</p> <p><input type="checkbox"/> Locomotive Engineer</p> <p><input type="checkbox"/> Locomotive Fireman</p> <p><input type="checkbox"/> Locomotive Machinist</p> <p><input type="checkbox"/> Railroad Section Foreman</p> <p><input type="checkbox"/> Steam-Diesel Loco. Eng.</p> <p><b>Stationary Eng'g Courses</b></p> <p><input type="checkbox"/> Boilermaking</p> <p><input type="checkbox"/> Combustion Engineering</p> <p><input type="checkbox"/> Engine Running</p> <p><input type="checkbox"/> Marine Engineering</p> <p><input type="checkbox"/> Power Plant Eng'g      <input type="checkbox"/> Steam Engr.</p> | <p><b>Textile Courses</b></p> <p><input type="checkbox"/> Cotton Manufacturing</p> <p><input type="checkbox"/> Loom Fixing      <input type="checkbox"/> Rayon Weaving</p> <p><input type="checkbox"/> Textile Designing</p> <p><input type="checkbox"/> Woolen Manufacturing</p> <p><b>Business and Academic Courses</b></p> <p><input type="checkbox"/> Accounting      <input type="checkbox"/> Advertising</p> <p><input type="checkbox"/> Bookkeeping</p> <p><input type="checkbox"/> Business Administration</p> <p><input type="checkbox"/> Bus. Correspondence      <input type="checkbox"/> Bus. Law</p> <p><input type="checkbox"/> Certified Public Accounting</p> <p><input type="checkbox"/> Commercial      <input type="checkbox"/> Commercial Art</p> <p><input type="checkbox"/> Cost Accounting</p> <p><input type="checkbox"/> Federal Tax      <input type="checkbox"/> First Year College</p> <p><input type="checkbox"/> Foremanship      <input type="checkbox"/> French</p> <p><input type="checkbox"/> Good English      <input type="checkbox"/> High School</p> <p><input type="checkbox"/> Higher Mathematics      <input type="checkbox"/> Illustration</p> <p><input type="checkbox"/> Industrial Supervision</p> <p><input type="checkbox"/> Motor Traffic      <input type="checkbox"/> Postal Civil Service</p> <p><input type="checkbox"/> Retailing      <input type="checkbox"/> Retail Bus. Management</p> <p><input type="checkbox"/> Salesmanship      <input type="checkbox"/> Secretarial</p> <p><input type="checkbox"/> Sign Lettering</p> <p><input type="checkbox"/> Spanish      <input type="checkbox"/> Stenography</p> <p><input type="checkbox"/> Traffic Management</p> |
|--|--|--|--|

Name \_\_\_\_\_ Age \_\_\_\_\_ Home Address \_\_\_\_\_

City \_\_\_\_\_ State \_\_\_\_\_ Working Hours \_\_\_\_\_ A.M. to \_\_\_\_\_ P.M.

Present Position \_\_\_\_\_ Employed by \_\_\_\_\_

Length of Service \_\_\_\_\_ Enrollment under G.I. Bill approved for World War II Veterans. Special tuition rates to members of the Armed Forces.  
In World War II \_\_\_\_\_ Canadian residents send coupon to International Correspondence Schools Canadian, Ltd., Montreal, Canada.

# INVENTORS

If you consider your invention to be something of importance—if you have invented any new and useful art, machine, manufacture or composition of matter or improvement thereof—you are advised to protect your invention by applying for a U. S. patent.

A patent is a valuable right. It grants you a monopoly—the right to exclude others from making, using or selling your invention as claimed for a term of seventeen years.

The specification and claims of a patent, particularly if the invention be at all complicated, constitute one of the most difficult legal instruments to draw with accuracy. Therefore, unless you are thoroughly familiar with such matters, you are advised to employ a competent registered patent attorney or agent.

This firm is registered to practice before the U. S. Patent Office and is available to assist in the preparation and prosecution of your patent application.

The "Evidence of Invention" form mentioned below is offered as a convenience to you in making your disclosure to us for search purposes.

You should date and sign your disclosure and have it witnessed by two or more persons who are capable of understanding your invention.

Your disclosure should be mailed to us together with a letter authorizing us to conduct a preliminary

search among previously granted U. S. patents for similar types of invention.

We then make this search and prepare a report of the probable patentability of your invention. If such report is favorable, we recommend the further course for you to take.

The "Evidence of Invention" form and booklet are suggested as conveniences to you and us in starting action on your invention.

**VICTOR J. EVANS & Co.** *Merlin M. Evans*  
REGISTERED PATENT ATTORNEY  
530-P MERLIN BUILDING, WASHINGTON 6, D. C.

We shall be glad to send you promptly and without obligation, an instructive booklet, "Patent Protection for Inventors", which was prepared to give inventors detailed information and steps to take toward patent protection—also our convenient "Evidence of Invention" form. Use address Victor J. Evans & Co., 530-P Merlin Building, Washington 6, D. C.

PATENTS

COPYRIGHTS

## WANTED MAN WITH CAR



### No Time Like Now to Get In McNess Business

It's no trick to make good money when you use your car as a McNess "Store on Wheels." Farmers buy everything they can from McNess Men because McNess Products are tops in quality, represent extra values. Attractive business-getting prizes and premiums; also money-saving deals to customers make selling McNess daily necessities a snap.

### We Supply Capital—Start Now!

There's no better work anywhere. Pays well, permanent, need no experience to start, and we supply capital to help you get started quick. You begin making money first day. Write at once for McNess Dealer Book. It's FREE. Tells all—no obligation. (1)

THE McNESS CO., 969 Adams St., Freeport, Ill.

Use Your  
CAR  
to Raise  
Your  
PAY

## NEW! MINIATURE DUST MASK



Wear when sanding, grinding, paint spraying, sweeping, dusting, furnace cleaning, etc. Handy as a pair of glasses. Just keep mouth closed and breathe through nose is all you do to operate. Protects against dusts, lint, coal, cement, grain dust. Has 9 sq. in. filter.

Order today.  
JERRY BRYANT, Dept. PM, 919 N. Michigan Ave., Chicago 11, Ill.

Order Today \$1.00  
POST PAID

## THERE'S MONEY IN CARTOONS!

RAYE BURNS will teach you HOW to CREATE ORIGINAL CARTOONS at home that you may SELL! Course contains 26 lessons and over 600 illustrations. All for Only...

\$2.85

Send name and address for free details.  
RAYE BURNS SCHOOL, Dept. P, Box 3583, CLEVELAND, OHIO



## Bar Bells

Buy Direct From Factory

Write for free booklet  
and price list

\$8.95  
up

INDEPENDENT IRON WORKS

2416 East 23rd Street, Dept. B  
Los Angeles 58, Calif.



## ITALIAN ACCORDIONS

Hand Made. Very Best. Buy Direct from Factory Representative at lowest wholesale prices and Save Money. Send Name and Address for FREE catalog.

ITALIAN ACCORDION MFG. CO.

7600 Cottage Grove Ave., Dept. PM-12, Chicago 19, Ill.

MAKE EXTRA  
MONEY

## PLASTICS

LEARN  
AT HOME



There are RICH OPPORTUNITIES for MEN and WOMEN with "know-how" in Plastics. Interstate's amazing new Plastics course tells and shows how to make hundreds of fast selling items out of Plastics. Gives complete training in fabrication, casting, lamination, molding, etc., in simple, easy, step-by-step language and pictures.

START A PLASTICS BUSINESS OF YOUR OWN. No other industry holds such promise for the future. You can make big money manufacturing novelties, toys, signs, etc., in your own home in spare or full time. Don't wait! Learn NOW how Interstate's Plastics Training qualifies you for success in the plastics field.

Write for FREE Information Today!

INTERSTATE TRAINING SERVICE

School of Plastics  
PORTLAND 13, OREGON

(Dept. 3-N)

THESE MEN ARE GETTING PRACTICAL TRAINING

# IN ELECTRICITY

*On Real:*



**A.C. and D.C. MOTORS  
GENERATORS  
SWITCHBOARDS  
CONTROLLERS  
WIRING JOBS  
APPLIANCES  
ELECTRONIC UNITS**

*(Shown at left—Instructor explaining operation and testing of a large Motor Generator in our A.C. Department.)*

# AND TELEVISION-RADIO

*On Real:*

**TELEVISION SETS  
RADIO RECEIVERS  
F.M.  
(Frequency Modulation)  
RECORD CHANGERS  
AUTO RADIOS  
PUBLIC ADDRESS Systems**

*(Right—Instructor helping students check the wiring and trace circuits of television receivers.)*



## Just Like YOU Can Get in the Great SHOPS of COYNE

Prepare NOW for a real future the quick, practical way. Come to the Great Shops of COYNE in Chicago. Largest and best equipped school of its kind—now in our 51st Year GI approved. Finance plan for non-veterans. Mail coupon.

**NOT "HOME-STUDY" COURSES!** At Coyne you learn on real, full-size equipment. Trained instructors show you how, then you do typical jobs yourself. We don't teach by mail.

**CLIP COUPON NOW** for big new illustrated Coyne book on either **ELECTRICITY** or **TELEVISION-RADIO** or both. No obligation; no salesman will call. Get the facts now!

# COYNE

**B. W. COOKE, Pres.  
ELECTRICAL & TELEVISION-RADIO SCHOOL  
500 S. Paulina St., Dept. 90-72H  
Chicago 12, Ill.**



**Mail Coupon for  
FREE BOOKS!**



**B. W. COOKE, President  
COYNE ELECTRICAL &  
TELEVISION-RADIO SCHOOL  
500 S. Paulina St., Chicago 12, Ill. Dept. 90-72H**

Send FREE, the book checked below, and details of your training offer. This does not obligate me and no salesman will call.

ELECTRICITY       TELEVISION-RADIO

NAME .....

ADDRESS .....

CITY.....STATE.....

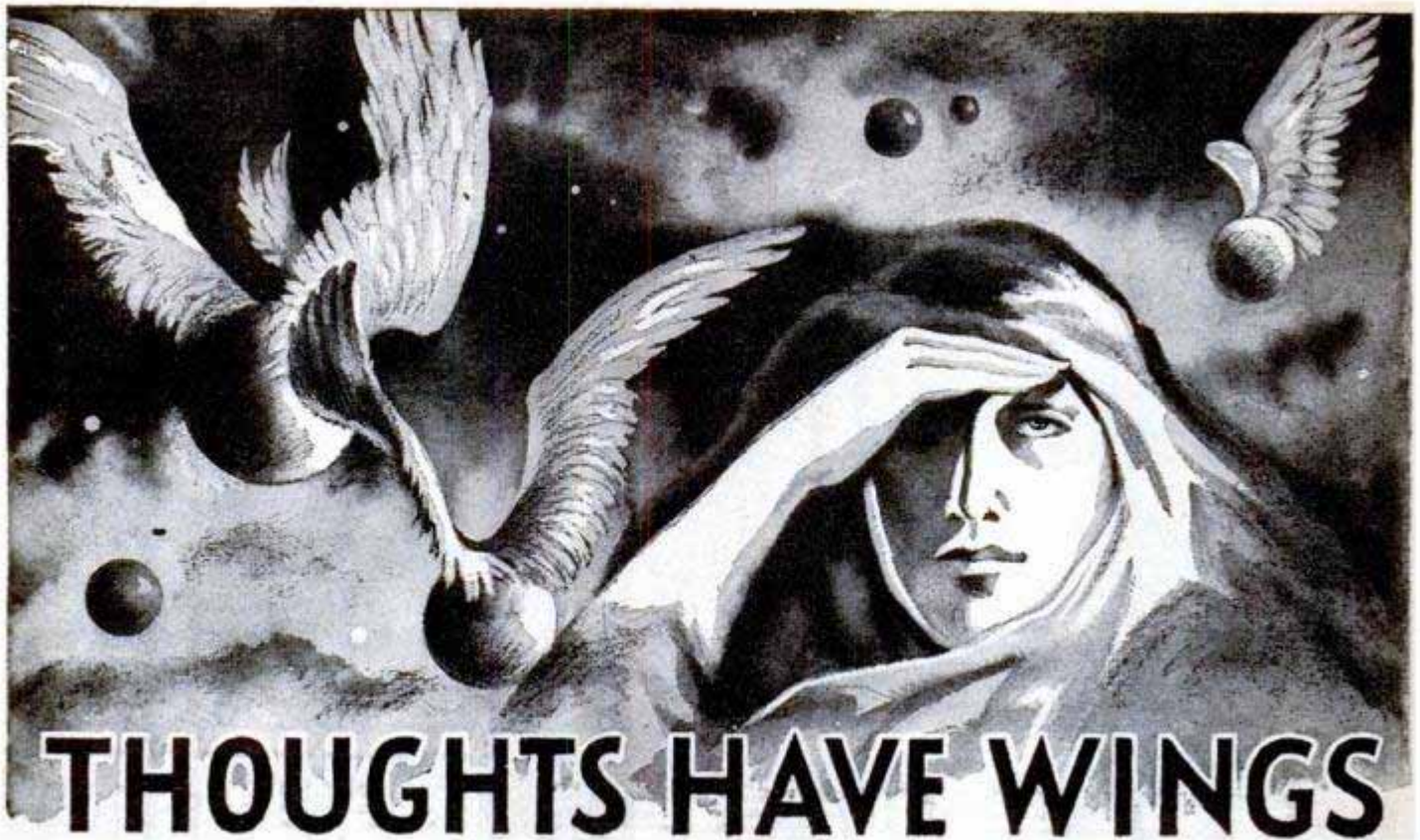

# THOUGHTS HAVE WINGS

## You Can Influence Others With Your Thinking!

**TRY IT SOME TIME.** Concentrate intently upon another person seated in a room with you, without his noticing it. Observe him gradually become restless and finally turn and look in your direction. Simple—yet it is a *positive demonstration* that thought generates a mental energy which can be projected from your mind to the consciousness of another. Do you realize how much of your success and happiness in life depend upon your influencing others? Is it not important to you to have others understand your point of view—to be receptive to your proposals?

### Demonstrable Facts

How many times have you wished there were some way you could impress another favorably—*get across to him or her your ideas*? That thoughts can be transmitted, received, and understood by others is now scientifically demonstrable. The tales of miraculous accomplishments of mind by the ancients are now known to be fact—not fable. The method whereby these things can be *intentionally*, not accidentally, accomplished has been a secret long cherished by the Rosicrucians—one of the schools of ancient wisdom existing throughout the world. To thousands everywhere, for centuries, the Rosicrucians have

privately taught this nearly-lost art of the practical use of mind power.

### This Free Book Points Out the Way

The Rosicrucians (not a religious organization) invite you to explore the powers of your mind. Their sensible, simple suggestions have caused intelligent men and women to soar to new heights of accomplishment. *They will show you how to use your natural forces and talents to do things you now think are beyond your ability. Use the coupon below and send for a copy of the fascinating sealed free book, "The Mastery of Life," which explains how you may receive this unique wisdom and benefit by its application to your daily affairs.*

## The ROSICRUCIANS (AMORC)

Scribe W. V. Z., The Rosicrucians, AMORC,  
Rosicrucian Park, San Jose, California.

Kindly send me a free copy of the book, "The Mastery of Life." I am interested in learning how I may receive instructions about the full use of my natural powers.

Name.....

Address..... State.....



GET INTO

# DIESEL-AUTO MECHANICS

Master All Phases

**JOBS LIKE THESE ARE AVAILABLE TO TRAINED MECHANICS. CHOOSE THE FIELD YOU LIKE BEST**

**Get Complete Training**

- ✓ Diesel Fuel Injection
- Automotive Motor Tune-up
- Diesel Engine Rebuilding
- General Garage Mechanic
- Agricultural Implements
- Auto Engine Rebuilding
- Auto Elec. Service
- Public Utilities
- Parts Dealers
- Bus & Truck Lines
- Industrial Maintenance
- Contracting & Excavating
- Business of Your Own
- AND MANY other similar openings

**As a National Schools graduate, you are trained for ALL opportunities in the Diesel & Auto Industries**

## EARN WHILE YOU LEARN

With our practical Master Shop-Method Home Training, you study at home in your spare time. You receive Spare Time Work Lessons, which show you how to earn while you Learn . . . for extra money and experience. You Learn by DOING.

## TOOLS AND EQUIPMENT

To make your training complete, we give you selected mechanic's tools and equipment, illustrated below, including all-metal toolbox — as a regular part of your instruction.

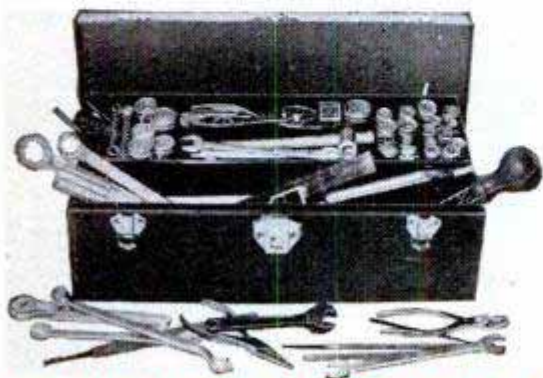

**WE GIVE YOU TOOLS OF YOUR TRADE**



### Shop-Method Home Training by an Established Resident School Prepares you for Many Good Jobs

Opportunity is everywhere for the trained Diesel-Auto Mechanic. Highways throng with cars, busses, trucks, tractors. Garages and Service Stations are kept busy. Factories, ships, farms, railroads, general industry, are dependent upon engine power. Here's a dynamic, fast-growing field that needs trained men who know ALL phases: installation, operation, maintenance and repair. Now—National Schools offers you a practical, all-embracing Diesel-Auto Mechanic's Course, including all of these advantages:

### Complete training, covering—Diesels, High Speed and Heavy Duty; Semi-Diesels, Gasoline and Special Fuel Engines AND Allied Mechanics.

- Basic Lesson Texts
- Diesel Installation
- Operation-Maintenance
- Diesel Chart Manual
- Spare Time Lessons
- Engine Service Manuals
- Engine Repair
- Drive Systems
- Diesel Electric Power
- Thermodynamics

### TOOLS AND EQUIPMENT

#### INVESTIGATE

Secure Full Information

**NEW, ILLUSTRATED BOOK & SAMPLE LESSON SHOW HOW WE TRAIN YOU . . . SEND FOR THEM TODAY!**



**NO COST**

**NO OBLIGATION**

**APPROVED FOR VETERANS**

Check coupon below

## NATIONAL SCHOOLS

LOS ANGELES 37, CALIF. • EST. 1905



### FIND OUT NOW...MAIL COUPON TODAY

NATIONAL SCHOOLS, DEPT. PMD-12  
4000 South Figueroa Street  
Los Angeles 37, California

(Mail in envelope or paste on penny postcard)

Mail me FREE the book, YOUR FUTURE IN DIESEL-AUTO MECHANICS, together with the Sample Lesson. I understand I may keep and use the information with no obligation.

Name \_\_\_\_\_ Age \_\_\_\_\_

Address \_\_\_\_\_

City \_\_\_\_\_ Zone \_\_\_\_\_ State \_\_\_\_\_

Check here if Veteran of World War II

# EARN MORE IN DRAFTING



More Opportunities for Employment and Promotion

"Here I am at work making good money as a draftsman. I'm glad I sent the coupon to Chicago Tech for that Free Trial Lesson and found out how easy it is to learn Drafting in spare time at home. Today I feel secure in my job because the draftsman's work comes first on any new project. And, in addition, draftsman can't be replaced with machines. What's more, I feel I'm slated for promotion and more pay, because I see so many draftsmen advancing to high-pay jobs."

## LEARN IN SPARE TIME—AT HOME! (or at the College in Chicago)

A few hours of pleasant home study every week—that's all. No interference with your present job. All the tools you need; drawing outfit included. With Chicago Tech's help, you train yourself step by step. This tested method—developed over 46 years of C.T.C. progress—prepares men quickly for good positions in industry.



### FREE INFORMATION—SEND COUPON

To prove to you how easy it is to learn Drafting at home by the Chicago Tech method, we will send you this FREE TRIAL LESSON. No charge for this lesson, now or later. Fill out and mail coupon, or send post card today.

## CHICAGO TECHNICAL COLLEGE

S-213 Tech Bldg., 2000 So. Michigan Ave., Chicago 16, Illinois

Mail me FREE Lesson with information about big opportunities in DRAFTING.

Name \_\_\_\_\_ Age \_\_\_\_\_

Address \_\_\_\_\_

City \_\_\_\_\_ Zone \_\_\_\_\_ State \_\_\_\_\_

## ENGINEERING DEGREE IN 27 MONTHS

### Big Demand for Graduates

Aeronautical, Chemical, Civil, Electrical, Mechanical and Radio Engineering (including Television)

Hundreds of young men are earning engineering degrees in this recognized institution each year—continuous operation. New terms start quarterly. Many students earn a major part of their college expenses in this large industrial center.

Low tuition. Competent instruction. Thorough, intense, practical program. Modern laboratory facilities including new physics lab. and modernized wind tunnel. Individualized instruction emphasized.

Approved for Veterans. Engineering preparatory courses. Students from 48 states and 21 foreign countries. Enter December, March, June or September. Send coupon for free catalog and full information. Enroll now.

SEND COUPON TODAY

## INDIANA TECHNICAL COLLEGE

5120 E. Washington Boulevard  
Fort Wayne 2, Indiana

Please send me free information on B.S. Engineering Degree in 27 months as checked.

Aeronautical,  Chemical,  Civil,  Electrical,  
 Mechanical,  Radio-Television.

Name \_\_\_\_\_

Address \_\_\_\_\_

# Command Bigger Money! STUDY LAW

STUDY AT HOME for BUSINESS SUCCESS and LARGER PERSONAL EARNINGS. 40 years expert instruction — over 114,000 students enrolled. LL.B. Degree awarded. All text material furnished. Easy payment plan. Send now for FREE BOOK — "Law and Executive Guidance." It explains the course — how you may enroll and the many ways you can profit from Law Study. Write TODAY to:

AMERICAN EXTENSION SCHOOL OF LAW  
Dept. 33-PM, 646 N. Michigan Ave., Chicago 11, Ill.

## STOPS FOGGY WINDSHIELDS NEW Chemical Mitt



Amazing Discovery! Autoists wild over new FOG-STOP Windshield Cleaner. Simply glide over windshield chemically-treated Mitt—at once glass sparkles crystal clear. Blurry mist, frost, sleet, snow disappear like magic. Stops fogging. Sells like wild!

SAMPLES FOR AGENTS Sample offer sent immediately to all who send name at once. Hurry. Postcard will do. SEND NO MONEY—just your name. KRISTEE CO., Dept. 680, AKRON 8, OHIO

## FREE Bargain Book

Packed with hundreds of sensational bargains—new and used—in still and movie photo equipment and accessories. Write for your free copy today to

Central Camera Co.

Dept. 8N, 230 S. Wabash, Chicago 4, Ill.

Photographic Headquarters Since 1899

## STAMMERER?

New booklet, "Stammering, and How to Stop It," sent free to any stammerer upon request. Write today. BENJAMIN N. BOGUE, Dept. 504, Circle Tower, Indianapolis 4, Ind.

GET THIS FREE BOOK!



## LABORATORY TECHNICIAN

BE A LABORATORY SPECIALIST; complete course. Big demand from hospitals, doctors, clinics. We teach all branches of medical laboratory work, including Medical and Dental X-Ray.

Approved by American College of Medical Technologists

Co-educational Free Placement Bureau Free Catalog

Accredited for "veteran" training

CHICAGO COLLEGE OF LABORATORY TECHNIQUE

Dept. P.M., 431 S. Wabash Ave.

Chicago 5, Illinois

## This New Type Accordion Is Much Easier to Play

It combines the advantages of the piano and the chromatic accordion. With our New Method you can even learn to play it all by yourself.

For free information write to  
HUNIBEL ACCORDIONS

5154 N. Clark St.  
Chicago 40, Ill.



**NOW... GET EVERYTHING YOU  
NEED TO LEARN AND MASTER**

# TELEVISION

**RADIO-ELECTRONICS  
...AT HOME!**

Use REAL commercial-type equip-  
ment to get practical experience

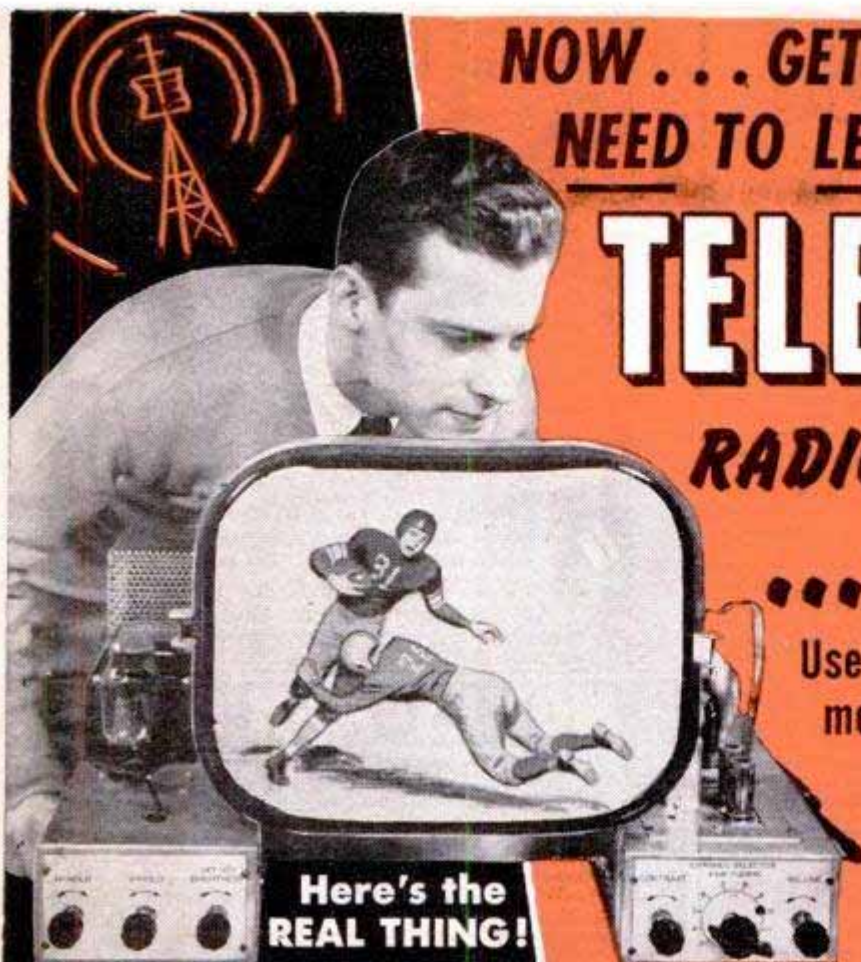

**Here's the  
REAL THING!**

**SET UP YOUR OWN  
HOME LABORATORY**

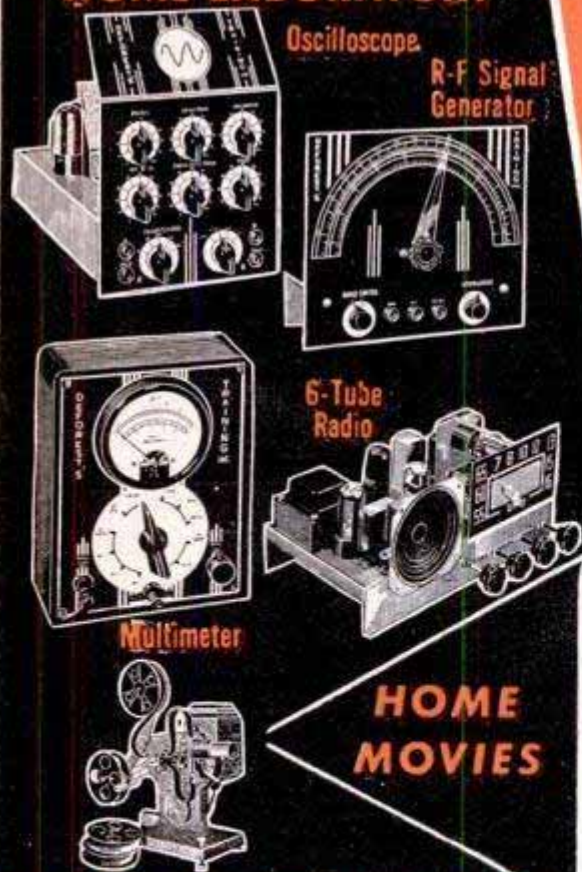

Oscilloscope

R-F Signal  
Generator

6-Tube  
Radio

Multimeter

**HOME  
MOVIES**

ABOVE: Build and keep a real 16 INCH commercial TV receiver. Optional after completing regular training at slight additional cost.

**D.T.I., ALONE, INCLUDES BOTH MOVIES and HOME LABORATORY** In addition to easy-to-read lessons, you get the use of HOME MOVIES — an outstanding training advantage — plus 16 big shipments of Electronic parts. Perform over 300 fascinating experiments for practical experience. Build and keep real commercial-type test equipment shown at left.

**MODERN LABORATORIES** If you prefer, get all your preparation in our new Chicago Training Laboratories—one of the finest of its kind. Ample instructors, modern equipment. Write for details!

**MILITARY SERVICE!** If you're subject to military service, the information we have for you should prove doubly interesting. Mail coupon today.

**Get BOTH of these  
information packed  
publications FREE!**



**ACT NOW! MAIL COUPON TODAY!**

DeFOREST'S TRAINING, INC., Dept. PM-G-12  
2533 N. Ashland Ave., Chicago 14, Ill.

Without obligation, I would like your late News-Bulletin showing 89 ways to earn money in Television-Radio-Electronics ... and how I may prepare to get started in this thrilling field.

Name ..... Age .....  
Street ..... Apt. ....  
City ..... Zone ..... State .....

**De FOREST'S TRAINING, INC.**  
CHICAGO 14, ILLINOIS  
A De VRY INSTITUTION

# Learn this Profitable Profession



**IN 90 DAYS AT HOME**

## Money-Making Career Open to Men and Women, 18 to 60

Hundreds of men and women between 18 and 60 make \$10 to \$20 in a single day giving scientific Swedish Massage and Hydro-Therapy treatments. There is big demand from doctors, hospitals, sanatoriums and clubs. Graduates earn large full time incomes from these or in private practice in their own offices. Others make good money from home treatments given in spare time. Learn this interesting, money-making profession in your own home, through our home study course. Same instructors as in our nationally known resident school. You can win independence and prepare for future security by qualifying for your Diploma. Course can be completed in 3 to 4 months. Many earn while they learn. Begin your training at once.



### Anatomy Charts & Booklet FREE

Enroll now and we will include, at no extra cost, many needed supplies. Fit yourself to help meet growing demand for Scientific Swedish Massage. Send the coupon at once for complete details. Anatomy Charts and 32-Page Illustrated Booklet, FREE, postpaid.

**THE COLLEGE OF SWEDISH MASSAGE**  
Dept. 064R, 41 E. Pearson, Chicago 11, Illinois  
Please send me FREE and postpaid, Anatomy Charts, 32-page Booklet and complete details on Home Training.

Name \_\_\_\_\_ Age \_\_\_\_\_  
Address \_\_\_\_\_  
City \_\_\_\_\_ State \_\_\_\_\_

# 9 BIG BUILDING BOOKS

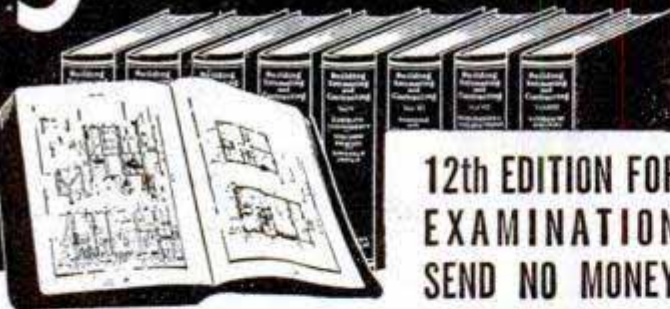

**12th EDITION FOR EXAMINATION SEND NO MONEY**

Learn to draw plans, estimate, be a live-wire builder, do remodeling, contracting. These 9 practical, profusely illustrated books cover subjects that will help you to get more work and make more money. Masonry, concrete forms, carpentry, steel square, roof framing, construction, plumbing, heating, painting, decorating and many other subjects. More than 4000 pages — 2750 illustrations.

### BETTER JOBS — BETTER PAY UP-TO-DATE EDITION

A nationwide building boom is in full swing and trained men are needed. Big opportunities are always for MEN WHO KNOW HOW. These books supply quick, easily understood training and handy, permanent reference information that helps solve building problems.

These books are the most up-to-date and complete we have ever published on these many subjects.

### Coupon Brings Nine Big Books for Examination

**AMERICAN TECHNICAL SOCIETY—Publishers since 1898**  
Dept. G919 Drexel at 58th Street Chicago 37, Ill.  
You may ship me the Up-to-Date edition of your nine big books, "Building, Estimating and Contracting," without any obligation to buy. I will pay the delivery charges only, and if fully satisfied in ten days, I will send you \$3.00, and after that only \$4.00 a month, until the total price of only \$34.80 is paid. I am not obligated in any way unless I keep the books.

Name \_\_\_\_\_  
Address \_\_\_\_\_  
City \_\_\_\_\_ State \_\_\_\_\_

Please attach a letter stating your age, occupation, employer's name and address, and name and address of at least one business man as a reference. Men in service, also please give home address.

# PRINT YOUR OWN POST CARDS



**COMPLETE OUTFIT only \$7.50**

Amazing results in sales, inquiries and contacts... saves time and money... very easy to use GEM STENCIL DUPLICATOR is ideal for Advertising, Announcements, Notices, Labels, Forms, Price Lists—hundreds of uses for every type of business and organization. Comes complete with all supplies, instructions and 60-page Book of Ideas.

**FREE TRIAL OFFER:** Try it before you buy it! Write and a GEM OUTFIT will be sent you postpaid. After 10 days, send only \$7.50 or return the GEM, no questions asked. The GEM must sell itself; you be the judge.

**BOND EQUIPMENT CO. • Dept. 135**  
6633 Enright • St. Louis 5, Mo.

**SEND NO MONEY • FREE TRIAL OFFER**

# MONEY for MEN ALL DATA FREE

THE PLASTEX Industry needs manufacturers on small scale and for big production of Lamp and Clock Stands, Art Goods and Novelties in Plaster and Marble imitation. Experience unnecessary. 1/2¢ material makes regular 10¢ store sellers. Rubber moulds furnished for speed production. Small investment brings good returns. We are now placing big Chain Store Orders with manufacturers. Ambitious men have chance for real prosperity. Our Free booklet will interest and benefit you.

**PLASTEX INDUSTRIES, Dept. A**  
3400 Third Ave. New York 56, N. Y.

## LEARN AERONAUTICAL ENGINEERING

**Aircraft and Engine Mechanics (A & E)**

Train at the Flying Wing school—New classes starting soon. Write for illustrated catalog.

*Northrop Aeronautical Institute*

APPROVED FOR VETERANS DIVISION OF NORTHROP AIRCRAFT, INC.  
1527 E. Broadway, Hawthorne, Los Angeles County, California

# REAL ESTATE BE A BROKER

**PAYS BIG! SEND FOR FREE, BIG, ILLUSTRATED CATALOG NOW!** No obligation. Graduates report making substantial incomes. Start and run your own business quickly. Men, women of all ages, learn easily. Course covers Sales, Property Management, Appraising, Loans, Mortgages, and related subjects. **STUDY AT HOME** or in our classrooms in big cities. Diploma awarded. G.I. approved. Nationally known.

**WEAVER SCHOOL OF REAL ESTATE (Est. 1936)**  
15 E. Pershing Road Dept. PM Kansas City, Mo.

**FREE BOOK TELLS HOW**

## Tells How You Can Learn to MOUNT BIRDS!

**FUN! RECREATION! PROFIT!**

**FREE BOOK**

**Learn At Home**

Men, Boys, Hunters, Fishermen, mount and save your lovely wild-game trophies. Be a Taxidermist. Mount Birds, Animals, Heads, Fish, Tan skins. YOU learn easily, quickly in spare time. Have a grand home-museum. The finest and the greatest hobby known, for sportsmen. Fun, real profits.

**FREE BOOK**

Yes, FREE. Beautiful strange, valuable Book, telling all about Taxidermy. Contains over 100 beautiful game-pictures. And it's yours FREE, if you rush your request. You can mount all kinds of wild-game, and common specimens too. We can positively TEACH YOU. So GRASP this opportunity. RUSH letter or postal for this amazing FREE BOOK. Don't delay. State your AGE.

**N. W. SCHOOL OF TAXIDERM, 2572 Elwood Bldg., Omaha 2, Neb.**

**GET THIS FREE BOOK!**

Worth Big Money To: Mechanics, Handymen, Garagemen, Farmers, Repair Men, Service Station Operators, Taxi Owners.

# NOW ANY Auto Repair Job IS A "Cinchor" for YOU!



MoToR's BRAND-NEW 1950 Edition AUTO REPAIR MANUAL is Showing Thousands of Men How to Handle ANY Job on ANY Car—Faster and Easier! Now Let It Go to Work For You!



"MoToR's Manual paid for itself on the first 2 jobs and saved me valuable time by eliminating guess-work."—W. SCHROF, Ohio

WITH MoToR's amazing brand-new AUTO REPAIR MANUAL you can whiz through ANY job—in LESS time, and with LESS work! Just look up make, model, and job—and go to it! With this easy-to-follow book, any job—from radiator to rear end—becomes a pushover.

"EVERYTHING You Need to Know about EVERY Make and Model Car Since 1935!"



"I have done jobs with this Manual that I would not attempt without it."—C. L. VANERSTROM, Hazel Park, Mich.

MoToR's Manual brings you the complete "dope" from over 150 Official Factory Shop Manuals, boiled down in simple easy-to-read and understand words and 2100 big clear pictures. Over 200,000 service, repair, tune-up facts on all standard makes and models built from 1935 thru 1950! 35,000 essential dimensions and specifications. Almost 750 big 8½ x 11-inch pages. Includes automatic transmissions; new GM Rochester carburetor. Used by the U. S. Army and Navy, technical schools! No wonder thousands of auto repairmen call it their auto "Bible"!

Win Prestige! Earn More Money!

MoToR's Manual makes every operation so easy that you'll find yourself tackling jobs you wouldn't think of doing before. And you'll win added prestige and more money in the bargain. Beginners will find usable, helpful guidance on every kind of repair and service job imaginable. Experts will be amazed by time and labor-saving short cuts they'll discover.



"A boy can easily follow its instructions."—CURTIS AUBERRY, Murfreesboro, Tenn.

- Used by U. S. Army and Navy
- COVERS ANY CAR BUILT SINCE 1935!
- |                |         |
|----------------|---------|
| American       | Cord    |
| Bantam         | Crosley |
| Auburn         | De Soto |
| Austin         | Dodge   |
| Buick          | Ford    |
| Cadillac       | Frazer  |
| Chevrolet      | Graham  |
| Chrysler       | Hudson  |
| Hupmobile      |         |
| Kaiser         |         |
| Lafayette      |         |
| La Salle       |         |
| Lincoln        |         |
| Lincoln Zephyr |         |
| Mercury        |         |
| Nash           |         |
| Oldsmobile     |         |
| Packard        |         |
| Pierce Arrow   |         |
| Plymouth       |         |
| Pontiac        |         |
| Reo            |         |
| Studebaker     |         |
| Terraplane     |         |
| Willys         |         |

Same FREE Offer on  
**MoToR'S TRUCK & TRACTOR REPAIR MANUAL**

Brand-New! Covers EVERY job on EVERY popular make gasoline truck and farm tractor made from 1936 thru 1949! Over 1400 pictures, 961 pages, 300,000 facts. All types Gasoline Engines, Fuel Systems, Governors, Lubrication, Ignition, Starters, Clutches, Axles, Brakes, etc., etc., and much more!

For FREE 7-DAY TRIAL, check box in coupon.



**FREE TRIAL**

**SEND NO MONEY**

Find out for yourself—with-out risking a cent—how this book pays for itself the first few times you use it. Mail the coupon without money. Try it out—FREE—for 7 days. Then if not convinced it's the greatest time-saver and work-saver you ever saw, return the book and pay nothing. **MoToR Book Dept., Desk 1P, 250 W. 55 Street, New York 19, N. Y.**

Published by MoToR, The Leading Automotive Business Magazine



**MAIL COUPON NOW FOR 7-DAY FREE TRIAL**

**MoToR Book Dept. Desk 1P, 250 W. 55th St., New York 19, N. Y.**

Rush to me at once (check box opposite book you want):

- MoToR's New AUTO REPAIR MANUAL. If O. K., I will remit \$1 in 7 days (plus 35c delivery charges). \$2 monthly for 2 months and a final payment of 95c one month after that. Otherwise I will return the book postpaid in 7 days. (Foreign price, remit \$8 cash with order.)
- MoToR's New TRUCK AND TRACTOR REPAIR MANUAL. (Described at left.) If O. K., I will remit \$2 in 7 days, and \$2 monthly for 3 months, plus 35c delivery charges with final payment. Otherwise I will return book postpaid in 7 days. (Foreign price, remit \$10 cash with order.)

Print Name ..... Age .....

Print Address .....

City ..... State .....

Check box and save 35c delivery charge by enclosing WITH coupon entire payment of \$5.95 for Auto Repair Manual (or \$8 for Truck and Tractor Repair Manual). Same 7-day return-refund privilege applies.

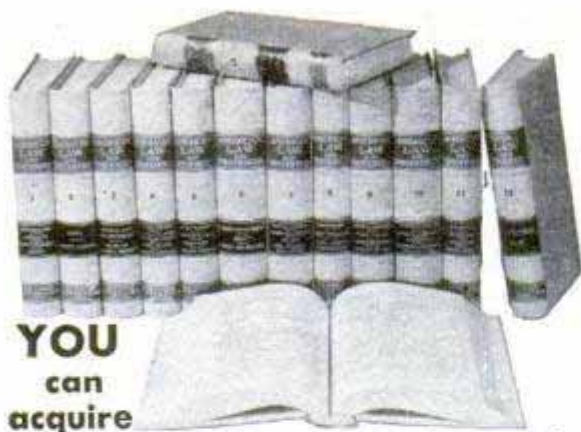

**YOU**  
can  
acquire

## **LAW** NIGHTS AT HOME! L. B. DEGREE

LaSalle's famous Law Library—used as reference in many Law libraries and Law offices—has enabled thousands to master Law surprisingly fast, in spare hours at home, for business and professional advancement.

These 14 remarkable volumes, compiled by leading professors and lawyers, cover the whole basic field of Law in condensed, orderly, simplified manner.

You advance rapidly with this great library, plus special lectures furnished. We guide you step-by-step with personalized Problem Method of instruction . . . you learn by doing—handling legal problems—not by memorizing rules.

Send for two FREE 48-page booklets, "Law Training for Leadership," and "Evidence," answering questions about Law and its value to you, and telling how LaSalle Law graduates are winning rapid advancement in business and public life. Mail coupon below. No obligation.

### **LA SALLE EXTENSION UNIVERSITY** A Correspondence Institution

417 S. Dearborn St., Dept. 1264L, Chicago 5, Ill.

Send me your two FREE booklets described above, without obligation.

Name..... Age.....

Street.....

City, Zone & State.....

## **BOYS-IT'S FREE!**

**"THE WONDERS OF CHEMISTRY"**

This exciting new book shows how to amaze your friends with chemical magic, describes many fascinating home experiments, tells of fun, thrills and big future opportunities for boys who know chemistry. Special atomic energy feature. Send today!

**THE PORTER CHEMICAL COMPANY**  
43 Prospect Avenue, Hagerstown, Maryland

## **LEARN DRAFTING AT HOME**

With a few hours effort each week, our practical comprehensive course in Engineering Drafting will prepare you for immediate employment in this highly paid profession. All books, equipment and supplies furnished.

**VETERANS FREE UNDER G. I. BILL**

### **LAIN DRAFTING COLLEGE**

601 N. DELAWARE • INDIANAPOLIS, IND.

Mail me FREE information about Engineering Drafting.

NAME.....

ADDRESS.....

CITY..... STATE.....

Check if Veteran.  Approved under G. I. Bill.

# TRY HOME STUDY WATCHMAKING

## FREE Sample Lesson

Famous Sweazey System shows how to master watchmaking . . . expertly, quickly, successfully . . . right in your own home. No previous experience needed to learn one of the highest paid trades. Try it without obligation.

**G. I. APPROVED RESIDENT COURSES**

. . . in Watchmaking, Engraving, Jewelry Repair, Diamond and Stone Setting at our modern, fully-accredited resident school. Founded 1908. Write for FREE CIRCULAR.

**CHICAGO SCHOOL OF WATCHMAKING**  
1608 N. Milwaukee Avenue Dept. 1120 Chicago 47, Ill.

## **TRI-STATE COLLEGE**

**B. S.**  
**DEGREE IN**  
**27 MONTHS**

**Founded 1884**  
**World-Wide**  
**Enrollment**

Civil, Elect., Mech., Chem., Aero., Radio and Telev., Engineering; Bus. Adm., Acct. Visit Campus, see well equipped labs. Low cost. Prep. courses. Personalized instruction. Grads. successful. Enter Jan., March, June, Sept. Catalog 4120 College Ave., Angola, Ind.

## **MAKE MONEY IN LANDSCAPING**

Thorough training by Internationally known Landscape Architect to start your own business, improve your home or advance in this well paid field. Many Opportunities. Approved for Veterans. Send for FREE BOOK.

**NATIONAL LANDSCAPE INSTITUTE**  
Dept. P-12, 310 So. Robertson Los Angeles 48, Calif.

## **BE A CRIMINOLOGIST**

**WORK HOME or TRAVEL. Experience unnecessary.**

**CRIMINOLOGY** Particulars FREE. Write to **GEO. C. R. WAGNER, 125 W. 86th St., N. Y.**

## **HOMESITES \$300 LOW TERMS**

In California's loveliest Garden Spot, on scenic shores of beautiful Morro Bay. Enjoy future independence with excellent soil, soft water, wonderful fishing, hunting, boating, bathing, etc. Grow fruits, vegetables, poultry. Perfect temperate climate. Congenial community. Finest investment. Free literature.

**RICHARD S. OTTO**  
DEPT. M SAN LUIS OBISPO, CALIFORNIA

**Say You Saw It in Popular Mechanics**

## **SILK SCREEN PRINTING!**

**for FUN and PROFIT!**

Prints like magic on paper, wood, metal or cloth . . . . .

**... SEND ONLY \$2.50**

pay postman the balance plus postage...materials are fully guaranteed!...

**MAKE GREETING CARDS, POSTERS, NOVELTIES GALORE!**

Print on any surface with this amazing outfit—made for production use includes enough tools and materials to make hundreds of dollars worth of items. Includes: Easy to follow Instruction Manual—shows every step in complete detail—no previous experience necessary, 11" x 14" silk covered Printing Frame, 15" x 24" Base and Back-bar, Patented Process Films, 4 half pt. cans of Adherents, Fillers, No-clog Varnish, and Removers, 6 half pt. cans of Brilliant Waterproof Colors, Stencil Cutter, and 11" Bantam Rubber Squeegee, all for only \$12.50.

**THE SILK SCREEN ARTS INSTITUTE**  
450 N. UNION AVE., DEPT. M, CHICAGO 10, ILLINOIS

GET INTO

# RADIO-TELEVISION

## ELECTRONICS By

### Shop-Method Home Training

#### GOOD JOBS AWAIT THE TRAINED RADIO-TV TECHNICIAN

There is a place for you in the great Radio-Television-Electronics industry when you are trained as National Schools will train you at home!

Trained technicians are in growing demand at good pay—in manufacturing, broadcasting, television, communications, radar, research laboratories, home Radio-TV service, and other branches of the field. National Schools Master Shop-Method Home Training, with newly added lessons and equipment, trains you in your spare time, right in your own home, for these fascinating opportunities. **OUR METHOD IS PROVED BY THE SUCCESS OF NATIONAL SCHOOLS TRAINED MEN, ALL OVER THE WORLD, SINCE 1905.**

#### EARN WHILE YOU LEARN

Many National students pay for all or part of their training with spare time earnings. We'll show you how you can do the same! Early in your training, you receive "Spare-time Work" Lessons which will enable you to earn extra money servicing neighbors' and friends' Radio and Television receivers, appliances, etc.



Signal Generator

Audio Oscillator

T. R. F. Receiver

#### National Schools Training Is All-Embracing

National Schools prepares you for your choice of many job opportunities. Thousands of home, portable, and auto radios are being sold daily—more than ever before. Television is sweeping the country, too. Co-axial cables now under construction will soon bring Television to every city, town, and farm! National Schools' complete training program qualifies you in all fields. Read this partial list of opportunities for trained technicians:

- Business of Your Own • Broadcasting
- Radio Manufacturing, Sales, Service • Telecasting
- Television Manufacturing, Sales, Service
- Laboratories: Installation, Maintenance of Electronic Equipment
- Electrolysis, Call Systems
- Garages: Auto Radio Sales, Service
- Sound Systems and Telephone Companies, Engineering Firms
- Theatre Sound Systems, Police Radio
- And scores of other good jobs in many related fields.

#### TELEVISION TRAINING

A complete series of up-to-the-minute Television lessons is an important part of your course. They cover all phases of Television repairing, servicing and construction. The same lesson texts used by resident students in our own modern and complete Television broadcast studios, laboratories and classrooms!



### MASTER ALL PHASES!

Get Master Shop-Method Home Training from an Established Practical Resident School with its own Training Shops, Laboratories, and Studios—and almost 50 Years of Successful Experience in Training Ambitious Men.



### We Bring National Schools To You



You also receive this Multitester

#### LEARN BY DOING

You receive and keep all the modern equipment shown above, including tubes and valuable, professional quality Multitester. **No extra charges.** You build the fine Superheterodyne Receiver with parts we send you.

**FREE!** These 2 Free Books give you all the facts. Send today for National Schools' new, illustrated Book of Opportunity in Radio-Television-

Electronics, and an actual Sample Lesson. No cost—no obligation. Use the coupon now—we'll answer by return airmail.

**APPROVED FOR VETERANS AND NON-VETERANS**  
Check coupon below

Both Resident & Home Study Courses offered



### NATIONAL SCHOOLS

LOS ANGELES 37, CALIF. • EST. 1905

### FIND OUT NOW... MAIL COUPON TODAY

National Schools, Dept. PM-12  
4000 South Figueroa Street  
Los Angeles 37, California

Mail in envelope or paste on penny postal.

Send me your FREE book "Your Future in Radio" and the sample lesson of your course. I understand no salesman will call on me.

NAME \_\_\_\_\_ AGE \_\_\_\_\_

ADDRESS \_\_\_\_\_

CITY \_\_\_\_\_ ZONE \_\_\_\_\_ STATE \_\_\_\_\_

Check here if Veteran of World War II

# I'LL TRAIN YOU for **RADIO**

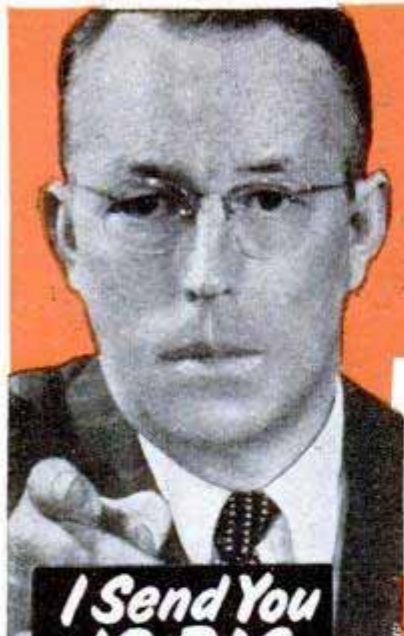

**MEET  
A FEW of My  
GRADUATES**



**Appreciates Sprayberry  
Personal Interest**  
"Before completing  
your course I had  
a good paying job.  
I appreciate the personal  
interest you  
gave me."—Leonard  
Petrus, Arkansas



**Best Investment  
He Ever Made**  
"Began fixing radio  
sets after first  
few lessons. Your  
course is one of the  
best investments  
I've ever made."  
—A. R. Foronda,  
Hawaii

**I Send You  
18 BIG  
KITS  
OF RADIO-  
TELEVISION  
EQUIPMENT**

## **EXTRA MONEY**

**Earn While You Learn  
In Your Spare Hours!**  
You do all your training  
with me **AT HOME** in  
spare hours. Keep right on  
with your present job and  
income while learning—and  
earn extra cash besides! The  
day you enroll I begin sending  
you plans and ideas for  
doing profitable spare time  
Radio-TV work. Many of  
my Sprayberry students  
pay for their entire Radio-  
TV training this way!



## **YOU KEEP THIS VALUABLE EQUIPMENT**

The many big kits of Radio-Television parts and equipment are sent to my students "for keeps." Nothing need be returned—it is **YOURS!** There is absolutely nothing else to buy!



# AT HOME IN SPARE TIME TELEVISION



**Training Leads To Good Radio Job**  
 "Got a job in local radio shop soon after enrolling. Very satisfied with training"—Stanley Clemmons, Kansas



**Lucky To Be Sprayberry Trained**  
 "I consider myself lucky I chose your training in preference to others I considered. Here's thanking you again."—Paul White, Ohio



**Radio Profits Pay Cost of Training**  
 "I have more than taken in the cost of your training doing spare time radio repair work. See bright future ahead"—Thomas Shearer, N. Y.



**Earns Easy Spare Time Cash**  
 "While training I made about \$180.00 in spare time. Thank you for wonderful Radio-TV training"—Herbert Burroughs, W. Va.

## My Proved Training System—Backed by a Quarter Century of Experience—Prepares You FAST for a Good Job or Your Own Profitable Radio-Television Business!

Radio-Television is now America's greatest opportunity field. Correctly trained men are needed NOW—more than ever—to fill good jobs and handle the profitable Radio-Television Service work. I have trained hundreds of successful men for Radio-Television—and I stand ready to train YOU too—even if you have no experience or knowledge of this field. My training is modern—right up to the second—with all the newest developments included! This is 100% practical training that eliminates the frills that only waste your time and progress. Sprayberry Training provides the all-important practical knowledge and skill you need to start making money in Radio-Television in the shortest possible time. You can start at once and be earning welcome spare time cash in a few short weeks. Upon completion of my Training you will be ready to handle any practical Radio-Television job.

You receive all the equipment I have illustrated on the opposite page—and MUCH MORE besides! In addition to your fascinating Sprayberry home study lessons, I send you a total of 18 kits of quality parts and equipment with which you do over 300 practical demonstrations, experiments and construction projects. You build a complete television set that you can use in your shop or at home—you build a powerful TWO-BAND superheterodyne radio set—a multi-range test meter—signal generator and other valuable test equipment—a cathode ray oscilloscope—everything needed to set up your own Radio-Television Service Shop! All equipment I send you is yours to keep. In addition I send you many valuable service manuals, books and reference material to help you in your day-to-day Radio-Television work. I firmly believe I offer the ambitious man the most outstanding training value of its kind in America today!

### Be Ready for Top Paying Radio-Television Jobs!

Radio-Television is growing with amazing speed. More than 2000 broadcasting stations PLUS an additional 102 Television stations are now on the air. Radio sets and TV receivers are being made and sold in record breaking numbers. If you enjoy working with your hands . . . if you like interesting and varied work . . . YOU BELONG IN RADIO-TELEVISION. But you MUST have good Training to "cash in" . . . the training that starts with basic fundamentals and carries through every circuit and problem of Radio-TV.



### No Previous Experience Needed to Succeed

My Training in Radio-Television is so complete, so down-to-earth that previous experience is not necessary. I start you with basic fundamentals and carry you in easy, practical steps through one Radio-Television subject after another. You will be amazed at your rapid progress and your knowledge of Radio-Television. Best of all, you put this knowledge to work making spare time cash soon after you enroll! You may train as fast or as slowly as suits your convenience. Each of my students receives individual training!

### VETERANS

My Radio Training is approved for Veterans under the G. I. Bill.

### If you are Experienced...

In radio . . . I'll qualify you for Television in 4 to 8 weeks. Check coupon for special details.



## FREE 3 Big Radio and Television Books

I want you to have ALL the facts about my complete system of Radio-Television Training! Act now! Rush the coupon for my three big Radio-Television books: "How To Make Money in Radio-Television," PLUS my new illustrated Television bulletin PLUS an actual sample Sprayberry Lesson—all FREE with my compliments. No obligation and no salesman will call on you. Send the coupon in an envelope or paste on back of post card. I will rush all three books at once!

**Mail Coupon Today!**

**NO OBLIGATION No Salesman Will Call**

SPRAYBERRY ACADEMY OF RADIO, Dept. 10-R  
 111 North Canal St., Chicago 6, Ill.

Please rush to me all information on your Radio-Television Training plan. I understand this does not obligate me and that no salesman will call upon me.

Name..... Age.....

Address.....

City..... State.....

Please Check Below About Your Experience

Are You Experienced?  No Experience

**Sprayberry Academy of Radio, Dept. 10-R**  
 111 North Canal St., Chicago 6, Ill.

## The Steady Pay Profession Good Times or Bad!

### SCIENTIFIC CRIME DETECTION

FOLLOW  
THIS MAN

Operator  
No. 38



#### It Is Easy to Learn!

I will teach you this fascinating science during your spare time at home. It pays to be an expert in Finger Printing, Firearms Identification, Police Photography and Criminal Investigation. I have trained hundreds of men and women now successfully serving in identification bureaus throughout America. You, too, may quickly prepare yourself to become a well-paid valued officer of the law, often sharing in the generous rewards offered for wanted criminals.

## FREE! OVER 800

### "BLUE BOOK OF CRIME"

This book is full of exciting information on scientific crime detection. It will show how you can get started in a grand career. Now, at amazingly low cost. Clip coupon now... Mail it today.

Of all Identification Bureaus in the U.S. employ students and graduates of I.A.S. A majority of these men are heads of Bureaus. Many of them knew nothing about crime detection before training with me. Now they have steady jobs, good salaries and a fine future. Write today for full particulars and free book. Give age.

#### INSTITUTE OF APPLIED SCIENCE

1920 Sunnyside Ave., Dept. 1359, Chicago 40, Ill.

INSTITUTE OF APPLIED SCIENCE  
1920 Sunnyside Ave., Dept. 1359, Chicago 40

Gentlemen: Without any obligation on my part, send me the "Blue Book of Crime," and complete list of Identification Bureaus employing your students or graduates, together with your low prices and Easy Terms Offer. (Literature will be sent ONLY to persons stating their age.)

Name..... Age.....

Address.....

RFD or Zone..... State.....

### Can a Man MY Age Become a

## HOTEL EXECUTIVE

Even Though He Has No Previous Hotel Experience?

Would you like to step into a well-paid position as Hotel, Club, Restaurant or Inn Manager, Purchasing Agent, Social Director or Assistant Manager? Would you like to look forward happily to the future? The success of Lewis graduates from 18 to 50 PROVES you can — though you have no experience in hotel work.



**Clyde B. Corley, Veteran, Without Hotel Experience Wins Assistant Manager's Position**

"After my release from the Air Force, I enrolled for Lewis Training. Now Assistant Manager of this Club, my position is fascinating as well as lucrative. The people with whom I am associated are of the finest calibre. My salary is more than \$400 a month, and I've been in this work less than a year! All thanks to Lewis Training."

### Step Into a Well-Paid Hotel Position

#### FREE Book Gives Fascinating Facts

Our FREE Book, "Your Big Opportunity," explains how you can qualify for a well-paid position at home, in leisure time; tells how you are registered FREE of extra cost in the Lewis National Placement Service. Most important, it shows how you can be a Lewis Certified Employee—certified to "make good" when placed in a position. Mail the coupon NOW!

#### Course Approved for Veterans' Training

LEWIS HOTEL TRAINING SCHOOL

Room SX-324, Washington 7, D. C.

35<sup>th</sup> SUCCESSFUL  
YEAR

Send me the Free Book, "Your Big Opportunity," without obligation. I wish to know how to qualify for a well-paid position at home, in my leisure time.

Name.....

(Please Print Name & Address)

Address.....

City..... Zone..... State.....

Check here if eligible under G. I. Bill of Rights.

## BURN WATER OR ALCOHOL OR BOTH IN YOUR CAR!



FOR ALL CARS, TRUCKS & TRACTORS

"...New high compression automobile engines which

increase gasoline mileage up to 30%

with alcohol-water gasoline fuels"

says U. S. Dept. of Agriculture.

WRITE FOR FREE LITERATURE  
Illustrated — Interesting — Descriptive  
YOU'LL BE GLAD YOU DID



NEWHOUSE  
AUTOMOTIVE INDUSTRIES

Dept. 50 5805 E. BEVERLY BLVD.  
LOS ANGELES 22, CALIF.

## Want to Get Ahead in Business? Get A BUSINESS EDUCATION!



Regardless of whether your aim is to specialize or generalize in your business education, this nationally known and approved school will gladly counsel with you. We offer you nation wide recognition and placement service as secretary, stenographer, accountant or salesman. Hill's offer both Resident & Home Study Courses. Write FREE

Dept. PMS today for Big 32 page SUCCESS BOOK

Hills BUSINESS UNIVERSITY AND  
EXTENSION SCHOOL

619 W. MAIN ST. OKLAHOMA CITY 2, OKLAHOMA

## RADIO ENGINEERING, Broadcasting, Television, FM, Servicing, Electronics, Aviation, Marine & Police Radio taught thoroughly.

Engineering course equivalent to 3 years' college radio work. Approved Veteran Training. Catalog free.

VALPARAISO TECHNICAL INSTITUTE, Dept. D, Valparaiso, Ind.

## Learn PHOTOGRAPHY

There's big money in PHOTOGRAPHY—and an action-packed career for you. Our HOME STUDY COURSE is your spare-time SHORT CUT TO SUCCESS! Or, if you wish—PERSONAL ATTENDANCE TRAINING at our famous New York School is available with subsistence under the G. I. Bill. Our 41st year. Write immediately!

NEW YORK INSTITUTE OF PHOTOGRAPHY

Dept. "49," 10 West 33 Street, New York 1, N.Y.

## Learn CARTOONING

HAVE FUN! MAKE MONEY! Cash in on your sense of humor at HOME—BY MAIL. No experience needed to start. Write today for FREE TRIAL LESSON and full particulars.

MooN Gag Cartoon School, Dept. E, Fall Creek, Wis.



## SAY YOU SAW IT IN POPULAR MECHANICS



Yakity-Yak

## Talking Teeth

ONLY  
\$1  
POSTPAID

Do you know people who "yakity-yak" constantly? Create a sensation by placing Talking Teeth before them. No dentist ever saw plates like these! They're amazingly realistic and chatter away by means of a concealed motor. A howling hit at card games, parties, business conferences, club meetings, etc. The biggest laughs you've had for a dollar! At novelty counters everywhere or order direct. Get several, too, as gifts.

FISHLOVE INDUSTRIES, Dept. T-12, 712 N. Franklin St., Chicago 10, Ill.

# TO THOSE WHO THINK LEARNING MUSIC IS HARD

Just strike these notes and you're playing the beginning of the "Merry Widow" Waltz



Look at the diagram. The first note of the music is "D." Following the dotted line to the keyboard you'll find "D" is the white key between the two black keys near the middle of the keyboard. Now read below how you can learn to play any instrument quickly and easily.



## EASY AS A-B-C — COSTS JUST A FEW CENTS A DAY!

• Perhaps you think learning music is a tedious grind. It isn't any longer! Long hours of practicing scales and monotonous exercise are over.

You have no excuse for not getting started toward musical good times now! For through an easy method you can now learn to play right at home—without a teacher—for a few cents a day.

### Learn to Play by Playing

The lessons come to you by mail from the famous U. S. School of Music . . . complete instructions, clear diagrams, and all the music you need. You learn to play by playing real tunes by note. First you are told how to do a thing. Then a picture shows you how. Then you do it yourself and hear it. Remember, don't confuse our method with any system claiming to teach music "by ear" or by trick methods. We teach you to play only from real notes!

### SUCCESS!

Here's what one of our thousands of pupils writes: "I learned more from your course than many of my friends who studied under private teachers have for years. The fact that I've already taken 2 courses and am now enrolling for a third should speak for itself." F. A. S., Indiana.

First you are told how to do a thing. Then a picture shows you how. Then you do it yourself and hear it. Remember, don't confuse our method with any system claiming to teach music "by ear" or by trick methods. We teach you to play only from real notes!

Don't delay. Send now for big 36 page illustrated FREE Booklet and "Print and Picture" Sample which fully explain this remarkable method. So decide which instrument you want to play and mail the coupon today. U. S. School of Music, 712 Brunswick Bldg., New York 10, N.Y. (Successful 52nd Year)

## FREE PRINT AND PICTURE SAMPLE

U. S. School of Music, 712 Brunswick Bldg., New York 10, N. Y. Please send me Free Booklet and Print and Picture Sample. I would like to play instrument checked below.

Piano	Saxophone	Modern Elementary
Guitar	Trumpet, Cornet	Harmony
Hawaiian Guitar	Pipe, Reed Organ	Mandolin
Violin	Tenor Banjo	Practical Finger
Piano Accordion	Clarinet	Control

Name \_\_\_\_\_ Have You Instrument? \_\_\_\_\_

Address \_\_\_\_\_

City \_\_\_\_\_ State \_\_\_\_\_

Save 2c—Stick Coupon on Penny Postcard

# BECOME AN ELECTRONIC TECHNICIAN IN 12 MONTHS

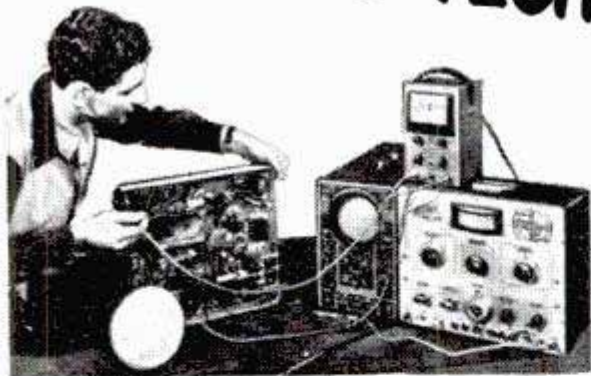

**BECOME AN ELECTRICAL ENGINEER**—The B.S. degree (Major in Electronics or Electrical Power) can be earned in 24 additional months by holders of Technician Certificates in Electronics, Radio-Television or Electrotechnics. Technicians can continue into degree courses immediately or at any future time.

### OTHER COURSES

**IN 6 MONTHS** earn occupational certificates in  
• Practical Electricity • Practical Welding • Refrigeration or Heating Service

**IN 24 MONTHS** become a Refrigeration, Heating and Air Conditioning Technician

## MILWAUKEE SCHOOL of ENGINEERING

Technical Institute • College of Electrical Engineering

TERMS OPEN JANUARY, APRIL, JULY, OCTOBER

Do you have 12 months to invest in a practical training program that can bring immediate and life-long opportunities? Then investigate the Technician courses available at this College of Electrical Engineering. For example, in those 12 months you can earn your Electronic Technician's certificate. You enter a field of tremendous growing importance to the nation's strength and welfare. This world-famous course specializes in Industrial Electronics.

### 6 additional months make you a RADIO-TELEVISION TECHNICIAN

TV requires men trained through an intensive, thorough course such as offered here, under the personal guidance of specialists. It is academically possible for the Electronic Technician to complete this course in 6 months.

Write today for helpful "Combination Catalog and Occupational Guidance Manual".



### MILWAUKEE SCHOOL OF ENGINEERING

Dept. PM-1250, 1020 N. Broadway, Milwaukee, Wis.

Rush free "Combination Catalog and Occupational Guidance Manual" on the following course.....

.....

Name.....Age.....

Address.....

City.....State.....

Check if Veteran of World War II

# Learn ELECTRIC APPLIANCE REPAIR IN YOUR SPARE TIME AT HOME



## START YOUR OWN BUSINESS

**ONE BUSINESS THAT IS NOT EFFECTED BY STRIKES, DEPRESSIONS OR POLITICS**

**WITH A POTENTIAL MARKET OF 50,000,000 CUSTOMERS**

New shop-method, home-training system gives you electrical know-how that used to take years to learn. Learn at home by building valuable testing kits, repairing your own and neighbors' appliances. It is not unusual for appliance repairmen to charge on the basis of \$5.00-\$6.00 an hour.

**FREE ILLUSTRATED BOOK**

Shows you how you learn every phase of electrical appliance. How to make money while you learn. Write today for your FREE copy.

**CHRISTY TRADES SCHOOL**  
Dept. D-8803  
4432 North Kedzie Ave., Chicago 25

# Learn A Trade NOW! PRACTICAL SHOP TRAINING!

## In Our Chicago Shops

- |   |  |
|---|--|
| <input type="checkbox"/> AUTO MECHANICS   | <input type="checkbox"/> WELDING—ARC and GAS |
| <input type="checkbox"/> DIESEL MECHANICS | <input type="checkbox"/> MACHINIST           |
| <input type="checkbox"/> REFRIGERATION    | <input type="checkbox"/> PIANO TUNING        |
| <input type="checkbox"/> BODY-FENDER      |  |

Above Approved For G. I.'s and Civilians  
One of America's Leading Practical Schools  
7 Floors of Fully Equipped Shops  
Over 50,000 Successful Graduates  
Expert Individual Instruction  
Learn by Doing—Low Living Expense  
Established 1902—Day and Evening Classes

## Also the following Home Study Courses

- |                                  |  |                                 |
|----------------------------------|--|---------------------------------|
| <input type="checkbox"/> PLASTIC | <input type="checkbox"/> REFRIGERATION | <input type="checkbox"/> DIESEL |
|----------------------------------|--|---------------------------------|

—CALL IN PERSON OR MAIL THIS AD TO—

# GREER SHOP TRAINING

(Desk 10) 460 South State St., Chicago 5, Ill.

Please send without obligation free information regarding trade checked above. (Specify whether you are a Veteran  or Civilian )

Name \_\_\_\_\_ Age \_\_\_\_\_  
Address \_\_\_\_\_  
City \_\_\_\_\_ State \_\_\_\_\_

# I Can Make You A New Man

## Let Me Prove It In Only 15 Minutes a Day!

LET me PROVE that "Dynamic Tension" can give you a gloriously healthy body—powerful muscles, smashing strength, tireless energy! Many of those I have helped were run-down, nervous, flabby. They got rid of their "bay windows"—and now feel new vigor flowing through their systems. They feel that they added years to their lives.

**FREE BOOK.** Send for my FREE 48-page book, "Everlasting Health and Strength." No obligation. Address:

**CHARLES ATLAS, Dept. 812**  
115 East 23rd St., New York 10, N. Y.



**CHARLES ATLAS**

# FREE AMAZING NEW BOOK "HOW TO ANSWER ADS"



Never before have you seen anything like this. Tells you in simple language the correct way to answer ads. Gets you quicker replies—better results, and greater satisfaction. Will save you time and money and it's ABSOLUTELY FREE. No obligation whatever. Every reader of advertising should have this booklet. Send a postcard for your copy NOW. Advertising Department, Popular Mechanics Magazine, Room 600, 204 East Ontario Street, Chicago 11, Ill.

# Learn WOOD PRODUCTION ENGINEERING

**FREE Booklet**



IN SPARE TIME AT HOME

Prepare for top wood-working positions or for more profitable shop ownership with KLOK TRAINING. Covers all woodworking arts in a Home Study Course or Resident Training Course at Grand Rapids. Free G.I. instruction. Money back trial for non-veterans. Write for FREE BOOKLET. State Age, veteran, non-veteran, Home or Resident Course, occupation. **JOHN H. KLOK, Pres. KLOK INSTITUTE**  
M. Louis St. N.W. Grand Rapids 2, Mich.

from **THE ONLY SCHOOL OF ITS KIND**

# LAW FREE BOOK



Your FREE copy of "The Law-Trained Man" shows how to gain prestige and greater earnings through Blackstone home law study. All instruction material furnished including 18-volume Law Library written by 65 well-known law authorities. Lawyers, Judges among our graduates. LL.B. degree. Low cost; easy terms. Write today. **BLACKSTONE COLLEGE OF LAW** 225 N. Michigan Ave. Dept. 59, Chicago 1, Ill.

A Correspondence Institution Founded in 1890

# LEARN MEAT CUTTING At Home—In Spare Time



Get into the vital meat industry. Concise, practical Home Training based on 25 years proven instruction methods used at National's famous resident school. Prepares you for bigger pay as Meat Cutter, Supervisor, market manager or more money in your own store. Go as rapidly as your spare time permits. Diploma. Start NOW to turn your spare hours into money. Send for FREE bulletin today. No obligation.

**NATIONAL SCHOOL OF MEAT CUTTING, INC., Div. U-123, Toledo 4, Ohio**

# RUPTURED?

## Get Relief This Proven Way

Why try to worry along with trusses that gouge your flesh—press heavily on hips and spine—enlarge opening—fail to hold rupture? You need the Cluthe. No leg-straps or cutting belts. Automatic adjustable pad holds at real opening—follows every body movement with instant increased support in case of strain. Cannot slip whether at work or play. Light. Waterproof. Can be worn in bath. Send for amazing FREE book, "Advice To Ruptured," and details of liberal truthful 60-day trial offer. Also endorsements from grateful users in your neighborhood. Write:

**CLUTHE SONS, Dept. 31, Bloomfield, New Jersey**

# FREE

## A NEW HOME INDUSTRY



Let us show you how extremely easy and PROFITABLE it is to make beautiful and useful things out of LIQUID PLASTICS, LIQUID MARBLE, LIQUID IVORY, LIQUID GLASS, CERAMICS, ETC. . . . as easy as pouring water out of a glass! Make novelties, jewelry, gifts, artware, toys, tools, dials, gidgets, ceramics . . . a million useful things! We supply everything—MATERIALS, INSTRUCTIONS and BUYERS! Send only 25c for 1. Big catalog of 300 casting materials, molds and accessories, 2. A beautiful CASTING free (to show you what you can do), and 3. Actual INSTRUCTIONS on how to cast and start in the CASTING BUSINESS! VALUABLE MOLDS given FREE with orders! Send 25c today—this may be the lucky coin that will start the most fascinating and profitable phase of your life.

**PLASTICAST COMPANY (DEPT. C)**  
 170 N. Halsted St. (Write to P. O. Box 987  
 Chicago 6, Ill. nearest address) Palo Alto, Calif.  
 CUSTOMERS OUTSIDE U. S. A. please remit \$3.35 for catalogue

## GUARANTEED TO INCREASE POWER



**RetMahr Automatic GASOLINE INJECTOR**

More power, quicker starting, faster acceleration and greater mileage! It atomizes fuel for the fullest power. Dynamometer tests show power increases up to 15%.

**\$9.95**

SOLD ON MONEY BACK GUARANTEE  
 Send Postcard for Information

WESCO Box 5, 1665 Mission, San Francisco 3, Cal.

## IT'S FUN LEARNING A LANGUAGE BY LINGUAPHONE

AT HOME, in leisure time, quickly, easily, correctly master Spanish, French, German—any one of 29 languages through proven Linguaphone Conversational Method. Add to job, school, travel opportunities. Send for fascinating FREE book.

**LINGUAPHONE INSTITUTE**  
 143-W RADIO CITY NEW YORK 20, N. Y.



## ILLUSTRATED COMIC BOOKLETS

### THE KIND YOU LIKE!

(VEST POCKET SIZE)  
 They are loaded with rare cartoons. Full of Fun and Humor. **20 DIFFERENT** booklets sent prepaid for \$1 in plain sealed wrapper. No C. O. D.'s.

GRAYKO, Dept. 2026, Box 520, G. P. O., N. Y. C. 1

Say You Saw It in  
**POPULAR MECHANICS**

## LEARN AT HOME TO MOUNT BIRDS

Animals, Heads, Fishes, Pets; to TAN. Be a Taxidermist. Profit and FUN. Hunters, save your valuable TROPHIES. Mount ducks, squirrels, everything. Learn to TAN for leather and furs. Wonderful HOBBY. Have a HOME MUSEUM.—BIG PROFITS mounting for others. INVESTIGATE NOW.

**FREE BOOK** With 100 fine game pictures. NOW absolutely FREE. Write TODAY.

Send Postal TODAY for FREE BOOK. State AGE. N. W. SCHOOL OF TAXIDERMY, Dept. 2512, Omaha, Neb.



# DRAW FOR MONEY

YOU Can Learn to —

# BE AN ARTIST

Here's the Amazing Way You Learn To Draw Step-by-Step At Home in Spare Time



Draw for money. You will enjoy W. S. A. training and can progress rapidly. COMMERCIAL ART, DESIGNING, CARTOONING — all in one complete, modern home study course. No previous art experience necessary. We start you from the beginning. Good art jobs available in advertising, television, newspaper and magazine publishing, department stores, art studios, etc. You can become your own boss. For 36 YEARS our graduates have been "making good" — WHY NOT YOU?

## Trained Artists Are Capable of Earning \$70-\$100 and MORE a WEEK

Write for FREE BOOK, "Art for Pleasure & Profit"—tells about our course, instruction service, material furnished, what our graduates say, and commercial opportunities for you. TWO ART OUT-FITS and other features included with training. Low cost — easy terms.

**VETERANS! Course G.I. Approved**

**FREE BOOK gives details!**

**WASHINGTON SCHOOL OF ART,**  
 Studio 1212W, Washington 5, D. C.

Please send information and Free Book, "Art for Pleasure & Profit." (Please print name.) No salesman will call.

Name \_\_\_\_\_ AGE \_\_\_\_\_  
 Street \_\_\_\_\_  
 City \_\_\_\_\_ Zone \_\_\_\_\_ State \_\_\_\_\_

## LEARN BY MAIL MATH-PHYSICS

Practical simplified courses in ALGEBRA and GEOMETRY, TRIGONOMETRY, PHYSICS, ENGINEERING DRAFTING

**VETERANS FREE UNDER G. I. BILL**

**MAIL COUPON TODAY** for free information about 30-lesson courses checked below:

ALGEBRA and GEOMETRY     TRIGONOMETRY  
 PHYSICS     ENGINEERING DRAFTING

NAME \_\_\_\_\_  
 ADDRESS \_\_\_\_\_  
 CITY \_\_\_\_\_ STATE \_\_\_\_\_

Check if Veteran.    Approved under G.I. Bill

**LAIN COLLEGE** 601 N. DELAWARE INDIANAPOLIS, IND.

# INVENTORS

Before you make any effort to market your invention, you should take the first steps toward proceeding for patent protection.

The usual first step is to have a search of the U. S. patent records conducted, so that I can report to you on the question of patentability.

I shall be pleased to furnish you with information relative to patent procedure, upon request from you, and this will be without any obligation on your part.

## PATRICK D. BEAVERS

(Formerly RANDOLPH & BEAVERS)

Registered Patent Attorney

934 Columbian Building Washington 1, D. C.

### FREE BOOK ON PAINTING



Get this illustrated book on how to buy and apply the right kind of aluminum paint—for weather-exposed wood, for metal and masonry, for heated metal surfaces. SEND NO MONEY—just write:

ALUMINUM COMPANY OF AMERICA,  
1718M Gulf Building, Pittsburgh 19, Penna.

# INVENTIONS

Cash-in on our connections with prominent manufacturers and national distributors who come to us for new products. We assist you with your invention from idea stage through to developed product. Full Protection for you. Write for Booklet "P."

W  
A  
N  
T  
E  
D

**ELO DEVELOPMENT CO., INC.**  
CHATHAM-PHENIX BLDG.  
LONG ISLAND CITY, 1, N. Y.

# INVENTORS

IF YOU WISH TO PROTECT YOUR INVENTION, You should take steps to protect it by a U. S. Patent. Write me for "RECORD OF INVENTION" form.

## CARL MILLER

REGISTERED PATENT ATTORNEY

WOOLWORTH BLDG., 35th FLOOR, 120A  
NEW YORK CITY



# PATENTS

## C. A. SNOW & CO.

REGISTERED PATENT ATTORNEYS

WRITE FOR INFORMATION TO

428 SNOW BUILDING, WASHINGTON 1, D. C.



# PATENTS

**E. E. VROOMAN, Registered Patent Atty.**

505 McKim Building, Washington 5, D. C.

"Proof of Invention" Folder mailed without obligation.

# PATENTS PATENT LAWYER

**GUSTAVE MILLER**  
REGISTERED PATENT ATTORNEY  
120-PM WARNER BLDG.  
WASHINGTON 4, D. C.

ASSOCIATE EXAMINER  
U. S. PATENT OFFICE 1922-1929  
Patent Attorney and Advisor  
U. S. NAVY DEPT. 1930-1947

Send for PATENT INFORMATION book and "INVENTOR'S RECORD" without obligation

# INVENTING

**-FOR PROFIT!** If you have an inventive turn of mind, write for free 28-page booklet explaining how the Institute of American Inventors is helping inventors pre-test the profit possibilities of proposed devices to fill today's unprecedented demand for useful new inventions.

**INSTITUTE of AMERICAN INVENTORS**  
Dept. 4, 631-E St., N.W., Washington 4, D. C.

# INVENTORS

Whether an invention is patentable can be substantially determined by a search of the U. S. Patent records. Without obligation, write for information explaining the steps you should take to secure a patent.

## JOHN N. RANDOLPH

Registered Patent Attorney

201 Columbian Building, Washington 1, D. C.

# CASH — ROYALTIES

## FOR INVENTIONS

(Patented and Patent Pending Only)

Write for FREE book. No obligation

## U.S. INVENTION EXCHANGE

239 HELLMAN BLDG. (Suite M)

LOS ANGELES 13, CALIF.

**14K GOLD TONE  
CHRONOGRAPH WRIST WATCH**

**LOWEST  
MARKET  
PRICE  
\$7.25**

(Formerly Priced at \$9.95)



Sweep Second Hand; Precision Workmanship; Rugged Shock-resistant case; Radium hands and numerals; Leather strap. It measures distance, speed of cars, planes, horses and other moving objects. It's a time keeper, stop watch, telemeter, tachometer. **ONE YEAR WRITTEN GUARANTEE** and full operating instructions enclosed with each watch. **SEND NO MONEY.** Mail your order today. Pay postman \$7.25 plus 10% Federal tax. Total \$8.00 plus postage. Or send cash (money order or check) with your order and save postage charge. **CHROME CASE MODEL \$6.75 Plus Tax. Total \$7.43.**

**MARDO SALES CO., Dept. M-328**

480 LEXINGTON AVE.

NEW YORK 17, N. Y.

**STUDY AT HOME**

**WITH AN EDUCATIONAL INSTITUTION**

**Courses in ARTS AND SCIENCES:** Philosophy; Education; Letters; Public Health; Medical Jurisprudence; Psychology; Sociology; Physics; Chemistry; Geology; Pol. Science; Theology; Law; Business and Commerce; Accounting; Mathematics; Statistics; Agriculture. **Courses in ENGINEERING:** Electrical, Civil, Mechanical, Drafting, Architectural, Automotive, Steam, Diesel, Aeronautical, Radio, Structural, Mining, Industrial, Petroleum, Marine, Refrigeration, Air Conditioning, Chemical. Send for free catalog.

McKinley-Roosevelt Incorporated, 4610-K3, Sheridan Rd., Chicago 40, Illinois

**MAKE THIS SUIT YOURS NEW PLAN**



**EARN CASH Showing to Friends!**

Write at once if you want this fine made-to-measure suit! You can get it by taking a few orders from friends and earn up to \$10.00, \$12.00 in a day. Your bonus suit helps you take more orders with latest style, made-to-measure **guaranteed** suits at amazingly low prices. Also complete line of **LADIES' TAILORED SUITS**. No experience, no money needed. Write today for **FREE SAMPLES**—telling about yourself—age, etc. No obligation—**ACT NOW!**  
**PIONEER TAILORING COMPANY**  
Congress & Troop Streets, Dept. M-1116, Chicago 7, Ill.

**TAKE  
HIGH  
SCHOOL  
AT HOME**

**YOU NEED A DIPLOMA**

...to get a better job or more rapid promotions! C.T.I. guided study method helps you earn yours in **months**. Equals resident work. Saves time. **Texts supplied.** College prep. Credit for work elsewhere. Easy terms. Write for valuable **free booklet today!**

**COMMERCIAL TRADES INSTITUTE**

1400 Greenleaf Ave. Dept. E 2-12 Chicago 26

**BECOME A BETTER PAID MAN  
BY BEING A WELL TRAINED MAN**

Learn a profitable trade—the Eastern Technical School way. Enroll now for an eight month course in Radio or Refrigeration. New classes beginning every April—August—December. Veterans—Nonveterans. Write for free catalogue. Graduates successfully placed from Coast to Coast.

**EASTERN TECHNICAL SCHOOLS**  
888 PURCHASE STREET NEW BEDFORD, MASSACHUSETTS

**Be an INVESTIGATOR**

**JAMES S. BOLAN, FORMER NEW YORK CITY POLICE COMMISSIONER** offers **MEN & WOMEN** an opportunity for a Professional Career in Modern Investigation & Criminology by comprehensive Home Study Course. Free placement service assists graduates to obtain jobs. **APPROVED FOR VETERANS.** Licensed by State of New York. Write for Booklet P

**THE BOLAN ACADEMY, INC.**  
EMPIRE STATE BLDG. NEW YORK 1, N. Y.

**Get into BUSINESS  
for Yourself!**

**METALIZING  
BABY SHOES  
AT HOME IN  
SPARE TIME**



Get facts about amazing money-making Warner Success Plan that shows you every easy step in completely charted path to personal independence—with your home as your headquarters... This proved and tested Plan is working like magic. It's backed by an old, reliable company... And we send it to you on a **No-Risk Trial Money Back Guarantee.**

**QUICK CASH WAITING**

Demand for METALIZED Baby Shoes and other keepsakes is growing bigger daily. Our Tested Plan Shows How to Do the Work, How to Bring in the Business, How to Make as much as \$5 an Hour. Spare or full time, big steady profits are waiting for you. Send penny postcard or mail coupon for **FREE Facts.** Act! Time is precious.

**FREE**  
offer of  
**COMPLETE  
MONEY  
MAKING  
PLAN**  
•  
**SEND NO  
MONEY  
Just Mail  
COUPON**

**Ray Brandell, Mgr., Warner Electric Co.,  
1512 JARVIS AVE., DEPT. 3-W, CHICAGO 26, ILL.**

Please rush complete details about your No-Risk Trial Money Back Plan for Metalizing Baby Shoes. Everything you send is **FREE** and costs me nothing—now or ever.

NAME \_\_\_\_\_  
ADDRESS \_\_\_\_\_  
CITY \_\_\_\_\_ ZONE \_\_\_\_\_ STATE \_\_\_\_\_



**GOVERNMENT  
JOBS  
START  
AS HIGH  
AS \$3,450.00 YEAR**

**Veterans Get Special Preference**

**MEN — WOMEN**

Railway Mail Clerks  
Postoffice Clerks, Carriers  
Liquor Inspectors  
Stenographers-Typists  
Meat Inspectors  
Many Other Jobs

**PREPARE  
IMMEDIATELY  
FOR NEXT EXAMS**

Common Educa-  
tion Often  
Sufficient

Mail  
Coupon  
TODAY



**Franklin Institute**  
Dept. L-83  
**ROCHESTER 4, N. Y.**  
(Not Government Controlled)

Gentlemen: Rush to me, **FREE** of charge, list of U.S. Government big pay jobs. Send **FREE** 40-page book describing salaries, vacations, hours, work. Tell me how to qualify for one of these jobs.

Name \_\_\_\_\_  
Street \_\_\_\_\_  
City \_\_\_\_\_ Vet? \_\_\_\_\_

# "TOOK IN \$217 FIRST 10 DAYS"

Some Make More,  
Some Less... We Help  
You to Start Your  
Own All-Year  
Business, Make  
Big Money!

With our easily operated, highly efficient wall washer, Chas. Stelle took in \$217 gross in first ten days. E. L. Goss took in more than \$10,000 in one year. E. C. Taber wrote, "I made \$400 gross in two weeks." And no wonder — this machine washes walls 6 times faster and better than by hand.

### Your Money-Making Opportunity

We want more men to go into this profitable business for themselves and enjoy independence. There are customers everywhere—homes, offices, schools, churches, hotels, stores, etc. What you take in is mostly profit, for material costs are low. And there's no need to rent a shop or office. Operate your business from your home.

Lose no time. Get all facts without obligation. **WRITE FOR FREE INFORMATION.** Ask for Wall Washer Details at once.

**VON SCHRADER MFG. CO., W66 PL, RACINE, WIS.**

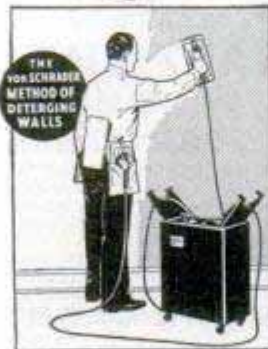

## In Industry and In Emergency TRAINED MEN ARE PREFERRED



Jewelry-  
Stone Setting



WATCHMAKING



Engraving

### "3 High-Paying Trades in 1 Career"

Serve in Emergency — Profit in Industry

There are increasing needs in industry and the Jewelry Trade for thoroughly trained men.

Write for catalog and full information.

MAIL THIS COUPON TODAY

**KANSAS CITY SCHOOL OF WATCHMAKING**  
1218 Admiral Blvd.  
Kansas City 6, Missouri

Please send me, without obligation, complete information on training in the above courses.

Name \_\_\_\_\_

Street \_\_\_\_\_

City \_\_\_\_\_

State \_\_\_\_\_

Check if Veteran

G. I. Approved

## BE AN AUTO MACHINIST



Draw Top Pay • No Job Worries

Earn more money in auto mechanics—Specialize! New FREE booklet tells how to prepare for good jobs with high pay and job security. Our modern equipment and practical instructions make it easy to learn—get experience in

**ENGINE REBUILDING** or  
**GENERAL AUTO MECHANICS**

Job  
Placement  
Service  
FREE

**Practical Shop Training**  
Learn to operate the very latest shop machinery. Friendly instructors take a real interest in preparing you for a good job.

**VETERANS**  
American is a G.I.  
approved school

WRITE TODAY FOR  
**FREE BOOKLET**

**AMERICAN TRADE SCHOOL**  
2417H McGee Kansas City, Mo.



## Rupture Troubles Ended

Advanced method has healed thousands. No leg straps, no elastic, no plasters. No pressure on hips or spine. Flexo-pad. Entirely different. Endorsed by doctors, mechanics, clerks. Very light. **INEXPENSIVE. GUARANTEED.** Write for information and trial.

**SMITH MANUFACTURING COMPANY**  
EST'D 1893 DEPT. PM PRESTON, ONTARIO



## OWN a Business

Clean and Mothproof rugs and upholstery "in the home." Patented equipment. No shop needed. Duraclean dealer's gross profits up to \$20 a day on EACH serviceman. These Nationally Advertised services create repeat customers. Easy to learn. Quickly established. Easy terms. Send today for FREE Booklet — Full details.

**DURACLEAN CO., 0-16D DURACLEAN BLDG.**  
DEERFIELD, ILL.



## Be a TELEVISION CAMERAMAN

Work with "live" equipment in station-size studios. TRAIN with "Big Name" TV instructors. Graduates employed at leading TV stations. Easy payment plan. Free National Placement Service. Housing accommodations secured. Approved for Vets.

Send for FREE Booklet M-1

**TELEVISION WORKSHOP**

1780 Broadway, New York 19, N. Y. PLaza 7-3721



## Money In Hamsters

The new wonder animals from Syria. Often called Toy Bears. Delightful pets. Everyone wants them. Laboratories use thousands. Clean, odorless. Raise anywhere. NOW, spotted and golden breeds. We furnish breeders, equipment and manual of instructions. Write today for free illustrated literature.

**GULF HAMSTERY 1536 BASIL ST., MOBILE 17, ALA.**

## CARPENTRY BRICKLAYING

APPROVED FOR VETERAN TRAINING • FREE CATALOG

**PENNSYLVANIA INSTITUTE SCHOOL OF TRADES**  
30th & MARKET STS. PHILA. 4, PENNA.

Say You Saw It in Popular Mechanics

## Learn BAKING At Home

Baking is one of America's high industries in wages. Nearly depression-proof. Thorough basic home course lays sound foundation. If you have aptitude, write for FREE BOOKLET, "Opportunities in Commercial Baking."

National Baking School, 1315 Mich. Ave., Dept. 1359, Chicago 5





## Watch Repairing Pays Big Money **Learn at home**

### Free Literature Tells How

Watchmakers in big demand. You train step-by-step under experts. You learn to take a watch apart—repair and put in perfect working order. 10 easy lessons. We furnish all tools, and a 15 jeweled watch. Practicemovement with first lesson.



Turn spare time into cash—perhaps a business of your own. A licensed school. Students 18 to 65 have profited by our training. Low cost.

Write Today for All the Facts—No Obligation

**WATCH REPAIRING** Dept. P-120, 2870 Elston Ave. Chicago 18, Ill.

## SHORTHAND in 6 Weeks at Home

Famous Speedwriting system. No signs; no symbols; no machines; uses ABC's. Easy to learn; easy to write and transcribe. Low cost. 100,000 taught by mail. For business and Civil Service. Also typing. 27th year. Write for free booklet to:

## Speedwriting

Dept. 1512-A, 55 W. 42 St., New York 18 (R)



### SILVER SOLDER TORCH & KIT \$6

Do your own repairing. KIT includes one tube silver solder flux and 10 5-in. lengths silver solder alloy. Hottest ALCOHOL TORCH known. 2700° F. flame. Operates in any position, indoors or out. Torch alone \$5. KIT alone \$1.50. AMERICAN PRODUCTS CORP. 422 S. Dearborn St. Dept. 3-A Chicago 5, Ill.

### A "GOOD HAND" HELPS YOU SUCCEED!

#### LEARN TO WRITE WELL

Handwriting quickly improves with our easy-to-understand picture lessons! Put your spare time to good use; send today for  FREE BOOK, "How to Become a Good Penman", or check volumes wanted below at \$1 each:  Business Writing  Artistic Writing  Card Writing  Bird & Design Flourishing  Engrossing Alphabets. COMPLETE SET \$4.50

*Your Name*  
beautifully written, plus special pen-point for shaded writing.  
Only 10¢

OUR 53rd YEAR  
**TAMBLYN SCHOOL of PENMANSHIP**  
S. A. Ziller, Pres. 442 Ridge Bldg., Kansas City, Mo., USA

### Aptitude Tests

for men, women, boys, girls, discover the kind of work or studies best for your success! You get a personal report—a guide for life—more happiness—more prosperity. . . . Write for complete facts. . . . VOCATIONAL COUNSELORS, 5057 Woodward Avenue, Detroit

## How to Make Money with Simple Cartoons



A book everyone who likes to draw should have. It is free; no obligation. Simply address **FREE BOOK**

**CARTOONISTS' EXCHANGE**  
Dept. 912D Pleasant Hill, Ohio

## NEW! CHEAP! OIL BURNER SWEEPING THE COUNTRY!

**SALESMEN BIG MONEY** SLIPS INTO ANY COAL RANGE, STOVE OR FURNACE. Amazing quick, intense heat. By finger-tip control. Cheaper than coal. No more shoveling coal or ashes. SENT ON TRIAL. Prove it pays for itself quickly by what it saves. \$1 bonus for testing. We'll let you try one in your own home for one month. Write for details today. Northwest Mfg. Co., Dept. 836-P, Mitchell, S. Dak.

## SHAKESPEARE'S BIG NEWS FOR '51!



Model 1924 chrome plated for fresh or salt water \$1050 List Price

### NEW DIRECT DRIVE REELS with LQT\* NYLON GEARS

A three year test under severest conditions proved these revolutionary new reels the finest ever for ruggedness and casting ease. \*Lighter—nylon gears weigh a third as much as metal; \*Quieter—nylon absorbs sound, metal conducts sound; \*Tougher—nylon gears outwear metal by far in laboratory tests. Two gear DIRECT DRIVE construction gives you the greatest sturdiness ever built into reels.

Model 1926 lightweight aluminum, List Price, \$11.00  
Model 1973-D with Carboloy bushings, List Price, \$15.00

### SHAKESPEARE HOWALD-PROCESS FIBER GLASS WONDERRODS . . . Now as Low as \$9.25

#### SHAKESPEARE COMPANY

Dept. PM-12, Kalamazoo 2, Michigan  
Send me your free 1951 Tackle Book and Fishing Calendar.

Name .....

Address .....

City.....Zone.....State.....

## LEARN TELEVISION RADIO-ELECTRONICS

Learn in your home. Then earn BIG PAY and SECURITY. Tremendous growth has made more jobs than there are trained men! NOW is the time to get into this NEW, RICH field of OPPORTUNITY. FREE placement service. SEND FOR FREE, BIG ILLUSTRATED CATALOG.

### MAIL TODAY

I want complete information on how to succeed in Television, Radio, and Electronics. This does not obligate me in any way.

NAME \_\_\_\_\_

ADDRESS \_\_\_\_\_

CITY \_\_\_\_\_ STATE \_\_\_\_\_

**CENTRAL RADIO & TELEVISION SCHOOLS**  
Dept. P12, 1644 WYANDOTTE, KANSAS CITY, MO.

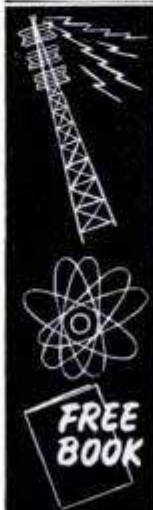

# Draw me!

**\$1,275 IN PRIZES! 5 PRIZES!**

**5 Complete \$255 Art Courses,  
including Drawing Outfits!**

Here's your big chance, if you want to become a commercial artist, designer, or illustrator! An easy-to-try way to win FREE art training!

Whether you win or not we send you our comments on your work, if your drawing shows promise! Trained illustrators, artists and cartoonists now making big money. Find out now if YOU have profitable art talent. You've nothing to lose—everything to gain. Start your drawing now. Mail it today.



**COPY THIS GIRL**

**Amateurs Only!** Our students not eligible. Make copy of girl 5 ins. high. Pencil or pen only. Omit the lettering. All drawings must be received by Jan. 31, 1951. None returned. Winners notified.

**Latest Winner List!** Free course winners in previous contest—from list just released: J. West, Dodd Field, San Antonio, Tex.; R. Parks, 305 S. Urbana, Urbana, Ill.; K. Balodis, CPR Sec. Kinogama, Kormak, Ont., Canada; J. Bazin, 305 E. 87th, N. Y. City; E. Melecinsky, 1549 Corbin, New Britain, Conn.

*Art Instruction, Inc.*

MINNEAPOLIS • NEW YORK • CHICAGO  
MEMBER NATIONAL HOME STUDY COUNCIL

**ART INSTRUCTION, INC., Dept. 12130**

500 S. 4th St., Minneapolis 15, Minn.

Please enter my attached drawing in your January drawing contest.  
(PLEASE PRINT)

Name \_\_\_\_\_ Age \_\_\_\_\_

Address \_\_\_\_\_ Phone \_\_\_\_\_

City \_\_\_\_\_ Zone \_\_\_\_\_ County \_\_\_\_\_

State \_\_\_\_\_ Occupation \_\_\_\_\_

## High School at Home

**Many Finish in 2 Years**

No classes. No time wasted going to and from school. Progress as fast as your time and abilities permit. Standard H. S. texts supplied. Thousands enroll each year in this 52-year-old school. Send for FREE descriptive booklet.

**AMERICAN SCHOOL, Dept. H945**  
Drexel at 58th St., Chicago 37, Ill.

Without obligation, please send FREE descriptive booklet.

Name \_\_\_\_\_

Address \_\_\_\_\_

### MODEL BUILDERS!

**NEW 1951 CATALOG**

MODEL AIRPLANE ENGINES • GLOW

PLUGS • MARINE ENGINES • FUELS

MODEL RACERS • ACCESSORIES



CUT OUT AND MAIL TODAY

OHLSSON & RICE, INC.  
3344 Emery St., Los Angeles 23, Calif.  
Los Angeles 23, California

Please RUSH \_\_\_\_\_ copies of the NEW 1951 O&R Catalog at 15c each for which I am enclosing \_\_\_\_\_ in stamps or coins to cover handling and mailing.

Name \_\_\_\_\_

Address \_\_\_\_\_

City \_\_\_\_\_ Zone \_\_\_\_\_ State \_\_\_\_\_

### CARNEGIE INSTITUTE INC.

CARNEGIE at E. 107 St.  
CLEVELAND 16, OHIO

complete professional training for

**Doctor's Assistants**

**Medical Laboratory Technicians**

APPROVED FOR VETERANS—Train in a few months for a career in a well paying professional field. Our graduates are in demand and are receiving special classifications in military service. Free Placement. Co-ed. Club residence. Send for free booklet.

## LOCKSMITHING & Key Making

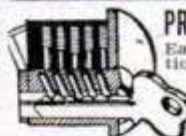

PRACTICAL UP-TO-DATE COURSE—ONLY \$4.95

Easy-to-learn modern information for self-instruction. How to work on locks, de-code, make master-keys, repair, install, service, etc. For every handyman, home owner, carpenter, mechanic, service station operator, fix-it shop, hardware dealer, gunsmith. 53 plain illustrated lessons. FULL PRICE ONLY \$4.95. SEND NO MONEY.

Just pay postman plus C.O.D. postage. Or send \$4.95 with order, we'll ship postpaid. Satisfaction guaranteed or refund.

NELSON-HALL CO., 210 S. Clinton St., Dept. M-2, Chicago 6, Ill.

## ANALYZE Handwriting

More and more men and women in home and various professions report greater earnings spare time. Home study. Test lesson, YEAR BOOK free. No children. I.G.A.S., Wilhoit Bldg., 507, Springfield, Mo.

## LEARN WATCH REPAIRING



**AT HOME.** By our modern and original system of instruction you can learn every part of the **WATCH REPAIRING TRADE AT HOME.** Prepare yourself for a well-paying position or start in business after completing our course of instruction. Good watch repairers are in demand and generally earn very good salaries. For particulars apply to the **WISCONSIN SCHOOL OF WATCH REPAIRING**, 759 North Milwaukee St., Milwaukee 2, Wis.

**Say You Saw It in Popular Mechanics**



Thrilling Work **COLORING PHOTOS**

Fascinating vocation learned at home by those with aptitude. Thrilling pastime. National method brings out life-like colors. Free booklet.

**NATIONAL PHOTO COLORING SCHOOL**

1315 S. Michigan, Dept. 1359, Chicago 5

# Two Ways YOU Can Make More Money

# on all AUTO REPAIR JOBS



**NEW**  
Both Books Sent  
for 7 Days  
FREE Trial

**Do a Better Job, Easier, Quicker—With These Time-Saving, Money-Making Kinks on 20 Leading Cars. Learn All About Automatic Transmissions. Know How to Service All Makes. Be a Specialist in this New Big Pay Field.**



Be among the first to cash in on the outstanding, money-making and time-saving information that is packed into these new books. Get the one that suits your work—that fits your needs best. Better still—get both books now—on our no-money-down, FREE seven day trial. Each book can easily be worth many hundreds of dollars to auto mechanics, repair men, taxi owners, garage men, service station operators and others. See FREE trial offer below.

## AUTO REPAIR KINKS

*Describes Hundreds of Short Cuts That Have Helped Mechanics Out of Tough Spots*

This unusual book describes hundreds of out-of-the-ordinary, but tried and proven time-saving auto repair kinks. Gives hundreds of ways to do tough, time-consuming repair and tune-up jobs on 20 leading cars. It will pay for itself over and over on almost every job you handle. Common factory procedures are omitted—no space is wasted in telling you those things you already know. But it will give you money-making, time-saving facts you can use in your own work right now. Over

300 easier ways to do things including How to Step Up Speed and Power, Build Hot Rods, Save Fuel and Cure High Oil Consumption and all kinds of smart service, repair and tune-up jobs from bumper to bumper. Prepared by Bill Toboldt, Editor Motor Service Magazine, Auto Repair Kinks gives you the combined experience and KNOW HOW of the world's best mechanics. 125 pictures, diagrams and charts make every detail simple as A. B. C. Tool box Size. No excess weight to carry around.

**Only \$3. Sent on 7 Days Free Trial. See Coupon.**

## Mechanical and Tune-Up Specifications 1938-1950

20 Leading Cars, including: Buick, Chrysler, Dodge, Hudson, Mercury, Packard, Studebaker, Cadillac, Crosley, Ford, Kaiser, Nash, Plymouth, Willys, Chevrolet, DeSoto, Frazer, Lincoln, Oldsmobile, Pontiac.

### How They Work — What Goes Wrong—How to Service All Makes.

Hydra-Matic, Dynaflo, Ultramatic, Powerglide, Gyromatic, Tip-Toe Shift, Simplimatic, Drive-Master, Vacumatic, Fluid Flywheels, Torque converters, Overdrives, Hydraulic Servos, Synchromesh, Free Wheeling, Vacuum Boosters, Etc.

## AUTOMATIC TRANSMISSIONS SIMPLIFIED

*Engineering Terms Converted Into "Ham and Eggs" Language*

Complicated Automatic transmissions are bothering hundreds of good mechanics. But don't let any transmission throw you. Get Automatic Transmissions Simplified and know how to service every job that comes your way. Prepared by Jud Purvis, Technical Editor Motor Service Magazine with co-operation of service managers and experts of all automobile manufacturers. It is the actual experience gained in thousands of service operations,

boiled down into priceless KNOW HOW, ready for you to use. It covers ALL past, present and some features of future power transmissions. It is detailed, up-to-the-minute, practical information that you can't get in regular shop or service manuals. This is the one book you should have for all transmission jobs. 264 pages. 170 illustrations, diagrams, etc., many of them in colors.

**Only \$4. Sent on 7 Days Free Trial. See Coupon.**

Picture below from Auto Repair Kinks, shows how hole drilled in Ford torque tube permits replacing drive pin without disassembling torque tube. Over 125 pictures, charts, etc., in this book. Bottom picture is cut-away of Chevrolet's Powerglide transmission. 170 illustrations in transmission book. (Many in color.) All pictures are many times larger than shown here.

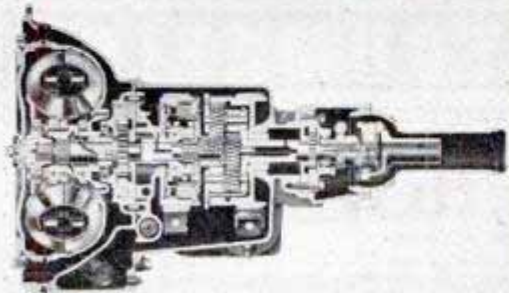
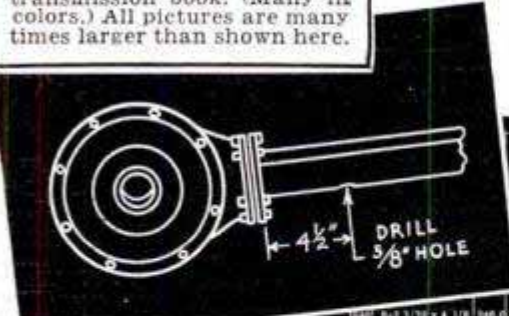

Model	Year	Price	Operating
1938	...	...	...
1939	...	...	...
1940	...	...	...
1941	...	...	...
1942	...	...	...
1943	...	...	...
1944	...	...	...
1945	...	...	...
1946	...	...	...
1947	...	...	...
1948	...	...	...
1949	...	...	...
1950	...	...	...

## BOTH BOOKS SENT TO YOU ON 7 DAYS FREE TRIAL

Mail Coupon below, without money. We'll send either or both books to you promptly. Then you be the judge. Make the books prove their value to you. If you don't agree with everything we have said about them, send them back and you will owe nothing. Mail coupon now to: Goodheart-Willecox Co., Dept. 147, 1321 South Michigan Ave., Chicago 5, Ill.

## SEND NO MONEY-MAIL COUPON

**Goodheart-Willecox Co., Dept. 147  
1321 S. Michigan Avenue, Chicago 5, Ill.**

Send to me at once, the books checked below:

- AUTO REPAIR KINKS**, 224 Pages, 125 pictures, charts, etc. \$3.00 plus 25c postage and handling charges.
- AUTOMATIC TRANSMISSIONS SIMPLIFIED**, 264 pages, 170 illustrations, drawings, etc. \$4.00 plus 25c postage and handling charges.

I agree to remit the price as indicated above in 7 days or return the books to you and owe you nothing.

Check here if you remit with this order and save postage and handling charges. If books are returned in 7 days we will refund full purchase price.

NAME \_\_\_\_\_

ADDRESS \_\_\_\_\_

CITY \_\_\_\_\_ ZONE \_\_\_\_\_ STATE \_\_\_\_\_



NOW — YOU CAN MAKE IT AN  
**"OLD TIMERS" Christmas!**

Give Hobby-Lovers Miniature, ANTIQUE AUTO SETS

1903 MODEL 'A' FORD \$2.50 He Wants These Easy-To-Build Models. Choose His Favorites From All Pictured Here!



- Check "OLD TIMERS" You Want to Give:
- |  |  |
|--|--|
| <input type="checkbox"/> 1911 Maxwell \$2.50         | <input type="checkbox"/> 1911 Buick \$2.50               |
| <input type="checkbox"/> 1904 Olds. \$1.95           | <input type="checkbox"/> 1903 A Ford \$2.50              |
| <input type="checkbox"/> 1910 T Ford \$2.50          | <input type="checkbox"/> 1910 Internat. Harvester \$2.95 |
| <input type="checkbox"/> 1903 Stanley Steamer \$2.95 | <input type="checkbox"/> 1903 Cadillac \$2.50            |
| <input type="checkbox"/> 1909 T Ford \$2.95          | <input type="checkbox"/> 1900 Packard \$2.50             |
| <input type="checkbox"/> 1903 Rambler \$2.50         | <input type="checkbox"/> 1914 Stutz \$3.95               |
| <input type="checkbox"/> 1911 Mercer \$3.95          | <input type="checkbox"/> Bearcat \$3.95                  |
- Mail order to us for your favorites. Add 25c for postage and handling. No C. O. D.'s please

HOBBYISTS and Collectors want these nostalgic Antique Autos—each one easy to assemble with pre-labricated parts! Actual 1/4" scale models, they're decorative and authentic. 6 1/2" to 10 1/2" in length. See them at hobby, toy or department stores. Perfect Xmas gifts for youngsters 9 to 90 years old! Prompt delivery. Guaranteed satisfaction.

"OLD TIMERS" MINIATURE AUTO SETS  
 Mail to: SCRANTON HOBBY CENTER  
 Dept. 14, Scranton 10, Pa.



**30 DAY FREE TRIAL**  
**7 x 50 Prism BINOCULARS**

Finest Precision Optics  
 Lightweight Magnesium Bodies  
 Money Back Guarantee  
 Many other models AS LOW AS \$6.00\* (\*plus Fed. Tax)  
**FREE Illustrated Catalog & Book, "How To Select Binoculars"**  
 Dealer Inquiries Invited

**BUSHNELL Binoculars** 43 E. Green St., Dept. M-12  
 Pasadena 1, California

**MAKE REAL MONEY AT HOME IN TELEVISION**

Get to the top faster through practical-shop-training methods! You can earn big money at home while learning; start your own business! Television has proved to be the fastest growing industry in the country. Trained men are in demand NOW for high-paying jobs. RTTA also prepares you for your FCC license! Better pay! Don't wait another day. Send for RTTA's free TV Catalog, Sample Lesson, and details on FREE Round-Trip to New York City from anywhere in U.S. or Canada.

**FREE TV CATALOG & SAMPLE LESSON**

**RADIO TELEVISION TRAINING ASSOCIATION**  
 Dept. 2412  
 972 BROAD ST.  
 NEWARK 1, N. J.

Rush me your FREE Catalog "How to Make Money in Television," in spare time, **AT HOME**, while learning; details FREE round trip to N. Y. C.; together with FREE Sample Lesson. No obligation. (No salesman will call).

Name.....Age.....  
 Address.....

**SPEED AND POWER Handbook**

50 CHAPTER LIBRARY EDITION  
 Build Fast Stock Cars! California Roadsters! 160 MPH Rods! Covers Cross-leys to Cadillacs—all makes—Authentic—Direct from California!  
 Tens of thousands have been sold!  
**SAVE SAVE SAVE**  
 Photos Drawings 128 ENAMELED PAGES

Build your own Dual Manifolds! Superchargers! Hot Cams! Water Injectors! Hi-Compression Heads! Mileage Devices! Get up to ten more miles per gallon! Get racing speed, lightning acceleration, dynamic power increases from any make passenger automobile! Get construction drawings! Tuning techniques! Speed tricks! Economy secrets! Ingenious formulas! Covers "Racing Frames"—"Reciprocating Masses"—"Jet Engines"—"Wheel Geometry"—"Dynamometers"—Dual Pipes, Gears, Fuels, Porting, Relieving, Lowering! Balancing—50 breathtaking chapters!  
 Includes "CALIFORNIA CUSTOMIZING"—Diagrams! Newest Ideas! Restyling—all makes! Plus 1951 Racing Catalogue. Plus big "Economy Manual" and "Alcohol Injection."  
**5 ITEMS Postpaid \$1.98**  
**SPEED SHOP METHODS 300 ILLUSTRATIONS**  
**NEWHOUSE AUTOMOTIVE INDUSTRIES**  
 5805 EAST BEVERLY BLVD. DEPT. B4  
 LOS ANGELES 22, CALIF.

**500 TRICKS MAGIC TRICKS**  
 It's FUN to do MAGIC  
 Be popular! Amaze—mystify—entertain! For 30 years Douglas has satisfied customers all over the world. Now you can enjoy this fascinating hobby. Only 10c brings our new 1950-51 Catalog 500 Tricks, containing brand new tricks for pocket, parlor, stage. Join in the fun—send 10c today!  
 Douglas Magicland, Dept. C, Dallas, Texas

**GREAT PROFITS MAKE YOUR OWN RUBBER MOLDS**  
 will realize your great profits quickly!  
**WRITE FOR NEW FREE CATALOG**  
 YOU can EASILY learn to cast thousands of perfect plaques, book ends, figurines, ash trays, etc. IT'S EASY, FUN, PROFITABLE!  
 X.L. Rubber, Pts. \$2.00; Qts. \$3.50; Models and enough rubber for 3 molds \$1.30 postpaid.  
**PLASTIC ARTS STUDIO** Address Dept. 2  
 3403 S. Madison St. Muncie, Ind.

**WHY DON'T YOU WRITE?**

Writing short stories, articles on business, sports, hobbies, travel, shop crafts, local and club activities, etc., will enable you to earn extra money. In your own home, on your own time, the New York Copy Desk Method teaches you how to write the way newspaper men learn—by writing. Our unique "Writing Aptitude Test" tells whether you possess the fundamental qualities essential to successful writing. You'll enjoy this test. Write for it, without cost or obligation.  
**Veterans: Course approved for Veterans' Training.**  
**NEWSPAPER INSTITUTE OF AMERICA**  
 SUITE 5590-W, ONE PARK AVENUE, NEW YORK 16, N. Y.

**Learn CARPENTRY BRICK LAYING**

Get into the billion dollar building trades. Learn now while opportunities are greatest. Train in our completely equipped shops under expert instructors. G.I. Approved. Enroll now. Limited classes. Write for FREE Catalog.  
**MIDWEST SCHOOL OF BUILDING TRADES, Dept. PM-12**  
 411 N. Center St. Bloomington, Ill.

**WATCHMAKING**

★ Watch Repairing ★ Jewelry Engraving ★ Jewelry Repairing  
 Combination men earn top pay. Learn in school fully accredited by Horological Institute of America in Washington, D. C. and United Horological Association of America. Approved for veterans. Receive tools, tuition and subsistence while learning.  
 Established 1935. Write for FREE booklet  
**The Baronian School, Inc.**  
 2116 WALNUT ST. (DEPT. C) PHILA. 3, PA.

# MAIL THIS OPPORTUNITY COUPON TODAY!!

## GET FASCINATING NEW FREE PROFIT PLAN



**NELS IRWIN** says — "Benefit by my experience. My plan has helped thousands."

Tired of monotonous, low-pay jobs... tired of working for the other fellow? Cash in on rich profits in this huge NEW field. Have your own successful lifetime business... earn REAL money and say goodbye forever to time clocks and bosses! Become a part of this tremendous new expanding industry — yet work right from your own home!

Learn how to get BIG PROFITS on new MIRACLE finish that makes old objects beautiful, solable — new things worth much more.

**COVERS: WOOD, JEWELRY BOXES, RADIOS, SHOES**

**FABRICS, METALS, PLASTER, ANY SURFACE**

**LAMPS, AUTOTRUNK INTERIORS, TOYS BUSINESS.**

**PHONOGRAPH TURNTABLES**

**PHOTOGRAPH TURNTABLES**

**FREE BOOKLET & SAMPLE**

**YOUR BIG OPPORTUNITY - GET INTO A NEW AND PROFITABLE BUSINESS.**

**NOW!**

**LEARN IN A FEW DAYS THROUGH PROVED, TESTED METHODS**

To start earning more money than you've dreamed of with this amazing MIRACLE finish, which gives a velvety, luxurious surface to radios, lamps, toys, signs, store displays, figurines auto dashboards and hundreds of other items. FREE PROFIT PLAN offers everything you need to start at once!

**ENORMOUS DEMAND FOR NEW MIRACLE FINISH**

We show you every step on the road to success, filling huge year-round demands plus tremendous XMAS holiday business... easy to understand instructions tell you how to earn up to \$5 an hour full or spare time. A few cents worth of materials brings you dollars!

**GRASP THIS OPPORTUNITY TODAY**

It's too good to miss... Fill out coupon above, mail today. Get FREE sample, FREE plan, big IDEA booklet. No salesman will call! Do it NOW... be first in your community to cash in on this huge new market!

**FLOK KRAFT**

**USE COUPON FOR FREE SAMPLE**

**COAST INDUSTRIES Dept. 2C**  
1004 S. Los Angeles St., Los Angeles 15, Calif.  
Gentlemen: Please rush me all the details - FREE.

NAME \_\_\_\_\_

STREET \_\_\_\_\_

CITY \_\_\_\_\_ STATE \_\_\_\_\_

**INVESTIGATE TODAY!**

**AMAZING NEW Miracle Finish**

**MEANS \$\$\$ TO YOU**

**FREE BOOKLET & SAMPLE**

**COAST INDUSTRIES**

"Pleased with your course and I'm being swamped with work to do." - W.F., Pa.

"Got \$52.50 for those 7 trunk interiors for about 4 hours work. \$7.50 per trunk." - J.O., Missouri

**ICE SLED ENGINES**

**SMALL AIRPLANE RADIAL TYPE**

Write for descriptive literature.

**GAARE SUPPLY CO., Dept. A, Box 277, Weatherford, Texas**

**TRAIN Your VOICE!**

**RESULTS GUARANTEED**

STRENGTHEN your voice this tested, scientific way. Yes—you may now be able to improve the POWER of your speaking and singing voice... in the privacy of your own room! Self-training lessons, mostly silent. No music required. Write TODAY for Everett Feuchtinger's great booklet "How to Develop a Successful Voice." It's absolutely FREE! You must state your age. Booklet mailed post-paid in plain wrapper. No salesman will call! Send your name and age RIGHT NOW! Perfect Voice Institute, 210 S. Clinton St., Studio M-2, Chicago 6, Ill.

**Earn up to \$6,000 a year!**

**MORE JOBS THAN WE CAN FILL! PAY AS YOU EARN**

**Increase Your Earning Power**

Learn By Doing In Big Allied Shops

Men who are mechanically inclined have a wide open field to choose employment in the Machine Tool Industry. Jobs are going begging for lack of qualified trained men. You need no previous experience to start your training at this school.

Get full particulars on our Job Placement and Deferred Payment Plan.

Write for FREE BOOKS A 1c Postcard will do

**ALLIED SCHOOL OF MECHANICAL TRADES, Inc.**  
1338-1340-1342 S. MICHIGAN AVENUE  
412 ALLIED BUILDING, CHICAGO 5, ILL.

Which of these 2 one time WEAKLINGS PAID only a Few Cents to become an All-Around HE-MAN at Home?

Larry Campbell Rex Ferris

Which One Paid Hundreds of Dollars to Train At My Side? Rex Ferris was a skin-weakening, paid a few cents to start building into a Champion All Around He Man! Larry Campbell paid me hundreds of dollars to train at my side years ago. Start to become an All-Around He Man at home with these same secrets for only a few cents like Rex Ferris did!

**5 Great Body Building Picture Courses All Yours FOR ONLY 10c instead of \$1.00**

"The Jowett System is the greatest in the world!" says R. F. Kelly, Physical Director, Atlantic City

**Be a Winner at Anything YOU Tackle with Progressive Power SPORTS! JOB! SCHOOL! FRIENDS!**

**Let's Go, Pal! I'll prove I can make YOU an "ALL-AROUND" HE-MAN**

**FAST — OR NO COST!** says George F. Jowett World's Greatest Body Builder

**JOWETT INSTITUTE, 230 Fifth Avenue, N. Y. 1, PM-012**

Dear George:—Please send by return mail, pre-paid, FREE Jowett's Photo Book of Strong Men, plus all 5 Muscle Building Courses. 1. Molding a Mighty Chest. 2. Molding a Mighty Arm. 3. Molding a Mighty Grip. 4. Molding a Mighty Back. 5. Molding Mighty Legs—Now all in One Volume "How to Become a Muscular He-Man." Enclosed find 10c for postage and handling. No C.O.D.'s.

Name \_\_\_\_\_ Age \_\_\_\_\_

Address \_\_\_\_\_

City \_\_\_\_\_ Zone & State \_\_\_\_\_

# INVENTIONS

and

# CASH from your IDEAS

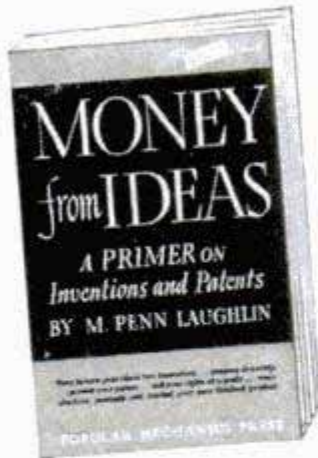

## Needed Inventions for Today's Market

Why waste time and effort inventing something impractical? Let Money from Ideas show you what inventions are needed today—which inventions can pay their way and bring you a share of the more than \$200,000,000 paid in royalties to inventors each year.

### How to Get Started

Before you make a drawing or even set a line on paper, you are given a time-tested outline to follow—an outline that shows you the qualifications your invention should have to become a successful money maker.

### How to Apply for a Patent

Step-by-step, with drawings, photographs and diagrams, you are taken through the patent procedure for an actual invention—one that was made up following the "magic" outline and has already made thousands of dollars for the author. Right before your very eyes you see each step he took to get a patent.

### Sample Patent Forms Included

Photographic reproductions of the actual forms you use in applying for a patent are included in the book. Each form is explained clearly and completely.

### How to Market Your Invention

You are told by a man who has hundreds of successful inventions to his credit how you should go about getting your invention manufactured; how to enter into royalty agreements; how you can promote and market your invention to realize a profit.

### Cash In on Your Talent Now

Send for your copy of Money from Ideas today. Let the information contained in its fact-packed 144 pages help you begin getting your share of the millions of dollars in royalties paid to inventors each year.

### Money Back if not Satisfied

Mail the coupon now. Send only \$2.50 or you can pay postman. Money back guarantee protects you.



### How to prepare patent forms



### How to manufacture, promote and market

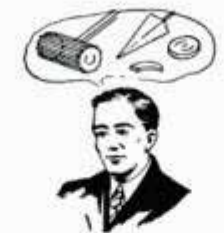

### Needed inventions

## USE THIS HANDY ORDER BLANK

POPULAR MECHANICS PRESS, Dept. 22  
200 E. Ontario Street Chicago 11, Illinois

Send Money from Ideas at once. If not satisfactory I will return it within five days and you will refund full purchase price.

Remittance for \$2.50 enclosed.  Send C.O.D.

Name \_\_\_\_\_

Address \_\_\_\_\_

City \_\_\_\_\_ Zone \_\_\_\_\_ State \_\_\_\_\_

MONTH AFTER MONTH, YEAR AFTER YEAR, YOU SEE OUR AD.

**REMEMBER IT'S DANGEROUS** to pay less if you want the finest matched USED tires. Hundreds of thousands of folks in U. S. have sent their money in advance, assured by satisfied friends, that we will never break faith.

**GOOD YEAR**  **Firestone** 

GOODRICH, UNITED STATES, GENERAL, FISK, KELLY & OTHERS

**FREE WITH 2 OR MORE TIRES, A TIRE "SKID" CHAINS**  
SET OF EMERGENCY RUBBER

Our policy is to select your tires so carefully, as if our very future depended on the service given by that particular tire. Read that top line again, positively not recaps.

**FREE TUBE WITH "ALL" BLATT'S FINE GRADE TIRES**  
GOOD GRADE, 16 MONTHS GOLDEN RULE GUARANTEE BOND.

600-16	\$4.16	700-15	\$4.56	650-20	\$7.96	32x6-8	\$8.66
650-16	4.66	670-15	4.76	700-20	8.56	32x6-10	9.96
700-16	5.06	710-15	4.96	750-20	8.66	900-20	13.96
650-15	4.46	550-17	4.66	825-20	13.96	1000-20	13.96

**FINEST GRADE, 26 MONTHS GOLDEN GUARANTEE BOND**  
THIS GRADE MADE THE BLATT NAME "WORLD FAMOUS."

MATCHED BALANCED TIRES		MATCHED BALANCED TRUCK TIRES	
600-16	\$5.36	650-15	\$5.96
650-16	5.96	670-15	6.26
700-16	5.96	700-15	6.56
750-16	6.96	710-15	6.36
550-17	5.96	760-15	6.56
525-18	5.56	820-15	7.06
650-15	6.96	475-19	5.96
600-20	\$9.96	900-20	\$16.56
650-20	9.96	1000-20	17.56
700-20	10.96	1100-20	17.56
32x6-8	10.56	1200-20	18.56
32x6-10	11.96	1000-22	15.56
750-20	12.56	1100-22	17.56
825-20	16.56	750-15	9.96

**MILITARY REG. GUAR. 16 MOS. (Super-hy 45,000 miles)**

600-16	Reg. \$6.46	750-16	Reg. \$9.96	900-16	Reg. \$9.66	750-20	Reg. \$10.46
Super-hy	9.26	Super-hy	14.46	Super-hy	13.46	Super-hy	16.66

Factory Rebuilt Snow-Tred Tires. 24 Mo. Guar. "New Tire Traction" Tread Not Worn. Perfect Casings

670-15	760-15	650-15	600-16	700-16	\$9.95
710-15	820-15	700-15	650-16	550-17	

**BLATT** BLATT BLDG., GIRARD & LANCASTER AVES., DEPT. PM, PHILADELPHIA 31, PA. Send check or money order and this ad for rush shipment. We won't ship a tire we wouldn't use. The name to trust in rubber.

## NEW EASY WAY TO MAKE BIG MONEY FULL OR SPARE TIME COSTS YOU 5c - YOU MAKE \$5.00

Make \$5 per hour right in your own home metalizing Baby Shoes in real Bronze, Silver, Gold, and Pearl. No experience needed. Start making money in one week—up to \$500-\$1,000 per month full time, up to \$75 per week spare time. Act at once—Send postcard for complete FREE details today!

KIKTAVI CO., DEPT. PM-5012  
2111 W. MANCHESTER • LOS ANGELES 44, CALIFORNIA

**GROW YOUR OWN** . . . vegetables, flowers, house plants by hydroponics (without soil). It's easy to get big returns in a small space, indoors or outdoors. A clean pleasant way to grow any plant for fun or profit. Send postcard for free picture book.

GILBERT & CO., 35351 Enterprise, San Diego 10, Calif.

## LEARN RADIO-ELECTRONICS

Train for an important job in Radio, Television and Radar—with unlimited future. Spartan resident study is backed with actual construction and operation. Write Department PM-120

**SPARTAN SCHOOL of RADIO-ELECTRONICS**  
MUNICIPAL AIRPORT • TULSA, OKLAHOMA

## Model Railroading is more fun

than you imagine, and less expensive than you think!

● 250,000 people can't be wrong. They are having real fun with the world's fastest growing hobby. Get this picture-packed book that tells how simple it is to start . . . and how surprisingly little money is needed.

Fully illustrated, this book tells how constructive this hobby is. Enjoyed by anyone from 7 to 70. Send 10c today for your copy of "Model Railroading for You," written by a well-known authority.

**MODEL RAILROADER MAGAZINE**  
Dept. 1548 — Milwaukee 3, Wis.



**5 YEAR WRITTEN GUARANTEE  
BENRUS 15 & 17 JEWEL**

**YOUR CHOICE  
only  
\$14.95**

Originally Sold Up To **\$59.50**  
**OFFICIAL SHOCK-PROOF WATCH OF FAMOUS AIRLINES Choice of MEN'S OR LADIES'**

**MOVEMENT**

In latest style Yellow Gold Cases. You get these unredeemed 5-year guaranteed lifetime quality **FAMOUS BENRUS WATCHES** now at only \$14.95 because we bought out SURPLUS STOCKS of leading N.Y. and Md. jewelers. Order now. Order men's or ladies'.



**TRIAL OFFER! WEAR AT OUR RISK!**

Money back in 5 days if not delighted. SEND ONLY \$1 with order. Pay balance COD, plus postage. Or we pay postage if you enclose \$14.95, plus \$1.50 tax. **FREE! Handsome Expansion band included with Prepaid Orders. Order now. XMAS DELIVERY GUARANTEED.**

**15 or 17 Jewel Wrist Watches**

Water-resist Shock-protected Precision Movement Originally \$30  
**Our Price \$9.95**  
**PLUS \$1. Tax.**

**MARYLAND DISTRIBUTORS**  
501 E. BALTIMORE ST. DEPT. 208  
BALTIMORE 2, MD.

Free Watch & Diamond Ring Catalog. Practically Wholesale Prices to User Direct. War or no war, no inflation on our prices.

**Secrets of VENTRILOQUISM  
Now Revealed!**



Fit yourself NOW for bigger income in highly admired and UNCROWDED profession. Ventriloquism can be learned by any one, with proper instruction. Let an expert teach you. "Ventrilo-Aid" and "Dummy" included. Training guaranteed. Be popular, earn money at clubs, stage, television, radio. Information free.  
**FRED MAHER SCHOOL OF VENTRILOQUISM**  
Box 36, Studio K, Kensington Sta.,  
Detroit 24, Michigan

**RUPTURE**



**RELIEF...OR YOUR MONEY BACK**  
A simple... sturdy truss support built nature's way by old surgical appliance manufacturer. You risk nothing... relief or your money back. Send now for free booklet.

**WEB TRUSS CO. Dept. M-12 Hagerstown, Md.**

**Become a Doctor of PSYCHOLOGY**

Win the degree of Ps.D. Teach the secret of contentment, happiness. Solve mental worries. Experience the revelation of truth. Chartered college. Individual help. Write for FREE book. **COLLEGE OF UNIVERSAL TRUTH, 5153-B North Clark St., Chicago.**

**IDENTIFY WOODS EASILY!**

**Let a Government Expert Show You How!**

More than 30 commercial hardwoods in a simple 24 page chart form. Your naked eye and hand lens will do the trick with this Wood Identification Chart at only \$1.00 per copy postpaid. Send your dollar today.

**VANCE PUBLISHING, Sec. 5, 139 N. Clark St., Chicago 2, Ill.**

**SAY YOU SAW IT IN POPULAR MECHANICS**



**OPPORTUNITIES AHEAD!  
TRAIN FOR A FUTURE IN  
DIESEL**

Prepare for the big earning power of Diesel Trained Men. Start learning at home, in spare time. UEI's easy, practical training covers all phases of DIESEL engine operation, fuel systems, auxiliary equipment, repairs and maintenance. Also new Scientific Auto Motor Tune-up. After home course, you come to Chicago for actual practice in UEI's modern shop under experienced instructors. **GET ALL THE FACTS FREE. WRITE TODAY!**

**DIESEL UTILITIES ENGINEERING INSTITUTE**  
DIVISION  
2525 Sheffield Avenue, Dept. DC-10 Chicago 14, Illinois

**\$15.95 BUYS THE  
ELECTRIC SHAVER  
THAT CONVINCED BARBERS**



**WhiskER®**

**COSTS LESS YET DOES MORE!**

Take the word of leading barbers—WhiskER's new thin (.002") clipper blade cuts 1 to 7 day beards (even those other shavers will not touch) clean and close. Operates quietly on 110 v., 60 cycle AC; no TV or radio interference! Fast—14,400 shaving strokes per minute! Women like WhiskER for safely removing superfluous hair on legs and under arms. Get WhiskER at your Barber or Dealer. **ELECTRO TOOL CORPORATION**  
DEPT. 520-M RACINE, WISCONSIN

**If Your Barber or Dealer Cannot Supply You  
USE THIS COUPON TO ORDER**

**ELECTRO TOOL CORP., Dept. 520-M, Racine, Wis.**  
 Encl. find \$15.95 (check, m. o.). Send WhiskER for 10-Day trial (money back if not delighted).  
 Encl. find \$5. Send WhiskER C.O.D. for 10-day trial. I'll pay postman balance plus postage.

Name \_\_\_\_\_  
Address \_\_\_\_\_  
City \_\_\_\_\_ Zo. \_\_\_\_\_ State \_\_\_\_\_

**A FASCINATING, MONEY-MAKING  
art career  
can be yours**

**AMERICA'S 12 MOST FAMOUS  
ARTISTS SHOW YOU HOW!**



**Write Today  
FAMOUS ARTISTS COURSE**

Dept. L-6-Westport, Conn.  
**FREE** Send book about your home study art course.

Name \_\_\_\_\_ Age \_\_\_\_\_  
Street \_\_\_\_\_  
City, State, Zone Number \_\_\_\_\_

## DIESEL MECHANICS NEEDED BIG PAY . . . GOOD FUTURE



If you have no trade or profession that assures you steady employment and top pay through good times or bad, and regardless of whether you want to be a mechanic, technician, salesman, executive — or have

your own profitable shop—you should investigate NOW this opportunity to enter world-famous Bailey Diesel Schools. Prepare yourself, this proven way, for an important place in the fast growing field of Diesel.

### Why Gamble With Your Future!

Your future success depends largely on the reputation of the school you attend. Don't take chances! Train at Bailey's—America's foremost school of diesel training. Approved by Missouri State Board of Education. Approved, also, for G. I. Training. Full details FREE. Return coupon below NOW.

### MAIL TODAY FOR FREE CATALOG

BAILEY DIESEL SCHOOLS  
1656 So. Grand Blvd., St. Louis, Mo.  
Please Send Me Your FREE Catalog.

Name \_\_\_\_\_  
Address \_\_\_\_\_  
Town \_\_\_\_\_ State \_\_\_\_\_  
 Veteran     Non-Veteran  
Resident Training     Home Study



## Learn DRAFTING and BLUE PRINTING!

Both fields offer ambitious men remarkable opportunities for advancement. Neither profession will ever be replaced by machines. Before any production can start, plans must be drawn. Draftsmen are the first to be hired. Blueprints are essential in every shop.

### CLEAR UNDERSTANDABLE TRAINING

Quickly you learn the hows and whys of successful production planning. You are sent professional drafting instruments, drafting table, equipment, etc., at no extra cost. Learn by making actual drawings.

### BIG MONEY . . . ADVANCEMENT OPPORTUNITIES

Offered trained draftsmen. It is light, pleasant work paying big salaries. Drafting is the stepping stone to top managerial jobs. It is work that stimulates the mind . . . keeps one interested.

### A BUSINESS OF YOUR OWN

Either as an independent drafting firm or as the operating head of a business firm producing products you created. Act now.

## MAIL THIS COUPON TODAY!

CHRISTY TRADES SCHOOL, Dept. DB-403  
4432 N. Kedzie Ave., Chicago 25

Mail me at once your big FREE book on Drafting and Blue Printing. Tell me how your Home Training and Professional Drafting Instruments, Drafting Table, Drafting Equipment, etc., can be had on PAY AS YOU LEARN plan.

Name \_\_\_\_\_ Age \_\_\_\_\_  
Address \_\_\_\_\_ City \_\_\_\_\_ State \_\_\_\_\_

## WAR SURPLUS OPTICAL BARGAINS

**BINOCULARS**—An opportunity to own a truly fine pair of American-made Glasses at substantial savings. Light weight, dust-proof, moisture-proof, expertly collimated. Optics low reflection coated. Metal parts chemically treated to prevent corrosion. Sturdy Carrying Case included. Guaranteed for full year against any defects in workmanship or materials. Sold with 10 DAY MONEY BACK PRIVILEGE.

Stock #963-H	6x30	\$75.00	Postpaid
Stock #964-H	7x35	85.00	Postpaid
Stock #965-H	7x50	98.50	Postpaid
Stock #966-H	9x50	99.50	Postpaid

(Be sure to add 20% Fed. Tax)

**10 POWER SPOTTING SCOPE**—A WONDERFUL BUY! Pocket-size! Complete with tripod and swivel head. Only 5 1/2" long—8 1/2" high on tripod. Adapted from Army telescope and worth many times our price. Has prism erecting system, achromatic objective, Ramsden Eye-Piece. Lenses low reflection coated. Stock #955-H . . . \$14.95 Postpaid

**SIMPLE LENS KITS**—Include plainly written, illustrated booklet showing how you can build lots of optical items. Use these lenses in photography and for dozens of other uses in experimental optics, building TELESCOPES, low power Microscopes, etc.

Stock #2-H—10 lenses	\$ 1.00	Postpaid
Stock #5-H—45 lenses	5.00	Postpaid
Stock #10-H—80 lenses	10.00	Postpaid

We Have Literally Millions of War Surplus Lenses and Prisms for Sale at Bargain Prices. Numerous Types of Instruments, Too! Write for FREE CATALOG-H

EDMUND SALVAGE CO., BARRINGTON, NEW JERSEY

## LEARN WATCHMAKING JEWELRY REPAIRING

Start your training now for a better paying job or your own profitable business. Our training is nationally recognized, outstanding and supervised by expert craftsmen. Write for free catalogue.

APPROVED FOR VETERANS

SCIENTIFIC SCHOOL OF WATCHMAKING, Dept. PM-12  
3923 San Fernando Road    Glendale 4, California

## NEW INVENTORS

AVOID  
THESE  
MISTAKES!

New book, MAKING INVENTIONS PAY, shows how to avoid costly mistakes—in dealing with promoters or manufacturers. Tells how to get a good idea, protect it fully. How to make it appealing to manufacturers, test its market, announce it to the public, secure financial backing, solve production problems, etc. How much to ask, how to get patent, copyright, trademark. Gives many fascinating success stories; tells mistakes others made. EXAMINE BOOK FREE for 10 days. Only \$2.95, on easy terms, if you keep it. Write: McGraw-Hill Book Co., Dept. PM-12, 327 W. 41st St., New York 18, N. Y.

## MASTER MIND!



### Learn Short-Cut Mathematics

Juggle figures, do baffling number tricks. Make people gasp at your marvelous lightning-quick mind. Multiply 4 figures by 4 figures without using old-fashioned multiplication! Big cloth-bound volume; fully illustrated course. Includes worked-out problems, answers, etc. Sensational bargain, only \$1.95, postpaid—or COD plus postage. Satisfaction guaranteed or refund. Order this amazing "Short-Cut Mathematics" today!

NELSON-HALL CO., 210 S. Clinton St. \$1.95  
Dept. 2M-2    Chicago 6, Ill. Complete

## 'How to MAKE MONEY with Simple CARTOONS'



A book everyone who likes to draw should have. It is free; no obligation. Simply address **FREE BOOK**

CARTOONISTS' EXCHANGE  
Dept. 912-A    Pleasant Hill, Ohio

## Say You Saw It in POPULAR MECHANICS

"It Measures As It Rolls"

### ROLLER RULE

HANDY MECHANICAL PENCIL

Measures Curves and Straight Lines. Any Shape. Any Distance. Any Surface.

\$1.00  
POST PAID

Roll head over surface. Inches and fractions record accurately on "Inch-O-Meter". Excellent pencil too! Order Now! 10 Day Money Back Guarantee! C.O.D. (postage extra). In Calif. add 3% Sales Tax.

PENCIL SALES CO., Dept. PM12  
Room 6, 1213 E. Ocean Blvd., Long Beach, California



# LEARN MEAT CUTTING AT NATIONAL

Pay After Graduation



The steady dependable trade of Meat Cutting taught easily in 8 short weeks. YOU LEARN BY DOING under actual meat market conditions in big modern school at Toledo.

For beginners or men with experience. Get a profitable store of your own. Remember, PEOPLE MUST EAT! Big pay jobs. Free employment help. Thousands of successful graduates.

Buying, cutting, percentage, pricing, advertising, selling, etc. A complete retail meat education. National School established over 25 years. Get National training NOW. Pay your tuition in easy weekly payments

after you graduate. G. I. approved. Send coupon for FREE 52 page school catalog — TODAY.

**National School of Meat Cutting, Inc., Dept. 50-M, Toledo 4, Ohio**

Send me your FREE school catalog on National Training at Toledo in Meat Cutting, Meat Merchandising and Self Service Meats. No obligation. No salesman will call.

Name \_\_\_\_\_  
 Address \_\_\_\_\_  
 City \_\_\_\_\_ State \_\_\_\_\_  
 ( ) Check here if Veteran of World War II

BUY NOW FOR XMAS. Use Our Lay-Away Plan

**OUT OF PAWN**

**GENUINE DIAMONDS**

Diamonds from estates, banks, unredeemed pledges offered at substantial savings



**SAVE UP TO 50% AND MORE**

Unmatched values in genuine blue white diamonds. Each diamond sold with a written iron-clad money back guarantee. All diamonds set in brand new mountings.

**BERMAN'S DIAMOND LOAN BANK DEPT. P — BERMAN BLDG., BALTO. 1, MD.**

Our reference—your own bank or any mercantile agency.

## BE A PHOTO-ENGRAVER

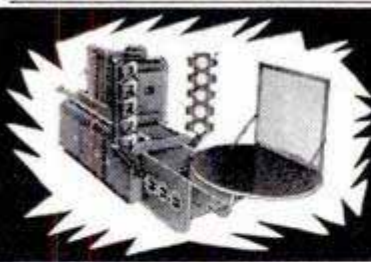

We furnish complete equipment and supplies. Learn at home or in our modern, friendly APPROVED school in MISSOURI. Get into this big demand, high profit, high wage field. You can start your own profitable, full time or part time PHOTO-ENGRAVING business right in your own home.

Be independent, be your own boss or pave the way to a high pay job with experience gained in your own shop.

TASOPÉ TRAINING and TASOPÉ EQUIPMENT has enjoyed world wide recognition since 1931. Write for descriptive literature today. No obligation.

**THE AURORA SCHOOL OF PHOTO-ENGRAVING, DEPT. 9PM., TASOPÉ BLDG., AURORA, MO.**

**NEW! DURABLE! 7 JEWELS!**  
 3 YEAR SERVICE GUARANTEE

- Shock Resist.
- Dust Proof
- Radium Dial
- Sweep Second Hand
- Chromed Case
- Leather Band

**\$6.95** Post Paid  
 Plus 70c tax



Refund if not satisfied. Special! Order Now! Sorry, no C.O.D.'s.  
 LADIES Watch, as above, smaller Size \$7.95 plus 80c tax.

**ELCO PRODUCTS, Dept. 15 166 W. WASHINGTON CHICAGO 2, ILL.**

SAY YOU SAW IT IN POPULAR MECHANICS

*Learn PHOTOGRAPHY at Home*

Splendid opportunities. Prepare in spare time. Practical basic training. Long-established school. Send for free book, "Opportunities in Photography." No obligation.

American School of Photography, 1315 S. Michigan Ave., Dept. 1359, Chicago 5, Ill.

## AERONAUTICAL ENGINEERING



Design Aircraft & Components — Study with Jets & Rockets — Great Future — Advanced Aeronautical Subjects — World-Wide Enrollment — Fully Accredited — Established 1929 — Approved for Vets — CAL-AERO grads in heavy demand.

WRITE TODAY for Special Information. PNE-12

NAME \_\_\_\_\_ AGE \_\_\_\_\_  
 ADDRESS \_\_\_\_\_  
 CITY \_\_\_\_\_ ZONE \_\_\_\_\_ STATE \_\_\_\_\_

**CAL-AERO TECHNICAL INSTITUTE**  
 GRAND CENTRAL AIR TERMINAL • GLENDALE 1, CALIFORNIA

# POPULAR MECHANICS

## Books of Practical Help and Information

Give You Pride in  
Your Work--  
Hobbies, Home  
Improvements,  
Home Workshop.

Now you can have Popular Mechanics famous HOW-TO-DO-IT instruction in permanent, bound form, lavishly illustrated with photos, diagrams and plans. Select from this list of some of the most popular books of all time for workshop fans, hobbyists, home owners—others on skills and trades that make all jobs easier—help you earn more.



Help You  
**EARN MORE**  
on Any Job!

### MONEY-MAKING HOBBIES

Tells how to make hobbies pay their own way, using leather, plastics, wood, ceramics, weaving, metal and paper craft. Illustrated. \$2.00.

### PLANNING YOUR HOME WORKSHOP

Edited by Sam Brown. Shows how to set up a home workshop on a limited budget. Illustrated. \$2.50.

### FORTY POWER TOOLS YOU CAN MAKE

Explains how to make forty different machines, such as lathes, drill press, jig saw, band saw, circular saw, sanders, from pipe fittings, old auto parts, wood, etc. \$1.50.

### YOUR HOME and How to Build It Yourself

One of the most unusual books ever published. Step-by-step instruction by which anyone with ordinary knowledge of use of hand tools can build a five-room house, complete. Profusely illustrated—many plates in color. Spiral bound. \$3.00.

### CONCRETE BLOCK HOUSE

Second of the sensational "Build-it-Yourself" home books. Complete instruction for building a five-room concrete block house for less than \$3650.00. Many illustrations and cover in colors. Plastic bound. \$2.00.

### CHRISTMAS HANDBOOK

An exciting collection of ideas, gifts, decorations, toys, greeting cards, etc., to make at home. Christmas wrappings, hints for hostesses, etc. Illustrated in colors. \$2.00.

### MOTORIST'S HANDBOOK

Packed with helpful, proven articles on operation, service and repair of all cars. \$2.00.

### CONCRETE HANDBOOK

How to do all types of concrete work and make ornamental things of cement. \$2.00.

### WELDING, BRAZING and SOLDERING

How to construct welding equipment and use it effectively. Small arc welder, spot welder, arc torch, tricks of soldering, brazing, heat treating iron and steel. \$1.75.

### PAINTING, FURNITURE FINISHING and REPAIRING

A book for craftsmen and home owners. Covers repairs and finishing, restoring antiques, spray and brush painting. \$1.50.

### BUILD A BOAT

How to build 17 low-cost boats—power, sail or rowboat. Prepared especially for inexperienced builders with limited tools. \$2.00.

### WHAT TO MAKE—Volumes 1 to 11

Popular Mechanics annual Craftsman's Guide. Shows what to make and how to make hundreds of things. Set of 11 books, \$16.50. Single volumes \$1.75 each.

### MONEY FROM IDEAS

A primer of inventions and patents. A must for every man of inventive mind who believes his ideas can be patented. \$2.50.

### FARM MANUAL

Hundreds of articles on making farm implements and equipment, maintaining the home, farm workshop, live stock and poultry, many farm hints and kinks. 284 pages. Hundreds of illustrations. \$3.00.

### PHOTO HANDBOOK

An excellent all 'round guide to better pictures. Features darkroom technique, gadgets to make. \$2.00.

### OUTDOOR SPORTS MANUAL

220 helpful articles and hints for fishermen, hunters, campers, trappers, archers and boatmen. 334 illustrations. \$2.00.

### THE BOY MECHANIC

Describes hundreds of things for boys to do and make. Develops natural talents and industry. Illustrated. \$2.00.

### THE YOUNG CRAFTSMAN

The book that thrills, entertains and trains young minds and hands. Over 450 easy craft projects—things to make—things to do. Hundreds of pictures. \$2.00.

### WHAT TO MAKE FOR CHILDREN

A timely book on making toys, dolls, dollhouses, slides, seesaws, rocking horses and pieces of furniture. 175 easy-to-make things designed to amuse and delight your child. \$2.00.

### GARDEN BOOK

How to build trellises, fences, lawn furniture, outdoor fireplaces, attractive ornaments, etc. \$1.50.

At Leading Booksellers Everywhere or Order by Mail from the Address Below



**Popular Mechanics Press**  
200 East Ontario Street, Chicago 11, Illinois



# CLASSIFIED Advertisements



Advertisements in this section 75 cents per word, each insertion, minimum 10 words, payable in advance  
To be inserted under proper classification, copy must be in our office the 22nd of the  
second month preceding date of issue

F. W. Johnson, Manager, Classified Advertising  
Popular Mechanics Magazine, 200 East Ontario Street, Chicago 11, Illinois

## YOU'LL PROFIT

By reading and answering the classified ads in this section. Hundreds of opportunities for you to make and save money

### AUTOMOBILES, MIDGET CARS

**LONDON** And Paris 1950 Automobile Show numbers. London Times Motor Industry 75c. 3 separate issues Motor—\$1.00. 3 separate issues Autocar \$1.00. L'Automobile Salon 60c. France Illustration Salon \$1.75. Automobila Salon 90c. Send for complete list. The International News Company, 131 Varick Street, New York 13, N. Y.

**FLOYD Clymer's** new antique automobile book Treasury of Early American Automobiles—Published by McGraw-Hill. foreword by James Melton, 224 large pages, 500 illustrations. New York-Paris, Indianapolis, Vanderbilt races, Glidden tours, cartoons, songs, early motoring styles, costumes, Gasoline, steam, electric, spring driven automobiles illustrated, described, 1600 American automobiles named. Latest, finest largest, most interesting book ever published automobile history, illustrations never before shown. Beautiful cloth binding, attractive colored cover. Wonderful gift, \$5.00 postpaid. A. Clymer, 1268 S. Alvarado, Los Angeles 6, Calif.

**WIGLESWORTH-Chasteen's** Automobile History Scrapbook #1. Just published! Over 250 ads and illustrations of antique and vintage automobiles—all new material. \$1.50. Wiglesworth-Chasteen, 7134-P4 Alhambra, Mission, Kansas.

**WORLD'S** First economical gas turbine jet engine for automobiles. Wow for hot rods. Custom built. Literature 25c. Plans \$10.00. Dealers wanted. Jet Engine Co., St. Augustine, Fla.

**SPECIAL** Racing Cars and Hot Rods of the World book, 160 photographs, charts, drawings. Complete mechanical information cars of all nations. Supercharging, engines, suspension, transmissions. Postpaid, \$1.50. A. Clymer, 1268 S. Alvarado, Los Angeles 6, Calif.

**RACING** Equipment from California—Speed-dress-up accessories for every make passenger automobile. Also, racing ignitions, carburetors, flywheels, camshafts, water injectors, mufflers, crash helmets, jet engines—thousands of items in stock! Dual manifolds (for "Jeeps" to "Rockets"), finned hi-compression heads, covering 155 makes, models. Big "1951 Illustrated Catalogue"—plus, "Driving Economy"—25c. (Dealers, request wholesale catalogue). Newhouse Automotive Industries, 5805-B7 East Beverly, Los Angeles 22.

**1950 INDIANAPOLIS** Race Official Yearbook by Clymer. New larger, better than ever, 112 pages, 300 photos. Articles by famous authorities. Technical information, feature stories, driver histories, cartoons, newsy comments. The "bible" of Indianapolis racing. \$1.50 postpaid, Fabrikoid bound deluxe edition \$3.00. A. Clymer, 1268 S. Alvarado, Los Angeles 6, Calif.

**AUTOMOTIVE** Collectors, mechanics, hobbyists: Now, for the first time, a new and growing non-profit organization provides old car literature, new car information, engineering papers, shop manuals, glossy photos, data books, free magazines. Write today and get on free mailing list. Auto Maniacs Inc., Stockbridge, Michigan.

**SOUPING** The Stock Engine. Explains the 5 paths to power, covers all engines from road to track, effective speed tuning theories, tells why and how, 150 photos, charts, drawings, fuels. All new. Postpaid \$2.00. A. Clymer, 1268 S. Alvarado, Los Angeles 6, Calif.

**"SPEED** And Power" Handbook—128 enameled pages! Covers all makes of cars! Fifty breathtaking chapters. Including jet propulsion, racing frames, wheel geometry, dynamometers, reciprocating masses, gear ratios, dual pipes, fuel formulas, porting, balancing, lowering, relieving. Authentic, direct from California! Shows exactly how to build your own dual manifolds. Superchargers. Hot cams. Water injectors. Hi-compression heads. Mileage devices! Save, save! Get up to ten more miles per gallon, racing speed, lightning acceleration. Get dynamic power increases from any passenger automobile! Build fast stock cars. California roadsters, 160 m.p.h. rods! Includes construction drawings! Tuning techniques! Speed tricks! Economy secrets! Ingenious formulas! Plus California customizing, photographs, diagrams. Newest ideas. Conversions. Re-styling all makes. Also, big Speed Equipment Picture Catalogue. Plus Alcohol Injection. Plus 36 page Economy Handbook. 300 illustrations. Five items \$1.98 postpaid. Newhouse Automotive Industries, 5805-B2 East Beverly, Los Angeles 22. See page 32.

**SEE** Our ad under Motorscooters for midget car bargains. Midget Motors Directory. Athens, Ohio.

**SPEED** And Mileage Manuals. World famous Power Digest shows how to double your power, gas mileage, get terrific acceleration! Covers all cars. Shows simplified speed tuning, souping, racing tricks, customizing, economy secrets, hot rod plans, championship methods! Covers racer construction, California roadster building, sports conversions, engine rebuilding, frames, fuels, formulas, ratios, charts, Indianapolis tips! Shows easy ways to build speed equipment, superchargers, dual manifolds, high compression heads, dual mufflers, racing cams, water injectors, economizers! Reveals 100 ways to save gas. Also covers California custom restyling, streamlining, lowering, sport changes! Diagrams! Photographs! 320 illustrations! Beautiful manual plus Speed Equipment Catalog plus California Hot Rod Handbook. Three books \$1.98. Guaranteed. Almuist Engineering, Dept. 61P, Milford, Pennsylvania.

**CHEVROLET** Owner's Handbook. Complete data servicing all Chevrolet cars, 1929 to 1950 inclusive. Powerglide. Postpaid \$1.50. A. Clymer, 1268 S. Alvarado, Los Angeles 6, Calif.

**SPORTS** Car Engine Book. Complete information speed tuning, design, maintenance. Postpaid, \$1.50. A. Clymer, 1268 S. Alvarado, Los Angeles 6, Calif.

**NEW** Sensational seat cover. Mono, 6545 Santa Monica Blvd., Hollywood, California.

**SPEED** Equipment for Fords, Chevrolets, Willys, Studebaker, Lincoln. New illustrated literature and instructions \$1.00. R. & R. Mfg. Co., Box 546A, Anderson, Ind.

**"WATER** Injection". Also speed, power, economy methods. Free illustrated information. Neher Industries, La Verne, California.

**CALIFORNIA** Custom accessory headquarters. Buy direct from original designers and save. Chrome dash panels, solid hood sides, grille panels, speed equipment, dual pipes, push button door conversions, chrome motor accessories, fender skirts. 34 page illustrated catalog 25c. Eastern Auto, 3319A South Grand, Los Angeles 7, Calif.

**SILENCE** Overhead-valves, attachments unnecessary. \$2.00. Derderian, Box 542, Sandston, Virginia.

**SMITHYS** Mufflers for all automobiles. Free list. Buck's Auto Parts, Box 1296H, Merced, California.

**FROM** Speedway to roadway! Track-proved hi-speed heads and manifolds now available for your passenger car! No special tools needed! Increase horsepower 25%! Astounding getaway! Free illustrated catalog. Speedsport, 6215P Diversey, Chicago 39.

### AUTO SUPPLIES AND EQUIPMENT

**GASOLINE** Economizer. A precision automatic device that better atomizes gasoline. Better mileage, less carbon, smoother performance, no power loss, better acceleration. Sales representatives, jobbers, dealers—write Horan and Son, 620 Chestnut Street, St. Louis 1, Missouri.

**GET** Extra profits on repair work. Do your own welding. Easy to use. Catalog free. Hobart Welders, Box M-1205, Troy, Ohio.

**TIRES:** (New.) Wholesale prices! Truck, passenger, tractor. Free list. Field Tire Co., Downingtown 3, Penna.

**HYDRAULIC** Jack repair kits. Repair your own. Send for prices. Beerman Machine Works, 430 North Rampart Street, New Orleans 13, Louisiana.

**AUTO** Conversions and parts. Marine manifolds for all engines. Your transmission converted to marine gear, propellers, shafts, struts, couplings, etc. Everything you need for your boat. Money back guarantee. Conversion Parts Company, 278 Adams Street, Boston 22, Massachusetts.

**SEND** For free life membership card—"Water Burners" of America, La Verne, California.

**AUTOMATIC** Devil Dog burglar alarm for autos, tractors, trucks, trailers. Sounds warning instant tampering begins. Simple installation. Written guarantee. Only \$5.00. M. Joyce Distributing Co., 29 Harrison St., Oak Park, Illinois.

**THAW** Your car lock. Clog-free de-icer. Harmless. \$1.00 postpaid. Thermo, 1745 Milwaukee, Chicago 47.

**OFFENHAUSER'S** New catalog available. Send 25c. Complete line of speed equipment. Offenhauser Equipment Corp., 5054-p Alhambra Ave., Los Angeles 32, Calif.

**FREE** Race car sticker, included with big 1951 hot rod and speed equipment catalog showing 1000 speed accessories, Hollywood mufflers, duals, manifolds, cams, heads, all bargains! Complete 25c. Dealers wanted. Almuist Engineering, 65P, Milford, Pennsylvania.

**AMAZING** New automobile water-injector! Send for free information. Standard Products, Box 247, Berkeley, California.

**NEW** Doubleseal insulates sectional overhead doors. Edwards Industries, Dept. 107, 4268 Shenandoah Ave., St. Louis 10, Mo.

**MOTORISTS** Save gasoline by Vacuumating overrich mixtures. Fits all cars. For free particulars write Vacuumatic, Dept. 1687, Wauwatosa, Wis.

**1950 SUPERIGNITIONER:** Starting, pep, mileage \$4.50. EG Mfg., Elmsford, N. Y.

**SPEED Equipment Xmas specials:** chrome exhaust megaphones \$1.55, Hollywood mufflers \$4.50, V-8 duals \$15.90, racing stacks 98c, dual manifolds \$9.95, adjustable tappets \$9.95, camshafts \$29.95, V-8 hi-compression heads \$23.50, finned aluminum \$49.50. Bargains galore! Free racer stickers with big illustrated catalog 25c. Dealers wanted. Almqvist Engineering, Milford 63P, Pennsylvania.

**REBUILD Starters, generators, regulators, batteries.** Introductory manual \$1.00. Modern Technical Manuals, Box 4704, Kansas City, Mo.

**DRIVE Safely—Side window wiper \$1.00 postpaid.** Agents wanted. Park Sales, P.O. Box 73, Forest Park, Illinois.

**BUICK Parts—Enjoy new-car pep and power in your old Buick.** Same day service from world's largest stock of new (not rebuilt) Buick parts and engines. Ship anywhere. Write today. Robertson Buick Co., 1001 S. Wabash Ave., Chicago 5, Ill.

**JUST Out!** Get the largest auto accessory and parts catalog in the world. Over fifteen thousand items, including Hollywood accessories, hi-speed equipment, rebuilt engines; all parts and accessories for all cars and trucks. New, used and rebuilt! We have that hard-to-get-part! Completely illustrated, jam-packed with bargains. Send 25c. J. C. Whitney & Co., 1919 Archer Ave., Chicago 16, Ill.

**AUTO And truck parts.** New and used. Lowest prices. Complete stock. Prompt replies. Babbitt Auto Parts, 2833 Chicago Ave., Chicago 22, Ill.

**NEW And used guaranteed parts** for civilian and army cars and trucks. Largest stock in America. Mail orders. Pioneer Auto Wrecking Co., 734 W. 13th Ave., Denver, Colorado.

**LACHAPPELLES Motor and motor fuel treatment (patented)** stops ping, gives more miles per gallon, more miles per motor. It puts bearings on the pistons. 100,000 miles treatment \$3.00 postpaid or c.o.d. Ferns Products, 8120 Walnut Dr., Los Angeles 1, Calif. (Data sheet on request.)

**NEW Government surplus.** Low voltage circuit tester in steel box cost \$202. Our price \$27.50. Will test batteries, starters, generators, voltage regulators, grounds, short circuits. Wilt Electrical Company, 7829 S. Racine Ave., Chicago 20, Ill.

**CHEVROLET Parts.** Scarce motor, body, sheet metal parts. Grossman Chevrolet, Minneapolis, Minnesota.

**BRUSH Plating outfits** connect to a battery. No tanks or shop required. Free particulars. Gunmetal Co., Avenue J, Decatur, Illinois.

#### AUTO TRAILERS

**BUILD Your own trailer!** Plans for all kinds. Illustrated catalog 10c. Jim Dandy, 125-M, Wausau, Wisconsin.

#### MOTORCYCLES, BICYCLES, MOTORSCOOTERS AND SUPPLIES

**ARMY Motorscooter \$25;** Speedbike motorbike \$15; Motocoot \$30; three wheeled Cushman \$35, Henderson motorcycle \$10, Servicycle \$12, less engines. Engines \$3 up; Smith motorwheel \$10. Four balloon tires \$3. Mailorder only. Send 25c for catalogue Number Thirty-eight, just out, listing these and hundreds of other bargains in new and used midget cars, motorscooters, homebuilders parts, plans, transmissions, engines, war surplus, etc. (35c by first class mail). Midget Motors Directory, Athens, Ohio.

**VELOCETTE Wins 1950 World Motorcycle Championship 350cc class.** Velocette clocked 122.03 m.p.h. at Dry Lakes. MAC Model \$499.50 f.o.b. Los Angeles. Mail order service. Lou Branch Motors, 2019 West Pico Blvd., Los Angeles, California.

**REBUILT Tested 1½ to 3 h.p. engines** for motorscooters, motorbikes, small autos, farms, shops, etc. \$9.00 to \$30.00. Send for catalogue. Cauffiel Motor Industries, Dept. 125, Temperance, Michigan.

**TRES And industrial wheels.** All sizes. Bicycles and accessories. Send dime for list. Cycle Transport Company, 1241 So. Michigan Ave., Chicago 5, Illinois.

**INCONTRA — For bicycle necessities.** New! Fast! Strong! Send postcard today for free folder. P-626 West Eighth, Los Angeles 17, Calif.

**MOTORCYCLE Magazine — Worldwide coverage.** Yearly subscription \$1.00. Sample 15c. Motorcycle News, 5424-A Sawyer, Chicago 25.

**RECONDITIONED Motorcycles and motors.** Chromium accessories. Complete stock Indian parts. Expert rebuilding. Fast service. Indian Motorcycle Sales, Kansas City 1, Mo.

#### AVIATION

**BUILD Knight Twister biplane.** Drawings—\$9.75, 6 pictures \$1.25; racer monoplane drawings \$35.00. Vernon Payne, 1708a Tower Grove Ave., St. Louis 10, Mo.

**PROPELLERS, Plans, supplies, for ice sleds, snow sleighs, air boats.** Catalog 20c. Banks-Maxwell, Box 3301E, Ft. Worth.

**PROPELLERS—For sleds, airdrive boats.** Literature. Standard Aircraft, Box 387, Ft. Worth, Texas.

#### BATTERIES, GENERATORS

**NICKEL Edison batteries.** 37½ to 600 ampere hour sizes. Long unconditional guarantee. Free interesting literature. Hawley Smith Co., Croton Falls 1, N. Y.

#### ELECTRICAL SUPPLIES

**BE Independent, be secure, have your own profitable business—earn \$20.00 and more a day making beautiful, fast-selling lamps at home.** No equipment needed. Illustrated course teaches you quickly. Course, parts catalog, wholesale price list—only \$2. Gearon Co., Dept. 200-B12, 27 S. Desplaines, Chicago 6, Ill.

**LAMPS—Build own originals, parts wholesale, any amounts.** Catalogue 10c. Brown Lamp Co., Box 501, Wellston, St. Louis 12, Mo.

**FREE—Send for new catalog.** Bargains in welders, motors, generators, surplus equipment, or build your own and save. LeJay Company, Minneapolis, Minnesota.

**TRANSFORMERS Lamination, magnet wire, insulation, supplies.** Morton Electrical Service, Maywood, Ill.

**LAMPS—Electrify oil lamps, vases, bottles, etc.** Instructions 10c. Fisher Lamp Supplies, 3825P Eastern Avenue 26, Cincinnati, Ohio.

**LAMP Parts—Sockets, wire, harps, cords, bases, pipes—all parts to build and repair.** 60 page catalog with charts and instructions 25c. Gyro Lamps, 5402P Clark, Chicago 40.

**ELECTRIC Pencil: Engraves all metals \$1.25.** Beyer Mfg., 10511-H Springfield, Chicago 43.

**32 VOLT Appliances—World's largest line.** Catalog free. Haines Corporation, Dept. N, Minneapolis, Minn.

#### WELDING, SOLDERING, PLATING

**200 AMP. Welding generators.** Brand new. \$25.00. Free literature. Thorndyke Mfg. Co., Pipestone, Minn.

**SET up your own profitable welding business.** "Build your own" portable arc welder with low cost generator. Free book tells how. Hobart Welders, Box M-1202, Troy, Ohio.

**ACETYLENE Welding outfits, new, \$45; used \$25; arcwelders \$46.50.** Eagle Welding, Dept. PM, 5085 Broadway, Chicago 40, Ill.

**BUILD Your own 100 ampere electroplating rectifier at a low cost.** Stark-weather, Ottawa, Kans.

**RADIATOR Repairing books, supplies, equipment, gasoline torch.** Write, Curfman Co., Maryville, Mo.

**BUY Direct from factory.** Welding and cutting equipment. All makes of equipment repaired. Established 1913. Box 331, Hamilton, Ohio.

**ELECTROPLATING Salts and rectifiers.** Mirror resilvering and chipped glass nameplate supplies. John Sprinkle, V55, Marion, Indiana.

**RADIATOR Repairing, cleaning, recoring.** How to equip small shop at low cost. Supply sources, trade secrets, instructions. Now only \$3.50 postpaid. Radiator Service, McBain, Mich.

#### MACHINERY, TOOLS, SUPPLIES

**HONES—Ideal sharpening tools imported—Belgian surgical slight imperfections top yellow hard finishing; bottom blue-green soft.** 10 x 2 inch. \$9.95. Targee Company, 7144 Bennett Avenue, Chicago, Illinois.

**CONCRETE Block machines.** Standard sizes. \$39.50. Average 400 daily. Free catalog. Concrete Machine Company, 5129 South Compton, St. Louis 11, Mo.

**CIRCULAR Saw blades: Longer runs without sharpening: 8" diameter, \$2.98.** Satisfaction guaranteed. Van Dick, Little Falls, New Jersey.

**CUT Costs! Make metalworking, farm, home machinery from salvage.** 25c (refundable) brings descriptive handbook. Free information. Kimo, Box 307MB, New York 19.

**BUILD Your own belt sander plans.** Also, flat face pulleys, all sizes. Free literature. Hawthorne Tool Co., Otsego 3, Mich.

**PRECISION Drill press planer.** 3" diameter. Four high speed cutters. \$4.95 postpaid. Clanon, 1355 Fielding, Ferndale, Michigan.

**POWER Hacksaw, 4x4 capacity, 45° swivel vise, auto-lift, auto-shut off, cast iron, bronze bearings \$57.50, motor \$15.00.** Catalog 10c. Montgomery, Inc., 49 Park Place, New York City.

**WATCH Makers lathe, gov't. surplus, complete with motor and foot pedal.** Value \$225.00, like new, \$95.00. Public Sport Shops, 11 S. 16th Street, Philadelphia 2, Penna.

**DRILL Grinder for twist drills, \$2.95.** See ad on page 272.

**NEW! "Automatic-locking" plier.** Free literature. Sarvie Tool Company, Alexandria, Minn.

**ATLAS Mill accessories; slotter, \$82.00.** Vertical head, \$65.00. 6" worm drive table, \$93.00. 4½" dividing head, \$99.00. Catalog 10c. Montgomery, Inc., 49 Park Place, New York City.

**WATCHMAKER'S Lathe with Racine jewelers' lathe motor—foot pedal control for forward and reverse action, \$85.00.** Miller's Sport Shop, Dept. P, 142 North 8th Street, Philadelphia 7, Penna.

**POWER tools, equipment, wholesale prices.** Free bulletin. Homecrafters Cooperative, Grand Rapids 6, Michigan.

**POWER Tools.** Build your own with Lewis castings. Save up to 80%. Complete castings, material and blueprints supplied for 23 woodworking and metalworking tools. 32 page catalog 10c. Write today. Lewis Machine Tool Co., 3217 Union Pacific Avenue, Dept. M, Los Angeles 23, Calif.

**LOST Wax casting process equipment.** Southwestern, Box 3506, Station A, El Paso, Texas.

**CHUCKS, Independent, universal; threaded 1½"-8, 1"-8, 1"-10, 1"-12, or with adapter recess.** Other chucks to 16" diameter. Write for quotation and free literature. No obligation. Westcott Chuck Co., 3600 Walnut, Oneida, N. Y.

#### ENGINES, MOTORS, DYNAMOS

**MOTORS ½ Horse \$15. ¾, \$22. 1, \$35.** Compressors, \$17.50. Other bargains. State your needs. Butler, 1885 Milwaukee, Chicago 47.

**MOTOR Winders, free bulletins, winding and testing equipment.** Motor Industries, Quincy, Illinois.

**ICE-SLED Engines, small airplane radial type.** Write for descriptive literature. Gaare Supply Co., Box 277, Weatherford, Texas.

**WINDING Data, listing 225 motors, single and three phase, \$1.00.** Motor Data Co., Box 7631, Kansas City 3, Mo.

#### BOATS, OUTBOARD MOTORS

**SAVE ¾ Cost.** Assemble your own boat. We furnish parts. No experience necessary. Rowboats, cruisers. Illustrated catalog 25c. Midwest Boat Company, Menomonee Falls, Wisconsin.

**COMPASSES, AAF magnetic, \$4.95.** Compass, master navigators, D-12, read vertically, 6" face, \$11.95. Navigators sextants, Fairchild, w/wood case, used, not guaranteed, \$5.95. Fuel, oil tank w/filler cap (4.1 gal.), \$2.95. 10% for shipping. Aero Parts Supply, 8102 Lockheed, Houston, Texas.

**BOATING men save time and money on marine engines, outboard motors, conversion parts, propellers and marine supplies.** 15c brings complete listing. Established 1906. Masters, 214 W. Chicago Ave., Chicago 10.

**EXPRESS Cruiser or open utility, 20'.** Prefabricated, Mahogany, oak, bronze. 15 to 40 m.p.h. Easy terms! Complete illustrated information 25c, refundable. Bay City Boats, Inc., Bay City 212, Michigan.

**FREE Illustrated folder and literature** describing Sea Craft, famous 25 ft. cabin cruiser you can build yourself. Sleeps four people, fully seaworthy, cruises at 15 knots with converted auto engine. Complete with galley, fresh water tank, sink, toilet and spacious cabin interior. Save hundreds of dollars—use Popular Mechanics blueprints and step-by-step instructions. Popular Mechanics Press, Dept. BP, 200 E. Ontario St., Chicago 11, Ill.

GET Our big 224-page low priced marine hardware and boat equipment catalog. Send \$1.00 to cover packing and mailing; refunded with first order. Garland Frasher Marine Sales, 540-J 31st St., Huntington, W. Va.

BOAT Plans, patterns, kits. Thirty designs. Descriptive folders 10c. Boat construction book, \$1.50 value, 50c postpaid. Germain Boat Company, W. Saginaw 3, Michigan.

KNOCK-DOWN Boat kits. Outboards, inboards, sails, hydroplanes. Easy to assemble. Minimum cost. Catalog with specifications, prices, 25c. Brooks Boat Company, Carrollton, PM, Michigan.

BUILD Your own—Three point racing hydroplanes, others. Illustrated catalog 25c. Champion Boats, P.O. Box 7132 D, Long Beach, California.

TWENTY Plywood boat plans \$1.00. Catalog boat building plans 10c. The Rudder, 15 Murray Street, New York 7.

STEERING Wheels, windshield brackets, from \$6.95. Modern fittings, water skis at lowest prices. Complete pre-cut plywood boats. Bargains galore. Folder 10c. Marine, Box 681, Mendota, Minnesota.

OUTBOARD Motor bargains—\$35.00 up. Send for free list! Save big money! Used parts for most makes and models. Crandall-Hicks, 911 Commonwealth, Boston, Mass.

CONVERT Fords and Jeep to 100% marine engines with Osco's world famous Convo-Kits. Deluxe catalogue 25c (coin). Oscomotors, 3627B Lawrence, Philadelphia 40, Penna.

P38 BELLY Tanks, steel, \$9.95. Free picture. Bucks Auto Wrecking, Box 89, Merced, Calif.

NEW, Used, rebuilt marine motors. Marine conversions, fittings. Free catalog. Stokes Marine Supply, Dept. 24, Coldwater, Michigan.

MARINE Conversions for Ford and Jeep engines. Catalog 10c. Lehman Manufacturing Company, Department D, Newark 2, New Jersey.

FULL Size, cut to shape boat patterns, blueprints, 7½-38 feet. Illustrated "Build a Boat" catalog, 25c (coin). "How to Build Boats" book, \$1.00. PolyWog houseboat plans \$10. Marine catalog \$1.00. Marine Specialty Mfg. Co., 3107 Detroit Ave., Cleveland 13, Ohio.

### ATHLETIC EQUIPMENT, BODY BUILDING COURSES

MASTER Enemies! Learn fierce, wrestling "Judo"! Complete course \$1.00. University Publications, 615 Davis, Evanston, Illinois.

MASSIVE Proportions, barbells, personal course. Catalog 50c. EG, Elmsford, N. Y.

TALLER! Be one to three inches taller. A new scientific method for permanent height increase has now been developed. Free information. Natural Methods, Box 453, Briggs Station, Los Angeles.

DEADLY Judo—Fiercest fighting technique. Trick knockouts. (Over 200 illustrated pictures.) Expert instructions; three volumes. Complete \$2.25. Variety House, Box 46-B Wall Station, New York 5.

BARBELLS, Exercise equipment. Courses. Free booklet. Good Barbell Co., Reading, Penna.

### TAXIDERMY

MODERN Taxidermist Magazine, Greenfield Center 2, N. Y. Devoted entirely to taxidermy, photos, articles, methods. Trial year's subscription, \$1.00.

### BINOCULARS, TELESCOPES, MICROSCOPES, MAGNIFIERS

NIGHTVISION Tube \$14.95 with instructions. Snooperscope book \$1.50. Infrared filters 15c. Catalogue-data 10c. Precise, 942 Kings Highway, Brooklyn 23, N. Y.

IMPORTED Binoculars, save 75%. Catalog free. Far Eastern, 2251 West Pico, Los Angeles 6, California.

SAVE 50% On new binoculars! Free catalog. Free book, "How to Select Binoculars." Write today! Bushnell's 43-M-12 Green, Pasadena 1, California.

MICROSCOPES. Pocket pen type, 20 power, \$2.95, 40 power, \$4.95 postpaid. Pocket pen telescope, 6 power, coated lens, \$9.95. Public Sport Shops, 11 S. 16th Street, Philadelphia 2, Penna.

BRAND New, imported 6x30 precision binoculars \$24.00. Others amazingly priced. Folder, pricelist free. Prentiss Importers, 226 Mercury Building, West Los Angeles, Calif.

SAVE 50% On new binoculars! Free catalog. Free book, "How to Select Binoculars." Write today! Bushnell Importers, 43-M-12 East Green, Pasadena 1, California.

WAR Surplus bargains, binoculars, telescopes, sextants, millions of lenses, prisms, reticles, eyepieces, objectives, etc. Mail 10c for big catalog CH. Send \$1.00 for Stock CH—10-piece lens kit and big instruction booklet. Edmund Salvage Co., Barrington, N. J.

REFLECTOR Telescope kits, refractors. Free illustrated bulletin. Rake Instrument Laboratory, 612 Adams, Hoboken, N. J.

WEATHER Instruments for amateurs. Send 10c for catalog. Science Associates, Philadelphia 8, Penna.

ASTRONOMICAL Telescopes, binoculars, microscopes, bought, sold, repaired. Books. Lists 10c. Rasmussen-Reece, Amsterdam, N. Y.

BINOCULARS, Telescopes, watches, guns. Buy, sell, trade. Schweer's, Donnellson, Iowa.

GIANT Astronomical telescope with 6 ft. tripod \$15.00, f.o.b. factory. 100 power. (10,000 area magnification). Clear vision, full power guaranteed. Ready for use. Suffolk Science Service, Dept. BT, Riverhead, N. Y.

REFLECTING Telescopes, 60X, completely assembled \$25.00. Guaranteed observatory clearness. Free information. Skyscope, 475 Fifth Avenue, New York 17.

TELESCOPES, Binoculars, microscopes, big bargain catalog free. Brownscope Company, 24 West 45th Street, New York.

POWERFUL Astronomical telescopes easily made. Perfect lenses and instructions; 100X \$3.00; 100X and 200X \$4.00; 100X, 200X and 400X \$6.00. Full power, clear vision guaranteed. Instructions alone 10c. Suffolk Science Service, Riverhead, N. Y.

### SPORTING GOODS, GUNS, FISHING TACKLE, ARCHERY, TRAPPING

NIGHTVISION Tube \$14.95 with instructions. Snooperscope book \$1.50. Infrared filters 15c. Catalogue-data 10c. Precise, 942 Kings Highway, Brooklyn 23, N. Y.

ARCHERS: Make your own bow this winter for next summer's enjoyment. Instructions, 35c. Coggiola, 4761 Broadway, New York City.

CROSSBOWS: \$39.95 Up. Free literature. Schmidt, 1511 Gardner St., Hollywood, Calif.

FISHERMEN—Make your own sinkers with our molds. Free illustrated booklet. Reading Instrument Co., Box 78, Reading, Penna.

BLACK Mink trappers bait \$1 per jar postpaid. Kenyon Mfg., Ortonville, Minn.

GUNS, Ammunition lists, best ever 25c. Frank Parish, Vicksburg, Miss.

ANTIQUE, Modern guns. Bargain list 10c. Martin Rywell, Harriman, Tenn.

"FREE" Crow hunting information, calling, decoys. Toad Woodward, Lamar, Missouri.

AAF Helmets aviators (caps), gabardine, w/ear flaps, postpaid, 75c. APS, 8102 Lockheed, Houston, Texas.

ANTIQUE Firearms, accessories and parts. Illustrated lists for year \$1. Weisz, 100 South Uhle Street, Arlington 4, Va.

DON'T Suffer. Use plastic innersoles, boots, shoes. Washable. Send \$1.00 for 3 pair with size. Independent Sales Service, 5518 First South, Seattle 8, Washington.

RELOAD Used rifle and pistol cartridges, or shotshells at savings up to 80%. Produce safe, accurate loads, using 144 page Ideal Reloading Handbook #36. Send 10c. (Limited offer). Lyman Gun Sight Corporation, Dept. 7, Middlefield, Conn.

LEARN Gunsmithing—Write for free information, or send 25c for copy "Guns and Gunsmithing" plus our 50 page gun catalog. Gunsmith's Service, Palatine, Ill.

SEND 10c For list either rifles, shotguns, handguns, or send 25c for all lists. Frayseth's, Willmar, Minn.

TENTS, Camping equipment. Ideal Xmas gifts. Low prices. Free catalogue. Morsan, 10-19R 50th Avenue, Long Island City 1, N. Y.

FREE Catalog—Glass fishing rod kits. America's largest selection. Anyone can build them—ideal Christmas gifts. Simple illustrated instructions. Write today. Dept. Z, Trimline Tackle Co., 508 Tinton Ave., New York City 55.

RIFLE Stocks: Laminated and regular, blanks and semi-finished. For Enfield, Springfield, Mauser, etc. Banks-Maxwell, Box 3301E, Ft. Worth.

MOLDS. (For fisherman's sinkers, squids, jigs and lures.) Handled and hinged. Quality fishing tackle. Free catalogue. E. L. Sweet & Son., Tonawanda, New York.

190 PROFUSELY illustrated pages antique and modern pistols, swords, daggers, armor, etc. 50c. Robert Abels, A860 Lexington Ave., New York 21.

5000 BARGAINS. Firearms, binoculars, war relics. Catalog 40c. Smith Firearms, Runnemed, New Jersey.

### PETS—DOGS, BIRDS RABBITS, HAMSTERS, ETC.

"TREATISE On Breeding and Raising Canaries"—\$1.00. American Canary Magazine, 3449 North Western Ave., Dept. PM, Chicago 18, Illinois.

SOUTH American chinchillas, young pairs, bred pairs, guaranteed. Three Circle Ranch, Box 1275, Huron, South Dakota.

RAISE Guinea pigs. Money makers. Booklet free. Taylor, B426A, Hapeville, Georgia.

BEAUTIFUL Pure white pedigreed police puppies. Ansonia Kennels, Mose, N. Dak.

HAMSTERS—Best breeding stock available, \$3.00 pair. Buy from us and save high advertising costs. Write for free information. Lakeview Hamster Colony, Newfield, N. J.

BRED Female mink. Booklet, pen plans, \$1.00. Lake Ontario Mink Ranch, Gravel Road, Webster, N. Y.

HAMSTER Special—One pair hamsters with 80 page instruction manual, market list and folio for \$3.50 f.o.b. Waterford. Free information. Pat's Hamster Farm, Waterford 3, N. J.

HAMSTERS—Send \$3.00 for pair virgin breeders and illustrated instructions. Pair and cage \$5.00. Free prices. Dixie Hamstery, 502-C Trinity Lane, Nashville 7, Tenn.

FREE Book. Quick money raising Angora rabbits. Gives markets, profit opportunities. Wilson, Stanton 17, California.

RAISE Pedigreed rabbits for us. We buy all you raise. Literature free. Grinsteeds, Edwardsville, Illinois.

MAKE Big money! Raise Chinchilla rabbits. Cash markets supplied for your production. Write today! Rockhill Ranch, Sellersville 15, Penna.

EARN Up to \$400 monthly. Raise Angora rabbits! Experience unnecessary. Wool brings \$5 pound. Plenty markets. Folder free. White's Rabbitry, Newark 38, Ohio.

SPORTSMEN: 200 Pointers, setters, straight cooners, combination hunters, rabbit and fox hounds. Reasonable. List free. Ramsey Creek Kennels, Ramsey, Illinois.

A Practical beginning to successful rabbit raising. 48 page illustrated booklet. Dime. American Rabbit Breeders Association, 36 AR & CBA Bldg., Pittsburgh, Penna.

INCREASE Your income by raising domestic rabbits. Small space needed. Ready market for delicious meat, fur and wool. Largest magazine in the industry tells you how. \$1.50 per year. Sample 15 cents. No stamps. Small Stock Magazine, Lamoni 20, Iowa.

MINK Raising information free. Complete. Lake Superior Mink Farm, Superior, E.E. Wisconsin.

### FARMS, FARM LANDS, REAL ESTATE

BIG Free winter catalog! Farm and country real estate bargains, good pictures, many states, easy terms, feed included. For special service, state requirements, desired location. United Farm Agency, 220-PM South State St., Chicago 4, Ill.

FLORIDA—Hunting, fishing, fruit growing, 5 acres, \$245.00. \$10.00 down, \$10.00 month. G. B. Potterfield, Union Building, Charlottesville, W. Va.

STROUT'S Catalog—Farms, homes, country businesses. World's largest! 3029 outstanding bargains, 31 states. Mailed free. Buy now and save thru Strout, 7 So. Dearborn St., Chicago 3, Ill.

FLORIDA. Beautiful homesites in new Lake County development, \$245 at \$10 monthly. Near Ocala National Forest, many pretty lakes, streams, pavement. World's best bass fishing, wonderful hunting. Folder free. Howard Vernor, DeLand, Florida.

\$5.00 MONTHLY Buys 40 acres near town; price \$200. Free list. Box 425-P, Carthage, Mo.

**GOOD Farms—Ranches.** Washington, Minnesota, Montana, Idaho, Oregon, North Dakota. Dependable crops, favorable climate. Write for literature, lists describing typical farm opportunities. Specify which state. J. W. Haw, 119 Northern Pacific Ry., St. Paul 1, Minn.

**HOMESITES \$300**—Convenient payments. California's finest garden section. On Morro Bay's scenic shores. Wonderful fishing, hunting, boating, bathing. Fertile soil, softest water, temperate climate, congenial community. Free literature. Richard Otto, Department M, San Luis Obispo, California.

### POULTRY, FARM SUPPLIES

**KNOW** How to raise poultry for profit. Read Poultry Industry. Every issue packed with helpful hints and practical suggestions. Latest articles on breeding, feeding and management. Subscribe now, 1 year 65c. 2 years one dollar, foreign subscriptions \$1.00 a year. Poultry Industry, Dept. P.M., 376 Boylston St., Boston 16, Mass.

**EARN \$4 To \$12 hourly.** Chick sexing, turkey sexing, culling and caponizing. G.I. approved. Pilch's School, Box SSC-10, Thompsonville, Connecticut.

**RAISE** Turkeys the new way. Write for free information explaining how to make up to \$3,000 in your own backyard. Address—National Turkey Institute, Dept. 3, Columbus, Kansas.

**POULTRY** Farmers, broiler growers, turkey raisers read the new American Poultry Journal for latest ideas and greater profits. 12 months, 50c. Special offer, 4 years, \$1.00. American Poultry Journal, 562 South Clark, Chicago.

### PROFITABLE OCCUPATIONS

**TURN** Your spare time into cash. Make quick-selling, highly profitable lamps—every home a prospect. No experience or special tools required. New 1950 56-page illustrated catalog shows shades, shade frames, figurines and bases, oil lamp converters, boring compounds, and dozens of similar items. Also all kinds of sockets, cords, pipes, harps, finials, bases, and hundreds of other parts—everything you need. Special 8-page section shows 6 beautiful lamps in kit form ready to assemble. You buy wholesale, sell at retail—make big profits. Hundreds doing it. You can, too. Send 25c today for catalog and wholesale price list. Refundable first order. Gearon Co., Dept. 500-B12, 27 S. Desplaines, Chicago 6, Ill.

**\$5 HOUR Easy!** Sell name plates for houses. Free sample, order blanks. Write: National, 214 Summer, Boston, Mass.

**RAISE** Pheasants on the \$100 week plan. Little capital and space can make you independent. Free details. Great Central Game Management System, Columbus 1, Kansas.

**WANT A diesel job?** Our approved, up-to-the-minute diesel training program can help you qualify for steady, big pay jobs or specialized military training. Covers diesel, tractor, heavy equipment. Easy to master. No loss of present income. Job placement advisory service. Investigate! Write for information today. Interstate Training Service, Dept. 3N, Portland 13, Oregon.

**JIGSAW** Owners attention! Start earning money at home cutting out wooden novelties and souvenirs. Write H. Cook, Dept. A, 4407 S. Normal Ave., Chicago 9, Ill.

**LEARN** Arc welding at low cost in non-profit school. Easy to learn in short time. V-A contract. Write for free book. Hobart Trade School, Box M-1203, Troy, Ohio.

**ALASKA**—America's frontier. \$1.00 brings 1951 business directory, large government map giving up-to-date construction projects, current employment information, homestead and highway facts; hunting, fishing, game rules; firm's hiring and application forms. Alaska Opportunist, P.O. Box 883-P, Hollywood 28, Calif.

**FREE** Book "How to Make Money With Home Workshop" describes amazing methods used by hundreds of successful craftsmen. Tells what to make, how to sell workshop output spare time. Write at once for details. Remember it's free! Craftsman, 115-A12 Worth St., New York City.

**FOREIGN** And Latin American employment. 1951 "Foreign Service Directory" gives up-to-minute facts on military and civilian construction, government jobs, major oil listings, aviation, transportation, steamship lines, mining, importers, exporters, how-when-where to apply, application forms, hot list firms hiring. \$1.00 postpaid. Global Reports, P.O. Box 883-P, Hollywood 28, Calif.

**RESILVER** Mirrors at home. Formula 25c. Ideal Service, Park Ridge 9, Illinois.

**\$250 WEEK** Reported! Free book "505 Odd, Successful Businesses." Work home! Expect something odd! Pacific-E. Ocean-side, California.

**50,000 FULLFASHION** Nylons, rayons, cottons, 8c pair, up. Sample razor blades, complete stock list, 25c. Sibert Co., Chattanooga 4, Tenn.

**FOREIGN** Employment. Construction men, building trades, mechanics, helpers, office men. Good workers interested in foreign development projects. Pipe lines, dams, power plants, roadways, shipping, oil refineries, etc. Transportation and quarters furnished: High wages. Listings of firms actively working on projects in Arabia, Persian Gulf, Africa, Alaska, Canada, South America, Europe, etc. Send \$1.00 for Foreign Construction Compendium and application forms, Foreign Service Bureau, Dept. PM12 Employment P.O. Box 295, Metuchen, N. J.

**MUSHROOMS** Grown boxes, barrels, instructions 50c. Spawn \$1.00. Manureless process. \$2.00. Gordons, 553 William, Winnipeg, Manitoba.

**YOUR** Own fertilizer factory! Domesticated earthworms and garbage, other wastes only requirements. Booklet 10c. Avere, 112-D Elizabeth, Wichita 12, Kan.

**WONDERFUL** Opportunity to make big money, no experience needed. Post card brings details free. G. & G. Adv., Box 175, Blue Lake, Calif.

**"FROG Raising!"** New book tells how! Illustrated literature free. Mariboro-A, Box 7002, New Orleans 19, Louisiana.

**CANDY-Making.** Well paying home business. Amazing instruction course with formulas. \$1.00 postpaid. Neiko, Box 3462-C, Chicago 54, Ill.

**TYPISTS,** Profitable business at home. Complete copyrighted information 50c. Rosdahl Industries, 4901 Elston Avenue, Chicago 30, Illinois.

**HAVE Fun!** Make money! "Working With Leather"—64-page booklet tells how. Send 25c for copy. Free catalog and valuable information included. Wilder-Graft, 1039 Crosby, Chicago 10.

**MAKE** Flexible molds! Cast plaques, bookends, figurines! Free sample! H. Tooker, 630-M Chestnut, Hamilton, Ohio.

**LIFETIME** Income as notary public. Appointment assistance. Stationers, Heites 50, Texas.

**RAISE** Fishworms. Easy, profitable. Send 25c in coin for complete instructions. Huffman Worm Ranch, Rives Junction 2, Mich.

**BE** The Popular Mechanics representative in your neighborhood and earn big profits in your spare time. Write Popular Mechanics Magazine, Room 408M, 200 E. Ontario St., Chicago, Ill.

**\$46 FROM** Square foot plywood; jigsaw necessary. Write, Woodarts, P-38, Bridgewater, Mass.

**\$40.00 WEEKLY** Made growing mushrooms, fresh, dried. Dominion patent 331583. Free spawn. North American, 169P Yonge, Toronto, Canada.

### BOOKS, PERIODICALS, PICTURES POSTCARDS

**SAVE** Money. Rent books from us. Latest fiction, non-fiction. Catalog 10c. Santens, 2700-A Ann, St. Louis 4, Missouri.

**WHAT** Every Mason wants. We have Masonic books for Blue Lodge, Chapter, Commandery, Scottish Rite and Shrine. Our rituals are used the world over. Send for free catalog of books and rituals for Masons, Odd Fellows, Knight of Columbus, etc. Ezra A. Cook, Publisher, P.O. Box 796-PD, Chicago 90, Ill.

**BOOKS,** Out-of-print. Hard-to-find. Banker Book Co., Dept. 45, Sherman Oaks, Calif.

**HARD-To-Find** Books supplied. Send wants. Pierce's, Winthrop, Iowa.

**RARE,** Ancient Weekly "Scientific American," science, mechanics, inventions; w/many illustrations, Years 1873-73-74; per copy \$1.00; four, \$3.00. Bartholomew, 8102 Lockheed, Houston, Texas.

**BOOKS,** Old, rare, otherwise; catalog, 10c. Ed Bartholomew, 8102 Lockheed, Houston, Texas.

**"INSTALL** And service oil burners." Photo-illustrated instruction book. Originally \$5.00. Now only \$1.00 postpaid. No c.o.d. Delta Heating Corp., Jackson Heights, New York.

**GENERAL** Fiction, two used books, our selection, \$1.00 postpaid! Bartholomew, 8102 Lockheed, Houston, Texas.

**FARMERS** And owners of all livestock—Do you want to save money in taking care of your animals? Send for amazing new book Veterinary Guide for Farmers. New facts on the diagnosis, treatment and prevention of diseases of farm animals. Authoritative, easy-to-understand and guaranteed to satisfy you or your money back. Postpaid \$3.50. Windsor Press, 200 E. Ontario Street, Chicago 11, Illinois.

**POLICE** Jiu-Jitsu, 50c! Scientific Boxing, 50c. 130 Main, Spring Valley, N. Y.

**SELF-Explaining** Bible: Illustrated circular free. Box 446-P, Minneapolis, Minn.

**LOW** Subscription prices. Free list. Rural Magazine Agency, Grenada, Miss.

**BOOKHUNTERS!** All subjects. Send wants! Jaher Book Service, 620-P East 178 Street, New York 57.

**BOOKS** On every subject. Written in Popular Mechanics famous easy-to-understand style. Profusely illustrated. Subjects include workshop planning and practices, projects, hobbies, household repairs, motor, outdoor sports, photography, home building and many others. Also booklets on specific topics. Illustrated catalog free. Popular Mechanics Press, 200 E. Ontario, Chicago 11, Ill.

### MAGIC TRICKS, PUZZLES, JOKER NOVELTIES

**LEARN** Ventriloquism. Free information. Dummy catalogue 25c. Maher, Box 36-M125 Kensington Station, Detroit 24, Michigan.

**MAGIC**—Hundreds of famous professional secrets of magic are yours at low cost. Profusely illustrated—"How-to-do-it" pictures. Interesting literature free. Sultz, Box 303, Silverton, Oregon.

**MAIL** 25c For magic catalog latest tricks. Lerro's Magic, 509 80th Street, Brooklyn, New York.

**584 PAGE** Catalog. 7500 novelties, jewelry, funmakers, gadgets, hobbies, sports, tricks, jokes, timesavers, radios, animals, music, guns, etc. 10c. Johnson Smith Company, Dept. 314, Detroit 7, Michigan.

**LIGHTNING** Bolts from fingertips. Simple. Complete instructions \$2.00. Majical, 80-A Maxwell, Rochester 11, N.Y.

**JOIN** Our New Magic Club. Send 10c for illustrated catalogue and free particulars. Magic and Fun Mart, 55-Y Prince St., New York 12.

**ESCAPE** From any handcuff. Sensational secrets. Twenty-year professional. Book, \$1.00. Martully, 86 Akron, Westmont, New Jersey.

**200 ELECTRIC** Stunts, 110 volts, \$1. Kutting Sons, Los Altos, Calif.

**FREE** Jokers' item with giant catalog, tricks, jokes, puzzles, 10c. Andersen's Fair, 6815-P Ardmore, Chicago 31.

**500 TRICKS,** New 1950 edition now ready! Send only 10c for your copy, containing latest in good magic for pocket, parlor, stage. Unequaled service to magicians for 30 years. Douglas Magicland, Dept. 1, Dallas, Texas.

**BE** A magician. Large professional magic catalog of latest tricks, 35c. Ireland, C-109 North Dearborn, Chicago 2.

**PROFESSIONAL** Catalog, 124 pages, 25c. Williams, 900 Plymouth, Ellwood City, Penna.

**MAGIC** Tricks, puzzles, books, cards, punch boards. Catalog 10c. Specialty, Box 671, St. Louis 1, Mo.

**512-PAGE** Catalogue of 2500 tricks, pocket, parlor, stage. World's finest magic. Send \$1.50 for catalogue (refunded first \$6.00 order). Kanter's, M-1311 Walnut, Philadelphia 7.

**16 CARD** Tricks and catalog 25c. Sterling Magic, Royal Oak, Mich.

**WORLD'S** Largest professional magic shop. keeps you in touch with latest tricks. To receive mailings, send 50c for new catalog. Holden's, M220 West 42nd St., New York.

**VENTRILOQUISM** Taught, 3c stamp bring particulars. Smith, 801 Bigelow, Peoria 5, Ill.

## COINS, TOKENS, CURRENCY

OLD Money wanted. Will pay \$100.00 for 1894 dime, S. mint. \$50.00 for 1913 Liberty head nickel (not buffalo). Big premiums paid for all rare coins. Send 4c for large coin folder. May mean much profit to you. Numismatic Co., Dept. 20, Fort Worth, Tex.

COIN Collectors new magazine, just out, and two wooden nickels 10c. Lawrence Brothers, Anamosa, Iowa.

100 COINS And bills, \$1.00. Oddehon, Box 482, St. Louis, Mo.

OUR Price list speaks for itself. Fairway Company, Rye, N. Y.

INDIAN Head penny with list, 10c. Charles Banker, Salina, Kansas.

WANTED—Rare coins will pay \$5.00 to \$5,000.00 each. Complete illustrated catalogue 25c. Worthycoin Corporation, 294 Washington (D-314), Boston 8, Mass.

50 ASSORTED Indian pennies, \$1.50; 1892 Columbian half-dollar, 75c; Whitman coin album, 25c; 1863 Civil war cent, 15c; 25 foreign coins, \$1.00; check list, 3c; large catalog, 15c; 100 2 x 2 coin envelopes, 25c. Coin Shop, 31 North Clark, Chicago 2.

COINS Wanted, will pay up to \$2000 for certain coins, send 25c for catalogue. Burton's, 111 So. Third, Columbus, Ohio.

FREE! Foreign coin, banknote and coin collectors illustrated catalog to approval service applicants. Send 3c postage. Tatham Coinco, Springfield 30, Mass.

GET Profit and pleasure in collecting old coins. Send 10c for 56 page illustrated coin catalog. You'll be delighted with it. Send for it now. B. Max Mehl, 370 Mehl Bldg., Fort Worth, Texas. Largest rare coin establishment in U. S. Established 50 years.

COMMEMORATIVE \$1 $\frac{1}{2}$ . Oregon, Texas, Kentucky, Cleveland, Long Island, \$2.00 each. Illustrated catalogue 25c. Norman Shultz, Salt Lake 9, Utah.

## STAMP COLLECTING

LAURELBILT Stamp Collector's Guild membership drive special, 2,000 different world \$3.25. New members only. Long Beach Stamp Company, Long Beach, New York.

FIRST U. S. (1847) government reissues 5c, 10c, plus giant bargain U. S. collection—only 5c to applicants U. S. approvals. Metropolitan, Box 312G, Jackson Heights, N. Y.

ALL Stamps at 1c each. Collection of 10,000 different, divided in 20 \$5 lots each containing 500 stamps. You just buy one lot at a time as often as you like. Each lot delivered as soon as paid for. No contract. No obligation. Real savings. N. V. Robillard, 812 West Vantrees Street, Washington, Indiana.

FREE! Super offer. Complete Armenia set 16 stamps, picturing winged animals. Mount Ararat (landing place of the ark). Fiji map stamp, Borneo monkey stamp, airmails, bicolored, over 100 stamps, with approvals. X. Mounblow, 740 Hegney, Bronx 56, N. Y.

FREE Collection—Over 100 different stamps of the world—commemoratives, she-wolf, camels, giraffes, ships, rare Austria race horse, others all to approval buyers; also Scott International Albums, stamp catalogs. Bell Stamp Service, Dept. S-2, Bell, California.

10 DIFFERENT Sets 10c! To increase our mailing list, we give to new approval applicants the following unheard of bargain in sets: Bohemia castles 2 values complete, Denmark Anderson 3 values, China post office 4 values complete, Ireland Gaelic League complete, Spain Franco 5 values, Uruguay presidents 6 values, San Marino airmail 3 values, Switzerland landscape 6 values, Russia broken chains 2 values, Portugal queen 5 values. All for only 10c. Please state whether approvals shall consist of United States or foreign stamps, or both. Globus Stamp Company, 268 Fourth Avenue, New York 10, New York, Dept. 218.

FREE—Famous Americans set, Flag set, National Parks set, and Presidential set to \$5.00. A total of 90 stamps free to customers for our unsurpassed U. S. and foreign selections. Send 3c for 15 of the above stamps and full particulars. Triboro Stamp Co., 145 Nassau St., Dept. 112, New York.

EXCHANGE Stamps universe. Particulars free. "Exchangers," Bry 126, Seine, France.

FREE! Canadian sets, royal visit, George VI, George V, coronation, jubilee, others to approval applicants. Ensign, Box 118-M, South Orange, N. J.

LOOKING For bargains? Try our 1 and 2c approvals mounted in books of 1,000. We believe in both quantity and quality. First try will satisfy. Clark, Box 544P, Muskegon, Mich.

ZANZIBAR, Pitcairn Islands, Turks, Caicos, Gilbert, Ellice, Solomon, Borneo, Gambia, Tanganyika and others. Complete collection free. Send 5c for postage. Gray Stamp Company, Dept. PM, Toronto 5, Canada.

WHOLESALE Lists to dealers. 3c postage. Grossman, 100 West 42nd, New York 18.

ILLUSTRATED Stamp magazine, 26 weeks 25c. Stamp Journal, Kalamazoo, Michigan.

WURTEMBERG! Serbia! Antioquia! Bonus approvals! Colonial, Box 326A, Passaic, N. J.

307 ALL Different—Only 15c! Beautiful collection: commemoratives, triangles, high values, bicolored stamps, etc. Garcelon, Calais 400, Maine.

POSTAGE Stamps on approval. G. D. Ridings, Dept. D, Melvin Hill, N. C.

TRY Hutch's approval service. Free gifts. Hutchinson's, 3463 "T" Street, Philadelphia 34, Pennsylvania.

PUT This reminder in your "do today." Write to K. Archibald, Railroad Avenue, Taunton, Massachusetts, for a selection of "personalized approvals."

PENNY Approval bargains! Write Department PM, 1267 Tutwiler, Memphis 7, Tennessee.

SERIOUS Collectors—Selections by country at sacrifice prices. References. Book Nook, Oronoco, Minn.

200 CHINA For 10c! Contains giant sized commemoratives; beautiful airmails; amazing \$10,000,000.00 high value; many others. Garcelon, Calais 67, Maine.

101 DIFFERENT Given to approval applicants. Broadmoor Stamp Company, Pittsburgh 34, Penna.

GENUINE Hawaiian stamps, 15 for \$2.50. Helene K. Berman, Kealahou, Hawaii.

FREE U. S. price list, postage 3c. Mark Hanna, 335 5th Ave., Pittsburgh 22, Penna.

FREE—Pictorial set cataloging \$2.14. Approvals. Jay Matthews, Lynbrook, N. Y.

UNITED States approvals. Complete, personalized service. Attractive prices. Fine quality. Patrick Agencies, 3650B Central, Indianapolis 5, Ind.

BARGAIN! Assortment triangles, Borneo, Cook Islands, Swaziland, Mauritius, 10 African pictorials and souvenir. Everything 10c with approvals. Eckman, 2852 S. W. 37 Ct., Miami, Florida.

COLUMBIANS, Trans-Mississippi, Pan Americans, Pan Pacific, ten other different commemoratives. All 10c with your request for U. S. approvals. Moda Stamps, Box 251, C.S.A., New York 8.

UNITED States stamps nearly 100 years old, Roosevelt set, others, 40c value—only 5c to applicants United States approvals. Wakonda, Box 272K, Jackson Heights, N. Y.

GIANT, Pigmy, triangle, other odd stamps free with bargain approvals. Niagara Stamps, Niagara-on-the-Lake 11, Can.

66 STAMPS From 66 different countries 10c. Approvals. Impex, Box 134F, Jackson Heights, N. Y.

100 DIFFERENT U. S. commemoratives, one dollar. Request approvals. Harold Holub, 18 East 198th Street, New York 58, N. Y.

400 DIFFERENT Scandinavian \$1.00. Edgar Kimber, Box 278, Norrkoping, Sweden.

U. S. All different: 100, 40c; 200, \$1.00; 300, \$2.50; 100 commemoratives, 80c. Pat Knowles, 1626 North Harvard, Hollywood 27, Calif.

COMPLETE Roosevelt set, other commemoratives 5c with United States approvals. Locust Stamp Co., Box 390T, Peekskill, New York.

APPROVAL Books by countries. Complete list free. Charles Chase, 152 Court St., Portsmouth, N. H.

FREE "Stamp Finder." Tells instantly country to which any stamp belongs. 32 pages profusely illustrated. Garcelon, Calais 17, Maine.

STAMP Magazine! Copy free! "Stamp Post." South Catalina, Pasadena, Calif.

WHOLESALE List to dealers, 5c. Halay, 132 West 63rd, New York 23.

500 DIFFERENT Stamps—only 25c to introduce our bargain-packed, excitingly "different" approvals! Niagara Stamps, Niagara-on-the-Lake 30, Canada.

50 U. S. Airmails, commemoratives, 25c. Norwood Exchange, 4005 Ivanhoe, Norwood, Ohio.

BIG New 1951 catalog free! 32 pages of bargains. Ewing-Stamps, 109 N. Dearborn, Chicago 2.

FREE Sample newsy, informative stamp weekly. Southern Philatelist, Box 1948, Miami 35, Florida.

WORLDWIDE Mixture! Parcel containing 400 stamps 25c. Garrow, Chula Vista, Calif.

SPECTACULAR Packet with one stamp alone cat. \$1.25, only 10c. Allmendinger, 709 Dover, Philadelphia 31, Penna.

MONACO Nudes set—10c. Approvals accompany. Atlas, 3210-M Republic, Racine, Wisconsin.

WORLD Wide new issue service. McQuesten, 185 Puritan, Detroit 3, Mich.

MIDDLE East stamps, circular free. Arshak, Box 222, Baghdad, Iraq.

GIFT Nicaragua baseball airmails, 5 to approval applicants. Deane Stamps, Box 87, Miami 35, Florida.

FLAG Stamp—Free with hydrate U. S. approvals. Wenigman, 1933 Patterson, Chicago 13.

WORLDWIDE Stamps. All different. 200, 25c; 500, 50c; 1000, \$1.00; 2000, \$2.50; 5000, \$12.50. Beacon Sales, Maynard, Mass.

WONDERFUL Offer 7 complete mint sets Manchukuo, Bohemia and Moravia and Germany, only 10c with approvals. Reich Stamp Co., 4647 Kenmore, Chicago 40, Illinois, Dept. M23.

FREE! 500 Mixture, with 1000 worldwide collection for just \$1.00! Dimond Company, 3152 Cuthbert, Oakland 2, Calif.

GERMANY B257-69, warplanes, destroyers, paratroopers, machinegunners; free with approvals. Will Deems, Ravenswood, West Virginia.

FREE—1,000 Prefolded hinges! Approvals. DiMilla, 72 Scholes, Brooklyn 6, N. Y.

GOYA Nude set complete 50c. Catalogs \$1.55. Approvals. Royal Stamp Company, Tamaqua, Penna.

FREE U. S. catalogue. Over 500 illustrations, for stamps, albums, supplies. Stone, X-52, Dorchester 24, Mass.

FREE 100 Different world, approvals 1c up. Southworth, Weston, Mich.

FREE Beautiful prisoner set. Approvals. Hurt and Posse, Blue Ridge, Virginia.

DENMARK 25 Different free. Request approvals. Knight, Box 3770, Portland 8, Oregon.

100 DIFFERENT Superb Hungary stamps—25c! No approvals. Wethly, 15-F Stegman Court, Jersey City 5, N. J.

1 $\frac{1}{2}$ -1c APPROVALS! 12,000 Bargains! Cole, 43-A Rinewalt, Buffalo 21, N. Y.

25 FRENCH Colonies pictorials 3c with approvals. Potomac, Washington 15, D. C.

100 WORLD 10c. 1 $\frac{1}{2}$ c Approvals. Page-wood, 1355-P No. Dearborn, Chicago 10, Ill.

MOZAMBIQUE Triangulars, unused set 10c with approvals. Vargo Stamps, 6044 South Fairfield, Chicago 29, Illinois.

BICOLORED, Picturesque Clark issue—10c! U. S. approvals. AKM, 3424 Durand, Racine, Wisconsin.

555 MIXED Worldwide plus mint set—10c to approval applicants. Wethly, 15-E Stegman Court, Jersey City 5, N. J.

FREE Albums, catalogues, stamps, etc., to our customers. Ask for details and selection of approvals. Prices, stamps, and service that satisfy mounted in books and sheets—priced from 1/10 to 1/2 catalogue. References appreciated. Roseland Stamp Co., Dept. 10, Spring Lake, Michigan.

50 DIFFERENT Free to approval applicants. Buckeye Stamps, Urbana, Ohio.

FREE! Price list of 10c-15c sets. Floyd Frederick, 513 $\frac{1}{2}$  Green Street, Lancaster, Penna.

1893 BALKANS Packet! Bonus approvals. Brunning, Box 326, Passaic, N. J.

U. S. Mint, used blocks, and plate blocks. Price list free. Lush, 47 Tyler, Detroit 3, Michigan.

199 DIFFERENT—33 countries including 38 19th century; diamonds, airmails, jubilees 10c. Approvals. Brooks, 2352B East 23rd Street, Brooklyn 29, New York.

100 DIFF. U. S. old and new, 25c. Weatherby, Medina, Ohio.

10 ASSORTED U. S. Commemorative 15c. Five U. S. Air Mail 15c. 10 Famous Americans 25c. All for 50c. Ideal Stamp Shop, Box 179, Park Ridge, Illinois.

**REVOLUTIONARY!** Complete miniature sheet free! Knott, 434 East 76th, New York 21, N. Y.

**FREE.** Mexico airmails, mint block; plus Africa, Indies, animals, ships, etc. Approvals. Crystal Stamp Company, Dept. A, Crystal City, Texas.

**GRAND Value packet** containing five foreign sets. Free with approvals. Illustrated bargain lists. Stoll Stamp Service, 2632 Burnett, Louisville 10, Kentucky.

**POSITIVELY Greatest free offer!**—Latest Scott's international \$6.00 stamp album, covering entire world, contains 36,000 illustrated descriptive spaces. Scott's New Standard \$7.00 catalogues "Philately's Encyclopedia"—absolutely free to applicants for foreign approvals becoming customers. Plymouth Specialty Co., Dept. A-9, Box 510, Bell, California.

**FREE!** Powerful magnifying glass. Jamestown Stamp, Jamestown 202, New York.

**WOW!** 203 All different Germany 10c! Zeppelins, semipostals, airmails, high values, etc. to new customers. Jamestown Stamp, Jamestown 512, New York.

**TRY "Gold Nugget" approvals:** U. S., Americas, British Colonies, world. Nothing like them! 312 mixed U. S. only 10c to approval applicants. Kessel's, Folsom, California.

**UNUSUAL—Unheard of.** Cancelled sets of Roosevelts and Washington bicentennials complete. All yours for fifteen cents. Bargain approvals accompanying. Park Stamp Co., Box 191, New York 21, N. Y.

**FREE.** Scott's International Album. Other big premiums. Full particulars with approvals. Raymax, 123-Z William St., New York City 7.

**FREE Gigantic beautiful bi-colored mint U. S. Yorktown stamp** to approval applicants. Mohawk, Box 524, Albany, New York.

**HOW To recognize rare stamps.** Free book—Illustrated! Kenmore, Arlington 74-H8, Mass.

**FREE!** 50 Different Japanese stamps! Approvals. Star Stamps, 225 Willard, Jamestown, New York.

**UNITED States approvals complete coverage, fine quality, attractive prices.** Seminole Stamps, Box 1138-P, Coral Gables, Florida.

**FREE!** Beginner's collection! With lists! Stampmart, Box 2071, Hartford 1, Conn.

**KOREA, Mongolia, Manchukuo, U.P.U., triangle; free packet** to approval applicants. Worthmore, Box 156, Miami 45, Florida.

**WHOLESALE Lists for junior dealers.** Edward Hammond Company, Auburndale 66, Massachusetts.

**GIGANTIC Bargain!** Solomons, Caymans, Dominica, Grenada, Mauritius, Nauru, Gilberts, triangles and multitude others. Everything 10c with approvals. Seeley, Box 483P, Baytown, Texas.

**300 DIFFERENT Given free** with approvals. Postage 3c. Windsor Stamps, 1435 East 67th Place, Chicago 37.

**110 DIFFERENT Hitlers, Roosevelt, Liberia, Haiti, etc. 10c.** Buckey, 208 Ludlow Bldg., Dayton 2, Ohio.

**500 STAMPS For only 10c!** This mammoth value includes airmails, pictorials; stamps from strange countries, cataloging up to 25c each! Also approvals. Mystic Stamp Company, Camden 80, New York.

**500 JAPAN Stamps 10c.** Kenmore, Arlington 74-J4, Mass.

**FREE—Cuba Roosevelt issue** and illustrated catalog. Littleton Stamps, Littleton 12, N. H.

**50 DIFFERENT U. S. 10c.** No approvals. Seidenberg, Box 944, Appleton, Wis.

**10,000 DIFFERENT 1c Each!** Gordon Davison, Box 1019S, Manchester, N. H.

**AMAZING Offer!** 500 United States stamps—including commemoratives, airmails, high values to \$5.00. Only 10c to approval applicants! Illustrated bargain lists free. Mystic Stamp Co., Dept. 80, Camden, New York.

**FREE Philatelic supply list.** Penny approvals on request. Reed, Box 980, Chicago 90, Illinois.

**100 EXOTIC Japan—All different, 10c.** Kenmore, Arlington, 74-K7, Mass.

**PENNY Approvals that satisfy.** Neil Gronberg, Box 5441-P, Philadelphia 43, Penna.

**OLD Scarce U. S. seconds on approval.** Slightly defective. Bargain prices. Hernefield, Clintonhill Station, Newark 8, N. J.

**STAMPS Wanted.** Collections, duplicates, surplus stock, mint and used. Trade for printing; buy outright if bargain. What have you, what's wanted. Vanroy Shirk, Lebanon, Penna.

**200 DIFFERENT** Including Roosevelt triangle, 5c to approval applicants. M. Avallon Stamp Company, Springfield, Mass.

**FREE—Illustrated catalog!** Kenmore Stamps, Arlington 74-C7, Mass.

**ARMENIA.** Ten bicolored stamps, value 75c free to approval buyers. Apex Stamps, Box 2188, Miami 13, Florida.

**200 BRITISH Empire stamps plus valuable publications only 3c.** Kenmore Stamps, Arlington 74-B17, Mass.

**MAGNIFIER.** Big stamp magazine; first U. S. commemorative; plus unused \$5000 Foreign Legion, diamond, giant, and other worthwhile stamps. Everything free to approval buyers. Capital Stamp Company, Little Rock 2, Arkansas.

**WORLD—500 Diff. 50c, 1000-\$1.00, 75 Canada 25c.** Approvals, lists. Victoria Stamp Company, London 4, Canada.

**200 DIFFERENT Stamps 10c with approvals.** 500 mixed United States 25c. Carlton's, Tujunga, Calif.

**U. S. Price list.** Send postage. State Stamp Service, 1225 Park Building, Pittsburgh 22, Penna.

**WORLD'S Largest stamp (7½x14 inches).** A real curiosity! Retail for 50c, only 3c to approval applicants. Tatham Stamp Co., Springfield 30, Mass.

**FREE!** 100 Worldwide different stamps to approval buyers. Big U.S. and illustrated bargain lists sent with approvals. Bookman, Maplewood, N. J.

**LOOK!** 110 Different U.S.—25c. Heier, 608 Marlboro, Brooklyn 26, N. Y.

#### ANTIQUES, RELICS, INDIAN GOODS, CURIOS

**4 PERFECT Prehistoric arrowheads \$1.00.** List free. Lear's, Glenwood, Ark.

**GENUINE Arrowheads, eight, \$1.00; 20, \$2.00; 50, \$3.95; postpaid!** Illustrated catalog Indian relics, guns, minerals, Texanna books; 25c. Ed Bartholomew, 8102 Lockhead, Houston, Texas.

**INDIAN Bead work, buckskin, beads, feathers, moccasins, wigs, supplies; buying direct from Indians; prices reasonable; free list.** Pawnee Bill's Indian Trading Post, Box 35-P, Pawnee, Okla.

#### PRECIOUS STONES, MINERALS

**MINERAL—Treasure locators, Geiger counters.** Superior performance, lowest prices. Payment plan available. Free literature. Fisher Research Lab., Inc., Palo Alto, California.

**AGATES, Cutting machines, mountings.** Free list. North West Gems, Box 305, Tacoma 1, Wash.

**MINERAL Specimens, cutting material, slabs, and gems.** Send for free booklet. Warren's Minerals and Gems, 1969 Abbott St., San Diego 7, Calif.

**ROSE Quartz, jasper, agate and catalogue.** Quarter. Gemco, Elkhart Lake, Wisconsin.

**GEMSTONES, Mineral specimens.** Every variety. Lowest prices. Postcard brings free booklet. Plummer's, 2183C Bacon, San Diego 7, California.

#### HOBBIES AND COLLECTIONS

**MULTI-HOBBY Magazine!** Informative, friendly, constructive; sample 25c. Klings, Blue Island, Illinois.

**COMPLETE Stamp collectors outfits** for beginners. Details free. The Stamp Shop, Capitol Heights, Maryland.

**50 DIFFERENT Army embroidered patches \$1.** Other bargains. Insignia Mart, 703A Broadway, New York 3, N. Y.

**KLONDIKE Novelty and jewelry findings!** Novelty jewelry findings swept from manufacturers' tables. Parts for bracelets, pins, earrings, finished and unfinished chains, rings, stones, clips, beads, many others. Sample pound assortment \$2.00, 5-pound lots, \$5.00. Also unset stones, for rings, jewelry; all colors, sizes, designs, 1,000 assortment \$5.00, sample 100 assortment \$1.50. Also beads, assorted colors, sizes, 5-pound lots \$3.00, sample pound \$1.00. Prepaid only. Merchandise Distributing Company, 19 East 16th Street, Dept. 4, New York 3, N. Y.

**INVENTING Can be an interesting and profitable hobby.** Write for complete particulars. Institute of American Inventors, Dept. 40-E 631-E St. N.W., Washington 4, D. C.

**NEW—15 Different match covers 10c.** Box 202, Rochester 1, N. Y.

**UNUSED Matchbook covers—100 different \$1.00.** Catalog 25c. Charles Edelman, 1311C East 84, Cleveland 3, Ohio.

#### CAMERAS, PHOTO SUPPLIES

**BASS Says:** Trading cameras a national habit since 1910. Write to Bass the old "horse trader." A postcard will do. Simply say: "Bass, I have and I want. How much will you allow me?" It's fun to trade with Bass. Satisfaction guaranteed. Bass buys, sells, and trades. Bass Camera Company, Dept. AG., 179 W. Madison St., Chicago 2.

**ALL Metal box camera, #620 film** Worth \$3.95, now \$1.50 postpaid; case 50c. Aero Parts Supply, 8102 Lockhead, Houston, Texas.

**FREE Photographic bargain book** packed with hundreds of sensational values in still and movie cameras, lenses and latest accessories. Super savings for you in new and used equipment. Liberal trade-in allowances, too, on your equipment. Write now for your free copy to Central Camera Company, Dept. 9N, 230 S. Wabash Ave., Chicago 4. (Photographic headquarters since 1899.)

**PHOTOMURALS.** Your negatives or ours. Catalogue 25c. Photomammoth Murals, 12048 Vanowen St., North Hollywood, Calif.

**FLASH Cameras loaned free.** Card brings details. Camera Loan, Des Plaines, Illinois.

#### PHOTO FINISHING

**16 PRINTS Or 8 jumbos from roll, 25c** with this ad. S. Skrudland, River Grove, Ill.

**FREE 5 x 7 Enlargement** with each roll developed and printed. 6 or 8 picture roll 35c. 12 or 16 picture roll 55c. Send coin with roll. No c.o.d. If you fail to get pictures on your roll of film, we will mail a new roll to you at no additional cost. Overnight service. Malters sent free on request. Deluxe Film Service, Box 1268-A, Shreveport, Louisiana.

**FLASH Cameras loaned free.** Card brings details. Camera Loan, Des Plaines, Illinois.

**OIL Coloring photographs** can be a fascinating hobby or profitable sideline for those with artistic talent. Learn at home. Easy simplified method. Send for free booklet. National Photo Coloring School, 1315 Michigan, Dept. 3437, Chicago 5, Ill.

**MAIL Us your films.** Prompt service. 8 exposures developed and printed 30c. Free enlargements. Foto Art Studio, Box 406, San Francisco, Calif.

**TWO Beautiful prints** from each picture on 8 exposure roll 35c. 29 years of satisfied customers. Quick service. Lens Photos, Dept. J-4, Janesville, Wis.

**BEAUTIFUL Enlargement** from each picture on 8 exposure roll 35c. Cut Rate Photos, Dept. B-4, Janesville, Wis.

**2 BEAUTIFUL Hi-Gloss prints** each good negative and enlarging coupon with each 8 exposure roll developed 28c. Free mailers. Owlphoto Co., Weatherford, Oklahoma.

**20 EXPOSURE 35 MM. jumbos, 35c; 36 exposure, \$1.25.** Quality Labs, P.O. Box 34, Homecrest Sta., Brooklyn 29, N. Y.

#### MOTION PICTURES AND SOUND EQUIPMENT

**BASS Says:** Leadership since 1910 guarantees satisfaction. Finest Cine equipment: 8mm., 16mm., and 35mm., silent and sound. Write the old "horse trader." Satisfaction or your money back always! Bass Camera Company, Dept. A, 179 W. Madison St., Chicago 2.

**CLEARANCE Sale.** Want a real buy in 16 mm sound films? Take advantage of the I.C.S. 1950 clearance sale of 16 mm sound films, features, comedies, educationals, cartoons, novelties, etc. Send for our giant list "A" today stating machine you own (make and model). Institutional Cinema Service, Inc., 1560 PM Broadway, New York 10, N. Y.

**MISCELLANEOUS 16MM. sound movies.** Rush \$2.00 for 300 foot, postpaid. Pastime, 122 Hackensack Street, Wood-Ridge, N. J.

**LOOK—"The World's Greatest Passion Play"** 8mm., 16mm. and 35mm. Mention sound or silent, purchase or rent. Hemenway Film, 33-F Melrose St., Boston 16, Mass.

**EXCITING Movies (8-16mm.).** Enormous selection. Cameras, accessories, bargains, surprises galore! Big illustrated catalog, 25c; refunded first order. National Film Supply, Toledo 9-H, Ohio.



"CINE-VOICE" Sound-on-film camera shoots your own 16mm. color talking pictures. \$695. Write for free illustrated folder. Berndt-Bach, Inc., 7345 Beverly Blvd., Hollywood 36, California.

RENT 16MM. sound films, 50c reel. Rogers Films, Box 3526, East Atlanta, Ga.

WORLD'S Biggest stock of used 16 mm. sound film bargains—over 200,000 prints on hand! Hundreds of good feature pictures, \$39.95 up. Cartoons, \$5.95; one reel sports, \$7.95; travels, musicals, \$9.95; two reel comedies, \$17.95; 100' Panoram musicals low as \$9.95 a dozen. New one reel, discontinued Castle, pictorial cartoons, musicals, travels, \$7.95, \$9.95. Write for free catalog 5-D. Blackhawk Films, Daventport, Iowa.

FREE Movie bargaingram. Wonderful values. 8mm., 16mm., 35mm., sound-silent projectors, cameras, film, accessories. Trades welcomed. Mogull's, Dept. NP, 112 W. 48, New York 19.

1000' 16MM. Silent-sound projection film \$7.50. International, 2120 Strauss, Brooklyn 12, N. Y.

MAKE Films for the huge television industry. Also learn Hollywood, free lance, and educational film technique at home. Write for free catalog. Motion Picture Institute, Birmingham 4, Michigan.

NEW 16mm., 35mm. sound projectors. Cine, 582, Ithaca, N. Y.

WILD Game films. 16mm, 8mm. Color, black-white. Sound, silent. Rare closeups taken in natural habitat by famed Eberhart organization. Send for free catalog. Wild Life Films, Dept. 9-PM, 6063 Sunset Boulevard, Hollywood, California.

FREE MOVIES. Thousands of subjects. Interesting. Entertaining. Fascinating. Latest directory—only 50c. National Cine Society, 126 Lexington Avenue, New York 16, N. Y.

BETTER 8MM. and 16mm. movie camera film. Free equipment catalog. Better Films, 742 New Lots, Brooklyn 7, N. Y.

UNUSUAL 8 And 16mm. films, used by many art students. Write for free catalogue. Send 25c for sample strip. Friart, 140-A-Liberty Street, New York 6.

RENT 16MM. sound films, 50c reel. Large selection; free catalog. Film Service, 128 Chestnut St., Roselle Park, N. J.

GUARANTEED Fresh anti-halo outdoor movie film! Weston 16! Daylight loading! Processing free! Three spools double 8 mm. \$4.50! Six single 8 mm. for Univex, \$4.60! Postpaid! Catalog. Eso-S, 47th Holly, Kansas City 2, Missouri.

8-16MM. Silent-sound films. Complete rental library. All latest subjects. Free catalogue, (sample film 10c). Garden Film, 317 West 50th, New York 19.

## MUSIC AND MUSICAL INSTRUMENTS

PIANO—Play popular music. Beginner's self-instruction book—anyone can learn! Advanced book teaches chords, rhythm bass the easy way! Choice \$2 each, both \$3. Moreau Studios, Dept. A-2, 139 Mathewson St., Providence 3, R. I.

1950 ACCORDIONS — Wholesale. Free catalog. American Accordion Center, 5329 Belmont, Chicago.

POEMS Wanted. Percentage basis collaboration. Terry Tunemith, 22 PM Northwest 8th, Oklahoma City 3.

POEMS Wanted for musical setting. Send poems for free examination. Five Star Music Masters, 630 Beacon Bldg., Boston, Mass.

PIANO—Play by ear quickly. Easy, proven method. Universe Distributors, Box 206, Toronto, Canada.

POPULAR Piano lessons by mail. No musical knowledge necessary. Two new popular songs with every lesson. Play 2 songs in first lesson, or money back. Send for free details. Stuart Piano Studio, 127A Morris Ave., Union, N. J.

SONGWRITERS — Publication opportunity. Royalties. Abbey Music, 242 West 10th, New York 14, N. Y.

SONGWRITERS. Opportunity for recording on royalty basis by large recording company with national sales, distribution. Send song material, free examination. No charge for melody. Lead sheets, records furnished. Music Makers, Dept. G3, Box 1989, Hollywood, California.

ACCORDIONS — All brands. New and used. Save 50%. Wholesale to every one. Del Principe, 307 So. Washab, Chicago, Ill.

RECORDS—Guaranteed new. Hillbilly, popular, spirituals. 4 for \$1.00. Free record with first order. Free catalog. Mailor, Dept. 137, 570 N. Gay Street, Baltimore 2, Maryland.

WANTED! Poems for musical settings. Write Songwriters' Service, Clifton, N. J.

WRITE Songs. Big money and reputation. Write for information. J. Gordon Pub. Co., 4700 South California Avenue, Chicago.

SONGWRITERS! Outstanding, ethical offer. Hibbeler, C-5, 2157 N. Avers, Chicago 47.

SONGWRITERS! Send poems, songs. Music Service, 243 West 72nd St., PM, New York 23.

POEMS Wanted to be set to music. Free examination. Send poems. McNeil, Master of Music, 510-PM S. Alexandria, Los Angeles, California.

MUSIC Arranged, songs printed. Frank Wildt, Music Publisher, Lancaster, Penna.

## RADIO AND TELEVISION

FIX Any radio. Amazing new instrument locates radio troubles double quick. Simple instructions show you how. Thousands now in use. Free. Write today for 32-page illustrated technical manual, "The Inside Story." Feiler Engineering Co., Dept. 12PM5, 1601 S. Federal St., Chicago 16, Ill.

FREE—Send for latest radio catalog and bargain bulletin. Has thousands of top values in television, radio, electronic supplies. Concord Radio Corp., Dept. LM-50, 901 W. Jackson, Chicago 7, Illinois.

FREE! 212 Page radio and television catalog! World's largest stocks, lowest prices. Complete supplies for builders, experimenters, amateurs, servicemen. Latest radios, phonos, television, recorders, sound equipment. Thousands of parts, tubes, test instruments, books, diagrams. Top quality money saving values. Get it now! Allied Radio Corp., 833 W. Jackson Blvd., Dept. 34-M-O, Chicago 7, Illinois.

EARN While building radios. Learn television. Experience unnecessary. Parts, tools, instructions supplied. Free details. Federal, 176-71 Union Turnpike, Flushing 3, New York.

24 PAGE Plans 18 long distance crystal sets 25c, including Radiobuilder, catalog. Laboratories, 578-C, San Carlos, Calif.

BUILD Crystal radio. Diagram-information free! Radio Builders, 1738 North West 12th, Oklahoma City 6.

MAKE Simple, tubeless, batteryless, distance-getting crystal radios. Crystal and illustrated instructions 25c postpaid. Allen, 427-P, Clinton, Mo.

## BUSINESS OPPORTUNITIES

GIFT Manufacturing is big business. I have shown 26,000 men and women how to enter this profitable business. Positively no tools, equipment or experience necessary. My home instruction course covers everything: How to make pins, earrings, necklaces, bracelets, candy dishes, ash trays, trinket boxes, wall plaques, vases, ming gardens, etc. Includes secret home methods of color-metallizing, pearlizing, dyeing, golding, silvering, etc. Includes wholesale prices on hundreds of raw materials. Over 150 beautifully photographed designs. Only \$1 a copy postpaid. Satisfaction guaranteed. Giftcrafts, Box 4550-PM, Coral Gables, Florida.

CONVERT Hand mowers to power mowers. Do it now, this winter. Sell the Handy-Dandy conversion kits. Easily installed on 16 to 20" mower. Use any small gasoline or electric motor. Quick delivery. Kits purchased with or without engines. Also new garden cultivator. Cultivates 3" deep. Attachments available: weed cutter, lawn mower and snow plow. Discount to dealers. LeClaire Manufacturing Company, LeClaire, Dept. PM, Iowa.

MAKE Money at home by mail. Amazing new book tells how. 12,000 words. Illustrated. Details sent free. Northmore's, Highland Park 91, Illinois.

BUY Wholesale—Million articles. Supply source directory, dime. Neiko, Box 3462-DL, Chicago 54, Ill.

START Your own business on credit. Always your own boss. 1559 dealers sold \$5,000 to \$28,000 in 1949; their average \$6,834. We supply stocks, equipment on credit. 200 home necessities. Selling experience unnecessary to start. Wonderful opportunity to own pleasant profitable business backed by world-wide industry. Write Rawleigh's, Dept. L-U-PPM, Freeport, Ill.

BIG Money in your own business. Sharpen circular saws for builders, lumber yards, farmers, others—with new Belsaw complete circular saw shop. Low cost, no experience needed. Write Belsaw Machinery Co., 22 Field Bldg., Kansas City 2, Mo.

START Home manufacturing business making cleaning compounds, soaps, insecticides, cosmetics, polishes, food flavors. No machinery. Literature free. Kemix, Park Ridge 10, Ill.

BOOKKEEPERS Boost income operating simplified bookkeeping service. Kern, 4942 Vineland Avenue, No. Hollywood, Calif.

EARN Big money at home. Make genuine rubber molds, plaques, figurines, etc. Complete China-glaze kit only \$4.95, with instructions. Catalog free. Ken-Dor, Studio E, Lake Geneva, Wis.

LEARN Piano tuning, repairing — At home in 30 days. Unlimited income. Phonograph recordings, tools and instructions furnished. Write Capitol City Tuning School, Department C-1234, 129 East Michigan, Lansing 16, Michigan.

EASY To make expensive perfume with low cost "essential concentrate base." Fast, tremendous profits. Write post card. H. May, Box 4473-PD, Coral Gables 34, Fla.

MIRROR Resilvering. Wonderful home business. Complete formula 25c. Magic two-way mirrors. You can see out—no one can look in. Formula 50c. How to make coppered mirrors, vases, glasses. Formula 50c. All three \$1.00. Neiko Chemical Service, Box 3462-ML, Chicago 54, Ill.

MAKE Perfumes at home. Write "Carey Laboratories," 1914 Chouteau PM-12, St. Louis 3, Missouri.

BUY A business. All kinds, all locations, \$500 up. Terms. No fees, no charges. Catalogue on request. May Bros., Binghams, N. Y.

YOU For president of local collection agency. Many who have answered our ads now have names on office doors. Franklin Credit, Roanoke 7, Va.

MADE Big money. So can you. Wamsteker, Box 34-A, Wynberg, Cape, South Africa.

OPERATE Profitable mailorder business. Details free. Mail Order News, 1041 South Garfield, Alhambra, California.

MAKE Tough, durable plastic — 1c pound. Makes attractive floors, walls, built-ins, roofs. Build good home, \$150.00 room. Bays Laboratory, Oklahoma City 9.

\$5 HOUR Easy! Sell name plates for houses. Free sample, order blanks. Write: National, 214 Summer, Boston, Mass.

SELL By mail; free booklet, instructions. Manhattan House, P.O. Box 50-M, New York 28, N. Y.

REVOLUTIONARY Conception of public bookkeeping! \$5.00 hourly. Simple instructions. Full, spare time. Systems, shortcuts, obtaining clients. Auditax, 10775-5 Tabor, Los Angeles 34.

GOLDEN Opportunity earn big money easily at home, no investment. Particulars free. Harrison, 954 Empire, Benton Harbor, Mich.

MAKE Perfume. Men. Women. Write International, 6347 Parnell-PM-12, Chicago 21, Illinois.

ALUMINUM Products—Cast letter sample 25c. Z. & Z., 1143 Manhattan Ave., Brooklyn 22, N. Y.

BIG Money! Spare or full time in your home. No selling! Spray new miracle finishes, plush and suede, on signs, radios, automobiles, figurines, lamps, toys, etc. Our business is booming. Help us fill huge demand. New easy Flok-Kraft methods. Material costs few pennies. You get dollars. Free samples, complete powerful money-making plan free. Write now! Coast, 1002R S. Los Angeles St., Los Angeles 15, Calif.

TO \$35.00 Weekly. Spare time, home operated, mail order business. Successful small "beginner's" plan. Everything supplied. Lynn, 5710-M Bankfield, Culver City, California.

START Own profitable mailorder business. Copyrighted instructions tell how. Free folder. E. Lay, 3819 Kenmore, Chicago 13.

EARN While building radios. Learn television. Experience unnecessary. Parts, tools, instructions supplied. Free details. Federal, 176-71 Union Turnpike, Flushing 4, New York.

CAST Figurines! Novelties! Rubber molds! Dollar each! Castcraft, 508-P Marion St., Brooklyn 33, N. Y.

ELIMINATE Financial worries, with the biggest money making opportunity you've ever seen. Ages, West Liberty, Iowa.

REPAIR Sewing machines. Age no barrier. Highest earnings. Complete simplified manual \$5.95 postpaid. Satisfaction guaranteed. Fielding Sewing Machines, Box 9738, Philadelphia 40, Penna.

NEW, Proved methods get money by mail. Amazing, eye-opening. Details free. Lexington Mail, 5538-A Lexington, Chicago 44.

**LADIES**—Housewives, office workers, students, make excellent spare-time profits selling beautifully bottled, new, exclusive perfume. Write for information. Enclose 50c for sample. M. Joyce Distributing Co., 29 Harrison St., Oak Park, Illinois.

**READY** Made mail order business. Granada, Box 712, Panama City, Florida.

**WOULD** You pay 3%—first \$350 made? Book "505 Odd Successful Businesses" free! Work home. Expect something odd! Pacific-PM, Oceanside, Calif.

**HALF** Million articles wholesale. Directory 10c (refundable). Publishers, Box 1302-P12, Detroit 31.

**OLD** Newspaper? Turn it into cash at home. Instructions 50c. Silvercraft, Box 574-PM, Great Falls, Mont.

**ELECTROPLATING**—K now-H ow, includes baby shoe, chrome and brush plating; other lucrative fields. Learn easily. Free booklet. Joseph B. Kushner, Electroplating Engineer, Stroudsburg 32, Penna.

**ENGRAVING** Is profitable! Large capacity machine priced under \$100; carves, engraves jewelry, plastics. Sample 25c. Desco, 6334-B Sepulveda, Van Nuys, Calif.

**MILLER'S** Modern manufacturing formulas can make 1951 your biggest money year! Fifty years supplying the best. Literature free! Miller, Consulting Chemist, Tampa, Florida.

**START** Small town mimeographed shopping paper. Shopping News, Oxford, Wis.

**NEW** Industrial hand cleaner. Free manufacturing-distributing plans. Unusual money-making proposition. "Acro-Sol-Ex," 2438 Fifteenth, Denver 11, Colorado.

**WHOLESALE** Baby shoe mountings. Electroplaters, \$49.95. Foster's, 1520 Ardmore, Chicago 26.

**MAKE** Money by mail! Write Wehner, Box 142-A-11, Roxbury 19, Mass.

**HOW** And where to obtain capital. Small and large loans. Free particulars. Star Service, Wapekoneta, Ohio.

**FIX** Typewriters, full or part time. Inexpensive copyrighted home study course quickly trains you for high earnings. Factory methods cover all phases with drawings and illustrations. No curiosity seekers. Typewriter Repair, 1215 Corbet, Tarentum, Pennsylvania.

**SAWDUST**. Turn it into cash. Six methods. Instructions 25c. Charles Co., 12-AWZ, Norwood, Ohio.

**WANTED!** Home producers by manufacturers in our clearing house service. Become a sub-contractor, casting plastic products for these companies. Thousands of easy to make items required. Cash in at home without previous experience. For details write Plastic Service Guild, Dept. PM, 233 Condor St., E. Boston 28, Mass.

**BABY** Shoes—Brushplate your own gold, silver, copper a few cents each. Complete (2) shoe kit, brush, instructions, wholesale list mountings, supplies \$1.00. Agents wanted. Pearl-Cote Metallic Products, 6931-N Greenview, Chicago.

**EARN** Money at home! Thousands do! "Home Worker Magazine" tells how. Sample, 25c. Sizemore, Box 7, 4917 Kostner, Chicago 30, Ill.

**MEN** And women grow mushrooms. Cellular, shed. We pay \$3.00 lb. We paid O. Babbitt \$4,165 in few weeks. Send \$2.00 for 40-page illustrated manual and start mushrooms. Dept. 122, Washington Mushroom Ind., 2954 Admiral Way, Seattle, Wash.

**SELL** By mail. Work at home. Full or spare time. Everything furnished. Great money-making opportunity. Write Universal, 24B Main, Tangier, Va.

**PROFIT** Tested plans and amazing big "Mail Order News" Magazine 25c. Lindbergh, 245 Plymouth Bldg., Minneapolis 2, Minn.

**AMERICAN'S** Outstanding mail order opportunity. Partnership plan similar to other chain systems. Details 10c. L. W. McCann, 5117 N. Station, Amarillo, Texas.

**"YOU** Can actually see the metal flow on" with a portable Tyco Electro-Plater! Electroplate metals, mirrors, leather, wood, glass, plastics! Inexpensive, profitable home business. Free booklet. Tyco Metals, Box 13231-E, Houston 19, Texas.

**WOULD** \$200 A month interest you? Your part time business in your home. Details free. Austin A. Maxsted, 619 47th St., Western Springs, Ill.

**200** MOLDS Popular Dresdencraft figurines. Cheap. Plaster Figures, Minneapolis 15, Minn.

**MAKE** Money spare or full time, casting metal toys and novelties. Big wholesale and chain store demand for cast metal autos, soldiers, ashtrays, banks, etc., keeps manufacturers busy. Production molds furnished for up to 100 and more castings per hour. No experience or special place necessary. Write for information and illustrations of patterns needed. Metal Cast Products Co., Dept. A, 1696 Boston Road, New York 60, N. Y.

**HOME** Work dollars from wood scrap. Booklet 25c. Lee, Box 502, Chicago 90.

**UNPAINTED** Bookends, plaques, statues, figurines. List. Haverty Products, 822-17th St., Altoona, Penna.

**FABULOUS** Earnings—Fascinating pastime growing genuine, living miniature (ming) trees. New sensational business or hobby. Astounding information free. Dwarf Trees, Box 355, Briggs Station, Los Angeles 48, Calif.

**BUILD** Big business at home making hand soap, shampoo, polishes, washing powder, magic spot remover, amazing cleaners—Over 50 fast selling products. Easy to mix. No machinery needed. Only 1 and 2 ingredients. Complete set over 50 formulas only \$1.00 postpaid. Neiko Chemical Service, 3462-SK Merchandise Mart Sta., Chicago 54, Ill.

**COLOR** Concrete with chemicals. Marble-glaze cement benches, pottery, garden ornaments. Home—shop. 10c brings sample, pictures. Hollywood Cementcraft, 8527-R Wonderland, Hollywood 46, Calif.

**EARN** Money at home with your typewriter! Spare time! Details free. Edwards, Publisher, 3915-PM, 12th, Des Moines 13, Iowa.

**WHERE** To buy .600,000 articles wholesale. Details free. Krueger, 3418 Wolcott, Chicago 13.

**SPECIAL** Rubber for making molds. Literature and sample free. Universal, Box 1076-A, Peoria, Ill.

**ANNOUNCING** Home study course in commercial baking. Practical basic training. Good field for those with aptitude. Nearly depression proof. Send for free booklet, "Opportunities in the Baking Industry." National Baking School, 1315 Michigan Ave., Dept. 3436, Chicago 5, Ill.

**CASH** For your idea, 280 manufacturers need inventions, patented or unpatented. List free. Invention Bureau, 208M Clinton, Oak Park, Illinois.

**IMPORTING** Opportunities—Unlimited profits. Hundreds overseas connections seeking representatives. List \$1.00. Imports, 35E, Pasadena 8, Calif.

**YOUR** Own profitable home business. Preserve live flowers to last for years. New simple discovery. Enormous demand all year 'round. Tremendous profits! Light fascinating work. Send \$2.00 for working equipment, instructions, and valuable sales plans. Satisfaction guaranteed or money promptly refunded. Alfred Hermansen, 210 Fifth Ave., Suite 1102A, New York 10, N. Y.

**MAKE** Rubber stamps, metalize baby shoes, repair dolls, silver mirrors, make beautiful figurines. Catalogue of "30 ideas" free! Universal, Box 1076-A, Peoria, Ill.

**BOOKKEEPERS** Earn \$100.00 weekly operating simplified "bookkeeping and tax service." Details free. Universal Bookkeeping, Box 664-M, Springfield, Missouri.

**NEW** Profitable home business repairing zippers. Thousands of customers waiting. No experience required. We furnish everything. Write Texas Specialty Company, 204-B Texas, Texarkana, Texas.

**MINK** Raising information free. Complete. Lake Superior Mink Farm, Superior, EE1, Wisconsin.

**LIQUID** Marble! Formula 25c. Alpha Service, Box 3459, Rincon Annex, San Francisco, Calif.

**MOLD** Makers—Attention! Genuine natural latex for reproduction of figurines, statuary, plaques, etc. Instructions free. B. M. Barron, 77 Francis St., Everett, Mass.

**I** MAKE Big money in the mail-order business. You can do the same at home with copyrighted system. Write me. I'll tell you how. F. Little, R.D. #1, Glenshaw, Penna.

**NEW** Ideas—From other countries. 5000 different magazines—in English. Many single copies available. Free descriptive list. Caron & Son, 45-A Fairview Ave., No. Plainfield, N. J.

**A** Factory in your home, garage! Mechanics' waterless hand cleaner, glass cleaner, auto cleaner-polish; many others. All formulas free, but if you also want free samples send 15c postage. Western Aircraft, Dept. B, Los Angeles 6.

**MEN**—Women. Everybody likes candy. Learn to make professionally. Our 40th year. Ragsdale Candies, D5, East Orange, New Jersey.

**EARN** At home casting novelties. Free instructions using latex molds. Major Chemical Company, 164 Portland Street, Cambridge 39, Mass.

**MAKE** Money at home as renewal headquarters for all magazines. Big Christmas sales profits now. Liberal commissions. Supplies furnished. Write for free catalog. McGregor Magazine Agency, Dept. 500B, Mount Morris, Ill.

**VENDING** Machines earn big money! An investment as low as \$10.50 will start you in this fascinating, profitable business that can lead you to the road of success and independence. Routes can be established and operated in either full or spare time with no experience needed. Write for full details and our free catalog illustrating our nut, candy, gum and stamp vendors; also pin ball machines, music boxes, etc. Write immediately to Parkway Machine Corporation, Dept. 7, 715 Ensor Street, Baltimore 2, Maryland.

**DRESDEN** Craft figurine molds and many others, natural liquid rubber, statuary plasters, flock finishes, etc. Illustrated catalog and "Plastercraft" manual free. Blue Rapids Supply, Blue Rapids, Kansas.

**LIQUID** Rubber, make flexible molds. Free sample. Chaney, 1130 E. 16th St., Jacksonville 6, Fla.

**MAIL** Order opportunities galore. Sanchez, Box 66-P, Chelsea Station, New York 11.

**DOLLARS** Three ways with "Kitty-Kat" readi-cut baby shoes. Complete local and mail order plans. Write No-Co-Ro, Oakland 6-K, California.

**\$46** FROM Square foot plywood. Jigsaw necessary. Write, Woodarts, X-38, Bridgewater, Mass.

**OWN** A printing business. Good profit printing cards, stationery, etc. in spare time. Easy rules furnished. Have home shop. Send dime for complete printer's supply book and samples. Kelsey, Inc., Z-24, Meriden, Conn.

**LEARN** Sewing machine repairing at home. Earn \$125.00 week spare time. Plus, new machines, motors, etc. wholesale. Free particulars. Taylor Service Co., Hamilton, Ohio.

**BUY** It wholesale! Manufacturers, distributors offer 850,000 items. Literature free. Olsen, 1231-A East Third St., Duluth 5, Minn.

**UNPAINTED** Figurines. Beautiful models. Write for new wholesale price list. Oman, 642J Broadway, St. Paul 1, Minn.

**COPUBLISH** Leading m.o. paper. Latest copy Mail Sale Advertiser, details, dime. Vanroy Shirk, Lebanon, Penna.

**MADE** \$24,500 Using money making plans from Schemer Magazine, world's oldest mailorder publication. Box 775M, Alliance, Ohio. Year \$2.00. Sample 20c.

**WRITE** For free booklet and catalog telling how to earn substantial profits in your spare time by forwarding new and renewal subscriptions to all magazines for your friends and neighbors. Oldest U. S. agency. Established 1869. Moore-Cottrell, North Cohocton, New York.

**MAKE** Flexible molds! Cast plaques, bookends, figurines! Free sample! H. Tooker, 630-R Chestnut, Hamilton, Ohio.

**BE** Appointed state notary public now! Details. Stationers, Helotes 50, Texas.

**COMMERCIAL** Deep frying course. Mock chicken legs, potatoes. New and proven methods. Learn about this money-making field. \$2.50 p.p. Concession, Toledo 13, Ohio.

**NATURAL** Molding Latex. Extra thick. Free sample. W. Wooley, 115-A Donald, Peoria, Ill.

**PROFITABLE** Business making and building with easy-laying interlocking building blocks. Rex Products, Dept. 10, Piqua, Ohio.

**\$25** WEEKLY Working two hours daily. No canvassing. No manufacturing. Lycke, Box 2471-A, Cleveland 12, Ohio.

**POPCORN** And potato chip equipment. Long Eakins Company, 5060 High, Springfield 99, Ohio.

**WANTED** Unused U. S. postage stamps, small discount. Advance Stamp Co., 24 East 23rd St., New York.

**CO-PUBLISH** And advertise in The Central Mail Advertiser. Sample copy 10c. Low rates. Large circulation. Bagby Printing Co., Georgetown, Ohio.

**RECAST** Old batteries into new. Latest achievements. Battery Laboratories, Minneapolis.

**EARTHWORM** Breeding. Valuable bulletins on successful methods mailed free. Earthmaster Publications, Dept. 14, Sun Valley, Calif.

**LIQUID Marble**—Colorful, glossy! Molded, brushed, sprayed! Cast novelties, statuary, colored tiles. Flexible molds. Comparison floors. Particulars free. Marbleizing Service, Edwardsville, Illinois.

**EXTRA Money.** No selling; operate vendors. Amazing profits, details free. Silver King, Suite B, 622 Diversey, Chicago 14.

**HOW** To set up and run a mirror shop! Resilver mirrors. Make chipped glass nameplates. Electroplating salts and rectifiers. John Sprinkle, V60, Marion, Indiana.

**READ "Advance"**—The voice of mail order. Offers money-making opportunities, sources of supply, personal guidance, etc. Issued monthly. Sample copy 25c. Yearly subscription \$2.00. Advance Publishing Company, 313 East 21st Street, Suite 450, New York 10, N. Y.

**MAKE Money** making new greaseless doughnuts at home on electric machine. Wholesale to grocers, drug stores, cafes, hamburger shops. Send for free recipes and plans. M. Ray Company, 3605 South 15 Ave., Minneapolis 7, Minnesota.

**START** Mailorder bookshop—Everything furnished. 25c brings booklet, samples, exciting ideas. General Publications, Ossining, N. Y.

**OPERATE** Profitable mail order business. Write Walter Service, 4159-A East 112th, Cleveland 5, Ohio.

**MAILING** Postcards selling repeat merchandise is profitable. Everything supplied. Details free. Gordon Publishers, Box 23, Pawtucket, R. I.

**137 WAYS** To make money, in home or office, business of your own. Full particulars free. Elite Co., 220 Grand St., New York 13.

**BRUSH** Plating outfits connect to a battery. No tanks necessary. Good paying business at home plating autoparts, bathroom fixtures, bicycles, reflectors, silvering mirrors. No shop or experience required. Outfits furnished. Free booklet. Gunmetal Co., Ave. H, Decatur, Ill.

**COLORGLAZED** Concrete pottery made without molds. Patented method. Cemetery products, novelties, tiles. Basement leak-sealing. Money-making projects. Booklet, details free. Men only. National Potteries Company, Grand Rapids, Minnesota.

**OWN A Venetian** blind laundry on protected territory basis. 50 units successfully operating. Total cost \$6750.00 on time payment plan. Ask for booklet "Aiming at a First Year \$15,000 Profit." D. L. Laundry, Inc., 101 S. 44th St., Philadelphia 4, Penna.

**EXPORT-Import** offers trained men unlimited big paying job opportunities. Buy at low foreign labor costs. Sell at high American dollar living standards. Gain own business, financial independence, etc. Free facts book. International Trades, 246-P Fifth Ave., New York City 1.

### MONEYMAKING OPPORTUNITIES

**MAKE** Silhouette portraits at home. Easily learned. Fascinating work. Offers good moneymaking opportunity. Sample, details, free. J. Odell, Route 4, Warren, Ohio.

**MAILORDER** Specialist. What have you? \$10 personal report—free. Smith Advertising Agency-PM, Excelsior Springs, Mo.

**DRAW** Cartoons for money! Easy home course. Free literature. Modern Books, Box 1063-M, New York City 7.

**FREE** List. Used ball gum, peanut vendors. Bowers Vending, Claypool, Ind.

**YOU** Can buy thousands of articles wholesale. "Supply Source Directory" 10c. Ideal Service, Park Ridge 40, Illinois.

**WIN** Cash, cars in prize contests! Write for copy filled with current contests, winning hints and tips. Send only 25c. Wright Contest Digest, Dept. 17-N, P.O. Box 2266, St. Louis 9, Mo.

**BARGAINS.** New and used arc welders. Electric or gas engine. a.c. or d.c., all sizes, portable or stationary. Write needs. Hobart Welders, Box M-1204, Troy, Ohio.

**EARN** Money at home. Your own mail-order business. Free details. Hunt Service, Burt, New York.

**EASY** Ways to earn extra income are described in Money Making Hobbies. 132 projects you can make and sell anywhere. 160 pages, \$2.00. Popular Mechanics Press, 200 E. Ontario St., Chicago 11, Ill.

**NEW—Unusual** opportunities in "backyard profits"! Interesting booklet free. Pickett's, Florence, Kentucky.

**COSTS** 4c. Sells fast for \$1.00. Formulas, sales plan \$1.00. Pacific Sales, 1458A, Wenatchee, Wash.

**WOULD** You pay 3%—first \$350 made? Book "505 Odd Successful Businesses" free! Expect something odd! Pacific-PM, Oceanside, Calif.

**UNPAINTED** Bookends, plaques, novelties. Free list. Plastercraft Arts, 1611 East Fifteenth St., Cheyenne, Wyoming.

**MAIL** Order opportunities. Ask for "How." Lou Wiltsch, Steelville, Mo.

**EARN** Money evenings, copying and duplicating comic cartoons for advertisers. Adservice, Argyle 1, Wisconsin.

**MAKE** Money with your typewriter or sewing machine. Details free! Heidorn, Box 184, New York 25, N. Y.

**RAISE** Bean sprouts in dark room. Pays well. Complete instructions plus 25 other practical money making plans and 60 handicraft markets, \$1.00. D. Nickell, R-3 Box 84, Bend, Oregon.

**FREE** Literature—Thousands wholesale supply sources. Moneymaking business ideas. Wilkin Company, Hillsboro 4, Ohio.

**FORTUNES** Won by contest fans! Enclose stamp for lifetime opportunities! National Contest Bulletin, Box 2685-P, Miami 16, Florida.

**EARN** Money at home! Work mornings, afternoons free. Big income possible. Details free. Chambers Enterprises, Box 871, Augusta 1, Georgia.

**BUY** Nylons direct from mill. Make good profits on fast selling nylons. Quick delivery on any quantity. Write for confidential wholesale price list. Joy Hosiery Mills, Delawanna 13, New Jersey.

**WORK** At home. Get orders by mail. Everything supplied at low cost. Big earning possibilities. Write: Edmondson, Box 4865-P, Atlanta 2, Ga.

**ASSEMBLE** And sell Swiss musical churches. Complete kit \$3.95 postpaid. Piltzcker Imports, Wood-Ridge, N. J.

**RESURFACE** Butcher's chopping blocks with easy, fast-working, portable electric machine. Unique service in wide demand with little competition. Large steady profits from full or part-time work. Hill Machine Company, Box 677B, Rockford, Ill.

**TESTED** Mail order plan shows you how to make money. Write Chambers, 1826 Ward Street, Berkeley 3, Calif.

**QUICK** Profits taking magazine subscriptions, handling greeting cards. Cassell Publishers Service, Westfield, N. J.

**CASH** For box tops, labels, wrappers, etc. Send 25c for buyer and items desired. Northland Service, P.O. Box 23, Laurium, Mich.

**DOLLARS** In personalized baby record books. Sell by mail. Use same literature we do. No-Co-Ro, Oakland 6, Calif.

**RAISE** Your business value, standing, as state notary public. Information. Stationers, Helotes 50, Texas.

**PUBLISH** Your own magazine. Hand-size 52 page format, well edited, illustrated. Cost low as \$1.00 month. Brings you prestige, profits. 25c brings sample, details. National, Ord, Nebr.

**READ** Progressive Mailtrade, the magazine that tells how to make money by mail. Dime brings sample and special offer. Progressive Mailtrade, Box 357, Sheboygan, Wisconsin.

### CHEMISTRY

**OH Boy!** New book of science. Experiments, formulas, secret processes, together with catalogue of laboratory supplies, only 25c. National Scientific Company, 2204 W. North Avenue, Chicago 47, Illinois.

**URANIUM** Ore sample, weighing scale, catalog of chemicals, apparatus, kits, \$1.00. Catalog only. 10c. Rex Laboratories, 2849-A Birchwood, Chicago 45, Illinois.

**LABORATORY** Apparatus, chemicals, microscopes, complete chemistry sets, minerals, uranium ore. 10c brings catalog. Porter Chemical Company, Hagerstown 1, Maryland.

**CHEMICALS** And apparatus for industrial, analytical, and private laboratories. Catalog 15c. Dept. M-50, Biological Supply Co., 1176 Mt. Hope Ave., Rochester, 20, N. Y.

**ILLUSTRATED** Catalog: Chemistry, mineralogy, biology. 10c. Tracey Laboratories, Evanston, Illinois.

**NEW** Idea chemical and apparatus outfits for home experimenting. Photo-scales, microscopes, chemicals, biological and laboratory supplies in small quantities. Catalog 15c. Established 1931. John H. Winn, 124A West 23rd Street, New York 11, N. Y.

### PLASTICS

**PLASTIC:** Sheets, cut pieces, and scrap in clear and colors. Rod, tubing, acetate, dies, jewelry findings. Send \$1.00 for 4 pound scrap assortment and fabricating manual. Regal Plastic Supply, 720 Main, Kansas City, Missouri.

**COMPLETE** Line internally carved gifts and jewelry. Free catalog. Pilot Plastics, 67 C-Fulton St., New York City 7.

**PLASTICS**—Complete line. Wholesale, retail. We make our own full-color carving dyes. Casting plastic at quantity prices. Catalog, bargain lists, ideas, instructions, 10c. Gem-O-Lite, Box 686B, North Hollywood, Calif.

**NEW** Liquid plastic. Clear, colors. Cast without heat. Embed flowers, insects, coins. Saw, drill, carve. Send 25c for exciting new home project manual showing how to get started. Castolite, Dept. P-101, Woodstock, Illinois.

**AMAZING** Liquid plastic kit \$3.25. Embed photographs, keepsakes, coins, make solid objects, clear, colors. Beautiful results in half hour. Easily tooled. Inexpensive hobby. Send 15 cents for catalogue. Kristalon Plastics, Dept. Z-120, Box 29, Wilmette, Illinois.

**MOLDED** Plastic letters and numbers. Samples 25c, information free. Plastic Exchange, Box 302, Bradenton 3, Fla.

**50c LB.** Masked plexiglas. Good sized pieces. Smaller pieces (some unmasked) 25c lb. Min. order \$1.00. Add postage; no c.o.d. H. Wilson, 6711 Lewis, Long Beach, Calif.

**LUCITE.** Plexiglas. Any size sheets, masked. Square foot (12 x 12) cost, 1/16". 96c; 1/8", \$1.25; 3/16", \$1.52; 1/4", \$1.80. Colors add 10%. Include 10% postage. Almac Plastics, 230 Fifth Ave., New York 1, N. Y.

**INTERNAL** Carved roses, orchids, swans, goldfish, butterflies, etc. Jewelry and gifts. Crystal Floral Novelty Co., Bound Brook, New Jersey.

**PLASTIC.** Sheets, rods, tubes, etc. Free list. Plastic Supply Co., 2901 N. Grand Blvd., St. Louis 7, Mo.

### FORMULAS, PLANS, ETC.

**MAKE**—Sell cleaners, soaps, polishes, flavors, cosmetics. No machinery. Formula literature free. Kemico, Park Ridge 16, Illinois.

**WATERLESS** Hand cleaner. (No ammonia.) Easily made. Good profit. 2 dependable formulas \$1.00. Wipe-on auto paint, all colors, complete formula \$1.00, both \$1.50. Neiko Chemical Service, 3462-WP, Merchandise Mart Sta., Chicago 54, Ill.

**FORMULAS.** Trade secrets, for nearly everything. Catalog free. Creative Publishers, Winnetka 6, Illinois.

**10,000 FORMULAS** And trade secrets. Free literature. Stillman, 555 Kingston Ave., Brooklyn 3, N. Y.

**CINOKETE** Manufacturing instructions and formulas, full lines: perfumes, flavorings, auto specialties, polishes, etc., \$2 each. Plastics, Box 1574, Boston 4, Mass.

**MAKE** 1951 Your biggest money year with Miller's modern manufacturing formulas. Fifty years supplying the best. Literature free! Miller, Chemist, Dept. 1517, Tampa, Florida.

**RELIABLE** Formulas, Polishes, cleaners, etc. List free. Monde, Pulaski, Wisconsin.

**MONEY** Making formulas, ideas, trade secrets. Literature free. Ultra, 3519 Troost, Kansas City, Mo.

**TESTED** Formulas. Interesting descriptive booklet free. Pont, Box 635-PM, Terre Haute, Indiana.

**REAL** Manufacturing formulas. Lists free. Cummings, Chemist, Gordon Ave., Syracuse 4, N. Y.

### HELP WANTED

**\$5 HOUR** Easy! Sell name plates for houses. Free sample, order blanks. Write: National, 214 Summer, Boston, Mass.

**AGENTS**—Sell automatic fire alarms. Low-cost, big profits, needed in every home, store, farm. Write Harmony Brass Co., Plano 3, Ill.

## AGENTS WANTED

IS \$210 A week worth a penny postcard to you? Then rush card with name and address for special free trial plan that sells amazing new automatic refrigerator defroster "like hot cakes!" Write to Mr. Lewis, D-Frost-O-Matic Corp., Dept. PMC-12, 6 N. Michigan, Chicago 2, Ill.

"FOG-Stop" windshield cloth. Instantly removes blurry mist, frost, sleet, snow. Stops windshield fogging. Samples sent on trial. Kristee, 161, Akron, Ohio.

40% PROFIT—Buy direct. Power mowers—51 models. Prepaid. Rotacut-PM, Excelsior Springs, Mo.

ABSOLUTELY Free! Big package actual sample fabrics and style presentation of dresses, lingerie, hosiery, etc. Take orders. Commissions big. Send no money. Melville Co., Dept. 5705, Cincinnati 3, Ohio.

WANTED—Purchasing agents. No money or experience required. Write Dept. C, Purchasing Manager, 2719 Lawrence, Chicago, Ill.

UP To \$50.00 in a week and tailored suit for yourself without paying one cent. Write for plan. Progress Tailoring Co., Dept. M-217, Congress & Throop, Chicago 7, Ill.

LOOK Here! Wanted—Men to start in business on credit. Sell some 200 farm-home products. Thousands our dealers now make quick sales, big profits. For particulars write Rawleigh's, Dept. L-192-PPM, Freeport, Ill.

\$1.00 STARTS You in business. Sell men's neckwear full or part time. Low investment big profits. Send \$1.00 receive sample tie, free color catalogue, selling plan, wholesale price list. Radio City Neckwear, Dept. M8, 112 W. 50th, New York City 19.

WIN Suits and earn money! Both easy with amazing plan. Show finest made-to-measure tailoring to friends, neighbors. No experience or investment. Free outfit. Write Stonefield Corp., 532 S. Throop, Dept. M-817, Chicago 7, Ill.

FREE Complete sales kit. Sell personal initialed belts and buckles, cap badges, tie holders, etc. Choice of 2000 emblems. Write for free selling outfit today. Hook-Fast, Box 1425PM, Providence, Rhode Island.

WOMEN Who can sew and alter dresses, make extra money part time taking orders for big manufacturer. All sizes. Amazing values. Everything furnished. Harford Frocks, Dept. D-135, Cincinnati 25, Ohio.

\$5 HOUR Easy! Sell name plates for houses. Free sample, order blanks. Write: National, 214 Summer, Boston, Mass.

MEXICAN Feather pictures. Sell on sight; 200% profit! Free details; sample 10c stamps. Sylvia-PH, Apartado 9036, Mexico City.

200% PROFIT. Bulk or packaged rat killer. Kilesem, Crystal Beach, Fla.

AGENTS Wanted by seat cover manufacturer. Featuring the only triple chain stitched seat cover made in America. No trade exposed. Mono, 6545 Santa Monica Boulevard, Hollywood 38, California.

STRANGE "Dry" window cleaner. Sells like wild. Replaces messy rags, liquids. Simply glide over glass. Samples sent on trial. Kristee, 160, Akron, Ohio.

FREE Sample nylon stocking of world's only nationally advertised hosiery line actually guaranteed against runs, snags or excessive wear, regardless of cause! It's amazing but true. Every weight from sheerest 15 denier to heavy 70 denier—all gauges to luxury 60 gauge. Amazingly low prices, starting at \$1.08 prepaid for sheerest 15 denier 51 gauge. Not sold in stores. Good Housekeeping guarantee seal. Also complete line men's hosiery guaranteed one full year or replaced free. Full variety lingerie in crepe, satin and nylon, featuring all nylon slip at \$2.95, satin slip at \$1.58, etc. Housecoats and robes. Kendex sales people will earn one million dollars this year. Get your share. No money or experience needed. Pay nothing now or later. Just show free outfits. Write orders. We deliver and collect. Advance cash plus huge bonus. Earn money spare or full time. Become manager; appoint others to sell for you; earn steady income on their sales. Man or woman—young or old, you can earn more money than you ever thought possible. Everything you need is furnished free and prepaid, including nylon stocking, samples of materials, sales books, 36-page salesmanual, color cards, etc. Simply write your name and address on postcard and mail to Kendex Corporation, Babylon 93, N. Y.

GENUINE Fur coats, capes, jackets. Lowest prices. Free wholesale catalog. HMJ, 150P W. 28, New York City.

EARN Big profits! Every home needs new Tapaline Multiplug that makes 8 appliances available from one outlet. Sample \$1.50. 16-page catalog of household items free. Sunshine Sales, Dept. WP-6, Loudonville, Ohio.

GARAGE And service station jobbers—Cash in on our new patented tool for pressure lubricating auto speedometer cables. Fast, profitable, \$3.50 seller. Write General Engineering, 1745 Pontius, Los Angeles 25, Calif.

NYLONS Direct from mill. Sample free. Guaranteed against runs. No experience or money needed. Also nylon slips, briefs. Earn big money spare or full time. Become manager, appoint agents. We pay you 40c for every \$1 your agents earn. Sell men, women necessities needed all year 'round. Ergim Co., 992 Columbus Ave., New York.

MEXICAN Feather pictures. Christmas novelty \$1.00 (stamps) brings \$2.00 worth samples. Refunded if unsatisfied. Aztec Art-P, Apartado 762, Mexico City, Mexico.

PERFUME—Sideline to independence. Learn all free. International, 6347 Parnell-AM-12, Chicago 21, Illinois.

AMAZING! Silk 'n' lace women's garters, hankies, sets. Big profits. Free samples, swatches, moneymaking details. Holiday, 85-06 96 St., Woodhaven, N. Y.

BUY Thousands of nationally advertised products direct from manufacturers and distributors. Write for "Buy Direct and Save." Service Publishing, 1420-A Investment Bldg., Pittsburgh 22, Penna.

\$75 WEEKLY—Men, women everywhere. Write Interstate, 5546 Metro, Los Angeles 55.

EASY Money, wonderful work. Mix water with our concentrates. Make flavors, lotions, perfumes, shampoos, cleaners, polishes, 125 products. Free catalog. Qualco E20030 Russell, Detroit 3.

MAKE Products yourself right at home. Windshield cleaner, rug cleaner, vanilla, spot remover, moth killer, auto polish, radiator cleaner, glass cleaner, soapless shampoo. Use just one ingredient formulas. No mixing. Amazing profits. Complete set \$1.00. Ideal Formula Service, Park Ridge, Ill.

SCHOOL Seniors! A postal will bring you our wonder, Kwick-Sell Cardalog of popular graduation name cards. Biggest profits! Only firm giving free Golden Memory Book and Souvenir Chest. Don't miss out. Hurry that postal! Craftcards, Box 235 (L), Pittsburgh 30, Penna.

FAST Profits—No investment. Send for big, free catalog. Plastic aprons, tablecloths, etc. 150 sure-fire items. We guarantee sales. Write The Halliday Co., Dept. M-9, 15-19 Pennington, Passaic, N. J.

MEXICAN Feather pictures. Christmas novelty \$1.00 (stamps) brings \$2.00 worth samples, details. Refunded if unsatisfied. Aztec Art-P, Apartado 762, Mexico City.

THERE'S Big money taking orders: Personal initialed buckles with belts, tie holders, choice of over 3,000 emblems, cap and breast badges for every purpose. Uniforms, work clothes, embroidered with company name, trademark, sales message, etc. Prospects everywhere. Latest styles, finest fabrics. Write for selling kit. Hook-Fast Co., Box 480PM, Roanoke, Virginia.

BIG Money taking orders: Shirts, ties, Sox, pants, jackets, sweaters, shoes, uniforms, etc. Sales equipment free. Experience unnecessary. Nimrod, 4922-BG Lincoln, Chicago.

PHOTO-Salesmen, agents. Sell beautiful hand colored plastic enlargements and sensational new photo compacts, rings, bracelets, lockets, etc. Collect deposit, we deliver. Profitable sideline. Send card, for free sample kit. Novel Portrait Co., 3343 North Ave., Chicago, Ill.

MAKE \$20 A day! Sell Staybright brass name plates for front doors. Write Hubstamp, 357-E Congress, Boston, Mass.

\$184.00 CONTINUOUS Profit from every \$8.00 investment. Shampoo powders in bulk. Bottle yourself or sell powders. Request convincing facts. Morael Manufacturing Company, 505-R Fifth Ave., New York City 17.

BE A money maker. Represent magazines year around. Wonderful home work. Big Christmas profits now. Liberal commissions. Everything furnished. Write for free catalog. McGregor Magazine Agency, Dept. 500A, Mount Morris, Ill.

MAGIC Cleaner—Laundry soap deal. Hotter than a firecracker. Big profits. Sample free. Bestco, 4642 No. Central, Chicago.

SCHOOL Seniors—Earn sensational profits selling classmates America's most beautiful graduation name cards. Largest selection. Outsell all others. Free sample kit. Printerart, Dept. M, 1425 E. Elm St., Scranton 5, Penna.

FREE Samples. Big profits showing amazing Glow-in-the-Dark specialties. House numbers, pictures, plastic novelties, ashtrays, keyholders, religious and nursery objects, etc. Madison Plastics, 303 Fourth Ave., New York 10, N. Y.

DRESSES, 18c; Coats \$1.00, blouses 35c. Free catalog. Crown, 164-P Monroe Street, New York.

WRITE for free booklet and catalog telling how to earn substantial profits in your spare time by forwarding new and renewal subscriptions to all magazines for your friends and neighbors. Oldest U. S. agency. Established 1869. Moore-Cottrell, North Cohocton, New York.

SELL Balloons! Combs! Novelties! Excellent sideline. Carleton House, Texas City, Texas.

JEWELRY Factory desires salesmen, distributors, jobbers. Pickcraft, 19 Bank Street, Attleboro, Mass.

SELL Big money-maker to men and women. Easy handwork makes fast-selling useful articles. Sunmade Company, Brockton 64, Mass.

GOLD Lacquered window sign letters. Large sizes penny each. New foils. Absolutely beautiful. Free samples. Atlas, 544 W. 79th, Chicago 20.

AGENTS: Stamping names on key protectors. Sample 25c. Stamping outfits, checks, social security and name plates. Hart Mfg. Co., 303 Degraw St., Brooklyn, N. Y.

EXCELLENT Sideline for printing and advertising salesmen. Decalomania name plates in small quantities. Great demand. Also, make money with our line of automobile initials and sign letters. Free samples. "Ralco" XL-Roxbury, Boston 19, Mass.

WHERE To buy 800,000 articles direct from manufacturers. Including hundreds of scarce items. Sent free. "Your Profits Under the Spotlight." Glass Publishing Co., Ellwood City, Penna.

AGENTS—300% Profit selling genuine gold window letters; stores and offices. Free samples. Metallic Letter Co., 438-B North Clark, Chicago.

## HIGH-GRADE SALESMEN

MAN! This is hot! Make \$6.35 on every sale! Make over \$30.00 a day! We have new adding machines in original cartons. You can sell for only \$12.95! Yes, only \$12.95, and you'll make 49%. They're executive model portables, precision built, fully guaranteed. Send for life-size color photo and full details. Write today to Lightning Adding Machine Co., Inc., Dept. P-1, 543 So. Spring St., Los Angeles 13, California.

AUTOMATIC Fire control. Beautiful units for the finest homes. Powerful units for serious hazards. Low selling price and guaranteed highest profits. Red Ball Inc., P.O. Box 1552, Salt Lake City, Utah.

ADVERTISING Book matches—Cash in on big demand; sell union label matches. Cuts for all businesses and political parties. Free powerhouse selling kit, low prices, protection guaranteed on repeat orders. Cash commissions. Superior Match Co., Dept. M-1250, 7530 Greenwood, Chicago.

\$5 HOUR Easy! Sell name plates for houses. Free sample, order blanks. Write: National, 214 Summer, Boston, Mass.

PRINTED Cellophane tape for advertising, labeling, industrial parts marking. Complete line. Excellent commission. Department PM, Topflight, York, Penna.

ADVERTISING Specialties. Steady income. Earn \$20 day up working 5 hours selling calendars, pencils, yards, leather, plastics, good-will gifts for West's largest adv. jobbers. Few territories open for exp. dependable, ages 33 to 50. Write Banco, 836 Montgomery, San Francisco.

POSITIVELY New—Over 100% profit. Two sided reversible neckties. Free details. Farrell Company, Dept. P-17, 1377 Van Zandt, Cincinnati 31, Ohio.

MAN To earn \$85 week and up. Long needed invention. Advertised in Saturday Evening Post. Full or part time. Exclusive territory. No investment. Free sample outfit. Write Red Comet, Inc., Dept. 814, Littleton, Colorado.

SHINER-Hook: New sensational seller to fishermen, dealers. Free sample. Nelson Company, St. Paul 2, Minnesota.

**AD Matches!** Sell amazing designs—20, 30, 40 and 240-light book matches. Big spot cash commissions; every business a prospect. Low prices for high quality. Repeats. Start without experience; men, women; full, part time. Buy nothing! Sales kit furnished. Match Corp., Dept. PM-12, Chicago 32, Illinois.

**SALESMEN**—Would you like a seagoing yacht for one dollar? The writer has one, and after 45 years of successful selling, tangibles and intangibles, has condensed a few priceless and proven secrets of his successes into one small pocket book you can carry with you. This booklet is unlike anything you have read and satisfaction is guaranteed no matter what you are selling. For example the writer sold and placed 34 ordinary life insurance policies in a single day. (Not industrial or group.) A world's record. See "The Insurance Salesman," Oct., 1934. Mail one single dollar for "P.M.S." to Stroud and Sowle, 195 26th Ave., #5, San Francisco 21, Calif. (Crew and Sales Managers, 6 for \$5.00).

A Fine income, your own nylons free! Show nylons, lingerie, men's socks with amazing free replacement guarantee against runs, snags, tears. Write for free sales kit. Group organizers invited. Rosalee Hosiery Co., Clifton 58, N. J.

**SELL** The fastest money maker out! Handy Hannah automatic wax dispenser pays you over 100%. Every housewife wants it. Saves time, labor, stooping, mess, waste. Press button and wax is released. Sample and details write Everett Young Co., Whitman, Mass.

**NEW Jobs** open in selling! Send name, address for five free issues of Opportunity Magazine's money-making guide, listing hundreds of companies who'll pay you well, full or part-time. No experience needed. Opportunity, 28 E. Jackson, Dept. 17, Chicago 4, Ill.

**BIG Money** taking orders. Shirts, ties, Sox, pants, jackets, sweaters, shoes, uniforms, etc. Sales equipment free. Experience unnecessary. Nimrod, 4922-AN Lincoln, Chicago.

## EDUCATIONAL AND INSTRUCTION

**ACHIEVE** Business and financial success in your own collection-credit agency business. Home or office. Quickly learned. Free folder. Write Cole & Associates, Syracuse 2, N. Y.

**IT'S Fun** learning a language by Linguaphone. At home, in leisure time, quickly, easily, correctly master Spanish, French, Italian—any one of 29 languages through proved Linguaphone conversational method. Send for free book. Linguaphone Institute, 83-W Radio City, New York City.

**BE A** real estate broker through home study or classroom instruction. Write for free book. Approved for veterans. Weaver School of Real Estate, 15 E. Pershing Rd., Box CP-12, Kansas City 8, Missouri.

**LEATHER** Carving. Fascinating, highly-paid art; age-old secrets now taught for first time in home study course. For hobby, profession or profitable business, write: Baird School of Leather Carving, Box 1367-M, Dept. 11C, Manitou Springs, Colo.

**MAKE Up** to \$35-\$45 week as a trained practical nurse! Learn quickly at home. Booklet free. Chicago School of Nursing, Dept. M-12, Chicago.

"**HOW To Break and Train Horses**"—A book every farmer and horseman should have. It is free; no obligation. Simply address Beery School of Horsemanship, Dept. 11012-C, Pleasant Hill, Ohio.

**STUDY** For game warden, fish, park, forestry, patrol and wildlife conservation service. Details free. Write Delmar Institute, D11, Denver, Colo.

**USEFUL** "Dictionary of Electrical Symbols and Formulas." 25c. Michigan Technical Institute, 2281 W. Fort Street, Detroit 16, Michigan.

**TUTORING** Radio, television, electronics \$5. Missouri Tech, 3907 N. 25, St. Louis 7.

**USED** Correspondence courses and educational books bought, sold, rented. Catalog free. Educational Exchange, Summer-ville, Ga.

**MEN**—Women. Get U. S. govt. job! Openings for many important positions available. Experience usually unnecessary. Qualify now. Start high as \$66.34 week. Free 40-page book shows jobs, salaries, details. Write today: Franklin Institute, Dept. M-24, Rochester, N. Y.

**MEDICAL** Laboratory Technicians in great demand. We train you in your own home. Catalogue free. Imperial Technical Institute, Box 973-J, Austin, Texas.

**USED** Correspondence courses. Bought, sold, rented. Free literature. Baker, 5509-B Winthrop, Chicago 40.

**SHOE** Repair offers big income. Learned by doing; ages 18-60. Free illustrated book tells how. Write Modern Shoe Rebuilding School, A-806 S. Figueroa, Los Angeles.

**READ 100% Faster!** New amazing method. Save time. Learn more. Earn more. Free home test. Speed-Reading, 9111-h Hoyle, Chicago 20.

**SUCCESS** Simplified! Become a financial wizard; a mental giant; a muscular superhero; a romantic magnet; an expert in any field! Free literature. National Advisory, Box 5852, Cleveland 1, Ohio.

**MENTAL** Dynamics, the key to a successful happier life. Overcome fears, nervousness, lack of confidence, anxieties. Sensational results. Free details. Dynamics, 1553 Sunset Blvd., Los Angeles 26.

**INVESTIGATOR** Courses. Free literature. Allied Academy, 14 No. East, Indianapolis.

**3800 LATEST** Used correspondence courses. Catalog 50c. EG, Elmsford, N. Y.

**LEARN** To play Scrimmage by correspondence. New football game sensation. Big demand for instructors. Write to-day. Fred Welna, 2220 North 33rd Avenue, Omaha 10, Nebraska.

**STUDY** To be a doctor of psychology or metaphysics. Obtain Ps.D., Ms.D., D.D. or Ph.D. degree. Chartered by state. Write for free book telling how. The Neotarian Fellowship, Dwight Building, Kansas City 6, Missouri.

**USED** Correspondence courses and books sold and rented. Money back guarantee. Catalog free. (Courses bought.) Lee Mountain, Pisgah, Alabama.

**HOME** Study course, drugless therapy. Free literature. Institute of Drugless Therapy, Tama, Iowa.

**INVESTIGATOR** Training. Phillips Secret Service System, 1917-B North Keneth, Chicago 39.

**BOOKKEEPERS!** Increase your earnings! Operate your own simplified "dollar-a-week" bookkeeping and tax service. Full or spare time. Details free. No obligation. Ellis, Box 200, Cedar Grove, N. C.

**SECRET** Investigation. Experience unnecessary. Investigators particulars free. George Wagner, M 125 West 86th, New York.

**PIANO** Tuning pays. Learn this profitable profession at home. Our Tonometer and mechanical aids make learning easy. No knowledge music necessary. Diploma granted. Largest and oldest school—52nd year. G.I. approved. Write for booklet. Niles Bryant School, 78 Bryant Bldg., Washington 16, D. C.

## PLAYS, STORIES, MANUSCRIPTS

**I WANT** New writers to cash checks of \$1 to \$100 offered daily. The easiest way to write for pay. No previous experience necessary. Free details. Saunders M. Cummings, 468-11 Independence Bldg., Colorado Springs, Colo.

## INFORMATION

**WHERE** To sell more than 500 items. List \$1.00. D. L. Crawford, 61 Werden, Vallejo, Calif.

## BUSINESS SERVICE

**KNOW** Anything about Mexico. Information on business, personal, Mexican matters reliably handled confidential. Mailing address 25c each. No coins. \$3.00 monthly. Mr. Acuña, Box 25612, Mexico 12, D. F.

## SPECIAL SERVICES

**SUNNY** Latin America, 6 attractive, typical postcards, (one air forwarded when returned) \$1. Letters received, air forwarded, two for \$1. Read about vast zones, untapped, immune atomic warfare, invaluable, detailed report (5,000 words), local color, prospects, costs, jobs, airmailed \$1. Write Casilla Correo Central, 4342, Buenos Aires, (Argentina).

**BOURNEMOUTH**, England, two letters airmailed, \$1. 6 views, post cards, \$1. Bushby, 29 Richmond Mansions, Richmond Gardens, Bournemouth, England.

**TEXAS** Address! Letters remailed 25c. Field's, Box 2431, Dallas, Texas.

## CARTOONING, COMMERCIAL ART, SHOWCARD WRITING, SIGN PAINTING

**FREE** Strok-o-graph shows correct method for brush lettering plus money making opportunities. Home study course in Shocard art, Midwest School of Art, Fort Wayne 2, Indiana.

**DRAW** Beautiful human figures for profit, 20 lessons, 147 illustrations, \$1.00 complete. Aldcroft Studios, Bendix Building, Los Angeles 15, California.

"**HOW To Make Money With Simple Cartoons**"—A book everyone who likes to draw should have. It is free; no obligation. Simply address Cartoonists' Exchange, Dept. 911-C, Pleasant Hill, Ohio.

**FREE** Book! Gagwriting, cartooning. Rush postal. Cartoon Agency, La Habra, Calif.

**BARGAINS**, Quick landscape painting, poster art-lettering, art lessons, catalog 10c. Art Book Shop, Arnold 8-L, Mo.

**ART** Work. Cartoon made your photo \$1.50. EG, Elmsford, N. Y.

**TRACING** Folios—Twelve alphabets, ten numerals, \$1.10. Three different \$3.00. Demonstrators, 639-P Paulina Street, Chicago, 12.

**9 ALPHABET** 3 Numeral pattern sets and catalog, \$1.00. Sign Letter Distributors, P.O. Box 101, Mineola, N. Y.

**TALENT** Test—Information. Give age. Art, Box 8066, Dallas 5, Texas.

**SIGN** Painting taught at home. Test lesson free. Ben Kerns, Box 812-T, Greenville, S. C.

**CHALK** Talks. Laugh producing program, \$1.00. Catalog 10c. Balda The Cartoonist, Oshkosh, Wisconsin.

## ADVERTISING AGENCIES, LETTER WRITERS, FOR ADVERTISERS

**TESTED**, Responsive, rural mailorder buyers. Men, women. Gummed labels, \$10 1000. Muchnick Co., 150 Nassau, New York 7.

**SPECIAL**—1000 Opportunity seekers names, \$1.00. Wilbur Erickson, English-town, New Jersey.

**FRESH** Names, compiled weekly; men, women mailorder buyers, opportunity seekers, etc. 1,000, \$4.00; trial 300, \$1.00. Wright Publications, Memphis 8, Tenn.

**24 WORDS** In 50 weeklies, \$4.96. J. Darnell, 730 Hays, Jackson, Tenn.

**ADVERTISE**: 24 Words, 40 newspapers \$3.50. Lists free. Advertising Bureau, 10511-C Springfield, Chicago 43.

**MAILING** Lists; \$5.00-1000 up. Write Dixie Service, King, N. C.

**ADVERTISERS!** Reach nearly 18,000,000 readers, 25 Sunday national key newspapers, 18 words, \$51.50. "Terrific pullers." 20 popular newspapers, \$10.00. "Free booklet." Special—One inch display 2,-821,198 circulation, \$48.30. Newmark's Advertising Agency, (Established 1893), 217-7th Ave., New York 11.

**ADS** Placed in out of town newspapers and magazines. Low rates. Catalogue free. Ideas that pay. Baker Advertising Agency, Successors Ankrum Agency, 189 W. Madison, Chicago 2.

## TYPEWRITERS, DUPLICATORS, OFFICE DEVICES

**TYPEWRITERS**, Calculators, adding machines, rebuilt, reconditioned. Write Singer Typewriter Company, Fordham Road, Bronx, New York.

**TYPEWRITERS** \$25.00. Duplicator \$12.50. adders \$12.50. addressers \$9.95. Typewriters, 118N Spruce, Wichita, Kansas.

**PRINTOMATIC** Selffeeding post card printing duplicator \$13.50. Envelope addressing machines \$24.50. Pittsburgh Typewriter Company, 336-R Fourth Ave., Pittsburgh 22, Penna.

**RECONDITIONED** Typewriters, devices. Write Dixie Service, King, N. C.

## RUBBER STAMPS AND SUPPLIES

**READY** Made stamps, typewriter, Box 2326, Denver, Colo.

**LINE** 20c; 2-35c. Auburn, Nebraska.

**DECEMBER**



**CASH** For your idea. 280 manufacturers need inventions, patented or unpatented. List free. Invention Bureau, 208M Clinton, Oak Park, Illinois.

**INVENTIONS** Promoted. Patented or unpatented. Write Adam Fisher Company, 61 Enright, St. Louis, Mo.

**INVENTORS:** Nationally-known manufacturer seeks new patented products suitable for manufacture by high production methods. Write P.O. Box #7312, Chicago.

**INVENTIONS** Wanted. Patented or pending only. Inventors' Exchange-B, Hartford 1, Conn.

### PATENTS FOR SALE

**FOR** Sale outright. Patents and dies for new comb; best offer takes it. Frank Kuszyk, R.D. #4, Pottstown, Penna.

**FOR** Sale. Locomotive oil burner. Saves fuel. No smoke. No carbon in fire box. M. Brittain, Chickasha, Oklahoma.

**SKIMMING** Boat U. S. patent 167049. Rides water surface faster than cars. Write air mail. Mohideen c/o Proctor Cassim, Puttalam, Ceylon.

**UNOPENABLE** Shoe lace; coin holder tie clasp; two pants hanger. Proposition wanted. Belenfant, 631-3rd Avenue, New York City 17.

**PERFUMING** Electric light globes. Patented formula. Money maker. Scent-O-Lite, 4042 Kimball, Chicago 18, Illinois.

**INVENTORS:** Test the commercial value of your patented or unpatented inventions, quickly and inexpensively. Write for free information. Institute of American Inventors, Dept. 40-B, 631-E St. N.W., Washington 4, D. C.

### MODELS, MODEL SUPPLIES

**GJQA**, Arctic sloop, and City of Pekin, steam canal barge, two new kits. Also Notebook for Shipmodel Builders, by Pratt, 32 pages, illustrated \$1.00 postpaid. Send 25c for new 1951 catalog. Folio 20, Model Shipways, 476 Main St., Fort Lee, N. J.

**POWER** Models. Unusual steam, gasoline and traction engines. Metals, tools, accessories. Catalog 50c. Chas. Cole, Ventura, Calif.

**STEAM** Locomotives, 1½", 1", ¾", ½" ¼" scales. Castings, rail, steam fittings! Thorough drawings with instructions. Catalog 50c. Little Engines, Wilmington, California.

**RAILROADERS**—50c Gets new Catalog Reference Manual. State O or HO gauge. Walthers, 247 Erie, Milwaukee 2, Wis.

**METALS** For home workshops. Aluminum, brass, copper, monel and steel. Bars, angles, channels, sheets and tubes. Write for small quantity price list. Cashmetals Co., 9 Arlington Park, Pittsburgh 34, Penna.

**BUILD** An electric motor. Complete parts with assembly instructions. \$1.50 postpaid. Harry Langton, 402 S. E. Hawthorne, Portland 14, Oregon.

**FIRE** Engines. Will-O-Line authentic ½" scale kits. Hose wagons, steamer, ladders and many others. Horses ½" scale \$2.25 pr. Complete. Stamp for circular. Bay Models, Box 1012, Braintree 84, Mass.

**TOY** Replica of Rex Mays' famous race car. Nine inch scale model, high speed wind-up motor, off set cockpit, rubber tires. Durable and appealing to all ages. \$2.00 postage included. Satisfaction guaranteed. Jones Enterprise, 63 Canterbury Court, Eggertsville 21, New York.

**POWER** Models. Unusual steam, gasoline and traction engines. Metals, tools, accessories. Catalog 50c. Chas. Cole, Ventura, Calif.

**BRASS** Gears and model supplies for the inventors. Send 10c for catalog. Pierce Model Works, Tinley Park, Ill.

**BUILD** Historic ship models, complete kits 39c to \$9.00. Catalog 10c. Ideal Models, 19 W. 18th, New York 11, N. Y.

**SHIP** Models and yacht supplies complete. Large 64 page catalogue 30c. Bill Wild's, 510 East 11 St., New York City 9.

**LIONEL** Trains, accessories, switches. Tremendous stock; fast delivery. Guaranteed repairs. Authorized Lionel Train Station, 72 West Washington, Chicago 2.

**SHIP** And yacht model fittings; blueprints. Send 25c for illustrated catalog No. 25—listing hundreds of items. A. J. Fisher, 1002-1 Etowah Ave., Royal Oak, Mich.

**DOWMETAL** Magnesium for all model makers. Rod, bar, sheet and scale structural shapes. The Craftsmiths, 15427 Robson, Detroit 27, Michigan.

### MANUFACTURING

**COMPLETE** Inventors' model construction services. Mechanical Development Company, Salem, Virginia.

**MODELS**—Small lot manufacturing. Metals, plastics, etc. Milburn, Burlington, Kentucky.

### HOME CRAFTSMEN

**89 FULL** Size jig saw patterns of beautiful shelves, ornaments, toys, novelties. Plus "How, Where to Sell." Only \$1.00. Mastercraft 124M, 7041 Olcott, Chicago 31, Illinois.

**LEATHERCRAFT.** Everything needed by beginners, advanced hobbyists and professional leatherworkers. Largest stock of supplies in U.S. Moderate-priced tooling leathers, top quality calfskins, tools, supplies, kits. Send 10c for big catalog. J. C. Larson Co., 820 S. Tripp, Dept. 575, Chicago 24.

**300 PROJECTS** You can make in Popular Mechanics 32 page Blueprint Catalog. Send 3c stamp for copy. Popular Mechanics Press, Dept. BP, 200 E. Ontario St., Chicago 11, Ill.

**NEW 96** Page leather and craft catalog. 1000's of items. Send 10c. Russo Handicraft Supplies, Dept. 12D, 245 South Spring, Los Angeles, California.

**EARLY** American working model spinning wheel. Also grandfather clock case to fit any pocket watch. Both models 12" high, plans and instructions \$1.25 each or both for \$2.00. Williams Woodcraft, 6408-31st Ave., Kenosha, Wis.

**FOAM** Rubber do it yourself. Auto pads 24"x60"x1½" \$6.00. Chair pads 12"x12"x1½" set of 4 \$3.60. Other sizes 15"x15"x1½" \$1.50. 18"x24"x1½" \$2.10. 24"x24"x1½" \$3.00. Order from ad, shipped prepaid except c.o.d. Free gov't surplus catalogue. Ben's Surplus, 287 Kleiman Bldg., Grand Rapids, Michigan.

**JIGSAW** Owners attention! Start earning money at home cutting out wooden novelties and souvenirs. Write H. Cook, Dept. A, 4407 S. Normal Ave., Chicago 9, Ill.

**16 NEW** Lawn chairs, 22 picnic tables, benches, trellises, etc. All 38 plans with necessary full size patterns. \$1.00. Mastercraft 123M, 7041 Olcott, Chicago 31, Ill.

**LEATHERCRAFT** Supplies, leather and tools, low prices. Send 10c for catalog. Jonas Handicraft Co., (Dept. M-12), 30 Frankfort St., New York 7, N. Y.

**ARTIFICIAL** Flower supplies and sea shells. Free catalog. Herbert Diamond Co., Box 1625, Riverside Sta., Miami, Fla.

**LEATHERS** For every need. List free. Sam Tinnin Company, 213 East Walnut, Columbus 15, Ohio.

**70 LAWN-Ornament** and novelty patterns \$1. Write for new price list. Mosbro Patterns (M), 44 Victor, Mimico, Ontario.

**90 ALL** New, full size lawn ornament and novelty patterns, up to 20" high. Only \$1.00. Mastercraft 122M, 7041 Olcott, Chicago 31, Illinois.

**SAVE** Money on Xmas presents. Get Christmas Handbook—make toys, gifts and decorations yourself. \$2.00 postpaid. Popular Mechanics Press, 200 E. Ontario St., Chicago 11, Ill.

**GARDEN** Figures, lawn chairs, furniture, novelties, toys, etc. 68 popular plans, with full size patterns, \$1.00. Mastercraft 121M, 7041 Olcott, Chicago 31, Illinois.

**POPULAR** Full scale woodwork patterns. 106 useful gifts \$1.50, 50 toys \$1.00, 110 pins 50c. All \$2.50. Mrs. James Schilder, Cresbard, South Dakota.

**VIOLIN** Makers, amateurs, professionals. Fine tone, European wood, materials, supplies. Illustrated catalogue 10c, refunded. Premier Violin Supply, 430 S. Broadway, Los Angeles 13, California.

**SELL** All metal duck windmills. Sample \$1.95. Reitz, 13820 Wentworth Ave., Chicago 27, Ill.

**LEATHERCRAFT** Supplies, leather, tools, lacing. Catalogue 10c. Mail orders. Crown Leather Co., 22 Spruce Street, New York 7.

**SWISS** Music movements, finest make, assorted tunes. \$1.90. Direct imports. Helaxe Company, 233 West 72 Street, New York.

**BANDSAW**, Jigsaw owners, let your machine bring extra profits, fun. Free details. Nu-Art, Dept. B, Box 2235, Boston, Mass.

**SHELLCRAFT** Made easy, for hobby or profit. Giant new illustrated catalogue full of new designs for jewelry, plaques, etc., with instructions. Send 25c for this big combination catalogue. Southern Shellcraft Supply, Clearwater, Florida.

**NEW** Leathercraft catalogue. Pleasure and profit. New styles, belts, purses, shoes. Largest leathercraft school in U.S.A. G. I. approved. Send 10c for catalogue. Dept. PM, Apache Leather Co., 2804 E. Washington St., Phoenix, Arizona.

**INDIAN** Style leather moccasin kits. Pieces die cut. Sizes, small (1-5), medium (5-8), large (8-12) \$1.75. Shearling moccasins \$2.75, postage paid. Walter E. Berger, Atchison, Kansas.

**ALL** Leathercraft supplies! Catalogue 10c, refunded first order. Rosenblum Leather, Box 507, Sheboygan, Wisconsin.

**LEATHERCRAFTERS:** Big illustrated catalog of materials, tools, kits, 10c. Art Leather, 411 Joseph Ave., Rochester 5, N. Y.

**SHELLS, Plastics, findings.** Lowest prices. Catalog 5c. Frances Jones, Box 251, Sarasota, Fla.

**GOLD-Plated** jewelry supplies. Rhinestones, pearls. Illustrated catalog, 10c. Barry's, 47-N Branford Place, Newark 2, N. J.

**BEAUTIFUL** Lawn ornament patterns, ready cut, full size. 20 assorted \$1.00 postpaid. Lincoln Craft Studio, Farmington, Conn.

**LEATHERCRAFT,** Copper tooling, textile painting. Make spare time, profitable time. Free illustrated catalog shows everything you need. Kit Kraft, 7377 Melrose, Hollywood 46, California.

**LEATHER, Tools, lacings, supplies.** Free catalog. National Handicraft, 199 William St., New York 7.

**OZARK** Wood samples. Eleven useful identified varieties. Prepaid \$1.25, check or cash to Davis Lumber, Cabool, Mo.

**8 BEAUTIFUL** Full-size whatnot patterns 25c. Joannes, P.O. Box 141-M, Omaha 7, Nebr.

**80 FULL** Sized patterns. Lawn ornaments, toys, novelties \$1.00. Modern Woodcraft, Saginaw, Mich.

**KNOCKDOWN** Cedar chests. Lumber and veneers. Free price list. Giles & Kendall Company, Huntsville, Ala.

**JEWELRY** Findings, rhinestones, pearls, sequins, cameos, J & M Novelties, Box 464P, Griffith, Ind.

### MAKE IT YOURSELF

**BUILD** Your own "tractor." Plans. Walking, riding. Free information. Ellsworth Tractor Co., D-1, Camptonville, California.

**HOW** To design or build your own cabin, cottage, house or tourist cabins. Tech-Talk Design, 19375 Charleston Ave., Detroit 3, Michigan.

**FREE** Literature describing needed farm and home machinery, easily built by you, from salvage materials. Kenneth Reeves, Box 3357-A, El Paso, Texas.

**BUILD** Your own concrete blockmaker. Easy. Inexpensive. Motor or hand. Make block per minute. Write, C. Lee, Mountain View, Okla.

**BUILD** 21" Heavy duty band saw. Cast aluminum parts, full ball bearing. Parkraft, 246 Reo, Warren, Ohio.

**YOU'VE** Seen three dimensional pictures but none as beautiful as you can make inexpensively with our plans. \$1.00 for plans and instructions. Wojcik, 141 Home St., Pittsburgh 1, Penna.

**GRANDFATHER** Clock easily built. Big savings. See ad on page 272.

**\$600** BUILDS Cozy 4 rooms and bath. Concrete block, stuccoed. Instructions and blueprint \$1.00. Farrow, G83, Box 645, Columbus 16, Ohio.

**WHY** Don't you build? Plans: End table 30c, bookcase 30c, desk 60c. All 3, \$1.00. Folder 10c. Craft-Plan, 3928½ W. 27th St., Los Angeles 18, California.

### WATCHES, OLD GOLD, JEWELRY

**WATCHMAKERS'** Jewelers', hobbyists', tools. Supplies. Catalogue! Bengal Company, Culver City, California.

**UNREDEEMED** Diamond, 1 carat, \$295. 30-day refund. Free catalog. Broff's Diamond Loan Association, 411 Smithfield, Pittsburgh, Penna.

**10 HIGH** Grade Swiss wrist watches needing some repairs, in yellow gold cases \$18; in white cases \$15. B. Lowe, Holland Bldg., St. Louis 1, Mo.

**GOLD** Plated jewelry supplies—Rhinestones, pearls. Illustrated catalog 10c. Barry's, 47-A Branford Place, Newark 2, N. J.

HIGHEST Prices paid for old gold, silver, platinum, diamonds, watches, gold teeth, spectacles. Goods returned if offer unsatisfactory. Government licensed. United Smelting Works, (The Old Reliable), 39-B South State, Chicago 3.

WATCHES Completely overhauled \$4.00. Fifty-three years' experience. No-Stop Watch Shop, Glenwood, Arkansas.

HIGHEST Cash prices paid promptly for old and broken watches, jewelry, spectacles, dental gold, diamonds, etc. Mail articles today or write for free shipping container. Lowe's, Dept. PM, Holland Bldg., St. Louis 1, Mo.

WATCHES Cleaned, repaired. Maximum charge \$4.00! Year guarantee. National Watch Repair, Box 2414-EA, Cleveland 12, Ohio.

WATCHMAKERS! Beginners! Watches, movements, descriptive list 15c. Box 150, Chicago 90.

DIAMONDS Lowest wholesale prices. Airmail for price list. Joachim Goldenstein Diamond Club, Antwerp, Belgium.

HIGHEST Cash paid for old, broken jewelry, gold teeth, watches, silverware, diamonds, spectacles, platinum. Free information. Satisfaction guaranteed. Government licensed. Rose Smelting Company, 29-A East Madison, Chicago.

### TOBACCO, SMOKERS' SUPPLIES

MAKE Pipes for pleasure and profit. Free literature. Carvape, 2829-G Dixie, Hamilton, Ohio.

EASIBILD Pipemaking kits \$1.00. Interesting circular free. Bulldapipe, PM12, Ivoryton, Conn.

### RAZORS, BLADES, SHARPENING

SLICK Trick worth dollars and drinks. Make ordinary razor blades last 100 or more shaves. No special equipment needed. Complete details of practical method for 25c coin and self-addressed, stamped envelope. Satisfaction guaranteed. Billmil, Dept. C, Box 104, Burnet Woods Station, Cincinnati 20, Ohio.

FREE. Pocket knife with 100 double edge razor blades. Surgical steel. Guaranteed. \$1.00. Payne, 5426 5th Ave., Los Angeles 43, Calif.

### OF INTEREST TO WOMEN

STREAMLINED. Built-in kitchen cabinets to fit any kitchen. Illustrated manual describes designing and construction. All for \$1.00. Thombert Company, Newton 20, Iowa.

TEN Home sewing projects 25c. Possible to make \$4 to \$12 daily. Fast, easy. Liebig Industries, Beaver Dam 2, Wis.

MAKE Excellent profits with amazing cuticle and nail nourish. E-Z-On, 1009 Harvard, Evanston 19, Ill.

EXCELLENT Profits. Make fast-selling chenille Christmas poinsettias, corsages, Santas, monkey trees, dolls. Literature free. Velva, Dept. M, Bohemia, N. Y.

### FOR SALE—MISCELLANEOUS

WAR Surplus! AAF: Headphones, \$1.00 (cord 50c); hand microphone, \$1.95. Parachute, 24', white silk, complete w/harness, \$14.95. 200 amp. P-1 28V generator, convertible as welder, \$13.95. Instruments: Tachometer, airspeed, air temperature (electric), manifold pressure, suction gage, 0-2000# oil gage; \$1.95 each. 10% shipping charges. AAF surplus catalog 25c. Aero Parts Supply, #102 Lockheed, Houston, Texas.

FREE Catalog! War surplus clothing. Amazing bargains. N. Y. Clothing Co., New York 29.

HANDSIGHTING Levels, improved, new model, used for grading land, contouring and laying out fences, piers, roads and gardens, price \$2.00 postpaid. Public Sport Shops, 11 S. 16th Street, Philadelphia 2, Penna.

SAVE Money on army, navy and factory surplus. Write today for new 60-page illustrated catalog. Tennusa Sales Co., Dept. AE, 1451 Market, Chattanooga, Tenn.

10"x1 1/2"-10T WOOD And bone cutting saw blades, punched. 10 for \$1.00 P.D. Bassett Industries, Vinton, Iowa.

GENUINE Buckskin coin purse and illustrated buckskin catalogue, both only 15c. Berman Buckskin Co., 253 No. 1st, Minneapolis, Minn.

DRESSES 18c; Coats \$1.00; blouses 35c. Free catalog. Crown, 164-PA Monroe Street, New York.

### WANTED—MISCELLANEOUS

WANTED—Scrap mercury (quicksilver), tantalum, bismuth, tungsten. Metallurgical Products Co., Established 1909, 35th and Moore Sts., Phila. 45, Penna.

### PERSONAL

BORROW By mail. Loans \$50 to \$300 to employed men and women. Easy, quick. Completely confidential. No endorsers. Repay in convenient monthly payments. Details free in plain envelope. Give occupation. State Finance Co., 210 State Finance Bldg., Dept. 257, Des Moines 5, Iowa.

ATOMIC Tags. Name, address and blood type or social security number impressed in metal disc. 25c. R. Roth, Laurel Springs, N. J.

"INTERESTING Mails" — 25c keeps name on mailing lists three months. Bentz, Desk-C/38, Chatawa, Mississippi.

MEXICAN Mailing service. Your letters remailed, received 20c. Mystify friends. Photographic postcards 10c. Tillotson, Apartado 1405, Guadalupe, Jalisco, Mex.

FREE: 100 Double edge razor blades, with every \$1.50 Sta-Neet hair trimmer. R. Plumb, Herkimer 21, New York.

REVOLUTIONARY Hearing device. No battery, no wires. Just a simple ear plug that carries sound to the ear drum. Beaudry, 4337-30th Avenue South, Dept. H, Minneapolis 6, Minn.

LONDON, Paris, Rome, or Madrid view-cards, 4 for \$1.00, remailed free from representative countries. Travelpost, Box 1250, Albuquerque, New Mexico.

100 GUARANTEED Blue blades \$1.50. Bretey Co., Box 8, Staten Island 14, N. Y.

HERE'S How and where to borrow \$50.00 to \$300.00 by mail. Confidential. Free particulars. Postal Finance Company, Dept. 45, Sioux City, Iowa.

CHICAGO Remail 25c. T. Roche, 6025 S. Harper Ave., Chicago 37, Ill.

A Magazine subscription makes useful Christmas gift. Free catalog listing lowest rates. Sappington Company, Marion, Ohio.

VALUABLE Big mails, four months listing, 25c. Wright Publications, Memphis 8, Tennessee.

MEXICAN Law. General Practice Attorney, 1203 Arizona Street, El Paso, Tex.

MEXICAN Legal matters reliably handled. Box 263, El Paso, Texas.

"HOW Can I find out?" You can! Information discreetly developed. Any matter, person, problem, anywhere. Worldwide. Officially licensed, bonded service. Established 1922. Reasonable. Confidential. William Herman, 170 Broadway, New York.

### MISCELLANEOUS

\$5 HOUR Easy! Sell name plates for houses. Free sample, order blanks. Write: National, 214 Summer, Boston, Mass.

SILVER Cleaning plate—Removes tarnish like magic. No rubbing. Really amazing. Make and sell this wonder. Formula, full instructions \$1.00. Money-back guarantee. Kemsil, Park Ridge, Ill.

SAVE Money on paint brushes. Buy direct. Post card brings descriptions and prices. Kenmore Brushes, P.O. Box 53, Kenmore 17, N. Y.

"SWAPPERS Manual" 25c. Offers needs listed 5c per word. Cathers, 824 17th St., Altoona, Penna.

MENTAL Freedom—Your lifelong confidential counsellor book personally autographed \$5. Address: Dr. Vincenzo Cattano, Box 6296, Metropolitan Station, Los Angeles, California.

HOW To grow miniature orange trees \$1. Sams Grove, Perrine, Fla.

YOUR Voice made loud, magnetic, powerful, with my diaphragm exerciser. Write. Inventor "Oz," 34a Box 665, St. Louis, Mo.

FORTUNE May be yours. Detect uranium, gold, silver, precious metals, minerals. America's finest Geiger counters, metal and mineral detectors. None finer at any price. Factory guaranteed. Write manufacturer for free information. Detection Co., 5631 Cahuenga, Dept. B-12, North Hollywood, California.

PANNING Gold—Beginners booklet 36 pages; catalogue, supplies, mining books, maps "where to go." 25c. Old Prospector, Box 729, Lodi 1, Calif.

ADD "Spice" to home projection shows with old-time Nickleodeon slides. 2x2. Kodachrome. Write for free list. Nickleodeon Co., New Fliedner Bldg., Portland 5, Oregon.

TREASURE—M-Scope Geiger counters, mineral locators. Why buy something inferior when you can buy the best at a lower price? Backed by years of experience. Fully guaranteed by factory. Detects minerals, metals, gold, silver, coins. Payment plan available. Proven superior performance. Free 16 page illustrated booklet. Fisher Research Lab., Inc., Palo Alto, California.

INCREDIBLE! Unprecedented! Become a mental superman overnight! Floor everybody! No studying! "Memoprop" does all your thinking! It's uncanny! Revolutionary! Write: Bijou, Box 1737-M6, Hollywood 28, California.

HAIRCUT As you like it. New booklet tells how. 25c. Mastrolia 5 1/2-G Jane, New York 14.

SPIT-FIRE. Guaranteed the hottest, most dependable alcohol blow torch. Write Robert Livingston, 1425 Scott, Williamsport, Penna.

BALLOONS — Large asst. Airships, rounds, giant paddles, serpentine, knobby and novelty balloons, all sizes, bright colors. 50 for only \$1 postpaid. Satisfaction guaranteed. J. Lewin, P.O. Box 38, Dyker Heights Sta., Brooklyn 28, N. Y.

EARN Up to \$200 month, inventing toys, games, gadgets. Write, Hendrickson, Argyle 1-A, Wisconsin.

HALF Million articles wholesale. Directory 10c (refundable). Publishers, Box 1302-P12, Detroit 31.

WHITE Birch logs, fireplace length 50c. Candelsticks, single 75c, double \$1.00. White Birch Logs, 159 State Street, Rutland, Vermont.

HOME Turkish steam bath, portable, collapsible, inexpensive. Free information. Perspir-Ator, 1186-A 180th, New York 60.

GLASS Cutter and instructions on how to cut glass \$1.00. Crawford Glass Shop, St. Helens, Ore.

ELECTRIC Paint remover from wood, plaster surfaces, curved or irregular. Safe, flameless. Precision built of chromeplated and stainless steels. Absolutely guaranteed. \$12.95. Your dealer or B & L Tool Company, 51 Pine St., Plainville, Conn.

BLESSED Event novelty for expectant fathers, brand new fathers, one dollar. Free samples. Mersand, 1906 Strauss, Brooklyn 12, New York.

20% DISCOUNT On radios, television, electric appliance, mixers, binoculars. Catalog \$1.00 (refundable). Points Mail Order House, Box 331, Middleton, Penna.

URANIUM Prospecting information free. Prospector, Box 142-D, North Battleford, Saskatchewan, Canada.

VERMONT Maple syrup, sugar, cream, 100% pure. 1950 crop. Butternuts. List. Christmas suggestion. H. Marshall, Poultney, Vt.

70 BIBLE Lessons, 25c. Bulletin, Box 87, Cathedral Station, New York 25.

TREASURE Finders for gold, silver and minerals. Money back guarantee, best available. Also Geiger counters for uranium prospectors, free information. Write Goldak Company, 1541 West Glenoaks, Glendale 1, Calif.

RECEIVE Hundreds of valuable items absolutely free. Supply source directory 25c. Nelko Service, 3462 Merchandise Mart Sta., Chicago 54, Ill.

LUMINOUS Reflective paints glow day and night in technicolor! New angle money-maker. Assorted color samples 25c. Research, 1842-PM Byron, Chicago 13.

DRESSES 18c; Coats \$1.00; blouses 35c. Free catalog. Crown, 164-PM Monroe Street, New York 2.

TATTOOING Machines, outfits. Free catalogue. Jensen, 120 West 83rd Street, Los Angeles 3.

"RECEIVE Mail." Money-making offers, opportunities, catalogs. Name listed 10c. Ideal Service, Park Ridge 10, Ill.

SQUARE Dance instructions. 40 dances, \$1.00. Wesley Rader, 1922 Grant, Denver 5, Colorado.

YOUR Leather jacket renovated by our craftsmen expertly, reasonably. Request free descriptive circular. Berlew Mfg. Co., Dept. 8, Freeport, N. Y.

TATTOOING Outfits, supplies. Illustrated list free. Zeiss, 728 Leslie, Rockford, Illinois.



# Earn Big Money

## WRITING ORDERS

# AMAZING NYLONS

*Guaranteed Against*  
**RUNS AND SNAGS**  
*Regardless of Cause!*

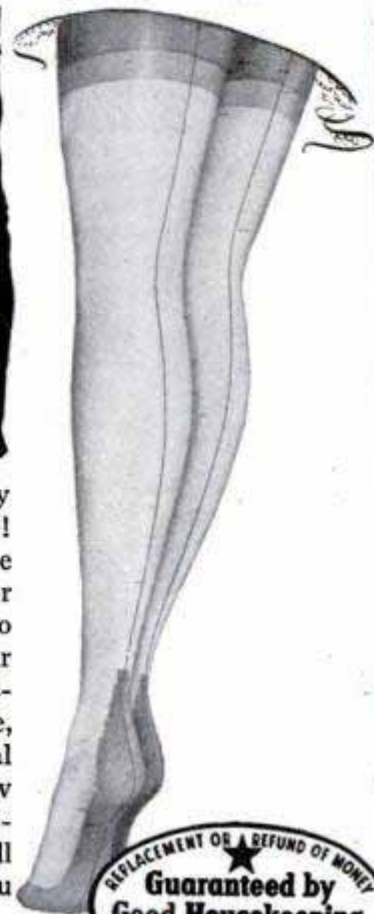

The world's ONLY complete, nationally advertised nylon hosiery line actually guaranteed against runs, snags or excessive wear, REGARDLESS OF CAUSE! It's amazing, but true! No matter what the cause—hard use or deliberate abuse—Kendex nylons are replaced FREE if they run, snag or become unfit for wear within entire guarantee period! Every weight from sheerest 15 denier to heavy 70 denier—all gauges up to luxury 60 gauge—all sizes, lengths, popular shades, fancy heels, black seams—full fashioned and seamless. Nothing is missing to make sure every woman is pleased. In spite of the amazing guarantee, retail postage prepaid prices are no higher than comparable quality national brands. Should free replacement be necessary, actual cost is cut in half! How could any woman possibly resist saving money and solving her hosiery problems? NOT SOLD IN STORES. Men and women wanted NOW, spare or full time, to write orders and earn big money. You can get orders even if you never sold a thing in your life!

### **MEN'S HOSE** **GUARANTEED 1 YEAR**

Kendex gives you FOUR complete lines, including sensational men's hosiery line actually guaranteed for ONE YEAR! Any pair not giving satisfactory wear within 12 months is replaced FREE without question. All styles, patterns, colors, yarns (including nylon) at lowest prices that mean steady income for you 52 weeks a year.

### **LINGERIE** **HOUSECOATS - ROBES**

Full line of lingerie, housecoats and robes. Materials used include nylon crepe, nylon runproof tricot, multifilament rayon crepe, rayon tricot, rayon satin, etc. Nothing is lacking. Every garment at prices that defy competition and make women eager to order. Kendex values sell themselves.

### **NATIONALLY** **ADVERTISED**

Kendex has advertised in Life, Look, Collier's, McCall's, Saturday Evening Post, Ladies' Home Journal, Good Housekeeping, etc. Carries the Good Housekeeping Guarantee Seal. Thousands of orders shipped daily. Yearly volume in millions. A dependable responsible national organization.

## **FREE SAMPLE MATERIALS AND MONEY-MAKING OUTFITS**

Man or woman—young or old, YOU can easily earn steady income, spare or full time. No money or experience needed. We supply EVERYTHING free and set you up in business at OUR expense. Nothing to buy or deliver. Write orders, we deliver and collect. Big advance pay plus huge cash bonus that increases your earnings up to 40%! Your name and address on postcard will bring you sample materials—samples of lingerie, hose, robe materials; self-selling sales books with FULL COLOR illustrations; 36-page sales manual showing you easy steps to success; color cards, free "door openers" worth \$1 each but which you give away free; special plan to have others sell for you, etc., etc. You can start making money the minute you receive the complete FREE outfits!

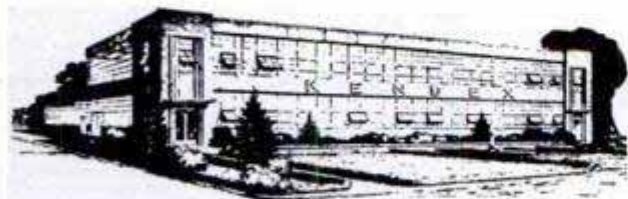

### **YOUR COST ONE CENT!**

SEND NO MONEY. Pay nothing now or later. No obligation. Not even a promise to return outfits. Simply write your name and address on a penny postcard and mail to us. We'll immediately rush you everything you need FREE and postage prepaid. WRITE TODAY!

# KENDEX CORPORATION • BABYLON 546, N.Y.



\*Grand Guy and/or Gorgeous Gal  
Who Has Everything... But...

## Bushnell's New 6 POWER BINOCULARS

World's Smallest, handiest full 6 Power Coated Binocular. Brings objects 83% closer. Field: 370 ft. Color-Corrected Achromatic Lenses. Originated in World War II for secret agents; Size 2" x 3 3/4". Wt. 5 Ozs. Beautiful 2 tone Chrome. 1,000 and 1 uses!

\$35  
VALUE  
**\$17.95\***



## Amazing 7 POWER, 35 MM.

Extremely accurate. Highly color-corrected. Advanced design. Coated. Needle sharp vision. High resolving power. Amazing clarity. Extreme lightness. Field: 375 ft. 4 3/4" x 5 3/4". Featherlight Magnesium Model **\$54.50\*** (Central Focus \$4.00 extra.)

\$145  
VALUE  
**\$45.50\***

**33 More BUSHNELL MODELS**  
From 2.5 x 25 MM to 16 x 50 MM — **\$5.95 Up**  
6 Power, 30 MM. Fine Precision **\$34.75\***  
10 Power, 50 MM Power Plus **\$68.50\***

**AT LEADING DEALERS! WRITE FOR NAME!**  
\$5 Reserves any model till Xmas. Ask for Bushnell's "Lay Away Plan." Money back guarantee. 30 Day Free Trial Plan.

\*Add Usual 20% Fed. Tax

**FREE! XMAS CATALOG AND GUIDE**  
"How To Select Binoculars"

**BUSHNELL Binoculars**

Bushnell Bldg., Dept. MA-12, Pasadena 1, Calif.



# FREE TRIAL PROVES YOUR ENGINE RUNS BETTER WITH WATER!

You'll find this device on new cars next year—but why wait? Engineers have at last perfected new fool-proof way to inject water into fuel mixture—just like in airplanes. Gives tremendous upsurge of extra power—amazing acceleration. You pass other cars on hills! Engine knocking, pinging disappears, even with cheaper gasoline. Positively guaranteed not to rust or harm any engine. New engineering principle—thoroughly tested on all cars and trucks. Never fails to improve performance spectacularly. Easily installed on any car or truck—pays for itself on gas saved. Write for absolutely **FREE 30-DAY TRIAL. SEND NO MONEY.** Mail card with your name, address, make and year of car to AUTO-JET Co., 4573 Melrose, Los Angeles 27, Calif.

**SPEED UP  
YOUR CAR!**

**Get rid  
of ping  
'knocks'**

**Makes regular gas  
perform like Ethyl!**

## New Advertising Machine Prints Post Cards

**FREE** LEARN HOW thousands of business men, in every line, boost sales in spite of conditions—with ads printed on postcards by amazing new patented **CARDMASTER** advertising machine. Low price, sold direct. Guaranteed 5 years. **SEND NAME** for **FREE** illustrated book, new money-making ideas and complete, unique advertising plans. **Cardmaster Co., 1920 Sunnyside, Dept. 1312, Chicago 40, Ill.**



## Say You Saw It in POPULAR MECHANICS

### Handy Mail Order List

### Little Library of Useful INFORMATION

**5 for \$1.00**  
**12 for \$2.00**  
**25¢ Each**

Here at amazingly low cost is the practical help and information you have always wanted. Articles in previous issues of Popular Mechanics have been classified according to subject and are now available in these handy reprint booklets.

- How to Use Measuring Tools—Micrometers, Calipers, etc.—106.
- Power Driven Saws—74.
- Drill Presses, Grinders, Etc.—79.
- Wood, Metal Turning—Lathes—81.
- Filing Machine, Hacksaw, Cutoff Wheel, Shaper—82.
- Lathe Tools You Can Make—101.
- Workbenches—Tool Cabinets—47.
- Spray Painting—94.
- From Pattern to Casting—91.
- Tool and Saw Sharpening—92.
- Sharpening Drills, Wood Bits—90.
- Successful Wood Turning—32.
- How to Read Blueprint—71.
- Metal Turning Lathe Kinks—99.
- Operating a Metal Lathe—100.
- Heat Treating, Hardening—102.
- Working With Glass—103.
- Servicing Elec. Motors—75.
- Electromagnets & Solenoids—44.
- Transformer Construction—41.
- The Boy Electrician—43.
- Soldering and Brazing—17.
- Arc and Spot Welders—5.
- Electroplating With Nickel, Chromium, Cadmium, Etc.—86.
- Plating Leather, Wood, etc.—87.
- Lower Your Fuel Costs—31.
- Curing Leaky Basements—45.
- Fitting Home Game Room—55.
- Indoor & Outdoor Fireplaces—88.
- Backyard Gardening—39.
- Lawn and Garden Novelties—72.
- Trellises, Pergolas, Fences—76.
- Lawn and Garden Furniture—77.
- Playground Equipment—73.
- How to Use Your Drill Press—125.
- Making Serving Trays—53.
- Knots and Ropework—105.
- Sanders—80.
- House Wiring—89.
- Hanging Wallpaper—38.
- Built-in Fixtures—78.
- Bird Houses—7.
- Magazine Racks—49.
- Clock Cases—50.
- Book Ends—52.
- Small Tables—54.
- Smoking Stands—56.
- Desks—58.
- Book Cases—59.
- Action Toys—66.
- High Flying Kites—67.
- Telescopes—20.
- Metal Craft—28.
- Small Looms—37.
- Gem Cutting—42.
- Photo Enlargers—1.
- Photo Kinks—98.
- Cleaning Formulas—11.
- Taxidermy—9.
- Photo Lighting—119.
- Training Dogs—35.
- Small Furnaces—36.
- Working With Plastics—61.
- Simple Home Improvements—104.
- Ridding Home of Insect Pests—107.
- Children's Room Furniture—51.
- Jigsawed Novelties—57.
- Doll House & Doll Furniture—60.
- 25 Shelves You Can Make—64.
- Novelties Turned on Lathe—62.
- Inlay Pictures—Veneering—63.
- Wood, Soap Carving—65.
- Windmills & Weathervanes—68.
- Lamos from Wood, Metal—69.
- Rustic Furniture—18.
- Wood Finishing—40.
- How to Fix Electrical Appliances—111.
- Painting Your House—117.
- Build Your Own Relays—123.
- Rowboats, Small Dinghy—83.
- Small Sail Boats—84.
- Two Outdoor Runabouts—85.
- Build Own Canoe, Kayak—30.
- Build Class-E Ice Yacht—22.
- Auto Kinks, Shortcuts—10.
- Lawn and Garden Equipment—124.
- Motor-Driven Midget Cars—34.
- Stop Auto Elect. Troubles—95.
- Photo Printers and Dryers—25.
- Photo Darkroom Equipment—96.
- Trick and Table Top Photos—97.
- Home Movie Equipment—118.
- Poultry Houses—108.
- Guns and Decoys—109.
- Re-Silvering Mirrors—70.
- Chemical Experiments—93.
- Log Cabins, Tourist Houses—14.
- Using Basic Tools—120.
- Farm and Garden Tractors—8.
- Building Extra Attic Rooms—23.
- Attractive Basement Rooms—24.

## IS \$21000 A WEEK Worth a Penny Post Card?

Then RUSH postcard with name and address. Get FREE details of amazing full-and-spore-time PROFITS made by ambitious men handling new Automatic Defroster for refrigerators on FREE TRIAL basis. Learn how housewives hand you big profits when you just plug in the D-Frost-O-Matic to end defrosting mess forever. Send card for Special Offer TODAY.

**D-FROST-O-MATIC** Dept. PM-12  
6 N. Mich. Ave.  
Chicago, Ill.

# PAINT STRIPING TOOL

## Works Like a Fountain Pen Stripes with PAINT instead of INK!

This amazing new PAINT STRIPING TOOL makes it easy to do expert striping on furniture, bikes, model planes, autos, signs, linoleum, toys, wall board, etc. Makes plain, painted walls look like tile. Paint straight lines, curved, circular or evenly spaced parallel lines the same way a professional painter does. Simply fill Tubular Glass Paint Fountain with any color paint & wheel tip feeds paint evenly without spreading, smearing, smudging. Tips interchangeable—jaws split apart for easy cleaning. Tool complete with tip for 1-16 in. stripe only \$1 postpaid. Other complete tools with 1-64, 1-32, 3-64, 1-16, 5-64, 3-32, 1-8 in. tips, \$1.50. Separate tips, 75¢. Complete kit with tool and 7 tips, \$5.00. Handiest tool in painter's kit. Get it now.

**WENDELL MFG. CO.**  
4234 N. Lincoln Avenue  
Dept. 312, Chicago 18, Illinois  
Paints Curved, Circular or  
Straight Lines



Tubular  
Glass  
Paint  
Fountain

A Visible  
Paint  
Supply

**DEALERS**  
Paint  
Striping Tool  
Packed in attractive  
Display Cartons of one dozen.  
Fast, profitable  
seller. Write for  
illustrated cir-  
cular, discounts.

Thumb and Finger Rests.  
Easy to Guide Tool

Guide Keeps Lines Straight!  
Knurled Wheel Distributes Paint

Check Titles Wanted, Clip, Mail with Remittance to  
**POPULAR MECHANICS PRESS, Dept. 23, 200 E. Ontario, Chicago 11**

**WAR SURPLUS BARGAINS**

**WAR SURPLUS BARGAINS**

**\$500,000.00 INVENTORY for QUICK LIQUIDATION**

Surplus items—hundreds of them for home, shop, factory, farm and outdoor use. New items, used items, reconditioned items—all at tremendous savings—all priced for quick sale.

**Page After Page of Values**

This big catalog shows page after page of amazing money saving values. Write for your copy today. Send 10c to cover postage, mailing, etc. Write today!

SEND TODAY FOR YOUR COPY **10c**

**STARK'S** Dept. 509 So. STATE STREET CHICAGO 5, ILLINOIS

**WHAM-O SPORTSMAN\*** **\$1.00** 45-LB. PULL

HITS LIKE A .22 RIFLE—KILLS RABBITS, SQUIRRELS. Powerful, silent, accurate. For hunting, target, routing pests.

**HUNTING SLINGSHOT**

Heavy duty 7" ash stock. 40 steel balls, extra rubber straps.

GUARANTEED—of dealers, or send \$1. to Wham-O Mfg. Co., Box 2L, South Pasadena, Calif.

\* Professional model of Nat'l Slingshot Assn

**HOT ROD** and **POWER HANDBOOK** Plus **BIG CATALOG—only 25c**

Shows Custom, Racing, Economy equip't.—all cars—ALMQUIST cams, hi-compression heads, dual manifolds, Hollywood mufflers, water injectors, chrome accessories, Tuning Tips, Track Secrets, Racer Plans. (Dealers Wanted)

Write: ALMQUIST Engineering & Mfg., Milford 66P, Pa.

**PLEASE SEND ME**

**POPULAR MECHANICS** MAGAZINE

for the time checked.

I am enclosing . . .

1 year \$3.50  
2 years \$6.00

name \_\_\_\_\_  
address \_\_\_\_\_  
city \_\_\_\_\_ zone \_\_\_\_\_ state \_\_\_\_\_ C-12

Hand this order to your newsdealer or send it to

**POPULAR MECHANICS**  
200 East Ontario St. Chicago 11, Ill.

**LET US PUT THIS Magnificent NEW 1951 MIDWEST TELEVISION-RADIO-PHONO Console In Your Home**

**for 30 DAYS MONEY BACK TRIAL**

**FACTORY TO YOU** **EASY TERMS**

**MAMMOTH 19 1/2-Inch PICTURE TUBE**  
AM-FM Radio and 3-Speed Phonograph

Be your own judge! See and hear Midwest Television in your own home. Then decide whether to keep it or have your money refunded. Low Factory Prices.

**Also Available on 30 DAYS TRIAL!**

**The Sensational New 5-Band World-ranging 1951 Model MIDWEST RADIOS**

Send This COUPON on 1c Post Card for NEW 1951 FREE 4 Color MIDWEST CATALOG

**MIDWEST RADIO & TELEVISION CORP.**  
Dept. 25-E, 909 Broadway, Cincinnati 2, Ohio

NAME \_\_\_\_\_  
ADDRESS \_\_\_\_\_  
CITY \_\_\_\_\_ ZONE \_\_\_\_\_ STATE \_\_\_\_\_

**RELIEVES PAIN OF  
HEADACHE • NEURALGIA  
NEURITIS**

**FAST**

The way  
thousands of  
physicians  
and dentists  
recommend



Anacin® relieves headache, neuralgia, neuritis pain fast because Anacin is like a doctor's prescription—that is, Anacin contains not just one, but a combination of medically proven, active ingredients in easy-to-take tablet form. Thousands have been introduced to Anacin through their own dentist or physicians. If you have never used Anacin, try these tablets yourself for incredibly fast, long-lasting relief from pain. Don't wait. Buy Anacin today.

**NO-NAIL PICTURE HANGER**

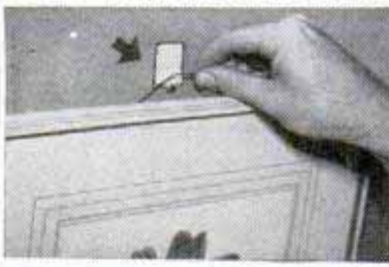

Save surfaces, money and time! Hang pictures, mirrors, ornamental copper, china, and wall planters without driving a nail. Use NO-NAIL HANGER directly on walls, glass, paint, metal, paper, tile and wood. Simply moisten hanger and press firmly to any cleaned surface. Properly applied, will hold 10 pounds. Package of 12 NO-NAIL HANGERS \$1.00. We pay postage. (No C.O.D.'s, please.)  
**WALTER G. LARSON CO.**  
Dept. P  
1028 S. FIGUEROA STREET  
LOS ANGELES, CALIFORNIA

**DRIVING RELIEF!** **New LEFT-FOOT ACCELERATOR**

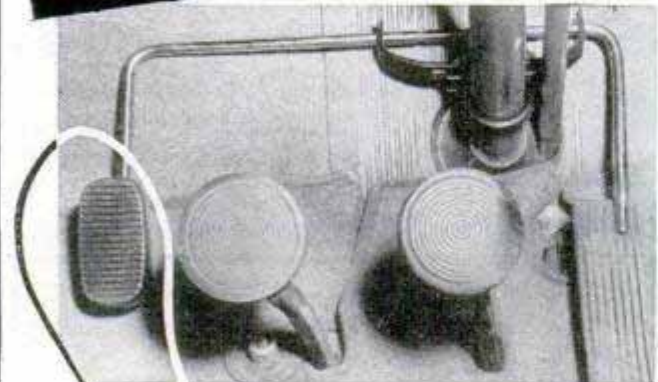

Dealer inquiries invited.

Cut driving fatigue in half with Lefty! Install this new left foot accelerator yourself in 60 seconds with just a wrench—no alterations to your car are necessary. Enjoy relaxed comfort on long drives. Lefty lets you feed the gas with your left foot when you desire, relieves tension and fatigue in leg, back, and foot. Safe, positive and convenient. Swings out of way when not in use. Brings your car up to date. \$5. ppd. Specify year and make. No COD's please.

**INVENTOR'S MARKETING LAB.**

1401-A De Young Bldg., 690 Market St., San Francisco, Calif.

**BUILD THIS HOUSE Yourself**



**The Famous Popular Mechanics House**

The picture below is from an actual photograph of the Build-It-Yourself House with breezeway and garage, as built by Jack Brownson, 23-year-old veteran, in Aurora, Illinois.

Designed by Popular Mechanics and Famous Architects. Every Detail Simplified and Explained. No Previous Experience Needed!

Can you use everyday tools as well as the average Popular Mechanics reader? Then you, too, can easily build this modern house in any of its five designs, doing every part of the job yourself. The new Popular Mechanics Book, "Your Home—How to Build it Yourself" will show you how.

**Space for Living and Family Growth**

This beautiful, modern house is 1½ stories, with basement, living room, kitchen, dining nook, two bedrooms, bath, plenty of closets and space for two additional bedrooms on second floor. The house itself is 35' 9"x28' 11"; breezeway 20' 10"x8'; garage 20' 10"x12'.

**The House That Has Everything**

Designed for easy construction and the most living space for the least cost, the Build-It-Yourself House is also most attractive and suitable for any community and most income groups. The basic plan is adaptable to four other exterior designs.

**Get Book and Plans Now—Build When You Can**

You may never have thought about actually building a house yourself, but now that building restrictions have been lifted, it is easier than you think. So order book and plans today. Even if you engage a contractor to build for you, you will need the plans. And you certainly will want the book which can easily save you hundreds of dollars, whether you build this or any other house.

**Mail Coupon for New Book and Plans!**

*Build It Yourself or Have It Built—Save Hundreds of Dollars!*

**PLANS YOU CAN READ AND FOLLOW**

Plans consist of ten working-size blueprints—floor plans, elevations, construction notes, framing, joints, lumber and mill list, specifications, plumbing and wiring diagrams. Every measurement is marked—every detail made clear as ABC. Book has 100 pages—three-fifths are photographs and drawings. Some sections in colors, showing just how your house will look when finished.

**BIG BOOK 8½x11 inches**



**MAIL COUPON FOR BOOK AND PLANS**

**POPULAR MECHANICS PRESS, Dept. 16**  
200 E. Ontario St., Chicago 11

I enclose \$\_\_\_\_\_ Send me the items checked at once.

- Your Home and How to Build It Yourself.....\$ 3.00
- Complete set of plans for Popular Mechanics Home... 12.50
- Book and plans at reduced price..... 14.00
- Duplicate sets of plans..... 5.00

Name \_\_\_\_\_

Address \_\_\_\_\_

City \_\_\_\_\_ Zone \_\_\_\_\_ State \_\_\_\_\_

## USE the POLICE METHOD to



The bigger they come, the harder they fall when the Commanding knowledge of POLICE JIU JITSU IS YOURS! Brute strength, giant size and bulging muscles will not beat you when You master Police Jiu Jitsu. A complete course easy to read and learn in one illustrated volume. JUST PIN \$1 to this ad and we will send Police Jiu Jitsu to you POST-PAID. Satisfaction guaranteed or money refunded.

handle wise guys and bullies

BOOKS PUBLISHING CO. 56 W. 24 St. New York 10



## NEW! PORTABLE DRAWING BOARD ONLY \$2.95 COMPLETE

New portable drafting board with precision instruments invites "on the spot" ideas and drawings in the office—home—classroom—plane or car. Ideal for salesmen—engineers—architects—students—executives with ideas.

Drafting unit includes 12"x9" professional type Basswood board, calibrated transparent plastic "T" square—two transparent plastic triangles, 30 (degree)—60 (degree) and 45 (degree), which lock securely to back of board. Only \$2.95 complete—postpaid. Money back guarantee. For immediate shipment send check, cash or money order to:

MARTIN-BARRISS CO., Dept. PM, 2048 W. 3rd, Cleveland, Ohio



**A PROFITABLE HOBBY** Figurines and Supplies for Dresden painting. Gift ornaments. Unpainted. Many to choose from. Send 25c in coin for Photo Illustrated Catalog, or 3c stamp for price list.

RAY ART INDUSTRIES

314 WESTPORT Dept. A KANSAS CITY 2, MO.

## SHOE REPAIR OFFERS BIG INCOME

LEARN IN 12 WEEKS TIME

You can own your own shop or earn big income as skilled shoe repairman. Growing demand everywhere at top wages for men who know how. We teach you quickly by actually working on shoes and modern machines. School open to all from 18 to 60 years of age. FREE BIG 20 PAGE BOOK explains everything. Send for your copy today. Established 1927.

MODERN SHOE REBUILDING SCHOOL

Chicago and Los Angeles only Approved for Vets Dept. PM  
2937 Belmont Ave., Chicago, Ill. 361-12th St., Oakland, Calif.  
806 So. Figueroa St., Los Angeles 14, Calif.

## Profit From A Business of Your Own

Learn this highly skilled and technical trade of watch repairing. Both resident and home study courses with Certificate upon completion. Watch repairing pays well either for part time or full time work, and paves the way to an independent business of your own. School catalog sent free by return mail. Address Dept. B-62.

American Institute of Specialized Watch Repair  
1012 Franklin, Southeast, Grand Rapids 7, Mich.

## Catch Garden Pests, Rats, Varmints!

Protect grain, poultry with a guaranteed HAVAHART trap. Captures without injuring; can't hurt children or pets.

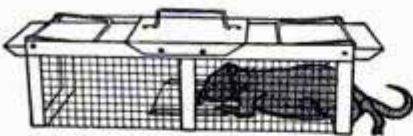

No springs or jaws. Rustproof. Many sizes. Free Booklet:

HAVAHART, 36-D Water St., Ossining, N. Y.



## GOLD-SILVER-COINS

Easily located with new Lightweight M-Scope Detector. Superior performance, lowest price, monthly payment plan.

FREE LITERATURE  
FISHER RESEARCH LAB., INC.  
PALO ALTO CALIF.

## BE A LOCKSMITH

LEARN LOCKSMITHING and KEYMAKING from EXPERTS in YOUR SPARE TIME at HOME! Locksmiths in big demand! No layoffs, no slow seasons! Age or physical handicap no disadvantage. Year-round, steady income in this permanent, respected field. Full or part time. Practical, illustrated lessons show you how to make money even while learning! All materials and special tools supplied. Send for FREE BOOKLET.

INSTITUTE OF LOCKSMITHING, Dept. P-13  
55 Park Ave., Rutherford, N. J.

WANT TO

# SAVE GAS?

BE PREPARED IF RATIONING RETURNS

1/4 MILLION NOW IN USE

TRY IT FREE IN YOUR CAR

TEST FOR  
✓ MORE MILEAGE ✓ FASTER PICK-UP  
✓ EASIER STARTING ✓ BETTER IDLING

You can install it easily in a few minutes.

Many Gane Needle users report up to 25% more mileage, faster pick-up, easier starting and smoother idling.

Try a Gane Needle in your car for ten days at our expense, then compare your mileage and performance. If fully satisfied, send only \$1.50 per needle (8 cylinder cars take 2). If not satisfied, just return it—FAIR ENOUGH? Since authorities differ on merits and some users report no improvement, TRY BEFORE YOU BUY!

WRITE TODAY • ENCLOSE NO MONEY • PAY POSTMAN NOTHING. Send us your name, address, make and year of car—and the make of carburetor if convenient.

NATIONAL AUTOMOTIVE RESEARCH CORP., Dept. J-12  
350 West Washington Blvd. Venice, California

THE AMAZING GANE

AIR FLOW NEEDLE

Gane replaces the idling adjustment screw in gasoline carburetors.



Holes for Air Flow

**BOOK SENT FREE!** This auto economy manual is sent absolutely free, to all who try Gane Needles. It tells how to save gas, tires, brakes and tells how you can gain more power, speed and better performance from your car. This combination manual-catalog also introduces many new and ingenious economy products.

brand NEW just off the press



CONSTANTINE'S MANUAL FOR WOODWORKERS HOBBYISTS HOME OWNERS 116 PAGE BOOK

a complete catalog!

AND REFERENCE BOOK OF WOODS, VENEERS, LEATHER, METAL, PLASTICS, ETC.

This is the biggest, most complete manual we ever published. More new items, on leatherscraft, decorative metals, wood finishing, hard to get items of all kinds... in addition to our power and hand tool sections, upholstery, picture frame mouldings, rare and domestic woods, veneers, lumber, inlay panels, 83 inlay designs, inlay borders, all in full natural color, plus a full color wood identification panel of 60 different woods suitable for framing. All items at lowest prices from America's Biggest Supplier to Craftsmen.

Send today for your copy of the hobbyist's most helpful book.

SEND FOR YOUR COPY TODAY

FREE ALBERT CONSTANTINE & SON, INC., DEPT. PM12  
797 East 135th St., New York 54, N. Y.

With each copy of our Master Manual, you get a year's subscription to Chips and Chats, a breezy bimonthly to keep you up-to-date on what craftsmen are doing.

Enclosed find 25¢ for a copy of your "Master Manual" and a FREE one year's subscription to Chips and Chats.

NAME \_\_\_\_\_  
ADDRESS \_\_\_\_\_  
CITY \_\_\_\_\_ STATE \_\_\_\_\_



**PERFECT XMAS GIFT**

FOR DAD • BROTHER  
OR YOURSELF . . .

**Famous BEATTIE  
JET LIGHTER**

EXPRESSLY DESIGNED  
FOR LIGHTING  
PIPES

Tilted slightly, flame jets directly into pipe bowl. Upright, an excellent cigarette or cigar lighter. Protective windshield guarantees strong flame out-of-doors and indoors.

Pigskin covered. Gun metal trim. Factory guarantee enclosed with each lighter.

Buy now while they last.

REG.  
**\$5.00**

**NOW ONLY \$2.00**  
PPD

Orders shipped  
by return mail

Please send cash, check or money order.

**E. G. HOWARD CO.**

80 Washington St., Dept. A, Boston 8, Mass.

**ORDER BY MAIL TODAY!**



**WATCH-CLOCK REPAIRING**  
LEARN AT HOME OUR EASY WAY!  
BASIC TRAINING FOR AIRCRAFT INSTRUMENT WORK.  
Write for free information.  
MODERN TECHNICAL SUPPLY CO.  
Dept. 12PM, 55 West 42nd STREET, NEW YORK 18, N. Y.

**NEW PLASTIC MODEL PLANE**



that **FLIES**

Only **\$1.50**

Postpaid  
For **COMPLETE KIT**  
including ALL parts & materials needed.

**IDEAL XMAS GIFT**

**READ**  
About it  
in Aug.  
Pop Mech.  
Page 95

**GUARANTEED TO FLY** from the very first try. **ASSEMBLED QUICKLY** in "one sitting" even by youngsters. Made of new **LIGHTWEIGHT** plastic yet amazingly **STRONG** and flexible to take hardest landings. Rubber band motor fits in fuselage. Easily converted to gas motor. A **SUPERIOR** flying scale model plane—a sensational value. **IDEAL XMAS GIFT.** Send only \$1.50 (chk. or M.O.) **NOW!**

THE KEMNITZ CORP., PM12, 1021 N. Water St., Milwaukee 2, Wis.

SAY YOU SAW IT IN  
**POPULAR MECHANICS**

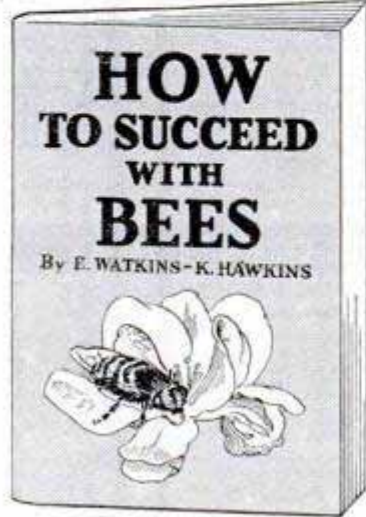

**RAISE BEES  
SELL HONEY  
MAKE MONEY!**

Get How to Succeed with Bees, written by two experts, which tells you all you need to know. Contains 190 tested successful plans to produce big crops of honey. Easy work and little capital required. There is always a ready market for honey and working with bees is fascinating. This 96-page well-illustrated book is only \$1.00 and is absolutely guaranteed to satisfy you or we shall refund your money. *Send for your copy today!*

**POPULAR MECHANICS PRESS**  
200 E. ONTARIO STREET  
CHICAGO 11, ILLINOIS

**PLYMOUTH**  
*Owners*  
**SAVE MONEY!**



Learn How to Make Your  
Car Run Better . . . Last  
Longer . . . and Save Hundreds of Dollars!

Get this book, written especially for you, without one penny of risk and get more out of your car. Mail coupon for **MANUAL FOR PLYMOUTH OWNERS** today. When the book comes, skip through the pages and see how your investment in one of America's most popular automobiles can be even a better investment than you thought. If you don't agree, send the book back and you'll get your money back.

**Official, Authoritative,  
Practical Information**

Written by C. E. Packer, formerly service school instructor and auto show lecturer for automobile manufacturers, Member Society of Automotive Engineers, Special Services Editor of Automobile Digest, contributor to leading magazines, author of some of the biggest selling books on Automotive subjects. Prepared with the full authority and active cooperation of the Plymouth Division of the Chrysler Corporation.

**A Popular Mechanics  
Book Written Just for You**

Not a re-hash of service manuals. A complete new Popular Mechanics book written for the Plymouth owner by an outstanding automotive authority with the full cooperation of Plymouth engineers and service directors. It will save you money on repairs and service; make your Plymouth last longer; give you safe, economical and trouble-free motoring. And this is true whether you take your Plymouth to a regular service station or service it at home.

**Prevents Trouble. Cuts  
Down on Repair Bills**

Nothing like this manual anywhere. It covers all phases of operation, service and maintenance. It has entire chapters on the individual parts of your Plymouth—battery, ignition, starter, generator, regulator, lighting, fuel system, engine, lubrication, gasoline qualities, cooling systems, transmission, differential, rear axle, brakes, wheel alignment, tire care, body maintenance, trouble shooting on the road, etc. It covers your Plymouth, new and older models, step by step—bumper to bumper—showing you how parts operate; what can go wrong; how repairs and adjustments should be made and how to avoid all types of troubles.

**Money Back  
if Not Satisfied**

Mail the coupon today. Send only \$3.50 or you can pay postman. Money back guarantee protects you.

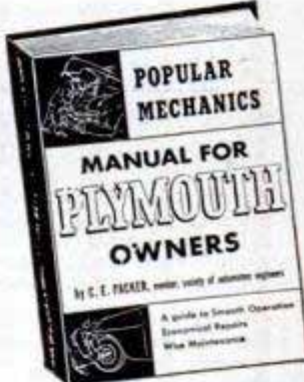

**288 Pages. Hundreds of How-To-Do-It Illustrations and Diagrams**

The entire book follows Popular Mechanics famous easy-to-read and easy-to-understand style. While primarily intended for the Plymouth owner, to help him get more out of his car at lower cost, it can be worth its weight in gold to the auto mechanic and service station operator who works, not only on Plymouths, but on all other makes as well, to which the information in the book can be easily applied.

*Order on this Handy Coupon*

**POPULAR MECHANICS PRESS, Dept. 17**  
200 E. Ontario St., Chicago 11, Ill.  
Send Manual for Plymouth Owners at once. If not satisfactory I will return it within 5 days and you will refund full purchase price.

Remittance for \$3.50 enclosed.  Send C.O.D.

Name \_\_\_\_\_  
Address \_\_\_\_\_  
City \_\_\_\_\_ State \_\_\_\_\_

## UP TO 25% MORE GAS MILEAGE—



**— QUICKER PICK-UP with STARK HUMIDIFIER**

Your car, truck or tractor gives you faster, smoother power PLUS up to 25% more mileage—with this amazing Stark Air Saturator. Based on the extra-power jet on fighter planes, it improves vapor-air mixture. Reduces carbon formation. Install without mechanical changes or adjustments. Simple, automatic, safe. Order STARK AIR HUMIDIFIER CARTRIDGE.

Send \$1.00  
POSTPAID

**N. H. STARK and CO.**  
DEPT. PM-1, THIENSVILLE, WISCONSIN

## TORSO CUFF LINKS

for the man who has "everything." Gold plate on Sterling 13.50. 14K gold 60.00. In Sterling a pair. **12.50**

All taxes and postage included. Another exclusive by mail from



*Pee Wee House*

Culver City 13, Cal.

## SAVE MONEY ON CHRISTMAS PRESENTS

Popular Mechanics CHRISTMAS HANDBOOK shows you how to save many dollars on Christmas presents. Colorful, fascinating articles you can make at home quickly and easily in your spare time including beautiful Christmas cards, gift wrappings, candles, toys, for children of all ages and Xmas tree ornaments. Also tells how to select a tree, helpful hints on home decorating, tips for the holiday hostess, centerpieces Xmas customs and Xmas celebrations in other countries. 144 pages. Cloth bound.

POPULAR MECHANICS PRESS  
200 E. Ontario Street, Chicago 11

**\$2.00**



## AUTO RACING TRAILER Coaches



Four Books Every Fan Needs

Famous for authoritative, detailed information on auto racing, every type of race car, rules, specifications, working drawings, plans, etc. No duplication. Every book different. Money back if not satisfied.

### AUTO RACING • 6th Edition

Championship cars, big cars, midge-ets, roadsters, Offenhauser dirt track car. Specifications on Indianapolis cars, four-wheel drive details, front drive drawings, etc. Plans for Ford 60 midgelet, roadster racer. Data on engines, gear boxes, friction and dog clutches, axle ratios, compression ratios, independent suspensions. Indianapolis rules and regulations, etc. More than 100 illustrations. \$2.00.

### TRAILER COACHES

By Ray F. Kuns. Contains information on the history of trailers, trailer parks and camps; materials, furnishings, trailer chassis, engineering, etc. Construction data on 10, 16 and 22 foot trailers which you can build yourself. 100 illustrations. \$1.50.

### AUTO RACING • 5th Edition

Tells you—Why the Fast Ones are Fast—How to Make Them Fast—How to Build Engines—How to Build Chassis—How to Build Bodies—Who Holds What Records—What the International Formula Is—What Midget Racing Rules Are—How World's Record Cars Are Built—How to Speed Up Ford V8 Cars. \$1.00.

### AUTO RACING • 4th Edition

Includes eight working drawings and complete building instructions for standard midgelet racers, drawings for midgelet road cars, Miller-Ford V8 front-drive racers are illustrated and described and other big-time data given. Technical pictures give the inside dope on these cars, together with authentic descriptions. 50 pages. 60 illustrations. \$1.00.

## ORDER ON COUPON

POPULAR MECHANICS PRESS, Dept. 31, 200 E. Ontario St., Chicago

Remittance for \$\_\_\_\_\_ enclosed. Send books checked, postpaid.

- Auto Racing, 6th Edition       Trailer Coaches  
 Auto Racing, 5th Edition       Auto Racing, 4th Edition  
 Send C.O.D., postage extra.

NAME \_\_\_\_\_

ADDRESS \_\_\_\_\_

CITY \_\_\_\_\_ ZONE \_\_\_\_\_ STATE \_\_\_\_\_

## Don't Envy The PLUMBER—Be One

### Make \$15 to \$50 a Day

Every skilled workman will tell you Plumbers have the best of it. WINTER and SUMMER the Plumber is busy at top wages. No skilled Plumber is ever out of a job. Compare his opportunities with any trade. To the man with know how. Plumbing means profit. Investigate Universal Plumbing School. Not a "war born school." but a plumbing school developed and operated by plumbers since 1923.



The Plumber Protects the Health of the Nation

### Own Your Own BUSINESS

Have your own business and big profits with little other than training and a kit of tools.

### JOURNEYMAN Gets Good Salary

Master Plumbers own their own shop. A Journeyman works for a Master. With this training journeymen can depend on high wages.

### BE A PLUMBER IN JUST 32 WEEKS Learn With Tools—Not Books

No need ever serve an apprenticeship. Don't envy the plumbers big profits — enjoy them. Learn every trick of the trade—Leadwork — Blueprint for plan reading, etc. under Licensed Master Plumbers.

### Over 7,000 Successful Plumbers Recommend This School

This system has made more than 7,000 plumbers. Investigate our past performance. If you like to work with tools this is your opportunity. Become a Plumber in America's largest and only school devoted exclusively to plumbing. Write today for FREE information.

G. I. Approved. Established 1923

## UNIVERSAL PLUMBING SCHOOL

877 Holmes Street

Kansas City, Mo.

## MAKE Big MONEY

### SHARPENING LAWN MOWERS

## WITH THE Universal LAWN MOWER GRINDER

Enjoy a profitable lawn mower sharpening business of your own. No previous experience needed. Place a hand or power



mower on the Universal Grinder. With only one set-up you quickly grind the stationary blade and all of the reel blades to proper clearance without removing a single blade from mower.

G. Spurlock of Arkansas writes: "I have had my Universal Grinder only 2 months. Live 1½ miles from town. Yet have already made net profit of \$227.00."

J. L. Peterman of Pa. writes: "Thank you for getting me started in this wonderful business . . . I averaged \$100.00 a week in May, and made \$1000.00 spare time this season."

TRULY A BIG MONEY MAKING BUSINESS  
ROGERS MFG. CO., Dept. M-120, Lindsey, Ohio

## SEND THIS COUPON NOW

ROGERS MFG. CO., Dept. M-120, Lindsey, Ohio  
Please send me full facts about the Universal Lawn Mower Grinder and its big money making opportunities.

NAME \_\_\_\_\_

ADDRESS \_\_\_\_\_

CITY \_\_\_\_\_ STATE \_\_\_\_\_



# Recipro Register CHRONOGRAPH

## WORLD FAMOUS SPLIT-SECOND TIMER

**10 DAY FREE EXAMINATION** A handsome wristwatch of incredible accuracy! Precision made in the highest traditions of Swiss craftsmanship. Thoresen's new **RECIPRO-REGISTER CHRONOGRAPH** automatically computes speeds and distances down to 1/5th second tolerance! **RECIPRO-REGISTER** system **HOLDS** the result indefinitely. It remembers for you while movement continues to keep time. Compare with other stop-chronographs and you will never be satisfied with anything less than this truly precision timepiece.

### OVER 25 HIGH QUALITY FEATURES!

- Times Planes
  - Times Races
  - Times Sports
  - Times Photography
  - Times Lab experiments
  - Times Shop Work
  - Shock-Resist
  - It "remembers"
  - 17 Ruby Jewels
- Three multi-function dials automatically coupled and synchronized for hours, minutes, seconds & 1/5th seconds. Contact clutch to start computation and brake clutch to freeze Recipro-Register result. Erases back to zero. Hairline sweep-second. Radi-um-active dial. Unbreakable crystal. Sturdy, yet thin case with stain-less steel back. Its 17 Jewel Ruby movement is electrically time tested for accuracy. A smart, thin timepiece of functional beauty. The pride of every owner. **SAVE \$50.00—ORDER YOURS DIRECT!** Recent list price 79.95. Now reduced for quick sales to \$29.95 tax paid... while supply lasts. Featured in *Esquire* and leading magazines. Instructions and gift case included. Price subject to change without notice because of international crisis. Remit 29.95, or order C.O.D. plus postage. **Money Back in 10 days if not delighted.** THORESEN DIRECT SALES, Dept. 6N-233, 131<sup>st</sup> West 33rd Street. (Phones: LA 4-5996 & 7) New York 1, N. Y.

**UNLIMITED SERVICE GUARANTEE**

Exclusive of Parts  
FREE repair service ANYTIME if needed by skilled watchmakers. NO COST EVER for labor, "handling" or adjustment, provided watch is returned with all parts. FREE: Annual oiling, cleaning & makes lifetime Thoresen friends!

**Buy Direct**

## HOW TO GET A KICK OUT OF MATH

Now, You Too Can Solve Math Teasers This Fun-Making Way



Here is an amazing new book that makes mathematics an interesting, entertaining game. Hundreds of puzzles, brain teasers and tricks give you hours of pleasure. You don't have to be a math genius to enjoy this book — just make use of the math you learned in school.

## Be The Life Of The Party

Stick your friends with these trick puzzles. Have the answers at your fingertips. Here is an ideal Xmas gift for any mechanically inclined person. Illustrated. Hurry—Order MATH IS FUN Now! Only \$2.75. C.O.D.'s accepted (you pay postage). 5 Day Money Back Guarantee.

GRESHAM PRESS, Dept. P

11 Broadway New York 4, N. Y.

# FOAM RUBBER

FOR HOBBYISTS, CRAFTSMEN, EXPERIMENTERS



Lowest Prices—SAVE 50%		AUTO SEAT TOPPER PADS	
16 x 16 x 1 1/2"	ea. \$1.35	Place under seat cover.	
16 x 22 x 1 1/2"	ea. 1.75	24" x 60" x 1 1/2"	ea. \$5.95
18 x 24 x 1 1/2"	ea. 2.00	24" x 60" x 2"	ea. 7.95
24 x 24 x 1 1/2"	ea. 2.75	12" x 14" x 1 1/2"	ea. 1.25

Use for furniture cushion fillers, mattresses, mattress pads, cushions. Foam Rubber is available in any size or thickness. Send For Free Price List. Immediate delivery. No C.O.D.'s. Add 10% for Postage & Handling to Above Prices. Please print.

**RIOR RUBBER COMPANY, Dept. P-12**  
50 East 22nd St. Chicago 16, Ill.

## SEND ME



every month so I am sure to see each new issue. Here's

- \$3.50 for 1 year
- \$8.00 for 3 years

name \_\_\_\_\_

address \_\_\_\_\_

city \_\_\_\_\_

zone \_\_\_\_\_

state \_\_\_\_\_

B-12

Hand this order to your newsdealer or send it to

**POPULAR MECHANICS**  
200 East Ontario St. Chicago 11, Ill.

MAKE A "Stradivarius" **VIOLIN**

—For Pleasure  
—For Profit  
—For Your Own Use

BOOK AND PLANS ALL YOU NEED

You Can Do It at Little Cost!  
It's Easy! It's Fun!

Here is the "tops" of all home crafts projects. Make a violin—a replica of a famous "Strad"—the original of which sold for \$80,000.00. Joe Reid who has made hundreds of fine violins makes the job so easy—so inexpensive—in his new book "You Can Make a 'Stradivarius' Violin." You don't need any tools. Reid shows you how to make all the tools you need from old table knives, worn out files, sheet metal, etc. Eight full-size plans, 16x23 inches, folded into the book give you every detail in actual size.

### Violins Bring High Prices

Make a violin and you probably will never want to sell it. But good tone modern violins bring terrific prices, yet the materials cost comparatively little. With Reid's plans and step-by-step instructions you can make such a violin for yourself! 15 chapters guide you in selection of wood, fashioning the belly, back, sides, mold, lining, neck, scroll, purfling. Other chapters cover varnishing, finishing, stringing. Others show how to make tools and clamps at little or no cost.

Order Book Today.  
Money Back if Not Satisfied.

Make your own violin for pleasure or profit. Get book and plans now. Clip this ad and mail with check, money order or cash for only \$3.50 or we will send C.O.D. Money back in 5 days if not satisfied.



Complete Instructions

8 Actual Size Plans  
How to Make the Tools You Need  
Where to Get the Materials

You trace or work direct from actual size plans. No measurements to translate or confuse you. You see the entire violin in the plans. You read the how-to-do-it instructions in the book.

**POPULAR MECHANICS PRESS** Dept. 30  
200 E. Ontario St., Chicago



# Get into Good Paying AUTO BODY and FENDER WORK



BIG DEMAND in Auto Body and Fender work. Start training now in your spare time at home for good pay work. Practical shop experience included. U.E.I. Training covers metal work, welding, painting, etc. Placement service—or we will show you how to start your own shop. Behind U.E.I. TRAINING is a large national organization founded 1927. Write today for FREE FACTS—No obligation.

Approved  
for Training  
under G.I. Bill

AUTO-CRAFTS  
DIVISION • UTILITIES ENGINEERING INSTITUTE  
2525 SHEFFIELD AVE., DEPT. XC-6, CHICAGO 14, ILLINOIS

# REAL ESTATE BE A BROKER

PAYS BIG! SEND FOR FREE, BIG, ILLUSTRATED CATALOG NOW! No obligation. Graduates report making substantial incomes. Start and run your own business quickly. Men, women of all ages, learn easily. Course covers Sales, Property Management, Appraising, Loans, Mortgages, and related subjects. STUDY AT HOME or in our classrooms in big cities. Diploma awarded. G.I. approved. Nationally known.

WEAVER SCHOOL OF REAL ESTATE (Est. 1936)  
15 E. Pershing Road, Dept. PMB, Kansas City, Mo.

FREE  
BOOK  
TELLS  
HOW

**SANDIEE**  
SPORTONE MUFFLERS  
Ford & Chevrolet.....\$ 4.45  
All other popular cars..... 5.45  
V-8 Dual Sets..... 15.95  
Chromed Silentips..... 2.95  
(Please state make & year of car on all orders.)  
**SANDIEE MUFFLER CO.**  
5643 Corryne Place • Culver City, California

## MAGIC-SCREEN INCOME PLAN OFFERS BIG MONEY, AT HOME, SPARE OR FULL TIME

Reproduce any painting, design, trade-mark, picture, printing, in full color, on any surface! Proven new method enables you to cash in on established business where Profits up to \$5.00 or more an hour are being made, right now! Examine complete Plan and equipment without risk! Write today for free sample — complete free details! Act NOW!

CALIFORNIA ACADEMY OF SCREEN PROCESS — Dept. 212  
5100 S. VERMONT AVE., LOS ANGELES 37, CALIF.

SAY YOU SAW IT IN POPULAR MECHANICS

**SEND FOR THIS FREE!**  
Make money. Know how to break and train horses. Write today for this book FREE, together with special offer of a course in Animal Breeding. If you are interested in Galting and Riding the saddle horse, check here ( ) Do it today—now.  
**BEERY SCHOOL OF HORSEMANSHIP**  
Dept. 11012-D Pleasant Hill, Ohio

# RATIONING?

Get more miles, more power  
per gallon of gasoline



## Hydro-Power fits all cars, Injector trucks, tractors & stationary engines

Incorporates latest principles of water vapor injection now used in combat aircraft. Fully automatic, easily installed, low cost. Increases motor life, brings new zip, power with less gas.

For single or double throat carburetors under 120 h.p., \$12.50; over 120 h.p., \$15.

### MONEY BACK GUARANTEE

Order today from your service station or dealer. If unavailable, order direct and send us your dealer's name and address.

## HYDRO-POWER SALES Inc.

462 Bank Block Bldg., Denver 2, Colorado

Wholesale territories open. Details on request.

## NOW—3-Piece Pen and Pencil Set

Sensational value. Regularly sells for \$1.98. You save 1/2. An attractive, serviceable, quick-acting fountain pen that writes smoothly and easily... A Ball Point pen comparable to any dollar pen on the market... and an expel-repel pencil with concealed eraser, barrels of durable plastic, non-breakable, with gold-colored caps and clips. Matching colors. Choice of BLUE, MAROON, GREEN or BLACK. 2 Pens and Pencil in Gift Box, Complete Post Paid  
Unconditionally Guaranteed—Money refunded if not entirely satisfied.  
Send Check or Money Order. No C.O.D.'s

G. O. PRODUCTS CO., Dept. M, Box 66, Canal St. Sta., N. Y. C. 13

# ATHEARN authentic scale model RAILROAD CARS

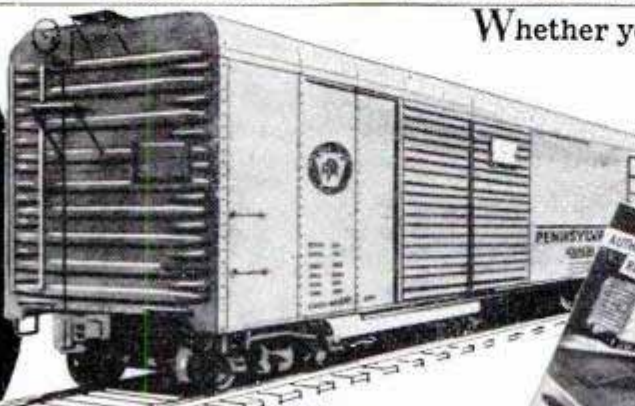

Send 10c  
in stamps for  
Athearn's big catalog

Whether you want an evening's mantle piece project or a complete scale model railroad, ATHEARN car kits give you more realism. Each model is exactly scaled, down to the last rivet from the actual car... even the trucks have real springs! ATHEARN kits are so easy to build that beginners get professional results. Build one tonight. On sale at all hobby shops.  
**IRVIN R. ATHEARN CO.**  
11129 Van Buren Ave.  
Los Angeles, Calif.

Perfect Circle's  
Sensational New

# 2 in 1 chrome piston ring set!

## NEW CHROME OIL STOPPER

Steel rails plated with solid chrome. Optional Hi Pressure spring packed with each Chrome Oil Stopper for use in badly worn engines.

## TOP COMPRESSION RING

PLATED WITH  
SOLID CHROME

## Double the Life of Cylinders and Rings!

**Now! The biggest piston ring news in years**—Perfect Circle's amazing new 2-in-1 Chrome Piston Ring Set, containing Chrome Top Rings, Chrome Oil Stoppers, plus Normal and HiPressure springs.

It assures *genuine economy* of both oil and gasoline . . . twice the life of cylinders and rings with *sustained power*. Whether the cylinders are slightly or badly

worn—tapered or straight—round or out-of-round, the 2-in-1 Set establishes a new high of piston ring performance.

If your car has lost its pep—uses too much gasoline and oil—ask your Doctor of Motors to install a Perfect Circle 2-in-1 Chrome Piston Ring Set. You'll be sure of top economy, with sustained power for thousands of *extra miles*.



# Perfect Circle

*The Most Honored Name  
in Piston Rings*

# POPULAR DECEMBER 1950 MECHANICS

WRITTEN SO YOU CAN UNDERSTAND IT  
VOL. 94 NO. 6



## those handy-andy eggbeaters

by Lt. Comdr. Arthur L. Schoeni, U.S.N.R.

**I**N THE BLUE SKIES over Panama a small brightly painted target airplane, used by pilots or by anti-aircraft gunners to sharpen up their shooting, buzzed along blithely ignoring all radioed impulses by the "mother" control plane.

Out of control, the target drone was flying wild, imperiling the near-by military encampment and the homes nestled around it. Into the breach rushed a helicopter. Chasing the little drone, the helicopter outmaneuvered and caught up with it. As it sped along, the pin-wheel pilot steered his aircraft so that it came directly over the top of the wild-flying target plane.

Heavy drafts of wind from the spinning rotors of the helicopter shot downward on the plane. Hitting the wing surfaces, the downdraft tilted the drone





Hovering over the Mexican volcano, Paracutin, an Army Sikorsky helicopter carries a group of volcanologists. Despite turbulent air, this Handy Andy provided a stable platform. Photo below shows how a helicopter dropped raft to couple off Hawaii and "pushed" them to shore against tide

so that it veered from its Kamikaze course. The pilot then dropped a small smoke flare on the plane, which sent it into a spin ending in a crash at sea.

That incident is just one of the thousand-and-one odd and unusual uses the Navy or Air Force has found for helicopters since the end of World War II. Helicopters are nothing new in the aviation picture, but during the war nobody did much about the pinwheels. Many fighting pilots looked on them as Buck Rogers stuff. They saw practically no combat action, but since the end of hostilities the helicopter really has come of age in a big way.

Private enterprise has made use of helicopters for such things as flying the mail through city





**Downdraft from the rotors of Navy helicopter helped dry a rain-soaked field before a model-airplane meet**

areas, crop dusting or short-haul hops, but the military has really put them to work.

An Air Force captain and his wife were swimming in inner tubes near Hickam airfield in Hawaii. Offshore currents swept them onto a reef 250 yards out, from which a rescue boat was unable to save them. An air-rescue helicopter was sent out and dropped the pair a life raft. The tide sweep threatened to carry them farther to sea, so the pilot hovered over them to the seaward and used the rotor slipstream to "blow" them right up onto the beach.

The Navy uses helicopters in many ways for military tasks on its aircraft carriers, battleships and cruisers. But its pinwheels also find time to perform odd jobs like hovering over swimming sailors to guard against sharks and chasing spent torpedoes after firing practice.

Then there was the picnic party down by the Naval Air Station at Pensacola, Fla., which was late coming home one week end. A searching helicopter found the party — the borrowed Jeep had run out of gasoline. So the pinwheel pilot landed, siphoned some gas out of his tanks and the picnic party went home happy on aviation gasoline.

The Marines have a down-draft story of their own, too, with a slightly different twist.

Corsair fighter planes dropped bombs on a target near Cherry Point, N. C., starting a small brush fire. A rescue helicopter from the Marines' Air Station took a party of fire fighters out to size up the fire. The pilot brought his plane over the flames to give them a better look. Hovering over the blaze, he speeded up his rotors. The downdraft from the spinning blades literally blew out the fire. No ground crew of fire fighters had to be sent out.

In New Jersey, a helicopter from Lakehurst searched for and found a crazed ex-serviceman who was terrorizing the

**"Taxicab" of the fleet not only drops life rafts and picks people out of the drink, but carries admirals and messengers between ships**





In the Antarctic, a Navy photographer uses helicopter as a steady "tripod" to get some aerial shots.

Below, when bombs dropped by Marines started brush fire in North Carolina, helicopter "blew" out fire



neighborhood with a pistol. After posses had failed to find him, the slow-flying search helicopter spotted the man in a clump of trees.

Helicopters have a long record of saving civilians' lives as well as those of Navy and Air Force personnel. Scores of persons in the Middle West were saved a year ago when helicopters flew in food and medical supplies to snow-isolated farms. One Army sergeant was flown to a farm and acted as midwife at a child birth. He also attended a Nebraska farmer with a broken leg and treated six other persons for severe frostbite.

After long days of fruitless effort helicopters dismantled and flown north in transport planes were reassembled and rescued 18 persons from the Belgian airliner crash at Gander, Newfoundland. The Navy sent out an aircraft-carrier load of big transport helicopters to Greenland to rescue a plane load of Air Force men marooned for many days on the ice cap. Dozens of Navy pilots are alive today because helicopters picked them out of the ocean behind their carriers when their planes crashed on take-off or landing.

Out on the outer banks of Cape Hatteras, residents have come to rely on helicopters when trouble strikes. Coast Guardsmen fly expectant mothers inland and transport injured persons to hospitals. Navy helicopters fly doctors to otherwise inaccessible swamp areas to treat student pilots forced down and injured.

When a whipping fuel line knocked a crewman off the carrier Midway into the frigid Atlantic, the plane guard helicopter picked him up in three minutes. A fighter plane crashed on a sandbar in the Gulf of Mexico. A helicopter picked up the pilot who stood on the wing and never even got his feet wet.

A carrier's boxing team was flown over to a near-by ship to participate in matches with that ship's team. Armed with pistols, helicopter pilots from the Naval Air Station at Lakehurst hunted and shot wild dogs, formerly war dogs in the Sandy Hook area. The animals had become a menace to the residents. A helicopter pilot reconnoitering a forest fire spotted a fawn in a clearing, so he dropped down and rescued the animal from the flames.

At sea, a destroyer's washing machine ran out of soap, so a helicopter flew over a load from another ship so the men could boast of white "whites." One high-ranking Navy admiral got in his required submarine dives in the Caribbean by flying from his flagship to a sub by helicopter, making the dives and returning, all in an hour.

Down at Corry Field, Fla., some model-



airplane enthusiasts wanted to hold a model meet but the Admiral Mullinex Field was soaked from recent rains. A helicopter was called in. It hovered a few feet over the ground and downdrafts from its rotors swept aside the puddles and dried out the ground sufficiently for the meet to go ahead as scheduled.

Pilots know hitting a bird in flight can destroy a plane, so before important test flights at the Navy's big Patuxent River Air Station, a helicopter carries a shotgun-armed marksman aloft to clear the air of buzzards.

At that same air station, the Navy was having some trouble getting civilian laborers at a far spot on the giant air base to work at a good rate. One day the Admiral in charge dropped out by helicopter to see how work was progressing. The laborers were leaning on their shovels but when the Admiral stepped out of the pinwheel the dirt flew. The supervisor thereafter requested frequent "flyovers" by helicopter—just any helicopter.

Some other odd uses for helicopters included using them to take lead-line soundings in sea areas where water was too rough for boats, flying the commanding

(Continued to page 248)

Helicopter comes to the rescue when target drone is out of control. Downdraft guides it away from base. Below, off Korea, helicopter hovers over a sinking F9F jet to rescue pilot from the carrier Valley Forge



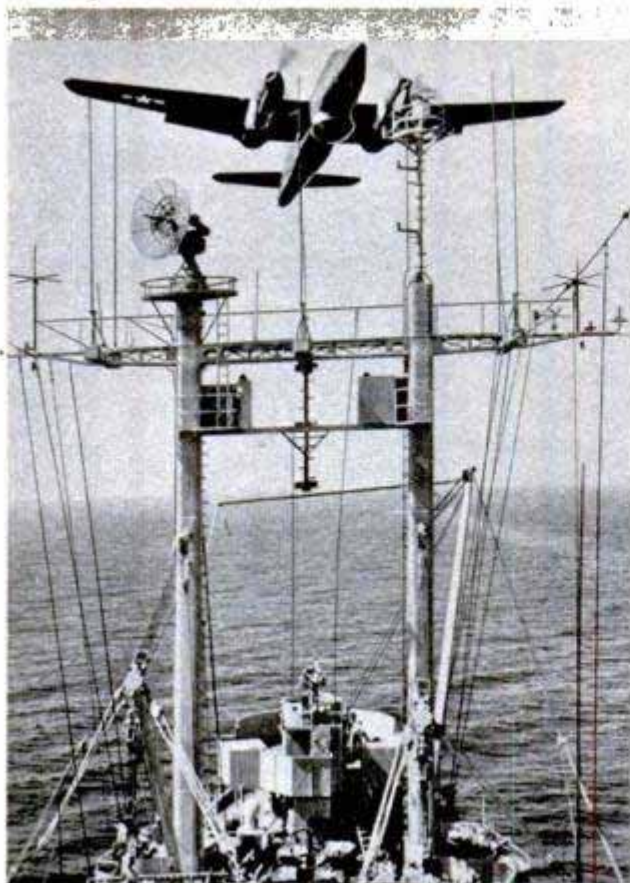

### Flying Messenger

Low-flying American planes dropped messages to convoy flagships during the Korean landings. In this way, use of radio was avoided as such messages might have been picked up by the enemy.

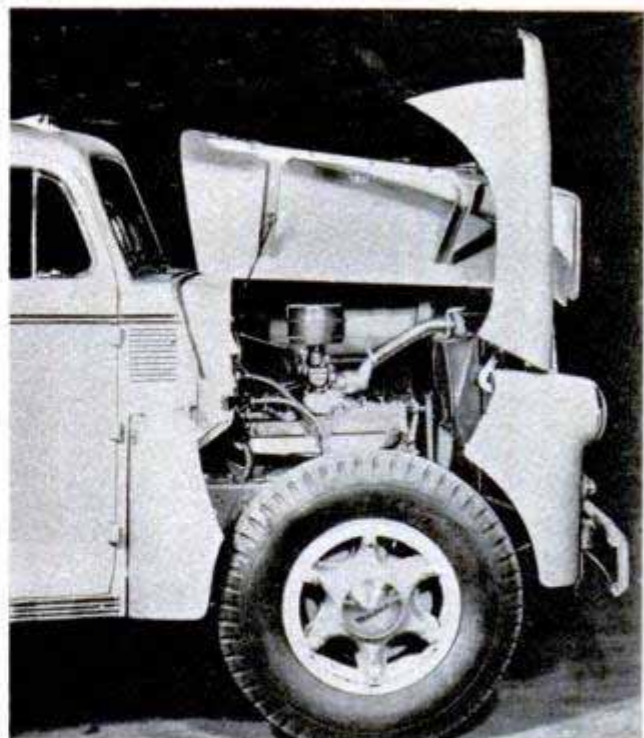

### Hinged Fender Speeds Repairs

Mechanics will welcome the new Federal truck with its hinged front fenders that swing forward, completely uncovering the engine, steering mechanism and front-wheel brakes. The concealed hinge holds the fender upright out of the mechanic's way during maintenance and repairs. Because of this accessibility, a radiator core can be removed in less than 10 minutes.

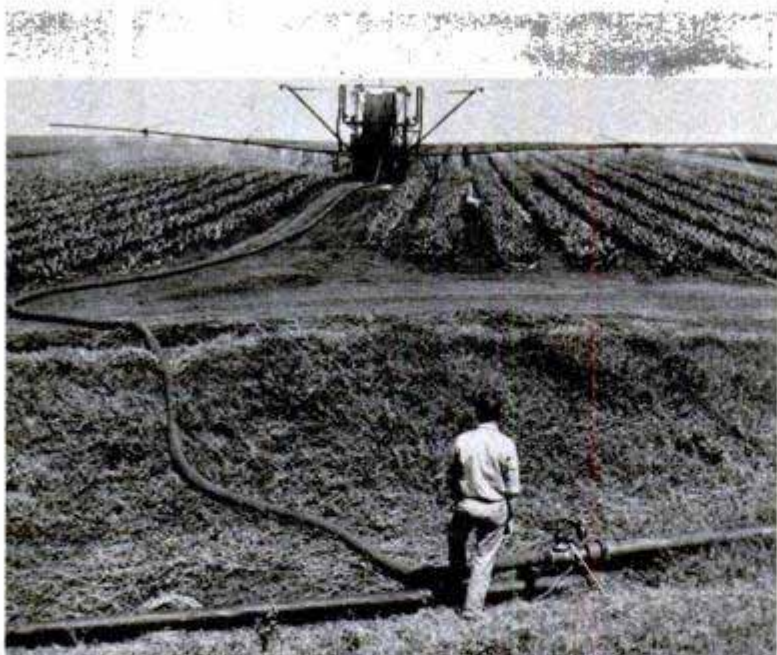

### Shower Bath for Pineapples

One of the biggest reels of "garden hose" in captivity carries water to a huge sprinkler used on a Hawaiian pineapple plantation. Two 50-foot spray booms, mounted on a truck, extend over the plants and irri-

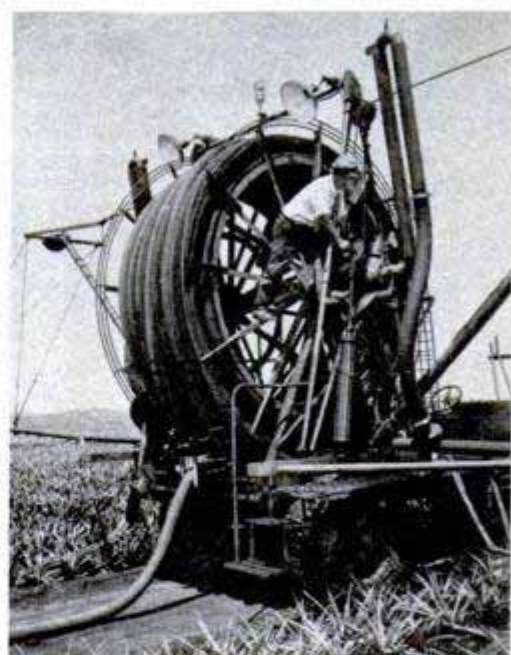

gate 12 acres every 8 hours, providing an equivalent of 1½ inches of rainfall. A large reel on the truck holds 800 feet of 4-inch hose which connects to the water main and reels out automatically as the truck is driven across the field. The rig has a capacity of 800 gallons of water a minute.



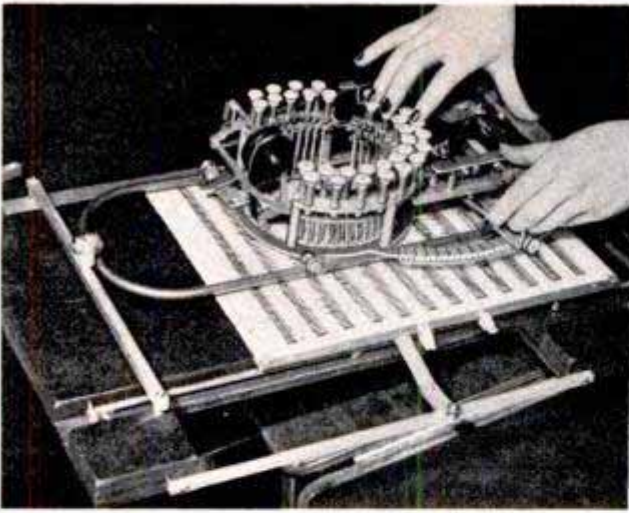

### Mechanical Note Writer

Composers and arrangers don't have to spend hours hand-lettering their scores now that a musical typewriter is available. The machine has a circular keyboard containing all the notes and signs the musician needs. When finished, the typewritten score looks like a printed sheet and is just as legible.

### Daylight Tank Develops Movies

Motion-picture film can be developed as soon as it is exposed with a daylight developing tank that automatically winds and rewinds the film in the solutions. Once the tank has been loaded, all operations can be performed in the light. When the reversal process is required, a transparent tank is used. Business firms using microfilm can quickly process their own film, assuring complete privacy for their records and permitting immediate forwarding or disposal of the material being copied. The tank, which is powered by a small electric motor in the lid, develops up to 200 feet of movie film at a time. A larger model handles 70-mm. X-ray film.



### Aluminum Screen Is Radiant Heater

Electric heating strips of aluminum screen or foil that are installed under floor surfaces are being introduced by a California company. They do not produce the objectionable humming noise created by iron or steel-mesh heating elements. The aluminum elements can be installed under tile, plywood, linoleum and most other types of flooring as well as in concrete slabs. Operating through a 24-50-volt transformer from house current, they consume up to 15 watts per square foot. The temperature adjacent to the element does not rise above 120 degrees and the average floor temperature is 75 degrees.

### Zip-On Coating Stops Corrosion

Applied in a fraction of the time required for hot coating, an anticorrosion coating for pipe joints is closed snugly by a slide fastener. Designed for use on couplings, welded and insulating joints, the coating eliminates the hazards of handling hot materials. The zipper and ends of the sleeve are sealed with a cold compound.

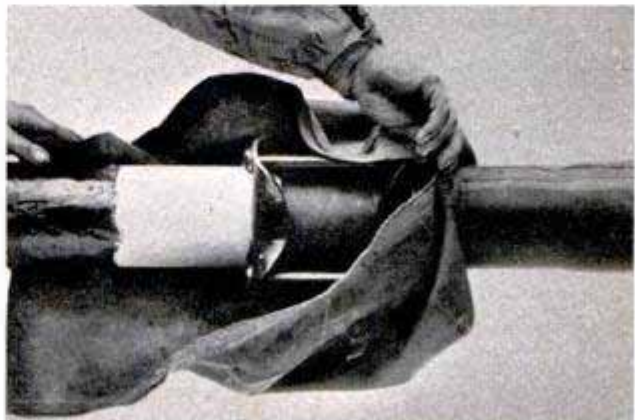

# Telescoping



Ready for the road, the trailer measures 23 feet long and eight feet wide. But look what happens when the owner starts turning a crank. At right the home is partially "unwound." Outer section is moving to left to double the space

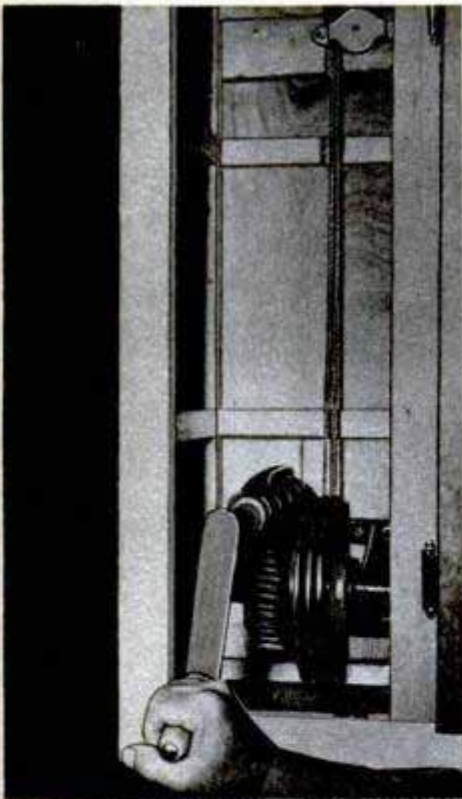
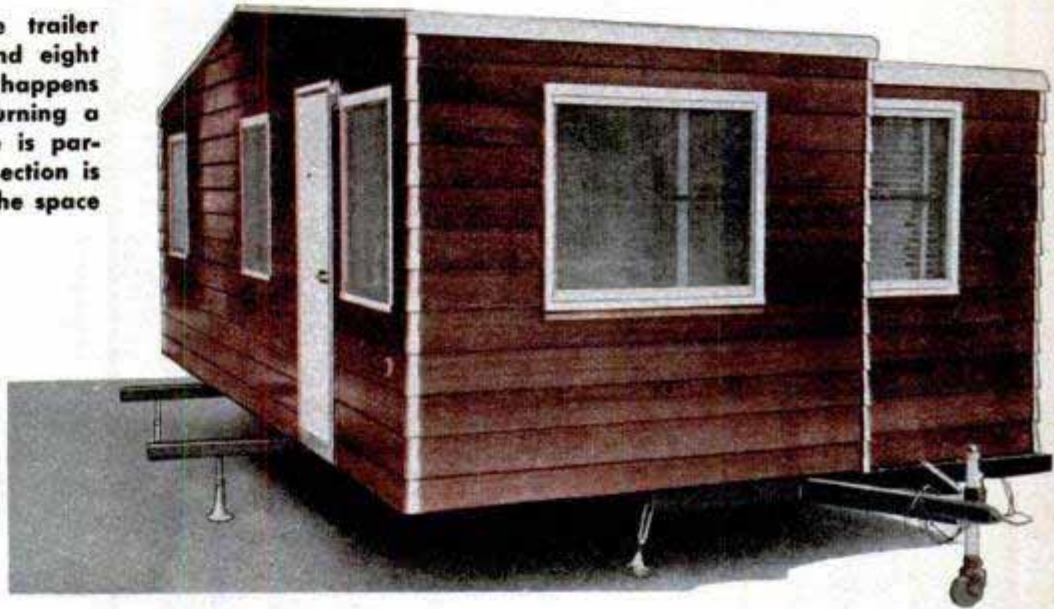

Simple hand crank operates gears to "build" the big living room of the home on wheels. Right, set up and landscaped, this home has a living room, dinette, a kitchen, a bath and a bedroom



# Trailer Home

By Claude M. Kreider

**B**Y MERELY turning a crank the owner of this trailer can double its capacity.

The trailer has telescoping rooms that fit snugly together on the road, then "unwind" to form a modern three-room-and-bath home. The owner pulls up at his chosen site, steps into the kitchen of the trailer and turns a crank 100 revolutions. The gears connected with the crank lower a new floor section flush with the one on which he is standing and move an outer shell of the trailer out over the new floor. The owner then swings folding beams out under the new section and supports them with screw jacks. Presto—he has the room of the original trailer plus a living room as large as all the rest of the vehicle. The home can be ready for occupancy 10 minutes after it leaves the road.

On the road, the trailer measures 23 feet long and has a standard 8-foot width. The expanded living area has interior dimensions of 14½ by 22½ feet. The weight of 7400 pounds handles easily behind an ordinary car. Only about 400 pounds of weight rest on the trailer hitch.

The trailer is designed as a seasonal home to be towed to the beach or the mountains. It may also be used by families who work on large construction jobs throughout the West in localities where housing is at a premium. Such workers sometimes have to move about as some stages of the project are completed.

The trailer proper has a dining nook; a kitchen equipped with refrigerator, gas range, double sink and cupboards; a bathroom with a shower, lavatory and toilet; and a bedroom with a full-size bed, coil springs and an innerspring mattress. Reading lamps beside the bed rest on twin bedside tables.

Exterior electric connections are provided at both front and rear of the trailer. Several outlets are spaced throughout the rooms.

On the road the living-room furniture is carried in the dining nook and bedroom. As soon as the living room is slipped outward, the furniture—including two divans, three tables and three chairs—can be moved into place.

The telescoping living room fits snugly over the trailer proper. When it is extended the joint is sealed to exclude wind, dust and rain.

All the walls, floors and ceilings of the trailer are insulated. The interior is curly birch, varnished to a natural finish. The exterior walls are made of eight-inch rabbeted redwood, oiled and varnished.

Double-hung windows are used instead of the conventional trailer-type windows. Heavy plate-glass panes operated by pull chains move in metal channels. All the doors and windows are fitted with Venetian blinds. The inside head clearance of the trailer is seven feet.

Diagram shows how the outer shell moves away from inner shell to double the space. The joint between the two sections is sealed against wind and rain

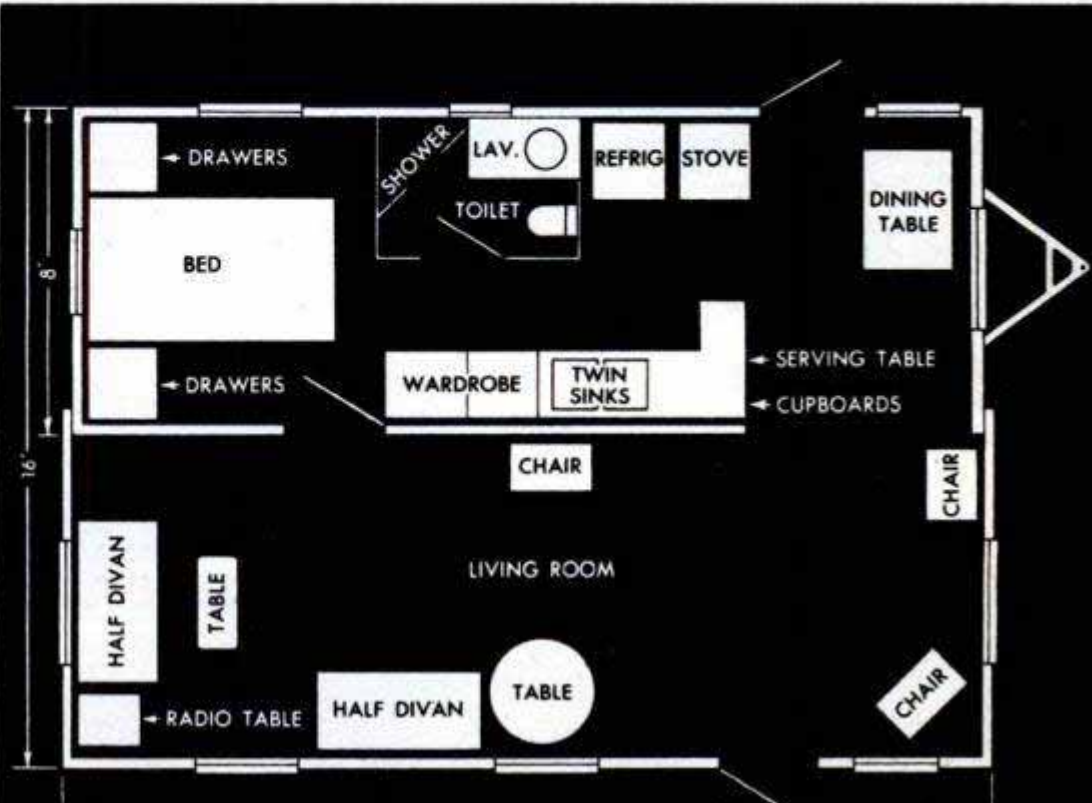



## Illuminated Garden Ornaments

Garden ornaments, illuminated from the inside like Japanese lanterns, can be made to any design by a spray-on process. A wire frame is fashioned in the desired

shape. Then the coating, in liquid form colored as desired, is sprayed over the frame. It dries immediately to form a thin skin. Subsequent coatings thicken the covering. Illumination is provided by electric bulbs inside the waterproof ornament.

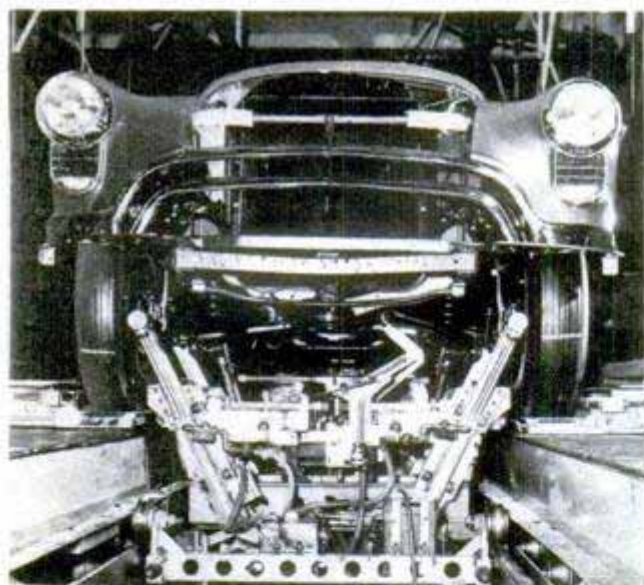

## Aligner Sets Exact Wheel Toe-In While Car Is Assembled

Precise toe-in of front wheels is set into new cars while they roll along the final assembly line in the Oldsmobile plant. A wheel-alignment machine moves with the car 12 feet along the conveyor line. Gauge arms on each side measure the toe-in and show the operator how much tie-rod adjustment is necessary. The machine also centers itself automatically, permitting an accurate spoke setting to be made on the steering wheel so that the horn ring and spokes are in a normal position for driving.

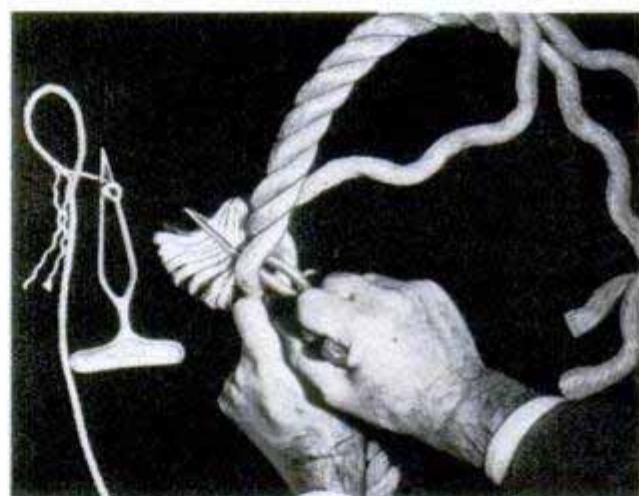

## Rope Splicer

Splicing a rope—usually a difficult job for a landlubber—is made easy by a tool with a point shaped like an arrowhead. Strands to be drawn through the rope are held in the eye of the tool. Made of bronze, the tool can be used on all ropes up to one inch in diameter. It can also be used on small-size wire ropes.

Sources of available products described in this issue are listed on pages 14, 16 and 18. Sources of further information on other articles are listed in the WHERE-TO-FIND-IT LIST, which is available without charge from the Bureau of Information, 200 East Ontario Street, Chicago 11, Illinois

# SOWING PICTURES



SEEDS by the thousands are the "paint" of a unique artist in Ventura, Calif. Mrs. Ellen Cunnane started gathering seeds years ago as a hobby. Noticing the amazing variety of shapes, sizes and colors, she decided to try to duplicate one of her husband's oil paintings with seeds. So successful was she that she has been painting with seeds for 15 years. Her "canvas" is a sheet of white or gray paper, to which she applies paste with a fine brush. She mounts each seed on the paper individually.

Using a fine brush, the seed painter covers her "canvas" with a coat of paste. Then with tiny scissors or tweezers she mounts each seed. Her "palette" consists of many small boxes of seeds, each labeled

Girl walks her dog down a village street in one painting. First pictures, made 15 years ago, look new today



- 1 — Lock-switch for garage door
- 2 — Garage-door motor
- 3 — Burglar-alarm switches
- 4 — Basement elevator
- 5 — Garage-door control
- 6 — Radio controls
- 7 — Dinner-bell control
- 8 — Combination doorbell and light switch
- 9 — Fire-alarm switches
- 10 — Automatic draperies
- 11 — Automatic windows
- 12 — Automatic-window control
- 13 — Master-control room
- 14 — Floor-lamp control box

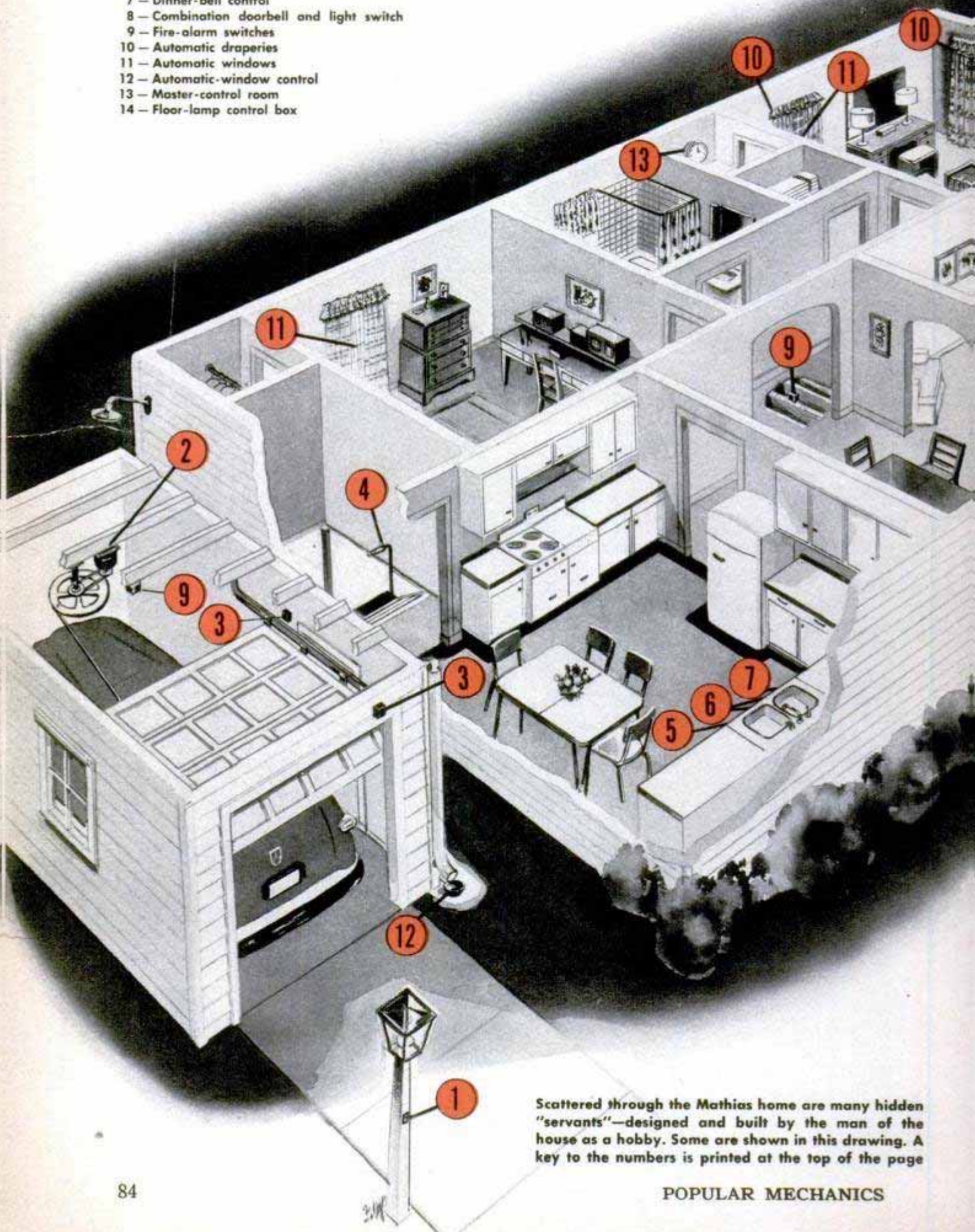

Scattered through the Mathias home are many hidden "servants"—designed and built by the man of the house as a hobby. Some are shown in this drawing. A key to the numbers is printed at the top of the page

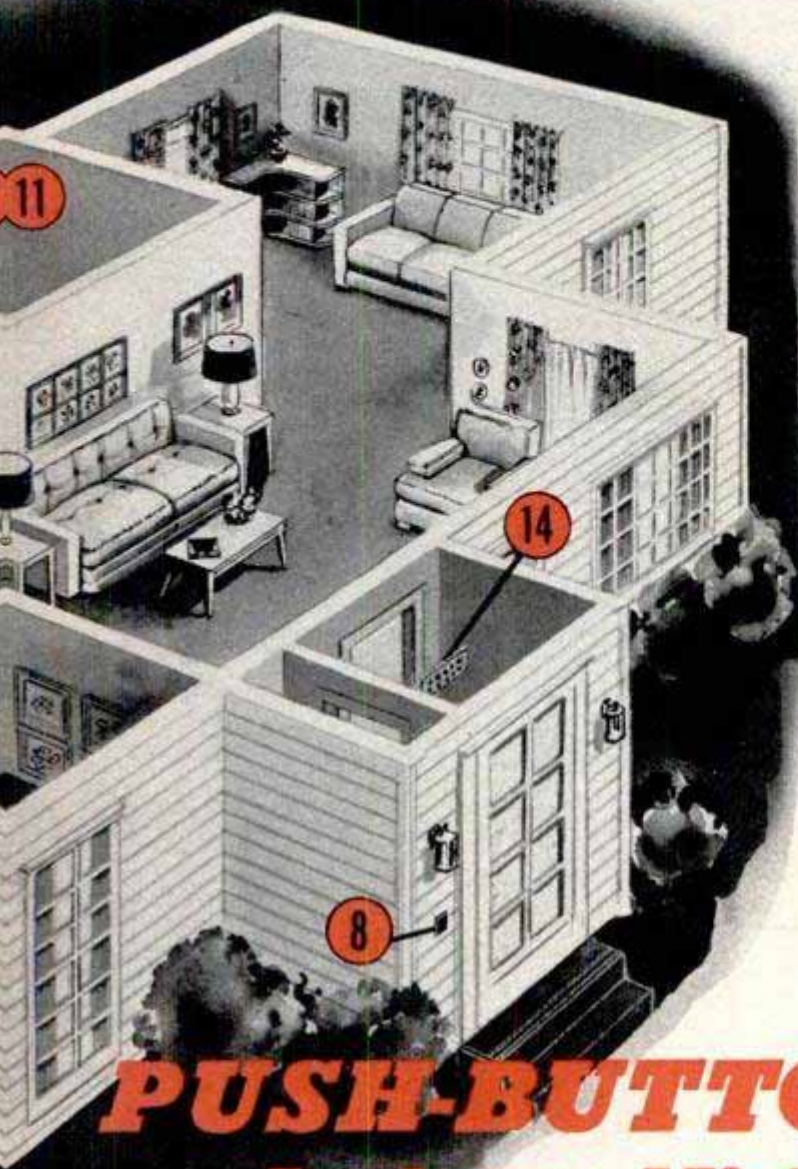

Once an ordinary closet, the master-control room is lined with many switches, timers and relays

## **PUSH-BUTTON MANOR** *Jackson, Mich.*

By Arthur R. Railton

**R**EMEMBER those wartime dreams of lazy living in postwar homes with push buttons to do all the work? Well, like most of us, you're probably still getting by in a house where the only push button rings the doorbell. But there's at least one fellow who is making those dreams come true.

Emil Mathias of Jackson, Mich., traces his mechanical aptitude back to his youth when he harnessed the wind to grind the family's weekly supply of coffee. A small windmill, some gears, a shaft or two, all went together to create a power coffee grinder that Mathias still remembers as one of his favorite devices.

Ever since that day, about 25 years ago, he's been figuring out ways to make electricity and mechanics do more work around the house. He still recalls with a smile another youthful venture. It was an elec-

tric doorbell chime. Five pie pans and a magnetic clapper were the raw materials. Hooked up by young Mathias, they provided a reasonable facsimile of today's fancy-sounding door chimes. And that was a quarter of a century ago.

Today, he and his wife and son live in a neat, six-room house where just about anything can be done by pressing a button. To make this possible, Mathias has strung 7000 feet of wire and installed innumerable switches, relays and motors. He uses low-voltage current, reducing the fire hazard and expense. Incidentally, his electricity bill is not much larger than that for an ordinary household, despite the many push buttons.

To the casual visitor, the Mathias house looks no different from any other comfortable American home — until Mathias

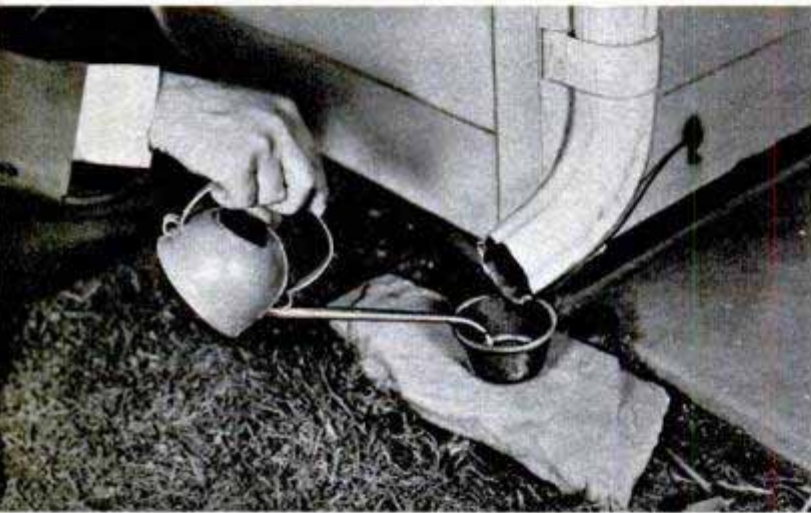
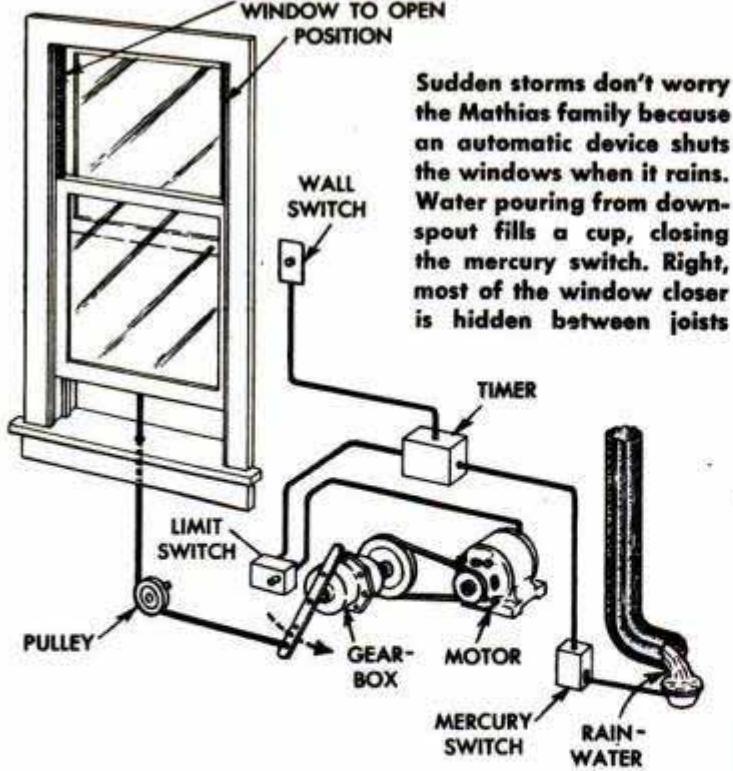

To demonstrate how the ingenious window-closing device operates, Mathias pours some water into the cup under the downspout, simulating a sudden rainstorm

Below, right, this clockless timer uses the heat from a tiny light bulb to open a thermostatic switch that automatically turns off the light at the front door

Below, once operating a bombsight in a big bomber, this war-surplus motor now has a peaceful duty. It opens and closes the draperies in the Mathias home

touches a switch and things begin to happen! Everything is hidden away between floor joists or walls. There are no dangling wires. You wouldn't suspect the presence of scores of mechanical servants that await your command.

But just step into the nerve center of the system, a closet in Mathias' bedroom, and you realize that this house is unlike any you've ever seen! The walls of the closet are lined with paraphernalia. Switches, relays, clocks that turn on things, clocks that turn off things, thermostats, transformers, rectifiers, yards of wire connecting everything to something else! To the uninformed, it's an electrician's nightmare, but to Mathias it all makes sense. Everything has a practical function. There's no Rube Goldberg scheme in the place.

Mathias believes that half the fun of having something is making it. Every one of his mechanical servants is his own design and construction. He admits he could have bought commercial models in many cases, but where's the fun in that?

"Take that elevator I'm building on the

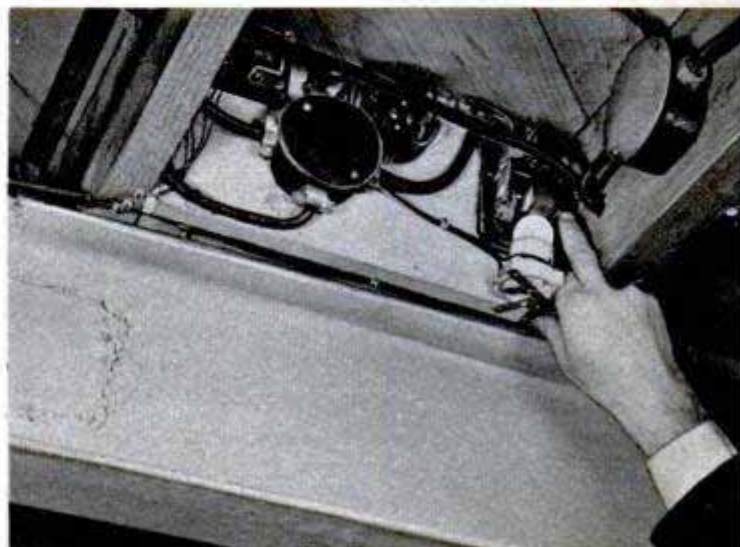



basement stairs," he explains. "I could buy one of those home elevators, but that would eliminate most of the fun. So I'm building one myself."

When the doctor said Mrs. Mathias should cut down the number of trips up and down stairs, Mathias went to work on the elevator. He got a few lengths of square door track, like the kind barn doors slide in, and bolted them to the side of the stairway. A rectangular steel platform, just large enough for one person to stand on, is the "cage." Its supporting brackets slide smoothly inside the door track. Push-button switches on the safety railing at waist height control the reversible motor that operates the elevator. Push one button, you ride downstairs to the basement. Push the other and you ride up!

Step into the bedroom and Mathias flips a wall switch. The draperies close automatically over the two windows. A surplus bombsight motor in the basement does the work. He throws another switch and the windows close. The radio in the living room can be turned on and off from the bedroom (and from the kitchen and basement as well). Extension speakers bring the sound to you wherever you are.

Clocks in the closet shut the radio off at 10 o'clock each night and turn it on at 6 a.m. On Saturdays and Sundays, the radio stays on until 11 and resumes at 8 in the morning. A special switch cuts out the shut-off clock, if Mathias wants to listen to programs after the usual sign-off hour.

When Mrs. Mathias sits down at her dressing table she doesn't have to fumble with the twin lamps to turn them on. She merely pulls out the center drawer a fraction of an inch and the lights go on. A microswitch in the drawer does the trick.

The house and garage are protected by a burglar alarm that goes on automatically at bedtime and shuts itself off in the morning. If anybody opens a door in the house or garage during the night, the yard lights go on and a buzzer sounds in the bedroom. An interphone picks up any sounds in the garage and pipes them into the bedroom.

Scattered around the house are fire alarms—simply spring-type clothespins held open by a thin thread. Should fire break out, the thread burns through, releasing the clothespin jaws which close a circuit, sounding an alarm.

Should it rain during the night or when the Mathias family is away, there's no chance of water damaging the plaster or furnishings. Beneath a downspout is a small metal cup that tips down when filled with water, operating a switch that closes the windows!

The garage doors are opened and closed

(Continued to page 252)

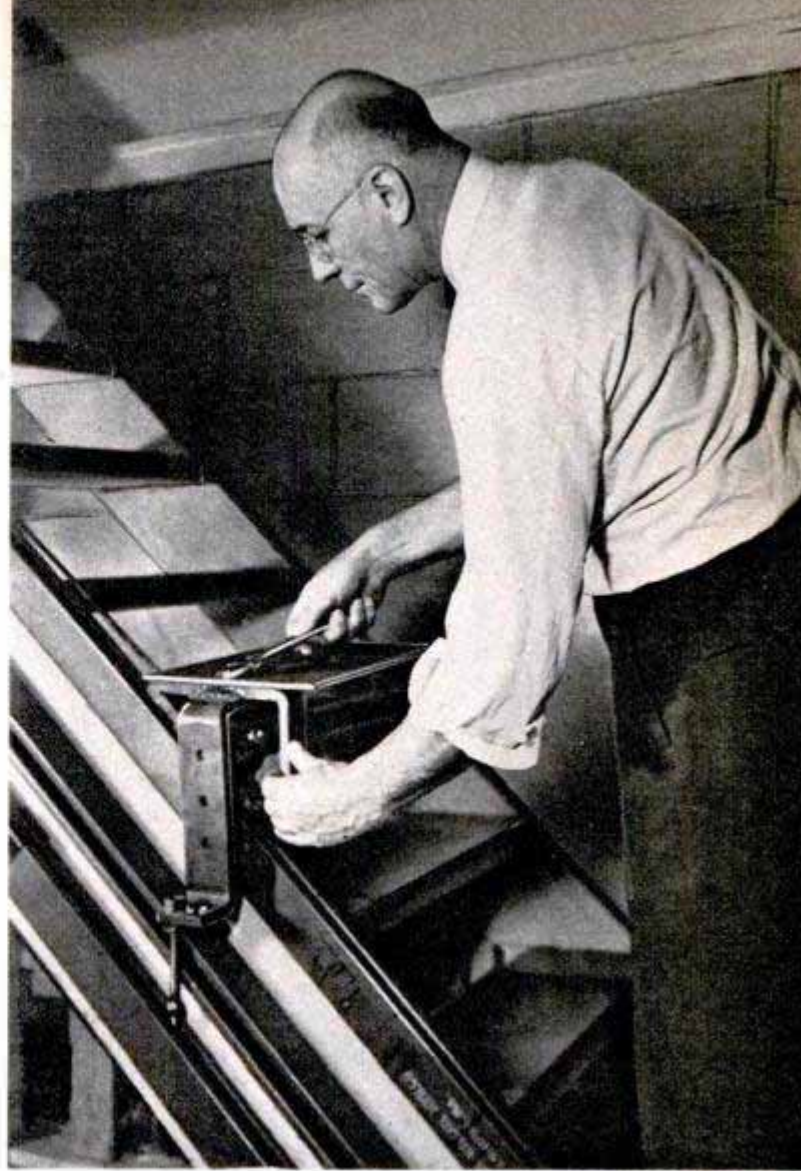

Newest project is an electric elevator to the basement so Mrs. Mathias won't have to climb the stairs

Below, Mathias took time out from his electrical hobby to make this crank-down, dogproof garbage-can lid





## Aluminum House Window Has Screen and Storm Sash

Delivered to the building site assembled and ready to hang, a new aluminum window comes complete with storm windows and screen, all in one unit. The glass is mounted in Koroseal plastic instead of putty and the screen is also plastic. Both

house and storm sash are quickly removable for washing. The window unit is simply nailed into position just as it comes from the factory and requires no painting or glazing. Each of the four sash can be raised or lowered as desired.

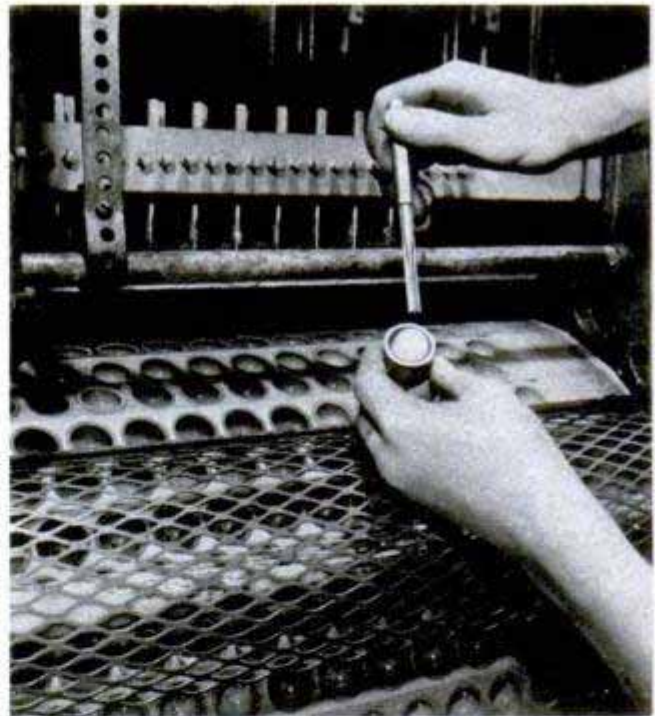

## Machine Pits 1000 Pounds of Cherries Per Hour

Cherries are pitted at a rate of 1000 pounds an hour by a new machine that handles the fruit in tiny rubber cups. The cherries enter the machine on a conveyor belt and each falls automatically into one of the 700 cups. Needles then punch out the pits, forcing them through small holes at the bottom of the cups. The rubber

pockets absorb the shock which otherwise would tear the cherries apart. The cups are on a rotating cylinder which tips the cherries onto another conveyor belt where they are sorted while the pits are carried away in a stream of water. The machine is said to reduce waste in cherry pitting from about 18 percent to 9 percent.



Here's Roy Halvorson, a man who has cut 11,000,000 Christmas trees and reaped the praise of conservationists

## Meet Mr. Christmas Tree

By Clifford B. Hicks

AT THE very moment you are happily stringing lights and tinsel, popcorn balls and high spirits on this year's Christmas tree, a rugged old logger named Nick Finni may be honing his ax, ready to snake your next year's tree out of the wilds of northern Minnesota.

Old Nick's ruddy face will be pleasantly wreathed in the good humor of a year-round Yuletide, and his eyes will have a twinkle that would do justice to Santa himself. It's a rather surprising fact that even Christmas trees have succumbed to the machine age—they now are cut out of the north woods on a controlled, mass-production basis many months of the year. Yet despite this industrialization there is enough romance wrapped around Old Nick and his fellow tree-cutters to satisfy even a four-year-old's conception of the proper inhabitants of Christmas Tree Land.

Nick's boss, Roy Halvorson, is the ingenious man who has developed a preservation

Nick Finni—Santa minus a beard—saws down another swamp spruce. Foliage is sparse except at the top

Basgen-Presley photos





**Old-time cutter toted these two bundles of trees out of the muskeg last winter—for use this Christmas!**

system whereby Christmas trees can be turned out the year 'round, making a stable industry out of a fly-by-night enterprise which, in past years, has been a national disgrace. It's true, of course, that a good many opportunists still are slashing through our valuable forests to take advantage of the average American's yen for a tree

**Bundles are stacked on a swamp sled, an iron dish big enough for Paul Bunyan himself. Tractors tow the sleds across swamp or snow to the highway. Tractor here is gradually settling into water of the spongy swamp**

“about this high” during the Yule season. But Halvorson — “Mr. Christmas Tree” — has discovered how to “preserve” trees indefinitely. He has combined this system with a unique phenomenon of nature to “make” Christmas trees without damaging our timberland. His factory in Duluth, Minn., runs full-tilt 7½ months of the year turning out gay little trees; yet his scientific methods have drawn the unqualified praise of leading conservationists.

Take a look at the figures. In his lifetime Halvorson has harvested a whopping 11,000,000 trees out of the wilds of Minnesota and Canada. To find them he has selectively cut 110,000 acres of wilderness; and to conquer the wilderness he has constructed a thousand miles of tractor roads, 3000 miles of survey lines and 7500 miles of trails, all cut straight and in cardinal directions. This Christmas, housewives will buy about 1½ million Halvorson trees in grocery marts and 10-cent stores.

Damage to our forests? None. Here's what Dr. T. Schantz-Hansen, Director of the University of Minnesota's Cloquet Forest Experimental Station, has to say about this tremendous logging operation: “Roy Halvorson's cutting methods improve the forest and contribute much to the economic life of the north country. The State of Minnesota owes him a vote of thanks for his very real contribution to the true conservation of Minnesota's forests.”

The secret of Halvorson's contribution is the little 50 to 100-year-old tree itself. In





Trimmer at the factory in Duluth whisks off straggly lower branches and makes a fresh cut across the trunk. In the background are just a few of the 1,500,000 trees that Halvorson will sell through small stores this year

its natural state the northern or "swamp" spruce is a scrawny, ugly tree you wouldn't think of bringing into your home — yet through Halvorson's magic it becomes a sparkling symbol of the Christmas season.

Covering vast areas of northern Minnesota and Ontario is the muskeg—a spongy swamp country. In winter the muskeg is a frozen wasteland and in summer it's a

treacherous bog that can suck you down to your hips in motionless water. No undergrowth flourishes here except sphagnum moss and Labrador tea, which die each winter to add another layer to the sponge. In this sterile land the northern spruce makes its stand, struggling up through the layers of moss to grow in forests so crowded that only the tops of the trees receive

Huge electric mixer whips up a fresh batch of the water-emulsion paint, which gives trees a waxy protective coating. Right, mechanical hands grab trees and swish them through paint, then whirl off the excess

Basgen-Preasley photos





Trees circle the "merry go round" machine which installs the metal stands and fills them with an artificial sap that retards the dropping of needles. Trees are produced in three colors—green, silver and white. Below, Halvorson's daughter June trims a white tree



sunlight. Each tree wages a fierce struggle for existence against its neighbors. Its barren trunk rises like a pole to a height of 10 to 25 feet. At the peak the trunk tufts out into a densely branched, perfectly symmetrical top, three or four feet high. The wood in these swamp forests is so poor it doesn't pay to cut the trees. Nature turned down a blind alley in producing the dwarf spruce until Roy Halvorson came along.

Roy is an energetic 46-year-old, as cheerful as his gay little product. When he was a school kid in Duluth he tramped the woods early each December, cutting trees to earn Christmas money. At 14 he joined forces with an elderly man to market them. One hitch developed—the old-timer insisted on cutting big evergreens 10 to 20 feet high, whereas Roy figured smaller trees would sell better. Come Christmas Eve, all the small trees were sold and most of the larger ones still awaited buyers.

(Continued to page 226)

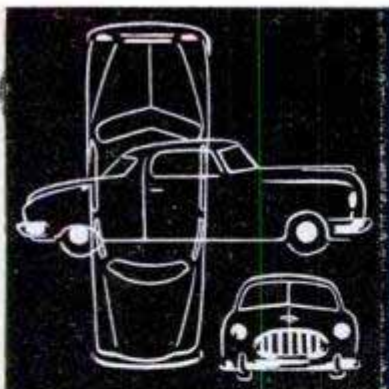

# Detroit Listening Post

*By Siler Freeman*

**A**S THE automotive industry comes down the home stretch to the highest production pinnacle in its half-century history, only two things are certain for next year:

1. Output will be cut in 1951 an estimated 10 to 25 percent, this range depending on how seriously the defense program cuts down manpower, materials and freedom from controls.

2. Prices of new cars will be higher.

A 10 to 25 percent reduction in schedules for 1951 would still leave the industry in an enviable position. The plants would still look forward to a receptive market for more than 5,000,000 cars and trucks, more realistically perhaps 6,000,000 unless a "shooting war" turns the plants into another "arsenal of democracy."

At any rate, the impact of government orders on manpower and materials is not expected to be felt before the second half of next year.

The manpower pinch has already been felt among skilled labor. The diversion of engineers, technicians, tool and die makers to defense work started when Cadillac took on the tank job in Cleveland and has continued. It probably will not lessen next year but get worse, as government orders get the emphasis.

Luckily for the auto industry, the 1951 model work was out of the way before the inroads started on the skilled trades. It is not so good for the 1952 models, which have not yet been finalized. The industry still feels confident it will have 1952 models, again subject to the factor of an all-out war.

Guessing right now is that any indication of trouble on a global scale will cut the 1951-model runs short and bring the 1952s on the scene much earlier than expected. The 1952 changes are on a much larger scale than the new models just appearing in dealer showrooms.

High-compression engines are still the engineering high spot of the future planning in the industry. The hectic maneuverings within the various companies have been somewhat stymied by the war situation. But the planning goes on.

Ford's overhead-valve V-8 is being de-

layed by tooling and will not be ready for the 1951, but is almost certain to be in the 1952 models. Buick's new engine, latest of General Motors offerings in high-compression power plants, will not be ready for the 1952 models and will be held off until 1953. It involves an expenditure of about \$60,000,000 and the building of an entirely new plant to receive the new job.

Ethyl Corp. recently demonstrated the intrinsic value of the combination of anti-knock fuels and high-compression engines. It showed in actual tests of 1925 engines and fuels compared with 1950 engines and fuel that at about the same price levels, two gallons of the modern fuel used in the new engines are actually worth more than three gallons of the 1925 gasoline.

An interesting part of the tests was the use of the next step in high-compression engines. This is an 8 to 1 compression ratio GM research job which was used in an Oldsmobile and gave 25.7 miles per gallon. Packard now has the highest compression ratio, 7.8 to 1.

But here again, the uncertainties ahead may upset planning. High-compression engines need high-octane fuels. And the military is getting jealous of the motorists' inroads in its supplies of high-test gasoline. The stepping up of compression ratios could very well be reversed if premium grades are robbed of too many octanes.

Higher prices, however, are an established trend in the industry. Every 1951 car brought out so far has been priced above its 1950 counterpart. The surprise has been that 1950 cars have not been boosted in the face of climbing labor and material prices.

Only General Motors and Chrysler lines remain to be shown to complete the changeovers to new models. Neither is expected to hold the line, despite the huge profits their annual reports are expected to show. Like the record production this year, earnings are almost certain to show the inroads of a nation on a semiwar footing next year.

Indication that the auto companies face an "austerity" program may be found in GM's cancellation of its annual Waldorf Astoria show in New York.

This is a firsthand report by a Popular Mechanics editor who flew on a big C-97 loaded with military freight to Tokyo and returned on a "flying hospital"

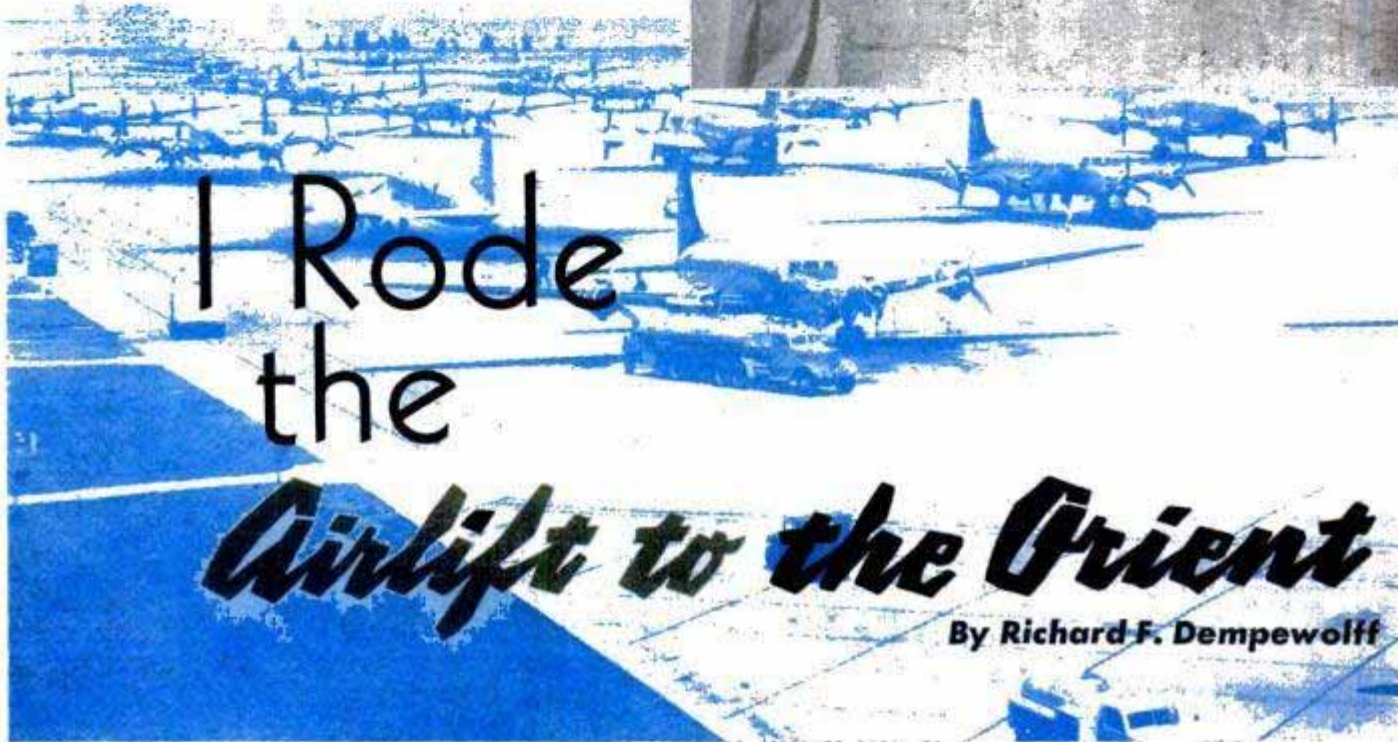

# I Rode the *Airlift to the Orient*

By Richard F. Dempewolff

At Fairfield-Suisun Air Base in California a huge fleet of four-engine planes awaits take-off. Top, map shows airlift routes over the Pacific

## Part I

New C-97A has a side hatch being loaded here with a self-propelled cargo hoist. Older C-97s had only the rear opening beneath the tail



FROM Fairfield-Suisun air base in California to Tokyo's Haneda field I rode with 10 tons of war freight packed into the twin decks of a giant C-97 "convertible" air liner. From Tokyo I flew back in the same craft, now a hospital on wings, hurrying home with 64 of our wounded men resting on tier after tier of litters. One thing I made sure of before the return trip—no wounded soldier would be "bumped" to make way for a mere journalist.

Waiting in the control tower at Fairfield-Suisun, nestled in the sun-baked hills 45 miles northeast of San Francisco, I watched them go—monster four-engine planes, one on the "heels" of another. From dawn to dawn they roar down the



At Haneda field in Tokyo, the planes undergo a quick transformation to hospital ships. Litters fit into hanging straps; this C-97 carries 64 "beds"

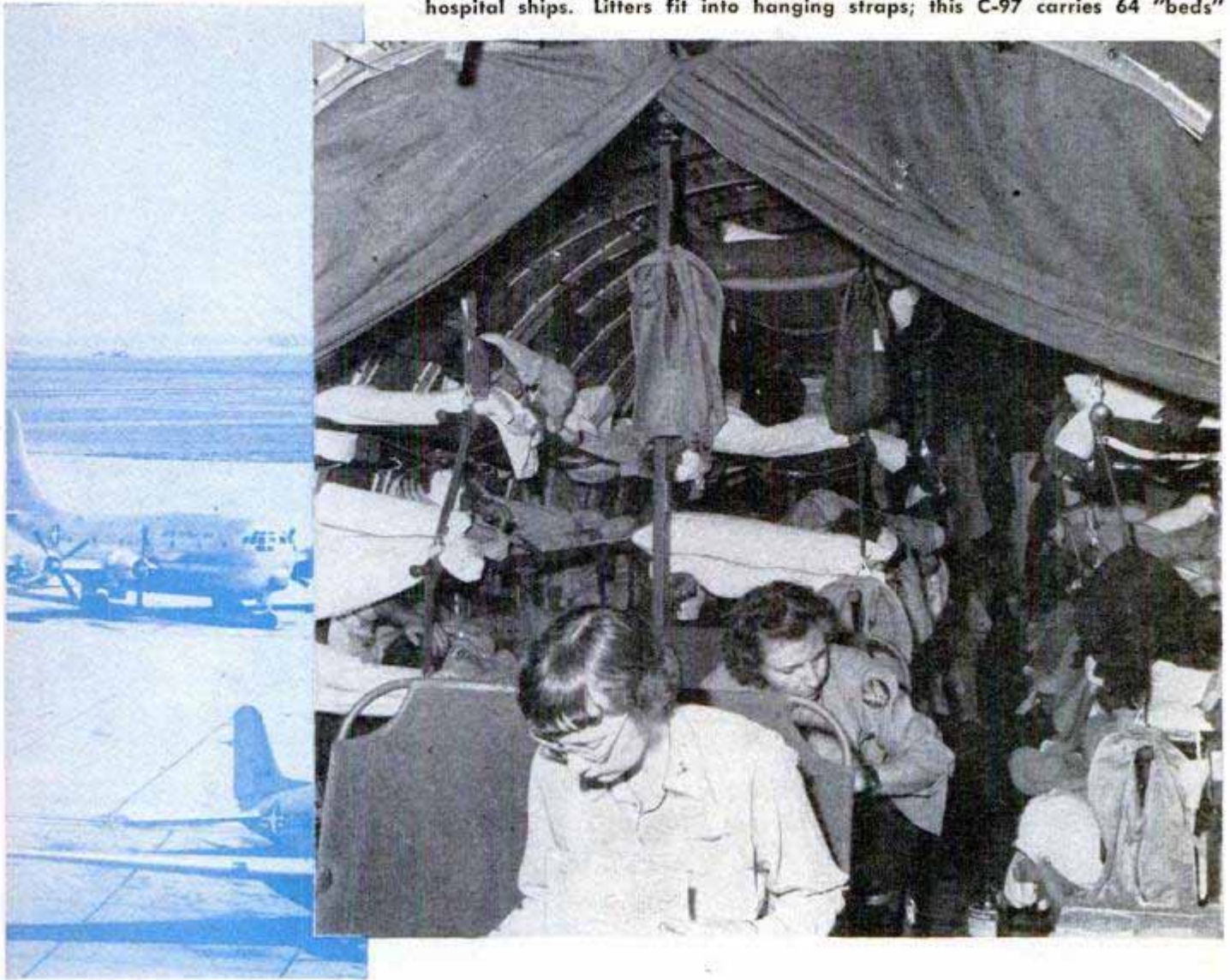

mile-long concrete runways in a thundering parade, kicked off by the prevailing breeze that gives the field its name. Suisun (pronounced soo-soon), the sergeant informed me, is an Indian word meaning west wind. It's the "soo-soon" that helps lift the heavily loaded C-74s, C-54s and double-decked C-97s of this incredible fleet into the air with their staggering loads of gasoline, troops and war materiel. For these big babies are off on the first leg of an airlift that reaches 6000 miles over the Pacific—longest airlift in military history.

Thirty to forty hours later, their heavy tires will screech down the runways of Haneda Air Base in Tokyo. Another few hours and the cargoes of men and materiel will be right out on the battle lines.

For their return, cargo holds of the air freighters are cleaned. In 20 minutes, straps and stanchions are lowered and bolted to the decks. These provide racks to hold up to 74 litters for wounded men who are being moved from the front—within hours of the time they are hit—to hospitals near their home towns in the States. At the time of my trip there were 100 airlift planes

in the air constantly over the Pacific Ocean.

When the Korean war began last June, the Pacific Division of the Military Air Transport Service consisted of a mere handful of C-54s. Today, the aprons at Fairfield and other airlift ports bristle with the propellers of some 200 aerial behemoths. Not all are military planes. Many still carry the insignia of 17 different U. S. commercial airlines, the RCAF and even a Belgian airline. The "commercials" were diverted to the MATS command last summer, thus making up the emergency fleet. Gradually the commercials are being returned as MATS is able to handle more tonnage with its own fleet.

Seen on a military ramp, the "lift" is an odd-looking conglomeration of aircraft. Among the commercials, which make up about a fourth of the fleet at this writing, each company provides its own crew and uniforms. But there's no telling which crew will be flying whose plane. They may be reassigned on occasions to expedite flight schedules which, at rush periods, often call for nose-to-tail departures that are five minutes apart. You can see "Pan

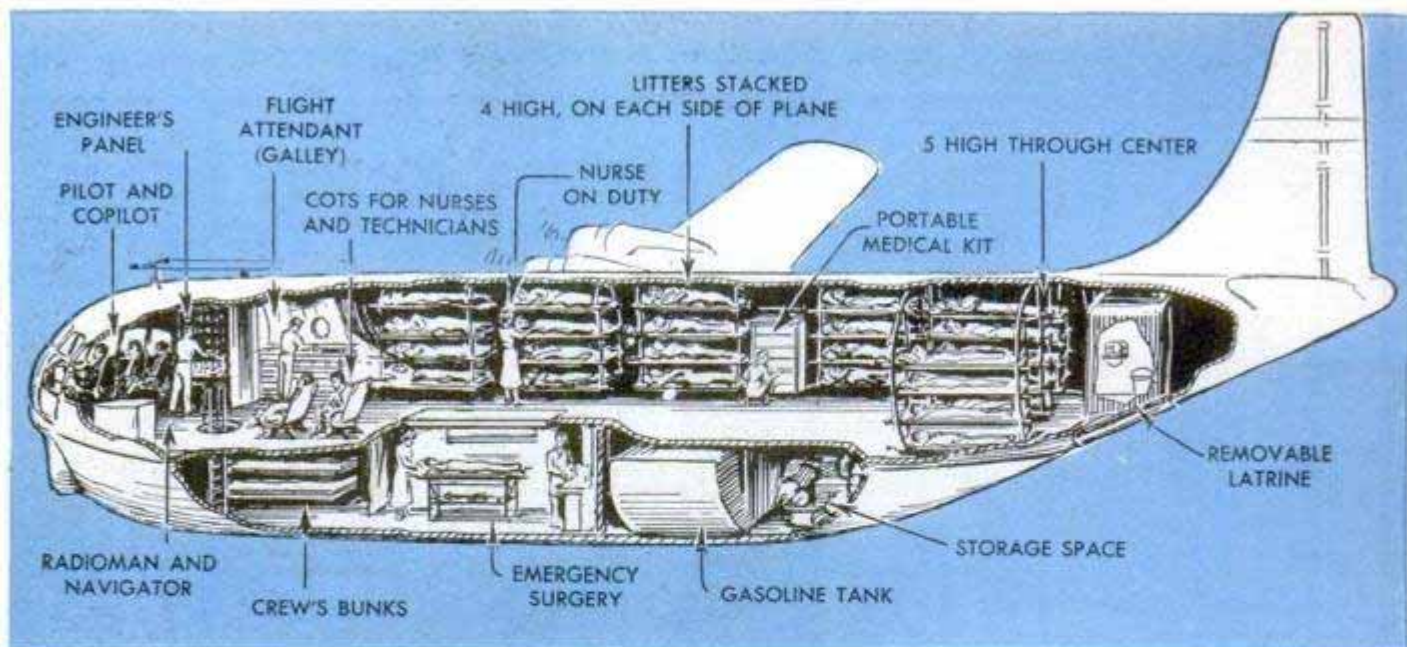

Cutaway of the double-deck C-97 shows how it is transformed to hospital ship including emergency surgery

Am" uniforms debarking from Alaska Airlines planes; "United" uniforms may take off in Northwest's transports.

"I'd give anything," one American Airlines pilot said with a grin, "to see the report a Russian pilot at Haneda airport in Tokyo made to his chief. He saw me debark from a Capital Cargoliner, followed by my second officer who was wearing a Pan Am outfit. He did a double take and shook his head in amazement, 'those crazy

capitalists' written all over his face."

There's nothing "crazy" about results delivered by the lift, though. Before Korean Reds poured down across the 38th parallel last June, MATS planes in the Pacific hauled about 70 tons of men and materiel a month. By August, they were moving 100 tons a day. "And that tonnage is increasing," says Major General Laurence Kuter, MATS commander who headed up the Berlin airlift and is now applying his know-

Pilot Leon Musgrove is a busy man at take-off or landing. There are 125 items on the take-off check list and it takes 20 minutes to clear them all



how to the Tokyo run. In one early 40-day period, according to the general, some 1500 tons of critical cargo and 15,000 passengers—the equivalent of almost a full division—were lifted across the big pond. No one will let on what the lift costs, but this much is known: every time one of those big planes makes a round trip, it burns up 14,680 gallons of gasoline—enough to keep your car rolling for about 22 years!

You get some idea of the immensity of the operation when you stand on the loading aprons at Fairfield, see the long lines of planes, and watch the bustle. Fork lifts and hydraulic elevator trucks scoot back and forth across the concrete, laden with high-priority cargo in odd-looking crates: whole blood—packed in two circular racks of jars

that fit snugly around a canister of chipped ice in an insulated carton, plasma, rockets, ammunition, tank parts, machine-gun mounts, radio parts, engines to keep big bombers flying and plastic cowlings for fighter planes.

Built-in elevators, slung by steel cable from each corner, drop from the bellies of big C-74s to receive and lift the cargo aboard. Above the yawning tail hatch of a double-bellied C-97 Stratofreighter, a hydraulic hoist whines as it pulls a massive bomber engine off a truck and into the cavernous cargo space on the top deck. On another, a small field vehicle bounds up a steel ramp, disappears in the darkness and is bolted to the deck. Several times a day the acres of warehouses at Fairfield are filled and emptied.

Without referring to tables, expert logistics crews know the load limits, speed, gas consumption, lifting power of the hoists, width of cargo doors on each of the three types of planes used. No time is lost getting things aboard. At Honolulu, where cargo is sometimes switched, loaders have diagrams of planes painted on the warehouse floors, so loads can be predistributed for weight, balance, size and shape, and moved right out to the plane in sections—sort of a prefab loading operation.

Over toward the operations building, men with steel helmets, high boots, rifles and packs are filing aboard a C-54 "plush job." These are special troop units, needed in a hurry: Signal Corps specialists, ordnancemen, highly trained combat-infantry teams. A few hours ago they came in by truck from inland training camps and were loafing around the lounge drinking Cokes, writing letters home, or spending a last few minutes saying good-bye to friends and relatives, while weapons carriers hauled their gear out to the waiting planes. In another two days they'll be half way around the world, on a battlefield, or wherever they're needed.

Not all troops ride the plush jobs. Many climb in with cargo and sit on litters running along the sides of the plane. These, the boys told me, were far more comfortable than the old hard steel lengthwise bucket seats. Later, I discovered it was true. At night, more litters are strung up in tiers, and everyone will get a bed to

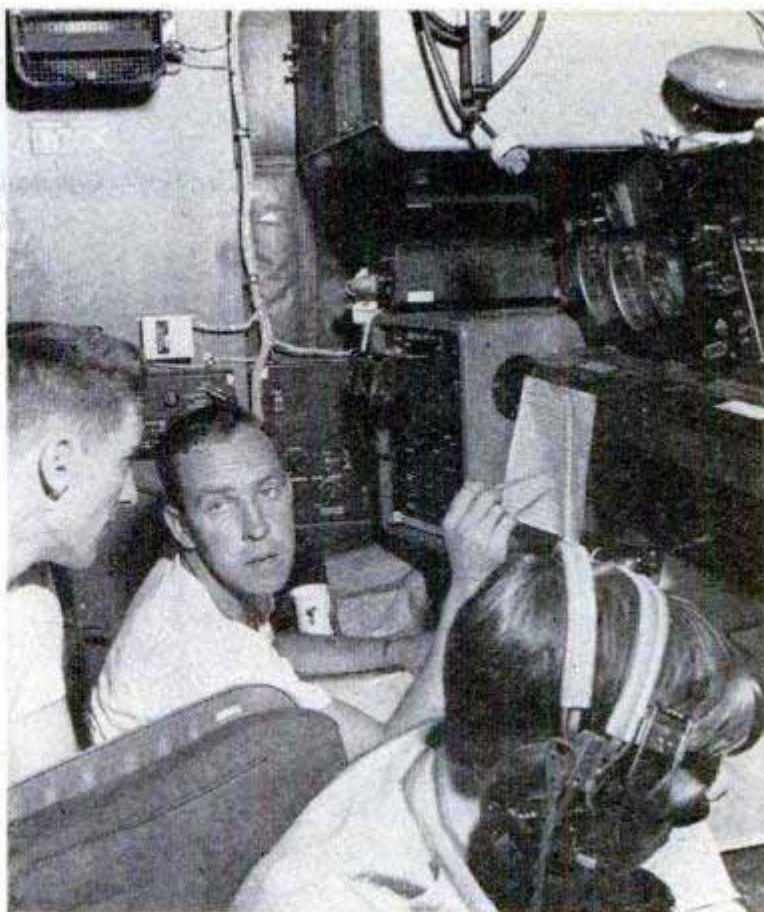

Loran operator over Pacific constantly computes position and feeds information back to man at "How Goes It" graph at Fairfield. Below, portable lavatory was a necessary innovation aboard C-97s designed for freight but converted for passengers

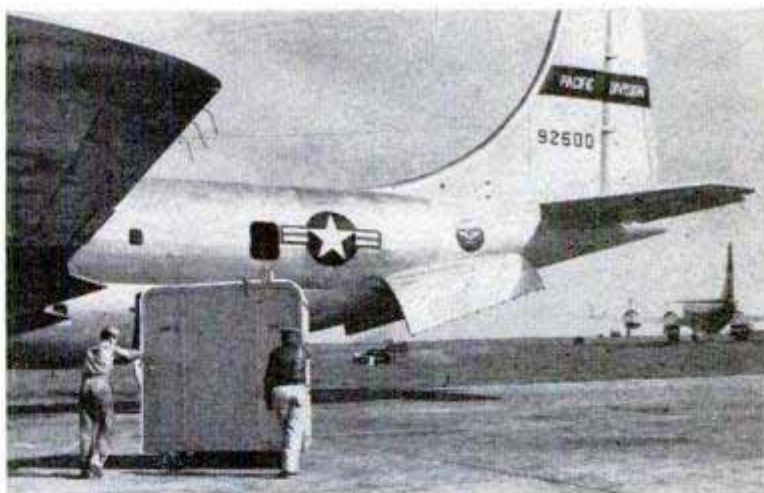

stretch out on. "It's not bad," said one GI, "if you don't mind staring at a knothole in an ammunition crate six inches from your nose for 40 hours."

Most planes leaving Fairfield carry both cargo and men. The C-54s will start with 8000 pounds of freight, or 35 passengers. The C-97 takes off with 21,000 pounds, or part of that and 50 passengers. The C-74, biggest of all, starts with 26,000 pounds, or 74 passengers. All of them can pick up more en route since the gas load is lighter for the hops from Honolulu to Japan.

(Continued to page 266)

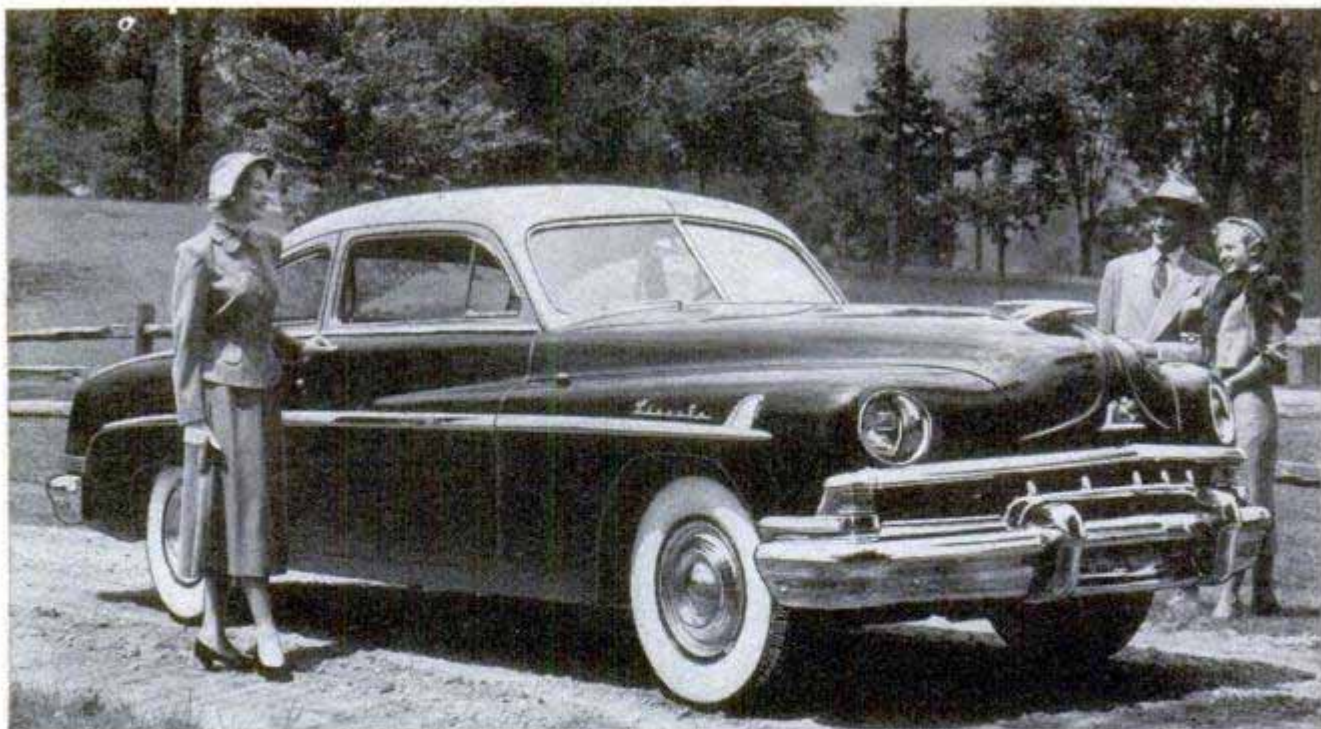

## 1951 Lincoln With the Long Look

Extended rear fenders, a wider rear window, new grille and bumpers are among numerous body changes in the graceful '51 Lincolns and Lincoln Cosmopolitans. Headlamps have been moved to the outside and there is a new taillight assembly. The general effect is a lower and longer appearing car without an increase in over-all

length. Although the power plant remains essentially the same, it has been stepped up from 152 to 154 horsepower with a compression ratio of 7.1 to 1. Lincoln will continue to use Hydra-Matic transmissions in the '51s. A new engine, scheduled for this car, has been delayed until next year. Interiors of the cars are luxurious.

## Reflector Rims on Auto Wheels Shine Warning

Applied to the rim of each wheel, a ring of highly reflective material helps prevent automobile accidents. Of special value when the car is pulling away from the curb or crossing the highway, these reflecting

rings pick up the headlight beam of any approaching car, warning the driver. They reflect enough light to be seen several blocks away. Cut to fit standard wheel sizes, the rings are cemented to the wheels.

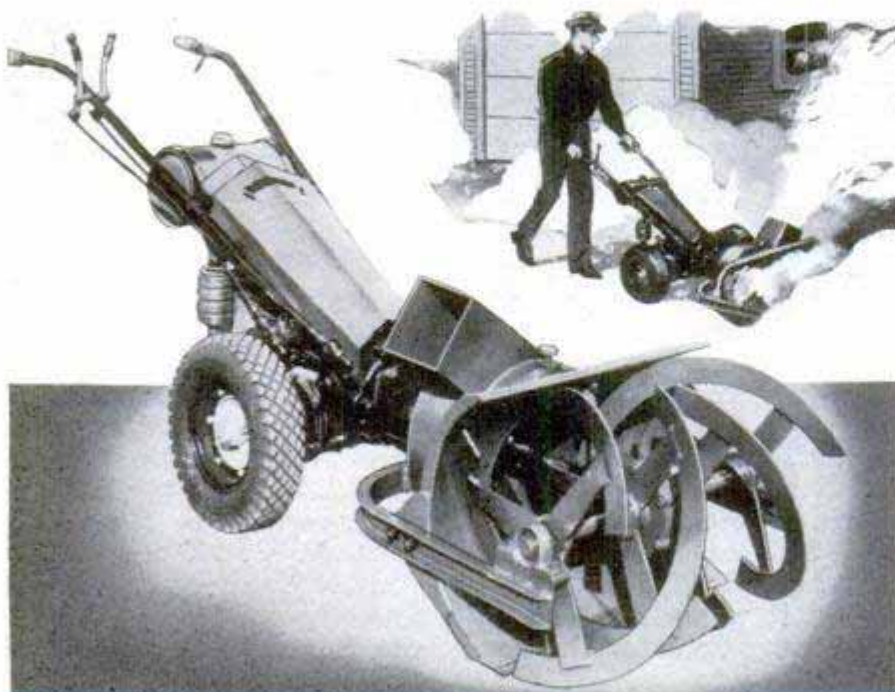

## Snow Blower

Snow up to four feet deep is blown away by an attachment for a garden tractor. The snow blower is quickly adjusted to throw snow either to the left or right. It cuts a 25-inch swath in the snow, tossing it well away from the path.

☐ For the first time in history, automobiles outnumbered horses on United States farms in 1950, the Department of Agriculture putting the number of farmer-owned cars at 5,800,000, and horses 5,310,000.

# Chrome "Skin" Doubles Life of Piston Rings

DURING early operations in the African campaign of World War II, tank and aircraft engines were practically useless after only a few hours in an atmosphere saturated with dust and sand. The Armed Forces had to extend the life of this vital equipment—cost no object. Because of high resistance to wear, chrome "skin" piston rings were sent to the fighting front and proved to increase the life of engines up to five times. Today, after seven years of research and field-testing, chrome ring sets are available to motorists at a cost that compares with ordinary rings. Installations in all types of engines have shown the life of rings and cylinders to be more than doubled, according to the manufacturer. Applied over a thread finish on the edge of the compression ring, .004 to .007 inch of solid chrome gives the rings and cylinders long life.

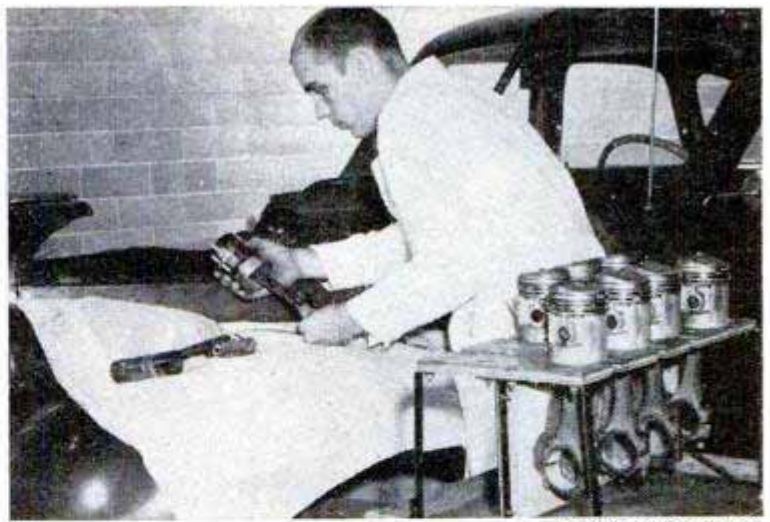

Perfect Circle photos

Mechanic replaces piston fitted with set of long-life rings



Center, installing chrome-faced, oil-stopper rail. Below, left, detail of three-ring set showing photomicrograph of top compression-ring edge, right. Solid chrome over thread finish gives highest resistance to wear

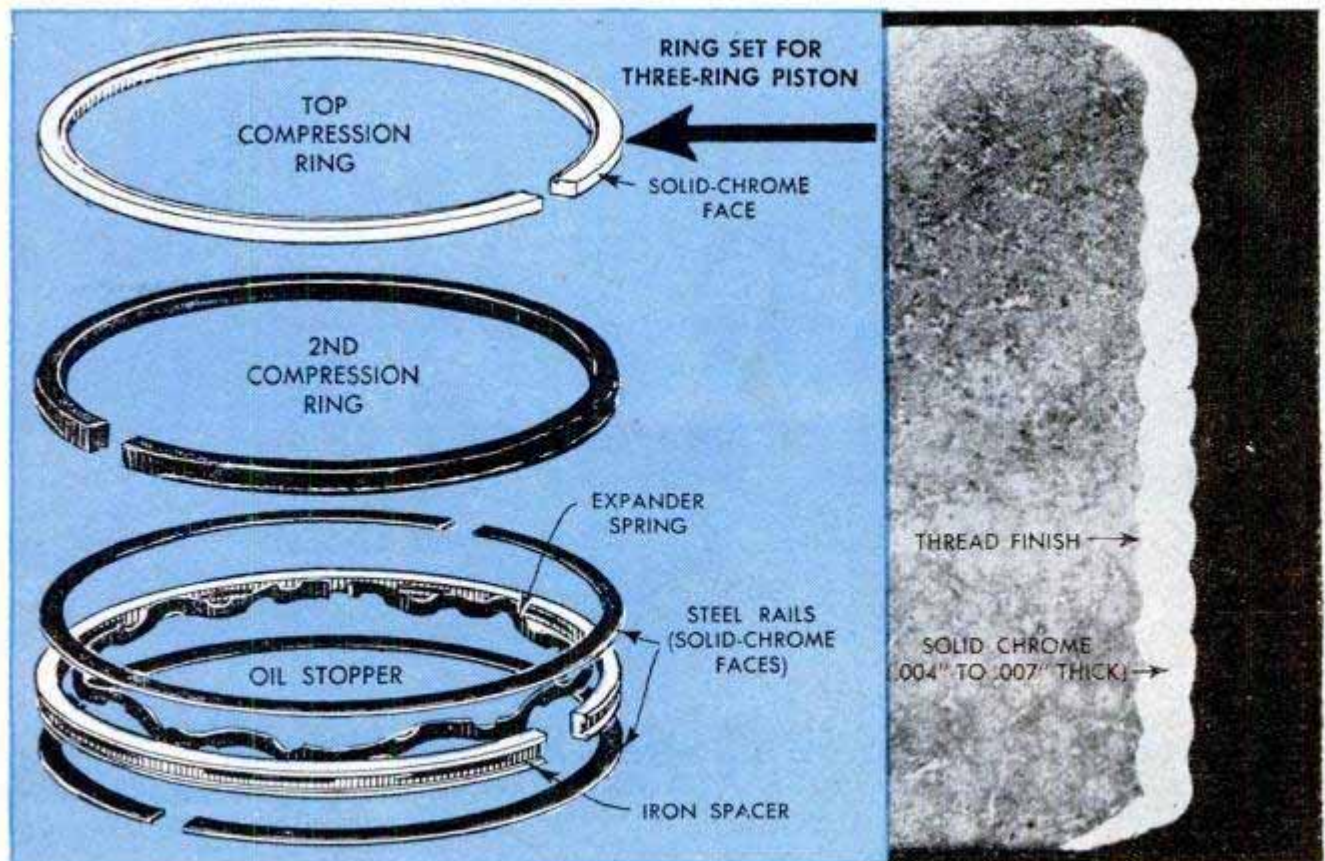

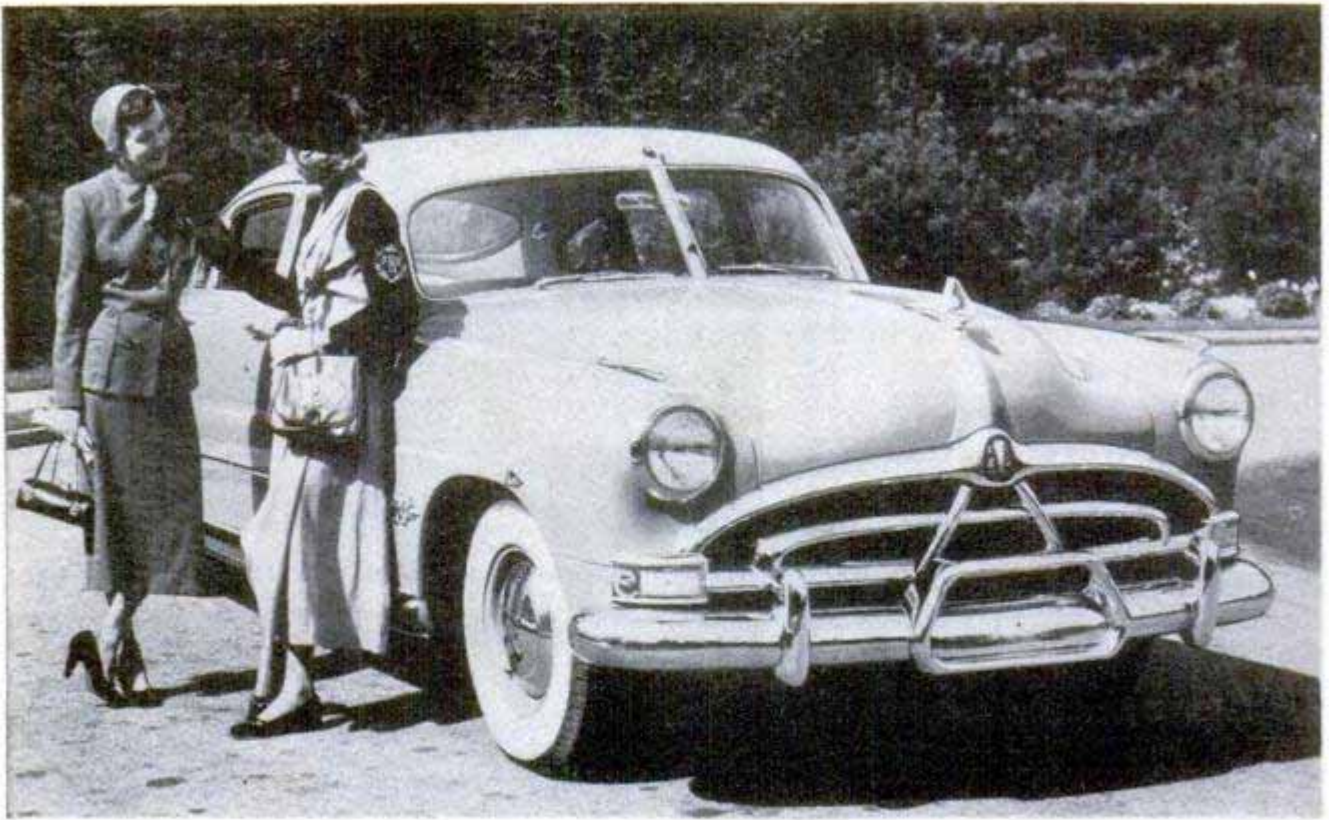

## Hudson Features New Six-Cylinder Engine

With its 1951 line the Hudson Motor Car Company introduces the industry's most powerful six-cylinder engine. The new power plant develops 145 horsepower and has a compression ratio of 7.2 to 1. This

engine is used in an addition to the line called the Hornet which replaces the Super Eight. The company has adopted a new waterproof ignition. Hydra-Matic Drive is available on the Hornet and Commodore.



## Bayonet Unipod

While photographing the war in Korea, Sgt. Ray Turnbull of the Signal Corps devised a camera attachment that seems particularly fitting for such work. He fastened a threaded socket to the top of a bayonet. After screwing the camera into the socket, he jabs the bayonet into the ground and takes his pictures from a steady unipod.

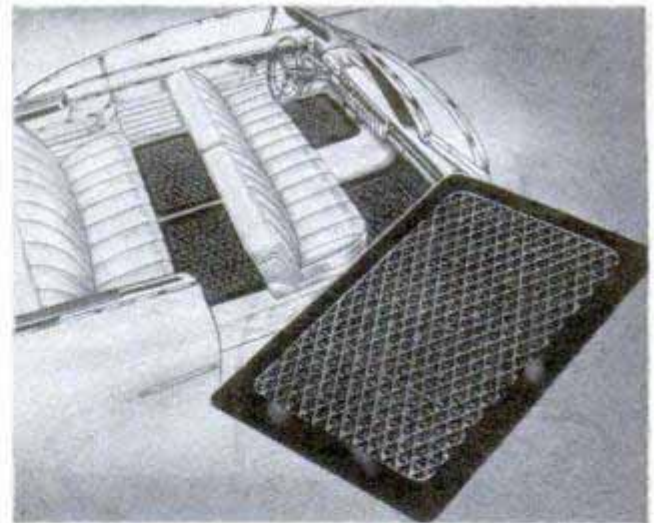

## Car Rugs

Rubber "throw rugs" for automobiles protect the original mat from wear and dirt and, at the same time, make cleaning easier. You simply lift out the rugs, shake them and put them back clean. The rugs come in various colors and are shaped to fit each make of car.

☐ Some kind of rubber—real or synthetic—is used in 116 places in the average automobile manufactured today.

# Driver, Take Your Choice— LIFE OR DEATH ON ICE

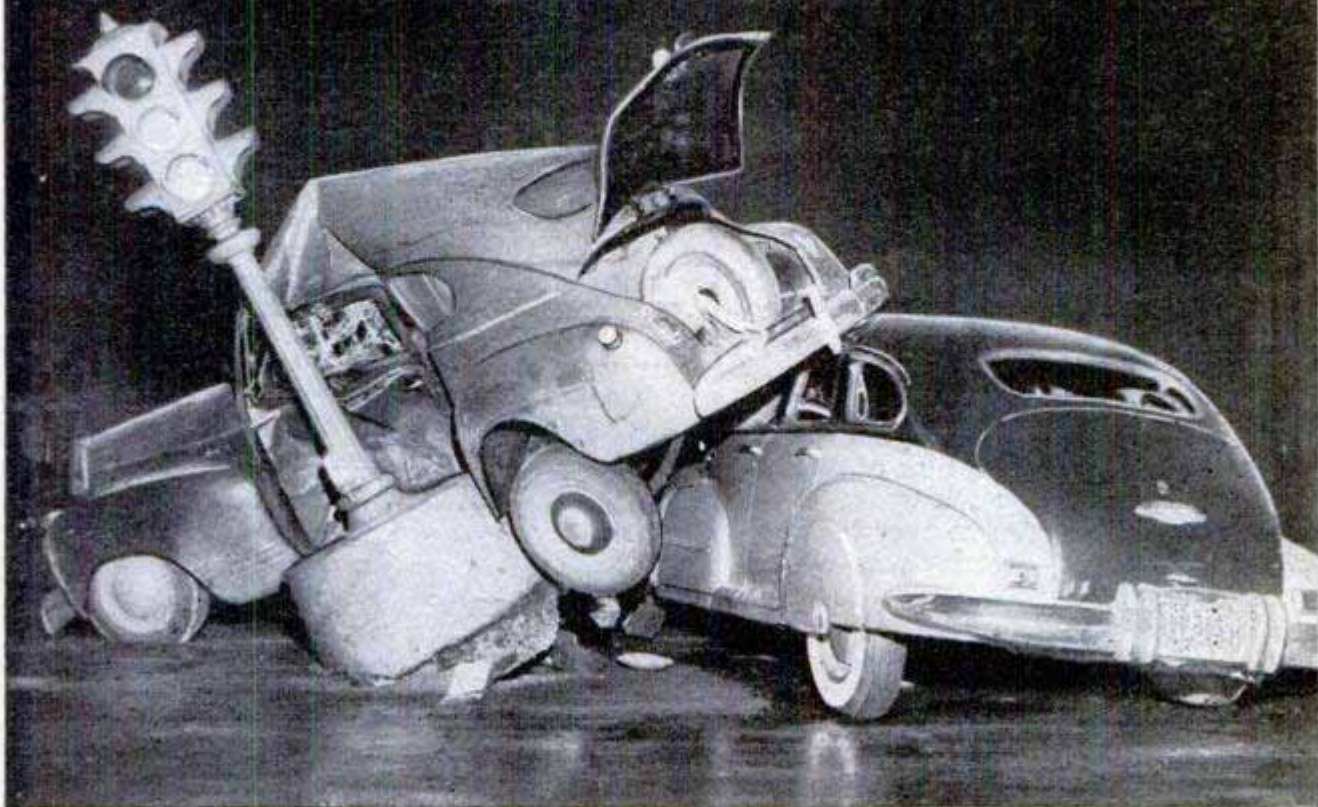

Winter driving is as hazardous as we make it. Accidents like this can be prevented, say the driving experts

By Arthur R. Railton

**I**T'S RAINING AND FREEZING. The road you're driving on is as slick as a toboggan slide. Suddenly, stabbing through the damp darkness, your headlights pick up a huge truck straddling the highway. What do you do?

There's no time to experiment. You must be right the first time. The wrong move might make you a statistic—another victim of winter driving.

During the winter months, the highway death rate zooms upward as much as 50 percent above summer rates in northern states. In the South, it bounces up nearly 30 percent.

These zooming death rates can be reduced if drivers use increased caution and proper equipment for winter driving. You wouldn't dress the same in winter as in

summer and, for safety's sake, you shouldn't drive the same. Driving experts of the National Safety Council (who should know because it's their business) state that you can reduce braking distances on icy highways by more than 50 percent—a 50 percent that may mean life for you.

There are many devices, such as chains, special tires, sanders, defrosters and fog lights, designed to make winter driving safer. Yet none of these will assure you of safety and long life. You must drive with added care when roads are slick even though you are using every safe-driving accessory made. It's a simple, undecorated fact that we haven't licked the problem of winter driving and until we do you'd better slow down if you want to live.

Let's look at some of the factors that

## STEER INTO THE SKID



make winter driving as dangerous as tangling with a playful gorilla. Take temperature as an example. There probably isn't an outside-air thermometer on your car, but it is just as important as your speedometer when roads are ice covered. In one test by the National Safety Council, stopping distance for a car going 20 miles an hour at 26 degrees Fahrenheit was 122 percent greater than at 4 below zero! The same car, the same driver, the same tires, the same speed—but at the sub-zero temperature the car traveled only 107 feet compared with 238 feet when the mercury rose close to the melting point.

How's that? Simply because the warmer air and the friction between the tires and ice are enough to coat the surface with a thin film of water. And you know how slick water-covered ice can be if you've ever taken a cropper on an icy patch some warm winter day.

Air temperature is just one of the variables that make winter driving complex. There are so many uncertainties that not even the most skilled driver can afford to ignore the dangers. The average driver, and he represents most of us, can minimize his chances of accident by being super-cautious and by following a few simple driving rules.

The best way to avoid skids, obvious as it sounds, is not to let one start.

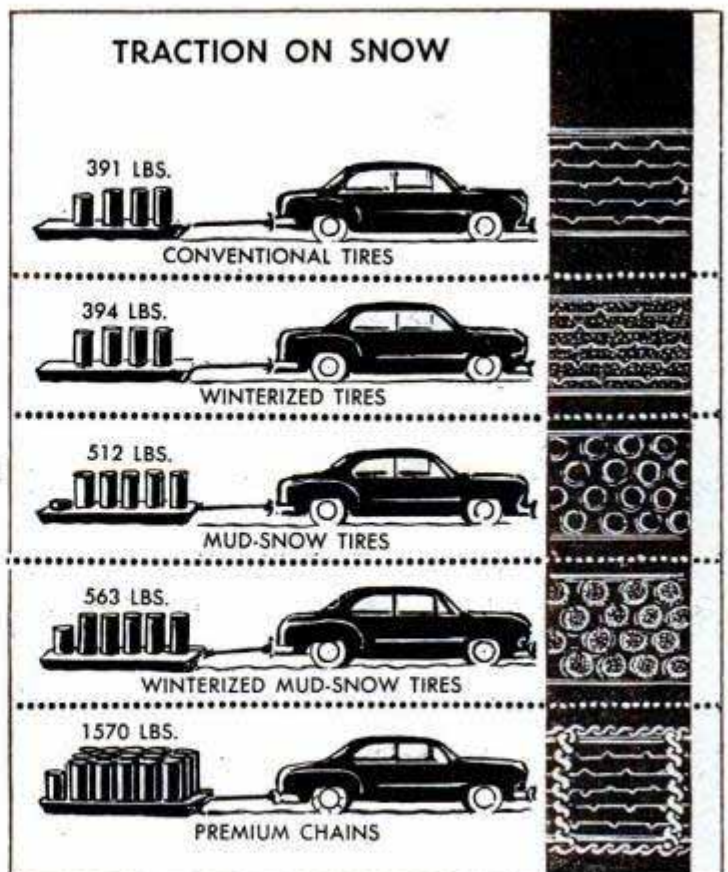

Diagrams show drawbar pull, above, and stopping distances, opposite, with the four types of tires and premium chains. The tires and chains being tested were on rear wheels only. Winterized tires have conventional tread with lacerations or materials embedded in the rubber to increase traction. Mud-snow tires have the rugged knob or cleat tread design. Winterized mud-snow tires are lacerated and premium chains are those with reinforcing cleats or teeth on cross links. Below, in testing truck tires and chains this dynamometer truck was used to measure and record the pull on drawbar





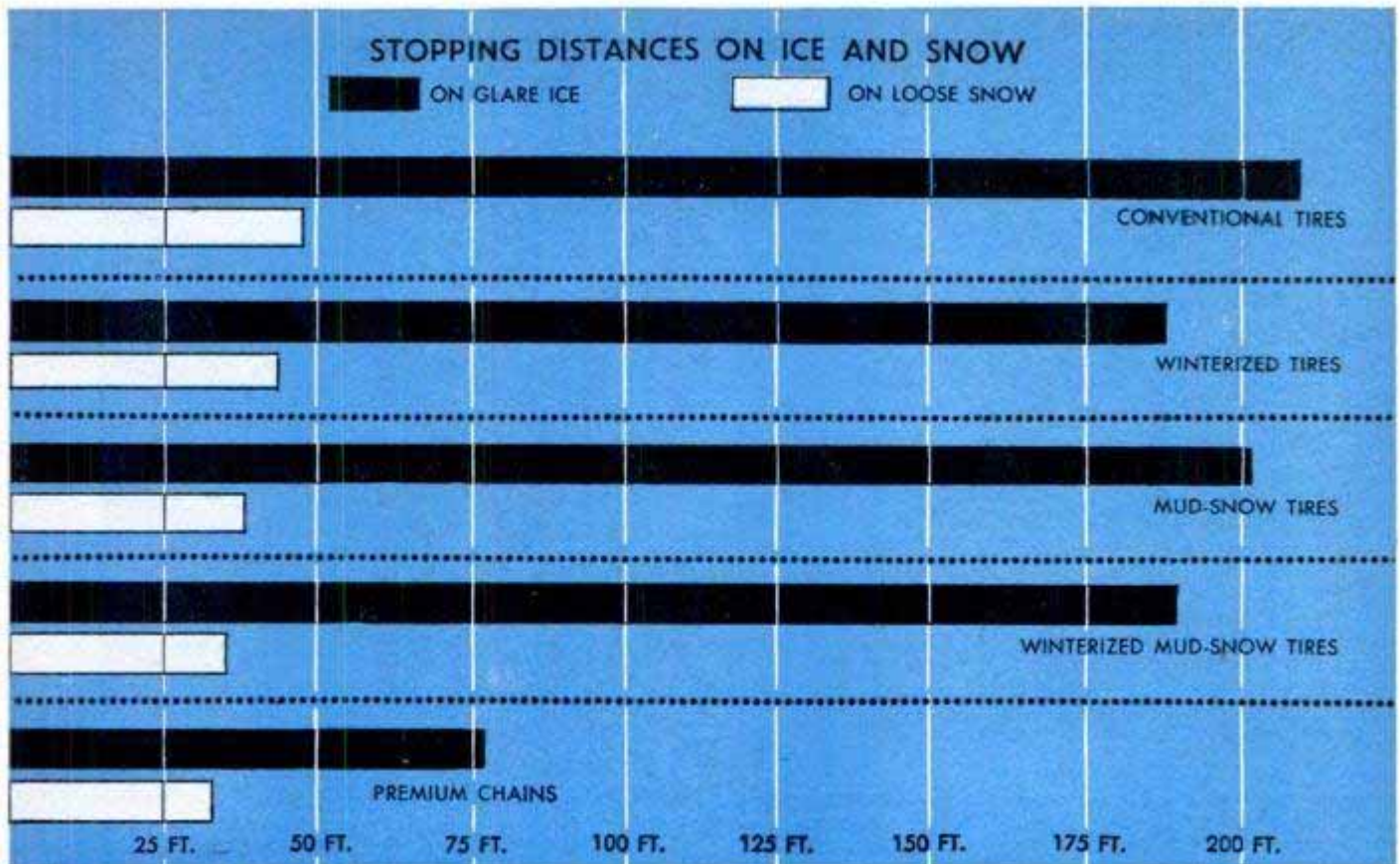

Once a high-speed skid starts, you toss your fate into the lap of coincidence. If you're on a crowded highway, almost no amount of skill can prevent an accident. If there are no other cars near by, you can, by manipulating the throttle, brakes and steering wheel, minimize the skid and stay on the road. That old reliable rule about "turning in the direction of the skid" is a good one and it works, but it will prevent accidents only when there is room for the corrective action to take effect.

How can you prevent these dangerous skids from starting?

First, slow down. The faster you drive the more momentum you develop. Therefore, there is more tendency to skid when you try to stop or to make any change in your direction. On icy pavements, at all

speeds, handle the wheel, accelerator and brake pedal as though they were new-born babies. Sudden moves may mean sudden death! The mere act of releasing the accelerator abruptly when you're rolling along the highway can cause a skid as the compression of the engine suddenly slows down the wheels. Any quick change of direction is an invitation to crash. When you have to turn the front wheels, ease them around carefully after slowing down. It helps to accelerate slightly as you are making the turn, but be gentle about it!

There is an exception to the "think fast move slow" rule. It's the art of braking. There you must think fast and move fast for best results. Expert pumping of the brake pedal reduces braking distance as much as 18 percent, The Safety Council

**Dynamometer truck is towed on ice during traction test for University of Wisconsin's Truck Research Project**



## SAFE-SPEED CHART

IF A SAFE SPEED ON DRY CONCRETE IS 50 MILES AN HOUR, THESE ARE SAFE SPEEDS ON GLARE ICE. IN ALL CASES STOPPING DISTANCES WOULD BE THE SAME



engineers learned. But the pumping must be done skillfully.

For emergency stops, the pedal should be jabbed on and off like a trip hammer. This is a fast maneuver that requires considerable skill. It should be performed at a rate of about five on-off cycles a second. Be certain that the brake is fully applied and fully released with each stroke. To do this properly, you have to be fast and heavy-footed, but it is much more effective than the gentle pumping technique. However, the jab-jab system won't work unless your brakes are responsive. Sluggish brakes don't release fast enough. So, right now, have your brake system checked to make certain it will do the job when you need it.

For normal stops (and for the inept

driver who doesn't want to try the trip-hammer technique), the slow pumping method is recommended by the National Safety Council. It won't stop the car as fast as the jab method, but it is easier to use and safer for inexperienced drivers. To use this system, you apply the brakes until you feel the wheels lock, then release and repeat until you have stopped the car.

Every winter you'll see motorists letting air out of their tires to increase traction. Don't do it. It is true that soft tires do give a very slight increase in braking capacity, but this is more than offset by a greatly increased tendency to side skid. Anyway, soft tires wear out faster and make blow-outs more likely. So keep your tires up to recommended pressures at all times.

For the driver who wants the best in

Below, left, caster-mounted wheel between front wheels of truck is a slip-angle meter and it measures the amount of skidding as vehicle is moving. Right, one of the truck sanders tested in the Safety Council study



safe winter-driving accessories, chains are essential. Any kind of metal-link chains helps you stop and go more safely, but there seems to be some evidence that ordinary round-wire chains increase the tendency to side skid. Because of this, "premium" chains, those with reinforcing teeth or cleats on the cross links, are the "best buy" in safety. In fact, premium chains on the rear wheels only stop vehicles faster on glare-ice tests than regular chains on all four wheels.

Recent years have seen the development of "winterized" tires of many types. Every company has a special technique for increasing friction between the ice or snow and the tire. Drivers should not assume that any winterized tire is as effective as chains. There isn't a single tire tread available today that comes close to providing the braking ability of premium chains on glare ice, although some specialized tires do help in stopping on ice.

The average stopping ability for chains was 46 percent better than for conventional natural-rubber tires alone. These tests by the Safety Council included stops on glare ice, loosely packed snow and granular ice and were with chains on rear wheels only. The best of the special winter-tread tires tested showed a 22-percent improvement in stopping ability over the conventional tires. The poorest winter tire actually was 6 percent less effective in stopping than the conventional tire!

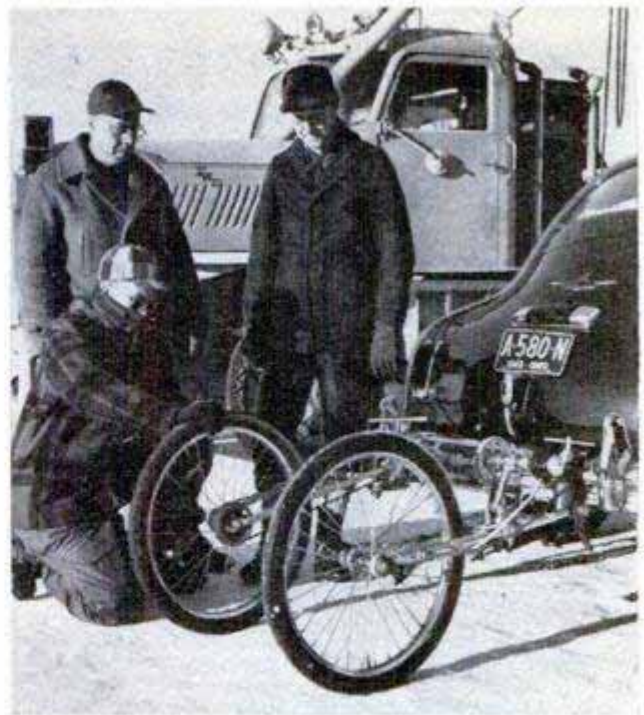

Trailing fifth wheels were used during the tests to assure precise measurements of speeds and distances

What type of winterized tire is best? The tests on lake ice and snow seem to show that for all-around driving the best tire is a grooved-lug mud-snow tire. It had a composite rating of 132, compared with 100 for the control tire, a conventional natural-rubber tire. This composite rating includes stopping, traction and cornering ability.

(Continued to page 254)

Air view of the Safety Council's test course on Pine Lake, Wis. The big circle was used for cornering tests





Masked worker tests viscosity of metallic brew used to spray fabric used in lining of coat shown at right

### "Radiant" Cloth Holds Heat

Any fabric sprayed with an aluminum solution reflects back to the body much of the heat normally lost by radiation. This new textile finish, called Milium, is now in limited production with most of the output

devoted to lining materials such as rayon satins, crepes and twills. It is also used in an all-weather jacket for golfers. Manufacturers are considering its possibilities for bedding and draperies while military authorities are studying the process for application to sleeping bags and flying suits.

### Dust Jackets for Grain Prevent Insect Damage

Weevils, beetles and other pests which eat up about 10 percent of the nation's grain crop after harvest may soon be going hungry, thanks to a one-shot chemical treatment. Applied in dust or talc form, the chemical is a relatively new insecticide

called pyrenone. The dusts cling to the kernels, providing an insectproof jacket that lasts as long as 9½ months. The chemical is harmless to humans or animals and is expected to eliminate fumigation which kills insects but provides no lasting protection.

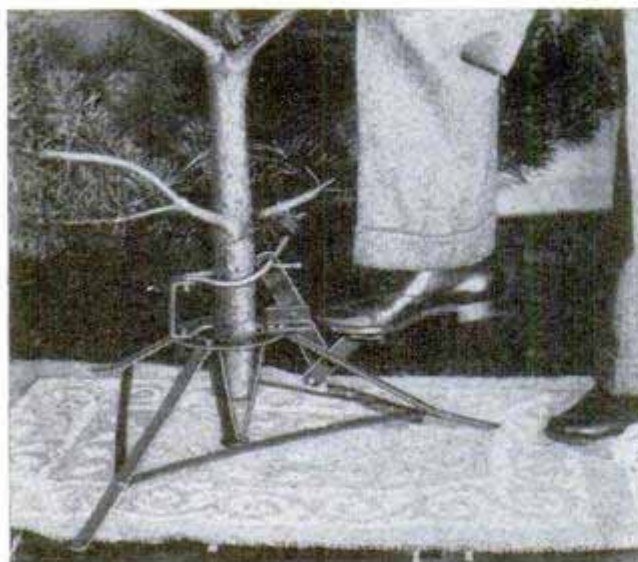

### Christmas-Tree Holder

Easy to operate, a new Christmas-tree holder has a steel ring that closes around the base and holds the tree upright. After a foot pedal is depressed, the tree is set into the stand and aligned by conical guides. Releasing the pedal tightens the ring around the base. A 21-inch tripod provides stability and affords enough clearance to set the base in water.

DDT proved to be one stone that kills two birds in Department of Agriculture experiments in California rice fields. DDT powder mixed with the seed rice killed both mosquito larvae and tiny shrimp that feed on rice seedlings.

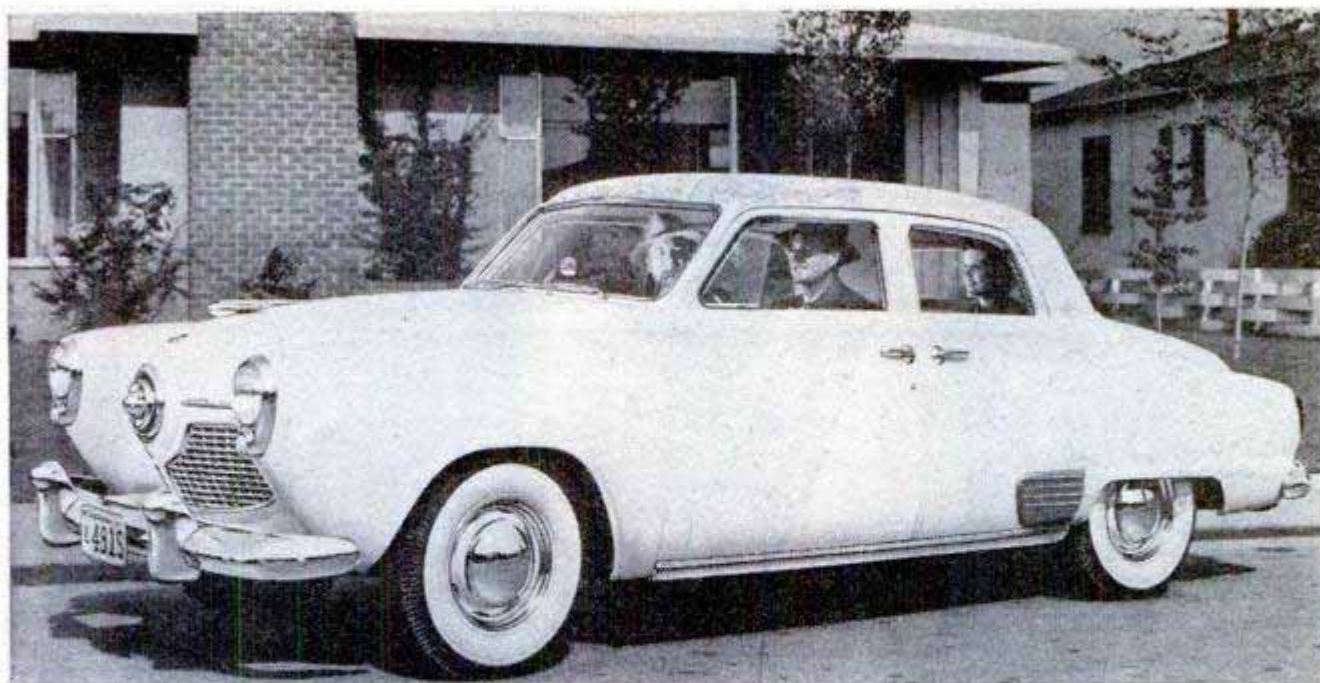

With a new grille and "spinner," the Champion Regal sedan still retains the distinctive Studebaker design

## V-8 for Studebaker

CONTINUING this year's parade of new cars, Studebaker's 1951 line features a V-8, valve-in-head engine on Commanders and optional automatic transmission on all models. Body designs are little changed. A new radiator grille, plastic "spinner" and redesigned tail lamps and trunk handle are the most obvious changes. Wider rear springs increase lateral stability and one-piece windshields give greater visibility. The economical Champion engine is unchanged except for a new oil-pan design to provide clearance for centerpoint steering, which is standard on all 1951 models.

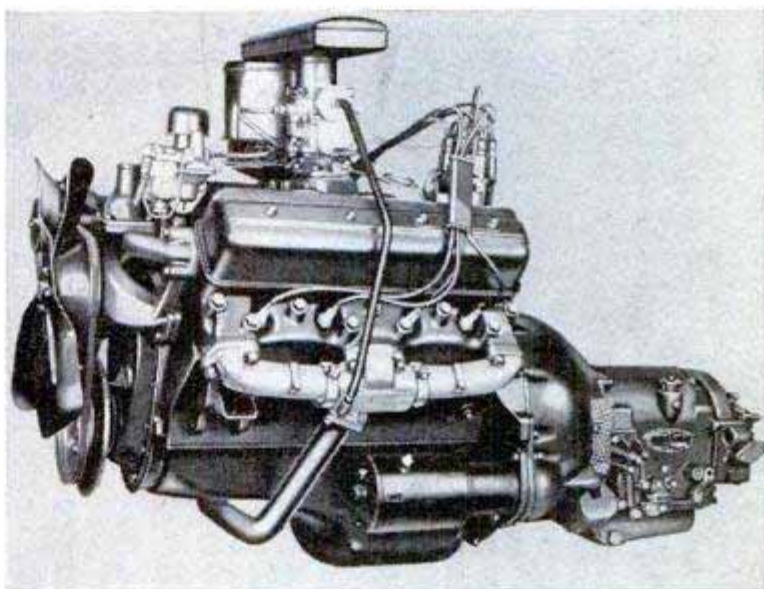

Rated at 120 horsepower, this new V-8, valve-in-head engine is the Commander's power plant. Compression ratio is 7 to 1

Here's the Commander convertible. Automatic transmission is available on all models including the Champion

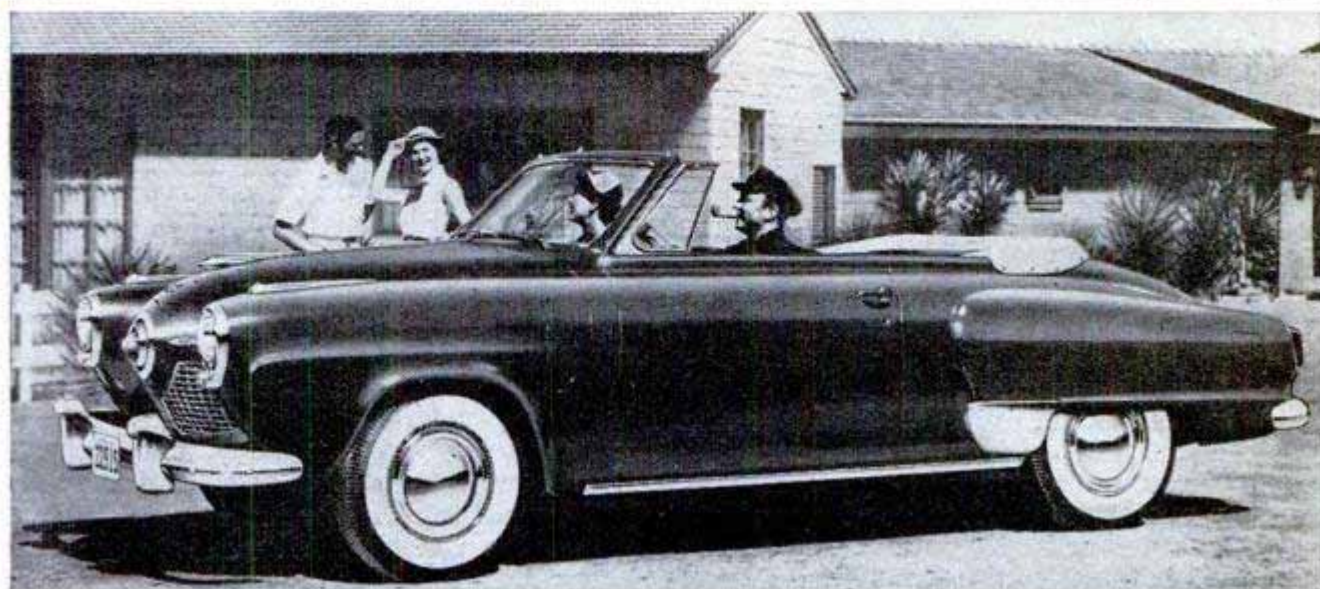

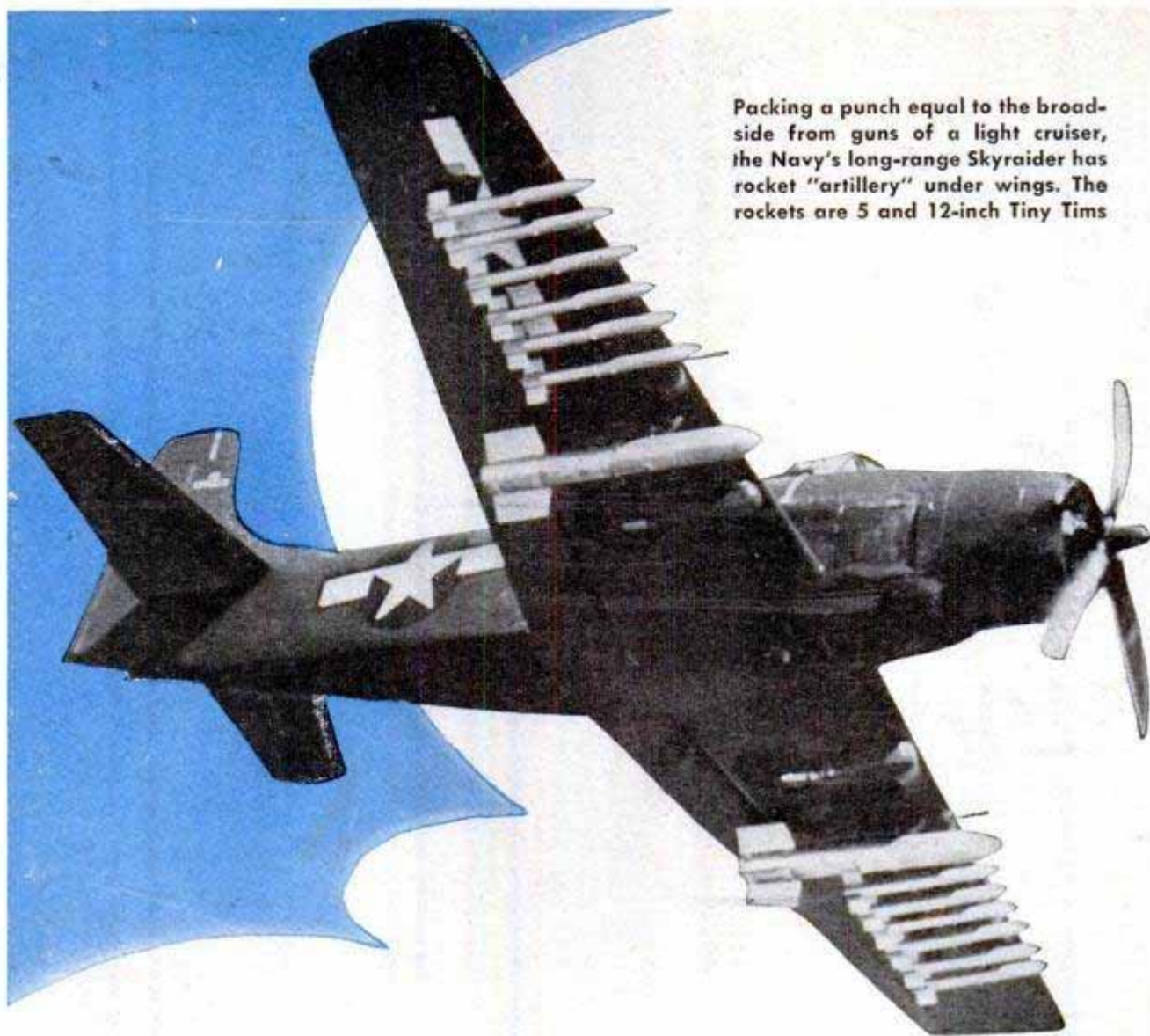

Packing a punch equal to the broadside from guns of a light cruiser, the Navy's long-range Skyraider has rocket "artillery" under wings. The rockets are 5 and 12-inch Tiny Tims

## WEAPONS WITH A NEW WALLOP!

By Richard F. Dempewolff

**I**F G. I. JOE on the battle front could get his hands on some of the gadgets being readied for production in the mysterious labyrinths of our Armed Forces' research labs, he'd feel better. Even most of our newest nonatomic weapons—which are the most immediate concern of men in the front lines—are veiled in secrecy. But a few hints at what's cooking have been seeping from official crannies.

Up in the Navy's Bureau of Ordnance, men are now testing a big antisubmarine rocket that takes off from a new type of shipboard launcher at incredible speed and packs a jolt staggering enough to blow any sub clear out of the water. A monster plane, already prototyped by the Air Forces, will carry 240 men or 50,000 pounds of cargo. It can deliver tanks to the front lines. Work

is also afoot to develop a tank that can be dropped to beleaguered infantry by parachute. In the anti-aircraft end of things, there's the 75-mm. Skysweeper which, as one Army Ordnance man puts it, "automatically does everything but sweep up the debris of planes it knocks down." Instead of being hooked up to a radar tracking center on one end and an electronic computer on the other, the Skysweeper has everything in one package. Its own radar finds the target, its own computer computes aim, its own mechanism aims it and keeps it tracking the target while it automatically triggers itself and peppers the sky with an inferno of VT-fuzed shells.

For "potting" supersonic enemy planes above the reach of the Skysweeper, the Navy has a little pencil-thin, air-to-air



Formidable is the word for Army's 8-inch gun below being tested at Aberdeen Proving Ground. With the carrier shown in background it has combat-loaded weight of 99,075 lbs.

rocket affectionately dubbed the Mighty Mouse, which they have developed for all the services. A score of "mice" can be hooked on a big fighter plane. They have folding fins to reduce air resistance on the mother plane, are aimed simply by aiming the plane's nose at the target, and can be fired singly or in salvo. They take off like lightning streaks, catch up with and blow to smithereens any high-flying supersonic craft in the sky.

Short of an A-bomb, probably the most fantastic weapon on hand is Army Ordnance's Earthquake bomb. This Goliath of an aerial menace weighs 42,000 pounds, is almost 5 feet in diameter and 27 feet long—with its fins on. It packs enough TNT in its monstrous warhead to crumble several city blocks.

All these and many other new implements of war are fine for tomorrow, when production wheels roll full tilt. Of more immediate interest to the G. I. a few weeks ago was something to stop tanks. Early in the Korean war high-powered shells

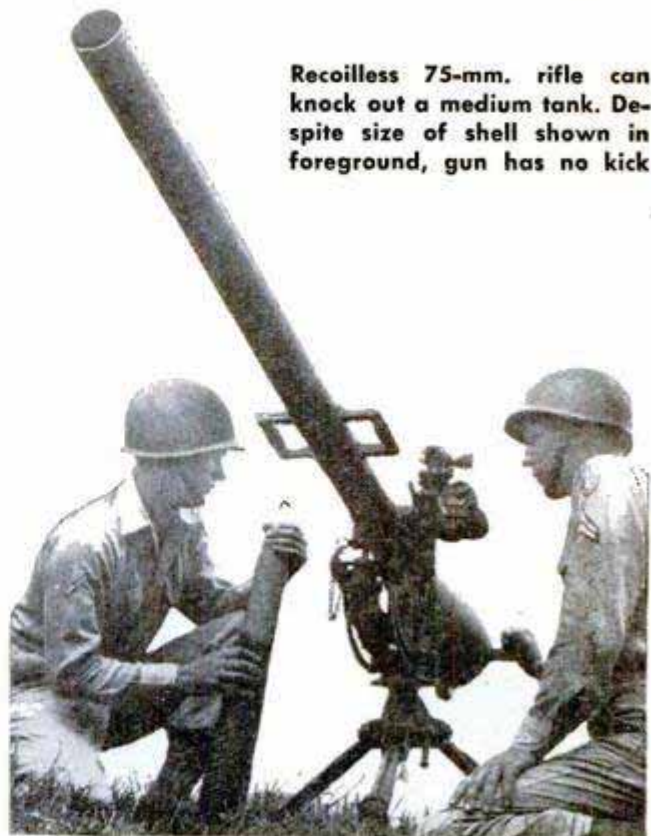

Recoilless 75-mm. rifle can knock out a medium tank. Despite size of shell shown in foreground, gun has no kick

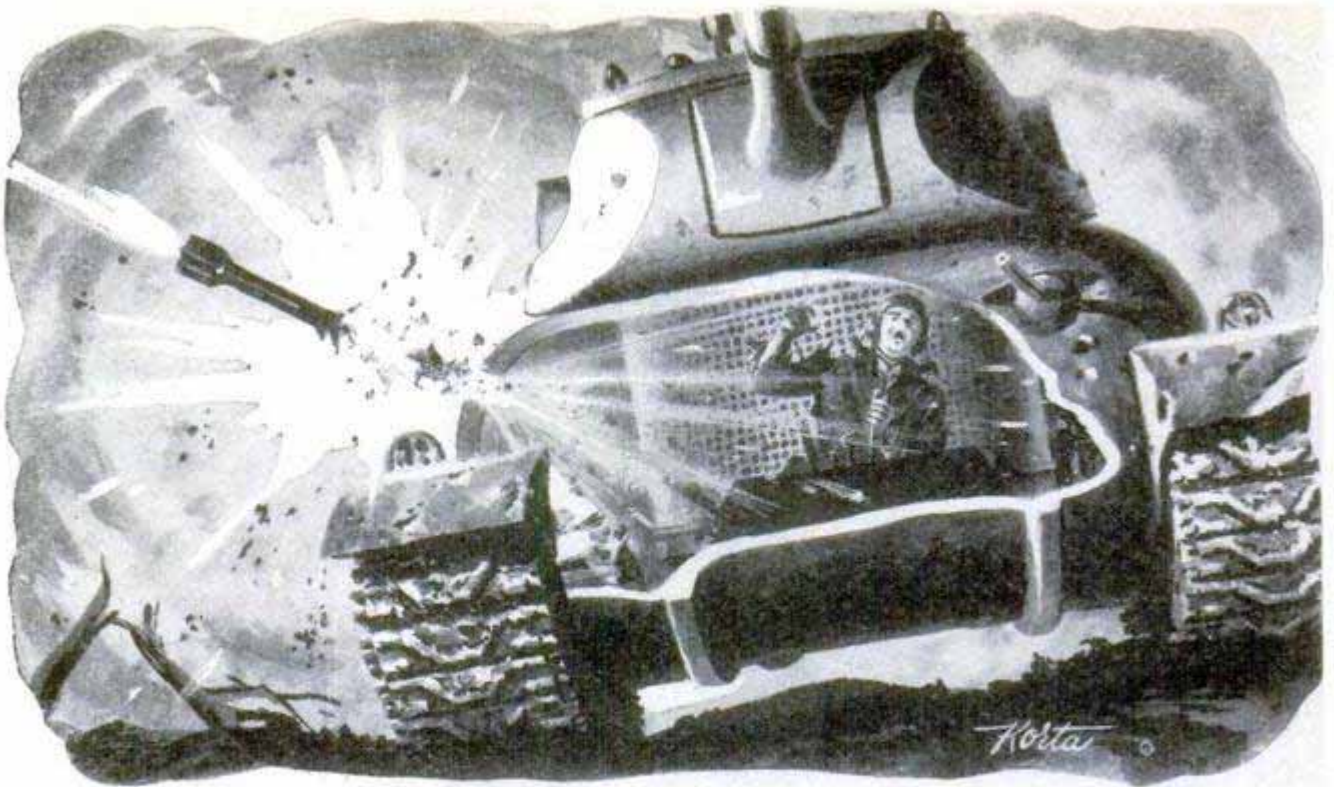

**BAZOOKA ROCKET WITH SHAPED CHARGE**

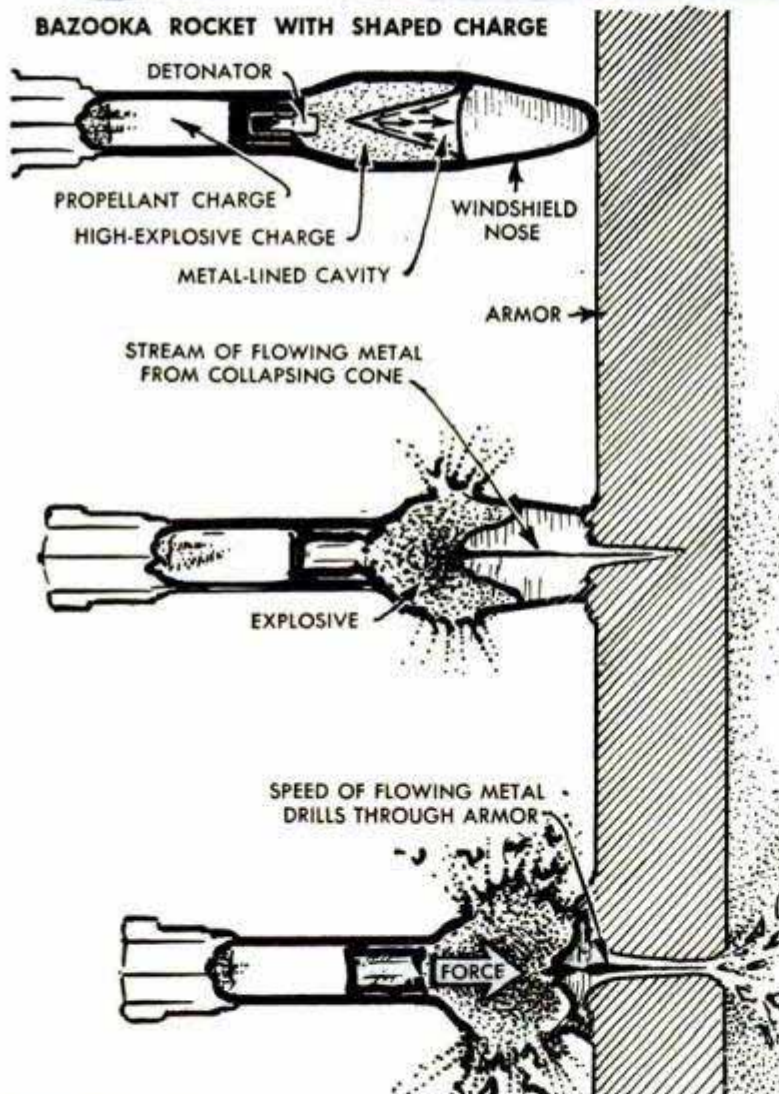

When shaped-charge rocket hits tank a supersonic jet of hot metal cuts tough armor plate like wax and creates havoc

of the armor-piercing variety bounced off the armor of Soviet tanks like golf balls. Land mines lumped up their ride a little, but they kept right on going. Then the Army reached down in its sock and pulled out the 3.5 bazooka (which gets its title from the inside measurement of a light portable launcher that folds in half for easy carrying). The 3.5's projectile is a slow-moving, wobbly, 3-foot rocket projectile—with a muzzle velocity of only 325 feet per second, a range of less than 900 yards, and a fiery tail somewhat less than frightening. It looks as though it couldn't make a dent in cotton batting. Not only did it dent the Communists' heavies; it drilled holes through them and completely demolished the interiors. Right

Diagram shows progressive steps in the detonation of a shaped-charge bazooka shell. Explosive force is increased four to five times because at front of the cavity it comes from both sides and meets in the middle. Below, cutaway of shell

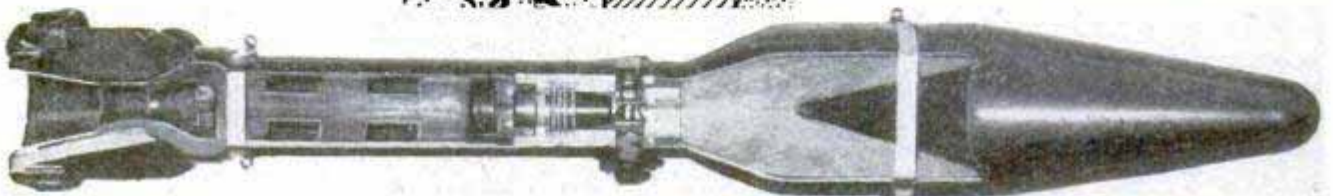





Infantry sergeant demonstrates the 3.5 bazooka which fires a three-foot rocket projectile. The muzzle velocity is only 325 feet per second and range 900 yards. It stops heavy tanks

on the heels of the new bazooka came a 90-mm. shell for use in the big guns on our 45-ton General Pershing tanks. A high-velocity projectile, with a range many times that of a bazooka rocket, makes it a sure-fire tank-killer.

Actually, velocity has little to do with the effectiveness of either of these weapons. They'd do about the same job if you could get close enough to throw them at a tank without being caught in the draft. Both get their lethal sock from a built-in "shaped charge," an old ordnance trick known by mining engineers for more than 100 years, and used on a small scale by the Germans and the Japanese in the last war. The Japanese shaped-charge weapon was

Beneath the wing of this Navy Corsair hang four new antitank rockets of shaped-charge type used in Korea

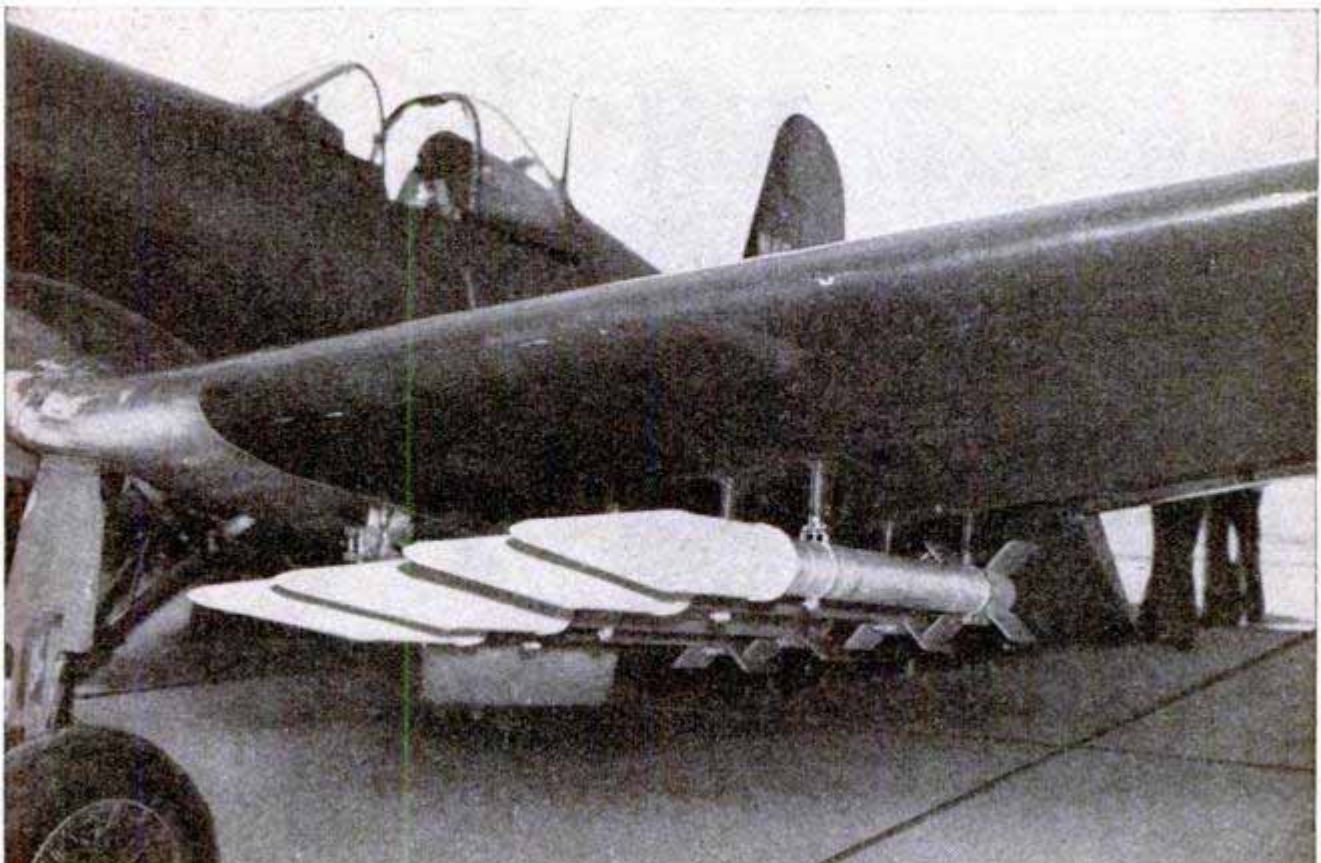

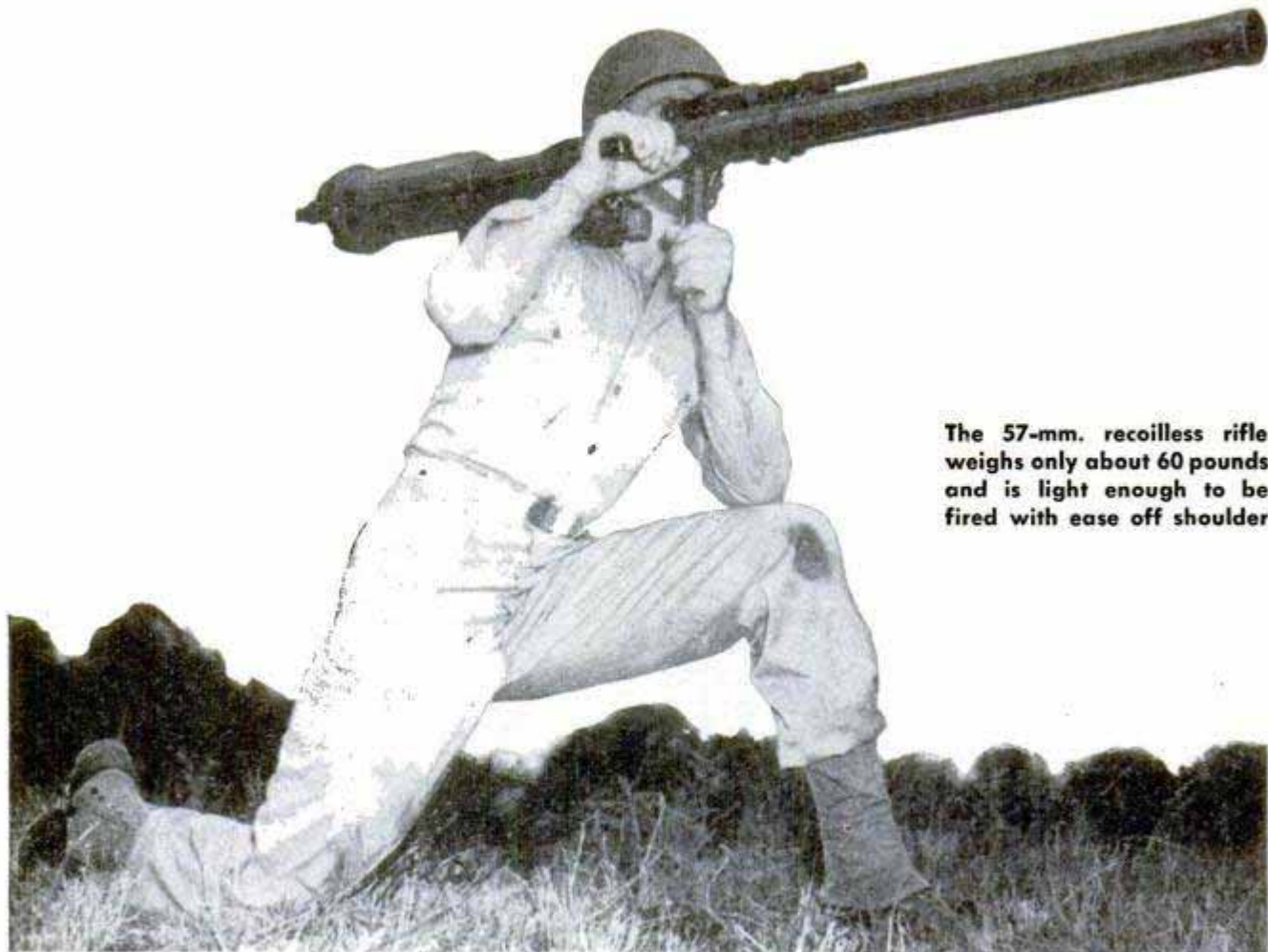

**The 57-mm. recoilless rifle weighs only about 60 pounds and is light enough to be fired with ease off shoulder**

hooked to the end of a pole, jammed against a tank by a soldier at the other end, and triggered by hand. The tank was demolished, and the soldier joined his ancestors.

A shaped charge is simply a method of

arranging an explosive so most of its blast will focus in one pin-pointed direction. This is done by making a concave hole in the powder at one end. The sock of the blast will bounce out that end like light

**Navy's guided missile Bat has 10-foot wingspread and carries a general-purpose bomb. It glides to target guided by radar**



waves focusing off the reflecting mirror of a telescope. In the new shells something else has been added. In the cone-shaped hole carved out of the front end of the explosive charge, a thin metal cone liner is fitted. When the shell hits its steel target, the charge goes off, starting a tremendous shock wave that travels along the sides of the metal liner, collapsing it as it proceeds. So tremendous and fast is the pressure on the cone that the metal in it, instead of breaking up, flows like a liquid. At the cone's apex, a long thin jet of its own steel spurts straight out in a supersonic ribbon, moving about 2000 miles an hour, continuing until the blast is over and the cone is flattened. The horrendous pressure of that jet-propelled stream of hot metal is so much greater than the strength of any known armor, that it will penetrate with almost no resistance—like a high-pressure fire-hose

(Continued to page 240)

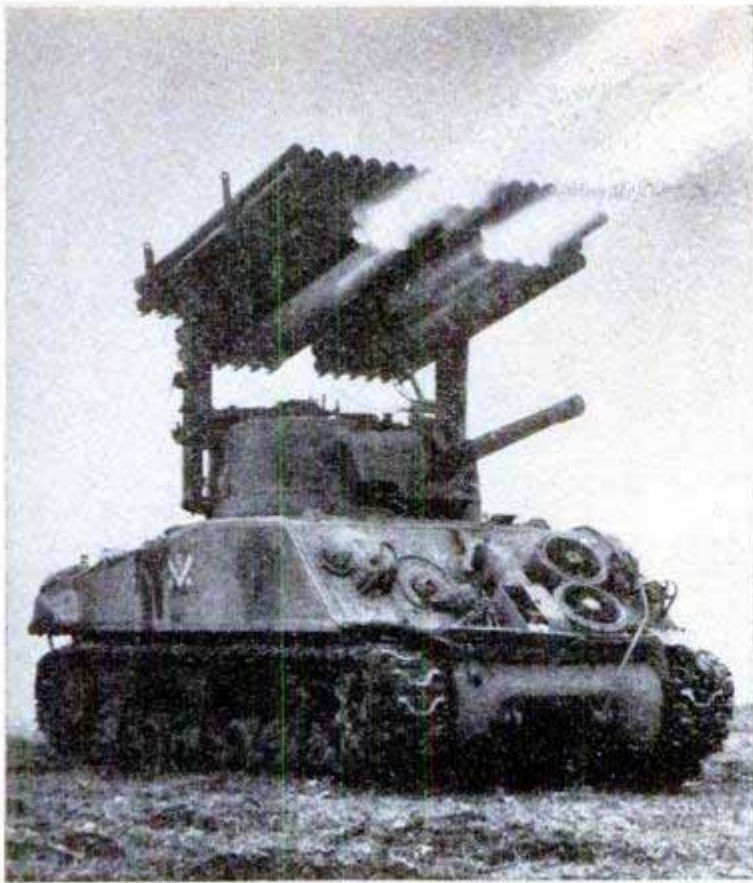

Special launcher mounted on tank fires 4.5-inch rockets one at a time. Time exposure here gives effect of firing a salvo

Right, man is dwarfed beside Earthquake bomb which is 27 ft. high, weighs 42,000 pounds and could level many city blocks

Below, T-8 transport has just "broken apart" and will pull away to allow tank to be unloaded; it can carry a heavy tank

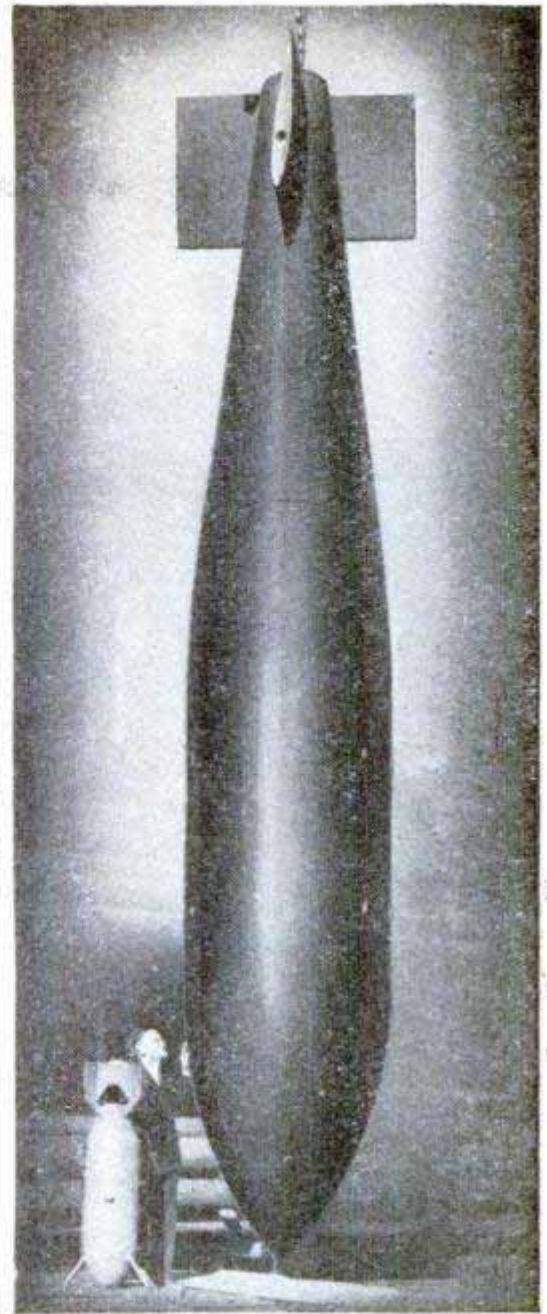

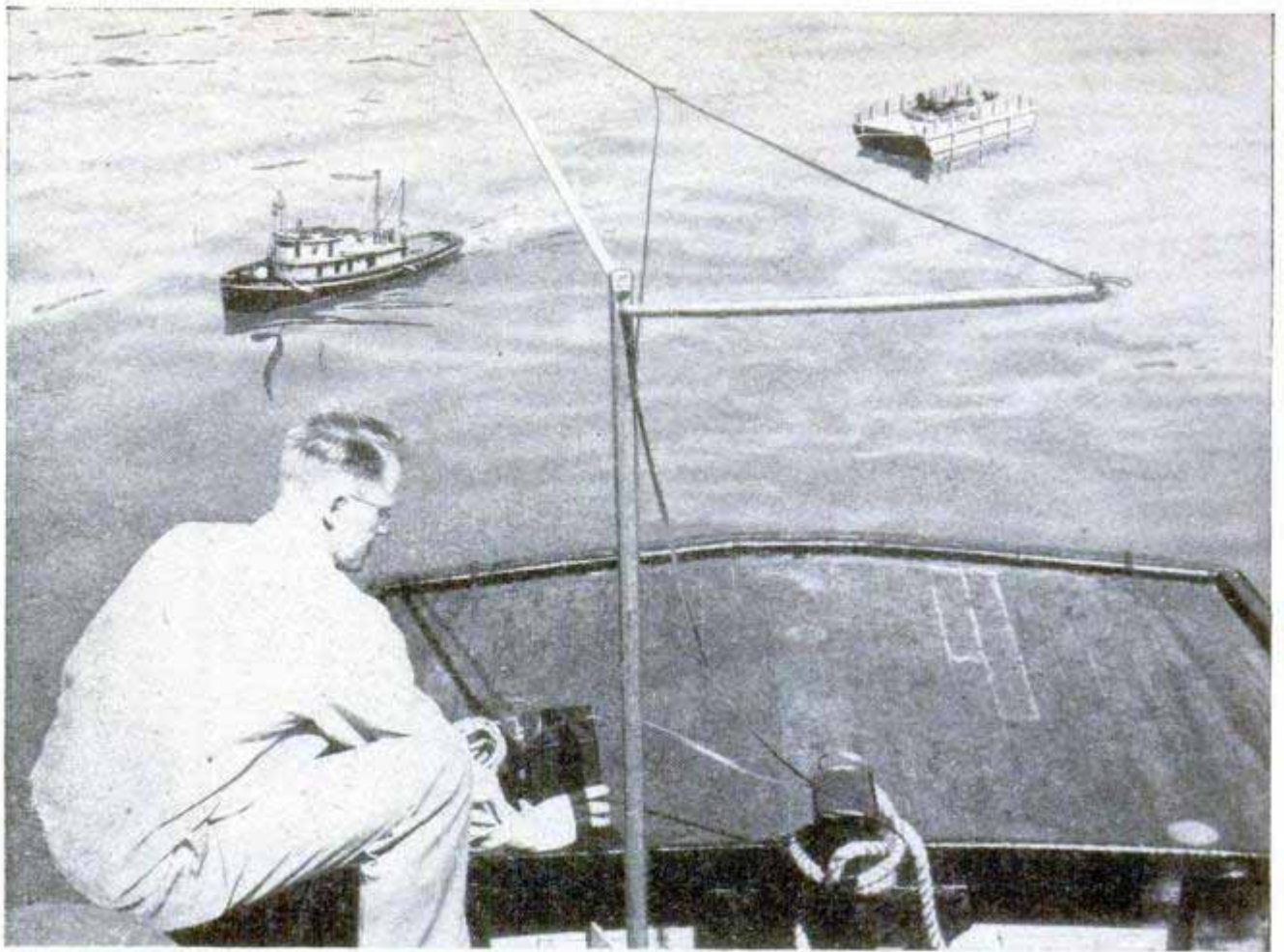

Little tug is steered by impulses sent out through the radio antenna in the foreground. It pulls its own barge, loaded with an anchor. Below, the model is cast off beside its big brother



## Radio-Guided Ship Model Tows Miniature Barge

From two miles away a model of an ocean-going tug can be steered by radio. The little ship, a  $\frac{1}{32}$  scale model of an Army craft, weighs 50 pounds and develops enough power to pull a rowboat with two occupants or a miniature barge carrying an anchor for a deck load. A motor from a large electric fan, operating on a motorcycle storage battery, provides the power. The motor turns a three-bladed wheel at 1000 revolutions per minute. Instead of an anchor, a large storage battery sometimes is placed on the barge as a deck load and coupled to the engine. The radio receiver is installed under the pilothouse. Both parts of the model's superstructure can be removed for work on the motor or receiver. The power winch, lifeboats and rigging all work exactly as they do on the full-size craft. The antenna for sending out impulses to guide the tug can be set up on shore or placed aboard a boat. Two brothers, Jack and James Emel, spent eight months building the ship.

## Homemade Sweeper Cleans Hangar Floor

Two Oklahoma mechanics have fashioned salvaged parts into a power sweeper that cleans a 170 by 240-foot airplane hangar floor in less than an hour. The job was formerly a half day's work for four men with hand brooms. Its rows of brushes are bolted to a four-foot-wide metal drum that turns 700 times a minute. The machine's muffler and steering wheel came from junked planes and the wheels were on a bombsight trainer. Now the inventors are converting the hydraulic system from a Curtiss Helldiver plane into a lift that will raise and lower the sweeper's big brush.

## Old Railroad Rails Serve Many Uses

Don't look now, but your porch glider may be made of metal that once carried speedy streamliners across the country. There are about 20 mills in the country that convert old railroad rails into metal bars used in the manufacture of fence posts, clothes poles, wheelbarrow handles, porch gliders and other items. The rails are not remelted,

simply heated to rolling temperature and sliced into three parts: the head of the rail; the middle section, called the web; and the flange or base. Each of these sections is then rolled to the required size and shape for its new use.

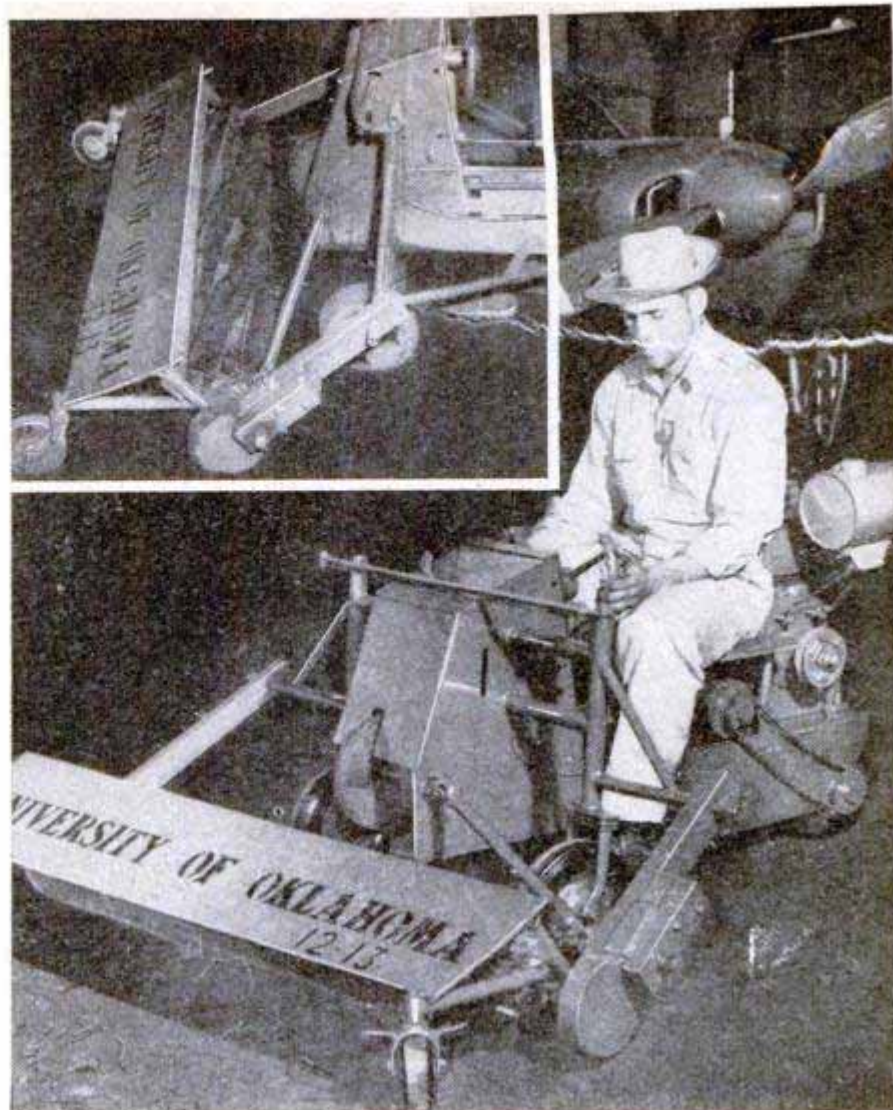

Copyright: Mirrorpics

## Mobile X-Ray For Animals

Injured animals can be X-rayed at the scene of the accident with a portable machine being used by England's Royal Society for the Prevention of Cruelty to Animals. It will save the lives of many animals which would otherwise be destroyed because veterinarians did not know the extent of their injuries.

☐ It costs the average motorist \$441.52 to drive his car one year, according to the latest survey made by the American Automobile Association.



# Spare-Time Railroader

Engine passes a slow-moving freight on a curve. At right, a tiny farmer heads for town behind old Dobbin

**WHEN HE** was a small boy, Watson D. Pritchard rode in the engine cabs of his grandfather's shortline railroad in West Virginia. Now Pritchard, a Los Angeles electrical engineer, has his own shortline railroad in his back yard, and it duplicates many of the scenes of the West Virginia countryside. In his two-car garage he has constructed a model railroad that covers an area 15 by 20 feet and contains more than 1400 feet of HO double track. The shortline is complete with several subur-

ban communities, farms, river crossings and mountain tunnels. In Middletown, the metropolis of the layout, there are more than 100 buildings which Pritchard has fashioned from cardboard. In the Middletown Terminal, about 100 people wait for the next scheduled train. The line's rolling stock consists of 39 passenger cars and 100 freight cars, with seven engines to move them. When made up for scheduled runs, the trains include three freights, a Super Chief and a local passenger train.

There's a four-trunk main line in the layout. Realistic backgrounds came from Pritchard's boyhood memories

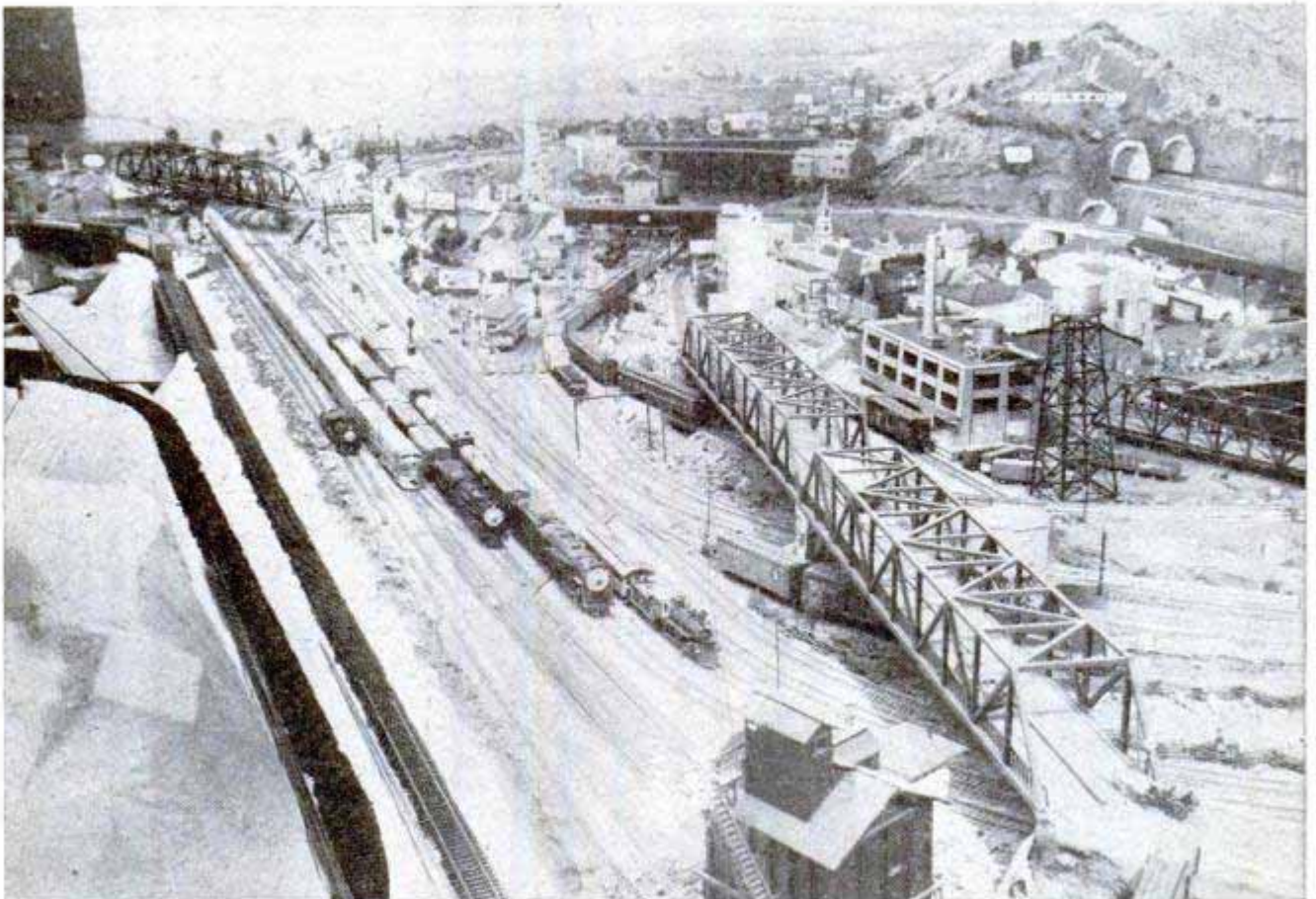

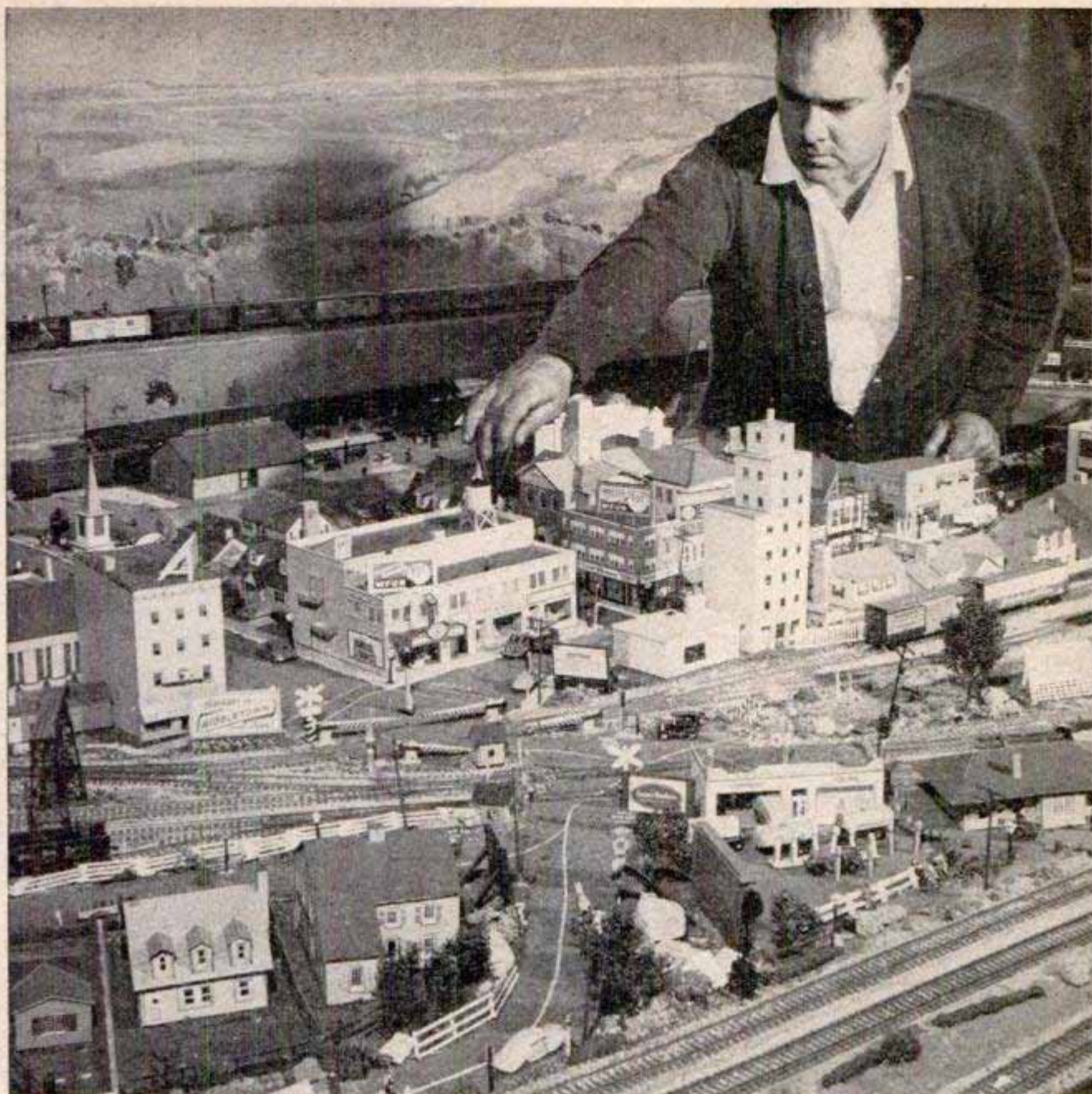

Metropolis of Middletown consists of about 100 cardboard buildings. Below, left, tiny hobas made of lead hook a ride on the tender. Right, Pullman porters and redcaps add a touch of realism to observation car



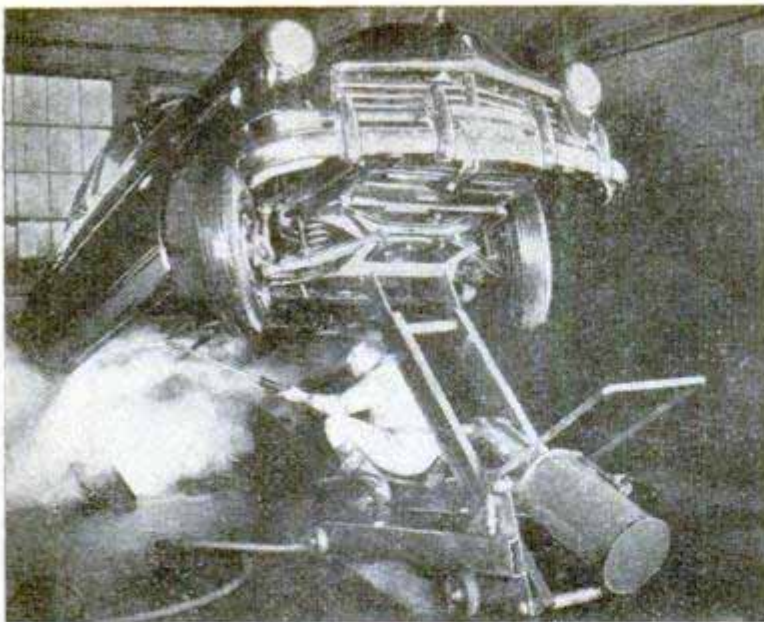

## Portable One-End Lift Speeds Work on Cars

Capable of lifting either end of a car to a height of more than four feet, a pneumatic lift speeds car repair and maintenance. An excellent auxiliary greasing lift, it is especially useful in small garages where space limitations don't permit a full-size lift. It is completely portable and can be stored in a corner of the garage when not in use. Only 44 pounds of air pressure are required for each 1000 pounds of load. The lifting hook locks at six different heights ranging from 21 to 50 inches to provide absolute safety for mechanics.

## Turbine-Powered Truck

As powerful as conventional engines 10 times heavier, the world's first turbine-powered truck has been started on intensive highway-endurance and mountain-driving tests. The 200-pound, 175-horsepower unit occupies only one thirteenth the space taken by the diesel engine it replaced in the 10-ton test vehicle. Though similar to a jet airplane engine in design, the turbine's power is harnessed to turn a shaft rather than being exhausted as jet thrust. It runs equally well on light or heavy fuel oil, kerosene, gasoline and even bottled gas, consuming two to three times as much fuel as diesel or gasoline engines of similar rating. Developed by the Boeing



Airplane Company for the U. S. Navy, the turbine will next be tested for possible use as boat propulsion.



## Small Racing Sulky Pulled by Dog

One of the proudest lads in Copenhagen, Denmark, is a six-year-old whose father built him a racing sulky. Peter's little sulky is pulled by his big police dog. Made of metal tubing, the cart gives the boy all the thrills of a real racing rig, including the fun of handling the reins.

Sources of available products described in this issue are listed in the index, starting on page 14. Sources of further information on other articles are listed in the WHERE-TO-FIND-IT LIST, which is available to readers without charge from the Bureau of Information, Popular Mechanics Magazine, 200 East Ontario Street, Chicago 11, Illinois





Wing floats from amphibious planes keep the craft afloat and give it a weird appearance. Right, when the operator pedals, there's a powerful thrust against water

## Watercycle

Like a strange bug, a homemade watercycle crawls across the surface of a lake or river. The weird craft was built by William Dein, an employee of the Republic Aviation Corporation. Dein purchased some surplus wing floats used on amphibious airplanes, fastened them together with a framework and mounted part of a bicycle atop the structure. The operator pedals, and presto—the craft moves across the water.



## Fuel Pours Into Jetliner at Rate of 200 Gallons per Minute

Jet-propelled airliners, which require tremendous quantities of fuel, are now refueled four times faster by a system developed for the Avro Canada Jetliner. The lightweight underwing refueling system is virtually fireproof and has automatic shut-offs to prevent overfilling. Fuel lines are connected to the underside of the wing, eliminating any necessity to climb on the wing during refueling. The fuel is pumped in at a rate of 200 gallons a minute. Float switches stop the pump when each tank

is filled. The spark hazard is eliminated by connecting the external fuel pump to the plane's electrical circuit. The system will refuel a plane with 3000 gallons in 6 minutes, instead of 25 minutes required with the older system.

☐ More than 300,000 calls handled daily by operators in the Pentagon Building, headquarters of the Department of Defense, make it the busiest private branch telephone exchange in the world.

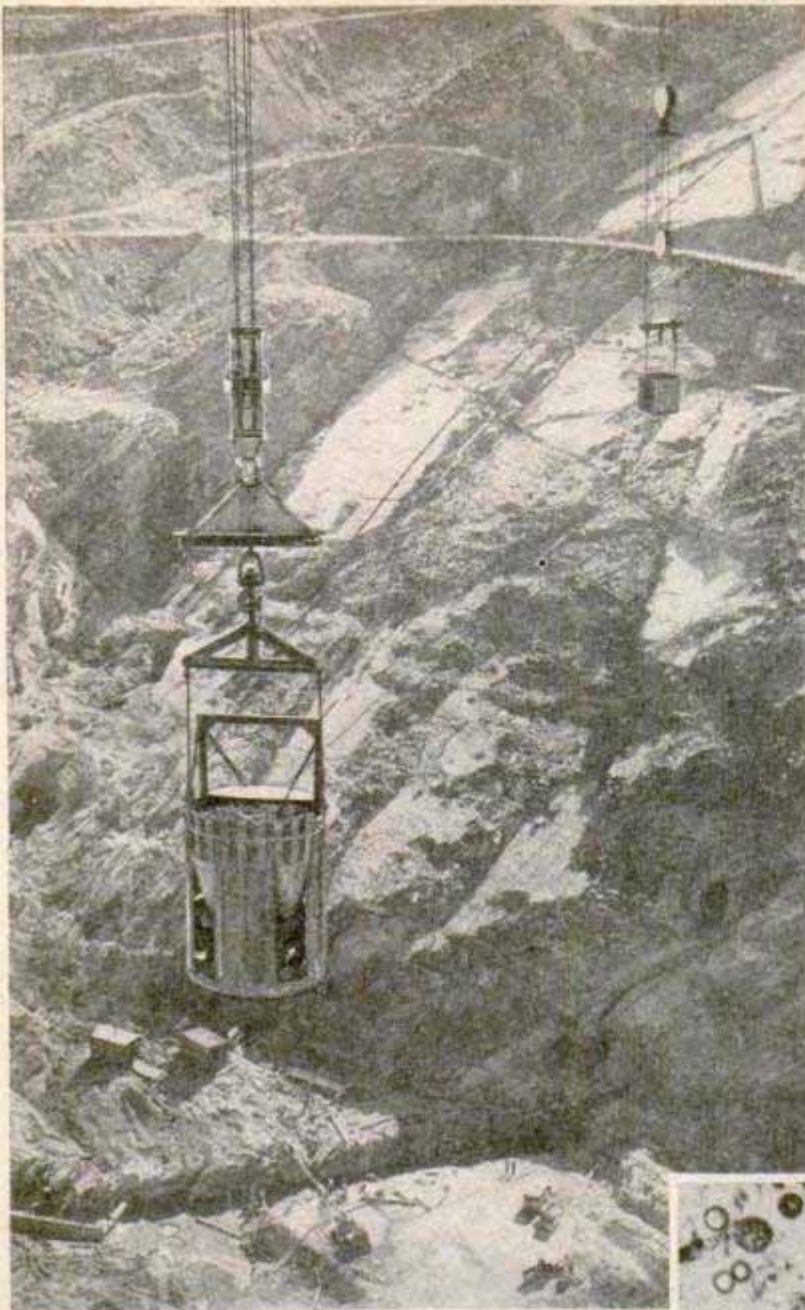

Riding on an overhead cable, this huge bucket is carrying fly-ash concrete to Hungry Horse Dam. Below, fly ash looks and feels like portland cement



Millions of dollars are being saved by building huge dams with concrete using the waste that flies up smokestacks

*By Richard H. Syring*

GOING UP in smoke" isn't as wasteful as it used to be. Today, fly ash, the annoying material that pours from smokestacks of giant power plants, has a productive role in our economy. The airborne dirt that was, and in many cities still is, the bane of the tidy housewife is now being used to build dams, highways, conduits and other concrete products.

Out in northwestern Montana, the United States Bureau of Reclamation is using this smokestack waste in its mammoth Hungry Horse Dam, the largest dam under construction in the world today. Stretching across the south fork of the Flathead River, this concrete barrier will contain carload upon carload of fly ash removed from the smoke of Chicago power plants, saving millions of dollars for the

Below, fly ash is made up of spherical particles as this photomicrograph shows

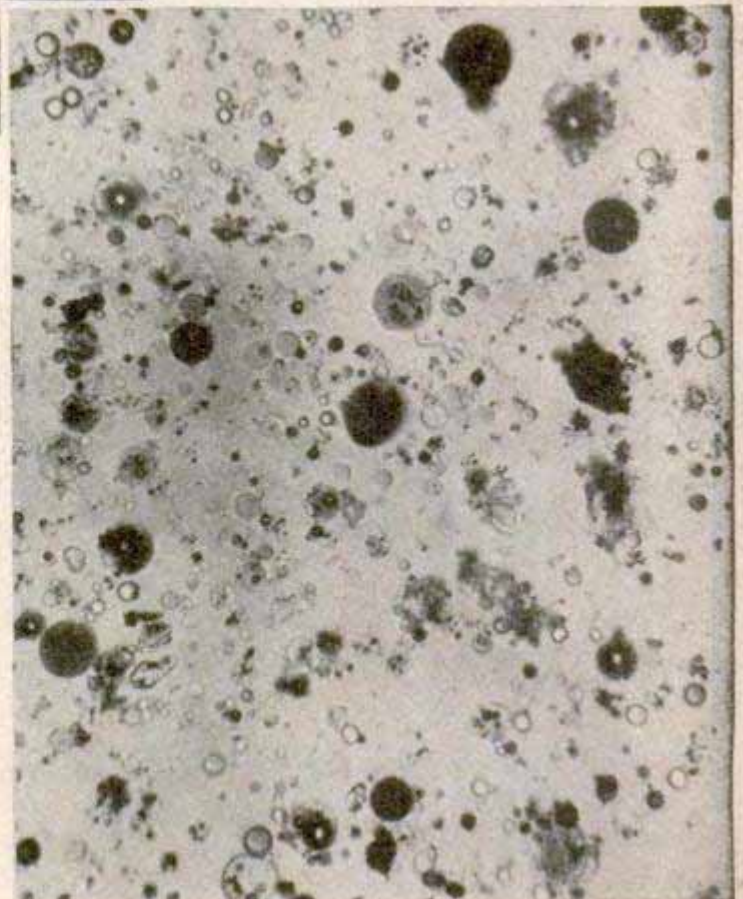

# CONCRETE FROM FLY ASH

taxpayers. Estimates on the savings in concrete alone run from \$2,000,000 to \$3,500,000 and the total cost of the dam is expected to be as much as \$5,000,000 less, thanks to the former waste product.

In the past 16 years, the Bureau of Reclamation has been one of the nation's largest users of concrete. Power dams and irrigation projects that dot the West, turning barren fields into fertile farms, have gobbled up 32,000,000 yards of concrete. The problem of reducing the cost of concrete has long plagued this government agency.

The Bureau's big concrete laboratory at Denver has been testing various cement substitutes for years. In some earlier dams, pozzolanic materials were used. They included volcanic, siliceous sedimentary rocks, burnt clays and shales or industrial by-products. None of these materials has any binding properties by itself. However, combined with the lime set free in the hardening of cement, pozzolan forms a compound that will set under water.

The various forms of pozzolan aren't new. The remarkable features of this substance were known to the Romans who used the volcanic ash found near the town of Pozzuoli, from which pozzolan gets its name. A form of pozzolan was used in the

Pantheon and Colosseum which have withstood the elements to a remarkable degree for almost 2000 years.

But pozzolan materials that can be used for concrete are scarce. Sometimes they are expensive to prepare. Other times they are found in deposits too far from construction projects to make their use practical. Because of these limitations, the Bureau of Reclamation has searched for years for natural materials which were readily available at comparatively low cost.

When the researchers discovered that fly ash is one of the best and cheapest pozzolanic materials, they not only solved the cheaper concrete problem, but also eliminated the disposal problem that was pestering our large power plants. Removed from the smoke by electrostatic precipitators, the fly ash is now being shipped by the carload to Hungry Horse Dam and other projects around the country.

Fly ash is a fine flue dust that results when powdered coal is burned. Somewhere between 50 and 90 percent of all the ash in the coal is carried through the boiler in the smoke. It's a minute, hard, crystalline substance that looks and feels so much like cement you couldn't tell the difference. The minute particles are spherical in

**At Hungry Horse, building materials are carried by 14,000 feet of conveyor belts, some of which are shown here**

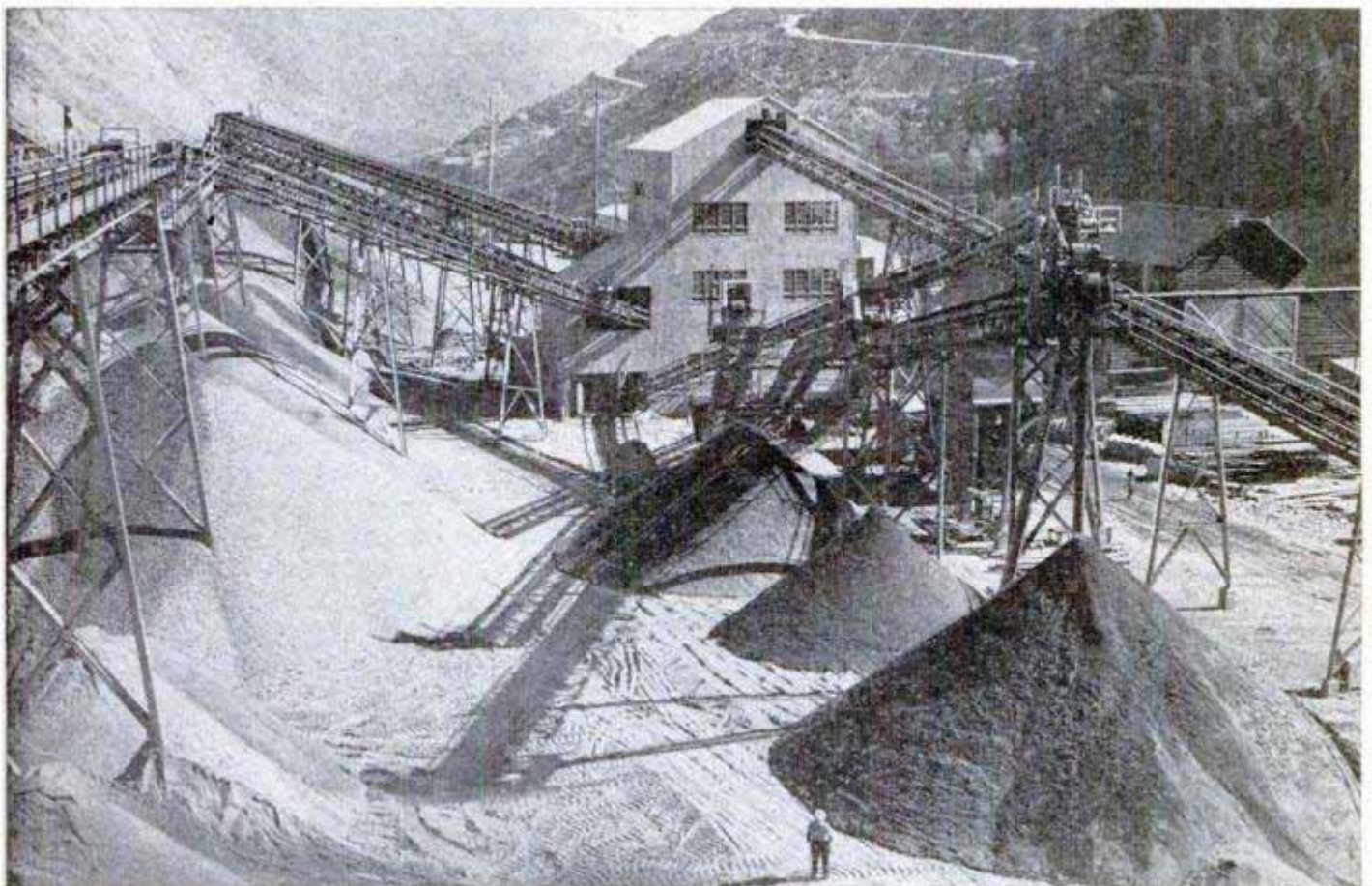



Left, fly ash is also used to make concrete pipes on this machine. Right, dumping concrete at Hungry Horse

shape. Researchers say that this round shape is a most important characteristic. The particles act as tiny ball bearings in the concrete mix, giving it great workability and permitting the concrete to be made with a minimum of water.

L. W. Bartsch, head of the Denver lab's engineering division, says this is of extreme importance because concrete is stronger when less water is used.

Out at Hungry Horse Dam, fly ash is replacing 30 percent of the cement. Previously, the bureau used one barrel of cement (equal to four sacks) to one cubic yard of concrete. In the new and cheaper mixture, two sacks of cement and 90 pounds of fly ash are used per cubic yard. Contractors are buying pozzolan for \$1.00 a ton in Chicago, which means about \$11.50 a ton delivered to Hungry Horse, a good \$10.00 a ton less than portland cement.

Not only does fly ash cut cement costs, but it also means lower costs for cooling the concrete as it sets. During hydration or hardening, concrete gets hot. Ordinary cement concrete generates from 80 to 95 calories of heat per gram of cement, which is enough in mass structures to raise temperatures from 60 to 80 degrees within 14 days. It takes about 28 days for the cement concrete to set. Use of fly ash with the cement will shorten that period by at least six days.

Hungry Horse Dam is a massive structure. It will be 330 feet thick at the base, 39 feet thick at the top and it extends across the canyon for 2115 feet. The concrete is poured in huge blocks, allowing for the shrinkage that occurs during cooling. The blocks are then grouted with cement

to form a single monolith. The fly-ash concrete requires less space between the blocks and that means less sealing work, an important saving in time and labor on a construction project as large as the dam at Hungry Horse.

However, even with the cooler mix of fly-ash concrete, it is necessary to run one-inch, thin-wall steel tubing through the concrete for cooling. Cold water is pumped through the tubing to carry off the tremendous heat released by the hardening mixture. When the water comes out of the tubing, it is boiling hot. Hungry Horse Dam will use about 1000 miles of tubing to speed the cooling process. Engineers estimate that enough heat will be liberated at Hungry Horse Dam to heat 800 five-room homes for a year in a cold climate. When the concrete has cooled, the tubes are filled with concrete.

But Hungry Horse Dam is not the only user of fly-ash concrete. Miles of electric cable have been laid in pipes made with fly-ash concrete. The addition of pozzolan to the mix permits a reduction of 20 to 33 percent in the amount of cement used. The pipes made with fly ash are denser and stronger than those made in the normal manner with straight cement mixes.

In Detroit, the Edison Company, faced with the problem of disposing of its fly ash, discovered that the waste material makes a satisfactory mineral filler in "blacktop" road construction.

No longer just a nuisance that must be removed from smoke for health reasons, fly ash is rapidly becoming a valuable by-product that may make smoke elimination profitable as well as healthful.

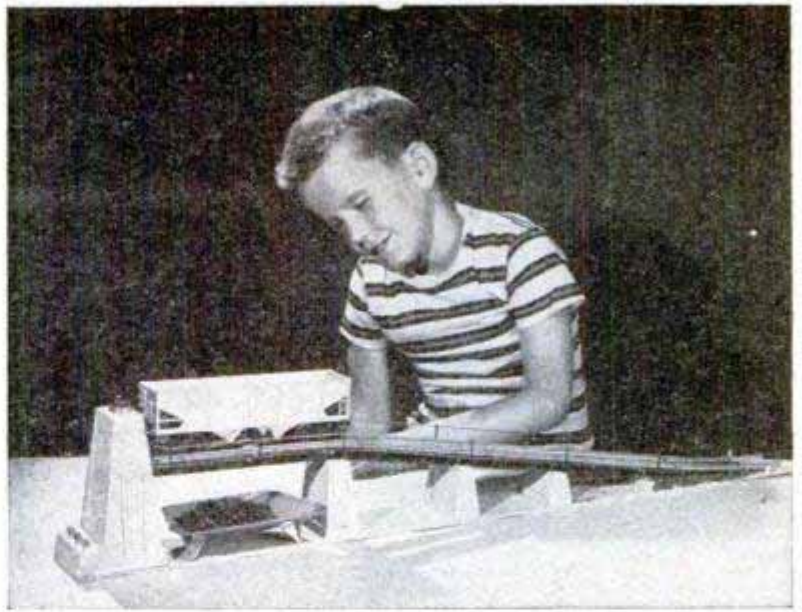

## "Workin' on Railroad" By Remote Control

Completely automatic and detailed down to the last rivet, there are now a coal ramp and hopper car, a lift bridge and an oil derrick and pump for model-train fans. A knuckle coupler on the hopper car holds it at the top of the ramp and the bottom is opened remotely to dump cargo into a waiting bin. The bridge has automatic or remote-control operation. Its center span is raised by chains and has a section that can be removed. A "walking beam" operates the pump with a rocking motion at slow speed and flow is simulated by an illuminated oil column.

Oil derrick and pump at left simulate all moves of big equipment. Coal drops from hopper car, above, with realistic clatter. Below, center span of model-railroad bridge is lifted by chains

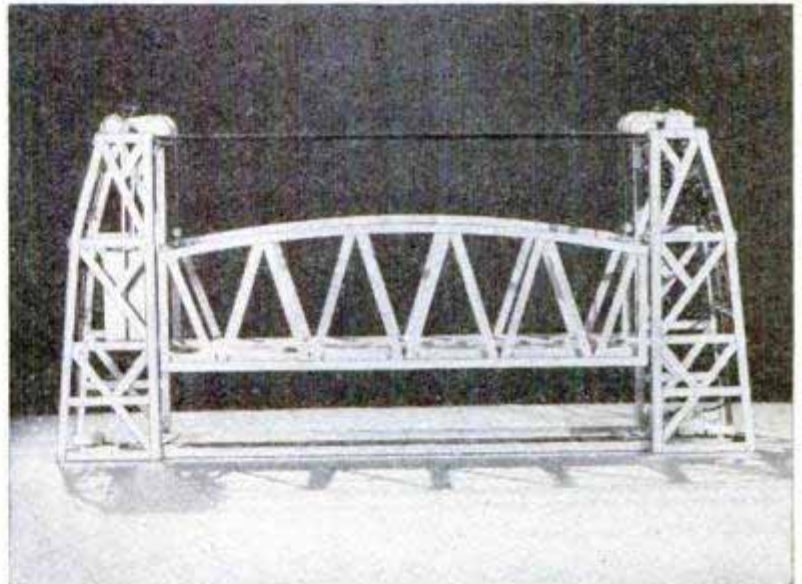

## Quick-Change Mount for Sportsmen's Rifle Sights

Sportsmen can change from telescopic to receiver sights instantly without making zeroing adjustments when they use a zero-return mount. With only one moving part, which sets or releases the V-shaped interplane lock, the mount assures perfect cen-

tering of the scope reticle. The receiver sight is mounted low for accurate sighting and has two eyepieces, one for hunting and the other for target shooting. The sight also has micromatic windage and elevation adjustments.

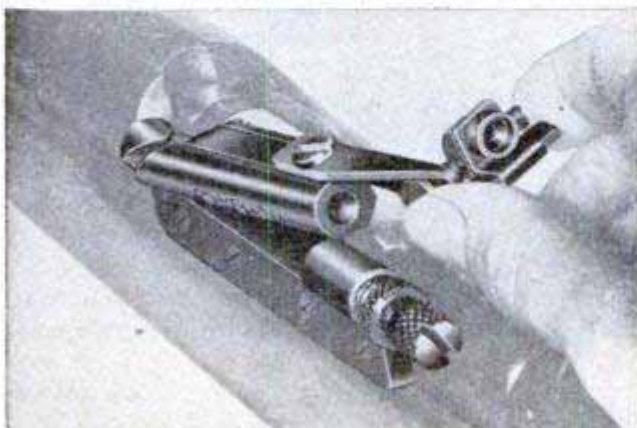

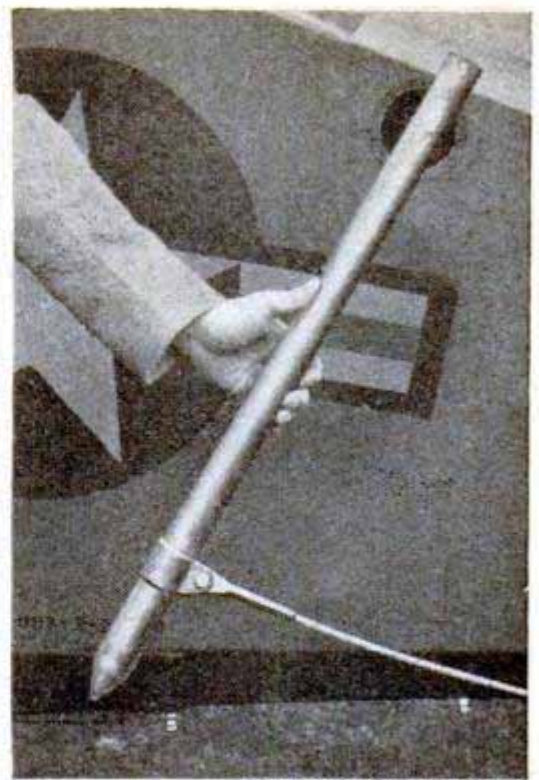
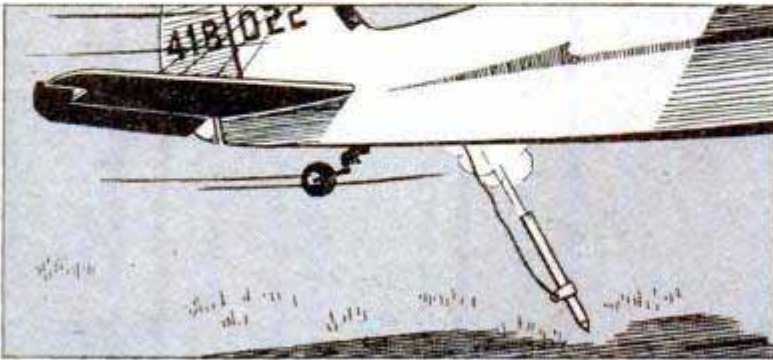
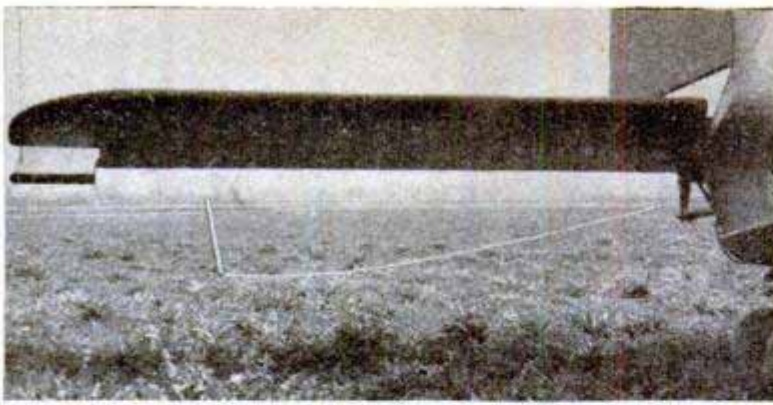

Air Materiel Command photos

## Plane Anchor Is Shot Into Ground

Light airplanes are brought to a stop in less than a fourth of their usual landing run by a 28-inch steel tube which serves as an anchor. The slender tube, filled with rocket propellant, is fired into the ground from a holder near the tail as the plane approaches the field. Attached to it are 200

feet of steel ribbon wound on a hydraulic reel that absorbs the energy at the time of the braking action and permits a smooth, easy stop. An L-13 landing at 75 miles an hour and normally requiring 700 feet of runway space can be halted in 168 feet. The explosive anchor was developed by the U. S. Air Force for use where planes must use small fields in combat areas.

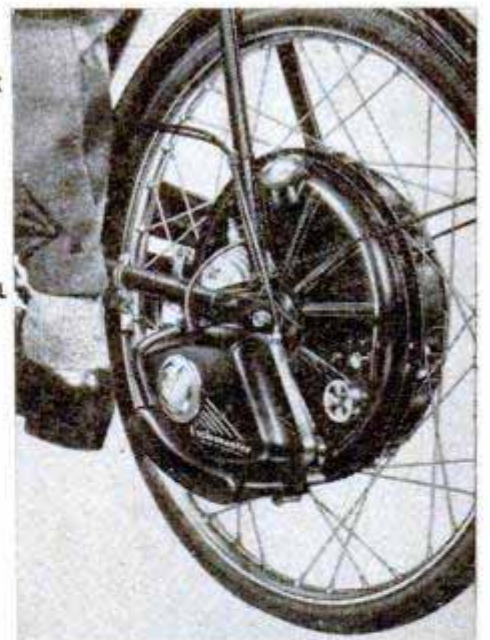
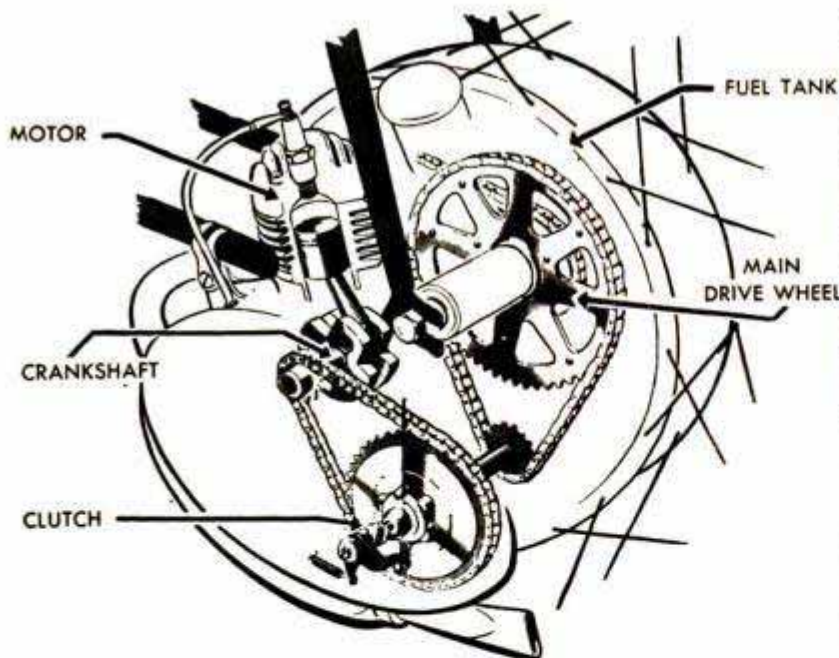

## Rear-Wheel Motor Powers Bicycle

Everything necessary to convert a bicycle into a motorbike is built into a wheel assembly that replaces the standard rear wheel of the bicycle. The enlarged hub of the wheel contains a circular fuel tank. The tiny motor, which is mounted on the left

side of the wheel, drives the bike at 20 miles an hour and averages 300 miles to the gallon. The single piston drives a crankshaft which transmits power to the wheel by gears and chains. Installation is simple, requiring only about a half hour. The motor is being manufactured in England and is designed for 26-inch-wheel cycles.



## *How Fast Can We Fight?*

**By James L. H. Peck**

**Blurring speed! A Republic F-84 landing at a U. S. Air Force base**

**F**EW AMERICAN defense problems so urgently need immediate solution as the question: How fast can we fight?

Operational fighter aircraft now fly at transsonic speeds. Faster ones are undergoing service-test trials. But the airman's ability to fight at today's—and tomorrow's—combat speeds will depend upon his weapons as well as his warplanes. We streamlined the aircraft but did not succeed, until recently, in streamlining the armament.

A fighter pilot needs all of the high performance he has available to climb quickly to high altitudes, and to overtake any hostile aircraft. But, from a tactical standpoint, this speed begins to work against him from the moment the

**Hits by any one of this salvo of "Mighty Mouse" rockets could cripple largest of today's bombers**



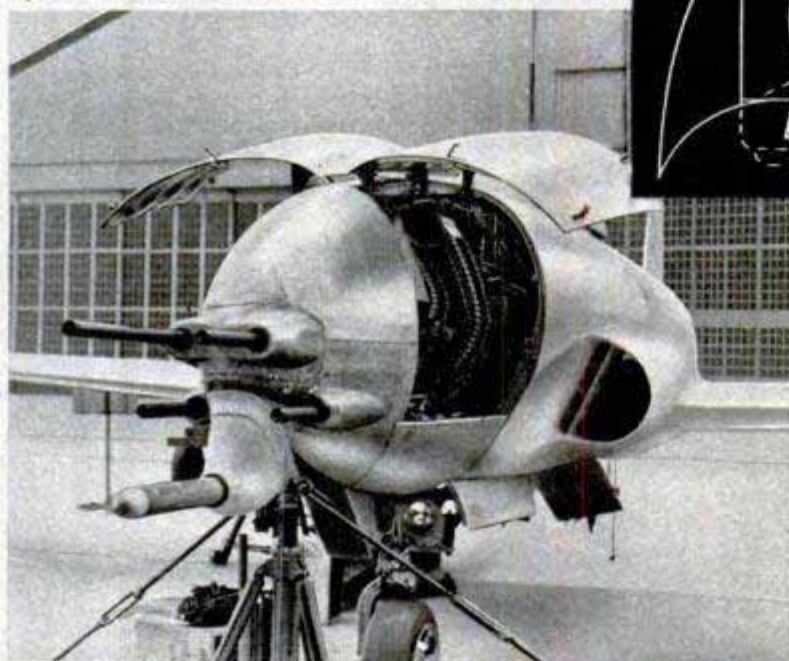
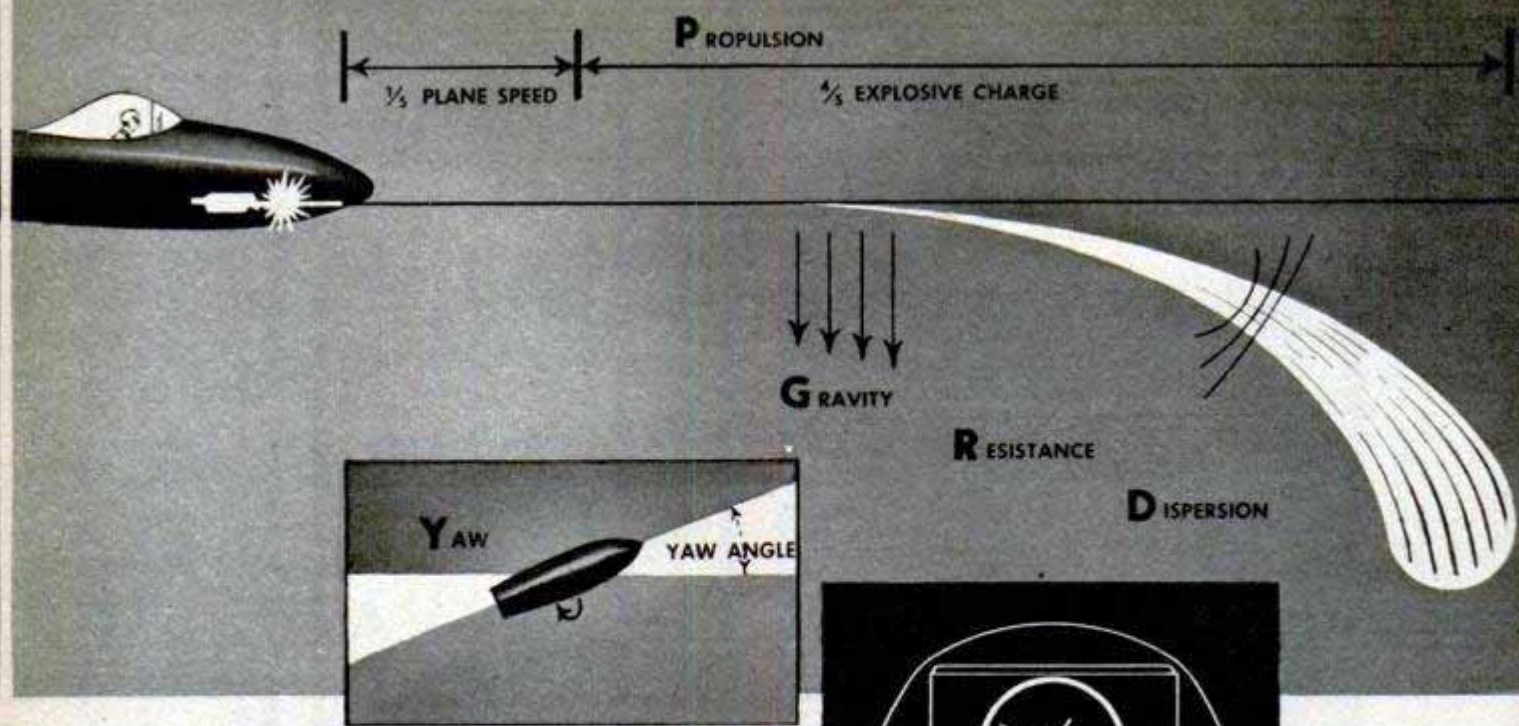

Sketches above show factors affecting bullet after firing. Airplane's speed adds fifth of missile's force. Gravity causes four-yard drop in 800 yards and air resistance cuts velocity one third. Dispersion, bullet yaw and "mushing" by plane further alter course to target

Radomes, like one below nose guns, hold gear used in search and aiming

For low attack, bomb dropping from F-84 hit ground and skipped to target

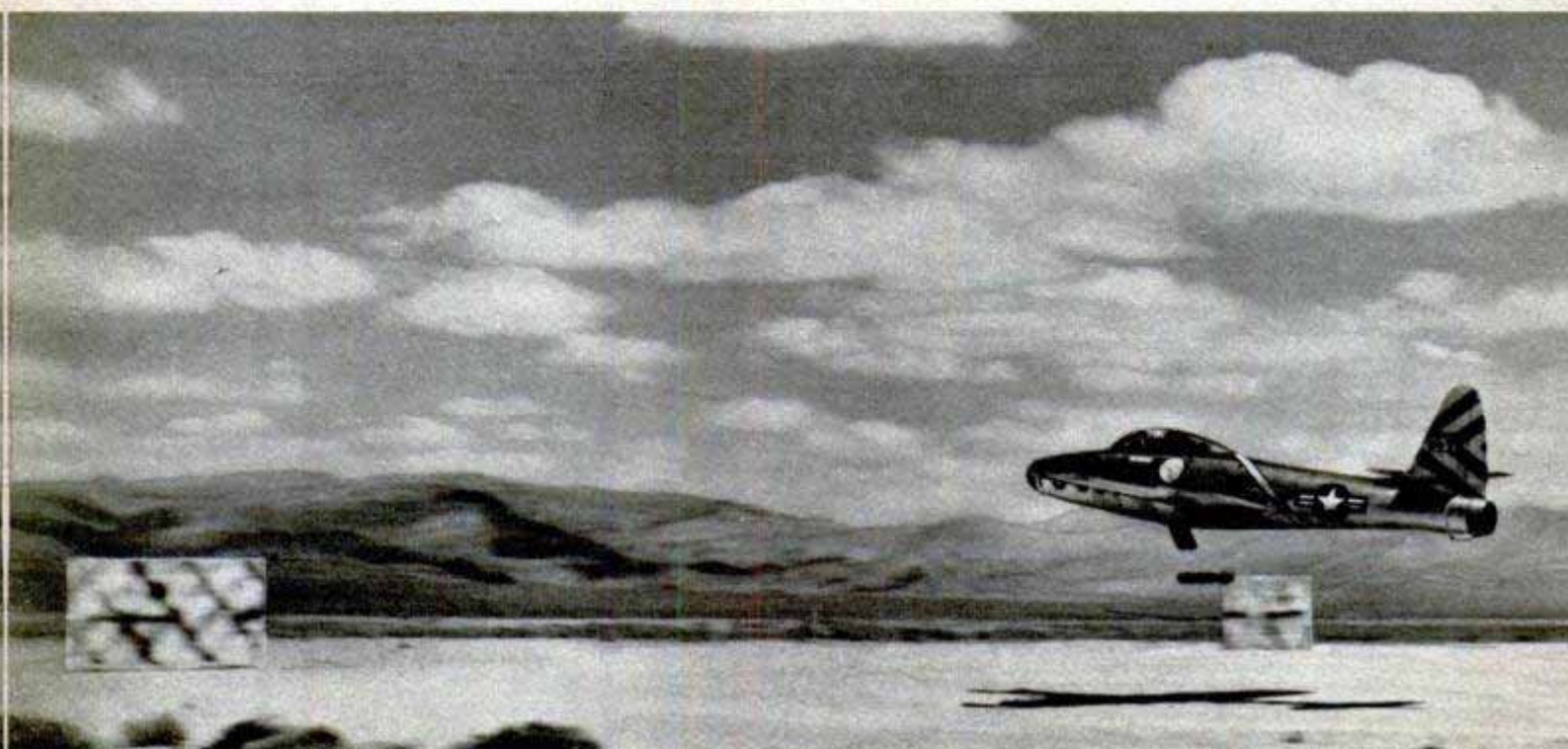



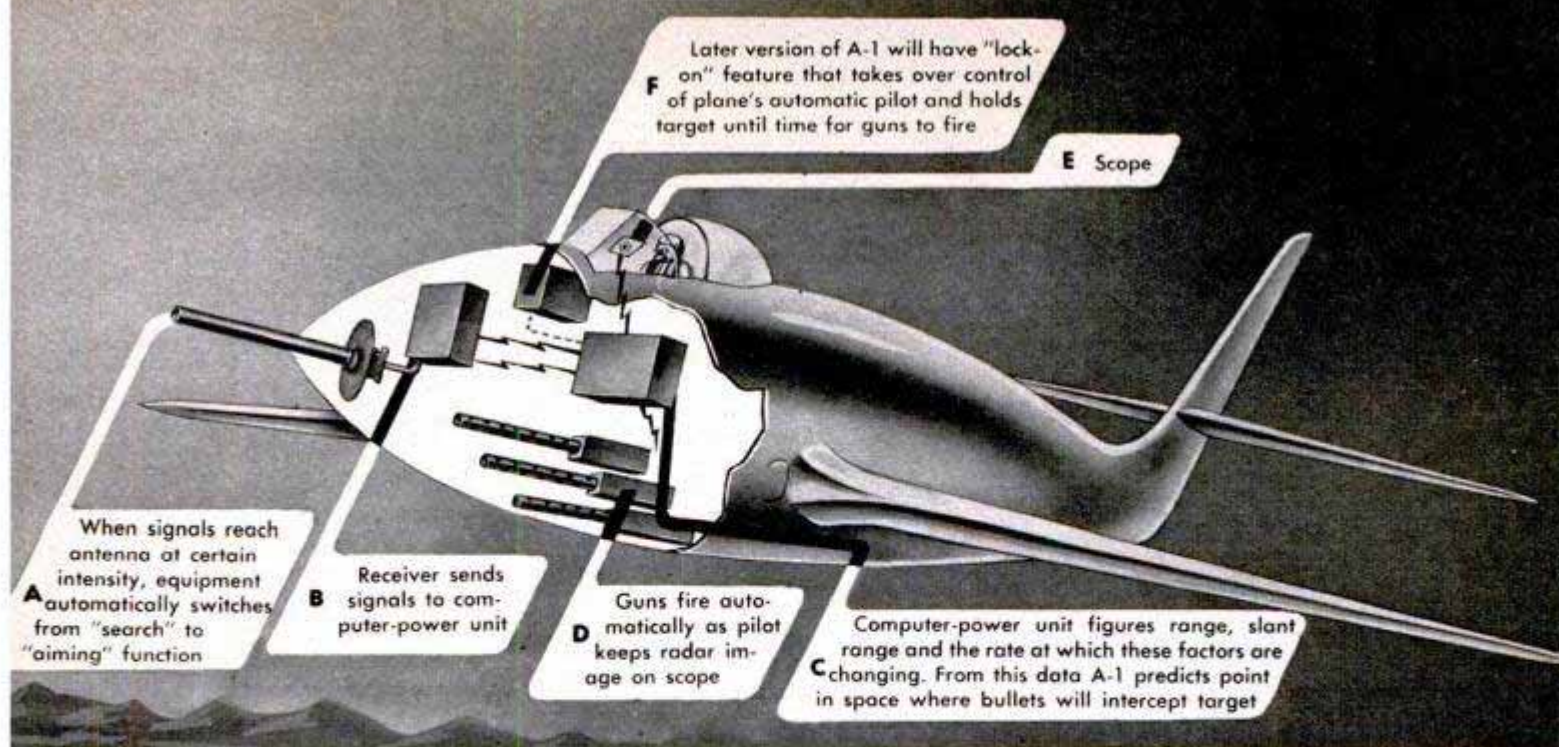

At a given range, coming versions of A-1 radar sight shown in cutaway will take control of plane's automatic pilot and hold the target, even against evasive action. Flyer's sole job will be to press firing switch

enemy is sighted. This transsonic warrior has only half the time to recognize, sight on, and fire at his target as did the 1941-45 aces who flew Mustangs, Thunderbolts, or Lightnings.

Anticipating these and other problems which would arise from the use of transsonic aircraft, USAF planners called into conference nearly four years ago the best brains from Wright, Eglin, and the Headquarters directorates within the Pentagon who could contribute to the development of high-speed weapons and tactics. Ordnance experts, tacticians, aero-medical men, and electronics specialists submitted potential problems. With these, they also contributed data and possible theoretical solutions.

Out of this came a set of "interim" tactical requirements. These, they agreed, would have to be met circa 1951—long before that push-button era of all-missile warfare. Moreover, with their solution would also come a clearer conception of the tactical employment of missiles, when these did finally become available for Air Force operational use.

This prescription for combat called for equipment and techniques that would carry out these tactical functions:

**DETECT** targets beyond the pilot's range of vision. A pilot flying 700-m.p.h. penetrators and interceptors would require, even in clear weather, airborne intercept gear as well as ground "vectoring." At altitude, such a pilot would—if approaching head-on a plane of similar size and performance—be able to spot the enemy visually at a maximum distance of six miles, even if the foe were streaming a vapor trail.

He would have just 12 seconds for recognition, two seconds to aim and track, and about two seconds' in-range shooting time.

**IDENTIFY** immediately a target within or beyond the pilot's vision. Wartime IFF (Identification of Friend or Foe) radars worked reliably much of the time, but they were not foolproof. New devices would have to be made more simple and positive to meet the requirements of transsonic combat.

**SIGHT** automatically and furnish the pilot with prompt range and deflection indications, or compensations therefor. Wartime sights provided adequate range information, but airmen had to estimate their "lead" when shooting at some "angle off" the target's line of flight. The 700-m.p.h. pilot would have too little time for visual estimates; and the speeds would, moreover, influence human perceptions adversely.

**SHOOT** at twice the cyclic rate of fire and at double the range of the wartime M-2 caliber .50 machine gun. These would be minimum requirements, since the transsonic pilot would close on his target twice as fast and have only half the shooting interval.

**KILL** the target with improved firepower. This would be increased by means of projectile size, shape, or explosive power so as to give the fighter pilot fire superiority even with the fewer hits he could be expected to register in high-speed combat.

Those minimum requirements have been met ahead of schedule, despite limited appropriations. Several interim weapons and devices have been developed to the point of service-test or production status. And research is progressing rapidly on allied

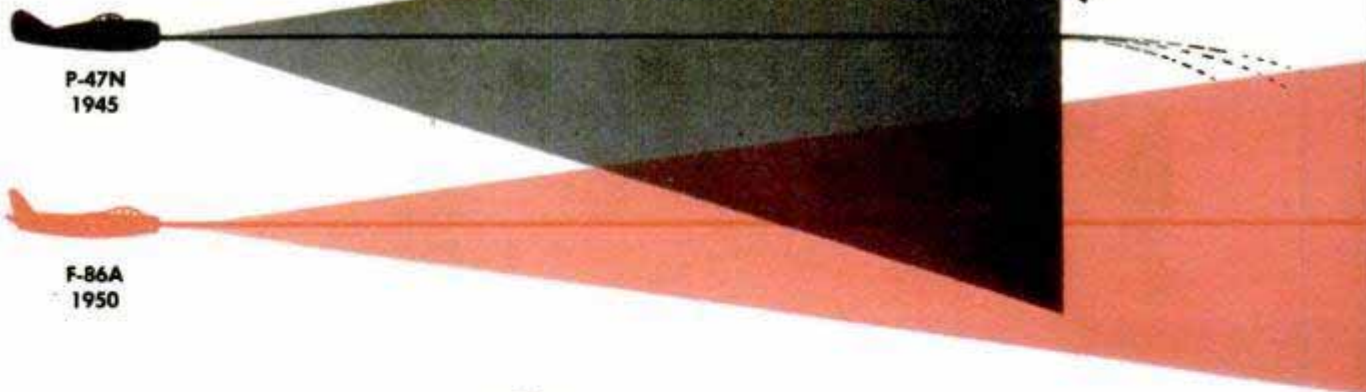

P-47N  
1945

F-86A  
1950

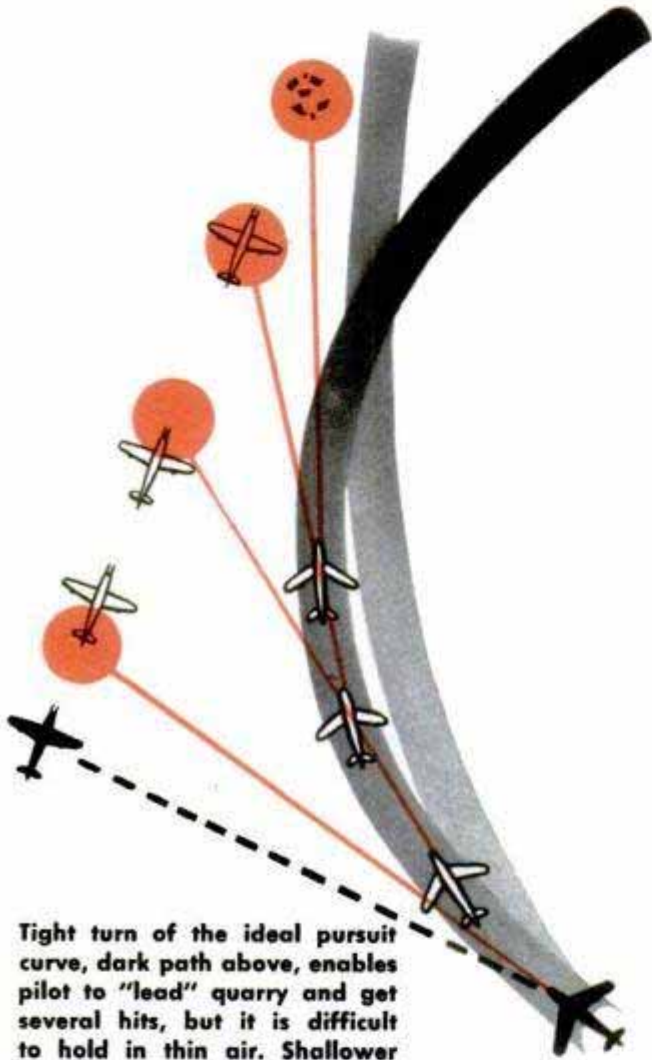

Tight turn of the ideal pursuit curve, dark path above, enables pilot to "lead" quarry and get several hits, but it is difficult to hold in thin air. Shallower curve allows less shooting time

phases of both ordnance and electronics.

The M-3 caliber .50 machine gun arms several fighter models already in operational service. Maximum effective range is 800 yards, double that of the wartime M-2 gun. Shooting twice as fast, the M-3 has a cyclic rate of approximately 1200 rounds per minute. The improvement was made largely through the use of a new barrel design and lining, better feed and ejection mechanisms, and improved lubrication.

Essentially the same modifications were made to produce the new Mark 4 20-millimeter cannon, with a cyclic rate exceeding 600 rounds per minute and a maximum effective range of 1100 yards. The high-velocity Mark 1 caliber .60 machine gun shoots approximately 1000 rounds per minute. With a muzzle velocity exceeding 3300 feet per second, it shoots a flat trajectory and has a maximum effective range of 1100 yards.

The fourth new weapon is a subcaliber rocket, the "Mighty Mouse." This 2.75-inch flies farther and faster than the wartime 4.5-inch M-8 or 5-inch HVAR, and is better suited for aerial combat than either. Quantities of them can be carried in compact launchers under a fighter's wings or fuselage. Ordnance people will not say whether or not the Mouse is fitted with a proximity fuse, but they do claim that a

Bomber's firepower makes it a tough foe. Fighter swerving in for attack is exposed to series of turrets. Each line traces streams of cannon fire

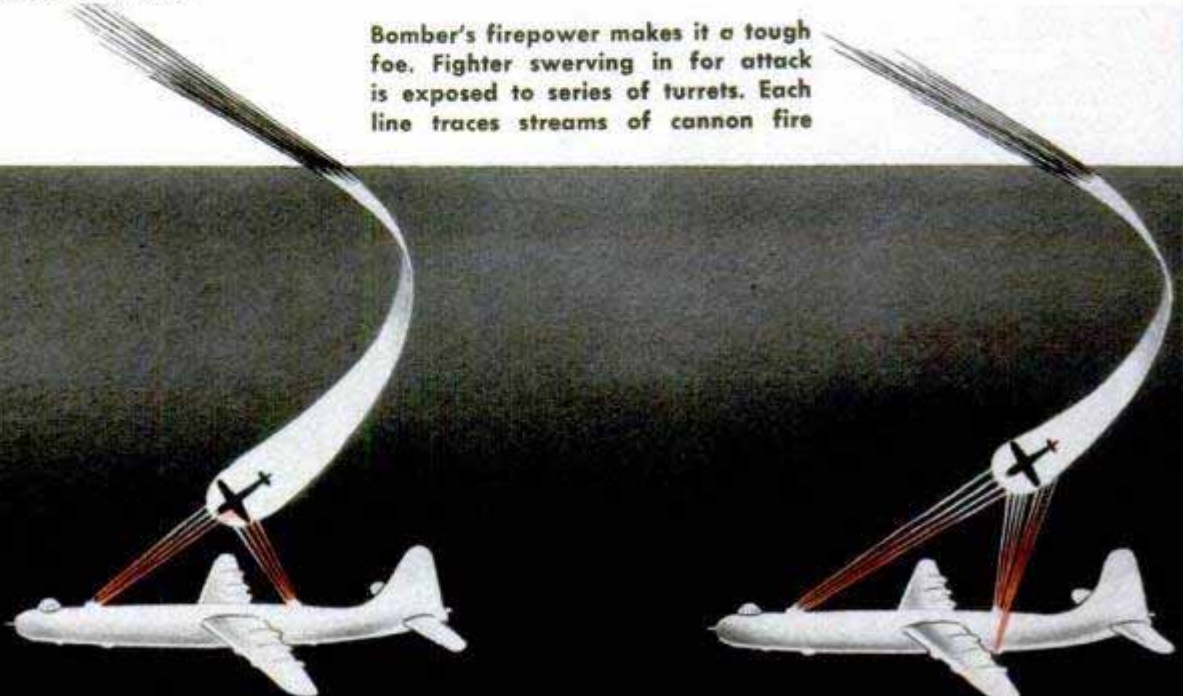

Weapon development has been pressed to keep abreast of increasing air speeds. The cones at left contrast effective combat ranges of M-3 caliber .50 machine gun and earlier M-2, with former firing twice as fast. Dipping lines indicate areas of doubtful efficiency

20 MM.  
CAL. .60

M-3 CAL. .50

"MIGHTY MOUSE" →

800 YDS.

1150 YDS.

single hit will put the whammy on the largest bomber. (This weapon and the caliber .60 gun are products of interservice exchange. The USAF developed the caliber .60 gun, now shared with the Navy. Naval ordnance experts developed the Mouse, used jointly by both services.)

To aim this armament, operational fighters are now equipped with one of three types of gyro computing gunsights, the K-14A, 14B, or Mark 18. A twist grip on the throttle is worked by the pilot to keep his target framed within the sight reticle and to track target movement. Lead is indicated automatically by a pattern of six diamonds. When the pilot lines up on his

(Continued to page 260)

With target at a 90-degree angle, gyro sight above automatically computes lead for perfect shot. Clocks below show how pilot of transonic plane would spend 16 seconds left before meeting a foe seen approaching head-on from six miles away

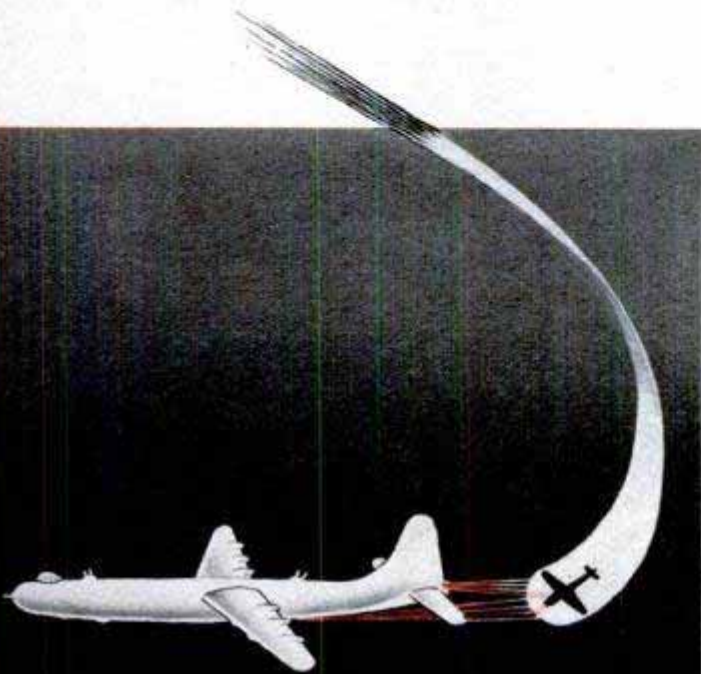
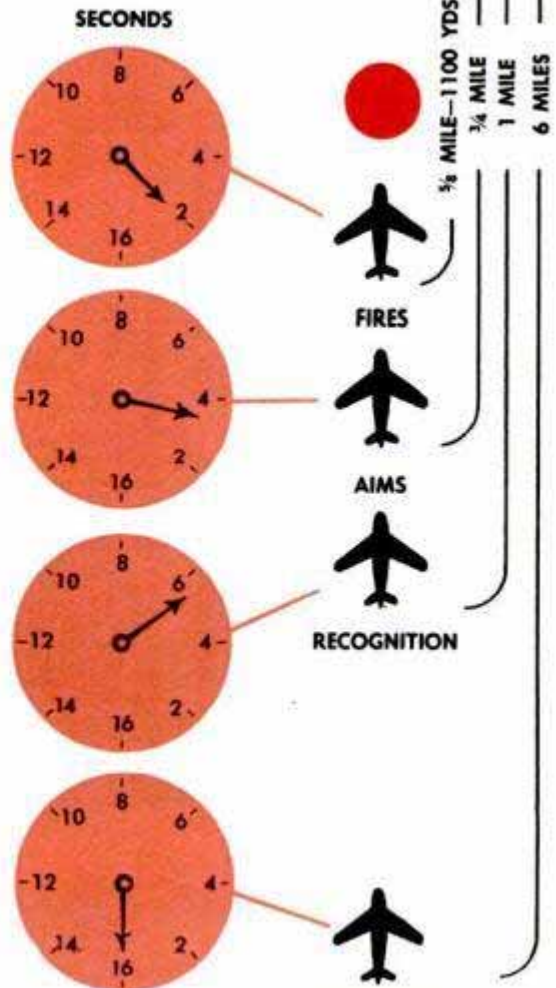

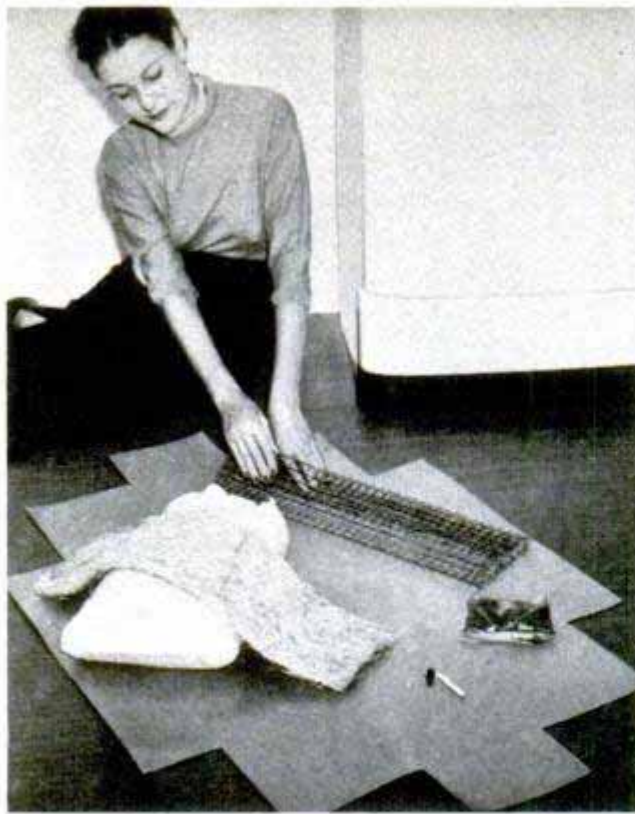

### Parcel-Post Garden

Packed flat and delivered by mail, an indoor flower box requires no soil. The box is made of plastic-coated cardboard. The amateur gardener folds it along precreased lines to make the waterproof container. A metal grid then is placed in the bottom of the box to support a mat of wood excelsior.

The remainder of the box is filled with sawdust in which the seeds, plants or bulbs are placed. Included in the kit is a six-month supply of dry plant food which is mixed with water and poured into the box. The kit contains all the materials except the sawdust, and bags of sawdust are available for persons living in areas where sawdust is difficult to obtain.



### Portable Sun Screen

With a portable sunshade made of louver-type screening, you can regulate the amount of sunshine coming through to insure comfortable tanning. In the vertical position, the screen's angled louvers completely shut out the sun's rays without interfering with visibility and ventilation. It is mounted on an aluminum stand that can be set up anywhere.

### Striking Strip for Matches Resists Moisture

Water or perspiration won't affect a new striking strip for book matches. A match can be struck immediately after the excess water is wiped off. The strips, which are being colored gray, were kept under 100 percent humidity for six months without deteriorating or becoming soft. They will not bleed off and can be carried without danger of staining the pockets or shirts of workers or sportsmen.



Three miles from shore, fisherman at left repairs net attached to birch pole. Right, after shaking net a few shad have to be picked off by hand. Fishermen work at low tide and must hurry because the tremendous tides of the Cumberland Basin rise and fall as much as 28 feet in a six-hour period. Below, mud flats at low tide



## Fishing With a Ladder

SEVEN fishermen who live near the head of the Bay of Fundy, Nova Scotia, gather their harvest of shad from mid-May to September with a team of horses, wagon and a ladder. The fish are caught high off the ground, when the tide is high, in nets stretched between 12-foot poles. The fishermen drive a wagon over the mud flats to collect the fish. They use 28 nets, each 23 yards long, and a good catch is about 150 fish. The wagon trip is made twice every 24 hours at low tide.

Below, team waits while Edmund Brine removes 2½-pound shad from net. The season is from mid-May to September and these hardy fishermen wage a constant battle against tides and fog

*Imperial Oil Limited photos*



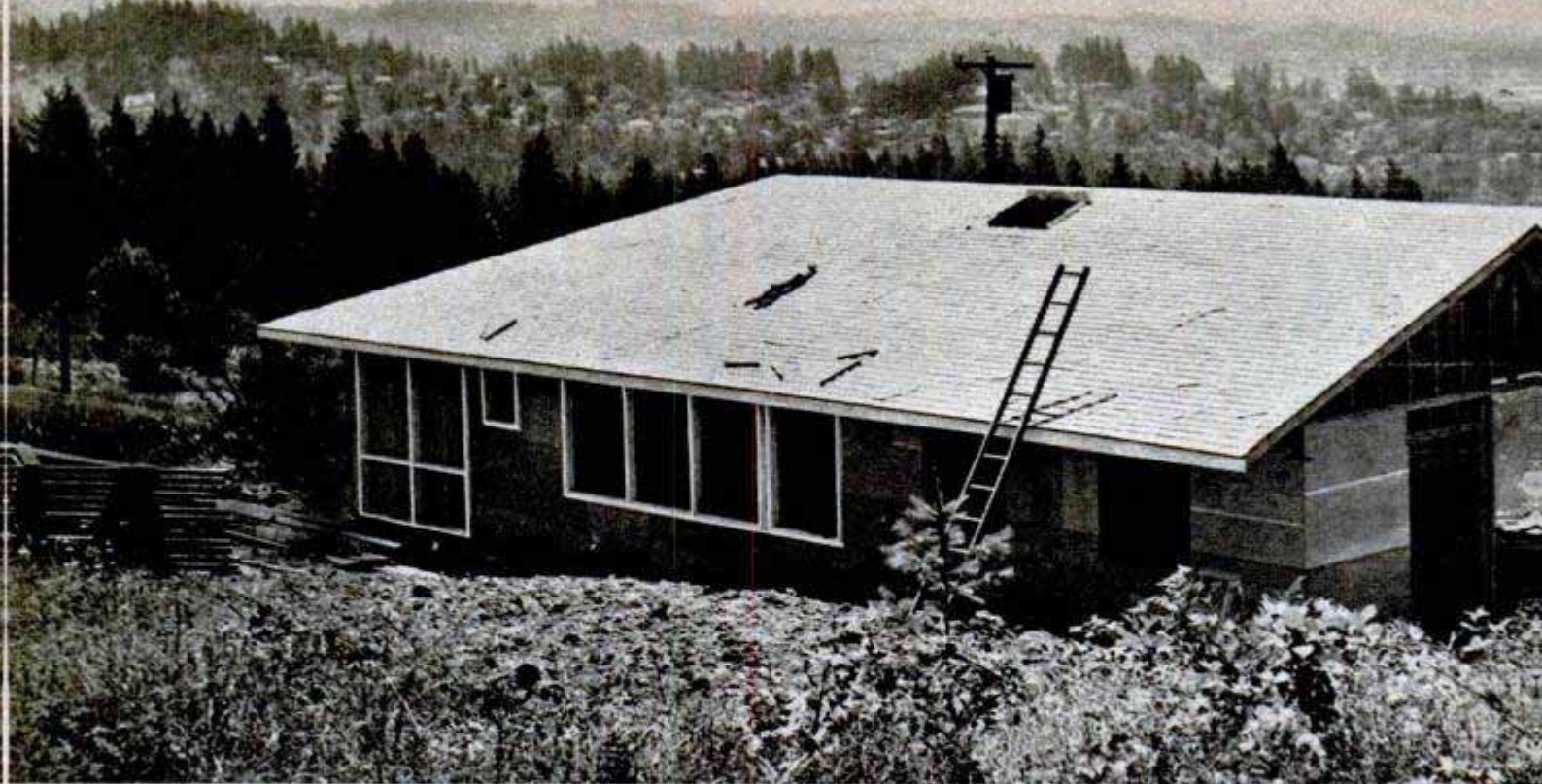

Its roof completed, the house begins to reveal its final form. Sign, right, was put up by a realty company

# I'm Building the Popular Mechanics

By Tom Riley

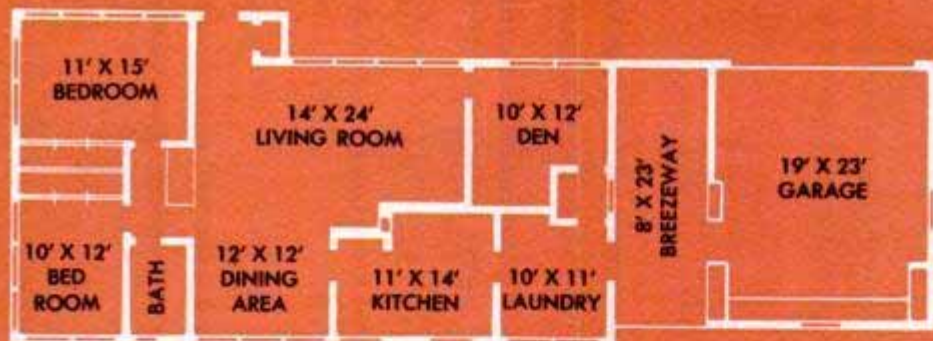

FLOOR PLAN

**W**HEN WE STARTED on the floor beams of the *Popular Mechanics* ranch house our muscles had finally stopped aching from the concrete work and things really began to hum. Our dream home has complete and adaptable plans (I sometimes marvel how the editors and architect John Whelan thought of everything) and at the start this amateur builder had the choice of a wood floor with full basement, a radiant-heat concrete slab or the new stepped-down wood floor. My wife and I chose the stepped-down wood floor, having always wanted a true one-level home and not wanting the jarring solidity of the concrete slab.

My friend, Norman Chapman, and I first

Riley, on ground, uses a sledge to align roof trusses. Helper on roof is checking the ridge line

POPULAR MECHANICS

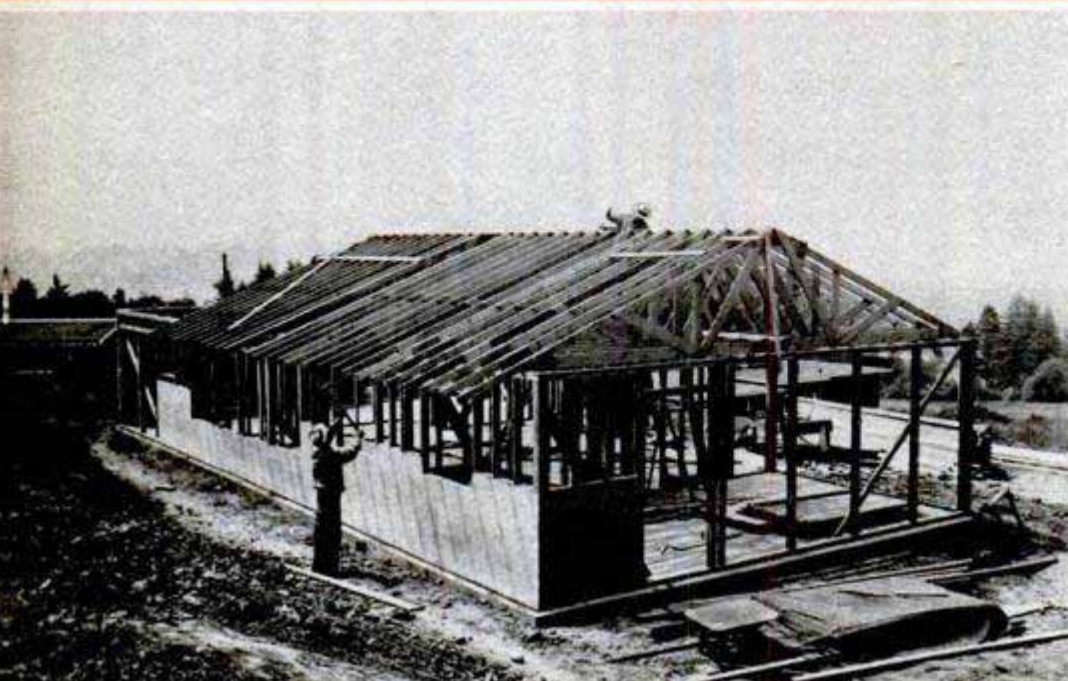



Left to right, Riley, James R. Ward, crafts editor, and John Whelan, the architect, talk over the house plan

## Plywood Ranch House

### Part II

placed the 6 by 6 floor beams on their short posts. The 2 by 10 floor joists rest directly on them and also lock down inside the "step" of the concrete foundation. There's an important item here that's often overlooked in the hurry of house construction—the preserving of wood members that touch concrete. We doubly preserved everything, painting the concrete surfaces with asphalt and also soaking the wood members that touch them with one of the new wood preservatives to discourage rot and termites.

Then there was the bridging to make, the crisscross bracing between the floor joists that prevents "joist roll" and squeaking of the floor. This is a hard, slow job with a hand-saw, one reason why it's often done poorly, but we are using a portable power saw as everyone advised and a contractor showed us how to set the saw blade at an angle in a simple jig

(Continued to page 248)

Even in construction, a woman's place is in the home! Riley's wife, Vinita, helps by handing nailing blocks to him



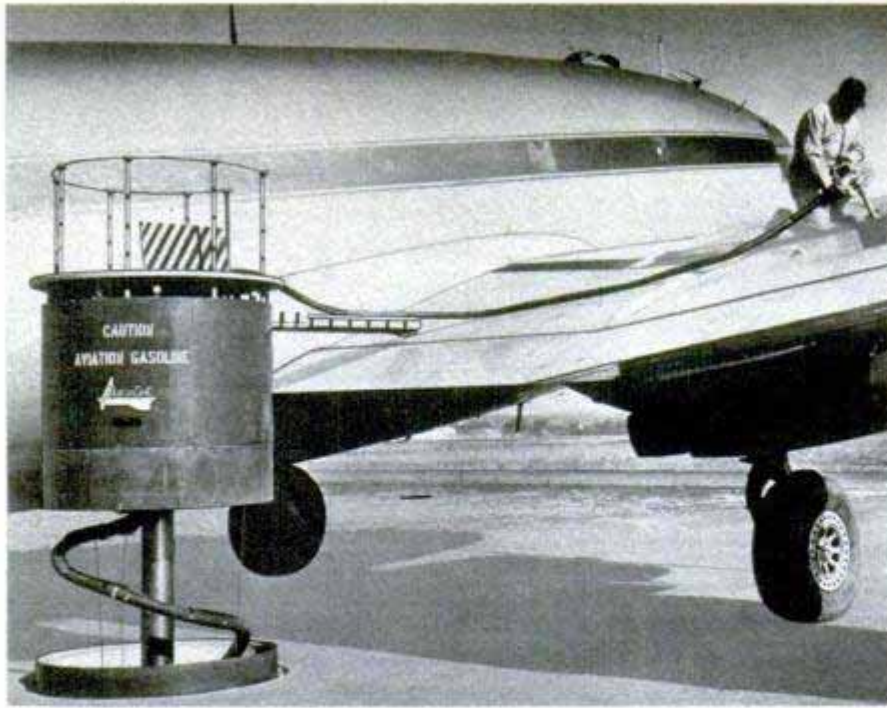

## Pump Pops Up To Fuel Planes

Fueling units that rise and have walk-way extensions to the airplane wing are a new time and space saver at airports. A hose, meter, ground wire and CO<sub>2</sub> equipment are within the steel cell, which is five feet in diameter and three feet thick. Fuel is fed from a remote storage tank. The attendant turns a switch that raises him and the cell to the desired height in less than a minute. When not in use, the top of the cell can be lowered flush with the surface.

## Emergency Door Lock

Installed on the inside of a door, a new lock prevents unauthorized persons from leaving a building unless they sound an alarm. The lock is designed primarily for use in buildings and projects where important documents and valuable materials are stored. Keys for the lock permit authorized persons to pass through the door at any time. In an emergency such as a fire, anyone can leave through the door by pushing a striker, which breaks a thin piece of glass. This unlocks the door immediately, but also sounds an alarm to inform authorities that the door is being used.



## Camera Caddy

Tired of lugging heavy camera equipment a mile or more through a big factory, Westinghouse photographers have come up with a back-saving camera caddy. They adapted it from a golfer's two-wheel cart by riveting canvas supports to the metal frame and using leather thongs to tie on their equipment. Now with one hand they can roll all their gear to the machine which is to be photographed. At the shooting site, a metal leg is dropped down to support the caddy while the equipment is unpacked. The cart, when collapsed, is small enough to fit inside a car trunk.





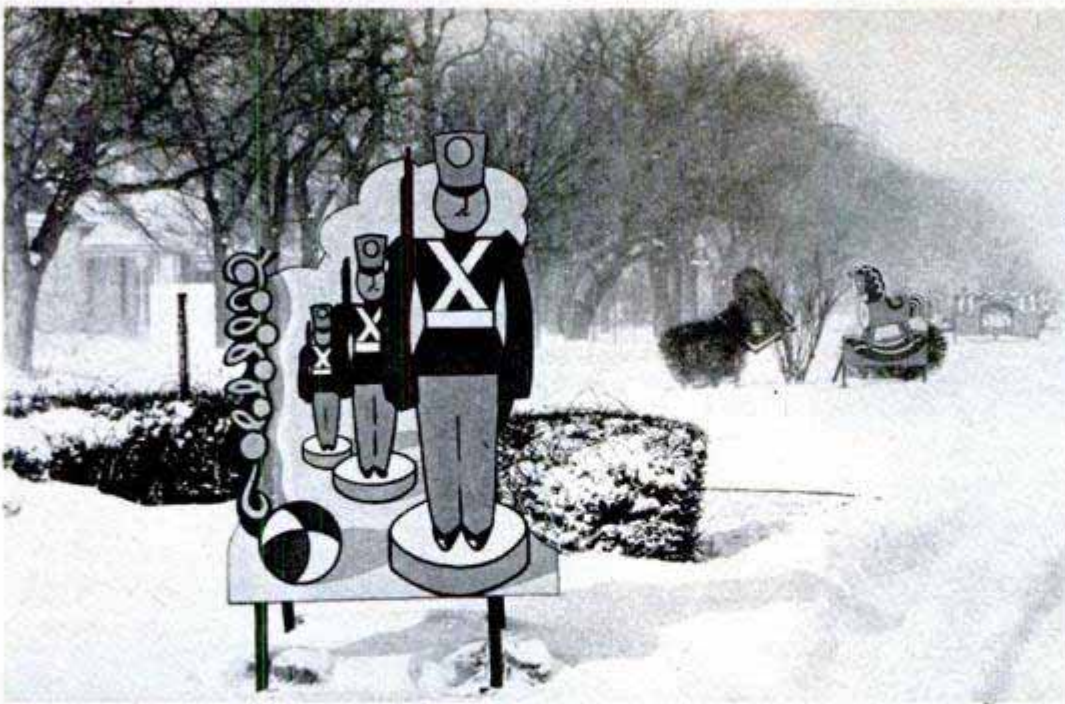

During the day toy soldiers, a rocking horse and other cheerful figures stand guard along the streets in an attractive display. At night, the same figures spring to life in brilliant colors whenever an automobile passes by

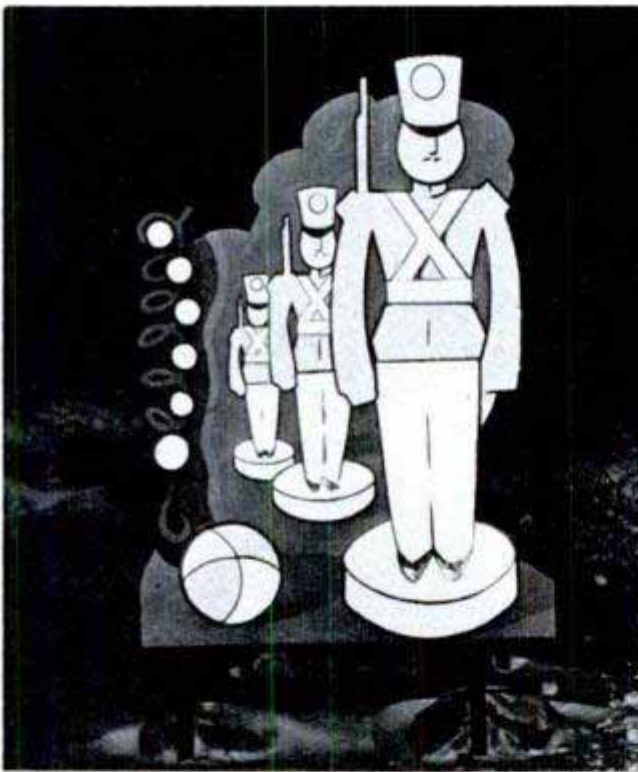

## Unlighted Decorations Glow in Dark

Inexpensive Christmas decorations shown here on the streets of McCook, Neb., are not wired for electricity, yet they reflect brilliant colors when they catch the light of auto headlamps. Made of ¼-inch plywood, the figures first are painted and then covered with a highly reflective material in the desired colors. Wood supports are anchored with sandbags. The decorations can be used year after year, permitting the city to enlarge the display each year with funds otherwise needed for replacements





## Traffic Light on Bus Protects Children

Attached to the side of a school bus, a portable traffic light provides safety for children crossing the street. The three-signal light is installed on the driver's side of the bus where it can be seen by motorists who are approaching from both directions. The new safety aid was invented by Fred S. Martin, who is the superintendent of accident investigation for the Chicago Transit Authority.

## "Rough Roads" in Laboratory Check Auto Vibrations

Fisher body engineers have "moved" rough roads right into their laboratories in their study of vibration and its effects on passenger comfort. The first of the two tests they have devised is a method of creating vibration by spinning one of the front wheels of the car. The wheel is thrown out of balance by the addition of small weights to one section and the car is placed on a hoist. A flexible shaft, powered by an electric motor, is attached to the wheel. As the unbalanced wheel is spun, it sets up vibrations which are transmitted to the body of the car. The second test is termed the mechanical oscillator test. In it an offset cam is set against the frame of the car and the powered flexible shaft attached to it. The cam is then rotated against the various sections of the frame and the amount of vibration transmitted to



the various sections of the body is measured. In both tests, delicate vibration meters, so sensitive they can be used to measure a human's heartbeat, are used to ascertain the exact amount of vibration which is transmitted to the different body areas of the automobile.

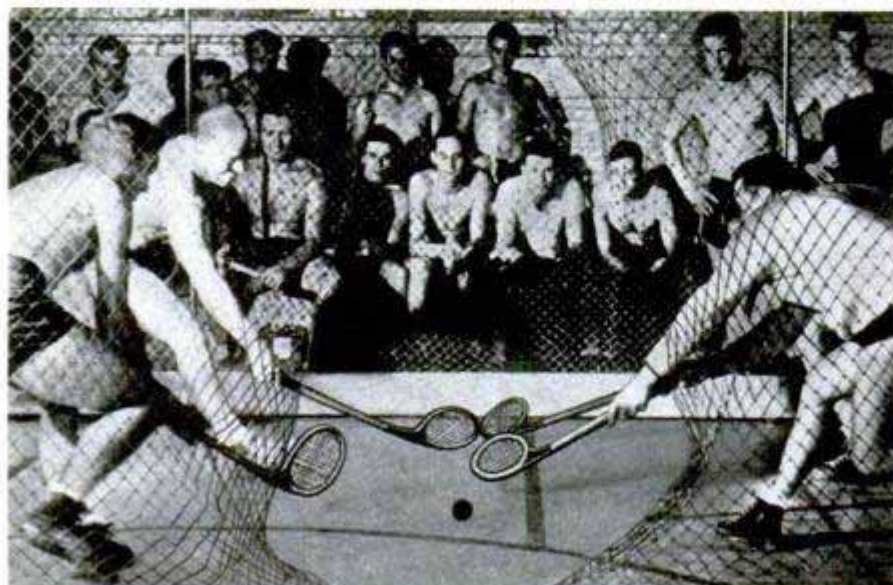

## Florball

Played on a portable court, Florball is a fast, new racquet game. It embraces principles of hockey, tennis, golf and handball. Goals are scored by driving a sponge-rubber ball against eight-inch-high boards at either end of the court and three goals in succession are needed for one point. The ball has to be kept on the floor when serving and close to it at all other times.

# TOM THUMB FIRE DEPARTMENT

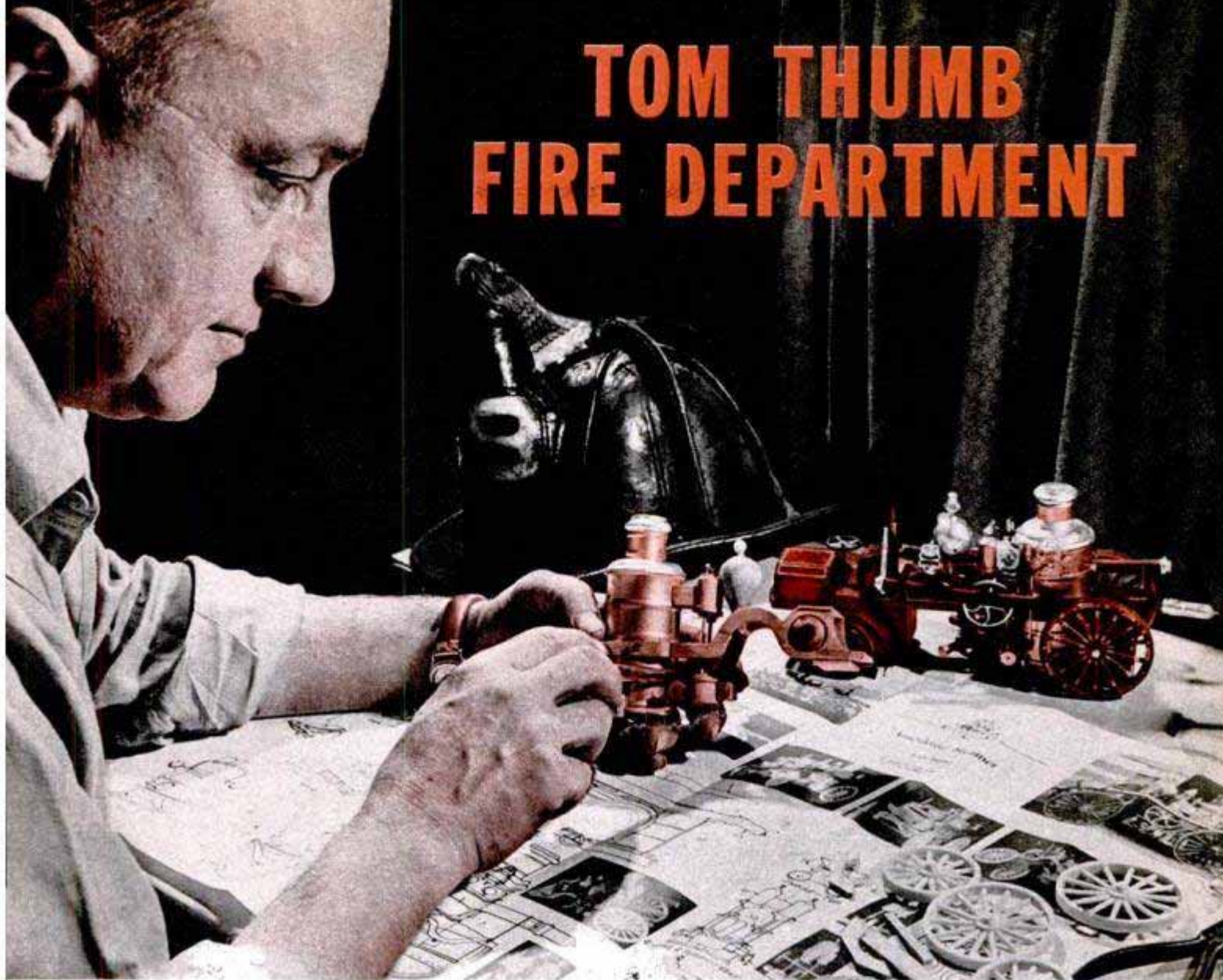

**Photographs by  
Alfred Eris**

"Chief" William H. Low assembles his model of the Amoskeag Steamer of 1898 used all over the U. S. as late as 1948 for stand-by service. Below, Bill, Jr., in a British helmet inspects Halloway Combination

THERE'S something about a fire engine that William H. Low of Braintree, Mass., has never been able to get out of his blood. Most "fire masheen" fans, known as "buffs" or "sparks" in certain parts of the country, must be content with watching the red engines race by or looking at old prints. Not Bill Low. He is chief of a Tom Thumb Fire Department that has become a nationwide enterprise.

Just a little over three years ago Low was trudging the streets of Boston selling corrugated packaging materials. One day when sales were at a low ebb and his spirits even lower he heard the whine of fire engines racing up the street. As the fire buggies clanged by in glamorous parade he noticed that everybody on the street had stopped to watch with sparkling eyes.

Then and there an idea was born that has already placed more than 35,000 fire-engine kits in the hands of delighted owners from coast to coast.



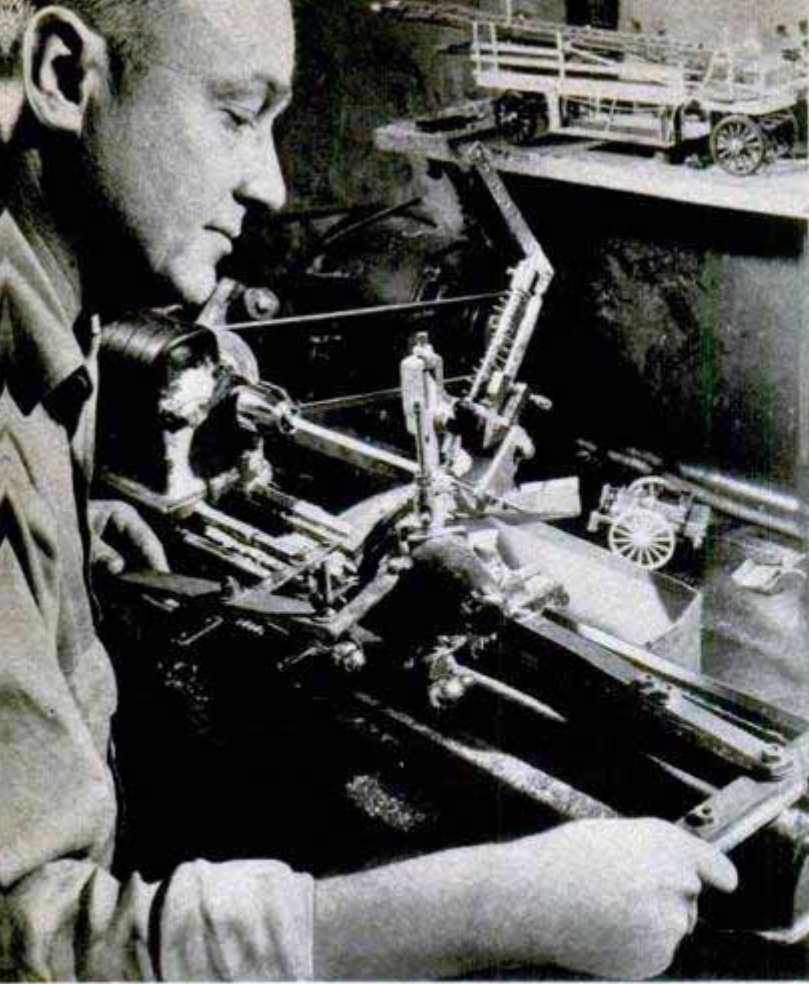

Here the "chief" is at work on one of his specially adapted machines which turns out small wood parts to exact scale. Low builds all the original models

Below, combination hose and reel model of 1850 was widely used throughout U. S. It has a cloth-cushion seat, die-cast lanterns and molded-plastic wheels

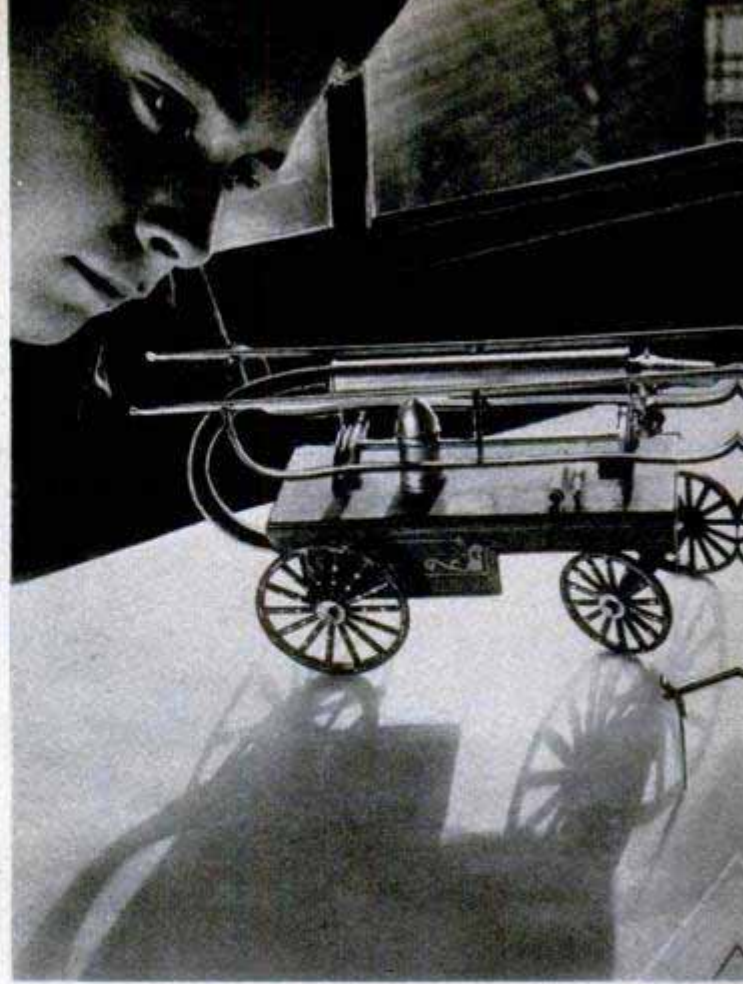
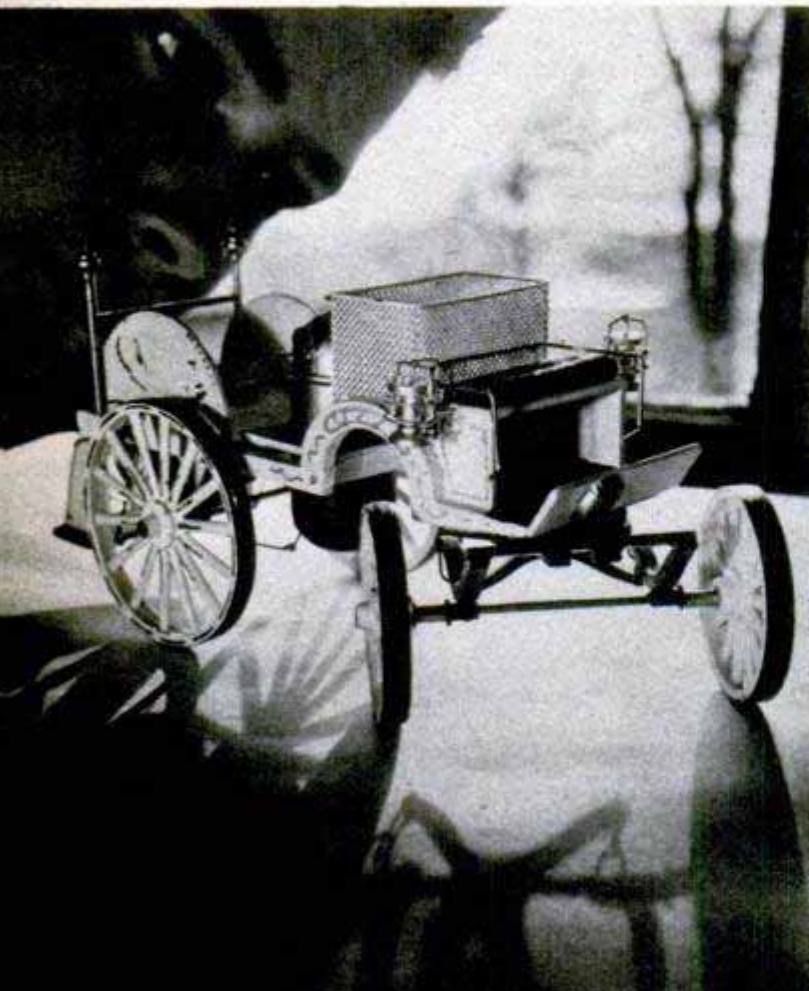

Famous 1853 Blue Boy was one of the finest engines of its day. Low uses old advertisements and photos in making first model from which kits are developed

First he enlarged his basement workshop and set to work on early models. After exhausting research he built several original models with specially adapted machines and jigs. Then followed months of breaking down the numerous details and producing kits which can be easily assembled. He now has seven kits ranging from 50 to 130 pieces each.

His earliest models include chemical-engine and hose-reel trucks introduced early in the 19th century. Among these are such famous engines as Blue Boy, introduced in 1853, and the Amoskeag Steamer of 1898. He has a chemical engine combination developed in 1875 which was used in small towns up to a few years ago.

Present-day manufacturers of fire engines are cooperative when Low tries to unearth data about early engines, but many records have disappeared. His study is packed with helmets and books on fire-fighting and his shelves are lined with models. He employs three workmen in the shop and now has to sub-contract such parts as plastic wheels, lanterns and axes.

The shop boasts a "tapper" connected to the local fire station and when it rings out an alarm bedlam reigns. Workmen and the Low family (including the dog) pile into cars and race away to the scene of the blaze. They call this local research.

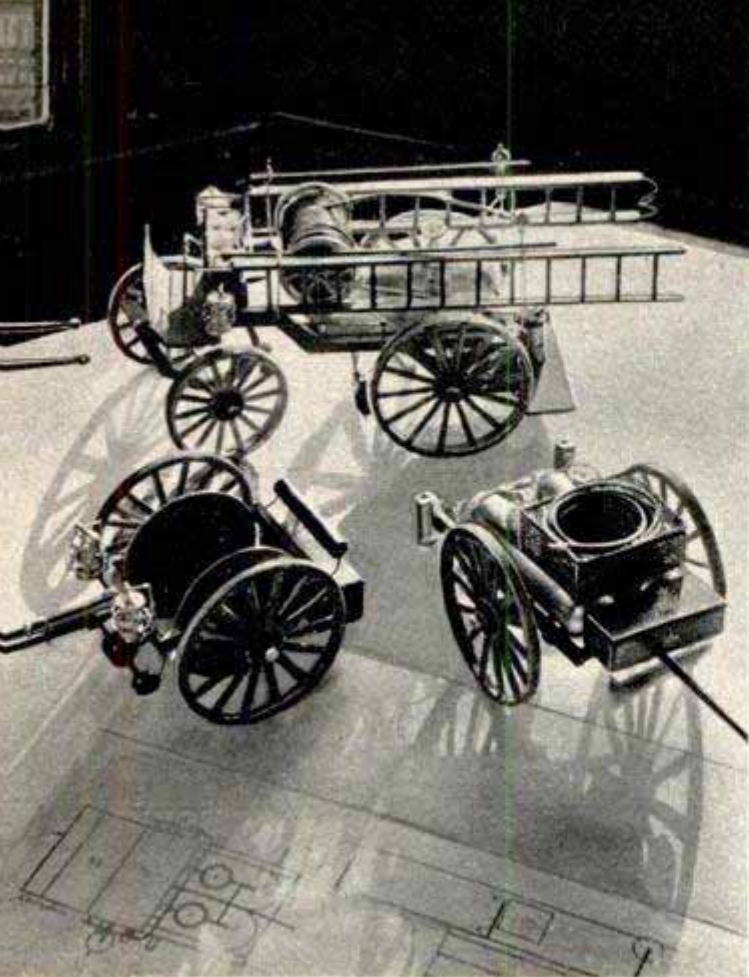

In foreground are the two earliest models in Low's collection, early 19th century chemical engine at left; hose-reel truck, right. At rear, combination



The Lows—Sr. and Jr.—are handling a light city service ladder apparatus which won a silver star award back in 1895. Low's study is full of exhibits

A busy corner of the basement workshop where Low and his crew (one is missing) turn out thousands of fire-engine kits. Firemen are favored customers

Below, Low at work on the prototype of a new engine which will be carefully analyzed for breakdown into 75 or 100 parts which must be easy to assemble

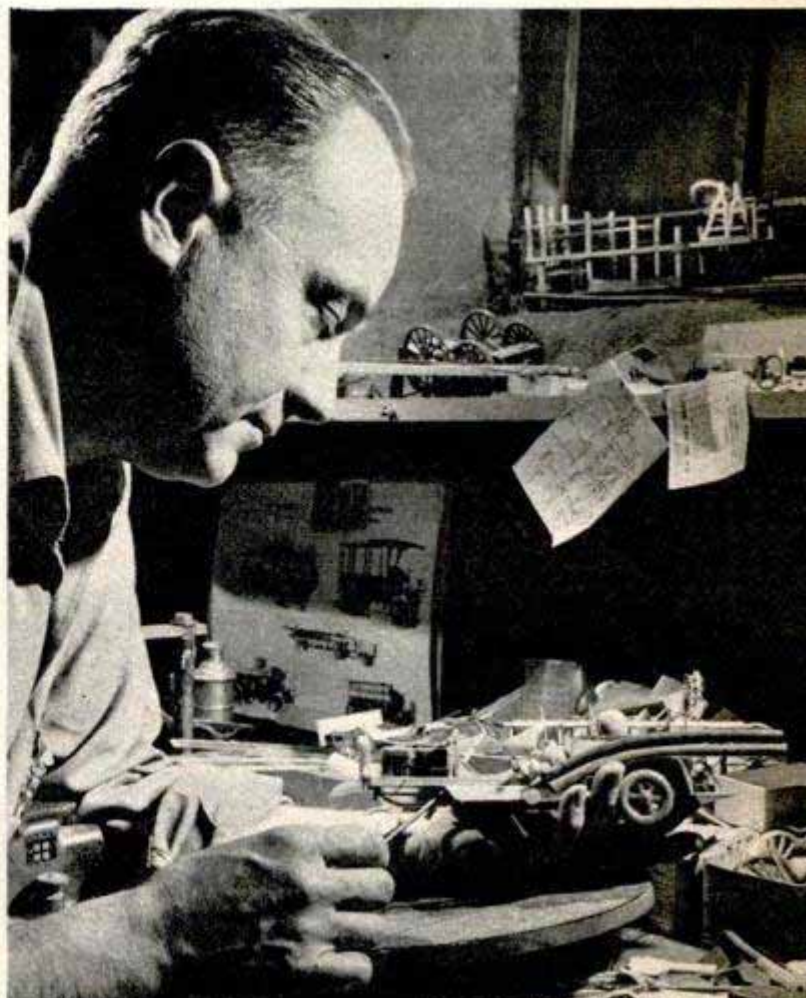



## TV Floor Chair

Television spectators who like to lounge on the floor in front of the set now can lean comfortably against a padded backrest. The collapsible seat, similar in style to a familiar type of lawn chair, has a long pad which extends out across the floor. The

pad not only provides a cushion for the viewer, but also prevents the backrest from scooting across the floor when he leans against it. Adjustable to three positions, the backrest places some viewers low enough so that they don't interfere with the view of others who are seated on conventional chairs.

## Age of Sturgeon Is Told by Counting of Rings in Chest Fins

Fishermen have been hauling in giant white sturgeon for years, but until recently there has been little knowledge about the life span of this largest fresh-water fish of North America. Fish experts at Bonneville Dam on the Columbia River have discovered that the chest fins of sturgeons grow like trees, in cycles that are marked by rings. The age of the fish can be determined, the experts believe, by counting these rings. They are seeking further evidence to support their theory. One 10-footer recently examined was estimated to be between 46 and 50 years old. The record sturgeon catch is a 12½-foot 1285-pounder caught near Vancouver, Wash., in 1912.



Cross section of this fin shows sturgeon to be about 16 years old. Just count the rings

Fish was caught by R. B. Laroy, Kalama, Wash., in channel drift. It weighed 90 pounds



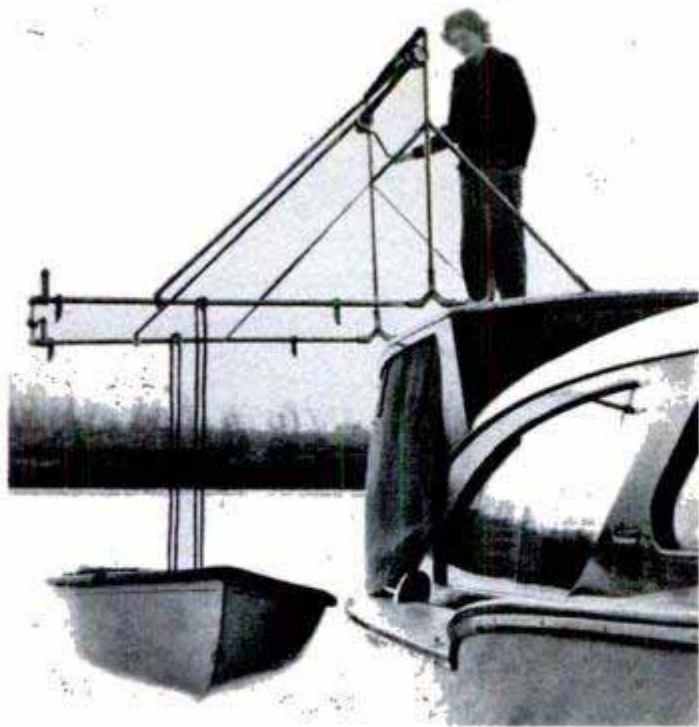

## Dinghy Hoist

So simple a child can operate it, a new hoist raises or lowers a dinghy in 60 seconds. All the work is done by a crank and self-locking worm gear. The dinghy is raised straight up from the water, tipped automatically to a vertical position and



then swung down on the cabin top where it locks in place. Stowed upside down, the dinghy does not have to be covered for protection against the weather. Another version of the hoist is designed for storing the dinghy on the transom.

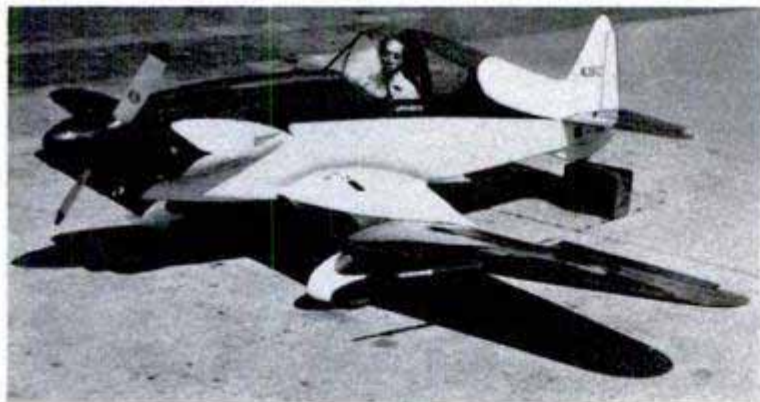

## Wheels on Wing

Both the weight and drag of a midget racer built by Neal Loving of Detroit are reduced by attaching the wheels directly to its gull wing. The need for struts is eliminated. It also has a steerable tail wheel, faired in by spring-loaded flaps that open when the wheel is turned. The trim craft has a 20-foot wingspan and is 17 feet 7 inches long.

## Plastic Shield Diffuses Flash

Quickly slipped over the entire reflector assembly, a plastic shield for flashbulbs protects the subject from flying glass should a bulb explode on a close-up shot. One side of the shield is clear plastic. The other side has a dull finish which diffuses the light, providing softer tones for flash portraits.

Information not listed on articles in the index, starting on page 14, frequently is listed in the WHERE-TO-FIND-IT LIST, which is available to readers without charge from Bureau of Information, Popular Mechanics, 200 E. Ontario St., Chicago 11

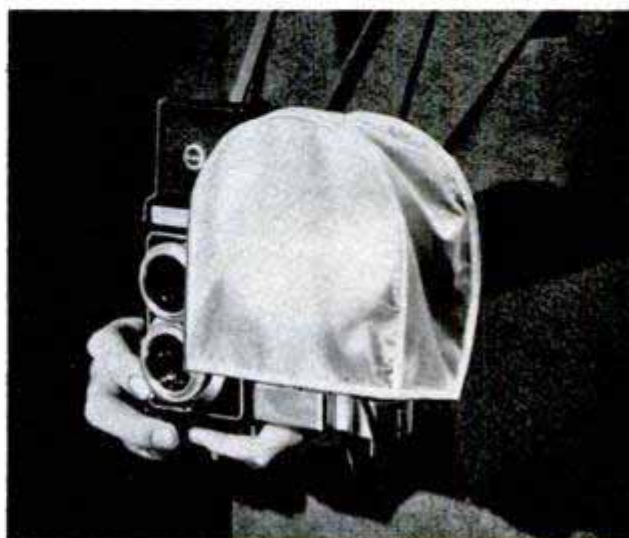

# WHAT'S NEW *For Your Home*



**SNAP-IN WASHER** for faucets is made of Monel metal and will last indefinitely

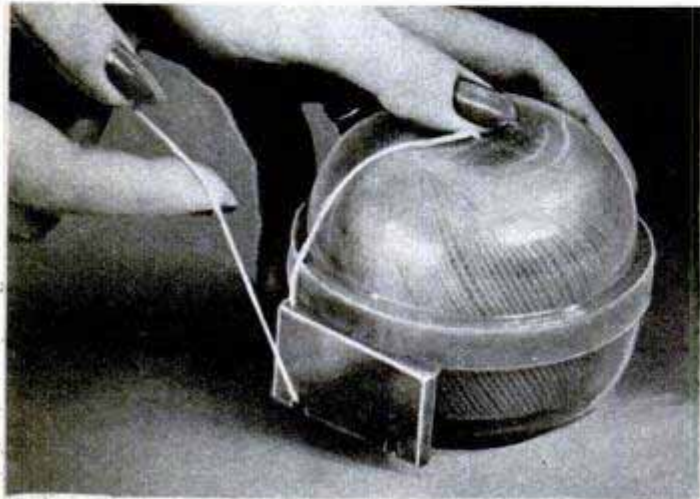

**CORD CAGE** made of plastic dispenses twine neatly, has a built-in cutting edge



↑ **WASHERS** by the inch: ropelike, semimetallic material can be shaped into a self-lubricating washer to fit any opening

↓ **STRETCHER** for curtains has no pins, holds fabric by metal rods inside the two hems

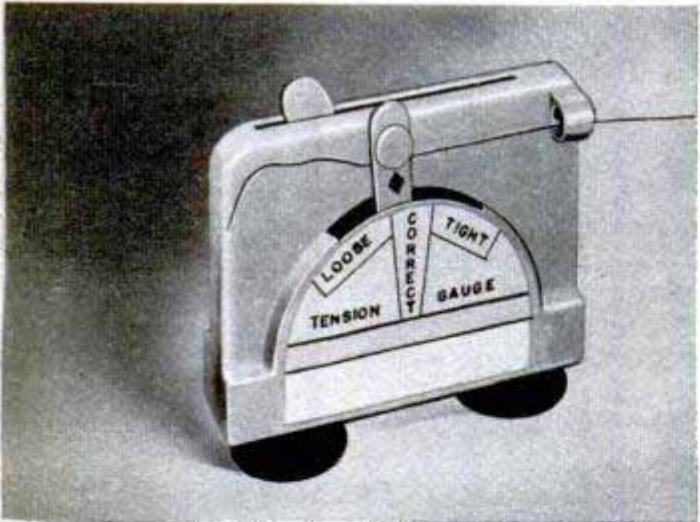

**TENSION TESTER** tells whether the thread tension on a sewing machine is correct

**HANDLE HOLDER** traps mops and brooms by their own weight in a rubber grip







**ELECTRIC OVEN** can be mounted near eye level anywhere in the kitchen for convenience, need not be attached to the range

**RUBBER MOLDING** shapes itself around straight or curved walls and cabinets. It is held in place by rubber or linoleum cement



DECEMBER 1950



**ALL-PURPOSE** piece of furniture for Junior has three main parts which snap together in various combinations to form a high chair, stroller, desk and chair or car seat



143



### Balance Bar for Stepladder

Designed for attachment to a stepladder, a handy balance bar keeps the ladder from toppling over. Holding onto the bar, the housewife can reach out and work in a wide circle without upsetting the ladder. The bar is fastened to the top platform by an oversize C-clamp.

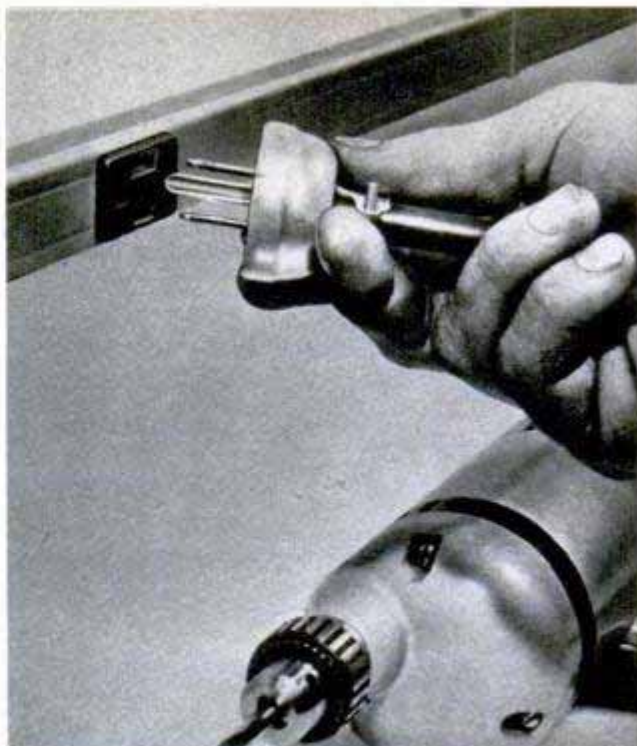

### Electric Channel Installed in Strips

Electric receptacles, grounded for safety, can be installed in strips. The six-foot channels can be joined to make a strip as long as desired, with outlets at 6 or 18-inch intervals. In addition to the two conventional slots in each outlet, there is a third slot containing a copper insert connected to the steel base. When the base is grounded to the earth, each receptacle is grounded. Thus either the conventional two-prong plug or three-prong plug for grounded equipment can be used.



### "Piano Roll" Operates Four Lathes Simultaneously

Inexperienced persons can turn out precision work on as many as four lathes at a time with the help of an electronic robot that controls the machines' operations by means of a perforated "piano roll." The preparation of the roll is simple and takes only a few minutes. Blueprints are trans-

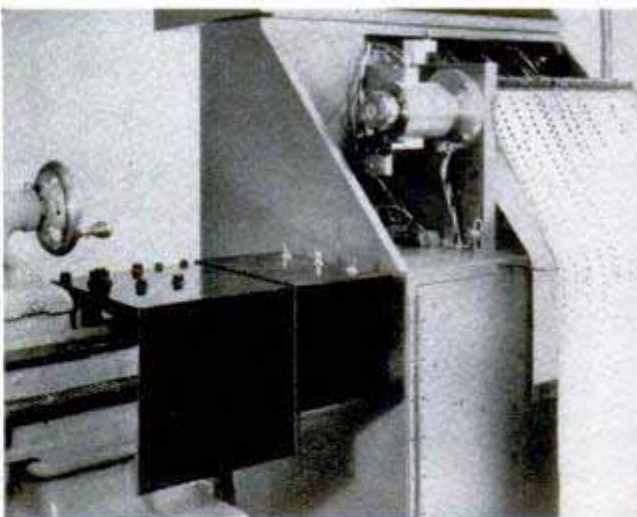

lated into holes in the paper which is fed through an electronic controller. Impulses then actuate the cutting tools. Productivity even with inexperienced operators is increased as much as seven times by the rolls, which can be used over and over, producing uniform work each time.

# PIPES

## by Old Masters

*By Michael Day*

**I**N A WORKSHOP above a unique pipe shop in Washington, D. C., the atmosphere hummed with strangely assorted activity. Over near the door one man sat at a workbench whittling a queer-shaped object from a battered tenpin that had seen too many days at the far end of a bowling alley. Close by, the guide wheel on a cutting machine thumped over the contours of a bulbous iron casting, which bore as much resemblance to a pipe as a lump of clay. Yet, on the other end of the machine, a singing saw blade, guided by the curves of that iron model, bit into a piece of seasoned brier and precisely turned out the delicately rounded bowl of a pipe.

At drying racks, men picked over an assortment of Algerian brier blocks which gave the room a spicy oriental aroma. From the finishing room came the whirr of sanding and polishing machines, and the roar of big blowers sucking pungent particles of brier dust from the air.

Out of all this confusion in Sid Bertram's little pipe factory pours a steady assortment of natural brier pipes to join the famous collections that line the cases, like works of art in a museum, in the shop below. Here are \$200 to \$1000 meerschaums whose bowls have been carved into heads, skulls or hands by master craftsmen using needle-sharp tools and magnifying glasses to achieve the ultimate in intricate detail. There are briars carved in relief and full round, varying in size from the three-foot



This three-foot French-carved brier is the biggest pipe in Bertram's collection. It was made from a single root. Below, fine Rothenfeld meerschaums

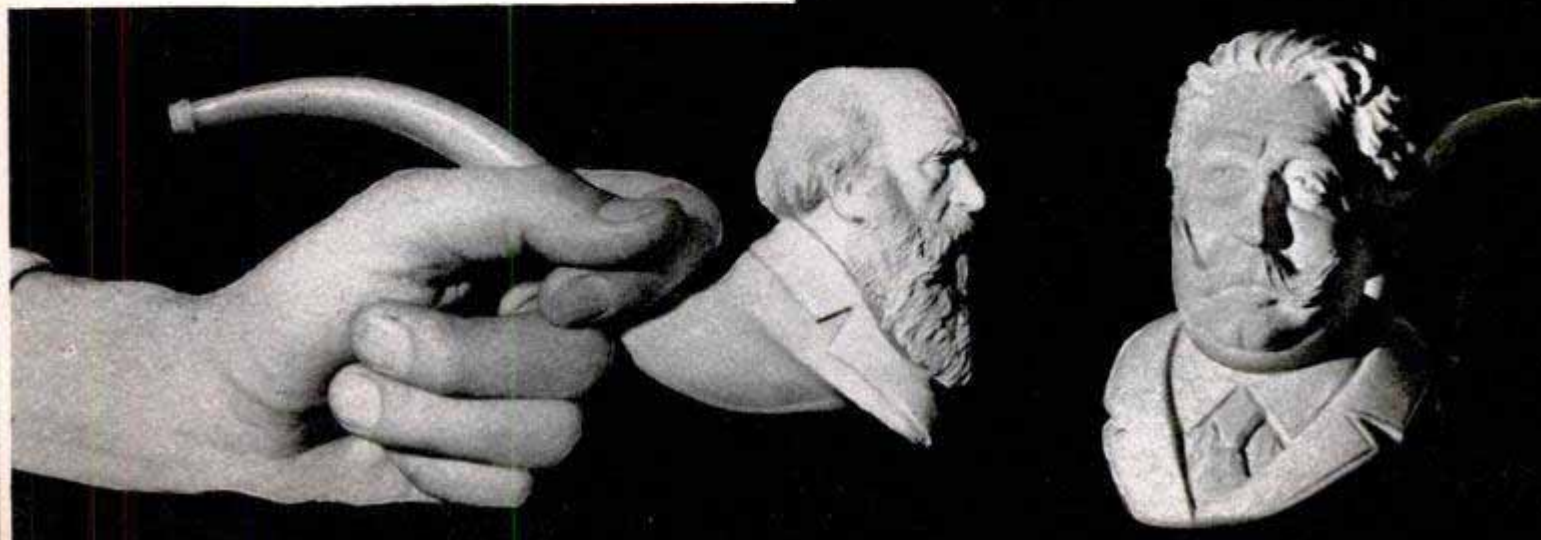



Algerian brier root looks like this as it comes from the ground. It makes the best pipes. Below, carving tough brier block begins with coping saw

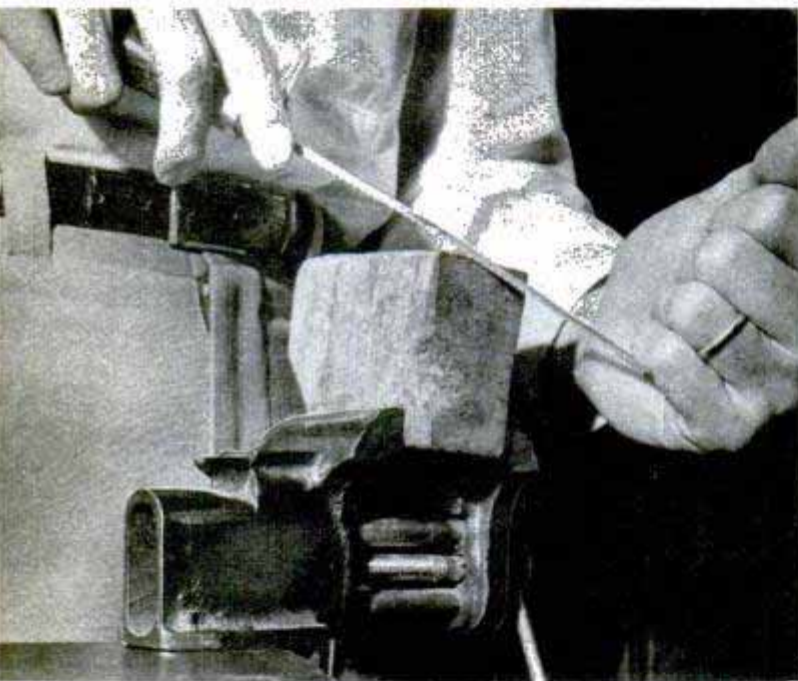

Below, iron model guides saw blade (under hood) and out comes a perfect pipe bowl. Right, outside top of bowl and well of the pipe are drilled from the brier block by a whirling three-pronged blade

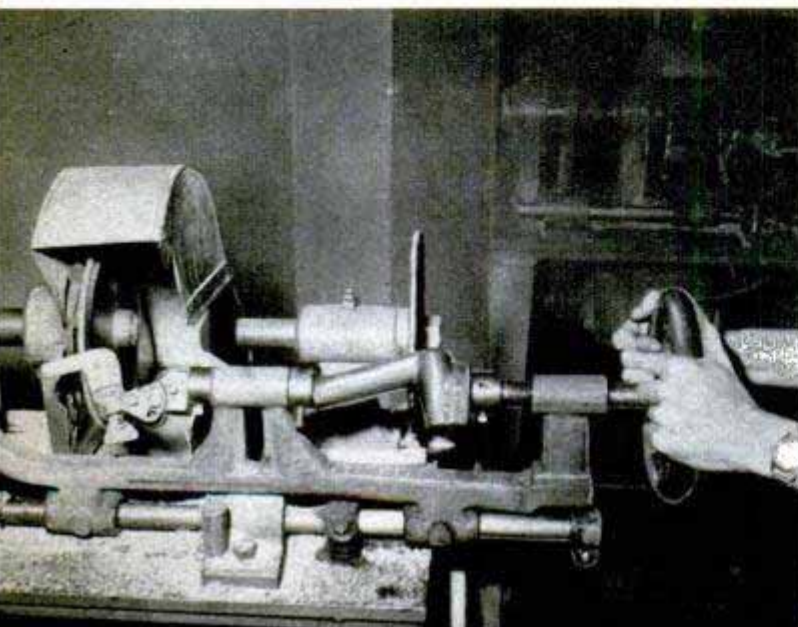

monster sculptured from a whole root, to three-inch miniatures for ladies. There are pipes with long stems and short, curved or straight, big pipes and little, with fat bowls or thin, whose unvarnished sides gleam with the luster of old pine paneling.

Like many old-school master pipemakers, Bertram does not believe in coating his pipes with any kind of paint, stain or varnish. "After smoking a natural brier for a short time," he says, "you will notice the pipe 'sweating.' This is the result of natural brier in action, absorbing heat and moisture from the burning tobacco inside the bowl, and allowing it to seep through the pores to the outside and evaporate."

This, according to natural brier fans, means that the pipe is "breathing," sopping up nicotine and tars, removing the bite and bitterness and keeping the smoke cool. Smokers who don't care for the burnished tan color of a new natural brier have only to wait a little while. Eventually the juices seeping through open brier pores will color the pipe to a dark cherry mahogany.

"Until the last war," Bertram explains, "brier pipemaking was a secret craft. Methods of curing the wood and turning bowls were family secrets."

Bertram himself is the third in a line of family pipemakers who still harbor a special technique for curing the rare wood. Grandfather Bertram brought the system over from Leipzig in 1870. Today, the final stages of that curing process are still secret.

The best pipes are made from the root of Algerian brier—a scrawny, two-foot shrub with a fat, knobby, reddish underpinning or burl. Brier was first used in the middle 1800s when a Frenchman, visiting

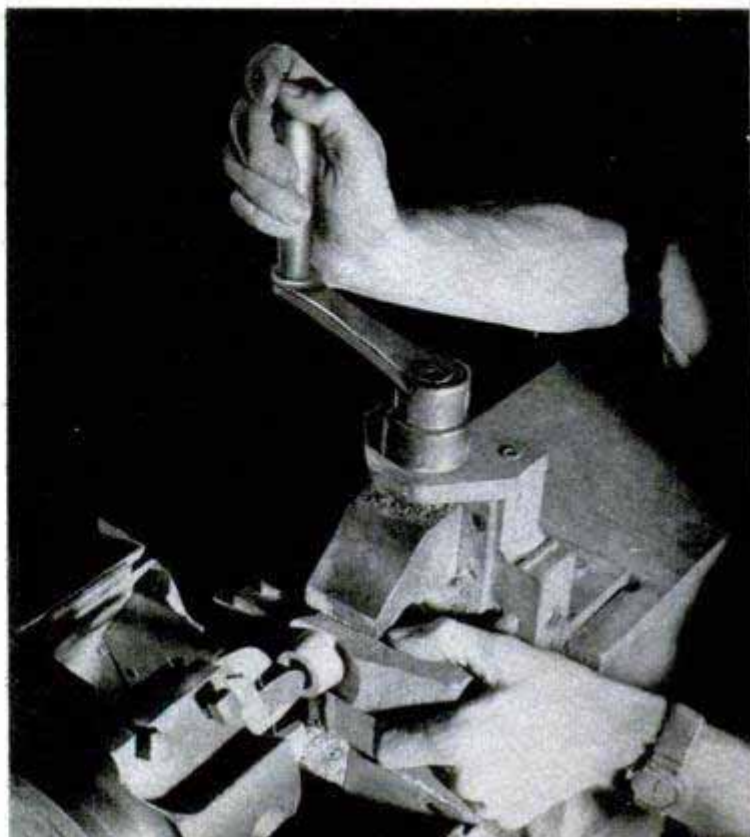

Napoleon's birthplace on a holiday, accidentally broke his only pipe—a meerschaum. He quickly carved a makeshift bowl from a handy native bruyere root, stuck the amber stem from his shattered meerschaum in it, and then discovered that he had something.

For years, pipemakers had been looking for a material that would smoke "cool." Pipes of the day were of clay, meerschaum, porcelain and hardwoods that cracked under heat.

So, when the Frenchman's bruyere turned out porous as a sponge, but tough as oak, the brier pipe was born. Pipe craftsmen grabbed at it, and developed their curing secrets.

Today, laborers in Algeria and Corsica, where the best bruyere comes from, dig the root and perform initial curing—a long process taking years. First the sap is boiled out in huge kettles. Then the burl is buried in wet sand for months, where it seasons evenly without checking. Finally, the root is removed and cut into blocks that are racked in a dry place for more months.

Cutting brier root is an art almost as delicate as diamond cutting. The burl cutter sights and tests the grain of the root, then carefully cleaves it. "The king of pipes," any expert will tell you, "is the one with beautiful straight grain running up and down the bowl." Degree of grain perfection, and quality of the burl (whether or not it is pitted or marred) are what determine whether a pipe is worth \$2.00 or \$25.00.

The cut, semicured blocks arrive at the pipemakers in big burlap sacks, and after further curing by special formula, they are ready for the magic that will turn them

into pipes. Most of them will never make it.

"We never know," says Galen Martz, Bertram's foreman, "what we'll find inside those blocks. They may look good outside, and be pitted like wormy apples once we start turning them."

The process begins with a pattern—and that's where the tenpins come in. Unlike most modern industries, pipemaking can't be handled entirely by machines and mathematics. Pipe shapes are too varied and awkward. Models over which the guide wheels of the saws must run to produce proper contours in a pipe bowl must first

Special drill press (below left) cuts hole in stem into which mouthpiece will be fitted. Contours of the bowl are perfected (bottom right) by holding the pipe against spinning emery wheel. Final touch is buffing the natural brier which is never varnished

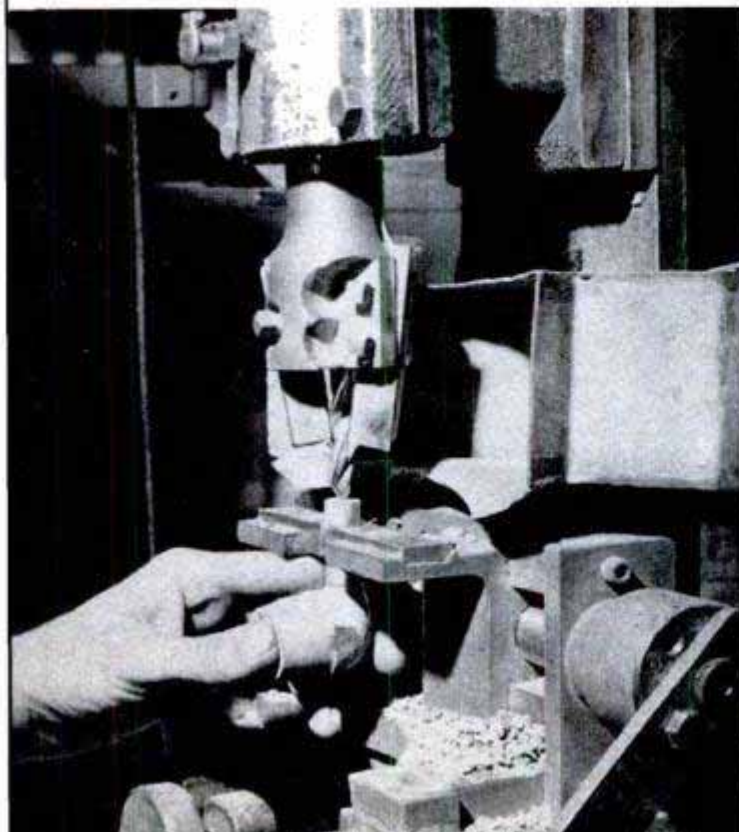
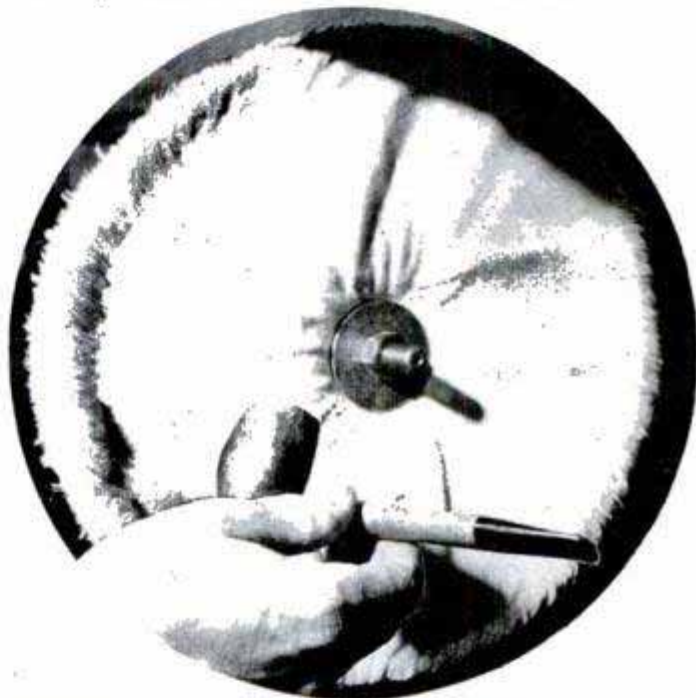



Carved meerschaum, aristocrat of pipes, is worth over \$200. Blocks in front of the hand are examples of sea rock amber used in stems

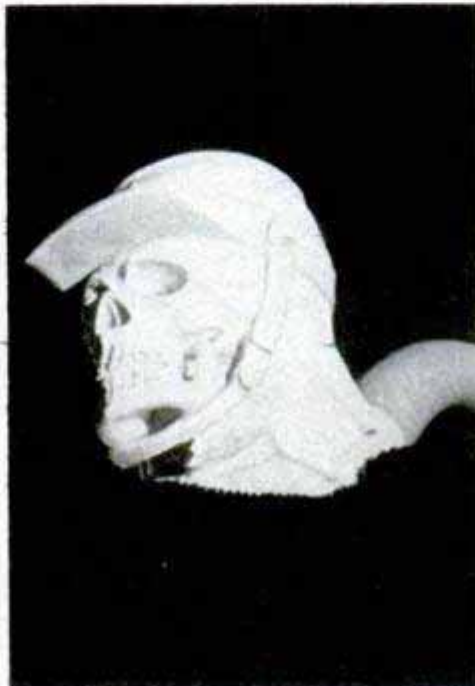

Left, special tool for punching V-shaped eyes in carved pipes was made by Ernest Mehaffey, Bertram craftsman, from a stainless-steel tube sliced off at the end. Right, meerschaum Foreign Legion skull pipe. Below, carving of a full head like this one of Franz Liszt takes 25 hours of labor. Tool is end of file with a needle point

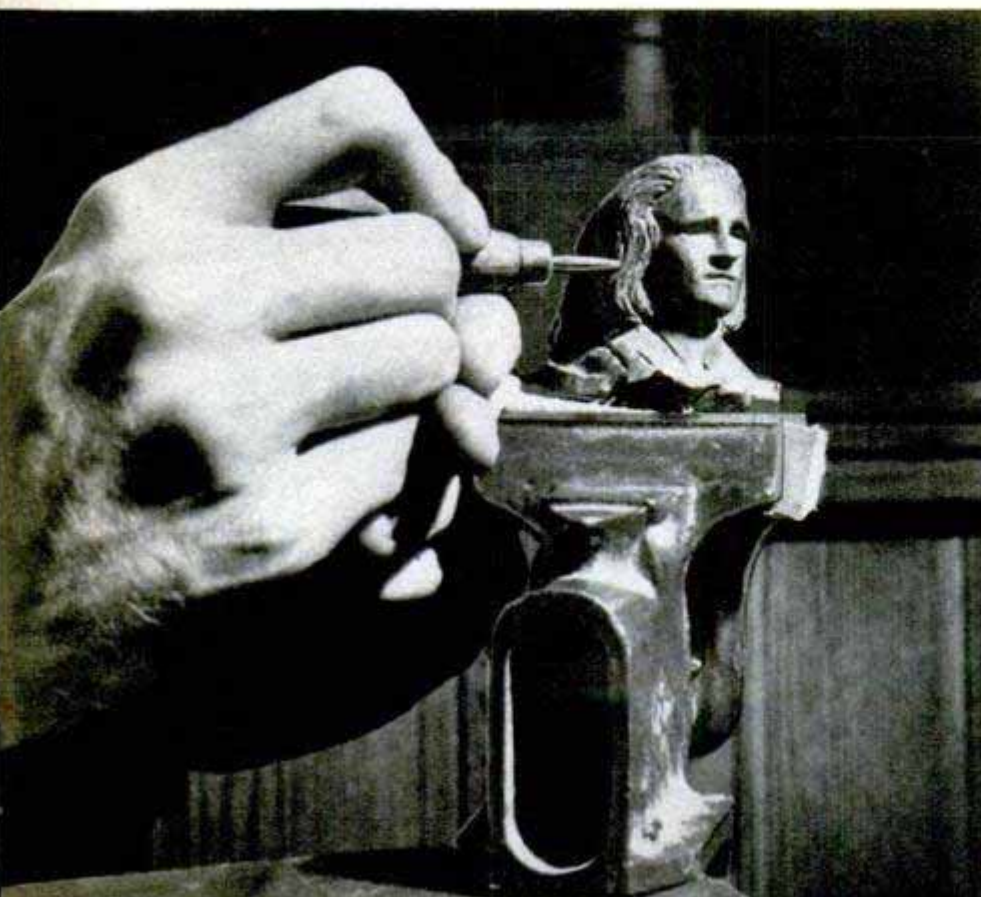

be handcarved in wood. "Tenpins," says Martz, "are good close-grained maple, so we buy up old ones from local bowling alleys."

The guide models are painstakingly whittled from the tenpins and tested, until they produce just the shape pipe desired. Since the scale and contours are exaggerated, the models look unlike any pipe bowl known to man. They are wide and squatty, but when the contours are transmitted to the saw, proportions on the brier block will be perfect. Finally, the model is cast in iron, which is finished off by hand and used on specially designed duplicating saws, which will turn out as many replicas of the bowl as desired. One whirling machine with a knifelike bit resembling Neptune's three-pronged fork, turns out the top of the bowl and bores the well. Another rounds off the base. A specially adapted drill press runs the hole into the stem, which will be fitted with a rubber or amber mouthpiece.

The rest is a hand process. Expert craftsmen sit at whirling emery wheels, turning the pipes until they are smooth as glass. Many of the pipes, though good, will have what the men call "pinholes"—tiny pocks uncovered by the grinding. These were caused by bugs gnawing at the brier root when it was growing back in Algeria. They must be filled and burnished by hand. In a natural brier, such filling shows and no attempt is made to hide it. Finally, the natural wood is buffed to a soft glow.

Despite the tremendous amount of handwork, good pipe craftsmen can turn out an amazing number of finished products. During the war, Bertram's factory employed as many as 21 pipemakers who ground out more than 3500 pipes a week.

Though no handcarving is officially produced at Bertram's, one of the young veteran craftsmen, Ernest "Bud"

(Continued to page 236)

# Human-Fly WHIRLIGIG

LITERALLY stuck to the wall are patrons of a new amusement-park ride in Frankfurt, Germany. Fun-seekers climb into a giant drum, about 15 feet in diameter, which is open at the top. The drum begins to revolve, building up speed. When whirling at top speed the floor drops away, leaving the patrons stuck against the wall with a centrifugal force double their own weight. Tables, chairs, clothing or anything else can be suspended against the wall. Above the drum the amusement park has constructed several tiers of balconies from which the spectators can watch the fun. The antics of the riders are plainly visible because at top speed the drum rotates only 15 miles an hour. About 30 persons can climb into the drum and be "glued" to the wall at the same time, frozen into any position they may choose.



Above, spectators line the tiers of balconies to watch the strange behavior of those "glued" to the wall of the spinning drum. Onlookers have almost as much fun as those inside the whirligig. Below, left, patrons are frozen against the wall by centrifugal force. Right, chairs, tables and clothing stick to wall without support





## Radar Measures Rainfall Over 200-Mile Area

Weathermen are now watching rainstorms come and go over a 200-mile area by radar. The radar beam scans the area 24 hours a day to present a continuous picture of weather conditions. A movie camera photographs the radar scope as it operates. Single-frame time exposures are made, one for each 360-degree sweep of the beam. This film provides a condensed record of

the weather, more accurate than 54 rain gauges could provide. By varying the intensity of the radar waves, the meteorologists can measure the amount of rain that is falling in any area. By watching the movement of storms on the radar scope, they can predict local weather conditions. The radar rain gauge is operated by Illinois State Water Survey meteorologists.

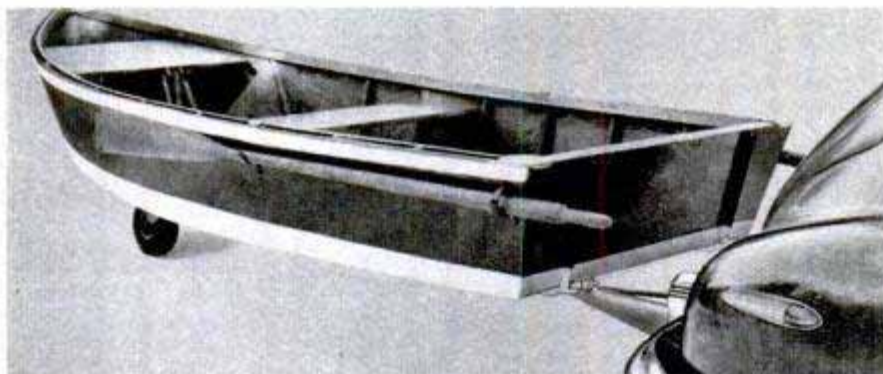

## Rowboat With Wheel Is Its Own Trailer

Serving as its own trailer, a plywood rowboat has a bow wheel that retracts into a metal well when the boat is launched. A two-point trailer hitch that comes with the boat eliminates sway at high speeds and prevents jackknifing when the car is backed down to the water. One person can handle the boat on land, picking up the stern and pushing in the manner one would push a wheelbarrow.

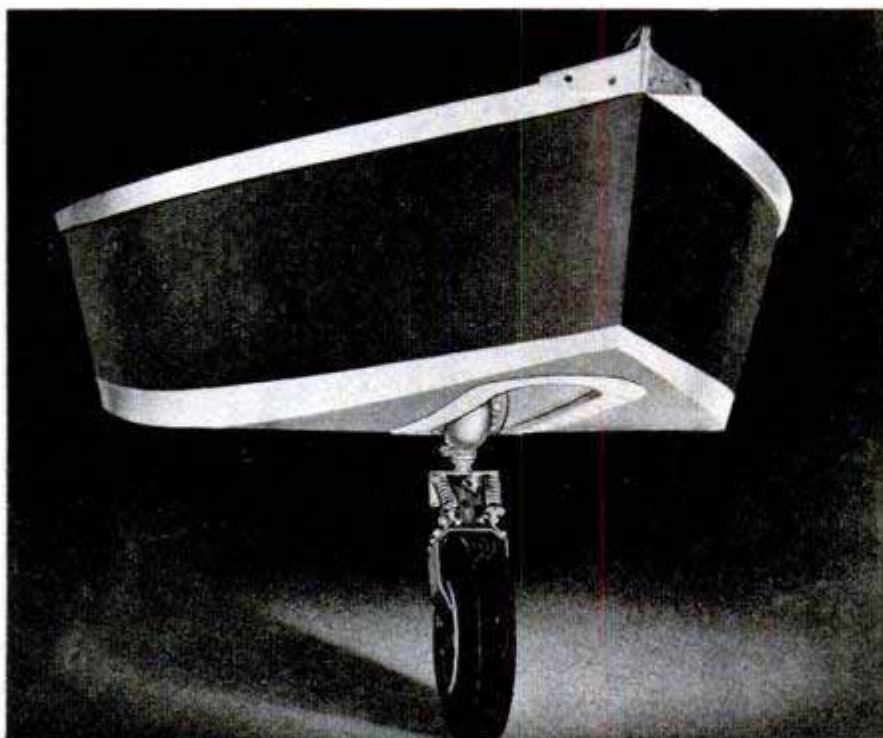

## Paper-Pulp Waste Makes Rubber

Raw materials for synthetic rubber can be obtained from a waste product in the manufacture of paper from spruce wood. The chemical is called PADMS, short for para alpha dimethyl styrene. Early tests seem to indicate that synthetic tires made with this new styrene might be superior to those now manufactured.



# Twelve-Hour CONCRETE HOUSE

IN 12 WORKING HOURS a new concrete house can be "blown" into existence. Even the roof is built by blowing concrete against a ready-made form. Wall forms are erected first. Steel mesh and bars for reinforcing the concrete are tied to the forms, and steel window frames and electrical outlets are installed. When all is ready, workmen standing inside the house spray the forms with concrete from pneumatic hoses. The wall is built up to a thickness of four inches, and when it has hardened the forms are removed, leaving the cast shell of the house. The metal forms are specially treated so the concrete will not adhere to them as it hardens. Similar forms are then set up to build the roof, which also is made of sprayed concrete. When the roof hardens these forms are removed to complete the exterior of the home. The smooth, interior dome ceiling is 11 feet 9 inches high from the floor to the peak. A two-bedroom home of this type with an area of 816 square feet can be built for less than \$4000. Because of its concrete and steel construction the home is vermin and termite proof and will withstand severe earth shock, a factor to be considered in California where the construction method was developed. As a finishing treatment, the home is given a coat of waterproof paint. No dressing is needed because the walls are cast against the smooth metal forms. Several different types of homes are built by joining the forms in various combinations.

Top, workmen tie reinforcing mesh and steel bars to the ready-made metal forms. Window frames and electrical outlets also are installed before any concrete is applied. Center, concrete is blown against the wall form with pneumatic hoses. Right, after concrete hardens the forms are removed. Below, finished home, built in 12 working hours for \$4000, has five rooms

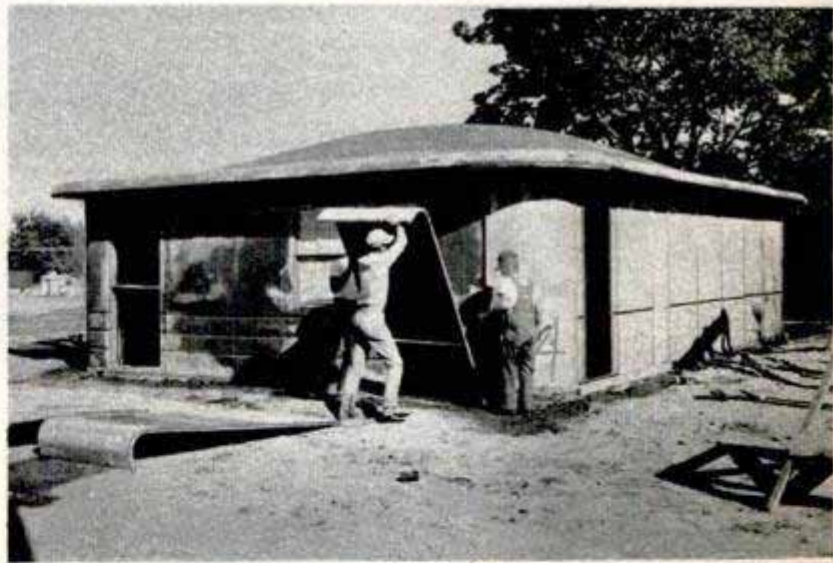

# BIRDS IN BRACELETS



Banded towhee is free to depart, yet fails to realize it. Small birds on their backs frequently won't attempt to fly



Pelicans wear bracelets at St. Petersburg, Fla. Bands permit a study of the life history of the birds. Above is a special type of band used by a Canadian bird hobbyist. Thousands of birds that have been banded scatter as missionaries

By **Hugo H. Schroder**

**T**HE 12-YEAR-OLD BOY had just shot down a marsh hawk. Elated at his marksmanship, he ran over to retrieve the fallen bird. One look showed him that the hawk had an odd-looking bracelet around one of its legs. The discovery frightened the boy, for he believed he had shot down a very special bird. He promptly buried the hawk, and a long time passed before he told what he had done and thereby learned the secret of the banded bird.

The bracelet had been clamped around the hawk's leg by one of the many wildlife students scattered across the country, who consider the study of bird movements a fascinating hobby. These men, in cooperation with the U. S. Fish & Wildlife Service, have come up with virtually the only substantiated facts on bird migrations, nesting habits, flight times and age.

Here's a bird-bander's kit. It includes bands of different types and the tools for installation



Bird banders fasten to the bird's leg a light metal bracelet which contains a number. The Fish & Wildlife Service provides the bands and keeps the records. When he has released a bird, the bander sends the number, kind of bird, point of release and date to the service. Years later the bird may turn up thousands of miles away, but if the number corresponds, the service knows it is the same bird.

Of the more than 5,000,000 bands installed up to 1945, there have been more than 300,000 returns.

The records have turned up some interesting facts. For example, all migration is not on a north and south axis. Certain kinds of birds fly in other directions. Some from northwestern regions wander far southeastward, while others move from west to east.

One unusual winter flight was discovered by Lockhart Gaddy, whose wild goose refuge in Ansonville, N.C., harbors thousands of Canada geese each winter. Gaddy bands some of the birds that spend the cold months in his refuge. Two were shot down in southern Illinois just four days after he banded them. This proved that the geese moved westward when they were supposed to be settled for the winter, and they covered more than 500 miles in four days.

A brown pelican banded in California was reported 1400 miles north of its point of release. A blue-winged teal was banded in Quebec and eventually was shot down in British Guiana.

A mourning dove from Missouri was brought down by a hunter in Guatemala two years after it was banded. Laughing gulls from Virginia eventually scattered

and were recovered in Colombia, Guatemala and the Canal Zone.

Banding has also proved that birds occasionally fly the Atlantic—in both directions. A ring-billed gull banded at Georgian Bay, Ontario, was killed at Horta, Azores. A black-headed gull released in Holland was taken the following year in Labrador.

For a long-distance flight there aren't many that can beat the record of a Swainson's hawk. A bracelet was clamped on its leg and the bird was released in Saskatchewan. A year later it came fluttering down at the feet of a hunter in the Province of Cordoba, Argentina.

Until recently one of the unsolved mysteries of migration was the location of the winter home of chimney swifts. Thanks to banding, it has been discovered that many swifts spend their winters in Peru.

Band is installed on leg of a gently held cardinal. Note the special pliers for closing bands of different sizes





Doors on this trap snap shut when bird steps on a treadle. It has two compartments for snaring birds

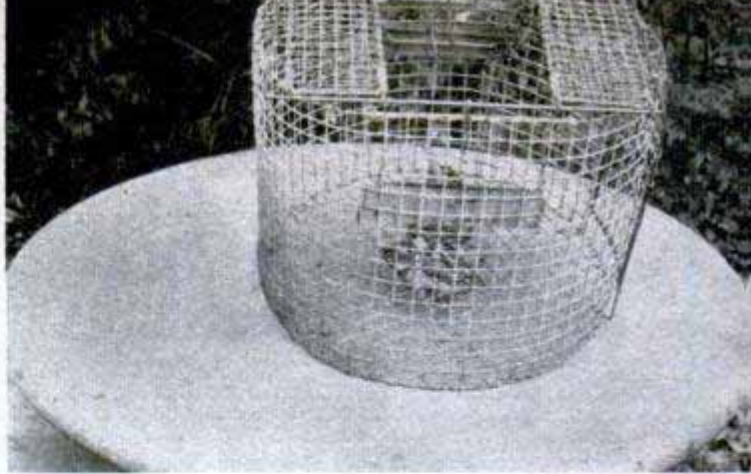

Bird is completely surrounded by netting in a circular trap, which even closes a drawstring at top

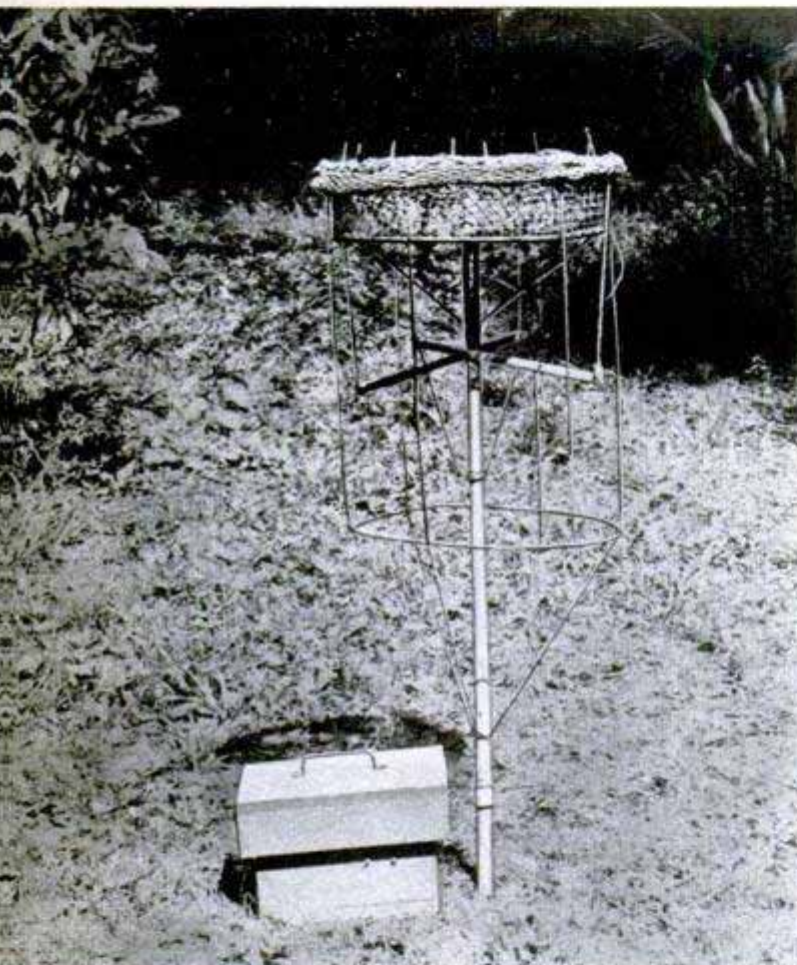

Ingenious trap developed in Florida is electrically tripped by bander when bird steps on bait platform

Automatic trap has a baited pan in the center. When the bird steps on the pan, the spring is triggered

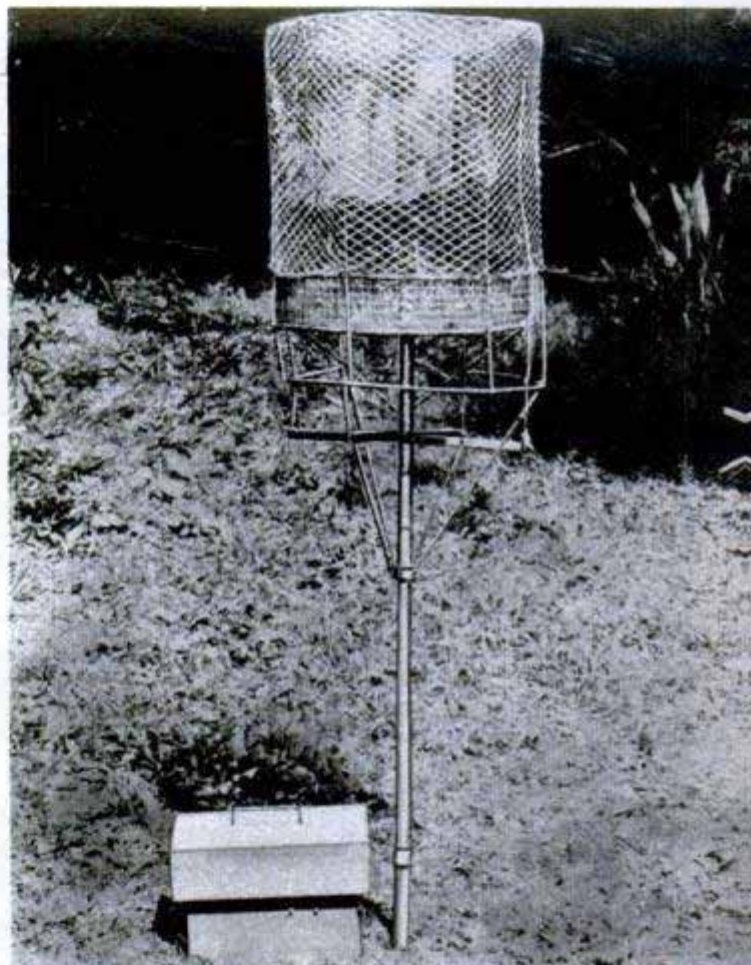

Same trap as the one at left, now closed around bird. Cloth netting covers the quick-operating wire frame

Trap at left in the shut position. Many traps are developed by banders themselves during their work

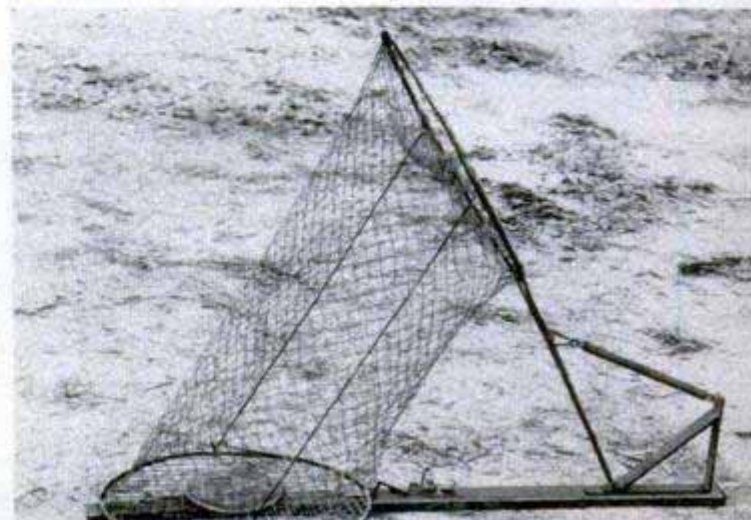

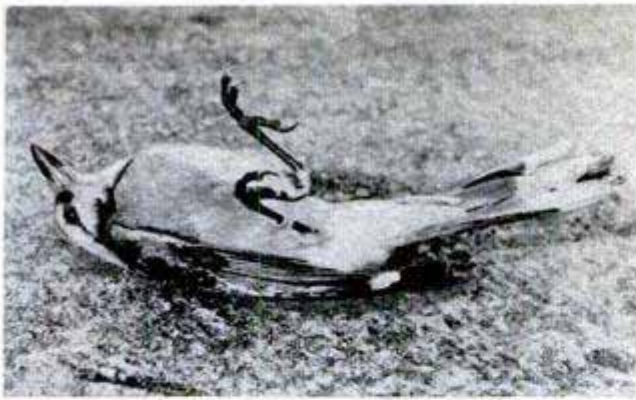

Dead? No, bird on its back is virtually hypnotized, still believing it is held captive and that it can't fly

Then of course there's the bird that finds a home and likes it well enough to return. A Harris sparrow banded in Iowa returned to the same area every year except one until 1933. A chimney swift given a bracelet at Quincy, Ill., was found at the same place 11 years later.

Until bird students began banding their feathered companions, they could only speculate on the life expectancy of a particular species. Now numerous records of longevity are available. An osprey, banded as a nestling, was found dead at its point of release 21 years later. In 1920 a Louisiana heron was fitted with a bracelet. In 1934 it was captured and released again.

The bands also give some indication of the odds in favor of a bird living through the hunting season without being peppered by lead. One banded mallard was lucky—it returned to the same nest box from 1927 through 1933. For seven years it managed to escape the hunters' guns.

One summer a large number of ducks was banded at the Bear River Refuge in Utah. Eventually, they produced returns from almost every state west of the Mississippi, 13 of them turned up in Mexico and nine were brought down in Canada.

Typical of the hobbyists who enjoy studying bird movements is a former Canadian banker who retired and spends his winters in Florida. Deciding to band bald eagles, he devised a rope ladder for ascending to the lofty aerie instead of using the conventional spurs for tree climbing. So far this one hobbyist has slipped bracelets over the legs of more than 1000 eagles.

In Canada, Jack Miner and his sons have converted birds into missionaries. They band thousands of wild geese which stop over at their refuge in Kingsville, Ont. The Miners use a special type band, quite different from the official United States bracelet. It is much larger and includes Miner's name and address, a control number for the bird, a direct quotation from the Scriptures and the Bible reference from which it was taken. Frequently, the geese turn

up at the Gaddy refuge in North Carolina. Occasionally geese are found with a band on each leg—the Miners' and the official United States version.

Many varieties of traps are used in capturing the birds for banding. Large cages snare geese and other wildfowl. Cage traps are placed over chimneys for capturing large numbers of swifts. Nest boxes have wood or metal covers which can be slid or dropped over the nest, thus making the nesting bird a temporary captive while he is banded.

The easiest trap to make is the drop trap—simply a box which is propped up with a stick to which a string is attached. When the bird approaches the bait under the box, the bird student pulls out the prop.

There also are a good many traps of the automatic type in which the bird himself touches off the trigger by stepping on a treadle. Other types include water drip traps, traps fastened to trees to capture woodpeckers, and traps which are placed along the water's edge to snare shore birds.

Birds are not always easy to remove from the traps, so some traps have a receiving cage of smaller size which confines the bird while the bander gets a firm hold that can do no harm. Many of the traps, though, are small enough so the operator can seize the bird by cornering it.

(Continued to page 254)

White ibis, about to be released, sports a new piece of jewelry. Band must be snug fit so it won't snag





Helicopter hovers over Sardinian mountain, spraying every possible mosquito breeding place with deadly DDT

## Man Recaptures Sardinia From Mosquitoes

HELICOPTERS spraying DDT have ended Sardinia's 3000-year reputation as a malaria pesthole and made it livable for a million immigrants from overcrowded Italy. The "battle" for the island was financed by Marshall Plan funds. Seven tenths of Sardinia is uninhabited mountains and the low-flying helicopters reached steep hillsides and rocky gorges that spray guns and airplanes have never been able to touch.

A protective film of DDT and oil laid over every possible mosquito-breeding inch of the island had to be renewed at seven-day intervals, since the insect can grow from egg to adult in 10 days. Thousands of Sardinians tramped the island with spray guns, covering even the mule prints on mountain roads. Now, with the mosquitoes gone, the government is reclaiming interior swamps and desert for the expected settlers.

Workers spray churches, homes, even mule prints on the road. Below, helicopter pauses for a reload of DDT

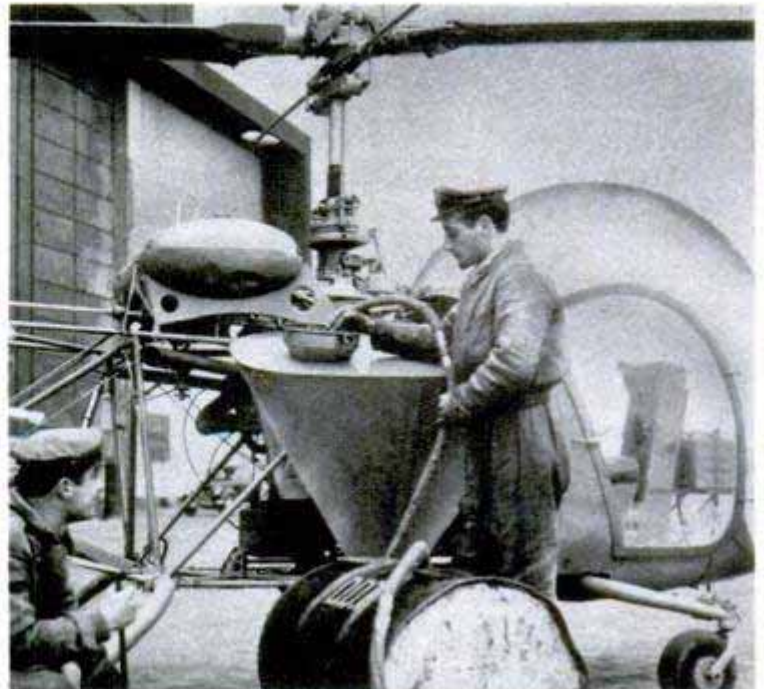

the

POPULAR  
MECHANICS

# CRAFTSMAN

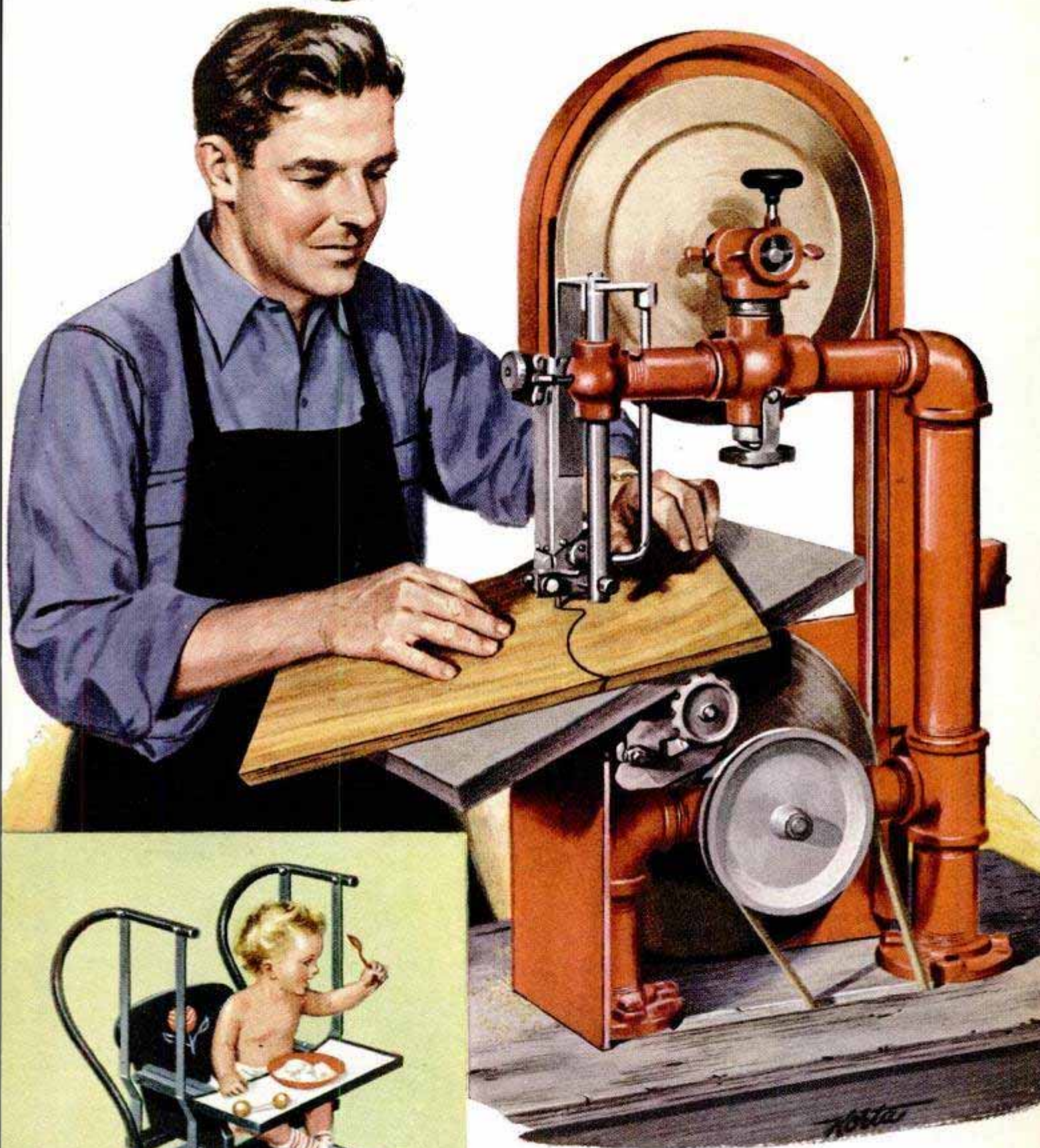

Need a bandsaw? This home-built one of pipe fittings and odd parts cuts both wood and metal. Part I on page 204 gets you started  
Baby swing, page 171, features glider action

# Keep it a

## INSURANCE AGAINST A TREE FIRE

excellent nontip base for a tree can be improvised from a 5-gal. paint pail as in Fig. 1. To permit the tree to absorb the maximum amount of water, it is best to cut the end of the trunk at a slant as in Fig. 2. Stones or bricks keep the trunk centered in the bottom of the pail, while a two-part wooden cover holds the tree vertically and keeps the water from evaporating.

In addition, there are several types of fire-resistant coatings that greatly retard the spread of flame when applied to the branches of a Christmas tree. One formula which produces a shiny, transparent coating consists of a mixture of sodium silicate (water glass), 9 parts by volume and water, 1 part. A soapless detergent is mixed with the water in the proportions of 1 teaspoonful per quart of water. Whether dipping or spraying the tree, it should be kept in mind that a heavy coating is necessary to insure maximum protection. For spraying, the coating may have to be thinned somewhat.

Faulty wiring in tree lights is an ever-present fire hazard, as the slightest spark may be sufficient to ignite a dry tree. So each year make it a practice to inspect your light sets carefully before placing them on the tree. Look especially for loose wires where they enter the sockets and any frayed wires between sockets, and then either buy new sets or make the necessary repairs to be sure they are safe. If your lights are of the type that do not have socket clips for attaching them to the tree, do not resort to the practice of twisting them around the branches as in Fig. 3. This soon results in the wire breaking, causing a short in the wiring. And as a common-sense precaution, do not leave the tree lights burning when no one is at home.

TO MOST of us, Christmas just isn't complete without an illuminated tree, but careless use often has brought a tragic end to this happiest of birthdays. Being filled with pitch and resin, a Christmas tree, especially one that has dried out, can become a roaring mass of flames in a matter of seconds.

Keeping the fire hazard low can be done by exercising a few simple precautions. When setting up an indoor tree be sure to stand it in water. Keeping moisture in the tree is, perhaps, the best insurance against fire. Not only does it retard drying out, but the moisture prevents the needles from falling, particularly in the case of a spruce tree. While the addition of 2 lbs. of ammonium sulphate to 1 qt. of water is sometimes recommended, the United States Department of Agriculture has found that plain water does just about as well. An

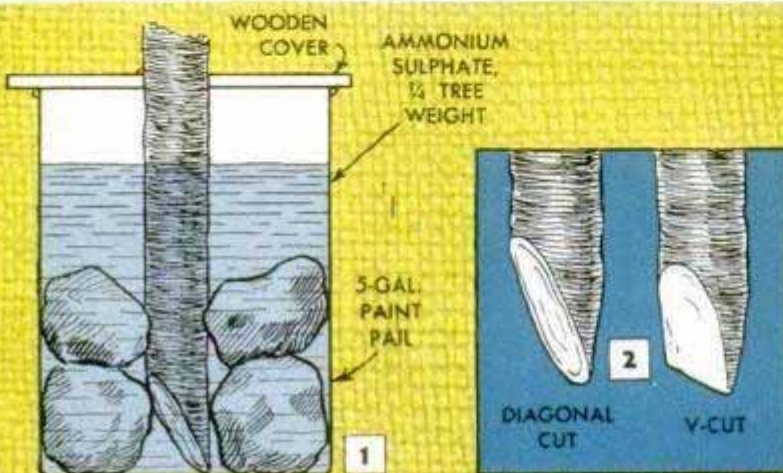



# Merry Christmas

MAKE YOUR OWN GREETING CARDS

By Paul Will



WHEN CHRISTMAS draws near, many take care of the greeting-card problem by simply going out and buying them. But the card that bears a really personal and sincere greeting is one that represents the handiwork of the sender. Today, most of the personalized cards are limited to the photographic type, largely because they can be mass-produced with a minimum of effort. While photo cards offer a variation from commercial cards, in most cases they lack color. However, there are several other types of greeting cards that can be duplicated in quantity, as well as color, on a production

# Silk-Screen Cards

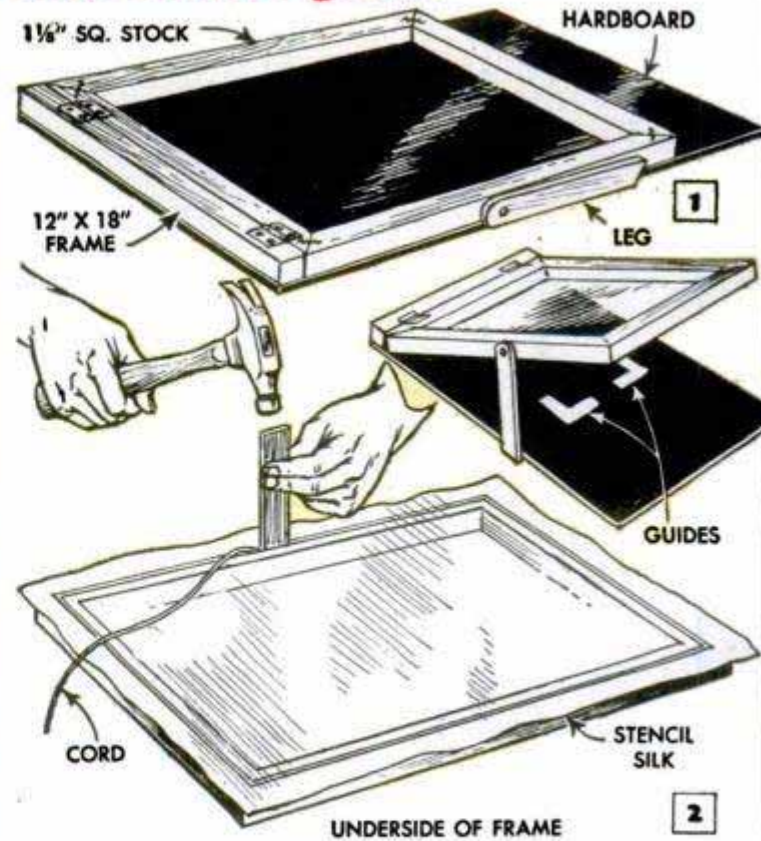
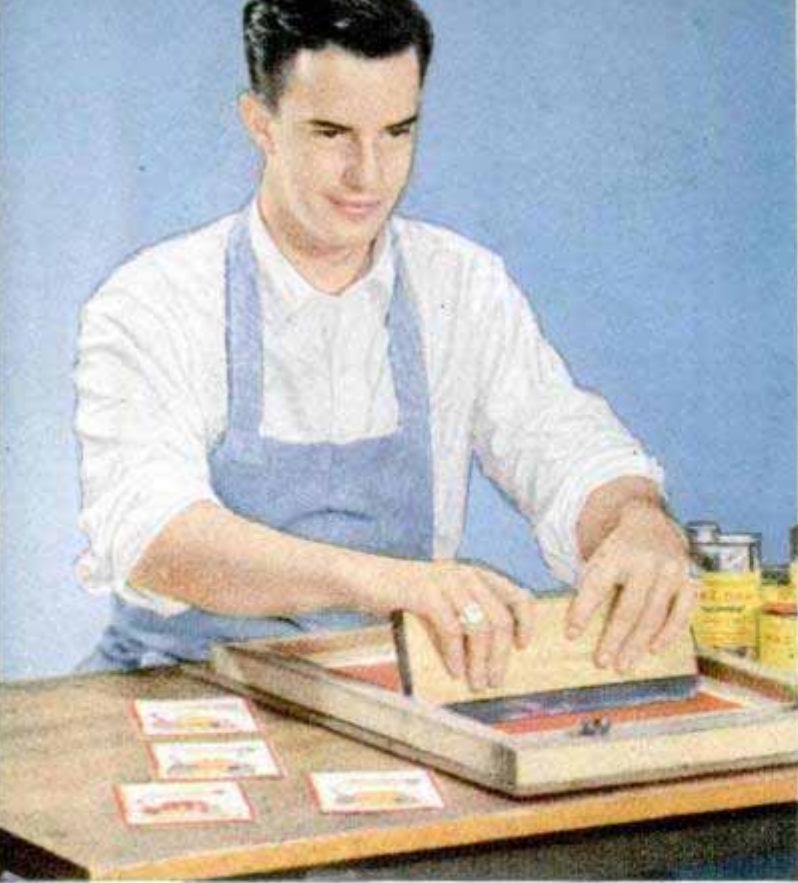

basis. The group of cards on the preceding page pictures five different types: (A) spatter, (B) monoprint, done with a roller, (C) collage, (D) silk-screen and (E) cellophane. All are easy to produce at home from fairly common materials and tools.

**Silk-screen process:** Printing by silk screen requires a frame such as the one detailed in Fig. 1. This can be purchased as part of a kit including paints, or you can easily make one yourself. The underside of the frame is covered with No. 6 or 8 stencil silk. The silk is stretched taut as a drumhead and held by a length of cord which is wedged into a groove running completely around the frame, Fig. 2. The use of loose-pin hinges in hinging the frame to its base makes it convenient to remove

the printing frame for cleaning and when applying the design.

Two different methods of printing may be used. In the direct method, the design to be printed is first drawn on paper, then placed under the silk and traced onto the screen with a fine pencil. When this is done, a medium, called resist (tempera show-card colors), is applied to the screen to block out portions of the design not to be printed. Areas of the screen surrounding the actual card size are masked off with paper and tape to save paint and keep the unused portion of the screen clean.

The design is reproduced by forcing paint through the open meshes of the silk screen, using a rubber squeegee as shown in the photo on this page. In the indirect method,

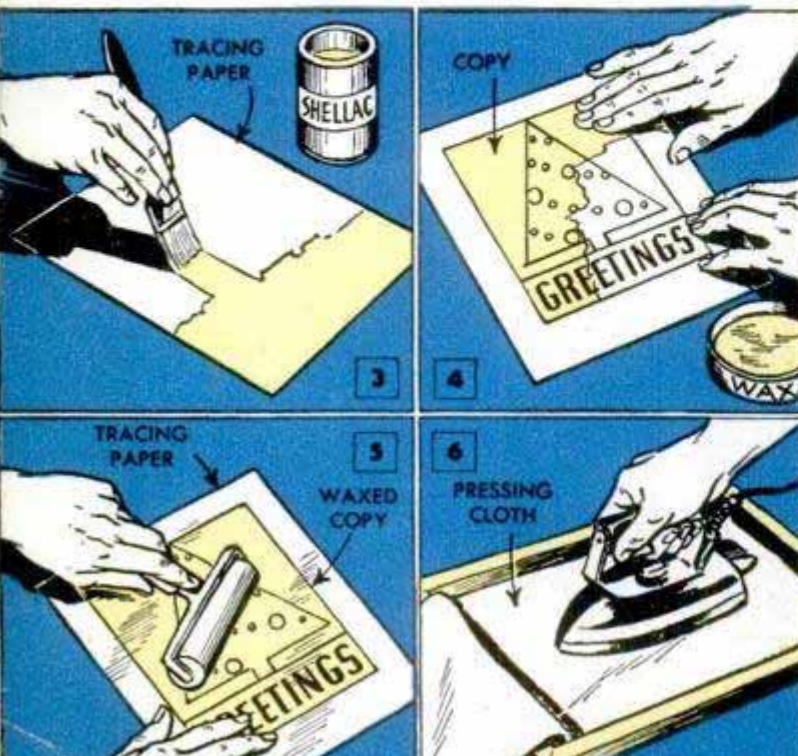

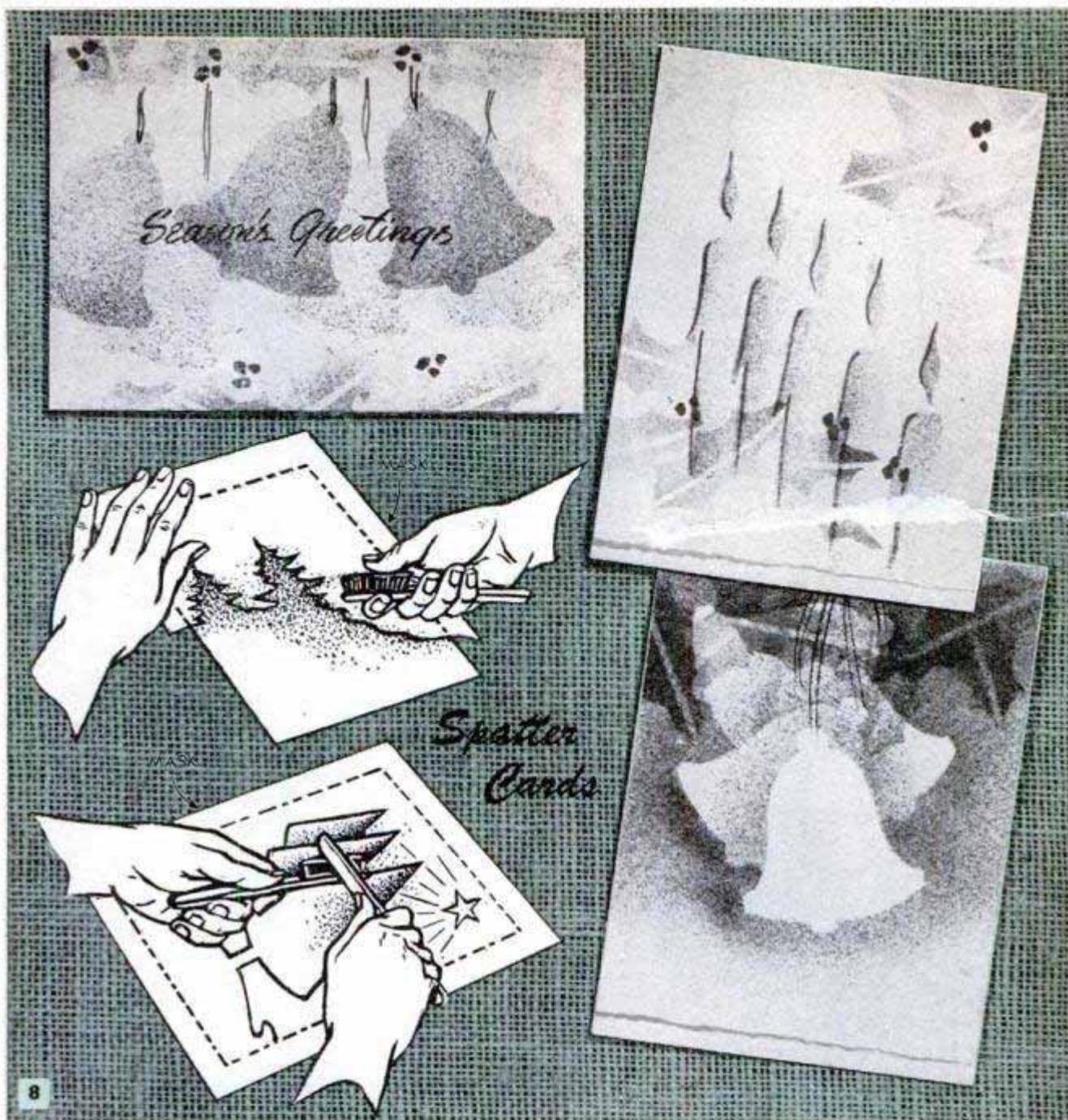

the design is made into a stencil which is attached to the underside of the screen, and the paint is transferred to the card through the stencil. Figs. 3 to 6 inclusive show the steps in preparing a stencil. First, a piece of tracing paper large enough to cover the entire screen is coated with shellac. Then the card design is coated with a thin film of wax with the fingers. Next, the tracing paper, shellac side up, is rolled over the waxed copy. Now all portions of the design that you want to print are cut out with a razor blade and finally the stencil is attached to the underside of the screen by pressing with a medium-hot iron. A quantity of thick silk-screen paint is poured onto the screen and wiped across the open portions of the stencil with the squeegee. Duplicate work is held in register under the screen by cardboard guides which are fastened to the base of the unit. By using

colored paper for your cards, a two-color job can be produced with one printing.

Fig. 7 shows an example of four-color silk-screen work. Here, the tree branches, greeting and border of the card are drawn directly onto the screen and a separate tracing-paper stencil is made for each ball. The screen pattern is run off first and then, when the cards are dry, the screen is cleaned and each colored ball is printed in turn, registering the stencil of each in the proper position on the underside of the screen. Printing can be done on almost any material, wood, cloth, metal or paper.

**Spatter technique:** A toothbrush is the main item you need for producing spatter cards. Several sample cards are shown above, consisting of a single fold, the lower edge of the front flap having a torn, or deckled, edge. The card design is produced by means of paper masks or stencils which

## Cellophane Cards

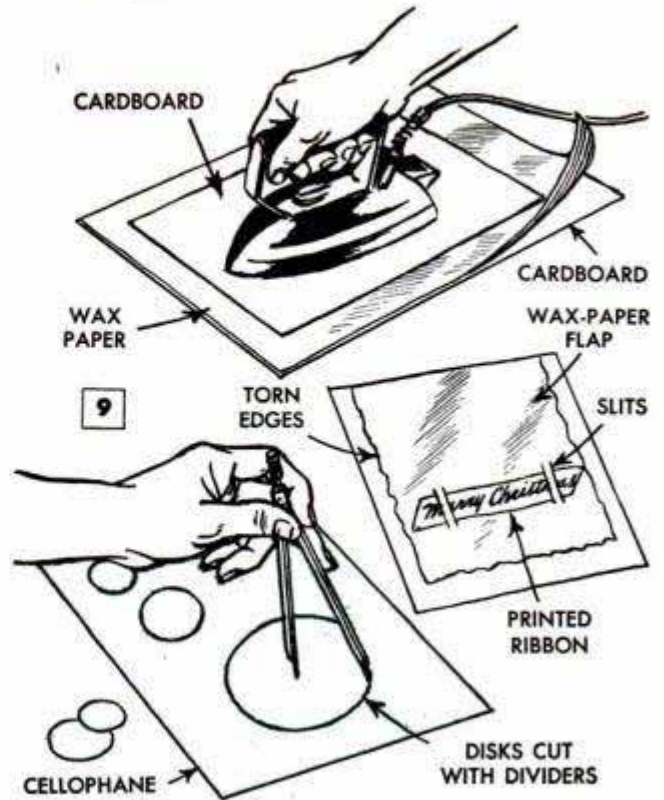
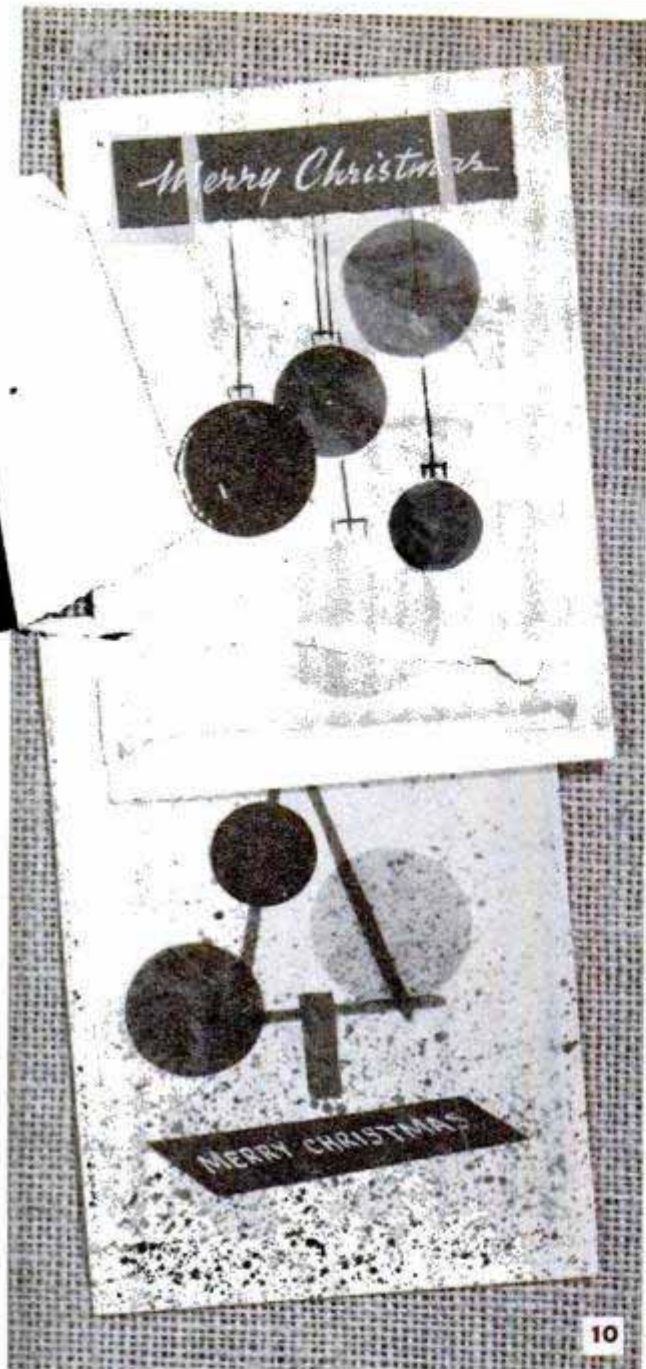

are placed over the areas that are not to be spattered. Fig. 8 shows two methods that can be used to flick the paint from the toothbrush, and another good method is to hold a tea strainer over the card and rub the brush over the wire mesh. Using show-card paints, dip the brush in the paint and hold it about 4 in. from the work.

**Collage:** Card C, page 159, shows an example of a collage. This type of card is made of scrap bits of material, such as lace, tinsel, cotton, cloth, etc. The card pictured features a background of yellow burlap pasted to a cardboard backing, to which

## Novelty Cards



11

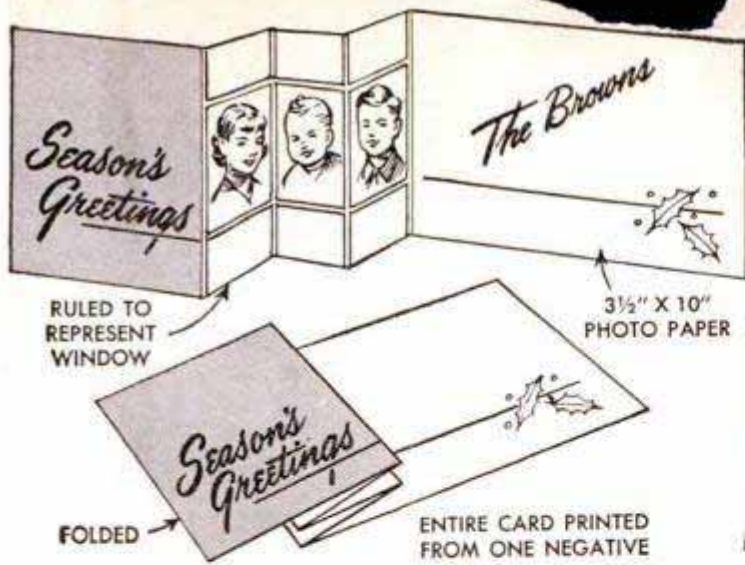

are pasted a tree of grasslike material, a shadow of greenish-gold paper, a tree trunk of Manila paper and a greeting cut from a strip of printed gift-wrapping ribbon.

**Wax paper and cellophane.** This is, perhaps, the quickest and most inexpensive type of card to produce. Here, balls, trees, candles, etc., are cut from colored cellophane and fastened to the back side of a wax-paper flap which adds a "frosty" effect to a twig or other design painted on the card itself. A household iron is used to stick the cellophane to the waxed paper as shown in Fig. 9, and Fig. 10 gives two examples of what can be done. Note in the lower card that spatter work is used also.

**Photo and novelty cards:** Figs. 11, 12 and 13 offer suggestions for several unusual cards. Fig. 13 shows how color can be introduced in the case of a photo card by using a cellophane insert between the folds.

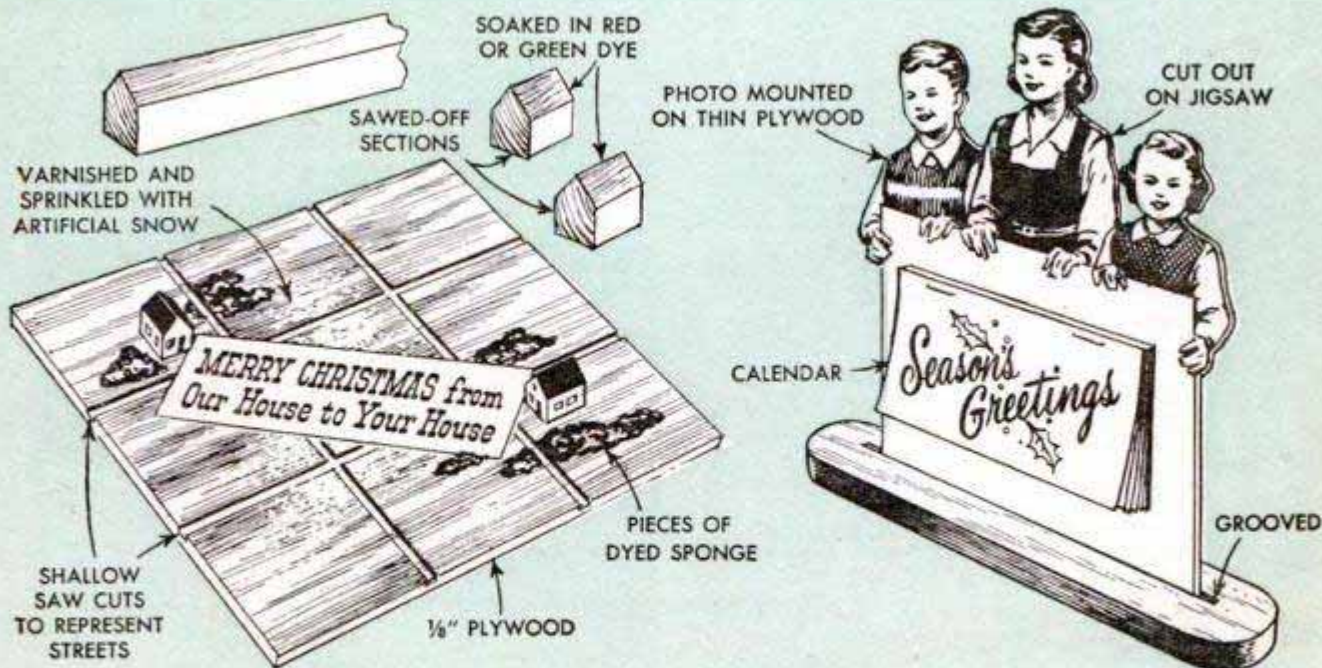
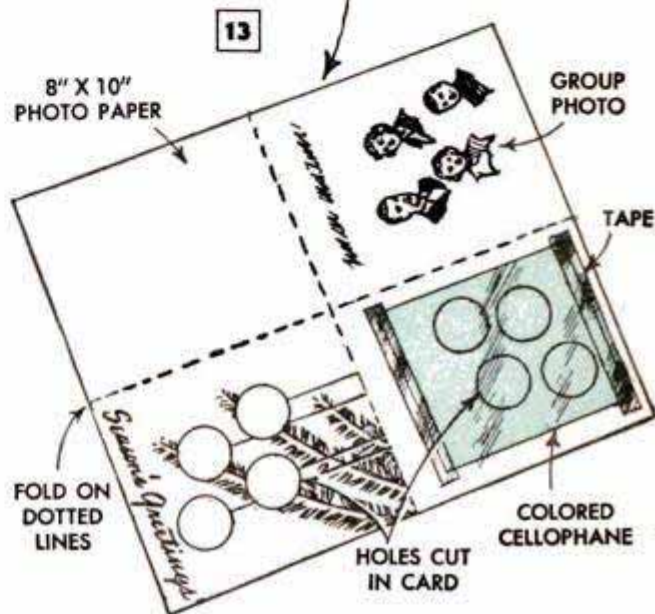

## Forms Spud for Chopping Ice



WOODEN HANDLE

1" PIPE

To save time and extra exertion often spent in chopping through thick ice with an ax, one ice-fisherman made this pipe-fitted spud which quickly cuts through to the water. The blade of the spud is a short length of 1-in. pipe, the end of which has been cut off at an angle and sharpened with a file. The pipe is driven over a tenon formed at the end of a long wooden handle, and pinned, if desired, to assure that the parts will not separate in use. If a heavier spud is desired, one can be had simply by cutting off one end of a 40-in. length of 1-in. pipe. A third style of spud can be fashioned from two lengths of pipe and a reducing coupling, using a pipe of smaller diameter as a handle and joining the two members with the coupling. The cutting edge of the spud can easily be touched up with a file.—W. Fehlberg, La Crosse, Wis.

## Can Lowered Through Flue Removes Chimney Soot

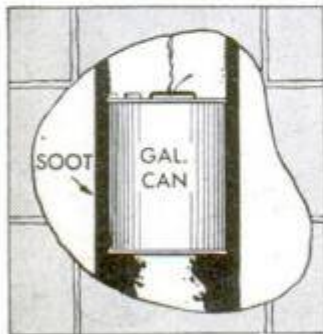

A simple way to clean a chimney is to lower a water-filled can through the flue, thus removing excess soot or other obstructions. Select an empty can having a handle or bail

fill the can with water and lower it down the full length of the flue.

Victor H. Lamoy, Upper Jay, N. Y.

## Electric Wires Kept From Fraying By Applying Fingernail Polish

When connecting the bared ends of electric wires, such as lamp cords, to the terminals of a plug or outlet, the wire, even though twisted, tends to fray when the screws are tightened. To prevent fraying and assure good contact, twist the ends of the wires and apply a drop of fingernail polish to the extreme tip of each one to hold the strands in place. Application of a little fingernail polish also will prevent fraying of the silk covering where it has been cut away from the insulation.



William B. Eagan, Louisville, Ky.

## Hardboard Kerfed on Underside Is Bent to Small Radius

Bending  $\frac{1}{4}$ -in. hardboard to a small radius is done easily if the board is kerfed on the underside. The photo shows a strip of  $\frac{1}{4}$ -in. hardboard being bent to a 5-in. radius with the heat of an ordinary pressing iron. The back of the hardboard was notched at  $\frac{1}{4}$ -in. intervals throughout the area to be bent, making the saw cuts  $\frac{1}{8}$  in. deep or half the thickness of the board. As the particular job pictured required a  $\frac{3}{8}$ -in. thickness, this was built up by first applying a strip of  $\frac{1}{8}$ -in. hardboard to the surface. This was bent without notching simply by applying heat and gradually bending the board around the radius.

Michael Ligocki, Gary, Ind.

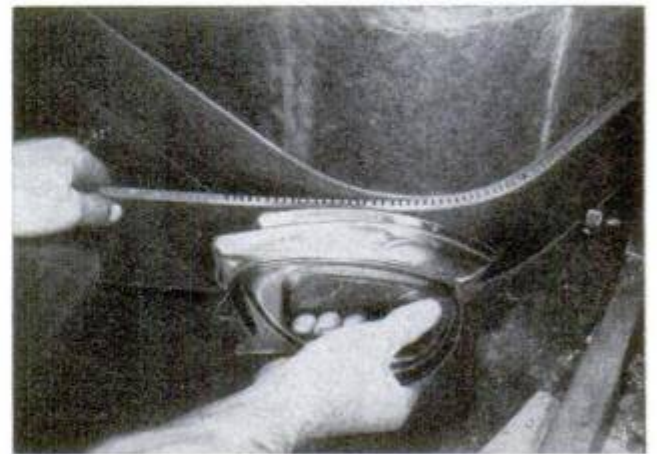

# Have Fun With This Chariot-Type Tricycle Trailer



Rolling along on semipneumatic wheels, this little trailer will double the enjoyment the youngsters get from their tricycles. The frame, rail and tongue are all bent from thin-wall conduit, either by using a standard pipe bender or by filling the conduit with sand, plugging the ends and then bending by hand. The trailer-hitch bolt engages a hole drilled in a piece of flat iron which is bolted to the tricycle-seat frame. The wheels are fastened with cotter pins or the axle is drilled and tapped for attaching them with roundheaded screws

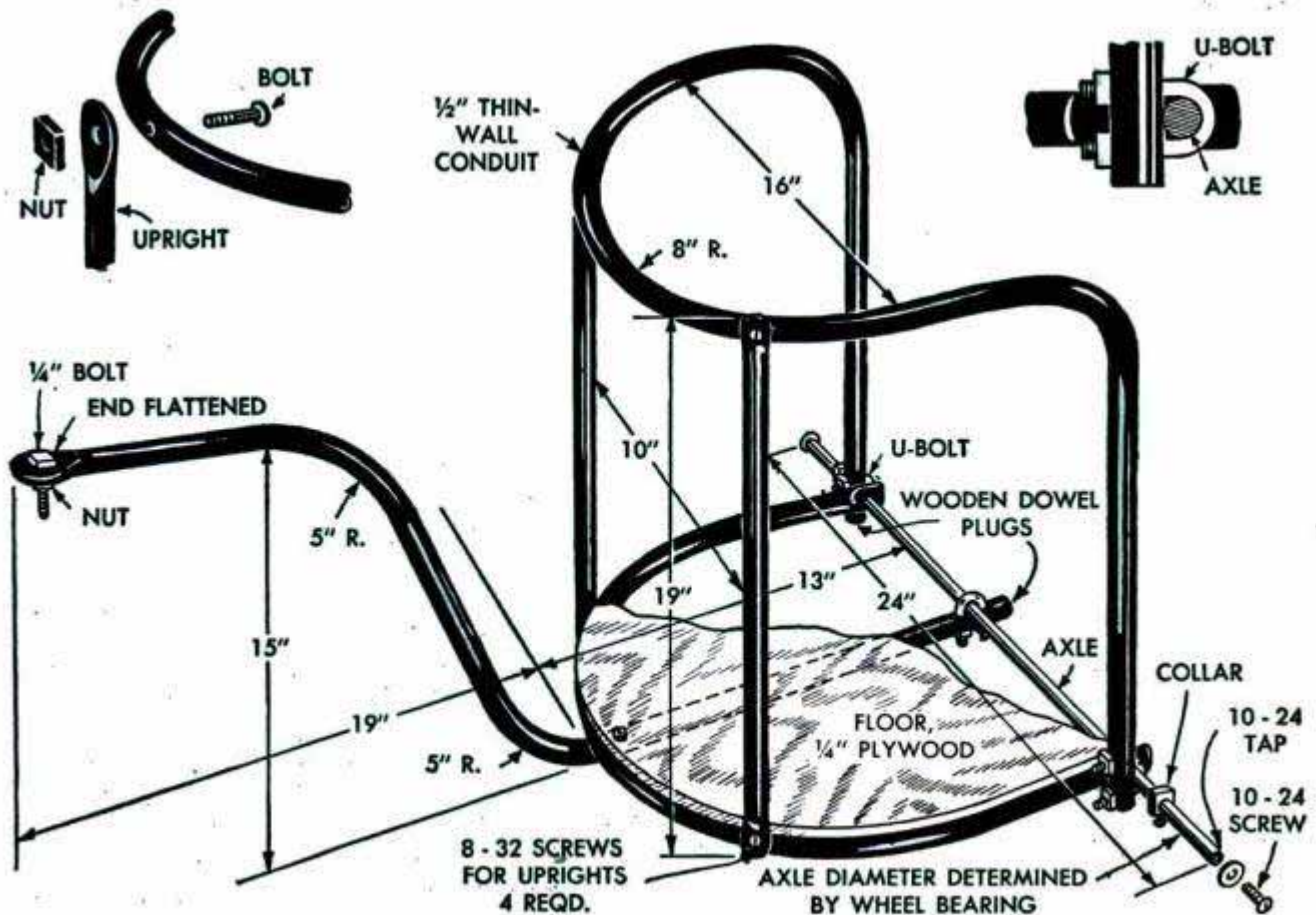



### Calculating Roof Pitch in Degrees

To find the pitch of a roof in degrees, you can use a yardstick, a straightedge and a level to arrive at a reasonably accurate answer without involved calculations. The straightedge, which could be a selected length of 1 x 2, is cut 57 in. long, and a carpenter's level is temporarily fastened to the top center of the straightedge. With one end of the straightedge resting on the roof, move the other end along a yardstick held vertically on the roof. When the bubble level is centered, the reading on the yardstick at the end of the straightedge is about the same as the pitch of the roof in degrees. This is based on the fact that a circle with a 57-in. radius has a circumference of nearly 360 in., thus each inch mark on the yardstick roughly indicates 1 deg. of pitch as both the straightedge and the roof itself serve as radii of the circle.

### Under-Shelf Rack for Rolling Pin

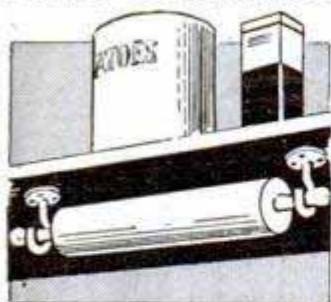

In addition to conserving drawer space, this rolling-pin rack is a real timesaver for the housewife who does a considerable amount of baking. The rack is made by attaching two screw hooks or clothesline hooks to the underside of a kitchen or pantry shelf. The hooks are fastened in a convenient location and spaced to receive the handles of the rolling pin. However, if the pointed tips of the hooks are likely to interfere with removing the rolling pin from the rack, the tips should be cut off and rounded before mounting the hooks.

Use thread of a contrasting color for basting so it is easy to locate when you wish to remove the stitches.

### Hanging Ornamental Flowerpot

An ornamental flowerpot having three holes in the rim can be hung neatly by using ordinary cotter pins as eyes to engage lengths of chain. After cutting three equal lengths of lightweight chain, attach a cotter pin to the bottom link



COTTER PIN

of each length and then pass the pins through the holes in the flowerpot rim. Bend the arms of the pins outward to anchor them in place and slip the loops at the free ends of the chain over a stiff wire ring to permit hanging them from a hook. The cotter pins should be about  $\frac{1}{2}$  in. longer than the thickness of the pot rim.

Wm. A. Novak, Maywood, Calif.

### Car Freed From Icy Pavement With Nonslip Rug Mats

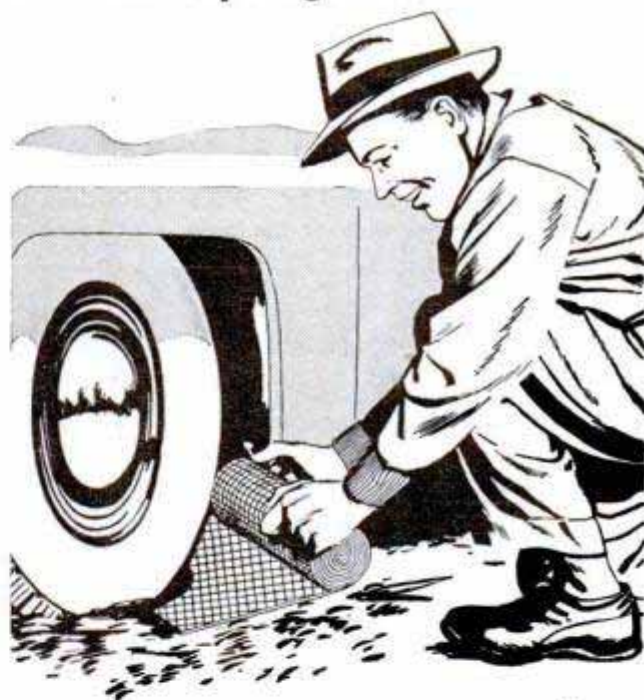

When there is danger of becoming stalled on icy pavement, carry two pieces of corrugated-rubber rug mat in the trunk of your car. The pieces should be about 15 in. wide by 6 ft. long, and a semicircular notch the same width as the tire is cut in one end of each piece. Then, when traction is impossible on the slippery road surface, stretch out the mats in front of the rear tires, placing the notched portion around the tire as shown in the drawing. The mats will grip the road surface providing sufficient traction to free the car. The two mats can be rolled together for compact storage.

G. Jaffin, Silver Spring, Md.



# Personalized Laundry Bag for Child's Room

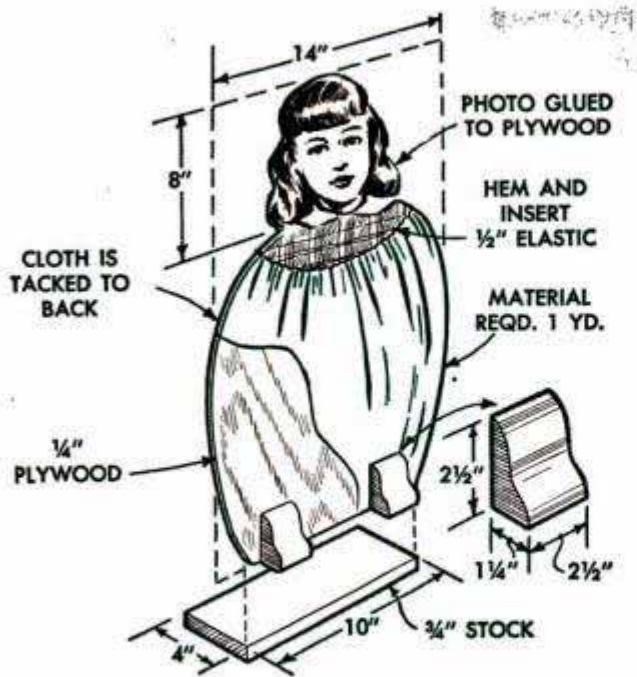

Topped with a portrait of its little owner, this child's laundry bag looks much like a life-size doll, and its novelty will go far to encourage children to take care of their soiled clothing. A good close-up snapshot of the child is selected and that portion of the negative showing only the head and possibly part of the shoulders is enlarged as close to 8 x 10 in. as possible. Then the enlargement is glued to the top of a 14 x 25-in. sheet of 1/4-in. plywood, after which the latter is jigsawed to outline the photo and follow previously marked guide lines in order to form the rounded contours of the cutout. The laundry bag itself is made from a piece of colorful fabric (about one sq. yd. will do). This is hemmed along the top edge and fitted with a length of elastic. Then both the fabric and elastic are drawn around the edges of the plywood and tacked

to the back. If the enlargement includes the shoulders of the model, the photo probably will cover the plywood which would otherwise be exposed just above the elastic when the bag is partially filled. However, if only the head is used, a simulated dress can be painted directly on the plywood or made from fabric stretched taut and tacked to the back. The plywood cutout is held upright by two wooden blocks fastened to the front and a 4 x 10-in. piece of wood attached along the bottom edge at the back. For a neater appearance, the tacked edges of the fabric can be hidden with another piece of fabric or cardboard which is cut to shape and stretched across the back of the plywood, tacking it along the outer edges. If fabric is used, its edges should be folded double before tacking.

Herman R. Wallin, Washington, D.C.

## Safety Panel on Bicycle Wheel Guards Foot From Spokes

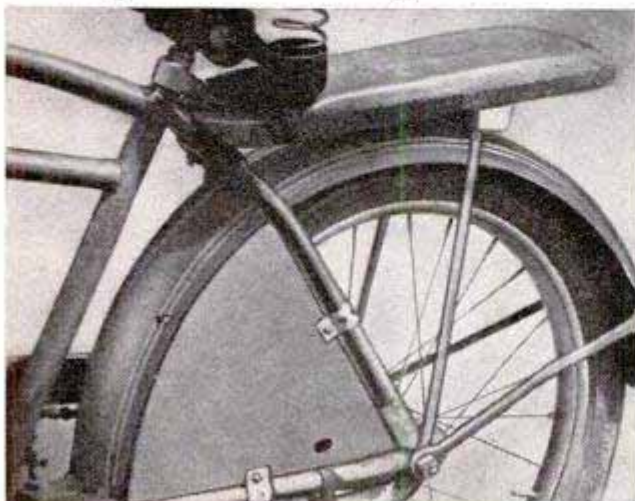

After one youngster had caught his foot in the rear wheel of his bicycle and taken a serious fall, his dad mounted a safety panel on the bicycle frame to shield the forward portion of the wheel. The guard is a wedge-shaped section of hardboard cut to fit between the frame members and rounded to conform with the shape of the fender. The panel is held to the frame with sheet-metal clamps as pictured.

Grover Brinkman, Okawville, Ill.

☐ A leaky inner-tube patch can be removed by holding it against a hot exhaust manifold until it is thoroughly heated. It then can be peeled off easily.

# Solving HOME



**SEED PACKED** in cardboard cartons without inner liners often is lost through the bottom edges of the carton. This is corrected by sealing the bottom of the carton with cellulose tape pressed over the edges

**DRYING RACK FOR HOSE** that doubles as a skirt hanger is made by slipping plastic clothespins on a wire coat hanger. Open the hanger with pliers and slip the coil springs of the clothespins over the wire

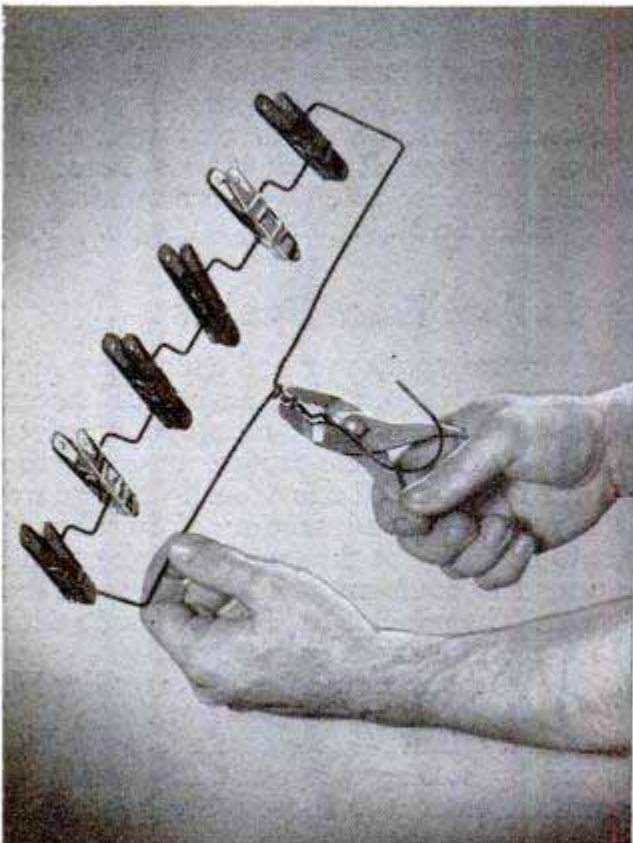

**CORRUGATED-RUBBER SCRUB BRUSH** cleans linoleum and painted surfaces efficiently and acts as a squeegee to remove excess water. The brush consists of a piece of stair tread cemented to a wooden block

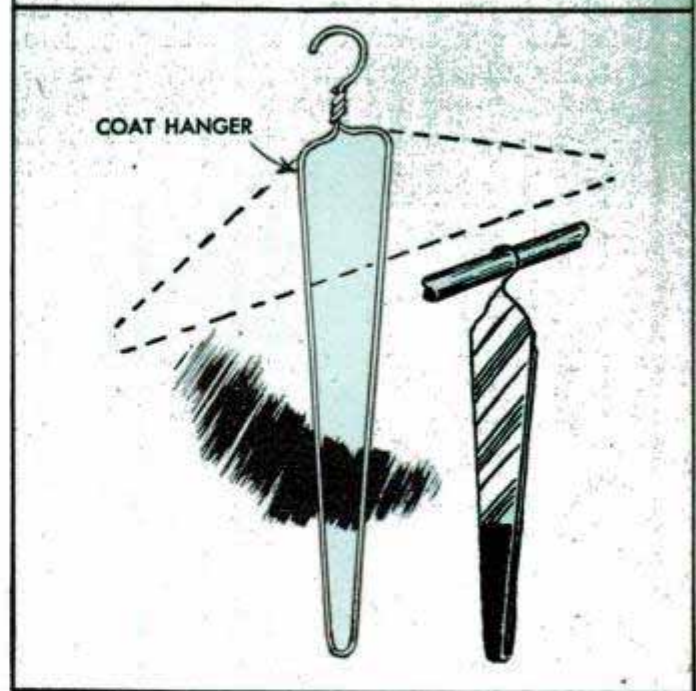
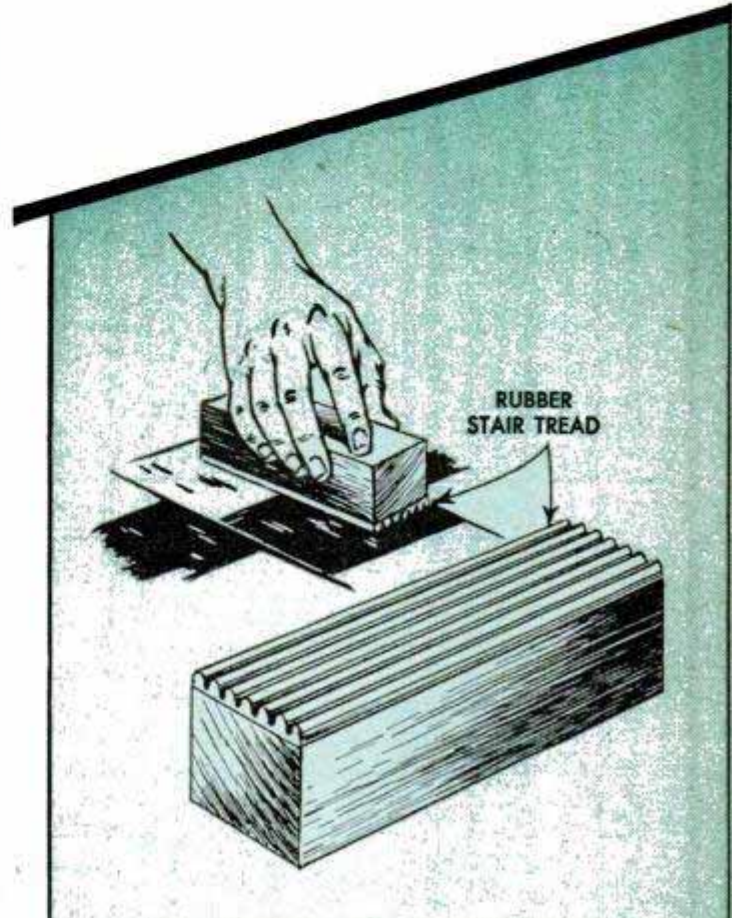

**YOUR TIES** will always have that newly pressed look if each one is kept on a tie stretcher while hanging in the closet. Bend the stretcher from a wire coat hanger and just slip the tie over the end as shown

# PROBLEMS

**WATER PIPES CAN BE PLUGGED** temporarily when pipe caps are not available. Press a wooden plug into the end of the pipe, wrapping it with cloth if necessary for a tight fit. Then use a C-clamp to anchor the plug

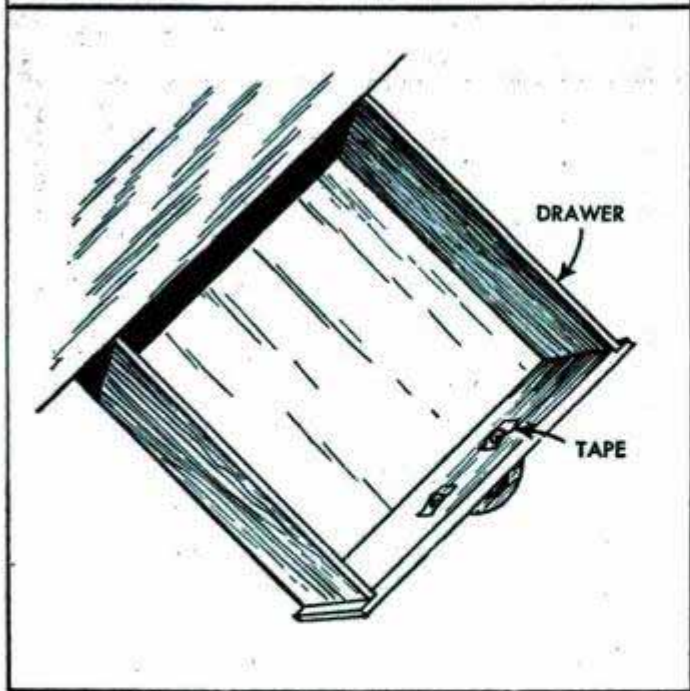
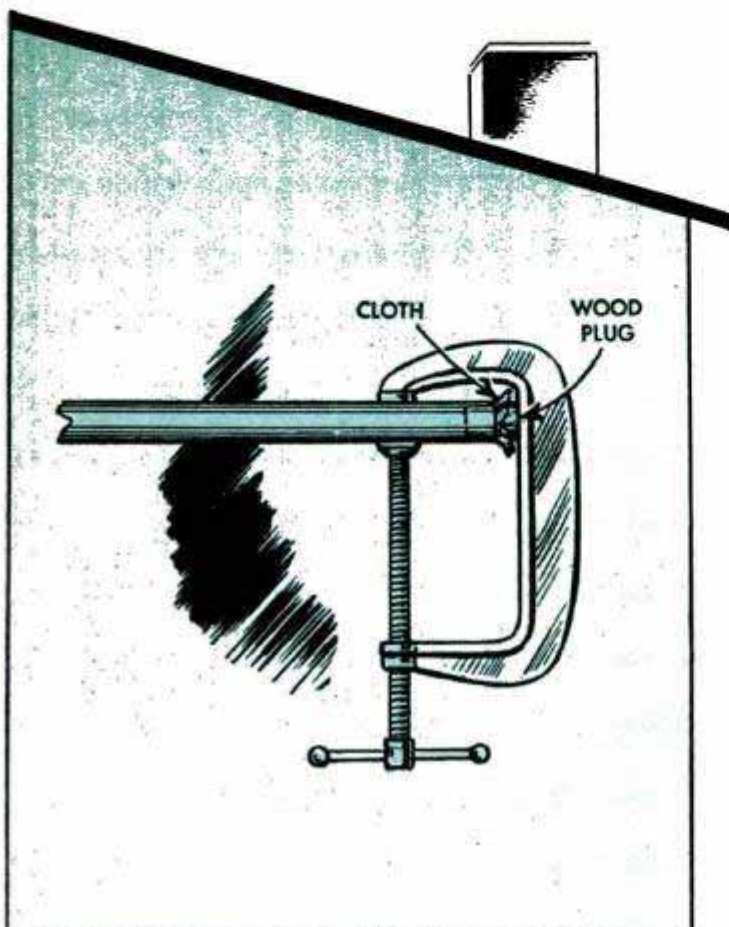

**COVERING DRAWER-PULL FASTENINGS** with tape prevents snagged clothing. Place a strip of cellulose or adhesive tape over each fastening, pressing the tape tightly to the inside of the drawer front



**CAN TOPS** are kept from dropping into the food when opening the can if a suction cup, fitted with a handle, is first pressed against the lid. Drill end of a  $\frac{1}{4}$ -in. dowel and turn it onto the suction-cup screw

**BRUSH HANDLE** doubles as a paint-can opener if it is fitted with a piece of metal to permit prying open the lid. The metal is drilled and then fastened to the end of the brush handle with two small wood screws



## Spools Screwed to Cabinet Door Provide Kitchen-Knife Holder



Paring knives are always within easy reach if they are kept in a holder made from wooden thread spools. Just fasten several spools side by side to the inside of a cabinet door, using long flat-headed screws. Then place the knives in the holder by slipping the blades in the slots formed by the flanged ends of the spools.

## Removing Wristwatch Back

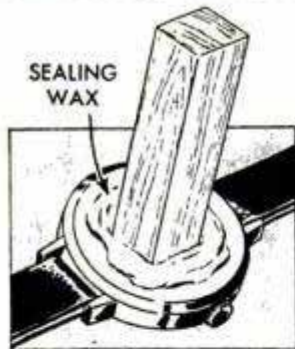

When all usual methods fail to unscrew the threaded back from a wristwatch, try using sealing wax and a small block of wood. Drop a little of the melted wax on the watch back and press the end of the block

into the wax, holding it in place until the wax hardens. Then grasp the block and twist it slowly to unscrew the back of the watch. To remove the block, heat the sealing wax slightly with the flame of a match or cigarette lighter.

G. E. Hendrickson, Argyle, Wis.

## Unfinished Furniture Painted Easily By Using Shellac as Undercoat

To attain a professional-appearing finish when painting unfinished furniture, use shellac as an undercoater. In addition to sealing the wood to stop absorption of the paint, the shellac forms a smooth, hard

film which provides an excellent surface for painting. Old furniture which does not harmonize with the present color scheme can be given a rich-looking, modern finish quickly by coating with black shellac.

A. E. Kessler, New York City.

## Doorstop Forms Small Hammer

Fitting a metal doorstop with a handle provides a small rubber-tipped hammer for modelmaking. The threaded screw is cut from the shank of the doorstop and then a hole is drilled and tapped in the side of the shank. A 5-in. length of rod is threaded and turned into the hole to form the handle.

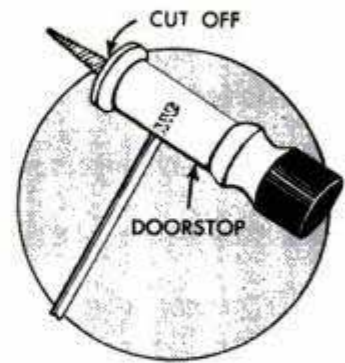

George J. Berkwitt, New York City.

## Centerpiece for Dining Table Utilizes Angel-Cake Pan

If you have an extra angel-cake pan or large gelatin mold, you can use it to provide an attractive centerpiece for the holiday table. First dip the tin in vinegar and let it dry. Next, dip it in vinegar again and, after it has dried, rinse it in water. Then coat the pan with clear shellac or paint as desired. Set a long tapered candle in the center hole of the pan and arrange fresh or artificial flowers or evergreen sprigs in the trough around the candle.

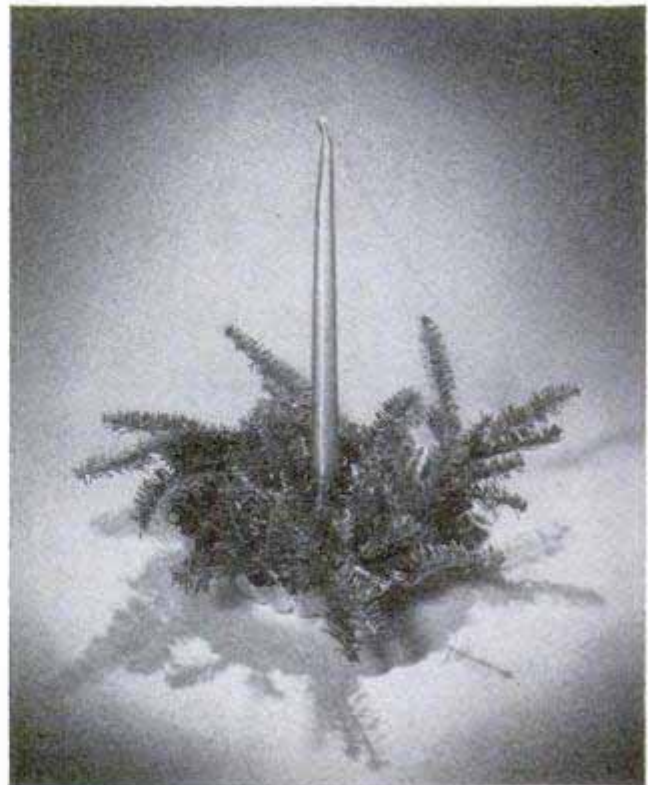

# Child's Glider Swing

By Hi Sibley

DESIGNED so that it may be rolled from room to room, this novel swing will keep baby amused as mother works near by. The tray remains level while the swing is in motion, and when locked in the down position will serve as a belt to hold a lively youngster safely in place. The platform consists of a panel of  $\frac{1}{2}$ -in. plywood mounted on four casters, and the seat is suspended on parallel hangers supported by two curved uprights made of steel tubing. To bend the tubing, plug one end and pack full of dry sand. Plug the other end, heat in a forge or with a blowtorch and bend around a wooden form. Finish the wooden platform in natural grain. Paint the tubing light red, the seat in ivory and add a decal decoration. To retain oil on the bolts and lag screws, wind two or three turns of soft cotton cord between the washers and flat-iron hangers.

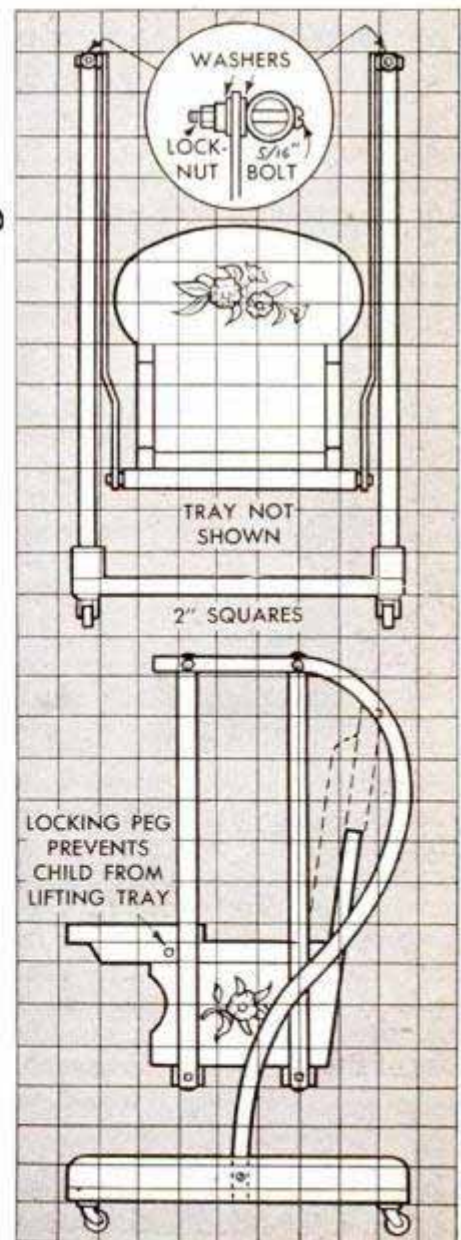
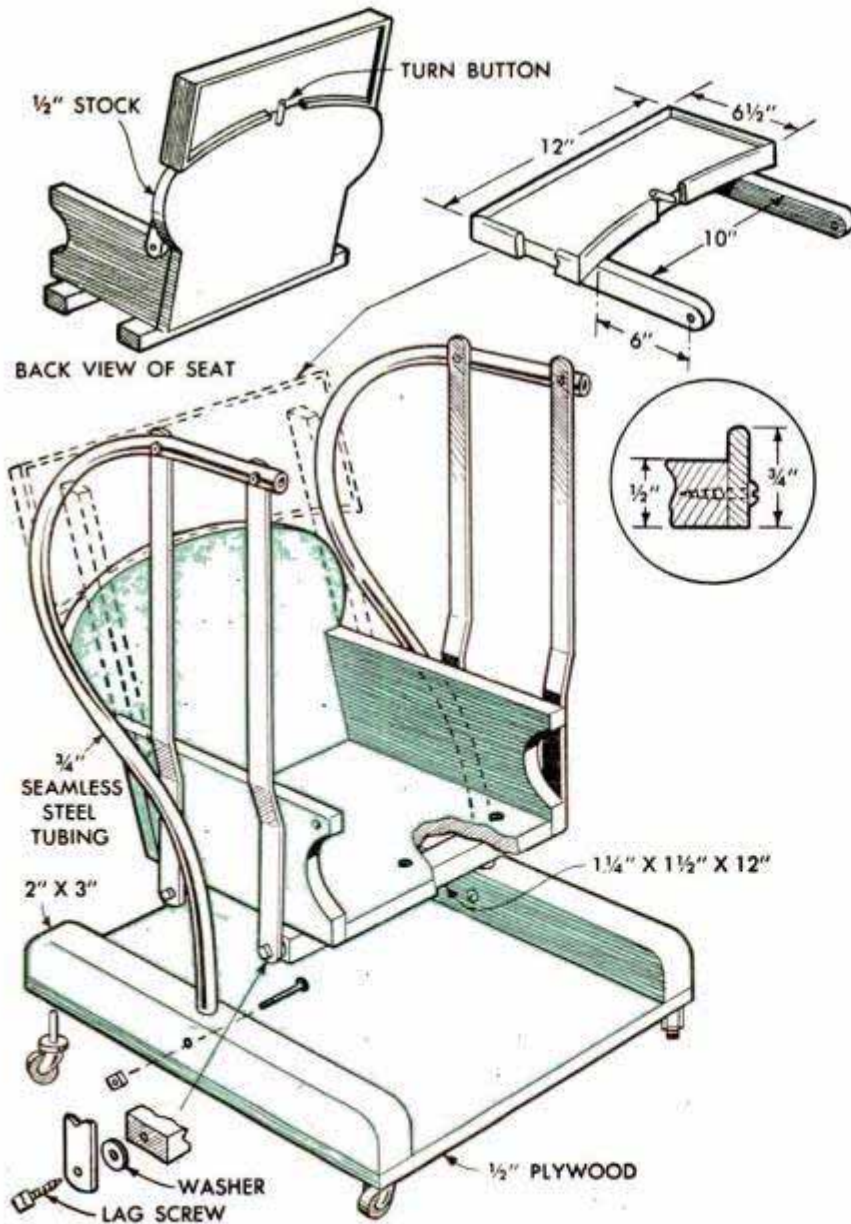

## Handleless Cabinet Door Is Opened Easily With Plumber's Force Cup



## Plastic Container Dispenses Fuel To Model Gasoline Engines

Spray-shampoo bottles of pliable transparent plastic are just the thing for refueling model gasoline engines. To adapt the bottle for dispensing the fuel, fit it with a length of transparent-plastic hose, reaming the hole in the bottle cap with a rattail file until the hose can be forced into the opening



with a turning motion. This will form a liquid-tight seal at the joint of the hose and bottle cap. The hose should project about  $\frac{1}{4}$  in. into the bottle to trap any foreign matter in the fuel. As an aid in metering the fuel, use India ink to graduate one side of the bottle

in fractions of an ounce. The head and a portion of the shaft cut from an aluminum knitting needle or a golf tee will provide a stopper for the hose. To use the dispenser, remove the plug from the hose and press the end of the hose over the fuel-tank filler tube. Then squeeze the bottle until the desired amount of fuel has been injected into the tank, and kink the hose to prevent loss of fuel. Fill the dispenser like a syringe.

Richard Warner, Oswego, N. Y.

☐ Bait minnows used for ice fishing will not freeze and become brittle if they are kept in a jar filled with glycerin.

If the handle should break off a closed cupboard or linen-closet door, it is not necessary to pry the door open and take the chance of damaging it. Instead, press a plumber's force cup against the surface of the door and simply pull it open. Be sure not to press the cup over any holes left by the handle as, of course, no suction would be formed.—Pat Fey, New York City.

## Hooked Can-Opener Blade Provides Linoleum Knife

Sharpening the inside edges of a hook-type can opener increases the uses of a jack knife to include cutting linoleum and snipping cord. Although the blade will not serve as well as a regular linoleum knife, it

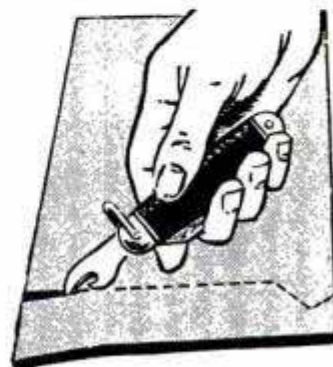

is a handy substitute for odd jobs, and adapting it for this purpose does not interfere with its function as a can opener. When using the linoleum knife, be sure to tilt it at a slight angle to the work, as this will bevel the edges of the cut and separate the material to prevent binding.

Andrew Vena, Philadelphia, Pa.

## Reinforcing Vacuum-Bottle Filler Lessens Chance of Breakage

The chances of breaking the fragile filler of a vacuum bottle are reduced to a minimum if it is reinforced with rubber or cellulose tape. Remove the filler, wrap the tape around the vacuum-seal projection at the bottom of the filler and then wrap the tape spirally to the neck.

Paul Vanuk, Rahway, N. J.

## Sanding Block From Softboard Results in Better Work

Next time you tackle a job of hand-sanding, try using a block of softboard (insulating sheathing) as a sanding block. Two 3 x 5-in. pieces stacked one on top



SOFTBOARD

of the other will form a block convenient to handle, and the resiliency of the material speeds attaining an even surface.

Harrison Neustadt, Miami Beach, Fla.

# One-Evening Projects

By R. J. DeCristoforo

A COUPLE of the seven projects included in this article can be made easily in a few hours. All the items feature neatness of appearance as well as simplicity of construction and are especially suitable for decorative or utility purposes in the kitchen or dinette. Carefully made and painted in suitable colors, the projects provide attractive gifts that will delight your friends and, as almost all the parts lend themselves readily to multiple cutting, the items can be mass-produced rapidly and inexpensively for sale at a handsome profit. If you wish to put your spare time to work, a neighborhood gift shop and the local department store will doubtless provide a market for these items that will keep your power tools humming.

Half-round molding, some 1½-in. pine and ¼-in. plywood or solid stock are the materials needed, although any wood scraps approximating these dimensions will serve to make reasonable duplications of the projects. Gum-faced plywood is excellent for this type of work because of its adaptability to sanding and painting. However, the prominent grain of fir plywood presents a surface that is somewhat difficult to paint.

The holder for salt and pepper shakers, which is pictured in Fig. 1 and detailed in



Fig. 2, is made entirely from plywood. Although the size given in the squared pattern is suitable for a great many types of salt and pepper shakers, some of the larger novelty designs likely will require altering the dimensions of the base. When laying out the scallops, the rounded top of the handle and also the center cutout, you can be sure that matching arcs are identical by using the rim of a jar, small bowl or water tumbler to draw them on the pattern or directly on the work. After establishing the desired arc, mark the edges of the glass rim with a china-marking pencil (grease pencil) so that the arc can be duplicated exactly. After cutting out the parts, join them with glue and brads. Then finish with enamel, varnish or clear shellac which

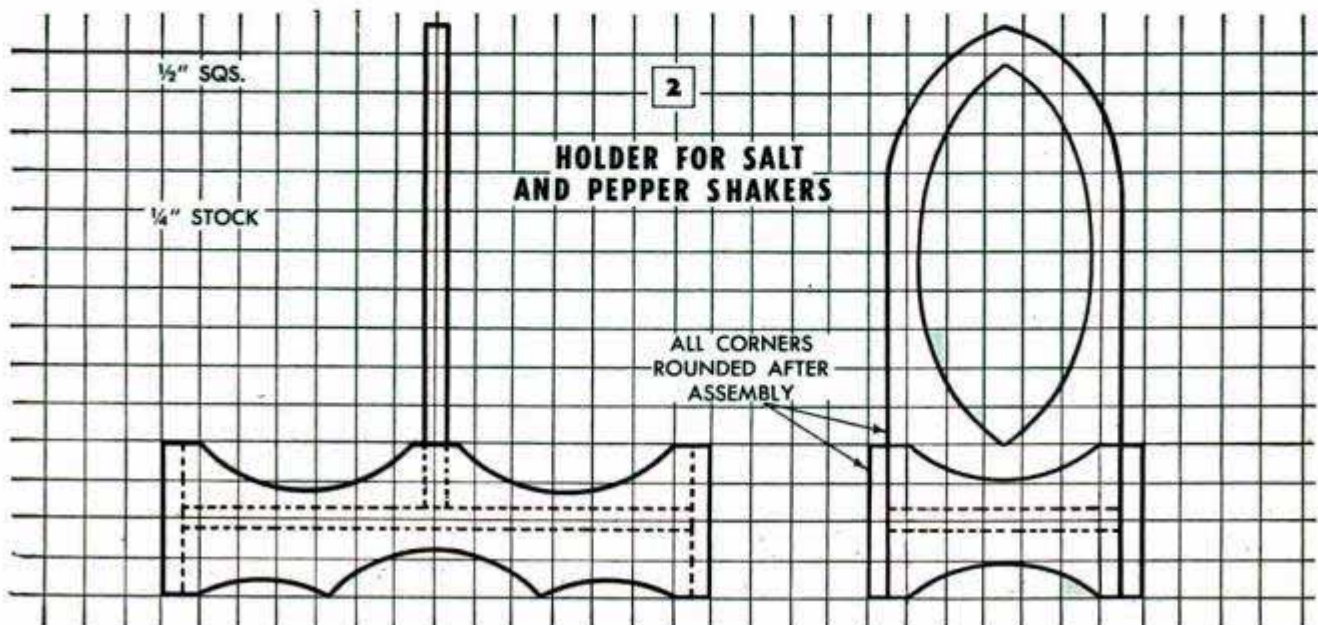

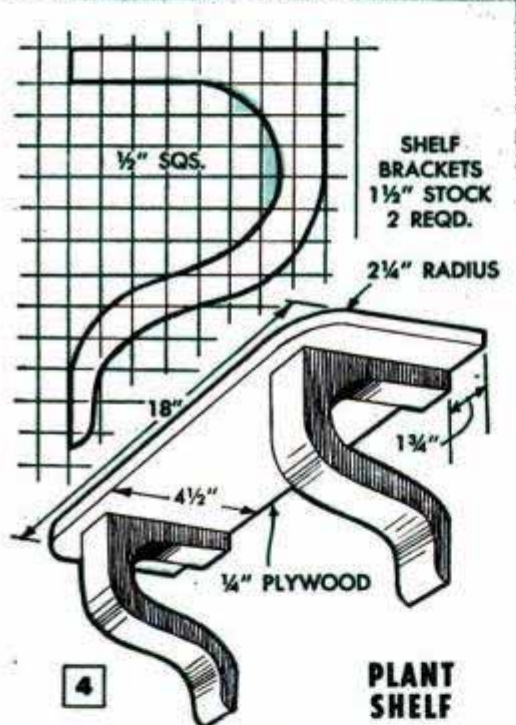
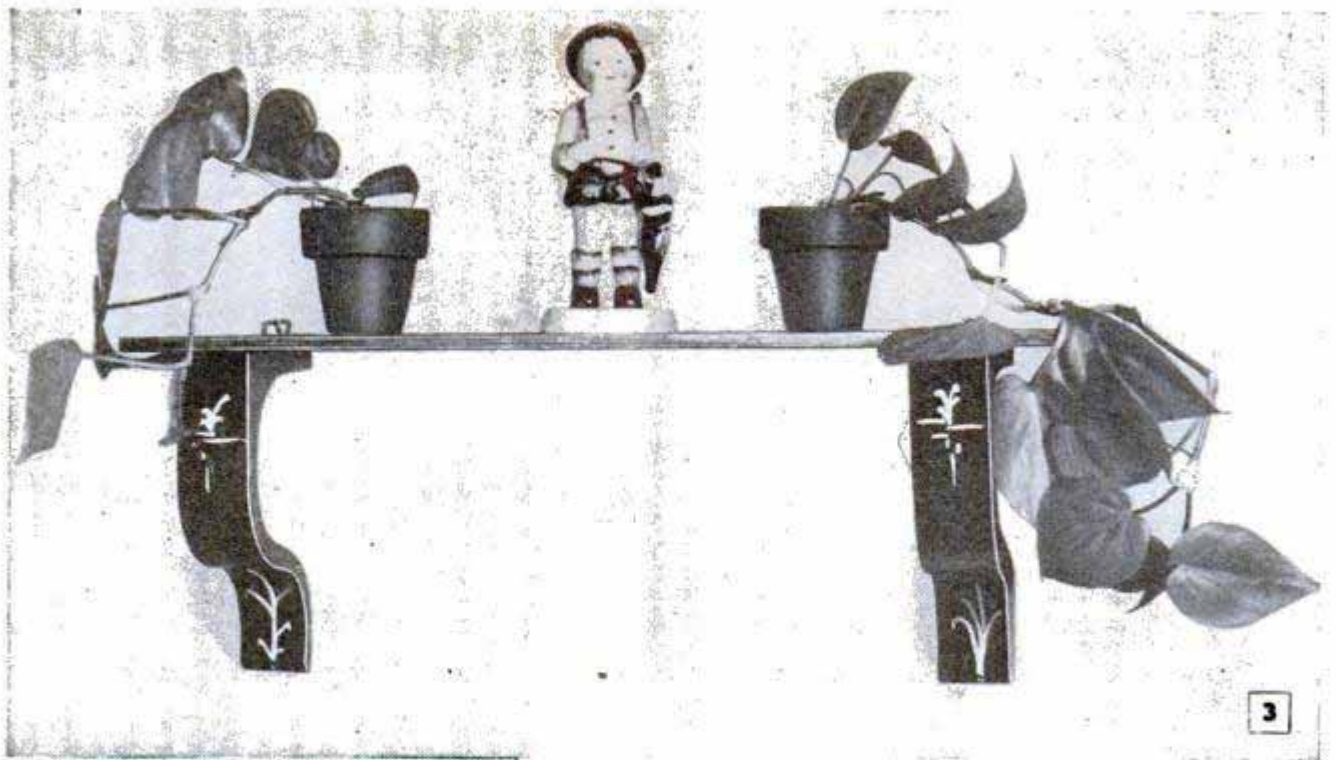

has been colored with lampblack or other pigment.

A neat wall shelf, Fig. 3, for potted plants, novelty planters and knickknacks consists simply of a 4½ x 18-in. piece of plywood mounted on two wooden brackets. The bracket design, shown in the squared pattern in Fig. 4, is enlarged on paper which has been ruled to form ½-in. squares and then is transferred to a piece of 1½-in. pine. After brackets have been cut out on the jigsaw, the curved portions are carefully sanded. The plywood shelf is fastened to the brackets with brads or countersunk screws driven from the top, the brackets being located 1¾ in. from the ends of the shelf. Loops for hanging the shelf are provided by driving a staple into the rear edge of each bracket and then bending it upward to project above the shelf. Screw eyes also can be used for this purpose if they are driven through the shelf and into the brackets near the back of the shelf. The loops are merely slipped over nails or screws driven into the wall.

Kitchen book ends for holding cookbooks and in-

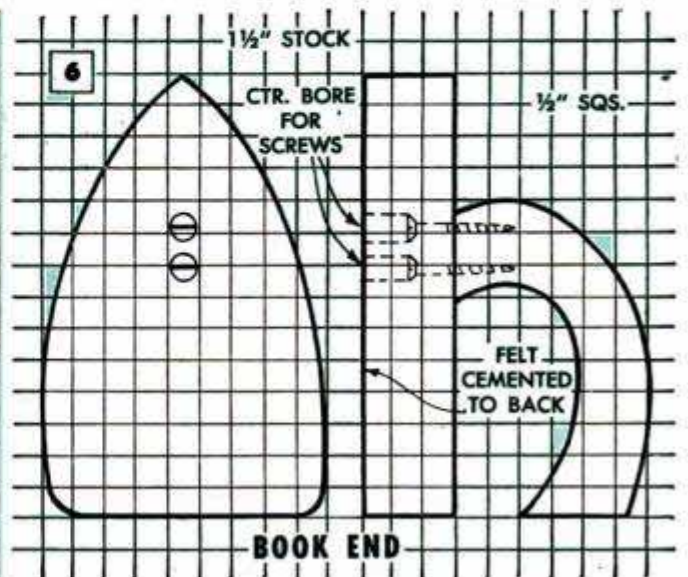



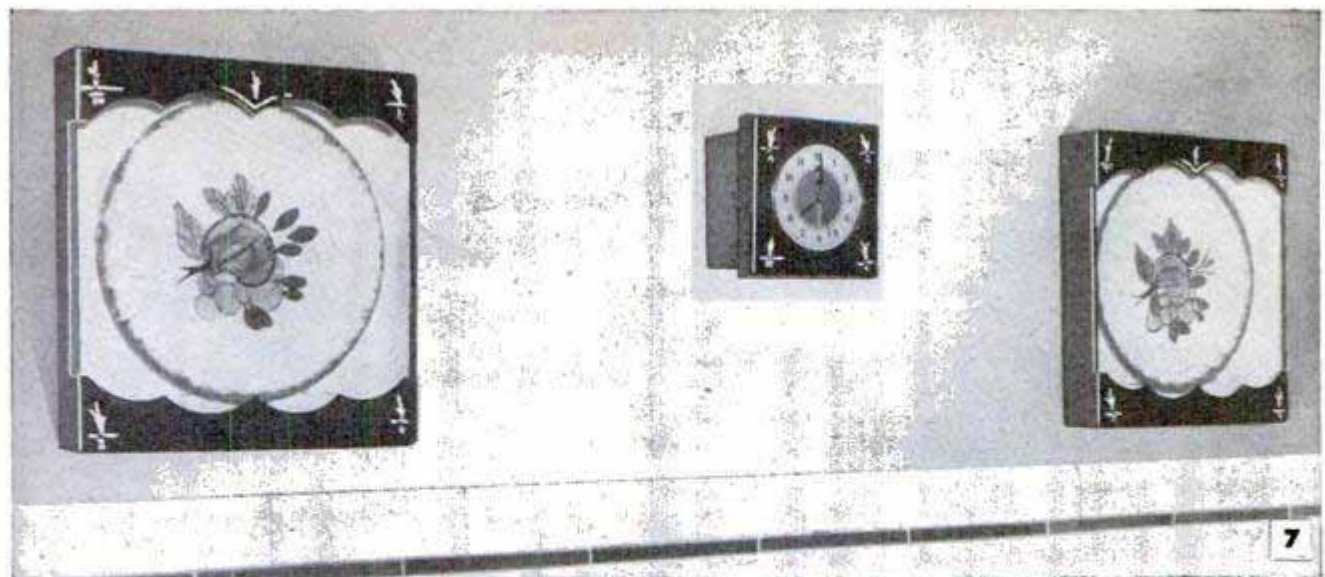

7

struction pamphlets are simulated pressing irons set on end. Both the base of the iron and the handle are painted the same color except for contrasting stripes which are run along the outer corners of the handle as pictured in Fig. 5. The book ends are cut from 1½-in. pine as detailed in Fig. 6, and the handles are attached with screws and glue, the screws being driven in counterbored holes in the base of the iron. These holes will not be noticeable when the book ends are in use, but they may be plugged with short pieces of dowel after assembly. The dowels, which should be a tight fit in the holes, are sanded flush with the surface before painting. If the book ends do not seem heavy enough, their weight can be increased by boring several holes in the wooden base and partially filling the holes with lead. These holes are plugged as the others were or covered with wood putty.

Fig. 7 pictures a pair of shadow-box plate holders and a matching clockcase. The three can be used as a set or the shadow boxes as well as the clockcase can be used alone. The shadow boxes are assembled from plywood, using simple box construction, as in Fig. 8. The matching scrolled pieces at the top and bottom can be cut out in pairs or four at a time, if you're making both shadow boxes. In this case also, jar rims will come in handy for scribing the arcs of the scallops. The brads used in assembly won't be noticeable if their heads are set below the surface and the holes filled flush with wood putty. Brads are driven into the back of the shadow box to center the plate when it is mounted. If you are making the boxes for sale or for a gift and do not know the design or coloring of the plate which will be inserted in them, it is best to paint the inside of the boxes white regardless of the colors used on the outside.

The clockcase is made as in Fig. 9, the

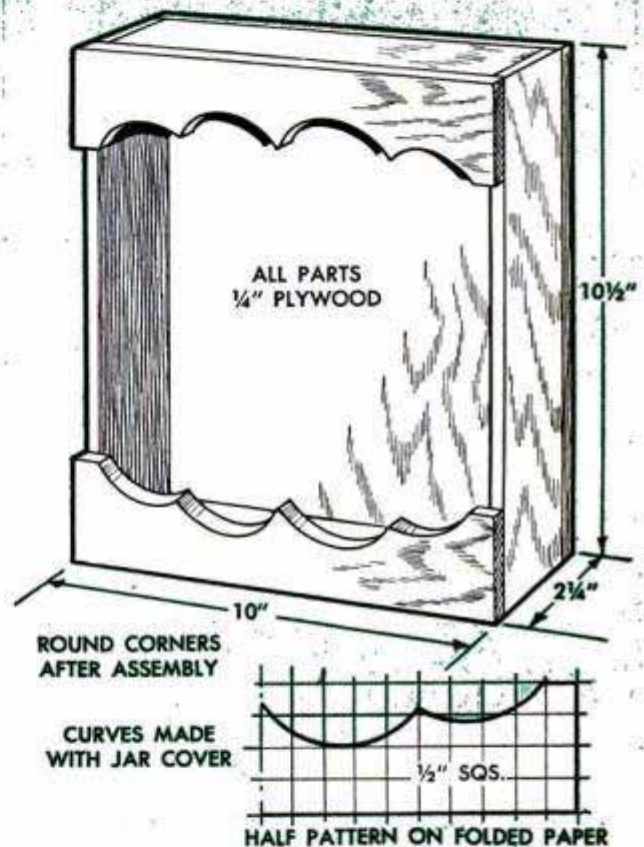

**8 PLATE SHADOW BOXES**

DIMENSIONS MUST BE ALTERED TO FIT CLOCKWORKS

9

**CLOCKCASE**

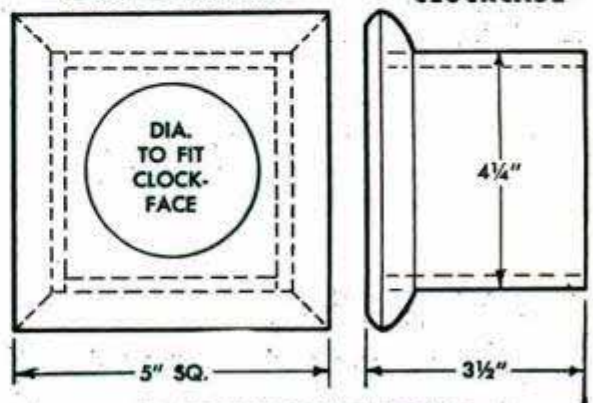

FRAME, HALF-ROUND MOLDING  
ALL OTHER STOCK ¼" PLYWOOD

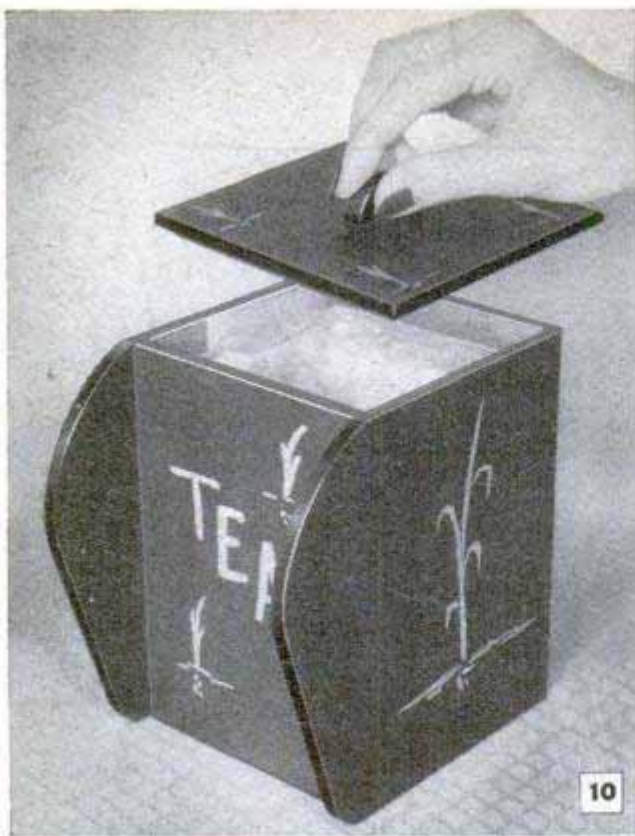

10

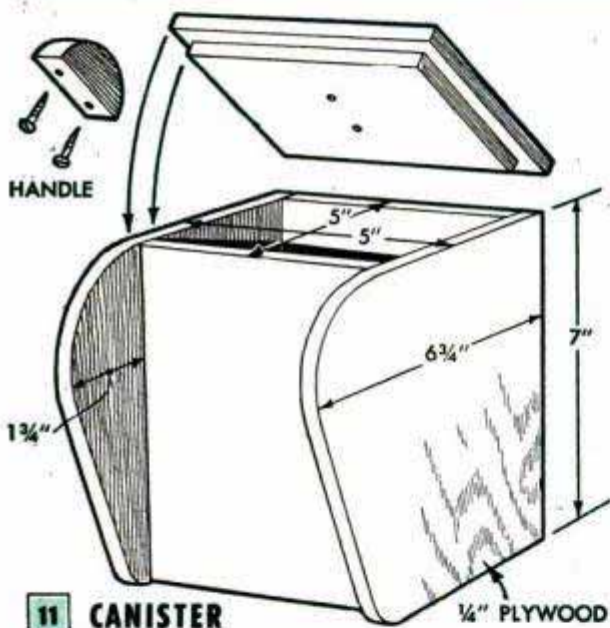

11 CANISTER

1/4" PLYWOOD

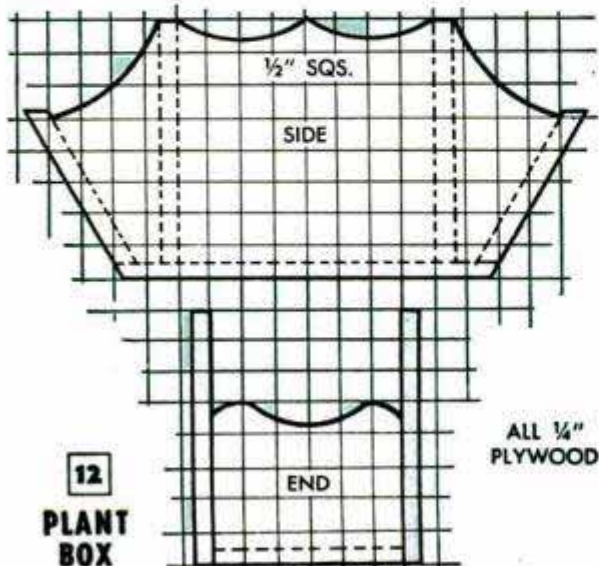

12 PLANT BOX

ALL 1/4" PLYWOOD



13

dimensions being varied to fit the particular clockworks on hand. The hole for the clockface can be cut quickly with a hole saw if you have one. Otherwise, lay out the circle on the work and jigsaw and sand it to the desired radius. Note that the front of the clockcase is framed with half-round molding. This is cut in two lengthwise and the outside edges are rounded as shown.

The plywood canister, Fig. 10, can be tilted forward and set at a convenient angle for scooping out the last of the contents. Canisters can be made in pairs for tea and coffee or in sets of four graduated sizes for tea, coffee, sugar and flour. Liners of sheet metal or cardboard covered with wax paper should be provided as they will not only protect the contents but also facilitate cleaning. The handle, shown in Fig. 11, is a semicircular piece cut from 1/2-in. stock.

Filled with artificial flowers or growing plants, the plant box pictured in Fig. 13 and detailed in Fig. 12 is just the thing for a window-sill decoration or a table centerpiece. The box is divided into three compartments, all of which can be left unlined for artificial flowers or fitted with sheet-metal liners to serve as a planter. A liner can be made only for the center compartment, if desired, leaving the two outer sections for artificial flowers.

All the pieces should be sanded carefully before painting or staining and the sharp corners should be rounded slightly with sandpaper. A coat of shellac will fill and seal the wood surfaces prior to painting. The finish coat of paint should be allowed to dry thoroughly before applying the lettering and decorations. If you don't feel confident of your hand-painting abilities, it will be worth while to cut a stencil for the decorations or apply them by the silk-screen process, particularly if you intend to produce the items in any quantity. Decals are easy to use and provide a wide variety of decorative effects for this type of work.

# Decorated Stationery for the Holiday Season

Your stationery will be in tune with the season if the edge of the paper is decorated with artists' oils floated in a water bath. A year-round color theme can be had in this way, using pastel shades for spring and summer, browns and reds for fall, Christmas colors during the holiday season and blues for the late winter months. Christmas colors, for example, may be red, green and yellow with the green predominating. After selecting the desired colors, mix each one with a little turpentine to thin it out. Then partially fill a shallow cake pan with water and pour the paint onto the surface where it will float to give a marbled effect. Be sure to pour the oil colors slowly onto the water, and use more of one color than the others. Then dip the edge of the stationery or note paper into the floating



paint, immersing the paper no more than  $\frac{1}{4}$  in. as too much color will destroy the pleasing effect. If matching envelopes are desired, touch the edges of the flaps to the paint bath.—Paul Will, Chicago.

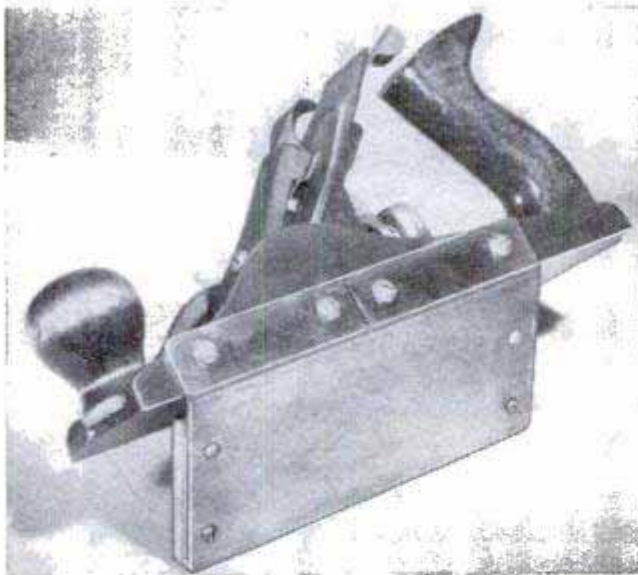

## Fence Fastened to Plane Provides Mitering Guide

By fitting an ordinary block or jointer plane with a sheet-metal fence, you have an accurate guide for mitering the edges of wooden panels. Cut a piece of  $\frac{1}{16}$ -in. sheet metal 4 in. wide and about two thirds the length of the plane. Bend the top edge of the sheet to the desired angle by clamping the metal in a vise and then hammering over the edge  $\frac{3}{4}$  in. from the top. Screw a strip of  $\frac{1}{4}$ -in. plywood to the inner face of the fence, and attach the fence to the plane with small machine screws which are driven into holes drilled and tapped in the side of the plane.

Morris S. Dollens, Los Angeles, Calif.

## Vise Clamps Small Work Between Wooden Blocks

A suitable bar clamp can be improvised from a bench vise and a couple of blocks of wood in just a few minutes. Clamp one of the blocks to the top of the workbench and place the second block against the end of the vise shaft. Then lay the work on the bench between the two blocks of wood and tighten the vise so that the shaft will press the work together as it moves outward from the rear of the vise.

Louis Hochman, Sherman Oaks, Calif.

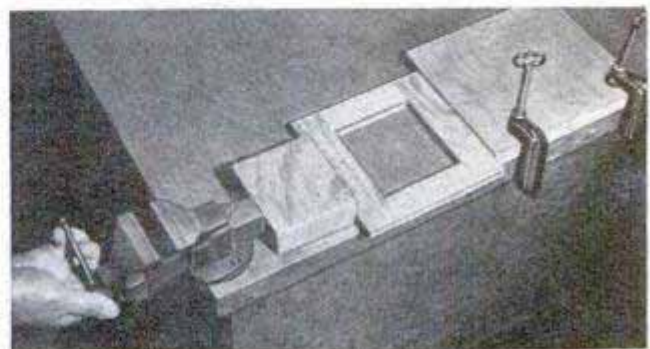

## Making Wooden Blocks for Children

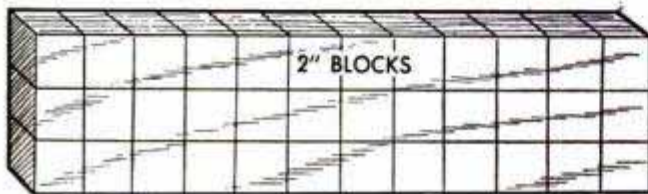

A quick and inexpensive way to make a generous set of building blocks for your child is to cut them from a plank and then paint them to suit. Mark the plank lengthwise and crosswise to form squares of the same dimension as the thickness of the board, being sure to allow for the width of the saw cuts when laying out the squares. Rip the plank lengthwise into strips and then saw along the cross marks to form the individual blocks. After cutting, paint the blocks with a nontoxic enamel, glue appropriate numbers, decals or animal pictures clipped from magazines to the faces of the blocks and then coat with clear shellac. The latter will facilitate keeping the blocks clean and also prevent the pictures from wearing off. If the glue does not adhere to the paint, roughen the surface with sandpaper before gluing.

Warren W. Howe, Longview, Wash.

## Towel Draped Across Door Edge Prevents Accidental Slamming

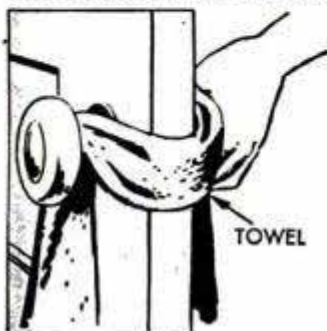

There will be no danger of thoughtlessly slamming a sickroom door and disturbing the patient if a towel is used to dampen the sound and to keep the door from closing tightly.

Drape a small hand towel over both door-knobs so that it stretches across the edge of the door as shown in the drawing.

David Deutsch, Brooklyn, N. Y.

## Plastic Liner Protects Shirt Pocket From Damage by Pencils

If you carry several sharpened pencils in a shirt pocket, this easily made plastic liner can be used to protect the shirt from being soiled or damaged by the pencils. Just cut a strip of sheet plastic to fit snugly in the pocket, heat the plastic and bend it double, leaving a space the thickness of a pencil between the plastic folds. Then bend down one end of the plastic to slip over the edge of the pocket.

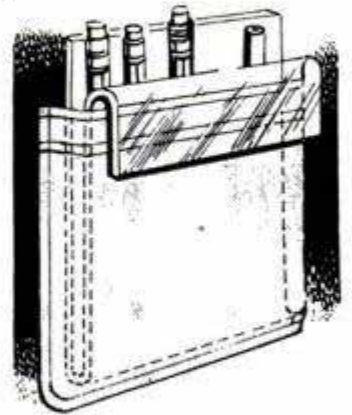

T. C. Evans, Baltimore, Md.

## Ice Cube Numbs Injured Finger

Removing a splinter from a finger is less painful if an ice cube is held against the injured area immediately beforehand. Just press the ice against the finger until the flesh is numb from the cold.

## Level Anchored to Straightedge

When a wooden level is used in conjunction with a straightedge it is more convenient to use the two together if two dowel pins driven in the top of the straightedge are used to attach the level. The dowels, which engage corresponding holes drilled in the level, serve to hold the level in place when using it horizontally. The level is also kept from shifting when checking for plumb. The straightedge must be thick enough so the weight of the level will not cause it to tip when being used horizontally and left unsupported.

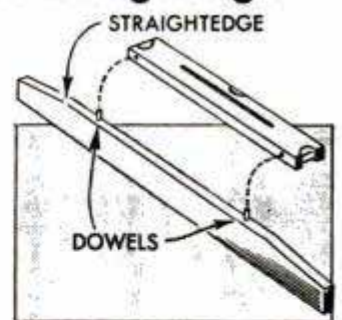

## Clay Shields Glass Cutter

To protect a glass cutter from rust as well as damage resulting from contact with other tools, completely enclose the cutting end in a wad of modeling clay before storing. Wipe the cutter with an oiled cloth to keep the clay from adhering to it.

# HOLDERS for Earrings

By Herman R. Wallin

THESE plastic earring holders not only are attractive and useful additions to the dressing-table appointments, but each one is an especially interesting one-evening project for the crafter who likes to work plastics. The first step in making either cutout is to enlarge the squared patterns to full size and transfer them to the protective paper covering on a sheet of  $\frac{3}{16}$ -in. clear plastic. Then cut on the pattern lines with a hand or power jigsaw, using a fine-toothed blade. After sawing, go over the edges with a fine file to remove the saw marks. Now, polish the edges with a buffing wheel charged with rouge polishing compound. The wheel should be run at a slow speed as, otherwise, heat may soften the plastic. Note in the details below that the tip of the clown's hat and the dancer's toe are extended somewhat for attaching to plastic bases. These edges should be left square. Holes in the body, arms and legs of the clown are drilled clear through, but the eyes, mouth and other lines are cut into the surface with a sharp-pointed tool. Holes also are drilled in the bases to varying depths with drills of different sizes. The holes are filled with plastic dye and after allowing time for the dye to color deeply, the excess is drained out. The eyes of the clown are dyed blue and the mouth red. When the cutouts are finished, force the dancer's toe and the tip of the clown's hat into shallow holes drilled in the bases and cement in place.

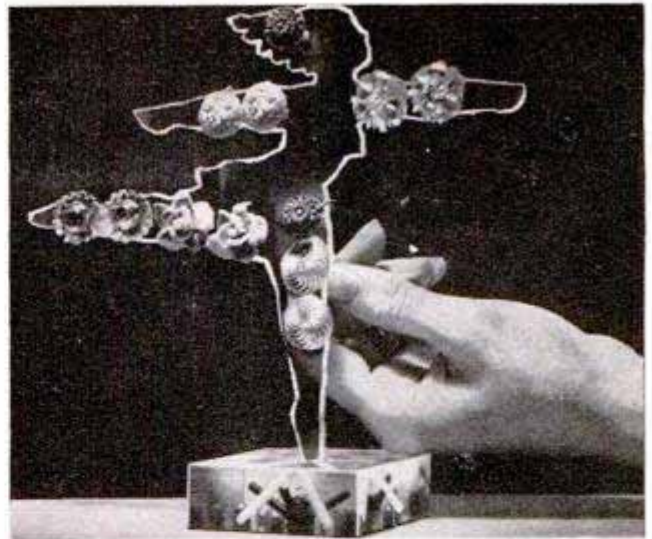

Clear plastic is used for this cutout and base. Holes of various sizes drilled in the base from the bottom are dyed in harmonious colors by using plastic dyes

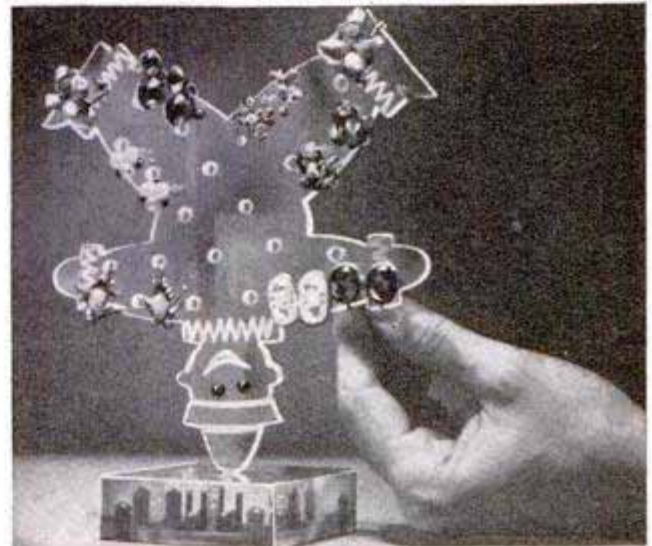

Although standing continually on his head this clown cutout provides a novel rack for hanging clusters of colorful earrings. Eyes, nose and ruffles are engraved

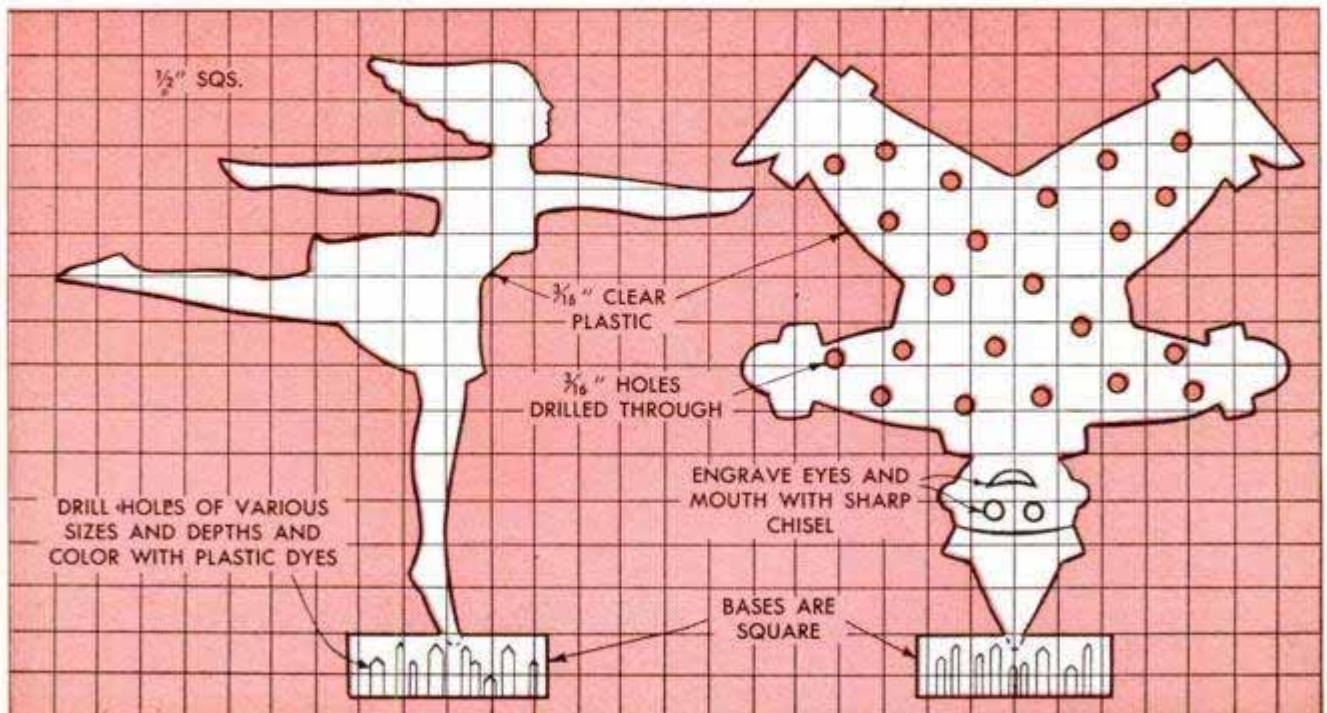

# Two Take-Apart UTILITY TABLES

By Elma Waltner

THESE all-purpose plywood tables will have many uses around the home, three of which are suggested at the left. The tables also can be readily taken apart and stored in small space when not needed. The one shown on the opposite page is made from a 4 x 8-ft. panel of plywood cut in half, making two separate sections with side rails and folding legs added. Locking strips and wing-nut bolts fasten the sections together for use as one large table. After making the top in two separate 4 x 4-ft. squares, thoroughly sand the edges and make the framework or side rails. These are glued and screwed to the lower side of the top boards, using 1 1/4-in. screws in countersunk holes drilled through the edge of the side rails as shown in the detail, Fig. 1. Round off the top ends of the legs and cross drill for the 1/4-in. bolts which hinge them to the mounting blocks, Fig. 2. The legs are held in the open position by folding table brackets, which may be purchased ready to attach or made up from flat iron to the dimensions shown in Fig. 1. Care must be used in laying out the dimensions for the screws holding these brackets in place. Any inaccuracy in locating the screws will prevent the legs from folding properly. The detail in Fig. 1 shows the dimensions for brackets, how they are riveted together and the location of the drilled holes for

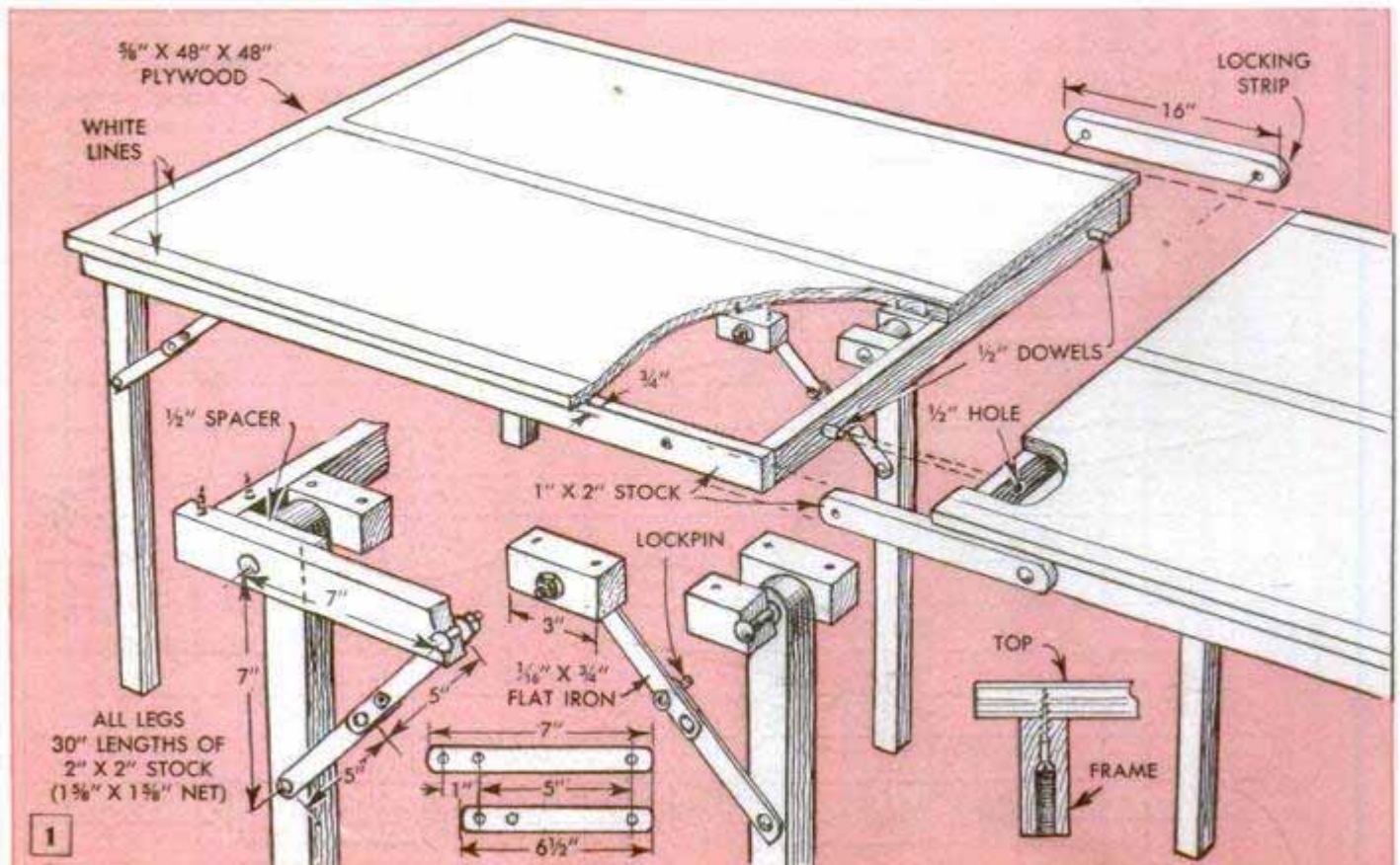



inserting the cotter key, Fig. 3, when the brackets are extended for locking the legs in an open position while the table is in use. Center locking strips for holding the two table sections together are made up from 1 x 2-in. stock 16 in. long. Matching holes are drilled through the strips and into the table side rails for the insertion of 1/4-in. bolts, which are fitted with wing nuts for quickly clamping the two parts together, or for quick removal when collapsing the table for storage. When the carpenter work has been completed, thoroughly sand the various parts and apply two coats of exterior enamel undercoater, painting the entire table surfaces, top, bottom, side rails and legs as well. When dry, apply a third coat of exterior, dark-green, flat-finish enamel. While 5 x 9 ft. is the regulation size for a table-tennis table, the game can be played on this undersize table. The white lines can be made 3/4 in. wide and neatly applied by first laying off the lines with decorator's masking tape, as in Fig. 4. Be sure edges of the tape are firmly pressed down in perfect contact with the table top at all points so that the paint cannot run under. Two coats of white paint will be needed to make a good finish. When the paint has thoroughly dried the tape may be stripped off.

The utility table shown in Fig. 5 is entirely of plywood construction. The simple lock joints, which hold the base rigid without the use of any fastenings, allow the table to be quickly assembled for use or readily taken apart for storage. It is of regulation height for table tennis. If the table is to be used outdoors it should be built of exterior-type plywood which will

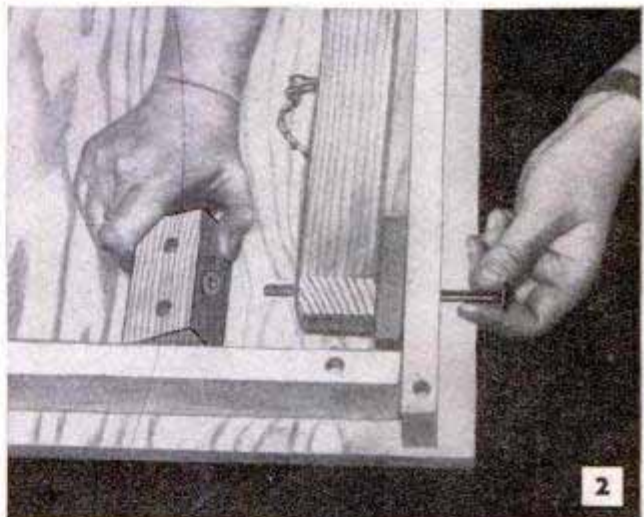

Hinge legs with bolt through side rail and mounting block; then screw block to table top. Below, insert cotter key in table bracket to lock the leg in place

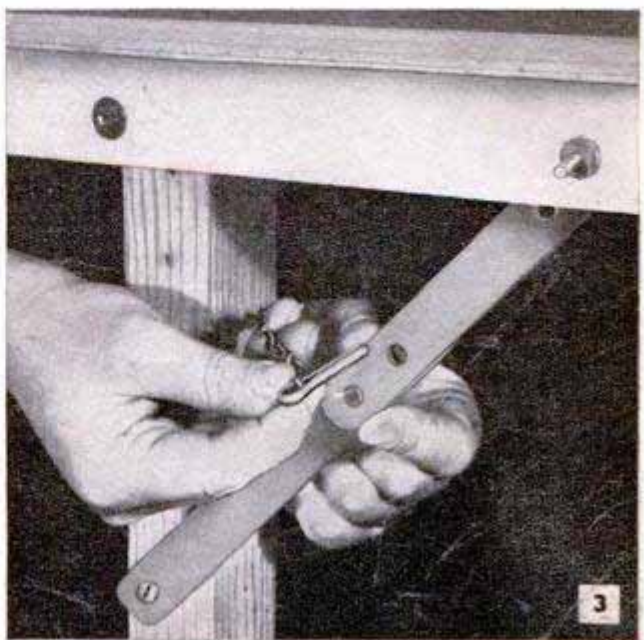

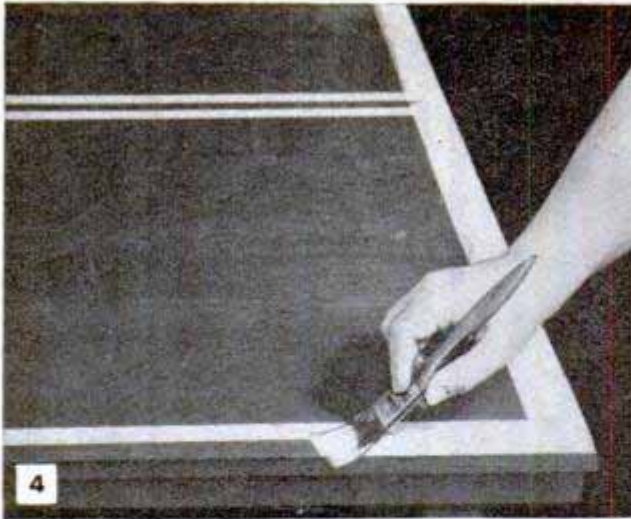

Paint white lines around the edge and lengthwise down the center of the table top. Lay out lines with decorator's masking tape. Apply paint with soft brush. Strip off tape when paint is thoroughly dry

stand up well under all weather conditions. For indoors, where not permanently exposed to weather or repeated wettings, use the ordinary grade of plywood which is considerably less expensive. Panels  $\frac{3}{4}$  in. thick are preferred. The top can be made from one piece, 5 x 9-ft., which can be had on special order, or two pieces 5 x 4 $\frac{1}{2}$ -ft., hinged in the center, as shown in the detail in Fig. 5. The pieces for the base, the rails and the legs, can all be cut from one 96 x 30-in. panel. Carefully mark the frame pieces to the dimensions shown in the drawing, Fig. 5, and cut them with a sharp handsaw or power equipment if available. The notches in the various panels should be accurate in width. They can be made easily by drilling a hole at the bottom line and sawing each edge into the hole. The corners can be trimmed with a chisel.

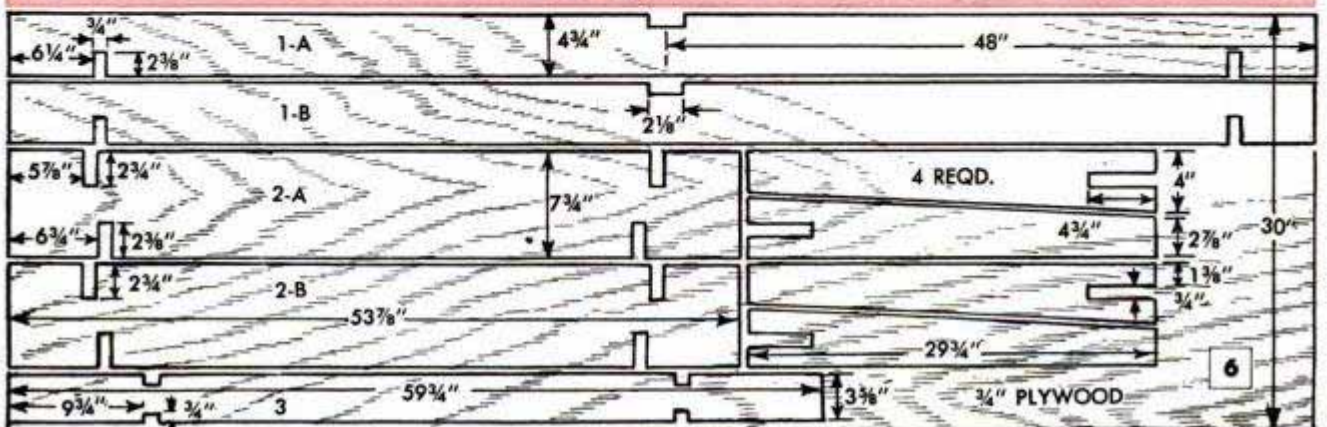
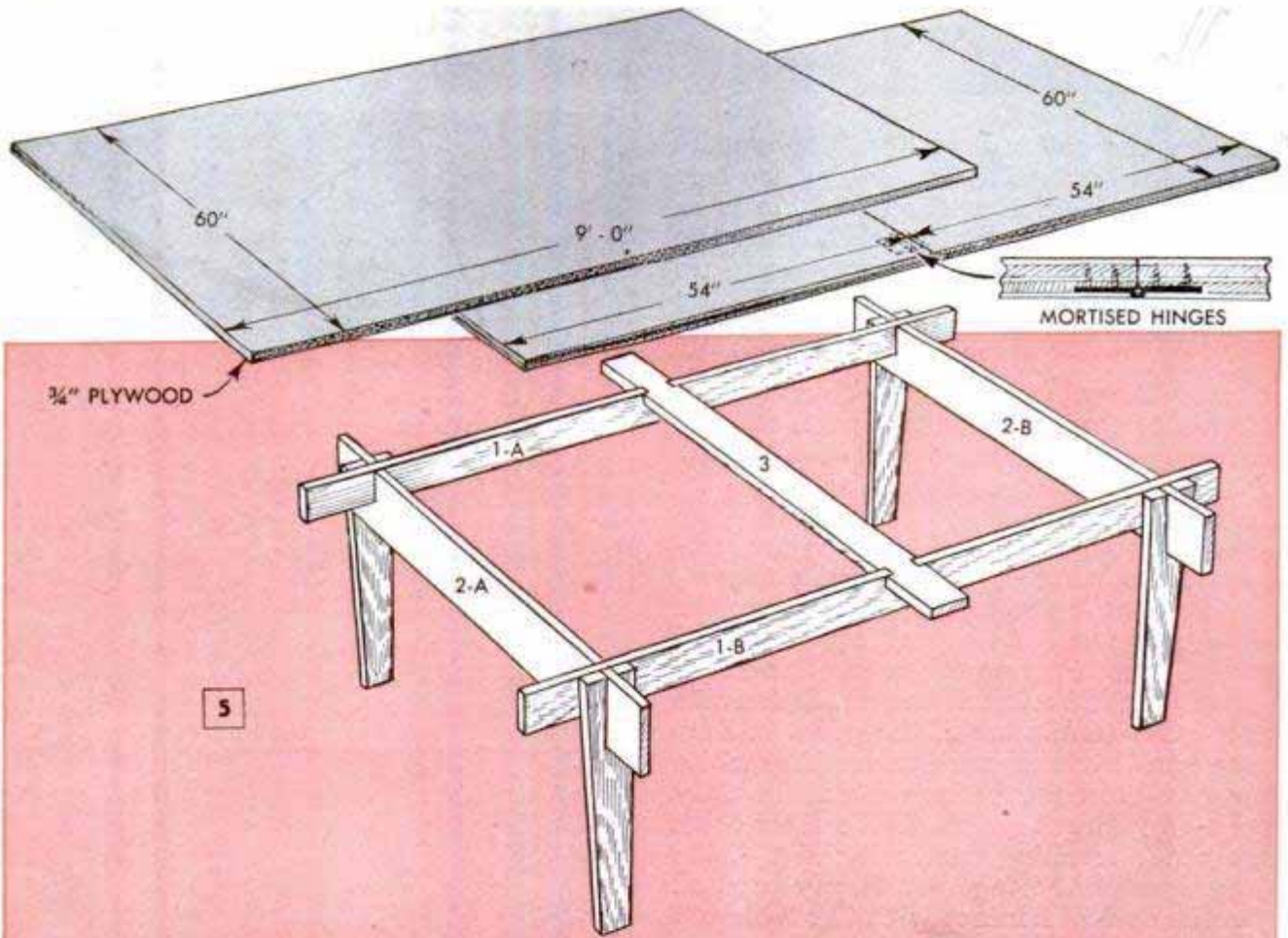



## Refinishing Taillight Lenses With Red Fingernail Polish

FINGERNAIL POLISH

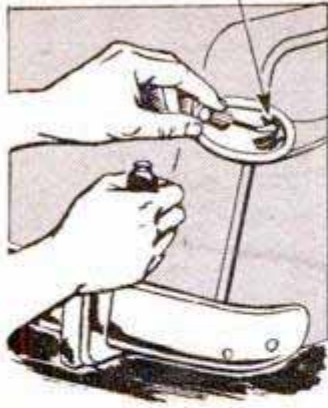

Prolonged exposure to sun and weather sometimes bleaches plastic taillight lenses and dulls their surface, resulting in a loss of color when turned on and detracting from the appearance of the lens during the day-time. To restore

the lens to a bright, safe red, coat it with red fingernail polish. If the surface of the lens is rough, first smooth it with fine sandpaper. Then, thin the polish with acetone and apply a light coat to the lens with long, fast strokes of the brush to attain a transparent coating. It is best to do this with the taillights turned on so it is easy to tell whether or not the polish is being applied evenly.—Frank C. Byrnes, Chicago.

## Tubing Bent Around Pulley To Prevent Kinking

There is always the danger of kinking when bending copper or aluminum tubing. However, this trouble may be eliminated by placing the tubing between two pulleys which are mounted on a board a short distance apart. The tubing is worked between the pulleys while making the bend gradually. Best results are obtained by moving the tubing up and away from the larger pulley as the bending progresses.

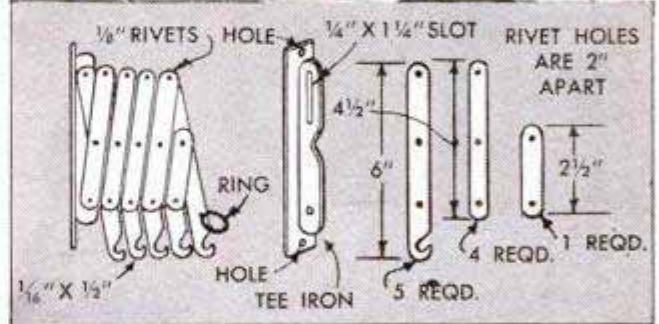
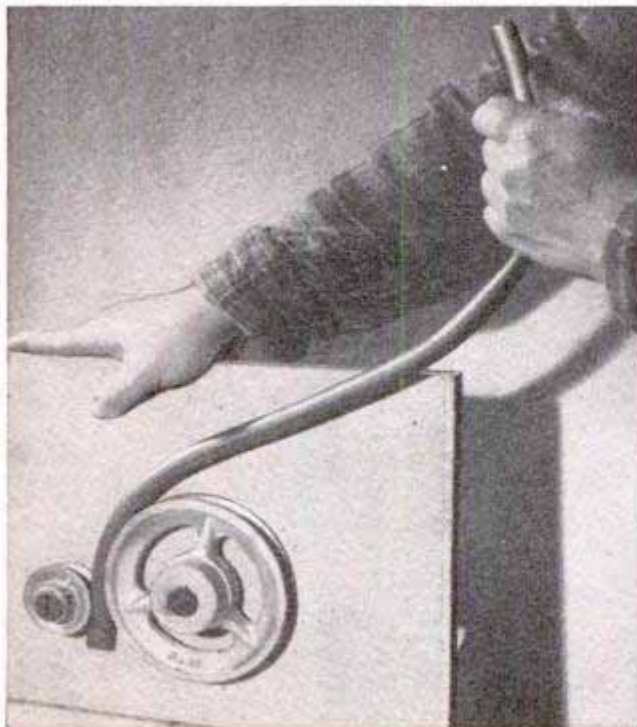

## Hanging Clothes From Lazy Tongs Saves Space in Small Closet

Having trouble selecting any one certain garment from an overloaded wardrobe closet? By equipping the closet with a flat-iron lazy tongs made to support several coat hangers, you may be sure of easy access to the garments. Insert a ring through the first flat-iron section to serve as a handle for pulling out the lazy tongs.

T. Sparks, Warrington, England.

## Spectacle Case Clamped on Saw Muffles Sound of Filing

One carpenter uses a discarded spectacle case to muffle the annoying squeaking sound when he is filing the teeth of his handsaw. He merely clamps the case over a portion of the blade not being filed and then moves it along the blade as necessary.

## Rubber Hose Slipped Over Bail Forms Comfortable Handgrip

Although empty 5-gal. paint pails find many uses around the home, the wire bails are hard on the hands when heavy loads are carried. To provide a comfortable handgrip, remove one end of the bail from the boss on the side of

the pail and slip a length of rubber hose over the wire. The hose should be long enough so it will not slip out of position.

W. B. Kennedy, McCool, Miss.

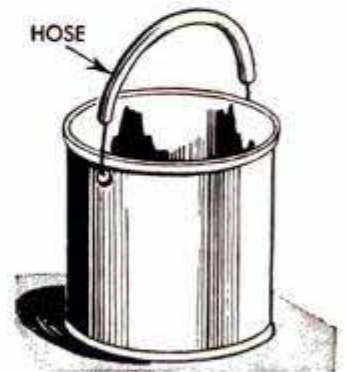

## Double-Hung Clothesline Conserves Space in Yard or Basement



Double-hung clotheslines are real space-savers when it comes to hanging socks, washcloths and the smaller articles of clothing. If the space for hanging your wash is limited, string one or more of these double lines by locating the top one as high as you can reach and then locating a second line two or three feet below it.

## Rubber Band Around Paint Can Indicates Level of Contents

You will know at a glance how much paint is left in the partially empty cans that accumulate in the shop if you use a rubber band to indicate the amount remaining in each can. Just slip the rubber band over the can and adjust it approximately to the same position as that of the paint level.



Ira A. Minor, New York City.

## Trap Improves Trailer Icebox By Forming Water Seal

Slipping a short length of rubber hose over the drain outlet of a trailer icebox forms a water seal which prevents warm air from entering the box through the drain. The hose is looped as shown in the

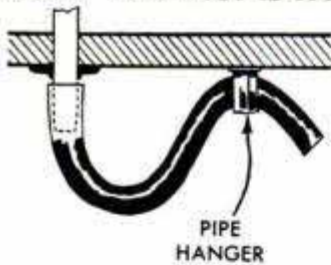

detail and the free end is attached to the underside of the trailer floor by means of an ordinary pipe hanger. —Clinton R. Hull, Costa Mesa, Calif.

## Simulated Pork-Rind Bait

Scraps of drumhead material cut to the desired shape and length provide imitation pork rind that can be used over and over again with your fishing lures. The material, which can be obtained from many music repair shops, needs no preservative.

R. A. Jenkins, St. Louis, Mo.

## Improved Tipup for Ice Fishing Made From Three-Pronged Branch

If you want an extra ice-fishing tipup and have no materials with which to make one, you can improvise a suitable one from a three-pronged branch. Cut two of the arms shorter than the third one and notch the third arm to permit tying the fishline securely. Tie a piece of colored cloth to the end of the tipup to serve as a warning. Be sure that the spread of the two smaller arms is greater than the diameter of the hole in the ice. Otherwise, the tipup is likely to be pulled right through the hole.

Kenneth Gabrosek, Fly Creek, N.Y.

## Cork Backs Plaster Patch

Small holes left in a plastered wall by removal of a pipe can be patched quickly by using a bottle cork to serve as a backing for the plaster. The cork should be trimmed so that it can be pressed in the hole flush with the face of the lath.



# GARDEN URNS

*molded in concrete*

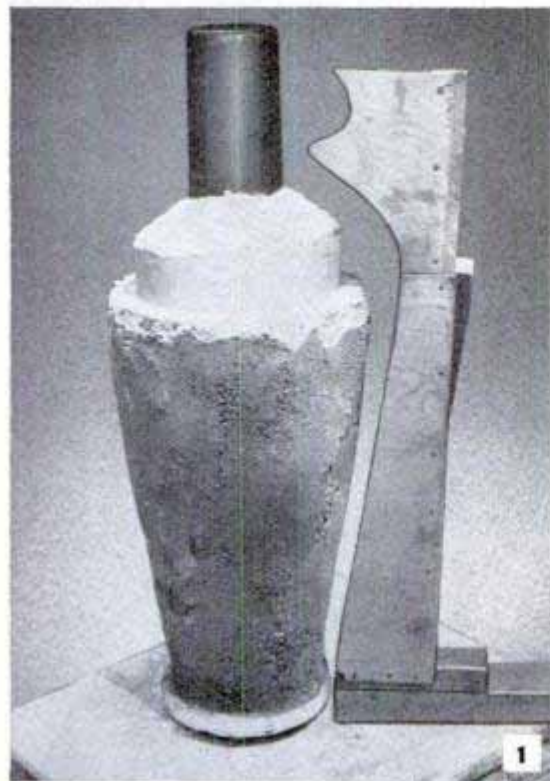

By Dick Hutchinson

LENDING a Spanish touch to the entrance of a ranch-type home, these large ornamental urns are fashioned without molds. Built up on a modified potter's wheel, a workable mixture of sand, 1 part, and portland cement, 3 parts, is applied to a core of sand held in a wrapping-paper form. The sectional drawing in Fig. 2 shows how the core is set on a 2-in.-thick base of concrete placed on a turntable and then covered with a 1-in.-thick layer of concrete. The core at the top is made up of a paper collar filled with sand in which a bottle is placed inverted to form the neck opening. When set, the concrete is wet thoroughly and more concrete is applied to build up the outside to conform with the plywood template, Fig. 1. The bottle is removed and the urn is turned upside down to pour out the sand. A thin brush coat of water and red-iron oxide is daubed over the outside of the urn.

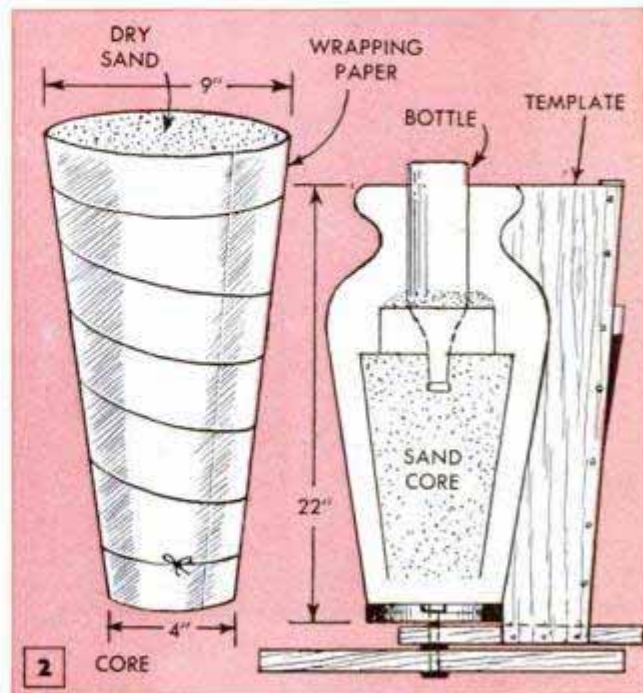

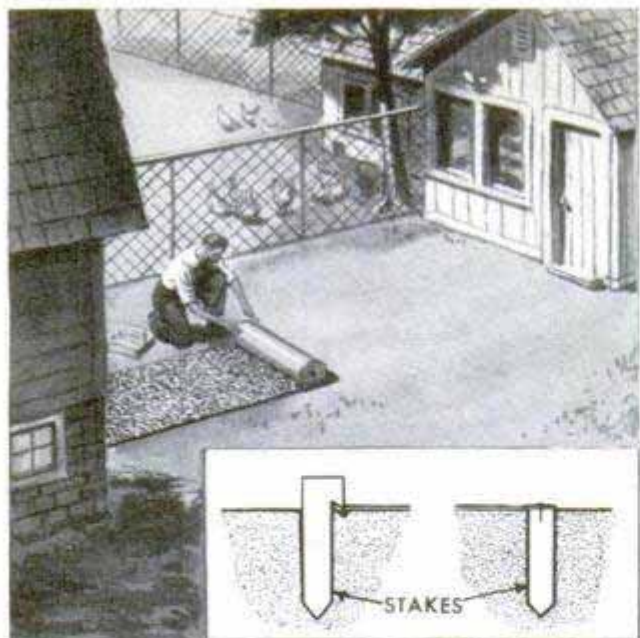

### Asphalt Roofing Laid on Ground Provides Temporary Walk

Roll roofing laid directly on the ground and held in place with stakes provides an excellent substitute for a concrete walk. It is inexpensive and sturdy, making it ideal for providing a reasonably dry path on new construction where there will be considerable delay in laying concrete walks or on the farm between the various out-buildings. Two methods of anchoring the roofing are shown in the detail. One consists of a notched stake which is driven into the ground to grip the edge of the roofing. The other method is accomplished by tacking the roofing to the tops of stakes which have been driven flush with the surface of the ground at intervals of a few feet.

Ralph J. Patterson, Fairfield, Me.

### Old Putty Removed From Sash With Altered Plane Blade

Removing putty from window sash is done quickly by one glazier who uses an old plane blade to do the job. One half of the cutting edge is ground off the blade which is then set in the plane at the required depth. In use, the plane rests on the sash frame while the projecting blade chips away sections of the putty as the tool is pushed along.

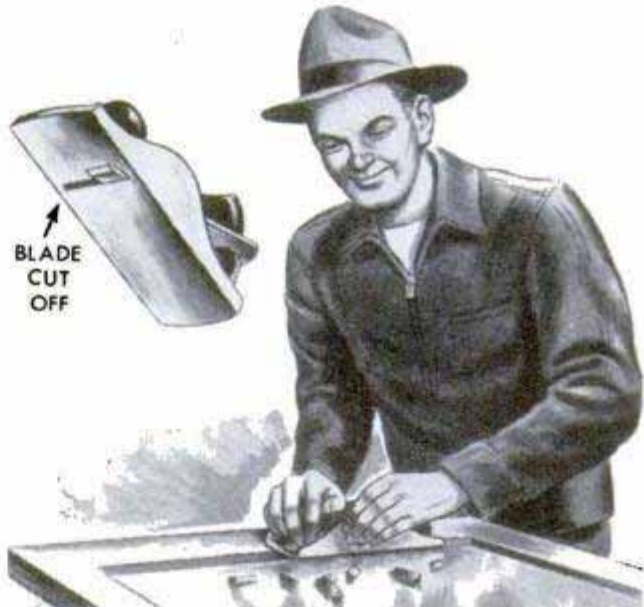

### Varnish Aids in Patching Plaster

When patching a plastered wall, brush the edges of the old plaster with varnish. Allow the varnish to dry until tacky and then add the patching plaster. The varnish will result in a better bond, giving added strength and a neater-looking job.

L. Larsen, Ludington, Mich.

### Walnut Phonograph Top Forms Modern Hopper-Type Picture Frame



Don't throw away that old walnut phonograph top. It will make a deep picture frame of real interest and beauty to hang over your modern radio or television set. After removing the original finish and filling any holes or deep scratches, including the holes left by the hinge screws, coat the top with shellac, and then rub with linseed oil to bring out the natural luster and rich grain of the wood. A three-dimensional scene was fashioned for the frame shown by gluing a calendar illustration of a marshy lake to the inside of the phonograph top. Then two carved wooden ducks were fastened in flight formation over the background, using small screws driven from the back of the frame. An engraved brass strip not only titles the picture but also conceals the spot where the lock used to be.

Maurine Russel, Denver, Colo.

# Installing HOT-WATER HEATERS

How to maintain top efficiency and avoid common troubles. Includes safety features, "side arm" heaters, tempering tanks, heat exchangers and installation

By E. R. Haan

**H**OT-WATER heaters of the automatic types designed to use electricity, gas or oil are available in a wide range of sizes for new installations. There also are special conversion units which can be installed in tanks connected to older-type furnace coils or other sources of heat. One of these is a simple electrically operated immersion unit which can be installed in any existing tank to convert it to full automatic operation at very little cost. Another inexpensive unit is a thermostatically controlled gas valve especially designed for converting a hand-controlled gas heater of the older type. Although these newer units are fully automatic in operation, they require periodic checks to keep them operating at peak efficiency. Before installing a new heater, it's a good idea to check costs of electricity, gas and oil in your locality so that you can install the heater utilizing the most economical fuel.

**Safety controls:** As heated water expands and tends to build up excessive pressures, every automatic water heater must be provided with safety controls on the burner unit and also should be fitted with a pressure-relief valve, Figs. 1, 2 and 4. One type of relief valve opens when excessive pressure develops and also is fitted with a fusible plug that melts at about 210 deg. F. The pressure element usually is adjustable to open under pressures ranging from 50 to 125 lbs. per sq. in. Of course, the fusible plugs are replaceable, several being supplied with each new unit. Two types of these valves are shown in Fig. 2. Some other types of relief valves have a manual tripping mechanism that should be test-operated once or twice a year to see that the valve is in reliable working condition. In some installations it also is necessary to install a check valve in the cold-water line

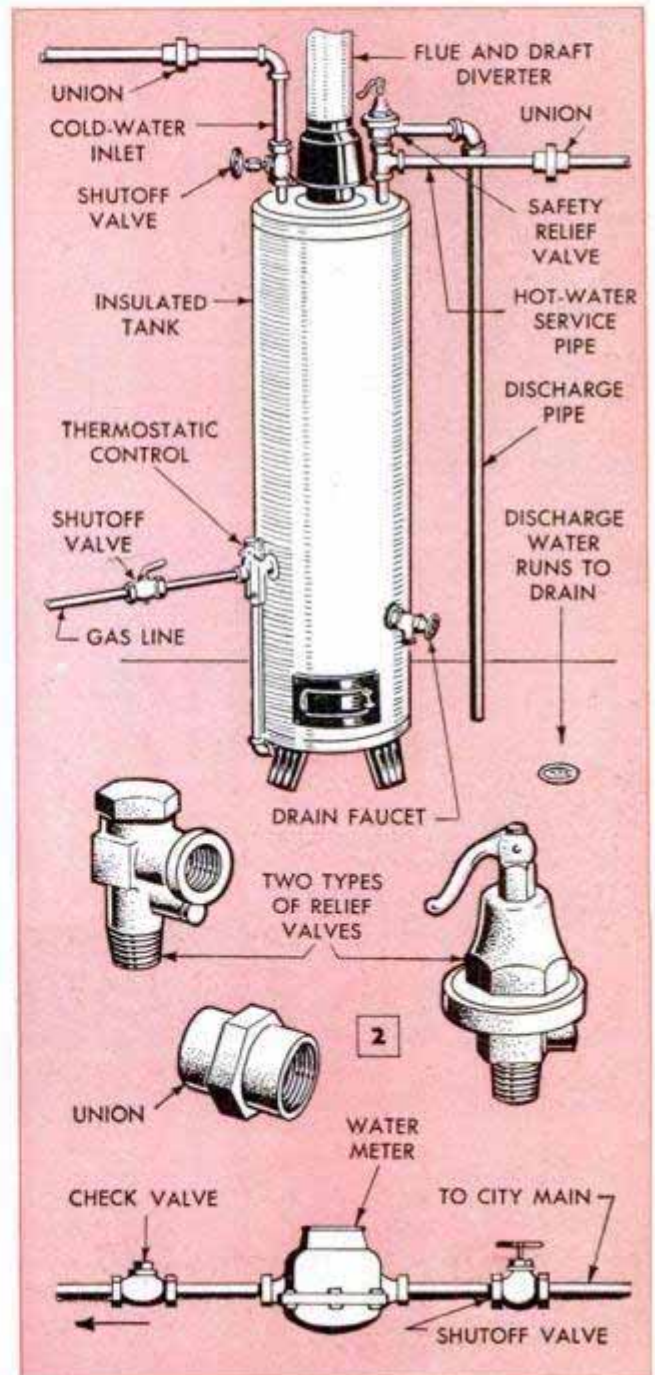
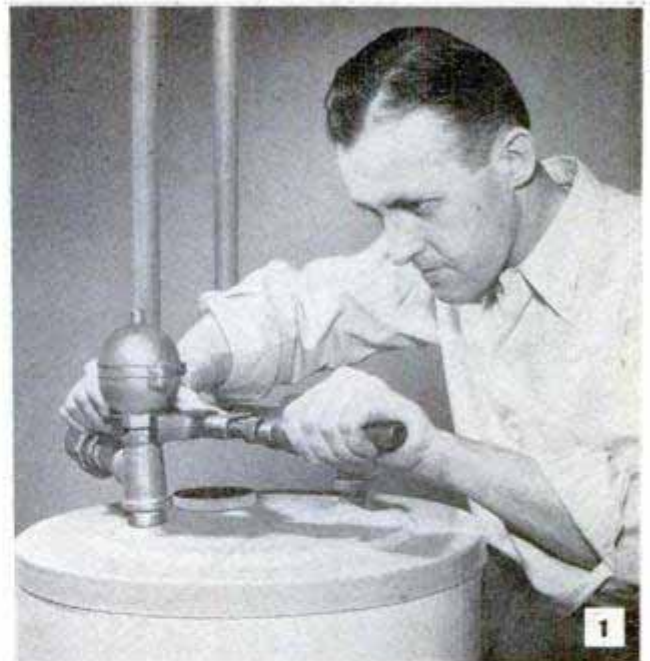



A—SHUTOFF VALVE; B—NIPPLES; C—REDUCER; D—BUSHING;  
E—COLD-WATER TUBE WITH HOLE TO PREVENT SIPHONING;  
F—TEE; G—RELIEF VALVE; H—ELBOW; I—DISCHARGE PIPE; J—  
WATER-TANK UNIONS; K—STREET ELBOW; L—COUPLING; M—  
DRAIN FAUCET

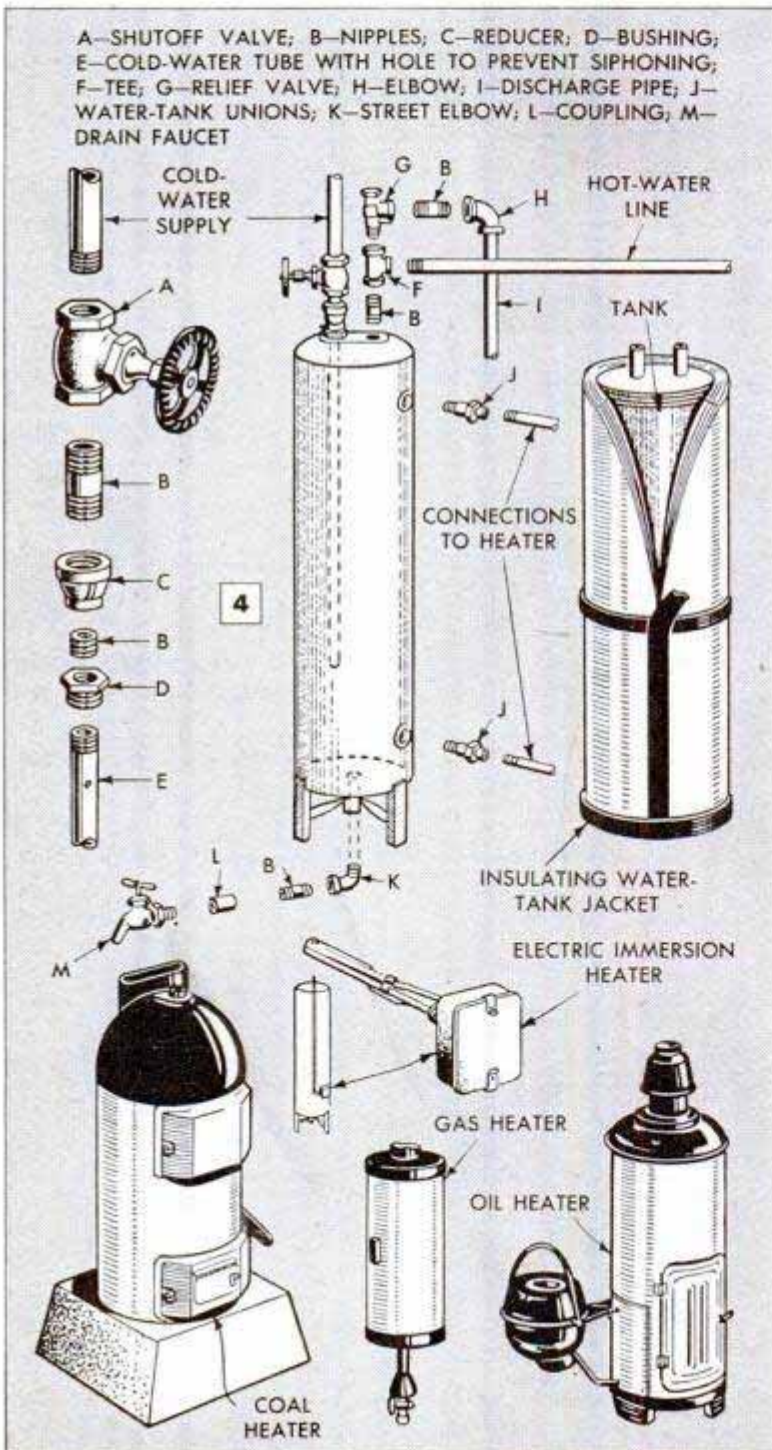

as shown in Fig. 2. This valve protects the water meter from being damaged should hot water back up against the normal pressure in the water line. Electric heaters are controlled by thermostatic switches which ordinarily do not require attention. The heating unit is turned on and off automatically between the heat ranges for which the thermostat is set. Automatic gas-fired water heaters have thermostatically controlled burners which maintain uniform water temperatures and will shut off the gas supply completely in case the pilot light goes out.

**Pipe and flue sizes:** Pipe connections on the heater tank determine the size of pipe to use in connecting the unit to the water supply lines. The main hot-water lines usually are of  $\frac{3}{4}$ -in. pipe while  $\frac{1}{2}$ -in. pipe is used for branch lines. Pipe smaller than  $\frac{1}{2}$  in. should not be used. Pipe runs from the heater to existing lines are connected by means of unions as in Fig. 4. Of course, electric heaters do not require flues, or vents, but all gas, oil and coal-fired water heaters require flues either to an existing chimney, or direct to the outside. Many homeowners install vent pipes, or flues, of stainless steel as this material does not corrode. Gas and oil-burning water heaters should always be fitted with a draft diverter of the type in Figs. 2 and 3.

**Water-heater installation:** Gas and oil-burning water heaters are comparatively easy to install. Just place the unit on a level floor, or a concrete base 2 to 3 in. thick, and as close as possible to a flue opening in the chimney. Flue or vent-pipe sizes generally are 3 to 4 in. in diameter for gas, 4 to 5 in. for oil and 4 to 6 in. for the coal-burning heater. In connecting the gas and oil supply lines, follow the directions of the heater manufacturer in all details. A shutoff valve should be installed in the cold-water line near the tank and, in oil-burning heaters, it is customary to install a valve in the fuel line near the burner, as in Fig. 2. A shutoff valve is not required in the hot-water line. Never locate a shutoff valve between the relief valve and the tank.

Hot-water storage tanks having

A tempering tank saves on water-heating costs. Such tanks are generally installed overhead, being hung from joists with flat-iron bands

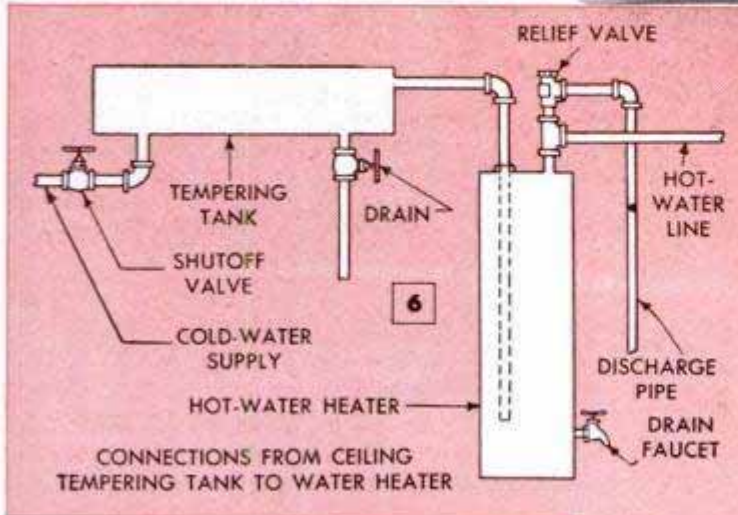
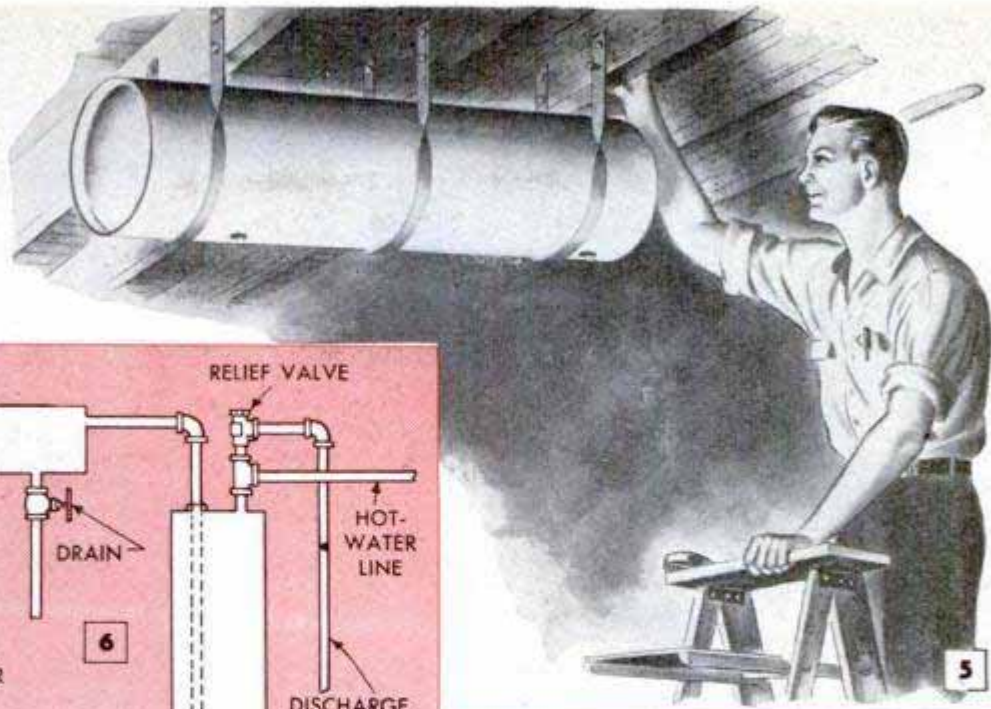

no built-in heater units have six standard tappings and come uninsulated. The tank stand, pipe fittings, relief and drain valves and the cold-water tube are installed as in Fig. 4. The cold-water tube, preferably of brass, usually is about 4 ft. long for a 5-ft. tank. It extends inside the tank so that cold water is discharged near the bottom to prevent cooling the hot water above. A small hole is drilled near the top end of the pipe, its purpose being to prevent hot water from being siphoned out of the tank when cold water is drawn from the system at a level lower than the top of the tank. After installing the storage tank it will pay to insulate it as in Fig. 4. This will prevent a 15 to 30-percent heat loss by radiation. It also is advisable to insulate long runs of hot-water pipe for the same reason.

**Connecting separate heater:** When separate heating units of the gas, coal or oil-fired types are hooked up to hot-water storage tanks, inefficiencies in heating are caused by faulty installations such as those detailed in Fig. 8. Gas-fired side-arm heaters should be connected as in Fig. 9, and as in Fig. 12 when a water back is used in the furnace or boiler. The hot-water pipe from the heater to the tank should rise vertically from the heater and then run horizontally to the tank connection. When making the right-angle bend, use two 45-deg. elbows and a short nipple rather than a single 90-deg. elbow. Fig. 9 also shows the installation of a thermostatic gas-con-

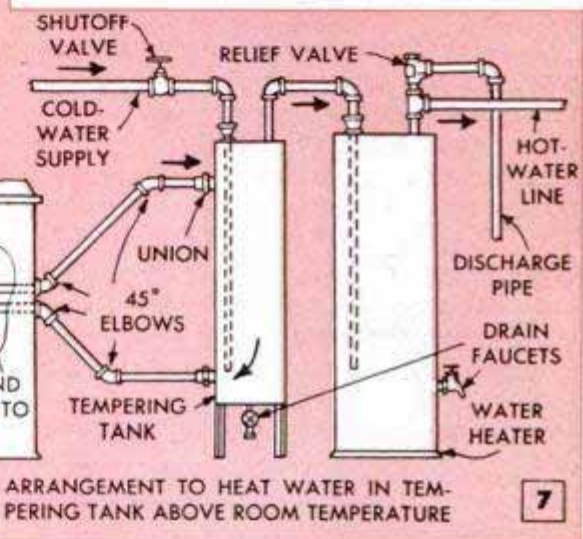

trol unit for full automatic operation of the heater. If desired, an electrically operated immersion unit, Fig. 4, can be installed in place of the side-arm gas heater. This unit also is controlled automatically.

**Tempering tanks:** Worth-while savings can be made in water-heating costs by the installation of tempering tanks in which cold water is preheated to room temperature before entering the heater tank. Figs. 5, 6 and 7 detail common methods of installing tempering tanks. In ordinary installations, it is regular practice to hang the tank from the floor joists as in Figs. 5 and 6, but it also can be arranged as in Fig. 7 and connected to a heating coil in the boiler or furnace. A 20 or 30-gal. tank usually is sufficient for either type of installation. The ordinary pipe connections are shown in Figs. 6 and 7. Note that in both types of installations drain valves are provided. In a coal-fired furnace or boiler the water coil projects only a short distance into the firebox. On furnaces or boilers in which intermittent flash heating with gas or oil is used,

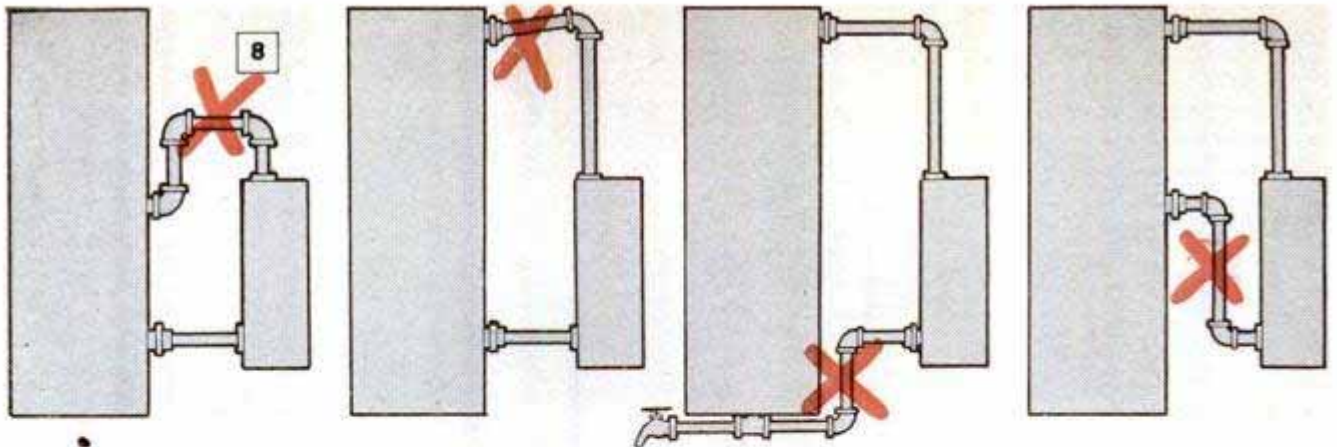

8  
THREE 90° TURNS AND DOWNWARD FLOW OF HEATED WATER RETARDS CIRCULATION; CENTER CONNECTION TO TANK NOT ADVISABLE

DOWNWARD TRAVEL OF HEATED WATER TO TANK RETARDS FLOW. USE SHORTER VERTICAL PIPE TO GET UPPER ONE HORIZONTAL

COLD-WATER RETURN AT TANK BOTTOM PERMITS SEDIMENT AND RUST TO CIRCULATE WITH WATER; SEDIMENT WILL CLOG LOWER PIPE

COLD-WATER RETURN FROM CENTER OF TANK KEEPS LOWER PORTION TOO COLD AND UPPER PORTION TOO HOT

the return bend of the coil must be inserted farther into the firebox in order to obtain satisfactory results from the installation.

**Heat exchangers:** In many homes, various installations are used to warm the water in a storage tank by piping in steam or hot water from the boiler. In some cases a steam or hot-water coil is submerged directly in the storage tank. The details in Fig. 10 show both the direct and indirect types of hookups for this purpose. With the indirect method, water from the storage tank flows through a coil submerged in a smaller tank in which hot water from the boiler is circulated. A coil connected to a storage tank may be placed inside a steam or hot-water boiler below the water line. In these systems steam or hot-water lines from the heating plant are automatically

opened and closed by thermostatic valves or by aquastats on the storage tank, which prevents overheating of the water. Very often heating plants equipped in this way are used throughout the summer season for heating water. In these installations special controls are installed to prevent circulation of heated water or steam throughout the heating system. As a rule, however, an auxiliary water heater, shown by the dotted lines in the lower detail in Fig. 10, is used during the summer months.

**Water backs:** A water back, Fig. 12, should always be installed in the furnace or boiler in a level position, as otherwise a pocket of live steam may form at A, and blow back periodically through the line into the storage tank, causing a sharp, metallic hammering which in time will damage the installation. Water backs generally overheat during the coldest weather when the heating plant is operating over long periods at full capacity. The lower detail in Fig. 12 shows one practical way to utilize excess heat from the installation by circulating the water through a radiator installed in a room directly above the storage tank. This type of installation is frequently used when hot water is drawn from the storage tank only at comparatively long intervals.

**Liming of heating coils:** In localities where only hard water is available, heating coils in side-arm heaters, water backs and furnaces gradually become coated inside with deposits of lime. This hard coating not only acts as insulation, requiring more and more heat to keep up the water temperature as the coating thickens, but it also restricts the water passage and eventually clogs the coil. Hot water circulating through a restricted passage may cause such severe hammering that it will loosen the pipe joints and cause leakage. The remedy, of course, is then to install a

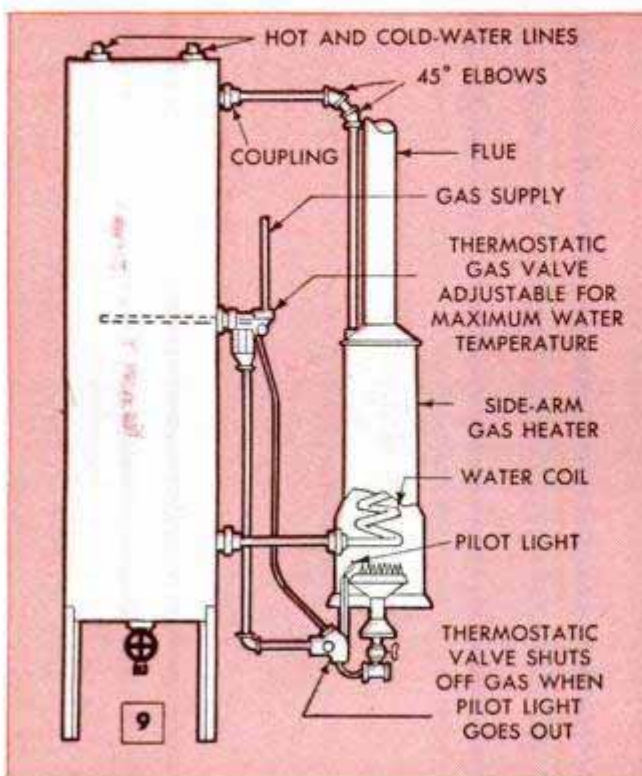



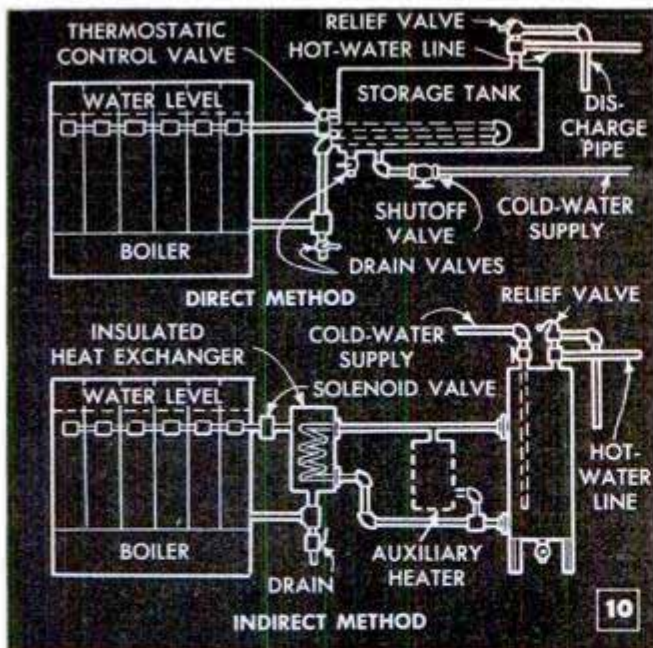

water softener and replace the faulty coil.

**Flushing and refilling storage tank:** Impurities contained in water settle to the bottom of hot-water storage tanks and form a film of sediment across the bottom of the tank. It's a good idea to open the drain faucet at the lower end of the tank once a month and drain off 2 to 4 gal. of water. This precaution will remove most of the accumulated sediment and keep the tank comparatively clean. However, a thorough flushing of the tank at least once a year is advisable. To do this, shut off the heating unit and close the valve in the cold-water supply line. Open a hot-water faucet at a level above the tank. Then drain the tank completely. Leave the drain faucet open and turn the valve in the cold-water line full on so that the full force of the water strikes the tank bottom. This will dislodge sediment and wash it out through the open drain faucet. In some cases it will help when cleaning and flushing an older tank to remove the cold-water tube and insert a hose so that a forceful stream of water can be directed around the sides and across the bottom of the tank. After a thorough flushing, close the drain faucet, open the cold-water valve and refill the tank and the line until water runs from the hot-water faucet. Then start the heating unit. When flushing tanks connected to a cast water back, do not fill the tank with cold water until the water back has cooled sufficiently to prevent breakage. On automatic gas heaters the baffle tube in the vent should be removed at intervals and cleaned as in Fig. 11. Wipe off all the dirt and rust which have collected and then swab the vent tube, or flue, with a stiff-bristle flue brush. Be sure to replace the baffle in the same position as it was originally. Periodic cleaning of the flue and baffle gives faster heat transfer

and there will also be greater economy in water-heating costs.

**Leaky drain faucet:** Sometimes a persistent leak will develop in the drain faucet at the bottom of the tank. Usually it will be necessary to drain the tank in order to make a reliable repair. As a rule, a thorough cleaning of the parts and the installation of a new washer will stop the leak unless, of course, the seat is badly corroded.

In gas installations it is likely that the work will have to be approved by your local utility company before the gas is turned on.

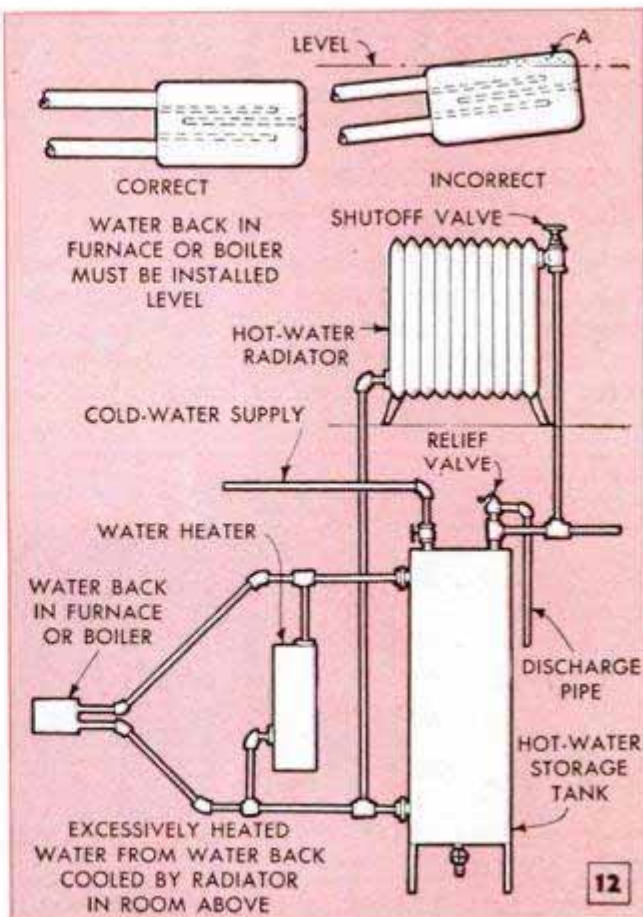

## Tray Slipped Under Car Seat Holds Maps and Sundries

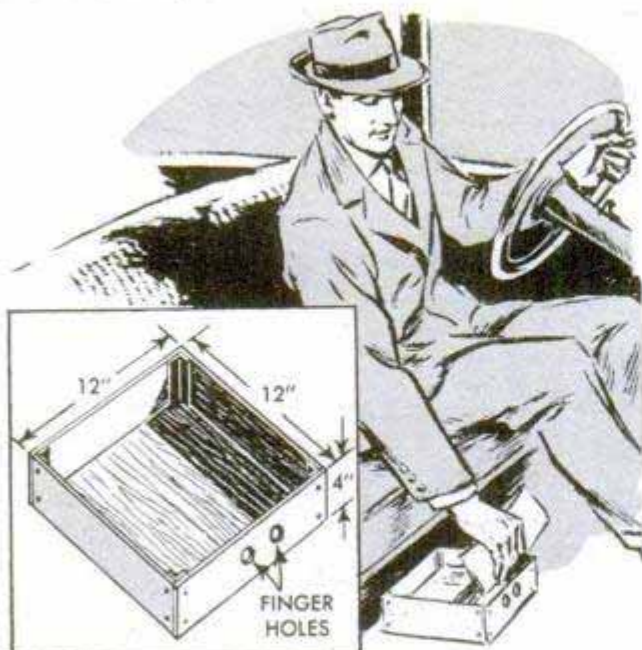

The overflow from the glove compartment can be stored out of the way and yet within easy reach if such items as road maps, rags and a flashlight are kept in a wooden tray that fits under the front seat of the car. Although the dimensions given provide a tray of a convenient size, it is best to check under the car seat to see if there are any obstructions which will limit the width or depth of the tray. The corners of the tray are reinforced with sections of angle iron, and fingerholes drilled through the front aid in grasping the tray when sliding it out from under the seat.

Robert Hertzberg, Jackson Heights, N. Y.

## Fluorescent Fixtures Decorated With Christmas Trimmings

Trimming fluorescent ceiling fixtures with colored paper adds to the holiday atmosphere of the room. As the bulbs burn cool enough to permit using paper decorations, treatments similar to the one photo-

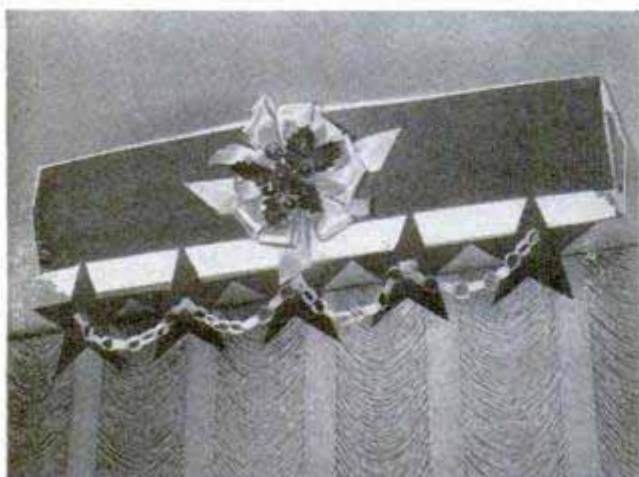

graphed can be used to decorate most any type of fluorescent ceiling fixture. In this case, a panel of heavy red paper was cut to fit over the frosted glass panel of the fixture, allowing five stars to hang below the lamp. Chains of white crepe paper join the stars, and a white satin bow, having a cluster of varicolored ornaments in the center, is tacked with thread to the paper panel. The latter is fastened to the ends of the fixture with cellulose tape.

## Glass Fuses Provide Paint Cups

Both the model-maker and the amateur artist will find that the glass inserts of burned-out plug fuses form handy individual paint cups that are not easily upset. The brass threads can be removed from the fuse by grasping the edge of the brass with a pair of long-nosed pliers and rolling the thin metal around the nose of the tool.



Andrew Brennan, Philadelphia, Pa.

## Lubricating Car-Window Channels Prevents Binding of Glass

Failure of car windows to move freely is not only inconvenient but is also injurious to the lifting mechanism. To assure that the glass will move easily in the channels, lubricate them with a mixture of paraffin and carbon tetrachloride. Mix enough paraffin in the liquid to form a creamy fluid and then brush the mixture on the fabric in the glass channels. The mixture will penetrate the fabric and, after the carbon tetrachloride evaporates, the paraffin will be deposited on the surface.

## Venting Outdoor Fuel Drums

One of the simplest ways of venting an outdoor fuel drum which is mounted horizontally is to drill one or two ventholes just under the rim at the end of the drum. Two  $\frac{1}{16}$ -in. holes will allow

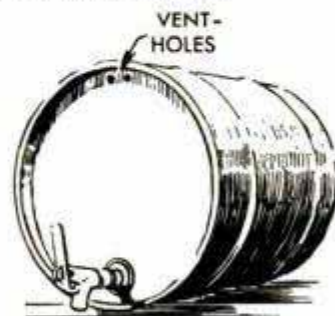

the fuel to flow freely from the spigot and the overhang of the rim will prevent moisture from entering the drum through the holes.—Dan Lobianco, Somerville, N. J.

# WEATHER VANES

WIND DIRECTION may not be important to most homeowners but a weather vane pointing to windward atop the garage cupola adds that final touch in decorating the exterior of your home. The metal vane can be almost any design that suits your fancy, but profiles, or silhouettes, of horses either at rest or in action have always been the favorites. Shown at the right and detailed below are suggested cut-outs for sheet-metal vanes which can be made of steel or aluminum, the latter being somewhat easier to work and less subject to corrosion. After you've selected the design you want, sketch it full size from the details and transfer the pattern to the sheet metal. Cut on the pattern lines with the jigsaw, using a fine-toothed, metal-cutting blade. Rough edges and sharp corners are then smoothed with a fine file and the completed cutout is riveted or welded to the directional arrow, which is made up from a length of  $\frac{3}{8}$ -in. rod slotted at one end to take a sheet-metal arrow point, or head. The assembly is then welded to a  $\frac{3}{8}$ -in. rod which pivots in a pipe sleeve. The lower end of the pivot rod is ground to a blunt, rounded point which seats on a metal plug welded to the inside of the pipe sleeve at the lower end as in the sectional view. The direction letters are cut from sheet metal and welded to short rods which are then welded to a coupling turned onto the upper end of the sleeve. The open top of the sleeve is closed by a brass rain collar soldered to the pivot rod while the lower end of the sleeve is welded to an angle-iron base which has been drilled for fastening to the ridge of the roof with wood screws. Finish both the vane and mounting assemblies with two coats of flat-black lacquer.

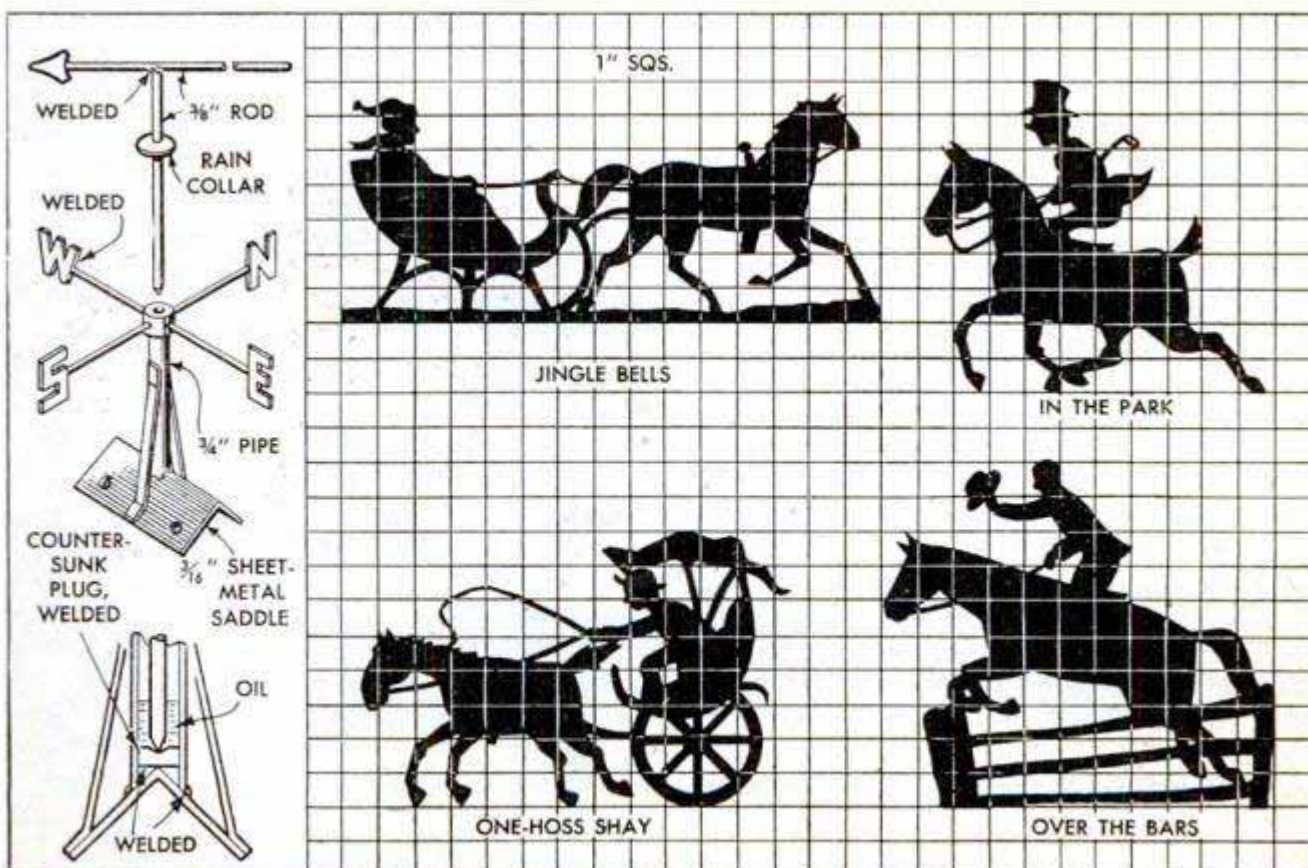
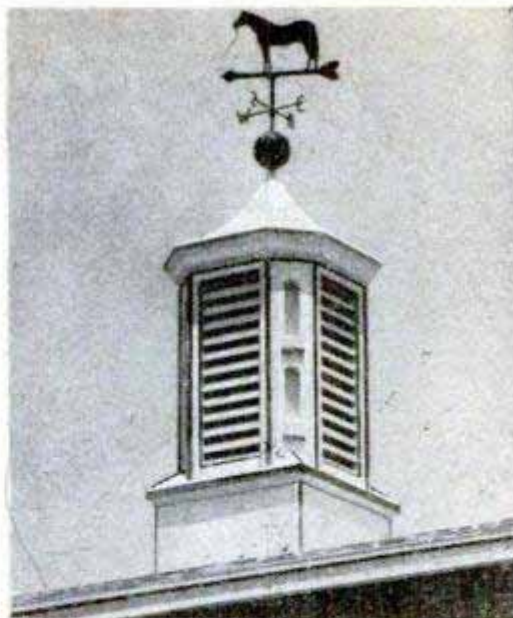

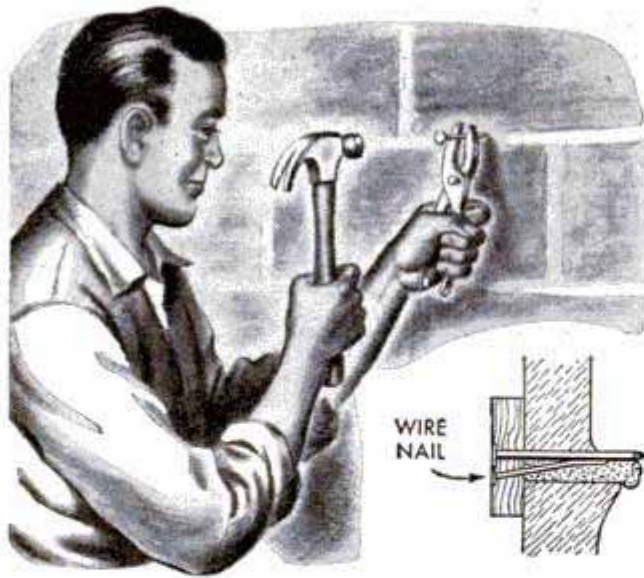

### Boards Fastened to Block Wall With Hammer and Nails

When a star drill and toggle bolts are not available to attach shelf brackets, furring strips or backboards to a concrete-block wall, here is how you can use a hammer and some 8d or 10d nails to do the trick. Grasping one of the nails in a pair of pliers, hammer the nail into the mortar at the edge of one of the blocks. When the nail bends after a few hammer blows, select a new nail and continue to deepen the hole. It will usually take five or six nails to pierce through the mortar. After the necessary holes have been made in this way, use a large concrete nail or an ordinary nail of larger diameter than the hole to fasten the board. Should the board work loose owing to the load or vibration, drive a wire nail, 1½ or 2 in. long, on each side of the concrete nail so that the point will be driven against the shank of the concrete nail. The wire nails being harder will dig somewhat into the metal of the larger nail, holding it tightly in place.

Frank M. Burtick, Jr., Alma, Mich.

### Reflection in Saw Squares Board

To mark a board for sawing off the end squarely when a try square is not at hand, use the blade of your handsaw. Hold the blade across the board with the top edge of the blade down, noting the reflection of the edge of the board

in the side of the blade. When the reflection lines up with the edge of the board, as shown, the blade is at a right angle to the edge and can be used as a straight-edge to mark the board square.

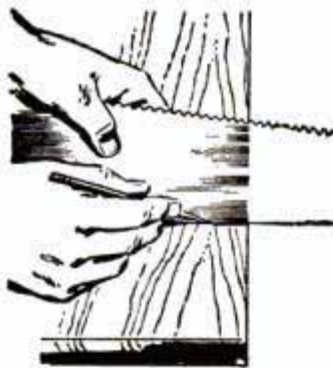

100 W.P.

### Caster Cups Support Cot Legs

Camping on soft ground often results in the legs of a folding cot working their way into the tent floor, causing the cot to tilt at an uncomfortable angle. To prevent this, carry along several metal caster cups and place one of them under each leg of the cot when setting up camp.

Lee H. Schimpf, Tulsa, Okla.

### Christmas-Tree Ornaments Cut From Paper Simulate Giant Snowflakes

If you enjoy making your own Christmas-tree ornaments and would like something a little different this year, dress the tree in these paper "snowflakes." They are easy to make by coating a paper cutout with artificial snow. Cut the paper into 3-in. squares and then fold each square as shown in the upper details, first diagonally and then double through the center. Next, fold both corners of the triangular piece toward the center, as in the lower left-hand detail. Cut the folded piece of paper straight across the top, leaving a wedge-shaped piece, and then cut the design in this piece as indicated by the dotted lines in the lower right-hand detail. When unfolded, the paper will resemble the snowflake pictured except that it will have 12 points. To get the

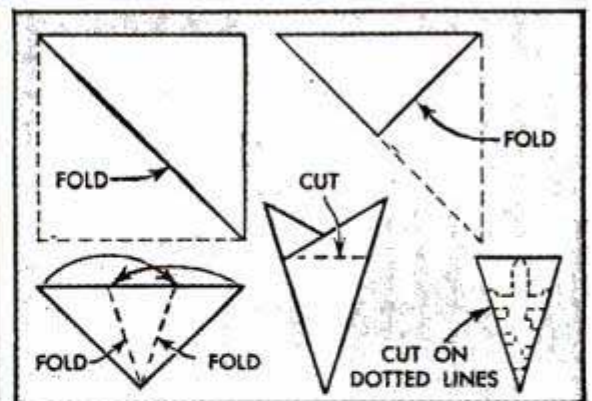
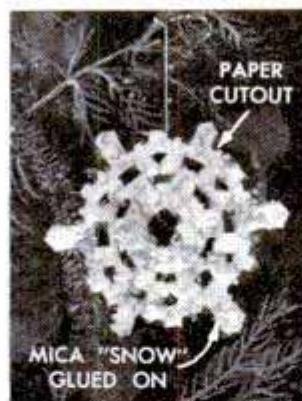

6-pointed flake, simply cut off every other point near the outer ring of the design. After you are satisfied with the over-all appearance of the snowflake, coat it with paste or mucilage and sprinkle with artificial snow. After the paste has dried, shake off the excess particles of snow and tie the flake to the Christmas tree with colored wrapping string or ribbon.

Paul Handley, Philadelphia, Pa.

# Negative and Print Filed in One Packet

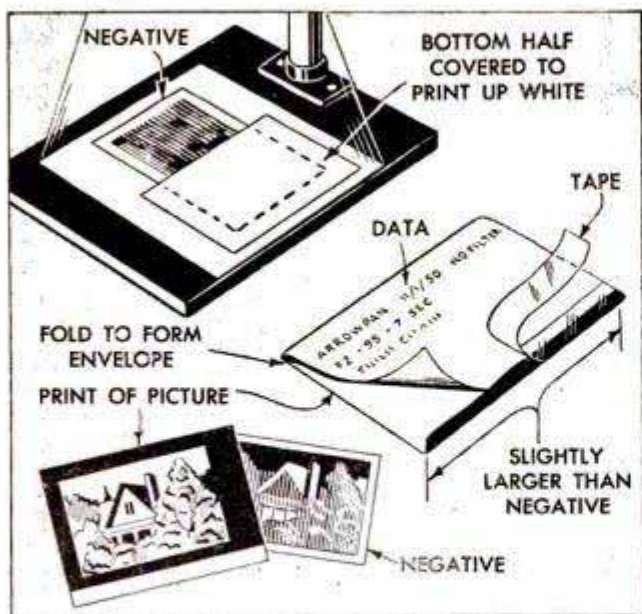

Most amateur and professional picture shooters have lost at least one valuable negative because of a haphazard system of filing. After experiencing this myself, I adopted this foolproof filing system whereby both the print and the negative are filed in one handy packet, including exposure data, date and other specific information pertaining to that particular negative. The process is simple. Place a sheet of printing paper, twice the size of the negative, on the enlarger easel and lay the negative, emulsion side down, on one half of the paper. Cover the other half of the paper so that

it will print white. Lay a piece of plate glass over the parts to hold them flat. Then make the exposure and develop and ferrotype the print. Now, fold the unexposed portion to the back of the print as in the right-hand center detail. Tape the fold securely in place and there's the file envelope for the negative with the print on the front as you see it in the lower left-hand detail. Write data on the back of the envelope with India ink so that you will have a permanent record. It's a good idea to use glossy paper as this withstands handling.

Michael Ligocki, Gary, Ind.

## Wire Recorder Saves Time by Handling Data on Photographs

Photographers who do considerable work in the field can save time by using a wire recorder to keep track of pertinent infor-

mation. Details and remarks can be recorded in a moment and then edited later when time is available. The recorder is set up in the front seat of the car, and the necessary 110-volt a.c. is supplied by a war-surplus converter carried in the trunk.

Robert H. Horn, Yakima, Wash.



## Pipe Rack Holds Darkroom Items

Stirring rods, print tongs, spotting brushes and similar darkroom items will be at hand when they are needed if you store them in an inexpensive pipe rack. Either the table stand or wall-type rack may be used, depending on your particular setup.



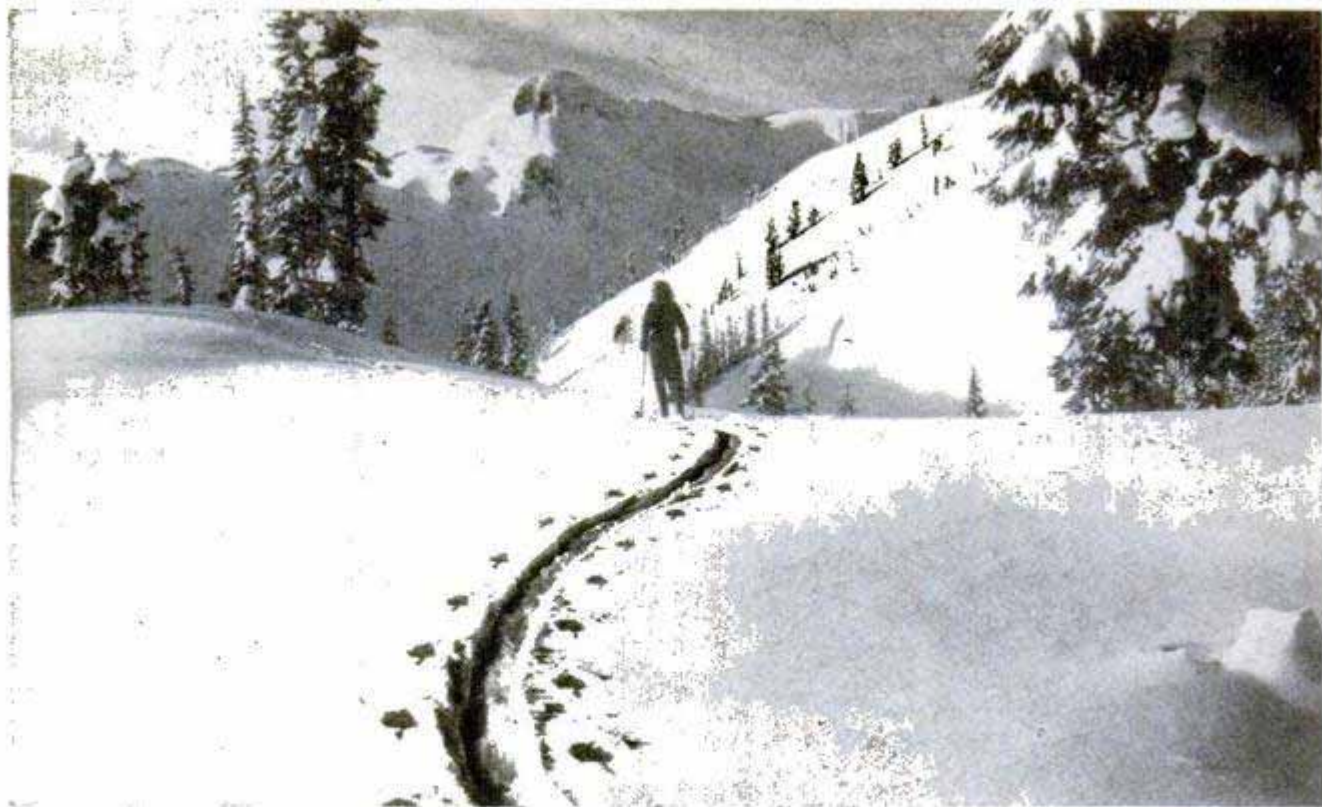

Side-lighting emphasizes snow texture. Filter increases the contrast between the shadows and high lights

Side-lighting gives the strongest filter effects. Panchromatic film, yellow filter produce dark sky

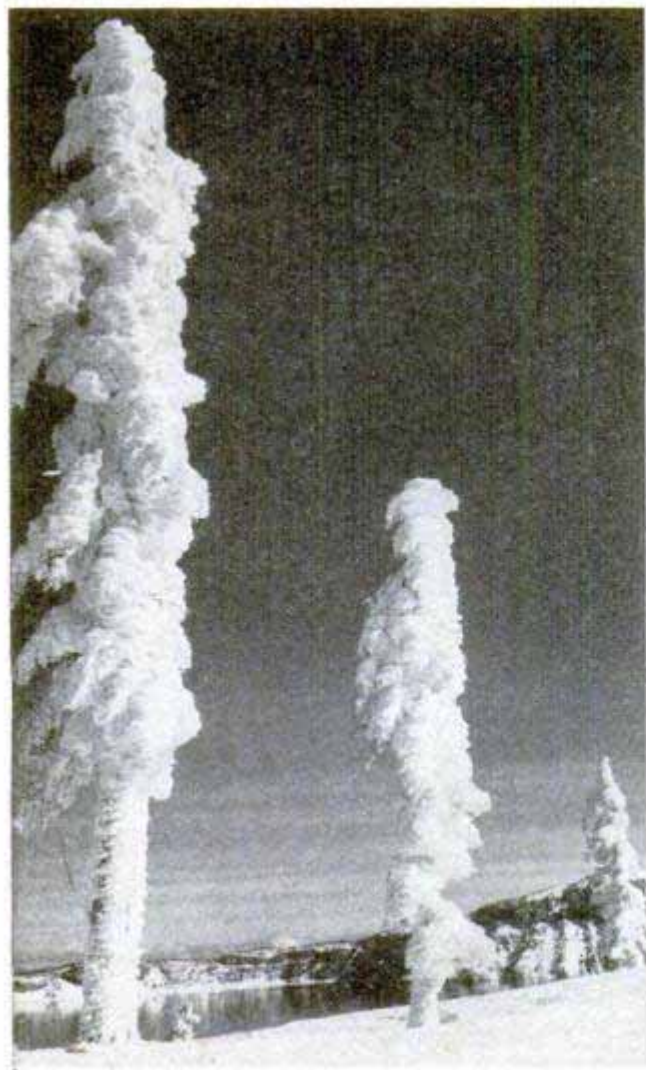

## Picture Winter Through a Filter

**S**NAPSHOOTING the cold, brilliant beauty of winter snowscapes takes more than just a good eye for picture composition and a knack of making the proper exposure. There's the problem of oblique natural lighting, for the sun will be low, even in the midday sky, and the picture-shooting "day" will be only a few hours long at best. Bright, pin-point reflections and broad halations may "burn up" the film even though the exposure is timed short. On some winter days the low haze over a snowy landscape diffuses weak, slanting sunlight and scatters reflections from distant objects so much that backgrounds "gray out," foreground subjects lose sharp outline and the sky goes "white" in a blending of subject and mass that results in a flat, uninteresting negative.

The solution to these picture problems of the winter snaphooter is careful use of the right filter. Combine the correct filter, exposure, and winter-picture composition and you're well on the way to producing a salon-quality print.

When the sky is dark and overcast, or when it's gray and cloudy outside, no filter is needed, but when the sun is shining brightly on the snow and the sky is a rich, clear, blue—that's when a filter, through its ability to control light of different col-



Red filter produces this dramatic effect. Note strongly rendered shadow and sky tones



A yellow filter and ordinary film produced this natural effect, strongly contrasting the snow and figures with sky

ors, gets the picture in all its true values.

The action of a filter is to stop or filter out light of certain colors, allowing the rays of other colors to pass through freely, while still others are partially absorbed in varying degrees.

By absorbing a certain portion of light, all filters reduce the amount of light reaching the film and to compensate for this the exposure must be increased. The number by which the exposure should be multiplied for the filter and film used is called the multiplying factor or filter factor for that particular filter.

There are two classes of filters used in black-and-white photography, correction filters and contrast filters. Correction filters enable the film to record the image at the brightness values as seen by the eye. Contrast filters are used to lighten or darken certain colors, causing a brightness difference between two colors which would otherwise photograph nearly the same.

Control of sky brightness is one of the most frequent uses of correction and contrast filters. A blue sky can be darkened to make white clouds stand out more prominently or to emphasize a subject seen against the sky. Yellow and red filters and the Pola-Screen are used for this purpose and their effectiveness depends on the blueness of the sky. One of the most helpful filters is the medium-yellow. With ordinary snapshot film its use results in pictures which look natural. Sky tones appear in their proper relation to everything else

Use of filter here increases contrast, produces a snappier print and emphasizes texture in the snow





Effect of ordinary film when no filter is used. Note how the snowman, the horizon line and sky all blend together

Strong side-lighting emphasizes snow texture. Yellow filter helps heighten contrast and feeling of texture in the snow



When shooting directly into sun, with lens shielded, filter gives interesting sky tones

in the picture area. Clouds stand out clearly against the sky, and contrasts between light and shade appear in the picture much as they do in the scene photographed.

In ordinary winter photography, the use of a medium-yellow filter with ordinary snapshot film is a must because it takes a filter to darken sky tones and differentiate between a snow-covered hill or horizon and the sky behind it, and to accentuate the shadows which give the snow surface texture and interest. If ordinary snapshot film is used in winter without this filter, snow-covered hills and horizons may appear to blend with the sky while the snow itself will appear a flat, uninteresting blanket.

For use with panchromatic film, a heavier and more strongly corrective filter is desirable. The deep-yellow, or G filter, gives the best results in this case. This filter has a more pronounced effect on sky tone than the medium-yellow because it cuts out more of the blue light. Clouds, therefore, stand out more strongly against the sky, and snow-covered tree branches or hills contrast more definitely with sky tones. Since the filter also has a strong effect on the blue light reflected from shadows in and across the snow, it is extremely useful for heightening apparent texture of the snow itself. Just as the medium-yellow filter can be considered





Showing how red filter, used for strong contrast in sky, can "wash out" all interesting flesh tones

standard for use with ordinary snapshot film, so is the deep-yellow filter standard for use with panchromatic film.

The next strongest filter, so far as effects produced are concerned, is the red, or A, filter. This filter has a very decided effect on sky tone and is used where extreme contrast is desired. If, in your winter snapshots, you want white clouds to stand out dramatically against the filter-darkened sky, then use a red filter. Such extreme effects, however, should be used in moderation. An occasional picture of this tone quality is interesting in the album collection but it's better to sprinkle an occasional red-filter shot here and there in your picture collection than it is to try to build up a collection of pictures made with red filters alone. Do not, however, attempt to use either a deep-yellow or a red filter with ordinary snapshot film. The reason for this is that orthochromatic film is not sensitive to red light and these filters admit too high a percentage of red or deep-orange light. Use these filters only with panchromatic film.

The Pola-Screen filter is the closest approach to an all-around filter because it is variable in its effect. The effect produced depends upon the position of the filter when it is slipped over the lens. Results



Using a medium-yellow filter results in a pleasant sky tone for informal portraits such as shown above

in sky-tone control equivalent to a medium-yellow, a deep-yellow, a red, or even a deep-red filter may be obtained if desired, but the over-all characteristics of the scene will not be otherwise altered.

The Pola-Screen filter is the only corrective mechanism which can be used to control sky tone with color films. In usefulness, therefore, it is one of the most broadly helpful of all filters.

The usefulness of any filter in winter photography is, however, determined to a large extent by the way it and the camera are used. Here are two pointers in that respect which we all would do well to remember.

First, filters should be used only on bright sunny days with a clear blue sky. Second, for maximum sky-tone control and contrast, full advantage should be taken of side-lighting, since filters produce their strongest effects when the camera is pointed at right angles to the sun. This is due to the fact that the sky at right angles to the sun has the deepest hue. As a result, the waves of colored light—which the filter either passes or blocks out of the lens—are at their strongest in this region. The more directly the camera is pointed toward the sun, or the more directly away from it, the less effect will the filter have.

## Glossy Prints Dried Quickly With Fan and Heat Lamp

Drying glossy prints on ferrotype tins can be done quickly with the aid of a fan and infrared heat lamp. Play the lamp on the prints to remove the moisture and use the air stream from the fan to blow the

moist air away. Either the fan or the lamp will speed drying when used alone, however, the combination of the two does an exceptionally fast job.

Virginia Hanson, Santa Monica, Calif.

## Enlarger Lens Illuminated With Red Plastic Rod

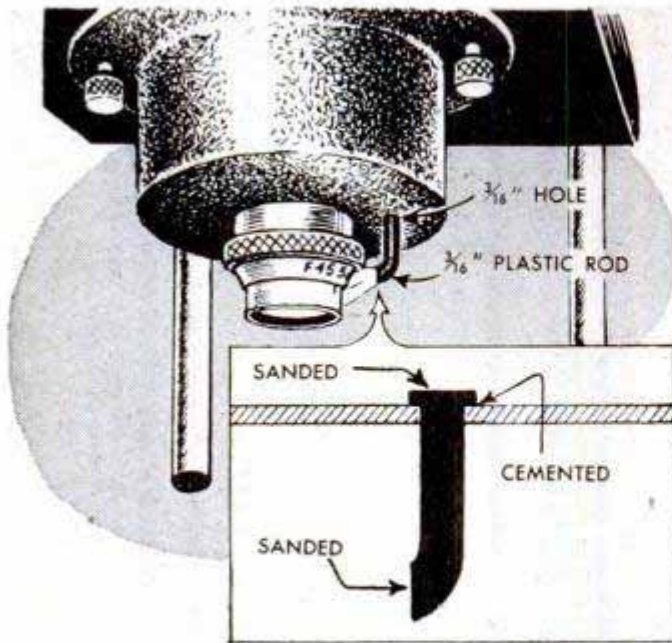

Fitting the lens board of your enlarger with a curved length of plastic rod will direct a faint red light from the enlarger lamp to the index mark on the lens mount, thus enabling you to check the lens stop opening at a glance without turning on the darkroom lights. Using either red fluorescent plastic or clear plastic dyed red, turn and bend or mold a short length of rod to the shape shown in the detail. Both top and bottom faces of the rod are sanded

and the remainder of the rod is painted black so that the only light emitted from the plastic is the tiny red spot opposite the lens mount. Note that the shouldered end of the rod is cemented to the edges of a hole drilled in the lens board.

## Book End Doubles as Stand For Clamp-On Reflector

Sometimes a particular photo setup, such as a low light for background illumination, requires the use of a clamp-on photoflood reflector without a convenient spot to mount it. When this happens, try using an ordinary sheet-metal book end as a stand for the reflector. Clamp the reflector to the book end as shown in the photo, and place a couple of the books on the base of the stand if there is a tendency for it to tip over.—John J. Rea, Urbana, Ill.

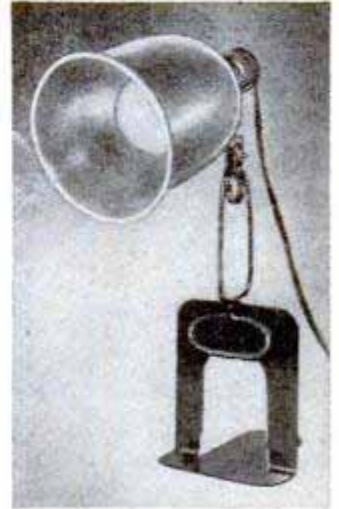

Chemical-bottle caps of various sizes provide handy lens caps. If desired, felt or velvet can be glued to the inside of the cap.

## Books That Help You Get Things Done

Are you a man who likes to venture into unfamiliar fields and get things done—a man who is precise and will not tackle a job until he is familiar with all phases of its mechanics so that he can produce good work? Then, the how-to-do-it books prepared by the editors of *Popular Mechanics*, who also like to do things themselves, will save you many hours of hard work.

*Popular Mechanics* WHAT TO MAKE, is a good example of the many books that are available. Here you will find almost anything you can think of to make. There are 12 books in the series, which are available at \$1.75 each or the library of 12 for \$18.00. The full set has over 3000 things to make, an average of almost 300 per book. You will find projects in leather, wood, metal and glass as well as toys of all kinds. There are also projects for your lawn and garden, home and workshop.

*Popular Mechanics* CHRISTMAS HANDBOOK is a must for every home at this time of year. It is both informative and practical with articles on entertaining and decorating for the holiday hostesses, and complete how-

to-do-it instructions for making greeting cards, gifts and toys. You will also find featured articles on selecting and decorating Christmas trees with special emphasis on safety precautions. Send \$2.00 and the book is yours by return mail.

If your business is farming, or if you are interested in it, or are thinking of buying a farm, *Popular Mechanics* FARM MANUAL is a book that will pay for itself many, many times. It has been adopted by state farm-training programs in nine states. The book contains 284 pages and hundreds of illustrations telling how to make farm machinery and implements, how to set up a farm workshop to make and repair farm equipment, how to build poultry houses, incubators, brooders, etc. There are also sections on vegetable storage and processing, farm-home improvement in which are covered fencing, repairing electrical appliances, plumbing, electrical wiring and hundreds of other things that are necessary. In addition to this, you will find 40 pages of farm hints and kinks. Price \$3.00.

All books are available from *Popular Mechanics* Book Dept., 204 E. Ontario St., Chicago 11, Ill.



## Combination ELECTRIC SWITCH

By John Beaton

**I**F YOU have electric motors and appliances that you wish to prevent unauthorized persons from using, this combination switch will solve your problem. It is also ideal for use in connection with a solenoid door bolt to prevent small children from opening drawers and doors that are used frequently by adults so that locking them with a key would be an inconvenience. Another use is as a substitute for a key switch to open or close a mechanically operated garage door. As pictured in diagram A of Fig. 2, only 6 to 12-volt current from a small transformer should be wired through the switch when it is used with a solenoid door bolt. If the switch is used to control a motor or other 110-volt appliance, a 6 to 12-volt circuit is used through the switch to operate a relay, diagram B of Fig. 2, the relay being a normally open or closed type, depending on its use.

As detailed in Fig. 1, the switch consists of three numbered fiber dials, each about 3 in. in diameter. These are mounted side by side in a shallow box behind a control panel having projecting knobs for turning

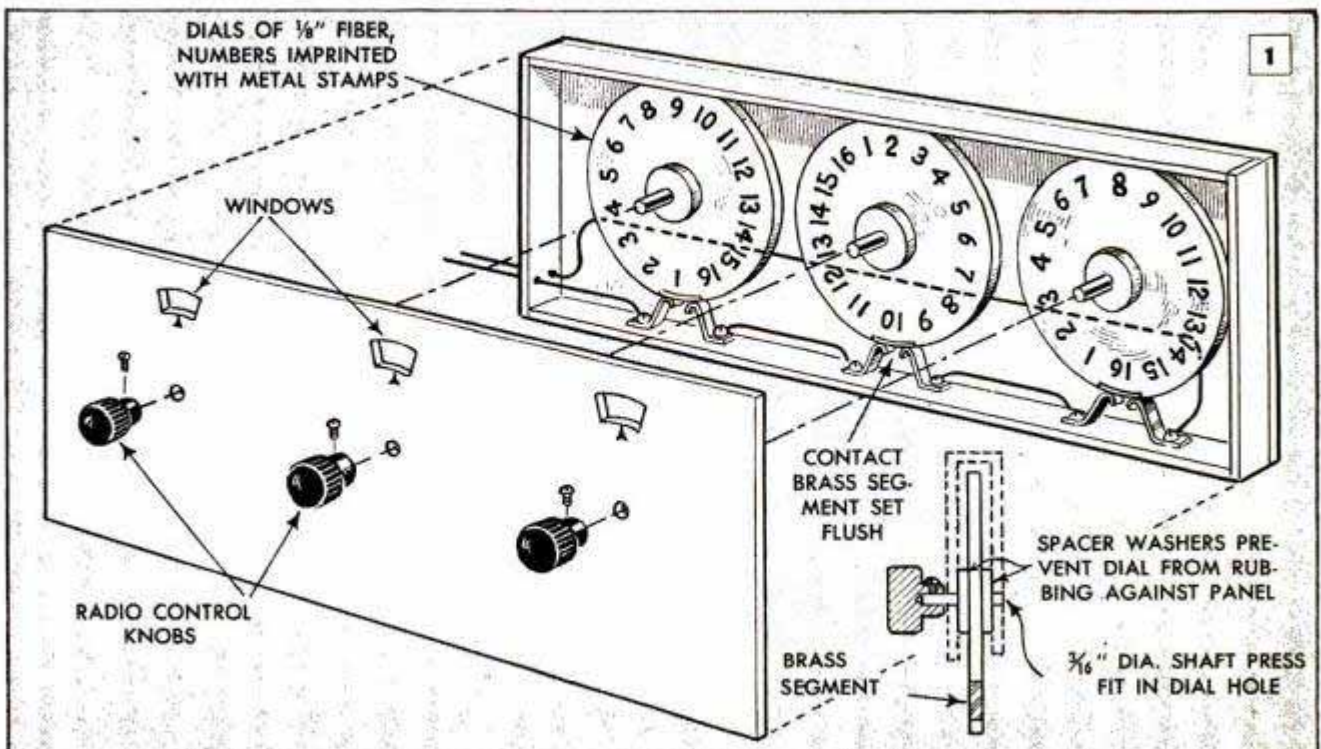
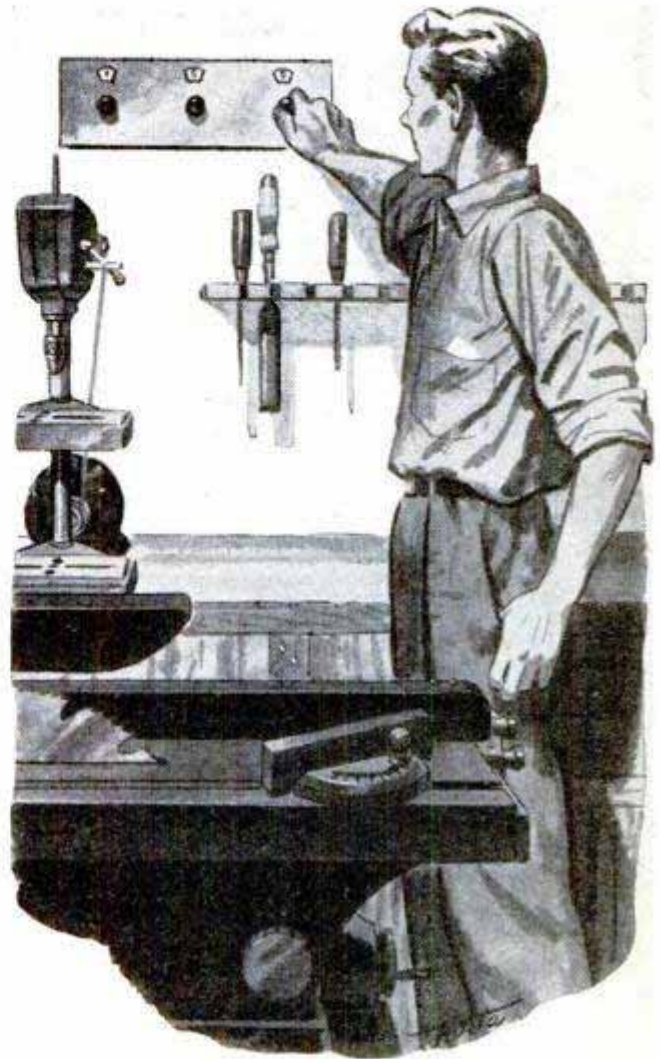

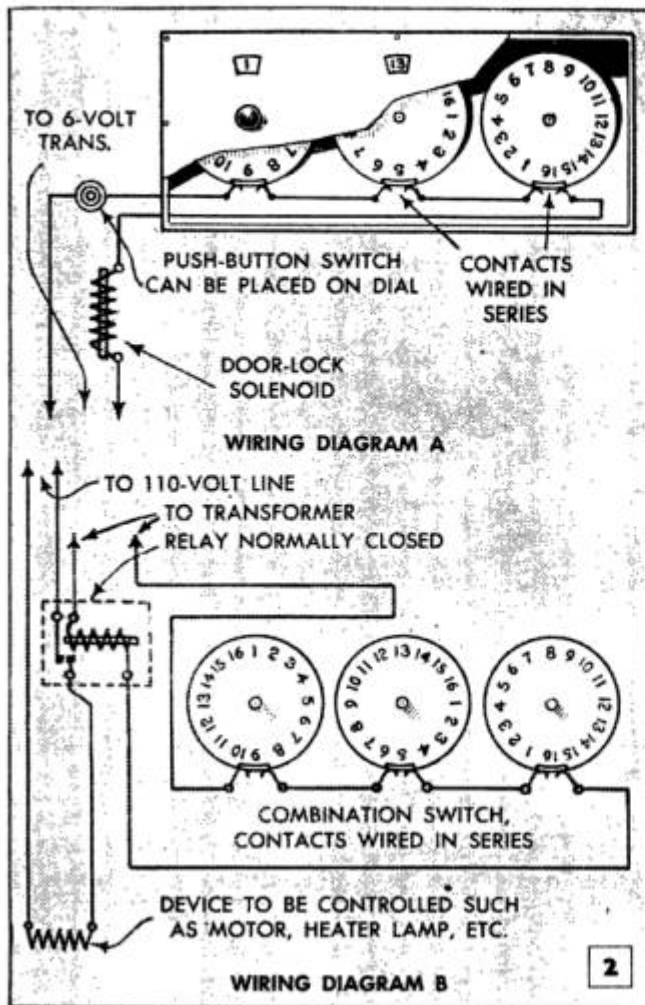

the dials. Each dial is numbered from 1 to 16 and carries a short brass segment, flush-fitted into the rim. This segment is sufficiently long to span two stationary bronze contacts when the dial has been turned to expose the correct number in the control-panel window. All three dials are fitted with brass segments of the same length, but the segments must be located opposite a different number on each dial. Of course, you can use any number combination you like; the important thing is to make sure that the segment is located exactly opposite the number selected. The stationary contacts are wired in series, so that when all three dials are turned to the correct combination the circuit is closed. Moving any one of the three dials opens the circuit, but when the switch is reset after use, all the dials are moved, making it necessary to know the combination before the circuit can again be closed.

Note that each of the dials is mounted between spacer washers and that the control-knob shaft is a press fit in a center-drilled hole. If possible, drill the shaft holes after the control box has been assembled. If it is desired to cut the power momentarily to a particular tool or appliance without disturbing the setting of one of the switch dials, a push-button switch can be wired in the circuit as shown in Fig. 2, diagram A.

## Shafting Holds Disk Blanks Between Centers for Multiple Turning

By clamping thin, sheet-metal stock between two short pieces of shafting, thin disks can be accurately turned to a specific diameter without marring the surface of the work with a center hole or other means of mounting. The shafting used in clamping the work should be slightly smaller than the diameter of the finished blanks and one length of shafting should be longer than the other. The ends of each shaft are faced square and the shorter piece center-drilled for supporting with the tailstock center. Use a ball-bearing tailstock center if available. The longer piece is held in the three-jaw chuck. Using the ball-bearing center in the tailstock allows the rough blanks to be firmly clamped between the two pieces of shafting by merely tightening the tailstock handwheel. A medium speed,

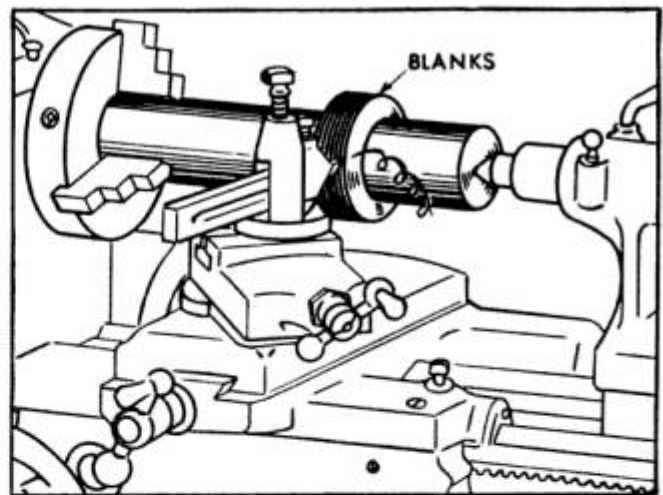

light cuts and a keen-edged tool combine to give best results.

Alex Brechko, Jackson Heights, N. Y.

## Improvising Small Caliper From Spring-Type Clothespin

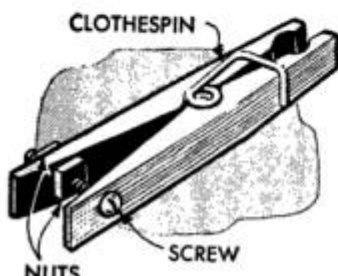

A pair of small calipers, which can be used to check turnings with sufficient accuracy for modelmaking, can be improvised quickly from an

ordinary spring-type clothespin. This is done by drilling through the arms of the clothespin and inserting a machine screw which is turned into two nuts as shown. Simply tighten the screw to open the jaws of the clothespin the desired distance. When the screw is backed off, the tension of the spring will force the jaws closed.

# How to Weigh Cattle With a Length of String

INCHES	WEIGHT	INCHES	WEIGHT	INCHES	WEIGHT	INCHES	WEIGHT
26	80	43	257	60	637	77	1285
26½	82	43½	266	60½	652	77½	1308
27	84	44	275	61	668	78	1331
27½	86	44½	284	61½	684	78½	1354
28	89	45	294	62	700	79	1377
28½	92	45½	304	62½	716	79½	1400
29	95	46	314	63	732	80	1423
29½	98	46½	324	63½	749	80½	1446
30	101	47	334	64	766	81	1469
30½	104	47½	344	64½	783	81½	1492
31	108	48	354	65	800	82	1515
31½	113	48½	364	65½	817	82½	1538
32	118	49	374	66	835	83	1561
32½	123	49½	384	66½	853	83½	1584
33	128	50	394	67	871	84	1607
33½	133	50½	404	67½	889	84½	1630
34	138	51	414	68	908	85	1653
34½	143	51½	424	68½	927	85½	1676
35	148	52	434	69	947	86	1699
35½	153	52½	445	69½	967	86½	1722
36	158	53	456	70	987	87	1745
36½	163	53½	467	70½	1007	87½	1768
37	168	54	478	71	1027	88	1791
37½	174	54½	489	71½	1048	88½	1814
38	180	55	501	72	1069	89	1837
38½	186	55½	513	72½	1090	89½	1860
39	192	56	526	73	1111	90	1883
39½	200	56½	539	73½	1132	90½	1906
40	208	57	552	74	1153	91	1929
40½	216	57½	565	74½	1175	91½	1952
41	224	58	579	75	1197	92	1975
41½	232	58½	593	75½	1219		
42	240	59	607	76	1241		
42½	248	59½	622	76½	1263		



To estimate the weight of a calf, steer, cow or bull, draw a length of string tightly around the body of the animal just behind the front legs. Measure the string and find its length on this chart to arrive at a close estimate of the animal's weight

## Special Brackets for Spark-Plug Wires Reduce Low-Speed Missing

Sometimes the low-speed missing of 1949 Ford V-8s and Mercurys is the result of the grouping of the spark-plug wires which run from the distributor to the far bank of cylinders. The engine missing is caused by the leakage of high-frequency current

between the four long wires, particularly when high-compression loads exist. I have found that if the original brackets which carry the wires are replaced with sheet-metal brackets made as shown in the detail, the current leakage will be cut down greatly and the chances of missing reduced. It may be necessary to bend the upright of the bracket slightly to align the wires and, if you are comparatively inexperienced, it is best to disconnect and replace one wire at a time to avoid disturbing the firing order.—Delmer H. Clow, Venice, Calif.

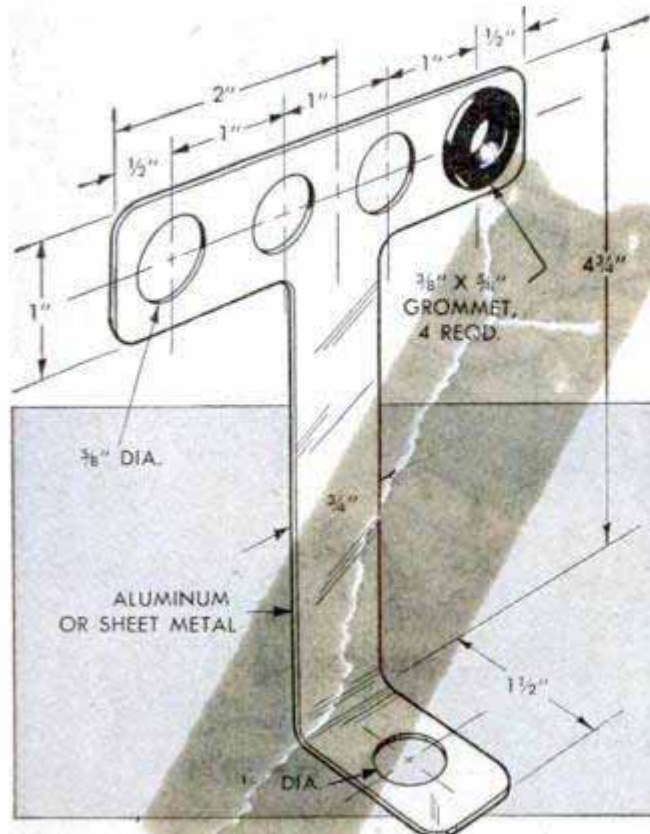

## Drilling Holes in Duplicate Parts

When holes in duplicate parts must be drilled in exact alignment, you can be sure that the parts will not slip out of line by tack-welding them together. Place the parts one on top of the other and tack-weld between the layers at opposite ends of the stack. In this way, the work is easy to handle on the drill press with no possibility of shifting.—W. F. Schaphorst, Newark, N. J.

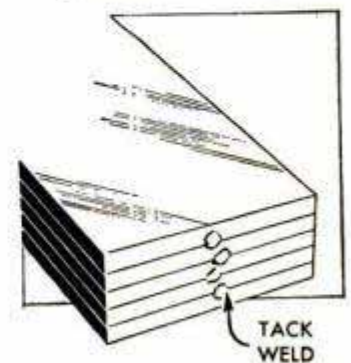

# TWO-SPEED Cuts Wood

By A. L. Mills

## Part I

**T**HIS BANDSAW for cutting wood and metal is a home-built unit throughout, yet it has every essential feature of the average dual-purpose-type machine. The frame is assembled from pipe and fittings, band wheels are made from hardboard for lightness and strength and are mounted on ball bearings. The table tilts on double trunnions, Fig. 1, and the upper wheel-bearing assembly is fitted with a spring-loaded blade-tensioning-and-tracking device. The necessary speed reduction for metal cutting is made through

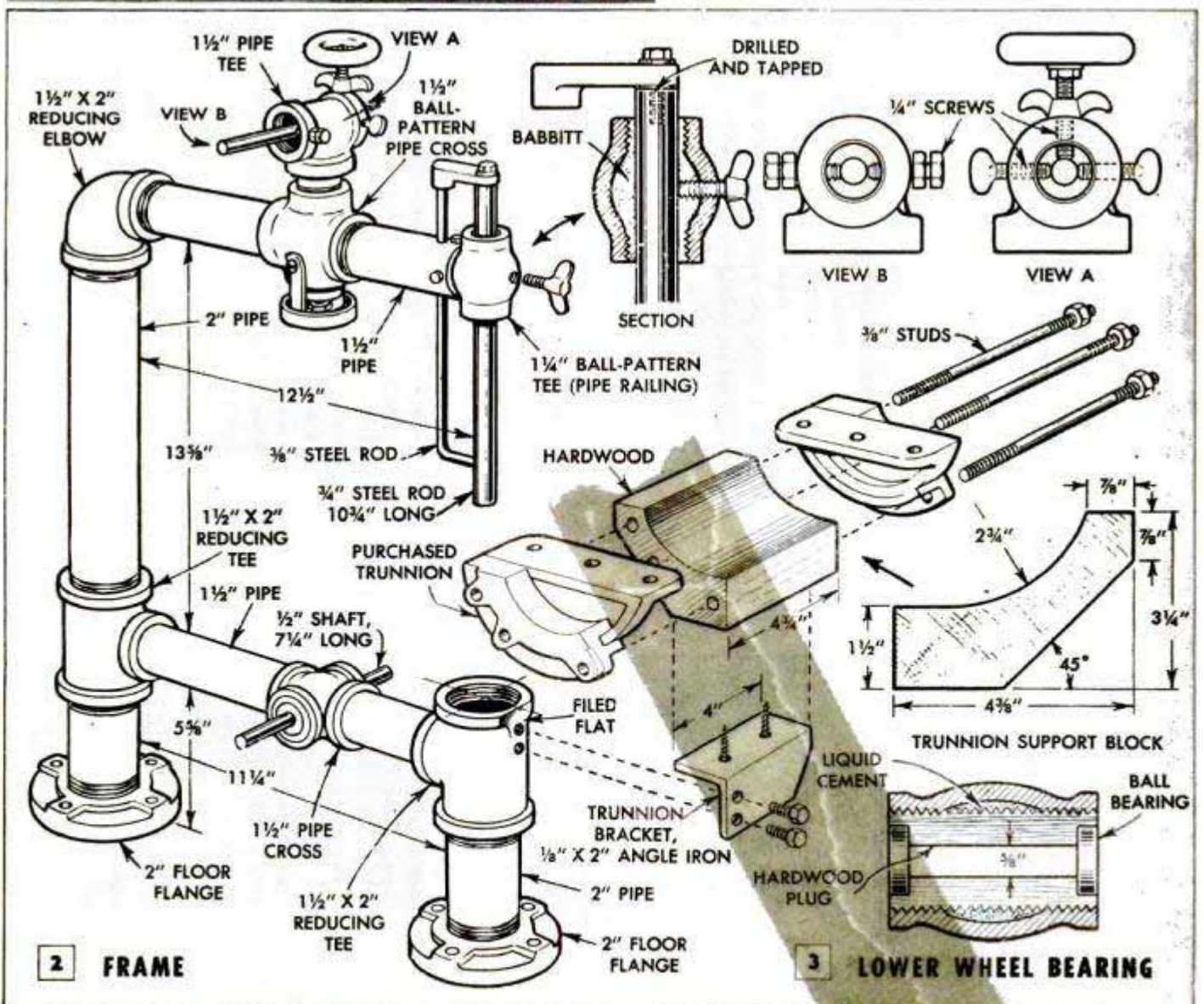
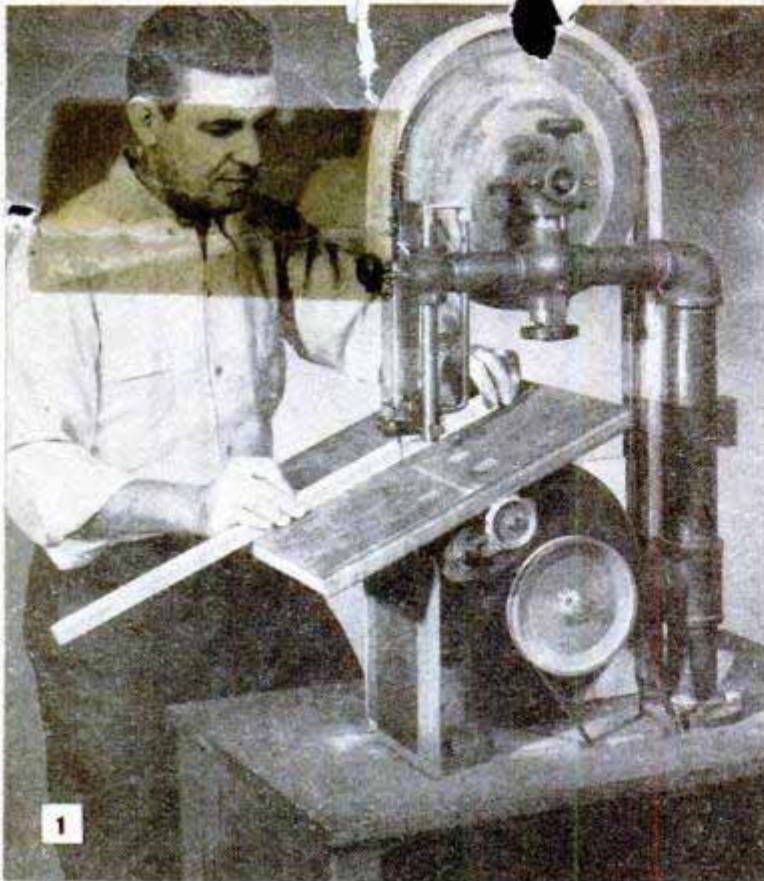

# and Metal

two step pulleys on a jackshaft mounted in a base which has been especially designed and built to reduce vibration to the minimum. A simple belt shift to direct drive provides the higher speeds necessary for cutting wood. Note the trim, neat design of the machine in Fig. 4.

Fig. 2 details the frame and Fig. 3 the lower wheel-bearing and the trunnion assembly. Long and short pipe nipples, reducing elbows, tees and floor flanges are assembled to form the frame shown in Fig. 2. One thing to note especially at the outset: You will see in Fig. 2 that the over-all dimensions are given from side to side and not from center to center. In detailing an assembly of this type made from pipe fittings it is not possible to give precise center to center dimensions. Those given represent the distances on the original assembly with the threaded joints drawn moderately

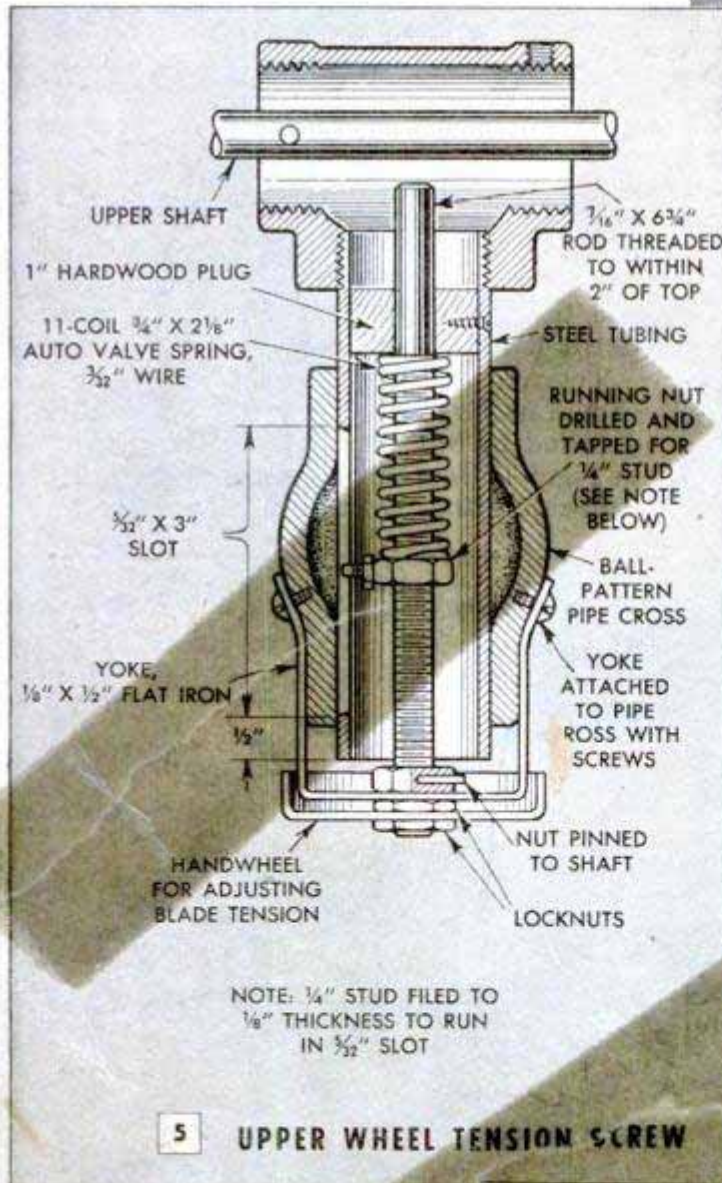
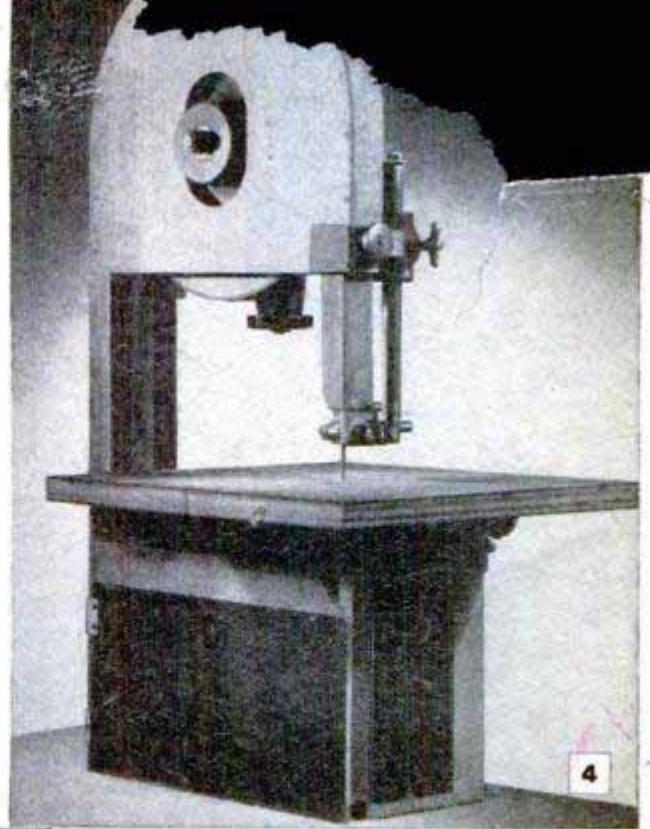

tight. Because of slight allowable variations in threading and tapping pipes and fittings, frames built up in this way from a number of fittings may vary somewhat in over-all size. Probably the best procedure is to make a trial assembly, drawing each of the joints as nearly as possible to the same tension. Then check the dimensions. If actual measurements are slightly over or under, it usually is possible to correct the error by tightening or loosening several joints.

Note in the frame assembly, Fig. 2, that the blade-tension unit is fitted into a ball-pattern pipe cross, and also that the steel rod, which supports the upper blade guide, slides in a bearing formed by pouring molten babbitt into a ball-pattern pipe tee. Views A and B, Fig. 2, show opposite ends of the pipe tee which houses the wheel-tilting mechanism. At the inner end, next to the wheel hub, the spindle pivots on two pointed set-screws provided with jam nuts. At the opposite end two horizontal set-screws bear against the spindle to prevent lateral movement. The spindle is tilted by a vertical screw fitted with a small handwheel and provided with a wing nut for locking the adjustment. This assembly is supported on a short length of steel tubing, threaded at one end and turned, or ground, to a sliding fit in the pipe

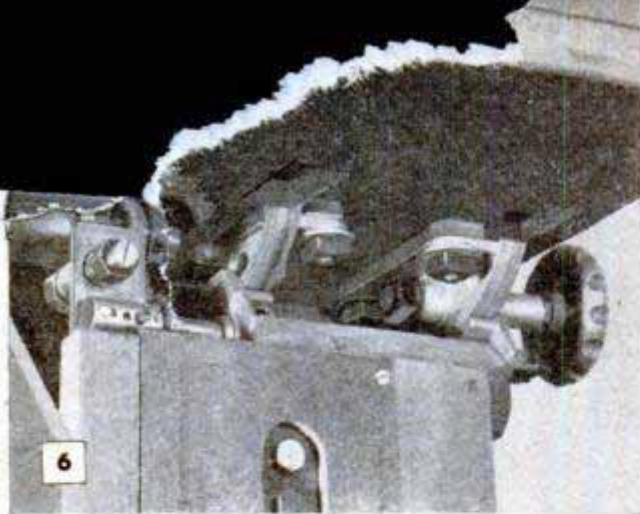
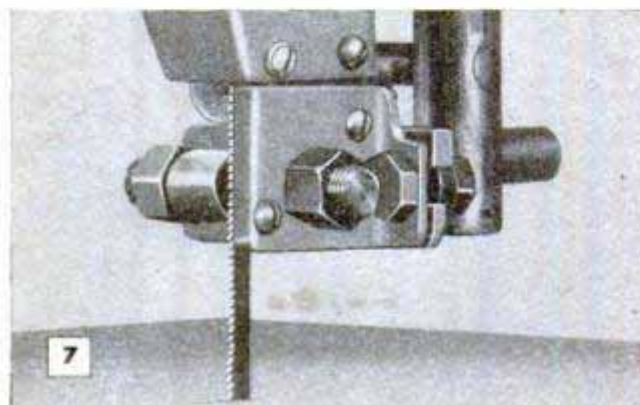
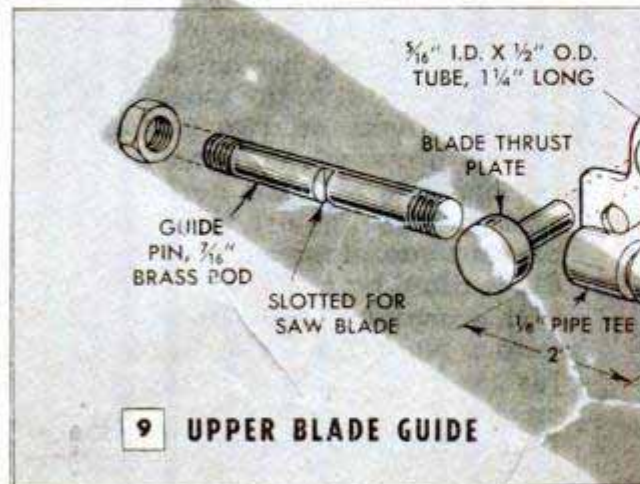
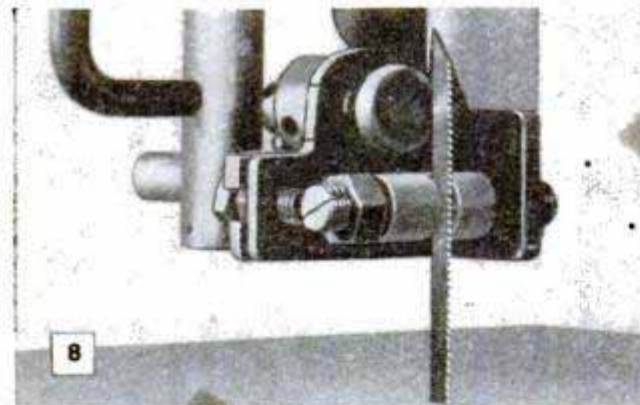

Table trunnions and lower guide in place on the band-saw frame. Note that table is recessed for clearance



Above and below are views of the upper blade guide completely assembled and with the blade in position



9 UPPER BLADE GUIDE

reamed out as in Fig. 5. A hard-wood plug, forced into the upper end of the tube and fastened with three wood screws, forms a bearing for the upper end of the tension spring. The running nut which bears against the lower end of the spring is prevented from turning by a short stud which turns into a tapped hole in the nut. Flats are filed on the opposite end of the stud permitting it to enter a  $\frac{5}{32}$ -in. slot cut in the wall of the tubing. The stud is provided with a jam nut to hold the adjustment securely. The lower end of the tension screw is fitted with a handwheel and is supported by a flat-iron yoke bent to a U-shape and attached to the pipe cross with short cap screws. To give ample range of adjustment of the upper wheel, the  $\frac{7}{16}$  x  $6\frac{3}{4}$ -in. tension screw is threaded to within 2 in. of the top end as in Fig. 5.

Construction of the lower wheel bearing is easily worked out from the detail in Fig. 3. The double trunnion, which is purchased, is quite simple to assemble by following the upper details in Fig. 3. Note that a flat is filed on one side of the reducing tee at the front of the frame and that two holes are drilled and tapped for cap screws which hold the trunnion bracket. The trunnion must be assembled completely before attaching to the frame. An underside view of the trunnion is given in Fig. 6. The locking handwheel has a threaded sleeve that is turned onto a stud which passes through a hole drilled through the two halves of the outer trunnion. One of the halves of this trunnion is slotted to permit the table to tilt 45 deg. forward.

Two views of the upper blade guide are shown in Figs. 7 and 8, and the assembly is detailed in Fig. 9. The first thing to note in Fig. 9 is the relation of the slotted angle-iron mounting pad to the rest of the parts



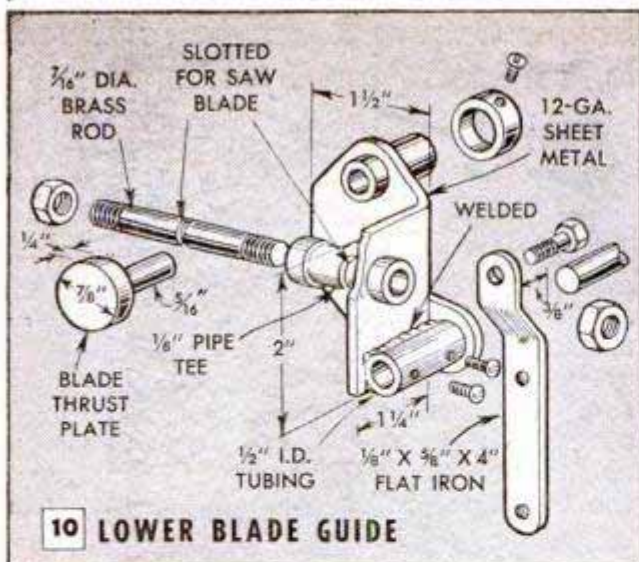

which make up the complete guide. The short length of tubing which forms a bearing for the blade thrust plate fits into a collar welded to the top of the pad. The latter is welded to a short support rod which passes through a hole drilled transversely at the lower end of the sliding guide rod, Fig. 2, and also Figs. 7 and 8. When the assembly is made, a second rod,  $\frac{3}{8}$  in. in diameter, is attached to the sliding guide rod with a bracket arm at the upper end. The smaller rod is passed through a hole drilled in the upper arm and the lower end is then bent at a right angle and inserted in a hole drilled part way through the sliding rod, Figs. 8 and 11. This rod, sliding parallel with the support rod, serves to hold the blade guide in the same position relative to the saw blade when the guide is raised or lowered.

The two angles, Fig. 9, are bent to shape from 24-ga. sheet steel and are drilled and tapped as indicated. The brass guide pin is threaded at each end and slotted at the center for the saw blade. The guide pin is an easy, sliding fit in the reamed pipe tee and a nut on each end permits a lateral adjustment to position the blade in the center of the wide slot in the tee. The thrust plate and the assembled guide pin are shown in position in Fig. 8. Fig. 9 shows a  $\frac{5}{16}$ -in. dowel pin, or plug, in the left-hand slot of the mounting pad. The projecting

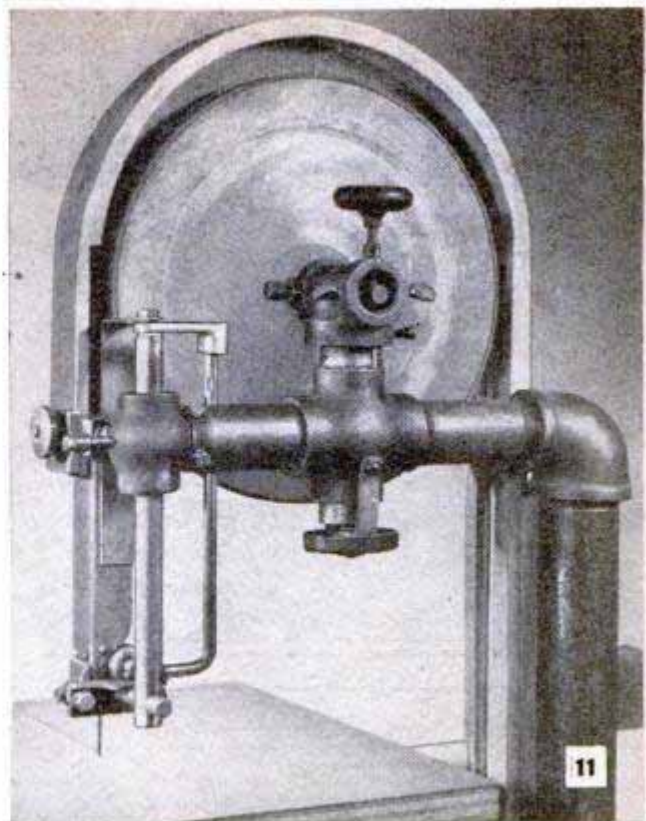

end of the pin enters a hole drilled and reamed through the left-hand angle bracket of the guide and serves to hold the parts in alignment. However, if desired, the hole can be tapped and a cap screw used as in Fig. 8.

The lower blade guide, Fig. 10, is quite similar to the upper guide except that it is supported by a horizontal rod and a flat-iron bracket, which is bolted to the angle bracket and to the side of the lower pipe tee. The horizontal rod enters a hole drilled in the outer half of the trunnion which is next to the guide. The opposite end is inserted in a bushing welded to the side of the angle bracket. Parts of this guide can be made at the present stage of the construction, but do not attach it to the frame until the table has been made and fitted in place and the wheels completed and mounted on the spindles. Then, with a blade in place on the band wheels, it is an easy matter to locate the lower guide in the correct position.

(To be continued)

## Forming Press for Sheet-Metal Parts Improvised From Bench Vise

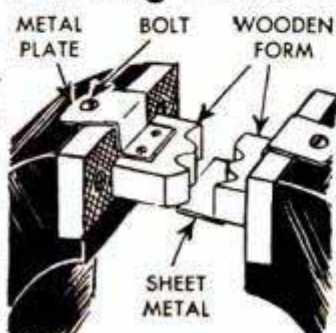

When forming a number of thin sheet-metal parts, the bench vise can be made to serve as a press by using hardwood forming dies cut to shape on the jigsaw. Each die is held in

the vise by a strip of sheet metal bent as shown. The strips are fastened to the vise with machine screws driven in holes drilled and tapped in the vise jaws. A piece of sheet metal fastened to the bottom of one of the forming dies acts as a stop holding the work in position. A turn or two of the vise handle will bring the dies together with sufficient pressure to form the part.

E. M. Harris, Kansas City, Mo.

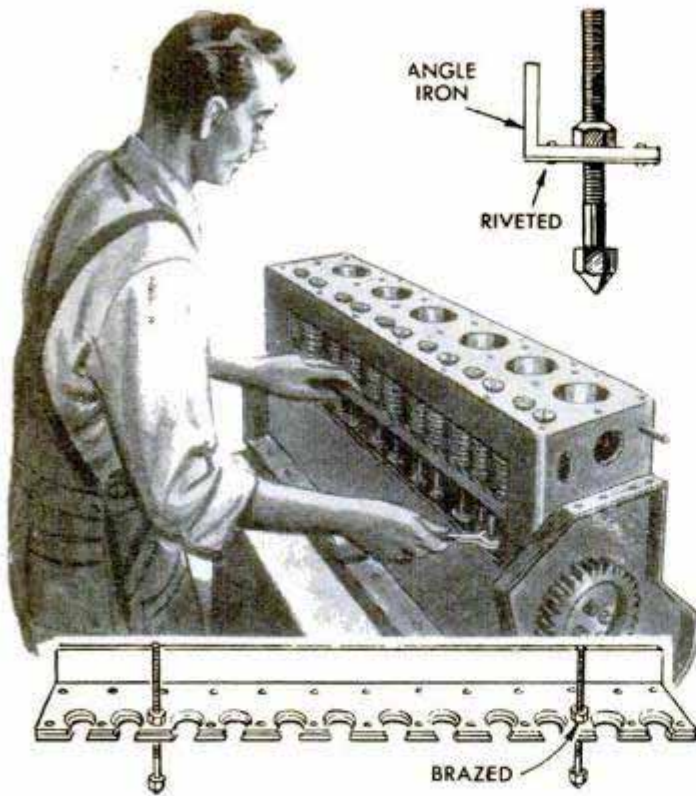

### Gang Valve Lifter Saves Time

With the aid of this gang valve lifter, all of the valve springs, on some engines, can be lifted at the same time. However, on others, only a four-valve gang can be used because of webbing in the engine block. The tool is easily constructed from 1 x 2-in. angle iron and a strip of  $\frac{1}{8}$  x 2-in. steel plate. The sketch shows a 12-valve lifter, for a 6-cylinder engine, with holes drilled in the 2-in. face of the angle iron. These holes are laid out with their centers accurately in line with those of the valve stems. To give the valve-spring washers a narrow ledge to rest on, rivet a strip of  $\frac{1}{8}$  x 2-in. cold-rolled steel to the bottom of the angle iron. Drill holes through the steel strip, making them concentric with the holes in the angle iron but  $\frac{1}{4}$  in. smaller. Slot the edge of the lifter to each hole for valve-stem clearance. At a point near each end of the tool, drill and tap holes for the  $\frac{7}{16}$ -in. lifting screws. To increase the threaded surface through the angle iron for these screws, weld or braze a  $\frac{7}{16}$ -in. nut directly over each hole. The lifting screws are merely  $\frac{7}{16}$ -in. cap screws, 4 in. long, threaded practically their full length. The heads are turned to a blunt point in the lathe. When the tool has been slipped into place under the valve springs and these screws turned with a wrench, as in the illustration, the valve springs are lifted and compressed so that the valve-stem keys or pins can be easily removed. The gang lifter is left in place until the grinding job is completed and the valve-stem pins replaced. The gang lifter can then be lowered and removed from the engine.

### Binder Canvas Rolled in Tar Paper Is Protected From Rodents

If it is inconvenient to hang a binder canvas where rodents cannot reach it, the canvas can be stored safely by rolling it in tar paper or old linoleum. Use paint or syrup pails to enclose the ends of the tar-paper roll.

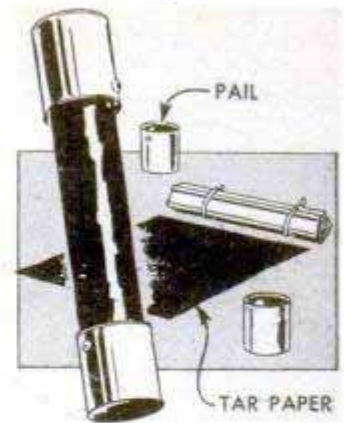

### Hydrometer Measures Salt Content Of Water-Softener Brine Tank

To keep a constant check on the salt supply in the brine tank of his water softener, one homeowner built a simple hydrometer from a short length of glass tubing of the type having one end closed. In this he placed a sufficient number of lead shot to keep the tube floating upright. Then he corked the open end tightly and placed the tube in a saturated salt solution. When floating free, the water line on the tube is noted and the glass is scored at this point to form a witness mark. When the mark on the tube sinks measurably below the surface of the brine solution it indicates that fresh salt should be added.

### Portable Bench and Toolbox

This portable workbench and toolbox was made up from 2 x 16-in. native lumber, 10 ft. long. A pair of caster wheels mounted on one end and conventional legs on the other end make it possible to push the

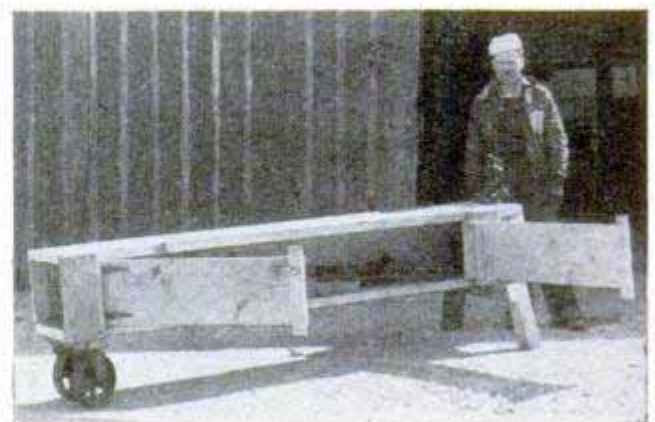

bench to the job like a wheelbarrow. A pipe vise is mounted on one end. Tools and materials are stored in the compartment below the bench top and are always conveniently at hand. Two hinged doors fitted to the front of the compartment offer protection with free access to the tools.

# Making Box Joints on Your Circular Saw

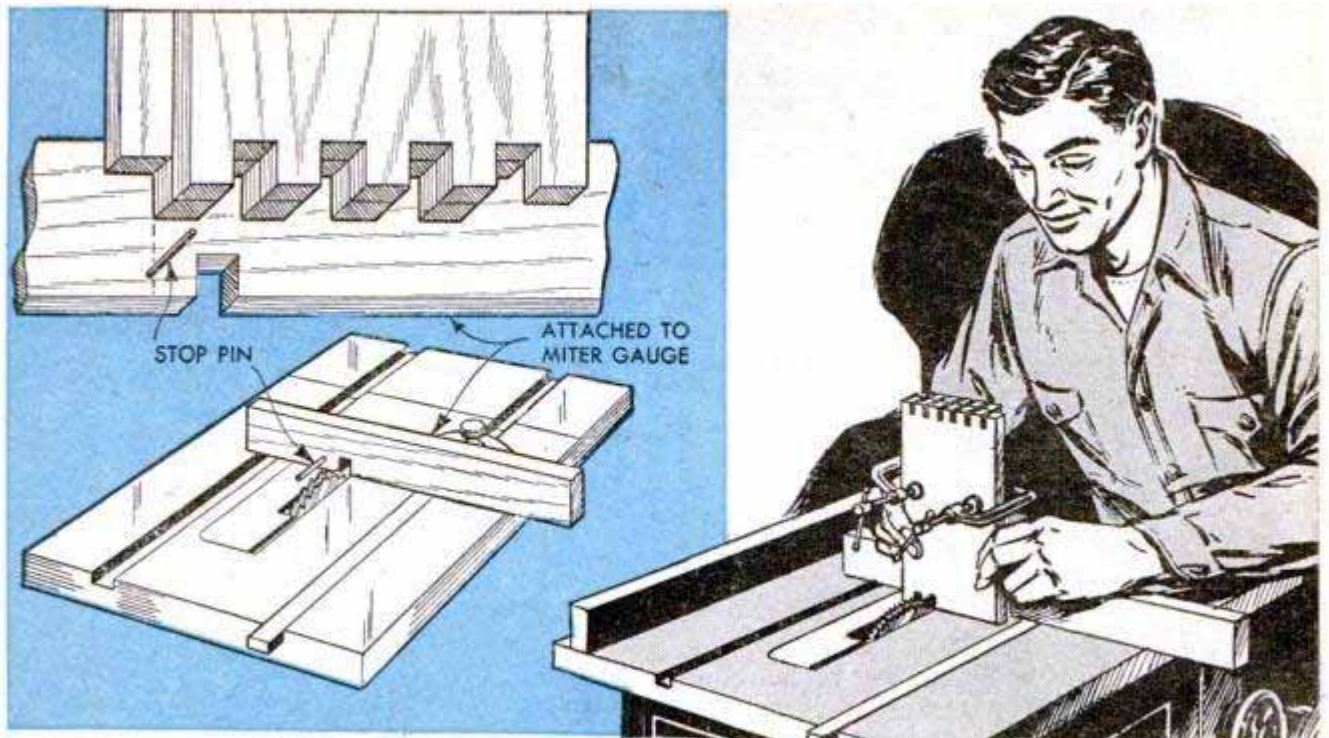

Here's an easy way of making box joints, sometimes called dovetail joints, on your circular saw. First, rip the sides and end-pieces of the box to size from stock of the same thickness. Then assemble the dado head on the saw arbor to cut a groove approximately equal in width to the thickness of the stock. Raise the head, or the saw table, depending on the type of machine, so that the dado will cut a groove of the same depth as the thickness of the stock. Now, screw a strip of  $\frac{3}{4}$ -in. stock, about 3 in. wide and 18 in. long, to the miter gauge and, with the dado head adjusted to the proper height, cut a groove across the lower edge of the strip. Then measure to the right, from the right edge of the groove, a distance equal to the exact width of the groove. Drive a brad or fin-

ishing nail at this point to serve as a stop pin for spacing the successive cuts uniformly. In running the grooves with this setup it generally is best to work the ends and sidepieces of the box in pairs. Stand one of the sides and an endpiece on end and offset the edges a distance equal to the width of the groove. Clamp the pieces together in this position. Now place them against the miter guide with one edge flush with the right side of the groove in the guide strip. Pass the work over the dado head to make the first cut. Slide the work to the right against the stop pin and run the second cut. Now, lift the work, place the last groove cut over the pin, lower the stock to the table and slide it to the right. Now you're all set to space the series of grooves across the ends of the pieces.

## Eaves Trough Fitted to Side of Coop Provides Poultry Feeder



A length of eaves trough mounted outside a coop or fattening pen, as pictured, provides an easily filled feeder for the birds kept inside. The open-end trough is attached with regular wire hangers nailed to the pen and should be tilted at a slight angle to permit drainage of rainwater.

## Removing Rust From Metal Scrap

Rust can be removed from salvaged metal scrap by rubbing it off with an old hacksaw blade. Mount the blade in the hacksaw frame and then run it across the surface of the metal, using a simultaneous forward and sideward motion.

Danton Go, Kapatagan, P. I.

# How to Turn PLASTICS



By Sam Brown

**I**T'S FUN to turn plastics in either a metal or wood-turning lathe. Common craft plastics turn beautifully, the chip comes off clean in a long, paper-thin ribbon and the surface left by a sharp tool requires a minimum of final finishing operations. Turnings that involve curves, such as candlesticks and lamp bases, are best handled on a wood-turning lathe as the tool must be worked freehand. Turning straight, true cylinders or tapers is best done on a metal lathe where the position of the tool is fixed and the feed uniform. Turning characteristics of common plastics are similar to non-ferrous metals and ordinary metal-turning operations can be duplicated on plastics. Nearly all plastics will take a fairly sharp knurl; they face off and shoulder perfectly and can be worked successfully with shaped cutters. With care you can run a clean, sharp thread.

General turning data is given in the table, Fig. 1, while Fig. 5 lists suitable lathe speeds and converts feet-per-minute (f.p.m.) to revolutions-per-minute (r.p.m.) for specific diameters. As an example of how these tables work out, suppose you are turning down a 1-in. spindle of the

thermoplastic Tenite II, Fig. 1 shows the correct speed to be 300 f.p.m. and referring to Fig. 5 you will see that a surface speed of 300 f.p.m. on a 1-in. spindle requires a lathe speed of 1150 r.p.m. However, surface speeds ranging from 100 to 400 f.p.m. will work satisfactorily. Note from the table Fig. 1 that the phenolics (cast resins) require a high spindle speed and a slow tool feed, and that the reverse is generally true of the thermoplastics. The speed recommendations apply quite closely to all work under 2 in. in diameter, but on work over 2 in. in diameter the turning speeds for thermoplastics can be increased considerably because of the longer cooling cycle.

A good indication of the correctness of procedure is the shape and nature of the chip. If it gums and adheres to the point of the lathe tool, the speed is too high; if the chip tends to shatter or powder, the tool is dull or the feed is too fast. But with the correct adjustments and the proper feed you get a long, ribbon chip that curls away from the tool point without breaking, Fig. 6.

Much of the technique of turning plastics requires a careful study of methods of

**1 PLASTICS TURNING DATA**

	TECHNICAL NAME OF PLASTIC	REPRESENTATIVE TRADE NAMES	FEET-PER-MIN. SPEED	FEED RATE (INCH PER REV.)	REMARKS
THERMO-SETTING	CAST PHENOLIC	CATALIN, MARBLETTE	400 OK 100 to 600	.004 or less	Slight odor. Turns easily with mild pressure. Cuts can be up to 1/8" deep. Heavy feed causes a powdery chip.
	LAMINATES	FORMICA, MICARTA	200-300	.004 or less	Very abrasive. Best turned with carbide tools. High-speed tool bits should have positive rake of about 15°.
THERMOPLASTIC	CELLULOSE ACETATE	LUMARITH, TENITE I	300 OK 100 to 400	.007 or less	Sourish odor. Turns very easily with light pressure. Cuts can be up to 3/16" deep. Heavy feed causes excessive tearing. Both plastics in this group are practically identical in physical properties. Excellent for hand turning.
	CELLULOSE ACETATE BUTYRATE	TENITE II	300 OK 100 to 400	.007 or less	
	ACRYLIC	LUCITE, PLEXIGLAS	200 or less	.010 or less	Sweetish odor. Use firm pressure when turning by hand. Slow spindle speed.
	POLYSTYRENE	PLAX, STYRON	120 or less	.015 or less	Mild odor. Requires firm pressure. Gums easily and must be worked at low speed.

**METHODS OF CHUCKING SHEET PLASTIC**



**Chucking plastic disks with hardwood follow block**



**Plastic sheet is screw-fastened to block of hardwood**

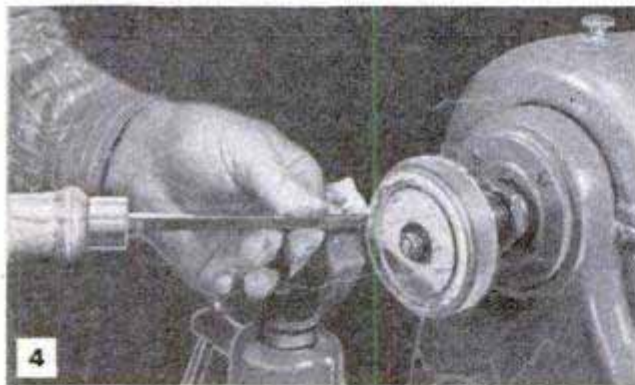

**Plastic held by small bolt through the center hole**

**5 F.P.M. to R.P.M.**

DIA. OF WORK	FEET PER MINUTE						
	100	120	200	300	400	500	600
	REVOLUTIONS PER MINUTE						
½"	764	917	1528	2290	3056	3820	4580
¾"	508	610	1016	1530	2032	2540	3060
1"	382	458	764	1150	1528	1910	2300
1½"	254	305	508	754	1016	1272	1508
2"	191	229	382	574	768	956	1148
3"	127	153	254	382	502	636	764
4"	96	115	191	286	384	476	572
6"	64	76	127	192	256	320	384
8"	48	57	96	144	192	238	288

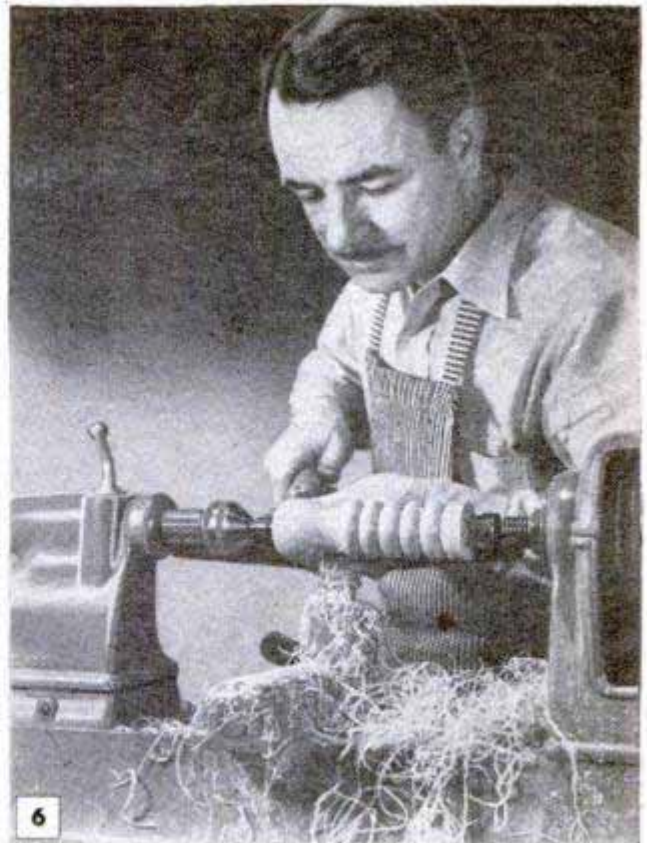

**Long, paper-thin chips indicate that turning setup is correct in all details. Negative rake is obtained by holding the tool handle slightly higher than point**

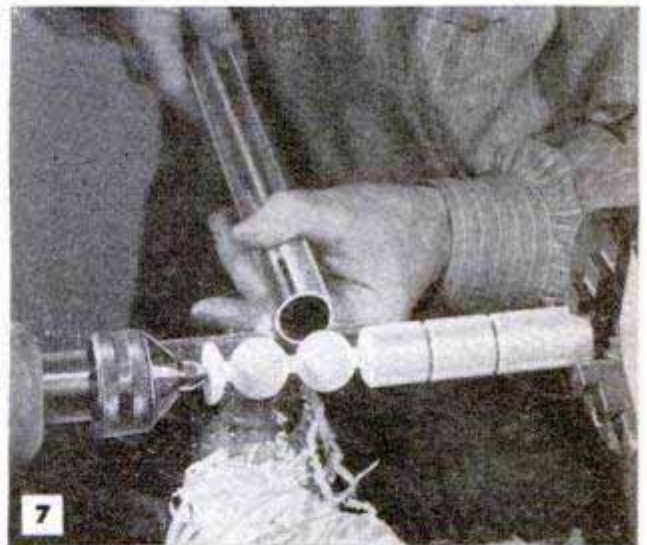

**Above and below, it's easy to turn plastic balls by using a short length of steel tubing as the turning tool. End of tubing is ground to form cutting edge**

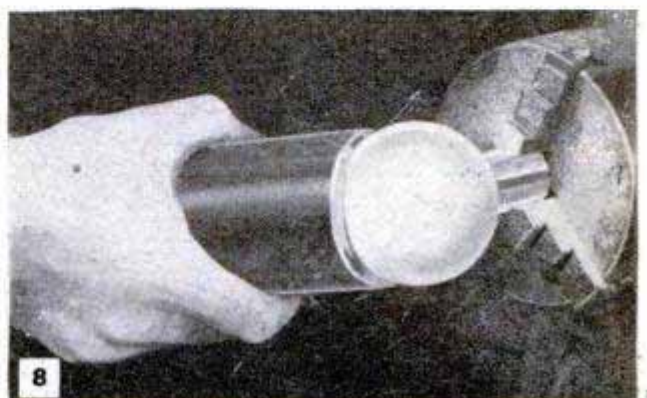

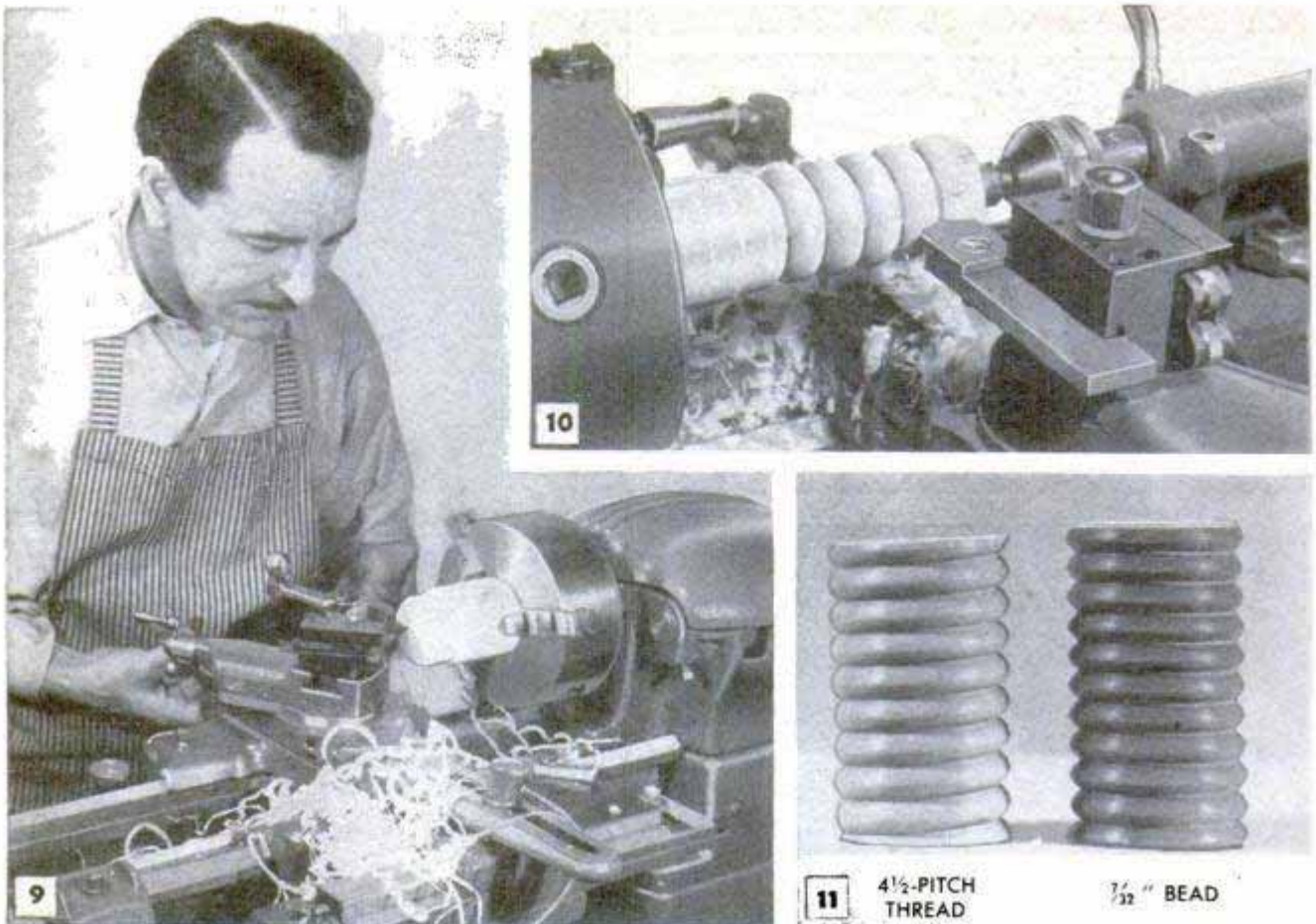

Beads and spirals are turned with a molding cutter mounted on a holder as in Figs. 10 and 12. Work longer than 4 in. should be supported on ball-bearing tailstock center as in Fig. 10. Short pieces are chucked as in Fig. 9



chucking the work. Figs. 2, 3 and 4 picture the fundamentals, and Fig. 9 shows the stock being held in a conventional 3-jaw chuck on a metal lathe. In Fig. 2 the plastic disk is clamped against a wooden backing plate with the tailstock center bearing against a hardwood follow block. In Fig. 3 a square of sheet plastic is simply screw-fastened to a block of hardwood attached to a faceplate. After the turning is completed it is cut free with a parting tool. Fig. 4 shows the simplest method of mounting thin sheet plastic where a center hole is permissible. A bolt passing through the center of a hardwood disk attached to the faceplate, holds the plastic disk firmly in place for turning. Figs. 7 and 8 show how to turn plastic balls to perfect spheres by means of a piece of steel tubing ground square across the end. The ball is rough-turned with the regular turning tools and then finished with the tube tool, the inside diameter of which should be about three quarters of the finished diameter of the sphere.

Plastic rounds (spindles) are mounted between centers in the same manner as are wooden squares. With the center head of

a combination square, score two lines at right angles to each other across the ends of the work to locate the centers. Then saw down the scored lines to a depth of about  $\frac{1}{16}$  in. on one end so that the lugs of the spur center will engage for a positive drive. Drill a small hole in the center of the opposite end of the piece so that the cup center will engage. In a metal lathe, the plastic also can be mounted between 60-deg. centers and driven with a dog just as in metal turning, or short rounds can be chucked as in Figs. 9 and 10. If the piece is more than 4 in. long, the outboard end should be supported by a ball-bearing tailstock center, Fig. 10. The latter illustration also shows how to utilize a molding cutter to form perfect beads by mounting the cutter on a short length of  $\frac{1}{4}$ -in. flat steel, Fig. 12. Then the unit is mounted in the toolholder of the metal lathe, Fig. 10. By connecting the carriage to the lead screw, the molding cutter will form a spiral as pictured at the left in Fig. 11. Of course, the thread feed must be equal to the width of the bead. While large beads, Fig. 10, can be spaced accurately enough with pencil marks, narrow beads are spaced by turning

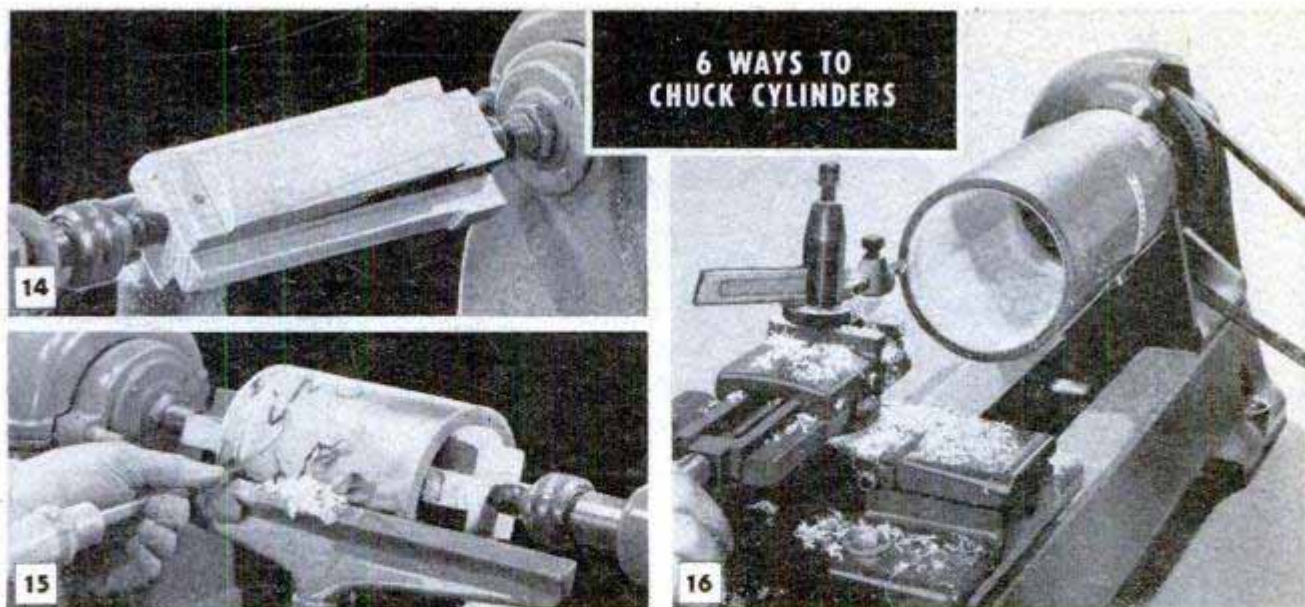

## 6 WAYS TO CHUCK CYLINDERS

**TAPERED HARDWOOD MANDRELS** are used in chucking large hollow cylinders. The mandrel is tapered slightly to fit the taper of the cylinder. Mandrel can be solid or built up. For light turning operations, hollow cylinders up to 8 in. long can be gripped internally in the lathe universal chuck, without support at outer end

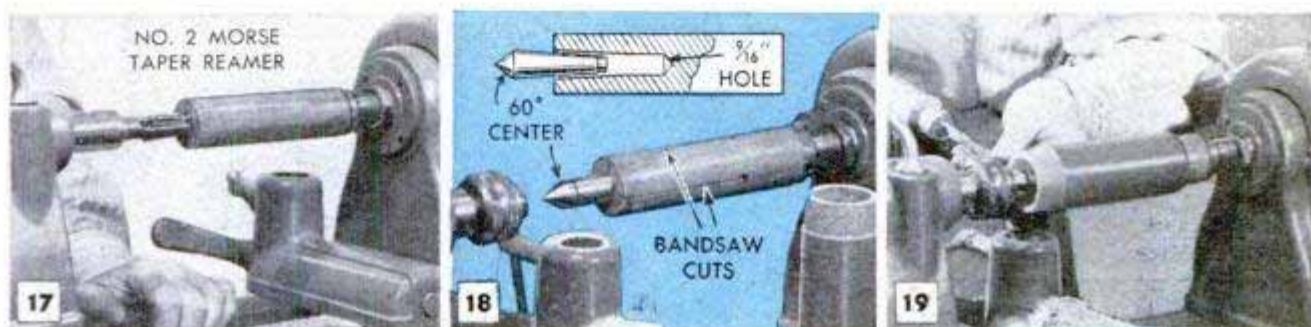

**THE EXPANDING, OR WEDGE, CHUCK** is ideal for holding small-diameter work. The chuck is drilled and slit lengthwise to take a standard Morse-taper center and chuck grips work by advancing the center into the hole

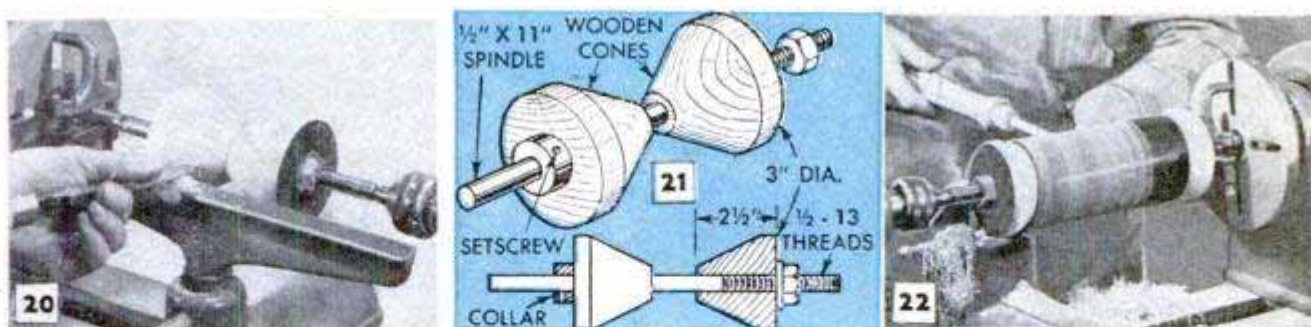

**THE CONE CHUCK** is especially useful for holding thin-wall cylinders. Two tapered turnings are placed on a threaded shaft and held between centers. Work is held securely between cones by tightening a nut on shaft



**THE SPINDLE, OR FRICTION, CHUCK** holds work by friction alone. For internal turning, the chuck is recessed to hold the work, the recess being slightly smaller than the diameter of the work. Work is limited to short lengths

## 27 FINISHING SCHEDULES FOR PLASTICS

TYPE OF PLASTIC	FIRST ROUGH	SECOND ROUGH	FIRST BUFF	SECOND BUFF	EXTRAS
PHENOLICS	Sand 150 Grit, Wet	Sand 240 Grit, Wet	Learock 155 or equal (Alum. Oxide)	Learock 304B or equal (Whiting)	
ANY	Sand 150 Grit, Wet	Sand 240 Grit, Wet	No. 2-0 or 3-0 steel wool		
ANY	No. 2-0 Pumice with water is equivalent to sanding operation		Any fine buffing compound, usually tripoli		Dry Buff
ACRYLICS	Sand 150 Grit, Wet	Sand 240 Grit, Wet	Learock 855 or equal (Sand 400 Grit)	Learock 884 or equal (Whiting)	Optional—low bake at 120° for 2 hrs.
ACETATES	Machine Smooth	Sand 220 Grit, Wet	Learock 855 or equal (Tripoli)	Learock 832 or equal (Lime)	



26 Wet sanding removes the tool marks and smoothes the surface ready for buffing and polishing operations



28 Above, high polish is easy to produce with buffing compounds. Below, use steel wool on wood-plastics

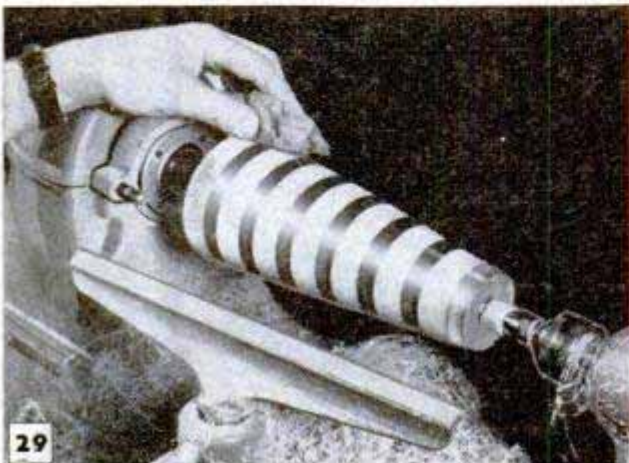

29

the compound parallel with the work and reading the spacing direct from the micrometer sleeve. For example, the  $\frac{3}{16}$ -in. beading shown at the right in Fig. 11 is spaced  $\frac{1}{32}$  in. between the crowns, making each individual bead about  $\frac{3}{32}$  in. wide. In thousandths this is .218, or roughly, .200 in. which is just two full turns of the compound handle for each new spacing. In turning a spiral the width of the bead is .218 in., approximately equal to a  $4\frac{1}{2}$ -pitch thread. Beads and spirals are worked at slow speeds, using light cuts.

The first rule in ordinary plastics turning is simply to grind the cutting tool with plenty of clearance and keep it sharp. Fig. 13 details the important points in grinding the tool, but this applies to the square tool bit held stationary in the toolholder. In working with hand tools on the wood lathe, the slight negative rake is obtained simply by holding the tool handle a little higher than the cutting point. Among the hand-held lathe tools, the roundnose tool is most commonly used in turning plastics. Because of the radius of the edge, it offers the minimum area of contact and is less likely to leave chatter marks. Figs. 14 to 25 inclusive picture and detail methods of chucking and turning hollow plastic cylinders and tubes of varying length. Wedge chucks, various types of hardwood expanding chucks, or mandrels, and cones are commonly used. As a rule, the chucks are made in the lathe to suit the job in hand.

Fig. 26 shows a common setup on the wood lathe for polishing the plastics job after turning. Fig. 27 gives recommended finishing schedules. Speeds for wet sanding and buffing can be somewhat higher than for turning. When the job is composed of wood and plastic as in Fig. 29 the dry, rough sanding is followed by a rubbing with fine steel wool. After sanding has removed fine scratches and tool marks, a high luster is produced in a jiffy with a buffing compound applied as in Fig. 28. In sanding and buffing, care must be taken not to heat the work unduly.



# Two-Wheel Trailer Safely Hauls Farm Tractors

Mounted on an under-slung axle, this trailer is used to haul four-wheel farm tractors at highway speeds. Channels for the tractor wheels are mounted on the trailer bed, hinged sections of the channel folding downward to provide a ramp. After loading the trailer, the hinged sections are folded flat on the bed to chock the tractor wheels. If desired, a hinged ramp of flat steel can be substituted for the channel sections to facilitate loading three-wheel tractors.

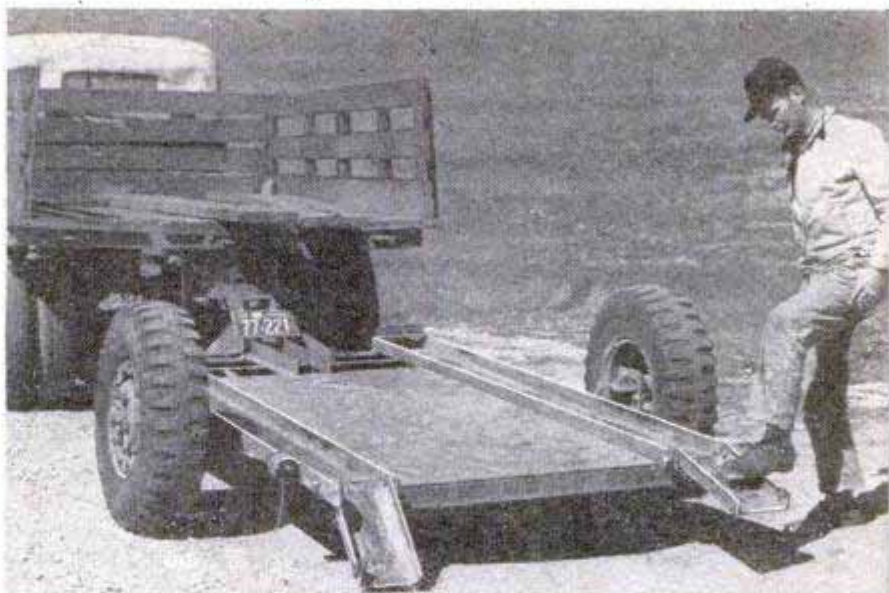

## Carpenter's Chalk Holder Prevents Soiling Hands

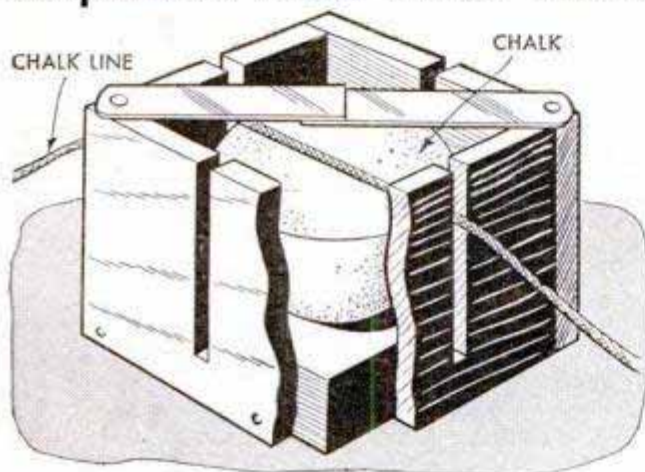

Carpenter's chalk kept in this holder will neither soil the hands when chalking a line nor crumble when stored in the toolbox. The holder is made in the form of a box  $1\frac{1}{4}$  in. deep and slightly larger than the diameter of the chalk. Two saw kerfs are cut across the box to guide the chalk line, and two strips of sheet metal, which are fastened to the corners with the ends overlapping, hold the chalk in place. In use, the holder is held in the hand. The string is then inserted between the metal strips and drawn across the chalk through the saw kerfs, as shown in the drawing.

## T-Wrenches Align Oil Pan When Bolting in Place

Replacing an oil pan is a less difficult job if two of these T-wrenches are used to align the bolt holes. The wrench is made by welding two lengths of rod to form the T-shaped handle, and then welding a bolt to the end of the handle. The bolt, which should be the same size as the oil-pan bolts, is ground to a taper, leaving enough threads intact near the base of the shank, however, to hold the oil pan temporarily in place. Turn the wrenches into bolt holes at opposite corners of the oil pan to align the holes. Then remove the wrenches after the rest of the bolts have been started.

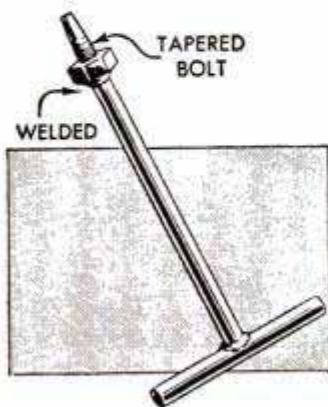

ily in place. Turn the wrenches into bolt holes at opposite corners of the oil pan to align the holes. Then remove the wrenches after the rest of the bolts have been started.

## Rump Strap for Dairy Cow Stops Switching of Tail

Even though the barn is thoroughly sprayed twice daily to eliminate flies, dairy cows accustomed to switching their tails during the day in order to keep off the pests frequently continue this habit during milking. To prevent it, one dairyman attaches a loop of rope or webbing to the milking-machine strap and places the loop in the position pictured to keep "Bossy's" switching tail under control.



☐ To remove printing-ink stains, soak in turpentine and then sponge with alcohol.

# SHOPPING

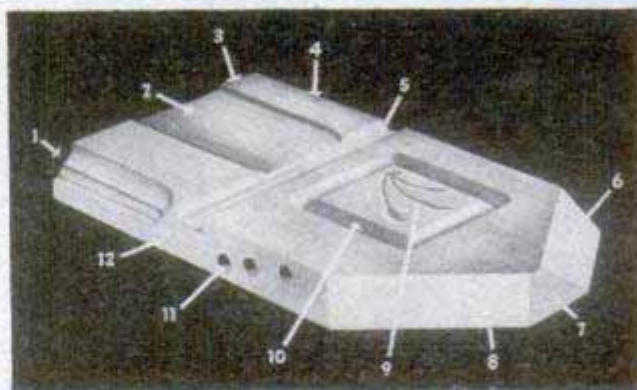

**TWO-SPEED RADIAL SAW** that does just about everything required in ordinary cabinet work has been made available to contractors and home craftsmen. Accessories include boring table, router-shaper table, miter gauge for accurate crosscutting, arbors for buffing, grinding and wire wheels, dado and molding heads and wood lathe. Numbered block above gives an idea of the multiplicity of cuts that can be made

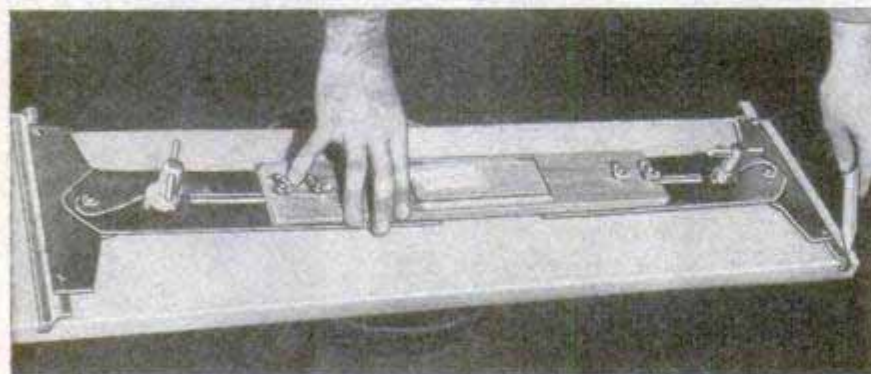
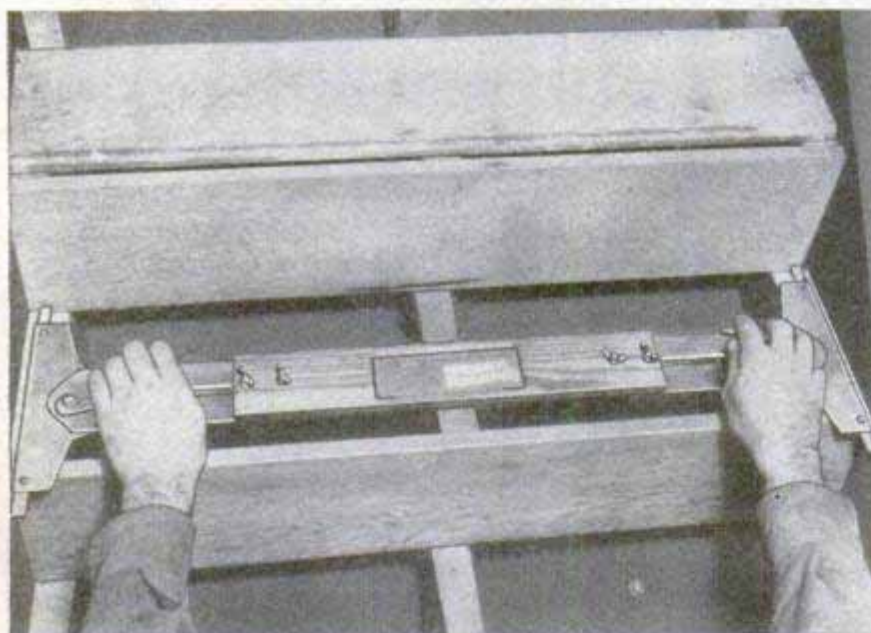

**AUTO-SET TEMPLATE** for measuring and fitting stair treads, closet shelves and flooring simplifies and speeds up these time-consuming jobs. The two ends of the template are adjusted to span the stringers as pictured, or, are forced against the skirt boards in closed stairways, and the adjustment locked. Then template is placed on the stock for marking



**MAGNETIC DRIVER** for hex-head screws and nuts has powerful magnet installed in hex socket to hold screw in place for starting in hard-to-reach corners. One-handed operation leaves other hand free to hold parts being assembled. Tool is about length of average screwdriver. Available in standard sizes from  $\frac{1}{4}$  to  $\frac{1}{2}$  in.

# FOR TOOLS

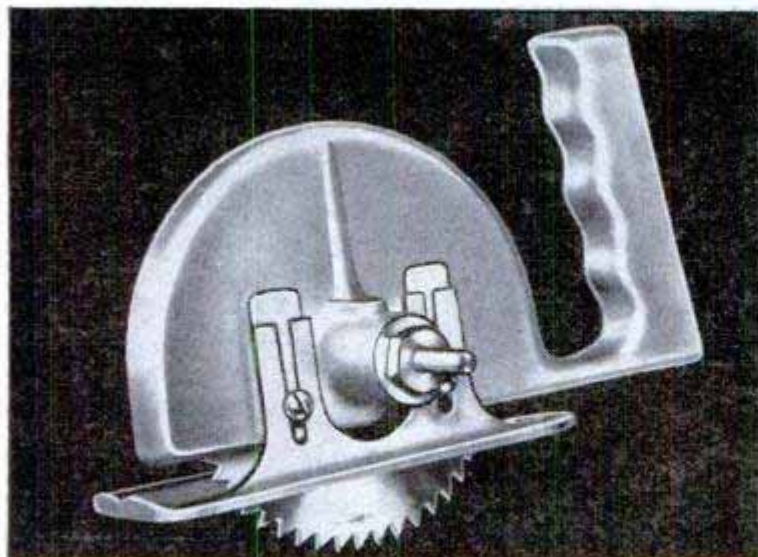

**CIRCULAR-SAW ACCESSORY** for use with any  $\frac{1}{4}$ -in. portable electric drill has 4-in. blade that can be used for ripping and crosscutting. Saw is adjustable for  $\frac{1}{4}$  to  $1\frac{1}{2}$ -in. cuts



**SELF-CONTAINED TAMPER** for earth and gravel fills is pictured above in operation. It is actuated by a piston sliding in a cylinder in which a fuel mixture is fired by magneto ignition. Thrust from piston can be adjusted to lift tamper from 12 to 20 in. It falls by its own weight. The tamper is operated by one man and will compact from 10 to 20 cubic yards of earth per hour on a quart of fuel, a gasoline-oil mixture similar to that used in two-cycle engines

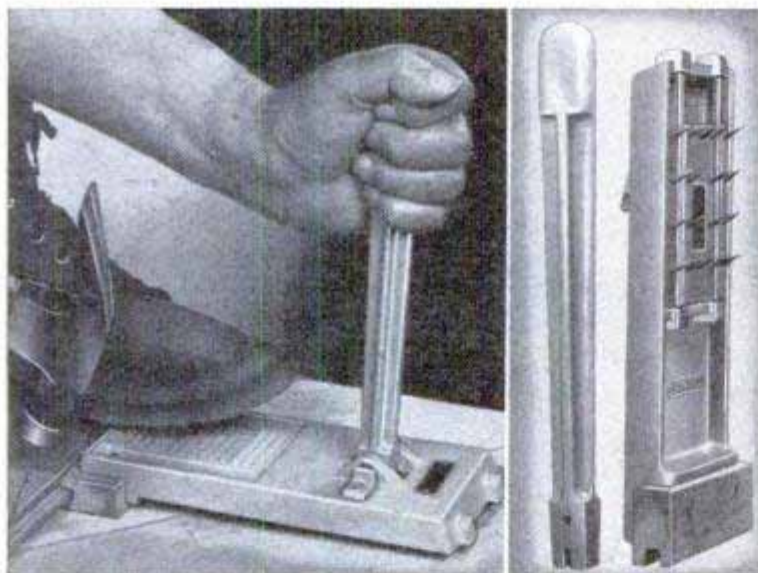

**FLOOR JACK** of a new type with lever action is a timesaver when laying top flooring or decking. Jack has many other applications as tightening aid when assembling parts for nailing

**SLIDE-SET VISE** for machinists and metal-working craftsmen is simple, fast and positive in operation. As pictured in the two views below, the handle is turned counter-clockwise to release the movable jaw, which then slides to any position. After engagement, the handle is tightened clockwise in the conventional manner as in the right-hand photo below. This construction eliminates the necessity of spinning the handle to open or close the vise jaws

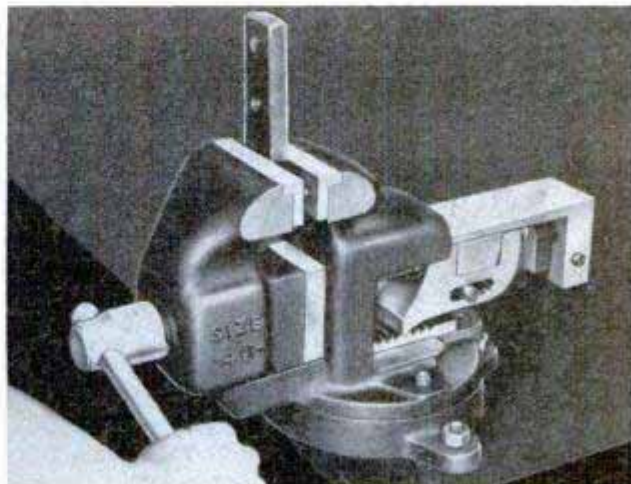
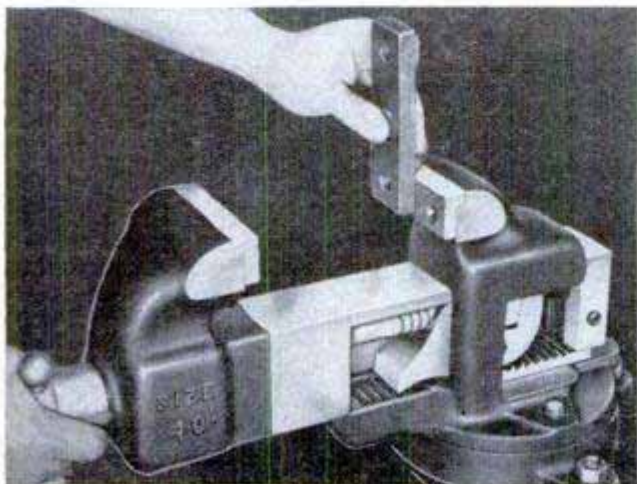

## Unusual Christmas-Tree Display Projects Through Store Window



One merchant achieved an unusually interesting Christmas-tree display by having the tips of the tree branches seemingly project right through the show window. This was done by setting up the tree close to the window, causing some of the longer branches to bend against the pane. These branches were cut off flush with the glass and then cemented to the outside so that the branches appeared to continue through the window. Ordinary household cement is used so that pulling off the branches will not endanger the plate glass.

Opie Read, Jr., Chicago.

## Eaves-Trough Chicken Feeder Handles Wet Mash

Poultrymen who prefer to feed wet mash to young chickens in low trough-type feeders can make an excellent and inexpensive feeder for this purpose simply by fitting wooden endpieces into short lengths of round eaves trough. After cutting the eaves

## Laying Nests Made From Oil Can Are Fitted With Wooden Perches

A square 5-gal. can, cut in half along the dotted line as in the detail and fitted with a wooden perch, makes two laying nests for the poultry house. The units can be attached to the walls

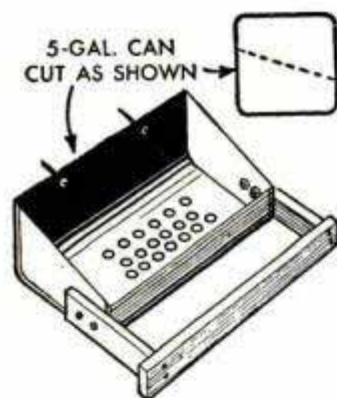

individually or in batteries. In batteries, they can be placed one unit above the other, or in line horizontally along the wall. After cutting the can, it's a good idea to snip the corners, turn the sharp edges in and hammer them flat.

The wooden perches can be attached with small stove bolts or roundheaded screws driven from the inside of the nest. Punch a pattern of small holes in the bottom of each unit to permit air circulation and to facilitate cleaning.

Albert Zanelli, Kahoka, Ark.

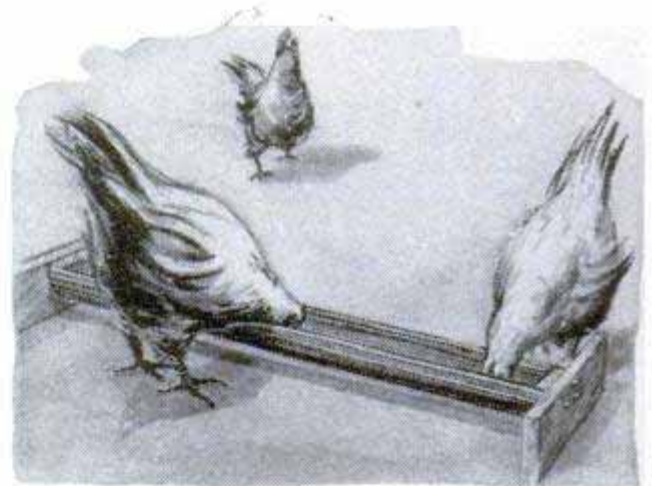

trough to the lengths required, a semicircular block is nailed in each end. Then the block is nailed to short lengths of 1 x 4-in. stock. The latter, which are nailed horizontally, support the feeder and prevent it from being tipped or upset easily.

Charles B. Mason, California, Mo.

## Self-Dumping Trailer Operated by Tractor Carries Heavy Load



This two-wheel, self-dumping trailer has a flat bed or platform fitted with slots for a standard hay rack. Designed for use with a tractor, the hitch is hinged so that, when the front latch is released, a slight backward motion of the tractor tilts the bed and dumps the load. Of very strong construction, the trailer will hold all the weight a tractor can move, including farm machines and equipment, baled hay and feed.

L. H. Houck, Jefferson City, Mo.

## TV MIRRORS "SEE" ONLY ONE COLOR

IF YOU would like a mirror that reflects your favorite color and no other, the men to see are the color-television specialists of the Westinghouse Research Laboratories. By depositing ultrathin layers of metallic compounds on clear glass they are able to produce mirrors that reflect only one color—either red, green or blue.

The mirrors are used at both the transmitting and receiving ends of their color-television system. At the transmitting end they pick up the color picture and break it down into its three basic colors—red, blue and green—which are sent in the proper sequence. At the receiving end another set of mirrors "gather" the colors for the picture.

To make one-color mirrors, a clear sheet of glass, photo A, is placed in a big glass-jar "oven" surrounded by a wire cage. This is lowered as shown in photo B, sealed, and evacuated of air. Special metal compounds are heated until they evaporate, and as the vapors rise in the jar they strike the glass sheet to apply a smooth, even coating. The thickness and number of layers deposited on the glass determine which color the mirror reflects.

The research scientist in photo C is studying how colors change under the influence of electricity. The telescope-like device can produce all colors of the rainbow by changing the voltage applied to a light beam.

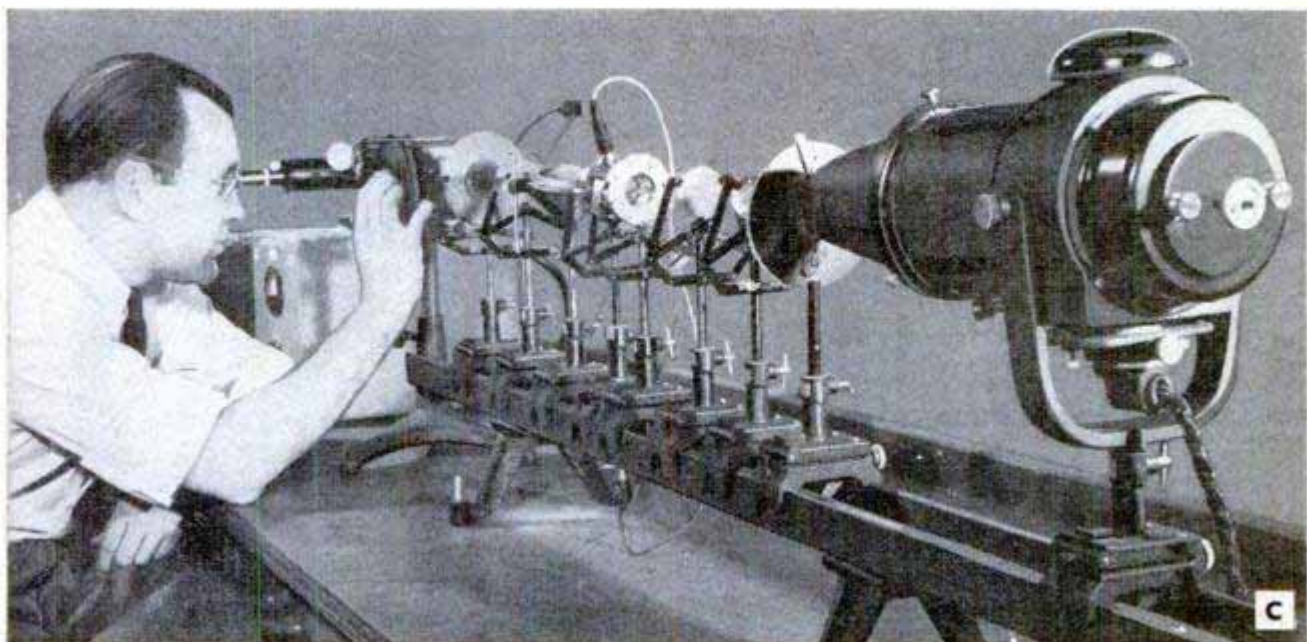

# THREE GERMANIUM DIODE CRYSTAL

By L. M. Dezettel

CRYSTAL sets have been a favorite of experimenters for many years as they are easy to build and they reproduce voice and music with true lifelike quality. The three crystal sets described here use sensitive Sylvania 1N34 germanium diodes as fixed crystal detectors. The diodes are available from all radio-parts houses.

Set No. 1, shown in photo A, is assembled on a  $\frac{3}{4}$  x 5 x 9-in. piece of well-sanded soft pine wood. All parts are mounted with  $\frac{1}{2}$ -in. No. 6 roundheaded wood screws. Set the parts up on the baseboard and mark the locations for the wood screws. Use a No. 36 drill, and drill about halfway into the wood at each of these points. Small angle brackets are employed to mount the variable condenser on the baseboard. Use  $\frac{3}{16}$ -in. 6-32 machine screws to fasten the brackets to the variable condenser; do not use longer machine screws. The same assembly method is used for all three receivers.

The schematic circuit diagram for set No. 1 is shown in Fig. 1, and the pictorial wiring diagram appears in Fig. 2. This is a standard crystal-set circuit using an inexpensive factory-wound coil. Variable condenser C1 can be any capacity between 365 mmfd. and 500 mmfd. It will provide reasonably loud signals from

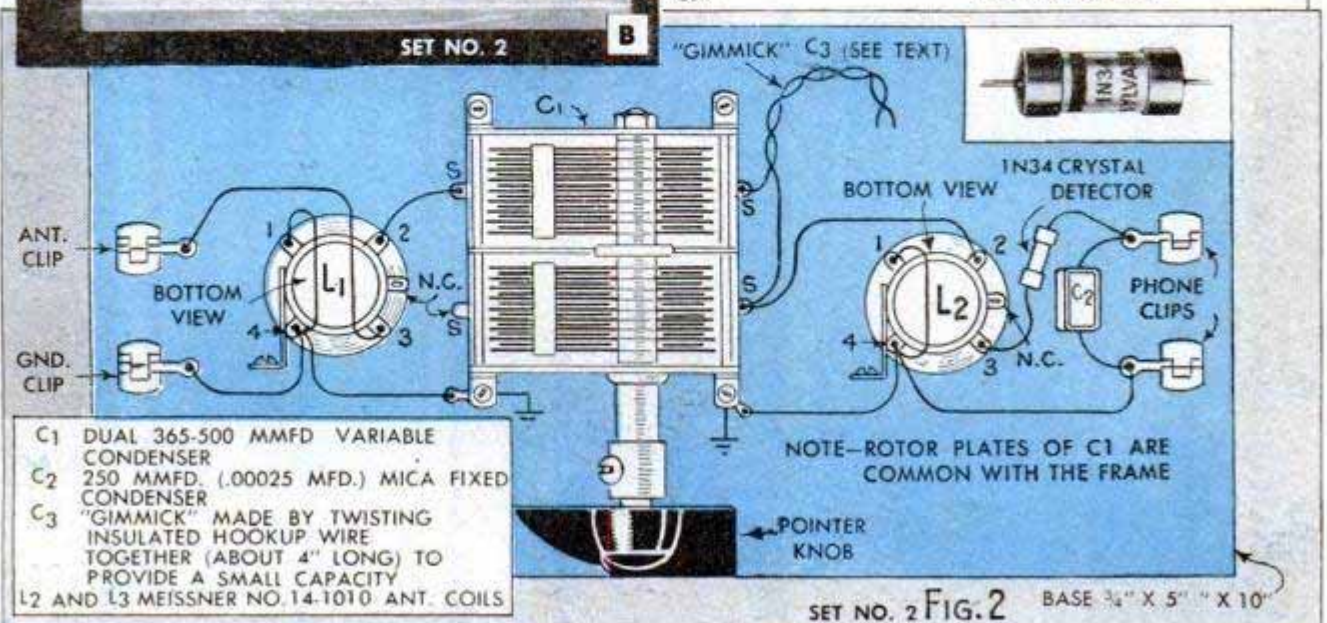
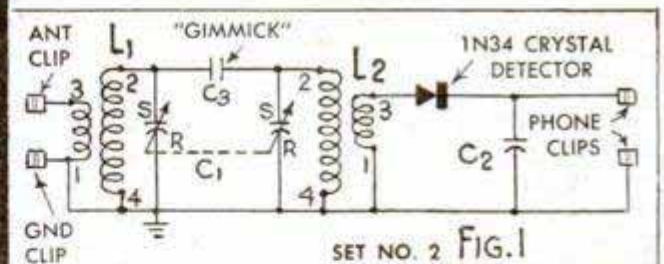
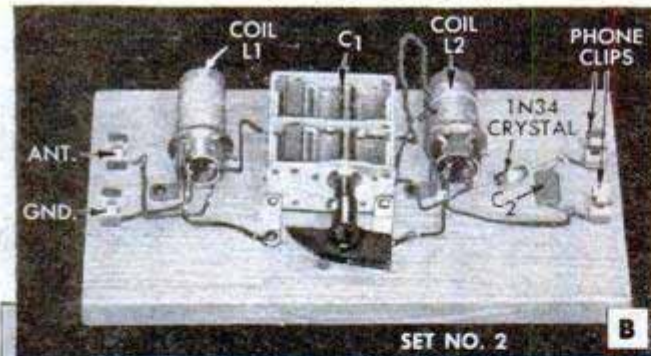
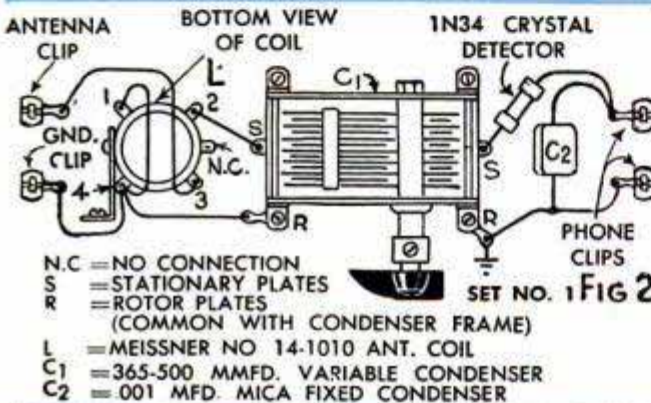
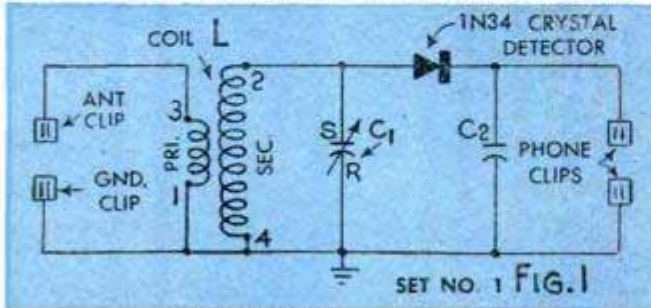
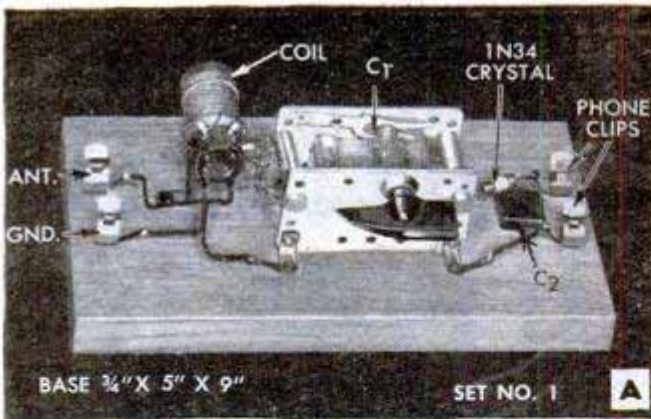

# RECEIVERS FOR BEGINNERS . . .

local broadcasting stations in dual-type headsets with an impedance of 2000 ohms, or higher. The antenna should be a high, well-insulated outdoor type at least 100 feet long, although antennas as short as 40 feet will work. The ground should be made to a cold-water pipe.

The practical receiving range of any crystal receiver is limited to about 40 miles for powerful broadcasting stations. Set No. 2 is double-tuned for improved selectivity. Two coils like the one used in set No. 1 are employed and each coil is tuned by one section of a dual variable condenser. Coupling between the two tuned circuits is by means of a "gimmick" made by twisting two pieces of insulated wire together for a length of about 4 in. This is condenser C3. The longer this "gimmick" the louder the signals, but the poorer the selectivity.

Set No. 3 is an experimental arrangement using two 1N34 diode crystals in push-pull to provide louder signals than conventional crystal circuits. The coils are hand-wound to provide a split secondary winding with a primary winding between. Both primary and secondary are tuned. The dual-section variable condenser tunes the secondary of the coil to the frequency of the station. Condenser C2 in primary L3 tunes the station but it has its greatest effect on very long antennas. If the desired station operates on 850 kc. or higher, "open" the toggle switch on the bracket. Detailed student material list is R-396. *now out of print*

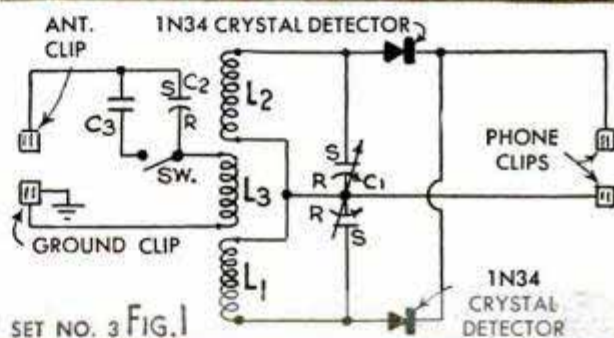
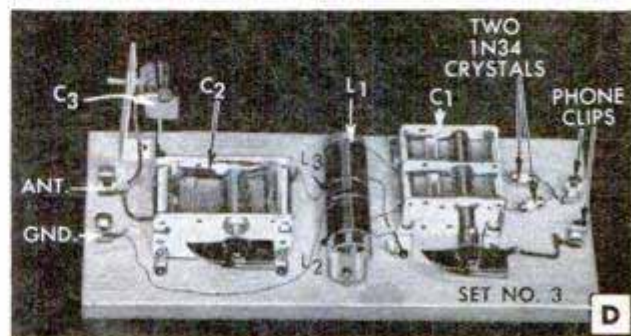

- C1 DUAL 365-500 MMFD. VARIABLE CONDENSER
  - C2 SINGLE 365-500 MMFD. VARIABLE CONDENSER
  - C3 .001 MFD. MICA FIXED CONDENSER
  - L HAND-WOUND COIL ON A 1" DIA. POLYSTYRENE TUBE (SEE TEXT)
  - L1 AND L2 120 TURNS OF NO. 32 ENAMELED WIRE
  - L3 43 TURNS OF NO. 32 ENAMELED WIRE
- ALL THREE COILS ARE CLOSE-WOUND IN THE SAME CLOCKWISE DIRECTION AND SPACED 1/8" APART  
NOTE-VARIABLE CONDENSER ROTORS ARE COMMON WITH FRAMES

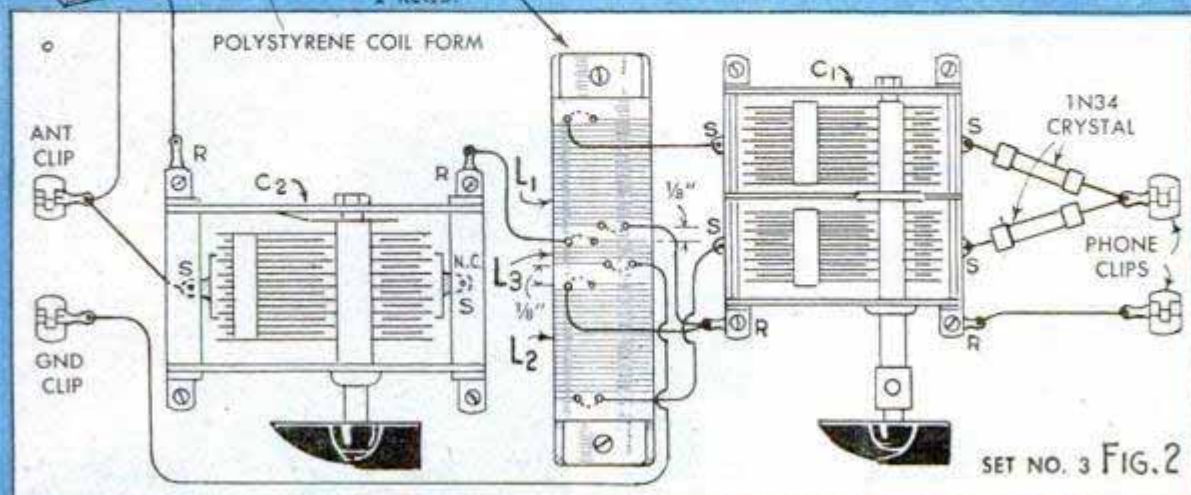
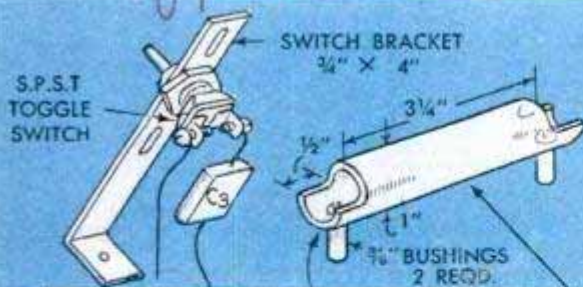

NOTE- N.C. - NO CONNECTION

BASE 3/4" X 3" X 12"

# TV ANTENNA INSTALLATION WITH

By Harry F. Leeper

**M**ANY homeowners wish to keep TV antennas off the roof if possible. Chimney mounts are not always practical for supporting the necessary high antenna-mast installations in fringe areas remote from television transmitting stations. Such TV antennas must be at least 45 feet from the ground, or higher in many locations.

Two practical solutions for this problem are illustrated and described on these pages. Both installations were made with metallic tubing extended from the ground up the side of the building to support the multiple-bay antenna arrays and only a few guy wires are required. The installation illustrated in photo A shows the tubing supported at the end of the roof ridge. A strap-iron bracket at the attic window provides another firm support as illustrated in photo B. This mast supports a two-bay Inline high-low TV antenna array with a single 300-ohm twin-lead lead-in. This is twisted and brought down through several TV lead-in standoff insulators attached to the tubing as shown in photo C.

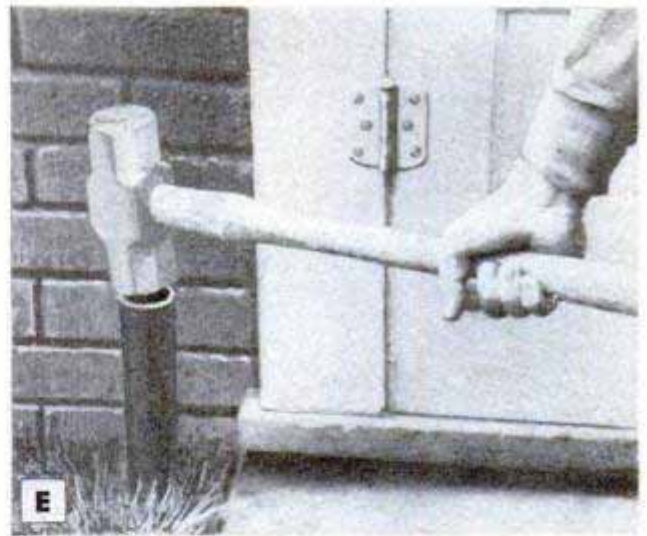
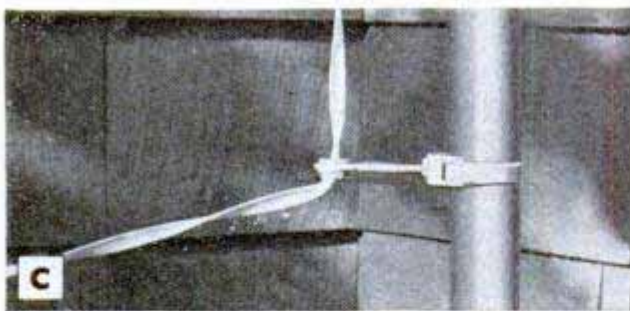
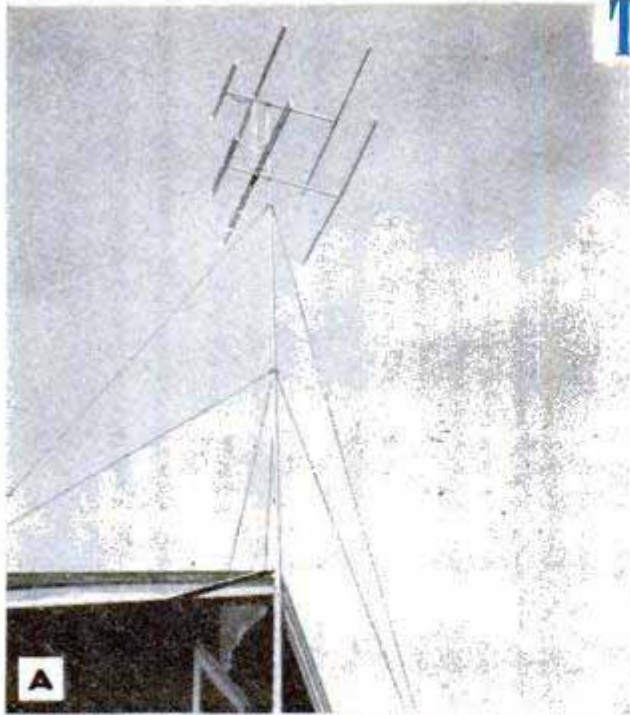



## MINIMUM ROOF ATTACHMENTS

A much higher and heavier installation is illustrated in photos G, H, I and K. Photos G and I show the final steps in the completed installation, looking up from the ground.

The antenna array is a combination In-line double-stacked for the low bands, and a Yagi-type array for the high bands is mounted on top. Two twin-line lead-ins are used with lightning arrestors in each lead-in as shown in photo H. These are mounted on the side of the building and grounded; lead-ins enter the building through porcelain tubes. A double-throw switch is used at the receiver. The antenna array was assembled on the ground as shown in photo K.

In making this particular installation, the pipe assembly consisted of four 10-foot lengths of 2-in., one length of 1½-in. tubing and one length of 1-in. tubing. Since the top lengths overlap, the total length of the antenna mast is 56 feet. Photo J shows the lengths bolted together ready for installation. The 2-in. pipe was joined flush by using short pieces of pipe and additional split tubing inside the adjoining lengths and by bolting through the entire assembly above and below the joint with ¼ x 2½-in. bolts. Any similar method may be used. For the base, a 6-ft. length of 1½-in. pipe was driven 5 feet into the ground as illustrated in photo E to take the 2-in. pipe; the cement base block, photo F, is optional. Rings for the guy wires, photo D, were placed where needed on the top sections of the antenna mast, after the tubing was through the overhang opening. In both installations the guy wires were fastened to short lengths of angle iron screwed to the underside of the roof overhang.

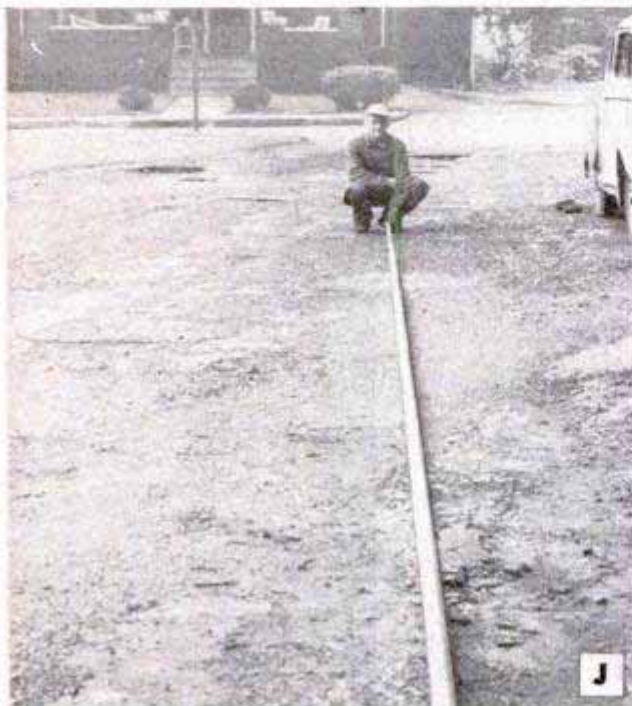
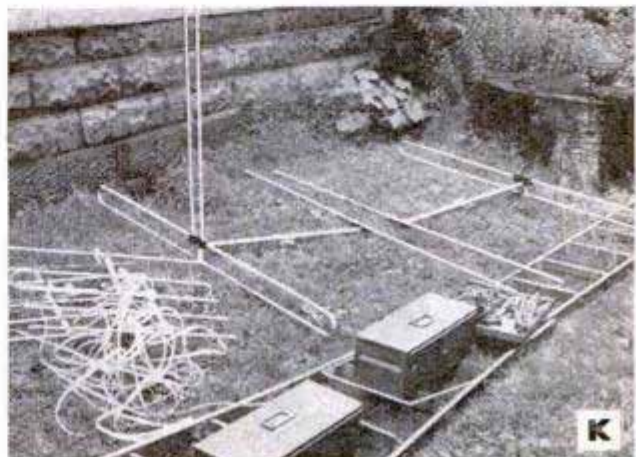
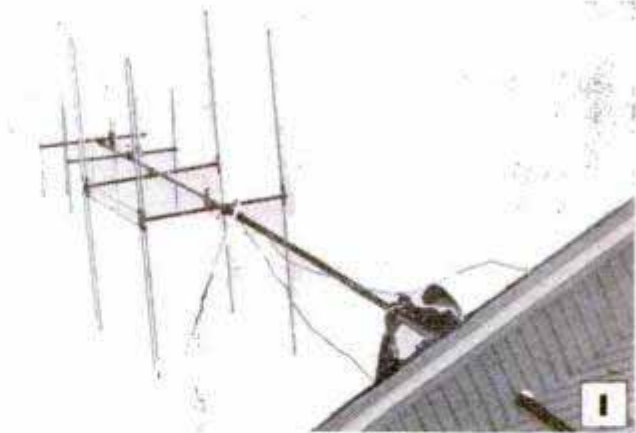
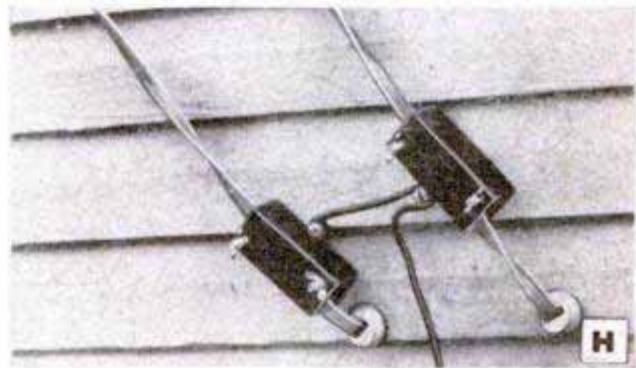

# RADIO-TELEVISION and ELECTRONICS TODAY

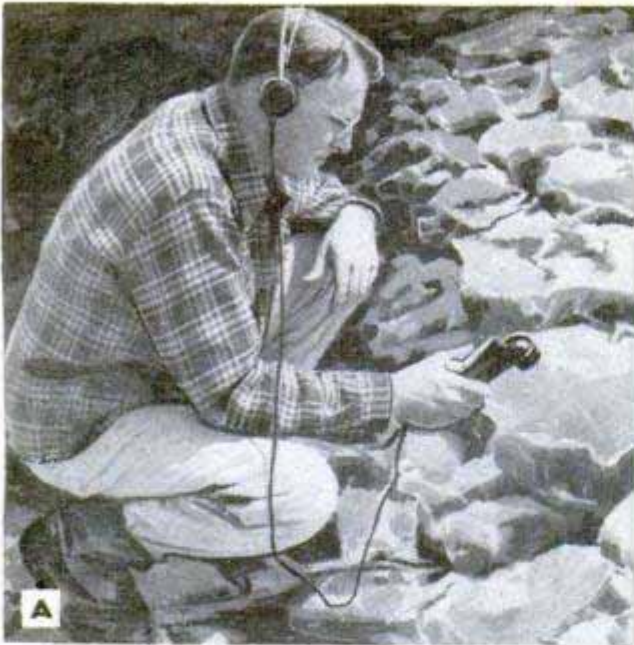

**A**

**A**—Pocket-size Geiger counter is only 9 in. long and 2¾ in. in diameter. It employs subminiature electronic elements. The weight of the entire unit, including headphones, is only 1¼ pounds. Power is supplied by a flashlight battery and vibrator unit

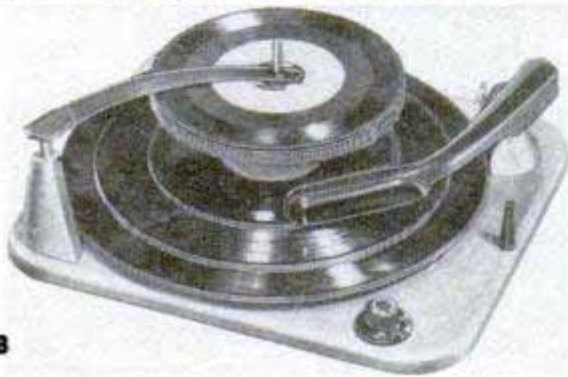

**B**

**B**—Three-speed record changer is completely automatic on all three speeds; the standard 78 r.p.m., the 33½-r.p.m. long-playing record and the 45-r.p.m. record. Changer has adaptor for large center hole



**C**

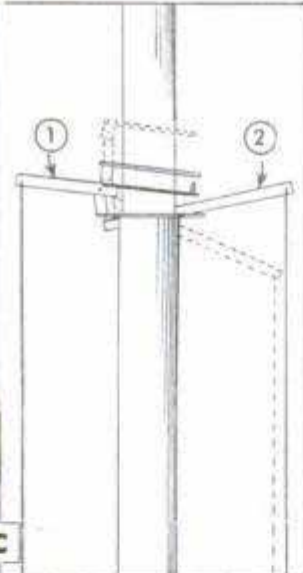

**C**—Jack-Up TV-antenna tower features variable height and quick lowering without the use of tools for making necessary antenna-array repairs. It is adjustable for either ground or roof installations. Jack handle (2) raises upper tube; lever (1) lowers it

**D**—Before installing a TV antenna on a chimney mount, turn off furnace primary-line control if the furnace is oil or gas-fired. Bank fire in the case of a coal furnace to protect installer from exhaust gases

**E**—Tiny personal FM receiver covers the entire FM band 88-108 megacycles. It employs two subminiature tubes. Built-in telescoping antenna extends to 14 in. Power is supplied with small A and B-batteries



**D**

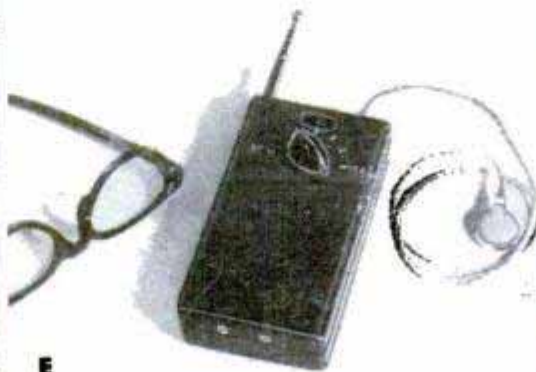

**E**

**F**—**RADIO-TV and ELECTRONICS HANDBOOK** is written especially for millions of radio and TV set owners, radio beginners, students and experimenters by Frank L. Brittin, Radio-Television and Electronics Editor of *Popular Mechanics Magazine*. You need no previous knowledge or experience in radio and TV work to put the information contained in the book into immediate practical money-saving use.

Learn how you can install TV and FM antenna systems; how to adjust and tune TV receivers and how to make many radio repairs yourself, eliminating unnecessary service calls.

For a fascinating hobby, find out how you can build your own radio sets, amplifiers and many other useful electronic devices. There are complete instructions, detailed material lists and pictorial and schematic diagrams to guide you every step of the way. Find out how you can join the ever-growing ranks of amateur radio "hams" and set up your own station.

Over 500 photographs, drawings and diagrams illustrate the 160 fact-packed pages. Glossaries of commonly used radio and TV terms and color codes are included. Order your copy of **RADIO-TV and ELECTRONICS HANDBOOK** today from your local bookstore or send your order direct to Popular Mechanics Press. Price \$2.50.

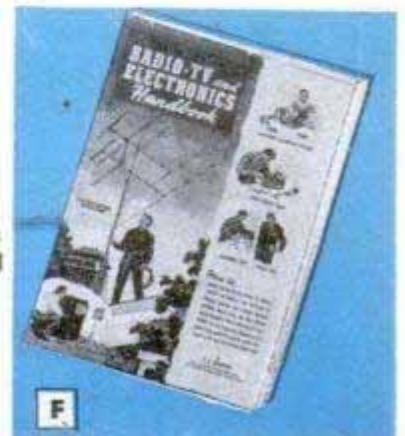

**F**



## YOU CAN USUALLY SPOT A GOOD HUNTER BY HIS GUN

Take the man who is a crank about his gun ... won't settle for less than a famous "name" make ... Winchester, Remington, Ithaca, for instance ... and takes care of it like a baby. Ten to one, he is a real hunter.

Take the man who is a crank about tools ... wouldn't give kit-room to anything less than a Bonney Wrench. Ten to one, he is a real mechanic. Yes, you can usually spot the real mechanic by his tools.

*This is one of a series of spirited sporting scenes (in full color, without advertising) available on request. Write for your free set today.*

**"CHEAP TOOLS ARE FOR CHUMPS"**, say the men who know tools and how to handle them. That is why they insist on Bonney Wrenches. "Bonney" is the word for lightness, strength, balance and precision. "Bonney" means quicker, easier, better work, with greater safety.



Dear Folks:

You can save yourself some dough and maybe get out from under a big repair bill if you'll drive right down to your motor specialist and ask to see his Danger Zone Book.

This book takes all the mystery out of car repairs—shows what the parts look like, what they cost, what the parts look like, what they cost, what the parts look like, what they cost, what the parts look like—installing them will be. And—most important—the book shows what you can save by having repairs done when first needed.

If you'd like to have a special edition of this Danger Zone Book to study in your own home, just send a postcard or letter to DANGER ZONE, HASTINGS, MICHIGAN. There's no charge. Just say: "Send me your Danger Zone Book."

*Tough Guy*



**WARNING ZONE**

Engine loses pep ...

**DANGER ZONE 1**

Engine begins to smoke ...

**DANGER ZONE 2**

Engine pumps oil badly ...

**DANGER ZONE 3**

Destructive wear sets in ...



**Needs a tune-up**

**Clean**, adjust and re-time ignition. Clean fuel supply and carburetor screens. **Adjust** carburetor. Adjust tappets and fan belt. Check compression and vacuum readings for symptoms of ring wear.

**Needs new piston rings and minor engine repairs**

Replace piston rings. Align rods. Adjust rods or replace rod bearings. Reseat and reface valves.

**Tune engine.**

These repairs are comparatively inexpensive and put the engine back in peak condition for thousands of economical miles. Delay puts the engine in Danger Zone 2.

**Needs new piston rings and major engine repairs**

Replace piston rings. Replace piston pins. Adjust—probably replace—main bearings. Align rods. Adjust rods or replace rod bearings. Reseat and reface valves. Tune engine.

These repairs naturally cost more than those needed in Danger Zone 1, but they put the engine back in condition for thousands of additional miles of satisfactory service. Delay leads to costly Danger Zone 3.

**Needs new piston rings and complete overhaul**

Repairs cost three or four times as much as in Danger Zone 1.

Remove engine. Rebore cylinders. Replace pistons, pins, rings. Replace main bearings. Align rods, refit or replace rods, or replace rod bearings. Overhaul valve lifters, rocker arms. Replace timing chains or gears. Reseat, reface valves. Replace guides and springs. Replace camshaft bearings. Clean oil lines. Overhaul oil pump.

Clean, re-install and tune engine.

**HASTINGS**

**STEEL-VENT PISTON RINGS**



**TOUGH on Oil-Pumping • GENTLE on Cylinder Walls**

MANUFACTURING COMPANY  
HASTINGS, MICHIGAN  
HASTINGS LTD. TORONTO

GET YOUR CAR OUT OF THE  
**DANGER ZONE**  
THE MORE YOU DELAY  
THE MORE YOU PAY!



**Kodacraft Printing Kit**—everything you need to print pictures—\$4.50



**Kodacraft Photo-Lab Outfit**—basic essentials for developing and printing—\$7.95



**Kodacraft Advanced Photo-Lab**—complete developing, printing equipment—\$13.50



**Kodak Timer**—tilting base, sweep second hand, large, easily legible dial—\$6.75



**Kodak Hobbyist and Fluorolite Enlargers**—cool fluorescent lamp, "integrating-sphere" lamphouse. Hobbyist (left)—\$49.50 complete. Fluorolite (right)—\$112.50 without lens.



**Kodak Automatic Tray Siphon**—converts tray to efficient print washer—\$5.25



**Kodak Utility Footswitch**—frees both hands for handling equipment and materials—\$10



**Kodak Electric Time-Control**—automatically controls printing time, 1 to 57 seconds—\$13.50

  
**Say "Merry Christmas"**  
**the Kodak way**  
**with a WANTED GIFT**



**Kodak Flashholder, Model B**—for cameras with flash-synchronized shutters—\$11.50



**Kodaslide Compartment File**—compartments hold 240 cardboard slides—\$3.75



**Kodak Turn-Tilt Tripod Head**—for panning, tilting with most tripods—\$15.46



**Kodak Combination Lens Attachments**—extend the scope of any camera.



**Kodak Service Range Finder**—split-field type; from 2 feet to infinity—\$14.58



**Kodaslide Table Viewer, 4X**—projector, screen combined in single unit—\$47.50

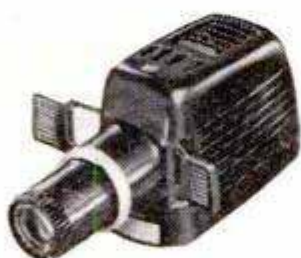

**Kodaslide Projector, Model 1A**—projects bright images up to 7 feet wide—\$29.50



**Kodaslide Projector, Model 2A**—Lumenized Kodak Ektanon Lens, 5-inch f/3.5—\$49.50



**Kodaslide Table Viewer**—famous Model A—\$95

See your Kodak dealer for his complete Christmas line-up of wonderful gifts

Prices are subject to change without notice and include Federal Tax where applicable

EASTMAN KODAK COMPANY • ROCHESTER 4, N. Y.

**Kodak**  
TRADE-MARK



# Care and Feeding of Engines

BY S. P. CORP

## WINNING THE COLD WAR

There's a perpetual cold war between winter weather and your automobile engine. If your car seems to be on the losing side when you try to start up some zero morning, it is best to get a thorough check of fuel and ignition systems. Have each cell of your battery tested to make sure it is fully charged, with no weak cells. Get a voltmeter check of your starting system. Be sure you are not using a too heavy motor oil. Your engine should be timed with a tachometer, especially if it has automatic transmission. Idling too slow may damage the starter. Generator springs and brushes should be clean and the commutator should not be dirty or burned. Faults in generator relay, current regulator, or voltage regulator may cause hard starting. Distributor, coil, carburetor, and fuel pump all deserve attention, too. All must be right, to win the cold war!



## WHY ENGINES BUCK

Let's say an engine is idling smooth as a purring kitten, but it begins to buck like a steer when you hook a vacuum gauge into the line to check compression. That's because you hooked in between crankcase ventilator and intake manifold,

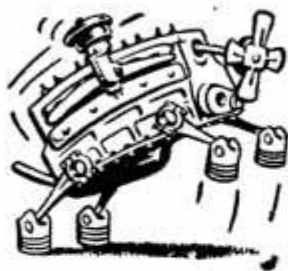

you cut off some of the air which ordinarily mixes with the fuel mixture from the carburetor. That causes an excessively rich mixture to feed directly to the cylinders, and the engine isn't used to such rich stuff. It bucks. You can avoid such a disturbance by hooking vacuum gauge into the special

plug provided for that express purpose in most intake manifolds.

## RING OUT THE OLD

It's getting close to the year's end. Time to take stock, to get ready for a new year. Among the old things you'll want to get rid of may be the old piston rings in your car. Give your car a real break. Start 1951 with the world's best piston rings—Sealed Power Piston Rings. There is a Sealed Power Ring Set specifically engineered to do the best possible job in your engine, whatever the make, model, or condition of wear. The Sealed Power MD-50 Steel Oil Ring is the finest oil control ring ever built—the only ring with the Full-Flow Spring. It works even in badly tapered and out-of-round bores. Ask for the free illustrated booklet, "7 Ways to Save Oil." It may save you some real money. Just address a postal card to Sealed Power, Dept. G-12, Muskegon, Michigan.

## Meet Mr. Christmas Tree

(Continued from page 92)

The incident taught the 14-year-old a lesson he's never forgotten. "You've got to make it easy for a customer to buy," he says today. "That's why you'll find my trees in grocery stores. The housewife can pick up her cranberries and pumpkin for Christmas dinner, tuck one of my little trees under her arm and walk home. A good many people prefer a large tree, but the big market is in the smaller size."

Roy's first job was as a tomato salesman in a produce warehouse where he met and married the bookkeeper. That fall he worked after hours, hauling small trees from the swamps to the newlyweds' basement. Every night Ede, his bride, trimmed off the lower branches while he cut birch disks to serve as stands. By December the basement was bulging, so Roy set off for Minneapolis with 2000 of the trees. Making a fortune seemed a cinch—until the weather turned warm. Needles began to fall and by the time people were ready to buy, his trees were bleak little skeletons.

Here he absorbed lesson number two—never skip the scientific approach. Roy poured over botany books, consulted forestry laboratories. He learned that each needle is clamped in place by two tiny sacs filled with sap; when the sap dries the needle falls. Very well, he'd keep the sap from drying. He started dipping and spraying trees with every liquid he thought might turn the trick. Tung oil worked very well, but after a few days in a warm room the tree exuded a disagreeable odor. Silicate of soda, suggested by a laboratory, made the needles drop off very quickly.

At last he hit on a water-emulsion paint consisting of pigment, oil and water. It not only gave the tree a waxy protective coating but also a beautiful green coloration which covered the unattractive yellow-brown of the natural dwarf spruce. To the formula for the coating he eventually added a fungicide.

Here's the history of any one of the little trees you may see in the grocery stores this month:

Last winter Roy and Dana Worrall, his chief forester who formerly managed the Christmas tree stands for the state of Minnesota, took off in Halvorson's four-seat plane and ranged thousands of miles in search of muskeg country. When they spotted a likely looking patch of wilderness from the air they sent a scouting crew in on snowshoes to check the trees. If the area was part of Halvorson's own 10,000 acres of timber, he sent in his cutting crews.

(Continued to page 232)

# A Welcome Gift!



R. J. Reynolds Tobacco Company, Winston-Salem, N. C.

*The National Joy Smoke*

● Say *Merry Christmas* to every pipe smoker on your Xmas shopping list—or to any man who likes to roll his own cigarettes—with a big, full, one-pound tin of Prince Albert!

Choice, crimp cut, mild, flavorful tobacco—all ready for Christmas in a colorful, gift-packed Yuletide package... with a built-in gift card right on top!

# Prince Albert

AMERICA'S LARGEST-SELLING  
SMOKING TOBACCO

# The Best and Safest For Your Boy



Beginner or expert, you will appreciate the extra quality, accuracy, and safety of a genuine Winchester rifle. The Winchester Model 69 is a young shooter's dream . . . a full size, lightweight, 5-shot box magazine repeater with the accuracy for which *all* Winchesters are famous. Shoots 22 Short, Long, Long Rifle cartridges interchangeably.

See this rifle at your dealer's. Operate its *precision* bolt action, notice the *fine* walnut stock, the simple dependable *safety* . . . all the features you recognize as extra value in this first quality, yet inexpensive, genuine Winchester rifle.



**FREE!** Folder giving full details of all Winchester 22 caliber sporting and target rifles. Address: Dept. 342-E, Winchester Repeating Arms Co., Division of Olin Industries, Inc., New Haven 4, Conn.



The World Famous Model 69  
**WINCHESTER**  
TRADE-MARK  
SPORTING RIFLE

## Clinic



## for Homemakers

As a service to our readers in solving the hundreds of problems pertaining to a home—inside or out—the editors of *Popular Mechanics* invite you to present your problems to The Clinic Editor for help and advice. Address your questions to The Clinic Editor, *Popular Mechanics Magazine*, 200 East Ontario Street, Chicago 11, Ill.

### Ice Dams



**Q**—My home has a low-pitched roof with a wide cornice, and during the last winter I noticed several damp spots on the ceiling near the outside walls on the north side of the house. On going into the attic I found that water was dripping from the roof boards near the lower ends of the rafters and running through the attic floor onto the plaster. What could cause this?

G.T., Plainfield, N.J.

**A**—Condensation is nearly always a possibility, but, judging from your description, your trouble is more likely due to the formation of ice dams on the roof just above the cornice. Because of heat loss to the attic from the rooms below, and also because of heat from the sun on warm winter days, the roof is warmed sufficiently from the ridge down to a point near the plate to melt snow and ice which collects on the roof. However, the area of the roof immediately above the cornice from the eaves to the wall line is much colder. Water coming from a higher level freezes on the roof at the wall line, or a short distance below it, and forms a dam. This usually happens during the latter part of a winter day when the temperature drops below freezing. Whenever the heat is sufficient to melt the snow above the wall line, water is trapped above the dam, from where it will gradually seep under the shingles and into the attic. The only remedy that can be considered permanent is the installation of one or two courses of heavy roll roofing under the shingles and reaching well up above the wall line.

### Figuring Length of V-Belt

**Q**—I want to change the pulley sizes on a home-shop power tool having a single V-belt drive. But how does one measure the pulleys to get a V-belt of the correct size? All instructions I've seen say to measure around the outside of the pulleys; not at the bottom of the grooves. B.U., Los Angeles, Calif.

**A**—Usually either the instructions that came with the machine or the repair parts list will specify the correct belt size and length to use. However, we assume from your letter that you wish to use pulley sizes differing from those that

(Continued to page 230)





*Anne Baxter says... These  
Gifts are Close to  
a Handy Man's  
Heart!*

Starring in  
**"ALL ABOUT EVE"**  
A Darryl F. Zanuck Production  
20th Century-Fox Studios

Priced for every pocketbook—built for every need!

**SPEED UP** all drilling, sanding, polishing, waxing,  
tool and cutlery sharpening, sawing, cleaning!

Light weight makes them easy for women  
to use in housework, tool



**NEW HOME-UTILITY 1/4" DRILL KIT** is easy to operate, fun to use, packed with uses for home, farm, workshop! Contains speedy H-U 1/4" Drill, 7 high-speed bits, wheel arbor, 4" wire wheel brush, 3 sanding discs, rubber backing pad in sturdy, streamlined metal kit!

**All for \$29.95**



**HOME-UTILITY 1/4" DELUXE DRILL KIT** gives you H-U 1/4" Drill, horizontal bench stand, 13 high-speed bits, 4" wire wheel brush, 3" grinding wheel, 3" buffing wheel, buffing compound, wheel arbor in handy metal kit.

**All for \$39.95**



**5" Sander-Polisher**  
**\$32.95**



**1/4" Drill**  
**\$19.95**



**1/2" Drill**  
**\$41.50**



**6" Bench Grinder**  
**\$42.00**



**6" Heavy-Duty LECTRO-SAW**  
**\$54.50**

**8" Heavy-Duty LECTRO-SAW** \$84.50

**TRY THEM—BUY THEM**

at your Hardware, Electrical or Implement Dealer's!

**ELECTRIC**  
**HOME-UTILITY**  
**TOOLS**

HOME-UTILITY Division, BLACK & DECKER Mfg. Co.  
Dept. H12M, Towson 4, Maryland



**NEW HOME-UTILITY SANDER-POLISHER KIT** contains versatile H-U 5" Sander-Polisher, 3 sanding discs, lambswool polishing bonnet, drill chuck, 7 high-speed bits, 4 wood augers, countersink, electric wax, auto polish, rubber backing pad in streamlined steel case.

**All for \$49.95**

# Grandest little gifts you can give yourself!

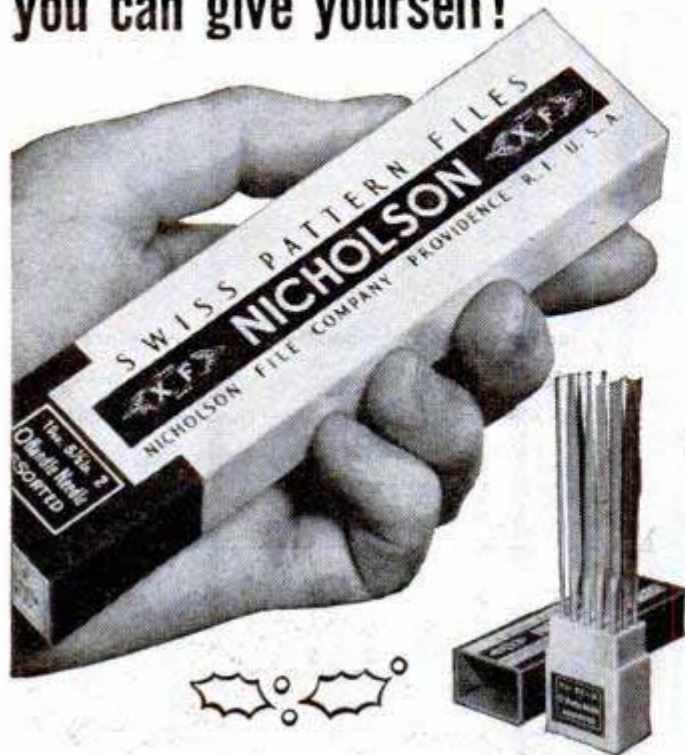

Next to the products of his own handcraft, fine tools are the average "basement hobbyist's" greatest source of satisfaction. Nicholson X.F. (Extra Fine) Swiss Pattern Needle Files are really fascinating! Amateur and professional craftsmen regard them as tops in precision files. They come in a handsome blue-and-orange plastic case, with bottom stand—in twelve shapes, all different. Sets in popular lengths, choice of cuts. *Displayed and sold this year by more hardware stores than ever before.*



**ROTASET No. 55.** Have you a power tool or flexible shaft? Then you'll get a thrill out of this kit of 8 assorted Nicholson High Speed Steel Ground Burs with  $\frac{1}{8}$ -inch shank. Also obtainable through good hardware stores.

**FREE BOOK, "File Philosophy,"** on kinds, use and care of files . . . 48 pages jam-packed with interesting illustrations and text. Postcard request brings you your copy.



**NICHOLSON FILE COMPANY**  
22 Acorn St., Providence 1, R. I.  
(In Canada, Port Hope, Ont.)



# NICHOLSON FILES FOR EVERY PURPOSE

(Continued from page 228)

were supplied with the new machine. One fairly accurate method is to measure around the outside of the pulleys with a flexible steel rule. Of course, this must be done with the pulleys in place on the shafts. This method of measuring is done somewhat more accurately by cutting two lengths from a discarded V-belt, each of which is long enough to reach a little more than halfway around each of the pulleys. Tape the lengths of V-belt in place and then measure the distance around the pulleys with a measuring tape, flexible rule or a length of cord. Another way of computing the length of the belt is to use a formula that runs something like this: Add the diameters of the driving (motor) and driven (machine) pulleys and multiply by 1.57. Then add twice the distance between the centers of the pulleys when they are mounted on the motor and machine. The final figure is the length of the belt required. It's a good idea to make sure you are driving the machine at the correct speed with the new pulleys.

## Winter Planting

**Q** — I've been told that I can sow garden seed, such as lettuce, radish, beets, onions, etc., in a well-spaded plot of good soil in late fall before the ground freezes and cover the plot with straw. Then, in the spring, I can harvest vegetables two to three weeks earlier than normal. How about it? Can it be done?

A. T., Ft. Wayne, Ind.



**A**—Of course it can be done, as a stunt, and, if Nature cooperates fully by breaking the season just right the following spring, you can harvest certain garden crops as much as a week to 10 days earlier than your neighboring gardeners. However, at present at least, the procedure can be regarded only as a novel experiment and not as a practical gardening measure. If you decide to try it, select an open, well-drained plot exposed to direct sunlight and sow the seed in the late fall when the soil is fairly dry and in a light, friable condition. Sow the seed at the normal depth and cover as you would in the spring. Rake the topsoil lightly and then cover with dry straw to a depth of about 2 ft. The straw covering should extend 2 to 3 ft. beyond the edges of the planting. Wheat straw is best. Weight the covering with woven wire and boards, or planks, to prevent it from blowing away. Remove the covering in the early spring as soon as the danger of freezing is past.

## Insulating Ducts

**Q** — I have recently had a forced air heating system installed in which there are several long runs of warm-air duct in the basement and I think that these should be covered with an insulating material, such as asbestos paper, to prevent loss of heat. My heating contractor says this is not necessary. Who is right? R. F., Mason City, Iowa.



**A**—Your contractor is right, in the sense that any thin, noncellular material is of little or no value in insulating against heat loss from the warm-air ducts. To be measurably effective as insulation it would require wrapping each duct with six or more thicknesses of ordinary asbestos paper—an unnecessary expenditure of time and money. There is, of course, a cellular material made for the purpose of insulating warm-air ducts, but we would not recommend its use on the rectangular ducts of a forced warm-air heating system as we do not think it is necessary, especially where the unit is installed in a basement.

*"Operation Frostbite"*  
Calls for the Dependability of

**CHAMPION**

Spark Plugs

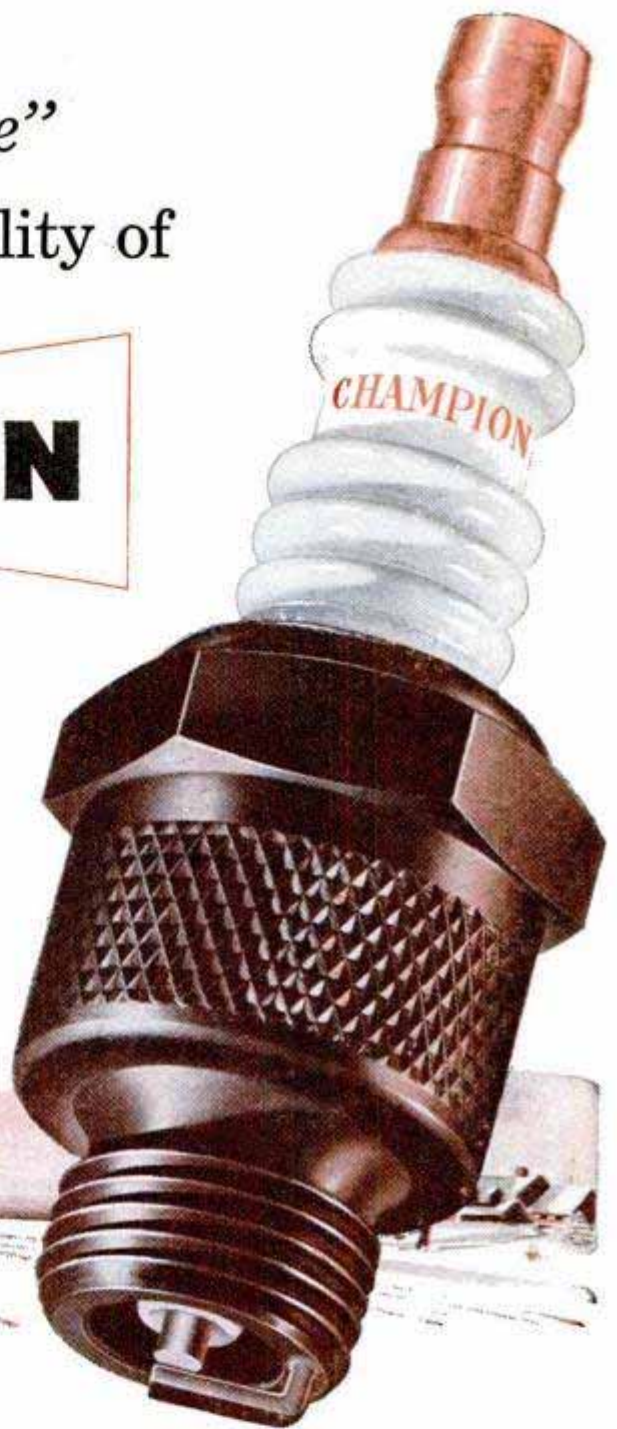

**BE A CHAMPION DRIVER**

*... Keep Plugs Clean for Winter Starting!*



Most service calls in winter involve cars that won't start. Dirt and oil accumulations on spark plug insulators often short circuit plugs under cold, damp conditions. Be sure to wipe off insulators frequently.

Plugs dirty on the outside are likely to have carbon or oily deposits on the inside at the firing end, causing hard starting and a wasteful engine. Have electrodes cleaned and regapped often. Replace with new Champions when necessary.

Champion dealers are backed by the world's best spark plug engineers and equipment to give you top performance with Champion Spark Plugs. It pays to let them inspect your plugs frequently for full power and economy!

CHAMPION SPARK PLUG COMPANY, TOLEDO 1, OHIO

**SEARS**  
ROEBUCK AND CO.

**TRY IT  
10 DAYS!**

**YOUR MONEY BACK . . . without  
question . . . if this superb**

**CRAFTSMAN**  
REG. U.S. PAT. OFF.  
**ELECTRIC SHAVER**

**doesn't give you the FINEST  
SHAVING you've ever known!**



Complete in  
handsome,  
handy  
carrying  
case



**\$17<sup>50</sup>**  
Complete  
with Case

**Here's why CRAFTSMAN gives you such  
a quick, smooth, comfortable shave!**

- Double-action square head and TWO round heads combine efficient long-hair cutting EDGES with effective, close, smooth-shaving SURFACES!
- These heads are set on a scientifically designed, face-fitting contour-angle . . . to give maximum shaving surface for faster, smoother, better shaving!

Prove the faster, cleaner, smoother shaving of this superior CRAFTSMAN shaver on your OWN face in this easy 10-day test! Compare its smoother-shaving ability and its low price with ANY other shaver! UL approved! One-year guarantee and service at no extra cost! For 110-120-volt AC-DC use. See it . . . buy it . . . at your nearest Sears Retail Store TODAY!

**CRAFTSMAN by SEARS, ROEBUCK and CO.**

If a good stand was found on state land he waited until the trees were sold at public auction and submitted his bid. Providing his bid was tops, he sent Old Nick Finni and the other 75 cutters, under woods boss Joe Mavec, to bring in the trees. Every time Roy cuts a tree off state-owned land, two cents of the purchase price goes into the state school fund. In his lifetime Roy has paid \$200,000 to the state schools, so the once-worthless swamp spruce has educated a good many Minnesota children.

To do the cutting, boss Mavec and his men first built a tractor road through the muskeg, corduroying it with logs in all bad spots. From the tractor road, the men cut footpaths through the swamp. Then the cutters tramped the muskeg in search of trees with symmetrical tops. It was Old Nick Finni, perhaps, who found our scrawny tree somewhere in the swamp. With a few strokes of his saw or ax he felled it, trimmed off the top about three feet long and tied the top into a bundle with nine other such tufts. Eventually, the stump and trimmings of the tree were swallowed by the swamp, and a little hole now exists in the overhead tent. Through it sunlight pours to give other struggling trees an opportunity for life. No more than five percent of the trees in any area are cut in one season and all cutting is done under the supervision of government rangers.

Old Nick carried the bundle of trees out to the tractor road where it was loaded aboard a swamp sled—a Paul Bunyan “dish” made of iron. In winter the big pan slides over the snow; in summer it slips over the bog behind the tractor. At the nearest highway point our tree was shifted, along with 10,000 others, to a huge truck, thence to the factory at Duluth.

Here a wonderland of mechanical equipment went to work on the tree.

First an operator seized our tree and zipped it through a circular saw, trimming off the lower branches and making a neat, fresh cut across the bottom of the trunk. It ended up on a hand truck beside a girl who operates a fascinatingly active machine called the undercoater. This is a huge tube which runs up through the ceiling above her head. About waist-high there's an opening in the tube, and just beneath the opening is a well which is full of waxy liquid. Looped through the tube is an endless chain with mechanical “hands” which seize and hold the tree. The tree gurgles down through the liquid, disappearing from sight, then climbing up out of the liquid inside the tube. As it ascends, the “hand” spins it rapidly to whirl off excess undercoat. Seconds later

(Continued to page 234)

# 3 Workshop Favorites to Please any Craftsman!



## CRAFTSMAN Rotary Electric Tool Outfit

For tool-room, production line, or home shop

GRINDS	CUTS	ROUTS	BRUSHES
SHARPENS	CARVES	SANDS	CLEANS
DRILLS	ENGRAVES	POLISHES	Has many
SAWS	ETCHES	BUFFS	other uses!

Unequaled for its type, at ANY price! A perfect Christmas gift! Check these features! 50% more power than any other rotary tool of its type we know of! Cool-running, even after hours of use! New tapered design, strong metal housing — not plastic! New precision 3-jaw chuck adjusts 1/64 to 1/8-in.; takes 3/32 and 1/8-in. shank tools AND wire gauge drills. Large bronze bearings and ball thrust bearing. On-off switch. Condenser (cuts radio interference). Powerful 15,000 R.P.M., 110-120-volt, 25-60 cycle AC-DC motor; 6-ft. cord; plug. Underwriters' Labs. approved! 7 1/2-in. long. 54-piece set with cutters, saws, drills, polishing and emery wheels, bench stand, etc., in 11x8 3/4 x 3 1/2-in. workshop case.



Use it on WOOD, METALS, LEATHER, PLASTICS, GLASS; other materials.



1/64 to 1/8-in. chuck capacity



120° rotating bench stand



Cool running; easy to handle

54-piece Set  
**\$28.95\***  
Cash  
\$3 Down

## DUNLAP 1/4-inch Electric Drill and Utility Kit

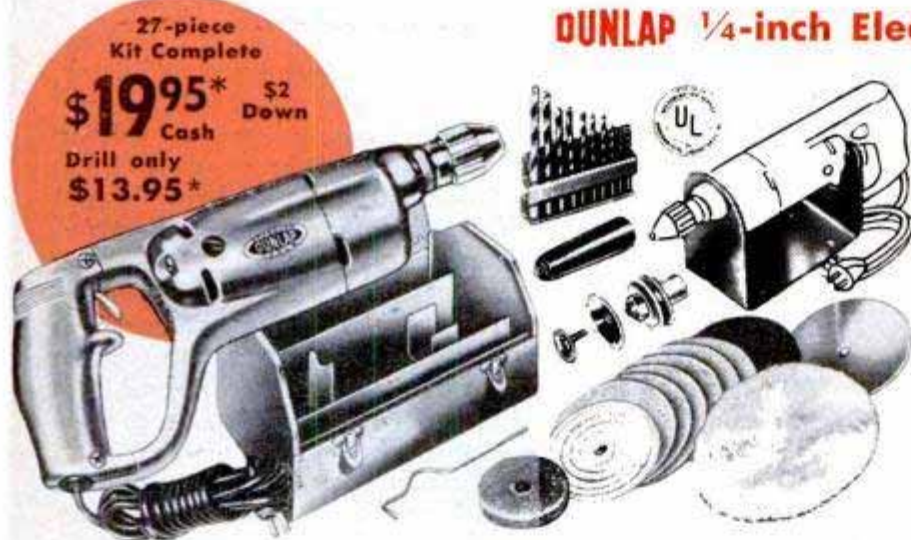

**Drills . . . Grinds . . . Sands . . . Polishes!**

Handy, dependable, precision-built! Powerful enough to drive 1/4-in. bits in steel! Entire drill *UL approved!* 1/4-in. 3-jaw chuck. Triple reduction gears; aluminum alloy frame. 110-120-volt, 25 to 60-cycle AC-DC motor; 6-ft. cord, plug. 1500 R.P.M. 12 in. long. Complete with 10 HIGH SPEED drill bits (1/16 to 1/4-in.); 4-in. cloth buffer; 3-in. grinding wheel; 5 1/2-in. sheepskin bonnet; 4 3/4-in. rubber sanding disc; 6 assorted sanding discs; disc template; adapter; auxiliary handle; paint mixer; drill stand; in handy 13x6 1/4 x 6-in. steel carrying case.

## CRAFTSMAN Electric Magnetic Jig Saw

Look at its capacity!

Cuts wood up to 1-inch thick;  
Plastics up to 3/4-inch thick;  
Aluminum up to 3/32-in. thick;  
Brass up to 1/16-inch thick;  
Zinc up to 1/16-inch thick.

A perfect hobby gift for young or old! Use it anywhere; just plug it in! *UL approved!* Magnetic unit gives 7200 SAFE, short cutting strokes per min. (TWICE former power)! Smooth edges need no sanding. 8 1/2 x 8-in. table; rubber feet. All-metal; well made. For 110-120-volt, 60-cycle AC use only. With six 5-in. pin-end blades, 5 1/2-ft. cord and plug, and instructions.

ONLY  
**\$12.95\***  
With 6 blades

Cuts to center of 22-in. circle



\*Prices slightly higher south of the Ohio and west of the Mississippi rivers.

**CRAFTSMAN** and **DUNLAP** Tools by **SEARS, ROEBUCK and CO.**

Famous for fine quality . . . precision performance . . . low price!

# Coleman

# Gifts

## FOR THE OUTDOORSMAN

NEW  
GOLDEN  
ANNIVERSARY  
MODEL



### Coleman Folding CAMP STOVE

For better, quicker meals and more fun on all types of camping and outing trips, picnics or backyard parties. Instant lighting. Cooks like city gas stove. Folds up... carries like a suitcase.

Used and Endorsed by  
**LEADING OUTDOORSMEN**  
Everywhere!



### Coleman FLOODLIGHT LANTERN

For more hours of fun in camp. 20 times as bright as ordinary wick-type lanterns. Storm-proof. Safe. Can't spill fuel. Sturdy. Instant lighting.

### Coleman POCKET STOVE

For the man who travels light. Fits in hunting coat pocket. Instant lighting. Burns any kind of gasoline. Safe. Cooks like city gas. Complete with two aluminum cooking utensils. See your Coleman dealer for demonstration of these products. Mail coupon for free literature.



THE COLEMAN COMPANY, Wichita 1, Kansas

MAIL COUPON TO: THE COLEMAN COMPANY, Inc.  
Dept. 036-PM, Wichita 1, Kan.

Please send me free literature on Coleman Camp Stoves, Lanterns, and other Coleman appliances.

NAME \_\_\_\_\_

ADDRESS \_\_\_\_\_

CITY \_\_\_\_\_

STATE \_\_\_\_\_



on the floor above, another operator is carting it to the drying racks.

When the undercoat is dry the tree passes through the same treatment again, only this time it is pulled through a paint bath. Halvorson now produces trees in three colors—green, silver and white. All three paints are waxy coatings, so there is a film of wax over every needle and every sap-filled sac.

The tree then moves down a conveyor to the first floor where a worker inserts it into the "merry go round machine." A clamp seizes the trunk and carries the tree upright around the complicated mechanism. At one stage a cutter neatly dowels the bottom of the trunk, at another a metal stand is automatically jammed into place over the dowel. Another bit of machinery squirts a fluid which Halvorson calls "liquid life" into the stand.

Roy has been working on the fluid for years. It gradually moves up the trunk of the tree and flows out to the needles to keep them from drying. The liquid is a secret formula, very similar to the natural sap. He hints that it is 90 percent water, contains an artificial sap and glycerin.

Thus our finished tree is covered with a shimmering waxy paint and has a little metal stand, filled with "liquid life." These elements add up to longer-life. Halvorson, a cautious man, won't guarantee how long the needles will stay in place, maintaining that the tree is a cut plant and therefore will die sooner or later, depending upon the temperature and humidity at which it is kept. A thick file of testimonials proves that the process works, though. A woman in arid La Jolla, Calif., put her tree out on the patio after Christmas. Late the following July her husband hinted that it was time to stop playing Santa Claus, even though the tree looked exactly as it did when they bought it. Eventually hubby burned up the tree, but not before the woman had trimmed off all the cones and some branches, which she used to decorate gifts the following Christmas.

The finished tree is packed in a carton and placed in cold storage at 20 to 25 degrees, where it may stay for as long as eight months. In November it is shipped out under Ede's astute direction. Halvorson is proud of his good market in Venezuela, the West Indies and the Orient. Carloads are shipped to the Northwest and New England where, it may be noted, millions of local trees are available for cutting.

Sales, in ratio to population, are highest in Georgia for one reason or another. Southerners prefer silver trees, while Northerners have a fondness for green.

(Continued to page 236)



FOR PLEASURE AND PROFIT IN SHOP AND HOME

# IDEAL CHRISTMAS GIFTS TO GIVE OR GET!

PRACTICALLY DESIGNED . . . EASILY OPERATED . . . QUALITY BUILT . . . FULLY GUARANTEED

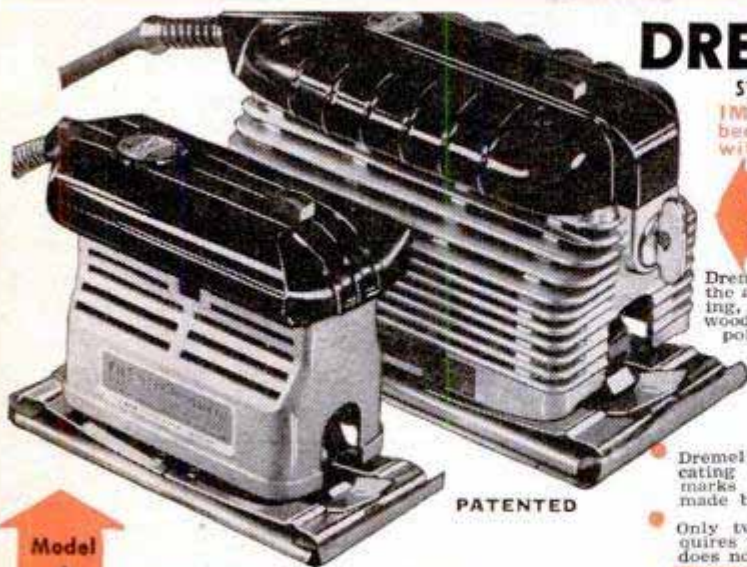

## DREMEL *Electric* SANDERS

STRAIGHT-LINE Action for Guaranteed SCRATCH-FREE Surfaces

**IMPORTANT**—Before you buy just any sander, remember you cannot get an absolutely scratch-free finish with rotary, orbital, or arc-type sanders.

Model 2000  
**\$24.50**

**FOR HEAVY-DUTY CRAFT AND WOODWORKING PROJECTS**

Dremel's new Model 2000 is a fast-cutting, production sander. It has the added stroke and extra power required for furniture and cabinet making, boat building or refinishing. Great for building operations, sanding woodwork, dry wall joints, siding and other surfaces. Does a superb wax polishing job, too. Weighs only 5 pounds yet has 21 sq. in. sanding surface. Over-all size 31 1/2" x 4 1/2" x 7". Complete with steel carrying case, 25 asstd. sheets sandpaper, polishing pad. \$24.50.

### LOOK FOR THESE DREMEL FEATURES

(IN MODEL A AND MODEL 2000 SANDERS)

- Dremel's Straight-Line Reciprocating Action leaves no sanding marks . . . removes scratches made by other type sanders.
- Only two moving parts . . . requires no oiling . . . sanding dust does not affect action.
- 14,400 cutting strokes per minute assure faster sanding-polishing.
- Cam-type holder permits changing paper in seconds.
- 8 ft. Underwriter's approved cord . . . operates on 110-120 volt, 60 cycle A.C. . . . fully guaranteed.

PATENTED

Model A  
**\$14.85**

**FOR HOBBY WORK, REFINISHING AND REDECORATING . . . . .**

Dremel Model "A" Sander is a time and labor saver for hobbyists, homeowners and housewives. Over a quarter million now in use. Like Model 2000, its straight-line reciprocating action will not leave cross-grain scratches and abrasive marks made by other type sanders. Ideal for sanding woodwork, cabinets, unfinished furniture, workshop projects, etc. Weighs only 2 1/2 lbs. Takes the drudgery out of polishing waxed surfaces—furniture, woodwork, etc. Sanding pad 2 1/4" x 5 1/4". Furnished with 6 sheets sandpaper, 1 sheepskin, 1 felt pad \$14.85.

## DREMEL MOTO-TOOL

THE POCKET-SIZE MACHINE SHOP



Don't confuse Moto-Tools and Accessories with so-called "bargain offers". Compare Dremel feature for feature with competitive tools. If our products are not superior in every way, we don't want you to buy.

Portable  
**DRILL PRESS**

Only  
**\$9.95**  
(Less Moto-Tool)



**MOTO-TOOL KIT NO. 2**  
With 23 Accessories  
(High Speed Steel Cutters, Grinding Wheels)  
**\$22.50**

**MOTO-TOOL NO. 2**  
(only) with one emery wheel point — **\$16.50**

Moto-Tool is the most versatile tool you can own—grinds, routs, drills, carves, engraves, polishes, etc. Look at these features: Approx. 27,000 R.P.M. • Dynamically balanced armature eliminates vibration. Oilless (oil-sealed) bearings • Dust-filtered air-cooling system • Weighs 13 oz. • Uses 110-120 v. A.C. • Used in plants of General Electric, Ford, Remington Arms, Nash-Kelvinator, etc.

## DREMEL *Electric* COPING SAW

CUTS SCROLLS LIKE MAGIC—SANDS AS IT SAWS



BLADE  
FACES  
4 WAYS

FREE  
PROJECT  
PLANS

JUST  
GUIDE IT!

Only  
**\$5.85**  
with 3 saw blades

**SAFE! AS A HANDSAW**

For home, hobby, repair work—no other tool pleases so much for so little cost. Works in any direction—delivers 7,200 strokes per minute smoothly, effortlessly. Saws through 3/4" medium-hard wood at a foot-a-minute speed. Touch-of-the-trigger, foolproof action. Only 2 moving parts, never needs oiling. Uses 110-120 v. A.C.

. . . for 6 useful projects packed with each saw

### WHERE TO BUY DREMEL TOOLS



Dremel Tools are sold everywhere. If your dealer cannot supply you, send remittance in full and we will ship postpaid. Or send only \$2, and pay postman balance plus postage and fee. Money back if not delighted after 5 days' trial.

DREMEL MFG. CO., DEPT. 110-M, RACINE, WIS.

## BIG VALUE!

### MOTO-TOOL KIT NO. 1

Moto-Tool Kit No. 1 contains the lighter Model No. 1 Moto-Tool and 34 practical accessories (steel cutters, grinding wheels, etc.) in an attractive lacquer-finish wood case. It's the biggest value in the field. With 34 Accessories Only . . .

**\$17.50**

**MOTO-TOOL NO. 1** with one emery wheel point . . . . **\$9.85**



## FREE AMAZING NEW BOOK "HOW TO ANSWER ADS"



Never before have you seen anything like this. Tells you in simple language the correct way to answer ads. Gets you quicker replies—better results, and greater satisfaction. Will save you time and money and it's ABSOLUTELY FREE. No obligation whatever. Every reader of advertising should have this booklet. Send a postcard for your copy NOW. Advertising Department, Popular Mechanics Magazine, Room 602, 204 East Ontario Street, Chicago 11, Ill.

Only  
**\$498**



## OTTAWA Mule Team Tractor

Finest low-cost tractor. Costs too little to do without. Engines burn gasoline. Seven models. Starter and lights available. Other larger Models to choose from. Over 4,000 in world-wide use. Time-proved and tested. At low cost they easily mow, plow, disc, harrow, plant, cultivate, etc. Sold only direct to user. Write for FREE details.

**OTTAWA MFG. CO., 2-027 Garden St., Ottawa, Kansas**

*The*  
**GIFT**  
*THAT'S*  
**PRECISELY**  
*RIGHT*



**Starrett TOOLS**

For the man or boy who loves fine tools. Always welcome, always appreciated . . . at prices to fit your purse. See them at your Starrett Tool Distributors.



**Handyman**  
Steel Tape No. 530  
Popular 50' Length

**Handyman**  
Hacksaw Frame No. 153  
Pistol Grip — Adjustable Frame

**Hobbyist**  
Combination Set No. 9  
Eight Handy Tools in One

**Hobbyist**  
Toolmaker's Hammer No. 815  
With Built-In Magnifying Glass

**Craftsman**  
1" Micrometer No. 230  
With No-Glare "Satin Chrome" Finish

**Craftsman**  
Dial Indicator Gage No. 1010  
Vest Pocket Size — Plastic Case

**Apprentice**  
The Starrett Book For Student Machinists.  
Only \$1.00 Per Copy

**Apprentice**  
Kit of Tools No. 902 — Basic Measuring Equipment

**MORE GIFT IDEAS**  
Write for Starrett New Tools Booklet AP

THE L. S. STARRETT CO. • ATHOL, MASS., U. S. A.

TRADE MARK

**Starrett**

REG. U. S. PAT. OFF.

Since 1880 . . . Standard of Precision

Mechanics' Hand Measuring Tools and Precision Instruments  
Dial Indicators • Steel Tapes • Hacksaws • Band Saws  
and Band Knives • Precision Ground Flat Stock

**Buy Through Your Distributor**

A reporter, after interviewing Halvorson, once wrote a colorful story about the tree-cutters. There was an overstatement in the article to the effect that bears continually pilfer the cutters' lunch boxes. Upon seeing the story, one reader wrote a serious application for a job as lunch-box guard. Halvorson replied that "most of the stories of damage by wild animals are told by wild people." The man shot back a long letter of advice on how to "civilize the wild people" of northern Minnesota.

When Old Nick Finni heard about the wild people, he laughed 'til his little round belly shook like a bowl full of jelly. Then he sneezed, swallowed a tablespoonful of kerosene for his cold and loped off into the wilderness in search of your next year's Christmas tree.

### Pipes by Old Masters

(Continued from page 148)

Mehaffey, turns out carved briars to rival any of the masters, in his spare time. In three years he has done some 20 heads of famous composers and U. S. presidents. Each of the intricate carvings has averaged about 25 hours of painstaking labor, and found ready buyers at \$35 or \$40.

"The first one," Bud recalls with a shudder, "was carved with razor blades. I soon found out that that wouldn't do." Today he works with surgical knives and dental tools, plugging away evenings on his kitchen table.

All of Mehaffey's tools have been ingeniously contrived. Bits of sharpened nail-file tips make fine points for gouging hairlines in the tough wood. "I used to punch eyes with an awl-like tool," he says, "but I wasn't satisfied. I noticed some of the old meerschaum masters made V-shaped pupils, which brightened the face considerably. But how to get a 1/32-inch-high vee in rock-hard brier?" He solved it by browsing around shops until he found a piece of 1/16-inch steel tube. He cut off one end diagonally, pinched the lip into a vee and sharpened the edges with a file. Now he punches V-shaped eyes that give his figures a lifelike appearance that is almost startling.

Mehaffey took to pipe carving simply because the dying art appealed to him. Few living masters are at it today. His technique is as painstaking as that of any craftsman of bygone years. He works from busts and pictures, using calipers whenever possible, to get his proportions and scale true.

He starts with a perfect piece of brier block, marks off his general contours with

(Continued to page 238)



# WHAT LASTS FOREVER?



**THIS DEAD BLADE** still looks new but it blurs rain, smears muck, streaks glass. DEAD blades make dead drivers!

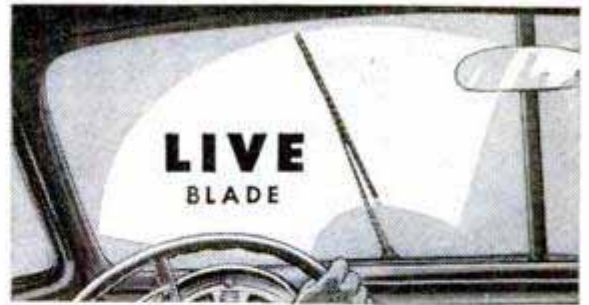

**THIS LIVE ANCO BLADE** wipes clean, clears rain, clears road muck . . . lets you SEE. Protects your loved ones.

**WHAT LASTS FOREVER?** Nothing does. This is especially true with Windshield Wiper Blades—even though made of finest natural rubber. Corrosive windshield film, wind burn and hot sun BAKE the life out of wiper blades, often in six months or less. DEAD blades cause dangerous windshield smear. DEAD blades make dead drivers. Make sure your car has live, new windshield wipers.

## Change Your Wiper Blades

Next time you buy gas, change to LIVE,

NEW ANCO BLADES . . . RAIN-MASTER for Flat windshields . . . CLEAR-FLEX for Flat or Curved windshields. They fit all cars—wipe quicker and cleaner than any other blades.

**Mr. Dealer:** Ask your ANCO Distributor about the sensational new ANCO Wiper Motor. A quick, easy replacement for lazy vacuum motors. Gives lots more power . . . lots less stall. Compensates for linkage wear to control wiping arc. Eliminates blade slap.

**THE ANDERSON COMPANY**  
GARY, INDIANA

## MAKE BIG MONEY!

Be a floor surfacing contractor and sand both new and old floors. Sanders are easy to operate and better still, you're your own boss. Write for latest "tell-all" booklet entitled "Opportunities In Floor Surfacing", enclosing 25 cents in coin or stamps to cover handling.



**AMERICAN**  
FLOOR SURFACING MACHINE CO.  
325 So. St. Clair Street - Toledo 3, Ohio

Make Money  
SELLING  
Eshelman  
Kull-Mowers  
and DOING  
GARDEN  
WORK

PLOWS  
CULTIVATES  
HARROWS  
HAULS  
SPRAYS  
SAWS  
DOZER  
MOWS  
CUTS  
ROLLS  
RAKES

**ESHELMAN**



FOR BETTER  
LAWNS  
and GARDENS  
also POWER MOWERS  
and RIDING TRACTORS  
Women can operate it.  
Free Catalog, Write  
ESHELMAN CO.,  
Dept. 126  
119 Light St., Balto., 2, Md.

BeMaCo Dependable

## AUTOMATIC SAW SET

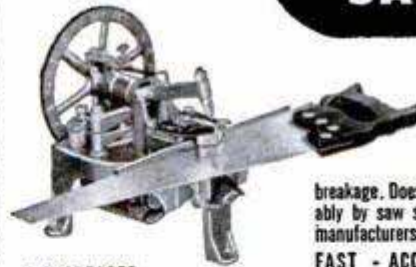

Sets 400 teeth per minute on hand or band saws 4 to 16 point. Hammer and anvil action sets teeth accurately and uniformly . . . No tooth breakage. Does a perfect job. Used profitably by saw shops everywhere and saw manufacturers. Every machine guaranteed!

★ INCREASES PROFITS

**BEAVER MFG. CO.**

Saw Machine Div. #3M  
800 SO. ISIS AVE. • INGLEWOOD, CALIF.

# SPLIT-SECOND STARTS for Any Car or Truck!

## WITH A Stewart-Warner *Electric Fuel Pump*



Make sure of quick, sure starts in any weather with a dependable Electric Fuel Pump. This Stewart-Warner Pump fits any car or truck. Feeds a steady, even flow of fuel into your engine as soon as you switch on the ignition. Thousands now in use!

Easy to Install. Complete fittings supplied. Do it yourself or see your local Carburetor Shop or Service Garage.

FREE—Illustrated Booklet on request  
Stewart-Warner Corp., Dept. J-120  
1840 Diversey Pkwy., Chicago 14, Ill.  
Please send FREE Illustrated Booklet on the dependable new Stewart-Warner Electric Fuel Pumps.

Name .....

Address .....

City ..... Zone ..... State .....

For Cars  For Trucks



What better gift  
for man or boy!

# STANLEY TOOLS

Give them Stanley Tools. Preferred by skilled tool users . . . priced for everyone. Sold in chests and gift packages. See them at your local dealer's. Look for the famous trade-mark.

## TOOL CHESTS

**No. 910 Hobby House Set**  
29 tools in a roll-up oak chest

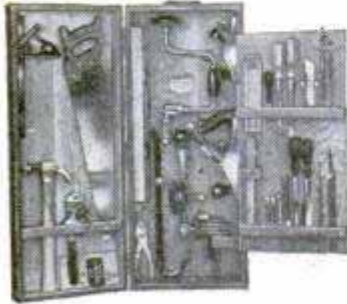

**No. 895 Better Home Kit**  
28 Defiance Tools  
in metal cabinet

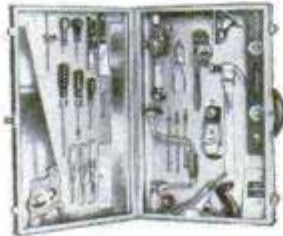

**No. 888 Fix-it Kit**  
12 Defiance Tools in  
tote tray



**No. X2000M SCREW  
DRIVER SET.** Four  
handy size drivers.

## GIFT PACKAGES



**No. X610 Hand Drill**  
New style with enclosed gear.

Also available — 14 other gift-packed tools and 3 chests.

### NEW EDITION Stanley Tool Guide

All about the care and use of tools, 40 pages — 38 charts — 200 illustrations. Gives you the "know-how" on handling tools to make finished work more professional.

only  
**25¢**

THE TOOL BOX OF THE WORLD

**STANLEY**

Reg. U.S. Pat. Off.

Hardware • Tools • Electric Tools • Steel Strapping • Steel



### SEND NOW!

Stanley Tools, 1120 Elm St., New Britain, Conn.  
(In Canada send to: Stanley Tool Co. of Canada, Ltd.,  
112 Stanley St., Roxton Pond, Quebec.)  
Enclosed is 25c. for the Stanley Tool Guide.

Name.....

Street.....

City..... State.....

calipers, and cuts off excess wood with a coping saw or gouges. Then comes the whittling down with fine, sharp tools — measuring, chipping, slicing a hair of wood at a time. Brier is so hard it often takes hours to shape out a single delicate nostril the size of a pinhead.

Most fine pipe carving practiced by the European masters was confined to meerschaum. It's much easier to work, and a more precious material. Meerschaum is a magnesium silicate, found in liver-shaped lumps in Asia Minor. When removed from the soil it is soft and grayish. It is soaked in water and carved wet. It cuts like a raw potato and often malleable enough to shape with the fingers. When dried in the sun, it solidifies to a porous white substance like chalk, only harder. It is polished with beeswax. When smoked, it, too, absorbs the tobacco juices, and colors to a fine mahogany after many years.

For many years, a few master pipemakers turned out works of true art in meerschaum, and the most ingenious of these craftsmen supplied Bertram, with the result that today he displays one of the finest collections of carved meerschaum known. One of the greatest carvers was Ignatz Rothenfeld whose detailed pipe bowls are so cleverly conceived that their value ranges upward of \$200.

Many Rothenfeld pipes are still at Bertram's, and some of the finest appear in the pictures accompanying this article.

By and large, the most beautiful meerschaums were carved by Viennese masters like Rothenfeld. French carvings are more crude, but a few surpass themselves. The most valuable pipe in Bertram's collection is a foot-long carved French meerschaum depicting Napoleon's retreat from Russia. Bertram has refused a \$1000 offer for it.

The craftsmen at Bertram's are all veterans. Immediately after the war, Bertram announced that wounded veterans would make as good pipe craftsmen as anyone, and his shop was almost entirely staffed by men with battle disabilities.

Galen Martz, the foreman who has been in the shop for five years, started pipemaking from scratch after leaving service. "I saw Bertram's ad for a job opening in a pipe factory," he recalls, "and when I applied, I thought it was some kind of plumbing business." Today he's one of the most skilled craftsmen in the place. And to him, as well as all the other workers in the shop, pipemaking is not just a job, but a way of life.

### RULES FOR CARE OF YOUR PIPE

1. Before smoking a new natural brier,

(Continued to page 240)

# GIVE The Thrill That Comes Once-in-a-Lifetime

A large illustration of a Marlin 39-A lever-action rifle, shown in profile, angled upwards from the bottom left towards the top right. The rifle has a wooden stock and a long, tapered barrel. A decorative wreath with a bow is positioned behind the rifle's receiver and trigger guard area.

## Marlin 39-A



### WORLD'S ONLY LEVER-ACTION .22 REPEATER

• The Marlin 39-A is not only the world's one lever-action .22 — it is also the only take-down rifle exposing, with the turning of a screw, all working parts for easy cleaning.

More — its 24" round-tapered blued steel barrel with Ballard-Type rifling is exceptionally sweet-feeling — and accurate. The action is trouble-free.

The Marlin 39-A holds 25 short, 20 long or 18 long-rifle cartridges . . . takes regular or high-speed loads without adjustment. Comes equipped with ramp front and Rocky Mountain rear sight. 'Scope and any standard receiver sights can be attached immediately.

See the unmatched Marlin 39-A—gift of gifts for any boy—at Marlin Dealers now. \$57.95\*

Marlin Guns and Marlin Blades also available in Canada

### FOR AUTOMATIC SHOOTERS!

The sensational new Marlin 88-C butt-loading, tubular-magazine .22 Automatic. \$32.95.\* Marlin also makes bolt-action clip and tubular-magazine models. Prices from \$24.55\*

\*Slightly higher West of the Rockies.  
Prices subject to change without notice.

# Marlin

THE NAME FOR GAME  
Fine Guns Since 1870

The Marlin Firearms Company  
Dept. Z, New Haven, Conn., U.S.A.

Send me catalog with full data and illustrations of Marlin Guns. Also (please specify) 4 Marlin single  or double-edge  blades. I enclose 10¢ for postage.

Name \_\_\_\_\_

Address \_\_\_\_\_

City \_\_\_\_\_ Zone \_\_\_\_\_

State \_\_\_\_\_



"SAVE IT AND  
FIX IT"

# MENDS

DISHES, FURNITURE, LUGGAGE

It's transparent, water-  
proof, flexible and  
durable. Get a  
tube today.

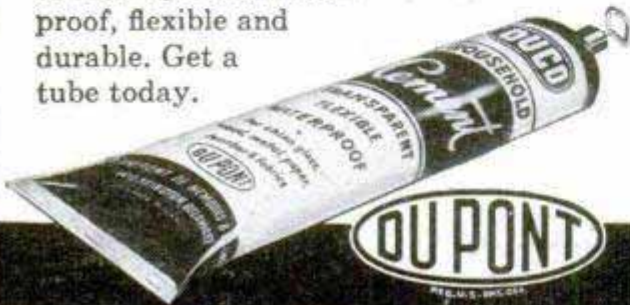

## DUKO CEMENT

REG. U. S. PAT. OFF.

HOME CRAFTSMEN AND HOBBYISTS!

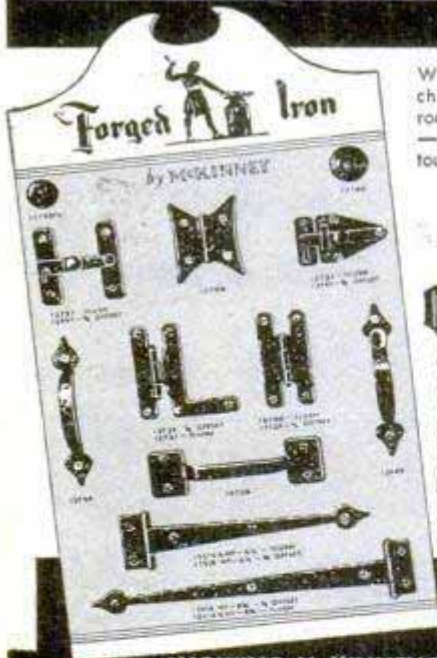

When you build cabinets,  
chests, furniture, remodel  
rooms, redecorate your home  
—add the distinctive finishing  
touch by using

MCKINNEY

### Forged Iron Cabinet Hardware

Attractive authentic Heart  
pattern strap hinges, H and  
L hinges, latches, drawer  
pulls and knobs, etc. in dull  
black or Swedish iron finish.  
Buy them at your local  
hardware, lumber or paint  
dealer. Look for the  
McKinney display.

SEND FOR  
**FREE  
FOLDER**

SHOWING MCKINNEY PERIOD PATTERNS  
AND SUGGESTED USES.

McKinney Manufacturing Company  
1400 Metropolitan Street, Pittsburgh 33, Pa.  
Please send free folder on McKinney Forged Iron Hardware to:

NAME \_\_\_\_\_

ADDRESS \_\_\_\_\_

CITY \_\_\_\_\_

STATE \_\_\_\_\_

FM \_\_\_\_\_

moisten the inside of the bowl with a finger that has been dipped in port or sherry wine (or clear water).

2. Load the pipe rather firmly around the sides and light the entire surface evenly.

3. Don't allow the pipe to "cake" too much. Cake is carbon, which has a different degree of expansion from briar and may cause the bowl to crack. Natural briar, being porous, needs no cake to absorb heat and moisture. The bowl walls do the job.

4. To clean your pipe, dip a pine cleaner half its length in grain alcohol and thoroughly swab the stem. Also swab the outside and inside of the bowl with the same cleaner. Let the pipe dry a moment, then wipe it with a dry cloth. You will be amazed by the luster brought back to the bowl.

5. After cleaning, allow the pipe to dry for at least 12 hours. Veteran pipe smokers find it pays to rotate pipes, giving each one a good chance to dry and thus restore optimum absorption qualities.

## Weapons With a New Wallop!

(Continued from page 112)

stream boring into a soft mudbank. The liner of a tiny shaped charge, no more than 5 inches long and 2 inches in diameter, can bore a hole 7 inches into solid steel. Bigger charges and bigger cones do much better than that. What happens to Soviet-made tank armor is obvious.

The condition of the insides of tanks that have been hit tells some of the story. When the jet of hot metal and the gases pierce the armor, they raise the temperature inside a tank 500 to 600 degrees. Small pieces of hot metal fly around knocking things loose. Depending on where the shell hits, fuel may explode. Ammunition in the tank usually goes off. Of seven tank hits made by the first 3.5 bazooka rockets at Taejon, every tank looked fine from outside, except for the little one-inch hole drilled in its armor. But they were just shells. The insides were burned-out ruins.

New ordnance doesn't stop with shaped-charge shells. Nor are they the only new antitank weapon of note. One of these days, you'll be getting details on "squash head" ammunition, "capable," say the experts, "of knocking out or, at least, buttoning up the biggest tank going." As its name indicates, the squash-head shell flattens its nose against a tank like a mushroom, spreading itself over a large part of the tank's surface. The ensuing blast of its high-explosive charge is thus transmitted to a large area. "It will jolt the back teeth out of everyone in the tank, jar every rivet loose, break seams, explode ammunition,

(Continued to page 242)

# SPRAYING MADE EASY

## BECKER *Self-Contained* PRESSURE GUN

Saves Cost of Compressor and Motor

TAKE IT ANYWHERE—the first completely portable spray gun. Needs no compressor, motor, or electrical outlet. Pressure-powered with an inexpensive CO2 cartridge that sprays up to 21 liquid ounces, depending on viscosity. Extra cartridges, 10 for \$1. postpaid, or buy from your dealer.

PAINTS • VARNISHES • ENAMELS  
MOTH-PROOFS • INSECTICIDES

Every home needs a Becker Spray Gun for dozens of jobs in the house, workshop, garden or garage. Complete instructions furnished for effective results. Order yours today for the season ahead.

**HOW TO ORDER**—If your dealer can't supply, send \$15.95 and we ship postpaid—or \$2 now and pay postman balance plus postage and fee. Money back if not delighted after 5 days' trial.

**SULLIVAN-BECKER CO.**  
Dept. 110-M, Kenosha, Wis.



ONLY  
**\$15.95**  
with 3 cartridges



### NEW CHEMICAL MITT

Sensational! DRY Window Cleaner! Uses no water, no messy liquids. Chemically Treated. Simply glide over windows; leaves glass sparkling clear. No heating water, no heavy buckets to carry. No rags, powders, sponges, chemicals. No mess or muss. No red chapped hands. Dust, dirt, grime, fog disappear like magic. *Wonderful for auto windows, windshield!*

**SAMPLES FOR AGENTS** Sample offer sent immediately to all who send name at once. A penny postal will do. **SEND NO MONEY—Just your name.** KRISTEE CO., Dept. 681, AKRON 8, OHIO

## KING MIDGET *Home Assembled Auto*

WORLD'S LOWEST PRICED CAR!

Drive this car for as low as 50c per week. Precision built parts direct from factory with beautiful all steel body. Get the facts on this amazing small auto—send 25c for detailed circular with large picture, 3 view drawings and price of all parts, or send \$1 (refunded first order) for this plus actual assembly book with 42 photos, drawings; blueprints of snow, ice conversions. Ideal for micro-midget racing — Get this information.



MIDGET MOTORS MFG. CO.  
ATHENS 1, OHIO

# MAKE YOUR OWN!

WITH

## Griffin READCUT LEATHER PROJECTS

Over 100 KITS in every kind of Tooling and Carving Leather, accurately cut, all parts included. Only Top Grade Leathers used. You do the choosing. You do the tooling, carving, stamping, the punching and assembling.



SEND FOR COMPLETE CATALOG  
Please send 10¢ to cover mailing.

SINCE 1924  
OUT OF THE WEST, THE HOME OF LEATHER CARVING  
**Griffin CRAFT SUPPLIES**  
5626-A TELEGRAPH AVE.  
OAKLAND 9, CALIFORNIA

### EVERYTHING FOR THE LEATHER WORKER

Largest, most complete stock of Leathercraft Tools and Accessories in U.S.A.



HIDES AND SKINS of Craft Leathers of every kind if you prefer to cut your own.

A "COMPLETE HOME WORKSHOP" IN ONE COMPACT UNIT!

Patent Applied For

Cuts 1/2" wood, 1/4" plywood, thin metal, plastic.

ONLY  
**\$14.95**  
POST PAID

NEW and IMPROVED  
**atkins** ELECTRIC MOTOR DRIVEN  
**3 in 1** JIGSAW! SANDER! FILER!

Complete with built-in Motor — 3 Project Patterns — 3 Blades — 2 (4" x 9") Pieces of Wood and Allen Wrench!

## POWER PLUS—ABSOLUTELY SAFE—MADE OF LIGHT WEIGHT CAST ALUMINUM!

POWERFUL ELECTRIC MOTOR (do NOT confuse with ordinary, less powerful vibrator type motors.) 3000 revolutions per minute! SAW cuts to center of 16" circle . . . adjustable SAW GUIDE permits cutting ANY length material. Strokes 3000 per minute. 110 V - A.C. TILTING and ROTATING TABLE TOP (6"x8") cuts at any angle. SANDING TABLE tilts through 45°. FOR FAST, EASY FILING simply remove saw blade, chuck and saw guide . . . insert 1/4" diameter standard file.

Guaranteed 1 Year against defects in materials and workmanship

Try it FREE for Five Days—Money Back if Not Satisfied!

Wonderful PROJECT PATTERNS. It's Simple To Make Most Anything! Household Items, Toys and Many Others!



All pattern parts are actual size for finished projects. All you do is paste them down or trace them right on the wood! **FOR \$1**

GROUP 1 . . . 10 patterns for beginners  
GROUP 2 . . . 10 patterns for the advanced  
GROUP 3 . . . 10 patterns for the skilled

Sold in leading Department, Hardware and Hobby Stores.

If your dealer cannot supply, send coupon direct: **FREE 5 day trial... MONEY BACK if not satisfied!**

**atkins INDUSTRIES, inc.** Dept. PM12—  
5823 N. Ravenswood Ave., Chicago 26, Ill.

- Enclosed is \$14.95 (check or M.O. in full.) Rush, 3-in-1 Jig Saw POST PAID.
- Enclosed is \$2.00 part payment. I will pay postman balance plus postage on C.O.D. delivery.
- Enclosed is \$.....(check or M.O. in full.)  
Rush Group No.s.....Project Patterns at \$1.00 each POST PAID.

Name.....  
Address.....Zone.....  
City.....State.....

# Free Sticky Rings and Valves



...*Before they Stick You!*

Add **BARDAHL**  
to *Your Crankcase Oil*

Cut repair bills by as much as 50%!  
Simply add one quart of BARDAHL to  
regular oil.

BARDAHL penetrates metal pores,  
frees sticky rings and valves, keeps en-  
gine bright and clean.

BARDAHL holds regular oil film in  
place. And thus—stops drainage, reduces  
cylinder wear, speeds up starts, prevents  
breakdowns under toughest driving.

Ask the best mechanic in town about  
BARDAHL. He's been us-  
ing it for years!

**BARDAHL**  
**OIL**

*Reduces Friction  
to a Fraction*

BARDAHL OIL COMPANY  
Seattle • St. Louis



## MODERN LAWN MOWER SHARPENER

FOR LAWN MOWER SHOPS  
FIX-IT SHOPS

GOLF COURSES • PARKS  
101 OTHER JOBS

Sharpens All Reel Type Mow-  
ers • Hand, Power or Gang  
• 10 to 20 Minutes • No  
Dismantling • No Extra At-  
tachments Needed.

All reel type mowers, from 5-inch edgers to  
36-inch power mowers, are quickly sharpened  
to extreme ends of both left and right  
twist blades.

**ORDER  
NOW**

Immediate  
Delivery

Handle, wheels, roller and mo-  
tor remain in place when sharp-  
ening is in process. Bed knife  
is sharpened in same brackets.  
Grinding head rides on five ball  
bearing races. Easy to operate.  
Also sharpens chisels, joiner knives, planer  
blades. Big profit maker. Own your own business.  
Send Today for **FREE** Illustrated Bulletin No. 10-C  
Prices Subject to Change Without Notice

MODERN MFG. CO. 160 N. FAIR OAKS AVE  
PASADENA, CALIFORNIA

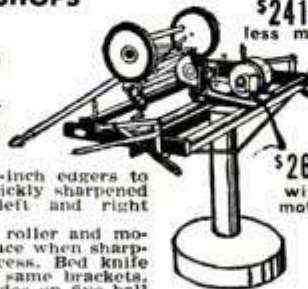

PRICE  
\$241.50  
less motor

\$263.00  
with  
motor

jam the engine in a corner and otherwise disrupt a lot of steelwork," explains an Army antitank man.

These shells can be fired from many kinds of guns—including the new 75-mm. recoilless rifle developed by the infantry. Like its earlier cousin, the 57-mm. recoilless, the new rifle is open at both ends. The explosion goes out the back end, the projectile out the front, in an equal and opposite reaction that leaves the gun standing so still that it can be slung from a single wire and won't even jump a little. It has an effective range of 2000 yards. But stay away from the tail. The charge exploding through Venturi openings sends a searing cone-shaped fire 50 feet deep by 20 feet across, burning the shrubbery to the roots. A strong man can fire the gun from his shoulder. It weighs 105 pounds, is equipped with tripod, special 2½-ton truck and ordinarily calls for a crew of five. It's as accurate as a rifle, and its regular armor-piercing shells will knock off light tanks or blow a whale-sized hole in a brick wall. It can be used against pillboxes, armored and wheeled vehicles and people. For tougher targets, a 105-mm. recoilless is in the works.

More spectacular than developments in smaller arms are the things coming out of the rocket and guided-missiles program. Aside from the long-range dream of scientists working on big babies like the V-2 Bumper, some immediately usable equipment already is on the way. Almost ready for war work are a couple of rocket launchers, whose honeycomb of tubes will perch on big tanks or trucks and spray salvos of high explosive across enemy lines. The Army also has developed a new anti-aircraft rocket which will be able to destroy enemy planes at altitudes above 60,000 feet.

Men in the field constantly try new ideas to load more rockets on planes, shoot them faster and more efficiently. Latest trick was to take rockets off the usual underwing hangers, and put them in a magazine like rounds of machine-gun ammunition. Two such experimental rocket guns were mounted on a Navy Skyraider recently, giving it more fire power than the big 75-mm. aircraft cannon of World War II. Each gun fired 19 five-inch, spin-stabilized rockets which were completely housed in magazines inside the plane's wings. Rockets could be fired machine-gun fashion up to three rounds per second per gun—all 38 rockets, weighing almost a ton, could be whammed away in 6½ seconds.

The G.I.s in Korea got a first look at the effectiveness of bigger rockets when the Navy's Tiny Tim went to work for them. Tim, packing a wallop equal to a pair of

(Continued to page 244)

**Easy To Build**  
**U-MAK-IT BOAT KITS** 8 FT. PRAMS ROWBOATS  
 OUTBOARDS INBOARDS & CRUISERS

**SEND 25c (coin) NEW CATALOG ORDER YOURS TODAY**

**U-MAK-IT PRODUCTS** 703P-WHITTIER ST. New York 59, N. Y.

**Keep Fords all Ford**  
**with Genuine Ford Parts**  
 Made Right to Fit Right to Last Longer

Plane it square with **SQUAR-EZY.**

**BRATCO**

• The new attachment that makes your woodworking plane an accurate edging and joining tool. Fits all standard planes—Quickly attached or removed—Rugged malleable iron, accurately machined and cadmium plated. Order direct or ask your dealer. Model 7 for Block planes and Nos. 2-3-4, \$1.98. Model 11 for No. 5 Jack and larger, \$2.49. Satisfaction guaranteed.

**The BRATTON COMPANY**  
 Dept. 123 Edwardsville, Kansas

**Don't Neglect Slipping FALSE TEETH**

Do false teeth drop, slip or wobble when you talk, eat, laugh or sneeze? Don't be annoyed and embarrassed by such handicaps. **FASTEETH**, an **alkaline** (non-acid) powder to sprinkle on your plates, keeps false teeth more firmly set. Gives confident feeling of security and added comfort. No gummy, gooey, pasty taste or feeling. Get **FASTEETH** today at any drug store.

**ARC WELDING**  
**FOR PROFIT OR PLEASURE**  
**60 lbs. OF READY MADE PARTS** Only \$24.95

**BUILD YOUR OWN HEAVY DUTY WELDER** **SAVE** Buy Only NECESSARY PARTS

All necessary parts Ready-Made and easy to assemble. You can do all around welding on steel, cast iron and other metals after only a few hours practice. Illustrated instruction manual included. Free plans for building case. Sold on 30-Day Money-Back Guarantee!

**FREE:** Write today for fully illustrated Pamphlet P-12

**ATOMIC ARC WELDER CO.**  
 1037 So. 19th St. OMAHA, NEBR.

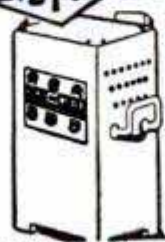

Gives 100% penetration. Welds are stronger than original metal. Operates on 110 or 220 AC.

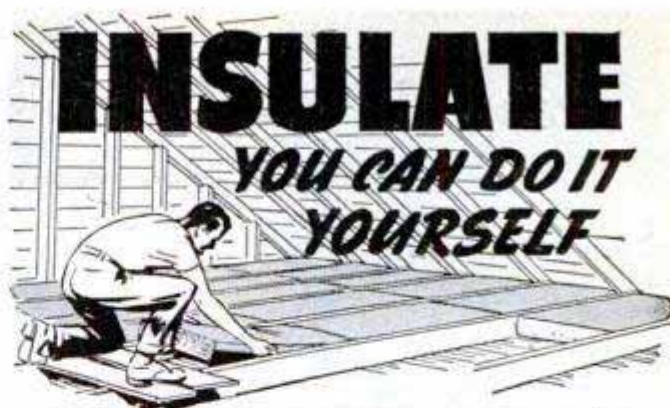

**INSULATE**  
**YOU CAN DO IT YOURSELF**

IT'S a cinch to insulate your home with Gold Bond Rock Wool Batts or Blankets. You'll save a lot of money in fuel bills and keep your house warmer in winter, cooler in summer. Light, easy-to-handle batts slide between rafters or attic floor joists. You get extra fire protection too. Gold Bond Rock Wool Batts and Blankets *can't burn*. Batts are 2 and 4 ft. long, Blankets 8 ft. long. Both come in standard widths to exactly fill the space between framing members. Be sure they're "full-thick" and bear the Gold Bond name for maximum insulation and fire protection. For a free booklet giving details, write Division Y, Department PM-12.

Available at your local Gold Bond Lumber and Building Supply Dealer!  
**NATIONAL GYPSUM COMPANY**  
 BUFFALO 2, N. Y.

**BLACK ON WHITE**  
**IS EASIER TO SEE —**

**ANYWHERE!**

The Master Brite-Blade with its white blade and jet black permanent graduations makes accurate measuring a cinch—even in dimly lighted corners. It's the most dependable tool in your kit! Case of tough zinc alloy chrome plated to resist dampness. 10 foot spring steel replaceable blade with a snow white, non-chipping, non-peeling finish, costs only \$2.25. See your hardware dealer or mail the coupon below.

Prices slightly higher outside U.S.A.

**MASTER**

REG. U.S. PAT. OFF.

WOOD AND STEEL TAPE RULES

**MASTER RULE MFG. CO., INC.**  
 Middletown, New York

PM-12

Please send me

306W— 6 ft. Brite-Blade—\$1.75  
 308W— 8 ft. Brite-Blade—\$1.90  
 310W—10 ft. Brite-Blade—\$2.25

My check (or Money Order) is enclosed.

NAME \_\_\_\_\_

ADDRESS \_\_\_\_\_

CITY \_\_\_\_\_

STATE \_\_\_\_\_

"I'll take the **WHITE** one every time!"



WYTEFACE Steel Tapes, with their jet black markings on a white background, are easier to read in any light. They are rust-resisting, hard to kink and easy to clean.

Protected by U. S. Patent 2,089,209

**WYTEFACE**

TRADE MARK

**STEEL TAPES**

**KEUFFEL & ESSER CO.**

**Mall POWER TOOLS**  
THE RIGHT "FOUNDATION" ON WHICH TO BUILD YOUR WORKSHOP!

★A Complete line of "matched" tools, attachments and accessories, engineered to work together. ★World-wide service, 37 Factory Branches, 100% interchangeable parts. ★Thirty years experience in building Power Tools for American Industry, Railroads and Contractors.



(A) **MallDrill Model 149** perfect for home or workshop use, has the speed and power to drill any material. Capacity  $\frac{1}{4}$ " in metal to  $\frac{1}{2}$ " in wood. Slintered bronze bearings, aluminum alloy housing, powerful universal type motor gives spindle speed of 2000 rpm. Weighs only 3  $\frac{1}{2}$  lbs. Genuine Mall dependability at extremely low price. Complete with hand-tight chuck, \$17.50. Complete with Jacobs' geared chuck, \$19.50.

**PARTIAL LIST OF ATTACHMENTS**

(B) **Sanding Pad Kit** includes 4" pad, 6 abrasive discs and assembling wrench. For fast, all-purpose sanding. No. 35555, \$4.20.

(C) **Belt Sander.** Cuts sanding time to a minimum. Gives smooth finishes on all woods. No. 38170. Price \$14.95.

(D) **Slitting Saw.** Attachment that will cut wood, non-ferrous metals and plastic. Saves hours of tedious hand sawing on any job. No. 32940. Price \$7.50.

(E) **Mall Electric Hand Chain Saw** is ten times faster than hand sawing. Power to outlast 10 men cutting timber to 12" dia. with one cut; 24" dia. with two cuts. Light weight, but sturdy (only 11 lbs.). In a tree or on a scaffold or ladder it can be operated with one hand. Universal electric Motor, 115-230 volt AC. or DC. current. Heavy duty Mall construction. Model 1E12, Complete Price \$95.00.

Order from your dealer or direct from us. Send for free "Magic Power" Bulletin 2317

**MALL TOOL COMPANY**

7805 South Chicago Ave. • Chicago 19, Ill.

Navy 12-inch guns, is larger than any combat-proven rocket to date. It measures 12 feet long, a foot in diameter and has an armor-piercing projectile that will zing through three-inch steel plate. It weighs more than half a ton—152 pounds of it a TNT warhead, with a 500-pound bomb just aft. Two Tims fit comfortably under the wings of a Douglas Skyraider in company with a dozen smaller rockets. A Martin Mauler can pack three or four. In a single sortie over North Korea on their first genuine combat mission, Tims helped wreck 13 locomotives, damage 23 others, blow up eight ammunition cars, set two fuel-oil trains afire, and were wholly responsible for complete destruction of the Han River bridge. After release, the Tiny Tim drives into its target under a jet from 146 pounds of solid fuel—so powerful the rocket motor burns out in a little over one second. Though designed as an air-to-surface missile, for operation against ships, Tiny Tim is fast proving its value against land targets.

Operational guided missiles, any expert will tell you, still present a host of problems, due primarily to the whimsical nature of Nature. There are too many things to correct for—wind, temperature, gravity, magnetism, fuel characteristics and on and on. When asked how far engineers could be sure of control over a big guided rocket, a famous Johns Hopkins' rocket expert recently scratched his chin, mulled it over a minute and replied: "Oh, about—uh, let me see—about 10 feet."

Nevertheless, a few guided missiles have proved themselves operationally — among them, the Navy's Bat. The almost forgotten little steel-and-plywood miniature airplane, an air-to-surface missile about 12 feet long with a 10-foot wingspan, with an electronic mind of its own, is still operating after a poor war record. But it's doing a much better job today than most people know. It carries a big general-purpose bomb, is slung under the wing of a mother plane and, though it has no motive power, it glides almost unerringly into its target, making corrections by radar up to the moment of impact. Though primarily designed for moving targets like ships, it can be used with success against bridges, strategic buildings, supply trains and the like.

"Push-button warfare" is tedious and deceiving, but a few successful projects like the Bat have encroached on it. A good example is in automatic navigation. Recently a pilotless plane was flown by complete remote control for many hundreds of miles.

Probably no field of military development has been as highly publicized as aircraft—high-speed jet bombers, like the

(Continued to page 246)



**FIX IT or FASTEN IT**  
*Better and Faster!*



**NEW TINNEMAN**  
*Speed Nut®*

**TINKER KIT**



**SPEED NUT**—the one-piece, self-locking, vibration-proof fastener—famous throughout industry... **NOW READY FOR HOME USE!** Handy assortment of 10 popular sizes of **SPEED NUTS** and matching screws. Over 100 home repair and hobbycraft uses. Once on—they stay on! Replace threaded nuts and lock washers.

**ONLY \$1.00**  
POSTAGE INCLUDED  
SEND CASH OR CHECK—NO STAMPS

**TINNEMAN PRODUCTS, INC.**  
DEPARTMENT 13 • CLEVELAND 1, OHIO

**FREE** get it Now—

**ALLIED'S 1951 TV and RADIO CATALOG!**  
**212 Pages of BIG VALUES**

**EVERYTHING IN RADIO AND TV AT LOWEST PRICES**



**EVERYTHING FOR EXPERIMENTERS, BUILDERS, AMATEURS, SERVICEMEN, ENGINEERS, SOUNDMEN**



Save money on every Radio and TV need! Get the big 212-page 1951 ALLIED Catalog featuring the world's largest stocks of top-quality equipment at low, money-saving prices! See the latest TV releases, home radios, radio-phonos, Amateur equipment, P.A. systems and Hi-Fidelity Custom Sound, recorders, test instruments, builders' kits—plus thousands of parts, tools, books and diagrams. Get more for your money from the World's Largest Radio Supply House. Send today for your **FREE** new 212-page 1951 ALLIED Catalog!

P. A. SYSTEMS, RECORDERS

**ALLIED RADIO**.....  
833 W. Jackson Blvd., Dept. 5-MM-O  
Chicago 7, Illinois

**FREE CATALOG**

Rush **FREE** 212-Page ALLIED Catalog.

Name.....

Address.....

City.....Zone....State.....



**FREE SAMPLES!**  
**GLOW IN THE DARK!**

**BIG PROFITS** showing amazing Luminous Specialties—house numbers, pictures, plastic novelties, religious and nursery objects, ash trays, key-holders, etc. Largemanager. Enormous demand. Sell on sight. **WRITE AT ONCE** for **FREE** samples. Madison Mills, 303 4th Ave., Dept. S-4, New York 10, N.Y.

**WANT \$10,000?**

Earn the govern- Super Sensitive P.R.I. ment bonus. Locate Uranium with a **GEIGER COUNTER**



Also get one for Atom Bomb Defense! Find gold, silver, and other valuable ores with a P.R.I. Treasure Locator. World's finest instruments. **FREE** catalog. Write!

**PRECISION RADIATION INSTRUMENTS, Inc.** Dealer Inquiries 5478PM Wilshire Blvd., Los Angeles 36, Cal. Invited

**BRUSH PLATING OUTFITS**

for re-plating articles in the home and shop. No tanks necessary. Free particulars.  
**GUNMETAL CO., AVE. M, DECATUR, ILLINOIS**

**SAY YOU SAW IT IN POPULAR MECHANICS**

**SAVE TIME, WORK, MONEY!**

**SHAW DU-ALL**

and "PEPPY PAL" TRACTORS



**PLOW**

These rugged walking or riding tractors are ideal for farm, truck garden, orchard, poultry farm. Operate on a few cents an hour. A child can handle them.



**CULTIVATE**

**DO DOZENS OF JOBS** Both riding and walking tractors quickly and easily plow, cultivate, harrow, disk, bulldoze, spray, haul, grind, saw wood, etc. **LOW FACTORY PRICES** Buy direct or through your dealer. Year's guarantee!



**RIDING TRACTORS** 4 models from 5 to 12½ H.P., 58 in. wheelbase, 36 to 52 in. wide, 24 in. plant clearance. Hand or electric starter. Walking Tractors 1½ to 5 H.P.

**FREE** Illustrated folders giving complete details and price lists—write today!

**SHAW MFG. CO.**

4512 FRONT ST., GALESBURG, KANS.  
668G NORTH 4TH ST., COLUMBUS, O.

Announcing the New CUSHMAN

# EAGLE

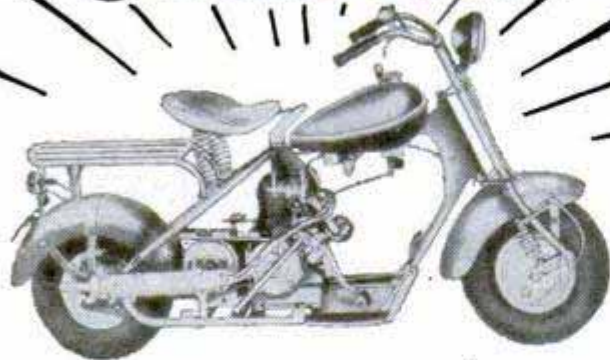

The sensational New Cushman EAGLE is ready! And, Boy! O Boy!—how you'll enjoy this entirely new thrill in motoring pleasure! It's big, husky, powerful, speedy! Has you moving at high speed within yards! Cruises up to 50 miles an hour out on the open road! Amazing fuel economy—up to 75 miles to the gallon! Luxurious comfort—big motor-bike saddle seat mounted on double coil springs . . . shock-absorbing springs on front wheel . . . big balloon tires designed for comfortable riding as well as easy steering and long life. Powerful 2-wheel brakes. 2-gallon (plus) fuel tank. Brilliant headlight, tail-light. Nothing else like it—and it's yours for only \$307.00 f.o.b. factory.



Long-time favorite for lowest cost motoring! Thousands in use. Cheaper than bus fare or operating your car. Handles easy. Slips through traffic, parks anywhere. Wonderful for getting to work, school or market—making deliveries. Famous Husky engine.

**WRITE**

See your Cushman dealer for the New EAGLE and regular Cushman Scooter. Or send for Folder M12.



**85**  
MILES  
PER  
GALLON

Rider Agent Plan Available

DEALER INQUIRIES INVITED

**CUSHMAN MOTOR WORKS, Inc**  
LINCOLN NEBRASKA USA



**EARN \$6.00 PER HOUR**

At a cost of 20c with the NEW JENZ SUPER CHIEF STEAM CLEANER. Portable—No moving parts—Cleans anything—Any place—Motors—Chassis—Machinery—Floors—Buildings—Oil Rigs, etc.—Oil fired—Economic—Fully tested and warranted. 75 lbs. steam in ten min.—Model 80. Complete as illustrated. . . . . **\$315.50**

F.O.B. shipping point  
**HI-PURE LABORATORIES, Evansville, Ind.**

B-47 which crossed the country in less than four hours, higher-speed fighters that go so far beyond the sonic barrier that no one even shrugs anymore, "X" planes that fly to the limits of the stratosphere, hump-backed planes with special radar equipment for patrol, cargo planes with detachable cargo pods that will hold 20,000 pounds of equipment. But little has been said about the small improvements for military planes that may prove more important from an immediate, practical standpoint than the spectacular "X" craft.

There's a new liquid-propellant, rocket-assist take-off engine, for instance. Unlike the famous Jato unit, which burned out and was thrown away after a run, the new engine is a permanent part of the plane to which it is attached, and can be used over and over simply by filling it with fuel. Ramjets, using regular aviation fuels, have already been operated repeatedly on the wing tips of F-80 fighters. Since ramjets don't begin to function until a ground speed of about 350 miles per hour is reached, you can imagine what happens to any plane to which they are a party.

During World War II, everyone saw pictures of wing-mounted aircraft machine-gun barrels, warped and twisted beyond recognition as a result of heat set up by rapid fire. Navy Research and Development has the answer to that, now—a substance called nitro guanadine which is used as an ingredient in the explosive charge. It makes the powder burn cooler, without hurting the power of its bang.

All down the line, improvements are being made in equipment. The Signal Corps has gone all out to reduce sizes and weights of everything. The new Handie-Talkie field radio, FM variety, is less than half as big or heavy as its World War II predecessor. Some radio sets are reduced to cigarette-pack size, crystal rectifiers to the size of a match head. A new field switchboard weighs only 22 pounds, sits on a tripod and plugs right in. The last one weighed 72 pounds. A new "droppable" teleprinter weighs in at 45 pounds, compared with the 225-pound job the last war's field men had to juggle around.

All over the lot, plastics are replacing hard-to-get metals for use in snowshoes, sleds, toboggans, helmets, table tops, skis, breadboxes, lockers and scores of other items. Some of them are proving out.

All in all, a lot of things are happening in weapons. The big, fantastic ones—if we have them—are being kept quieter than the Manhattan Project. But plenty of the less spectacular ones mentioned here will soon be on their way to war if they aren't already.

# NEW Millers Falls "NEST OF SAWS"

BLADE TURNS AND LOCKS  
IN 8 POSITIONS



10-tooth blade for steel, cast iron, plaster, etc.

24-tooth blade for thin sheet metal, tubing, etc.

7-tooth blade for all woods and other soft materials

**Cuts Most ANYTHING—Most ANYWHERE!**

For carpenters, tinmiths, electricians, plumbers, home owners, farmers, hobbyists, auto mechanics

**\$2.95**

Sure-grip pistol handle and 3 quickly interchangeable blades — 10-tooth for hard steel, asbestos shingles, nails, bolts, etc. — 24-tooth for thin metals, gutter pipe, BX cable, etc. — 7-tooth for hard and soft woods, fibre board, Masonite, etc. Blade rotates and locks in desired position, handle stays always in the clear . . . makes work easy in tight corners, ends skinned knuckles. A Millers Falls quality tool and one of the handiest you can own. Ask for it at your hardware dealers — the new Millers Falls No. 725 "Nest of Saws" only \$2.95\* complete.

**MILLERS FALLS  
TOOLS**

SINCE  
1868

MILLERS FALLS  
COMPANY

GREENFIELD  
MASS.

\*Prices slightly higher in West and Canada

Pioneers

Leaders

**AIR  
RIFLES**

**BENJAMIN**

**AIR  
PISTOLS**

SHOOT WITH SAFETY

BE SAFE—SHOOT WITH COMPRESSED AIR—ALWAYS READY No Cartridges or Tanks to Replace or Recharge. If you want the most PRACTICAL GUN to use anywhere—inside or outdoors—get a SAFE—CLEAN—ECONOMICAL BENJAMIN with Adjustable Power and Amazing Accuracy. Send for Free Folder of Latest Models Today. BENJAMIN AIR RIFLE CO., 890 MARION ST., ST. LOUIS 4, MO.

**Your car...**

. . . can be seriously damaged by a leaky radiator. Don't take chances—take care! Use Warner Liquid Solder . . . it's non-metallic, deposits tiny fibers to repair leaks anywhere in the cooling system. Fast, sure and easy to use—just shake . . . pour . . . and fret no more.

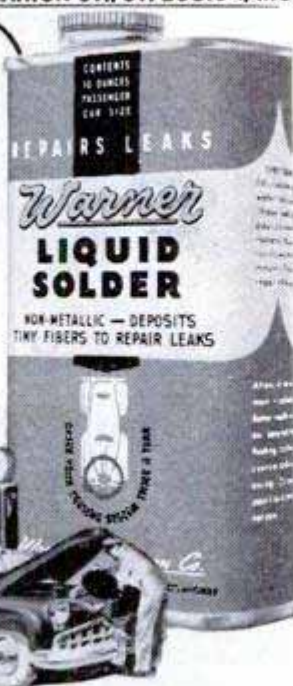

**Warner**  
A FAMOUS NAME  
IN AUTOMOBILE HISTORY

In Two Sizes, at Service Stations, Accessories Stores, Car Dealers, Auto Repair Shops

**Save time! Save money!**  
SEND FOR THIS BIG NEW

**HUNT'S  
WOODWORKERS  
CATALOG NO. 17**

**NEW  
LOW  
PRICES**

Greatest selection of fine domestic and imported woods—144 pages of real money-saving bargains

**QUICK DELIVERY**  
on maple, poplar, oak, mahogany, red cedar, cherry, walnut, and many others—all properly seasoned and kiln dried.

EVERY wood craftsman should have this big new catalog. Shows 32 rare and fancy woods in color... 43 veneer designs... multicolored bandings, inlays, overlays... 275 scroll patterns... all kinds of tools, machinery, cabinet hardware, ornaments, mouldings... plus... pages of ideas, hints, instructions, and information for beginner and advanced craftsman. You'll save time and money with this catalog. Yours for only 15 cents—refundable on first order. Use the coupon—send for your copy NOW.

**ONLY 15c**

**MAIL TODAY**

CRAFTSMAN WOOD SERVICE CO.  
2729 South Mary Street, Dept. A-12  
Chicago 8, Illinois

Please send me your big, new Catalog No. 17. Enclosed is 15c—to be refunded on my first order.

NAME.....  
ADDRESS.....  
CITY.....ZONE.....STATE.....

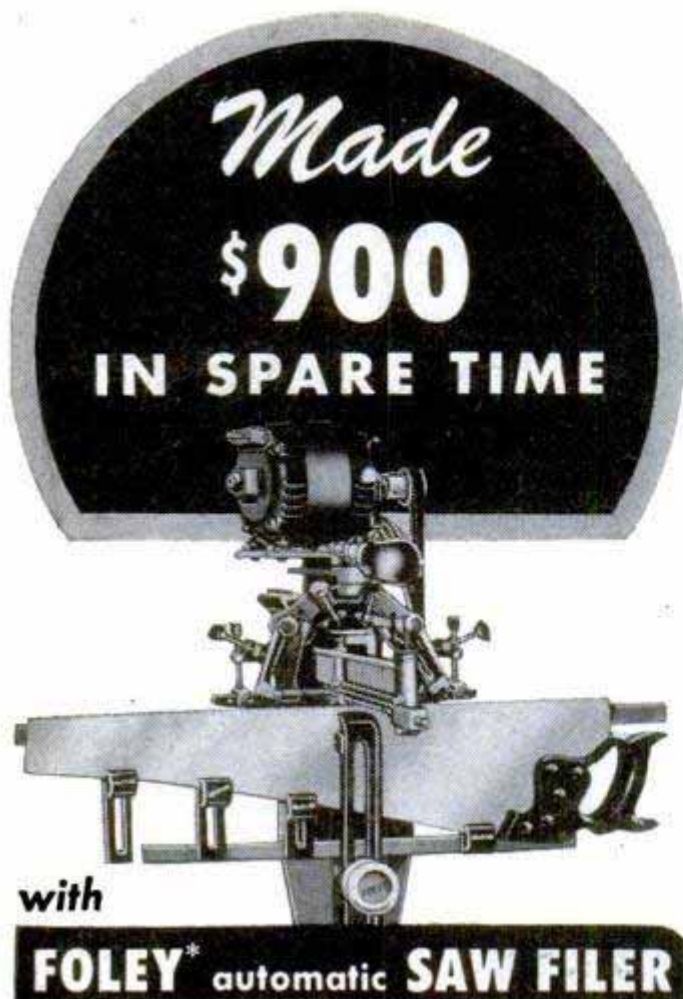

\*Trade Mark Reg. U. S. Pat. Off.

"I did very well last year with my Foley equipment, about 950 saws and 240 lawn mowers, in my spare time. About \$900 for me." Leo H. Mix. Len Crego says: "I have done 4 or 5 thousand saws in my spare time in the 4½ years since I got the outfit, and they are all coming back."

Make up to \$2 or \$3 an hour in Spare Time. With the high prices of food, clothing and everything else, just think what you could do with extra money every week! With a Foley Automatic Saw Filer you can file hand, band and circular saws better than the most expert hand filer. "The first saw I sharpened with my Foley Filer came out 100%"—writes Clarence E. Parsons. Every saw you sharpen with the machine accuracy of the Foley Saw Filer is an ad that brings you more customers. Cash business, no canvassing. No eyestrain, no experience needed.

### FREE BOOK INDEPENDENCE AFTER 40!

Shows just how you can start at home in spare time in your basement or garage. Just think—with a small investment, no overhead, no stock of goods to carry, you can get right into a cash business—and later on develop into a full-time repair shop. Send coupon today. No salesman will call.



### Send Coupon for FREE BOOK

FOLEY MFG. CO., 1216-O Foley Bldg., Minneapolis 18, Minn.  
Send FREE BOOK—"Independence After 40."

Name \_\_\_\_\_

Address \_\_\_\_\_

## Those Handy-Andy Eggbeaters

(Continued from page 77)

officer around a ship so he could inspect the sides, and counting muskrat hutches for the Federal Wildlife Service. The popular helicopter locates rocks and shoals for hydrographic mapping, rescues marooned hunters off a sandbar in a flood-swollen river, carries mountain artillery to Marine combat troops already landed by pinwheel. One day a small Navy vessel's engine was disabled out in the Gulf of Mexico and a helicopter flew a mechanic out to repair the damage.

Whether it is to fly chaplains around to ships of the fleet to hold services, flying mail, spotting gunfire or acting like an aerial taxicab, the ubiquitous helicopter has come to stay in the Navy and its sister services. Every day brings a new idea on how to put the Handy Andys to work.

## I'm Building the Popular Mechanics Plywood Ranch House

(Continued from page 133)

so that we could cut all the bridging in one hour's time.

Then came the subfloor. We used 5/8-inch unsanded utility-grade fir plywood for the flooring. It gives the smoothest and strongest flooring and is not too expensive at today's prices, especially as plywood is measured in square feet, covering more area than a board foot of shiplap, and it has no waste or "dropoff." The same plywood panels were used in our foundation forms. Personally, I was delighted most by the ease of laying the big sheets of flooring—only one day's work to place and finish the whole subfloor.

We assembled the stud walls the way modern contractors are doing it, completely finishing the rough wall while it is still flat on the subfloor. You lay the top and bottom plates (2 by 4s) together on the floor and mark off the positions of all studs and openings on both at the same time; then nail everything together, including the bottom plate and window headers. I found that the two of us could easily raise a 30-foot length of wall into place and we are far from a monopoly of muscles. Built this way the walls are well-nailed and there is no chance of making a mistake and getting a window or door out of line.

The house requires no tricky corner bracing because its wall sheathing is also plywood. Unsanded 5/16-inch fir plywood, the same utility or Plyscord grade as the 5/8-inch flooring, is all that is necessary here

(Continued to page 250)

# GROBAN'S NEW WAR SURPLUS SPECIALS

ALL ITEMS UNCONDITIONALLY GUARANTEED: ORDER TODAY

Brand New

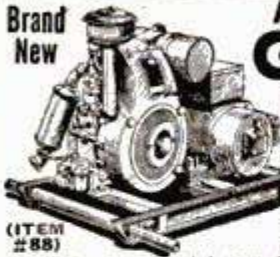

## AUXILIARY ELECTRIC A.C. GENERATING PLANT

FOR GENERAL UTILITY AND EMERGENCY USE  
2500 WATTS - 115 VOLTS A.C.  
60 CYCLES

Plenty of current to operate your: Oil Burner, Sump Pump, Refrigerator, Home Freezer, Power Saw, Lights, Radio and Television, Home Water System Pumps.

Complete integrated heavy duty electric power plant. Signal Corps Model PE-75, driven by Briggs & Stratton, one cylinder, 6 1/2 H.P. Model ZZ, electric engine with killer button, oil bath air cleaner, governor, muffler, starting rope, and radio interference filter. The self-excited Leland or Westinghouse generator is rated 2500 Watts, 115 Volts, 60 Cycle A.C. single phase, belt driven, with guard and duplex receptacle.

When generator is not in use, you can use the engine separately to power other equipment. Mounted on adjustable steel skids, notched for carrying poles. Net wt. 310 lbs. Shpg. wt. 440 lbs. Dimen. 36"x19 1/2"x24". 12 month guarantee. \$726.00 value. **NOW 295.00**

**295.00**  
F.O.B. Chicago

## DIRECT CURRENT GENERATORS



For welders, plating, truck and marine use, D.C. appliances, lights, etc. Aircraft quality—lifetime grease sealed ball bearings. Heavy duty.

ITEM #89—Type M-2, rated 50 Amps.—24 Volts. Mfd. by Leece-Neville Co. Shpg. wt. 32 lbs. Gov't. Acq. Cost \$176.00. F.O.B. Chicago. **16.50**

ITEM #90—Type P-1, rated 200 Amps.—28 Volts, 2500 RPM. Mfd. by General Electric, Ford, Delco-Remy and Westinghouse. Gov't. Acq. Cost \$300.00. Shpg. wt. 70 lbs. **22.50**

ITEM #91—Type R-1, rated 300 Amps.—30 Volts. Mfd. by Jack & Heintz. Gov't. Acq. Cost \$380.00. Shpg. wt. 70 lbs. F.O.B. Chicago. **35.00**

Each individually packed in wooden box.

## D. C. GENERATOR — FOR 12 VOLT SYSTEMS

ITEM #99—BRAND NEW. Rated 15 Volts at 50 Amps. Use on 12 Volt circuits on trucks, tractors, ships, planes, battery chargers, auxiliary lights etc.

Base mounting with 4 bolt holes. 5/8" threaded shaft with keyway. Mfd. by Bendix-Eclipse. Gov't. acq. cost \$136.00. Shpg. wt. 53 lbs. F.O.B. Chicago. **21.50**

## UTILITY PUMP ROTARY VANE TYPE

Perfect For Water, Oil or Insecticides  
Sprays DDT, 2-4D, sulphur compounds, etc. Pressure to 150 lbs., 15 gals. per min. at 1200 RPM using 2 HP. As vacuum pump for milking machines, lab use, etc., delivers 20" vacuum, 4.5 cu. ft. per min. at 1500 RPM using 3/4 HP. Rotate either direction. 3/8" pipe thread ports, 1/2" standard shaft, 4 ball bearings. Easy to mount—ready to run. Shpg. wt. 13 lbs. (ITEM #51) F.O.B. Chicago. **16.50**



## Hydraulic Cylinders—Air or Oil

Large supply of new labor-saving, economical hydraulic equipment in many types and sizes. Use these positive, highly efficient, smooth pressure hydraulics on presses, arbors, lifts, loaders, power control, positioning, brakes, plastic dies, auto frame alignment, etc., etc.

ITEM #70—Piston hydraulic cylinder, 3/4 HP. Permanent element type. 3/4" female pipe thread ports. Capacity, 16 gallons per minute. A \$13.00 value. Now **4.95** Postpaid

ITEM #4—All steel double action hydraulic cylinder, 1 1/2" bore, 27 1/2" stroke. Clevis mounting. Will lift 1000 lbs. with 1000 P.S.I. line pressure. Perfect for positioning and feeding movements. Shpg. wt. 4 lbs. Postpaid. **4.95**

ITEM #33C—Double action hydraulic cylinder, 1 1/2" bore, 4 1/2" stroke. Clevis mountings at both ends. Uses 1/4" pipe fittings. Postpaid. **8.95**

ITEM #32—Double action, 1 1/2" bore, 9" stroke, will lift 1760 lbs. with 1000 P.S.I. line pressure. Sure. Wt. 4 lbs. A \$45.00 value. Postpaid **10.95**

ITEM #41—Double action hydraulic cylinder, 2" bore, 6" stroke, clevis mounting at base and end of shaft. Overall length closed 12 1/2". Has 3/4" stainless steel shaft, uses 1/4" tubing fittings. Will lift up to 3100 lbs. with 1000 P.S.I. line pressure. Weight 7 lbs. Postpaid. **12.50**

ITEM #15—Double acting cylinder, 3" bore 10 1/2" stroke. All steel hydraulic cylinder, will lift up to 7000 lbs. with 1000 P.S.I. line pressure. Wt. 12 lbs. A \$78.00 value. Postpaid **19.50**

ITEM #31C—Double action hydraulic cylinder, 3 1/2" bore, 11" stroke. Aluminum alloy cylinder wall and all steel 1 1/2" diameter piston rod. Clevis mounting at base and shaft. 19 1/2" overall length closed. Will lift 9625 lbs. using 1000 PSI from Logan Heavy Duty Hydraulic Pump. Uses 3/8" tubing fittings. Value \$102.00. Shpg. wt. 11 lbs. F.O.B. Chicago. **22.50**

ITEM #6A—Double action hydraulic cylinder, 3" bore, 25" stroke, will lift 7070 lbs. with 1000 P.S.I. line pressure. Steel barrel, 1 1/2" stainless steel shaft. Gov't. acq. cost, \$176.00. Shpg. wt. 28 lbs. F.O.B. Chicago. **28.00**

ITEM #42—Double action hydraulic cylinder, 4" bore, 32" stroke. Rated lift capacity with 1000 P.S.I. line pressure is 12,560 lbs. Ship. wt. 30 lbs. AN EXCELLENT BUY **32.50**

ITEM #55—Hydraulic cylinder, 6" bore, 80" stroke, with flange mounting at base, machine thread at shaft end. Working pressure 1,000 P.S.I., maximum load capacity, 28,000 lbs. This cylinder has 3/4" pipe thread ports. Shipping weight 263 lbs. **75.00**

F.O.B. Chicago  
HI-PRESSURE FITTINGS for cylinders and valves available at 50c ea. for 3/8" pipe and 65c ea. for 1/2" pipe.

NEW! STATIONARY OR PORTABLE

## D.C. ARC WELDER

250 AMPS. MODEL 252  
FOR ANY WELDING JOB,  
LIGHT OR HEAVY

Stop Costly Repair Bills,  
Weld It Yourself and Save

Designed for many years of trouble-free service. This precision engineered Direct Current ELECTRIC ARC WELDER is offered at but a fraction of its original value. It can be mounted permanently or easily transported for portable use. Does the job instantly where and when you need it. Has dial type rheostat for easy pinpoint control and a high-low range switch. Run welder at 2500 RPM from drive pulley or power take-off of tractor, a 7 1/2 HP electric motor or a 10 HP gas engine. Use two V belts or flat belt (on pulley). Now... AT A FRACTION OF ITS VALUE. Price includes double V or flat belt pulley and instruction book. Shipping wt. 107 lbs. F.O.B. Chicago. **99.50**



Only one or two jobs will pay for entire welder.

ACCESSORY KIT including welding helmet, electrode holder, two 10 ft. cables with clamp and 5 lbs. of assorted welding rods. (ITEM #66) Shpg. wt. 17 lbs. F.O.B. Chicago **10.50**

IF MORE INFORMATION IS DESIRED, write for WELDER CIRCULAR.

## FINGERTIP SPEED CONTROL HYDRAULIC TRANSMISSION

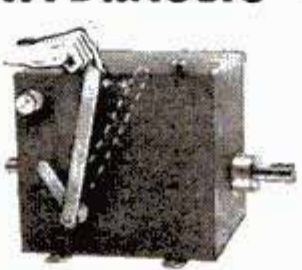

Variable output speeds ranging from 0 to input speed now available. Merely move control handle until desired speed is attained. Then turn locking handle to maintain the setting. Internal relief valves prevent overloading. Use input power of 1/4 to 1 1/2 H.P.

Use for reamer drives, midgeet cars, feed mills, canning machines, conveyors, lathes, milling machines, motor boats, cream separators, garden tractors, pumps, blowers, etc. This Westinghouse-Oil Gear Unit converted to commercial use from 40 MM anti-aircraft traversing mechanisms consists of a variable displacement hydraulic pump feeding a fixed displacement hydraulic motor. These components are contained in a crackle-finish steel oil reservoir (capacity 2 qts.). Adjustable relief valves set at factory for 100 inch pounds of torque may be reset up to 180 inch pounds. Independent reverse control allows full output power and speed selection in either direction of rotation.

Both input and output shafts measure 5/8" diam., include keyway. Input rotation is counter-clockwise facing shaft. Recommended input speeds not to exceed 750 RPM. Overall dimensions, 7 1/2" x 7 1/2" x 11 1/2". Gov't. acquisition cost, \$428.00. Shipping weight 26 lbs. Complete with 2 qts. of oil and full instructions. **54.50** Postpaid

LOGAN HEAVY DUTY

## HYDRAULIC PUMP

For operating hydraulic cylinders and hydraulic motors on tractors, bulldozers, construction machinery, lift trucks, industrial applications, etc. Delivers 10 GPM at 1200 RPM at 1000 P.S.I. using 6 HP. Has a 3/4" inlet, 1/2" outlet, 3/4" shaft with flat and keyway for direct or pulley drive. Has flange with 4 bolt holes for convenient mounting. Ship. wt. 22 lbs. Overall dimen.: 7" L x 5 1/2" H x 5 1/2" W. A \$105.00 value. FOR ONLY... **22.50** F.O.B. Chicago



(ITEM #29)

## HYDRAULIC CONTROL VALVES

ITEM #24. Four-way control valve with built-in relief valve, for use with one double action hydraulic cylinder, may be used with 1500 P.S.I. hydraulic system to open and close hydraulic cylinders. Ship. wt. 8 lbs. A \$38.00 value **9.95** Postpaid

ITEM #26. Four-way control valve for use with two hydraulic double-action cylinders. Each cylinder may be operated independently of the other or in conjunction with the other. Oil may be locked in any of the cylinders to hold the piston at any required position. Ship. wt. 6 lbs. A \$60 value... **12.95** Postpaid



(ITEM #24)

## HAND HYDRAULIC PUMPS

Used for hydraulic jacks, presses, hoists and other hydraulic applications. For operating hydraulic cylinders to pump oil or hydraulic fluid under pressure.

ITEM #11—Hand pump has built-in check valve and is capable of delivering 1000 lbs. of pressure. Has alloy aluminum housing. Dimen.: 8" long x 3 1/2" high x 2 3/4" wide. Ship. wt. 3 lbs. A \$45.00 value Complete with handle... **8.95** NOW Postpaid

ITEM #83—Hand hydraulic pump with built-in transfer valve. **12.95** Postpaid

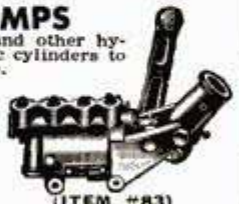

(ITEM #83)

FREE: NEW 1951 48-PAGE CATALOG  
YOURS IS WAITING FOR YOU. WRITE TODAY!

ORDER DIRECT FROM AD — SEND PAYMENT OR PURCHASE ORDER TODAY — SATISFACTION GUARANTEED

GROBAN SUPPLY CO. 1507 SOUTH MICHIGAN AVE. Chicago 5, Ill. Dept. PM 12

# THROW AWAY NICOTINE

When the Filter in Medico Pipes or Cigarette Holders turns brown, throw it away with the nicotine, tars, juices and flakes it has trapped. Insert a fresh Filter for cooler, cleaner, dryer, purer smoking!



Real Filters  
...not mere hollow tubes!

10  
for  
10¢

## MEDICO V. F. Q. (VERY FINE QUALITY)

Pipes of specially selected imported briar. \$2  
Wide variety of shapes. With 10 filters...  
Also Frank Medico "Standard"...

America's Outstanding Dollar (\$1) Pipe

Frank Medico Cigarette Holders \$1 & \$2

# MEDICO

## FILTERED SMOKING

Write to S. M. Frank & Co., New York 22, for booklet M

ALL MEDICO PIPES NOW MADE OF  
PRE-WAR QUALITY IMPORTED BRIAR

## LAWNMOWER SHARPENER OPERATORS

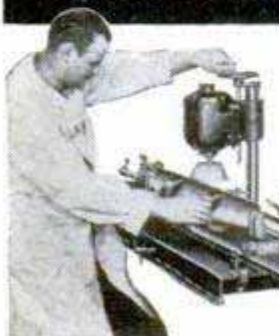

Increase your output...  
Year 'round business!

## NEW BED KNIFE GRINDER

sharpens all  
STRAIGHT EDGE TOOLS  
New Ideal Bench Grinder

doubles your output of sharpening jobs, speedily grinds straight blade knives. Sharpens all kinds of straight edge tools and ice skates. Write for FREE, fact-filled folder.

THE FATE-ROOT-HEATH COMPANY  
Dept. D-3, Plymouth, Ohio

and at today's prices is actually less expensive than shiplap. The sheathing was easy, taking us less than a day to complete.

One of the key details in the plans is use of modern trusses in the roof. The new trusses, built of ordinary lumber secured with 5/8-inch plywood gussets and ordinary 8-penny nails, allow you to have a living room extending completely across the house without any special beaming or bearing partitions. There are, in fact, no bearing partitions in the house—you can, if you wish, move the interior walls willy-nilly to suit your preferences in room sizes.

But frankly this poor amateur builder was a trifle dubious at first as to his ability to build the trusses correctly. Trusses always reminded me of bridges, factories and other huge projects. As Whelan predicted, I found that this is actually the easiest way to build a roof. And it is especially good for us amateurs. The roof cannot help but be true and there is no tricky sawing or fitting high in the air.

In a way it's an assembly-line job. We watched experienced contractors making these modern trusses and built ours the same way. You lay out a pattern on the subfloor with a pencil and straightedge, then nail scraps of 2 by 4 along the pencil lines to hold the truss members in place. One truss is then carefully cut to fit in this form and its pieces are used for patterns. As fast as one man can cut the pieces of lumber and plywood with a power saw, another can nail the trusses together in the form. The two men then simply hang the trusses upside down between the house outside walls, flip them right side up with a rope or pole, align them and the roof is finished. Made in a form, all the trusses are the same—your roof will be true and although you will use a little less lumber than with conventional raftering your roof will be twice as strong!

Shingling the truss roof is no difficult job. One thing I especially liked was that the roof is fairly low, as befits a ranch house, and we could walk on it anywhere without fear of falling. We used wood shingles and spaced the roof boards underneath a good 2½ inches to allow the shingles to "breathe." The only difficult part to the shingling was learning how to hold the shingle nails in the mouth!

(Continued next month)

Beginning July 1, 1952, aircraft speeds and distances in the United States will be standardized in knots and nautical miles, instead of conventional miles per hour and statute miles, according to the Civil Aeronautics Administration.

## A New . . . and Better Push Drill by "YANKEE"

No.  
45

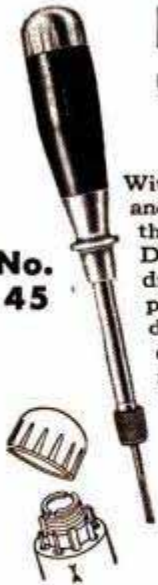

With a handle that fits your hand and a flange to rest your thumb, the ALL-NEW "Yankee" Push Drill No. 45 makes quick work of drilling small holes . . . in wood or plastics. Magazine handle holds 8 drill points ( $\frac{1}{8}$ " to  $\frac{1}{4}$ "). Improved chuck . . . drills can't pull out. Automatic return action clears chips. Buy it from Hardware Dealers and Industrial Supply Houses everywhere. Send for booklet "How 'Yankee' Tools Make Good Mechanics Better" FREE. North Bros. Mfg. Co., 217 West Lehigh Ave., Philadelphia 33, Pa.

"YANKEE" TOOLS  
NOW PART OF



THE TOOL BOX  
OF THE WORLD

NORTH BROS. MFG. CO., Philadelphia 33, Pa.

## WONDER-PASTE Paint Remover

The modern, easy way  
to strip paint, varnish,  
enamel, lacquer, etc.  
AT PAINT AND  
HARDWARE STORES

COATED!! FEATHERWEIGHT!!

6x30 — \$29.50  
8x30 — \$34.50

Two (2) superb FEATHERWEIGHT glasses. Weigh only 16 to 18 ounces each. COATED so each gives maximum results . . . sharply . . . clearly. Each measures a compact 4 $\frac{1}{2}$ " x 6". Only in power and price do they differ. Each offers a tremendous field of view.



UNCONDITIONALLY GUARANTEED TRY FOR 20 DAYS  
AT OUR RISK!

If not fully satisfied return for full refund! Cash orders rushed post-paid. On C.O.D.'s include \$2.00 deposit. Add Federal tax. Prices include handsome genuine leather case and straps. UNITED BINOCULAR CO., 9043 S. Western, Dept. ARF-2108, Chicago 20.

## AGENTS 300% Profit SIGN LETTERS

For Store Fronts and Office Windows. Anyone can put them on. Free samples. Liberal Offer to General Agents.

METALLIC LETTER CO., 430 N. Clark, Chicago 10

## STOPS LEAKS PERMANENTLY

Cut your fixture replacement, water and fuel bills with Economy Renewable Seats. Make economical, permanent repairs quickly and easily with the Junior Kit (illus.). Repair bathroom, kitchen and laundry fixtures. Everything you need included in steel box. This is a natural for the "Fixit" shops—get extra income from making permanent repairs on your customers' faucets.

Senior Master Kit also available—repairs faucets and valves up to 1" pipe. Write for illustrated circular and prices.

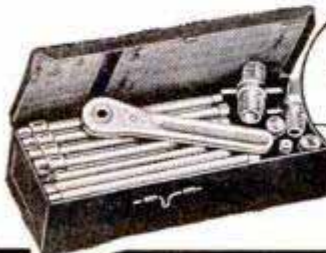

ECONOMY VALVE SEAT CO.

3122 N. California Ave. Chicago 18, Ill.

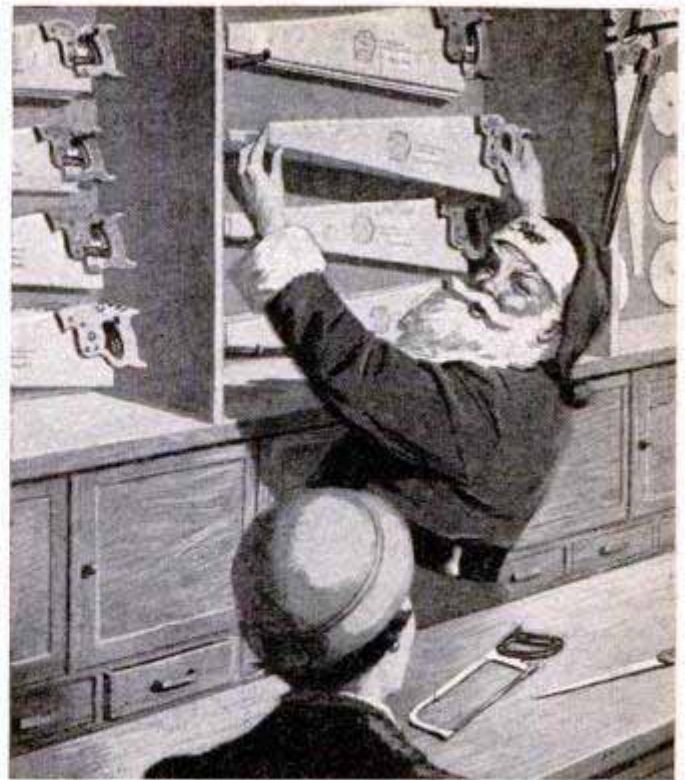

## A Merry Christmas Suggestion! Disston Saws

For that man about the house . . . a gift he's sure to go for—a wonderful Disston Saw! Among the many types to choose from you'll also find the ideal saw for your boy. See your hardware dealer's selection of other fine Christmas gifts, too. Let your Hardwareman advise you.

Add to their tool box with tools  
they'll be proud of—Disston!

Hand Saws  
Compass Saws

Hack Saws  
Circular Saws

Wood Turning Chisels

HENRY DISSTON & SONS, INC.

1211 Tacony, Philadelphia 35, Pa., U.S.A.

In Canada, write:

2-20 Fraser Ave., Toronto 3, Ont.



# DISSTON®

THE SAW MOST CARPENTERS USE

# NEW amazing SPRAY GUN works from car engine!

WITH SPARK PLUG COMPRESSOR AND HOSE FOR INFLATING TIRES

NOW! Your car engine provides the air pressure to operate the amazing Dupli-color Touch-Up Spray Gun. Just replace any spark plug with Compressor, attach air hose to Spray Gun, start the engine and you're set for a quick, easy job!

WORKS LIKE A CHARM FOR SMALL REFINISHING AND SPRAY PAINT JOBS!

Ideal for car touch-up, home and shop use

Gun has fine tool balance; factory-set to work smooth and quick, permanently adjusted for perfect spraying 4"-6" from object or area to be painted. Fool-proof, efficient! Complete kit includes polished Cast Aluminum Gun, Compressor, 18 foot hose, 4 oz. bottle, tire connector and spark plug adaptors. Compact, light; smartly packed kit fits in glove compartment. A "must" for motorists and hobbyists at \$5.95 complete (KIT GC).

Spark Plug Compressor (only) with 18 feet of hose, spark plug adaptors and tire connector, \$2.98 (KIT C).

Spray Gun (only) with 6 feet of hose, tire connector, 1 1/4 oz. bottle, \$2.98 (KIT G).

At your auto supply store, service station or car dealer... if not available send M.O. or check—we pay the postage.



ONLY \$5.95

COMPRESSOR & HOSE also PUMPS TIRES... CAR ENGINE DOES THE JOB QUICKLY

GET YOURS TODAY

**DUPLI-COLOR** Dept. H.—2440 S. Michigan PRODUCTS CO., INC. CHICAGO 16, ILLINOIS

RETAIL PRICE \$125.00  
FACTORY TO YOU \$59.95

**SUPERSHOP** includes precision-built 8" tilting table saw, vertical and horizontal drill press, 30" lathe, sander, grinder. 100% BALL BEARING. Write for FREE catalog, full details, trial plan.

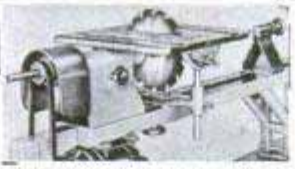

**POWER TOOLS, INC.** 118 YATES AVENUE BELOIT, WISCONSIN



The Right Tool for a Right Job  
IN YOUR WORKSHOP  
**EMPIRE LEVELS**



Get more value for less money! Make Your Choice an Empire Level

No. 151 Aluminum Level. Extremely accurate with adjustable-interchangeable vials. Has 2 levels, 2 plumbs, and a choice of 2 45° vials or 2 additional plumbs. Beautifully finished, easy to work with. A tool you can be proud to own.

18" ... \$6.40 24" ... \$6.80 28" ... \$7.80

Order EMPIRE Levels from your local dealer, or write for complete information.

**EMPIRE LEVEL MFG. COMPANY**

Dept. PM 10930 W. Potter Rd., Milwaukee 13, Wis.

## Push-Button Manor

(Continued from page 87)

remotely from a light post alongside the driveway. Mathias simply puts a key in a lock in the post, turns it and the door opens. Inside the garage he throws another switch and the door closes. Or he can open and close the doors from the kitchen. A 1/4-horsepower motor in the garage ceiling does the work.

Press the doorbell button and you automatically turn on the porch light. If there's nobody home, the light goes off in three minutes. A thermostatic switch is hooked into the light circuit. When you ring the doorbell, a relay turns on a small light bulb under the bellows of the thermostatic switch. It takes three minutes for the heat from the bulb to expand the thermostat enough to open the switch, turning off the light.

Mathias is a bit apologetic about the incompleteness of his push-button house.

"We've lived here only two years and it takes time to do everything," he explains.

In the house he lived in previously, Mathias had a complex system for checking locked doors nightly. Mrs. Mathias had challenged her husband to eliminate the nightly chore of walking around trying every door to make certain it was locked.

Taking up the challenge, he came up with the solution. A simple light circuit was set up to run through every exterior door lock in the house. When the bolts were all latched, the current ran through, lighting the lamp in the bedroom. If one was unlocked, the circuit was broken and the light failed to go on when he turned on the test switch. He's planning to add this to his new house and it will include the garage doors.

"There's always something for me to do," Mathias says. "I'm working on an automatic lawn sprinkler that will turn on the water during the night for any preset time. And I have almost finished work on a remote control that will enable me to tune the radio to any station from any place in the house.

"But what I really want to get working on is a mechanical waitress for our basement picnics. We have a long table and when there's a crowd here it takes too much time and effort passing food from one end of the table to the other. The way I figure it, electric trains running on tracks in the center of the table will do the job. There'll be switches at each plate and if you want more salad, you press the button and the train rolls up with the salad bowl."

Push-Button Manor will never be quite finished.



# BRIKCRETE



## Local Manufacturing of this Modern Masonry Has High Earning Power

Several hundred territories are being opened up for local Brikcrete manufacture by men of vision and aggressiveness. Brikcrete ties in with today's huge building program. Makes possible better construction at lower cost. Truly better than brick; actually cheaper than lumber. Combines strength, safety, insulation value, colorful beauty that fits today's styling.

Brikcrete is made in locally owned plants, using local materials and local labor. That's why high quality and low price still permit a 100% to 150% mark-up. We supply complete equipment; easy terms if required; generous co-operation. Exclusive manufacturing privileges in protected territory. Write for information. **Brikcrete Associates, Inc.** 4679 Division Ave. S Grand Rapids 8, Mich.



## GARAGEMEN... Write for the new K. R. WILSON Catalog of Garage Tools and Equipment. Lowest Prices. K. R. WILSON, 213 Main Street, Buffalo 3, N. Y.

### THE IDEAL WOODWORKER'S VISE!

Whatever any vise can do with wood—Versa Vise does it better, easier. There's nothing like it. Vertical work? Just lay it on its side on the permanently attached post. Horizontal? Place it upright on the same post! Turns a full circle in either position. Tightens automatically on the post when you tighten the jaws. Beautifully machined 2 1/2 x 3 3/4" jaws open to full 5", 16 lbs., finest cast semi-steel. Only \$9.95, f.o.b. Orrville. Buy it from your dealer, or send \$9.95 now and pay small shipping cost on delivery (Ohio residents add 3% sales tax). Handiest woodworking vise you ever used. Money-back guarantee. Thousands sold. Made by makers of the famous Will-Burt stoker. Ask any bank. **The WILL-BURT Company Dept. PM-3, Orrville, Ohio**

## SLOW SPEED—80-1 GEAR BOX

Ball-bearing, easily turned by hand or motor. Dimen. 2" x 4 1/2" x 6"..... **\$4.95**

**FLEXIBLE COUPLING** for gear box to motor. 3/8" to 3/4", or 3/8" to 1/2" shaft— **\$1.25** each.....

**WRITE FOR FREE CATALOG**

**HYDRAULIC HAND PUMP** with Handle 1000 PSI. Dimen. 2 3/4" x 3 1/2" x 8"..... **\$7.50**

**HYD. PRESSURE GAUGE** 0-2000 PSI. 2" diam. .... **\$1.50**

**ANCHOR SURPLUS 10616 GRAND RIVER DETROIT 4, MICH.**

## HYDRAULIC Power Transmission WITH INFINITELY VARIABLE SPEEDS, Clutch and INSTANT REVERSE—OUTPUT TORQUE ADJUSTMENT UP TO 180 inch POUNDS

This positive displacement Hydraulic Torque Converter is the ideal fluid drive with thousands of uses... Output Speeds Infinite .0 to 350 R.P.M. ... in either direction... Change Speeds WHILE RUNNING... Control and Transmit your power this SMOOTH Oil-Way... Will handle 1/4 H.P. to 1 1/2 H.P. Motor. Industrial or Home & Farm Use... Cost government \$300. High Quality Precision Workmanship. Buy this unit to get the most for your money. Case measures 7 1/2" long 7" high 6 1/2" wide. Input & Output Shafts 3/8" dia. Beautiful Red Crackle Finish Case.

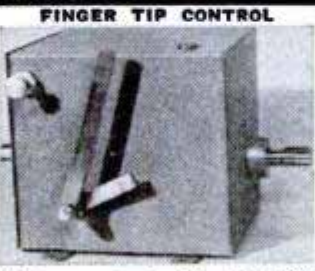

Shipping Wght. 25 pounds **Only \$54.50**  
If C.O.D. is requested a 10% Deposit must accompany order and we ship F.O.B. Chicago.  
**DIRZIUS MACHINE SHOP "1" 1423-25 So. 52nd Ave., Cicero 50, Ill.**



## Repair Bills? NOT IN MY HOUSE!



Fix doors, cabinets, furniture... quickly, easily with

# SKIL Home Shop Tools



Make your leisure hours pay in money and fun with SKIL Home Shop Tools. They take the work out of heavy jobs, speed ordinary repairs and household chores.

SKIL Home Shop Tools are quality-built by Skilsaw, Inc., for 25 years leading maker of portable electric tools for industry. Specially designed for general use in homes, on farms, in hobby work. Priced so low they pay for themselves on a single job! At your favorite dealer's now!



**SKIL Home Shop 1/4" Drill** Light, streamlined, powerful. Model 518 (with hex key chuck)... **\$19.95**

Model 549 (with geared chuck) **\$22.95**



**SKIL Home Shop 1/2" Drill** For heavier drilling in wood, metals. Model 522 **\$39.95** Model 542 **\$43.45**



**SKIL Home Shop Drill Kit** SKIL 1/4 inch Drill and accessories for drilling, sanding, and countless other jobs. Complete **\$41.45**

### ASK YOUR DEALER ABOUT THESE OTHER SKIL HOME SHOP TOOLS

SKIL Home Shop Belt Sander • SKIL Home Shop Saws • SKIL Home Shop Saw Table • SKIL Home Shop Bench Stands • SKIL Trimmer—The electric hedge trimmer



**SKILSAW, INC.** Home Shop Division 5033 Elston Ave. Chicago 30, Ill. C-12

Please send me full information on SKIL Home Shop Tools and the name of my nearest dealer.

Name \_\_\_\_\_  
Address \_\_\_\_\_  
City \_\_\_\_\_ Zone \_\_\_\_\_ State \_\_\_\_\_  
Send Coupon Today for Full Information

**SKILSAW, INC.** 5033 Elston Ave. Chicago 30, Ill.

Prepaid in U.S.A. 2 quarts oil included FREE



## When Screws Won't Stay TIGHT, Use SMOOTH-ON

Apply Smooth-On No. 1 Iron Cement to screw threads and into the screw hole. Insert and tighten up the screw. It will take hold and, when set, will STAY TIGHT, for Smooth-On expands slightly as it hardens, wedging the screw in place. This is only one small use for this general-purpose iron cement. With it you can stop leaks and seal cracks in cast metal parts, tighten loose knobs, casters, tool and utensil handles, make many auto repairs. Buy it in 1 $\frac{3}{4}$ -oz., 7-oz., 1-lb. or larger size at your hardware store. If they haven't Smooth-On, write us.

### FREE 40-page Repair Handbook

Many original uses for Smooth-On around the house, on the car, etc. Simple directions, 170 illustrations. Send postcard for YOUR free copy.

SMOOTH-ON MFG. CO., Dept. 37M  
570 Communipaw Ave., Jersey City 4, N. J.

Do it with  
**SMOOTH-ON**  
THE IRON CEMENT OF 1000 USES



for AUTOS... TRUCKS... TRACTORS



## DON'T "CURSE" WINTER STARTING! INSTALL A SHUR-HETE No. 5 MOTOR WATER HEATER

Get easy starts and actually save money this winter. How? By installing a Shur-Hete No. 5 — it will keep your engine warm all night long by heating the liquid in the water jacket. Operates on regular 110V, AC or DC electric current... consumes only 300 watts per hour.

### Save Time and Money with Shur-Hete No. 5

Eliminate run-down batteries... towing charges... needless engine wear... and wasted gas.

Uses about 5 cents worth of electric power for overnight protection.

Safe to use with any standard anti-freeze.

Will not overheat engine or burn out.

Fits all straight engines with "freeze plugs" 1" to 2 $\frac{1}{2}$ " dia. (Except Ford 6, small Jeeps and V-type engines).

**GUARANTEED only \$9.95**

Shipped parcel post prepaid if remittance is enclosed; Send \$1.00 with C.O.D. orders.

Dealerships Open!

**JOHANSON MOTOR HEATER CO.** 818 W. Webster St. Chicago 14, Illinois

## Birds in Bracelets

(Continued from page 155)

The method of holding the bird for banding depends upon the size of the bird. A small bird is removed from a trap by placing the neck of the bird between the fingers or between the thumb and first finger.

Bands are spread wide enough so they can be slipped over the bird's leg easily. Pliers are used to close the band securely so it won't snag any vegetation.

Frequently, a small bird on its back doesn't realize it is free to depart. A blue jay was placed on the sidewalk so a photograph could be taken. It remained motionless for many minutes, and only fluttered away when it was tickled with a grass stem.

The Fish & Wildlife Service issues banding permits only to persons who are properly familiar with bird species. Others must vouch for their experience. Then the service provides the bands, and the bird student can begin his work.

If you kill a banded wildfowl during hunting season or find a dead bird with a band on its leg, you'll be aiding this widespread research if you report your find. Send the band, or its number, to the Fish & Wildlife Service along with a record of the date and place you found the bird. You don't have to identify the bird, for a check on the number will turn up its history.

The tiny bit of information on this one bird, when combined with hundreds of thousands of reports, provides many vital statistics on our feathered wildlife.

## Driver, Take Your Choice—Life or Death on Ice

(Continued from page 105)

(To illustrate the superiority of chains again, the chain rating was 286 or 154 points better than the mud-snow tire!)

Second best in all-around score was another mud-snow tire, a stud-tread tire which had been lacerated for winter driving. The tread had been cut thousands of times with a sharp instrument to increase the number of gripping edges. This tire had an all-around rating of 128 compared with 100 for the conventional control tire. Two other tires, both conventional treads lacerated for winter, were close behind this second-best tire in the over-all rating.

Tires with embedded materials, such as salt, sawdust, steel chips, steel wool, steel coils or peanut shells, in the tread generally showed up poorly. Although designed as specialized winter tires they failed to prove their value. The best of

(Continued to page 256)

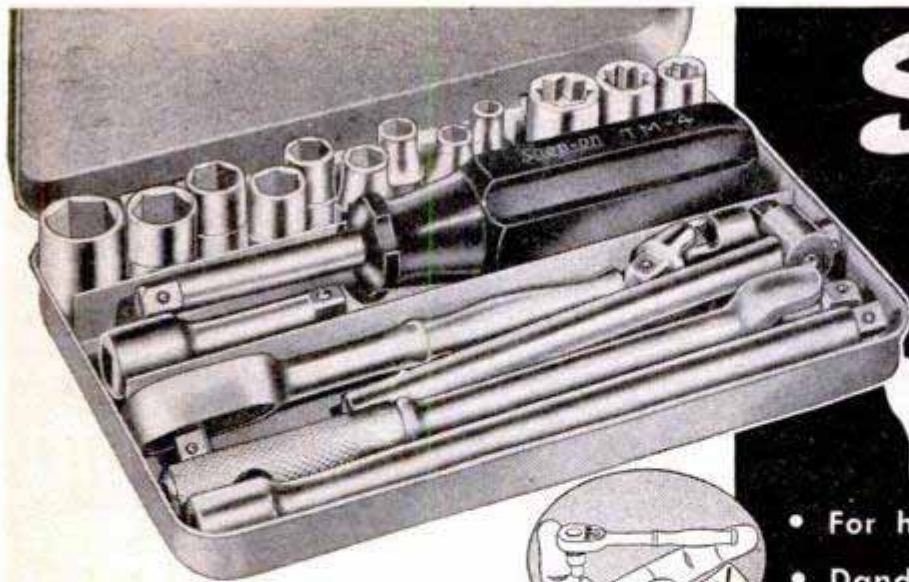

# Snap-on\*

## 19-PIECE MIDGET WRENCH SET

IN RED ENAMEL METAL BOX  
ONLY 6 3/8" x 4 1/4" x 1"

**\$18<sup>05</sup>** POSTPAID  
(Add local tax)



### FINEST PROFESSIONAL-QUALITY TOOLS

Famous Snap-on quality is incorporated in this 19-piece set for countless uses around the home, workshop, garage. Every item forged from finest alloy metals and carefully heat-treated for maximum strength and greatest durability. Add to that, Snap-on's lustrous chrome finish and you own the finest professional-quality wrenches money can buy!

Set includes: 6" Nut Spinner, 2" and 6" Extension Bars, Ratchet, 5 3/4" Plastic-Grip Handle, Sliding Bar, Universal Joint, nine hexagon sockets (3/16" to 1/2") and three square sockets (1/4" to 3/8").

\*Trade-mark of Snap-on Tools Corp.

- For household appliance repairs
- Dandy around the hobby shop
- Television and radio adjustments
- Small instrument and car service

### SNAP-ON TOOLS CORPORATION

8062-L 28th Ave., Kenosha, Wis.

Please send me the 119-TM-B Midget Standard Set.

I enclose  Check,  Money Order,  
 Company Purchase Order.

Name .....

Address .....

City ..... State .....

*Thrilling...  
Mystifying* **ART-LITE PENCIL**

For you alone, the exquisite Parisian charms of Mlle. Arté. Yes, Arté is invisibly captured in your ART-LITE PENCIL until you touch the miracle Injecto-Lite feature and compel her to appear in a vivid full-color natural pose. You'll be amazed and delighted. Pencil is precision built, handsomely gold finished, completely self-powered and automatic.

only **1<sup>00</sup>**

Made to last for years. Order one or more today. Send \$1.00 for each pencil, we pay postage.

**BETTER PRODUCTS CO.**  
154 NASSAU STREET  
DEPT. PR-1, N.Y.C. 7, N.Y.

*Earns*  
**\$100 a MONTH**  
in spare time

with  
**FOLEY  
LAWN  
MOWER  
SHARPENER**



"I did nearly \$100 worth of business in May, sharpening and repairing lawn mowers in my spare time"—says R. D. Fancett. "I figure I made \$100 a month," writes L. R. Michaletz. When you can sharpen 3 or 4 hand mowers an hour with the Foley Lawn Mower Sharpener, at \$1.50 to \$3.00, or 1 or 2 power mowers at \$5.00 to \$8.00 each—just figure out the possibilities for yourself! 99¢ out of every dollar you take in is profit.

**How to  
Sharpen  
POWER  
MOWERS**

**FREE BOOK "HOW TO SHARPEN POWER MOWERS"** shows just how to sharpen any make of power lawn mower with the Foley. Prices \$97.50 to \$159.50—easy payment terms available. Mail coupon today—we'll also send **FREE PLAN** telling how to start your own business without previous experience. No salesman will call.

SEND  
COUPON  
TODAY

**FOLEY MFG. CO., 1207-O Foley Bldg., Minneapolis 18, Minn.**  
Send **FREE BOOK** "How to Sharpen Power Mowers," and **FREE PLAN** on lawn mower business.

NAME .....

ADDRESS .....

## ELECTRICITY *Anywhere*

FOR PORTABLE, EMERGENCY OR HOME USE

**ONAN** Electric Plants furnish modern city-type electric service for homes, farms, cabins and resorts beyond the high-line. Lightweight, portable A.C. and D.C. plants serve contractors, estates, fire departments, etc. Automatic standby plants protect hospitals, radio stations, hatcheries. Over a hundred models—400 to 55,000 watts. *Gasoline or Diesel powered*

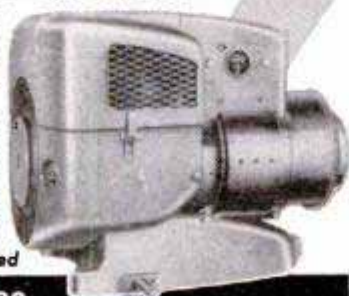

WRITE FOR CATALOG

**D. W. ONAN & SONS INC.**

5840 ROYALSTON AVE. • MINNEAPOLIS 5, MINN.

No. 2728  
 1/2" Combination  
 Box-Open end wrench

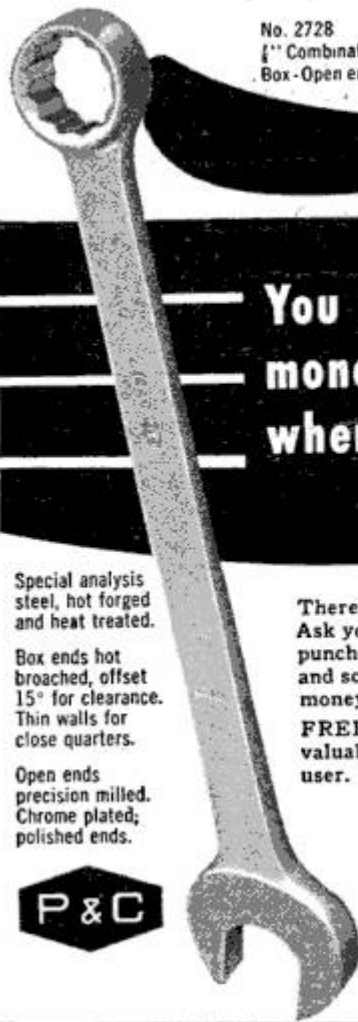

You own the **BEST**  
 money can buy...  
 when it's **P&C**

Special analysis steel, hot forged and heat treated.

Box ends hot broached, offset 15° for clearance. Thin walls for close quarters.

Open ends precision milled. Chrome plated, polished ends.

There is a P&C tool for every job. Ask your hardware dealer for P&C punches, pliers, sockets, wrenches and screwdrivers—the **BEST** tools money can buy.

**FREE TOOL BOOKLET** gives valuable information for every tool user. Send for your *free copy!*



**P&C HAND FORGED  
 TOOL COMPANY**  
 PORTLAND 22, OREGON



**FREE**

**New Christmas  
 Catalog of  
 Mossberg Firearms**

An easy way to solve your gift problems — and to decide what you, yourself, would like. Complete array of rifles, shotguns, telescopic sights and spotting scope—all at Mossberg rock-bottom prices—and all available at your dealer's.

Use the coupon at once to give yourself ample time to decide.



**O. F. MOSSBERG & SONS, Inc., New Haven 5, Conn.**

Sirs: Rush me your New Christmas Catalog of Mossberg Firearms available at my dealer's.

9712

NAME .....

STREET .....

CITY ..... STATE .....

(Zone)

the group was only 10 percent more effective than the control tire while the poorest was, surprisingly, 8 percent less effective than the conventional tread control.

In only one test did any tire match the performance of premium chains. That was in stopping on loosely packed snow where a lacerated mud-snow tire developed a rating equal to the chains.

In traction tests, chains were 600 percent more effective than the control tire. The best tire was only 56 percent better.

What does all this mean? For safest winter driving use premium tire chains. Yet, the Safety Council points out many drivers refuse to use chains. For them, the grooved-lug mud-snow tires are best.

If winter fogs are frequent where you drive, a pair of fog lights is a good investment. These lights must be placed as low as possible on the front of the car for good results. There is usually a gap in the fog just above the road surface and that's where you want to direct the light. Fog lights should have clear lenses. Coloring the lenses, amber or otherwise, does nothing except reduce the amount of light. The secret of a good fog light is its powerful beam that has a sharp vertical cutoff so there is no light above the horizontal.

Sanders are now being used on many trucks and, to a very limited extent, on pleasure cars. When the proper grit is used, they do increase stopping ability and provide added traction for hill climbing. However, they do not furnish protection against side skids. The grit should be sharp, hard and angular. Flat or smooth grit may actually make the ice slicker. When using sanders, never "lock" the wheels. Stopped wheels simply wipe away the grit as they slide along the ice. Intermittent brake application is essential so the tires roll over the grit and grind it into the ice.

The most important winter-driving hint is the simplest: Drive slowly on ice and snow. If you consider 50 miles an hour a safe speed on dry concrete, then on glare ice you should drive only 25 miles an hour even with chains. Without chains, your top speed should be about 15 miles an hour regardless of what tires you're using. These are equivalent speeds and your stopping distances will be the same for each of them.

On loosely packed snow, you're driving the stopping-distance equivalent of 50 miles an hour on dry concrete when you're going 38 miles an hour with chains or 30 to 37 miles an hour without chains depending on the tires you're using.

So slow down this winter and help reduce the death rate. Speed and ice are a deadly combination. Don't give them the chance to kill you.

# General SALVAGE CO.

# THE BIGGEST SURPLUS BARGAIN Sale!

IN YEARS  
BUY DIRECT FROM AD!

## DIRECT CURRENT GENERATORS



FOR ANY WELDING JOB LIGHT OR HEAVY, portable, or D.C. Appliances, PORTABLE AND RURAL LIGHTING, or

power plant. Heavy duty, aircraft quality, air cooled commutator, and lifetime grease sealed ball bearings.

Stock No. 535 - Type P-2, rated 200 amps. 28 Volts. Mfg. by Eclipse-Bendis. Gov't. cost approx. \$300

NEW, ONLY. \$24.50

Used, but in guaranteed condition - ONLY. \$17.50

Build your own light plant (cap. load 5,000 watts) the easy inexpensive way. Simple instructions included for P-2 generator.

Stock No. 537 - Type R-1, rated 300 amps. 30 Volts. Mfg. by Jack & Helutz. Gov't. cost over \$350. New, only. \$32.50

Used, but in guaranteed condition. Only \$17.50

Make your own ARC HEAVY DUTY WELDER the easy inexpensive way of continuous welding, rating 200-300 amps. Simple instruction included, for P-2 and R-1 types. Prices f.o.b. K.C. Ship. wt. approx. 70 lbs.

## DELCO CARBON PILE GENERATOR VOLTAGE REGULATOR

For use with 24 or 32 Volt D. C. Generators. Also recommended for the P-2 and R-1 type generators in "build your own" Light plant. Complete with mounting base. Only \$6.50



## BRAND NEW KIDDE HY-PRESSURE CYLINDER

Filled with CO<sub>2</sub>. Valve and safety locking pin. Applicable as tire inflator, fire extinguisher, spray painting, life raft, etc. Shatterproof. Size 12"x2 3/8". Wt. 3 lbs. Now only \$2.95

## VOLTMETER D.C. Brand New

The basic element of this meter is 30 Volt D.C. Voltmeter with zero center. The internal resistance is 300 Ohms. The dial may be easily calibrated to read D.C. Volts. Price \$3.50 Postpaid

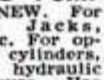

## WEAVERS HYDRAULIC HAND PUMP

BRAND NEW. For hydraulic jacks, presses, hoist, etc. For operating hydraulic cylinders, to pump oil or hydraulic fluid under pressure. Has built in check valve, and is capable of delivering 1000 lbs. pressure. Wt. 10 1/2 lbs. A \$50.00 value. Instructions incl. Price \$7.95 Postpaid

## Valuable Gears Bargains—Speed Reducer

10-1 or 5-1 ratio, 90 degree angle. Shaft driven 1/2" spline Shaft with 3 mounting holes 5/16". Gears held in forged and machined aluminum housing with two needle bearings, one bronze bearing, and three high speed shielded bearings. Sealed self lubricating chamber. Price \$4.95 (Plus 35c postage)

## New Ampidyne Motor Generator

#5AN31N18A—Use as 24/32 Volt D.C. motor, pulls 1/2 H.P. or 0/60 V. D.C. can be adapted to 110 V. A.C./D.C. 10,000 R.P.M. 1/2 H.P. by simple changes in connections. This unit can be adapted to independent and rural lighting, power, etc. Instructions incl. (Stock #790). Gov't. cost \$140.00. Wt. 30 lbs. Only \$5.95



## SENSATIONAL SELSYNS

Two or more connected together. Work perfectly on 110 V. A.C. For weather vane, rotating directional antennas or controlling distance control. Complete with diagram and instructions. Wt. 3 1/2 lbs. PER PAIR \$6.50 Postpaid



## PESCO FOUR VANE ROTARY POSITIVE DISPLACEMENT LARGE VOLUME PUMP

Including built in relief and bypass valve. Capacity 400 G.P.H. 1/2" drive spline shaft, 3/4" pipe inlet and outlets. Rotates either direction or in any position. Ideal for gasoline, oil and various types of sprayers. Engineering data incl. (Stock #600) only \$7.95 Postpaid



## Brand New PURULATOR GASOLINE FILTER.

For all cars, trucks, tractors or boats. Permanent type. \$4.95 Postpaid

## CUNO OIL FILTER — Brand New

Aircraft type. Filters oil without cartridge replacements. Just turn handle and cartridge is clean. Standard 3/8" inlet and outlet ports to accommodate 12 gallons per minute. STOP CHANGING OIL. Instructions incl. \$4.95 Postpaid

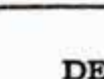

**ELECTRIC MOTOR 1/2 H.P.** 27 V. D.C. R.P.M. 4000 No. 750. For Intermittent or Continuous Duty. 5/8" SHAFT. VARIABLE SPEED MOTOR CAN BE ADAPTED TO 110 V. A.C. or R.E.A. line by simple arranging armature brush leads. UNUSED. Instructions incl. \$5.50

**ELECTRIC MOTOR 1/2 H.P.** 24 Volt D. C. Amp. 22 #HCA24. Gov't cost \$75.00. Brand New. \$4.50

**ELECTRIC MOTOR 1/4 H.P.** 28 Volt D. C. #2832 with simple instructions to convert to 28-32 Volt A.C. Gov't cost \$82.84. Brand New. \$3.50

**ELECTRIC MOTOR 6 Volt D.C. Delco—New** Handles 6" fan blade. Use as windshield wiper motor, hot water car heater motor, commercial or toy applications. 3/4" Dia. 1 1/2" long shaft. Size 5" long X 3". 2 mounting studs. 1200-2000 R.P.M. NEW Only \$2.35 Postpaid

**DYNAMOTORS** Brand New Type DA-3A. Input 28 V. DC 10.5 amps. Output 300 Volts, 150 volts or 14.5 Volts. R.P.M. 4700 Continuous \$5.50 f.o.b. KC

**Dyn., New.** Input 28 V. 19 amps. Output 1000 V. D.C. Base mounting incl. G.E. Model PE-73-CM. Wt. 38 lbs. only \$4.50 f.o.b. KC

**Dyn., New.** Model 23350. Input 27 V. D.C. Output 285 V. D.C. \$1.75 Postpaid

**ECLIPSE MOTOR & GEAR UNIT** Brand New. This is a 24 V. D.C. motor with built in planetary and bevel gear reduction. Has 1- horizontal and 1- vertical take off shaft. Overall gear ratio to motor is 40-1 can be adapted for 2-1 or 20-1 ratio. Unit can be operated from 32 D.C. Farm light plant. Ideal as OVERHEAD GARAGE DOOR OPERATOR, DRIVE FOR SMALL HOIST, WELL PUMP JACK, LAWN MOWER DRIVE, DRIVE FOR POST DRILL, etc. Wt. 23 lbs. Gov't. cost \$221.00. (Instructions incl.) Only \$12.50

**Pesco Vacuum Air—General Purpose Pump** Here is a pump for air, fluid, pressure or vacuum. Standard 1/2" pipe thread. Delivers 300 G.P.H. at 2000 R.P.M. Runs forward or reverse. Self aligning shaft. Spline terminal for direct drive, readily replaced with a pulley. Use them for oil burners, MILKING MACHINES, COMPRESSORS, VACUUM PUMP, etc. Engineering report and instructions incl. Now only \$9.95 Postpaid

**Brand New Wonderful ROTATOR MOTOR** For rotating Ham, FM Antennas, Turntables, Telescopes, etc. Applicable for 110 V. A.C. 60 cycles or for 24 V. D.C. as reversible motor. Approx. 7 R.P.M. Free Swing, Reversible, Light Weight, Rugged, quiet. Motor & Gears oil sealed. Including 3 mounting lugs on motor. Simple instructions & diagram incl. Wt. approx 3 1/2 lbs. Stock No. 572. \$75.00 Value. Now Only \$6.50 Postpaid

**Adel Self-Priming ELECTRIC PUMP** For pumping light oils, oil burners, fluid metering, fuel pump, tool post grinder, coolant, pressure lubricating pump, etc. Double ball bearing series wound motor, continuous duty. 1/30 H.P. rated 12000 R.P.M. Applicable for 24 V. D.C./A.C. or use on 110 Volt A.C. Size 6 3/8"x3 1/8"x3 1/8". Remove pump and use motor as high speed grinder, etc. Diagram and instructions incl. \$50.00 value. \$8.95 Postpaid

**Pesco Centrifugal Heavy Duty Electric Pump** With built in 1/4 H.P. MOTOR included. BRAND NEW. COMPLETE. Self Contained, Explosion proof. Ideal for pumping Gasoline, Oil, Water and non-corrosive liquids. Applicable for 24 V. D.C./A.C. or on 110 Volts A.C. The Discharge is for 3/4" hose connection. Capacity 400 G.P.H. Use them for Cottages, Basements, Laboratories, Boats, etc. Here's your Greatest PUMP VALUE IN YEARS. Engineering data and instructions incl. \$85.00 value. Stock #659 \$12.95 f.o.b. KC. Only \$12.95

**Adel HEAVY DUTY VALVE #D-8660** Here's your four way hydraulic control valve for use with 2 double action cylinders. Each cylinder may be operated independently of the other or in conjunction with the other. Oil may be locked in any of the cylinders to hold the piston at any required position. Brand New. \$60.00 value. Only \$8.95 Postpaid

**Adel PRECISION #10086 Brand New.** For controlling 2 single action cylinders or one double action cylinder. When pressure is applied to one cylinder the return to the opposite cylinder is opened. Connections are for 3/8" pipe thread. Including operating lever 6" long and has quadrant for locking in either position. A tremendous bargain \$8.95 Postpaid

**PESCO FLOW EQUALIZER** & Pressure Balancer Valve. Brand New. Guarantees equal flow and equal pressure for Two cylinders or Two systems. Capacity 360 G.P.H. 1500 P.S.I. Data & instructions incl. A \$75.00 value. Stock 1-D-397 \$60 Value \$12.50 Postpaid

**ROMEK WOBBLE PUMP** Hand lever operated. Ideal for camp, farm, ranch, for fuel transfer to boat, etc. Connections are 1/2" I.P.S. New. \$8.50 postpaid.

**Hydraulic Accumulators—Vickers Ball Type** Dia. 5 1/4". Built to stand 2000 P.S.I. Stock #A-65. Wt. 4 lbs. only \$5.50

**BENDIX or VICKERS ACCUMULATOR.** Ball Type. Dia. 10". Built to stand 2000 P.S.I. Wt. 15 lbs. Stock #A-85. Only \$12.95

**VICKERS CONSTANT DISPLACEMENT HIGH PRESSURE PUMP** Use it for any type liquid pumping job. 375 gal. per hr. at 3750 R.P.M. 1000 pounds pressure per sq. in. Can be used as hydraulic motor. O. Acq. \$100.00. Brand new, directions \$9.95 postpaid

**HYDRAULIC Check & Relief VALVE** \$2.50 postpaid

**VICKERS UNLOADING VALVE** Brand New—By passes full amount output of the pump while the cylinder is not in operation. Takes starting load off of electric motor driving the pump. 1/4" AC TUBE PORTS (3/4"-18) thread. Price \$7.50 postpaid

**AIR OR OIL HYDRAULIC CYLINDERS** Stock No. 33. Double action cylinder Bore 2", Stroke 3", shaft 3/4", Length 13". Shaft extends from both ends of cylinder. Capacity 6285 lbs. with 1000 P.S.I. Has a capacity of 8799 lbs. with our STRATOPOWER pump. Now only \$5.50

**Stock No. 27 Cylinder.** Air operated. Bore 2 1/2", Shaft 2 1/4", Stroke 6", one way Stroke. Can be used as snubber or Brake. Length 15". Wt. 11 lbs. \$6.50 f.o.b. Mo. Stock No. 11 Double Action 1 1/2" Bore, 6" Stroke, 5/8" Dia. Shaft. Clevis mounting base and shaft end. Capacity 1160 lbs. with 1000 P.S.I. input. Has a capacity of 1625 lbs. with our STRATOPOWER PUMP 1400 P.S.I. A \$50.00 value. \$8.50 Postpaid

**HYDRAULIC CYLINDER SPECIAL** Stock No. 12 Gives 12560 lbs. with 1000 P.S.I. input. Capacity 17584 lbs. with our STRATOPOWER PUMP 1400 P.S.I. or will produce 34168 lbs. with 3000 line pressure. Can also be operated on low pressure system. 4" Bore, 8 1/4" Stroke, 1.5/16" Shaft. Clevis mounting O. Gov't cost \$300 A tremendous Bargain only \$17.50

**BRAND NEW Hydraulic CONTROL VALVES** Four way control for use with two hydraulic double action cylinders. Each cylinder may be operated independently of the other or in conjunction with the other. Oil may be locked in any of the cylinders to hold the piston at any required position. Brand New. \$60.00 value. Only \$8.95 Postpaid

**STRATOPOWER CONSTANT DISPLACEMENT HEAVY DUTY PUMP** For operating Hydraulic cylinders, hydraulic motors on Contractors, Bulldozers, Construction machinery, Lift trucks, For fuel or oil transfer, Industrial Applications, etc. Delivers up to 400 G.P.H. at 3750 R.P.M. Rated 1250 to 1400 P.S.I. 3750 to 4500 R.P.M. HAS BUILT IN RELIEF AT HEAD. Rotation either direction without adjustment. Can be used as hydraulic motor \$85.00 value. Engineering data & instructions incl. Stock #37. Wt. 8 lbs. \$15.50

**AIR OR OIL HYDRAULIC CYLINDERS** Stock No. 33. Double action cylinder Bore 2", Stroke 3", shaft 3/4", Length 13". Shaft extends from both ends of cylinder. Capacity 6285 lbs. with 1000 P.S.I. Has a capacity of 8799 lbs. with our STRATOPOWER pump. Now only \$5.50

**Stock No. 27 Cylinder.** Air operated. Bore 2 1/2", Shaft 2 1/4", Stroke 6", one way Stroke. Can be used as snubber or Brake. Length 15". Wt. 11 lbs. \$6.50 f.o.b. Mo. Stock No. 11 Double Action 1 1/2" Bore, 6" Stroke, 5/8" Dia. Shaft. Clevis mounting base and shaft end. Capacity 1160 lbs. with 1000 P.S.I. input. Has a capacity of 1625 lbs. with our STRATOPOWER PUMP 1400 P.S.I. A \$50.00 value. \$8.50 Postpaid

**HYDRAULIC CYLINDER SPECIAL** Stock No. 12 Gives 12560 lbs. with 1000 P.S.I. input. Capacity 17584 lbs. with our STRATOPOWER PUMP 1400 P.S.I. or will produce 34168 lbs. with 3000 line pressure. Can also be operated on low pressure system. 4" Bore, 8 1/4" Stroke, 1.5/16" Shaft. Clevis mounting O. Gov't cost \$300 A tremendous Bargain only \$17.50

**BRAND NEW Hydraulic CONTROL VALVES** Four way control for use with two hydraulic double action cylinders. Each cylinder may be operated independently of the other or in conjunction with the other. Oil may be locked in any of the cylinders to hold the piston at any required position. Brand New. \$60.00 value. Only \$8.95 Postpaid

**Adel HEAVY DUTY VALVE #D-8660** Here's your four way hydraulic control valve for use with 2 double action cylinders. Each cylinder may be operated independently of the other or in conjunction with the other. Oil may be locked in any of the cylinders to hold the piston at any required position. Brand New. \$60.00 value. Only \$8.95 Postpaid

## STRATOPOWER CONSTANT DISPLACEMENT HEAVY DUTY PUMP



For operating Hydraulic cylinders, hydraulic motors on Contractors, Bulldozers, Construction machinery, Lift trucks, For fuel or oil transfer, Industrial Applications, etc. Delivers up to 400 G.P.H. at 3750 R.P.M. Rated 1250 to 1400 P.S.I. 3750 to 4500 R.P.M. HAS BUILT IN RELIEF AT HEAD. Rotation either direction without adjustment. Can be used as hydraulic motor \$85.00 value. Engineering data & instructions incl. Stock #37. Wt. 8 lbs. \$15.50

**AIR OR OIL HYDRAULIC CYLINDERS** Stock No. 33. Double action cylinder Bore 2", Stroke 3", shaft 3/4", Length 13". Shaft extends from both ends of cylinder. Capacity 6285 lbs. with 1000 P.S.I. Has a capacity of 8799 lbs. with our STRATOPOWER pump. Now only \$5.50

**Stock No. 27 Cylinder.** Air operated. Bore 2 1/2", Shaft 2 1/4", Stroke 6", one way Stroke. Can be used as snubber or Brake. Length 15". Wt. 11 lbs. \$6.50 f.o.b. Mo. Stock No. 11 Double Action 1 1/2" Bore, 6" Stroke, 5/8" Dia. Shaft. Clevis mounting base and shaft end. Capacity 1160 lbs. with 1000 P.S.I. input. Has a capacity of 1625 lbs. with our STRATOPOWER PUMP 1400 P.S.I. A \$50.00 value. \$8.50 Postpaid

**HYDRAULIC CYLINDER SPECIAL** Stock No. 12 Gives 12560 lbs. with 1000 P.S.I. input. Capacity 17584 lbs. with our STRATOPOWER PUMP 1400 P.S.I. or will produce 34168 lbs. with 3000 line pressure. Can also be operated on low pressure system. 4" Bore, 8 1/4" Stroke, 1.5/16" Shaft. Clevis mounting O. Gov't cost \$300 A tremendous Bargain only \$17.50

**BRAND NEW Hydraulic CONTROL VALVES** Four way control for use with two hydraulic double action cylinders. Each cylinder may be operated independently of the other or in conjunction with the other. Oil may be locked in any of the cylinders to hold the piston at any required position. Brand New. \$60.00 value. Only \$8.95 Postpaid

**Adel HEAVY DUTY VALVE #D-8660** Here's your four way hydraulic control valve for use with 2 double action cylinders. Each cylinder may be operated independently of the other or in conjunction with the other. Oil may be locked in any of the cylinders to hold the piston at any required position. Brand New. \$60.00 value. Only \$8.95 Postpaid

**Adel PRECISION #10086 Brand New.** For controlling 2 single action cylinders or one double action cylinder. When pressure is applied to one cylinder the return to the opposite cylinder is opened. Connections are for 3/8" pipe thread. Including operating lever 6" long and has quadrant for locking in either position. A tremendous bargain \$8.95 Postpaid

**PESCO FLOW EQUALIZER** & Pressure Balancer Valve. Brand New. Guarantees equal flow and equal pressure for Two cylinders or Two systems. Capacity 360 G.P.H. 1500 P.S.I. Data & instructions incl. A \$75.00 value. Stock 1-D-397 \$60 Value \$12.50 Postpaid

**ROMEK WOBBLE PUMP** Hand lever operated. Ideal for camp, farm, ranch, for fuel transfer to boat, etc. Connections are 1/2" I.P.S. New. \$8.50 postpaid.

**Hydraulic Accumulators—Vickers Ball Type** Dia. 5 1/4". Built to stand 2000 P.S.I. Stock #A-65. Wt. 4 lbs. only \$5.50

**BENDIX or VICKERS ACCUMULATOR.** Ball Type. Dia. 10". Built to stand 2000 P.S.I. Wt. 15 lbs. Stock #A-85. Only \$12.95

**VICKERS CONSTANT DISPLACEMENT HIGH PRESSURE PUMP** Use it for any type liquid pumping job. 375 gal. per hr. at 3750 R.P.M. 1000 pounds pressure per sq. in. Can be used as hydraulic motor. O. Acq. \$100.00. Brand new, directions \$9.95 postpaid

**HYDRAULIC Check & Relief VALVE** \$2.50 postpaid

**VICKERS UNLOADING VALVE** Brand New—By passes full amount output of the pump while the cylinder is not in operation. Takes starting load off of electric motor driving the pump. 1/4" AC TUBE PORTS (3/4"-18) thread. Price \$7.50 postpaid

**GENERAL SALVAGE CO.**  
2922 E. 27 ST. DEPT. 177  
KANSAS CITY, MO.

# This Christmas suggest



**\$169<sup>50</sup>** complete  
except for motor.

With special, 1/2-hp., ball-  
bearing, heavy-duty motor  
(shown)... **\$199<sup>50</sup>**

# Shopsmith

you get a complete workshop . . .

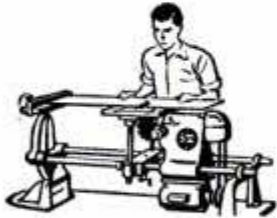

8" CIRCULAR SAW



12" DISC SANDER

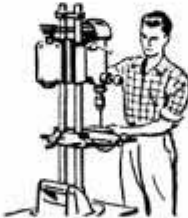

15" DRILL PRESS



33" WOOD LATHE



HORIZONTAL DRILL

your family gets the benefits



FURNITURE



TOYS



OUTDOOR EQUIPMENT

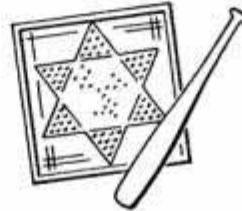

GAMES

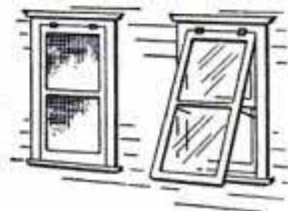

HOME IMPROVEMENTS

What more practical gift could you ask for? For SHOPSMITH is more than high-quality hobby equipment. It's an investment that pays year-round dividends to you, your home and your family. With SHOPSMITH, you can build, remodel, repair. You can save time and money on hundreds of jobs. You can do more, actually turn out better work, than with any \$500 combination of single-purpose tools with motors.

If you know power tools, you'll recognize SHOPSMITH's advantages. Production-shop capacity. Hairline accuracy. Precision features found only in the finest tools, and *extra features* found only in SHOPSMITH.

If you're a beginner, you'll go for SHOPSMITH's compactness, its quiet, vibration-free operation, the ease with which you can convert it from tool to tool—saw, disc sander, lathe, vertical or horizontal drill press—in less than sixty seconds.

Take the family to see SHOPSMITH! Compare it feature-for-feature with any other power tool or combination of single-purpose tools. Compare its accuracy, its capacity, its all-around utility. Compare prices *complete!* At leading hardware and department stores and all Montgomery Ward stores.

## NEW RETRACTABLE CASTERS FOR SHOPSMITH

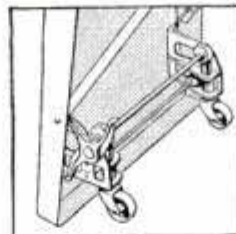

They save space, increase SHOPSMITH'S great flexibility

Now your SHOPSMITH can be completely mobile. Move it, roll it, lock it — on specially designed, three-stage, retractable casters. They're easily mounted on any wood or metal bench.

Easy to set, too — each pair of wheels is operated by a unique foot lever. See your SHOPSMITH dealer. Price complete (4 wheels, 2 levers) . . . \$11.95.

FREE—Attractive 16-page SHOPSMITH booklet



Address:  
SHOPSMITH, Dept. 150-B  
at factory nearest you:  
12819 Coit Road  
Cleveland 8, Ohio, OR  
417 Montgomery Street  
San Francisco 4, Calif.

Please send me the free SHOPSMITH booklet.

Name \_\_\_\_\_

Address \_\_\_\_\_

City \_\_\_\_\_ State \_\_\_\_\_



JUSTRITE

*Yellow-Flash*

**MOST POWERFUL  
FLASHLIGHT  
MADE!\***

**\*Throws powerful  
half-mile  
BEACON BEAM**

- Fishing, Hunting, Boating
- Camping and picnicking
- Farm chores and field work
- Outside home chores
- Roadside auto repairing
- Any purpose needing brilliant portable light

Uses 8 standard flashlight batteries to give 4 times the light of an ordinary lantern. Baked-on enamel body, chrome head. Rust-resistant. 8" high. At your dealer's or send check or m.o. Postpaid \$3.95 without batteries, \$4.75 with. Colorful Christmas box.

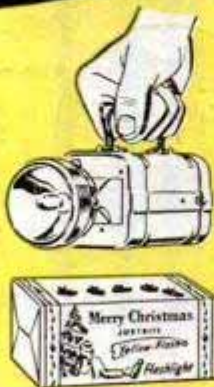

**JUSTRITE MANUFACTURING COMPANY**  
Dept. 11, 2061 N. Southport Ave., Chicago 14, Ill.

## How Fast Can We Fight?

(Continued from page 129)

target a ringed dot called the "pipper," the diamond pattern slides out ahead of the target to indicate the proper amount of lead. This is accomplished by a gyro that operates as a function of the fighter's rate of turn.

These sights are popular with jet airmen; and they are good enough to permit one contestant in the Las Vegas gunnery meet to score, while flying a North American F-86 Sabre, 217 hits out of an allotted 240 rounds of ammunition.

Electronic sighting is, of course, the real answer. And the USAF has this in the remarkable A-1 radar sight, now being service-tested by several operational fighter units, as well as by experts at Wright-Patterson and Eglin Air Force bases.

Although details are still classified, certain information has been released or is immediately obvious. The A-1C has a search function which is followed, in sequence, by automatic ranging and aiming functions. It can be used also in manual operation, and aims rockets or dive-bombing missiles as well as gunfire. In this application, the pilot triggers his release when the target is centered within the circular image or "reticle." In the automatic search-and-aim functions, the guns are fired electronically when the target fills the reticle. Range, lead, and other ballistic factors are compensated for automatically.

Further modification, the USAF indicates, will incorporate a "lock on" function. At a given range, the A-1 will latch onto the target by taking over control of the fighter's auto pilot. Even evasive action will not break the contact. The pilot has only to press an arming switch, then sit and watch it happen. Another significant feature is the new radar scope that projects the target image on an optical flat just aft of the windscreen, in the pilot's normal scope of forward vision.

The high fighter's battleground is the strange region of the "twilight limit," where, in a recent flight to 52,400 feet, this correspondent saw the sky as purple-black in color. Against this weird background a few first-magnitude stars were distinctly visible, despite the sun's brightness. There are too few reflective atmospheric particles at this altitude to scatter the sunlight, and this condition causes the darker sky color. Above this limit there is no twilight. Even in daylight, however, other planes appear as glinting slits of light instead of the dark silhouettes to which the lower-flying pilot is accustomed. Electronic supplement to

(Continued to page 262)



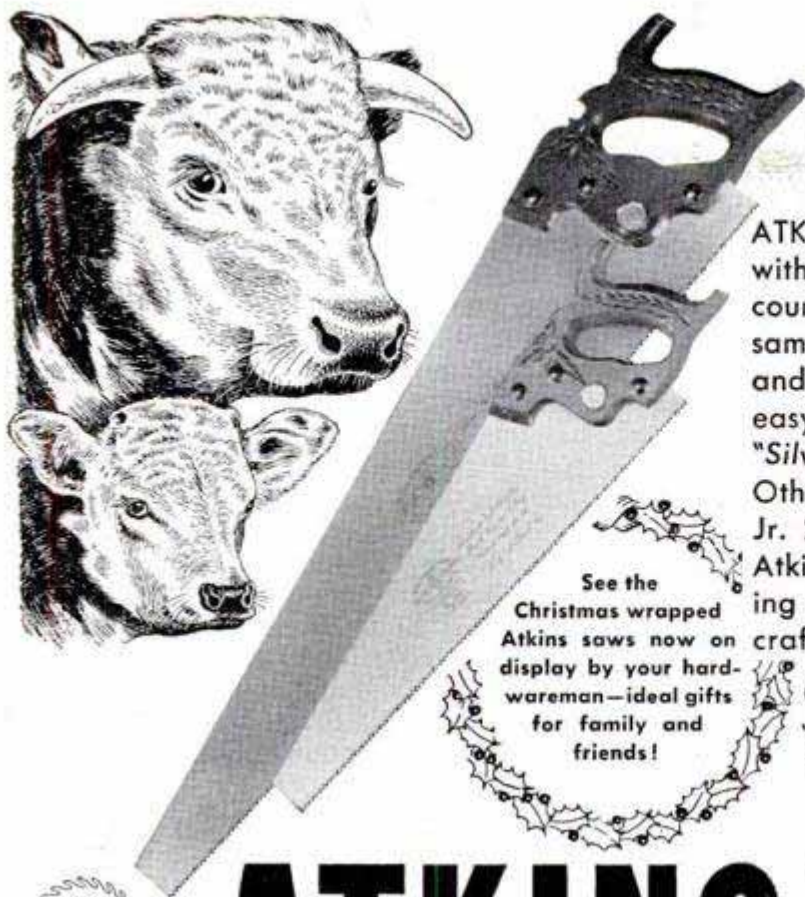

# Champions

ATKINS Jr.-65, identical in everything but size with the famous Atkins No. 65, its larger counterpart—same Perfection-Pattern handle, same super-fine steel, same precision balance and taper grinding! But reduced in size for easy handling by smaller hands! High-speed, "Silver Steel" quality through and through! Other saws in the Atkins Junior Line include Jr. 2, Jr. 4 and Jr. 6 — all small editions of Atkins saws which have proved their outstanding superiorities in the hands of particular craftsmen for many years!

See the Christmas wrapped Atkins saws now on display by your hardwareman—ideal gifts for family and friends!

Only ATKINS makes "Silver Steel" products

ATKINS "Silver Steel" Files — designed for every filing need.



Of all fine saws . . . the finest are "Silver Steel" saws

**E. C. ATKINS AND COMPANY**

Home Office and Factory:  
402 S. Illinois St., Indianapolis 9, Ind.  
Branch Factory: Portland, Oregon  
Knife Factory: Lancaster, New York  
Branch Offices:  
Atlanta • Chicago • Portland • New York



# ATKINS

## BOYS—IT'S FREE!

### "THE WONDERS OF CHEMISTRY"

This exciting new book shows how to amaze your friends with chemical magic. Describes many fascinating home experiments, tells of fun, thrills and big future opportunities for boys who know chemistry. Special atomic energy feature. Send today!

**THE PORTER CHEMICAL COMPANY**  
43 Prospect Avenue, Hagerstown, Maryland



### LATHE GRINDING ATTACHMENT

The New "HURON CHIEF"—A Wet Grinder For 8" to 18" metal lathes! BUILD IT YOURSELF from our semi-machined castings and save \$5. Grinds with coolant on wheel and work. Controls dust and heat. Will grind with the finish and precision of a specialized grinding machine. Does both external and internal work, valve and piston grinding, cutter and tool sharpening, production grinding, etc. WRITE for FREE illustrated folder and price list of castings, parts, grinding wheels, coolant, etc. Mention your lathe.

**HURON MACHINE AND TOOL CO.**  
Dept. B Yale, Michigan



## MAKE HER LOOK YOUR WAY!

Winks and smiles come your way when shoes sparkle and shine. No one is well groomed unless shoes have that patent leather look. It's easy and thrifty to keep shoes smartly shined at home with Shine Boy Shoe Holder. Used by Army and Navy personnel. Fully guaranteed. Lasts a lifetime! Fits men's, women's and children's shoes. No bending. No mess.



SHINE BOY SHOE HOLDER

B. E. CO.

5829 OCEAN VIEW DRIVE, OAKLAND 18, CALIF. DEPT. P

\$2.00

PLUS 25c HANDLING CHARGE  
NO C.O.D.'s

REMOVES WHEN NOT IN USE

# BE INDEPENDENT!

## START YOUR OWN BUSINESS

installing the lifetime BELCO BALL BEARING FAUCET WASHER. Every home, apartment, factory, public building and all types of institutions are prospects. Satisfied customers because you save them money on water, fuel and costly maintenance. Start small with a modest investment, expand on your earnings. Steady profits. Light weight BELCO CONVERTER MACHINE makes short work of converting standard faucets to BELCO.

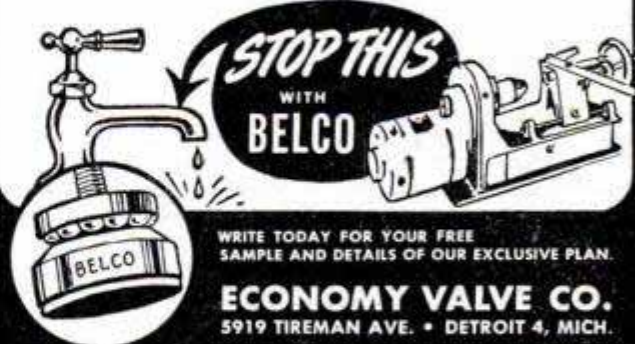

WRITE TODAY FOR YOUR FREE SAMPLE AND DETAILS OF OUR EXCLUSIVE PLAN.

**ECONOMY VALVE CO.**  
5919 TIREMAN AVE. • DETROIT 4, MICH.

## SEND THIS COUPON NOW!

**ECONOMY VALVE COMPANY**  
5919 TIREMAN AVE. • DETROIT 4, MICH.

NAME \_\_\_\_\_  
ADDRESS \_\_\_\_\_  
CITY \_\_\_\_\_ STATE \_\_\_\_\_

SAY YOU SAW IT IN POPULAR MECHANICS

# BUILD YOUR OWN TILTING ARBOR SAW!

Exclusive GIL-BILT Build-It-Yourself Features

- No machining—build easily with hand tools only
- No blueprint reading—step-by-step pictorial plans, full scale patterns, actual photographs
- Sturdy wood, aluminum, and steel construction
- Capacity and performance of commercial saws selling for \$60 and up

SAVE  
**\$50**  
OR MORE

## GIL-BILT 10-INCH TILTING ARBOR SAW



- 27x28 in. table, 13½ in. capacity in front of blade
- 10 in. blade cuts 3¼ in. deep, tilts full 45 degrees
- Floor model 34" high, table always stays level
- New Departure ball bearing arbor, 3/4" precision shaft turned down for 5/8" bore blades, alum. housing, shipped ready to run
- Jackscrew and 4½ in. dia. handwheel lowers and raises blade
- Cast aluminum miter gauge and self-aligning rip fence guide

GIL-BILT Metal Parts Kit includes Plans, ball bearing arbor, miter gauge and bar, rip fence guide, dado insert, lock knobs, jack screw mechanism and handwheel, and all other metal parts (less blade).....**\$20.95**  
Same Kit with 10" Combination Blade **\$24.90**  
Same Kit with 8" Combination Blade **\$23.90**

## GIL-BILT 12-INCH BAND SAW



- Cuts to center of 24 inch circle
  - Handles stock up to 6 inches thick
  - 18x18 inch table tilts 45 degrees
  - Lower wheel and drive pulley runs on sealed New Departure Ball Bearings; Upper wheel runs on two 5/8" bore Oilite Bronze bearings.
  - Upper wheel tension and tilt mechanism of cast aluminum, completely assembled.
  - Upper and lower blade guides. Each has ball thrust bearing, self-lub bronze jaws
  - Rubber tired wheels. Choice of cast aluminum or make-your-own wood wheels on metal hubs.
  - Uses standard 78 inch blades up to 3/8 in. wide.
  - Fully enclosed mechanism for utmost safety.
- GIL-BILT Metal Parts Kit includes Plans, rubber tires, 1/4 inch blade, hubs for wood wheels, ball bearing spindle, tilt mechanism, guides, table tilt segments and all other metal parts.....**\$16.95**  
Same Kit with two machined ready-to-install 12" cast aluminum wheels.....**\$20.95**

Return Kits in 10 days for refund if not satisfied.

(Prices include postage within 600 miles. Over 600 add 5%)

Also available—Plans and Parts Kit for 8" Tilt/Table saw. Order Plans at \$1.00 each—sent postpaid anywhere in the world or write for FREE descriptive catalog.

**GILLIOM POWER TOOLS** P. O. Box 1-PN, Lambert Field St. Louis 21, Missouri

## The JIFFY metal CABINET

### YOUR ANSWER TO SMALL ITEMS STORAGE

at home, office, and shop  
(IDEAL GIFT, TOO)

So handy to keep nuts, bolts, screws, nails, parts, washers, stamps, hobbyists' needs, etc., at your fingertips.



THIS 32 DRAWER UNIT ONLY \$8.95 POSTPAID

Stop searching, get a 32 or 64 drawer Jiffy to keep those small items that usually get mislaid. Spot welded steel, gray enamel finish, metal drawer guides. Dividers included with aluminum drawers make possible three compartments per drawer. Looks good anywhere. Send check or money order, please—no C. O. D.'s. Prices below. Your money refunded if not satisfied. Dealers write for quantity discount.

#### SPECIFICATIONS

##### 32 Drawer Unit

6" Deep  
12¾" Wide  
15¼" High

##### 64 Drawer Unit

6" Deep  
25½" Wide  
15¼" High

##### Drawer Size

1¼" Deep  
2¾" Wide  
6" Long

#### WITH ALUMINUM DRAWERS

##### Dividers and Index Cards Included

One piece rustproof aluminum drawers for heavy service—good for work bench and industry use.

**32 drawer - \$8.95**

**64 drawer - \$15.95**

OHIO ORDERS ADD 3% SALES TAX

Marproof Rubber Feet included with all cabinets

POSTAGE PAID

#### NEW SPECIAL!

**ONLY \$2.95**

**8 DRAWER UNIT**  
(24 compartments)

**16 Drawer Unit \$4.95**  
(48 compartments)

**SPECIFICATIONS**  
6" Deep—8¼" High  
8 Drawer 6½" Wide  
16 Drawer 12¾" Wide

OHIO ORDERS ADD 3% SALES TAX

POSTAGE PAID

**KAYTEE PRODUCTS, Dept. M, Box 588, Canton, O.**

human vision is, therefore, most essential.

Planes such as the Sabre close head-on from the maximum visual distance in about 16 seconds. At altitude, one might not even see the approaching plane unless the eye happened to be focused on just the right sector of sky. "If the other pilot's aim is good, you may never know what hit you," explained Lt. Col. Walker M. "Bud" Mahurin, a top war ace who is now chief of Strategic Fighter Requirements Branch. "For this reason, among others, the element of surprise in transsonic combat is going to be almost frightening."

Because of their all-around armament and visual points of vantage, the bombers are less likely to be "bounced" successfully by unseen fighters. The invulnerability of the high bomber is, for the present at least, almost axiomatic. The difficulty in making high-altitude interceptions and the bomber's superior maneuverability are now generally appreciated. But there are other interesting reasons why modern bombers are hard to kill.

To gain a first-hand understanding of these tactical factors, this correspondent flew as an observer in a recent high-altitude combat demonstration over Andrews AFB. The pilots of the planes involved were two of the USAF's top jet instructors, Lts. Parks M. Rea, who later fought in Korea, and Richard G. Bull.

The F-80B target plane was flown by Lt. Rea along a straight course at 40,000 feet. He maintained a "B-36 speed" of 435 m.p.h. true. Our T-33A, with Lt. Bull flying from the rear seat to give this observer a good view through the gunsight up front, made several high side pursuit curves. Such attacks give the fighter pilot a maximum shooting interval, since he "leads" the target by turning in its direction. Passes were made at a true airspeed of 580 m.p.h. just under the T-33A's Mach number. During four of the six pursuit curves we flew—three from either side, approaching from the target's 3 o'clock and 9 o'clock positions—accelerated stalls were encountered just as the ship banked about 45 degrees into perfect shooting position.

Recovery was made promptly in each case by easing off the radius of turn; but the target plane slid ahead, meanwhile, to a point where our guns could not be brought to bear. These attacks were broken off close behind the F-80B's 6 o'clock tail position. The two shallower curves afforded only a couple of seconds' shooting time, since our plane could not continue to lead the target for any longer period of time. With or without stalling, the gunnery runs ended each time just below the

(Continued to page 264)

# Sale! WAR SURPLUS BARGAINS Sale!

## SPECIAL! MERCURY HEAT CONTROL

Made by Minneapolis-Honeywell—a name known for the best in controls. 1000 watts—115 to 220 volts. Element length 10 ft. Range 70° to 212° Fahrenheit. Control fans, motors, furnaces. This control makes an ideal automatic combination when hooked up to the heat booster below! List price \$16.00. Our price ..... \$4.95



## HEAT BOOSTER

Fits any 8", 9", 10" furnace pipe. 1500 RPM motor with 6" cord, mounting frame, 7" blade. Motor 110 volt 60 cycle 1550 RPM. Easy to install. Silent operation. Warm those rooms with long runs. Stock #583. Regular \$11.95. Your price \$6.95

## STAINLESS STEEL TUBE

HALF PRICE — 6' to 10' Lengths

SIZE	O.D.	WALL	MILL PRICE	OUR PRICE
1/4	3/16	01506	51c Ft.	Ft. 25c
3/8	11/32	01301	63c Ft.	Ft. 32c
7/16	13/32	01508	70c Ft.	Ft. 35c
1/2	15/32	01205	72c Ft.	Ft. 36c
3/4	11/16	05001	91c Ft.	Ft. 46c
7/8	1-3/16	03125	1.01 Ft.	Ft. 50c
1	1-3/16	105	1.10 Ft.	Ft. 55c
1 1/2	1-3/8	05015	1.74 Ft.	Ft. 87c
2	1-15/16	05003	2.20 Ft.	Ft. 1.10
2 1/2	2-7/16	0500	2.74 Ft.	Ft. 1.37

## ALL PURPOSE VISE

Opens to 7 1/4", 4 1/2" wide x 2 1/2" deep. 7" handle, 5/8" sq. thread. Wt. 8 lbs. Use it on the bench as a drill press vise. Ruggedly constructed and an amazing buy. Stock #570—Your price ..... \$2.95



## AIR COMPRESSORS

Gas or electric. Awarded from government.

1/2 HP	12 gal. tank	\$89.50
1 HP	50 gal. tank	\$229.00
1 1/2 HP	50 gal. tank	\$237.00
2 HP	50 gal. tank	\$264.00
3 HP	60 gal. tank	\$325.00
5 HP	60 gal. tank	\$385.00
7 1/2 HP	80 gal. tank	\$568.00
10 HP	80 gal. tank	\$642.00

## CLUTCH

For Motor-scooters, Motor-bikes, Lawn Mowers, etc. Mercury centrifugal clutch for use with any small gas engine. 3" "A" belt pulley. 5/8" bore. Brand new only. Stock #400. \$8.95  
8 1/2" bore. NEW ..... \$9.95  
1" bore ..... \$10.95



## BALL BEARING ARBORS



Grinding and saw arbor, has 1/2" double end shaft, 1 1/2" long with 2" center pulley. New Departure double roll ball bearings. Right and left hand thread. Self aligning Dodge pillow block, 10,000 RPM. Bearings alone list at \$10. Complete arbor new. Stock #305. Only \$4.95

## ELECTRIC RUBBER CABLE

(all new)

## CORD SETS

Extension cords 100 ft. Heavy duty. Plug, socket, and guard. No. 15 wire. Worth at least \$10.00. Stock #310. Our price ..... \$5.95  
Same as above 50' lengths \$4.95



## GENERATORS

300 Watt, RPM 3400. 110 and 220 volt, 1/2" shaft \$40.00; 1000 Watt, RPM 1800. 115 volt AC 60 cycle \$109.00; 2500 Watt, RPM 1800. 115 volt AC \$165.00; 3000 Watt, RPM 2800. 110 volt DC Delco ball bearing, 1" shaft. List \$343.00 to you at only ..... \$99.50

## LIGHT PLANTS

It's unbelievable. 50 to 75% savings. Use for: Farms, cottages, stores, garages, flood-lighting, drilling rigs, refineries, house trailers, fire departments, sound trucks, yachts, fairs, construction, airports, police radios, etc.

5 KW 120 Volts 60 cycle AC. ENGINE: Hercules 4 cycle. Gasoline. GENERATOR: Mfr'd by Hobart Bros. Unit includes remote control cable, 150' 2-wire, #6 and 150' 3-wire, #18, exhaust pipe, power cable plug, remote control stop start switch, automatic volt regulator. Valued at over \$300.00. Continuous duty 6.3 KVA at 80% power factor, frequency meter, radio and television filtered. Unit is completely automatic and cannot be damaged by lack of care. Net weight 770 lbs. Shipping weight 1070 lbs. 44" long, 22 1/2" wide, 30" high, 220 volt output can be supplied on all units at a small additional cost. List price today \$1900.00. Now priced for you at \$895.00. 2500 Watt, AC 115 volt 60 cycle, single phase. ENGINE: Briggs & Stratton, air cooled, 6 1/2 HP. GENERATOR: Westinghouse or Leland, belt drive with guard and Duplex receptacle mounted. NET WEIGHT 310. Gross shipping weight 441. Shipping size 36" x 19" x 20". Complete with \$30.00 worth of spare parts and rubber cable, tools, instructions and fully GUARANTEED. Was formerly priced at approx. \$700.00. Now priced for you NEW only ..... \$295.00  
Reconditioned ..... \$245.00  
Generator NEW ..... only \$165.00  
750 to 1000 watt, all single phase, 110 volt AC NEW ..... \$189.50

VOLTS	WATTS	PRICE
110-220	300	\$89.50
110	5000	\$895.00
110-220	10000	\$1195.00
110-220	25000	\$2100.00
110-220	35000	\$2750.00
110-220	60000	\$5500.00

All units 10,000 watts and over, 110-220 single or 3-phase.

## BOOSTER FAN

10" ball bearing fan Mfg. by Robbins & Meyers. Can be run vertically or horizontally. 110 volt AC 60 cycle motor with plug and cord. New in original box. Use it for the kitchen as an exhaust fan, heat booster, etc. High pitch blade, 1/25 HP 1550 RPM. only ..... \$11.95



## GEAR REDUCER

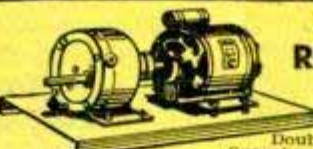

Double reduction. Operates on any 1/6 to 1/2 HP electric motor. 22 RPM. Can be used as winch, barbecue, dummy elevator, operate turntable, electric garage door opener, television antenna. REGULAR \$38.00 NOW ONLY ..... \$16.00

## JARVIS GRINDER

Three phase, 220-440 volt, with flexible shaft; 3450 RPM Totally enclosed motor.  
1 HP List \$165 Now \$65.00  
1 1/2 HP List \$195 Now \$75.00  
2 HP List \$225 Now \$85.00  
1/2 HP, 110 Volt stand & shaft ..... \$39.50

## ALL BRONZE GEAR PUMP



All bronze corrosion resistant Gear Pump. Will lift water 25 feet. Will deliver 1020 gnl. per hour at 1200 RPM. Develops 110 lbs. pressure or 250 foot head. Self-locking packing nuts, drain cock, reversible head. Will pump brine, salt water, oil, vinegar, gasoline, etc. Dimensions—10" L. x 7" H. x 5 1/2" W. Base holes 1 3/8" x 3". Shaft 1 1/16". 1" x 1" inlet and outlet. Wgt. 24 lbs. Mfg. by Sherwood Brass Works. Required 1 to 3 H.P. Motor. \$80.00 Value. NEW ..... only \$24.00  
More H.P. More Pressure  
Same pump. Belt drive, with motor  
1/2 H.P. Motor, 110 Volt, 220 Volt \$77.00  
3/4 H.P. Motor, 110 Volt, 220 Volt \$84.00  
1 H.P. Motor, 110 Volt, 220 Volt \$91.00

## SPECIAL! HOT ROD SUPERCHARGER

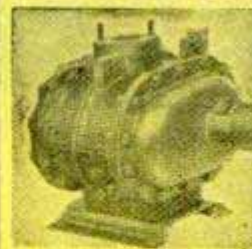

Here's a hot rod supercharger at a price you can't afford to miss. SEE HOW THIS TYPE SUPERCHARGER IS USED IN PICTURE and ARTICLE on Page 67 AUG. Issue of POPULAR MECHANICS. Mfg. by Borg & Warner. SPECIFICATIONS: 7 1/2" wide, 5" deep, 7" high. Weight 17 lbs. Compact and sturdy, 4 base mounting holes. 3/4" outlet, 5/8" shaft. Includes female Lovejoy coupling. Priced today at \$85. OUR SPECIAL SALE PRICE ONLY ..... \$16.95

## HEAVY ELECTRIC CABLE

Electric rubber cable, 20 cond., No. 18, solid, 100 feet or more, per foot ..... \$ 12  
Electric rubber cable, 10 cond., No. 18, solid, 100 feet or more, per foot ..... \$ 08  
Electric rubber cable, 4 cond., stranded, No. 18, water and oil resistant; run in parallel No. 18; 100 ft. \$4.25; 250 ft. \$10.00; 500 ft. \$19.00; 1320 ft. reel ..... \$43.00  
Electric rubber cable, 2 wire, stranded, No. 12; 50 ft. with plug and lugs ..... \$7.00  
Electric rubber cable, 3 wire, stranded, No. 10; 65 ft. with lugs. Val. \$26.00 ..... \$13.00  
Electric rubber cable, 3 wire, stranded, No. 10, submarine cable, underwater, underground, overhead—50 ft., \$15; 100 ft. \$30; 250 ft. \$75; 500 ft. .... \$125.00  
Electric rubber cable, 3 wire, stranded, No. 6—150 ft. reels, with 1 male connector; 2 female, crouse hinds connectors—Value, \$211.00 ..... \$75.00  
Electric rubber cable, 2 wire, No. 4—75 ft. lengths, male & female connectors ..... \$50.00  
Electric rubber cable, 4 wire, No. 6 stranded, heavy duty. List price, \$2.36 per foot; 50 ft. \$30.00; 100 ft. \$55.00; 250 ft. \$125.00; 500 ft. \$225.00; 1,000 ft. reel ..... \$400.00  
Heavy duty R cable, 2 wire, 2.0 carry, 200 amp, 100 ft. \$80.00; 200 ft. \$150.00; 500 ft. \$350.00; 1000 ft. \$600.00.

## Mall Electric CHAIN SAWS

MODEL	BLADE	WT.	MOTOR	AC-DC	Cut	Reverse	Price
1E	12"	11	115	Volts	24"	Reverse	\$ 95.00
22E	18"	20	115	Volts	18"	Straight	\$195.00

(Single Gear)

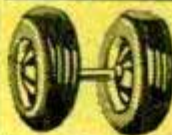

## RUBBER WHEELS

Hollow core rubber wheels made by Goodrich. 2.75 x 10. Ball bearing 1/2" or 5/8" bore. 3 1/2" across hub ..... \$3.95

## BLOCK AND TACKLE

70-Foot 3/4 rope, 1 double block, 1 single block—both have swivel hooks, galvanized tensile strength, 4000 lbs.; No. 6 block, 3 1/2" wheel; weight 27 lbs. Value, \$27.00. Price ..... \$9.95

## HORNS and HOWLERS



Motor driven, (not a vibrator). Heavy duty with great power and long life. Adjustable for high, medium or low tone. 110 volt AC current. Weather proof. For alarm or signal horn on boats, school yards, factories, etc. List price \$47.00. N E W stock #302. Your price \$12.45

## and other bargain items

HEAVY DUTY GRINDER 1 HP, 3400 RPM, 3 phase, 220 Volt 60 cycle, 20 ft. cord, 24" Long, GUARANTEED. Mfg. by Thor & Chicago Pneu. Special SALE PRICE ..... \$29.50  
HAND WINCH Alloy frame, Bronze gears 24 to 1 ratio, 1/4" stainless cable with hook. Lifts 2000# 12" x 10" Wt. 20#. PRICE ..... \$27.50  
ROCKFORD CLUTCH Manual, bronze throw rope 1 1/2" bore, 1" female spline; 5" long, 3 1/2" OD. Takes to 25 HP. PRICE ONLY \$15.00  
STEEL AIR TANK 8"x4" 12 gal. 23 1/2" openings, 1 3/4" open each end, 150# pressure \$7.75. With saddle & legs \$10.95  
POWER PRODUCTS ENGINE 1 HP, 2 cycle, 17 lbs., 2.43 cu. in. disp., 2700 to 3800 RPM, All aluminum. List \$50. YOUR PRICE ..... NOW \$26.50

# ALL ITEMS GUARANTEED C & H ELECTRIC Co. AS REPRESENTED

434 W. JUNEAU AVE. MILWAUKEE 3, WISCONSIN

All prices F.O.B. Milwaukee, 25% deposit required on all C.O.D. orders. No C.O.D.'s under \$10.00. Use stock number when ordering. Many other bargain items not listed—write for our free circulars.

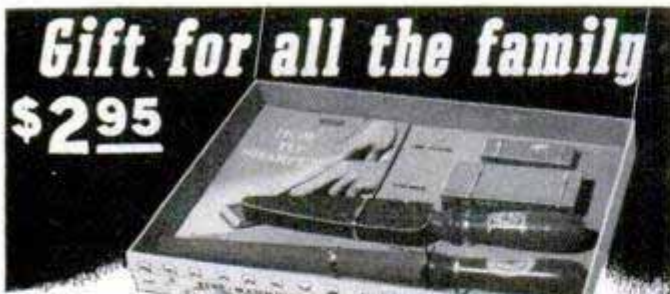

*The*  
**Sharp-N-All\* Home Kit**

Now—*always-sharp* scissors, kitchen knives, carvers, can-openers . . . also garden shears, sickles, scythes, hoes . . . and shop tools of all kinds (including Junior's jack-knife). This set includes four specially selected NORTON Abrasives Sharpening Stones, plus the new 32-page "How to Sharpen" Book telling how experts do it. Give the home a Christmas present of sharp edges on all cutting tools and utensils. \$2.95 at your hardware store — or from us direct.

**AND FOR YOUR SHOP** what better present than a selection of NORTON Abrasives INDIA® Files, ARKANSAS® Slips, a WASHITA® or ARKANSAS Bench Stone? Your dealer has them—or write us.

\* Trade Mark



**Does Difficult Jobs Like Magic**



low as  
**\$1.85**

He'll be more than delighted with this all-purpose tool that packs a world of power. You've never seen such gripping . . . **LOCKS** to work with more than Ton-Grip. Only the Genuine VISE-GRIP has these features: **Involute Jaw Curve** holds all shapes. **Knurled Jaw Tips** won't slip. **Thin Nose, Super Wire-Cutter.** With cutter—No. 7W, 7", \$2.25; No. 10W, 10", \$2.60. Without cutter—No. 7C, 7", \$1.95; No. 10C, 10", \$2.25. No. 7, 6", \$1.85; No. 10, 10", \$2.15.

ORDER FROM YOUR DEALER

Manufactured Only By

**PETERSEN MFG. CO., INC.**

Dept. P-12, DeWitt, Nebr.



"bomber's tail" at distances varying from 30 to 50 yards—point-blank range for tail gunners in a real bomber, even if we had escaped the side armament. That would have been improbable.

The speed differential between fighter and bomber is not high enough—nor does it promise in the immediate future—to afford the fighter pilot sufficient speed advantage. Although our runs were made at 580 m.p.h., the relative closing speed along the pursuit curve was actually this speed minus the F-80B's 435 m.p.h. From a turret gunner's viewpoint, we would have been hanging out in space at a mere 145-m.p.h. speed differential.

The fighter pilot is outgunned by at least two to one during any part of the exchange of fire. For these reasons, pilots currently favor the head-on attack, despite the terrific rate of closure. Less bomber armament can be brought to bear against fighters attacking from the front. Armament such as the Mighty Mouse promises to give the fighters the means to make such head-on attacks profitable.

At the moment, airmen favor the caliber .50 gun for high-altitude combat over the 20-millimeter and caliber .60 guns. Reasons: The reduced mass of the smaller .50 bullet meets with less resistance in the thinner air than do the larger 20-mm. shells. Thus, the .50 has almost equal range at altitude. The explosive effect of the 20-mm. leaves something to be desired, and the USAF wants a thinner-walled projectile which will accommodate greater amounts of explosives. The 20 mm.'s larger cartridge size limits the number of rounds fighters can carry, the same problem existing with the caliber .60 casing, which is nearly as large. For low and intermediate altitude operations, however, the larger guns are favored.

The next logical step in armament is, of course, the AAM (Air-to-Air Missile) robot that homes automatically without any of the present ballistic considerations. Within three years, at least one fighter-borne missile will be available to both services. This is the "Meteor," a 500-pound liquid-fuel rocket with a 25-pound warhead. Another missile under development is the "Oriole," a larger, 1500-pound job powered by a rocket-ramjet and with a range exceeding 20 miles. Both of the new missiles will be able to catch anything in the air with estimated top speeds of Mach number 3.0.

In the race against time, our present weapons progress is reassuring. One of the top ordnance experts answered the big question by saying, "We'll be able to fight as fast as we can fly."

# SURPLUS MACHINE SHOP TOOLS

## HIGH SPEED MORSE TAPER SHANK DRILLS



**SET 1H** 15 Different Size High Speed Morse Taper Shank Drills up to 9/16" with No. 1 and 2 tapers. \$50 value. Priced at only **\$6.49**

**SET 2H** 20 Different Size High Speed Morse Taper Shank Drills from 1/4 to 1". \$70 value. Priced at only **\$12.95**

**SET 3H** 10 Different Size High Speed Morse Taper Shank Drills from 1/2 to 1 1/4". \$50 value. Priced at only **\$9.95**

**SET 4H** 10 Different Size High Speed Morse Taper Shank Drills from 1 to 2" with No. 3, 4 and 5 tapers. \$180 value. Priced at only **\$39.95**

## HIGH SPEED TAPER SHANK CHUCKING REAMERS



**SET 5H** 20 Different Size High Speed Morse Taper Shank Chucking Reamers up to 1 1/2" with No. 1 and 2 tapers. Priced at only **\$6.95**

**SET 6H** 8 Different Size High Speed Morse Taper Shank Chucking Reamers from 1/4 to 1". Priced at only **\$4.95**

**SET 7H** 10 Different Size High Speed Morse Taper Shank Chucking Reamers from 1/2" to 1 1/8". \$65 value. Priced at only **\$9.95**

**SET 8H** 20 Different Size High Speed Morse Taper Shank Chucking Reamers from 1/4 to 1". Priced at only **\$9.98**

## HIGH SPEED STRAIGHT SHANK CHUCKING REAMERS



**SET 9H** 20 Different Size High Speed Straight Shank Chucking Reamers up to 1 1/2". Priced at only **\$6.95**

**SET 10H** 10 Different Size High Speed Straight Shank Chucking Reamers from 1/2 to 1 1/4". Priced at only **\$9.95**

**SET 11H** 15 Different Size High Speed Straight Shank Chucking Reamers from 1/4 to 1". Priced at only **\$6.95**

## HIGH SPEED HAND TAPS



**SET 12H** 14 Different Size High Speed Standard Thread Hand Taps up to 3/4". Priced at only **\$2.95**



## HIGH SPEED MILLING CUTTERS

**SET 4** High Speed Milling Cutters. Set consists of two side 13H milling cutters, size 2 x 3/8 x 5/8" arbor and two side milling cutters, size 2 x 3/16 x 5/8" arbor. Set of four priced at only **\$3.95**

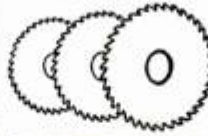

## SLITTING SAWS

**SET 7** Different Size High Speed Slitting Saws 2 3/4" dia. x 1" arbor. Thickness from .040 to .071. Cuts wood, aluminum, brass, steel, etc. \$25 value. Priced at only **\$4.95**



## BRAND NEW HIGH SPEED COMBINATION DRILL AND COUNTERSINKS

**SET 8** Different Size from C2 to M1 (1/16 drill x 13/64 body to 7/32 drill x 5/8 body) 60 degree 15H of countersink. These new countersinks sell new from 75c to \$2.50 each. Your price for this set of 8, while they last, only **\$3.95**

# HYDRAULIC DEPARTMENT

## BRAND NEW HYDRAULIC UNIT

Pesco 1P203 GearType Hydraulic Pump rated at 3 G.P.M. @ 3750 R.P.M. and 1000 P.S.I. Priced at only **\$6.95**



Discounts on quantity.

## 1500# Reconditioned PESCO HYDRAULIC PUMP

Gear type, rated 1500 PSI, 2 1/2 G.P.M. at 1500 R.P.M. 5/8" drive spline. No. 1P203 reconditioned guaranteed. Priced at only **\$6.49**

## FOUR WAY HYDRAULIC VALVE

High pressure Adel valve for controlling one cylinder or other hydraulic equipment. 3/4" pipe ports. Heavy steel construction. Priced at only **\$5.98**

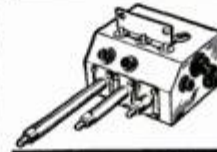

## Master Hydraulic Control Valve

Will operate 1 or 2 hydraulic cylinders independently of each other or together by means of 3 control handles. Rated at 1000 PSI. Valve made of heavy steel with standard pipe ports. Cost new over \$125. Priced to you at only **\$6.95**

Write for our catalog describing thousands of machine cutting tools, hydraulic equipment, etc.

All merchandise is sold with money back guarantee of satisfaction and is shipped postpaid unless otherwise stated.

**T & T TOOL, 101 West Archer, Tulsa, Oklahoma**



# EASY TO INSTALL LOW-COST TELEPHONE SYSTEMS

Save Time & Steps With ARMY FIELD

# TELEPHONES & WIRE

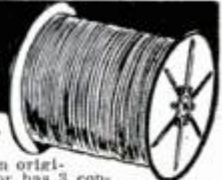

Genuine Battlefield-Proven Equipment. Same as used by UN forces in Korea.

Hundreds of uses anywhere. You can install field telephones and have communication in a matter of minutes. Just string this low-cost, 2-conductor, weatherproof wire, attach to phone terminals and you are ready to ring and talk any distance. Simple as that. You can use from 2 to 8 phones—any number you may require—on the same line. No maintenance required. All prices FOB Sacramento. No COD. (Calif. residents add 3% for sales tax.) Small orders sent postage collect, heavy orders freight.

**TELEPHONE WIRE**  
This is genuine WWII Army Field Wire on original steel reels, 2-conductor. Each conductor has 3 copper, 4 steel strands for extra tensile strength. Excellent for all-weather, all-purpose communication. Used extensively by telephone companies, industry, engineering projects, ranches, etc., for extended field communication systems.  
**NEW, unused, excellent condition per mile (wt. 160 lbs.) \$16.00**  
**1/2 mile (wt. 80 lbs.) \$8.25 NEW, unused, good, serviceable condition per mile.....\$12.50**  
**1/2 mile.....\$6.75**

### EEB FIELD TELEPHONES

Factory reconditioned—new  
Ea. \$15.00 Per pr. \$29.50

Reconditioned—excellent  
Each \$12.50 Per pr. \$24.50

Send check or money order

**LORIS SALES, P. O. Box 1896-B-12, Sacramento, California**

# PROFESSIONAL TYPE BUFFING WHEELS

KIT OF 5 COMPOSITIONS

by Mail

**\$175**

(Reg. Val. \$1.95)



## AND COMPOSITIONS

For best buffing results, depend on DICO—by the world's leading producer of buffing wheels for industry. Whatever your buffing job, you'll find the right DICO wheel and composition to do it. For free Buffing Manual, write Dept. B-1250.

**DIVINE BROTHERS CO.**

**UTICA, N. Y.**

ASK FOR

**Dico**

AT YOUR  
HARDWARE  
STORE

# Buy the Best... WISS!



for all sheet  
metal cutting

## WISS Metal Master Compound Action Snips

#M-3. Easily cuts 18 gauge sheet metal. Cuts curves and circles as well as straight. Ideal for the home workshop. \$4.25. Rubber grips recommended, 60¢ extra.

## WISS Straight Cut Snips

#9. Crucible steel inlaid blades. The basic snips for straight metal cutting. Gun metal handles. Overall length 12½". \$5.00.

## WISS Combination Snips

#V-13. Solid steel, gray japanned handles. Cuts curves and irregular shapes with ease. Handy pocket size, 7" long. Accurately tempered jaws and strong bolts. \$1.75.



Prices slightly higher  
Denver and West



Quality for more than a Century

J. WISS & SONS CO. • NEWARK 7, N. J.

## DU-FAST<sup>®</sup> OSCILLATING MOTION SANDER



## ... BEST VALUE BAR NONE!

Where in the world can you get FULL ½" OSCILLATING MOTION . . . LARGE 3-2/3" x 7" FAST-WORKING SURFACE THAT USES INEXPENSIVE STANDARD CUT PAPERS . . . LIGHT WEIGHT FOR EASY CONTINUOUS USE?

Where in the world can you get the economy and convenience of a powerful sander and polisher that attaches in 10 seconds to any Home Utility Black & Decker ¼" Electric Drill? Or (another Du-Fast model) that attaches just as easily to any Skil Home Shop ¼" Electric Drill?

Where can you get the safety that permits you to sand or polish with absolutely no chance of gouging, marring, swirling or burning? YET GIVES A PERFECT FINISH EVERY TIME?

See your nearest hardware dealer carrying either Skil or Black & Decker tools. ASK TO SEE AND TRY A DU-FAST UNIT . . . YOU'VE GOT A PLEASANT SURPRISE COMING!



DU-FAST OSCILLATING SANDER powered by Home Utility B & D ¼" Electric Drill.

ONLY \$14.95

FOR ATTACHMENT!



DU-FAST OSCILLATING SANDER powered by Skil Home Shop ¼" Electric Drill.

ONLY \$14.95

FOR ATTACHMENT!

\*Pat. Applied For

MANUFACTURED BY

## DU-FAST, INC.

32 East Fourth Street

New York 3, N. Y.

## I Rode the Airlift to the Orient

(Continued from page 97)

Three routes across the Pacific are followed by the thundering planes of the Pacific airlift. Shortest is a Great Circle course via McChord Field near Tacoma, Wash., thence to Anchorage, Alaska, out along the Aleutian Island chain to Shemya, and in to Tokyo. It adds up to 5688 miles. Flying time: 30 hours.

The other two routes chart a mid-Pacific course that is longer, but boasts better weather the whole way and has island strips capable of handling the wham of huge, heavily loaded aircraft setting down on them incessantly. Both routes leave Fairfield-Suisun for Hickam Field in Honolulu—the longest overwater hop in the Pacific: 2470 miles. Flying time is 9 to 12 hours, depending on the plane and wind. From here, the newer MATS craft and the commercial contract planes hop to Wake Island or Midway—two chunks of coral about the size of La Guardia Airport, and just as busy—then in to Tokyo. Total distance for the whole route is 6772 miles. Flying time: 36 hours. This was the route we were to follow.

Smaller, or more heavily loaded military planes go island-hopping out of Hickam, via Johnston, Kwajalein, Guam, Tokyo, for a total of 8083 miles. It takes them 45 hours.

From Tokyo, speedy shuttle planes take over the cargoes and move into battlefront areas. This is the newest wrinkle in air-lifting, known as "hose supply." The shuttle planes are the "nozzle" of the Air Force "hose." As this is written, the nozzle is aimed at Kimpo Airfield, just outside Seoul, Korea. But at any moment it might be turned toward Indo-China, the Philippines, Formosa or any other place where troops and supplies are needed.

Most of the airlift planes carry a basic crew of five, including pilot, co-pilot, navigator, radioman and engineer. Though crews lay over at way points to rest, fresh crews replace them and keep the plane moving. Except for fueling and checking, planes seldom spend more than an hour or two at any stop.

In emergencies, they may fireball through in much less than the average time. That's what happened when U.N. troops in Korea needed something—and fast—to stop Red tanks. Within a matter of hours, big 3.5 bazookas, with shaped-charge rocket ammunition, were flying from interior arsenals in great trains of four-engine sky freighters. The bazookas were delivered right to the front lines by airlift in less than 30 hours in many cases.

(Continued to page 268)

# Protect That Expensive Gift!

with **MARVEL MYSTERY OIL**

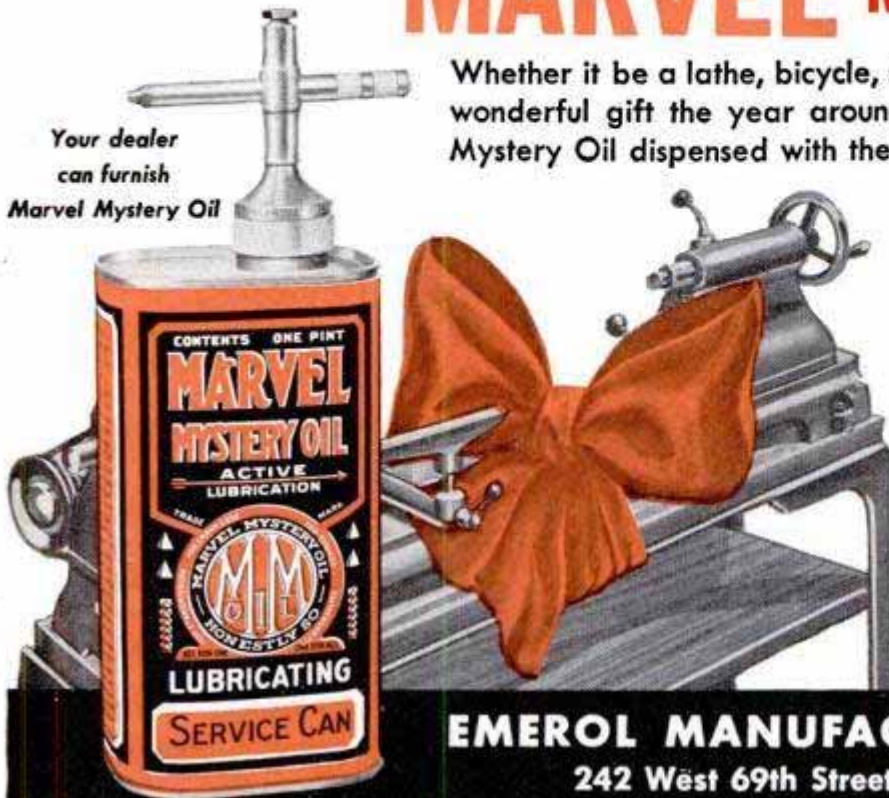

Your dealer  
can furnish  
Marvel Mystery Oil

Whether it be a lathe, bicycle, shot gun, or fishing reel, protect that wonderful gift the year around from rust and wear with Marvel Mystery Oil dispensed with the Marvel Oil Rifle.

The Marvel Oil Rifle — handy, economical, clean. Throws a needle-like stream of oil 15 ft. Easy to operate, gets in hard to oil places.

Guaranteed! Only if Marvel Mystery Oil is used.

Complete set — Oil Rifle with one pint can for Marvel Mystery Oil **\$3.50**.

Ask your dealer and get expert advice about the Marvel Oil Rifle or write for free information. Dept. 124

**EMEROL MANUFACTURING CO., INC.**  
242 West 69th Street, New York 23, N. Y.

## ALLISON "E" END PLATES

Price **\$75.00** each

Fit all Allison

**GROSSO & GROSSO**

7502 WHEATLAND SUN VALLEY, CALIFORNIA

## HANDY-DAPTOR

CONVERT YOUR 1/4" DRILL TO 1/2"  
Simply insert adaptor shank in 1/4" chuck. HANDY-DAPTOR chuck takes all bits to 1/2" incl. Send..... **\$2.95** direct if dealer cannot supply. For bargain Motor & Power Tool catalog, send 25c. Refund on 1st order. Daniels Products Co., 2224 N.E. 18 St., Oklahoma City, Okla.



## NOW DADO ANY WIDTH

**WITH DA-DALL!**  
Pat. Pend. U.S.A. & For

A simple turn of a screw adjusts your saw to any desired Dado cut! DA-DALL cannot slip, is self-tightening, self-adjusting, of all-steel construction does a clean, true job!

**ONLY \$4.95**

DA-DALL cuts hard or soft wood, plywood, without chipping! No blades or complicated dials. All arbor sizes  
**RULE-WAGNER CO**  
Box 694, Dept. D-8  
Walnut Creek, Calif.

Dealers, Jobbers Write for Information



Make 100% to 150% Profit!

## MANUFACTURE BUILDING BLOCKS In Your Own Back Yard



**AMAZING GENERAL BLOCK MACHINE**  
CAPACITY 1000 BLOCKS PER DAY  
only **\$218** LESS MOTOR  
F.O.B. PLANT  
SHIPPING WEIGHT 400 lbs.

Here is an outstanding opportunity for men of vision and small capital. Cinder and concrete blocks are in great demand. Millions used for homes, factories, public buildings. Sell all you produce at 100% to 150% mark-up.

**PEAK BUILDING DEMAND!**

The General Block Machine is amazingly practical, foolproof. Simple to operate indoors or outdoors. Rugged all steel construction. Vibrator mounted in sealed ball bearings. Produces up to 1,000 blocks per day. Superior 3 Core Type that meets all building code requirements. Can produce 4 x 8 x 16, 8 x 8 x 16, 12 x 8 x 16 blocks. All materials obtainable anywhere. All operating instructions and mixing formulas supplied. Full details FREE without obligation.

**HOW TO BUILD YOUR OWN CONCRETE BLOCK HOME**  
Only 1' Prepaid

Wonderful Book Written & Illustrated by Experts

## GENERAL ENGINES CO.

DEPT. P-15 • 307 HUNTER ST. • GLOUCESTER, N. J.

Includes floor plans for 6 beautiful, easy to build concrete block bungalows. Shows ways to save money. How to lay blocks, lay out building lines, mix concrete, build steps, porches and concrete floors. Mail coupon at once with \$1.

Name.....  
Address.....  
City..... Zone..... State.....

**FOR SURE  
QUICK STARTS**

**INSIST ON  
BOWES**



**Corrodeless**

**TERMINAL  
Battery Cables**

Most battery cable trouble starts at the terminal because of corrosion or bad fit. Bowes "Seal Fast" battery cable terminals positively will not corrode. They are specially engineered, tailored to fit the posts snugly, assuring longer cable life and full power from your battery. Stop battery cable trouble before it begins. For sure, positive starts insist on Bowes "Corrodeless Terminal" Battery Cables—then you'll get all the power your battery is designed to give you.



**BOWES  
DEPENDABLE  
SPARK PLUGS**

**Assure**

**SMOOTHER  
MOTORING**

There is a Bowes Spark Plug specially designed for your car! Oversize Special Alloy Electrode—with welded construction for positive connection assures longer life. One-piece, leakproof construction.

Every Bowes Plug is individually tested to assure complete motoring efficiency. **INSIST ON BOWES SPARK PLUGS FOR SMOOTHER MOTORING.**



**BOWES "SEAL FAST" CORPORATION  
INDIANAPOLIS 7, INDIANA**

Sitting in the cabin of a big MATS plane, thrumming along over the cloud-specked Pacific with no land to be seen for a thousand miles in any direction, is a monotonous job. Pilots spend their time shooting the breeze, watching the nightmare of engine and flight instruments, and listening to the crash-crackle of the radio.

The latter is the principal means by which MATS operations at Fairfield keeps track of every plane in the air. Position messages, sent in every hour by planes in flight to the nearest Airways Communications Center, are relayed to a bustling office at Fairfield. Here, the position of each plane is transposed to a big position-plotting board. If a plane is in bad shape on fuel, the boys at Fairfield may realize it before the captain of a plane 2000 miles out in the Pacific is aware of his predicament.

In the vast areas of the Pacific, radio is apt to be whimsical. Pilots work whatever stations they can, skipping around the bands until they find one. "For instance," explains Charles Huffman, radioman on our big MATS Stratofreighter, "sometimes we can't raise Honolulu one hour out of the place—but we can read Fairfield, eight or nine hours away—or perhaps Seattle or Anchorage. Any contact will do, and if there's a station alive anywhere, I'll find it." Positions are relayed instantly to the proper station for further relay to the control center.

Moving wartime freight swiftly to battle-front destinations is only half of the Pacific airlift story. Even more ingenious is the removal of wounded from front-line aid stations back to the States in these same big planes which, in a few moments' time, change from barren freight boxcars to fully equipped aerial ambulances. All across the Pacific, technicians with typical American ingenuity have had to invent and rig equipment to handle this unprecedented cargo. I saw special ramps and lifts with which stretcher bearers load the big planes in half the usual time. Big ambulances, made from fleets of bakery trucks, carry nine litter patients each. At one place there's a huge 30-litter ambulance made from an old truck trailer.

And I listened to the medicos talk about the big, double-decked C-97 becoming a regular air hospital, with wards on the upper deck and surgery below. It was on one of these huge Boeing planes that I rode out across 6700 miles of blue Pacific with a load of high-priority cargo. Later I returned with 64 litter patients, a crew of 12, three nurses, two flight attendants and two medical technicians. But that is the subject of another article.

(Continued next month)



**AIR  
COOLED**

**4  
H. P.  
DIESEL  
\$275<sup>00</sup>**



SEND FOR DESCRIPTIVE FOLDER

**Crofton**  
**DIESEL ENGINE COMPANY**  
San Diego, California

**CARBURETOR TOO RICH  
MAKES MOTORIST TOO POOR**



Car owners who are wasting money and not getting proper gas mileage due to over-rich mixtures will be pleased to learn how to save gasoline by VACU-MATING over-rich mixtures. VACU-MATIC fits all cars, trucks and tractors. It is automatic and operates on the supercharge principle. Easily installed in a few minutes.

**SALESMEN WANTED!** Big Profits! Send name, address on penny postcard for free particulars and how to get yours for introducing.

VACU-MATIC CO., 7617-1688 W. State St., Wauwatosa, Wis.

**Easy to Play!** **The Musical Saw**  
**The Glass-O-Phone**  
**The Musical Pitchfork**  
**Jazz-O-Nette, Flute-a-Phone**

If you can whistle or hum a tune, you can play these Novelty Instruments. Low priced. Write for FREE literature.

**MUSSEHL & WESTPHAL, Established 1921**  
10 FORT STREET, FT. ATKINSON, WISCONSIN

BEAUTIFIES natural wood, pine paneling

POLISHES furniture, woodwork

IMPROVES paint jobs

PROTECTS wood and metal surfaces

49¢ 89¢  
PINT QUART

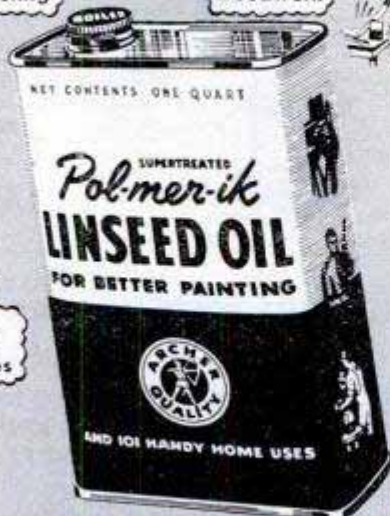

**101 HANDY HOME USES!**

Every home, every workshop, needs Pol-mer-ik BOILED Linseed Oil. Available at all stores. Free folder tells you how to use it. Write Dept. 603 . . .

ARCHER-DANIELS-MIDLAND CO., Minneapolis 2, Minn.

JUST LIKE

**Roy Rogers**

"KING of the Cowboys"

Delight a small  
**BUCKAROO**  
this Christmas

(Roy Rogers is shown using the SHOPMASTER Belt and Disc Sander)



BUILD THIS **ROCKING BRONCHO**  
WITH \$1.50 WORTH of LUMBER and YOUR

**SHOPMASTER tools**

Watch the shine in his eyes when he sees this hi-spirited bronc. You'll feel like a real dad! A little wood, a few of your happiest spare-time minutes and Shopmaster tools are all that's needed! For complete plans of this Rocking Broncho send 50c to SHOPMASTER, INC.



**15" Tilting Table Jig Saw**

This simple, easy-to-operate Jig Saw will do all types of intricate sawing. The 10" square table tilts up to 45 degrees. You'll be amazed at the work possible with this tool.

Priced in Zone 2 \$27<sup>95</sup>  
(Slightly Lower in Zone 1)

There are 16 different SHOPMASTER Tools to fit every purse . . . To fit every job.



Send for FREE Catalog

**SHOPMASTER, INC.**

1214 Third St. S., Minneapolis, Minn.

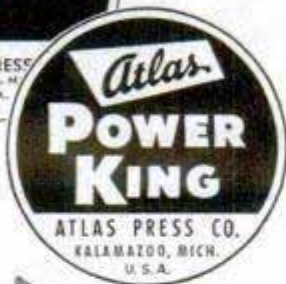
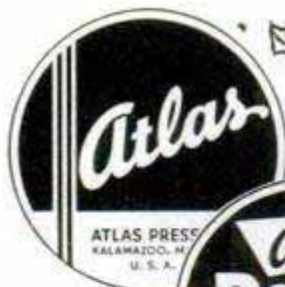

# Atlas and

## The Greatest Selection of Fine Tools



**Atlas**  
10" FLOOR SAW  
NO. 3170



**Atlas**  
10" FLOOR SAW  
NO. 3160



**Atlas**  
10" BENCH SAW  
NO. 3060



**Atlas**  
8" BENCH SAW  
NO. 3020



**Atlas**  
12" BAND SAW  
NO. 912



**Atlas**  
BELT and DISC SANDER  
NO. 5010



**Atlas**  
SPINDLE SHAPER  
NO. 3500



**POWER KING**  
SPINDLE SHAPER  
NO. 411



**Atlas**  
15" FLOOR DRILL PRESS  
NO. 1060



**Atlas**  
15" DRILL PRESS  
NO. 1020



**Atlas**  
12 $\frac{3}{4}$ " DRILL PRESS  
NO. 1010



**POWER KING**  
11 $\frac{1}{4}$ " DRILL PRESS  
NO. 611

Whatever kind of work you want to do in your shop—woodworking, metalworking, or plastics machining—there's an Atlas or Power King tool to meet your needs *precision engineered and built to industrial quality standards!*

They are backed by nearly 40 years of Atlas tool building experience. They are the finest low cost tools you've ever seen—designed for great

est efficiency, ruggedly built for smooth operation and a lifetime of service, and each one including distinctive and exclusive features to help you do more and better work.

The various tool sizes enable you to select the capacity you want at the price you want to pay. Equip now for the busy years ahead in your shop. Ask your Atlas or Power King dealer for full details.

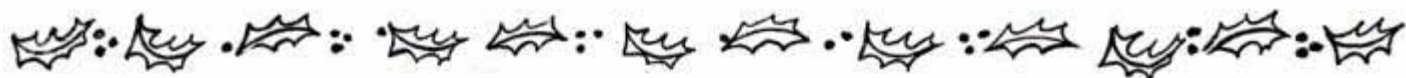

# POWER KING TOOLS

*for Your Shop Ever Produced by One Manufacturer!*



**POWER KING**  
8" BENCH SAW  
NO. 3102



**POWER KING**  
7" BENCH SAW  
NO. 3001

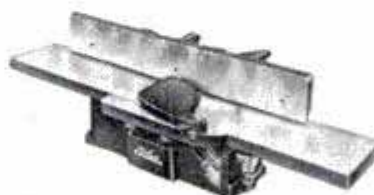

*Atlas*  
6" JOINTER-PLANER  
NO. 6000



**POWER KING**  
4" JOINTER-PLANER  
NO. 6050



*Atlas*  
24" JIG SAW  
NO. 4021



**POWER KING**  
18" JIG SAW  
NO. 4010



*Atlas*  
12" WOOD LATHE  
NO. 7122



**POWER KING**  
9" WOOD LATHE  
NO. 7090

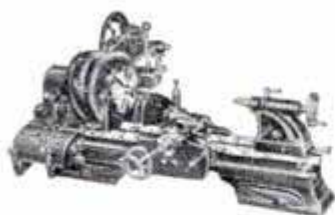

*Atlas*  
10" QUICK-CHANGE LATHE  
NO. QC42



*Atlas*  
6" LATHE  
NO. 618



*Atlas*  
7" SHAPER  
NO. 78

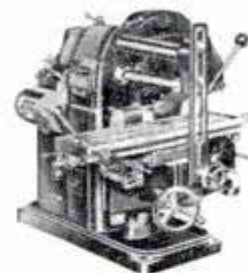

*Atlas*  
MILLING MACHINE  
NO. MFC

See Your *Atlas*  
or **POWER KING**  
Dealer Today — or  
SEND for CATALOG

ATLAS PRESS CO.  
1243 N. Pitcher St., Kalamazoo, Mich.

Please send catalog of  Atlas woodworking tools  Atlas metalworking tools  Power King woodworking tools.

Name \_\_\_\_\_

Address \_\_\_\_\_

City, Zone, State \_\_\_\_\_



# Speed Way

## Speed Drills

Advanced designs, new all-die-cast (aluminum) construction and bigger motors. Lighter, handier, yet faster-drilling than more expensive, more cumbersome old style drills. Drill steel, wood, concrete or stone rapidly and efficiently.

**No. 400** 1/2" capacity—more power than drills costing almost double. Jacobs Geared Chuck, removable top handle. **\$39.50**

See these new Speed-Drills before you buy; for more drill per dollar and more power per lb.



**No. 200** 1/4" capacity. Fast-drilling with added power. **\$16.50**  
With Jacobs Geared Chuck. **\$19.50**

**No. 79** 3/8" capacity—power of ordinary 1/2" drill. **\$22.50**  
With Jacobs Geared Chuck **\$27.50**



Write for Circular on drills, grinders and sander

**Speed Way MANUFACTURING CO.**  
1863 So. 52nd Ave., Cicero 50, Illinois



### EASY PROFIT IN PAINT SPRAYING

Paints walls, ceilings, screens, furniture and machinery faster, better. All complete as shown less motor. Carry anywhere. Fully guaranteed. Could be used with 1/4 H.P. motor or less. Price **\$35.00** less motor F.O.B. Chicago. \$5.00 deposit balance C.O.D. or see your dealer. With motor \$55.00.

**IDEAL AUTOMATIC PUMP CO., Dept. P.M.8**  
801 W. Washington Blvd. Chicago 7, Ill.

## ALNICO MAGNETS LIFT 125-lb.

**AMAZING PERMANENT MAGNETS — WILL NOT WEAKEN! NON-ELECTRIC.** Retrieve guns, tackle, tools and other steel items from lake, river, plating tanks, drains or other hard-to-reach spots. Recover drills, taps, etc. from floor sweepings. Clear alley of harmful tacks, nails. Many other uses listed. Pays for itself quickly. **GUARANTEED!** Try any magnet one week. Money refunded if you are not well-pleased. Cat. No. 430 (has a pull of 125 lbs. on a flat steel block) . . . \$7.50  
Cat. No. 410 (40 lb. pull) \$2.50. Cat. No. 528 (10 lb. pull) \$1.00  
Cat. No. 500—Hobbyists assortment of seven medium magnets \$1.25  
**MIAMI MAGNET CO.**  
3240 N.W. 27th Ave., Aviation Bldg. No. 43, Miami, Florida

## BARGAIN! BRAND NEW! SPINNER!

only **\$57<sup>50</sup>** Save **\$25!** REG. \$82.50  
7-in. disc

**While They Last — Direct From Manufacturer**  
Uses 7-in. or 9-in. disc—Sands, grinds, wire brushes, etc. Makes tough jobs easy. 1/2 h.p., Heavy Duty Motor, 10-day, money-back guarantee. No C.O.D. Send check or M.O. TODAY — while they last! Californians add 3% State Sales Tax

**HOLT MFG. CO.** 651 20th Street | 272 Badger Avenue  
Oakland 12, Calif. | Newark 8, New Jersey

### BUILD FINE GRANDFATHER CLOCK NOW

The simple sensible Red-i-Kut way as thousands have—**SAVE HALF. SHOP TESTED PLANS "SPIRIT OF THE CENTURY"** Narrow waist 83" tall or stately straight side **"SPIRIT OF AMERICA."** **EASY-TO-FOLLOW** photo-**copy** PLANS tell all — plus **BROCHURE** of heavy brass weight Westminster, tube chime, movements, *gorgeous* dials, 3/4" solid mahogany case kits. Send **\$1.00** today — Both Plans **\$1.50** NOW.

**KUEMPEL CHIME CLOCK CO.,** 28 Kuempel Bldg., Minneapolis 16, Minn.

### NONE BETTER! SUPER DRILL GRINDER

Sharpens round shank drills from 3/32" to 1/2" in diameter, up to 6" long. Grinds old drills like new in 4 different point angles, using hand or power grinding wheels. Money-back guarantee.

Price only **\$2.95**  
At Dealers or Postpaid

**CRANDALL MFG. CO.** 1512 W. Stauson, Dept. FA-54, Los Angeles 44, Calif.

### LEATHER AVIATORS HELMET

**NO HOOKS, TUBES OR HOLES**

Cordovan brown leather NAVY Aviators helmet with warm fleece lining. Brand new. Detachable chin strap. Perfect for cyclists, flyers, farmers, hunters, . . . all outdoor wear. Children love them! Best helmet service had. Cost Gov't. \$10.00. Sizes small, medium, large. Send check, cash, M.O. COD's plus postage accepted. Money back guarantee. **\$1.75 p.p.**

**GRAND-HAWTHORNE SURPLUS**  
1439 S. E. Grand, Dept. PM-11, Portland, Oregon

### BRONZE FOUNDRY

Schools and Home Workshops

Make your own castings of aluminum, copper, bronze, silver. Foundry sets are available in three sizes including 2400 Deg. F. blast Furnaces. \$22.50; \$29.50; and \$42.00. f.o.b. Kansas City. Free Circular.

**KANSAS CITY SPECIALTIES CO.** P. O. BOX 6022, DEPT. P-12  
KANSAS CITY, MO.

### Have fun! BUILD YOUR OWN CHAMPION SPEEDBOAT

Build your own 3 point racing Hydroplane or Runabout! Complete plans available for fastest boats in the world. Send 25c now for new illustrated catalog to **CHAMPION BOATS**, P. O. Box 7132 M, Long Beach 7, California

## The Chief WORK BENCH

*Built to Last a Lifetime!*

With Bottom Shelf and 18" Sq. Drawer. 2"x6", Solid Plank, Grooved and Dovetailed Top and 1"x8" Back Rail, Shellacked to a Smooth, Satiny Finish.

**MOHAWK LUMBER CO.** Dept. 33  
14525 W. Chicago Blvd. Detroit 27, Mich.  
Enclosed  Check  Money Order for \$.....  
Ship..... **CHIEF WORK BENCHES** at  
Quantity  
\$19.95 each, F.O.B. Detroit, Mich.  
 Send C.O.D., \$5 Deposit Enclosed.

• 6 Ft. Long • 34" High • 26" Deep. Shipped Knock-down, with Bolts, Nuts and Screws and ABC Chart for Quick, Simple Assembly.

*Prompt Delivery*  
**MOHAWK LUMBER CO.**  
14525 W. Chicago Boulevard  
DETROIT 27, MICHIGAN

**A CHRISTMAS PRESENT HE'D APPRECIATE**

**\$19<sup>95</sup>**  
F.O.B. DETROIT

Send Check or Money Order, or Will Ship C. O. D. (\$5 Deposit)

NAME.....  
ADDRESS.....  
CITY..... STATE.....

## A NEW PAINT BRUSH PROTECTOR



THE AUSTIN BRUSH SAVER (Patent Pending) does away forever with hooks, wires, drilling holes in paint brush handles and other makeshift methods of brush protection. Just place brush in the AUSTIN BRUSH SAVER as illustrated, set in liquid container and forget it. It will clean itself, retain its shape and stay chisel sharp. It costs a few cents, but will save many dollars. Remember good brushes are expensive and are becoming scarce. Available in three popular sizes. 2"-3"-4" at 69¢, 79¢, 89¢, or set of three for \$2.00 postpaid. If more convenient when ordering single units send dollar bill, money order or check, correct change will be packed with brush saver.

**AUSTIN MACHINE & TOOL COMPANY**  
36 COLEBROOK STREET HARTFORD 12, CONN.  
No C.O.D. or stamps

### Each Christmas more thousands give HULL AUTOMOBILE COMPASSES

EVERY CAR OWNER on your list will appreciate a handsomely designed, accurate, scientific instrument that always shows the right way to turn, at a glance. Write for literature.

**STREAMLINE**

standard \$3.95

**Beaconlite**

illuminated \$5.95

HULL MFG. CO.,

P. O. BOX 246-D12  
WARREN, OHIO

At Your Dealer's

## CASH IN YOUR SPARE TIME



**BIG MONEY IN OWN BUSINESS**  
YOU CAN MAKE UP TO \$40 A DAY sharpening and setting circular saws for factories, builders, lumber yards — with NEW BELSAW COMPLETE CIRCULAR SAW SHOP. LOW COST, Sharpens 4 to 5 saws per hour, no experience needed, complete instructions. Send today for FREE Catalog.

**BELSAW MACHINERY CO**

3702 Field Bldg.

Kansas City 2, Mo.

# K-R-O KILLS RATS

• K-R-O BIS-KITS are ready-made, easy to use; containing fortified red squill, they're safer around livestock, pets, and poultry. K-R-O POWDER is 100% fortified red squill; economical to use in badly infested areas when mixed with natural baits. BIS-KITS, 35c and \$1.00; POWDER, 75c at drug, seed, and feed stores. Money-back guarantee. The K-R-O Company, Springfield, Ohio.



*Just dial* ANY WIDTH CUT ON YOUR SAW



WITH

**Warren**

**DADO SAWING WASHERS**

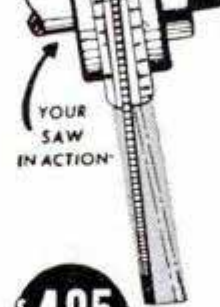

\$4.95 SET

Cut clean, accurate, parallel grooves—12 widths, any angle. No chatter, burning, chewing—or sanding! No more blade vibration—no screws to fuss with—just four balanced washers. Simply dial desired width with Micro-matic adjustment. Can be left on blade for straight cuts. Available in 5 sizes— $\frac{1}{2}$ ",  $\frac{3}{4}$ ",  $\frac{5}{8}$ ", 1",  $1\frac{1}{8}$ ". A perfect gift for woodworkers. See your dealer or write—

**WARREN WASHERS CO.**  
Dept. 32 • 70 Medbury • Detroit 2, Mich.

**LUFKIN SUGGESTS...**

**CHROME-CLAD  
MEZURALL tape-rules**

You can stop shopping around right now—here's the one gift that everybody appreciates... a genuine LUFKIN Mezurall Tape-Rule

Chrome-Clad non-glare finish blade will not chip, crack, peel or corrode! Markings are easy-to-read—durable. Patented self-adjusting end hook provides accurate butt-end and hook-over measurements. Blades are replaceable. Case handsomely finished in two colors. Select the size you want at your nearest hardware dealer or tool store.

C-926—6 ft. size \$1.70  
C-928—8 ft. size \$1.95



**Buy LUFKIN**

104-A

THE LUFKIN RULE CO. • TAPES • RULES • PRECISION TOOLS  
SAGINAW, MICHIGAN • New York City • Barrje, Ontario

**NEW  
Saginaw  
BALL-BEARING  
BUMPER JACK**

- SAFEST, STURDIEST BUMPER JACK EVER BUILT!
- PRESSED-STEEL TUBULAR SHAFT—RIGIDLY ATTACHED BASE.
- SAME PRINCIPLE OPERATES AIRPLANE WING FLAPS.
- HANDLE CAN'T SPIN WHILE CAR IS IN AIR—FOLDS OUT OF WAY FOR STORING.
- FITS EVERY BUMPER.
- ROLLING BALLS REDUCE FRICTION—A CHILD CAN OPERATE IT.

AVAILABLE NOW THROUGH YOUR UNITED MOTORS DEALER OR USE THIS COUPON



United Motors Service, Dept. S-31  
General Motors Bldg., Detroit 2, Mich.  
Send me information about the new Saginaw jack, and where I can buy it.



**Guard Against ATOMIC RADIATION DANGER with a compact, low-cost Beck SAFERADE**

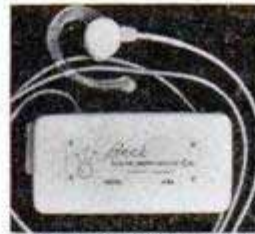

Ideal for civilians, defense groups, atomic workers, miners, X-ray tech., lab. workers, etc.

Carefully engineered pocket-size Geiger counter. Both neon and head-phone indicators. If the neon flashes radiation is too high for safety. Complete with full instructions; nothing else to buy. Guaranteed for 90 days against defects in materials (except batteries) and workmanship.

FREE LITERATURE ON REQUEST **\$37.50** Cash with order ppd in U.S.

BECK INSTRUMENTATION CO. 310 - 17TH ST., OAKLAND 12, CAL.

**MARCOT KEY MACHINE**



MARCOT No. 8 KEY MACHINE, less motor... \$95.00  
Auto Code Book and Depth Keys... 12.50  
75 Dz. Popular Key Banks... 60.00  
Set — Key File, Follow-Through Rods, Lock Picks, Bit Key Gauge, Thimble, Pins, Springs... 10.50  
"Locksmith Trade Books"... 6.75  
How to Open Locks without Keys or Picks, Secret of Locksmithing: How to Make Keys by the Impression Method; Master Key Systems. TOTAL COST... \$184.75

Immediate Delivery  
A. J. MARCOTTE CO., 1200 N. Kedzie Ave., Dept. PM, Chicago 51, Ill.

**TERRIFIC POWER, NO "PUMPING"!  
WITH CROSMAN'S NEW CO<sub>2</sub> GUNS**



Amazing new "Power without Powder" principle adds new thrills to shooting the Crosman CO<sub>2</sub> Pistol and Rifle with safety indoors or out. See them at your Crosman dealers. Write for free literature. Crosman Arms Co., Inc., Rochester 7, N.Y.

**THRILLS! TRAVEL! ADVENTURE!  
RIDE THE NEW 1951**



**HARLEY-DAVIDSON Hydra-Glide**  
Share in this glorious fun! Make new friends. See faraway places. Be free to go when and where you wish... with the exciting new 1951 Harley-Davidson Hydra-Glide, world champion! Amazingly smooth, powerful, beautiful. See your dealer. Write for FREE ENTHUSIAST magazine and literature. HARLEY-DAVIDSON MOTOR CO. Dept. P, Milwaukee 1, Wisconsin

**SUMP PUMPS**

2,400 GALLON CAPACITY

1 1/4" outlet — No screen to clog — fool proof

The time tested Lokomona sump pump is absolutely automatic—has a special fool-proof trap at the intake—oilless bearing at the bottom. Made of aluminum castings, it's 42" high and carries a 1/4 H.P. 110 V. A.C. heavy duty motor. The pump is designed for continuous service. Enclosed switch. All parts always available. Order yours today. C.O.D. If cash with order, we pay postage.

**\$39.50** COMPLETE  
**\$24.00** LESS MOTOR  
**\$19.75** PUMP ONLY



MONEY BACK GUARANTEE  
LOKOMONA PUMP CO., P.O. BOX 86, ROYAL OAK 1, MICH.

**LAWN ORNAMENT-NOVELTY PATTERNS**



28 Lawn Ornament Patterns, 25c. Other patterns; 15-20" high: Dutch Girl, Dutch Boy, Pirate, Bull Terrier, Mexican Girl, Mexican Boy, Dwarf, Penguin, Flower Girl, 10c each. 25 Novelty Patterns, 30c. All 62 Full Size Patterns, \$1.00 Postpaid. Strother Pattern Service, Dept. BZ-8, Box 128, Belington, W. Va.

Say You Saw It in Popular Mechanics

**SPORTSMAN'S REFRIGERATOR BAG**

New! National Sportsmen's Research Award Winner for 1950! Simply place fish or game inside, pack with ice, zip it closed. Refrigerates up to 50 lbs. Keeps cold hours longer. Automatically drains off moisture. Weighs less than 2 lbs. empty. folds into small packet, goes into auto glove compartment.



Send check or money order **\$6.95** Postpaid  
FLEXIBLE PRODUCTS CO., 2708 WRIGHT AVE., RACINE, WIS.

# BRAND NEW SURPLUS UP TO 85% DISCOUNT



**Portable LIGHT PLANT**  
PUSH BUTTON START  
(Item 24)  
500-700 watts 110-120 v. — 60 cyc. A.C. Powered by a sturdy dependable, easy starting, air cooled 2 hp. gas engine. No wiring necessary, just plug in and operate. Plenty of current for oil burner, emergency lights, freezer, radio, incubator, etc. Complete protection against current failure. Ideal for hunting or camping. Complete with Voltmeter and built-in winding to charge 6 v. auto batteries. Wt. 85 lbs. Fully guaranteed. Be prepared if electric power fails. Reg. \$275.00 value..... **\$138.50**



**EXTENSION CORD**  
(Item 16) 40 ft. heavy duty, made of specially insulated No. 14 2-conductor wire. So tough that you can drive over it and yet amazingly flexible and easy to handle. Resists oil, grease or water. Extends electricity up to 400 ft. without voltage drop. Use indoors or out. Complete with heavy rubber plug and outlet. Wt. 2 1/2 lbs. Usually \$4.50—Special 40 ft. \$1.99. Comb: 2-40 ft. and 1-20 ft. (total 100 ft.) \$4.95. Ideal for Christmas.



**HEATING & VENTILATING FAN**  
(Item 10) Easily installed in furnace pipes or on oil heaters. Forces even heat to all rooms. Over range, removes kitchen smoke and odors. Powerful continuous duty motor, 110-120 V. A.C. Quiet, super efficient fan moves huge volume of air (400 to 600 c.f.m.) 8" Fan \$5.95, 10" Fan \$7.95, 12" Fan \$8.95.



**GAS ENGINE**  
(Item 25) Air-cooled, 1 1/2-2 h.p. Complete with gas filter, air cleaner, governor, fuel tank. Ready to run. Speed range 2000-3600 r.p.m. 5/8" shaft. Rope start. Ideal for pumps, air compressors, power tools, generators, etc. One of the best made. Wt. 40 lbs. Worth \$62.50. Special **\$38.50**.



**ANGLE DRILL**  
(Item 23) Fits into chuck of any electric or pneumatic drill or flex. shaft. Operates at any angle in a full 360° arc. Makes possible drilling, grinding, carving, routing, etc. in close cramped quarters. Makes impossible jobs easy. Made by Kett Tool Co. Complete with built-in chuck and adjusting key. A precision tool. Lists at \$39.95—while they last **\$9.95**.



**FRAM OIL FILTER**  
(Item 12), Model F21. Big 73 cu. in. size. Ample capacity for all cars, trucks, tractors. Universal bracket, standard openings. Fram filters are tops. Easy to install. Wt. 8 lbs. Usually \$7.95—now **\$3.75**.



**PARTS WASHER**  
(Item 20) Store gas or carbon tet. in 5 gal. safety can. Valve releases just the right amount into washing compartment. Parts are washed and drained on a "dunking" screen—no fishing for parts. Eliminates fire-danger, waste, spillage, evaporation. Wt. 8 lbs. Reg. \$19.50—Special **\$4.95**.



**GAUGE TESTER**  
(Item 27) Precision made of solid bronze by Star Brass Co. Calibrated weights (incl. acting against hydraulic piston, provides quick, accurate testing of all pressure gauges up to 3000 lbs. per sq. in. Brand new in hardwood cases. Wt. 100 lbs. Reg. \$435.00. Our Spec. **\$125.00**.



**PRESSURE SWITCH**  
(Item 30) Penn Electric Model 110 BPO2, best made. For pumps and air compressors. Heavy duty. Will handle up to 250 lbs. press. and up to 5 h.p. Autom. unloader valve, for easy starting. 110-220 v. A.C. or D.C. 2 pole. Wt. 4 lbs. Reg. list \$17.50. Our Spec. **\$8.95**.



**CLIP BOARD**  
(Item 17) Heavy Masonite, with self-adjusting spring hinge to hold up to 100 sheets of 8 1/2 x 11 paper. Push back cover for instant release. Flip cover shut and notes or drawings are protected. Perfect for pilots, engineers, students, artists, truck drivers. Wt. 2 1/2 lbs. Usually \$2.95. Spec. \$1.10. 2 for **\$2.00**.

All items BRAND NEW. Prices f.o.b. Chicago area. Money back guarantee. Send check or M.O.  
**The A & K EQUIPMENT & SUPPLY CO., Dept. 54, Burlington, Wis.**

Get  
**Into the  
BIG PAY  
Welding  
Jobs**

## WELDS anywhere! Earns MORE PROFIT!

Cash in on big paying repair and emergency service jobs with this Gas Drive Combination A.C. Welder and A.C. Power Unit. It's actually two machines in one. Lets you make arc welded repairs or flip a switch and operate A.C. lights, tools, motors, etc. Makes you independent of power lines and brings you extra money on emergency break down jobs. Find out how easy it is to own one of these profitable 2 in 1 units. Write today for details and free catalog. **HOBART BROTHERS COMPANY, BOX M-1201, TROY, OHIO.**

**HOBART** "One of the world's largest builders of arc welders"





**GERSTNER Tool Chests**  
Most machinists and toolmakers hope to own a genuine GERSTNER High Grade tool chest. Choose yours now from free catalog.  
**GERSTNER TOOL CHESTS**  
450 Columbia St. Dayton 7, Ohio



**EV-READY MIRACLE SHOE RE-SHINER** BEAT the HIGH COST OF SHINES  
\$1 postpaid for complete family set. 3 Re-Shiner Mts.  
Polish is in the cloth permanently. Gives you not 10, not 20, but hundreds of shines. Fast & simple to use. Clean—no messy hands. One each for Dad, Mother & Junior. For black & brown shoes. Satisfaction assured. Order today. Send check or M.O. C.O.D.'s accepted. 7 day money back guarantee.

Needlecraft Pad Corp., Dept. PM, 234 W. 39 St., New York 18



10 Days Free Trial—Prepaid or C.O.D.  
**8 Mile Range — High Grade BINOCULARS \$5.**  
Made in U.S. Optically accurate, center focusing, hinged body Binoculars, with high-powered 30 mm lenses, giving a clear, sharp field of vision of 100 yds. Width at 1,000 yds. distance. Case & Straps included. Marvelous for hunting. All Sports or as a gift. Tax included. Money Refunded if dissatisfied.  
**BENNER & CO., PO Box 426-PM, Trenton 3, N. J.**

## TODAY'S BIGGEST PREFAB BOAT BUY

Build a better boat than you can buy. Save up to 55%. See OZARKA's deluxe line of trim, top-quality 12- and 14-footers with exclusive laminated rib construction, all-oak frame and other features, for motors up to 25 H.P. Send 25c for complete Boat & Accessory Catalog, to be refunded on first purchase. **OZARKA, INC., 6120 BORDEN LANE, WOODSTOCK, ILL.**



**OZARKA**

## Give Him the All Time Favorite Gift for Boys! Electric STEAM ENGINE

First, SAFE ELECTRIC WORKING MODEL At This Amazing Low Price **\$4.95** WHISTLES While It Works

Plenty of Power - Speed!  
Fun for EVERYBODY!

The dandiest performing steam engine you've ever seen. One filling of water, and it runs a full hour. Heated by electricity so no fire hazard to youngsters from matches, canned heat or alcohol lamp. A well made educational toy—40-lb. pressure tested boiler is drawn from high tensile, cold rolled steel for extra safety—long life. Has counter balanced, machined crankshaft, a two-cycle piston, steam whistle and pop off valve. Nickel finish. Stands 8 3/4" high, works off standard 110 volt AC or DC current.



FULLY GUARANTEED  
Insured by LLOYD'S of London

**MAIL COUPON TODAY!**

**STEAM ENGINE INDUSTRIES**  
1511 Davenport St. Omaha, Nebr.  
Enclosed find remittance for \$4.95  
Check  Money Order   
Send complete Steam Engine as described above, complete with warranty. Postage paid.

Name \_\_\_\_\_  
Address \_\_\_\_\_  
City \_\_\_\_\_

XMAS GIFT For "Boys" 6 to 60

SAY YOU SAW IT IN POPULAR MECHANICS



No. 37-595 Saw-Jointer Combination — 6" jointer. 10" tilting-table saw. Cuts 3 1/4" stock. Rips to center of 50" panel. Joints 1/2" deep by 6" wide . . . . . \$259.00\*

No. 40-305 24" Scroll Saw — The smoothest-running saw you can buy. Cuts up to 1 3/4" thick. Table tilts left, right, front . . . \$102.45\*

No. 14-007 14" Bench-model Drill Press — Has free-floating, self-aligning drive for always-accurate work. 4" quill stroke. Capacity, 1/2" cast iron . . . . . \$79.50\*

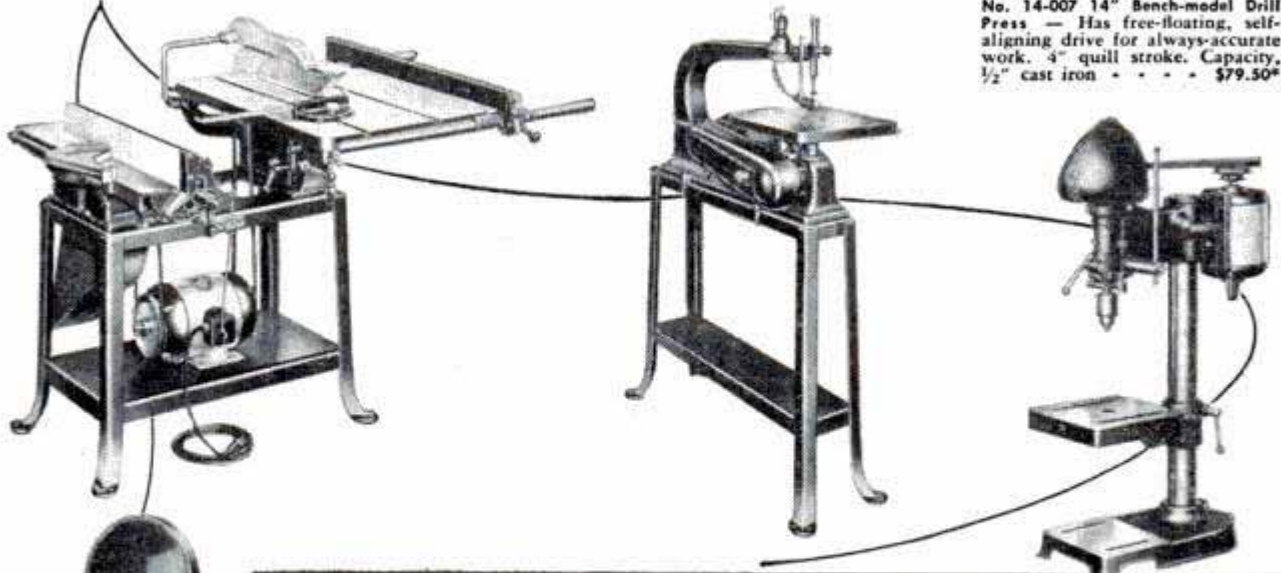

No. 28-205 14" Band Saw — Takes 6 1/4" under guide. 30 3/4" blade to frame. 14" x 14" table tilts 45° right, 10° left . . . . . \$162.50\*

No. 20A Delta Multi-plex® Radial Arm Saw — Does more than 125 jobs! Complete with motor and switch . . . . . \$205.00

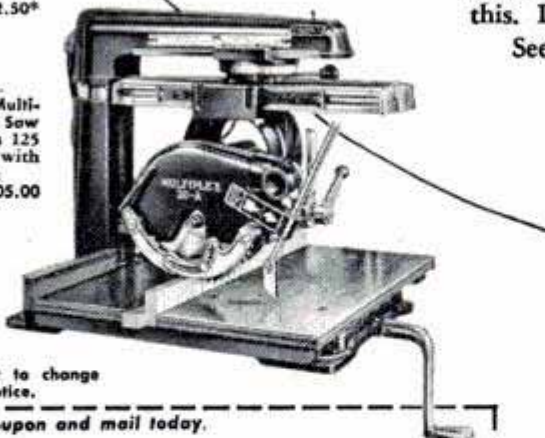

\*Motor and switch extra.

All prices subject to change without notice.

Tear out coupon and mail today.

Delta Power Tool Division.  
ROCKWELL MANUFACTURING CO.  
802N E. Vienna Ave., Milwaukee 1, Wisconsin

Send me Delta's new AB-50 catalog.

Name.....

Address.....

City..... (.....) State.....

# Whatever power tool you need... DELTA'S YOUR BEST BUY

for safety, accuracy, dependability—at a price to fit every budget

Delta gives you better selection, a better price, and *quality* that means extra value every time.

In the past 25 years, thousands of satisfied users in schools, industrial plants, commercial shops, and home workshops have come to know Delta tools as the last ones in the shop to need replacing.

Anything *less* than Delta quality usually costs *more* later — in maintenance, repairs, replacements. Don't risk this. Decide on Delta!

See your Delta dealer. Send for new catalog today.

DELTA POWER TOOL DIVISION



**Rockwell**

Manufacturing Company  
MILWAUKEE 1, WISCONSIN

# DELTA MILWAUKEE

53 Machines 246 Models  
Over 1300 accessories  
— plus 14 Delta Homecraft® tools



# MASTER HOBBY ARBOR TOOL KIT AT THE GIVE-AWAY PRICE \$6.95

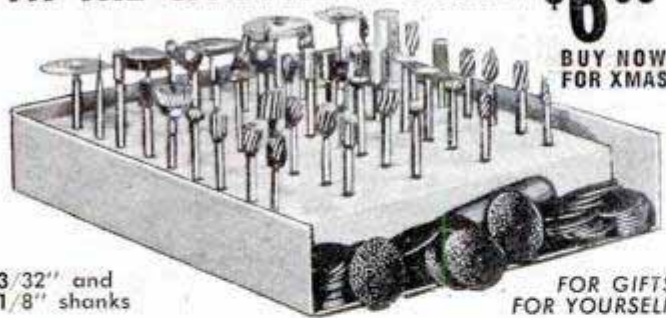

BUY NOW  
FOR XMAS

3/32" and  
1/8" shanks

FOR GIFTS  
FOR YOURSELF

The greatest value we have ever offered in our 15 years in business. Only possible because we bought out a factory of their complete line of burrs. If the tools were bought separately in Hobby shops, you would pay more than \$30 at the regular prices. The tools have a value of 35c to \$2 each and include burrs, saws, drills, routers, carvers, emery discs, reamers, borers, shapers, grinding points. Also a 60c heavy duty mandrel.

Will fit any hand tools such as Dremel, Kasco, Handy, etc. This is a real super value that you cannot afford to miss—Buy several sets.

All orders shipped P.P. prepaid. Send check, Money order or C.O.D. to Dept. P.M.

## GENERAL AIRE CO.

447 W. NORRIS ST. • Dept. PM • PHILA. 22, PA.



### CAPE COD CHAIRS TRELLISES • ARBORS DUTCH WINDMILLS

Chairs style B-C-A PLANS 50c Ea., all 3 only \$1.00. 12 different trellis designs PLAN of all 12 only 50c. Authentic 40" high Dutch Windmill Detailed PLAN only 75c. Unique 40" high Light-house having copper lantern, ideal for garden or on lake shore of summer home. Large detailed PLAN 75c.

SPECIAL ALL PLANS ABOVE \$3.00 VALUE ONLY \$2.50

SEND 10c for catalogue of many fine projects.

Dept. P23

CRAFTSMAN'S MODEL CO. DELAFIELD, WISCONSIN

Tune in the  
AUTO-LITE  
Show

"Suspense!"

THURSDAY NIGHTS—CBS

## STOP CHANGING MOTOR OIL!

End this needless  
expense forever with

### RECLAIMO Today's Most Advanced OIL RE-REFINING filter FOR CARS, TRUCKS, TRACTORS & DIESELS

Continuously cleans and RE-REFINES motor oil as you drive (by utilizing motor heat)—keeps oil in high grade lubricating quality at all times!

#### "RECLAIMO"

- REMOVES SOLIDS (by filtration)
- REMOVES WATER (by distillation)
- PREVENTS Excess Fuel Dilution
- PREVENTS Acid and Sludge Formation
- ADDS Thousands of Miles to Engine Life

**MAINTAINS** Stable Viscosity **ELIMINATES** All Oil Changes  
FREE 32-PAGE BOOK "OIL FACTS" (with bonafide \$1000.00 offer on page 30), gives you the complete "Reclamo" story and details of our extraordinary 90-DAY NO-RISK TRIAL OFFER! Write for your copy TODAY!

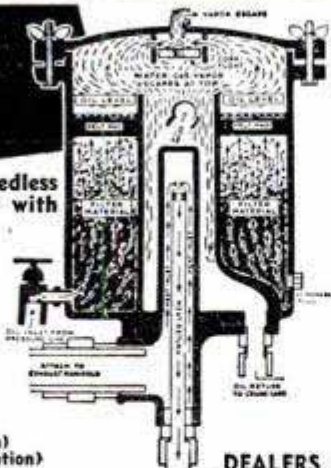

DEALERS  
WANTED

U.S. BUREAU  
OF STAND-  
ARDS, Bul. 86  
States, "Oil  
does not wear  
out - mechan-  
ically."

MONEY-BACK  
GUARANTEE

Reclamo Sales Div., Inc.

4508 S. Logan, Dept. M-4, Lansing, Mich.

# SANDS FASTER Than 10 Pairs of Hands!



Weights  
Only 9 lbs.

PORTER-CABLE  
**Guild**  
SANDER

only

**\$59.50**



**Speeds Paint Removal . . .** Used to be tough and messy to remove paint and varnish — not any more! It's easy with this powerful motor and high belt speed working for you.



**Plane-Sands Faster . . .** Another job made easy. The Guild A-2 Sander is perfect for taking off stock to close dimensions.



**A Whiz at Preparing for a Finish . . .** Always a uniformly fine, velvet-smooth surface. No waves or swirls — levels perfectly — cleans blemishes! And that's not all!

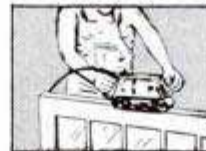

**Speeds Screen, Sash and Door Fitting . . .** And does a workmanlike job that will amaze you.

• Guild Sander does that job fast — without hand-sanding drudgery! No bearing down — the powerful motor insures effortless, efficient cutting. So light, so perfectly balanced, Guild handles easily in any position. High speed abrasive belts have a variety of grits for work on wood, composition, plastic, metal, glass. Handy bench stand (extra) converts Guild Sander to a tool grinder — and to a machine for truing and smoothing butt and mitre joints.



Bench Stand

See your dealer for free demonstration.  
It'll open your eyes. Send in coupon today.

Send me literature on the Guild A-2 Sander and Bench Stand.  
Also name of my nearest dealer

Name .....

Address .....

City ..... State .....

**PORTER-CABLE MACHINE CO.**

2292 N. Salina St., Syracuse 8, N. Y.

LIFETIME CHRONOGRAPH, STOP-WATCH  
**CALENDAR WATCH**



It's also a  
**TELEMETER &  
TACHOMETER**

CALENDAR  
WINDER

**NEW LOW PRICE**  
**8.95**  
with  
Steel  
Expansion Band  
Plus 10% Tax (90c)

**FULLY  
GUARANTEED**  
for One Year

Plus Lifetime  
Service Certificate  
5-Day Free Trial.

**31-Day Calendar**  
Changes dates automatic-  
ally! For Sportsmen,  
Scouts, Photographers, En-  
gineers, Chemists, Navi-  
gators, Doctors.

Remarkable Import Buy—these ideal all-around timepieces and chrono-  
graphs at an unbelievable low, low price. Imported Swiss jeweled move-  
ment, Radium Glow 1" dial, red sweep-second hand, shock-resistant case,  
unbreakable crystal. And—included is the handsome, rich-looking steel  
expansion wristband. Complete instructions included together with guar-  
antee and service certificate. White, Pink or Black dial face, specify color.

**GAYLORD** Dept. PM-7, Fifth & Hamilton, Pittsburgh 6, Pa.

I enclose  Check  Money Order  Send C.O.D.  
Send Chronograph watches at 8.95 (Postpaid), plus 10% tax on  
5-day free trial. Money Back Guarantee. Name & Address on Margin.

**Clark EXPANSIVE BIT**

**CUTS BETTER • COSTS LESS!** Accurate, fast; cuts  
smooth holes in hard or soft wood. Chrome vanadium  
steel blades, all chrome body. No. 250, 1/2"-1 1/4", \$1.89; No.  
251, 3/4"-3" \$1.89. **GUARANTEED** At your dealer or write  
ROBERT H. CLARK COMPANY Beverly Hills, Calif.

**EVERY ELECTRIC DRILL  
A PORTABLE SAW**

**9.95**  
with 4" "HYCARBON"  
Crosscut  
Blade

**Can Be Used With One Hand!**  
Any 1/4" or 3/8" Drill a Powerful Saw  
in ONE MINUTE

"ARCO-SAW" is a rugged tool with  
right angle gear drive (no clumsy,  
dangerous, direct drive with drill  
sideways). Works like a high priced  
Portable Saw.

**CUTS 1-5/16", or 2x4 by turning over**  
**ONLY ARCO GIVES YOU ALL THESE**  
**FEATURES: Safety-yoke assures**  
**rigid connection and absolute safe-**  
**ty—Big handle affords firm grip for**  
**two-hand operation—Precision one-**  
**piece gear box—Self-lubricating life-**  
**time bearings—Visual guide and**  
**wide shoe-plate for straight, square**  
**cuts—Lowest priced, quality Re-**  
**placement Blades.**  
"HYCARBON" 4" Crosscut or  
4" Combination Blade. \$1.60 ea.  
**90-day Factory Guarantee**

**ARCO SAW** NOW! EVERY "ARCO-SAW" AN  
**ANGLE SANDER & POLISHER**

Your "ARCO-SAW" becomes a powerful right angle  
sander & polisher in just a few minutes.  
Ideal for removing paint from cars & walls,  
simonizing cars, polishing linoleum & fur-  
niture. Swivel action between drill chuck  
& gear box permits new freedom of use  
at any angle on every surface, or when  
necessary safety-yoke can be used to hold  
unit rigid. No need to buy an expensive  
special angle gear drive. New ARCO  
"SAND-N-POLISH" Attachment consists  
of flexible molded rubber head, sanding  
disc, lamb's wool polisher, bot-  
tom plate, hexagon adaptor, &  
also 1/4" adaptor for use in  
drill chuck.



**1.95**

**ORDER TODAY** at your dealer or send us check or M.O.  
(Postpaid). C.O.D.'s—Postage extra  
**UNCONDITIONAL 10-DAY  
MONEY BACK GUARANTEE**

**ARROW METAL PRODUCTS CO.**  
DEPT. PM-12, 140 WEST BROADWAY, NEW YORK 13, N. Y.

**MOUNTED STONES AND POINTS**

**24 TOOLS**  
(As Illustrated)  
**FOR CUTTING  
ANY MATERIAL**



Assorted shapes and sizes up to 1"  
diameter, with 1/8" shafts. Packed in  
attractive and substantial box.

PRICE **\$5.00** POST PAID  
ONLY IN U. S. A.

**COMPLETE "300 UNIT" ACCESSORY KIT**  
FOR OWNERS OF HANDGRINDING AND FLEXIBLE SHAFT EQUIPMENT

12 assorted stones, mounted, with 1/8" shanks... 15 abrasive  
stones up to 1" for use with mandrels... 24 rotary cutters  
with 3/32" shafts... 44 rubber bonded abrasive wheels and  
points, assorted grits, shapes and sizes... 15 cut off wheels  
up to 1 1/4" diam... 6 muslin buffs to 2"... 6 felt wheels to  
1"... 6 mandrels for stones and rubber points... 3 bristle  
brushes... 4 polishing cups... 1 drum sander... 24 as-  
sorted bands for sander... 15 rubber pumiced polishing  
wheels and discs... 125 assorted sandpaper discs, 300 units,  
in all, for grinding, polishing, and shaping metal, plastic or  
wood.

**PRICE ONLY**  
**\$8.85**  
**POST PAID**  
IN U. S. A.

SEND FOR 68 PAGE ILLUSTRATED CATALOG TODAY!

Every worker in metal, wood or plastic should have a copy of the Schrader Catalog,  
giving information on gold, silver, brass and nickel silver, as well as burs, cutters,  
stones, polishing supplies... Handgrinders, flexible shaft equipment, small tools,  
etc. Price only 25c. Write Dept. PM-3

**SCHRADER INSTRUMENT CO., INDEPENDENCE, IOWA**



**\$2.95**  
EACH

**NOW! FILE YOUR  
OWN SAWS**

Do expert saw filing at home. Precision  
filing easy without experience. Two  
simple adjustments. Keeps any hand  
saw extra sharp and true-cutting. Com-  
plete with file. Money back guarantee.  
Cash with order, prepaid. (COD postage  
extra.) Order today, \$2.95.

ANOTHER SPEEDCOR TOOL  
**THE SPEED CORP. PM-12**  
512 N.E. 73 Ave., Portland 16, Oregon

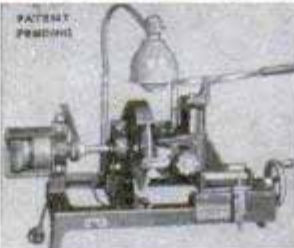

**Start a NEW BUSINESS!**

or Add to your present  
Repair Business

**SHARPEN DULL PIPE WRENCHES**  
**PIPE TAPS & DIES**  
**"GUM" CIRCULAR SAWS**  
Write for Information

**J. C. MOORE INDUSTRIES**  
BOX M 276 FREDONIA, PA.



No More Frozen Car Locks, Windshields, Garage Locks,  
Gas Caps, etc., with the

**JET LOCK DEFROSTER**

This compact, precision-built, scientific in-  
strument works on a chemically-proven principle and  
will defrost the most stubborn lock or frozen sur-  
face in about twenty seconds. A jet of super-  
heated steam does the trick, and is  
guaranteed to work every time.

**\$1.00**

ONLY Postpaid or C.O.D. plus postage.  
**COMMERCIAL SALES CO.**  
Dept. PM-12, 1303 Fulton Street, Brooklyn 16, N.Y.

**SPECIAL OFFER!**

**LOCK-STITCH SEWING AWL** **\$1.**  
Postpaid

Famous, pat-  
ented lock-stitch  
sewing awl complete  
with needles, waxed thread  
and direction folder. Hundred  
uses — sewing, repairing leather  
goods, canvas, belting, harness, sad-  
dies, gun cases, awnings, golf bags. Extra  
needles and thread available. Satisfaction guar-  
anteed or money back. Send currency, check or money order.  
Yates Mfg. Co., 611-H Main St., Lake Geneva, Wisconsin

**New Invention!**  
**SLING-O-MATIC**

**IT'S AUTOMATIC**  
**BB shot drops**  
**from handle**  
**into Sling!**

only \$2.00  
We pay postage  
**Be first to own one.**  
**Accurate...powerful...**  
**small game & target practice.**  
**Money Back Guarantee. Order today.**

Tropical Sales, P. O. Box 35, Miami 33, Fla.

# GIVE SOMEONE or GIVE YOURSELF...



these



## 4 POPULAR Christmas-Wrapped CRESCENT TOOLS

● Your friends don't have to be expert mechanics to appreciate any one of these four handy Crescent Tools. They have many everyday uses around the house. To your hobby-minded friends, the name "Crescent" is a symbol of Quality. And if you give one or all of them to yourself, you're bound to be complimenting your own good judgment for a long time to come. Packed in bright red Christmas boxes all ready to hang on the tree.

CRESCENT TOOL COMPANY, JAMESTOWN, N. Y.

"Crescent" is our trade-mark, registered in the United States and abroad, for wrenches and other tools. Sold by leading distributors and retailers everywhere and made only by Crescent Tool Company, Jamestown, N. Y.

### AC18 CRESTOLOY WRENCH

Popular 8" size fits average needs. Forged from alloy steel, chrome-plated. Every householder and mechanic needs one .....\$210

### 654-6" CRESTOLOY PLIER

A fine quality, long nose plier with side cutter. Ideal for radio and electrical work. Individually tested..\$275

### L26 CRESCENT PLIER

A 6" thin nose, slip-joint plier of excellent design and construction. Finished in hand buffed nickel-plate....\$110

### T47 CRESCENT SNIPS

A handy household tool for light cutting of sheet metal, canvas, cardboard, linoleum, etc. Will cut intricate patterns as well as straight lines..\$240

**CRESCENT TOOLS**

*Give Wings to Work*

*Sign of the Artisan  
Symbol of Excellence*

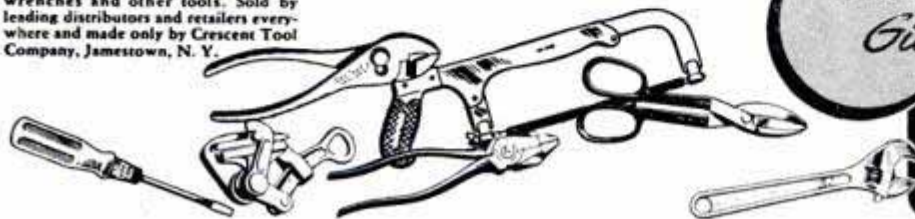

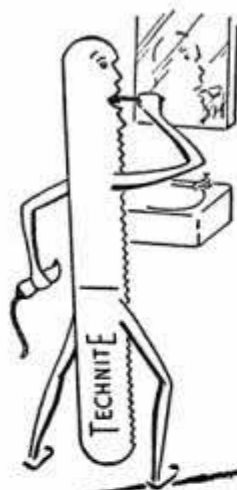

**Ammoniated Tooth Paste Didn't Help These Hack Saw Teeth**

**But Capewell Introduced "STATISTICAL QUALITY CONTROL" Which Gives a 10% Sawing Bonus**

Capewell's exclusive "Statistical Quality Control" assures a bonus of 10% additional cutting because it raises standards and eliminates sub-standard blades. Another Capewell exclusive — printed instructions stamped on every blade — enables you to select the hack saw blade with the right number of teeth for each cutting job. Always ask for...

**ASK YOUR DISTRIBUTOR ABOUT:**

Capewell hack saw blades, hack saw frames, band saws, Da-files, spiral saws, band saw machines, ground flat stock, hammers, pipe and bolt threaders, pipe cutters, pipe reamers, pipe vises, tubing cutters, power pipe machinery.



**THE CAPEWELL MFG. CO.** DEPT. 912 HARTFORD 2, CONN.

**YES! SEND**



directly to my door every month

I am enclosing

- \$3.50 for 1 year
- \$8.00 for 3 years

name \_\_\_\_\_

address \_\_\_\_\_

city \_\_\_\_\_

zone \_\_\_\_\_

state \_\_\_\_\_

Hand this order to your newsdealer or send it to

**POPULAR MECHANICS**  
200 East Ontario St. Chicago 11, Ill.



**FULLY GUARANTEED TIRES COST LESS!**

Nationally famous FIRESTONE, GOOD-RICH, U.S. ROYAL, GOODYEAR, and other makes. Every tire selected and inspected for your safety.

**NEW TREAD TIRES GUARANTEED 24 MONTHS**

600x16	7.98	650x16 (6)	12.98	650x15	10.48	670x15	9.98
600x16 (6)	8.98	700x16	11.98	700x15	11.48	710x15	11.98
650x16	10.98	550x17	7.98	700x15 (6)	13.48	760x15	12.98

**SNOW TIRES—Add \$2.00 More to Above Prices**

**GOOD TIRES GUARANTEED 12 MONTHS**

600x16	4.14	700x16	5.14	32x6 (8)	8.84	825x20	14.24
650x16	4.54	670x15	4.74	32x6 (10)	10.84	900x20	13.34
650x15	4.34	650x20	7.84	750x20 (8)	8.84	1000x20	14.14
700x15	4.64	700x20 (8)	8.94	750x20 (10)	9.94	1100x20	16.14

**AAA PREMIUM GRADE GUARANTEED 18 MONTHS**

600x16	5.28	710x15	5.68	650x20	9.88	825x20	15.68
650x16	5.88	600x16 (6)	5.88	700x20	10.88	900x20	15.98
650x15	5.68	700x15 (6)	6.98	32x6 (8)	10.48	1000x20	16.48
700x15	5.88	760x15	6.28	32x6 (10)	12.48	1100x20	17.58
700x16	6.18	550x17	5.88	750x20 (8)	11.48	1100x22	18.78
820x15	6.98	600x20	8.88	750x20 (10)	13.48	1400x20	39.98

**MILITARY SPECIAL AA Guaranteed 12 Months — New Tread Guar. 24 Mos.**

900x16	9.58	1000x20	16.48	600x16	8.38
750x20	9.68	1100x20	18.48	600x16 (6)	10.98
				750x20	24.98

**AAA GUARANTEED 18 MONTHS**

900x16	12.49	750x20	13.98
--------	-------	--------	-------

Largest stock of used tires in the East. Thousands of satisfied customers. Write for sizes not listed.  
**MONEY ORDER OR CHECK WITH ORDER.**

**PYRAMID TIRE CO.**

1333-35 North 5th St. Dept. M, Phila. 22, Pa.



**BUILD YOUR OWN BOAT**

**Have Fun! Save 1/2 the Cost!**

Anyone can do it! Schneider plans have full size details and include complete, step-by-step instructions. Cut-to-fit KITS ALSO available. No special tools needed—all parts accurately machined; notches and bevels cut. SEND 10c for illustrated literature on our complete line of boat kits and plans.

**SCHNEIDER BOAT COMPANY**

Dept. 1120 1913 W. VLIET ST. MILWAUKEE 5, WIS.

POSTPAID ANYWHERE IN U.S.A.

**WE FURNISH ALL MACHINED METAL PARTS, EVERY SCREW, NUT, BOLT, WASHER, AND COMPLETE PLANS FOR THIS...**

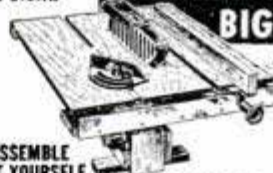

**BIG 10" POWER SAW**

**\$10.95** FULL REFUND IF LESS GUARD NOT SATISFIED & WOOD IN 10 DAYS

ASSEMBLE IT YOURSELF WITH SIMPLE HOUSEHOLD TOOLS!

COMPLETE PLANS 10c  
**MARCUS-POLLAK**  
DEPT. N, ROYERSFORD, PA.

**DRAINS CELLARS, WASH TRAYS CIRCULATES OIL**



Pumps 1800 GPH 300 gal. 30' high, use 1/8 to 1/2 HP motor. Will not clog. **\$6.50**

Postpaid if cash with order. (Add 50c for west of the Mississippi.)

Thousands in use since 1936

LABAWCO PUMPS, BELLE MEAD 7, N. J.

**FLASH Your Turns**



**ELIMINATE HAND SIGNALLING S & L DIRECTIONAL SWITCH THE LOWEST PRICED DIRECTIONAL SWITCH THAT MEETS ALL S.A.E. REQUIREMENTS**

Here is a safe, comfortable way of signalling your intention to make a left or right turn. Flashes from 60 to 80 times per minute. No need to roll down window to signal turns in cold winter weather.

Kits furnished with all necessary material for perfect installation. No outside mounting of any kind. Uses your present parking and tail lights. Either of our two models fits most cars from 1942 to 1950. Specify year and make of car. Money-back guarantee.



**\$5.95** postpaid in U.S.A.

SEND CHECK OR MONEY ORDER. POSTAGE EXTRA ON C.O.D.'s

**A PERFECT CHRISTMAS GIFT FOR MOTORISTS**

**S & L AUTO SALES**  
Box 6414, Dept. 2, Chicago 7, Ill.

# WELD

BRAZE, SOLDER, CUT  
quickly...easily

The **FOUR-WAY**  
PORTABLE ARC-WELDER

COMPLETE ONLY \$11.95  
10 DAY TRIAL \$11 F.O.B.

YOU'LL BE AMAZED by the work you can do on your first job! Plugs into any convenient properly wired 110 volt A.C. or D.C. line. Follow simple directions. Work on iron, steel, bronze, brass, aluminum and other metals. Save money doing own repairs. Make money repairing for others. Thousands of users among maintenance and repair men, farmers, tinsmiths, engineers, home and auto owners, etc. Pays for itself over and over. Order on ten-day trial or send for details.

MAKE OR REPAIR HOME & FARM APPLIANCES FENDERS BICYCLES METAL FURNITURE & 1001 ITEMS

FOUR-WAY WELDER CO., Dept. F2-NA  
2326 So. Michigan Avenue, Chicago 16, Ill.

**FREE Full Details SEND TODAY**

New 18 karat gold finish or chrome plated engraved **MONOGRAM INITIALS** for your car. Put on in a jiffy. Guaranteed to hold on permanently. Simple to apply. Used on metal, leather, glass, wood and cloth. Script type initial or Block type initial.



STYLE 2



STYLE 3



STYLE 4

Three styles—actual sizes illustrated above

**6 MONOGRAM INITIALS for \$1.00 postpaid**

Style 2—Script initial, gold. Style 22—Same, chrome plated.  
Style 3—Block type initial, gold. Style 33—Same, chrome plated.  
Style 4—Block type initial, gold. Style 44—Same, chrome plated.

Specify style number and the 6 initials wanted.

APEX CORPN., Box 2PM12, 1120 Race St., CINCINNATI 10, OHIO  
Dealer Inquiries Invited

## HEAT THAT COLD ROOM WITH

### McLARTY VENTILATED BOOSTER FAN

INSTALL IT YOURSELF!

Get forced air circulation in those hard to heat rooms with this easy to install booster fan. Patented cooling feature prevents burn outs. Quiet, efficient. Fits pipe sizes from 8" to 12", runs on A.C. house current. If your dealer cannot supply, order direct \$10.95 POSTPAID

**McLARTY SYSTEMS** 2609 DICKMAN ROAD BATTLE CREEK, MICH.

## New MOTOR BARGAINS for Home, Farm & Industry

**General Utility Motors**

1/50 H.P., shaded pole motor, brushless, non-radio interfering, 1550 R.P.M., 110 volt, 60 cycle A.C. for light machinery duty, exhaust fans, furnace fans, oil heater blowers and many practical purposes. Handles any 10 or 12 inch fan blade. Special at \$4.50

No. UM-50, 1/50 H.P. Mtr. & Speed Controller (\$1. val.) both postpaid..... \$4.50

No. F-10, 10 inch fan blade to fit above motor, Postpaid...\$1.00

No. F-12, 12 inch fan blade to fit above motor, Postpaid...\$1.50

No. B-4, 4 inch, Sirocco Blower Wheel to fit above motor \$1.50

**TOY MOTOR BARGAIN**

1/250 H.P., shaded pole motor, 110 volt, 60 cycle, A.C., for powering toys, display and experimental work. Only \$1.75.

No. TM-12, 1/250 H.P. A.C. Motor & Speed Controller (\$1 val.) both postpaid \$1.75.

**BARGAIN RHEOSTAT SPEED CONTROLLER.** Small 2-inch dia. rheostat for 1/50 H.P. and smaller motors gives approximately 30% speed reduction, light dimmer, etc.

No. RHEO-1, Rheostat complete with instructions... Postpaid..... \$1.00

**THE VAPORITE** Automatic HUMIDIFIER for Warm Air Furnaces. THERMOSTATICALLY controlled water supply puts more moisture in the air. Easily installed in bonnet of air furnace. Complete with THERMOSTAT Water Control Valve. Tubing and parts for complete installation. GIVES HEALTHIER AIR. \$15. Value ONLY \$7.50 POSTPAID.

NO.	H.P.	VOLTS	R.P.M.	PRICE
GEH-5	1/2	110	3450	\$21.75
W-5	1/2	110	1725	\$21.75
WDH-34	3/4	110	3450	\$29.75
EBB-4	3/4	110/220	1725	\$34.50
EH-1	1	110/220	3450	\$37.50
BB-1	1	110/220	1725	\$45.00
EH-15	1 1/2	110/220	3450	\$52.50
EH-20	2	220	3450	\$62.50
BB-20	2	110/220	1725	\$75.00

The above prices are F.O.B. Chicago. Order by number. We have large stock of special & standard motors, ALL SIZES. Write for prices on the motor you need.

**C. MARSHALL SALES, 3546 W. Fullerton Av., Dept. P-12, Chicago 47**

# Make it a Hobby Christmas! with

## HANDEE

tool of 1001 Uses

**FINEST IN POWER TOOLS PLUS 51 ACCESSORIES**

Complete... designed for every hobbyist and mechanic! Grind, drill, polish, carve, sand, saw, etc. Packs plenty of power in the 25,000 r.p.m. motor, with approved 7-segment commutator. Handsome fitted steel carrying case.

Complete, with liberal 10-day money back trial offer..... **\$27.50**  
with 7 accessories... **\$19.95**

## HANDEE WORKSHOP

"Tornado-Powered" with NEW HANDEE "85"

Versatile, with 41 accessories... suitable for shop or home use. For novice or expert... precision routing, molding cuts. HANDEE "85" a production wizard... automatically air-cooled, pin-point accuracy. Sensational power!

Complete, packed in handsome case, **\$29.95**

**FREE! New 64-page Manual**

Chicago Wheel & Mfg. Co., Dept. PM  
1101 West Monroe St. Chicago 7, Ill.

SAY YOU SAW IT IN POPULAR MECHANICS

**ELECTRIC SIREN**6 volt. Complete with push button... **\$10.95****Fender Skirts for All Cars**Give year, make & model of car when ordering.  
All Metal. Prime finish. Rubber beading prevents rattle.  
Easy to install. **\$9.95 PAIR...****FLO-WINGS Fender & Hood Side Ornament****CUSTOM STYLING FOR ALL CARS**Graceful, flowing lines. Triple CHROME PLATED. Gives your car that Custom Style look. Easy to install on fender or hood. **\$4.95 PAIR****HOLLYWOOD MUFFLERS****FOR ALL CARS**Gives that Motorboat Tone. Universal type to fit all cars, ea... **\$4.45****NEW CONVERTIBLE TOPS & REBUILT MOTORS for all Cars. Write for Prices.****Send 25% Cash With Orders, Balance C.O.D.****JUST OUT!** Get the largest Auto Accessory & Parts Catalog in the world. Over fifteen thousand items, including Hollywood Accessories, Hi-Speed Equipment, Rebuilt Engines, all parts & accessories for all cars & trucks. We have that Hard-to-Get-Part! Completely illustrated. Jam packed with bargains. Send 25c.**J. C. WHITNEY & CO.**

1917GA ARCHER AVE.

CHICAGO 16, ILL.

**RUBBER HOSE SALE****TERRIFIC VALUES!**

Brand new genuine Neoprene Hose—outlasts ordinary rubber 3 to 1. Reinforced with super tough cotton cord plies. Flexible, easy to handle. Easy Flo brass couplings with standard pipe threads for quick connections, included. Pump water for irrigation, stock, tanks, home, barn, fire fighting, etc. Pump Gas or Fuel Oil. Save more than 60%.

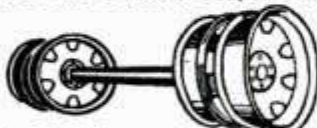
(Inside Diam.) 1 1/4 in. 1 1/2 in. 1 3/4 in.  
Length 25 ft. 40 ft. 30 ft.  
Price **\$9.25 \$14.75 \$14.75**  
If specified we will send special hose for gas or oil at same prices.**HYDRAULIC HOSE**High pressure, heavy duty, complete with swivel fittings, Pipe thread connections. Any length desired. Minimum order \$2.00.  
**INSIDE DIAMETER**  
1/4"—40c per ft., 3/8"—50c per ft., 1/2"—70c per ft., 5/8"—90c per ft.**EXTENSION CORD** 40 ft. heavy duty, made of specially insulated No. 14 2-conductor wire. So tough that you can drive over it and yet amazingly flexible and easy to handle. Resists oil, grease or water. Extend electricity up to 400 ft. without voltage drop. Use indoors or out. Complete with heavy rubber plug and outlet. Wt. 2 1/2 lbs. Usually \$4.50—Special 40 ft. **\$2.05**. Comb: 2-40 ft. and 1-20 ft. (total 100 ft.) **\$4.95**.All prices f.o.b. Chicago area. Satisfaction guaranteed. Send ck. or M.O.  
**MASTER MECHANIC CO., Dept. 32, BURLINGTON, WIS.****PARTS FOR MILITARY TRUCKS****At A Savings New FREE Catalog**  
For Jeep, Dodge, Chevrolet, G.M.C., StudebakerBrand New — Not War Surplus — Complete **JEEP TOPS and SIDE CURTAINS**  
Fits all Military Jeeps. Also adaptable to some Civilian Jeeps. Waterproof O.D... **\$59.50****TRAILER AXLE**  
Heavy duty trailer axle suitable for many types of trailer construction. Also excellent for building of heavy farm trailers and wagons. It is a 12,000 lb. capacity square type straight

trailer axle complete with Timken roller bearings, hubs, and 6 hole 750 x 20 Budd Wheels. Without brakes. Axle is 2 inches square and 69 inches between wheel mounting flanges. Std. width.

**With Single Wheels. \$59.50 With Dual Wheels. \$69.50**  
Hundreds of Other Truck & Jeep Parts and Supplies  
All prices quoted good 30 days FOB, Kansas City  
25% DEPOSIT REQUIRED ON COD ORDERS**American AUTO PARTS CO. INC.**1830 LOCUST—DEPT. PM  
KANSAS CITY, MISSOURI**BINOCULARS TELESCOPES****Big Bargain Catalog Free****BROWSCOPE CO.**  
Dept. 12M,  
24 WEST 45TH ST.  
NEW YORK 19, N. Y.

7x50

**\$36**

Illustrated

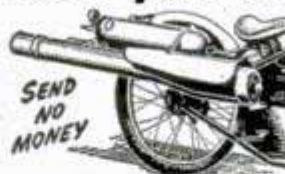
**ROTARY FILES**Special Assortment of 10—\$19.95 Value, now ONLY \$9.95. Ground from the solid and hand cut—1/4" shanks. We also offer a complete regrinding service—SATISFACTION GUARANTEED. Inquiries invited.  
**INDEPENDENT TOOL CO., 6007 Euclid Ave, Cleveland 8, Ohio****AMAZING NEW CHEMICAL MAKES****OLD BUMPERS LIKE NEW!**Not a Paint! Not a Polish! Looks like expensive chrome plating!  
Wonderful new chemical puts chrome-like finish on car bumpers, door handles, trim, etc. No electricity—no plating tanks—no acids needed. Just smooth it on and watch it gleam! Takes a brilliant polish JUST LIKE CHROME—no simple a child can do it. REFINISH BUMPER IN 10 MINUTES! WORKS LIKE MAGIC—finish lasts for years. Increases resale value of your car and adds NEW beauty to other chrome plated or metal items. TRY AT OUR RISK! SEND NO MONEY! Just send name and address. Pay postman amazing low price of \$1.00 plus few cents postage for each kit ordered, or send cash and we pay postage. Try kit 10 days. If not delighted return for instant refund! **BUMPER RE-NU CO., Rm. 24, Box 147, Hamtramck, Mich.****\$1.00****LIQUID MARBLE****COMPOSITION FLOORS FLEXIBLE MOLOS**MOLD, BRUSH, TROWEL, SPRAY IT! MOLD, MOLD, MOLD! Molds, Statuary, Art Goods in Flexible Plastic Molds; or material makes \$1 seller. Make Marbleized floors, Tile Walls. Colorful, glossy, amazing! Easily learned; start in garage or basement. Particulars free.  
**MARBLEIZING SERVICE, Dept. 10-F, Edwardsville, Ill.****HELPFUL BOOKS**Send post card asking for **FREE catalog**  
Popular Mechanics Press, 200 E. Ontario, Dept. 601, Chicago 11**SAW SHARPENER**Table model, gums and sharpens rip saws, combination saws & cut-off saws. Ideal for "Skil-saw" blades. Cap. 4" to 20" diam. Complete with 1/4 h.p. motor & 1 grinding wheel & cord — \$64 f.o.b. Portland. Shipping weight, 63#. SEND FOR **FREE LITERATURE.****P. T. HOBBS-MACHINERY**  
— 8375 N. Interstate, Dept. 57, Portland 17, Ore.**Build your own JET ENGINE!**Order these plans today  
1. JET PROPELLED BICYCLE. Assemble your own. Photo and instructions, \$1.00.  
2. HOW TO MAKE EXPERIMENTAL JET ENGINES. Seven sheets drawings with information and instructions \$2.95.  
3. BOTH OF ABOVE in one order \$3.75. SEND NO MONEY. Order both at once \$3.75 C.O.D. in USA plus c.o.d. postage. Send check or Money Order and we pay postage. Get other information too. Wash Order.**J. HOUSTON MAUPIN, Dept. 55, Tipp City, Ohio****INCREASE YOUR BUSINESS and SOCIAL PRESTIGE**Yes—you too can write like this and improve your business ability and chances for advancement. Just a few minutes a day is all it takes to become an expert penman using C. P. Zaner's **Ornamental Penmanship**—96 pages of instructions, diagrams and illustrations that show how to improve your writing. Send in for your copy of **Ornamental Penmanship** today and begin improving your writing and increasing your business and social prestige. Quantity limited. **\$1.50.****POPULAR MECHANICS PRESS, 200 E. Ontario St., Chicago 11, Ill.**

**When You Need a  
SMALL POWER GRINDER  
You Need a FOREDOM!**

**Finger Tip Control Keeps Your  
Work Always Well in View**

In the precision-made Foredom you get MORE POWER—LONGER MOTOR LIFE because MOTOR IS NOT DWARFED TO FIT THE HAND. DOES HUNDREDS OF JOBS WITH MARVELOUS EASE because pencil-size handpiece gets into hard-to-reach places. Chuck guard protects fingers—provides positive easy control—FINGER TIP CONTROL. Model #100, \$17.75 complete with motor and other heavy duty models for industrial use available at proportionately attractive prices. Choice of 3/32" or 1/8" collets. Add 85c if you want both. Foot Rheostat \$5.25 extra. OVER 100,000 FOREDOMS IN USE. GRIND, POLISH, DRILL, SAW, SAND, CARVE, ETCH, CLEAN, ROUT, ENGRAVE, etc. on all metals, wood, plastics, glass, leather, linoleum, etc.

Write for FREE Catalog No. 1136-E  
Since FOREDOM ELECTRIC CO., Dept. 1136-E  
1922 27 Park Pl., New York 7, N. Y.



35" Flexible Shaft  
**\$17.75**  
Complete with Motor

Model 100

**WHEELS - WHEELS**

- 5" Disc Wheel 5/8" Tire 5/16" or 3/8" sleeve ..... 30c ea.
- 6" Disc Wheel 5/8" Tire 5/16" or 3/8" sleeve ..... 35c ea.
- 7" Disc Wheel 3/4" Tire 3/8" sleeve ..... 45c ea.
- 8" Disc Wheel 1 1/8" Tire 1/2" sleeve ..... 70c ea.
- 7" Disc Wheel 1" Tire 1/2" ball bearing ..... 80c ea.
- 8" Disc Wheel 1 1/8" Tire 1/2" ball bearing ..... \$1.00 ea.
- 8" Disc Wheel 2" semi-pneum. T. 1/2" B.B. .... \$1.35 ea.
- 10" Disc Wheel 1.75 semi-pneum. T. 1/2" B.B. .... \$1.50 ea.
- 12" Disc Wheel 1.75 semi-pneum. T. 1/2" B.B. .... \$1.85 ea.

Above wheel prices include hub cap  
Plus postage, 20% — C.O.D.'s accepted

**UNITED WHEEL STAMPING CO., PM-12**  
2756 W. 115th STREET CHICAGO 43, ILLINOIS

**D. C. ARC WELDER**

**\$300 VALUE - ONLY \$97.50**

200 Amperes Continuous Duty. Up to 250 amps. Intermittent duty. Easily mounted on your tractor. Welding range from 0-up by dial type control. 1-yr. guarantee with money back 10-day trial period. Write for FREE literature. OR send 35c for PLAN "Build Your Welder from Aircraft Generator." Write today.



LEJAY MFG.

847 LeJay Bldg., Minneapolis 8, Minn.

**SAY YOU SAW IT IN POPULAR MECHANICS**

**SAVE MONEY**

Build this 18 ft. House Trailer yourself \$288.00. Blueprints, Building instructions and 1950 parts catalog 50c. Don't Delay, Write Today



**NATIONAL TRAILER EQUIPMENT COMPANY**  
Dept. PM-12, 431 W. MITCHELL ST., MILWAUKEE 4, WISCONSIN

**KLEAN-STRIP**

**Peels off Paint  
Clean • Fast  
Non-Inflammable  
No after-wash**

Made by W. M. BARR & CO., Memphis, Tenn.



**TRAILER COACHES**

Here's everything you want to know about trailers, with plenty of pictures and plans and instructions for building three different types. Covers also, history of trailers, trailer parks, camps and overnight-stops information, furniture, furnishings, materials and engineering data. If you want to build a trailer, live in a trailer, or just want to know more about trailers, get this book. Only \$1.50 postpaid. Rush order to:

**Build it Yourself!**

**Complete Trailer Book and Construction Data for 10, 16 and 22 Foot Trailers — Only \$1.50**

**Partial Contents**

Trailer Parks—Living in a Trailer—Towing a Trailer—Floor Plans—Service—Classifications—Balance—Dollies—Jacks—Weight Distribution—Construction—Working Drawings for a Two-Place, Standard Travel and Standard Dwelling Trailers. Size 8 1/2 x 11 1/4 inches.

POPULAR MECHANICS PRESS • Dept. 350, 200 E. Ontario St., Chicago



*Best Gift for an*  
**OUTDOOR MAN**

**NORTHLAND SKIS**

Put a pair of brand new Northlands on your gift list. World's finest skis—a model for every skier, novice or expert. Own Northlands, give Northlands.

**FREE!** Write for famous Northland Ski Manual. Tips from experts.

**NORTHLAND SKI MFG. CO.**

WORLD'S LARGEST SKI MANUFACTURER  
95 NORTHLAND PARK NORTH ST. PAUL 9, MINN.

**Precision Caliper**

**M. Z. B. MAUSER-TYPE  
VERNIER CALIPER**



**\$13.75**  
POSTPAID

An Indispensable measuring tool for precision work in any trade or workshop. Highest accuracy and dependability. Measures inside, outside, thread and depth to 1/1000" and 1/20 millimeter. 8" overall, 6" graduation. Highest quality throughout with glass-hard measuring surfaces. M.Z.B. Calipers are made up by the same men who made the old "MAUSER" world-famous. This is your opportunity to buy a first-class precision tool at about half the price of comparable tools. Shipment from stock. Be sure to get yours by ordering it now. Sold with a money back guarantee for only \$13.75 postpaid if you send us your check or M. O. You pay postage on C.O.D.

**INTER-CONTINENTAL TRADING CORP.**  
90 West Street New York 6, N. Y.



**FEDCO  
Saw-Rite**  
Fits any 1/4" drill

get this  
**WONDER-WORKING  
DRILL SAW**

**FINEST YET MADE... ZIPS THROUGH  
WOOD, PLASTICS, WALLBOARD, ETC.**

You'll never use a handsaw again after you try this light-weight, fast-cutting beauty. Careful design, rugged, precision manufacture and a better blade make this an outstanding buy. Quick-acting, worm-drive, patented clamp gets it on and off your drill in seconds. Combination blade is chrome nickel alloy steel, precision ground, correctly heat treated, balanced and fitted. Cuts grooves, dados, crosscut, rip, hour after hour without sharpening. Depth of cut fully adjustable from 1/8" to 1 1/8", cuts plywood, shelving, wallboard, 2x4's to 2x10's in two cuts, one from each side. Special sighting notch enables you to follow line. Lifetime Oilite bearings, finest quality hardened steel gears, shafts. One or two hand operation with hand-fitting knob. Use coupon to order at once for immediate delivery. Try it for 10 days, full refund if not completely satisfied.

Fedco also makes Saw-Rite Jr. at \$6.95 and Stanzall at \$2.95... ask for FREE literature.

**FEDCO \$9.95**  
Saw-Rite Attachment

COMPLETE WITH COMBINATION BLADE  
**ELECTRO SPECIALTY CO.**  
128 Church Street, N. Y. 7, N. Y.

Electro Specialty Co., 128 Church St., N. Y. 7  
Send me \_\_\_\_\_ Saw-Rite #600 Saw Attachment(s) @ \$9.95; \_\_\_\_\_ Additional blades @ \$2.00; \_\_\_\_\_ metal cutting blades @ \$3.00; \_\_\_\_\_ FREE literature.  
(Write name and address on margin)  
(All prices postpaid except C.O.D.'s)

# BARRON Drill Press TOOLS

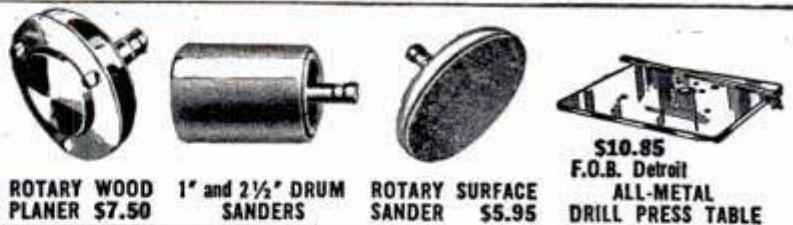

ROTARY WOOD  
PLANER \$7.50

1' and 2 1/2" DRUM  
SANDERS

ROTARY SURFACE  
SANDER \$5.95

\$10.85  
F.O.B. Detroit  
ALL-METAL  
DRILL PRESS TABLE

ALL-METAL  
SHAPER FENCE  
\$9.50  
F.O.B. Detroit



ROUTER &  
MORTISING  
BITS  
\$10.50  
set of six  
1/8" to 1/2"

SHAPER  
CUTTERS  
\$5.75  
Inc. 4 Blades  
for Shaper of  
Drill Press



## 15 ESSENTIAL WORKSHOP OPERATIONS . . .

You can convert any standard make drill press into your most versatile, useful, low cost workshop tool. Barron Precision Tools now enable you to perform 15 indispensable shop operations—surface-plane woods and plastics—rabbet—tenon—panel—bead—groove—bevel—mortise—route—cut dovetail—sand surfaces and contours—shape—cut moldings—grind and buff. Over 200,000 Barron Tool users. Every tool sold on full 10 day money back guarantee.

See Your Dealer . . . Or Write Direct

BARRON TOOL COMPANY, INC.  
325 Architects Bldg., Detroit 1, Mich.

FREE  
Workshop  
Guide &  
Catalog

3 U. S. Fighting Ships With  
Detailed Plastic Parts —  
Set — Only \$9.95



## Build These Sensational

# PLASTIC MODELS

Easy to Put Together.  
Pliers and Razor Blade  
Only Tools Required.

Make Fine Xmas Gifts. Give You Lots of Fun

Get these sensational kits and make the most beautiful models you ever saw. All parts are finished and fit together in a jiffy. No cutting—no shaping—no sanding. Just pure fun. Make beautiful exhibition models as pictured—real museum pieces—that you'll be proud to show or tender as welcome gifts. Regular price for set of three \$21.65. You pay only \$9.95 for all three kits and save \$11.70.

Three Complete Models for Only \$9.95

**P. T. BOAT.** 15 inches long. Shaped wood hull and 130 precision parts mostly plastic. **L. S. T. Landing Ship, Tank.** Length 16 1/4 in. Shaped wood hull and 126 parts, over 100 of plastic. **FLEET SUBMARINE.** Length -15 in. Hull and all parts molded plastic.

**RUSH ORDER NOW.** Clip this ad and mail with check, M.O. or currency for \$9.95 for set of 3 Fighting Ships. Send \$2.25 for Chris-Craft Cruiser. Send only \$12.00 for both offers (4 ships). Postpaid delivery. Money back if you are not satisfied.

HOME SHOP PRODUCTS CO., Dept. 19  
4821 Sheridan Road Chicago 40



Chris-Craft Express Cruiser.  
All Plastic Molded Parts  
and Plastic One-Piece Hull.

Length 10 in. Beam 3 in.  
Can be powered with Tiny  
Atom or Supermite Electric  
Motor.

Only \$2.25 Postpaid



## Set Up Your Own Welding Business—Save \$300 to \$500

### Get Into Big Profits on Repair and Contract Work

"Build Your Own" big capacity arc welder and save! This HOBART generator plus your own hook-up builds a welder that will earn hundreds of extra dollars for you.

Let Hobart help you "build your own" welder and save \$300 to \$500 over cost of factory-built unit. Select the type and capacity generator you want from our complete line and belt or couple to a good used auto engine. Don't miss this opportunity. Write for FREE booklet.

erator you want from our complete line and belt or couple to a good used auto engine. Don't miss this opportunity. Write for FREE booklet.

**HOBART** HOBART BROTHERS CO., BOX M-120, TROY, OHIO  
"One of the world's largest builders of arc welders"

## SHARPEN CIRCULAR SAWS LIKE AN EXPERT



### THE SUPER GADGET FOR HOME WORKSHOP

Two simple adjustments. Gets hollow-ground, cross-cut or combination saw blades true and sharp. Fits 6" to 12" blades 1/2" to 13/16" centers. Includes file, complete instructions. \$6.95 postpaid. (C.O.D. postage extra.) Guarantee—Money back if not satisfied after 10-day trial. Soon pays for itself. Order today. Free Folder.

SURE SHARP MFG. CO., Dept. M-120  
P. O. Box 24 Santa Ana, Calif.

\$6.95

## 584 Page Novelty Catalog Now Ready!

584 Pages; 7500 Amazing Novelties

Send 10c today for this mammoth, amazing new catalog of over 7,500 novelties. More fascinating than a World's Fair. Thousands of things you never knew existed—never knew where to get. Includes novelties, tricks, jokes, live animals and pets, scientific supplies, dog novelties, hobby supplies, planes and boats, looms, magic, unusual seeds, gadget time savers, cameras and optical goods, movies, projectors, lucky jewelry, religious novelties, telegraph sets, magnets, disguises, easy musical instruments, stamps, coins, puzzles, fortune tellers, radios, experimental sets, auto & bike accessories, Western belts and wearing apparel, telescopes, magnifiers, compasses, banks, smokers' gadgets, artists' supplies, printing sets, engines and motors, electric shockers, knives, billfolds, weird articles, archery, swimming helps, 1000 fascinating books, games, locks, live chameleons, rings, watches, charms, barometers, imported novelties, exercisers, money savers, handy tools, Indian novelties, etc., etc. Jammed and packed with sensational funmakers and useful articles. Big catalog—over 1 inch thick. 6 color cover. (De Luxe Bound Edition, 25c)

10c

JOHNSON SMITH & CO., Dept. 321, Detroit 7, Mich.

## HELPFUL BOOKS

Send post card asking for FREE catalog

Popular Mechanics Press, 200 E. Ontario, Dept. 601, Chicago 11

## FURNITURE for YOUR BEDROOM

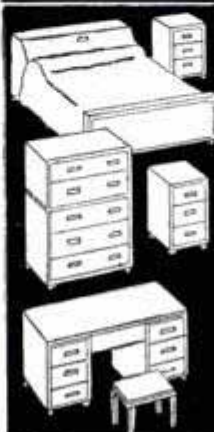

SAVE MONEY, be the envy of your neighbors by making this beautiful bedroom suite yourself! Only a power saw and jointer are needed to turn out this smart suite, featuring bed with storage space, three-piece vanity with cosmetic compartment and makeup mirror, Mr. and Mrs. dresser, and twin night stands with drawers. Letters demanding detailed plans poured in after this furniture was pictured in Popular Mechanics Magazine. Now the 4 plans are ready—easy-to-follow scale drawings—and they're yours for only \$2.00! Send for a complete set today.

POPULAR MECHANICS PRESS  
200 EAST ONTARIO STREET, CHICAGO 11, ILL.



## AMAZING TOOL BARGAINS!

### 300 PIECE ELECTRIC GRINDER OUTFIT

**THE MASTER KIT** \$9.75  
fits all hand grinders for CUTTING, SHAPING, GRINDING, POLISHING Wood, Metal or Plastic

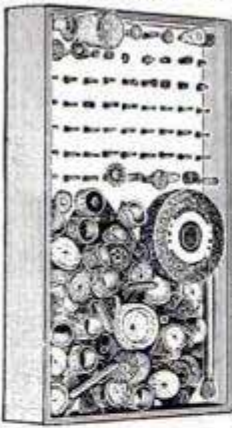

- \$50 VALUE**
- 1 High Speed Steel Rotary File
  - 3 Grinding Wheels 1 to 3" in diameter
  - 12 Mounted Stones 1/8, 3/32, 1/4" Shanks
  - 9 Rotary Cutters 1/8 and 3/32 Shanks
  - 30 Miniature Rotary Cutters 3/32 Shank
  - 10 Cut off Discs and Grinding Wheels
  - 1 Drum Sander 1/8" Shank
  - 15 Abrasive Bands for Drum Sander
  - 15 Leather and Felt Polishing Wheels 1/2 to 1" in diameter
  - 15 Felt Polishing Cylinders with Mandrel
  - 25 Abrasive Sanding Discs 1 1/2 to 2" dia.
  - 3 Rubber Wheels 7/8" diameter
  - 2 Speed Drills 3/32 Shank
  - 2 Mandrels 1/8 and 3/32" Shanks
  - 3 Bristle Brushes
  - 1 Rotary Wire Wheel Brush
  - 1 Circular Saw on Mandrel 1/2" Shank
  - 2 Rubber Cylinders with 3/32" Mandrels
  - 150 other items—all new and valuable

Send check or money order today for these Big Bargains  
SCHUPACK SUPPLY CO., 7331 Cottage Grove, Dept. M-12, Chicago 19, Ill.  
ILLUSTRATED BARGAIN CATALOG 10c

## BLOOD PRESSURE GAUGE



and STETHOSCOPE..... \$5.98  
Keep check on yourself! Prevent strokes, kidney damage, etc. Manual has full details on what is prescribed in 95% of ALL high blood pressure cases. You get a Blood Pressure Gauge, Arm Bandage, Sleeve, 2 Valve Bulb, Base, Stethoscope and 25 Grams of MERCURY. Send a \$2.00 deposit and pay postman \$3.98 plus C.O.D. charges or send a \$5.98 money order and we will pay postage.

**JOY SPECIALTY COMPANY**  
Scientific Instrument Department  
2320 W. Hubbard St., Chicago 12, Ill.  
Details on request. (Dealers Wanted)

**SAVE \$150** MAKE YOUR OWN 3-Dimensional Camera  
ALL YOU NEED IS YOUR OLD CAMERA AND THE STEREO-TACH



No costly stereo camera is needed to take realistic 3-D slides and prints. Use your present camera and a Stereo-Tach outfit. Changes practically any camera to a 3-D camera instantly. See your dealer or write  
**ADVERTISING DISPLAYS, INC.**  
Dept. PM10 COVINGTON, KY.

For 35 MM cameras, outfit #101 (Stereo-Tach & 3-D slide viewer) \$17.70\*  
For larger cameras #100 or for Polaroid Cameras #100 PL (Stereo-Tach and print viewer) \$16.25\* plus 2.09 fed. tax

HOME OWNERS! FARMERS! CRAFTSMEN! HOBBYISTS!

JUST PRINTED, IT'S BRAND NEW. Nearly 300 items for the home, farm and shop at low prices. Hand and power tools, electro-plating and metal fabricating equipment, electric motors, paint sprayers, unusual items. Materials to make and build valuable equipment plus 2 pages of premiums you can get without cost. Send only 10c today to cover handling and postage.  
**General Products Division, Dynamic Welder Co.**  
Dept. DP2NA, 15 E. 23rd St., Chicago 15, Ill.

SAY YOU SAW IT IN POPULAR MECHANICS

## AIR COMPRESSORS

Lowest-Ever Closeout Price!

**WESTINGHOUSE**

Reg. \$60.50

**19.50**  
FOR PGH.

Model T-1 Complete

Brand New Surplus Special at an amazing low price. Westinghouse Double-piston type, 6.54 CFM volume. Mounts on truck or car engine—or operate with 1/2 HP motor. For farm, home, industry, painters. Instructions and spare parts kit included. Send check or money order. Weight 26 lbs. We carry a complete line of spare parts.  
**AIR HOSE**—to fit, 25-ft. length with fittings & chuck \$2

Terrific Gov't Surplus Value! Complete Portable Automatic Air Compressor Unit using above Compressor and Double Pressure Tank Assembly. Maintains any desired pressure up to 150 lbs. Measures 52"x23"x21". Write for specifications.

**58.80**  
Freight

**NATIONAL STORES** 200 SMITHFIELD ST., Dept. MA Prepaid  
PITTSBURGH 22, PA.

# Build A FIREPLACE



around this scientifically designed steel form which also provides circulating heat that assures perfect fireplace operation.

## free folder tells how

TELLS HOW TO BUILD YOUR FIREPLACE—Step by Step

- Foundation
- Steel heat-circulating form
- Cold and warm air ducts
- Chimney and flue construction
- Mantel or decorative front

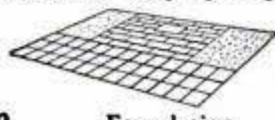

Foundation

ASK FOR BOOK "100 FIREPLACE IDEAS"

Beautiful fireplace designs modern and conventional—shows artistic use of available material.

Enjoy circulating heat and the radiance of an open fire in your Home, Playroom, Cottage or Camp.

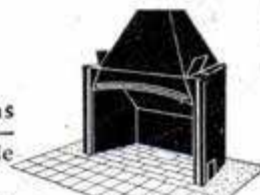

Fireplace form set on foundation includes firebox, damper, down draft shelf and smoke dome.

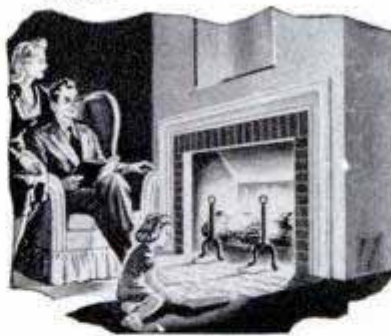

Brick, stone or cement block can be used around the form.

- Send free directions for building heat-circulating fireplace.
- Send Book "100 Fireplace Ideas." Pocket size book, sent free.
- Send larger book, 8 1/2 x 11, beautifully illustrated, 25c.
- Send outdoor fireplace folder with 10 beautiful designs Free.

Name .....

Street .....

City .....

Sold Through Leading Building Materials Dealers

**PRICE FIREPLACE HEATER & TANK CORP.**  
191 W. Austin Street, Buffalo 7, New York



**KNOW YOUR  
COASTER BRAKE  
INSIDE and OUT!**



**Ride  
a Bike  
- it's  
Fun!**

Unmatched construction features make the Bendix® Coaster Brake the outstanding performer in its field. That's why Bendix Coaster Brakes—stop quicker—pedal easier—coast farther—last longer. Your bicycle dealer will put on the brake you want—so just say "Bendix Coaster Brake."  
\*REG. U. S. PAT. OFF.

**DOUBLE THE FUN  
WITH A *Bendix*  
COASTER BRAKE**

ECLIPSE MACHINE DIVISION of  
Elmira, New York



**MOULDING DESIGNS UNLIMITED**

**PRICE  
only  
\$39.50  
Complete**



**"MULTIMOLD"  
MIRACLE SHAPER HEAD**

MODEL A for 1/2" SPINDLE

From Design to Finished Moulding in 5 Min.

"MULTIMOLD" cuts moulding costs and is simple and easy to operate. It eliminates the necessity of using cutting tools that serve only a single purpose or shape. Any style of moulding can be duplicated or created in a matter of minutes. Equally good on production or short run opera-

tions, "MULTIMOLD," the miracle tool, is a *must* for every good wood-working shop. In addition to cutting mouldings, "MULTIMOLD" can be used for Jointing, Rabbering, Beading, Dovetailing, Tongueing, Tenoning, Sanding Blocks, etc.

**MAIL CHECK OR MONEY ORDER TODAY... "MULTIMOLD" SENT POSTPAID ON MONEY BACK GUARANTEE OF SATISFACTION**  
California residents add 3% Sales Tax

**P-R CORP. Tool Division**

127-129 W. ALAMEDA AVE., BURBANK, CALIF.

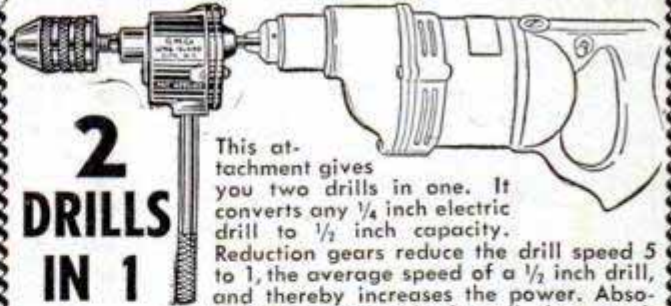

**2  
DRILLS  
IN 1**

This attachment gives you two drills in one. It converts any 1/4 inch electric drill to 1/2 inch capacity. Reduction gears reduce the drill speed 5 to 1, the average speed of a 1/2 inch drill, and thereby increases the power. Absolutely indispensable for all shop work and home craftsmen. Satisfaction guaranteed. Order yours now..... **\$11.95** post paid  
Send check or Money Order with order.  
Jobbers write for special information.

**G. M. CO. MANUFACTURING, INC.**  
1308 43rd AVE. LONG ISLAND CITY 1, NEW YORK

**ONE-MAN SAWMILL** LOW \$50.00 AS... **50** DOWN



Take BELSAW Portable Sawmill right to the trees—turn out valuable lumber for local yards—do "custom sawing" for neighbors. BELSAW lasts a lifetime. No crew needed. Power with old auto engine. Beginners get excellent results. Send postcard for FREE BOOK, "How To Make Lumber."  
**BELSAW MACHINERY CO**  
8113 Field Bldg. 315 Westport Rd, Kansas City 2, Mo.

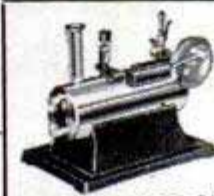

**GIANT ELECTRIC STEAM ENGINE**

Develops 1/20 HP 3200 RPM. Piston driven, has nickel-plated steel boiler, automatic safety valve, throttle control, water level gauge, pulley attachment, electric cord. UL appx. 9" long, 6" wide, 9" high. Powers all models.  
WAS \$18.95  
NOW \$9.95  
POST PAID  
MONEY BACK GUARANTEE

IDEAL XMAS GIFT SEND CHECK OR MONEY ORDER.  
**STANLEY AND CO.** 1613 SOUTH ORANGE GROVE AVENUE  
LOS ANGELES 35, CALIF.

**SPECIAL OFFER to Hobbyists** ONLY **4.95**

Hard Angle Jobs Set-up in 5 Seconds  
Save TIME! MONEY! Drill, mill, grind, etc., round, square, irregular pieces at any angle—Quickly—Easily—Accurately with **PALMGREN "HOBB-E" ANGLE VISE** Accurately machined and graduated, 1 1/2" Jaws, 1-Plain, 1-Grooved. Order NOW! Only \$4.95. Write for "HOBB-E-TOOL" Circular.  
**CHICAGO TOOL & ENGINEERING CO.**  
8365 SOUTH CHICAGO AVE. CHICAGO 17, ILL.



**OWN A Printing Business**  
Cards, Tickets, Stationery, etc. Good profit in spare time. PRINT YOUR OWN greeting cards, movie titles, church work, etc. Save money. Easy rules supplied. Raised printing like engraving too. Have home shop. Sold direct from factory only. Pays for itself in short time. Write for free catalog of outfits, and all details.  
**KELSEY PRESSES, 0-32, MERIDEN, CONNECTICUT.**

**HELPFUL BOOKS**

Send post card asking for FREE catalog  
Popular Mechanics Press, 200 E. Ontario, Dept. 601, Chicago 11

**TUBELESS Personal RADIO**

POCKET SIZE! GUARANTEED to play on local stations



• No Tubes  
• No Batteries  
• No Electricity  
Costs nothing to run, lasts indefinitely. Range up to 25 miles (some users report up to 50 miles on 50,000 Watt stations). New Germanium Diode crystal detector—same as used in Army, Navy Radar sets. Extra sensitive stethophone. Designed, mfgd, by an internationally known electronic engineer. Beautiful red plastic case with green trim. Single-control tuning, has rich, mellow tone. Just hook it up on simple instructions—it plays instantly, never turns off. Nothing to wear out; should last for years. Sent postpaid—cash, check or money order. No C.O.D.'s. Complete—nothing else to buy—\$5.00.  
Pat. App. for  
**Patrick Laboratories, Inc.** 2450 E. 52nd St., Indianapolis, Indiana — Dept. PM-12

# WAR SURPLUS INSTRUMENTS—RADIO—CAMERAS

## RCA VOLTOHMYST JR.

Range AC-DC 0-1000 V. 0-1000 Megohms. Power 105/125 V. 50-60 Cycles. An ideal instrument for all types of radio servicing. Multi-purpose unit that is a must.

Govt. Cost \$69.50..NOW \$34.50



## DUMONT #224 OSCILLOGRAPH

3" Cathode Ray. Sweep 0-30 KC. Vertical 20 to 90,000 cycles. Horizontal 15 to 22,000 cycles. Power 105/125 AC. 50/60 cycles. A leader in the field of high frequency test equipment.

List price \$290.00..NOW \$149.50



## WESTON ANALYZER #772

The combination tester with both 20,000 and 1000 Ohms per volt. From 0 to 100 Microamps with a high scale to 10 amps. AC-DC 0-1000 V. Output -10 to +48 DB.

Brand New..... ONLY \$39.50



## CHRONOMETRIC TACHOMETER

Precision RPM counter combined with chronometric operation. Automatic computing period of test in 6 seconds. No stop watch or personal equation necessary.

Govt. Cost \$81.25..NOW \$19.75



## ELGIN & WALTHAM

Waterproof. Shockproof A-11 Hack watch. 16 Jewel. Black face. Sweep second hand. Used by AAF. Add \$1.98 Federal Tax... \$19.75



## MAGNESYN INDICATOR

For remote indicating compass. Automatic direction finder. Calibrated from 0 to 360 degrees.

Govt. Cost \$90.00...NOW \$3.75



## HICKOK 19XD SIGNAL GENERATOR

Modulated and unmod. Output 1-100,000 Microvolts. 225 KC-144 MC. A most accurate AM-FM Microvolt generator.

Govt. Cost \$225.00..NOW \$119.50



## MINIATURE COMPRESSOR

2 Piston air compressor. 27 V. AC-DC. Individual thermo cutoff for motor and compressor. Positive regulator. 2 to 15 PSI. Can be used as vacuum pump. For jewelers, dentists, aerating fish ponds, etc.....NOW \$10.95

## 16 MM BELL & HOWELL MOVIE CAMERA

F 3.5 lens. Battery operated. Takes standard 50' Eastman magazine film.

Govt. Cost \$290.00..NOW \$29.75



EASTMAN 16mm x 50' magazine war surplus film, processing included. .... \$2.50



## KOHLSMAN ALTIMETER

For auto or airplane. Used, guaranteed accurate. Govt. cost \$168.00 NOW..... \$10.95



## MARK IV COMPASS

Self-compensating floating compass. U.S. Navy. Govt. cost \$72.00...NOW \$4.75



## TACHOMETER

Bendix C-1 0-2500 RPM. Direct Drive for planes, boats autos, etc. Govt. cost \$95.00 ..... NOW \$4.75

All merchandise guaranteed. Order these surplus bargains today. 20% Deposit on C.O.D.'s.

**Semlers' ASSOCIATED SURPLUS** Dept. PM-112 5730 WILSHIRE BLVD., LOS ANGELES 36, CALIF.

# NOW Preserve Every Issue of POPULAR MECHANICS In The NEW POPULAR MECHANICS MAGAZINE LIBRARY FILE

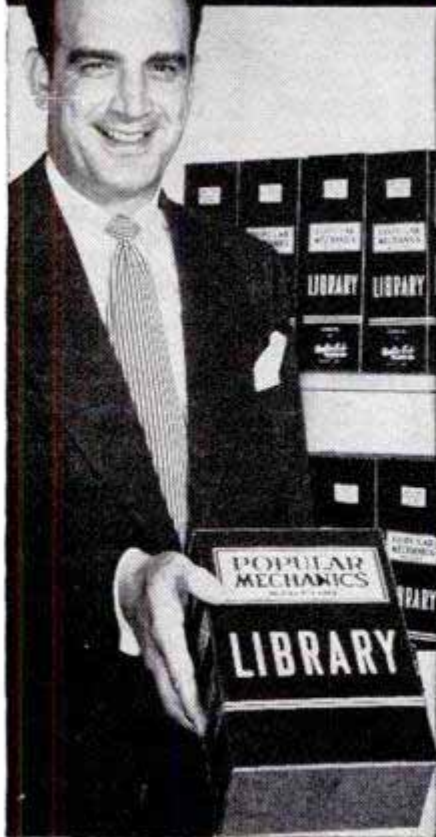

## INGENIOUS CUSTOM-BUILT STORAGE FILE

A Sensational Popular Mechanics Value Scoop

PER SET OF 2  
(set holds 12 issues)

Only **70c**

POSTAGE PAID

5 sets only \$3.10

10 sets only \$6.00

POSTPAID

Here it is... the brand new, grand new way to preserve each and every issue of Popular Mechanics in orderly sequence... indexed and ready for instant reference. Made of Kraft fibre board, printed in rich colors and constructed to look like an attractively bound book. Doubles the usefulness of your collection of Popular Mechanics Magazines. Makes every volume and article instantly accessible. A "must" for every reader of Popular Mechanics. Order now for immediate delivery. Use the handy coupon, today!

### CHECK THESE OUTSTANDING FEATURES:

1. Convenient size. Measures 6 3/4" wide, 3 3/4" thick by 10" high. Ideal for table-top, shelf or bookcase.
2. Special Reference Index Form, printed on back, records exact location of selected articles, diagrams and other wanted information.
3. Date Label Stickers — enough to index 10 years issues, furnished FREE.

### USE THIS COUPON... MAIL TODAY

Popular Mechanics Magazine, Dept. PL 200 East Ontario Street, Chicago 11, Illinois P12-50

Please rush PREPAID \_\_\_\_\_ sets Popular Mechanics Magazine Library Files. (QUANTITY)

Remittance for \$ \_\_\_\_\_ is enclosed. (AMOUNT)

Name \_\_\_\_\_

Address \_\_\_\_\_

City \_\_\_\_\_ Zone \_\_\_\_\_ State \_\_\_\_\_

Our 342nd Advertisement

# REAL DIESEL ENGINE!

## \$2.95

You just can't beat this price for a completely assembled precision diesel engine!

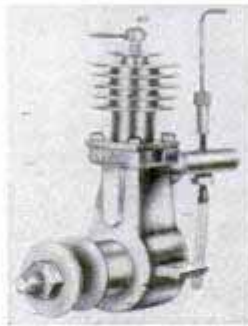

- Ideal for planes, boats, midget cars
- Actually runs at 7500 RPM, produces 1/7 HP
- Height a full 3 1/2 inches; weight 5 ounces
- Comes to you completely assembled, ready for operation

**MAYBE WE'RE CRAZY**, giving away a precision diesel engine, complete with cylinder and piston, carburetor, crankshaft, connecting rod, etc. for **ONLY \$2.95**. But we're selling thousands of DEEZILS all over the world, and that keeps our production costs down. DEEZIL is streamlined, compact, rugged. Starts quickly, easy to install, runs for years! Fast delivery if you **ORDER DEEZIL TODAY!**

Send \$2.95 plus 25c postage

**GOTHAM HOBBY CORP.** Dept. P, 107 E. 126 St. NEW YORK 35, N. Y.

## UNUSUAL, PRACTICAL CHRISTMAS GIFT!

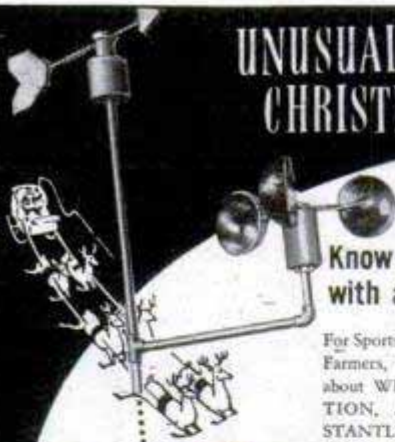

Know "what's in the wind" with an A-C-I windometer

For Sportsmen, Yachtsmen, Private Pilots, Farmers, Scientists. Get accurate facts about WIND SPEED, WIND DIRECTION, AIR TEMPERATURE INSTANTLY, without moving from your desk or easy chair! Windometer Cabinet, with constant reading dials, sits on desk or table. Indicators mounted easily and quickly outside. All instruments and transmitters used in the ACI Windometer are highest quality precision aircraft type, with Gold-Palladium and Silver contacts. Plugs into any AC outlet. Never before such quality and precision at this amazingly low price! Hundreds installed in homes, airports, farms, yacht clubs, etc.

ORDER NOW FOR XMAS DELIVERY **\$89.50**

**AIRCRAFT COMPONENTS, INC.**  
1500 Woodland Avenue • Benton Harbor, Michigan

**SAVE \$7.00 LIMITED SPECIAL OFFER**

**NATIONALLY ADVERTISED FAIRCHILD FLEXIBLE SHAFT TOOL KIT**



Complete with 1/20 H.P. Motor 20,000 RPM, AC or DC, 10 accessories in Fitted Wood Case.

3 Ft. Flex Shaft with solid brass chrome plated couplings, Pencil size Oilless Bearing Chuck for 1/4" or 3/32" Tools, 2 Point and 2 Wheel Grinders, Bristle Brush, 3 Types of Burrs, 3/4" Circular Saw, Factory Packed.

**90 DAY FACTORY GUARANTEE**

Ideal for Grinding, Sawing, Engraving, Carving, Drilling, Polishing, Cleaning, etc. Excellent Gift for the Hobbyist and Home Craftsman.

REG. PRICE \$19.95

**SPECIAL \$12.95** add 50c for Mailing and Handling.

Send Check or M.O. Sorry no C.O.D.s

**P. KATZ** 149 BROADWAY, NEW YORK 6, N. Y.



**DUST-O-VAC FOR ALL MACHINES**

For Home Workshops & Industry. DUST-O-VAC collects & bags wood & plastic chips, wood & metal dust, wood shavings. Free Bag. Attaches to circular saw, planer, band saw, grinder, belt or disc sander, shaper, drill press with shaper or sander attachment, spindle shaper, wood lathe, jig saw, 110 A.C., D.C. Send for mounting instr. for all machines.

**\$19.95**

Free Ship. east of Miss. West of Miss. add \$1. Check. M.O.

**HEAVY CAST ALUMINUM BLOWER — ONLY \$11.25**  
For workshop, lab., kitchen, cellar, app. 100 CFM. Send for circular.  
**UNIVERSAL YONKERS CORP., 137 Alexander St., M-12, Yonkers 2, N. Y.**

## DEPENDABLE CRAFT SUPPLIES

LEATHER CRAFT • PLASTICS • POTTERY  
CRAFT • BLOCK PRINTING • BELT CRAFT •  
TEXTILE COLORS • POWER TOOLS • WOOD  
BURNING • INSTRUCTION BOOKS • ETC.  
**DWINNELL CRAFT SHOP**  
Dept. PM-512—Wheeling, W. Va.

## SHEET METAL BRAKES

Forms angles, flanges and Pittsburgh locks. 26 gauge steel, heavier aluminum. Cam locking. Portable, can be bolted to bench, or clamped to edge of truck. All steel, reinforced. Shipped Exp. Coll. 30" size. Wt. 42 lbs., \$26.50. 36" Wt. 52 lbs. \$31.00. 48" \$45.00  
Floor mountings, portable, 32" high, \$7.00  
12" BRAKE. Fits in vise to form difficult compound bends, up to 20 gauge steel. Not illustrated. \$12.50 pp.  
18" CURVE FORMER, Capacity — 18 gauge steel. \$10.00  
SHEET METAL PLIERS, 2 1/2" wide, \$2.00; 5" \$2.50  
Immediate delivery. Order direct, cash or C.O.D. or send for folder.

**VYKE BRAKE CO., P-1116 So. 27th St., Omaha 5, Nebr.**

## Cracked Block? BLOCK SAVER

Four BLOCKSAVER copperized powder into block. Finds all cracks. Permanent metallic repair guaranteed. Cars, Trucks, Tractors. \$3.00 postpaid. No. C.O.D.s.  
**ZO-TITE PRODUCTS, Box 373, Lindenhurst, N.Y.**

## POW'R - HAM'R The Most Amazing Tool You'll Ever Own!

Changes Your Electric Drill into Powerful Hammer in Seconds!  
**DRILLS THRU:**  
• BRICK  
• CEMENT  
• TILE  
• STONE  
**FACTORY GUARANTEED! WARRANTY INCLUDED WITH EVERY ITEM!**

**A PRACTICAL GIFT!**  
Order at Today's Low Prices!  
• SPECIAL "KIT" BUY! Multi-Tool-in-One Attachment for 1/4" electric drill — POW'R DRIVER Model 800, 1 Sander-Polisher Attachment — 1 Saw Attachment \$14.95.  
Dealer Inquiries Invited. Send check, M.O. Today! Remit with order, we pay postage. C.O.D. plus postage. Immediate Delivery!  
**ROTO-POWER CORP.** Add 50c on all items West of Miss. River  
283 Greene Ave., Dept. P-12, Brooklyn 5, N. Y.

Say "Merry Christmas and a  
Handy New Year" with these  
**BULL TOOL CHRISTMAS SPECIALS**



**New  
B-T HACK SAW**  
Powerful . . . \$4.95  
Portable . . .  
Pocket-size!

For 1/4" elec. drill. Saws wood, plastic, steel & sheet metal, pipe, plaster board, celotex. No gears, no bearings, nothing to wear out. Full 3/4" chip clearance. Weighs only 11 oz. Complete with blade, \$4.95 (Extra blades, 10¢ each).



**BULL  
BUFFER**

America's first and most famous polisher-sander fits any 1/4" elec. drill. Complete with sheepskin bonnet, rubber pad, 2 sanding discs. **\$9.95**

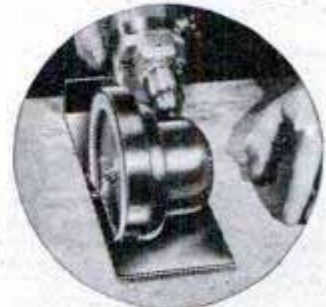

**NEW BULL SAW**

Fits any 1/4" elec. drill. Powerful, portable, easy one-hand operation. Depth of cut: 1 1/8". Complete with saw blade. **\$9.95**



**New  
BULL "200"  
ELECTRIC  
DRILL**  
\$16.50

You'll never "stall out" with this portable powerhouse!—WE GUARANTEE your MONEY BACK if it isn't more powerful than any 1/4" elec. drill at ANY price! Standard model, \$16.50. (Model 200-J, with Jacobs geared chuck, \$19.50).



**Sensational  
new  
ZIP-SAW**  
\$39.95

A heavy-duty, perfectly - balanced, portable electric hand saw with full 6 1/4" blade. New, unusual features — mitre gauge, depth gauge and rip fence! Mitres 2x4's at any angle—90°, 15°, 30°, 45°. Depth of cut: 2 1/8". Motor is 5200 rpm Universal AC-DC, 110-120 V. (Beautiful Blue steel case, \$5.95 extra.)



**New BENCH GRINDER KIT**

For sharpening, drilling, buffing, sanding, grinding, scraping, brushing and polishing everything around the home, farm or shop. Comes complete with motor, eye shields, rubber pad, assorted abrasive discs, bonnet, wire wheel, cloth buffs, chuck and adapter, buff compound & 3 chrome alloy twist drills. **\$19.95**

Time's A-Wastin' & Good Tools are scarce!—ORDER TODAY at these low prices and be sure of pre-Christmas delivery! Send cash, check, or M.O. today!

**BERTRAM D. ENGINEERING & SUPPLY COMPANY**  
3121 MAIN ST. KANSAS CITY, MO.



**HOT RUNNING WATER!**

Attaches easily, quickly to any standard faucet. Regulates temperature by turning faucet. Operates AC or DC. Comes with S-ft. rubber cable and plug. Our DELUX heater has delighted many thousands of users. Send \$3.95-cash, check, or M.O.—we will ship prepaid or, if you wish, we will ship C.O.D.—you pay postman \$3.95 plus few cents postage. Order 3 for \$10—save \$1.85.  
METROPOLITAN ELECTRONICS CO.  
Dept. 184, 106 Fifth Ave., New York 11, N.Y.



**FOR BOYS  
FROM 6 TO 60**

Start your collection of HISTORICAL WEAPONS with this ACCURATE SCALE construction Kit of an 1851 Colt Cap and Ball Pistol, truly representative of Frontier guns.

**ONLY \$5.95**  
SEND CHECK OR M. O. PREPAID  
DEPT. A, 433 SO. PROSPECT AVE., PARK RIDGE, ILL.

**THE BIGGEST VALUE ON THE MARKET DIRECT FACTORY TO YOU**

**DYNAMIC ARC-WELDER**  
*Super Charged*

**DOES WELDING, BRAZING, SOLDERING, CUTTING**

This is one of the finest scientifically designed and precision-built genuine heavy duty transformer-welders on the market today! Made by an old established firm. High efficiency, heavy-duty output does work you'd expect from costlier machines. It's EASY TO OPERATE. Do expert work in a jiffy by following the simplified instructions furnished. Works on iron, steel, brass, bronze, aluminum or other metals. OPERATES from any convenient properly wired 110 VOLT A. C. line. SAVE TIME AND MONEY . . . build or repair your own auto, home, farm, or shop equipment and appliances, etc. Make big money doing work for others in spare or full time. OVER 50,000 SATISFIED USERS all over the country, hobbyists, maintenance and repair men, farmers, tinsmiths, engineers, home and auto owners. Send coupon today for full details on 10-day trial.

**LOWEST PRICED TRANSFORMER TYPE INDUSTRIAL WELDER**

**VALUABLE ATTACHMENTS included as gift for prompt action! Write for free details**

**SEND TODAY FOR FREE DETAILS**

Please send complete descriptive Dynamic Welder literature and details on 10 day Money back trial and gift offer.

Name.....  
Address.....  
City..... State.....

**DYNAMIC WELDER CO., Dept. D2-NA6, 15 E. 23rd St., Chicago 16, Ill.**

The **NEW Model 50 UTILITY TESTER**  
**FOR REPAIRING ALL ELECTRICAL APPLIANCES-MOTORS**  
*an all-around electrical trouble shooter*



- Measures A.C. and D.C. Voltages, A.C. and D.C. Current, Resistances, etc.
- Will measure the current consumption while the appliance under test is in operation. The appliance or utility may be plugged directly into the front panel receptacle. A special pair of insulated clip-end leads is included for motors, etc.
- Incorporates a sensitive direct-reading resistance range which will accurately measure all resistances commonly used in electrical appliances, motors, etc. This range will enable continuity checks and tests for shorts and opens.
- Will test thermostats, radio tube filaments, bulbs, fuses, fluorescents, condensers, switches, field coils, circuit breakers, lighting systems, etc.

Handsome round cornered molded bakelite case 3 1/8" x 5 7/8" x 2 1/4". Complete with all test leads and instructions.

**\$13.90**

**SHIPPED ON APPROVAL**  
**No Money With Order - No C.O.D.**

Try it 10 days before you buy. If completely satisfied send check or M.O. for \$13.90, if not, return to us—no explanation necessary.

**SUPERIOR ELECTRONIC CO., INC.**  
 Dept. A-5 • 227 FULTON STREET • NEW YORK 7, N. Y.

**NEW WITTE "REDHEAD"**

an independent power supply for only 1 1/4 cents per kilowatt-hour!

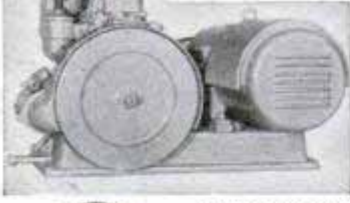

Operates under full load for 24 hours on a little over 11 gallons of low-cost fuel. Ask your Witte distributor or write for complete information.



**WITTE ENGINE WORKS, KANSAS CITY 3, MO.**  
 Division of Oil Well Supply Company  
**WITTE DIESELECTRIC PLANTS and DIESEL POWER UNITS**

**UNITED STATES STEEL**

Make Your Own  
**POWER LAWN MOWER**  
 with this DRIVE CUTTER ASSEMBLY

Complete with 18" blade and double ball bearing drive, only **\$11.95**  
 Add 50c for shipping charges

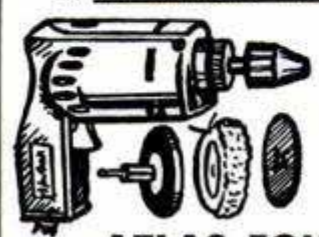
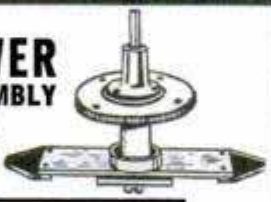

**GENUINE MALL**  
 1/4" Electric 110 Volt AC  
**DRILL SET**  
 Special with sander and polisher and 9 Drill Bits. All for **\$17.95**

ALL PRICES FOB, K. C.  
 SEND CHK. OR M. O.

**ATLAS EQUIPMENT CO.**

229 S.W. Blvd. Dept. PM-12 Kansas City, Mo.

**WAR SURPLUS BARGAINS**

**GENERATORS 115V-AC**



FOR AUXILIARY LIGHT PLANTS

NOW... here's the buy of the year. Brand new Eclipse Generators in the original box. These generators have an AC output of 115 volts, 10.4 amps, 1200 watts, single phase, 800 cycles at 2400 R.P.M. They also have a DC output of 28.6 volts, 60 amps. The unit has a spline drive shaft and is self excited. It will serve as a dependable 115 V-AC auxiliary light plant when driven by a gasoline engine for farms, cottages, flood lighting, trailers, boats, or wherever power is not readily accessible. Shipping wt. 55 lbs. Govt. cost more than 10 times selling price. *F.O.B. Pasadena*

ONLY **\$19.95**

**BRAND NEW POLE CLIMBERS**

Buckingham pole climbers in their original package. (Without Straps) ONLY **\$2.95 PER PAIR**



**LINEMAN'S TOOL & SAFETY BELT**

Brand new web-type belts in their original box. SPECIAL **\$3.95**

**C and H Sales Company**

BOX 356-S EAST PASADENA STATION • PASADENA 8, CALIFORNIA

**POWER HACKSAW \$52.75**

LESS MOTOR  
 F. O. B. Benton Harbor

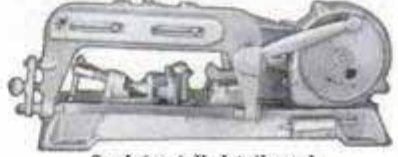

• Rugged cast iron construction. Wt. 56 lbs. bronze bearings. Draw cut. Auto. return lift. Auto. shut-off. Vise swivels 45°. Cap. 4"x4".

Send for full details and name of nearest dealer.

**EXCEL MACHINE TOOLS** Dept. PM-120 BENTON HARBOR, MICHIGAN

**MACHINE SHOP EQUIPMENT**



• The No. 49 edition of the famous Center Tool Co. Catalog is now ready! Every workshop owner should have a copy. 240 pages full of illustrations, descriptions, and prices of the latest tools made by best known manufacturers in U. S. You pay the cost of printing—50c. We refund your 50c with your first order of \$10.00 or more. Prompt delivery on most tools. Send check or money order today!

**CENTER TOOL CO.**  
 153 Centre Street, Dept. C, New York 13

**WAR BARGAINS**  
 Over 200 terrific  
**SURPLUS** ALSO FACTORY SURPLUS VALUES!  
 SEND FOR FREE CATALOG  
**STIOUX FALLS SURPLUS STORE**  
 STIOUX FALLS, S. DAK.

Say You Saw It in  
**POPULAR MECHANICS**

**MAKE A CIRCULATING HEATER OUT OF YOUR COOK STOVE**  
 with "EVEN-TEMP"



Just set "Even-Temp" on Gas, Oil or Electric stove or hot plate, circulates warmed air high and low, eliminates cold spots, warms room for baby's bath. Lightweight aluminum, attractive, portable. Even-Temp cuts down fuel bill!

Only **\$2.95 Postpaid**  
 Money-back guarantee, send cash with order.

**NEFF EQUIP. CO., 510 PETROLEUM BLDG., WICHITA, KS.**

**SAVE UP TO 60%! GIGANTIC MAIL SALE!**

**COMPLETE BARGAIN CATALOG**  
Order from ad. Satisfaction guar.  
Or, rush card for big free catalog.

**Power Plants • Welders • Pumps • Compressors • Tools**

**WE PAY SHIPPING COSTS**

**A-C POWER PLANTS (2500 watt)**

New 110-volt, 60-cycle, Army's finest plant. Real buy. Ideal for farmers, contractors, camps, city power.

• Briggs 6.5 h.p. engine. Leland self-excited generator. Automatic voltage regulation. Easy starting.

• Tools, spare parts, full instruction manual. \$726.00 value. . . . **\$289.20**

• 115-volt, 60-cycle, 5,000-watt Hobart generators. Cost \$390.00. **SALE . . . . . \$229.70**



**D-C ARC WELDER**

0-250 amps. \$300.00 value. Outstanding welding unit. Easy to drive with tractor, engine, etc. Excellent control. Complete unit with G. E. helmet, electrode holders, cables, rod asst., etc. Guar. Brand New. . . . . **\$89.50**

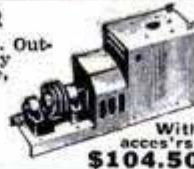

**WELDING GENERATOR (200 Amp.)**

Excellent direct current generator with full instructions for use as welder. Includes heat control, cooling fan, etc. Type P-1. Delco-Remy. 30-v. . . . . **\$29.89**



**WATER PUMPS and SYSTEMS**

Genuine brand new Burdex bronze self priming all purpose water pumps. Std. pipe threads. Will lift up to 22 ft. Pressures to 30 lbs. Up to 22 g.p.m. Other pumps up to 150 lbs.

- 1/2" BRONZE . . . . . \$12.79
- 3/4" BRONZE . . . . . 15.99
- 1.0" BRONZE . . . . . 19.49
- 3/4" CENTRIFUGAL . . . . . 6.50

**AUTOMATIC WATER SYSTEM**

Automatic 110-v. 60-c. running water system. For wells with lifts up to 22 ft. Easy to install. Turns on-off automatically. Pressure water in every home. . . . . **\$59.50**



**Weed-Cattle Tractor Power Sprayer**  
Finest direct-tractor-drive outfit. Best stainless steel pressure pump (up to 400 lbs. pressure.) Fits any tractor. 14' brass boom, gauges, valves, etc. \$160.00 outfit. **SALE . . . . . \$79.90**

Burden pays all freight. Free Bargain Catalog. Request free data on any item.

**"We pay shipping costs on everything"**

- A. Utility Clutch up to 6.5 h.p. \$13.95
- B. V-belt Clutch up to 1.5 h.p. \$ 7.49
- C. Hand Gas Pump 10 g.p.m. \$15.90
- D. Army Field Telephone EE-8 \$11.25
- E. Rural Phones (5 bar) . . . . . \$12.40
- F. City-Desk Phones (Com. Batt.) 4.99
- G. Briggs 3.5 h.p. Engine. . . . . 75.50
- H. 2 sta. phone inter com. . . . . 11.60
- I. 110-v. Electric Chain Saw. . . . . 94.50
- J. Auto Compression Tester. . . . . 3.94
- K. 1.5 to 2.0 H.P. Engine. . . . . 44.85
- L. 110-v. 3,000-watt Heater. . . . . 26.80
- M. 110-v. 60-c. 2000-w. Gen. . . . . 149.50
- N. 110-v. 1000-w. A-C Gen. . . . . 18.96

**POWER & HAND WINCHES**

• Amazing Values. Jeep winch 80 to 1 ratio. 5,000 lb. capacity. Mounts on front trucks, jeeps, cars. Cost over \$150.00 (New) **SALE \$21.95**

• Finest Steel Hand Winch. Powerful unit complete with 50 ft. 3,000 lb. cable. Complete with crank. \$50.00 Value (New) **SALE \$29.95**

• Aircraft electric motor-driven winch Complete with brake, motor, etc. Wonderful unit. **\$38.90**

• Engine (11 h.p.) hoist winch. Hundreds uses. Complete with clutch, gear shift, etc. **\$295.50** FOB

• Cost \$1200. **SALE \$295.50** Lincoln

**BURDEN SALES COMPANY**  
802 "O" ST. LINCOLN, NEBR.

**A-C POWER PLANTS (1400-watt)**

New Homelite plant, complete, original crate, with tools, parts, manual. 115-v. 400-c. . . . and 400-w. at 27-v. 4 h.p. engine. Ideal for 115-v. Lights, heaters, radio-camper, contractors, etc. Cannot be used for 60-c. motors. Cost Gov't. \$565.00. Prepaid. . . . . **\$129.60**



**AIR COMPRESSOR KIT**

Assemble own unit. Consists of finest one cyl. piston compressor (see below), stainless steel 2100 cu. in. tank, 160 lb. gauge, safety valve, paint spray gun, blow gun, 15 ft. hose, assembly instructions, tire chuck, fittings. Drive with engine or motor. \$60.00 Value (Brand New) **SALE \$36.90**



• Quincy One-Cyl. Compressor Top quality. 150 lbs. pressure. 2.88 c.f.m. \$25.00 Value. (Brand New) **SALE \$18.15**

**AIR SUPPLY COMPONENTS**

• Quincy 2-cyl. compressor, 9 c.f.m. \$44.90  
• Finest stainless steel 12"x25" tanks. . . . 8.95  
• Also bargains in automatic switches, hose, valves, regulators, gauges, air chucks, blow guns, etc. Write for "Air Bulletin."

**SAY YOU SAW IT IN POPULAR MECHANICS**

**DUAL CROSS and ROTARY FEED**

**PALMGREN TABLE** ROTARY, INDEX, MILLING No. 83

Has 8" table, 360° movement and 4" cross feed travel. Adjusting wheels and dials graduated in degrees and thousandths. Slotted for bolting to table. No. 83 Priced \$49.50. No. 82 without rotary feed \$39.75. Write for Circular No. 10  
**CHICAGO TOOL and ENGINEERING CO.**  
8365 South Chicago Ave., Chicago 17, Ill.



**HOLLYWOOD MUFFLER**

**THE TONE YOU LOVE TO HEAR**

Not a gutted muffler. Ford, Chevrolet, Plymouth \$6.00  
Easy to install. All other makes . . . \$8.00

Dealers Write **WILKINSON MUFFLER CO.** 811 WILT STREET FT. WAYNE, IND.

**SAW, DRILL and GRIND**

Without Stopping Machine or Changing Set-ups

"Saw alone worth price of entire combination" . . . say thousands of users!



**Get an Emrick — do better work FASTER, EASIER.** Only ONE set-up for sawing, drilling, grinding; only ONE change for lathe work and sanding. No heavy lifting. Basic 5-in-1 Machine (20" x 52" x 28" high) still only \$39.95; Specials to \$89.50. **10-Day Free Trial.** Write for FREE Catalog covering our entire line. **EMRICK, Inc. 1120 Clinton, Kalamazoo, Mich.**

**make your own Gems 29.50** F.O.B.

All necessary lapidary equipment is furnished, including a super-charged diamond blade for sawing, and all wheels for grinding, shaping and polishing also complete instructions. The complete equipment as shown, less motor and belt, for only \$29.50, f.o.b., Burlington, Wisconsin. Write today for information and literature.

**B&I MANUFACTURING CO.**  
Dept. S Burlington, Wis.

**Local Colorcretors Can Earn High Incomes**

**COLORCRETE** is today's biggest business opportunity in the building field. High returns from a low investment. Easy, fascinating work. Large waiting market because Colorcrete is applied over all kinds of old and new masonry surfaces — exterior and interior.

**Beautifies and Protects All Types of Buildings**

Pneumatic pressure sprays plastic-like Colorcrete to give enduring beauty and water-resistant values. Range of 30 gleaming colors; many textures. Easy to wash. Smartly modern. Write or wire today for Opportunity Portfolio, which gives complete story.

**COLORCRETE INDUSTRIES, INC.**  
570 Ottawa Ave., Holland, Mich.

# WAR SURPLUS AND OTHER BARGAINS

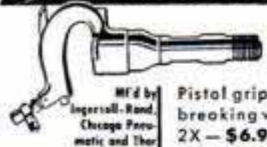

## PNEUMATIC RIVETER & CHIPPING HAMMER

Mfd by Ingersoll-Rand, Chicago Pneumatic and others. Pistol grip. Ideal for fender, brake lining, concrete breaking work. Weight 5 lbs. Like new. Price each...  
 2X — \$6.95    3X — \$7.50    4X — \$8.50

## INSIDE MICROMETER 2" to 8"

Precision made of tool steel. Hardened tips on all six measuring rods. One 1/2" spacer. Chrome finish. Complete with case. \$6.95



## FANCY BRIAR PIPES

We have been awarded 100,000 fancy briar pipes by Quartermaster Corps. Assorted shapes and sizes. All popular makes. Buy now for Christmas Gifts. Set of 7. \$3.50



## MICROMETERS

Chrome plated, precision engineered and carefully tooling to give long life. All new.  
 0-1" capacity . . . each \$2.25  
 1-2" capacity . . . each 3.50  
 2-3" capacity . . . each 5.50  
 3-4" capacity . . . each 6.50

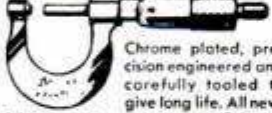

## EXPANSION REAMERS



Spiral Flute. Mfd. by Alvord Polk Tool Co. All New, original pack. 1/4"-3/8"-7/16" Recommended expansion limit, .006" Original value \$12. Set of 3 . . . . . \$4.95

## DRILL GRINDER

... Sharpens round, square or tapered drills up to 6" long. Even an amateur mechanic can get a new, factory finish on a drill in 25 seconds. New protractor feature gives every drill sharpening angle, with 5 convenient angles already marked off. Usable with hand or power stone. A brand new development, manufactured by Ten Eyck. Shipped postpaid



All New. \$2.80 each.

## HIGH SPEED DRILLS

All New. Fractional & numbered. Orig. Val. \$15. Nationally known brand. Astd. sizes. Set 30. \$3.50



## EXTENSION DRILLS

High Speed Steel, like new. Ass't'd sizes from No. 1/4 to 40. Lengths from 6" to 12". Approximately \$20 value. Set of 12 . . . . . \$3.75

**ELECTRIC BELLS** — Vibrating type, high pitch. 115 V., 60 Cycle. Ideal for use indoors or outdoors — on ranches, for schools, plant installations, as signal systems, burglar alarm systems, etc. Nationally known Mfr. ALL NEW in orig. Pkgs. Solid brass clapper & 8 1/2" gong. Wt. 8 lbs. Govt. cost about \$67.50. Close out at . . . \$7.95



Send check, money order or cash. 25% deposit required on C.O.D. orders. All prices F.O.B. Culver City, California, unless otherwise stated. Send 25c for illustrated Catalog.

## AIRBORNE SALES CO., INC. DEPT. PM 12-0 CULVER CITY, CALIF.

SAY YOU SAW IT IN POPULAR MECHANICS

# Sharpen SAWS FOR PROFIT

**RETOOTH HAND SAWS IN 60 SECONDS.** Increase your income with automatic retooth that cuts 4 to 16 point rip or cross-cut teeth in hand saws.

Requires less space, less time and less effort . . . while doing a perfect job. Gives a lifetime of service and has a 1 year guarantee. Free folder on request.



Automatic Retoother



Motor Driven Saw Filer

## EARN \$6 AN HOUR WITH THE MOTOR DRIVEN BURR SAW FILER

It does a better, faster and easier filing job. No time killing adjustments necessary . . . the accurate operator-controlled file arm will file from both sides. Gives a lifetime of service and has a 1 year guarantee. FREE FOLDER ON REQUEST.

**WRITE FOR VALUABLE BOOK**  
 Send 25c in coin for Burr's Blue Book of saw shop charges and other valuable information.

**SAW SHOP CHARGES COAST TO COAST**

BURR MFG. CO., Dept. 12, 8933 Venice Blvd., Los Angeles 34, Calif.

# PUNCHING

MADE EASY WITH **PIONEER HAM-R-PRESS**  
 FAST - ACCURATE!  
 IMPACT PRESSURES TO SEVERAL TONS  
 SIMPLE OPERATION — Insert die, slip punch on ram, lower to work, strike with hammer blow.  
 Normal capacity to 16 ga. sheet steel

MODEL	THROAT	PRICE
50	5"	\$9.95
75	7 1/2"	16.95
120	12"	24.95
240	24"	39.95

PUNCH AND DIE SETS COMPLETE  
 ROUND—1/4", 3/8", 1/2", 5/8", ea. \$1.45  
 3/4", 1", 1 1/4", 1 1/2", 1 3/4", 2", ea. 2.00  
 SQUARE—1/4", 3/8", . . . . . ea. 2.25  
 1/2", 5/8", 3/4", . . . . . ea. 2.75

KEYED ROUND—1 1/4" . \$2.60  
 DIE RAISER, 3" high . . . 3.95  
 SHEARING SET—  
 1" length cut . . . . . 3.75  
 RIVETING SET . . . . . 1.50

DIE ADAPTOR — required for rivet and punch sets under 1/2" . . . . . 1.00

Adjustable ram bushing and spot centering pin on models 75, 120, 240 only.

## PIONEER TOOL CO.

1424 S. MAIN ST., LOS ANGELES 15, CALIF.

## HANDY CALCULATOR FOR WOODWORKERS.. ONLY 10c

Just set dial, quickly solves countless problems. Converts linear to board feet, compares workability of various woods, shows bit sizes, nail specifications. Also tool sharpening tips, etc. 6" diameter heavily varnished cardboard. Send 10c to Greenlee Tool Co. 2112 Columbia Av., Rockford, Ill.

## Drill any masonry CONTINUOUSLY

### ... with new CARBOLOY "LIVE-SPIRAL" Masonry Drill

No packing or stalling. Spiral wire lifts dust as it drills. Tipped with Carboloy Cemented Carbide. Fits any rotary drill or hand brace. 1/4" drill—\$1.60. Also 1/4", 3/8", 1/2" in Kit C. Free folder at dealer's or write.  
 "Carboloy" and "Live-Spiral" are trademarks of **CARBOLOY COMPANY, INC., 11185 E. 8 Mile Street, Detroit 32, Mich.**

## \$ Free Course! Big Profits! \$

### Flocks & Sandblasts

Dual Purpose Spray Gun! Uses only 25 lbs. Air Pressure  
 • Thousands of uses in Home, Shop, Industry: Makes Auto Interiors Clean & New, Lines drawers, Marproofs lamp bases, Refinishes any object. All in colorful Flock. Etch & Frost windows, glassware, etc. Removes Paint & Rust from Autos, Tools. Guaranteed! Send \$19.75 or write for free information. Flocking supplies!

**BLASTO SPRAY GUN MFG.**  
 Dept. PM-12, 7007 Haas Avenue, Los Angeles 47, Calif.

## HELPFUL BOOKS

Send post card asking for FREE catalog  
 Popular Mechanics Press, 200 E. Ontario, Dept. 601, Chicago 11

## BUILD HEAVY DUTY MACHINES

SAVE UP TO 90%— You can build, using our practical, easy-to-read plans, all kinds of machines, for home, farm or shop — scooters, portable sawmills, metal working machines, concrete machinery of all kinds, printing equipment, woodworking machines, midget autos, dish washers, farm equipment, freezers, tractors.

**FREE CATALOG HANDBOOK**  
 183 SETS OF PLANS  
 VALUABLE INFORMATION

**NICHOLS EQUIPMENT COMPANY**  
 D-11 PURVIS, MISS.



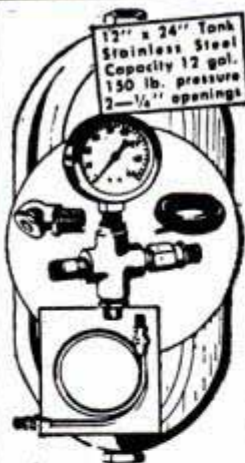

## WESTINGHOUSE Air Compressor

Reg. \$60.50 . . . Only

Model T-1 Brand New  
— 2 CYLINDER \$21.50  
PISTON TYPE.  
Operates with 1/2 H.P. Motor or  
equivalent gas engine.

Compressor has 2" bore, 1 1/4" stroke,  
ball bearing, 3.27 CFM at 600 R.P.M.  
Capacity up to 6.54 CFM. Size 9"x  
11 3/8"x6 5/8". Wt. 26 lbs.

Compressor, pressure tank, air gauge,  
air chuck, 20-ft. hose, pop valve, copper  
tubing with 4 brass flared fittings  
for connecting compressor to tank,  
4-way cross and 3 nipples.

COMPLETE OUTFIT, wt. 52 lbs. . . . \$32.50  
EQUIPMENT LESS COMPRESSOR, \$12.50  
COMPRESSOR SEPARATELY, \$21.50—TANK ONLY \$5.95

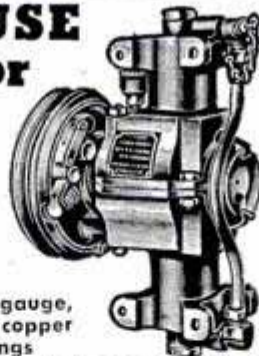

## LIGHT PLANTS

Brand New!  
War Surplus

Signal Corps Power  
Unit PE 197

115 volt 60 cycle  
A.C. single phase  
5 K.W. Hobart,  
water cooled, 14  
h.p. 4 cylinder  
Hercules engine.  
Remote Control,  
complete panel  
board with instruments. 150 ft. automatic re-  
mote control cable with reel; 150 feet #8 heavy  
duty wire with reel; housed in metal case with  
replacement parts and tools. Cable with reels  
alone worth \$400. Regular  
price of unit \$1900. Shipping  
wt. 1250 lbs. Our price, com-  
plete. . . . \$895.00  
f.o.b. Chicago

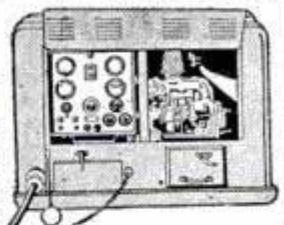

2 3/4 K.W. LELAND POWER PLANT . . . \$295.00

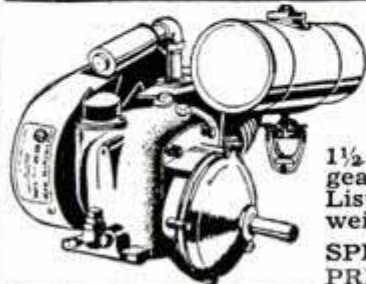

Save 50% on Gas Engines!

Red Seal Continental  
6 to 1 REDUCTION GEAR  
1 CYLINDER — 4 CYCLE

1 1/2 HP with 6 to 1 reduction  
gear. Operates at 450 R. P. M.  
List Price \$79.50. Shipping  
weight 54 lbs.

SPECIAL PRICE . . . \$39.50

## AUTOMATIC COMPRESSOR UNIT

1/2 H.P. heavy duty capacitor mo-  
tor. AC 110/220 volt, 60 cycle,  
2x1 3/4 inch piston type  
compressor, splash feed  
lubrication. 12x24 inch  
tank, automatic pressure  
switch. CFM 2.8 at 100  
lb. pressure, or 150 lbs. pres-  
sure for intermittent duty.  
Check valve, safety valve, air  
regulator with gauge and filter,  
20 ft. air hose with air chuck  
for inflating tires. V. belt drive.  
Mounted on 2 wheels, ball bearing, with  
2"x10" pneumatic tires. Portable with  
handle. Shipping wt. 90 lbs.

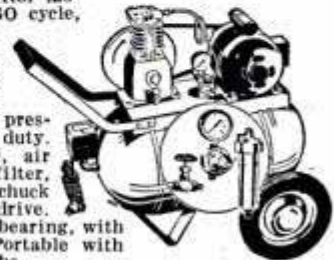

SPECIAL PRICE . \$89.50

## WELLWORTH V-BELT CLUTCH



Takes starting load off engines or motors. When  
speed is reached, a flip of handle shifts clutch  
from idling to driving position. Handles "A"  
belts, 3.35" pitch diameter, 5/8" bore. Ideal for  
use with lawn mowers, garden tractors, home  
workshop motors, etc. 3 1/2" long. Safe, easy to  
mount, sealed bronze bearings.  
positive action. Shpg. wt. 3 lbs. \$7.50

SAME CLUTCH FURNISHED WITH 3/4" BORE \$8.50

## 1/2" ELECTRIC DRILL

Streamline Design — U. L. Approved

Universal air-cooled motor—110/115 V. AC-  
DC Blower type fan for air cooling. Removable  
side handle for close quarter drilling. Jacob's  
Chuck with key. No load speed  
450 RPM; full load, 290 RPM.  
1/2" capacity in steel; 1" ca-  
pacity in hard wood. 10 ft.  
cord and plug. Shipping wt. 11  
lbs.

PRICE ONLY \$34.50

Same drill furnished with Ja-  
cob's Hex. chuck, only. . . . \$29.65



It's a  
Honey!

CHICAGO PNEU-  
MATIC RIVETER &  
CHIPPING HAMMER  
CP4X Pistol grip  
handle. Takes up to  
3/16" rivet. Weight  
6 lbs. List price  
\$73.00.  
BRAND \$22.50  
NEW . . .

## WELLWORTH ZIP SAWER, JR. PORTABLE HAND SAW

Takes the work out of hand  
sawing

Convert your electric drill into a  
portable power saw. Light weight—  
easy to use with any 3/4-inch elec-  
tric drill or flexible shaft. Saw blade  
3" diam. Maximum vertical dept  
of cut 1". Oil bearing lubrication.  
Oilite Bronze Bearing.  
Overall length 7 1/2".  
Shipping weight 2 lbs. \$7.95



## PORTABLE ELECTRIC HAND SAW

The Zip Sawer With ALL the Features

6 1/4" Diameter saw blade, 1/2" square arbor hole.  
Maximum depth of cut 2 1/8". (At 45°, 1 3/4")  
Minimum depth of cut 0". Angular adjustment 90°  
to 45°. No-load speed, 5200 r.p.m. Full load speed,  
3200 r.p.m. Amperes, full load, 8.0. Universal AC-  
DC motor, 110/220 volt. Dimensions: 11 1/4" long;  
9 1/2" wide (ripping guide removed); 7 1/8" high  
(without blade). Furnished complete  
with 6 1/4" diameter combination blade  
and 10 ft. cord and plug. Wt. 11 1/2 lbs.  
Price. . . . \$39.95



## "Wellworth" BLOWER

at a Bargain Price

Quiet operating. Double wheel in-  
let, double width blower. For heat-  
ing, ventilating, cooling, air wash-  
ing, exhausting and forced draft.  
DIMENSIONS: 10" wheel; outlet  
13 1/2"x11 3/8"; inlet 8 3/4". Height  
19". Width 18". Depth 16 1/2".  
C.P.M., 1/4" S.F. 1600; outlet vel.  
1375; motor 1/4 H.P. with overload  
relay; cord & plug  
110 v. 60 cy. A.C.  
Sht. wt. 67 lbs. . . . \$42.75  
Special price. . . .

BLOWER LESS MOTOR \$27.50  
AND DRIVE . . . . .

Prices f. o. b. Chicago.  
Money back guarantee.  
Send check or money or-  
der today. Prompt ship-  
ment.

## NEW CATALOG

Motor guide, air compressors, home and  
factory workshop tools, light plants,  
luggage bargains. Send 10c for postage.

## WELLWORTH TRADING CO.

1831 S. STATE ST. DEPT. D-12 CHICAGO 16, ILL.

## NEW PACKAGED BOATS



17 models. 8'-16'; Trednic  
racers, cruisers; Outboard, in-  
board, skiffs. Assembled frames;  
Tri-Keel construction; Trednic  
bottom; spray rails; easy to build!  
SEND 25c FOR CATALOG!  
Catalog and booklet "Plywood Boats", \$1.00

## BOAT PATTERNS—BLUE PRINTS

1950 Catalog—100 designs by naval architects. Racing  
classes, cruisers, inboard, outboard, sail. 6 to 35 ft.  
Plywood—Steel—Plank. Construction plans, full-size pat-  
terns. SEND 35c FOR CATALOG or \$1.00 for catalog  
and booklet on "Boat Building."

MARINE MART—DEPT. 24—BUFFALO 7, N. Y.

## ACE TOOLS

No. 8-A SET

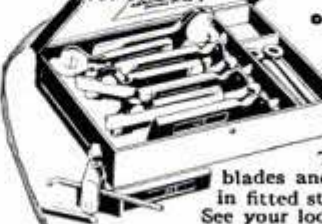

Be permanently  
tooled-up for every operation  
on your Metal Cutting Lathe.

No. 8-A Ace Tool Set  
for 9" and 10" Swing  
Lathes—fits shank size  
3/4" x 3/4" Includes Turn-  
ing, Cutting-off, Boring,  
Knurling and Threading  
Tools with high speed cutters,  
blades and wrenches. 8 complete tools  
in fitted steel case—nothing else to buy  
See your local dealer or order direct.

ARMSTRONG BROS. TOOL CO.  
5268 W. Armstrong Ave., Chicago 30, Ill.

\$26<sup>95</sup>

# WAR SURPLUS SPECIAL

NEW! STATIONARY or PORTABLE

## D.C. ARC WELDER

300 Amps Continuous. 350 - 400 Amps Intermittent. For ALL WELDING - LIGHT or HEAVY !!

This rugged air-cooled precision built electric ARC WELDER - designed to weld for hours comes complete with pulley reactor, output controls, Hi-Lo switches, rheostat. The heart of this unit is the famous R-1 generator, specially developed for B-29 Bombers, and with features no other generator has. Heavy steel frame, easily adapted to mounting on Jeep, Tractor or other power supply (10 H.P. gas or electric). Never before offered at this low price.

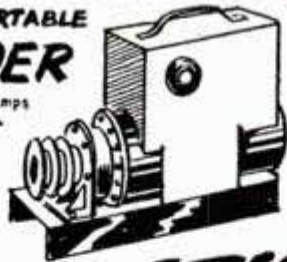

**97<sup>50</sup>**

### Ellinwood "44"

Here's a Real BUY!! This engine is rated from 4.4 to 5 HP. Has optional power take-off of 1 to 1 from crankshaft or 2 to 1 reduction from camshaft. Makes an ideal auxiliary power plant or can be used to drive pumps, generators, compressors, small boats, etc. Lightweight rugged and contains such fine component parts as Bendix-Timken-Air Mase, etc. . . . . ONLY



**5995**

**CONTINENTAL** The famous 4 cycle, air-cooled "L" head gas engine, 1 1/2 to 2 HP. Cheap power for Farm, Factory, Shop.

**3995**

NEW READY TO RUN

### PNEUMATIC AND AIR TOOLS

**1180 RIVET GUNS**  
Pistol & Goose-neck Type  
Goose-neck \$55 **\$8.95**

10,000 in various popular makes, sizes, types, Cleco, Ara, Ingersol Rand, Chicago, Pneumatic Buckeye, etc.

### MANUFACTURERS!

We stock 1000's Tons of NEW BEARINGS, BOLTS, NUTS, SCREWS, RIVETS and other small hardware. These were purchased in the past 5 years from ARMY, NAVY, War Assets Administration, Aircraft Factories, and other Govt. agencies. We are selling these at a fraction of their original cost. Most of the stock is in their original packings. All is new and clean. Please write us for particulars based on your requirements. Illustrated in Palley Tool Catalog.

### 3/4" HEAVY DUTY - 2 SPEED Portable DRILL

Never before such a value. Converted from aircraft starter-energizer. Ideal for all types heavy drilling. Has 2 speed control for 200 RPM low, or 275 RPM high. Heavy duty gear box gives extremely high torque. 3/4" Std. Jacobs Chuck. Universal ball bearing motor - 110 - 115 volt AC or DC. Length 32 inches.



Only **62<sup>50</sup>**

Equipped with 50h. Electric cable

### CHEMISTRY SET

Made for Chemical Warfare Division for testing water, etc. A handy addition to the chemistry lab.

or an exciting experiment for the amateur. Set includes test tubes, complete instructions, 15 different items. Packed in attractive lucite box with cover & dividers. Set **\$1.39**

**Plexiglass & Nascollite clear plastic shts.**  
NASCOLLITE - Full sheets app. 1/8" x 37 1/2" x 49 1/2", app. 10 1/2 lbs. each **\$12.50**

**PLEXIGLASS - Full Sheet**  
5/16" x 36" x 24" ... Per Sheet... **\$13.00**  
5/16" x 36" x 48" ... Per Sheet... **\$25.00**  
Patenters write in for our special quantity prices. All above are new & marked. Also inquire about other large stocks of Plastics.

### NEW TARPS - HEAVY CANVAS

Mildew & Flame Resistant. Cheap outside storage! They are really moving at these prices.

9' x 16' . . . **\$11.95**  
5' x 7' . . . . . **3.95**  
16' x 16' . . . . . **25.60**

Rubberized Nylon Tarp 7' x 11' . . . . . **6.95**

New Rubberized Linen Tarp - 7' x 11' Waterproof, weighs only 3 lbs. Ideal for outside car storage. **5.95**

18 OZ. TARP - 6' x 6' - O.D. Duck. Can be used as a tent floor covering or storage protector. A terrific buy! Used - but in excellent condition . . . . . **3.95**

### New SUN VISOR

Stop That Glaring Sun!! Here is a Visor made of clear Green Plastic. Has swivel lead and adjustable arm. Can be swung in any direction. Made for the USAAF. SPECIAL **\$1.29**

**LINEMAN'S KIT** - Type used by U.S. Army Signal Corps. Consists of pair of heavy duty lineman's pliers with pipe jaws & side cutters - a fine quality 2 bladed wire-skining knife. In reg. Signal Corps leather pouch. **2.39**

# PALLEY

SUPPLY CO

Dept. PM-12 GLENDALE 1, CALIF.

SEE OPPOSITE PAGE FOR TERMS



### BRAND NEW COMPRESSION TESTERS

Tests Compression up to 200 P.S.I.

Made by U. S. Gauge Co. A highly dependable, accurate instrument for auto and diesel mechanics, garage, service station operators. Dial has large numerals, black indicator arm. Calibrations are in 5 lb. increments starting with 10 lb. to 200 psi. Hex angle stem is equipped with tapered rubber nose piece. Black dial case is 1 1/2" deep, 3 3/4" dia. Overall length, 9 1/4". Wt. 11 1/2" lb. **ORIGINALLY WORTH MUCH MORE. \$4.75**

**Relays** Struthers-Dunn, type 116BXX-102. Dbl. contacts rated at 115V AC. 1/8 HP. 5 amps. Single coil. 6 terminals. Mounting bracket. Size 1 3/8 x 1 3/8 x 1-5/16". Wt. 4 oz. **65c**

**MICROSWITCHES**  
Pin Type-110V, AC. 10 amps. Dbl. acting. Normally open and normally closed. 3 lug terminals. Size 1-15/16 x 13/16 x 9/32". . . . . **6 for \$1. ppd.**  
Wire Actuator-250V, AC. 5 amps. Dbl. acting. Normally open and normally closed. 3 terminals. UL inspected. Size 1-3/16 x 9/16". . . . . **4 for \$1. ppd.**  
Wire Actuator-5 amps. 125 or 250V AC. Normally open. 2 terminals. UL inspected. Size 1-3/16 x 9/16". **5 for \$1. ppd.**

ORDER FROM THIS AD! All prices F.O.B. St. Louis, Mo. except items marked "ppd." Include postage with cash, bank draft, or M.O. MONEY BACK IF NOT SATISFIED!  
**MAIN SURPLUS & SUPPLY CO., Desk M-12**  
11 South 3rd St., St. Louis 2, Mo.



### Aircraft VIBRATOR INVERTERS

Can be used on Neon Lights, etc. Made by Electronic Laboratories, Inc., type S663. Delivers 3 volt power from 24V DC. Capacity 1L. Vibrator type R35. Has 3 threaded terminals, 1/2" dia., 1/2" high. Sturdy aluminum case, size, less terminals, 5 x 4 1/2 x 3-7/16". 4 mounting legs. Wt. 2 3/4 lb. Used in excellent condition. **ORIGINALLY WORTH MANY TIMES MORE. \$1.00**

Following 6 electrical items are used, but in good condition. Are priced to save you considerable money. **20 RPM.**

### BACKGEAR MOTORS

110V AC. 60 C. Single Phase For experimenters, model builders, hobbyists, displays, etc. Has steel gears, brass side plates, 4 mounting ports. Size, less shaft, 4 1/2 x 2 1/2 x 3/8". Shaft, 3/16" dia., 1" long. Solder lug terminals. **\$1.25**  
Wt. 1 lb.

**TOGGLE SWITCHES** - AC-DC, 110 V. **6 for \$1. ppd.**

# FIND AUTO ELECTRIC TROUBLES. QUICK



Low Cost Unit Needed in Every Garage. . . . . Reveals condition of condensers, Coils, Armatures, Starters, Batteries, Battery Connections, High-Tension Wiring, etc.

Saves time—actually sells parts. **WRITE FOR FREE DETAILED INFORMATION.**

**JOBBERS Distributors Salesmen Write For Deal.**

T & H MFG. CO., 811 EAST 31st ST., Dept. A, KANS. CITY, MO.

### ELECTRIC MOTOR BARGAINS!



1/4 HP 1750 RPM **\$8.00** 1/2 HP 3450 RPM **15.00**  
1/2 HP 1750 RPM **17.50** 1 1/2 HP 3450 RPM **37.50**

Every Motor Fully Guaranteed  
Heavy Duty, Repulsion Induction or Capacitor Types, 110-220 Volts, 60-cycle, Single phase. Standard Makes (G.E., Wagner, Leland, Westinghouse, etc.). Rush your order TODAY—large stock of motors—1 & 3 phase. 32-v. direct current bargains. Prices f.o.b. **ROBERTS ELECTRIC CO., 7232 Madison, Forest Park 9, Ill.**



### 12 VOLT BATTERIES

**EXIDE - NEW - DRY CHARGED**  
8 1/2" x 5 1/4" x 8 1/2" high. 26 3/4 lbs. filled. Suitable for 12 volt foreign cars, hot rods, boats, light aircraft, etc. In self-contained shielded metal case. Filling instructions included. **\$14.95 each**

**GAARE SUPPLY CO., Dept. G, Box 277, Weatherford, Texas**

### SAY YOU SAW IT IN POPULAR MECHANICS

# BEARINGS ANY SIZE OR TYPE AT BARGAIN PRICES

Inventors - Hobbyists - Repairmen - Service Stations - We have millions of new bearings in stock - from the smallest to large industrial sizes. What do you need? Write giving detailed information or send sketch or sample for our special low prices. See our ad on page 273, Oct. issue, and page 297, Nov. issue P.M.



**MEDALLION MFG. CO.** 25 E. 25th ST. Phone CHICAGO 16, ILL. CA 5-0327

**SAVE UP TO 85%**

**IN WAR SURPLUS from "GADGETEERS" HEAVEN**

**NEW 1950 TOOL CATALOG**  
72 pages of Machine Tools (taps, drills, dies, reamers, etc.) Hydraulic cylinders Air tools. Send 25¢ for your copy today.



**SHEEPSKIN LINED LEATHER JACKET**

These Navy Arctic jackets are fully lined with the finest quality sheepskin obtainable. Comes with storm tabs and fur collar. Two deep patch pockets, adjustable waist and heavy duty zippers. Sizes 36 thru 44 in excellent cond. Cost Gov't approx. \$80. **ONLY 27.50**

**NAVY WADING SUIT**

Here's a suit that will make surf fishing a pleasure. Made of rubberized canvas, with vulcanized seams. It will keep you absolutely dry. Has built in rubber gloves and 1/2 length rubber boots. Air tight Buoyancy pockets inside keep you balanced in deep water. Has 100% waterproof liner. **6.95** Guaranteed condition.

**AAF CASE**

Genuine top grade leather. Multi-compartment. Lock and Straps. Ideal for Artists, Students, Salesmen, etc. Used, good condition. . . . **7.95**

**AIR CORPS BRIEF CASE**

This is a genuine piece of AAF equipment. Made of best grade Brown Leather in a handsome Pebble finish with a light canvas liner. Has two full length map or paper compartments and three smaller pockets. An ideal case for students, salesmen, artists, etc. Full heavy duty zipper closure. 12" x 16". Shpg. Wt. 3 lbs. **ONLY 2.95**

**Loose Leaf BINDER**

3 metal post. Cylindrical locking heavy duty 3/16" fabricated hinged cover. End identification window. Ideal for price books, salesmen catalogues, photoalbums, students, publications, Reference books, etc. Will hold 500 sheets, 8" x 14". **59c ea**

**PLEXI DOME**

Overall length 21" - Width at widest point 11" - at base 4". 6" deep. For Fish & Flower Bows - Cab Roof - Lights. **1.89**

**GOOSENECK LAMP**

Consists of 24 volt control box with dimmer switch, 18" flexible extension & frosted glass shade. Can be used on 110 volt current. **2.49**

**NAVIGATORS LAMP**

A handy light for desk, work bench, chart table, engine room, etc. Can be used on 6-12-24-110 V by changing bulb. 3 ft. shaft has 4 joints to adjust position. . . . **ONLY 2.95**

**NAVY Sealed Beam LAMP**

U.S. Navy Portable Pistol Grip light. Has sealed beam and aiming sight. Ideal for search, spot or Emergency light on auto, boat, farm etc. . . . **2.25**  
24 Volt, 5" lens & carry case . . . **3.29**  
Set of 3 filters, Red, Gen, Amber. (specify type lamp) . . . **99¢**



**16 mm MOVIE CAMERA** Has semi-telephoto 1-3/8" (35mm) lens with yellow filter - 3 shutter speeds: for normal (16 frames), semi-slow motion (32 frames), and for slow motion (64 frames) per second. Uses any standard Eastman film magazine - or Type "G" AAF magazine. Takes Black & White or Full Color pictures. Operates on 24V. (dry cell batteries) & requires slight conversion for hand use. Diagram furnished. Cost Gov't \$235.00. **24.50**



**CONVERTED GUN CAMERA** - Fully reconditioned with start switch on front. Grey Crackle Finish . . . . . **33.95**



**NEW WATCH** Here's a real Shock Absorbing watch. Has jewel movement, sweep second hand, luminous dial, chrome case. Guaranteed for one year. Ideal for young and old. . . . . **16.95**

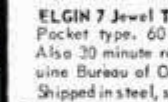

**ELGIN 7 Jewel TIMER** Pocket type. 60 second dial divided into 5th's of second. Also 30 minute recorder dial, shatterproof crystal. This genuine Bureau of Ordnance watch has \$35.00 value. **15.95** Shipped in steel, shock-absorbing suspension case. Plus 102 P.D.T.W.



**17 JEWEL Chronograph.** One of the finest made anywhere. Cased in Switzerland. Sweep second hand, stop and re-set buttons. Measures distance, airspeed, ground-speed, races. Ideal for the sportsman. . . . **23.95** Plus tax

**Genuine ARMY AIR FORCES**



**SUNGLASSES** HERE'S THE REAL McCoy! **ARMY AIR FORCE - 6 base.** Precision Polished & Ground. Glare-Free caliber lenses. Leather case to be attached to belts. Gold plated adjustable frame. Pearlaid sweat bar and pads. \$17.50 Palley value for **ONLY 13.95**

**NIGHT DRIVING GLASS**

With 57mm yellow, amber, 6 base lenses. Optically precision ground and polished! Your doctor will recommend these. Not a cheap "Process" lens. Reduces headlight glare and sharpens "object focus" during night driving. **Men's size or Ladies Marlequin 14.29** **STYLE ND-1, \$16.00 VALUE** **SAME GLASSES but clip-on's. 13.95** Fit-over style without temple bars.



**Aviators (AN-6530)** Windproof & Distorted **GENUINE GOGGLES** Rubber or chamois covered frame. Clear or Green **GROUND LENSES** are inter-changeable. Adjustable nose bar. Ideal for flying, motor cycling, etc. . . . **11.69**



**GO-1 GOGGLE KIT** NEW! U.S. Navy - Has soft sponge rubber frame. 4 Polaroid lenses. 2 green, 1 red, 1 clear. Perfect for racing, cycling, etc. **89¢**

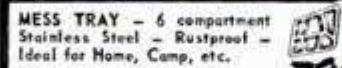

**MESS TRAY - 6 compartment** Stainless Steel - Rustproof - Ideal for Home, Camp, etc. Used but excellent condition . . . **79¢**



**ARMY PUP TENTS** 2 Man . . . Used . . . Perfect . . . **5.95**

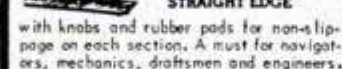

**HUNTING KNIFE.** 6" Polished blade, leather sheath **1.69**



**BOLO KNIFE** 10" Parkerized blade, with case **1.19**



**15 MONKEY WRENCH** Adjustable Jaw - Opens to 4" Drop Forged. . . Auto Type. Cadmium Plated **89c** Black **79c**

**AAF FLEECE LINED JACKET**



Will keep you warm & comfortable in the roughest weather. Fur lined thru-out sleeves & body. 2 slash pockets & hvy duty zipper. Ideal for Farmers, Ranchers, Hunters and Mechanics. **9.95**

**U.S. SIGNAL CORPS MICROPHONE**



Telephone type - Highly Sensitive with excellent, clear tone. This was the Signal Corps favorite. An ideal instrument for the radio "ham" and professional recording studio, broadcasting, home recording, public address, etc. A Sensational Buy! Complete with cord and plug. . . . **ONLY 2.29**

**RADIO HEADSET**

Low Impedance. Ideal for amateur radio, crystal sets, or professional use. Adjustable ear phones. Used and in excellent condition. . . . **1.59**

**FIELD TELEPHONE**

A private phone or intercom system - Easy to operate. Reception up to 20 miles. Uses 2 standard flashlight batteries. Several phones can be used on same line. Set contains generator for ringing. leather carrying case & phone. **7.95**

**COMPLETE SYSTEM OF two generators PER & two phones. SET**

**Only 15.50**

**COMPASSES -**

Match Box . . . . . **39¢**  
Jeweled Watch-Pocket . . . . . **1.29**  
Wrist Strap Type . . . . . **69¢**

**FLYING SUIT or Blue Bunny SUIT**

For hunting, winter sports, skiing or "bundling". As coveralls for cold outdoor, or farm work, 100% woven wool with extra flannel inner lining for double warmth & utility. Wiring so fine, flexible it does not interfere with movement. Can be used with or without heating or can be plugged into car, tractor, or truck battery. Sizes 36 thru 44. **\$3.49**



**EISENHOWER JACKET**

Trim, smart military cut jacket - for sports and outdoor wear. Warm and comfortable. Has two patch pockets - two inside pockets - adjustable side straps. Waist belt with buttons and snaps. . . . **ONLY 5.95 each**

**FLYING HELMET**

Fine grade leather - Chamois lined with chin cup on strap. Intermediate weight - Ideal for summer wear. **NEW ONLY 1.59**

**RUBBER BOOTS**

A Sturdy Boot of finest rubber. Completely Waterproof with adjustable strap. Warm with or without shoes. **3.95**

**FELT INNER-SOLE & SHOE PAD INSERT**

For Cold Weather (Sold only with boots.) Set complete. **1.50**

**NEW NAVIGATOR'S MAGNETIC COMPASS**

D-12 Type - Rotating verge range ring, calibrated in 1 degree increments from 9 to 360°. Two parallel grid wires for N-S line alignment. Fine for boats, etc. **14.95**

**JEEP CANS WATER or GAS**

Be sure of your reserve supply of GAS and WATER. Top condition. Gas type has screw top, takes standard flex nozzle. Water type - Porcelain lined - Gasket top. . . . **1.95**

**NEW PRESSURE TANKS**

Stainless Steel, Shatterproof & Rustless. Ideal for painting, cooking, spraying, ocean buoys, underwater fishing, or diving.

G-1-12 1/2 x 24 inches. 2100 Cu. In. capacity . . . . . USED	<b>4.25</b>
F-1-10 x 18 inches. 1000 Cu. In. capacity . . . . . USED	<b>4.19</b>
F-2-6 x 45 inches. 1000 Cu. In. capacity . . . . . USED	<b>3.95</b>
D-2-6 1/2 x 24 inches. 500 Cu. In. capacity. Stainless Steel Construction . . . . . USED	<b>3.49</b>
D-2A-Corrosion resistant steel. Same as D-2 . . . . . USED	<b>2.49</b>
A-6-5 1/2 x 15 inches. 280 Cu. In. capacity . . . . . USED	<b>2.25</b>
A-4-5 x 8 inches. 104 Cu. In. capacity . . . . . USED	<b>1.35</b>

NOTE: All tanks listed are used are guaranteed serviceable and free from leaks or dents.

**TANK**

Dural with welded seams, 2" filler with cap, two standard pipe ports for hookup. Visible liquid level gauge on side. Ideal for Gas, Oil, Water, or "spare" on auto, tractor, truck or boat. Sturdy, light. Capacity 6 gal. . . . . **14.95**

**NEW TANK**

For Gas, Oil, Water, etc. Seamless, welded tank, made of aluminum with filter Screen and Pack. Has stick level gauge. 19 gal. capacity . . . . . **16.95**

Order from this Ad. All sales final. All Prices F. O. B. Glendale. Pay by M.O. or Check. P.O.'s Accepted from D. & B. firms. 1/2 deposit with C.O.D.'s.

**PALLEY SUPPLY CO**  
Dept. PM-12 GLENDALE, CALIF.

**LARGEST FIRM OF ITS TYPE IN THE WORLD**

# SOUTH BEND 7" PRECISION SHAPER

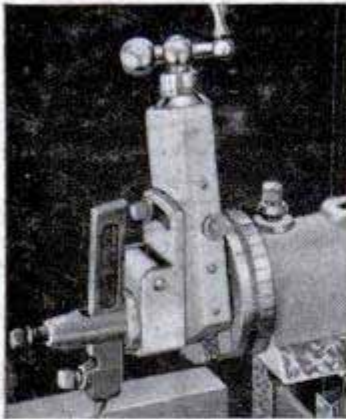

Tool head locks in any position. Rugged clapper box also adjustable.

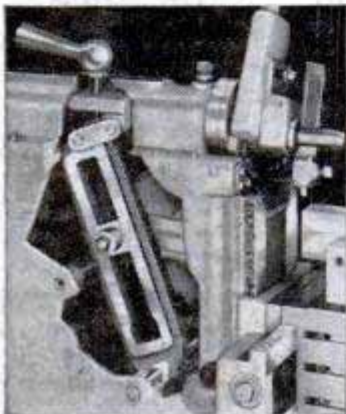

Rocker and crank with graduated eccentric adjustment for stroke.



Guards on all belts and pulleys. Quick-acting belt tension release.

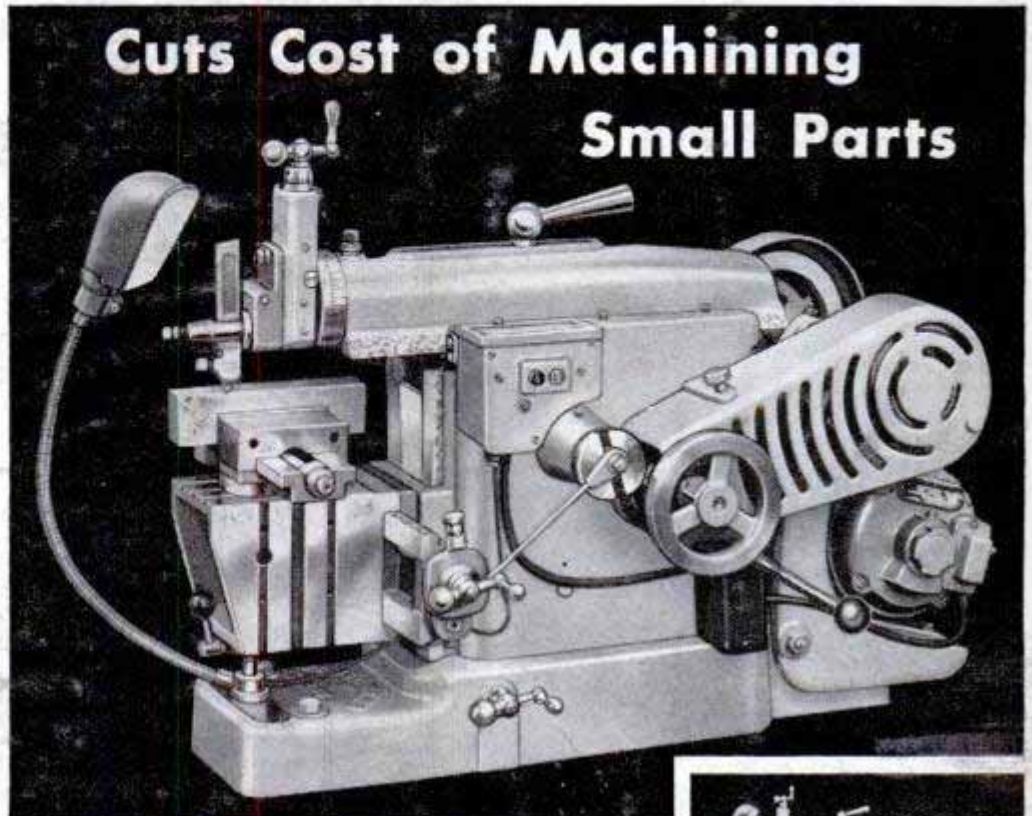

## Cuts Cost of Machining Small Parts

### Saves Time...Saves Labor

It's fast—accurate—easy to operate. The South Bend 7" Precision Shaper can consistently give you low machining costs on small parts. Designed to handle a wide variety of work in this class, it will enable you to release larger shapers for heavier work, save on machine investment and economize on both power and upkeep. Find out how this versatile shaper can give you better production, toolroom or maintenance machining. *Send coupon for literature.*

#### SPECIFICATIONS

**RAM**—Stroke length—0 to 7". Strokes per minute (4)—42 to 195. Cutting speeds—3 to 114 feet per minute.

**TOOL HEAD**—Vertical feed—3". Swivels—360°. Tool Post opening—13/32" x 7/8".

**TABLE**—Horizontal travel—9-1/2". Vertical travel—5". Power cross-feeds (6)—.002" to .012". Ram clearance—1/2" to 5-1/2". Table size—5-3/8" x 5" x 6-5/16".

**WISE**—Jaw width—4". Jaw depth—1". Maximum opening—4". Swivel base.



Steel stand for shaper—3 drawers and built-in chip pan.

#### PRICES

7" Precision Bench Shaper . . . \$468  
(Price includes light fixture, vise, drive unit with belt guards, motor pulley, V-belt, switches. Steel stand and motor extra.)  
Steel Stand . . . . . \$137.50  
Motor—1/3 h.p., 115 v., 1 ph., 60 cy., A. C. . . . . \$36.05

*Prices f.o.b. factory  
Time Payments Available*



## SOUTH BEND LATHE

SOUTH BEND 22, IND. • Building Better Tools Since 1906

Send Information Checked:

7" PRECISION SHAPER  LATHE ATTACHMENTS  TIME PAYMENT PLAN

Name \_\_\_\_\_

Street \_\_\_\_\_

City \_\_\_\_\_ State \_\_\_\_\_



9" and 10" BENCH LATHES  10" to 16-24" FLOOR LATHES  1/2" and 1" collet TURRET LATHES  14" DRILL PRESSES

Printed by Popular Mechanics Company, Chicago, Ill., U. S. A.

# Santa's "LAST MINUTE" Gift Suggestions

**All SYNCRO POWER UNITS GUARANTEED**  
 During Your OWNERSHIP AGAINST BURN-OUT or Replaced **FREE!**

**SAFE!**  
 EVEN SMALL CHILDREN CAN USE. FINGERS CAN'T BE PULLED INTO BLADE!

ARM ADJUSTS TO SAW ANY LENGTH MATERIAL!  
 IT'S THE BIGGEST, MOST POWERFUL AND HAS GREATEST CLEARANCE OF ANY MAGNETIC JIG SAW!

NO EXTRA MOTOR TO BUY, FOLKS! IT'S BUILT-IN!

I HAVE TO LAUGH... IT'S SO EASY TO USE!  
 NO OILING, NO BELTS, NO GEARS. PORTABLE. PLUG IN AND SAW!

Still only **\$17.50**  
 NO. 500



ALL ENTIRE SYNCRO TOOLS TESTED and APPROVED BY "UL" to be free from SHOCK and FIRE HAZARD... Not Just the Cord!

## Famous SYNCRO ELECTRIC JIG SAW CUTS 1" WOOD—50% MORE POWER—QUIET!

Santa delivered THOUSANDS of SAFE SYNCRO SAWS to schools, homes, hospitals last Christmas. He's even more enthusiastic over this new, improved model! now 50% MORE POWER. "Sands" as it cuts ANY length 1" wood, thin metal, plastics. 70% QUIETER OPERATION. Portable. Ideal for apartments. Stroke easily adjustable. A basic tool for homeshops—SAFE for children's craft use. Give or get SYNCRO!

COMPLETE with Built-In Motor, 3 blades, cord—\$17.50



Make... house numbers, photo silhouette stands, book-ends, what-nots, pipe-holders, many others... for personal use or profit.

240 STROKES A SECOND!



NO. 201 \$12.50

# SYNCRO

QUALITY ELECTRIC TOOLS

### ELECTRIC HONE

Another unique gift—an all-purpose hone with stones that M-O-V-E 240 strokes per second! Speeds up honing s-h-a-r-p home and workshop tools—almost anything else. With built-in motor, 3 interchangeable hone stones, cord—\$12.50. Operate on 60 cycle, 110-120 volt, AC only. Buy at hardware stores. If none near, send article price, we'll ship POSTPAID.

### SANDER-POLISHER

Comparison proves it best for light sanding, high polishing, re-finishing. Massages too. Superior quality, durability. Works at 240 strokes a second—just guide it! Stroke adjustable. With built-in motor, 10 sandpapers, sand 1 wood and fabric pads, cord—\$14.50.

WITH EXCLUSIVE DOUBLE ARC MOTION



NO. 401 \$14.50

QUALITY PRODUCTS OF SYNCRO CORPORATION, DEPT. D-120, OXFORD, MICHIGAN, U. S. A.

# Whether the weather's...

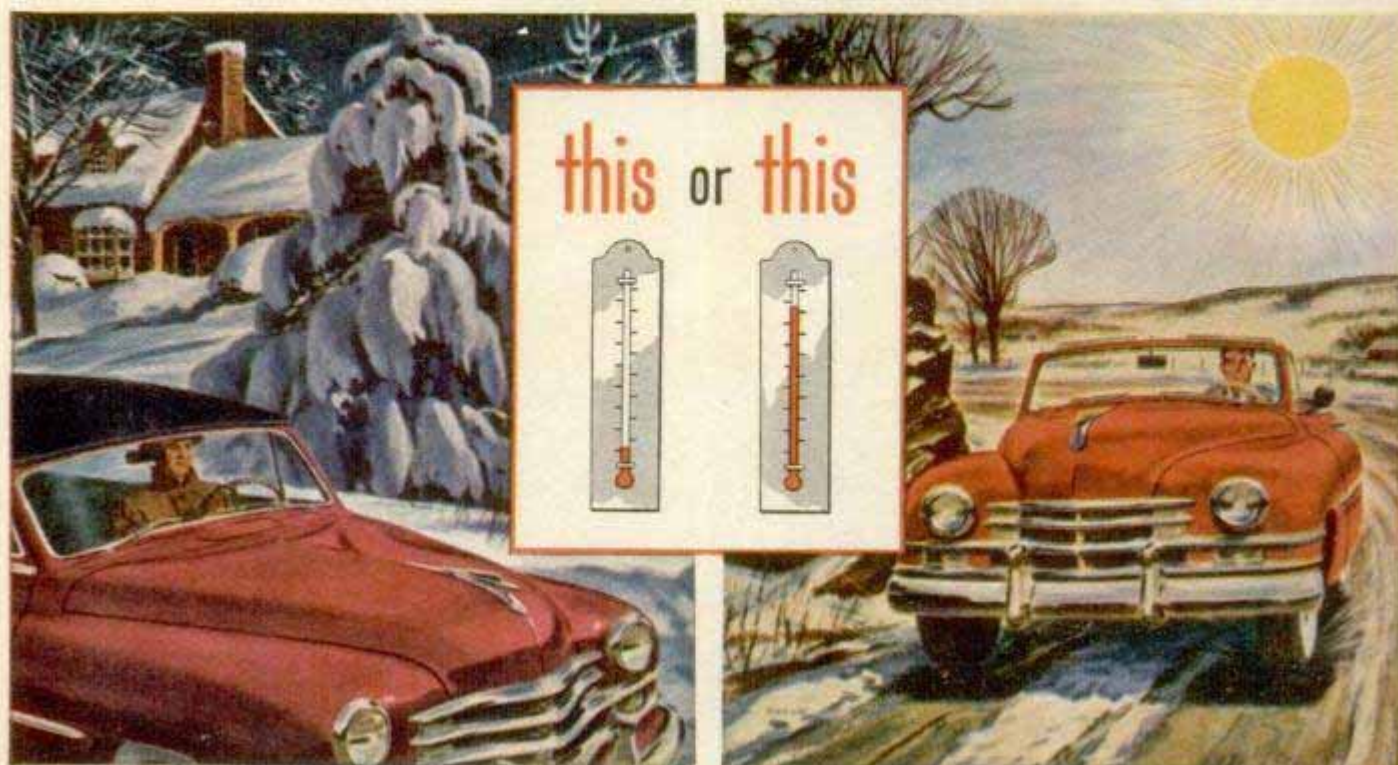

this or this



## You're safe and you know it

with **PRESTONE** BRAND

### Anti-Freeze

Best Protection against  
**FREEZE-UPS...RUST...FOAMING**

No other Anti-Freeze can give you this same protection!

**One shot lasts all winter!**



SAME PRICE

**\$3.50**

PER GALLON

The registered trade-marks "Prestone" and "Eveready" distinguish products of  
**NATIONAL CARBON DIVISION**  
UNION CARBIDE AND CARBON CORPORATION  
30 East 42nd Street, New York 17, N. Y.