

ANC



POPULAR MECHANICS

MAGAZINE

WRITTEN SO YOU CAN DO IT

REG'D. TRADE MARK, GREAT BRITAIN, NO. 41042

REG. U.S. PAT. OFF.



Dave Mink

WINTER AHEAD



INSTALL NEW

CHAMPION

SPARK PLUGS

*"ALL-GLASS" headlamps give most light when new
... most light throughout life!*

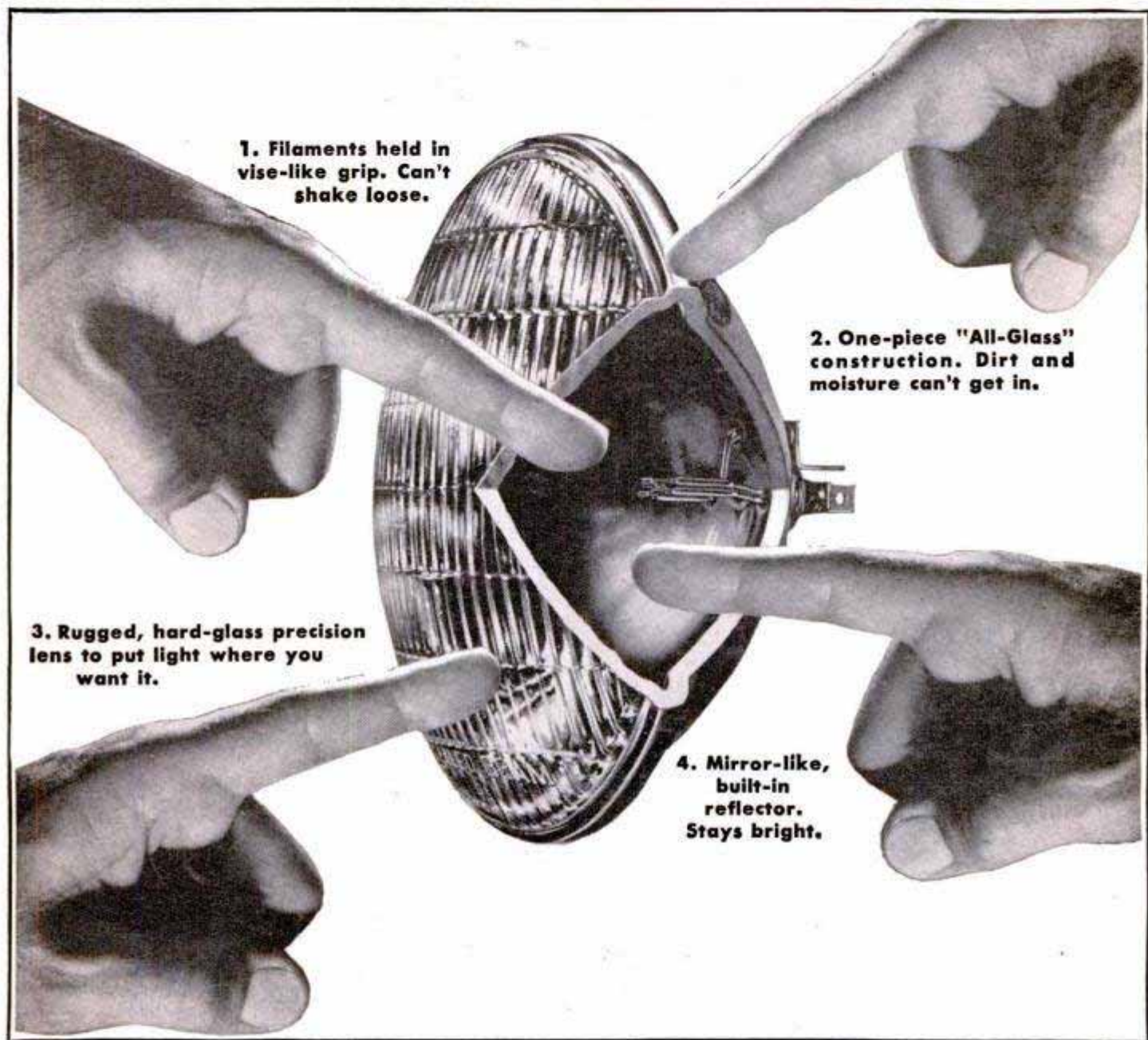

General Electric headlamps are **ALL-GLASS**
... they do not grow dim!*

* Road and laboratory tests prove that the average G-E Sealed Beam headlamps give 99% as much light at the end of life as when new.

You can put your confidence in—

GENERAL  **ELECTRIC**

GET READY FOR
WINTER DRIVING
**HAVE YOUR
LIGHTS
CHECKED**

NOVEMBER 1950

This One





How a whiff of stibine led toward lower telephone costs

At the New York Telephone Company's Triangle exchange in Brooklyn, emergency batteries stand ready to deliver 3000 amperes for several hours.

In the Bell System there are a million lead storage battery cells connected to telephone circuits in the central offices. Current seldom flows in or out of these cells beyond the trickle which keeps them charged. In the rare event of power failure, however, they stand ready to supply the current for your telephone service.

Even in this stand-by service, cells require water to make up for electrolysis. And they consume power and eventually wear out. But Bell Laboratories chemists discovered how to make a battery which lasts many more years and requires less attention — by changing a single ingredient, the clue to which came unexpectedly from another line of their research.

The clue was a minute trace of stibine gas in battery rooms — detected by electrochemists looking into atmospheric causes of relay contact corrosion. In small traces the gas was harmless but it gave chemists a useful hint.

For stibine is a compound of antimony — and antimony is used to harden the lead grids which serve as mechanical supports for a battery's active materials. Tracing the stibine, the chemists discovered that antimony is leached out of the positive grid and enters into chemical reactions which hasten self-discharge and shorten battery life.

Meanwhile, in the field of cable sheath research Bell metallurgists had discovered that calcium could be used instead of antimony to harden lead. And theory showed that calcium would not react destructively in a battery. The result is the new long-life calcium-lead battery which cuts battery replacement costs, goes for months without additional water, and needs but $\frac{1}{5}$ the trickle current to keep its charge.

It demonstrates again how diverse lines of research come together at Bell Telephone Laboratories to keep down the cost of telephone service.

BELL TELEPHONE LABORATORIES

Working continually to keep your telephone service big in value and low in cost.



Popular Mechanics Magazine

Registered in U. S. Patent Office and Canada

H. H. WINDSOR, Founder

H. H. WINDSOR, JR., Editor and Publisher

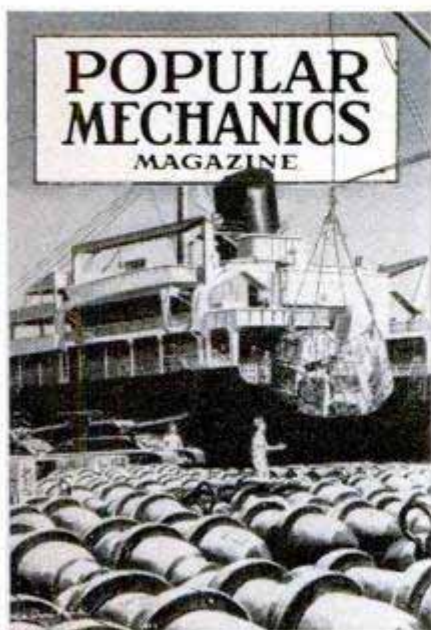

this month's cover

MIGHTY SUPPLY LINES of the U. S. Department of Defense are humming with activity in the Pacific. Dave Mink, noted cover artist, has caught the spirit of this tremendous mechanical operation with his painting of a cargo ship taking on a load of 500-pound bombs, tanks, guns and other vital materiel being rushed to the Korean war front. Mink is shown below in his Chicago studio working on one of the sketches from which the final painting was made



Published monthly by Popular Mechanics Company, 200 E. Ontario St., Chicago 11, Ill. H. H. Windsor, Jr., president; William Harrison Pettridge, vice president; D. F. Windsor, vice president and secretary-treasurer; Clover L. Perkins, advertising manager; Alan M. Deyoe, circulation manager. Single copy in the United States and Canada, 35 cents; subscription rates in United States and possessions, Canada, Philippines and countries of the Pan-American Postal Union, 1 year \$3.50; 2 years, \$6.00; 3 years \$8.00. To all other countries add \$1.00 a year over United States prices for overseas postage. If you plan to move, notify us at least 30 days in advance so you will not miss an issue. Give both your old and new addresses.

Entered as Second Class Matter, September 15, 1903, at the Post Office at Chicago, Illinois, under Act of March 3, 1879. Entered as Second Class Matter at Post Office Dept., Canada. Registered as Second Class Matter at the Post Office at Mexico, D. F., Mexico, June 20, 1950.

Copyright 1950 by Popular Mechanics Company, Copyright under International Copyright Union. Copyright in France. All rights reserved under Pan-American Copyright Union. Printed in the United States of America.

NOVEMBER 1950

Volume 94

NOVEMBER 1950

Number 5

Managing Editor.....	Roderick M. Grant
Assistant Managing Editor.....	Wayne Whittaker
Shop Notes and Crafts Editor.....	James R. Word
Radio-Television, Electronics Editor.....	Frank L. Brittin
Associate Editor, Aviation.....	Aubrey O. Cookman, Jr.
Associate Editor.....	Clifford B. Hicks
Automotive Editor.....	Siler Freeman
Art Director.....	Frank Beatty
Director, Bureau of Information.....	Allan Carpenter

Assistant Editors

Donald R. Brooks	Dorothy E. Hoffmann	Arthur R. Railton
	H. H. Windsor III	

Assistant Editors, Shop Notes and Crafts

W. Clyde Lammey	Wayne C. Leckey	Frank N. Stephany
Eastern Editor.....	Richard F. Dempewolf	
	Empire State Bldg., Room 2906, New York 1, N. Y.	

Western Editor..... Thomas E. Stimson, Jr.

Representative in Great Britain..... Douglas W. Wedderspoon
77 Baker St., London W. 1, England

IN THIS ISSUE

TV's Little Brother - - - - -	81
I'm Building the P.M. Plywood Ranch House	88
On Permanent Alert - - - - -	91
Rockets on a Timetable - - - - -	97
This Business Is Next to Nothing - - - -	108
Small Homes of Pumice Block - - - - -	121
Tortillas Meet the Machine Age - - - -	129
The Navy's Chamber of Horrors - - - - -	133
What's New for Your Home - - - - -	140
Skyroads to Everywhere - - - - -	144
Tailor-Made for Bull's-Eyes - - - - -	153
The War In the White Pines - - - - -	162

For the Craftsman

Give Santa a Hand - - - - -	166
Trail Knives - - - - -	179
Pickaback Billiard Table - - - - -	188
Typewriter Hideaway - - - - -	192
Doorways—Make Your Own - - - - -	195
Servicing Your Car Generator Regulator - -	201
Finger-Tip Control Panel - - - - -	206
Circle Cutters for Sheet-Metal Shops - - -	211
How to Use Wood Taps and Screw Boxes -	218
Radio-Television, Electronics - - - - -	227
Clinic for Homemakers - - - - -	236

Other items, and manufacturers of available products described, are listed on pages 10, 14 and 16

Maybe you don't need expensive anti-freeze

Results of Du Pont tests show most motorists can get complete winter protection from \$1.25-a-gallon "ZERONE"

This may surprise you—but here's what exhaustive winter road and laboratory tests made by Du Pont now prove about anti-freeze performance.

Du Pont "Zerone"*—at only \$1.25 per gallon—will provide efficient, proper protection against cold weather, rust and corrosion for four out of five cars on the road today. These are the cars with low-opening thermostats, operating at normal altitudes, and requiring protection no lower than -30°F .

If you've been overspending on anti-freeze in the past, you can save money with Du Pont "Zerone."

- With "Zerone," there is no evaporation problem—it needs only an occasional check-up.
- You buy less—"Zerone" is so efficient that 3 quarts do the work of 4 quarts of most other kinds of anti-freeze.
- "Zerone" has a chemical rust-inhibitor that helps keep a clean cooling system clean—won't attack rubber; and because it stays in solution, it can't clog cooling systems.

This winter, save good money on anti-freeze. Ask your service station attendant if you, too, can't use inexpensive Du Pont "Zerone" in your cooling system.

*REG. U. S. PAT. OFF.



Listen to "Cavalcade of America"
Tuesday Nights,
NBC Coast to Coast



THE DEALER WHO DISPLAYS THIS EMBLEM offers you a special winter service. Make a date with him early for anti-freeze and for a thorough cooling system check-up before the anti-freeze rush jams his driveway.



REG. U. S. PAT. OFF.

BETTER THINGS FOR BETTER LIVING... THROUGH CHEMISTRY

More motorists use Du Pont "ZERONE" anti-freeze than any other brand

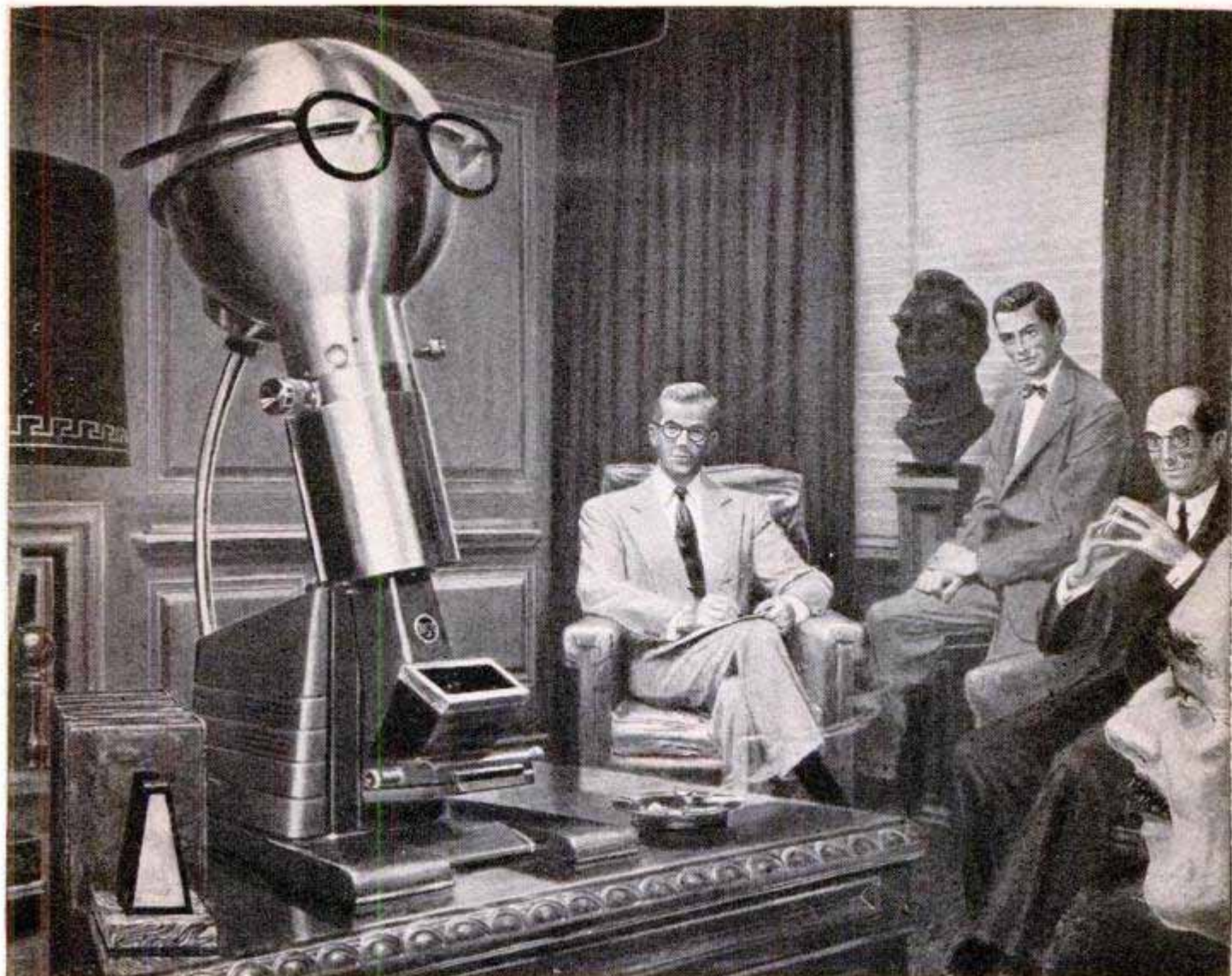

Portable electron microscope, developed by RCA, widens research in universities, industries, hospitals.

The new instructor gets a hearty welcome

You've read, in both newspapers and magazines, about the powerful electron microscope. Now this amazing "instructor" of scientists and physicians becomes even more useful — in more research fields.

Through basic principles uncovered at RCA Laboratories, RCA engineers have developed a compact "table model" electron microscope, at a price which makes it practical for use in an increased number of universities, industries, hospitals, clinics. So

simplified is the new instrument that a high school student or unskilled laboratory technician can quickly learn to use it!

Magnifications of 6000 times can be obtained directly in RCA's portable electron microscope—four times that of ordinary light microscopes—and photography lifts this to 30,000! A new "instructor," yes—and one that gets a very hearty welcome.

* * *

See the latest wonders of radio, television and electronics at RCA Exhibition Hall, 36 West 49th Street, N. Y. Admission is free. Radio Corporation of America, Radio City, New York 20, N. Y.



RCA research develops better scientific instruments, and better television instruments for you—RCA Victor's 1951 home television receivers.



RADIO CORPORATION of AMERICA
World Leader in Radio — First in Television

PYROIL

smooths out

TROUBLE SPOTS

A few ounces of Pyroil in the gas tank—12 ounces or a pint in the crankcase — and you're all set for smoother, trouble-free driving. Pyroil causes oil to form a protective film on metal surfaces. It sets up anti-friction defense on cylinder walls and piston rings. It wipes out sludge and carbon formation. It guards against battery drain.

That's why Pyroil is your best defense against trouble spots and higher maintenance costs. Next time you stop for gas or oil, add Pyroil — add miles to your car.

Pyroil for Aircraft Engines

Use Aircraft Pyroil B for lubricating oil, Aircraft Pyroil A for gasoline.

GIVEN! An attractive Pyroil metal savings bank, takes coins up to 50c pieces. **MOTORISTS**, it's yours for the asking—sent postage paid.



Manufactured and Guaranteed by
Pyroil Company, 109 Pyroil Bldg.,
La Crosse, Wisconsin

Canadian Distributors: Central
Purchasing Agencies, Ltd.,
Toronto, Ontario

PYROIL COMPANY

109 Pyroil Bldg.,
La Crosse, Wisconsin

I want my car to last and run properly. Please tell me more about Pyroil and how it can accomplish this for me.

Name _____

Address _____

City or Town _____ State _____



in this corner.....

THE EDITORS



American Airlines photo

Buena Suerte, Amigo Jack

When a man is young enough to play a fast and steady game of tennis every Sunday from the first spring thaw until they lock the courts up for the winter at Evanston, Ill., he seems too young to retire from business.

But at 70 a man is entitled to relax a while and turn his vocation into a hobby. So Jack Atkin walked out of the darkroom the other day and said goodbye to us and to you. For, if the artist had signed all his work, you would have seen the name John Drew Atkin under thousands of photographs in *Popular Mechanics Magazine* in the last 31 years.

Jack is an artist with a camera. He needed little direction from the editors who accompanied him on a story hunt that might take him from coast to coast. He knew how to take pictures that tell a story.

Born in Ireland, Jack was already a veteran photographer when H. H. Windsor, Sr., founder of the magazine, brought him to *Popular Mechanics* July 24, 1919, from the pioneer Essanay Motion Picture studios in Chicago, where he had been a movie

(Continued to page 8)

Let me send You **FREE PROOF** that you can become an expert **ACCOUNTANT... BOOKKEEPER** **OR C.P.A.**

LOWELL C. DOAK
C. P. A., M. B. A.
Director of
LaSalle Accountancy
Instruction

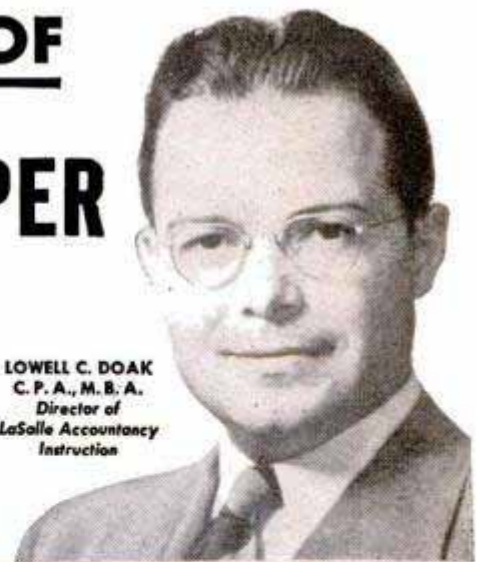

FREE SAMPLE LESSON

I offer you this free sample lesson so that you can *prove to yourself* that you CAN master Accountancy—quickly, thoroughly—in spare time at home.

You will see exactly how LaSalle's famous "Problem Method" works . . . how you are led step-by-step through actual accounting work—*learning by doing* and not by study of theory alone. First you tackle easy problems, then more difficult ones—until soon you master them all. And at every step you have the close personal guidance of LaSalle's large staff of C.P.A. instructors.

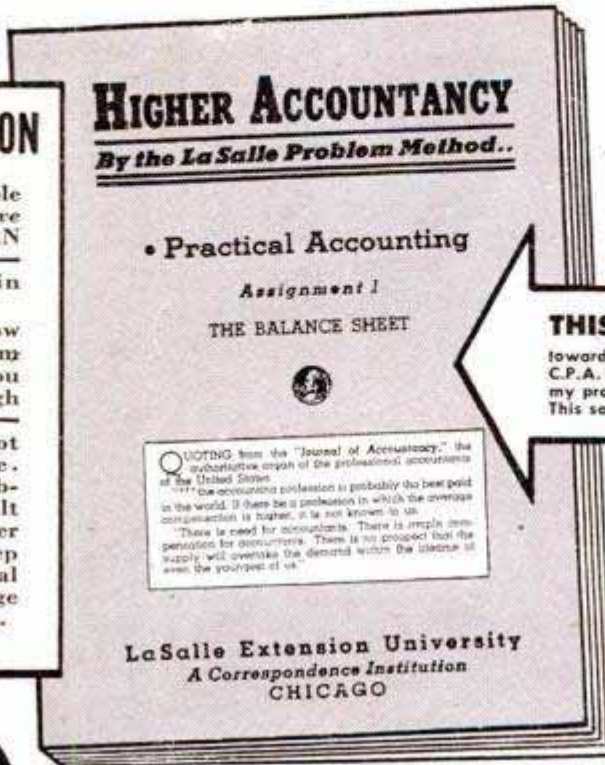

THIS SAME LESSON STARTED ME

toward a well-paid public accounting career—and my C.P.A. degree. I knew nothing of accounting before—yet my progress was rapid—my earning power climbed fast. This sample lesson will show you why.

QUOTING from the "Journal of Accountancy," the authoritative organ of the professional accountants of the United States:
"The accounting profession is probably the best paid in the world. If there be a profession in which the average compensation is higher, it is not known to us."
"There is need for accountants. There is ample compensation for accountants. There is no prospect that the supply will overtake the demand within the lifetime of even the youngest of us."

LaSalle Extension University
A Correspondence Institution
CHICAGO

IF you have been envying the high incomes and good jobs enjoyed by thousands of men and women Accountants today . . . incomes ranging from \$4,000 to \$10,000 and more per year . . . why not launch such a career for yourself?

Do you doubt that you can?

Then let me send you—without cost or obligation—the same Lesson Number One with which LaSalle has started several hundred thousand

men and women toward successful accounting careers. I want you to see for yourself how this remarkable method, originated by LaSalle, makes Accountancy simple, interesting, practical, and certain . . . how it leads you step-by-step to a complete mastery of Accounting—and on up to the coveted degree, of Certified Public Accountant if you so aspire.

It doesn't matter whether you've had previous bookkeeping experience, or whether you don't know a debit from a credit. Whether you wish to qualify as an expert bookkeeper, advanced accountant, cost accountant, auditor, government accountant, income tax specialist, or public accountant . . . you'll find in LaSalle's Problem Method the exact plan to prepare you rapidly and inexpensively—in spare hours at home—without losing a day from your present job.

So right now, today . . . if you are an adult, employed, and earnestly ambitious for rapid advancement in this highest-paying of all professions . . . send your name and address to me on the coupon below. I'll send the free sample lesson—plus our 48-page book outlining today's career opportunities and how you can qualify for them. A coupon like this has started many thousands toward greater success. It can do the same for you. Mail it today!

**Nearly 10%
of all C.P.A.'s
in the U.S. have
been trained by the
LaSalle Problem
Method**

GOOD-PAY JOBS IN 5 BIG FIELDS

If you were an expert accountant right now, chances are you would find yourself among the highest-paid of all professional men and women. Surveys show that accountants earn more than those in other major professions.

There are five big fields of opportunity open to Accountancy-trained men and women . . . opportunities that are wide open and highly inviting, offering maximum income and job security in good times or bad. And under LaSalle's "Problem Method" you can start earning while still learning—either in spare-time or full-time employment . . . or in business for yourself with no capital required.

Get the latest information by sending for our 48-page book, "Accountancy, the Profession That Pays" . . . plus free sample lesson. The coupon at right will bring both to you without cost or obligation. LaSalle Extension, 417 S. Dearborn St., Chicago 5, Ill.

Clip Coupon . . . Mail TODAY!

LaSalle Extension University . . . A Correspondence Institution
Dept. 1164H, 417 S. Dearborn Street, Chicago 5, Illinois

YES, MR. DOAK, I want to see how LaSalle's "Problem Method" works . . . how I can qualify for high-pay Accountancy positions. Also, send your 48-page book, "Accountancy, the Profession That Pays" . . . all without cost or obligation.

Name Age
Street Address
City, Zone & State
Present Position



AVIATION



ESSENTIAL

in peace or war

**A MESSAGE TO YOUNG MEN...
AND PARENTS**

We have an urgent demand for Embry-Riddle graduates. Aircraft manufacturers and operators need thousands of properly trained young men for essential positions in civilian aviation.

SAVE TIME

Now, more than ever before, you need maximum school training in minimum time. Embry-Riddle offers complete eight-month to two-year aeronautical engineering, master A & E mechanic, flying and specialist courses, backed by a quarter-century experience in training today's aviation leaders.

BE PREPARED

No one can safely predict the course of events today. Be assured, however, that no matter what happens, you will be one step ahead of the crowd with up-to-date, intensive Embry-Riddle aviation training. Write, wire or call today for catalog and full information.



Wherever planes fly, men know Embry-Riddle . . .
A Famous Name in Aviation.

Dean of Enrollments - Dept. 99
Embry-Riddle School of Aviation
Miami 30, Florida

Please Print

NAME _____

ADDRESS _____

City _____

State _____ Age _____

I am interested in...

- A.&E. Mechanic
- Commercial Pilot
- Engineering
- A.&E. Combined with Commercial Pilot
- Flying Mechanic
- Drafting & Design

Check One Veteran Non-Veteran

TRAIN IN MIAMI-- AIR CAPITAL OF THE WORLD

(Continued from page 6)

cameraman almost from the industry's beginning. For the first few years he was The *Popular Mechanics* photographer. When he said goodbye to H. H. Windsor, Jr., now Editor and Publisher, the magazine's operations had grown so great that Jack had three assistants.

His experiences in chasing down photographic stories for the magazine would fill a fascinating book. In the early days of flying he hung out of windows of pioneer crates to make aerial pictures. He rode the cab of the first streamline trains. He was always looking for the best angle for his pictures; the managing editor likes to remind Jack of the time he took him to a locomotive yard to get the story of the turn-around servicing of a big Burlington steam engine. Jack had to get an overhead shot as the locomotive pulled up to a coal tower to fill its tender. He climbed the iron ladder to the top of the tower, and just as he was ready to trip the shutter, tons of coal poured down the chute and a cloud of coal dust billowed high alongside the tower, completely enveloping him. He came down unrecognizable, but for his grinning white teeth. He got the picture.

If this reads like Jack Atkin's farewell to photography, it is nothing of the sort. A few weeks ago he boarded a plane for Mexico, accompanied by Mrs. Atkin and their daughter, Jaqui. There he will make his home—and there, we are certain, he will also make some more good tennis shots and a lot of beautiful photographs of that beautiful land south of the border.



"My Kingdom for Some Horsepower!"

At the moment this photograph was taken, Thomas E. Riley of Portland, Ore., was just about ready to trade in his spade on a

(Continued to page 18)

THOUSANDS OF SKILLED AIRCRAFT WORKERS ARE NEEDED NOW!

REMEMBER those wartime jobs in the nation's aircraft plants? It was not uncommon for unskilled workers to draw \$75-\$100 a week. *Trained men virtually wrote their own tickets.*

If you've been reading the papers, you know what's happening today in the aircraft industry. Congress has just appropriated hundreds of millions of dollars for new planes, equipment and research.

The industry is undergoing an almost explosive expansion program. It means unlimited opportunities for the men who act NOW!

During the last war, I. C. S. trained thousands of aircraft workers—*more than any other technical school.* The training paid off in promotion and increased

pay. Hundreds of letters poured in every month reporting advancement in salary and position.

Fortunately, these courses are still available!

They have been revised and brought up to date to include the latest developments in aircraft design and manufacturing techniques.

Look over the subjects listed in the coupon and pick the one that interests you most. Information will be rushed to you by return mail. Within a short time you can begin your studies—progressing as rapidly as you wish.

Get in on the ground floor! The best jobs won't wait! Mark and sign the coupon now—before you turn this page.

INTERNATIONAL CORRESPONDENCE SCHOOLS

APPROVED
under the
G.I. BILL

BOX 5687-K, SCRANTON 9, PENNA.

Without cost or obligation, please send me full particulars about the course BEFORE which I have marked X:

- | | | | |
|---|--|--|--|
| <input type="checkbox"/> AIRCRAFT ENGINES
MECHANICS | <input type="checkbox"/> Building Estimating | <input type="checkbox"/> Forging | <input type="checkbox"/> Marine Engineering |
| <input type="checkbox"/> PRIVATE PILOT | <input type="checkbox"/> Civil Engineering | <input type="checkbox"/> Heat Treatment of Metals | <input type="checkbox"/> Steam Electric |
| <input type="checkbox"/> COMMERCIAL PILOT | <input type="checkbox"/> Coal Mining | <input type="checkbox"/> Industrial Engineering | <input type="checkbox"/> Steam Engines |
| <input type="checkbox"/> FLIGHT ENGINEER | <input type="checkbox"/> Contracting and Building | <input type="checkbox"/> Industrial Metallurgy | Textile Courses |
| <input type="checkbox"/> AERONAUTICAL
ENG'R'S JR. | <input type="checkbox"/> Highway Engineering | <input type="checkbox"/> Machine Shop | <input type="checkbox"/> Cotton Manufacturing |
| <input type="checkbox"/> AIRCRAFT DRAFTING | <input type="checkbox"/> Lumber Dealer | <input type="checkbox"/> Mechanical Drafting | <input type="checkbox"/> Rayon Weaving |
| <input type="checkbox"/> WEATHER OBSERVING | <input type="checkbox"/> Reading Structural Blueprints | <input type="checkbox"/> Mechanical Engineering | <input type="checkbox"/> Textile Designing |
| <input type="checkbox"/> ELECTRONICS | <input type="checkbox"/> Sanitary Engineering | <input type="checkbox"/> Mold-Loft Work | <input type="checkbox"/> Woolen Manufacturing |
| <input type="checkbox"/> Air Conditioning and
Plumbing Courses | <input type="checkbox"/> Structural Drafting | <input type="checkbox"/> Patternmaking—Wood, Metal | Business and
Academic Courses |
| <input type="checkbox"/> Air Conditioning | <input type="checkbox"/> Structural Engineering | <input type="checkbox"/> Reading Shop Blueprints | <input type="checkbox"/> Accounting |
| <input type="checkbox"/> Heating | <input type="checkbox"/> Surveying and Mapping | <input type="checkbox"/> Sheet-Metal Drafting | <input type="checkbox"/> Arithmetic |
| <input type="checkbox"/> Refrigeration | Communications Courses | <input type="checkbox"/> Sheet-Metal Worker | <input type="checkbox"/> Bookkeeping |
| <input type="checkbox"/> Plumbing | <input type="checkbox"/> Practical Telephony | <input type="checkbox"/> Ship Drafting | <input type="checkbox"/> Business Administration |
| <input type="checkbox"/> Steam Fitting | <input type="checkbox"/> Radio, General | <input type="checkbox"/> Tool Designing | <input type="checkbox"/> Business Correspondence |
| Chemistry Courses | <input type="checkbox"/> Radio Servicing | <input type="checkbox"/> Toolmaking | <input type="checkbox"/> Certified Public Accounting |
| <input type="checkbox"/> Chemical Engineering | <input type="checkbox"/> Telegraph Engineering | <input type="checkbox"/> Welding—Gas and Electric | <input type="checkbox"/> Commercial |
| <input type="checkbox"/> Chemistry, Analytical | Electrical Courses | Railroad Courses | <input type="checkbox"/> Commercial Art |
| <input type="checkbox"/> Chemistry, Industrial | <input type="checkbox"/> Electrical Drafting | <input type="checkbox"/> Air Brake | <input type="checkbox"/> Cost Accounting |
| <input type="checkbox"/> Chemistry, Mfg. Iron & Steel | <input type="checkbox"/> Electrical Engineering | <input type="checkbox"/> Diesel Locomotive | <input type="checkbox"/> Federal Tax |
| <input type="checkbox"/> Petroleum Refining | <input type="checkbox"/> Electric Light and Power | <input type="checkbox"/> Locomotive Engineer | <input type="checkbox"/> First Year College |
| <input type="checkbox"/> Plastics | <input type="checkbox"/> Lighting Technician | <input type="checkbox"/> Locomotive Fireman | <input type="checkbox"/> Foremanship |
| <input type="checkbox"/> Pulp and Paper Making | <input type="checkbox"/> Practical Electrician | <input type="checkbox"/> Railroad Section Foreman | <input type="checkbox"/> Good English |
| Civil Engineering, Architectural
and Mining Courses | Internal Combustion
Engines Courses | Steam Engineering Courses | <input type="checkbox"/> Higher Mathematics |
| <input type="checkbox"/> Architecture | <input type="checkbox"/> Auto Technician | <input type="checkbox"/> Boilermaking | <input type="checkbox"/> Motor Traffic |
| <input type="checkbox"/> Architectural Drafting | <input type="checkbox"/> Diesel-Electric | <input type="checkbox"/> Combustion Engineering | <input type="checkbox"/> Salesmanship |
| <input type="checkbox"/> Bridge and Building Foreman | <input type="checkbox"/> Diesel Engines | <input type="checkbox"/> Engine Running | <input type="checkbox"/> Sign Lettering |
| | <input type="checkbox"/> Aviation | | <input type="checkbox"/> Spanish |
| | <input type="checkbox"/> Gas Engines | | <input type="checkbox"/> Stenography |
| | | | <input type="checkbox"/> Ship Fitting |
| | | | <input type="checkbox"/> French |
| | | | <input type="checkbox"/> High School |
| | | | <input type="checkbox"/> Postal Service |
| | | | <input type="checkbox"/> Secretarial |
| | | | <input type="checkbox"/> Traffic Management |

Name _____ Age _____ Home Address _____

City _____ State _____ Present Position _____

Employed by _____ Working Hours _____ A. M. to _____ P. M.

Special tuition rates to members of the Armed Forces. Enrollment under G.I. Bill and P.L. 16 approved for World War II Veterans.
Canadian residents send coupon to International Correspondence Schools Canadian, Ltd., Montreal, Canada.

Something missing?



...buy the **PROTO***
Adjustabull!

NEW Finishes

MORE Quality Features

When you hear users rave about PROTO* adjustable and pipe wrenches—it's no "bull." Special steels and I-beam handles give extra strength. Smooth-operating knurls and thin, light jaws make the adjustables faster than a bull-fighter on a bicycle. Full-finish wrenches now have lustrous chrome plating. Buy needed adjustable and pipe wrenches from your PROTO* dealer.

Write for catalog to

PLUMB TOOL COMPANY

2255Y Santa Fe Ave.,
Los Angeles 54, Calif.

Adjustable
Wrench
Nos. 704-
7205
4" to 20"

Pipe
Wrench
Nos.
806-824

*** PROTO** means **PROfessional**
TOols. It's the new name for the tools
that have been preferred for 43 years.

5087

PROTO
Professional Quality
TOOLS
LOS ANGELES

WHERE-TO-BUY-IT INDEX

Source of supply appears after items commercially available.

AUTOMOBILES, TRANSPORTATION AND TRUCKS

Armrest for car (Drive-Eze Mfg. Co., Box 163, Austin Tex.)... 90
Road-sign language 96
Detroit listening post..... 104
1951 Mercury (Mercury Division of Ford Motor Co., 6200 W. Warren, Detroit, Mich.)..... 105
Chemical cleans sidewall tires (R. M. Hollingshead Corp., 840 Cooper St., Camden 2, N. J.)..... 106
Island commuter (Sulak Mfg. Co., 4th S. & E. Marginal Way, Seattle, Wash.)..... 118
Dashboard rack holds road map (Francis R. Good, 244 Nieto Ave., Long Beach 3, Calif.)..... 125
Dry-land sailing..... 142
Back shield for convertibles has paraffin-friction hinges (Link Anderson, 1558 10th St., Santa Monica, Calif.)..... 143
Snack tray hangs from dashboard..... 148
Shielded spark plug (Leonard Spark Plug Co., Inc., 148-150 Summit St., Newark 4, N. J.)..... 149
Emergency brake stops truck (Runaway Truck Control Co., 929 N. Hollywood Blvd., Burbank, Calif.)..... 157
"Slow" light (Michigan Shores Products, Inc., 1210 Washington St., Wilmette, Ill.)..... 159
Jets go to sea..... 161
Indoor ambulance (Crosley Motors, Inc., 2530 Spring Grove Ave., Cincinnati, Ohio)..... 250

AVIATION

Automatic parachute 107
Barriers deflect blowtorch blast of jets..... 113
Mobile air-lift dock fashioned from Jeep..... 161

FARM

Color photos of "off color" eggs..... 90
Flax weeder 95
Portable sprinkler covers 1/8 mile (Stout-Wyss Irrigation, Inc., Kenton Station, Portland, Ore.)..... 117
Chlorine powder makes a nontoxic farm disinfectant..... 132
Tree puller 139
Tractor saw (General Farm Equipment Co., 305 E. 7th St., Pittsburg, Kans.) 152
Farmers put air to work (Johnson-King Mfg. Co., 819 Main St., Woodland, Calif.)..... 160
Bottled gas powers tractor..... 160

FIRE FIGHTING

Log-weighing aids forecasts of forest fires..... 116
Fire put out in split second..... 132
Mechanical "creep" aids fire fighters..... 152

GAMES AND NOVELTIES

Shuffler mixes Canasta deck (Atlantic Playing Card Co., Inc., 230 5th Ave., New York City 1)..... 90
Monkey tells time by rolling eyes..... 90
Retired fire engine..... 139
"Big Ben" made of paper..... 148
Sipper with built-in refrigerant (Donbert Co., Inc., 264 5th Ave., New York City)..... 149
Playground planet teaches geography..... 159

HOUSE AND HOME

No-steam coating for mirrors and windows (Master, 4444 Brooklyn Ave., Los Angeles 22, Calif.)..... 95
Prefabricated eaves 95
Burglar guard (Welbury Engineering Co., 15 Thornsett Rd., Sheffield 7, England)..... 106
Grass trimmer (Bolens Products Division, Port Washington, Wis.) 106
Pumice roof (A. C. McCoy, 2655 Valencia Ave., San Bernardino, Calif.) 120
Mesh tube keeps gutters clean (Wynnco Products Corp., 344 Luckie St., N. W., Atlanta, Ga.) 124
Tender feeds dog for seven days (Sports Engineering Div., James R. Coffing Co., Danville, Ill.)..... 139
Shower stall (Standard Steel Cabinet Co., 3701 Milwaukee Ave., Chicago 41)..... 140
Hair drier (Filtex Corp., 417 E. 15th St., Los Angeles 15, Calif.) 140
Utensil for cleaning shrimps (Arthur Paoli & Son, 2042 N. 2nd St., Rockford, Ill.)..... 140
Corner bin for wasted space (American Central Div., Avco Mfg. Corp., Connersville, Ind.)..... 140
Paper guest towels (Irving Worthman, 11 W. 42nd St., New York City) 141
Plastic holds cut flowers (O. E. Linck Co., Valley Rd. & Rte. 6, Clifton, N. J.) 141
Hot tray for skillet (Art Metal Appliance Co., 6758 Hollywood Blvd., Hollywood 28, Calif.)..... 141
Plastic pocket (See-Shell Products Co., 6840 N. Western Ave., Chicago 45) 141
Adjustable bed (Simmons Co., 1870 Merchandise Mart Plaza, Chicago 54) 141
Stationary window (Panel Windows, Inc., 207 Winchester Ave., Martinsburg, W. Va.)..... 141
Dehumidifier (Dri-Z-Air Co., 1005 E. Northlake Ave., Seattle 5, Wash.) 141
Radio-controlled lawn mower lets inventor loaf in shade (Reo Motors, Inc., Lansing 20, Mich.) 149
"Hidden" radiators keep house warm (Copperheat Industries, Inc., Detroit 21, Mich.) 152
Antifog for bathroom (Charles Parker Co., 412 Jordan St., Meriden, Conn.) 158
Hot water for sale via special delivery..... 159

(Continued to page 14)

WHAT Every AUTO MECHANIC Wants to Know

A motor vehicle is a machine of many parts, each part designed and constructed for its own special function. All good mechanics, like good doctors, should know the working theory and operation of each part and understand what causes trouble and how to remedy it.

LET AUDELS AUTO GUIDE SOLVE YOUR PROBLEMS

Every auto mechanic, helper, serviceman and operator can use AUDELS AUTO GUIDE. The information it gives saves time, money and worry. Highly endorsed by all users. It presents the whole subject of auto mechanics from A to Z in plain language and simple terms.

This Big Practical Book gives full information with working diagrams covering the principles, construction, ignition, service and repair of modern cars, trucks and buses.

A complete Guide of 1800 pages, with over 1500 illustrations showing inside views of the working parts, with instructions for service jobs. Diesel engines, Fluid and Hydra-matic drives fully explained.

IT PAYS TO KNOW HOW TO

How to fit pistons—How to locate engine knocks—How to fit connecting rod bearings—How to service main bearings—How to recondition valves—How to time valves—How to adjust fan belts—How to adjust carburetors & chokes—How to rebuild a clutch—How to service automatic transmissions—How to service brakes—How to adjust steering gear—How to cope with ignition troubles—How to service distributors—How to time ignition—How to "tune up" an engine.

INFORMATION IN A HANDY FORM

73 INTERESTING CHAPTERS—Read this partial list of subjects on which practical information is fully given for quick reference under the headings as shown below. Ready Reference Index.

All Parts of an Automobile—Automotive Physics—The Gas Engine—Gas Engine Principles—Multi-Cylinder Engines—Horse Power—Automobile Engines—Stationary Parts—Moving Parts—Pistons—Piston Rings—Connecting Rods—Crank Shafts—Valves—Valve Gear—Cams and Cam Action—Valve Timing—Cooling Systems—Fuel Feed Systems—Dual Fuel Feed—Mixture—Carburetors—Carburetor Service—Automatic Choke—Super-Chargers—Transmissions—Special Transmissions—Fluid and Hydra-matic Drives—Clutches—Universals and Propeller Shafts

A Ready Reference

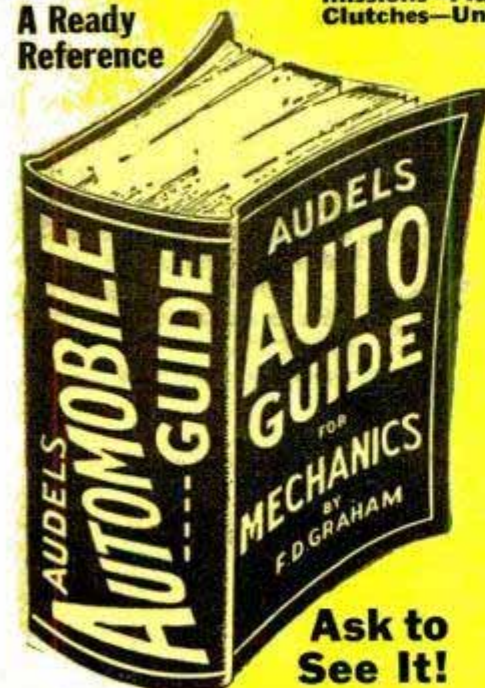

Ask to See It!

—The Differential—Rear Axles—Rear and Front Suspension—Running Gear—Brakes—Wheel Alignment—Knee Action—Steering Gear—Tires—Lubricants and Lubrication—Automotive Electricity—Ignition Systems—Magneto Ignition—Spark Plugs—Ignition Coils—Distributors—Automatic Spark Control—Ignition Timing—Generators—Starters—Generator and Starter Testing—Lighting Systems—Storage Batteries—Charging and Testing—Diesel Engines and Trouble Shooting.

7 DAYS' FREE TRIAL
TO GET THIS ASSISTANCE FOR YOURSELF SIMPLY FILL IN AND MAIL COUPON TODAY.

\$4 COMPLETE PAY \$1 A MONTH ONLY!



Sent on 7 Days Approval

Step up your own skill with the facts and figures of your trade. Audels Mechanics Guides contain Practical Inside Trade Information in a handy form. Fully Illustrated and Easy to Understand. Highly Endorsed. Check the book you want for 7 DAYS FREE EXAMINATION. Send No Money. Nothing to pay postman.

CUT HERE MAIL ORDER

AUDEL, Publishers, 49 W. 23 St., NEW YORK 10, N. Y.

Please send me postpaid for FREE EXAMINATION books marked (x) below. If I decide to keep them I agree to mail \$1 in 7 Days on each book or set ordered and further mail \$1 monthly on each book or set until I have paid price, otherwise I will return them.

- AUTO GUIDE**, 1800 Pages **\$4**
- DIESEL ENGINE MANUAL, 400 Pages 2
- WELDERS GUIDE, 400 Pages 1
- MACHINISTS Handy Book, 1600 Pages 4
- POWER PLANT ENGINEERS Guide, 1500 Pages. 4
- ENGINEERS & FIREMANS EXAMS, 528 Pages. 1
- PUMPS, Hydraulics & Air Compressors, 1658 Pgs. 4
- MARINE ENGINEERS Handy Book, 1280 Pages 4
- ENGINEERS & Mechanics Guides (8 Book Set) 12
- Answers on Practical ENGINEERING, 254 Pages 1
- ELECTRIC WIRING DIAGRAMS, 210 Pages 1
- ELECTRICIANS EXAMINATIONS, 250 Pages. 1
- ELECTRICAL DICTIONARY, 9000 Terms 2
- ELECTRIC MOTOR GUIDE, 1000 Pages 4
- HANDY BOOK OF ELECTRICITY, 1440 Pages 4
- ELECTRICAL POWER CALCULATIONS, 425 Pgs. 2
- RADIOMANS GUIDE, 914 Pages 4
- ELECTRONIC DEVICES, 216 Pages 2
- ELECTRIC LIBRARY, 7000 Pages (12 Book Set). 18
- Vols. I, II, III, IV, V, VI, VII, VIII, IX, X, XI, XII \$1.50 Ea. 1
- OIL BURNER GUIDE, 384 Pages 4
- HOUSE HEATING GUIDE, 1000 Pages 6
- CARPENTERS & Builders Guides (4 Book Set). 6
- PLUMBERS & Steamfitters Guides (4 Book Set). 6
- MASONS & Builders Guides (4 Book Set). 2
- BLUE PRINT READING, 416 Pages 2
- PAINTERS & DECORATORS MANUAL, 450 Pgs. 6
- GARDENERS & GROWERS Guides (4 Book Set). 4
- REFRIGERATION & Air Conditioning, 1280 Pgs. 1
- SHEET METAL WORKERS Handy Book, 388 Pgs. 4
- SHEET METAL PATTERN LAYOUTS, 1100 Pgs. 1
- AIRCRAFT WORKER, 240 Pages 1
- MECHANICAL DRAWING GUIDE, 160 Pages. 2
- MECHANICAL DRAWING & DESIGN, 480 Pgs. 2
- MATHEMATICS & CALCULATIONS, 700 Pgs.. 2
- MECHANICAL Dictionary, 968 Pages 4
- MILLWRIGHTS & Mechanics Guide, 1200 Pgs. 4

Name _____

Address _____

Occupation _____

Employed by _____ O.A.

AUDEL, Publishers, 49 W. 23 St., New York 10, N. Y.

I Trained These Men



E. J. STREITENBERGER, New Boston, O., says, "After completing a 10-week course, I made a week fixing sets in my spare time. Now set up a Television sets business."



PHILLIP G. Louisville 8, K... have been operating a Servicing business for 14 years I did \$14... business; net p...



S. W. DINWIDDIE, ville, Ill., writes, "After finishing course, worked in servicing shop. Now Engineer of WCUN Police Radio Instal...



A. HERR, New C... Pa., writes, "Have doubled my salary since starting in Radio full time. Am employed by Station WKBO as transmitter operator. Future looks bright to me."



L. HAUGER, San Bruno, Calif., tells us, "I accepted a position as Radio and Television Technician... promoted to manager of Television Service and Installation."



LEANDER ARNOLD, Pontiac, Mich., says, "While learning, made \$5 to \$10 a week repairing Radios in my spare time. Now I have a spare time shop in my home."



NORMAN H. WARD, Ridgefield Park, N. J., writes, "4 years ago, I was a book-keeper with a hand-to-mouth salary. Now I am employed by a key ABC station."



H. B. MILLS, Washington, Ohio, finds, "Word traveled fast in regard to my N.R.I. training. Have been doing Television installation and servicing, tracing out and eliminating interference, etc."



C. STAETH, Fort Madison, Iowa, informs us, "Do Radio Servicing full time in my own shop and am making more money than ever before. I owe this to N.R.I."



T. S. NORTON, Hamilton, Ohio, says, "My first job was obtained for me by your Graduate Service Department. Am now Chief Engineer, Station WQOX."



W. R. NICK writes from... in... control



I'll Train You RADIO-

PRACTICE SERVICING OR COMMUNICATIONS with Radio Kits I Send

For both my Servicing Course and my NEW Communications Course, I send you many Valuable Kits of Parts for PRACTICAL EXPERIENCE. They "bring to life" theory you learn in my illustrated texts. Some equipment from both courses is shown below. As part of my Servicing Course, you build a complete, powerful Radio Receiver, a Set Tester useful in earning extra spare time money, an A. M. and F. M. Signal Generator, etc. In my Communications Course, you assemble a low-power Broadcasting Transmitter that shows how to put a station "on the air," a Wavemeter, an Electronic Multitester for measuring voltage, current, resistance, impedance, etc. This and other equipment you build with Kits I send is yours to keep.



Make Extra Money in Spare Time While Learning

Many of my students earn money fixing neighbors' Radios in their spare time while learning, often average \$5, \$10 a week. I send you SPECIAL BOOKLETS that show you how to do it... and I send parts to build a Tester that helps you do it.



AT HOME for Good Jobs in TELEVISION

There is Success--Good Pay--Security for You in America's Fast Growing Industry

VETERANS HURRY!

To get this valuable training under G. I. Bill. Time is running out. **Mail Coupon NOW!**

Want Your Own Business?

Many N.R.I. trained men operate successful Radio-Television sales and service businesses. Let me show you how, starting with spare time earnings as their capital, they build good incomes from their own shops.



Do you want good pay, a bright future, and security? Want your own profitable shop? Get into fast growing, prosperous RADIO-TELEVISION! Radio alone is bigger than ever. 81 million home and auto Radios, 2,700 Broadcasting Stations, expanding Aviation and Police Radio, Micro-Wave Relay, Two-Way Radio are making opportunities for Servicing and Communications Technicians and FCC-Licensed Operators.

Television is TODAY'S Good Job Maker

In 1949, almost 3,000,000 TV sets sold. By 1954, 20,000,000 TV sets estimated. 100 TV Stations now operating. Authorities predict 1,000 TV Stations. This means more jobs, good pay for qualified men all over the United States and Canada.

No Previous Experience Needed

Keep your job while training. Hundreds of successful RADIO-TELEVISION TECHNICIANS I trained had no previous experience, some only a grammar school education. Learn Radio-Television principles from illustrated lessons. Get PRACTICAL EXPERIENCE. See on the opposite page some of the devices my students build from Kits of Parts I furnish; also practice servicing Radios or operating transmitter

... experiment with circuits common to Radio and Television. Many of my students make \$5, \$10 a week extra fixing neighbors' Radios in spare time while training. Many start their own profitable Radio-Television sales and service business, using these earnings as capital.

Send Now for 2 Books FREE — Mail Coupon

Send now for my FREE DOUBLE OFFER. You get actual Servicing lesson to show how you learn at home. Also my 64-page book, "How to Be A Success in Radio-Television." Read what my graduates are doing, earning; see equipment you practice with at home. Send coupon in envelope or paste on postal. J. E. SMITH, President, Dept. OMP, National Radio Institute, Washington 9, D. C. OUR 37th YEAR.

Actual Lesson and 64 page Book BOTH FREE

The ABC's of SERVICING

How to Be a Success in RADIO-TELEVISION

Mail Coupon Now!

MR. J. E. SMITH, President, Dept. OMP National Radio Institute, Washington 9, D. C.

Mail me Sample Lesson and 64-page Book, "How to Win Success in Radio-Television"—both FREE. (No salesman will call. Please write plainly.)

NAME.....AGE.....

ADDRESS.....

CITY.....ZONE.....STATE.....

Check if Veteran Approved Under G. I. Bill

Power!



He's power from head to toe... he's the star performer on the gridiron.

Star performer in bicycling is the New Departure Safety Brake — the lightest, strongest, most powerful brake ever built. New Departure's greater braking surface (38 percent more than any other) assures constant control at all times. It brings any bike to a



Be sure your new bike has a

New Departure
SAFETY BRAKE 
a product of

1899A

NEW DEPARTURE • DIVISION OF GENERAL MOTORS
 BRISTOL, CONNECTICUT

(Continued from page 10)

MILITARY

Ship's gun does shore duty.....	124
Russian tanks.....	150
"Switch engine" tank shuffles boxcars.....	158

OUTDOOR RECREATION

Three-speed transmission slips into bike wheel (New Departure, Division of General Motors, Bristol, Conn.).....	113
Sky-riding bus.....	114
"Upside down" lamp for night hikers.....	117
Pier seat for anglers.....	125
Rifle from shotgun (Dial-Hanna Firearms Co., Orlando, Fla.).....	128
Tennis trainer (Gary & Biglow, Suite 1106, 101 Park Ave., New York City 18).....	148
Hook holder (M-B Mfg. Co., Inc., 2535 15th St., Denver, Colo.).....	157

PHOTOGRAPHY AND TV

Title aligner for movie fans (Hollywood Cine Products, Lakeland Village, Elsinore, Calif.).....	116
Faster processing of color films (Anso Division, General Aniline & Film Corp., Binghamton, N. Y.).....	125
Floating TV theater.....	126
Stereoscopic-slide viewer has built-in light source (Sawyer's, Inc., Portland 7, Ore.).....	148

TESTERS

Radioactive car engines test efficiency of oil.....	112
Plastic sphere tests lamps (Westinghouse Electric Corp., 2114 Investment Bldg., Pittsburgh 30, Pa.).....	119
Aerial waterworks.....	128
Truck-mounted sugar mill.....	138
Dye shows metal flaws (Dy-Chek Co., Division of Northrop Aircraft, Inc., 1515 E. Broadway, Hawthorne, Calif.).....	138
Fluorescent-light tester (Ideal Industries, Inc., Sycamore, Ill.).....	142
Flash-bulb tester serves as night light (Davis Mfg. Co., Plano, Ill.).....	158

MISCELLANEOUS

Sun operates window louvers in school.....	88
Chimney is shaft for bricklayer's elevator.....	87
Army paint mixer.....	87
Steel hook gloves (Steel Grip Co., 4610 New Utrecht Ave., Brooklyn, N. Y.).....	103
Fountain pen for radium paint (John F. Swinney, Box 3211, Edmonds, Wash.).....	103
Contour marker (Ckola Co., 555 Gateway Bldg., Minneapolis 1, Minn.).....	106
Wool trampler (Indiana Farm Bureau Cooperative Association, 47 S. Pennsylvania St., Indianapolis, Ind.).....	107
Flame-sprayed rubber protects underwater metal (Thiokol Corp., 778 N. Clinton Ave., Trenton, N. J.).....	112
Banks for bones.....	112
Graphite atoms are wet.....	119
Auto bank "reaches" for cash (Herring-Hall-Marvin Safe Co., Hamilton, Ohio).....	142
Life without germs.....	143
Strips guide typists' fingers (Type-N-Guide, Inc., 522 5th Ave., New York City 18).....	157
Hot air fog dispersal.....	158
Remote salesmanship (Lear, Inc., 110 Ionia Ave., N. W., Grand Rapids, Mich.).....	161
Competition for the bees.....	266

Craftsman and Shop Notes Index

DRAWING AND LAYOUT

Drawing board is easily adjusted if held by storm-sash brackets.....	178
Resting artists' brush on washer raises bristles off table.....	194
Notched molding on drawing board holds freshly inked signs.....	214
Colors identify edges of scale.....	223

FARM

Scaling yard-light pole.....	214
Boarded stock-tank shelter.....	216
Bales of straw check soil erosion in sloping fields.....	222
Sturdy sawhorses from angle iron.....	223
Dual-wheel farm trailer used on muddy fields.....	223
Barrel provides self-feeder.....	223
Tractor-mounted concrete mixer dumps load into forms.....	226
Oil-drum halves welded together provide large stock feeder.....	226
Corncrib protected from rats.....	226

HOUSE AND HOME

Pressing cloth taped to coat hanger.....	177
Scrapbook stores materials for repairing garments.....	177
Flashlight aids in darning socks.....	177
Measuring spoon kept handy saves soap.....	177
Tinfoil protects candleholders and linens.....	177
Oil paintings given new life.....	177
Ring facilitates removing vacuum-bottle cork.....	177
Floating candles form novel centerpiece.....	177
Camel-hair brush used to dust plants and artificial flowers.....	177
Altered lamp-shade clamps fit large bulb.....	178
Butter churn from washer.....	184
Hairpin controls trailing vine.....	187
Shaving brush stored conveniently by magnetic wall fixture.....	194
Extension handle for wooden match bent from wire coat hanger.....	200
Oilcloth utilized to fashion shopping bags in attractive color combinations.....	200
Laundry starch loosens wallpaper.....	204
Prolonging life of outdoor steps by draining moisture.....	204

(Continued to page 16)

INVENTORS

Learn how to protect your invention. The U. S. Patent Laws provide that any new and useful art, machine, article of manufacture, or composition of matter, or any new and useful improvement thereof, may be patented if the act of invention is involved. Therefore, every inventor with a valuable invention should take advantage of the Patent Laws and proceed for patent protection in order to safeguard his rights.

A patent gives the inventor the exclusive right to prevent others from making, using, or selling the invention claimed in the patent for a period of seventeen years.

The Patent Laws were enacted for the benefit of the inventor to give him protection for the features of his invention which are patentable. These features must be properly and concisely set forth and claimed in a formal application for patent, in order to comply with the requirements of the Patent Laws. For that reason, unless the inventor is familiar with patent matters, he should engage a competent registered patent attorney or agent to represent him. We are registered to practice before the U. S. Patent Office and are prepared to serve you in the handling of your patent matters.

A specially prepared booklet entitled "Patent Guide for the Inventor", containing detailed information with respect to patent protection and procedure, together with a "Record of Invention" form will be promptly forwarded to you without obligation upon request.

CLARENCE A. O'BRIEN & HARVEY JACOBSON

Registered Patent Attorneys

01-L DISTRICT NATIONAL BUILDING

WASHINGTON 5, D. C.

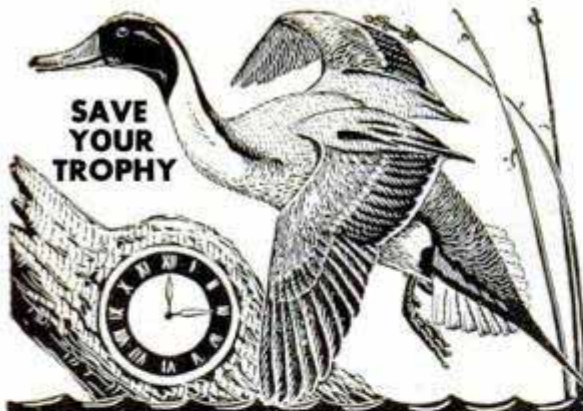

SAVE
YOUR
TROPHY

MOUNT your own Hunting Trophies

WORLD'S FINEST HOBBY FOR MEN & BOYS

Save and MOUNT your WILD-GAME
Be Your Own Taxidermist!

Hunters, anglers, nature-lovers, you will be **AMAZED** to learn and know the pleasures of Taxidermy. Your home-museum of beautiful **TROPHIES** will delight you and your family and friends.

LEARN AT HOME BY MAIL

We can teach you with fine success. More than 450,000 students have learned from this reliable school. **EASILY AND QUICKLY**. Here is the greatest **HOBBY** you ever dreamed of.

Mount Ducks, Quail, Deer, Fish

Save these beautiful trophies. **TAN** skins and furs. Decorate your **HOME AND DEN**. Become widely known and **FAMOUS** as a Taxidermist.

MEN AND BOYS Double your interest in hunting and outdoor-life. Have a magnificent hobby that will **enthrall** you all your lifetime. **WRITE TODAY**.

Ask for FREE BOOK

MAIL THE COUPON—TODAY

Tells how **YOU** can learn Taxidermy at home. 48 pages, 100 pictures of wild-game. A wonderful book, strange, unique. You never saw the like before. This book is **PRICELESS** to hunters, trappers and nature-lovers. **ABSOLUTELY FREE** if you **WRITE AT ONCE**, this minute! Use the **COUPON** or a **POSTAL** will do.

PLEASE STATE YOUR AGE.

FREE BOOK

Northwestern School of Taxidermy,
2511 Elwood Bldg., Omaha 2, Neb.

Send me your free illustrated book, "How to Mount Game." Also tell me how I may learn this fascinating art easily and quickly by mail. No obligation. State your age.

Name _____ Age _____
Address _____



Be Sure To Send For Free Book Now!

(Continued from page 14)

MODELS AND NOVELTIES

Guest-book cover features decorative overlay.....	174
Flush door fitted with legs forms modern coffee table.....	174
Marshmallow candleholders.....	178
How to tie a Gaucho knot.....	182
Jar covers provide small V-pulleys.....	184
Combination storage-control box for model trains.....	185
Decorated potato-chip cans form novel wastebaskets.....	186
Old clockcases make attractive shadow boxes.....	187
Unique floor lamp has aquarium base improvised from gaso- line-pump bowl.....	191
Salt and pepper shakers fashioned from shotgun shells.....	193
From chandelier to candlesticks.....	199
Eye-catching outdoor murals of wallpaper color child's playroom.....	199
Kitchen novelties.....	205

OFFICE

Paper clip aligns rubber stamp.....	194
Correcting typewritten sheets stapled together.....	213
Open teletype enclosure has sound-absorbing walls to mini- mize noise.....	213

OUTDOOR RECREATION

Removing muddy taste from fish caught during cold weather.....	178
Simple toboggan for children has sheet-metal bottom.....	182
Partially empty fuel can serves as sea anchor.....	184
Nylon fishline dyed with tea.....	193
Melted paraffin simplifies removing duck feathers.....	200

PHOTOGRAPHY

Wall rack for drying cut film improvised from board and dowels.....	209
Cotton stored in bottle cap.....	209
Wooden stand supports funnels to filter photo solutions.....	210
Inexpensive darkroom heater utilizes photoflood reflector.....	210

TOOLS

Bit holder filled with grease prelubricates and affords rust protection.....	175
Floating mount for small motor slides to new location along bench edge.....	175
Compression spring on vise screw provides positive action.....	182
Combination pusher and hold-down increases bench-saw safety.....	204
Bandsaw made from hardwood plywood (W. R. Vermillion Co., Inc., 2201 Grand Ave., Kansas City, Mo.).....	224
Thread gauge matches nuts and bolts (Stewart Mfg. Co., Washington 9, D. C.).....	224
Quality ignition kit (Palmer Wellock Tool Corp., Meadville, Pa.).....	224
Brake-lining cutter (Permafuse Corp., 12 Commercial Ave., Garden City, N. Y.).....	224
Motor-driven pipe threader (Thread-Ezy Mfg. Co., Corunna, Mich.).....	225
Hand-operated chain saw (Johnson's Fair, 8th & Allegheny Ave., Philadelphia 40, Pa.).....	225
Level for a portable drill (Singer Kennedy Corp., 21 E. Van Buren St., Chicago 5).....	225
Cap screw serves as lathe dog for working close to faceplate.....	226
Improvised cutoff tool.....	226

MISCELLANEOUS

Installing rubber stair treads simplified by using chalk line.....	174
Tongue-and-groove edges cut in lumber by utilizing dado head on circular saw.....	175
Top section of lighter-fluid can provides small funnel.....	178
Ready-cut framing for panel doors.....	184
Bottom cut from motor-oil can provides small-parts tray.....	187
Mixing faucet of pipe fittings controls water temperature.....	191
Edge of shingled roof reinforced with galvanized-metal strip.....	194
Strainer holds damp washcloth for carrying in suitcase.....	194
Clothespins slipped over handles facilitate carrying bushel basket.....	204
Emergency repair for pipe line.....	204
Low-clearance hoist sling of steel channel grasps drums with positive-action hooks.....	213
Flexible baffles in chute retard falling bricks.....	214
Repairing holes in car bodies without removing upholstery.....	214
Prize-winning inventions.....	215
Two-wheel cart for hauling linen speeds motel-operator's chores.....	216
Filling master brake cylinder with aid of curtain rod.....	216
Removing broken screws.....	216
Picture-frame vise has many uses in the shop.....	217
Sand supports work for welding.....	223

Radio-Television, Electronics

Television today (Color TV receiver, RCA Victor Corp., Cam- den, N. J.; base mount for antennas, L. S. Brach Mfg. Corp., Newark, N. J.; air-spaced feedline, Don Good Inc., 1014 Fair Oaks Ave., South Pasadena, Calif.; TV booster, Elec- tro-Voice, Inc., Buchanan, Mich.; remote control, Philco Corp., Philadelphia, Pa.; high-voltage probe, Insuline Corp. of America, Long Island City, N. Y.).....	227
Stroboscope unit for studying parts in motion.....	228
Master TV antenna system for apartment buildings (Jerrold Electronics Corp., 121 N. Broad St., Philadelphia, Pa.).....	230
Hints for radio experimenters (Hat retainer clips, Times Facsimile Corp., New York City).....	232

IMPORTANT NOTICE—It is the intention of this magazine to provide its readers with information regarding the latest developments in the mechanical arts. We take no responsibility as to whether the disclosures contained in our articles are covered by patents and advise readers to investigate this subject before making, using, or selling any of the products, machines, or processes described in order to avoid possible liability for patent infringements.

WATCHMAKING

★ Watch Repairing ★ Jewelry Engraving ★ Jewelry Repairing

Combination men earn top pay. Learn in school fully accredited by Horological Institute of America in Washington, D. C. and United Horological Association of America. Approved for veterans. Receive tools, tuition and assistance while learning.

Established 1935. Write for FREE booklet



The Baronian School, Inc.

2116 WALNUT ST. (DEPT. C) PHILA. 3, PA.

INVENTORS

If you believe that you have an invention, you should find out how to protect it. The first step is to have a search made of the prior pertinent U. S. patents. If a report on this search indicates that the invention appears patentable you can apply for a patent, and the specifications and claims should be prepared.

The firm of McMorrow, Berman & Davidson, with offices in Washington, D. C., is qualified to take the necessary steps for you. We can make a preliminary search on your invention, advise you whether we think it can be patented, and prepare your application for patent.

Unless you are fully familiar with the U. S. Patent Laws, we recommend that you engage the services of a Registered Patent Attorney to protect your interests. The patent laws are *your* laws. A patent gives you the right to prevent others from making, using or selling the invention claimed in your patent for a period of 17 years.

Use these patent laws for your protection. Investigate whether your invention can be patented. If you have what you believe to be an invention, we suggest that you have this firm make a search for you.

Send for a copy of our Patent Booklet entitled "How To Protect Your Invention," containing information about patent protection and patent procedure. Along with this we will also send you an "Invention Record" form, for your use in writing down and sketching details of your invention. We will mail them promptly. No obligation. They are yours for the asking.

McMORROW, BERMAN & DAVIDSON

Registered Patent Attorneys

PATENTS • COPYRIGHTS • PATENTS

135-K VICTOR BUILDING, WASHINGTON 1, D. C.

Will You Let Me PROVE I Can Make YOU a New Man?

LET ME START SHOWING RESULTS FOR YOU

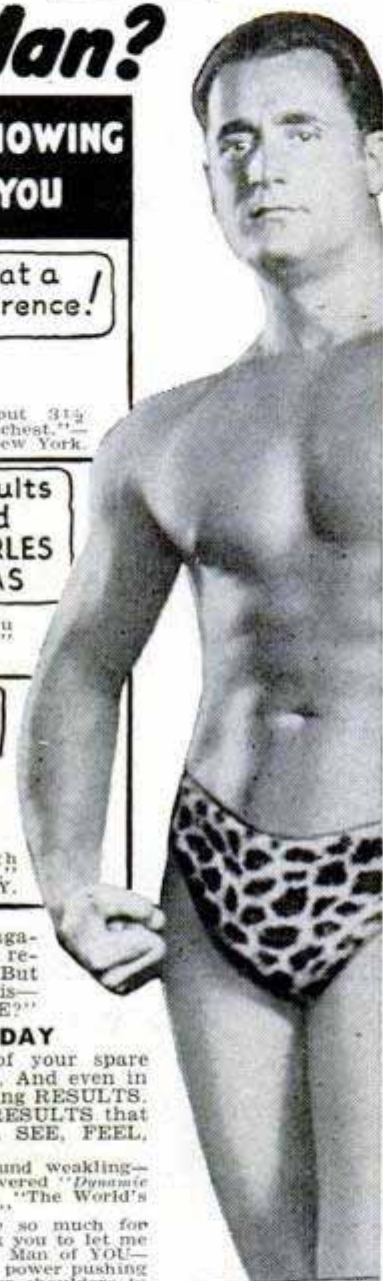

I COULD fill this whole magazine with enthusiastic reports from OTHERS. But what you want to know is—"What can Atlas do for ME?"

15 MINUTES A DAY

Just give me 15 minutes of your spare time daily. That's all I ask. And even in that short time I'll start giving RESULTS. And it will be the kind of RESULTS that you (and anyone else) can SEE, FEEL, MEASURE with a tape.

I myself was once a 97-pound weakling—sickly, half-alive. Then I discovered "Dynamic Tension." And I won the title, "The World's Most Perfectly Developed Man!" "Dynamic Tension" has done so much for other fellows that I simply ask you to let me prove that it can make a New Man of YOU—that it can start new inches of power pushing out your chest—build up your shoulders to champion huskiness—put new, hard, firm muscles of your biceps—make those stomach muscles of yours hard ridges!

My Illustrated Book is Yours — Not for \$1.00 or 10c — But FREE

Send for my book, "Everlasting Health and Strength." 48 pages, packed with actual photos, valuable advice. A real prize for any fellow who wants a better build... but yours FREE! Rush coupon to me personally: Charles Atlas, Dept. 811, 115 East 23rd St., New York 10, N. Y.



**CHARLES ATLAS, Dept. 811
115 East 23rd St., New York 10, N. Y.**

Send me—absolutely FREE—your famous book, "Everlasting Health and Strength"—48 pages, crammed with photos, answers to vital questions, valuable advice. I understand book is mine to keep, and sending for it does not obligate me in any way.

Name _____ Age _____
 (Please print or write plainly)
 Address _____
 City _____ State _____

(Continued from page 8)

couple of trenchers and excavators. But a short time later on his beautiful hillside plot the new *Popular Mechanics* Build-It-Yourself Home was beginning to take shape.

The Riley home will be a rambling ranch-type house of plywood. It is the third in a series of homes planned by the magazine editors to show the man of average mechanical aptitude that he can build his own home, from the first turn of the spade to the last rub-down of built-in cupboards.

The preview of Tom Riley's project begins on page 88 in this issue. Progress reports will continue each month until the full story and detailed how-to-build instructions begin in the Craftsman Section early in 1951. This will be followed by a complete book of plans and instructions, to be published by our Book Department. We are confident that this ranch-type home will be as popular with our readers as the two earlier houses described in two preceding books, of which many thousands have been sold: "Your Home and How to Build It Yourself" (the Cape Cod cottage) and "Popular Mechanics Concrete-Block House."

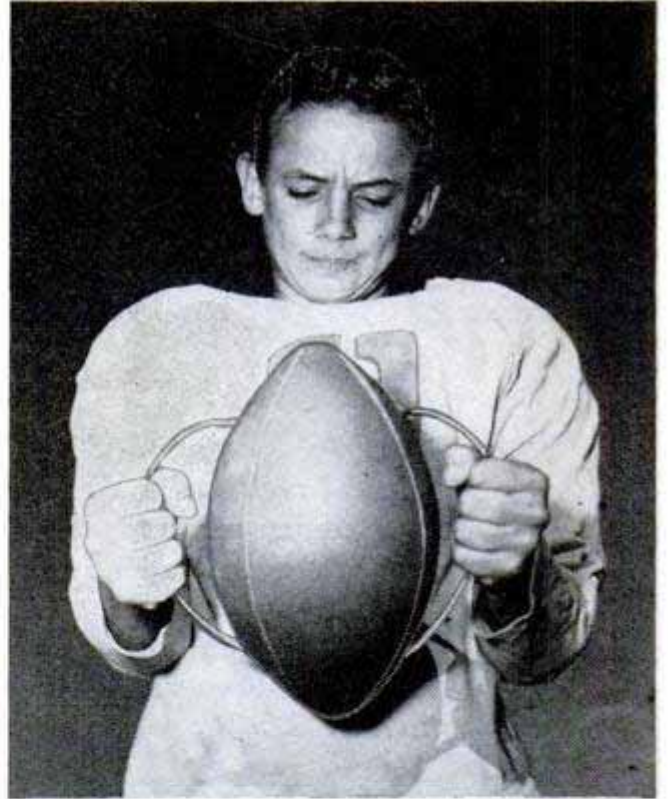

Woops! Horn on the Play!

Here's a sure cure for football fumbles, cooked up as a gag by a San Benito, Tex., sporting goods salesman. Yep, it's a football with handles, warranted fumbleproof, and the junior high backfield player wondering about how to handle it is Billy Broxton of Travis Junior High School, Harlingen, Tex.



You've got to compete with trained men!

The untrained man stands a slim chance today. Right now there are 14 million more highly skilled, experienced workers in the country than before the war.

Jam-packed schools and colleges are still turning out record classes two and three times a year. The armed services continue to return hundreds of technical experts to civilian life every month.

That's why it is so important that you get all the training you can—now, before "the squeeze" begins. Continue your formal

education if you can. If not, investigate the opportunities offered by I. C. S.

For more than 59 years, I. C. S. has been training those determined to make good regardless of the odds. Leaders in nearly every field of business and industry are counted among the men and women who have taken I. C. S. courses. Their records of success prove the worth of sound, practical I. C. S. training. Don't gamble with your future. It may be later than you think. Mark and mail the coupon today!

INTERNATIONAL CORRESPONDENCE SCHOOLS



BOX 5688-K, SCRANTON 9, PENNA.

Without cost or obligation, please send me full particulars about the course BEFORE which I have marked X:

- | | | | |
|---|--|--|--|
| <p>Air Conditioning and Plumbing Courses</p> <ul style="list-style-type: none"> <input type="checkbox"/> Air Conditioning <input type="checkbox"/> Heating <input type="checkbox"/> Refrigeration <p>Chemical Courses</p> <ul style="list-style-type: none"> <input type="checkbox"/> Chemical Engineering <input type="checkbox"/> Chemistry, Analytical <input type="checkbox"/> Chemistry, Industrial <input type="checkbox"/> Chemistry, Mfg. Iron & Steel <input type="checkbox"/> Petroleum Refining <input type="checkbox"/> Pulp and Paper Making <p>Civil Engineering, Architectural and Mining Courses</p> <ul style="list-style-type: none"> <input type="checkbox"/> Architecture <input type="checkbox"/> Architectural Drafting <input type="checkbox"/> Bridge and Building Foreman <input type="checkbox"/> Building Estimating <input type="checkbox"/> Civil Engineering <input type="checkbox"/> Coal Mining <input type="checkbox"/> Contracting and Building <input type="checkbox"/> Highway Engineering <input type="checkbox"/> Lumber Dealer <input type="checkbox"/> Reading Structural Blueprints <input type="checkbox"/> Sanitary Engineering <input type="checkbox"/> Structural Drafting | <ul style="list-style-type: none"> <input type="checkbox"/> Structural Engineering <input type="checkbox"/> Surveying and Mapping <p>Communications Courses</p> <ul style="list-style-type: none"> <input type="checkbox"/> Electronics <input type="checkbox"/> Practical Telephony <input type="checkbox"/> Radio, General <input type="checkbox"/> Radio Operating <input type="checkbox"/> Radio Servicing <input type="checkbox"/> Television <input type="checkbox"/> Telegraph Engineering <p>Electrical Courses</p> <ul style="list-style-type: none"> <input type="checkbox"/> Electrical Drafting <input type="checkbox"/> Electrical Engineering <input type="checkbox"/> Electric Light and Power <input type="checkbox"/> Lighting Technician <input type="checkbox"/> Practical Electrician <p>Internal Combustion Engines Courses</p> <ul style="list-style-type: none"> <input type="checkbox"/> Auto Technician <input type="checkbox"/> Diesel-Electric <input type="checkbox"/> Diesel Engines <input type="checkbox"/> Gas Engines <p>Mechanical Courses</p> <ul style="list-style-type: none"> <input type="checkbox"/> Aeronautical Engineer's, Jr. <input type="checkbox"/> Aircraft Drafting <input type="checkbox"/> Flight Engineer <input type="checkbox"/> Forging <input type="checkbox"/> Foundry Work <input type="checkbox"/> Heat Treatment of Metals <input type="checkbox"/> Industrial Engineering <input type="checkbox"/> Industrial Instrumentation | <ul style="list-style-type: none"> <input type="checkbox"/> Industrial Metallurgy <input type="checkbox"/> Machine Shop <input type="checkbox"/> Mechanical Engineering <input type="checkbox"/> Mold-Loft Work <input type="checkbox"/> Patternmaking—Wood, Metal <input type="checkbox"/> Reading Shop Blueprints <input type="checkbox"/> Sheet-Metal Drafting <input type="checkbox"/> Sheet-Metal Worker <input type="checkbox"/> Ship Drafting <input type="checkbox"/> Tool Designing <input type="checkbox"/> Welding Engineering <input type="checkbox"/> Welding—Gas and Electric <p>Railroad Courses</p> <ul style="list-style-type: none"> <input type="checkbox"/> Air Brake <input type="checkbox"/> Diesel Locomotive <input type="checkbox"/> Locomotive Engineer <input type="checkbox"/> Locomotive Fireman <input type="checkbox"/> Locomotive Machinist <input type="checkbox"/> Railroad Section Foreman <input type="checkbox"/> Steam-Diesel Loco. Eng. <p>Stationary Eng'r's Courses</p> <ul style="list-style-type: none"> <input type="checkbox"/> Boilermaking <input type="checkbox"/> Combustion Engineering <input type="checkbox"/> Engine Running <input type="checkbox"/> Marine Engineering <input type="checkbox"/> Power Plant Eng'r's | <p>Mech. Drafting</p> <ul style="list-style-type: none"> <input type="checkbox"/> Mech. Drafting <p>Textile Courses</p> <ul style="list-style-type: none"> <input type="checkbox"/> Cotton Manufacturing <input type="checkbox"/> Loom Fixing <input type="checkbox"/> Textile Designing <input type="checkbox"/> Rayon Weaving <input type="checkbox"/> Woolen Manufacturing <p>Business and Academic Courses</p> <ul style="list-style-type: none"> <input type="checkbox"/> Accounting <input type="checkbox"/> App. Psychology <input type="checkbox"/> Business Administration <input type="checkbox"/> Bus. Correspondence <input type="checkbox"/> Certified Public Accounting <input type="checkbox"/> Commercial <input type="checkbox"/> Cost Accounting <input type="checkbox"/> Federal Tax <input type="checkbox"/> Foremanship <input type="checkbox"/> Good English <input type="checkbox"/> Higher Mathematics <input type="checkbox"/> Industrial Supervision <input type="checkbox"/> Motor Traffic <input type="checkbox"/> Retailing <input type="checkbox"/> Salesmanship <input type="checkbox"/> Sign Lettering <input type="checkbox"/> Spanish <input type="checkbox"/> Traffic Management |
|---|--|--|--|

Name _____ Age _____ Home Address _____

City _____ State _____ Working Hours _____ A.M. to _____ P.M.

Present Position _____ Employed by _____

Length of Service in World War II _____ Enrollment under G.I. Bill approved for World War II Veterans. Special tuition rates to members of the Armed Forces. Canadian residents send coupon to International Correspondence Schools Canadian, Ltd., Montreal, Canada.

INVENTORS

If you consider your invention to be something of importance—if you have invented any new and useful art, machine, manufacture or composition of matter or improvement thereof—you are advised to protect your invention by applying for a U. S. patent.

A patent is a valuable right. It grants you a monopoly—the right to exclude others from making, using or selling your invention as claimed for a term of seventeen years.

The specification and claims of a patent, particularly if the invention be at all complicated, constitute one of the most difficult legal instruments to draw with accuracy. Therefore, unless you are thoroughly familiar with such matters, you are advised to employ a competent registered patent attorney or agent.

This firm is registered to practice before the U. S. Patent Office and is available to assist in the preparation and prosecution of your patent application.

The "Evidence of Invention" form mentioned below is offered as a convenience to you in making your disclosure to us for search purposes.

You should date and sign your disclosure and have it witnessed by two or more persons who are capable of understanding your invention.

Your disclosure should be mailed to us together with a letter authorizing us to conduct a preliminary

search among previously granted U. S. patents for similar types of invention.

We then make this search and prepare a report of the probable patentability of your invention. If such report is favorable, we recommend the further course for you to take.

The "Evidence of Invention" form and booklet are suggested as conveniences to you and us in starting action on your invention.

VICTOR J. EVANS & Co. *Merlin M. Evans*
REGISTERED PATENT ATTORNEY
530-M MERLIN BUILDING, WASHINGTON 6, D. C.

We shall be glad to send you promptly and without obligation, an instructive booklet, "Patent Protection for Inventors", which was prepared to give inventors detailed information and steps to take toward patent protection—also our convenient "Evidence of Invention" form. Use address Victor J. Evans & Co., 530-M Merlin Building, Washington 6, D. C.

PATENTS

COPYRIGHTS

PRINT YOUR OWN POST CARDS

COMPLETE OUTFIT
only
\$7.50



Amazing results in sales, inquiries and contacts... saves time and money... very easy to use GEM STENCIL DUPLICATOR is ideal for Advertising, Announcements, Notices, Labels, Forms, Price Lists—hundreds of uses for every type of business and organization. Comes complete with all supplies, instructions and 60-page Book of Ideas.

FREE TRIAL OFFER: Try it before you buy it! Write and a GEM OUTFIT will be sent you postpaid. After 10 days, send only \$7.50 or return the GEM, no questions asked. The GEM must sell itself; you be the judge.

BOND EQUIPMENT CO. • Dept. 135
6633 Enright • St. Louis 5, Mo.

SEND NO MONEY • FREE TRIAL OFFER

A CAREER & INDEPENDENCE!

AT ANY AGE - IN GROWING PROFESSION

FREE BOOK & Details

Train now in respected profession - Scientific CHARACTER ANALYSIS from HANDWRITING. Used by Armed Forces, Industry, Psychologists, private parties, DeWitt B. Lucas System - Famous for a Half-Century!

THE ACCURATE, SCIENTIFIC SYSTEM

Over Half a Century! • PLEASANT HOME STUDY can prepare you to Earn Real Money in growing field, full or part time. No educational requirements. Write today for FREE BOOKLET "X"!

LUCAS FOUNDATION, 8844 Sunset Blvd., Los Angeles 46, Calif.

GREAT PROFITS
MAKE YOUR OWN RUBBER MOLDS

X.L. RUBBER MOLDS

will realize your great profits quickly!

WRITE FOR NEW FREE CATALOG

YOU can EASILY learn to cast thousands of perfect plaques, book ends, figurines, ash trays, etc. IT'S EASY, FUN, PROFITABLE! X.L. Rubber, Pts. \$2.00; Qts. \$3.50; Models and enough rubber for 3 molds \$1.30 postpaid.



SEND FOR FREE FACTS

PLASTIC ARTS STUDIO Address Dept. 2
3403 S. Madison St.



ITALIAN ACCORDIONS

Hand Made. Very Best. Buy Direct from Factory Representative at lowest wholesale prices and Save Money. Send Name and Address for FREE catalog.

ITALIAN ACCORDION MFG. CO.
7600 Cottage Grove Ave., Dept. PM-11, Chicago 19, Ill.

NEW! MINIATURE DUST MASK



Wear when sanding, grinding, paint spraying, sweeping, dusting, furnace cleaning, etc. Handy as a pair of glasses. Just keep mouth closed and breathe through nose is all you do to operate. Protects against dusts, lint, coal, cement, grain dust. Has 9 sq. in. filter.

Order today.

JERRY BRYANT, Dept. PM, 919 N. Michigan Ave., Chicago 11, Ill.

Order Today \$1.00 POST PAID

STOPS GAS WASTE

ReMahr Automatic GASOLINE INJECTOR

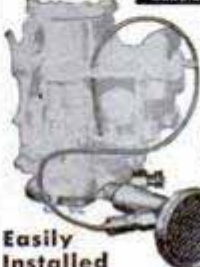

More power, quicker starting, faster acceleration and greater mileage! It atomizes fuel for the fullest power. Dynamometer tests show power increases up to 15%.

\$9.95

SOLD ON MONEY BACK GUARANTEE
Send Postcard for Information

Easily Installed

WESCO Box H, 1665 Mission, San Francisco 3, Cal.

COYNE HAS STARTED

Thousands of men
ON THE PATH TO Good Jobs..Security



You'll find men in every town and city working happily at important good pay jobs in Electricity, Television and Radio. Thousands of these men could tell you that they were trained for these jobs in our great training shops right here in Chicago, the Electronic center of the world.

Just like yourself, these men heard about Coyne practical, down-to-earth shop training method. And they were wise enough to recognize their opportunity when it knocked. This is YOUR opportunity. I urge you not to let it slip by.

B. W. Cooke,
President

TELEVISION-RADIO



TELEVISION-RADIO FIELD WIDE OPEN

Television is growing so rapidly that actual shop training on the latest new equipment is the **only** way to be sure of up-to-date knowledge in the Television-Radio Field. There is no room for the half trained man. Today you have to **know** how.

It's easy to learn at Coyne because you are actually **doing** the job. You work right here in our great shops with a fine group of young men. The instructors are experts in their line with the skill and patience to be **real** teachers. At Coyne you learn thoroughly and you learn rapidly.

ELECTRICITY

NOT "HOME STUDY"

This is no "Home Study" course. You work right in our own big shops—with the latest, most modern equipment. Then in informal class rooms you'll learn the necessary **theory** of the equipment you are actually working with.

ELECTRICAL JOBS PAY WELL

Good pay and plenty of opportunity—that's the way this business is. See the endless possibilities for men with practical training, in power plant work, motors, generators, armature winding, home and factory wiring, appliances, refrigeration, maintenance, etc. That's for you.

GI APPROVED MAIL COUPON FOR BIG FREE BOOK

And non-veterans who are short of cash can finance their tuition and pay in easy monthly payments.

Whether you prefer Electricity or Television-Radio this is **your** school. Find out all about it. We will send you a big, fully illustrated book that will answer all your questions about either or both courses. They cost you nothing and nobody is going to call to high pressure you. We only want students whose interest is sincere. Mail this coupon NOW.

B. W. Cooke, Pres.



B. W. Cooke, President
COYNE ELECTRICAL AND TELEVISION-RADIO SCHOOL
500 S. Paulina St., Dept. 80-72H
Chicago, 12, Ill.

Send me the book checked below and details of your training offer. This does not obligate me and no salesman will call.

- TELEVISION-RADIO
 ELECTRICITY

NAME.....
ADDRESS.....
CITY.....STATE.....

COYNE

ELECTRICAL & TELEVISION-RADIO SCHOOL

500 S. Paulina St., Dept. 80-72H, Chicago 12, Ill.



Thoughts . . . THAT MOVE MOUNTAINS

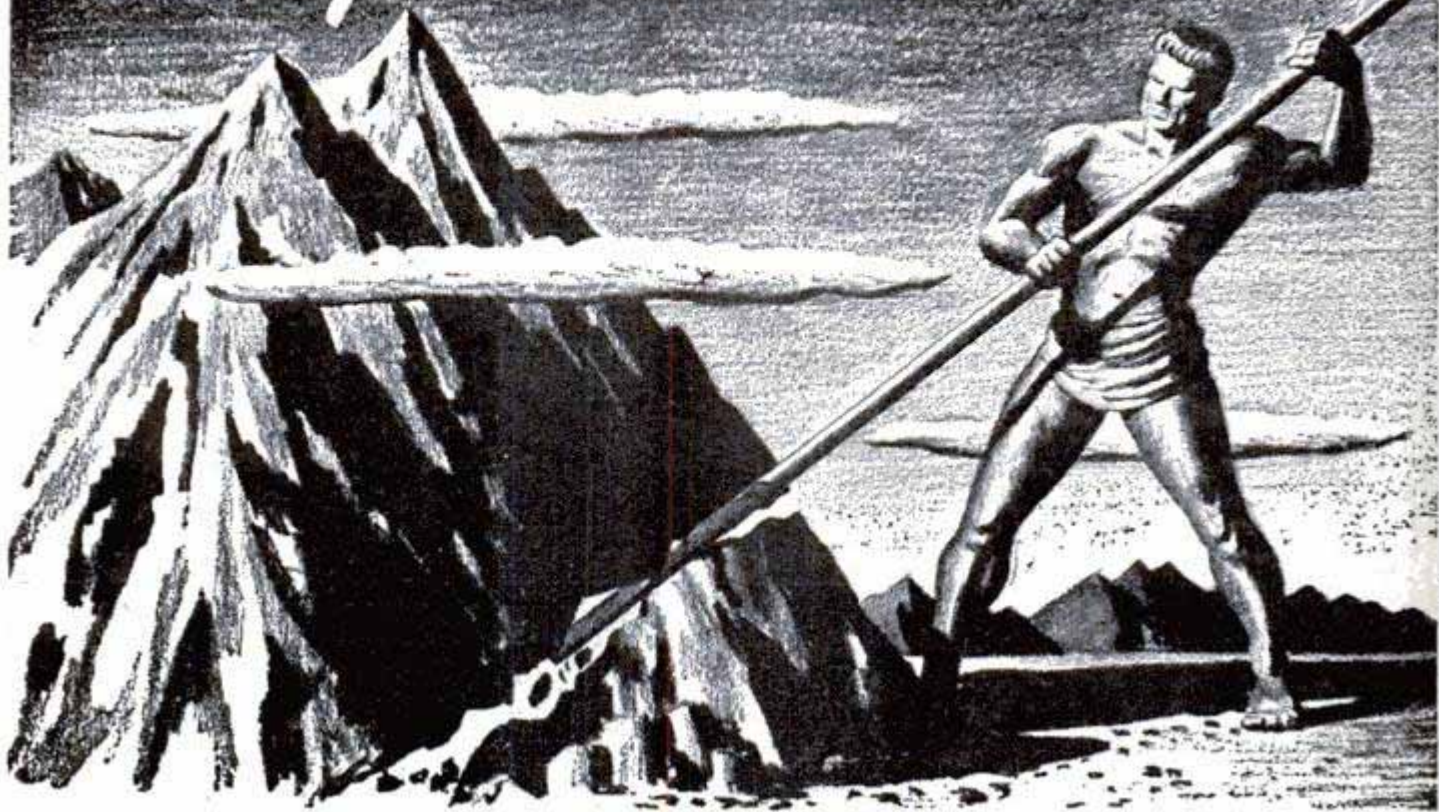

. . . IS MIND POWER REAL?

HAVE YOU READ volumes on the power of thought? Perhaps you have listened to lengthy theoretical addresses on the forces of mind. You may have wondered if these same writers and lecturers on mind power know how to use it. How many mountains of personal obstacles—everyday trials and tribulations—have *they* moved? What are these subtle principles whereby man can skillfully remove the barriers that impede his progress? How can *you* displace the obstructions and hindrances to *your* goal... the mountains in *your* life? Can practical information about inner power be reduced to mere words... words for public dissemination? Or, is there a secret method especially and uniquely preserved for the worthy seeker... practicable only under ideal circumstances? If so, who has the secret method? Where can it be found?

The
ROSICRUCIANS (AMORC), San Jose, California

Investigate the Rosicrucians (NOT a religion), the oldest *practical* philosophical fraternity on earth. See if they cannot show you a method for attainment such as you may not have dreamed possible. Thousands of men and women today are enjoying mental mastery... realization of ideals... the attainment of their objectives. They *know* the secret methods for converting mountains of personal problems into green valleys of achievement.

ACCEPT THIS OFFER

A FREE book, *The Mastery of Life*, is yours for the asking. It explains how easily you may enter upon the path of attainment. Fill in and send coupon *today!*

SCRIBE W. F. Y.
THE ROSICRUCIANS (AMORC)
San Jose, California

Please send me the book, *The Mastery of Life*, which explains how I may learn to use my faculties and powers of mind.

Name _____

Address _____

City _____

Zone Number _____ State _____

GET INTO

DIESEL-AUTO MECHANICS

Master All Phases

JOBS LIKE THESE ARE AVAILABLE TO TRAINED MECHANICS. CHOOSE THE FIELD YOU LIKE BEST

Get Complete Training

Diesel Fuel Injection
Automotive Motor Tune-up
Diesel Engine Rebuilding
General Garage Mechanic
Agricultural Implements
Auto Engine Rebuilding
Auto Elec. Service
Public Utilities
Parts Dealers
Bus & Truck Lines
Industrial Maintenance
Contracting & Excavating
Business of Your Own
AND MANY other similar openings

As a National Schools graduate, you are trained for ALL opportunities in the Diesel & Auto Industries

EARN WHILE YOU LEARN

With our practical Master Shop-Method Home Training, you study at home in your spare time. You receive Spare Time Work Lessons, which show you how to earn while you Learn . . . for extra money and experience. You Learn by DOING.

TOOLS AND EQUIPMENT

To make your training complete, we give you selected mechanic's tools and equipment, illustrated below, including all-metal toolbox — as a regular part of your instruction.

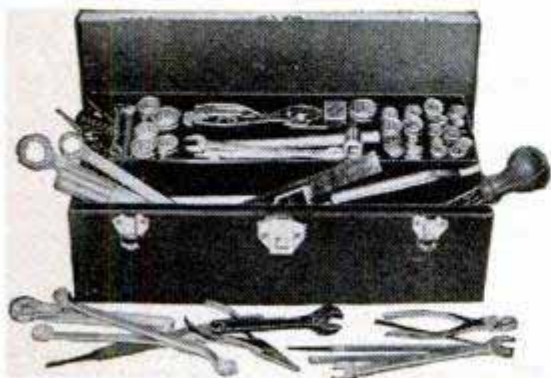

WE GIVE YOU TOOLS OF YOUR TRADE



Shop-Method Home Training by an Established Resident School Prepares you for Many Good Jobs

Opportunity is everywhere for the trained Diesel-Auto Mechanic. Highways throng with cars, busses, trucks, tractors. Garages and Service Stations are kept busy. Factories, ships, farms, railroads, general industry, are dependent upon engine power. Here's a dynamic, fast-growing field that needs trained men who know ALL phases: installation, operation, maintenance and repair. Now—National Schools offers you a practical, all-embracing Diesel-Auto Mechanic's Course, including all of these advantages:

Complete training, covering—Diesels, High Speed and Heavy Duty; Semi-Diesels, Gasoline and Special Fuel Engines AND Allied Mechanics.

- Basic Lesson Texts
- Diesel Installation
- Operation-Maintenance
- Diesel Chart Manual
- Spare Time Lessons
- Engine Service Manuals
- Engine Repair
- Drive Systems
- Diesel Electric Power
- Thermodynamics

TOOLS AND EQUIPMENT

INVESTIGATE

Secure Full Information

NEW, ILLUSTRATED BOOK & SAMPLE LESSON SHOW HOW WE TRAIN YOU . . . SEND FOR THEM TODAY!



NO COST

NO OBLIGATION

APPROVED FOR VETERANS

Check coupon below

NATIONAL SCHOOLS

LOS ANGELES 37, CALIF. • EST. 1905



FIND OUT NOW... MAIL COUPON TODAY

NATIONAL SCHOOLS, DEPT. PMD-11
4000 South Figueroa Street
Los Angeles 37, California

(Mail in envelope or paste on penny postcard)

Mail me FREE the book, YOUR FUTURE IN DIESEL-AUTO MECHANICS, together with the Sample Lesson. I understand I may keep and use the information with no obligation.

Name _____ Age _____

Address _____

City _____ Zone _____ State _____

Check here if Veteran of World War II



YOU
can
acquire

LAW NIGHTS AT HOME!
L. L. B. DEGREE

LaSalle's famous Law Library—used as reference in many Law libraries and Law offices—has enabled thousands to master Law surprisingly fast, in spare hours at home, for business and professional advancement.

These 14 remarkable volumes, compiled by leading professors and lawyers, cover the whole basic field of Law in condensed, orderly, simplified manner.

You advance rapidly with this great library, plus special lectures furnished. We guide you step-by-step with personalized Problem Method of instruction . . . you *learn by doing*—handling legal problems—not by memorizing rules.

Send for two FREE 48-page booklets, "Law Training for Leadership," and "Evidence," answering questions about Law and its value to you, and telling how LaSalle Law graduates are winning rapid advancement in business and public life. Mail coupon below. No obligation.

LA SALLE EXTENSION UNIVERSITY
A Correspondence Institution

417 S. Dearborn St. Dept. 1164L Chicago 5, Ill.
Send me your two FREE booklets described above, without obligation.

Name.....Age.....
Street.....
City, Zone & State.....

ENGINEERING DEGREE IN 27 MONTHS

Big Demand for Graduates

Aeronautical, Chemical, Civil, Electrical, Mechanical and Radio Engineering (including Television)

Hundreds of young men are earning engineering degrees in this recognized institution each year—continuous operation. New terms start quarterly. Many students earn a major part of their college expenses in this large industrial center.

Low tuition. Competent instruction. Thorough, intense, practical program. Modern laboratory facilities including new physics lab. and modernized wind tunnel. Individualized instruction emphasized.

Approved for Veterans. Engineering preparatory courses. Students from 48 states and 21 foreign countries. Enter December, March, June or September. Send coupon for free catalog and full information. Enroll now.

SEND COUPON TODAY

INDIANA TECHNICAL COLLEGE

5110 E. Washington Boulevard
Fort Wayne 2, Indiana

Please send me free information on B.S. Engineering Degree in 27 months as checked.

- Aeronautical, Chemical, Civil, Electrical,
- Mechanical, Radio-Television.

Name.....
Address.....

CAUGHT BY THEIR FINGER PRINTS



YOU

Can Train for
CRIMINAL INVESTIGATION
and **IDENTIFICATION**
WORK AT HOME!

During the past 32 years the I. A. S. has trained hundreds of men at home to fill positions of responsibility and steady pay as finger print experts. This fascinating, profitable profession can be learned at home during spare time. More than 800 American Identification Bureaus employ I. A. S. graduates or students. Write today for complete list of these Bureaus.

Send Now for "BLUE BOOK of CRIME"
Thrilling, inspiring, helpful. Be sure to state your age when sending for book. **FREE!**

INSTITUTE OF APPLIED SCIENCE
Dept. 1358, 1920 Sunnyside Ave., Chicago 40, Ill.

AVIATION CAREERS



Prepare for success in aviation — World's fastest growing industry. Train at Spartan—Internationally-famous school. Complete, thorough courses in all phases of aviation. Gov't approved. Write Department PM-110

SPARTAN SCHOOL OF AERONAUTICS
MUNICIPAL AIRPORT • TULSA, OKLAHOMA

RADIO ENGINEERING, Broadcasting, Television, FM, Servicing, Electronics, Aviation, Marine & Police Radio taught thoroughly. Engineering course equivalent to 3 years' college radio work. Approved Veteran Training. Catalog free.
VALPARAISO TECHNICAL INSTITUTE, Dept. D, Valparaiso, Ind.

EASY TO LEARN CODE

Learn or increase speed with an Instructograph—the Radio-Telegraph Code Teacher that takes the place of an operator-instructor and enables anyone to master code without further assistance. Available tapes from beginners alphabet to typical messages on all subjects. Speed range 5 to 40 WPM. Always ready—no QRM. Thousands have "acquired the code" with the Instructograph System. Write today for convenient rental and purchase plans.



INSTRUCTOGRAPH COMPANY
4701-V Sheridan Road, Chicago 40, Illinois

Aptitude Tests for men, women, boys, girls, discover the kind of work or studies best for your success! You get a personal report—a guide for life—more happiness—more prosperity. . . . Write for complete facts.
VOCATIONAL COUNSELORS, 5057 Woodward Avenue, Detroit

BRUSHES ONLY 4¢ EA.

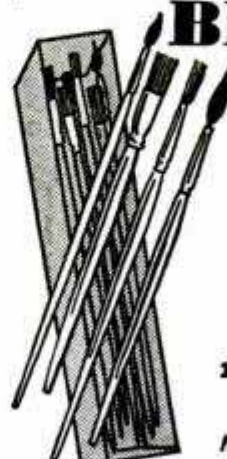

- Suitable for**
- PAINT, ENAMEL
 - LACQUER
 - GLUE, PASTE
 - OIL & CHEMICALS

Ideal for
WORKSHOP use, HOUSEHOLD, FACTORY and HOBBYISTS

- 100 Assorted Brushes \$4.00
 - 50 Assorted Brushes 3.00
 - 25 Assorted Brushes 2.00
- Minimum Order \$2.00 Postpaid. No C.O.D.

O. ELGENE MFG. CO. Box 147, FT. HAMILTON STA. BROOKLYN 9, N. Y.

**NOW... GET EVERYTHING YOU
NEED TO LEARN AND MASTER**

TELEVISION

**RADIO-ELECTRONICS
...AT HOME!**

Use REAL commercial-type equip-
ment to get practical experience

Your future deserves and needs every advantage you can give it! That's why you owe it to yourself to find out about one of the most COMPLETE, practical and effective ways now available to prepare AT HOME for America's billion dollar opportunity field of TELEVISION-RADIO-ELECTRONICS. See how you may get and keep the same type of basic training equipment used in one of the nation's finest training laboratories... how you may get real STARTING HELP toward a good job or your own business in Television-Radio-Electronics. Mail the coupon today for complete facts — including 89 ways to earn money in this thrilling, newer field.

ABOVE: Build and keep a real 16 INCH commercial TV receiver. Optional after completing regular training at slight additional cost.

D.T.I., ALONE, INCLUDES BOTH MOVIES and HOME LABORATORY — in addition to easy-to-read lessons, you get the use of HOME MOVIES — an outstanding training advantage — plus 16 big shipments of Electronic parts. Perform over 300 fascinating experiments for practical experience. Build and keep real commercial-type test equipment shown at left.

MODERN LABORATORIES

If you prefer, get all your preparation in our new Chicago Training Laboratories — one of the finest of its kind. Ample instructors, modern equipment. Write for details!

MILITARY SERVICE!

If you're subject to military service, the information we have for you should prove doubly interesting. Mail coupon today.

Get BOTH of these information packed publications FREE!



ACT NOW! MAIL COUPON TODAY!

DeFOREST'S TRAINING, INC., Dept. PM-G-11
2533 N. Ashland Ave., Chicago 14, Ill.

Without obligation, I would like your late News-Bulletin showing 89 ways to earn money in Television-Radio-Electronics... and how I may prepare to get started in this thrilling field.

Name Age
Street Apt.
City Zone State

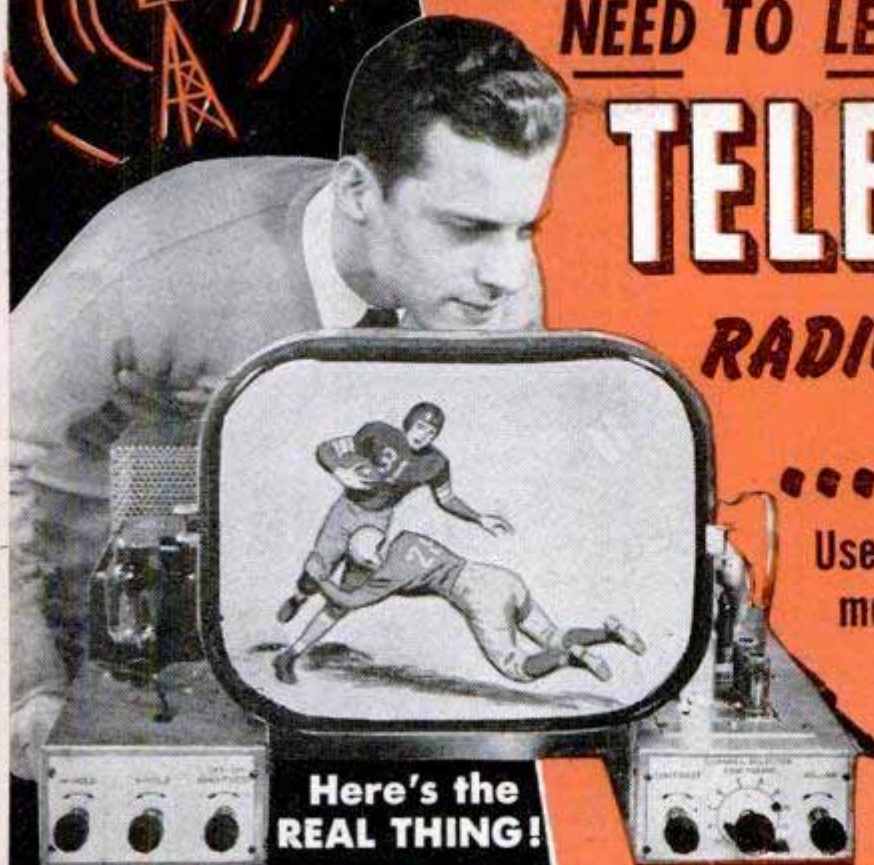

Here's the REAL THING!

SET UP YOUR OWN HOME LABORATORY



Oscilloscope

R-F Signal Generator

6-Tube Radio

Multimeter

HOME MOVIES

De FOREST'S TRAINING, INC.
CHICAGO 14, ILLINOIS
A De VRY INSTITUTION

FREE

ALLIED'S NEW 1951 RADIO and TV CATALOG



SEND FOR THIS
212-PAGE BOOK



SAVE ON EVERYTHING
IN RADIO AND TV



Get Radio's Leading Buying Guide!

Save money on every purchase you make from the world's largest radio supply house! Send for ALLIED'S new 212-page 1951 Catalog packed with *everything* in Radio and Television. Widest selections of home radios, TV equipment, phonoradios, Amateur equipment, P.A. systems, Hi-Fidelity music systems, recorders, test equipment, builders' kits—plus thousands of parts, tubes, tools, books and diagrams. Get more for your money—send today for your FREE 1951 ALLIED Catalog, the preferred Buying Guide to *everything* in Radio, TV and Electronics.

BUILDERS' KITS • TELEVISION
HI-FIDELITY CUSTOM SOUND
AMATEUR GEAR • THOUSANDS
OF PARTS, TUBES, TOOLS,
TESTERS, BOOKS, DIAGRAMS

Everything for:
Servicemen
Engineers
Experimenters
Builders
Amateurs

ALLIED RADIO

FREE
CATALOG

ALLIED RADIO CORP., Dept. 5-L-0
833 W. Jackson Blvd., Chicago 7, Ill.

Rush FREE 212-Page ALLIED Catalog
Name.....

Address.....

City.....Zone.....State.....

SAY YOU SAW IT IN POPULAR MECHANICS

NEW! FLAME-PROOF CHRISTMAS TREES

NOTHING LIKE IT That GLOW IN THE DARK



Different! Needles never shed—no dirt—lasts lifetime. Safe—flameproof! Amazingly beautiful in light or darkness. Folds for storage. Imported from Europe—limited supply. Order now.

2 Ft. \$2
3 Ft. \$3
4 Ft. \$4

SEND NO MONEY
Just pay postman on delivery, plus postal charges. Be sure to state size tree desired. Or send cash with order and we prepay all postage. Satisfaction or money back. Dealers wanted.

TOY SHOP, Dept. 33-M, 2241 Gravois, St. Louis 4, Missouri



Bar Bells

Buy Direct From Factory **\$8.95**
Write for free booklet and price list up

INDEPENDENT IRON WORKS

2416 East 23rd Street, Dept. B
Los Angeles 58, Calif.

HOW to Make Your Own RUBBER MOLDS

Here's a quicker, easier way to make exact reproductions of an object in any quantity. No heat curing required; no shrinking of materials. Objects of clay, plaster, wood, metal, glass or stone-like ashtrays, book ends, medals, souvenirs, plaques, sculpture can be copied exactly right at home! Perfect for reproducing Dresden figurines. No previous experience needed. No special tools required. Our new Brochure 3211 gives exact, step-by-step instructions anyone can follow. Send 10c for it to SCULPTURE HOUSE, 304 West 42 Street, New York 18, N. Y.



THERE'S MONEY IN CARTOONS!

RAYE BURNS will teach you HOW to CREATE ORIGINAL CARTOONS at home that you may SELL! Course contains 26 lessons and over 600 illustrations. All for Only... **\$2.85**

Send name and address for free details.
RAYE BURNS SCHOOL, Dept. P, Box 3583, CLEVELAND, OHIO

REAL ESTATE BE A BROKER

PAYS BIG! SEND FOR FREE, BIG, ILLUSTRATED CATALOG NOW! No obligation. Graduates report making substantial incomes. Start and run your own business quickly. Men, women of all ages, learn easily. Course covers Sales, Property Management, Appraising, Loans, Mortgages, and related subjects. **STUDY AT HOME** or in our classrooms in big cities. Diploma awarded. G.I. approved. Nationally known.

WEAVER SCHOOL OF REAL ESTATE (Est. 1936)
15 E. Pershing Road Dept. PM Kansas City, Mo.

FREE BOOK TELLS HOW

MAKE EXTRA MONEY PLASTICS LEARN AT HOME

LEARN HOW TO MAKE fast selling PLASTIC NOVELTIES FURNITURE JEWELRY SIGNS TOYS LAMPS

There are RICH OPPORTUNITIES for MEN and WOMEN with "know-how" in Plastics. Interstate's amazing new Plastics course tells and shows how to make hundreds of fast selling items out of Plastics. Gives complete training in fabrication, casting, lamination, molding, etc., in simple, easy, step-by-step language and pictures.

START A PLASTICS BUSINESS OF YOUR OWN. No other industry holds such promise for the future. You can make big money manufacturing novelties, toys, signs, etc., in your own home in spare or full time. Don't wait! Learn NOW how Interstate's Plastics Training qualifies you for success in the plastics field.

Write for FREE Information Today!

INTERSTATE TRAINING SERVICE

School of Plastics
PORTLAND 13, OREGON

(Dept. 3-M)

NOW YOU CAN "Breeze Through" ANY AUTO REPAIR JOB!



Yes—EVERY Auto Repair Job is a "Snap"—with This Big, BRAND-NEW, Time-Saving, Money-Saving Manual. Shows You How to Service and Repair ANY Part of ANY Standard Car, Including 1950 Models!

DON'T waste time and patience trying to "dope out" difficult car repairs! Just look up make, model, and job in MoToR's AUTO REPAIR MANUAL—and you can "whiz" through ANY job in almost no time. Clear, illustrated instructions lead you step by step all the way.

WORTH BIG MONEY TO:
Mechanics, Handymen, Garagemen, Farmers, Repair Men, Service Station Operators, Taxi Owners.

See How Much You Get!

This BIG, brand-new 750-page book combines information from over 150 official Factory Shop Manuals. OVER 200,000 service, repair, tune-up facts—35,000 essential dimensions—on all makes and models, 1935 thru 1950! More than 2100 cut-away photos, diagrams show you exactly WHAT to do and HOW to do it. Used by the U. S. Army, tech schools; thousands of auto servicemen.

Win Prestige! Earn More Money!

MoToR's Manual makes every operation so easy that you'll find yourself tackling jobs you wouldn't think of doing before. And you'll win added prestige and more money in the bargain.

Beginners will find usable helpful guidance on every kind of repair and service job imaginable. Experts will be amazed by the time and labor-saving short cuts. Includes automatic transmissions; new GM Rochester carburetor.

SEND NO MONEY

Without risk, see for yourself how easily, clearly this book covers every job on every car! Just mail coupon — without money—for FREE 7-Day Trial. Unless you're convinced it's worth many times its cost, return book in 7 days and pay nothing! MoToR Book Dept., Desk 1N, 250 W. 55th Street, New York 19, N. Y.

Published by MoToR, The Leading Automotive Business Magazine.



Used by U. S. Army and Navy

COVERS ANY CAR BUILT SINCE 1935!

- | | |
|--------------|---------|
| American | Cord |
| Bantam | Crosley |
| Auburn | De Soto |
| Austin | Dodge |
| Buick | Ford |
| Cadillac | Frazer |
| Chevrolet | Graham |
| Chrysler | Hudson |
| Hupmobile | |
| Kaiser | |
| Lafayette | |
| La Salle | |
| Lincoln | |
| Lincoln | |
| Lincoln | |
| Zephyr | |
| Mercury | |
| Nash | |
| Oldsmobile | |
| Packard | |
| Pierce Arrow | |
| Plymouth | |
| Pontiac | |
| Reo | |
| Studebaker | |
| Terraplane | |
| Willis | |



Just 2 of the Many Letters of Praise

"MoToR's Manual paid for itself on the first 2 jobs, and saved me valuable time by eliminating guesswork."—W. SCHROP, Ohio



"Instructions so clear have no trouble learning anything about any car. Now working as mechanic in big plant."—S. M. ORDÓÑEZ, Cal.

MAIL COUPON NOW FOR 7-DAY FREE TRIAL

MoToR BOOK DEPT.
Desk 1N, 250 W. 55th St., New York 19, N. Y.

Rush to me at once (check box opposite book you want):

MoToR's New AUTO REPAIR MANUAL. If O.K., I will remit \$1 in 7 days (plus 35c delivery charges), \$2 monthly for 2 months and a final payment of 95c one month after that. Otherwise I will return the book postpaid in 7 days. (Foreign price, remit \$8 cash with order.)

MoToR's New TRUCK AND TRACTOR REPAIR MANUAL. (Described at left.) If O.K., I will remit \$2 in 7 days, and \$2 monthly for 3 months, plus 35c delivery charges with final payment. Otherwise I will return book postpaid in 7 days. (Foreign price, remit \$10 cash with order.)

Print Name..... Age.....

Print Address.....

City..... State.....

Check box and save 35c delivery charge by enclosing WITH coupon entire payment of \$5.95 for Auto Repair Manual (or \$8 for Truck and Tractor Repair Manual). Same 7-day return-refund privilege applies.

Same FREE Offer on MoToR'S TRUCK & TRACTOR REPAIR MANUAL



Brand-New! Covers EVERY job on EVERY popular make gasoline truck and farm tractor made from 1936 thru 1949! Over 1400 pictures, 961 pages, 300,000 facts. All types Gasoline Engines, Fuel Systems, Governors, Lubrication, Ignition, Starters, Clutches, Axles, Brakes, etc., etc., and much more!

For FREE 7-DAY TRIAL, check box in coupon.

Would YOU Like to Make \$1,000 A MONTH?

That's what Stanley Hyman is making selling the amazing new **PRESTO Fire Extinguisher!**

OVER 11,000 people died in fires last year. An eager public has been waiting for a practical new kind of fire extinguisher. Now it's here! Tiny "Presto" is about the size of a flashlight. Does the job of bulky extinguishers that cost 4 times as much and are 8 times as heavy. Ends fires fast as 2 seconds. Fits in palm of hand. Never corrodes. **Guaranteed for 20 years!** Sells for only \$3.98!

You can make good money showing this new discovery to owners of homes, cars, boats, farms, etc., and to stores for re-sale. Stanley Hyman reports making over \$1000 a month. H. J. Kerr, \$20 a day. William Wydallis, \$15.20 an hour.

What's the secret of "Presto's" amazing power? It's a new wonder chemical developed during the war, found to be 1.5 to 6 times as effective as chemical contents of other extinguishers on an equal-weight basis. Makes possible, for the first time, an extinguisher that is small, light, and amazingly effective.

Help supply the demand for this important new discovery. Write for FREE Sales Kit. No obligation; no capital required. But don't put it off. Every day you hesitate may cost you \$10, \$15, or even \$50 you could be making.

Send postcard or letter to: **MERLITE INDUSTRIES, Inc., Dept. 511, 201 East 16th Street, New York 3, N. Y.** IN CANADA: Mopa, Inc., 371 Dowd St., Montreal 1, P.Q. (If you want a regular Presto to use as a demonstrator too, send \$2.50. Money back if you wish. Returnable for FREE refills.)

Science's New Midget Miracle "PRESTO"



Stanley Hyman

CHRONOGRAPH WRIST WATCH \$7.90 Plus Tax



Lifetime Guarantee

(EXCLUSIVE OF PARTS)

3 DIALS—5 HANDS—2 BUTTONS

Multi-purpose watch that measures distance, speed, time, moving objects. Used as Stop Watch or Timepiece. Has Sweep-Second Hand for full 60 Second count. Second Dial records up to 45 minutes. Third Dial then records up to 6 hours. Seconds—Minutes—Hours, all recorded automatically.

INDEPENDENT MOVEMENTS

The movement of this fine Swiss Made watch continues to run when sweep hands are stopped. For sports-men, professional men and women—time-keeper works when other hands and dials are stopped—separate movements permit dual use at same time.

RUGGED CONSTRUCTION

Precision workmanship and shock resistant features are added to enhance the value of this watch. Sold elsewhere for as high as \$17.00. Our low introductory price is only \$7.90 plus 10% tax. (Total \$8.69). Send check or money order and we prepay postage. Or sent C.O.D. plus charges. LIMITED STOCK!

MARDO SALES CO., 480 Lexington Ave., Dept. C-228, N.Y. 17, N.Y.

MONEY for MEN ALL DATA FREE

THE PLASTEX Industry needs manufacturers on small scale and for big production of Lamp and Clock Stands, Art Goods and Novelties in Plastex and Marble imitation. Experience unnecessary. The material makes regular 10¢ store sellers. Rubber moulds furnished for speed production. Small investment brings good returns. We are now placing big Chain Store Orders with manufacturers. Ambitious men have chance for real prosperity. Our Free booklet will interest and benefit you.

PLASTEX INDUSTRIES, Dept. A
3400 Third Ave. New York 56, N. Y.

AGENTS 300% Profit SIGN LETTERS

For Store Fronts and Office Windows. Anyone can put them on. Free samples. Liberal Offer to General Agents.

METALLIC LETTER CO., 430 N. Clark, Chicago 10

"How to Make Money with Simple Cartoons"

A book everyone who likes to draw should have. It is free; no obligation. Simply address **FREE BOOK**

CARTOONISTS' EXCHANGE
Dept. 911D Pleasant Hill, Ohio

FREE AMAZING NEW BOOK "HOW TO ANSWER ADS"



Never before have you seen anything like this. Tells you in simple language the correct way to answer ads. Gets you quicker replies—better results, and greater satisfaction. Will save you time and money and it's ABSOLUTELY FREE. No obligation whatever. Every reader of advertising should have this booklet. Send a postcard for your copy NOW. Advertising Department, Popular Mechanics Magazine, Room 600, 204 East Ontario Street, Chicago 11, Ill.

Model Railroading is more fun than you imagine, and less expensive than you think!



• 250,000 people can't be wrong. They are having real fun with the world's fastest growing hobby. Get this picture-packed book that tells how simple it is to start . . . and how surprisingly little money is needed.

Fully illustrated, this book tells how constructive this hobby is. Enjoyed by anyone from 7 to 70. Send 10¢ today

for your copy of "Model Railroading for You," written by a well-known authority.

MODEL RAILROADER MAGAZINE
Dept. 1547 — Milwaukee 3, Wis.

9 BIG BUILDING BOOKS

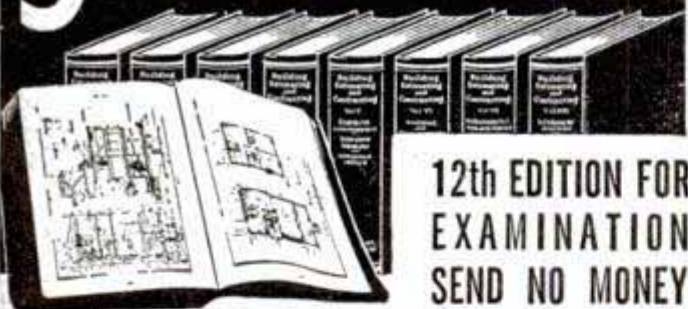

12th EDITION FOR EXAMINATION SEND NO MONEY

Learn to draw plans, estimate, be a live-wire builder, do remodeling, contracting. These 9 practical, profusely illustrated books cover subjects that will help you to get more work and make more money. Masonry, concrete forms, carpentry, steel square, roof framing, construction, plumbing, heating, painting, decorating and many other subjects. More than 4000 pages — 2750 illustrations.

BETTER JOBS — BETTER PAY UP-TO-DATE EDITION

A nationwide building boom is in full swing and trained men are needed. Big opportunities are always for MEN WHO KNOW HOW. These books supply quick, easily understood training and handy, permanent reference information that helps solve building problems.

Coupon Brings Nine Big Books for Examination

AMERICAN TECHNICAL SOCIETY—Publishers since 1898 Chicago 37, Ill.
Dept. G819 Drexel at 58th Street

You may ship me the Up-to-Date edition of your nine big books, "Building, Estimating and Contracting," without any obligation to buy. I will pay the delivery charges only, and if fully satisfied in ten days, I will send you \$3.00, and after that only \$4.00 a month, until the total price of only \$34.80 is paid. I am not obligated in any way unless I keep the books.

Name _____

Address _____

City _____ State _____

Please attach a letter stating your age, occupation, employer's name and address, and name and address of at least one business man as a reference. Men in service, also please give home address.

GET INTO

RADIO-TELEVISION

ELECTRONICS By

Shop-Method Home Training

GOOD JOBS AWAIT THE TRAINED RADIO-TV TECHNICIAN

There is a place for you in the great Radio-Television-Electronics industry when you are trained as National Schools will train you at home!

Trained technicians are in growing demand at good pay—in manufacturing, broadcasting, television, communications, radar, research laboratories, home Radio-TV service, and other branches of the field. National Schools Master Shop-Method Home Training, with newly added lessons and equipment, trains you in your spare time, right in your own home, for these fascinating opportunities. **OUR METHOD IS PROVED BY THE SUCCESS OF NATIONAL SCHOOLS TRAINED MEN, ALL OVER THE WORLD, SINCE 1905.**

EARN WHILE YOU LEARN

Many National students pay for all or part of their training with spare time earnings. We'll show you how you can do the same! Early in your training, you receive "Spare-time Work" Lessons which will enable you to earn extra money servicing neighbors' and friends' Radio and Television receivers, appliances, etc.



Signal Generator

T. R. F. Receiver

Audio Oscillator

National Schools Training Is All-Embracing

National Schools prepares you for your choice of many job opportunities. Thousands of home, portable, and auto radios are being sold daily—more than ever before. Television is sweeping the country, too. Co-axial cables now under construction will soon bring Television to every city, town, and farm! National Schools' complete training program qualifies you in all fields. Read this partial list of opportunities for trained technicians:

- Business of Your Own • Broadcasting
- Radio Manufacturing, Sales, Service • Telecasting
- Television Manufacturing, Sales, Service
- Laboratories: Installation, Maintenance of Electronic Equipment
- Electrolysis, Call Systems
- Garages: Auto Radio Sales, Service
- Sound Systems and Telephone Companies, Engineering Firms
- Theatre Sound Systems, Police Radio
- And scores of other good jobs in many related fields.

TELEVISION TRAINING

A complete series of up-to-the-minute Television lessons is an important part of your course. They cover all phases of Television repairing, servicing and construction. The same lesson texts used by resident students in our own modern and complete Television broadcast studios, laboratories and classrooms!

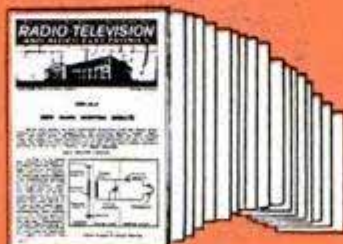

MASTER ALL PHASES!

Get Master Shop-Method Home Training from an Established Practical Resident School with its own



Training Shops, Laboratories, and Studios—and almost 50 Years of Successful Experience in Training Ambitious Men.

We Bring National Schools To You

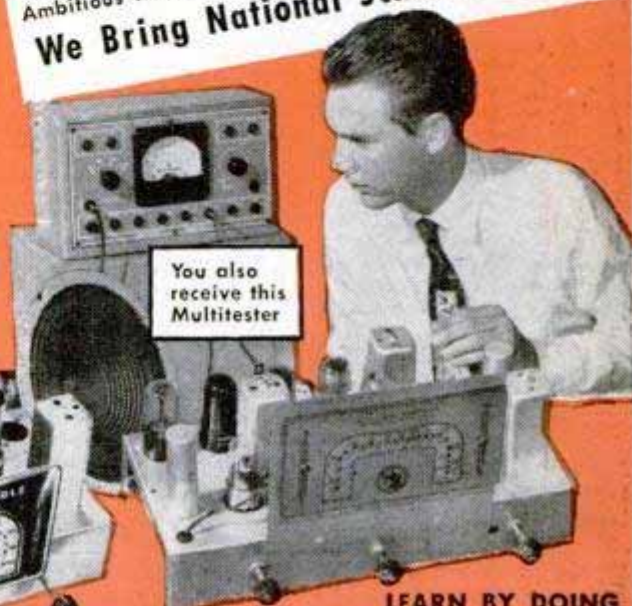

You also receive this Multitester

LEARN BY DOING

You receive and keep all the modern equipment shown above, including tubes and valuable, professional quality Multitester. No extra charges. You build the fine Superheterodyne Receiver with parts we send you.

FREE! These 2 Free Books give you all the facts. Send today for National Schools' new, illustrated Book of Opportunity in Radio-Television-

Electronics, and an actual Sample Lesson. No cost—no obligation. Use the coupon now—we'll answer by return airmail.

APPROVED FOR VETERANS AND NON-VETERANS
Check coupon below

Both Resident & Home Study Courses offered



NATIONAL SCHOOLS

LOS ANGELES 37, CALIF. • EST. 1905

FIND OUT NOW... MAIL COUPON TODAY

National Schools, Dept. PM-11
4000 South Figueroa Street
Los Angeles 37, California

Mail in envelope or paste on penny postal.

Send me your FREE book "Your Future in Radio" and the sample lesson of your course. I understand no salesman will call on me.

NAME _____ AGE _____

ADDRESS _____

CITY _____ ZONE _____ STATE _____

Check here if Veteran of World War II

Have

YOUR OWN BUSINESS

This New Easy Way



Real pansy embedded in Castolite



Real Ocean Crab embedded in Castolite



Child photo embedded in Castolite



Baby Shoe Set made of Castolite

MAKE BIG PROFITS with New Wonder Plastic

With prices jumping—merchandise getting scarce again—now is the time for a smart fellow to start his own spare-time business. Instead of having "all your eggs in one basket," get going on a **SECOND SOURCE OF INCOME**. Begin at home by making swell things with Castolite, the new wonder liquid plastic. Embed real flowers, photos, butterflies, etc. to make costume jewelry, hi-style buttons, fancy coasters, trays, baby shoe sets, book ends, desk accessories—other things that **SELL ON SIGHT**.

Quits Job — Now Has Own Business
Pat Queen, Mt. Vernon, Wash., started making key chain tags (like one shown here). Queen writes: "My key chain tags have sold fast right from the beginning. I now make several times as much as when I had a job." Others also succeeding far better than they expected.

Do Big Christmas Business
New BOOK Shows HOW
Proved Success Methods bring business fast. Use only home tools. New 32-page book shows how to make things: how to sell at fine profit. Act NOW—to **CASH IN BIG** on Christmas orders. Send 25c today for a copy of "A Success Plan for You."

The Castolite Co., Dept. M-1, Woodstock, Ill.

Save time! Save money!
SEND FOR THIS BIG NEW

HUNT'S WOODWORKERS CATALOG NO. 17

NEW LOW PRICES

Greatest selection of fine domestic and imported woods—144 pages of real money-saving bargains

QUICK DELIVERY
on maple, poplar, oak, mahogany, red cedar, cherry, walnut, and many others—all properly seasoned and kiln dried.

EVERY wood craftsman should have this big new catalog. Shows 32 rare and fancy woods in color... 43 veneer designs... multicolored bandings, inlays, overlays... 275 scroll patterns... all kinds of tools, machinery, cabinet hardware, ornaments, mouldings... plus... pages of ideas, hints, instructions, and information for beginner and advanced craftsman. You'll save time and money with this catalog. Yours for only 15 cents—refundable on first order. Use the coupon—send for your copy NOW.



ONLY 15c

Write Dept. A-11
CRAFTSMAN WOOD SERVICE CO.
2272 South Mary Street
Chicago 8, Illinois

Please send me your big, new Catalog No. 17. Enclosed is 15c--to be refunded on my first order.

MAIL TODAY

NAME.....
ADDRESS.....
CITY.....ZONE.....STATE.....

Command Bigger Money! STUDY LAW

STUDY AT HOME for BUSINESS SUCCESS and LARGER PERSONAL EARNINGS. 40 years expert instruction — over 114,000 students enrolled. LL.B. Degree awarded. All text material furnished. Easy payment plan. Send now for FREE BOOK — "Law and Executive Guidance." It explains the course — how you may enroll and the many ways you can profit from Law Study. Write TODAY to:

AMERICAN EXTENSION SCHOOL OF LAW
Dept. 32-PM, 646 N. Michigan Ave., Chicago 11, Ill.

NEW! DURABLE! 7 JEWELS!
3 YEAR SERVICE GUARANTEE

- Shock Resist.
- Dust Proof
- Radium Dial
- Sweep Second Hand
- Chromed Case
- Leather Band

\$6.95 Post Paid Plus 70c tax

Refund if not satisfied. Special! Order Now! Sorry, no C.O.D.'s.
LADIES Watch, as above, smaller Size \$7.95 plus 80c tax.

ELCO PRODUCTS CO., Dept. 15 166 W. WASHINGTON CHICAGO 2, ILL.



Rupture Troubles Ended

Advanced method has healed thousands. No leg straps, no elastic, no plasters. No pressure on hips or spine. Flexo-pad. Entirely different. Endorsed by doctors, mechanics, clerks. Very light. **INEXPENSIVE. GUARANTEED.** Write for information and trial.

SMITH MANUFACTURING COMPANY
EST'D 1893 DEPT. PM PRESTON, ONTARIO

Learn PHOTOGRAPHY

There's big money in PHOTOGRAPHY—and an action-packed career for you. Our HOME STUDY COURSE is your spare-time SHORT CUT TO SUCCESS! Or, if you wish—PERSONAL ATTENDANCE TRAINING at our famous New York School is available with subsistence under the G. I. Bill. Our 40th year. Write immediately!

NEW YORK INSTITUTE OF PHOTOGRAPHY

Dept. "49," 10 West 33 Street, New York 1, N.Y.

500 TRICKS MAGIC TRICKS

It's FUN to do MAGIC.

Be popular! Amaze—mystify—entertain! For 30 years Douglas has satisfied customers all over the world. Now, you can enjoy this fascinating hobby. Only 10c brings our new 1950-51 Catalog 500 Tricks, containing brand new tricks for pocket, parlor, stage. Join in the fun—send 10c today!

Douglas Magicland, Dept. C, Dallas, Texas

SAY YOU SAW IT IN POPULAR MECHANICS

Be an INVESTIGATOR

JAMES S. BOLAN, FORMER NEW YORK CITY POLICE COMMISSIONER offers MEN & WOMEN an opportunity for a Professional Career in Modern Investigation & Criminology by comprehensive Home Study Course. Free placement service assists graduates to obtain jobs. APPROVED FOR VETERANS. Licensed by State of New York. Write for Booklet P

THE BOLAN ACADEMY, INC.

EMPIRE STATE BLDG., NEW YORK 1, N. Y.

POPULAR MECHANICS

RTS will gamble a reputation of 28 years

YOU STUDY
AT HOME

YOU LEARN TO
MAKE BIG MONEY

YOU BUILD FOR
THE FUTURE

YOU GET
30 DAYS TRIAL

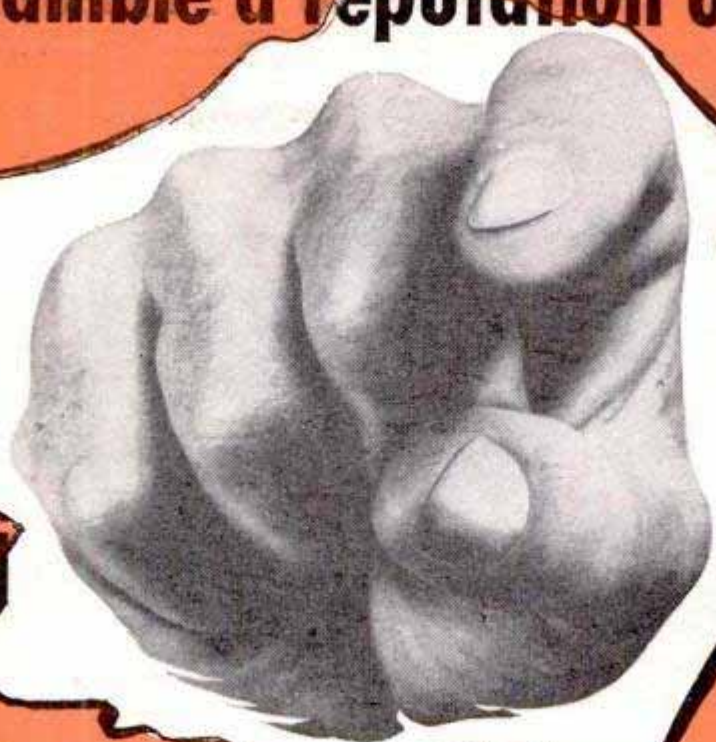

YOU too

CAN LEARN RADIO & TELEVISION

OUR 30 DAY TRIAL OFFER WILL PROVE IT

Send this coupon **NOW** and

YOU WILL GET

1. Big FREE Illustrated Book
2. Actual Free Lesson
3. Information About RTS Kits
4. Facts on Big Pay Opportunities

and Above All

OUR 30 DAY TRIAL OFFER

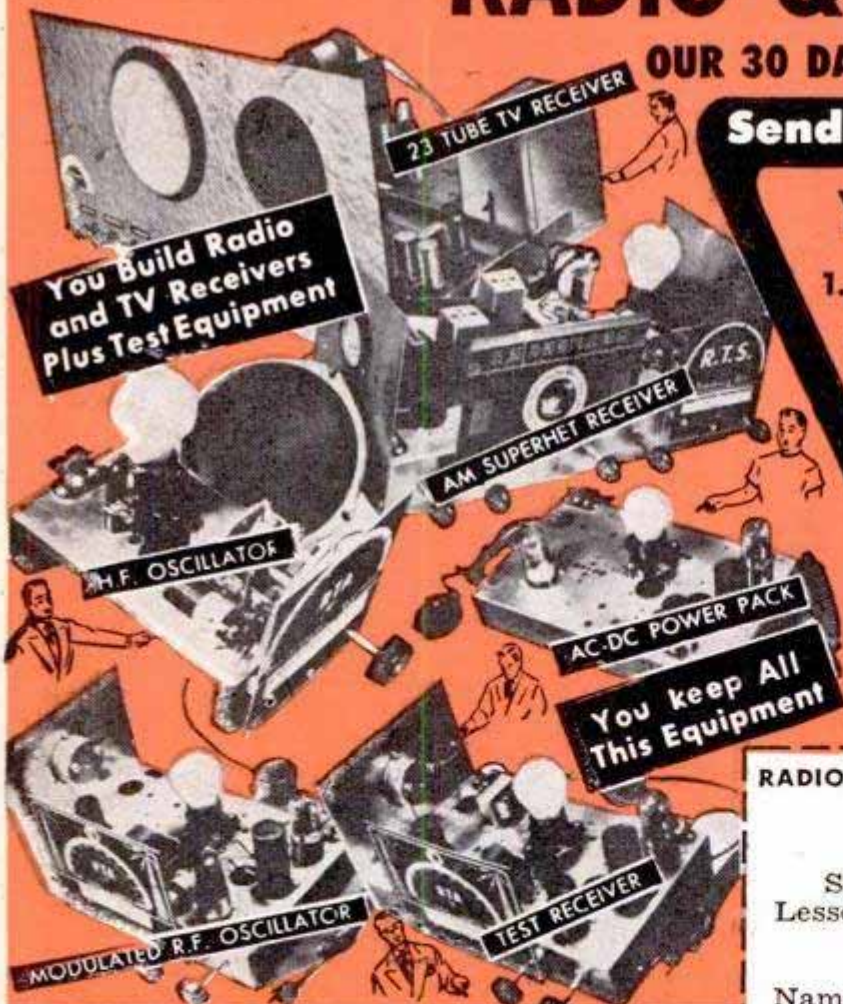

RADIO-TELEVISION TRAINING SCHOOL
 5100 SOUTH VERMONT AVENUE
 LOS ANGELES 37, CALIF., U.S.A.

RADIO-TELEVISION TRAINING SCHOOL, Dept. PM-11

5100 South Vermont Avenue
Los Angeles 37, Calif., U.S.A.

Send FREE Illustrated Book, Sample Lesson, and Details on 30 Day Trial Offer.

Name _____ Age _____

St. & No. _____

City _____ Zone _____ State _____

I'LL TRAIN YOU for **RADIO**

**MEET
A FEW OF MY
GRADUATES**



**Appreciates Sprayberry
Personal Interest**
"Before completing
your course I had
a good paying job.
I appreciate the personal
interest you
gave me."—Leonard
Petrus, Arkansas



**Best Investment
He Ever Made**
"Began fixing radio
sets after first
few lessons. Your
course is one of the
best investments
I've ever made."
—A. R. Foronda,
Hawaii



**I Send You
18 BIG
KITS
OF RADIO-
TELEVISION
EQUIPMENT**

EXTRA MONEY

**Earn While You Learn
In Your Spare Hours!**
You do all your training
with me **AT HOME** in
spare hours. Keep right on
with your present job and
income while learning—and
earn extra cash besides! The
day you enroll I begin sending
you plans and ideas for
doing profitable spare time
Radio-TV work. Many of
my Sprayberry students
pay for their entire Radio-
TV training this way!



YOU KEEP THIS VALUABLE EQUIPMENT

The many big kits of Radio-Television parts and equipment are sent to my students "for keeps." Nothing need be returned—it is **YOURS!** There is absolutely nothing else to buy!

AT HOME IN SPARE TIME TELEVISION



Training Leads To Good Radio Job
 "Got a job in local radio shop soon after enrolling. Very satisfied with training"—Stanley Clemmons, Kansas



Lucky To Be Sprayberry Trained
 "I consider myself lucky I chose your training in preference to others I considered. Here's thanking you again."—Paul White, Ohio



Radio Profits Pay Cost of Training
 "I have more than taken in the cost of your training doing spare time radio repair work. See bright future ahead"—Thomas Shearer, N. Y.



Earns Easy Spare Time Cash
 "While training I made about \$180.00 in spare time. Thank you for wonderful Radio-TV training"—Herbert Burroughs, W. Va.

My Proved Training System—Backed by a Quarter Century of Experience—Prepares You FAST for a Good Job or Your Own Profitable Radio-Television Business!

Radio-Television is now America's greatest opportunity field. Correctly trained men are needed NOW—more than ever—to fill good jobs and handle the profitable Radio-Television Service work. I have trained hundreds of successful men for Radio-Television—and I stand ready to train YOU too—even if you have no experience or knowledge of this field. My training is modern—right up to the second—with all the newest developments included! This is 100% practical training that eliminates the frills that only waste your time and progress. Sprayberry Training provides the all-important practical knowledge and skill you need to start making money in Radio-Television in the shortest possible time. You can start at once and be earning welcome spare time cash in a few short weeks. Upon completion of my Training you will be ready to handle any practical Radio-Television job.

You receive all the equipment I have illustrated on the opposite page—and MUCH MORE besides! In addition to your fascinating Sprayberry home study lessons, I send you a total of 18 kits of quality parts and equipment with which you do over 300 practical demonstrations, experiments and construction projects. You build a complete television set that you can use in your shop or at home—you build a powerful TWO-BAND superheterodyne radio set—a multi-range test meter—signal generator and other valuable test equipment—a cathode ray oscilloscope—everything needed to set up your own Radio-Television Service Shop! All equipment I send you is yours to keep. In addition I send you many valuable service manuals, books and reference material to help you in your day-to-day Radio-Television work. I firmly believe I offer the ambitious man the most outstanding training value of its kind in America today!

Be Ready for Top Paying Radio-Television Jobs!

Radio-Television is growing with amazing speed. More than 2000 broadcasting stations PLUS an additional 102 Television stations are now on the air. Radio sets and TV receivers are being made and sold in record breaking numbers. If you enjoy working with your hands . . . if you like interesting and varied work . . . YOU BELONG IN RADIO-TELEVISION. But you MUST have good Training to "cash in" . . . the training that starts with basic fundamentals and carries through every circuit and problem of Radio-TV.



No Previous Experience Needed to Succeed

My Training in Radio-Television is so complete, so down-to-earth that previous experience is not necessary. I start you with basic fundamentals and carry you in easy, practical steps through one Radio-Television subject after another. You will be amazed at your rapid progress and your knowledge of Radio-Television. Best of all, you put this knowledge to work making spare time cash soon after you enroll! You may train as fast or as slowly as suits your convenience. Each of my students receives individual training!

VETERANS

You get my Radio Training without cost under the G. I. Bill. Check coupon.

If you are Experienced . . .

In radio . . . I'll qualify you for Television in 4 to 8 weeks. Check coupon for special details.



FREE 3 Big Radio and Television Books

I want you to have ALL the facts about my complete system of Radio-Television Training! Act now! Rush the coupon for my three big Radio-Television books: "How To Make Money in Radio-Television," PLUS my new illustrated Television bulletin PLUS an actual sample Sprayberry Lesson—all FREE with my compliments. No obligation and no salesman will call on you. Send the coupon in an envelope or paste on back of post card. I will rush all three books at once!

Mail Coupon Today!

NO OBLIGATION No Salesman Will Call

SPRAYBERRY ACADEMY OF RADIO, Dept. 10-P

111 North Canal St., Chicago 6, Ill.

Please rush to me all information on your Radio-Television Training plan. I understand this does not obligate me and that no salesman will call upon me.

Name Age

Address

City State

Please Check Below About Your Experience

Are You Experienced? No Experience

Sprayberry Academy of Radio, Dept. 10-P
 111 North Canal St., Chicago 6, Ill.

**AUTO
MECHANICS**

STILL LOOKING FOR THE RIGHT SPOT?

Train for Success thru C.T.I.

**BODY-
FENDER
REPAIR**

**RADIO-
TELEVISION**

**FACTORY
MANAGE-
MENT**

**DIESEL
MECHANICS**

**MECHANICAL
DRAFTING**

**HIGH
SCHOOL**

**ELECTRIC-
ITY**

**BUILDING
CONSTRUC-
TION**

Want a better job or quick promotions? C.T.I. trains you at home in spare time, or in our big resident school. Mail coupon for valuable booklet on your opportunities.

**REFRIGER-
ATION**

COMMERCIAL TRADES INST.

1400 Greenleaf, Dept. E2-11
Chicago 26 Veteran Non-Vet.
Name _____ Age _____
Address _____
City & State _____
Course _____

Prepare for PROFITABLE CAREER

in Spare Time
at Home



HEALTH FIELD OPPORTUNITIES

FOR MEN AND WOMEN, 18 TO 60

Many graduates between 18 and 60 make big money giving scientific Swedish Massage and Hydrotherapy treatments. There is big demand from doctors, hospitals, sanatoriums and clubs. Graduates earn large full time incomes from these or in private practice in their own offices. Others make good money from home treatments in spare time. Learn this interesting, money-making vocation through our easy-to-understand home study course. Same instructors as in our nationally known resident school, founded in 1906. You can win independence by qualifying in short time for graduation certificate.



32-Page Success Book FREE

This free booklet tells you what you want to know about this real opportunity to achieve success and security in the health field. Send the coupon now and learn what can be accomplished in scientific Swedish Massage. There's no obligation.

THE COLLEGE OF SWEDISH MASSAGE

Dept. 064P, 41 E. Pearson, Chicago 11, Illinois

Please send me FREE and postpaid, 32-page Success Book with information on Home Training.

Name _____ Age _____
Address _____
City _____ State _____



**USE OUR
CAPITAL**

NO SALES EXPERIENCE NEEDED

The biggest opportunity ever, to quickly establish a money-making, lifetime business, now awaits you as a McNeess Dealer. Sell things farmers need and use up. Serve same families year after year. Pleasant work--no bosses--easy to do. We supply capital to work on. Also provide offers--advertising--premiums and trade secrets that bring sales.

First to apply get best trading areas. Don't wait--write us today for McNeess proposition. Tell us county and state you want to serve. Ask for free McNeess Book. 7

The McNEESS CO., 968 Adams St., Freeport, Ill.

BRAND
NEW



30 DAY FREE TRIAL 7x50 Prism BINOCULARS

Finest Precision Optics
Buy Direct From Importer
Money Back Guarantee

Many other models
AS LOW AS \$6.00 *
(*plus Fed. Tax)

FREE Illustrated Catalog & Book,
"How To Select Binoculars"
Dealers: Write for discounts.

BUSHNELL Importers

43 E. Green St., Dept. M-11
Pasadena 1, California



GROW YOUR OWN . . . vegetables, flowers, house plants by hydroponics (without soil). It's easy to get big returns in a small space, indoors or outdoors. A clean pleasant way to grow any plant for fun or profit. Send postcard for free picture book.

GILBERT & CO., 3535f Enterprise, San Diego 10, Calif.

BOYS-IT'S FREE!

"THE WONDERS OF CHEMISTRY"

This exciting new book shows how to amaze your friends with chemical magic. Describes many fascinating home experiments. Tells of fun, thrills and big future opportunities for boys who know chemistry. Special atomic energy feature. Send today!

THE PORTER CHEMICAL COMPANY
42 Prospect Avenue, Hagerstown, Maryland



"It Measures As It Rolls"

ROLLER RULE HANDY MECHANICAL PENCIL

Measures Curves and Straight
Lines. Any Shape. Any
Distance. Any
Surface.

\$1.00
POST
PAID

Roll head over surface. Inches and fractions record accurately on "Inch-O-Meter". Excellent pencil tool! Order Now! 10 Day Money Back Guarantee! C.O.D. (postage extra). In Calif. add 3% Sales Tax.

PENCIL SALES CO., Dept. PM11
Room 6, 1213 E. Ocean Blvd., Long Beach, California





**TO HELP YOU PREPARE FOR
ONE OF THE BETTER JOBS
IN BUSINESS or INDUSTRY**

**You can take subjects which have *Real Job Value*
and still earn graduation!**

• This is *your* opportunity to make completion of high school *work* for you. Your AMERICAN SCHOOL home study course can include high school subjects closely related to your present job or the kind of work you want to do later. Not only can you qualify for your high school course diploma but you can benefit from course subjects that will aid greatly in winning promotions.

**50 Job Help Subjects
from Which to Choose**

Our FREE, 44-page book of detailed information lists 100 high school subjects, of which 29 are technical and 21 are commercial. Whether you work in a shop, factory, garage or office you will find subjects of practical benefit in your climb toward better jobs at better pay. Some of these are Blueprint Reading, Mechanical and Machine Drawing, Tool Making, Foundry Work, four Automotive subjects, Electricity, Carpentry—and Bookkeeping, Accounting, Secretarial Practice, Office Machines, Salesmanship.

Turn Spare Time Into Money

During more than 50 years American School has helped thousands to reach higher job goals by profitable use of spare time at home—and it can help *you*. Others have prepared for college entrance. If you have not completed high school, check that subject on the coupon below, add your name and address and mail it *right now*. Or if you are a high school graduate and are ambitious to succeed in the vocation of your choice, check that subject. Your coupon will bring you the book of information, without obligation of any kind. Mail it *now*.

PRACTICAL, EFFECTIVE HOME - STUDY TRAINING SINCE 1897

Take This First Easy Step

CHECK, CLIP AND MAIL COUPON NOW

• AMERICAN SCHOOL, Dept. G845, Drexel at 58th, Chicago 37, Ill.
Without obligation, please send me FREE information on training course checked below.

- | | | |
|---|--|---|
| <input type="checkbox"/> HIGH SCHOOL COURSES | <input type="checkbox"/> Bookkeeping | <input type="checkbox"/> Plastics Engineering |
| <input type="checkbox"/> Accounting | <input type="checkbox"/> Business Management | <input type="checkbox"/> Plumbing—Practical |
| <input type="checkbox"/> Air Conditioning | <input type="checkbox"/> Contracting | <input type="checkbox"/> Private Secretary |
| <input type="checkbox"/> Architecture & Building | <input type="checkbox"/> Diesel Engineering | <input type="checkbox"/> Radio Operating & Servicing |
| <input type="checkbox"/> Automotive Engr. | <input type="checkbox"/> Drafting & Design | <input type="checkbox"/> Railway Training |
| <input type="checkbox"/> Aviation—Practical | <input type="checkbox"/> Electrical Engineering | <input type="checkbox"/> Refrigeration |
| <input type="checkbox"/> Aviation Drafting & Design | <input type="checkbox"/> Electricity—Practical | <input type="checkbox"/> Sheet Metal Pattern Drafting |
| <input type="checkbox"/> Better Foremanship | <input type="checkbox"/> Electronics, Industrial | <input type="checkbox"/> Shop Management |
| | <input type="checkbox"/> Machine Shop Operations | <input type="checkbox"/> Tool Making |
| | <input type="checkbox"/> Mechanical Engineering | |

Name _____ Occupation _____
 Address _____ Age _____
 City & Zone _____ State _____

AMERICAN SCHOOL
 Dept. G845, Drexel at 58th Street, Chicago 37

INVENTORS

Before you make any effort to market your invention, you should take the first steps toward proceeding for patent protection.

The usual first step is to have a search of the U. S. patent records conducted, so that I can report to you on the question of patentability.

I shall be pleased to furnish you with information relative to patent procedure, upon request from you, and this will be without any obligation on your part.

PATRICK D. BEAVERS

(Formerly RANDOLPH & BEAVERS)

Registered Patent Attorney

934 Columbian Building Washington 1, D. C.

Want to Get Ahead in Business?
Get A BUSINESS EDUCATION!

Regardless of whether your aim is to specialize or generalize in your business education, this nationally known and approved school will gladly counsel with you. We offer you nationwide recognition and placement service as secretary, stenographer, accountant or salesman. Hill's offer both Resident & Home Study Courses. Write **FREE**

Dept. PMR today for Big 32 page SUCCESS BOOK

Hills BUSINESS UNIVERSITY AND EXTENSION SCHOOL
 619 W. MAIN ST. OKLAHOMA CITY 2, OKLAHOMA

INVENTORS

IF YOU WISH TO PROTECT YOUR INVENTION, You should take steps to protect it by a U. S. Patent. Write me for "RECORD OF INVENTION" form.

CARL MILLER
 REGISTERED PATENT ATTORNEY

WOOLWORTH BLDG., 35th FLOOR, 110A
 NEW YORK CITY

STUDY AT HOME

WITH AN EDUCATIONAL INSTITUTION

Courses in **ARTS AND SCIENCES**: Philosophy; Education; Letters; Public Health; Medical Jurisprudence; Psychology; Sociology; Physics; Chemistry; Geology; Pol. Science; Theology; Law; Business and Commerce; Accounting; Mathematics; Statistics; Agriculture. Courses in **ENGINEERING**: Electrical, Civil, Mechanical, Drafting, Architectural, Automotive, Steam, Diesel, Aeronautical, Radio, Structural, Mining, Industrial, Petroleum, Marine, Refrigeration, Air Conditioning, Chemical. Send for free catalog.

McKinley-Roosevelt Incorporated, 4610-K3, Sheridan Rd., Chicago 40, Illinois

PATENTS

C. A. SNOW & CO.

REGISTERED PATENT ATTORNEYS
 WRITE FOR INFORMATION TO
 428 SNOW BUILDING, WASHINGTON 1, D. C.

INVENTING

-FOR PROFIT! If you have an inventive turn of mind, write for free 28-page booklet explaining how the Institute of American Inventors is helping inventors pre-test the profit possibilities of proposed devices to fill today's unprecedented demand for useful new inventions.

INSTITUTE of AMERICAN INVENTORS
 Dept. 4, 631-E St., N.W., Washington 4, D. C.

PATENTS PATENT LAWYER

GUSTAVE MILLER
 REGISTERED PATENT ATTORNEY
 110-PM WARNER BLDG. WASHINGTON 4, D. C.

ASSOCIATE EXAMINER
 U. S. PATENT OFFICE 1922-1929
 Patent Attorney and Advisor
 U. S. NAVY DEPT. 1930-1947
 Send for PATENT INFORMATION book and "INVENTOR'S RECORD" without obligation

PATENTS

"Proof of Invention" Folder mailed without obligation.

E. E. VROOMAN, Registered Patent Atty.
 505 McKim Building, Washington 5, D. C.

INVENTORS

Whether an invention is patentable can be substantially determined by a search of the U. S. Patent records. Without obligation, write for information explaining the steps you should take to secure a patent.

JOHN N. RANDOLPH
 Registered Patent Attorney

201 Columbian Building, Washington 1, D. C.

Say You Saw It in Popular Mechanics

HIGHEST ROYALTIES and CASH

FOR YOUR INVENTIONS

(Patented and Patent Pending Only)

Write for **FREE** booklet without obligation

UNIVERSAL MARKETING CO.

354 S. SPRING ST. (Suite M)

LOS ANGELES 13, CALIF.



GEORGE R. KEMP
 Managing Director
 Studied music at Andover, and at Williams College; also special piano coaching Leschetizsky method.



CLAUDE LAPHAM
 Piano, Organ, Composition
 Famous pianist, Victor Records; Grad., Juilliard School of Music. Concerts, Hollywood Bowl.



JOHN SERRY
 Piano Accordion
 Columbia Broadcasting Staff Accordionist. Formerly with great Radio City Music Hall Orchestra.



HARRY VOLPE
 Guitar, Fretted Instruments
 Voted America's finest Guitarist. Awarded cup. Plays for Decca Records.



PAUL VAN BODEGRAVEN
 Clarinet and Band Instruments
 Former Assoc. Prof. Music, Univ. of Missouri. Now Dir. of Instrumental Curriculum, Cond. of Orch., N. Y. Univ.



Mrs. DOROTHY ROOSEVELT
 Violin
 Studied under Ovide Musin, who was companion player of great violinist, Wieniawski. Concerts, White House, Washington.



HUGH McEDWARDS
 Pipe Organ
 Mus. Bach., Chicago Musical College; Studied Organ with famous M. Bonnet, Paris, and Dr. T. Tertius Noble, N. Y.

Music Lessons By Mail from Fine Teachers

Now You Can Learn to Play Any Musical Instrument Right at Home . . . Less than 38c per Lesson . . . including Sheet Music



Thousands Now Play
 WHO NEVER THOUGHT THEY COULD!



"Easy as Felling Off Log"
 "The lessons are interesting; easy as falling off a log. I've always wanted to play and NOW a life-long dream is being fulfilled."—Mrs. Phyllis B. Jones, Blanding, Utah.

How Famous Orchestra Leader
 Got His Start

"I got my start in music with your Course. How easy it is to learn to read notes and play an instrument this 'teach yourself' way! You did so much for me that I've enrolled my 2 daughters."—Lawrence Welk, famous orchestra leader.



Didn't Know a Note—
 Now Plays for Dances

"Before I took your Course I didn't know one note. Three months later I started to play for dances. Have been invited to many parties and made people very happy with my music."—Miss Rosie Montemurro, Vancouver, B.C., Canada.



"Never Dreamed I Would
 Ever Play"

"I never dreamed I would ever play. Before I took your Course I didn't know one note. Today I play delightful pieces, after only two months."—Mrs. Dallas B. Kerk, Lodgepole, Nebr.



NOW—no matter where you live or what your circumstances—you may receive instruction by mail from any of the leading instructors shown above. These lessons will be as clear, complete, and easy-to-understand as any you might receive from a private teacher. You will enjoy **ADVANTAGES** ordinary private instruction cannot offer:

- (1) **Save Money.** Cost of your U. S. School of Music Course is less than 38c per lesson . . . a mere fraction of the cost-per-lesson of private teachers.
- (2) **Determine Your Own Rate of Progress.** Advance more slowly if other engagements tie up your time—or more rapidly if your spare time permits.
- (3) **Pick Your Own Lesson Time.** No need to keep hard-and-fast appointments with a private teacher. YOU can decide which

and how many spare-time hours you wish to devote.

- (4) **Entire Family Can Learn for Price of One.** Several people can make use of U. S. School Courses, at no extra cost. An economical way to give your children a musical education.

Over 850,000 people have studied music by these easy printed words-and-pictures lessons. Easy as A-B-C—you learn by playing actual pieces **BY NOTE**, from very first lesson. No "numbers" or trick systems. No tiresome scales, boring exercises. Start with simple melodies, gradually take up more advanced pieces. Almost before you realize it, you find yourself playing your favorite pieces.

Don't Miss Half
 the Fun of Life!



FREE BOOK— and Instruction-Sample

Mail coupon for FREE 36-page book describing our methods, Courses, Instructors—and FREE sample of printed instruction. No cost or obligation; and NO SALESMAN WILL CALL. U. S. School of Music, 711 Brunswick Bldg., New York 10, N. Y. (Special Reduced Price on instruments to our students.)



NOW IN OUR 52nd YEAR

U. S. SCHOOL OF MUSIC,
 711 BRUNSWICK BLDG., NEW YORK 10, N. Y.

I am interested in learning to play, particularly the instrument checked below. Send me free booklet, "How to Learn Music at Home"—also free Instruction-Sample of simplified words-and-pictures teaching method. NO SALESMAN IS TO CALL UPON ME.

- | | | |
|--|--|--|
| <input type="checkbox"/> Piano | <input type="checkbox"/> Trumpet, Cornet | <input type="checkbox"/> Flute, Piccolo |
| <input type="checkbox"/> Guitar | <input type="checkbox"/> Pipe, Hammond, Reed Organ | <input type="checkbox"/> Modern Elementary Harmony |
| <input type="checkbox"/> Hawaiian Guitar | <input type="checkbox"/> Tenor Banjo | <input type="checkbox"/> Mandolin |
| <input type="checkbox"/> Violin | <input type="checkbox"/> Ukulele | <input type="checkbox"/> Practical Finger Control |
| <input type="checkbox"/> Piano Accordion | <input type="checkbox"/> Clarinet | |
| <input type="checkbox"/> Saxophone | <input type="checkbox"/> Trombone | |

Do you have the instrument? _____

Mr. _____
 Miss _____ (Please Print Carefully)

Address _____

City _____ State _____
 (Insert Zone Number, If Any)

NOTE: If you are under 15 years of age parent must sign coupon.

PEARL

FINISHING OFFERS YOU

BIG MONEY

RIGHT AT HOME

AMAZING NEW PEARL FINISH can be instantly applied to any article—leather—wood—plastic—glass—metal, etc.

BABY SHOES preserved for life in beautiful Baby Pink, Blue, and Ivory thrill mothers and bring immediate sales.

Nothing else like it! Costume jewelry, buttons, earrings, treasured mementos, etc., etc., take on new splendor and beauty at once.

TREMENDOUS DEMAND—Help us fill it—Fantastic profits await those who act NOW. Be First! Scoop the market. Never before has such an opportunity been offered. Never before such Big Profits made so quickly.

DON'T PASS THIS UP—It costs Absolutely Nothing to get the FREE FACTS that show you the EASY WAY to QUICK, BIG MONEY overnight. Mail Coupon TODAY!

PEARL-KOTE CO., Dept. P-5011
 2111 W. Manchester Ave., Los Angeles 47, Calif.
 Okay! RUSH me FREE FACTS at once.

Name _____

Address _____

City _____ Zone _____ State _____

MACHINE SHOP MEN

Needed Now!

TODAY shop men are in big demand. Don't miss the chance to get into the big money class and to qualify for promotions to high pay positions. Opportunities are open to men who add to their "know how" day by day. Equip yourself without delay.

8 BIG BOOKS ON APPROVAL

Modern Shop Practice, 14th edition, is the 8-volume set for the use of ambitious men. It contains 4,000 pages of vital information—3848 illustrations—167 tables. Written simply and clearly by 41 experts in tool making, pattern making, foundry work, forging, mechanical drawing, blueprint reading and many other skills. With the set we include a special binder of 860 profusely illustrated pages covering machine shop operations step by step, and 293 actual job tickets. 9 books in all! See also our gift offer at the left.

DICTIONARY OF MACHINE SHOP TERMS

Pocket Size included as gift if you act NOW, whether you keep or return the set.

Send the coupon NOW. Examine these books and note their great help to you. If you want to keep the set, pay on the very easy terms. If not, return the 9 books and owe us nothing. Remember—we now give a year's consulting privileges with our engineers without charge.

PUBLISHERS SINCE 1898

AMERICAN TECHNICAL SOCIETY, Dept. S-819
Drexel at 58th St., Chicago 37, Illinois

Send me the 8 big books and special binder on approval. I will pay delivery charges only. If I decide to keep the books I will send \$3.00 in ten days and \$4.00 per month until the total price of \$34.80 is paid. If I return them in 10 days I can keep the dictionary and owe you nothing. You also agree to send me a certificate entitling me to consulting privileges without extra charge.

Name _____

Address _____

Please attach a letter stating age, occupation, employer's name and address and name and address of at least one business man as reference. Men in service, also please give home address.

K-R-O KILLS RATS

• K-R-O BIS-KITS are ready-made, easy to use; containing fortified red squill, they're safer around livestock, pets, and poultry. K-R-O POWDER is 100% fortified red squill; economical to use in badly infested areas when mixed with natural baits. BIS-KITS, 35c and \$1.00; POWDER, 75c at drug, seed, and feed stores. Money-back guarantee. The K-R-O Company, Springfield, Ohio.



CLEANS WINDOWS WITHOUT WATER

NEW CHEMICAL MITT

Sensational! DRY Window Cleaner! Uses no water, no messy liquids. Chemically Treated. Simply glide over windows; leaves glass sparkling clear. No hating water, no heavy buckets to carry. No rags, powders, sponges, chemicals. No mess or muss. No red chapped hands. Dust, dirt, grime, fog disappear like magic. Wonderful for auto windows, windshield!

SAMPLES FOR AGENTS Sample offer sent immediately to all who send name at once. A penny postal will do. SEND NO MONEY—just your name. KRISTEE CO., 679 Bar Street, AKRON, OHIO



SELLS FAST

The new necklace and Miraculous Medal encased in permanent, transparent plexiglas, 18" gold plated chain with safety lock. Blue, red, gold or clear backing. Individually packed in gift boxes. Sell direct to wearer and to churches and religious groups. High discounts. Write for details at once, and send \$1.00 for sample, postpaid.

STEPHENS PRODUCTS CO.
1947 BROADWAY, Dept. "P-2", New York 23, N.Y.

LAW FREE BOOK



Your FREE copy of "The Law-Trained Man" shows how to gain prestige and greater earnings through Blackstone home law study. All instruction material furnished including 18-volume Law Library written by 65 well-known law authorities. Lawyers, judges among our graduates. LL.B. degree. Low cost; easy terms. Write today. **BLACKSTONE COLLEGE OF LAW** 225 N. Michigan Ave. Dept. 58, Chicago 1, Ill.

A Correspondence Institution Founded in 1890

MEN URGENTLY NEEDED!

To service millions of coin-operated vending and amusement machines. Get in on this sky-rocketing, billion dollar business by enrolling NOW in the only school of its type in the nation. Take our accelerated nine month course and be prepared to make \$50 to \$100 per week and more. G. I. approved. Determine from your local operators the great need for skilled men in this field. Write or phone for FREE literature and descriptive folder.

MEMPHIS VENDING & AMUSEMENT MACHINE SCHOOL
643 Madison Ave., Memphis, Tenn., Ph. 37-6330

SPEED AND POWER Handbook

50 CHAPTER LIBRARY EDITION

Build Fast Stock Cars! California Roadsters! 160 MPH Rods! Covers Cross-leys to Cadillacs—all makes—Authentic—Direct from California!

Tens of thousands have been sold!

SAVE SAVE SAVE

Build your own Dual Manifolds! Superchargers! Hot Cams! Water Injectors! Hi-Compression Heads! Mileage Devices! Get up to ten more miles per gallon! Get racing speed, lightning acceleration, dynamic power increases from any make passenger automobile! Get construction drawings! Tuning techniques! Speed tricks! Economy secrets! Ingenious formulas! Covers "Racing Frames"—"Reciprocating Masses"—"Jet Engines"—"Wheel Geometry"—"Dynamometers"—Dual Pipes, Gears, Fuels, Porting, Relieving, Lowering! Balancing—50 breathtaking chapters!

Includes "CALIFORNIA CUSTOMIZING"—Diagrams! Newest Ideas! Restyling all makes! Plus 1951 Racing Catalogue. Plus big "Economy Manual" and "Alcohol Injection."

Photos Drawings 128 ENAMELED PAGES

5 ITEMS Postpaid \$1.98

NEWHOUSE AUTOMOTIVE INDUSTRIES
5805 EAST BEVERLY BLVD. DEPT. B4
LOS ANGELES 22, CALIF.

SPEED SHOP METHODS
300 ILLUSTRATIONS



FREE Bargain Book

Packed with hundreds of sensational bargains—new and used—in still and movie photo equipment and accessories. Write for your free copy today to

Central Camera Co.
Dept. 8M, 230 S. Wabash, Chicago 4, Ill.

Photographic Headquarters Since 1899

BE A CRIMINOLOGIST
WORK HOME or TRAVEL. Experience unnecessary.
CRIMINOLOGY Particulars FREE. Write to
GEO. C. R. WAGNER, 125 W. 86th St., N. Y.

SAY YOU SAW IT IN POPULAR MECHANICS

Find HIDDEN TREASURES

GEIGER COUNTERS for Uranium Detection. (see at left). **TREASURE DETECTORS** for gold, silver, etc. Lightweight, ultra sensitive. None finer at **ANY PRICE.** Information FREE.

Detectron Co. Dept. 11-B
5631 Cahuenga, No. Hollywood, Calif.



LEARN MEAT CUTTING AT NATIONAL

Pay After Graduation



The steady dependable trade of Meat Cutting taught easily in 8 short weeks. **YOU LEARN BY DOING** under actual meat market conditions in big modern school at Toledo.

For beginners or men with experience. Get a profitable store of your own. Remember, **PEOPLE MUST EAT!** Big pay jobs. Free employment help. Thousands of successful graduates.

Buying, cutting, percentage, pricing, advertising, selling, etc. A complete retail meat education. National School established over 25 years. Get National training **NOW.** Pay your tuition in easy weekly payments

RADIO-ELECTRONICS-TELEVISION FOR MEN OVER DRAFT AGE

Prepare now for high-pay jobs with SECURITY. Big demand for trained men! Get to the top faster through practical shop-training methods! You earn big money at home while learning; start your own business! Fastest growing industry in the country!

RTTA FURNISHES EVERYTHING—TUBES, BATTERIES, LARGE TV PICTURE TUBE

YOURS TO KEEP—AND ENJOY

YOU KEEP ALL EQUIPMENT!

YOU BUILD THIS LARGE SCREEN TELEVISION RECEIVER

YOUR CHOICE OF 10, 12½, OR 16 INCH PICTURE TELEVISION TUBE

CAN BE CONVERTED FOR COLOR TELEVISION

STUDY AT HOME IN YOUR SPARE TIME

NO PREVIOUS EXPERIENCE NECESSARY FREE EMPLOYMENT HELP

RTTA helps you earn while you learn. Open to men of all ages! RTTA prepares you for BIG PAY and to open your own shop.

DRAFT AGE MEN

15 BIG TELEVISION-RADIO KITS AT NO EXTRA COST YOU BUILD THESE & THREE OTHER UNITS

RF SIGNAL GENERATOR

AUDIO OSCILLATOR

FREE... At No Extra Cost... YOU GET A ROUND TRIP TO NEW YORK CITY

After completing home study training, your transportation both ways from any point in U.S. or Canada will be paid by RTTA. At our affiliated training shops in New York City you get 2 solid weeks of laboratory work on newest equipment.

FREE "SPEED-UP OFFER" COUPON

RADIO TELEVISION TRAINING ASSOCIATION
972 Broad Street, Dept. 2411, Newark 1, N. J.

Rush me **FREE** Sample Lesson & Catalog "How to Make Money in Television," in spare time. **AT HOME**, while learning; also () Special Home Plan for Men over Draft Age. () "Speed-Up" Service Rating Plan for Draft Age Men. No obligations! I understand no salesman will call.

Name.....Age.....

Address.....

National School of Meat Cutting, Inc., Dept. 50-L, Toledo 4, Ohio

Send me your **FREE** school catalog on National Training at Toledo in Meat Cutting, Meat Merchandising and Self Service Meats. No obligation. No salesman will call.

Name.....

Address.....

City.....State.....

() Check here if Veteran of World War II

C. T. C. TRAINING IN DRAFTING

PREPARES FOR
PROMOTION
MORE MONEY
SUCCESS



"Here I am at work making good money as a draftsman. I'm glad I sent the coupon to Chicago Tech for that Free Trial Lesson and found out how easy it is to learn Drafting in spare time at home. Today, I feel secure in my job. What's more, I feel I'm slated for promotion and more pay."

LEARN IN SPARE TIME—AT HOME! (or at the College in Chicago)

A few hours of pleasant home study every week—that's all. All the tools you need; drawing outfit included. This tested method—developed over 46 years of C.T.C. progress—prepares men quickly for good positions in industry.



FREE INFORMATION — SEND COUPON

To prove to you how easy it is to learn Drafting at home, we will send you this FREE TRIAL LESSON. Mail coupon or send post card today.

CHICAGO TECHNICAL COLLEGE

P-213 Tech Bldg., 2000 So. Michigan Ave.,
Chicago 16, Illinois

Mail me FREE Lesson with information about big opportunities in DRAFTING.

Name _____ Age _____

Address _____

City _____ Zone _____ State _____

BIG PAY JOBS for men who qualify in DIESEL



ASSURE YOUR FUTURE. Steady, high-pay jobs await men qualified in Diesel, Tractor, and Heavy Equipment. Are you qualified for job and advancement opportunities in this fast-growing field? You can qualify!

COMPLETE DIESEL COURSE NOW AVAILABLE. If you are ambitious and want to get ahead in this big money field, you'll want to know about the complete Diesel home training course now offered by Interstate Training Service. Covers all phases of operation, repair, service. Easy to master in spare time. No interference with present job. Up-to-the-minute. Regularly revised to cover new developments. We invite comparison of material offered. Placement advisory service comes with course.

PLANNING TO ENTER SERVICE? I.T.S. home training can help you qualify for specialized military training and higher rating!

YOU OWE IT TO YOURSELF to investigate Interstate Training Service Diesel Training. Thousands agree it has helped them to better jobs... better pay. It can do the same for you!

WRITE FOR FREE INFORMATION TODAY

INTERSTATE TRAINING SERVICE, Portland 13, Ore.
Please see that I receive FREE 24-page book, (3-M)
"Getting Ahead in Diesel."

NAME _____ AGE _____

ADDRESS _____

CITY _____ ZONE _____ STATE _____

WANT TO Write Stories Articles Mysteries?

FREE LESSON
shows how you
learn at home



The demand for writers is creating great new opportunities for people with an urge to write. It's not as hard to succeed as you may imagine. Most famous authors come from ordinary walks of life. At home, you too may learn fiction writing, the best basis for all fields—short stories, features, articles, technical, mechanical and business items. Palmer Institute's Home Study Training (Established 1917) is endorsed by Rupert Hughes, Gertrude Atherton, Keith Monroe, and other famous authors and by scores of successful graduates. Complete instruction material and professional coaching to develop your own style. FREE book and lesson show how you may enjoy an ideal part time or full time career. Write today (no salesman will call). Veterans: advise us if you are eligible for G.I. Training.

PALMER Institute of Authorship • Est. 1917
Approved for Veterans 1680 NO. SYCAMORE, Dept. T-110
HOLLYWOOD 28, CALIFORNIA

BECOME AN EXPERT IN TRAFFIC

Traffic men earn \$4,000 to \$10,000 and up. Thousands of firms need experts on rates, tariffs, regulations. We train you thoroughly in spare time at home for executive traffic jobs. Personal training under traffic authorities. Placement counsel and help. Write for free 48-page book "Traffic Management—the Fast Growing Profession."

LASALLE Extension University, 417 So. Dearborn St.
A Correspondence Institution Dept. 1164T, Chicago 5, Ill.

LEARN MEAT CUTTING At Home — In Spare Time



Get into the vital meat industry. Concise, practical Home Training based on 25 years proven instruction methods used at National's famous resident school. Prepares you for bigger pay as Meat Cuts, Supervisor, market manager or more money in your own store. Go as rapidly as your spare time permits. Diploma. Start NOW to turn your spare hours into money. Send for FREE bulletin today. No obligation.

NATIONAL SCHOOL OF MEAT CUTTING, INC., Div. U-122, Toledo 4, Ohio

SHORTHAND IN

Famous Speedwriting system. No signs; no symbols; no machines. Uses ABC's. Easy to learn, write, transcribe. Low cost. 100,000 taught by mail. Also typing. 27th year. Write for FREE booklet to:

Speedwriting
Dept. 1511-A

55 W. 42 St., N. Y. 18, N. Y.

6
WEEKS
AT HOME

HOMESITES \$300 LOW TERMS

In California's loveliest Garden Spot, on scenic shores of beautiful Morro Bay. Enjoy future independence with excellent soil, soft water, wonderful fishing, hunting, boating, bathing, etc. Grow fruits, vegetables, poultry. Perfect temperate climate. Congenial community. Finest investment. Free literature.

RICHARD S. OTTO

DEPT. M

SAN LUIS OBISPO, CALIFORNIA

Learn WOOD PRODUCTION ENGINEERING

FREE Booklet



IN SPARE TIME AT HOME

Prepare for top wood-working positions or for more profitable shop ownership with KLOK TRAINING. Covers all woodworking arts in a Home Study Course or Resident Training Course at Grand Rapids. Free G.I. instruction. Money back trial for non-veterans. Write for FREE BOOKLET. State Age, veteran, non-veteran, Home or Resident Course, occupation. JOHN H. KLOK, Pres. KLOK INSTITUTE

L. Louis St. N.W. Grand Rapids 2, Mich.

from
THE ONLY SCHOOL
OF ITS KIND

SAY YOU SAW IT IN POPULAR MECHANICS

Learn BAKING At Home

Baking is one of America's high industries in wages. Nearly depression-proof. Thorough basic home course lays sound foundation. If you have aptitude, write for FREE BOOKLET, "Opportunities in Commercial Baking."

National Baking School, 1315 Mich. Ave., Dept. 1358, Chicago 5



SAVE UP TO \$50

Sensational WATCH Values
DIRECT FROM IMPORTER TO YOU!

5 Yr. Written Guarantee
10 DAY FREE TRIAL
MONEY BACK GUARANTEE

SAVE \$50 17 JEWEL PRECISION BUILT CHRONOGRAPH

- ◆ 4-in-1 PRECISION TIMEPIECE
- ◆ ACCURATE WRIST WATCH
- ◆ ACCURATE STOP WATCH
- ◆ ACCURATE TELEMETER
- ◆ ACCURATE TACHOMETER
- ◆ FORMERLY \$71.50

You'll be proud to own this unusually handsome, exceptionally accurate timepiece! Computes time and distance down to 1/5 of a second with absolute accuracy. 3 multi-purpose dials automatically coupled & synchronized for hours, minutes, seconds and 1/5 seconds. Luminous dial and hands. Hairline sweep-second. Unbreakable crystal. Stainless steel back. Only \$21.95 plus \$2.20 tax. Order now.

OUR PRICE ONLY
\$21.95



SAVE \$47 17 JEWEL AUTOMATIC SELF-WINDING INCABLOC

NOW **\$24.95** FORMERLY \$71.50. The Watch of the Future! Winds itself automatically by a twist of the wrist. Everlasting mainspring. Incabloc. Extremely accurate. Water resist. Luminous. Sweep-second. Only \$24.95 plus \$2.50 tax. Order now.

FORMERLY \$59.00. Absolutely accurate after 84-hr. under-water test! INCABLOC gives finest balance staff protection. Unbreakable crystal. Sweep-second hand. Luminous. Only \$16.95 plus \$1.70 tax. Order now.



ORDER TODAY

FOR SELF AND XMAS GIFTS—Free Gift Case also included with each watch ordered. Send only \$1 down payment with order. Pay postman balance on arrival. Or we pay postage if you enclose full payment plus tax with your order. **ORDER NOW & SAVE!**

FREE ADMIRAL STAINLESS STEEL EXPANSION BAND nationally advertised on radio & TV. Sold for up to \$6.95. PLUS EXTRA calf skin band. (2 bands Free) Order now.

NATIONAL JEWELRY SALES CO.

Dept. PM1-29 Forsyth St., New York 2, N.Y. (phone, WALKER 5-0740) (DEALER INQUIRIES INVITED)

BE A PHOTO-ENGRAVER

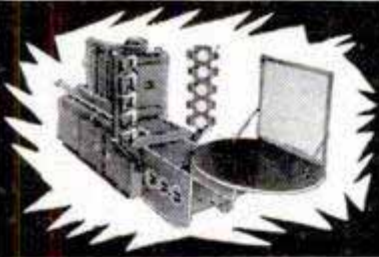

We furnish complete equipment and supplies. Learn at home or in our modern, friendly APPROVED school in MISSOURI. Get into this big demand, high profit, high wage field. You can start your own profitable, full time or part time PHOTO-ENGRAVING business right in your own home.

Be independent, be your own boss or pave the way to a high pay job with experience gained in your own shop.

TASOPÉ TRAINING and TASOPÉ EQUIPMENT has enjoyed world wide recognition since 1931. Write for descriptive literature today. No obligation.

THE AURORA SCHOOL OF PHOTO-ENGRAVING, DEPT. 9PM., TASOPÉ BLDG., AURORA, MO.

NEON SIGN SCHOOL

G.I. APPROVED

Learn Neon. Interesting, clean work, BIG PAY—\$1.50 to \$2.00 an hour to start. Our 12½ week Job-Practice Course gives you practical training in Glass Blowing, Neon Tube Bending, Color Gassing, other branches. No home study. No text books. No mathematics. FREE FOLDER explains. Write today.

ACME NEON INSTITUTE, Dept. M-3
330 South Paulina St. Chicago 12, Ill.

LEARN IN 12½ WEEKS

TRAVEL - for 'UNCLE SAM'

ARE YOU JOB-SATISFIED?
GET A U. S. GOVERNMENT JOB
Many Positions to Be Filled

Railway Mail Clerks — Postoffice Clerks — Mail Carriers — Stenographers — Typists. Statistical Clerks — Liquor Inspector, etc. 40-page Civil Service Book—FREE.

MEN — WOMEN
Veterans Get Preference

Mail Coupon immediately — today sure. Although not government controlled this can be your first step toward a secure Civil Service career.

As high as \$3,450.00
FIRST YEAR



COUPON

FRANKLIN INST., Dept. K-83, Rochester 4, N. Y.
Gentlemen: Rush to me, without charge, 40-page book with list of U. S. Government big paid positions. Advise me also regarding salaries, hours, work, vacations, etc. Tell me how to qualify for a position.

Name _____
Address _____ Vet? _____

Yes, More Brilliant Than a Diamond!



Amazing New Discovery

Write today for the **FREE** illustrated booklet that tells the full story of the latest miracle of science—the story of a glorious jewel discovered in the laboratories of one of the world's largest corporations. Read all about the Kenya Gem that so closely resembles a diamond that only an expert can tell the difference.

More Fire! More Brilliance!

Yes, this marvelous gem has more brilliance, more fire and more dazzling display of color than the finest diamond of equal size. And yet you can now own a brilliant one (1) carat unset Kenya Gem for only \$24. Kenya Gems run from 1/2 carat to 8 carats, all expertly cut; also men's brilliant,

stylish rings of all sizes and ladies' rings, bar pins, brooches and earrings. If you wish, you can buy on **EASY PAYMENTS**.

The Cinderella of Science

Kenya Gems are the sensational discovery that you read about in the Jewelers' magazine and The Sat. Eve. Post, "the only thing on earth more brilliant than a diamond." It is a true gem, crystallized by science instead of nature.



Copyright 1950
Kenya Gem Corp.

Write Today or Send Coupon
for **FREE** Illustrated Booklet

KENYA GEM CORPORATION, Dept. 280
Philadelphia 44, Pa.

Mail This **FREE** Coupon Today

Kenya Gem Corporation, Dept. 280 Philadelphia 44, Pa.

Please send me, without obligation, the **FREE** illustrated booklet telling all about Kenya Gems.

Name

Address

City State



Easy Way to Practice Radio Code

NEW amazing Telegraph Code Practice Set. Light touch of **DUPLEX PRACTICODE** telegraph key produces **LOUD PROFESSIONAL "BEEP"** thru its large 4-inch Permanent Magnet Speaker. Works 6 months on only one 1 1/2 volt cell—No parts to burn out! Safe! **COMPLETE WITH REAL PROFESSIONAL TELEGRAPH KEY AND BATTERY**—Nothing else needed!

As many as 6 sets can operate on one line! Colorful Wood Cabinet, 3 1/2 x 5 x 10 1/2", in red, green, yellow or blue pastel. One-year factory guarantee. **\$5.95** complete plus 50c for shipping & handling

Send M. O. or Check. Write for Catalog 11-M
MARTIN MFG. CO., Dept. 11-PM, 194 Gelston Ave., Brooklyn 9, N.Y.

AERONAUTICAL ENGINEERING

Design Aircraft & Components—Study with Jets & Rockets—Great Future—Advanced Aeronautical Subjects—World-Wide Enrollment—Fully Accredited—Established 1929—Approved for Vets—**CAL-AERO** grads in heavy demand.

WRITE TODAY for Special Information. PM-11

NAME AGE

ADDRESS

CITY ZONE STATE

CAL-AERO TECHNICAL INSTITUTE
GRAND CENTRAL AIR TERMINAL • GLENDALE 1, CALIFORNIA

MEN! WOMEN!

New Car given
as Bonus!



TAKE ORDERS for
Nationally Advertised

NYLONS

GUARANTEED NINE MONTHS

Sensational Guarantee creating a tremendous demand for Wilknit Nylons! If they run, wear out or even snag from any cause whatever... within **NINE MONTHS**... depending on quantity... they are replaced **FREE OF CHARGE**. No wonder it's easy to quickly build up fine, steady, year-'round income. Earnings start immediately. Look at these exceptional figures—Ralph Shearer made \$67.11, **first week**—Mrs. Paul Estes, \$42.92—Mrs. Ivey Gentry, \$43.37. Doris Jensen in addition to making as much as \$17.00 in a single day, earned two cars as **EXTRA BONUSSES**. Learn how you can make money in your full or spare time without a bit of previous experience.

SEND NO MONEY... Just Hose Size

When you send for Selling Outfit, I also send your choice of Nylons or Socks for your personal use. Don't lose a minute. Rush name on penny postcard for full money-making facts on Sensational Sales Kit. Send hose size, too. **Lowell Wilkin, WILKNIT HOSIERY CO., 3011 Midway, Greenfield, Ohio**

EARNED
TWO NEW CARS

... and as much as

\$120.00 in one week

That's the exceptionally fine record of Chas. Mills with the famous Wilknit hosiery line. Offer of New Chevrolet as a bonus open to EVERYONE. Send name for facts **FREE**.

PLASTICS CATALOG

Wholesale — Retail

There's more information and tricks-of-the-trade and a larger variety of plastics materials listings packed into this catalog than you've ever seen before. Sheets, rods, tubes, casting, draping, molding plastics, supplies, findings, etc. We make our own **Carving Dyes**. Prices quoted for any quantity—large or small. For fast, courteous, personalized service—**TRY US! FREE Catalog**—Airmailed for 12¢ postage.

GEM-O-LITE PLASTICS CO.

5350-M Riverton Ave.

North Hollywood, Calif.

AUTO WALLET



TIE CADDIE

Specialty Auto
Wallet placed on
sun visor adds

greatly to motoring pleasure. Holds letters, notes, stamps, cards, pencils, coins, small tools and accessories—all within easy reach. Ends search for misplaced articles. It is also a custom tailored necktie case. Pliable simulated leather, zipper closure, light or dark color—only

\$3.50 prepaid. Gilbert Rose, Zircag, Oregon.

TRI-STATE COLLEGE

B. S.

**DEGREE IN
27 MONTHS**

Founded 1884

World-Wide
Enrollment

Civil, Elect., Mech., Chem., Aero., Radio and Telev., Engineering; Bus. Adm., Acct. Visit Campus, see well equipped labs. Low cost. Prep. courses. Personalized instruction. Grads. successful. Enter Jan., March, June, Sept. Catalog 4110 College Ave., Angola, Ind.



ILLUSTRATED COMIC BOOKLETS

THE KIND YOU LIKE!
(VEST POCKET SIZE)

They are loaded with rare cartoons. Full of Fun and Humor. **20 DIFFERENT** booklets sent prepaid for \$1 in plain sealed wrapper. No C.O.D.'s.

GRAYKO, Dept. 2025, Box 520, G. P. O., N.Y.C. 1

SAY YOU SAW IT IN POPULAR MECHANICS

FREE of BOOKS

25,000 books of all publishers listed in our 56th Annual Bargain Catalog of 256 pages. Old-time favorites — latest "best sellers." Reference, Fiction, Juvenile, History, Scientific, etc. Supplying schools, colleges, libraries and thousands of individual customers. Send postcard today for our new 1951 catalog, "Bargains in Books."

THE BOOK SUPPLY COMPANY, DEPT. 134
564-566 West Monroe St. Chicago 6, Ill.

Harold von Schmidt

FAMOUS ILLUSTRATOR OF SEA AND WESTERN STORIES SAYS:

"Make ART your career!"



America's 12 Most Famous Artists Show You

Norman Rockwell • Al Parker • Jon Whitcomb
Ben Stahl • Stevan Dohanos • Robert Fawcett
Harold von Schmidt • Peter Helck • Austin Briggs
John Atherton • Fred Ludens • Albert Dorne

¶ The demand for well-trained artists exceeds the supply and America's 12 most famous illustrators have perfected a new method of showing you. You can learn our short-cuts and secrets at home in your spare time. ¶



Send for FREE
illustrated booklet—today!

• FAMOUS ARTISTS COURSE •

FREE Dept. K-6, Westport, Conn.
Please send book
about Famous Artists Course.

Mr. Mrs. _____
Miss _____
Street _____
City, Zone, State _____
Phone No. _____ Age _____

LEARN POULTRY BUSINESS AT HOME!

Thorough knowledge can mean greater success in this \$3½ billion business. Our interesting, practical, home-study courses have trained thousands during past 29 years. For full information on courses, methods, opportunities—Write Today to Dept. 50



NATIONAL POULTRY INSTITUTE Adams Center, N.Y.



FREE SAMPLES! GLOW IN THE DARK!

BIG PROFITS showing amazing Luminous Specialties—house numbers, pictures, plastic novelties, religious and nursery objects, ash trays, key-holders, etc. Large manufacturer. Enormous demand. Sell on sight. WRITE AT ONCE for FREE samples. Madison Mills, 303 4th Ave., Dept. R-4, New York 10, N.Y.

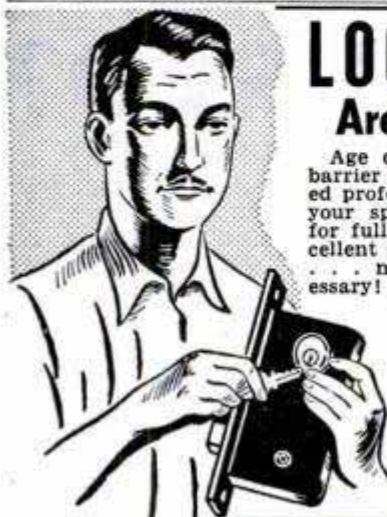

LOCKSMITHS Are Always Busy!

Age or physical condition is no barrier to this good paying, respected profession! Learn it at home in your spare time. Uncrowded field for full or part-time business. Excellent profits and interesting work... no previous experience necessary!

Practical, illustrated lessons by professional locksmiths show you how to make money while learning. Special tools, materials, and practice locks without additional charge! Send for FREE BOOKLET.

Institute of Locksmithing
Dept. P-12, 55 Park Ave.,
Rutherford, N. J.



I HELPED T.E.H. MAKE \$14 A DAY WHILE STILL LEARNING!

T. E. H.—West Virginia. "By the time I finished half your course, I was making \$14.00 per day. I have made enough on the side to more than pay for the course."

H. T. ARMSTRONG

Learn ELECTRIC APPLIANCE REPAIR & SERVICE

WE TEACH:

How to Repair
Washing Machines
Vacuum Cleaners
Electric Ranges
Lamps, Motors,
Irons, etc.,

REFRIGERATION
and
House Wiring
At Home
In Your
Spare Time!

For a man handy with tools, and happiest when working with his hands, OPPORTUNITY is Wide Open Today in this great and growing field. Everyone is a customer for the man trained to service electric appliances.

Open Your Own Shop

Our practical HOME COURSE teaches you this business from A to Z—preparing you to take a well paid job or open your own shop. You can actually start in your basement or garage with the tools we send you... before finishing.

We
Include An
ELECTRICAL
APPLIANCE
TESTER

A Big Kit of Tools
at NO EXTRA
COST

MAIL THIS COUPON for FREE BOOK

H. T. ARMSTRONG

PACIFIC TRAINING SCHOOLS

7217 So. Broadway, Dept. P-5011, Los Angeles 3, Calif.

Dear Sirs: Please send me, without obligation, your free booklet, and complete details.

Name _____
Address _____
City _____ Zone _____ State _____

SAY YOU SAW IT IN POPULAR MECHANICS

In Industry and In Emergency
TRAINED MEN ARE PREFERRED



Jewelry-
Stone Setting



WATCHMAKING



Engraving

"3 High-Paying Trades in 1 Career"

Serve in Emergency — Profit in Industry

There are increasing needs in industry and the Jewelry Trade for thoroughly trained men.

Write for catalog and full information.

MAIL THIS COUPON TODAY

KANSAS CITY SCHOOL OF WATCHMAKING
1218 Admiral Blvd.
Kansas City 6, Missouri

Please send me, without obligation, complete information on training in the above courses.

Name _____

Street _____

City _____ State _____

Check if Veteran G. I. Approved

Learn A Trade NOW!
PRACTICAL
SHOP TRAINING!

In Our Chicago Shops

- | | |
|---|--|
| <input type="checkbox"/> AUTO MECHANICS | <input type="checkbox"/> WELDING—ARC and GAS |
| <input type="checkbox"/> DIESEL MECHANICS | <input type="checkbox"/> MACHINIST |
| <input type="checkbox"/> REFRIGERATION | <input type="checkbox"/> PIANO TUNING |
| <input type="checkbox"/> BODY-FENDER | |

Above Approved For G. I.'s and Civilians
One of America's Leading Practical Schools
7 Floors of Fully Equipped Shops
Over 50,000 Successful Graduates
Expert Individual Instruction
Learn by Doing—Low Living Expense
Established 1902—Day and Evening Classes

Also the following Home Study Courses

- | | | |
|----------------------------------|--|---------------------------------|
| <input type="checkbox"/> PLASTIC | <input type="checkbox"/> REFRIGERATION | <input type="checkbox"/> DIESEL |
|----------------------------------|--|---------------------------------|

—CALL IN PERSON OR MAIL THIS AD TO—

GREER SHOP TRAINING

(Desk 10) 460 South State St., Chicago 5, Ill.

Please send without obligation free information regarding trade checked above. (Specify whether you are a Veteran or Civilian)

Name _____ Age _____

Address _____

City _____ State _____

PROTECT CHILDREN

Keep Pets Clean

with **FLEA-NO MAT**



KILLS INSECTS—STOPS DOG ODORS—NO POWDERING

15" x 28"
ONLY
\$2.95
post paid

For large dogs
28" x 36"

\$4.95 POST PAID

Very Economical!

Use this revolutionary, chemically treated mat on regular bed of pet, or separately—rids cats or dogs of fleas, ticks, nits. Pleasant, clean odor counter-acts animal smell. Kennel-tested by veterinarians. Order today—money back guarantee! Check or Money Order.

V. F. GARRETT CO. P. O. Box 1143-53
DALLAS, TEXAS



Free Book

Money In Hamsters

The new wonder animals from Syria. Often called Toy Bears. Delightful pets. Everyone wants them. Laboratories use thousands. Clean, odorless. Raise anywhere. NOW, spotted and golden breeds. We furnish breeders, equipment and manual of instructions. Write today for free illustrated literature.

GULF HAMSTERY 1536 BASIL ST., MOBILE 17, ALA.

ELECTRICIANS' SCHOOL

HOUSE AND COMMERCIAL WIRING • MOTOR REPAIR
AND REWINDING • ELECTRIC REFRIGERATION

Approved for Veterans Training

PENNSYLVANIA INSTITUTE SCHOOL OF ELECTRICITY

42nd and SPRUCE STS.

PHILADELPHIA 4, PENNA.

LOCKSMITHING & KEYMAKING

HOME TRAINING OUTFIT INCLUDES KEY MACHINE, SUPPLIES AND TOOLS TO GET STARTED IN BUSINESS

Professional outfit. Get practical training from Master Locksmiths. Learn to cut keys by code, master locks, change combinations, quickly identify key blanks, many profitable "tricks of the trade." Booklet of Information FREE. Write today. **UNITED SUPPLY & SERVICE**, 3527 Madison St., Dept. PM-11, Chicago, Illinois.



LABORATORY TECHNICIAN

BE A LABORATORY SPECIALIST; complete course. Big demand from hospitals, doctors, clinics. We teach all branches of medical laboratory work, including Medical and Dental X-Ray.

Approved by American College of Medical Technologists

Co-educational Free Placement Bureau

Free Catalog

Accredited for "veteran" training

CHICAGO COLLEGE OF LABORATORY TECHNIQUE
Dept. P.M., 431 S. Wabash Ave. Chicago 5, Illinois

RUPTURED?

Get Relief This Proven Way

Why try to worry along with trusses that gouge your flesh—press heavily on hips and spine—enlarge opening—fail to hold rupture? You need the Cluthe. No leg-straps or cutting belts. Automatic adjustable pad holds at real opening—follows every body movement with instant increased support in case of strain. Cannot slip whether at work or play. Light. Waterproof. Can be worn in bath. Send for amazing FREE book, "Advice To Ruptured," and details of liberal truthful 60-day trial offer. Also endorsements from grateful users in your neighborhood. Write:

CLUTHE SONS, Dept. 31, Bloomfield, New Jersey

SHOCK RESISTANT

SWISS WATCH
only \$6.95



HIT IT



DROP IT



Get this Sharp-Looking Swiss Wrist Watch. Specially made Shock Resistant to take all kinds of punishment: Can be dropped and we still Guarantee it to Run. Handsome SILVER color finish with matching Steel Expansion Band. Sweep Second Hand, Luminous dial. **Send No Money!** Pay Postman \$6.95 C. O. D. plus 10% tax and postage. Order Now!

WORLD-WIDE DIAMOND COMPANY

Dept. K-989, 2451 S. Michigan Av., Chicago 16, Ill.

**NEW!
CHEAP!**

OIL BURNER

SWEEPING THE COUNTRY!

**SALESMEN
BIG MONEY**

SLIPS INTO ANY COAL RANGE, STOVE OR FURNACE. Amazing quick, intense heat. By finger-tip control. Cheaper than coal. No more shoveling coal or ashes. **SENT ON TRIAL.** Prove it pays for itself quickly by what it saves. \$1 bonus for testing. We'll let you try one in your own home for one month. Write for details today. Northwest Mfg. Co., Dept. 835-N, Mitchell, S. Dak.

MAKE MONEY at Home

With Easy-to-Assemble Leathercraft Kits

YOU will be amazed at how easy it is to make attractive leather articles, for gifts or to sell, with LARSON Ready-cut Leathercraft Kits. **FREE** instructions, no experience or tools needed. Make purses, belts, billfolds, woolskin toys, gloves, etc. Send 10c Now for newest 24-page illustrated catalog of complete supplies, top quality leathers for beginners and advanced leatherworkers. **J. C. LARSON CO., 820 S. Tripp Ave. DEPT. 318 • CHICAGO 24, ILLINOIS**

LARSON
Leathercraft
Everything for
EXPERT OR
BEGINNER

BECOME A BETTER PAID MAN BY BEING A WELL TRAINED MAN

Learn a profitable trade—the Eastern Technical School way. Enroll now for an eight month course in Radio or Refrigeration. New classes beginning every April—August—December. Veterans—Nonveterans. Write for free catalogue. Graduates successfully placed from Coast to Coast.

EASTERN TECHNICAL SCHOOLS

888 PURCHASE STREET NEW BEDFORD, MASSACHUSETTS

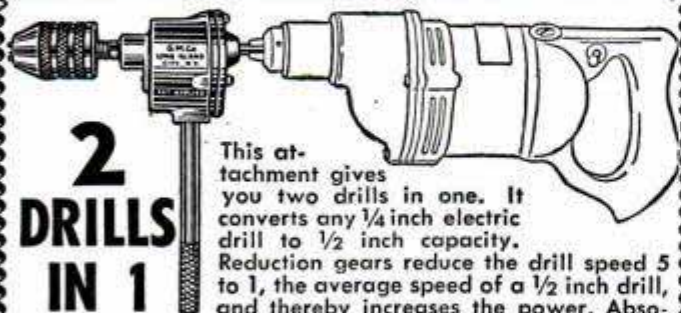

2 DRILLS IN 1

This attachment gives you two drills in one. It converts any 1/4 inch electric drill to 1/2 inch capacity. Reduction gears reduce the drill speed 5 to 1, the average speed of a 1/2 inch drill, and thereby increases the power. Absolutely indispensable for all shop work and home craftsmen. Satisfaction guaranteed. Order yours now.

\$11.95 post paid

G. M. CO. MANUFACTURING, INC.
1308 43rd AVE. LONG ISLAND CITY 1, NEW YORK

**FREE
10-DAY TRIAL**

HOUSE CARPENTRY and Joinery

DO IT YOURSELF AND SAVE MONEY!

Every step of carpentry in and around a house is clearly explained and illustrated in this big, useful book. Shows you how to build forms for foundations, footings, walls, steps, walks—How to build sills, girder supporting posts and girders—How to figure loads for house framing—How to lay out, cut and erect floor joists—How to lay flooring—How to frame outside and inside walls, allowing for openings—How to check the plumb of studs—How to brace and sheathe up outside walls—How to erect ceiling joists—How to frame around a chimney and stair well—How to lay out rafters for a gable roof, dormer roof, porch roof—How to sheathe the gable ends and rafters—How to build cornices—How to lay shingles—How to build porches and bays—How to apply siding—How to frame up inside walls—How to construct stairs—How to place trim around windows and doors—How to fit and hang sash—How to hang doors—How to make closets, shelving and built-in equipment—How to lay finished wood flooring, linoleum flooring—How to hang a set of garage doors—How to insulate.

OVER 600 ILLUSTRATIONS SHOW YOU JUST WHAT TO DO AND HOW TO DO IT

If you have a hammer, saw and plane, just follow the step-by-step directions and do any house carpentry job from foundation forms to interior trim. Here, in one remarkable volume, is the practical know-how that saves you time and money on house carpentry jobs of every description.

"I built my entire 5-room house myself with no other instruction except your book."—James Sidwell, Twin Falls, Idaho.

USE IT FOR TEN DAYS FREE

Don't send us a penny. Just mail coupon and get "HOUSE CARPENTRY" for 10 days FREE trial. If not delighted, send book back to us and owe nothing. If you keep it, entire cost is only \$3.98, plus few cents postage. Mail coupon below for your free-trial copy.

Send No MONEY

MAIL THIS COUPON

Simmons-Boardman Publishing Corp. PM-1150
30 Church Street, New York 7, N. Y.

Send me for 10 DAYS' FREE TRIAL, "House Carpentry and Joinery." I will either return it in 10 days and owe nothing, or send only \$3.98 (plus shipping charges) in full payment.

Name _____

Address _____

City _____ State _____

SAVE! Send \$3.98 with this coupon and we pay postage. Same return and refund privilege.

High School at Home

Many Finish in 2 Years

No classes. No time wasted going to and from school. Progress as fast as your time and abilities permit. Standard H. S. texts supplied. Thousands enroll each year in this 52-year-old school. Send for FREE descriptive booklet.

AMERICAN SCHOOL, Dept. H845
Drexel at 58th St., Chicago 37, Ill.

Without obligation, please send FREE descriptive booklet.

Name _____

Address _____

"TOOK IN \$217 FIRST 10 DAYS"

**Some Make More,
Some Less... We Help
You to Start Your
Own All-Year
Business, Make
Big Money!**

With our easily operated, highly efficient wall washer, Chas. Stelle took in \$217 gross in first ten days. E. L. Goss took in more than \$10,000 in one year. E. C. Taber wrote, "I made \$400 gross in two weeks." And no wonder — this machine washes walls 6 times faster and better than by hand.



Your Money-Making Opportunity

We want more men to go into this profitable business for themselves and enjoy independence. There are customers everywhere—homes, offices, schools, churches, hotels, stores, etc. What you take in is mostly profit, for material costs are low. And there's no need to rent a shop or office. Operate your business from your home.

Lose no time. Get all facts without obligation. **WRITE FOR FREE INFORMATION.** Ask for Wall Washer Details at once.

VON SCHRADER MFG. CO., E66 PL, RACINE, WIS.

START YOUR OWN WELDING BUSINESS AT HOME... Turn spare time to spare cash



BE THE WELDER FOR YOUR NEIGHBORHOOD

Repair Torn Fenders... Fix Toys... Braze and Solder Broken Parts... Charge Batteries with the

- Plugs into 110 volt AC appliance socket.
- Easy to weld, cut, braze or solder.
- Comes complete with full instructions.
- Approved by Underwriters Laboratories.
- Built by The Lincoln Electric Company, world leader in arc welding.
- Price with standard accessories only \$48.00.



**NEW
"LINCWELDER
60"
Lincoln
Arc Welder**

Fill out order and mail to The Lincoln Electric Co., Dept. 196, Cleveland 1, O.

Ship me the "Lincwelder 60" with accessories \$48.00 (including headshield, electrodes, carbons, electrode holder, ground clamp and cable).

Enclosed is check money order

Send me free bulletin on the new "Lincwelder 60"

Name _____

Address _____

City _____

State _____

New! PRINT YOUR OWN ADVERTISING POST CARDS

New, easy, low-cost way to greatly increase sales for any business! **ROTO-PRINT DUPLICATOR** prints and illustrates your Advertising messages on 1c Government Post Cards, or larger cards. Thousands surprised at great amount of extra business such low-cost advertising brings—and great amount of money it saves on printing. Also prints Announcements, Notices, Price Lists, Order Blanks, etc., on cards or paper. Dozens of uses for business concerns, churches, clubs, any organization. Many make big profits printing for others. Should pay for itself first time used. Not a toy—but a strong, speedy, professional machine. Easy to use. Cylinder and Handle of finest steel. Hard, smooth Base has Card Guide—to assure even, uniform printing. Prints several colors. **GUARANTEED FOR LIFE-TIME.** Comes complete with necessary supplies, instructions and **FREE Book of Money-Making Ideas.**



complete outfit
only \$9.95

LOW DIRECT-TO-YOU PRICE

AGENTS WANTED

FREE TRIAL OFFER! Write and a **ROTO-PRINT** will be sent you postpaid. Try for 10 days—then send only \$9.95, or return **ROTO-PRINT** with no questions asked. You are the sole judge. Write NOW!
ROTO-PRINT CO., 211 North 7th St., Dept. B-3, St. Louis 1, Mo.

New Way to Improve YOUR ENGLISH



A command of effective English gives you added advantages and better opportunities. Poor English handicaps you more than you will ever realize. You can improve your English through Sherwin Cody's 100% self-correcting invention. If you are embarrassed by mistakes in grammar, spelling, punctuation, or pronunciation, this new free book "How You Can Master Good English in 15 Minutes a Day" will prove a revelation to you. Send for it now. It is free. No obligation. No agent will call. Address **SHERWIN CODY COURSE IN ENGLISH, 511 B&O Building, Rochester 14, N. Y.**



CARTOONING

HAVE FUN! MAKE MONEY! Cash in on your sense of humor **AT HOME—BY MAIL.** No experience needed to start. Write today **FOR FREE TRIAL LESSON** and full particulars.
MOON Gag Cartoon School, Dept. D, Fall Creek, Wis.

"PLASTICS"

Fabricating Manual and Catalogue

Work in a fascinating and profitable hobby. Just out—our latest fabricating manual. Tells you how to work with Plastics. Our new Catalogue provides all needed materials: Plexiglas—Lucite—Tenite—Catalin—Acetate—all in sheets, rods, and tubes. Complete line of cements, dyes, accessories and supplies. Send 10c today for latest catalog and handbook.

HOUSE OF PLASTICS

8648 Linwood Avenue Dept. PM11 Detroit 6, Michigan

TRADE MAGAZINES

BUSINESS, VOCATIONAL, DIVERSION

For ideas to help you get ahead. Choose current copies, all fields, through our easy-to-get-acquainted plan. Send now for list. It's free.
COMMERCIAL ENGRAVING PUBL. CO., 34AB No. Ritter, Indianapolis 19, Ind.

BE AN AUTO MACHINIST



Draw Top Pay • No Job Worries

Earn more money in auto mechanics—Specialize! New **FREE** booklet tells how to prepare for good jobs with high pay and job security. Our modern equipment and practical instructions make it easy to learn—get experience in

ENGINE REBUILDING or GENERAL AUTO MECHANICS

VETERANS

American is a G.I. approved school.

Practical Shop Training Learn to operate the very latest shop machinery. Friendly instructors take a real interest in preparing you for a good job.

Job Placement Service FREE

PLANNING YOUR FUTURE IN AUTO MECHANICS

WRITE TODAY FOR FREE BOOKLET

AMERICAN TRADE SCHOOL

2417G McGee Kansas City, Mo.



PERFECT XMAS GIFT
FOR DAD • BROTHER OR YOURSELF . . .
Famous BEATTIE JET LIGHTER
EXPRESSLY DESIGNED FOR LIGHTING PIPES



GOVT. SURPLUS BARGAIN

Tilted slightly, flame jets directly into pipe bowl. Upright, an excellent cigarette or cigar lighter. Protective windshield guarantees strong flame out-of-doors and indoors.

Pigskin covered. Gun metal trim. Factory guarantee enclosed with each lighter.

Buy now while they last.

REG. \$5.00
NOW ONLY \$2.00 PPD



Please send cash, check or money order.
E. G. HOWARD CO.
 80 Washington St., Dept. A, Boston 8, Mass.
ORDER BY MAIL TODAY!

WANT FAST PROMOTIONS? **COMPLETE HIGH SCHOOL AT HOME**

Employers prefer high school graduates for managerial jobs. You can complete the C.T.I. guided study course in months. It equals resident work. Approved H.S. texts supplied. Credit for work elsewhere. College prep. Handsome diploma. Easy terms. Get set for success!—Write for valuable free booklet today!

COMMERCIAL TRADES INSTITUTE
 1400 Greenleaf Dept. H2-11 Chicago 26

STAMMERER? **GET THIS FREE BOOK!**

New booklet, "Stammering, and How to Stop It," sent free to any stammerer upon request. Write today. **BENJAMIN N. BOGUE**, Dept. 504, Circle Tower, Indianapolis 4, Ind.

LEARN AERONAUTICAL ENGINEERING
Aircraft and Engine Mechanics (A & E)

Train at the Flying Wing school—New classes starting soon. Write for illustrated catalog.

Northrop Aeronautical Institute
 APPROVED FOR VETERANS DIVISION OF NORTHROP AIRCRAFT, INC.
 1527 E. Broadway, Hawthorne, Los Angeles County, California

SAY YOU SAW IT IN POPULAR MECHANICS

Watch Repairing Pays Big Money Learn at home

Free Literature Tells How

Watchmakers in big demand. You train step-by-step under experts. You learn to take a watch apart—repair and put in perfect working order. 10 easy lessons. We furnish all tools, and a 15 jeweled watch. Practicemovement with first lesson.

Turn spare time into cash—perhaps a business of your own. A licensed school. Students 18 to 65 have profited by our training. Low cost.



Write Today for All the Facts—No Obligation

WATCH REPAIRING Dept. P-110, 2870 Elston Ave. Chicago 18, Ill.



SAVE ON WINTER FUEL BILLS!

WANT to chop \$25—\$50 off your heating bills this winter, and enjoy greater comfort at the same time? Then insulate your attic or top floor ceiling with new fireproof Gold Bond Rock Wool Insulation. A cinch to install. Comes in 2' or 4' Enclosed Batts and new 8' Sealed Blankets, in standard widths that fit snugly between attic floor joists or roof rafters. Completely enclosed for easy handling with Vapor Barrier on face side. Keeps furnace heat in and summer heat out. Get Gold Bond Enclosed Batts or Sealed Blankets from your dealer today. And for best results be sure to order them "full-thick"! Free descriptive booklet sent on request. Write Div. Y, Dept. PM-11.

Available at your local Gold Bond lumber and building materials dealer

NATIONAL GYPSUM COMPANY
 BUFFALO 2, NEW YORK

WANT A GOVERNMENT JOB?



START AS HIGH AS \$3,450 YEAR

Many Early Examinations Expected. Prepare NOW! Veterans Get Special Preference! 40 Page Civil Service Book FREE Mail Coupon Today SURE

Franklin Institute
 Dept. K-84
 Rochester 4, N. Y.
 (Not Government Controlled)

Gentlemen: Rush to me, FREE of charge, list of U. S. government big pay jobs. Send FREE 40-page book describing salaries, vacations, hours, work, etc. Tell me how to qualify for one of these jobs.

Name _____
 Street _____
 City _____ Vet? _____

★

Learn ELECTRIC APPLIANCE REPAIR IN YOUR SPARE TIME AT HOME



START YOUR OWN BUSINESS

ONE BUSINESS THAT IS NOT EFFECTED BY STRIKES, DEPRESSIONS OR POLITICS

WITH A POTENTIAL MARKET OF 50,000,000 CUSTOMERS

New shop-method, home-training system gives you electrical know-how that used to take years to learn. Learn at home by building valuable testing kits, repairing your own and neighbors' appliances. It is not unusual for appliance repairmen to charge on the basis of \$5.00-\$6.00 an hour.

FREE ILLUSTRATED BOOK

Shows you how you learn every phase of electrical appliance. How to make money while you learn. Write today for your FREE copy.

CHRISTY TRADES SCHOOL
Dept. D-8703
4432 North Kedzie Ave., Chicago 25

Handy Mail Order List

Little Library of Useful INFORMATION

5 for \$1.00
12 for \$2.00
25¢ Each

Here at amazingly low cost is the practical help and information you have always wanted. Articles in previous issues of Popular Mechanics have been classified according to subject and are now available in these handy reprint booklets.

How to Use Measuring Tools—
Micrometers, Calipers, etc.—106.

Power Driven Saws—74.
Drill Presses, Grinders, Etc.—79.
Wood, Metal Turning—Lathes—81.
Filing Machine, Hacksaw, Cutoff Wheel, Shaper—82.
Lathe Tools You Can Make—101.
Workbenches—Tool Cabinets—47.
Spray Painting—94.
From Pattern to Casting—91.
Tool and Saw Sharpening—92.
Sharpening Drills, Wood Bits—90.

Successful Wood Turning—32.
How to Read Blueprint—71.
Metal Turning Lathe Kinks—99.
Operating a Metal Lathe—100.
Heat Treating, Hardening—102.
Working With Glass—103.
Servicing Elec. Motors—75.
Electromagnets & Solenoids—44.
Transformer Construction—41.
The Boy Electrician—43.
Soldering and Brazing—17.
Arc and Spot Welders—5.

Electroplating With Nickel, Chromium, Cadmium, Etc.—86.
Plating Leather, Wood, etc.—87.
Lower Your Fuel Costs—31.
Curing Leaky Basements—45.
Fitting Home Game Room—55.
Indoor & Outdoor Fireplaces—88.
Backyard Gardening—39.
Lawn and Garden Novelties—72.
Trellises, Pergolas, Fences—76.
Lawn and Garden Furniture—77.
Playground Equipment—73.
How to Use Your Drill Press—125.
Making Serving Trays—53.
Knots and Ropework—105.

Sanders—80.
House Wiring—89.
Hanging Wallpaper—38.
Built-in Fixtures—78.
Bird Houses—7.
Magazine Racks—49.
Clock Cases—50.
Book Ends—52.

Small Tables—54.
Smoking Stands—56.
Desks—58.
Book Cases—59.
Action Toys—66.
High Flying Kites—67.
Telescopes—20.
Metal Craft—28.
Small Looms—37.

Working With Plastics—61
Simple Home Improvements—104
Ridding Home of Insect Pests—107
Children's Room Furniture—51.
Jigsawed Novelties—57.
Doll House & Doll Furniture—60.
25 Shelves You Can Make—64.
Novelties Turned on Lathe—62.
Inlay Pictures—Veneering—63.
Wood, Soap Carving—65.
Windmills & Weather vanes—68.
Lamps from Wood, Metal—69.
Rustic Furniture—18.
Wood Finishing—40.
How to Fix Electrical Appliances—111
Painting Your House—117
Build Your Own Relays—123
Rowboats, Small Dinghy—83.
Small Sail Boats—84.
Two Outboard Runabouts—85.
Build Own Canoe, Kayak—30.
Build Class-E Ice Yacht—22.
Auto Kinks, Shortcuts—10.
Lawn and Garden Equipment—124
Motor-Driven Midget Cars—34.
Stop Auto Elect. Troubles—95.
Photo Printers and Dryers—25.
Photo Darkroom Equipment—96.
Trick and Table Top Photos—97.
Home Movie Equipment—118
Poultry Houses—108.
Guns and Decoys—109.
Re-Silvering Mirrors—70.
Chemical Experiments—93.
Log Cabins, Tourist Houses—14.
Using Basic Tools—120
Farm and Garden Tractors—8.
Building Extra Attic Rooms—23.
Attractive Basement Rooms—24.
Gem Cutting—42.
Photo Enlargers—1.
Photo Kinks—98.
Cleaning Formulas—11.
Taxidermy—9.
Photo Lighting—119
Training Dogs—35.
Small Furnaces—36.

Check Titles Wanted, Clip, Mail with Remittance to
POPULAR MECHANICS PRESS, Dept. 23, 200 E. Ontario, Chicago 11

EARN BIG MONEY

RADIO TELEVISION ELECTRONICS

RADIO-TELEVISION is growing too fast for qualified men to handle it! Studios need trained technicians and broadcast operators. RIGHT NOW you can get in on the ground floor in Television as a studio control operator or as a TV installation and service man. Start a service shop in your own home!

ELECTRONICS means rich opportunity for thousands of qualified men! Government and industry send expert electronics engineers all over the world to install, service and operate electronics equipment. In America, thousands of job openings call for trained men!

Central's MASTER COURSE in Radio-Television-Electronics can prepare you quickly for a bright future in these fast-growing industries. LEARN AT HOME IN YOUR SPARE TIME with practical lessons and nine big home lab kits for fascinating experiments.

FREE PLACEMENT SERVICE to help you secure a top pay job!

NOW IS THE TIME TO GET INTO THIS NEW, RICH FIELD OF OPPORTUNITY!

Central Radio and Television Schools, Inc.
Dept. PM, 1644 Wyandotte, Kansas City, Mo.
I want complete information on how I can succeed in Radio, Television and Electronics. This does not obligate me in any way.

Name _____
Address _____
City _____ Zone _____ State _____

CENTRAL RADIO AND TELEVISION SCHOOL
17th & WYANDOTTE ST. KANSAS CITY, MO.

YES! SEND



directly to my door every month

I am enclosing

\$3.50 for 1 year

\$8.00 for 3 years

name _____

address _____

city _____ zone _____ state _____

Hand this order to your newsdealer or send it to

POPULAR MECHANICS
200 East Ontario St. Chicago 11, Ill.

NEW "PAINT PEN"

PAINT STRIPING TOOL
Works like a Fountain Pen
Stripes with Paint instead of Ink!

This amazing new "PAINT PEN" is a Paint Striping Tool that makes it easy to do expert striping on furniture, bikes, model planes, autos, signs, toys, linoleum, wall board, etc. Makes plain, painted walls look like tile. Paint straight, curved, circular or evenly spaced parallel lines the same way a professional painter does. Simply fill Tubular Glass Paint Fountain with any color paint and wheel tip feeds paint evenly without spreading, smearing, smudging. Tips interchangeable — jaws split apart for easy cleaning. Tool complete with tip for 1-16 inch stripe only \$1.00 postpaid. Other complete tools with 1-64, 1-32, 3-64, 1-16, 5-64, 3-32, 1-8 inch tips, \$1.50. Separate tips, 75c each. Complete KIT with 7 tips, \$5.00. Here's the handiest tool in your whole painter's kit. Get yours today.



Paint STRAIGHT, CURVED OR PARALLEL LINES

Home Craftsmen

Just the tool you've been waiting for! New Paint Striping Tool gives "professional" results every time, yet simple and easy to use as a fountain pen. Adjustable guide keeps lines straight as an arrow. Just as easy to make curves or free hand designs. Adds new beauty and finished look to everything you paint. Send \$1 now!

DEALERS
PAINT STRIPING TOOL packed in display cartons of 1 doz. Fast, profitable seller. Write for illustrated circular, discounts

Only **\$1.00**

WENDELL MFG. CO., Dept. 311, 4234 LINCOLN AVENUE, CHICAGO 18, ILL.

Secrets of VENTRILOQUISM Now Revealed!



Fit yourself NOW for bigger income in highly admired and UNCROWDED profession. Ventriloquism can be learned by any one, with proper instruction. Let an expert teach you. "Ventrilo-Aid" and "Dummy" included. Training guaranteed. Be popular, earn money at clubs, stage, television, radio. Information free.
FRED MAHER SCHOOL OF VENTRILOQUISM
Box 36, Studio K, Kensington Sta., Detroit 24, Michigan

LEARN WATCHMAKING JEWELRY REPAIRING

Start your training now for a better paying job or your own profitable business. Our training is nationally recognized, outstanding and supervised by expert craftsmen. Write for free catalogue.

APPROVED FOR VETERANS

SCIENTIFIC SCHOOL OF WATCHMAKING, Dept. PM-11
3923 San Fernando Road Glendale 4, California

YOU CAN BE AN All Around HE-MAN 10c
All 5 famous courses by George F. Jowett, world's greatest body builder, in 1 complete muscle building volume (valued at \$5 each) now only 10c. Packed with How-to-Do-it pictures. 1. How to Mold a Mighty Arm. 2. Mighty Chest. 3. Mighty Back. 4. Mighty Grip. 5. Mighty Legs. Free strong men photo book. Quick results or money back! Send 10c name, address, age. **JOWETT INSTITUTE, Dept. PM-011, 230 Fifth Avenue, New York City**

TRAIN Your VOICE!
RESULTS GUARANTEED
STRENGTHEN your voice this tested, scientific way. Yes—you may now be able to improve. . . in the POWER of your speaking and singing voice . . . in the PRIVACY of your own room! Self-training lessons, mostly silent. No music required. Write TODAY for Eugene Feuchtinger's great booklet "How to Develop a Successful Voice." It's absolutely FREE! You must state your age. Booklet mailed postpaid in plain wrapper. No salesman will call. Send your name and age RIGHT NOW! Prefect Voice Institute, 210 S. Clinton St., Studio L-2, Chicago 6, Ill.

RUPTURE-EASER

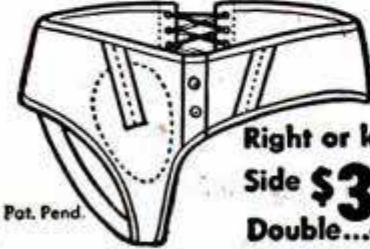

Right or left Side **\$3.95** Double...**4.95**

right or left side or double. We Prepay Postage Except on C.O.D.'s.
PIPER BRACE CO.
308 EAST 12th, DEPT. PM-115, KANSAS CITY 6, MO.

PLASTICAST

THE GREATEST THING IN PLASTICS!



A NEW HOME INDUSTRY and HOBBY!



We have started THOUSANDS of people in a wonderful new kind of business! Here are 4 reasons why: (1) The work is pleasant and very easy . . . actually as easy as pouring water out of a glass! (2) VERY LITTLE investment is required; imagine, less than \$5.00 is required in order to start you off in your own manufacturing business! (3) Can be started ANYWHERE . . . at home, garage, basement, etc. and most important (4) The things you can make in QUANTITY PRODUCTION are not only exceptionally attractive and useful but are always in big demand every season of the year! **VAST QUANTITIES OF PLASTIC COMPONENTS NOW NEEDED BY ARMED SERVICES!**

YOU CAN MAKE ANYTHING!

What is this new business? It is **CASTING** . . . Casting with liquid plastics. **CASTING** is a method of production manufacturing WITHOUT MACHINERY OR TOOLS! **CASTING** is the exceedingly simple process of pouring liquids into molds . . . It is as simple as that: Like making Jello, only these liquid plastics **SOLIDIFY** in a few minutes after mixing into extremely **HARD, DURABLE** and **ATTRACTIVE** articles such as Jewelry, Novelties, Giftware, Figurines, Statuary, Knick-Knacks, Baby Shoes, Souvenirs, Ceramics, Imitation Marble, Bookends, Lamps, Pen sets, Cigarette Lighters, Toys, Dolls, Banks, Fishing Lures, Tools . . . **A THOUSAND USEFUL THINGS!** The field is really unlimited. We supply EVERYTHING . . . Casting Materials, Molds, Accessories and Instructions.



1000 GOLDEN OPPORTUNITIES!



Regardless what you are doing now you can get into the **CASTING BUSINESS** in your spare time or evenings. We assure you, once you do, you will be eagerly devoting all of your time to this very easy, fascinating and **HIGHLY PROFITABLE OCCUPATION** until it leads into a dependable business all your own! **BUT LET US PROVE IT.** Send only 25c for our big 40 page Catalog of Casting Materials, hundreds of Molds, etc. We will also send you **FREE** an attractive **CASTING** to show you what can be done with liquid plastics in a few minutes! We will also send you **FREE** a valuable book giving you details on the **ART AND BUSINESS OF CASTING** which shows you how to cast and get started! All this for only 25c, but write for it today. *This may be the lucky coin that will start the most fascinating and profitable phase of your life!*

10 VALUABLE MOLDS FREE!



If you want to get started at once without delay then send for our big **SENIOR PLASTICAST OUTFIT** . . . here is what you receive! **TEN VALUABLE MOLDS** for making extremely beautiful and useful **TRANSPARENT** crystal-clear or colored plastic articles, as illustrated directly above! Make unusual Penholders, Cigarette Lighters, Ash Trays, Perfume Sets, Pendant Hearts, Imbedded Flowers and Photos, Buttons, Key Chain Fobs and countless other attractive items! Outfit also includes 1 qt. **PLASTICAST** liquid casting plastic and hardener which will make about \$100. worth of material, pipette, measuring glass, colorful imbedding material, polishing material, 2 dyes and Instruction Manual. **OUTFIT No. 646, price postpaid \$7.50**

Our **MASTER OUTFIT** contains 4 molds, pint of **PLASTICAST** and hardener, pipette, measuring glass, imbedding material and Manual. **OUTFIT No. 4 Price, postpaid . . . \$3.50** C.O.D. orders filled (not postpaid) if \$1.00 deposit sent with order.

FREE

An attractive Casting and valuable **BOOK** shown at the right sent **FREE** with our Catalog! See 3rd paragraph above.

PLASTICAST COMPANY (DEPT. C)

170 N. Halsted St. (Write to P. O. Box 987 Chicago 6, Ill. nearest address) Palo Alto, Calif.
CUSTOMERS OUTSIDE U. S. A. please remit \$3.35 for catalogue and add 10% to all list prices.

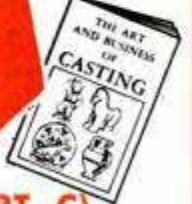

FREE Trial Uke Offer Play Famous Islander Uke in 5 Minutes or No Cost



Here's the Maccaferri "ISLANDER" Arthur Godfrey talked favorably about on television . . . AND . . . it's yours with lessons at a bargain price. It's a beauty in looks and a honey in tune. You'll be proud of it . . . prouder when you play it. Enchanting melody at your finger tips with words and music. Professional type and tone. Popularity is easily yours with this Uke. Has frets, non-slip thumb screws, nylon strings. Guaranteed not to warp or chip . . . you'll play in 5 minutes . . . yes, love songs, westerns, hymns. Step up your enjoyment. Take and play your uke everywhere.

OUR OFFER

Send your name and address today. Your "ISLANDER" lessons, songs, sent by return mail. Pay postman introductory price of \$5.95, plus postage. If not thrilled, return in 10 days for full refund. (Save postage, enclose \$6.00 now. Same guarantee).

FREE LESSONS

Four easy steps start you playing in 5 minutes. Pictures and story guide you just like a teacher. No musical experience needed. It's so easy! It's all FREE with this offer, including 20 favorites... Love Songs, Westerns, Hymns, etc.



SPECIAL: Deluxe ISLANDER, finest uke made, only \$7.95. State Deluxe, if desired.

BECCY, INC. 534 Pearl St., N.Y. 7, N.Y., Studio 1411

LEARN WATCH REPAIRING



AT HOME. By our modern and original system of instruction you can learn every part of the **WATCH REPAIRING TRADE AT HOME.** Prepare yourself for a well-paying position or start in business after completing our course of instruction. Good watch repairers are in demand and generally earn very good salaries. For particulars apply to the **WISCONSIN SCHOOL OF WATCH REPAIRING** 759 North Milwaukee St., Milwaukee 2, Wis.

LEARN BY MAIL

MATH-PHYSICS

Practical simplified courses in ALGEBRA and GEOMETRY, TRIGONOMETRY, PHYSICS, ENGINEERING DRAFTING

VETERANS FREE UNDER G. I. BILL

MAIL COUPON TODAY for free information about 30-lesson courses checked below:

- ALGEBRA and GEOMETRY TRIGONOMETRY
 PHYSICS ENGINEERING DRAFTING

NAME _____

ADDRESS _____

CITY _____ STATE _____

Check if Veteran. Approved under G.I. Bill

LAIN COLLEGE 601 N. DELAWARE INDIANAPOLIS, IND.

FIX IT or FASTEN IT
Better and Faster!



NEW TINNEMAN Speed Nut®

TINKER KIT



SPEED NUT—the one-piece, self-locking, vibration-proof fastener — famous throughout industry... **NOW READY FOR HOME USE!** Handy assortment of 10 popular sizes of **SPEED NUTS** and matching screws. Over 100 home repair and hobbycraft uses. Once on—they stay on! Replace threaded nuts and lock washers.

ONLY \$1.00
POSTAGE INCLUDED
SEND CASH OR CHECK—NO STAMPS

TINNEMAN PRODUCTS, INC.
DEPARTMENT 13 • CLEVELAND 1, OHIO

\$100 "MIRACLE" CAMERA

can be Yours for **\$3.95** Only



Make your own High-Speed Camera—Enlarger—Slide Projector—Movie Film Viewer—Shadowgraph—Burglar Alarm Lights—Engraving Spot—Telescope—Signal Light—Magnifier—Code Blinker Light. ALL OF THESE and many more useful things can be made with this fine precision made piece of optical equipment.

Contains color corrected anastigmat lens 2 1/4 inches in diameter, 5 1/2 inch focal length, Cast Aluminum Case, Water-Tight Cover Glass, Front Surface Reflecting Mirror, Reticle, Lamp Socket, 28-Volt Lamp Bulb, Micrometer Adjustment of Socket, Bull's-Eye, etc. Booklet of instructions showing how to make many of the above items included. This offer may never be repeated. Rush check or money order today to

ELECTRONIC PRODUCTS CO., Dept. PM-2, St. Charles, Ill.

SAY YOU SAW IT IN
POPULAR MECHANICS

ARTISTS MAKE MONEY

Do you like to draw? Send name, address, age and occupation for **FREE ART TEST**, to find out your ability.

ART INSTRUCTION, Inc.

11130 ART INSTRUCTION BLDG., MINNEAPOLIS 15, MINN.

A "GOOD HAND" HELPS YOU SUCCEED!

LEARN TO WRITE WELL

Put Your Name beautifully written, plus special pen-point for shaded writing. **OUR 53rd YEAR** Only 10¢

Handwriting quickly improves with our easy-to-understand picture lessons! Put your spare time to good use; send today for **FREE BOOK**, "How to Become a Good Penman", or check volumes wanted below at \$1 each: Business Writing Artistic Writing Card Writing Bird & Design Flourishing Engrossing Alphabets. **COMPLETE SET \$4.50**

TAMBLYN SCHOOL of PENMANSHIP
S. A. Ziller, Pres. 442 Ridge Bldg., Kansas City, Mo., USA

IS \$21000 A WEEK Worth a Penny Post Card?

Then RUSH postcard with name and address. Get **FREE** details of amazing full-and-spate-time **PROFITS** made by ambitious men handling new **Automatic Defroster** for refrigerators on **FREE TRIAL** basis. Learn how housewives hand you big profits when you just plug in the **D-Frost-O-Matic** to end defrosting mess forever. Send card for Special Offer **TODAY**.

D-FROST-O-MATIC Dept. PM-11
6 N. Mich. Ave. Chicago, Ill.

Specialize in These Expanding Fields—

⇨ AIR CONDITIONING ⇨ HEATING

⇨ REFRIGERATION

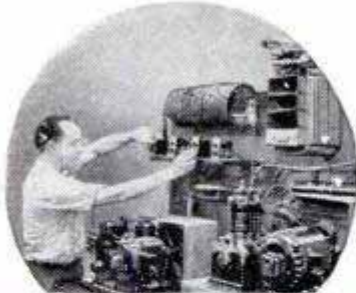

In 6 to 24 months you can prepare for a substantial opportunity in industry or a business of your own. This 47-year-old school of technology offers world-famous training programs in these fascinating fields. Experts from private business cooperate with faculty specialists to keep courses geared to latest developments. Laboratories and shops are well equipped. Specialized technical training is coupled with solid education in basic sciences and related arts. You pass step-by-step to certificates of "Refrigeration Serviceman" in 6 months — "Refrigeration and Heating Serviceman" 6 months later — "Refrigeration, Heating, Air Conditioning Technician" in 12 additional months.

Courses Offered by This College and Technical Institute

SERVICE — 6 to 12 months
• Electricity • Welding
• Refrigeration, Heating

TECHNICIAN—12 to 24 mo.
• Radio — Television •
Electronics • Electro-
technics • Refrigeration,
Heating, Air Condition-
ing • Welding

PROFESSIONAL—36 months
• Electrical Engineering
(Major in Electronics or
Power) — B. S. Degree

— Alma mater of 35,000
— Terms start Jan., April,
July, Oct.



WRITE FOR NEW, comprehensive, "Occupational Guidance" pamphlet on Refrigeration, Heating and Air Conditioning.

MILWAUKEE SCHOOL of ENGINEERING

Technical Institute • College of Electrical Engineering

MILWAUKEE SCHOOL OF ENGINEERING
Dept. PM-1150, N. Broadway and E. State, Milwaukee, Wis.
RUSH free "Combination Catalog and Occupational Guidance Manual" on the following course.....

NAME..... AGE.....

ADDRESS.....

CITY.....ZONE...STATE.....

Check if World War II Veteran

OUT OF PAWN SAVE UP TO 50% AND MORE

GENUINE DIAMONDS

Approx. 1/2 Carat \$95 Tax Incl. \$200 Value

SAVE ON DIAMONDS FROM ESTATES, BANKS AND UNREDEEMED PLEDGES

SEND FOR FREE ILLUSTRATED Catalog

MONEY BACK GUARANTEE

All diamonds reset in brand new modern mountings. Values from \$10.00 to \$10,000.

BERMAN'S DIAMOND LOAN BANK
DEPT. P—BERMAN BLDG., BALTO. 1, MD.

Our Ref. Your own bank or any mercantile agency.

PREPARE NOW FOR A TV CAREER



AT LAST

The ABC's of TELEVISION

Covers Every TV Service & Repair:

Tube installation, adjustment; circuit trouble, tuning, scanning repairs; control adjustments; sight-sound synchronization; "poor picture" cures; testing equipment; Color TV; brightness control and D-C reinsertions; techniques of camera pickup.

Same FREE EXAMINATION Offer On —

"Elements of Radio Servicing." 474-page manual explains every radio repair job. 375 pictures, diagrams. Only \$4.50 on easy terms.

ALL IN ONE BIG BOOK

GIANT guide shows how to prepare now for the big-pay jobs or your own business—in this fast-growing field. 592 pages, 401 pictures, diagrams, 14 tables, charts. Trouble-shooting charts show how to install, service, repair receivers. How to read oscilloscope screen patterns. Covers every FM receiver alignment problem. Everything you need to know to qualify for FCC's 1st Class License Test. **FREE 10-DAY EXAMINATION**—Coupon will bring you "Basic Television" to examine FREE—without obligation. Mail it NOW!

McGraw-Hill Book Co., Inc., Dept. PM-11, 327 West 41st St., New York 18, N. Y.
Please send me for 10 days' FREE EXAMINATION:

Basic Television (Grob). If not satisfied, I will return it, pay nothing. Or, I will keep it, send only \$2. then (plus shipping) and \$2.25 for 2 months.

Elements of Radio Servicing (Marcus). If not satisfied, I will return it, pay nothing. Or, I will keep it, send \$1.50 then (plus shipping) and \$1.50 for 2 months.

WE'LL PAY POSTAGE if you enclose full payment WITH coupon.

Name.....

Address.....

City..... State..... PM-11

CHECK HERE TO GET INFO. ON WEEKLY CASH COMMISSION PLAN, taking orders where you work for McGraw-Hill books like these. Easy, profitable, no obligation!

STATEMENT OF THE OWNERSHIP, MANAGEMENT AND CIRCULATION REQUIRED BY THE ACT OF CONGRESS OF AUGUST 24, 1912, AS AMENDED BY THE ACTS OF MARCH 3, 1933, AND JULY 2, 1946 (Title 39, United States Code, Section 293) of Popular Mechanics Magazine, published monthly at Chicago, Ill., for October 1, 1950. 1. The names and addresses of the publisher, editor, managing editor, and business managers are: Publisher, Popular Mechanics Company, 200 E. Ontario St., Chicago 11, Ill.; Editor, H. H. Windsor, Jr., 200 E. Ontario St., Chicago 11, Ill.; Managing Editor, R. M. Grant, 200 E. Ontario St., Chicago 11, Ill.; Business Manager, W. H. Petridge, 200 E. Ontario St., Chicago 11, Ill. 2. The owner is: (If owned by a corporation, its name and address must be stated and also immediately thereunder the names and addresses of stockholders owning or holding 1 percent or more of total amount of stock. If not owned by a corporation, its name and address, as well as that of each individual owner, must be given. If owned by a partnership or other unincorporated firm, its name and address, as well as that of each individual member, must be given.) Popular Mechanics Company, 200 E. Ontario St., Chicago 11, Ill.; H. H. Windsor, Jr., 200 E. Ontario St., Chicago 11, Ill.; H. H. Windsor, Jr., Trustee for H. H. Windsor III and Wm. T. Windsor, 200 E. Ontario St., Chicago 11, Ill. 3. The known bondholders, mortgagees, and other security holders owning or holding 1 percent or more of total amount of bonds, mortgages, or other securities are: (If there are none, so state.) The Equitable Life Assurance Society of the United States, 29 So. LaSalle St., Chicago 3, Ill. 4. Paragraphs 2 and 3 include, in cases where the stockholder or security holder appears upon the books of the company as trustee or in any other fiduciary relation, the name of the person or corporation for whom such trustee is acting; also the statements in the two paragraphs show the affiant's full knowledge and belief as to the circumstances and conditions under which stockholders and security holders who do not appear upon the books of the company as trustees, hold stock and securities in a capacity other than that of a bona fide owner. 5. The average number of copies of each issue of this publication sold or distributed, through the mails or otherwise, to paid subscribers during the 12 months preceding the date shown above was: (This information is required from daily, weekly, semiweekly, and triweekly newspapers only.) (not daily publication) H. H. Windsor, Jr., Editor. Sworn to and subscribed before me this 21st day of September, 1950. Vera L. Freehill, Notary Public. (My commission expires July 17, 1954.)

**The Money Saving and
Time Saving Book for
Every Home Owner—
Repairman—Handy-
Man and Others!**

**NEW
POPULAR MECHANICS
HOW-TO-DO-IT
Practical Help!**



**Tells How To Protect Your Investment
by Keeping Your Home, Equipment,
Furnishings Up to Date!**

Popular Mechanics Complete Book of Home Repair and Improvements is the last word in dependable, money-saving help for every home owner. It can easily save hundreds of dollars every year on home maintenance and improvement, inside and out, including equipment, furnishings and the lawn and garden. Packed with practical, simplified HOW-TO-DO-IT instruction and hundreds of pictures and diagrams, it eliminates expensive labor costs and annoying delays. It shows you how to make things you want in your home—how to do things that will keep it up to date—at little or no cost—and with only the simple tools anyone can use.

Hundreds of Around-the-Home Jobs Explained

It shows you in plain simple words and lots of pictures, how to cure a leaky basement—hang a new door—even build your own deep freeze. How to do electric wiring—repair appliances—replace old plumbing and electrical fixtures. It tells how to get more heat with less fuel—how to do your own upholstery—hang wallpaper—make kitchen cabinets—built-in shelves—make a coffee table—kneehole desk—an outdoor fireplace. These are only a few of the hundreds of things you can make and do by following simple instructions and pictures, and best of all, you'll enjoy the fun of doing it yourself and save three-fourths or more of the cost.

Mail This Coupon Today . . .

POPULAR MECHANICS PRESS, Dept. 13
200 East Ontario St., Chicago 11
Send at once _____ copies of HOME REPAIR AND IMPROVEMENTS at \$3.98 each. Remittance enclosed. Outside U.S.A. add 15%.
 Send C.O.D. postage extra

Name _____
Address _____
City _____ Zone _____ State _____

**BIG
512 PAGE BOOK
HUNDREDS OF
ILLUSTRATIONS
Only \$3⁹⁸**

**A Few of Hundreds of
Things You Can Do
With the Help of
This Book**

- Step-Saving Kitchens
- Weather Strip New Roof
- Laying Hardwood Flooring
- Building Sturdy Fences
- Finishing Floors
- Glass Cutting Made Easy
- How to Install a Door
- How to Make Concrete
- Air Filters for Your Windows
- Garden Fireplace
- "Built-Ins" and Cabinets
- Tuckaway Picnic Furniture
- Cure Leaky Basements
- Garden Furniture
- Home Freezer Unit
- Electric Hedge Trimmer
- Paint Magic for Walls
- Motorize Your Mower
- Hanging Wallpaper
- Carved Desk Set
- Wood Finishing Stains
- Bunks and Storage
- Modern Finishes
- Kneehole Desk
- How to Fix Appliances
- Restoring Antique Furniture
- Rewire Your Home
- Welsh Dresser for China
- Basic Plumbing
- Replacing Cane Webbing
- Stop Heat Waste
- Upholster It Yourself
- Make Storm Sash
- Easy-to-Make Stool
- Save Fuel by Caulking
- Pad It with Foam Rubber
- Home Landscaping with Evergreens
- Solder It Right
- Folding Workbench

Pays For Itself—Over and Over

The saving on one home job will more than pay the low cost of this amazing book. Multiply that saving by the number of jobs that must be done about the average house each year and you realize how Home Repair and Improvements can so easily reduce your living costs. Mail coupon today for immediate, money-saving benefits.

**WORLD'S
BEST
WANT AD
MEDIUM**

CLASSIFIED Advertisements



Advertisements in this section 75 cents per word, each insertion, minimum 10 words, payable in advance
To be inserted under proper classification, copy must be in our office the 22nd of the
second month preceding date of issue

F. W. Johnson, Manager, Classified Advertising
Popular Mechanics Magazine, 200 East Ontario Street, Chicago 11, Illinois

1030 CLASSIFIED ADVERTISEMENTS 1030 OPPORTUNITIES FOR YOU

AUTOMOBILES, MIDGET CARS

WORLD'S 1st Economical gas turbine jet engine for automatic use. Wow! For hot rods. Custom built. Literature 25c. Plans \$10.00. Dealers wanted. Jet Engine Co., St. Augustine, Fla.

SEE Our ad under Motorscooters for midget car bargains. Midget Motors Directory, Athens, Ohio.

PARK Safely without lights. Use brilliant fluorescent reflectolite tape on your car, tractor, wagon, motorcycle. Send \$1.00 postpaid per bumper. Red for rear, silver for front. Lasts for years. Child can apply. Donross Co., 60 So. Prairie, Galesburg, Ill.

RACING Equipment from California. Speed-dress-up accessories for every make passenger automobile. Also, racing ignitions, carburetors, flywheels, camshafts, water injectors, mufflers, crash helmets, jet engines. Thousands of items in stock! Dual manifolds for jeeps to rockets. Finned hi-compression heads, covering 155 makes, models. 1951 illustrated 40 page catalogue plus, Driving Economy 25c. Dealers, request wholesale catalogue. Newhouse Automotive Industries, 5805-B7 East Beverly, Los Angeles 22.

YOUR Car burn oil? Poor compression? Slow starting? Excessive cylinder wear? Holt's Piston Seal restores compression! Cuts oil consumption! Checks piston slap! Lasts 10,000 miles! This amazing British product, now available, forms self-expanding pliable lubricating seal around pistons. Compensates for wear! Cannot harm finest engine. Easily installed; full directions enclosed. \$4.95 tube for 6 or 8 cylinders up to 240 cubic inches. Free details. Treglown Company, 200 West 7th Street, Plainfield 8, New Jersey.

FREE Cash discount coupons included with big 1951 hot rod and speed equipment catalog showing 1000 accessories, Hollywood mufflers, duals, manifolds, cams, heads, bargains! Complete 25c. Dealers wanted. Almqvist Engineering, Milford 54P, Pennsylvania.

GENUINE Crosley parts. Factory rebuilt engines \$124 exchange; clutch plates \$5.75; new Goodyear #50 x 12 tires \$7.50; heavy duty 35 amp. generator change-over kit \$59; parts book \$1.25. Glenn Walraven Motors, "King of the Crosleys," Marion, Ohio.

SPEED And Mileage Manuals. New deluxe 60th edition, world famous power book, endorsed by champions! Covers speed, power, economy, increasing for all passenger cars. Shows speed equipment construction, speed tuning, race car building, California hot rod plans, custom restyling, sports car conversions, etc. Double your power, gas mileage, acceleration. Get top racing performance from any car! Shows easy ways to build speed equipment, superchargers, dual manifolds, high compression heads, dual mufflers, racing cams, water injectors, economizers. Save 75%! Complete instructions with working diagrams on engine rebuilding, souping-up, restyling, gas saving, racing tricks, fuels, speed secrets, balancing, porting, jet, formulas, ratios, frames, Offys, Indianapolis methods! Also reveals 100 ways to save gas. Covers California customizing! Streamlining! Lowering! Sport changes! Roadster plans! Blueprints! 200 m.p.h. conversions, Fords, Chevs., Plys. All makes! 320 illustrations. Guaranteed finest! Worth \$10.00. Big Manual plus Speed Equipment Catalog, plus California Hot-rod Handbook, all three books \$1.98. Almqvist Engineering, Milford 51P, Penna.

NEW Sensational seat cover. Mono, 6545 Santa Monica Blvd., Hollywood, California.

PISTON Displacement chart—Send 25c for new big wall chart and handy pocket piston speed calculator. Warren Fraser's, 5853 W. Washington Blvd., Culver City 2, Calif.

WIGLESWORTH - Chasteen's Automobile History Scrapbook #1. Just published! Over 250 ads and illustrations of antique and vintage automobiles—all new material. \$1.50. Wiglesworth-Chasteen, 7134-P3 Alhambra, Mission, Kansas.

STOP Excessive oil consumption. Save money. Complete instructions for a dollar bill. Kerman Instrument Co., 407 S. Dearborn, Chicago 5, Ill.

MOTORIST'S Handbook saves time, money on service and repairs. 156 pages of auto hints and kinks, only \$2.00. Popular Mechanics Press, 200 E. Ontario, Chicago 11, Illinois.

NEW Small cars. Immediate delivery. Crosley, Morris, M.G., Hillman Minx. 1/2 down. 21 mo. to pay. Fly to Marion, via regular airline for your car. All expenses paid. Literature 25c. Phone, wire or write, Glenn Walraven Motors, "King of the Small Cars," Marion, Ohio. Phones 2-4135; 2-5708.

1951 SPEED Equipment bargains. New dual manifolds \$9.95, adjustable tappets \$9.95, V-8 hi-compression heads \$23.50, Hollywood mufflers \$4.50, V-8 duals \$15.90, racing stacks 98c, camshafts \$29.95, chrome tailpipe megaphones \$1.55. All popular lines! Free premiums! Big speed equipment catalog 25c. Dealers wanted. Almqvist Engineering, Milford 53P, Penna.

SPEED And Power Handbook, 128 enameled pages! Covers all makes of cars! Fifty breathtaking chapters. Including jet propulsion, racing frames, wheel geometry, dynamometers, reciprocating masses, gear ratios, dual pipes, fuel formulas, porting, balancing, lowering, relieving. Authentic, direct from California! Shows exactly how to build your own dual manifolds. Superchargers. Hot cams. Water injectors. Hi-compression heads. Mileage devices! Save, save, save! Get up to ten more miles per gallon, racing speed, lightning acceleration. Get dynamic power increases from any make passenger automobile! Build fast stock cars. California roadsters. 160 m.p.h. rods! Includes construction drawings! Tuning techniques! Speed tricks! Economy secrets! Ingenious formulas! Plus California Customizing. Photographs. Newest ideas. Conversions. Re-styling all makes. Also, 40 page speed equipment picture catalogue. Plus alcohol injection. Plus big "Economy Handbook." 300 illustrations. Five items \$1.98 postpaid. Newhouse Automotive Industries, 5805-B2 East Beverly, Los Angeles 22. (See page 39.)

SPEED Equipment for Fords, Chevrolts, Willys, Studebaker, Lincoln. New illustrated literature and instructions \$1.00. R. & R. Mfg. Co., Box 546A, Anderson, Ind.

"WATER Injection". Also speed, power, economy methods. Free illustrated information. Neher Industries, La Verne, California.

CALIFORNIA Custom accessory headquarters. Buy direct from original designers and save. Chrome dash panels, solid hood sides, grille panels, speed equipment, dual pipes, push button door conversions, chrome motor accessories, fender skirts. 34 page illustrated catalog 25c. Eastern Auto, 3319A South Grand, Los Angeles 7, Calif.

CHEVROLET Owners—Don't "Watch the Fords go by." Your Chevy can beat the Fords. Stamp brings particulars. Hi-Torque Speed Shop, Liberty, N. Y.

SILENCE Overhead-valves, attachments unnecessary. \$2.00. Derderian, Box 542, Sandston, Virginia.

SMITHYS Mufflers for all automobiles. Free list. Buck's Auto Parts, Box 1296H, Merced, California.

FROM Speedway to roadway! Track-proved hi-speed heads and manifolds now available for your passenger car! No special tools needed! Increase horsepower 25%! Astounding getaway! Free illustrated catalog. Speedsport, 6215P Diversey, Chicago 39.

AUTO SUPPLIES AND EQUIPMENT

AMAZING \$3.95 Motor heater helps start autos in coldest weather. Write for free circular. Utilities Mfg. Co., Box 446, Easton, Penna.

REBUILD Starters, generators, regulators, batteries. Introductory manual \$1.00. Modern Technical Manuals, Box 4704, Kansas City, Mo.

GET Extra profits on repair work. Do your own welding. Easy to use. Catalog free. Hobart Welders, Box M-1105, Troy, Ohio.

1950 SUPERIGNITIONER \$4.50, 13 Improvements cars \$1.00. EG, Elmsford, N. Y.

MAGNETIC Dash trays, plastic steering wheel covers, visor mirrors, T-V antennas, curb feelers, window frost shields, \$1.00 each. Jay Sales, 161 Wisconsin, Milwaukee, Wis.

DOUBLESEAL Insulates under sectional overhead doors. Edwards Industries, Dept. 106, 4268 Shenandoah, St. Louis 10, Mo.

MOTORISTS Save gasoline by Vacuumating overrich mixtures. Fits all cars. For free particulars write Vacuumatic, Dept. 1671, Wauwatosa, Wis.

DRIVE Safely—Side window wiper \$1.00 postpaid. Agents wanted. Park Sales, P.O. Box 73, Forest Park, Illinois.

CHEVROLET Speed catalog (illustrated). Finest proven equipment for increasing mileage, power and all-round performance '37 thru '50 models. Only 25c. California Bill, 4411 York (Dept. B-9), Eagle Rock, California.

SAFETY Pilot belts. Ideal for racing cars. \$1.95. Special price to dealers. Harmelin, 5459 Blackstone, Chicago 15.

BUICK Parts—Enjoy new-car pep and power in your old Buick. Same day service from world's largest stock of new (not rebuilt) Buick parts and engines. Ship anywhere. Write today. Robertson Buick Co., 1001 S. Washburn Ave., Chicago 5, Ill.

JUST Out! Get the largest auto accessory and parts catalog in the world. Over fifteen thousand items, including Hollywood accessories, hi-speed equipment, rebuilt engines; all parts and accessories for all cars and trucks. New, used and rebuilt! We have that hard-to-get-part! Completely illustrated, jam-packed with bargains. Send 25c. J. C. Whitney & Co., 1919 Archer Ave., Chicago 16, Ill.

AUTO And truck parts. New and used. Lowest prices. Complete stock. Prompt replies. Babbitt Auto Parts, 2833 Chicago Ave., Chicago 22, Ill.

CHAMPION, A-C, Auto-Lite spark plugs. Rebuilt. Guaranteed 10,000 miles. 25c each. 23c sets of 6. Postpaid. State brand, type, quantity. Philip Minor, 5707 Arnsby Place, Cincinnati 27, Ohio.

NEW And used guaranteed parts for civilian and army cars and trucks. Largest stock in America. Mail orders. Pioneer Auto Wrecking Co., 734 W. 13th Ave., Denver, Colorado.

NEW "Economy and power" methods. Free. Neher Industries, La Verne, Calif.

LACHAPELLES Motor and motor fuel treatment (patented) stops ping, gives more miles per gallon, more miles per motor. It puts bearings on the pistons. 100,000 miles treatment \$3.00 postpaid or c.o.d. Ferns Products, 8120 Walnut Dr., Los Angeles 1, Calif. (Data sheet on request.)

NEW Government surplus. Low voltage circuit tester in steel box cost \$202. Our price \$27.50. Will test batteries, starters, generators, voltage regulators, grounds, short circuits. Wilt Electrical Company, 7829 S. Racine Ave., Chicago 20, Ill.

CHEVROLET Parts. Scarce motor, body, sheet metal parts. Grossman Chevrolet, Minneapolis, Minnesota.

BRUSH Plating outfits connect to a battery. No tanks or shop required. Free particulars. Gunmetal Co., Avenue J, Decatur, Illinois.

AUTO TRAILERS

BUILD Your own trailer! Plans for all kinds. Illustrated catalog 10c. Jim Dandy, 125-M, Wausau, Wisconsin.

MOTORCYCLES, BICYCLES, MOTORSCOOTERS AND SUPPLIES

ARMY Motorcycle \$25; Speedbike motorbike \$15; Motoscoot \$30; three wheeled Cushman \$35, Henderson motorcycle \$10, Servicycle \$12, less engines. Engines \$3 up; Smith motorwheel \$10. Four balloon tires \$3. Mailorder only. Send 25c for catalogue Number Thirty-eight, just out, listing these and hundreds of other bargains in new and used midget cars, motorscooters, homebuilders parts, plans, transmissions, engines, war surplus, etc. (35c by first class mail). Midget Motors Directory, Athens, Ohio.

REBUILT Tested 1½ to 3 h.p. engines for motorscooters, motorbikes, small autos, farms, shops, etc. \$9.00 to \$30.00. Send for catalogue. Cauffiel Motor Industries, Dept. 124, Temperance, Michigan.

MOTORCYCLE Pistons, parts, new, used, Harley, Indian, Henderson. List and wings pin 25c. Ballak, 811 N 9th, St. Louis 1, Missouri.

MOTORCYCLE Magazine — Worldwide coverage. Yearly subscription \$1.00. Sample 15c. Motorcycle News, 5424-A Sawyer, Chicago 25.

HARLEY-Davidson parts, accessories, repair manuals on all models. 24 hour service. Authorized factory dealer. Philadelphia Harley-Davidson Company, 857 North Broad Street, Philadelphia 23, Penna.

RECONDITIONED Motorcycles and motors. Chromium accessories. Complete stock Indian parts. Expert rebuilding. Fast service. Indian Motorcycle Sales, Kansas City 1, Mo.

TIRES And industrial wheels, suitable for scooters, wheelbarrows, farm equipment, etc. All sizes. Bicycles and accessories. Send dime for list. Cycle Transport Company, 1241 So. Michigan Ave., Chicago 5, Illinois.

AVIATION

LIGHTPLANE. Circulars illustrated 20c. Craftsmann Books, Box 1153, Milwaukee 1, Wis.

PROPELLERS, Plans, supplies, for ice sleds, snow sleighs, air boats. Catalog 20c. Banks-Maxwell, Box 3301E, Ft. Worth.

PROPELLERS—For sleds, airdrive boats. Literature. Standard Aircraft, Box 387, Ft. Worth, Texas.

BATTERIES, GENERATORS

EDISON Nickel batteries. Foolproof. Odorless. Low prices. Sizes 37 to 600 ampere hour. Interesting literature. Hawley Smith Co., Croton Falls 1, New York.

GENUINE Edison batteries, fifteen year life. Unconditionally guaranteed. Free literature. See-Jay Company, 300-12th Avenue, Paterson, N. J.

ELECTRICAL SUPPLIES

BE Independent, be secure, have your own profitable business—earn \$20.00 and more a day making beautiful, fast-selling lamps at home. No equipment needed. Illustrated course teaches you quickly. Course, parts catalog, wholesale price list—only \$2. Gearon Co., Dept. 200-B11, 27 S. Desplaines, Chicago 6, Ill.

FREE. Send for new catalog just off press. Wonderful bargains in super welders, motors, generators, surplus equipment at real buys, or, build your own. Save dollars. LeJay Company, Minneapolis, Minnesota.

NEW Electrical tester. Tests 110V-220-444 a.c. Tells 3 phase from 1 phase. Checks phase rotation on 110-220-440 a.c. Tests fuses, appliances, shorts, opens, etc. Does the work of \$20.00 instrument. Furnished with informative instruction sheet. Satisfaction or money back. Complete \$5.00 postpaid. Spicers Products, Dept. P.M. 11, 1834 Milburn St., Indianapolis 2, Ind.

LAMPS—Electrify oil lamps, vases, bottles, etc. Instructions 10c. Fisher Lamp Supplies, 3825P Eastern Avenue 26, Cincinnati, Ohio.

LAMP Parts—Sockets, wire, harps, cords, bases, pipes—all parts to build and repair. 60 page catalog with charts and instructions 25c. Gyro Lamps, 5402P Clark, Chicago 40.

LAMPS—Build own originals, parts wholesale, any amounts. Catalogue 10c. Brown Lamp Co., Box 501, Wellston, St. Louis 12, Mo.

TRANSFORMER Lamination, magnet-wire, insulation, supplies. Morton Electrical Service, Maywood, Ill.

ELECTRIC Pencil: Engraves all metals \$1.25. Beyer Mfg., 10511-H Springfield, Chicago 43.

32 VOLT Appliances—World's largest line. Catalog free. Haines Corporation, Dept. N, Minneapolis, Minn.

WELDING, SOLDERING, PLATING

SET Up your own profitable welding business. "Build Your Own" portable arc welder with low cost generator. Free book tells how. Hobart Welders, Box M-1102, Troy, Ohio.

A.C. Welders, four sizes. Lowest prices. Holgeron's Service, Canton, Kans.

ACETYLENE Welding outfits, new, \$45.00; used \$25.00; arcwelders \$46.50. Eagle Welding, Dept. PM, 5085 Broadway, Chicago 40, Ill.

WELDERS—It's timely and profitable. The versatile Atlas transformer welder, in portable metal case. 110V. a.c., develops to 75 amps; 9 heat stages. Welds, brazes, solders, cut all metals. Easy to use. Simple instructions. Special flame weld torch free. Splendid for shop, farm and home repairs. Saves hundreds of dollars yearly. Only \$38.50. Also other models. 10 day free trial. Magic Welder Co., 239 MB Canal St., New York, N. Y.

BUILD Your own 100 ampere electroplating rectifier at a low cost. Starkweather, Ottawa, Kans.

RADIATOR Repairing books, supplies, equipment, gasoline torch. Write, Curfman Co., Maryville, Mo.

BUY Direct from factory. Welding and cutting equipment. All makes of equipment repaired. Established 1913. Box 331, Hamilton, Ohio.

ELECTROPLATING Salts and rectifiers. Mirror resilvering and chipped glass nameplate supplies. John Sprinkle, V55, Marion, Indiana.

RADIATOR Repairing, cleaning, recoring. How to equip small shop at low cost. Supply sources, trade secrets, instructions. Now only \$3.50 postpaid. Radiator Service, McBain, Mich.

MACHINERY, TOOLS, SUPPLIES

CONCRETE Block machines. Standard sizes. \$39.50. 400 daily. Free catalog. Concrete Machine Company, 5129 South Compton, St. Louis 11, Mo.

MACHINES For your shop. 14" lathe \$150. Milling machine \$260. Drill press \$100. Shaper \$220. 300 amp. welder \$125. Good condition, money back guarantee. Conversion Parts Co., 278 Adams St., Boston 22, Mass.

POWER Tools. Build your own with Lewis castings. Save up to 80%. Complete castings, material and blueprints supplied for 23 woodworking and metalworking tools. 32 page catalog 10c. Write today. Lewis Machine Tool Co., 3217 Union Pacific Avenue, Dept. M, Los Angeles 23, Calif.

ABRASIVES: All sizes; discs, rolls, belts. Mutual, Box 202, Kansas City, Mo.

16" AND 26" Size jigsaws. Ten dollars and fourteen dollars. Mail money order. Shellington Machinery, 2055 W. Hunting Park Ave., Philadelphia 40, Penna.

NEW Power tools, accessories, hand tools, kits, 500 items to make, postpaid bargains. New catalogue, send 3c stamp. Lloyd's Craftlines, 921-MB Cedar, Burbank, California.

FLAT Belt pulleys, for sanders or general purpose, aluminum core, laminated wood face, heavy duty, light, neat, any width or hole sizes. \$1.15 per inch diameter, postpaid. Hawthorne Tool Co., Otsego 3, Mich.

IMMEDIATE Delivery — Machine tools and woodworking machinery. Location, former McKees Rocks plant, Pressed Steel Car Co. Lathes 18"x8", to 48"x30"; drill presses; grinders; millers; saws — band, swing, hack; jointers and other woodworking machines. Approximately \$300,000.00 worth of small tools such as drills, reamers, milling cutters, office equipment such as desks, chairs, files, typewriters, calculators, etc. Priced right for quick sale. The opportunity of a lifetime! Dept. PM, McKees Rocks Industrial Enterprises, Nichol Ave., McKees Rocks (Pittsburgh), Penna. Phone Federal 1-0746.

SAVE Plenty! Build woodworking, metalworking, farm and home machinery from plans, using salvage materials. 25c (refundable) brings descriptive handbook. Free folder. Kimo, Box 307MA, New York 19.

POWER Hacksaw, 4x4 capacity, 45° swivel vise, auto-lift, auto-shut off, cast iron, bronze bearings \$49.00, motor \$15.00. Catalog. Montgomery, Inc., 49 Park Place, New York City.

DIALS 2½" Vernier reading for Atlas, Craftsman and Logan lathes. \$10.50 postpaid C.L.D. Mfg. Co., 661 W. Harriet St., Altadena, Calif.

ATLAS Mill accessories: slotter, \$82.00. Vertical head, \$65.00. 6" worm drive table, \$93.00. 4½" dividing head, \$99.00. Catalog. Montgomery, Inc., 49 Park Place, New York City.

LOST Wax casting process equipment. Southwestern, Box 3506, Station A, El Paso, Texas.

IF You use micrometers, get a Mike-Lap. Dress your micrometers to pinpoint accuracy using the Mike-Lap Patented Sleeve. Assures parallel planes at right angle to axis of spindle without disassembling micrometers. Handles 1" and 2" micrometers. Complete with charged lapping blocks and precision sleeve. Price \$7.50 postpaid. Easy to follow instructions. Satisfaction guaranteed. The Mike-Lap Company, Northboro, Massachusetts.

CHUCKS, Independent, universal; threaded 1½"-8, 1"-8, 1"-10, 1"-12, or with adapter recess. Other chucks to 16" diameter. Write for quotation and free literature. No obligation. Westcott Chuck Co., 3600 Walnut, Oneida, N. Y.

HYDRAULIC Cylinder double acting, 2½ bore, 16½" travel, 1-3/16" shaft, brand new \$11.00. Discount ten or more. Spencer Aircraft, 8410 Dallas, Seattle, Wash.

BOATS, OUTBOARD MOTORS

BUILD A better boat than you can buy for the money, with Ozarka's exclusive laminated-rib construction and carefully pre-formed and pre-fitted parts. Save to 55% on all popular types from simple car-top models to one-design knockabout sailboats, priced from \$39.50 and up. Shipped complete, ready for easy assembly. Send 25 cents for literature, refunded on first purchase. Ozarka, Inc., 6110 Borden Lane, Woodstock, Illinois.

SAVE ¾ Cost—Assemble your own boat. We furnish parts. No experience necessary. Rowboats, cruisers. Illustrated catalog 25c. Midwest Boat Company, Menomonee Falls 1, Wisconsin.

\$1.00 BUYS Outboard motor protection! New type lock-plate prevents theft or loss of any outboard motor. Fits any boat. Money-back guarantee. Send \$1.00 today. Ozarka, Inc., Dept. 61, Woodstock, Illinois.

FREE Illustrated folder and literature describing Sea Craft, famous 25 ft. cabin cruiser you can build yourself. Sleeps four people, fully seaworthy, cruises at 15 knots with converted auto engine. Complete with galley, fresh water tank, sink, toilet and spacious cabin interior. Save hundreds of dollars—use Popular Mechanics blueprints and step-by-step instructions. Popular Mechanics Press, Dept. BP, 200 E. Ontario St., Chicago 11, Ill.

KNOCK-DOWN Boat kits. Outboards, inboards, sails, hydroplanes. Easy to assemble. Minimum cost. Catalog with specifications, prices, 25c. Brooks Boat Company, Carrollton, PM, Michigan.

BUILD A better boat than you can buy for the money, with Ozarka's exclusive laminated-rib construction and carefully pre-formed and pre-fitted parts. Save to 55% on all popular types from simple car-top models to one-design knockabout sailboats, priced from \$39.50 to \$329.00. Shipped complete, ready for easy assembly. Send 25 cents for literature, refunded on first purchase. Ozarka, Inc., 6100 Borden Lane, Woodstock, Illinois.

BUILD Your own—Three point racing hydroplanes, others. Illustrated catalog 25c. Champion Boats, P.O. Box 7132 D, Long Beach, California.

TWENTY Plywood boat plans \$1.00. Catalog boat building plans 10c. The Rudder, 15 Murray Street, New York 7.

STEERING Wheels, windshield brackets, from \$6.95. Modern fittings, water skis at lowest prices. Complete pre-cut plywood boats. Bargains galore. Folder 10c. Marine, Box 681, Mendota, Minnesota.

OUTBOARD Motor bargains—\$35.00 up. Send for free list! Save big money! Used parts for most makes and models. Crandall-Hicks, 911 Commonwealth, Boston, Mass.

CONVERT Fords and Jeep to 100% marine engines with Osco's world famous Convo-Kits. Deluxe catalogue 25c (coin). Oscomotors, 3627B Lawrence, Philadelphia 40, Penna.

P38 BELLY Tanks, steel, \$9.95. Free picture. Bucks Auto Wrecking, Box 89, Merced, Calif.

NEW, used, rebuilt marine motors. Marine conversions, fittings. Free catalog. Stokes Marine Supply, Dept. 24, Coldwater, Michigan.

MARINE Conversions for Ford and Jeep engines. Catalog 10c. Lehman Manufacturing Company, Department D, Newark 2, New Jersey.

FULL Size, cut to shape boat patterns, blueprints, 7½-38 feet. Illustrated "Build a Boat" catalog, 25c (coin). "How to Build Boats" book, \$1.00. PolyWog houseboat plans \$10. Marine catalog \$1.00. Marine Specialty Mfg. Co., 3107 Detroit Ave., Cleveland 13, Ohio.

ENGINES, MOTORS, DYNAMOS

MOTOR Winders, free bulletins, winding and testing equipment. Motor Industries, Quincy, Illinois.

WELDING Generators 150 amp. \$47.50. Motors ½ horse \$15; ¾ \$22; 1 \$30. Compressors \$17.50. Butler, 1885 Milwaukee, Chicago 47.

ICE-SLED Engines, small airplane radial type. Write for descriptive literature. Gaare Supply Co., Box 277, Weatherford, Texas.

WINDING Data, listing 225 motors, single and three phase, \$1.00. Motor Data Co., Box 7631, Kansas City 3, Mo.

ATHLETIC EQUIPMENT, BODY BUILDING COURSES

MASSIVE Proportions—Barbells, catalog, muscle finder \$1.00. EG, Elmsford, N. Y.

GREAT Strength easily obtained. Write Joseph Dryer, Box 5527-P, Chicago 80.

BIG Bargain. 12 big muscle courses, Hercules chart, physique circular, etc. only \$2.00. (New picture news 10c). Agents wanted. Write Sids System, P.M. Southgate, Calif.

STRENGTH With stretchers. He-man cable course. Illustrated. \$1. Comborep, 79 Oakland Terr., Newark 6, New Jersey.

TALLER! Be one to three inches taller. A new scientific method for permanent height increase has now been developed. Free information. Natural Methods, Box 453, Briggs Station, Los Angeles.

DEADLY Judo—Fiercest fighting technique. Trick knockouts. (Over 200 illustrated pictures.) Expert instructions; three volumes. Complete \$2.25. Variety House, Box 46-B Wall Station, New York 5.

BARBELLS, Exercise equipment. Courses. Free booklet. Good Barbell Co., Reading, Penna.

BINOCULARS, TELESCOPES, MICROSCOPES, MAGNIFIERS

BINOCULARS Repaired, all makes. Authorized dealer, Hensoldt and Zeiss binoculars, scopes, Tele-Optics, 5514 Lawrence, Chicago 30, Illinois.

SAVE 50% On new binoculars! Free catalog. Free book, "How to Select Binoculars." Write today! Bushnell Importers, 43-M11 East Green, Pasadena 1, California.

WAR Surplus bargains, binoculars, telescopes, sextants, millions of lenses, prisms, reticles, eyepieces, objectives, etc. Mail 10c for big catalog CH. Send \$1.00 for Stock CH—10-piece lens kit and big instruction booklet. Edmund Salvage Co., Barrington, N. J.

REFLECTOR Telescope kits, refractors. Free illustrated bulletin. Rake Instrument Laboratory, 612 Adams, Hoboken, N. J.

WEATHER Instruments for amateurs. Send 10c for catalog. Science Associates, Philadelphia 8, Penna.

ASTRONOMICAL Telescopes, binoculars, microscopes, bought, sold, repaired. Books. Lists 10c. Rasmussen-Reece, Amsterdam, N. Y.

BINOCULARS, Telescopes, watches, guns. Buy, sell, trade. Schweer's, Donnellson, Iowa.

GIANT Astronomical telescope with 6 ft. tripod \$15.00, f.o.b. factory. 100 power. (10,000 area magnification). Clear vision, full power guaranteed. Ready for use. Suffolk Science Service, Dept. BT, Riverhead, N. Y.

REFLECTING Telescopes, 60X, completely assembled \$25.00. Guaranteed observatory clearness. Free information. Skyscope, 475 Fifth Avenue, New York 17.

TELESCOPES, Binoculars, microscopes, big bargain catalog free. Brownscope Company, 24 West 45th Street, New York.

POWERFUL Astronomical telescopes easily made. Perfect lenses and instructions; 100X \$3.00; 100X and 200X \$4.00; 100X, 200X and 400X \$6.00. Full power, clear vision guaranteed. Instructions alone 10c. Suffolk Science Service, Riverhead, N. Y.

TAXIDERMISTRY

MODERN Taxidermist Magazine, Greenfield Center 2, N. Y. Devoted entirely to taxidermy, photos, articles, methods. Trial year's subscription, \$1.00.

SPORTING GOODS, GUNS, FISHING TACKLE, ARCHERY, TRAPPING

NIGHTVISION Tube \$14.95 with instructions. Snooperscope book \$1.50. Infrared filters 15c. Catalogue, data 10c. Precise, 942 Kings Highway, Brooklyn 23, N. Y.

CROSSBOWS: Sport or hunting \$39.95. Free literature. Schmid, 1511 Gardner St., Hollywood, Calif.

SEND 10c For list either rifles, shotguns, handguns, or send 25c for all lists. Frayseth's, Willmar, Minn.

ANTIQUE, Modern guns. Bargain list 10c. Martin Rywell, Harriman, Tenn.

TENTS, Camping equipment. Ideal Xmas gifts. Low prices. Free catalogue. Morsan, 10-19R 50th Avenue, Long Island City 1, N. Y.

BLACK Mink trappers bait. Want your game to follow your tracks to traps? Send \$1 per jar postpaid. Kenyon Mfg. Co., Ortonville, Minn.

FREE Catalog—Glass fishing rod kits. America's largest selection. Anyone can build them—ideal Christmas gifts. Simple illustrated instructions. Write today. Dept. Z, Trimline Tackle Co., 508 Tinton Ave., New York City 55.

RIFLE Stocks: Laminated and regular, blanks and semi-finished. For Enfield, Springfield, Mauser, etc. Banks-Maxwell, Box 3301E, Ft. Worth.

PERCUSSION Colt and Remington parts. Flint and percussion locks. List 25c. Weisz, 160 South Uhle Street, Arlington 4, Va.

PISTOLS, Firearms, ammunition. Complete list 25c. Frank Farish, Vicksburg, Miss.

MOLDS, (For fisherman's sinkers, squids, jigs and lures.) Handed and hinged. Quality fishing tackle. Free catalogue. E. L. Sweet & Son., Tonawanda, New York.

MOUNTED Maine deer heads. Fine specimens for camp or den. \$30.00 each. Ed Howe, Coopers Mills 52, Maine.

190 PROFUSELY Illustrated pages antique and modern pistols, swords, daggers, armor, etc. 50c. Robert Abels, A860 Lexington Ave., New York 21.

5000 BARGAINS. Firearms, binoculars, war relics. Catalog 40c. Smith Firearms, Runnemed, New Jersey.

PETS—DOGS, BIRDS, RABBITS, HAMSTERS, ETC.

HAMSTER Special—One pair hamsters with 80 page instruction manual, market list and folio for \$3.50 f.o.b. Waterford. Free information. Pat's Hamster Farm, Waterford 3, N. J.

NEW Profits from hamsters! Easily raised. Small space. Odorless. Rapid breeders. Sell laboratories, people, pet shops. Pair \$3.00. Trio (1M-2F) \$5.00. Literature free. American Hamstery, 3826-C Lemmon Avenue, Dallas, Texas.

HAMSTERS—Send \$3.00 for pair virgin breeders and illustrated instructions. Pair and cage \$5.00. Free prices. Dixie Hamstery, 502-C Trinity Lane, Nashville 7, Tenn.

RAISE Guinea pigs. Money makers. Booklet free. Taylor, B426A, Hapeville, Georgia.

FREE Book. Quick money raising Angora rabbits. Gives markets, profit opportunities. Wilson, Stanton 17, California.

BEAUTIFUL Pure white pedigreed police puppies. Ansonia Kennels, Mose, N. Dak.

RAISE Pedigreed rabbits for us. We buy all you raise. Literature free. Grinsteeds, Edwardsville, Illinois.

MAKE Big money! Raise Chinchilla rabbits. Cash markets supplied for your production. Write today! Rockhill Ranch, Sellersville 15, Penna.

EARN Up to \$400 monthly. Raise Angora rabbits! Experience unnecessary. Wool brings \$5 pound. Plenty markets. Folder free. White's Rabbitry, Newark 38, Ohio.

GOLDEN Hamsters — Finest quality breeding and pet stock, \$2.50 pair, \$3.75 trio. Free folio. Valley Hamstery, 734 North Millam, San Benito, Texas.

SPORTSMEN: 200 Pointers, setters, straight cooners, combination hunters, rabbit and fox hounds. Reasonable. List free. Ramsey Creek Kennels, Ramsey, Illinois.

A Practical beginning to successful rabbit raising. 48 page illustrated booklet. Dime. American Rabbit Breeders Association. 36 AR & CBA Bldg., Pittsburgh, Penna.

INCREASE Your income by raising domestic rabbits. Small space needed. Ready market for delicious meat, fur and wool. Largest magazine in the industry tells you how. \$1.50 per year. Sample 15 cents. No stamps. Small Stock Magazine, Lamoni 20, Iowa.

MINK Raising information free. Complete. Lake Superior Mink Farm, Superior, Eel, Wisconsin.

SEE Gulf Hamstery ad on page 44. Shows picture of Hamster.

PLANTS, SEEDS, NURSERY AND GARDEN SUPPLIES

GLADIOLI—Special Christmas present offer. You'll be surprised. Glad Haven, Sebastopol, California.

FARMS, FARM LANDS, REAL ESTATE

STROUT'S Catalog—Farms, homes, country businesses. World's largest! 3029 outstanding bargains, 31 states. Mailed free. Buy now and save thru Strout, 7 So. Dearborn St., Chicago 3, Ill.

\$5.00 MONTHLY Buys 40 acres near town; price \$200. Free list. Box 425-P, Carthage, Mo.

BIG Free winter catalog! Farm and country real estate bargains, good pictures, many states, easy terms, many equipped, unharvested crops included. For special service, state requirements, desired location. United Farm Agency, 220-PM South State St., Chicago 4, Ill.

GOVERNMENT Lands \$2.00 acre up. Information all states twenty-five cents. National Tax Service, 901-A Majestic Bldg., Detroit.

FLORIDA. Beautiful homesites in new Lake County development, \$245 at \$10 monthly. Near Ocala National Forest, many pretty lakes, streams, pavement. World's best bass fishing, wonderful hunting. Folder free. Howard Vernor, DeLand, Florida.

GOOD Farms—Ranches. Washington, Minnesota, Montana, Idaho, Oregon, North Dakota. Dependable crops, favorable climate. Write for literature, lists describing typical farm opportunities. Specify which state. J. W. Haw, 119 Northern Pacific Ry., St. Paul 1, Minn.

HOMESITES \$300—Convenient payments. California's finest garden section. On Morro Bay's scenic shores. Wonderful fishing, hunting, boating, bathing. Fertile soil, softest water, temperate climate, congenial community. Free literature. Richard Otto, Department M, San Luis Obispo, California.

WEST'S New Digest of farms and country real estate—free! Values galore—Maine to Florida. West's, CK-9, Pittsburgh 17, Penna.

POULTRY, FARM SUPPLIES

RAISE Turkeys the new way. Write for free information explaining how to make up to \$3,000 in your own backyard. Address—National Turkey Institute, Dept. 3, Columbus, Kansas.

POULTRY Farmers, broiler growers, turkey raisers read the new American Poultry Journal for latest ideas and greater profits. 12 months, 50c. Special offer, 4 years, \$1.00. American Poultry Journal, 562 South Clark, Chicago.

INCREASE Your poultry income—Thorough knowledge means greater success. Our interesting, practical, home study course has trained thousands during past 29 years. Don't delay, write today for free booklet describing courses, methods, opportunities. National Poultry Institute, Dept. 50-C, Adams Center, New York.

ATTENTION! Farmers, homeowners! Interested in amazingly low-priced machinery? Get know-how handbook, 25c. Climax Products, 1324 S. Bond, Los Angeles 15, Calif.

RAISE Fryers new easy way. One man home plan earns \$3000 yearly. Circular free. Poultryman's Institute, 1046 So. Olive, Los Angeles 15, Calif.

PROFITABLE OCCUPATIONS

TURN Your spare time into cash. Make quick-selling, highly profitable lamps—every home a prospect. No experience or special tools required. New 1950 56-page illustrated catalog shows shades, shade frames, figurines and bases, oil lamp converters, boring compounds, and dozens of similar items. Also all kinds of sockets, cords, pipes, harps, finials, bases, and hundreds of other parts—everything you need. Special 8-page section shows 6 beautiful lamps in kit form ready to assemble. You buy wholesale, sell at retail—make big profits. Hundreds doing it. You can, too. Send 25c today for catalog and wholesale price list. Refundable first order. Gearon Co., Dept. 500-B11, 27 S. Desplaines, Chicago 6, Ill.

FREE Book "How to Make Money With Home Workshop" describes amazing methods used by hundreds of successful craftsmen. Tells what to make, how to sell workshop output spare time. Write at once for details. Remember it's free! Craftsman, 115-A11 Worth St., New York City.

FOREIGN Employment. Construction men, building trades, mechanics, helpers. Office men. Good workers interested in foreign development projects. Pipe lines, dams, power plants, roadways, shipping, oil refineries, etc. Transportation and quarters furnished; high wages. Listings of firms actively working on projects in Arabia, Persian Gulf, Africa, Alaska, Canada, South American, Europe, etc. Send \$1.00 for foreign construction compendium and application forms. Foreign Service Bureau, Dept. PM-11, (Employment), P.O. Box 295, Metuchen, N. J.

MUSHROOMS Grown boxes, barrels. Instructions 50c. Spawn \$1.00. Manureless process. \$2.00. Gordons, 553 William, Winnipeg, Manitoba.

LEARN Arc welding at low cost in non-profit school. Easy to learn in short time. V-A contract. Write for free book. Hobart Trade School, Box M-1103, Troy, Ohio.

400,000 MEN. Women needed. Lifetime career. Federal civil service vacancies exist now. How to qualify. Job descriptions. Mail \$1 for book. American Ext. School, Portland 13, Ore.

JIGSAW Owners attention! Start earning money at home cutting out wooden novelties and souvenirs. Write H. Cook, Dept. A, 4407 S. Normal Ave., Chicago 9, Ill.

"FROG Raising!" New book tells how! Illustrated literature free. Marlboro-A, Box 7002, New Orleans 19, Louisiana.

MAKE Fancy ornamental dolls without sewing. Very profitable. Write: Lakeshore Supply, 534-G Surf St., Chicago 14, Ill.

EARN Money at home with your typewriter. Manual tells how. Complete only 50c. Burnley & Co., Box 287, Dayton 1, Ohio.

CANDY-Making. Well paying home business. Amazing instruction course with formulas. \$1.00 postpaid. Nelko, Box 3462-C, Chicago 54, Ill.

TYPISTS. Profitable business at home. Complete copyrighted information 50c. Rosdahl Industries, 4901 Elston Avenue, Chicago 30, Illinois.

HAVE Fun! Make money! "Working With Leather"—64-page booklet tells how. Send 25c for copy. Free catalog and valuable information included. Wilder-Craft, 1039 Crosby, Chicago 10.

RAISE Pheasants on the \$100 week plan. Little capital and space can make you independent. Free details. Great Central Game Management System, Columbus, Kansas.

WANTED—Purchasing agents. No money or experience required. Write Dept. C, Purchasing Manager, 2719 Lawrence, Chicago, Ill.

MAKE Flexible molds! Cast plaques, bookends, figurines! Free sample! H. Tooker, 630-M Chestnut, Hamilton, Ohio.

LIFETIME Income as notary public. Appointment assistance. Stationers, Heites 50, Texas.

RAISE Fishworms. Easy, profitable. Send 25c in coin for complete instructions. Huffman Worm Ranch, Rives Junction 2, Mich.

\$250 WEEK Reported! Free illustrated book "505 Odd, Successful Businesses." Work home! Expect something odd! Pacific-E, Oceanide, California.

INTERESTED in Latin America and foreign employment? \$1.00 brings 1950 copyrighted "Foreign Service Directory," world wide listings in construction; oil; mining; aviation; steamships; manufacturers; transportation; exporters, importers. Hot list firms hiring. How-when-where to apply. Application form free. Global Reports, P.O. Box 883-P, Hollywood 28, Calif.

BE The Popular Mechanics representative in your neighborhood and earn big profits in your spare time. Write Popular Mechanics Magazine, Room 408M, 200 E. Ontario St., Chicago, Ill.

\$46 FROM Square foot plywood; jigsaw necessary. Write, Woodarts, P-38, Bridgewater, Mass.

\$40.00 WEEKLY Made growing mushrooms, fresh, dried. Dominion patent 331583. Free spawn. North American, 169P Yonge, Toronto, Canada.

ALASKA—Last great American frontier. \$1.00 brings 1950 copyrighted directory and government map free. Big construction projects; fishing; mining; aviation; hunting-fishing-game rules; fur-farming; lumber; live stock; agriculture. Homestead land and highway information. Listing firms hiring. Application form. Alaska Opportunist, P.O. Box 883-P, Hollywood 28, Calif.

BOOKS, PERIODICALS, PICTURES POSTCARDS

BOOKS. Hard-to-find. Out-of-print. Banker Book Co., Dept. 39, Sherman Oaks, Calif.

POLICE Jiu-Jitsu, 50c! Scientific Boxing, 50c. 130 Main, Spring Valley, N. Y.

ANY Spanish or French books: Art, literature, etc. Write indicating requirements. Wholesale prices! Catalog 10c. Idap, 26, Hollande, Tangier, Morocco.

POLICE Wrestling 50c. Scientific boxing 50c. Mesa, Box 55-A, New York 19.

SPANISH Dictionary—"Pequeño Larousse Ilustrado." Latin-American and foreign idioms. History and geography. 1528 pages, 5900 illustrations, 200 charts, 102 maps. David Hernandez, Apartado 223, Arcibo, P. R.

ONE Dozen 1950 photographs, postcard size, of Hot Springs, Ark., for \$1; two dozen \$1.75. Glenn Squires, Box 5375, Chicago 7, Ill.

SEND 10c For catalogue. Hawaiian books, postcards, 10c refunded first order. Maui Book Store, Wailuku, Hawaii.

FARMERS And owners of all livestock—Do you want to save money in taking care of your animals? Send for amazing new book Veterinary Guide for Farmers. New facts on the diagnosis, treatment and prevention of diseases of farm animals. Authoritative, easy-to-understand and guaranteed to satisfy you or your money back. Postpaid \$3.50. Windsor Press, 200 E. Ontario St., Chicago 11, Ill.

HOW-To-do-it books on every subject. Written in Popular Mechanics famous easy-to-understand style and profusely illustrated. Subjects include workshop planning and practices, projects, hobbies, household repairs, motoring, outdoor sports, photography, home building and many others. Also booklets for specific topics. Write for free illustrated catalog. Popular Mechanics Press, 200 E. Ontario, Chicago 11, Illinois.

CATALOGS! Business and technical books. Both for 10c. Savell Sales Company, Maspeth 7, New York.

BOOKS—Government surplus. Textbooks, including International Correspondence School's Home Study Pamphlets. One half million volumes. Bargain prices. Free catalog. Long's College Book Co., Dept. PM, Columbus 1, Ohio.

THE Fair Monthly, years subscription \$1.00; sample copy 25c. Junior Maness, (P.M.), East Rockingham, N.C.

SELF-Explaining Bible: Illustrated circular free. Box 446-P, Minneapolis, Minn.

LOW Subscription prices. Free list. Rural Magazine Agency, Grenada, Miss.

BOOKHUNTERS! All subjects. Send wants! Jaher Book Service, 620-P East 178 Street, New York 57.

BOOKFINDERS! (Scarce, out-of-print, unusual books). Quickly supplied. Send wants. Clifton, Box 1377-PM, Beverly Hills, Calif.

NATIONAL Geographic Magazines 1888-1949. Any issue, Box 327-PM, Periodical Service, Swarthmore, Penna.

MAGIC TRICKS, PUZZLES, JOKER NOVELTIES

JOIN Our New Magic Club. Send 10c for illustrated catalogue and free particulars. Magic and Fun Mart, 55-M Prince St., New York.

UNIQUE Children's recorded surprise! 35c. Personalized Record, 180 Grafton, Brooklyn 12.

LEARN Ventriloquism. Make money. Have fun. Big opportunity! Radio, television, stage appearances. Free information. Write, stating your age. Dummy catalogue 25c. Maher, Box 36-M115 Kensington Station, Detroit 24, Mich.

ESCAPE From any handcuff. Sensational secrets. Twenty-year professional. Book, \$1.00. Martully, 86 Akron, Westmont, New Jersey.

ASTOUNDING Tricky card when pitched into air, completely vanishes, later appearing in most bewildering manner from spectators pocket, free if 25c is sent for great catalog, 500 magicians tricks. Magician, 2463 P Kensington Ave., Philadelphia 25, Penna.

200 ELECTRIC Stunts, 110 volts, \$1. Cutting Sons, Los Altos, Calif.

FREE! 25 Jokes, tricks, with catalogue 25c. Finko, (1618-A), Philadelphia 5.

FREE Jokers' item with giant catalog, tricks, jokes, puzzles, 10c. Andersen's Fair, 6815-P Ardmore, Chicago 31.

500 TRICKS, New 1950 edition now ready! Send only 10c for your copy, containing latest in good magic for pocket, parlor, stage. Unequaled service to magicians for 30 years. Douglas Magician, Dept. 1, Dallas, Texas.

BE A magician. Large professional magic catalog of latest tricks, 35c. Ireland, C-109 North Dearborn, Chicago 2.

PROFESSIONAL Catalog, 124 pages, 25c. Williams, 900 Plymouth, Ellwood City, Penna.

MAGIC Tricks, puzzles, books, cards, punch boards. Catalog 10c. Specialty, Box 671, St. Louis 1, Mo.

512-PAGE Catalogue of 2500 tricks, pocket, parlor, stage. World's finest magic. Send \$1.50 for catalogue (refunded first \$6.00 order). Kanter's, M-1311 Walnut, Philadelphia 7.

16 CARD Tricks and catalog 25c. Sterling Magic, Royal Oak, Mich.

WORLD'S Largest professional magic shop, keeps you in touch with latest tricks. To receive mailings, send 50c for new catalog. Holden's, M220 West 42nd St., New York.

VENTRILLOQUISM Taught. 3c stamp bring particulars. Smith, 801 Bigelow, Peoria 5, Ill.

COINS, TOKENS, CURRENCY

OLD Money wanted. Do you know that coin collectors pay up to \$100.00 for certain U. S. cents? And high premiums for all rare coins? We buy all kinds. Send 4c for large coin folder. May mean much profit to you. Numismatic Co., Dept. 20, Fort Worth, Texas.

WORLD'S Greatest paper for coin collectors and two wooden nickels 10c. Lawrence Brothers, Anamosa, Iowa.

HALF Dollar over 100 years old, large cent, two cent, three cent, 5 different dates Indian cents, \$2.00. 20 different dates Indian cents \$1.00. Walton Coin Co., 7 Water, Boston 9, Mass.

BARGAINS! Rare collection contains United States half dollar over 110 years old, Colonial coin before 1790, half cent, large cent, flying eagle cent, white Indian cent, 1865 cent, first Lincoln cent, 2c piece, 3c silver, 3c nickel, half dime, shield nickel, first liberty head nickel, 1913 buffalo nickel, dime before 1838, old large \$2.00 bill, Jackson cent, Civil War cent, Confederate money, foreign coin, foreign bill, ancient coin over 1500 years old and buying-selling catalogue. Everything \$5.00. 40 different dates Indian cents \$4.00. 30 different dates large cents \$7.00. Catalogue 25c. Worthy Coin Corporation, 294 Washington, D-403, Boston, Mass.

INDIAN Penny with catalog. 10c. Brunk Coins, 3530-N Osceola, Chicago 34, Illinois.

100% SATISFACTION Always at Bebee's. Everything in coins, currency, albums, etc. Giant bargain retail catalogue 15c. 256 page retail guidebook \$1.50. 127 page premium handbook also our copyrighted buying list \$1.00. Bebee Coin Company, 1180 East 63rd, Chicago 37, Illinois.

UNITED States rare coin value guide 50c; premium catalog of modern foreign coins 50c. Johnny Flood, 826-P South Wabash Avenue, Chicago.

INDIAN Heads. 15 different 50c. Free bargain list. Nelson's Coinery, Rye, N.Y.

FREE Price list. Bargains. Fairway Company, Box 121, Rye, N.Y.

100 COINS And bills \$1.00. Oddehon, Box 482, St. Louis, Mo.

30 DIFF. World coins \$1.00. 20 diff., 50c. Bishop, Box 2201, Kansas City, Mo.

I'LL Buy your old coins. Send 50c for illustrated coin catalog listing highest prices paid. Jack Farrell, 19370 Stratford Rd., Detroit 21, Mich.

50 ASSORTED Indian pennies, \$1.50; 1892 Columbian half-dollar, 75c; Whitman coin album, 25c; 1863 Civil War cent, 15c; 25 foreign coins, \$1.00; check list, 3c; large catalog, 15c; 100.2 x 2 coin envelopes, 25c. Coin Shop, 31 North Clark, Chicago 2.

COINS Wanted. will pay up to \$2000 for certain coins. Send 25c for catalogue. Burton's, 111 So. Third, Columbus, Ohio.

FREE! Foreign coin, banknote and coin collectors illustrated catalog to approval service applicants. Send 3c postage. Tatham Coinco, Springfield 30, Mass.

GET Profit and pleasure in collecting old coins. Send 10c for 56 page illustrated coin catalog. You'll be delighted with it. Send for it now. B. Max Mehl, 370 Mehl Bldg., Fort Worth, Texas. Largest rare coin establishment in U. S. Established 50 years.

COMMEMORATIVE \$1.25. Oregon, Texas, Kentucky, Cleveland, Long Island, \$2.00 each. Illustrated catalogue 25c. Norman Shultz, Salt Lake 9, Utah.

STAMP COLLECTING

199 DIFFERENT—33 countries including 38 19th century; diamonds, airmails, jubilees 10c. Approvals. Brooks, 2352B East 23rd Street, Brooklyn 29, New York.

100 DESIRABLE Stamps—Free with temptingly different, priced-right approvals. Ironton Stamps, Box 186, Ironton, Ohio.

ESPECIALLY Made to order approvals. New Stamp Studio, 368A Alexander, Rochester, N. Y.

100 DIFF. U. S. old and new, 25c. Weatherby, Medina, Ohio.

U. S. Penny approvals—Foreigns (first 200 half-priced \$1.00). Betters 1/3 catalogue. Stampinground, East Hartford 8, Conn.

1/2-1c APPROVALS! Bargains galore! Cole, 43-A Rinewalt, Buffalo 21, N. Y.

DIAMOND, Pigmy, jumbo, other queer stamps—Free with bargain-packed, excitingly "different" approvals. Niagara Stamps, Niagara-on-the-Lake 11, Canada.

39 DIFF. China, stamp wallet, 10c with approvals. Fred Pittsley, Napa, Calif.

COLUMBIANS, Trans-Mississippi, Pan Americans, Pan Pacific, ten other different commemoratives. All 10c with your request for U. S. approvals. Moda Stamps, Box 251, C.S.A., New York 7.

FRIENDLY Information service. Stamp collectors write Sophus Jensen, Coupeville, Washington. On beautiful Whidbey Island.

UNUSED Commemorative stamp collection including airmails, pictorials, high values, sets. Only 3c. Approvals. Sunlite, Box 1259-M, Grand Central, New York 17.

STAMPS. Albums, packets! Big new money saving catalog free. Ewing Stamps, 109 N. Dearborn, Chicago 2.

10 ASSORTED U. S. Commemorative 15c. Five U. S. Air Mail 15c. 10 Famous Americans 25c. All for 50c. Ideal Stamp Shop, Box 179, Park Ridge, Illinois.

FREE! Triangles, diamond stamps, giant bicolored set from Monaco, midgets, Liberia animal stamp, multicolored Paraguay flag stamp, complete set 14 Italian Social Republic stamps showing drummer and churches. V. Moulblow, 740 Hegney, Bronx 56, N. Y.

500 MIXED Stamps and surprise packet for 10c, with approvals. Fahsing, Dept. PM, Atascadero, California.

SEND 25 U. S. stamps: I'll return 25 beautiful Scandinavian stamps. Enclose 2 International Reply Coupons, obtainable at your postoffice. Isgaardsvej 119, Odense, Denmark, Europe.

BIG Clearance sale! Bargains. Premium given free. Verne, 916-E Fallowfield, Charleroi, Penna.

FINE Approvals. Fast personal service. What countries do you prefer? I'll send their stamps. Skinner, 438 Locust, Long Beach 12, Calif.

100 DIFFERENT Worldwide, 5c. Approvals. Stearns, 26970-B Princeton, Inkster, Michigan.

ARE You a serious stamp collector? Please send us your name, address. You will not regret it. Idap, 26, Hollande, Tangier, Morocco.

FREE—Famous Americans set, Flag set, National Parks set, and Presidential set to \$5.00. A total of 90 stamps free to customers for our unsurpassed U. S. and foreign selections. Send 3c for 15 of the above stamps and full particulars. Triboro Stamp Co., 145 Nassau St., Dept. 111, New York.

POUND Stamps containing thousands \$1.00. Longacre Shop, 108 West 42nd, New York 18.

PAYING High prices for approvals? If your collection numbers under 15,000 try our 1c and 2c approvals. In books of 1000 different. Lots to choose from at lowest prices. Also special offer to customers. Clark, Box 544-P, Muskegon, Michigan.

STAMP Magazine! Copy free! "Stamp Post," South Catalina, Pasadena, Calif.

SERIOUS Collectors! Custom made approvals to your requirements. Reference. Brooks, 2352B East 23rd Street, Brooklyn 29, New York.

BELIEVE It or not: 25 different British, West Indies stamps are yours for the asking. Beautiful pictorials, 19th and 20th century, including free monthly magazine. Send only 5c for postage. Empire Stamp Company, Dept. PM, Toronto 5, Canada.

PAY Less, buy more, books of 1,000 at 1c and 2c each. Very good fillers. Attractive stamps. Adults only. Daniel Graveline, 14702 Troester, Detroit, Michigan.

REQUEST Fine used U. S. approvals, also blocks. Harold Holub, 18 E. 198th St., New York 58, N. Y.

FREE Packet of French Colonials to approval applicants. Arjay Stamp Co., Box 472, Aberdeen, Maryland.

FREE! 500 Mixture, with 1000 worldwide collection for just \$1.00! Dimond Company, 3152 Cuthbert, Oakland 2, Calif.

FREE! Illustrated, bargainful packet-collection list. Buczynski, 19315-K Syracuse, Detroit 34, Michigan.

REVOLUTIONARY! Complete miniature sheet free! Knott, 434 East 76th, New York 21, N. Y.

FREE: Mint British Colonies from Brunel, Nauru, Dominica, Ascensions, Solomon Islands, Caymans, Tonga, Gilbert Ellice, Pitcairns—free with approvals! Viking, 130-Z Clinton St., Brooklyn, N. Y.

FREE. Mexico airmails, mint block; plus Africa, Indies, animals, ships, etc. Approvals. Crystal Stamp Company, Dept. A, Crystal City, Texas.

BARGAINS, 100 Greece 30c with approvals. Book Nook, Oronoco, Minn.

SPECTACULAR 100 Different worldwide packet featuring U.P.U. only 10c. approvals. Lou Allmendinger, 709 Dover, Philadelphia 31, Penna.

MONACO Nudes set—10c. Approvals accompany. Atlas, 3210-M Republic, Racine, Wisconsin.

ALL Stamps at 1c each. Collection of 10,000 different, divided in 20 \$5 lots each containing 500 stamps. You just buy one lot at a time as often as you like. Each lot delivered as soon as paid for. No contract. No obligation. Real savings. N. V. Robillard, 812 West Vantrees Street, Washington, Indiana.

TRY Our quality approvals. References. North Andover Stamp, North Andover, Mass.

UNUSED United States bargain! 33 different unused commemoratives: \$1.00. Unused United States approvals accompany. Patrick Agencies, 3650A Central, Indianapolis 5, Ind.

1000 MIXED U. S. and foreign 25c. Monjar, Fairmount, Cincinnati 14, Ohio.

FLAG Stamp—Free with hygrade U. S. approvals. Wenigman, 1933 Patterson, Chicago 13.

FREE! Liberia triangle, airmails, approvals. Greenwood, 441 Washington, Miami Beach, Fla.

FREE Packet, 50 different—approvals. L. V. Metcalf, Box 95, Benicia, Calif.

GIFT—Tokelau Is. complete mint to approval applicants. Deane Stamps, Box 87, Miami 35, Florida.

TASMANIA Included! Stamps from forty countries 10c. No approvals. Elsea, Bowling Green, Ohio.

FIFTEEN Different old U. S. sent for 10c to approval applicants. Donald Brunner, 832 Union Street, Lancaster, Penna.

FROM Norway, Land of the Midnight Sun we offer a colorful, complete UPU set. With this set we include an attractive airmail stamp cataloging 50c or more. Italy complete set Constitution commemoratives, plus Finland beautiful complete Red Cross set all for 20c with request for selected, foreign approvals. Sorensen, Box 21, Jackson Heights, New York.

6 IONIAN Stamps free. Approval. WBM, Box 758, Wilkes-Barre, Penna.

FREE! Honor-bill packets list! 1c approvals. John's Quality Stamps, 834 Hickory Street, Scranton, Penna.

FREE Sample newsy, informative stamp weekly. Southern Philatelist, Box 1948, Miami 35, Florida.

2 SETS Free from first approvals. Jim Hotchkiss, Montpelier, Vt.

GRAND Value packet containing five foreign sets. Free with approvals. Illustrated bargain lists. Stoll Stamp Service, 2632 Burnett, Louisville 10, Kentucky.

VALUABLE Bulgaria set, catalogue \$1.87, for 10c, with approvals. Kingman, Highbridge, Box 42, New York 52.

ZOUNDS! Amazing queer countries packet, free with approvals! Saxon, Escondido, California.

SAN Marino collection free, 25 different, old and new issues, airmails, commemoratives, high values, absolutely free with approvals. Viking, 130-ZZ Clinton St., Brooklyn, N. Y.

VATICAN Complete 197 values \$10.00 bill. Guaranteed. Catalogue 25c. Beverini, Genova Pegli (Italy).

FREE. Scott's international album. Full particulars with approvals. Royal Stamp Company, Tamaqua, Penna.

POSITIVELY Greatest free offer—Latest Scott's international \$6.00 stamp album, covering entire world, contains 36,000 illustrated descriptive spaces. Scott's New Standard \$7.00 catalogues "Philately's Encyclopedia"—absolutely free to applicants for foreign approvals becoming customers. Plymouth Specialty Co., Dept. A-9, Box 510, Bell, California.

FREE—Ten different United States airmails with United States or British approvals. Gables Stamp Studio, Box 985-P, Coral Gables, Florida.

100 WORLD 10c. 1/4c Approvals. Page-wold, 1355 No. Dearborn, Chicago 10, Ill.

TRAINS! Trains! Trains! 12 train stamps and packet of 100 different stamps for 10c with approvals. Reich Stamp Company, 4647 Kenmore, Dept. M20, Chicago 40, Illinois.

307 ALL Different—Only 15c! Beautiful collection: commemoratives, triangles, high values, bicolored stamps, etc. Garcelon, Calais 400, Maine.

FREE! \$10.00 Airmail! Madagascar! Nigeria! Philippines! Approvals. Keating, 637-P Bergen, Jersey City, New Jersey.

BIG! Valuable! U.S. illustrated catalogue free. S. Stone, Dorchester Center 24, Mass.

500 MIXED Plus mint set, 10c to applicants for low-priced bargain approvals. Wethly, 15A Stegman Court, Jersey City 5, N. J.

100 DIFFERENT 10c. Free magazine. Bellet, 70 Mapledale, Hazel Park, Mich.

QUEENSLAND, Palestine, Fezzan! Bonus approvals! Colonial, Box 326A, Passaic, N. J.

1000 DIFFERENT Pictorials, commemoratives, etc. \$1.00. Jay Matthews, Lynbrook, N. Y.

FREE—Seldom seen "Springbok" stamp. Request approvals. Suburban Stamp Sales, St. Louis 14, Mo.

FREE "Stamp finder." Tells instantly country to which any stamp belongs. 32 pages profusely illustrated. Garcelon, Calais 17, Maine.

U.S. Complete price list free. Lush, 47 Tyler, Detroit 3, Mich.

FREE! Bulgaria, Dansig, Wurttemberg! Approvals. Colonial, Box 326D, Passaic, N. J.

UNUSUAL! Barcelona sets free! Approvals. Grabin, Box 1111, Sioux City 6, Iowa.

GERMANY! Mint Hitlerheads, 12 free. Exciting foreign approvals. William Deems, Ravenswood, West Virginia.

100 DIFFERENT 10c With approvals. Jacobsen, 59 Nagle Ave., New York 34, N. Y.

300 DIFFERENT, Collectors' Magazine—25c. Bargain approvals. Pabmart, 641—45th Street, Brooklyn 20P, N. Y.

FREE! Powerful magnifying glass. Jamestown Stamp, Jamestown 202, New York.

WOW! 203 All different Germany 10c! Zeppelins, semipostals, airmails, high values, etc. to new customers. Jamestown Stamp, Jamestown 512, New York.

LIBERIAN Triangulars, 10c with approvals. Vargo Stamps, 6044 South Fairfield, Chicago 29, Illinois.

HEY Collectors! Penny paradise, approvals. Sparta, Box 426A, Dansville, New York.

100 DIFFERENT 10c With approval applicants. Schramm's, 1511 Ottawa Dr., Toledo 6, Ohio.

FREE Golden booklet. Sell out lot \$1. Approvals. Schollmeyer, Box 48, Brooklyn 25, N. Y.

UNHINGED Approvals! Good, clean selections of foreign sets and singles. Sawpit Stamp Co., Box 224, Port Chester, N. Y.

WILL Buy your U.S. stamps. Write New-Way Stamp, Lawrence, Mass.

100 DIFFERENT Hungarian stamps 10c with request for foreign approvals. Ward, 241 So. Winchester, Campbell, Calif.

200 CHINA For 10c! Contains giant sized commemoratives; beautiful airmails; amazing \$10,000,000.00 high value; many others. Garcelon, Calais 67, Maine.

POSTAGE Stamps on approval. G. D. Ridinger, Dept., Melvin Hill, N. C.

ELEGANT Offer! Includes Norfolk, Brunei, Kedah, Nigeria, Cook, etc. 10c to approval applicants. Val Stamps, 16 Powell, Evansville 9, Indiana.

1000 WORLD Wide guaranteed different stamps—60c. Mint and used. Many countries. Special (one-time) offer sent with approvals. Steiners, Box 201-A, Ithaca, New York.

750 FRANCE And colonies stamps 10c. Littleton Stamp Co., Littleton 25, N. H.

BAHAWALPUR Set 10c, attractive approvals. Rheaume, 6591 11th Ave., Montreal 36, Canada.

5 SETS 5c. Sports, airplanes, pictures. Approvals. Wirth, Norwichtown, Conn.

TRY "Gold Nugget" approvals: U. S., Americas, British Colonies, world. Nothing like them! 312 mixed U. S. only 10c to approval applicants. Kessel's, Folsom, California.

UNUSUAL—Unheard of. Cancelled sets of Roosevelts and Washington bicentennials complete. All yours for fifteen cents. Bargain approvals accompanying. Park Stamp Co., Box 191, New York 21, N. Y.

FREE. Scott's International Album. Other big premiums. Full particulars with approvals. Raymax, 123-Z William St., New York City 7.

TOPS! Our book "How To Collect Stamps." Send for your free copy today! Littleton Stamp Co., Littleton 37, N. H.

10 AUSTRALIA Commemoratives in popular "111" packet. 10c. Approvals. Pleasure Stamps, 1865P - 52nd Street, Brooklyn 4, N. Y.

FREE Collection—Over 100 different stamps of the world—commemoratives, she-wolf, camels, giraffes, ships, rare Austria race horse, others all to approval buyers; also Scott International Albums, stamp catalogs. Bell Stamp Service, Dept. S-2, Box 190, Bell, California.

FREE Gigantic beautiful bi-colored mint U. S. Yorktown stamp to approval applicants. Mohawk, Box 524, Albany, New York.

HOW To recognize rare stamps. Free book—Illustrated! Kenmore, Arlington 74-H8, Mass.

TRY Hutch's approval service. Hutchinson's, 3463 "I" Street, Philadelphia 34, Penna.

FREE! 50 Different Japanese stamps! Approvals. Star Stamps, 225 Willard, Jamestown, New York.

GOYA Nude (2) 5c. Approvals. Han-nay's, 310 Quail, Albany 3, N. Y.

WANT Quality approvals? Try Roscoe's penny approvals. Roscoe Stamp, 1321 Roscoe, Chicago 13.

UNITED States approvals complete coverage, fine quality, attractive prices. Seminole Stamps, Box 1138-P, Coral Gables, Florida.

FREE! Beginner's collection! With lists! Stampmart, Box 2071, Hartford 1, Conn.

KOREA, Mongolia, Manchukuo, U.P.U., triangle; free packet to approval applicants. Worthmore, Box 156, Miami 45, Florida.

WHOLESALE Lists for junior dealers. Edward Hammond Company, Auburndale 66, Massachusetts.

U. S. Collection unbelievable! 300 different mostly commemoratives. \$1.10 post-paid. Franklin Stamp Co., 53 East Main St., Rochester, New York.

GIGANTIC Bargain! Solomons, Caymans, Dominica, Grenada, Mauritius, Nauru, Gilberts, triangles and multitude others. Everything 10c with approvals. Seeley, Box 483P, Baytown, Texas.

FREE! United States, foreign price lists. Floyd Frederick, 513½ Green Street, Lancaster, Penna.

\$33.00 FOR 10c! Special bargain offer of eleven different used \$1.00 to \$10.00 United States stamps with a face value of \$33.00, seldom found in most collections and usually selling for far more, offered for only 10c to introduce our sparkling approvals. Money back if not delighted. D. M. Darling & Co., Dept. 403, Ridgway, Penna.

300 DIFFERENT Given free with approvals. Postage 3c. Windsor Stamps, 1435 East 67th Place, Chicago 37.

INDISPENSABLE U. S. list 10c. Stanley Gibbons, 38-P Park Row, New York.

TWENTY Diff. 19th century given to approval applicants. Rossom, 218 West 59th St., Chicago 21, Ill.

110 DIFFERENT Hitlers, Roosevelt, Liberia, Haiti, etc. 10c. Buckey, 208 Ludlow Bldg., Dayton 2, Ohio.

LOOK—Gift of United States commemorative sets. Free premiums with each order. Approval applicants send 5c. Locust Stamp Co., Box 390T, Peekskill, New York.

WORLDWIDE Stamps. All different. 200, 25c; 500, 50c; 1000, \$1.00; 2000, \$2.50; 5000, \$12.50. Beacon Sales, Northboro, Mass.

500 STAMPS For only 10c! This mammoth value includes airmails, pictorials; stamps from strange countries, cataloging up to 25c each! Also approvals. Mystic Stamp Company, Camden 80, New York.

500 JAPAN Stamps 10c. Kenmore, Arlington 74-J4, Mass.

FREE—Cuba Roosevelt issue and illustrated catalog. Littleton Stamps, Littleton 12, N. H.

50 DIFFERENT U. S. 10c. No approvals. Seidenberg, Box 944, Appleton, Wis.

10,000 DIFFERENT 1c Each! Gordon Davison, Box 1019S, Manchester, N. H.

AMAZING Offer! 500 United States stamps—including commemoratives, airmails, high values to \$5.00. Only 10c to approval applicants! Illustrated bargain lists free. Mystic Stamp Co., Dept. 80, Camden, New York.

FREE Philatelic supply list. Penny approvals on request. Reed, Box 980, Chicago 90, Illinois.

100 EXOTIC Japan—All different, 10c. Kenmore, Arlington, 74-K7, Mass.

STAMPS Wanted. Collections, duplicates, surplus stock, mint and used. Trade for printing; buy outright if bargain. What have you, what's wanted, Vanroy Shirk, Lebanon, Penna.

PENNY Approvals that satisfy. Neil Gronberg, Box 5441-P, Philadelphia 43, Penna.

OLD Scarce U. S. seconds on approval. Slightly defective. Bargain prices. Her-nfield, Clintonhill Station, Newark 8, N. J.

200 DIFFERENT Including Roosevelt triangle, 5c to approval applicants. M. Avalon Stamp Company, Springfield, Mass.

FREE—Illustrated catalog! Kenmore Stamps, Arlington 74-C7, Mass.

ARMENIA. Ten bicolored stamps, value 75c free to approval buyers. Apex Stamps, Box 2188, Miami 13, Florida.

200 BRITISH Empire stamps plus valuable publications only 3c. Kenmore Stamps, Arlington 74-B17, Mass.

MAGNIFIER. Big stamp magazine; first U. S. commemorative; plus unused \$5000 Foreign Legion, diamond, giant, and other worthwhile stamps. Everything free to approval buyers. Capital Stamp Company, Little Rock 2, Arkansas.

WORLD—500 Diff. 50c, 1000—\$1.00, 75 Canada 25c. Approvals, lists. Victoria Stamp Company, London 4, Canada.

200 DIFFERENT Stamps 10c with approvals. 500 mixed United States 25c. Carlton's, Tujunga, Calif.

DEALERS—Wholesale list. Postage 3c. Frank, 5031 Queensberry, Baltimore 15, Md.

U. S. Price list. Send postage. State Stamp Service, 1225 Park Building, Pittsburgh 22, Penna.

WORLD'S Largest stamp (7½x14 inches). A real curiosity! Retail for 50c, only 3c to approval applicants. Tatham Stamp Co., Springfield 30, Mass.

FREE! 100 Worldwide different stamps to approval buyers. Big U.S. and illustrated bargain lists sent with approvals. Bookman, Maplewood, N. J.

200 WORLD Wide 27c. Pacific, P.O. Box 5704, Los Angeles, Calif.

ANTIQUES, RELICS, INDIAN GOODS, CURIOS

INDIAN Relics. Old guns, minerals, frontier books. Illustrated catalog 25c. 8 arrows, \$1.00. Ed. Bartholomew, 8102 Lockheed, Houston, Texas.

INDIAN Relics, fossils, minerals, fire-arms, curios, den decorations, catalogue 25c. Museum Supplies, Burlington 8, Wis.

8 ANCIENT Indian arrowheads \$1.00, tomahawk \$1.00, list free. Lear's, Glenwood, Arkansas.

10 PREHISTORIC War-game arrow-heads \$1.00. 2 fine tomahawks \$1.00. Fine selected grooved axe \$2.00. 3 gem points \$1.00. Pendant \$1.00. Fish spear \$1.00. 2 heavy buffalo spears \$1.00. 3 stunners \$1.00. 3 flint drills \$1.00. Folsom type arrowhead \$1.00. 5 colorful points \$1.00. 3 pipe drills \$1.00. Dog-eared arrowhead \$1.00. 2 Kickapoo spears \$1.00. 75 disc wampums \$1.00. Indian relic guide \$1.00. 2 books on Great Temple Mound, Lost City \$1.00. 12 postal cards of famous Indians, history 50c. New book covering exciting history of over hundred famous Indians, fifty authentic illustrations \$3.00. Catalogue with identification chart 25c. No fakes, old established. Museum Supplies, Burlington 8, Wisconsin. Postage 20c.

TEN Good arrowheads \$1.00. L. Crandall, Box 697, Idaho Falls, Idaho.

DECLARATION Of Independence, Lincoln's Gettysburg address, Bill of Rights. Authentic reproductions from Library of Congress on aged parchment paper. Appear hundreds of years old! All three for one dollar cash. Added; special premium free; copy of Constitution if you act promptly. Evelyn Bedard, 7416 Castor Ave. (15), Philadelphia, Penna.

INDIAN Bead work, buckskin, beads, feathers, moccasins, wigs, supplies; buying direct from Indians; prices reasonable; free list. Pawnee Bill's Indian Trading Post, Box 35-P, Pawnee, Okla.

PRECIOUS STONES, MINERALS

"GENUINE" Deep red Arizona rubies (garnets). Send quarter for packet. Box 724, Scottsdale, Arizona.

CARD 9 Mounted fossils, including trilobite, petrified dinosaur bone, \$2.00. Card 9 mounted minerals, including opal flakes, jade, \$1.00. Postage 20c. Museum Supplies, Burlington 8, Wisconsin.

GEMMOLOGY Books, list available. Atlantic Books, Lawrence Avenue, Charlestown 29, Massachusetts.

UNCUT Montana agates \$3. (Troy) pound, third with order balance c.o.d. M. Felland, Box 1950, Great Falls, Mont.

AGATES, Cutting machines, mountings. Free list. North West Gems, Box 305, Tacoma 1, Wash.

MINERAL Specimens, cutting material, slabs, and gems. Send for free booklet. Warren's Minerals and Gems, 1969 Abbott St., San Diego 7, Calif.

MINERAL-Treasure locators — Geiger counters. Can be purchased on monthly payment plan. Free literature. Fisher Research Lab., Inc., Palo Alto, Calif.

ROSE Quartz, Jasper, agate and catalogue. Quarter. Gemco, Elkhart Lake, Wisconsin.

GEMSTONES, Mineral specimens. Every variety. Lowest prices. Postcard brings free booklet. Plummer's, 2183C Bacon, San Diego 7, California.

METAL Detectors. The very latest circuit. Send 25c for literature. Hedden Metal Detectors, 3329 Liberty Ave., Pittsburgh 1, Penna.

HOBBIES AND COLLECTIONS

COLLECT Cigarette cards. New fascinating hobby. Interesting packet containing birds, butterflies, aeroplanes, flowers, trains and other rare cards plus big illustrated catalogue. All for 10c. International Card Company, 1152 Yonge St., Toronto, Canada.

WANTED—Cigarette, tobacco cards. Write Charles Bray, East Bangor, Penna.

HOBBYGUILD Members: Free! Military emblems, Korean divisions. 57M Sumner, Brooklyn, N. Y.

FOREIGN Medal ribbons packet. \$1.00. Free illustrated book. Browns, 3419 Center B, Calgary, Canada.

NEW—15 Different match covers 10c. Box 202, Rochester 1, N. Y.

UNUSED Matchbook covers—100 different \$1.00. Catalog 25c. Charles Edelman, 1311C East 84, Cleveland 3, Ohio.

INVENTING Can be an interesting and profitable hobby. Write for complete particulars. Institute of American Inventors, Dept. 40-E 631-E St. N.W., Washington 4, D. C.

CAMERAS, PHOTO SUPPLIES

NIGHTVISION Tube \$14.95 with instructions. Snooperscope book \$1.50. Infrared filters 15c. Catalogue—data 10c. Precise, 942 Kings Highway, Brooklyn 23, N. Y.

FREE Photographic bargain book packed with hundreds of sensational values in still and movie cameras, lenses and latest accessories. Super savings for you in new and used equipment. Liberal trade-in allowances, too, on your equipment. Write now for your free copy to Central Camera Company, Dept. 9M, 230 S. Wabash Ave., Chicago 4. (Photographic headquarters since 1899.)

PHOTOMURALS. Your negatives or ours. Catalogue 25c. Photomammoth Murals, 12048 Vanowen St., North Hollywood, Calif.

PICTORIAL Figure photography, 48 full page illustrations also a discussion of the human figure in art of all types. Send for free literature. Film Agency, 935 Cincinnati St., Dayton, Ohio.

FLASH Cameras loaned free. Card brings details. Camera Loan, Des Plaines, Illinois.

BASS Says: Bargaingram 257 ready and waiting for you. The book which tells all. The finest in new and used camera equipment, a veritable encyclopedia. Write, phone or call the sign of the old "Horse Trader." 40th year of satisfaction or your money back dealing. Bass buys, sells and trades. Bass Camera Company, Dept. AG, 179 W. Madison St., Chicago 2.

PICTORIAL Figure photography, 48 full page illustrations also a discussion of the human figure in art of all types. Send for free literature. Film Agency, 935 Cincinnati St., Dayton, Ohio.

PHOTO FINISHING

16 FOR 25c. Any standard 8 exposure roll developed with 16 velox deckledge prints 25c. 10c package mounting corners and enlargement coupon free with this ad. Skrudland, 6444-W Diversey, Chicago, Ill.

PRINTS 2½c. Send rolls or negatives. Giant 4x6 6c. Studio Experts, Albany, Wisc.

PERSONALIZED Photo Christmas cards. New, colorful. Send 10c and negative for sample. Techni-Foto, Lorain, Ohio.

FLASH Cameras loaned free. Card brings details. Camera Loan, Des Plaines, Illinois.

OIL Coloring photographs can be a fascinating hobby or profitable sideline for those with artistic talent. Learn at home. Easy simplified method. Send for free booklet. National Photo Coloring School, 1315 Michigan, Dept. 3437, Chicago 5, Ill.

MAIL Us your films. Prompt service. 8 exposures developed and printed 30c. Free enlargements. Foto Art Studio, Box 406, San Francisco, Calif.

TWO Beautiful prints from each picture on 8 exposure roll 35c. 29 years of satisfied customers. Quick service. Lens Photos, Dept. J-4, Janesville, Wis.

XMAS Cards with envelopes, 18—\$1.00. Send negative. 5c for sample card, list of styles. Graphic Photo Service, 3 Saint John Street, Plains, Pennsylvania.

BEAUTIFUL Enlargement from each picture on 8 exposure roll 35c. Cut Rate Photos, Dept. B-4, Janesville, Wis.

FREE Price list on quality developing, printing, enlarging. Write for it today. Bryan's Photo Shop, Dept. M, Panama City, Florida.

FREE 5 x 7 Enlargement with each roll developed and printed, 6 or 8 picture roll 35c. 12 or 16 picture roll 55c. Send coin with roll. No c.o.d. If you fail to get pictures on your roll of film, we will mail a new roll to you at no additional cost. Overnight service. Mailers sent free on request. Deluxe Film Service, Box 1268, Shreveport, Louisiana.

2 BEAUTIFUL Hi-Gloss prints each good negative and enlarging coupon with each 8 exposure roll developed 28c. Free mailers. Owipphoto Co., Weatherford, Oklahoma.

MOTION PICTURES AND SOUND EQUIPMENT

BRAND New 16mm. sound one reel Castle, pictorial discontinued titles, \$7.95, \$9.95 each, plus postage. Hundreds of other film bargains. Big list free. Blackhawk Films, Dept. PMH, Davenport, Iowa.

FILMS And equipment exchanged or bought for cash. Sound, silent. Bargains. Lists free. Frank Lane, Little Bldg., Boston, Mass.

SPECIAL Features bought and sold, exchanged \$3.75. Pembroke Films Exchange, 195 Spring St., Charleston 25, S. C.

ADD "Spice" to home projection shows with old-time Nickleodeon slides. 2x2. Kodachrome. Write for free list. Nickleodeon Co., New Fliedner Bldg., Portland 5, Oregon.

EXCLUSIVE Selling. Regular musical soundies. Brand new. 3 for \$7.95. Free special offer. Gaines, 5105-PM Mulford, Skokie, Ill.

ALPHABETS Quick-stick letters 120, \$1.80 up. Send check or COD. Booklet. Prospect Products, 9 Crary, Mt. Vernon, New York.

SAVE 50%—On movies. Free circulars. Fromaders, Box 637-A, Davenport, Iowa.

1000' 16MM. Silent-sound projection film \$7.50. International, 2120 Strauss, Brooklyn 12, N. Y.

MAKE Films for the huge television industry. Also learn Hollywood, free lance, and educational film technique at home. Write for free catalog. Motion Picture Institute, Birmingham 4, Michigan.

NEW 16mm., 35mm. sound projectors. Cine, 582, Ithaca, N. Y.

FREE Movie lists, bargain prices; sample films, 10c. Goodwill Company, Jackson, Tennessee.

PORTABLE 35 M.M. sound projectors. 5322 No. 51st, Milwaukee 16, Wis.

BASS Says: 40 years of leadership guarantees satisfaction. Finest cine equipment, 8mm., 16mm., and 35mm., silent and sound. Write the old "Horse Trader." Satisfaction or your money back always! Bass Camera Company, Dept. A, 179 W. Madison St., Chicago 2.

"CINE-VOICE" Sound-on-film camera shoots your own 16mm color talking-pictures. Write for free illustrated folder. Berndt-Bach, Inc., 7345 Beverly Blvd., Hollywood 36, Calif.

LOOK—"The World's Greatest Passion Play." 8mm., 16mm. and 35mm. Mention sound or silent, purchase or rent. Hemenway Film Co., 33-F Melrose St., Boston 16, Mass.

WILD Game films, 16mm, 8mm. Color, black-white. Sound, silent. Rare closeups taken in natural habitat by famed Eberhart organization. Send for free catalog. Wild Life Films, Dept. 9-PM, 6063 Sunset Boulevard, Hollywood, California.

FREE MOVIES. Thousands of subjects. Interesting. Entertaining. Fascinating. Latest directory—only 50c. National Cine Society, 126 Lexington Avenue, New York 16, N. Y.

BETTER 8MM. and 16mm. movie camera film. Free equipment catalog. Better Films, 742 New Lots, Brooklyn 7, N. Y.

UNUSUAL 8 And 16mm. films, used by many art students. Write for free catalogue. Send 25c for sample strip. Friart, 140-A-Liberty Street, New York 6.

RENT 16MM. sound films, 50c reel. Large selection; free catalog. Film Service, 128 Chestnut St., Roselle Park, N. J.

RENT 16MM. sound films, 50c reel. Rogers Films, Box 26, East Atlanta, Ga.

GUARANTEED Fresh anti-halo outdoor movie film! Weston 16! Daylight loading! Processing free! Three spools double 8 mm. \$4.50! Six single 8 mm. for Univex, \$4.60! Postpaid! Catalog. Eso-S, 47th Holly, Kansas City 2, Missouri.

8-16MM. Silent-sound films. Complete rental library. All latest subjects. Free catalogue, (sample film 10c). Garden Film, 317 West 50th, New York 19.

MUSIC AND MUSICAL INSTRUMENTS

SWISS Musical movements \$2.50. Also wholesale. Spielman, 131 West 42nd, New York 18.

POEMS Wanted. Percentage basis collaborations. Terry Tune Master, 709½-PM North Broadway, Oklahoma City 2.

SONGWRITERS. Opportunity for recording on royalty basis by large recording company with national sales, distribution. Send song material, free examination. No charge for melody. Lead sheets, records furnished. Music Makers, Dept. G-1, Box 1989, Hollywood, California.

ACCORDIONS—All brands. New and used. Save 50%. Wholesale to every one. Del Principe, 307 So. Wabash, Chicago, Ill.

RECORDS—Guaranteed new. Hillbilly, popular, spirituals, 4 for \$1.00. Free record with first order. Free catalog. Mailorc, Dept. 137, 570 N. Gay Street, Baltimore 2, Maryland.

WRITE Songs. Big money and reputation. Write for information. J. Gordon Pub. Co., 4700 South California Avenue, Chicago.

POEMS Wanted for musical setting. Send poems for free examination. Five Star Music Masters, 630 Beacon Bldg., Boston, Mass.

WANTED! Poems for musical settings. Write Songwriters' Service, Clifton, N. J.

SONGWRITERS! Outstanding, ethical offer. Hibbeler, C-5, 2157 N. Avers, Chicago 47.

SONGWRITERS! Send poems, songs. Music Service, 243 West 72nd St., PM, New York 23.

1950 ACCORDIONS—Wholesale. Free catalog. American Accordion Center, 5329 Belmont, Chicago.

POEMS Wanted to be set to music. Free examination. Send poems. McNeil, Master of Music, 510-PM S. Alexandria, Los Angeles, California.

MUSIC Arranged, songs printed. Frank Wildt, Music Publisher, Lancaster, Penna.

RADIO AND TELEVISION

BUILD Modern improved "Diode Detector Radio." Diode and complete illustrated instructions, \$1.00. Electronics, Dept. A110, Box 7101, Chicago 80, Illinois.

MAKE "Loudest" crystal radios. Instructions, loud crystal, catalog: 25c. Amrose, Route Four, Richmond, Virginia.

CRYSTAL And ten diagrams 10c. Sadler Radio, Clayton, New Mexico.

TUTORING Radio, television, electronics \$5. Missouri Tech, 3907 N. 25, St. Louis 7.

FREE! 212 Page radio and television catalog! World's largest stocks, lowest prices. Complete supplies for builders, experimenters, amateurs, servicemen. Latest radios, phonos, televisions, recorders, sound equipment. Thousands of parts, tubes, test instruments, books, diagrams. Top quality money saving values. Get it now! Allied Radio Corp., 833 W. Jackson Blvd., Dept. 34-L-O, Chicago 7, Illinois.

FIX Any radio. Amazing new instrument locates radio troubles double quick. Simple instructions show you how. Thousands now in use. Free. Write today for 32-page illustrated technical manual, "The Inside Story." Peiler Engineering Co., Dept. 11PM5, 1601 S. Federal St., Chicago 16, Ill.

FREE—Send for latest radio catalog and bargain bulletin. Has thousands of top values in television, radio, electronic supplies. Concord Radio Corp., Dept. LL-50, 901 W. Jackson, Chicago 7, Illinois.

BUILD Beginner's all-purpose tester. Pictorial plans, 25c. Arthur Alena, Wall Street Station, Box 271, New York 5.

RADIO Repair steps 50c. Brown, 7818B Hampson St., New Orleans 18, La.

TELEVISION And radio engineering taught practically, also electrical engineering, armature winding, electrical drafting. Day and evening classes. Special correspondence courses. G. I. approved. Canadian School of Electricity, 282 Ontario W., Montreal.

MAKE Simple, tubeless, batteryless, distance-getting crystal radios. Crystal and illustrated instructions 25c postpaid. Allen, 427-P, Clinton, Mo.

BUSINESS OPPORTUNITIES

"DRUGGISTS' Guidebook!" Home use! Prescription filling! 50c! Robins, 17-P, No. Pulaski, Chicago 24, Ill.

MILLER'S Modern manufacturing formulas make new products that get the business. Fifty years supplying the best. Literature free! Miller, Analytical Chemist, Tampa 6, Florida.

START Home manufacturing business making cleaning compounds, soaps, insecticides, cosmetics, polishes, food flavors. No machinery. Literature free. Kemix, Park Ridge 10, Ill.

COMPANIES Selling direct. Refrigerators, tools, paints. Folder 25c. Silber, 331 Glenmore Ave., Brooklyn 7, N. Y.

UNPAINTED Bookends, plaques, statues, figurines. List. Haverly Products, 822-17th St., Altoona, Penna.

HALF Million articles wholesale. Directory 10c (refundable). Publishers, Box 1302-P11, Detroit 31.

BUY Wholesale—Million articles. Supply source directory, dime. Nelko, Box 3462-DK, Chicago 54, Ill.

REVOLUTIONARY Conception of public bookkeeping! \$5.00 hourly. Simple instructions. Full, spare time. Systems, shortcuts, obtaining clients. Auditax, 10775-3 Tabor, Los Angeles 34.

FABULOUS Earnings — Fascinating pastime growing genuine, living miniature (ming) trees. New sensational business or hobby. Astounding information free. Dwarf Trees, Box 355, Briggs Station, Los Angeles 48, Calif.

QUICK Money! "Repairing car batteries!" At home! Easy too! Batteryman, Grand Junction, Colorado.

EARN \$100/\$250 Weekly, installing, maintaining fluorescent lighting. Exclusive, inexpensive illustrated instructions enables you to cash in on this fast growing billion dollar industry. Send for free facts on this proven business opportunity. "Fluorescent," 712-A State Tower Bldg., Syracuse 2, N. Y.

TRADE Magazines—Business, vocational, diversion. Current copies, all fields, through easy-to-get-acquainted plan. Send now for list. It's free. Commercial Engraving Publishing Co., 34C North Ritter, Indianapolis 19, Indiana.

EARTHWORM Breeding. Illustrated system \$1. Literature, 3c. Stoners, Chattanooga 4, Tenn.

BUILD Big business at home making hand soap, shampoo, polishes, washing powder, magic spot remover, amazing cleaners—Over 50 fast selling products. Easy to mix. No machinery needed. Only 1 and 2 ingredients. Complete set over 50 formulas only \$1.00 postpaid. Nelko Chemical Service, 3462-SK Merchandise Mart Sta., Chicago 54, Ill.

GROW Plants, flowers. Details free. Shiffers, Box 129, Millersburg, Penna.

START Your own business on credit. Always your own boss. 1559 dealers sold \$5,000 to \$28,000 in 1949; their average \$6,834. We supply stocks, equipment on credit. 200 home necessities. Selling experience unnecessary to start. Wonderful opportunity to own pleasant profitable business backed by world-wide industry. Write Rawleigh's, Dept. K-U-PPM, Freeport, Ill.

EASY To make expensive perfume with low cost "essential concentrate base." Fast, tremendous profits. Write post card. H. May, Box 4473-PC, Coral Gables 34, Fla.

BE Independent — Operate America's lowest price penny vending machine. Big profits. Immediate shipments. Write for bulletin and prices. Fielding Mfg. Co., Desk 110, Jackson, Mich.

LEARN Piano tuning, repairing — At home in 30 days. Unlimited income. Phonograph recordings, tools and instructions furnished. Write Capitol City Tuning School, Department C-1134, 129 East Michigan, Lansing 16, Michigan.

BE Successful, prosperous, happy! Opportunity Analysis shows how. Enlightening, illustrated booklet. Now \$1.00. Details free. K. Beese, 4929 Winona St., Chicago 30, Ill.

\$35 WEEKLY Spare time. No manufacturing or canvassing. Walsh, 894 Main St., Buffalo 2, N. Y.

BIG Money in your own business. Sharpener circular saws for builders, lumber yards, farmers, others—with new Belsaw complete circular saw shop. Low cost, no experience needed. Write Belsaw Machinery Co., 21 Field Bldg., Kansas City 2, Mo.

MAKE Perfumes at home. Write Carey Laboratories, 1914 Chouteau PM-11, St. Louis 3, Missouri.

"HOW To Sell by Mail." 40 profitable pages, 25c. Send now! E. Lay, 3819 Kenmore, Chicago 13.

COLOR Concrete with chemicals. Marble-glaze cement benches, pottery, garden ornaments. Home-shop, 10c brings sample, pictures. Hollywood Cementcraft, 8527-R Wonderland, Hollywood 46, Calif.

EARN Extra money mailing circulars. Postal brings details. Chadwick's Service, Tacoma 7, Wash.

MIRROR Resilvering. Wonderful home business. Complete formula 25c. Magic two-way mirrors. You can see out—no one can look in. Formula 50c. How to make coppered mirrors, vases, glasses. Formula 50c. All three \$1.00. Nelko Chemical Service, Box 3462-MK, Chicago 54, Ill.

EARN Money at home with your typewriter! Spare time! Details free. Edwards, Publisher, 3915-PM, 12th, Des Moines 13, Iowa.

PROFITABLE Mail selling propositions free! Wehner, Box 142-A10, Roxbury 19, Mass.

PROFITABLE Home business. Start in spare time. Experience unnecessary. Complete information. Useful Products Co., 166-29 88th Ave., Jamaica 3, N. Y.

ESTABLISH A mail business with your own exclusive item. Idea to mailbox service. Planning, preparation, production. Descriptive booklet free. National, Box 88-W, Dorchester, Mass.

WHERE To buy 600,000 articles wholesale. Details free. Krueger, 3418 Wolcott, Chicago 13.

SAWDUST. Turn it into cash. Six methods. Instructions 25c. Charles Co., 12-AWX, Norwood, Ohio.

LIFE-Time manufacturing business! Extremely profitable homework! Formula lists free. Thermolab, Peoria 4, Ill.

BIG-Paying home mailorder business. Details free. Jackson, Newfoundland, Kentucky.

MAKE Perfume. Men, women. Write International, 6347 Parnell-PM-11, Chicago 21, Illinois.

BIG Money! Spare or full time in your home. No selling. Spray new miracle finishes, plush and suede, on signs, radios, automobiles, figurines, lamps, toys, etc. Our business is booming. Help us fill huge demand. Cash in now on big Christmas orders. New easy Flok-Kraft methods. Material costs few pennies. You get dollars. Free samples, complete powerful money making plan free. Write now. Coast, 1002P S. Los Angeles St., Los Angeles 15.

FORGE Ahead financially! Start profitable business; mail, locally! Amazing invention. Free sample offer! Consolidated Equipment Corporation, 791 Guardian Bldg., Cleveland, Ohio.

SPECIAL Rubber for making molds. Literature and sample free. Universal, Box 1076-A, Peoria, Ill.

EARN Big money at home. Make genuine rubber molds, plaques, figurines, etc. Complete China-glaze kit only \$4.95, with instructions. Catalog free. Ken-Dor, Studio D, Lake Geneva, Wis.

MAKE \$4 To \$6 an hour! Filing saws with the Zapart Filer. A complete unit, to cut new teeth and sharpen a variety of hand, circular and band saws, \$48.50. Andrew Zapart, 586 Manhattan Avenue, Brooklyn 22, N. Y.

FIX Typewriters, full or part time. Inexpensive copyrighted home study course quickly trains you for high earnings. Factory methods cover all phases with drawings and illustrations. No curiosity seekers. Typewriter Repair, 1115 Corbet, Tarentum, Pennsylvania.

REPAIR Sewing machines. Highest earnings. Age no barrier. Complete simplified manual \$4.95 postpaid. Satisfaction guaranteed. Fielding Sewing Machine, 3550 N. 23, Philadelphia 40, Penna.

ANNOUNCING Home study course in commercial baking. Practical basic training. Good field for those with aptitude. Nearly depression proof. Send for free booklet. "Opportunities in the Baking Industry." National Baking School, 1315 Michigan Ave., Dept. 3436, Chicago 5, Ill.

\$7,000 A Year in your own auto upholstery business. New and proven method. Write Howell, P.O. Box 907, Longview, Washington.

NEW, Proved methods get money by mail. Amazing, eye-opening. Details free. Lexington Mail, 5538-A Lexington, Chicago 44.

BIG Mails, opportunity offers, 3 months, 10c. Underhill, Beebe, Arkansas.

15 MAIL Order publications 10c. Sponsor, Box 805, Beverly Hills 91, California.

ELECTROPLATING Know-How includes baby shoe metalizing, brush plating, chrome plating; other lucrative fields. Learn easily. Free particulars. Joseph B. Kushner Electroplating School, Stroudsburg 881, Pennsylvania.

\$200 WEEKLY Reported! No selling. Free booklet. T. J. Surface, Roanoke 4, Virginia.

"YOU Can actually see the metal flow on" with a portable Tyco Electro-Plater! Electroplate metals, mirrors, wood, glass, leather, plastics! Inexpensive, profitable home business. Free booklet. Tyco Metals, Box 8535E, Dallas 16, Texas.

FORTUNE'S Favorite plan. Mailorder natural. Only \$1.00. Satisfaction guaranteed. Rowland Plain, 1 Laurel Ave., Binghamton 44, N. Y. Dept. 111.

HOW To make money with a lettershop. New course shows how. Profitable, dignified work. Becker, 1018 South Central, Burlington, Iowa.

OLD Newspaper? Turn it into cash at home. Instructions 50c. Silvercraft, Box 574-PM, Great Falls, Mont.

START Home business, work in spare-time, make good money, 101 different ideas 25c. Universal Distributors, P.O. Box 191, Tangier, Virginia.

CASH For your idea, 280 manufacturers need inventions, patented or unpatented. List free. Invention Bureau, 208M Clinton, Oak Park, Illinois.

DIANETICS: Can be your profession! Amazing new science of mental therapy wide open. No age, educational requirements. Spare-time study. Genuine "ground floor" opportunity! Free booklet. American Dianetics Society, 8627B Melrose, Los Angeles 46, Calif.

FREE Details. Make extra money spare-time. Little capital. No experience. L. & M. Service, Box 377, Sharon, Penna.

IMPORTING Opportunities — Unlimited profits. Hundreds overseas connections seeking representatives. List \$1.00. Imports, 35E, Pasadena 8, Calif.

GET Into advertising for increased earnings—Your own business; working for others. Real future. Vincent Cremata, 1216 Washington, Key West 6, Florida.

YOUR Own profitable home business. Preserve live flowers to last for years. New simple discovery. Enormous demand all year 'round. Tremendous profits! Light fascinating work. Send \$2.00 for working equipment, instructions, and valuable sales plans. Satisfaction guaranteed or money promptly refunded. Alfred Hermansen, 210 Fifth Ave., Suite 1102A, New York 10, N. Y.

BIG Money awaits you, if you follow practical, workable, profitable, ideas and plan in 10,000 word mail order booklet. 25c. Ideal Sales, P.O. Box 1281, San Antonio 6, Texas.

MAKE Rubber stamps, metalize baby shoes, repair dolls, silver mirrors, make beautiful figurines. Catalogue of "30 ideas" free! Universal, Box 1076-A, Peoria, Ill.

SMALL Investment insures real profits—Your own mail order business. 25c brings details. Humphrey, 905A Bellevue Court Bldg., Philadelphia, Penna.

BOOKKEEPERS Earn \$100.00 weekly operating simplified "bookkeeping and tax service." Details free. Universal Bookkeeping, Box 664-M, Springfield, Missouri.

HAVE Your own mail order business. Send now for free particulars. Charles H. Clum, 730-15th Street N.W., Washington 5, D. C.

NEW Profitable home business repairing zippers. Thousands of customers waiting. No experience required. We furnish everything. Write Texas Specialty Company, 204-B Texas, Texarkana, Texas.

MINK Raising information free. Complete. Lake Superior Mink Farm, Superior, E.E1, Wisconsin.

LIQUID Marble! Formula 25c. Alpha Service, Box 3459, Rincon Annex, San Francisco, Calif.

MADE Big money. So can you. Wamsteker, Box 34-A, Wynberg, Cape Africa.

WIPE-ON Auto paint. Make and sell this wonder. All colors. Complete formula 50c. Nelko Chemical Service, 3462 Merchandise Mart Sta., Chicago 54, Ill.

EARN While you sleep. Coin-radios. John Kratz, Grantham, Pennsylvania.

MOLD Makers—Attention! Genuine natural latex for reproduction of figurines, statuary, plaques, etc. Instructions free. B. M. Barron, 77 Francis St., Everett, Mass.

SILICONE Auto polish—Make, sell this new wonder. Amazing profits. Easily made. No machinery. Guaranteed formula \$2.00. Kemico, Park Ridge 21, Ill.

EXCEPTIONALLY Profitable making finest perfume. Sample fragrance, particulars free. Torrey, 13 Sewallwoods, Melrose 76, Massachusetts.

MAKE Money at home! 101 proven ideas. All for 25c. Success Distributors, 903-PM Pine, Marshall, Ill.

I MAKE Big money in the mail-order business. You can do the same at home with copyrighted system. Write me, I'll tell you how. F. Little, R.D. #1, Glen-shaw, Penna.

NEW Ideas—From other countries. 5000 different magazines—in English. Many single copies available. Free descriptive list. Caron & Son, 45-A Fairview Ave., No. Plainfield, N. J.

OPPORTUNITIES! Five mail order magazines, all different, 25c. Allens, Dept. PM, Box 543, Tallahassee, Fla.

MEN—Women. Everybody likes candy. Learn to make professionally. Our 40th year. Ragsdale Candies, D5, East Orange, New Jersey.

BRONZING Baby shoes is big business. Start your own business for \$9.85. Includes all materials and instructions. Copyrighted "Metal Sealed" process requires no equipment. Particulars free. Box 2095, Wichita, Kans.

EARN At home casting novelties. Free instructions using latex molds. Major Chemical Company, 164 Portland Street, Cambridge 39, Mass.

BUILD Home business by mail. Extra money. Future independence. Details free. Arnold, Butler Rd., R-11, Ft. Wayne, Ind.

A Factory in your home, garage! Mechanics' waterless hand cleaner, glass cleaner, auto cleaner-polish; many others. All formulas free, but if you also want free samples send 15c postage. Western Aircraft, Dept. B, Los Angeles 6.

BRONZED Baby shoe mountings, supplies wholesale. Box 2095, Wichita, Kans.

DRESDEN Craft figurine molds and many others, natural liquid rubber, statuary plasters, flock finishes, etc. Illustrated catalog and "Plastercraft" manual free. Blue Rapids Supply, Blue Rapids, Kansas.

LIQUID Rubber, make flexible molds. Free sample. Chaney, 1130 E. 16th St., Jacksonville 6, Fla.

MAIL Order opportunities galore. Sanchez, Box 66-P, Chelsea Station, New York 11.

MAKE Money at home as renewal headquarters for all magazines. Big Christmas sales profits now. Liberal commissions. Supplies furnished. Write for free catalog. McGregor Magazine Agency, Dept. 500B, Mount Morris, Ill.

VENDING Machines earn big money! An investment as low as \$10.50 will start you in this fascinating, profitable business that can lead you to the road of success and independence. Routes can be established and operated in either full or spare time with no experience needed. Write for full details and our free catalog illustrating our nut, candy, gum and stamp vendors; also pin ball machines, music boxes, etc. Write immediately to Parkway Machine Corporation, Dept. 7, 715 Ensor Street, Baltimore 2, Maryland.

1000 GOLDEN Opportunities! Most amazing new money-making home occupations! 600 illustrations! Beautiful gold sample free! Stamp brings details. C. Bellehaven, P.O. Box 606, Redwood City, Calif.

DOLLARS Three ways with "Kitty-Kat" readi-cut baby shoes. Complete local and mail order plans. Write No-Co-Ro, Oakland 6-K, California.

NEW Industrial hand cleaner! Sensational product. Immense market. Tremendous possibilities. Unusual money-making plan free! Keenelo, 2438 Fifteenth, Denver 11, Colorado.

\$46 FROM Square foot plywood. Jigsaw necessary. Write, Woodarts, X-38, Bridgewater, Mass.

OWN A printing business. Good profit printing cards, stationery, etc. in spare time. Easy rules furnished. Have home shop. Send dime for complete printer's supply book and samples. Kelsey, Inc., Z-24, Meriden, Conn.

MAKE Money spare or full time casting metal toys and novelties. Big wholesale and chain store demand for autos, soldiers, ashtrays, banks, etc. keep manufacturers busy. Production moulds furnished for up to 100 and more castings per hour. No experience or special place necessary. "Cash-in" on holiday orders now being placed. Write for information and illustrations of patterns needed. Metal Cast Products Co., Dept. A, 1696 Boston Road, New York 60, N. Y.

LEARN Sewing machine repairing at home. Earn \$125.00 week spare time. Plus, new machines, motors, etc. wholesale. Free particulars. Taylor Service Co., Hamilton, Ohio.

OPERATE Profitable mailorder business. Particulars free. George Lenhoff, Lincoln 8, Nebraska.

HOME Business making statuettes, plaques, artificial marble, rubber molds. Silvering mirrors. Formulas. Folder free. Creative, 236-L, Winnetka, Illinois.

SPIN Angora wool into yarn. Interesting work. House of Angora, PM5, Springfield, Illinois.

BUY It wholesale! Manufacturers, distributors offer 850,000 items. Literature free. Olsen, 1231-A East Third St., Duluth 5, Minn.

UNPAINTED Figurines. Beautiful models. Write for new wholesale price list. Oman, 642J Broadway, St. Paul 1, Minn.

COPUBLISH Leading m.o. paper. Latest copy Mail Sale Advertiser, details, dime. Vanroy Shirk, Lebanon, Penna.

MADE \$24,500 Using money making plans from Schemer Magazine, world's oldest mailorder publication. Box 775M, Alliance, Ohio. Year \$2.00. Sample 20c.

WRITE For free booklet and catalog telling how to earn substantial profits in your spare time by forwarding new and renewal subscriptions to all magazines for your friends and neighbors. Oldest U. S. agency. Established 1869. Moore-Cottrell, North Cohocton, New York.

MAKE Flexible molds! Cast plaques, bookends, figurines! Free sample! H. Tooker, 630-R Chestnut, Hamilton, Ohio.

BE Appointed state notary public now! Details. Stationers, Helotes 50, Texas.

COMMERCIAL Deep frying course. Mock chicken legs, potatoes. New and proven methods. Learn about this money-making field. \$2.50 p.p. Concession, Toledo 13, Ohio.

NATURAL Molding Latex. Extra thick. Free sample. W. Wooley, 115-A Donald, Peoria, Ill.

PROFITABLE Business making and building with easy-laying interlocking building blocks. Rex Products, Dept. 10, Piqua, Ohio.

\$250 WEEK Reported! Free illustrated book "505 Odd Successful Businesses." Work home! Expect something odd! Pacific-E, Oceanside, California.

\$25 WEEKLY Working two hours daily. No canvassing. No manufacturing. Lycke, Box 2471-A, Cleveland 12, Ohio.

POPCORN And potato chip equipment. Long Eakins Company, 5060 High, Springfield 99, Ohio.

WANTED Unused U. S. postage stamps, small discount. Advance Stamp Co., 24 East 23rd St., New York.

CO-PUBLISH And advertise in The Central Mail Advertiser. Sample copy 10c. Low rates. Large circulation. Bagby Printing Co., Georgetown, Ohio.

EARTHWORM Breeding. Valuable bulletins on successful methods mailed free. Earthmaster Publications, Dept. 14, Sun Valley, Calif.

LIQUID Marble—Colorful, glossy! Molded, brushed, sprayed! Cast novelties, statuary, colored tiles. Flexible molds. Composition floors. Particulars free. Marbleizing Service, Edwardsville, Illinois.

EXTRA Money. No selling; operate vendors. Amazing profits, details free. Silver King, Suite B, 622 Diversey, Chicago 14.

HOW To set up and run a mirror shop! Resilver mirrors. Make chipped glass nameplates. Electroplating salts and rectifiers. John Sprinkle, V60, Marion, Indiana.

READ "Advance"—The voice of mail order. Offers money-making opportunities, sources of supply, personal guidance, etc. Issued monthly. Sample copy 25c. Yearly subscription \$2.00. Advance Publishing Company, 313 East 21st Street, Suite 450, New York 10, N. Y.

RECAST Old batteries into new. Latest achievements. Battery Laboratories, Minneapolis.

MAKE Money making new greasless doughnuts at home on electric machine. Wholesale to grocers, drug stores, cafes, hamburger shops. Send for free recipes and plans. M. Ray Company, 3605 South 15 Ave., Minneapolis 7, Minnesota.

START Mailorder bookshop— Everything furnished. 25c brings booklet, samples, exciting ideas. General Publications, Ossining, N. Y.

OPERATE Profitable mail order business. Write Waiter Service, 4159-A East 112th, Cleveland 5, Ohio.

MAILING Postcards selling repeat merchandise is profitable. Everything supplied. Details free. Gordan Publishers, Box 23, Pawtucket, R. I.

137 WAYS To make money, in home or office, business of your own. Full particulars free. Elite Co., 220 Grand St., New York 13.

BRUSH Plating outfits connect to a battery. No tanks necessary. Good paying business at home plating autoparts, bathroom fixtures, bicycles, reflectors, silvering mirrors. No shop or experience required. Outfits furnished. Free booklet. Gunmetal Co., Ave. H, Decatur, Ill.

COLORGLAZED Concrete pottery made without molds. Patented method. Cemetery products, novelties, tiles. Basement leak-sealing. Money-making projects. Booklet, details free. Men only. National Potteries Company, Grand Rapids, Minnesota.

OWN A Venetian blind laundry on protected territory basis. 50 units successfully operating. Total cost \$6750.00 on time payment plan. Ask for booklet "Aiming at a First Year \$15,000 Profit." D. L. Laundry, Inc., 101 S. 44th St., Philadelphia 4, Penna.

EXPORT-Import offers trained men unlimited big paying job opportunities. Buy at low foreign labor costs. Sell at high American dollar living standards. Gain own business, financial independence, etc. Free facts book. International Trades, 246-P Fifth Ave., New York City 1.

MONEYMAKING OPPORTUNITIES

MAKE Money with easily installed weatherstripping. Double Seal Co., 2725 Ross, Waco, Texas.

WIN Cash, cars in prize contests! Write for copy filled with current contests, winning hints and tips. Send only 25c. Wright Contest Digest, Dept. 17-M, P.O. Box 2266, St. Louis 9, Mo.

SELL Guatemalan Indian curios. Beautiful sample assortment \$5.00 in draft or write: R. Quesada, 2nd. Ave., Norte 7, Guatemala, Central America.

ASSEMBLE And sell Swiss musical churches. Complete kit \$3.95 postpaid. Piltzecker Imports, Wood-Ridge, N. J.

\$3000 YEARLY Making party mints. Recipe \$1.00. H. Gill, 1612 Harrison, Topeka, Kansas.

BARGAINS, New and used arc welders. Electric or gas engine, a.c. or d.c., all sizes, portable or stationary. Write needs. Hobart Welders, Box M-1104, Troy, Ohio.

MAKE Backyard profits! Unusual opportunities! Interesting booklet free. Pickett's, Florence, Kentucky.

SHELLCRAFT! Make beautiful seashell jewelry and novelties, income or hobby. Supplies, instructions. Pace's, Cortez-M. Florida.

EARN Money evenings, copying and duplicating comic cartoons for advertisers. Adservice, Argyle 1, Wisconsin.

"HOW To Make Money With Simple Cartoons"—A book everyone who likes to draw should have. It is free; no obligation. Simply address Cartoonists' Exchange, Dept. 911-CM, Pleasant Hill, Ohio.

BIG, Big mails! Send dime. Sherman, 933 Judah Street, San Francisco 22.

RESURFACE Butcher's chopping blocks with easy, fast-working, portable electric machine. Unique service in wide demand with little competition. Large steady profits from full or part-time work. Hill Machine Company, Box 677B, Rockford, Ill.

MAIL Order stars for money making. Get them. Lou Wiltch, Steelville, Missouri.

TESTED Mail order plan shows you how to make money. Write Chambers, 1826 Ward Street, Berkeley 3, Calif.

YOUR Own profitable mail business supplying new instruction manual, thousands prospects! Everything furnished wholesale. Stamp brings sample imprints, full information. Neetso Publishers, Suite 712 P, Asheville, N. C.

QUICK Profits taking magazine subscriptions, handling greeting cards. Cassell Publishers Service, Westfield, N. J.

WORK At home. Get orders by mail. Everything supplied at low cost. Big earning possibilities. Write: Edmondson, Box 4865-P, Atlanta 2, Ga.

HOME Manufacturing courses and formulas for complete lines. Perfumes, baking powders, flavorings, auto specialties, \$2 each. Plastics, Box 1574, Boston 4, Mass.

CASH For box tops, labels, wrappers, etc. Send 25c for buyer and items desired. Northland Service, P.O. Box 23, Laurium, Mich.

COLORED And light reflecting crystals, luminous pigments. Catalog and samples 25c. Glowell Co., 475-D, Fifth Ave., New York, N. Y.

YOU Can buy thousands of articles wholesale. "Supply Source Directory" 10c. Ideal Service, Park Ridge 40, Illinois.

WIN Contest money. General Contest Bulletin gives hundreds of tips. Lists current contests and rules. Sample 25c. General Contests, 1609½ East 5th, Duluth, Minn.

MANUFACTURE Own products. Any formula \$1. O. S. McCollum, 383 Miller, Vaux Hall, N. J.

BOOKKEEPERS Boost income operating simplified bookkeeping service. Kern, 4942 Vineland Ave., No. Hollywood, Calif.

SALESMEN—Sell 12 oz. bottle vanilla with premiums. Write, Economy Supply Service, 913 Asa St., Defiance, Ohio.

SCHOOL Seniors—Sell classmates America's most beautiful graduation name cards. Largest selection. Highest commission. Outsells all others. Free sample kit. Printcraft, Dept. M, 1425 E. Elm St., Scranton 5, Penna.

DOLLARS In personalized baby record books. Sell by mail. Use same literature we do. No-Co-Ro, Oakland 6, Calif.

INDEPENDENT Income! Make leather belts, billfolds, purses. Big catalog and genuine steerhide keyholder. 10c. Tandy Leather, Box 397E, Tulsa, Okla.

BUY Nylons direct from mill. Make good profits on fast selling nylons. Quick delivery on any quantity. Write for confidential wholesale price list. Joy Hosiery Mills, Delawanna 13, New Jersey.

RAISE Your business value, standing, as state notary public. Information. Stationers, Helotes 50, Texas.

\$250 WEEK Reported! Free illustrated book "505 Odd Successful Businesses." Work home! Expect something odd! Pacific-E, Oceanside, California.

PUBLISH Your own magazine. Handsome 52 page format, well edited, illustrated. Cost low as \$1.00 month. Brings you prestige, profits. 25c brings sample, details. National, Ord, Nebr.

READ Progressive Mailtrade, the magazine that tells how to make money by mail. Dime brings sample and special offer. Progressive Mailtrade, Box 357, Sheboygan, Wisconsin.

EARN \$15,000 Yearly. Become automobile salesman. "Expert Car Buyer" enables anyone to easily evaluate automobiles. Reveals authoritative inside information. 96 pages. \$2.00; COD—\$2.30. Superior Co., 1321-B Arch, Philadelphia, Penna.

RESILVER Mirrors at home. Formula 25c. Ideal Service, Park Ridge 8, Illinois.

CHEMISTRY

LABORATORY Chemicals and apparatus. Catalogue 10c. Luther Laboratories, New Britain, Connecticut.

LABORATORY Apparatus, chemicals, microscopes, complete chemistry sets, minerals, uranium ore. 10c brings catalog. Porter Chemical Company, Hagerstown 1, Maryland.

LABORATORY Supply catalog, 10c. Rex Laboratories, 2849-A Birchwood, Chicago 45, Illinois.

NEW Idea chemical and apparatus outfits for home experimenting. Photo-scales, microscopes, chemicals, biological and laboratory supplies in small quantities. Catalog 15c. Established 1931. John H. Winn, 124A West 23rd Street, New York 11, N. Y.

CHEMICALS And apparatus for industrial, analytical, and private laboratories. Catalog 15c. Dept. M-50, Biological Supply Co., 1176 Mt. Hope Ave., Rochester, 20, N. Y.

ILLUSTRATED Catalog: Chemistry, mineralogy, biology. 10c. Tracey Laboratories, Evanston, Illinois.

PLASTICS

PLASTICS—Complete line. Wholesale, retail. We make our own full-color carving dyes. Casting plastic at quantity prices. Catalog, bargain lists, idea, instructions, 10c. Gem-O'-Lite, Box 686B, North Hollywood, Calif.

NEW Liquid plastic. Clear, colors. Cast without heat. Embed flowers, insects, coins. Saw, drill, carve. Free folder, "Liquid Magic" shows fine things you can make for Christmas. Write today. Castolite, Dept. M-101, Woodstock, Illinois.

PEARLIZING Kit. For applying pearl finishes to plastics, glass, metal, jewelry, etc. Kit includes all materials needed to make necklaces, earring, buttons. \$2.00. Florentine Pearl Co., 216 Weybosset St., Providence, R. I.

INTERNAL Carved plastic jewelry—Photostamps and novelties. Free list. Fred Farrar, 3510 Broadway, Kansas City 2, Mo.

MASKED Plexiglas, fair sized pieces. 50c per lb. plus postage. No C.O.D. Supply limited. Harold Wilson, 6711 Lewis, Long Beach, Calif.

AMAZING Liquid plastic kit \$3.25. Embed photographs, keepsakes, coins, make solid objects, clear, colors. Beautiful results in half hour. Easily tooled. Inexpensive hobby. Send 15 cents for catalogue. Kristalon Plastics, Dept. Z-110, Box 29, Wilmette, Illinois.

PLASTIC: Sheets, cut pieces, and scrap in clear and colors. Rod, tubing, acetate, dies, jewelry findings. Send \$1.00 for 4 pound scrap assortment and fabricating manual. Regal Plastic Supply, 720 Main, Kansas City, Missouri.

LUCITE, Plexiglas. Any size sheets, masked. Square foot (12 x 12) cost, 1/16", 98c; 1/8", \$1.25; 3/16", \$1.52; 1/4", \$1.80. Colors add 10%. Include 10% postage. Almac Plastics, 230 Fifth Ave., New York 1, N. Y.

INTERNAL Carved roses, orchids, swans, goldfish, butterflies, etc. Jewelry and gifts. Crystal Floral Novelty Co., Bound Brook, New Jersey.

PLASTIC, Sheets, rods, tubes, etc. Free list. Plastic Supply Co., 2901 N. Grand Blvd., St. Louis 7, Mo.

FORMULAS, PLANS, ETC.

RELIABLE Formulas. Polishes, cleaners, etc. List free. Monde, Pulaski, Wisconsin.

MILLER'S Modern manufacturing formulas make new products that get the business. Fifty years supplying the best. Literature free! Miller, Manufacturer's Chemist, Tampa 6, Florida.

MAKE Cosmetics, beauty preparations. 12 widely used formulas and directions \$1. C. Jackson, 3140 Douglas Blvd., Chicago 23, Ill.

MONEY Making formulas, ideas, trade secrets. Literature free. Ultra, 3519 Troost, Kansas City, Mo.

ANY Formula \$1.00, or money refunded. Nelko Chemical Service, 3462-F Merchandise Mart Sta., Chicago 54, Ill.

10,000 FORMULAS And trade secrets. Free literature. Stillman, 555 Kingston Ave., Brooklyn 3, N. Y.

PRODUCTS Analyzed. Improved. Guaranteed formulas. Consulting Scientific Company, Swarthmore, Pennsylvania.

MAKE—Sell cleaners, soaps, polishes, flavors, cosmetics. No machinery. Formula literature free. Kemico, Park Ridge 16, Illinois.

WATERLESS Hand cleaner. (No ammonia.) Easily made. Good profit. 2 dependable formulas \$1.00. Nelko Chemical Service, Box 3462, Chicago 54, Ill.

TESTED Formulas. Interesting descriptive booklet free. Pont, Box 635-PM, Terre Haute, Indiana.

FORMULAS For nearly everything. Catalog free. Write Creative, Winnetka, Ill.

REAL Manufacturing formulas. Lists free. Cummings, Chemist, Gordon Ave., Syracuse 4, N. Y.

HELP WANTED

ENGINEERS—Send brief qualification record for free listing of all current openings in your field. Rapid confidential nationwide service. Boulevard Engineering Personnel Service, Dept. H-1, 116 S. Michigan, Chicago 3, Illinois.

AGENTS WANTED

ADVERTISING Novelty. Fits over telephone dial. Fast outstanding seller. Liberal commission. Free samples. Acme Mfg. Co., 67 Chelmsford St., Boston 22, Mass.

SELL Extra fine quality floral tooled belts with the famous Flexo buckle that breathes with you. Selling price \$3.75. Sample \$2.00. Perry's, Rt. #4 Middle Road, Rockford, Ill.

AGENTS For black hand soap. Waterless. Removes grime, paint. Sample 25c. 4223 East 14th, Oakland, Calif.

BARGAINS! Save up to 50%. Hosiery, lingerie, toys, school supplies, blades, novelties, carded goods, drygoods, cosmetics, stationery, jewelry, notions, perfume, soaps, etc. Send 10c for illustrated 1000 bargain catalog. Valuable surprise gift free with first order. Reliable Jobbers, 311-B North Desplaines, Chicago 6.

MEXICAN Feather pictures. Sell on sight; 200% profit! Free details; sample 10c stamps. Sylvia-PH, Apartado 9036, Mexico City.

EASY Money, wonderful work. Mix water with our concentrates. Make flavors, lotions, perfumes, shampoos, cleaners, polishes, 125 products. Free catalog. Qualco E20030 Russell, Detroit 3.

LOOK Here! Wanted—Men to start in business on credit. Sell some 200 farm-home products. Thousands our dealers now make quick sales, big profits. For particulars write Rawleigh's, Dept. K-192-PPM, Freeport, Ill.

CASH In on tremendous demand for new low priced burglar alarm for cars, homes and farm building. Nothing like it. Everybody wants one. 286% profit. Unique sample offer. Northwest Electric Co., Dept. K-10, Pukwana, S. Dak.

FREE Samples, and amazing plan giving you gorgeous dress without penny cost. Rush name today with dress size. Harford, Dept. C-535, Cincinnati 25, Ohio.

SELL Ultra-blue stock signs to stores. 1000 slogans, comedy, general, religious. "7x11" cost 6c, sells 35c. Make money. 15 samples \$1.00 postpaid. Lowy, 812 Broadway, Dept. 571, New York City 3.

TO \$35.00 Weekly. Spare time, home operated, mail order business. Successful small "beginner's" plan. Everything supplied. Lynn, 5710-M Bankfield, Culver City, California.

NYLONS Direct from mill. Sample free. Guaranteed against runs. No experience or money needed. Also nylon slips, briefs. Earn big money spare or full time. Become manager, appoint agents. We pay you 40c for every \$1 your agents earn. Sell 14K neckchains "Flat-Curb" \$6, cost \$2.50. Ergim Co., 992 Columbus Ave., New York.

\$1.00 STARTS You in business. Sell men's neckwear full or part time. Low investment big profits. Send \$1.00 receive sample tie, free color catalogue, selling plan, wholesale price list. Radio City Neckwear, Dept. M7, 112 W. 50th, New York City 19.

BALL Point pens. Dozen two dollars. Samples twenty-five cents. L. S. Distributing, White Bear Lake, Minn.

STRANGE "Dry" window cleaner. Sells like wild. Replaces messy rags, liquids. Simply glide over glass. Samples sent on trial. Kristee 158, Akron, Ohio.

NEW Plastic mending tape. Just press on! Repairs clothing instantly. Lightning seller. Samples sent on trial. Kristee 159, Akron, Ohio.

YOUR Own business selling army surplus, new clothing. Lowest prices. Enormous profits. Catalog free. Moro, 558-J Roosevelt, Chicago 7.

NEW, Novel plastic "slideon" pricing sets sell fast to stores, manufacturers, others. Exclusive features. Take easy orders—collect big profits. Free starting outfit. Mastercraft, 223 Tyler, Dept. PM-1, Trenton, N. J.

OWN A big moneymaking used clothing business. Men's used suits \$2, pants 35c, topcoats \$1.25, jackets 60c, shoes 20c. No experience necessary. Free wholesale catalog. Superior, 1250-A Jefferson, Chicago 7, Ill.

AGENTS Make big money! Sell new invention needed in every home, hotel, institution. Does double job at fraction of old cost! Top quality! Quick repeater! Your profits huge, almost 100%! Rush name for free money-making details. Universal, 29 Hall Avenue, Tuckahoe 7, N. Y.

ALL-Purpose power mowers. 10" wheels. Gas-electric. Rotacut, R-2011, Excelsior Springs, Missouri.

FREE Sample nylon stocking of world's only nationally advertised hosiery line actually guaranteed against runs, snags or excessive wear, regardless of cause! It's amazing but true. Every weight from sheerest 15 denier to heavy 70 denier—all gauges to luxury 60 gauge. Amazingly low prices, starting at \$1.08 prepaid for sheerest 15 denier 51 gauge. Not sold in stores. Good Housekeeping guarantee seal. Also complete line men's hosiery guaranteed one full year or replaced free. Full variety lingerie in crepe, satin and nylon, featuring all nylon slip at \$2.95, satin slip at \$1.58, etc. Housecoats and robes. Kendex sales people will earn one million dollars this year. Get your share. No money or experience needed. Pay nothing now or later. Just show free outfits. Write orders. We deliver and collect. Advance cash plus huge bonus. Earn money spare or full time. Become manager; appoint others to sell for you; earn steady income on their sales. Man or woman—young or old, you can earn more money than you ever thought possible. Everything you need is furnished free and prepaid, including nylon stocking, samples of materials, sales books, 36-page salesmanual, color cards, etc. Simply write your name and address on postcard and mail to Kendex Corporation, Babylon 83, N. Y.

WALKER'S Tooth powder, user's favorite, can multiply your profits. Write J. Walker, 633 Plymouth Ct., Dept. 1, Chicago 5.

PERFUME—Sideline to independence. Learn all—free. International, 6347 Parnell-AM-11, Chicago 21, Illinois.

IS \$210 A week worth a penny postcard to you? Then rush card with name and address for special free trial plan that sells amazing new automatic refrigerator defroster like hot cakes! Write to Mr. Lewis, D-Frost-O-Matic Corp., Dept. PMC-11, 6 N. Michigan, Chicago 2, Ill.

MAKE Products yourself right at home. Windshield cleaner, rug cleaner, vanilla, spot remover, moth killer, auto polish, radiator cleaner, glass cleaner, soapless shampoo. Use just one ingredient formulas. No mixing. Amazing profits. Complete set \$1.00. Ideal Formula Service, Park Ridge, Ill.

SELL NuSilver Plating Polish, cloth applied products. Contain genuine silver. Silverplates copper, brass, silver. Nu-Silver, 508-PM11 N. Y. Street, Aurora, Ill.

SCHOOL Seniors! A postal will bring you our wonder, Kwick-Sell Cardalog of popular graduation name cards. Biggest profits! Only firm giving free Golden Memory Book and Souvenir Chest. Don't miss out. Hurry that postal! Craftcards, Box 235 (L), Pittsburgh 30, Penna.

BUY Thousands of nationally advertised products direct from manufacturers and distributors. Write for "Buy Direct and Save." Service Publishing, 1420-A Investment Bldg., Pittsburgh 22, Penna.

FAST Profits—No investment. Send for big, free catalog. Plastic aprons, tablecloths, etc. 150 sure-fire items. We guarantee sales. Write The Halliday Co., Dept. M-9, 15-19 Pennington, Passaic, N. J.

SALESMEN, Distributors. Fast selling jewelry items. National Distributing Company, Calumet Building, Miami, Florida.

SELL Watches, silverware, cookware, appliances, etc. Lowest prices. Top profits. Write: Kriston, Pemberville, Ohio.

EARN Big profits! Every home needs new Tapaline Multiplug that makes 8 appliances available from one outlet. Sample \$1.50. 16 page catalog of household items free. Sunshine Sales, Dept. WP5, Loudonville, Ohio.

MEXICAN Feather pictures. Christmas novelty \$1.00 (stamps) brings \$2.00 worth samples, details. Refunded if unsatisfied. Aztec Art-P, Apartado 762, Mexico City.

BIG Week's pay every day. Demonstrating new light weight Zip-Kwik All-Purpose Folding Chairs for quantity sales to homes, churches, clubs, schools, resorts, hotels, restaurants and so forth. Profits and prospects unlimited. Wire or write, Valley Steel Products Co., 126 Sidney Street, St. Louis 4, Mo.

NEW Plastic rayon towels selling rapidly everywhere with spectacular demonstration. Large profits. Sample package \$1.00. Sunbeam Products, 634 4th St., South, St. Petersburg, Florida.

THERE'S Big money taking orders: Personal initialed buckles with belts, tie holders, choice of over 3,000 emblems, cap and breast badges for every purpose. Uniforms, work clothes, embroidered with company name, trademark, sales message, etc. Prospects everywhere. Latest styles, finest fabrics. Write for selling kit. Hook-Fast Co., Box 480PM, Roanoke, Virginia.

BIG Money taking orders: Shirts, ties, Sox, pants, jackets, sweaters, shoes, uniforms, etc. Sales equipment free. Experience unnecessary. Nimrod, 4922-BG Lincoln, Chicago.

PHOTO-Salesmen, agents. Sell beautiful hand colored plastic enlargements and sensational new photo compacts, rings, bracelets, lockets, etc. Collect deposit, we deliver. Profitable sideline. Send card, for free sample kit. Novel Portrait Co., 3343 North Ave., Chicago, Ill.

SELL Direct finest quality, fastest sellers in \$1.00 and \$1.50 neckwear. Hosiery. Lowest prices, top profits. Write: Wolfmark, 931-P West Roosevelt, Chicago, Ill.

MAKE \$20 A day! Sell Staybright brass name plates for front doors. Write Hubstamp, 357-E Congress, Boston, Mass.

TIES Christmas boxed free. New patented tie and regular ties. Sensational Christmas gift line. Perma-Knot Tie Company, Dept. 101, Williamsville 21, New York.

\$184.00 CONTINUOUS Profit from every \$8.00 investment. Shampoo powders in bulk. Bottle yourself or sell powders. Request convincing facts. Morael Manufacturing Company, 505-R Fifth Ave., New York City 17.

BE A money maker. Represent magazines year around. Wonderful home work. Big Christmas profits now. Liberal commissions. Everything furnished. Write for free catalog. McGregor Magazine Agency, Dept. 500A, Mount Morris, Ill.

CASH in on plastics! Big profits with our 350 new plastic home needs. Perfect for party demonstrators, canvassers, stores. Lowest prices—highest quality. Write for free details. Durever, 2781-G Atlantic Ave., Brooklyn 7, N. Y.

SCHOOL Seniors—Earn sensational profits selling classmates America's most beautiful graduation name cards. Largest selection. Outsell all others. Free sample kit. Printcraft, Dept. M, 1425 E. Elm St., Scranton 5, Penna.

FREE Samples. Big profits showing amazing Glow-in-the-Dark specialties. House numbers, pictures, plastic novelties, ashtrays, keyholders, religious and nursery objects, etc. Madison Plastics, 303 Fourth Ave., New York 10, N. Y.

MAGIC Cleaner—Laundry soap deal. Hotter than a firecracker. Big profits. Sample free. Bestco, 4642 No. Central, Chicago.

1950 XMAS Card catalog ready! Earn more money as a wholesale jobber! Large selection of dollar box assortments, imprints, religious, personalized Christmas cards! Three dollar sample boxes \$1, postpaid! Write for free holiday bulletin. Elfko, 438 North Wells, Chicago 10.

DRESSES, 18c; Coats \$1.00, blouses 35c. Free catalog. Crown, 164-P Monroe Street, New York.

WRITE for free booklet and catalog telling how to earn substantial profits in your spare time by forwarding new and renewal subscriptions to all magazines for your friends and neighbors. Oldest U. S. agency. Established 1869. Moore-Cottrell, North Cohocton, New York.

SELL Balloons! Combs! Novelties! Excellent sideline. Carleton House, Texas City, Texas.

NEWEST Money making sensation. Sell personal initialed belts, buckles, cap and breast badges, tie holders, etc. Choice 2000 emblems. Write special outfit offer today. Hook-Fast, Box 1425PM, Providence, R. I.

JEWELRY Factory desires salesmen, distributors, jobbers. Pickcraft, 19 Bank Street, Attleboro, Mass.

SELL Big money-maker to men and women. Easy handwork makes fast-selling useful articles. Sunmade Company, Brockton 64, Mass.

GOLD Lacquered window sign letters. Large sizes penny each. New fells. Absolutely beautiful. Free samples. Atlas, 544 W. 79th, Chicago 20.

AGENTS: Stamping names on key protectors. Sample 25c. Stamping outfits, checks, social security and name plates. Hart Mfg. Co., 303 Degraw St., Brooklyn, N. Y.

EXCELLENT Sideline for printing and advertising salesmen. Decalomania name plates in small quantities. Great demand. Also, make money with our line of automobile initials and sign letters. Free samples. "Ralco" XL-Roxbury, Boston 19, Mass.

WHERE To buy 800,000 articles direct from manufacturers. Including hundreds of scarce items. Sent free, "Your Profits Under the Spotlight." Glass Publishing Co., Ellwood City, Penna.

AGENTS—300% Profit selling genuine gold window letters; stores and offices. Free samples. Metallic Letter Co., 438-B North Clark, Chicago.

AGENT Or exclusive distributor for cigarette lighter manufacturer. MacGregor, Tahoe Valley 16, Calif.

HIGH-GRADE SALESMEN

EARN Big money fast! Sell finest-quality advertising work uniforms to garages, factories, filling stations, etc. Free selling kit. Topps, Dept. 5311, Rochester, Ind.

POSITIVELY New—Over 100% profit. Two sided reversible neckties. Free details. Farrell Company, Dept. P-16, 1377 Van Zandt, Cincinnati 31, Ohio.

SALESMEN—Sell America's finest, biggest line of advertising specialties. Sensational sellers to all types of business. Big commissions advanced. Sensational sales plan nets you top earnings. Free outfit. Charms & Cain, 407-MPM South Dearborn, Chicago 5.

ADVERTISING Book matches—Cash in on big demand; sell union label matches. Cuts for all businesses and political parties. Free powerhouse selling kit, low prices, protection guaranteed on repeat orders. Cash commissions. Superior Match Co., Dept. M-1150, 7530 Greenwood, Chicago.

BUILD Your own business—Sell nationally known cushioned sole Charles Chester Shoes direct from our factory established 1876. Complete line for entire family. Full time or side line. Advance commission up to \$2.50 per pair plus generous monthly cash bonus. Samples and equipment free to producers. Chas. Chester Shoe Co., 150 Foundry St., Brockton, Mass.

CALENDARS And advertising novelties. All sizes, styles and prices, including household, religious, 12 sheet, girls, pencils, rulers, key chains, thermometers, etc. Fleming Calendar Co., 6539 Cottage Grove, Chicago 37, Ill.

AD Matches! Sell amazing designs—20, 30, 40 and 240-light book matches. Big spot cash commissions; every business a prospect. Low prices for high quality. Repeats. Start without experience; men, women; full, part time. Buy nothing! Sales kit furnished. Match Corp., Dept. PM-11, Chicago 32, Illinois.

SHINER-Hook; New sensational seller. Fishermen, dealers. Sample 10c. Catalog free. Nelson Company, St. Paul 2, Minn.

WANTED: Man who needs to earn at least \$75 weekly. Work full or part time. Permanent. National organization. Free outfit. Write Red Comet, Inc., Dept. 775, Littleton, Colorado.

SALESMEN—Would you like a seagoing yacht for one dollar? The writer has one, and after 45 years of successful selling, tangibles and intangibles, has condensed a few priceless and proven secrets of his successes into one small pocket book you can carry with you. This booklet is unlike anything you have read and satisfaction is guaranteed no matter what you are selling. For example the writer sold and placed 34 ordinary life insurance policies in a single day. (Not industrial or group.) A world's record. See "The Insurance Salesman," Oct., 1934. Mail one single dollar for "P.M.S." to Stroud and Sowle, 195 26th Ave., #5, San Francisco 21, Calif. (Crew and Sales Managers, 6 for \$5.00).

BE A master salesman. Powerful secret key in new book, "How to Sell Faster." Send \$2.00. Free literature. Helpful Press, 2212 Cuming, Omaha, Nebraska.

A Fine income, your own nylons free! Show nylons, lingerie, men's socks with amazing free replacement guarantee against runs, snags, tears. Write for free sales kit. Group organizers invited. Rosalee Hosiery Co., Clifton 58, N. J.

SELL The fastest money maker out! Handy Hannah automatic wax dispenser pays you over 100%. Every housewife wants it. Saves time, labor, stooping, mess, waste. Press button and wax is released. Sample and details write Everett Young Co., Whitman, Mass.

NEW Jobs open in selling! Send name, address for five free issues of Opportunity Magazine's money-making guide, listing hundreds of companies who'll pay you well, full or part-time. No experience needed. Opportunity, 28 E. Jackson, Dept. 17, Chicago 4, Ill.

BIG Money taking orders. Shirts, ties, Sox, pants, jackets, sweaters, shoes, uniforms, etc. Sales equipment free. Experience unnecessary. Nimrod, 4922-AN Lincoln, Chicago.

EDUCATIONAL AND INSTRUCTION

MEDICAL Laboratory Technicians in great demand. We train you in your own home. Catalogue free. Imperial Technical Institute. Box 973-J, Austin 65, Texas.

ACHIEVE Business and financial success in your own collection-credit agency business. Home or office. Quickly learned. Free folder. Write Cole & Associates, Syracuse 2, N. Y.

BECOME A Doctor of Psychology or Metaphysics. Teach secret of contentment and happiness. Win degree of Ps.D. or Ms.D. Solve mental worries. Free book. College of Universal Truth, 5153-C North Clark, Chicago.

USED Correspondence courses and educational books bought, sold, rented. Catalogue free. Educational Exchange, Summerville, Georgia.

USED Correspondence courses. Educational books. Bought, sold, rented. Free list. (Satisfaction guaranteed.) Home Study, 150, Salem, Indiana.

LEATHER Carving. Fascinating, highly-paid art; age-old secrets now taught for first time in home study course. For hobby, profession or profitable business, write: Baird School of Leather Carving, Box 1367-M, Dept. 11B, Manitou Springs, Colo.

"HOW To Break and Train Horses"—A book every farmer and horseman should have. It is free; no obligation. Simply address Beery School of Horsemanship, Dept. 11011, Pleasant Hill, Ohio.

MAKE Up to \$35-\$45 week as a trained practical nurse! Learn quickly at home. Booklet free. Chicago School of Nursing, Dept. M-11, Chicago.

BE A real estate broker through home study or classroom instruction. Write for free book. Approved for veterans. Weaver School of Real Estate, 15 E. Pershing Rd., Box CP-11, Kansas City 8, Missouri.

3800 LATEST Used correspondence courses. Cat. 50c. EG, Elmsford, N. Y.

USED Correspondence courses. Bought, sold, rented. Free literature. Baker, 5509-B Winthrop, Chicago 40.

VOICE Secrets! Information free! Studio, 14356B South Jersey, Norwalk, Calif.

READ With speed! New amazing method! Save hundreds of hours yearly. Free test. Speed-Reading, 9111-g Hoyne, Chicago 20.

"CONCRETE Block Homes." 32 page booklet on how to build. \$1.00. H. C. Lightfoot, Civil Engineer, Richboro 1, Pennsylvania.

INVESTIGATOR Courses. Free literature. Allied Academy, 14 No. East, Indianapolis.

LEARN To play Scrimmage by correspondence. New football game sensation. Big demand for instructors. Write to-day. Fred Welna, 2220 North 33rd Avenue, Omaha 10, Nebraska.

IT'S Fun learning a language by Linguaphone. At home, in leisure time, quickly, easily, correctly master Spanish, French, Italian—any one of 29 languages through proved Linguaphone conversational method. Send for free book. Linguaphone Institute, 83-P Radio City, New York City.

U.S. Gov't. jobs. Men, women qualify now. Study course, service helps you. Complete \$10. Wellwood Agency, Box 363, Oak Park, Ill.

STUDY To be a doctor of psychology or metaphysics. Obtain Ps.D., Ms.D., D.D. or Ph.D. degree. Chartered by state. Write for free book telling how. The Neotarian Fellowship, Dwight Building, Kansas City 6, Missouri.

USED Correspondence courses and books sold and rented. Money back guarantee. Catalogue free. (Courses bought.) Lee Mountain, Pisgah, Alabama.

HOME Study course, drugless therapy. Free literature. Institute of Drugless Therapy, Tama, Iowa.

INVESTIGATOR Training. Phillips Secret Service System, 1917-B North Keneth, Chicago 39.

BOOKKEEPERS! Increase your earnings! Operate your own simplified "dollar-a-week" bookkeeping and tax service. Full or spare time. Details free. No obligation. Ellis, Box 200, Cedar Grove, N. C.

SECRET Investigation. Experience unnecessary. Investigators particulars free. George Wagner, M 125 West 86th, New York.

PIANO Tuning pays. Learn this profitable profession at home. Our Tonometer and mechanical aids make learning easy. No knowledge music necessary. Diploma granted. Largest and oldest school—52nd year. G.I. approved. Write for booklet. Niles Bryant School, 78 Bryant Bldg., Washington 16, D. C.

PLAYS, STORIES, MANUSCRIPTS

MUSICAL Comedy plays. Dorby Publications, P.O. Box 738, Morristown, New Jersey.

I WANT New writers to cash checks of \$1 to \$100 offered daily. The easiest way to write for pay. No previous experience necessary. Free details. Saunders M. Cummings, 468-11 Independence Bldg., Colorado Springs, Colo.

INFORMATION

WHERE To buy most anything. We furnish supply sources. Single item, 50c. 3 for \$1.00. Service Bureau, Box 5053, Chicago 80, Ill.

WHERE To sell more than 500 items. List \$1.00. D. L. Crawford, 61 Werden, Vallejo, Calif.

BUSINESS SERVICE

INCORPORATE Your business. Delaware laws. Free details. Tax Research Bureau, Inc., Box 710, Wilmington, Del.

SPECIAL SERVICES

TANGIER Postmark! Letters reairmailed 3 for dollar bill. Idap, 26, Hollande, Tangier, Morocco.

YOUR Letter remailed in San Francisco, 25c. Prompt, confidential. Sherman, 1600-12th Avenue, San Francisco 22, California.

ALASKA Postmark! Letters remailed 25c each. P. H. Williams, Box 1164, Anchorage, Alaska.

DRAWINGS To order, labels, trademarks, monograms, etc. \$15. c.o.d. Co-Op Art, Box 384, Madison, Wis.

MEXICAN Mailing address, 25c each, \$3.00 monthly. Businesses, personal. Mexican matters reliably handled, confidential. Acuña, Box 25612, Mexico, 12, DF.

INVESTIGATION And cash liquidation—Old or recent stock certificates, bonds, bank books, promissory notes, deeds, wills, insurance policies, financial documents of every description. Send us your list for appraisal. National Evaluators, P.O. Box 5852, Cleveland 1, Ohio.

CARTOONING, COMMERCIAL ART, SHOWCARD WRITING, SIGN PAINTING

DRAW Beautiful human figures, 20 lessons, 147 illustrations, \$1.00 complete. Aldcroft Studios, Bendix Building, Los Angeles 15, California.

PROFESSIONAL Pen cartoon from your photo \$2.00. EG, Elmsford, N. Y.

"HOW To Write Cartoon Gags" \$2.00. "How to Earn \$100.00 Weekly Cartooning" \$2.00. "How to Sell Your Cartoons" \$2.00. Literature 25c. Free details. Lew Card, 16-13, La Habra, California.

TRACING Folios—Twelve alphabets, ten numerals, \$1.10. Three different \$3.00. Demonstrators, 639-P Paulina Street, Chicago, 12.

9 ALPHABET 3 Numeral pattern sets and catalog. \$1.00. Sign Letter Distributors, P.O. Box 101, Mineola, N. Y.

ART—Learn to draw in spare time. Commercial art, designing, cartooning all in one course. Write for free book "Art for Pleasure & Profit." Studio C129, Washington School of Art, 1115-15th St., Washington 5, D.C.

TALENT Test—Information. Give age. Art. Box 8066, Dallas 5, Texas.

SIGN Painting taught at home. Test lesson free. Ben Kerns, Box 812-T, Greenville, S. C.

CHALK Talks. Laugh producing program. \$1.00. Catalog 10c. Balda The Cartoonist, Oshkosh, Wisconsin.

ADVERTISING AGENCIES, LETTER WRITERS, FOR ADVERTISERS

LET Me mail your circulars to "live" clients. 25c per hundred. "Keyed" circulars welcomed. Sherman, 933 Judah Street, San Francisco 22, California.

FRESH Names, compiled weekly: men, women mailorder buyers, opportunity seekers, etc. 1,000, \$4.00; trial 300, \$1.00. Wright Publications, Memphis 8, Tenn.

SPECIAL. 1000 Opportunity seekers names, \$1.00. Wilbur Errickson, English-town, New Jersey.

MAILING Lists for all purposes. Purchasing salesmen, agents, home owners, etc. \$1.00. A. Reeves, College Station, Box 271, New York City.

TRADEMARKS Designed complete with cut, \$10.00. Rough sketch, \$1.00. Catalogue free. Burke, 3208 McKinney, Dallas.

MAILING Lists executives and engineers. Write Columbia Graphs, Columbia, Connecticut.

MAILORDER Advertisement, 2,000,000 nationwide circulation, \$32.90 inch. 24-word classified, 20 Sunday newspapers, \$25.00. Instructive Ad-Guide—ratebook magazines, newspapers, mailing-lists—10c. Ideas developed. Ads prepared free. Chicago Advertising Agency, (Established 1900), Chicago 4.

24 WORDS In 50 weeklies, \$4.96. J. Darnell, 730 Hays, Jackson, Tenn.

FREE! 1950 Advertisers Rate and Data Directory. 52 pages! E. H. Brown Advertising Agency, 20 N. Wacker, Chicago 6.

ADVERTISE: 24 Words, 40 newspapers \$3.50. Lists free. Advertising Bureau, 10511-C Springfield, Chicago 43.

MAILING Lists; \$5.00-1000 up. Write Dixie Service, King, N. C.

ADVERTISERS! Reach nearly 18,000,000 readers. 25 Sunday national key newspapers, 18 words, \$51.50. "Terrific pullers." 20 popular newspapers, \$10.00. "Free booklet." Special—One inch display 2-821,198 circulation. \$48.30. Newmark's Advertising Agency, (Established 1893), 217-7th Ave., New York 11.

ADS Placed in out of town newspapers and magazines. Low rates. Catalogue free. Ideas that pay. Baker Advertising Agency, Successors Ankrum Agency, 189 W. Madison, Chicago 2.

TYPEWRITERS, DUPLICATORS, OFFICE DEVICES

PRINTOMATIC Selffeeding post card printing duplicator \$13.50. Envelope addressing machines \$24.50. Pittsburgh Typewriter Company, 336-R Fourth Avenue, Pittsburgh 22, Penna.

TYPEWRITERS \$19.50, Duplicators \$9.95, adders \$12.50, addressers \$9.95. Meiers, 118 N. Spruce, Wichita, Kansas.

RECONDITIONED Typewriters, printing devices. Write Dixie Service, King, N. C.

RUBBER STAMPS AND OFFICE SUPPLIES

RUBBER Stamps. Send for catalog. Excello, Box 500, Shreveport, Louisiana.

RUBBER Stamps, 3 or 4 line, \$1.00 postpaid. Dealer proposition. Smallwood Printery, 2715 Vine, Cincinnati 19, Ohio.

DELUXE Cushioned, indexed, knob handle; 3 lines 50c, 4-60c. Inked pads 40c. Free literature. 500 two color gummed stickers 3/4 x 2" \$1.00. Quick service. Warner Stationery, Havre de Grace, Maryland.

READY Made stamps, free list. Criterion, Box 2326, Denver 27, Colo.

LINE 20c; 2-35c; 3-50c. Stamp Works, Auburn, Nebraska.

PRINTING OUTFITS AND SUPPLIES

CAPABLE Home-built press, details free. Roberts, Box 184, Walpole, Massachusetts.

PRESSES. Type, cabinets, supplies. List for stamp. Lincoln Press Company, 220-P Hartwell, Fall River, Mass.

MAKE Your own rubber printing cuts. Self-molding process. Plexirubber, Argyle 1, Wisconsin.

PHOTOCOPY Anything—Papers, books. No darkroom. 8 1/2" x 11" complete \$6.95. Fotoflex, 3751 St. John's Terrace, Cincinnati 36, Ohio.

PRINT Your own cards, stationery, circulars, advertising. Save money. Simple rules. Print for others, nice profit. Raised printing like engraving too. Have home shop. Details free. Kelsey Presses, L-11, Meriden, Conn.

PRESSES, Supplies, paper. Catalog 10c. Printers Supply, 211, Springfield, Missouri.

PRINTING Presses, type, supplies. Lists 3c. Turnbaugh Service, Loysville, Penna.

**PRINTING, MULTIGRAPHING,
MIMEOGRAPHING
GUMMED LABELS**

BUSINESS Printing. Samples, prices free. Howprint, 723M Eunice, Webster Groves 19, Missouri.

500 3/4x2 1/4 **FOUR** Line gummed stickers 50c. Red border \$1.00. Moritz Printery, Saginaw, Mich.

HAMMERMILL Paper, office supplies, lithographed letterheads, YCP, Box 31, Hammondsville, Ohio.

LETTERHEAD — Form letter combination, printed one operation. Inexpensive. Any quantity. Robbins, 415 20th, Baltimore 18.

PRINTING: Get our prices first. Crane, Box 7625-D, Kansas City, Missouri.

500 **LETTERHEADS** or envelopes \$3.25 postpaid. Advocate, 437 Harvey, Greenville, Miss.

1000 6 3/4 **WHITE** Wove envelopes \$5.00; # 10 \$6.50. Ideal Printing Company, Hudson 7, New York.

NEED Printing? Get my samples, prices. Gooch, 202PM, Hernando, Miss.

1000 **EMBOSS** Business cards \$3.50. Samples. Ziegler, 694 Rockaway, Brooklyn, N. Y.

100 8 1/2x11 **HAMMERMILL** Letterheads and 100 envelopes, \$1.75. Don Johnson, 410 East Okla. Place, Tulsa 6, Oklahoma.

1000 **EMBOSS** Business cards \$2.95. Samples. Gaffney, Printer, 110B Ashburton, Yonkers 2, New York.

100 **LETTERHEADS**, 100 Envelopes, Hammermill, \$2.00 postpaid. Boyle, Clinton, New York.

125 **LETTERHEADS**, 8 1/2x11 Hammermill, \$1.00 postpaid. Envelopes, business cards, same. Race Printers, Hudson 4, New York.

MONOGRAM Stationery, paneled cards, excellent quality. Samples, prices on request. Mrs. B. Pokorny, P.O. Box 402, Grants Pass, Oregon.

1000 **EMBOSS** Business cards postpaid \$3.00. Fast service. Free samples. Shatford, Palmdale, California.

YOUR Name, address 300 letterheads, \$2.00. Roy Press, Box 96, Brookline, Mass.

100 **ENVELOPES**, Printed 2-colors \$1.25. Samples. Box 523, Rochester 2, N. Y.

MIMEOGRAPHING, Vari-typing. Free price list. Loyal Brush, 3712 Walnut, Kansas City 2, Missouri.

\$3.00 **PRINTING** Specials. Samples free. Travelonian Press, 55 South Tuxedo, Indianapolis 1, Indiana.

1000 **BUSINESS** Cards \$2.50. Printery, 1485 Cota, Long Beach 13, Calif.

MIMEOGRAPHING — Free informative price list, samples. Anything legibly reproduced. Corley, F285 Carlton, E. Rutherford, New Jersey.

MIMEOGRAPHING — Reasonable. Any copy. Mailers Service, Box 606-S, Chicago 90, Ill.

100 **BUSINESS** Cards \$2.50 prepaid. Samples free. Reliable Print Shop, 905 East Jefferson, Louisville 6, Ky.

MIMEOGRAPHING, Multigraphing. Like personal typing. Down low prices. Free samples. Packer, Box 1674, New Haven 7, Conn.

QUALITY Printing. We specialize in publications, newspapers, tabloids. Send copy for estimate. Bagby Printing Co., Georgetown, Ohio.

SEND 10c Now, for our 48 page 1950 price list—refunded first order. McCall Press, 1326 South 27th, Omaha, Nebraska.

MIMEOGRAPHING—Letters, pricelists, formulas, instructions. Lowest prices. Lem's Letter Shop, 5710 Stanton, Detroit 8.

PATENT ATTORNEYS

REGISTERED Patent attorney offers services. Sanders, 6430 Evans, Chicago 37, Ill.

PETER Fries, Jr., Registered Patent Attorney. Patents, novelty searches, designs, copyrights, 110 East 42nd Street, New York City.

INVENTORS—If you believe you have an invention, you should find out how to protect it. The firm of McMorrow, Berman & Davidson with offices in Washington, D. C., is qualified to take the necessary steps for you. Send for copy of our patent booklet "How to Protect Your Invention." We will also send you an "Invention Record" form. No obligation. They are yours for the asking. McMorrow, Berman & Davidson, Registered Patent Attorneys, 134-E Victor Building, Washington 1, D. C.

INVENTORS—If you consider your invention to be something of importance, take steps to protect it with a United States Patent which gives you the right to exclude others from making, using and selling your invention as claimed. "Patent Protection for Inventors" outlines steps to take to secure patent protection. Mailed promptly without obligation. Victor J. Evans & Co., Merlin M. Evans, Registered Patent Attorney, 531-M Merlino Building, Washington 6, D.C.

INVENTORS: Learn how to protect your invention. Unless the inventor is familiar with patent matters, he should engage a competent registered patent attorney or agent to represent him. We are registered to practise before the U.S. Patent Office and prepared to serve you in handling your patent matters. "Patent Guide for the Inventor" containing detailed information concerning patent protection and procedure with "Record of Invention" form will be forwarded to you upon request—without obligation. Clarence A. O'Brien & Harvey Jacobson, Registered Patent Attorneys, 01B-K District National Building, Washington, D. C.

PATENTS. "Proof of Invention" folder mailed without obligation. E. E. Vrooman, Registered Patent Attorney, 507 McKim Building, Washington 5, D. C.

INVENTORS: When you are satisfied that you have invented something of value write me, without obligation, for information as to what steps you should take to secure a patent. Write Patrick D. Beavers (Formerly Randolph & Beavers) Registered Patent Atty., 935 Columbian Bldg., Washington 1, D. C.

PATENTS — Irving L. McCathran, 315 McLachlen Bldg., Washington 1, D. C. Registered Patent Attorney.

CANADA—Ramsay Company Registered, 273 Bank Street, Ottawa, Canada.

C. A. SNOW & Co.—M-427, Snow Building, Washington 1, D. C. Registered Patent Attorneys. Write for information.

"**INVENTOR'S** Guide" free on request. Frank Ledermann, Registered Patent Attorney, 154 Nassau St., New York 7, N. Y.

INVENTORS: Write for free brochure "Evidence of Invention." Labiner, World Building, New York 7.

INVENTORS: Without obligation, write for information explaining the steps you should take to secure a patent. John N. Randolph, Registered Patent Attorney, 203 Columbian Bldg., Washington 1, D. C.

PATENT Practice before U. S. Patent Office. Validity and infringement investigations and opinions. Booklet and form "Evidence of Conception" forwarded upon request. Lancaster, Allwine & Rommel, Registered Patent Attorneys, Suite 411, 815-15th Street, N.W., Washington 5, D. C.

INVENTORS. For "Record of Invention" form, contact Carl Miller, Registered Patent Attorney, Woolworth Building, New York.

FOR INVENTORS

INVENTORS—If you believe you have an invention, you should find out how to protect it. The firm of McMorrow, Berman & Davidson with offices in Washington, D. C., is qualified to take the necessary steps for you. Send for copy of our patent booklet "How to Protect Your Invention." We will also send you an "Invention Record" form. No obligation. They are yours for the asking. McMorrow, Berman & Davidson, Registered Patent Attorneys, 134-D Victor Building, Washington 1, D. C.

SELLING Your inventions made easier by our consulting, design and drafting services. Complete information—free. Machine Design Service, 416 Madison Avenue, Rahway, New Jersey.

INVENTORS: The usual first step is to have a search of the U. S. Patents conducted, so I can report on patentability. Write, without obligation. Patrick D. Beavers (Formerly Randolph & Beavers), Registered Patent Atty., 936 Columbian Bldg., Washington 1, D. C.

PATENT Searches \$5.00, including patent copies. Reliable and accurate results. Free protection forms and information, 48 hour service. Write us first! Patent Service Institute, 945-A Pennsylvania Avenue, Washington 4, D. C.

INVENTORS—This firm is registered to practice before the United States Patent Office and is available to assist you in the preparation and prosecution of your patent application. "Patent Protection for Inventors" booklet containing detailed information and steps to take toward patent protection will be sent upon request. No obligation. Victor J. Evans & Co., 532-M Merlino Building, Washington 6, D.C.

INVENTORS With patents and working models only interested in exhibiting and interviews. Send short biography with photograph and description of model. Meet the Inventor, 521—5th Ave., New York, N. Y.

HOW To handle ideas. Free booklet. Grayland, 5312D Grace, Chicago 41.

CASH For your idea. 280 manufacturers need inventions, patented or unpatented. List free. Invention Bureau, 208M Clinton, Oak Park, Illinois.

PATENT Searches \$5.00. 48-hour service. Patent copies included. Protection forms free. Write Raymond L. Smith, Patent Searcher, 410 Bond Building, Washington 5, D. C.

PATENT Searches by former patent office examiners \$5.00. 48-hour service. Protection forms free. Write Patent Engineering Service, 1404 New York Avenue, Washington 5, D. C.

PATENT Searches \$5.00. Reports airmailed within 48 hours. Invention protection forms free. Write Miss Ann Hastings, Patent Searcher, P.O. Box 176, Washington 4, D. C.

CASH In on your ideas! Learn which inventions are profitable; how to sell or finance and market your invention. Send only \$2.50 for the big 144-page book "Money From Ideas," a primer on inventions and patents by a real, successful inventor. Popular Mechanics Press, 200 E. Ontario, Chicago 11, Ill.

INVENTORS Get your invention to hundreds of manufacturers at lower costs. Landene Co., Box 441, Minneapolis, Minn.

INVENTORS: Learn how to protect your invention. Unless the inventor is familiar with patent matters, he should engage a competent registered patent attorney or agent to represent him. We are registered to practise before the U.S. Patent Office and prepared to serve you in handling your patent matters. "Patent Guide for the Inventor" containing detailed information concerning patent protection and procedure with "Record of Invention" form will be forwarded to you upon request—without obligation. Clarence A. O'Brien & Harvey Jacobson, Registered Patent Attorneys, 01A-K District National Building, Washington, D. C.

PATENT Searches, including patent copies, patent drawings, invention marketing, protection forms free. For complete inventor's services write: Industrial Patent Reports, Box 1081, Massachusetts and North Capitol, Washington 13, D. C.

PATENT Owner Representative. Years of experience. Can I help you? Charles A. Scott 773PM Garson Avenue, Rochester 9, N. Y.

SUCCESS Guaranteed. Inventors with patented and patent pending inventions for sale or lease, request our free book. No obligation. Dept. 1-F, Universal Marketing Co., 354 South Spring St., Los Angeles 13, Calif.

INVENTORS: If you have an invention for sale, patented or unpatented, write Institute of American Inventors, Dept. 40A, 631-E St. N.W., Washington 4, D. C.

INVENTIONS Wanted. Prominent manufacturers and national distributors look to us for new products. You can also benefit by having us assist you with your invention from the idea stage through to the developed product, fully protected. Ask for Booklet "M." Elo Development Co., Chatham Phenix Bldg., Long Island City 1, New York.

"**INVENTOR'S** Guide" free on request. Frank Ledermann, Registered Patent Attorney, 154 Nassau St., New York 7, N. Y.

INVENTORS: Without obligation, write for information explaining the steps you should take to secure a patent on your invention. John N. Randolph, Registered Patent Attorney, 202 Columbian Bldg., Washington 1, D. C.

INVENTORS. For "Record of Invention" form, contact Carl Miller, Registered Patent Attorney, Woolworth Building, New York.

PATENT? Don't—May not pay! Get valuable free details. F. B. Roth, 657 East 26 St., Brooklyn 10, N. Y.

INVENTIONS WANTED

100% GUARANTEED Marketing services, patented, patent pending inventions of merit. Our booklet free without obligation. Market Contacts, 11106-N2 Longwood, Chicago 43.

INVENTORS Marketing assistance. Circular free. Stanley Hull, 7829-K Euclid, Cleveland 3, Ohio.

NEW Industrial or consumer items, ideas, inventions or formulas wanted by qualified organization for manufacturing and distribution on a profit-sharing basis. No red tape! Immediate action guaranteed! Only offers considered giving complete details, drawings or samples. All replies kept in strict confidence. Nimco, 1090 S. La Brea Ave., Los Angeles 35, Calif.

INVENTION Wanted to sell through chain stores or photographic stores. Royalty contract offered on right product. Dean Studios, Dept. NP-6, 211 W. 7th, Des Moines 2, Iowa.

CASH For your idea. 280 manufacturers need inventions, patented or unpatented. List free. Invention Bureau, 208M Clinton, Oak Park, Illinois.

INVENTIONS Promoted. Patented or unpatented. Write Adam Fisher Company, 61 Enright, St. Louis, Mo.

INVENTORS: Nationally-known manufacturer seeks new patented products suitable for manufacture by high production methods. Write P.O. Box #7312, Chicago.

INVENTORS: Hundreds of manufacturers have requested our assistance in locating marketable new products. Complete information free. Institute of American Inventors, Dept. 40-D, 631-E St. N.W., Washington 4, D. C.

HIGHEST Royalties—Cash. Patented and patent pending inventions only. Request our free book. No obligation. Dept. 1-W, Universal Marketing Co., 354 South Spring St., Los Angeles 13, Calif.

INVENTIONS Wanted. Patented or pending only. Inventors' Exchange-B, Hartford 1, Conn.

PATENTS FOR SALE

NEW Metal adjustable weather stripping. Outright or royalty. McDonough, 5101B 39th Ave., Long Island City 4, N. Y.

INVENTORS: Test the commercial value of your patented or unpatented inventions, quickly and inexpensively. Write for free information. Institute of American Inventors, Dept. 40-B, 631-E St. N.W., Washington 4, D. C.

MODELS, MODEL SUPPLIES

STEAM Locomotives, 1 1/2", 1", 3/4", 1/2" scales. Castings, rail, steam fittings! Thorough drawings with instructions. Catalog 35c. Little Engines, Wilmington, California.

TINY Power steam models—Locomotives, stationary engines, boilers, fittings. Model machining to order. Catalog 35c (coin). Chas. Arnold, Box 218, Corvallis, Oregon.

POWER Models. Unusual steam, gasoline and traction engines. Metals, tools, accessories. Catalog 50c. Chas. Cole, Ventura, Calif.

BRASS Gears and model supplies for the inventors. Send 10c for catalog. Pierce Model Works, Tinley Park, Ill.

MODELS, Hobbies, crafts, Magic, jokes, novelties. Catalogue 10c. Magic assortment 10 different complete, \$1.00. Fun Shop, Box VEE, Avalon, California.

BUILD Historic ship models, complete kits 39c to \$9.00. Catalog 10c. Ideal Models, 19 W. 18th, New York 11, N. Y.

SHIP Models and yacht supplies complete. Large 64 page catalogue 30c. Bill Wild's, 510 East 11 St., New York City 9.

LIONEL Trains, accessories, switches. Tremendous stock; fast delivery. Guaranteed repairs. Authorized Lionel Train Station, 72 West Washington, Chicago 2.

SHIP And yacht model fittings; blueprints. Send 25c for illustrated catalog No. 25—listing hundreds of items. A. J. Fisher, 1002-1 Etowah Ave., Royal Oak, Mich.

DOWMETAL Magnesium for all model makers. Rod, bar, sheet and scale structural shapes. The Craftsmiths, 15427 Robson, Detroit 27, Michigan.

MANUFACTURING

MODELS — Small lot manufacturing. Metals, plastics, etc. Milburn, Burlington, Kentucky.

HOME CRAFTSMEN

GARDEN Figures, lawn chairs, furniture, novelties, toys, etc. 68 popular plans, with full size patterns, \$1.00. Mastercraft 111M, 7041 Olcott, Chicago 31, Illinois.

SELL All metal duck windmills. Sample \$1.95. Reitz, 13820 Wentworth Ave., Chicago 27, Ill.

LEATHERCRAFT Supplies, leather, tools, lacing. Catalogue 10c. Mail orders. Crown Leather Co., 22 Spruce Street, New York 7.

16 NEW Lawn chairs, 22 picnic tables, benches, trellises, etc. All 38 plans with necessary full size patterns, \$1.00. Mastercraft 113M, 7041 Olcott, Chicago 31, Ill.

50 LAWN-Ornament and novelty patterns \$1. Dept. M, Mosbro Patterns, 44 Victor, Mimico, Ontario.

PIPE Smokers—Make your pipes in your own workshop. It's easy. Our large imported briar blocks 50 cents. Stems 25 cents. Smokers Supply Co., Box 917, Rochester, N. Y.

LEATHERCRAFT Supplies, leather and tools, low prices. Send 10c for catalog. Jonas Handcraft Co., Dept. M-11, 30 Frankfort St., New York 7.

89 FULL Size jig saw patterns of beautiful shelves, ornaments, toys, novelties. Plus how, where to sell. Only \$1.00. Mastercraft 114M, 7041 Olcott, Chicago 31, Ill.

FREE Details; bulletin, catalog offer. Listing figurines, plastics, handcraft kits. Leisure Hour Products, 416 Rose, West Hazleton 3, Penna.

LEATHERCRAFT For pleasure or profit. Make easy-to-assemble purses, belts, gloves, woolskin toys, 100 other items for gifts or to sell. Send 10c today for big catalog. Largest leathercraft stock in U. S. J. C. Larson Co., 820 S. Tripp, Dept. 475, Chicago 24.

NEW 96 Page leather and craft catalog. 1000's of items. Send 10c. Russo Handcraft Supplies, Dept. 11D, 245 South Spring, Los Angeles, California.

90 ALL New, full size lawn ornament and novelty patterns, up to 20" high. Only \$1.00. Mastercraft 112M, 7041 Olcott, Chicago 31, Illinois.

SWISS Music movements, finest make, assorted tunes, \$1.90. Direct imports. Helaxe Company, 233 West 72 Street, New York.

BANDSAW, Jigsaw owners, let your machine bring extra profits, fun. Free details. Nu-Art, Dept. B, Box 2235, Boston, Mass.

ENAMEL—Surplus, \$2.40 gallon. Ivory, light blue, light green. Star, 309 Franklin, Allquippa, Penna.

SHELLCRAFT Made easy, for hobby or profit. Giant new illustrated catalogue full of new designs for jewelry, plaques, etc., with instructions. Send 25c for this big combination catalogue. Southern Shellcraft Supply, Clearwater, Florida.

NEW Leathercraft catalogue. Pleasure and profit. New styles, belts, purses, shoes. Largest leathercraft school in U.S.A. G. I. approved. Send 10c for catalogue. Dept. PM, Apache Leather Co., 2804 E. Washington St., Phoenix, Arizona.

JIGSAW Owners attention! Start earning money at home cutting out wooden novelties and souvenirs. Write H. Cook, Dept. A, 4407 S. Normal Ave., Chicago 9, Ill.

PEARLIZING Kit. For applying pearl finishes to plastics, glass, metal, jewelry, etc. Kit includes all materials needed to make necklaces, earrings, buttons, \$2.00. Florentine Pearl Co., 216 Weybosset St., Providence, R. I.

300 PROJECTS You can make in Popular Mechanics 32 page Blueprint Catalog. Send 3c stamp for copy. Popular Mechanics Press, Dept. BP, 200 E. Ontario St., Chicago 11, Ill.

SAVE Money on Xmas presents. Get Christmas Handbook—Make toys, gifts and decorations yourself. \$2.00 postpaid. Popular Mechanics Press, 200 E. Ontario St., Chicago 11, Ill.

FOAM Rubber do it yourself. Auto pads 24"x60"x1 1/2" \$6.00. Chair pads 12"x12"x 1 1/2" set of 4 \$3.60. Other sizes 15"x15"x 1 1/2" \$1.50. 18"x24"x1 1/2" \$2.10. 24"x24"x 1 1/2" \$3.00. Order from ad shipped prepaid except c.o.d. Free gov't surplus catalogue. Ben's Surplus, 359 Kleiman Bldg., Grand Rapids, Michigan.

INDIAN Style leather moccasin kits. Pieces die cut. Sizes, small (1-5), medium (5-8), large (8-12) \$1.75. Shearling moccasins \$2.75, postage paid. Walter E. Berger, Atchison, Kansas.

WHOLESALE Shellcraft Book 15c. Large shellcraft kit \$1.69 postpaid. Shell-Art Novelty, Dept. PM, 5th and Moore, Philadelphia 48, Penna.

LEATHERCRAFT Instruction book one dollar postpaid. Leather list free upon request. Sam Tinnin, 213 East Walnut, Columbus 15, Ohio.

ALL Leathercraft supplies! Catalogue 10c, refunded first order. Rosenblum Leather, Box 507, Sheboygan, Wisconsin.

LEATHERCRAFTERS: Big illustrated catalog of materials, tools, kits, 10c. Art Leather, 411 Joseph Ave., Rochester 5, N. Y.

SHELLS, Plastics, findings. Lowest prices. Catalog 5c. Frances Jones, Box 251, Sarasota, Fla.

GOLD-Plated jewelry supplies. Rhinestones, pearls. Illustrated catalog, 10c. Barry's, 47-N Branford Place, Newark 2, N. J.

NEW Pantograph hand motor tool attachment; carves wood, engraves plastics. Sample, details 25c. Desco Products Distr's., 6334-M Sepulveda, Van Nuys, Calif.

LEATHERCRAFT Bargains! Lacing. Francis Byrd, 3406 Montrose Ave., Richmond, Va.

BEAUTIFUL Lawn ornament patterns, ready cut, full size. 20 assorted \$1.00 postpaid. Lincoln Craft Studio, Farmington, Conn.

MAKE Leather belts, billfolds, purses. Big catalog and genuine steerhide keyholder, 10c. Tandy Leather, Box 397C, Tulsa, Okla.

LEATHERCRAFT, Copper tooling, textile painting. Make spare time, profitable time. Free illustrated catalog shows everything you need. Kit Kraft, 7377 Melrose, Hollywood 46, California.

LEATHER, Tools, lacings, supplies. Free catalog. National Handcraft, 199 William St., New York 7.

OZARK Wood samples. Eleven useful identified varieties. Prepaid \$1.25, check or cash to Davis Lumber, Cabool, Mo.

8 BEAUTIFUL Full-size whatnot patterns 25c. Joannes, P.O. Box 141-M, Omaha 7, Nebr.

80 FULL SIZED patterns. Lawn ornaments, toys, novelties \$1.00. Modern Woodcraft, Saginaw, Mich.

KNOCKDOWN Cedar chests. Lumber and veneers. Free price list. Giles & Kendall Company, Huntsville, Ala.

JEWELRY Findings, rhinestones, pearls, sequins, cameos, J & M Novelties, Box 464P, Griffith, Ind.

VELCOAT Makes any surface feel velvety. 18 exciting colors. Easily sprayed on. Single color \$1; 6-color kit \$4.95. Velcoated samples free. Velcoat, Box 5172-K, Tulsa 16, Oklahoma.

MAKE IT YOURSELF

BUILD Your own "tractor." Plans. Walking, riding. Free information. Ellsworth Tractor Co., D-1, Camptonville, California.

WHY Don't you build? Plans: End table 30c, bookcase 30c, desk 60c. All 3, \$1.00. Folder 10c. Craft-Plan, 3928 1/2 W. 27th St., Los Angeles 18, California.

FREE Handbook, build sawmills, block machines, freezers, tractors, scooters. 250 shop, farm, home machines. Nichols Co., Dept. C-1201, Purvis, Miss.

YOUR Name in lights. Make Lumi-Brite house and lawn markers for home or for profit. 15 designs plus alphabet and numerals ready to trace. Only \$1.50 postpaid. Free literature. Smithcrafters, Dept. PM11-6760 Stony Island Ave., Chicago 49, Ill.

REFERENCE Drawings—Architectural, small homes, cottages, cabins. Individual designs to order. If interested in building or designing, write Tech-Talk Design, 19375 Charleston, Detroit 3, Mich. Also part drawings and tool and die designing.

WHAT-To-Make and How to Make It. 1951 edition of famous annual now ready. \$1.75. Hundreds of fascinating projects. All 12 volumes at bargain \$18.00. Popular Mechanics Press, 200 E. Ontario, Chicago 11, Ill.

BUILD It yourself, save 50%. Send for handbook of 250 shop, farm, home machines, only 25c. Burnley and Co., Box 287, Dayton 1, Ohio.

\$50 BUILDS Large Zeolite water softener or automatic electric water heater. Details free. 204 Carson Products, 2505 Benjamin, Minneapolis 18, Minn.

ELECTRIC Clothes drier \$1.00, ceramics kiln \$1.00. Furniture, electronics, machinery. Catalog 200 plans 25c (refundable). MD 34, East Rockaway, New York.

GRANDFATHER Clock easily built. Big savings. See ad on page 280.

STREAMLINED, Built-in kitchen cabinets to fit any kitchen. Illustrated manual describes designing and construction. All for \$1.00. Thombert Company, Newton 10, Iowa.

PLANS AND BLUEPRINTS

OVER 300 Plans and blueprints in Popular Mechanics big 32 page Plan Catalog. Furniture, boats, trailers, tools, toys, gun rack, home freezer, many more. Send 3c stamp for copy. Popular Mechanics Press, 200 E. Ontario, Chicago 11, Ill.

WATCHES, OLD GOLD, JEWELRY

WATCHMAKERS! Beginners! Watches, movements, descriptive list 15c. Box 150, Chicago 90.

DIAMONDS Lowest wholesale prices. Airmail for price list. Joachim Goldenstein Diamond Club, Antwerp, Belgium.

UNREDEEMED Diamond, 1 carat, \$295. 30-day refund. Free catalog. Broff's Diamond Loan Association, 411 Smithfield Street, Pittsburgh, Penna.

10 **HIGH** Grade Swiss wrist watches needing some repairs, in yellow cases \$18; white cases \$15. B. Lowe, Holland Bldg., St. Louis 1, Mo.

WATCHMAKERS' Jewelers', hobbyists', tools—supplies. Catalogue! Bengal Company, Culver City, California.

MAKE Big money! No investment. Send us discarded jewelry, watches, spectacles, dental gold, etc., from friends, relatives, others. You receive 20% of cash we send them. Free shipping containers sent to you on request. Lowe's, Dept. A11, Holland Bldg., St. Louis 1, Mo.

WATCHES Cleaned, repaired. Maximum charge \$4.00! Year guarantee. National Watch Repair, Box 2414-DA, Cleveland 12, Ohio.

HIGHEST Prices paid for old gold, silver, platinum, diamonds, watches, gold teeth, spectacles. Cash immediately. Goods returned if offer unsatisfactory. Government licensed. United Smelting Works, (The Old Reliable), 39-B South State, Chicago 3.

WATCHMAKERS' Journal contains instructive articles on watch repairing. \$1.00 year. Sample copy 20c. Dean Co., 116-K Nassau St., New York 7, N. Y.

HIGHEST Cash paid for old, broken jewelry, gold teeth, watches, silverware, diamonds, spectacles, platinum. Free information. Satisfaction guaranteed. Government licensed. Rose Smelting Company, 29-A East Madison, Chicago.

GOLD Plated jewelry supplies—Rhinstones, pearls. Illustrated catalog 10c. Barry's, 47-A Branford Place, Newark 2, N. J.

TOBACCO, SMOKERS' SUPPLIES

FREE Circular. Pipemaking. Semi-finished kit \$1.00. CarvPIPE, 2829-Z Dixie, Hamilton, Ohio.

MAKE Pipes. Fun. Profit. Details free. BuildPIPE, PM11, Ivoryton, Conn.

FREE Color catalog, fine pipes. Terrific bargains, bonuses. Write Gaylords, 522, Brockton, Mass.

RAZORS, BLADES, SHARPENING

FREE. Pocket knife with 100 double edge razor blades. Surgical steel. Guaranteed. \$1.00. Payne, 5426 5th Ave., Los Angeles 43, Calif.

FOR THE HOME

STEAM Heat owners. Let us show you how to keep your house warmer this winter with less fuel by an amazing new vaporizing valve you can install yourself. Details free. Write Ralph M. Arato, 1651 East 14th Street, Brooklyn 29, N. Y.

OF INTEREST TO WOMEN

FOR Pleasure and profit learn to make beautiful embroidery lace edgings and paint pictures on your sewing machine. Twelve simplified lessons by mail. Write Mrs. Shirley Kau, Dayton, Oregon.

EXCELLENT Profits. Make fast-selling chenille Christmas poinsettias, corsages, Santas, monkey trees, dolls. Literature free. Velve, Dept. M, Bohemia, N. Y.

READ In bed in comfort with the new Relaxinjak, the jacket with closed front and open back. Inquire Sue-Don, 2733 W. 41-A Ave., Denver 11, Colorado.

SEW—Our ready-cut line. Fast, easy, illustrated folders 10c. Liebig Industries, Beaver Dam 5, Wisconsin.

FOR SALE—MISCELLANEOUS

POWER Tools, motors, appliances, radios, pumps, stoves, blowers, thermostats. Catalog contains 2000 items. Send coin 25c. Box 89, Troy, Ohio.

100 **HAWAIIAN** Shells—Miniature or 50 assorted for \$1.00. Alwin, Box 193, Puhikauai, Hawaii.

FREE Catalog! War surplus clothing. Amazing bargains. N. Y. Clothing Co., New York 29A.

SAVE Money on army, navy and factory surplus. Write today for new 60-page illustrated catalog. Tennusa Sales Co., Dept. AE, 1451 Market, Chattanooga, Tenn.

GENUINE Buckskin coin purse and illustrated buckskin catalogue, both only 15c. Berman Buckskin Co., 253 No. 1st, Minneapolis, Minn.

MICROSCOPES, Pocket pen type, 20 power, \$2.95; 40 power, \$4.95 postpaid. Pocket pen telescope, 6 power, coated lens, \$9.95. New 1950 catalog of firearms, gov't. surplus and sporting goods. Send coin 25c. Public Sport Shops, 11 S. 16th Street, Philadelphia 2, Penna.

DRESSES 18c; Coats \$1.00; blouses 35c. Free catalog. Crown, 164-PA Monroe Street, New York.

HANDSIGHTING Levels, improved, new model, used for grading land, contouring and laying out fences, piers, roads and gardens, price \$2.00 postpaid. New 1950 catalog of firearms, gov't. surplus and sporting goods. Send coin 25c. Public Sport Shops, 11 S. 16th Street, Philadelphia 2, Penna.

WANTED—MISCELLANEOUS

WANTED. Hand printing press, type, supplies. Jimton, Box 1373, Mobile 8, Ala.

WANTED—Scrap mercury (quicksilver), tantalum, bismuth, tungsten. Metallurgical Products Co., Established 1909, 35th and Moore Sts., Phila. 45, Penna.

PERSONAL

BORROW By mail. Loans \$50 to \$300 to employed men and women. Easy, quick. Completely confidential. No endorsers. Repay in convenient monthly payments. Details free in plain envelope. Give occupation. State Finance Co., 210 State Finance Bldg., Dept. 14, Des Moines 8, Iowa.

"INTERESTING Mails"—\$1.00! Bentz, Pine Hill's House, (C/21), Chatawa, Mississippi.

CHICAGO Remail 25c. T. Roche, 6025 S. Harper Ave., Chicago 37, Ill.

MEXICAN Mailing service. Your letters remailed, received 20c. Mystify friends. Photographic postcards 10c. Tillotson, Apartado 1405; Guadalajara, Jalisco, Mexico.

PEN—Portrait, 11x14, from photograph, returned unharmed, likeness guaranteed. Send photo and \$5. Bob Carlson, Morningdale, Mass.

A Magazine subscription makes useful Christmas gift. Free catalog listing lowest rates. Sappington Company, Marion, Ohio.

VALUABLE Big mails, four months listing. 25c. Wright Publications, Memphis 8, Tennessee.

MEXICAN Law. General Practice Attorney, 1203 Arizona Street, El Paso, Tex.

MEXICAN Legal matters reliably handled. Box 263, El Paso, Texas.

"HOW Can I find out?" You can! Information discreetly developed. Any matter, person, problem, anywhere. Worldwide. Officially licensed, bonded service. Established 1922. Reasonable. Confidential. William Herman, 170 Broadway, New York.

MISCELLANEOUS

"HAS Religion failed?" Unusual booklet, 25c. Harris, 4000 Nebraska, Nashville, Tenn.

MILLION Articles wholesale. Directory 25c (refundable). Publishers, Box 1302-P11, Detroit 31.

SELLING. Plans, interesting information, tips. Send 25c. Brewster, Eastport, Maine.

URANIUM Prospecting information free. Prospector, Box 142-D, North Battleford, Saskatchewan, Canada.

EXPLORE Abandoned mines, hills, deserts, streams for natural gold, silver, other precious metals. Seek fabulous riches in buried treasures. Details free! Pathfinder Company, Dept. 11PM, 1726 Beverly Drive, Pasadena 7, Calif.

INCREDIBLE! Unprecedented! Become a mental superman overnight! Floor everybody! No studying! "Memoprop" does all your thinking! It's uncanny! Revolutionary! Write: Bijou, Box 1727-M5, Hollywood 28, California.

HAIRCUT As you like it. New booklet tells how. 25c. Mastrolia, 51½-C Jane, New York 14.

100 **MARKETS** For handicrafts. Wood, leather, crochet, etc. Big buyers bulletin \$1.00. Free details. Research, 2409 12th Ave., Los Angeles 18, Calif.

DRAFTSMEN, Students. Drafting instruments, supplies. Loonin, West First, Brooklyn 24, New York.

VERMONT Maple syrup, sugar, cream. 100% pure. 1950 crop. Butternuts. List. Christmas suggestion. H. Marshall, Poultney, Vt.

MAKE The magic touch of success yours with our easy home-study plan. No results, no cost. Free brochure and details. Write School of Personal Psychology, 1008 Washington Bldg., Louisville 2, Ky.

70 **BIBLE** Lessons, 25c. Bulletin, Box 87, Cathedral Station, New York 25.

EARN Up to \$200 month, inventing toys, games, gadgets. Write, Hendrickson, Argyle 1-A, Wisconsin.

BABY Shoes bronzed, plated. Free literature. Precious Keepsakes, Box 133, Newark 1, New Jersey.

ENGINEER'S Slide rules \$17. Bartro, 26B Grenville Road, Watertown, Mass.

VALUABLE Free gifts sent with orders for Xmas cards, pipes, cigars, wallets, lighters, pens. Free details. Lytle Company, Security Warehouse, Minneapolis 1, Minn.

YOUR Popular Mechanics permanently bound into a beautiful book. Free details. Leatherman, 204 E. 6th, North Manchester, Ind.

CARICATURES! Photograph and \$1.00. Lowen, 952 St. Marks Ave., Brooklyn, N. Y.

SENSATIONAL New squirrel nut cracker, sample \$4.00. Big profit. Herman Cox, 205 Lee Circle, Norfolk 13, Va.

HOW To get rid of those pesky bed bug's. Write L. W. Rollier, Depew, Okla.

TREASURE Finders for gold, silver and minerals. Money back guarantee, best available. Also Geiger counters for uranium prospectors, free information. Write Goldak Company, 1541 West Glenoaks, Glendale 1, Calif.

20% **DISCOUNT** On radios, television, electric appliance, mixers, binoculars. Free catalog. Points Mail Order House, Box 331, Middletown, Penna.

RECEIVE Hundreds of valuable items absolutely free. Supply source directory 25c. Nelko Service, 3462 Merchandise Mart Sta., Chicago 54, Ill.

FORTUNE May be yours. Detect uranium, gold, silver, precious metals, minerals. America's finest Geiger counters, metal and mineral detectors. None finer at any price. Factory guaranteed. Write manufacturer for free information. Detector Co., 5631 Cahuenga, Dept. B-11, North Hollywood, California.

SAVE Money on paint brushes. Buy direct. Post card brings descriptions and prices. \$1.50 brings 3" brush, \$2.50 value. P.O. Box 53, Kenmore 17, N. Y.

LUMINOUS Reflective paints glow day and night in technicolor! New angle money-maker. Assorted color samples 25c. Research, 1842-PM Byron, Chicago 13.

DRESSES 18c; Coats \$1.00; blouses 35c. Free catalog. Crown, 164-PM Monroe Street, New York 2.

TATTOOING Machines, outfits. Free catalogue. Jensen, 120 West 83rd Street, Los Angeles 3.

"RECEIVE Mail." Moneymaking offers, opportunities, catalogs. Name listed 10c. Ideal Service, Park Ridge 10, Ill.

GEIGER Counter Model C-18, fits coat pocket, 2 pounds weight, ultra sensitive, dependable, immediate shipment, only \$35.00. Fisher Research Lab., Inc., Palo Alto, Calif.

SQUARE Dance instructions. 40 dances, \$1.00. Wesley Rader, 1922 Grant, Denver 5, Colorado.

YOUR Leather jacket renovated by our craftsmen expertly, reasonably. Request free descriptive circular. Berlew Mfg. Co., Dept. 8, Freeport, N. Y.

TATTOOING Outfits, supplies. Illustrated list free. Zeiss, 728 Leslie, Rockford, Illinois



Learn DRAFTING and BLUE PRINTING!

Both fields offer ambitious men remarkable opportunities for advancement. Neither profession will ever be replaced by machines. Before any production can start, plans must be drawn. Draftsmen are the first to be hired. Blueprints are essential in every shop.

CLEAR UNDERSTANDABLE TRAINING

Quickly you learn the hows and whys of successful production planning. You are sent professional drafting instruments, drafting table, equipment, etc., at no extra cost. Learn by making actual drawings.

BIG MONEY . . . ADVANCEMENT OPPORTUNITIES

Offered trained draftsmen. It is light, pleasant work paying big salaries. Drafting is the stepping stone to top managerial jobs. It is work that stimulates the mind . . . keeps one interested.

A BUSINESS OF YOUR OWN

Either as an independent drafting firm or as the operating head of a business firm producing products you created. Act now.

MAIL THIS COUPON TODAY!

CHRISTY TRADES SCHOOL, Dept. DB-303
4432 N. Kedzie Ave., Chicago 25

Mail me at once your big FREE book on Drafting and Blue Printing. Tell me how your Home Training and Professional Drafting Instruments, Drafting Table, Drafting Equipment, etc. can be had on **PAY AS YOU LEARN** plan.

Name _____ Age _____
Address _____ City _____ State _____

DIESEL MECHANICS NEEDED BIG PAY . . . GOOD FUTURE



If you have no trade or profession that assures you steady employment and top pay through good times or bad, and regardless of whether you want to be a mechanic, technician, salesman, executive — or have

your own profitable shop—you should investigate NOW this opportunity to enter world-famous Bailey Diesel Schools. Prepare yourself, this proven way, for an important place in the fast growing field of Diesel.

Why Gamble With Your Future!

Your future success depends largely on the reputation of the school you attend. Don't take chances! Train at Bailey's—America's foremost school of diesel training. Approved by Missouri State Board of Education. Approved, also, for G. I. Training. Full details FREE. Return coupon below NOW.

MAIL TODAY FOR FREE CATALOG

BAILEY DIESEL SCHOOLS
1656 So. Grand Blvd., St. Louis, Mo.
Please Send Me Your FREE Catalog.

Name _____
Address _____
Town _____ State _____

Veteran Non-Veteran

Resident Training Home Study



FULLY GUARANTEED TIRES COST LESS!

Nationally famous FIRESTONE, GOODRICH, U.S. ROYAL, GOODYEAR, and other makes. Every tire selected and inspected for your safety.

NEW TREAD TIRES GUARANTEED 24 MONTHS

600x16	7.98	650x16(6)	12.98	650x15	10.48	670x15	9.98
600x16(6)	9.98	700x16	11.98	700x15	11.48	710x15	11.98
650x16	10.98	550x17	7.98	750x15(6)	13.48	760x15	12.98

SNOW TIRES—Add \$2.00 More to Above Prices

GOOD TIRES GUARANTEED 12 MONTHS

600x16	4.14	700x16	5.14	32x6(8)	8.84	825x20	14.24
650x16	4.54	670x15	4.74	32x6(10)	10.84	900x20	13.34
650x15	4.34	650x20	7.84	750x20(8)	8.54	1000x20	14.14
700x15	4.64	700x20(8)	8.94	750x20(10)	9.94	1100x20	16.14

AAA PREMIUM GRADE GUARANTEED 18 MONTHS

600x16	5.28	710x15	5.68	650x20	9.88	825x20	15.68
650x16	5.88	600x16(6)	5.88	700x20	10.88	900x20	15.98
650x15	5.68	700x15(6)	6.98	32x6(8)	10.48	1000x20	16.48
700x15	5.88	760x15	6.28	32x6(10)	12.48	1100x20	17.58
700x16	6.18	550x17	5.68	750x20(8)	11.48	1100x22	18.78
820x15	6.98	600x20	8.88	750x20(10)	13.48	1400x20	29.98

MILITARY SPECIAL

900x16	9.58	1000x20	16.48	600x16	8.98
750x20	9.68	1100x20	18.48	600x16(6)	10.98
				750x20	24.98

AAA GUARANTEED 18 MONTHS

900x16 12.49 750x20 13.98

Passenger Tubes—Water Tested—All Sizes . . . \$1.25

Truck Tubes—Water Tested—All Sizes . . . \$2.95

PENNA'S LARGEST STOCK

Largest stock of used tires in the East. Thousands of satisfied customers. Write for sizes not listed.

MONEY ORDER OR CHECK WITH ORDER.

PYRAMID TIRE CO.
1333-35 North 5th St.
Dept. M, Phila. 22, Pa.

Earn More — Repair Watches

Learn this highly specialized trade that pays well. Attend resident school, or study in spare time at home without interference with your present employment. Do watch repairing as a part time or full time business, and build an independent business of your own. School catalog free by return mail. Address Dept. B-52.

American Institute of Specialized Watch Repair
1012 Franklin, Southeast, Grand Rapids 7, Mich.

How to Make Money with Simple Cartoons

A book everyone who likes to draw should have. It is free; no obligation. Simply address **FREE BOOK**

CARTOONISTS' EXCHANGE
Dept. 911-A Pleasant Hill, Ohio

REAL ESTATE BE A BROKER

PAYS BIG! SEND FOR FREE, BIG, ILLUSTRATED CATALOG NOW! No obligation. Graduates report making substantial incomes. Start and run your own business quickly. Men, women of all ages, learn easily. Course covers Sales, Property Management, Appraising, Leases, Mortgages, and related subjects. **STUDY AT HOME** or in our classrooms in big cities. Diploma awarded. G.I. approved. Nationally known.

WEAVER SCHOOL OF REAL ESTATE (Est. 1936)
15 E. Pershing Road, Dept. PMB, Kansas City, Mo.

FREE BOOK TELLS HOW

WAR SURPLUS BARGAINS

WAR SURPLUS BARGAINS

\$500,000.00 INVENTORY for QUICK LIQUIDATION

Surplus items—hundreds of them for home, shop, factory, farm and outdoor use. New items, used items, reconditioned items—all at tremendous savings—all priced for quick sale.

Page After Page of Values

This big catalog shows page after page of amazing money saving values. Write for your copy today. Send 10c to cover postage, mailing, etc. Write today!

SEND TODAY FOR YOUR COPY **10c**

STARK'S Dept. 509 So. STATE STREET CHICAGO 5, ILLINOIS

Earn Big Money

WRITING ORDERS

AMAZING NYLONS

Guaranteed Against
RUNS AND SNAGS
Regardless of Cause!

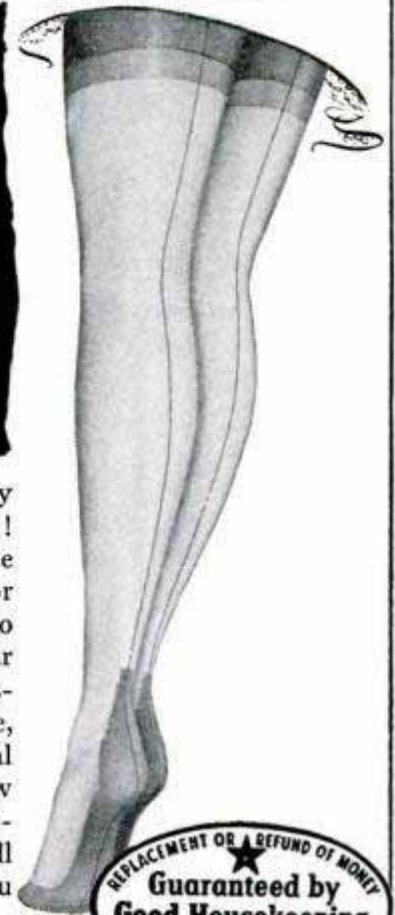

REPLACEMENT OR REFUND OF MONEY
★
Guaranteed by
Good Housekeeping
IF NOT AS ADVERTISED THEREIN

The world's ONLY complete, nationally advertised nylon hosiery line actually guaranteed against runs, snags or excessive wear, REGARDLESS OF CAUSE! It's amazing, but true! No matter what the cause—hard use or deliberate abuse—Kendex nylons are replaced FREE if they run, snag or become unfit for wear within entire guarantee period! Every weight from sheerest 15 denier to heavy 70 denier—all gauges up to luxury 60 gauge—all sizes, lengths, popular shades, fancy heels, black seams—full fashioned and seamless. Nothing is missing to make sure every woman is pleased. In spite of the amazing guarantee, retail postage prepaid prices are no higher than comparable quality national brands. Should free replacement be necessary, actual cost is cut in half! How could any woman possibly resist saving money and solving her hosiery problems? NOT SOLD IN STORES. Men and women wanted NOW, spare or full time, to write orders and earn big money. You can get orders even if you never sold a thing in your life!

MEN'S HOSE **GUARANTEED 1 YEAR**

Kendex gives you FOUR complete lines, including sensational men's hosiery line actually guaranteed for ONE YEAR! Any pair not giving satisfactory wear within 12 months is replaced FREE without question. All styles, patterns, colors, yarns (including nylon) at lowest prices that mean steady income for you 52 weeks a year.

LINGERIE **HOUSECOATS — ROBES**

Full line of lingerie, housecoats and robes. Materials used include nylon crepe, nylon runproof tricot, multifilament rayon crepe, rayon tricot, rayon satin, etc. Nothing is lacking. Every garment at prices that defy competition and make women eager to order. Kendex values sell themselves.

NATIONALLY **ADVERTISED**

Kendex has advertised in Life, Look, Collier's, McCall's, Saturday Evening Post, Ladies' Home Journal, Good Housekeeping, etc. Carries the Good Housekeeping Guarantee Seal. Thousands of orders shipped daily. Yearly volume in millions. A dependable responsible national organization.

FREE SAMPLE MATERIALS AND MONEY-MAKING OUTFITS

Man or woman—young or old, YOU can easily earn steady income, spare or full time. No money or experience needed. We supply EVERYTHING free and set you up in business at OUR expense. Nothing to buy or deliver. Write orders, we deliver and collect. Big advance pay plus huge cash bonus that increases your earnings up to 40%! Your name and address on postcard will bring you sample materials—samples of lingerie, hose, robe materials; self-selling sales books with FULL COLOR illustrations; 36-page sales manual showing you easy steps to success; color cards, free "door openers" worth \$1 each but which you give away free; special plan to have others sell for you, etc., etc. You can start making money the minute you receive the complete FREE outfits!

YOUR COST ONE CENT!

SEND NO MONEY. Pay nothing now or later. No obligation. Not even a promise to return outfits. Simply write your name and address on a penny postcard and mail to us. We'll immediately rush you everything you need FREE and postage prepaid. WRITE TODAY!

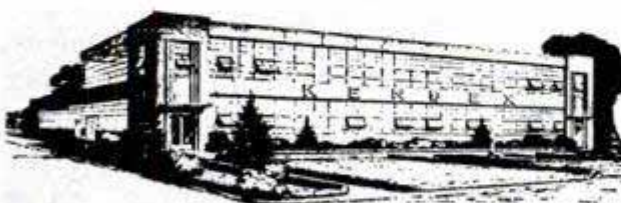

KENDEX CORPORATION • BABYLON 446, N.Y.

Don't Envy The PLUMBER-Be One

Make \$15 to \$50 a Day

Every skilled workman will tell you Plumbers have the best of it. WINTER and SUMMER the Plumber is busy at top wages. No skilled Plumber is ever out of a job. Compare his opportunities with any trade. To the man with know how, Plumbing means profit. Investigate Universal Plumbing School. Not a "war born school," but a plumbing school developed and operated by plumbers since 1923.



The Plumber Protects the Health of the Nation

Own Your Own BUSINESS

Have your own business and big profits with little other than training and a kit of tools.

JOURNEYMAN Gets Good Salary

Master Plumbers own their own shop. A Journeyman works for a Master. With this training journeymen can depend on high wages.

G. I. Approved. Established 1923

UNIVERSAL PLUMBING SCHOOL

877 Holmes Street

Kansas City, Mo.

BE A PLUMBER IN JUST 32 WEEKS

Learn With Tools—Not Books
No need ever serve an apprenticeship. Don't envy the plumbers big profits—enjoy them. Learn every trick of the trade—Leadwork—Blueprint for plan reading, etc. under Licensed Master Plumbers.

Over 7,000 Successful Plumbers Recommend This School

This system has made more than 7,000 plumbers. Investigate our past performance. If you like to work with tools this is your opportunity. Become a Plumber in America's largest and only school devoted exclusively to plumbing. Write today for FREE information.

SEND ME



every month so I am sure to see each new issue. Here's

- \$3.50 for 1 year
- \$8.00 for 3 years

name _____

address _____

city _____ zone _____ state _____ 11

Hand this order to your newsdealer or send it to

POPULAR MECHANICS
200 East Ontario St. Chicago 11, Ill.



200 ILLUSTRATIONS

SPEED & MILEAGE MANUAL

"DOUBLE the POWER and GAS MILEAGE of your Car..."
World-famous POWER BOOK shows how you can easily get top racing performance with up to 100% more power and gas mileage! COVERS ALL MAKES—Shows simplified Speed Tuning, "Soup Up Methods", Racing Tricks, Economy Secrets, "Customizing Plans", etc. Tells how to BUILD YOUR OWN SPEED EQUIPMENT! FAST SPORTS CARS! "CALIFORNIA HOT RODS"! RACERS! Big m.p.h. CONVERSIONS! Shows how to build inexpensive Superchargers, Dual Manifolds, Herts, Compression Heads, Water Injectors, Cams, Dual Mufflers, Economizers—SAVE MONEY! Covers engine Rebuilding, Gas Saving, Fuels, Formulas, Ratios, Bodies, Frames, "Offys", Shows latest "CALIFORNIA CUSTOM RESTYLING"! Streamlining! Sport Changes! Lowering! Roadster Plans! Working Diagrams! Blueprints! Charts! Color Photographs! Complete with 300 Illustrations! "Satisfaction Guaranteed"! YOU GET: "CALIFORNIA HOT ROD HANDBOOK" (plus SPEED CATALOG FREE with Manual, ORDER!)

FREE THESE BOOKS FREE

ORDER NOW by cash, check, or C.O.D.
Big Manual plus 2 free books \$1.98
1951 Speed Equipment Catalog
showing 1000 Items (without above books
25c) (Dealers send for wholesale catalog)
Almquist Engineering, Milford 52P, Pa.



There's BIG MONEY in

UNIFORMS and Work Clothes that ADVERTISE!

Every business and businessman is swinging over to employee uniforms and work clothes, embroidered with company name, trademark, sales message, etc. The field is new. Prospects are everywhere—garages, service stations, factories, coal dealers, dairies—and hundreds more. Profits are huge. You take orders by the dozen and gross! One man made over \$300.00 on a single deal! You get the business everytime because you offer latest style and finest fabrics. Big selling kit sent FREE!



TOPPS, Dept. 6111, Rochester, Indiana

MAKE MONEY IN LANDSCAPING

Thorough training by Internationally known Landscape Architect to start your own business, improve your home or advance in this well paid field. Many Opportunities. Approved for Veterans. Send for FREE BOOK.



NATIONAL LANDSCAPE INSTITUTE
Dept. P-11, 310 So. Robertson Los Angeles 48, Calif.

Learn CARPENTRY BRICK LAYING

Get into the billion dollar building trades. Learn now while opportunities are greatest. Train in our completely equipped shops under expert instructors. G.I. Approved. Enroll now. Limited classes. Write for FREE Catalog.

MIDWEST SCHOOL OF BUILDING TRADES, Dept. PM-11
411 N. Center St. Bloomington, Ill.

HAVE FUN!

LIKE SAWING A WOMAN IN HALF!



People like to be fooled—this way!

An Amazing Trick!

Here is a miniature version of that famous trick of sawing a woman in two, as performed by Thurston, Orson Welles, other magicians. This pocket-size illusion does the same with your finger. Apparently passing thru the finger and cutting a match or cigarette in two! Amazing trick, fools everybody. Simple, easy to do, no sleight of hand required. Colorful plastic. Have fun! Order today. Postpaid.

\$1

SEDGHILL INDUSTRIES, 1120-D Sedgwick St., Chicago 10

NOW READY! A Sensational New Line Of 1951 MIDWEST TELEVISION

Complete CHASSIS and BEAUTIFUL CONSOLES
Featuring the New MAMMOTH **19 1/2** Inch PICTURE TUBE

FACTORY-TO-YOU on
30 DAYS TRIAL



"VIDEO GRAND
19 1/2-Inch Picture (225 sq. in. image) Television-Radio-Phonograph Console

EASY TERMS



"CONSTELLATION"
19 1/2" Television Console with BIG 12" Panasonic Speaker

NOT A KIT!
This is A Completely Assembled Receiver

Never before have you seen such tremendously BIG clear pictures, such luxurious cabinets, such sensationally low Factory Prices as Midwest offers in its 31st Anniversary Line of 19 1/2-Inch and 16 1/2-Inch Television receivers. They are available in complete ready-to-use chassis for custom installation in your own cabinet...or in luxurious console cabinets with Television only or in TV-Radio-Phonograph combinations. All are offered on Midwest's famous 30 Days Trial right in your own home.

Plus Powerful New 1951 World-Ranging 5-Band
MIDWEST SERIES 16 **RADIOS**
In Beautiful Consoles and Complete Chassis



An entirely new line featuring the powerful Series 16 AM-FM Five-Band Radio Chassis and the magnificent Symphony Grand Radio-Phonograph with 3-Speed Automatic Intermix Record Player.

EASY TERMS

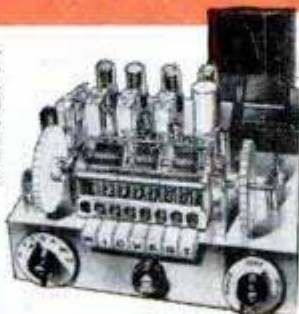

SEND COUPON TODAY
For This NEW 1951 4-Color

FREE MIDWEST
RADIO-TELEVISION
CATALOG



WRITE IN NAME AND ADDRESS (PLEASE PRINT) ON COUPON OR 1c POSTCARD

MIDWEST RADIO & TELEVISION CORP.
Dept. 25D, 909 BROADWAY • CINCINNATI 2, OHIO

Please send me your new FREE 1951 Catalog.

NAME _____

ADDRESS _____

CITY _____ ZONE _____ STATE _____

MIDWEST RADIO & TELEVISION CORP.
DEPT. 25D, 909 BROADWAY, CINCINNATI 2, OHIO

NEWEST BIG MONEY FIELD

Service Automatic Transmissions

How Automatic Transmissions Work • How They Are Constructed • What Goes Wrong • How to Locate Trouble and Service All Types

This new book by Jud Purvis, Technical Editor of Motor Service Magazine tells all about: Hydra-Matic, Dyna-flow, Ultramatic, Powerglide, Gyro-Matic, Tip-Toe Shift, Simplimatic, Drive-Master, Vacumatic, Torque Converters, Overdrives, Hydraulic Servos, Vacuum Boosters, Solenoids, etc.

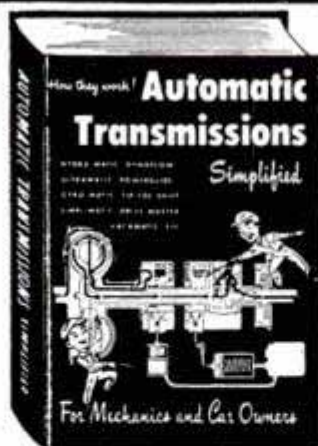

Engineering Terms and Thinking Translated Into "Ham and Egg" Language

Automatic Transmissions Simplified

is not a rehash of previously written articles; it is not a job-lot of assorted paragraphs from shop manuals. IT IS a planned encyclopedia of information on all past, present and some transmissions not yet available. Full use of photos, sectional views, diagrams and illustrations in color results in a book that is of practical value to everyone who wants authentic, usable information on modern auto transmissions. Price only \$4.00. Order Your Copy NOW. Clip this ad and mail with remittance or send name and address on post card and pay Postman \$4.00 plus few cents charges. Money-Back Guarantee.

GOODHEART-WILCOX CO. Dept. 144, 1321 S. Michigan, Chicago 5, Ill.

TALK TO THE WORLD!

GET YOUR F.C.C. AMATEUR RADIO LICENSE

BECOME A "HAM" OPERATOR IN A FEW WEEKS

No Previous Experience Necessary

THE HOBBY WITH A FUTURE

PASSING GOVERNMENT EXAMS MADE EASY BY

PHOTOSOUND

CUTS HOME-STUDY TIME IN HALF!

PHOTOSOUND makes preparation for F.C.C. amateur license quick and easy. You SEE the material, and actually hear your instructor's voice. Learn to operate your own radio station. Talk across the earth—make world-wide friends. Transmit from your car. Help in national emergencies. Enjoy this fascinating, useful and entertaining hobby!

Get full details and three free booklets NOW!

"OPPORTUNITIES IN ELECTRONICS"

F. C. C. EXAMS MADE EASY

SAMPLE F. C. C. EXAM

Mail Coupon

ELECTRONIC TECHNICAL INSTITUTE Dept. PM-110
769 Venice Blvd., Los Angeles 15, Calif.

Gentlemen: Please send me free of charge your three-in-one booklet, "F.C.C. Exams Made Easy", "Opportunities in Electronics", and "Sample F.C.C. Exam." I am interested in the F.C.C. AMATEUR () COMMERCIAL () Licenses.

NAME _____ AGE _____

ADDRESS _____

CITY _____ ZONE _____ STATE _____

WHEN YOU BUY BY MAIL

Every issue of POPULAR MECHANICS contains many products and services which you can obtain by mail. However, there are important points to check on to make sure you get quick and satisfactory service.

In writing to an advertiser:

Be sure your address and the advertiser's are correct and readable . . .

Tell the advertiser exactly what you want — include size, number, color, etc., if required . . .

Send the correct remittance — however, don't send cash through the mails — use a check or money order.

Taking time to check these points will help you get quicker replies and better results — and will make it well worth your while if you buy by mail!

EXTRA INCOME THE YEAR 'ROUND

Earn additional income and have fun at the same time! Popular Mechanics MONEY MAKING HOBBIES shows you how to make 132 different projects at home in your spare time! Complete instructions with over 600 illustrations, photographs, drawings and diagrams. Projects for everyone regardless of experience. Excellent resale value. State making your hobby pay a profit by ordering a copy of MONEY MAKING HOBBIES today from

POPULAR MECHANICS PRESS \$2.00
200 E. Ontario Street Chicago 11



HAVE A BIGGER — MORE EFFICIENT HOME WORKSHOP

Popular Mechanics PLANNING YOUR HOME WORKSHOP shows you how to make use of every inch of space in your workshop; detailed floor plans, wiring layouts and power tool hookups plus actual photographs of famous home workshops you can use as models. Save money by building your own shop furniture. Special Where-to-Buy-It Guide. 450 illustrations. Cloth Bound. Working Diagrams. Order your copy today from

POPULAR MECHANICS PRESS \$2.50
200 E. Ontario Street Chicago 11

Say You Saw It in POPULAR MECHANICS

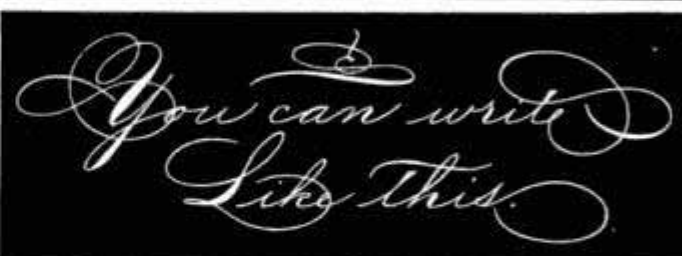

INCREASE YOUR BUSINESS and SOCIAL PRESTIGE

Yes—you too can write like this and improve your business ability and chances for advancement. Just a few minutes a day is all it takes to become an expert penman using C. P. Zaner's Ornamental Penmanship—96 pages of instructions, diagrams and illustrations that show how to improve your writing. Send in for your copy of Ornamental Penmanship today and begin improving your writing and increasing your business and social prestige. Quantity limited. \$1.50.

POPULAR MECHANICS PRESS, 200 E. Ontario St., Chicago 11, Ill.

DRAW for MONEY!

BE AN ARTIST

YOU CAN LEARN AT HOME IN YOUR SPARE TIME

Enjoy this fascinating hobby — Train for a profitable career

Trained artists are capable of earning \$75, \$100 and more a week. No previous Art experience necessary. We teach you step by step. Only WSA offers you this proven method famous since 1914. COMMERCIAL ART, DESIGNING, CARTOONING all in ONE up-to-date, complete course. You even can make money in spare time while learning. Prepare now for good art jobs in Advertising, Television, Newspapers, Magazines, Studios, etc. For 36 years WSA graduates have been "making good" — WHY NOT YOU?

VETERANS! HURRY
G.I. Training Ends July, 1951

TWO BIG ARTISTS OUTFITS GIVEN. When you enroll you receive your first complete set with all the materials you need to start. —Mail coupon for FREE BOOK, "Art for Pleasure and Profit," it fully describes course and commercial opportunities for you in art. Low cost — only \$5 monthly. (No salesman will call)

FREE BOOK gives details!

WASHINGTON SCHOOL OF ART, Studio 1211W
Washington 5, D. C.

Please send me full information and your Free Book, "Art for Pleasure and Profit." (please print)

Name _____ Age _____

Street _____

City _____ Zone _____ State _____



Recipro Register CHRONOGRAPH

WORLD FAMOUS SPLIT-SECOND TIMER

10 DAY FREE EXAMINATION A handsome wristwatch of incredible accuracy! Precision made in the highest traditions of Swiss craftsmanship. Thoresen's new RECIPRO-REGISTER CHRONOGRAPH automatically computes speeds and distances down to 1/5th second tolerance! RECIPRO-REGISTER system HOLDS the result indefinitely. It remembers for you while movement continues to keep time. Compare with other stop-chronographs and you will never be satisfied with anything less than this truly precision timepiece.

OVER 25 HIGH QUALITY FEATURES!

- Times Planes
- Times Races
- Times Sports
- Times Photography
- Times Lab experiments
- Times Shop Work
- Shock-Resist
- It "remembers"
- 17 Ruby Jewels

Three multi-function dials automatically coupled and synchronized for hours, minutes, seconds & 1/5th seconds. Contact clutch to start computation and brake clutch to freeze Recipro-Register result. Erases back to zero. Hairline sweep-second. Radium-active dial. Unbreakable crystal. Sturdy, yet thin case with stainless steel back. Its 17 Jewel Ruby movement is electronically time tested for accuracy. A smart, thin timepiece of functional beauty. The pride of every owner. **SAVE \$50.00—ORDER YOURS DIRECT!** Recent list price 79.95. Now reduced for quick sales to \$29.95 tax paid. . . . While supply lasts. Featured in Esquire and leading magazines. Instructions and gift case included. Price subject to change without notice because of international crisis. Remit 29.95, or order C.O.D. plus postage. Money back in 10 days if not delighted. **THORESEN DIRECT SALES, Dept. 6M-253, 131 West 33rd Street, (Phone: LA 4-5996 & 7) New York 1, N. Y.**

UNLIMITED SERVICE GUARANTEE

Exclusive of Parts
FREE repair service ANY TIME if needed by skilled watchmakers. NO COST EVER for labor, "handling" or adjustment, provided watch is returned with all parts. FREE: Annual oiling, cleaning & timing service. Makes lifetime friends!

Buy Direct

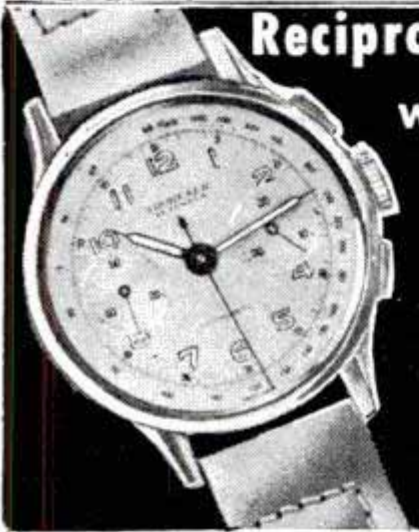

SHOE REPAIR OFFERS BIG INCOME

LEARN IN 12 WEEKS TIME

You can own your own shop or earn big income as skilled shoe repairman. Growing demand everywhere at top wages for men who know how. We teach you quickly by actually working on shoes and modern machines. School open to all from 18 to 60 years of age. FREE BIG 20 PAGE BOOK explains everything. Send for your copy today. Established 1927.

MODERN SHOE REBUILDING SCHOOL

Chicago and Los Angeles only Approved for Vets Dept. PM
2937 Belmont Ave., Chicago, Ill. 361-12th St., Oakland, Calif.
806 So. Figueroa St., Los Angeles 14, Calif.

Earn BIG PAY

While learning

EARN UP TO \$100. WEEK

MORE JOBS THAN WE CAN FILL!

PAY AS YOU EARN

Increase Your Earning Power

Learn By Doing In Big Allied Shops Men who are mechanically inclined have a wide open field to choose employment in the Machine Tool Industry. Jobs are going begging for lack of qualified trained men. You need no previous experience to start your training at this school.

ALLIED SCHOOL OF MECHANICAL TRADES, Inc.
1338-1340-1342 S. MICHIGAN AVENUE
411 ALLIED BUILDING, CHICAGO 5, ILL.

Get full particulars on our Job Placement and Deferred Payment Plan.

Write for FREE BOOKS A 1c Postcard will do

SAY YOU SAW IT IN POPULAR MECHANICS

HEY FELLOWS! LOOK!

Pre-War Engine Back on the Market

STEAM ENGINES

REAL WORKING MODELS!

Built in a precision machine tool factory from finest quality materials. Nickel finish. Years of pleasure—interesting and instructive.

- 40-lb. pressure tested boiler. Operates up to 1 hour on filling.
- Double action two-cycle piston.
- Counter-balanced machined crankshaft.
- Safety pop-off valve.
- Real steam whistle.
- Pulley power take-off on fly-wheel.
- Finest quality tested electrical cord and heating element. AC or DC current.

\$495 Fully guaranteed. Truly a quality working model, precision built of high tensile-cold rolled steel.

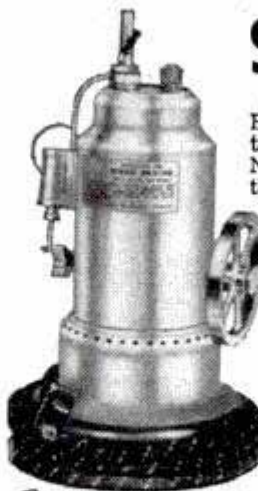

STEAM ENGINE INDUSTRIES

1511 Davenport St. Omaha, Nebr.

Enclosed find remittance for \$4.95. Check Money Order

Send complete Steam Engine as described above, complete with warranty. Postage paid.

Name _____
Address _____
City _____

MAIL COUPON TODAY!

NOW — YOU CAN MAKE IT AN

"OLD TIMERS" Christmas!

Give Hobby-Lovers Miniature ANTIQUE AUTO SETS



He Wants These Easy-To-Build Models. Choose His Favorites From All Pictured Here!



Check "OLD TIMERS" You Want to Give:

- | | |
|--|--|
| <input type="checkbox"/> 1911 Maxwell \$2.50 | <input type="checkbox"/> 1911 Buick \$2.50 |
| <input type="checkbox"/> 1904 Olds \$1.95 | <input type="checkbox"/> 1903 A Ford \$2.50 |
| <input type="checkbox"/> 1910 T Ford \$2.50 | <input type="checkbox"/> 1910 Internat. \$2.50 |
| <input type="checkbox"/> 1909 Stanley \$2.95 | <input type="checkbox"/> Harvester \$2.95 |
| <input type="checkbox"/> Steamer \$2.95 | <input type="checkbox"/> 1903 Cadillac \$2.50 |
| <input type="checkbox"/> 1909 T Ford \$2.95 | <input type="checkbox"/> 1900 Packard \$2.50 |
| <input type="checkbox"/> 1903 Rambler \$2.50 | <input type="checkbox"/> 1914 Stutz \$3.95 |
| <input type="checkbox"/> 1911 Mercer \$3.95 | <input type="checkbox"/> Bearcat \$3.95 |

Mail order to us for your favorites. Add 25c for postage and handling. No C. O. D.'s please

HOBBYISTS and Collectors want, these nostalgic Antique Autos—each one easy to assemble with pre-fabricated parts! Actual 1/4" scale models, they're decorative and authentic, 6 1/2" to 10 1/2" in length. See them at hobby, toy or department stores. Perfect Xmas gifts for youngsters 9 to 90 years old! Prompt delivery. Guaranteed satisfaction.

"OLD TIMERS" MINIATURE AUTO SETS

Mail to: SCRANTON HOBBY CENTER Dept. 14, Scranton 10, Pa.

PLYMOUTH SAVE MONEY!

Owners



Learn How to Make Your Car Run Better . . . Last Longer . . . and Save Hundreds of Dollars!

Get this book, written especially for you, without one penny of risk and get more out of your car. Mail coupon for MANUAL FOR PLYMOUTH OWNERS today. When the book comes, skip through the pages and see how your investment in one of America's most popular automobiles can be even a better investment than you thought. If you don't agree, send the book back and you'll get your money back.

Official, Authoritative, Practical Information

Written by C. E. Packer, formerly service school instructor and auto show lecturer for automobile manufacturers, Member Society of Automotive Engineers, Special Services Editor of Automobile Digest, contributor to leading magazines, author of some of the biggest selling books on Automotive subjects. Prepared with the full authority and active cooperation of the Plymouth Division of the Chrysler Corporation.

A Popular Mechanics Book Written Just for You

Not a re-hash of service manuals. A complete new Popular Mechanics book written for the Plymouth owner by an outstanding automotive authority with the full cooperation of Plymouth engineers and service directors. It will save you money on repairs and service; make your Plymouth last longer; give you safe, economical and trouble-free motoring. And this is true whether you take your Plymouth to a regular service station or service it at home.

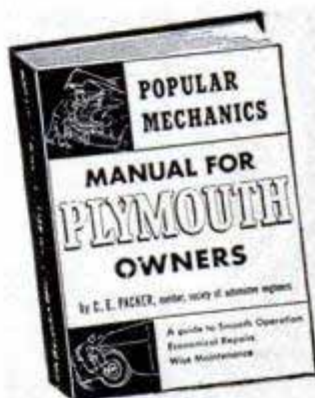

Prevents Trouble. Cuts Down on Repair Bills

Nothing like this manual anywhere. It covers all phases of operation, service and maintenance. It has entire chapters on the individual parts of your Plymouth—battery, ignition, starter, generator, regulator, lighting, fuel system, engine, lubrication, gasoline qualities, cooling systems, transmission, differential, rear axle, brakes, wheel alignment, tire care, body maintenance, trouble shooting on the road, etc. It covers your Plymouth, new and older models, step by step—bumper to bumper—showing you how parts operate; what can go wrong; how repairs and adjustments should be made and how to avoid all types of troubles.

Money Back if Not Satisfied

Mail the coupon today. Send only \$3.50 or you can pay postman. Money back guarantee protects you.

288 Pages. Hundreds of How-To-Do-It Illustrations and Diagrams

The entire book follows Popular Mechanics famous easy-to-read and easy-to-understand style. While primarily intended for the Plymouth owner, to help him get more out of his car at lower cost, it can be worth its weight in gold to the auto mechanic and service station operator who works, not only on Plymouths, but on all other makes as well, to which the information in the book can be easily applied.

Order on this Handy Coupon

POPULAR MECHANICS PRESS, Dept. 17
200 E. Ontario St., Chicago 11, Ill.

Send Manual for Plymouth Owners at once. If not satisfactory I will return it within 5 days and you will refund full purchase price.

Remittance for \$3.50 enclosed. Send C.O.D.

Name _____

Address _____

City _____ State _____

POPULAR MECHANICS

WANT TO SAVE GAS?

BE PREPARED IF RATIONING RETURNS

1/4 MILLION NOW IN USE

TRY FREE IT IN YOUR CAR

TEST FOR MORE MILEAGE FASTER PICK-UP EASIER STARTING BETTER IDLING

You can install it easily in a few minutes.

Many Gane Needle users report up to 25% more mileage, faster pick-up, easier starting and smoother idling.

Try a Gane Needle in your car for ten days at our expense, then compare your mileage and performance. If fully satisfied, send only \$1.50 per needle (8 cylinder cars take 2). If not satisfied, just return it—FAIR ENOUGH? Since authorities differ on merits and some users report no improvement, TRY BEFORE YOU BUY!

WRITE TODAY • ENCLOSE NO MONEY • PAY POSTMAN NOTHING. Send us your name, address, make and year of car—and the make of carburetor if convenient.

NATIONAL AUTOMOTIVE RESEARCH CORP., Dept. J-11
350 West Washington Blvd. Venice, California

THE AMAZING GANE

AIR FLOW NEEDLE

Gane replaces the idling adjustment screw in gasoline carburetors.



Holes for Air Flow

BOOK SENT FREE! This auto economy manual is sent absolutely free, to all who try Gane Needles. It tells how to save gas, tires, brakes and tells how you can gain more power, speed and better performance from your car. This combination manual-catalog also introduces many new and ingenious economy products.



Give



enough!

FOR ALL RED FEATHER SERVICES

MAKE YOUR OWN GIFTS

FOR PROFIT OR PLEASURE...



LEATHERCRAFT . . . the fascinating hobby that turns spare time into profit and pleasure. Learn this easy way to **MAKE EXTRA MONEY**. Make all kinds of hand-tooled leather goods. Tandy has everything for leathercraft. **WRITE FOR FREE CATALOG**

TANDY LEATHER CO.

P. O. Box 791-H, FORT WORTH, TEXAS

ANY BOOK IN PRINT

Delivered at your door. We pay postage. Standard authors, new books, popular editions, fiction, reference, medical, mechanical, children's books, etc. **Guaranteed savings**. Send card for Clarkson's 1951 Catalog.

FREE Write for our great illustrated book catalog. A short course in literature. Buying guide of 300,000 book lovers. The answer to your Christmas gift problem. **Free** if you write **Now—Today!**

CLARKSON PUBLISHING COMPANY
Dept. PM50 1257 S. Wabash Ave., Chicago, Ill.

MEN A Blue Print For YOUR SUCCESS!

Here is your opportunity for Success. An amazing new finishing system that will start you in your own profitable business. No experience necessary—up to \$10 an hour easy. Spare or full time in your own home or garage. Start small—grow big fast. We will guide you every step of the way. This is **BIG**—don't miss your chance. Send name now for **FREE SAMPLE** of my complete, easy profit plan for your success.

COAST INDUSTRIES

Dept. 2B, 1004 S. Los Angeles St., Los Angeles 15, Calif



ANALYZE Handwriting

More and more men and women in home and various professions report greater earnings spare time. Home study. Test lesson, **YEAR BOOK** free. No children. **I.G.A.S.**, Wilhoit Bldg., 507, Springfield, Mo.

MAKE BIG MONEY RAISE HAMSTERS!

FINANCIAL INDEPENDENCE IN JUST A FEW MONTHS!!
Don't Wait—Order Yours Today!
Pair \$2.50
Trio [1 male and 2 females] \$3.75
2 males and 5 females . . . \$9.00
See your profits multiply like magic — Rush order today.
Complete Breeding Instructions With Every Order.
Fred Clawson "The Hamster King"
12418 Oxnard St., N. Hollywood, Calif.

CASE HISTORIES
Mr. A. M. started with 5 Hamsters; Grossed \$417,000 a year.
R. & M. (2 school boys) started with 3, are grossing \$300 per month.



Learn PHOTOGRAPHY at Home

Splendid opportunities. Prepare in spare time. Practical basic training. Long-established school. Send for free book, "Opportunities in Photography." No obligation.
American School of Photography, 1315 S. Michigan Ave., Dept. 1358, Chicago 5, Ill.

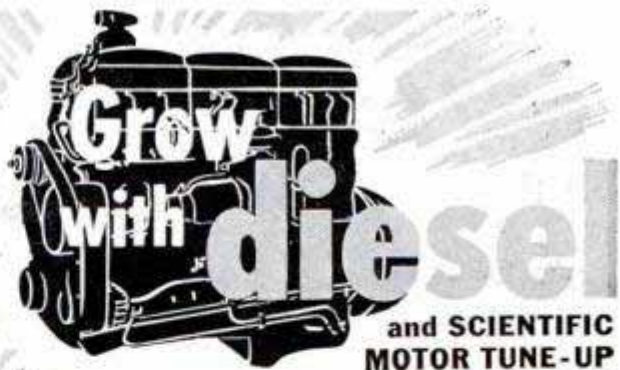

and SCIENTIFIC MOTOR TUNE-UP —One of America's Fast-Growing Big-Pay Industries!

● Lay the foundation now for something bigger and better—get into the fabulous Diesel industry. The U.E.I. Plan for learning Diesel and Scientific Motor Tune-Up is simple, practical and is based upon the principle of learning-to-do-by-doing. Essential fundamentals are gained through spare-time home-study, followed by actual shop practice. Competent instructors guide you step by step—you learn the HOW and WHY of Diesel operation, service and maintenance. Get all the facts—mail the coupon and we'll send you a free copy of "Earning Power in Diesel." Mail coupon today!



UTILITIES ENGINEERING INSTITUTE
Chicago 14, Illinois Founded 1927

UTILITIES ENGINEERING INSTITUTE, Dept. DC-9
2525 Sheffield Ave., Chicago 14, Illinois

Please send me, without obligation, your book "Earning Power in Diesel."

NAME (print).....AGE.....

ADDRESS

CITY..... Zone..... State.....

Check here for information if you are under 17



Men!

Reading This Message Could Be the Most Important 40 Seconds In Your Life

From every indication Auto Body and Fender Repair work will continue to be one of America's Big Income fields. Here at U.E.I. we're training men for it—a proven plan that combines spare-time, home study and actual shop practice. Men from coast to coast have successfully completed the U.E.I. course in Auto Body and Fender Repair—many earned money while learning—many now have their own shops. What about you? Isn't this the time for you to see what this big-pay field offers you? Do this: Mail the coupon below and we'll send you our big, descriptive book, "Opportunities." It's Free — Mail the Coupon.

UTILITIES ENGINEERING INSTITUTE, Chicago 14, Illinois
Founded 1927

UTILITIES ENGINEERING INSTITUTE,
2523 Sheffield Ave., Dept. XC-5, Chicago 14, Illinois

Please send, Free, Your Book "Opportunities".

NAME (print)AGE.....

ADDRESS

CITY..... (Zone).... STATE.....

Check here for information if you are under 17.

New Car?



No, New Shocks

Don't buy a new car just to get a new car ride. Save your money and get new shock absorbers instead. It's thrifter and easier than you think to replace old, rough riding shock absorbers with new smooth riding MONROE Hydraulics.

Send 10¢ FOR INSTRUCTIONS ON HOW TO INSTALL SHOCK ABSORBERS

One thin dime brings you our A B C Manual and other valuable information on shock absorber installation and service... tells which shocks fit your car, takes you step by step over everything you need to know.

MONROE SHOCK ABSORBERS are Standard Equipment on more makes of new cars than any other brand.



MONROE AUTO EQUIPMENT COMPANY, MONROE, MICH.

Got an Idea? An Inventive Mind? ...
Want to Cash In on It? ...

THEN GET

CLOTH
BINDING
\$2.50

MONEY from IDEAS

MONEY FROM IDEAS by Myron P. Laughlin, is a down to earth, informative and useful book for every man with an active, inventive mind, who believes he has ideas that can be patented.

Get this book to determine what inventions are needed for today's market, and how to go about inventing them; how to get a patent, protect it, sell it and make money out of it.

144 pages, well illustrated, indexed, and contains an appendix of patent forms, most valuable for the sale, assignment or licensing of patents.

Vital, Informative and Practical Help!

Inventions and How They Are Patented—What Inventions Can Do For You—The Growth of an Idea—Let Others Experiences Guide You—An Invention, How It Was Developed—An Invention, How It Was Protected—An Invention, How It Paid Its Way in the World—How to Make Money From Inventions—Invention is a Business—Specialization—Sources of Information, A Where-to-Find-It Index—Records of Progress—Development Work—Starting a Business—Selling Patent Rights—Selecting a Patent Attorney—Patent Forms—Form of Assignment and Royalty Agreement—Form of License—Helpful Books.



POPULAR MECHANICS PRESS
DEPT. 28 — 200 E. ONTARIO ST.
CHICAGO 11, ILL.

POPULAR MECHANICS

Christmas Handbook

144 PAGES
CLOTH
\$2.00

A Wonderful Collection of Ideas, Gifts, Decorations, Toys—You Can Make!

Popular Mechanics new Christmas Handbook is certain to fill a long felt Christmas-time need in thousands of American homes, and to be cherished as a practical, useful gift. There are articles on entertaining and decorations for Christmas-time hostesses—and how-to-do-it instructions for the making of beautiful greeting cards and gifts of all kinds.

Partial Contents

How to Select a Xmas Tree, Exterior and Interior Lighting, Rotating Xmas Trees, How to Make Your Own Greeting Cards, Helpful Hints on Home Decoration, Tips for the Holiday Hostess, How to Make Gifts for All Ages, The Story of Christmas, Christmas in Other Lands, Centerpieces, etc., Gift Wrappings, Christmas Games, How to Make Candles, Xmas-Tree Ornaments.



Order From

POPULAR MECHANICS PRESS
Dept. 29, 200 E. Ontario St., Chicago 11, Ill.

WAR SURPLUS OPTICAL BARGAINS

BINOCULARS—An opportunity to own a truly fine pair of American-made Glasses at substantial savings. Lightweight, dust-proof, moisture-proof, expertly collimated. Optics low reflection coated. Metal parts chemically treated to prevent corrosion. Sturdy Carrying Case included. Guaranteed for full year against any defects in workmanship or materials. Sold with 10 DAY MONEY BACK PRIVILEGE.

Stock #963-H	6x30	\$75.00	Postpaid
Stock #964-H	7x35	\$85.00	Postpaid
Stock #965-H	7x50	\$98.50	Postpaid
Stock #966-H	9x50	\$99.50	Postpaid

(Be sure to add 20% Fed. Tax)

10 POWER SPOTTING SCOPE—A WONDERFUL BUY! Pocket-swivel head. Only 5 1/2" long—8 1/2" high on tripod. Adapted from Army telescope and worth many times our price. Has prism erecting system, achromatic objective, Ramsden Eye-Piece. Lenses low reflection coated.

Stock #955-H \$14.95 Postpaid

SIMPLE LENS KITS—let showing how you can build lots of optical items. Use these lenses in photography and for dozens of other uses in experimental optics, building TELESCOPES, low power Microscopes, etc.

Stock # 2-H—10 lenses	\$ 1.00	Postpaid
Stock # 5-H—45 lenses	5.00	Postpaid
Stock # 10-H—80 lenses	10.00	Postpaid

We Have Literally Millions of War Surplus Lenses and Prisms for Sale at Bargain Prices. Numerous Types of Instruments, Tool

Write for FREE CATALOG-H
EDMUND SALVAGE CO., BARRINGTON, NEW JERSEY

TRY HOME STUDY WATCHMAKING

FREE Sample Lesson

Famous Sweazey System shows how to master watchmaking... expertly, quickly, successfully... right in your own home. No previous experience needed to learn one of the highest paid trades. Try it without obligation.

G. I. APPROVED RESIDENT COURSES

... in Watchmaking, Engraving, Jewelry Repair, Diamond and Stone Setting at our modern, fully-accredited resident school. Founded 1908. Write for FREE CIRCULAR.

CHICAGO SCHOOL OF WATCHMAKING
1608 N. Milwaukee Avenue Dept. 1110 Chicago 47, Ill.

WHY DON'T YOU WRITE?

Writing short stories, articles on business, sports, homemaking, travel, shop crafts, local and club activities, etc., will enable you to earn extra money. In your own home, on your own time, the New York Copy Desk Method teaches you how to write the way newspaper men learn—by writing. Our unique "Writing Aptitude Test" tells whether you possess the fundamental qualities essential to successful writing. You'll enjoy this test. Write for it, without cost or obligation.

Veterans: Course approved for Veterans' Training.

NEWSPAPER INSTITUTE OF AMERICA

SUITE 5590-T, ONE PARK AVENUE, NEW YORK 16, N. Y.

Free Book on CUSTOM-BUILT HIGH FIDELITY RADIO

by **DAVID RANDOLPH**
CONTENTS: How to assemble connoisseur's radio-phonograph for as little as \$132.64. How to select components. How to save money by installing system in existing furniture. How to install in existing furniture. Glossary of hi-fi terms. . . . Assemble your own hi-fi set. It's easy. Send today for FREE copy of David Randolph's "High Fidelity Guide."

WRITE: **LAFAYETTE RADIO, Dept. LK**
 100 Sixth Avenue, New York 13, N. Y.

\$ Free Course! Big Profits! \$ Flocks & Sandblasts

Dual Purpose Spray Gun! Uses only 25 lbs. Air Pressure
 • Thousands of uses in Home, Shop, Industry: Makes Auto Interiors Clean & New, Lines drawers, Marproofs lamp bases, Refinishes any object. All in colorful Flock. Etch & Frost windows, glassware, etc. Removes Paint & Rust from Autos, Tools. Guaranteed! Send \$19.75 or write for free information. Flocking supplies!
BLASTO SPRAY GUN MFG.
 Dept. PM-11, 7007 Haas Avenue, Los Angeles 47, Calif.



Only \$19.75 Complete

MASTER MIND!

Learn Short-Cut Mathematics

Juggle figures, do baffling number tricks. Make people gasp at your marvelous lightning-quick mind. Multiply 4 figures by 4 figures without using old-fashioned multiplication! Big cloth-bound volume; fully illustrated course. Includes worked-out problems, answers, etc. Sensational bargain. Only \$1.95, postpaid—or COD plus postage. Satisfaction guaranteed or refund. Order this amazing "Short-Cut Mathematics" today!
IELSON-HALL CO., 210 S. Clinton St. \$1.95
 Dept. 2L-2 Chicago 6, Ill. Complete



MAKE A "Stradivarius" VIOLIN

BOOK AND PLANS ALL YOU NEED

—For Pleasure
 —For Profit
 —For Your Own Use

You Can Do It at Little Cost! It's Easy! It's Fun!

Here is the "tops" of all home crafts projects. Make a violin—a replica of a famous "Strad"—the original of which sold for \$80,000.00. Joe Reid who has made hundreds of fine violins makes the job so easy—so inexpensive—in his new book, "You Can Make a 'Stradivarius' Violin." You don't need any tools. Reid shows you how to make all the tools you need from old table knives, worn out files, sheet metal, etc. Eight full-size plans, 16x23 inches, folded into the book give you every detail in actual size.

Violins Bring High Prices

Make a violin and you probably will never want to sell it. But good tone modern violins bring terrific prices, yet the materials cost comparatively little. With Reid's plans and step-by-step instructions you can make such a violin for yourself. 15 chapters guide you in selection of wood, fashioning the belly, back, sides, mold, lining, neck, scroll, purfling. Other chapters cover varnishing, finishing, stringing. Others show how to make tools and clamps at little or no cost.

Order Book Today. Money Back if Not Satisfied.

Make your own violin for pleasure or profit. Get book and plans now. Clip this ad and mail with check, money order or cash for only \$3.50 or we will send C.O.D. Money back in 5 days if not satisfied.

POPULAR MECHANICS PRESS



Complete Instructions
8 Actual Size Plans
How to Make the Tools You Need
Where to Get the Materials

You trace or work direct from actual size plans. No measurements to translate or confuse you. You see the entire violin in the plans. You read the how-to-do-it instructions in the book.

Dept. 30
 200 E. Ontario St., Chicago

I need 500 Men to wear SAMPLE SUITS



Pay No Money—Send No Money

My values in made-to-measure suits are so sensational, thousands of men order when they see the actual garments. I make it easy for you to get your own suit to wear and show—**MAKE MONEY IN FULL OR SPARE TIME THIS EASY WAY!**

My Plan is AMAZING!

Just take a few orders at my low money-saving prices—that's all! Get your own personal suit to wear and show—make money fast taking orders. No experience needed. Spare time pays big. You pay no money, now or any time.

MAIL COUPON!

Rush this coupon today for full facts and **BIG SAMPLE KIT** containing more than 100 fine wools in all popular weights and shades. Be one of the 500 top-notchers I need to wear, show, and take orders for my suits. Act now!

J. C. FIELD & SONS
 Dept. L-1716, Harrison and Throop Sts., Chicago 7, Ill.



J. C. FIELD & SONS, Dept. L-1716
Harrison and Throop Sts., Chicago 7, Ill.

Dear Sir: I WANT A SAMPLE SUIT TO WEAR AND SHOW, without paying 1c for it. Rush Valuable Suit Coupon and Sample Kit of actual fabrics, **ABSOLUTELY FREE.**

Name.....
 Address.....
 City..... State.....

Say You Saw It in Popular Mechanics

LEARN DRAFTING AT HOME

With a few hours effort each week, our practical comprehensive course in Engineering Drafting will prepare you for immediate employment in this highly paid profession. All books, equipment and supplies furnished.

VETERANS FREE UNDER G. I. BILL

LAIN DRAFTING COLLEGE

601 N. DELAWARE • INDIANAPOLIS, IND.
 Mail me FREE information about Engineering Drafting.

NAME.....
 ADDRESS.....
 CITY..... STATE.....
 Check if Veteran. Approved under G. I. Bill.

America's Famous **PAY RAISING BOOKS**

Step up in your job. Prepare for a better job — bigger pay. Do as thousands of others have done—get the extra money you want with the help of these famous books. This can easily be the golden opportunity you have waited for. Order today. Money back if not satisfied.

AUTO REPAIR KINKS (Just Out)

Describes hundreds of unusual short-cuts—easier ways to do TOUGH repair jobs on 20 popular makes of cars (no space wasted on regular procedure). Tells how to Step Up Speed, Power, Save Fuel, Cure High Oil Consumption . . . brings you combined experience and KNOW-HOW of world's best mechanics. Also, complete Mechanical and Tune-Up Specifications 1938-1950 models inclusive on: Buick, Chrysler, Dodge, Hudson, Mercury, Packard, Studebaker, Cadillac, Crosley, Ford, Kaiser, Nash, Plymouth, Willys, Chevrolet, DeSoto, Frazer, Lincoln, Olds, Pontiac \$3.00

AUTOMATIC TRANSMISSIONS SIMPLIFIED (New Book)

Right up to the minute. Covers Hydra-Matic, Dynaflo, Ultramatic, Powerglide, Gyro-Matic, Tip-Toe Shift, Simplimatic, Vacumatic and all other transmissions. Tells how transmissions work; how constructed, what goes wrong, how to locate trouble and service all types. \$4.00

DYKE'S AUTOMOBILE AND GASOLINE ENGINE ENCYCLOPEDIA

New 22nd Edition now available. Dyke's is a complete course in automotive mechanics with special emphasis on fundamentals, trouble shooting, testing, adjusting and repairing with every operation being shown and described in complete detail. Over 100 pages of new and revised material. An indispensable aid in servicing of all cars no matter when and where made. 1492 pages. \$7.50

AUTOMOBILE BODY AND FENDER REPAIRS

New Enlarged Edition. Few of subjects added are: Frame straightening, Infra-Red Painting, Flock Coating, Servicing Automatic Tops, Upholstery. Covers use of tools and equipment, approved methods, how to do a professional job. \$3.50

MODERN ELECTRIC AND GAS REFRIGERATION

New Fifth and Enlarged Edition includes full information on servicing Hermetic (Sealed) Units and Frozen Food Refrigerators. Non-technical. Covers theory and practical application of refrigeration in all its branches. Beginners and students will find this book the best means of getting started on a pleasant and profitable career. Experienced men will find it valuable as a guide and reference. . . . \$5.00

AUTOMOTIVE SERVICE MANAGEMENT

One and only book that shows exactly how to start and run an auto service business profitably. It tells how to build an efficient organization — obtain capital — equipment needed — how to get and hold customers. \$5.00

DYKE'S CARBURETOR BOOK

Use this book to become a specialist in auto engine tune-up. Covers carburetors, ignition, fuel pumps, etc. \$3.50

MODERN WELDING PRACTICE

Data on welding of all kinds, presented in a non-technical manner. Detailed information on metals and alloys, equipment and materials. Practical instruction on welds, joints, cutting, etc. as used and approved in modern production. \$4.00

SEND NO MONEY. Use this ad as your order blank. Check titles wanted, clip and mail. Pay postman on delivery. If remittance is sent with order we will ship postpaid. Either way—your **MONEY BACK** if not satisfied.

GOODHEART-WILCOX CO. Dept. 143, 1321 S. MICHIGAN AVE., CHICAGO 5

NEW EDITION



PLUMBING AND PIPE FITTING

New 2nd Edition. If you are interested in any phase of plumbing and pipe-fitting work and want to reach the top in this great business, this is the book you need. Covers pipe layout, fitting, blue print reading, fundamentals of drawing \$2.50

BAILEY'S HANDBOOK

Questions and Answers for Stationary, Marine, Diesel Engineers and Firemen. Information on boilers, pumps, fuel consumption, valves, heating systems, engines, etc. which will help those who master it pass any grade of license \$2.00

AUTOMOBILE MECHANICS JOB SHEETS

A stimulating method of learning auto mechanics. Directions for the execution of 48 jobs of auto assembly, adjustment and service are followed by tests of the true-false type. \$1.25

SIMPLIFIED METHODS IN SHEET METAL LAYOUT

Covers sheet metal layout in all phases for industrial, domestic and other uses. \$3.50

THE STORAGE BATTERY SIMPLIFIED

Covers principles, construction, operation, care and repair of various types of storage batteries \$3.00

HOUSE WIRING

Practical instruction in all phases of house wiring — a working manual for the student and the electrician alike. A novel feature of the book is breaking up of the Code into sections relating to particular chapters in book. . . . \$3.00

D. C. Power Wiring \$4.00

Airplane Drawing \$1.50

Air Navigation and Meteorology \$3.00

Vocational Mathematics (Shop Arithmetic) . . . \$1.25

Sheet Metal Die Design. . . \$2.25

Airplane Welding \$3.50

Aircraft Flight Instructor \$2.50

Electroplating \$2.75

Fractional Horsepower Motor Maintenance . . \$3.75

Upholstering Home Furniture \$3.75

Standard Auto Electrician's Manual \$17.50

40 Power Tools You Can Make \$1.50

MANY campaigns

in ONE

GIVE ENOUGH FOR ALL!

New Advertising Machine Prints Post Cards

FREE LEARN HOW thousands of business men, in every line, boost sales in spite of conditions—with ads printed on postcards by amazing new patented **CARDMASTER** advertising machine. Low price, sold direct. Guaranteed 5 years. **SEND NAME** for **FREE** illustrated book, new money-making ideas and complete, unique advertising plans. Cardmaster Co., 1920 Sunnyside, Dept. 1311, Chicago 40, Ill.



BARBELLS

Save Money — Buy the finest barbell equipment direct from our foundry — No other company can match our low price or value! **Send to-day for our FREE Barbell Catalog**
BUR BARBELL CO.
Lyndhurst 23, New Jersey

PLEASURE! — PROFIT!
Learn at Home Our Easy Way: **WATCH-CLOCK REPAIRING — BASIC TRAINING FOR AIRCRAFT INSTRUMENT WORK.**
Write for free information.
MODERN TECHNICAL SUPPLY CO.
Dept. 11PM, 55 WEST 42nd STREET, NEW YORK 18, N. Y.

LOCKSMITHING & Key Making

PRACTICAL UP-TO-DATE COURSE—ONLY \$4.95
Easy-to-learn modern information for self-instruction. How to work on locks, de-code, make master-keys, repair, install, service, etc. For every handyman, home owner, carpenter, mechanic, service station operator, fix-it shop, hardware dealer, gunsmith. 53 plain illustrated lessons. **FULL PRICE ONLY \$4.95. SEND NO MONEY.** Just pay postman plus C.O.D. postage. Or send \$4.95 with order, we'll ship postpaid. Satisfaction guaranteed or refund.
NELSON-HALL CO., 210 S. Clinton St., Dept. L-2, Chicago 6, Ill.

SAVE \$150 MAKE YOUR OWN 3-Dimensional Camera
ALL YOU NEED IS YOUR OLD CAMERA AND THE STEREO-TACH
No costly stereo camera is needed to take realistic 3-D slides and prints. Use your present camera and a Stereo-Tach outfit. Changes practically any camera to a 3-D camera instantly. See your dealer or write **ADVERTISING DISPLAYS, INC.**
Dept. PM10 COVINGTON, KY.
For 35 MM cameras, outfit #101 (Stereo-Tach & 3-D slide viewer) **17.70***
For larger cameras #100 or for Polaroid Cameras #100 PL (Stereo-Tach and print viewer) **16.25***
plus 2.09 fed. tax



Thrilling Work COLORING PHOTOS
Fascinating vocation learned at home by those with aptitude. Thrilling pastime. National method brings out life-like colors. Free booklet.
NATIONAL PHOTO COLORING SCHOOL
1315 S. Michigan, Dept. 1358, Chicago 5

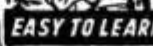

MONEY BACK
If Not Delighted
In 10 Days
WEAR AT OUR RISK

AMERICA'S BEST WATCH VALUES
PRACTICALLY WHOLESALE DIRECT TO USER

ORDER WITH CONFIDENCE
**5 YEAR WRITTEN
GUARANTEE**

17 JEWEL SELF WINDING
WHILE STOCKS LAST
NOW ONLY

Watch that winds itself! Latest improved self winding lever movement. Keeps 40 hours reliable time after few hours wear. Waterproof. Shock built. Non-magnetic. Accurate. Professional sweep second hand. Now only \$24.95 plus \$2.50 tax. Order now. Lowest price in U.S.A. for a watch of this quality. Compare!

\$24.95



MEN'S OR WOMEN'S BULOVA

15 or 17 JEWEL movement



Originally Sold up to \$59

OUR PRICE ONLY

\$16.95
Plus \$1.70 Tax

Also

- BENRUS
- GRUEN
- WALTHAM
- or ELGIN WATCHES

WAR OR NOT? WE'RE NOT RAISING OUR PRICES!

Genuine Bulova, Benrus, Gruen, Waltham, Elgin and other famous wrist watches in latest style Yellow Gold Cases. You get these unredeemed 5-year Guaranteed FAMOUS MAKE WATCHES now at truly enormous savings because we bought out SURPLUS STOCKS of leading New York and Maryland Jewelers. Order now while they last. State make preferred. Order men's or ladies'. Only \$16.95 plus \$1.70 tax. Order now.

17 JEWEL 2 Push Button CHRONOGRAPH

Thousands Sold at \$71.50

- WRIST WATCH While Stocks Last.
- STOP WATCH NOW ONLY
- TELEMETER
- TACHOMETER **\$24.95**

Precision 4-in-1 timepiece for professional scientists, aviators, engineers, sportsmen, etc. Nationally advertised. 3 multi-function dials automatically coupled. 30 min. register. Synchronized for hrs., min., seconds, 1/5 seconds. Luminous. Instructions included. Unbreakable crystal. Only \$24.95 plus \$2.50 tax. Order now.



2 PUSH BUTTON PLATED YELLOW GOLD CHRONOGRAPH

LOOKS LIKE A \$25 WATCH

Sweep second hand. Measures speed of cars, planes, horses, heart, etc. Combined time piece, stop watch, telemeter, tachometer. Perfect for Sportsmen, Boys, Young men. Shock-Resist Movement. Radium Dial. Leather Strap. Instructions enclosed. Only \$6.95, plus 70c tax.

\$6.95



17 JEWEL SHOCK PROTECTED WATER RESIST
While Stocks Last.

ORIGINALY \$59.00

OUR PRICE NOW ONLY

\$19.95
INCABLOCK Handsome. Accurate. Has Sweep Second Hand. Non-Magnetic. Passed 72 hour under water test and met rigid standards of Armed Forces during last war. Amazing value at \$19.95, plus \$2. Fed. Tax. Order now.



FREE! Handsome expansion band included free with your order.

War or No War, There's No Inflation in Our Prices. Write for FREE Watch & Diamond Ring Catalog. Practically wholesale prices to user direct.

TRIAL OFFER! WEAR AT OUR RISK! Money back if not delighted! ORDER DIRECT FROM THIS AD. FOR SELF AND FOR THRILLING GIFTS. Lowest prices ever, for these guaranteed watches! Order now on famous 5-year written guarantee. Send only \$1 down payment with order. Pay balance to postman on arrival plus postage. Or we pay postage if you enclose full payment plus tax with your order.

MARYLAND DISTRIBUTORS, Dept. 177, 501 E. Baltimore St., Baltimore 2, Md.

GOVT. COST
~~\$32.25~~

CHRONOMETRIC TACHOMETER

U. S. NAVY SURPLUS—ACCURACY—PRECISION—GUARANTEED

For PRECISION timing of all rotating mechanisms. Incomparable GUARANTEED ACCURACY of 1/10 of 1%. An RPM counter and surface speed indicator combined with chronometric operation which AUTOMATICALLY computes period of test in EXACTLY 6 SECONDS. No stop watch or personal equation necessary. UNSURPASSED for cameras, projectors, gen-

erators, motors, sanders, turbines, saws, shafts, looms, fans, lathes, etc. Packed in plush-lined, simulated leather case. UNCONDITIONALLY GUARANTEED subject to your inspection and approval. Manufactured by JAEGER and TOTCO, leaders in field of exacting measuring devices. Only \$19.75 Shipped postpaid in U.S.A. on cash orders.



NOW
\$19.75

TEST EQUIPMENT

Dumont—R. C. A.—Hickok Weston
World's Largest Selection of: Electronic Test Meters, Signal Generators, Oscilloscopes, Bridges, etc. Just purchased from U.S. Army. Send for latest catalog with low prices that will frighten you.

COMPASS

Mark IV Self-Compensating Floating Compass. U.S. Navy. 3 1/4 x 3 1/2 x 3 1/4" For car, plane, or boat. Govt. Cost \$72.00 Now \$4.95

A-10 Bubble SEXTANT

Never before at this price! Complete with hardwood case. Gov't cost, \$300. Now..... **\$7.95**

Kohlsman ALTIMETER



Ideal for Auto or Airplane. Used but GUARANTEED accurate. Don't wait. Order NOW! Original gov't cost, \$168. Each **\$10.95**

Order these surplus bargains today. We pay postage on cash tachometer orders. Add postage to other items. 20% dep. on C.O.D.'s

Semlers' ASSOCIATED SURPLUS Dept. PM-11 5720 WILSHIRE BLVD., LOS ANGELES 36, CALIF.

**EARN BIG MONEY!
BRONZED
BABY SHOES**

Big Christmas Demand!

CASH PROFITS—\$10 to \$50 in a day — EASY with famous Senti-Metal Bronzed Baby Shoes! Baby's first shoes beautifully preserved in SOLID METAL and mounted on picture frame stands, book ends, ash trays, desk sets, etc. Mothers, fathers, order on sight—BIG PROFITS FOR YOU!

FREE! No investment needed! We supply everything FREE —ACTUAL SAMPLE miniature Bronzed Baby Shoe, colorful Presentation of complete Senti-Metal line and money-making equipment. Write today. SENTI-METAL CO., 274 E. Capital St., Dept. L-18, Columbus 15, Ohio.



MODEL BUILDERS!

NEW 1951 CATALOG

- MODEL AIRPLANE ENGINES • GLOW PLUGS • MARINE ENGINES • FUELS
- MODEL RACERS • ACCESSORIES

CUT OUT AND MAIL TODAY

OHLSSON & RICE, INC.
3344 Emery St., Los Angeles 23, Calif.
Los Angeles 23, California

Please RUSH _____ copies of the NEW 1951 O&R Catalog at 15c each for which I am enclosing _____ in stamps or coins to cover handling and mailing.

Name _____

Address _____

City _____ Zone _____ State _____

SOMETHING
EXTRA

ABOUT THE MAN
WITH

P.A.*



P.A.*

MEANS PIPE APPEAL AND PRINCE ALBERT

● You can tell by her glance he has something special—he's got Pipe Appeal. And he has something extra special in a pipeful of fragrant Prince Albert.

P. A.'s choice, rich-tasting tobacco is specially treated to insure against tongue bite. Get P. A.! Crimp cut Prince Albert is America's largest-selling smoking tobacco.

R. J. Reynolds Tobacco Co., Winston-Salem, N. C.

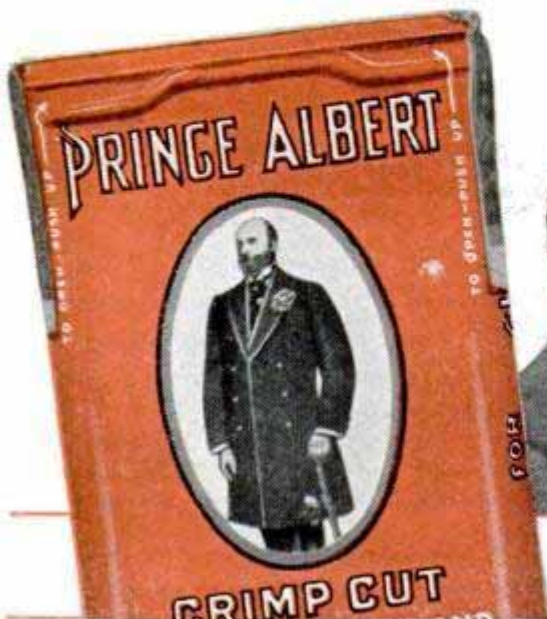

The National Joy Smoke

TV's LITTLE BROTHER

By Creighton Peet

YOU CAN use it for anything—absolutely anything. It will show you what's going on around corners, through walls, underwater, in the dark, at the bottom of an oil well—or inside the human stomach.

It's TV's little brother, a small and comparatively inexpensive wired television setup designed for industrial uses. Already three such devices are on the market. Diamond Power Specialty, a subsidiary of I. T. & T. has the Utiliscope; Remington Rand has developed its Vericon, and RCA the Vidicon. In one model the orthicon tube is the size and shape of a small flashlight, and its housing looks like a 16-mm. home movie camera.

Among the hundreds of uses to which such tubes have been, or could be, put, a few are: watching a machine in a factory, a flame under a boiler and a water gauge at the top of a giant boiler.

They also guard prison corridors, or keep an eye on a jewelry counter in a store. They can be used to check progress along an assembly line, or the density of traffic at critical intersections. One operator, one

When Nazi V-2 nests defied block-busters, bombers loaded with explosives and camera in nose were steered to hangar by mother plane with TV receiver

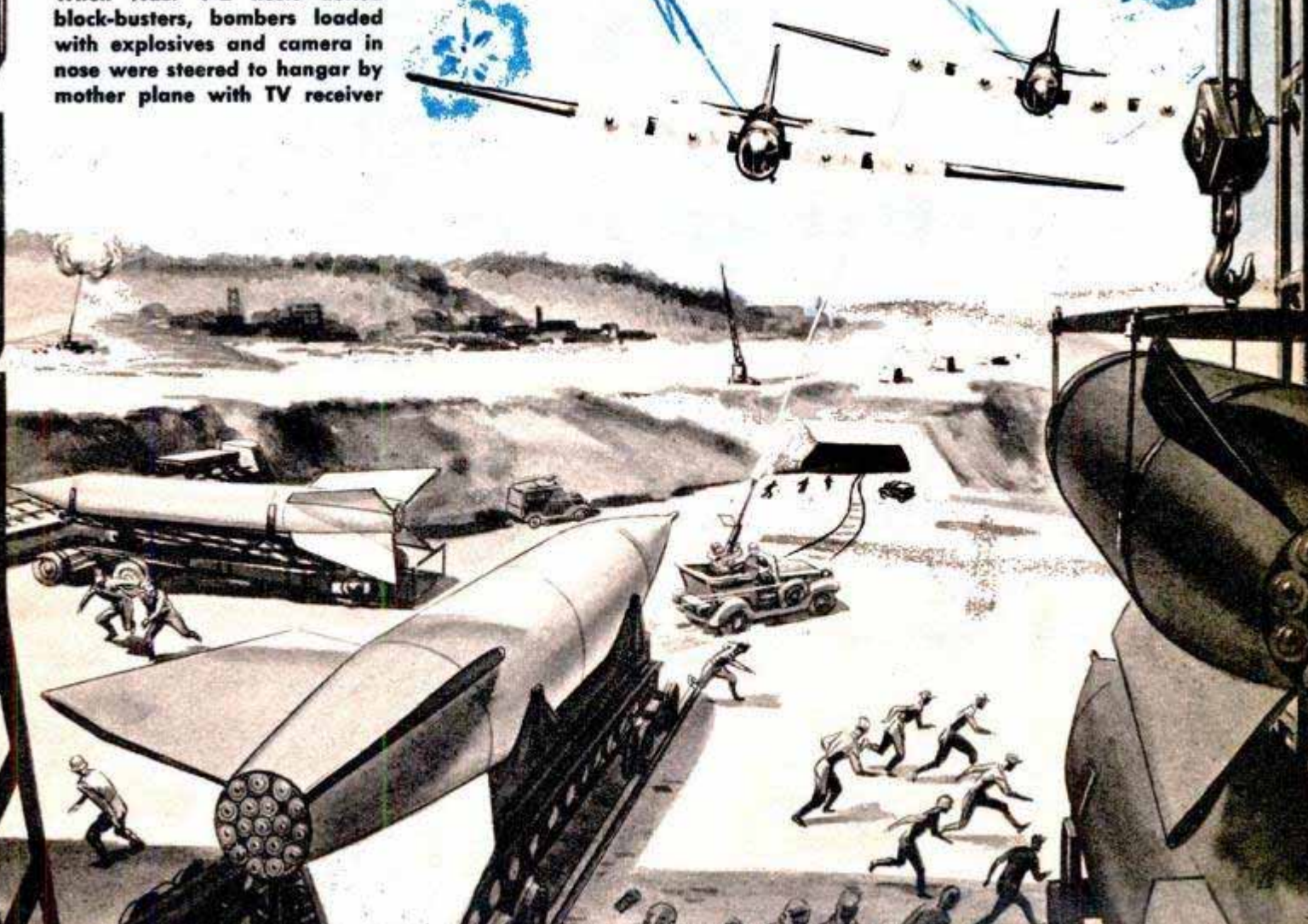

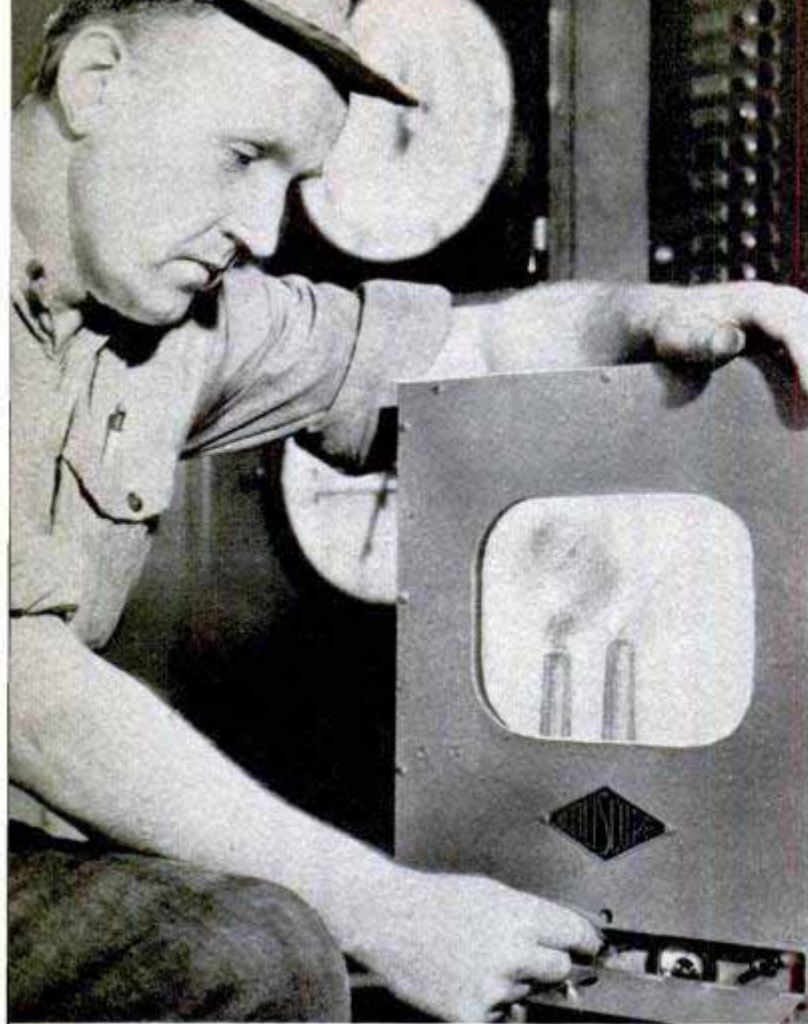

In a sub-basement boiler room, engineer watches TV screen to inspect smoke coming from three chimneys. Medical students at the University of Kansas, below, follow an operation taking place in the next room



guard, or one production manager can perform the work of a dozen or more men.

This junior TV has so many possibilities and implications that even its manufacturers are a little skittish about it. Compact and easily transported, it can be plugged into any standard 110-volt household electric outlet. Planted indoors or out to watch and trap suspects, it becomes an extra eye in police work. As such, it makes the much-debated wire-tapping seem as innocent as "drop the handkerchief."

Its relationship to labor will be even more complicated to resolve. How many pairs of human eyes these tiny TV tubes can replace, nobody has even tried to estimate—but coupled with the incredibly skillful automatic devices already speeding production in American industry—they are something to reckon with.

One use for this wired TV will meet with no opposition from anybody. In perfect safety, operators can now watch remote-control manipulations in areas filled with radioactivity. They also can observe critical blending of unstable chemicals and get a good close-up of the blast from an experimental jet or rocket. Sealed in a container with a suitable light source, it can report on the underwater damage to a ship's hull, or help in salvage operations.

In some situations camera units are expendable, and in years to come this device is destined to save many lives. A good number are already at work in atomic-energy plants, and other defense projects shrouded under security regulations.

Probably the "oldest" installations in continuous service are those of the four Utiliscopes which the New York Edison Company uses to check on the water level in some of its five-story steam boilers. For four years now, two or more of these little TV eyes have been at work 24 hours a day watching the gauges which indicate the water level in drums at the top of the boilers. This information is relayed to the main control panels on the ground floor.

A pressure of 1400 pounds to the square inch, and a temperature of 900 degrees require special mica-coated glass one inch thick—and even this blows out from time to time—so that watching these gauges can be dangerous.

Another early application of the Utiliscope was in strip coal mining. It was discovered that in operating a power shovel capable of picking up 40 tons in one load, the operator had no direct view of the scoop. Frequently, he came up with half loads, which resulted in a loss, as the shovel was very costly to operate.

A TV camera installed on the upper rim of the shovel, with the receiver in the operator's cab, gave him a clear picture of

exactly how much material he had picked up.

Still another use of the Utiliscope is in the steel industry, in the B & W Tube Works, of Beaver Falls, Pa. Here a camera equipped with a telephoto lens is used to watch the surface of molten metal in a continuous casting process. This eliminates the need of a man standing close to the casting pipe.

While standard broadcast television has about 525 scanning lines, the Utiliscope picture has but 220 lines. The resulting picture is not quite as clear as that on your home set, but is entirely adequate for the vast majority of industrial applications, and cameras and viewers can be connected with ordinary cables instead of coaxials. The picture will carry about 500 feet without booster equipment, farther with it, and as many as 10 viewers can be connected with one camera. The total cost of one complete Utiliscope installation is between \$3000 and \$3500.

Remington Rand's Vericon, developed under William L. Norvell, chief of the Guided Missiles Branch in Air Communications as a lieutenant colonel during the war, has found its chief uses so far in military and defense plants, and the observing of surgical operations. The Vericon uses a standard 525-scanning-line picture and a coaxial cable. A complete unit runs to about \$8500.

More than a score of Army ordnance depots around the country are also equipped with these little TV eyes to make the defusing and disassembling of various types of ammunition safer. Personnel located in a concrete bunker half a mile away can defuse a bomb

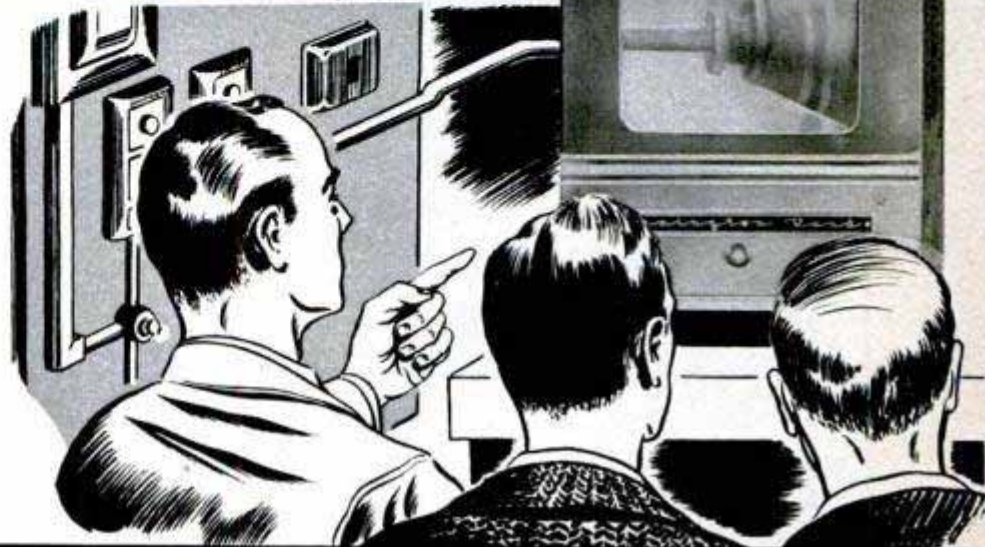
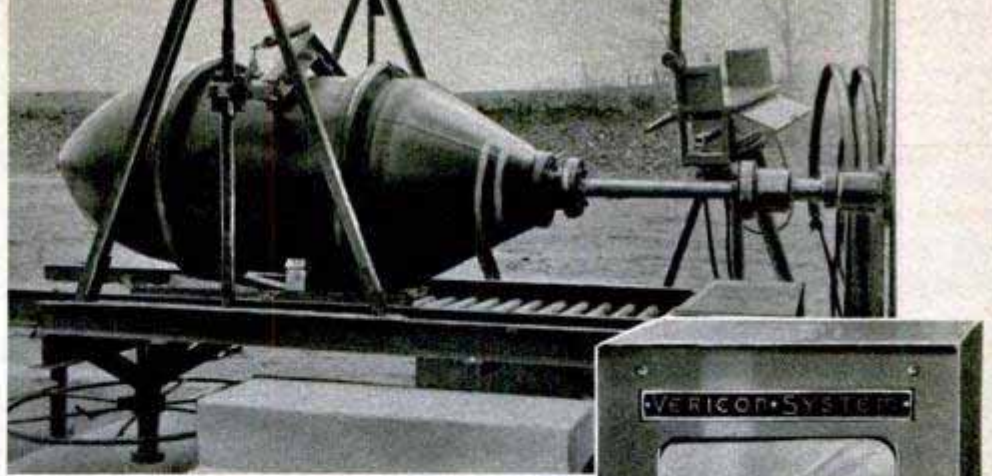

Defusing of a bomb, top, is about to begin under observation of camera while, safely within a concrete shelter, technicians watch the operation. Below, gauge on drum of steam boiler builds up to 1400 pounds' pressure under the watchful eye of an engineer who is safe in remote office

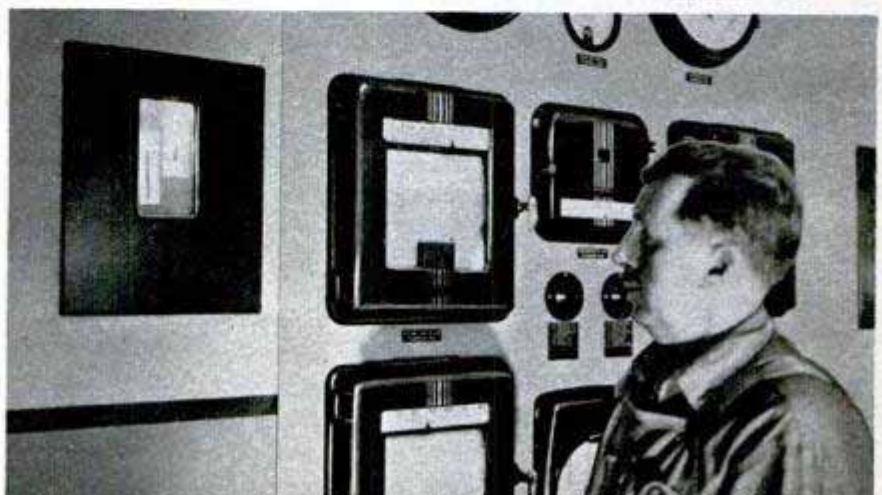
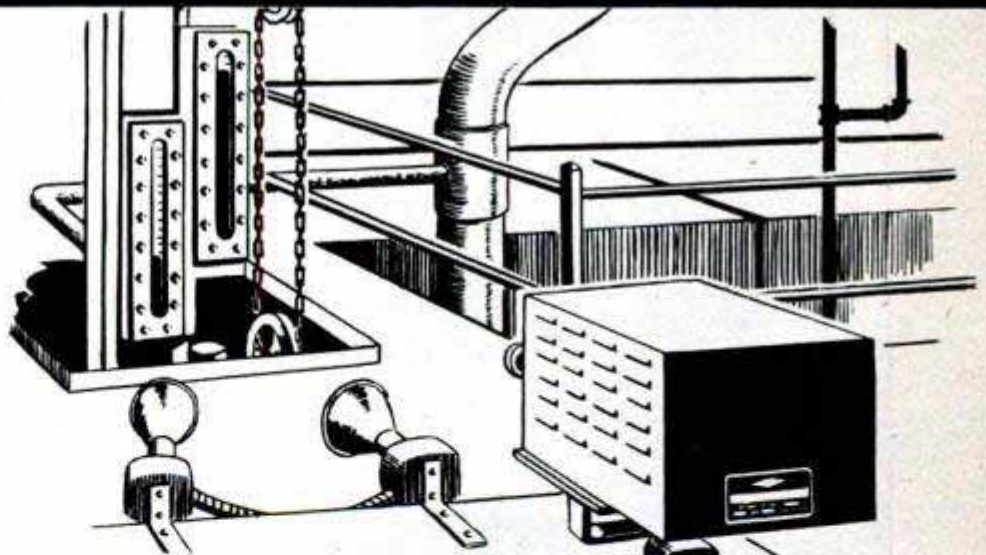

Other uses for the new television

- quick signature verification
- reducing production costs
- saving money on protection
- protecting safes, showcases
- increasing sales



When illuminated by infrared light at night, safes and showcases are apparently in total darkness, yet every detail is visible on viewing camera. A single guard in another room can observe many such scenes

Speed and accuracy in verifying signatures on checks and inspecting documents are vital to banks and other businesses. With a viewer convenient to verifier in vault or file room, comparison can be made quickly



by means of a power-operated wrench, watching the progress of the work in their viewer.

RCA's Vidicon, also using a 525-scanning-line picture and a coaxial, is just out of the laboratory and has had few installations as yet. The tube is but one inch in diameter, and its housing measures only 3½ by 5 by 10 inches, making it unusually compact.

It is expected that this device will find many jobs in industry in the inspection of small or inaccessible spaces, such as cylinder or cannon bores, the interior of factory chimneys, grain elevators, or the joints in oil-well casings.

Obviously, all of these devices can be adapted to almost any use, but here are a few additional applications which are either in use or being considered:

A bank in Texas is installing equipment so that checks and other documents presented at windows in its main banking floor can be inspected on screens in upstairs offices.

Department stores could install screens

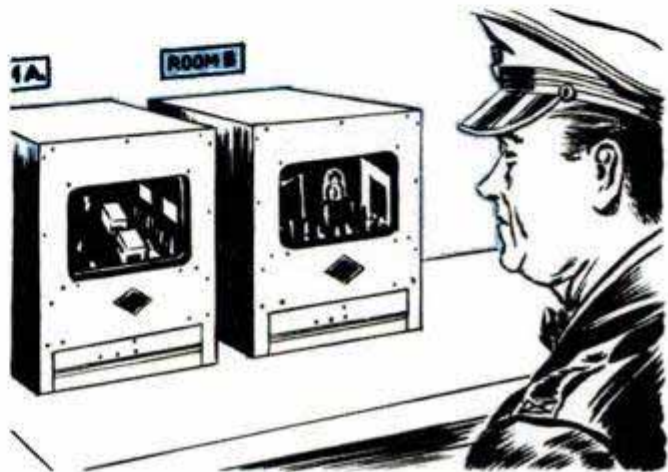
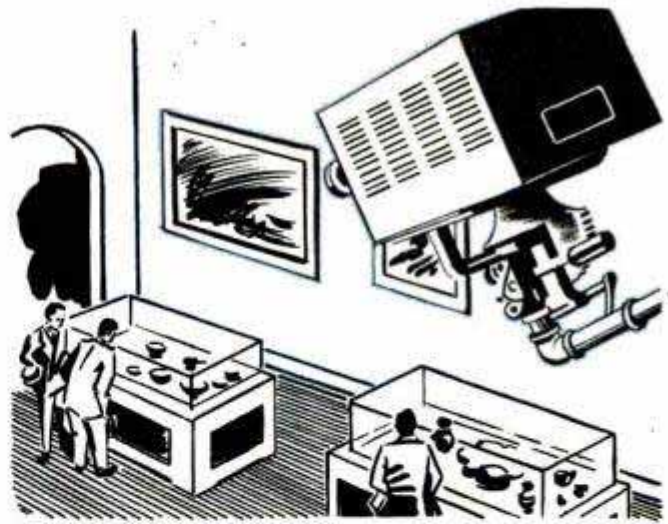
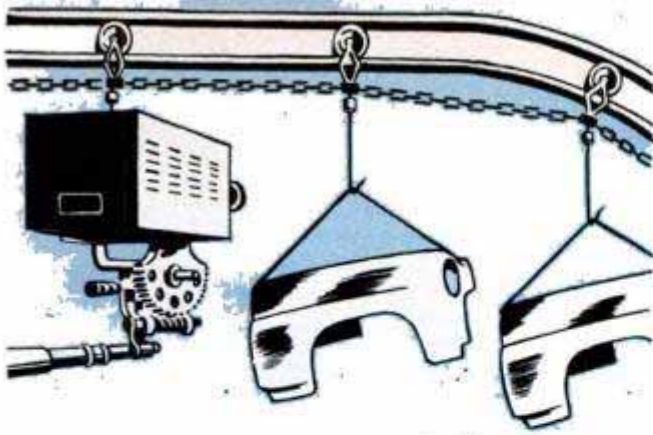

In large plants where economical scheduling and pacing of assembly are important, supervisors can be watching a series of key locations on screens at same time. Shortages can be caught before they are serious

Constant safeguards against thievery are necessary in museums where valuable objects are on display. From a central station, one watchman at viewing screen can keep a series of exhibition rooms under close scrutiny

in street windows or booths on the first floor, so that passers-by could see a fashion show or some other special event, such as Santa Claus, on an upper floor.

One watchman with an eye on a central control board, could cover 20 or more check points in a factory, or in a series of buildings. Automatic panning devices, similar to those which swing electric fans in wide arcs, could enable each camera to cover two or more corridors.

The Utiliscope, which is sensitive to infrared illumination, could spot intruders even though they were apparently operating in total darkness. Undoubtedly, the FBI and other detection agencies will make great use of this device in the near future.

In psychiatry, too, it has been suggested, students in one room could watch the reactions of a patient being treated in another room, without his being disturbed by their presence.

Traffic-control officers and highway, bridge and tunnel officials could get a clear picture of traffic jams in the process of forming by watching the flow of vehicles

at critical points in a central control room, and then directing motorists to detours and alternate routes, through traffic officers.

One project at present under consideration by a major motor manufacturer, would place cameras at key points on the subassembly lines feeding into the main assembly. Thus an engineer watching the progress of work on a dozen smaller lines, could spot a bottleneck before it developed, and do something about it.

Hooked up to a microscope, such a small TV unit would enable a whole class of students to watch a demonstration by an instructor. Several receiving sets could be placed around the classroom.

The present development of wired, industrial television was of course inevitable, but long before millions of people were watching Milton Berle in their homes, both the Navy and the Air Force had experimented with both planes and weapons equipped with television.

In one form tested at Lake Muroc, Calif., a TV transmitter was mounted in the nose

(Continued to page 260)



Electric eye measures sunlight and adjusts window louvers of this new school. Below left, switch permits teacher to darken room manually. Right, "eye" peers through one louver to measure light on adjacent panel

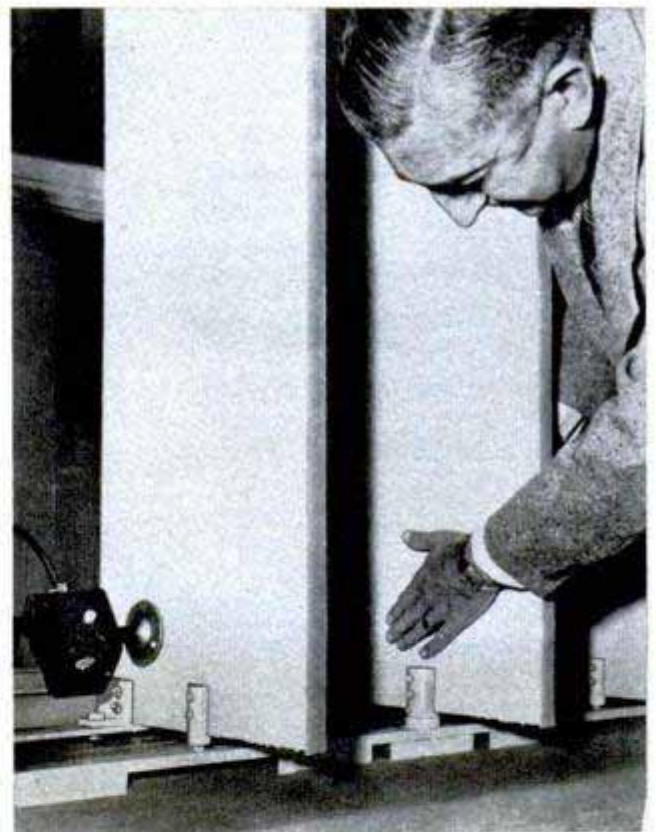
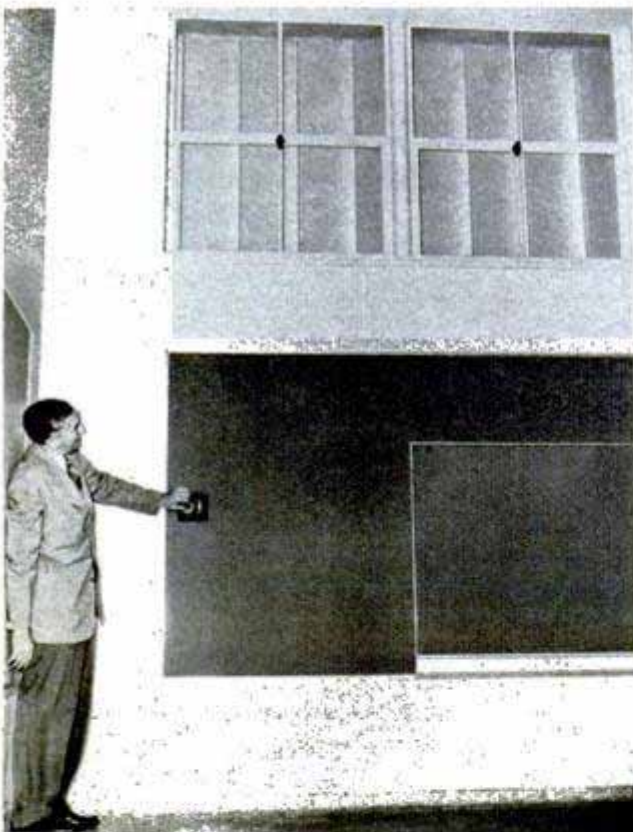

Sun Operates Window Louvers

There's never too much or too little sunshine in the classrooms of the new Will Rogers Elementary School, Ventura, Calif. Robot louvers automatically pivot to maintain exactly the right illumination inside the rooms. On a dull day the aluminum louvers are wide open; when the sun shines brightly the louvers are partially closed. An electric eye constantly meas-

ures the outdoor light that falls on a master louver to operate the concealed motors mounted in each classroom. The electric eye does an efficient job except on some foggy days when there is a great deal of glare from the sky. Then a second eye, installed inside one of the classrooms, takes control and measures the amount of light that is actually present. The louvers can be operated manually when the room is to be darkened.

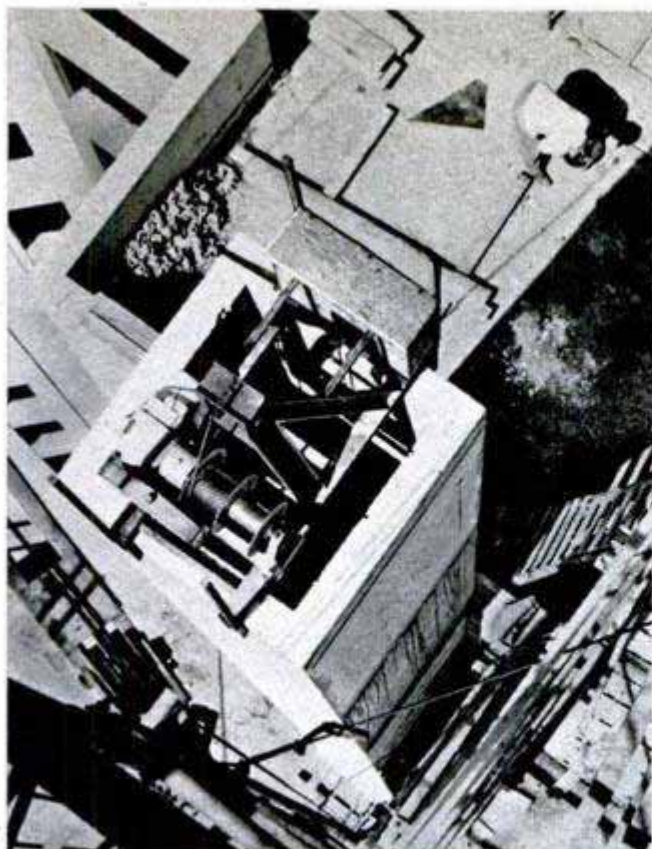

Chimney Is Shaft for Bricklayer's Elevator

Bricklayers at a giant housing project in Los Angeles must have felt like Santa Claus on Christmas Eve as they worked on one-man elevators inside the project's chimneys. The inside of the concrete stacks had to be lined with brick. To do the job, bricklayers rigged up tiny elevators inside the stacks on which they worked. Controls on the elevators allowed the bricklayer to

move up as his work progressed and to lower himself to the ground for more bricks and mortar. An electric motor and winch, mounted on a frame that straddled the stack opening, provided the power. There are 18 chimneys, each 150 feet high, in the project. It took 13,000 bricks to line each stack and the bricklaying time per stack was between 11 and 14 days.



Army Paint Mixer

Army ingenuity again makes news. T/Sgt. James Parish, at the Air Force Base, Chanute, Ill., was given the job of mixing paint for remodeling barracks. After mixing 15 gallons of the stuff, Parish figured there must be an easier way to do the job. With some discarded oil drums, borrowed electric drills and handmade paddles he fashioned a series of mixers which pour out the paint in wholesale lots. Parish can mix 150 gallons in 15 minutes.

¶ In 1949, 31 percent of our electricity was generated with gas and oil, a big jump over the 1929 figure of 14 percent.

U. S. Air Force photo

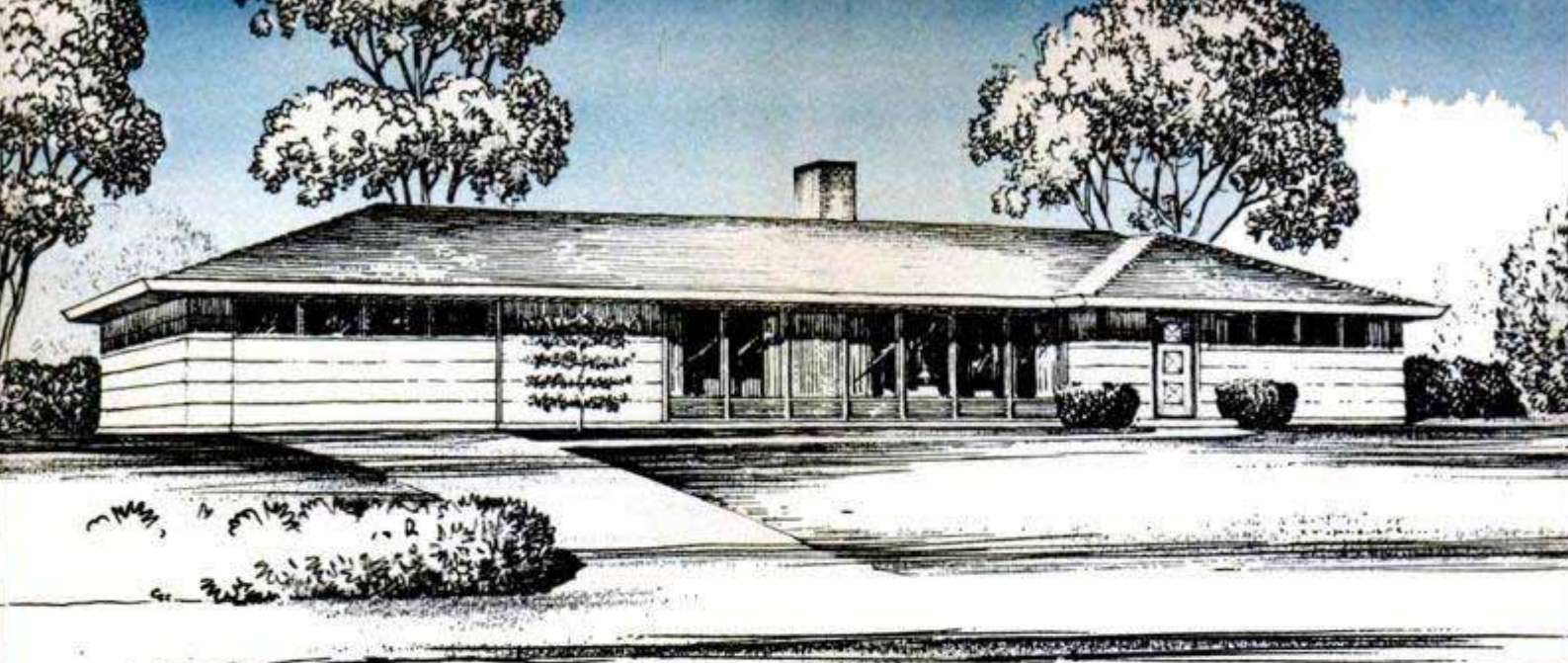

This is the architect's drawing of the new PM plywood house which Tom Riley is building in Portland, Ore.

I'm Building the POPULAR MECHANICS **PLYWOOD RANCH HOUSE**

By Tom Riley

HAVE YOU toyed with the idea of building your own home? After looking at some "for sale" prices I certainly did. Before the last war, few amateur carpenters even thought of building on their own. Since the war a hundred thousand families a year are building all or large part of their homes.

There are two reasons for this: One is that you can do it! Modern methods of construction and power tools have eased

the job for the amateur carpenter. The other is that you can do so much more with the money you have; 55 to 65 percent of the cost of a house is in the labor. You can save that 55 to 65 percent by doing it all yourself, or a very good percentage by doing part.

House-building is one of the few things you can jump into and learn the mechanics as you go. The first months are spent in rough carpentry, building forms and sub-floor, places where cabinet-fit joints are not needed. You can bang your fingers the first day (as I did) but you will have plenty of time to learn how to use a hammer and saw before it is important in the final appearance of the house.

This project started in June 1949 when Roderick M. Grant, the managing editor, was on a trip throughout the West Coast. He noticed the high amount of modern construction used there on the popular ranch-type home and as I live in Portland, Ore., amidst this modern construction, he asked me to write a book.

"Riley, you're not a carpenter. If you personally build a modern home you'll

James R. Ward, crafts editor, studies plans for the house with — you guessed it — Mrs. Riley who is helping Mr. Riley saw boards and drive nails



meet every complication the average amateur will meet. With that and the advice and supervision available from our staff in Chicago the book will be really authentic!"

My reaction was that if Riley could build it that would be a mighty good test.

One of the country's most capable home designers was on the West Coast, John J. Whelan, the architect who designed the Drew Pearson home in Virginia and the Lanai Rooms of Colorado Springs. The editors chose him to design the home.

This modern home will be outstanding in that it is designed for three different exteriors. Basically a ranch house, its exterior can be the rambling conservative ranch house, or the contemporary ranch house with louver windows and ground-hugging lines, the one I am building; or you can build it as a modernistic home with a flat, water-layer roof.

Today's improved plywoods will be used extensively; they are easy to build with, and give the strongest construction.

I am first building the basic house—for this design is also that of an expansible house. You can build to the stage of two bedrooms and a carport. Or you can include, or add later, the breezeway and garage. Then the carport becomes a third bedroom or den.

James R. Ward, crafts editor, flew to Portland last May to choose this site, and a friend and I started construction during May and were framing the house in a month. First job is the foundation. Don't be afraid of hiring power machinery for



After a few turns with the shovel, Tom advises: "Don't be afraid of hiring power machinery for the excavation." Mrs. Riley kibitzes

the excavation. We started digging a water trench—oh, our aching backs—and then hired a small power shovel to excavate trenches and all for \$60, a job that would have taken us two weeks of heavy labor. The modern foundation being used is called the "stepdown" wall—poured concrete with a step or pocket inside so that the floor joists will be low instead of resting on top of the concrete. The finished floor of this ranch house, with or without basement, can be just a few inches above lawn level, giving true ground-hugging lines.

Progress reports on this house, third in the series of Popular Mechanics "build-your-own-home" projects, will be published monthly until the detailed story and step-by-step plans begin in the Craftsman Section early next year

Site of the PM plywood house is in the foreground and this will be the view from the Rileys' front windows

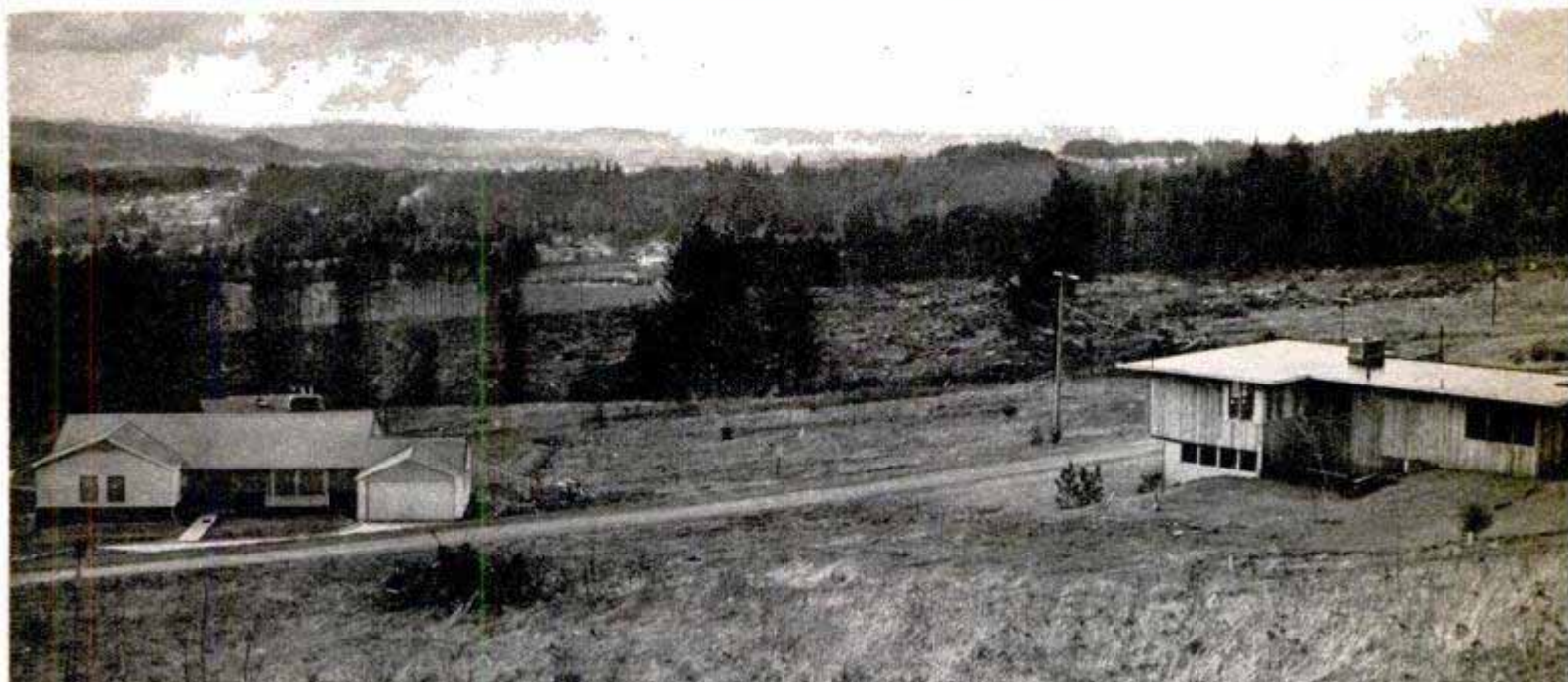



Color Photos of "Off Color" Eggs

Food inspectors who candle eggs to make sure they are suitable for eating now photograph each egg in color to preserve evidence of food-law violation until the case comes up in court. The egg-photographing machine, invented by Forrest E. Trimble, California agricultural inspector, uses a 35-mm. camera to photograph the egg as it is being candled. In natural color, the picture provides the court with an accurate description of the egg's condition even though the trial is held months after the violation was discovered.

Shuffler Mixes Canasta Deck

Canasta players will welcome a mechanical shuffler that thoroughly mixes the 108-card deck in 10 seconds. Two halves of the deck are placed in the shuffler and a simple finger-tip pressure on the boom riffles the cards without bending or curling. The device not only speeds shuffling, but is said to make cards last longer.

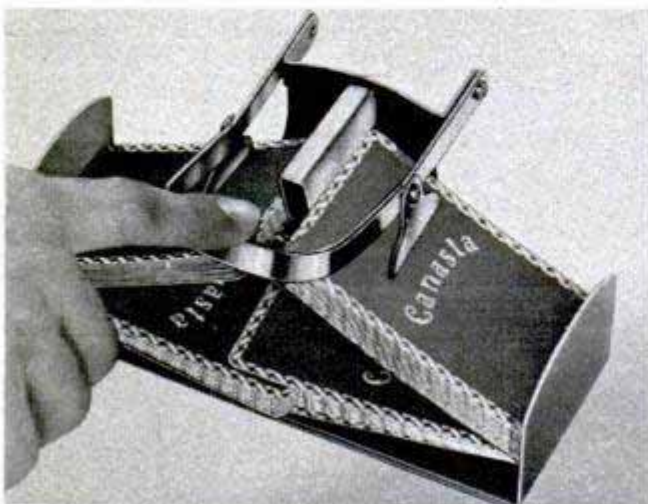

Armrest for Car

Easy-chair comfort for the car driver is provided by an adjustable armrest which hooks over the back of the front seat. The driving aid—a flexible metal bar with a sliding cushion—fits all cars. A small lever permits the foam-rubber cushion to be adjusted to the most comfortable height, then locked in place. The metal bar is covered with fabric to prevent damage to the car upholstery.

Monkey Tells Time By Rolling Eyes

You have to look a monkey in the eye to tell what time it is on a novelty clock manufactured in Germany. The monkey's right eye tells the hour and the left eye the minutes. The eyeballs revolve as the minutes elapse and a line painted on each iris serves as a clock hand. At quarter past three, the monkey has a sly expression, looking out of the corners of his eyes. At six o'clock, the monkey becomes completely confused with one eye looking up, the other down.



ON PERMANENT ALERT

By Thomas E. Stimson, Jr.

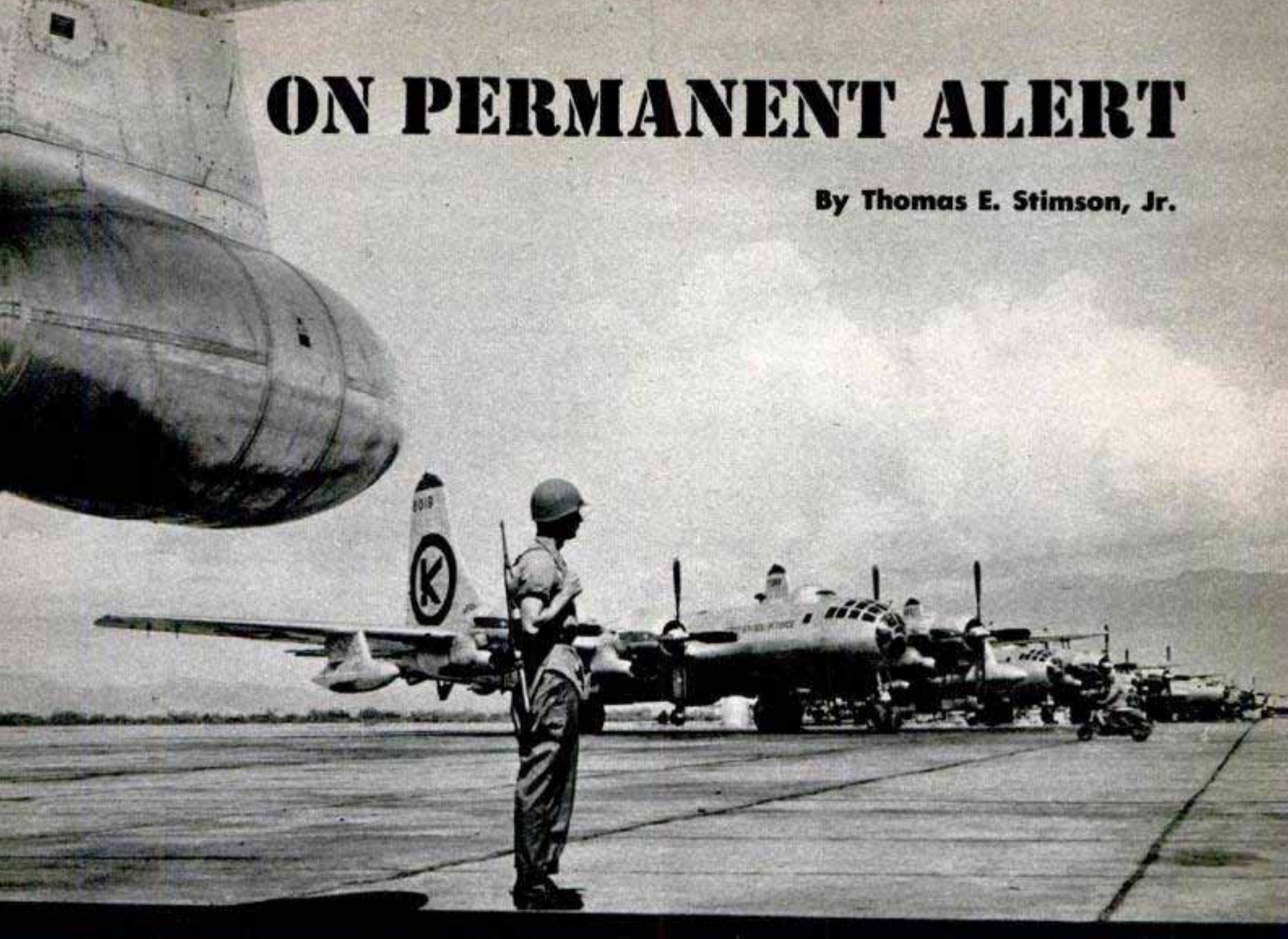

Guarding long line of "ready" B-50s in Arizona. Fitted for mid-air fueling, all are intercontinental bombers

LATE ONE RECENT evening the flight crews of the 43rd Bombardment Wing filed into their assembly hall for briefing on the next day's strike.

It was to be a training mission and it had been assumed that an aggressor nation had captured our west coast. The 43rd's big bombers were to hit enemy headquarters in San Francisco, simulate dropping of bombs and return to their base.

No bombs would be dropped, no shots would be fired; aside from that the training mission was in grim earnest.

Like the other elements of the Strategic Air Command, the 43rd is on a permanent alert. Intercontinental bombers can take off from Davis-Monthan Air Force Base in Arizona or any bomber base in America and fly direct to any part of the world, refueling as often as necessary from aerial tankers en route. In the

last couple of years the B-50s have roamed over much of the world on practice missions. They can carry anything from incendiaries to atom bombs.

In the 43rd's briefing hall the lights were turned off and on the stage an intelligence officer adjusted his microphone. Behind him a huge map of continental United States slowly became visible in the dark—

Eleven-man crew of bomber buckle on parachutes following a pre-take-off inspection by plane commander. Most missions are flown at high altitude





Intelligence specialists prepare a fluorescent map for briefing, marking route and other pertinent data

Two droppable 700-gallon fuel tanks, like this, or a pair of 4000-pound bombs can be hung beneath wing

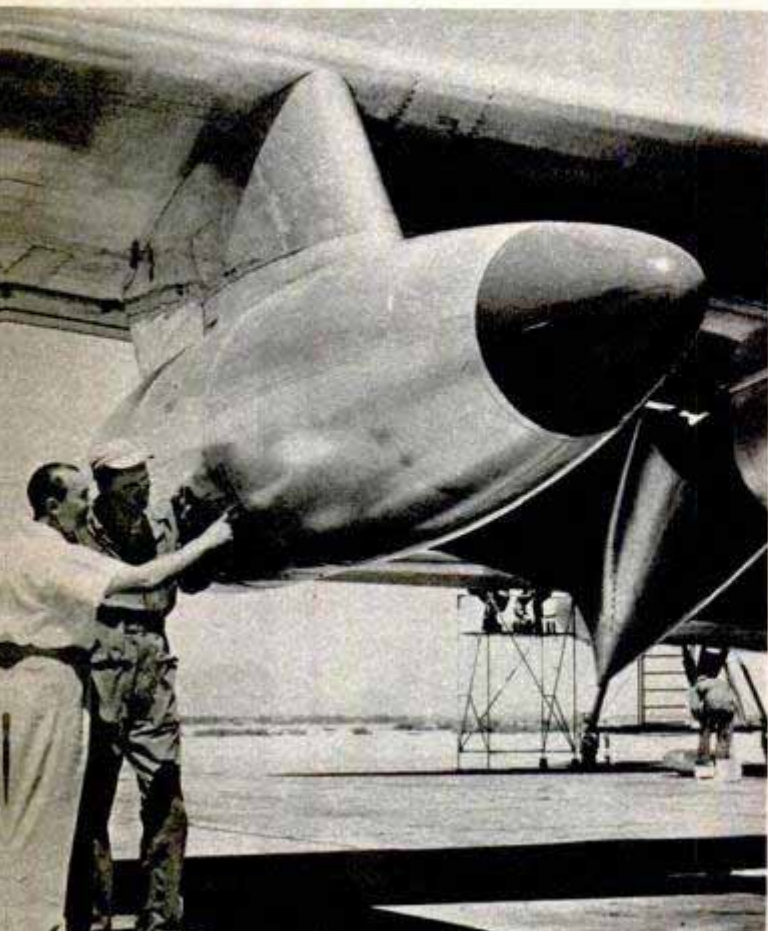

fluorescent colors glowing under the rays of concealed ultraviolet lights. Outlined across the map was the bright red course line that the bombers would follow.

"Remain on course from Mount Whitney to the initial point at Monterey," the intelligence officer instructed his audience after describing take-off and flight procedure. "The axis of attack from Monterey to the target is 343 degrees True and the 75-mile bomb run will take you 11 minutes.

"Primary method of bombing will be by radar, with the aircraft in the formation dropping by toggle switch as soon as the group leader's bombs fall away. In the event of a break in the clouds over the target, you will drop your bombs by visual reference."

A big round picture that glowed in the dark was pushed into place on the stage. "This," the speaker continued, "is a reproduction of a radar photograph. When you make your turn at the initial point the image you will see on your radar screen will look like this. The orange stripe on the picture is your bomb-course line.

"As you fly north you will be able to identify on your radar screens the bright image that locates Dumbarton Bridge and the area of return that identifies San Mateo Bridge. The next outstanding image ex-

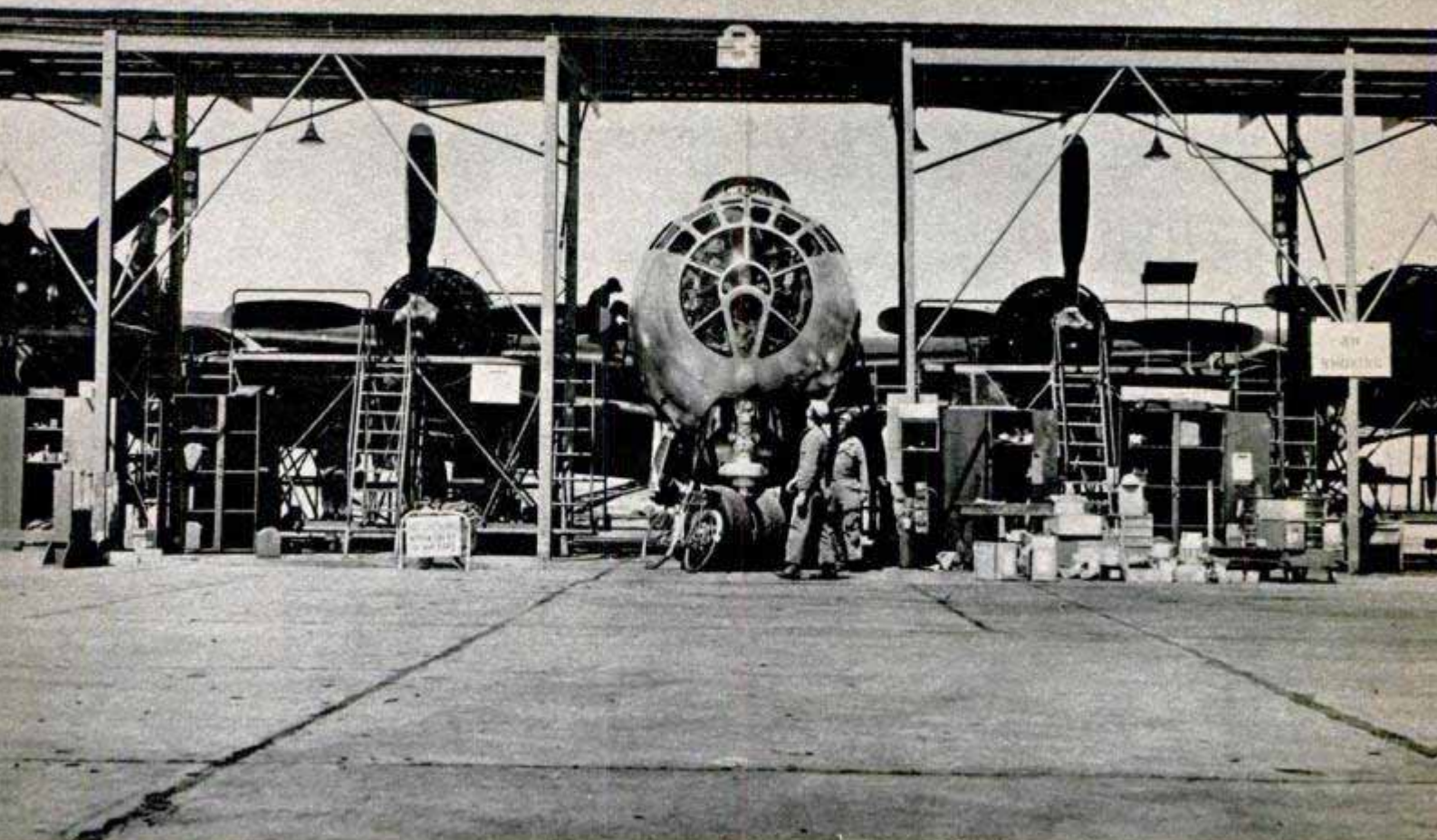

Complete "power package" speeds servicing. In an hour men can replace engine with pretested unit

tending across the water will be Oakland-San Francisco Bridge. Your aiming point is west of the southwestern approach."

He went on, using a pointer with a fluorescent tip to indicate points on other maps that were slid onto the stage.

"If you get into trouble over the target area and are forced down, head west to the Pacific Ocean. Ditch your aircraft at points A, B or C. Friendly submarines will surface there at exactly 1230 hours to rescue any of the unlucky."

Another intelligence officer took the stage to outline the support that the bombers would receive.

"Your first rendezvous with friendly fighters will be over Mount Whitney," he said. "The cover will consist of fifty F-86 jet fighters from Kingman, with two all-weather aircraft as guide planes.

"Fifty F-84 jets from Tonopah will join you at Monterey. They will provide high cover and will drop down for escort duty five minutes beyond the target. In addition you will have coverage from below by 50 F-80s from Elko, rendezvousing over the target at 1220 hours. A diversionary strafing and dive-bombing raid on Sacramento will precede your strike by one hour."

The talks went on, each member of the intelligence team contributing his special

Enlarged radar photo of the bombing-run area. Ultraviolet light causes the airman's face to appear black

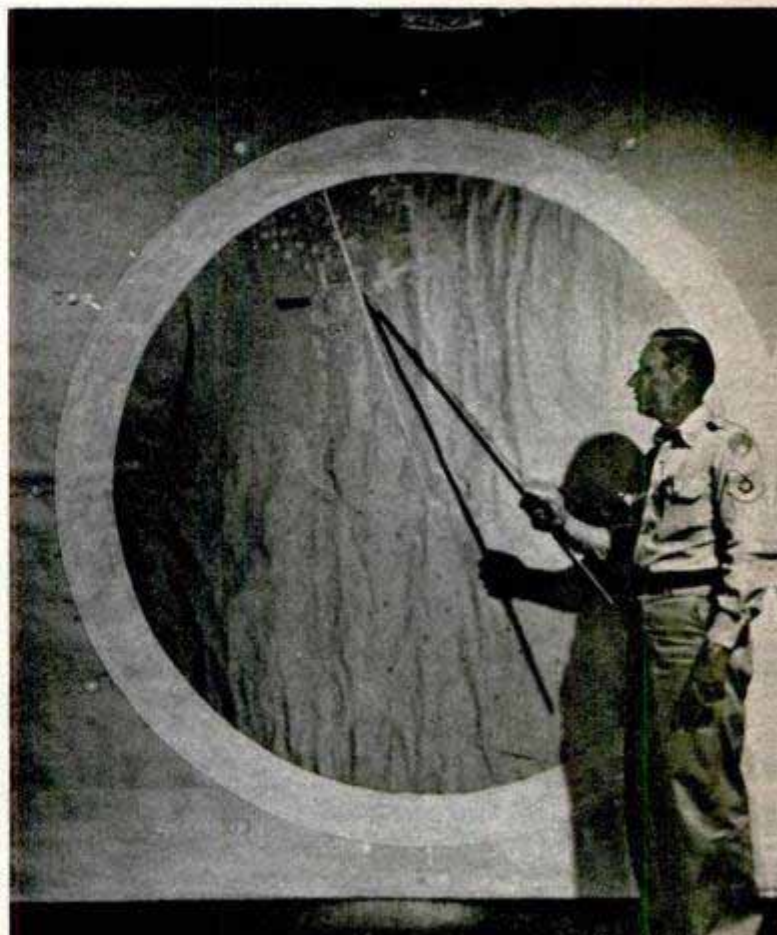

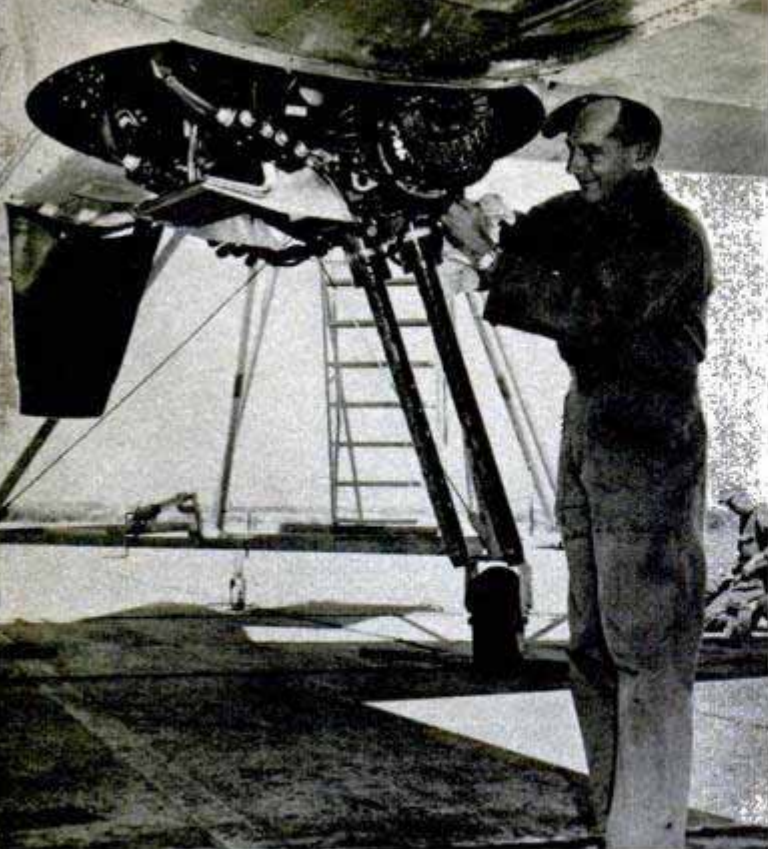

One of the remotely controlled gun turrets in belly. The 400-mile-an-hour B-50 can also drop atom bombs

information. The expert on enemy defenses was last.

"Gentlemen," he said, "here is what you are up against. The target will be defended by 200 swept-wing jets marked with a yellow triangle on the vertical stabilizer. Each is armed with a pair of 25-mm. cannon and four rockets. Your own guns plus fighter cover can take care of this interference.

"In addition there are 108 anti-aircraft guns of up to 200-mm. in the target area, as indicated by this map. They are all radar-directed.

"Only a few of these guns can reach your

altitude, and your axis of attack has been planned to avoid most of the guns that could get to you. You'll be relatively safe.

"Four flak boats in the target area are equipped for launching a new radar-controlled rocket, but your axis of attack will keep you at a good distance from them.

"The enemy also has three guided-missile sites in the immediate region. The missiles are radio-controlled and are very effective in a 50-mile radius, so you must be certain that your radio jammers are in constant operation to counteract their aim.

"We have information that the enemy is using a rocket which, when it reaches a certain altitude, opens a parachute and then shoots out incendiaries while it is descending. Report on these if observed. We want to know the size of the parachute, the area covered by the incendiary explosions, the color of the explosions and the number of times the substances are emitted. All this is important to our future operations.

"We will now turn on the lights and synchronize our watches with a time hack. Pick up your survival kits when departing from this room. Any questions?"

Change some of the names and figures, and this briefing could apply to a bombing raid against any enemy anywhere on earth. The job of the strategic bombers is to destroy an enemy's munitions and fighting materials no matter where they are located. The 50s, like the even bigger B-36s, could carry bombs halfway around the world and continue nonstop around the other half of the globe in returning to their bases if necessary. This was demonstrated last year by the world-girdling flight of the Lucky Lady II, a B-50 of the 43rd wing.

(Continued to page 262)

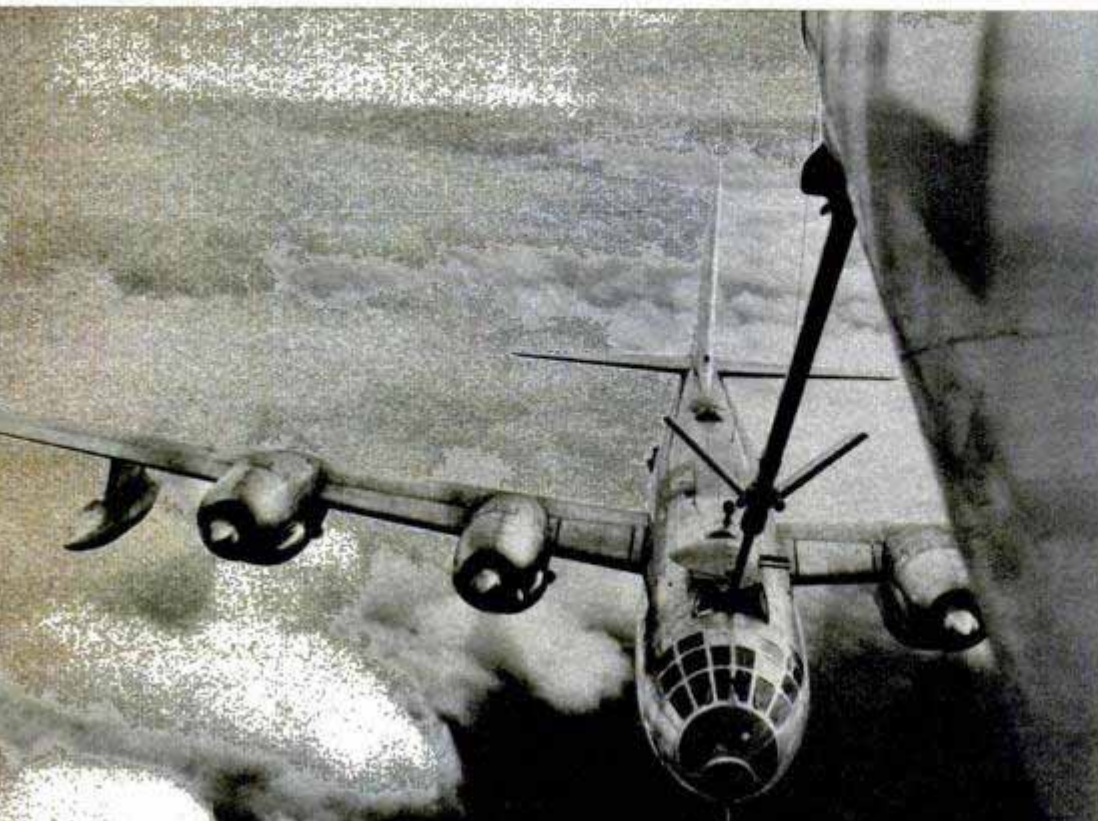

Fuel from a tanker plane flows through telescoping metal tube into a socket behind the nose. V-shaped wing on boom helps guide nozzle into position for mid-air fuel transfer

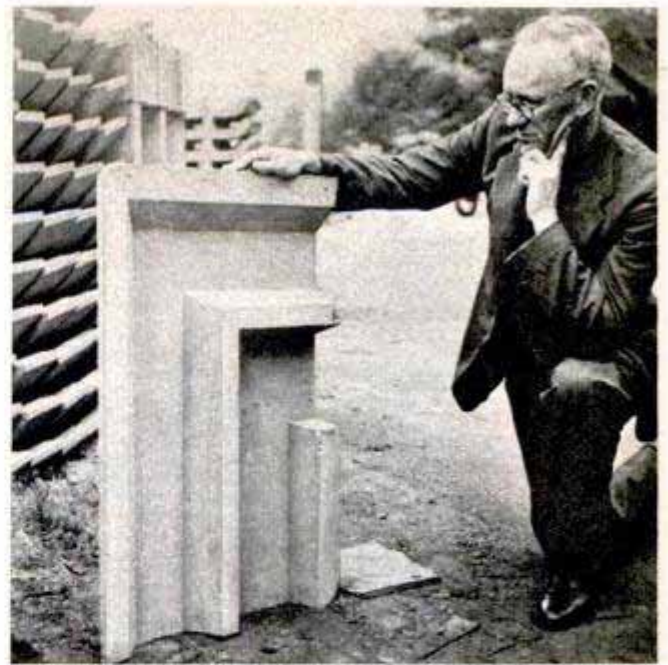

Copyright by Mirror Features

Prefabricated Eaves

Prefabricated concrete eaves for houses are being cast in England. The artificial stone block, made in nine-inch lengths, combines the gutter with the complete eaves, eliminating roof tiling and felting, some brickwork and rafters, offsets and

metalwork. Each block has a raised portion in the center and at either end. One raised strip holds the block under the rafters, and the outside "valley" forms the gutter. The blocks are cemented together and the gutter lined with a waterproof plastic. Special blocks are cast for the corners and for entrance of the downspouts.

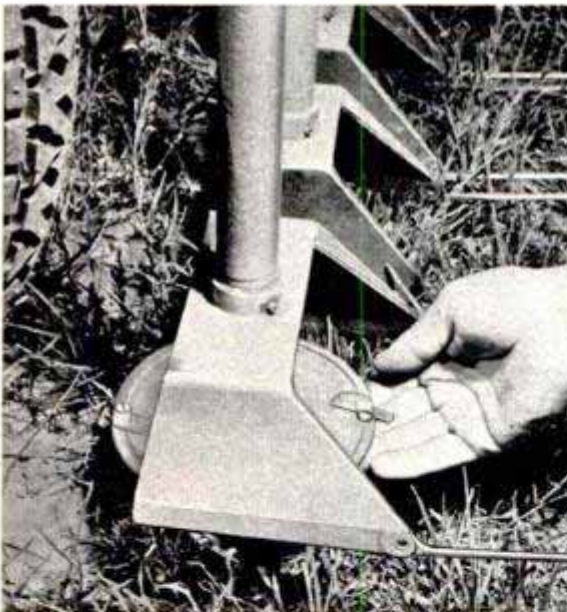

Flax Weeder

Weedless flax fields are possible through a cutting machine developed by Floyd Grapp, a University of Minnesota machinist. Flax straw, free of weeds, is needed to produce linen fiber which will compete

with European imports. The machine cuts weeds from more than 20 rows of flax simultaneously. Revolving shafts on the machine terminate in disks which whirl between the rows. On each disk are four razor blades which clip off the weed stalks close to the ground.

No-Steam Coating for Mirrors and Windows

Bathroom mirrors, eyeglasses and car windows won't steam up when sprayed with a liquid containing silicones. The liquid is packaged in a flexible bottle that

sprays it on the glass when squeezed. After being sprayed, the glass is wiped dry with a cloth and remains free of steam for as long as three weeks.



DRAWBRIDGE
AHEAD



TELEPHONE
AVAILABLE



PEDESTRIAN
CROSSING



GAS STATION
300 METERS AHEAD



ROAD UNDER
CONSTRUCTION



MECHANIC
AVAILABLE



ANIMAL CROSSING

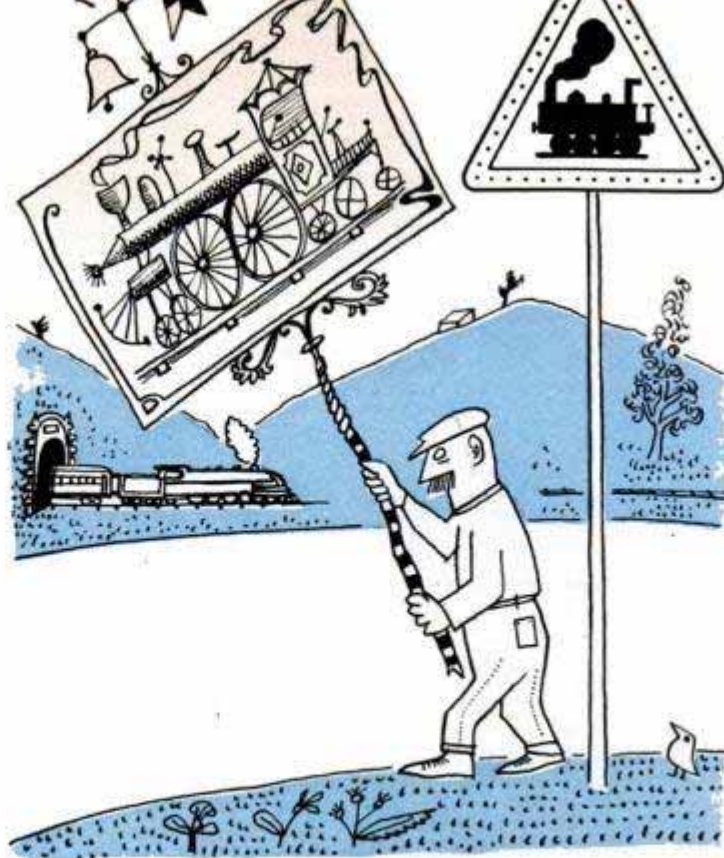

ROAD-SIGN LANGUAGE

MOTORISTS touring foreign countries won't be confused by strange, unintelligible road signs if a United Nations code goes into general use. Every country would use the same signs. Thus drivers with no knowledge of local language or custom would be able to "read" the warnings.

Many of the signs, some of which are shown here, have been in use abroad for several years. Cartoonist Steinberg's rib-tickling drawings are helping to make all of them familiar. Top, Steinberg's highway worker replaces a lacy railroad-crossing sign with the bold UN model. Below are two more of Steinberg's sketches.

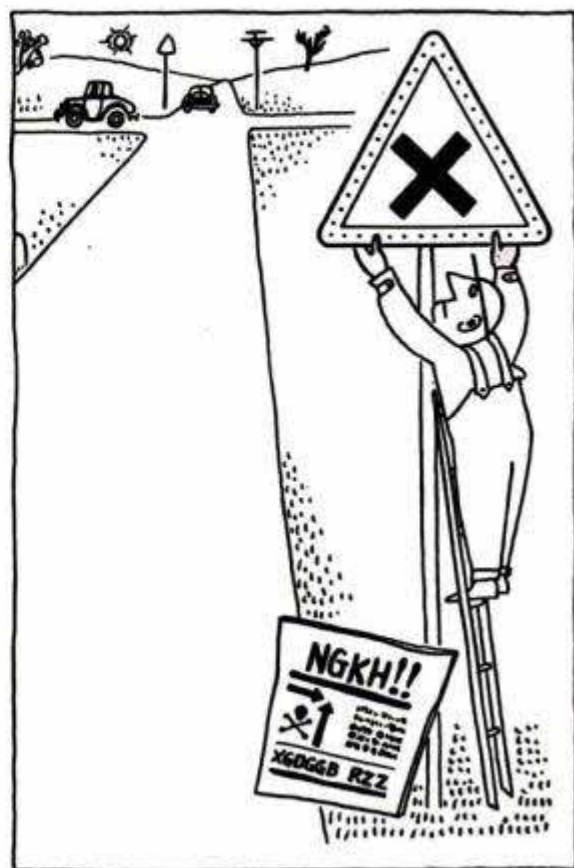

Rockets

on a timetable

By **Richard F. Dempewolff**

X IS ZERO; the exclamation point in time when the 58-foot, two-stage "Bumper" rocket—combining a modified V-2 with a 700-pound WAC Corporal riding its nose—will stand on its fiery tail above the new long-range proving ground in Cocoa, Fla., whoosh to the stratosphere and lay itself out for the world's first long, horizontal stretch above the Atlantic.

No one knows when X will arrive. At any moment, time may stand still while men, hanging half in and half out of yawning hatches in the side of the four-story monster rocket, hold up the count as they make final adjustments.

"It is X minus 20 minutes. Stand by," growls the PA system. In the massive concrete blockhouse beside the firing apron, you feel the tension tugging at the pit of your stomach. The "technical director" is clipping orders in gibberish: "Check the bucking voltage . . . you're four points down . . . keep a cheesebox on number three scope . . ."

Through the periscope mirror window in the 14-foot-thick concrete wall you see ladders come down. Hatches are locked. Knots of men move toward the blockhouse. Green lights flick on across a big board, as each department in the launching project indicates readiness. The droning count moves down the minutes—"X minus 15, X minus 14, X minus 13"—until minutes have run out. Then the loudspeaker punctuates the last tense 20 seconds with the finality of a metronome: "... five ... four ... three ... two ... one ..."

At "five" the engineer in the blockhouse jabs the red "fire" button. An electric current flashes out to the base of the rocket, igniting a pyrotechnic device like a Fourth of July pinwheel. There's a crack like a pistol shot as the rocket valves leap open. Alcohol and liquid oxygen drop through pipe

Instant XI Vivid color shot shows a V-2 as it stands on its fiery tail gathering power and speed. This moment is the result of months of preparation



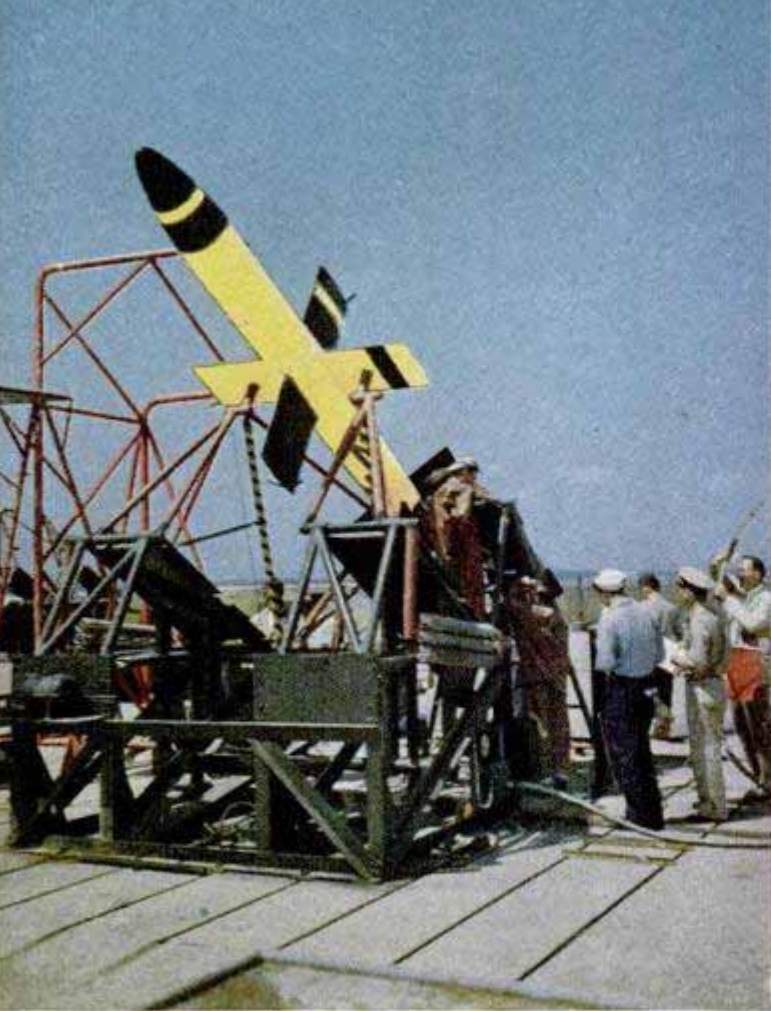

Elaborate tubular scaffold holds the Lark as it is prepared for firing. Below, fuel experts load a big rocket with hydrogen peroxide. Chemical, which will explode if touched, rolls off plastic suits



Few hours before X huge gantry rolls away to leave a four-story V-2 standing alone on launching pad

lines from fuel tanks into the motor, where the pinwheel spews its flame. Wispy vapors curl around the fins. A finger of fire stabs at the launching "pad." Then, with an uncanny roar, a dazzling fountain of white-hot flame gushes over the concrete in mushrooming waves.

"... ZERO!" The monster quivers, lifts slowly and hangs for one incredible instant on its own tail a few feet above the ground. There's a frightening storm of noise, like no other sound on earth. Another split second and the pad is empty of all but sound.

Before you can rush out the blockhouse door, the first preview of push-button warfare, and the first successful horizontal Bumper launching from the new 3000-mile proving grounds near Banana River, is over. Already the rocket is in the stratosphere, burning 10 tons of fuel per minute, traveling 2730 miles per hour and trailing a vapor plume. A gyroscopic steering device turns it on its side, to horizontal flight. As the main part of the rocket is spent, the WAC Corporal takes off and continues the flight to its watery finish while the V-2 shell drops to the sea. As they whoosh through the sky, both parts of the rocket send back valuable information to the telemetering stations.

X for this first big long-range rocket

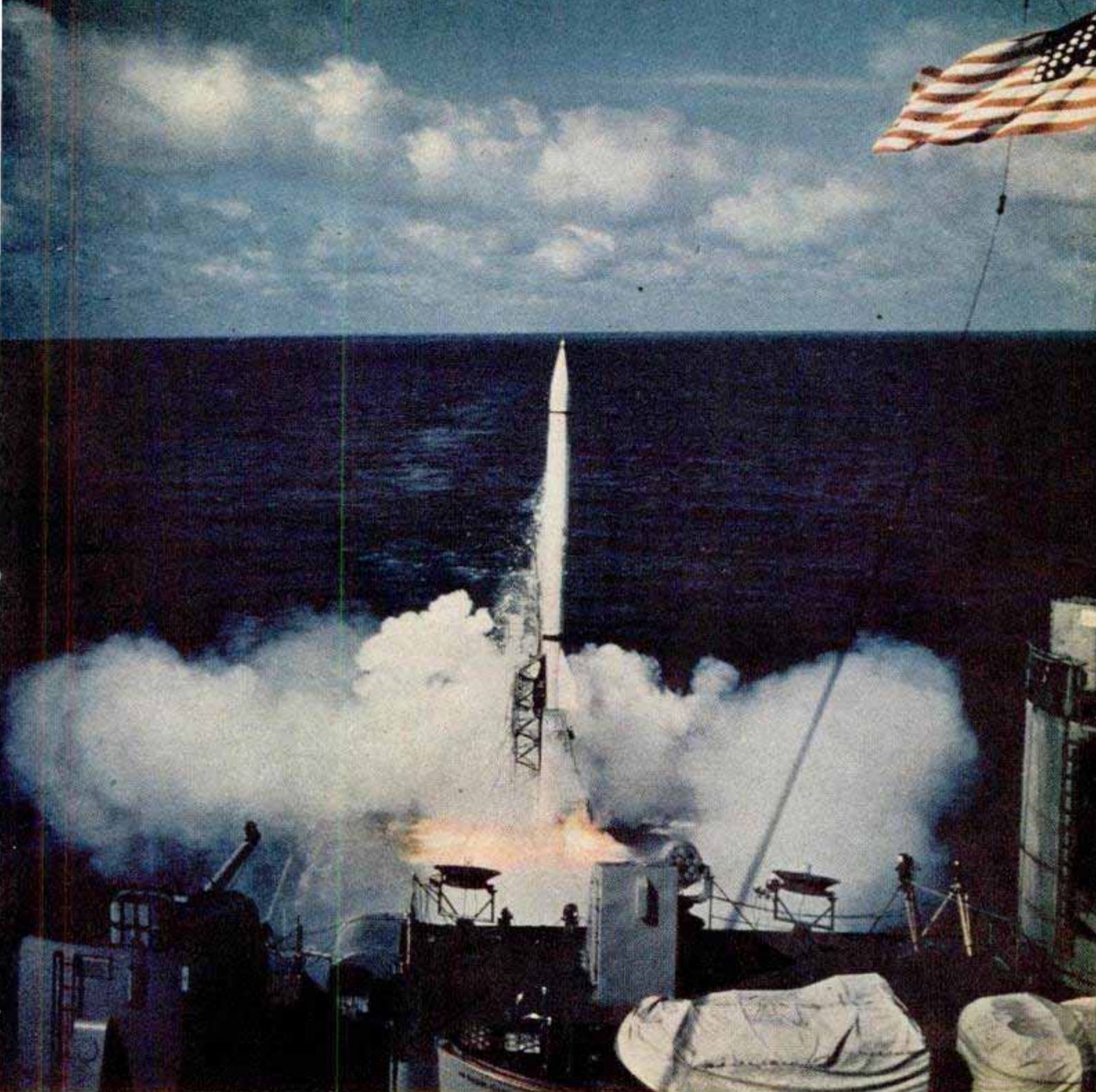

With a mighty roar a Navy Viking begins its 106-mile flight into space from deck of the USS Norton Sound

in the United States occurred last summer. Most details are still secret. But for any rocket, X is merely a crashing climax to months of preparation, tricky handling of fantastic materials, using equally fantastic equipment in a security-bound, guided missiles business that is strictly Buck Rogers.

More than a hundred days before firing, men hunch over drawing boards calculating trajectories, planning, revising, drawing up specifications for parts and instruments. Safety engineers, radar and radio operators, search units, optical scanners, fuel men—all form a vast army of experts marching toward X.

X ceases to be just a mark on a piece of paper on the day a big rocket rolls to the proving ground from the factory. It may come in several ways. V-2s arrive in three sections—nose, belly and fins—cradled on three weird flatcars with hayracklike ribs curling up from the sides. Rails lead right into the rocket hangar. The flatcars are pushed together until the rocket pieces butt so they can be joined.

About a week before X-Day, the rocket shell is transported from hangar to concrete launching site or pad. For smaller missiles like the eight-finned Lark or the WAC Corporal, Jeeps or trucks with special racks

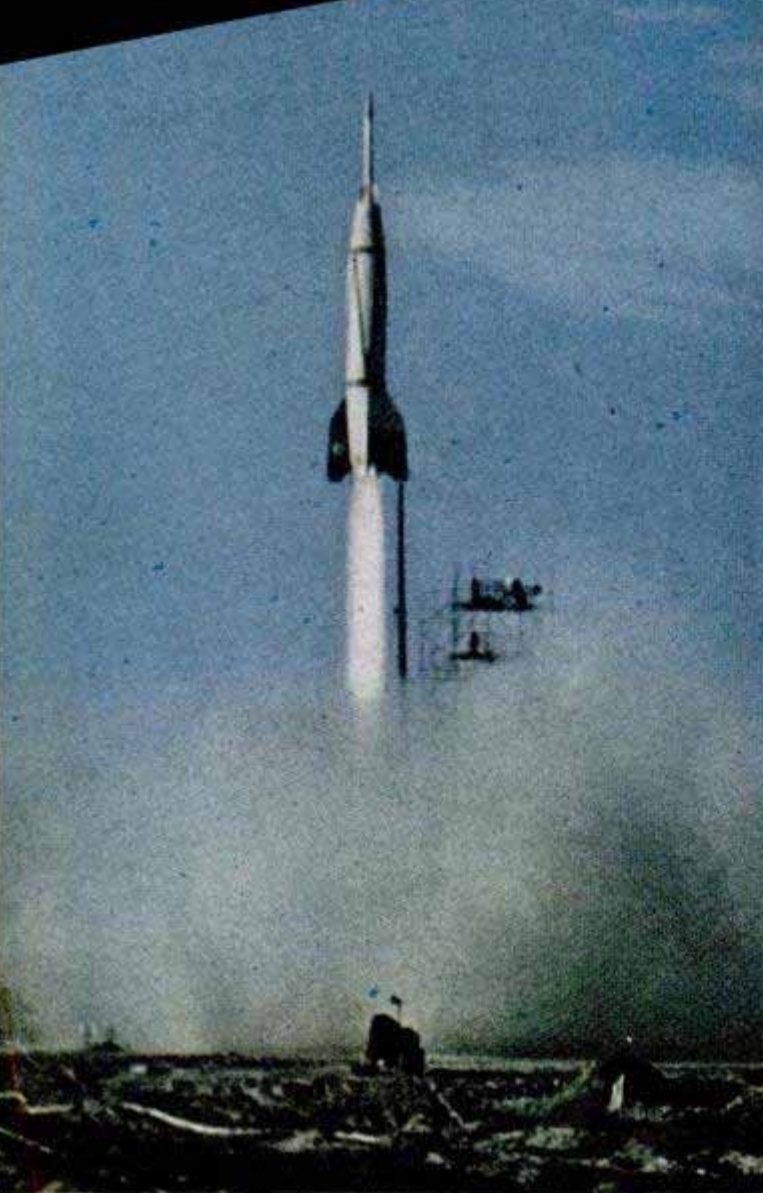

USAF photo

Spectacular color shot shows take-off of first two-stage rocket launched by the Air Force at Cocoa, Fla. Below, smaller rocket filled with dangerous nitric acid

do the job. Some of these rack assemblies can be jacked up to become portable launchers. The boys just roll to a selected spot on the desert, tilt the rack and "let 'er go."

V-2s and Vikings are not so easy. An empty V-2, without its one-ton warhead and 5000 gallons of fuel, weighs 10,000 pounds. You can punch a hole in the "skin" with a screwdriver—it's only as thick as ordinary aircraft skin, and unsupported except for the motor mounts. To lug this around without damaging it takes some doing. More than a third of the Germans' V-2s were wrecked before they ever reached wartime launching sites.

The Navy's big Viking wheels out of the hangar on a special Martin-built carriage. It is an elongated tricycle airplane landing gear assembly, strapped by yokes to the long cylinder. At launching site, a crane hauls up the nose and the tail follows into place, rolling on its rear wheels. This is especially handy on the Navy's rocket launcher, USS Norton Sound, where heavy, complicated apparatus is impractical. It made possible the record flight of the Viking from her unique launching deck last year.

The V-2 makes its trip to the pad on a Meilerwagen, invented and used by the Germans when they were launching the rockets against England. Still best for V-2 toting, the Meilerwagen is a massive trailer with a steel cradle on its back. The cradle is hinged at the rear of the trailer and equipped with hydraulic lifts capable of raising 10 tons. In the hangar, a crane lifts the nose of the assembled V-2 off its flat-



car bed. The Meilerwagen backs underneath the missile, the crane lowers the rocket gently into the Meilerwagen cradle, and off drives the rocket to the launching pad. Once at the site, the "wagen's" hydraulic pumps go to work, the cradle rises slowly like the big ladder on a fire rig, until the rocket is setting vertically on its four-legged launching platform.

Once the big rocket is pointed skyward, X is in sight. The huge metal scaffolding of the gantry crane, about 60 feet high, is wheeled over the monster. Crews swarm over it like ants. New gantries, like the one at Cocoa, are masterpieces of design. The structural members are used for ladders to reach various sections of the rocket. A handful of men can wheel the vast tangle of featherweight metal tubing on its casters. The whole thing weighs only 600 pounds. It comes in two slices, which clamp around the rocket like a mold. Three of its hinged decks, about 34, 42 and 50 feet high respectively, "drawbridge" down by handcrank around the V-2's belly.

For a week, the launching site is a beehive of activity. In mobile machine shops at the gantry's base, machinists turn out precision parts. Signal men at outlying stations check and test equipment. Telemetering films from 30 channels are studied and adjustments made. At night, rocket and gantry lie under the eerie glare of floodlights. Up on the top deck, or "widow's walk," shadowy figures install the telemetering devices in the rocket's high nose—or the secondary rocket, if it's a Bumper. On the

second platform, men's legs jut from open ports containing pressurization tanks for the fuel, and the maze of electronic controls. One engineer at White Sands has a standing bet that some day a technician will fall in, get lost in the spaghetti, and be locked up inside on X-Day. "He'll have quite a ride," he says. On the bottom gantry deck, engineers and fuel men make final adjustments in the cavernous engine. The steering vanes, made of pure carbon to withstand the thousands of degrees of heat blasting from the rocket's tail, are adjusted with microscopic precision.

About 16 hours before X the ambulance rolls into the launching site, fire fighters move on station in their weird, Martian asbestos suits and the men prepare for a full-scale rehearsal. "Take-off" is prevented only by four small bolts that are enough to hold the rocket to earth under 20,000 pounds of thrust. The gantry is then hauled away, power lines attached and everyone moves to the protection of the fortlike blockhouse with its 14-foot concrete walls and 27-foot-thick ceiling, some 150 feet from the pad. "From the looks of it," remarks one engineer, "you'd think they expected the rocket might fall on them. That is just what they expect—and it has happened!" One Aerobee at White Sands fell over on take-off and the ensuing blast of white heat from its exploding fuel seared everything for hundreds of yards around.

After the "test hop," the gantry comes back, and the pace quickens. From his microphone in the blockhouse, the technical

WAC Corporal has become the "workhorse" of rocketeering. Here is one with Tiny Tim booster on its tail

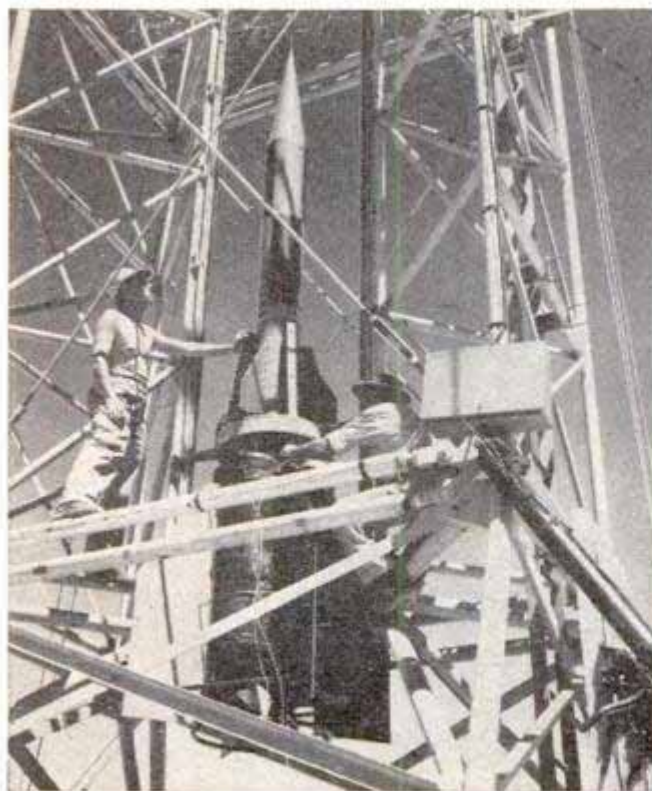

Fire fighter wearing a new suit of aluminum foil can safely approach within two feet of 1500-degree fire





"NATIV" rocket rests in launcher while final adjustments are made. It is a test rocket, not a weapon

director begins to call off the time every 15 minutes. At X minus 20 minutes, it will be every minute; at X minus 20 seconds, every second. Meteorologists have checked weather for optimum flight conditions and at last the moment for firing is set.

"X minus six hours," blares the loudspeaker. "Check water and cooling systems; fire fighters on station."

No one expects that in six hours the rocket will take off. At any point up to within a minute or two of firing, the count may "hold" for a recheck. "Hold at X minus 18," the speaker may groan. When the failure is

remedied, minutes or days later, the count will pick up again at "18." This can be nerve-wracking. A draftsman at White Sands recalls a Bumper launching that had everyone jittery. "X minus two minutes," grated the loudspeaker—then, "HOLD IT!" Something was jammed up in telemetering. The count backed up to X minus 10, then 20, then one hour. Three times it came back to two minutes. The rocket finally took off a week later.

At about X minus four hours, crews dressed from head to foot in plastic suits and hoods, like men from another world, move into the area with trucks carrying queer metal tanks. This is hydrogen peroxide which, when combined with another chemical, suddenly becomes steam that turns the rocket's high-speed fuel injector turbines. It's tricky stuff. Almost any foreign matter—including skin—that touches it, will set it off. A handful of sawdust thrown in a container of it will cause a fantastic explosion. "Somebody spilled some on a Jeep at White Sands," recalls Dr. H. E. Newell, head of the Rocket Sonde Research Branch of the Navy's program (which has nothing to do with the Army's V-2, but includes the big Viking) "and POOF—no Jeep." It runs off Pliofilm like water, however, and the sterile alloy drums lined with inert material in which it is carried make it as easy to handle as cordwood. But it's treated like nitroglycerin just the same. So is the nitric acid, used as an oxidizer for some rocket fuels. While not explosive, you can see what nitric would do simply by dropping a penny in it. The penny disappears in a cloud of ugly green fumes.

"X minus three hours and 30 minutes," drones "the voice," and fueling goes on—all of it dangerous and requiring vast precautions. Tanks of soda for neutralizing acid can be seen everywhere—including each deck of the gantry. Smoking is prohibited within 75 feet of the area; sandbags

Here's one reason everybody hides before take-off: jet blast from a rocket throws up tons of rock and dust



surround portable equipment. Firemen stand by with water and foam hoses ready to flood the entire place at an instant. The big rocket's 2500 gallons of ethyl alcohol are poured in from tank trucks. No one worries about the alcohol. It's pretty stable.

"X minus three hours. Move oxygen into area, move tool trailer behind blockhouse."

In rolls the ingenious vehicle which hauls the frigid liquid that will make the alcohol burn. It's a regular truck chassis on which is a 3000-gallon Thermos bottle that looks like a cement mixer. Inside the big steel cylinder are huge bottles, fitting one inside the other. The oxygen is in the innermost. One odd property of the 247-degrees-below-zero liquid is that it insulates itself by forming a wall of frost on the outside of its containers. If tightly confined, the constantly "boiling" fluid will build up pressure and burst its container. Hence, it must be vented. But that pressure can be useful, too. The truck spews vapor trails through its vents only until loading time. Then the vents are closed, and the pressure is used to force oxygen into the rocket.

Finally, fueling is completed; checks are almost finished. The loudspeaker takes on a deeper more concise tone: "X minus one hour." Slowly, the gantry rolls back and the rocket stands alone against the sky, a white plume of venting oxygen pouring skyward from a hole in its nose. A long pole beside the rocket supports a power cable hooked near the tip, supplying electric power and conserving the batteries inside. This will fall away at launching. Quickly removable "German ladders"—square, four-sectioned telescoping affairs—are raised by handcrank against the side for last-minute adjustments. Each section of these odd ladders pulls the next along behind it.

All up and down the range, tension is mounting steadily. Observer stations report readiness by radio and telephone. At one of them, men are tracking through high-powered telescopes. From the instant of launching, the arc described by the swing of their scopes will be automatically transmitted to pens that mark the exact course and landing spot of the rocket on a map of the area. On land-bound ranges, planes scout for stray civilians who might still be within the boundaries.

"X minus 45 minutes!"

Red lights switch to green on the blockhouse control-board panel as Radar Tracking announces readiness. "Dopples," or sound tracking, switches green. The "Telemetering" light goes green too, indicating that all gear is ready to receive impulses from the soaring rocket, providing a progress report of the trip. "Rocket Controls" blinks green—and so does "Cut-Off."

(Continued to page 242)

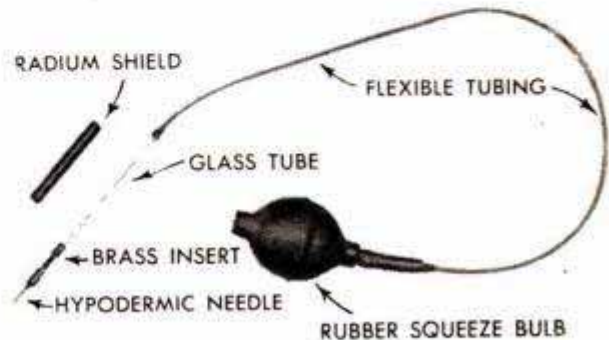
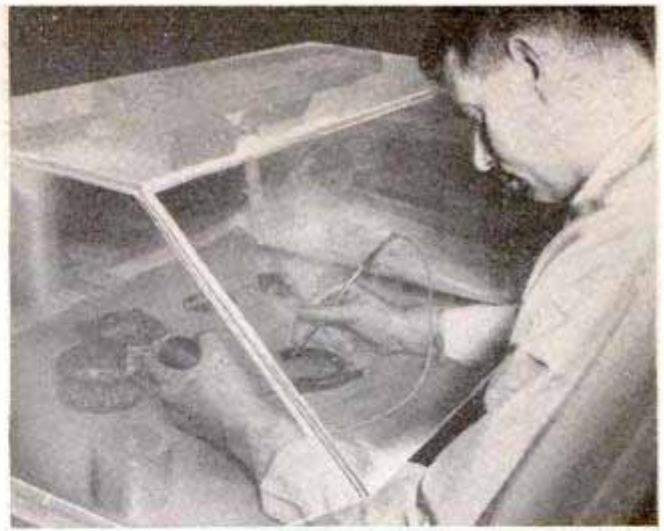

Fountain Pen for Radium Paint

Workers who apply radium paints to luminous dials are protected from contact with the dangerous substance by a fountain pen invented by a Naval Air Base employee. A small rubber squeeze bulb draws paint into the glass tubing that forms the body of the pen and also forces out the paint during use. A hypodermic needle serves as the writing point of the pen. A radium shield slips over the end of the glass tube to protect the writer's fingers from radiation.

Steel-Hook "Gloves"

Steel hooks on the palm of a new fingerless "glove" sink into wood, meat, ice and other materials to give the wearer a firm grip. Anchored to the palm of the glove is a steel plate with two projecting hooks. The glove aids linemen in climbing telephone poles and gives meat workers a stronger grip for loading sides of beef. All five fingers of the hand are left free to grasp tools or other equipment.





Detroit Listening Post

By Siler Freeman

THE AUTOMOBILE manufacturers are gradually taking almost every human element out of driving a car. If progress continues, all that will be needed to get to a destination is to give the address to some automaton controlling the wheel and it will do the rest.

The process of making the driver one-legged is almost complete. About every car being made today has or will have before very much longer an automatic transmission. The coordination between left and right foot that once made learning to drive tedious and uncertain is no longer necessary. In fact, we are about due to become a one-legged race so far as driving a car is concerned, unless some enterprising inventor comes along with a device to keep the left foot occupied.

Steering is still a necessity but one large manufacturer is dabbling around in the field of an electric device which will make steering much easier. It may be a motor that helps turn the wheel.

Electric window lifts are due for a big increase in the automotive field. The crank-type are on their way out, it appears from the announcement that the Hupp Corp. has finally perfected a device after five years which has gained the eye of the passenger-car manufacturers.

The Hupp lift actuates each window by its own electric motor. The motor is mounted compactly so as to regulate the steel arms which are attached to the window glass through a positive-drive gear assembly. According to Hupp officials, it doesn't take much power from the battery.

Hupp also has perfected a similar device to adjust the front seats. Heretofore, most of the automatic devices of this sort have been confined to convertibles and the very plush sedan jobs in the higher brackets.

With Ford installing the automatic transmission on its 1951 models, only Plymouth is left without one. Chrysler is silent on its plans for the new models, due around the first of the year. But it may meet the competition, either by adding Fluid Drive to Plymouth or offering a fully automatic transmission as optional equipment.

Right now, Chrysler is concentrating on having its new V-8 engine ready for its 1951 Chrysler line. The functioning of the engine plant and its ability to expand production will determine how far the corporation will extend the use of the V-8 to other divisions. DeSoto may get it.

Buick's V-8 is still far off. It must build a new building to put the job in and the rush for machine tools has set the program slightly behind. The goal is for the engine to go into the 1952 models on which a lot of work has already been done.

The announcement that Ford's Lincoln-Mercury division will build a new plant in Wayne, a suburb of Detroit, indicates the ambitious plans which young Benson Ford has for the unit. The old plant, while large in floor space, was not laid out efficiently and with the aim to bring both Lincoln and Mercury under one roof, it was not considered economical to try to change the layout.

While the record over-all production of the auto industry has been the surprise of the year even to the best informed executives, the real upset has been in the truck field. With two more months of production ahead, there is about an even chance that both sales and output may approach, if not pass, the former record made in 1948.

Truck sales started off slowly but hit an increasingly heavy sales from about March on. Several of the big producers missed their early guesses and, despite crowding on heavier schedules, have been unable to make up their early losses. If the rate set in the past four months is maintained through the rest of the year, the 1948 mark will fall.

Nash's signing of an Italian designer as consultant has raised some eyebrows in the industry. The NXI, Nash's proposed \$1000 car, has much of the appearance of the higher-priced works which Signor Pinin Farina of Turin brought with him when he was introduced to the industry in August. Of course, Nash's 1951 models, now on the street, have not yet attained the foreign look which observers will seek in the next series. They were designed before Signor Farina joined the Nash staff.



1951 MERCURY

FIRST of the Ford line to introduce a new automatic transmission is the 1951 Mercury. Called the Merc-O-Matic, the transmission made by Borg-Warner is the chief feature of the restyled car. The Mercury has a new grille and has "grown" rear fenders. The latter extend the horizontal lines beyond the deck lid and give the car a longer look, although there has been no wheelbase change. An improved 112-horsepower engine combines with the automatic transmission for more power. The transmission is a three-speed of the torque-converter type, which actually makes it four-speed. It differs from the present torque-converter transmissions, with the exception of Studebaker's, in that it has a starting gear. Unlike Studebaker's transmission, however, it does not lock into high.

The 1951 Mercury convertible looks longer with rear fenders which extend horizontal lines. It has automatic transmission

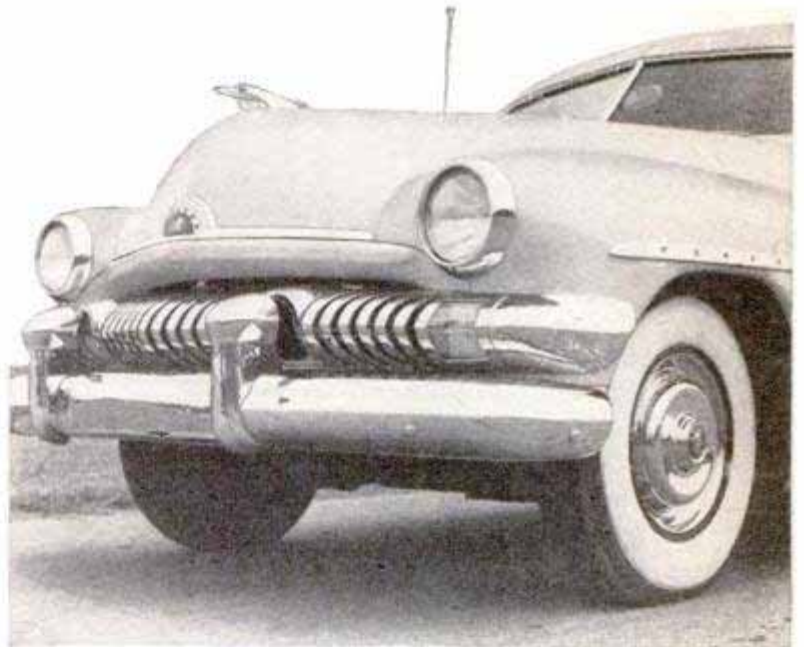

Restyled grille gives appearance of massiveness and strength. New headlamps and parking lights also add to the "new look"

Mercury two-door below is predicted to be one of the most popular cars of the line with torque-converter transmission





Grass Trimmer

Trimming the edges of a lawn is an easy job with a new cutter that snips along at the operator's walking speed. A rubber-tired aluminum wheel powers the trimmer. Cams on the wheel oscillate an upper set of blades against a set of stationary blades to cut the grass. The angle of the handle can be adjusted to fit comfortably in the hand of the operator.

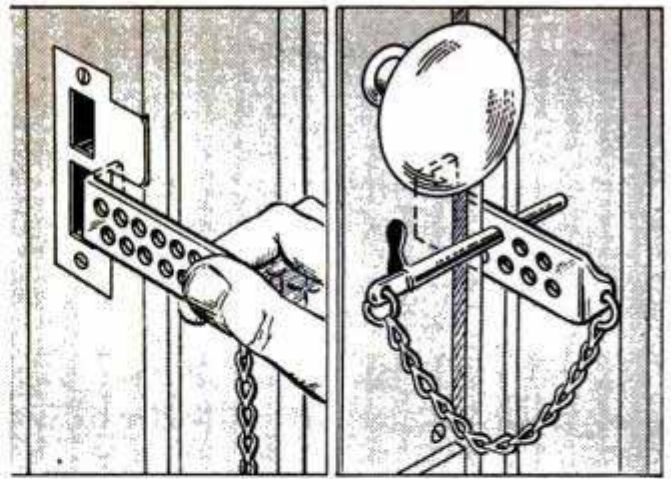

Burglar Guard

Passing a metal taper pin through one of a series of holes makes a portable door lock hold fast against intruders. The main portion of the lock is a strip that fits across the jamb and fits into the latch-bolt opening. After the door is closed, the pin is inserted in the hole that is closest to the door.

Chemical Cleans Sidewall Tires

Chemical action rather than an abrasive removes the dirt from white-sidewall tires when a new cleaner is used. The liquid is simply wiped on with a cloth, then rinsed off with clear water. Chemicals in the cleaner loosen the dirt, which is carried off by the water. No rubbing is required except in the case of deep scratches when the cleaner must be worked into the rubber to reach the dirt. The liquid also contains titanium, the whitening agent of sidewall tires, which restores the sheen of the rubber.

Contour Marker

Contours of moldings and other uneven lines are accurately copied by a new tool for carpenters and bricklayers. The tool consists of a series of aluminum blades bound together by a locking mechanism. To copy a contour, the worker opens the lock and presses the blades snugly against the uneven surface. He then locks the tool and the resulting contour can be marked off on the material to be matched.

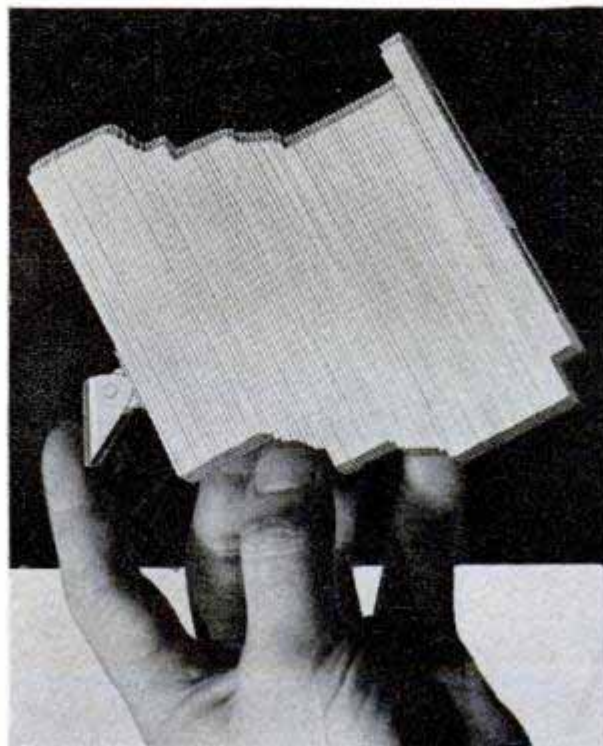

With lock open, marker can be pushed against uneven surface to record the shape. At right are a few of marker's many uses

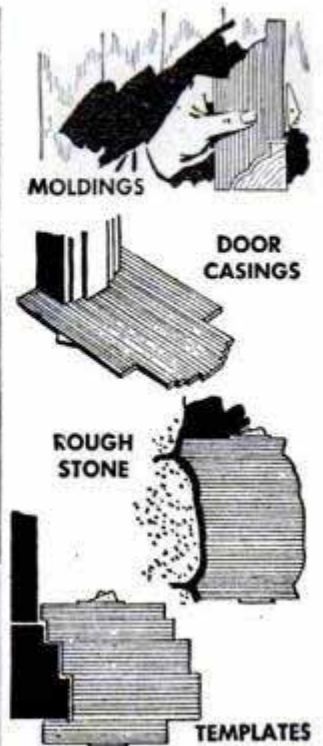

W. L. Bush & Co.
1570 Northwestern Bank Bldg.
Minneapolis, Minn.



Air Materiel Command photos

Automatic Parachute

All the thinking is done for the jumper by a parachute "brain" developed by the U.S. Air Force. It prevents accidents caused by failure to pull the rip cord at the proper time or by a blackout preventing the airman from pulling it at all. With the new device a handle is pulled immediately upon jumping and a timer and an air-pressure

device—both preset—control the opening of the parachute. The timer can be set for one to 26 seconds, depending on the plane's speed and altitude, to give the jumper enough delay to clear the plane and slow down before the parachute opens. The pressure device, which supersedes the timer at high altitudes, opens the chute at an altitude safely above the highest terrain over which the flight is being made.

Wool Trampler

Hard footwork in a wool warehouse now has been replaced by the action of a small hydraulic compress. The most despised job in the warehouse until recently was that of wool trampler—crawling down inside a seven-foot burlap bag and tramping down wool as it was packed. Now the job is done by a machine which is essentially an electrically operated hydraulic compress. When the bag is partially full of fleeces, the operator flips a lever which lowers a plunger into the bag. A five-man crew can pack 20 bags of wool an hour with the new machine.

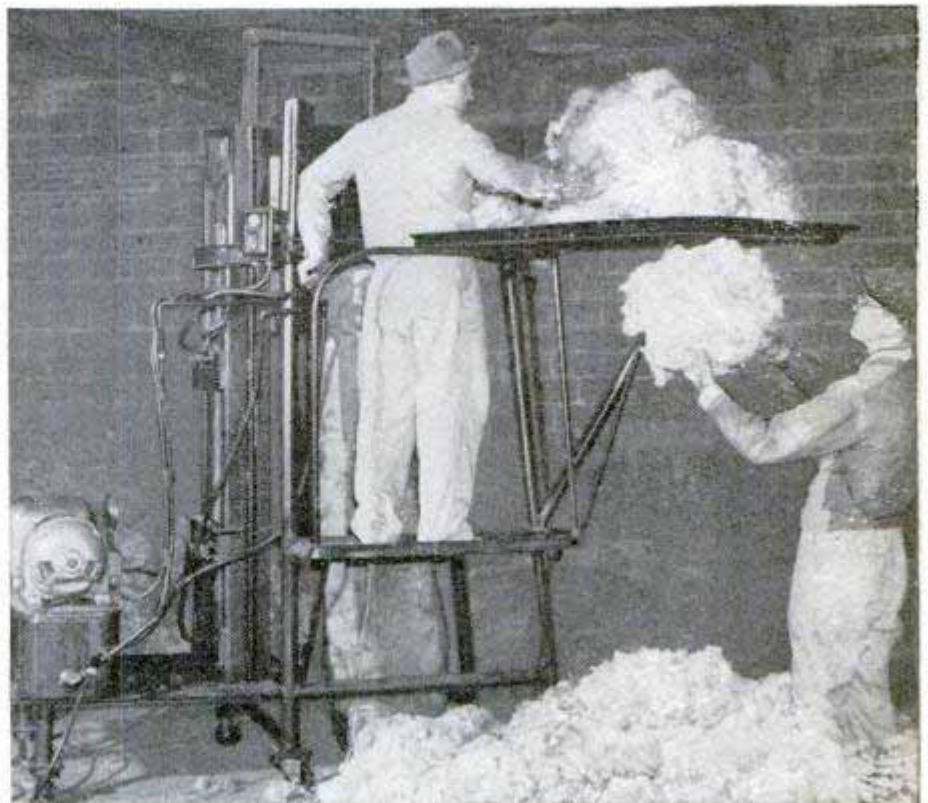

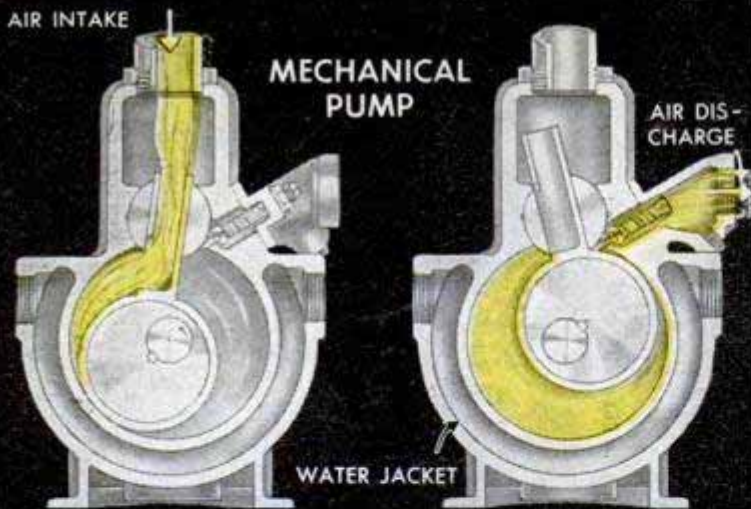

ROTATING PLUNGER SWEEPS AIR OUT DISCHARGE TUBE

STEAM-JET PUMP

HIGH-VELOCITY STEAM JET FORCES AIR OUT DISCHARGE TUBE

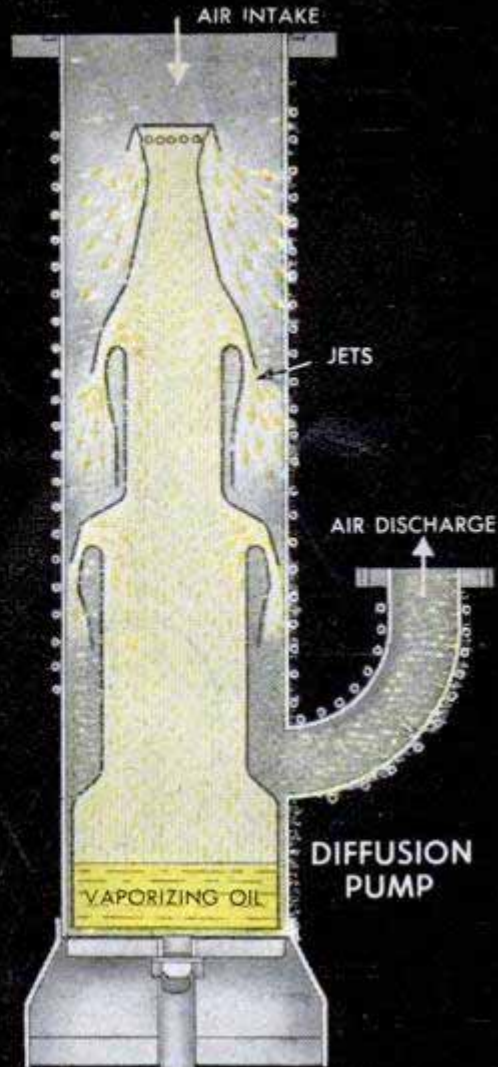
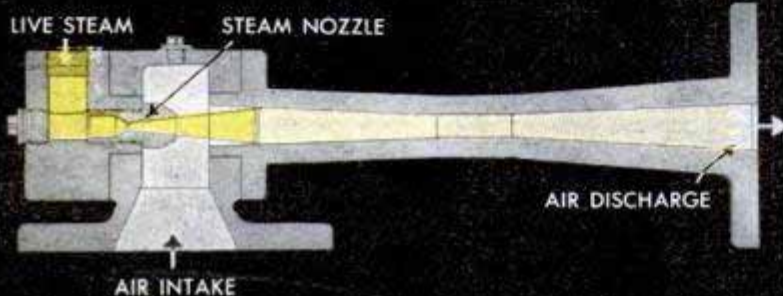

OIL VAPOR CONCENTRATES MOLECULES OF RAREFIED AIR SO THEY CAN BE PUMPED OUT DISCHARGE TUBE

This business is next

By Louis N. Sarbach

IMAGINE a tunnel with one end beneath New York City's Times Square. You enter a car at this end, stow your suitcase in the rack overhead and settle down comfortably with a magazine. You have been reading scarcely an hour when the vehicle stops. An escalator carries you back to the street level and you greet the light of day once more—in San Francisco!

Sounds like something out of pseudo-science fiction, doesn't it? Yet it's the idea of one of America's most practical scientist-executives, General Electric's noted physicist, Dr. Irving Langmuir.

"There is no fundamental reason," says Doctor Langmuir, "why we could not travel at a speed of 2000 to 5000 miles an hour in a vacuum tube. Such a tube extending from New York to Chicago, or to

San Francisco, could be constructed in which airtight vehicles would be magnetically suspended in space while moving forward at high speed. The Pacific coast might be only an hour away from the Atlantic."

Doctor Langmuir's cross-country vacuum tube is very much a project for the future, of course, but enough vacuum magic is going on right now to convince even the most skeptical that there's more to "nothing" than meets the eye.

High vacuum—until recently a tool mostly confined to research laboratories—plays a key role in a rapidly expanding list of industrial applications. Under high vacuum, vitamins and hormones are separated from their complex organic parent mixtures. Vital medicaments such as blood fractions and antibiotics, all notoriously unstable in the presence of heat, are safely freeze-dried in evacuated cabinets.



Drying time of penicillin has been reduced from 24 hours to 30 minutes with high vacuum. This bulbous device concentrates solution prior to final drying. Opposite page, the three basic types of vacuum pumps

of new technologists, vacuum engineers, men who humorously call themselves "specialists in nothing." These scientists spend their lives trying to produce the thing nature is said to abhor: a completely empty space. They haven't wholly succeeded yet and perhaps they never will. But of the estimated 400 septillion (400 followed by 24 zeros) gas molecules that occupy every cubic inch of air at sea-level pressure, high vacuum experts have managed to pump out all but some 18 billion—a mere trifle in this strange world of low pressure.

Why do we need vacuum in the first place? The most obvious reason is to prevent certain materials from reacting chemically with the gases of the air. In developing the incandescent lamp, Edison failed a thousand times until he realized that he would have to mount his electrical elements in an evacuated bulb to prevent the glowing filament from combining with oxygen—from burning up, in other words. Vacuum's newest and perhaps most interesting jobs have to do with materials too delicate to handle in certain ways under ordinary atmospheric conditions. At this point, let's take a brief trip upward, where the air is thin.

Everyone knows that water evaporates. Its molecules are always in motion, always trying to escape from the surface. But air molecules, pushing downward, force most of the water molecules back into the liquid.

To help overcome this air pressure, we energize the water molecules with heat. They then can force their way through the air molecules and into the atmosphere. In plain language, water boils when it has been sufficiently heated.

Now, the fewer air molecules pressing down on a liquid's surface, the less heat is needed to evaporate the liquid. That's why water, which requires 212 degrees Fahrenheit to boil at sea level, boils at 187 degrees Fahrenheit on the 14,108-foot summit of Pikes Peak, where the air is a good deal thinner.

Going a step further, we can bring Pikes Peak down to sea level, so to speak, by chasing enough of the air molecules out of a sealed chamber. In such a chamber, water will boil at 187 degrees Fahrenheit at sea level.

What happens if we continue pumping out air molecules? The boiling point drops still lower. It even falls below the freezing point! When this occurs, ice turns directly to vapor, without passing through the water stage.

to nothing

Lithium and magnesium, lively metals which eagerly unite with oxygen, are easily purified in furnaces from which all but a few stray molecules have been swept. Still other metals—gold, silver, aluminum—steam into luminous mists under vacuum, to condense a moment later as bright coatings on glass, paper, plastic and even fabrics.

To the housewife, high vacuum means flash-frozen foods. For the scientist, it plays a fundamental part in many new research tools: electron microscopes, mass spectrometers, synchrotrons, betatrons and cyclotrons.

For aviation people, high vacuum offers radar; for medical men, X-ray tubes; for the military, lenses of superior optical quality, and for all of us, the amazing magic of television.

Behind these developments is an army



Eastman Kodak photo

Camera lenses are coated in this bell jar. Coating material is vaporized in a high vacuum and the vapor covers lenses with thin, uniform coating

This "cold boiling" makes possible certain jobs once the despair of scientists. Penicillin, the miracle drug of World War II, quickly deteriorates in solution. For storage, it has to be bone-dry. The usual way to dehydrate anything is simply to build a fire under it and boil off the water. But penicillin breaks down in the presence of heat.

High-vacuum "freeze drying" solved the problem, not only for penicillin but for a host of other heat-sensitive organic substances: hormones, blood fractions (such as plasma), serums, protein solutions and the whole list of new antibiotic medicines.

There's nothing much wetter than an oyster, but the high-vacuum process dries the tasty sea food quickly without destroying its delicate flavor



Practically all food-stuffs contain heat-sensitive materials. That is why heat-dehydrated foods so often look unnatural and taste worse. With the new vacuum freeze-drying, foods not only keep their nutrient values intact but retain their original appearance and flavor.

In a typical process, a thin film of orange juice, running down the inside walls of a partly evacuated chamber, loses about 90 percent of its water. The residue is frozen, canned and sold. Or it can be processed still further, sprayed on chilled vertical cylinders under high vacuum. The frozen

coating gives up the rest of its liquid content, becoming a powder easily turned back into tasty orange juice simply by dissolving in water.

In the preparation of blood plasma, the liquid straw-colored plasma is separated from the red corpuscles in a centrifuge. It is then bottled, frozen and stacked on the shelves of a vacuum cabinet. As the inside pressure is pulled down, the water evaporates, forming as ice on condensers from which it is scraped by rotary blades. Eventually, shells of ivory-colored powder are all that remain in the bottles, which are then hermetically sealed. Penicillin, streptomycin and other heat-sensitive biologicals are dehydrated by the same process.

The new metal coating involves heat-sensitive substances, too. You can evaporate gold, silver and chromium without a vacuum — all you need is plenty of heat. But low temperatures are obviously needed to deposit films of these metals on such a material as paper. This can be done only under high vacuum.

In the center of a vacuum chamber, a heating element melts and vaporizes the metal to be deposited. The roll of paper (or cloth or cellophane) is rapidly unwound (500 feet per minute) passing over the vapor rising

over the vapor rising

from the molten metal, which condenses as an extremely thin film on the underside of the sheet. The coated paper rivals foil in brilliance.

Or, plastic articles are placed in racks and subjected to the low-temperature vapor cloud, from which they emerge evenly coated and no different, in appearance, from articles made of solid metal.

As vacuum coating becomes popular, you'll see innumerable applications. Already there are handsome metallized clock-cases, buttons, costume jewelry, sequins, decorative wrappings and ribbons. Zinc-coated paper is making its way in electronics for use in condensers. And aluminum-coated paper is being used in oil and wax-impregnated capacitors.

Lenses vacuum-coated with magnesium fluoride are rapidly replacing the old uncoated type in periscopes, telescopes, binoculars, cameras and other optical instruments. The microscopically thin film of the transparent salt cuts surface reflection to a remarkable degree.

On the other hand, if bright metals (silver or
(Continued to page 256)

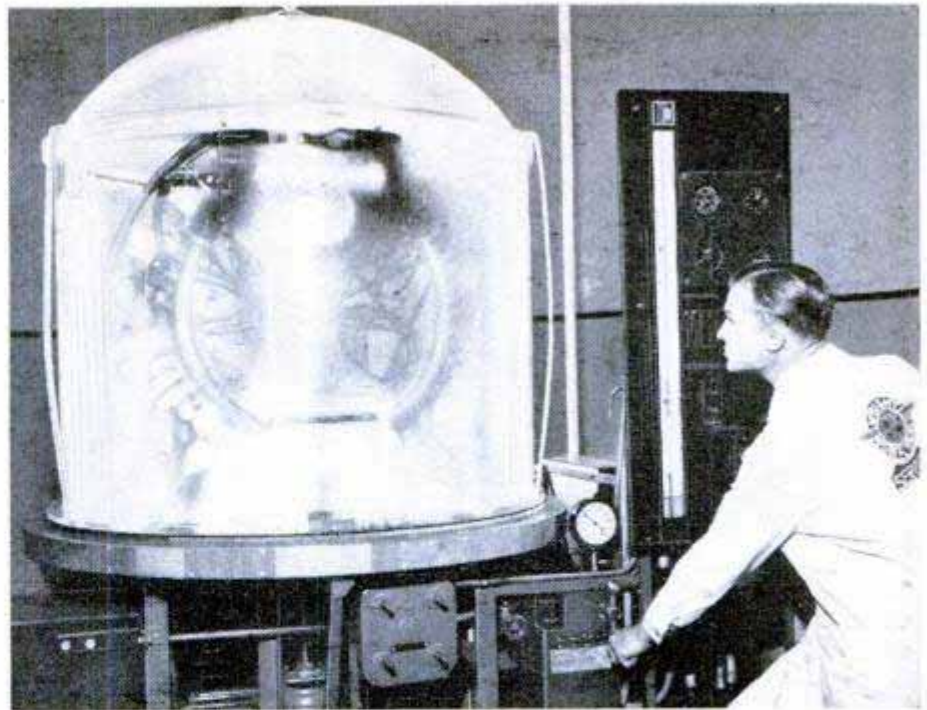

Although it's still on the ground, the aircraft engine inside the giant bell jar is being tested in atmosphere equivalent to that found at high altitudes, thanks to high-vacuum techniques. Below, TV tubes move along a DuMont conveyor line and are automatically evacuated by vacuum pumps

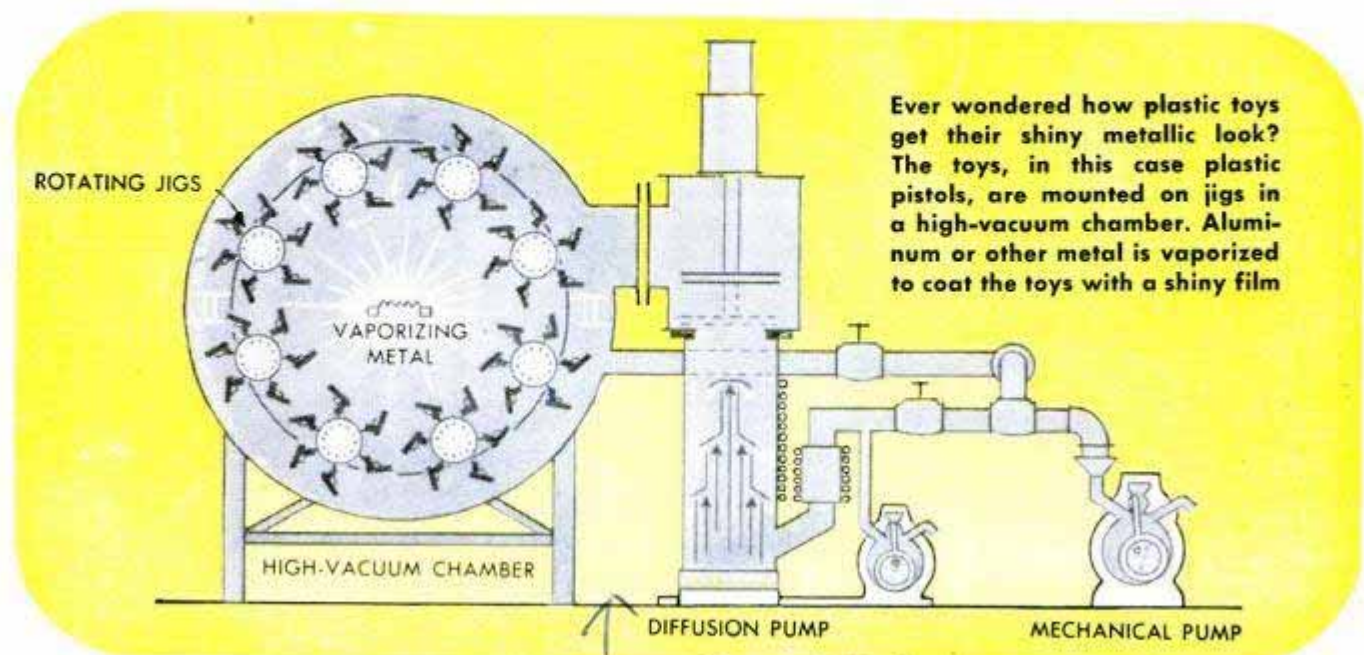

Ever wondered how plastic toys get their shiny metallic look? The toys, in this case plastic pistols, are mounted on jigs in a high-vacuum chamber. Aluminum or other metal is vaporized to coat the toys with a shiny film

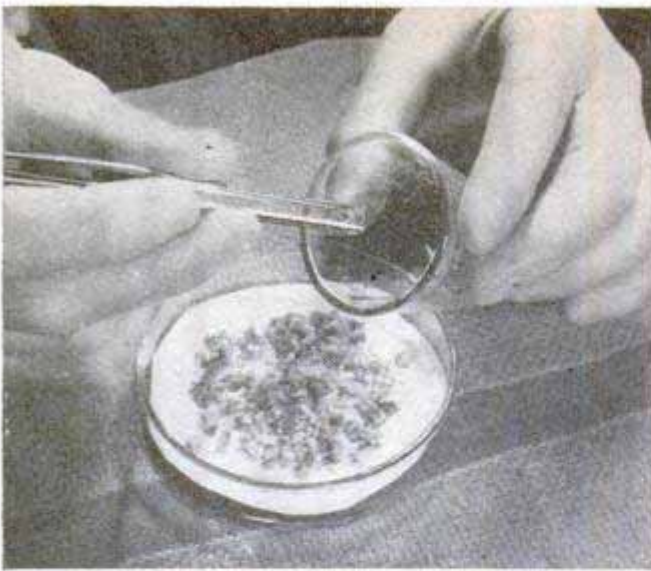

Ground bone is stored in sterile jars at low temperatures. Particles are fused to a patient's bones

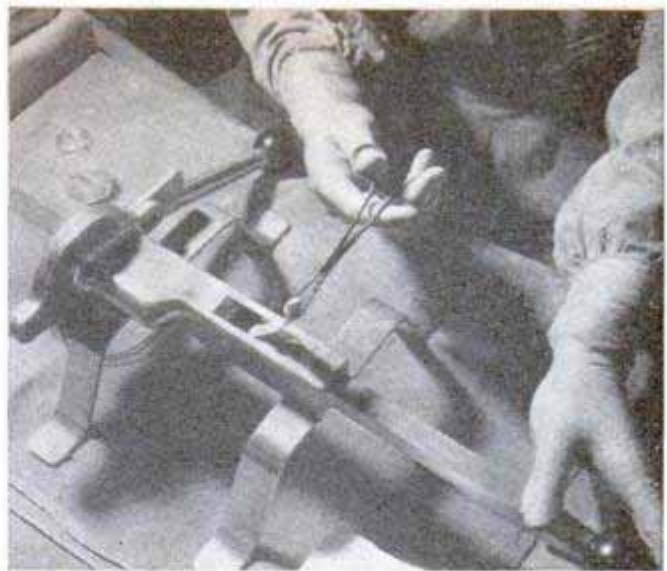

Technician wearing rubber gloves and working under the most sterile conditions grinds a bone to bits



Banks for Bones

Miracles of lifesaving accomplished by blood banks now are being duplicated by another type of "bank"—this one for the deposit of bones. The first bone bank was established two years ago; today there are bone banks in many American hospitals. They have restored health to hundreds of persons who otherwise would be cripples. In these banks, parts of man's bone framework are stored indefinitely. The bones are obtained from amputated limbs and kept in sterile jars inside freezing units at temperatures as low as 20 degrees below zero. They can be thawed for surgical use in 10 minutes. The bone particles are grafted and fused to patients to correct curvature of the spine and to repair bones damaged by infantile paralysis. Pieces of many bones may be used in the same operation, so it's not unusual for a patient to have spare parts from several fellow humans.

Into bone bank goes another jar of bone fragments. Navy believes bank would be invaluable during a war

Radioactive Car Engines Test Efficiency of Oil

Radioactive materials from the Oak Ridge pile are helping scientists improve the lubricating oil for your car's engine. Engine parts are made radioactive in the pile for the test. After the engine has run

for three hours, a Geiger counter is dipped into the crankcase oil. The counter measures the radioactive particles in the oil, revealing the amount of wear on the engine during the test.

Flame-Sprayed Rubber Protects Underwater Metal

Ship propellers, rudders and other metal parts below the water line are protected from the erosion of turbulent water by a coating of synthetic rubber sprayed through a ring of flame. The flame-spraying technique, developed for the Navy, covers the metal with a molten rubber that fuses to

form a resistant coating. The coating absorbs the shock of the turbulent water, which wears away metal just as a waterfall erodes rocks. The synthetic rubber, in powdered form, is forced in a stream through the flame, becoming a liquid which fuses to an impermeable film.



Barriers Deflect Blowtorch Blast of Jets

As protection against the blowtorch blasts of jet aircraft, both the Air Force and the Navy are working on defensive barriers. A person caught unawares 25 feet behind a taxiing or starting plane can be burned and blown away by a 225-mile-an-hour blast of air 340 degrees hot. Its stream is concentrated, issuing from the tail pipe in a cone of between 16 and 20 degrees. The Air Force has devised a sloping, port-

able fence that deflects the blast harmlessly upward. Nine feet high and 15 feet wide, with a sheet of corrugated iron covering the exposed side, they can be towed wherever needed on the air base. For aircraft carriers Navy men are experimenting with a deflector plate that would be set at an angle, like a blast fence, and direct the hot air skyward. This plate could be lowered flush with the deck when not in use.

Three-Speed Transmission Slips Into Bike Wheel

Bicycle riders can convert to three-speed transmissions with an adapter assembly that fits any New Departure coaster brake. For hill climbing and rough going, low speed provides a 25 percent gear reduction from normal or second speed. High gear is a 33 percent overdrive for high-speed cycling on level ground. Shifting is done by a convenient handle-bar control at any

time, whether driving or coasting. Back-pedal braking is retained in each speed. Installation of the conversion unit takes less than a half hour.

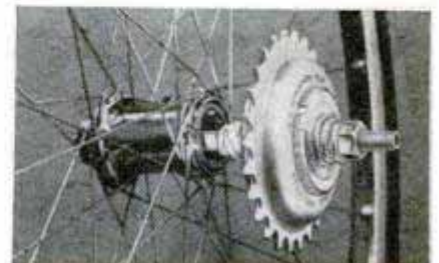
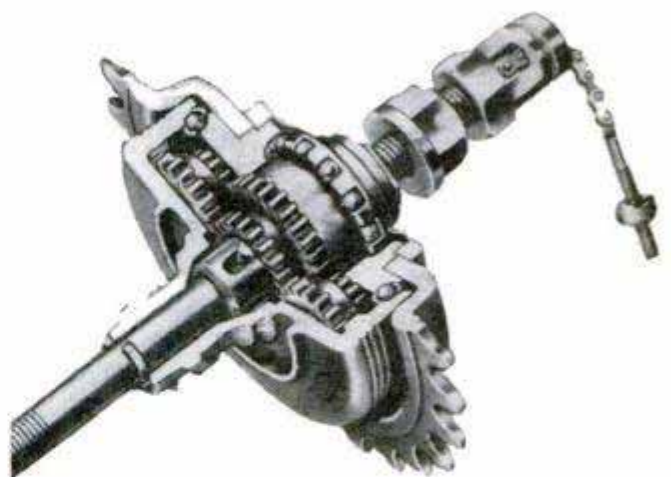
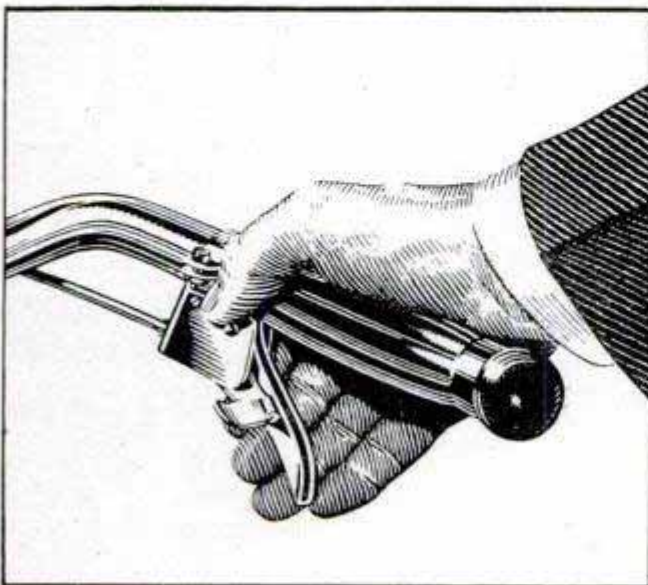

SKY-RIDING BUS



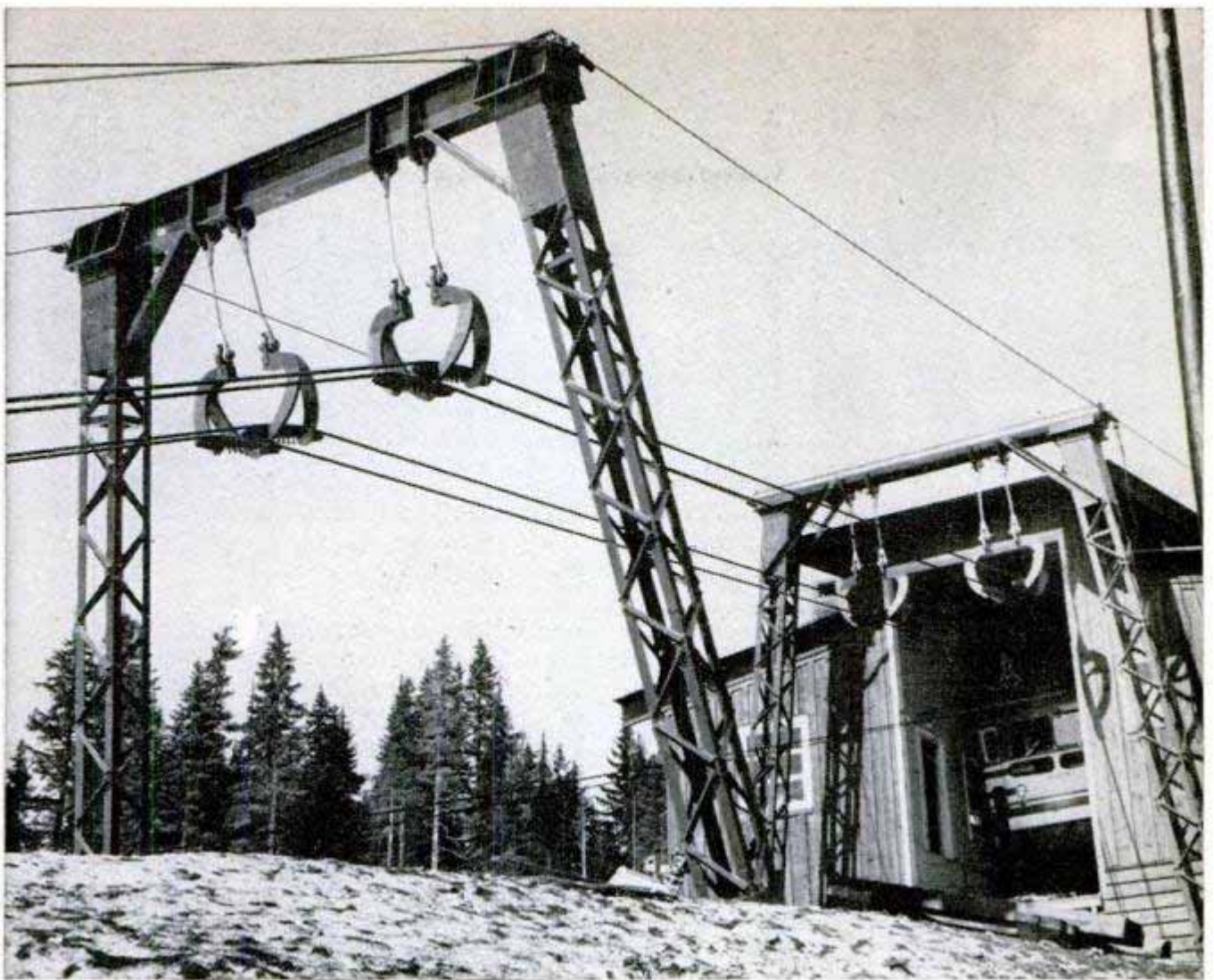

"Skyhooks" on steel towers support the aerial cables; 36-passenger bus is visible in the lower terminal

TWIN BUSES that glide high through the air will carry sightseers and skiers up the slopes of Mount Hood in Oregon during this year's winter sports season. The 36-passenger busses literally wind themselves along their cables, completing a trip of more than three miles in less than 10 minutes. Said to be the longest aerial pas-

senger lift in the world, the tramway whisks skiers from the 3800-foot level to Timberline Lodge at 6000 feet. The cables are supported by 38 A-shaped steel towers up to 72 feet tall. The traction cables wind around power pulleys on the car which are rotated by two 185-horsepower engines to carry the coaches up the mountain.

Both the support and traction cables are stationary. Drive wheels, powered by two gas engines, revolve to wind the bus up the mountain

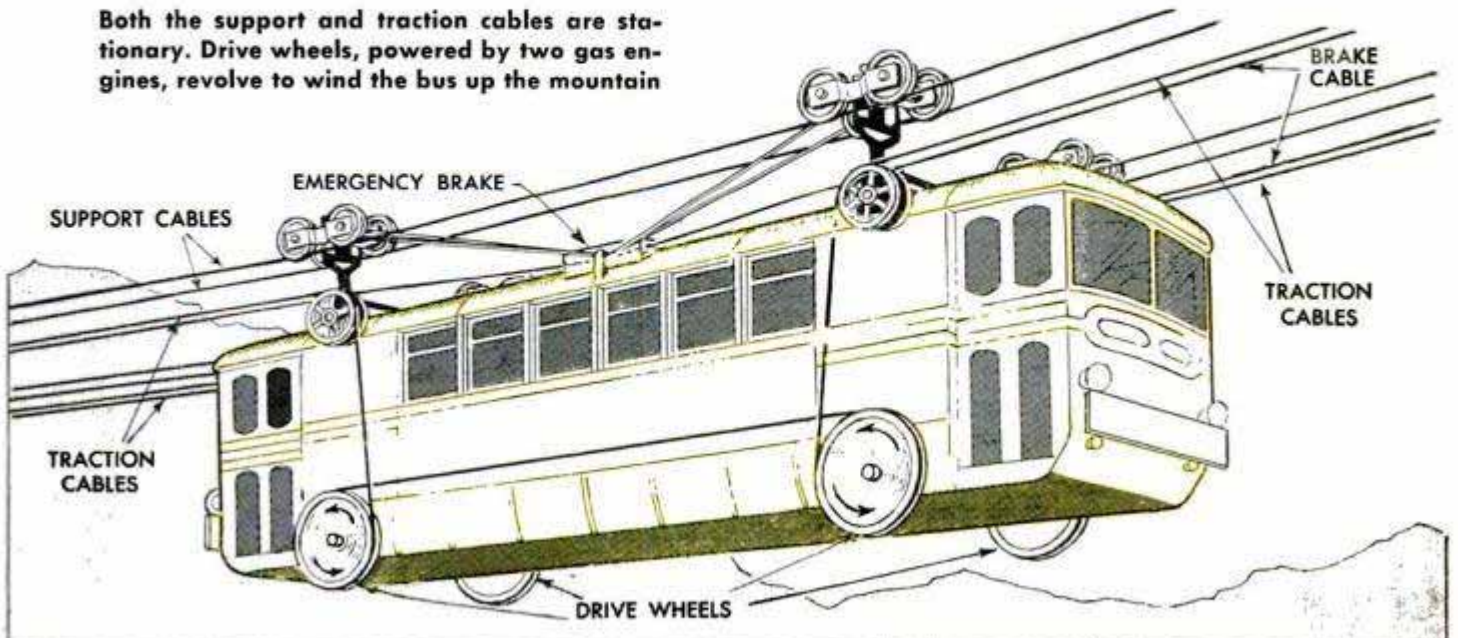



Log-Weighing Aids Forecasts of Forest Fires

Logs have their weights checked as closely as movie queens on a diet at the Priest River experimental station in northern Idaho. For the past nine years, two sets of logs have been weighed every 10 days during the months from June 1 to October 31, as a method of determining the likelihood of forest fires. Part of a program carried out in the National Forest system, the weighing-in of sticks and logs tells foresters when fallen branches are dry

enough to burn easily. There are two sets of logs, one in a clearing where it gets full sunlight and the other in a dense grove where the sun virtually never penetrates. Half of the logs lie on the ground and the other half are kept about 18 inches above the ground to provide full ventilation. By using weight to determine the log's moisture content, researchers can accurately determine the fire-danger rating of the forests in the vicinity.

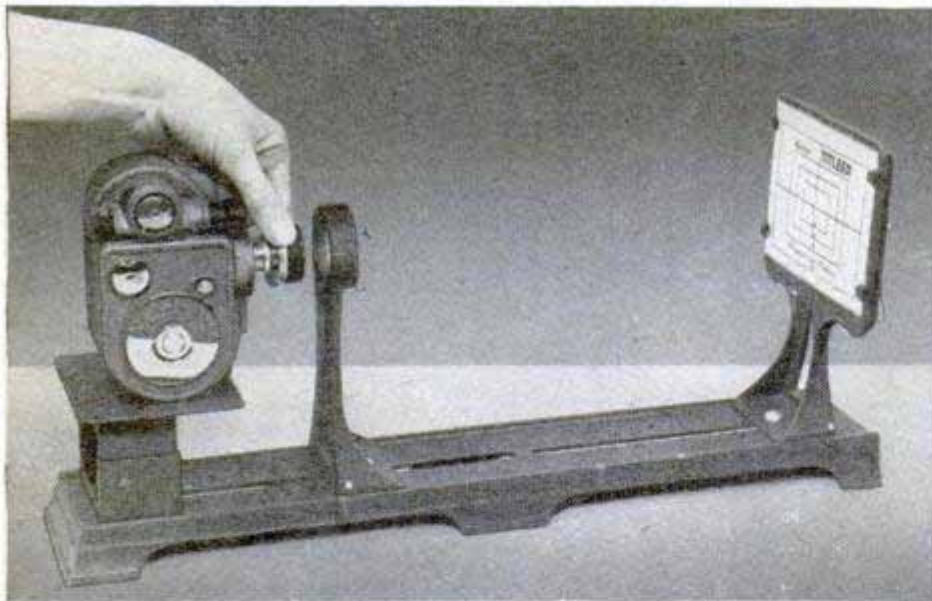

Title Aligner For Movie Fans

Using reflected light as a guide, an aligning device assures the photographer that the title is exactly in the center of the frame, thus saving film and time. In place of the title, a target with a hole in the center is inserted in the title holder. The aligning device is placed over the lens barrel and a light directed through the hole in the target toward the lens. The aligner reflects the light back to the target. If the lens is properly centered on the title area, the light rays are reflected back through the hole. If the light misses the hole, then the camera is adjusted until it is properly centered. The aligner also can be used with a still camera for centering close-ups.

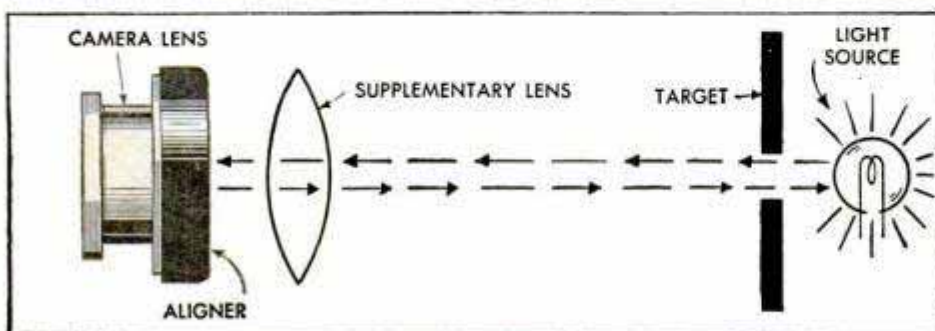

Top, target card replaces title in lining up camera. Diagram shows how light passes through hole in card and is reflected back by the aligner

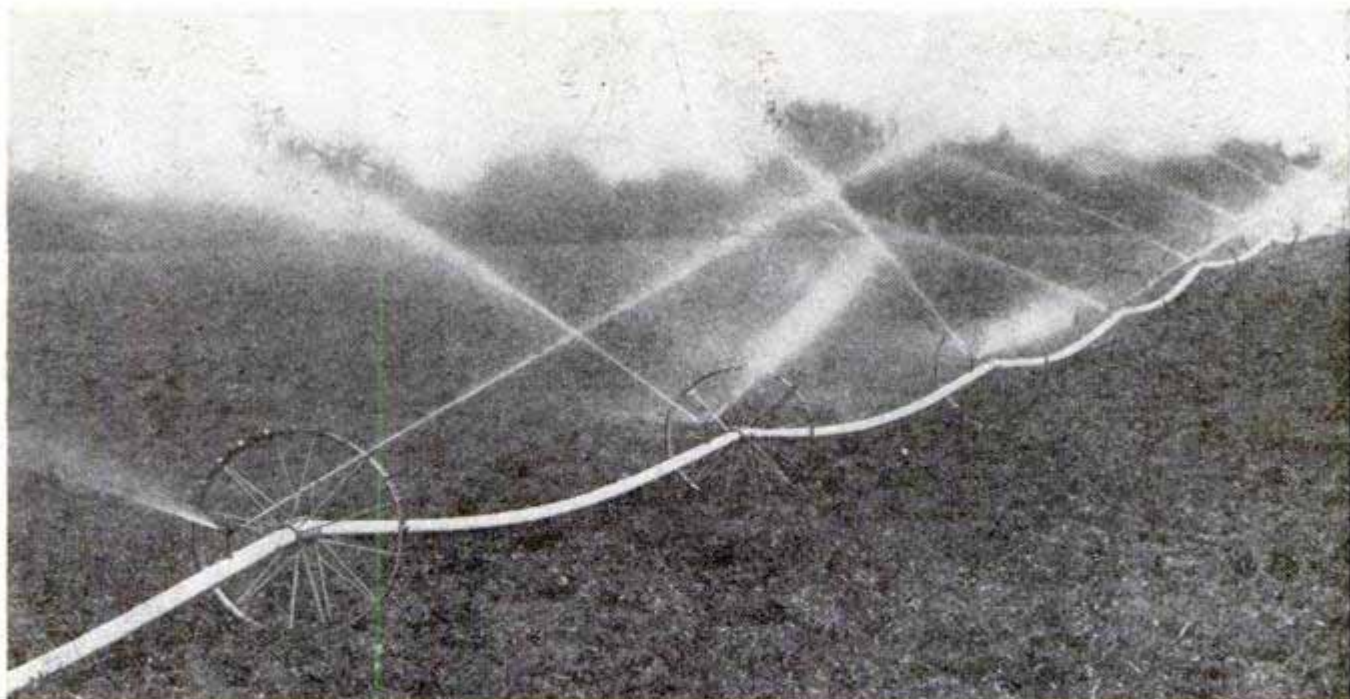

Above, 400 feet of irrigation pipe are supported by these wheels. Below, one man can roll the pipe system across the field with a ratchet drive

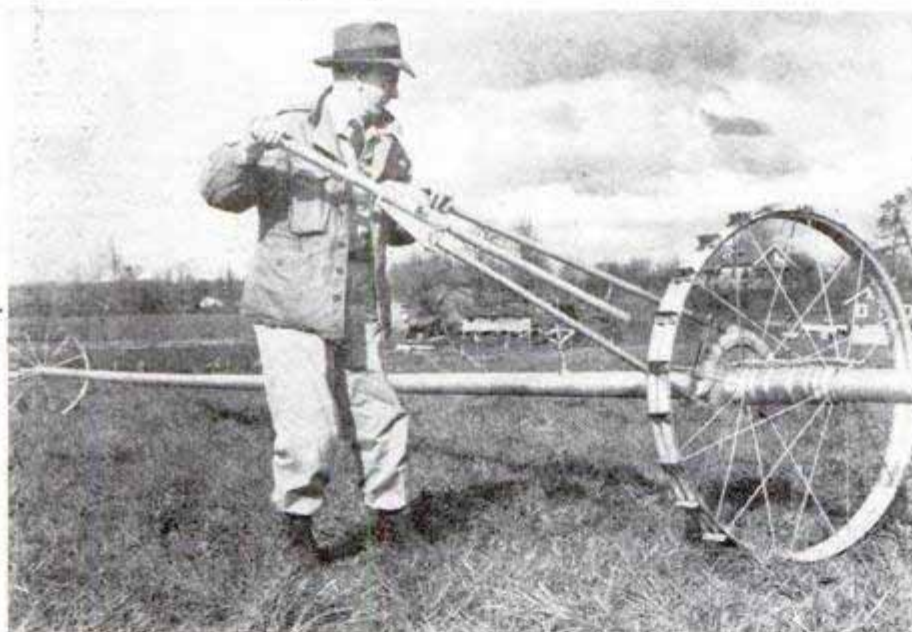

Portable Sprinkler Covers $\frac{1}{8}$ Mile

By using aluminum irrigation pipe as the axle for a series of wheels, farmers can make their sprinkler systems mobile. A ratchet drive at the center wheel of the system enables one man to roll a $\frac{1}{8}$ -mile line of pipe across a field. All wheels roll with the center wheel and sprinkler heads remain lined up. Automatic drain valves empty the system whenever the pressure is shut off, making it light enough to be rolled.

"Upside Down" Lamp For Night Hikers

Walking in darkness over unfamiliar ground is made less dangerous by a new "upside down" gasoline lantern developed by the Army Quartermaster Corps. It is carried by a chain so the light is just a short distance above the ground. The bottom of the lantern is protected by a metal grille.

Chemists have now synthesized a spearmint flavoring from the peels of oranges and grapefruits.



Department of Defense photos

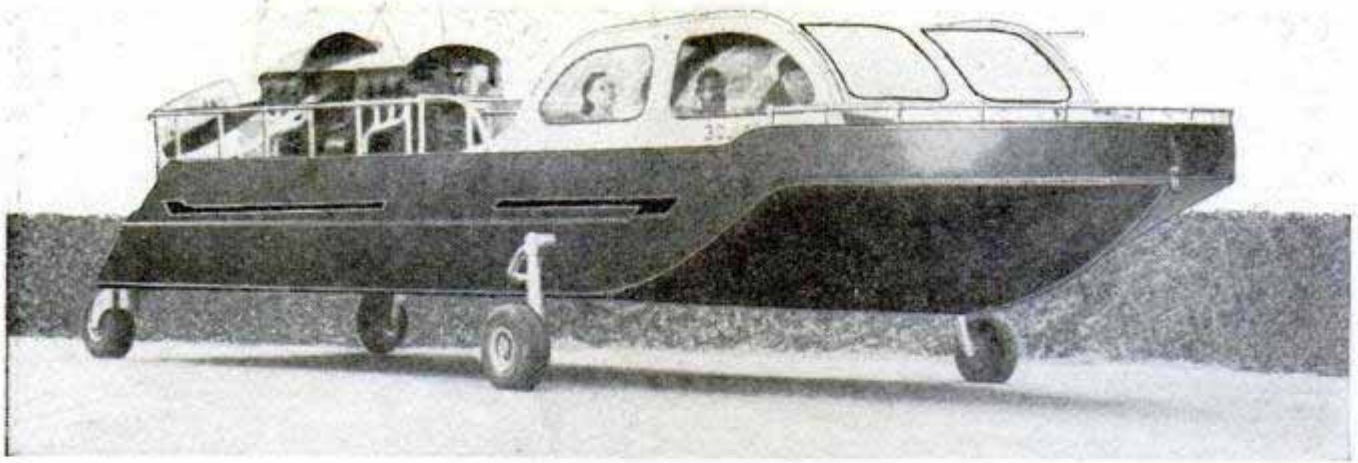

Strange craft rolls along the highway on its four aircraft wheels, which are retracted when vessel is in water



Built of aluminum, the boat is 36 feet long and weighs only 3200 pounds. There's room for pilot, copilot and five others

Island Commuter

COMBINING many features of an automobile, an airplane and a boat, the Island Commuter cruises through the water at 50 miles an hour. The 36-foot aluminum vessel was built by Anthony Sulak to carry him between Seattle and an island 85 miles away. Two airplane propellers drive the craft on water or land. The vessel has four retractable airplane wheels which are used when it is beached. At rest, it draws only 1½ inches and at top speed it planes four or five inches out of the water. The 3200-pound craft costs \$24,000.

In the water it draws only 1½ inches at rest. Two airplane propellers power the craft both in water and out

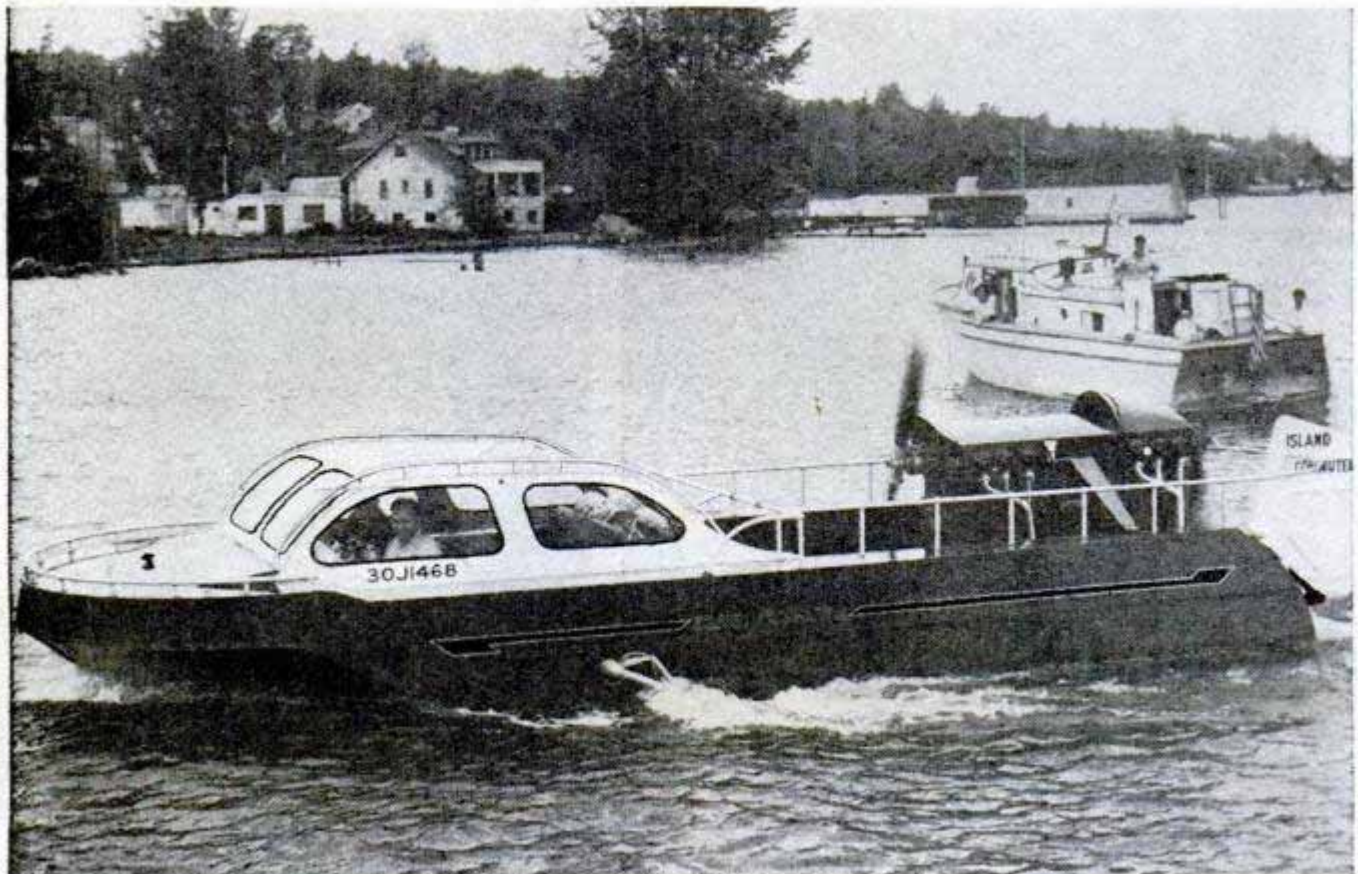

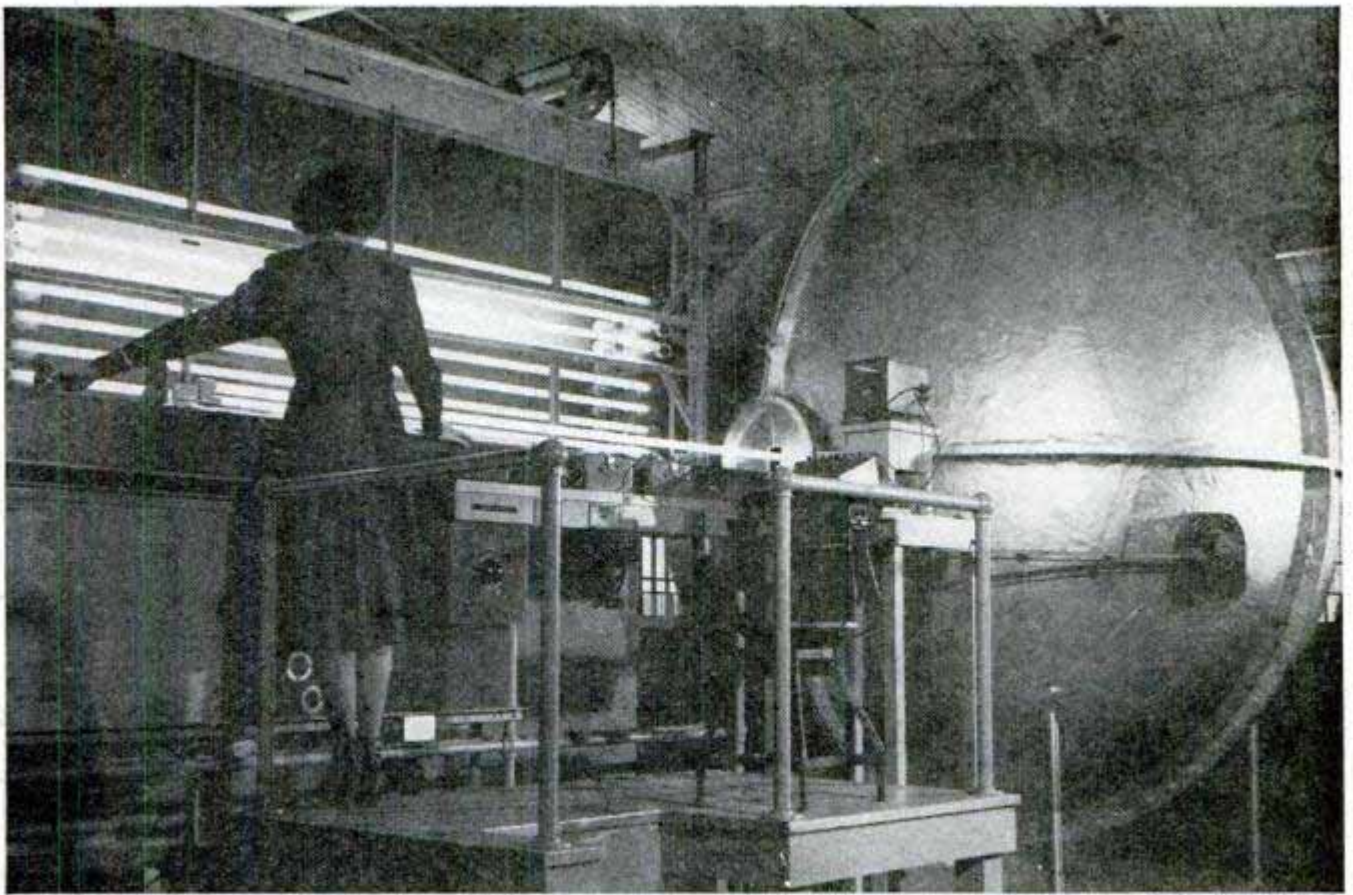

Westinghouse photos

Plastic Sphere Tests Lamps

King-size fluorescent lamps are tested inside a giant plastic sphere with such ideal reflective qualities that light output is measured to an accuracy of more than 99 percent. The 12-foot-high sphere contains instruments for recording watts, volts and amperes and its inside surface is covered with 11 coats of paint, including six top coats of white paint. Testing is done by an operator outside the huge ball. The tubes are fed on a track into the sphere through a small opening on one side. The light from the lamp bounces off the sides of the sphere in all directions, striking a photocell which measures its output.

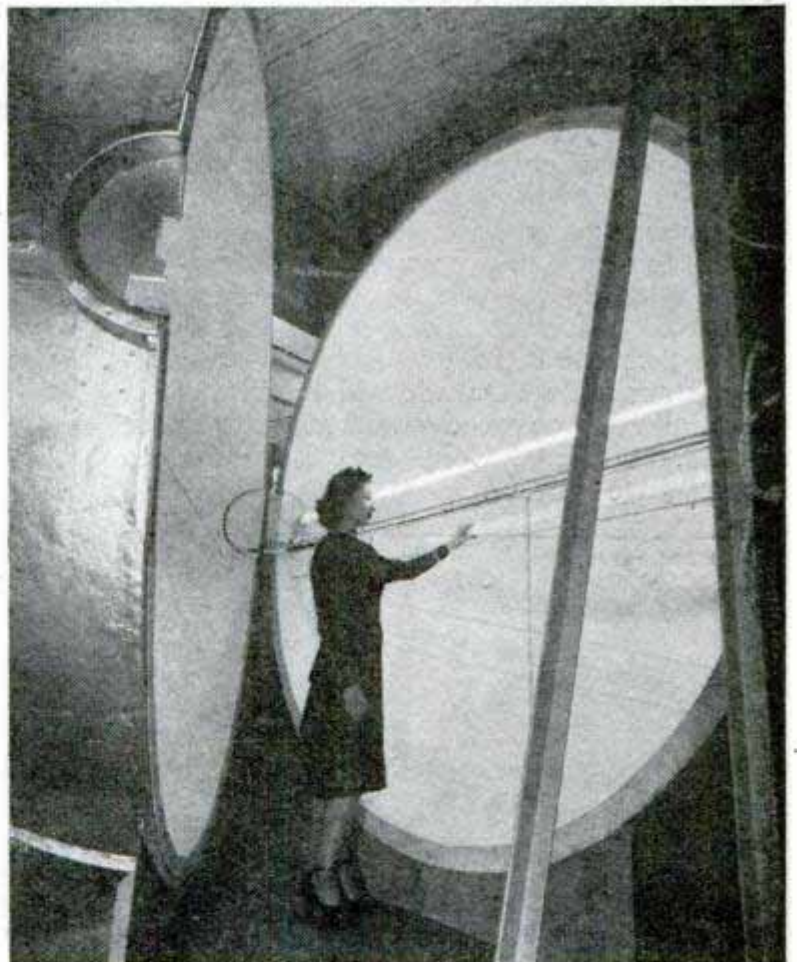

Graphite Atoms Are Wet

Invisible films of moisture are what make graphite the excellent lubricant it is, according to a General Electric scientist. Graphite consists of layers of atoms which slide easily over each other and it was formerly thought that this slippery quality was inherent in the graphite. The new discovery proves that an invisible film of moisture, such as is normally provided by the earth's atmosphere, is what makes the

particles slide so easily. Generators and motors used in high-altitude aircraft have to be specially designed to provide this vapor for the graphite brushes because of the absence of water vapor at such tremendous heights.

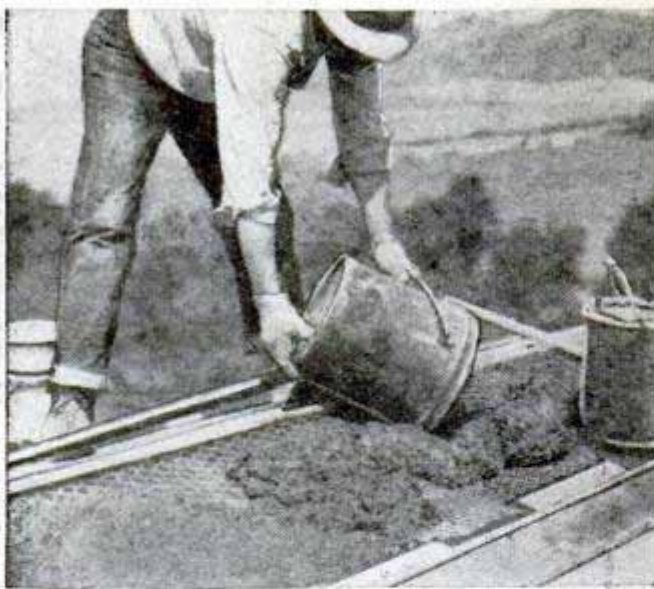

Left, pumice mixed with cement in about a one-to-five proportion is poured into a wooden form on the roof. The tapered form is two inches thick at one end and one inch at the other. Wire mesh reinforces the slab

Below, after it is poured, the pumice mix is troweled the same as concrete. Colors may be added to the wet mix if desired. Combing the slab before it sets gives the roof an attractive, nonglare surface

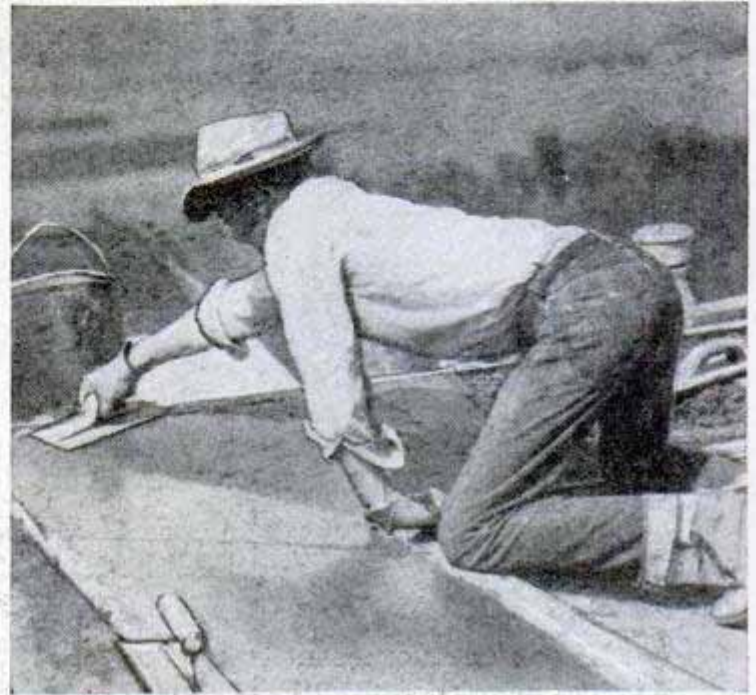

PUMICE ROOF

ROOFS made of pumice, which is poured and troweled like concrete, have the neat appearance of shingle roofs, yet they cut the requirements for ceiling insulation in half. Pumice weighs only one third as much as sand and gravel, so the roof structure which supports it need be no stronger than one designed for Mission tile. A. C. McCoy of San Bernardino, Calif., pours such a roof in three by eight-foot sections. First he applies two layers of tar paper and liquid tar to the roof sheathing. Then, beginning at the eaves, he builds forms, notched at random points to give the appearance of shingles. One-inch mesh wire is laid into the form and the pumice mix poured in and troweled. After it is set, another slab is poured beside it, followed by the overlapping slabs above. Oakum is driven between the slabs and covered with mastic to make expansion joints. Color may be added to the pumice mix if desired.

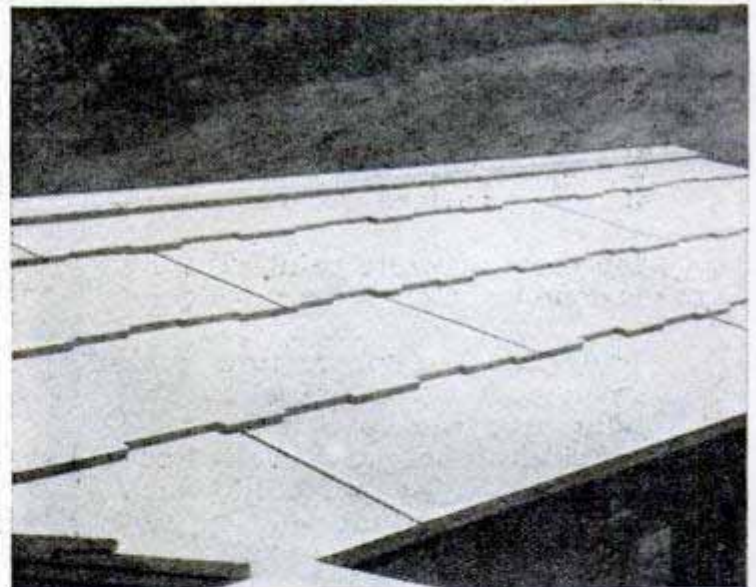

Above, finished roof has the appearance of shingles. Notches on lower edges are made by wood blocks set at random along the bottom of the form. Oakum, driven between slabs, provides a neat expansion joint

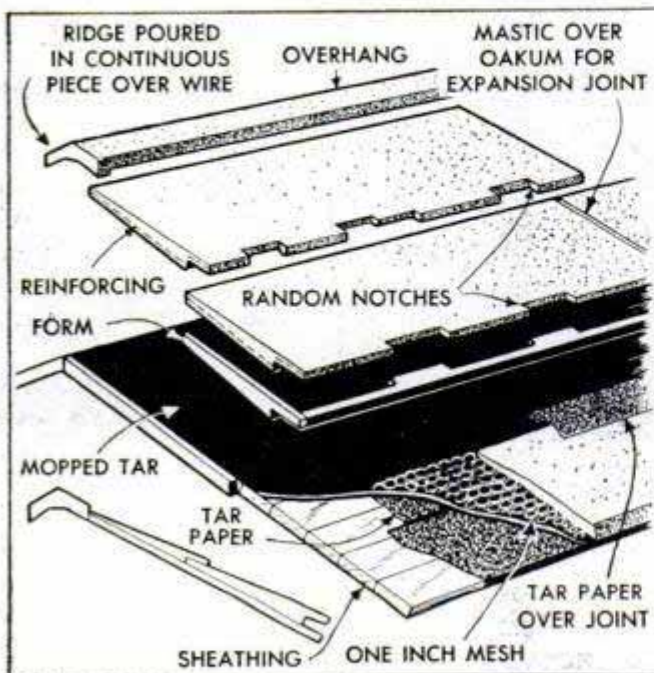

Exploded drawing shows how the slabs are made. Two layers of tar paper and liquid tar are first applied to entire roof sheathing. Strips of tar paper also are laid between the slabs in overlapping joints

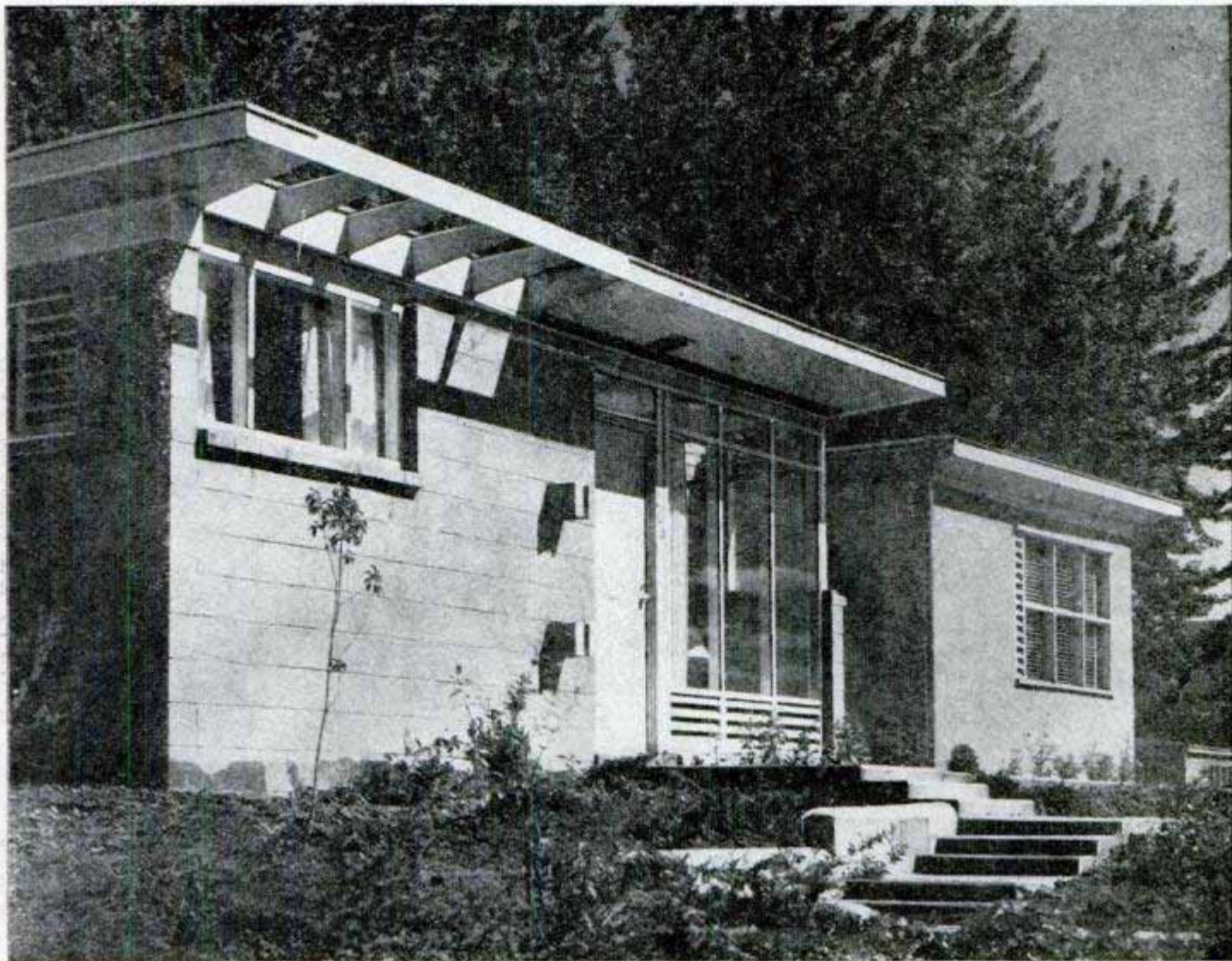

Small Homes of PUMICE BLOCK

Not castles, but mighty fine homes for married couples attending college. Each was built for less than \$2500

By *Kenneth M. Jackson*

LIKE MOST college towns, Pullman, Wash., home of Washington State College, had an acute housing shortage following the war. Married couples were ferreting out single rooms, shacks and trailers to live in. The home economics department decided to find out whether a comfortable, small home could be built by inexperienced labor at a cost an average college couple might be able to swing.

The result is a pair of bungalows erected by husband-and-wife teams, homes which now have withstood two of the severest winters in Northwest history and still look as new as

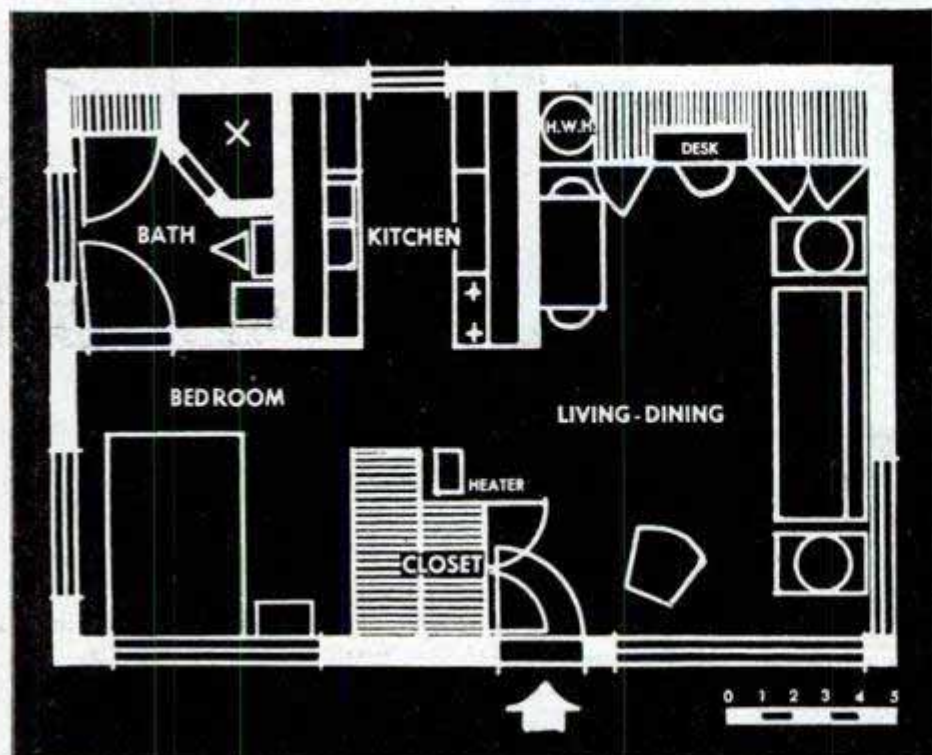

Floor plan of one of the houses has clear pathways through all the living areas and plenty of built-in storage

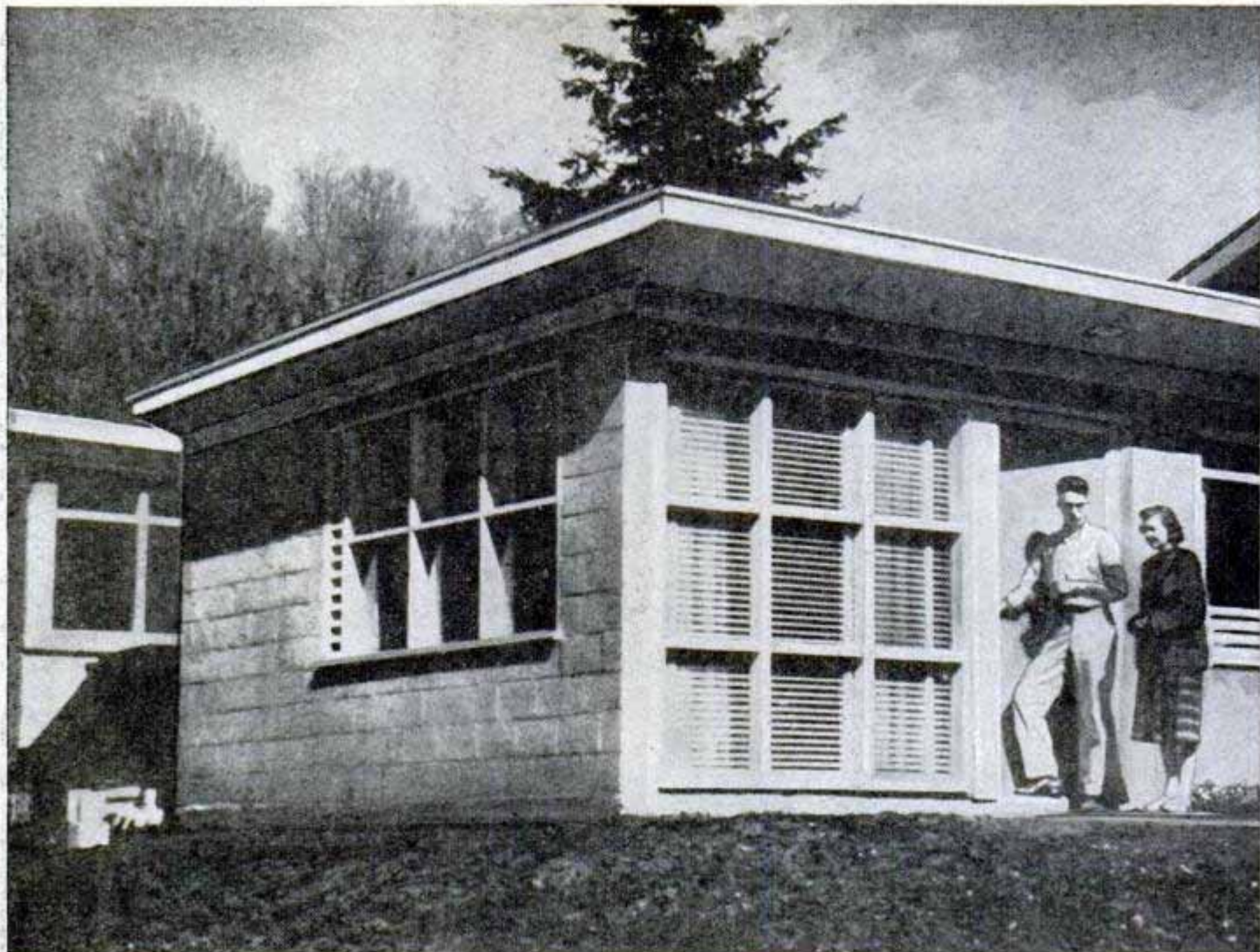

Student and his wife walk proudly into the home they built themselves. With no construction experience they laid up the frothy pumice blocks

Floor plan of the second home has a combined living-dining-kitchen area. It was designed after time and motion studies of typical housewife's work

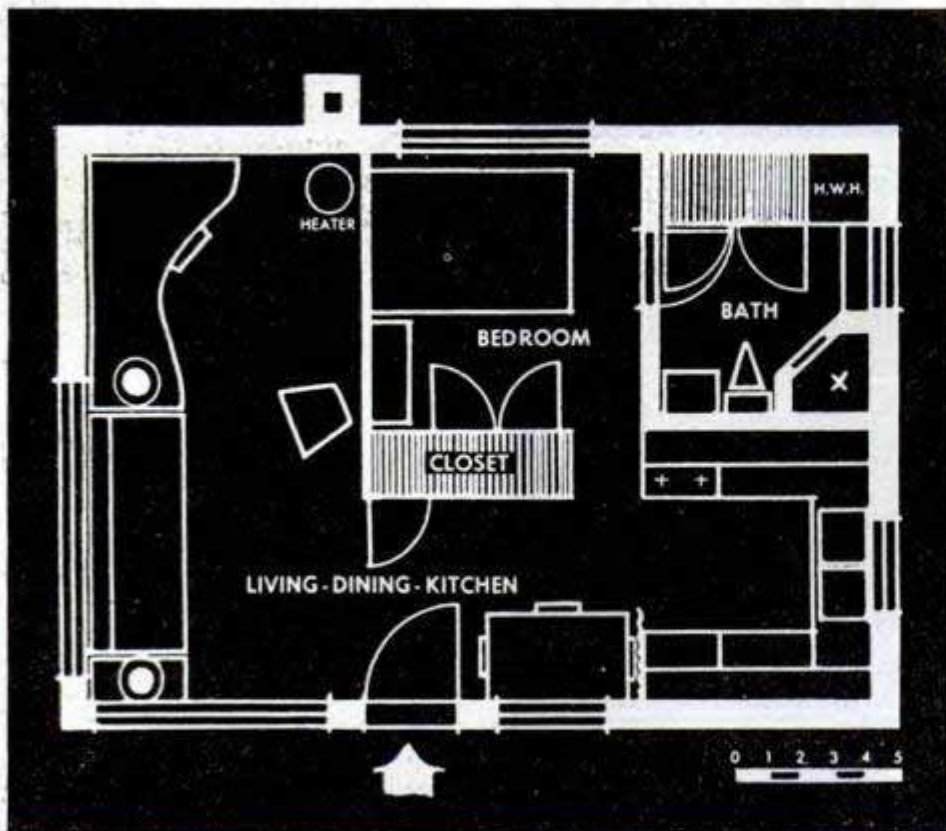

the day they were completed. Best of all, they cost under \$2500 apiece.

The magic construction material which made the houses—and their prices—possible is pumice. When volcanoes erupt they not only bubble up lava, but they also blow out a fine froth which solidifies as pumice. It is this airy quality of pumice which gives it superlative traits as a construction material. Pumice is cast into blocks which are lightweight and correspondingly easy to transport and lay. One row of pumice block has more than twice the insulating ability of two rows of concrete block.

Plaster can be applied directly to pumice blocks, or the surface can simply be painted. In addition, nails can be

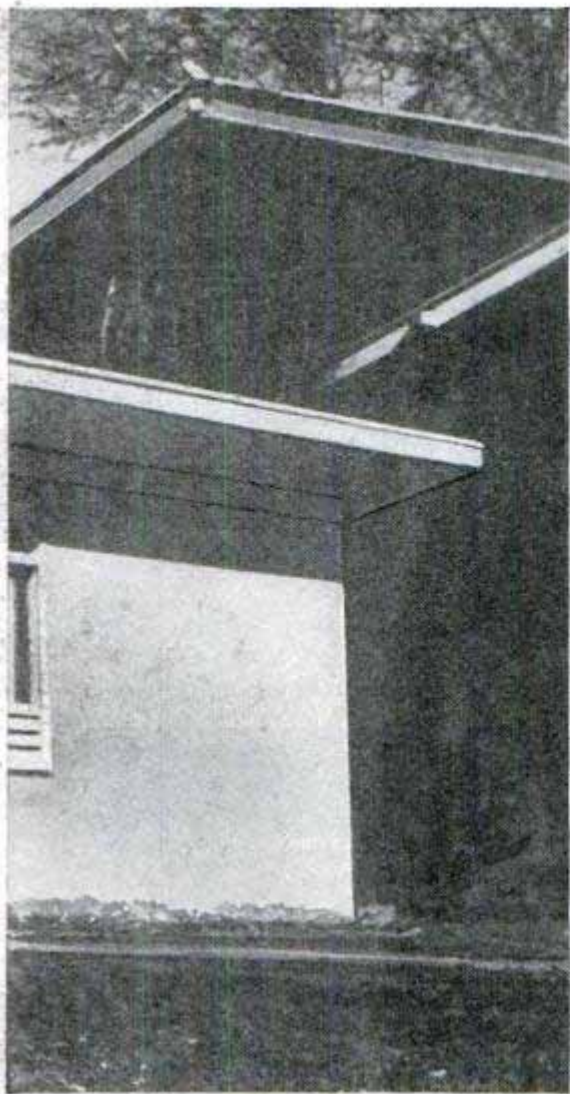

Above, right, co-builder of one of the homes tries her kitchen for size. Pre-made kitchen cabinets, windows and doors were included in the \$2500 cost



One of the homes has a storage wall with a built-in desk. The homes are small but take advantage of every inch of space for living area or storage

driven directly into the material, simplifying the job of installing door and window frames and rafters.

For all these reasons, the architectural experts at Washington State decided that pumice was their building material. Home economics and architectural students made time and motion studies, then designed floor plans which would lighten the housewife's work.

Eventually, the first blueprints and the building materials were turned over to a married couple with no previous experience in construction work. The husband poured the concrete foundation and floor

slab, then laid up the exterior walls in only 56 hours. His wife helped by painting, putting and laying asphalt-tile flooring while he installed the windows, partitions and cabinets. They finished their home in about 3½ months, despite the fact that the husband was taking a full college course and working part time as a bookkeeper.

The two bungalows are not alike, but both are designed to make the most efficient use of limited space. The amount of furniture is restricted and there are roomy pathways throughout the living areas. Storage space has been provided for everything from thimbles to skis.



Department of Defense photos

Above left, that's a 1000-pound bomb being lowered onto a tray at the muzzle end of the test gun. Right, at the breech, the gun crew places a powder charge in the chamber for firing the bomb. Below, this is what happens when the bomb hits the target. Clouds of sand and burned gases hide the target from view at instant of impact



Ship's Gun Does Shore Duty

Once mounted on the turret of the battleship, South Dakota, a 16-inch gun has been sawed off and altered to become an experimental 24-inch gun used for testing bombs and guided missiles on shore. The

gun shoots bombs and warheads as heavy as 2000 pounds against armor plate and concrete targets at supersonic velocities. The effect of the impact on the missiles and their components is measured and analyzed to determine possible changes that might improve them.

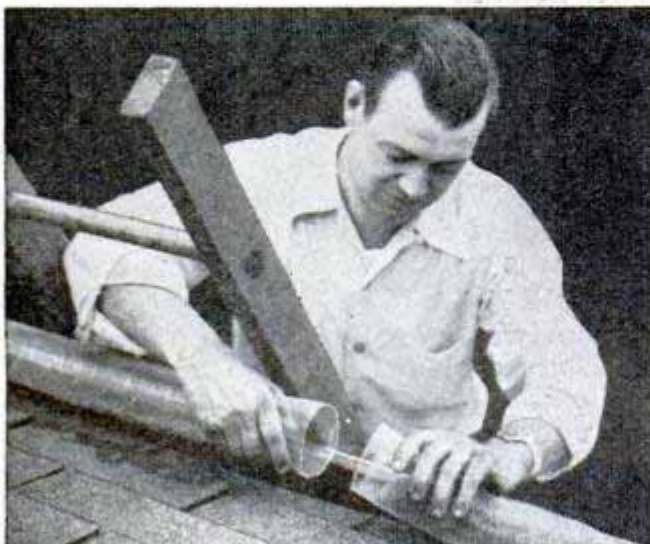

Mesh Tube Laid in Gutters Prevents Clogging by Leaves

Leaves can't collect in gutters protected by a tube made of bronze screen. The tube, 3½ inches in diameter, has an internal brass spring which prevents the screen from being bent out of shape. Five-foot sections of the tube are simply telescoped together at the ends and laid in the gutter. No fasteners are required and the tube can be lifted out when the gutter is to be repainted on the inside.

More than 7000 high schools in the United States are providing courses in automobile driving during the current school year.

Pier Seat For Anglers

Florida fishermen who stand for hours on a pier hauling in their catch can now sit down and relax. A sport-shop owner designed a simple seat arrangement that slips between the rails of the pier. The seat is not fastened to the rails, it simply fits between them. The designer has had many of the seats made and rents them out for a small fee.

Faster Processing Of Color Films

Developed for the United States Air Force, a high-speed technique for processing color film promises to make color pictures as readily available as black-and-white. Processing time for color film is reduced from 90 to 20 minutes and for color prints from 90 to 15 minutes by the system. Basis of the new Ansco system is a prehardener that permits processing to be done at 80 degrees instead of the 68 to 70 degrees normally used. The increased temperature speeds development. At present

the processing kits, which are the first ever developed for use with either paper or film, are available for distribution only to the Armed Services.

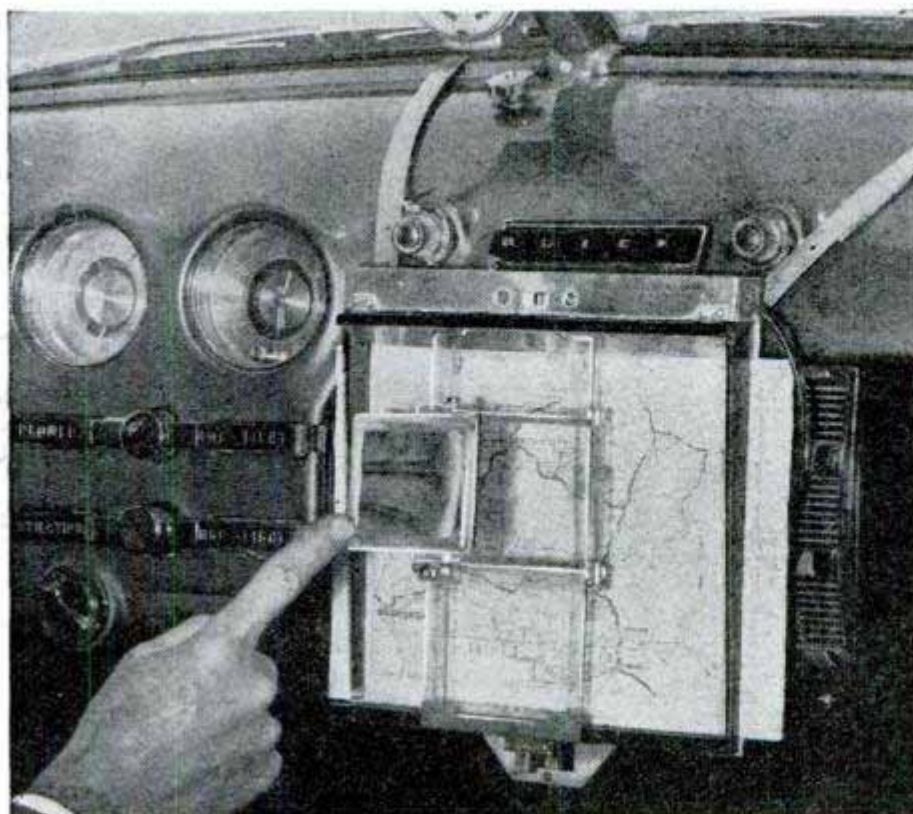
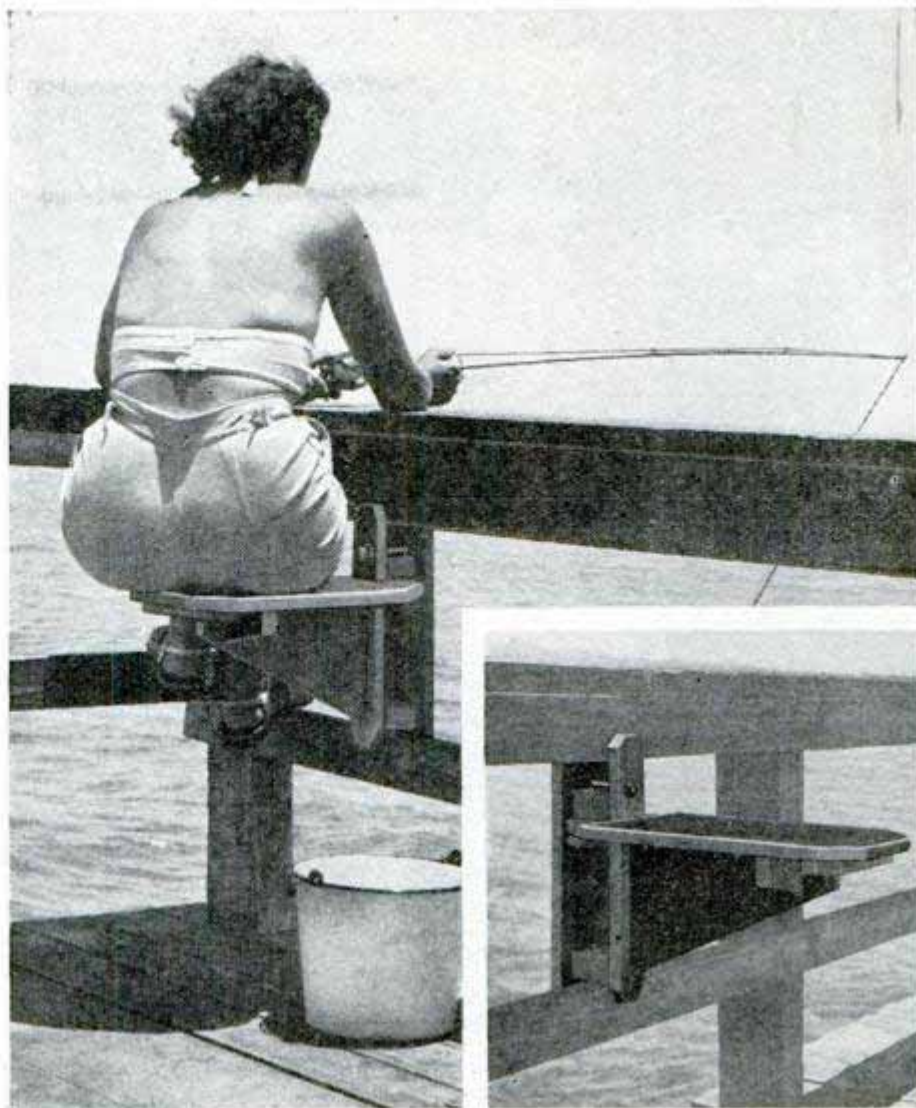

Dashboard Rack Holds Road Map

Mounted on the dashboard, a plastic-covered map holder provides the driver with a ready reference while driving over strange roads. Two concealed bulbs in the top of the device illuminate the map without glare. The light cord plugs into any cigarette-lighter socket. A sliding plastic lens, mounted on a swivel so it can be used by either the driver or passenger, enlarges any portion of the map, providing a large, clear view of the details. The mounting arms hook into the defroster openings at the base of the windshield.



Big band-shell studio gives listeners the impression that they are seated outdoors. All sound is projected forward, then absorbed in one end of room. Below, left, banks of fluorescent lights on lazy-tong hangers have replaced old TV "hot" lights. Drawing shows how the new studios float on rubber bags filled with air

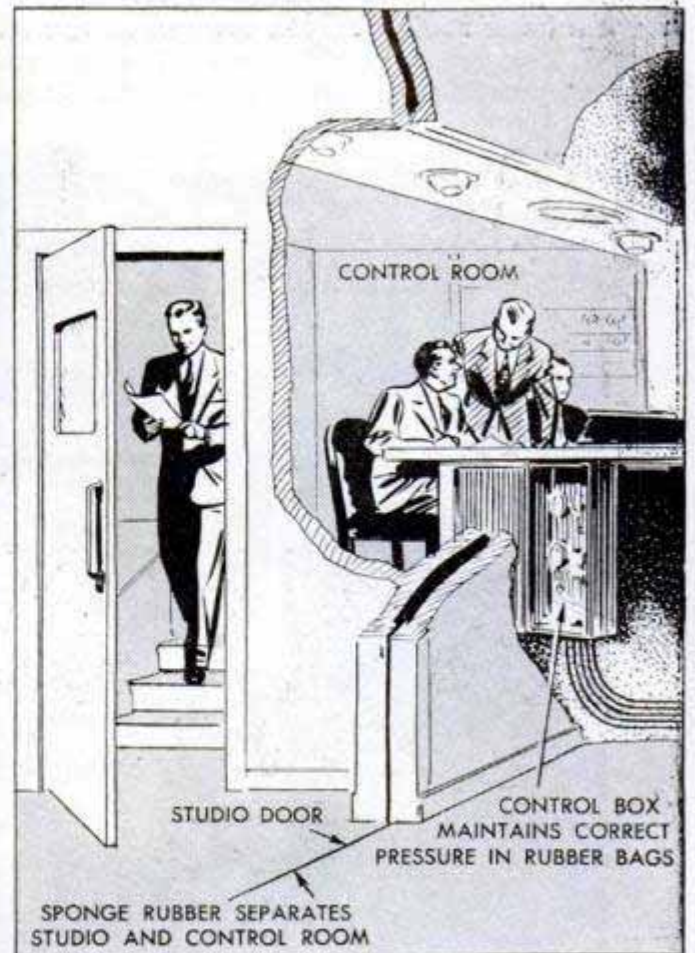
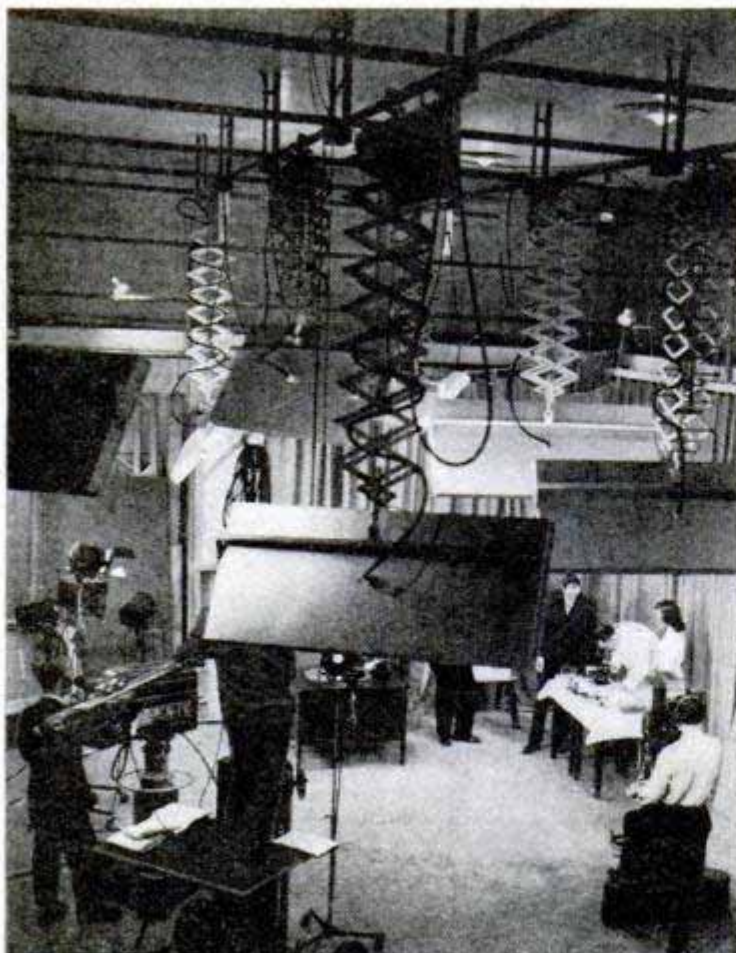

FLOATING TV THEATER

PROBLEM: How to construct a television studio in the same building with a battery of pounding newspaper presses in such a way that the TV picture won't shimmy all over the receiving screen.

Solution: Float the studio on a layer of air.

That's exactly what architectural engineers have done in building not just one, but 14 studios in an addition to The Chicago Tribune's big structure. Some of the studios will be used as TV theaters, others for AM and FM broadcasts and a few will accommodate both television and radio. Although some of the studios are in use already, others will not be completed for a year or more.

The conventional radio or TV studio is isolated because it is a room within a room. That wasn't enough in this case, for the rumbling presses would shake even the inner room to a degree that couldn't be tolerated. The new studios were designed so that they literally float on a layer of air without touching the primary structure.

A typical TV studio in the new building is separated from the rest of the structure by a 2½-inch air gap around all sides and at the top. The entire room floats on a nest of rubber bags, inflated like flat balloons.

These rubber shock absorbers, measuring 14 by 30 inches, are inflated to a pressure of 40 pounds per square inch. This raises the studio floor ¼ inch from its base, and the gap thus created is maintained to within ⅓₂ inch by automatic controls which pump more air in or release it as needed. All the control lines lead to a box, where sensing switches click on and off at intervals, raising or lowering one section of the studio to level up the room.

The outer row of rubber bags is tipped slightly toward the center of the room, so the studio nestles in the bags and can't shift in any direction. The studio is separated from the control room by a wide gasket of sponge rubber.

Most of the old-fashioned "hot" lights for telecasting have been replaced in the new studio by 12 banks of fluorescent tubes suspended from the ceiling on adjustable supports.

Another studio within the building, designed for both TV and radio broadcasts, is actually an outdoor band shell transplanted indoors. The band-shell area of the mammoth room has no sound absorbers. The sound is projected toward the "outdoor" end of the studio where it is absorbed in a porous acoustical material.

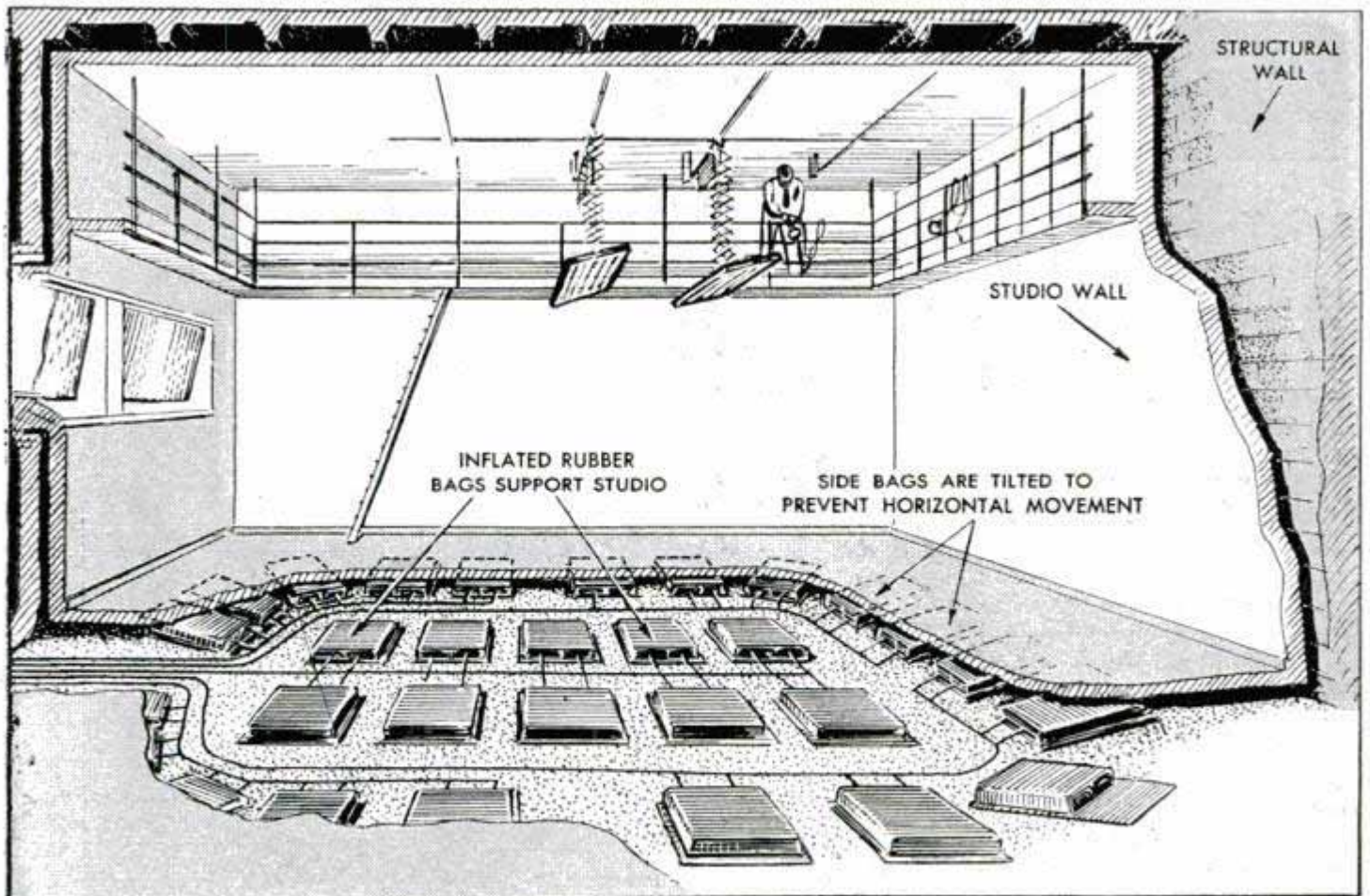

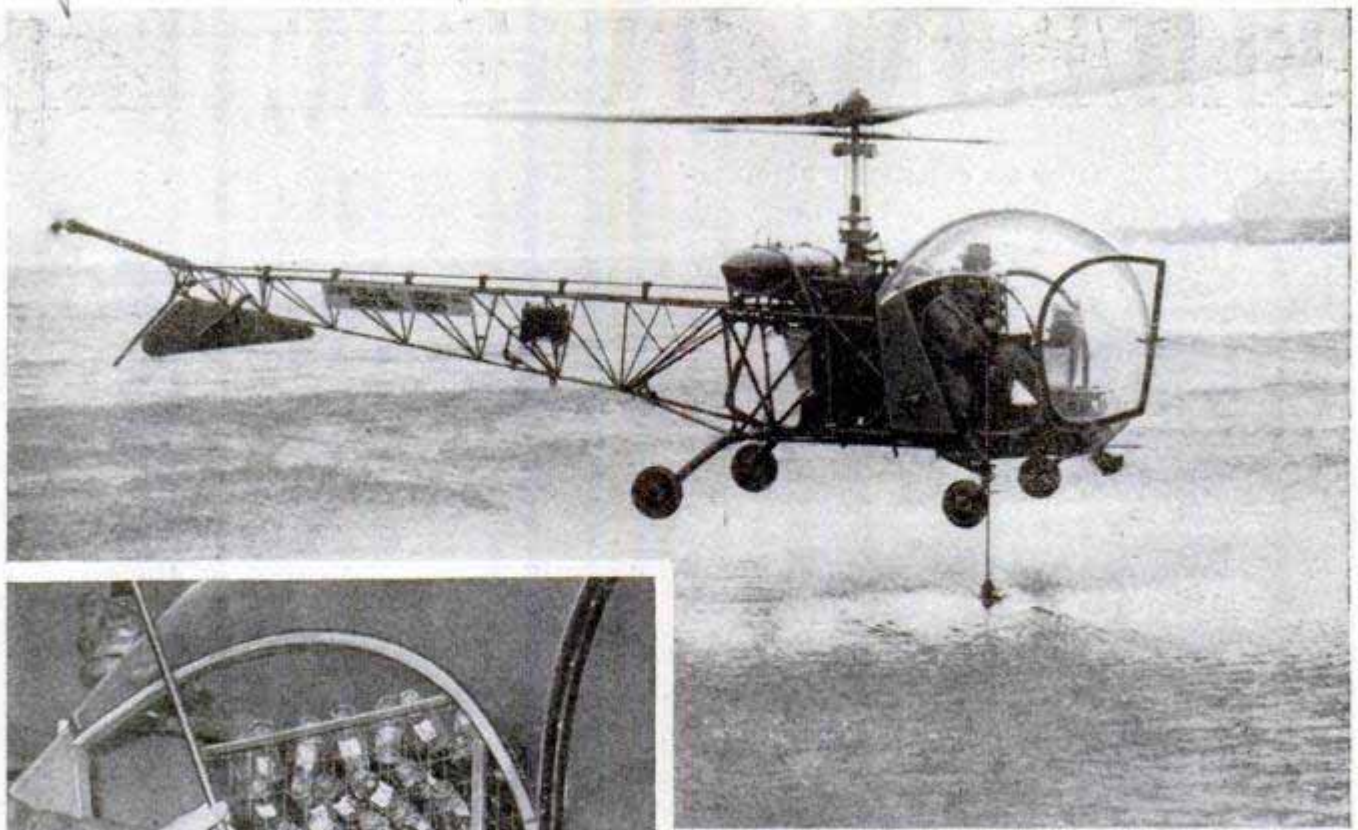

While helicopter hovers a few yards above surface, engineer with bottle attached to long pole scoops up water samples from lake for purity tests. Left, rack for bottles is in cockpit, beside sample taker

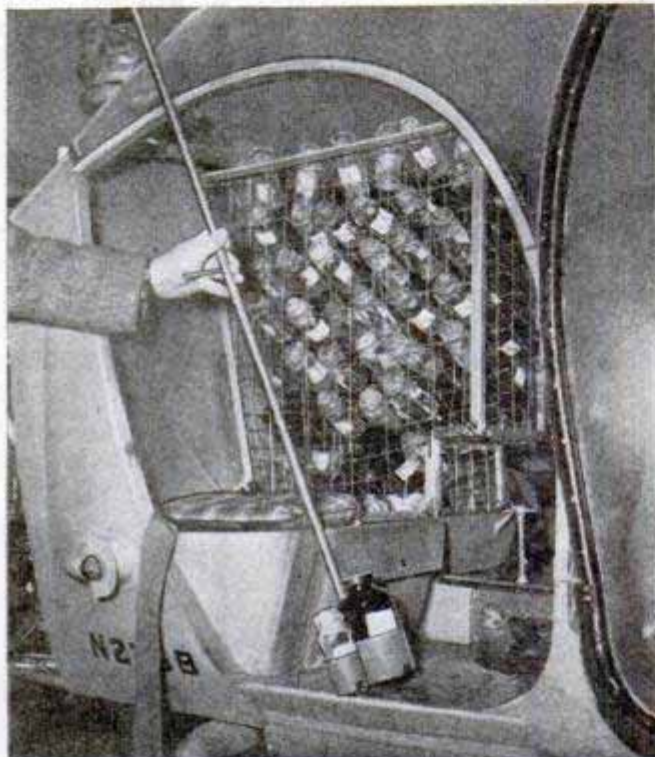

Aerial Waterworks

Samples from the source of Chicago's drinking water—Lake Michigan—are now being collected by helicopter for periodic purity tests. While the craft hovers a few yards above the surface, water samples are scooped up in bottles attached to the end of a long pole, then capped and labeled as to point of collection.

Rifle From Shotgun

Your shotgun does double duty when you use a converter that slips inside the barrel, changing the bore into one that takes .22 rifle bullets. The converter slips in and out easily and can be changed in the field. Double-barrel shotgun owners can convert one barrel for .22 ammunition, leaving the other for shotgun shells. The converter uses the shotgun's firing pin and shell ejector.

☛ Farm accidents take a toll of 17,500 lives each year and cause 1½ million disabling injuries.





Like cars on an assembly line, the machine-made tortillas, precisely baked, pour from the ovens on a conveyor

Tortillas Meet The Machine Age

By Jack B. Kemmerer

THE INDIANS of Mexico first made tortillas between 2000 and 1000 B.C., when most historians agree that corn originated in Guatemala and southern Mexico.

The ancient method of making tortillas by hand had never changed until recently. Now, the tortilla has met the machine age.

The El Zarape Tortilla Factory in Los Angeles uses an automatic tortilla-making machine that has reduced the cost of tortillas more than 30 percent. The dough is put in one end of the machine and a perfectly cooked, ready-to-eat tortilla comes out the other end. This machine has made more than 6,000,000 tortillas in the last three years. An expert can make about eight dozen tortillas per hour by hand while the machine makes 100 dozen.

Although the methods of making and cooking have changed, the tortilla is the same. Corn, powdered lime and water were used 3000 years ago. These same ingredients are used today.

Corn, the raw material for tortillas, is ground in this machine between porous stones called "canteras"

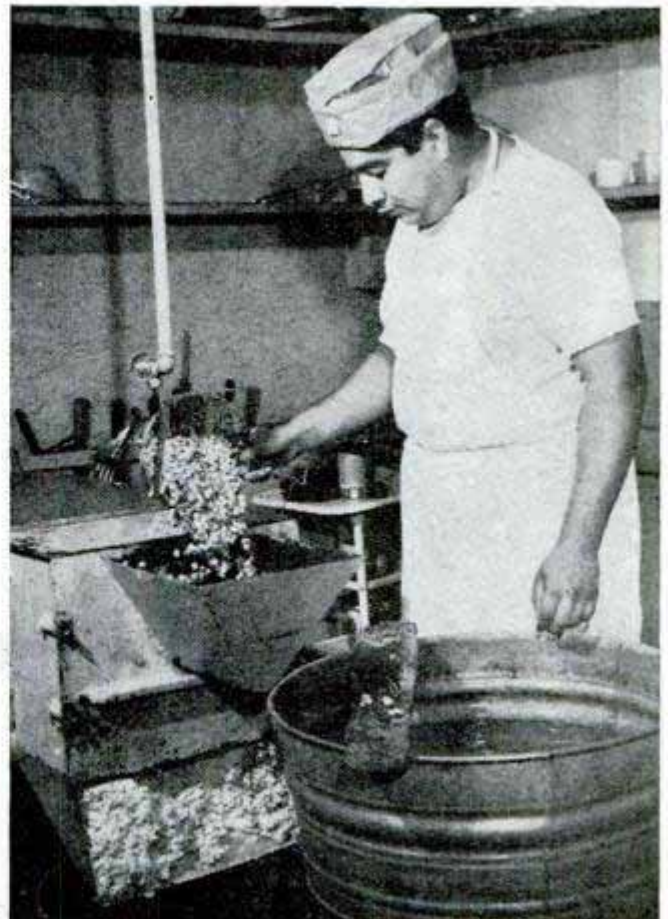

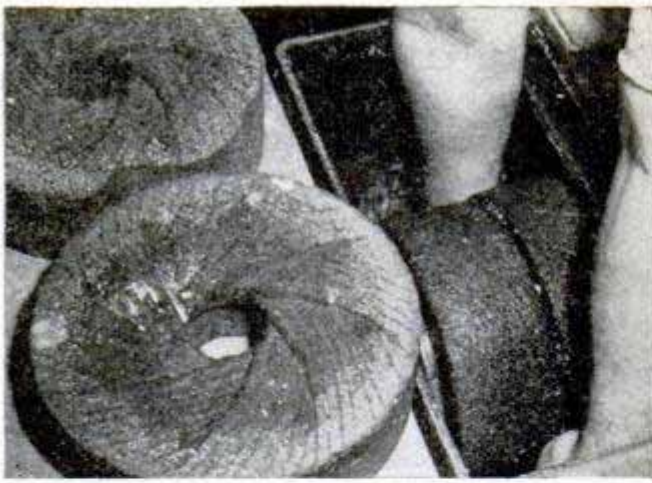

Above, these are the stones or "canteras" in the grinder. Very porous, they are cooled by a stream of water



Above, after grinding, corn is kneaded by hand and placed in cutter, below, coming out tortilla-shaped



The dried corn and lime are cooked slowly for several hours to soften the hull of the corn. After cooking, the grain sets overnight and is ground the following morning.

Grinding is done by a machine which uses two porous stones. These stones, called "canteras," are found only in Mexico. A stream of cool water flows on the stones during the grinding. The water goes through the porous stones keeping them cool and at the same time adds the required amount of water to the grain. If the stones were to get hot during the grinding the corn would be overcooked.

After grinding, the corn is rinsed to remove part of the hull, the remainder being left in the dough to add body to the finished tortilla. The corn is then kneaded into a stiff dough and is ready for the machine.

The dough, placed in the hopper of the machine, is rolled flat by two bronze rollers. These rollers are adjustable and the dough may be rolled to any thickness.

The cutter, which is a curved disk located below the rollers, rotates against the front roller and cuts a tortilla with each revolution. After being cut, the dough is carried on a canvas belt to the asbestos conveyor of the first oven.

The three gas ovens are located one above the other. Each oven has an endless belt which carries the tortilla through it. As the tortilla leaves the first oven it

Close-up of the cutter. Curved disk rolls against a front roller, cutting a tortilla with each revolution

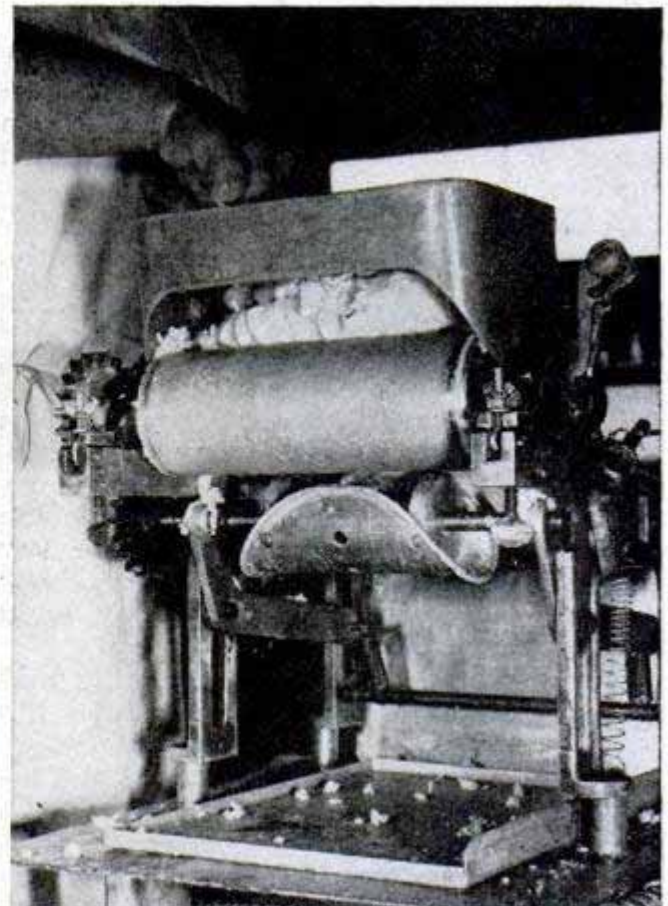

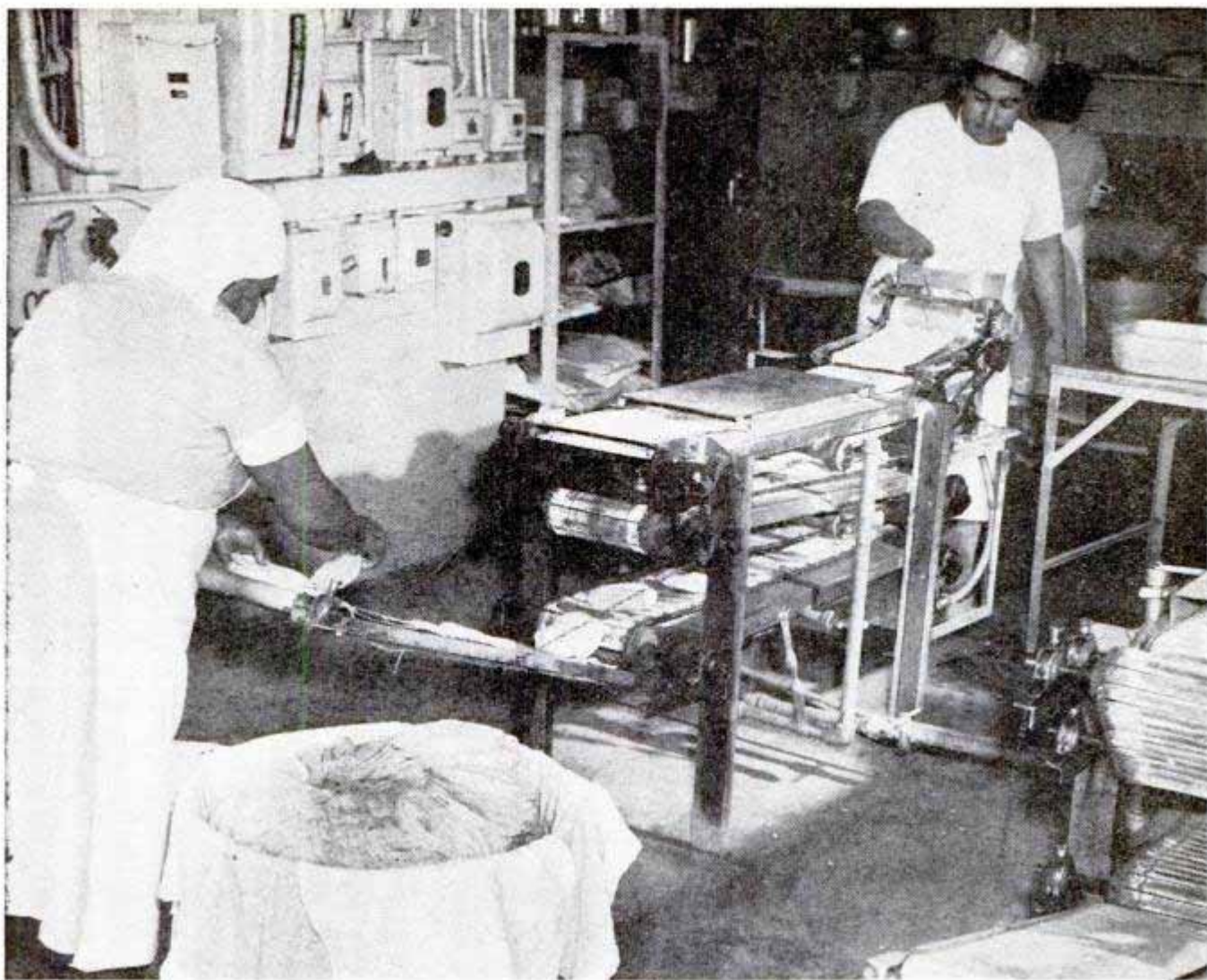

turns over and falls to the oven below. When it drops from the third oven it falls onto a canvas belt and is carried from the machine. This entire operation takes one minute.

As the tortillas leave the machine they are puffed up to about three times normal size. When cool they resume their normal thickness. They are then wrapped in wax paper for delivery.

The tortilla is rather stiff which is advantageous, because it is also used as an eating utensil. Tortillas are used as plates for salads, vegetables and meats, a practical application as the dishes are then eaten instead of washed. The tortilla, whether machine or hand made, is basically what it was 3000 years ago. It has met the machine age and come out of the battle unchanged.

From the cutter, the tortillas are carried through three gas ovens for baking. The complete machine is shown in this photo. Below, after they have cooled, the tortillas are wrapped and sealed for shipment to shops

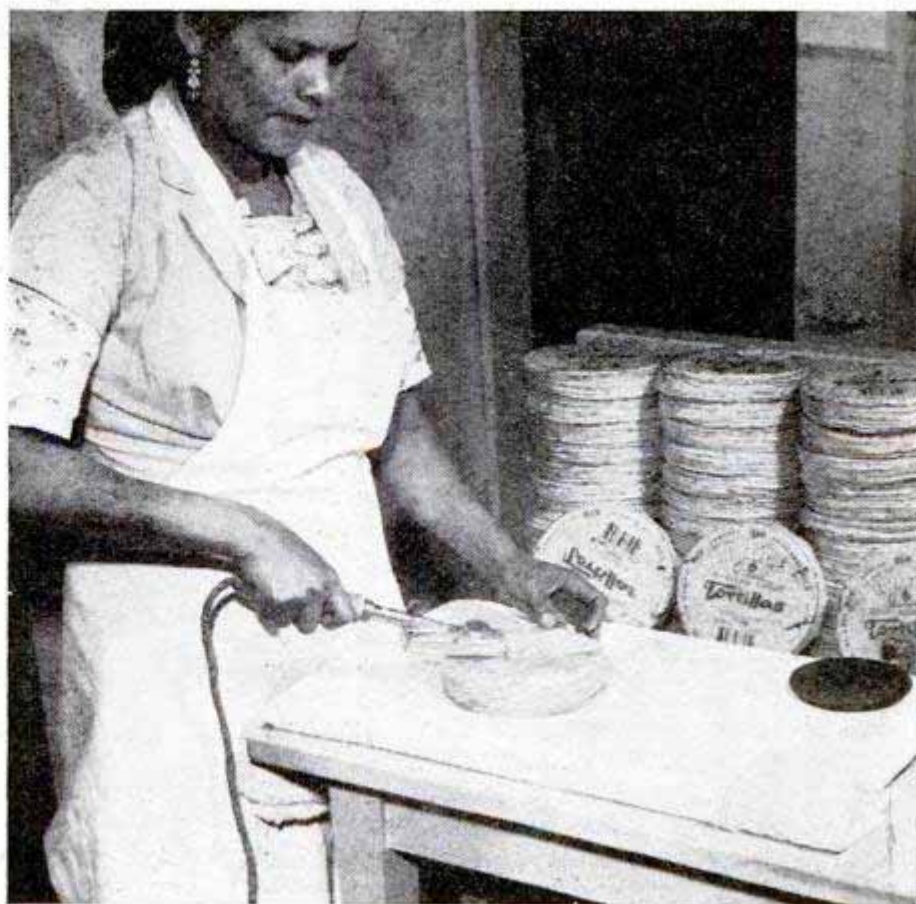

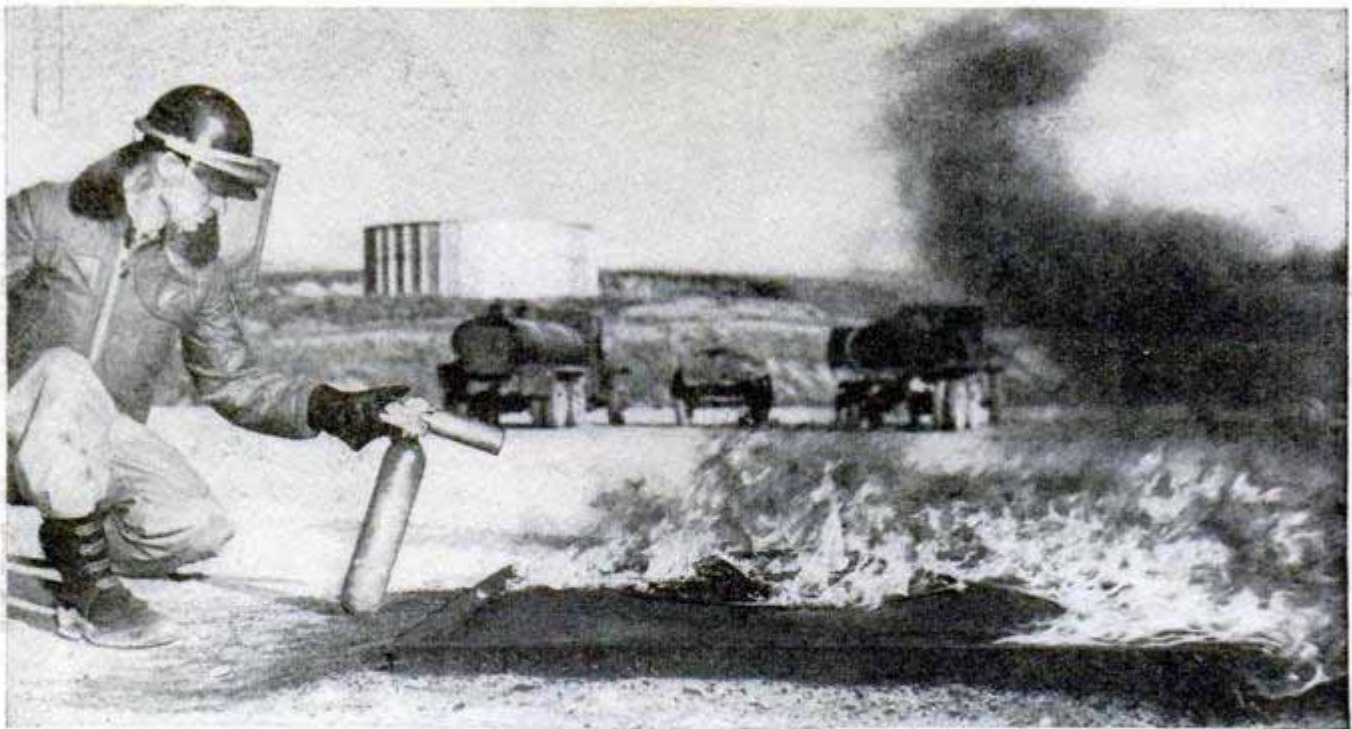

Department of Defense photos

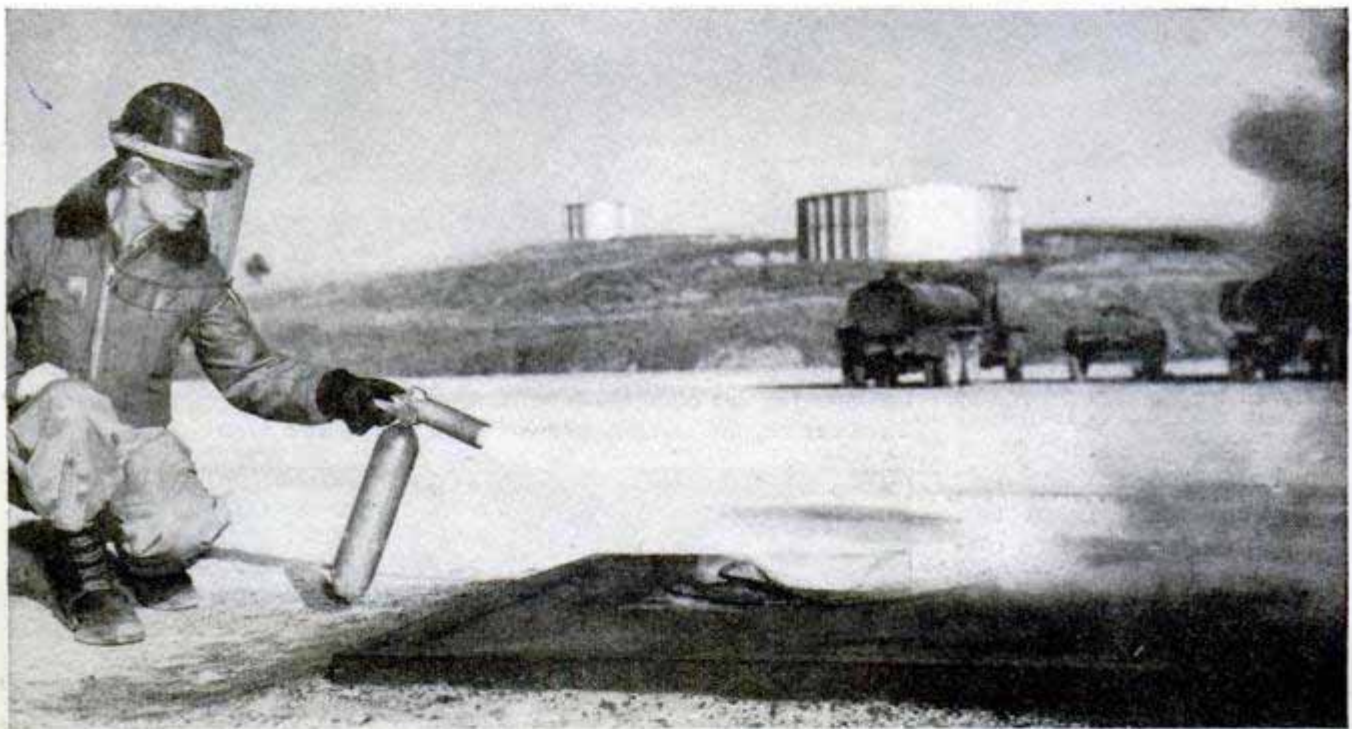

Fire Put Out in Split Second

Faster than you can say "dibromodifluoromethane," a new fire-extinguisher agent with that jawbreaking name snuffs out flame. Developed by the Army Engineers, the agent is said to be at least twice as ef-

fective as carbon tetrachloride, the standard fire-extinguisher fluid in use today. It is also less toxic than the present fluid. In a test at Fort Belvoir, Va., electrical wire was set afire with gasoline. One fifth second after the extinguishing agent was released, the fire was out.

Chlorine Powder Makes a Nontoxic Farm Disinfectant

Farmers can now keep milking equipment germfree with a newly developed form of chlorine that comes in powder form and is easily dissolved in water without leaving a toxic residue. The soluble disinfectant, a form of the organic compound, dactin, is inexpensive enough to be used for water purification and sewage decontami-

nation. Turkey and poultry runs can be disinfected with the chlorine compound, eliminating the necessity of moving flocks to different areas annually. The compound, which contains 66 percent available chlorine, leaves a residue containing nontoxic acetyl urea, a chemical similar to that used in antidecay toothpastes and chewing gums.

DAVE M. GOTTFRIED
N.W. ON

Lashed into place in a huge steel cylinder, ugly torpedo will be subjected to pressure equal to 1/2-mile depth

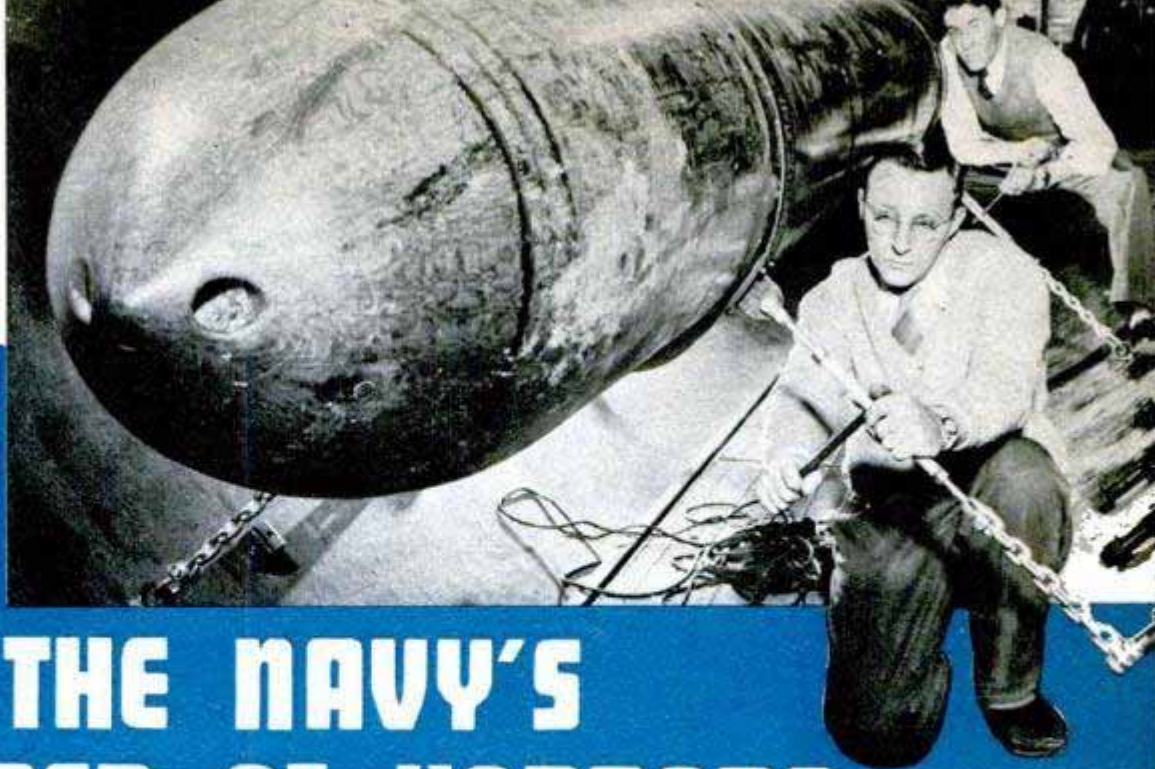

THE NAVY'S CHAMBER OF HORRORS

WITH A ROAR the big Navy plane nosed in over the testing grounds off Bermuda. A new-type surface mine hooked under its belly vibrated and tugged as the engine revved to a high whine and the plane flattened out. An instant later the mine dropped away. A parachute bloomed behind it, breaking its fall as it hit the waves with a mighty splash, tumbled and disappeared forever.

It wasn't supposed to do that. What happened? Navy engineers shook their heads. "Send those plans to White Oak and run a model through the tank," ordered the project chief.

Up in the Navy's new \$4,000,-000 environmental laboratory, opened this year at White Oak, Md., Dr. Albert May's staff of water-entry scientists took the plans and made a tiny model of the faulty mine. It was inserted in a steel cylinder and carefully loaded in the breech of a little air gun pointing downward into a glass-sided water tank. With a dull "pow" the model shot into the water, while a high-speed movie camera recorded the progress of its journey to the bottom.

Later, on a screen, the men watched the little model drift into the water, set up a great

By
Michael Day

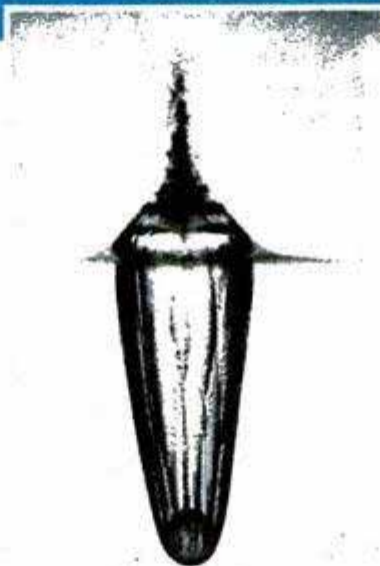

← When steel ball is fired into water, a "chimney" forms behind it. Depth charge which forms a similar cavity would blow most of its force up through the hole, wasting it

Mine is hoisted to the drop platform of a 75-foot tower. It will be released suddenly to crash in a steel enclosure. If it doesn't explode, it's safe to handle

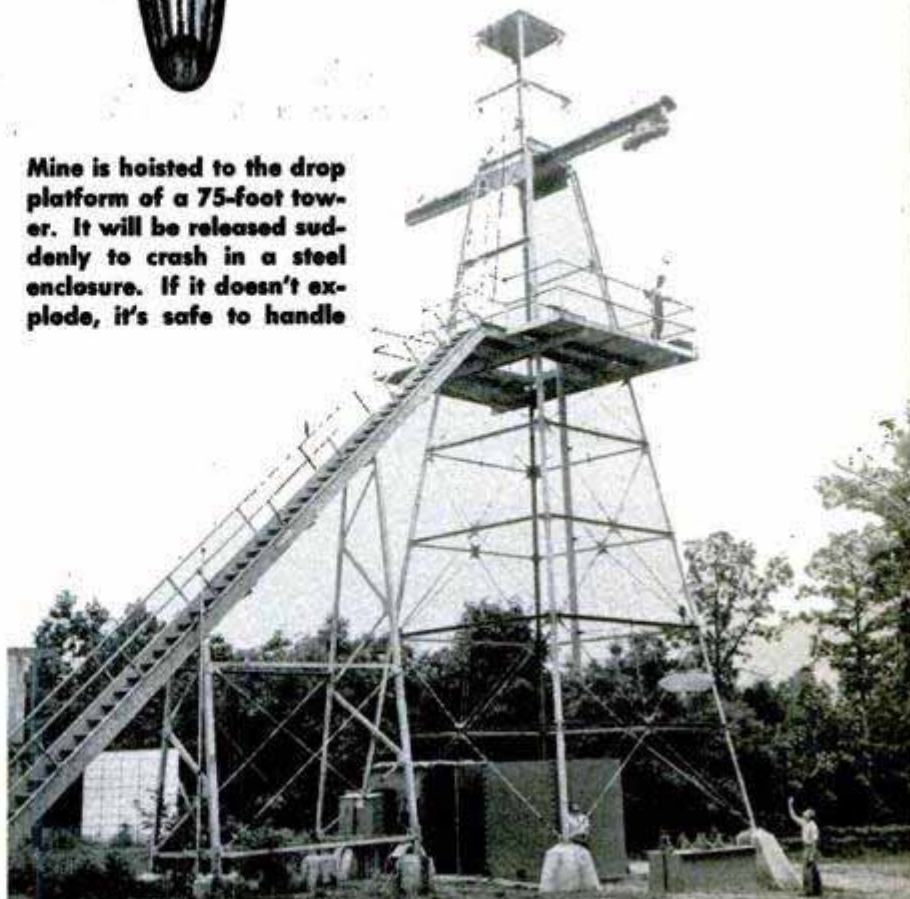



Models which duplicate all the metal construction on big ships enable the Navy engineers to learn to demagnetize hulls so enemy's magnetic mines won't be triggered as ships pass by



Model of mine goes into steel cylinder to be fired into water. Its behavior will be filmed

basket splash in slow motion and sink downward. "A small metal ring around the vanes for attaching the parachute had changed the hydrodynamics of the weapon," recalls one of the men. "Instead of the vanes guiding the mine in a long curved sweep up to the surface as they should have, the ring was acting as a sort of extra rudder, steering it to the bottom where it cracked up."

Ever since German ships in World War I blew themselves sky high on U. S. mines in the North Sea, the Navy has been elaborating on a wide variety of infernal machines with which to pepper enemy oceans in wartime. Out of Naval ordnance plants in the last war came a fiendish assortment of intricate mechanisms: acoustical mines and depth charges, triggered by the sound of ship propellers; explosive charges that wouldn't blow up unless set off by the magnetic field of particular ships they were designed to "get." Some mines lie on the bot-

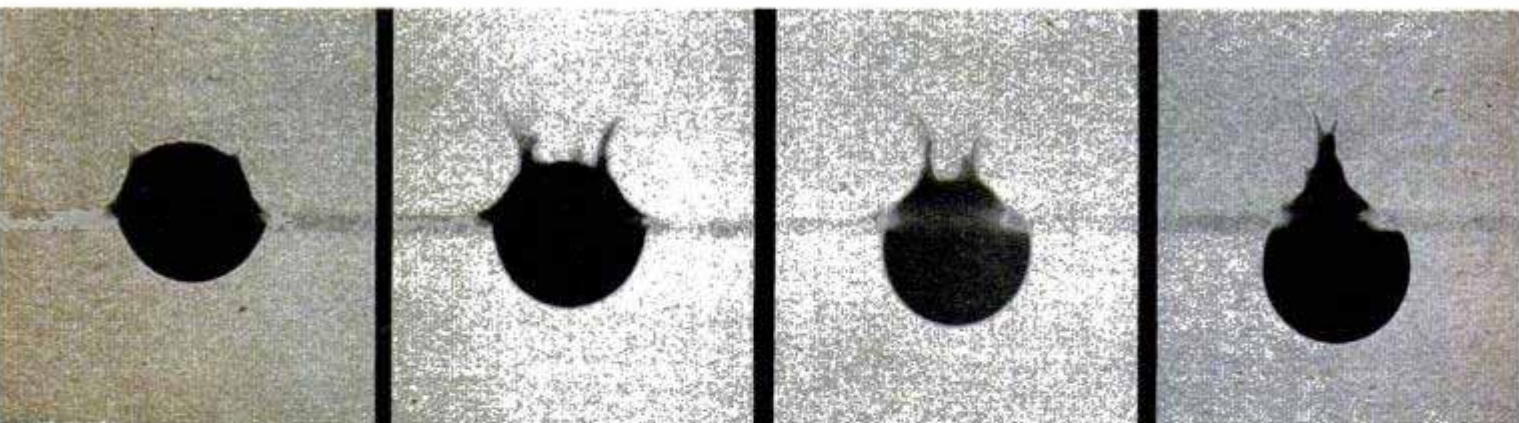

Series photos show how slightest projection on mine or depth charge can make a bad cavity. The steel ball above is perfectly clean, makes very little splash, and the water closes above it instantly. Below, a similar ball, touched only by fingers, enters water. Fingerprints cause a big splash and a wide cavity in water

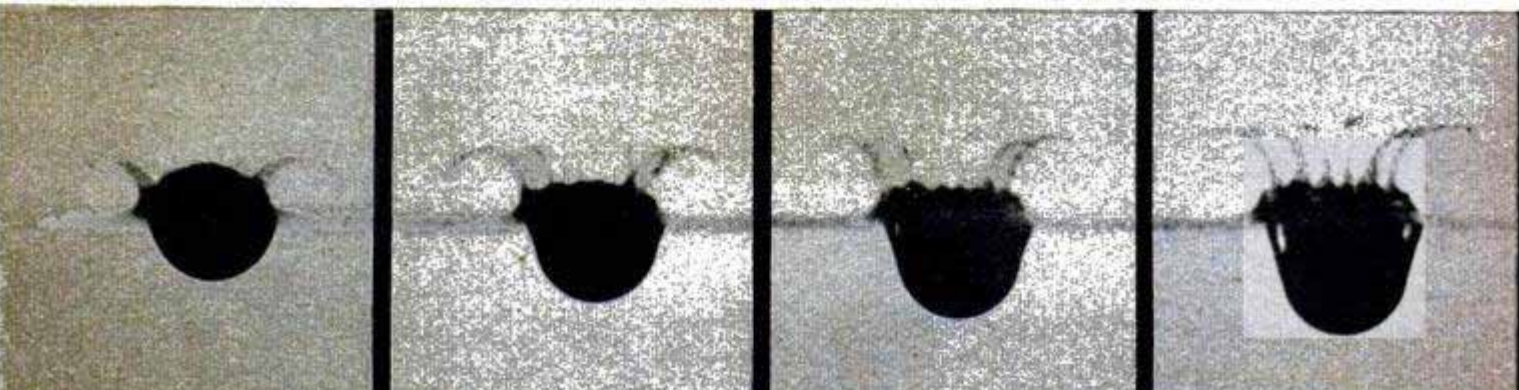

tom, some on the surface, some in between. "There were torpedoes and other ordnance," says one scientist, "that would do everything but play 'Taps' before sending an enemy ship to Davy Jones." There were mines and depth charges designed to let five ships go by, for instance, but blow the sixth out of the ocean. Others might change from magnetic to pressure-triggered after a designated time, to confuse the enemy.

All this delicately instrumented equipment was fine when the Navy could lower it gently over the side of a ship in the night. But today, it must withstand firing into the ocean from speeding jet planes. It must take thousands of miles of punishing travel in jolting trucks and shuddering transport planes, stock-piling in humid, corrosive jungle atmosphere or sub-zero Arctic. How it reacted to all this used to be a matter of expensive testing under actual conditions.

Now, in a huge three-story building taking up an entire wing of the new Naval Ordnance Laboratory at White Oak, a collection of fantastic machines fling weapon models into water at varying speeds, jolt and jar equipment to simulate the rough handling it may get. There are machines to bake it like the desert, freeze it like the Arctic, humidify it like the jungle, drop it, thump it, pummel it and squeeze it under the fantastic pressures of deep ocean. In this labyrinth of environmental wonders, marine weapons can be subjected to any conceivable condition they may encounter anywhere in the world—from assembly line to explosion against target.

To learn what happens when a mine, tor-

pedo or other weapon plunges into the water from speeding aircraft, Navy scientists have built a glass-sided tank about five feet high and three feet square. On top of it is an air gun into which the men load weapon models or steel pellets that they will fire into the water. By rotating the whole tank on geared wheels, projectiles from the gun can be made to enter the water from almost any angle.

The tiny mine or steel ball to be tested is dropped into a cylinder, which fits into the gun breech. Air hisses through the valves, fills the gun chamber. Then you hear the "pow" as the flap valve is released and the missile plunges into the water. It's all over in a second. So they can see what happened, engineers have rigged their electronically controlled high-speed photographic system to the tank. A special movie camera, which shoots 2000 frames a second, records every move the missile makes. Preserved on the film is a two-minute slow-motion record of how the mine, torpedo, depth charge or pellet behaved in one second of actual plunge time. Stills can also be taken. Doctor May points out an electric eye attached in front of a slitlike opening on the gun barrel. This tags the missile as it goes by and triggers the camera and flash simultaneously. On the big relay panel, time lag can be adjusted so that the plunging missile will be "trapped" at any point above or below the water line.

Mysterious things happen when missiles enter the water at supersonic speed. Doctor

Torpedo crackling with frost is suddenly dunked in warm water, simulating delivery by high-altitude plane

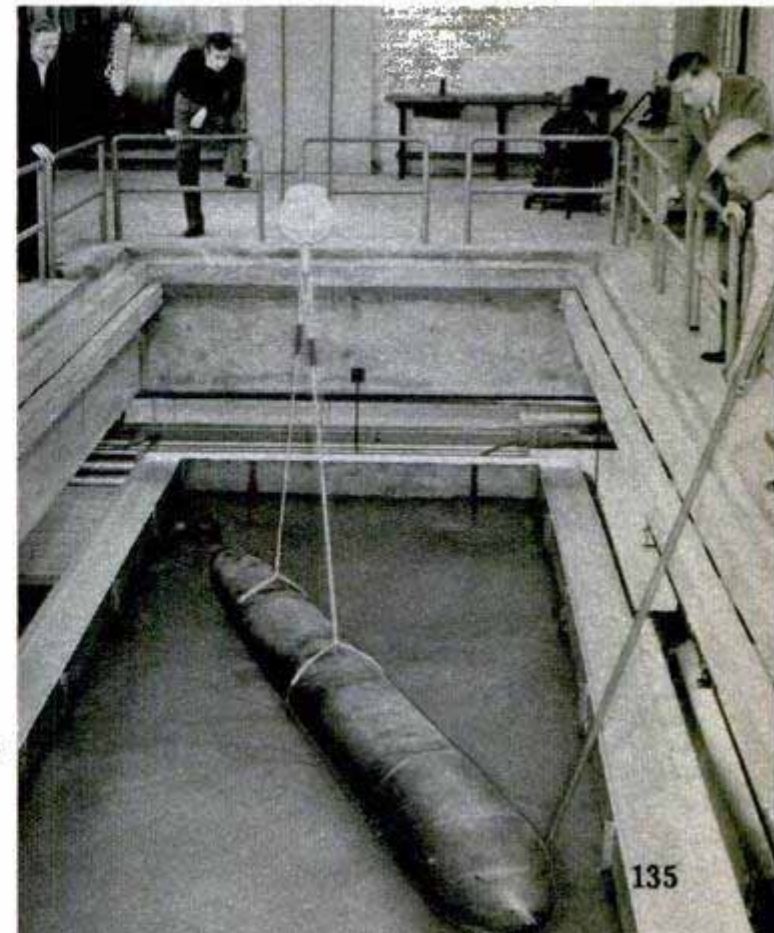
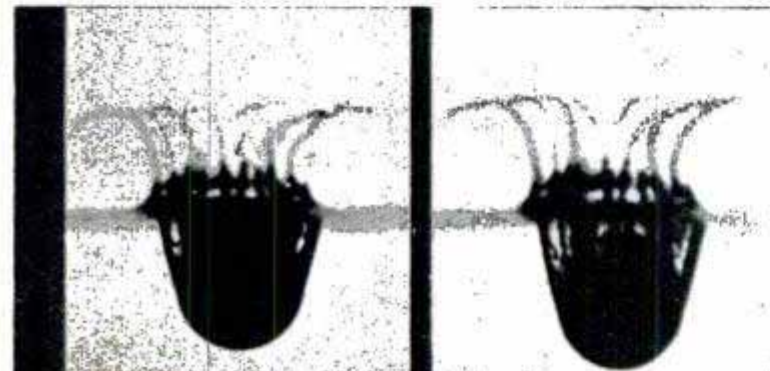
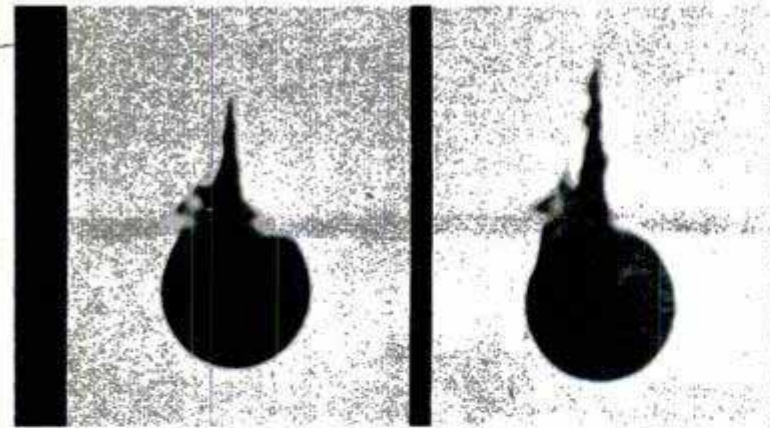

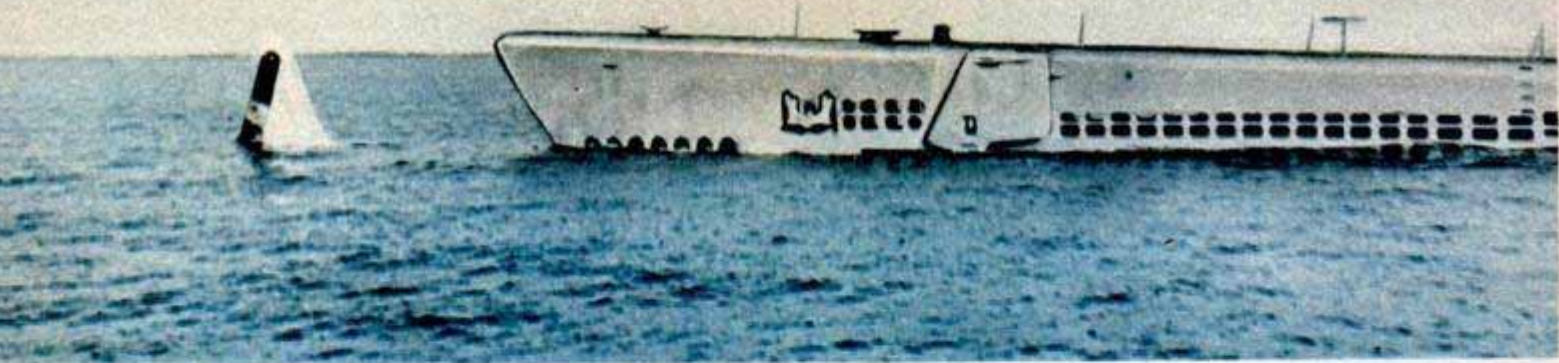

May's men have sent steel balls crashing into their tank at 4770 miles per hour. Water is almost like concrete at that rate. The balls slow down with the alarming force of about two million Gs. That's like hitting a brick wall in a supersonic plane. The average jet plane in sharp pull-out subjects its pilot to a blackout force of only about 10 Gs. You can guess what would happen to a delicate torpedo at that speed. The pellet also cuts a hole in the water behind it like a marble dropped in soft butter.

That hole, directly behind the missile, never completely closes, but stretches out like the tail of a comet—a long hole filled with air bubbles, created by the speeding missile as it pushes the water away from its nose and around itself. "Vaness on torpedoes and droppable mines," points out Doctor May, "are designed to act on the water and steer the weapon into place. If the cavity behind a piece of marine ordnance is too big, there's nothing for the vanes to grab hold of. If a depth charge makes too long a cavity, the cavity acts as a chimney and most of the explosive charge will go up

Sometimes torpedoes leap out of water like dolphins. Water-entry studies show how to correct this fault

through it instead of being transmitted through solid water."

By studying water-entry movies, Navy designers can see what makes their weapons tumble, why torpedoes "broach" or leap from the water like lively porpoises, why mines dive or act strangely when dropped from speeding aircraft. "The optimum mine case today is smooth and clean," says Doctor May. "We know that at low speeds, even fingerprints on a steel ball were enough to make a big splash and big cavity, whereas a perfectly clean ball went in smoothly and the cavity closed up quickly." Designers of droppable ordnance now make vanes that will guide the weapon properly by catching in the cavity's watery walls. Queer-shaped noses, proved out in the model tank, help steer the falling missile.

Soon the water-entry men at White Oak will have a bigger and better setup. A monster tank, already designed, will sit in a 15 by 40-foot pit in the sub-basement. Gun

This lightweight mine case couldn't take it. High water pressure inside cylinder pushed big dent into the case





Model of torpedo dives toward bottom of test tank instead of running along the surface. Experiments enable designers to change model to correct faults

mounts along the top will accommodate movable air guns for firing larger models into the water from any angle. A port on the side will open below the water level and take an air gun that will be used in studying submarine-torpedo launching.

What happens to a complicated piece of modern marine war ordnance when it whacks into the ocean? Will it break up on impact? Will the jolt set off the fuse? It's not supposed to. The new environmental lab has several mammoth air guns to find out. A 15-inch gun, 58 feet long, was made from a discarded 14-inch liner from a big gun on the USS Tennessee. But "Big Bertha," which has a tunnel-like barrel 93 feet long, was carved out of two discarded propeller shafts designed for the USS Iowa. This gun has a 21-inch bore, enlarged from a 14-inch hole in the original shafts. The shop that did the enlarging job wound up with 24 tons of steel chips.

The mine fuse or mechanism to be tested in the air gun fits in a cage-like piston which is inserted in the gun breech. Pressure is built up in a tank above the barrel, flap valves released, and wham! The cage zips to the other end, is stopped by the air cushion it builds up ahead of itself, rebounds back and forth until it stops. Impact is measured on the release—up to 25,000 Gs. And that's when the mechanism being tested either breaks or doesn't.

Odd things show up in Big Bertha. "One carefully constructed bit of ordnance on which we were testing a minor repair broke into hundreds of pieces—except for the spot that had been repaired," explains one of the men.

The rumble of the big gun is frightening, and so resembles the sound of ship propellers moving underwater that the boys had trouble for a while testing fuses for acoustical mines. They went off, not from the impact, but from the noise. It took weeks to mount them properly so they wouldn't "hear" the racket.

If the air guns aren't enough to assure that a new magnetic or acoustical fuse won't go off accidentally if dropped by a careless stevedore, or jolted loose from a plane landing on a carrier deck, then the live fuse is mounted in a 1000-pound bomb case, hauled outdoors, up to the top of the lab's 75-foot drop tower, and let go. Down she comes into a sand pit or concrete apron. If it still doesn't go off, then all's well. It goes on to tumbling ordeals in the tumble drums, and gets whirled in centrifuges up to 2500 revolutions per minute.

Some torpedo and mine mechanisms are
(Continued to page 264)

Diagram shows huge pressure vessel. Missile is subjected to pressure it would receive a half mile down

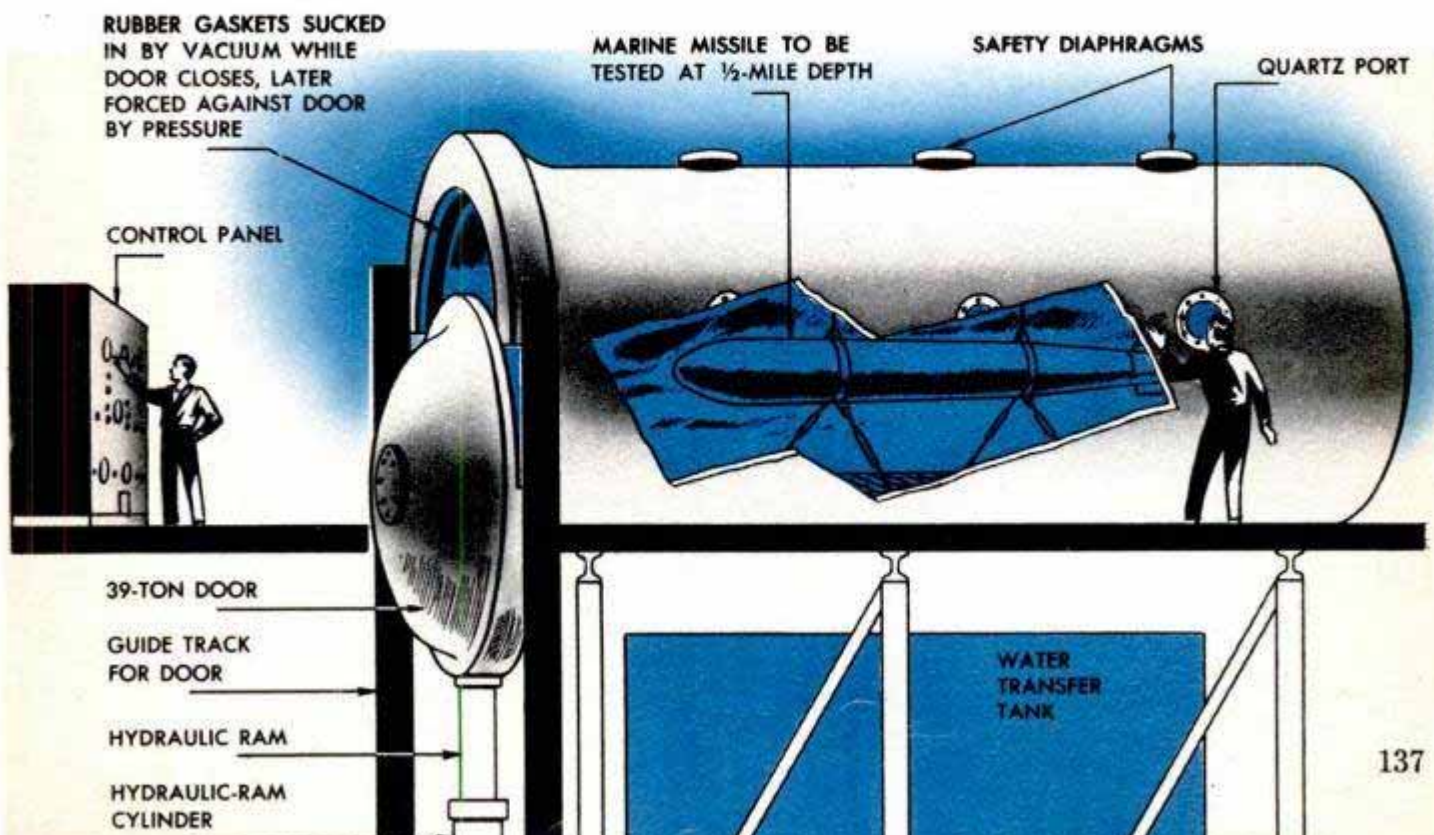



Kit contains the dye liquid, cleaning solutions and the white developer. Right, after dye has penetrated any cracks, white solution is applied to bring dye back to surface. Below, dark line shows crack in a crankshaft

Dye Shows Metal Flaws

Cracks and other flaws too small to be seen with a magnifying glass can be easily discovered in metal machinery parts through a new inspection process based on the penetration of a red dye. The dye is applied to the metal part and allowed to stand for five minutes, then wiped off. During this time it penetrates into any cracks which may exist. A white solution then is applied to the part. The dye, which has extremely high capillary action, is drawn from the cracks by the white solution. Any surface openings then can be detected by the presence of red lines created by the dye. The inspection system can be used on metals of any kind.

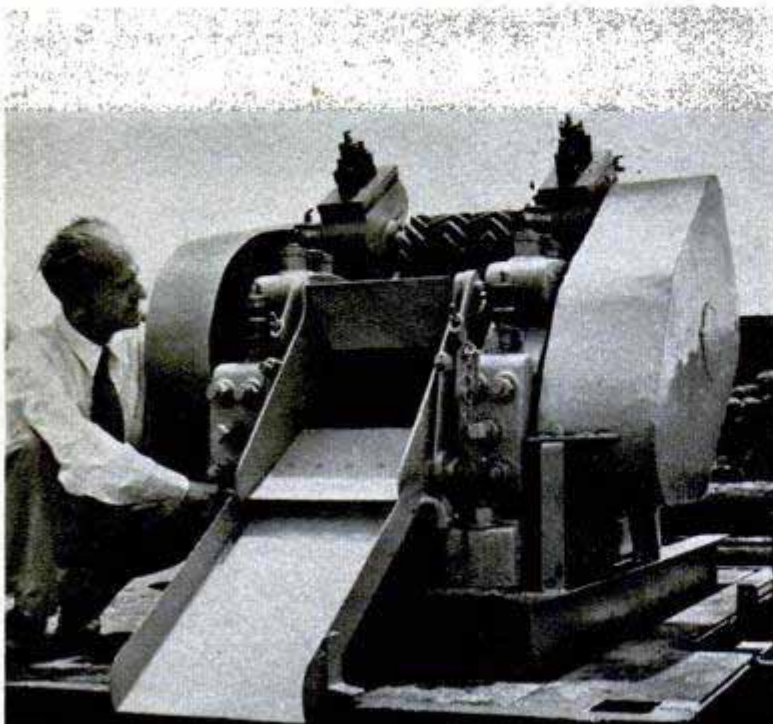
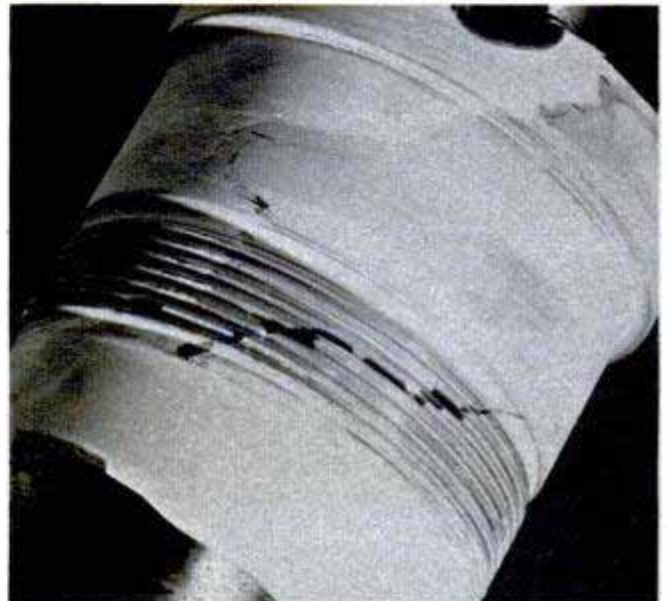

Truck-Mounted Sugar Mill

Mounted on a truck body, a miniature sugar mill rolls from plantation to plantation in the Hawaiian Islands, testing specific types of sugar cane for their juice content. Sampling cane juice in a regular mill is impractical because many types of cane are ground at one time. The miniature mill, operated by the Hawaiian Sugar Planters' Association, can roll to a particular area and determine the quality of the juice and the correct time to harvest the cane. The mill also supplies its own power.

☐ The pesky rabbit has a new foe—a rabbit repellent that can be dusted or sprayed on vegetables and flowers.

Tender Feeds Dog For Seven Days

For a seven-day period a new clock-operated feeder gives rations and water to a dog, making it possible for the owner to leave his animal unattended for a full week. The electrically operated feeder has 14 shelves, which hold moist or pellet-type foods or any other food that will not spoil, and a water tank. All the owner has to do is fill the feeder with food and water, set the time clock and close the door. Then once or twice a day, in accordance with the dog's established eating habits, a bell rings to call the animal and food drops out of the feeder into his pan. Water flows into another pan as fast as it is consumed by the

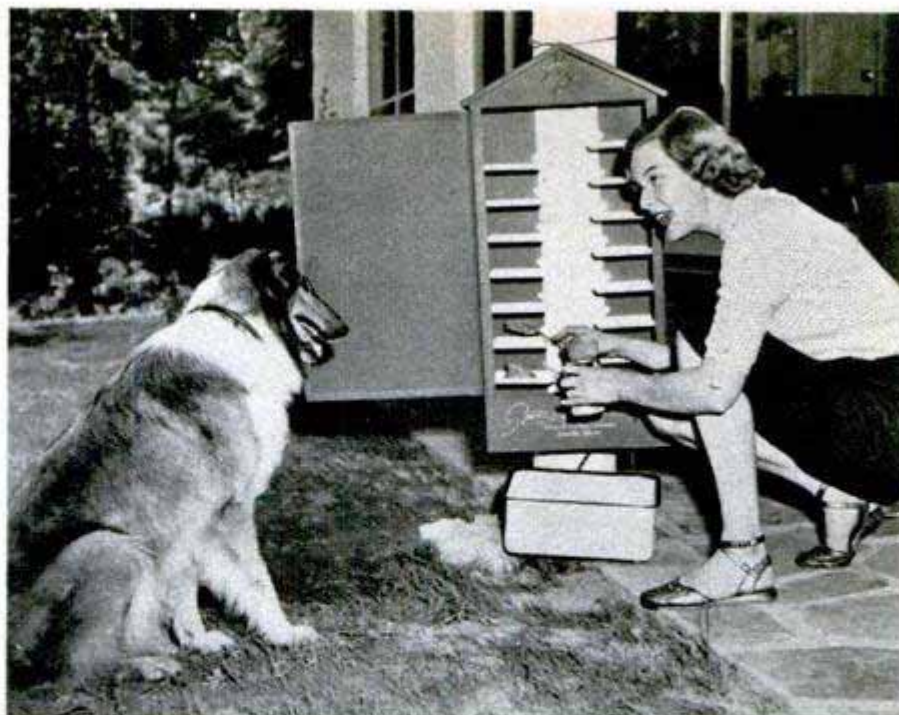

dog. Food remaining on the shelves is covered and can't be reached by insects. The feeder weighs about 32 pounds.

Retired Fire Engine

In Columbia, Mo., a retired fire engine is a stellar attraction on a children's playground. Sold by the city to a civic club for one dollar, the pump-er was polished up, all usable equipment taken off, and all removable parts welded on to make sure they survived prying fingers. Then it was mounted on concrete supports amid the slides and swings of the playground.



Tree Puller

Trees complete with their root systems are scooped out of the ground by a tractor attachment. James Bacon, who owns a small nursery in Lowell, Ind., developed the tree puller to prepare young trees for delivery. The attachment has a sharp scoop which noses down beneath the tree roots, lifts the entire tree and sets it down in the delivery truck. The digger not only speeds tree handling but also prevents heavy damage to roots.



WHAT'S NEW *For Your Home*



SHOWER STALL can be set up wherever there are running water and a drain. It can be connected by garden hose. Attached to the wall with screws, the stall is made splashproof by a wrap-around curtain



HAIR DRIER is an attachment for a new vacuum cleaner. With it, you can dry your hair quickly without heat. The upright is adjustable for height



CORNER BIN makes use of usually wasted corner space in the kitchen. It has ventilating holes to prevent spoilage of fruit or vegetables and it slides out for convenient access

LIKE SHRIMPS? You can clean them quickly with a daggerlike plastic utensil that separates shell from meat with a single thrust

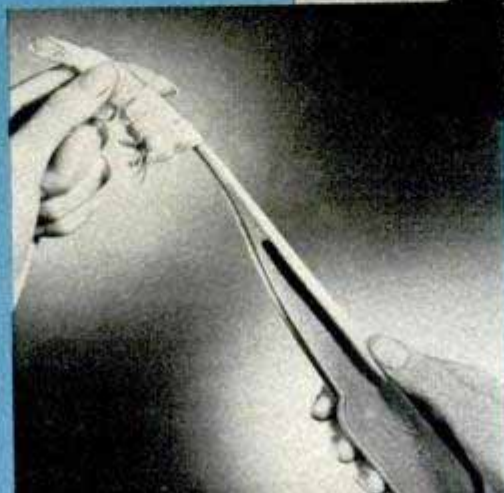

POPULAR MECHANICS

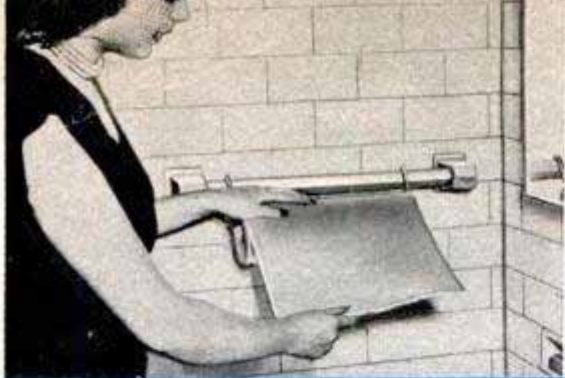

GUEST TOWELS of colored paper come in rolls. The dispenser fits over towel rack

CUT FLOWERS are held in place neatly by granular plastic. It is nonabsorbent

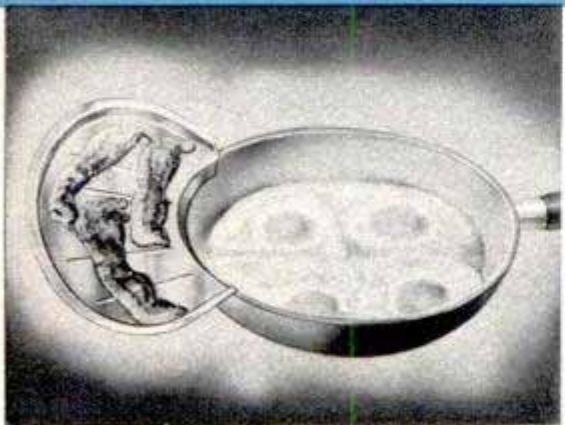

HOT TRAY snaps on skillet, allowing the grease to drain away as food is kept warm

PLASTIC POCKET keeps linen clean and wrinkle-free. Insert makes loading simple

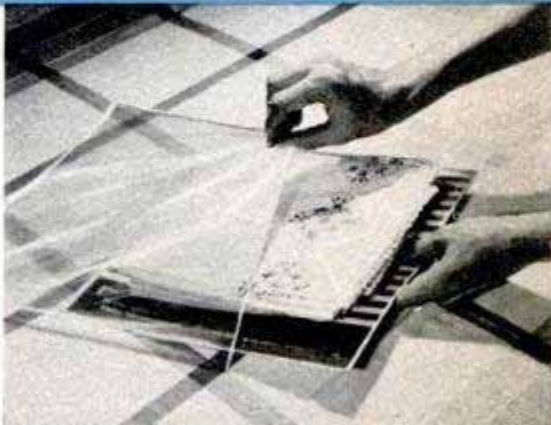

BED that adjusts like those in the hospital lets you eat, read or relax in comfort without extra pillows and backrests. A lever cranks it up



STATIONARY WINDOW can be sealed draftlessly into the wall. The panes slide open. No weights or springs are needed

DEHUMIDIFIER that uses absorbent crystals is molded of Tenite plastic so that it can't corrode. Water collects in base

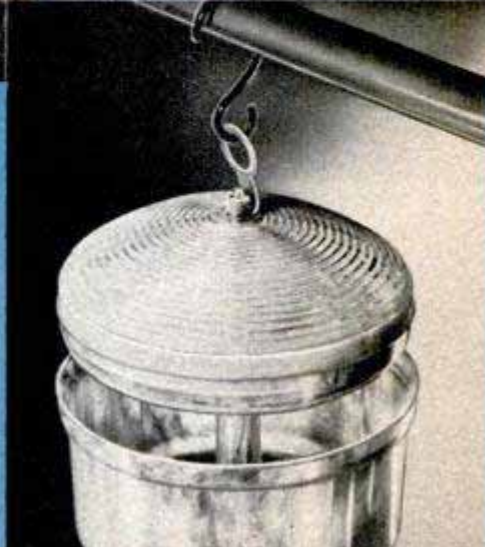
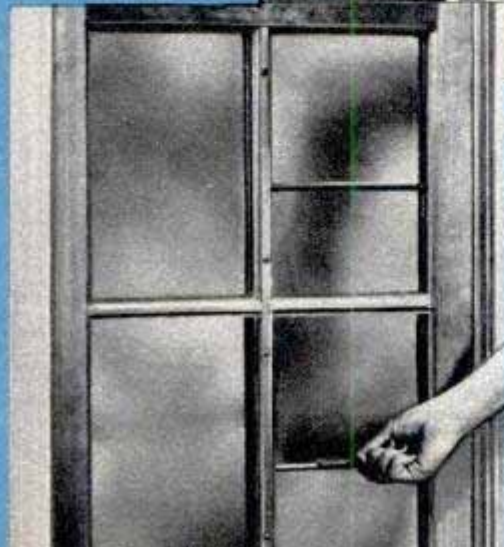

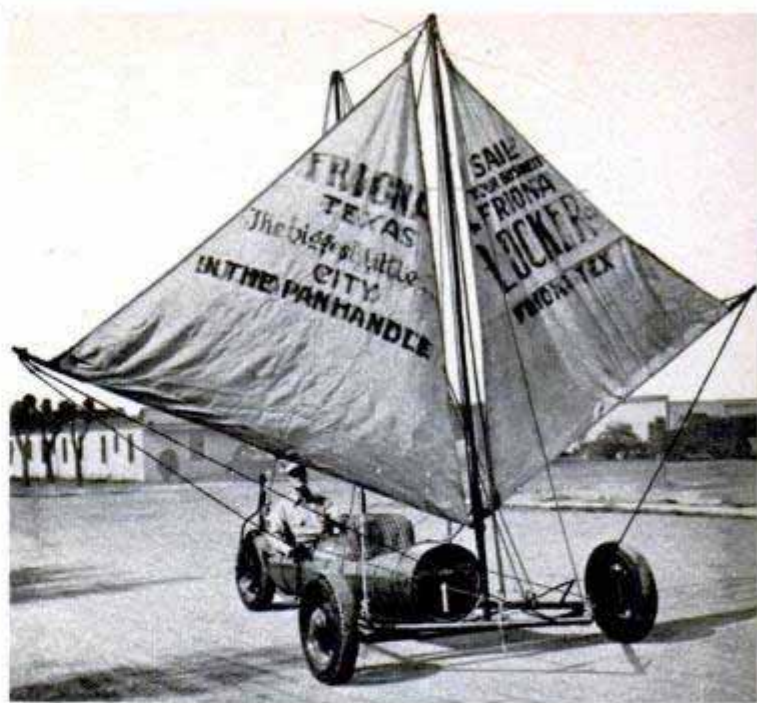

Dry-Land Sailing

Although his home town, Friona, Tex., is miles from any large body of water, Ray Landrum still goes sailing whenever he wants, but in a dehydrated fashion. He sails along the highway in a three-wheeled motorless vehicle called a Windmobile, which was built to his design by a local mechanic. In a brisk crosswind, the dry-land sailer has hit 60 miles an hour. In the

Windmobile, Landrum used the front axle, steering gear, brakes and three wheels from a 1934 Chevrolet sedan. The chassis consists of 1½-inch pipe welded in a triangle. Three oil drums, welded into a long cylinder, form the body. Two cotton sails, both hoisted on one mast, propel the vehicle. A second mast, mounted between the two single seats, serves as a brace for the mainmast. The steering wheel is linked to the single wheel in the rear.

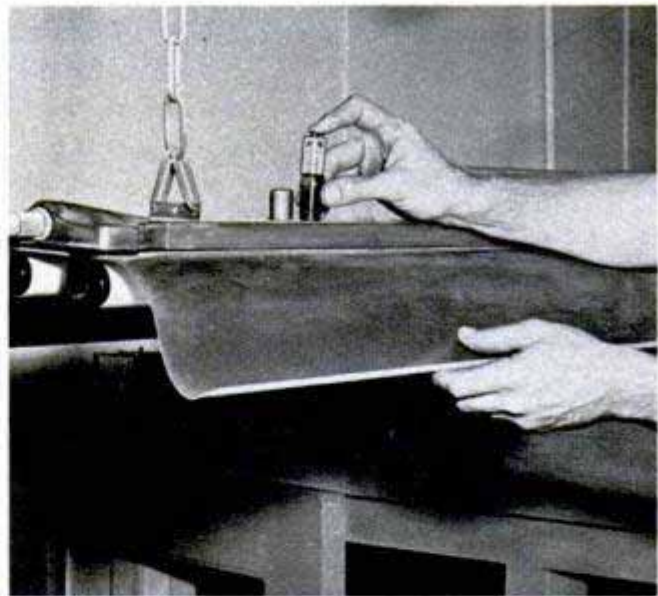
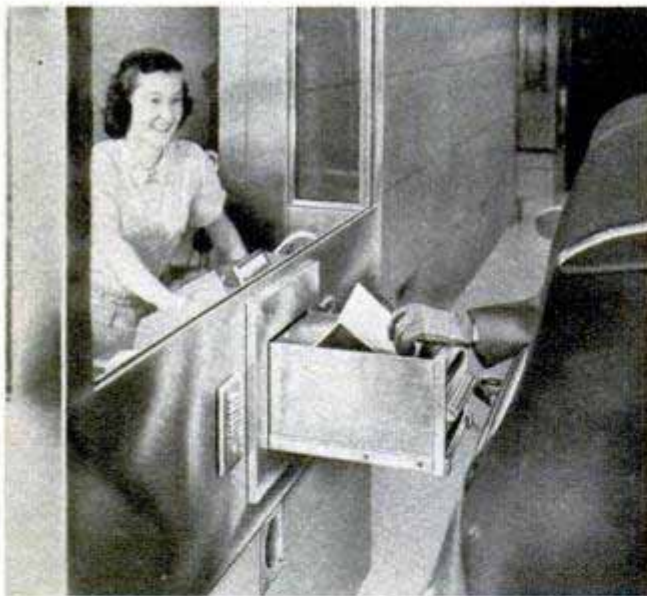

Auto Bank "Reaches" for Cash

Motorists can bank comfortably from their cars at a drive-in bank that has a sliding-drawer depository. The teller pushes the depository out so the motorist can reach inside easily without leaving his seat. He fills out a deposit slip, drops in his money and bank book and that's all. The teller then retracts the depository and makes a record of the transaction.

Fluorescent-Light Tester

Defective fluorescent lamps can be quickly checked with a pocket-size instrument to find out whether the circuit, tube or starter is at fault. Tests are made by removing the starter and inserting the instrument into its socket. If the starter socket is concealed behind the tube, an adapter enables the test device to be used with the tube in its sockets.

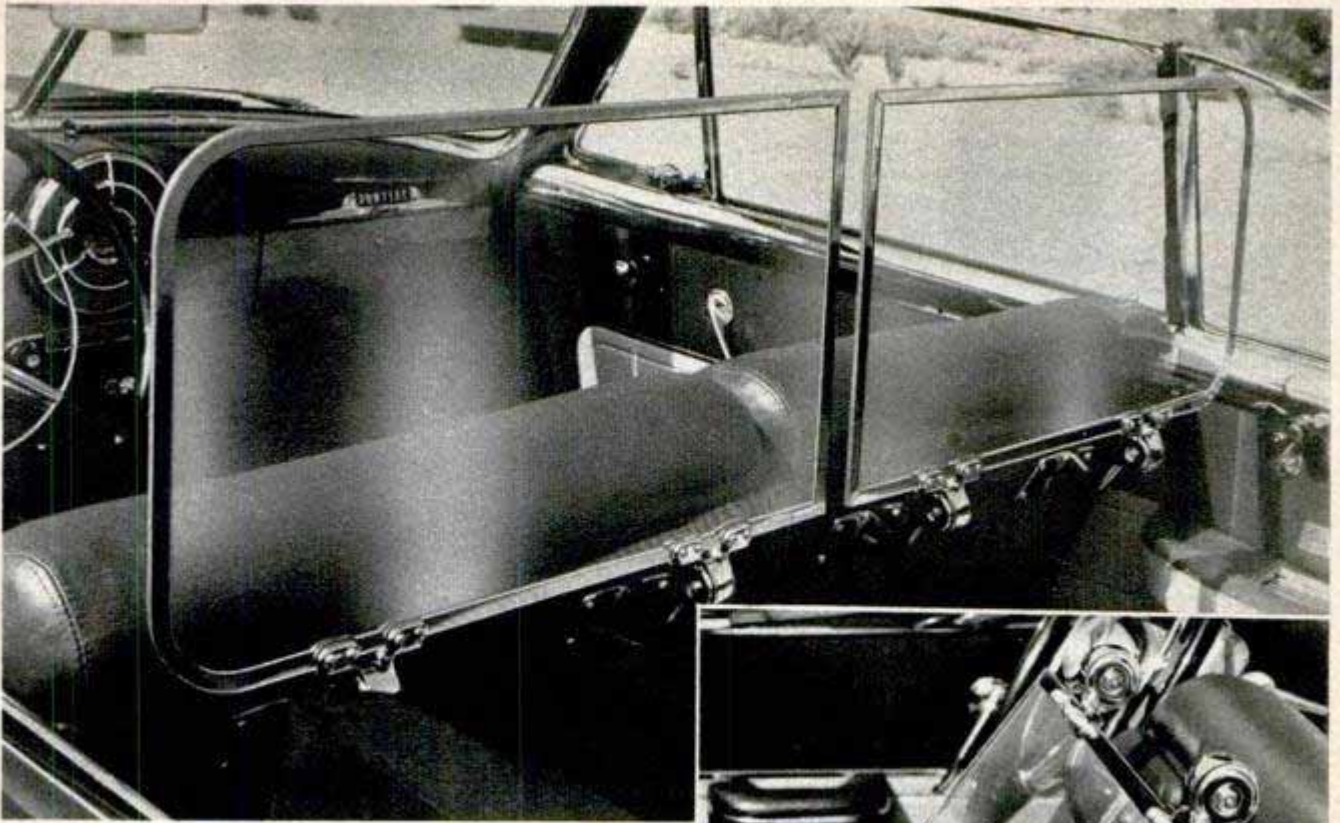

Back Shield for Convertibles Has Paraffin-Friction Hinges

Convertible riders are shielded from any back-of-the-neck drafts by a plastic back shield supported by unusual paraffin-friction hinges. Locknuts are unnecessary as the hinges "freeze" in any position, holding the shield securely. Similar to a multiple-disk clutch, the hinge consists of disks pressed tightly together. One disk is saturated with paraffin, allowing it to open and close smoothly. When the motion stops, the paraffin solidifies, locking the hinge. The shields are transparent plastic framed with chrome for strength. They can be swung down against the back of the front seat when not needed.

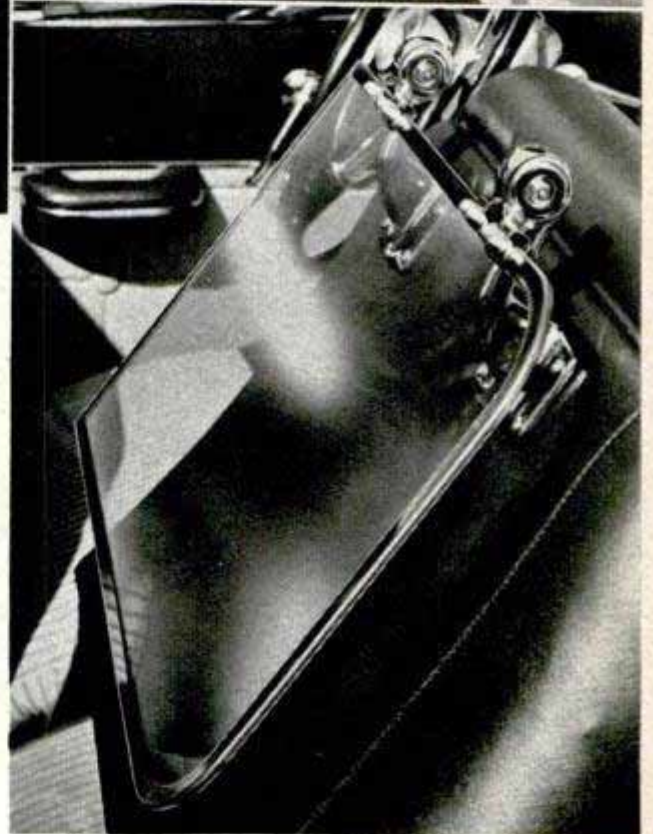

Life Without Germs In a Laboratory

At the University of Notre Dame there are some laboratory animals living in a world apart—a world without germs. Their world consists of a giant tank, large enough to hold 1000 animals, which has been made completely germfree. Attendants and scientists who must enter the tank to feed and examine the animals do so by diving through a germicidal solution. They also wear plastic suits and masks which completely enclose their bodies. The scientists hope to discover how much longer the animals will live if they are kept in a germfree atmosphere.

Three-quarters completed, by 1953 the CAA's system of fixed air "highways" will crisscross the entire United States

Small omni-range antenna is the only additional exterior equipment needed to use new simplified navigation system

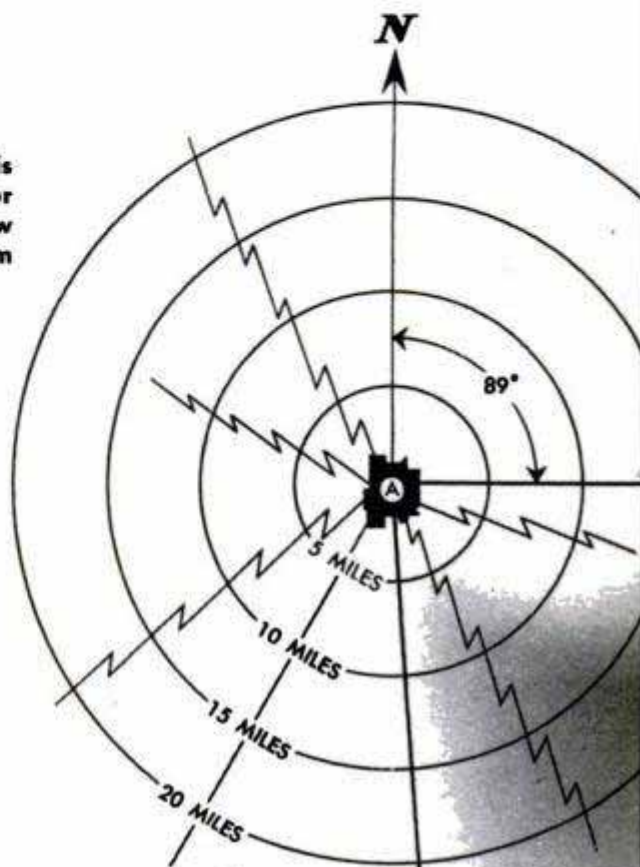

Skyroads to Everywhere

By
Aubrey O. Cookman, Jr.

52 MILES

IN TWO YEARS the sky above the United States will be crisscrossed by a vast network of straight, sharply defined "highways"—longer and more numerous than those on the ground below. Plainly marked and easy to follow in even the foulest weather, they'll offer scores of through routes to both coasts and the smallest hamlets.

This is no visionary's pipe dream. It is already three-quarters completed. Called omni range, it is a major part of the Civil Aeronautics Administration's new Common System of Air Navigation, an all-embracing traffic-control program that may do for the airplane's popularity what hard roads did for the automobile.

The Common System will help all airmen, from week-end putt-putt pilots to commercial veterans and the jet jockeys of tomorrow's bombers. Its goal is to make travel in the airspace over the nation's 3,022,387 square miles reliable and safe at all times. The overall plan won't be fully implemented until 1963.

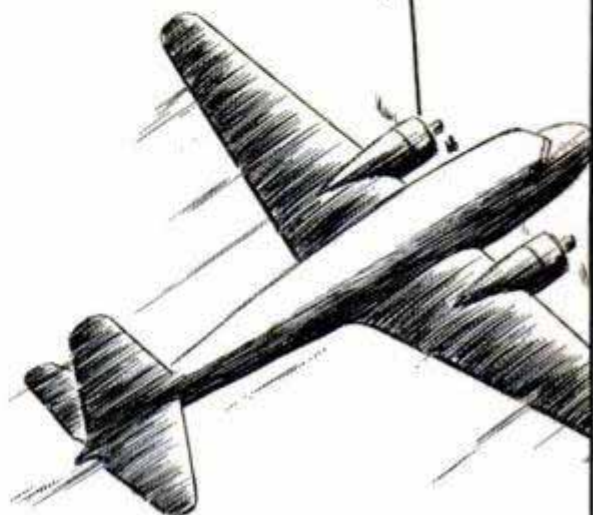

Three of its elements, distance-measuring equipment, the course-line computer and the instrument-landing system, require airborne equipment that will probably make them primarily useful to the large-plane users. Others, like ground controlled approach and the automatic direction finder, are now available for all with radio or a very-high-frequency voice transmitter.

Already operating, the omni range will be of direct value to the greatest number, some 85,000 private flyers, and potentially helpful to all air travelers. The "omni" in its title points up the fact it transmits fixed radio courses, or tracks, in all 360 degrees of the compass. The outmoded low-frequency system, which has been used since

aviation's babyhood, provides only four.

To show how the system works, let's pretend you fly your own small plane. You want to go from Oklahoma City to Mansfield, Ohio, on business and are taking the wife and daughter along.

Mansfield is about 900 miles away on a straight line, a long trip in a craft that will average under 100 miles an hour and require two or three fuel stops en route. Before omni it would have meant course plotting about a half dozen sectional maps, plus time-consuming compass and wind computations. Even then, the chances of flying a reasonably straight course would have been remote. And for 10 hours or more your ears would have been plagued by a monotonous "dit dah" radio signal.

Flights to places not having omni-range or distance-measuring equipment are guided by the course-line computer. This electronic calculator uses facts established by omni and DME in computing third side of triangle. Example below shows instruments as plane flies to right then left of course, finally finishing on correct path

CITY A (EQUIPPED WITH OMNI RANGE AND DME)

CITY B (NOT EQUIPPED WITH OMNI RANGE OR DME)

DME INDICATOR
(DISTANCE TO GO)

LEFT-RIGHT INDICATOR

76 MILES

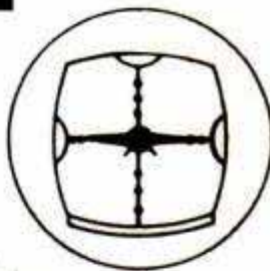
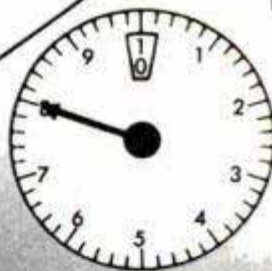
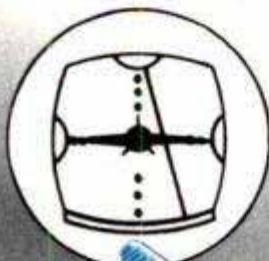
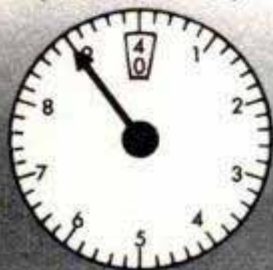

94 MILES

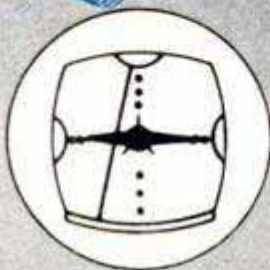

CAA inspector Paul McDonnell points out simple panel instruments for omni range. Left-right needle is at left, and dial at right combines heading, to-from reading

Now the trip can be much simpler. A glance at an aeronautical chart shows a string of stations at Tulsa, Okla., Neosho, Springfield and Vichy, Mo. Loogootee, Ill., Terre Haute and Indianapolis, Ind., are also directly on your path. Spreading out from each, like the spokes of a wheel, are 360 separate courses—as fixed in space as if they were built of concrete or steel.

Four basic instruments are all you need to make use of omni. Airborne over Oklahoma City, you twist a dial to tune in 115.5 mc., the local omni-range frequency. On the bearing selector, graduated to 360 degrees, you stop at 48. That's the outbound heading or "track" to your first guidepost at Tulsa.

You next watch a vertical needle, hinged at the top, until it is centered. Then you are on the track to Tulsa. Since it runs two ways, how do you know for sure which direction you are headed? A side-hinged needle swinging to "from" or "to" answers that one.

Unlike the four-course, low-frequency system it is replacing, omni operates high on the radio spectrum, between 112 and 118 megacycles, free of static that grows worse in bad weather—when navigational help is most needed. Even when storms rage, the Morse Code and voice identification signals are as distinct as ordinary telephone conversation. Voice instruction may take over completely in the future.

Transmissions follow a "line of sight" path, like television and FM radio, but the

sending units do not similarly have to be located on tall towers or buildings, since the receivers are thousands of feet above the earth. Maximum reception is approximately 200 miles at 20,000 feet. By 1953 over 400 of the stations will be strategically spaced across the country, all with overlapping tracks.

From here to Indianapolis your navigational problem is surprisingly simple. Twist the bearing selector to each of the en-route stretches of track you want in turn, then keep the vertical needle centered to hold the track.

You're satisfied now that you're on the correct permanent air road and headed the right way. The map even shows what crossroads, rivers and hamlets you'll pass over. But you're curious about the mileage to the first guidepost, Tulsa.

See that dial on your instrument panel, the one resembling an automobile mileage meter? That is DME, distance-measuring equipment, another of the Common System's helpers. It works on the radar principle, with a pulse from the airplane triggering a responding pulse from a ground station. The distance between you and the station is computed by the time lapse between the signal and the response. There will be DME units at all omni and many ILS sites, with 450 of them already ordered for 1952 installation.

With a little extra effort you can pinpoint your location on an omni track even without DME. While the magnetic compass holds the heading, another range station to the right or left is tuned in and the bearing selector turned until the needle centers. The selector now shows the second omni range's bearing and you draw

Plastic dome eight feet in diameter and seven feet high will house omni antenna, solving the problem of a weatherproof covering that would not distort the signals emitted. Surmounting it will be DME antenna

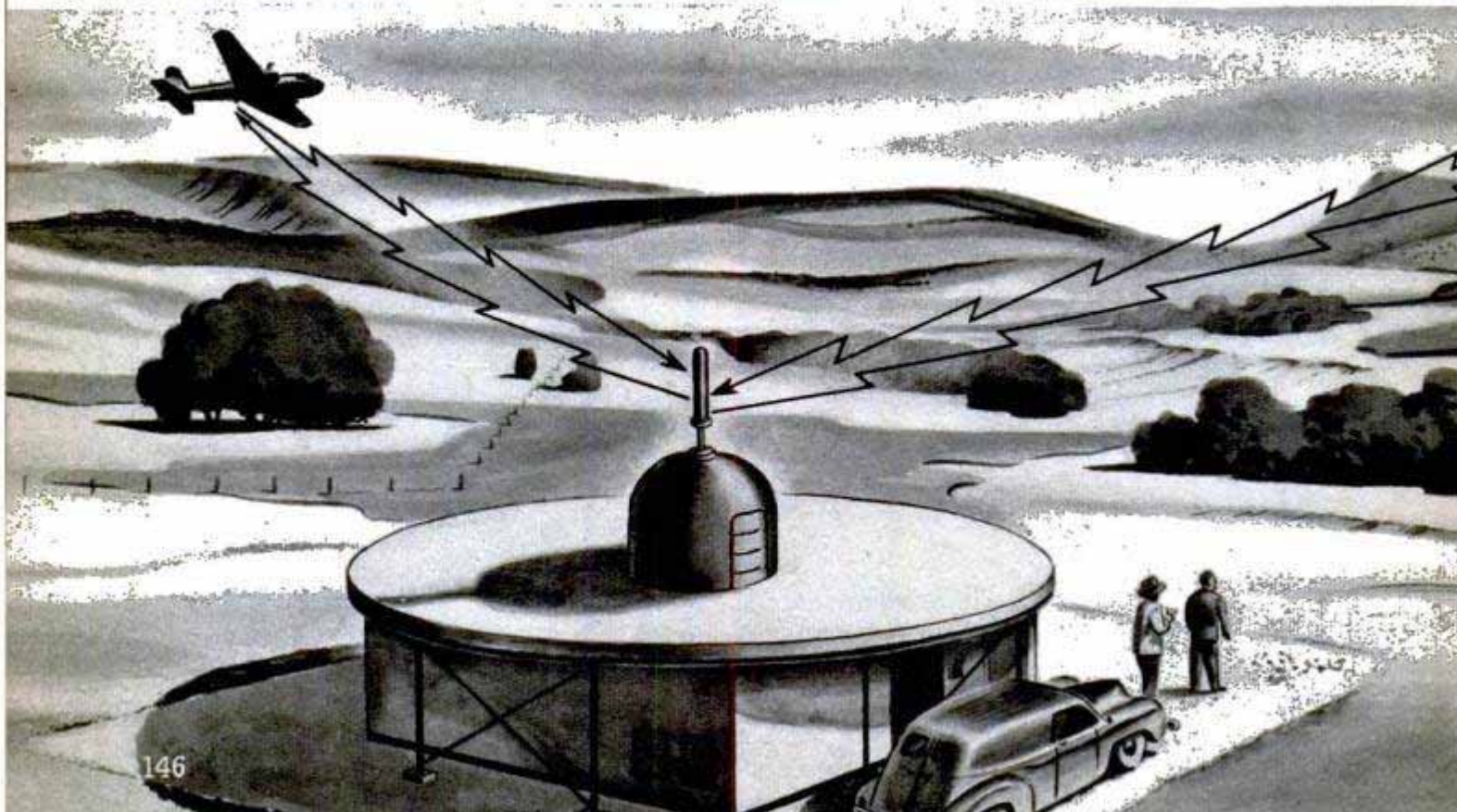

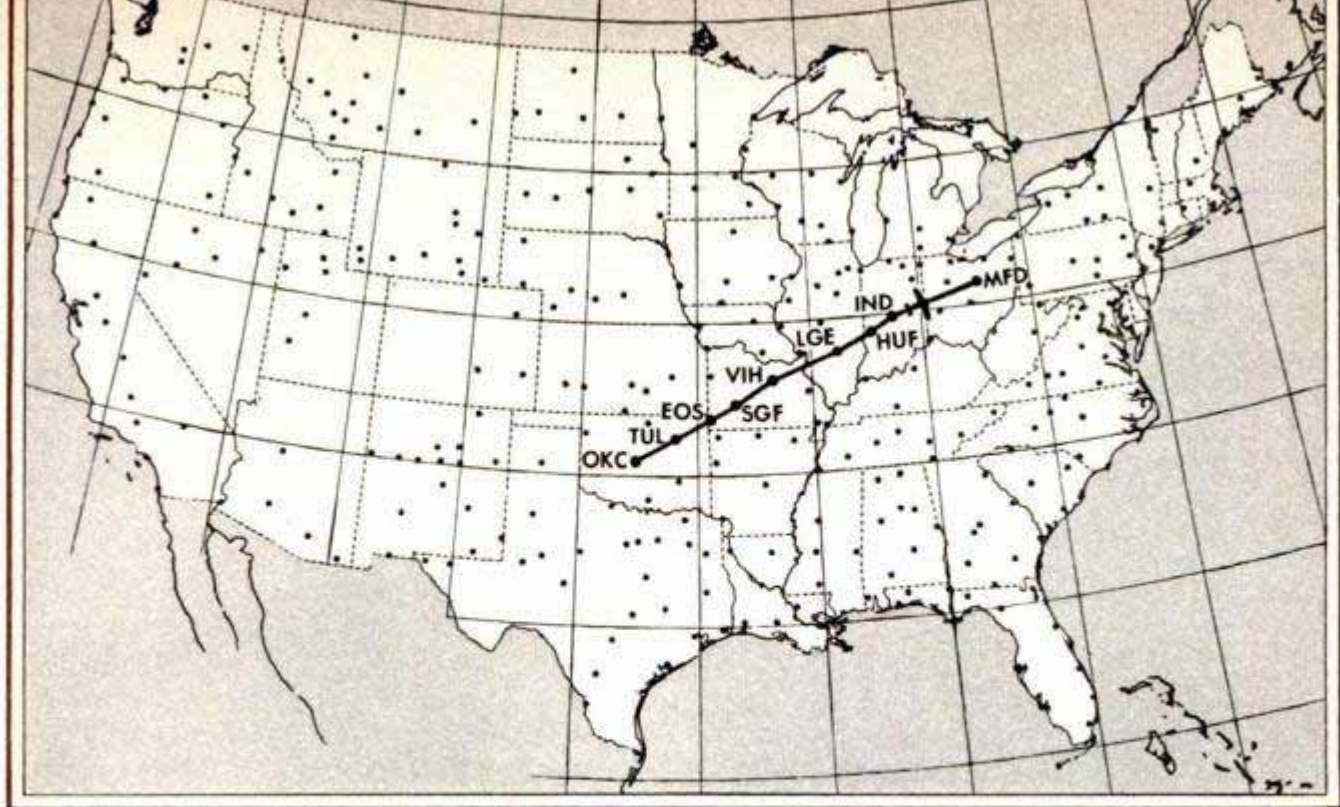

Path of flight author describes between Oklahoma City and Mansfield, Ohio, relying entirely on omni directions

a line to it. The point at which the new line intersects the original track is your present position.

Now you've completed three quarters of the trip and passed over omni stations at Tulsa, Neosho, Springfield, Vichy, Loogootee, Terre Haute and Indianapolis. For simplicity, you've stayed strictly with the omni tracks and yet flown on almost a straight line toward your destination.

The next straight-line omni site is Mansfield, over 200 miles away. By climbing above 5000 feet you could bridge this last and longest gap, staying in touch with In-

dianapolis omni until you picked up the Mansfield signal, and remain on the system of interconnecting tracks you've been flying. But you and the family want to fly below 5000 and continue enjoying a close look at the rolling countryside.

For a quick solution you turn to another new navigational aid, the course-line computer. This electronic calculating machine

(Continued to page 252)

As many as 28 voices can be recorded on a magnetic paper tape a little more than 1/2 inch wide. It registers all conversations between pilots and control tower

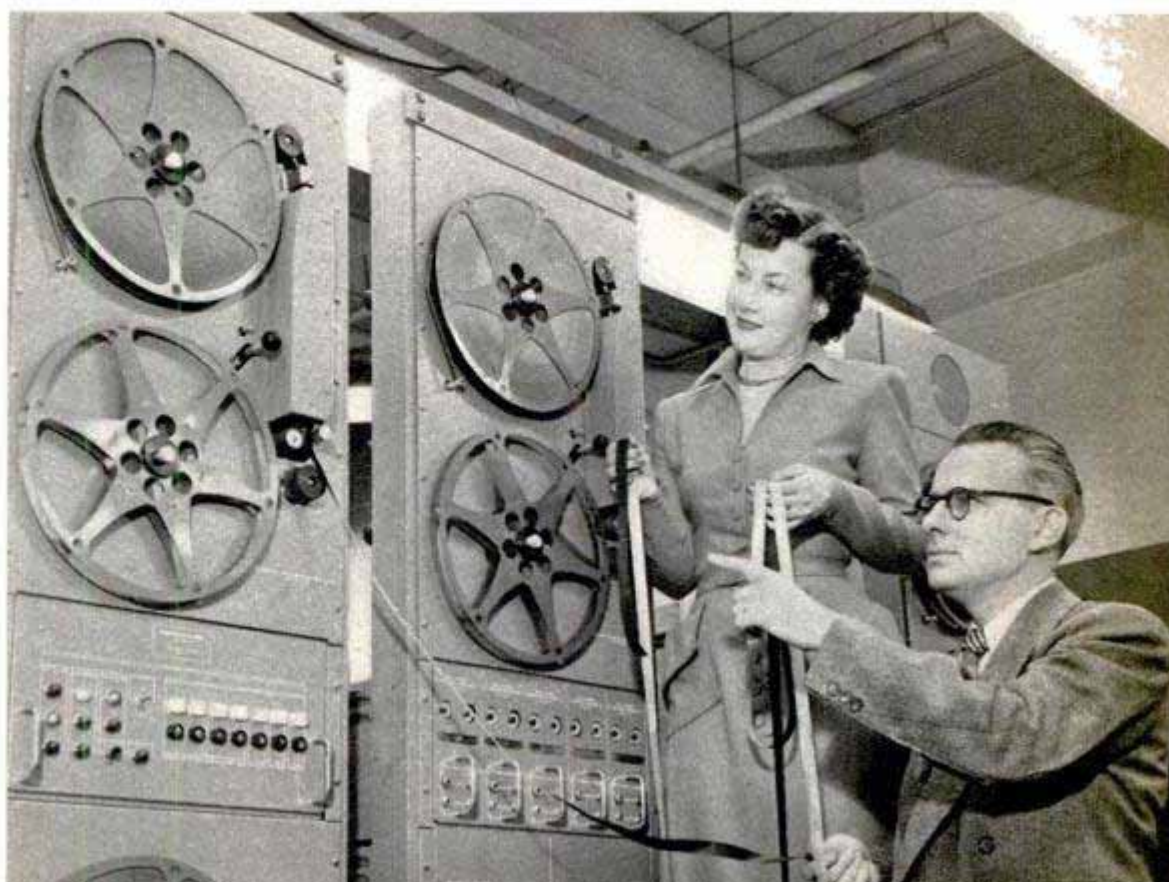



"Big Ben" Made of Paper

"Big Ben," the famous clock tower which rises above the Houses of Parliament in London, now has a seven-foot counterpart weighing less than two pounds. The model, built by E. Whiteside, is made of paper. Whiteside scaled it, item by item, from a large photograph. Made in sections, the miniature "Big Ben" can be dismantled and moved easily.

Tennis Trainer

Easily and quickly set up on any lawn or beach, a tennis-training device permits practice without a partner. When the suspended ball is hit, it snaps back like a returned volley toward the practicing player. Guy wires hold the trainer in place.

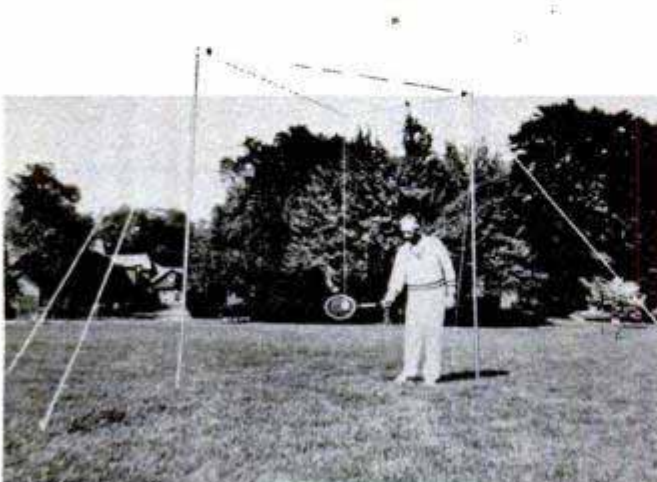

Snack Tray for Car Hangs From Dashboard

Travel snacks can be enjoyed while the car is in motion with a dashboard tray which prevents cold drinks or water glasses from tipping over. The tray hangs from two cords which are held on the dashboard by suction cups. Bottles or glasses rest on two disks which are suspended below the tray on chains. When not in use, the tray can be folded into small space for storage in the glove compartment.

Stereoscopic-Slide Viewer Has Built-In Light Source

Three-dimensional color transparencies are seen under perfect lighting conditions when an illuminator is attached to the back of the viewer. Two flashlight batteries supply the current for the bulb. Concave coated reflectors provide diffusion, eliminating hot spots. The illuminator is easily attached to a standard View-Master stereoscope.



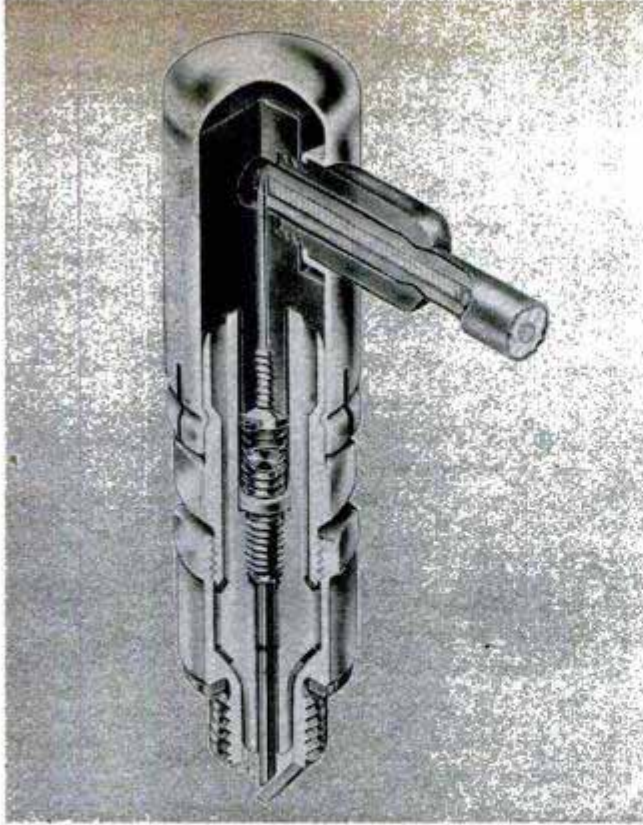

Shielded Spark Plug

Its insulator and terminal completely enclosed in a steel shell, a shielded spark plug is waterproof, shockproof, virtually unbreakable and does not interfere with radio reception. Available for any standard gasoline engine, the plugs are protection against starting failures due to wet and oily insulators. The snap-on waterproof cover is permanent and does not have to be replaced when the plug itself is worn out.

Radio-Controlled Lawn Mower Lets Inventor Loaf in Shade

Engineer Paul Rosenberg of Reo Motors has designed a remotely controlled power mower that obeys every command of an operator as much as 50 yards away. Mounted on it are a 25-pound high-frequency receiving set and battery, with a small antenna. The operator has a one-watt transmitter with two small keys that control start, stop and direction. A pivot wheel at the rear enables the mower to make 360-degree turns and it will cut within 1½ inches of obstructions. The transmitter can be carried in a knapsack or placed on the ground or floor while the user manipulates the controls. The mower would require an \$800 to \$900 price tag and Reo has no immediate plans for production.

☐ Replacing the conventional, harsh-sounding horn on a diesel locomotive, an experimental whistle sounds five different tones to produce a musical chord.



Sipper With Built-In Refrigerant

Every swallow is chilled when drinks are sipped through a novel aluminum tube containing a sealed-in refrigerant and tipped with a Tenite plastic mouthpiece and end. The sipper is kept in the freezing compartment of the refrigerator prior to use and its contents allowed to freeze solid. There is no dilution of the beverage and the plastic mouthpiece protects lips from frostbite. It is made in several colors and is easily cleaned and dried.

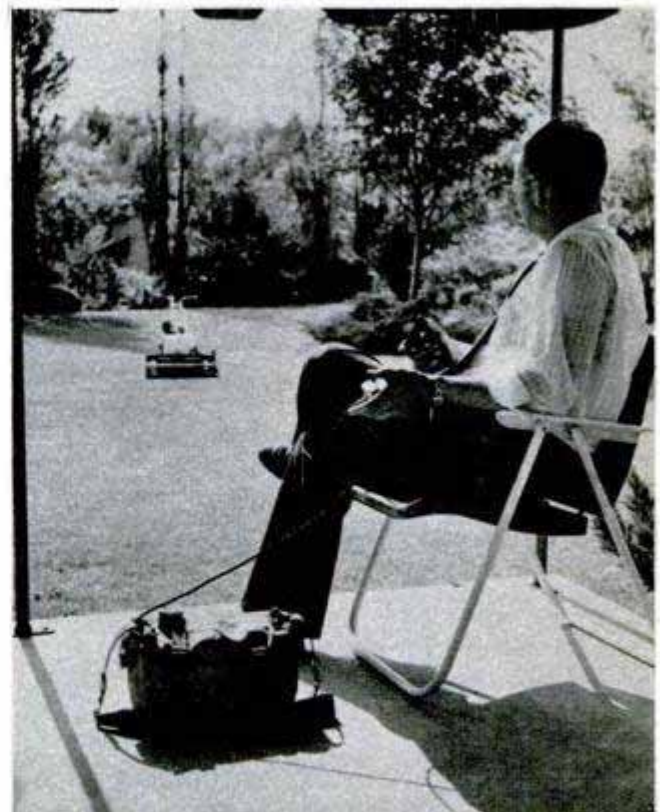

RUSSIAN TANKS

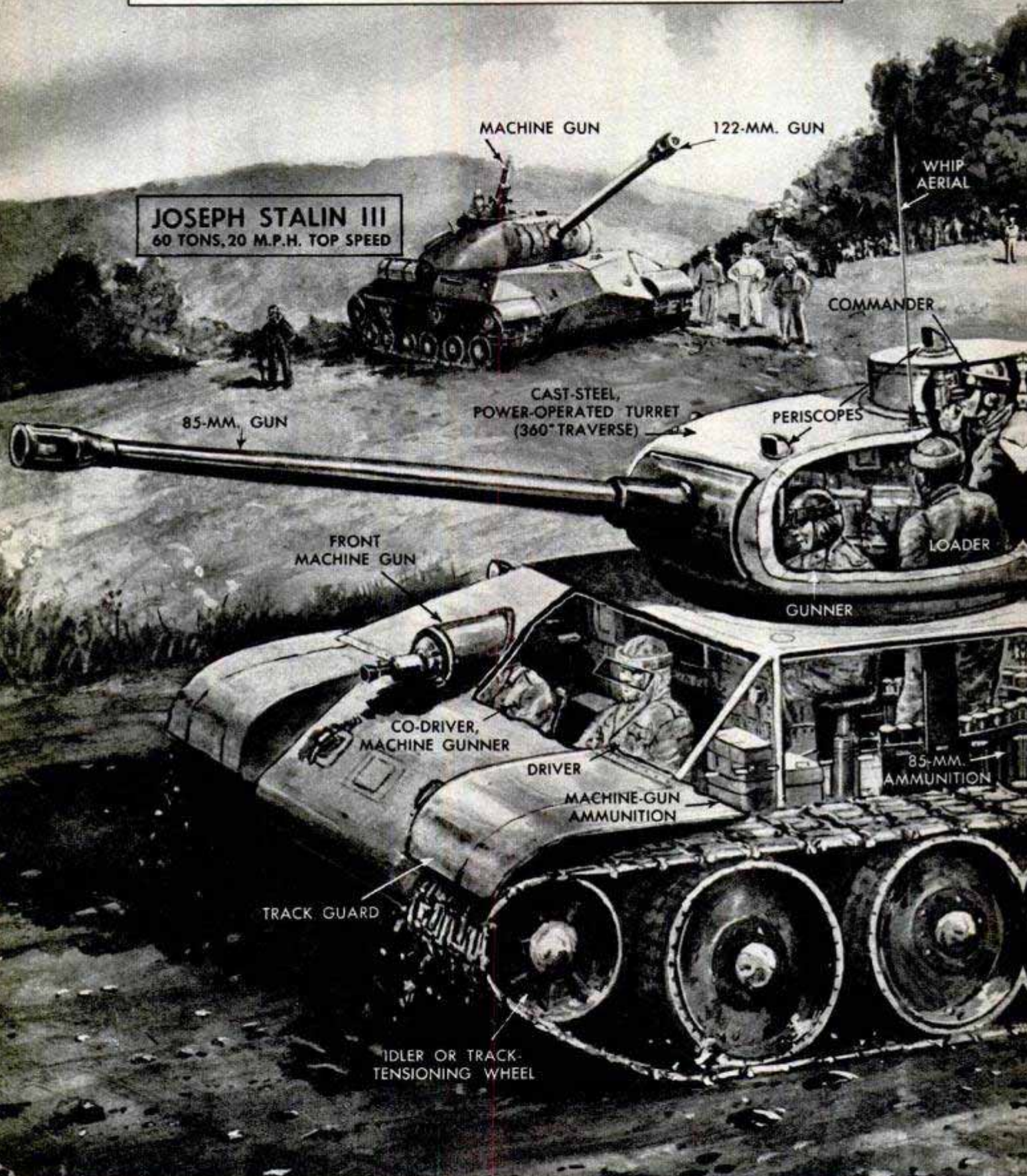

OUTSTANDING in number and effectiveness among the powerful ground armor used by North Korean forces in the opening phases of the Korean war was the Russian standard medium tank, the T-34, whose identity was fully authenticated by a number of captured examples. In the

foreground above and to the right are two illustrations of it, with one cut away to show the interior arrangement. The T-34 has been used by the Soviet army for nearly 10 years, with the most modern types radically improved by a different type turret, a heavier gun and carrying a crew of



T-34 MEDIUM TANKS
34 TONS, 30 M.P.H. TOP SPEED

five instead of four. It weighs about 34 tons and has a V-type 500-horsepower diesel engine that gives it a speed of 30 miles an hour. A heavier tank, not yet officially confirmed as the Joseph Stalin III, also was reported in the early action. Shown in the background above, the Stalin is the stand-

ard Russian heavy tank and an example of it crowns the Soviet war memorial in Berlin. It is described as one of the most powerful tanks in existence, weighing 60 tons—about 10 more than either the General Patton or the British Centurion—and mounting a long-barreled 122-mm. gun.

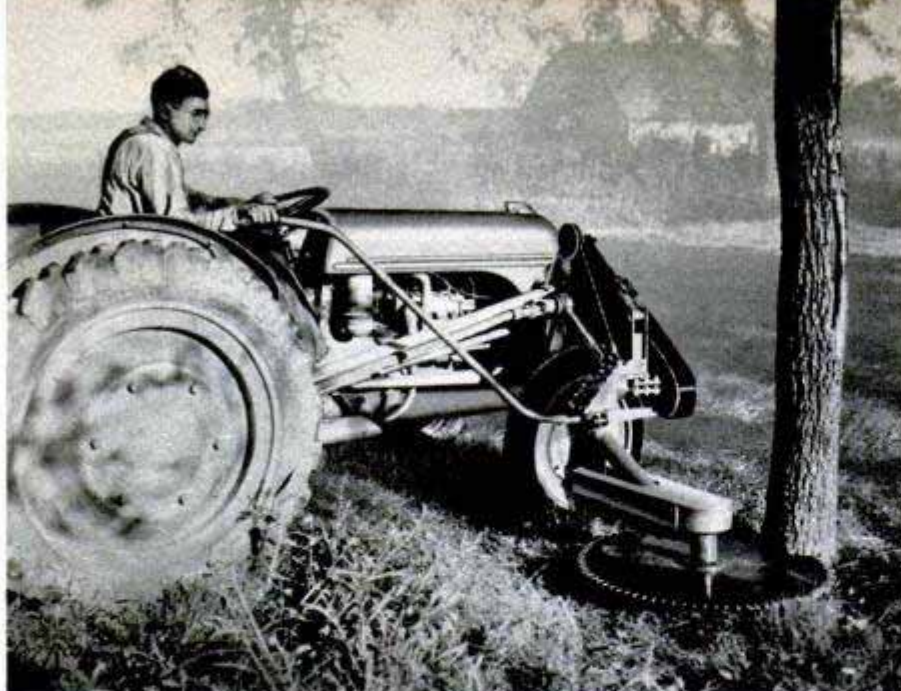

Tractor Saw

Without leaving the tractor seat, the operator can fell trees and cut brush with a saw attachment that is driven by the power take-off. The saw assembly mounts beside the front wheel and the blade is fed into the tree by a long lever that extends back to the driver's seat. A hydraulic system raises and lowers the blade. For cutting trees, the tractor must remain stationary, but in brush removal it can be driven forward at low speed while the saw is in operation.

Hidden Radiators Keep House Warm

Homeowners can install their own hot-water heating system in new or existing buildings now that a simplified low-cost system is available. The installation combines hot-water radiators and small fans to provide forced circulation of air through the radiator fins. Copper tubing is used throughout and the radiators, mounted between the studs flush with the wall, are connected in series to a small boiler. A high-velocity pump circulates the water through the system. There are two methods of control. A standard thermostat turns the heater on and off in

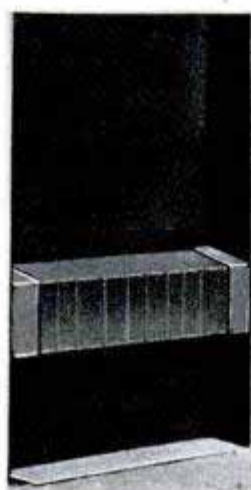

the usual manner. In addition, each radiator has a built-in rheostat to control the speed of its fan. These fans are turned on automatically when the thermostat turns on the heater.



Mechanical "Creep" Aids Fire Fighters

Fire fighters in Ontario forests now have a mechanical packhorse that carries their equipment over rough mountain trails without tiring. Powered by a single-cylinder engine, the track-laying machine will haul 700 pounds of hoses, nozzles, pumps and fuel cans. Steering is done by a dual clutch which throws one track out of gear. Canadian forest rangers have christened the machine the "Creep."

TAILOR-MADE for BULL'S-EYES

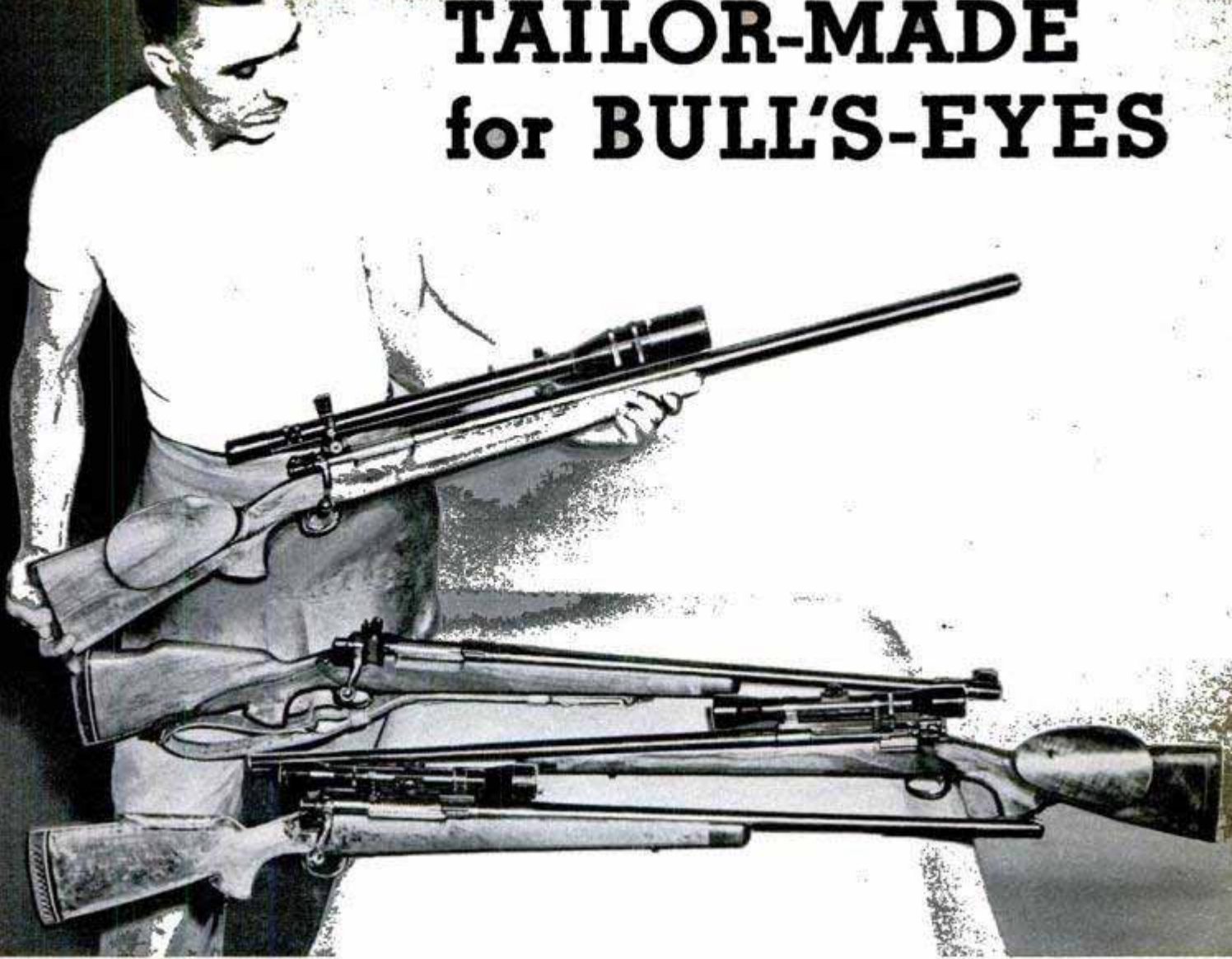

By Andrew Hamilton

EVER SINCE European artisans began building "gunnes" and "gonnes" in the 14th century, skilled craftsmen have been trying to construct a weapon that would pump a bullet into exactly the same hole every time it was fired.

Nobody's ever done it—and, chances are, nobody ever will.

But in the opinion of thousands of "gun bugs" in the United States and elsewhere in the world, the man who has come closest to building a 100 percent accurate, precision-perfect rifle is Joe Pfeifer of Sun Valley, Calif.

More than 90,000 Pfeifer-made rifle barrels are to be found all over the world. The barrels have set a large percent of the world's target records. They've knocked down elephants in Burma, bagged giant Kodiak bears in Alaska, killed pumas in Mexico.

A stocky chap with a shock of black, curly hair, Joe Pfeifer is a good example of a man who has built an interesting hobby into a prosperous business. Gunsmithing was once something he did at night after working hours. Now he spends full time at it as president of a \$500,000 corporation that hums with activity and frequently has more orders than it can fill.

As a kid in St. Louis, Mo., Joe got his first rifle

Four of the straightest-shooting rifles ever made are inspected by Monte Kennedy. In his hands is a 22-250 bench-rest "bull gun." On the table, back to front, are a .375 H and H for big-game hunting, a .220 Swift and a .300 H and H Magnum. All four are tailor-made

This is a world's-record target, made with a Pfeifer barrel. The tiny shot group was made by a rifle 312 yards away. Object of this kind of marksmanship is to group shots together





Kit made by Pfeifer includes the barrel and action above and the unfinished walnut stock with the rolled cheekpiece shown below. The sportsman who buys the kit can assemble the rifle with hand tools and decorate the stock himself

at the age of 12. It was a beat-up old Remington .30-06 caliber that had been used in World War I. But to Joe it was just about the most beautiful thing he'd ever seen. He cleaned it up, repaired the breech mechanism and made a new stock.

After high school he became a machinist and for several years worked at the U. S. Arsenal in Rock Island, Ill., turning out gun barrels for the Army.

In 1935 he came to California and served as an aircraft test pilot. A bad crash put an end to his flying and he turned once again to toolmaking and gunsmithing. For several years he built rifles in his own back-yard workshop. Orders increased so rapidly that three years ago he and Tod Oviatt, former Stanford athlete and one of the founders of Lockheed, set up their own gunsmithing business.

Today, the Pfeifer Rifle Company, Inc., in the opinion of many, is the leading custom gunshop in the United States. The difference between Pfeifer and, for example, Remington is the difference between a small outfit that builds high-speed racing cars and General Motors. One makes a product to the customer's own specifications, the other turns out fine rifles on a mass-production basis.

Located in a light, airy, functional building in the San Fernando Valley about 20 miles from Los Angeles, Pfeifer's shop is equipped with many power-driven machines that perform intricate operations on 100,000 pounds of high-grade steel annually. Some 27 different caliber barrels are

made, ranging from the well-known .22s to barrels for the .600 cordites, the largest rifle shot from the shoulder.

In addition to Pfeifer and Oviatt, the company employs 18 skilled craftsmen—including such men as Homer Brown, former armorer for the U. S. Navy rifle team; Sam May, shop foreman and big-game hunter; and Monte Kennedy, one of the best "stockers" in the country.

A Pfeifer barrel has no distinguishing mark on the outside. But if you look inside, you'll see the Pfeifer talisman: six wide grooves and six narrow lands with a right-hand twist. They're made that way because the smaller the lands, the less metal they scrape off the bullet—and consequently, the more accuracy you get.

A Pfeifer custom-built rifle costs all the way from \$350 to \$1800. Who are the people who buy this kind of highly accurate, precision-built weapon? In general, there are three classes:

The shooters. They're the target and range men who must have the straightest-shooting rifle obtainable. They want a weapon that will put all shots into a small ragged hole at long range. Shooters like Frank Parsons, holder of many N.R.A. records, and Audie Murphy, much-decorated soldier and movie star, use Pfeifer rifles.

The sportsmen. These are the nimrods who require dependable rifles of dead-eye accuracy and heavy striking energy. Howard Hill, the big-game hunter, carried eight Pfeifer rifles on his recent trip to Africa. Dr. Earl J. Thee of Los Angeles used a Pfeifer .300 Super Magnum in bagging the largest Dall sheep ever taken in the Yukon.

The gun collectors. These are the men who love and appreciate fine craftsmanship. They collect guns for the same reason that other men collect fine watches, vintage wines or yachts. They think nothing of paying a thousand dollars or more for a single rifle if it measures up to their standards of beauty. One of these is Lowell W. Saunders, noted Bakersfield geologist, who has one of the finest collections of modern weapons in the United States.

In addition to turning out custom-built jobs, the Pfeifer Rifle Company produces regulation barrels for a number of other American rifle manufacturers and gunsmiths. At the present time, production rate is about 700 per month. So you may get a Pfeifer barrel without knowing it.

Let's follow a rifle through the Pfeifer factory and see just how it is made:

We start with raw bar steel—12 to 20-foot lengths just as it comes from the mill. This is special, electro-furnace tool steel made to Pfeifer specifications. It is heat-treated and stress-relieved.

The 1¼-inch steel bars are cut into bar-

rel lengths and returned on semiautomatic lathes. This process removes 80 percent of the surplus metal and gives the bar a shape roughly comparable to that of a rifle barrel. It also allows complete liberation of any stress in the steel and assures perfect straightness of the bore.

Then the barrel is drilled, reamed, rifled and contoured—giving it a hole down the center and riflings to spin the bullet. Delicate, split-hair accuracy is obtained by modern precision tools made especially for this gunsmithing process.

Next, the barrels are individually fitted to the receiver, and the breech to the action, sights are set and corrected, and the metal finish blued so that a flash of sunlight on the barrel will not frighten game. A special method of etching provides a 700 percent greater area for blueing oxides, resulting in a soft, long-wearing finish.

Finally, the stock is fitted to the action and barrel. Walnut and maple wood from the eastern United States are most often used for gunstocks, although occasionally rare walnut woods from France, Italy and Austria are used on special jobs. When necessary, a whole tree is bought to get choice wood for one rifle.

The rifle is now ready for shipping—and it may be sent anywhere in the world, so widespread are Joe Pfeifer's customers. An average production barrel requires about 10 man-hours of work, the stock about three man-hours. A specially designed and executed barrel and stock, though, sometimes run as high as 100 man-hours.

The secret of Joe Pfeifer's success as a custom

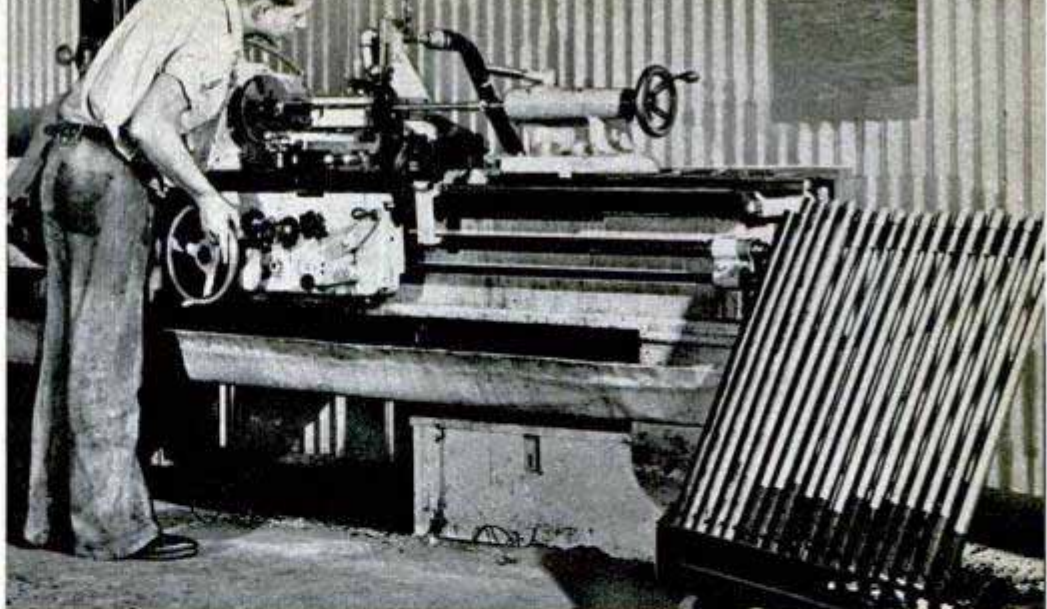

New barrel is started on a preturning lathe, which removes 80 percent of the metal from the special bar stock and produces a rough barrel shape

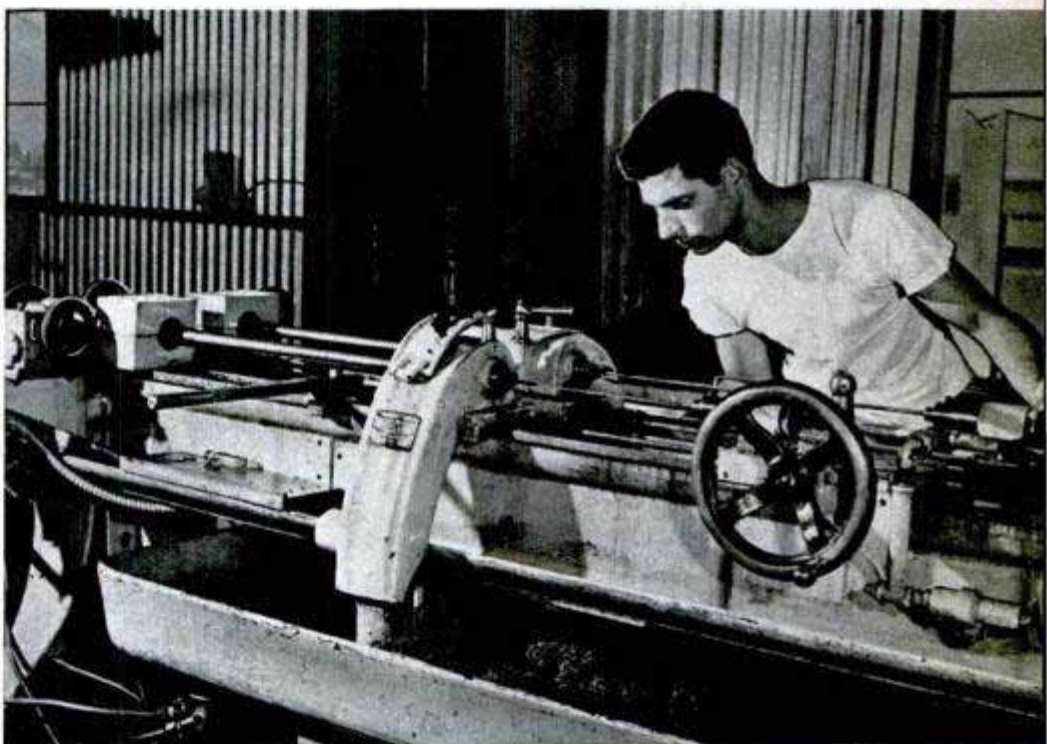

In next step the barrel is revolved against a hollow drill to produce the bore. The machine has split-hair accuracy. Below, the rifling machine produces the six narrow lands and six wide grooves inside the bore



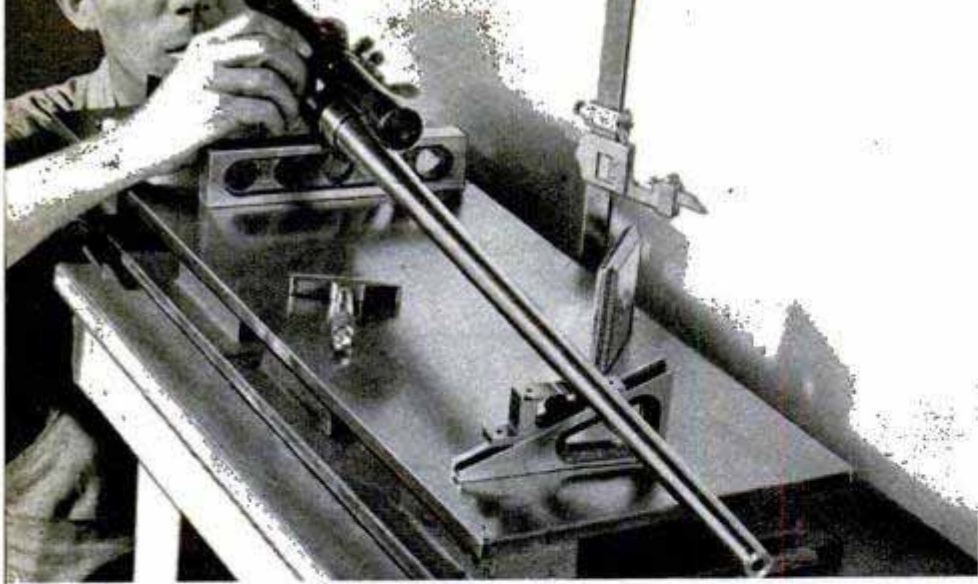

Top-notch gunsmith installs and aligns telescopic sight. Even the finest barrel will be inaccurate if sight isn't in perfect alignment

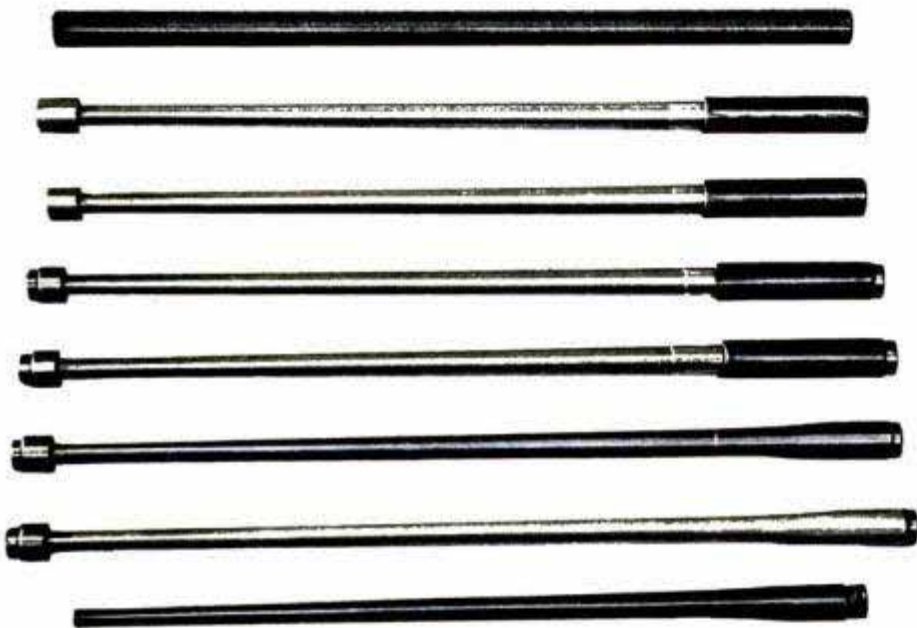

From top to bottom is a barrel in eight stages of manufacture: the raw-steel blank; pre-turned barrel; drilled; reamed; rifled; contoured; surface ground; and the finished barrel. Below, mechanism is fitted to stock. Right, hand-checkering adds beauty to the stock



gunsmith is that originally he was a machinist and toolmaker—and a good one. Today, he designs and makes all his own machine tools and thus is able to obtain the highest precision and accuracy.

His toolroom in one corner of the Pfeifer shop is fitted with a Rockwell hardness tester, a Pratt and Whitney precision measuring instrument accurate to 1/200,000 inch, a Bausch and Lomb microscope, Johansson gage blocks, several precision-grinding machines and hand-finishing tools.

In the several hundred custom-made rifles Pfeifer has built, some have been bizarre and beautiful specimens.

A Sacramento deer hunter who normally shot right-handed injured his eye in an automobile accident. He couldn't seem to learn to shoot left-handed. So he ordered a rifle that could be put to the right shoulder, but aimed with the left eye. It required a specially built stock with an eight-inch "cast off" in it.

Paul Mantz, the well-known speed flyer, has ordered a .270-caliber weapon that will probably be the most beautiful ever built. It will have four Mexican \$50 gold pieces, four Mexican \$20 gold pieces, a fleur-de-lis design in gold and the initials "P.M." mounted in gold on the stock.

(Continued to page 246)



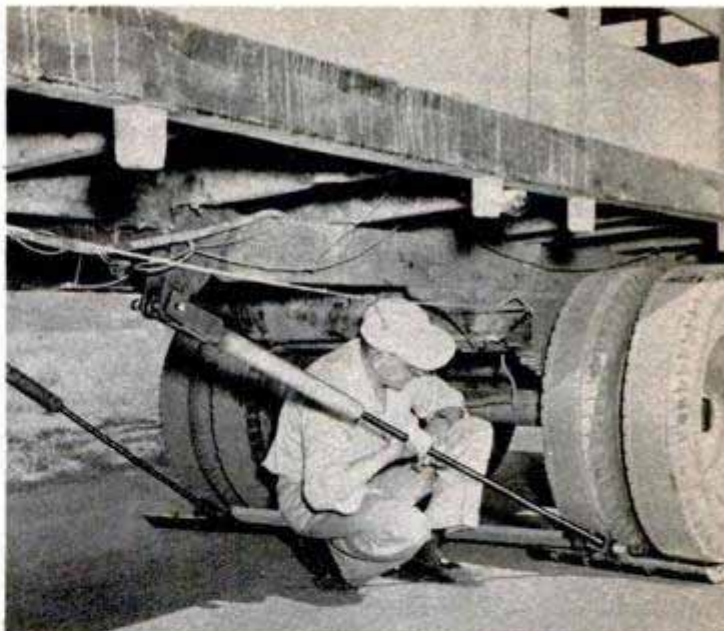
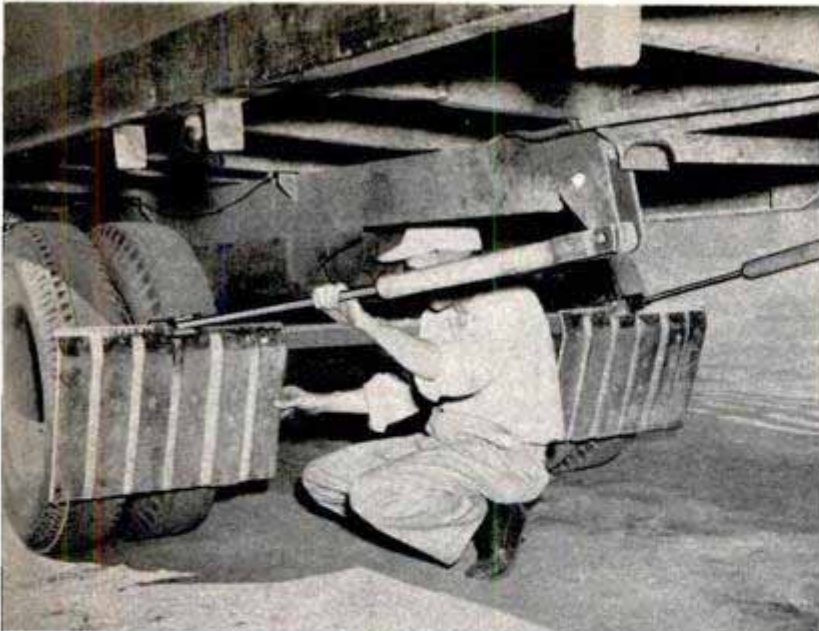

Emergency Brake Stops Truck

Completely independent of the regular brake system, an emergency brake for trucks will stop the vehicle quickly and safely when regular brakes fail. Designed to prevent runaway trucks, the braking device consists of a pair of steel plates that drop under the rear wheels. The combined area of the two plates is approximately the same as the braking area of the truck's

tires, so the vehicle stops in about the same distance as it would with full action of its regular brakes. Connecting rods between the plates and the truck body guide the plates into position under the wheels. These rods have heavy springs inside them to reduce the strain on the truck body as the brake plates take hold. The undersides of the plates are shod with rubber to prevent damage to the highway when the brakes are applied.



Strips Guide Typists' Fingers

Guide strips that separate the keys into finger groups are now available for typing students. Made of Lumarith, a Celanese acetate plastic, they are attached to a metal strip that fits in the back of the keyboard of any standard typewriter. When the fingers are correctly placed on the "home" keys, they can hit only the correct letters and numbers.

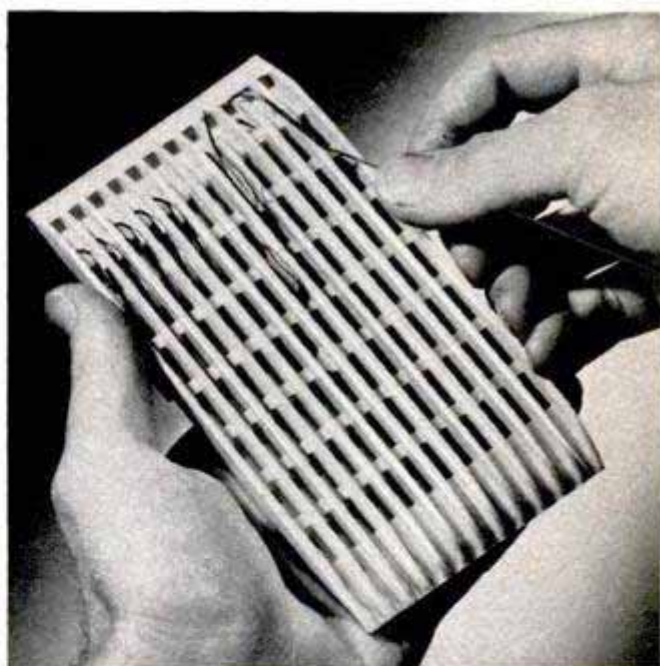

Hook Holder

There are no tangled leaders and no exposed barbs to bother the fisherman when he carries his hooks and flies in a slotted plastic holder. Made of Tenite, the holder has 12 lengthwise slots intersected by seven crossbars on which hooks can be mounted. The leaders are drawn over the end of the holder and around to the back where they are looped over spring-operated pegs.

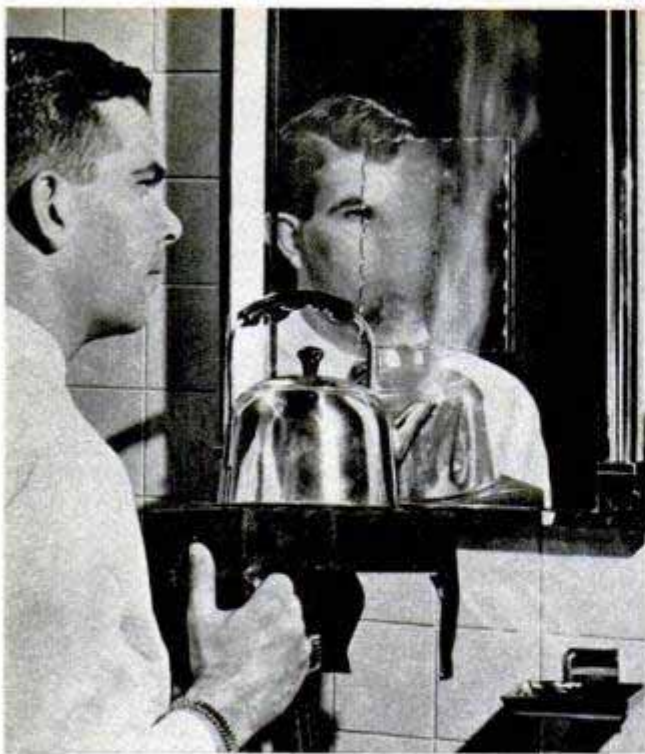

Steam from kettle condenses on regular mirror panel set in center of antifog mirror that stays clear

Antifog Mirror for Bathrooms

Irate shavers who find the bathroom mirror steamed over by someone else's shower now have an answer to their problem. Steam won't condense on a new "electrical mirror" which forms the door of a wall-type medicine cabinet. Behind the mirror is an electric heater made of an electrically conductive rubber which warms the glass to a temperature of 98 degrees—high enough to offset the condensation of steam. The rubber heater is turned off and on with a switch mounted in the corner of the mirror. It uses about the same amount of electricity as a 60-watt bulb.

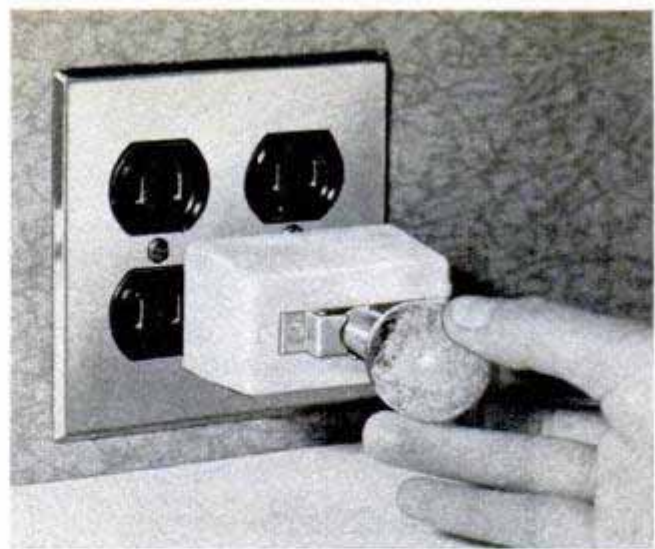

Flash-Bulb Tester Serves as Night Light

You can test flash bulbs, Christmas-tree lights, fuses and regular light bulbs on a testing device that also serves as a night light. A small bulb inside the tester glows if the bulb or fuse being tested is in good condition. When used as a night light, the tester gives off a diffused light from a six-watt bulb inside the plastic shell.

Hot-Air Fog Dispersal

Furnace-heated air, blown skyward by electric fans, is the heart of a new fog-dispersal system devised in England. The air is heated to 1200 degrees Fahrenheit and driven through a series of concrete ducts to discharge nozzles along the runways. It is estimated that it will push a low-lying fog to the 150-foot minimum altitude in 20 minutes, at much less cost than present methods involving the use of oil burners.



"Switch Engine" Tank Shuffles Boxcars

Freight cars at the New York Port of Embarkation are pushed around by an old Army tank that makes a powerful substitute for a diesel locomotive. The tank, equipped with a bumper made of scrap metal, can push as many as 17 loaded cars. It is used to speed shipment of materiel from the New York port to Europe.

☐ It was 150 million years ago that the first flowering plants appeared on the earth.

Hot Water for Sale Via Special Delivery

Want to buy some hot water? In Brookings, S. D., two war veterans have started a new business enterprise — selling and delivering hot, soft water to the harried housewife. The two young men first went into the trucking business, then started selling hot water to keep their trucks busy. A 10-gallon milk can filled with steaming water costs the housewife 25 cents, delivered to any part of the house. The veterans buy the soft water from the city light and power plant, where it is used in the boilers to prevent scale. Biggest business day, of



course, is Monday—washday. Customers also use the water regularly for scalding chickens and pigs.



"Slow" Light

In fast-moving city traffic, split-second delays often mean accidents so a new "slow" signal that gives advance warning of braking action should reduce rear-end collisions. The slow light, mounted on the rear of the car, flashes a bright yellow light the instant you take your foot off the accelerator. When you step on the brake pedal, the slow light goes off as the stoplight goes on. The light can also be used as a warning light when you're disabled on the highway. With the ignition switch on, you merely tap the accelerator pedal and the light goes on, remaining lit until you press the brake pedal.

Playground Planet Teaches Geography

Pupils in a primary school at Hermosillo, Mexico, combine their recess periods with their geography lessons. A giant globe, cast of concrete, is part of their playground equipment. The land areas of the world are shown in relief. A curved ramp, up which the youngsters climb, provides a close-up view of the world's geography.

☐ When part of a train hauled by a diesel locomotive, a 40-ton freight car travels 16 miles on a gallon of fuel.

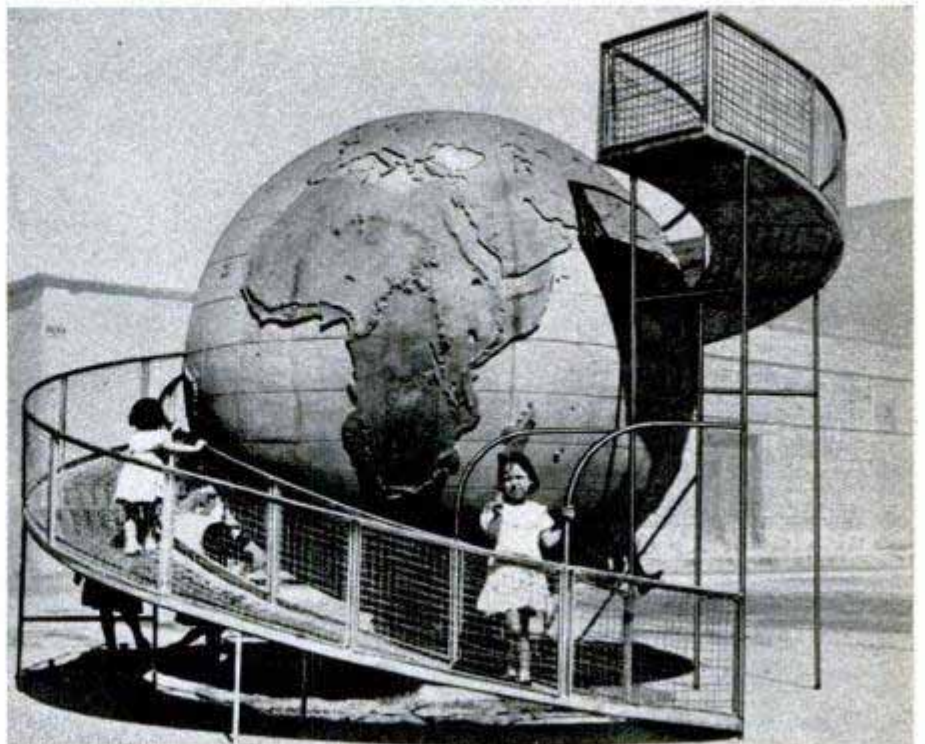



Farmers Put Air to Work

Some farmers don't hand-hoe the weeds these days—they just press a button and watch a blade flick out to topple the stalks. Likewise they saw wood, prune trees and trim hedges with pneumatic tools. New farm implements driven by compressed air even shake walnuts and prunes from the trees. To prune a tree, the orchard owner uses air-driven shears, or for larger limbs a vibrating saw powered by an air-motor piston inside the handle. Prune and walnut knockers operate similarly but deliver a shorter, faster stroke. The hooked end of the vibrator fits around a limb and gives it a severe shaking, plummeting the ripe fruit to the ground. All the pneumatic tools are built of aluminum or other light metals and weigh from three to eight pounds. They operate on 175 pounds' air pressure, and are connected by air lines to a portable compressor which can drive 12 of the tools simultaneously. In gang operations, the compressor is mounted on a light truck.

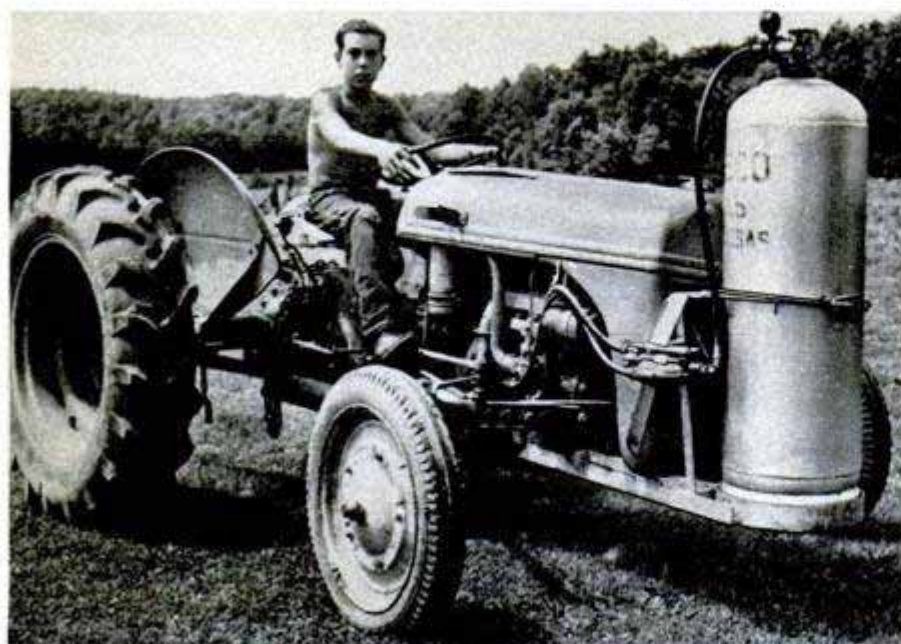

Bottled Gas Powers Tractor

Bottled gas is the fuel used in a tractor owned by Levi B. Miller, a Virginia farmer, who says the machine now develops more power than it did with gasoline. Miller converted the engine himself. Two holes were drilled in the carburetor and a metering valve mounted alongside the propane tank, which is mounted in an upright position directly ahead of the radiator on an extension of the frame.



Jets Go to Sea

Not satisfied with conquering land and air, jet propulsion has now gone to sea. A 62-year-old Scottish paddle steamer, the

Lucy Ashton, was fitted with four jet engines and made the first jet-propelled ocean trip in history. The engines are mounted on a girder superstructure amidships and develop a thrust equal to 5000 horsepower.

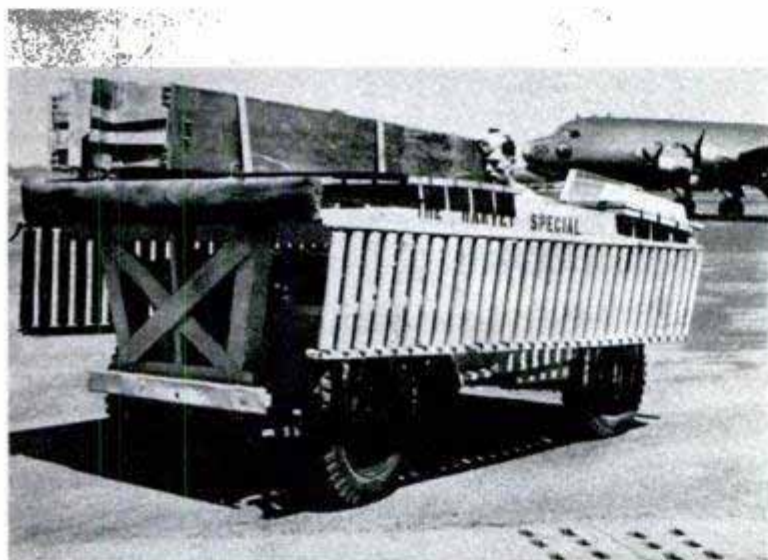

Mobile Air-Lift Dock Fashioned From Jeep

Cargo air lift to Korea is speeded by a Jeep converted into a mobile loading and unloading platform. It was built by U. S. airmen in Japan at their base's machine, welding and carpentry shops. The cushioned front end is driven flush against the fuselage of twin-engine transports, just below the door, and a trap door closed over the driver's compartment to form a sturdy dock. Roller-type conveyor ladders for handling cargo are carried on the Jeep's sides.

Remote Salesmanship

Recorded talks, triggered by a proximity impulse, are being used to "sell" customers in large self-service stores. The message concerns a single product and the sound mechanism with its endless tape is activated whenever a person approaches the merchandise. The recording is in a soft voice directed only to those in the immediate vicinity.

Information not listed on articles in the index, starting on page 10, frequently is listed in the WHERE-TO-FIND-IT LIST, available to readers without charge from Bureau of Information, Popular Mechanics Magazine, 200 East Ontario Street, Chicago 11, Illinois





THE WAR IN THE WHITE PINES

It's a bitter battle but it's being won by unique weapons — a college boy, a ball of twine and a secret pried loose from Nature

Science and Nature teamed up to accomplish the transformation on this page. Above, photo taken in 1931 shows timberland destroyed by blister rust and fire. Below, photo taken from the same spot 17 years later





Helicopter joins the battle, trailing fog across timber to wipe out bushes which spread the disease

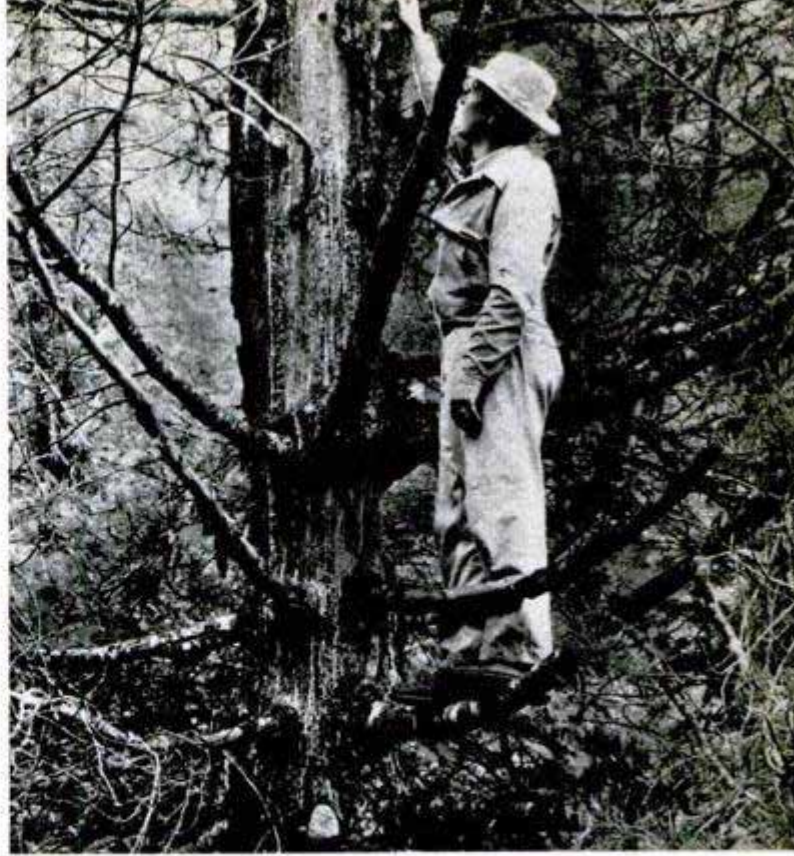

U. S. Department of Agriculture photos
Victim of deadly blister rust, this tree shows ugly cankers which gradually ring the white pine to kill it

By O. A. Fitzgerald

OUT OF THE TIMBER into the open spaces of northern Idaho thundered a bull moose. Trailing from his horns was a snarled mass of string.

"That moose really was sore," chuckled Frank O. Walters, assistant regional leader in blister-rust control, as he recalled the incident.

Over near Elk River, also in Idaho, a buck deer was even angrier. He was so tangled up in string he couldn't move. Hunting season was on and for once a hunter actually found his deer staked out for him.

Although an annoying travel hazard to the deer, elk and moose, the string is a valuable weapon in a war that is raging in our white-pine forests. The twine guides control crews who are fighting blister rust.

Sometimes within a year a whole carload of string is unwound in the white-pine forests of northern Idaho, western Montana and eastern Washington — generally called the Inland Empire. Here are the nation's largest and most important white-pine stands.

But for the work of the crews leaving this string, and that of other string-spreaders who battle the rust in the white-pine forests of the East, the South and along the Pacific slopes, we would be writing white pine off the forestry books. Instead, we are now talking about how safe the tree is.

Saw-log dividends from the successful

battle in the forests of the Inland Empire are forecast at \$65,000,000. Completion of control projects now under way will save another \$94,000,000. It costs money to fight blister rust, but compared to these dividends it's bargain-basement warfare.

"For the better forest areas it costs between two and three dollars per thousand board feet of saw timber to protect the white pine from blister rust," explains H. E. Swanson, leader in blister-rust control for the Inland Empire area.

White-pine stumpage today is around \$20 a thousand board feet but in figuring tomorrow's dividends foresters use the nearer normal figure of \$13 a thousand.

First observed in New York in 1906, white-pine blister rust by 1915 was so widespread that all hope of ever completely wiping it out was abandoned.

"White-pine blister rust threatens to eliminate an industry that now employs upward of 5000 men and pays more than \$7,000,000 annually in wages," Forest Service officials in the Idaho-Montana-Washington area declared when the full threat of the disease to forests became apparent.

The killer that threatened to topple our white-pine forests is a parasitic fungus. Spores from sick trees are carried up to 300 miles by wind. Landing on a currant or gooseberry bush, they take root and grow. These spores are like the seeds of a plant. When that berry bush gets the



Turntable from hook-and-ladder engine is used on this roadside sprayer which fires a weed-killing fog at 145 miles an hour

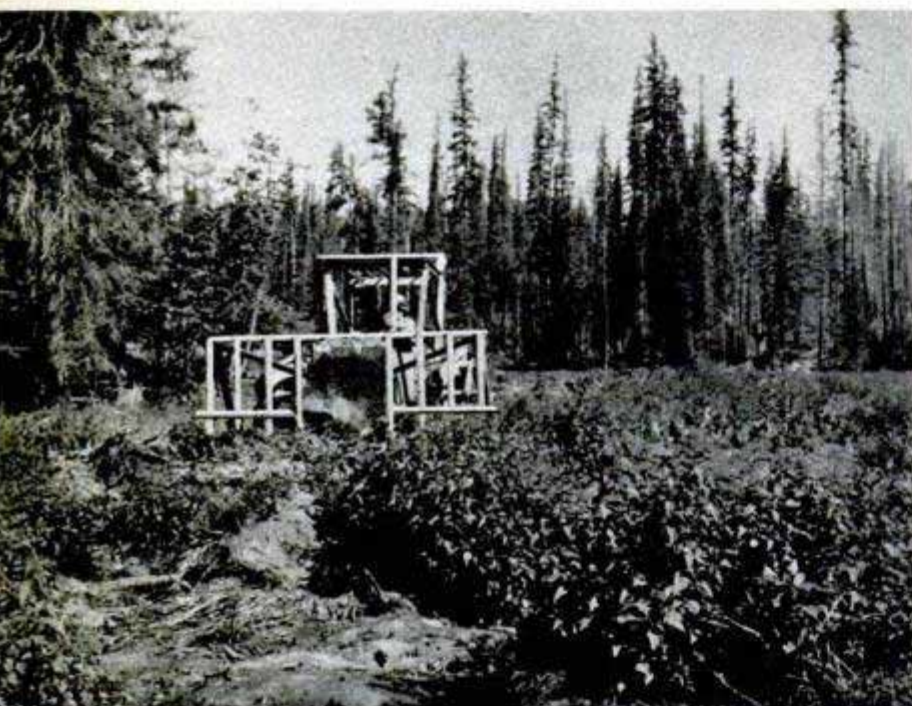

Bulldozer on a mountain meadow wipes out the currant and gooseberry bushes, which spread blister rust from one tree to another. Below, backpack sprayers are carried through mountains by college men to kill bushes. String shows area covered



disease it produces another kind of spore, which is also picked up by the wind. When this second spore lands on a pine, the tree gets the disease. Spores carried from pine to pine are harmless. Only those spores from gooseberry or currant bushes are deadly to the pines. Wind is the culprit in spread of the disease.

When the forest scientists first found that the rust spores were carried up to 300 miles the situation seemed hopeless. Then came the break that opened the door to control. Although spores from pine trees can give the disease to berry bushes hundreds of miles away, a tree must be within 900 feet of a sick bush to catch the disease. That discovery wrote the death ticket for all currant and gooseberry bushes in our white-pine forests.

For around a quarter of a century we've been digging up, killing with spray, and bulldozing out these bushes.

"Where the bushes have been eradicated, the progress of infection by blister rust has been definitely stopped," declares Swanson.

No section of the United States has a monopoly on blister rust. The disease is in Eastern white pine from Maine to Georgia, in sugar pine in Oregon and California, in all the white pines straddling the Rockies.

Blister rust operates very much like cancer in humans. At the start it is silent, insidious, relentless. Tree needles catch the flying spores. Slowly the disease creeps under the bark along the limbs to the trunk. First thing you know the tree breaks out in cankers. When the cankers completely girdle a tree its days are numbered.

Foresters nationally are busy trying to keep these cankers from forming on white pines. Cleaning out the currant and gooseberry bushes is a continuing job in 32 states. Organized extermination of these bushes began in 1922. Spearheading the rust-control drive is the Bureau of Entomology and Plant Quarantine of the U. S. Department of Agriculture.

About midway between two northern Idaho logging towns—Bovill and Clarkia—is a 200-acre argument for blister-rust control.

(Continued to page 234)

the

POPULAR
MECHANICS

CRAFTSMAN



↑
Your dining table supports this pickaback billiard table which lifts off easily for storing in a closet. Leveling device fits one leg of table. See page 188

↓
A master control panel permits up to six photo lights to be turned on or off individually or simultaneously right at the camera. Details on page 206

NOVEMBER 1950

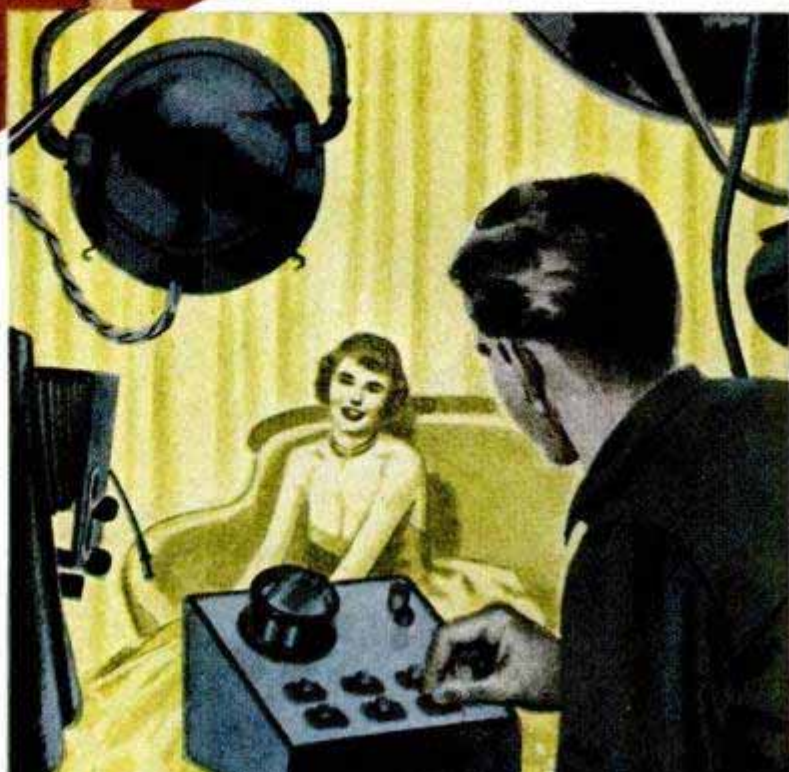

Give Santa a Hand

Route those toy orders to Santa through your workshop. Here are 10 wooden ones to bring shrieks of delight from your youngsters on Christmas morn



Photos by Paul Hutchinson, staff photographer

By Marvin Hartley

SANTA'S job will be easier when you turn toymaker and lend a helping hand to relieve the burden on his North Pole workshop. Among this group of 10 exciting toys, there's at least one that will surely make Christmas extra merry for some youngster. Except for the lighthouse stool, bucking bronco and the burp gun, which require some sheet metal, all of the toys are made mostly of wood. The step stool, shoe-shine kit and novelty lamp can be made of scraps from your wood box. Construction of these, as well as the others, is apparent from the drawings, which include patterns for the parts that require jigsawing. Enlarging the patterns full size is easy. First, count the number of squares given and rule on paper an equal number of 1-in. squares.





PLANS #105
INCLUDES
BOTH THE
BRONCO
&
GRAPPE
504

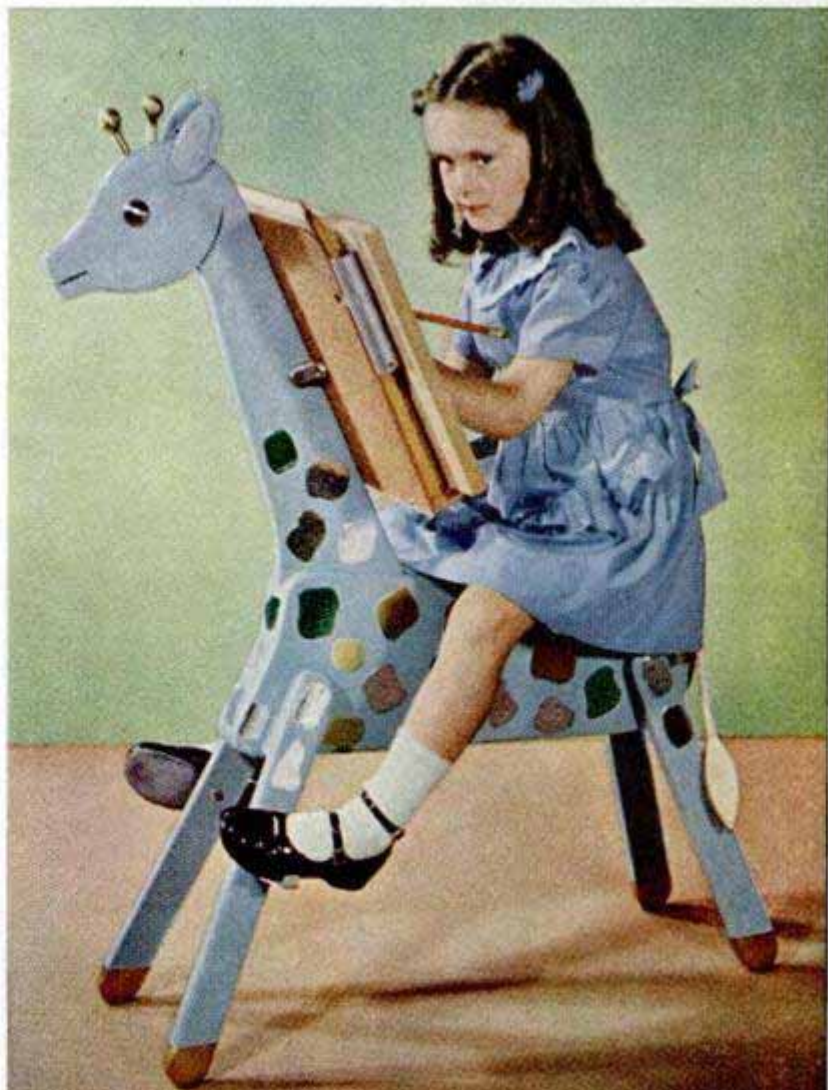

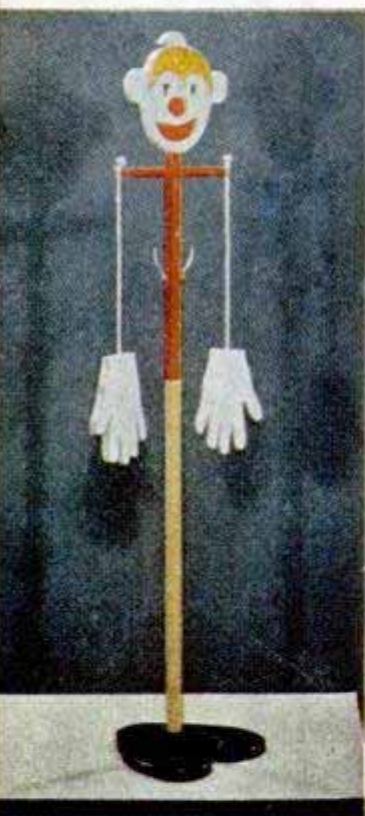

Next, number the rows of squares 1, 2, 3, etc., across the top and down one side of both the magazine pattern and the ruled paper. Now, begin enlarging the pattern by drawing that portion of the outline which is in square No. 1 in the magazine in the corresponding square on your ruled paper. Then advance to the next square, and so on, until the complete pattern is enlarged. With practice, you'll find it easy to enlarge any pattern by the square method.

With the exception of the table-and-chair set, which should be made of plywood, common $\frac{3}{4}$ -in. white pine is ideal material for practically all of the toys. Although the sides of the fish rocker were originally cut from wide solid stock, with the fins being added separately, they can be made in one piece by using plywood. Likewise, the hind leg of the bucking bronco, which shows the tail as a separate piece, can be of plywood. Duplicate parts of the various toys, such as the sides of the bodies, the legs, etc., can very well be cut at one sawing, thus assuring identical members. This is especially advisable if a bandsaw is being used. The pieces are simply tacked together in the waste areas and the work cut in multiple. In sawing duplicate parts, such as the clown hands, sides of the bronco body and fish rocker, you automatically produce a permanent pattern by simply inserting a sheet of thin cardboard or plywood in the stack of pieces being cut. Thus, when the sawing has been completed, you will have cut a full-size pattern at the same time. This is especially worth remembering if you plan to mass-produce any one of the toys in large quantities.

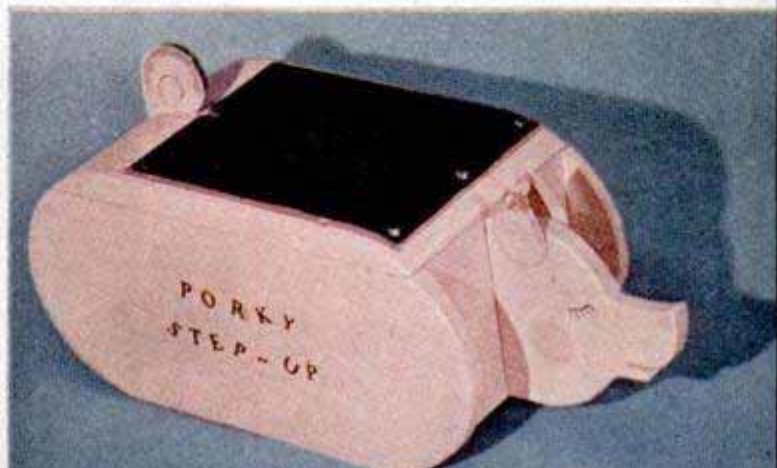

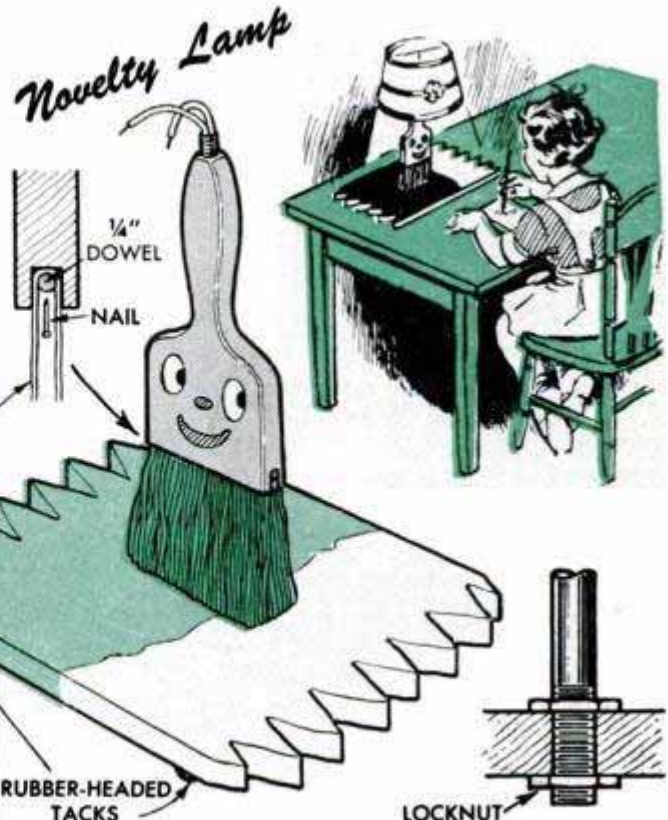
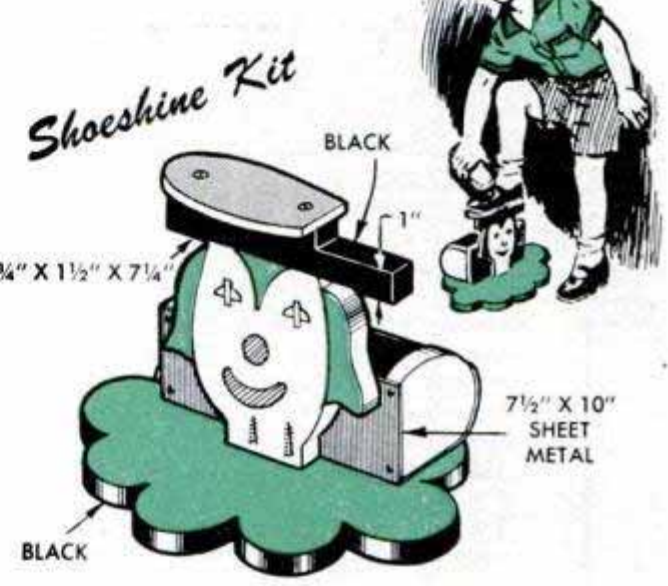
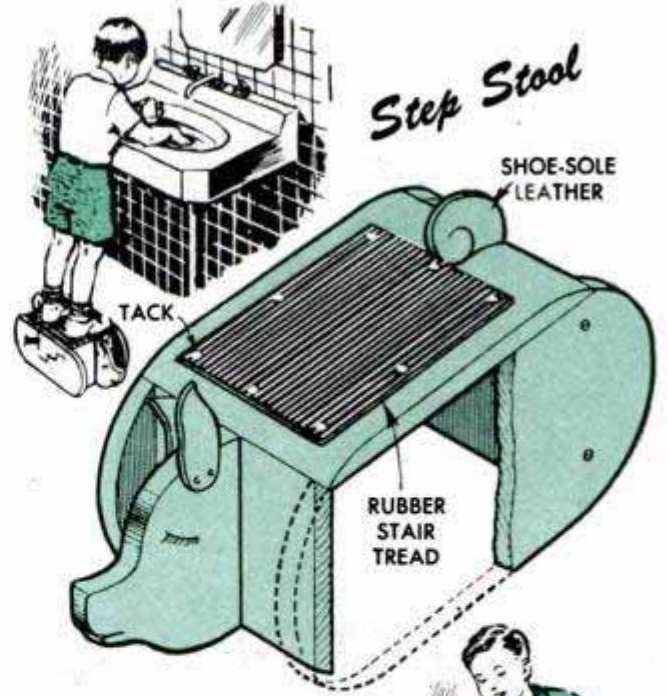
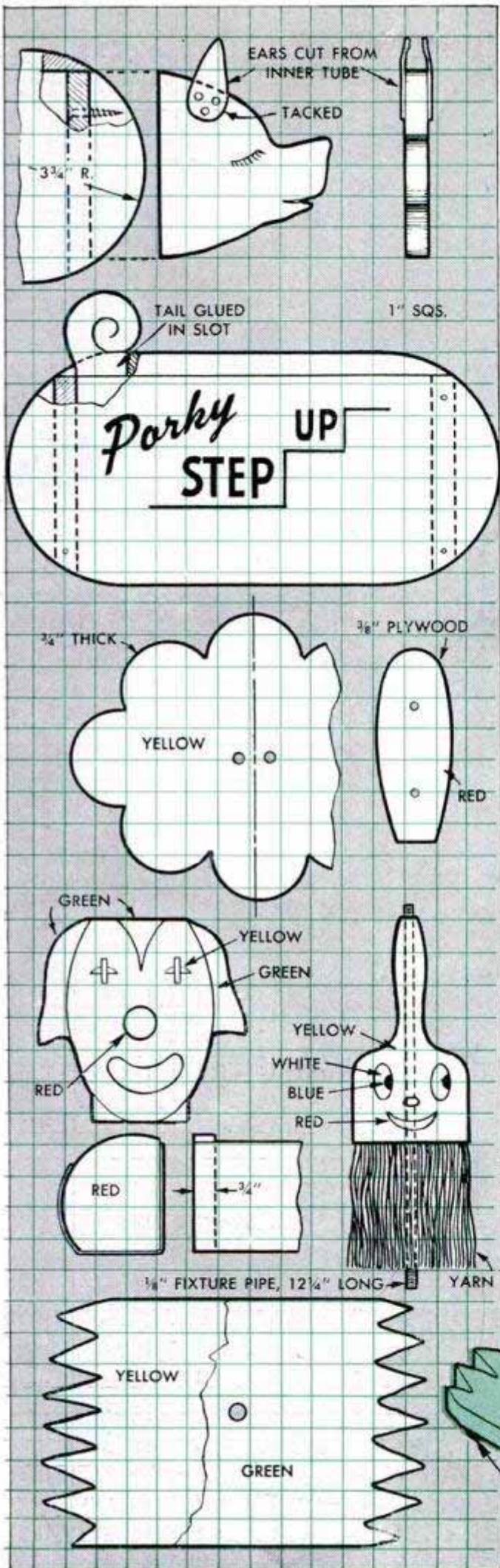

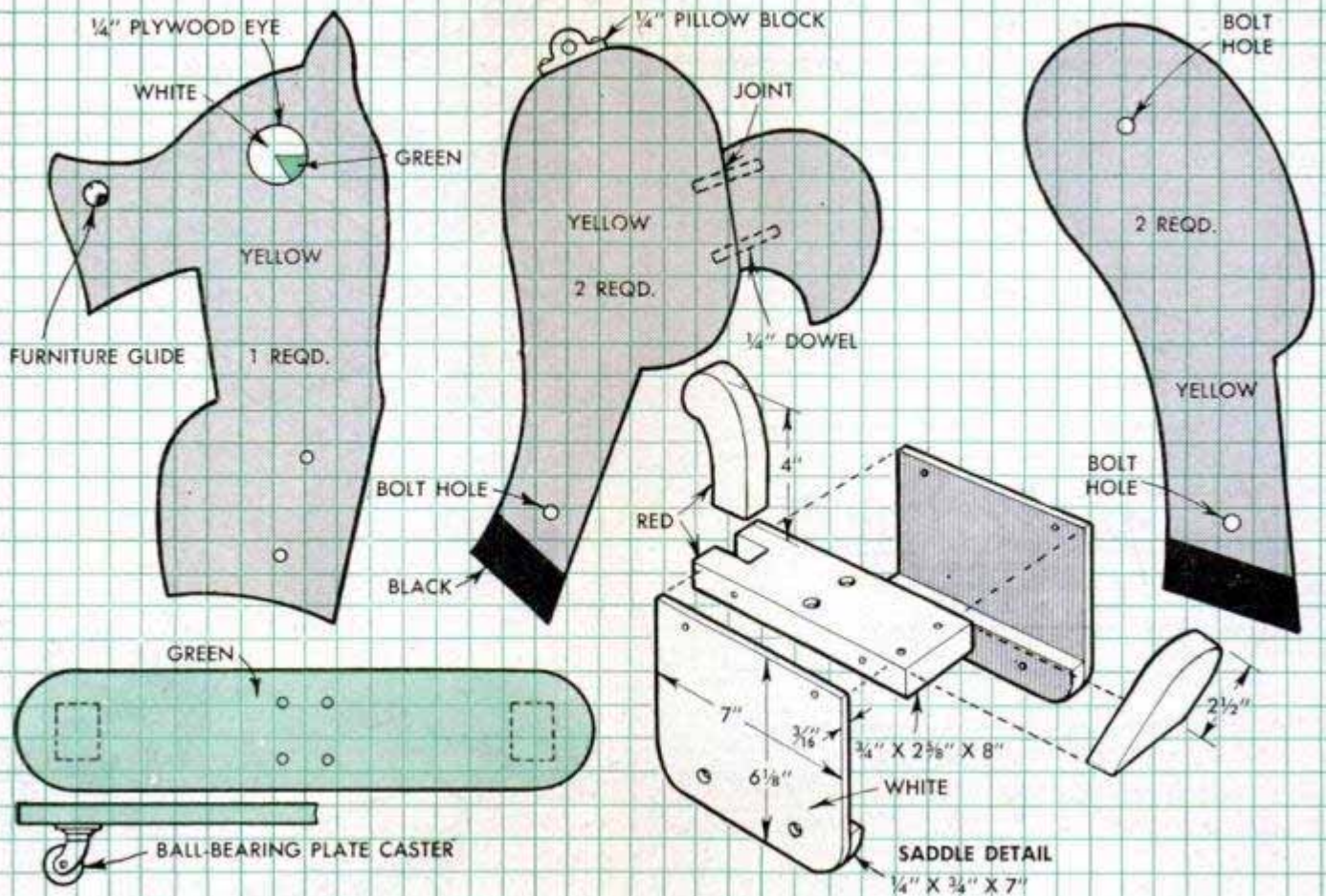

Bucking bronco requires plate casters for the footrest and a socket-type caster for the rear leg. The two sections of the toy are pivoted together with a carriage bolt and a small pillow-block bearing. A coil spring between the legs gives the "cowboy" a bucking ride that bounces him up and down in the saddle

The neck of the giraffe drawing board supports a compartment for paper which also serves as an easel for a small-size drawing board. The compartment can be made separately with holes provided in the front for admitting a screwdriver for attaching it, or the compartment can be partially assembled and fastened in place before fitting the front. Small metal brackets on each side of the neck cross-brace the compartment

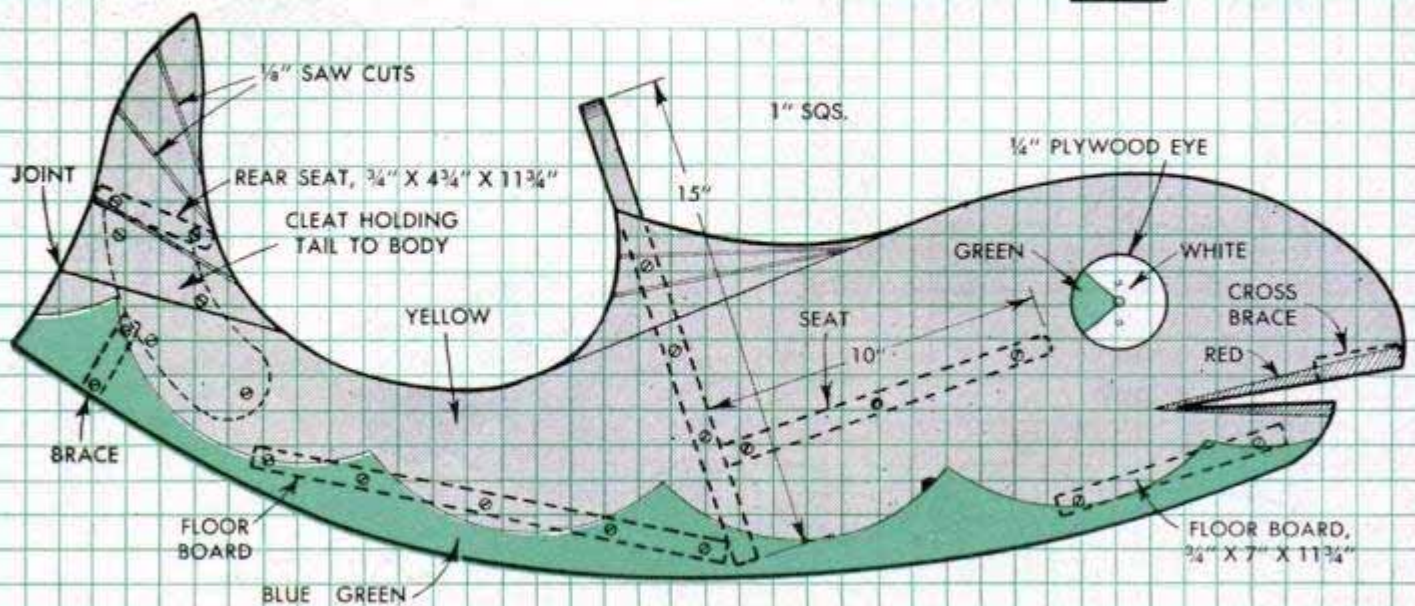
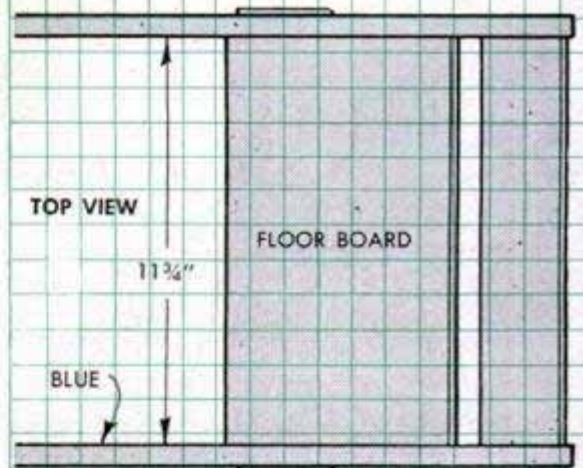

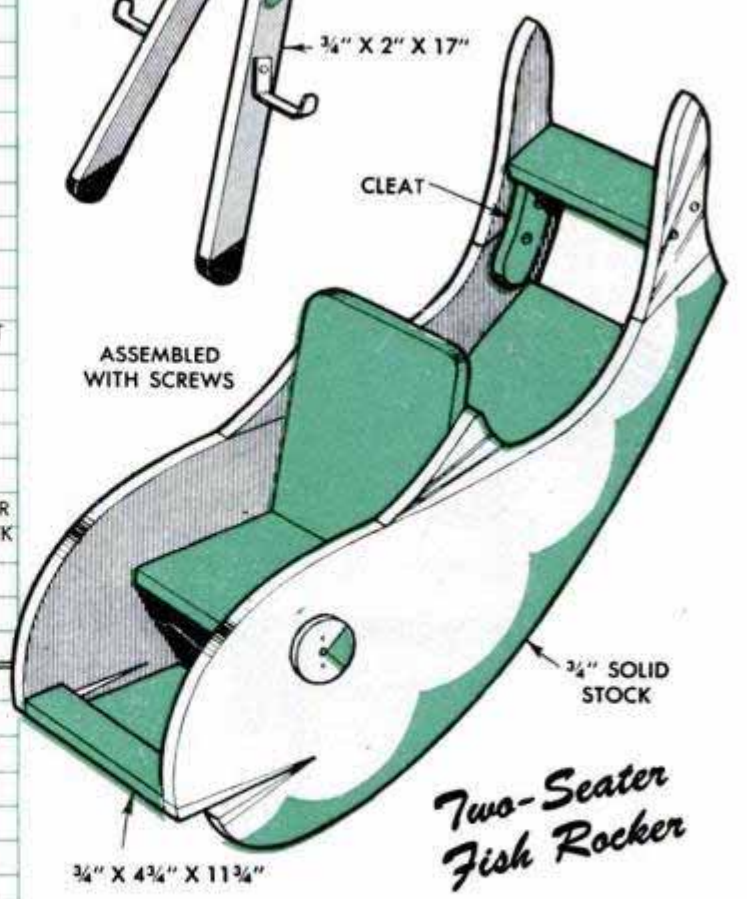
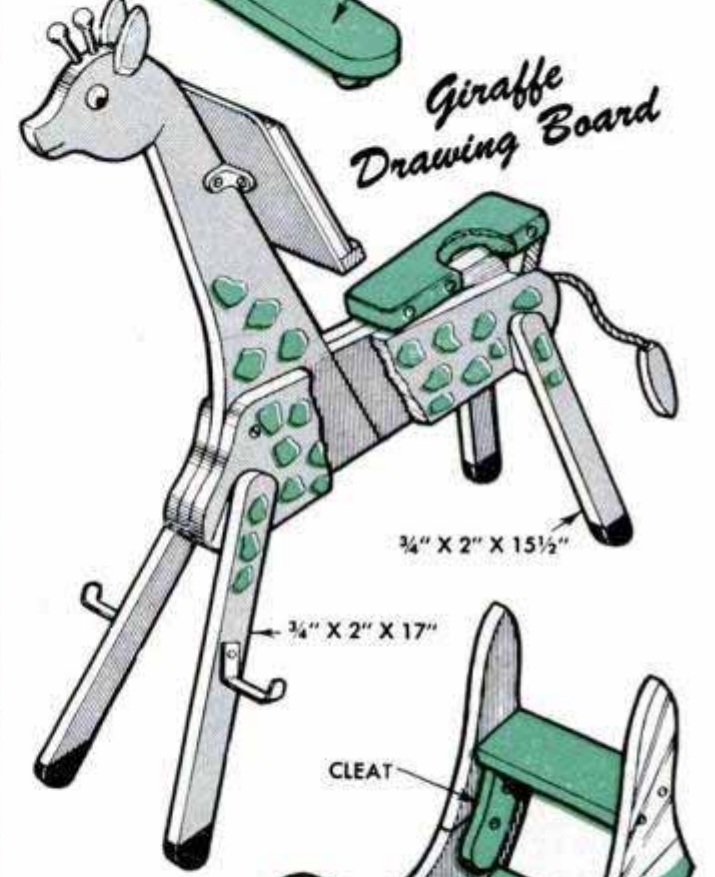
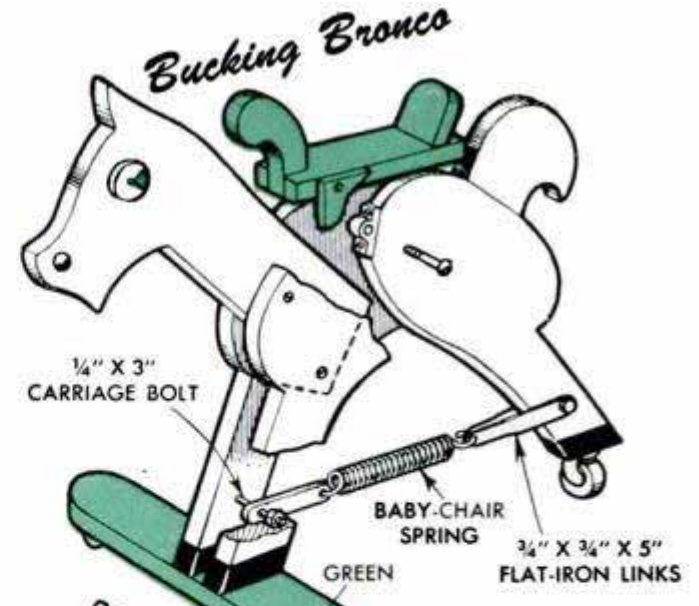
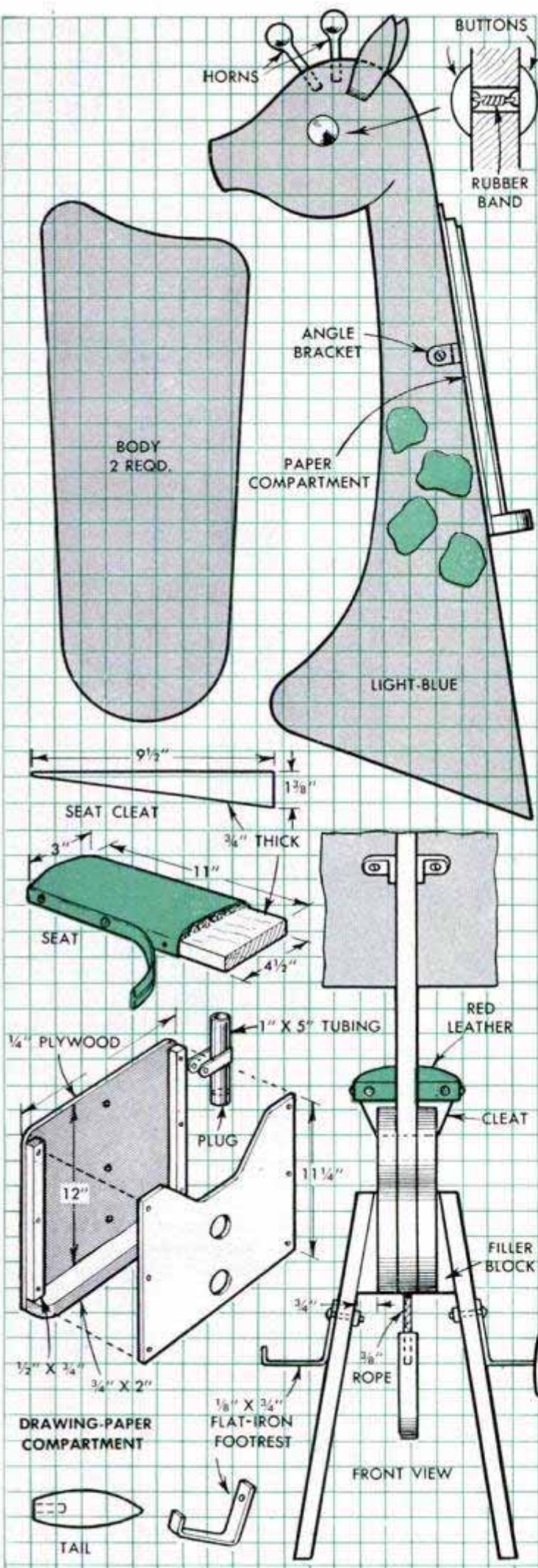

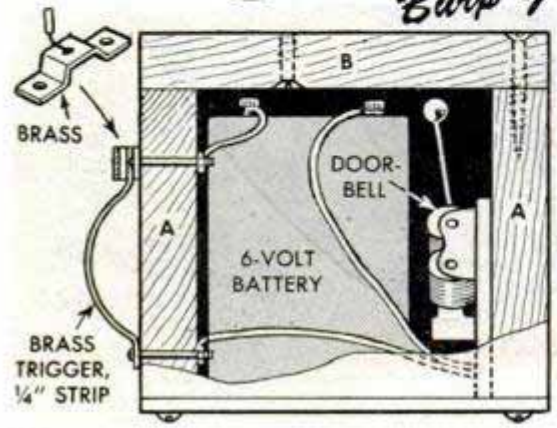
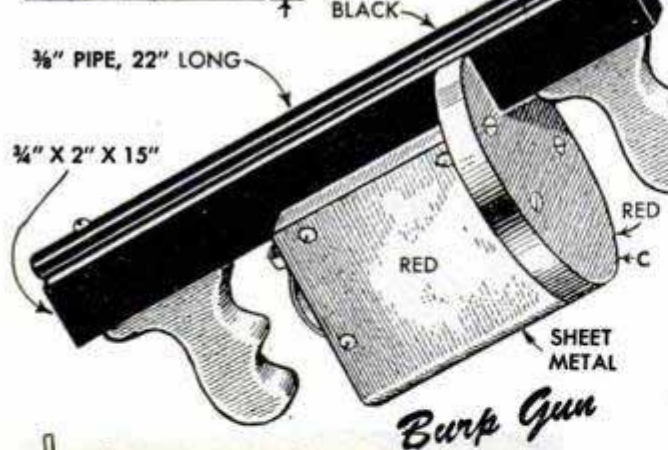
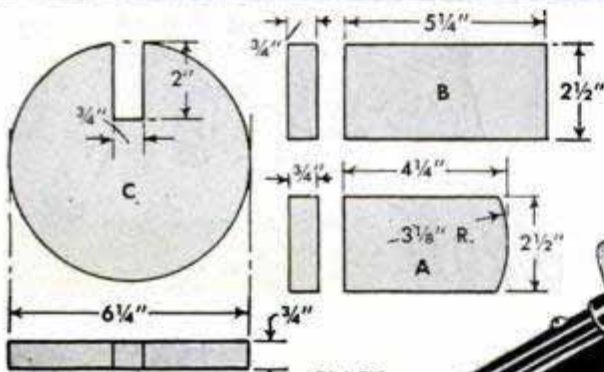
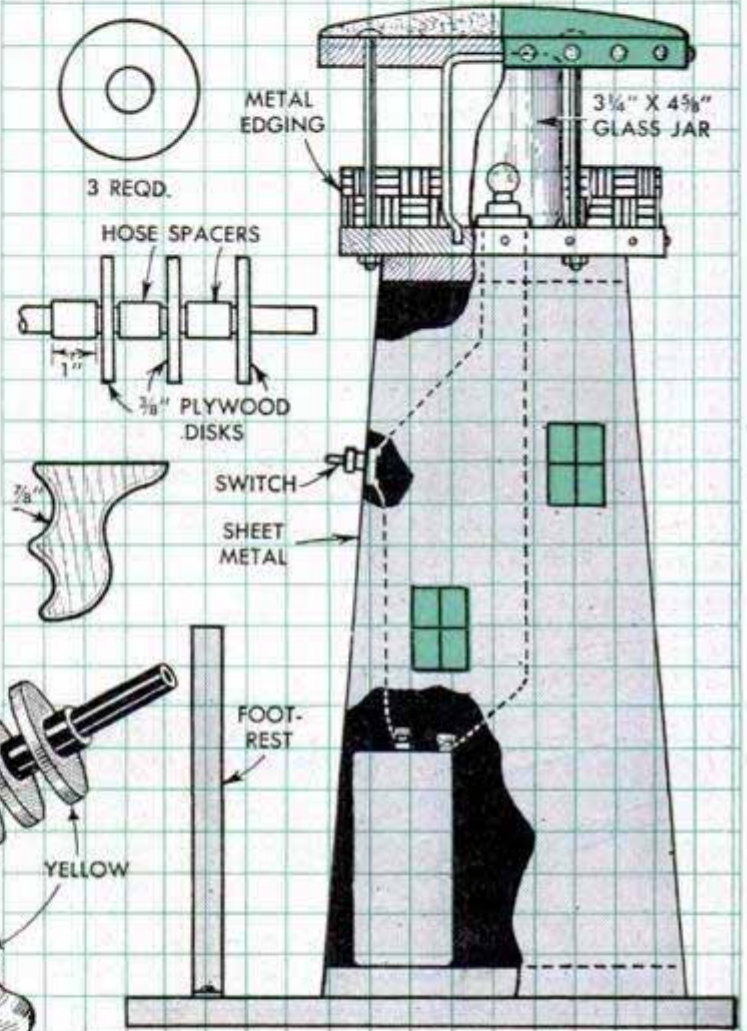
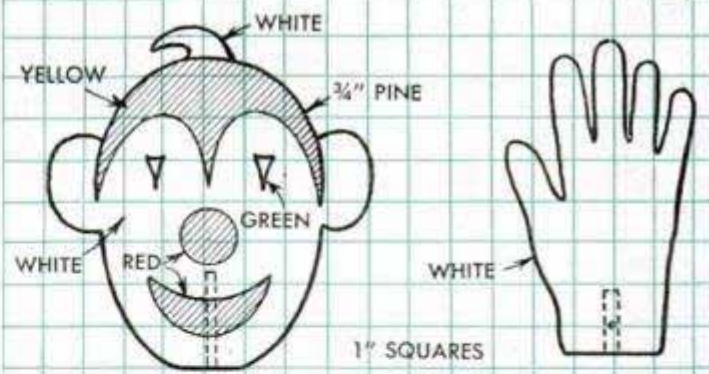

Burp Gun

Burp gun employs a doorbell unit with the bell removed, and a 6-volt battery to simulate the sound of a machine gun when the trigger is pulled. The wooden parts that form the compartment for the bell and battery are keyed to show how they fit together. A length of pipe provides the gun barrel, and the dummy cooling fins at the end are plywood disks held in place with 1-in. spacers cut from old garden hose

The "beacon" of the lighthouse stool, which is enclosed in an inverted glass jar, consists of a 1.5-volt flashlight bulb. This is inserted in a socket and wired to a push-button switch and dry cell. Removal of the screws at the base of the lighthouse permits renewal of the dry cell. Three 1/4-in. carriage bolts attach the padded top of the stool, lengths of tubing being slipped over the bolts to support the top slightly above the glass jar. The pattern for the sheet-metal base of the lighthouse is given at the right. The metal is lapped at the seam and fastened together with sheet-metal screws

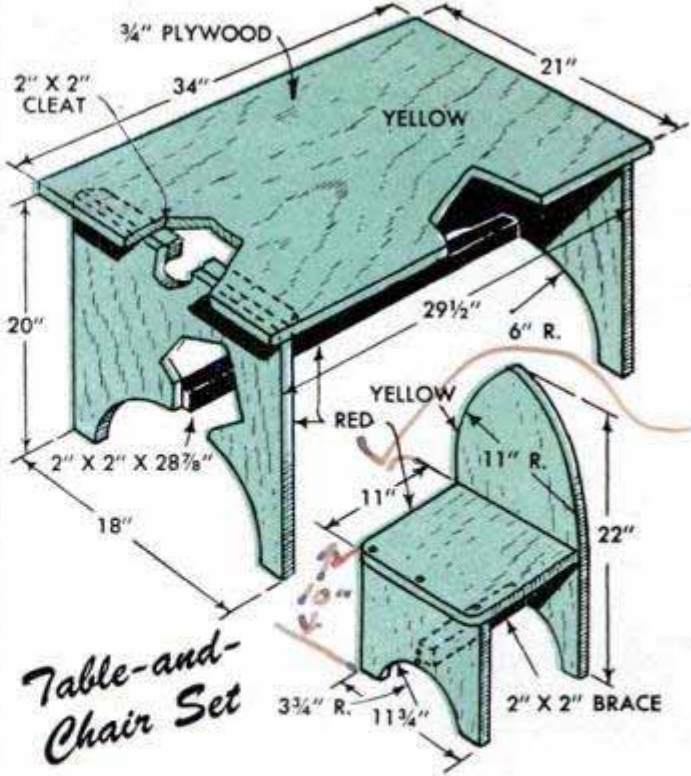
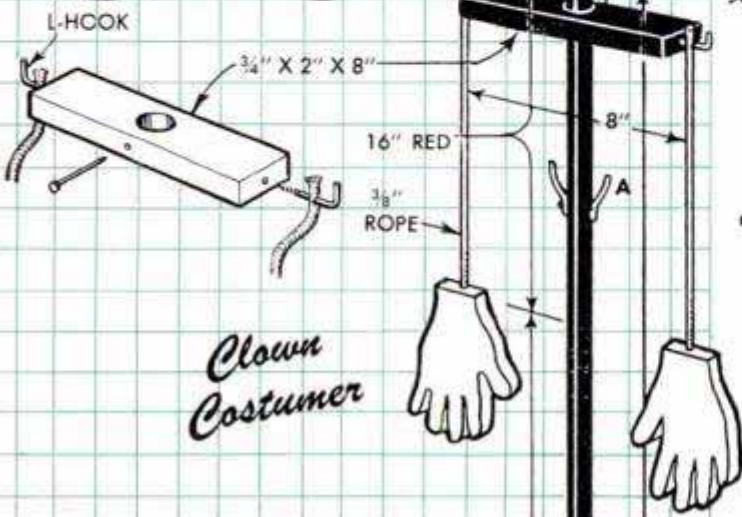
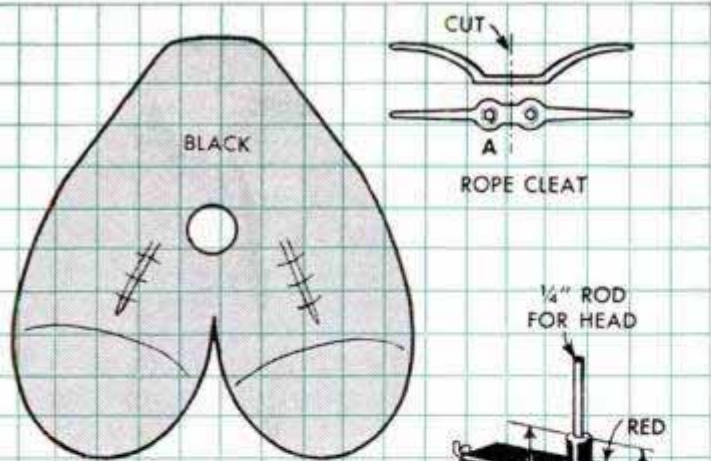

Exceptionally sturdy but not especially fancy, this plywood table-and-chair set will appeal to the dad or big brother who works with little more than a handsaw, drill, screwdriver and paintbrush

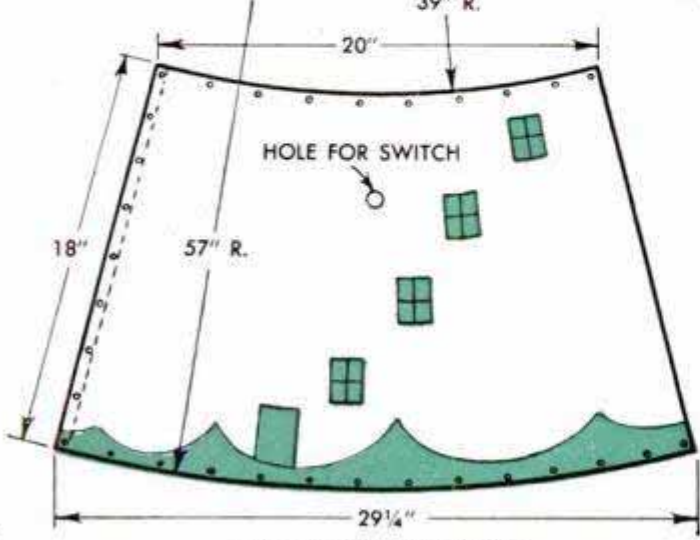
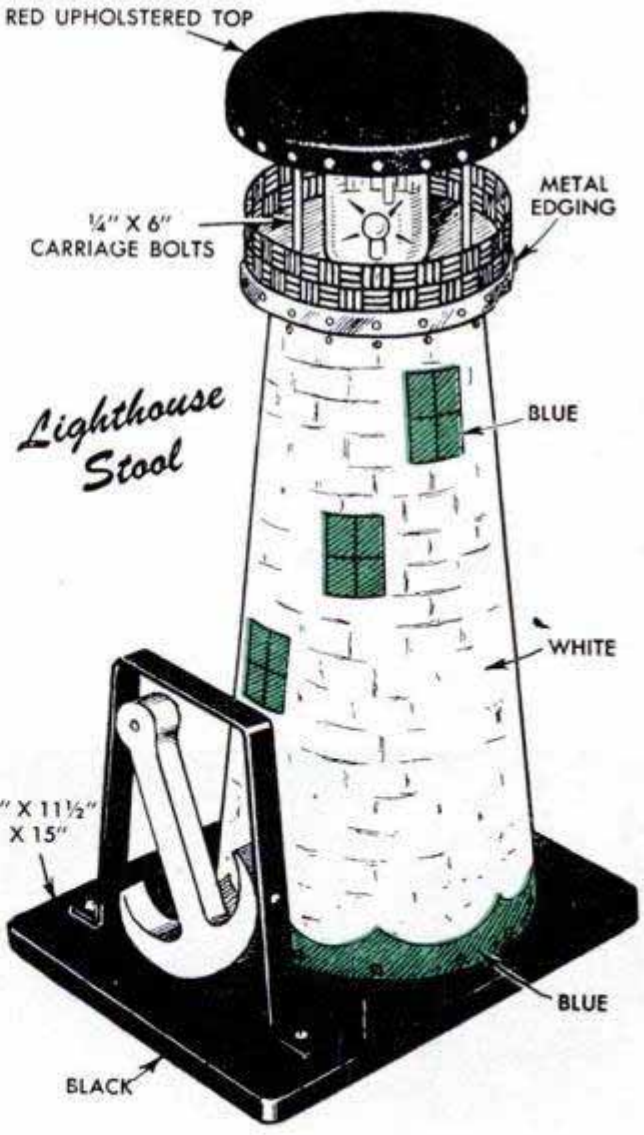
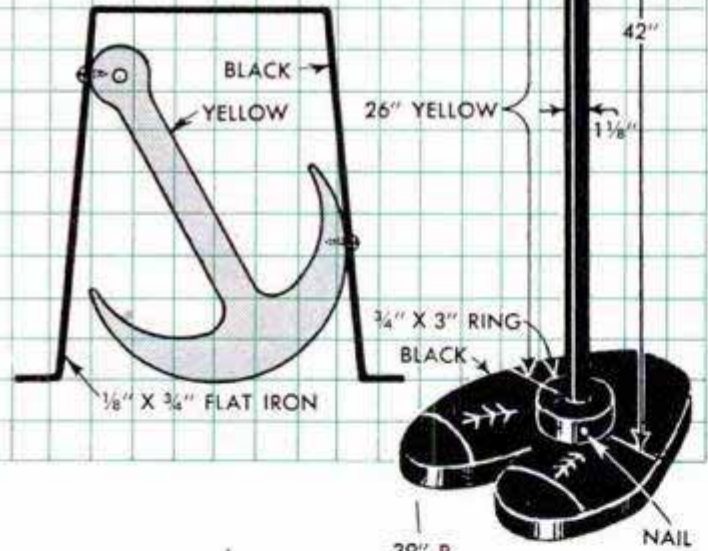

Dimension changes left out.

Guest-Book Cover Features Decorative Overlay

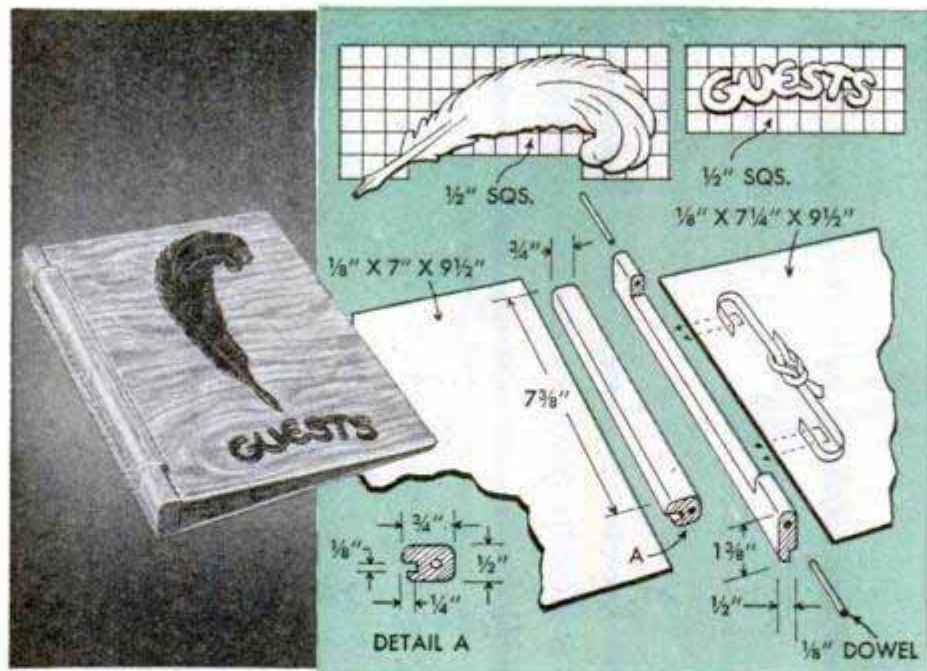

Combining birch-ply-wood covers, a hardwood hinge and a decorative overlay in veneer or hardboard, this guest book is a project that you can display with pride. Glue the covers in rabbets cut in the hinge sections, glue the overlays to the front cover and finish the book with shellac, painting the overlays if desired. The pages are sheets of paper which are punched, folded double and bound with thongs stapled to the lower hinge member.—Roland Cueva, Heyburn, Idaho.

Installing Rubber Stair Treads Simplified by Using Chalk Line

Installing rubber stair treads seems easy, but for successful, neat-looking results, the job must be done carefully to align all the rubber treads. First, determine the exact width of the stair treads and from this figure subtract the length of the rubber treads to be used. Divide the remainder by two, thus arriving at the distance which must be allowed on either side of the rubber tread to center it accurately. Measure this distance from one edge of both the top and bottom stair treads and mark these points with carpet tacks. Then tie a length of cord, such as chalk line, between the tacks and install the rubber treads, aligning one edge of each tread with the cord. The treads may be glued in place or fastened with carpet tacks.

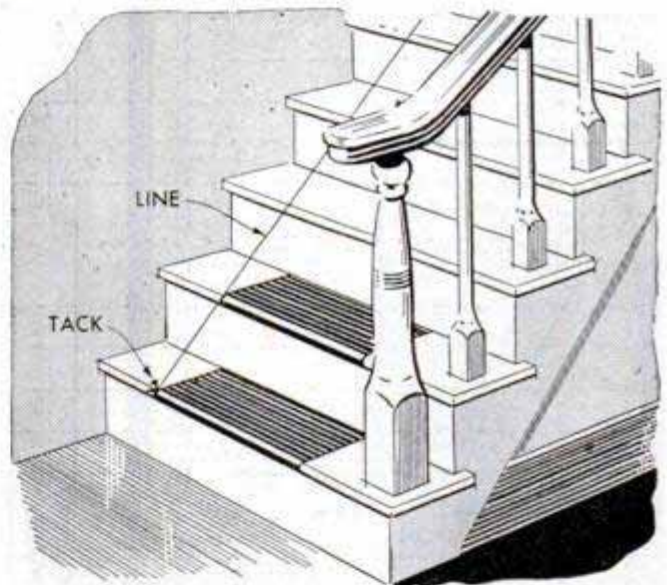

Flush Door Fitted With Legs Forms Modern Coffee Table

A modern coffee table which resembles the solid-oak tables available in decorator shops, can be made in just a few hours by fitting a flush-type door with four hard-

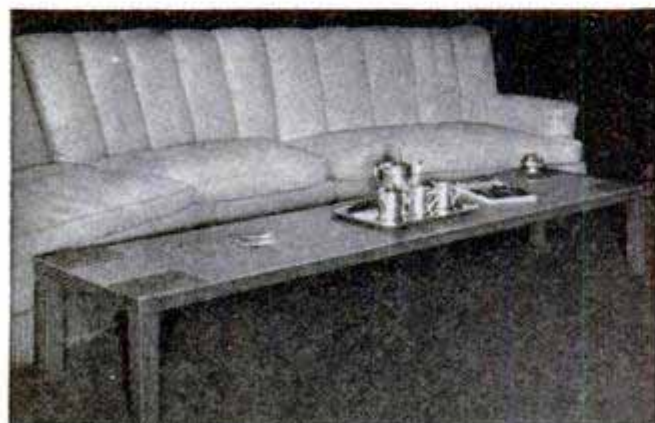

wood legs. Most lumber dealers carry rejected doors in several widths, the narrow closet doors being especially suitable for this purpose. Although the legs of the original table are 10-in. lengths of 2 x 2-in. stock, heavier stock may be used with wider doors, if a more massive appearance is desired. The legs can be fastened to the underside of the door with 2-in. angle irons, or screwed and glued in place, using cross-bracing or rails directly under the door for additional support. The table is finished to suit and may be fitted with small casters to facilitate moving it.

Richard L. Fisher, Milwaukee, Wis.

☛ Try a weak solution of household ammonia for cleaning crystal; rinse and dry.

Tongue-and-groove lumber is formed from ordinary stock by using the outside blades and chippers of your dado head to make the necessary cuts along the edges. As shown in the detail, a tongue can be cut on $\frac{3}{4}$ -in. lumber by using two pairs of $\frac{1}{8}$ -in. outside blades spaced $\frac{1}{4}$ in. apart, thus cutting $\frac{1}{4}$ -in. rabbets along both corners of the board simultaneously. To cut the groove, simply use one pair of $\frac{1}{8}$ -in. outside blades, locating the fence to run the kerf directly through the center of the work. Various thicknesses of stock can be cut similarly by employing single blades instead of pairs or inserting chippers between the pairs of blades. The tongue, of course, does not have to be in the proportion shown, but

Tongue-and-Groove Edges Cut in Lumber By Utilizing Dado Head on Circular Saw

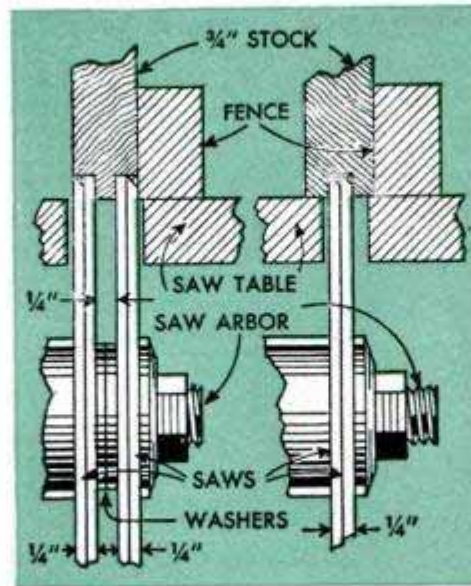

be careful to locate the fence so that the tongue and groove will be in exact alignment.—Dick Hutchinson, El Monte, Calif.

Bit Holder Filled With Grease Prelubricates and Affords Rust Protection

In basement shops that are excessively damp in summer, twist drills stored with their cutting edges embedded in grease are not only protected from rust but are also prelubricated for drilling metal. The holder illustrated is fitted with a sheet-metal top drilled for the various sizes of bits. In this way excess grease is wiped from the bits as they are removed from the holder. After the can is filled with grease, the sheet-metal disk, which has been drilled and marked to identify the bits, is simply soldered to the top edge of the can. A 1-lb.

coffee can is particularly suitable for a bit holder, as the original top may be drilled and replaced on the can, eliminating the necessity of cutting and soldering a separate metal disk—F. E. Berndt, Denver, Colo.

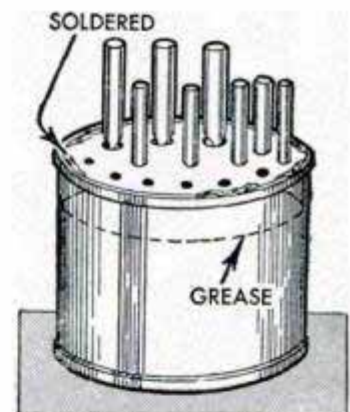

Floating Mount for Small Motor Slides to New Location Along Bench Edge

By means of this sliding motor mount, one craftsman is able to use a single motor to drive several power tools. The mount is pivoted on a length of rod which runs along the rear edge of the workbench, and the weight of the motor keeps the belt taut. The

motor is shifted from tool to tool as needed simply by lifting the mounting block upward slightly, releasing the belt and sliding the block into the new position. The rod is threaded for a nut at both ends and supported by two screw eyes driven into the bench top as near to the edge as possible. Three screw eyes turned into the edge of the mounting block hinge the block to the rod. Determined by its length, the diameter of the rod should be large enough to keep it from sagging and the screw eyes should just fit over the rod in order to minimize vibration of the motor.

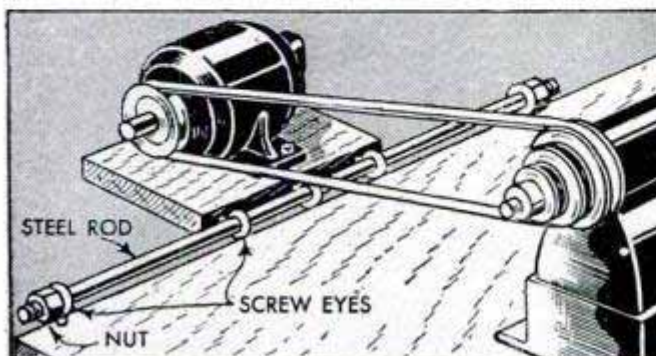

☞ To avoid finger smudges on lens filters, it is a good idea to wear lightweight cotton gloves when handling them.

Solving HOME

1



4



2

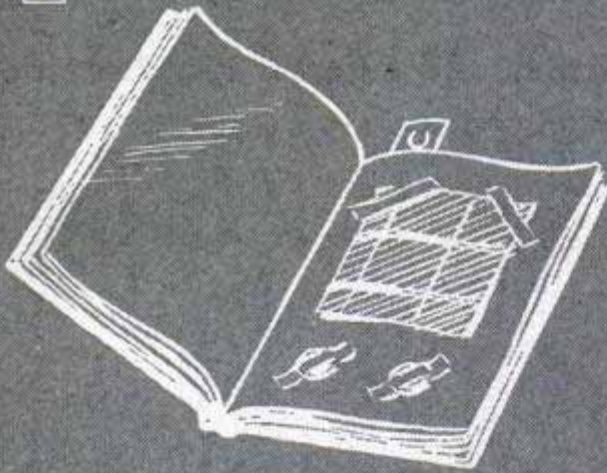

5

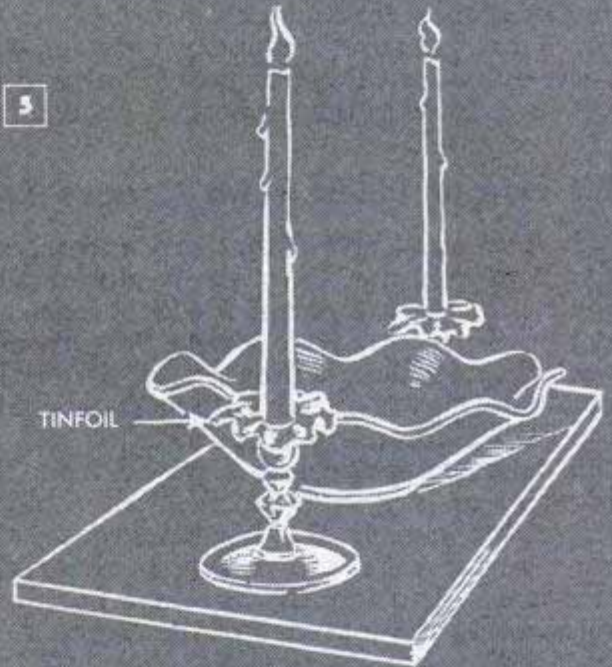

3



6

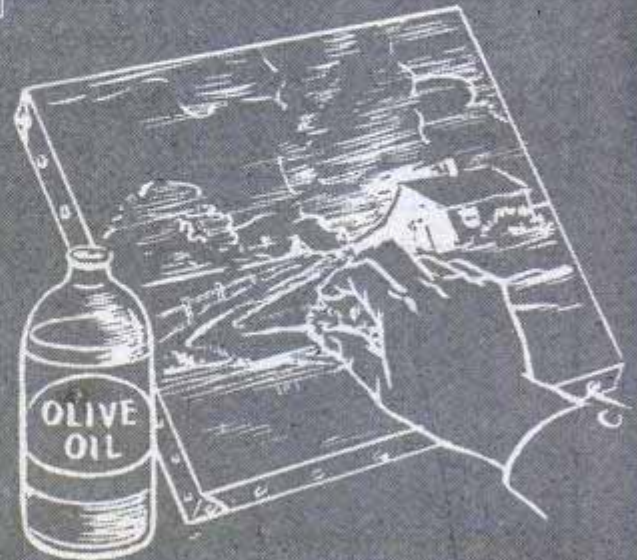

PROBLEMS

7

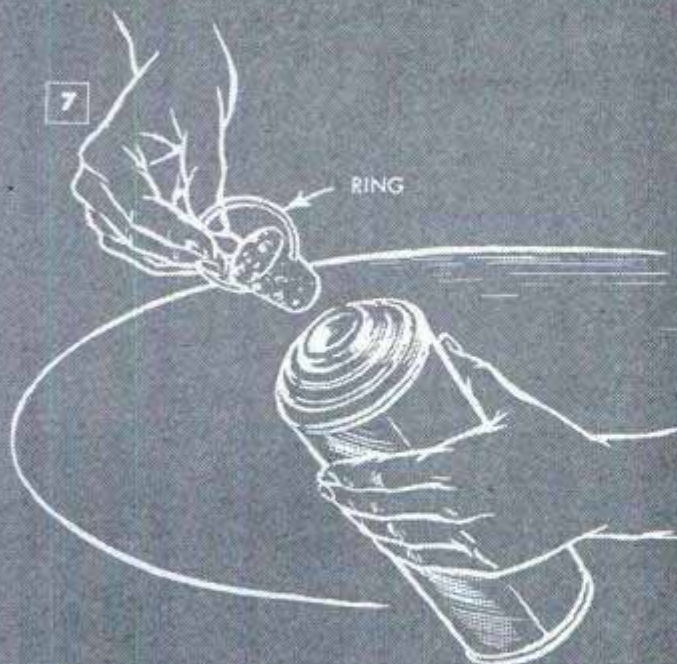

8



9

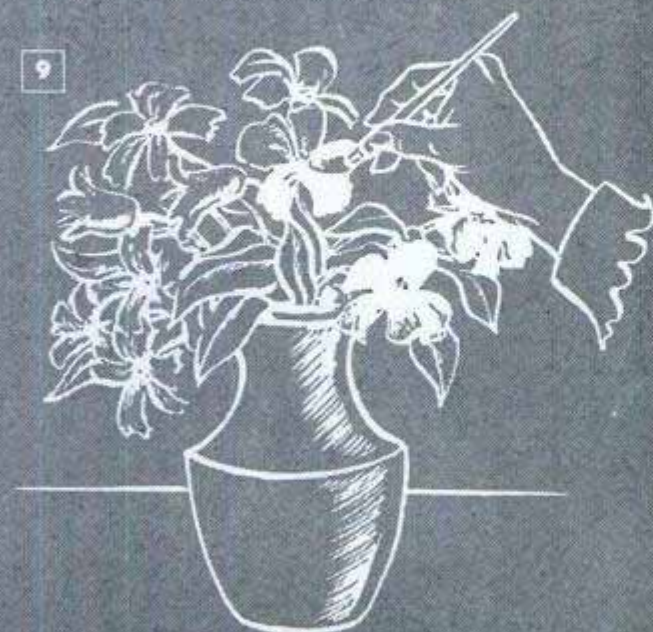

- 1 -

PRESSING CLOTH taped to a wire coat hanger remains evenly spread over the ironing board. This allows rearranging the cloth with your free hand without setting down the iron

- 2 -

HOMEMADE GARMENTS are patched and repaired quickly if an extra piece of material and a few matching buttons are taped in a special scrapbook as soon as the garment is completed

- 3 -

DARNING SOCKS will not strain your eyes if the sock is slipped over a lighted flashlight while mending. The light from inside the sock outlines the threads and work area

- 4 -

YOUR SOAP SUPPLY will last longer if the amount of chips or powder is measured out. To keep a measuring spoon handy, attach it to the top of the soap jar with a rubber band

- 5 -

TO KEEP CANDLEHOLDERS CLEAN and protect liners, place tinfoil or aluminum foil in the holders to catch the drippings. Neatly arranged, the foil adds a decorative touch

- 6 -

OIL PAINTINGS that begin to look dull can be given new life by rubbing lightly with cotton dipped in olive oil. First, wash the painting with a mild soap-and-water solution

- 7 -

REMOVING VACUUM-BOTTLE CORK is easy if a stainless-steel or aluminum ring is passed through a hole that is drilled in the cork. The threaded drinking cup should fit over the ring

- 8 -

FLOATING CANDLES that form novel centerpiece are made by pouring wax in a cupcake or gelatin mold and inserting a birthday-cake candle in the center of the soft wax

- 9 -

A CAMEL-HAIR BRUSH is just the thing for dusting artificial flowers and growing plants. Although the soft bristles whisk away the dust, they will not damage delicate blooms

Drawing Board Is Easily Adjusted If Held by Storm-Sash Brackets



Adjustable storm-sash brackets used to support a portable drawing board allow the board to be moved quickly to almost any angle and held in place by tightening the nuts on the brackets. The latter are attached to the underside of the board near the edges and to each side of the supporting table. Fastening the brackets to cleats a little below the level of the table top permits the board to rest flat. The front edge of the board must be hinged to the front of the table.—Paul H. Will, Chicago.

Marshmallow Candleholders

Tasty novelties for a children's party, these individual candleholders may be eaten by the young guests after the candles have been blown out and removed. To make the holders, press a piece of hard candy, such as a mint, or lozenge, into the edge of a marshmallow to form a handle. Then simply press the end of the candle into the center of the marshmallow.

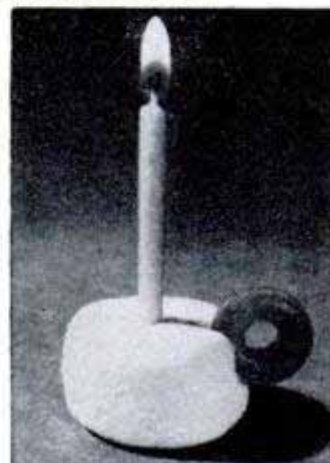

Top Section of Lighter-Fluid Can Provides Small Funnel

Ideal for filling tiny oilcans and small-necked bottles, the top portion of an empty lighter-fluid can forms a funnel having a spout of extremely small diameter.

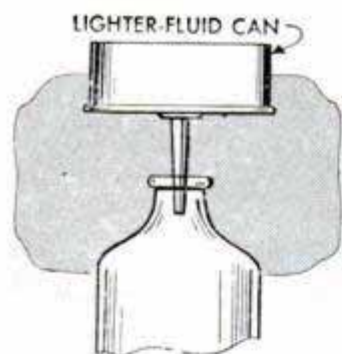

Use tin snips to cut around the sides of the can about 2 in. from the top, and cut off the tip of the spout to enlarge the opening for a faster flow of liquid.

Removing Muddy Taste From Fish Caught During Cold Weather

Fish caught in certain localities during the cold-weather months sometimes have an objectionable muddy flavor when cooked. To remove this taste, scale the fish as soon as it is caught, cleaning and scraping all clotted blood from along the backbone. Before frying the fish, soak it in salt water and a little vinegar for a few minutes. If the fish is scaled some time after being caught, scrub it with a fairly strong solution of baking soda after the scales have been removed and then soak it in salt-and-vinegar water before frying.

R. A. Jenkins, St. Louis, Mo.

☐ The inside of a metal salt-shaker cap will not corrode if it is coated with fingernail polish. When the polish is dry, the holes are opened with a needle.

Altered Lamp-Shade Clamps Fit Large Bulb

Homeowners frequently find that the wire rings of clamp-on lamp shades do not fit properly over large bulbs. This happens because the diameter of the rings does not increase and consequently they tend to slip off. This may be remedied, however, by cutting both the rings at their lowest point, forming a four-pronged wire claw which will hold firmly to any size lamp bulb used in the average home.

William Swallow, Brooklyn, N. Y.

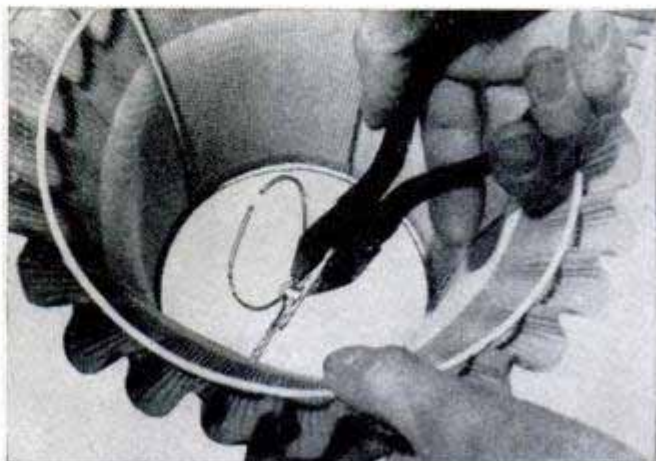

TRAIL KNIVES

P.O. Box 452

By Willis O. C. Ellis

Washington C. H., Ohio

WHEN experienced woodsmen, surveyors and hunters take to the back country trails on foot, they go light, of necessity. Only the bare essentials are selected for the pack, but these always include a sheath knife or a trail knife and sometimes both. To hikers and hunters in wilderness country where there are no overnight accommodations, a dependable sheath knife is indispensable for building a shelter, skinning game, preparing food and cutting fuel for the campfire. Most old-time woodsmen thought of all one-piece knives as trail knives—that's what they usually called them—but later usage and new developments in design and type have tended to classify knives by such variable characteristics as blade length and thickness, over-all length, and so on. Now the sheath knife, or hunting knife as it is commonly called, is furnished in a variety of blade styles.

Of the four illustrated at the right, the top knife pictured can be classed as a trail knife as it has a long, heavy blade equally useful for slicing bacon or cutting a path through thick undergrowth on a forest trail. The blade is about 10 in. long, thick at the back and deeply beveled. With leather sheath the weight will average about 1 lb., which is a trifle heavy for comfortable packing in a belt sheath. Many experienced hunters and campers say such a knife is more suitable for specialized work and is not so well adapted to the all-around requirements of campers and hunters on the trail in open country. The long, heavy blade makes this knife better suited to swinging or slashing cuts and not so well balanced for palm use such as chipping or slicing. However, for the severe service for which it is designed this style of knife is the thing.

The best compromise between the heavy-bladed special-purpose knife and the true all-purpose knife is either of the two pictured second and third from the top. The upper one has a heavy, fluted blade somewhat shorter than the trail knife pictured at the top. Considering the weight of the blade, this model is comparatively well-balanced for both swinging and slicing cuts or chipping cuts. Many sportsmen prefer it for skinning large animals. The third knife shown at the right is very nearly the all-purpose type, although the blade is a little longer and heavier than many campers would pick for all-around service. On this one the sides of the blade are nearly

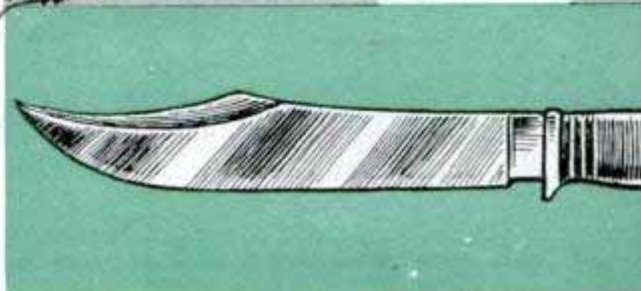

Classed as a trail knife, this one has a long, heavy blade suited to hard usage in camp and on the trail

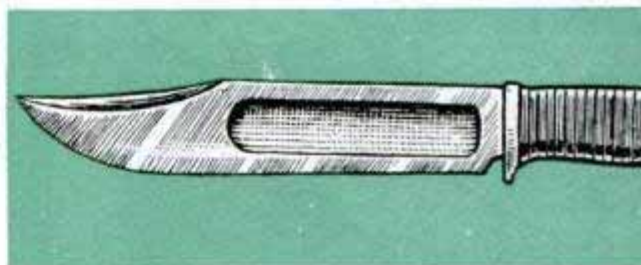

The blade of this knife is somewhat shorter and is deeply fluted. Edge has a shorter radius near point

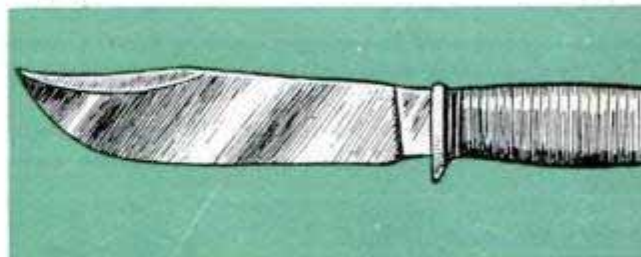

Above, short, wide blade is preferred by many hunters. Below, this knife is an ideal all-around choice

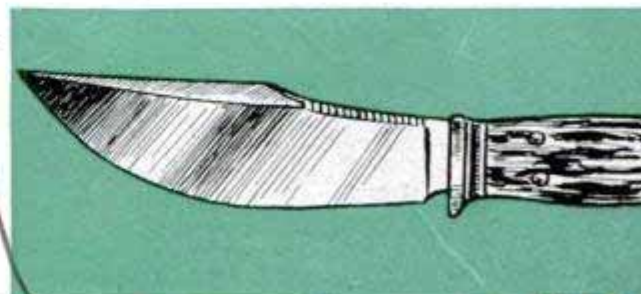

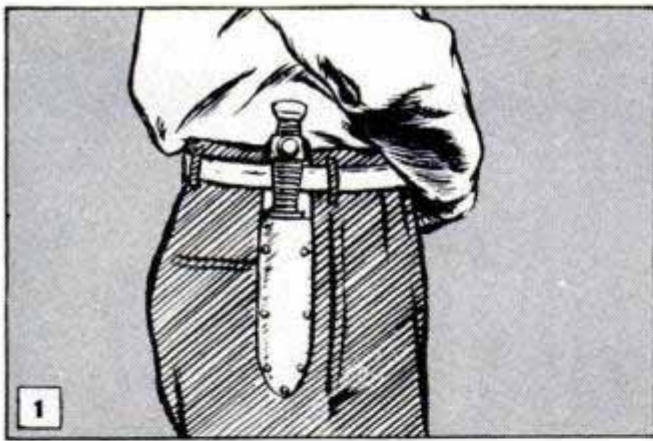

1 Experienced campers and hunters usually carry a sheath knife like this for comfort and maximum safety

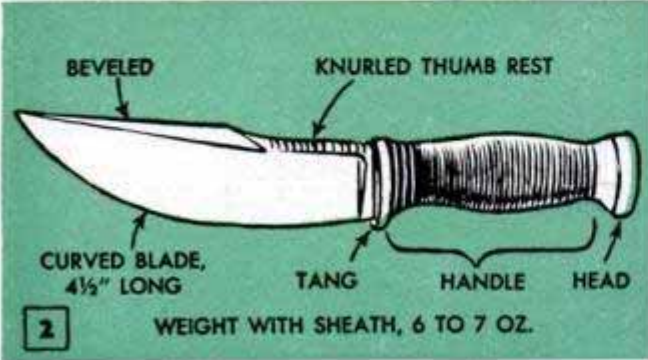

2 Points to look for in a good all-around hunting, or sheath, knife. Note blade knurl to provide thumb rest

straight from the edge to the back, making it especially suitable for slicing, skinning and chipping cuts.

Nearly everyone experienced on the trail will agree that the knife pictured in Fig. 2, and the lower illustration on the preceding page, is the ideal all-purpose type. The blade is short, a little over handle length, wide through the center and has a long bevel. The back of the blade is knurled with a straight knurl to form a secure thumb rest. It generally is available with either a staghorn handle or leather handle. As a rule, the stag handle is preferred, probably because this type seems most appropriate on a hunting knife. So far as durability and a firm grip are concerned, there is little choice between staghorn and leather, except perhaps when the knife is used in the preparation of meats and other foods and must be frequently cleansed by a thorough washing in water. Leather handles do not withstand continued soaking as well as stag handles.

Woodsmen and hunters carry a hunting knife of average size in the position shown in Fig. 1. The belt can be run through the loop and over the flap of the sheath as shown, or the belt can pass under the flap and through the loop. This position of the

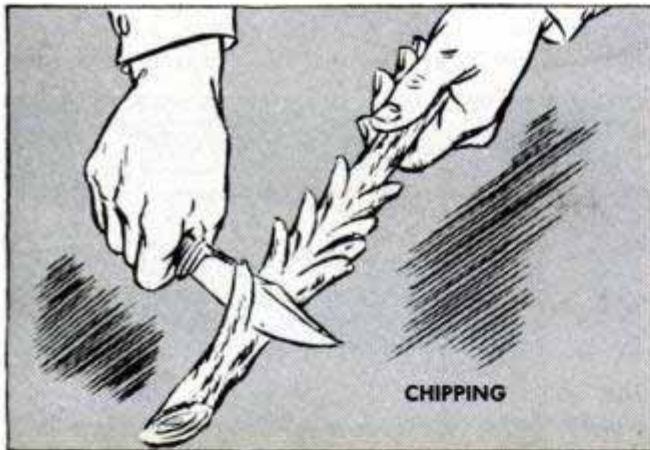

Here's a good way to prepare kindling for the campfire. Just make a series of chipping cuts on a stick

Your hunting knife can be used for chopping up twigs to make a good bed of live coals for roasting game

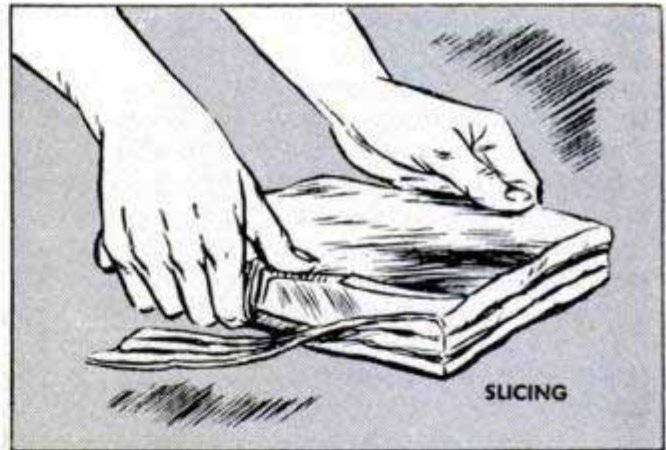

It takes a keen-edged knife to slice bacon to just the right thickness for frying over the open fire

In camp you may need to smooth a damaged ax handle or do a similar job. Use sheath knife as a scraper

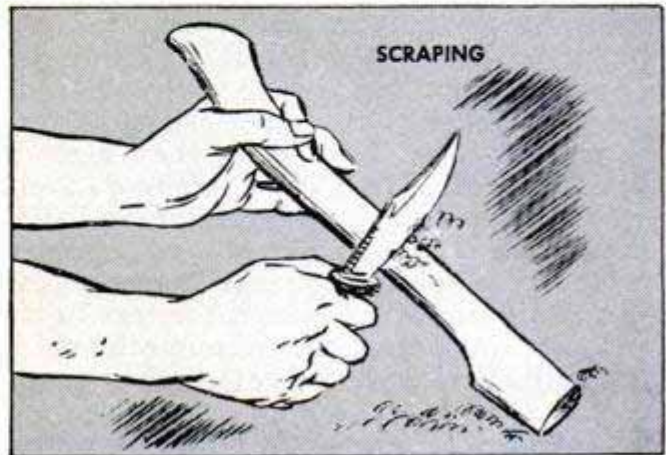

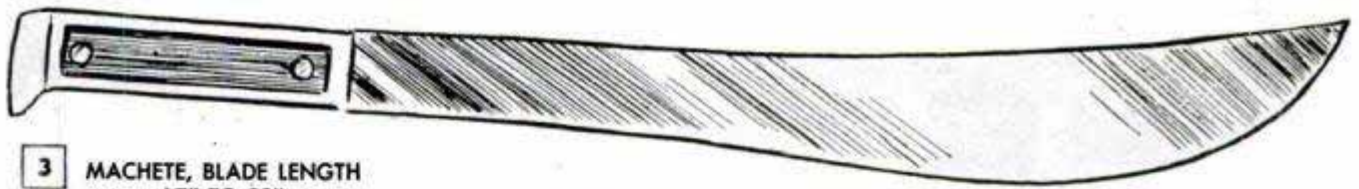

3 MACHETE, BLADE LENGTH
17" TO 22"
WEIGHT, 19 TO 25 OZ.

4 WOODSMAN'S COMBINATION
AX AND MACHETE. FUR-
NISHED WITH SHEATH.
WEIGHT, 1 3/4 TO 2 LBS.

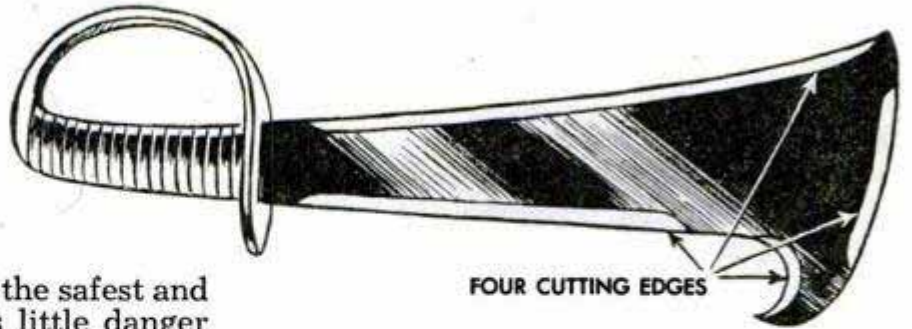

FOUR CUTTING EDGES

knife is generally considered the safest and handiest. If you fall there is little danger of the knife causing injury and the sheath does not interfere with access to the side and back pockets. Of course, in some cases it may be more convenient to carry the knife sheath attached to the shoulder pack. In addition to the one-piece hunting knives, there are several combination pocket-knives of the folding type which are well suited to the use of campers and hunters. Some of these combine blades and other useful tools, such as a can opener, lifter for bottle caps, corkscrew and leather punch. Others have a single self-opening blade of the hunting pattern. Usually the blade is opened by pressing a button or slide on the handle and it locks securely in both the open and closed positions. These knives are preferred by some outdoorsmen because of the convenience in carrying. However, knives of the pocket type are suitable only for light service.

For clearing a camp site, cutting a path through jungle, blazing trees for lumbering and for chopping fuel for the campfire, outdoorsmen often carry a machete, Fig. 3. The long, heavy blade is especially suited to slashing and chopping cuts. Many sportsmen and explorers prefer the machete to a light ax as it has a somewhat wider application in camp and on the trail and is relatively easier to carry. Another tool which combines the uses of the camp ax, bush hook and machete is shown in Fig. 4, and three applications of this special trail knife are pictured at the right. For working in thick undergrowth where there's little room to swing the knife effectively, the sharp cutting edges across the end of the blade and also in the hook can be used as in the upper and lower views at the right. For straight or slashing cuts on twigs or small saplings or in cutting campfire fuel, the long cutting edge is used as in the center view. This combination unit is furnished with a heavy sheath to protect the cutting edges. The average weight of 2 lbs. is a little heavy for the pack, but many experienced trail men sacrifice other less useful items in favor of the heavy knife.



This heavy trail knife has a cutting edge across end of blade, which is useful where space is restricted



Two other uses for the combination trail knife. For slashing cuts use long edge as shown above. Below, for clearing trail in heavy undergrowth use the hook



HOW TO TIE A

By Bruce Grant

An interesting project for the beginner in leatherwork is the tying of a Gaucho knot, for not only is it easy to weave, but the finished knot can be used as a neckerchief slide. The series of drawings on the opposite page shows step by step how the weaving is done around a piece of $\frac{3}{4}$ -in. dowel which is squared at the top and numbered on the four faces. A sleeve of cardboard or leather, over which the lacing is woven, provides a liner for the finished knot. The sleeve is formed by wrapping the leather or cardboard around the dowel and cementing the abutting edges with quick-drying cement.

Start with a length of $\frac{1}{8}$ -in. lacing about 32 in. long and wrap it twice around the sleeve according to step A. The end of the lacing marked X indicates the standing part, the other end being the working end. Step B shows how the two turns thus far in place should look on the back side of the dowel and how a third strand brought around to the back lies across the first two. Weaving actually is begun in step C. Pass the lace under the standing strand X and then over two strands. This same step is repeated on the back side of the dowel as shown in step D. An awl will be found helpful in working an opening under the strands. Keeping the numbered faces of the dowel in the relative positions shown, bring the lace around to the front again and pass it under two and over two strands as in step E. Again, this step is repeated at the back side of the dowel, step F. In step G, the sequence changes, in that you pass the lace over one and under two and over two, then repeat the step on the back, over one, under two and over two, so that the weaving looks like that shown in step H. Coming around to the front again, pass the lacing over two, under two and over two, step I, and then continue around to the back, again lacing over two, under two and over two, step J. Note that at this point you have six strands. In step K, the lace is brought around to the front, passing it under one, over two, under two and over two. The same procedure is repeated in step L. Now, as in step M, pass the lace under two, over two and under two at the front, continuing around to the back. Step N brings you back to the starting point and shows where the working end of the lace is passed up alongside the standing part to complete the knot. A dab of quick-setting cement will hold the loose ends of the lacing secure.

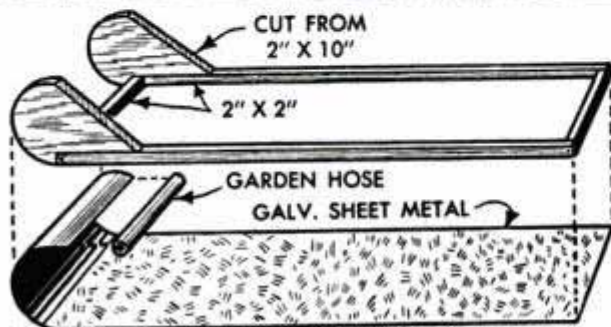

Simple Toboggan for Children Has Sheet-Metal Bottom

Winter will be a pleasure for your children if they have some means of enjoying it, such as this simply constructed toboggan. To make it requires little skill and few materials. The frame is constructed of 2 x 2-in. stock and may be built to any dimensions, this one being 24 in. wide and 6 ft. long. The curved pieces for the front are cut from 2 x 10-in. pine and fitted to the frame as shown. A piece of sheet metal, 24 in. wide and the length of the frame plus the curve of the front end of the toboggan, is attached to the frame with small nails. Finally, a section of garden hose which is split the entire length is placed over the sharp edge of the curved metal front to prevent possible injury.

Compression Spring on Vise Screw Provides Positive Action

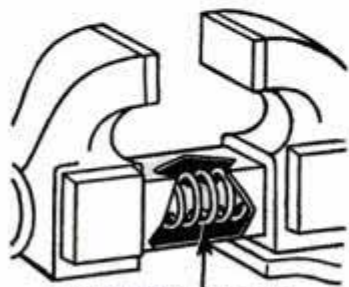

To obtain positive action when turning the handle of a bench vise, use a compression spring to take up the lag in the jaws. Just remove the traveling jaw and shaft from the vise, slip the spring over the screw and then reassemble the vise.

Victor H. Lamoy, Upper Jay, N. Y.

GAUCHO KNOT

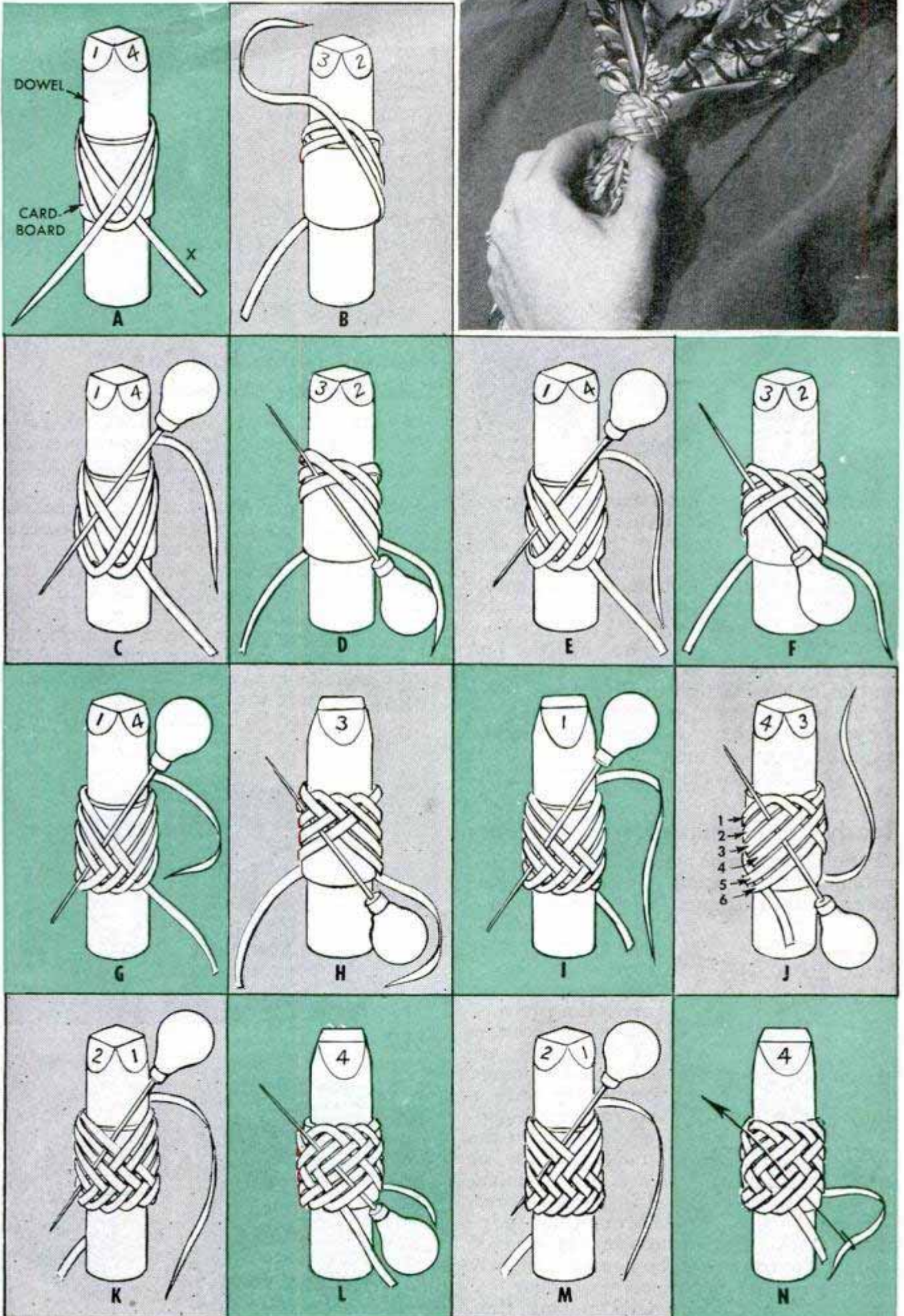

Butter Churn From Washer



Here is a way of converting your washer into a butter churn in just a few minutes. Cut a triangular hole in the center of a sheet of plywood so that it fits tightly over the agitator of the machine. Then assemble four separate compartments on the plywood base, making them $2\frac{1}{2} \times 3\frac{7}{8} \times 7$ in. to hold quart-size fruit jars. Fill the jars half full of cream to allow for expansion and fasten the lids tightly. Churn the cream by laying the jars in the compartments, as shown, and turning on the washer for the required length of time.

Elton L. Nash, Maple City, Mich.

Ready-Cut Framing for Panel Doors

Panel doors can be made quickly with just a handsaw by using tongue-and-groove flooring for the frame. The tongue is ripped or planed from the stock and the grooved edge is left intact to receive the plywood panel. The corners of the frame are mitered and joined securely with a corrugated fastener driven into the inside surface as well as a finishing nail driven through the edge

of the stock. The corners of the grooved edge of the frame can be rounded slightly to improve the appearance of the door.

C. Tate, Ottawa, Ont., Can.

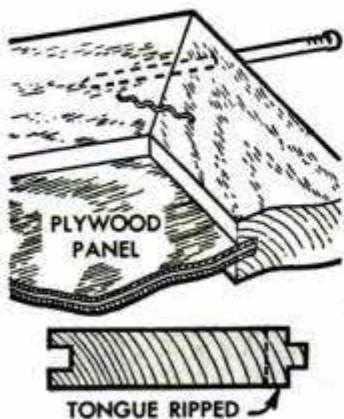

Jar Covers Provide Small V-Pulleys

If small V-pulleys are needed for a model or toy they can be improvised from the covers of paint cans or jelly jars. To make the pulleys, simply place two covers of the same size back to back and sweat-solder them together. By using jar covers of different sizes, the diameters of the pulleys can be varied to attain desired speeds.

Louis Hochman, Sherman Oaks, Calif.



Partially Empty Fuel Can Serves as Sea Anchor

A partially empty 5-gal. fuel can provides an emergency sea anchor for small power boats. Solder a heavy galvanized wire over the bail as in the upper photo to prevent it from pulling out of the bracket. Then, if the motor quits in a storm, the half-filled container is secured to the bow line and tossed overboard to keep the boat headed into the waves. Be sure that openings are tightly closed to prevent the can from filling with water. For runabouts and rowboats, 2-gal. cans will work well if the handles are crossed and the rope is tied as shown in the lower photo.

Clinton R. Hull, Costa Mesa, Calif.

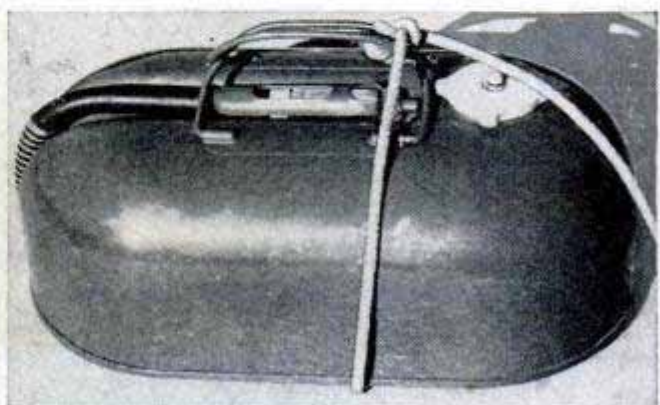

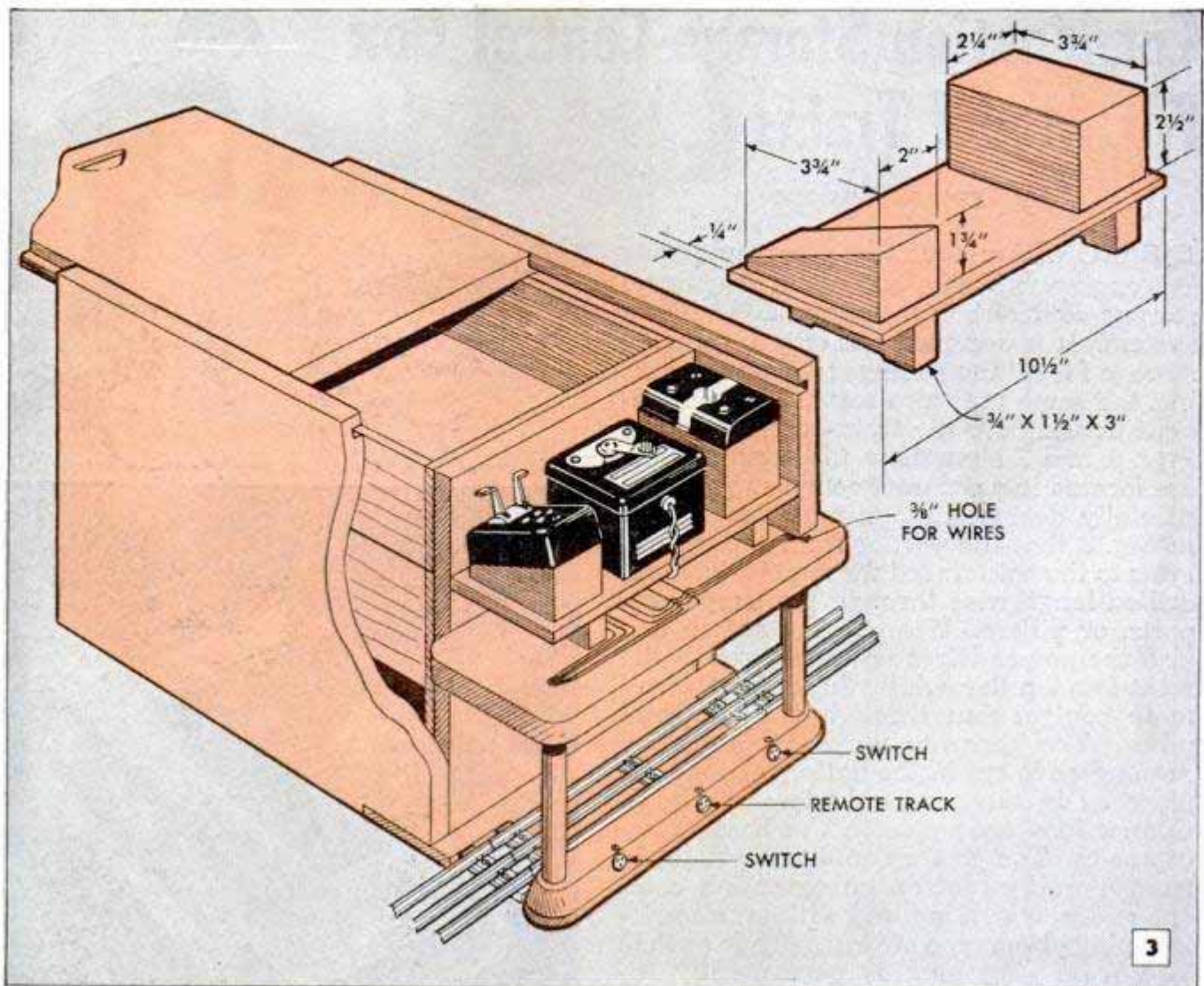

shut off at the control box. The cord from the male plug to the transformer is laid in a groove cut in the end of the box. It then passes through a hole drilled in the end of the box at the top of the groove and into the control compartment where it is connected to the transformer.

The storage box is made from $\frac{3}{4}$ -in. stock, the lower compartment being partitioned as in Fig. 2. In addition, there are two trays, each 3 in. deep. One is partitioned as in Fig. 1; the other is open for the storage of track sections. Both the main storage compartment and the control compartment are fitted with separate sliding

lids, or covers, having the edges rabbeted to form tongues which slide in grooves cut on the inside face of the box sidepieces. The track board, Figs. 2 and 3, is cut from $\frac{1}{4}$ -in. plywood and one section of track is permanently attached to it. The power wires leading to the track are laid in small grooves cut in the bottom of the track board. The ends of the wires are brought up through holes and soldered to the track terminals. The box is carefully sanded and the exterior finished in gray or orange enamel and trimmed in blue. The interior, including the trays, is finished in flat green of a light shade.

Decorated Potato-Chip Cans Form Novel Wastebaskets



Putting empty potato-chip cans to good use is accomplished by one homemaker who decorates the cans with old greeting cards to form attractive wastebaskets. The illustrated portion is cut from each card

and glued to the side of the can. Then a coating of thin shellac or plastic spray is applied over the cards to protect them. The wastebaskets can be decorated in a hobby theme by using empty seed packages, sheet music or appropriate magazine covers.—Jeanne Stasack, Chicago.

ⓘ When the wooden parts of children's construction toys become loose, swell the parts that fit in the holes by soaking them in lukewarm water for a minute or two.

OLD CLOCKCASES MAKE ATTRACTIVE SHADOW BOXES



Although the works may be damaged or worn beyond practical repair, most old clocks have cases made from fine cabinet woods and many of the cases, especially those of the mantel type, are just the right size for a shadow box. In converting the case to this new use, the first thing to do is to remove the face and works. In very old clocks, these parts often are attached to a wooden mounting board with screws and also with small metal brackets. In some old cases, it will be found that the mounting board is glued into a groove cut in the sides and across the top, or hood, of the case. If the board is glued in place, use care in removing it as otherwise you may damage the case itself. Remove the old finish with a varnish remover and refinish in the natural color of the wood with filler, sealer and varnish. Glue a suitable fabric or paper covering to the inside face of the back panel and trim the edges flush as shown in the photo at the right. Paint the interior of the case

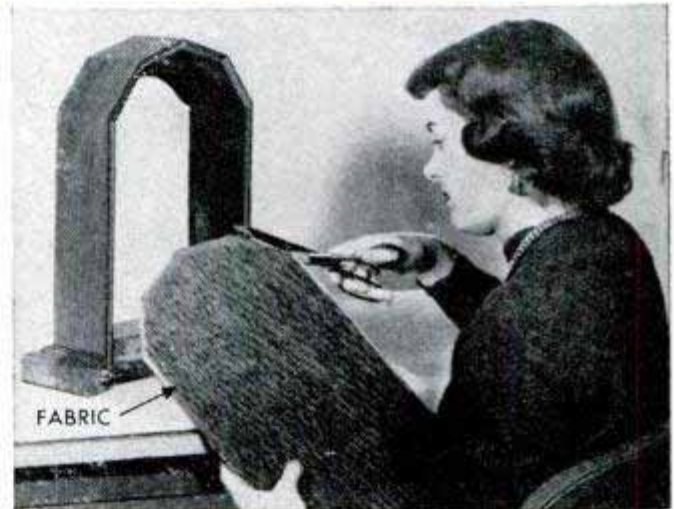

with a dark-colored flat paint and fit two glass shelves equally spaced as in the upper right-hand view. In some old cases, it will be necessary to fit a wooden block, or false shelf, in the bottom of the case to bring the shelf surface flush with the bottom of the door.—Otto Merker, Chicago.

Bottom Cut From Motor-Oil Can Provides Small-Parts Tray

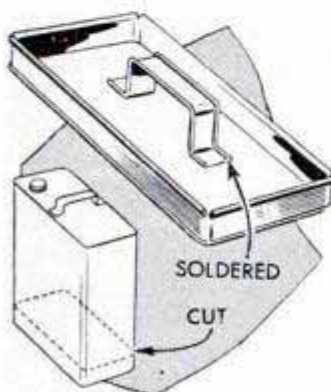

Just the thing for carrying a small assortment of screws and nails when making repairs around the house, this small-parts tray is simply the bottom portion of a motor-oil or syrup can. After the bottom is

cut from the can as shown by the dotted line, the edges are hammered over, and the handle, which has been removed from the top of the can, is soldered to the center of the tray.—William B. Egan, Louisville, Ky.

Hairpin Controls Trailing Vine

If you wish a vine to trail over the edge of a flowerpot at a particular point, press a hairpin over the stem and into the soil to keep the vine from shifting.



PICKABACK BILLIARD TABLE

By John C. Wilson

A PARTMENT dwellers and small-home owners whose recreation-room facilities are limited to the kitchen or dining room now can enjoy a game of billiards with this new portable table top. It rests on an extension-type kitchen or dinette table, providing a standard home-size playing surface that is lightweight and easily stored in a closet. The cushion rubber and felt can be purchased from any billiard-supply or sporting-goods store. Use $1\frac{7}{8}$ -in.-dia. balls and 52-in. cues.

By extending the table, a clear space is provided for the side pockets, Fig. 3, and leveling the playing surface is accomplished by a "jack" fitted to one of the table legs as in Fig. 6.

The billiard top is built around a 3 x 6-ft. panel of $\frac{1}{2}$ -in. plywood which is available at some lumberyards. However, you may find it necessary to cut a 12-in. strip from one side of a standard 4-ft. sheet. The first step is to lay out the holes for the pockets, Fig. 2. Each corner of the panel is cut off at

a 45-deg. angle to form a flat $3\frac{1}{4}$ in. long. The axis point for the 2-in. radius is located on a center line 1 in. in from the edge. The center of the side pockets is located $\frac{3}{4}$ in. in from the edge. The holes are cut best with a coping saw and then smoothed up with a wood rasp. The sectional detail through the edge of the table top shows how 2 x 2-in. hardwood rails are rabbeted to receive the plywood panel. Note that the depth of the rabbet brings the panel flush when it is covered with muslin and felt. The rails are joined at the corners and side pockets with $\frac{1}{8}$ x $1\frac{7}{8}$ -in. metal straps. These are fitted flush with the outer faces of the rails. Before fitting them to the rails, the straps are drilled and countersunk for oval-headed screws and then covered with sleeves of leather glued to the metal. The oval-headed screws make a neat job and prevent snagged clothing. Holes for bank markers are drilled at this time, the markers being flat-headed sleeve bolts located halfway between pockets. Measure from the center of one pocket to the center of the next one. Regular screw posts of the type

used for a memo pad make excellent markers and can be purchased in any stationery store.

At this point the side and end rails can be temporarily fastened to the plywood panel. The cushion mounting plates are ripped to size from 1-in. stock. With the ends mitered to suit the corner pockets, the plates are clamped in position on the rails and three holes are drilled through each rail and countersunk on the face to take long oval-headed screws which hold the plates. To determine the height of the cushion rubber above the playing surface, two pieces of felt are placed on the plywood, one representing the felt covering the top and the other the felt covering the cushion. The center of the ball should come about $\frac{1}{16}$ in. below the edge of the cushion. Now, hold the cushion rubber temporarily on the mounting plate, measure 1 in. up from the felt to the rounded edge of the rubber and mark along the lower edge of the rubber. Run this mark along the full length of each plate. This serves as a guide in gluing the rubber in position. Any good linoleum or tile cement can be



Using regular table for a base, top can be stored in closet

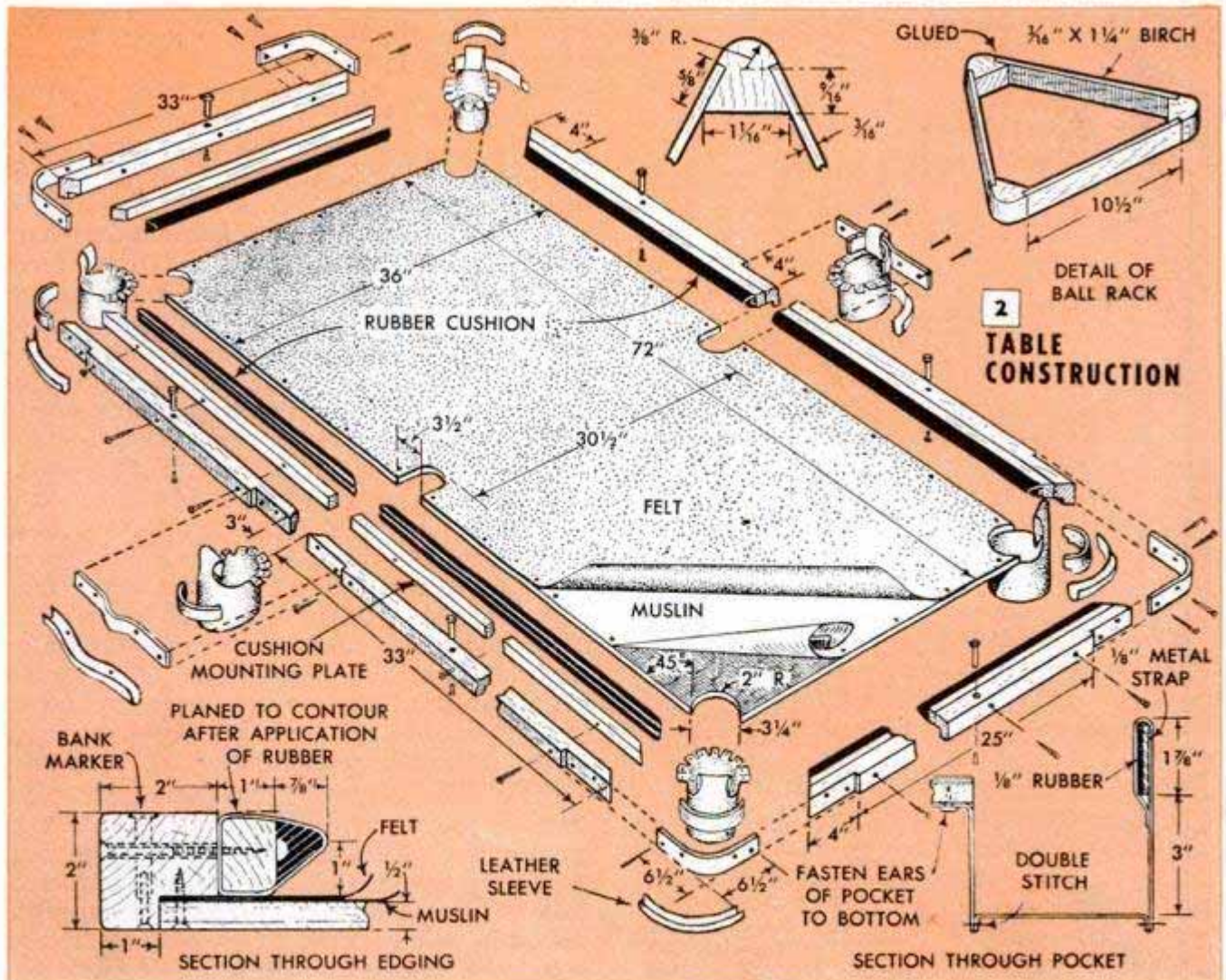
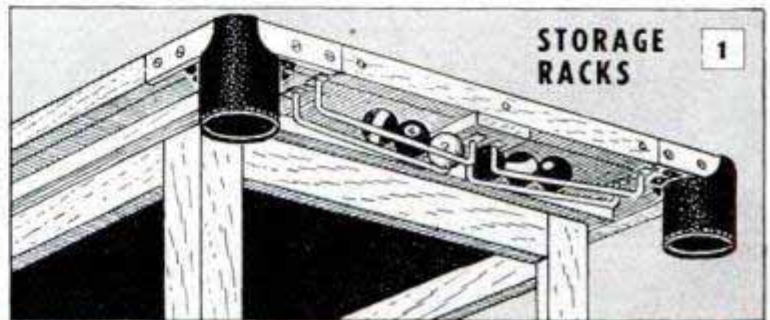

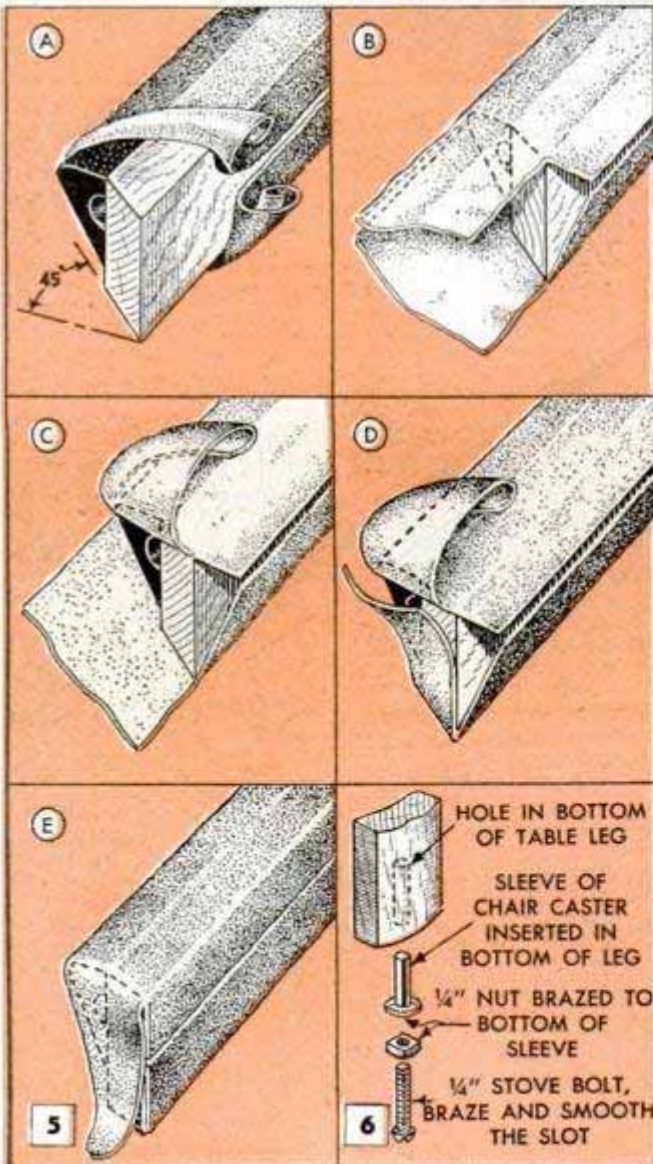
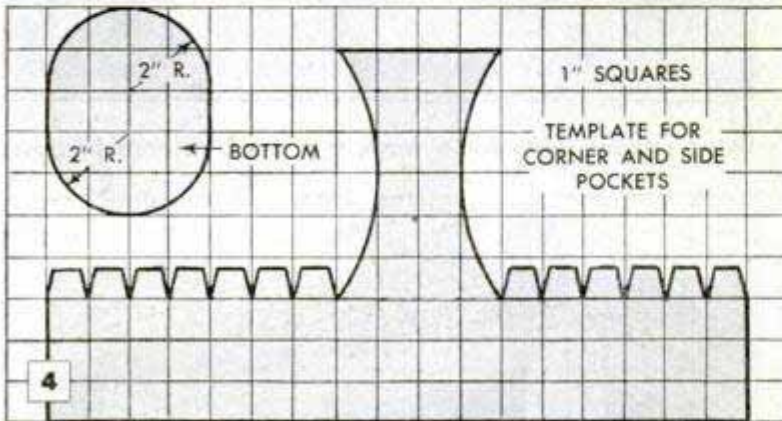
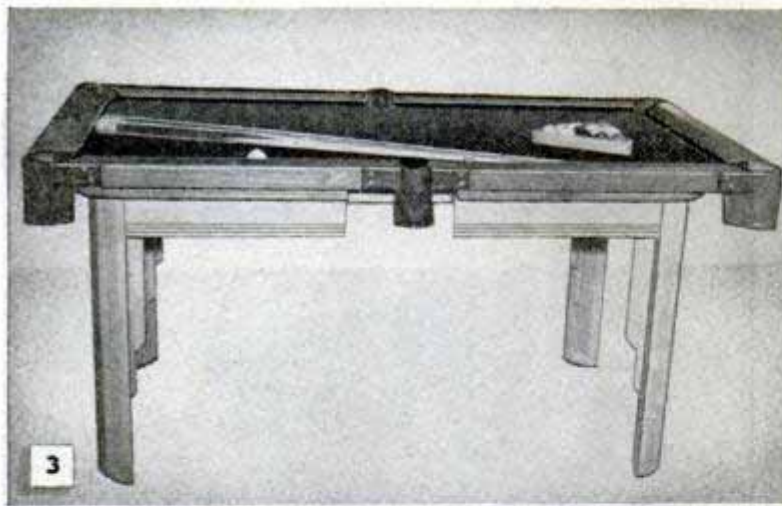

used and, after it dries, the inside edges of the plates are shaped to conform to the contour of the rubber strips. With the ends of the rubber cushions mitered to match the ends of the plates at the pockets, the cushions are covered with felt. In cutting the strips, allow enough felt to extend to the back side of the mounting plate, as in Fig. 5. The successive steps show the sequence in covering the rubber. Glue is applied to the wood surfaces only and the felt is pulled firmly from the top toward the bottom. The felt at the mitered ends of the cushions is double lapped and the end tucked under as in step E.

When all the cushion members are covered, felt is applied to the playing surface. First remove the rails which were temporarily fitted and apply two coats of shellac to the plywood, sanding each when dry. Next, stretch muslin over the plywood and tack it along the outer edges, letting the muslin cover the holes for the pockets. The felt is glued to the muslin and it is best

to work a small area at a time to prevent the glue from drying before the felt can be rolled out smoothly. The felt should be large enough to overhang the top all around so that it can be pulled and stretched tautly should any wrinkles remain after gluing. In the final stretching, the felt is tacked to the plywood all around the edges. The felt, which now covers the openings for the pockets, is cut into $\frac{1}{2}$ -in. strips. These are tapered slightly to form gussets so that, in bringing them down around the edge of the hole, adjacent edges of the strips will butt together. Drive tacks through the felt tabs and into the edges of the plywood and then tack the ends to the underside.

Fig. 4 gives a pattern for the leather pockets. The detail in Fig. 2, showing a sectional view through the pocket, indicates how each pocket is hung from the metal strap joining the rails. Note that the inner face of the metal is lined with a strip of $\frac{1}{8}$ -in. rubber glued in place to cushion the balls. After the pockets are stitched and slipped over the metal straps, they are tacked to the underside of the plywood, nailing through the tabs provided.

Finish the rails with two coats of shellac, sanding each one lightly, and then apply paste wax. The underside of the plywood should be covered with felt to prevent marring the finish of the table. Fig. 1 suggests a simple ball rack that can be installed at one end of the table, using towel bars.

Featuring an illuminated tropical aquarium, this unusual floor lamp combines beauty with utility. The lamp is relatively easy to build, the one pictured being made entirely with hand tools. An old floor lamp cut to the desired length provided the standard and lighting fixture for the aquarium lamp. However, if you have a wood lathe, the lamp standard can be a split turning which is first grooved for the wiring and then glued back together. Note that the 15-watt aquarium bulb is controlled by a small push-button switch making it independent of the floor lamp.

On the original lamp, the aquarium was fashioned from the glass bowl of a discarded gasoline pump. As one end of the bowl was broken upon removal from the pump, the irregular edge was cut off by clamping a 2-in. rubber belt around the bowl, marking the glass with a glass cutter and then tapping lightly on the inside. If this type of bowl cannot be found, a 5-gal. water bottle with the top cut off will serve the purpose. The aquarium rests on a wooden base consisting of a disk screwed to half-lapped legs. The bowl is set in a circular groove cut in the top surface of the disk. After the base has been stained and given three coats of marine-grade spar varnish, a strip of putty is placed in the bottom of the groove. Then the bowl is pressed into the putty and the joint is made watertight by tamping putty into the groove on both sides of the glass. As the pump-bowl glass was $\frac{1}{4}$ in. thick, a $\frac{1}{2} \times \frac{1}{2}$ -in. groove was cut in the base, thus allowing room for the putty seal. A disk of $\frac{3}{4}$ -in. plywood forms

Unique Floor Lamp Has Aquarium Base Improved From Gasoline-Pump Bowl

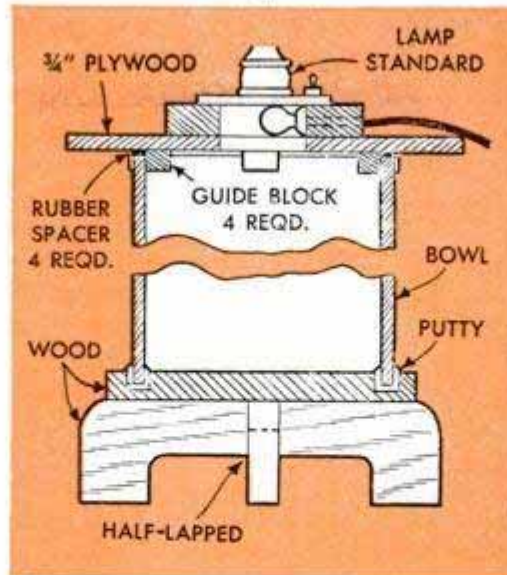

the aquarium top, and this is centered on the bowl by means of four guide blocks which fit against the inner surface of the glass. One-inch-square rubber spacers are glued to the plywood top at the outer edge of each guide block. These provide a bearing surface for the top of the bowl and also elevate the plywood disk to permit ventilation. If desired, the metal rim usually found around one end of the pump bowl can be left in place so that the plywood top will rest on the metal instead of the glass. The wooden lamp base, which houses the aquarium light, is attached to the plywood top by means of two dowel pins which fit in holes drilled in the plywood. The dowels align the lamp housing with a hole cut through the center of the aquarium top, and allow the entire lamp to be lifted from the aquarium when it is necessary to feed the fish. Small vent holes are drilled through the top of the aquarium-lamp housing and around the standard to keep the bulb from overheating.

R. E. McCrary, Brownwood, Tex.

Mixing Faucet of Pipe Fittings Controls Water Temperature

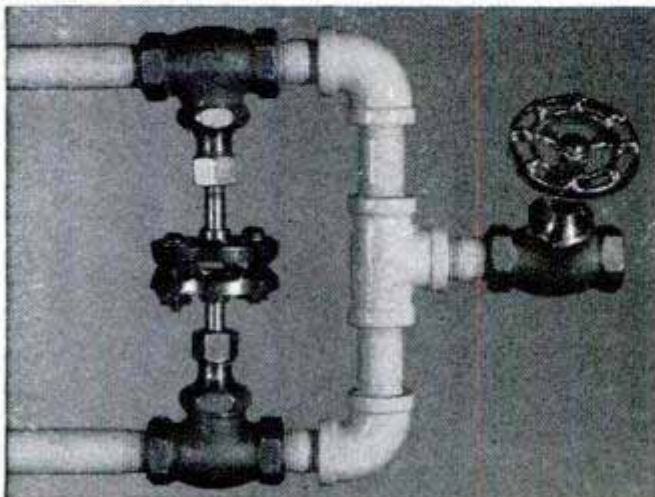

Utilizing either globe or gate-type valves, a convenient semiautomatic mixing faucet is quickly assembled for use in the laundry room or shop. As shown in the photo, supply valves are inserted in the hot and cold water lines directly opposite each other and their handwheels are bolted together. When assembling the valves, one should be completely open while the other is fully closed. In this way, turning the handwheels closes one valve and opens the other simultaneously. The two pipes are brought to a single outlet where the flow of water is controlled by a third valve.

Ned S. Goss, Wilmington, Ohio.

Home Repairs

HIDEAWAY



stand is made with glue and flat-headed screws, as all joints are invisible when the cover is in place. Exposed joints of the cover can be glued and bradded, or fastened with screws turned into countersunk holes which are then filled with hardwood screw-hole buttons. Note that the ends of the stationery compartment, Fig. 2, are grooved, or slotted, for plywood dividers. The door swings on special offset hinges made by bending ordinary strap, or gate, hinges to an S-shape and mortising the door so that the hinge joints fit flush. The drawer and door handles are handmade.



Salt and Pepper Shakers Fashioned From Shotgun Shells

A pair of decorative and practical salt and pepper shakers are made quickly from two empty shotgun shells. As a means of distinguishing between the shakers, use a

green 12-ga. shell for the salt and a red 16-ga. shell for the pepper. Remove powder residue from each shell with scalding water before using it. Then trim the blown-out ends of the shell by cutting them off straight. For the shaker caps, use plastic or bits of hardwood, turned as shown in the drawing, and drill them with a small bit. —Robert Hertzberg, Jackson Heights, N.Y.

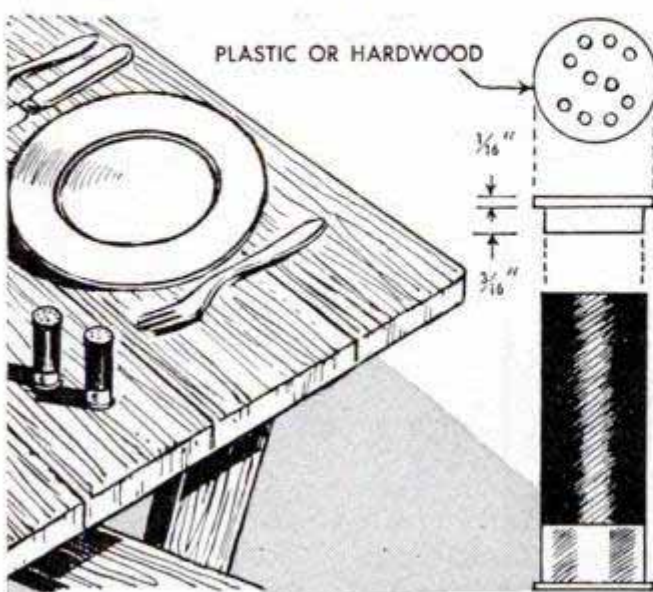

Nylon Fishline Dyed With Tea

Feeling that my white nylon fishline would bring better results if it were dyed a dark color, I was faced with the problem of dyeing it without using boiling water. I dyed the line an amber color, that is practically invisible in water, by soaking it for two hours in a cool solution of tea. I boiled 2 oz. of orange-peko tea in 1 qt. of water and then allowed it to cool to room temperature before immersing the line.

Karl N. Greife, Pittsfield, Ill.

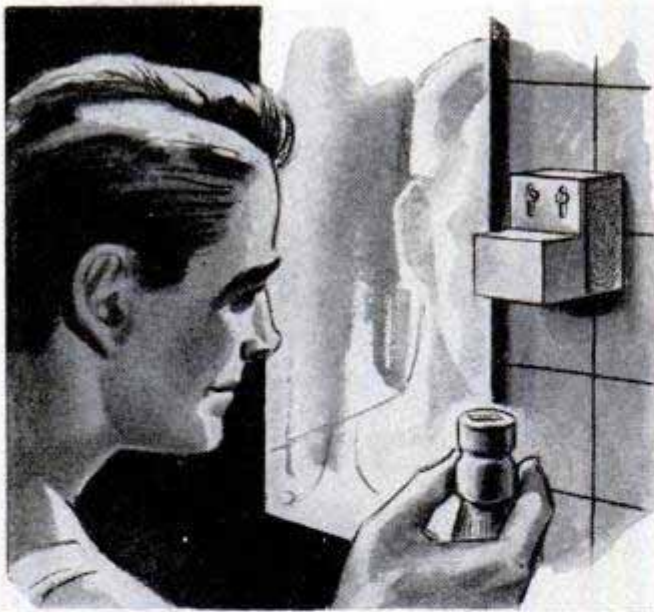

Shaving Brush Stored Conveniently By Magnetic Wall Fixture

Mounting a magnetic door latch on a bathroom wall provides a handy shaving-brush holder from which the brush is hung in a bristles-down position, thus prolonging its life. A wooden block serves as a spacer to hold the magnet slightly away from the wall. The block is fastened to the wall within easy reach of the lavatory and the magnet is screwed to the block so the bottom edges of both parts are flush. The metal plate which is included with the latch, or a thin strip of sheet iron, is set flush in the end of the shaving-brush handle and fastened with a flat-headed screw. To store the brush, simply touch the handle to the bottom of the magnet.

Murray E. Anderson, Fort Valley, Ga.

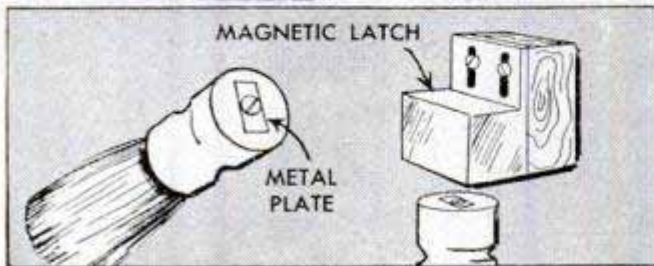

Edge of Shingled Roof Reinforced With Galvanized-Metal Strip

Old-fashioned methods of reinforcing the edges of a shingled roof are "out" so far as one contractor is concerned. He found an easier and better way of doing the job by placing a sheet of galvanized metal under the first row of shingles. The sheet

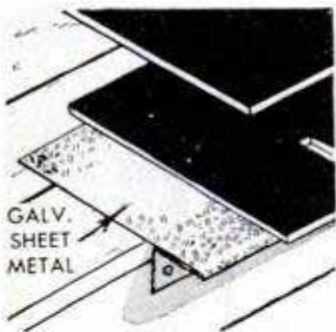

metal is crimped to overhang the roof about 2½ in. and also to form a flange for nailing to the cornice, giving the shingle overhang strong, durable support.—Grover Brinkman, Okawville, Ill.

Strainer Holds Damp Washcloth For Carrying in Suitcase

One of the perplexing problems of traveling is what to do with a wet washcloth while living out of a suitcase. The solution is to rinse and wring out the cloth thoroughly and then place it in a screw-top metal strainer. The latter will keep the cloth from coming in contact with other items in the suitcase while still permitting necessary ventilation.

Wade Porter, Jr., Edgewater, Colo.

☐ A small magnet will hold steel pins and needles and pick them up from the floor.

Paper Clip Aligns Rubber Stamp

When a rubber stamp is used to print a return address on post cards and envelopes, the impressions on all the mail will be uniformly neat if a paper clip is used to aid in aligning the stamp.



Pin the clip to one side of the stamp with a thumbtack, allowing it to project the desired distance. Then sight from above to bring the end of the clip directly over the top of the paper and keep the length of the clip parallel with the edge of the paper.

Resting Artists' Brush on Washer Raises Bristles Off Table

While using artists' brushes with different colors, slip a serrated washer over the handle and just behind the ferrule of each brush. This allows you to lay the brush down wet without danger of smearing the table top.—John J. Rea, Urbana, Ill.



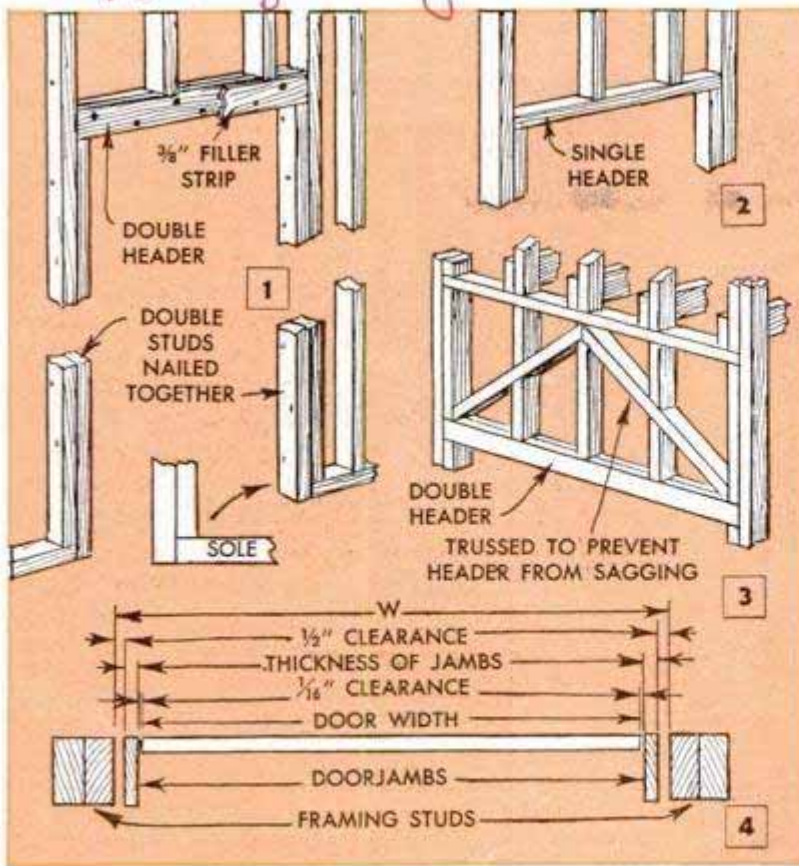

DOORWAYS— *Make Your Own*

How to frame and hang interior doors properly in new or old walls

By E. R. Haan

INSTALLING a new doorway in an added partition or relocating a door in a plastered wall are jobs that any careful homeowner can do. A door-frame is nailed to a sturdy framework of studs. There are double studs—two studs nailed together securely—on each side and a header across the top. In load-carrying partitions the header consists of two lengths of 2 x 4 or 2 x 6-in. stock set on edge and spiked together for maximum strength as in Fig. 1. Filler strips, such as wood lath, will make a double header come flush with the studs. A single header, Fig. 2, although generally not recommended, can be used in wallboard partitions not subjected to weight. Headers over all doorways 4 ft. wide or more should be reinforced by trussing, Fig. 3. The truss carries weight of the wall over the opening.

Doorway measurements: To determine the correct distance between the double studs of a doorway framework—distance W in Fig. 4—add together the door width, clearances and thickness of the door jambs. Vertical measurements, which include the thickness of the header, are given in Fig. 9. On outside doors allowance is made for a threshold above

After the door opening has been framed, cut the door to approximate size, install the hinges and then check for fit. A hand plane will enable you to shave down the edges of the door to compensate for the frame if it is slightly out of plumb

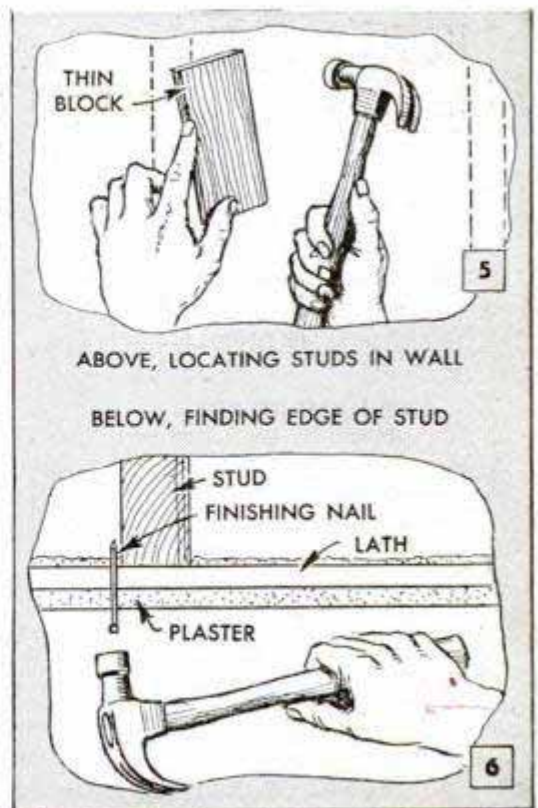

ABOVE, LOCATING STUDS IN WALL

BELOW, FINDING EDGE OF STUD

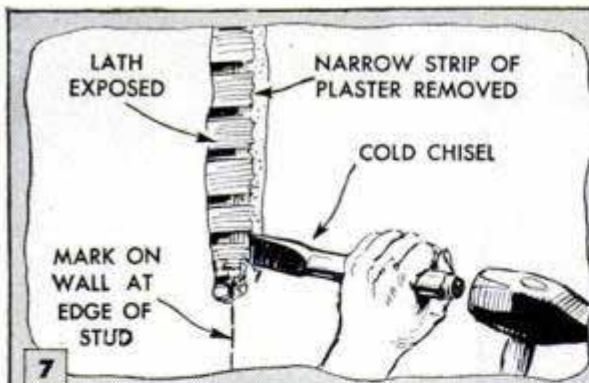

7

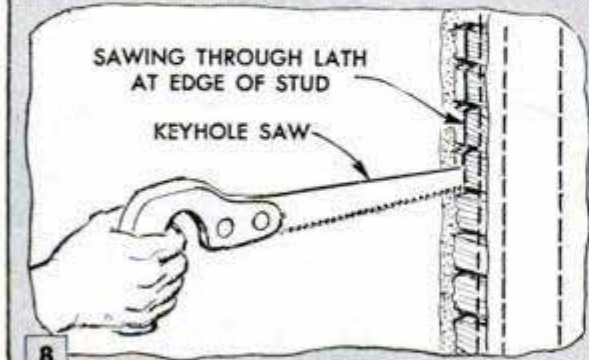

8

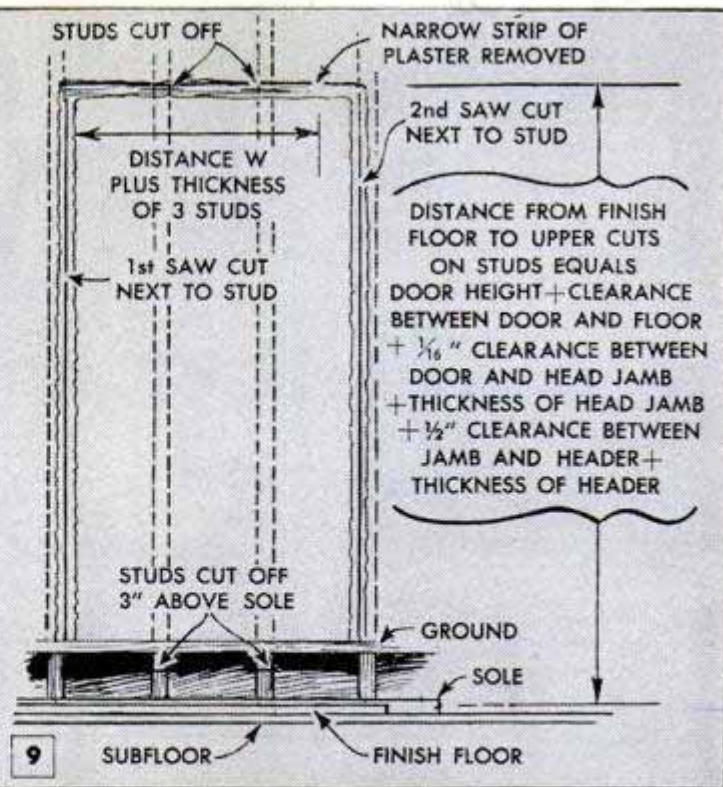

9

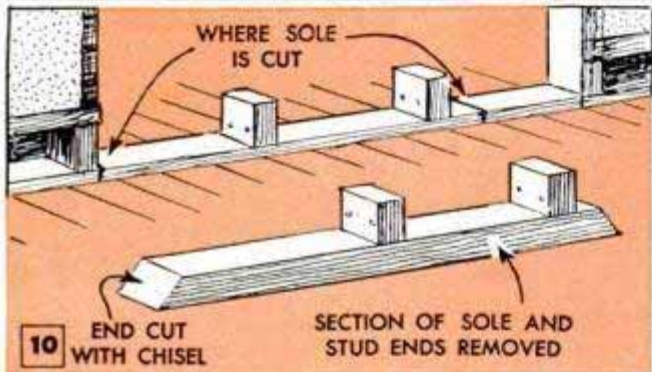

10

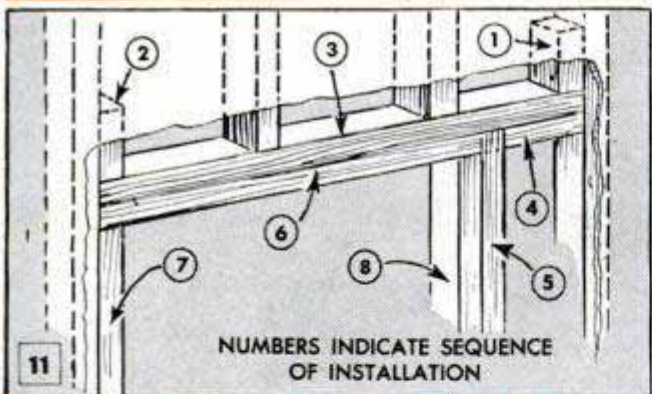

11

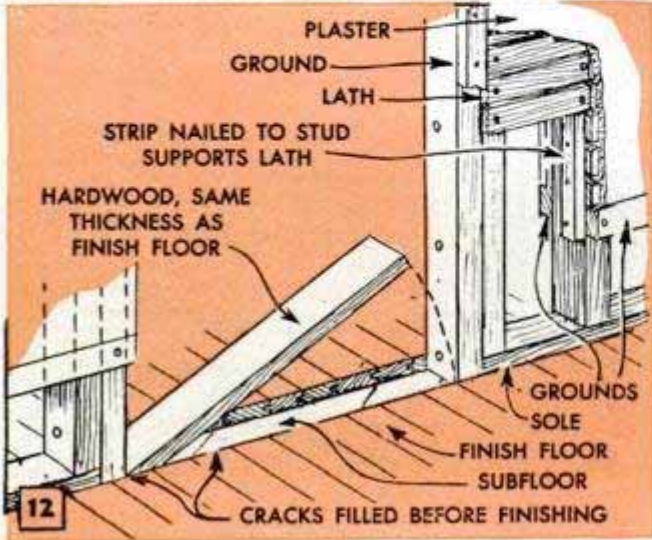

12

the finish floor when cutting the door to fit.

Changing doorway position: When changing the position of a doorway in a plastered wall, first make sure that there are no pipes or heating ducts in the partition where the doorway is to be located. Then remove the base shoe or quarter round and baseboard. Next locate the studs in the wall at the new position. If the plaster is not carried all the way down to the floor, but stops at a "ground" a few inches above the floor, the stud locations are obvious. If the plaster extends to the floor, studs are located by "sounding"—tapping as in Fig. 5—using a thin wood block to avoid hammer-head marks on the plaster. Locate the edge of the stud on the door side by driving in a finishing nail as in Fig. 6. Do this where the stud was located by tapping and also a few inches above the floor. Mark a pencil line between the two nail holes to indicate where plaster is to be chipped away with a cold chisel as in Fig. 7. Also push back plaster between the laths where sawing is to be done as in Fig. 8. Walls that are lathed with plasterboard are treated in much the same manner as wood lath in cutting a doorway. In the case of metal lath, shears are used to cut material when removing it.

Next, measure off distance *W* of Fig. 4 from the saw cut, add the thickness of three studs — $4\frac{7}{8}$ in. — then locate the doorway edge of the next wall stud beyond this point. After marking, cut through plaster and lath as before. The same procedure is followed on both sides of the wall. Studs between the vertical cuts are sawed off at the bottom first, then at the top. If plaster runs down to the floor, remove a horizontal strip about 6 in. wide and saw the studs about 3

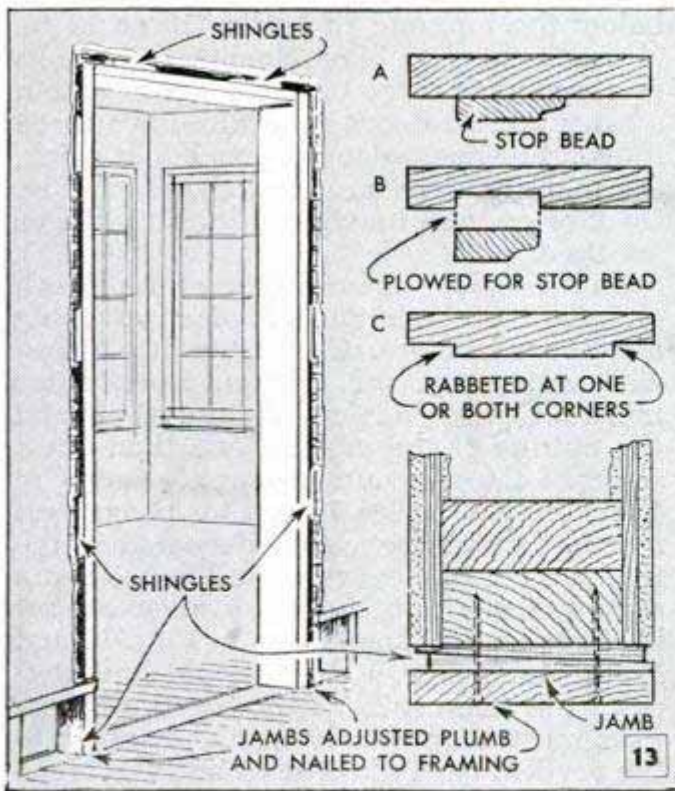

in. above the partition sole to avoid nails. A 2-in. strip of plaster and lath is removed across the top as in Fig. 9 to permit cutting off the studs at the top.

Now it should be possible to remove the cutout portion of the wall intact, after which the partition sole is cut off as indicated in Fig. 10, and the stud framework for the doorway is built following the sequence in Fig. 11. The joint at the bottom is shown in the lower details of Fig. 1. Lathing and plastering repairs are made as shown in Fig. 12. A strip of wood is nailed to the side of the stud where the old plaster ends to provide nailing support for the added lath or lath substitute. Other strips of wood of the same thickness as the plaster and lath are nailed along the edges of the opening to assure uniform thickness when plastering. These are "ground" strips, usually lengths of 1 x 2-in. stock beveled on one edge to "lock" the plaster. In applying wood lath it is customary practice to break the joints after each group of eight laths is applied to prevent plaster from cracking along a continuous joint. For plastering, it is advisable to get the services of a professional workman. Fig. 12 also shows how the floor can be patched with one or more hardwood boards of the same thickness as the finish floor.

Installing the doorframe is next. The head jamb must be horizontal and the side jambs plumb. Wooden wedges (butt halves of shingles) between the jambs and studs, Fig. 13, facilitate adjustment and provide nailing support. Use 10 or 12d finishing nails, and then apply trim pieces shown in Fig. 17. The stop bead generally is tacked on when hanging the door.

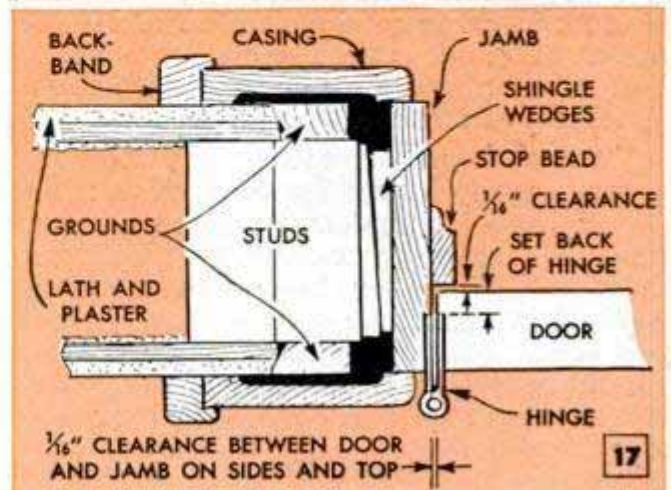
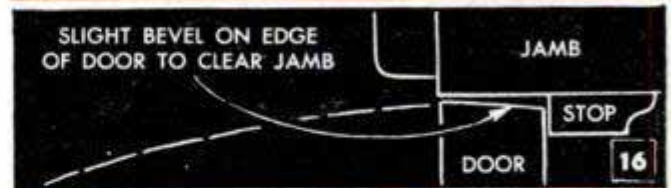
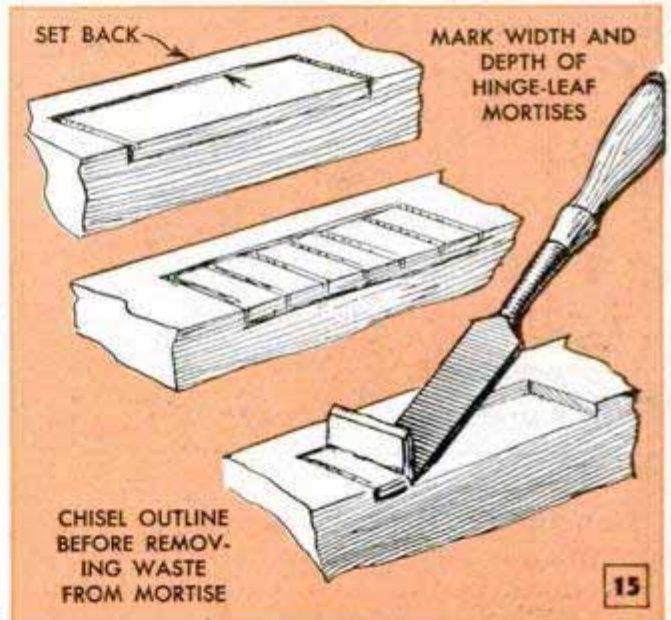

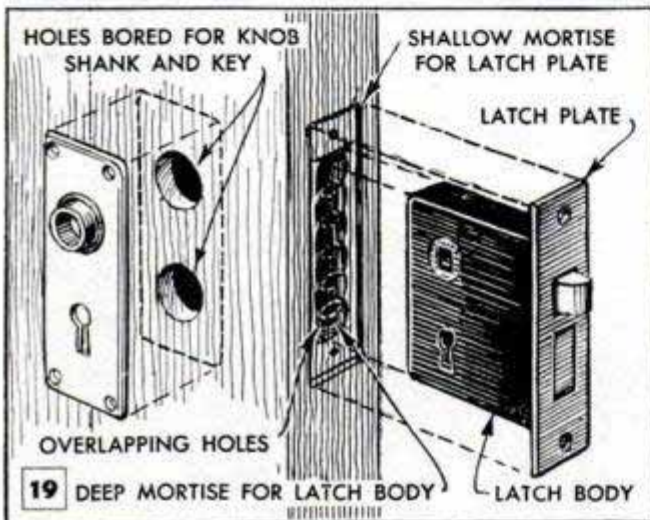
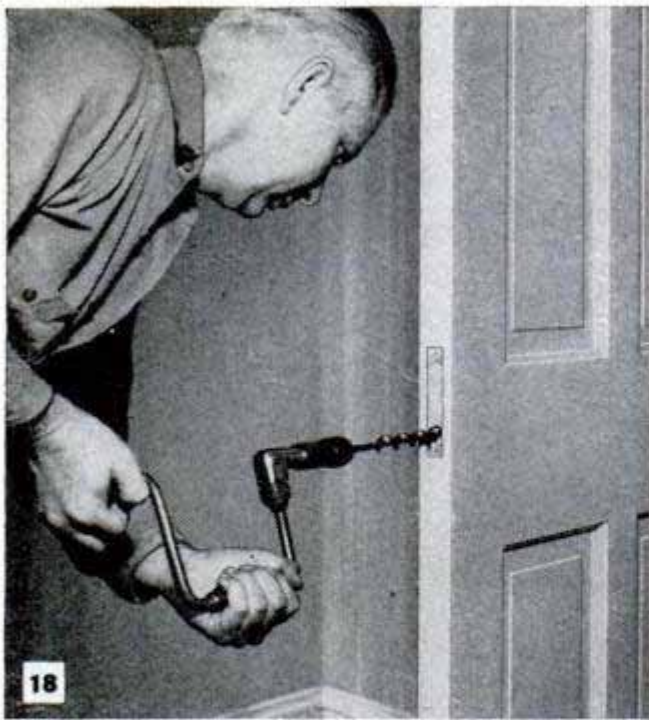

Hanging the door: By sighting, you can see which is the straightest edge of a door. This should be the latch edge since a slight warp can be corrected at the hinge edge by using a center hinge. On new doors the stile extensions are cut off first. Then the sides and top are planed to fit the jambs. There must be about $\frac{1}{16}$ in. clearance on each side and the top. The latch edge should be beveled slightly as in Fig. 16. On old doors planing to size is not done on the latch edge but on the hinge edge. The clearance at the bottom of an interior door should be about $\frac{1}{2}$ in. to avoid rubbing on rugs.

The stop beads are tacked in place temporarily while fitting the door which is inserted in the frame and removed a few times during the process of fitting. To mark door and jamb for hinges the door is wedged in the frame so that there is correct clearance all around. The surface should be flush with the edge of the jambs. Use a knife or scribe to mark the hinge positions on both door and jamb. Most interior doors have two hinges, one 5 or 6 in.

below the top, and the other 10 or 12 in. above the bottom. Make the hinge positions correspond to those on other doors within sight. Exterior doors generally have three hinges. For house doors $1\frac{1}{8}$ to $1\frac{3}{8}$ in. thick, $3\frac{1}{2}$ -in. butt hinges are used; for doors 2 in. thick or over 36 in. wide, 5-in. butt hinges are used.

Take the door down and mark the length and width of the hinge-leaf mortises, using a scribe as before. Carpenters use a special butt gauge for this purpose. After marking, make vertical chisel cuts around the outline of the mortise and then cut a series of chipping cuts to simplify paring to the right depth, Figs. 14 and 15. Hinge-leaf mortises should be a trifle deeper than the thickness of the leaves. On all house doors except those $1\frac{1}{8}$ in. thick, the hinges are set back about $\frac{1}{4}$ in. as shown in Figs. 15 and 17. All hinges on a door should have exactly the same setback; crosscuts of mortises must be precisely at right angles to the vertical edge of the door and the hinge pins must be in perfect alignment. After the hinge leaves are screwed to the door and jamb separately, the door is put in position and the hinge pins are inserted, the upper one first.

Jambs for most interior doors have the stop beads nailed on with 5 or 6d finishing nails, detail A of Fig. 13. Occasionally, in older construction, jambs are found that have stop beads set in plowed grooves as in detail B. Jambs for exterior doors generally have the jambs rabbeted as shown in detail C. There should be a clearance of $\frac{1}{16}$ in. between the door and stop bead at the hinge edge but the latch edge of a door should fit snugly against the stop bead to prevent rattling.

Fitting latches and locks: Most latches and locks are set into doors as shown in Fig. 19. To install a latch or lock, mark and cut the shallow mortise for the latch plate at the same height as those of other doors, which is usually about 36 in. above the floor. To make the deep mortise for the latch body, bore overlapping holes and then trim with a chisel. On cylinder-type latches only one or two holes are required instead of a mortise. As shown in Fig. 18, the door can be left in the frame and held securely with two wedges between it and the floor while cutting the latch mortise. After this has been done, bore the holes for the knob shank and the key, and screw on the side plates so that the knob shank will fit without binding. Then turn on the knobs and lock them with the setscrews. The strike plate is set into the jamb so that the latch bolt will slip into the hole when slight pressure is applied in closing the door. Be sure to locate the strike plate at the correct height so the bolt does not bind.

From CHANDELIER To CANDLESTICKS

By Walter E. Burton

There's a pair of fine candlesticks in many an old-fashioned brass chandelier. Generally, the chandeliers can be had for the asking as most homeowners engaged in remodeling are glad to get rid of them. Dangling spindles and other metal parts formed by spinning usually are assembled with threaded brass rods or pipe and are easily separated without damage. Photos at the right, left, and below show how, in one instance, the separate parts of a chandelier were assembled to form an attractive pair of candlesticks. Careful hacksawing with a fine-toothed blade, soldering, and then polishing with a rouge-charged buffer produced the job pictured. To prevent tarnishing, coat the polished work with metal lacquer, clear lacquer or shellac.

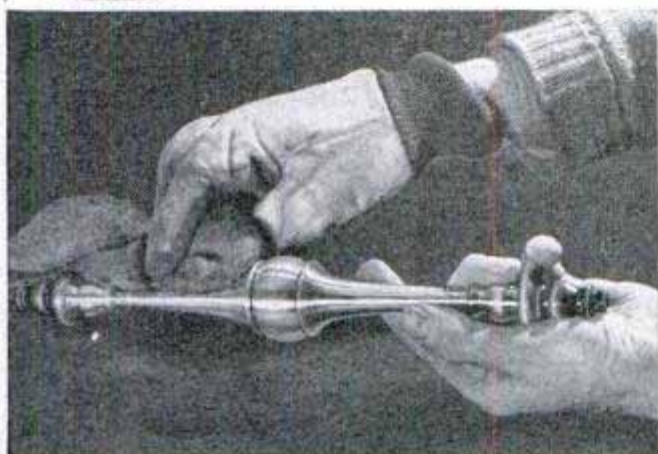

Eye-Catching Outdoor Murals of Wallpaper Color Child's Playroom

Lively wall decorations that feature an interesting variety of birds and animals will lend a carefree outdoor atmosphere to a child's playroom. By utilizing solid-color wallpaper along with animal and plant-life

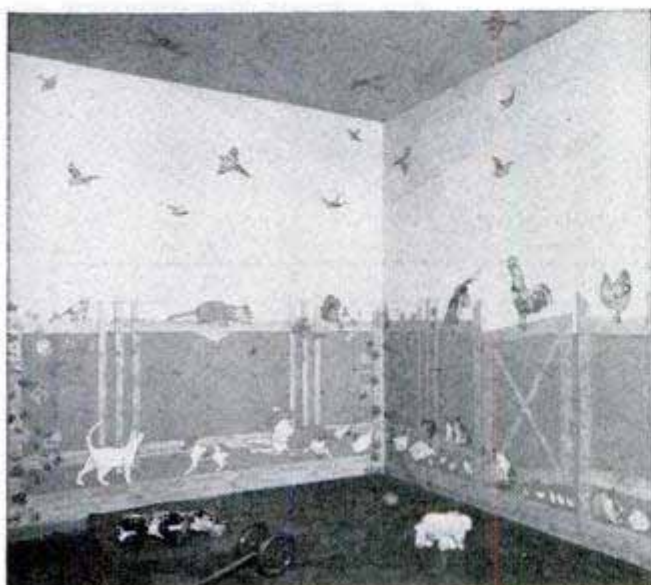

cutouts, one homeowner achieved the farm motif shown in the photo. Sky-blue paper is used for the ceiling and wall area above the fence and green paper for the wall below the top fence rail. The fence itself consists of strips of knotty-pine wallpaper pasted over the background. The animals and flowers are cut from wallpaper, magazine illustrations or children's cutouts. Mount the cutouts with regular wallpaper paste and use ordinary wax crayons to add nailheads to the fence, and stems and leaves to the flowers. For durability and ease of cleaning, the walls are covered with two coats of clear varnish. Other scenes can be depicted similarly or the murals may be applied only to the corner areas of the walls.—R. L. Morris, Washington, D. C.

☐ If you pump the water from a washing machine into a kitchen sink or laundry tub, place an old strainer over the sink drain. This will collect the lint which otherwise might clog the sink drain.

Extension Handle for Wooden Match Bent From Wire Coat Hanger



There is no danger of singeing your fingers when lighting the oven of a kitchen gas range if you use this wire extension handle to hold the match. The handle allows you to stand well away from the burner while placing the lighted match against the gas ports. The matchstick is inserted in a spiral holder formed at one end of a length of stiff wire which can be obtained by straightening a wire coat hanger. The other end of the wire is bent to form a handgrip. The spiral can be bent quickly by using a pair of pliers to wrap the wire around an ice pick or a length of small-diameter rod. If you have an oil-burning space heater, a similar extension handle will permit you to ignite the oil without cluttering the bottom of the pot with burned matches and scraps of paper. When using the extension to hold a match in a gas oven, be sure to stand in such a position that you can see when the flame of the match is near the burner ports. Otherwise, too much gas may collect before ignition, resulting in a small explosion.

Julius S. Hurst, Knoxville, Tenn.

Melted Paraffin Simplifies Removing Duck Feathers

It is no job at all to pluck the feathers from a duck while the bird still retains its body heat, but most hunters wait until the birds are cold and the feathers have set. In the latter case, use paraffin to help remove the feathers. Just melt several blocks of paraffin, strip the ducks of the larger wing and tail feathers and dip each bird

slowly in the melted paraffin. After the paraffin cools, peel it off, and the feathers will come with it. To remove the small pinfeathers and down, rub the bird's body with powdered resin and dip it quickly in boiling water. Then rub off the down and pinfeathers with a dry cloth or, if no cloth is available, with the palm of the hand.

Oilcloth Utilized to Fashion Shopping Bags in Attractive Color Combinations

Sturdy shopping bags of any convenient size and in a variety of attractive color combinations are made easily from oilcloth, leatherette or awning material. To fashion a bag 13 in. wide by 18 in. deep, use a piece of material of the size given in the detail. On the unfinished side of the material draw a line parallel to each edge as indicated and fold the material inward along these lines. Double the material temporarily and crease the folds. Then unfold it, double the material wrong side out and stitch the edges. After stitching, pull the bag right side out, and you are ready to apply the handles. The latter are made from three strips of material, 26 in. long and $\frac{1}{2}$ in. wide. These are braided tightly together, resulting in a braid about 20 in. long, and then are cut into two sections. Attach one of the sections to each side of the bag, stitching it securely in place and reinforcing the edge with cloth tape which also serves as a colorful trim.

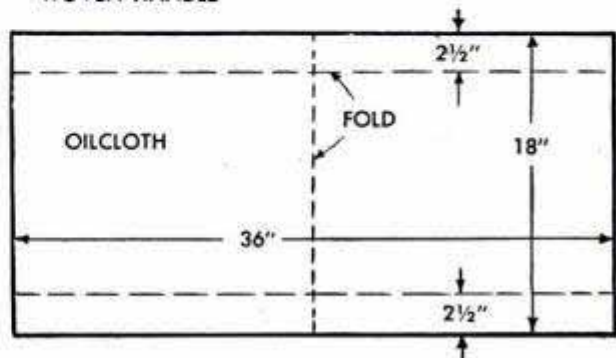

Servicing your car

GENERATOR REGULATOR

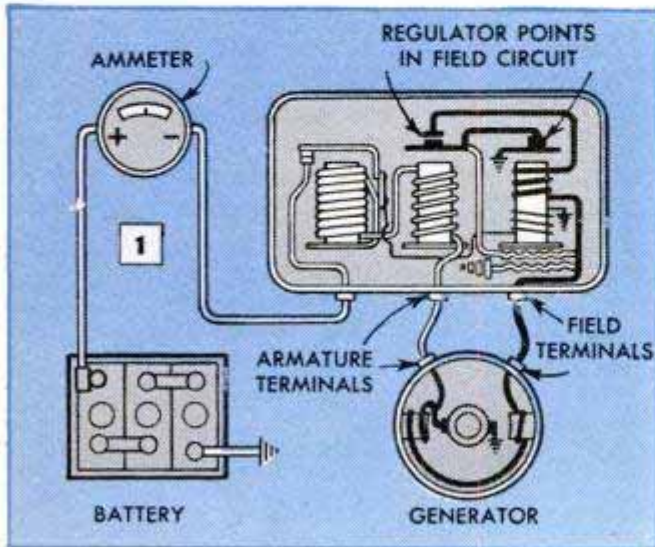

By C. E. Packer

UNDER the hood of every modern car you will find mounted on the fire wall or on one side of the motor well what appears to be an insignificant little metal box into which wires enter. Housed inside the box is the generator regulator on which depends not only the life of the battery and generator but, to a great extent, the operation of your car. The regulator controls the flow of current (amperes) and the voltage (pressure) produced by the generator, thus preventing overcharging or undercharging of the battery, or possible burning-out of accessories or the generator itself.

As pictured in Figs. 2 and 5, the regulator consists of three instruments—the circuit breaker, current regulator and the voltage regulator. All three instruments are merely relays, two of which—the current and voltage regulator—open and close the generator field circuit. In reality, the circuit breaker is an automatic switch, which opens the generator-charging circuit when the generator is inoperative, or when the voltage output is below that of the battery. This prevents discharging the battery back through the generator.

You will notice one of the two remaining instruments is wound with heavy wire and the other with fine wire. The heavy-wire instrument is the current regulator and the one with fine-wire winding is the voltage regulator. Space does not permit a complete description of construction, but

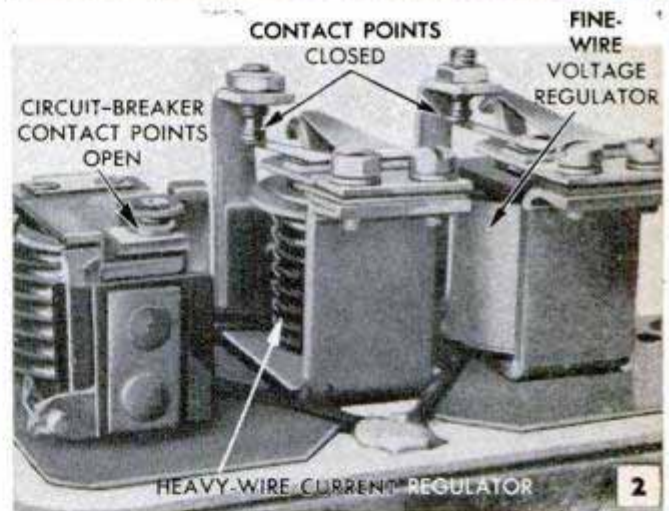
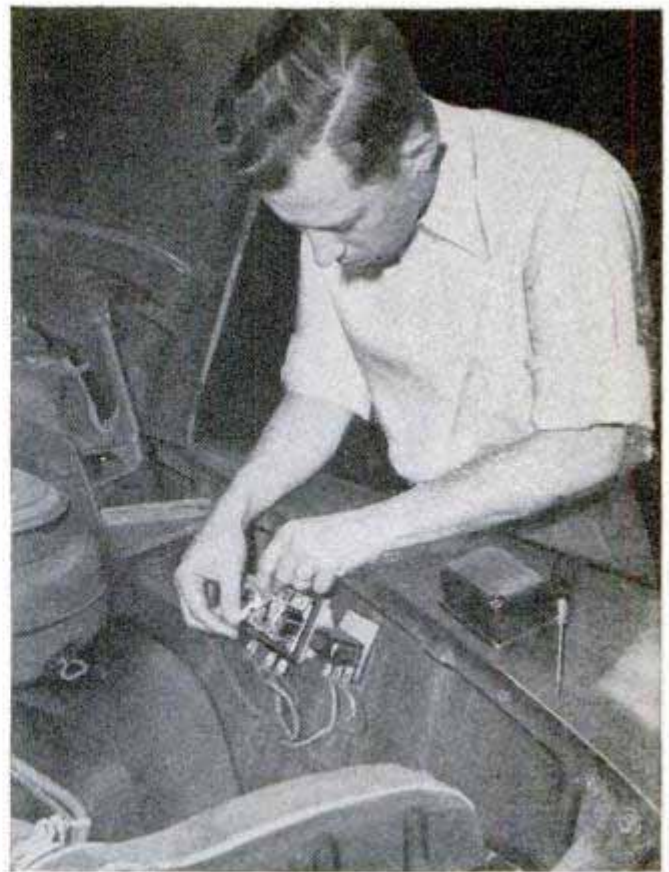

Above, a popular-type regulator having an automatic circuit breaker. Unit with heavy wire is the current regulator, one with fine wire is voltage regulator. Below, resistances on back of the regulator control field strength and, consequently, generator output

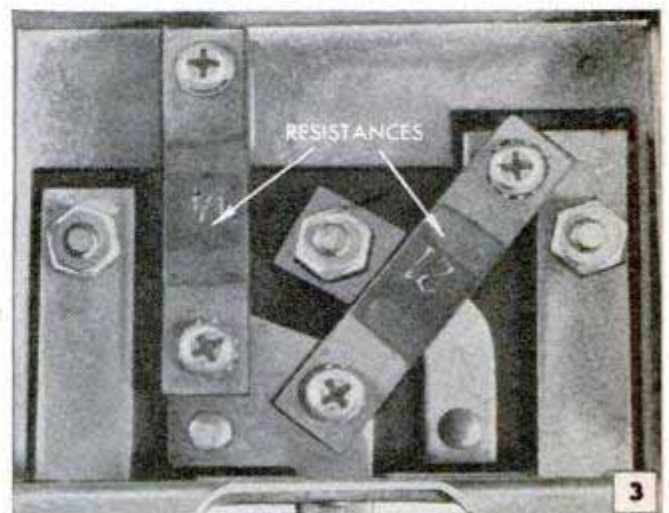



Be sure battery cables and posts are not corroded. Brighten with sandpaper and then apply baking soda

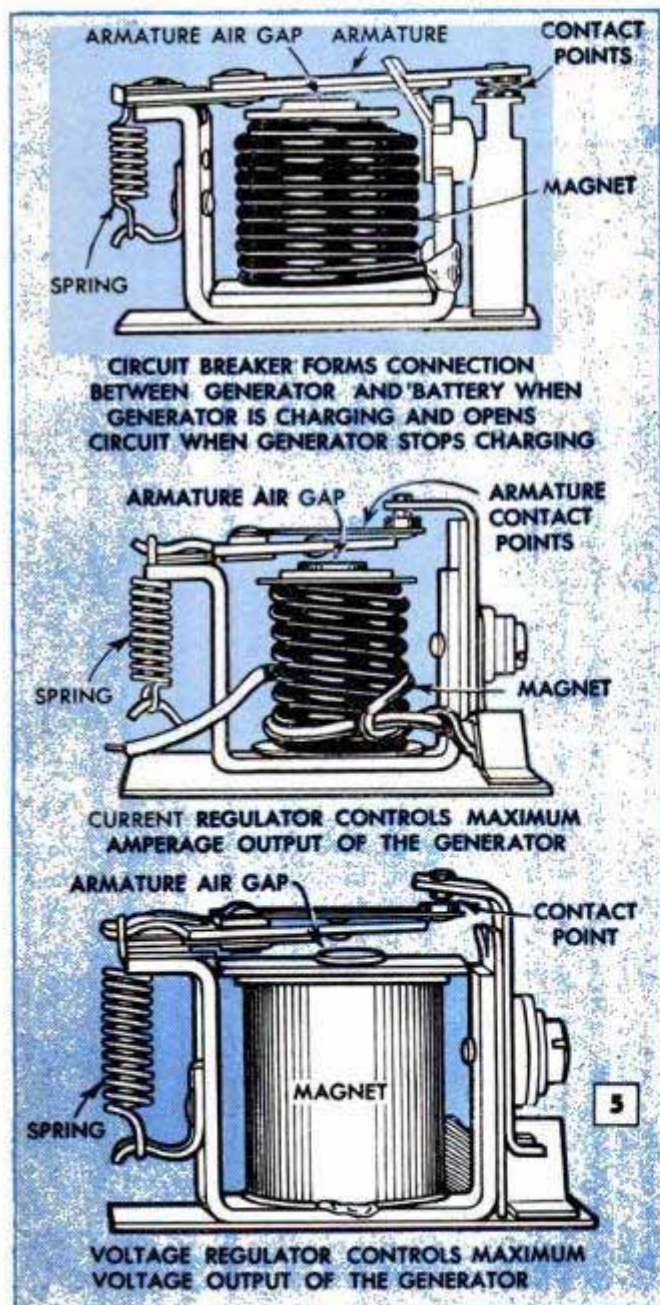

a study of Fig. 1 will show the generator wiring through the regulator to the battery. Modern generators are shunt-wound, that is, the field coil is connected directly across the main brushes. From the brushes, the charging current flows to the battery. However, the field coils are connected into this circuit, too, and the amount of current flowing through them determines the output of the generator. Increasing the flow of current into the field increases the generator output and decreasing the flow reduces the output. In Fig. 1, the heavy dark line is the field circuit and the lighter, small line is the armature or output circuit. Notice that the armature circuit goes through the coil of the current regulator—the center instrument—on through the coil of the circuit breaker and then to the battery. The field circuit flows through the breaker contacts of both the current regulator and the voltage regulator to a ground. However, the field circuit also is wired to by-pass the contact points when they are open and pass through resistances, which may be pieces of carbon or resistance wire as shown in Fig. 3.

In normal operation, the contact points of the current regulator are closed but, should the generator output go above a given amperage, the coil, which is an electromagnet, exerts sufficient pull to open the contact points, thus causing the current to flow through the resistance and reduce the current flow into the field coils. This immediately reduces the generator output. This cycle repeats many times per second when the current regulator is in operation.

The voltage regulator works in a similar manner except that it controls the voltage. When the amperage output of the generator increases, the voltage also increases. Therefore, it is necessary to control it, too, otherwise, the lights and accessories might burn out. This regulator is wound with fine wire, which will allow only a given voltage to pass through it. If the voltage increases beyond this point, the magnetic pull of the coil causes the points to break as in the current regulator.

Although most major servicing of the regulator units should be left to an experienced mechanic, a knowledge of how the regulator works will enable the motorist to detect impending trouble and, in some cases, make the necessary repair.

A quick check of regulator operation can be made by watching the charge indicator on the instrument panel. With a fully charged battery, a very low charging rate is normal. A fully charged battery and a high charging rate indicate trouble, which may include a defective voltage regulator, incorrect setting, or a ground at the generator field terminal or in the wire from

the latter to the field terminal of the regulator. Also, a poor regulator ground connection may be causing the trouble. You can check this by connecting the regulator frame to the frame of the generator as in Fig. 6. If this reduces the ammeter reading, clean and tighten the regulator base. A high charging rate is normal for a "low" battery, but a low charging rate for the same battery indicates trouble which may be due to one of the following conditions: 1. Loose, corroded or damaged wires. 2. Faulty battery. 3. High resistance in charging rate. 4. Low regulator setting. 5. Burned or rough contact points. 6. Faulty generator. After cleaning and tightening the connections in the charging circuit, check the generator by grounding the field terminal with a jumper wire or screwdriver as in Fig. 4. If the charging rate increases, the fault likely is in the regulator or wiring.

However, most regulator troubles are caused by oxidized or burned contact points, or weak spring tension. Only a fine-cut file like the one in Fig. 7, which is called a spoon or riffler file, should be used.

Before the points are cleaned, check the air gap between the core and its moving arm or armature with a feeler gauge for resetting the gap after filing the points. The same spacing or gap must be maintained as the magnetic influence diminishes with an increase in the air gap.

After servicing the regulator, Figs. 8 and 9, adjust the spring tension on the points, checking the final operation with the cover in place, as it forms part of the magnetic circuit in some regulators. Before adjusting the tension, allow the generator to charge 20 or 30 min. to establish a normal temperature. Newer regulators have a bimetallic arm which stiffens when cold to increase generator output until the unit warms up. After adjustments have been made, check the circuit breaker to see that it opens and closes correctly. Increasing spring tension on the cutout points will delay closing, decreasing it speeds closing, Fig. 8. Hold the voltage-regulator points firmly together and accelerate the engine to see if the current regulator limits the maximum output of the generator to a little less than a full-scale reading of the car ammeter.

With all connections in the charging system clean and tight, and the battery in good condition, only the slightest charge should show on the car ammeter, possibly three amperes. If the rate is greater than this, reducing spring tension on the voltage regulator points will lower the rate. If the generator is showing no charge whatever, a slight increase in the spring tension will usually produce the preferred charging rate.



Regulator and generator frames connected together with copper wire determine poor ground connection

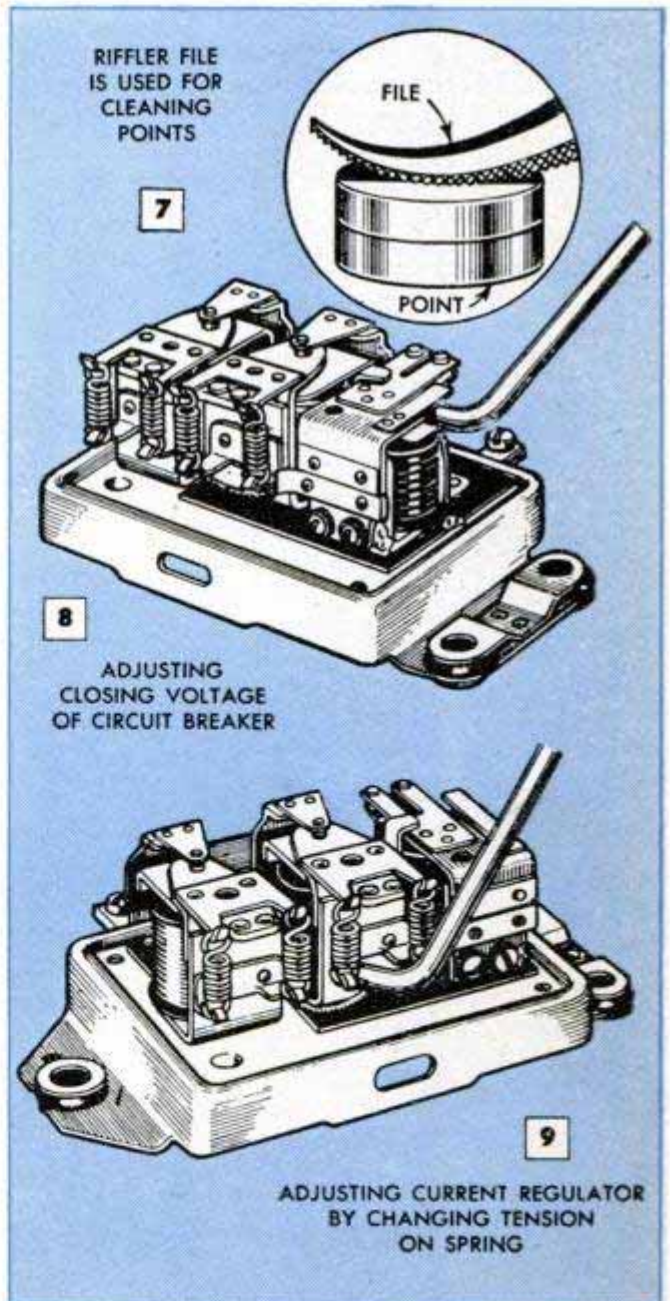

Clothespins Slipped Over Handles Facilitate Carrying Bushel Basket



When laundry, fruit or other heavy loads are carried in a wire-handled bushel basket, the task is easier if a wooden clothespin is slipped over each of the handles to provide a more comfortable grip. If the basket is used frequently, fasten the clothespins in place by wrapping strips of adhesive or cellulose tape around them as shown in the detail.

G. E. Hendrickson, Argyle, Wis.

Laundry Starch Loosens Wallpaper

After some experience in trying to remove wallpaper by loosening it with warm water, I have found that a solution of laundry starch does a much better and faster job. Soak the paper with the starch, applying it with a rag or brush. Allow the starch to remain on the paper for about 10 minutes and then scrape off the paper with a wide-blade putty knife.

Mrs. Jack Stewart, Milwaukee, Wis.

Emergency Repair for Pipe Line

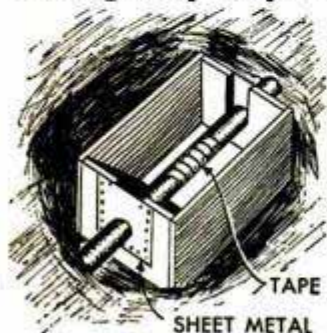

cut a slot in each end of a wooden box, making the slot at least as wide as the diameter of the pipe. After positioning the

box under the pipe and around the break, fit two sheet-metal shields over the pipe to close the slots at each end of the box, tacking the sheet metal to the box. Wrap the break with tape and fill the box with concrete. When the concrete has hardened, replace the earth around and over the box.

W. H. McClay, Pasadena, Calif.

Prolonging Life of Outdoor Steps By Draining Moisture

The life of wooden steps exposed to the weather can be prolonged two or three years by draining off the water which ordinarily clings to the underside. This is done by dabbing paint thickly on the underside of the treads so that it hangs in tiny strings or droplets which aid the water in dripping from the surface.

T. F. Watts, Charlotte, N. C.

Combination Pusher and Hold-Down Increases Bench-Saw Safety

By using this combination pusher and hold-down to feed narrow stock into the circular saw, the work can be ripped without endangering the fingers. The tool is easily made from scrap stock, the bottom

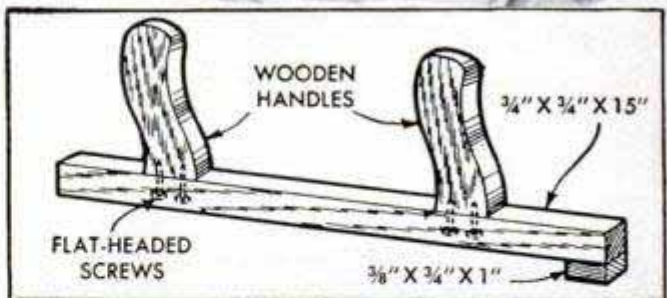
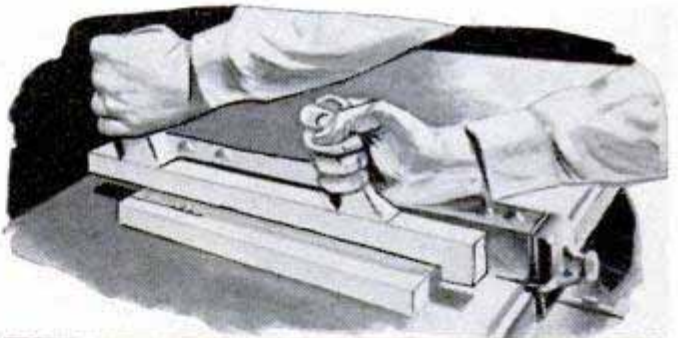

piece being about 15 in. long with a wooden block nailed under the rear end to engage the edge of the work. Jigsawed handles are mounted on the top of the cross-piece with countersunk flat-headed screws. Finally, a strip of coarse abrasive cloth or sandpaper is cemented to the underside of the tool to provide a gripping surface.

Will Thomas, Buffalo, N. Y.

☞ To make sure that you won't pull the garden hose over valuable plants, guide the hose between the plants by pressing croquet wickets over the hose as necessary.

KITCHEN NOVELTIES

By Roberta L. Fairall

JUST THE THING to brighten up the kitchen, these two wall novelties, representing little cottages, provide convenient storage for hot pads, pot holders and condiments. The salt-and-pepper shelf also includes a dinner gong and mallet.

To make the hot-pad holder, enlarge the design on paper ruled in 1-in. squares, transfer it to $\frac{1}{4}$ -in. plywood and jigsaw the parts. Sand the sections smooth and fasten them together with brads. Then drill two holes for hanging the shelf, one at the top and the other at the bottom of the backboard. Cloth pot holders are hung from two screw hooks turned into the backboard below the hot-pad shelf. Thin felt washers glued to the back of the plywood hot pads will keep them from marring the surface of the table.

The shaker shelf is assembled in the same manner as the hot-pad holder, except for holes drilled in the eaves and front of the shelf for decoration. The gong is made from a tin-can lid having a finished edge, such as the lid of a shortening can. Dish the gong and give it a hammered finish before polishing it with steel wool, and then punch two holes near the edge for hanging it from the shelf. Finally, wax the gong or coat it with clear shellac and hang it with a length of cord attached to the underside of the shelf. The mallet is made of plywood and should be hung from a brass screw hook directly in front of the gong.

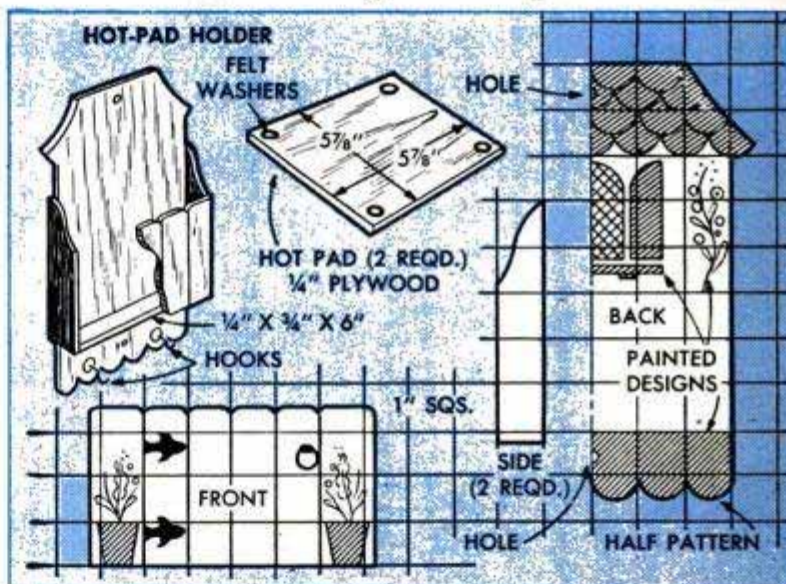
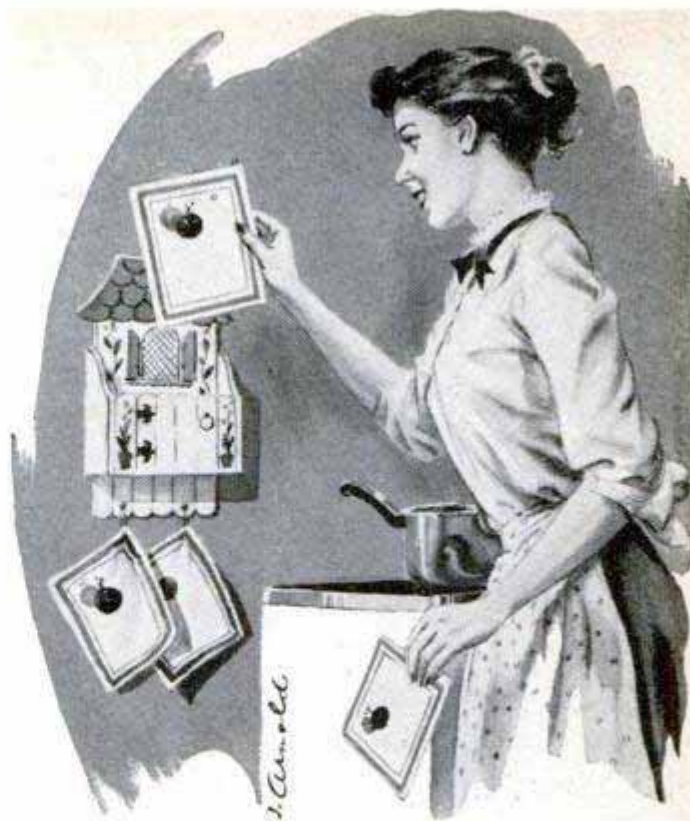

Colorful designs similar to those shown in the diagrams may be painted on the plywood shelves with poster, or show-card, colors and then protected with a coat of clear varnish

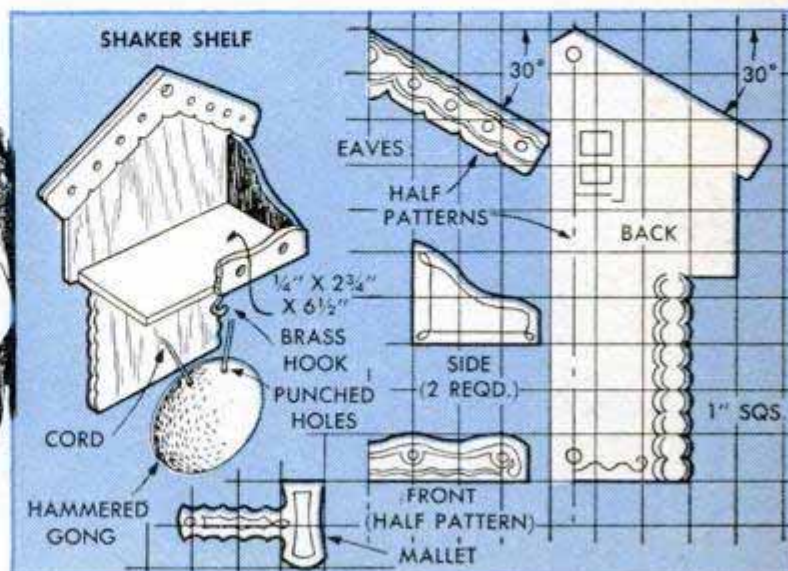

FINGER-TIP

By Alexander Maxwell



THIS UNIT is just the thing for controlling composition and lighting in the photo studio, spotlighting theatricals and operating apparatus in the school laboratory. Six separate electrical circuits are wired from a distribution panel, or board, to a control panel mounted on a portable stand. Each circuit is operated by its own switch and an ammeter of 15-amp. capacity provides a visible reminder of the current consumed to help avoid overloading the house wiring. A No. 1 floodlight bulb requires about 2 amps. and a 500-watt bulb, 4 amps. at 110 volts. The ammeter adds up the total amperage as the lights or other apparatus are switched on individually. A master switch cuts off all the circuits simultaneously and to short the ammeter out of the main circuit a separate line and switch are provided.



Nearly all parts used in assembling the distribution panel, control panel and stand are stock items and are readily available. Ammeters are obtainable in a wide range of readings but, of course, the 15-amp. meter is more or less standard and should be used if the control unit is plugged into branch circuits in the home photo studio. When convenient to do so, the feed line to the distribution panel should be run directly to the entrance box at the meter. Switches on the control panel and corresponding outlets on the distribution panel are of the ordinary types used in wall outlets and switch boxes. The switches preferably should be of the toggle type. The master switch is an industrial-type switch with red and black buttons. Pushing the red button closes the circuit; pushing the black button opens it.

Both the control panel and the distribution panel are spot-finished on drill press with improvised tool

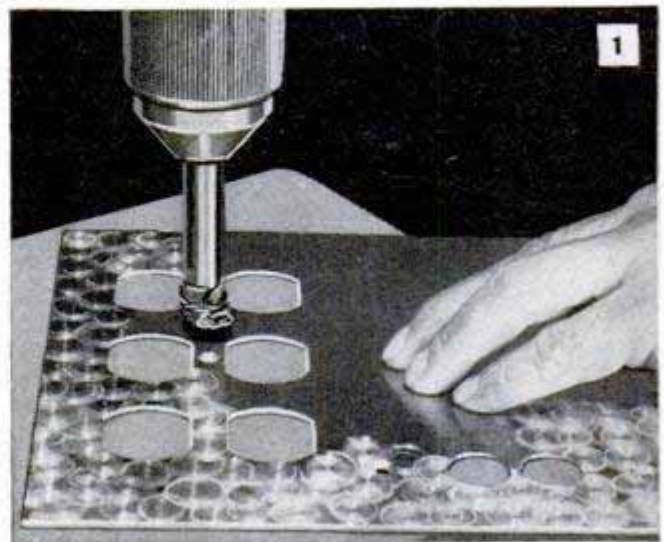
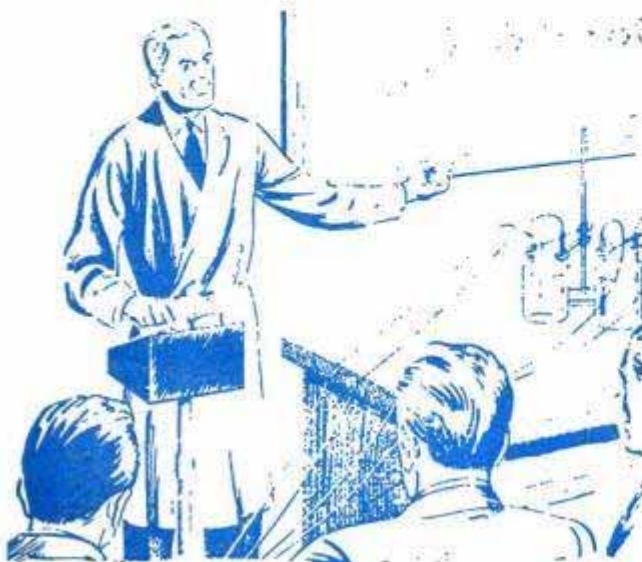

CONTROL PANEL

The control stand is built up on a three-legged base of the type used for light machine stands. Some of these units are tapped for pipe columns of various sizes, but the one pictured was not, so four holes were drilled and tapped through the flat top and a $\frac{3}{4}$ -in. pipe flange and four flat-iron arms, forming a spider, were attached to the base as in Figs. 2 and 3. The arms support the wooden frame carrying the distribution panel. The latter is made of sheet aluminum cut to the dimensions given in Fig. 3. Holes are drilled or sawed for the outlets and the pipe column, and the panel is set into a rabbeted frame as in Fig. 3 and the photo below. If desired, the surface of the panel can be burnished on a fine wire wheel, or, the surface can be attractively spot-finished as in Fig. 1. This is done with an improvised spot-finishing tool made by binding a felt pad and a strip of emery cloth on one end of a short length of $\frac{1}{2}$ -in. steel rod mounted in the drill-press chuck. Run the drill press at the lowest speed and use a very light spindle pressure. Although not shown, the circular patterns are frequently made to overlap in a straight line. This method takes longer and requires a guide, but it produces a somewhat neater job. Both panels may be finished in this way. If you have no way of drilling the large holes for the outlets, your plumber can do the job.

Note that the pipe column, Fig. 3, is 36 in. long over-all, but that it consists of two 18-in. lengths of $\frac{3}{4}$ -in.

Four flat-iron arms screwed to the base support wooden frame for distribution panel

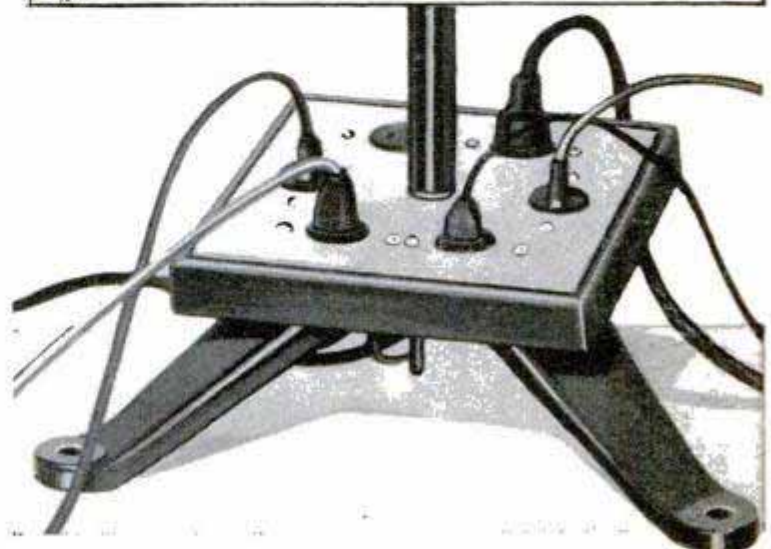
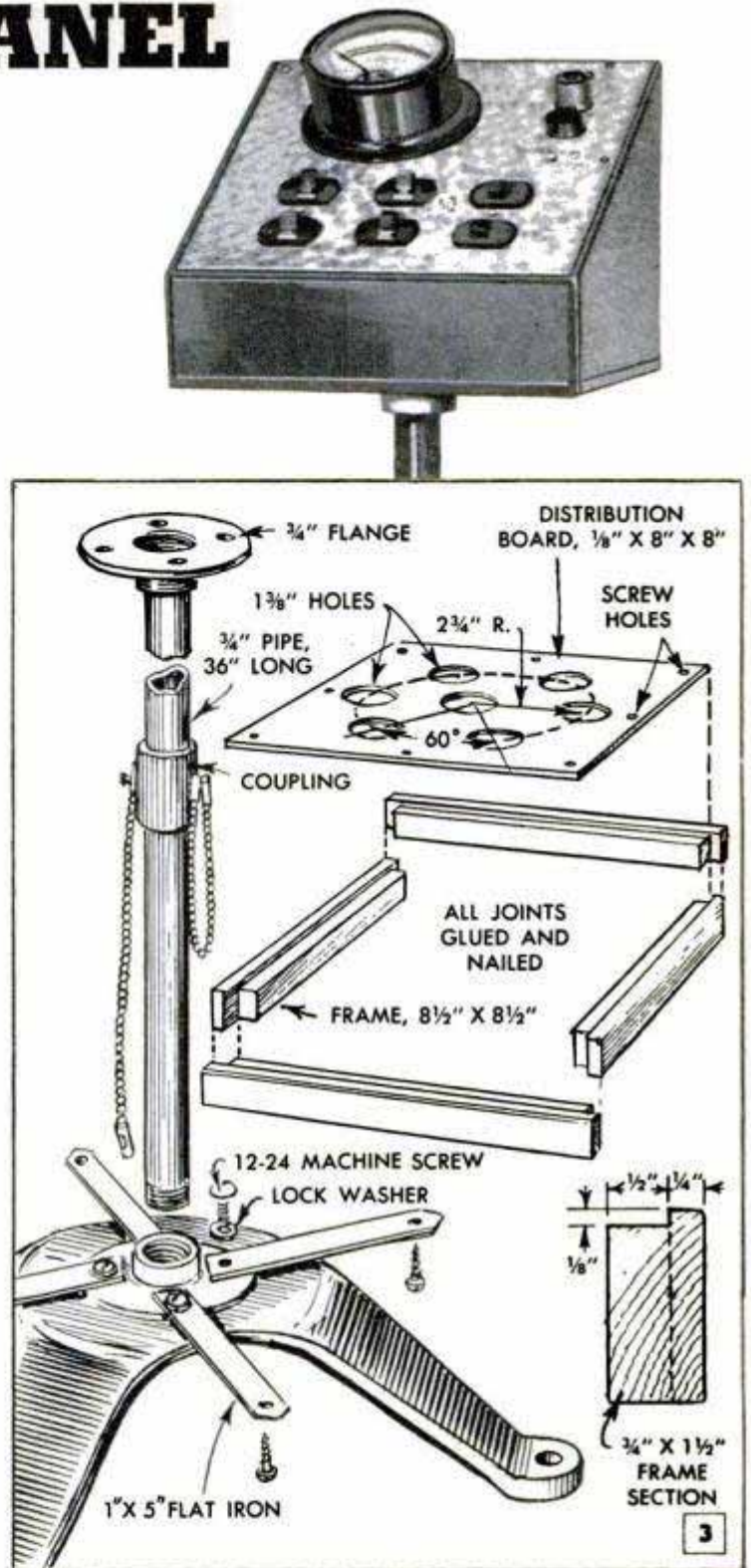
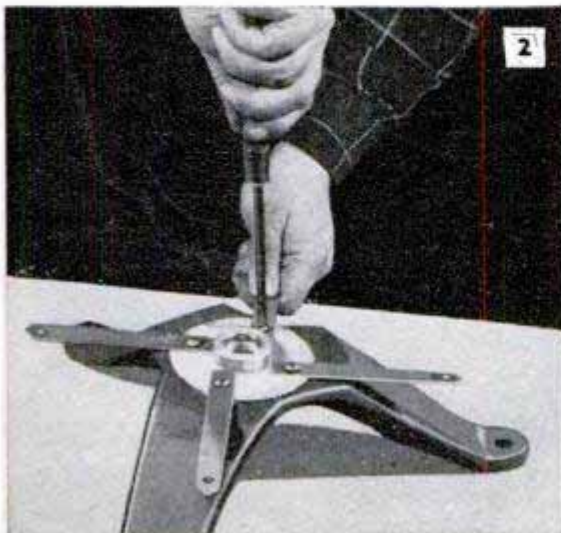

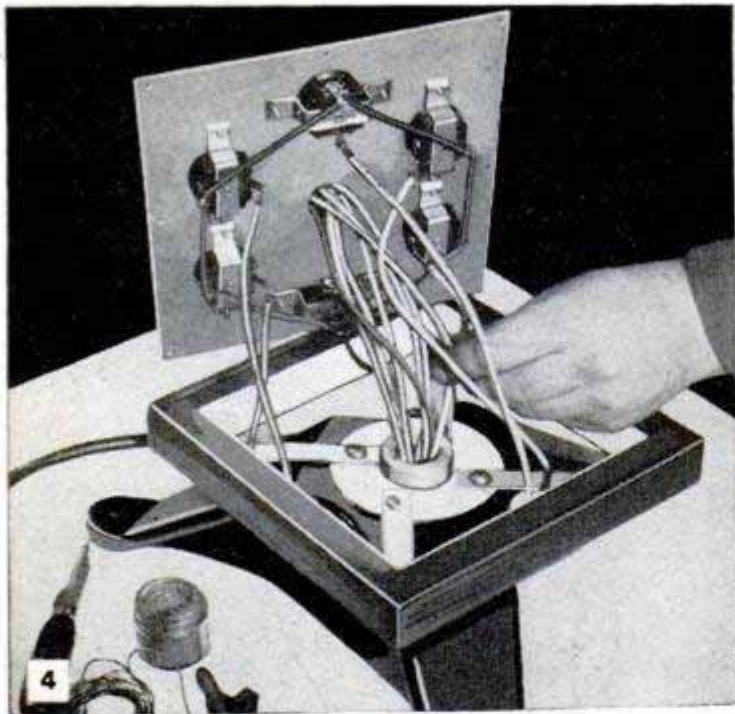

Here the outlets have been attached to underside of the distribution panel and wired ready for assembly in stand

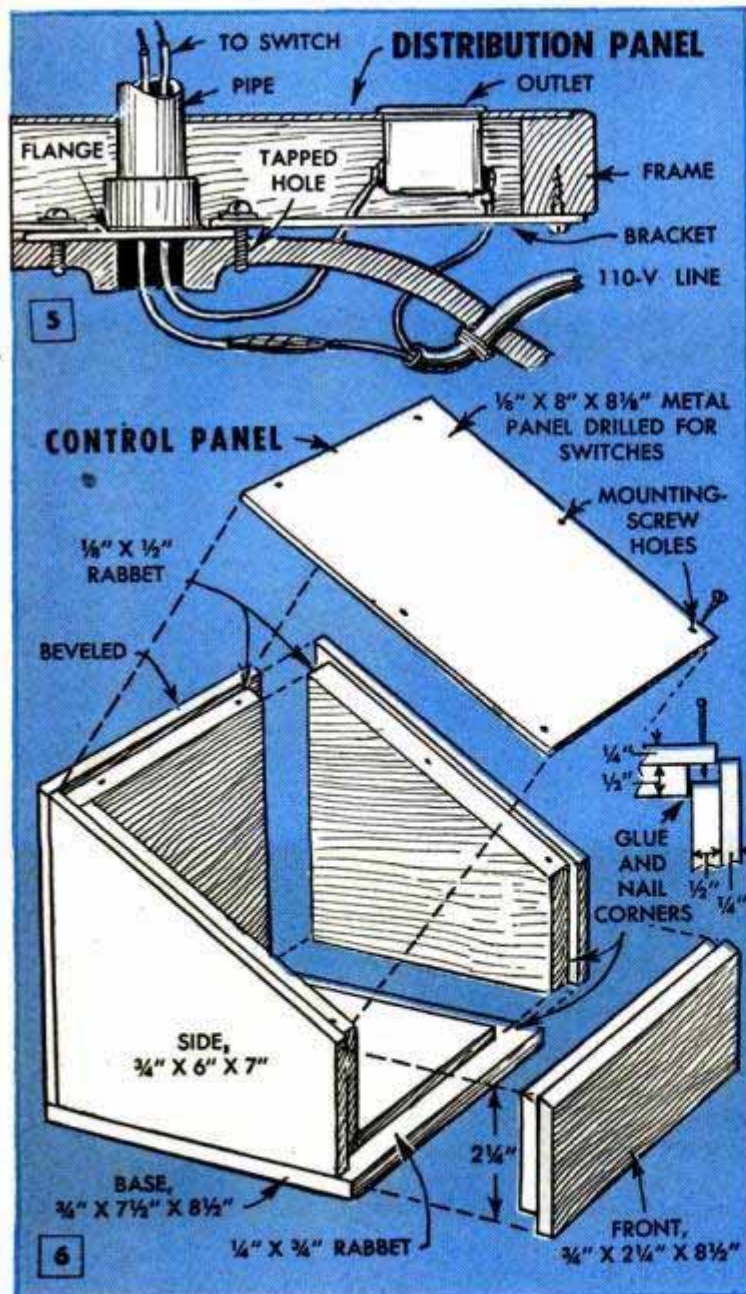

pipe joined with a coupling. Loops of ball-type pull chain are attached to the coupling for holding the coils of electric cord when not in use. A $\frac{3}{4}$ -in. pipe flange is turned onto the upper end of the column to provide a rigid base for the control box, which is assembled as in Fig. 6. To make a neat job of the box, use hardwood and join all parts with brads and glue. The method of wiring the distribution board is detailed in Fig. 5 and pictured in Fig. 4. The circuit is diagrammed in Fig. 8. Although the wiring looks rather involved it is actually quite simple. First, the six outlets are connected with a jumper wire and the free end of this wire is soldered to the common lead. Next, a lead from each load terminal is carried down around the spider, Fig. 5, and the end is brought up through the center hole in the distribution panel, as in Fig. 4. These wires are then "harnessed" by wrapping with tape at intervals along the length. The harness is next fed up through the column and into a hole in the bottom of the control box as in Fig. 7. To avoid confusion in making connections to the switches, it's a good idea to tag each wire with a key number or wrap the wires individually with cellulose tape of different colors. This will simplify the connections in the control box. Turn the flange at the upper end of the column down tightly and attach the control box to the flange with four

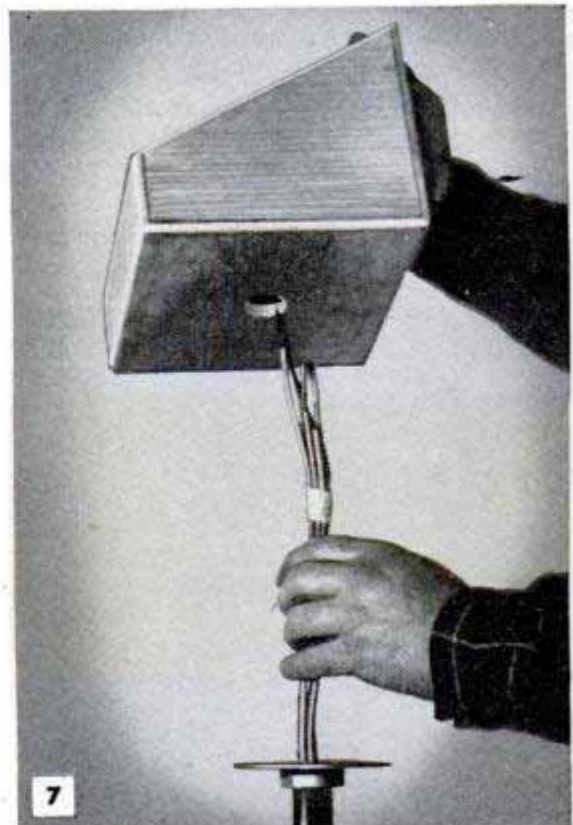

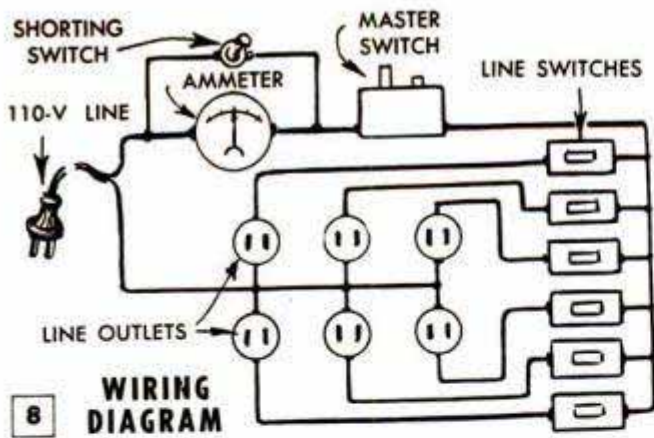

wood screws. After the switches and ammeter have been fastened in place on the underside of the control panel, you're ready to make the connections as in Fig. 9. Bare the free ends of the wires and twist each bared end into a small loop with long-nosed pliers before attaching to the switch terminals. Be sure to turn all the terminal screws down tightly. Then fold the wires into the box and screw the metal panel in place.

All parts of the stand, except the panel are painted flat black, or enameled in whatever color you choose. Sand the wood thoroughly and round the corners slightly. If you use an open-grained wood such as oak or walnut for the distribution-panel frame and the control box, then these parts will be very attractive if finished in the natural color of the wood. After sanding, fill the wood, sand again lightly after the filler is dry, and finish with two coats of varnish or

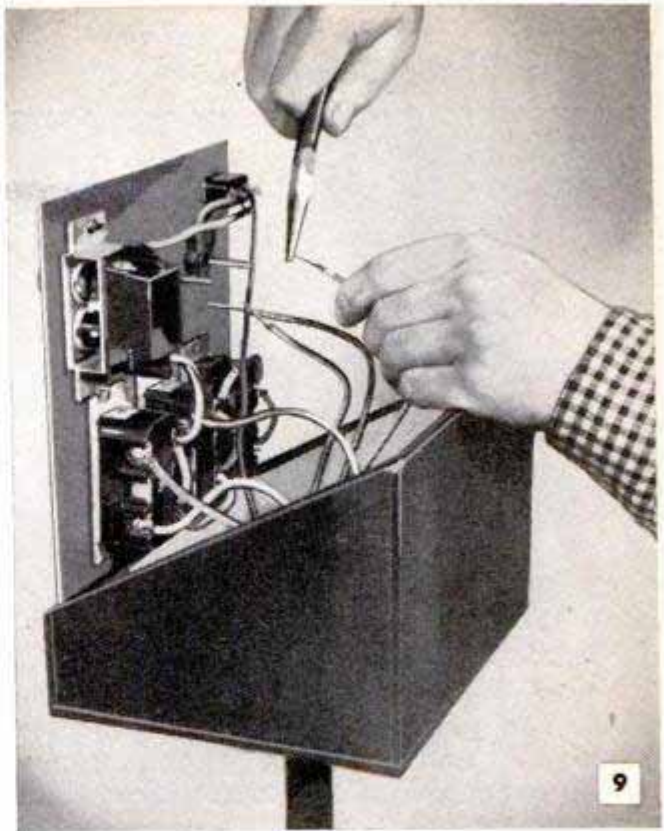

one coat of clear lacquer. Enamel all other parts except the panels. If finishing of the wooden parts is done before assembly the job will be somewhat simplified. The cord or cable connecting the unit to the current source should be of the heavy-duty industrial type which will carry a current load for long intervals at least three times as great as the maximum requirement.

Wall Rack for Drying Cut Film Improvised From Board and Dowels

Having a capacity of a dozen or more sheets of film, this inexpensive drying rack requires little space in the darkroom. The film sheets are attached to the ends of dowels, allowing adjacent film sheets to overlap without touching each other. Pushpins which leave only a small hole in one corner

of the sheet are used to hold the negatives in place. Alternate long and short dowels are pressed in blind holes drilled in the mounting board, the holes being spaced according to the size of the film. A screw eye is centered in the top edge of the mounting board or one is driven near each end to hook over a nail or screw driven into the wall.—Howard N. Findley, Fort Myers, Fla.

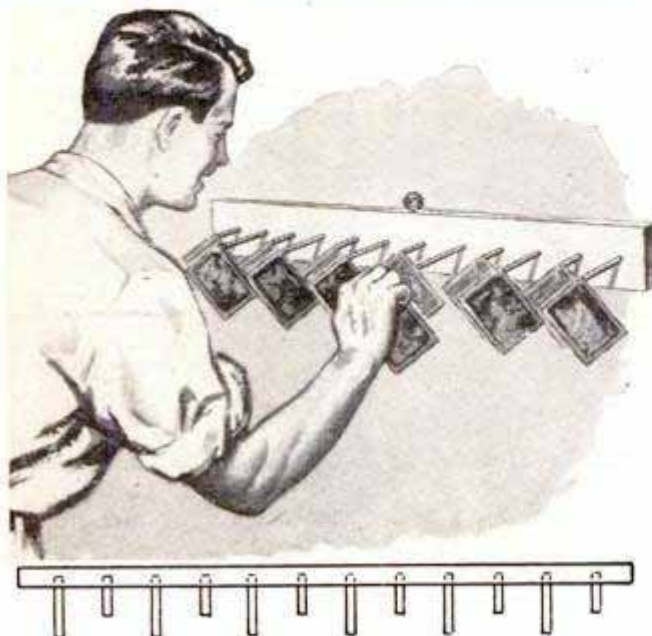

Cotton Stored in Bottle Cap

Cotton used for cleaning camera lenses is always handy if it is stored in the cap of the cleaning-solution bottle. As a wad of cotton placed in the cap is compressed when the cap is screwed on the bottle and as only a small amount is used for each application, the supply will last for a considerable length of time.



Wooden Stand Supports Funnels To Filter Photo Solutions



Filtering photo solutions can be done quickly and without danger of contamination by using several funnels supported on a wooden stand. The latter consists of a top piece nailed across two sides so that it can be set over a tray. Holes for the funnel spouts are drilled through the top and a bracing strip is nailed between the lower edges of the two sides at the rear of the stand. Ordinary absorbent cotton is placed in the funnels to filter the solutions. Various types of stands can be made to suit your particular needs, such as a single-funnel stand to filter the solution directly

into a measuring bottle, a double-funnel stand to take a film tank or a stand similar to the one shown to fit over a tray of the size on hand. Finish the stand with asphaltum paint or enamel. Be sure to rinse thoroughly both the funnels and the stand after each use.

Inexpensive Darkroom Heater Utilizes Photoflood Reflector

Installing a 500-watt heater coil in an old photoflood reflector provides an effective darkroom heater at a minimum cost.

The heater stand is made by mounting the upper section of a light stand in a wooden base, the latter being two pieces of wood which are half-lapped and drilled centrally for the standard. If desired, the clamp may be left on the reflector and used to mount the heater in various parts of the darkroom.

As there is no guard in front of the heater, do not use the unit where children are likely to come in contact with it.

Roland Wolfe, Palo Alto, Calif.



Let Your Workshop Pay Santa

How do you spend these cool November evenings and week ends? Ever think about using them for some needed recreation or to make a little Christmas money for yourself and son, or the whole family for that matter? If yours is like most families, Christmas presents put a severe strain on the pocketbook, which can be eased by making some of the gifts yourself. Difficult? No, that's where these evenings and week ends come in. If you already have a shop, you are all set. A little subtle questioning of persons on your list will bring to light things that you can make easily. If you do not have a shop, then *Popular Mechanics* book **PLANNING YOUR HOME WORKSHOP** will take care of that problem. The shop doesn't have to be elaborate—just a bench and a few hand tools will do. In this book you will find many shop floor plans, lighting layouts and projects. It is a must for anyone planning a shop at home. A remittance of \$2.50 will bring it to you.

A simple trinket isn't the only gift for Christmas. No doubt the important lady in your home has wanted a certain piece of furniture for a long time, or perhaps you need a

complete suite and have delayed buying because of the cost. Such a present would be the ideal gift so why not make it yourself?

This way it would be doubly appreciated.

Popular Mechanics book **100 BEAUTIFUL PIECES OF FURNITURE YOU CAN BUILD** will get you well on the road to a happy Christmas. This 160-page book is just off the press and contains plans, diagrams and step-by-step instructions for building suites for the dining

room, bedroom and living room as well as matched occasional pieces, all of which are shown in full color. There are also many other occasional pieces, in both period and modern design. Send \$3.00 for the book, get started so you can have the job completed in time and then see what an important guy you are on Christmas morning.



All books are available from *Popular Mechanics* Book Dept., 202 E. Ontario St., Chicago 11

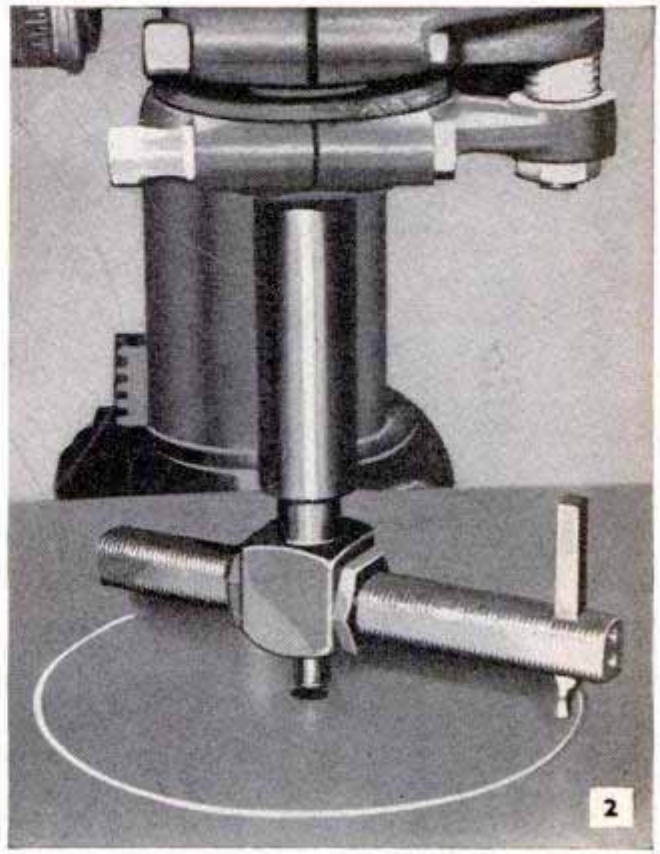

CIRCLE CUTTERS for sheet-metal shops

By J. C. Magee

SMALL SHOPS that do a variety of work in sheet metals have frequent use for circle cutters of the type that can be driven by a drill press. Home craftsmen also find use for these cutters in toymaking and ornamental metalwork. Pictured are two approved designs, one made from aluminum alloy especially for light work in wood, hardboard, plastics and soft metals, the

other for the heavy-duty jobs in metals. The latter type, shown in Fig. 1 and pictured in use in Fig. 2, is fully detailed in Fig. 6. The shank is machined with a No. 2 Morse taper to fit a drill-press spindle, or sleeve, and it also is turned with an integral pilot. The lightweight job detailed in Figs. 3 and 5 and pictured in operation in Fig. 4, clamps directly to the taper spindle of the drill press into which the pilot drill, of the tapered-shank type, is fitted.

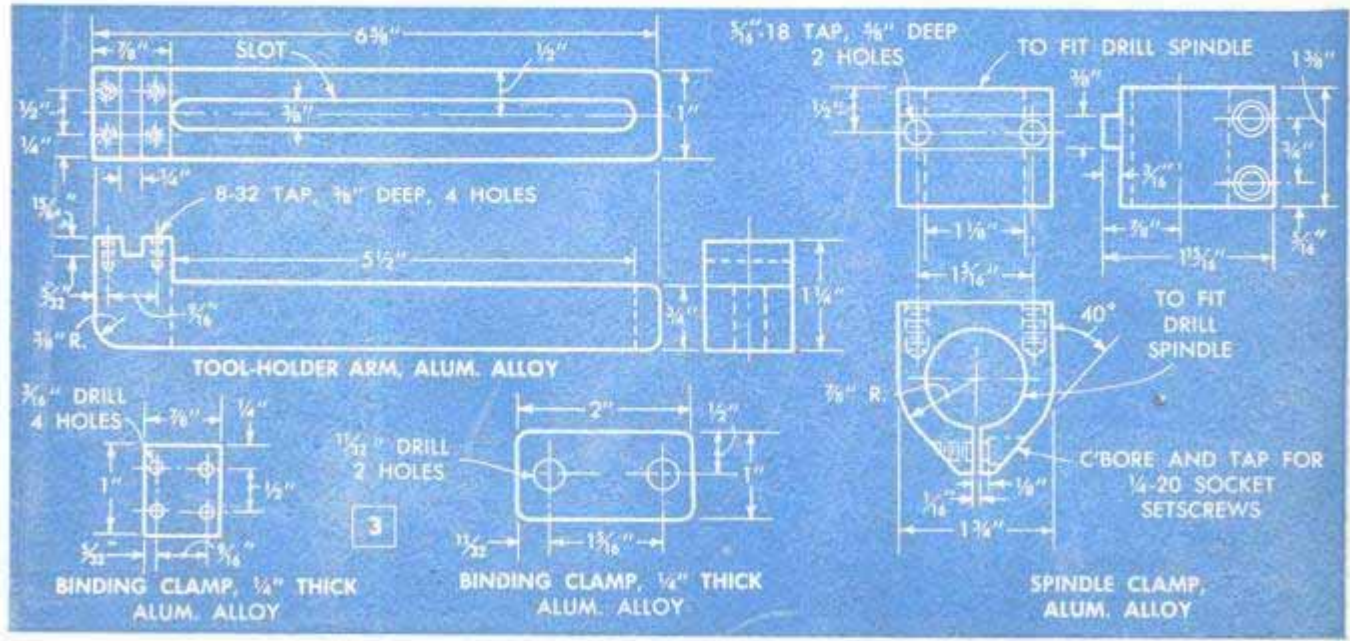

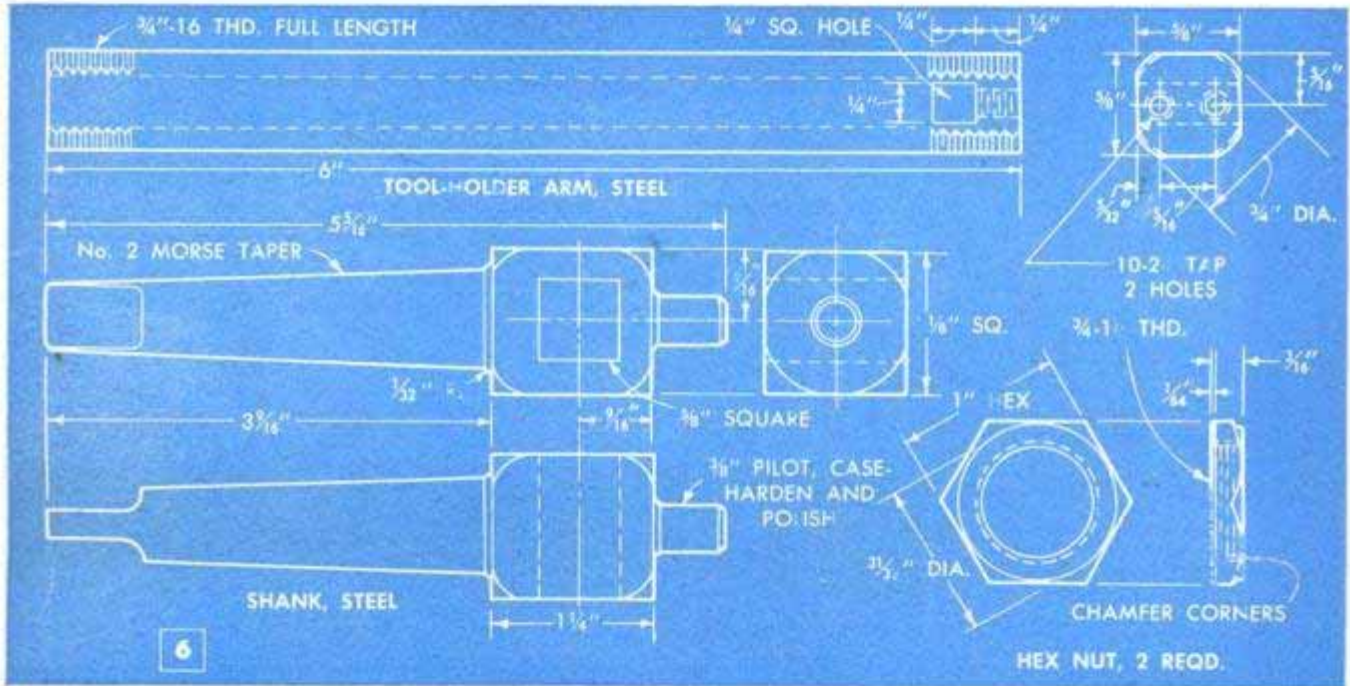
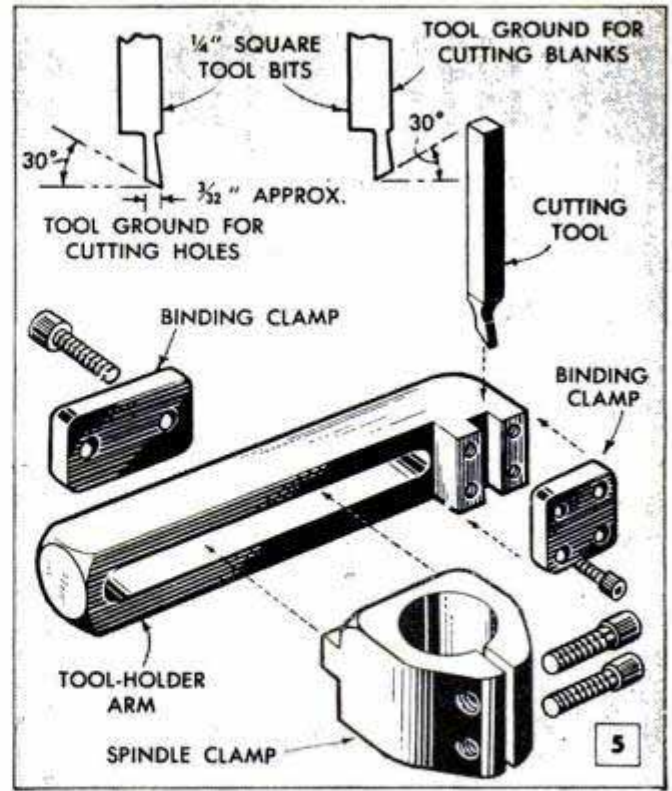
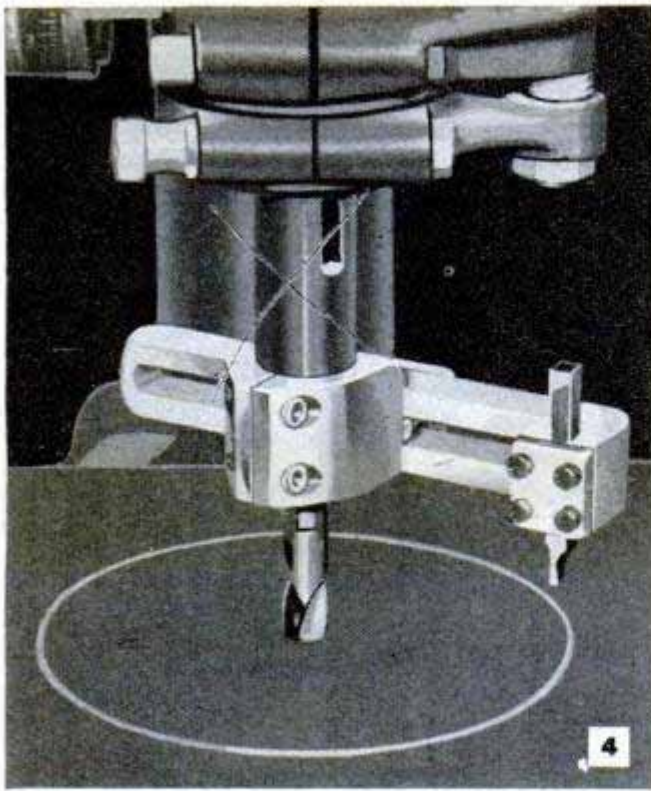

Although the best workmanship would require that the square holes in the shank and tool-holder arm, Fig. 6, be broached, it is possible to drill holes and square them with a file with sufficient accuracy. However, the tool-holder arm must be a smooth, sliding fit in the squared hole in the shank to prevent chattering in heavy cuts. The tool-holder arm, Figs. 1 and 6, is threaded its full length and flats are milled on the four sides, bringing the dimension across the flats to $\frac{5}{8}$ in. The length of the arm gives a maximum radius adjustment of approximately 5 in.

The lightweight cutter, Figs. 3, 4 and 5, does an exceptionally smooth, clean job on a variety of materials. When carefully made, it is practically chatterproof. Both

the cutting tool and the tool-holder arm are held in place with binding clamps of special design and these two parts are attached to the taper sleeve with a binding clamp of sufficient length to hold the parts in exact alignment. Note that the cutting bit is supported in a groove milled across the face of the binding-clamp seat and that the groove is slightly less than $\frac{1}{4}$ in. deep, Fig. 3. This allowance is necessary to permit the clamp to seat the bit firmly. The upper details in Fig. 5 show how to grind the bit for cutting holes and blanks in thin material. When ground for hole cutting, the bit leaves the outer edge smooth. When ground for blank cutting, the inner edge of the cut is smooth. For work in metals, the speed of the cutter should not exceed 100 r.p.m.

Designed for handling full 55-gal. drums where minimum clearance under the hoist hook is important, this drum sling affords as much as a 16-in. gain in hook-to-ground clearance. In addition, the sling is heavy enough to permit removing the antikinking weight from a cable-equipped hoist in some cases, thus gaining several inches in hoisting distance. The frame of the sling consists of two lengths of 3-in. steel channel joined with $\frac{1}{2}$ -in.-sq. bar stock. Aligning $\frac{1}{16}$ -in. holes are drilled through the frame, and a grabhook is fitted at each end, using a short length of $\frac{3}{4}$ -in. pipe as both spreader and bearing surface. The hoist hook engages a length of pipe bolted between the channels. Detail A shows how the grabhooks are formed from $\frac{1}{2} \times 1\frac{1}{2}$ -in. bar stock.—Harry H. McIntyre, Midland, Mich.

Low-Clearance Hoist Sling of Steel Channel Grasps Drums With Positive-Action Hooks

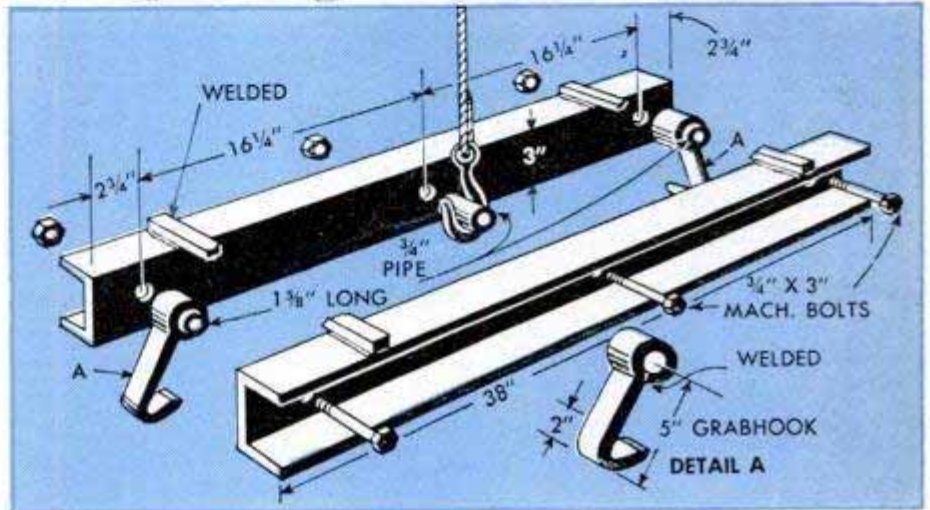
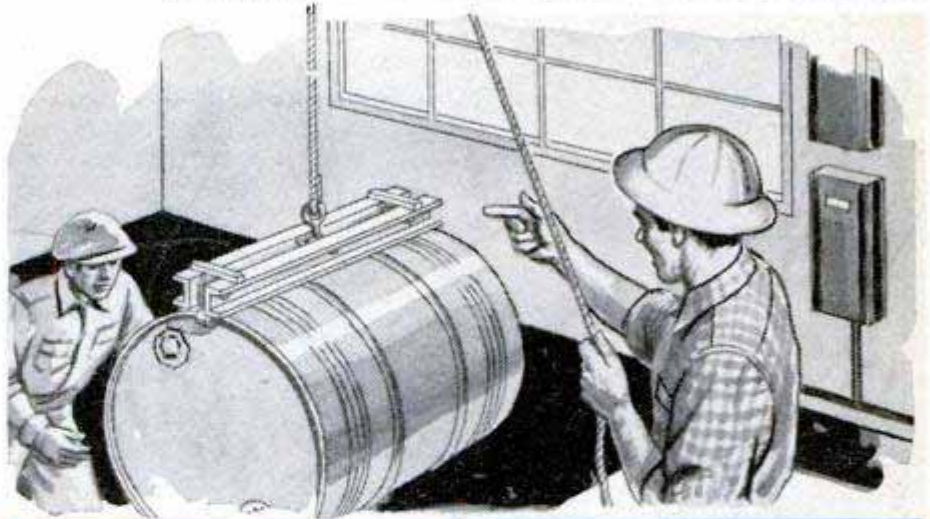

Correcting Typewritten Sheets Stapled Together

To make a correction on a typewritten page, which has been stapled to other pages, insert the page into the machine in front of the platen. To do this, place a sheet of paper in the typewriter and turn the platen until the paper projects above the roller guides. Then insert the page to be corrected between the projecting sheet and

platen at the front of the platen, and turn the platen backward until the second sheet is ejected. This pulls the typewritten page around the platen where it can be positioned to make the correction. This method, however, cannot be used where corrections must be made near the top of the page.—T. E. Mortimer, Isola, Miss.

Open Teletype Enclosure Has Sound-Absorbing Walls to Minimize Noise

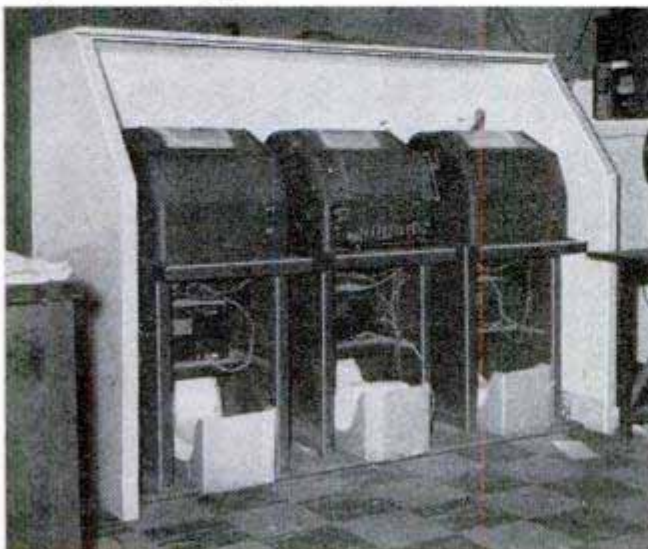

Newspaper offices and broadcasting stations as a rule have Teletype machines running constantly, and this is often annoying when there is other work being done in the same room. However, it is possible to eliminate most of this disturbance without making the machines less accessible. An open-faced enclosure lined with sound-absorbing material will do the trick. As an example, take the enclosure and three machines illustrated. The enclosure in this case is $2\frac{1}{2} \times 4\frac{1}{2} \times 5$ ft., and is made from 2×4 s covered on the outside with $\frac{1}{2}$ -in. wallboard and lined inside with sound-absorbing material, $\frac{7}{8}$ in. thick, forming a dead-air space between inner and outer walls.—S. P. McMinn, Fort Myers, Fla.

Notched Molding on Drawing Board Holds Freshly Inked Signs

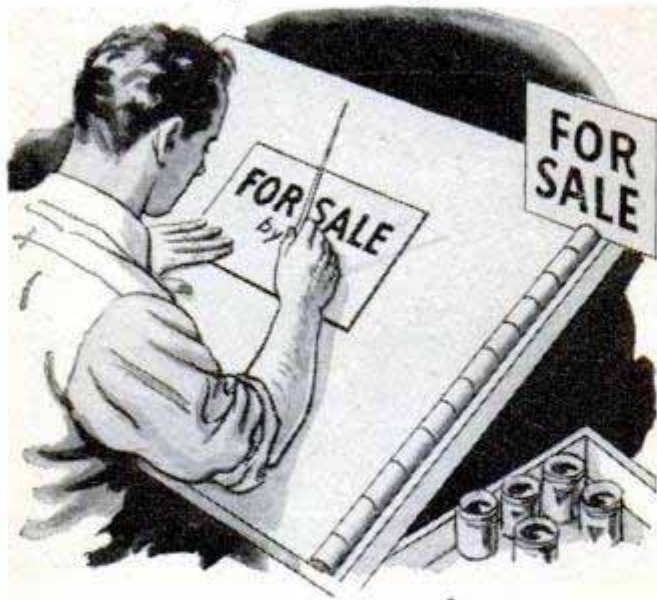

When inking a number of simple hand-lettered signs, there is always the danger that the ink on a finished sign will be smeared before it has had a chance to dry. To dry the signs safely, stand them upright in this handy rack which is made from a length of 1-in. half-round molding. Cut a series of saw slots partially through the molding and fasten the rack along one side of the drawing board or to a convenient table top.—Edmund Loper, Salem, N. J.

Flexible Baffles in Chute Retard Falling Bricks

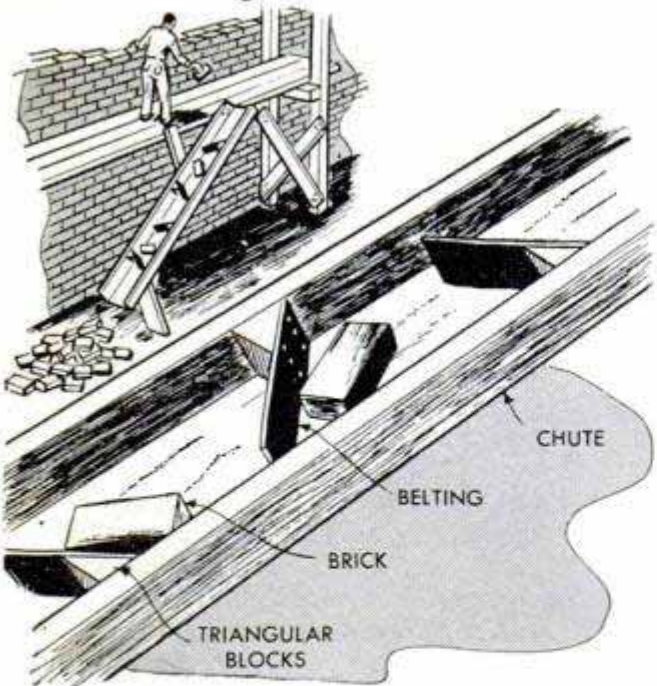

To reduce the percentage of damaged bricks on a wrecking job, one contractor installed flexible retarders in the chute which conducted the loose bricks from the scaffold to the ground. The retarders were made by nailing triangular blocks to the

sides of the chute. The blocks were spaced alternately with the sloping edge up as shown. Then lengths of heavy rubber belting were nailed securely to the sloping edges of the blocks, the free end of each piece of belting reaching diagonally across the raceway. Each brick coming down the chute must force its way past the retarders. This slows the fall so that the brick drops lightly onto the pile at the bottom of the chute without damage.

W. C. Wilhite, Carlinville, Ill.

Repairing Holes in Car Bodies Without Removing Upholstery

Small holes remaining in car and truck bodies after the removal of identification lights or spotlights can be repaired quickly from the outside without the necessity of taking off the upholstery or trim.

To provide a backing for the solder which is used to fill the hole, carefully cut a sheet-metal disk slightly smaller than the diameter of the hole, and solder a 6-in. length of wire to the center of the disk. Using the wire as a handle, hold the disk in the hole barely below the outer surface of the body metal. Then fill the hole with solder and, after the solder has cooled, file or cut off the wire. Finish the new surface flush with the car body prior to painting.

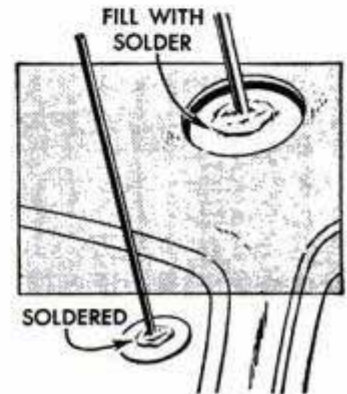

Claude E. Pitts, Lexington, Mo.

Scaling Yard-Light Pole

After experiencing the trouble of setting up a heavy ladder each time it was necessary to replace a burned-out bulb in his yard light, one farmer drilled a series of small holes on opposite sides of the light pole and drove in discarded teeth from a peg-tooth harrow to form steps for easier climbing. The holes are carefully located so that one tooth is about 14 in. above the other on alternate sides of the pole. The first tooth is placed 4 to 6 ft. above the ground to prevent children from climbing the pole.

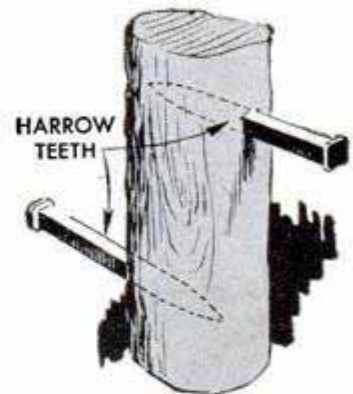

Kenneth Hadenfeldt, Storm Lake, Iowa.

PRIZE-WINNING INVENTIONS

EVERY inventor interested in promoting his ideas should consider the Inventors Congress held at Pueblo, Colo., during the latter part of June each year. Sponsored by the Pueblo Chamber of Commerce, this show offers inventors the opportunity of displaying their inventions to the public, and also a possibility of interesting manufacturers. The three items pictured shared the top prize money this year.

The first-prize article was a variable-speed pulley, which also could be used as a clutch on belt drives such as pictured on the scooter at the top of the page. This pulley differs from others in that steel balls, when under centrifugal force, bear against a pressure plate—one side of the pulley groove—to overcome pressure of a coil spring and thus increase the diameter of the pulley groove. The amount of increase is dependent on the speed of rotation. The detail in the center of the page shows the parts.

The fence-wire stretcher and splicer shown in the lower left-hand detail took second place, and consists of two parts with which broken wires can be pulled together and spliced or stretched as required. One part clamps to the wire near one broken end, and the other part, which somewhat resembles a hammer, is used to wind up the wire as pictured.

First prize in the gadget division of the congress went to a folding high chair pictured in the lower right-hand detail. As indicated, the chair folds flat for easy transportation or small storage space, yet can be opened to provide a sturdy chair of full size and neat appearance.

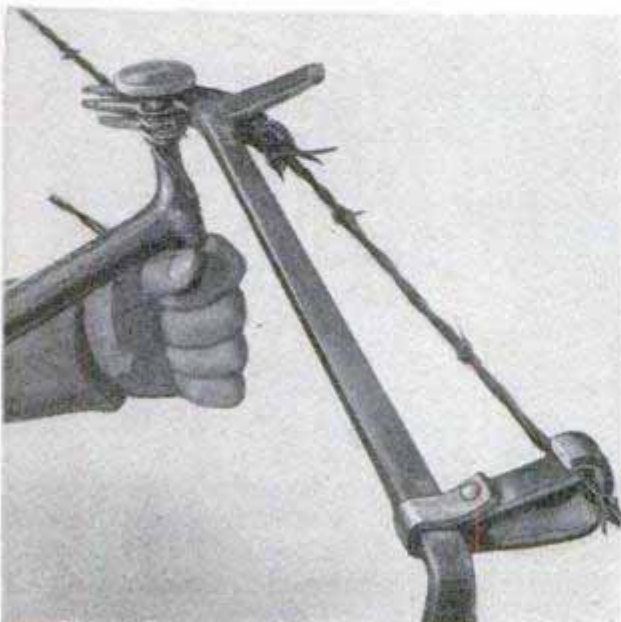
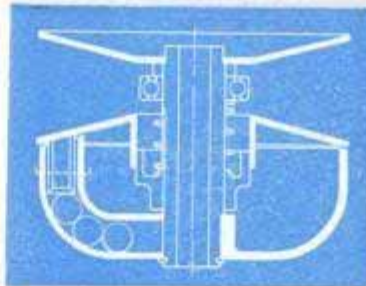
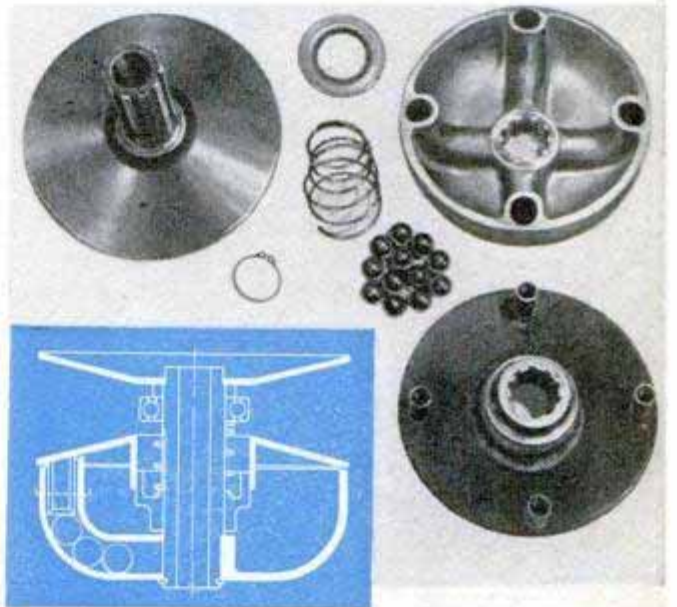
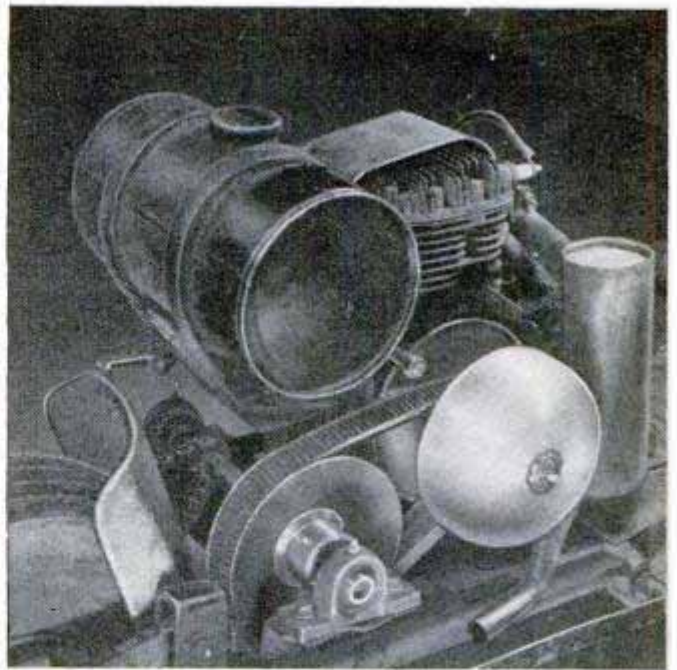



Two-Wheel Cart for Hauling Linen Speeds Motel-Operator's Chores

Having a number of cottages that require fresh linen every day, one motel operator devised this plywood cart to lighten the job of changing the linen. The front of the cart is divided into individual compartments for throw rugs and linens plus a drawer for cleaning supplies, while the rear of the cart forms a generous-sized laundry bin. As the cart is made entirely of $\frac{1}{2}$ -in. plywood and supported by the dividing partitions, the use of framing is eliminated. The cart rolls on two semipneumatic wheels positioned slightly forward of the center and rests on a pipe crosspiece fitted between two handles of bent pipe. The handles are drilled and bolted to the plywood sides. A door which comes within a foot or so of the top of the cart is hinged to the back to facilitate removal of the soiled laundry. Although the original cart was approximately 2 x 4 x 4 ft. over-all, these dimensions as well as those of the individual compartments are determined by the size of the finished linens and the quantity to be carried.

P. O. Anderson, Tacoma, Wash.

Filling Master Brake Cylinder With Aid of Curtain Rod

After experiencing considerable difficulty filling master brake cylinders with fluid, one auto mechanic did a little experimenting and finally came up with this novel stunt, which, he says, works perfectly.

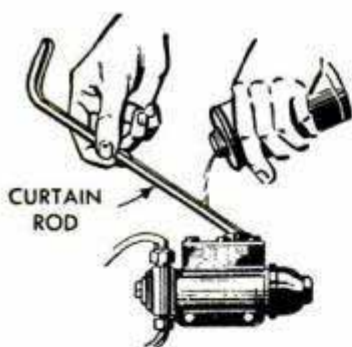

When filling brake cylinders, especially those located close up under the cowl, he places one end of a short length of flat telescoping curtain rod in the filler opening of the cylinder. Then he pours the fluid

into the rod channel at a point above the filler hole in a small steady stream. The liquid will follow the rod down to the end where it runs into the cylinder reservoir without dripping or spilling.

F. Schafer, Oak Ridge, Tenn.

Removing Broken Screws

Hardened-steel screws from which the heads have been broken can be removed by grinding a small pocket in the top end. This produces a shoulder against which a pin punch can be held for backing out the broken stub. Just chuck a small grinding wheel in a hand grinder and grind the pocket near the edge of the screw, holding the wheel at an angle so that one side of the pocket will be nearly vertical. To back out the stub, tap the shoulder until the stub can be grasped with a pair of pliers.

Boarded Stock-Tank Shelter

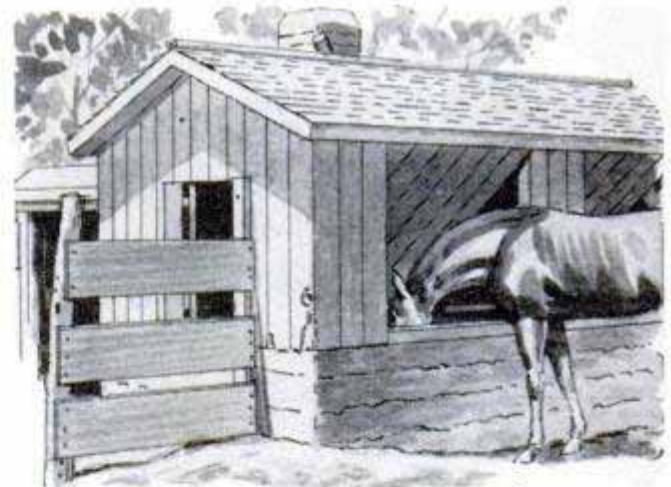

In severely cold weather, farmers and stockmen experience considerable trouble with freezing of exposed stock tanks, even though the tank heater is kept going full blast during the day and well into the night. One farmer, having this difficulty with a large, exposed concrete tank, built a tightly boarded and roofed shelter over the tank and also laid up a brick chimney to which the tank heater is vented. One side of the structure is fitted with large doors hinged at the top so that they can be swung inward during the day to give livestock access to the water. By closing the doors at night and banking the fire in the tank heater the water is prevented from freezing in the most severe weather.

PICTURE-FRAME VISE

has many uses in the shop

By John P. Arnold

A UNIVERSAL miter vise of the type used in assembling picture frames is handy in the shop for holding small, intricate parts firmly in place when assembling. The narrow metal jaws of the vise can be built up with hardwood pads for clamping work up to 2 or 3 in. wide. Wooden novelty boxes, mitered frames and similar parts are easily clamped in position for nailing, gluing, cementing or soldering. The illustrations below and at the right suggest a few of the many applications of this type of vise. Plastic parts of a considerable variety of shapes and sizes are readily held in place for cementing as in the upper right and left-hand photos. The unit pivots on the base so that it may be used either in the horizontal position as shown or in the vertical position. It may also be tilted at any convenient angle between and locked firmly in place. The movable jaws open to approximately 4 in., which makes it possible to use the unit as a drill vise, as in the lower left-hand photo, and for holding metal parts when soldering or brazing as pictured below at the right.

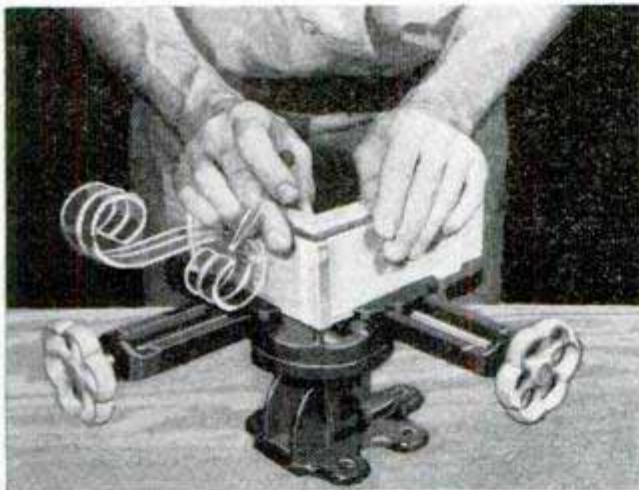

Plastic butt joints can be easily assembled and firmly clamped without marring adjoining surfaces

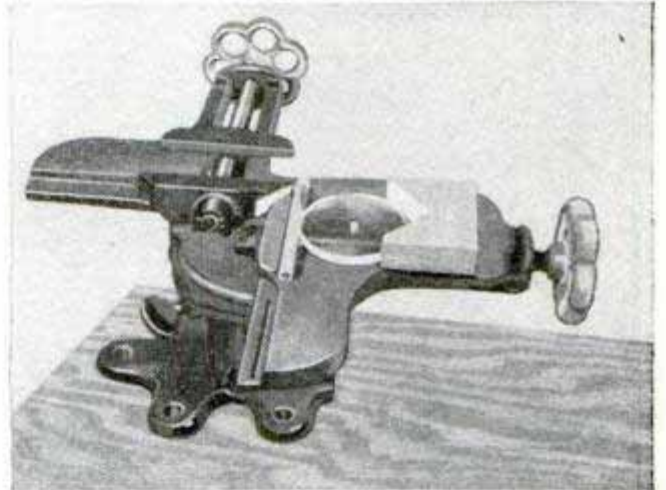

The wide jaws and flat bed of the vise are well adapted to clamping plastic parts for edge-cementing

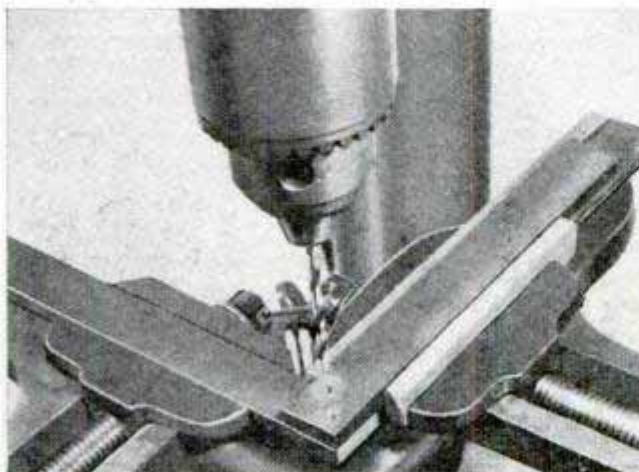

Showing how vise can be used on a drill press on work where accurate alignment of parts is important

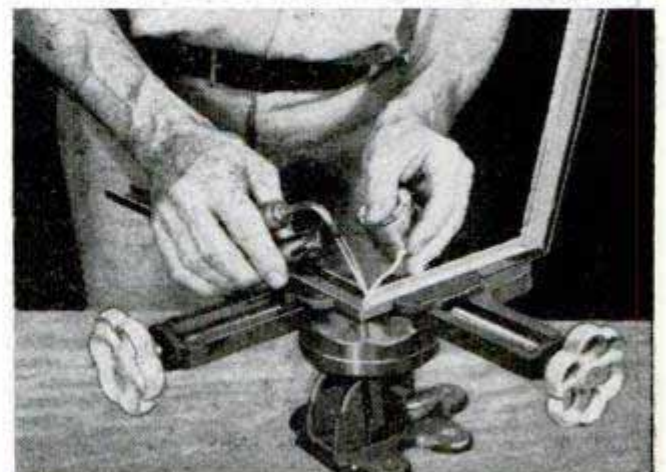

Securely holding two small pieces of brass channel positioned at an accurate right angle for soldering

How to Use

By Sam Brown



1 ABOVE, TAPPING IS DONE FIRST BEFORE MAKING SPINDLE. BELOW, CHUCKING ASSURES A TRUE START

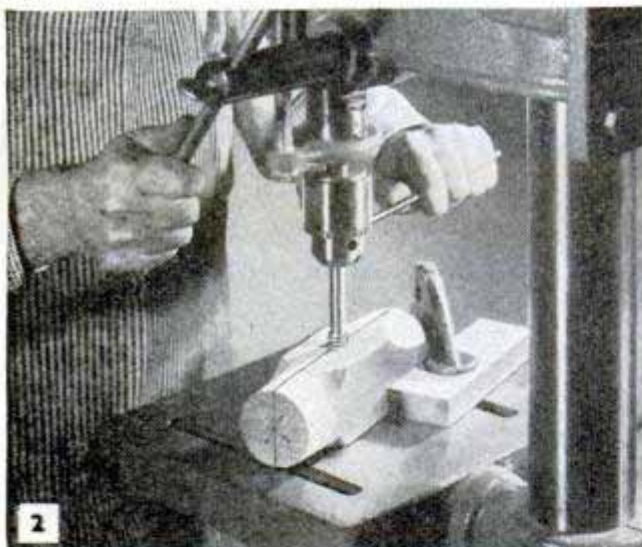

2

ONE OF THE less-known hand tools, yet one most home craftsmen often need, is the screw box, a device for cutting threads on a wooden spindle. The screw box is matched with a corresponding tap for internal threading, the two permitting all of the varied applications of the screw thread. Tap sizes run from $\frac{1}{4}$ to $1\frac{1}{2}$ in. in diameter, the corresponding screw box cutting a somewhat smaller spindle diameter. Practically all of the tools are handmade, with the tap matched to the screw box and sold as a set. Other than tap diameter, specifications vary considerably so that the table in Fig. 6 is only an approximation.

General construction: The working parts of a screw box and tap are given in Fig. 6. The metal thread cutter fits in a recess in the wooden body and is nonadjustable except that it can be driven forward to compensate for wear. The thread shape of the tap is approximately 68 deg., 8 deg. wider than the standard 60 deg. used for threads in metal. Screw boxes are available for cutting thread shapes ranging from 65 to 110 deg. Taps present no difficulty in conditioning or using. The cutting action can be improved slightly by giving the cutting edges more curve with a tiny grinding wheel as in Fig. 5.

Using the screw box: The spindle to be threaded should be turned to a snug fit inside the lead hole of the screw box, and the end of the work should be tapered a little to allow the thread to start easily. The screw box is turned like a tap wrench, Fig. 4, using a little pressure at first to get the cut started. If the cutter is sharp and properly set, the job is simple and fast. Evidence of a good cut is a continuous, peeling chip, as shown in Fig. 4. It is helpful in all cases to oil the work. Use linseed oil, rub-

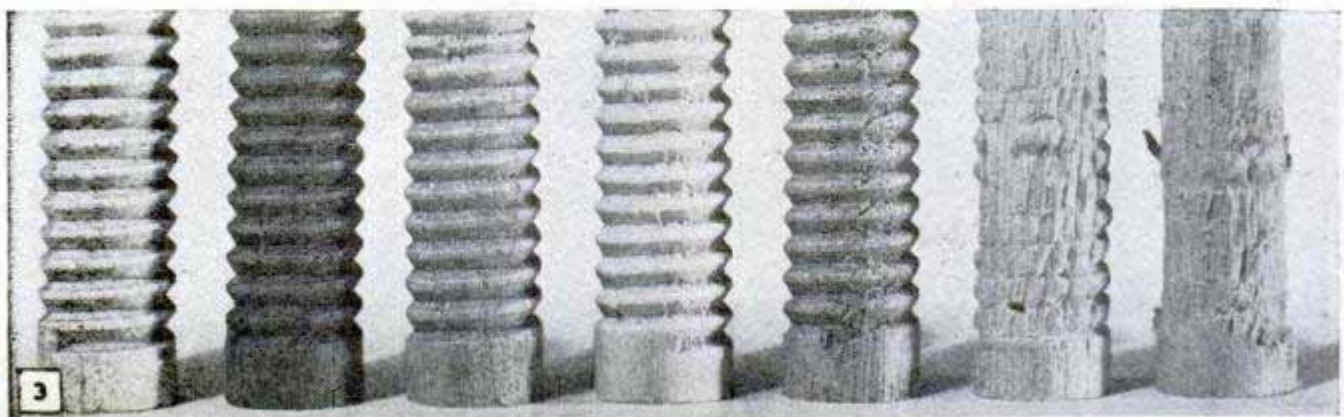

3

HARD MAPLE
(BEST)

WALNUT
(GOOD)

SOFT MAPLE
(FAIR)

BIRCH
(FAIR)

MAHOGANY
(POOR)

FIR
(FAILURE)

POPLAR
(FAILURE)

WOOD TAPS and SCREW BOXES

bing oil or castor oil—anything to bind the surface of the wood. However, don't expect oil to work wonders. If you are getting a fair thread with a slight amount of tearing, oil will make it better but it will not overcome a dull cutter or improper setting of the cutter.

Using taps: The tap will tear the wood slightly on entering and emerging. Where appearance is important, the best way to eliminate this is to use thick stock and then slice off $\frac{1}{16}$ to $\frac{1}{8}$ in. to remove the torn portion. Fair results can also be obtained by clamping the work between wood blocks. It is impractical to tap into end grain. When possible, the tap should enter from the flat grain side instead of the edge grain. Getting a straight start is the only difficult part of tapping. Chucking of small taps in the drill press, Fig. 2, is recommended. Tapping should be done before the work is cut to size, Fig. 1, as strain on delicate edges, especially near ends, may cause splitting.

Cutter mechanics: The main secret of a clean thread is minimum clearance behind the cutter. As a refresher, it is worth while to take a wood chisel and do some cross-grain paring, Fig. 7. You will find that a low angle of clearance—

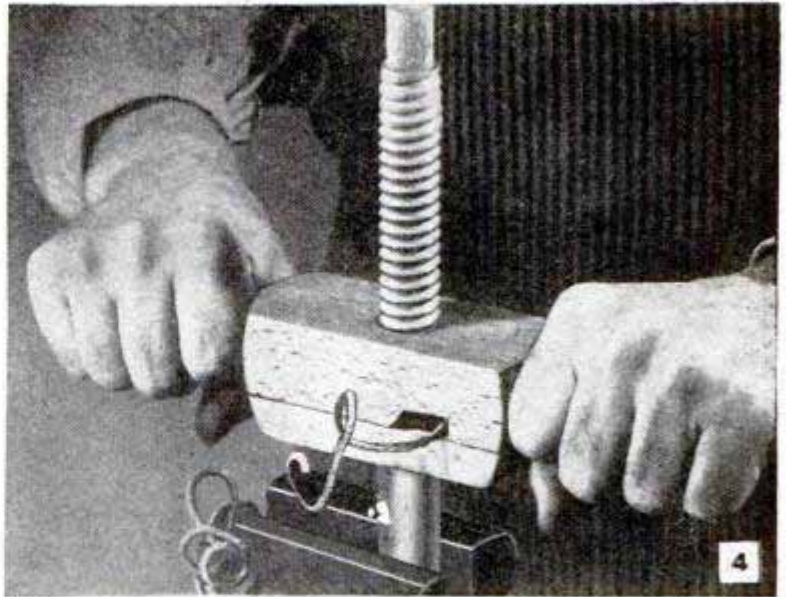

LONG, PARING CHIP INDICATES PROPER ADJUSTMENT

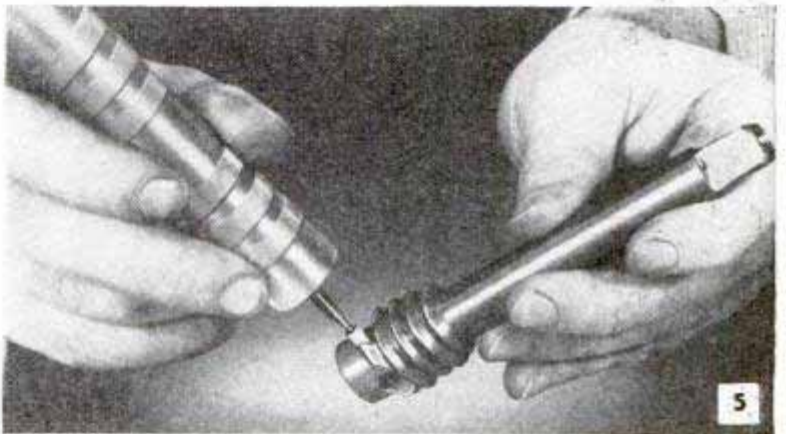

A LIGHT TOUCH WITH HAND GRINDER SHARPENS TAP

Average DIMENSIONS*

TAP DIA.	SPINDLE DIA.	TAP DRILL	THREADS PER INCH
$\frac{1}{4}$ "	$\frac{7}{32}$	$\frac{1}{8}$	10
$\frac{3}{8}$ "	$\frac{1}{4}$	$\frac{1}{4}$	9
$\frac{1}{2}$ "	$\frac{3}{8}$	$\frac{3}{8}$	8
$\frac{5}{8}$ "	$\frac{1}{2}$	$\frac{1}{2}$	6½
$\frac{3}{4}$ "	$\frac{5}{8}$	$\frac{5}{8}$	5
$\frac{7}{8}$ "	$\frac{3}{4}$	$\frac{3}{4}$	5
1"	$\frac{7}{8}$	$\frac{7}{8}$	4
1½"	1	1½	4
1¾"	1½	1¾	4
1¾"	1¼	1¾	4
1½"	1¾	1¾	4

*Tools are handmade and dimensions may vary from those given

Screw Box

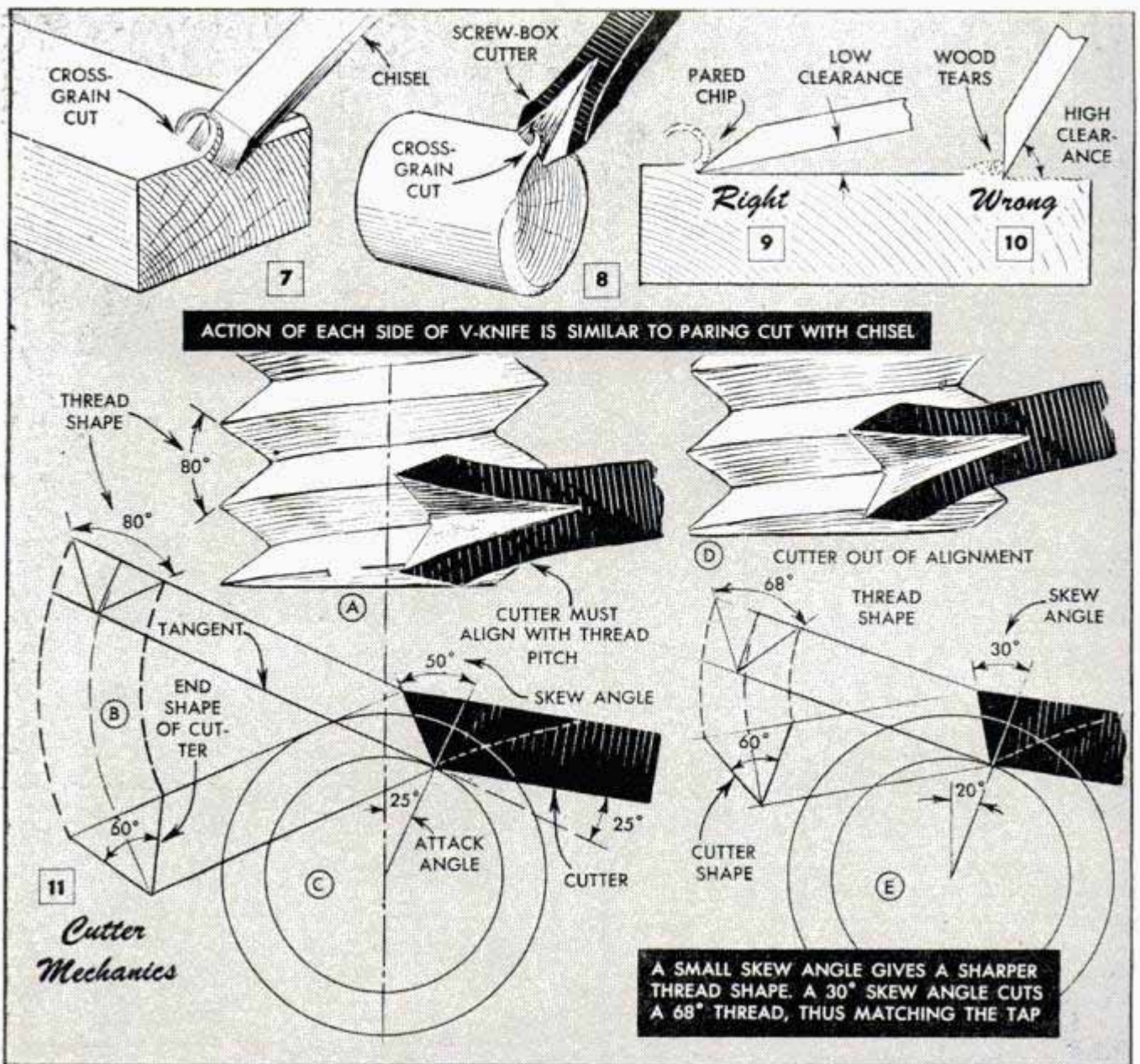

practically touching the wood—is essential for clean cutting. Observe also that if the chisel is held at a slant across the direction of cut a better slicing action will be obtained. These two features—minimum clearance and skew angle—apply to the screw-box cutter, Fig. 8. Each side of the vee cutter can be considered as a separate chisel. The clearance behind the cutting edge must be minimum and the cutting edge should attack at a skew angle.

If a new box does not cut, a systematic check should be made. First, see if the cutter is set too deep (too far forward). This is a common fault in a new box and can be corrected by regrinding the cutter, carefully maintaining the same angles. Next, check the cutter position in relation to the guide thread in the cutter body. The cutter point must align with the thread, as can be seen in Fig. 6. Now, turn the spindle into the box and check the slant of the cutter—it should align with the pitch of the thread as shown in detail A of Fig. 11. Any departure from this position will increase the

clearance angle on one side of the cutter and decrease it on the other as at detail D.

Carefully examine the cut thread on a wooden spindle at the point where the cutter stopped. If the cut is shallow and appears polished, it means the cutter lacks clearance on one or both sides. If you want to check this all-important point exactly, paint the underside of the cutter with bluing and then test to see if the bluing rubs off. Actually the bluing may rub off with a perfectly set cutter, but it should not rub off heavily. Rubbing can be corrected by regrinding or by pushing the cutter back in its slot. However, in no case should the chisel wedge be reduced to an angle of less than 20 deg. If the bluing does not rub off, the cutter evidently has clearance, but it may have too much clearance, and this is the condition that causes tearing. See Figs. 9 and 10. Excessive clearance can be reduced by regrinding or by pushing the cutter forward. It should be noted that the inner of the two chisels forming the vee knife requires less clearance than the outer chisel

because of the slant of the thread. Slight changes in the clearance angles can also be obtained by wedging the cutter up or down in its slot, but any radical change obtained by removing wood from the cutter slot should be avoided until everything else has been checked thoroughly.

Thread shape: In addition to giving the cutter a slicing action, the skew bevel controls the shape of the thread. A skew angle of 50 deg. will give a thread shape of about 80 deg., as shown in detail C, Fig. 11. Threads up to 90 deg., Fig. 15, are satisfactory for most work. If the skew angle is decreased, either by grinding or by tilting the cutter, the cut thread will be sharper, as shown in detail E. The small skew angle also gives more clearance. It should be noted that the skew angle is measured on a diagram of the work and is not the angle of the cutter itself. Attack and tangent angles, detail C, are not fixed values. The cutter will work at any point around the circle and can be set from exact tangency to about 40 deg. above the tangent from the contact point.

Most cutters will cut a more or less buttress thread, although not the extreme shown in Fig. 14. If the cutter is working well, it is not worth while bothering about this condition. However, if you are using inserted threads, Fig. 13, it is obviously good practice to reverse the thread as needed to resist the load. A thumbscrew should be reversed from the Fig. 14 position, and the same applies to a hand screw, Fig. 16. A definite buttress thread can be corrected by cocking the cutter slightly in its slot or correcting the cocking which has caused the off-balance thread.

Shoulder threads: With the cover plate in place, the screw box will thread to within about $\frac{1}{2}$ in. of a shoulder, Fig. 13. With the cover plate removed and the cutter clamped in place, Fig. 12, threads can be cut to within $\frac{1}{8}$ in. of a shoulder. If a complete thread is required, the remaining $\frac{1}{8}$ in. can be filed by hand or an inserted thread can be used.

Grinding the cutter: Cutters are carbon steel and the thin chisels (20 to 30 deg.) must be ground carefully, wetting the cutter repeatedly to avoid burning. The

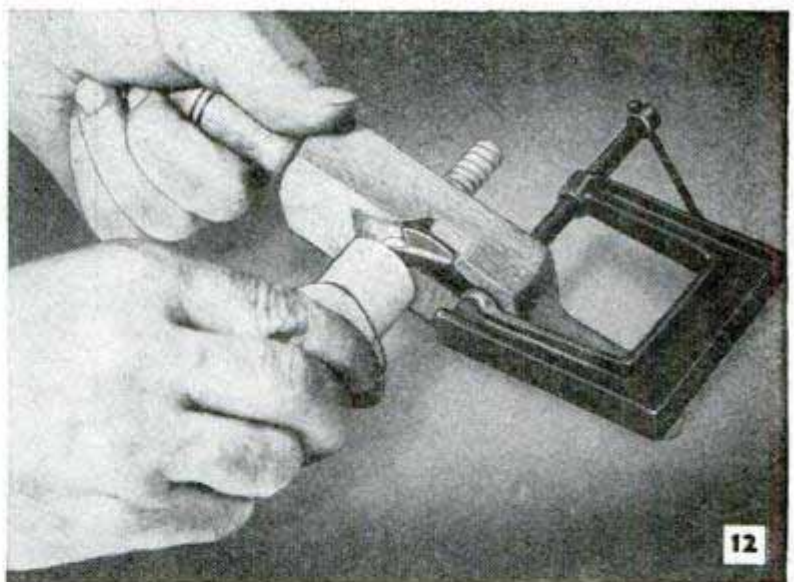

12

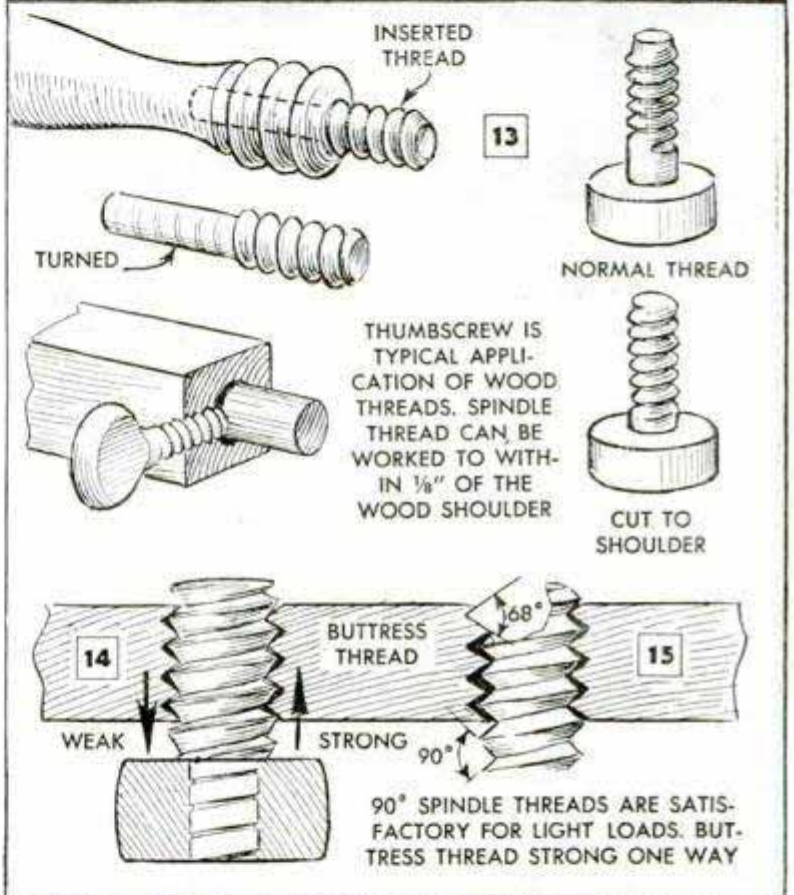

13

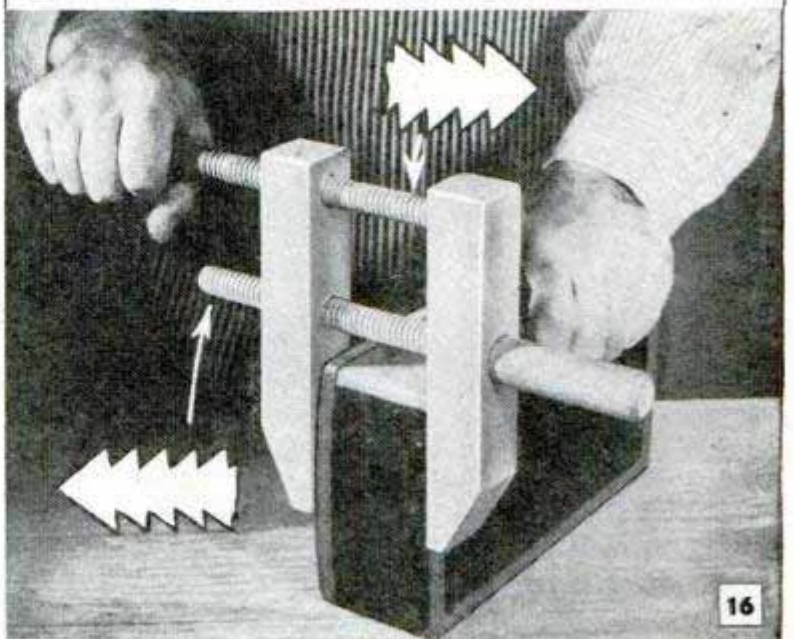

16



17

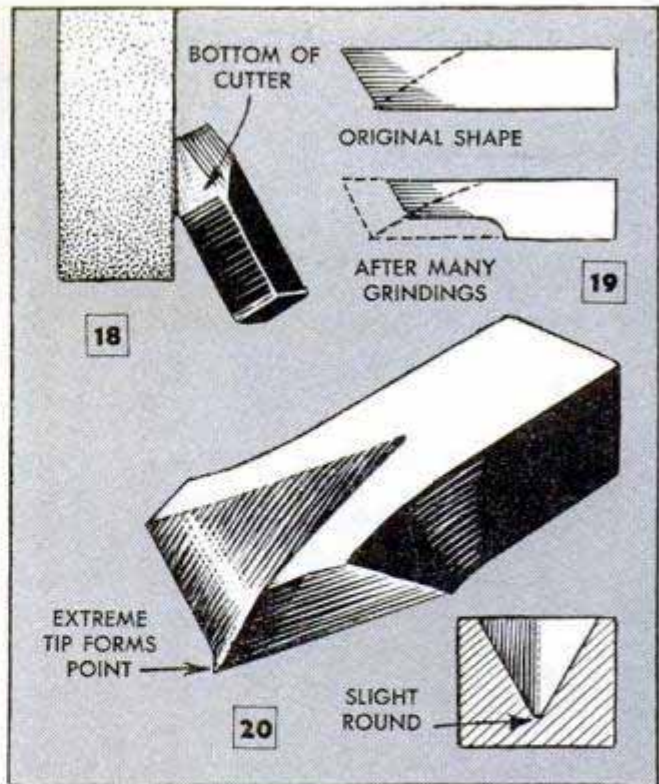

18

19

20

best grinding position is shown in Figs. 17 and 18. The bevel must be perfectly flat. Grinding will raise a small projection at the extreme tip of the cutter as indicated in Fig. 20. This is controlled by the round at the base of the vee groove—the more round, the more projection. Normally, the slight round obtained with a triangular file is sufficient. The cutter should not be ground unless chipped. Once ground it should be honed to a perfect edge, and will stay sharp by repeated honings. If grinding is required for any reason, the cutter will retain pretty much its original vee, but will have less height. Surplus metal at bottom of cutter should be ground back squarely, Fig. 19.

Woods to use: Threading a wooden spindle is a delicate job of cross-grain cutting and only a few woods will hold the cut without crumbling or tearing. White birch and hard maple are commonly used. Other good woods are apple, pearwood, cherry and walnut. Hard maple is by far the best and, since it is readily obtainable, there is no point in using anything else. Fig. 3 gives typical examples of how different woods thread. The tap will tear on the cross-grain portion of almost any kind of wood, but at the same time it will make a workable thread in almost any wood. As this part of the work is concealed it does not demand the perfection of the spindle thread.

Bales of Straw Check Soil Erosion in Sloping Fields

To prevent soil washing in sloping fields which have been newly planted, one farmer dams the shallow waterways with bales of

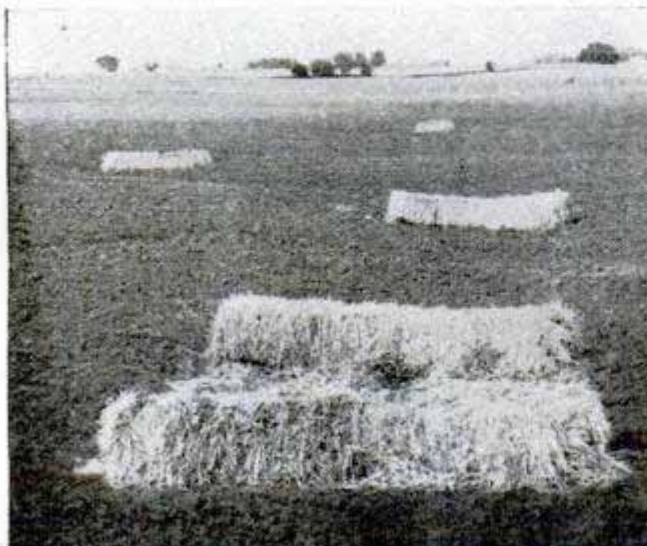

straw. The straw dams are placed across the waterway at intervals extending all the way from the top to the bottom of the slope, the distance between the dams varying with the degree of slope. On a steep slope the dams should be placed only a few feet apart, but where the fall is not more than 6 in. to 1 ft. in 100 ft. the dams may be placed from 1 to 3 rods apart. The purpose of the dams, of course, is to slow the flow of surface water and thus prevent it from carrying loose topsoil down the slope and forming a deep gully. This same method of checking the surface movement of water from heavy rains also can be used when establishing a sod waterway. The dams will slow the flow of water until the grass is rooted and has attained sufficient growth so that the individual blades will flatten and overlap under the flow of water.

Sturdy Sawhorses From Angle Iron

Wooden sawhorses soon break up under rough usage on the farm, so many farmers build a pair to suit their own needs from pipe and angle iron welded together to form light, rigid units. The legs are formed in pairs by bending 1 or 1½-in. pipe to a U-shape and then welding 2-in. angle iron to the leg units. Note in the illustration that the angle is turned with the corner up and that the sawhorse legs are inclined, or splayed, about 12 deg. from the vertical. After welding, place the units on a level floor and saw off one or two of the legs so that each sawhorse stands firmly.

A. M. Wettach, Mt. Pleasant, Iowa.

Sand Supports Work for Welding



Irregularly shaped parts or complicated assemblies which cannot be clamped or held by hand for welding are easily supported by partially embedding them in a container filled with sand. Pour the sand into a metal container such as a large

washtub or the bottom section of an oil drum, making the sand layer several inches deep.—George J. Berkwitz, New York City.

Dual-Wheel Farm Trailer Used on Muddy Fields

For heavy loads and a high degree of flotation on muddy fields, a dual-wheel trailer is recommended. This combination will also be a lifesaver for your tires, and in case one should become punctured the



trailer can be kept in operation until it is convenient to make repairs. The rig pictured here was made from the rear end of an old truck, using the original springs.

L. H. Houck, Jefferson City, Mo.



Barrel Provides Self-Feeder

A small barrel of the type used for storing buttermilk, or an old churn of the tumbler type, is just the thing for making a self-feeder for sheep. First, tighten the hoops by driving them down, then nail the hoops to the staves so that they cannot loosen. Next, drill holes for the insertion of a compass-saw blade and cut spaced openings around the circumference by sawing through the staves between the center hoops.

Leave at least one full stave between the openings, as pictured. Usually, the end cut from a 55-gal. oil drum will fit neatly over the top of a barrel of this size to provide a weather-proof cover. Self-feeders made in this way are suitable for either hay or grain.



Colors Identify Edges of Scale

When you pick up a draftsman's scale, you can tell at a glance which scale is up if the chamfered edges at the ends are painted with identifying colors. For instance, one end of the scale can be dipped in red ink and the other in blue, or the tips can be coated with colored fingernail polish.

H. Drouyn, Montreal, Que., Can.

SHOPPING



BANDSAW having guards, frame, table and quadrant made from hardwood plywood will be new to most homecrafters. Table tilts to 45 deg. and is grooved at the outer edge for a miter gauge which is furnished as an accessory. The machine will rip to the center of a panel 18 in. wide and will take work 3 $\frac{3}{4}$ in. thick under upper guide

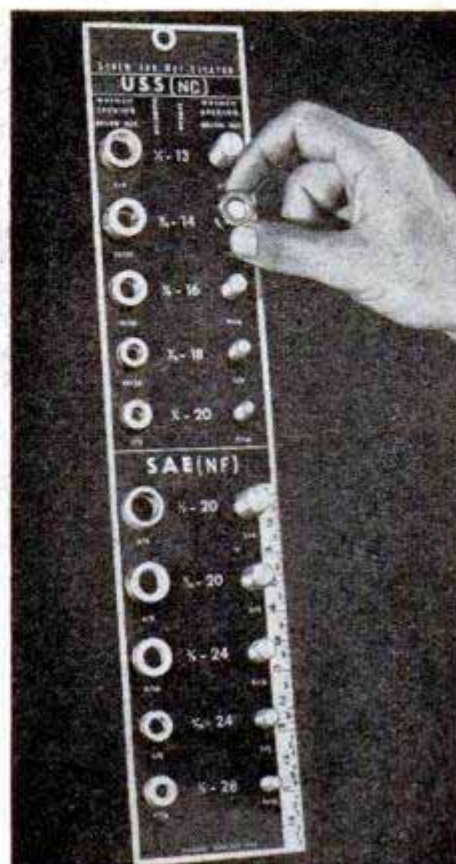

THREAD GAUGE that matches threaded nuts and bolts should prove useful in repair shops, garages and stock rooms. Threaded sleeves on one edge of the gauge are for checking the thread size of the bolt. On the opposite edge threaded studs make it easy to select a nut of the correct size to fit the bolt. Studs and sleeves threaded NC (National Coarse) and NF (National Fine) in various sizes are supplied on each gauge



QUALITY IGNITION KIT consisting of four tools—chisel-nose and slip-joint pliers, long-nose pliers, screwdriver—will find ready acceptance not only by garage mechanics but also by radio and electrical repairmen who have use for special tools of this type. The long-nose pliers are provided with a wire cutter and stripper. The four tools are supplied with a neat plastic holder having four pockets with flap for tight closure

BRAKE-LINING CUTTER now available performs two operations with only a simple change from guide to shear plate. With the guide in place, as pictured at the right, the tool removes either bonded lining or riveted lining from the shoe. Removing brake-shoe guide and substituting shear plate sets it up for cutting the new lining to required lengths. Unit is furnished complete with guide, shear plate and lugs for bolting to bench

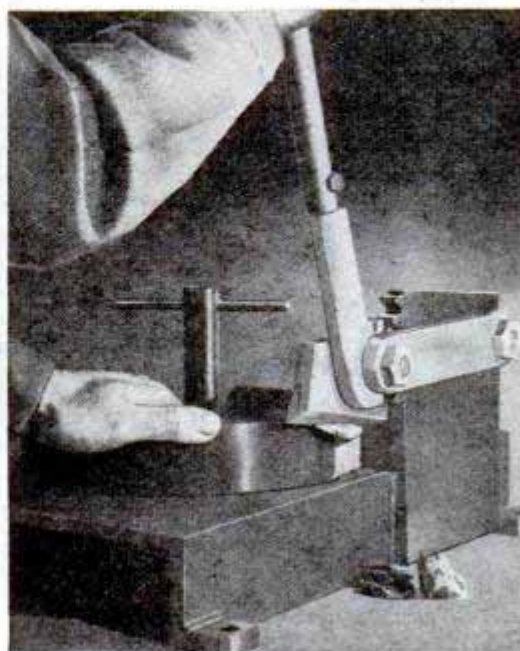

POPULAR MECHANICS

FOR TOOLS

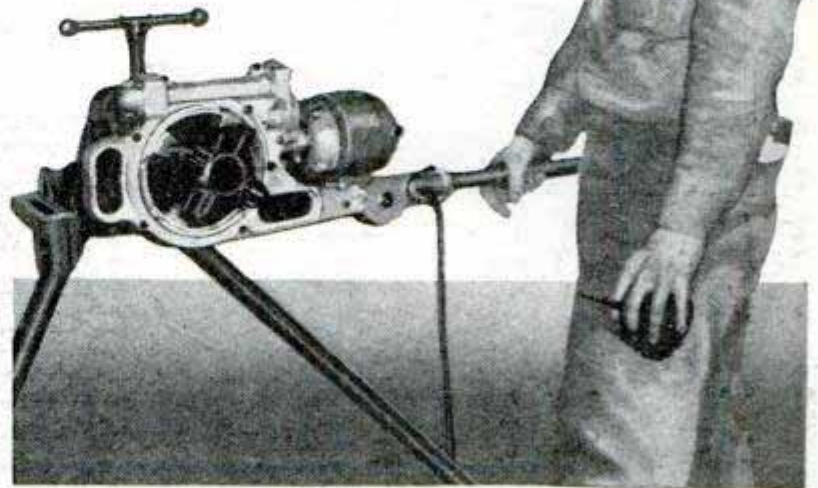
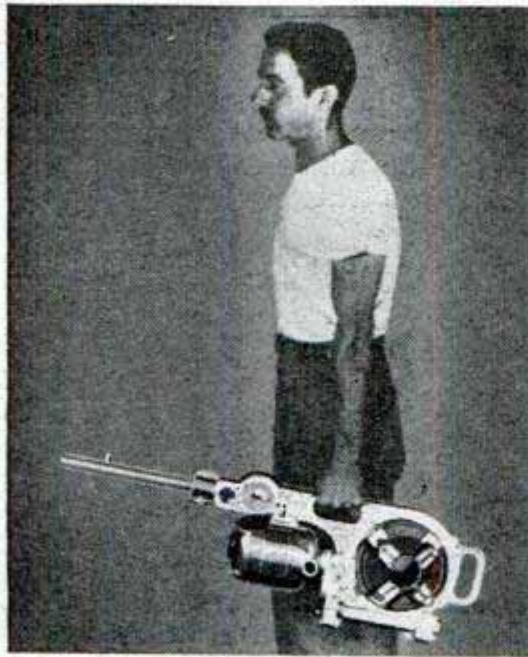

MOTOR-DRIVEN PIPE THREADER is carried to the job in one hand and mounted directly on the pipe-vice stand. It takes standard interchangeable pipe dies from $\frac{1}{2}$ to 4 in. Motor is directly connected to the die through a reduction gear which is reversed for backing off. The machine can be adjusted to operate in a space as small as 12 in. wide. It also can be set up to work within 5 in. of a wall without any interference

HAND-OPERATED CHAIN SAW is just the thing for tree trimming, cutting cordwood and felling small trees in the wood lot. It cuts horizontally, vertically and at any angle where you have elbow room to operate it. Just loop chain blade around material to be cut and pull alternately on the handles. In green wood it cuts faster than any one-man saw of conventional type. Because of narrow chain blade it does not bind in cut

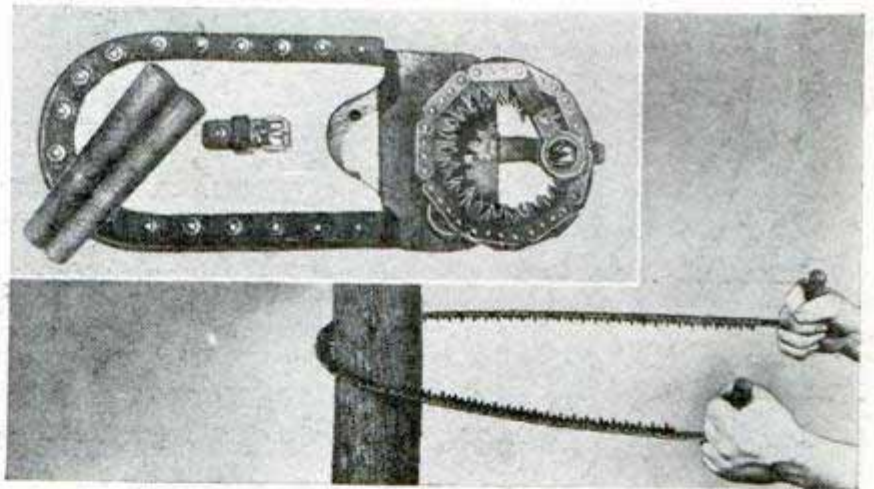

LEVEL FOR A PORTABLE DRILL makes it possible to drill true holes horizontally through timbers or at any angle in floors and ceilings. The level is a separate unit which is attached to the top of the motor frame. The level glass is supported in an adjustable frame which can be tilted on a center and locked at any point from 0 to 90 deg. to the drill bit. The level is easily detached from the drill motor by removing two screws

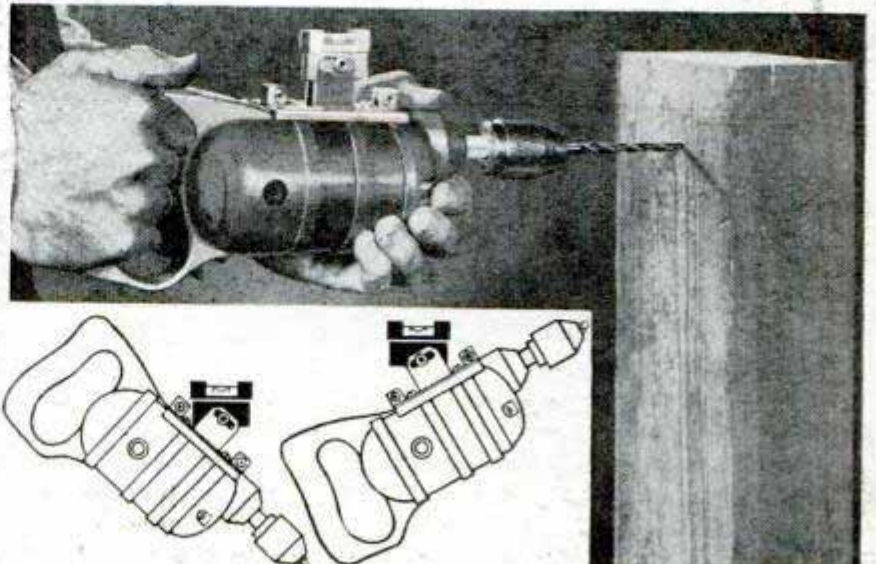

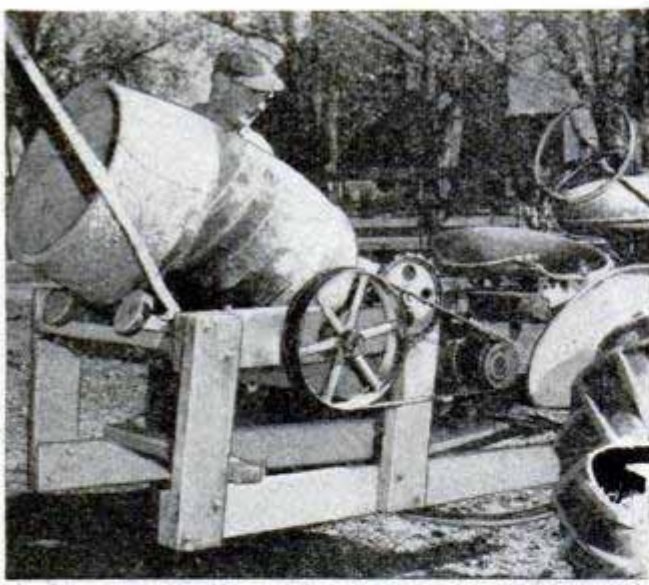

Tractor-Mounted Concrete Mixer Dumps Load Into Forms

Mounted on a tractor, this small concrete mixer can be emptied directly into the forms, thus saving time and work by reducing the amount of wheelbarrow pushing needed to complete a job. The mixer rests on a wooden frame fitted over the drawbar and under the axle of the tractor, and is driven from the power take-off. A V-pulley for the mixer drive was welded to the end of the tractor pulley.

Cap Screw Serves as Lathe Dog For Working Close to Faceplate

While machining work between centers, it frequently is necessary to work closer to the faceplate than an ordinary lathe dog will permit. When faced with this problem, one machinist mounts the work as in the illustration. First, a flat is ground on the end of the work at an angle of 45 deg. with the axis. Then a hole is drilled and tapped in the flat at right angles to its surface. A cap screw turned into the tapped hole serves as the driving dog, the head

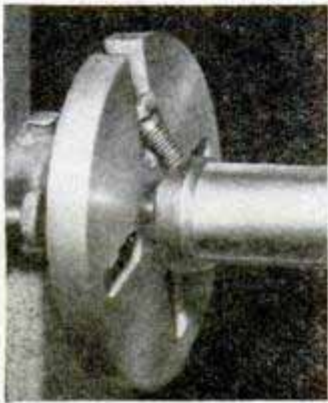

of the screw engaging the faceplate slot as shown. With this setup, it is possible to work within $\frac{1}{2}$ in. of the end of the stock.

Morris S. Dollens, Los Angeles, Calif.

Improved Cutoff Tool

When needing a cutoff tool and one was not available, I improvised one quickly from a broken center drill. I simply ground a flat on each side and sharpened the end of the drill to serve as the cutoff tool.

LeRoy Oaks, Glendale, Calif.

Corncrib Protected From Rats

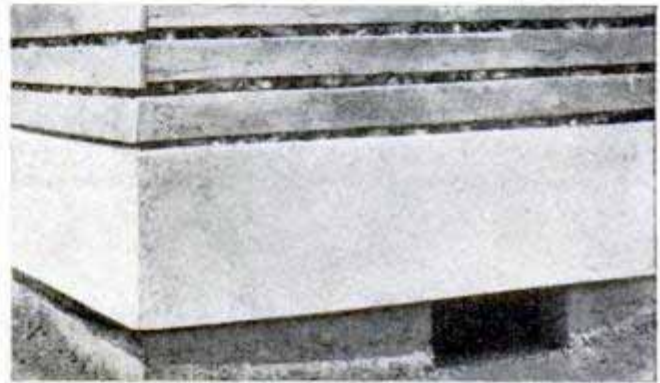

To prevent rats from climbing the concrete foundation and entering corncribs through openings between the slats, some farmers nail a strip of galvanized sheet metal to the slats all the way around the building as shown. The rats cannot gain a foothold on the smooth metal surface.

Oil-Drum Halves Welded Together Provide Large Stock Feeder

A large feeding trough which considerably reduces feed-hauling time is made by cutting two 55-gal. oil drums in half



lengthwise, tack-welding the four halves end to end and mounting them on a stand. Tack-welding the seams permits moisture

to drain off, thus helping to keep the feed from rotting. After the drums have been cut in two, remove both ends from the drum sections that will form the center portion of the trough, but remove only one of the ends from each of the two outer sections. The drum ends which are left intact will form the ends of the trough as in the photo.

TELEVISION TODAY

COLOR television in the home is claimed to be much nearer today because of two new factors, the RCA direct-view Tri-Color Kinescope tubes, and the recently announced General Electric's Frequency Interlace Color TV system. The single and three-gun RCA color tubes were described in detail in the August 1950 issue of *Popular Mechanics Magazine*. The original demonstration receiver using the Tri-Color three-gun color tube appears in photo A. General Electric's new Frequency Interlace Color TV system is claimed to have important advantages, and a preliminary demonstration will be given soon.

Photo B shows a sturdy "Brach" universal TV antenna base mount that may be installed vertically, horizontally, or at any angle. A new air-spaced feed line for TV and FM antenna installations is illustrated in photo C. This "Goodline Airlead" is claimed to have special low-loss features.

TV set owners in fringe areas can improve picture definition by adding a TV booster. The Electro-Voice unit shown in photo D is an easily installed, improved high-gain automatically tuned TV booster, with four stages of amplification. It turns on and off automatically with the TV set switch and all tuning is done with the television set controls. Photo E shows one of the recent Philco TV models which includes a new remote-control device so the viewer can adjust the receiver from any location. A high-voltage probe is a necessary tool for the TV serviceman. The I.C.A. model shown in photo F multiplies the ranges of any standard 10 or 11-megohm vacuum-tube voltmeter by a factor of 100.

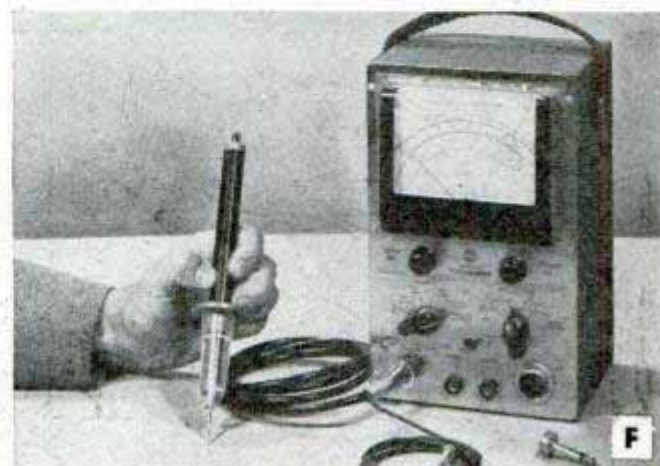
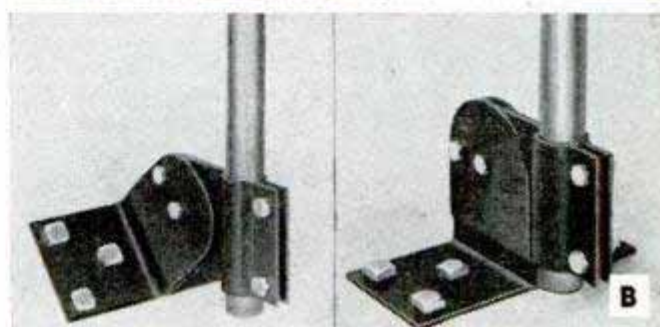

★★ STROBOSCOPE UNIT FOR

By Dr. R. C. Hitchcock

THIS "flashing lamp" for motion analysis is quite simple to build and operate. It has many useful applications in machine shops, classrooms, auto-service departments and in any shop, plant or laboratory where moving equipment is serviced or employed.

Several phenomena, common in some degree to all types of machines, occur only when the machines are operating at their rated speed. It is often possible to calculate the performance of the machine under these working conditions, but a short-cut method, and often a much better one, is to see the effect of speed instead of figuring it. Centrifugal force, absent when the machine is at rest, may assume important proportions at full speed—but the unaided eye sees only a blur. If, however, a light of short duration is flashed once per revolution, the blur is replaced with a distinct picture. The machine is apparently stationary but with the centrifugal forces in full action. The sponge-rubber wheel

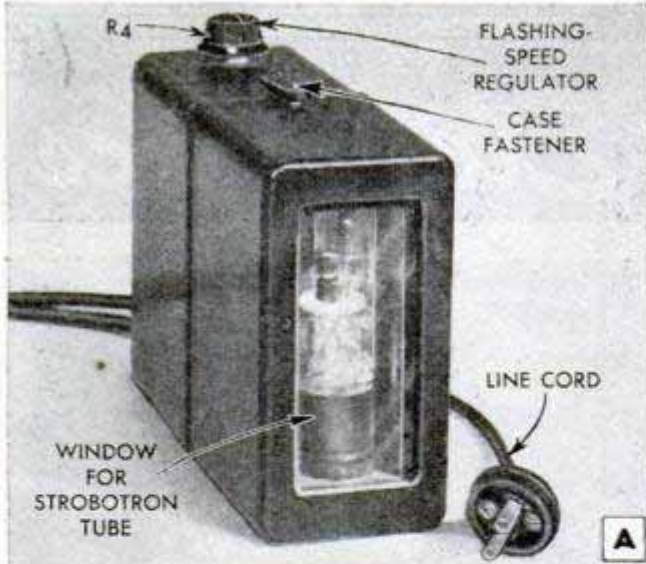

A

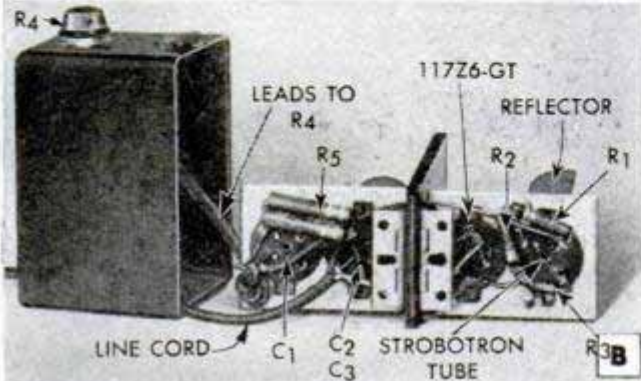

B

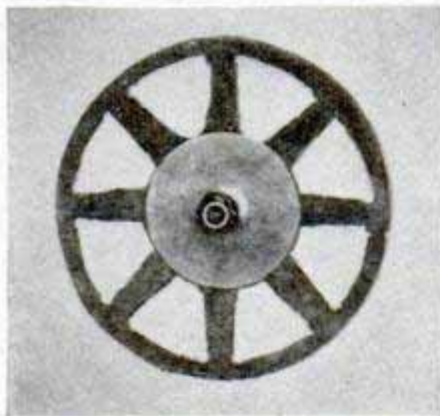

THE RUBBER WHEEL—AT REST

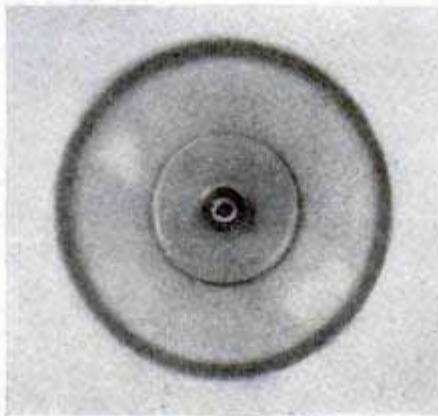

THE WHEEL AT 1800 RPM

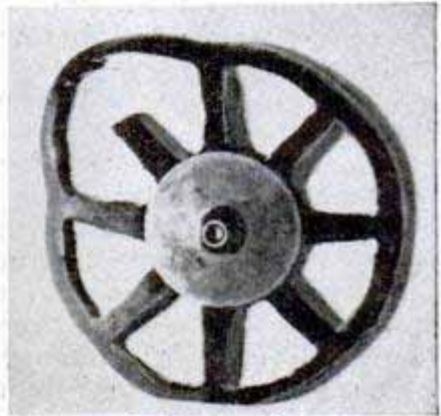

THE WHEEL AT 1800 RPM AS VIEWED UNDER THE STROBOSCOPE LIGHT

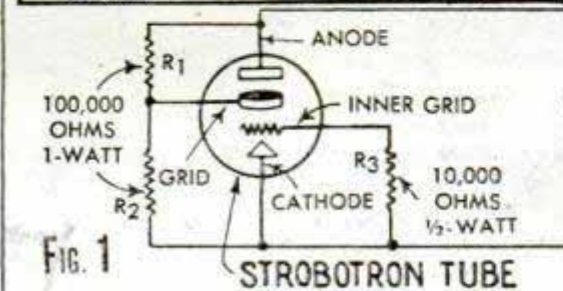
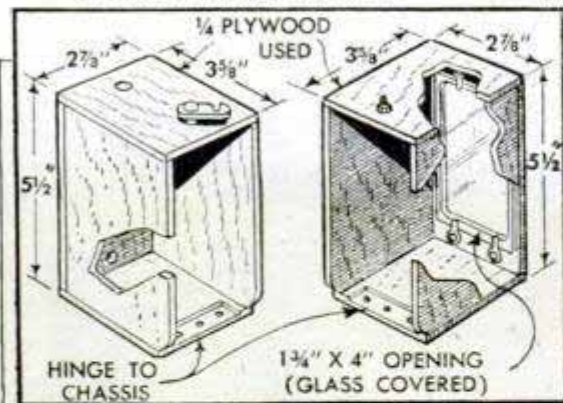
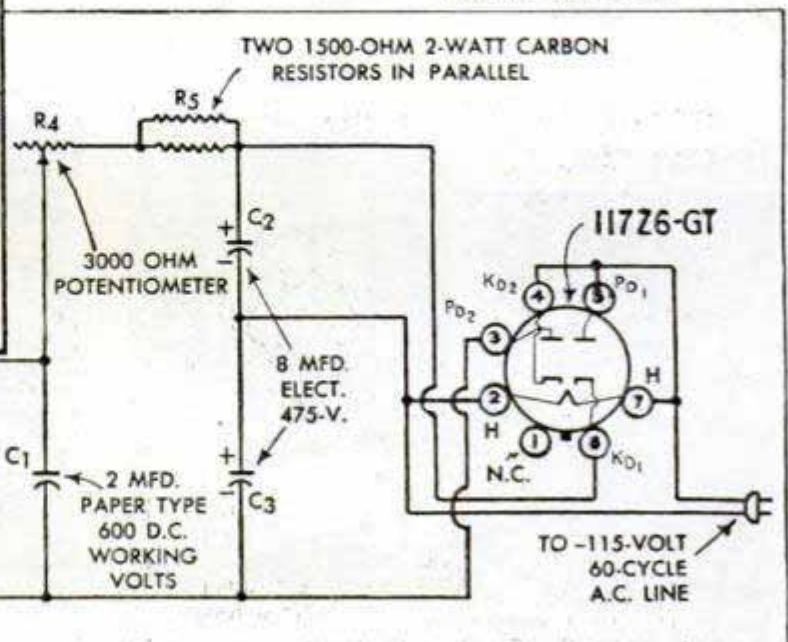

Fig. 1



STUDYING PARTS IN MOTION

shown in the photos gives a clear demonstration, and the principle is equally applicable to wheels which are made of stronger materials.

The case in the photos is made of Bakelite but any plywood case of the same dimensions may be used. A suitable wooden case is detailed in the inset sketch in Fig. 1. A schematic circuit diagram appears in Fig. 1, and a pictorial wiring diagram is shown in Fig. 3. The chassis base is in two sections and these are hinged to a Bakelite or plywood partition, as detailed in Fig. 2. Photos A, B and D show various views of the completed instrument. Holes are drilled in the partition for the various circuit leads, as indicated in Fig. 3. Chassis-base plates can be of sheet brass, $\frac{1}{16}$ -in. aluminum or sheet steel.

The Strobotron tube can be either a 631-P1 or a Sylvania 1D21/SN4. The type 631-P1 is available directly from the General Radio Company, Cambridge, Mass., and the Sylvania 1D21/SN4 Strobotron tube will be found listed in parts house catalogues.

It is important that the Strobotron tube socket be mounted on the chassis base with the tube prongs faced exactly as shown. Light emerges from the side nearest the small pins. Photo D shows the reflector that is mounted on the base directly back of the Strobotron tube. This reflector was made from sheet brass curved as shown and with two mounting tabs at the bottom. The reflecting surface was nickel plated. A piece of bright sheet tin can be substituted if desired. The frequency of timing is adjustable with the 3000-ohm potentiometer R4 which is mounted in the top of the case. The plug-in condensers are Tobe type, but any similar plug-in condensers may be used.

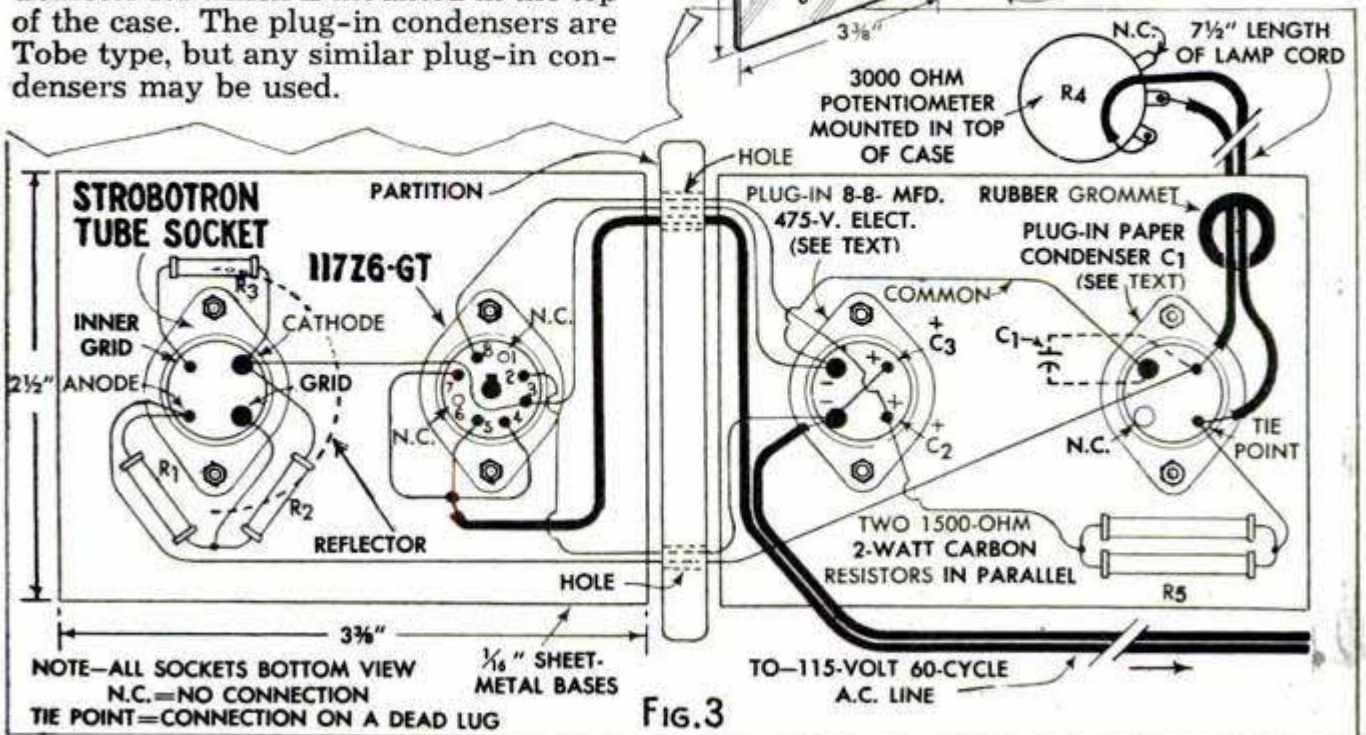
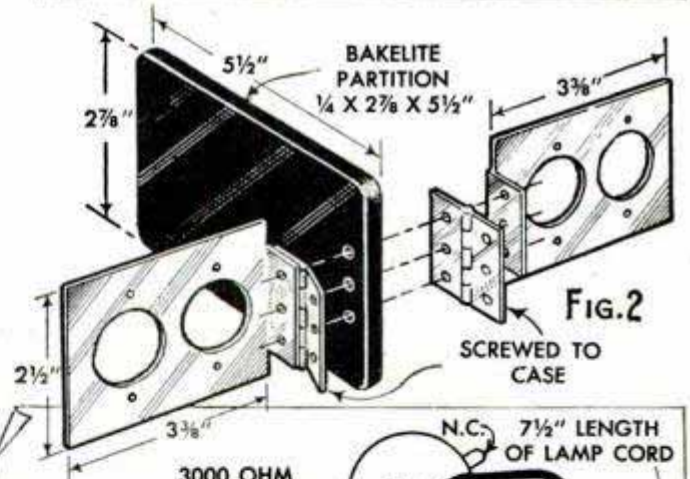
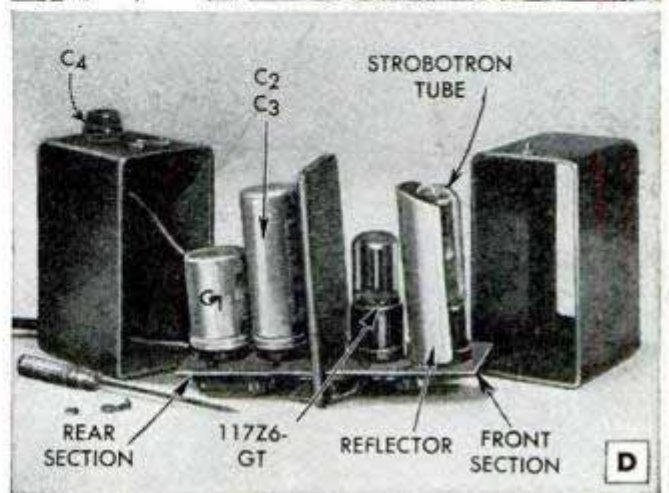

MASTER TV ANTENNA SYSTEM

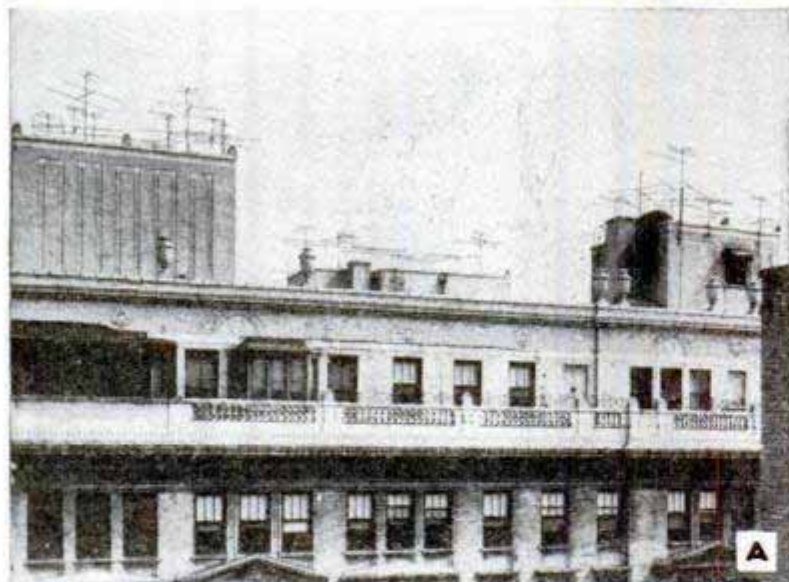

ROOF-TOP TV antennas on apartment buildings and hotels have presented a problem that has been troublesome to some managers of these properties in large metropolitan areas. Tenants in some locations are discovering that various types of indoor television antennas are not satisfactory. In many apartment buildings, these tenants cannot pick up a good picture signal by using anything except a roof antenna.

When the tenant finds out that he has a television reception problem of this sort his first course of action is to request permission to install a roof antenna. The manager desires to please the tenant and, if he gives his consent, the result may look like the TV-antenna jungle on a prominent Chicago building, photo A. The answer to this problem is a master TV-antenna system designed to accommodate a large number of TV receivers within a single building, or a number of buildings in a group or block. The installation illustrated is the Jerrold Mul-TV system that employs a master amplifier, photo C, and requires only the necessary number of roof-top antennas that will provide maximum reception from each TV transmitter in the area. Each channel signal is sent by means of shielded wires to the master amplifier unit where it is

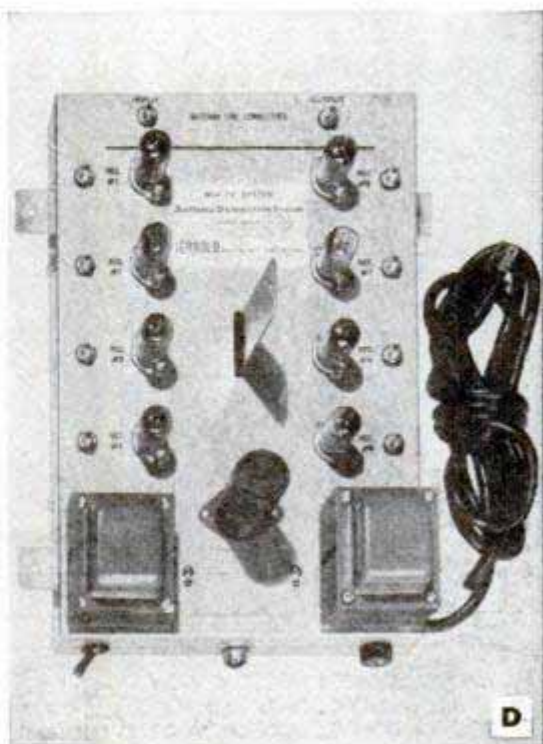
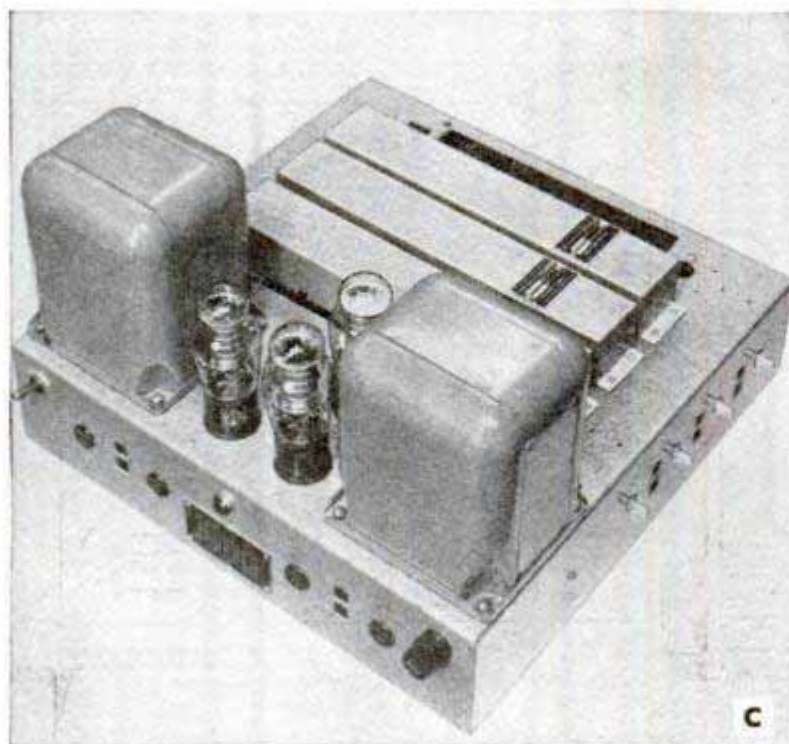
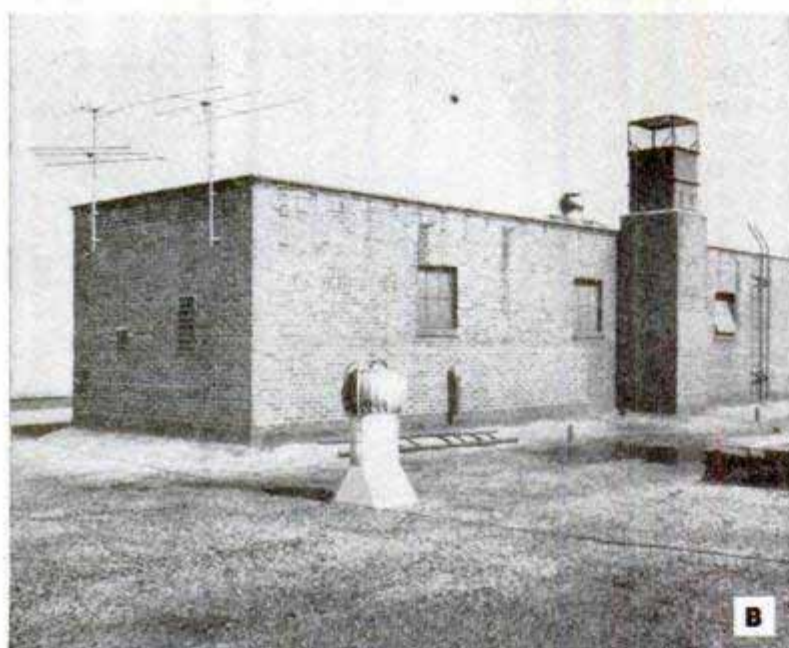

FOR APARTMENT BUILDINGS ..

amplified separately and distributed to the various apartments through one or more distribution units. Photo B shows the roof of another prominent building on Chicago's North Shore after the installation of this system by a local TV service company.

The distribution unit, type ADO-8, illustrated in photo D serves eight different apartments. Coaxial cable is employed to distribute signals to receivers. The cable permits picture signals from all local TV stations to be presented at one outlet which may be placed at a convenient spot in the apartment. Multiple ADO-8 distribution units are connected as shown in Fig. 1 to serve a large number of apartments. The entire block of buildings shown in photo E is served with one of these master TV-antenna systems. A typical master-amplifier installation in a basement office is shown in photo F. One of the individual plug-in TV channel amplifier sections appears in photo G. Some of these master TV-antenna installations are made on the basis of an agreement with each tenant and a fixed charge is made for the apartment installation, plus a yearly charge of \$10.00 per outlet for the service and maintenance of the system. To use the system the set owner merely plugs into the antenna outlet.

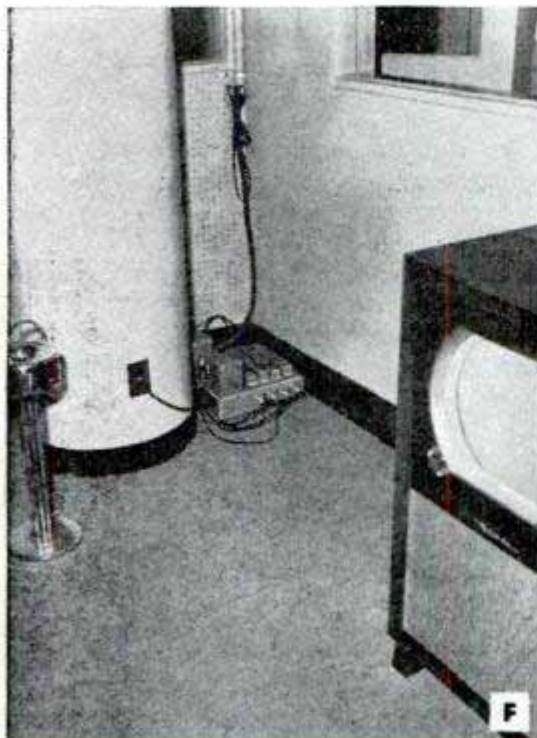
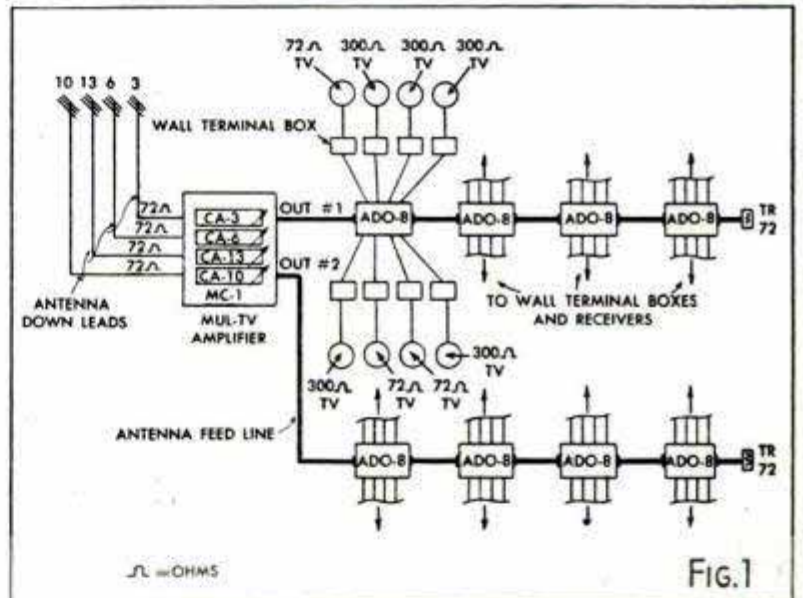

Below, one of the channel-amplifier strips that plug into the master amplifier unit. There is a strip for each of the TV channels; these strips amplify the sound and picture for each one of the local TV stations individually for maximum results

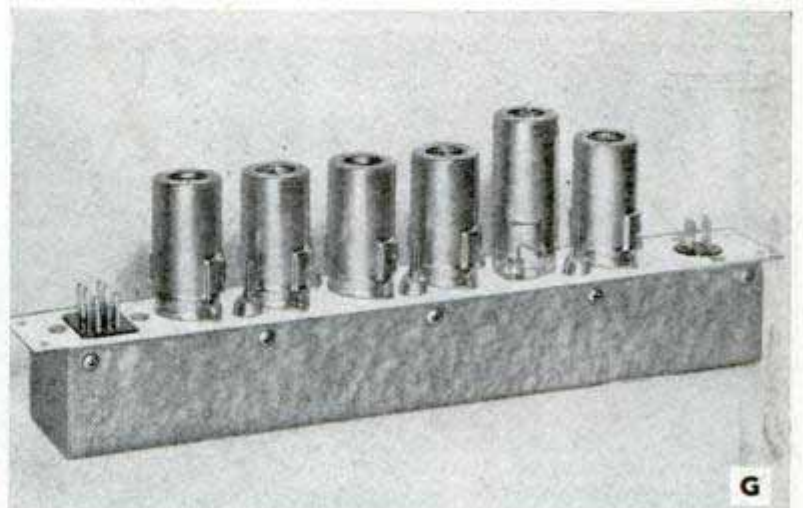

HINTS FOR RADIO EXPERIMENTERS



A—Small electric hand drills of the type illustrated are convenient for drilling out old solder in salvaged control terminals, or for enlarging such holes. They are also handy for marking chassis bases to identify tube-socket locations and various terminals. A tiny grinder attachment supplied with these tools is ideal for cleaning lugs and spots on chassis bases where soldered connections are to be made

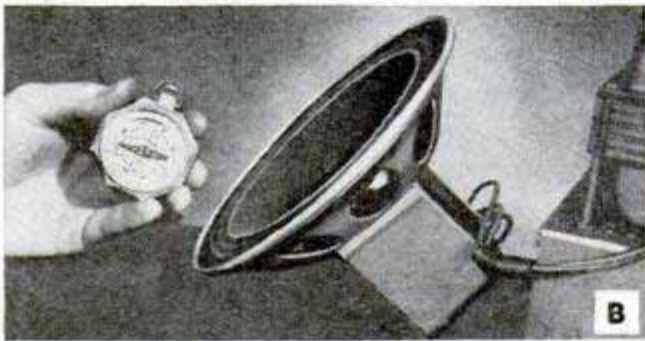

B—A compass provides a quick and accurate means for detecting an open coil in a loudspeaker. Hold the compass near the speaker, but not on it; switch your receiver on. If the speaker field coil is operating, the black end of the compass needle will be attracted and will move toward the speaker and remain in that position as long as the set is in operation

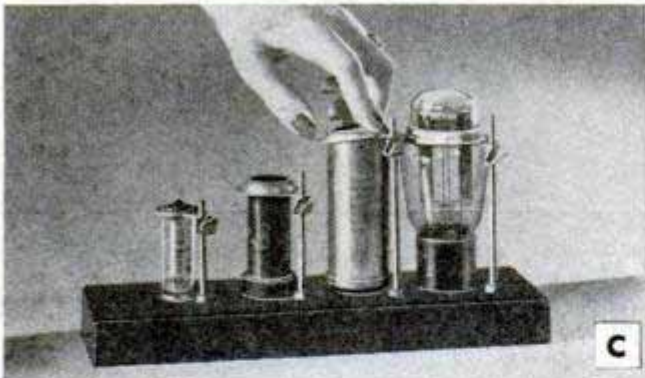

C—Plug-in parts will stay in position in portable radio and electronic equipment if they are held down with "Top Hat" retainers as shown in the photo. These adjustable retainers have a "hat" or clamp that slides down over a threaded post and locks in place on the thread. To release the clamp, a slight pressure is exerted downward on the upturned end. Where severe shocks might be encountered, as in mobile or aircraft installations, metal rings of various sizes can be employed with the retainers

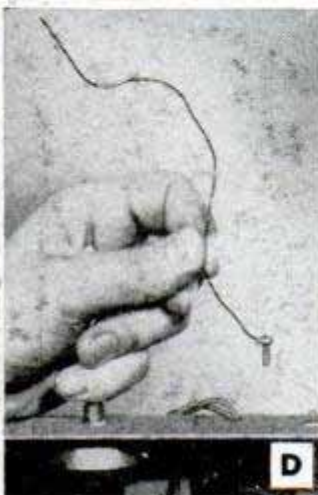

D—If you have ever tried to insert a machine screw in a chassis mounting hole in a narrow space between transformers or other components, you will welcome this idea of using a piece of soft wire which provides the necessary "third hand." When the threads start, the wire can then be pulled loose from the screw



E—The abrasive strip on match books or boxes makes a good emergency substitute for fine sanding paper to clean small contacts. Coupled contacts in the lead to a car radio were cleaned in this manner, as shown in the photo, while on an extended trip. Permanent repairs were made when emery cloth was available. Sticking vibrator contacts may also be given an emergency cleaning in the same manner

F—A discarded record holder of the type illustrated has many useful applications around the experimenter's workbench, radio shop or amateur radio "shack." It may be used as a holder for tube manuals, instruction booklets, diagrams, blueprints or maps. The amateur radio operator will also find it handy for holding mounted international prefix charts, time-conversion and postal-information charts



If it's worth enlarging



it's worth enlarging right

USE KODAK

EQUIPMENT

**KODAK
FLUROLITE ENLARGER**

Exceptionally even illumination with integrating-sphere lamphouse. Micromatic focusing and elevation simultaneous... rotary negative carrier for easy loading... light-tight cabinet for paper storage. With accessories, quickly converts to view camera for copying, cine-titling, photomicrography. \$112.50 (without lens).

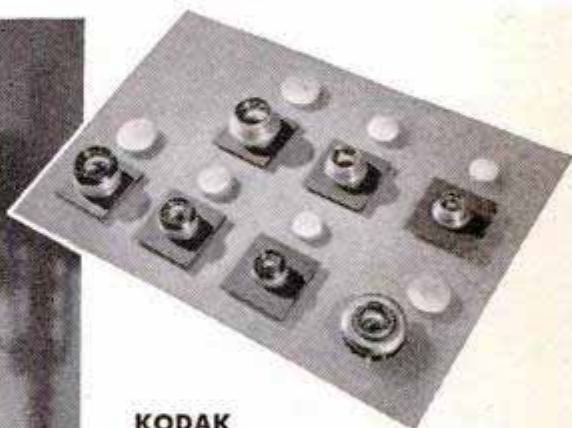
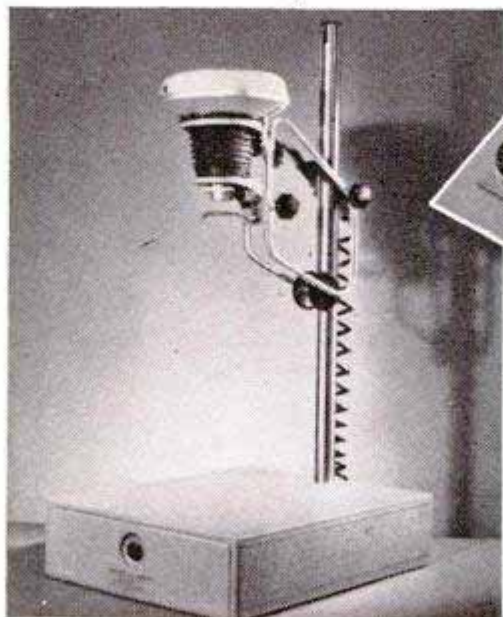

**KODAK
ENLARGING LENSES**

for the "Flurolite." All Lumenized... all designed for maximum correction at working distances required in enlarging and copying.

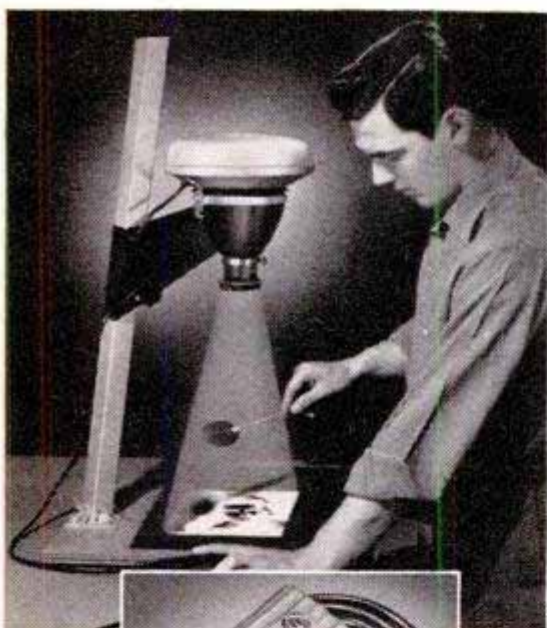

- Kodak Enlarging Ektanon Lens, 2-inch $f/4.5$, for negatives up to $1\frac{1}{8} \times 1\frac{1}{8}$ in. . . . \$22.50.
- Kodak Enlarging Ektanon Lens, 3-inch $f/4.5$, for negatives up to $2\frac{1}{4} \times 2\frac{1}{4}$ in. . . . \$25.75.
- Kodak Enlarging Ektanon Lens, 4-inch $f/4.5$, for negatives up to $2\frac{1}{4} \times 3\frac{1}{4}$ in. . . . \$32.75.
- Kodak Enlarging Ektar Lens, 2-inch $f/4.5$, for negatives up to $1\frac{1}{8} \times 1\frac{1}{8}$ in. . . . \$49.75.
- Kodak Enlarging Ektar Lens, 3-inch $f/4.5$, for negatives up to $2\frac{1}{4} \times 2\frac{1}{4}$ in. . . . \$52.50.
- Kodak Enlarging Ektar Lens, 4-inch $f/4.5$, for negatives up to $2\frac{1}{4} \times 3\frac{1}{4}$ in. . . . \$56.

KODAK HOBBYIST ENLARGER—Only \$49.50 complete with lens. "Cold" light protects negatives... smooth elevation with knob for locking enlarger head... new negative carrier simplifies loading for negative sizes through $2\frac{1}{4} \times 3\frac{1}{4}$ in.



Kodak Utility Foot-switch—Attaches to floor or vertical support. Low-intensity neon light marks location. \$10.



Kodak Electric Time Control—For use with Flurolite Enlarger. Intervals from 1 to 57 seconds. Repeat timing possible. \$13.50.



Kodak Projection Print Scale—10 sectors of varying density indicate different printing time. \$1.34.

Prices are subject to change without notice and include Federal Tax where applicable

Your Kodak dealer will be glad to show you this enlarging equipment... EASTMAN KODAK COMPANY, ROCHESTER 4, N. Y.

Kodak
TRADE-MARK

The War in the White Pines

(Continued from page 164)

Young white pines were planted on a burned-off area in 1938 by the Forest Service. Today, there are 200 healthy trees to the acre on this experimental planting. Foresters estimate these 200 acres will produce 47,000 board feet of white pine to the acre in another 60 to 80 years.

"Blister-rust-control cost on that 200 acres will be about \$1.50 per thousand board feet," Swanson explains. "That will be the total cost of control from seedlings to saw logs."

Without protection there wouldn't be any white pines at all on those 200 acres.

Protection of the young trees is but one phase of blister-rust control. The bushes also are being cleaned out of forests of older and middle-aged trees—trees that will keep the mills humming until the young stands grow up.

Blister-rust control does not attempt to protect every acre of forest land that has white pine on it. Foresters are getting to be very much like farmers; they are picking their best land for their best-paying trees. Land which produced the biggest and best trees in the past—and the most per acre—is drawing the tree-production assignment.

Foresters figure that out of the 3,600,000 acres once in white pine in the Inland Empire, around 2,600,000 acres are capable of producing trees again. Of this, around 1,000,000 acres have been spotted as the most productive in the past and therefore likely to be in the future. Nearly 2,000,000 acres have been partially cleared of the troublemaking bushes.

For the nation as a whole, 28,000,000 acres have been selected for white-pine production. Rust is now under control on about 12,000,000 acres. Initial phases have been started on another 11,000,000 acres.

Every possible type of attack is being used. Right now a new weed killer, 2,4,5,T (a close relative of the popular 2,4-D) is riding high—actually as well as figuratively. Helicopters spray it on hillside patches of bushes. Power sprayers with mile-long hoses and 300-foot laterals carry chemical control to patches that can be reached by road. An atomizer which generates a wind up to 145 miles an hour moves along logging roads. Bulldozers clean the bushes off open meadows.

But in blister-rust control, as in the Army, the foot soldier is still a mighty important fellow. In the Inland Empire forests last year, foot soldiers in blister-rust control worked out of 37 camps. Mostly

(Continued to page 240)



A "COMPLETE HOME WORKSHOP" IN ONE COMPACT UNIT!

Patent Applied For

NEW and IMPROVED **atkins** 3 in 1 JIGSAW! SANDER! FILER!

ELECTRIC MOTOR DRIVEN

ONLY \$14.95 POST PAID

Cuts 1/2" wood, 1/4" plywood, thin metal, plastic.

Complete with built-in Motor — 3 Project Patterns — 3 Blades — 2 (4" x 9") Pieces of Wood and Allen Wrench!

POWER PLUS—ABSOLUTELY SAFE—MADE OF LIGHT WEIGHT CAST ALUMINUM!

POWERFUL ELECTRIC MOTOR (do NOT confuse with ordinary, less powerful vibrator type motors.) 3000 revolutions per minute! **SAW** cuts to center of 16" circle . . . adjustable **SAW GUIDE** permits cutting ANY length material. Strokes 3000 per minute. 110 V - A.C. **TILTING** and **ROTATING TABLE TOP** (6"x8") cuts at any angle. **SANDING TABLE** tilts through 45°. **FOR FAST, EASY FILING** simply remove saw blade, chuck and saw guide . . . insert 1/4" diameter standard file.

Guaranteed 1 Year against defects in materials and workmanship

Try it FREE for Five Days—Money Back if Not Satisfied!

Wonderful PROJECT PATTERNS. It's Simple To Make Most Anything! Household Items, Toys and Many Others!



All pattern parts are actual size for finished projects. All you do is paste them down or trace them right on the wood! **FOR \$1**

GROUP 1 . . . 10 patterns for beginners
GROUP 2 . . . 10 patterns for the advanced
GROUP 3 . . . 10 patterns for the skilled

Sold in leading Department, Hardware and Hobby Stores.

If your dealer cannot supply, send coupon direct:
FREE 5 day trial... MONEY BACK if not satisfied!

atkins INDUSTRIES, inc. Dept. PM11

5823 N. Ravenswood Ave., Chicago 26, Ill.

Enclosed is \$14.95 (check or M.O. in full.) Rush, 3-in-1 Jig Saw POST PAID.

Enclosed is \$2.00 part payment. I will pay postman balance plus postage on C.O.D. delivery.

Enclosed is \$.....(check or M.O. in full.)

Rush Group No. Project Patterns at \$1.00 each POST PAID.

Name.....

Address.....Zone.....

City.....State.....

Exide has EVERYTHING

- A new high in **STARTING POWER**
- **LONGER LIFE** than ever before
- **MORE BATTERY FOR YOUR MONEY**

The new Exide Battery is the result of development by the largest research-engineering staff in the battery industry plus 62 years of battery making experience. And, in addition to more battery for your money, Exide has everything in service, too. Exide dealers know batteries. Their stocks are factory-fresh. Their scientific equipment takes all guess-work out of testing and servicing. *Depend on the Exide dealer for good products, good service.*



"Exide" Reg. Trade-mark U. S. Pat. Off.

THE ELECTRIC STORAGE BATTERY CO., Philadelphia 32

Exide Batteries of Canada, Limited, Toronto

WHEN IT'S AN **Exide** YOU START

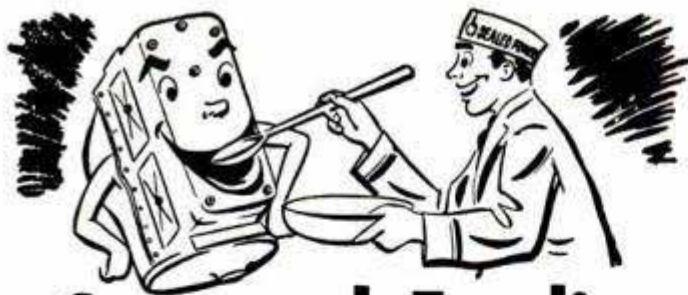

Care and Feeding of Engines

BY S. P. CORP

WHY CYLINDER WALLS WEAR

Cylinder walls wear faster at the top than they do at the bottom. Why? There are three good horse-sense reasons: Number One: Pistons move faster at the top of the stroke than they do at the bottom. That has been proved by checking piston speed through-out the stroke.

Number Two: There is more heat at the top of the cylinder, and less oil.

Number Three: If the air cleaner for the carburetor is not working efficiently, dust comes in with the fuel mixture. That dust naturally hits the top of the bore first, and helps grind away the metal. It always happens.

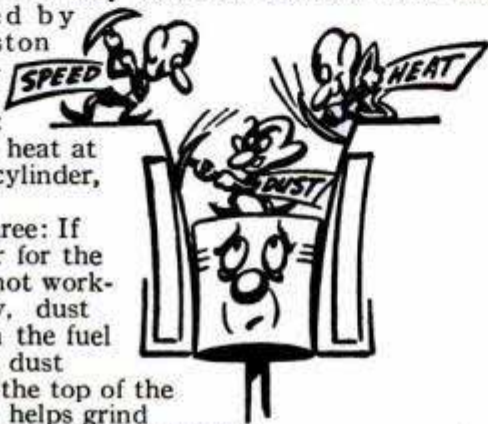

CHANGE OIL OFTEN

Back in the days when compression ratios were low, speeds were slow, and temperatures were less than now, lubrication was the one big job of motor oil.

In today's high speed, high-compression, high temperature motors, the oil must do FIVE jobs and do them well:

- (1) Reduce friction.
- (2) Cool.
- (3) Seal.
- (4) Penetrate.
- (5) Cleanse.

No motor oil can do all these jobs well, and keep on doing them indefinitely. The only safe way is to change oil often—every 1000 or 1500 miles!

WATCH THOSE RINGS

You can see rings in the bathtub. You can hear rings on the telephone. But the only way you can watch piston rings is to watch for the effects of wear—blue smoke at the exhaust, loss of power, excessive oil consumption. When those signs appear, re-ring with the best piston rings you can buy—Sealed Power Piston Rings. There is a Sealed Power Ring Set specifically engineered to do the best possible job in your engine, whatever the make, model, or wear condition. For oil control, the Sealed Power MD-50 Steel Oil Ring is the best ever built. It is the only ring with the Full-Flow Spring. It works even in badly tapered and out-of-round bores. Write a card to Sealed Power, Dept. G-11, Muskegon, Mich., and ask for free booklet, "7 Ways to Save Oil."



Clinic



for Homemakers

As a service to our readers in solving the hundreds of problems pertaining to a home—inside or out—the editors of *Popular Mechanics* invite you to present your problems to The Clinic Editor for help and advice. Address your questions to The Clinic Editor, *Popular Mechanics Magazine*, 200 East Ontario Street, Chicago 11, Ill.

Peeling Paint

Q—I painted my frame house last year for the second time in three years. Now the paint is peeling from the siding all around, although it seems to be worse on the north side of the house. It peeled in much the same way after I painted the first time. What causes this?

F. M., Danville, Ill.



A—Moisture condensation in the walls is a common cause of this trouble. Lowering the moisture content of the air in the building will help to cure the cause of the trouble. Of course, the installation of a vapor seal on the inner walls between the plaster and studding usually effects a permanent cure. This is expensive in homes already built. Another temporary measure is the application of two coats of oil-base paint to the interior walls and ceilings. This will result in a fairly reliable seal, but cannot be considered a permanent remedy. Recently a means of venting walls has been made available. This consists of a small, screened sleeve which is inserted in a hole drilled through the siding and sheathing between the studs. It is said to be quite effective when installed according to the manufacturer's instructions.

Stainless Chimney Liner

Q—I'm having a forced-air heating system installed to burn natural gas. My chimney is brick, lined with tile and is in good condition. However, my contractor insists that a stainless-steel liner will be required to prevent rapid deterioration of the chimney. The liner is quite expensive and I do not see the necessity for it because the chimney is already lined. Is the contractor right?

W. C., St. Louis, Mo.

A—Your contractor is right. In some cases, where round glazed tile have been used as a chimney lining, gas-fired installations have been permitted without a stainless-steel or monel-metal liner. However, to avoid trouble later, it's now a general practice to line chimneys of older brick construction when installing gas-heating equipment. When making gas-heating installations in new homes, special insulated chimneys, or vents, often are used. Probably it would be a good idea to check with your contractor to make sure that the unit is installed in accordance with recommendations

(Continued to page 238)

Midget Lawn Co. - 8 Vall St., Norwalk, Conn.

Wardlow + Jordan
723 Union Arcade

Mall

POWER TOOLS

The right "foundation" on which to build YOUR workshop!

★ A complete line of "matched" tools, attachments and accessories, engineered to work together.

★ World-wide service, 33 Factory Branches, 100% interchangeable parts.

★ Thirty years experience in building Power Tools for American Industry, Railroads and Contractors.

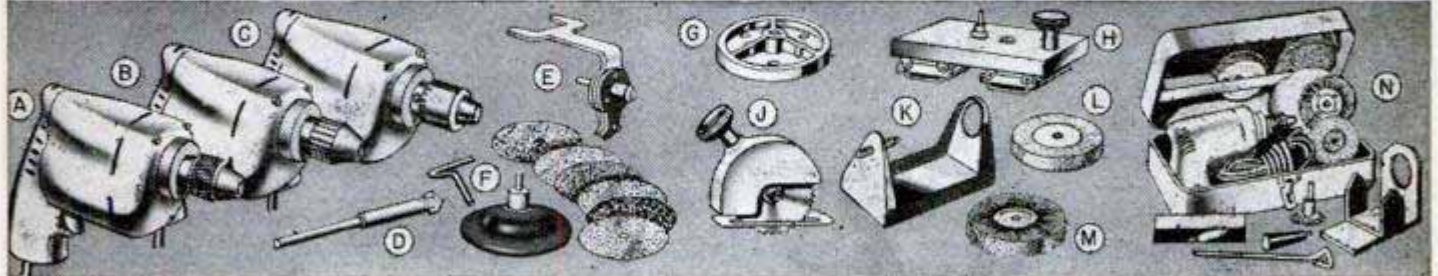

(A) Mall Drill Model 149, perfect for home or workshop use, has the speed and power to drill any material. Capacity $\frac{3}{4}$ " in metal to $\frac{1}{2}$ " in wood. Sintered bronze bearings, aluminum alloy housing, powerful universal type motor gives spindle speed of 2000 rpm. Weight only 3½ lbs. Genuine Mall dependability at extremely low price. Complete with hand-tight chuck, \$16.50 (B) Complete with hex key chuck, \$17.50 (C) Complete with Jacobs' geared chuck, \$19.50.

PARTIAL LIST OF ATTACHMENTS

(D) $\frac{1}{4}$ " Masonry Drill Bit (other sizes available). For fast drilling in brick, concrete, stone, etc. No. 32803, \$1.80.

(E) Metal Shear Attachment cuts sheet metal up to 18 gage, leaves smooth clean edges. No. 20980, \$7.20.

(F) Sanding Pad Kit includes 4" pad, 6 abrasive discs and assembling wrench. For fast, all-purpose sanding. No. 35555, \$4.20.

(G) Face Plate for wood turning. No. 31858, Price \$1.00.

(H) Reciprocating Sander, for fine sanding on any type of material. Many interchangeable types of abrasive bands available. No. 21000, Price \$14.50.

(J) Slitting Saw, cuts wood, plywood, masonite, plaster board, non-ferrous metals. Capacity 0 to $\frac{3}{4}$ ". Adjustable for depth of cut. Recommended for 800 to 2500 rpm. No. 32940, Price \$7.50.

(K) Horizontal Pedestal converts hand drill for use as bench grinder, buffer, tool sharpener, etc. No. 35890, Price \$2.00.

(L) Grinding Wheel 4" dia. Sharpens knives, chisels, bits, etc., grinds metal parts. No. 32099, Price \$1.00.

(M) Wire Wheel 4" dia. Made of the finest quality wire for long wear on tough jobs. Removes rust, paint, etc. No. 31263, Price \$1.25.

(N) Mall Electric Drill Kit. For all-around home and shop use, complete with Model 149 drill with hand-tight chuck, 4" grinding wheel, 4" wire wheel, paint stirrer, 2 abrasive Discs, rouge stick, 3 carbon steel drills $\frac{1}{4}$ ", $\frac{3}{8}$ ", $\frac{1}{2}$ " auxiliary handle, polished pad assembly, sheepwool bonnet, horizontal pedestal and carrying case. No. 38180, Complete, Price \$23.45.

(P) Mall Polisher-Sander, a light weight, portable unit that will do all kinds of polishing, buffing and sanding around the house and can also be converted into a powerful $\frac{3}{8}$ " or $\frac{1}{2}$ " drill for workshop and repair jobs. Oil impregnated bronze bearings, die-cast aluminum alloy housing, heavy duty switch with built-in trigger lock. Universal electric motor operates on 110-120 volt, 25 to 60 cycle, AC, or DC, current with attachment speed of 2000 rpm. Large 7" backing pad gives extra large surface coverage. A handtool as well as for waxing and polishing wood floors, linoleum, etc. Mall quality throughout. Model 387, Complete with 4" Handle, Price \$30.50.

SHOWN BELOW ARE ONLY A FEW OF THE MANY ATTACHMENTS AVAILABLE

(Q) Knife Sharpener, gives perfect cutting edges in seconds! A time saver for both kitchen and workshop. No. 30374, Price \$1.00.

(R) Hedge Trimmer, makes a tough job both quick and easy. No. 35370, Price \$14.95.

(S) Belt Sander, fast sanding for floors, etc. No. 38170, Price \$14.95.

(T) Buffing Wheel, for silverware and all types of polishing. No. 31265, Price \$6.00.

(U) Mall Electric Saw, has plenty of capacity to frame with 2" material. Sleeve and ball bearings, 7" dia. saw which will cut from 2½" to 1½" deep at 90°; to 1½" at 45°. Sturdy, powerful. Universal Motor, 110-120 volt, 25 to 60 cycle, AC, or DC, speed 5000 rpm., 9 types of blades available. Mall dependability throughout. Model 71 Saw with Combination 7" Blade, Price \$49.50.

(V) Mall Electric Hand Chain Saw is ten times faster than hand sawing. Power to outlast 10 men cutting timber to 12" dia. with one cut; 24" dia. with two cuts. Light weight, but sturdy (only 11 lbs.) In a tree or on a scaffold or ladder it can be operated with one hand. Universal electric Motor, 110-120 volt AC, or DC, current. Heavy duty Mall construction. Model 1E12, Complete, Price \$95.00.

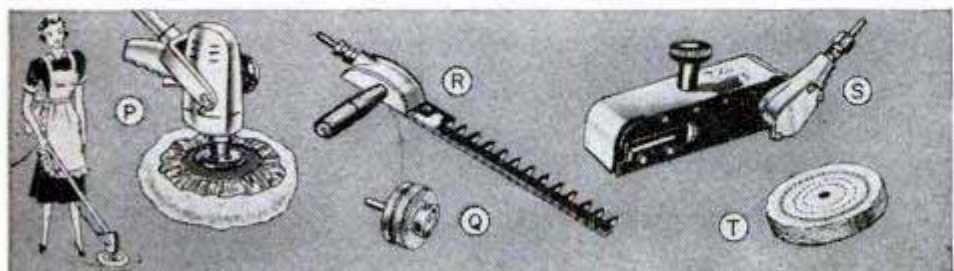

Get MALL TOOLS from your Dealer or send cash, money order or check direct to us. (Illinois residents add 2% for sales tax).

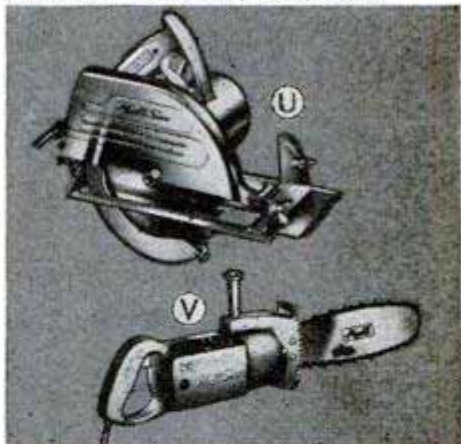

MALL TOOL COMPANY
7805 S. Chicago Ave.
Chicago 19, Illinois

Please send me item(s) checked post paid. I am enclosing money order (check) herewith.
 Please send me complete literature on items checked.

NAME.....
ADDRESS.....
CITY.....ZONE.....STATE.....

MALL TOOL COMPANY 7805 SOUTH CHICAGO AVE. • CHICAGO 19, ILL.

THE SAME NAME...

Starrett

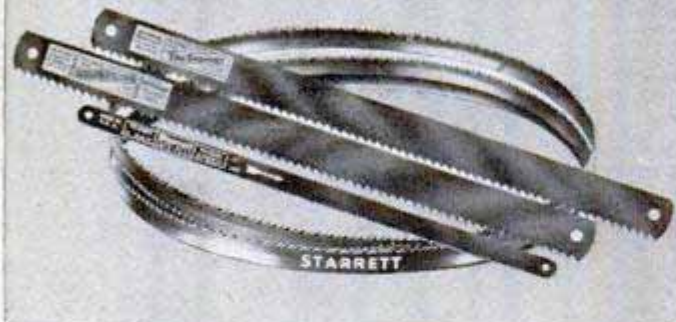

Your Guide To Greater Value In

HACKSAWS

AND

BAND SAWS

Hacksaws and band saws bearing the name "Starrett" must uphold the Starrett reputation for reliability. To insure top performance with easy cutting and maximum economy, insist on blades and bands precision made by the "World's Greatest Tool-makers."

HACKSAWS For Hand or Power Cutting

All types, all sizes, for hand frames and hacksaw machines. Every blade milled, heat treated, tested and inspected to meet Starrett standards of quality.

BAND SAWS For Metal, Wood, Plastics

Hard-edge flexible-back, spring temper and "Skip-Tooth" types for all precision cutting. Cut to length and welded, or as coil stock in handy reel dispenser.

Get This MECHANIC'S HAT — Only 15¢

Wear an official Starrett hat — the badge of a precision craftsman — on the job, in your home shop, working around the car, etc. Send 15¢ in coin to cover handling and mailing. Please specify head size. Address Dept. AP



THE L. S. STARRETT CO. • ATHOL, MASS., U. S. A.

Starrett

TRADE MARK
REG. U. S. PAT. OFF.

Since 1880... Standard of Precision

MECHANICS' HAND MEASURING TOOLS AND PRECISION
INSTRUMENTS • DIAL INDICATORS • STEEL TAPES • HACKSAWS
BAND SAWS AND BAND KNIVES • PRECISION GROUND FLAT STOCK

Buy Through Your Distributor

(Continued from page 236)

of the manufacturer and also any local regulations governing this particular type of installation. In some cases these recommendations specify the size of the liner, the length of the horizontal run of the vent pipe from the furnace to the chimney and also the size of the gas line from the meter to the burner.

Noisy Water Heater

Q—Lately my gas water heater has become noisy. The sounds are sharp, metallic clicks and at times a hammering noise. This noise is not very loud, but is annoying. The heater has been installed about eight years and is of a reliable make. What could cause the noise?

T. F., Sturgis, Mich.



A—There are several possible causes, some quite common, others comparatively rare. For example, if the water temperature is too high the symptoms you describe may develop. Contraction of the hot baffle in the vent may be the cause of the metallic click. There also is the possibility that pipes of a smaller diameter than recommended have been installed. Too many elbows in the water lines may in time collect lime and sediment which restrict the flow of water. A horizontal hot-water line that inclines slightly may collect sediment and permit a pocket of steam to form. We think that as a first step in checking to locate the cause of the trouble, it would be a good idea to test the relief valve to see that it is working properly. Some relief valves have a manually operated tripping mechanism. Other types of valves have pressure elements, or units, that can be adjusted to open at pressures ranging up to about 125 lbs. per sq. in. Some are fitted with a fusible plug which melts at a predetermined temperature. Examine the hot-water lines for any of the installation faults listed.

House Framing

Q—I'm planning to build my own home of frame construction but I'm puzzled by certain terms used to describe types of framing. For example, what is meant by "balloon" framing, "platform" framing and "balanced" shrinkage as applied to house framing. Also what is "fire stopping"?

R. T., Goshen, Ind.



A—In balloon framing of the exterior walls of a two-story structure, one-piece studs extend from boxed sills to the top plate and the ends of the second-floor joists are supported on a ribband, or ribbon, usually a 1 x 4 or 1 x 6-in. strip fitted flush in notches cut in the studs. In platform framing of two-story structures, a boxed-sill construction is built in at each floor line. The top ends of first-floor studs are capped with a false plate, or girt, and the ends of the second-floor joists butt against a header which rests edgewise on the girt. Shrinkage is equalized on each floor by using a similar construction on the bearing partitions. The simplest description of balanced shrinkage is that the total thickness of all horizontal members of the framing is equalized as nearly as possible to give a uniform shrinkage of the lumber in the building. This would include boxed sills, top and partition plates and also girders. Fire stopping, or stops, refers generally to headers placed between joists at the sills and second floor and also between the attic joists over partitions. In some cases incombustible mineral fills are poured in behind the headers. The purpose of fire stopping is to prevent circulation of air in the walls which in turn tends to prevent the rapid spread of flames in case of fire.



from cups to *Coralox*

Blin, the great French ceramist, made the first spark plug insulators at Limoges, about the time of the American Civil War. He called them "porcelains," because they were of the clay used for artists' paint cups.

Porcelain had many weaknesses.

New ceramic materials were developed to meet increasingly difficult operating conditions—but all contained clay, which severely limited reliable performance.

AC's new patented *CORALOX* Insulator is free of these restrictions. It has the following amazing characteristics:

Basic in chemical composition—resists oxide fouling • 4 times greater heat conductivity
 • 3 times the mechanical strength against fracture • Complete resistance to heat shock

• 10 times greater electrical resistance at high temperatures.

What do these qualities mean to you, the car owner? Easier starting—smoother idling—better performance—longer spark plug life.



PATENTED

CORALOX

INSULATOR

AC SPARK PLUG DIVISION • GENERAL MOTORS CORPORATION

Only ATKINS makes "Silver Steel" saws



Of all fine saws —
the finest are
"Silver Steel"
saws

PEDIGREED!

America's finest saw—the champion of champions —Atkins No. 65—is the proud sire of a pedigreed son—Atkins Jr. -65.

Atkins Jr. -65 has a genuine "Silver Steel" blade only 16 inches long. It has the same type Perfection Handle, the same taper grinding, the same high polish, the same precision balance that have made Atkins No. 65 the prime favorite with careful craftsmen everywhere!

Not only students and women with small hands, but men as well, will welcome Atkins Jr. -65 as a light-weight, easily-handled, accuracy-plus instrument for fast-cutting, no-fatigue workmanship.



E. C. ATKINS AND COMPANY
402 South Illinois Street
Indianapolis 9, Indiana

ATKINS

college boys, they dug up berry bushes in areas that could not be reached by faster and cheaper equipment. First camps usually open in May. The last close in September. Camps range from a dozen to nearly a hundred men. These are the men who leave the fantastic miles of string. It is their way of showing what ground they have covered and to assure complete coverage of a particular area.

Competition is keen among college boys, particularly forestry students, for summer jobs swinging a claw-hammer mattock grubbing out the bushes. Pay is good. So are the meals, which rival the grub of a logging camp. There's plenty of fun—camps have their own boxing, baseball and basketball leagues.

These boys are too busy having a good time during the summer to realize how much good they are doing for the nation's forests, but the men in charge of blister-rust control know the value of their work. Many a summer evening in 1929, Frank Walters spent the twilight hours on the hotel porch at Clarkia, the Idaho logging town once hemmed in by the mighty white pine. Across the valley the scene was one of complete desolation. Early loggers were not the least concerned about tomorrow's saw logs. Loggers today are different. Then came fire.

"It just didn't seem possible there ever would be another tree on those hills," Walters recalls.

Look at those same hills today and the picture is one of hope. Covering them is a solid blanket of green—white pines 15 to 25 years old.

"These trees have come from natural seeding," Walters explains. "There were a few mature trees on the ridges that escaped fire. The land was good and was meant for trees. They were protected for a few years from fire and blister rust and a new forest resulted."

Just goes to show what Nature can do when given a little help.

CHAMPION V-GLOW PLUGS

for model engines only

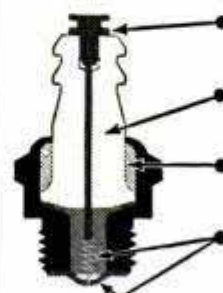

CHAMPION TERMINAL—assures better center electrode seal and provides sturdier electrical connection.

CHAMPION - CERAMIC INSULATORS—proved dependable in millions of Champion Spark Plugs.

CHAMPION SILLMENT SEAL—prevents excessive compression leakage between insulator and shell.

CHAMPION "THERM-O-FLEX" CONSTRUCTION—longer element life, more dependable performance.

Follow recommendations of plug types and fuels approved by engine manufacturer.

CHAMPION SPARK PLUG COMPANY, TOLEDO 1, O.

They're a Million Miles Ahead of Everything!



THE SENSATIONAL NEW
LIONEL TRAINS
 with **MAGNE-TRACTION**



MORE SPEED!

MORE PULL!

MORE CLIMB!

MORE CONTROL!

ONLY LIONEL HAS ALL THESE FEATURES PLUS **MAGNE-TRACTION!**

- Built-in, two-tone, remote-control whistle.
- Real smoke, puffing like a mainliner (clean, odorless, harmless)!
- Real R.R. remote-control knuckle couplers!
- Steel wheels, die-cast trucks

There's nothing like Magne-Traction...and only Lionel has it. With this permanent, motor-shielded magnetic force, wheels grip track so trains climb steep grades, take tight curves at top speed, pull twice as many cars twice as fast. Instant control, too...more thrills...more scope to track layout. *And prices are lower this year than in many years past!* Free catalog at your dealer's, or send coupon for special offer.

OPERATING COAL RAMP AND HOPPER CAR
 Remote control opens hopper bottom



OIL DERRICK & PUMP
 Motor-operated beam; illuminated oil column.



Look at the **JOE DIMAGGIO LIONEL CLUB HOUSE TELEVISION SHOW**

Every Saturday on NBC Network
 See local newspapers for time and station



- LIONEL TRAINS, Post Office Box 466
 Madison Square Station, N. Y. 10, N. Y.
 I enclose 25c. Please send me special Lionel Train Catalog offer postage prepaid.
1. The Big New Lionel 44-page full-color catalog.
 2. The "Magic of Magne-Traction Book" with new track layouts, scenic effects, landscaping, etc.
 3. The Lionel "Portfolio of 19th Century Locomotive Art Prints" —in color—suitable for framing.

SPECIAL COUPON OFFER

Name _____
 Address _____
 City _____ Zone _____ State _____

Rockets on a Timetable

(Continued from page 103)

Cut-Off is a fantastic safety system which consists of a detector circuit built into the radar scopes. If the radar loses contact with the rocket in flight, this system automatically detonates a TNT charge in the rocket, destroying it. A lost rocket may never be picked up again. In the early days, one V-2 from White Sands made an unscheduled stop in Juarez and the boys still hear about it. Though they carry no charge, big rockets falling from 100 miles up can blast a 50-foot crater 20 feet deep in the ground.

To double check against a rocket getting away, there's also a "continuous pressure button," which is held down under the safety engineer's thumb throughout the flight. If the rocket veers off its prescribed course, that button can be released and instantly the rocket explodes, no matter where it is.

By "X minus 30 minutes," all the hundreds of intricate operations involved in the launching project are ready. Everyone is standing by. Months of preparation border on climax. Faces of the men at the blockhouse control panel are grim. A dozen things still can go wrong. "Every rocket is different," explains Doctor Newell. We're still experimenting with new systems and firing techniques at every launching. Hence, there's always cause for new worries and tension—like the time we rigged a circle of jato units around the base of a big rocket. They were to fire on take-off and set the rocket spinning as it went up. Suppose they didn't fire simultaneously and the rocket went wild? Suppose they didn't fire at all? Actually, it worked perfectly, and the rocket bored its way skyward as planned—but the tension was rugged."

If anything goes wrong with any of the hundreds of circuits necessary to a perfect take-off, the firing button won't set off the rocket. Furthermore, there are fast-moving routines followed in such emergencies. They came in handy on one Aerobee at White Sands, Doctor Newell remembers. With only one minute to go, a diaphragm ruptured and hissing acid burst through it, poured to the pad and started a fire at the base of the rocket. Instantly the "fire" button was pushed—to get the rocket out of the way. But automatic controls already had cut the circuit. The button wouldn't work. Men raced around the blockhouse. Pressure was "dumped" from the rocket by remote control; within seconds water jets poured a Niagara over the missile; firemen standing by moved in with foam and high-pressure hose and added to the drenching;

(Continued to page 246)



AMAZING...worn Connecting Rod Bearings Killed this Plug!

Yes, amazing—but true—badly worn engine bearings affect other engine parts. With their increased clearance, worn bearings let excess oil reach combustion chambers, where it burns to performance-stealing carbon on spark plugs, valves, pistons and rings. *Performance goes up in smoke!* When you have sluggish engine performance, smoky exhaust or high oil consumption—check for worn engine bearings . . . replace in sets with Genuine Federal-Mogul Oil-Control Bearings for renewed power, pep and economy!

FEDERAL-MOGUL SERVICE

(Division of Federal-Mogul Corporation)

DETROIT 13, MICHIGAN

Control Oil Pumping
where it starts...replace with

FEDERAL-MOGUL
OIL CONTROL BEARINGS



What a Honey!



THE NEW 1951 HARLEY-DAVIDSON *HYDRA-GLIDE*®

SLEEK, smooth and beautiful. And what a performer. Takes off like a scared rabbit. Snuggles to the road like a clinging vine. Breezes over hills like a bird. Whisks you over rough spots with cloud-like ease ... brings you thrill after thrill as you take in exciting race meets, hillclimbs, gypsy

tours, sightseeing runs and other exclusive motorcycling fun events. You've never really been places and seen things until you've ridden *this* dazzler! Every moment in the saddle is fascinating. Every trip brings new adventures and new companionships. See your dealer today. Mail the coupon now.



Send free copy of ENTHUSIAST Magazine filled with motorcycle action pictures and stories; also literature on new models.

HARLEY-DAVIDSON MOTOR CO., Dept. P, Milwaukee 1, Wis.

Name.....

Address.....

City..... State.....

OPPORTUNITY: Valuable franchises available for full line of Big Twins and 125 Model. Write Today.

Sears Famous Power Tools . .



CRAFTSMAN Rotary Electric Tool Outfit

Unequaled for its type . . . at ANY price!

GRINDS	CUTS	ROUTS	BRUSHES
SHARPENS	CARVES	SANDS	CLEANS
DRILLS	ENGRAVES	POLISHES	Has many
SAWS	ETCHES	BUFFS	other uses!

A wonderful tool for hobbies, etc. A perfect Christmas gift! Look at these features! 50% more power than any other rotary tool of its type we know of! Cool-running, even after hours of use! New tapered design, strong metal housing—not plastic! New precision 3-jaw chuck adjusts 1/64 to 1/8-in.; takes 3/32 and 1/8-in. shank tools AND wire gauge drills. Large bronze bearings and ball thrust bearing. On-off switch. Condenser (cuts radio interference). Powerful 15,000 R.P.M., 110-120-volt, 25-60 cycle AC-DC motor; 6-ft. cord; plug. Underwriters' Labs. approved! 7 1/2-in. long. Complete 54-piece set with cutters, drills, bench stand, etc., in handsome, convenient 11x8 3/4x3 1/2-in. workshop case.

54-piece Set Complete

\$28⁹⁵*

Cash

\$3 Down



1/64 to 1/8-in. chuck capacity



120° rotating bench stand



Cool running; easy to handle

Use it on
WOOD
METALS
PLASTICS
GLASS
LEATHER
and other materials

Here's a Real Bargain!

SAVE \$2!
Was \$14.95*

NOW ONLY
\$12⁹⁵*

DUNLAP 4-inch Utility Grinder

It
buffs
grinds
cleans
polishes
sharpens!



Invaluable for light work! *UL approved!* Guaranteed 1 year! 4x1 1/2-in. grinding wheels; coarse, fine; 6 3/4 in. apart; Adjustable tool rests. Powerful 110-120-volt, 60-cycle AC motor; 3500 no-load RPM; 2 fans. Bronze bearings; on-off switch. With 6-ft. cord and plug. 6 1/4 in. high.

CRAFTSMAN Electric Magnetic Jig Saw

ONLY
\$12⁹⁵*
With 6 blades



No motor or belt needed!
Sturdy . . .
NOT a toy!

It's easy, inexpensive . . . to make hundreds of articles in wood, plastic or metal!

Look at its capacity!

Cuts to center of 22-in. circle
In wood up to 1-inch thick;
Plastics up to 3/8-inch thick;
Aluminum up to 3/32-in. thick;
Brass up to 1/16-inch thick;
Zinc up to 1/16-inch thick.

A perfect hobby gift for young or old! Use anywhere; just plug it in! *UL approved!* Magnetic unit gives 7200 SAFE, short cutting strokes per min. (TWICE former power)! Smooth edges need no sanding. 8 1/2x8-in. table; rubber feet. All-metal; well-made. For 110-120 volt, 60-cycle AC use only. With six 5-in. pin-end blades, 5 1/2-ft. cord and plug, and instructions.



ONLY
\$10⁹⁵*

Complete with 10 sanding sheets and polishing pads

CRAFTSMAN Electric Sander-Polisher

Hundreds of uses! No tiresome rubbing or pressing!



Polish cars easily



No pressing needed!



Adjustable stroke!

Handy! Easy to use! Weight of tool does work. A finishing sander only, for polishing cars, furniture, woodwork, silverware, even shoes! Sands furniture, walls, woodwork, shop projects super-smooth! Wonderful for body massage, too! *UL approved!* Heavy-duty magnetic power unit; 14-400 strokes per minute. Die-cast housing; bakelite handle. Size, 5 1/2x4 1/2x2 3/4 in. For 110-120-volt, 60-cycle AC only. Complete with 8-ft. cord and plug; 10 sanding sheets; and one lambswool and one velour polishing pad.

*Prices slightly higher south of the Ohio and west of the Mississippi rivers.

CRAFTSMAN Tools by **SEARS, ROEBUCK and CO.**

Sturdy! Accurate! Low Priced!

CRAFTSMAN 8-inch Tilting-Arbor Bench Saw



Saw Only

\$54.50*
Cash

Complete with blade, guard, splitter, miter-gauge, nonkickback pawls, rip fence, two pulleys and V-belt. \$5.50 Down, \$5 Monthly

Complete Outfit as shown

\$109.50*
Cash

With motor, front and side extensions, and bench \$11 Down



Sears Bench Saws are completely equipped; NOT stripped models, as are some saws on the market!

Sears Easy Terms make it easy to own the tools you need NOW... pay as you use them!

Look at these superior features!



Work stays level! Blade and guard (not table and work) tilt any angle up to 45°, for faster, easier and more accurate operation!



Exclusive! Tilting, raising and lowering blade are all controlled by a single hand wheel at front of saw!



Floating motor mount fastens to bench for easier tilting. Controls belt tension; reduces vibration; lessens strain on frame!

We know of NO finer, more complete Saw at anywhere NEAR this low price!

This superb, heavy duty CRAFTSMAN tilting-arbor saw meets the most rigid demands of professional craftsmen! Large, smooth-ground, cast semi-steel table, 20x17 in. (34x20 in. with side extensions), has insert removable for dadoing, 2½-in. depth of cut. Saw has automatic leveling guard, non-kickback pawls, splitter, miter gauge and rip fence, 2-in. machine and 2½-in. motor pulleys, ½x40-in. V-belt, motor mount, and 8-in. combination blade (½-in. bore). Complete outfit includes CRAFTSMAN ½-H.P. 3450 RPM ball bearing capacitor motor (110-120-volt, 60-cycle AC.; 2 side table extensions; front roller extension; and steel power tool-bench (height adjustable 22 to 32 in.). See it at your nearest Sears Retail Store TODAY!

Free!

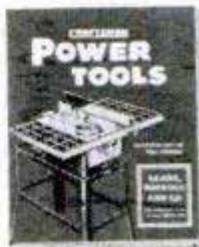

Sears new 60-page, 1951 Power Tool Catalog... FREE! Get yours NOW... at the Hardware Dept. of your nearest Sears Retail Store!

These handy accessories make your bench saw much more useful!

8-in. Cut-off Wheel. Cuts tile, concrete, stone, metals, ½, ⅝ or ¾-in. arbors.

\$1.39*



8-in. Nail-Cutting Saw. For rough work (rips; cross-cuts). ½, ⅝-in. arbors.

\$4.50

Molding Cutter Head and Cutter Bits. New! Make your own moldings. Dozens of uses! 3-in. diam. head fits most bench saws with ½ or ⅝-in. arbors. 1-in. wide bits cut styles as shown.

Cutter Head \$4.50 With Allen wrench

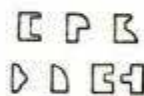

Cutter Bit styles \$2.95 per set, up.

Famous for fine quality... precision performance... low price!



MOLLY

SCREW ANCHORS



**IT'S EASY TO INSTALL MOLLY
NO SPECIAL TOOLS NEEDED**



**WHERE SCREWS
WON'T HOLD
USE MOLLYS**

MOLLY FASTENS SECURELY

- Sinks • Soap Dishes • Fuse Boxes • Wall Clocks • Mirrors
- Stair Hand Rails • Drapery Fixtures • Electric Fan Brackets
- Bathroom Cabinets • Tool Racks • Venetian Blind Fixtures
- Kitchen Cabinets • Awnings • Towel Racks • Wall Brackets
- Shelving • Heavy Pictures • Door Chimes • Curtain Fixtures

MOLLYS are inexpensive, easy to install in walls, floors, or ceilings and assure a safe, secure mounting that will never become loose. **ASK YOUR HARDWARE DEALER.**

MAIL THIS COUPON FOR **FREE** DESCRIPTIVE FOLDER

Name _____

Address _____

City _____ State _____

My hardware dealer is: _____

Address _____

MOLLY CORP., DEPT. 1157, READING, PA.

a switch in the blockhouse was thrown, sealing off the booster rocket so it wouldn't go off separately.

Usually, by the time the loudspeaker intones "X minus 20 minutes," everything rests on the success or failure of electronic and mechanical equipment. A purplish red smoke grenade goes off, warning all personnel that everything is set.

At X minus 2 minutes, a red Very flare streaks to the sky. There isn't much anyone can do now. "It is X minus one minute," drones the speaker, and you can hear a pin drop in the blockhouse. "The next count you hear will be minus 20 seconds. Stand by." If it's White Sands or Halloman, men at some 30 stations uprange will be fingering their instruments nervously. If it's Cocoa, observers way out on the Bahama Islands will be alert for the white vapor streak across the sky that tells them another long-range rocket is streaking horizontally for a new distance record.

"Eight . . . seven . . . six . . . five—down goes the button—four . . . three . . . two . . . one . . . zero."

ROCKET AWAY!

Tailor-Made for Bull's-Eyes

(Continued from page 156)

Also being built at the present time by the Pfeifer Rifle Company is a monster rifle that will weigh 70 pounds and will use .50-caliber machine-gun ammunition. This "Paul Bunyan" weapon will be used to test the accuracy characteristics of ammunition. The price will run around \$650.

In addition to making barrels and building custom rifles, Pfeifer does a considerable business in repairs and alterations. He rebarrels actions, supplies "velvet blue" metal finishing, installs sights, fits new stocks to weapons previously in use. If safety appears doubtful, however, the work is rejected—even though the customer assumes full responsibility for it.

All shooters know that some ugly rifles may show fair accuracy, while many beautiful showpiece weapons can be highly inaccurate. Joe Pfeifer sees to it that neither kind comes from his shop. Ugly rifles are poor publicity and beautiful "lemons" are worse. The gunsmithing business depends to a large extent on repeat orders and keeping the cost of high-grade craftsmanship within the reach of the majority of sportsmen and target shooters.

Not long ago Joe Pfeifer got to thinking about the average "gun bug" who can't pay a fancy price for a rifle—yet wants to own a weapon that will be highly accurate and

(Continued to page 250)

IF THE PIPES ACT LIKE THIS...IT'S TIME TO GET BUSY.

and

IF YOUR CAR FEELS LIKE THIS ...IT'S TIME FOR MARFAK CHASSIS LUBRICATION



THAT CUSHIONY FEELING LASTS LONGER WITH MARFAK!

Want "cushiony" driving ease that's feather-bed soft? Get longer-lasting *Marfak* lubrication. *Marfak* fights wear and friction for 1,000 miles and more! It's specially compounded to stand up to rough "road work," and resists wash-out and squeeze-out. As a result, *you* get "cushiony" driving right from one lubrication job to the next! Today, ask for *Marfak* lubrication from your Texaco Dealer, *the best friend your car ever had.*



THE TEXAS COMPANY

TEXACO DEALERS IN ALL 48 STATES

Texaco Products are also distributed in Canada and in Latin America



TUNE IN . . . TEXACO STAR THEATER starring MILTON BERLE on television every Tuesday night. See newspaper for time and station.

YOU GET A COMPLETE POWER WORKSHOP PLUS EXCLUSIVE BONUS FEATURES WITH SHOPSMITH

It's *more* than five rugged power tools in one compact unit. SHOPSMITH is a complete power workshop; saw, disc sander, horizontal and vertical drill press, lathe—each with *exclusive bonus features* that make SHOPSMITH far and away your best power tool buy!

Imagine a saw that locks in a vertical position for cutting extra-large panels, for trimming doors, screens, storm sash! A disc sander that *feeds into* the work. A drill press that does a perfect doweling job *without jigs*. A lathe that lets you *face the work* while faceplate turning.

Imagine a sturdy, guaranteed-for-one-year, precision-built unit so ingeniously engineered that you can convert it from tool to tool *in less than 60 seconds*. So compact it fits any 2 x 5 foot space. So completely flexible you can do 116 wood, plastic and metal-working operations. So unlimited in capacity you can build a house with it.

But why *imagine*? See SHOPSMITH for yourself. Compare it feature-for-feature with any other power tool or combination of single-purpose tools. Then compare prices *complete!* At any Montgomery Ward, leading hardware or department store.

\$169.50

complete except for motor.
With special, 1/2-hp., capacitor-type motor (shown) . . . \$199.50

CONVENIENT TERMS



NEW RETRACTABLE CASTERS FOR SHOPSMITH

They save space, increase SHOPSMITH'S great flexibility

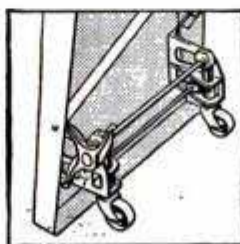

Now your SHOPSMITH can be completely mobile. Move it, roll it, lock it—on specially designed, three-stage, retractable casters. They're easily mounted on any wood or metal bench. Easy to set, too—each pair of wheels is operated by a unique foot lever. See your SHOPSMITH dealer. Price complete (4 wheels, 2 levers) . . . \$11.95

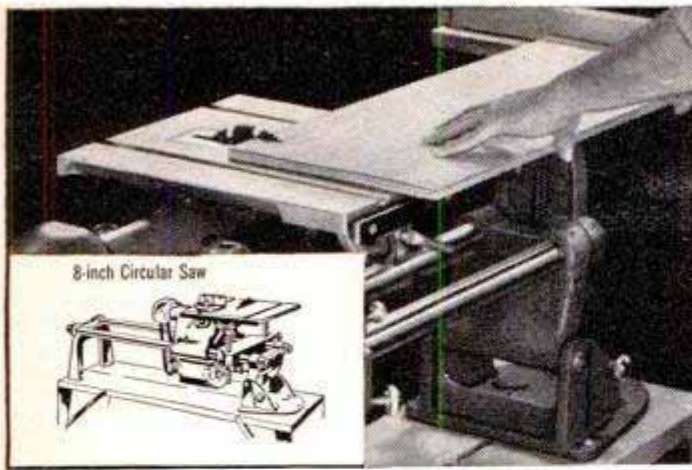

8-inch Circular Saw

HAIRLINE SETTING. Unique micro-quill adjustment positions saw blade for extremely accurate width of cut. No more difficult fence settings. Saw has 48" fence-to-blade capacity, large tilting table, precision tooled miter gauge, self-aligning rip-fence, table raiser. 2 1/4" depth of cut.

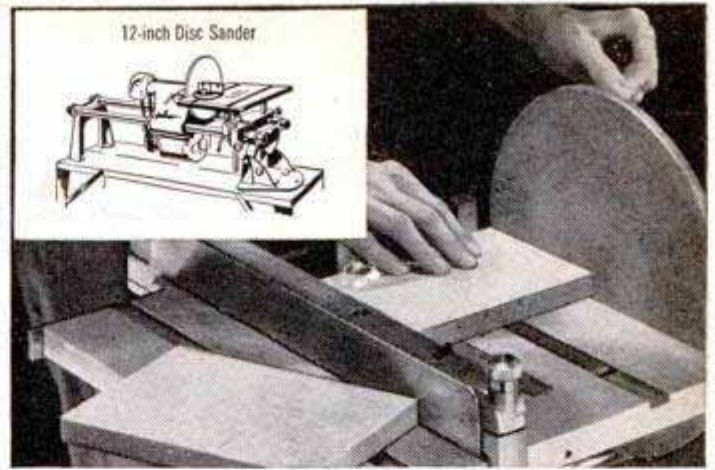

12-inch Disc Sander

DUPLICATE SANDING. For making two or more pieces exactly the same length. Only SHOPSMITH has this feature plus 12" precision balanced disc, 14 1/2" x 17" tilting table, both miter gauge and fence. Disc feeds into work for maximum speed, accuracy and safety. Stop-nuts set feed depth.

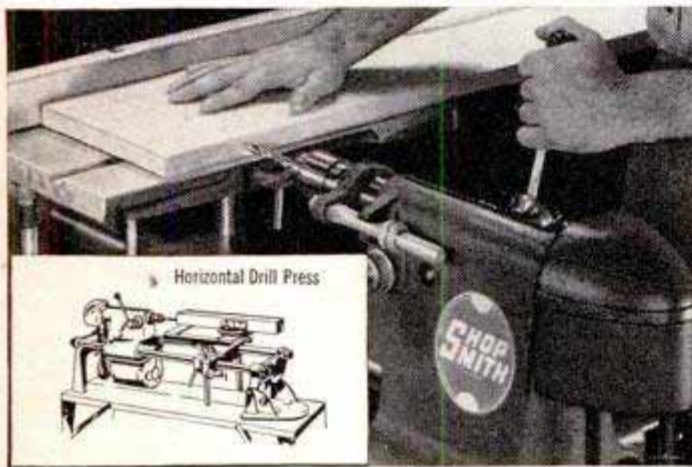

Horizontal Drill Press

PERFECT DOWELED JOINTS. No jigs required. Just lay work flat on table, feed drill from side. Dowel holes match perfectly. Especially handy for drilling or mortising large, heavy work. Speeds range from 875 to 3500 rpm. 4" quill feed. Unlimited capacity. Adjustable depth scale.

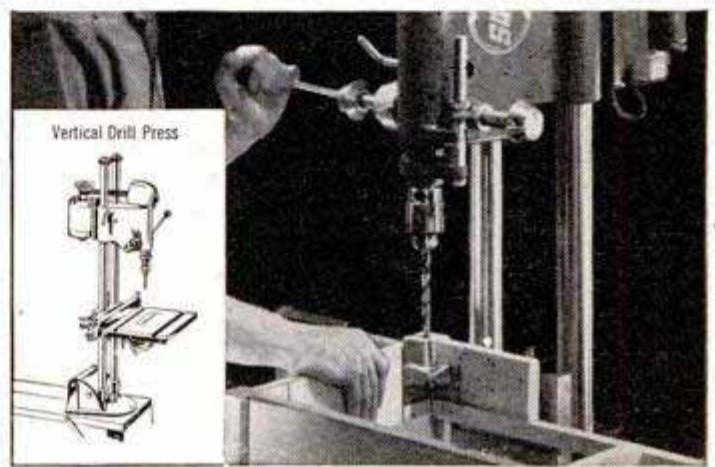

Vertical Drill Press

LEFT-HANDED, TOO. Only drill press on the market with right- or left-hand feed lever. Drills to the center of 15" circle. Maximum clearance table to chuck of 27", floor to chuck, 55". Jacobs key chuck takes drills up to 1/2" diameter. 4" quill feed. Miter gauge and rip fence form convenient jigs.

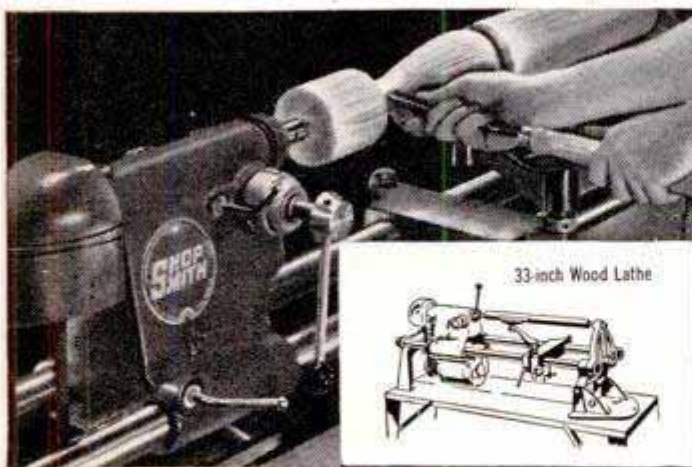

33-inch Wood Lathe

QUICK-SET TOOL REST. Always moves parallel to work. No need for constant adjusting. 15" swing, 3" more than most heavy-duty lathes. Distance between centers, 33". Absolutely rigid lathe bed assures minimum vibration, maximum accuracy. Steel ways take one ton stress.

SHOPSMITH TAKES ALL STANDARD ATTACHMENTS

GET ALL THE FACTS! Compare before you buy. Illustrated, 16-page booklet brings you detailed specifications, describes SHOPSMITH'S many operations. Send for it! It's FREE!



FREE

Address:

SHOPSMITH

Dept. 147-B, at factory nearest you:
12819 Coit Rd., Cleveland 8, Ohio, OR
417 Montgomery St., San Francisco 4, Calif.

Name _____

Address _____

City _____ Zone _____ State _____



Just dial ANY WIDTH CUT
ON YOUR SAW



WITH

Warren

DADO SAWING WASHERS

Cut clean, accurate, parallel grooves—12 widths, any angle. No chatter, burning, chewing—or sanding! No more blade vibration—no screws to fuss with—just four balanced washers. Simply dial desired width with Micro-matic adjustment. Can be left on blade for straight cuts. Available in 5 sizes— $\frac{1}{2}$ ", $\frac{3}{4}$ ", $\frac{5}{8}$ ", 1", $1\frac{1}{8}$ ". A perfect gift for woodworkers. See your dealer or write—

YOUR
SAW
IN ACTION

\$4.95
SET

WARREN WASHERS CO.

Dept. 31 • 70 Medbury • Detroit 2, Mich.

dependable. So he developed the "gun kit"—action, barrel and unfinished stock—which the sportsman puts together and decorates as he wishes.

The kits are of three types:

The sporter rifle—which contains an F.N. Commercial Mauser action, a 24-inch No. 10 sporter barrel chambered for cartridges from .220 to .30-06, and a production stock with a rolled cheekpiece.

The varmint and target rifle—consisting of an F.N. Commercial Mauser action, a 26-inch No. 25 sporter barrel chambered for cartridges from .220 to .30-06, and production stock with a high, thick comb.

The bench-rest rifle—including an F.N. Commercial Mauser action, a 30-inch barrel, chambered for cartridges ranging from .219 to .250, and production stock with a long, beavertail forearm for best bench-rest position.

Anyone who knows a little about firearms and how to use ordinary hand tools can put one of these kits together in a day. An expert can do it in three hours. Then he can decorate the stock in any way he likes.

Gunsmithing has always had some of the home-workshop, fine-handicraft atmosphere about it. Colt, Remington, Winchester, Smith and Wesson—all the well-known American gunmakers got their start at home.

In building rifles of deadeye accuracy, Pfeifer is following in the same tradition.



Indoor Ambulance

On duty 24 hours a day, a small ambulance can speed down the aisles of a big factory to pick up any worker who becomes sick or is injured. The ambulance, made from a Crosley station wagon, provides quick pickup service inside the Transformer Division plant of the Westinghouse Electric Corporation at Sharon, Pa. The factory is $\frac{3}{4}$ mile long.

BUILD THIS SPECTACULAR ERECTOR AMUSEMENT PARK

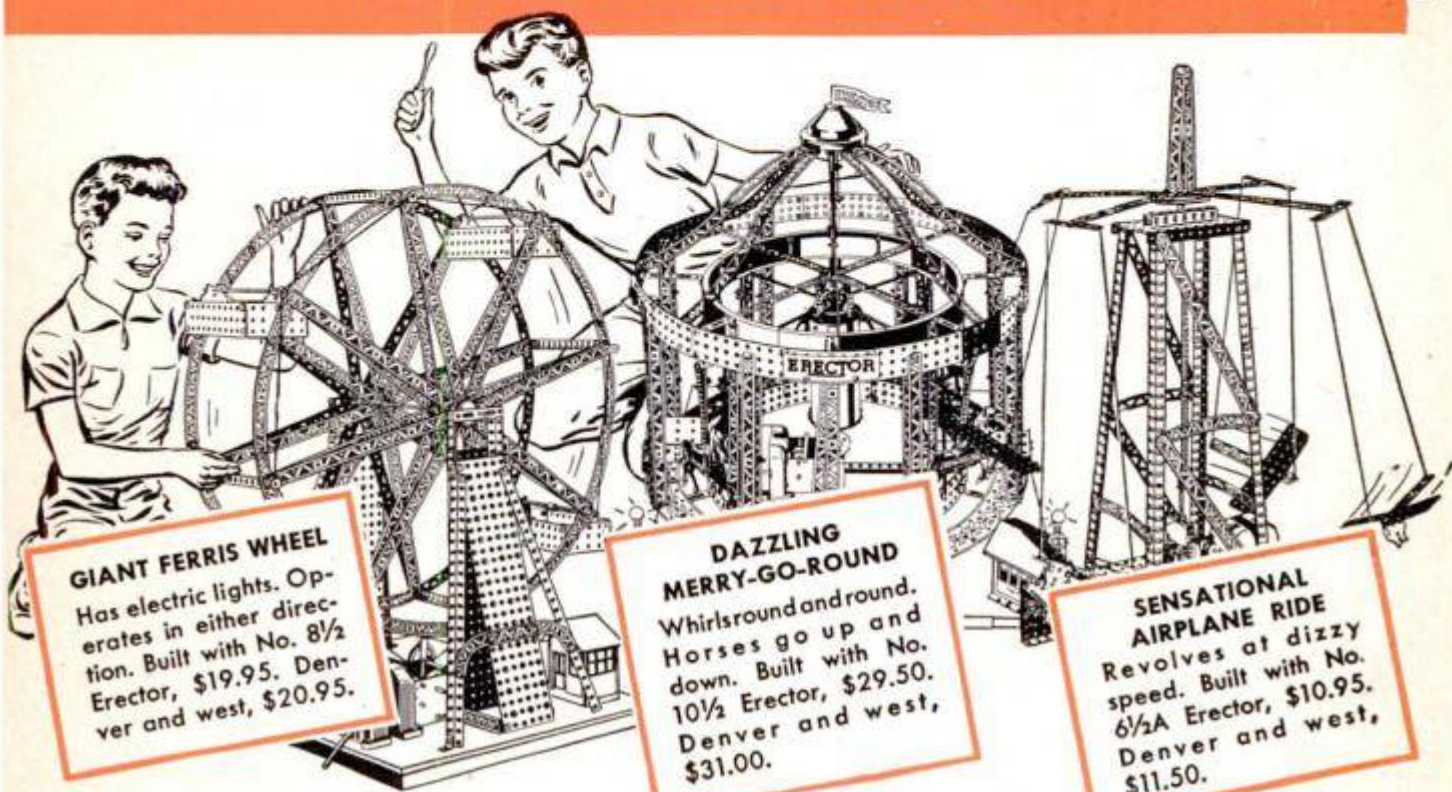

GIANT FERRIS WHEEL
Has electric lights. Operates in either direction. Built with No. 8½ Erector, \$19.95. Denver and west, \$20.95.

DAZZLING MERRY-GO-ROUND
Whirls round and round. Horses go up and down. Built with No. 10½ Erector, \$29.50. Denver and west, \$31.00.

SENSATIONAL AIRPLANE RIDE
Revolves at dizzy speed. Built with No. 6½A Erector, \$10.95. Denver and west, \$11.50.

ERECTOR World's Greatest Construction Toy

HELLO BOYS! Think of the fun of building and running these Erector Amusement Park models! With your own hands you fit gleaming girders and other parts together—see them grow into gigantic engineering marvels. Then you hook up the powerful Erector electric engine and make them swing into action with glorious realism. You can build hundreds of spectacular models with *one* Erector set. Only with Erector can you build models that buzz with action—blaze with electric lights—whistle—puff smoke—give off “choo-choo” sounds—operate by remote control. Get a genuine Erector set. Prices start at \$1.75. Denver and west, \$1.85.



SEND FOR GIANT CATALOG

Cost over \$125,000.00 to produce. 56 full-color pages on Erector, American Flyer trains and equipment. Describes thrilling Erector contest. Catalog free at your dealer or send 10¢ with coupon.

A.C. Gilbert

Erector gives you girders of steel, to build like real—and more different parts than any other construction set.

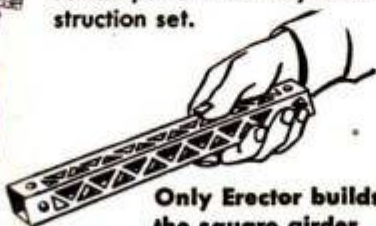

Only Erector builds the square girder with interlocking edges.



Gilbert Hall of Science
143 Erector Square, New Haven, Conn.

Rush Giant Erector and American Flyer Train Catalog. I enclose 10¢.

Name.....

Street.....

City..... State.....

This offer good only in U. S. A.

Free folder tells—

How to own a

Chris-Craft

for as little as \$39 full price

Chris-Craft
8-ft. Pram



Chris-Craft
14-ft.
Rowboat



Chris-Craft Model 14
Outboard Boat



Chris-Craft
21-ft. Sportsman



Chris-Craft 21-ft. Express Cruiser

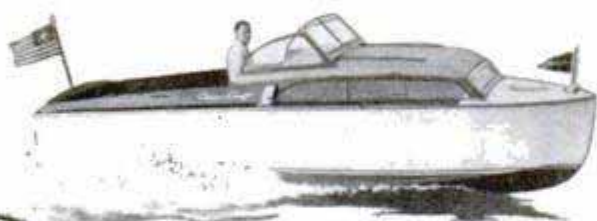

Easy-to-assemble Boat Kits! SAVE 1/2 or more! New Chris-Craft Boat Kits include pre-cut Genuine Philippine Mahogany parts, Fir Marine Plywood panels; all brass screws; illustrated instructions. Write for free folder today!

CHRIS-CRAFT CORPORATION
200 DETROIT ROAD, ALGONAC, MICHIGAN

Skyroads to Everywhere

(Continued from page 147)

uses omni and DME information to navigate when the pilot can't or doesn't want to follow the fixed radio tracks. After feeding in the three known factors—the destination's distance and bearing from the nearest omni station, and the actual course desired—you have only to keep the left-right needle centered to stay on course. The magic box is constantly figuring out the third side of the triangle. Relying on chains of omni stations, you can navigate anywhere in the U. S. without "riding the beam."

You're about 60 miles from Mansfield now and tune in on its 113.9 frequency. You put the track selector at 67 degrees, which will take you right into the airport.

It is a fine day and you need no help in getting downstairs, but the Common System offers additional aids for those who have to fly bigger, faster planes in all kinds of weather. Radio and radar combine to provide complementary guidance techniques for approach and landing. Operating separately and on different principles, together they provide an almost foolproof check against human errors and mechanical failures.

The instrument-landing system, older of the two, has a transmitter sending out one radio beam on a horizontal plane and another projecting a vertical beam. The correct approach follows the path along which the two beams intersect. The job of the pilot, watching a single dial with one needle hinged at the top and another at the side, is to fly so that those two needles keep crossed at the center of the dial—indicating he is centered on both beams. The needle's distance and direction off center show how much he must maneuver to make corrections.

Within three years over 50 of the busiest U. S. airports will probably also offer ground controlled approach, a radar boon that proved itself under high-pressure combat conditions. It differs from ILS in that ground observers, accurately following the plane's blip image on their screens, give the pilot a running voice commentary on his position relative to the landing path. All the pilot needs is a radio to receive the instructions.

Before the plane gets to the field it is picked up by surveillance radar, which keeps the airport traffic controller informed on the bearing and distance of all aircraft within 30 miles, and large planes for even greater distances. By 1953 the busier CAA towers will be equipped with

(Continued to page 254)

What's **NEW**
in Batteries?

AUTO-LITE **Sta-ful** BATTERY... *needs water* *only 3 times a year*

IN NORMAL CAR USE

A revolutionary new development, the Auto-Lite "Sta-ful" Battery, protects you against a major cause of battery failure . . . damage to plates due to liquid loss. This new "Sta-ful" Battery Design permits a liquid reservoir with more than 3 times the reserve capacity of ordinary batteries . . . keeps plates fully covered and active months longer in normal car use.

In addition, "Sta-ful" gives you 70% longer average life* than batteries without Sta-ful features. Fibre-glass retaining mats protect every positive plate and keep the power producing material in place for maximum dependability. Get more for your battery dollars—replace with an Auto-Lite "Sta-ful" Battery. See your Dealer today.

AUTO-LITE BATTERY CORPORATION

Toledo 1

Ohio



*Proven by tests conducted according to SAE Life Cycle Standards.

Because of its unique design and construction, the new Auto-Lite "Sta-ful" Battery holds more than 3 times the liquid reserve of ordinary batteries.

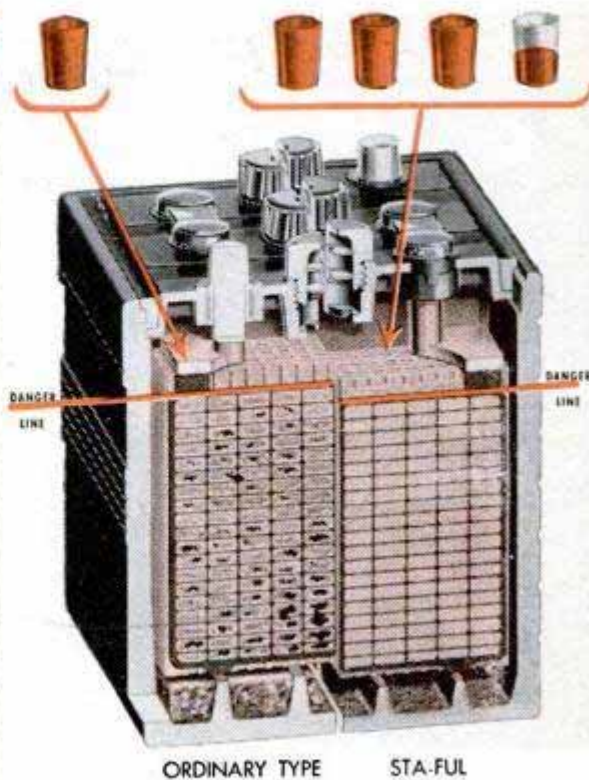

ORDINARY TYPE STA-FUL

Note how the protective Fibre-glass mat retains the power-producing material in the positive plate while ordinary battery plates shed the active material until it fills the sediment well.

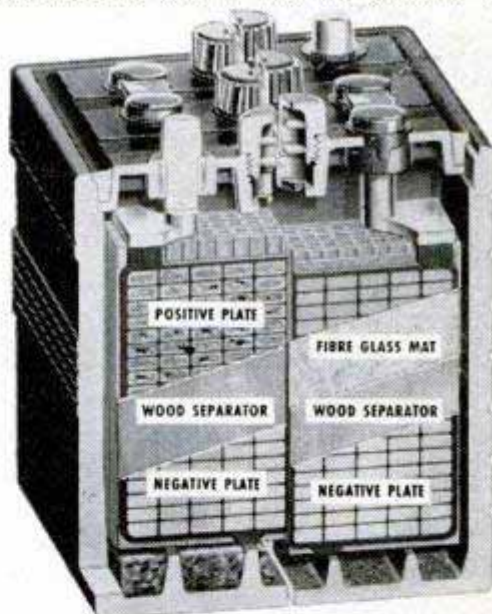

ORDINARY TYPE STA-FUL

AUTO-LITE **Sta-ful** BATTERIES

FREE get it Now—

**ALLIED'S 1951 TV
and RADIO CATALOG!
212 Pages of BIG VALUES**

**EVERYTHING
IN RADIO
AND TV AT
LOWEST PRICES**



**EVERYTHING FOR EXPERIMENTERS,
BUILDERS, AMATEURS, SERVICEMEN,
ENGINEERS, SOUNDMEN**



**TV, HOME RADIOS
& RADIO-PHONOS**



**SERVICE SUPPLIES
BUILDERS' SUPPLIES**



AMATEUR GEAR



P. A. SYSTEMS, RECORDERS

ALLIED RADIO.....

**FREE
CATALOG**

833 W. Jackson Blvd., Dept. 5-11-0

Chicago 7, Illinois

Rush FREE 212-Page ALLIED Catalog.

Name.....

Address.....

City.....Zone.....State.....

Save money on every Radio and TV need! Get the big 212-page 1951 ALLIED Catalog featuring the world's largest stocks of top-quality equipment at low, money-saving prices! See the latest TV releases, home radios, radio-phonos, Amateur equipment, P.A. systems and Hi-Fidelity Custom Sound, recorders, test instruments, builders' kits—plus thousands of parts, tools, books and diagrams. Get more for your money from the World's Largest Radio Supply House. Send today for your FREE new 212-page 1951 ALLIED Catalog!

high-frequency direction finders to simplify individual aircraft identification in dense traffic. The pilot's voice activates a line of light which passes through his particular aircraft's blip on the radar screen.

To check omni-range accuracy, the author flew with airways flight inspectors Paul McDonnell and Fred Kinsel of the Chicago CAA office. With the cockpit windows paper masked and his seat lowered to the floor to assure his inability to see outside—and only the four omni instruments within view—McDonnell made a test run on a small landmark 50 miles away.

After 20 minutes of blind flying, at about the time we should have neared our target, I tore a small strip from the top of our window mask and peered out. Directly ahead, as though we'd been sliding down a trolley line for 50 miles, was our landmark.

Charles F. Horne, who heads the CAA's federal airways program, believes the omni range will give the light-plane industry a badly needed "shot in the arm." By making cross-country navigation simple and safer, thus boosting the airplane's utility, Horne thinks the system will greatly widen the buying market. Max Karant, who tested omni for an association of some 35,000 personal-plane users, went even further to term it "the answer to the private pilot's prayer."

Changes and improvements are anticipated before the program reaches maturity in 1963, but the basic pattern is already forming. Scrapping of the antiquated four-course ranges, still the backbone of today's nationwide air navigation, should be finished by 1954. Now gaining consideration as possible additions are automatic block systems for traffic control and cockpit pictorial displays that show the pilot his own plane and all others in the vicinity. Another is a machine that makes continuous tape recordings of all conversations between the tower and pilots, a valuable adjunct for accident investigation.

Pioneering private pilots, using the first omni stations, are shuttling about on cross-country flights with growing ease and certainty. Indicating that the system may eventually have worldwide use, five experimental ranges are being set up in England, France and Italy. Commercial and military airmen have been reporting remarkable bad-weather assists from GCA already operating at Chicago, New York and Washington.

The U. S., with its progress historically in step with constantly improving transportation—from the horse and buggy through boats, trains and automobiles—is now crisscrossing the sky with reliable all-weather highways for the airplane.



ANNE BAXTER
starring in
"ALL ABOUT EVE"
A Darryl F. Zanuck Production
20th Century-Fox Studios

- ★ Perfect gifts for men—useful the whole year 'round!
- ★ Priced for every pocketbook—built for every need!
- ★ Easy to operate—fun to use—take the hard work out of home and farm jobs!
- ★ Also Home-Utility 1/2" Drills, Electric Saws and Bench Grinders, other Kits and attachments!
- ★ Quality—built by BLACK & DECKER, world's largest manufacturer of portable electric tools!



MEMO

Take a Tip from Anne Baxter Put "Home-Utility" on your Christmas Gift List!

HOME-UTILITY 1/4" ELECTRIC DRILL (\$19.95) is an ideal "all around" drill for wood, metal, plastics. Also drives many handy attachments for sanding, polishing, grinding, cleaning. Compact, light, shaped to fit the hand.



HOME-UTILITY 1/4" DRILL KIT (\$29.95) is packed with uses! Comes complete with H-U 1/4" Drill, 7 twist drills, wheel arbor, wire wheel brush, 3 sanding discs, rubber backing pad, in sturdy, streamlined metal kit!



HOME-UTILITY 5" SANDER-POLISHER (\$32.95)—*"the tool of 1,001 uses"*—plus sanding discs, lambswool bonnet, drill chuck, rubber backing pad, cans of wax and auto polish—all for one price! Perfect for women to use in speeding up housework; weighs only 3 1/2 lbs.

Try them at your hardware, electrical or implement dealer's.

ELECTRIC HOME-UTILITY TOOLS

HOME-UTILITY Division
BLACK & DECKER
Mfg. Co.,
Dept. H11M,
Towson 4, Md.

YOU'LL ENJOY

LEATHERCRAFT

THE KIT KRAFT WAY

AND COPPER TOOLING OR
TEXTILE PAINTING, TOO



FREE!
ILLUSTRATED
CATALOG

It's fun and it can be profitable! You can make fine leather goods, do beautiful copper tooling or decorative textile painting. Kit Kraft's big new catalog shows all supplies, tools, instructions, books, designs, everything you need, makes it easy, even for beginners. Write today for free catalog.

KIT KRAFT 7377 MELROSE AVE., DEPT. M-11
HOLLYWOOD 46, CALIFORNIA



EARN EXTRA DOLLARS

IDEAL LAWNMOWER SHARPENER

Saves work, saves time, helps you earn extra dollars! Sharpens hand, power mowers without disassembling. Complete shop in one machine—equipped with Bed Knife Grinder and "lapping-in" Reconditioner. Home owners, parks, clubs, cemeteries pay good money for efficient sharpening; get your share!

WRITE NOW FOR FREE CATALOG

THE FATE-ROOT-HEATH CO., Dept. I-3, Plymouth, Ohio

SPEEDS nearly every 'Round-The-House Job



GRINDS—
TAKES OFF RUST



SHARPENS TOOLS
AND CUTLERY



SANDS
OFF PAINT

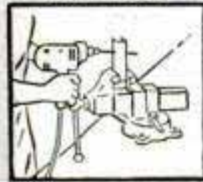

DRILLS WOOD
OR METAL



PORTER-CABLE
Guild
COMBO-TOOL

only
\$44.50



POLISHES
THE CAR



MIXES PAINT,
LIQUIDS

What *hard work* you and the Mrs. are going to be spared! What extra time you'll both enjoy all the year 'round! With this vibrationless tool you can grind, sand, sharpen, drill — even through steel — in a jiffy, too. You can remove rust, smooth welded joints, cut tiles — without drudgery. You can polish the car, the floors, the furniture; buff kitchenware and silver in a fraction of the usual time. You can practically whizz through an ordinary week's list of jobs in one day with this sensational tool. No wonder it's a popular gift for anybody who owns a home, camp, farm — or hobby shop.

Best of all, you'll *enjoy* working with this smooth-operating little "jack of all work." The Guild Combo-Tool is not a gadget but a full-fledged production tool — perfectly balanced for easy handling — precision built to be useful for years. See some of the things it can do at your hardware or implement dealer's — See the Guild Bench Stand (\$1.50) that converts it into a handy wheel grinder — See the Power Take-Off for driving light machines. The Guild Combo-Tool may be purchased separately or in your choice of three versatile kits full of attachments.

For further information send in coupon today

Please send me full information about the Guild Combo-Tool — also name of nearest dealer.

Name.....

Address.....

City..... State.....

PORTER-CABLE MACHINE COMPANY
2291 N. Salina St. Syracuse 8, N. Y.

This Business Is Next to Nothing

(Continued from page 111)

aluminum), instead of magnesium salt, are condensed on optical flats, the result is a mirror. These vacuum-coated mirrors, superior to those made in the conventional way, are used in precision devices: machine-tool comparators and infrared spectrographs, in television and astronomical instruments and in the latest types of sealed-beam headlights.

Quartz radio crystals are "loaded" with gold film under high vacuum until they vibrate at precisely the desired frequency. Then silver film, also vacuum-deposited, provides bases for soldering electrical leads to the crystals.

A particularly fascinating application of high-vacuum coating is metal shadow-casting, used by scientists in connection with the new electron microscope. The metallic mist is directed against the specimen to be studied, at an oblique angle. Irregularities on the surface of the specimen cause thickness variations in the layer of metal. This produces shadows from which heights and depths of the surface irregularities can be calculated.

Molecular (or "short path") distillation is still another of high-vacuum's important new jobs. Vitamin concentrates from fish oils, fine lubricating oils for watches and purification of hormones on a commercial scale are but three from a growing list of applications.

Vacuum engineers have upset the old theory that certain oils are "fixed"—undistillable. Under high vacuum, their long, delicate chains of molecules are tenderly handled, protected from disastrous bumps by the molecules of the air.

It was Dr. K. C. D. Hickman who first thought of molecular distillation, thereby providing millions of Americans with vitamins in convenient capsule form instead of thick, yellowish, evil-tasting cod-liver oil. Doctor Hickman mounted a heated, whirling disk inside an evacuated glass bell jar.

Fish oil, fed to the center of this "spinning pie plate," spreads outward in a thin film. Almost instantaneously the light-weight vitamin-bearing esters vaporize and condense on the bell jar's cool surface, from which they are collected and shipped to food and pharmaceutical concerns.

Three types of pumps are used in high-vacuum work:

Jet pumps trap air or gas molecules and sweep them forward in a high-speed jet of steam or oil vapor. The air goes into the atmosphere; the vapor condenses and returns to the boiler for recirculating.

(Continued to page 258)

STOP CHANGING MOTOR OIL!

End this needless expense forever with

RECLAIMO Today's Most Advanced OIL RE-REFINING filter FOR CARS, TRUCKS, TRACTORS & DIESELS

Continuously cleans and RE-REFINES motor oil as you drive (by utilizing motor heat)—keeps oil in high grade lubricating quality at all times!

"RECLAIMO"

- REMOVES SOLIDS (by filtration)
- REMOVES WATER (by distillation)
- PREVENTS Excess Fuel Dilution
- PREVENTS Acid and Sludge Formation
- ADDS Thousands of Miles to Engine Life

MAINTAINS Stable Viscosity **ELIMINATES** All Oil Changes
 FREE 32-PAGE BOOK "OIL FACTS" (with bona-fide \$1000.00 offer on page 30), gives you the complete "Reclamo" story and details of our extraordinary 90-DAY NO-RISK TRIAL OFFER! Write for your copy TODAY!

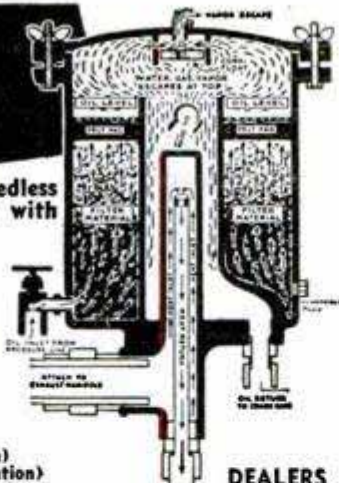

DEALERS WANTED

U.S. BUREAU OF STANDARDS, Bul. 86 States, "Oil does not wear out - mechanically."

MONEY-BACK GUARANTEE

Reclamo Sales Div., Inc.

4508 S. Logan, Dept. M-3, Lansing, Mich.

MAKE YOUR OWN!

WITH

Griffin READCUT LEATHER PROJECTS

Over 100 KITS in every kind of Tooling and Carving Leather, accurately cut, all parts included. Only Top Grade Leathers used. You do the choosing. You do the tooling, carving, stamping, the punching and assembling.



SEND FOR COMPLETE CATALOG Please send 10¢ to cover mailing.

SINCE 1924

OUT OF THE WEST, THE HOME OF LEATHER CARVING

Griffin CRAFT SUPPLIES

5626-A TELEGRAPH AVE. OAKLAND 9, CALIFORNIA

EVERYTHING FOR THE LEATHER WORKER

Largest, most complete stock of Leathercraft Tools and Accessories in U.S.A.



HIDES AND SKINS of Craft Leathers of every kind if you prefer to cut your own.

Time for a new tobacco pouch?

Rogers

the finest in smokers' accessories



Combination Model



Daily Model

• Rogers air-tite®

Enjoy a pouchful of fresh tobacco with a Rogers Air-tite tobacco pouch—with its patented inner pouch of seamless rubber that "seals as it closes"... The largest selling tobacco pouch made. Exquisitely created in many styles and leathers.

Above: Combination Model pouch of Brazilian Peccary \$10 (Killarney Pipe \$5). Other models, \$1.50 to \$20. At left: Daily Model holds one day's supply compactly. Beaver Calfskin, illustrated \$2.50. Other leathers, and other models for full pack of tobacco, \$1.50 to \$15.

Rogers imports, inc., N. Y. 16, N. Y.
 The finest in smokers' accessories

Peterson's PIPES
 LONDON • DUBLIN

Custombilt PIPES
 NO TWO ALIKE

FINE TOOLS NEED FINE OIL!



• Lubricates



• Prevents Rust

• Cleans • Polishes

SOLD EVERYWHERE

3-IN-ONE Oil

For **SMOOTHER
MOTORING**

**INSIST ON
BOWES**



**DEPENDABLE
SPARK
PLUGS**

*Here's
Why -*

★ **Every Bowes Plug is Individually Tested**—tested at higher voltage than is ever encountered in your car.

★ **Oversize Special Alloy Electrode . . .** welded construction assures positive connection.

★ **Extra Large Ground Electrode** assures longer life for plug.

★ **Husky Aluminum Oxide Type Insulator** assures against porosity—sure proof against shorting.

★ **One-Piece, Leak-Proof Construction.**

★ **Patented Engine Gasket Retainer Ring** assures better contact and better heat transfer.

BOWES PLUGS

are tailored to YOUR car's motor

If your favorite SERVICE STATION does not handle Bowes Spark Plugs, write us direct for further information.

BOWES "SEAL FAST" CORPORATION
INDIANAPOLIS 7, INDIANA

A single pump of this type can lower pressure to about 50 millimeters (around one fifteenth of atmospheric pressure at sea level). Hooked up in series, five pumps can cut this to as little as .03 millimeter. Such pumps are favored where large volumes of air or gas have to be handled at high speed and where higher vacua are not required.

In the most efficient oil-sealed mechanical type, a rotor revolves eccentrically within a cylindrical chamber so that air (from the container being evacuated) is admitted to the chamber. As the rotor revolves, the container is automatically sealed off—at the same time, the air in the pump chamber is compressed into a small space and driven off through a vent, into the outside atmosphere.

These mechanical pumps work fast, the rotor turning at the rate of 600 revolutions per minute. But the highest vacuum possible with such equipment (about .001 millimeter) is still a far cry from the kind of emptiness needed in many of the new applications.

The real evacuator is the diffusion pump, which uses a curtain of mercury or oil vapor as a jet for dragging out the air or gas molecules. In one form of diffusion pump, mercury or oil of low boiling point is heated in a tank at the bottom of an inverted U-shaped tube. High-pressure vapor soon rises in one arm of the tube and rushes past the opening of the space to be emptied, sweeping off air molecules by the billion.

The process is speeded by stages of ejector orifices along the way, which keep building up the pressure of the vapor. In its passage down the other arm of the tube, the vapor condenses on the cool sides and returns to the tank, to be vaporized once more. The air molecules, meanwhile, are drawn off by a mechanical pump.

Developed by Doctor Langmuir back in 1916, the diffusion pump is capable, in theory at least, of producing a perfect vacuum. The latest types, used in advanced laboratory research, leave such a small amount of gas that it would have to be increased at least ten trillion times to bring it back to normal atmospheric pressure.

That's about as close to nothing as any human being has come, thus far.

Running an industrial process in such an evacuated space would be like taking a factory off the surface of the earth and moving it up into the ionosphere.

Ten years ago, high vacuum was confined almost entirely to the laboratory. Today, its industrial uses have expanded until it has become one of industry's most valuable and promising tools.

NEW JIG SAW CUTS 1" WOOD with 50% MORE POWER and 70% LESS NOISE!

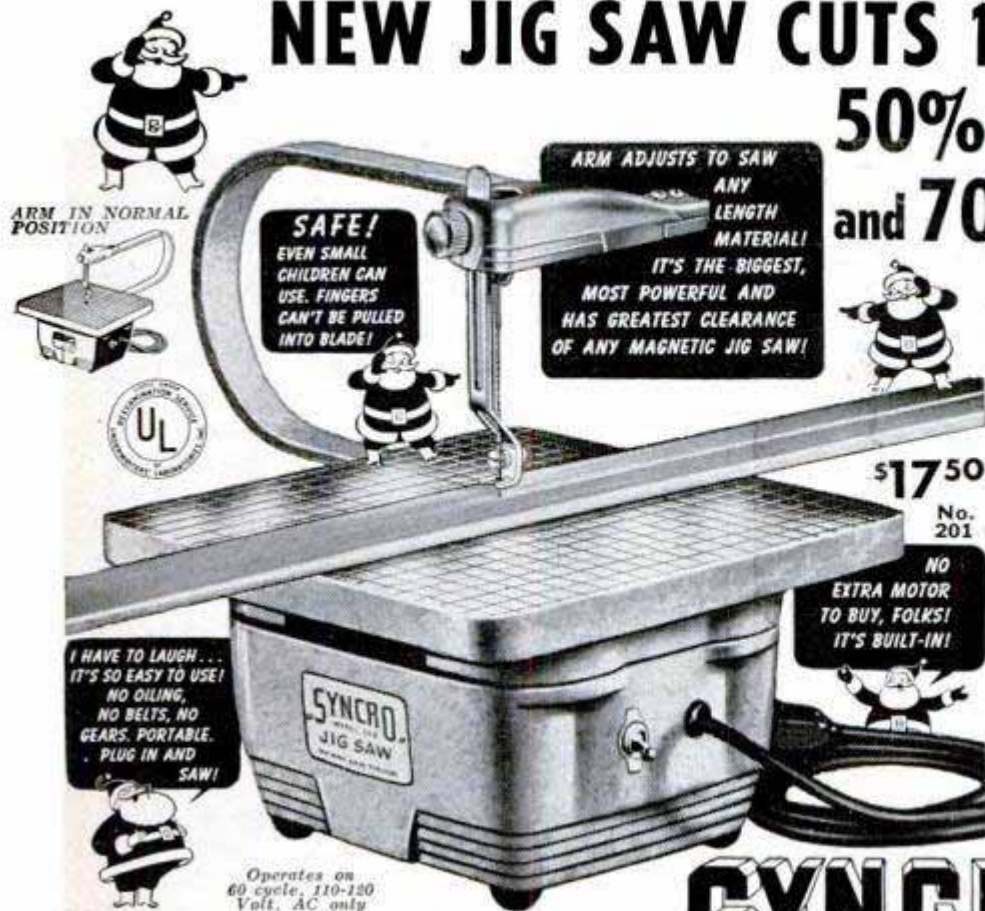

**SYNGRO POWER UNITS
GUARANTEED
AGAINST BURN-OUT
ALL DURING YOUR
OWNERSHIP—or Re-
placed FREE!**

Santa suggests the largest, most powerful, most versatile jig saw of its kind, yet **safe** for children—SYNGRO! The entire family will enjoy it. Now **70% quieter operation** with **50% MORE POWER!** Cuts **any** length 1" wood, thin metal, plastic. Precision-built to last a lifetime. Portable. Ideal for apartment use. Just plug in and saw. Not a "lumber" cutter, but for fine, delicate craftsmanship. TESTED and APPROVED BY UNDERWRITERS' LABORATORIES, INC. and Power Unit GUARANTEED **Against Burn-Out** by SYNGRO all during your ownership! Buy with **confidence**. Sold only at the best dealers!

SYNGRO
QUALITY TOOLS

COMPLETE with BUILT-IN MOTOR, \$17.50. If Dealer hasn't it, send \$17.50, we'll ship postpaid.

SYNGRO CORP., DEPT. D-110, OXFORD, MICH., U. S. A.

HYDRAULIC Power Transmission WITH Infinitely VARIABLE SPEEDS, Clutch and INSTANT REVERSE—OUTPUT TORQUE ADJUSTMENT UP TO 180 inch POUNDS

This positive displacement Hydraulic Torque Converter is the ideal fluid drive with thousands of uses . . . Output Speeds Infinite .0 to 550 R.P.M. . . . in either direction . . . Change Speeds WHILE RUNNING . . . Control and Transmit your power this SMOOTH Oil-Way . . . Will handle 1/4 H.P. to 1 1/2 H.P. Motor. Industrial or Home & Farm Use . . . Cost government \$300. High Quality Precision Workmanship. Buy this unit to get the most for your money. Case measures 7 1/2" long 7" high 6 1/2" wide. Input & Output Shafts 5/8" dia. Beautiful Red Crackle Finish Case.



Shipping Wght. 25 pounds **Only \$54.50**

IF C.O.D. is requested a 10% Deposit must accompany order and we ship F.O.B. Chicago.

1 1/2"-8 thread lathe Chuck Adapter, \$3 extra

Prepaid in U.S.A. 2 quarts oil included FREE

DIRZIUS MACHINE SHOP "H" 1423-25 So. 52nd Ave., Cicero 50, Ill.

Full-size patterns

MAKE IT EASY TO BUILD THIS COLONIAL CABINET YOURSELF

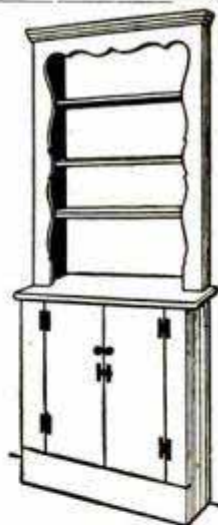

You can build this cabinet either as a recessed or projecting unit by the famous Easi-Bild* Pattern Method of Construction. Pattern permits you to build size of cabinet to space available.

Send 35¢ for Easi-Bild Pattern #136, and save important money "doing it yourself." An additional 20¢ brings you the Easi-Bild Pattern Book, illustrating over 100 other "Build It Yourself" pattern ideas.

*T.M. Easi-Bild Pattern Co.

UNITED STATES PLYWOOD CORPORATION

Dept. PM, P. O. Box 215, Pleasantville, N. Y.

MODERN LAWN MOWER SHARPENER

FOR LAWN MOWER SHOPS
FIX-IT SHOPS

GOLF COURSES • PARKS
101 OTHER JOBS

Sharpens All Reel Type Mowers • Hand, Power or Gang • 10 to 20 Minutes • No Dismantling • No Extra Attachments Needed.

All reel type mowers, from 5-inch edgers to 36-inch power mowers, are quickly sharpened to extreme ends of both left and right twist blades.

Handle, wheels, roller and motor remain in place when sharpening is in process. Bed knife is sharpened in same brackets. Grinding head rides on five ball bearing races. Easy to operate.

Also sharpens chisels, joiner knives, planer blades. Big profit maker. Own your own business. Send Today for FREE Illustrated Bulletin No. 10-C

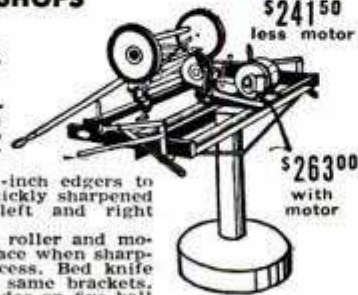

PRICE \$241.50 less motor

\$263.00 with motor

ORDER NOW

Immediate Delivery

MODERN MFG. CO. 160 N. FAIR OAKS AVE PASADENA, I, CALIFORNIA

New Allen-A Sensation!

"LIVE-RUBBER" Action-Fit!



Like comfort in action? This new Allen-A Atlastic* T-Shirt has live-rubber s-t-r-e-t-c-h in shoulder seams and collar for permanent shape-holding fit—both in action and at ease!



These new Allen-A Atlastic* Briefs have live-rubber s-t-r-e-t-c-h at legs and waistband, naturally. But their new live-rubber and combed-yarn knit fly is Allen-A's alone. It gives you permanent fit plus mild support. Ask for this newest Allen-A "wonder-wear" today!

**Allen
A**

Atlatic*
UNDERWEAR

engineered with "live-rubber"

—fits like your own skin!

*Reg. U.S. Pat. Off.—Pat. No. 2,282,217

TV's Little Brother

(Continued from page 85)

of a bomb equipped with small fins, or wings. The tail assembly held a steering mechanism operated by radio from the control plane.

Watching the drop in a receiving set in the plane, the bombardier could correct his drop by changing the pitch of the fins on the bomb as it fell. The difficulty with this was that these changes of direction could be achieved for only the first few seconds after the bomb had left the plane. As its velocity increased, changing the pitch of the fins had almost no effect.

Colonel Norvell, who was involved in this experimental work, recalls the horrifying experience of getting a bomb's-eye view of himself. In addition to the receiver in the control plane, another was set up in a shack in the desert not far from the bombing range. As the TV-equipped bomb ripped through the air, Norvell and his fellow officers could distinctly see the shack in which they were huddled grow larger and larger as the bomb came nearer the earth. Fortunately, the bombardier's aim was good and they were unhurt.

Stationed in England at the time the V-2 rockets were at their worst, Colonel Norvell was assigned the job of bombing the supply hangars in which the Nazis assembled and stored them. However, the roofs on these hangars were of reinforced concrete so thick that even blockbusters failed to open them up.

So Norvell equipped 34 bombers, B-17s and B-24s, with automatic pilots and loaded each one with 2400 pounds of TNT and Torpex. In the nose of each plane was a TV camera, and high over the Channel, in the Calais area, was a control plane with a TV receiver. The object was to fly these bombers, one at a time, right into the gaping mouths of the V-2 hangars, through which the rockets were brought before firing.

In order to follow the picture picked up by the cameras in these bombers, they were set to fly as slowly as possible. The openings to the hangars were not too large, and it was necessary to be very accurate. Consequently, many of them were hit by AA fire before they reached their objectives—but a fair number were successful—and this was the beginning of the end of the V-2s.

In recent months, the Army Signal Corps held a public demonstration in Fort Monmouth, N. J., of still another TV application. The camera was mounted in a small, low-flying reconnaissance plane, which sent back a picture to its ground base.

MILLER ROTARY

IT'S HI-SPEED (OPE-SAW) DRILL-BIT
SAWS CUTS REAMS

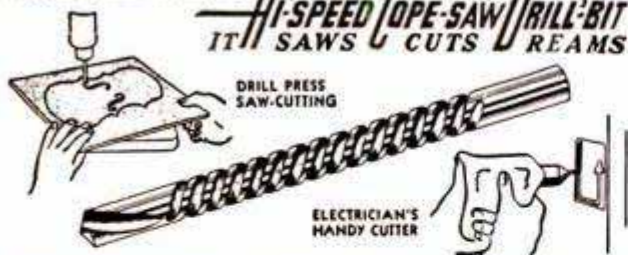

SAWS, CUTS, REAMS . . . Sheet metal, angle iron, pipe, wood, plastic, Transite, etc. Amazing high-speed combination bit and saw fits any 1/4" or 1/2" electric drill or slow drill press. Drills own starting hole to quickly cut, saw or ream opening. Easy to operate. Ideal for carpenters, auto mechanics, electricians, plumbers, hobby workers, many others. Abrasive resistant high speed steel. No breaking. Will withstand severe continuous use. Resharpener at no charge. 1/4" diameter, over-all length 3 1/2", cutting section 2" long with flutes ground from solid. Shipped same day — money back guarantee.

Discounts on quantity orders from dealers
Takes place of up to \$50 in tools. SEND
CASH, CHECK OR M.O.

Manufactured and distributed by:
INTERNATIONAL TWIST DRILL CORP.
624 Wyandotte, Rm. 639, Kansas City 6, Mo.

only
\$3.95
POST-PAID

OTTAWA Buzz Master

7 MODELS—\$99.00 up

Greatest offer made in our 46 years of manufacturing. A model to fit your needs and your pocketbook. Free details.

OTTAWA MFG. CO., 2-027 Brush St., Ottawa, Kans.



No
Other
Like It!

4000 WATTS

from this compact,
low-cost Witte
Diselectric Plant

Model ADRBA
Witte Diselectric Plant

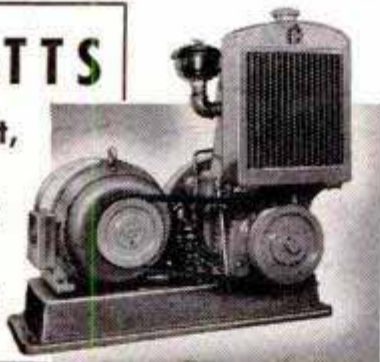

WITTE ENGINE WORKS

KANSAS CITY 3, MISSOURI

Division of Oil Well Supply Company

UNITED STATES STEEL

at last!
a BIG Rugged
Sprunger
8" TILT-ARBOR SAW

Does
everything
expensive saws do . . .
plus these features:

- 8" blade cuts 2 1/2" deep.
- 12"x16" gray iron cast table ground smooth. (Extensions available)
- Double shielded, lubricated for life, ball bearings.
- 5 1/2" arbor size.
- Motor and blade tilt to full 45°. No belt twist.
- Guaranteed material and workmanship.

See your dealer
or write Dept. PM-115

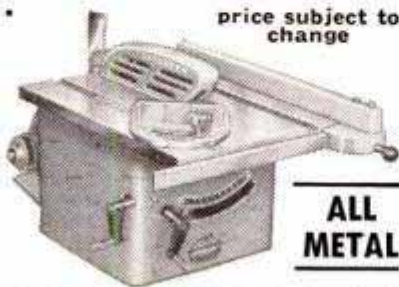

for only
\$38.95

complete
(less motor)
price subject to
change

ALL
METAL

SPRUNGER BROS. INC. TOPEKA, IND.

FREE PLAN

Tells How to Start
Your Own Business

FILING SAWS

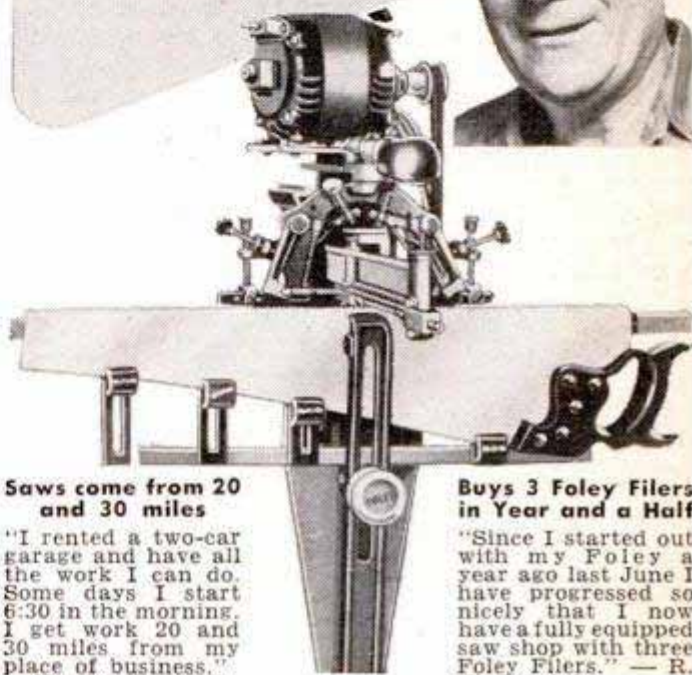

Saws come from 20
and 30 miles

Buys 3 Foley Filers
in Year and a Half

"I rented a two-car garage and have all the work I can do. Some days I start 6:30 in the morning. I get work 20 and 30 miles from my place of business."
—Charles H. Smith.

"Since I started out with my Foley a year ago last June I have progressed so nicely that I now have a fully equipped saw shop with three Foley Filers."
—R. W. Persinke.

FOLEY FILED SAWS BRING NEW CUSTOMERS

Here is a steady repeat CASH business you can start in your own basement or garage in your spare time. Every saw you sharpen with the machine accuracy of the Foley Saw Filer is an ad that brings you more customers. S. M. Hollingshead wrote to us: "I am doing very well with my Foley Filer, and I am glad I invested in your machinery. It is very satisfactory and works very well in the small community in which I live."

You can file all hand saws, also band and cross-cut circular saws on the Foley Saw Filer. The adjustments are simple — there is no eyestrain — and you can start right away to turn out perfect cutting saws. "The first saw I sharpened with my Foley Filer came out 100%. I think it is a marvel of perfection."
—writes Clarence E. Parsons.

FREE BOOK Shows How to Start

"INDEPENDENCE AFTER 40"

explains how you can get business from hardware stores, home owners, farmers, carpenters, schools, mills, factories, etc. Just think — with a modest investment, no overhead, no stock of goods to carry, you can start right in on a cash business that will help pay the rent, buy groceries, or a new car. Start now — send coupon today. No salesman will call.



Send For **FREE BOOK**

FOLEY MFG. CO., 1116-0 Foley Bldg.
Minneapolis 18, Minn.

Send me free book "INDEPENDENCE AFTER 40!"

Name _____

Address _____

PEEL OFF PAINT

WITH KLEAN-STRIP

**Amazing new-type remover
is fast, safe, easy-to-use**

Klean-Strip changes any finish into loose, wrinkled film. Use only a brush or putty-knife to peel off all layers of the old finish at one time.

Klean-Strip leaves the surface clean, smooth and dry. No sticky mess to wash off, no waxy residue to scrape. And Klean-Strip is absolutely safe: will neither burn nor explode.

Klean-Strip is brand new . . . not like any paint remover you've ever used. Takes all the danger and drudgery out of refinishing. Buy Klean-Strip whenever you buy paint. Available at better paint, hardware and department stores, everywhere.

Product of
W. M. BARR & CO.
2352 S. Lauderdale
Memphis, Tennessee



**New! No-Wash!
Non-Inflammable!**

Great Gift! Great Buy! "FORTY-NINER"

Complete set of X-acto Hobby Knives
and Tools in portable wooden chest **\$25**

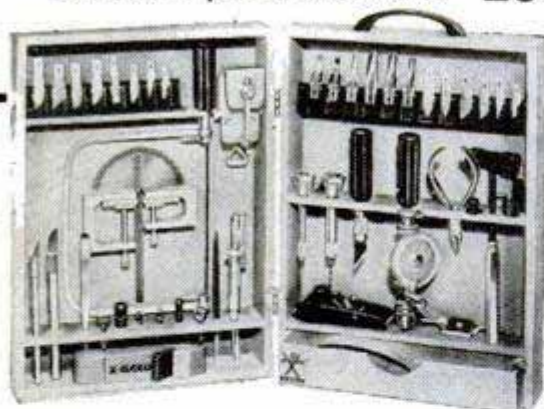

Every knife, tool and blade in the famous X-acto line. Precision made, easy to handle, joy of amateur and expert hobbycrafters in every field. X-acto knives and tools sell singly and in sets, 50¢ to \$50 at hobby, gift, hardware and department stores. (Prices slightly higher in Canada.)

x-acto 

X-acto Crescent Prod. Co., Inc., 440—4th Ave., N.Y. 16
In Canada: Handicraft Tools, Ltd., Hermant Bldg., Toronto

On Permanent Alert

(Continued from page 94)

Normally, it would be much simpler to first fly the bombers to an advanced base and make the attacks from there. Eight days from the time the 22nd Bomb Wing left California it had arrived in Japan, established a new base and had dropped its first bombs on targets in North Korea.

The bombers attached to the Strategic Air Command are B-29s, B-50s that resemble the 29s in appearance but that have greater power, range and bomb capacity, and huge new B-36s that are just now going into service.

Standard equipment on all the operational types includes facilities for bombing by radar, remote-controlled defensive-gun batteries and, in the case of the B-50s, a pair of streamlined external tanks that adds 1400 gallons to the plane's supply. The tanks may be dropped when empty or their fittings may be used to carry a pair of 4000-pound bombs.

The B-50s, too, are all equipped with mid-air refueling apparatus of the hose or of the newer flying-boom type. One squadron of tankers is attached to each group of bombers. The tankers can top off a bomber's fuel tanks after it has climbed away from the field with a maximum load of bombs and partly filled tanks, or they can give a final refueling deep in enemy territory.

Lt. Gen. Curtis LeMay, commanding the Strategic Air Command, has given his heavy and medium bombers a new job in addition to their traditional role of destroying the sources of an enemy's strength. Now they can be used for retaliation. It isn't true that the Air Force could be dropping atom bombs on an enemy capital an hour after we were attacked, but it is true that our bombers could be on their way within a few hours.

Equipment and procedures both have been redesigned so that most of the aircraft in a group are always ready for action. Instead of being grounded for days when one of its 3500-horsepower engines needs repairs, a B-50 needs to be tied up for no more than an hour. In that time, four men can remove an entire powerpack and replace it with a pretested unit.

Each bomber can carry a "fly away kit" in its bomb bay, complete enough to maintain the aircraft for 30 days. Mechanics to service the plane are carried as passengers to the new base. Meanwhile a larger stock of tools, supplies and parts is flown to the new base by Military Air Transport Service. In theory and pretty much in practice, the bombers are always ready for action.

Easy To Build
U-MAK-IT BOAT KITS 8 FT. PRAMS ROWBOATS
 OUTBOARDS INBOARDS & CRUISERS

BUILD THE BEST U-MAK-IT KITS

SEND 25c (coin) NEW CATALOG ORDER YOURS TODAY

U-MAK-IT PRODUCTS 703P-WHITTIER ST. New York 59, N. Y.

DO MORE PLANING JOBS WITH LOW-COST BELSAW \$189.50

AMAZING 12 1/4-IN. PLANER Does All Ordinary Planing Mill Jobs. Provides attachments for Jointing, Rabbeting, Tongue, Groove, Matching. 12 1/4 x 6-in. capacity, 3-knife solid round all-steel cutterhead. Power feeds at 24 feet per minute, 42 cuts per inch. Provides for full line of accessory attachments—Grind and Joint knives IN THE CUTTERHEAD WITHOUT REMOVING.

BELSAW MACHINERY CO
 1015 Field Bldg., 315 Westport Rd., Kansas City 2, Mo.

FREE BOOK

FREE AMAZING NEW BOOK "HOW TO ANSWER ADS"

how to answer ads

Never before have you seen anything like this. Tells you in simple language the correct way to answer ads. Gets you quicker replies—better results, and greater satisfaction. Will save you time and money and it's **ABSOLUTELY FREE**. No obligation whatever. Every reader of advertising should have this booklet. Send a postcard for your copy **NOW**. Advertising Department, Popular Mechanics Magazine, Room 602, 204 East Ontario Street, Chicago 11, Ill.

Pioneers Leaders
AIR RIFLES BENJAMIN AIR PISTOLS
SHOOT WITH SAFETY

BE SAFE—SHOOT WITH COMPRESSED AIR—ALWAYS READY
 No Cartridges or Tanks to Replace or Recharge. If you want the most **PRACTICAL GUN** to use anywhere—inside or outdoors—get a **SAFE—CLEAN—ECONOMICAL BENJAMIN** with Adjustable Power and Amazing Accuracy. Send for Free Folder of Latest Models Today. **BENJAMIN AIR RIFLE CO., 890 MARION ST., ST. LOUIS 4, MO.**

SAY YOU SAW IT IN POPULAR MECHANICS

12-VOLT Delta Power-King Electric Lantern

\$5.95 less batteries

NEW!

Same Delta quality as the world-famous **POWER-LITE** — with **twice the light!** **POWER-KING** shoots light 1/4 mile. Adjustable, all-chrome head. Uses two 6-volt lantern batteries. See your hardware, sport or electrical dealer.

DELTA ELECTRIC COMPANY
 Marion, Indiana

Delta POWER-KING

Announcing the New CUSHMAN
EAGLE

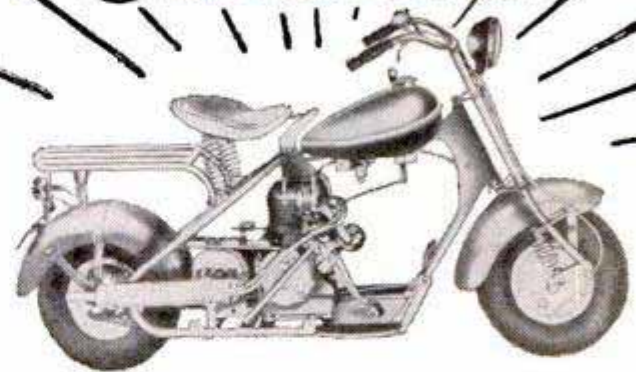

The sensational New Cushman **EAGLE** is ready! And, Boy! O Boy!—how you'll enjoy this entirely new thrill in motoring pleasure! It's big, husky, powerful, speedy! Has you moving at high speed within yards! Cruises up to 50 miles an hour out on the open road! Amazing fuel economy—up to 75 miles to the gallon! Luxurious comfort—big motor-bike saddle seat mounted on double coil springs . . . shock-absorbing springs on front wheel . . . big balloon tires designed for comfortable riding as well as easy steering and long life. Powerful 2-wheel brakes. 2-gallon (plus) fuel tank. Brilliant headlight, tail-light. Nothing else like it—and it's yours for only **\$282.50** f.o.b. factory.

Cushman
 MOTOR SCOOTER

85 MILES PER GALLON

Long-time favorite for lowest cost motoring! Thousands in use. Cheaper than bus fare or operating your car. Handles easy. Slips through traffic, parks anywhere. Wonderful for getting to work, school or market—making deliveries. Famous Husky engine.



WRITE
 See your Cushman dealer for the New **EAGLE** and regular **Cushman Scooter**. Or send for Folder M11.

Rider Agent Plan Available

DEALER INQUIRIES INVITED

CUSHMAN MOTOR WORKS, Inc
 LINCOLN, NEBRASKA USA

Exhibit this thrilling model Douglas SKYROCKET

Realistic Jet-Rocket solid-wood model, all parts ready-shaped for quick assembly. Complete with full-color decals, plastic canopy, and display stand, 59¢. At your hobby dealer.

Wingspan, 4 1/4"
 Fuselage, 8 1/2"

StromBecker

Send for free circular describing all models.
STROMBECK-BECKER MFG. CO., Moline, Illinois • Dept. PM 11



You own the BEST money can buy... when it's P&C

Square Opening
Movable jaw has full bearing surface on channel with any nut for greatest strength. Both chrome and semi-finish forged from tough alloy steel. Square opening grips square or hex nuts better.

There is a P&C tool for every job. Ask your hardware dealer for P&C punches, pliers, sockets, wrenches and screwdrivers—the BEST tools money can buy. **FREE TOOL BOOKLET** gives valuable information for every tool user. Send for your *free copy!*

P&C P&C HAND FORGED TOOL COMPANY
PORTLAND 22, OREGON

The Navy's Chamber of Horrors

(Continued from page 137)

so intricate that a 21-jewel watch movement seems almost crude by comparison. Yet these things must withstand interminable jouncing of trucks, the steady vibration of heavy airplanes, the heaving, jiggling decks of big ships under full speed. The lab's vibration tables test equipment for these hazards. Here, pieces of ordnance are put on platforms that can simulate any kind of jiggle known to man—from the slow, heavy thump of a trailer truck on a shell-pocked road, to the shivering tingle of a speeding plane. Vibrations can be increased to such a high frequency that the tables sometimes squeal like radios.

As for the careless handlers, there's a rough-handling machine that looks something like one of those rowing exercisers used in gymnasiums. A piece of ordnance, usually a live fuse, is fastened in the machine's claw, and gets pushed, pulled, yanked, twisted, jiggled, jogged and pounded in exactly 1024 different, accurately controlled directions at a rate of about one blow per second. An unsafe fuse doesn't stand a chance. Recently, the rough handler was incapacitated. It yanked so furiously it dislocated one of its own joints.

What happens to delicate mechanisms of mines and depth charges under the staggering pressures deep in the ocean? Big pressure vessels give Navy designers the answers. Pride of the new lab is the king-sized vessel recently completed. Its four-inch forged-steel walls measure eight feet in diameter and 30 feet long. Its yawning maw will accommodate anything up to a midget submarine and subject it to water pressures equal to a half-mile depth in the big briny. The torpedo, mine or whatever is to be tested, is rolled in on tracks and lashed to the monstrous walls. A gigantic hydraulic piston pushes the 39-ton door up into place. Then pneumatically controlled rubber gaskets squeeze against it and seal it. Valves open, pumps grind away and 15,000 gallons of water surge into the big tank. That fills it. Another 75 gallons, pumped in under pressure, raise the pressure inside the tank to 1000 pounds per square inch, or just what you'll find half a mile down. The water itself compresses about 45 of those extra gallons. The other 30 are taken up by—believe it or not—stretch in the 150-ton, four-inch steel-tank walls.

If the marine weapon stands up under all this, there still are a few more tortures. It can spend days in the salt-spray room, where it is doused and corroded within an

(Continued to page 266)

STOP FURNACE LEAKS

Save Fuel Costs

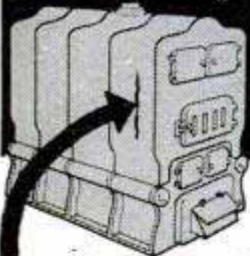

Seal up every heat-wasting crack, opened seam and other leak in your furnace, boiler, tank, radiators and piping **tight**—as professional repair men do—with **Smooth-On No. 1 Iron Cement**. Do it yourself—now—and cut this winter's fuel bills. You apply Smooth-On like putty, it hardens like metal, and *stays tight*, because it expands slightly as it sets. Buy Smooth-On No. 1 in 1 3/4-oz., 7-oz. or 1-lb. size at your hardware store. If they haven't it, write us.

FREE Repair Handbook

40 pages of ingenious, tested, short-cut repairs. Simple directions. 170 illustrations. Write today for YOUR free copy of the Smooth-On Handbook.

SMOOTH-ON MFG. CO., DEPT. 37L,
570 Communipaw Ave., Jersey City 4, N. J.

Do it with
SMOOTH-ON
THE IRON CEMENT OF 1 000 USES



Groban's WAR SURPLUS Bargains

ALL BRAND NEW—UNCONDITIONALLY GUARANTEED

DIRECT CURRENT GENERATORS



For welders, plating, truck and marine use, D.C. appliances, lights, etc. Aircraft quality—lifetime grease sealed ball bearings. Heavy duty.

- ITEM #89—Type M-2, rated 50 Amps.—24 Volts. Mfd. by Leeco-Neville Co. Shpg. wt. 32 lbs. Gov't. Acq. Cost \$176.00. F.O.B. Chicago **16.50**
 - NOW ONLY
 - ITEM #90—Type P-1, rated 200 Amps.—28 Volts, 2500 RPM. Mfd. by General Electric, Ford, Delco-Remy and Westinghouse. Gov't. Acq. Cost \$300.00. Shpg. wt. 70 lbs. F.O.B. Chicago **22.50**
 - ITEM #91—Type R-1, rated 300 Amps.—30 Volts. Mfd. by Jack & Heintz. Gov't. Acq. Cost \$380.00. Shpg. wt. 70 lbs. F.O.B. Chicago **35.00**
- Each individually packed in wooden box.

UTILITY PUMP ROTARY VANE TYPE

Perfect For Water, Oil or Insecticides

Sprays DDT, 2-4D, sulphur compounds, etc. Pressure to 150 lbs., 15 gals. per min. at 1200 RPM using 2 HP. As vacuum pump for milking machines, lab use, etc., delivers 26" vacuum, 4.5 cu. ft. per min. at 1500 RPM using 3/4 HP. Rotate either direction, 1/2" pipe thread ports, 1/2" standard shaft, 4 ball bearings. Easy to mount—Ready to run. Shpg. wt. 13 lbs. (ITEM #51) F.O.B. Chicago **16.50**



(ITEM #51)

D.C. GENERATOR FOR 12 VOLT SYSTEMS

BRAND NEW. Rated 15 Volts at 50 Amps. Use on 12 Volt circuits on trucks, tractors, ships, planes, battery chargers, auxiliary lights, etc. Base mounting with 4 bolt holes. 3/4" threaded shaft with keyway. Mfd. by Bendix-Ellipse Gov't. Acq. Cost \$136.00. Shpg. wt. 53 lbs. F.O.B. Chicago **21.50**



(Item #99)

HYDRAULIC CONTROL VALVES

- ITEM #24. Four-way control valve with built-in relief valve, for use with one double action hydraulic cylinder, may be used with 1500 P.S.I. hydraulic system to open and close hydraulic cylinders. Ship. wt. 8 lbs. A \$38.00 value **7.95** postpaid
- ITEM #26. Four-way control valve for use with two hydraulic double-action cylinders. Each cylinder may be operated independently of the other or in conjunction with the other. Oil may be locked in any of the cylinders to hold the piston at any required position. Ship. wt. 6 lbs. A \$60 value. **10.95** postpaid



(ITEM #24)

Hydraulic Cylinders—Air or Oil

Large supply of new labor-saving, economical hydraulic equipment in many types and sizes. Use these positive, highly efficient, smooth pressure hydraulics on presses, arbors, lifts, loaders, power control, positioning, brakes, plastic dies, auto frame alignment, etc., etc.

- ITEM #4—All steel double action hydraulic cylinder, 1 1/2" bore, 2 1/2" stroke. Clevis mounting. Will lift 1000 lbs. with 1000 P.S.I. line pressure. Perfect for positioning and feeding movements. Shpg. wt. 4 lbs. F.O.B. Chicago **4.95**
 - ITEM #33C—Double action hydraulic cylinder, 1 1/2" bore, 4 1/2" stroke. Clevis mountings at both ends. Uses 1/2" pipe fittings. Postpaid **8.95**
 - ITEM #32—Double action, 1 1/2" bore, 9" stroke, will lift 1760 lbs. with 1000 P.S.I. line pressure. Wt. 4 lbs. A \$45.00 value. Postpaid **10.95**
 - ITEM #41—Double action hydraulic cylinder, 2" bore, 6" stroke, clevis mounting at base and end of shaft. Overall length closed 12 1/2". Has 3/4" stainless steel shaft, uses 1/2" tubing fittings. Will lift up to 3100 lbs. with 1000 P.S.I. line pressure. Weight 7 lbs. Postpaid **12.50**
 - ITEM #6—Double acting cylinder, 1 1/2" bore, 27" stroke. Will lift 1760 lbs. with 1000 P.S.I. line pressure. Wt. 8 lbs. A \$55.00 hydraulic cylinder value for only Postpaid **12.95**
 - ITEM #15—Double acting cylinder, 3" bore 10 1/2" stroke. All steel hydraulic cylinder, will lift up to 7000 lbs. with 1000 P.S.I. line pressure. Wt. 12 lbs. A \$78.00 value, Postpaid **19.50**
 - ITEM #42—ITEM #31C—Double action hydraulic cylinder, 3 1/2" bore, 11" stroke. Aluminum alloy cylinder wall and all steel 1 1/2" diameter piston rod. Clevis mounting at base and shaft. 19 1/2" overall length closed. Will lift 9625 lbs. using 1000 PSI from Logan Heavy Duty Hydraulic Pump. Uses 3/4" tubing fittings. Value \$102.00. Shpg. wt. 11 lbs. F.O.B. Chicago **22.50**
 - ITEM #26A—Double action hydraulic cylinder, 3" bore, 25" stroke, will lift 7070 lbs. with 1000 P.S.I. line pressure. Steel barrel, 1 1/2" stainless steel shaft. Gov't. acq. cost, \$176.00. Shpg. wt. 26 lbs. F.O.B. Chicago **28.00**
 - ITEM #42—Double action hydraulic cylinder, 4" bore, 18" stroke. Rated lift capacity with 1000 P.S.I. line pressure is 12,560 lbs. Ship. wt. 30 lbs. AN EXCELLENT BUY **32.50** F.O.B. Chicago
- HI-PRESSURE FITTINGS for cylinders and valves available at 50c ea. for 3/4" pipe and 65c ea. for 1/2" size.



(ITEM #42)

HAND HYDRAULIC PUMPS

Used for hydraulic jacks, presses, hoists and other hydraulic applications. For operating hydraulic cylinders to pump oil or hydraulic fluid under pressure.

- ITEM #11—Hand pump has built in check valve and is capable of delivering 1000 lbs. of pressure. Has alloy aluminum housing. Dimen.: 8" long x 3 1/2" high x 2 3/4" wide. Ship. wt. 3 lbs. A \$45.00 value Complete with handle **8.95** Postpaid
- ITEM #82—Hand hydraulic pump with built-in transfer valve. **12.95** Postpaid

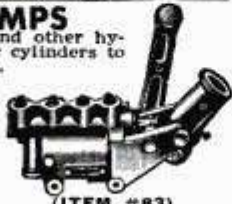

(ITEM #83)

AUXILIARY ELECTRIC A.C. GENERATING PLANT

FOR GENERAL UTILITY AND EMERGENCY USE 2500 WATTS - 115 VOLTS A.C. 60 CYCLES

Plenty of current to operate your: Oil Burner, Sump Pump, Refrigerator, Home Freezer, Power Saw, Lights, Radio and Television, Home Water System Pumps.

Complete integrated heavy duty electric power plant. Signal Corps Model PE-75, driven by Briggs & Stratton, one cylinder 6 1/2 H.P. Model ZZ, 4-cycle engine with killer button, oil bath air cleaner, governor, muffler, starting motor, and radio interference filter. The self-excited Leonard of Westinghouse generator is rated 2500 Watts, 115 Volts, 60 Cycle A.C. single phase, belt driven, with guard and duplex receptacle. When generator is not in use, you can use the engine separately to power other equipment. Mounted on adjustable steel skids, notched for carrying poles. Net wt. 310 lbs. Shpg. wt. 440 lbs. Dimen. 36"x19 1/2"x24". 12 month guarantee. \$726.00 value. **295.00** NOW F.O.B. Chicago

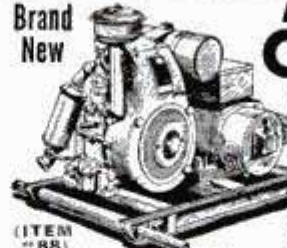

(ITEM #88)

NEW! STATIONARY OR PORTABLE D.C. ARC WELDER

250 AMP. MODEL 252 FOR ANY WELDING JOB, LIGHT OR HEAVY Stop Costly Repair Bills, Weld It Yourself and Save

Designed for many years of trouble-free service. This precision engineered Direct Current ELECTRIC ARC WELDER is offered at but a fraction of its original value. It can be mounted permanently or easily transported for portable use. Does the job instantly where and when you need it. Has dial type rheostat for easy pinpoint control and a high-low range switch. Run welder at 2500 RPM from drive pulley or power take-off of tractor, a 7 1/2 HP electric motor or a 10 HP gas engine. Use two V belts or flat belt (on pulley). Now...AT A FRACTION OF ITS VALUE. Price includes double V or flat belt pulley and instruction book, Shipping wt. 107 lbs. F.O.B. Chicago **99.50**

ACCESSORY KIT including welding helmet, electrode holder, two 10 ft. cables with clamp and 5 lbs. of assorted welding rods. (ITEM #66) Shpg. wt. 17 lbs. F.O.B. Chicago **10.50**

IF MORE INFORMATION IS DESIRED, write for WELDER CIRCULAR.

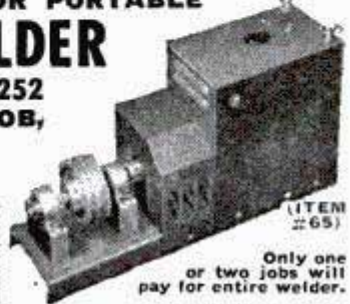

(ITEM #65)

SELF-PRIMING ELECTRIC PUMP

APPLICATIONS: Oil burners, aquariums, fluid metering, fuel pump, tool post grinder, coolant pump, pressure lubricating pump, general industrial, etc. Motor Mfd. by Black & Decker: Double Ball bearing, series wound, continuous duty 1/30 H.P. electric motor, rated 12,000 R.P.M. Transformer included for use on 110 V AC current. Also applicable for 24-32 V DC. Pump Mfd. by Weidon Tool Co. with standard 1/4" tubing ports; rated 2 G.P.H.; remove pump and use motor as high speed grinder. Overall Dimensions: 7 3/4" long x 3 1/4" wide x 3 1/4" high. Approx. wt. 5 lbs. \$31.00 value. (ITEM #1) postpaid **12.95**

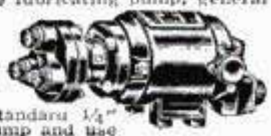

G-1 STAINLESS STEEL TANK

Use these tanks on compressors, for tire inflators, pulsation chambers, floats, buoys, hydraulic reservoirs, fluid and milk containers, fuel containers, etc. Tough, light, shatter-proof. 450 P.S.I. Aviator's Breath- ing Oxygen bottles, type G-1, 2100 cu. in. (approx. 9 gallons) int. vol. 24"x12", 1/4" threaded openings at ea. end. Wt. 19 lbs. F.O.B. Chicago **5.95**



(ITEM #63)

LOGAN HEAVY DUTY HYDRAULIC PUMP

For operating hydraulic cylinders and hydraulic motors on tractors, bulldozers, construction machinery, lift trucks, industrial applications, etc. Delivers 10 GPM at 1200 RPM at 1000 P.S.I. using 6 HP. Has a 3/4" inlet, 1/2" outlet, 3/4" shaft with flat and keyway for direct or pulley drive. Has flange with 4 bolt holes for convenient mounting. Ship. wt. 22 lbs. Overall dimen.: 7" L x 5 1/2" H x 5 1/2" W. A \$105.00 value. FOR ONLY **22.50** F.O.B. Chicago



(ITEM #29)

PUROLATOR OIL FILTER PERMANENT TYPE

The perfect oil filter to keep your motor oil or hydraulic fluid clean at all times. Protect your pump or engine with this unit. Just turn the handle and the element is clean. Standard 3/4" inlet and outlet ports to accommodate 12 gallons per minute. Shipping wt. 4 lbs. A \$13.00 value. (ITEM #70) Now **4.95** postpaid



FREE: 44-PAGE CATALOG WRITE TODAY

ORDER DIRECT FROM AD — SEND PAYMENT OR PURCHASE ORDER TODAY — SATISFACTION GUARANTEED

GROBAN SUPPLY CO. 1507 SOUTH MICHIGAN AVE. Chicago 5, Ill. Dept. PM 11

Want to start Fast?



You want Casite. Casite guarantees Quick Starting in Coldest Weather or Double-Your-Money-Back. Casite retards congealing of oil . . . lets the motor spin over and go . . . even in sub-zero temperatures.

Want more zip'n power?



You want Casite. Casite guarantees Better and Smoother Motor Performance or Double-Your Money-Back. Casite conditions your car for winter . . . gets rid of engine gum and goo . . . lets the power zoom through.

THEN GET CASITE—FOR ONLY 75¢

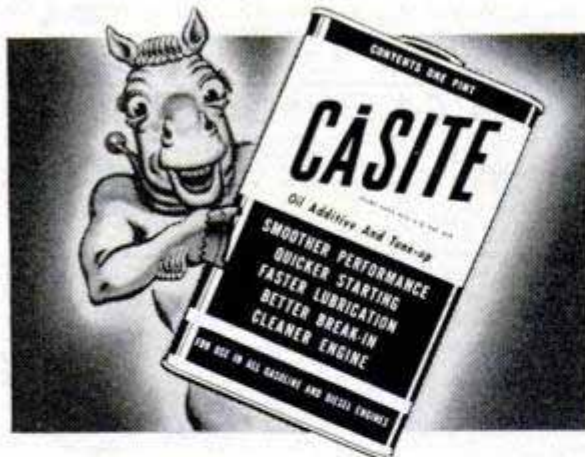

Whether you have a new car or old car, get Casite for your car today—from your garage, service station or car-dealer. You'll get smoother, happier driving for many miles to come. The Casite Corporation, Hastings, Michigan. Casite Division, Hastings Ltd., Toronto.

LIST PRICE 75¢ A PINT • 95¢ IN CANADA

QUICK STARTING IN COLDEST WEATHER
or Double-Your-Money-Back

inch of its steel hide—as it would be on the deck of a ship. In the big temperature rooms it will be subjected to almost any atmospheric condition you'll find on the face of the globe. Here it will run the gamut of temperatures from 100 degrees below zero Fahrenheit to 200 degrees above, in humidity ranging from a dose of tropical rain forest, to the dry frost of the stratosphere.

If you stand near the big sea-water tank, you can see how they test a torpedo's reaction to the warm tropic ocean after it has frosted for hours under the belly of an airplane flying at 35,000 feet. In the environmental lab, men dressed in Arctic clothing roll the torpedo out of the big temperature room where it has been crackling in stratosphere frost, and immediately plunge it into the near-by tank, where the brine has been warming to a tepid 100 degrees. Ice instantly forms around the hulk in a quarter-inch glaze. The propeller is started. If the works jam up, back it goes to the designers for a correction.

Other nooks and crannies in the lab contain strength testers for the parachutes that "let down easy" some of the more delicate implements of war. Row upon row of model-ship hulls, made of metal, permit designers to examine the magnetic fields set up by different ships, so they can be protected against the enemy's magnetic mines.

When a piece of ordnance survives all the ordeals of the Navy's new environmental lab, designers can be pretty sure their brain child will work in the field. The lab scientists love their work, but they love to needle the designers, too. "They make 'em; we break 'em," they say with a malicious grin. "We are devoted to the scientific destruction of our own weapons."

Competition for the Bees

Two former waste products now are yielding high-grade commercial wax, which was previously a monopoly of the bee in this country. Wax even harder than beeswax is extracted from Douglas fir bark by a process in which benzene acts as a solvent. Later the benzene is distilled off, leaving the wax. Very similar to the Douglas fir wax is the unusual oil of a little-known desert bush called Simmondsia. The plant, which for centuries has grown wild in Arizona and southern California, has nutlike seeds which yield a liquid wax. The treated wax is nearly as hard as carnauba, the hardest wax known.

Window shades made of plastic are washable, colorfast, fire-retardant and aren't affected by rain if a window is left open during a storm.

Success WITH Atlas



▲ From 3 to 19 employees in back room shop.

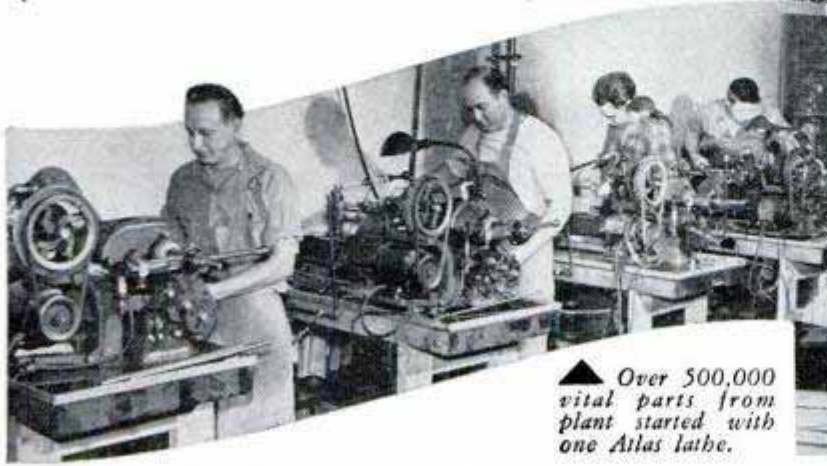

▲ Over 500,000 vital parts from plant started with one Atlas lathe.



◀ From garage shop to modern plant in three years.



▲ From 2 lathes and 1 drill press to 30 busy machines.



◀ From 2 Atlas tools in 10' x 18' shop to 65 Atlas tools in 50' x 135' plant — and all busy.



Perhaps you remember these pictures. Published during World War II, they showed how men with machining skill, and vision, and Atlas tools developed plants to handle war production.

Such needs are here again. As the nation strengthens its defenses the big production plants will have to rely on sub-contractors for many special operations and parts, just as they did before.

Atlas metalworking tools — lathes, drill presses, milling machines, and shapers — are ideal for such work. They are capable of the highest precision... are compact, need minimum space... and they are low in cost. Wherever new equipment is needed for defense production Atlas tools will serve efficiently and economically. Ask your Atlas distributor for complete details.

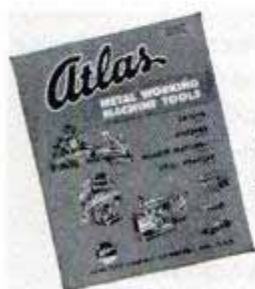

Use a postcard to send for this catalog today.

ATLAS PRESS COMPANY

1143 N. Pitcher St. • Kalamazoo, Mich.



**MATCHED PRECISION TOOLS FOR
WOODWORKING AND METALWORKING**



I built my own Garage
on weekends with
SKIL
Home Shop Tools

A new porch, an attic room, needed repairs, are
easy and economical with SKIL Home Shop Tools!

No project is too big or difficult for you with
SKIL Home Shop Tools to help. SKIL Home Shop
Saws cut wood and wallboard fast and true. Safe...
easy-to-use even by beginners and so inexpensive they
pay for themselves on a single job.

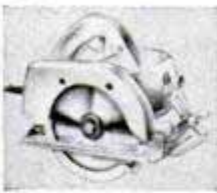

SKIL Home Shop
6 inch Saw
Bevel cuts! Adjustable— $3/4''$ to $1/8''$
Perfect for repairs,
remodeling, hobbies!
Model 520 \$59.50



SKIL Home Shop
Saw Table
Converts SKIL Home
Shop Saw to a tilting
arbor saw. Sturdy, ac-
curate, economical.
Model 497 \$29.95

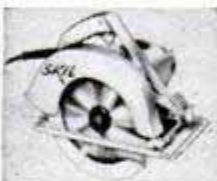

SKIL Home Shop
8 1/4 inch Saw
Bevel-cuts! Adjustable!
Rips, cross-cuts,
bevel-cuts 2 x 4's,
2 x 6's, 2 x 8's.
Model 565 \$84.50

Ask your dealer about these other SKIL Home Shop Tools

- 1/4 and 1/2 inch Drills
- Sander-Polisher
- Bench Stands
- Drill Kits
- 2 1/4" Belt Sander
- SKIL Trimmer

SKIL home shop Tools

Products of the
Home Shop Division
SKILSAW, INC.
Made by the makers of
world-famed SKIL Tools
for industry.

SKILSAW, INC. C-11
Home Shop Division
5033 Elston Ave. • Chicago 30, Ill.
Please send me full information
on SKIL Home Shop Tools and the
name of my nearest dealer.

Name.....
Address.....
City.....Zone.....State.....

Ball-Bearing SPEED WHEELS



JUVENILE WHEELS (No bearing, solid tires)
4"40c 6"65c
5"45c 7"75c
(Semi-pneumatic tire, ball bearing)
8 x 1.25...1.85 10 x 1.25...2.20
8 x 1.75...1.95 10 x 1.75...2.30
8 x 2.....2.20 10 x 2.00...2.65
12 x 1.75...3.45

INDUSTRIAL WHEELS
Lug Base, Semi-Pneumatic tire
5 x 1.75...3.65 10 x 2.00...6.10
6 x 2 SW...3.45 10 x 2.75...5.15
6 x 2.00...4.00 12 x 2.00...6.90
8 x 2.00...5.20 12 x 3.00...9.20
8 x 2.50...5.40 16 x 4.00...15.15
Smooth Base, Pneumatic tire and tube
8 x 3.00...11.00 12 x 4.00...12.10
10 x 2.75...6.80 4.00 x 8...13.10
10 x 3.50...10.55 14 x 4.50...13.40

Dealers, Jobbers, and
Manufacturers! Our new
prices will interest you.

Available Now—CASTERS
Write for circulars on all wheels.
No c.o.d. orders. Prices F.O.B. our plant.
JIM BROWN TOY COMPANY
1093 HOME AVENUE AKRON 10, OHIO

New BELT SANDER ONLY \$10.95



Stationary and Portable

Ideal all-purpose sander for home or shop! Stop-Fence Unit
adjusts to 4 positions — tilts to 45°. Sturdy aluminum con-
struction. May be powered by electric motor, drill, lathe, etc.
Send for free circular NOW!

JOHNSON Mfg. Co., Dept. 1G, Lincoln Park 7, R. L.



**TRAILER
PARTS**



**BULL DOG Hitches, Park-
ing Jacks and Axles for
all types of trailers!**

Write for **FREE Catalog**

Hammer Blow Tool Company
Wausau 13, Wisconsin

HANDEE-DAPTOR

CONVERT YOUR 1/4" DRILL TO 1/2"
Simply insert adaptor shank in 1/4" chuck.
HANDEE-DAPTOR chuck takes
all bits to 1/2" incl. Send... \$2.95

Direct if dealer cannot supply. For bar-
gain Motor & Power Tool catalog, send
25c. Refund on 1st order.
DANIELS PRODUCTS CO.
2224 N.E. 18 St., Oklahoma City, Okla.



DRAINS CELLARS, WASH TRAYS CIRCULATES OIL

Pumps 1800 GPH 300 gal.
30' high, use 1/8 to 1/2 HP motor. Will not clog. **\$6.50**

Postpaid if cash with order.
(Add 50c for west of the Mississippi.)
Thousands in use since 1936

LABAWCO PUMPS, BELLE MEAD 7, N. J.



FOR
FASTER WORK
IN HOME OR
SHOP...

HOLD-E-ZEE
The Original AUTOMATIC GRIP
SCREWDRIVERS

See these popular, high-quality
drivers with the exclusive Gripper
that holds, starts and sets up
screws in unhandy places!

New Models FOR RECESSED
HEAD SCREWS

At Leading Dealers Everywhere
UPSON BROS., INC., ROCHESTER 4, N. Y.

LONGER CAR LIFE!

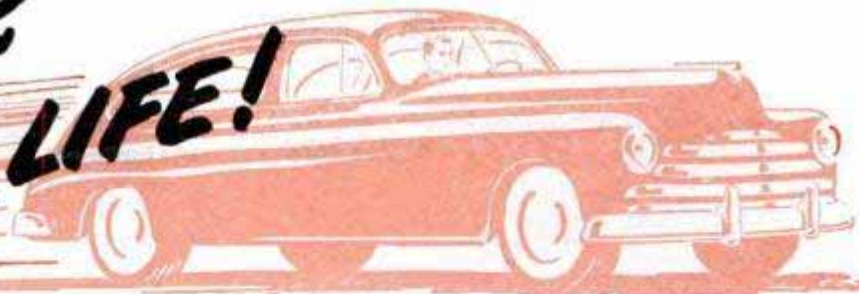

PRESERVE and PROTECT YOUR ENGINE

Marvel Mystery Oil pays out with Top Performance by protecting valves and rings, it leaves no sticky gum or carbon and gives your car added power through smoother lubrication.

With the scarcity of new cars Marvel Mystery Oil is more important to your car than ever. Automotive experts the world over know what Marvel does for a car.

• Install a Marvel Inverse oiler and eliminate damaging wear to your motor in the vital top-cylinder areas.



Ask your dealer and obtain expert advice about Marvel Mystery Oil; or Write today for Free information. Dept. No. 123.

EMEROL MANUFACTURING CO., INC., 242 West 69th St., New York 23, N. Y.



Asbestos Gloves for HOT Jobs

Handle hot things with safety. Wear Industrial's famous 210 asbestos gloves. Made of close woven 2 1/2 lb. Underwriters Grade cloth that resists burning. Big roomy cut, airy and comfortable. One piece construction with no seams at wrist or working edges to burn or pull out. Furnished lined or unlined. Almost 40 years experience designed and made these dependable gloves. Many styles. Write for prices and catalog.

INDUSTRIAL GLOVES CO.
1412 Garfield St., Danville, Ill.

In Canada:
Safety Supply Company, Toronto

INDUSTRIAL
Safety Apparel

Professional Quality

Snap-on

MIDGET PLIER SET

FOR JOBS AROUND CAR, HOME, CAMP



The 4 1/2" Needle Nose reaches into tight places . . . the 4" Side Cutter cuts wires, fish hooks, pins . . . the 4 1/2" Gripper is a general utility plier. All beautifully chrome-plated and fully guaranteed. In fine leatherette kit

\$7.15

Standard Size PL-30K Plier Kit \$11.05

MAIL THIS COUPON TODAY!

*T.M. Reg. U. S. Pat. Off.

SNAP-ON TOOLS CORPORATION
8062-K
28th Ave.
Kenosha,
Wisconsin

I enclose Check Money Order for the following plier kit

PLM-30K Plier Kit at \$ 7.15
 PL-30K Plier Kit at \$11.05

Add Local Sales Tax

Name

Address

City State

Give him this **THRILLING BOAT KIT** for Christmas

Sailfish

Trade Mark

SPORTABOUT



Now the fast, brilliant "Sailfish" comes knocked down for easy home assembly at a big saving! Safe-T-Plane hull can't sink or swamp. Carries conveniently on car top. Precision pre-cut and pre-formed parts of high quality materials go together quickly. All hardware included. **MULL KIT**, \$79.75. **SAIL KIT** with centerboard, rudder, spars, rigging and finished sail, \$59.75. **ASSEMBLED BOAT**, factory finished and complete with sail, \$217.50. All prices f.o.b. Waterbury, Conn. Illustrated literature on request.

Mfd. by **ALCORT, INC., Waterbury, Conn.**

also by California Sailfish Co., Newport Beach, Calif.
Tak-Kraft Mfg. Co., Montreal, Canada

Buy the Best... WISS!



for all sheet metal cutting

WISS Metal Master Compound Action Snips

#M-3. Easily cuts 18 gauge sheet metal. Cuts curves and circles as well as straight. Ideal for the home workshop. \$4.25. Rubber grips recommended, 60¢ extra.

WISS Straight Cut Snips

#9. Crucible steel inlaid blades. The basic snips for straight metal cutting. Gun metal handles. Overall length 12½". \$5.00.

WISS Combination Snips

#V-13. Solid steel, gray japanned handles. Cuts curves and irregular shapes with ease. Handy pocket size, 7" long. Accurately tempered jaws and strong bolts. \$1.75.



Prices slightly higher
Denver and West



Quality for more than a Century

J. WISS & SONS CO. • NEWARK 7, N. J.



"SAVE IT AND
FIX IT"

REPAIRS

CHINA, TOYS, FURNITURE
BOOKS AND LUGGAGE

It's transparent, waterproof,
flexible and durable.

Get a tube
today.



DUOCO CEMENT

REG. U. S. PAT. OFF.

NEW GRAVELY Snow-blower

5 HP

BLOW YOUR
SNOW TROUBLES
AWAY!

Snow Blower attachment for powerful 5-Horsepower Gravelly Tractor moves deep, dangerous snow swiftly and easily. 19 other attachments for every lawn, garden, field job. All-gear drive, reverse. Postcard brings complete story of "Power vs. Drudgery."



FREE! Write Today!

GRAVELY MOTOR PLOW & CULTIVATOR CO.
BOX 1163 DUNBAR, WEST VA.

END TROUBLE

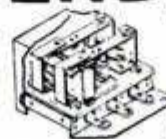

GENERATOR
REGULATOR
BATTERY
REPLACE VOLTAGE REGULATOR
WITH AMAZING NEW WATTAGE
REGULATOR
GREATEST ADVANCEMENT IN AUTO IGNITION
SINCE THE SELF-STARTER
DRIVE WITH OR WITHOUT BATTERY
100,000 MILE MONEY BACK GUARANTEE
STATE MAKE AND MODEL OF CAR AND SEND FOR FREE CATALOG

SCIENTIFIC ELECTRIC CO. P.O. BOX 2162-G STAN CLEVELAND, OHIO.



Print Your Own

Cards, stationery, circulars, tags, labels, photo and movie titles, advertising, etc. Save money. Print for Others, Good Profit; easy rules sent. Raised Printing like Engraving, too. Sold direct from factory only. Write for free catalog of outfit and all details. KELSEY PRESSES, M-37, Meriden, Conn.

POSTPAID
ANYWHERE
IN U.S.A.

WE FURNISH ALL MACHINED METAL PARTS, EVERY SCREW,
NUT, BOLT, WASHER, AND COMPLETE PLANS FOR THIS...

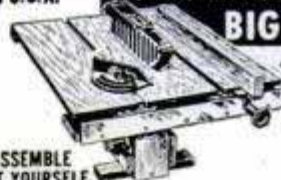

BIG 10" POWER SAW

\$10⁹⁵ FULL REFUND IF
LESS GUARD NOT SATISFIED
& WOOD IN 10 DAYS

ASSEMBLE
IT YOURSELF
WITH SIMPLE HOUSEHOLD TOOLS!

COMPLETE PLANS 10c
MARCUS-POLLAH
DEPT. N, ROYERSFORD, PA.



ROTARY FILES

Special Assortment of 10—\$19.95 Value, now ONLY \$9.95. Ground from the solid and hand cut—1/4" shanks. We also offer a complete regrinding service—SATISFACTION GUARANTEED. Inquiries invited.

INDEPENDENT TOOL CO., 6007 Euclid Ave., Cleveland 8, Ohio

SAY YOU SAW IT IN
POPULAR MECHANICS

SENSATIONAL WORLD WAR II BRAND NEW SOUVENIR



\$2⁹⁵

postpaid, complete
with official
sheath

The
Official British
Commando Issue
"FAIRBAIRN" FIGHTING KNIFE

ORDER TODAY! We have placed the entire available supply on sale. Here is another import scoop by R. H. Vazquez & Co. The "Fairbairn" is the actual knife used by British Commandos in hand-to-hand combat. Made of high quality steel. Blade length 7". Overall length 12". Genuine leather sheath with metal tip as issued. Absolutely the most beautiful knife of World War II, a rare and unusual bargain. Knives are brand new with blued finish. Postpaid... \$2.95

R. H. VAZQUEZ & CO., Dept. 11-PM
972 East Colorado Street, Pasadena 1, California



FOR PLEASURE AND PROFIT IN SHOP AND HOME

IDEAL CHRISTMAS GIFTS TO GIVE OR GET!

PRACTICALLY DESIGNED . . . EASILY OPERATED . . . QUALITY BUILT . . . FULLY GUARANTEED

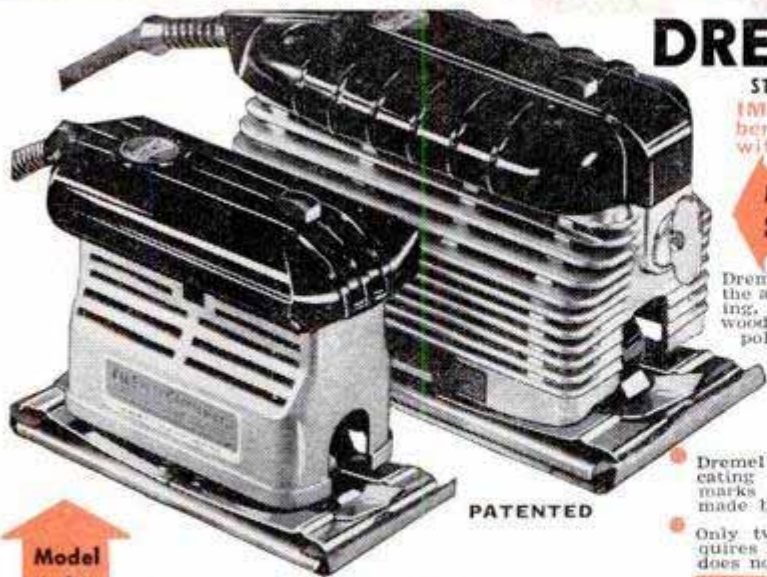

DREMEL *Electric* SANDERS

STRAIGHT-LINE Action for Guaranteed SCRATCH-FREE Surfaces
IMPORTANT—Before you buy just any sander, remember you cannot get an absolutely scratch-free finish with rotary, orbital, or arc-type sanders.

Model 2000
\$24.50

FOR HEAVY-DUTY CRAFT AND WOODWORKING PROJECTS

Dremel's new Model 2000 is a fast-cutting, production sander. It has the added stroke and extra power required for furniture and cabinet making, boat building or refinishing. Great for building operations, sanding woodwork, dry wall joints, siding and other surfaces. Does a superb wax polishing job, too. Weighs only 5 pounds yet has 21 sq. in. sanding surface. Over-all size, 3 1/4" x 4 1/2" x 7". Complete with steel carrying case, 25 asstd. sheets sandpaper, polishing pad. \$24.50.

LOOK FOR THESE DREMEL FEATURES

(IN MODEL A AND MODEL 2000 SANDERS)

- Dremel's Straight-Line Reciprocating Action leaves no sanding marks . . . removes scratches made by other type sanders.
- Only two moving parts . . . requires no oiling . . . sanding dust does not affect action.
- 14,400 cutting strokes per minute assure faster sanding-polishing.
- Cam-type holder permits changing paper in seconds.
- 8 ft. Underwriter's approved cord . . . operates on 110-120 volt, 60 cycle A.C. . . . fully guaranteed.

Model A
\$14.85

FOR HOBBY WORK, REFINISHING AND REDECORATING

Dremel Model "A" Sander is a time and labor saver for hobbyists, homeowners and housewives. Over a quarter million now in use. Like Model 2000, its straight-line reciprocating action will not leave cross-grain scratches and abrasive marks made by other type sanders. Ideal for sanding woodwork, cabinets, unfinished furniture, workshop projects, etc. Weighs only 2 1/2 lbs. Takes the drudgery out of polishing waxed surfaces—furniture, woodwork, etc. Sanding pad 2 1/4" x 5 1/2". Furnished with 6 sheets sandpaper, 1 sheepskin, 1 felt pad \$14.85.

DREMEL *Electric* COPING SAW

CUTS SCROLLS LIKE MAGIC—SANDS AS IT SAWS



BLADE
FACES
4 WAYS

FREE
PROJECT
PLANS

JUST
GUIDE IT!

Only
\$5.85
with 2 saw
blades

SAFE! AS A HANDSAW

For home, hobby, repair work—no other tool pleases so much for so little cost. Works in any direction—delivers 7,200 strokes per minute smoothly, effortlessly. Saws through 3/4" medium-hard wood at a foot-a-minute speed. Touch-of-the-trigger, foolproof action. Only 2 moving parts, never needs oiling. Uses 110-120 v. A.C.

. . . for 6 useful projects packed with each saw

WHERE TO BUY DREMEL TOOLS



Dremel Tools are sold everywhere. If your dealer cannot supply you, send remittance in full and we will ship postpaid. Or send only \$2, and pay postman balance plus postage and fee. Money back if not delighted after 5 days' trial.

DREMEL MFG. CO., DEPT. 110-L, RACINE, WIS.

DREMEL MOTO-TOOL

THE POCKET-SIZE MACHINE SHOP



MOTO-TOOL KIT NO. 2
With 23 Accessories
(High Speed Steel Cutters, Grinding Wheels)
\$23.50
MOTO-TOOL NO. 2
(only) with one emery wheel point — **\$16.50**

Moto-Tool is the most versatile tool you can own—grinds, routs, drills, carves, engraves, polishes, etc. Look at these features: Approx. 27,000 R.P.M. • Dynamically balanced armature eliminates vibration. Oilless (oil-sealed) bearings • Dust-filtered air-cooling system • Weighs 13 oz. • Uses 110-120 v. A.C. • Used in plants of General Electric, Ford, Remington Arms, Nash-Kelvinator, etc.

Don't confuse Moto-Tools and Accessories with so-called "bargain offers". Compare Dremel feature for feature with competitive tools. If our products are not superior in every way, we don't want you to buy.

Portable
**DRILL
PRESS**

Only
\$9.95

(Less
Moto-Tool)



BIG VALUE!

MOTO-TOOL KIT NO. 1

Moto-Tool Kit No. 1 contains the lighter Model No. 1 Moto-Tool and 34 practical accessories (steel cutters, grinding wheels, etc.) in an attractive lacquer-finish wood case. It's the biggest value in the field. With 34 Accessories Only. . . **\$17.50**

MOTO-TOOL NO. 1 with one emery wheel point. . . . **\$9.85**



M-SCOPE TREASURE-MINERAL LOCATORS

WRITE FOR FREE, ILLUSTRATED 16-PAGE BOOKLET

M-Scope Treasure-Mineral Locators, Geiger Counters. New Low Prices, unsurpassed in efficiency. Full factory guarantee. Immediate shipment.

YOU CAN PURCHASE THESE INSTRUMENTS ON A MONTHLY PAYMENT PLAN



URANIUM

FISHER RESEARCH LAB, INC., PALO ALTO, CALIF.



GOLD

EVERYWHERE in the home
keen edges do better work

Complete Set
\$295



An INDIA® Bench Stone, with coarse and fine sides —
A CRYSTOLON® Pocket Stone —
A QUICKCUT® Knife Sharpener —
A CRYSTOLON Home and Garden Sharpener —
A copy of the booklet, "How to Sharpen"
*Trade Mark

The Sharp-N-All Kit

of selected NORTON ABRASIVES® Stones will give you edges every craftsman wants, whether you're cutting a mortise, carving a roost, or trimming a hedge. Four stones, each one just right for its purpose. Also a copy of the new "How to Sharpen" book—32 pages of expertly compiled, profusely illustrated pages on sharpening scissors, carvers, shop tools, sickles, shears, etc. Every household needs this set. At your hardware store.



BEHR-MANNING
TROY, N. Y.

Also Mfrs. of Abrasive Paper and Cloth

up to **35 Miles Per Gallon**
With
"MILE-O-METER"

REG. U. S. PAT. OFF.



MILES PER GALLON AND MOTOR TUNE-UP GAUGE

Fits all cars—PERMANENTLY MOUNTED—Checks Spark Plugs—Carburetor and 31 other Motor adjustments. Registers miles per gallon at every speed and under every condition. 1 to 5 minute installation—4 Color Easy to Read Dial. Measures Gas vapor flow and Manifold pressure. No Holes to drill. Mounting Bracket Fits Dash or Windshield Frame. No experience to install and operate. Complete instructions and 16 page mileage book by Chrysler included. Makes a perfect gift. (Beautifully gift wrapped at no charge). 1,000,000 in use.

Recorded mileage up to 35 M.P.G. on light cars driven with pointer out of "Red" area. Shows best method of driving for economy. Works all the time as a constant mileage and motor checking device. A fine watch precision instrument to enhance any dash-board. Dealers and Distributors write for details. Money Back Guarantee.

Standard Model Chrome Ring 2 5/8" Dial — \$ 7.50
Deluxe All Chrome Model 3 5/8" Dial — \$12.95

SEND FOR YOURS TODAY FOR PROMPT DELIVERY!
Dept. 304

GALE HALL ENGINEERING BOSTON 18, MASS.
WORLD'S LARGEST PRODUCERS OF TUNE-UP GAUGES

SPRAYING MADE EASY

BECKER *Self-Contained* PRESSURE GUN

Saves Cost of Compressor and Motor

TAKE IT ANYWHERE—the first completely portable spray gun. Needs no compressor, motor, or electrical outlet. Pressure-powered with an inexpensive CO2 cartridge that sprays up to 21 liquid ounces, depending on viscosity. Extra cartridges, 10 for \$1. postpaid, or buy from your dealer.

PAINTS • VARNISHES • ENAMELS
MOTH-PROOFS • INSECTICIDES

Every home needs a Becker Spray Gun for dozens of jobs in the house, workshop, garden or garage. Complete instructions furnished for effective results. Order yours today for the season ahead.

HOW TO ORDER—If your dealer can't supply, send \$15.95 and we ship postpaid—or \$2 now and pay postman balance plus postage and fee. Money back if not delighted after 5 days' trial.

SULLIVAN-BECKER CO.
Dept. 110-L, Kenosha, Wisc.



ONLY
\$15.95
with 3
cartridges



MARCOT KEY MACHINE



Immediate Delivery

MARCOT No. 8 KEY MACHINE, less motor \$ 95.00
Auto Code Book and Depth Keys. 12.50
75 Dz. Popular Key Blanks. 60.00
Set — Key File, Follow-Through Rods, Lock Picks, Bit Key Gauge, Thimble, Pins, Springs. 10.50
"Locksmith Trade Books" 6.75
How to Open Locks without Keys or Picks; Secret of Locksmithing; How to Make Keys by the Impression Method; Master Key Systems.

TOTAL COST \$184.75

A. J. MARCOTTE CO., 1200 N. Kedzie Ave., Dept. PM, Chicago 51, Ill.

LAWN ORNAMENT-NOVELTY PATTERNS



28 Lawn Ornament Patterns, 25c. Other patterns; 15-20" high; Dutch Girl, Dutch Boy, Pirate, Bull Terrier, Mexican Girl, Mexican Boy, Dwarf, Penguin, Flower Girl, 10c each. 25 Novelty Patterns, 30c. All 62 Full Size Patterns, \$1.00 Postpaid. Strother Pattern Service, Dept. BY-8, Box 128, Belington, W. Va.

ONE-MAN SAWMILL LOW \$50.00 AS... \$50.00 DOWN



Take BELSAW Portable Sawmill right to the trees—turn out valuable lumber for local yards—do "custom sawing" for neighbors. BELSAW lasts a lifetime. No crew needed. Power with old auto engine. Beginners get excellent results. Send postcard for FREE BOOK, "How To Make Lumber."

BELSAW MACHINERY CO.
8112 Field Bldg. 315 Westport Rd. Kansas City 2, Mo.

WEATHER INSTRUMENTS

Barometers • Thermometers • Psychrometers
Anemometers • Wind Vanes • Rain Gages

send \$.10 in stamps for catalog

SCIENCE ASSOCIATES

401 N. BROAD ST., PHILADELPHIA 8, PA.

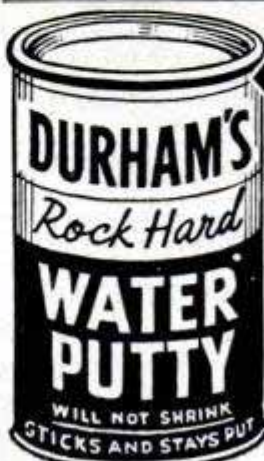

The Modern **PLASTIC**
for lasting Home Repairs

PERMANENTLY mends cracks or holes in wood, tile, stone or plaster. Sticks and stays put—Does not chip, shrink or fall out. Easy to use. Economical. Mold it, chisel it, polish or paint it. If unobtainable from your lumber, paint or hardware dealer, the big 4-lb. can will be sent you postpaid (in U.S.) for only \$1. Full money-back guarantee, order now.

DONALD DURHAM CO.
Box 804-W, Des Moines, Iowa

THE MOST *Versatile* TOOL
ON YOUR BENCH...

CHANNELLOCK Pliers

Made only by
CHAMPION DEARMENT!



In almost any job you can think of—Pliers are necessary—and Channellock pliers are the best you can buy. Whether you are working on your car, electrical repairs, plumbing work or just tightening nuts and bolts Channellock pliers do it better. Channellock pliers' outstanding features such as: Longer Service, No Wear On The Joint Bolt, Greater Strength, Closely Spaced Adjustments and Self Cleaning make them the most versatile tool on Your Bench. And remember, Only Champion DeArment makes Channellock—Nearly 3/4 of a century of experience in producing highest quality tools. Send for Catalog D15 Today.

CHAMPION DEARMENT TOOL CO.
Meadville, Pa.

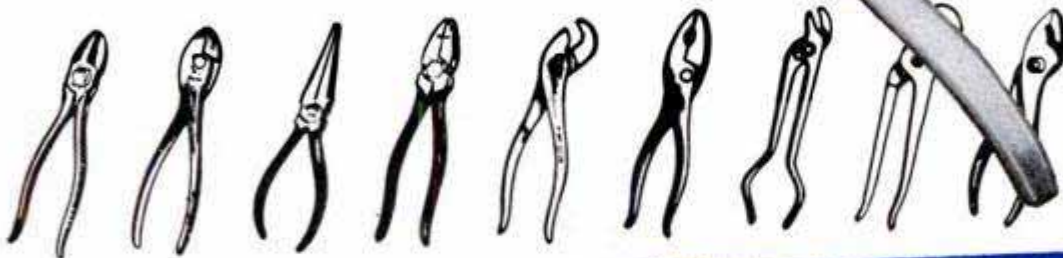

Channellock pliers are listed in the Yellow Pages of most Telephone Directories under "Tools"



Only CHAMPION DEARMENT...

makes

CHAN NEL LOCK

SEARS
ROEBUCK AND CO.

**TRY IT
10 DAYS!**

PROVE its faster, cleaner, smoother shaving
ON YOUR OWN FACE in this 10-Day Test!

**YOUR MONEY BACK . . . without
question . . . if this superb**

CRAFTSMAN ELECTRIC SHAVER

doesn't give you the **FINEST
SHAVING** you've ever known!



Complete in
handsome,
handy
carrying
case



\$17⁵⁰
Complete
with Case

Here's why **it gives you such
a quick, smooth, comfortable shave!**

- Double-action square head and TWO round heads combine efficient long-hair cutting EDGES with effective, close, smooth-shaving SURFACES!
- These heads are set on a scientifically designed, face-fitting contour-angle . . . to give maximum shaving surface for faster, smoother, better shaving!

Buy this fine quality CRAFTSMAN Electric Shaver at your nearest Sears Retail Store TODAY! Try it 10 days! If you don't get the quickest, cleanest, most comfortable shaving you've ever known . . . we'll return your money without question! Compare its smooth-shaving ability with ANY other shaver! UL approved! One-year guarantee and service at NO extra cost! For 110-120-volt AC-DC use. Try it TODAY for the finest shaving you've ever enjoyed! Its lower price will please you, too!

CRAFTSMAN by SEARS, ROEBUCK and CO.

**NEW
Coprion
SEAMLESS
BELL**



**MAKES YOUR
PLAYING
Easier!
Better!**

First and only seamless bell, of superior new metal, made by electro-mechanical process. Impossible to overblow or crack a note! Gives amazingly greater flexibility, richer tone quality, easier response. Exclusive on Conn trumpets, cornets, trombones. Most important development in years. Preferred by leading artists. See your Conn dealer or write us. Please mention instrument. Conn Band Instrument Div., C.G. Conn Ltd., 1131 Conn Bldg., Elkhart, Ind.



**Write
FOR FREE
FOLDER**

Only
\$498



**OTTAWA
Mule Team Tractor**

Finest low-cost tractor. Costs too little to do without. Engines burn gasoline. Seven models. Starter and lights available. Other larger Models to choose from. Over 4,000 in world-wide use. Time-proved and tested. At low cost they easily mow, plow, disc, harrow, plant, cultivate, etc. Sold only direct to user. Write for FREE details.
OTTAWA MFG. CO., 2-027 Garden St., Ottawa, Kansas

**STOPS FOGGY WINDSHIELDS
NEW Chemical Mitt**



Amazing Discovery! Autoists wild over new FOG-STOP Windshield Cleaner. Simply glide over windshield chemically-treated Mitt—at once glass sparkles crystal clear. Blurry mist, frost, sleet, snow disappear like magic. Stops fogging. *Sells like wild!*

SAMPLES FOR AGENTS Sample offer sent immediately to all who send name at once. Hurry. Postcard will do. **SEND NO MONEY—just your name.** KRISTEE CO., 678 Bar Street, AKRON, OHIO

Have fun! BUILD YOUR OWN CHAMPION

SPEEDBOAT

Build your own 3 point racing Hydroplane or Runabout! Complete plans available for fastest boats in the world. Send 25c now for new illustrated catalog to **CHAMPION BOATS, P. O. Box 7132 M, Long Beach 7, California**

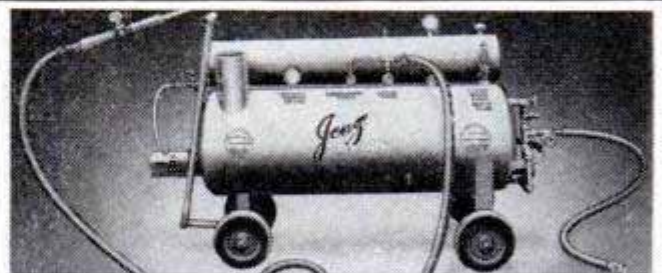

\$6.00 PER HOUR

At a cost of 20c with the NEW JENZ SUPER CHIEF STEAM CLEANER. Portable—No moving parts—Cleans anything—Any place—Motors—Chassis—Machinery—Floors—Buildings—Oil Rigs, etc.—Oil fired—Economical—Fully tested and warranted. 75 lbs. steam in ten min.—Model 80. Complete as illustrated. **\$315.50**

F.O.B., factory
HI-PURE LABORATORIES, Evansville, Ind.



No. 34-405 10" Tilting-Arbor Saw — The famous profit-making Unisaw®. Massive table 27" x 36". - \$234.00*

DELTA
MILWAUKEE
®



No. 34-305 10" Tilting-Table Saw — A low-cost dependable machine. Cuts stock 3 1/4" thick. Table 20" x 27". - \$190.90*

DELTA SAWS

are today's *Best Buys*

They give you **BIG-SAW** performance at small-saw cost



No. 20-A Delta Multiplex® Radial-Arm Saw — Does more than 125 jobs! Complete with motor and switch. - \$205.00

For over 25 years Delta Power Tools have set the standards in schools, industrial plants, commercial shops, home workshops. That's why thousands of satisfied users know and talk about Delta quality... quality that builds new profits at low cost.

Why risk the high cost of cheap tools today? Buy Delta **FIRST** and be satisfied from the start. Delta puts precision accuracy into every tool it builds... quality is always there.

Delta offers you the *only complete* line of power tools to choose from. You get capacity and quality at the price you want to pay.

See your Delta dealer and write today for the complete catalog.

DELTA POWER TOOL DIVISION



Rockwell

Manufacturing Company

802M East Vienna Avenue

MILWAUKEE 1, WISCONSIN

No. 34-265 8" Tilting-Arbor Saw — You get more saw for the money. Big table, 25" x 33". Cuts stock 2-5/16" thick. Rips to center of 54" panel. \$157.40*



*Motor and switch extra. All prices subject to change without notice.

8-6



Lubring



Utica's "Lubring" pliers are the finest in the world.

An exclusive, patented Utica process builds into the joint of these pliers a porous metal ring containing a lubricant. This lubricating ring "floats" in the joint, carries no stress, but assures smooth, free action.

Your tool supplier has Utica's "Lubring" pliers or can get them for you. Or write us. For the best, insist on "Lubring".

FREE Send for interesting folder describing the "Lubring" line. Utica Drop Forge & Tool Corporation, Utica 4, N.Y.



It pays to buy **U T I C A** quality tools

And the world's best tools are made in U.S.A.

A New... and Better Push Drill by "YANKEE"

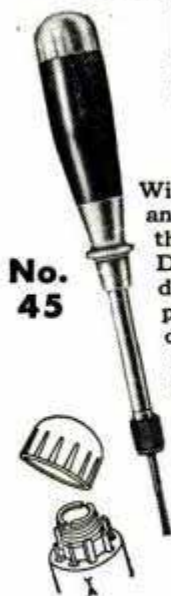

No. 45

With a handle that fits your hand and a flange to rest your thumb, the ALL-NEW "Yankee" Push Drill No. 45 makes quick work of drilling small holes... in wood or plastics. Magazine handle holds 8 drill points ($\frac{1}{8}$ " to $\frac{1}{4}$ "). Improved chuck... drills can't pull out. Automatic return action clears chips. Buy it from Hardware Dealers and Industrial Supply Houses everywhere. Send for booklet "How 'Yankee' Tools Make Good Mechanics Better" FREE. North Bros. Mfg. Co., 217 West Lehigh Ave., Philadelphia 33, Pa.

"YANKEE" TOOLS NOW PART OF

STANLEY
Reg. U.S. Pat. Off.

THE TOOL BOX OF THE WORLD

NORTH BROS. MFG. CO., Philadelphia 33, Pa.

STRIP PAINT



the EASY way

Avoid hours of hard scraping. Apply WONDER-PASTE with a paint brush, and the toughest paint, varnish, enamel, lacquer, or shellac becomes a soft sludge that peels off easily with a putty knife. Leaves surface so clean no sanding is needed. Won't run on upright surfaces. Harmless to your hands or fabrics. Try it—see why it's called WONDER-PASTE! At paint and hardware stores everywhere.

Write for leaflet

WONDER-PASTE

Wilson-Imperial Co. 119 Chestnut Street, Newark 5, N. J.

NEW PACKAGED BOATS



17 models. 8'-16'; Tredonite racers, cruisers; Outboard, inboard, skiffs. Assembled frames; Tri-Keel construction; Tredonite bottom; spray rails; easy to build!

SEND 25c FOR CATALOG!

Catalog and booklet "Plywood Boats", \$1.00

BOAT PATTERNS-BLUE PRINTS



1950 Catalog—100 designs by naval architects. Racing classes, cruisers, inboard, outboard, sail, 6 to 35 ft. Plywood—Steel—Plank. Construction plans, full-size patterns. **SEND 35c FOR CATALOG** or \$1.00 for catalog and booklet on "Boat Building."

MARINE MART-DEPT. 24-BUFFALO 7, N. Y.

FALSE TEETH

KLUTCH holds them tighter

KLUTCH forms a comfort cushion; holds dental plates so much firmer and snugger that one can eat and talk with greater comfort and security; in many cases almost as well as with natural teeth. Klutch lessens the constant fear of a dropping, rocking, chafing plate. 25c and 50c at druggists... If your druggist hasn't it, **don't waste money on substitutes**, but send us 10c and we will mail you a generous trial box.

KLUTCH CO. Box 5093-K ELMIRA, N. Y.

MAKE BIG MONEY!



Be a floor surfacing contractor and sand both new and old floors. Sanders are easy to operate and better still, you're your own boss. Write for latest "tell-all" booklet entitled "Opportunities in Floor Surfacing", enclosing 25 cents in coin or stamps to cover handling.

AMERICAN
FLOOR SURFACING MACHINE CO.
325 So. St. Clair Street - Toledo 3, Ohio

HOLLYWOOD MUFFLER

THE TONE YOU LOVE TO HEAR



MORE SPEED-POWER-MILEAGE

are yours with a Hollywood Muffler... plus a tone you'll love to hear! Not a gutted muffler. Easy to install.

Hollywood Muffler: Trade-mark Reg. U. S. Pat. Off.

IMPROVED DESIGN
PRECISION MADE
ELECTRIC WELDED!



Outlasts ordinary mufflers 3 to 1

Ford, Chevrolet, Plymouth \$6.00

All other cars \$8.00

Duals, Ford & Merc. \$24.50. 3" Chrome Barker Tip, \$3.25. Order direct. Send check or M.O. and save postage.

Dealers Write **WILKINSON MUFFLER CO.** 811 WILT STREET FT. WAYNE, IND.

DIRECT CURRENT GENERATORS



FOR ANY WELDING JOB, LIGHT OR HEAVY, plating, truck or D. Appliances. PORTABLE AND RURAL LIGHTING, or power plant. Heavy duty, aircraft quality, air cooled commutator, and lifetime grease sealed ball bearings.

Stock No. 535 - Type P-2, rated 200 amps. 28 Volts. Mfg. by Eclipse-Bendix. Govt. acq. cost approx. \$300

NEW, ONLY. \$21.50

Used, but in guaranteed condition - ONLY. \$15.50

Build your own light plant (cap. load 5,000 watts) the easy inexpensive way. Simple instructions included for P-2 generator.

Stock No. 537 - Type R-1, rated 300 amps. 30 Volts. Mfg. by Jack & Heintz. Gov't acq. cost over \$350. New, only. \$32.50

Used, but in guaranteed condition. Only HEAVY DUTY WELDER Make your own ARC HEAVY DUTY WELDER the easy inexpensive way of continuous welding, rating 200-300 amps. Simple instruction included, for P-2 and R-1 types. Prices f.o.b. K.C. Ship. wt. approx. 70 lbs.

NEW, ONLY. \$25.50

Used, but in guaranteed condition. Only

Make your own ARC HEAVY DUTY WELDER the easy inexpensive way of continuous welding, rating 200-300 amps. Simple instruction included, for P-2 and R-1 types. Prices f.o.b. K.C. Ship. wt. approx. 70 lbs.

NEW, ONLY. \$32.50

Used, but in guaranteed condition. Only

Make your own ARC HEAVY DUTY WELDER the easy inexpensive way of continuous welding, rating 200-300 amps. Simple instruction included, for P-2 and R-1 types. Prices f.o.b. K.C. Ship. wt. approx. 70 lbs.

NEW, ONLY. \$32.50

Used, but in guaranteed condition. Only

Make your own ARC HEAVY DUTY WELDER the easy inexpensive way of continuous welding, rating 200-300 amps. Simple instruction included, for P-2 and R-1 types. Prices f.o.b. K.C. Ship. wt. approx. 70 lbs.

NEW, ONLY. \$32.50

Used, but in guaranteed condition. Only

Make your own ARC HEAVY DUTY WELDER the easy inexpensive way of continuous welding, rating 200-300 amps. Simple instruction included, for P-2 and R-1 types. Prices f.o.b. K.C. Ship. wt. approx. 70 lbs.

NEW, ONLY. \$32.50

Used, but in guaranteed condition. Only

Make your own ARC HEAVY DUTY WELDER the easy inexpensive way of continuous welding, rating 200-300 amps. Simple instruction included, for P-2 and R-1 types. Prices f.o.b. K.C. Ship. wt. approx. 70 lbs.

NEW, ONLY. \$32.50

Used, but in guaranteed condition. Only

Make your own ARC HEAVY DUTY WELDER the easy inexpensive way of continuous welding, rating 200-300 amps. Simple instruction included, for P-2 and R-1 types. Prices f.o.b. K.C. Ship. wt. approx. 70 lbs.

NEW, ONLY. \$32.50

Used, but in guaranteed condition. Only

Make your own ARC HEAVY DUTY WELDER the easy inexpensive way of continuous welding, rating 200-300 amps. Simple instruction included, for P-2 and R-1 types. Prices f.o.b. K.C. Ship. wt. approx. 70 lbs.

NEW, ONLY. \$32.50

Used, but in guaranteed condition. Only

Make your own ARC HEAVY DUTY WELDER the easy inexpensive way of continuous welding, rating 200-300 amps. Simple instruction included, for P-2 and R-1 types. Prices f.o.b. K.C. Ship. wt. approx. 70 lbs.

NEW, ONLY. \$32.50

Used, but in guaranteed condition. Only

Make your own ARC HEAVY DUTY WELDER the easy inexpensive way of continuous welding, rating 200-300 amps. Simple instruction included, for P-2 and R-1 types. Prices f.o.b. K.C. Ship. wt. approx. 70 lbs.

NEW, ONLY. \$32.50

Used, but in guaranteed condition. Only

Make your own ARC HEAVY DUTY WELDER the easy inexpensive way of continuous welding, rating 200-300 amps. Simple instruction included, for P-2 and R-1 types. Prices f.o.b. K.C. Ship. wt. approx. 70 lbs.

NEW, ONLY. \$32.50

Used, but in guaranteed condition. Only

Make your own ARC HEAVY DUTY WELDER the easy inexpensive way of continuous welding, rating 200-300 amps. Simple instruction included, for P-2 and R-1 types. Prices f.o.b. K.C. Ship. wt. approx. 70 lbs.

NEW, ONLY. \$32.50

Used, but in guaranteed condition. Only

Make your own ARC HEAVY DUTY WELDER the easy inexpensive way of continuous welding, rating 200-300 amps. Simple instruction included, for P-2 and R-1 types. Prices f.o.b. K.C. Ship. wt. approx. 70 lbs.

NEW, ONLY. \$32.50

Used, but in guaranteed condition. Only

Make your own ARC HEAVY DUTY WELDER the easy inexpensive way of continuous welding, rating 200-300 amps. Simple instruction included, for P-2 and R-1 types. Prices f.o.b. K.C. Ship. wt. approx. 70 lbs.

NEW, ONLY. \$32.50

Used, but in guaranteed condition. Only

Make your own ARC HEAVY DUTY WELDER the easy inexpensive way of continuous welding, rating 200-300 amps. Simple instruction included, for P-2 and R-1 types. Prices f.o.b. K.C. Ship. wt. approx. 70 lbs.

ELECTRIC MOTOR 1/2 H.P. 27 V.D.C. R.P.M. 4000 No. 750.
For Intermittent or Continuous Duty. 3/8" SHAFT. VARIABLE SPEED MOTOR CAN BE ADAPTED TO 110 V. A.C. or R.E.A. line by simple armature brush leads. UNUSED. Instructions incl. \$5.50

ELECTRIC MOTOR 1/2 H.P. 24 Volt D.C. Amp. 22 #HCA24. Gov't cost \$75.00. Brand New. \$4.50

ELECTRIC MOTOR 1/4 H.P. 28 Volt D.C. #2832 with simple instructions to convert to 28-32 Volt A.C. Gov't cost \$82.84. Brand New. \$3.50

ELECTRIC MOTOR 6 Volt D.C. Delco-New Handies 6" fan blade. Use as windshield wiper motor, hot water car heater motor, commercial or toy applications. 1 1/4" Dia. 1 1/8" long shaft. Size 5" long X 3". 2 mounting studs. 1200-2000 R.P.M. NEW Only. \$2.35 paid

DYNAMOTORS Brand New Type DA-3A. Input 28 V. DC 10.5 amps. Output 300 Volts, 150 volts or 14.5 Volts. R.P.M. 4700 Continuous duty. \$5.50

Dyn., New. Input 28 V. 19 amps. Output 1000 V. D.C. Base mounting incl. G.E. Model PE-73-CM. Wt. 38 lbs. only. \$4.50 f.o.b.

Dyn., New. Model 23350. Input 27 V. D.C. Output 285 V. D.C. \$1.75 Postpaid

ECLIPSE MOTOR & GEAR UNIT

Brand New. This is a 24 V. D.C. motor with built in planetary and bevel gear reduction. Has 1- horizontal and 1- vertical take off shaft. Overall gear ratio to motor is 40:1 can be adapted for 2-1 or 20:1 ratio. Unit can be operated from 32 D.C. Farm light plant. Ideal as OVERHEAD GARAGE DOOR OPERATOR, DRIVE FOR SMALL

HOLST, WELL PUMP JACK, LAWN MOWER DRIVE, DRIVE FOR POST DRILL, etc. Wt. 23 lbs. Gov't. cost \$221.00. (Instructions incl.) Only \$12.50

Pesco Vacuum Air—General Purpose Pump

Here is a pump for air, fluid, pressure or vacuum. Standard 1/2" pipe thread. Delivers 300 G.P.H. at 2000 R.P.M. Runs forward or reverse. Self-aligning shaft. Splined terminal for direct drive, readily replaced with a pulley. Use them for oil burners, MILKING MACHINES, COMPRESSORS, VACUUM PUMP, etc. Engineering report and instructions incl. \$8.95 Postpaid

Brand New Wonderful ROTATOR MOTOR

For rotating Ham, FM Antennas, Turntables, Telescopes, etc. Applicable for 110 V. A.C. 60 cycles or for 24 V. D.C. as reversible motor. Approx. 7 R.P.M. Free Swing, Reversible, Light Weight, Rugged, quiet. Motor & Gears oil sealed. Including 3 mounting lugs on motor. Simple instructions & diagram incl. Wt. approx 3 1/2 lbs. Stock No. 572. \$75.00 Value. \$6.50 Postpaid

Adel Self-Priming ELECTRIC PUMP

For pumping light oils, oil burners, fluid metering, fuel pump, tool post grinder, coolant, pressure lubricating pump, etc. Double ball bearing series wound motor, continuous duty. 1/30 H.P. rated 2000 R.P.M. Applicable for 24 V. D.C./A.C. or use on 110 Volt A.C. Size 6 3/4" x 3 1/2" x 1 1/4". rated 3 G.P.H. Remove pump and use motor as high speed grinder, etc. Diagram and instructions incl. \$50.00 value. \$7.95 Postpaid

Pesco Centrifugal Heavy Duty Electric Pump

With built in 1/4 H.P. MOTOR included. BRAND NEW, COMPLETE. Self Contained, Explosion proof. Ideal for pumping Gasoline, Oils, Water and non-corrosive liquids. Applicable for 24 V. D.C./A.C. or on 110 Volts A.C. The Discharge is for 3/4" hose connection. Capacity 400 G.P.H. Use them for Cottages, Basements, Laboratories, Boats, etc. Here's your Greatest PUMP VALUE IN YEARS. Engineering data and instructions incl. \$83.00 value. Stock #659 \$12.95 f.o.b. K.C.

All items Guaranteed as represented. Send check or Money Order. Prices f.o.b. K. C. except when marked postpaid U.S.A. only

STRATOPOWER CONSTANT DISPLACEMENT HEAVY DUTY PUMP



For operating Hydraulic cylinders, hydraulic motors on tractors, Bulldozers, Construction machinery. Lift trucks. For fuel or oil transfer. Industrial Applications, etc. Delivers up to 400 G.P.H. at 3750 R.P.M. Rated 1250 to 1400 P.S.I. 3750 to 4500 R.P.M. HAS BUILT IN RELIEF AT HEAD. Rotation either direction without adjustment. Can be used as hydraulic motor, \$85.00 value. Engineering data & instructions incl. Stock #37. Wt. 8 lbs. \$14.50

AIR OR OIL HYDRAULIC CYLINDERS

Here's a double action 1" Bore, 3" Stroke, 3/8" Shaft, Clevis mounting, Overall length 9". Capacity 700 lbs. with 1000 P.S.I. input. Has a capacity of 9800 lbs. with our STRATOPOWER PUMP 1400 P.S.I. 1 1/2" perfect for applications such as door openers, positioners, small loaders, control units, etc. A REAL TERRIFIC VALUE. Stock No. 10 Postpaid \$3.50

Stock No. 25 Is double action, Bore 2 1/4", Stroke 6", Shaft 1/2". Has a capacity of 7850 lbs. with 1000 P.S.I. Delivers 1199 lbs. with our strato-power pump Postpaid \$7.50

Stock No. 27 Cylinder, Air operated, Bore 2 1/2", Shaft 2 1/4", Stroke 6", one way Stroke. Can be used as snubber or Brake. Length 15" Wt. 11 lbs. \$6.50 f.o.b. Now \$6.50 K.C., Mo.

Stock No. 11 Double Action 1 1/2" Bore, 6" Stroke, 5/8" Dia. Shaft, Clevis mounting base and shaft end. Capacity 1160 lbs. with 1000 P.S.I. input. Has a capacity of 1625 lbs. with our STRATOPOWER PUMP 1400 P.S.I. A \$50.00 value. Postpaid Only \$8.50

HYDRAULIC CYLINDER SPECIAL

Stock No. 12 Gives 12560 lbs. with 1000 P.S.I. input. Capacity 17584 lbs. with our STRATOPOWER PUMP 1400 P.S.I. or will produce 34168 lbs. with 3000 line pressure. Can also be operated on low pressure system. 4" Bore, 8 3/4" Stroke, 1-5/16" Shaft, Clevis mounting. Gov't cost \$300 A tremendous bargain only \$17.50

BRAND Hydraulic CONTROL VALVES

Four way control for use with two hydraulic double action cylinders. Each cylinder may be operated independently of the other or in conjunction with the other. Oil may be locked in any of the cylinders to hold the piston at any required position. Brand New. \$60.00 \$8.95 Postpaid

Adel HEAVY DUTY VALVE #D-8660

Here's your four way hydraulic control valve for use with 2 double action cylinders. Each cylinder may be operated independently of the other or in conjunction with the other. 3/8" pipe thread connections with mounting brackets attached to body of valve. A \$60.00 \$8.95 Postpaid

ADEL PRECISION #10086 Brand New. For controlling 2 single action cylinders or one double action cylinder. When pressure is applied to one cylinder the return to the opposite cylinder is opened. Connections are for 3/8" pipe thread. Including operating lever 6" long and has quadrant for locking in either position. A tremendous bargain \$8.95 Postpaid

PESCO FLOW EQUALIZER & Pressure Balancer Valve. Brand New. Guarantees equal flow and equal pressure for two cylinders or two systems. Capacity 360 G.P.H. 500 P.S.I. Data & instructions incl. A \$75.00 value. Stock No. 1-D-397 \$60 Value only \$9.95 Postpaid

Hydraulic Accumulators—Vickers Ball Type

Dia. 5 1/4". Built to stand 2000 P.S.I. Stock #A-65. Wt. 4 lbs. only \$5.50

VICKERS CONSTANT DISPLACEMENT HIGH PRESSURE PUMP

Use it for any type liquid pumping job 375 gal. per hr. at 3750 R.P.M. 1000 pounds pressure per sq. in. Can be used as hydraulic motor. O. Acq. \$100.00. Brand new, directions \$9.95 post-incl. Wt. 4 lbs. \$9.95

Check & Relief VALVE \$2.50 postpaid

VICKERS UNLOADING VALVE

Brand New—By passes full amount output of the pump while the cylinder is not in operation. Takes starting load off of electric motor driving the pump. 1 1/2" AC TUBE PORTS (3/4"-18) thread. \$7.50 postpaid

VOLTMETER D.C. Brand New

The basic element of this meter is 30 Volt D.C. Voltmeter with zero center. The internal resistance is 300 Ohms. The dial may be easily calibrated to read D.C. Volts. Price \$3.50 Postpaid

WEAVERS HYDRAULIC HAND PUMP

BRAND NEW. For hydraulic jacks, presses, hoist, etc. For operating hydraulic cylinders to pump oil or hydraulic fluid under pressure. Has built in check valve, and is capable of delivering 1000 lbs. pressure. Wt. 10 1/2 lbs. A \$50.00 value. \$7.95 Postpaid

ROMECC WOBBLE PUMP

Hand lever operated. Ideal for camp, farm, ranch, for fuel transfer to boat, etc. Connections are 1/2" I.P.S. New. \$8.50 postpaid.

VALUABLE GEARS BARGAINS

SPEED REDUCER 10-1 or 5-1 ratio, 90 degree angle. Shaft driven 1/2" splined shaft with 2 mounting holes 5/7" centers held in forged and machined aluminum housing with two needle bearings, one bronze bearing, and three high speed shielded bearings. Sealed self lubricating chamber. \$4.95 (Plus 35c postage)

AMPLIDYNE MOTOR GENERATOR

#5ANS1N18A—Use as 24/32 Volt D.C. motor, pulls 1/2 H.P. or 0/60 V. A.C. Can be adapted to 110 V. A.C./D.C. 10,000 R.P.M. 1/2 H.P. by simple changes in connections. New, instructions incl. (Stock #790). Gov't cost \$140.00. Wt. 40 lbs. Only \$5.50

SENSATIONAL SELSYNS

Two or more connected together, work perfectly on 110 V. A.C. For weather vanes, rotating directional antennas or controlling distance operations. Complete with diagram and instructions. Wt. 3 1/2 lbs. PER PAIR \$4.50 plus 35c postage

THOMPSON MOTOR DRIVEN CENTRIFUGAL PUMP

Including Built in Motor, Applicable for 24 V. D.C./A.C. or 110 V. A.C. The motor is explosion proof constructed, making it ideal for pumping GASOLINE, FUEL TRANSFER, HOT WATER HEATING CIRCULATOR. USE IT AS COOLANT PUMP, FUEL BOOSTER, OIL PUMP, etc. Discharge connection is for 1" hose. Rated Capacity 300 G.P.H. Directions & Engineering data incl. A tremendous bargain! Stock No. 1200—Only \$7.95

PESCO FOUR VANE ROTARY POSITIVE DISPLACEMENT PUMP

Including built in relief and by pass valve adjustable to give up to 400 P.S.I. oil pressure. Will operate in any position. For gasoline, oil, water pump, etc. Rated 400 G.P.H. Engineering data incl. Stock No. 600 Only \$7.95 Postpaid

Brand New PUROLATOR GASOLINE FILTER.

For all cars, trucks, tractors or boats. Permanent type. \$4.95 Postpaid

CUNO OIL FILTER—Brand New

Aircraft type. Filters oil without cartridge replacements. Just turn handle and cartridge is clean. Standard 3/4" inlet and outlet ports to accommodate 12 gallons per minute. STOP CHANGING OIL. Instructions \$4.95 Postpaid

GENERAL SALVAGE CO.
2922 E. 27 ST. DEPT. 181
KANSAS CITY, MO.

NO PRICE RISE ON SCARCE ITEMS!
Send for this CATALOG TODAY!
WAR SURPLUS BARGAINS

PRINTED BEFORE KOREA!
FISLER SALES CO.

Probably your last chance to buy SCARCE WAR SURPLUS at these low, low prices! Terrific savings for Sportsmen—Farm & Home. The greatest stock of gov't Surplus in America.

LOOK AT THIS!!

STORM SUIT 2 pc., parka hooded jacket, rubberized fabric, waterproof, windproof. Med., Lge., Ex. Lge.
Only.. \$7.88
NEW!
 Gov't cost \$14.20



MOUTON PARKA COAT
QUILTED SATIN LINING!
 Practical, long-wearing, handsome. Lamb lined and trimmed hood, adj. back-strap, drawstring, slash pockets, rub-knit cuffs. Fully insulated for warmth without bulky weight.
NOW JUST \$21.75
 SIZES 36-46
GENUINE M-6 PRECISION COMPASS
 Made by Sherrill Equipped with night light, easy to mount on car, truck, plane, or boat.
\$25.00 VALUE YOURS FOR ONLY \$5.95



FLYING JACKET
B-3 BROWN LEATHER
 Adj. waist and collar strap. Warm sheep lining, zipper. Recond. Sml., Med., Lge.
Only \$14.88



100% WOOL BLANKETS
 Olive drab, soft, soil-resistant nap. 66"x84" 3 1/2 lbs., brand new.
\$10.50 VALUE. Only \$4.98



BOMBER JACKET
DELUXE B-15 STYLE
 Sturdy, wind-resistant OD sateen. Big mouton collar, zipper front, alpaca lined through-out, 4 slash pockets.
Now \$14.88
 Only
 Sizes 36-46.



AIRFORCE Portable Gasoline Heater
 Brand new famous "Evans" Blue Flame, 30,000 BTU per hr., 3 gal. tank, fuel line.
\$50.00 VALUE. COMPLETE \$12.95



Famous Tanker Jacket
 O. D. Poplin outer shell, 100% wool lining, semi-turtle neck, zip front, slash pockets.
 Sizes 36-46. Worth \$12.50
Only \$8.88



Send 10¢ for Your Catalog Today!

FISLER SALES CO. DEPT. D-2, 723 WALNUT STREET KANSAS CITY, MISSOURI

MISTAKES SEEM TO HAPPEN WHEN IT MATTERS MOST
AT YOUR DEALER'S
INSURE AGAINST WRONG TURNS WITH A HULL AUTOMOBILE COMPASS
Beaconlite illuminated \$5.95
STREAMLINE standard \$3.95
HULL MFG. CO.
 P.O. BOX 246-D11, WARREN, O.



Start Small...Grow Big... with Success Equipment

Your big years are right ahead! You can tie in with the great building industry, yet develop your own business manufacturing concrete block, drain tile, brick, roof tile, etc. We'll start you right in the

Modern Masonry Products

business and help you put it over. We supply complete equipment, built and developed through forty years of dealing with men like you. Helps you build for local market, using local materials and labor. High income potentials. Our line of modern machinery enables you to start small and grow big. Write for new Descriptive Catalog.

CONCRETE EQUIPMENT CO.

512 Ottawa Ave., Holland, Mich.



100,000 WASHER REPAIR PARTS

Start Your Own Washing Machine Repair Business

RETAIL CUSTOMERS MAIL IN OLD PARTS OR MODEL NO. AND SERIAL NO.
 Tremendous field, excellent profits! Get our large complete wholesale catalogue showing thousands of repair parts illustrations; wringer rolls, V-belts, motors, gears, etc. Price \$2.00 per copy postpaid in U.S. Send check or money order today—Established 20 years
WESTERN APPLIANCE CO., Inc.
 5650 GRAND RIVER AVE., DETROIT 8, MICH.



MAGNETS OF ALL TYPES—10c UP
AMAZINGLY POWERFUL!
 4 oz. Alnico Magnet, lifts 10 lbs. \$1.00. Our Leader, 15 oz. Magnet, lifts 40 lbs. \$2.50. New alloy—will not weaken! Useful for lifting valuables from tanks, lakes, or rivers easily! 7 small magnets \$1.10 with list of many shop and home uses. Satisfaction guaranteed.
R. EYRICH, 2566 N. 49TH ST., MILWAUKEE 10, WIS.

LATHE GRINDING ATTACHMENT
The New "HURON CHIEF"—A Wet Grinder
 For 8" to 18" metal lathes! BUILD IT YOURSELF from our semi-machined castings and save 88. Grinds with coolant on wheel and work. Controls dust and heat. Will grind with the finish and precision of a specialized grinding machine. Does both external and internal work, valve and piston grinding, cutter and tool sharpening, production grinding, etc. WRITE for FREE illustrated folder and price list of castings, parts, grinding wheels, coolant, etc. Mention your lathe.
HURON MACHINE AND TOOL CO.
 Dept. B Yale, Michigan



The Chief WORK BENCH

Built to Last a Lifetime!

With Bottom Shelf and 18" Sq. Drawer. 2"x6", Solid Plank, Grooved and Dovetailed Top and 1"x8" Back Rail, Shellacked to a Smooth, Satiny Finish.

MOHAWK LUMBER CO. Dept. 33
 14525 W. Chicago Blvd. Detroit 27, Mich.
 Enclosed Check Money Order for \$.....
 Ship..... **CHIEF WORK BENCHES** at
 Quantity
 \$19.95 each, F.O.B. Detroit, Mich.
 Send C.O.D., \$5 Deposit Enclosed.

NAME.....
 ADDRESS.....
 CITY.....STATE.....

• 6 Ft. Long • 34" High • 26" Deep. Shipped Knock-down, with Bolts, Nuts and Screws and ABC Chart for Quick, Simple Assembly.
Prompt Delivery
MOHAWK LUMBER CO.
 14525 W. Chicago Boulevard
 DETROIT 27, MICHIGAN

A CHRISTMAS PRESENT HE'D APPRECIATE



\$19.95
 F.O.B. DETROIT

Send Check or Money Order, or Will Ship C. O. D. (\$5 Deposit)

NEW-ALL NEW!

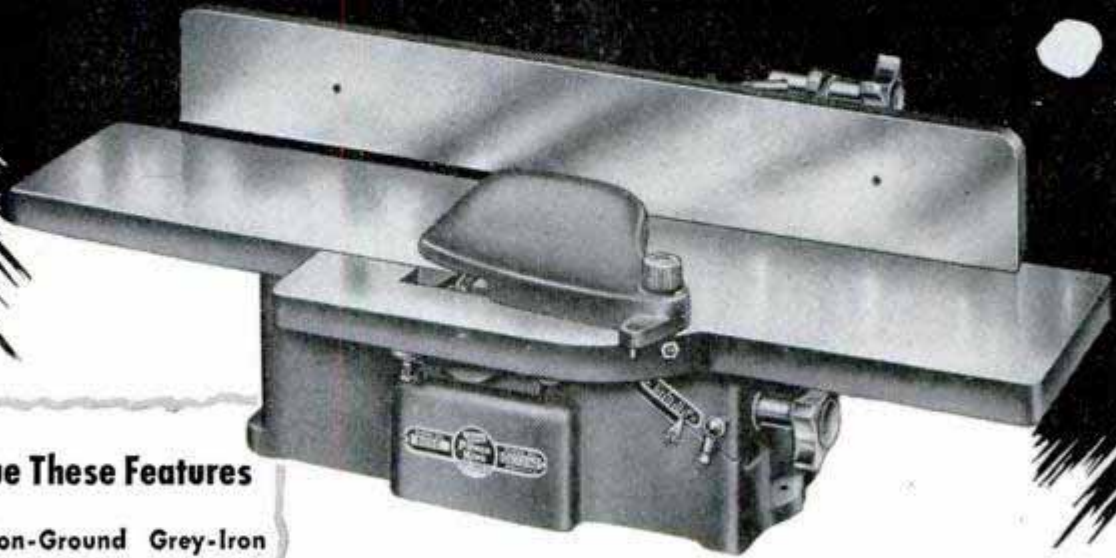

You'll Value These Features

- 25" Precision-Ground Grey-Iron Table with 21" x 3" Fence.
- Removable Cutter Head.
- Stationary Rear Table for Greater Accuracy.
- Simultaneous Blade Adjustment.
- Sealed-for-Life Ball Bearings.

Atlas POWER KING 4" JOINTER-PLANER

Completely new in design — tables, fence, bearings, cutter-head-spindle, base, controls — with every feature engineered to give you greater accuracy and efficiency — that's the new Atlas-Power King.

The rugged 25" table you'll appreciate at a glance — the fence will surprise you. Try it. Notice how it stays put. It's solid. Operate the controls — you'll be amazed how easy it is to position, how smoothly it tilts for bevel cuts. Then remove the fence — that's easy, too. Note how the fence bracket provides extra support for wide boards.

Then consider these standout features. Sealed-for-life ball bearings. *One-piece* solid steel cutter head. You can take the head right out of the machine and sharpen the blades without disturbing their setting. And once the head is replaced, *the blades position simultaneously.*

Those are but a few of the outstanding improvements of this great new tool. See them all at your Power King dealers, or send for new catalog.

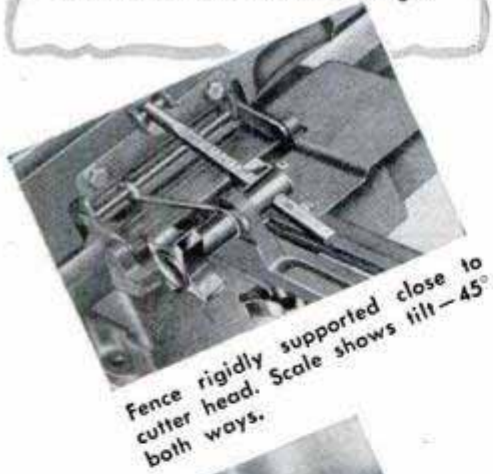

Fence rigidly supported close to cutter head. Scale shows tilt — 45° both ways.



Entire cutter head easily removes for sharpening blades without disturbing setting.



You can plane wide boards easily. 10 $\frac{7}{8}$ " wide infeed table gives plenty of support.



FREE!
NEW CATALOG
Shows all 8
Power King Tools
Send a Postcard

ATLAS PRESS CO.

1135 N. Pitcher St., Kalamazoo, Mich.



**MATCHED PRECISION TOOLS FOR
WOODWORKING AND METALWORKING**



Be a Wizard with Wood

It's easy to do professional work at home! Here are magical products to aid you—reflecting the experience of United States Plywood Corporation and proven by years of satisfaction.

Strongest Wood Glue Ever Made



To make things or fix things, use Weldwood Glue for all wood-to-wood bonds. Makes joints stronger than the wood itself. Mixes easily with water. Stain-free, rot-proof . . . highly water-resistant! 15¢, 35¢, 65¢, 95¢ and larger sizes.

WELDWOOD
PLASTIC RESIN GLUE

A MUST for Finishing Fir Plywood



Tame that wild grain with FIRZITE. It tight-seals the pores . . . virtually prevents grain rise or checking . . . readies the surface satin-smooth for paint, stain or enamel. (For blond, pickled, wiped or tinted effects use White Firzite).

FIRZITE

Newer than Shellac or Varnish



Pints, Quarts,
Gallons

For "natural wood" finishes on furniture or woodwork, there's nothing like Satinlac. Brings out the natural grain and color beauty of any plywood or solid wood. Avoids that "built-up" look, and will never turn yellow or darken with age. "Water-white", easy to brush or spray, dries ready for next coat in 2 or 3 hours.

SATINLAC

Ask for Weldwood Glue, Firzite and Satinlac at hardware, paint or lumber dealers.

Send post card for interesting glue and finishing leaflets.

UNITED STATES PLYWOOD CORPORATION
Dept. 140,55 West 44th St. • New York 18, N. Y.

AMAZING TOOL BARGAINS!



SURPRISE VALUE!
100 Pieces \$1.00
FOR ELECTRIC GRINDERS

Post Paid in U.S.A.

Grinding Wheels, Cut-off Wheels, Sanding Discs, Mounted Stones, Sharpening and Honing Stones, Rotary Cutting Burs, Abrasive Cartridges, Mandrels, and many other items.



2 CIRCULAR SAWS
ON 2 MANDRELS—
ALL AT ONE LOW PRICE \$1.50

Post Paid in U.S.A.

1" diameter saws on 1/8" Mandrels. For cutting wood, plastic, or soft metals. Order at once! Send Check or Money Order.



18 ROTARY CUTTERS
\$5.85

Post Paid in U.S.A.

Assorted sizes—cutter on 1/8" or 3/32" shank. Will fit all hand grinders. Ideal for cutting wood, metal, or plastic. Brand new.



2 DRUM SANDERS \$1.50

With 12 Bands in Assorted Grits. 1/2" dia. x 1" long on 1/8" arbor with 12 bands. 1" DIA. x 1" LONG ON 1/4" ARBOR WITH 6 EXTRA SLEEVES.

SCHUPACK SUPPLY CO., 7331 Cottage Grove, Dept. M-11, Chicago 19, Ill.
ILLUSTRATED BARGAIN CATALOG 10c

World's Finest Models From CLEVELAND KITS!

"SAUCERS" really fly! 2 for 39c. 2 ft. "SABRE" jet and "MUSTANG" kits make flying models of Korean fighters, \$1.50 each. Detailed "SPAD" kit \$1.75. NAVION in 3 kits—50c, \$1.25 and \$1.75. Giant 6 ft. "Condor" glider—\$1.25

JUST LIKE REAL AIR PLANES! 46 famous models described in new 10c catalog! (or order from ad); 50c diecut kits, up to huge \$7.50 scale models! All glide well and can use many different motors including rubber. Liquids & motors not supplied. Avoid copies—get genuine Cleveland kits! No order under \$1.00 plus 25c pack-post. Also at all hobby stores. Beautiful story-style catalog only 10c.

CLEVELAND MODEL & SUPPLY CO.
"World's Famous Model Kits Since 1919"
4516 L21 Lorain Ave. Cleveland 2, Ohio

SAUCER **SABRE** **MUSTANG** **SPAD** **NAVION** **CONDOR** **CATALOG 10c**

BUILD FINE GRANDFATHER CLOCK NOW

The simple sensible Red-i-Kut way as thousands have—SAVE HALF. SHOP TESTED PLANS "SPIRIT OF THE CENTURY" Narrow waist 83" tall or stately straight side "SPIRIT OF AMERICA." EASY-TO-FOLLOW photopack PLANS tell all—plus BROCHURE of heavy brass weight Westminster, tube chime, movements, gorgeous dials, 3/4" solid mahogany case kits. Send \$1.00 today—Both Plans \$1.50 NOW.

KUEMPEL CHIME CLOCK CO., 8 Kuempel Bldg., Minneapolis 16, Minn.

SAY YOU SAW IT IN POPULAR MECHANICS

NOW DADO ANY WIDTH

WITH DA-DALL!

Pat. Pend U.S.A. & For

A simple turn of a screw adjusts your saw to any desired Dado cut! DA-DALL cannot slip, is self-tightening, self-adjusting, of all-steel construction does a clean, true job!

ONLY \$4.95

DA-DALL cuts hard or soft wood, plywood, without chipping! No blades or complicated dials. All arbor sizes

RULE-WAGNER CO

Box 694, Dept. D-7
Walnut Creek, Calif.

Dealers, Jobbers Write for Information

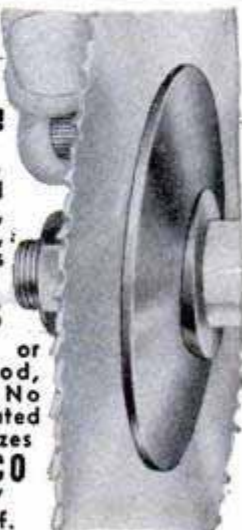

DON'T WORK HARD SCRAPING PEEL PAINT TO BARE WOOD WITH ONE EASY STROKE

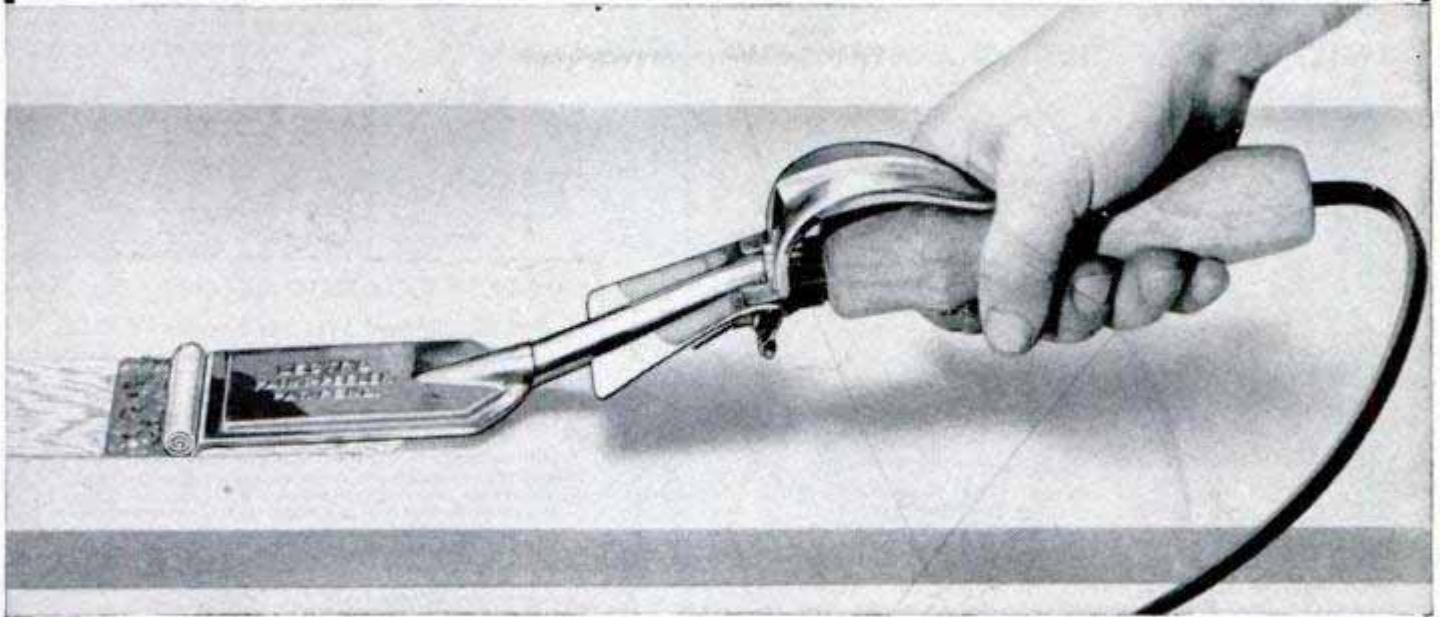

NO CHEMICALS — NO FLAME

With one easy stroke, the "LECTRO PAINT PEELER" removes any number of coats of paint—right down to the bare wood with little effort. No danger of fire if used according to instructions. Will not scorch or burn most delicate wood surfaces. Removes paint and enamel—quickly—easily—from any flat or contoured surface. Crisp paint curls removed are dry—won't stick to rugs or furniture. No mess—no smell, even fun to use! Complete with extra long quality electrical cord and automatic safety stand attached for use in rest position. Nothing else to buy—complete instructions included. Simple to use. Just plug into 115

AC or DC outlet, let heat for several minutes and remove paint to bare wood. Only \$4.95. Will pay for itself in a few hours in savings of your time and materials. Complete tool approved by Underwriters' Laboratories.

ORDER YOURS TODAY!

YOU MUST BE SATISFIED OR YOUR MONEY BACK

IF YOUR DEALER CANNOT SUPPLY YOU, ENCLOSE \$4.95 IN CHECK, CASH OR MONEY ORDER.

LECTRO WELD, INC.
2189 W. 26th STREET

Dept. PM-11
CLEVELAND 13, OHIO



TERRIFIC CHRISTMAS BUY! \$1

5 GIANT TOY ANIMALS

FOR ONLY

(Yes, All 5 for \$1) - 6 Complete Sets for \$5

- GIRAFFE—4 Ft. Long!
- REINDEER—3½ Ft. Long!
- PUPPY—12 in. Long!
- SANTA CLAUS—20 in. High!
- DACHSHUND—3½ Ft. Long!

Postpaid

Yes—all 5 amazing toys at the amazing price of ONE DOLLAR! Imagine the shrieks of delight when the kiddies discover these fascinating toy animals under the Christmas tree! They're taking the whole country by storm! You inflate and assemble these giant animals in a jiffy from unique balloons made of natural Latex and specially cured to take plenty of abuse. Children ride them, make their own zoos . . . have unending fun! It's the toy bargain of the year! Order several sets for all your favorite kiddies right now!

Immediate Delivery — Money Back If Not Delighted

Send only \$1 for each complete set of 5 Giant Animals (No C.O.D.'s)

UNION MART, Dept. 7A, 41 Union Sq., New York 3, N. Y.



A SURE CURE for Cold Weather Starting... the *new* SHUR-HETE Motor Water Heater

Install a Shur-Hete unit on your engine—plug it into a 110 volt A.C. outlet and your car will start easily and quickly, even on the coldest mornings. Why? Because the water around the sealed electric element is heated, causing automatic circulation which keeps the entire engine block warm; therefore the oil in the crankcase and around the cylinder walls is always free-flowing.

Easy to install—Any garage mechanic can install a Shur-Hete in a short time. ¼" connections into head block and into drain plug opening are all that are necessary. Fittings included—nothing else to buy.

Dealerships Open!

JOHANSON MOTOR HEATER CO.
818 W. Webster St. Chicago 14, Ill.



for All Autos, Trucks, Tractors
Pat'd and Pat. Pend.

Save Time and Money with Shur-Hete!

Eliminate run-down batteries . . . towing charges . . . needless engine wear . . . and wasted gas.
Uses only 1/3 to 1/2c electric power per hour.
Safe to use with any standard anti-freeze.
Will not overheat engine or burn out.

GUARANTEED!

Shur-Hete Outfits for
Autos, Trucks, Tractors
only \$9.95

Important: Give make and year of auto, truck or tractor. Shipped parcel post prepaid if remittance is enclosed; send \$1.00 with C.O.D. orders.

BUILD YOUR OWN TILTING ARBOR SAW!

Exclusive GIL-BILT Build-It-Yourself Features

- No machining—build easily with hand tools only
- No blueprint reading—step-by-step pictorial plans, full scale patterns, actual photographs
- Sturdy wood, aluminum, and steel construction
- Capacity and performance of commercial saws selling for \$60 and up

SAVE
\$50
OR MORE

GIL-BILT 10-INCH TILTING ARBOR SAW



- 27x28 in. table, 13 1/2 in. capacity in front of blade
- 10 in. blade cuts 3 1/4 in. deep, tilts full 45 degrees
- Floor model 34" high, table always stays level
- New Departure ball bearing arbor, 3/8" precision shaft turned down for 5/8" bore blades, alum. housing, shipped ready to run
- Jackscrew and 4 1/2 in. dia. handwheel lowers and raises blade
- Cast aluminum miter gauge and self-aligning rip fence guide

GIL-BILT Metal Parts Kit includes Plans, ball bearing arbor, miter gauge and bar, rip fence guide, dado insert, lock knobs, jack screw mechanism and handwheel, and all other metal parts (less blade).....**\$20.95**
Same Kit with 10" Combination Blade **\$24.90**
Same Kit with 8" Combination Blade **\$23.90**

GIL-BILT 8-INCH TILTING TABLE SAW

- 21x27 in. table tilts full 45 degrees, 13 in. capacity in front of blade
- 8 in. blade cuts from 0 to 2 1/2 inches
- New Departure ball bearing arbor, 5/8" precision shaft turned down for 1 1/2" bore blades, alum. housing, ready to run
- Cast aluminum miter gauge and self-aligning rip fence guide (same as above)



GIL-BILT Metal Parts Kit includes Plans, Ball Bearing Arbor, Miter Gauge and Bar, Rip Fence Guide, Machined Lock Knobs, Tilt Support Segments and All Other Metal Parts (less blade).....**\$15.95**
Same Kit with 8" Combination Blade.....**\$18.90**

GIL-BILT 12-INCH BAND SAW



- Cuts to center of 24 inch circle
- Handles stock up to 6 inch thick
- 18x18 inch table tilts 45 degrees
- Lower wheel and drive pulley runs on sealed New Departure Ball Bearings; Upper wheel runs on two 5/8" bore Oilite Bronze bearings.
- Upper wheel tension and tilt mechanism of cast aluminum, completely assembled.
- Upper and lower blade guides. Each has ball thrust bearing, self-lub bronze jaws
- Rubber tired wheels. Choice of cast aluminum or make-your-own wood wheels on metal hubs.
- Uses standard 78 inch blades up to 3/8 in. wide.
- Fully enclosed mechanism for utmost safety.

GIL-BILT Metal Parts Kit includes Plans, rubber tires, 1/4 inch blade, hubs for wood wheels, ball bearing spindle, tilt mechanism, guides, table tilt segments and all other metal parts.....**\$16.95**
Same Kit with two machined ready-to-install 12" cast aluminum wheels.....**\$20.95**

NO DEALERS—ONE LOW FACTORY PRICE! Return in 10 days for refund of purchase price if not satisfied. Prices include postage within 600 miles. Over 600 miles add 5%. Send cash, check, or money order for parts kit, or send \$1.00 for Step-by-Step Plans and order kit later less cost of Plans. Plans sent postpaid anywhere in the world.

GILLIOM POWER TOOLS

P.O. Box 1-PM, Lambert Field, St. Louis 21, Missouri

COMPLETE
PLANS
only
\$1.00
EACH

OIL FILTER REFILLS... 10c



Filters Oil the full length of the Pack
Plates Last Indefinitely

Here's News! Ordinary toilet paper makes an ideal oil filter. Laboratory tests prove it cleans oil faster and better than popular makes of filter elements. All you need is a simple set of **RETLIF ADAPTER PLATES**... and you can start using ordinary toilet paper rolls in your present oil filter. For proof and descriptive literature, send name and address to:

RETLIF CORPORATION, Dept. 61
1239 No. Highland Ave., Los Angeles 38, Calif.

make your own *Gems* 29.50 F.O.B.

All necessary lapidary equipment is furnished, including a super-charged diamond blade for sawing, and all wheels for grinding, shaping and polishing; also complete instructions. The complete equipment as shown, less motor and belt, for only \$29.50, f.o.b., Burlington, Wisconsin. Write today for information and literature.

B & I MANUFACTURING CO.
Dept. S Burlington, Wis.



NOW! FILE YOUR OWN SAWS

Do expert saw filing at home. Precision filing easy without experience. Two simple adjustments. Keeps any hand saw extra sharp and true-cutting. Complete with file. Money back guarantee. Cash with order, prepaid. (COD postage extra.) Order today, \$2.95.

ANOTHER SPEEDCOR TOOL
THE SPEED CORP. PM-11

512 N.E. 73 Ave., Portland 16, Oregon



\$2.95
EACH

Clark EXPANSIVE BIT

CUTS BETTER • COSTS LESS! Accurate, fast, cuts smooth holes in hard or soft wood. Chrome vanadium steel blades, all chrome body No. 250, 1/2"-1 1/4", \$1.68; No. 251, 3/4"-3" \$1.89 GUARANTEED. At your dealer or write **ROBERT M. CLARK COMPANY** Beverly Hills, Calif.

MACHINE YOUR OWN FACE PLATE

A \$10.00 value for \$2.75. Easily machined in your metal lathe. 9" diameter—10 lbs. Heavy, rigid casting six slotted holes, center core out to 1" diameter. For shop, Home craftsman or School. Immediate delivery upon receipt of cash, check, or money order. We pay postage.

MANITOWOC GREY IRON FOUNDRY, INC.
Manitowoc, Wisconsin



SAY YOU SAW IT IN POPULAR MECHANICS



ONAN Portable ELECTRIC PLANTS

FOR CABINS, TRAILERS, CONTRACTORS, BOATS

Light weight, compact, air-cooled, engine-driven. Furnish regular city-type A.C. electricity for lights, appliances, radios, etc. Can be carried by hand. Fits trunk of car. Plug-in receptacles on plant. Larger models for farms, homes, businesses beyond highlines. Catalog shows over hundred models. 400 to 55,000 units.

GASOLINE OR DIESEL POWERED
Prices begin at \$199.00

WRITE FOR CATALOG

D. W. ONAN & SONS INC.

5839 Royalston Ave., Minneapolis 5, Minn.



BEAUTIFIES natural wood, pine paneling

POLISHES furniture, woodwork

IMPROVES paint jobs

PROTECTS wood and metal surfaces

49¢ 89¢ PINT QUART

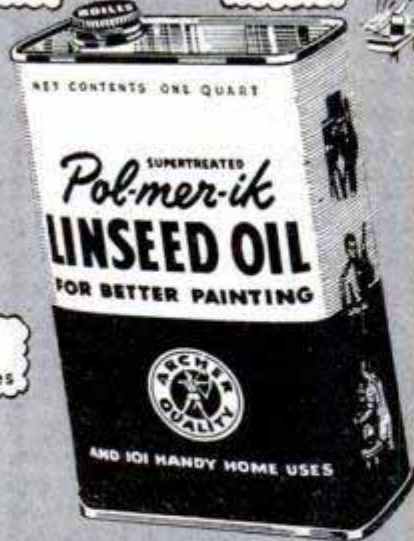

101 HANDY HOME USES!

Every home, every workshop, needs Pol-mer-ik BOILED Linseed Oil. Free folder tells you how to use it. Write . . .

ARCHER-DANIELS-MIDLAND CO., Minneapolis 2, Minn.



The Only SANDER with POWER UNIT
GUARANTEED ALL DURING YOUR OWNERSHIP AGAINST
 BURN-OUT OR REPLACED FREE!

DOES YOUR WORK
 WITH 240 STROKES
 A SECOND—JUST
 GUIDE IT!



The best Christmas Gift because SYNCRO is the only sander of its kind that guarantees its Power Unit—heart of ANY sander—all during your ownership—or replaces it FREE! And only SYNCRO gives you a magnetic-electric SANDER approved ENTIRELY to be free from shock and fire hazards by UNDERWRITERS' LABORATORIES, INC.—not just the cord but the ENTIRE Tool! This Power Unit GUARANTEE—and Seal of Approval from internationally-famous "UL" plus the exclusive SYNCRO DOUBLE ARC MOTION makes SYNCRO your safest and best buy. For all light sanding, high polish jobs in tight places, corners and on flat or curved surfaces. A marvelous massager. 240 Strokes Per Second! Just guide it. Buy at hardware stores. With BUILT-IN POWER UNIT, 10 sandpapers, lamb's wool and fabric pads—\$14.50. If Dealer hasn't it, send \$14.50 direct, we'll ship postpaid.



ENTIRE Sander Tested and APPROVED to be free from Fire, Shock Hazard!



STROKE EASILY ADJUSTED!

\$14.50 No. 500

EXCLUSIVE DOUBLE ARC MOTION!

Operates on 60 cycle, 110-120 Volt. AC only.



\$12.50 No. 401

SYNCRO Electric HONE

Greatest Sharpening Development Since Invention of The Hone!

Unusual gift! Stones M-O-V-E 240 times a second sharpening shop and home tools—knives, etc. Faster! Power Unit GUARANTEED and entire tool UL-Approved!

With 4 interchangeable stones, \$12.50 At dealers or direct.

SYNCRO CORP., Dept. D-110A, Oxford, Mich.

SYNGRO

QUALITY TOOLS with POWER UNIT
 GUARANTEED AGAINST BURNOUT
 ALL DURING YOUR OWNERSHIP OR REPLACED FREE!

GARAGEMEN... Write for the new K. R. WILSON Catalog of Garage Tools and Equipment. Lowest Prices. K. R. WILSON, 213 Main Street, Buffalo 3, N. Y.

Save HALF! Slight Factory Imperfect Dress PANTS



Genuine 100% GABARDINE

Imperfections very slight—positively do not affect wear. Ideal for dress, school, play, work. Firm hard finish. Wrinkle and shine resistant. Retains neat press. Zipper front. Roomy pockets. Blue, Tan, Gray, Sand, Lt Brown, Dk. Brown, Blue-Gray or Green. Waist: 28-42.

SEND NO MONEY Send name, waist size, 1st, 2nd and 3rd color choice. Pay postman only \$4.95 plus small pstg. Or send money and save pstg. Money Back Guarantee. © L.T.-1950

LINCOLN TAILORS, Dept. PM-3, Lincoln, Nebr.

Worth \$10
\$4.95

Make 100% to 150% Profit!

MANUFACTURE BUILDING BLOCKS In Your Own Back Yard

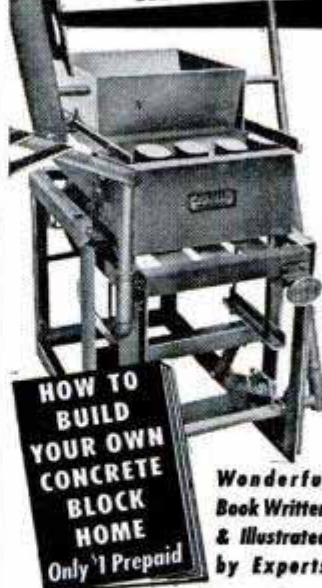

AMAZING GENERAL BLOCK MACHINE
 CAPACITY 1000 BLOCKS PER DAY
 Only \$218 LESS MOTOR F.O.B. PLANT
 SHIPPING WEIGHT 400 Lb.

Here is an outstanding opportunity for men of vision and small capital. Cinder and concrete blocks are in great demand. Millions used for homes, factories, public buildings. Sell all you produce at 100% to 150% mark-up.

PEAK BUILDING DEMAND!

The General Block Machine is amazingly practical, foolproof. Simple to operate indoors or outdoors. Rugged all steel construction. Vibrator mounted in sealed ball bearings. Produces up to 1,000 blocks per day. Superior 3 Core Type that meets all building code requirements. Can produce 4 x 8 x 16, 8 x 8 x 16, 12 x 8 x 16 blocks. All materials obtainable anywhere. All operating instructions and mixing formulas supplied. Full details FREE without obligation.

HOW TO BUILD YOUR OWN CONCRETE HOME Only \$1 Prepaid

Wonderful Book Written & Illustrated by Experts

GENERAL ENGINES CO.

DEPT. P-14 • 307 HUNTER ST. • GLOUCESTER, N. J.

Includes floor plans for 6 beautiful, easy to build concrete block bungalows. Shows ways to save money. How to lay blocks, lay out building lines, mix concrete, build steps, porches and concrete floors. Mail coupon at once with \$1.

Name.....
 Address.....
 City.....Zone.....State.....

ARC WELDING FOR PROFIT OR PLEASURE

60 LBS. OF READY MADE PARTS

BUILD YOUR OWN HEAVY DUTY WELDER

SAVE Buy Only NECESSARY PARTS

Only \$24.95

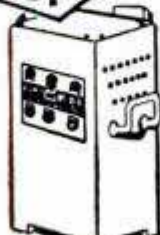

All necessary parts Ready-Made and easy to assemble. You can do all around welding on steel, cast iron and other metals after only a few hours practice. Illustrated instruction manual included. "Free plans for building case." Sold on 30-Day Money-Back Guarantee!

FREE: Write today for fully illustrated Pamphlet P-11

ATOMIC ARC WELDER CO.
 1037 So. 19th St. OMAHA, NEBR.

Gives 100% penetration. Welds are stronger than original metal. Operates on 110 or 220 AC.

NEW 15-SHOT AUTOMATIC WITH OPEN SIGHTS

Here's one you've been asking for! A beautiful, streamlined automatic with open sights—just the rifle for quick, off-hand shooting at vermin, small game—or for plinking.



The "Sporter"
Model 151K 22 cal. Long Rifle
\$31.95

\$32.95 west of Rockies

SEE IT AT YOUR DEALER'S
No sales at Factory

Send for FREE Catalog
O.F. Mossberg
L & SONS, INC.
9711 St. John St., New Haven 5, Conn.

Look!—still only \$39.95 for this 5-in-1 Machine!

Wonderful Christmas Gift

5 big power tools in ONE machine using one motor. 63 pounds of REAL machinery at low factory-to-you price. Have fun working in wood, metals, plastics; making useful articles, handling home repairs. Thousands of delighted customers—our 52nd year. FREE literature covers 10-day Free Trial, Money-Back GUARANTEE, Easy pay Plan., EMRICK, INC., 1110 Clinton, Kalamazoo, Mich.

Plane it square with SQUAR-EZY.



• The new attachment that makes your woodworking plane an accurate edging and joining tool. Fits all standard planes—Quickly attached or removed—Rugged malleable iron, accurately machined and cadmium plated. Order direct or ask your dealer. Model 7 for Block planes and Nos. 2-3-4, \$1.98. Model 11 for No. 5 Jack and larger, \$2.49. Satisfaction guaranteed.

The BRATTON COMPANY
Dept. 123 Edwardsville, Kansas

CARBURETOR TOO RICH MAKES MOTORIST TOO POOR



Car owners who are wasting money and not getting proper gas mileage due to over-rich mixtures will be pleased to learn how to save gasoline by VACU-MATING over-rich mixtures. VACU-MATIC fits all cars, trucks and tractors. It is automatic and operates on the supercharge principle. Easily installed in a few minutes.

SALESMEN WANTED! Big Profits! Send name, address on penny postcard for free particulars and how to get yours for introducing.

VACU-MATIC CO., 7617-1672 W. State St., Wauwatosa, Wis.

SHARPEN CIRCULAR SAWS LIKE AN EXPERT



THE SUPER GADGET FOR HOME WORKSHOP
Two simple adjustments. Gets hollow-ground, cross-cut or combination saw blades true and sharp. Fits 6" to 12" blades, 1/2" to 13/16" centers. Includes file, complete instructions. \$6.95 postpaid. (C.O.D. postage extra.) Guaranteed—Money back if not satisfied after 10-day trial. Soon pays for itself. Order today. Free Folder.

SURE SHARP MFG. CO., Dept. M-110
P. O. Box 24 Santa Ana, Calif.

SAVE TIME, WORK, MONEY!



SHAW DU-ALL
and "PEPPY PAL" TRACTORS



These rugged walking or riding tractors are ideal for farm, truck garden, orchard, poultry farm. Operate on a few cents an hour. A child can handle them.



DO DOZENS OF JOBS Both riding and walking tractors quickly and easily plow, cultivate, harrow, disk, bulldoze, spray, haul, grind, saw wood, etc. **LOW FACTORY PRICES** Buy direct or through your dealer. Year's guarantee!

RIDING TRACTORS 4 models from 5 to 12 1/2 H.P., 58 in. wheelbase, 36 to 52 in. wide, 24 in. plant clearance. Hand or electric starter. Walking Tractors 1 1/4 to 5 H.P.

SHAW MFG. CO.

FREE Illustrated folders giving complete details and price lists—write today!
4511 FRONT ST., GALESBURG, KANS.
668G NORTH 4TH ST., COLUMBUS, O.



BETTER MEASURE WITH LUFKIN

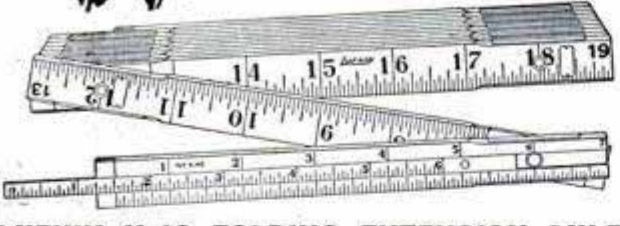

LUFKIN X-46 FOLDING EXTENSION RULE IS EXTRA RIGID—DURABLE—ACCURATE!

No. X-46 is the superior extension rule—ideal for both inside measuring of openings and general purpose measuring. 3/8 inch wide sections are of straight grained hardwood in boxwood finish. Other features are:

- Sections 1/8 inch thick . . . 33% stronger.
- Prominent black markings—easy to read.
- Patented Brass Plated spring lock joints.
- Brass strike plates prevent wear.
- 6-in. graduated slide in one end.

See it—Buy it . . . at your nearest Hardware Dealer.

LUFKIN

THE LUFKIN RULE CO. • TAPES • RULES • PRECISION TOOLS
SAGINAW, MICHIGAN • New York City • Barrie, Ontario

BINOCULARS



BRAND NEW. Quality glasses. Achromatic lens! Have precision ground optics. Light weight metal bodies. Moisture-Dust proofed.

16 x 50 COATED \$69.50
CENTER FOCUS

Lightweight. Superb craftsmanship. Combines tremendous power, instant center focusing plus magnificent light transmission. Objective lens is 2 inches in diameter.

COATED!! FEATHERWEIGHT!!

6x30 - \$24.95
8x30 - 29.50
10x30 - 45.00



Three (3) superb FEATHERWEIGHT glasses. Weigh only 10 to 18 ounces each. COATED so each gives maximum results . . . sharply . . . clearly. Each measures a compact 4 1/2" x 6". Only in power and price do they differ. Each offers a tremendous field of view.

UNCONDITIONALLY GUARANTEED TRY FOR 20 DAYS AT OUR RISK!

If not fully satisfied return for full refund! Cash orders rushed postpaid. On C.O.D.'s include \$2.00 deposit. Add Federal tax. Prices include handsome genuine leather case and straps.

UNITED BINOCULAR CO.

9043 S. WESTERN DEPT. ARF-2008 CHICAGO 20

KING MIDGET Home Assembled Auto

WORLD'S LOWEST PRICED CAR!

Drive this car for as low as 50c per week. Precision built parts direct from factory with beautiful all steel body. Get the facts on this amazing small auto—send 25c for detailed circular with large picture, 3 view drawings and price of all parts, or send \$1 (refunded first order) for this plus actual assembly book with 42 photos, drawings; blueprints of snow, ice conversions. Ideal for micro-midget racing — Get this information.



MIDGET MOTORS MFG. CO.
ATHENS 1, OHIO

BATTERIES!—START

—a factory at home and re-cast junk batteries into new; latest achievement. We supply complete instructions and everything needed. Big Profits!

BATTERY LABORATORIES, Dept. PM, Minneapolis 4, Minn.



"Build your own" A.C. Welder and Power Unit



Get into the high profit welding business at low cost. Save \$250 to \$450 by building your own welder. Choose type and capacity generator needed from our complete line and hook up your outfit in spare time.

Write today for FREE CATALOG

Welding, power for tools, lights
All in ONE LOW-COST UNIT

Cash in on big pay outside jobs with this 2 in 1 unit. Meet emergencies caused by power failure. Make arc welded repairs or flip a switch and operate A-C lights, tools, motors. HOBART BROTHERS CO., Box M-1101, TROY, OHIO.



HOBART — "One of the World's Largest Builders of Arc Welders"

SAY YOU SAW IT IN POPULAR MECHANICS

PROFESSIONAL TYPE BUFFING WHEELS



AND COMPOSITIONS

For best buffing results, depend on DICO — by the world's leading producer of buffing wheels for industry. Whatever your buffing job, you'll find the right DICO wheel and composition to do it. For free Buffing Manual, write Dept. B-1150.

DIVINE BROTHERS CO.

UTICA, N.Y.

INTRODUCTORY KIT by Mail

Contains 2 big 6" Dico Buffing Wheels, 2 tubes of Dico Composition and Buffing Manual, MAILED POSTPAID if dealer can't supply. Give spindle diameter of your power unit.

\$259
(Reg. Val. \$2.85)

ASK FOR



AT YOUR HARDWARE STORE



HORNS WITH VOLUME CONTROL

for the man who has everything

Buell Air Horns are softer than standard horns for city driving. Give miles of volume for highway emergencies. Also a complete range in between instantly available with convenient foot control.

Chromed band instrument horns sound a pleasing, true-pitch chord. Case histories prove Buell Air Horns increase driving security and avoid accidents. Very popular with traveling executives.

Under-hood as well as outside mountings are available in several models and tones. Avoid the Christmas rush by writing now for literature, prices and name of your dealer.

BUELL MFG. CO., 925 W. 49th Place, Chicago 9, Ill.



EASY PROFIT IN PAINT SPRAYING

Paints walls, ceilings, screens, furniture and machinery faster, better. All complete as shown less motor. Carry anywhere. Fully guaranteed. Could be used with 1/4 H.P. motor or less. Price \$35.00 less motor F.O.B. Chicago. \$5.00 deposit balance C.O.D. or see your dealer. With motor \$55.00.

IDEAL AUTOMATIC PUMP CO., Dept. P.M.8
801 W. Washington Blvd. Chicago 7, Ill.

DU-FAST[®] OSCILLATING MOTION SANDER



... BEST VALUE BAR NONE!

Where in the world can you get FULL 1/2" OSCILLATING MOTION... LARGE 3-2/3" x 7" FAST-WORKING SURFACE THAT USES INEXPENSIVE STANDARD CUT PAPERS... LIGHT WEIGHT FOR EASY CONTINUOUS USE?

Where in the world can you get the economy and convenience of a powerful sander and polisher that attaches in 10 seconds to any Home Utility Black & Decker 1/4" Electric Drill? Or (another Du-Fast model) that attaches just as easily to any Skill Home Shop 1/4" Electric Drill?

Where can you get the safety that permits you to sand or polish with absolutely no chance of gouging, marring, scuffing or burning? YET GIVES A PERFECT FINISH EVERY TIME?

See your nearest hardware dealer carrying either Skill or Black & Decker tools. **ASK TO SEE AND TRY A DU-FAST UNIT**.. YOU'VE GOT A PLEASANT SURPRISE COMING!



DU-FAST OSCILLATING SANDER powered by Home Utility B & D 1/4" Electric Drill.

ONLY \$14.95

FOR ATTACHMENT!



DU-FAST OSCILLATING SANDER powered by Skill Home Shop 1/4" Electric Drill.

ONLY \$14.95

FOR ATTACHMENT!

*Pat. Applied For

MANUFACTURED BY

DU-FAST, INC.

32 East Fourth Street

New York 3, N. Y.



MAKE BEAUTIFUL TRAYS, COASTERS, GIFTS

of Aluminum, Brass, Copper, Stainless Steel

*Easily! Quickly!
at Low Cost!* For beginners and experienced craftsmen—here's a complete supply of quality metals pre-cut to the size you want... and at lowest metal warehouse prices!

ALUMINUM and COPPER CIRCLES. RECTANGULAR SHEETS of Aluminum, Brass, Copper and Stainless Steel. Easy to work, ready to be formed into trays, coasters and hundreds of useful items and gifts.

BRACELET BLANKS of Aluminum, Brass, Copper and Stainless Steel. Perfect for jewelry, ornaments... simple to work into attractive handicraft.

FREE BOOKLETS! "Making Aluminum Trays and Coasters", and "Copper Metalcraft" give complete directions for making beautiful metalcraft items easily and quickly. Send for your Free Copy Today!



METAL GOODS CORPORATION
628 Rosedale Ave., St. Louis 12, Mo.

ELECTRIC SIREN



6 volt. Complete with push button... \$10.95

Fender Skirts for All Cars



Give year, make & model of car when ordering.

All Metal. Prime finish. Rubber beading prevents rattle.

Easy to install. \$9.95 PAIR...

FLO-WINGS Fender & Hood Side Ornament



CUSTOM STYLING FOR ALL CARS



Graceful, flowing lines. Triple CHROME PLATED. Gives your car that Custom Style look. Easy to install on fender or hood. \$4.95 PAIR...

HOLLYWOOD MUFFLERS



FOR ALL CARS

Gives that Motorboat Tone. Universal type to fit all cars, ea... \$4.45

NEW CONVERTIBLE TOPS & REBUILT MOTORS for all Cars. Write for Prices.

Send 25% Cash With Orders, Balance C.O.D.

JUST OUT! Get the largest Auto Accessory & Parts Catalog in the world. Over fifteen thousand items, including Hollywood Accessories, Hi-Speed Equipment, Rebuilt Engines, all parts & accessories for all cars & trucks. We have that Hard-to-Get-Part! Completely illustrated, Jam packed with bargains. Send 25c.

J. C. WHITNEY & CO.
1917GA ARCHER AVE. CHICAGO 16, ILL.

CRESCENT TOOLS

Give Wings to Work

ASK YOUR HARDWARE DEALER



DUST-O-VAC FOR ALL MACHINES

For Home Workshops & Industry. DUST-O-VAC collects & bags wood & plastic chips, wood & metal dust, wood shavings. Free Bag. Attaches to circular saw, planer, band saw, grinder, belt or disc sander, shaper, drill press with shaper or sander attachment, spindle shaper, wood lathe, jig saw, 110 A.C., D.C. Send for mounting instr. for all machines.

\$19.95

Free Ship. east of Miss. West of Miss. add \$1. Check, M.O.

HEAVY CAST ALUMINUM BLOWER — ONLY \$11.25 For workshop, lab., kitchen, cellar, app. 100 CFM. Send for circular. UNIVERSAL YONKERS CORP., 137 Alexander St., M-11, Yonkers 2, N. Y.



HANDY CALCULATOR FOR WOODWORKERS.. ONLY 10c

Just set dial, quickly solves countless problems. Converts linear to board feet, compares workability of various woods, shows bit sizes, nail specifications. Also tool sharpening tips, etc. 6" diameter heavily varnished cardboard. Send 10c to Greenlee Tool Co., 2111 Columbia Av., Rockford, Ill.

BRUSH PLATING OUTFITS

for re-plating articles in the home and shop. No tanks necessary. Free particulars. GUNMETAL CO., AVE. M, DECATUR, ILLINOIS

SAY YOU SAW IT IN POPULAR MECHANICS



NEW! TIRE-TUBE-WHEEL Complete!
For Trailers, Hand Carts, Wheelbarrows, Midget Racers, Dollies, Feed Trucks, Boat Trailers, etc. With 10 1/2"x4" 6-ply tire (standard, replaceable), choice of heavy duty or "balloon" tread; tube; and choice of 3 wheels:

- A. Pressed steel, 5/8" ball bearing \$6.95
- B. Pressed steel, 3/4" ball bearing \$6.95
- C. Permanent mold cast aluminum, heavy duty, high speed, 1" I.D. bearing \$9.95

All prices freight prepaid. 5% discount for 4 or more units. Immediate delivery. Send cash, check or M.O.—sorry, no C.O.D.'s.

CRAFT, INC., Dept. PM-11, 6671 Telegraph Rd., Los Angeles 22, Calif.

BRAND NEW SURPLUS UP TO 85% DISCOUNT



Portable LIGHT PLANT (ITEM 24)

500-700 watts 110-120 v. — 60 cyc. A.C. Powered by a sturdy dependable, easy starting, air cooled 2 hp. gas engine. No wiring necessary, just plug in and operate. Plenty of current for oil burner, emergency lights, freezer, radio, incubator,

etc. Complete protection against current failure. Ideal for hunting or camping. Complete with Voltmeter and built-in winding to charge 6 v. auto batteries. Wt. 85 lbs. Fully guaranteed. Reg. \$275.00 value. Only..... **\$129.50**

GAS ENGINE

(Item 25) Air-cooled. 1 1/2-2 h.p. Complete with gas filter, air cleaner, governor, fuel tank. Ready to run. Speed range 2000-3600 r.p.m. 3/8" shaft. Rope start. Ideal for pumps, air compressors, power tools, generators, etc. One of the best made. Wt. 40 lbs. Worth \$62.50. Special **\$38.50**.



PARTS WASHER

(Item 20) Store gas or carbon tet. in 5 gal. safety can. Valve releases just the right amount into washing compartment. Parts are washed and drained on a "dunking" screen — no fishing for parts. Eliminates fire danger, waste, spillage, evaporation. Wt. 8 lbs. Reg. \$19.50—Special **\$4.95**.



GAUGE TESTER

(Item 27) Precision made of solid bronze by Star Brass Co. Calibrated weights acting against hydraulic piston, provides quick, accurate testing of all pressure gauges up to 3000 lbs. per sq. in. Brand new in hardwood cases. Wt. 100 lbs. Reg. \$435.00. Our Spec. **\$125.00**.



EXTENSION CORD

(Item 16) 40 ft. heavy duty, made of specially insulated No. 14 2-conductor wire. So tough that you can drive over it and yet amazingly flexible and easy to handle. Resists oil, grease or water. Extends electricity up to 400 ft. without voltage drop. Use indoors or out. Complete with heavy rubber plug and outlet. Wt. 2 1/2 lbs. Usually \$4.50—Special 40 ft. **\$1.95**. Comb: 2-40 ft. and 1-20 ft. (total 100 ft.) **\$4.75**.

FRAM OIL FILTER

(Item 12), Model F21. Big 73 cu. in. size. Ample capacity for all cars, trucks, tractors. Universal bracket, standard openings. Fram filters are tops. Easy to install. Wt. 8 lbs. Usually \$7.95—now **\$3.75**.



HYDRAULIC HOSE

High pressure, heavy duty, complete with swivel fittings. Pipe thread connections. Ideal for farm equip., bulldozers, air brakes, etc. Any length. Minimum order \$2. **INSIDE DIAMETER 1/4" 40¢ per ft. 3/8" 50¢; 1/2" 70¢; 5/8" 90¢.**

HOT WATER HEATER

(Item 26) Immersion type, heavy duty. 115v. A.C. 300w. Does not require watching. Thermostat shuts off at 165°. Keeps water hot for shaving, washing, dishes, etc. Also good for keeping water from freezing in big troughs or tanks. Made by Cities Service. Wt. 4 lbs. Worth \$9.50. Our Spec. **\$4.50**.



RUBBER HOSE

New genuine Neoprene Hose —outlasts ordinary rubber 3 to 1. Reinforced with super tough cotton cord plies. Flexible. Easy Fit brass couplings with standard pipe threads for quick connections, included. Pump water for irrigation, stock, tanks, home, barn, fire fighting, etc. Pump Gas or Fuel Oil. Save more than 60%. (Inside Diam.) 1 1/4" 11 1/4" 1 1/2" Length 25 ft. 40 ft. 30 ft. Price \$8.75 13.75 13.75 If specified we will send special hose for gas or oil at same prices.



TERRIFIC VALUES!

ANGLE DRILL

(Item 23) Fits into chuck of any electric or pneumatic drill or flex. shaft. Operates at any angle in a full 360° arc. Makes possible drilling, grinding, carving, routing, etc. in close cramped quarters. Makes impossible jobs easy. Made by Kett Tool Co. Complete with built-in chuck and adjusting key. A precision tool. Lists at \$39.95—while they last **\$9.95**.



5 GAL. STRAINER FUNNEL

(Item 28) Made of heavy galv. steel. Fine brass strainer built into neck. Perfect for straining milk, gas, diesel fuel, spray mixes, etc. Includes 10" flex. extension hose (not illus) for hard to reach spots. Wt. 6 1/2 lbs. Worth \$5.95. Our Spec. **\$2.25**, 2 for **\$3.95**.



WELDING HELMET

(Item 29). Hand type, complete with medium filter lenses. Made by Hobart. Best quality. Wt. 2 lbs. Reg. \$6.95. Spec. **\$2.35**.



HEATING & VENTILATING FAN

(Item 10) Easily installed in furnace pipes. Forces even heat to all rooms. Over range, removes kitchen smoke and odors. Powerful continuous duty motor, 110-120 V. A.C. Quiet, super efficient fan moves huge volume of air (400 to 600 c.f.m.) 8" Fan **\$5.95**, 10" Fan **\$7.95**, 12" Fan **\$8.95**.



CLIP BOARD

(Item 17) Heavy Masonite, with self-adjusting spring hinge to hold up to 100 sheets of 8 1/2 x 11 paper. Push back cover for instant release. Flip cover shut and notes or drawings are protected. Perfect for pilots, engineers, students, artists, truck drivers. Wt. 2 1/2 lbs. Usually \$2.95. Spec. **\$1.10**, 2 for **\$2.00**.



All items BRAND NEW. Prices f.o.b. Chicago area. Money back guarantee. Send check or M.O. **The A & K EQUIPMENT & SUPPLY CO., Dept. 51, Burlington, Wis.**



Better Sights FOR BETTER "SHOTS"



Sheard "Gold" Front Sight **\$1.75**
Standard Front Sight **\$1.25**

For faster, more accurate sighting equip with a combination of

MARBLE'S SIGHTS



Flat Top Rear. Price **\$2.00**
Semi-Buckhorn Rear Price **\$2.00**

No. 69 Flat Top Sporting Leaf. **\$2.00**

Marble's Flexible Rear Sight, with automatic spring joint. Can be locked down. With 2 discs. Price **\$5.50**.

At your dealer, or write for Catalog **Marble Arms & Mfg. Co.**
578 Delta Ave. Gladstone, Mich.

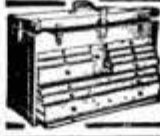

GERSTNER Tool Chests

Machinists and toolmakers will derive pleasure from the better, finer, more desirable GERSTNER Chests they choose. Free catalog. **GERSTNER TOOL CHESTS**
450 Columbia St. Dayton 7, Ohio

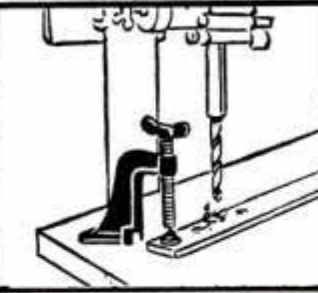
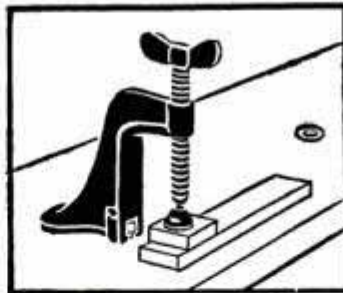

New 3" all-purpose surface clamp fastens to any surface, holds like a vise. Hundreds of uses. Indispensable to all craft workshops. Simple manual installation on wood or steel. Simply slide clamp on or off without tools, leaving surface clear of any obstructions.

Mail this coupon NOW

Clamp complete with instructions **\$2.00 ea. Postpd.**
Order Today Guaranteed

Enclosed \$...for...clamps
Name.....
RFD.....St.....Zone.....
City.....State.....

HENRY E. CASTON
788 Yale St. Akron 11, Ohio

WAR BARGAINS

Over 200 terrific
ALSO FACTORY
SURPLUS VALUES!

SURPLUS

MAIL ORDERS
Please remit with order. Include postage. You will also receive FREE SURPLUS CATALOG.

Surplus O. D. WOOL MELTON PANTS
\$10.00 Val.
4.99

NEW. 20 oz. all wool. Price drastically reduced due to limited sizes. 28 to 34.
Add 25c postage.

Surplus O.D. ALL WOOL SHIRTS
SIZES 15 & 15.5
1.66

PANTS
SIZES 27 & 32
1.99

CLOSE OUT 16,000 GARMENTS

Used, cleaned and pressed by the Q. M. Corp., ready to wear 100% all wool serge. Prices slashed on account of limited sizes. Add 15c postage per garment.

WATCH CAPS
77¢

NEW. All wool Navy blue. Ideal for sports, outdoor wear. Add 5c postage.

OFFICERS PINKS

NEW. Just like the officers wore. Elegantly tailored, 17 oz. elastic material. All sizes. Add 25c postage.

9.95

COMBAT BOOTS
6.88

NEW. Sturdy, comfortable. About 12" high. Reversed uppers, oak leather sole with composition outer sole. Add 27c postage.

Officer type
OXFORDS
\$6.88

NEW. Top grain uppers and oak leather sole. Comfortable. Excellent quality. Add 17c postage.

FIELD SHOES
4.88

NEW. Reversed uppers, oak leather sole with composition outer sole. Add 20c postage.

6 TO 12

DUST MASKS

5 for **33c** or \$1.50

NEW. Ideal for spraying, for millers, etc. \$1.50 Val. Add 5c postage.

BOMBER JACKET
12.99

NEW. Made identical to the regulation jacket. 4 pockets, mouton collar, full pile lining, wool knit wristlets. Add 25c postage.

B-15 style
FLIGHT JACKET

all wool WRISTLETS
13¢ 6 PAIR or \$1.00

NEW. Worth 75c per pr. Ideal for liners, wristlets, etc. Add 3c post.

NAVY WHITE T-SHIRTS
59c

NEW. Full cut. Fine combed yarn. Add 3c postage.

BARGAINS

- **NAVY WADERS**
NEW. Best quality black rubber Armpit length. Add \$1.00 post.
9.95
- **SADDLES**
\$60.00 Val.
NEW. 12" seat. Complete with stirrups. Best quality russet leather. Add \$1.00 postage.
12.99
- **CUSHION FOOT SOCKS**
NEW. 50% wool, khaki color, double sole. Add 3c post.
59c

ORDER NOW! **Sioux Falls Surplus Store**
113 N. PHILLIPS SIOUX FALLS S.D.

5 BIG POWER TOOLS in ONE

8" TILTING TABLE SAW

30" LATHE SANDER

VERTICAL AND HORIZONTAL DRILL PRESS

GRINDER

RETAIL PRICE \$125.00
FACTORY TO YOU \$59.95

SUPERSHOP the PRECISION BUILT WORKSHOP. Lifetime lubricated BALL BEARINGS. All running parts precision GROUND. Compare finest production tools. BIG capacity. Amazing VALUE. Write for FREE catalog, full details, trial plan.

POWER TOOLS, INC. 117 YATES AVENUE BELOIT, WISCONSIN

FUN to BUILD NOW!

A pleasure to have later

DUTCH WINDMILLS

It's easy! Build these and 100 others from our simplified plans and kits. Charming B10 windmill, at left, is 40" high — wings operate on roller bearings. Plans and instructions 75c. Knockdown kit \$14.75. Wings of novel B30, at right, operate farmer at bucksaw. Plans 65c. Knockdown kit \$7.85.

CAPE COD CHAIRS

Add beauty and comfort to your garden. Style B-C-A PLAN 50c each, all 3 ONLY \$1.00. Our catalog also includes trellis designs, bench and swing arbors, birdhouses, etc.

SPECIAL ALL PLANS ABOVE \$3.05 VALUE ONLY \$2.50
SEND 10c for catalog of many fine projects.

CRAFTSMAN'S MODEL CO. Dept. P22 DELAFIELD, WISCONSIN

LIQUID MARBLE COMPOSITION FLOORS FLEXIBLE MOLDS

Mold, Brush, Trowel, Spray It! MOLD novelties, Statuary, Art Goods in Flexible Plastic Molds; 5c material makes \$1 seller. Make Marbleized floors, Tile Walls. Colorful, glossy, amazing! Easily learned; start in garage or basement. Particulars free.

MARBLEIZING SERVICE, Dept. 10-F, Edwardsville, Ill.

NOW! GRIND YOUR OWN DRILLS

Sharpen 3/32" to 1" drills like an expert in 30 seconds. Precision lock insures factory accuracy. No experience necessary. Full instructions. Use with any hand or power grinder to keep drills extra sharp and true cutting. Guaranteed. Order Today \$2.95 postpaid (COD postage extra)

Another Speedcor Tool

THE SPEED CORP., PM-11
512 N.E. 73 PORTLAND 16, OREGON

SILVER SOLDER TORCH & KIT \$6

JOINS ALL METALS PERMANENTLY

Do your own repairing. KIT includes one tube silver solder flux and 10 5-in. lengths silver solder alloy. Hottest ALCOHOL TORCH known, 2700° F. flame. Operates in any position, indoors or out. Torch alone \$5. KIT alone \$1.50.

AMERICAN PRODUCTS CORP.
422 S. Dearborn St. Dept. 3 Chicago 5, Ill.

BUILD YOUR OWN BOAT

Have Fun! Save 1/2 the Cost! Anyone can do it! Schneider plans have full size details and include complete, step-by-step instructions. Cut-to-fit KITS ALSO available. No special tools needed—all parts accurately machined; notches and bevels cut. SEND 10c for illustrated literature on our complete line of boats.

SCHNEIDER BOAT COMPANY
Dept. 1110 1913 W. VLIET ST. MILWAUKEE 5, WIS.

TOOTHACHE? TOOTH GUM TOOTH DROPS POULTICE

Ask your Druggist for **DENT'S**

SAY YOU SAW IT IN POPULAR MECHANICS

BARGAIN! BRAND NEW! SPINNER!

only **\$42.50** Save \$40! REG. \$82.50 7-in. disc

Direct From Manufacturer—

Uses 7-in. or 9-in. disc—Sands, grinds, wire brushes, etc. Makes tough jobs easy. 1/2 h.p., Heavy Duty Motor. 10-day, money-back guarantee. No C.O.D. Send check or M.O. TODAY—while they last! Californians add 3% State Sales Tax

HOLT MFG. CO. 651 20th Street Oakland 12, Calif. | 272 Badger Avenue Newark 8, New Jersey

Announcing the NEW...POPULAR MECHANICS MAGAZINE LIBRARY FILE



Check these Outstanding Features

1 Convenient size, measures 6¾" wide, 3¾" thick x 10" high. Ideal for tabletop, shelf or bookcase storage.

2 Special Reference Index Form, printed on back, records exact location of selected articles, diagrams and other information.

3 Date Label Stickers—enough to index ten years issues, furnished FREE.

NEW! NOVEL! INEXPENSIVE!
Never before so much convenience and utility at such a low price. So act now. Place your order today!

INGENIOUS CUSTOM-BUILT STORAGE FILE

A Sensational Popular Mechanics Value Scoop!

Now you can preserve every issue of Popular Mechanics Magazine in orderly, chronological sequence... indexed and ready for instant reference! Made of high quality kraft fibre board, printed in rich colors and constructed to look like an attractively bound book, Popular Mechanics Magazine Library Files enhance the reference value and double the usefulness of your collection of Popular Mechanics Magazines.

Serviceable, convenient, handsome in appearance, Popular Mechanics Magazine Library Files make every volume and article instantly accessible. No more hunting for the issue or special data you want. No misplaced copies. A "must" for every reader of Popular Mechanics. Order now for immediate delivery. Use the handy coupon below.

PER SET OF 2
(Set holds 12 issues)

Only

70¢

POSTAGE PAID

5 SETS **\$3.10**
ONLY

10 SETS **\$6.00**
ONLY

POSTPAID

Best of all, production economies by the distributor service organization appointed by us to serve your needs—plus our large volume purchases—makes the phenomenally low cost of the Libraries possible.

USE THIS COUPON...Mail Today

POPULAR MECHANICS MAGAZINE, Dept. PL
200 East Ontario Street, Chicago 11, Illinois

P11-50

Please rush PREPAID _____ sets Popular Mechanics Magazine Library Files.

(QUANTITY)

Remittance for \$ _____ is enclosed.

(AMOUNT)

PRICES — 1 set (2 files) Holds 1 yr's. issues only \$.70

5 sets (10 files) Holds 5 yr's issues only \$3.10

10 sets (20 files) Holds 10 yr's issues only \$6.00

Includes Prepaid Parcel Post anywhere in U.S. and Possessions

Name _____

Address _____

City _____ Zone _____ State _____

ARMY ORDNANCE SURPLUS SPECIAL

WESTINGHOUSE AIRBRAKE CO.

Portable AUTOMATIC AIR COMPRESSOR UNIT

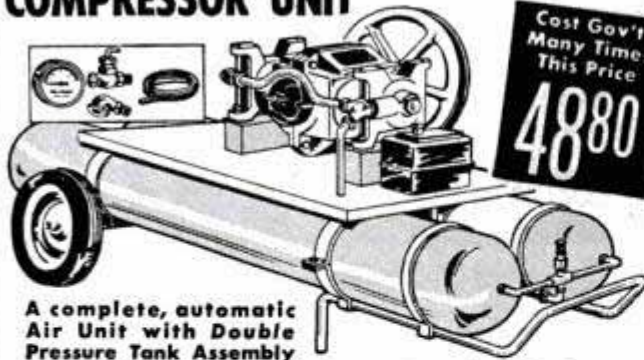

Cost Gov't.
Many Times
This Price
4880

A complete, automatic Air Unit with Double Pressure Tank Assembly

Terrific Value in this Large Capacity Unit for Farm, Home, Industry, Painting, Air Tools, etc.

INCLUDES: • COMPRESSOR; horizontally opposed, 2 cylinder piston type, huge volume, 6.54 CFM, 2" bore, 1 1/2" stroke. • TANKS; 6" x 45", 400 PSI test, heavy gauge steel, 1000 cu. in. capacity each tank, pressure capacity—13.8 cu. ft. each tank. • PLATFORM; 12" x 32" for easy mounting of electric motor or gas engine. • WHEELS; 10 x 1.75, full ball bearing with semi-pneumatic, puncture proof tires, can be drawn as a trailer. • PRESSURE SWITCH; Cutler-Hammer, adjustable automatic motor control, with overload protection for motor. • PETCOCK; for air shut-off and water drainage. • SAFETY RELIEF VALVE; adjustable. • GAUGE; by U. S. Gauge Co. • HOSE; 25 ft., 2 braid, high pressure, with fittings and tire chuck. • CHECK VALVE; seals air in tanks. Comp. takes 1/2-1 1/2 H.P. Motor. Shipping wt. 85 lbs.

COMPLETE ASSEMBLY WITHOUT COMPRESSOR \$29.50

All prices FOB Pittsburgh, Pa. Send Check or Money Order

NATIONAL EQUIPMENT CO.

929 Fifth Avenue Dept. MZ Pittsburgh 22, Pa.

The JIFFY metal CABINET

YOUR ANSWER TO SMALL ITEMS STORAGE at home, office, and shop (IDEAL GIFT, TOO)

So handy to keep nuts, bolts, screws, nails, parts, washers, stamps, hobbyists' needs, etc., at your fingertips.



THIS 32 DRAWER UNIT ONLY \$8.95 POSTPAID

Stop searching, get a 32 or 64 drawer Jiffy to keep those small items that usually get mislaid. Spot welded steel, gray enamel finish, metal drawer guides. Dividers included with aluminum drawers make possible three compartments per drawer Looks good anywhere Send check or money order. please—no C. O. D.'s. Prices below. Your money refunded if not satisfied. Dealers write for quantity discount.

SPECIFICATIONS

32 Drawer Unit
6" Deep
12 3/4" Wide
15 1/4" High
64 Drawer Unit
6" Deep
25 1/2" Wide
15 1/4" High
Drawer Size
1 1/4" Deep
2 3/4" Wide
6" Long

WITH ALUMINUM DRAWERS

Dividers and Index Cards Included

One piece rustproof aluminum drawers for heavy service—good for work bench and industry use.

32 drawer - \$8.95

64 drawer - \$15.95

OHIO ORDERS ADD 3% SALES TAX
Marproof Rubber Feet included with all cabinets
POSTAGE PAID

NEW SPECIAL!

ONLY \$2.95

8 DRAWER UNIT (24 compartments)

16 Drawer Unit \$4.95 (48 compartments)

SPECIFICATIONS
6" Deep—8 1/4" High
8 Drawer 6 5/8" Wide
16 Drawer 12 3/4" Wide
POSTAGE PAID

KAYTEE PRODUCTS, Dept. M, Box 588, Canton, O.

YOU CAN MAKE THESE WITH POPULAR MECHANICS PLANS AND BLUEPRINTS



- 501—Colonial Grandfather's Clock. 25c
- 507-508—Doll-House, 5-Rooms, Open staircase, fireplace. 50c
- 526—Queen Anne Coffee Table: True replica of antique. 25c
- 528—Duncan Phyfe Console Table: 30 in. high. 25c
- 529—Lawn Chair: Southern style. 25c
- 593—Three Attractive Corner Shelves: Scroll-sawed. 25c
- 596—Three Hanging Type Shelves: Hold books, china, etc. 25c
- 661—Rocking Horse: Scroll-sawed from plywood. 25c
- 705—12 Ft. Rowboat: Flat-bottom, four seats. 25c
- 795—Two Handsome Cedar Chests. 25c
- 811-812—16 Ft. Canoe: Canadian type, cedar planking. 50c
- 813-814—Pops Outboard Racer: 10 ft. long, stepped bottom. 50c
- 828-835—Sovereign of the Seas: English warship model. \$2.00
- Sovereign of the Seas: Instruction Book. \$1.00
- 836—12 in. Bandsaw: Uses plywood, cuts two in. stock. 25c
- 839—Melrose Corner Cabinet: Old Colonial design. 25c
- 846-848—Governor Winthrop Desk: True copy of original. 75c
- 896-897—Three Easily Made Workbenches—Simplified construction. 50c
- 906-909—Midget Auto: 58 in. wheelbase, 1/2 to 3/4 h.p. \$1.00
- 910—Circular Saw Table: Hardwood, 24" x 36", Stationary. 25c
- 917—Outdoor Fireplaces: Several simple but practical. 25c
- 920-922—Lawn and Garden Furniture: Swings, arbors, tree seat. 75c
- 923—Indoor Fireplaces: Standard Sizes. 25c
- 926-927—Venetian Blinds: Three different styles. 50c
- 930—Hooked Rug Frame—Quilting Frame. 25c
- 933—Cape Cod Cupboard: 4 ft. wide, 5 ft. 8 in. high. 25c
- 935—Knee-Hole Desk: 40 in. long, 30 in. high, 3 1/2 in. wide. 25c
- 936—Modern Coffee Table: 24 in. long, 15 in. wide. 25c
- 952—Child's Crib in Maple. 25c
- 958—Colonial Corner Cupboard: 6 ft. 8 in. high. 25c
- 961—Hanging China Cabinet: 38 in. long, 40 in. high. 25c
- 969—Combined Chest and Writing Desk: 35 1/4 in. high. 25c
- 970—Modern Clothes Chest: Built of Plywood. 25c
- 977—Bookcase in Chippendale Style: 47 in. high, 10 in. wide. 25c
- 978—Lawn Chair on Wheels: Lightweight, easy to wheel. 25c
- 981—Colonial Wall-Shelf: 30 in. high, 19 in. wide. 25c
- 984—Duncan-Phyfe Drop-Leaf Table: Reproduction of historic piece. 25c
- 986-987—Utility Trailers: Built of old auto parts. 50c
- 989-990—Speedy Motor Scooter: Gas engine, 40 to 60 miles on gal. of gas. 50c
- 991—Gun Cabinet: Handy cabinet includes rack for rifles. 25c
- 993—Twin-Deck Beds: 6 ft. 4 in. long, 3 1/2 ft. wide. 25c
- 1106-1112—SEACRAFT—25 FT. CABIN CRUISER: Adaptable as sport fisher, express cruiser, or utility boat. Cruises at 15 knots with marine engine or converted auto engine. Cabin sleeps four. Galley has fresh-water tank, sink, and cook stove. Set of seven large-sized blueprints scaled 1 in. per ft. plus 40-page two-color illustrated booklet, only. \$10.00
- 1011—Fireplace Fittings: Andirons, log rack, etc. 25c
- 1080-1081—Banta: 12 Ft. Plywood Runabout: Vee-Bottom, 3-passenger. 50c
- 1086—Black Forest Corner Shelf: Scroll-sawed. 25c
- 1089-1090—Home-Constructed Freezing Unit: reaches 30 degree temp. 50c
- 1091-1096—17 ft. trailer, 7 ft. wide. Steel chassis. \$1.50
- 1102-1105—Midget Trailer: "Teardrop" body. Sleeping quarters for two. \$1.00
- 1113-1114—Gold Rush of '47: The A.M.A. Open Class B Record Holder Plane Model. \$1.00

FILL OUT AND MAIL THIS COUPON NOW

POPULAR MECHANICS COMPANY, Dept. 19
200 E. Ontario St., Chicago 11

Please send the following plans _____

I am enclosing \$ _____

Name _____

Address _____



"ONE-STOP SHOPPING"

for ALL electric drill accessories — ORDER TODAY!



NEW
BULL "200"
1/4" ELECTRIC DRILL
A PORTABLE POWERHOUSE!
only **\$14.95**

WE GUARANTEE YOUR MONEY BACK if it isn't more powerful than any 1/4" electric drill at ANY price!



AUTOMATIC SCREWDRIVER

for any electric drill, drill press or flexible shaft. When ordering, specify standard **\$4.95** or Phillips head.



NEW PORTABLE BELT SANDER

Fits any 1/4" elec. drill; does every job from roughing to finishing. Complete with 3 pressure pads and 2 sanding belts. **\$19.95**

Send 10c for catalog of other new drill accessories

TO INSURE EARLY CHRISTMAS DELIVERY SEND CASH, CHECK OR M. O. TODAY.

BERTRAM C. ENGINEERING & SUPPLY CO.
3121 MAIN STREET KANSAS CITY, MO.



BULL BUFFER

complete with sheepskin bonnet, rubber pad, 2 sanding discs. **\$9.95**



Portable BULL MORTISING KIT

For on-the-job mortising with elec. drill or drill press. Complete with adapter and 1/4", 3/8" and 1/2" chisels and corresponding bits. **\$23.90**

BULL MORTISING ADAPTER only, \$6.95

Fits any 1/4" elec. drill and any standard shank chisel. (Bit and chisel prices on request.)



BULL MANDREL KIT

includes mandrel, 2 1/2" grindstone, 3" wire brush, 4" cloth buffing wheel. **\$2.19**



NEW BULL SAW

Fits any 1/4" electric drill. Powerful, portable, easy one-hand operation. Complete with saw blade. **\$9.95**



BULL High Speed JITTER SANDER

For 1/4" drill. Makes perfect, flawless finishes; one-hand operation. **\$9.95**



4-IN-1 HOLE SAW!

For any 1/4" electric drill or drill press. Complete with arbor and 1", 1 1/2", 2" and 2 1/2" blades. **\$4.95**



Power for...

WELDING
TOOLS
LIGHTS

"Build your own" ARC WELDER and POWER UNIT!

... FOR BIG PROFITS. Smart operators all over the country are setting up their own welding business at low cost. They're saving \$250 to \$450 by building their own welders and are getting most of the big pay repair and contract work. You can do the same thing. Choose the type and capacity generator you need from our complete line and belt or couple to a good used auto engine. You get a full capacity welder plus power for lights, tools. Don't miss this opportunity, write today for FREE catalog. HOBART BROTHERS COMPANY, BOX M-110, TROY, OHIO

Write for book HOW TO BUILD YOUR OWN WELDER. Send 10c to cover postage.



HOBART "One of the World's Largest Builders of Arc Welders"

JUNIOR ENGINEERS! — MAKE YOUR OWN REAL ELECTRIC MOTOR!

A V-4 ELECTRIC ACTION-PACKED MOTOR —

EXPERIENCE the Thrill of actually Constructing — Using

Have FUN putting it together! Then—have MORE FUN watching it WORK! And then—have STILL MORE FUN using it to Power your mechanical sets! The V-4 Motor is NEW! It's ACTION-PACKED! Every MOTION is Clearly Visible! That's why you Will be Fascinated by its ACTION!

FEEL the Complete Control you have over The Motor with the Master Control Lever—Continuously Variable Speed Control from Full Speed Forward-to-Full Speed Reverse! Run it on SAFE—Low-voltage A.C. or D.C. 18 volts, 60 cycles from a Transformer—Or, 5 volts from a Battery or Rectifier.

The "V-4 ACTION MOTOR" is "MORE than a MOTOR"



— WITH THE DANEL 400-K MOTOR KIT!

this NEW — REVOLUTIONARY — ACTION-PACKED MOTOR!

Ask your Toy or Hobby Dealer for the DANEL 400-K Motor Kit complete with all Parts — full — easy-to-follow Instructions. **\$5.95**

Or — the Completely Assembled Model 400 V-4 Motor (Illustrated) Ready to Operate **\$6.95**

If your Dealer is unable to supply you, either the Kit or Assembled Motor can be ordered directly from —

DANEL, Inc. - BOX 165M - WAYNE, PA.

Write for Free Descriptive Folder
\$1.00 Deposit Required for C.O.D.'s
DEALERS — JOBBERS!
WRITE for INFORMATION

**RELIEVES
HEADACHE
NEURALGIA
NEURITIS PAIN**

FAST



Here's Why...

Anacin® is like a doctor's prescription. That is, Anacin contains not one but a combination of medically proved active ingredients. Anacin is specially compounded to give **FAST, LONG LASTING** relief. Don't wait. Buy Anacin today.

ACE TOOLS

No. 8-A SET



Be permanently
tooled-up for every operation
on your Metal Cutting Lathe.

No. 8-A Ace Tool Set for 9" and 10" Swing Lathes—fits shank size 3/8" x 3/4". Includes Turning, Cutting-off, Boring, Knurling and Threading Tools with high speed cutters, blades and wrenches. 8 complete tools in fitted steel case—nothing else to buy. See your local dealer or order direct.

ARMSTRONG BROS. TOOL CO.
5268 W. Armstrong Ave., Chicago 30, Ill.

\$24²⁵

PARTS FOR MILITARY TRUCKS

At Big Savings New FREE Catalog

For Jeep, Dodge, Chevrolet, G.M.C., Studebaker

Brand New — Weatherizing Kits — Complete

JEEP TOPS and SIDE CURTAINS
Fits all Military Jeeps. Also adaptable to Civilian Jeep. Waterproof O.D. **\$59.50**

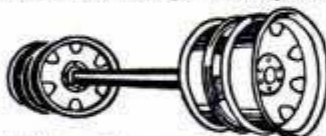

TRAILER AXLE

Heavy duty trailer axle suitable for many types of trailer construction. Also excellent for building of heavy farm trailers and wagons. It is a 12,000 lb. capacity square type straight trailer axle complete with Timken roller bearings, hubs, and 6 hole 750 x 20 Budd Wheels. Without brakes. Axle is 2 inches square and 69 inches between wheel mounting flanges. Std. width.

With Single Wheels. \$59.50 With Dual Wheels. \$69.50

Hundreds of Other Truck & Jeep Parts and Supplies
All prices quoted good 30 days FOB, Kansas City

American AUTO PARTS CO. INC.

1830 LOCUST—DEPT. PM
KANSAS CITY, MISSOURI

Precision Caliper

**M. Z. B. MAUSER-TYPE
VERNIER CALIPER**



**\$13.75
POSTPAID**

An indispensable measuring tool for precision work in any trade or workshop. Highest accuracy and dependability. Measures inside, outside, thread and depth to 1/1000" and 1/20 millimeter. 8" overall, 6" graduation. Highest quality throughout with glass-hard measuring surfaces. M.Z.B. Calipers are made up by the same men who made the old "MAUSER" world-famous. This is your opportunity to buy a first-class precision tool at about half the price of comparable tools. Shipment from stock. Be sure to get yours by ordering it now. Sold with a money back guarantee for only \$13.75 postpaid if you send us your check or M. O. You pay postage on C.O.D.

INTER-CONTINENTAL TRADING CORP.
90 West Street New York 6, N. Y.

BIG MONEY FOR YOU

Selling Mechanical Trades



**\$9.00
Prepaid**

It saws all Metals, Bolts, Asbestos, Rivets, Wood, Fibre, Pipe and Tubing. Invest only \$9 in demonstrating sample. You can make over \$50 daily. Write for details.

E. H. STACKHOUSE
219 N. 63rd St.
Dept. PM9-5
PHILA., PA.

**Keep Fords all Ford
with Genuine Ford Parts**

Made Right to Fit Right to Last Longer

BOYS-IT'S FREE!

"THE WONDERS OF CHEMISTRY"

This exciting new book shows how to amaze your friends with chemical magic, describes many fascinating home experiments, tells of fun, thrills and big future opportunities for boys who know chemistry. Special atomic energy feature. Send today!

THE PORTER CHEMICAL COMPANY
42 Prospect Avenue, Hagerstown, Maryland



WONDERFUL LITTLE MONEY-SAVER

Helps keep oil cleaner, engine safer, repair bills lower.

PUROLATOR Micronic REFILL

... fits almost any oil filter. \$1.38 to \$3.00 (depending on make of car).



**AMAZING NEW
WOOD-TURNING
TOOLS! Outlasts Steel
Up to 50 to 1!**



**SHARPEN ONCE IN 12-YEARS!
(UNDER NORMAL USE)**

These remarkable tools tipped with TUNGSTEN CARBIDE will astound you with their performance. They work FREE HAND equally well in wood, plastic or soft metals—and at the same time hold their razor-like edge almost indefinitely. Tests show that they will turn wood or plastic for days and days CONTINUOUSLY without showing any signs of dulling. They are the finest tools available at any price. Beautifully finished 5" blade—flush ground, polished tip—finest brass tube ferrule—9" hardwood handle—over all length 14"—25 tools to choose from: round & square nose from 1/8" to 1 1/2";—1/8 and 3/16 cut off; 1/2"x30° skew, spear, r. & l. skew, turning and parting. Amazingly Low Prices! Write at once for free literature.

JOHNS MFG. CO., DUNELLEN 11, N. J.

You Can Have Local Manufacturing Rights

Here's an outstanding manufacturing opportunity for men with vision, energy and a little capital. Brikcrete is sweeping the country because it has beauty, long life and ultra comfort. Truly the world's most modern masonry. Distinctively different. Yet costs less than lumber because it is locally manufactured of local materials by local labor for local building needs.



100%-150% Mark-Up on Costs

You can be one of a national chain of local plants. High income potentials. Can be started on moderate investment. Wide-open market. Requires no experience; no skilled labor. We supply all equipment. Easy terms, if necessary. We work with you to put it across. Write for Brikcrete Book No. 2 today... free.



Brikcrete Associates, Inc.
4679 Division Ave., S.
Grand Rapids 8, Mich.

BRIKCRETE

CUTTING SAWS AND STONES

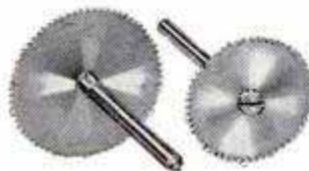

2 - High speed steel circular saws 1" and 1 1/4" diam. by .025" thick, with 1/4" mandrels, for cutting wood, plastic and most metals. Both postpaid in U.S.A. \$2.25
2 - Tungsten steel saws 3/4" diam. by .025" thick, with 1/4" mandrels. Both, postpaid in U.S.A. \$1.50
12 - Abrasive stones, assorted shapes and sizes up to 1" diam. by 1/4" thick used with mandrel for cutting stone, glass, metal, etc. Postpaid in U.S.A. \$1.00

48 ROTARY CUTTERS only \$2.50 postpaid

Assorted sizes (approx. 1/32" to 3/32") and shapes ideal for workshops. 3/32" shfts. Brass and nickel-silver for model makers - Gold, silver, amateur jewelers supplies. 68-page illustrated catalog of accessories for hand grinders, polishing supplies, small tools - only 25c. Write Dept. P.M.

ENLARGED ILLUSTRATIONS OF CUTTER HEADS



SCHRADER INSTRUMENT CO., INDEPENDENCE, IOWA

CHECK BATTERY CONDITION

without leaving the driver's seat!
DETECTO-CELL



Amazing, instant visual check on battery strength, condition of cells, need for service!

Saves Money by Prolonging Battery Life...

Add as much as 70% to battery life! DETECTO-CELL shows instantly—in glowing lights—battery strength, condition of each cell, water levels, warns of battery weakness in time to prevent failure. No more unexpected dead batteries, no more needless, costly replacements!

SIMPLE INSTALLATION

Takes just a few minutes and ordinary hand tools. No moving parts, foolproof operation. Will last life of your car, or longer. Send check or money order today!

MYRIATRON CORP., Pontiac, Mich.
Dept. 31

\$5⁹⁵ complete.



DEALERS • JOBBERS
Write—We've got a good deal for you!



BUILD THIS

Modern Bedroom Suite
for only \$76³⁰ with your
SHOPMASTER tools

SAVE \$155.⁰⁰

You'll be surprised how easily you can build this complete bedroom ensemble or any of its matching pieces. Designed for flexibility, the pieces are functional, interchangeable and best of all, extremely simple to construct. You need only two SHOPMASTER Tools—a saw and a jointer. But these two SHOPMASTER Tools are nearly a workshop in themselves. For complete plans for building this modern, functional bedroom set, send \$2 to SHOPMASTER, INC.

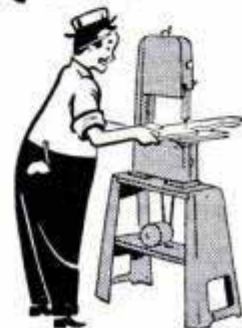

10" BAND SAW
Built for accurate work, long life, dependability

\$43⁹⁵

Table tilts to 45° for cross-cutting, ripping, curve-cutting. Complete with blade, less motor.

Build this Modern

COFFEE TABLE



Requires only three pieces. Fits any type of furniture. Can be folded and stored away. Complete plans and instructions... 50c

TABLE LAMP

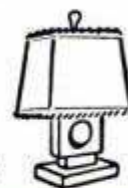

A modern lamp completely built of wood except for electrical fixture. Complete plans and instructions... 50c

There are 16 different SHOPMASTER Tools to fit every purse... To fit every job.



Send for FREE Catalog



SHOPMASTER, INC.

1214 Third St. S., Minneapolis, Minn.

LATHEMASTER

the revolutionary new woodturning set that makes woodturning by hand a CINCH — even for beginners!

only
\$9.95



- Now one tool makes 12 standard cuts, hundreds of variations!
 - No more "guesswork"—makes each cut and bead exactly alike!
 - Chisel blades of high-carbon heat-treated shaper steel are interchangeable, reversible!
 - Hardwood handle, chrome-plated shank! Complete as pictured, mounted on attractive wood rack. **\$9.95**
- To insure early Christmas delivery send cash, check, or M. O. today.

BERTRAM C. ENGINEERING AND SUPPLY CO.
3121 MAIN ST. KANSAS CITY, MO.



MAKE YOUR OWN FURNITURE

With these simple, useful plans, you can make handsome end tables, sewing chests, book cases, etc. So easy to follow that beginners do almost professional work. FREE with the purchase of a full size 10c bottle of Rogers famous "Cabinet-maker's Glue" — the glue that holds for a lifetime.

Send your 10c today to Rogers Linsglass and Glue Co., Gloucester, Mass.



ROGERS

the best LIQUID FISH GLUE

GLOUCESTER, MASS.

SHEET METAL BRAKES

Forms angles, flanges and Pittsburgh locks. 26 gauge steel, heavier aluminum. Cam locking. Portable, can be bolted to bench, or clamped to edge of truck. All steel, reinforced. Shipped Exp. Coll. 30" size. Wt. 42 lbs., \$26.50. 36" Wt. 52 lbs. \$31.00. 48" \$45.00

Floor mountings, portable, 32" high, \$7.00
12" BRAKE. Fits in vise to form difficult compound bends, up to 20 gauge steel. Not illustrated. \$12.50 PP.
18" CURVE FORMER, Capacity —16 gauge steel. \$10.00

SHEET METAL PLIERS, 2 1/2" wide, \$2.00; 5" \$2.50

Immediate delivery. Order direct, cash or C.O.D. or send for folder.

VYKE BRAKE CO., P-1116 So. 27th St., Omaha 5, Nebr.

BE INDEPENDENT!

START YOUR OWN BUSINESS installing the lifetime **BELCO BALL BEARING FAUCET WASHER**. Every home, apartment, factory, public building and all types of institutions are prospects. Satisfied customers because you save them money on water, fuel and costly maintenance. Start small with a modest investment, expand on your earnings. Steady profits. Light weight **BELCO CONVERTER MACHINE** makes short work of converting standard faucets to BELCO.



WRITE TODAY FOR YOUR FREE SAMPLE AND DETAILS OF OUR EXCLUSIVE PLAN.

ECONOMY VALVE CO.
5919 TIREMAN AVE. • DETROIT 4, MICH.

SEND THIS COUPON NOW!

ECONOMY VALVE COMPANY
5919 TIREMAN AVE. • DETROIT 4, MICH.

NAME _____
ADDRESS _____
CITY _____ STATE _____



NOW! A MIDGET PLANE EASY TO GRIP

Pat. extension handle makes it as easy to Grip as a big one. Handy for small spots and all around fitting and finishing. 3 1/4" x 1 1/4" face. Precision made. Blade guaranteed to hold edge. Cash with order Prepaid (C.O.D. Postage extra). Order today. Only \$1.50.

Another Speedcor Tool

THE SPEED CORP., PM-11
512 N.E. 73rd Ave., Portland 16, Oregon



SUMP PUMPS 2,400 GALLON CAPACITY

1 1/4" outlet — No screen to clog — fool proof

The time tested Lokomona sump pump is absolutely automatic—has a special fool-proof trap at the intake—oilless bearing at the bottom. Made of aluminum castings, 10" 42" high and carries a 1/4 H.P. 110 V. A.C. heavy duty motor. The pump is designed for continuous service. Enclosed switch. All parts always available. Order yours today. C.O.D. If cash with order, we pay postage.

\$39.50

COMPLETE

\$24.00

LESS MOTOR

\$19.75

PUMP ONLY

LOKOMONA PUMP CO., P.O. BOX 86, ROYAL OAK 1, MICH.

SAY YOU SAW IT IN POPULAR MECHANICS

HIGH SPEED STEEL ROTARY CUTTERS

1/8" Shanks

SET No. 18..... **\$6.85** POST PAID



Send check or money order today.

This set of 18 cutters consists of the most popular shapes and sizes used by individuals throughout the country.

Due to the high quality workmanship, these cutters are unsurpassed for performance and efficiency.

Packed in sturdy case as illustrated. Dealer inquiries invited.

RICO SUPPLY COMPANY

P. O. Box 828 Dept. C Saginaw, Mich.

URGENT

Don't-While They Last-DON'T Miss out on This Terrific Value!

**LIFETIME
Chronograph
Stop-Watch
CALENDAR
WATCH**

It's Also a
Telemeter & Tachometer

**NEW
LOW PRICE
895**

With Steel
Expansion Band
Plus 10% Tax (90c)

YES, IT'S URGENT THAT YOU ACT NOW to take advantage of this remarkable import buy. Never in the history of watchmaking has such an amazing precision instrument sold for so little. But in face of rising watchmaking costs, we can't guarantee to hold this low price forever. Has imported Swiss Jeweled Movement, Radium Glow 1" dial, red sweep second hand, shock resistant case, unbreakable crystal. And included is the handsome, rich-looking, steel expansion wrist-band. Complete instructions included together with guarantee and service certificate. White, Pink or Black dial face. Specify color. Order Today!



**FULLY GUARANTEED
FOR ONE YEAR**
Plus Lifetime Service Certificate and 5-Day Free Trial

GAYLORD Dept. PL-7, 5th & Hamilton, Pgh. 6, Pa.
Send.....Chronograph watches @ 8.95 (Postpaid) plus 10% tax.
Enclosed Check Money Order Send C.O.D. Dial color.....
Money Back Guarantee, 5-Day Free Trial.
Print Name & Address on Margin.

Attention CUB owners

Special CUB Tractor Saw cuts 'em down and saws 'em up. Operates from driver's seat. 30 in. saw. Nothing else like it. Big money maker. Other implements available: drag saw with tree faller and post hole digger. Similar saws for Fords, Fergusons and others. Send for FREE details. **OTTAWA MFG. CO., 2-027 King St., OTTAWA, KANSAS**



DUAL CROSS and ROTARY FEED

PALMGREN ROTARY, INDEX, MILLING TABLE No. 83
Has 8" table, 360° movement and 4" cross feed travel. Adjusting wheels and dials graduated in degrees and thousands. Slotted for bolting to table, No. 83. Priced \$49.50. No. 82 without rotary feed \$39.75.
Write for Circular No. 10
CHICAGO TOOL and ENGINEERING CO.
8365 South Chicago Ave., Chicago 17, Ill.



Make Ur-Own Rotary Type POWER MOWER

**THIS IS NOT A KIT
BUT A COMPLETE MOWER ASSEMBLED
AS ILLUSTRATED**

Model 50M KEEN MOWER. Just add electric motor or gas engine, concealed blade for safety, 3 cutting heights, 1½" to 3½". Ball bearing rubber tired wheels, 18" cut. Cuts to within ½" of sidewalk. Wght. 48 lbs. America's Greatest Power Mower value. **\$39.95**
Guaranteed. Order Now!

Price FOB, K.C. Send chk. or M.O.

ATLAS EQUIPMENT CO.

229 S.W. Blvd. Dept. PM11 Kansas City, Mo.

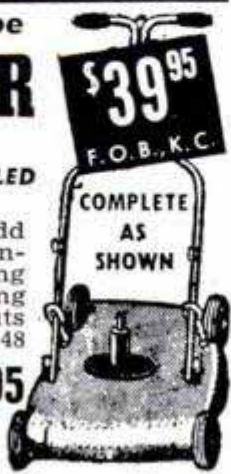

SAY YOU SAW IT IN POPULAR MECHANICS

NEW! FOREDOM Model #100 at an Amazing LOW PRICE

\$17.75
COMPLETE
WITH
MOTOR

**FLEXIBLE SHAFT
MACHINE
with PENCIL-SIZE
HANDPIECE**



USES
HUNDREDS OF
ACCESSORIES
35"
FLEXIBLE
SHAFT
PENCIL-SIZE
HANDPIECE

The choice of tens of thousands because: — Pencil-size handpiece provides positive, sensitive, finger-tip control, works in hard-to-reach places. Your work always well in view. Precision construction and silencer-equipped flexible shaft assures smooth-running performance. Motor not dwarfed to fit the hand, hence more power, longer motor life. Buy the Foredom Model 100 Flexible Shaft Machine. Price only \$17.75. Foot rheostat \$5.25 extra.

Use it to GRIND, POLISH, DRILL, SAW, SAND, CARVE, MILL, CLEAN, ETCH, ENGRAVE, etc. on all metals, wood, plastics, glass, leather, linoleum, etc.

ORDER TODAY
Send check or money order for items above or sent C.O.D. plus postage. Sold on 10 day money back TRIAL. Write today for FREE CATALOG No. 1135-E.

Name _____
Address _____
City & Zone _____ State _____

FOREDOM ELECTRIC CO.
27 Park Place, Dept. 1135-E, New York 7, N. Y.

**12" DARRA-JAMES TILTING ARBOR SAW
LOWEST PRICE EVER OFFERED**



Now you can get a BRAND NEW deluxe 12" saw... a Darra-James 95C—for less than you pay for lighter, smaller units. This saw formerly sold at \$295.00—now marked down for quick sale. Use the saw professionals use—do your ripping, cutting-off, mitering, grooving, dadoing better, faster, easier. Fully guaranteed. 2 H.P. motor recommended.

\$179.50

F.O.B. Waterbury, Conn.

Less motor, switch, blade, guard, and splitter.

Guard, Splitter and Anti-Kick Back Pawls \$7.00

- 4" cut
- 42" x 32" table, incl. extensions
- 3/4" arbor with New Departure Bearings
- Positive Tilt, Elevating mechanism
- Cast aluminum Rip Fence
- No die castings used anywhere
- Weight 430 lbs.

We can furnish new ball-bearing, standard make 2 H.P. motors as follows:

1/60/110-220 v. 1750 RPM...\$89.20
3/60/220-440 v.....\$67.20

ACT NOW...
WE CAN'T GUARANTEE THE PRICE VERY LONG!

ORDER NOW—BE SURE OF CHRISTMAS DELIVERY

Write for illustrated circular



ACME EQUIPMENT COMPANY, INC.
128 South Clinton Street Chicago 6, Illinois
ANdover 3-3430

**Make all your tools more useful with a
DESMOND-SIMPLEX VISE**

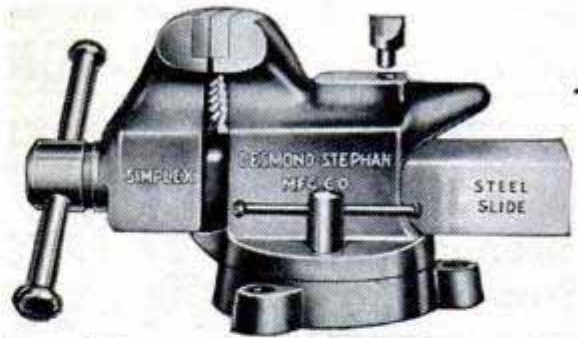

Enclosed Screw . . . Steel Channel Slide

Here's your best vise value by far. And at a surprisingly low price. Steel slide encloses screw; prevents damage from falling chips. Swivel base for maximum convenience. Non-pinching type handle. Pipe jaws part of vise. Replaceable hardened steel jaw inserts fit snugly on heavy shoulder, withstand heaviest blows from any angle. Hardened steel cut-off tool on anvil. Get a Desmond-Simplex Vise from your hardware store. Write us direct for valuable folder on your basic shop tool.

The Desmond-Stephan Mfg. Co.
Walnut Street, Urbana, Ohio

NEW! Automatic **LITE SWITCH**
Perfect for your Closet
5 minutes installation with screwdriver—that's all! Complete with 2 mounting screws and 6 ft. of UL approved cord. No wiring connections to make. Sent postpaid or C.O.D. on Money Back Guarantee.
Rene-Craft Products WILMETTE 2, ILLINOIS

Open door Light's on! Close door Light's off!

only **\$1.69** 2 for \$2.98

SURPLUS BARGAINS REDUCED!

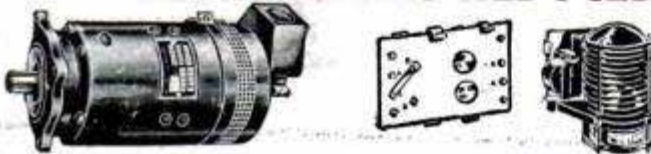

AIRCRAFT GENERATOR WAS \$19.95; NOW ONLY \$7.95. Type L3. 24-28V, 25 Amps; rotation CW, 2500 rpm; weight 24#, measures app. 12x5 inches. Guaranteed good condition! Shipping weight 35#; CLOSING out 1000 at only \$7.95 fob.

AIRCRAFT VOLTAGE REGULATOR & BASE Was \$9.95; now only \$3.95. Type AN3080-1, famous Carbon Pile type; holds voltage within given operating range at varied generator speeds. Hurry!

SHOCK MOUNTS For mounting electric motors, radios, etc.; base 2" square; #10 lb. type, rubber center; Lord type; save 95%! Dozen, \$1.25; 25 for \$2.00; 50 for \$3.50; 100 for \$5.95. Postpaid.

NAVIGATOR'S SEXTANTS Fairchilds: A10, \$5.95; A10A \$7.95. No charge for Wood Carrying case; no guarantee at all. Postage 75c.

INSTRUMENTS AND METERS Airplane; assortment 10, used, electric, pressure types, our choice, postpaid for \$7.95.

SHIELDED SPARKPLUG & WIRE ASSEMBLY AAF type; set includes 2 AAF spark plugs (shielded), 2 shielded wires (over 30" each) made up w/elbows, connectors, etc. Each set, \$1.79. (State spark-plug hole size, 14 or 18 MM)

SMALL BEARING MIX Our choice, 20 for \$1.50 postpaid.

AAF BOLTS, NUTS, WASHERS, ETC., MIX 10#-\$2.00; 50#-\$7.50; 100#-\$12.50 (all fob).

HOSE CLAMP MIX Small to over 2"; AAF screw type; 20-\$1.50; 50-\$3.00; 100-\$5.00 (all fob).

TOGGLE SWITCH MIX AAF type; 10-\$2.00; 50-\$7.50 (all postpaid)

FIRE EXTINGUISHERS Pyrene carbon tet 1 gallon type, air pressure self contained and filled; unused, worth \$50.; while they last, fob, \$14.95
CO2 hand type, w/horn; foggs fire, reconditioned by Kidde & charged, \$9.95.

SEND CASH, CHECK OR MONEY ORDER

Aero Parts Supply, 8102 Lockheed, Dept. PM-10, Houston 17, Texas

Unbreakable Fire-Safe Amber Hammer Proof Shock Proof

Ask Your Hardware Store for FULLER'S Unbreakable Amber Handle SCREW DRIVERS

TOOL STEEL PRICED FROM 5c TO \$1.00 EACH

America's most popular line of moderately-priced screw drivers! Wide range of sizes. FULLER TOOL COMPANY, Inc. 911 Faile St. New York 59 World's largest makers of Amber-Handle Tools

SQUIRREL CAGE BLOWER
For Heating, Ventilating, Air Circulation; complete with motor
Continuous duty—runs on 110 volt, 60 cycle. 190 cu. ft. minute output

• Kitchen ventilator (sucks heat out)
• Photo Dark Room (sucks fumes out)
• Work Shop (Sucks dust out)
• Hot Rooms (Circulates air)
• Drying purposes
• Controlled draft for furnaces

\$9.95 LISTS TODAY FOR \$29.50 WE PAY POSTAGE!

AKRON Army & Navy Store, 4400 Sunset Blvd., Los Angeles, Calif.

SAVE YOUR TOOLS—TEMPER—TIME
with this special ALL LEATHER TOOL KIT

only **\$2.95** postpaid
8" x 11"

Genuine chrome leather, sturdy stitching, re-enforced with rivets to last a lifetime. One large pocket for drivers, cutters, pliers, chisels—two medium pockets for knives, markers, rules, etc. Large pocket accessible to very bottom without digging hands. Small pockets hold tools without flopping. Worn on belt to make tools easy to get at—always in place, as you need them! SATISFACTION GUARANTEED.

Order direct today—Send for free catalog.

WESTERN TOOL KITS
516 Allen Avenue, Glendale, Calif.

WELD

BRAZE, SOLDER, CUT
quickly...easily

The **FOUR-WAY**
PORTABLE ARC-WELDER

COMPLETE ONLY \$11.95 F.O.B.
10 DAY TRIAL

MAKE OR REPAIR HOME & FARM APPLIANCES FENDERS BICYCLES METAL FURNITURE & 1001 ITEMS

YOU'LL BE AMAZED by the work you can do on your first job! Plugs into any convenient properly wired 110 volt A.C. or D.C. line. Follow simple directions. Work on iron, steel, bronze, brass, aluminum and other metals. Save money doing own repairs. Make money repairing for others. Thousands of users among maintenance and repair men, farmers, tinsmiths, engineers, home and auto owners, etc. Pays for itself over and over. Order on ten-day trial or send for details.

FOUR-WAY WELDER CO., Dept. F2-MA
2326 So. Michigan Avenue, Chicago 16, Ill.

FREE Full Details SEND TODAY

WHEELS - WHEELS

5" Disc Wheel	5/8" Tire	5/16" or 3/8" sleeve	30c ea.
6" Disc Wheel	5/8" Tire	5/16" or 3/8" sleeve	35c ea.
7" Disc Wheel	3/4" Tire	3/4" sleeve	45c ea.
8" Disc Wheel	1 1/2" Tire	1 1/2" sleeve	70c ea.
7" Disc Wheel	1 1/2" Tire	1 1/2" ball bearing	80c ea.
8" Disc Wheel	1 1/2" Tire	1 1/2" ball bearing	\$1.00 ea.
8" Disc Wheel	2" semi-pneum.	T. 1 1/2" B.B.	\$1.35 ea.
10" Disc Wheel	1.75 semi-pneum.	T. 1 1/2" B.B.	\$1.50 ea.
12" Disc Wheel	1.75 semi-pneum.	T. 1 1/2" B.B.	\$1.85 ea.

Above wheel prices include hub cap
Plus postage, 20% - C.O.D.'s accepted

UNITED WHEEL STAMPING CO., PM-11
2756 W. 115th STREET CHICAGO 43, ILLINOIS

FREE GASOLINE

CHEVROLET HEADERS

INSTALL CLARK HEADERS AND SAVE 13% of YOUR GASOLINE!

When you drive your Ford V-8 or Chevrolet 45 mph 10% of your gasoline is wasted in the exhaust manifold—at 50 mph 13%—at 70 mph 20%. Replace your exhaust manifold with Clark Headers and get 3 miles more per gallon, 13% more top speed, and much greater acceleration. Save 10% of your motor wear. For other Ford and Chevrolet Products that save gas and motors, write for FREE information today! Dealer inquiries invited.

CLARK HEADER CO., 6980 Firestone Blvd., Downey, Calif.

SAY YOU SAW IT IN POPULAR MECHANICS

When Other Tools Fail...

WISE-GRIP WRENCH

Does it QUICK and EASY

low as \$1.85

CAN'T BUDGE IT!

NOW! SO EASY!

Ever try to remove a round-head screw so battered your screwdriver wouldn't take hold—and rusted so tight that pliers wouldn't budge it? It's TOUGH! Yet, WISE-GRIP's LOCKED Ton-Grip will turn it easily!—does other "impossible" jobs just as easily! Turn rusted nuts, broken bolts—pull headless nails—clamp parts for soldering, gluing, grinding, etc. Holds all shapes. Grips to the very tip. Power cutter cuts heaviest wire, even small bolts. Most useful tool you can own. With cutter—No. 7C, 7", \$1.95; No. 10C, 10", \$2.25. No. 7, 7", \$1.85; No. 10, 10" \$2.15. If not at your dealer's, order direct.

PETERSEN MFG. CO., Dept. P-11, DeWitt, Nebr.

GAME ROOM

build your own



HAVE your winter fun headquarters right in your own cellar. You can build a delightful rumpus room at very low cost with Gold Bond Gypsum Wallboard. The strong lightweight panels saw like lumber, are easy to nail in place directly to wood framing. For decoration, use Gold Bond Sunflex, the low-cost, one-hour wall paint. Or, if you prefer, Gold Bond Gypsum Wallboard can be textured or wallpapered beautifully. At low cost you'll have a firesafe room that'll give you many hours of year round enjoyment. You can get Gold Bond in the standard ivory color or wood grain finishes.

Available at your local Gold Bond lumber and building materials dealer

NATIONAL GYPSUM COMPANY
BUFFALO 2, NEW YORK

SMALL BALL BEARING

ASSORTMENT 100 POPULAR SIZES & MAKES IN PARTITIONED PLASTIC BOX

NEW - PRECISION { FACTORY LIST PRICE ON BEARINGS OVER \$250.00

Bearings are SKF—FAFNIR—MRC—NEW DEPARTURE—NORMA—FEDERAL and others. Sizes from 2mm to 8mm inside diameter, and 4mm to 24mm outside diameter. MECHANICS—TECHNICIANS—HOBBYISTS—just the thing for servicing small machines such as Washing Machines, Vacuum Cleaners, Home Appliances, Cameras, Toys, Instruments, Automotive and equipment of all kinds.

No. MA-1 Assortment of 100 Ball Bearings in Plastic Box complete as shown, postpaid **ONLY \$15.95**

No. MA-2 Junior Assortment of 50 Ball Bearings in Plastic Box complete, postpaid **ONLY \$7.95**

ORDER Now

MEDALLION MFG. CO., 25 E. 25th St., Chicago 16, Ill., PM-11

Send me postpaid, Ball Bearing Assortment No. _____ in Plastic Box. I enclose check (or Money Order) for \$_____.

Name _____
Street _____
City _____ State _____



NEW BULL PORTABLE ROUTER!

only **\$9.95**

Fits any $\frac{1}{4}$ " electric drill

• Now your electric drill converts into a portable router that grooves, rabbets, tenons, engraves, mortises!

• Depth gauge automatically permits routing to a uniform depth!

• Use it as a jig saw on wood of any dimension!

• You can rout "free hand" . . . follow a pattern line . . . or use the adjustable fences for perfect parallel inside routing!

• Two-handed grip gives you perfect control!

Complete as shown with $\frac{3}{16}$ " router bit, stand and guides, only **\$9.95**. (Extra routing bits, $\frac{1}{8}$ ", $\frac{3}{16}$ " or $\frac{1}{4}$ ", \$2.25 ea.)

To insure early Christmas delivery send cash, check, or M. O. today.

BERTRAM C. ENGINEERING & SUPPLY CO.
3121 MAIN ST. KANSAS CITY, MO.



Bet You Don't Know This About Advertising

by Susan

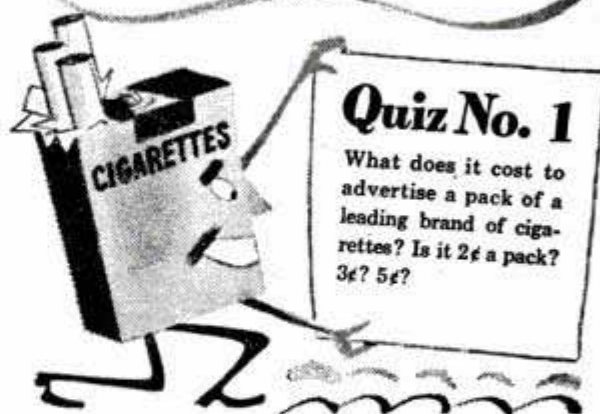

Quiz No. 1

What does it cost to advertise a pack of a leading brand of cigarettes? Is it 2¢ a pack? 3¢? 5¢?

Answer: It costs less than $\frac{1}{2}$ ¢ a pack to advertise the big brands of cigarettes.

That's only half the story. Advertising lowers your cost two ways:

Cuts the selling costs. And by helping make mass production possible, lowers the production costs, too.

So advertising saves you many times that $\frac{1}{2}$ ¢ per pack.

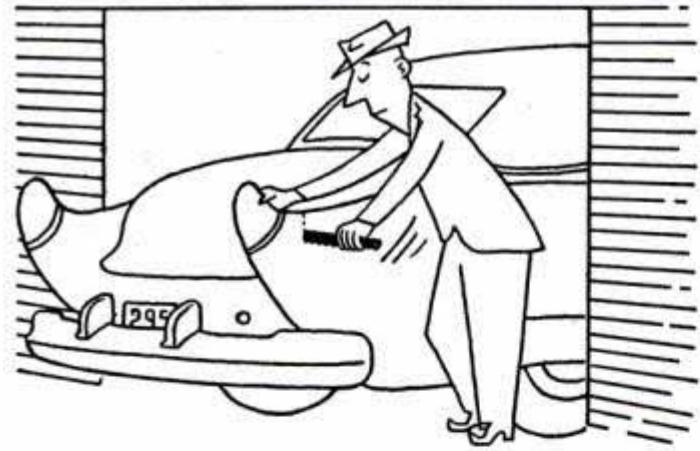

It's the CUT that COUNTS

and Capewell's Exclusive "Statistical Quality Control" Gives You 10% More Cutting

When you buy Capewell hack saw blades you get a bonus of 10% additional cutting because Capewell's "Statistical Quality Control" eliminates sub-standard blades. Another exclusive Capewell advantage—the printed blade, carrying instructions for proper use.

Always ask for Capewell hack saw blades and frames, band saws (in coils or welded), Dafilés, ground flat stock, hammers. Pipe and Bolt Threaders. Pipe Cutters. Pipe Reamers. Pipe Vises. Tubing Cutters. Power Pipe Machinery.



THE CAPEWELL MFG. CO.
Dept. 911
Hartford 2, Conn.

THE KEY TO ECONOMY



Famous for authoritative, detailed information on auto racing, every type of race car, rules, specifications, working drawings, plans, etc. No duplication. Every book different. Money back if not satisfied.

AUTO RACING • 6th Edition

Championship cars, big cars, mid-gets, roadsters, Offenhauser dirt track car. Specifications on Indianapolis cars, four-wheel drive details, front drive drawings, etc. Plans for Ford 60 midget, roadster racer. Data on engines, gear boxes, friction and dog clutches, axle ratios, compression ratios, independent suspensions, Indianapolis rules and regulations, etc. More than 100 illustrations. \$2.00.

TRAILER COACHES

By Ray F. Kuns. Contains information on the history of trailers, trailer parks and camps; materials, furnishings, trailer chassis, engineering, etc. Construction data on 10, 16 and 22 foot trailers which you can build yourself. 100 illustrations. \$1.50.

AUTO RACING • 5th Edition

Tells you—Why the Fast Ones are Fast—How to Make Them Fast—How to Build Engines—How to Build Chassis—How to Build Bodies—Who Holds What Records—What the International Formula Is—What Midget Racing Rules Are—How World's Record Cars Are Built—How to Speed Up Ford V8 Cars. \$1.00.

AUTO RACING • 4th Edition

Includes eight working drawings and complete building instructions for standard midget racers, drawings for midget road cars. Miller-Ford V8 front-drive racers are illustrated and described and other big-time data given. Technical pictures give the inside dope on these cars, together with authentic descriptions. 50 pages. 66 illustrations. \$1.00.

ORDER ON COUPON

POPULAR MECHANICS PRESS, Dept. 31, 200 E. Ontario St., Chicago

Remittance for \$_____ enclosed. Send books checked, postpaid.
 Auto Racing, 6th Edition Trailer Coaches
 Auto Racing, 5th Edition Auto Racing, 4th Edition
 Send C.O.D., postage extra.

NAME _____
 ADDRESS _____
 CITY _____ ZONE _____ STATE _____

ARCO

WORK-SAVERS OF THE WORKSHOP - "ARCO" QUALITY TOOLS AT BETTER HARDWARE STORES EVERYWHERE

EVERY ELECTRIC DRILL A PORTABLE SAW

ARCO
SAW

CUTS
1-5/16"
or 2x4 by
TURNING
OVER

Pat.
Pend.

ARCO

90-DAY
FACTORY
GUARANTEE

9.95

compl.
with 4"
"HYCARBON"
Crosscut
Blade

CAN BE USED WITH ONE HAND

Any 1/4" or 3/8" Drill or Powerful Saw in ONE MINUTE "ARCO-SAW" is a rugged tool with right angle gear drive (no clumsy, dangerous, direct drive with drill sideways). Works like a high priced Portable Saw.

Only ARCO Gives You All These Features: Safety-yoke assures rigid connection and absolute safety—Big handle affords firm grip for two-hand operation—Precision one-piece gear box—Self-lubricating lifetime bearings—Visual guide and wide shoe-plate for straight, square cuts—Lowest priced, quality Replacement Blades.

"HYCARBON" 4" Crosscut Blade \$1.60
"HYCARBON" 4" Combination Blade \$1.60

NOW! EVERY "ARCO-SAW" AN ANGLE SANDER & POLISHER

Your "ARCO-SAW" becomes a powerful right angle sander & polisher in just a few minutes. Ideal for removing paint from cars & walls, sanding floors, polishing linoleum & furniture. Swivel action between drill chuck & gear box permits new freedom of use at any angle on every surface, or when necessary safety-yoke can be used to hold unit rigid. No need to buy an expensive special angle gear drive. New ARCO "SAND-N-POLISH" Attachment consists of flexible molded rubber head, sanding disc, lambwool polisher, bottom plate, hexagon adaptor, & also 1/4" adaptor for use in drill chuck



\$1.95

BETTER BLADES AT LESS ARCO "HYCARBON" SAW BLADES

Made of finest, heavy gauge,
TEMPERED TOOL STEEL,
HANDFILED.

Unexcelled Workmanship.

For top-notch quality and performance you can rely on these famous precision-made ARCO "HYCARBON" CIRCULAR SAW BLADES. Designed especially for long and rugged use, they cut cleaner and faster.

ARCO QUALITY AND PRICE CAN'T BE BEAT

4" Crosscut, or Combination \$1.60 each
6" Crosscut, Rip or Combination 2.00
7" Crosscut, Rip or Combination 2.50
8" Crosscut, Rip or Combination 3.00

All Blades Supplied with 1/2", 5/8" or 3/4" Bore
(Bore for Mail, Skil, Black & Decker Saws 30c more)

ORDER TODAY at your dealer or send us check or M.O. (Postpaid). C.O.D.'s — postage extra.

UNCONDITIONAL 10-DAY
MONEY BACK GUARANTEE

DEALERS—Write for
nearest jobber.

ARROW METAL PRODUCTS CO.

Dept. PM-11, 140 WEST BROADWAY, NEW YORK 13, N. Y.



TRAILER COACHES

Here's everything you want to know about trailers, with plenty of pictures and plans and instructions for building three different types. Covers also, history of trailers, trailer parks, camps and overnight-stops information, furniture, furnishings, materials and engineering data. If you want to build a trailer, live in a trailer, or just want to know more about trailers, get this book. Only \$1.50 postpaid. Rush order to:

POPULAR MECHANICS PRESS • Dept. 350, 200 E. Ontario St., Chicago

Build it Yourself!

Complete Trailer Book
and Construction Data
for 10, 16 and 22 Foot
Trailers — Only \$1.50

Partial Contents

Trailer Parks—Living in a Trailer—Towing a Trailer—Floor Plans—Service—Classifications—Balance—Dollies—Jacks—Weight Distribution—Construction—Working Drawings for a Two-Place, Standard Travel and Standard Dwelling Trailers. Size 8 1/2 x 11 1/4 inches.

Build your own JET ENGINE!



SEND
NO
MONEY

Order these plans today

1. JET PROPELLED BICYCLE, Assemble your own. Photo and instructions, \$1.00.
2. HOW TO MAKE EXPERIMENTAL JET ENGINES, Seven sheets drawings with information and instructions \$2.95.
3. BOTH OF ABOVE in one order \$3.75. SEND NO MONEY. Order both at once \$3.75 C.O.D. in USA plus e.o.d. postage. Send check or Money Order and we pay postage. Get other information too. Rush Order.

J. HOUSTON MAUPIN, Dept. 55, Tipp City, Ohio

Say You Saw It in POPULAR MECHANICS

OWN a Business

Clean and Mothproof rugs and upholstery "in the home." Patented equipment. No shop needed. Duraclean dealer's gross profits up to \$20 a day on EACH serviceman. These Nationally Advertised services create repeat customers. Easy to learn. Quickly established. Easy terms. Send today for FREE Booklet—Full details.

DURACLEAN CO., 0-16N DURACLEAN BLDG.
DEERFIELD, ILL.

WAR SURPLUS AND OTHER BARGAINS



PNEUMATIC RIVETER & CHIPPING HAMMER

Mfd by
Ingersoll-Rand,
Chicago Pneumatic
and Ther

Pistol grip. Ideal for fender, brake lining, concrete breaking work. Weight 5 lbs. Like new. Price each...
2X — \$6.95 3X — \$7.50 4X — \$8.50

INSIDE MICROMETER 2" to 8"

Precision made of tool steel. Hardened tips on all six measuring rods. One 1/2" spacer. Chrome finish. Complete with case. \$6.95



FANCY BRIAR PIPES

We have been awarded 100,000 fancy briar pipes by Quartermaster Corps. Assorted shapes and sizes. All popular makes. Buy now for Christmas Gifts. Set of 7 \$3.50

MICROMETERS

Chrome plated, precision engineered and carefully tool to give long life. All new.

0-1" capacity . . . each \$2.25
1-2" capacity . . . each 3.50
2-3" capacity . . . each 5.50
3-4" capacity . . . each 6.50

EXPANSION REAMERS



Spiral Flute. Mfd by Alford Polk Tool Co. All New, original pack. 1/4"-3/8"-7/16" Recommended expansion limit, .006" Original value \$12. Set of 3 \$4.95

HIGH SPEED DRILLS

All New Fractional & numbered Orig. Val. \$15 Nationally known brand Ast. sizes. Set 30, \$3.50

EXTENSION DRILLS

High Speed Steel, like new. Ass'd sizes from No. 1/4 to 40. Lengths from 6" to 12". Approximately \$20 value. Set of 12 \$3.75



ELECTRIC BELLS—Vibrating type, high pitch. 115 V., 60 Cycle Ideal for use indoors or outdoors—on ranches, for schools, plant installations, as signal systems, burglar alarm systems, etc. Nationally known Mfr. ALL NEW in orig. Pkgs Solid brass clapper & 8 1/2" gong Wt. 8 lbs. Govt. cost about \$67.50. Close out at . . . \$7.95
Send check, money order or cash. 25% deposit required on C.O.D. orders. All prices F.O.B. Culver City, Calif.
Send 25c for illustrated Catalog.

AIRBORNE SALES CO., INC. DEPT. PM 11—O
CULVER CITY, CALIF.

SURPLUS MACHINE SHOP TOOLS

HIGH SPEED STRAIGHT SHANK DRILLS



SET 1G 30 Selected High Speed Straight Shank Drills from 1/8" to 1/4", \$15 value. New and slightly used surplus. Priced at only..... **\$2.95**

SET 2G 10 Different Size High Speed Straight Shank Drills from 1/4 to 1/2", Extra Long Drills. \$30 value. Priced at only..... **\$4.95**

SET 3G 10 Different Size High Speed Straight Shank Drills from 1/4 to 1", Extra Long Drills. \$40 value. New and slightly used surplus..... **\$6.95**

HIGH SPEED MORSE TAPER SHANK DRILLS



SET 4G 15 Different Size High Speed Morse Taper Shank Drills up to 9/16" with No. 1 and 2 tapers. \$50 value. Priced at only **\$6.49**

SET 5G 20 Different Size High Speed Morse Taper Shank Drills from 1/4 to 1". \$70 value. Priced at only..... **\$12.95**

SET 6G 10 Different Size High Speed Morse Taper Shank Drills from 1/2 to 1 1/4". \$50 value. Priced at only..... **\$9.95**

SET 7G 10 Different Size High Speed Morse Taper Shank Drills from 1 to 2" with No. 3, 4 and 5 tapers. \$180 value. Priced at only..... **\$39.95**

HIGH SPEED TAPER SHANK CHUCKING REAMERS



SET 8G 20 Different Size High Speed Morse Taper Shank Chucking Reamers up to 1 1/2" with No. 1 and 2 tapers. Priced at only..... **\$6.95**

SET 9G 8 Different Size High Speed Morse Taper Shank Chucking Reamers from 1/4 to 1". Priced at only.... **\$4.95**

SET 10G 10 Different Size High Speed Morse Taper Shank Chucking Reamers from 1/2" to 1 1/8". \$65 value. Priced at only..... **\$9.95**

SET 11G 20 Different Size High Speed Morse Taper Shank Chucking Reamers from 1/4 to 1". Priced at only..... **\$9.98**

HIGH SPEED STRAIGHT SHANK CHUCKING REAMERS



SET 12G 20 Different Size High Speed Straight Shank Chucking Reamers up to 1/2". Priced at only..... **\$6.95**

SET 13G 10 Different Size High Speed Straight Shank Chucking Reamers from 1/2 to 1 1/8". Priced at only **\$9.95**

SET 14G 15 Different Size High Speed Straight Shank Chucking Reamers from 1/4 to 1". Priced at only..... **\$6.95**

HIGH SPEED HAND TAPS



SET 15G 14 Different Size High Speed Standard Thread Hand Taps up to 3/4". Priced at only.... **\$2.95**

HIGH SPEED MILLING CUTTERS



SET 16G 4 High Speed Milling Cutters. Set consists of two side milling cutters, size 2 x 1/8 x 5/8" arbor and two side milling cutters, size 2 x 3/16 x 5/8" arbor. Set of four priced at only.... **\$3.95**

SLITTING SAWS



SET 17G 7 Different Size High Speed Slitting Saws 2 3/4" dia. x 1" arbor. Thickness from .040 to .071. Cuts wood, aluminum, brass, steel, etc. \$25 value. Priced at only **\$4.95**

HIGH SPEED STRAIGHT SHANK DOUBLE END END MILLS



RIGHT HAND TWIST AND CUT, 3 & 4 FLUTE

SET 18G 4 High Speed Double End End Mills, 3/8" shank, sizes up to 3/8". New and slightly used surplus. Priced at only..... **\$3.49**

SET 19G 6 High Speed Double End End Mills, 7/16" shank, sizes up to 7/16". Priced at only..... **\$4.49**

SET 20G 4 High Speed Double End End Mills, 1/2" shank, sizes up to 1/2". Priced at only..... **\$4.95**

PLEASE SEND ME



for the time checked. I am enclosing ...

1 year \$3.50

2 years \$6.00

name

address

city

zone

state

11

Hand this order to your newsdealer or send it to

POPULAR MECHANICS

200 East Ontario St.

Chicago 11, Ill.

Say You Saw It in Popular Mechanics

HAND REAMERS



SET 21G 10 Different Size Hand Reamers up to 1-3/16". New and slightly used surplus. \$50.00 value.

PLUS a BRAND NEW ADJUSTABLE Hand Reamers 1-11/32" to 1-17/32". All 11 Hand Reamers - **\$11.95** priced at only.....

HYDRAULIC DEPARTMENT

PESCO HYDRAULIC PUMP

Gear type, rated 1500 PSI, 2 1/4 G.P.M. at 1500 R.P.M. 5/8" drive spline. No. 1P203 reconditioned guaranteed. Priced at only..... **\$6.49**

Discounts on quantity.

BRAND NEW HYDRAULIC UNIT

Pesco 1P203 Hydraulic Pump rated at 3 G.P.M. @ 3750 R.P.M. and 1000 P.S.I. Attached to 2 1/4 H.P. 24 volt D.C. electric motor. Pump priced at only \$9.95. Motor Free. Price F.O.B. Tulsa. Discounts on quantity.



\$9.95

FOUR WAY HYDRAULIC VALVE

High pressure Adel valve for controlling one cylinder or other hydraulic equipment. 3/4" pipe ports. Heavy steel construction. Priced at only..... **\$5.98**

Master Hydraulic Control Valve

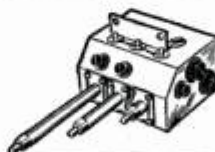

Will operate 1 or 2 hydraulic cylinders independently of each other or together by means of 3 control handles. Rated at 1000 PSI. Valve made of heavy steel with standard pipe ports. Cost new over \$125. Priced to you at only **\$8.95** Discounts on quantity.

Write for our catalog describing thousands of machine cutting tools, hydraulic equipment, etc.

All merchandise is sold with money back guarantee of satisfaction and is shipped postpaid unless otherwise stated.

T & T TOOL, 101 West Archer, Tulsa, Oklahoma

Sharpen SAWS FOR PROFIT

RETOOTH HAND SAWS IN 60 SECONDS. Increase your income with automatic retooth that cuts 4 to 16 point rip or cross-cut teeth in hand saws.

Requires less space, less time and less effort . . . while doing a perfect job. Gives a lifetime of service and has a 1 year guarantee. Free folder on request.

Automatic Retoother

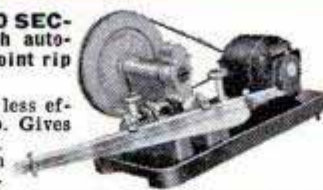

EARN \$6 AN HOUR WITH THE MOTOR DRIVEN BURR SAW FILER

It does a better, faster and easier filing job. No time killing adjustments necessary . . . the accurate operator-controlled file arm will file from both sides. Gives a lifetime of service and has a 1 year guarantee. FREE FOLDER ON REQUEST.

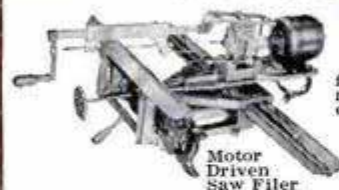

Motor Driven Saw Filer

WRITE FOR VALUABLE BOOK

Send 25c in coin for Burr's Blue Book of saw shop charges and other valuable information.

SAW SHOP CHARGES COAST TO COAST

BURR MFG. CO., Dept. 11, 8933 Venice Blvd., Los Angeles 34, Calif.

WANT \$10,000?

Earn the government Super Sensitive P.R.I. ment bonus. Locate Uranium with a **GEIGER COUNTER**

Also get one for Atom Bomb Defense!

Find gold, silver, and other valuable ores with a P.R.I. Treasure Locator. World's finest instruments. FREE catalog. Write!



PRECISION RADIATION INSTRUMENTS, Inc. Dealer Inquiries Invited
5478PM Wilshire Blvd., Los Angeles 36, Cal.

HELPFUL BOOKS

Send post card asking for FREE catalog

Popular Mechanics Press, 200 E. Ontario, Dept. 601, Chicago 11

No More Frozen Locks, Gas Lines or Gas Caps with the

JET LOCK DEFROSTER

This compact, precision-built, scientific instrument works on a chemically-proven principle and will defrost the most stubborn lock or frozen surface in about twenty seconds. A jet of superheated steam does the trick, and is guaranteed to work every time. Complete with 2 cartridges, ONLY \$1.00

Additional package of 4 refill cartridges . . . 25c Postpaid or C.O.D. plus postage.

COMMERCIAL SALES CO.

Dept. PM-11, 1303 Fulton Street, Brooklyn 16, N.Y.



110V TRANSFORMERS



#215. NEW. Input 110V. AC. Output 24V. 20 amps. Suitable for running 24V aircraft motors, etc. Mounting brackets. Size 4x4x5 in. Wt. 7 1/2 lb. OUR LOW PRICE... **\$4.65**

STEWART-WARNER TACHOMETERS



NEW. Checks speeds up to 2500 R.P.M. Runs clockwise. Size 3 1/2" dia., 4 1/2" long. Luminous dial. Has cup tip for flexible shaft. Mounting bracket. Wt. 1 1/2 lb. OUR LOW PRICE... **\$2.95**

TRADE WIND MARINE BLOWERS



NEW. Single exhaust. Ideal for heating, ventilating, air conditioning, drying, exhaust fan on boats, dust collectors. 4" sq. mounting flange; 4" dia. intake; 2 1/2" sq. discharge. Squirrel cage blower wheel powered by direct-connected 12V 6.5 amp. DC Redmond motor. Size, less flange, 8" wide, 7 1/2" high, 6 1/2" deep. Sturdily built. Wt. 6 1/2 lb. OUR LOW PRICE... **\$6.95**

SPEED REDUCTION BOX



NEW. Has 1 1/2" dia. take-off shaft with clutch. Cast aluminum housing, three mounting ports. Handle may be removed for motor drive. Ratio 75 to 1. Gear box is equipped with 8 ball bearings, permanent grease supply. Wt. 6 1/4 lb. OUR LOW PRICE... **\$3.75**

RHEOSTATS



NEW. Made for heavy duty use with Air Corps heated clothing. Ideal for regulating voltage on generators, soldering irons, electric welders, photoflood lamps, lights, etc. Rated 24V, 100 watts, 5.75 ohms. Double windings, dual female 25 amp 125V receptacles. Size 7x3 1/4x1 3/4 in. Wt. 2 lb. OUR LOW PRICE... **\$1.95**

ORDER FROM THIS AD! All prices F.O.B. St. Louis, Mo. Include postage with cash, bank draft, or money order. **MONEY BACK IF NOT SATISFIED!**

MAIN SURPLUS & SUPPLY CO., Desk M-10
11 South 3rd St., St. Louis 2, Mo.

FREE Catalog

Our 324th Advertisement

REAL DIESEL ENGINE!

\$2.95

You just can't beat this price for a completely assembled precision diesel engine!

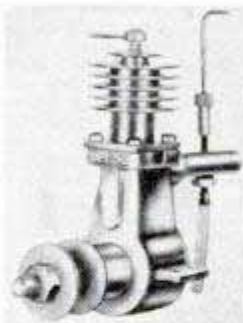

- Ideal for planes, boats, midget cars
- Actually runs at 7500 RPM, produces 1/7 HP
- Height a full 3 1/2 inches; weight 5 ounces
- Comes to you completely assembled, ready for operation

MAYBE WE'RE CRAZY, giving away a precision diesel engine, complete with cylinder and piston, carburetor, crankshaft, connecting rod, etc. for ONLY \$2.95. But we're selling thousands of DEEZILS all over the world, and that keeps our production costs down. DEEZIL is streamlined, compact, rugged. Starts quickly, easy to install, runs for years! Fast delivery if you ORDER DEEZIL TODAY!

Send \$2.95 plus 25c postage

GOTHAM HOBBY CORP. Dept. P, 107 E. 126 St. NEW YORK 35, N. Y.

Snap-on* DWARF BOXOCKET WRENCHES

"SHORT HANDLES FOR WORK IN CLOSE PLACES"



\$8.00

Plus local tax

A short, strong, sturdy set. Each tool has two wrench sizes. Set ranges from 5/16" to 3/4". Durable polished chrome finish. In kit bag.

*Snap-on is the trademark of Snap-on Tools Corp.

SNAP-ON TOOLS

CORPORATION
8062-K 28th Ave.
Kenosha,
Wisconsin

Please send me the XS-606-K Dwarf Boxocket Set.

I enclose Check Money Order

Name.....

Address.....

City.....State.....

Complete Metalcraft Workshop with this **LOW COST DYNAMIC WELDER** 12 tools in 1!

Over 50,000 Satisfied users! Here's the biggest shop value offered. Now you can make or repair 1001 useful auto & home appliances, farm and shop equipment. Fabricate anything of iron, steel, brass, bronze and other metals. Can pay for itself on first job or project. No experience needed. Complete instructions furnished. Works on any properly wired 110 Volt 50/60 cycle A.C. line. **Everything Included.** Complete, ready-to-use. You get Power Unit, Electric Torch, Etching & Soldering Tool, Headshield, Electrode Holder, Welding ground and power cables, Ground clamp. Simplified instruction manual, Metal fabricating rods, Flux, Etc.

Only
\$33.50
F.O.B.
Complete
with gift
attachments
worth \$8.30

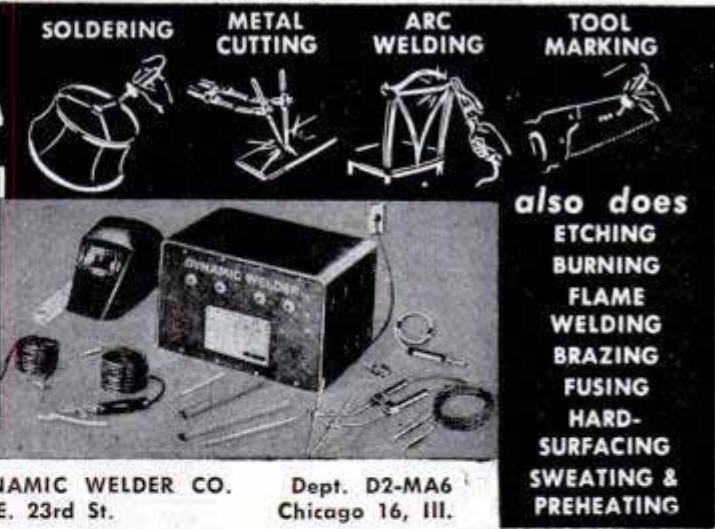

DYNAMIC WELDER CO. Dept. D2-MA6
15 E. 23rd St. Chicago 16, Ill.

FREE Complete Illustrated Descriptive Literature. Write Today for Details on Money-Back Guarantee. 10 Day Trial Offer!

Aladdin Tools

Make These Cuts—And Hundreds More—with Aladdin Shapers for Circle Saw and Drill Press!

CIRCLE SAW WOODSHAPER, MODEL #SA-10. (left) Solid steel. Absolutely safe—blades locked in position with screws all the way through. In ordering, state diameter of your circle saw shaft. Complete, as pictured, with 6 pair blades and tool rack. **\$14.95**

DRILL PRESS WOODSHAPER MODEL #60. (right) Heavy-duty shaper. Exclusive pilot bearing eliminates side thrust, chatter, vibration—assures smooth cutting action. Complete, as pictured with 6 pair blades. **\$12.95**

ALL ALADDIN TOOLS ARE GUARANTEED
To insure early Christmas delivery send cash, check, or M. O. today.

Nationally Distributed by

BERTRAM C. ENGINEERING & SUPPLY CO.
3121 MAIN STREET KANSAS CITY, MO.

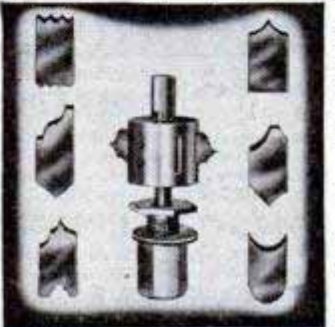

6 handy tools in ONE!

- 1 MITERING GUIDE
- 2 DIAMETER GAGE
- 3 ACCURATE SQUARE
- 4 MARKING GAGE
- 5 CENTER FINDER
- 6 CONVENIENT RULER

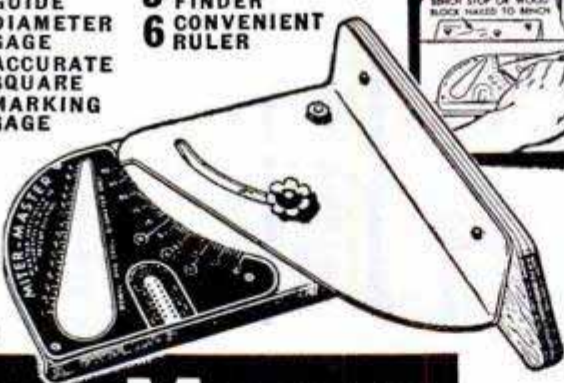

Miter Master takes the place of an expensive miter box accurately set to any angle. Scale marked for mitering 5, 6, and 8-sided frames. Steel construction. Built to last a lifetime. If your dealer can't supply you we will send it postpaid anywhere in the U. S. for \$2.00. (Foreign \$2.25). Unconditional guarantee. If not satisfied within ten days for any reason whatsoever, your money will be refunded.

IDEAL CHRISTMAS GIFT

MASTER SPECIALTY COMPANY
3018 EAST LAKE STREET • MINNEAPOLIS 6, MINN.

FREE TO RUPTURE SUFFERERS

Penny post-card brings free information on newly invented three-contact, painless pad that holds hernia at upper break thru, center and point of swelling. Safe! Comfortable! Write Dept. PM-11.

ACTIVE MAN APP.. 549 W. Randolph, Chicago 6

NOW! HANDIEST TOOL YOU EVER USED

Speedcor Handle works like drill chuck. Holds files, razor blades, taps, drills, allen wrenches, bits . . . any shape shank—flat, oval or round. 101 uses. Positive, non-slip grip. Precision made. Fully guaranteed. Order Today \$1 Postpaid.

Another Speedcor Tool

THE SPEED CORP., Dept. PM-11
512 N. E. 73rd PORTLAND 16, OREGON

\$8.95

1941 FORD CHROME DASH PANEL only
Added appearance for your car. Also 1940-1950 Ford and Mercury panels available. Complete "Custom Accessories" catalog—25c. Write **EASTERN AUTO** 3319 SO. GRAND, DEPT. P. Today LOS ANGELES 7, CALIFORNIA

SAY YOU SAW IT IN POPULAR MECHANICS

\$600 BUILDS 4 ROOMS & BATH! WHY PAY RENT?



For Six Hundred dollars and 30 days of your spare time you can build yourself this Beautiful Home.
Living room 10x15, Front bedroom 9x10, Back bedroom 10x11, Kitchen 8x10, Bath 5x7, Hall 3x4, Wind out steel Casement windows, Concrete block, stuccoed. \$1.00 brings you Step-by-Step Instructions, Blueprint & Material List.
L. H. FARROW, Dept. C
Box 645 Columbus 16, Ohio

3 different Engines in One



WALKING BEAM



HORIZONTAL



VERTICAL

GENUINE MACHINED COMPLETELY ASSEMBLED STEAM ENGINE!

THE IDEAL XMAS GIFT

SAFE—STURDY—ELECTRICALLY HEATED BOILER

Let junior be a real engineer with this amazingly instructive toy. It's fun for dad too. Here is a steam engine so designed that it can be taken apart and re-built in three different ways. It's put together with machine screws—all parts die cast and machined to close tolerances. Built to last. No open flame. Electric current automatically shuts off when water boils out. Runs for half hour with one boiler filling. Order today. Only \$7.95 complete post paid.

ONLY
\$7.95
COMPLETE
POSTPAID

Three blue prints of exploded drawings included giving simple assembly instructions for three basic types.



The K. J. MILLER CORPORATION
2900 S. 61st CT., Chicago 50, Ill.

Please ship me _____ steam engines. Enclosed find \$_____ send postpaid. Enclosed \$2.00 ship balance C.O.D. plus postage.

NAME _____

ADDRESS _____

CITY _____ STATE _____

ALTIMETER



Modernize your car. Fine desk ornament. Reads up to 20,000 feet. Fluorescent dial glows at night—no connections of any kind required—self contained—suitable as a laboratory standard instrument—Same as used in airplanes. Brand new—cost gov't many times\$4.50

REMOTE CONTROL THERMOMETER



For automobiles, homes, refrigerators, milk coolers, brooders, orchards, workshops, etc. Temperature bulb at end of 5 or 15 ft. flexible tube (state which). Dial thermometer glows in dark—non electric—very sensitive—-40° to +50° C. and -40° to +125° F on same dial. Aircraft quality—worth many times.....\$4.50

Above items sent postpaid—No COD's

AIRCRAFT COMPONENTS INC.

1135 Woodland Avenue • Benton Harbor, Michigan

MAKE BIG MONEY Sharpening Lawn Mowers...

SPARE OR FULL TIME

PROOF "I have had my Universal Grinder only 2 months. Live 1 1/2 miles from town. Yet have already made net profit of \$227." G. Spurlock, Arkansas. "I am doing a fine business with the Universal Grinder. One customer sends another. A 40c newspaper ad produced nearly \$500 worth of business." writes C. E. Hardy of Missouri. "A real machine, works fine on power mowers, too." This from J. H. Fisher, Pennsylvania.



ONLY ON THE UNIVERSAL LAWN MOWER GRINDER

... can the inside face and edge of the stationary blade, as well as all the reel blades, be ground to proper clearance **ALL IN ONE SET-UP**, without removing any blade from either hand or power mower. Send today for **FREE Facts**. **ROGERS MFG. CO. Dept. M-110 LINDSEY, OHIO**

Make Money
SELLING
Eshe!man
Kulti-Mowers
and DOING
GARDEN
WORK

PLOWS
CULTIVATES
HARROWS
HAULS
SPRAYS
SAWS
DOZER
MOWS
CUTS
ROLLS
RAKES



FOR BETTER
LAWNS
and GARDENS
also POWER MOWERS
and RIDING TRACTORS
Women can operate it.

Free Catalog, Write
ESHELMAN CO.
Dept. 125
119 Light St., Balto. 2, Md.



HOT RUNNING WATER!

Attaches easily, quickly to any standard faucet. Regulates temp. by turning faucet. Operates AC or DC. Comes with 8-ft. rubber cable and plug. Our DELUX heater has delighted many thousands of users. Send \$3.95 cash, check, or M.O.—we will ship prepaid or, if you wish, we will ship C.O.D.—you pay postman \$3.95 plus few cents postage. Order 3 for \$10—save \$1.85.
METROPOLITAN ELECTRONICS CO.
Dept. 175, 106 Fifth Ave., New York 11, N.Y.

GIFT Extraordinary!

4-COLOR Mechanical PENCIL

2⁹⁹

Writes Red, Green, Blue, or Black. Precision-made, beautifully streamlined.

Takes the place of four ordinary pencils. Flick finger to get any of 4 colors, always ready to use. Slim barrel, reversible eraser cap, always-visible color indicator. Reserve lead supply. Looks like a \$6.00 value.

GAYLORD Dept. PL-8, 5th & Hamilton, Pittsburgh 6, Pa.
Send _____ PENCILS @ 2.99 + 11¢ handling. Check M.O.
 C.O.D. Money Back Guarantee. Print Name and Address in Margin



**Speed Way
Speed Sander**

\$34⁵⁰



**Sands,
Cleans,
Smooths, Polishes Electrically**

Designed for industry, for professional work, this light, beautifully balanced, orbital-motion, Speed Sander is rapidly becoming a standard home appliance. With its powerful electric motor and all-ball-bearing construction, anyone can easily re-surface and refinish furniture, woodwork, metal surfaces or walls. It will quickly remove old paint, stain, or enamel down to the bare wood or metal; will sandpaper to a "piano finish"; remove rust and corrosion or "feather edge" a scraped fender. It will burnish pots and pans or with lambs wool bonnet, delicately polish fine furniture. It makes tedious, tiresome jobs fun—saves hands! In design, convenience and efficiency it is today's finest sander regardless of price. Ask your local dealer to demonstrate it.

Write for Catalog

Speed Way MANUFACTURING CO.
1863 So. 52nd Ave., Cicero 50, Illinois

NEW B-T HACK SAW!

Fits any 1/4" electric drill



For
Home
Craftsmen
Farmers
Carpenters
Plumbers
Mechanics
Electricians
Contractors

**POWERFUL ...
PORTABLE ...
POCKET-SIZE ...**

and only **\$4.95!**

- SAWS WOOD, PLASTIC, STEEL & SHEET METAL, PIPE, PLASTER BOARD, CELOTEX!
- 2-1 reduction prevents burning saw teeth on metal!
- NO GEARS, NO BEARINGS—ABSOLUTELY NOTHING TO WEAR OUT!
- LIFETIME GUARANTEE—At any time, we'll put this tool in perfect working order for only 50¢!

Prices subject to change without notice after December 1, 1950

To insure early Christmas delivery send cash, check, or M.O. today.

BERTRAM C. ENGINEERING & SUPPLY CO.
3121 MAIN ST. KANSAS CITY, MO.

WHAM-O SPORTSMAN*

\$1.00
45-LB. PULL

HITS LIKE A .22 RIFLE—
KILLS RABBITS, SQUIRRELS.
Powerful, silent, accurate.
For hunting, target,
routing pests.
Sportsman's choice
sold world
over!



**HUNTING
SLINGSHOT**

Heavy duty 7" ash stock.
40 steel balls, extra rubber straps.
GUARANTEED—at dealers, or send \$1. to
Wham-O Mfg. Co., Box 21, South Pasadena, Calif.
*Professional model of Nat'l Slingshot Assn

THE IDEAL WOODWORKER'S VISE!

Whatever any vise can do with wood—Versa Vise does it better, easier. There's nothing like it. Vertical work? Just lay it on its side on the permanently attached post. Horizontal? Place it upright on the same post! Turns a full circle in either position. Tightens automatically on the post when you tighten the jaws. Beautifully machined 2 1/2 x 3 3/4" jaws open to full 5". 16 lbs., finest cast semi-steel. Only \$9.95, f.o.b. Orrville. Buy it from your dealer, or send \$9.95 now and pay small shipping cost on delivery (Ohio residents add 3% sales tax). Handiest woodworking vise you ever used. Money-back guarantee. Thousands sold. Made by makers of the famous Will-Burt stoker. Ask any bank.

The WILL-BURT Company Dept. PM-2, Orrville, Ohio

KEEP YOUR TOOLS SHARP!

The revolving Oilstone Tool Dresser offers an oilstone with a continuous motion. The accepted method of putting a keen edge on a sharp cutting edge is to oilstone it. Round carving tools and gouges, the most difficult tools to oilstone by hand, can be rolled back and forth over the revolving oilstone and sharpened as easily as a flat tool. Write for circular.



CLAUSING MANUFACTURING CO.
235 RICHMOND AVE. OTTUMWA, IOWA

MAKE YOUR OWN FOLDING TABLES · BENCHES · HORSES

WITH **FOLD-A-WAY...**
CHANNEL STEEL LEGS!



Shipped complete, ready to fasten to your top in a minute. **FOLDS** flat for easy carrying or storage. Rubber tipped. Used on the job, in homes, workshops, ping pong tables, camps, boats, trailers, banquet halls, lodges, churches, etc.

SEND FOR
FREE
CIRCULAR

THE DIAMOND MFG. CO., Dept. PM 100 ALTA MOUNT AVE. - SCHENECTADY 7, N.Y.



BRONZE FOUNDRY

Schools and Home Workshops

Make your own castings of aluminum, copper, bronze, silver. Foundry sets are available in three sizes including 2400 Deg. F. blast Furnaces. \$22.50; \$29.50; and \$42.00. f.o.b. Kansas City. Free Circular.

KANSAS CITY SPECIALTIES CO. P. O. BOX 6022, DEPT. P-11 KANSAS CITY, MO.

HELPFUL BOOKS

Send post card asking for **FREE** catalog

Popular Mechanics Press, 200 E. Ontario, Dept. 601, Chicago 11



Power Products Late Production \$60 Model #1000

GASOLINE ENGINES

- 1 H.P. "Flyweight" 18 lbs. 2-cycle Air Cooled
- New Departure Ball Bearings on Crankshaft
- Wico Magneto
- Tillotson Float Feed Carburetor
- Aluminum Construction

**COMPLETE
RECONDITIONED \$17**

Check or \$5 Deposit — Top Quantity Discounts

AIR MERCHANT, Springfield 9, Mass.

NEW \$23
F.O.B. Springfield



AUTOMATIC VAPORIZER INJECTS WATER VAPORS

Economy Injector Is Easily
Installed On Any Car Or Truck

Some users claim up to 25% more mileage, quicker starting and better performance with this inexpensive water vapor injector. This fully automatic unit is proving a boon to thousands of motorists. However, some users report no improvement and take advantage of our 30 day money back guarantee. Write Today — Free Literature on Request. Send cash, check or money order.

**ONLY
\$5.95**
Postpaid

AUTOMATIC VAPORIZER CO.
Box 7033, Station G, Los Angeles 37, California

Revolutionary New SAFETY Circular Saw Blade



THE PTI SAFETY SAW BLADE.



New "Cut-Control" principle practically eliminates all "kick-back" dangers!

The first basic improvement in circular saw blades in years . . . tested and approved by world's leading laboratories . . . now removes most dangers from circular sawing and gives more efficient sawing. Fewer teeth (8 instead of 100), new cutting principle, smooth blade edge between teeth . . . combine to eliminate "kick-back" hazards and minimize extent of finger and hand cuts. Hailed by safety experts as the greatest advance ever made in circular sawing. Ideal for home, school and industrial shops.

Saves power—cuts smoother, cleaner, quieter, too!

This unique new blade lets you slice through the hardest wood with ease . . . and do it with 30% less operating power. Because it has fewer teeth it runs whisper-silent . . . stays sharp longer than ordinary saw blades. Keeps your shop cleaner by producing chips instead of saw dust!

Order this amazing new safety saw blade today!

Here are the prices and sizes, delivered, postpaid.

7" diameter blade....\$4.65— 8" diameter blade....\$5.35
10" diameter blade....\$6.85—12" diameter blade....\$8.50

In ordering, be sure to give the *diameter* and *bore* of the blade. Send check or money order or we will ship C.O.D. *Money back guarantee*, either way.

PTI Incorporated, Dept. PM-11
401 Broadway, New York 13, New York

Gentlemen: Rush me the following units:

Quantity	Blade Diameter	Blade Bore

Please check:

Money order or check for \$.....Enclosed. Send C.O.D.

Name.....

Address.....

City..... Zone..... State.....

NEW BAND SAW CUTS METAL, FIBER, PLASTIC FASTER, MORE ACCURATELY AND AT LOWER COST!



NOW every shop can have the advantages of band sawing. Wells new Model 49A is a rugged, horizontal cut-off saw that will do a man sized job. Welded steel frame and tubular base along with

many design features proved in Wells' widely used larger machines make it portable and easy and economical to operate. Automatic shut off at end of cut. Capacity—rectangular, 3½" x 6¾"; rounds, 3½" diameter. Shipped ready to operate complete with heavy-duty 1/6 H.P. Motor.

WELLS MANUFACTURING CORP.
95 Mechanic Road • Three Rivers, Michigan

ELECTRIFY your **SEWING MACHINE**



NEW LOW PRICE!
\$11.50 1 YR. GUARANTEE

Buy direct from manufacturer and save! Kit comes fully wired, installed in a jiffy. Fits all machines! You get these all-new parts:
• Motor & Bracket
• AC-DC 115v 60c
• Multi-speed foot control
• Cord set & block
• Easy instructions
• Steel pulley & belt

FREE . . . reg. \$2.95 chrome SEWLITE given with every kit.

10 DAY FREE TRIAL — ORDER NOW!

Send no money, pay COD or send money order and we'll pay postage. Please state whether wheel on your machine turns toward you or away from you. Shipping wt. 6 lbs.

CONTINENTAL SALES CO.

1046 BEDFORD AVENUE Dept. PM-21 BROOKLYN 5, N.Y.

DRIVING RELIEF! **New LEFT-FOOT ACCELERATOR**

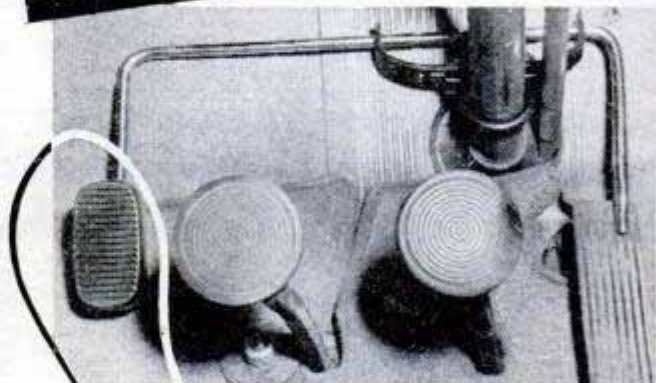

Dealer inquiries invited.

Long drives are short with "Lefty"! Eliminate leg, back, and foot fatigue and enjoy greater driving comfort . . . feed gas with left foot when desired with "Lefty," the new left-foot accelerator. One trip will convince you. Cars, \$4.85; trucks, \$6.75; plus 3% California sales tax. Specify year and make.

INVENTORS MARKETING LAB.

690 MARKET ST., ROOM 1401 SAN FRANCISCO 4, CALIF.

WAR SURPLUS

Below are just a few of the many items we have in stock at sensationally low prices:

- | | | | |
|-----------------|------------|------------|--------------|
| Pumps | Air Tanks | Fire Pumps | Gear Reducer |
| Grinders | Drop Cords | Saws | Clutches |
| Air Compressors | Generators | Winches | Motors |
- Slightly used but reconditioned and fully guaranteed, 2500 Watt. AC, 110 volts, 60 cycle. **\$245.00**
ONLY.....
Same unit NEW \$295.00 with spare parts
- | | | | |
|-----------------|--------|-----|----------|
| 300 Watt Reg. | \$135 | Now | \$ 89.50 |
| 1,000 Watt..... | | Now | \$179.00 |
| 1,500 Watt Reg. | \$535 | Now | \$220 |
| 2,500 Watt Reg. | \$700 | Now | \$295 |
| 5,000 Watt Reg. | \$1900 | Now | \$895 |
- Comes with 150' No. 6/2 cable; 150' No. 18/2 cable, valued at \$306
10,000 Watt Reg. \$1,795 Now \$1,195
25,000 Watt Reg. \$2,695 Now \$2,100
35,000 Watt..... \$2,750
All units 10,000 watts and over, 1 or 3 phase 110-220 volts.

Write today for free catalog. Thousands of \$8 saving buys.

C & H ELECTRIC Co.
434 W. JUNEAU AVE.
MILWAUKEE 3, WISCONSIN

Make it a Hobby Christmas! with

HANDEE®

tool of 1001 Uses

FINEST IN POWER TOOLS PLUS 51 ACCESSORIES

Complete... designed for every hobbyist and mechanic! Grind, drill, polish, carve, sand, saw, etc. Packs plenty of power in the 25,000 r.p.m. motor, with approved 7-segment commutator. Handsome fitted steel carrying case.

Complete, with liberal 10-day money back trial offer..... **\$27.50**
with 7 accessories... **\$19.95**



Drill any masonry CONTINUOUSLY

...with new **CARBOLOY** "LIVE-SPIRAL" Masonry Drill

No packing or stalling. Spiral wire lifts dust as it drills. Tipped with Carboloy Cemented Carbide. Fits any rotary drill or hand brace. 1/4" drill—\$1.60. Also 1/4", 3/8", 1/2" in Kit C. Free folder at dealer's or write.

"Carboloy" and "Live-Spiral" are trademarks of **CARBOLOY COMPANY, INC.**, 11185 E. 8 Mile Road, Detroit 32, Mich.



HELPFUL BOOKS

Send post card asking for **FREE** catalog

Popular Mechanics Press, 200 E. Ontario, Dept. 601, Chicago 11

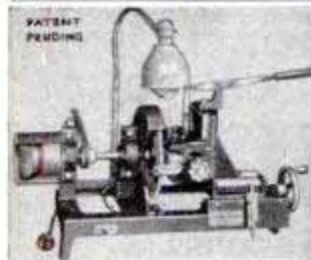

Start a NEW BUSINESS!

or Add to your present Repair Business

SHARPEN DULL PIPE WRENCHES

PIPE TAPS & DIES "GUM" CIRCULAR SAWS
Write for Information

J. C. MOORE INDUSTRIES
BOX M 276 FREDONIA, PA.

MACHINISTS' TELESCOPING GAGES

An ABSOLUTELY NEW TOOL made of Stainless Steel with hardened contact ends. These compact instruments measure by lens of thousandths the exact size of holes and slots using outside caliper or micrometer to determine measurement, and making shrink or loose fit. WITH MICROMETER THREADS A SCREW ADJUSTMENT is its GREAT ADVANTAGE.

Measures from 1/8" to 8 1/2". Includes 5 adjustment gages 1 extension rod to be adaptable to measure 8 1/2".

Guaranteed accurate and durable. Order direct from factory postage prepaid, C.O.D.. Send for illustrated leaflet. Patent applied for. Price... **\$22.50**

SEABOARD TOOL COMPANY, 2312 Boone St., Baltimore 18, Md.



HANDEE WORKSHOP

"Tornado-Powered" with NEW HANDEE "85"



Versatile, with 41 accessories... suitable for shop or home use. For novice or expert... precision routing, molding cuts. HANDEE "85" a production wizard... automatically air-cooled, pin-point accuracy. Sensational power!

Complete, packed in handsome case, **\$29.95**

Chicago Wheel & Mfg. Co., Dept. PM

1101 West Monroe St.

Chicago 7, Ill.

New MOTOR BARGAINS for Home, Farm & Industry



New General Electric, Leland, Delco, Westinghouse, Eico, Brown & Brockmeyer, Emerson & others. Repulsion induction type motors, alternating current, 60 cycle, single phase. All new, never used, some shopworn, but all fully guaranteed and every one a whale of a bargain.

NO.	H.P.	VOLTS	R.P.M.	PRICE
GEN-5	1/2	110	3450	\$19.75
W-5	1/2	110	1725	\$21.75
WDH-34	3/4	110	3450	\$29.75
EBB-4	3/4	110/220	1725	\$34.90
EH-1	1	110/220	3450	\$37.50
BB-1	1	110/220	1725	\$45.00
EH-15	1 1/2	110/220	3450	\$52.50
EH-20	2	220	3450	\$62.50
BB-20	2	110/220	1725	\$75.00

The above prices are F.O.B. Chicago. Order by number. We have large stock of special & standard motors, ALL SIZES. Write for prices on the motor you need.

C. MARSHALL SALES, 3546 W. Fullerton Av., Dept. P-11, Chicago 47

General Utility Motors

1/50 H.P., shaded pole motor, brushless, non-radio interfering, 1550 R.P.M., 110 volt, 60 cycle A.C. for light machinery duty, exhaust fans, oil heater blowers and many practical purposes. Handles any 10 or 12 inch fan blade. Special at \$4.50



No. UM-50, 1/50 H.P. Mtr. & Speed Controller (\$1. val.) both postpaid..... **\$4.50**

No. F-10, 10 inch fan blade to fit above motor, Postpaid... **\$1.00**

No. F-12, 12 inch fan blade to fit above motor, Postpaid... **\$1.50**

No. B-4, 4 inch, Sirocco Blower Wheel to fit above motor **\$1.50**

TOY MOTOR BARGAIN



1/250 H.P., shaded pole motor, 110 volt, 60 cycle, A.C., for powering toys, display and experimental work. Only **\$1.75.**

No. TM-12, 1/250 H.P. A.C. Motor & Speed Controller (\$1 val.) both postpaid **\$1.75.**

BARGAIN RHEOSTAT SPEED CONTROLLER. Small 2-inch dia. rheostat for 1/50 H.P. and smaller motors gives approximately 30% speed reduction, light dimmer, etc.

No. RHEO-1, Rheostat complete with instructions... Postpaid... **\$1.00**

WRITE FOR BIG BARGAIN MOTOR CATALOG & ELECTRICAL GOODS AND SAVE MONEY.

THE VAPORITE

Automatic HUMIDIFIER for Warm Air Furnaces. THERMOSTATICALLY controlled water supply puts more moisture in the air. Easily installed in bonnet of air furnace. Complete with THERMOSTAT Water Control Valve. Tubing and parts for complete installation. GIVES HEALTHIER AIR. \$15. Value ONLY **\$7.50** POSTPAID.



15 ESSENTIAL OPERATIONS ON ANY DRILL PRESS

● Spark your hobby or manufacturing operations with the most complete line of all-purpose drill press tools and accessories. Barron Tools make any drill press your most economical, versatile workshop machine. You can surface-plane woods and plastics, tenon, rabbet, panel, groove, mortise, rout, dovetail, bead, shape contours and moldings, vein, sand surfaces, drum sand, grind, and drill.

The Barron Workshop Guide tells how. Sent free on request with catalog and prices.

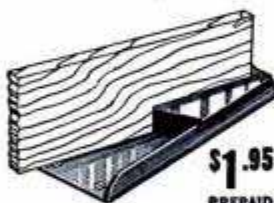

ALL-PURPOSE BENCH VISE

Holds workpieces up to 3 1/2" wide—solid and secure—for planing, sawing, drilling, sanding, filing.

\$1.95
PREPAID

BARRON TOOL CO., INC.
315 Architects Bldg., Detroit 1, Mich.



\$7.50
Drill Press Planner



\$5.95
Rotary Surface Sander



\$9.00
Safety Shaper Cutter and Blades



\$9.50
Set of 6 Hi-Speed Router Bits

BARRON PRECISION WORK SHOP TOOLS

FOAM RUBBER

FOR HOBBYISTS, CRAFTSMEN, EXPERIMENTERS



Lowest Prices—SAVE 50%

16 x 16 x 1 1/2" . . . ea. \$1.35	AUTO SEAT TOPPER PADS
16 x 22 x 1 1/2" . . . ea. 1.75	Place under seat cover.
18 x 24 x 1 1/2" . . . ea. 2.00	24" x 60" x 1 1/2" . . . ea. \$5.95
24 x 24 x 1 1/2" . . . ea. 2.75	24" x 60" x 2" . . . ea. 7.95
	12" x 14" x 1 1/2" . . . ea. 1.25

Use for furniture cushion fillers, mattresses, mattress pads, cushions. Foam Rubber is available in any size or thickness. Send For Free Price List. Immediate delivery. No C.O.D.'s. Add 10% for Postage & Handling to Above Prices. Please print.

RIOR RUBBER COMPANY, Dept. P-11
50 East 22nd St. Chicago 16, Ill.



Handy Flexible SHAFT

With 1/8 Inch Adjustable Chuck

ONLY \$3.95

Converts any motor, drill press, electric drill, electric fan (10 inch or larger) into a handy rotary tool.

Attach ROTA-SHAFT in a jiffy. Use for grinding, polishing, sharpening, cleaning, engraving, making tools, carving on metal, plastic, wood, leather, glass. Handles tools from zero to 1/8 inch diameter. 40-inch overall length. Complete with buff and sanding disc ready to use in a drill press chuck. ORDER TODAY!

SEND NO MONEY! Mail your order. Pay postman only \$3.95 plus postage on delivery. Try 10 days — if not delighted return for money back. For use on motor—35c extra for Special Coupling. Give exact size of motor shaft diameter.

STRADER PRODUCTS CO., Dept. A-101
259 Strader Ave. Cincinnati 26, Ohio

OLD FAN MOTOR



VACUUM CLEANER MOTOR



MONTH AFTER MONTH, YEAR AFTER YEAR, YOU SEE OUR AD. REMEMBER IT'S DANGEROUS to pay less if you want the finest matched USED tires. Hundreds of thousands of folks in U. S. have sent their money in advance, assured by satisfied friends, that we will never break faith.

GOOD YEAR Firestone

GOODRICH, UNITED STATES, GENERAL, FISK, KELLY & OTHERS
Our policy is to select your tires so carefully, as if our very future depended on the service given by that particular tire. Read that top line again, positively not recaps.

FREE TUBE WITH ALL BLATT'S GOOD GRADE TIRES
GOOD GRADE, 16 MONTHS GOLDEN RULE GUARANTEE BOND.

600-16 \$4.16	700-15 \$4.56	650-20 \$7.96	32x6(8) \$8.66
650-16 4.66	670-15 4.76	700-20 8.56	32x6(10) 9.96
700-16 5.06	710-15 4.96	750-20 8.66	900-20 13.96
650-15 4.46	550-17 4.66	825-20 13.96	1000-20 13.96

BEST GRADE, 26 MONTHS GOLDEN GUARANTEE BOND
THIS GRADE MADE THE BLATT NAME "WORLD FAMOUS."

MATCHED BALANCED TIRES

600-16 \$5.56	650-15 \$5.96	600-20 \$9.96	900-20 \$16.56
650-16 5.96	670-15 6.26	650-20 9.96	1000-20 17.56
700-16 5.96	700-15 6.56	700-20 10.96	1100-20 17.56
750-16 6.96	710-15 6.36	32x6(8) 10.56	1200-20 18.56
550-17 5.96	760-15 6.56	32x6(10) 11.96	1000-22 15.56
525-18 5.56	820-15 7.06	750-20 12.56	1100-22 17.56
650-18 6.96	475-19 5.96	825-20 16.56	750-15 9.96

MILITARY REG. GUAR. 16 MOS. (Super-hy 45,000 miles)

Reg. 600-16 \$6.46	Reg. 750-16 \$9.96
Super-hy 8.46	Super-hy 12.26
Reg. 900-16 \$9.66	Reg. 750-20 \$10.46
Super-hy 12.46	Super-hy 14.46

BLATT BLATT BLDG., GIRARD & LANCASTER AVES., DEPT. PM, PHILADELPHIA 31, PA.
Send check or money order and this ad for rush shipment. We won't ship a tire we wouldn't use. The name to trust in rubber.

LEATHER AVIATORS' HELMET

NO HOOKS, TUBES OR HOLES

Cordovan brown leather NAVY Aviators' helmet with warm fleece lining. Brand new, Detachable chin strap. Perfect for cyclists, flyers, farmers, hunters . . . all outdoor wear. Children love them! Best helmet service had. Cost Gov't. \$10.00. Sizes small, medium, large. Send check, cash, M.O. COD's plus postage accepted. Money back guarantee. **\$1.75 p.d.**

GRAND-HAWTHORNE SURPLUS
1439 S.E. Grand, Dept. PM-11, Portland, Oregon

UNIQUE MODEL BOAT FROM TURKEY BONE

Here's a remarkably accurate scale model of a graceful sailing ship with standing rigging . . . using the breastbone of a turkey for the hull. Stands 15" high. Truly a collector's item. Easy to build yourself. Send \$1 for blueprint complete with instructions.

JACKSON SERVICE CO.
Dept. M 530 Cooper Bldg. Denver, Colo.

GIANT ELECTRIC STEAM ENGINE

Develops 1/20 HP 3200 RPM. Piston driven, has nickel-plated steel boiler, automatic safety valve, throttle control, water level gauge, pulley attachment, electric cord. UL apprx. 9" long, 6" wide, 9" high. Powers all models.

Develops 1/20 HP 3200 RPM. Piston driven, has nickel-plated steel boiler, automatic safety valve, throttle control, water level gauge, pulley attachment, electric cord. UL apprx. 9" long, 6" wide, 9" high. Powers all models.

STANLEY AND CO. 1613 SOUTH ORANGE GROVE AVENUE LOS ANGELES 35, CALIF.

BURN WATER OR ALCOHOL OR BOTH IN YOUR CAR!

FOR ALL CARS, TRUCKS & TRACTORS

"...New high compression automobile engines which increase gasoline mileage up to 30% with alcohol-water gasoline fuels" says U. S. Dept. of Agriculture.

WRITE FOR FREE LITERATURE
Illustrated — Interesting — Descriptive
YOU'LL BE GLAD YOU DID

NEWHOUSE AUTOMOTIVE INDUSTRIES
Dept. 50 5805 E. BEVERLY BLVD. LOS ANGELES 22, CALIF.

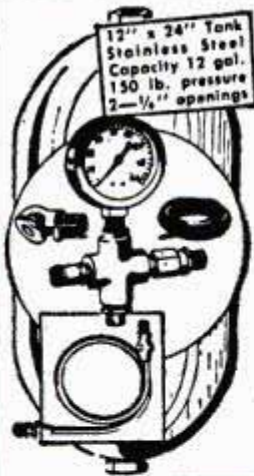

WESTINGHOUSE Air Compressor

Reg. \$60.50 . . . Only

Model T-1 Brand New
— 2 CYLINDER \$21.50
PISTON TYPE.
Operates with 1/2 H.P. Motor or
equivalent gas engine.

Compressor has 2" bore, 1 1/2" stroke,
ball bearing, 3.27 CFM at 600 R.P.M.
Capacity up to 6.54 CFM. Size 9" x
11 3/8" x 6 3/8". Wt. 26 lbs.

Compressor, pressure tank, air gauge,
air chuck, 20-ft. hose, pop valve, copper
tubing with 4 brass flared fittings
for connecting compressor to tank,
4-way cross and 3 nipples.

COMPLETE OUTFIT, wt. 52 lbs. \$32.50
EQUIPMENT LESS COMPRESSOR, \$12.50
COMPRESSOR SEPARATELY, \$21.50—TANK ONLY \$5.95

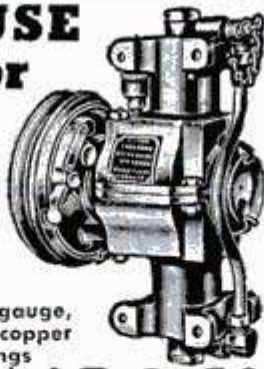

LIGHT PLANTS

Brand New!
War Surplus

Signal Corps Power
Unit PE 197

115 volt 60 cycle
A.C. single phase
5 K.W. Hobart
water cooled, 14
h.p. 4 cylinder
Hercules engine.
Remote Control
complete panel
board with instruments, 150 ft. automatic re-
mote control cable with reel; 150 feet #6 heavy
duty wire with reel; housed in metal case with
replacement parts and tools, Cable with reels
alone worth \$400. Regular
price of unit \$1900. Shipping
wt. 1250 lbs. Our price, complete.
f.o.b. Chicago \$895.00

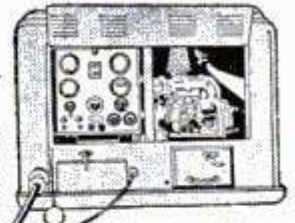

- 2 1/2 K.W. LELAND POWER PLANT \$295.00
- 10 K. W. Light Plants 110/220 V. \$1295.00
- 25 K. W. Light Plants 110/220 V. \$2500.00
- 37 K. W. Diesel Light Plants, 110/220 V. \$3000.00

WRITE FOR FREE FOLDER

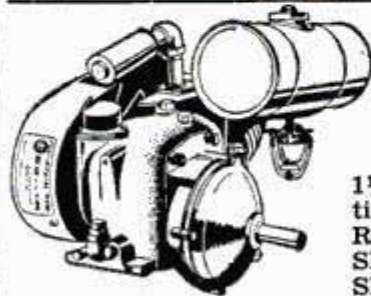

Save 50% on GAS ENGINES!

← RED SEAL CONTINENTAL

6 TO 1 REDUCTION GEAR 4 CYCLE \$39.50

1 1/2 HP with 6 to 1 reduction
gear. Operates at 450
R. P. M. List Price \$79.50.
Shipping weight 54 lbs.
SPECIAL PRICE \$39.50

WELLWORTH V-BELT CLUTCH



Takes starting load off engines or motors. When
speed is reached, a flip of handle shifts clutch
from idling to driving position. Handles "A"
belts, 2-3/32" pitch diameter, 5/8" bore. Ideal for
use with lawn mowers, garden tractors, home
workshop motors, etc. 3 1/4" long. Safe, easy to
mount, sealed bronze bearings.
positive action. Shpg. wt. 3 lbs. \$7.50

SAME CLUTCH FURNISHED WITH 3/4" BORE \$8.50

WELLWORTH ZIP SAWER, JR. PORTABLE HAND SAW

Takes the work out of hand sawing

Convert your electric drill into a portable power saw.
Light weight—easy to use with any 1/4-inch electric
drill or flexible shaft. Saw blade 4" diam. Maximum
vertical depth of cut 1". Oil bearing
lubrication. Oilite. Bronze Bearing. \$7.95
Overall length 7 1/2". Shipping weight
2 lbs.



PORTABLE ELECTRIC HAND SAW

The Zip Sawyer With ALL the Features

6 1/4" Diameter saw blade, 1/2" square arbor hole.
Maximum depth of cut 2 1/8". (At 45°, 1 3/4")
Minimum depth of cut 0". Angular adjustment 90°
to 45°. No-load speed, 5200 r.p.m. Full load speed,
3200 r.p.m. Amperes, full load, 8.0. Universal AC-
DC motor, 110/220 volt. Dimensions: 11 1/4" long;
9 1/2" wide (ripping guide removed); 7 1/8" high
(without blade). Furnished complete
with 6 1/4" diameter combination blade
and 10 ft. cord and plug. Wt. 11 1/2 lbs.
Price \$39.95



AUTOMATIC COMPRESSOR UNIT

1/2 H.P. heavy duty capacitor
motor. AC 110/220 volt, 60
cycle, 2x1 3/4 inch
piston type com-
pressor, splash
feed lubrication.
12x24 inch tank.

automatic pressure
switch. CFM 2.8 at 100
lb. pressure, or 150 lbs.
pressure for intermit-
tent duty. Check valve,
safety valve, air regu-
lator with gauge and
filter, 20 ft. air hose
with air chuck for in-
flating tires. V. belt
drive. Mounted on 2 wheels,
ball bearing, with 2"x10"
pneumatic tires. Portable with han-
dle. Shipping wt. 90 lbs.

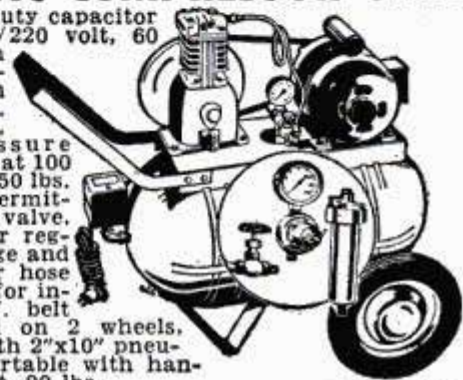

SPECIAL PRICE \$89.50

"Wellworth" BLOWER

at a Bargain Price

Quiet operating. Double wheel in-
let, double width blower. For heat-
ing, ventilating, cooling, air wash-
ing, exhausting and forced draft.
DIMENSIONS: 10" wheel; outlet
13 1/2"x11 3/8"; inlet 8 3/4". Height
19". Width 18". Depth 16 1/2".
C.F.M., 1/4" S.P. 1600; outlet
vel. 1575; motor 1/4 H.P. with
overload relay; cord &
plug. 110 v. 60 cy. A.C. \$42.75
Ship. wt. 67 lbs. Spe-
cial price \$27.50



BLOWER
LESS MOTOR \$27.50

Prices f. o. b. Chicago.
Money back guarantee.
Send check or money or-
der today. Prompt ship-
ment.

NEW CATALOG

Motor guide, air compressors, home and
factory workshop tools. Also big bar-
gains in luggage. Send 10c for postage.

WELLWORTH TRADING CO.

1831 S. STATE ST. DEPT. D-11 CHICAGO 16, ILL.

BINOCULARS TELESCOPES

BROWSCOPE CO., Dept. 11M, 24 West 45th St., New York 19, N.Y.

Big
Bargain
Catalog
Free

SPECIAL AUTO SPEED EQUIPMENT

Stock Car Does 125 M.P.H. New folder lists and illus-
trates special parts and
equipment that can boost the speed of stock cars to 100 to 125
M.P.H. All parts and equipment are recommended and used by
America's foremost racing drivers.

SPECIAL HEAD GASKETS INCREASES COMPRESSION

6.75 to 7.125 to 1.
FORD-MERCURY OWNERS get quicker acceleration! Higher top
speeds! More gas mileage with Wohlfeil's new, special thin head
gaskets. Easily installed by anyone. Money back guarantee. Order
Today. State year of car. \$4.95 per pair. Postpaid.
Send 10c for folder. Dealers Wanted
WOHLFEIL-DEE ENGINEERING, 2276 So. Telegraph, Pontiac, Mich.

SAY YOU SAW IT IN POPULAR MECHANICS

New Wood Shaper Tool

Attaches To Drill Press—Does Rout-
ing—Tongue & Groove, Notching
Inlay—PLUS Any Type Of Joint

Make window sills, cabinets, doors, etc., in
your own workshop. New. Low Cost wood
shaper tool attaches to your drill press—
no expensive motors or benches. Complete
unit costs less than having one shaping job
done out. Write for FREE information.



Complete
with 3 blades

T & H MFG. CO., Dept. SPB 11, 811 East 31 St., Kansas City, Mo.

SAVE UP TO 85% IN WAR SURPLUS



RADIO HAMS ATTENTION! U.S. NAVY RADIO TRANSMITTERS #GP-7 AT A SPECIAL PALLEY PRICE!

Send on the following frequency ranges - from 350 to 9050 KCS. Here is the "chance of a lifetime" to own your own short wave sending station at a fraction of the cost of building or buying one. These sets are genuine U.S. NAVY equipment - Built by Westinghouse and used on big Navy Aircraft.

Set consists of the following:

1 Transmitter-Rectifier Unit - operating on 120V.-AC, 600 - 800 Cycles and 14 or 28V.-DC... 2 Control Boxes... 6 Tuners in the following KC ranges: 350 to 800 - 800 to 1500 - 1500 to 3000 - 3000 to 4525 - 4525 to 6500 - 6200 to 9050... Also 1 each Type 803 - 801 - 843 - 523... 2 Type 1616 Tubes - 1 Pilot Control Box - 1 Operator's Control Box - and 1 Loading Antenna Coil. Ideal for licensed Radio "Hams" - Private Communications - Mobile Units - Aircraft, etc. Comes with complete operating instructions and test data. We made a terrific buy and we're passing it on to you as...

A PALLEY SPECIAL AT **Only 98.00**

K-21 AERIAL CAMERA

Equipped with f2.5 E.K. Aero Ektar 7" focal length Coated Lens. 24 Volt D.C. Electrically operated, complete with motor, cables, filter and carrying trunk. Lens alone is worth over \$250.00 and can readily be adapted to 4 x 5 Press type camera. Don't miss this chance to own the "Pride" of professional color photographers.....



ARMY RE-ISSUE - CAMERA COMPLETE **\$79.00**

ANTENNA REEL

Just the thing for tuning beam antenna. Powered by 1/8 H.P. 24v G. E. Motor. Removable 6" Reel-limit Switch - Cam Warm gears, Bevel gear. Solenoid clutch.



Motor engaged to gear reduction only when electrical contact made. Operates in either direction. Ideal for auxiliary power take-off, opening and closing doors, etc. #711

429

ELECTRIC ACTUATOR

CTU-4



Lear No. 42DA Linear Actuator. 24V.D.C. motor, 9000RPM. Approximately 1.5H.P. Drives actuator through a high reduction gear box, resulting in 4 1/2" stroke in 12 seconds. Compression and tension loads up to 600 pounds. Has adjustable micro switch for limits of travel. Length retracted 14 1/2".....

8.95

SHOE PACS

For long wearing - real protection - on all - weather friendly 14" boot with all leather upper - rubber shoe and sole. Has felt inner sole for warmth and comfort - A REAL BUY!!



3.95



Sperry Aircraft Directional GYRO COMPASS

Dial is 360° swing calibrated 1/10° (6 min). Panel Mount 4 1/2" square with 3" luminous dial. Can be used in autos, planes, or boats by attaching one tube to intake manifold for required vacuum. Complete with reset caging knob. Gov't. overhauled - ONLY.....

\$449

HUNTING KNIFE

Has 6" Polished Steel Blade Handle has leather grip - in leather sheath.

\$5.98 Value for ONLY **1.69**
With Parkerized black Finish **1.49**

BOLO KNIFE

10" x 2" Parkerized blade. 5" Grippd Handle. Weight 1 1/2 lbs. Ideal for Hunting, Clearing Brush or Trails. With Case **1.19**



BATTERIES

A 9 Volt, Dry Cell unit. 3, wired in series will run a 24 or 27 Volt motor. Ideal for Lights, Boats, Portable Radios, etc. While they last... **79¢**

PALLEY SUPPLY CO
6321 SAN FERNANDO RD.
Dept. PM-11 GLENDALE 1, CALIF.

SEE AD ON OPPOSITE PAGE FOR TERMS!

MAGNETIC TOOL HOLDER

Guaranteed Permanent

Saves VALUABLE TIME and MONEY!

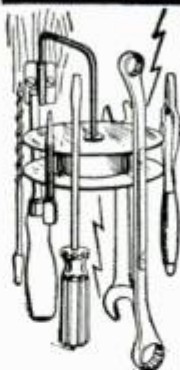

ZIP! YOUR TOOLS OFF OR ON WAS \$2.95

Now Only **\$1.95** POST PAID No C.O.D.



Will Never Weaken

IDEAL CHRISTMAS GIFT

KEEP YOUR MOST-USED TOOLS AT YOUR FINGER TIPS!

Works like magic. Just TOUCH the tool to the holder, the powerful Alnico magnet holds it there until needed again. Holds steel tools & utensils of all shapes; keeps them cleaner-sharper. Holder rotates for easy accessibility. Large capacity-15 1/2" circ.

TRIAL OFFER-Send \$1.95 for your HOLDER. If you don't agree that it's worth every penny paid, return it for FULL REFUND. Dealers wanted.

RONALD EYRICH, 2566 N. 49th St., Milwaukee 10, Wis. Dept. 11 (Manufacturer of Permanent Magnets)

POWER HACKSAW \$52.75

LESS MOTOR

F. O. B. Benton Harbor

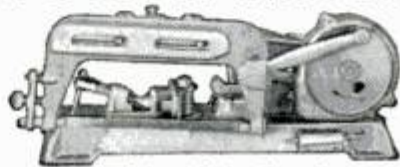

● Rugged cast iron construction. Wt. 56 lbs. bronze bearings. Draw cut. Auto. return lift. Auto. shut-off. Vise swivels 45°. Cap. 4"x4".

Send for full details and name of nearest dealer.

EXCEL MACHINE TOOLS Dept. PM-110 BENTON HARBOR, MICHIGAN

ELECTRIC MOTOR BARGAINS



Every Motor Guaranteed. Prices F.O.B. **\$7.50**
1/4 h.p. Eicore 1750 R.P.M., 110 V. 60 Cy. A.C. Split phase #J100 110 V. 60
1/2 h.p. Power Eng. 1750 R.P.M., Cy A.C. Ball Bear. **14.00**
Cap. Type. #PE146
1/2 h.p. Delco 3450 R.P.M., 110 V. 60 Cy. **19.50**
A.C. Double Shaft Cap. Type #D111
1 h.p. Various Makes 3450 R.P.M. 110/220 V. **37.50**
60 Cy. A.C. Cap. & Rep. Ind. #199

Write for prices on other sizes, single and 3 phase.

Also 32 Volt Direct Current Bargains.

ROBERTS ELECTRIC CO., 7322 Madison, Forest Park 7, Ill.

BUILD AN ARC WELDER FROM OLD GENERATOR

For Light or Heavy Work. 75-200 amps. No previous experience needed. Complete PLANS and valuable Catalog 35c.

LEJAY MANUFACTURING CO.
1347 LeJay Bldg., Minneapolis 8, Minn.



SAY YOU SAW IT IN POPULAR MECHANICS

FLASH Your Turns



ELIMINATE HAND SIGNALLING S & L DIRECTIONAL SWITCH THE LOWEST PRICED DIRECTIONAL SWITCH THAT MEETS ALL S.A.E. REQUIREMENTS

Here is a safe, comfortable way of signalling your intention to make a left or right turn. Flashes from 60 to 80 times per minute. No need to roll down window to signal turns in cold winter weather.

Kits furnished with all necessary material for perfect installation. No outside mounting of any kind. Uses your present parking and tail lights. Either of our two models fits most cars from 1942 to 1950.

Specify year and make of car. Money-back guarantee.

A PERFECT CHRISTMAS GIFT FOR MOTORISTS

S & L AUTO SALES
Box 6414, Dept. 1, Chicago 7, Ill.

\$5.95 postpaid in U.S.A.

SEND CHECK OR MONEY ORDER.

POSTAGE EXTRA ON C.O.D.'s

WRITE TODAY for 1950 TOOL CATALOG
72 PAGES of BARGAINS in Machine tools
(taps, drills, dies, reamers, etc.) Hydraulic
Cylinders, Valves, Pumps, & Motors. Air
Tools & Bearings. Send 25c to cover handling.

SAVE UP TO 85% IN WAR SURPLUS

Order from this Ad. All sales final. All
Prices F.O.B. Los Angeles. Pay by
M.O. or Check, P.O.'s Accepted from
D & B. firms. 1/2 deposit with C.O.D.'s.



PALLEY FAMOUS MIXES! Prepared especially for the HOME CRAFTSMAN, HOBBYIST, INVENTOR, GADGETEER or SHOP MECHANIC.

GADGET MIX - Rivets, Spacers, Bolts, Screws, Gears, Wheel bearings, Springs and C clamps. No. 106, 5 lbs. **1.19**

BEARING MIX, No. 170A. Approx. 20 needle, Ball & Roller Bearings, New & Used. Sizes: 1/2" to 4". Some of these cost Gov't \$10 a piece. Never such a value! 5 lbs. ONLY **1.59**

HINGE MIX, No. 170H. 12 pairs of Strap and butt hinges, Hasps, 1" x 1" to 7/8" x 10" in length and 8" strap. 2 lbs. **1.09**

ABRASIVE AND GRINDING WHEEL MIX - 50 pieces including honing stone, pencil rolls, wheels, etc. A sharp value. No. 170AG **99c**

SPRING MIX, No. 206 - Tension, Compression & Tension Springs. Ass'd. sizes. A treasure trove for emergencies. Scores of springs. 5 lbs. for ONLY **1.69**

RIVET MIX - 3 POUNDS - Consisting of sizes from 1/4" long to 3" long in many diameters & alloys. **1.19**

FILE MIX - Ten assorted Files, 4" to 12", includes 3 Vixens, half rounds bastards, mills, etc., in seconds and used but in good condition. 1 Vixen alone worth our price for entire mix. F-1 **99c**

PULLEY MIX, No. PL-1 - You'll want this one around. 10 micarta & metal pulleys ranging from 1" to 5" with ball and one piece bearings. These are aircraft pulleys, the best made with 100's of uses. **A WONDERFUL BUY!!! 2.95**

COUNTERSINK MIX, No. 168. Wide assortment. Excellent condition. High speed steel. Assortment of ten 1000 and 1100 with pilot sizes ranging from 3/32" to 3/16" No. CM-1 **2.69**

SCREW MIX - 5 lbs. incl. 2 1/2 lbs. wood screws & 2 1/2 lbs. machine screws. All sizes. Save dollars and always have plenty of screws on hand. **1.39**

NUT MIX NM-1-3 lbs. approx. 500 nut. Anchor, Lock, Castle, Hex, Elastic Stop Nuts, etc. You'll always have plenty of Nuts in the shop. NM-1 **1.39**

SUPER COMBO MIX - No. SC2. Here's a real bargain. All eleven above mixes for ONLY **14.95**

REAMER MIX - No. 168. Reamer assortment: Special Taper line finish Reamers. High Speed Steel, Slightly used but in excellent condition. Ten assorted sizes ranging from .168 x .165 & .244 x .215 to .425 x .385 & .432 x .403. One alone worth our selling price of ten. For set of ten Reamers **4.49**

AIRCRAFT CABLE
Rust resistant alloyed steel, extra flexible, pre-formed - 7 x 19 strand-on reels.

1/16" 3 1/2 ft.	7/32" 7 1/2 ft.
5/64" 4 ft.	1/4" 9 ft.
3/32" 4 1/2 ft.	9/32" 10 ft.
1/8" 5 ft.	5/16" 12 ft.
5/32" 5 1/2 ft.	3/8" 13 ft.
3/16" 6 1/2 ft.	1/2" 16 ft.

Stainless Steel Cable
1/16" 5 ft. 1/8" 14 ft.
1/4" 24 ft.

PIANO HINGE
Overall Width Length Price Ea.
1 1/2" (5/8" side) 7 1/2" alum. \$1.00
2" (1" side) 9" alum. \$1.75
3 1/2" (1-3/4") 5 1/2" st. steel \$1.69
BRASS HINGE - 1 1/2" (5/8" side), 0.40
Any length at 29c per ft.

PALLEY SUPPLY COMPANY
6321 SAN FERNANDO RD.
DEPT. PM-11 GLENDALE 1, CALIF.

NOW! MAKE YOUR OWN ARC WELDER

Here's a Real Buy! Finest precision built R-1. Generators, used on B-29's, cost the Government approximately \$400.00. Gives from 300 to 400 amps at 27 volts. Ideal for all welding, light and heavy up to 5/8" thickness. FREE complete instructions for conversion of this Generator to welding unit. R-1 NOW AVAILABLE AT

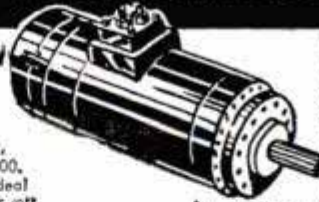

17.95

Other AIRCRAFT GENERATORS

That can be made into Arc Welders.

P-1	27 Volts	200 Amps	15.95	E-5A	12 to 15 Volts	50 Amps	12.95
1273-1A	27 Volts	75 Amps	12.95	03	27 Volts	100 Amps	25.00

ELECTRIC ACTUATOR

CTU-2 Foote Linear Actuator. 24 Volt A.C. or D.C., 8500 R.P.M., 1/6 H.P. Series wound motor, 4 1/2" stroke in 1 1/2 seconds. Compression and tension. Loads up to 750 lbs. Adjustable micro switch for limits of travel. Overall length retracted 11" **Only 6.95**

LEAR ELECTRIC MOTOR, 24 volt, 6 amps, series wound reversible motor with overload clutch. Motor turns 11,000 R.P.M. Has 11 to 1 gear reduction box turning 1000 R.P.M. at take-off. Adjustable to flex or rigid drive. Limit switch box. Size 10" x 4" **\$7.95**

DUMORE ELECTRIC MOTOR. Adaptable to rigid or flex drive, 400 R.P.M. at power take-off. Contains 1/25 H.P., 24 volt, 7 1/2 amp reversible motor for indicating position. Has limit switches, magnetic brake, resistor to coordinate instrument. Overall dimensions 8 1/2" x 4 1/2" long. **ONLY 7.50**

G.E. GEAR HEAD MOTOR
Heavy Duty G.E. Gear Head Motor, 1 1/2 H.P., 24 volt DC, 125 amp reversible motor will drive reduction gear box unit 44.5 to 1, resulting in 168 R.P.M. at 5/8" diameter take-off shaft. Motor contains electro magnetic brake. **UNIT COMPLETE 10.95 MOTOR 4.95 GEAR BOX ALONE 7.95**

REMOTE INDICATING SELSYN MOTOR. Will operate on 115 volt, 60 cycle AC. 2 1/2" diameter, 4" length. Works on simple electrical connection and can be used for any distance. Turn shaft of one unit and the other will follow accurately. Can be used on TV and Ham antennas, lens focus, weather vanes, film footage, liquid levels, etc. **2.95 PAIR**

SAMELL MOTOR. 27 volts, 16 amps, 1/5 H.P. reversible, series wound on motor. 3800 R.P.M., shaft 9/32" diameter, 12-spline, 4-1/8" x 2-3/8". **ONLY 3.95**

TWO HEAT SOLDERING IRON

World's Hottest Iron Value! Two soldering irons in one with buffer, heat control. Push the button—Select 150 or 300 Watt heat for light or heavy work. Complete with tip, bench holder, 5' asbestos cord. 110V AC. A \$15.00 Value For . . . **3.95**

RAWHIDE Mallet For working soft metal, or plastics, driving pins, etc. Weight 2 1/2 lbs., metal collar with rolled leather insert head **1.09**

UTILITY HAMMER For use as masonry chisel, stake driver, sledge, etc. Head special forged steel, sharp cutting edge. Handle is select hardwood. 1 1/2 lbs., 14" handle . . . **79c**
2 lbs., 21" handle . . . **99c**

AUTO PULSE PUMP—Ideal for fuel pump for auto or boat, 24 Volt D.C. Can be adapted to 6 Volt D.C., 1/8" stand. **5.50**

Sperry Aircraft Directional GYRO COMPASS
Dial is 360° swing calibrated 1/10" (6 min.) Panel Mount 4 1/2" square with 3" luminous dial. Can be used in autos, planes, or boats by attaching one tube to intake manifold for required vacuum. Complete with reset caging knob. Gov't. overhauled - **ONLY \$4.49**

AIR COMPRESSOR
High Pressure General Electric, 2 stage AC - DC. Rated pressure 1000 lbs. per sq. in. with 1/3 H.P., 27 volt, 7 AMP series wound motor with fan for cooling. These sands now in use for spraying, inflating, laboratory use, etc. Can be adapted to 110 volt A.C. with transformers. A tremendous value at approx. 5% of original cost **22.50**
We also have transformers for above.

TACHOMETER - Type C-9A. Operates on direct drive with flexible shaft. Range is 0 to 4500 RPM. Ideal for use on single engine planes or boats, autos, etc. Drives direct from camshaft or at 2:1 reduction from crankshaft. **\$4.75**

FIRE EXTINGUISHER
Kiddie Lux CO2 Type. Built to Gov't spec. Shatter-proof, heavy case. Fully re-charged. with horn No. 602A - 7 1/2 lb. \$35 Value. **19.25**
No. 603 - 10 lb. A \$65 Value. . . **25.75**
No. 605-A - 15 lb. New. Break disc Type. A \$75 Value . . . **29.75**
No. 605-B - 15 lb. Wheel Control Type **32.95**
No. 605-C - 15 lb. New. Squeeze Grip Type. \$85 Value. . . **39.95**
Note: Weights listed are capacity extinguisher charge.

NEW HYDRAULIC CYLINDER SPECIAL

Gives 20,000 lb. thrust (push pull) using 1500 PSI line pressure as obtained from our hyd. pumps. Or will produce 40,000 lb. thrust with 3,000 lb. line pressure. CAN ALSO BE OPERATED ON LOW PRESSURE AIR SYSTEMS. 4" Bore, 1 1/2" dia. piston shaft, 18" stroke, length 30 1/2". Equipped with ball bearing loaded clevis type mounting and swivel type high pressure steel pipe bracket for easy use. Ideal for road, farm & shop machinery, presses, etc. Cost Gov't \$390.00 **22.50**

We carry the World's Largest Supply of New Hydraulic Equipment featuring over 20,000 Cylinders in 61 Sizes & Types. Can also supply all accessories such as Pumps, Fittings, Valves, Tanks, Hose Fittings. Let us solve your Hydraulic problems. Write for information.

2 SPEED PORTABLE MOTOR ENERGIZER. Used as auxiliary power source, to actuate starters or as principal power source, 1001 uses as high speed drill motor, power booster, etc. Has governor, 50 ft. electrical cable, Length 34". Power - 110-115V - 60 cycle A.C. or D.C. **27.50**

Vickers Hydraulic Transmission
Self contained, 2 H.P. constant torque at all speeds with variable volume reversible, piston pump (controlled by outside lever) supplying piston hydraulic motor. Automatic pressure, dash pot for smooth control. Power output R.P.M. - 0 to 1/3 input R.P.M. in both directions. Input R.P.M. 1800 continuous 4000 intermittent. Dash pot can be removed for greater R.P.M. Ideal for Lathes, Dupli-cator Setup on Mills, Conveyors, Small Cars, Drives, Gearing, etc. Includes 2-4" Spline Shafts for input & power take-off. Cost Gov't, approx. \$400. **25.00**

Hydraulic PUMPS
Logan Gerator type. For operating hydraulic systems on trucks, tractors, etc. Delivers 8 GPM at 1200 RPM, at 1000 PSI with 5 HP. Can also be used as Hydraulic Fluid Motor. Has 3/8" stand pipe ports, 1/2" splined shaft for pulley or direct attachment. 5 1/2" dia. by 7" long. Used, but condition guaranteed. **ONLY 17.50**

VALUABLE GEAR BARGAINS
6 to 1 with screw shaft #111 \$4.98
85 to 1 (can be used for radio, antennae, etc.) **\$3.95**

GEAR BOXES VTG-1 - 90° bevel gear 1 1/2 to 1 reduction, size 7" x 6". A Life-time Value. **\$3.95**
VTG-2 - Inline spur gear 16 to 1 reduction, thru 4 gears. Final take-off 4 1/2" dia, 26 tooth, 1/2" Alum. spur gear. . . **\$6.49**
Both above gear boxes have lever control for engaging & disengaging positive clutch. Dust proof housing. Lubricated bearings. Both can be adapted to Vickers Transmission.

ELECTRONIC TRANSMISSION GEAR TRAIN
GT-1, approx. 50 Bronze Spur & Pinion Gears - 3/8" to 4" dia., 5 sets of 7 cluster gears, 2 complete worm and worm gear drive sets, 40 N.D. ball bearings 1/2" to 1 1/2" dia., watch springs, bushings posts, face plates, housings-Micro Switches, 2 miniature controlled clutches, etc. Gears in multiple size & sequence, identical teeth ratio, giving 100's of gear reduction combinations. **\$8.49**
Wt. 19 lbs.



CENTERS AND DRILL PADS

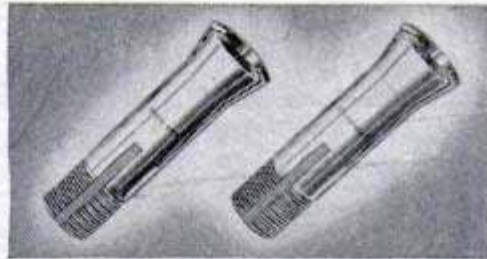

STEEL AND BRASS COLLETS

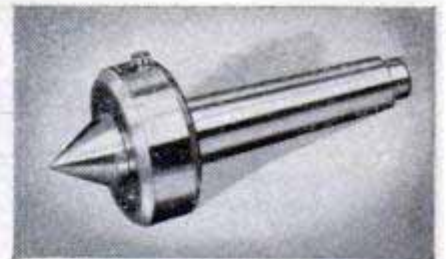

BALL BEARING LIVE CENTER



HANDWHEEL COLLET ATTACHMENT

Get More Use Out
of Your Lathe
WITH THESE
SOUTH BEND
ATTACHMENTS

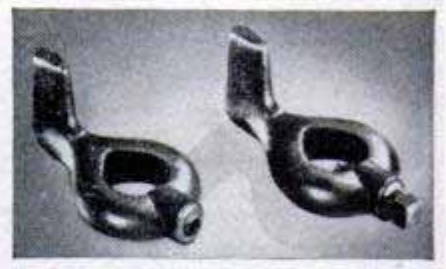

SAFETY and STANDARD LATHE DOGS

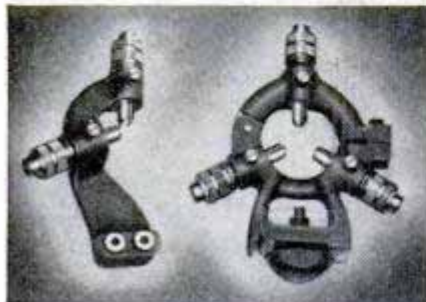

FOLLOWER AND STEADY RESTS



ADJUSTABLE COLLET BUSHING CHUCK



South Bend Attachments will enable you to do more and better lathe work. Write for Attachment Catalog No. 77-U.

SOUTH BEND LATHE
BUILDING BETTER TOOLS SINCE 1906 • SOUTH BEND 22, INDIANA

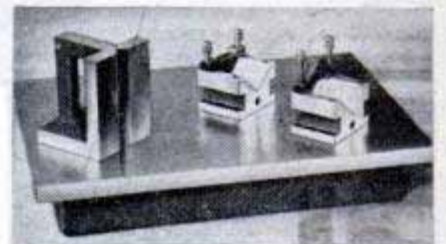

SURFACE and ANGLE PLATES, V-BLOCKS



TELESCOPIC TAPER ATTACHMENT

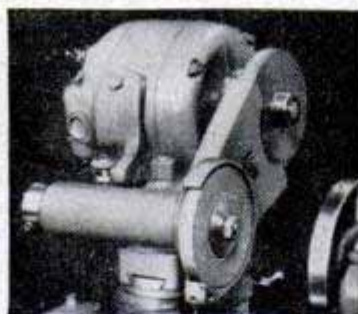

EXTERNAL GRINDER



MILLING ATTACHMENT



10 in 1 TOOL BLOCK

Send this Information:



CATALOG 77-U

LATHE TOOLS, ATTACHMENTS



9" and 10" BENCH LATHES

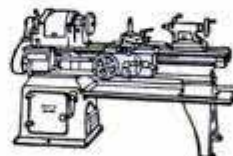

10" TO 16-24" FLOOR LATHES



14" DRILL PRESSES

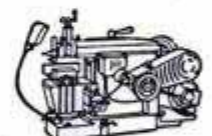

7" BENCH SHAPERS

Name _____

Street _____

City _____ Zone _____ State _____

1/2" and 1" Collet TURRET LATHES



Printed by Popular Mechanics Company, Chicago, Ill., U. S. A.

Now! YOU CAN MAKE MONEY...

TURNING WORTHLESS OBJECTS INTO GOLDEN TREASURES—

...BY METALIZING!

HERE ARE JUST A FEW OF THE HUNDREDS OF ARTICLES THAT CAN BE RESTORED BY REPLATING—INCREASED IN VALUE—OR “ETERNALIZED” AS KEEPSAKES WITH A COATING OF EVERLASTING BRONZE, STERLING SILVER, OR 14 KARAT GOLD.

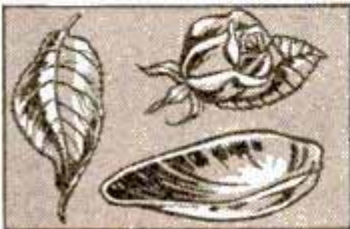

Costume Jewelry from flowers, insects, shells, and leaves.

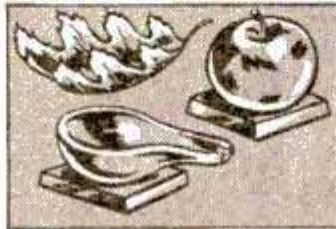

Ash trays, paper weights, from leaves, fruit, vegetables.



Metalize busts, figure, from plaster cast or wood carvings.

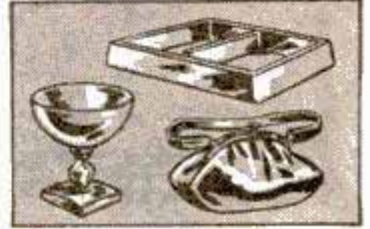

Metal plate object of glass, cloth, leather, plastic or rubber.



Eternalize Baby Shoes, Toys, and other sentimental mementoes.



Metalize baskets, plates, ceramics and other non-metallic objects.

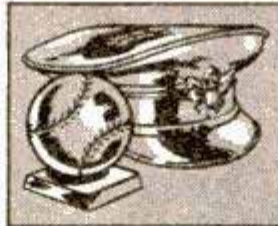

Preserve sports and war trophies in solid Bronze, Silver or Gold.

YES—ANY MAN OR WOMAN CAN DO WORK LIKE THIS IN ONE CORNER OF THE KITCHEN OR IN ANY SPARE ROOM!

Make \$5⁰⁰ An Hour For Your Spare Time!

Amazing book tells you how

HOW to do the work—how to get customers coming to you—how to set up the simple equipment—how and where to buy the materials—what to charge—how to start in spare time—how to expand into a full time business whenever you wish. Shows you in pictures and words how to put a coating of pure metal on such things as flowers, leaves, insects, shells, wood carvings, plaster castings, busts, statues, religious figures, buttons, baskets, feathers, base balls, golf balls, mementoes of all kinds, such as, baby shoes, party and wedding favors and decorations. Operating a home metalizing business is one of the greatest insurance policies a man could ask for his future. Read about it without risking a penny.

OWN YOUR OWN HOME-OPERATED BUSINESS

Think of turning 56 cents worth of materials into a profit of \$5.00 and over for just a few minutes of easily learned handiwork. Sounds fantastic? . . . Yet it is absolutely true . . . **AS YOU CAN QUICKLY PROVE TO YOURSELF.**

AN EXCITING NEW OPPORTUNITY

Just at a time when hundreds of men and women would like to make an extra \$35.00 to \$50.00 a week in spare time home work, the old—established—and highly profitable Metalizing Business has been turned into a home-work money-maker. Where in the past a few big companies have been making fortunes, now hundreds of smaller home operators can become independent. I have ready to send you a complete set of simple instructions by which anyone—regardless of age or education—can learn the fascinating art of metalizing.

By this process you can replate worn objects in silver, copper, or real gold—you can change silver to gold by overplating—you can even deposit a heavy coating of solid metal on non-metallic objects such as baby shoes, golf balls, toys and other precious keepsakes—or you can take inexpensive articles and make them worth 10 to 20 times their cost by jewel plating with precious metals.

ALL THIS INFORMATION IS FREE

The information is free. A stamp brings you the details of the exact plan by which hundreds are NOW MAKING EXTRA MONEY EVERY WEEK. Study it over. Analyze the possibilities. Then if you don't think it's made to order for you—your only loss is your 3c stamp. You can read every fact, every secret, every step of the instructions—all at my risk.

NO "CATCH" TO THIS OFFER . . . DON'T SEND ME A PENNY . . . Just Your Name!



Learn about this wonderful "Ace in the hole". See how you can start without risking job or pay check—how you can turn spare hours into \$5.00 bills—how you can actually have fun making money in a business that all the family can help with. No charge now or at any time for the

complete facts about this permanent lifetime business that has now opened its door to home operation. Scores of men and women have already started . . . Plenty of opportunity for hundreds more. **BUT DON'T PUT IT OFF.** Send your name and address **TODAY . . .** It may open new horizons in your life.

R. E. Brandell, Warner Electric Co., 1512 Jarvis, Dept. 3-T, Chicago 26, Ill.

R. E. Brandell, Warner Electric Co.
1512 Jarvis, Dept. 3-T, Chicago 26, Ill.

Rush complete facts showing how the old and profitable Metalizing Business has now been converted into a homework money-maker for full or spare time. No charge or obligation for the information you send.

Name _____

Address _____

City _____ Zone _____ State _____

You're **safe** when
it's cold...



You're **safe** when
it's hot...
with

“PRESTONE”

BRAND

Anti-Freeze!

YOU'RE **SAFE** FROM FREEZING!
YOU'RE **SAFE** FROM FOAMING!
YOU'RE **SAFE** FROM
RUST AND CLOGGING!

*No other Anti-Freeze can
give you this same protection!*

One shot lasts
all winter!

The registered trade-marks
“Prestone” and “Eveready”
distinguish products of
NATIONAL CARBON DIVISION
UNION CARBIDE
AND CARBON CORPORATION
30 East 42nd Street,
New York 17, N. Y.

SAME PRICE
\$3.50 PER
GAL.

